



# KICKS

OWNER'S MANUAL

# Foreword

This manual was prepared to help you understand the operation and maintenance of your vehicle so that you may enjoy many kilometers (miles) of driving pleasure. Please read through this manual before operating your vehicle.

A separate Warranty Information & Maintenance Booklet explains details about the warranties covering your vehicle.

Your NISSAN dealer knows your vehicle best. When you require any service or have any questions, we will be glad to assist you with the extensive resources available for you.

## IMPORTANT SAFETY INFORMATION

### Reminders for safety!

Follow these important driving rules to help ensure a safe and complete trip for you and your passengers!

- **NEVER drive under the influence of alcohol or drugs.**
- **ALWAYS observe posted speed limits and never drive too fast for conditions.**
- **ALWAYS use your seat belts and appropriate child restraint systems. Preteen children should be seated in the rear seat.**
- **ALWAYS provide information about the proper use of vehicle safety features to all occupants of the vehicle.**
- **ALWAYS review this Owner's Manual for important safety information.**

## When reading the manual

This manual includes information for all options available on this model. Therefore, you may find some information that does not apply to your vehicle.

All information, specifications and illustrations in this manual are those in effect at the time of printing. NISSAN reserves the right to change specifications or designs without notice and without obligation.

## MODIFICATION OF YOUR VEHICLE

This vehicle should not be modified. Modification could affect its performance, safety or durability, and may even violate governmental regulations. In addition, damage or performance problems resulting from modifications may not be covered under NISSAN warranties.

## Read first – then drive safely

Before driving your vehicle, read this Owner's Manual carefully. This will ensure familiarity with controls and maintenance requirements, assisting you in the safe operation of your vehicle.

Throughout this manual we have used the symbol  followed by the word **WARNING**. This is used to indicate the presence of a hazard that could cause death or serious personal injury. To avoid or reduce the risk, the procedures must be followed precisely.

The symbol  followed by the word **CAUTION** is also used throughout this manual to indicate the presence of a hazard that could cause minor or moderate personal injury or damages to your vehicle. To avoid or reduce the risk, the procedures must be followed carefully.

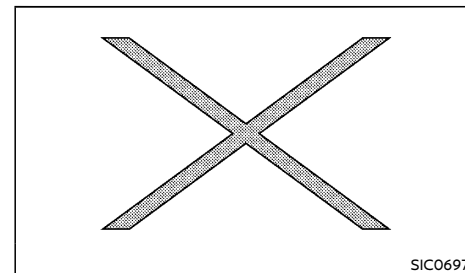

If you see this symbol, it means "**Do not do this**" or "**Do not let this happen**".

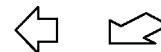

If you see a symbol similar to these in an illustration, it means the arrow points to the front of the vehicle.



Arrows in an illustration that are similar to these indicate movement or action.



Arrows in an illustration that are similar to these call attention to an item in the illustration.



Bluetooth® is a trademark owned by Bluetooth SIG, Inc., and licensed to Visteon Corporation.

**Air bag warning label:**

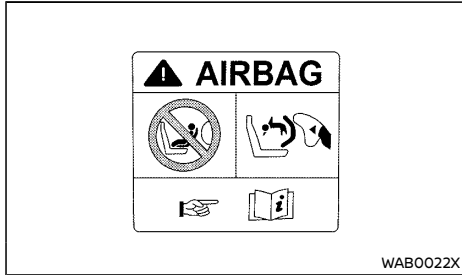

"NEVER use a rearward facing child restraint on a seat protected by an ACTIVE AIRBAG in front of it, DEATH or SERIOUS INJURY to the CHILD can occur."

Be sure to read "Air bag warning label" (P.1-22).

© 2020 NISSAN MOTOR CO., LTD.



# **OWNER'S MANUAL**

---

## **Nissan Connect**

---



# Table of Contents

<b>Illustrated table of contents</b>	<b>0</b>
<b>Safety – seats, seat belts and supplemental restraint system</b>	<b>1</b>
<b>Instruments and controls</b>	<b>2</b>
<b>Pre-driving checks and adjustments</b>	<b>3</b>
<b>Monitor, heater and air conditioner, and audio system</b>	<b>4</b>
<b>Starting and driving</b>	<b>5</b>
<b>In case of emergency</b>	<b>6</b>
<b>Appearance and care</b>	<b>7</b>
<b>Maintenance and do-it-yourself</b>	<b>8</b>
<b>Technical information</b>	<b>9</b>
<b>Index</b>	<b>10</b>





# 0 Illustrated table of contents

Seats, seat belts and Supplemental Restraint System (SRS) .....	0-2	Instrument panel .....	0-7
Exterior front .....	0-3	Meters and gauges .....	0-8
Exterior rear .....	0-4	Engine compartment .....	0-9
Passenger compartment .....	0-5	H4K engine model .....	0-9
Cockpit .....	0-6	HR13DDT engine model .....	0-10

## SEATS, SEAT BELTS AND SUPPLEMENTAL RESTRAINT SYSTEM (SRS)

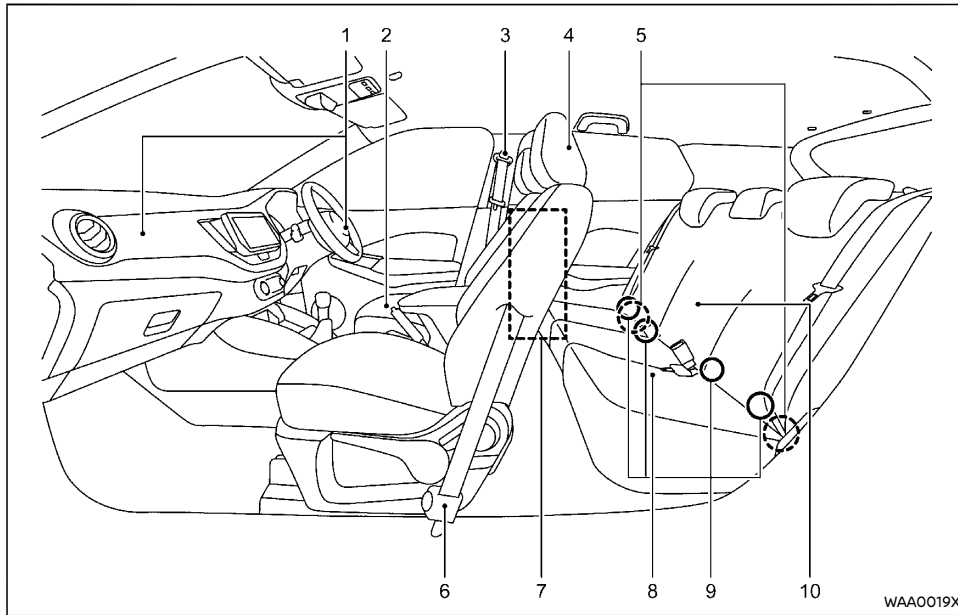

- |  |  |
|--|--|
| 1. Supplemental front-impact air bags (P.1-19)                                   | 8. Rear seats (P.1-3)<br>— Child restraints (P.1-10) |
| 2. Front seats (P.1-2)   | 9. ISOFIX child restraint system (P.1-14)            |
| 3. Seat belts (P.1-6)  | 10. Rear armrest* (P.1-4)                            |
| 4. Head restraints (P.1-4)   | *: if equipped                                       |
| 5. Child restraint anchor points (for top tether strap child restraint) (P.1-15) |  |
| 6. Pre-tensioner seat belt system (P.1-26)                                       |  |
| 7. Supplemental side-impact air bags* (P.1-19)                                   |  |

## EXTERIOR FRONT

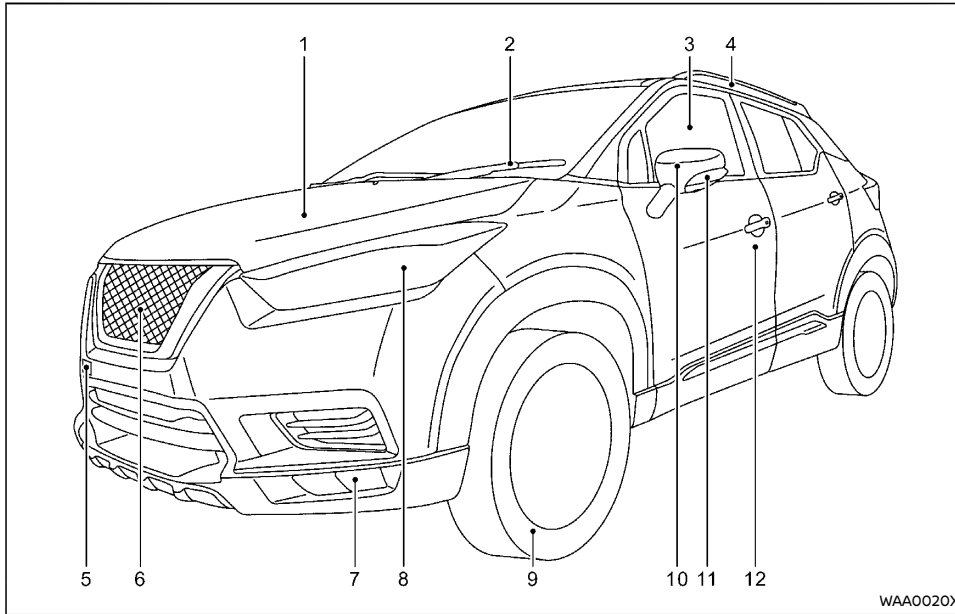

- |  |  |
|--|--|
| 1. Engine hood (P.3-14)  | 7. Fog lights* (P.2-16)  |
| 2. Windshield wiper and washer <ul style="list-style-type: none"><li>— Switch operation (P.2-17)</li><li>— Blade replacement (P.8-14)</li><li>— Window washer fluid (P.8-16)</li></ul> | 8. Headlights and turn signal lights (P.2-15)  |
| 3. Power windows (P.2-19)  | 9. Tires <ul style="list-style-type: none"><li>— Tires and wheels (P.8-26, P.9-5)</li><li>— Flat tire (P.6-2)</li><li>— Tire placard (P.9-7)</li></ul> |
| 4. Roof rack* (P.2-24)   | 10. Outside rearview mirrors (P.3-18) <ul style="list-style-type: none"><li>— Side view camera* (P.4-7)</li></ul>                                      |
| 5. Recovery hook (P.6-12)  | 11. Side turn signal light (P.2-16)  |
| 6. Front view camera* (P.4-7)  |  |

## 12. Doors

- Keys (P.3-2)
- Door locks (P.3-3)
- Intelligent Key system\* (P.3-5)
- Remote keyless entry system\* (P.3-4)
- Remote engine start\* (P.3-12)

\*: if equipped

## EXTERIOR REAR

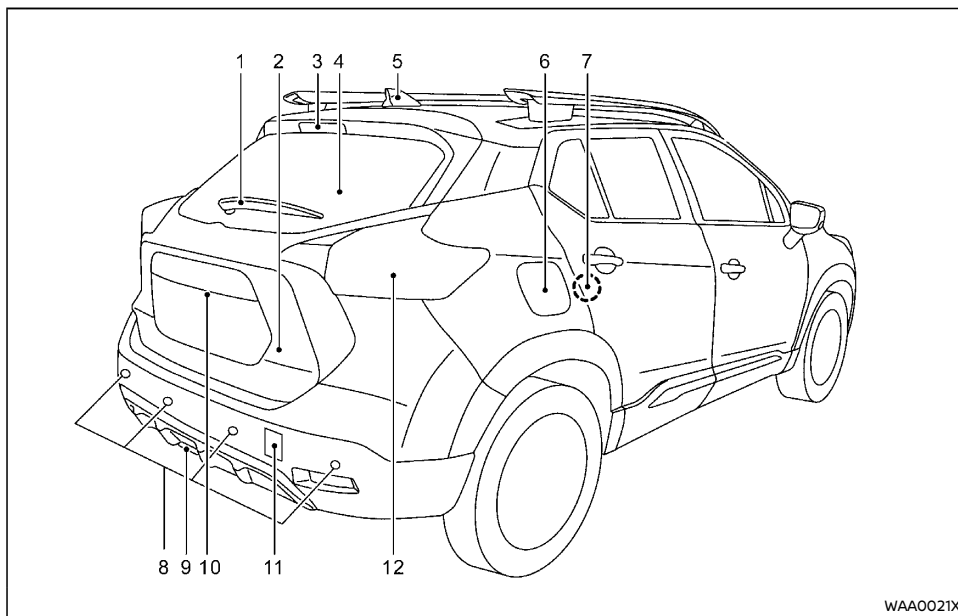

WAA0021X

- |  |   |
|--|---|
| 1. Rear window wiper and washer*<br>— Switch operation (P.2-18)<br>— Window washer fluid (P.8-16)    | 6. Fuel-filler lid (P.3-17)               |
| 2. Back door (P.3-15)<br>— Remote keyless entry system* (P.3-4)<br>— Intelligent Key system* (P.3-5) | 7. Child safety rear door lock (P.3-4)    |
| 3. High-mounted stop light (P.8-22)  | 8. Parking sensor (sonar) system (P.5-23) |
| 4. Rear window defogger (P.2-19)   | 9. Rear fog light* (P.2-16)               |
| 5. Antenna (P.4-23)  | 10. Rearview camera* (P.4-3, P.4-7)       |
|  | 11. Recovery hook (P.6-12)                |
|  | 12. Rear combination lights (P.8-22)      |
|  | *: if equipped                            |

## PASSENGER COMPARTMENT

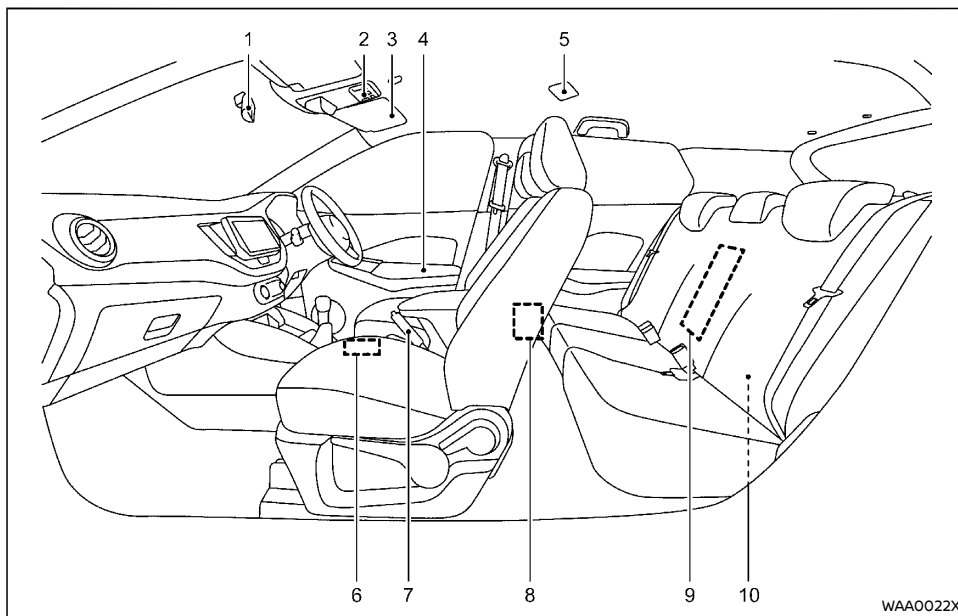

- |  |                             |
|--|-----------------------------|
| 1. Inside rearview mirror (P.3-18)                                       | 7. Parking brake (P.3-19)   |
| 2. Front room light (P.2-25)   | 8. Power outlet (P.2-21)    |
| 3. Sun visors (P.2-25, P.3-19)   | 9. Rear armrest* (P.1-4)    |
| 4. Door armrest  | — Rear cup holders (P.2-22) |
| — Power window switch (P.2-19)   | 10. Luggage room            |
| — Outside rearview mirror remote control switch (driver's side) (P.3-18) | — Luggage hooks (P.2-24)    |
| 5. Rear room light (P.2-25)  | — Cargo cover (P.2-23)      |
| 6. Fuel-filler lid opener lever (P.3-17)                                 | *: if equipped              |

## COCKPIT

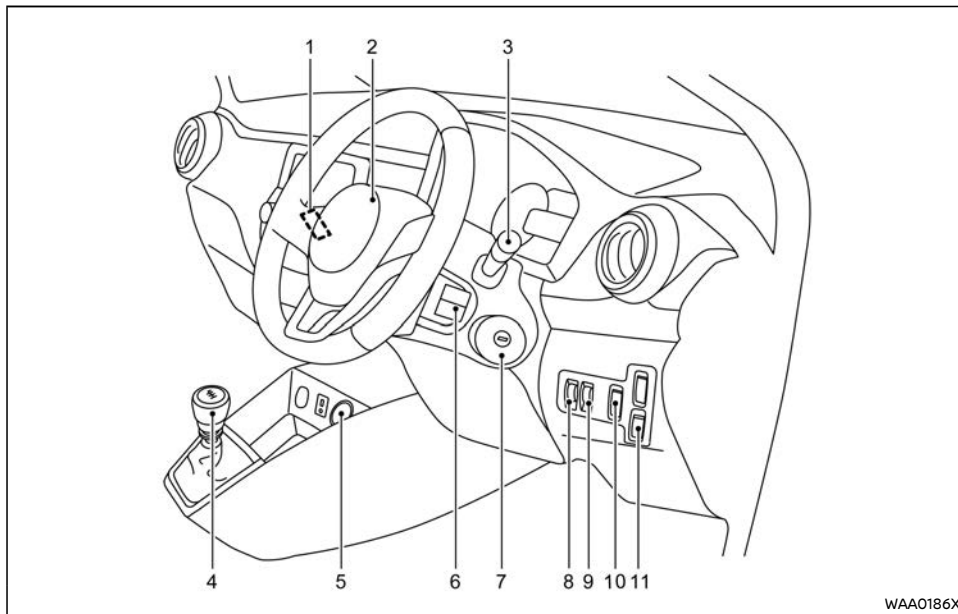

1. Headlight and turn signal switch (P.2-15)/ Fog light switch\* (P.2-16)
2. Steering wheel
  - Power steering (P.5-24)
  - Horn (P.2-19)
  - Driver's supplemental front-impact air bag (P.1-19)
3. Wiper and washer switch (P.2-17)/Trip computer mode switch (P.2-13)
4. Shift lever
  - Continuously Variable Transmission (CVT) (P.5-9)
  - Manual Transmission (MT) (P.5-12)
5. Push-button ignition switch (models with Intelligent Key system) (P.5-5)
6. Steering column switches\*\*
7. Ignition switch (models without Intelligent Key system) (P.5-5)
8. Headlight aiming control switch (P.2-15)

9. Instrument brightness control switch (P.2-5)
10. Stop/Start OFF switch\* (P.5-15)
11. Cruise control MAIN switch\* (P.5-18)/ Speed limiter MAIN switch\* (P.5-17)

\*: if equipped

\*\* : Refer to the NissanConnect Owner's Manual (if equipped).

## INSTRUMENT PANEL

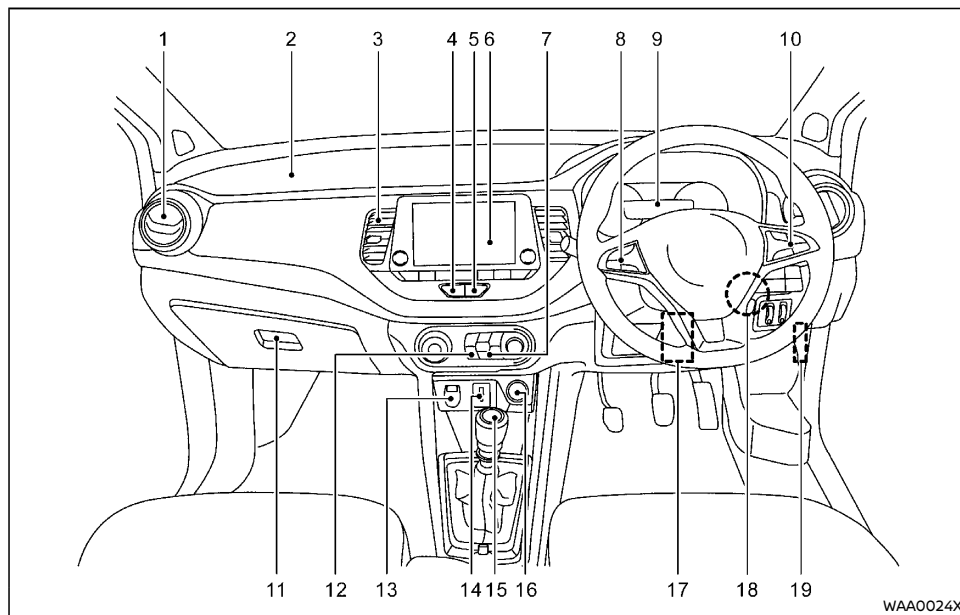

- |  |   |
|--|---|
| 1. Side ventilator (P.4-14)                    | 8. Steering-wheel-mounted controls (left side)*   |
| 2. Passenger's front-impact air bag (P.1-19)   | — Cruise control switches (P.5-18)                |
| 3. Center ventilator (P.4-14)                  | — Speed limiter switches (P.5-17)                 |
| 4. Hazard indicator flasher switch (P.6-2)     | 9. Meters and gauges (P.2-4)                      |
| 5. Power door lock switch (P.3-3)              | 10. Steering-wheel-mounted controls (right side)* |
| 6. Audio system* (P.4-17 or **)                | — Cruise control switches (P.5-18)                |
| — Rear view monitor* (P.4-3)                   | — Speed limiter switches (P.5-17)                 |
| — Around View Monitor* (P.4-7)                 | 11. Glove box (P.2-22)                            |
| 7. Heater and air conditioner control (P.4-14) | — Fuse box (P.8-20)                               |

- Key card port\* (P.5-7)
  - 12. Defogger switch (P.2-19)
  - 13. Power outlet (P.2-21)
  - 14. USB (Universal Serial Bus) connection port/AUX (auxiliary) input jack (P.4-28 or NissanConnect\*\*)
  - 15. Shift lever
    - Continuously Variable Transmission (CVT) (P.5-9)
    - Manual Transmission (MT) (P.5-12)
  - 16. Push-button ignition switch (models with Intelligent Key system) (P.5-5)
  - 17. Tilting steering wheel lock lever (P.3-18)
  - 18. Ignition switch (models without Intelligent Key system) (P.5-5)
  - 19. Hood lock release handle (P.3-15)
- \*: if equipped  
 \*\*: Refer to the NissanConnect Owner's Manual (if equipped).

## METERS AND GAUGES

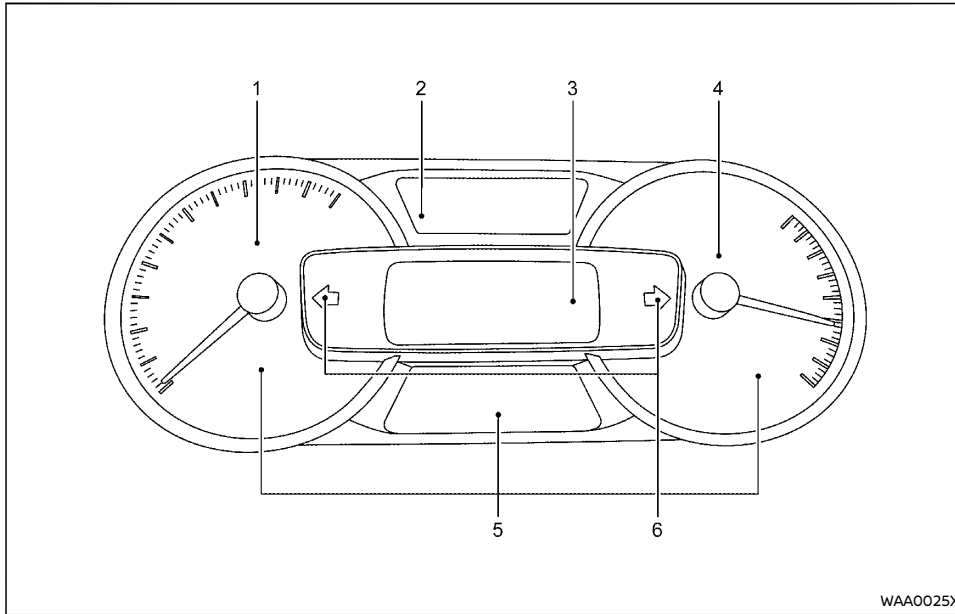

WAA0025X

- |  |  |
|--|--|
| 1. Tachometer (P.2-4)  | 4. Fuel gauge (P.2-5)                            |
| 2. Vehicle information display (P.2-11)<br>– Trip computer (P.2-13)<br>– Outside air temperature (P.2-14)<br>– Warnings and indicators (P.2-11)                                | 5. Warning and indicator lights (P.2-6)          |
| 3. Speedometer (P.2-4)<br>– Gear shift indicator* (P.2-5)<br>– Stop/Start System indicator* (P.2-10)<br>– Continuously Variable Transmission (CVT) position indicator* (P.2-5) | 6. Turn signals/hazard indicator lights (P.2-10) |
|  | *: if equipped                                   |



## ENGINE COMPARTMENT

### H4K ENGINE MODEL

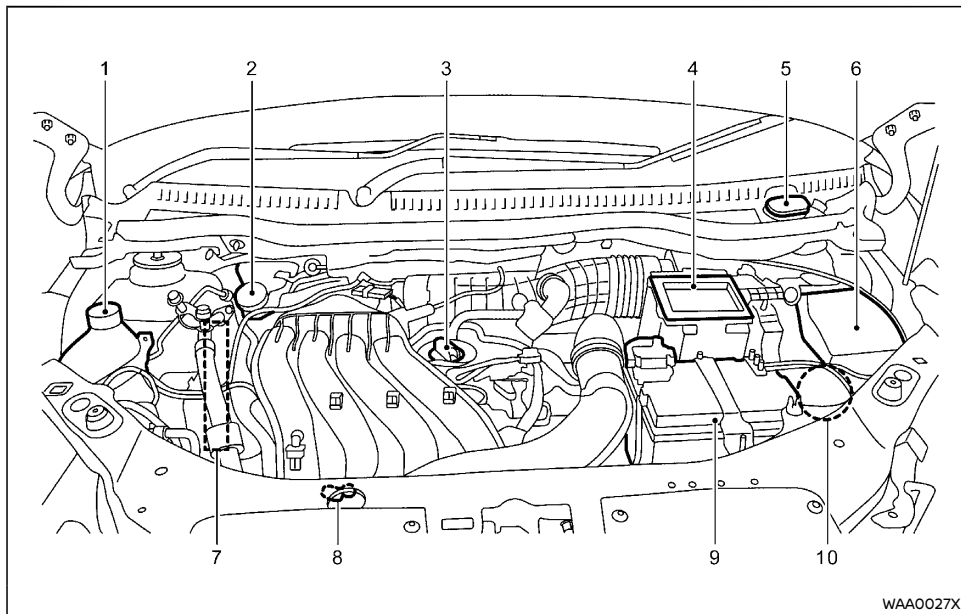

- |  |   |
|--|---|
| 1. Engine coolant reservoir (P.8-6)                  | 8. Engine oil dipstick (P.8-7)              |
| 2. Brake and clutch fluid reservoir (P.8-12, P.8-13) | 9. Battery (P.8-17)                         |
| 3. Engine oil filler cap (P.8-7)                     | 10. Power steering fluid reservoir (P.8-14) |
| 4. Air cleaner (P.8-14)                              |   |
| 5. Window washer fluid reservoir (P.8-16)            |   |
| 6. Fuse/fusible link holders (P.8-19)                |   |
| 7. Engine drive belt location (P.8-10)               |   |

## HR13DDT ENGINE MODEL

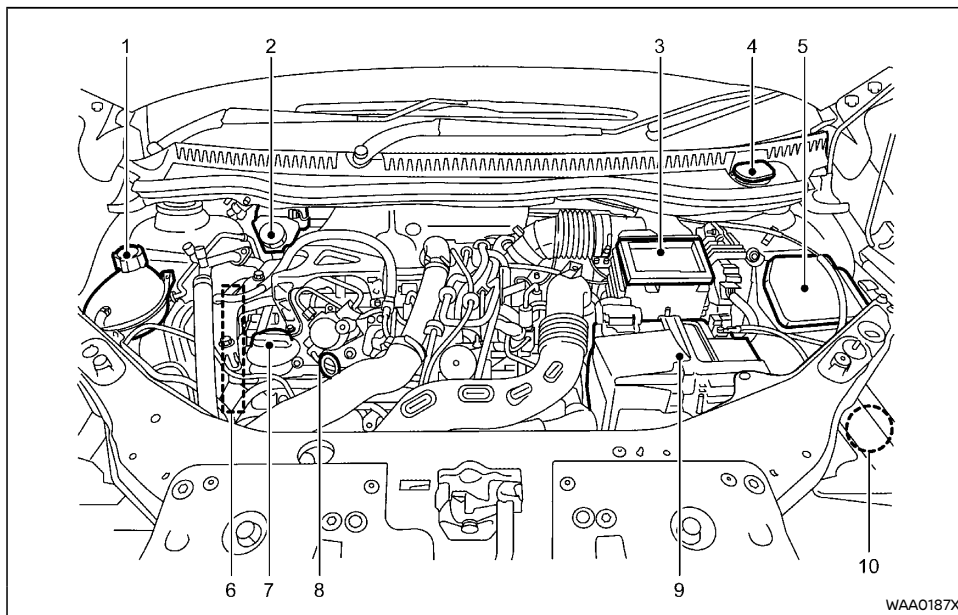

- |   |   |
|---|---|
| 1. Engine coolant reservoir (P.8-6)                   | 8. Engine oil dipstick (P.8-7)              |
| 2. Brake and clutch* fluid reservoir (P.8-12, P.8-13) | 9. Battery (P.8-17)                         |
| 3. Air cleaner (P.8-14)                               | 10. Power steering fluid reservoir (P.8-14) |
| 4. Window washer fluid reservoir (P.8-16)             | *: For Manual Transmission (MT) Model       |
| 5. Fuse/fusable link holders (P.8-19)                 |   |
| 6. Engine drive belt location (P.8-10)                |   |
| 7. Engine oil filler cap (P.8-7)                      |   |

# 1 Safety — seats, seat belts and supplemental restraint system

Seats .....	1-2	Child restraints .....	1-10
Front seats .....	1-2	Precautions on child restraint usage .....	1-10
Rear seats .....	1-3	Universal child restraints for front seat and rear seats .....	1-11
Armrest (if equipped) .....	1-4	ISOFIX child restraint system .....	1-14
Head restraints .....	1-4	Child restraint anchorage .....	1-15
Adjustable head restraint components .....	1-4	Child restraint installation using ISOFIX .....	1-15
Non-adjustable head restraint components .....	1-4	Child restraint installation using three-point type seat belt .....	1-17
Remove .....	1-5	Supplemental Restraint System (SRS) .....	1-19
Install .....	1-5	Precautions on Supplemental Restraint System (SRS) .....	1-19
Adjust .....	1-5	Supplemental air bag systems .....	1-23
Seat belts .....	1-6	SRS air bag deployment conditions .....	1-24
Precautions on seat belt usage .....	1-6	Pre-tensioner seat belt system .....	1-26
Child safety .....	1-8	Repair and replacement procedure .....	1-27
Pregnant women .....	1-8		
Injured persons .....	1-9		
Center mark on seat belts .....	1-9		
Three-point type seat belts .....	1-9		
Two-point type seat belts .....	1-10		
Seat belt maintenance .....	1-10		

## SEATS

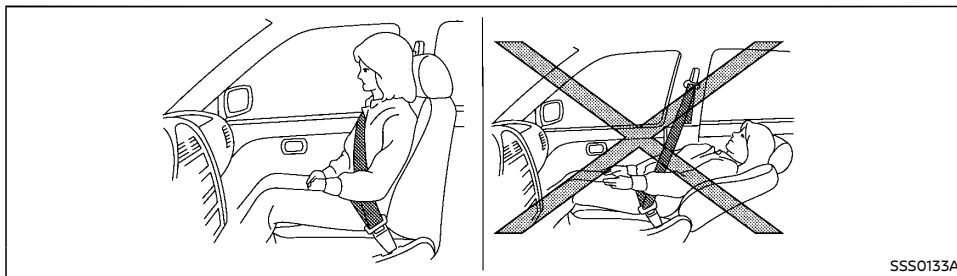

### **WARNING:**

- Do not drive and/or ride in the vehicle with the seatback reclined. This can be dangerous. The shoulder belt will not be properly against the body. In an accident, you and your passengers could be thrown into the shoulder belt and receive neck or other serious injuries. You and your passengers could also slide under the lap belt and receive serious injuries.
- For the most effective protection while the vehicle is in motion, the seatback should be upright. Always sit well back and upright in the seat and adjust the seat belt properly. (See "Seat belts" (P.1-6).)
- Do not leave children unattended inside the vehicle. They could unknowingly activate switches or controls. Unattended children could become involved in serious accidents.
- To help avoid risk of injury or death through unintended operation of the vehicle and/or its systems, do not leave children, people who require the assis-

tance of others or pets unattended in your vehicle. Additionally, the temperature inside a closed vehicle on a warm day can quickly become high enough to cause a significant risk of injury or death to people and pets.

### **CAUTION:**

When adjusting the seat positions, be sure not to contact any moving parts to avoid possible injuries and/or damages.

## FRONT SEATS

### **WARNING:**

Do not adjust the driver's seat while driving so that full attention may be given to vehicle operation.

## Manual seat adjustment

### **WARNING:**

After adjusting a seat, gently shake the seat to confirm that the seat is locked securely. If the seat is not locked securely, it may move suddenly and could cause the loss of control of the vehicle.

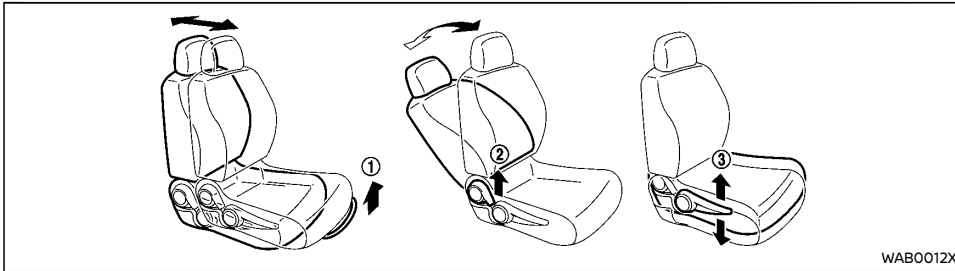

#### Forward and backward:

1. Pull up the adjusting lever ①.
2. Slide the seat to the desired position.
3. Release the adjusting lever to lock the seat in position.

#### Reclining:

1. Pull up the adjusting lever ②.
2. Tilt the seatback to the desired position.
3. Release the adjusting lever to lock the seatback in position.

The reclining feature allows the adjustment of the seatback for occupants of different sizes to help obtain the proper seat belt fit. (See "Seat belts" (P.1-6).)

The seatback may be reclined to allow occupants to rest when the vehicle is parked.

#### Seat lifter (if equipped):

Pull up or push down the adjusting lever ③ to adjust the seat height until the desired position is achieved.

## REAR SEATS

### Folding



#### WARNING:

- **Never allow anyone to ride in the luggage area or on the rear seats when they are in the fold-down position. Use of these areas by passengers without proper restraints could result in serious injury in an accident or sudden stop.**
- **Do not fold down the rear seats when occupants are in the rear seat area or any luggage is on the rear seats.**
- **Properly secure all luggage to help prevent it from sliding or shifting. Do not place luggage higher than the seatbacks.**
- **When returning the seatbacks to the upright position, be certain they are completely secured in the latched position. If they are not completely secured, passengers may be injured in an accident or sudden stop.**
- **Head restraints should be adjusted properly as they may provide significant protection against whiplash injury. Al-**

ways replace and adjust them properly if they have been removed for any reason.

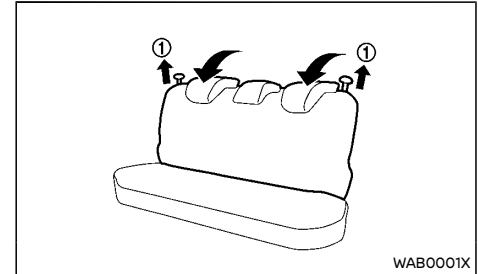

To fold the seatback, pull the knob ①.

To return the seatback to the seating position, lift up the seatback and push it to the upright position until it is latched.



#### CAUTION:

- **When loading the luggage in the luggage area, be careful not to scratch or damage the seat belt.**
- **When operating the seatback, be careful not to scratch or damage the seat belt.**

## HEAD RESTRAINTS

ARMREST (if equipped)

Rear

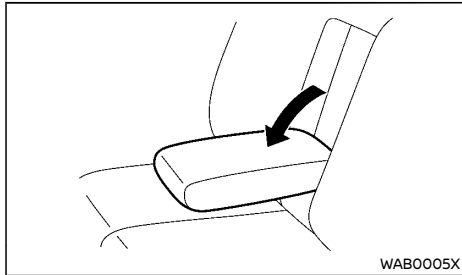

Pull the armrest down as shown.



### WARNING:

Head restraints supplement the other vehicle safety systems. They may provide additional protection against injury in certain rear end collisions. Adjustable head restraints must be adjusted properly, as specified in this section. Check the adjustment after someone else uses the seat. Do not attach anything to the head restraint stalks or remove the head restraint. Do not use the seat if the head restraint has been removed. If the head restraint was removed, reinstall and properly adjust the head restraint before an occupant uses the seating position. Failure to follow these instructions can reduce the effectiveness of the head restraint. This may increase the risk of serious injury or death in a collision.

- Your vehicle is equipped with a head restraint that may be integrated, adjustable or non-adjustable.
- Adjustable head restraints have multiple notches along the stalk to lock them in a desired adjustment position.
- The non-adjustable head restraints have a single locking notch to secure them to the seat frame.
- Proper Adjustment:
  - For the adjustable type, align the head restraint so the center of your ear is approximately level with the center of the head restraint.
  - If your ear position is still higher than the recommended alignment, place the head restraint at the highest position.
- If the head restraint has been removed, ensure that it is reinstalled and locked in place before riding in that designated

seating position.

### ADJUSTABLE HEAD RESTRAINT COMPONENTS

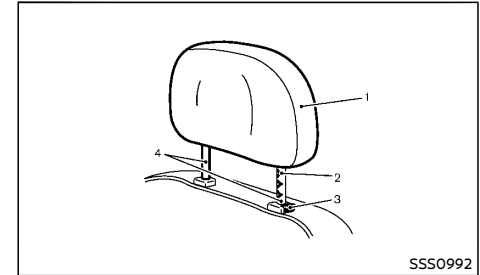

1. Removable head restraint
2. Multiple notches
3. Lock knob
4. Stalks

### NON-ADJUSTABLE HEAD RESTRAINT COMPONENTS

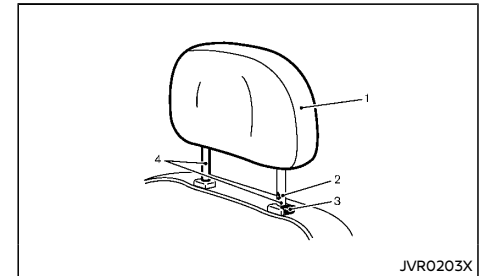

1. Removable head restraint

2. Single notch
3. Lock knob
4. Stalks

## REMOVE

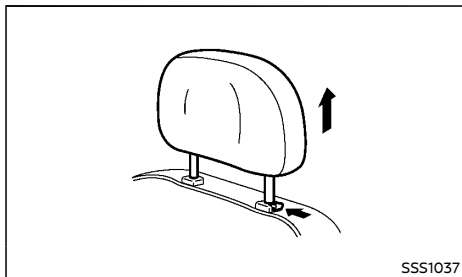

Use the following procedure to remove the head restraint.

1. Pull the head restraint up to the highest position.
2. Push and hold the lock knob.
3. Remove the head restraint from the seat.
4. Store the head restraint properly in a secure place so it is not loose in the vehicle.
5. Reinstall and properly adjust the head restraint before an occupant uses the seating position.

## INSTALL

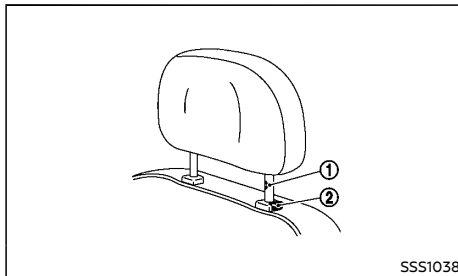

1. Align the head restraint stalks with the holes in the seat. Make sure that the head restraint is facing the correct direction. The stalk with the adjustment notch ① must be installed in the hole with the lock knob ②.
2. Push and hold the lock knob and push the head restraint down.
3. Properly adjust the head restraint before an occupant uses the seating position.

## ADJUST

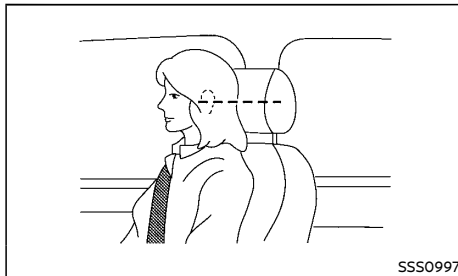

## For adjustable head restraint

Adjust the head restraint so the center is level with the center of your ears. If your ear position is still higher than the recommended alignment, place the head restraint at the highest position.

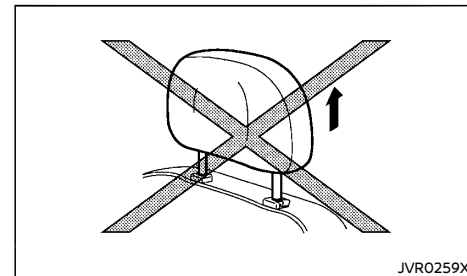

## For non-adjustable head restraint

Make sure the head restraint is positioned from the stored position or any non-latch position so the lock knob is engaged in the notch before riding in that designated seating position.

## Raise

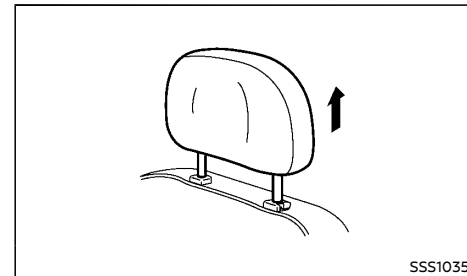

To raise the head restraint, pull it up.

## SEAT BELTS

Make sure the head restraint is positioned from the stored position or any non-latch position so the lock knob is engaged in the notch before riding in that designated seating position.

### Lower

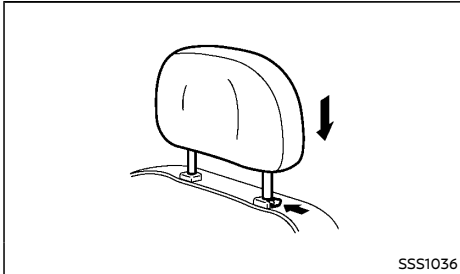

To lower, push and hold the lock knob and push the head restraint down.

Make sure the head restraint is positioned so the lock knob is engaged in the notch before riding in that designated seating position.

### PRECAUTIONS ON SEAT BELT USAGE

If you are wearing the seat belt properly adjusted and sitting upright and well back in the seat, chances of being injured or killed in an accident and/or the severity of injury may be greatly reduced. NISSAN strongly encourages you and all of your passengers to buckle up every time you drive, even if your seating position includes the supplemental air bag systems.



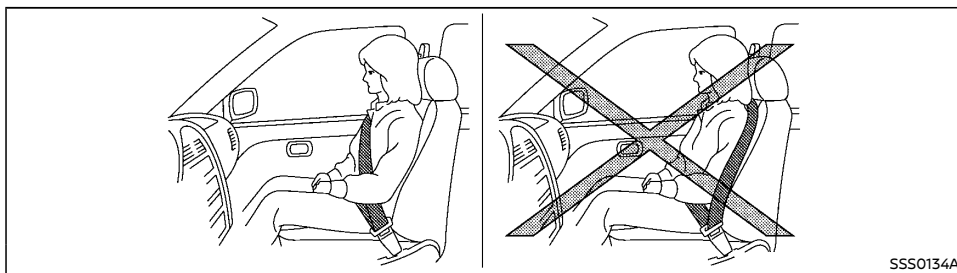

SSS0134A

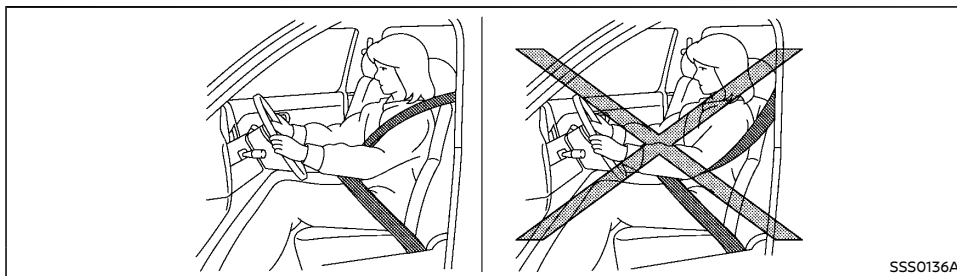

SSS0136A

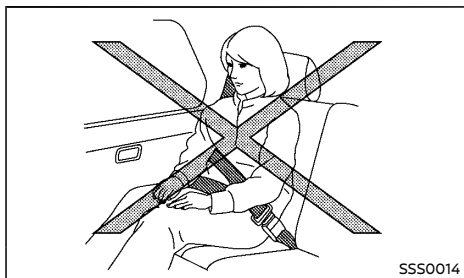

SSS0014

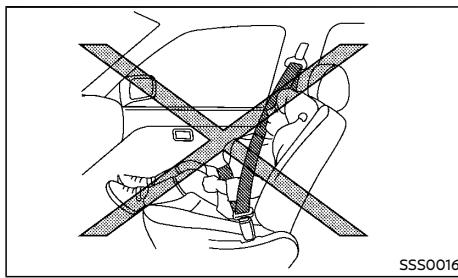

SSS0016



**WARNING:**

- Seatbelts are designed to bear upon the bony structure of the body, and should be worn low across the front of the pelvis or the pelvis, chest and shoulders, as applicable; wearing the lap section of the belt across the abdominal area must be avoided. Serious injury may occur if a seat belt is not worn properly.
- Position the lap belt as low and snug as possible around the hips, not the waist. A lap belt worn too high could increase the risk of internal injuries in an accident.
- Do not allow more than one person to use the same seat belt. Each belt assembly must only be used by one occupant; it is dangerous to put a belt around a child being carried on the occupant's lap.
- Never carry more people in the vehicle than there are seat belts.
- Never wear seat belts inside out. Belts should not be worn with straps twisted. Doing so may reduce their effectiveness.
- Seatbelts should be adjusted as firmly as possible, consistent with comfort, to provide the protection for which they have been designed. A slack belt will greatly reduce the protection afforded to the wearer.
- Every person who drives or rides in this vehicle should use a seat belt at all times. Children should be properly restrained in the rear seat and, if appropriate, in a child restraint system.
- Do not put the belt behind your back or under your arm. Always route the shoulder belt over your shoulder and across your chest. The belt should be

away from your face and neck, but not falling off your shoulder. Serious injury may occur if a seat belt is not worn properly.

- No modifications or additions should be made by the user which will either prevent the seat belt adjusting devices from operating to remove slack, or prevent the seat belt assembly from being adjusted to remove slack.
- Care should be taken to avoid contamination of the webbing with polishes, oils and chemicals, and particularly battery acid. Cleaning may safely be carried out using mild soap and water. The belt should be replaced if webbing becomes frayed, contaminated or damaged.
- All seat belt assemblies including retractors and attaching hardware should be inspected after any collision by a NISSAN dealer. NISSAN recommends that all seat belt assemblies in use during a collision be replaced unless the collision was minor and the belts show no damage and continue to operate properly. Seat belt assemblies not in use during a collision should also be inspected and, when necessary, replaced if either damage or improper operation is noted.
- It is essential to replace the entire assembly after it has been worn in a severe impact even if damage to the assembly is not obvious.
- Once the pre-tensioner seat belt has activated, it cannot be reused. It must be replaced together with the retractor. Contact a NISSAN dealer.
- Removal and installation of the pre-tensioner seat belt system components

should be done by a NISSAN dealer.

## CHILD SAFETY



### WARNING:

- Infants and children need special protection. The vehicle's seat belts may not fit them properly. The shoulder belt may come too close to the face or neck. The lap belt may not fit over their small hipbones. In an accident, an improperly fitted seat belt could cause serious or fatal injury.
- Always use an appropriate child restraint system.

Children need adults to help protect them. They need to be properly restrained. The proper restraint depends on the child's size.

### Infants and small children

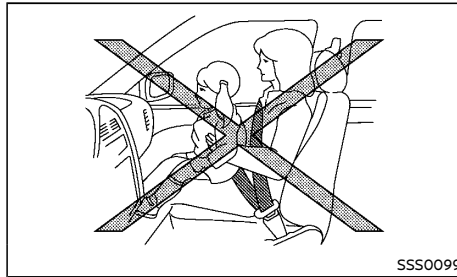

NISSAN recommends that infants and small children be seated in a child restraint system. You should choose a child restraint system that fits your vehicle and the child, and always follow the manufacturer's instructions for installation and use.

### Large children



### WARNING:

- Never allow children to stand or kneel on any seats.
- Never allow children in the luggage area while the vehicle is moving. A child could be seriously injured in an accident or sudden stop.

Children who are too large for a child restraint system should be seated and restrained by the seat belts that are provided.

If the child's seating position has a shoulder belt that fits close to the face or neck, the use of a booster seat (commercially available) may help overcome this. The booster seat should raise the child so that the shoulder belt is properly positioned across the top, middle portion of the shoulder and the lap belt is low on the hips. The booster seat should also fit the vehicle seat. Once the child has grown so that the shoulder belt is no longer on or near the face or neck of the child, use the shoulder belt without the booster seat. In addition, there are many types of child restraint systems available for larger children that should be used for maximum protection.

### PREGNANT WOMEN

NISSAN recommends that pregnant women use seat belts. The seat belt should be worn snug, and always position the lap belt as low as possible around the hips, not the waist. Place the shoulder belt over your shoulder and across your chest. Never run the lap/shoulder belt over your abdominal area. Contact your doctor for specific recommendations.

## INJURED PERSONS

NISSAN recommends that injured persons use seat belts. Contact your doctor for specific recommendations.

## CENTER MARK ON SEAT BELTS

Selecting correct set of seat belts

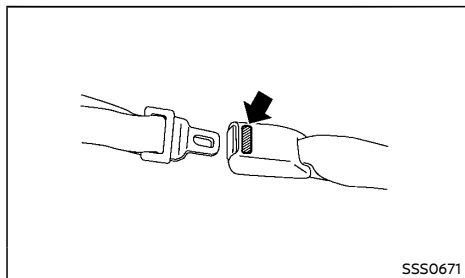

The center seat belt buckle is identified by the CENTER mark. The center seat belt tongue can be fastened only into the center seat belt buckle.

## THREE-POINT TYPE SEAT BELTS

Fastening seat belts

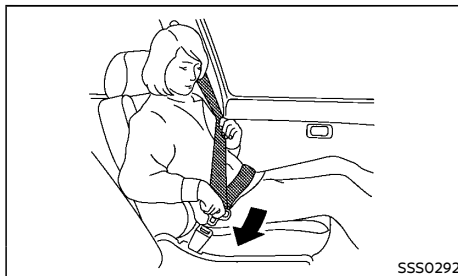

### WARNING:

**The seatback should not be in a reclined position any more than needed for comfort. Seat belts are most effective when the passenger sits well back and straight up in the seat.**

1. Adjust the seat. (See "Seats" (P.1-2).)
2. Slowly pull the seat belt out of the retractor and insert the tongue into the buckle until you hear and feel the latch engage.
  - **The retractor is designed to lock during a sudden stop or on impact. A slow pulling motion permits the belt to move, and allows you some freedom of movement in the seat.**
  - **If the seat belt cannot be pulled from its fully retracted position, firmly pull the belt and release it. Then smoothly pull the belt out of the retractor.**

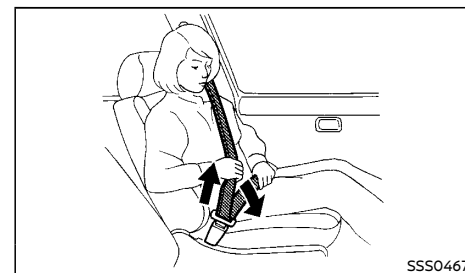

3. Position the lap belt portion low and snug on the hips as shown.
4. Pull the shoulder belt portion toward the retractor to take up extra slack. Be sure the shoulder belt is routed over your shoulder and is snug across your chest.

## Unfastening seat belts

Push the button on the buckle. The seat belt automatically retracts.

## Checking seat belt operation

Seat belt retractors are designed to lock seat belt movement:

- When the seat belt is pulled quickly from the retractor.
- When the vehicle slows down rapidly.

To increase your confidence in the seat belts, check the operation by grasping the shoulder belt and pulling forward quickly. The retractor should lock and restrict further belt movement. If the retractor does not lock during this check, contact a NISSAN dealer immediately.

## TWO-POINT TYPE SEAT BELTS

### Fastening seat belts

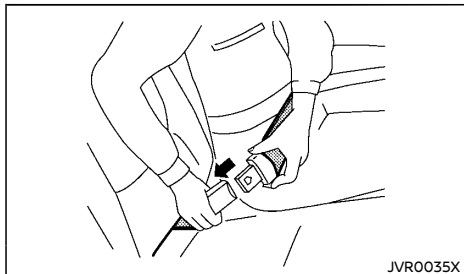

1. Insert the tongue into the buckle until you hear and feel the latch engage.

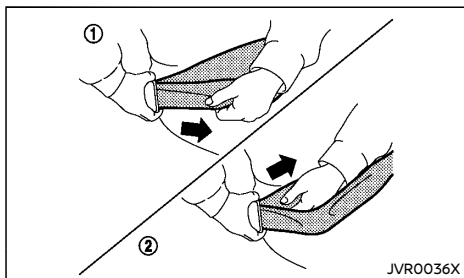

2. Adjust the seat belt length. To shorten, hold the tongue and pull the upper belt as illustrated ①. To lengthen, hold the tongue and pull the under belt as illustrated ②.

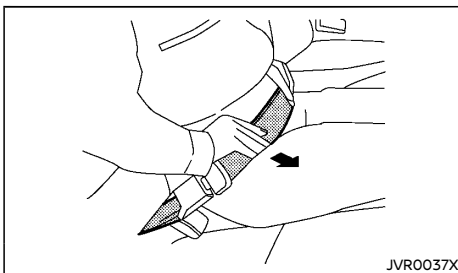

3. Position the lap belt portion low and snug on the hips as shown.

### Unfastening seat belts

Push the button on the buckle.

### SEAT BELT MAINTENANCE

Periodically check that the seat belt and all the metal components, such as buckles, tongues, retractors, flexible wires and anchors, work properly. If loose parts, deterioration, cuts or other damage on the seat belt webbing is found, the entire seat belt assembly should be replaced.

If dirt builds up in the shoulder belt guide of the seat belt anchors, the seat belts may retract slowly. Wipe the shoulder belt guide with a clean, dry cloth.

To clean the seat belt webbing, apply a mild soap solution or any solution recommended for cleaning upholstery or carpet. Then wipe with a cloth and allow the seat belts to dry in the shade. Do not allow the seat belts to retract until they are completely dry.

## CHILD RESTRAINTS

### PRECAUTIONS ON CHILD RESTRAINT USAGE

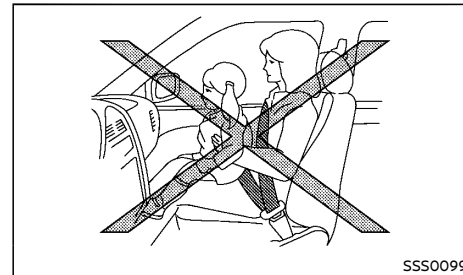

### WARNING:

- Infants and small children should always be placed in an appropriate child restraint while riding in the vehicle. Failure to use a child restraint can result in serious injury or death.
- Infants and small children should never be carried on your lap. It is not possible for even the strongest adult to resist the forces of a severe accident. The child could be crushed between the adult and parts of the vehicle. Also, do not put the same seat belt around both your child and yourself.
- NISSAN recommends that the child restraints be installed in the rear seat. According to accident statistics, children are safer when properly restrained in the rear seat than in the front seat.
- Improper use or improper installation of a child restraint can increase the risk or severity of injury for both the child and other occupants of the vehicle and can

lead to serious injury or death in an accident.

- Follow all of the child restraint manufacturer's instructions for installation and use. When purchasing a child restraint, be sure to select one which will fit your child and vehicle. It may not be possible to properly install some types of child restraint in your vehicle.
- The direction of the child restraint, either front-facing or rear-facing, depends on the type of the child restraint and the size of the child. Refer to the child restraint manufacturer's instructions for details.
- Adjustable seatbacks should be positioned to ensure full contact between child restraint and seatback.
- After attaching a child restraint, test it before you place the child in it. Push it from side to side and tug it forward to make sure that is held securely in place. The child restraint should not move more than 25 mm (1 in). If the restraint is not secure, tighten the belt as necessary, or install the restraint in another seat and test it again.
- When the child restraint is not in use, keep it secured with the ISOFIX child restraint system or a seat belt to prevent it from being thrown around in case of a sudden stop or accident.
- Never install a rear-facing child restraint on the front passenger's seat when the front passenger's air bag is available. Supplemental front-impact air bags inflate with great force. A rear-facing child restraint could be struck by the supplemental front-impact air bags in an accident and could seriously injure or kill your child.

- If the seat belt in the position where a child restraint is installed requires a locking device and if it is not used, injuries could result from a child restraint tipping over during normal vehicle braking or cornering.



#### CAUTION:

Remember that a child restraint left in a closed vehicle can become very hot. Check the seating surface and buckles before placing your child in a child restraint.

NISSAN recommends that infants and small children be seated in a child restraint. You should choose a child restraint that fits your vehicle and always follow the manufacturer's instructions for installation and use. In addition, there are many types of child restraints available for larger children that should be used for maximum protection.

## UNIVERSAL CHILD RESTRAINTS FOR FRONT SEAT AND REAR SEATS

### NOTE:

Universal child restraints approved to UN Regulation No.44 (UN R44) or UN Regulation No.129 (UN R129) are clearly marked "Universal".

When selecting any child restraint, keep the following points in mind:

- Choose a child restraint that complies with the UN R44 or UN R129.
- Place your child in the child restraint and check the various adjustments to be sure the child restraint is compatible with your child. Always follow all of the recommended procedures.
- Check the child restraint in your vehicle to be sure it is compatible with vehicle's seat belt system.
- Refer to the tables later in this section for a list of the recommended fitment positions and the approved child restraints for your vehicle.

### Mass group of child seat

Mass group	Child's weight
Group 0	up to 10 kg
Group 0+	up to 13 kg
Group I	9 to 18 kg
Group II	15 to 25 kg
Group III	22 to 36 kg

**Kind of child seats (example):**

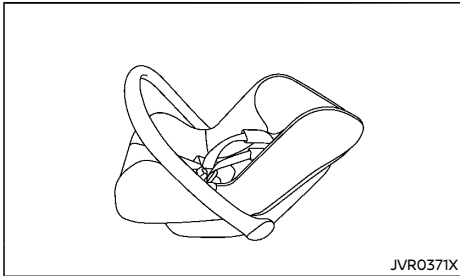

**Child safety seat categories 0 and 0+**

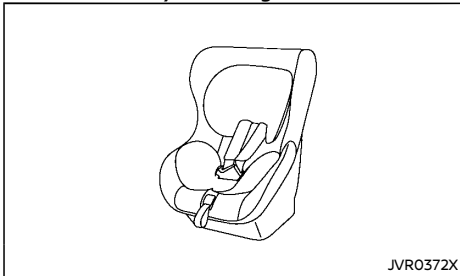

**Child safety seat categories 0+ and I**

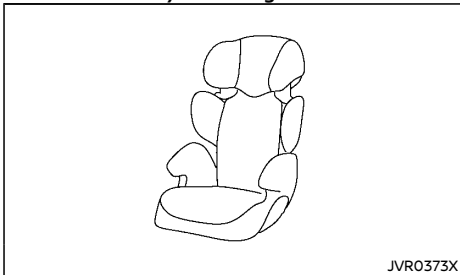

**Child safety seat categories II and III**

**Approved child restraint positions (without ISOFIX)**

The following restriction is applied when using child restraints varying by infants weight and installation position (without ISOFIX child restraint).

Mass group		Suitability		
		Front passenger seat	2nd row outer seat	2nd row center seat
0	<10 kg	X	U/L*1	X
0+	<13 kg	X	U/L*1	X
I	9 - 18 kg	X	U/L*1	X
II	15 - 25 kg	X	U/L*1	X
III	22 - 36 kg	X	U/L*1	X

X: Seat position not suitable for children in this mass group.

U: Suitable for universal category child restraint systems, forward and rearward facing, approved for use in this mass group.

L: Suitable for particular child restraint systems given in the following list. These restraints may be of the “Child restraint systems manufacturer vehicle list (online)” or “Semi-universal” categories.

\*1: If you install a child restraint system in the rear seat, remove and store the rear seat head restraint.

## Approved child restraint positions (with ISOFIX)

The following restriction is applied when using child restraints varying by infants weight and installation position (ISOFIX child restraint).

Mass group			Suitability		
			Front passenger seat	2nd row outer seat	2nd row center seat
Carry-cot	F	ISO/L1	X	X	X
	G	ISO/L2	X	X	X
0+ (<10 kg)	E	ISO/R1	X	IL*1	X
0+ (<13 kg)	E	ISO/R1	X	IL*1	X
	D	ISO/R2	X	IL*1	X
	C	ISO/R3	X	IL*1*2	X
I (9 - 18 kg)	D	ISO/R2	X	IL*1	X
	C	ISO/R3	X	IL*1*2	X
	B	ISO/F2	X	IUF/IL*1	X
	B1	ISO/F2X	X	IUF/IL*1	X
	A	ISO/F3	X	IUF/IL*1	X
II (15-25 kg)	—	—	X	IL*1	X
III (22-36 kg)	—	—	X	IL*1	X

- X: Not suitable for installation of ISOFIX child restraint system (CRS) in these seating positions.  
 IUF: Suitable for ISOFIX forward facing CRS of universal category approved for use in this mass group.  
 IL: Suitable for the particular ISOFIX CRS given in the following list. These ISOFIX CRS are those of the "CRS manufacturer vehicle list (online)" or "Semi-universal" categories.  
 \*1: If you install a child restraint system in the rear seat, remove the rear seat head restraint.  
 \*2: If you install a child restraint system in the rear seat, set the front seat slide position for clearance to the rear seat child restraint/child's legs.

## List of recommended ISOFIX child restraints

	Front passenger seat	Rear outboard seat		Rear center seat
0 (<10 kg)	—	—		—
0+ (<13 kg)	—	RÖMER/Britax Babysafe plus ISOFIX Base	Belted & Support leg Rearward facing	—
	—	Maxi Cosi Cabrio Fix plus Easy Fix	Belted & Support leg Rearward facing	—
I (9 - 18 kg)	—	Maxi Cosi pearl plus family fix	Belted & Support leg Forward facing	—
II (15 - 25 kg)	—	RÖMER/Britax Kid fix XP	Belted & ISOFIX Forward facing	—
III (22 - 36 kg)	—	RÖMER/Britax Kid fix XP	Belted & ISOFIX Forward facing	—

### ISOFIX CHILD RESTRAINT SYSTEM

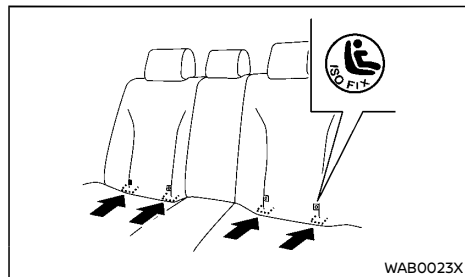

#### ISOFIX label location

Your vehicle is equipped with special anchor points that are used with ISOFIX child restraint systems.

### ISOFIX lower anchor point locations

The ISOFIX anchor points are provided to install child restraints in the rear outboard seating positions only. **Do not attempt to install a child restraint in the center seating position using the ISOFIX anchors.**

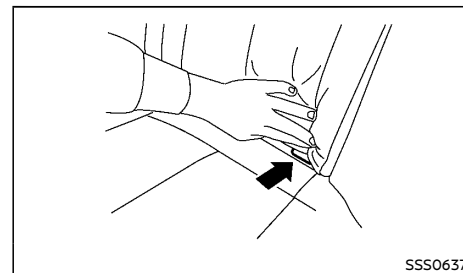

#### ISOFIX lower anchor location

The ISOFIX anchors are located as shown. A label is attached to the seatback to help you locate the ISOFIX anchors.

### ISOFIX child restraint anchor attachments

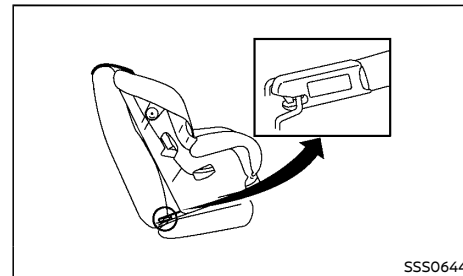

#### Anchor attachment

ISOFIX child restraints include two rigid attachments that can be connected to two anchors located in the seat. With this system, you do not have to use a vehicle seat belt to secure the child restraint. Check your child restraint for a label stating that it is compatible with the ISOFIX child restraints. This information may also be in the instructions provided by the child restraint manufacturer.



ISOFIX child restraints generally require the use of a top tether strap or other anti-rotation devices such as support legs. When installing ISOFIX child restraints, carefully read and follow the instructions in this manual and those supplied with the child restraints. (See "Child restraint installation using ISOFIX" (P.1-15).)

## CHILD RESTRAINT ANCHORAGE

Your vehicle is designed to accommodate a child restraint system on the rear seat. When installing a child restraint system, carefully read and follow the instructions in this manual and those supplied with the child restraint system.



### WARNING:

- Child restraint anchorages are designed to withstand only those loads imposed by correctly fitted child restraints. Under no circumstances are they to be used for adult seat belts, harnesses or for attaching other items or equipment to the vehicle. Doing so could damage the child restraint anchorages. The child restraint will not be properly installed using the damaged anchorage, and a child could be seriously injured or killed in a collision.
- The child restraint top tether strap may be damaged by contact with the cargo cover or items in the luggage area. Remove the cargo cover from the vehicle or secure it and any luggage. Your child could be seriously injured or killed in a collision if the top tether strap is damaged.

## Anchorage location

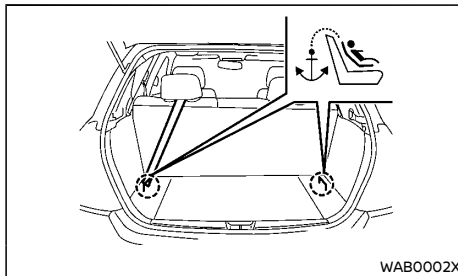

The anchor points are located as illustrated.

## CHILD RESTRAINT INSTALLATION USING ISOFIX



### WARNING:

- Attach ISOFIX child restraints only at the specified locations. For the ISOFIX lower anchor locations, see "ISOFIX child restraint system" (P.1-14). If a child restraint is not secured properly, your child could be seriously injured or killed in an accident.
- Do not install child restraints that require the use of a top tether strap to seating positions that do not have a top tether anchor.
- Do not secure a child restraint in the center rear seating position using the ISOFIX lower anchors. The child restraint will not be secured properly.
- Inspect the lower anchors by inserting your fingers into the lower anchor area and feeling to make sure there are no obstructions over the ISOFIX anchors,

such as seat belt webbing or seat cushion material. The child restraint will not be secured properly if the ISOFIX anchors are obstructed.

- Child restraint anchorages are designed to withstand only those loads imposed by correctly fitted child restraints. Under no circumstances are they to be used for adult seat belts, harnesses or for attaching other items or equipment to the vehicle. Doing so could damage the child restraint anchorages. The child restraint will not be properly installed using the damaged anchorage, and a child could be seriously injured or killed in a collision.

## Installation on rear outboard seats

### Front-facing:

Be sure to follow the manufacturer's instructions for the proper use of your child restraint. Follow these steps to install a front-facing child restraint on the rear outboard seats using ISOFIX:

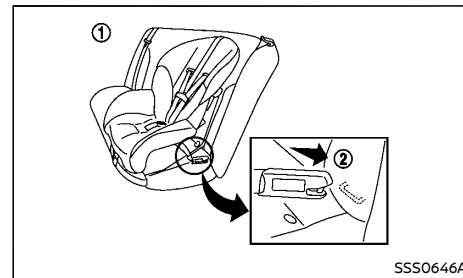

### Front-facing: Steps 1 and 2

1. Position the child restraint on the seat ①.

- Secure the child restraint anchor attachments to the ISOFIX lower anchors ②.
- The back of the child restraint should be secured against the vehicle seat back. If necessary, remove the head restraint to obtain the correct child restraint fit. (See "Head restraints" (P.1-4).) If the head restraint is removed, store it in a secure place. Be sure to install the head restraint when the child restraint is removed. If the seating position does not have an adjustable head restraint and it is interfering with the proper child restraint fit, try another seating position or a different child restraint.

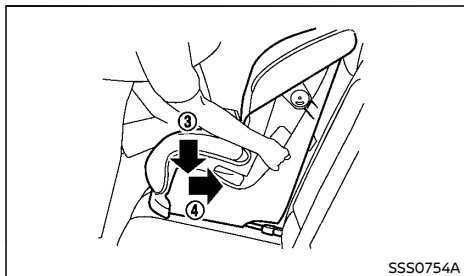

**Front-facing: Step 4**

- Shorten the rigid attachment to have the child restraint firmly tightened; press downward ③ and rearward ④ firmly in the center of the child restraint with your knee to compress the vehicle seat cushion and seatback.
- If the child restraint is equipped with a top tether strap, route the top tether strap and secure the tether strap to the tether anchor point. (See "Child restraint anchorage" (P.1-15).)

- If the child restraint is equipped with other anti-rotation devices such as support legs, use them instead of the top tether strap following the child restraint manufacturer's instructions.

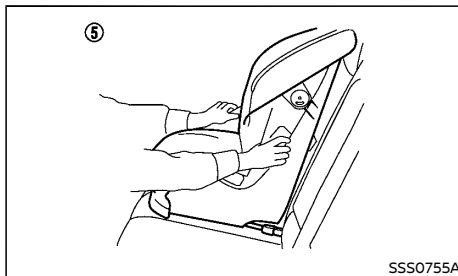

**Front-facing: Step 7**

- Test the child restraint before you place the child in it ⑤. Push the child restraint from side to side and tug it forward to make sure that it is held securely in place.
- Check to make sure that the child restraint is properly secured prior to each use. If the child restraint is loose, repeat steps 3 through 7.

**Rear-facing:**

Be sure to follow the manufacturer's instructions for the proper use of your child restraint. Follow these steps to install a rear-facing child restraint on the rear outboard seats using ISOFIX:

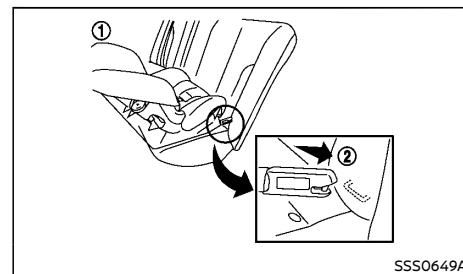

**Rear-facing: Steps 1 and 2**

- Position the child restraint on the seat ①.
- Secure the child restraint anchor attachments to the ISOFIX lower anchors ②.

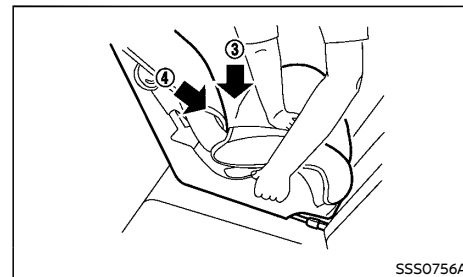

**Rear-facing: Step 3**

- Shorten the rigid attachment to have the child restraint firmly tightened; press downward ③ and rearward ④ firmly in the center of the child restraint with your hand to compress the vehicle seat cushion and seatback.
- If the child restraint is equipped with a top tether strap, route the top tether strap and secure the tether strap to the tether anchor point. (See "Child restraint anchorage" (P.1-15).)

- If the child restraint is equipped with other anti-rotation devices such as support legs, use them instead of the top tether strap following the child restraint manufacturer's instructions.

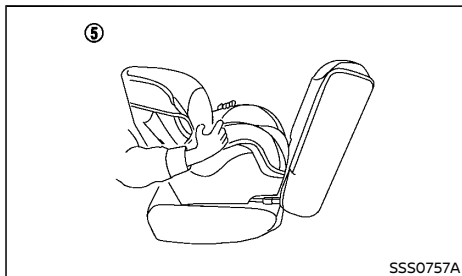

**Rear-facing: Step 6**

- Test the child restraint before you place the child in it ⑤. Push the child restraint from side to side and tug it forward to make sure that it is held securely in place.
- Check to make sure that the child restraint is properly secured prior to each use. If the child restraint is loose, repeat steps 3 through 6.

**CHILD RESTRAINT INSTALLATION USING THREE-POINT TYPE SEAT BELT**

**Installation on rear seats**

**Front-facing:**

Be sure to follow the manufacturer's instructions for the proper use of your child restraint. Follow these steps to install a front-facing child restraint on the rear seats using three-point type seat belt:

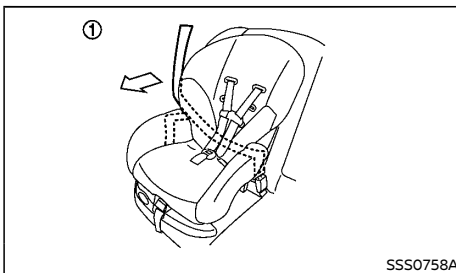

**Front-facing: Step 1**

- Position the child restraint on the seat ①.

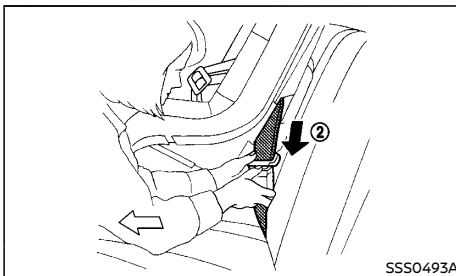

**Front-facing: Step 2**

- Route the seat belt tongue through the child restraint and insert it into the buckle ② until you hear and feel the latch engage.
- To prevent slack in the seat belt webbing, it is necessary to secure the seat belt in place with locking devices attached to the child restraint.

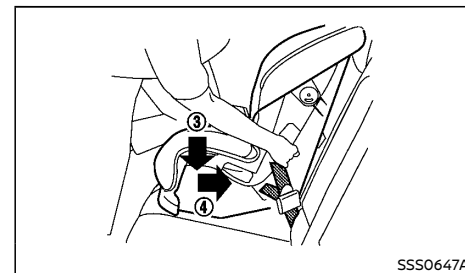

**Front-facing: Step 4**

- Remove any additional slack from the seat belt; press downward ③ and rearward ④ firmly in the center of the child restraint with your knee to compress the vehicle seat cushion and seatback while pulling up on the seat belt.

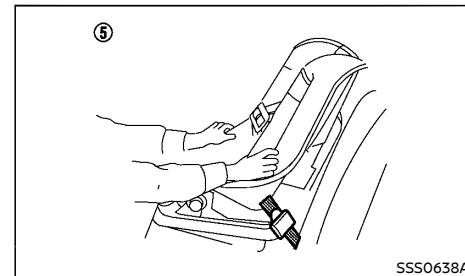

**Front-facing: Step 5**

- Test the child restraint before you place the child in it ⑤. Push the child restraint from side to side and tug it forward to make sure that it is held securely in place.
- Check to make sure that the child restraint is properly secured prior to each use. If the child restraint is loose, repeat steps 3 through 5.

**Rear-facing:**

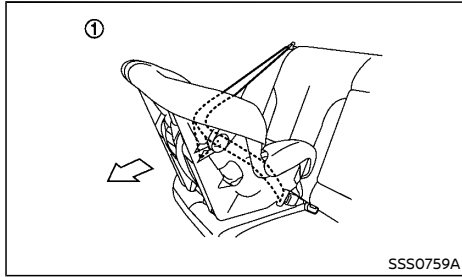

**Rear-facing: Step 1**

Be sure to follow the manufacturer's instructions for the proper use of your child restraint. Follow these steps to install a rear-facing child restraint on the rear seats using three-point type seat belt:

1. Position the child restraint on the seat ①.

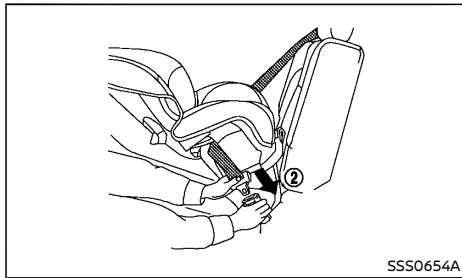

**Rear-facing: Step 2**

2. Route the seat belt tongue through the child restraint and insert it into the buckle ② until you hear and feel the latch engage.
3. To prevent slack in the seat belt webbing, it is necessary to secure the seat belt in place with locking devices attached to the child

restraint.

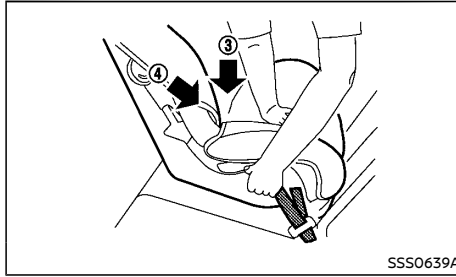

**Rear-facing: Step 4**

4. Remove any additional slack from the seat belt; press downward ③ and rearward ④ firmly in the center of the child restraint with your hand to compress the vehicle seat cushion and seatback while pulling up on the seat belt.

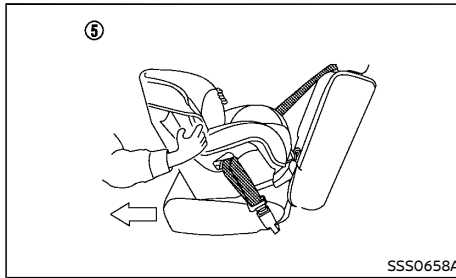

**Rear-facing: Step 5**

5. Test the child restraint before you place the child in it ⑤. Push the child restraint from side to side and tug it forward to make sure that it is held securely in place.
6. Check to make sure that the child restraint is properly secured prior to each use. If the

child restraint is loose, repeat steps 3 through 5.

## SUPPLEMENTAL RESTRAINT SYSTEM (SRS)

### PRECAUTIONS ON SUPPLEMENTAL RESTRAINT SYSTEM (SRS)

This Supplemental Restraint System (SRS) section contains important information concerning the driver's and passenger's supplemental front-impact air bags, supplemental side-impact air bags and pre-tensioner seat belts.

#### Supplemental front-impact air bag system

This system can help cushion the impact force to the head and chest area of the driver and/or front passenger in certain frontal collisions. The supplemental front-impact air bag is designed to inflate on the front where the vehicle is impacted.

#### Supplemental side-impact air bag system (if equipped)

This system can help cushion the impact force to the chest and pelvis areas of the driver and front passenger in certain side-impact collisions. The supplemental side-impact air bag is designed to inflate on the side where the vehicle is impacted.

The SRS is designed to **supplement** the accident protection provided by the driver's and/or front passenger's seat belts and **is not** designed to **substitute** for them. The SRS can help save lives and reduce serious injuries. However, inflating air bags may cause abrasions or other injuries. Air bags do not provide protection to the lower body. Seat belts should always be correctly worn and occupants should always be seated a suitable distance away from the steering wheel and the instrument panel. (See "Seat belts" (P.1-6).) The air bags inflate quickly in order to help protect the occupants. The force of the air bags inflating can increase the risk of injury if the occupants

are too close to, or are against, the air bag modules during inflation.

The air bags will deflate quickly after deployment.

**The SRS operates only when the ignition switch is in the "ON" position.**

**When the ignition switch is in the "ON" position, the SRS air bag warning light illuminates for about 7 seconds and then turns off. This indicates that the SRS is operational. (See "SRS air bag warning light" (P.1-22).)**

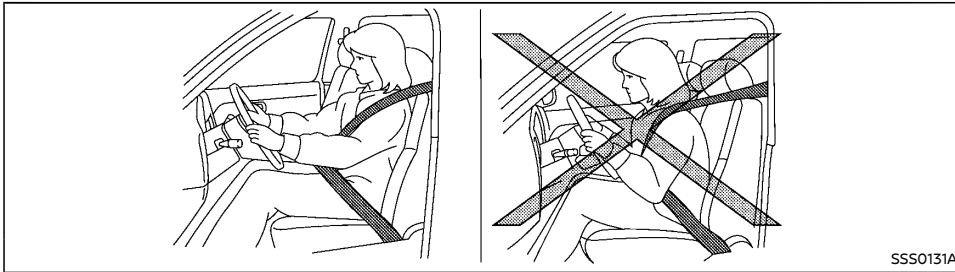

SSS0131A

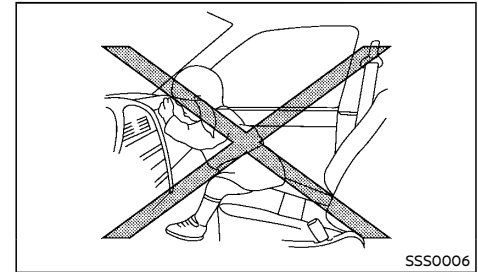

SSS0006

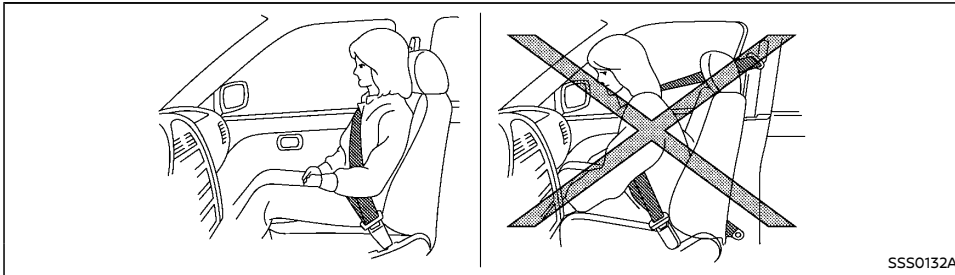

SSS0132A

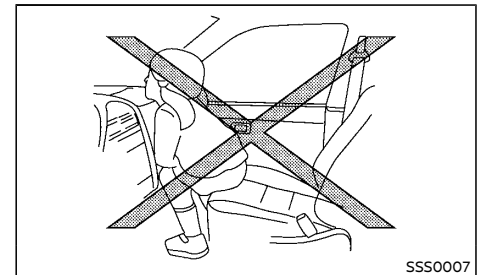

SSS0007



**WARNING:**

- The supplemental front-impact air bags ordinarily will not inflate in the event of a side impact, rear impact, rollover, or lower severity frontal collision. Always wear the seat belts to help reduce the risk or severity of injury in accidents.
- The seat belts and the supplemental front-impact air bags are most effective when you are sitting well back and upright in the seat. The front-impact air bags inflate with great force. If you are unrestrained, leaning forward, sitting sideways, or out of position in any way,

you and your passengers are at greater risk of injury or death in an accident. You and your passengers may also receive serious or fatal injuries from the supplemental front-impact air bag if you are up against it when it inflates. Always sit back against the seatback and as far away as practical from the steering wheel or instrument panel. Always use the seat belts.

- Keep hands on the outside of the steering wheel. Placing them inside the steering wheel rim could increase the risk of injury if the supplemental front air bag inflates.

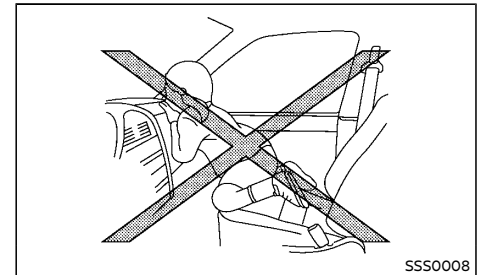

SSS0008

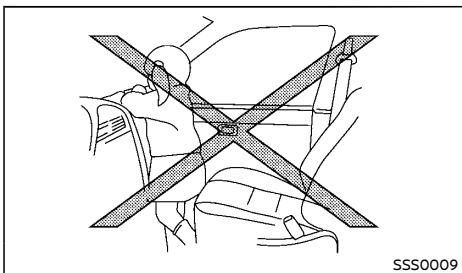

**⚠ WARNING:**

- Never let children ride unrestrained or extend their hands or face out of the window. Do not attempt to hold them in your lap or arms. Some examples of dangerous riding positions are shown in the illustrations.
- Children may be severely injured or killed when the air bags inflate if they are not properly restrained.
- Never install a rear-facing child restraint system in the front seat. An inflating supplemental front-impact air bag could seriously injure or kill your child. (See "Child restraints" (P.1-10).)

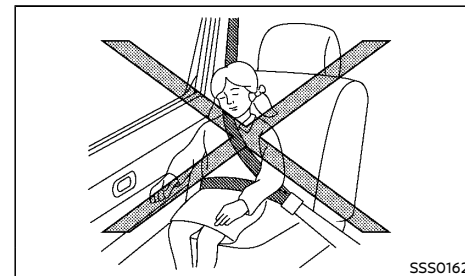
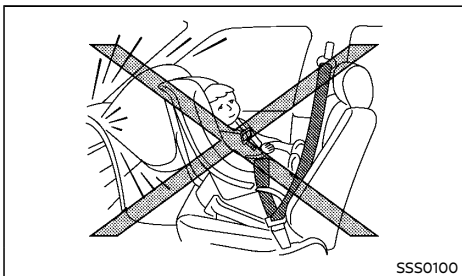
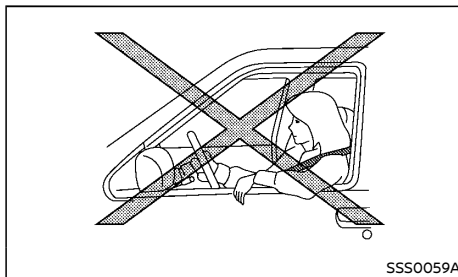
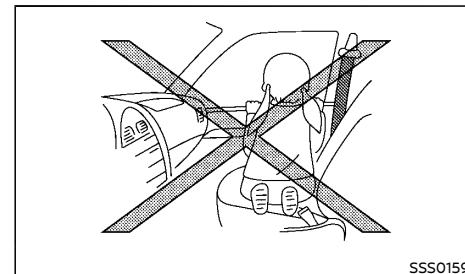
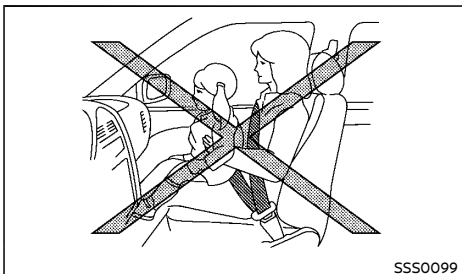
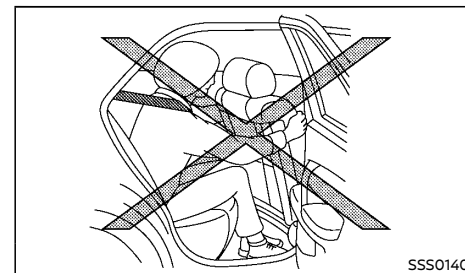

**WARNING:**

- The supplemental side-impact air bags ordinarily will not inflate in the event of a front impact, rear impact, rollover, or lower severity side collision. Always wear the seat belts to help reduce the risk or severity of injury in accidents.
- The seat belts and the supplemental side-impact air bags are most effective when you are sitting well back and upright in the seat. The supplemental side-impact air bags inflate with great force. If you and your passengers are unrestrained, leaning forward, sitting sideways, or out of position in any way, you and your passengers are at greater risk of injury or death in an accident.
- Do not allow anyone to place their hands, legs, or face near the supplemental side-impact air bags on the sides of the seatback of the front seats. Do not allow anyone sitting in the front seats to extend their hands out of the windows or lean against the doors. Some examples of dangerous riding positions are shown in the illustrations.
- When sitting in the rear seats, do not hold onto the seatback of the front seats. If the supplemental side-impact air bags inflate, you may be seriously injured. Be especially careful with children, who should always be properly restrained.
- Do not use seat covers on the front seatbacks. They may interfere with the supplemental side-impact air bag inflations.

### Pre-tensioner seat belt system

The pre-tensioner system may activate with the supplemental air bag system in certain types of collisions. Working with the seat belt retractors, it helps tighten the seat belt when the vehicle becomes involved in certain types of collisions, helping to restrain front seat occupants. (See "Pre-tensioner seat belt system" (P.1-26).)

### Air bag warning label

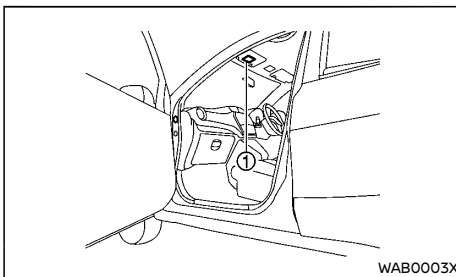

Warning labels about the supplemental air bag system are placed in the vehicle as shown in the illustration.

### SRS air bag:

The warning label ① is located on the surface of the passenger's sun visor.



The label warns:

"NEVER use a rearward facing child restraint on a seat protected by an ACTIVE AIRBAG in front of it, DEATH or SERIOUS INJURY to the CHILD can occur."

In vehicles equipped with a front-impact passenger air bag system, use a rear-facing child restraint system only on the rear seats.

When installing a child restraint system in your vehicle, always follow the child restraint system manufacturer's instructions for installation. For additional information, see "Child restraints" (P.1-10).

### SRS air bag warning light

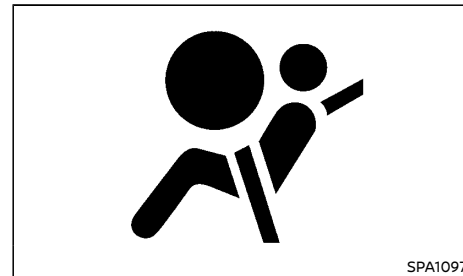



The supplemental air bag warning light, displaying  in the instrument panel, monitors the circuits for the air bag systems, pre-tensioners and all related wiring.

When the ignition switch is in the "ON", the SRS air bag warning light illuminates for about 3 seconds and then turns off. This indicates that the SRS air bag systems are operational.

If any of the following conditions occur, the air bag and/or pre-tensioner seat belt systems need servicing:

- The SRS air bag warning light remains on after approximately 3 seconds.
- The SRS air bag warning light does not illuminate at all.

Under these conditions, the air bag and/or pre-tensioner seat belt systems may not operate properly. They must be checked and repaired. Contact a NISSAN dealer immediately.

## SUPPLEMENTAL AIR BAG SYSTEMS

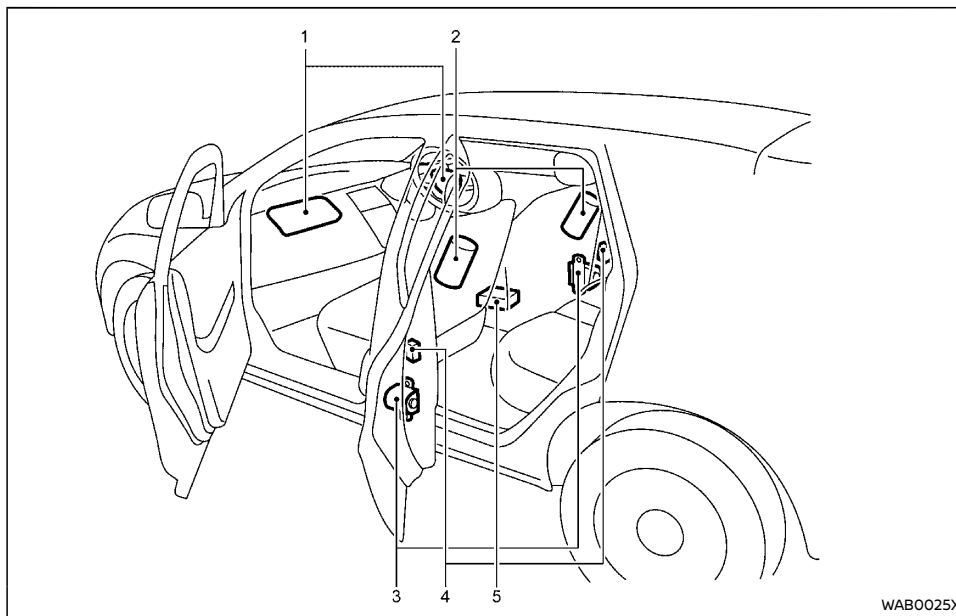

1. Supplemental front-impact air bag modules
2. Supplemental side-impact air bag modules (if equipped)
3. Pre-tensioner seat belt retractors
4. Satellite sensors (if equipped)
5. Air bag Control Unit (ACU)



### WARNING:

- Do not place any objects on the steering wheel pad, on the instrument panel, and near the front door finishers and the front seats. Do not place any objects between any occupants and the steering wheel pad, on the instrument panel, and near the front door finishers and the front seats. Such objects may become dangerous projectiles and cause injury if

a supplemental air bag inflates.

- Immediately after inflation, several supplemental air bag system components will be hot. Do not touch them: you may severely burn yourself.
- No unauthorized changes should be made to any components or wiring of the supplemental air bag systems. This is to prevent accidental inflation of the supplemental air bags or damage to the supplemental air bag systems.
- Do not make unauthorized changes to your vehicle's electrical system, suspension system, front end structure, and side panels. This could affect proper operation of the supplemental air bag systems.
- Tampering with the supplemental air bag systems may result in serious personal injury. Tampering includes changes to the steering wheel and the instrument panel by placing materials over the steering wheel pad and above, around or on the instrument panel or by installing additional trim materials around the supplemental air bag systems.
- Work around and on the supplemental air bag systems should be done by a NISSAN dealer. The SRS wiring should not be modified or disconnected. Unauthorized electrical test equipment and probing devices should not be used on the supplemental air bag systems.
- The SRS wiring harness connectors are yellow and/or orange for easy identification.

When the air bags inflate, a fairly loud noise may be heard, followed by the release of smoke. This smoke is not harmful and does not indicate a fire. Care should be taken not to

inhale it, as it may cause irritation and choking. Those with a history of a breathing condition should get fresh air promptly.

### Supplemental front-impact air bag system

The driver's supplemental front-impact air bag is located at the center of the steering wheel. The passenger's supplemental front-impact air bag is located at the instrument panel above the glove box.

The supplemental front-impact air bag system is designed to inflate in higher severity frontal collisions, although it may inflate if the forces in another type of collision are similar to those of a higher severity frontal impact. It may not inflate in certain frontal collisions. Vehicle damage (or lack of it) is not always an indication of proper supplemental front-impact air bag system operation.

### Supplemental side-impact air bag system (if equipped)

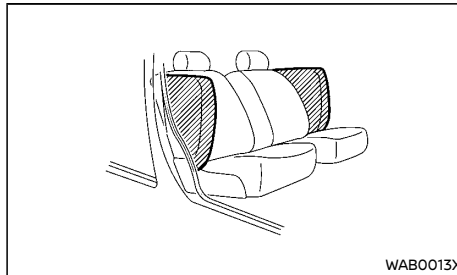

The supplemental side-impact air bag is located at the outside of the front seats' seat-backs.

The supplemental side-impact air bag system is designed to inflate in higher severity side

collisions, although it may inflate if the forces in another type of collision are similar to those of a higher severity side impact. It may not inflate in certain side collisions. Vehicle damage (or lack of it) is not always an indication of proper supplemental side-impact air bag system operation.

### SRS AIR BAG DEPLOYMENT CONDITIONS

The SRS air bags activate in the event of a front or side impact in which the vehicle occupants may be severely injured even if they are wearing the seat belts properly.

They may not activate when the crash energy is absorbed and/or distributed by the vehicle body. Vehicle damage (or lack of it) is not always an indication of proper SRS air bag system operation.

### When the SRS air bag will deploy

#### Supplemental front-impact air bags:

The supplemental front-impact air bag system is designed to inflate in higher severity frontal collisions. Some examples are shown in the following illustrations.

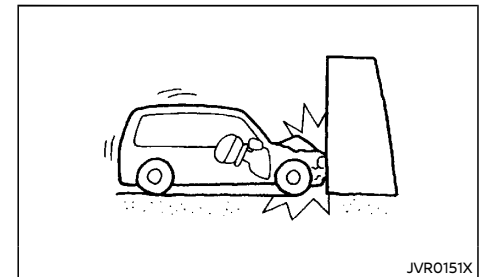

The supplemental front-impact air bag system

will deploy in the event of an impact which exceeds a 25 km/h (16 MPH) frontal collision with a solid wall that does not move or deform.

The supplemental front-impact air bag system may also deploy when the vehicle receives severe damage to the undercarriage.

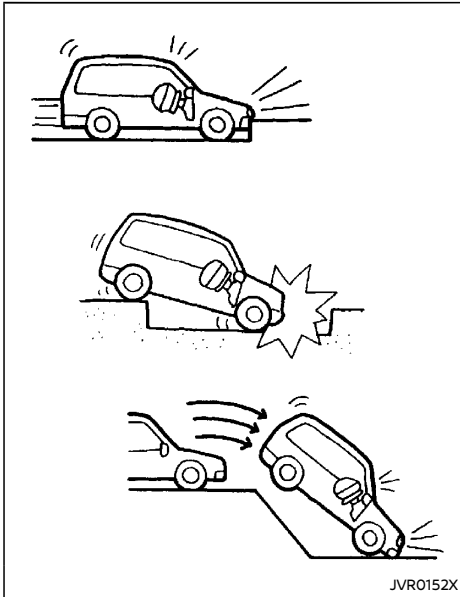

- Hitting a curb, pavement edge or hard surface at high speed
- Falling into a deep hole or ditch
- Landing hard on the ground after jumping

### Supplemental side-impact air bags (if equipped):

The supplemental side-impact air bag system is designed to inflate in higher severity side collisions. An example is shown in the following illustrations.

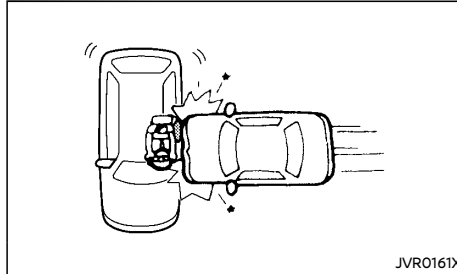

The supplemental side-impact air bag will deploy in the event of a side impact with a normal passenger vehicle that exceeds at a speed of 25 km/h (16 MPH).

### When the SRS air bag is unlikely to deploy

The SRS air bags may not deploy in cases where the impact is not forceful enough to inflate the SRS air bags.

For example, if the vehicle strikes an object, such as a parked vehicle or sign pole, which can move or deform on impact, the SRS air bags are unlikely to deploy.

### Supplemental front-impact air bags:

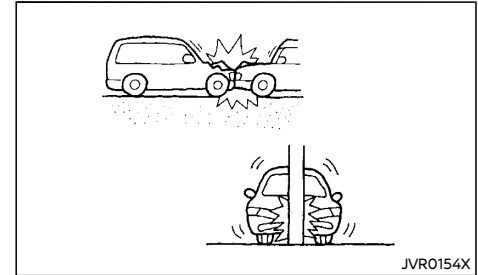

- Striking a vehicle of the same class that is parked
- Crashing into a solid utility pole

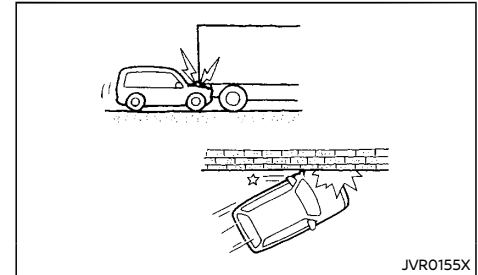

- Running under the tail gate of a truck
- A frontal offset impact to the guard rails

### Supplemental side-impact air bags (if equipped):

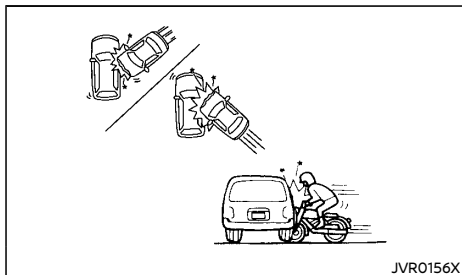

- A collision from the side at an angle
- A side impact with a two-wheeled vehicle

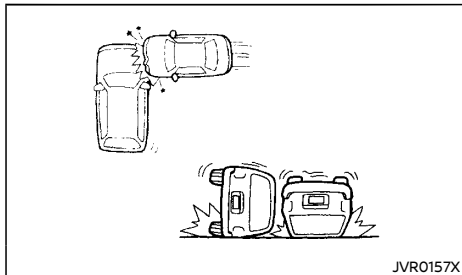

- A collision from the side impacting the vehicle engine room (luggage room)
- Vehicle rollover

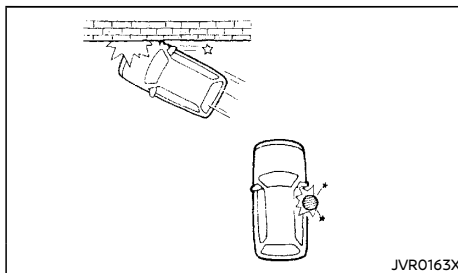

- A frontal offset impact to the guard rails
- A collision with a pole

### When the SRS air bag will not deploy

Once the SRS air bag has inflated, the air bag module will not function again if your vehicle collides with another vehicle or an object.

Other examples where the SRS air bag will not deploy are shown in the following illustrations.

### Supplemental front-impact air bags:

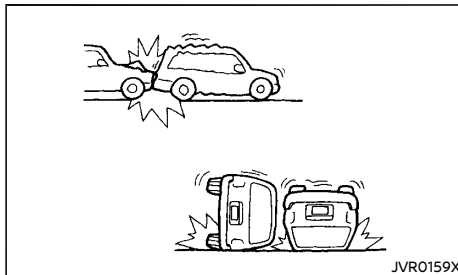

- A collision from the side or rear
- Vehicle rollover

### Supplemental side-impact air bags (if equipped):

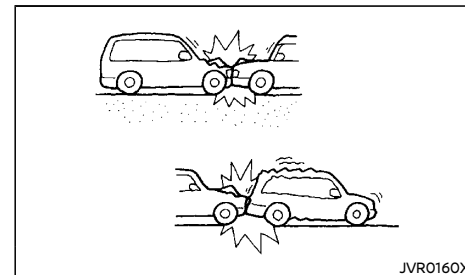

- A frontal collision with a parked or moving vehicle
- A rear collision

### PRE-TENSIONER SEAT BELT SYSTEM



#### WARNING:

- The pre-tensioner seat belt cannot be reused after activation. It must be replaced together with the retractor and buckle as a unit.
- If the vehicle becomes involved in a collision but the pre-tensioner is not activated, be sure to have the pre-tensioner system checked and, if necessary, replaced by a NISSAN dealer.
- No unauthorized changes should be made to any components or wiring of the pre-tensioner seat belt system. This is to prevent accidental activation of the pre-tensioner seat belt or damage to the pre-tensioner seat belt system.

- **Work around or on the pre-tensioner seat belt system should be done by a NISSAN dealer. The SRS wiring should not be modified or disconnected. Unauthorized electrical test equipment and probing devices should not be used on the pre-tensioner seat belt system.**
- **If you need to dispose of the pre-tensioner seat belt system, or scrap the vehicle, contact a NISSAN dealer. Correct pre-tensioner disposal procedures are set forth in the appropriate NISSAN Service Manual. Incorrect disposal procedures could cause personal injury.**

The pre-tensioner system may activate with the supplemental air bag system in certain types of collisions. Working with the seat belt retractor, it helps tighten the seat belt when the vehicle becomes involved in certain types of collisions, helping to restrain front and rear seat occupants.

The pre-tensioner is encased with the front seat belt's retractor and anchor. These seat belts are used the same as conventional seat belts.

When the pre-tensioner seat belt activates, a fairly loud noise may be heard, followed by the release of smoke. This smoke is not harmful and does not indicate a fire. Care should be taken not to inhale it, as it may cause irritation and choking. Those with a history of a breathing condition should get fresh air promptly.

## REPAIR AND REPLACEMENT PROCEDURE



### WARNING:

- **Once the air bags have been inflated, the air bag modules will not function and must be replaced. The air bag modules must be replaced by a NISSAN dealer. The inflated air bag modules cannot be repaired.**
- **The air bag systems should be inspected by a NISSAN dealer if there is any damage to the front end portion of the vehicle.**
- **If you need to dispose of the SRS or scrap the vehicle, contact a NISSAN dealer. Correct disposal procedures are set forth in the appropriate NISSAN Service Manual. Incorrect disposal procedures could cause personal injury.**

The air bags and pre-tensioner seat belts are designed to activate on a one-time-only basis. As a reminder, unless the SRS air bag warning light is damaged, the SRS air bag warning light remains illuminated after inflation has occurred. The repair and replacement of the SRS should be done only by a NISSAN dealer.

When maintenance work is required on the vehicle, information about the air bags, pre-tensioner seat belts and related parts should be pointed out to the person performing the maintenance. The ignition switch should always be in the "LOCK" position when working under the hood or inside the vehicle.

**MEMO**

# 2 Instruments and controls

Cockpit .....	2-2	Fog light switch (if equipped) .....	2-16
Instrument panel .....	2-3	Front fog lights .....	2-16
Meters and gauges .....	2-4	Rear fog light (if equipped) .....	2-17
Speedometer .....	2-4	Wiper and washer switch .....	2-17
Tachometer .....	2-4	Windshield wiper and washer switch .....	2-17
Fuel gauge .....	2-5	Rain-sensing auto wiper system (if equipped) .....	2-18
Gear shift indicator (if equipped) .....	2-5	Rear window wiper and washer switch (if equipped) .....	2-18
Instrument brightness control .....	2-5	Defogger switch .....	2-19
Continuously Variable Transmission (CVT) position indicator (if equipped) .....	2-5	Horn .....	2-19
Warning lights, indicator lights and audible reminders .....	2-6	Windows .....	2-19
Checking lights .....	2-7	Power windows .....	2-19
Warning lights .....	2-7	Power outlet .....	2-21
Indicator lights .....	2-9	Storage .....	2-22
Audible reminders .....	2-10	Glove box .....	2-22
Vehicle information display .....	2-11	Card holder .....	2-22
Vehicle information display warnings and indicators .....	2-11	Cup holders (if equipped) .....	2-22
Trip computer .....	2-13	Cargo cover .....	2-23
Outside air temperature .....	2-14	Luggage hooks .....	2-24
Headlight and turn signal switch .....	2-15	Roof rack (if equipped) .....	2-24
Headlight switch .....	2-15	Sun visors .....	2-25
Headlight aiming control .....	2-15	Interior lights .....	2-25
Turn signal switch .....	2-16	Front and rear room light .....	2-25
		Front map lights .....	2-26
		Cargo room light .....	2-26

## COCKPIT

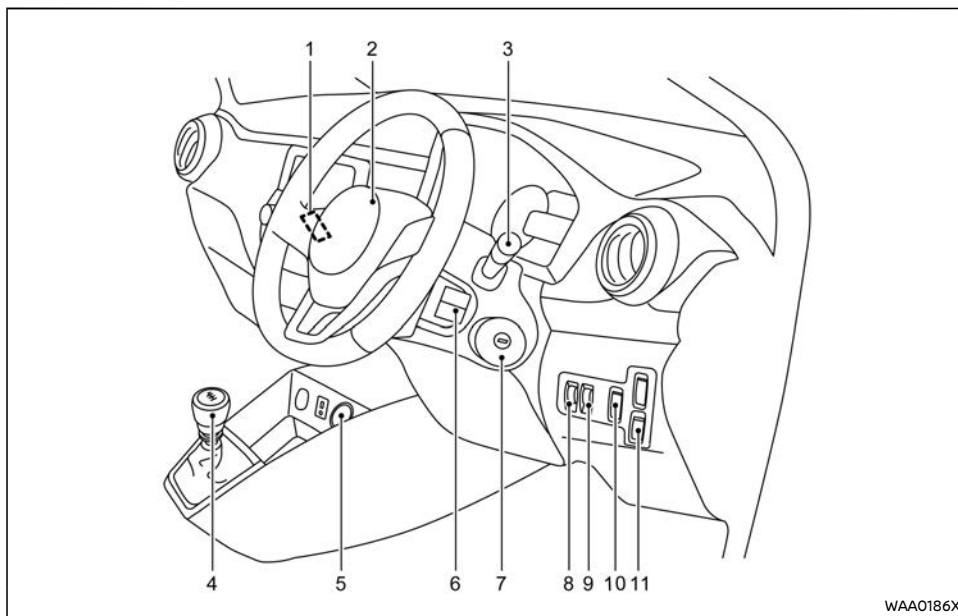

1. Headlight and turn signal switch/Fog light switch\*
2. Steering wheel
  - Power steering
  - Horn
  - Driver's supplemental front-impact air bag
3. Wiper and washer switch/Trip computer mode switch
4. Shift lever
  - Continuously Variable Transmission (CVT)
  - Manual Transmission (MT)
5. Push-button ignition switch (models with Intelligent Key system)
6. Steering column switches\*\*
7. Ignition switch (models without Intelligent Key system)
8. Headlight aiming control switch
9. Instrument brightness control switch
10. Stop/Start OFF switch\*
11. Cruise control MAIN switch\*/Speed limiter MAIN switch\*

11. Cruise control MAIN switch\*/Speed limiter MAIN switch\*

\*: if equipped

\*\* : Refer to the NissanConnect Owner's Manual (if equipped).

## 2-2 Instruments and controls



## INSTRUMENT PANEL

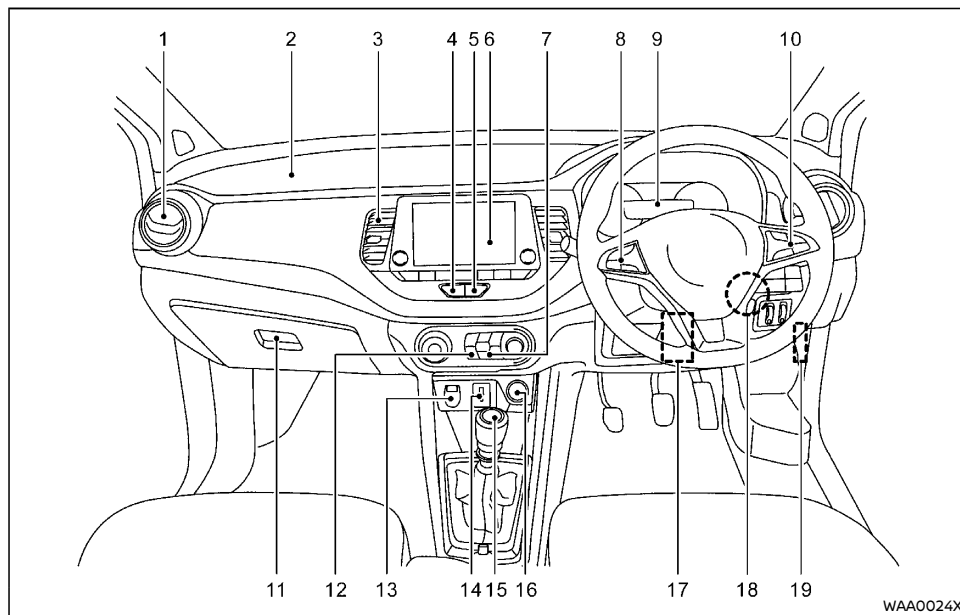

- |                                       |   |
|---------------------------------------|---|
| 1. Side ventilator                    | 8. Steering-wheel-mounted controls (left side)*   |
| 2. Passenger's front-impact air bag   | — Cruise control switches                         |
| 3. Center ventilator                  | — Speed limiter switches                          |
| 4. Hazard indicator flasher switch    | 9. Meters and gauges                              |
| 5. Power door lock switch             | 10. Steering-wheel-mounted controls (right side)* |
| 6. Audio system**                     | — Cruise control switches                         |
| — Rear view monitor*                  | — Speed limiter switches                          |
| — Around View Monitor*                |   |
| 7. Heater and air conditioner control | 11. Glove box                                     |
|                                       | — Fuse box  |

- Key card port\*
  - 12. Defogger switch
  - 13. Power outlet
  - 14. USB (Universal Serial Bus) connection port/AUX (auxiliary) input jack
  - 15. Shift lever
    - Continuously Variable Transmission (CVT)
    - Manual Transmission (MT)
  - 16. Push-button ignition switch (models with Intelligent Key system)
  - 17. Tilting steering wheel lock lever
  - 18. Ignition switch (models without Intelligent Key system)
  - 19. Hood lock release handle
- \*: if equipped  
 \*\*: Refer to the NissanConnect Owner's Manual (if equipped).

## METERS AND GAUGES

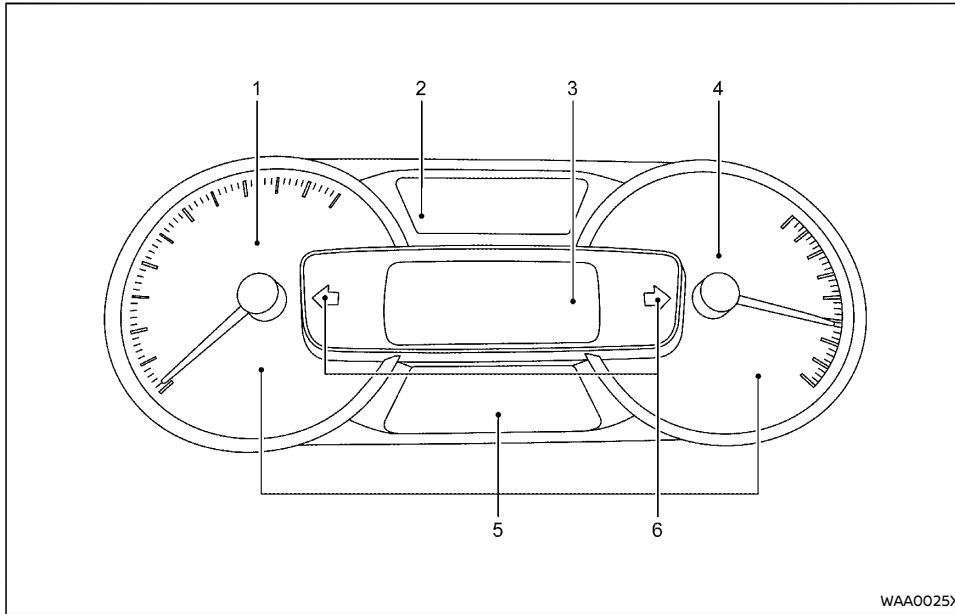

1. Tachometer
2. Vehicle information display
  - Trip computer
  - Outside air temperature
  - Warnings and indicators
3. Speedometer
  - Gear shift indicator\*
  - Stop/Start System indicator\*
  - Continuously Variable Transmission (CVT) position indicator\*
4. Fuel gauge
5. Warning and indicator lights
6. Turn signals/hazard indicator lights
  - \*: if equipped

**The needle indicators may move slightly after the ignition switch is placed in the "OFF" or "LOCK" position. This is not a malfunction.**

## SPEEDOMETER

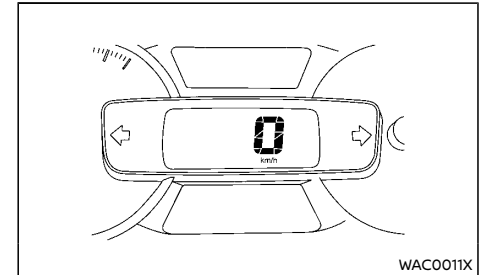

The speedometer indicates the vehicle speed.

## TACHOMETER

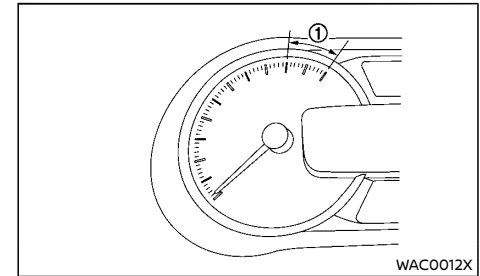

### Example

The tachometer indicates the engine speed in revolutions per minute (rpm). **Do not rev the engine into the red zone ①.**

The red zone varies with models.

## FUEL GAUGE

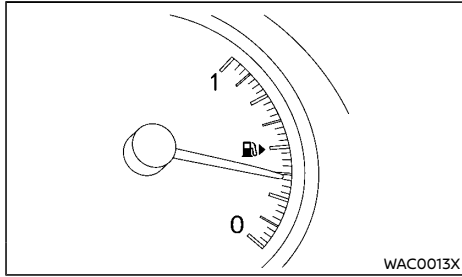

The fuel gauge indicates the approximate fuel level in the tank when the ignition switch is in the "ON" position.

The gauge may move slightly during braking, turning, accelerating, or going up and down hills due to movement of fuel in the tank.

The low fuel warning light  illuminates on the meter when the fuel level in the tank is getting low. Refuel as soon as it is convenient, preferably before the gauge reads the empty (0) position.

The arrow, , indicates that the fuel-filler lid is located on the right side of the vehicle.



### CAUTION:

**Refuel before the gauge reads 0 (empty).**

There is a small reserve of fuel in the tank when the fuel gauge reads 0 (empty).

## GEAR SHIFT INDICATOR (if equipped)

The indicator appears when upshifting or downshifting is recommended. The up or down arrow indicates the recommended shifting. See "Gear shift indicator" (P.5-13).

## INSTRUMENT BRIGHTNESS CONTROL

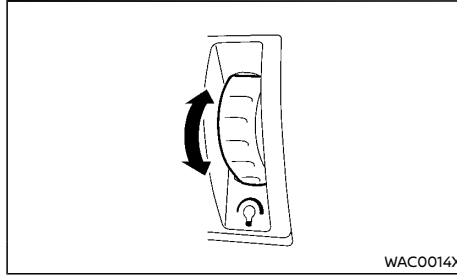

The instrument brightness control can be operated when the ignition switch is in the "ON" position and the headlight switch is on.

























Turn the control up to brighten the meter panel lights. Turn the control down to dim the lights.

## CONTINUOUSLY VARIABLE TRANSMISSION (CVT) POSITION INDICATOR (if equipped)

The Continuously Variable Transmission (CVT) position indicator indicates the shift lever position when the ignition switch is in the "ON" position.



See "Continuously Variable Transmission (CVT) position indicator light" (P.2-9) and "Driving with Continuously Variable Transmission (CVT)" (P.5-9) for further details.







## WARNING LIGHTS, INDICATOR LIGHTS AND AUDIBLE REMINDERS

	Anti-lock Braking System (ABS) warning light		Vehicle Dynamic Control (VDC) warning light*		Rear fog light indicator light*
	Brake warning light		Brake pedal indicator light*		Service indicator light
	Charge warning light		Continuously Variable Transmission (CVT) position indicator light*		Small light indicator light
	Door open warning light		Cruise control on indicator light*		Speed limiter indicator light*
	Engine oil pressure warning light*		Front fog light indicator light*		STOP indicator light
	High temperature warning light (red)*		High beam indicator light		Stop/Start System indicator light*
	Low fuel warning light		Low beam indicator light		Turn signals/hazard indicator lights
	Seat belt warning light		Low temperature indicator light (blue)		
	Supplemental Restraint System (SRS) air bag warning light		Malfunction Indicator Light (MIL)		

\*: if equipped

## CHECKING LIGHTS

With all doors closed, apply the parking brake, fasten the seat belts and place the ignition switch in the "ON" position without starting the engine. The following lights (if equipped) will come on: , .

The following lights (if equipped) will come on briefly and then go off: , , , , , , .

If any light does not come on or operates in a way other than described, it may indicate a burned-out bulb and/or a system malfunction. Have the system checked by a NISSAN dealer.

## WARNING LIGHTS

### Anti-lock Braking System (ABS) warning light

When the ignition switch is in the "ON" position, the Anti-lock Braking System (ABS) warning light illuminates and then turns off. This indicates the ABS is operational.

If the ABS warning light illuminates while the engine is running, or while driving, it may indicate the ABS is not functioning properly. Have the system checked by a NISSAN dealer promptly.

If an ABS malfunction occurs, the anti-lock function is turned off. The brake system then operates normally, but without anti-lock assistance. (See "Brake system" (P.5-24).)

### Brake warning light

#### WARNING:

- **If the brake fluid level is below the minimum mark on the brake fluid reservoir, do not drive the vehicle until the brake system has been checked by a NISSAN dealer.**
- **Even if you judge it to be safe, have your vehicle towed because driving it could be dangerous.**
- **Depressing the brake pedal without the engine running and/or with a low brake fluid level could increase the stopping distance and require greater pedal travel distance and effort.**

The brake warning light indicates the parking brake system operation, a low brake fluid level of the brake system and an Anti-lock Braking System (ABS) malfunction.

#### **Parking brake warning indicator:**

When the ignition switch is placed in the "ON" position, the brake warning light illuminates. When the parking brake is released, the brake warning light turns off.

If the parking brake is not fully released, the brake warning light remains on. Be sure that the brake warning light has turned off before driving. (See "Parking brake" (P.3-19).)

#### **Low brake fluid warning indicator:**

If the brake warning light illuminates during braking with the STOP indicator light and a beep, it indicates that the fluid level in the brake system is low or that there is a braking system malfunction. Stop the vehicle safely as soon as possible. Do not drive the vehicle and contact a

NISSAN dealer.

### **Anti-lock Braking System (ABS) warning indicator:**

When the parking brake is released and the brake fluid level is sufficient, if both the brake warning light and the Anti-lock Braking System (ABS) warning light illuminate, it may indicate the ABS is not functioning properly. Have the brake system checked, and if necessary repaired, by a NISSAN dealer promptly. (See "Anti-lock Braking System (ABS) warning light" (P.2-7).)

### Charge warning light

When the ignition switch is in the "ON" position, the charge warning light illuminates and then turns off. This indicates the charging system is operational.

If charge warning light illuminates with the STOP indicator light and a beep, this indicates an overload or discharge in the electrical circuit. Stop the vehicle safely as soon as possible. Do not drive the vehicle and contact a NISSAN dealer.

#### CAUTION:

**Do not continue driving if the alternator belt is loose, broken or missing.**

### Door open warning light

When the ignition switch is in the "ON" position, the door open warning light illuminates if any of the doors are open or not closed securely.

 Engine oil pressure warning light (if equipped)

When the ignition switch is in the "ON" position, the engine oil pressure warning light illuminates and then turns off. This indicates that the oil pressure sensors in the engine are operational.

If the engine oil pressure warning light and STOP indicator light illuminate and a beep sounds while the engine is running, it may indicate that the engine oil pressure is low.

Stop the vehicle safely as soon as possible. Stop the engine immediately and contact a NISSAN dealer.

 **CAUTION:**

- **Running the engine with the engine oil pressure warning light illuminated could cause serious damage to the engine.**
- **The engine oil pressure warning light is not designed to indicate a low oil level. The oil level should be checked using the dipstick. (See "Engine oil" (P.8-7).)**

 High temperature warning light (red) (if equipped)

When the ignition switch is in the "ON" position, the high temperature warning light illuminates and then turns off. This indicates that the high temperature sensor in the engine coolant system is operational.

 **CAUTION:**

- **If the high temperature warning light illuminates while the engine is running, it may indicate the engine temperature is extremely high.**
- **Stop the vehicle safely as soon as possible.**
- **If the vehicle is overheated, continuing vehicle operation may seriously damage the engine. (See "If your vehicle overheats" (P.6-10) for the immediate action required.)**

 Low fuel warning light

When the ignition switch is in the "ON" position, the low fuel warning light illuminates and then turns off.

The low fuel warning light illuminates when the fuel level in the tank is getting low. Refuel as soon as it is convenient, preferably before the fuel gauge reaches 0 (empty).

**There will be a small reserve of fuel remaining in the tank when the fuel gauge reaches 0 (empty).**

 Seat belt warning light

When the ignition switch is in the "ON" position, the seat belt warning light illuminates. The light will continue to illuminate until the front seat belts are fastened. (See "Seat belts" (P.1-6).)

When the vehicle speed exceeds 20 km/h (12 MPH), the light will blink and the chime will sound unless the front seat belts are securely fastened. The chime will continue to sound for about 95 seconds until the seat belt is fastened.

 Supplemental Restraint System (SRS) air bag warning light

When the ignition switch is in the "ON" position, the Supplemental Restraint System (SRS) air bag warning light illuminates for about 3 seconds and then turns off. This indicates the SRS air bag system is operational.

If any of the following conditions occur, the SRS air bag system and pre-tensioner seat belt need servicing. Have the system checked, and if necessary repaired, by a NISSAN dealer promptly.

- The SRS air bag warning light remains illuminated after about 3 seconds.
- The SRS air bag warning light does not come on at all.

Unless checked and repaired, the SRS air bag system and/or pre-tensioner seat belt may not function properly. (See "Supplemental Restraint System (SRS)" (P.1-19).)

 Vehicle Dynamic Control (VDC) warning light (if equipped)

When the ignition switch is in the "ON" position, the Vehicle Dynamic Control (VDC) warning light illuminates and then turns off. This indicates the VDC system is operational.

The warning light blinks when the VDC system is operating.

When the warning light blinks while driving, the driving condition is slippery and the vehicle's traction limit is about to be exceeded.

If the warning light illuminates when the ignition switch is placed in the "ON" position, it may indicate that the VDC system is not functioning properly and may need servicing.

Have the system checked, and if necessary repaired, by a NISSAN dealer promptly.

If a malfunction occurs in the system, the VDC system function will be cancelled but the vehicle is still driveable. (See "Vehicle Dynamic Control (VDC) system" (P.5-15).)

## INDICATOR LIGHTS



Brake pedal indicator light (if equipped)

The brake pedal indicator light illuminates when it is necessary to depress the brake pedal.



Continuously Variable Transmission (CVT) position indicator light (if equipped)

The Continuously Variable Transmission (CVT) position indicator light indicates the shift lever position when the ignition switch is in the "ON" position. (See "Driving with Continuously Variable Transmission (CVT)" (P.5-9).)



Cruise control on indicator light (if equipped)

The cruise control on indicator light indicates the activation of the cruise control system. (See "Cruise control" (P.5-18).)



Front fog light indicator light (if equipped)

The front fog light indicator light illuminates when the front fog lights are on. (See "Fog light switch" (P.2-16).)



High beam indicator light

The high beam indicator light illuminates when the headlight high beam is on. The indicator light turns off when the low beam is selected. (See "Headlight and turn signal switch" (P.2-15).)



Low beam indicator light

The low beam indicator light illuminates when the headlight low beam is on. The indicator light turns off when either the  $\text{OFF}$  position or the high beam is selected. (See "Headlight and turn signal switch" (P.2-15).)



Low temperature indicator light (blue)

The low temperature indicator light illuminates when the engine coolant temperature is low.

If the low temperature indicator light stays illuminated after the engine has sufficiently warmed up, it may indicate the low temperature sensor in the engine coolant system is not functioning properly and may need servicing. Have the system checked, and if necessary repaired, by a NISSAN dealer promptly.



Malfunction Indicator Light (MIL)



### CAUTION:

- **Continuing vehicle operation without proper servicing of the emission control system could lead to poor driveability, reduced fuel economy, and damage to the emission control system, which may affect the vehicle's warranty coverage.**

- **Incorrect setting of the emission control system may lead to non-compliance of local and national emission laws and regulations.**

When the ignition switch is in the "ON" position, the Malfunction Indicator Light (MIL) illuminates. After starting the engine, the MIL turns off. This indicates that the emission control system is operational.

If the MIL illuminates or blinks while the engine is running, it may indicate a potential emission control system malfunction. In this case, the emission control system may not function properly and may need servicing. Have the system checked, and if necessary repaired, by an authorized dealer promptly.

To reduce or avoid possible damage to the engine control system when the MIL illuminates or blinks:

- Avoid driving at speeds above 70 km/h (43 MPH).
- Avoid sudden acceleration or deceleration.
- Avoid going up steep uphill grades.
- Avoid carrying or towing unnecessary loads.



Rear fog light indicator light (if equipped)

The rear fog light indicator light illuminates when the rear fog light is on. (See "Fog light switch" (P.2-16).)

### Service indicator light

The service indicator light illuminates when the ignition is switched "ON" and turns off after few seconds. It can illuminate in conjunction with other indicator lights and/or messages on the instrument panel. It means you should drive very carefully to a NISSAN dealer as soon as possible. If you fail to follow this recommendation, you risk damaging your vehicle.

### Small light indicator light

The small light indicator light illuminates when the front clearance lights, instrument panel lights, rear combination lights and license plate lights are on. The indicator light turns off when these lights are turned off.

### Speed limiter indicator light (if equipped)

The speed limiter indicator light illuminates in orange when the speed limiter MAIN switch is pushed. This indicator light will also illuminate in green when the cruise control MAIN switch is pushed. (See "Speed limiter" (P.5-17) and "Cruise control" (P.5-18).)

### STOP indicator light

The STOP indicator light illuminates when the ignition is switched "ON" and turns off after few seconds. It comes on with other warning lights and/or messages, and is accompanied by a beep. It requires you to stop the vehicle immediately, for your own safety, as soon as traffic conditions allow. Turn off the engine and do not restart. Contact a NISSAN dealer.

### Stop/Start System indicator light (if equipped)

This indicator shows the Stop/Start System status. (See "Stop/Start System" (P.5-13).)

### Turn signals/hazard indicator lights

The turn signals/hazard indicator lights blink when the turn signal switch or hazard indicator flasher switch is turned on. (See "Headlight and turn signal switch" (P.2-15) or "Hazard indicator flasher switch" (P.6-2).)

## AUDIBLE REMINDERS

### Brake pad wear warning (if equipped)



The disc brake pads have audible wear warnings. When a brake pad requires replacement, it will make a high pitched scraping sound when the vehicle is in motion. This scraping sound will first occur only when the brake pedal is depressed. After more wear of the brake pad, the sound will always be heard even if the brake pedal is not depressed. Have the brakes checked as soon as possible if the wear warning sound is heard.

Have the system checked, and if necessary repaired, by a NISSAN dealer promptly. (See "Brakes" (P.8-11).)

### Door open reminder chime

When vehicle speed exceeds 20 km/h (12 MPH), the door open reminder chime will sound intermittently until the vehicle is stopped and the door is closed properly.

### Light reminder chime

The light reminder chime will sound if the driver's side door is opened and the headlight switch is in either the  or  position, and the ignition switch is in the "OFF" or "LOCK" position.

Be sure to turn the headlight switch to the "OFF" or "AUTO" (if equipped) position when you leave the vehicle.

### Parking brake reminder chime

The parking brake reminder chime will sound if the vehicle is driven at speeds more than 7 km/h (4 MPH) with the parking brake applied. Stop the vehicle and release the parking brake.

### Speed warning chime (if equipped)

#### Primary warning:

When vehicle speed exceeds 80 km/h (50 MPH), a chime will sound intermittently until the driver reduces the speed to less than 80 km/h (50 MPH).

#### Secondary warning:

When vehicle speed exceeds 120 km/h (75 MPH), a chime will sound continuously until the driver reduces the speed to less than 120 km/h (75 MPH), after which it will switch to the primary warning.



## VEHICLE INFORMATION DISPLAY

When the ignition switch is placed in the "ON" position, the vehicle information display shows the warnings and informations.

The following items are also displayed:

- Trip computer
- Outside air temperature

## VEHICLE INFORMATION DISPLAY

### WARNINGS AND INDICATORS

The display message may vary depending on the vehicle's equipment.

Display message	Possible cause, reason or action to take for the message
BATTERY CHARGING FAULT	Charge battery alert
BOOT OPEN	Back door open while driving alert (vehicle speed exceeds 20 km/h)
CHECK SPEED LIMITER	Speed limiter: failure
CRUISE CONTROL XXX	Cruise control: waiting for the target speed (speed in km/h)
CRUISE CONTROL XXX	Cruise control: set (speed in km/h)
DOOR OPEN	Doors open while driving alert (vehicle speed exceeds 20 km/h)
KEYCARD BATTERY LOW	Charge level of the Intelligent Key battery alert
KEYCARD NOT RECOGNISED	The Intelligent Key inserted in the port not identified
KEYCARD NOT DETECTED	The Intelligent Key removed from the port with closed doors
MEMORISED ----	Speed limiter: suspended (speed in km/h)
PARKING BRAKE ON	Parking brake applied while driving

PRESS BRAKE +START	Press brake pedal to start the engine
PRESS CLUTCH +START	Failed start due to engaged gear Quick start assistance after stall, transmission in gear (without defect) start assistance: Request to start while declutching
PLEASE INSERT KEYCARD	The Intelligent Key is not in the vehicle or the vehicle could not detect the intelligent key due to the flat battery, etc.
POWER STEERING FAULT	The hydraulic pump electric power steering is not functioning properly and may need servicing. Have the hydraulic pump electric power steering checked by a NISSAN dealer.
SPEED LIMITER XXX	Speed limiter: waiting for the target speed
TURN STEERING WHEEL + START	Push the ignition switch while lightly turning the steering wheel to release the steering lock
AUTO GEARBOX OVERHEATING	Continuously Variable Transmission (CVT): overheating Stop the vehicle as soon as possible to cool down the transmission (until the message disappears)
CHECK AUTO GEARBOX	Continuously Variable Transmission (CVT): failure
STOP AND START ACTIVATED	Stop/Start System: activated using the Stop/Start OFF switch
STOP AND START DEACTIVATED	Stop/Start System: deactivated using the Stop/Start OFF switch
CHECK STOP AND START	Stop/Start System: failure

## TRIP COMPUTER

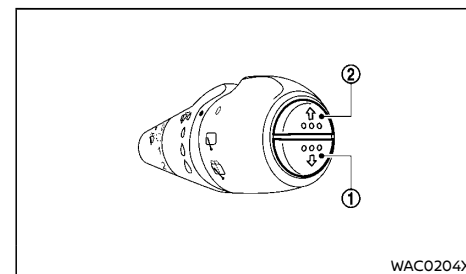
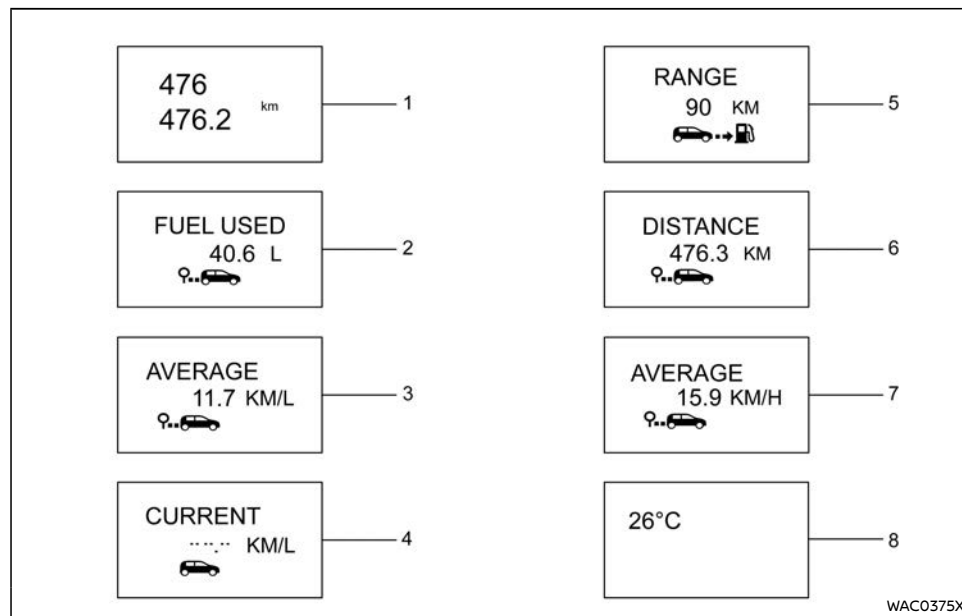

Type A

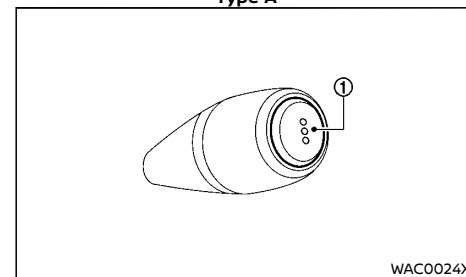

Type B

The trip computer display can be changed using the trip computer mode switch ① or ② (if equipped) located on the wiper and washer switch.

Navigate through the items in the vehicle information display.

Push the switch ① to change the display as follows:

1 → 2 → 3 → 4 → 5 → 6 → 7 → 8 → 1

Push the switch ② (if equipped) to change the display as follows:

8 → 7 → 6 → 5 → 4 → 3 → 2 → 1 → 8

## 1. Odometer and trip odometer

The odometer (upper digits) displays the total distance the vehicle has been driven. The trip odometer (lower digits) displays the distance of individual trips.

## 2. Fuel used (L)

The fuel used mode shows the amount of the fuel consumed since the last reset.

## 3. Average fuel consumption (AVG. km/l)

The average fuel consumption mode shows the average fuel consumption since the last reset. Resetting is done by pushing the trip computer mode switch ① or ② (if equipped) for longer than 1 second.

The display is updated every 30 seconds. At about the first 500 m (1/3 miles) after a reset, the display shows "----".

## 4. Current fuel consumption (km/l)

The current fuel consumption mode shows the current fuel consumption.

## 5. Distance to empty (dte - km)

The distance to empty (dte) mode provides you with an estimation of the distance that can be driven before refueling. The dte is constantly being calculated, based on the amount of fuel in the fuel tank and the actual fuel consumption.

The display is updated every 30 seconds.

## 6. Distance travelled since last reset (km)

The distance traveled since last reset mode shows the mileage from the last reset.

## 7. Average speed since last reset (km/h)

The average speed mode shows the average vehicle speed since the last reset.

## 8. Outside air temperature

See "Outside air temperature" (P.2-14).

### Resetting trip computer

#### Resetting trip odometer:

When the trip odometer is displayed, push the trip computer mode switch ① or ② (if equipped) until the trip odometer will be reset to zero.

#### Resetting other trip computer items:

To reset other trip computer items, select an item and push and hold the trip computer mode switch ① or ② (if equipped) until the relevant item will be reset to zero.

the ignition switch is in the "ON" position.

### OUTSIDE AIR TEMPERATURE

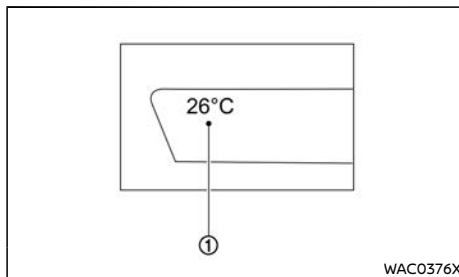

The outside air temperature ① is displayed in the range of -40 to 60°C (-40 to 140°F) when

## HEADLIGHT AND TURN SIGNAL SWITCH

### CAUTION:

Do not leave the lights on when the engine is not running for extended periods of time to prevent the battery from being discharged.

### HEADLIGHT SWITCH

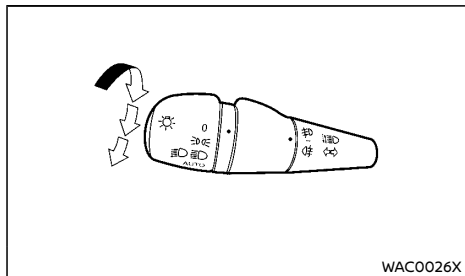

NISSAN recommends that you consult the local regulations concerning the use of lights.

#### position

The  position turns on the front clearance, instrument panel, tail and license plate lights.

#### position

The  position turns on the headlights in addition to the other lights.

#### AUTO position (if equipped)

When the ignition switch is in the "ON" position and the headlight switch is in the "AUTO" position, the headlights, front clearance lights, instrument panel lights, rear combination lights and other lights turn on automatically depending on the brightness of the surroundings.

When the ignition switch is placed in the "OFF" or "LOCK" position, the lights will turn off

automatically.

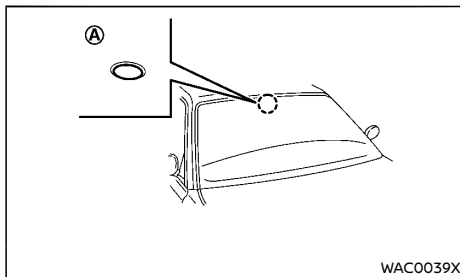



### CAUTION:

Do not cover the sensor . The sensor senses the brightness level. If the sensor is covered, it reacts as if it is dark, and the headlights will illuminate.

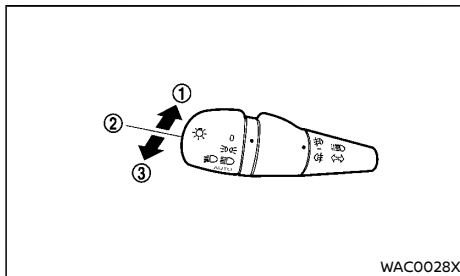
### Headlight beam



To turn on the high beam, push the lever towards the front position .

To turn off the high beam, return the lever to the neutral position .

To flash the headlights, pull the lever towards the rearmost position . The headlights can be flashed even when the headlights are not on.

If equipped, when the lever is pulled towards the rearmost position  after the ignition switch is placed in the "OFF" or "LOCK" position, the headlight will turn on and stay on for 30 seconds. The lever can be pulled 4 times for up to 2 minutes.

### HEADLIGHT AIMING CONTROL

#### Manual type

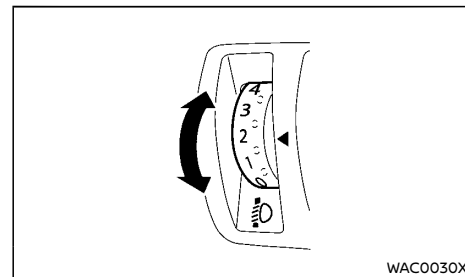

The headlight aiming control operates when the ignition switch is in the "ON" position and the headlight is on to allow the headlight axis to be adjusted according to the driving condition.

When driving with no heavy load/luggage or driving on a flat road, select the normal position "0".

If the number of occupants and load/luggage in the vehicle changes, the headlight axis may become higher than normal.

If the vehicle is traveling on a hilly road, the headlights may directly shine on the rearview and outside mirrors of a vehicle ahead or the

windshield of an oncoming vehicle, which may obscure other drivers' vision.

To adjust to the proper aiming height, turn the switch accordingly. The higher the number, designated on the switch, the lower the headlight axis.

Select the switch position by referring to the following samples.

Switch position	Number of front seat occupants	Number of rear seat occupants	Weight of load in luggage compartment
0	1 or 2	No occupants	No load
1	2	3	No load
1	2	3	Full load
2	1	No occupants	Full load

## TURN SIGNAL SWITCH

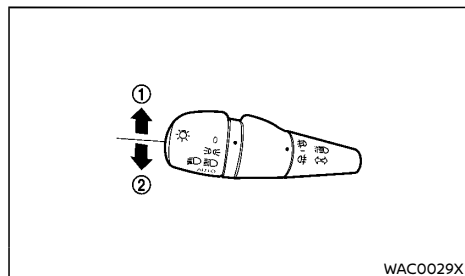

### CAUTION:

The turn signal switch will not be cancelled automatically if the steering wheel turning angle does not exceed the preset amount. After a turn or lane change, make sure that the turn signal switch is returned to its original position.

## Turn signal

To turn on the turn signals, move the lever up ① or down ② to the point where the lever latches. When the turn is completed, the turn signal cancels automatically.

## Lane change signal

To turn on the lane change signals, move the lever up ① or down ② to the point where the light begins to flash.

If the lever is moved back right after moving up ① or down ②, the light will flash 3 times.

To cancel the flashing, move the lever to the opposite direction.

## FOG LIGHT SWITCH (if equipped)

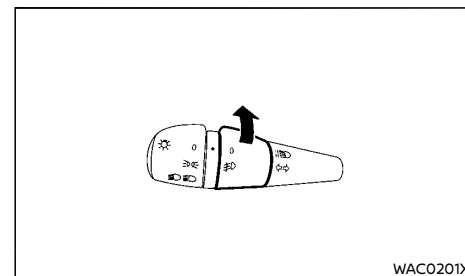

With front fog lights

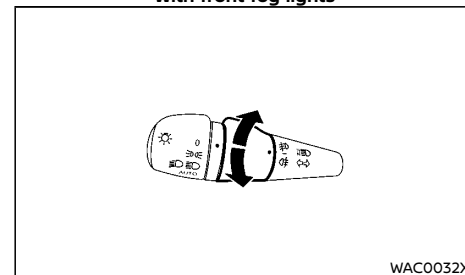

With front and rear fog lights

## FRONT FOG LIGHTS

To turn on the front fog lights, turn the headlight switch to the  $\text{DQ}$  or  $\text{D}$  or AUTO (if equipped) position, then turn the fog light switch to the  $\text{DQ}$  position. The front fog lights and the  $\text{DQ}$  indicator light on the instrument panel illuminate. For models with rear fog light, the fog light switch will return to the center position automatically.

To turn the front fog lights off, turn the fog light switch to the 0 position (models without rear fog light), or turn the switch to the  $\text{DQ}$  position again (models with rear fog light).

## WIPER AND WASHER SWITCH

### NOTE:





- If the headlight switch is turned to the **0** position, the front fog lights will turn off automatically.



### Cornering fog light function (if equipped)

When taking a corner with the low beam headlights on, under certain conditions (at speed, the steering wheel at an angle, in forward gear, the indicator lights on, etc.), one of the front fog lights will come on to light the inside of the corner.

### REAR FOG LIGHT (if equipped)

The rear fog light should be used only when visibility is seriously reduced [generally, to less than 100 m (328 ft)].

To turn on the rear fog light, turn the headlight switch to the  or AUTO (if equipped) position, then turn the fog light switch to the  position. The rear fog light and  indicator light on the instrument panel illuminate. The fog light switch will return to the  position automatically.

If the front fog lights are already turned on with the headlight switch in the  position, you can turn on the rear fog light without first turning the headlight switch to the  or AUTO (if equipped) position.

To turn the rear fog light off, turn the fog light switch to the  position again.

### NOTE:

- If the headlight switch is turned to the **0** position, the rear fog light will turn off automatically.



### WARNING:

In freezing temperatures, the washer fluid may freeze on the windshield and obscure your vision. Warm the windshield with the defogger before you wash the windshield.



### CAUTION:

- Do not operate the washer continuously for longer than 30 seconds.
- Do not operate the washer if the window washer fluid reservoir is empty.
- If the wiper operation is interrupted by snow or ice, the wiper may stop moving to protect its motor. If this occurs, turn the wiper switch to the "OFF" position and remove the snow or ice on and around the wiper arms. In approximately 1 minute, turn the switch on again to operate the wiper.

### WINDSHIELD WIPER AND WASHER SWITCH

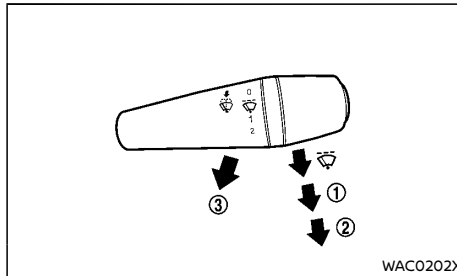

Type A

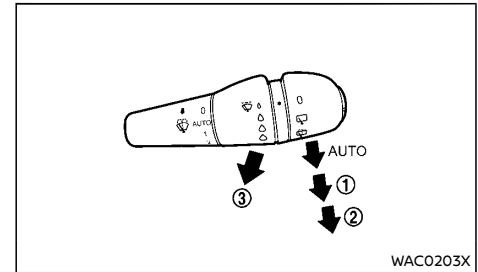

Type B

The windshield wiper and washer operate when the ignition switch is in the "ON" position.

### Wiper operation

The lever position "  " (Type A) operates the wiper intermittently.

The lever position "AUTO" (Type B) operates the rain sensing auto wiper system. (See "Rain-sensing auto wiper system" (P.2-18).)

The lever position "1" ① operates the wiper at low speed.

The lever position "2" ② operates the wiper at high speed.

To stop the wiper operation, move the lever up to the "0" position.

### Washer operation

To operate the washer, pull the lever toward the back of the vehicle ③ until the desired amount of washer fluid is spread on the windshield. The wiper will automatically operate one time or several times.

### Wiper drip wipe system:

The wiper will also operate once about 3 seconds after the washer and wiper are operated. This operation is to wipe washer fluid that has dripped on the windshield.

### RAIN-SENSING AUTO WIPER SYSTEM (if equipped)

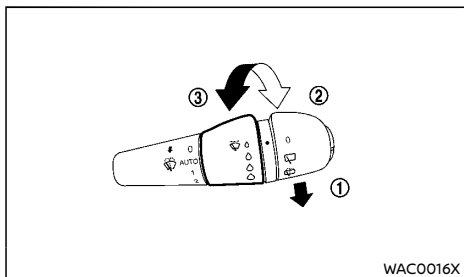

The rain-sensing auto wiper system can automatically turn on the wipers and adjust the wiper speed depending on the rainfall and the vehicle speed by using the rain sensor located on the upper part of the windshield.

To set the rain-sensing auto wiper system, push the lever down to the "AUTO" position ①. The wiper will sweep once while the ignition switch is in the "ON" position.

The rain sensor sensitivity level can be adjusted by turning the knob toward the front ② (High) or toward the rear ③ (Low).

- High — High sensitive operation
- Low — Low sensitive operation

To turn the rain-sensing auto wiper system off, push up the lever to the "0" position, or pull down the lever to the "1" or "2" position.

### ⚠ CAUTION:

- Do not touch the rain sensor and around it when the wiper switch is in the "AUTO" position and the ignition switch is in the "ON" position. The wipers may operate unexpectedly and cause an injury or may damage a wiper.
- The rain-sensing auto wipers are intended for use during rain. If the switch is left in the "AUTO" position, the wipers may operate unexpectedly when dirt, fingerprints, oil film or insects are stuck on or around the sensor. The wipers may also operate when exhaust gas or moisture affects the rain sensor.
- When the windshield glass is coated with water repellent, the speed of the rain-sensing auto wipers may be higher even though the amount of the rainfall is small.
- Be sure to turn off the rain-sensing auto wiper system when you use a car wash.
- The rain-sensing auto wipers may not operate if rain does not hit the rain sensor even if it is raining.

### REAR WINDOW WIPER AND WASHER SWITCH (if equipped)

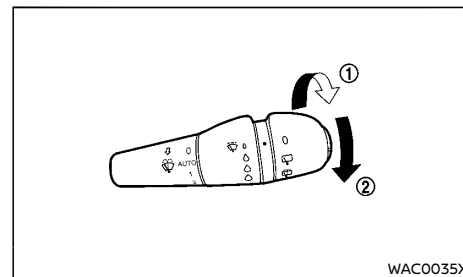

The rear window wiper and washer operates when the ignition switch is in the "ON" position.

### Wiper operation

The switch position " ⚡ " ① operates the wiper intermittently.

If the rear window wiper operation is interrupted by snow or ice, the wiper may stop moving to protect its motor. If this occurs, turn the wiper switch to the "OFF" position and remove the snow or ice on and around the wiper arms. In approximately 1 minute, turn the switch on again to operate the wiper.

### Washer operation

To operate the washer, turn the switch to the position " ⚡ " ② until the desired amount of washer fluid is spread on the windshield. The wiper will automatically operate several times.



## DEFOGGER SWITCH

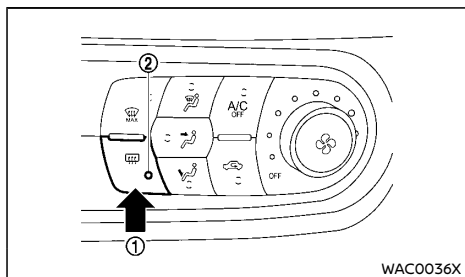

The defogger switch operates when the ignition switch is in the "ON" position.

The defogger is used to reduce the moisture, fog or frost on the rear window surface to improve the rear views.

When the defogger switch ① is pushed, the indicator light ② illuminates and the defogger operates for approximately 15 minutes. After the preset time has passed, the defogger will turn off automatically.

To turn off manually, push the defogger switch again.

### CAUTION:

- When operating the defogger continuously, be sure to start the engine. Otherwise, it may cause the battery to discharge.
- When cleaning the inner side of the window, be careful not to scratch or damage the electrical conductors on the surface of the window.

## HORN

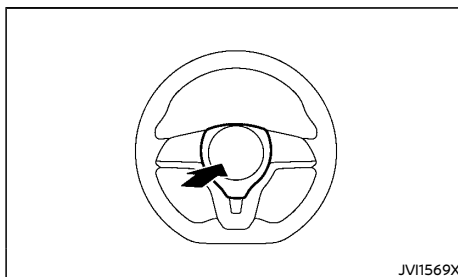

The horn switch operates regardless of the ignition switch position except when the battery is discharged.

When the horn switch is pushed and held, the horn will sound. Releasing the horn switch will cease the horn sound.

## WINDOWS

### POWER WINDOWS

#### WARNING:

- Make sure that all passengers have their hands, etc. inside the vehicle before operating the power windows.
- To help avoid risk of injury or death through unintended operation of the vehicle and or its systems, including entrapment in windows or inadvertent door lock activation, do not leave children, people who require the assistance of others or pets unattended in your vehicle. Additionally, the temperature inside a closed vehicle on a warm day can quickly become high enough to cause a significant risk of injury or death to people and pets.

The power windows operate when the ignition switch is in the "ON" position.

To open a window, push down the power window switch.

To close a window, pull up the power window switch.

### Driver's window switch

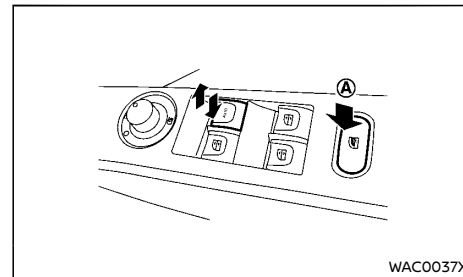

The driver's switch, the main switch, can control all windows.

#### Locking rear passengers' windows:

When the lock button (A) is pushed in, the rear passengers' windows cannot be operated.

To cancel the rear passengers' windows lock, push the lock button (A) again.

#### Passenger's window switch

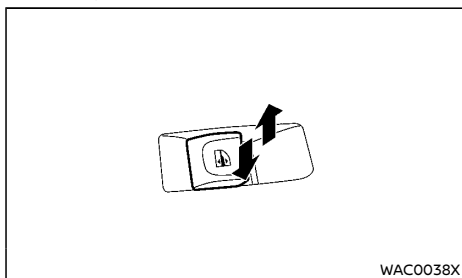

The passenger's switch can control its corresponding window.

When the rear passengers' windows lock button on the driver's switch is pushed in, the rear passenger's switch cannot be operated.

#### Automatic function

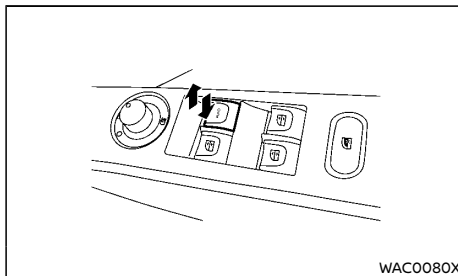

The automatic function is available for the switch that has an AUTO mark on its surface.

The automatic function enables a window to fully open or close without holding the switch down or up.

To fully open the window, push the power window switch down to the second detent and release the switch. To fully close the window, pull the power window switch up to the second detent and release the switch. The switch does not have to be held during window operation.

To stop the window open/close operation during the automatic function, push down or pull up the switch in opposite directions.

#### Window timer:

The window timer allows the window switch to be operated for a period of time even if the ignition switch is placed in the "OFF" or "LOCK" position. The window timer will be canceled when the driver's door is opened or the preset time has expired.

#### Auto-reverse function:



**There is a small distance just before the closed position which cannot be detected. Make sure that all passengers have their hands, etc. inside the vehicle before closing the windows.**

The auto-reverse function enables a window to automatically reverse when something is caught in the window as it is closing by the automatic function. When the control unit detects an obstacle, the window will be lowered immediately.

Depending on the environment or driving conditions, the auto-reverse function may activate if an impact or load similar to something being caught in the window occurs.

#### If the window does not close automatically

If the power window automatic function (closing only) does not operate properly, perform the following procedure to initialize the power window system.

1. Start the engine.
2. Close the door.
3. After starting the engine, open the window completely by operating the power window switch.
4. Pull the power window switch and hold it to close the window, and then hold the switch more than 3 seconds after the window is closed completely.
5. Release the power window switch. Operate the window by the automatic function to confirm the initialization is complete.

If the power window automatic function does

## POWER OUTLET

not operate properly after performing the procedure above, have your vehicle checked by a NISSAN dealer.

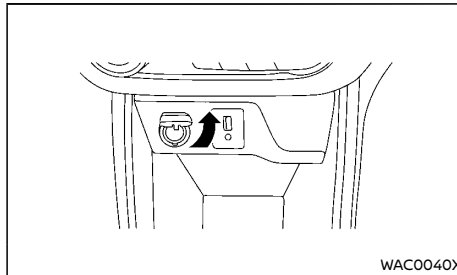

Front

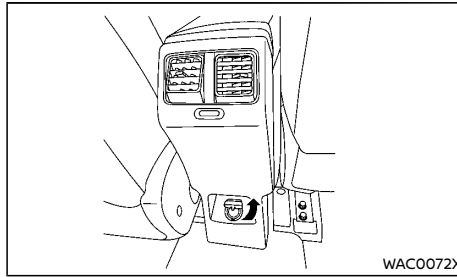

Rear

To use the power outlet, pull up the cover as illustrated.



### CAUTION:

- The outlet and plug may be hot during or immediately after use.
- This power outlet is not designed for use with a cigarette lighter unit.
- Do not use with accessories that exceed a 12 volt, 120W (10A) power draw. Do not use double adapters or more than one electrical accessory.

- Use power outlet with the engine running to avoid discharging the vehicle battery.
- Avoid using power outlet when the air conditioner, headlights or rear window defogger is on.
- Before inserting or disconnecting a plug, be sure to turn off the power switch of the electrical accessory being used and the ignition switch.
- Push the plug in as far as it will go. If good contact is not made, the plug may over-heat or the internal temperature fuse may blow.
- Do not allow water to contact the outlet.
- When not in use, be sure to close the cap.

## STORAGE

### WARNING:

- The storages should not be used while driving so that the full attention may be given to vehicle operation.
- Keep the storage lids closed while driving to help prevent injury in an accident or sudden stop.

### GLOVE BOX

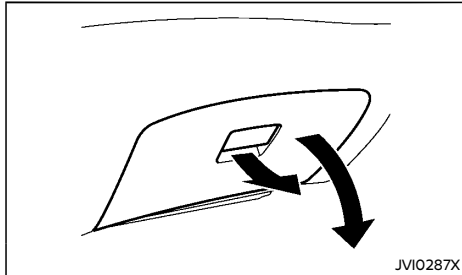

To open the glove box, pull the handle.

To close, push the lid in until the lock latches.

### Cool box function

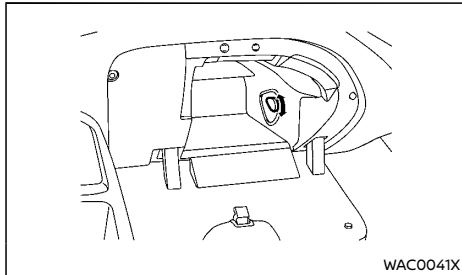

The glove box can be used as a cool box.

To use the cooling function:

1. Start the engine.
2. Turn the air conditioner on.
3. Open the glove box lid from the front passenger's seat.
4. Push the lever down to enable the cooling air inside the glove box, pull the lever up to disable the cooling air inside the glove box.
5. Put items in the box and close the lid.

**The cooling function only activates when the air conditioner is on.**

- The airflow coming from the glove box ventilator is the same temperature as the air conditioner. The temperature cannot be set independently.
- When the heater or the air conditioner is working in high temperature, the cooling function will not work even if the glove box ventilator is opened.

### CARD HOLDER

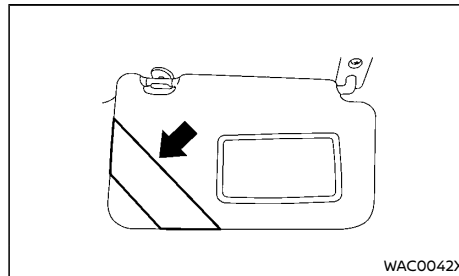

**Driver's side**

The card holder is located on the driver's sun visor.

To use the card holder, slide a card in the card

holder.

### CUP HOLDERS (if equipped)

### WARNING:

**The driver must not remove or insert cups into the cup holder while driving so that full attention may be given to vehicle operation.**

### CAUTION:

**Avoid abrupt starting and braking especially when the cup holder is being used to prevent spilling the contents. If the contents are hot, they could scald you or your passengers.**

### Rear

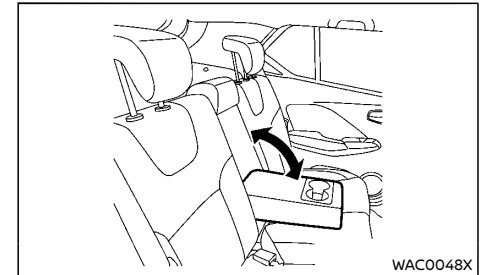

Pull the armrest down as shown.

## Soft bottle holder

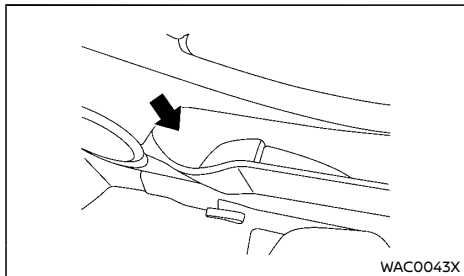

Front

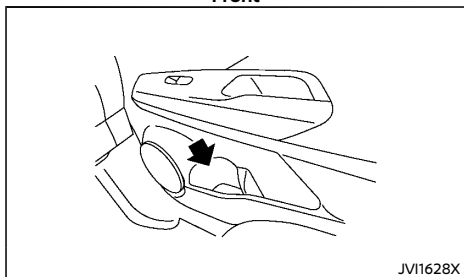

Rear

Soft bottle holders are located on the front and rear doors.

### CAUTION:

- Do not use bottle holder for any other objects that could be thrown about in the vehicle and possibly injure people during sudden braking or an accident.
- Do not use bottle holder for open liquid containers.

## CARGO COVER

### WARNING:

- Never put anything on the cargo cover, no matter how small. Any object on it could cause an injury in an accident or sudden stop.
- Do not leave the cargo cover in the vehicle with it disengaged from the holder.
- The child restraint top tether strap may be damaged by contact with the cargo cover or items in the luggage area. Remove the cargo cover from the vehicle or secure it and any luggage. Your child could be seriously injured or killed in a collision if the top tether strap is damaged.
  - If the cargo cover contacts the top tether strap when it is attached to the top tether anchor, remove the cargo cover from the vehicle or secure it on the cargo floor below its attachment location. If the cargo cover is not removed, it may damage the top tether strap during a collision.
  - Do not allow cargo to contact the top tether strap when it is attached to the top tether anchor. Properly secure the cargo so it does not contact the top tether strap. Cargo that is not properly secured or that contacts the top tether strap may damage the top tether strap during a collision.

The cargo cover keeps the luggage compartment contents hidden from the outside.

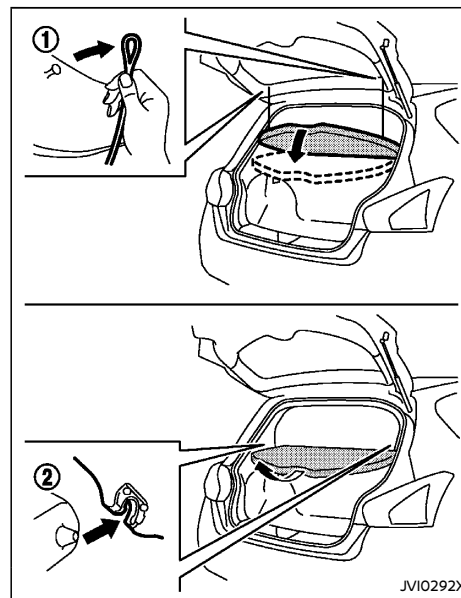

To remove the cargo cover:

1. Remove the straps ① from the back door.
2. Remove the outer cargo cover from the holders ②. Then remove the inner cargo cover from the holders, if necessary.

## ROOF RACK (if equipped)

### LUGGAGE HOOKS

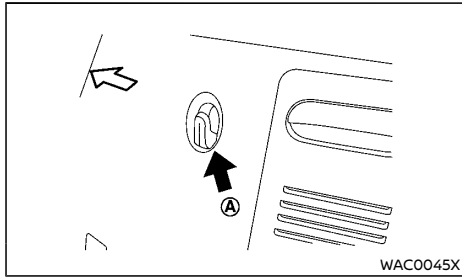

The luggage hooks (A) are located in the luggage area.

#### CAUTION:

- Always make sure that the luggage is properly secured. Use the suitable ropes and hooks.
- Unsecured luggage can become dangerous in an accident or sudden stop.
- Do not apply a total load of more than 3 kg (7 lb) to a single hook (A).

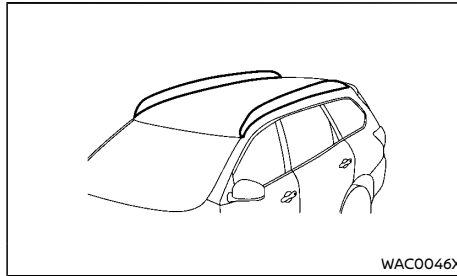

Do not apply any load directly to the roof side rails. Cross bars must be installed before applying load/cargo/luggage to the roof of the vehicle.

Concerning cross bars, it is recommended that you visit a NISSAN dealer for additional information.

The service load capacity for the roof side rails is 30 kg (65 lb), however do not exceed the accessory cross bars load capacity.

#### WARNING:

- Always install the cross bars onto the roof side rails before loading cargo of any kind. Loading cargo directly onto the roof side rails or the vehicle's roof may cause vehicle damage.
- Drive extra carefully when the vehicle is loaded at or near the cargo carrying capacity, especially if the significant portion of that load is carried on the roof rack.
- Heavy loading of the roof rack has the potential to affect the vehicle stability and handling during sudden or unusual handling maneuvers.

- Roof rack load should be evenly distributed.
- Do not exceed maximum roof rack load weight capacity.
- Properly secure all cargo with ropes or straps to help prevent it from sliding or shifting. In a sudden stop or collision, unsecured cargo could cause personal injury.

## SUN VISORS

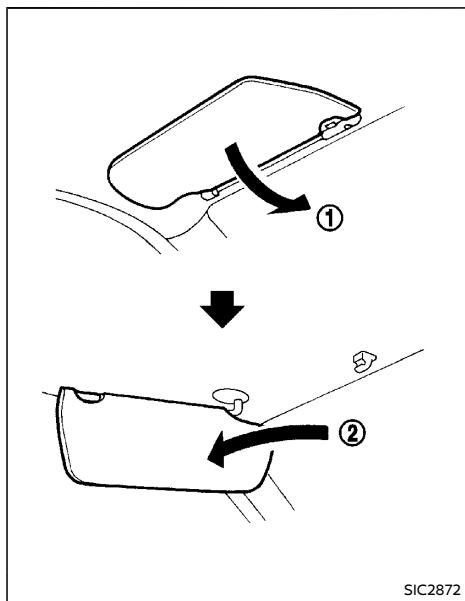

1. To block out glare from the front, swing down the sun visor ①.
2. To block glare from the side, remove the sun visor from the center mount and swing it to the side ②.

## INTERIOR LIGHTS



### CAUTION:

- Do not leave the light switch on when the engine is not running for extended periods of time to prevent the battery from being discharged.
- Turn off the lights when you leave the vehicle.

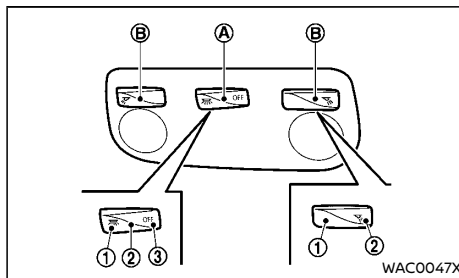

Front

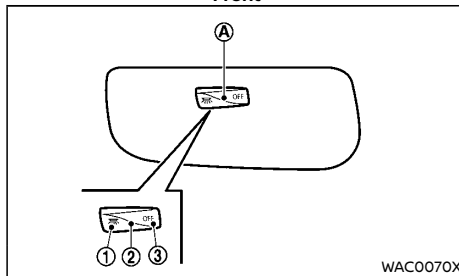

Rear

## FRONT AND REAR ROOM LIGHT

The room light has a three-position switch (A). When the switch is in the "ON" position ①, the room light illuminates.

When the switch is in the "DOOR" position ②, the room light illuminates when a door is opened.

The interior light timer will keep the room light on for a period of time when:

- The key is removed from the ignition switch with the driver's door closed. (model without Intelligent Key system)
- The ignition switch is placed in the "LOCK" position. (model with Intelligent Key system)
- The doors are unlocked by pushing the "UNLOCK" button (on the remote controller or Intelligent Key) or the request switch (Intelligent Key system equipped models), with the ignition switch in the "LOCK" position.
- Any door is opened and then closed with the ignition switch in the "LOCK" position and without the key in the ignition switch. (model without Intelligent Key system)
- Any door is opened and then closed with the ignition switch in the "LOCK" position. (model with Intelligent Key system)

The interior light timer will be cancelled when:

- The driver's door is locked.
- The ignition switch is placed in the "ON" position.

When the switch is in the "OFF" position ③, the room light does not illuminate, regardless of any condition.

Lead me to car function (if equipped)

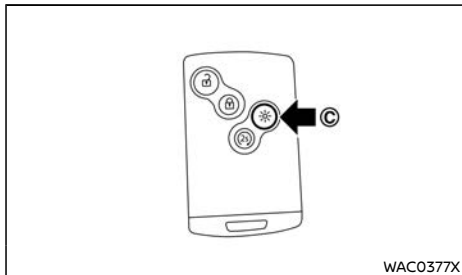

When the “\* ” button ④ on the Intelligent Key is pushed with the ignition switch is in the “LOCK” position, the room light will turn on and stay on for a period of time. Pushing the “\* ” button ④ again to turn of the room light.

**NOTE:**

**The lead me to car function can be cancelled by pushing the “\* ” button ④.**

**FRONT MAP LIGHTS**

To turn on the front map light ③, push the on switch ②, and the light illuminates. To turn off, push the off switch ①.

**CARGO ROOM LIGHT**

The cargo room light illuminates when the back door is opened. When the back door is closed, the light will turn off.



# 3 Pre-driving checks and adjustments

Keys .....	3-2	Initialization .....	3-13
NISSAN Anti-Theft System (NATS) key (if equipped) .....	3-2	Remote starting the engine .....	3-13
Intelligent Key (if equipped) .....	3-2	Extending engine run time .....	3-13
Doors .....	3-3	Canceling a remote engine start .....	3-13
Locking with key .....	3-3	Conditions the remote engine start will not work .....	3-13
Locking with power door lock switch .....	3-3	Hood .....	3-14
Vehicle speed sensing door lock mechanism .....	3-4	Opening hood .....	3-15
Impact sensing door lock releasing mechanism .....	3-4	Closing hood .....	3-15
Child safety rear door lock .....	3-4	Back door .....	3-15
Remote keyless entry system (if equipped) .....	3-4	Opening back door .....	3-16
Using remote keyless entry system .....	3-5	Closing back door .....	3-16
Intelligent Key system (if equipped) .....	3-5	Back door release lever .....	3-16
Operating range .....	3-7	Fuel-filler lid .....	3-17
Using Intelligent Key system .....	3-7	Opening fuel-filler lid .....	3-17
Troubleshooting guide .....	3-9	Fuel-filler cap .....	3-17
Using remote keyless entry function .....	3-10	Steering wheel .....	3-18
Hazard indicator operation .....	3-10	Tilt operation .....	3-18
Security system .....	3-12	Mirrors .....	3-18
NISSAN Anti-Theft System (NATS) .....	3-12	Inside rearview mirror .....	3-18
Remote engine start (if equipped) .....	3-12	Outside rearview mirrors .....	3-18
Remote engine start operating range .....	3-13	Vanity mirror .....	3-19
		Parking brake .....	3-19

## KEYS

Your vehicle can only be driven with the keys specific to your vehicle. A key number plate is supplied with your key (if equipped). Record the key number and keep the key number plate in a safe place, except in the vehicle, in case of the need to duplicate the keys.

The key can only be duplicated using an original key or the original key number. The key number is required when you have lost all of the keys and do not have the original key to duplicate from. If the key is lost, or you need extra keys, provide an original key or the key number to a NISSAN dealer.

### CAUTION:

**Do not leave the keys inside the vehicle when leaving the vehicle.**

### NISSAN ANTI-THEFT SYSTEM (NATS\*) KEY (if equipped)

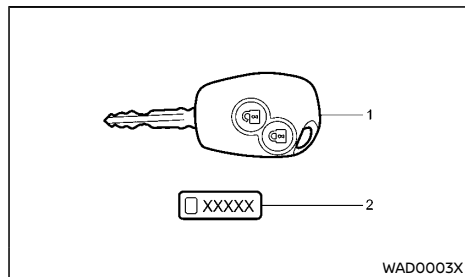

- 1 NATS key (2)
- 2 Key number plate

Your vehicle can only be driven with the NATS keys, which are registered to your vehicle's NATS components. As many as 4 NATS keys can be registered and used with one vehicle.

## 3-2 Pre-driving checks and adjustments

The new keys must be registered by a NISSAN dealer prior to use with the NATS of your vehicle. Since the registration process requires erasing all memory in the NATS components when registering new keys, be sure to take all NATS keys that you have to the NISSAN dealer.

### CAUTION:

**Do not allow the NATS key, which contains an electrical transponder, to come into contact with water or salt water. This could affect the system function.**

\*: Immobilizer

### INTELLIGENT KEY (if equipped)

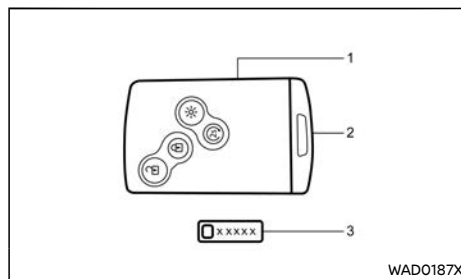

1. Intelligent Key (2)
2. Mechanical key (inside the Intelligent Key) (2)
3. Key number plate (if equipped)

Your vehicle can only be driven with the Intelligent Keys, which are registered to your vehicle's Intelligent Key system components and NISSAN Anti-Theft System (NATS\*) components. As many as 4 Intelligent Keys can be registered and used with one vehicle. The new keys must be registered by a NISSAN dealer

prior to use with the Intelligent Key system and NATS of your vehicle. Since the registration process requires erasing all memory in the Intelligent Key components when registering new keys, be sure to take all Intelligent Keys that you have to the NISSAN dealer.

\*: Immobilizer

### CAUTION:

- Be sure to carry the Intelligent Key with you. Do not leave the vehicle with the Intelligent Key inside.
- Be sure to carry the Intelligent Key with you when driving. The Intelligent Key is a precision device with a built-in transmitter. To avoid damaging it, please note the following.
  - The Intelligent Key is water resistant; however, wetting may damage the Intelligent Key. If the Intelligent Key gets wet, immediately wipe until it is completely dry.
  - Do not bend, drop or strike it against another object.
  - If the outside temperature is below  $-10^{\circ}\text{C}$  ( $14^{\circ}\text{F}$ ), the battery of the Intelligent Key may not function properly.
  - Do not place the Intelligent Key for an extended period in a place where temperatures exceed  $60^{\circ}\text{C}$  ( $140^{\circ}\text{F}$ ).
  - Do not change or modify the Intelligent Key.
  - Do not use a magnet key holder.
  - Do not place the Intelligent Key near equipment that produces a magnetic field such as a TV, audio equipment and personal computers.

## DOORS

- Do not allow the Intelligent Key to come into contact with water or salt water, and do not wash it in a washing machine. This could affect the system function.
- If an Intelligent Key is lost or stolen, NISSAN recommends erasing the ID code of that Intelligent Key. This will prevent the Intelligent Key from unauthorized use to unlock the vehicle. For information regarding the erasing procedure, please contact a NISSAN dealer.

### Mechanical key

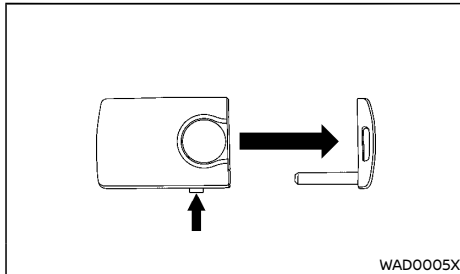

To remove the mechanical key, push the lock knob at the side of the Intelligent Key.

To install the mechanical key, firmly insert it into the Intelligent Key until the lock knob returns to the lock position.

Use the mechanical key to lock or unlock the doors. (See "Doors" (P.3-3).)

### WARNING:

- Always look before opening any doors, to avoid an accident with oncoming traffic.
- To help avoid risk of injury or death through unintended operation of the vehicle and or its systems, including entrapment in windows or inadvertent door lock activation, do not leave children, people who require the assistance of others or pets unattended in your vehicle. Additionally, the temperature inside a closed vehicle on a warm day can quickly become high enough to cause a significant risk of injury or death to people and pets.

### LOCKING WITH KEY

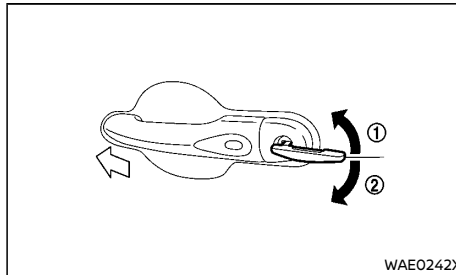

To lock the front passenger's door, insert the key to the door cylinder and turn the key counterclockwise ①.

To unlock the door, turn the key clockwise ②.

To lock or unlock the other doors, use the power door lock switch, the remote controller (if equipped) or the Intelligent Key (if equipped).

### LOCKING WITH POWER DOOR LOCK SWITCH

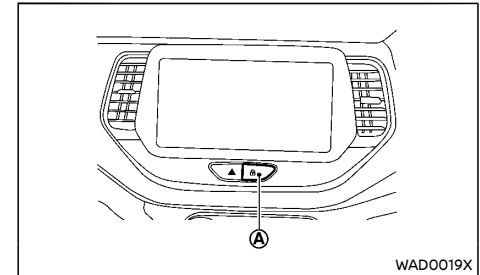

Operating the power door lock switch, located on the instrument panel, will lock or unlock all the doors.

To lock the doors, push the power door lock switch ① with all doors closed.

### CAUTION:

- When locking the doors using the power door lock switch, be sure not to leave the key in the vehicle.
- When the Intelligent Key (if equipped) is left in the vehicle while the driver's door is opened and you try to lock the door using the power door lock switch after getting out of the vehicle, all the doors will unlock automatically after the power door lock switch is operated.

To unlock, push the power door lock switch ② again.

## VEHICLE SPEED SENSING DOOR LOCK MECHANISM

All doors will be locked automatically when the vehicle speed reaches 7 km/h (4 MPH). Once the lock has been unlocked, while driving, the vehicle speed sensing door lock mechanism will not lock the door again unless one of the following is performed.

- Opening any doors.
- Placing the ignition switch in the "LOCK" position.

## To activate or deactivate vehicle speed sensing door lock mechanism

To activate or deactivate the door lock mechanism, perform the following procedures.

1. With the engine running, push and hold the power door lock switch for 4 seconds.
  2. The message will appear as follows in the vehicle information display if the switching operation is successful:
- AUTO DOOR LOCK ON — activated
  - AUTO DOOR LOCK OFF — deactivated

## IMPACT SENSING DOOR LOCK RELEASING MECHANISM

All doors will be unlocked automatically when the impact sensors sense an impact while the ignition switch is in the "ON" position.

## CHILD SAFETY REAR DOOR LOCK

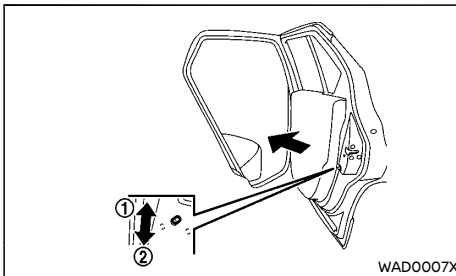

The child safety rear door locks help prevent rear doors from being opened accidentally, especially when small children are in the vehicle.

When the levers are in the lock position ①, the child safety rear door locks engage and the rear doors can only be opened by the outside door handles.

To disengage, move the levers to the unlock position ②.

## REMOTE KEYLESS ENTRY SYSTEM (if equipped)

The remote keyless entry system can operate all door locks using the remote controller. The remote controller can operate at a distance of approximately 1 m (3.3 ft) away from the vehicle. The operating distance depends upon the conditions around the vehicle.

As many as 4 remote controllers can be used with one vehicle. For information about the purchase and use of additional remote controllers, contact a NISSAN dealer.

The remote controller will not function under the following conditions:

- When the distance between the remote controller and vehicle is more than approximately 1 m (3.3 ft).
- When the remote controller battery is discharged.
- When the key is in the ignition switch.



### CAUTION:

- **When locking the doors using the remote controller, be sure not to leave the key in the vehicle.**
- **Do not allow the remote controller, which contains electrical components, to come into contact with water or salt water. This could affect the system function.**
- **Do not drop the remote controller.**
- **Do not strike the remote controller sharply against another object.**
- **If the outside temperature is below -10°C (14°F), the battery of the remote controller may not function properly.**
- **Do not place the remote controller for an extended period in an area where temperatures exceed 60°C (140°F).**

If a remote controller is lost or stolen, NISSAN

recommends erasing the ID code of that remote controller from the vehicle. This may prevent the unauthorized use of the remote controller to unlock the vehicle. For information regarding the erasing procedure, contact a NISSAN dealer.

For information regarding the replacement of a battery, see "Remote controller battery" (P.8-17).

## USING REMOTE KEYLESS ENTRY SYSTEM

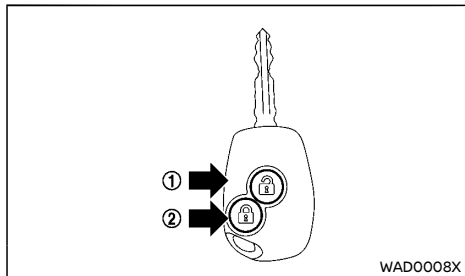

- ① UNLOCK button
- ② LOCK button

### Locking doors

1. Remove the key from the ignition switch.
2. Close all doors.
3. Push the "LOCK" button ② on the remote controller.
4. All doors will be locked.
5. Operate door handles to confirm that the doors have been securely locked.



### CAUTION:

**After locking the doors using the remote controller, be sure that the doors have been securely locked by operating the door handles.**

### Unlocking doors

1. Push the "UNLOCK" button ① on the remote controller.
2. All doors will be unlocked.

All doors will be locked automatically unless one of the following operations is performed within 30 seconds after pushing the "UNLOCK" button ①.

- Opening any doors.
- Inserting the key into the ignition switch.

### Hazard indicator operation

When you lock or unlock the doors, the hazard indicator will flash as a confirmation.

- "LOCK": The hazard indicator flashes twice.
- "UNLOCK": The hazard indicator flashes once.

## INTELLIGENT KEY SYSTEM (if equipped)

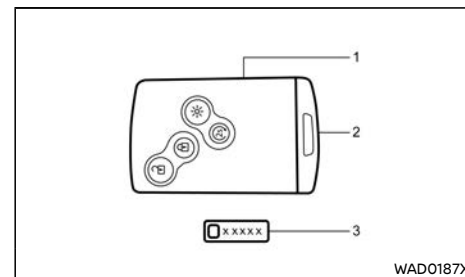

1. Intelligent Key (2)
2. Mechanical key (inside the Intelligent Key) (2)
3. Key number plate (if equipped)



### WARNING:

- **Radio waves could adversely affect electric medical equipment. Those who use a pacemaker should contact the electric medical equipment manufacturer for the possible influences before use.**
- **The Intelligent Key transmits radio waves when the buttons are pushed. The radio waves may affect aircraft navigation and communication systems. Do not operate the Intelligent Key while on an airplane. Make sure the buttons are not operated unintentionally when the unit is stored during a flight.**

The Intelligent Key system can be used to operate all the doors (including the back door) with the remote controller function or by pushing the request switch on the vehicle without taking the key out from a pocket or purse. The operating environment and/or conditions may affect the Intelligent Key system

operation.

Be sure to read the following before using the Intelligent Key system.

 **CAUTION:**

- **Be sure to carry the Intelligent Key with you when operating the vehicle.**
- **Never leave the Intelligent Key in the vehicle when you leave the vehicle.**

The Intelligent Key is always communicating with the vehicle as it receives radio waves. The Intelligent Key system transmits weak radio waves. Environmental conditions may interfere with the operation of the Intelligent Key system under the following operating conditions.

- When operating near a location where strong radio waves are transmitted, such as a TV tower, power station and broadcasting station.
- When in possession of wireless equipment, such as a cellular telephone, transceiver, and CB radio.
- When the Intelligent Key is in contact with or covered by metallic materials.
- When any type of radio wave remote control is used nearby.
- When the Intelligent Key is placed near an electric appliance such as a personal computer.

In such cases, correct the operating conditions before using the Intelligent Key function or use the mechanical key.

Although the life of the battery varies depending on the operating conditions, the battery's life is approximately 2 years. If the battery is discharged, replace it with a new one.

When the Intelligent Key battery is almost discharged, see "Intelligent Key battery dis-

charge" (P.5-7) to start the engine.

Since the Intelligent Key is continuously receiving radio waves, if the key is left near equipment which transmits strong radio waves, such as signals from a TV and personal computer, the battery life may become shorter.

For information regarding replacement of a battery, see "Intelligent Key battery" (P.8-18).

Because the steering wheel is locked electrically, unlocking the steering wheel is impossible when the vehicle battery is completely discharged. Pay special attention that the vehicle battery is not completely discharged.

As many as 4 Intelligent Keys can be used with one vehicle. For information about the purchase and use of additional Intelligent Keys, contact a NISSAN dealer.

 **CAUTION:**

- **Do not allow the Intelligent Key, which contains electrical components, to come into contact with water or salt water. This could affect the system function.**
- **Do not drop the Intelligent Key.**
- **Do not strike the Intelligent Key sharply against another object.**
- **Do not change or modify the Intelligent Key.**
- **Wetting may damage the Intelligent Key. If the Intelligent Key gets wet, immediately wipe until it is completely dry.**
- **If the outside temperature is below  $-10^{\circ}\text{C}$  ( $14^{\circ}\text{F}$ ), the battery of the Intelligent Key may not function properly.**
- **Do not place the Intelligent Key for an extended period in an area where temperatures exceed  $60^{\circ}\text{C}$  ( $140^{\circ}\text{F}$ ).**

- **Do not attach the Intelligent Key with a key holder that contains a magnet.**
- **Do not place the Intelligent Key near equipment that produces a magnetic field, such as a TV, audio equipment and personal computers.**

If an Intelligent Key is lost or stolen, NISSAN recommends erasing the ID code of that Intelligent Key from the vehicle. This may prevent the unauthorized use of the Intelligent Key to operate the vehicle. For information regarding the erasing procedure, contact a NISSAN dealer.

The Intelligent Key function can be disabled. For information about disabling the Intelligent Key function, contact a NISSAN dealer.

## OPERATING RANGE

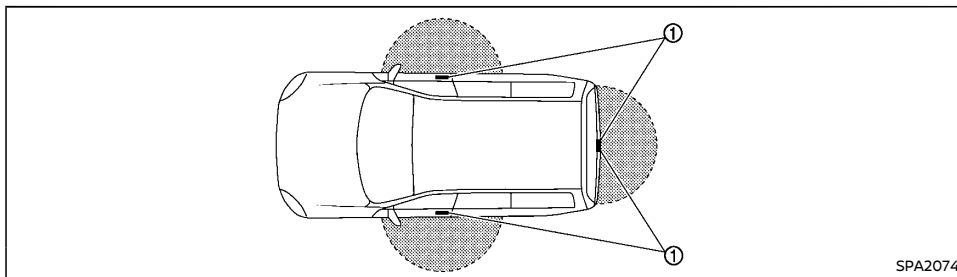

The Intelligent Key functions can only be used when the Intelligent Key is within the specified operating range from the request switch ①.

When the Intelligent Key battery is discharged or strong radio waves are present near the operating location, the Intelligent Key system's operating range becomes narrower, and the Intelligent Key may not function properly.

The operating range is within 80 cm (31.50 in) from each request switch ①.

If the Intelligent Key is too close to the door glass, handle or rear bumper, the request switches may not function.

When the Intelligent Key is within the operating range, it is possible for anyone, even someone who does not carry the Intelligent Key, to push the request switch and lock/unlock the doors.

## USING INTELLIGENT KEY SYSTEM

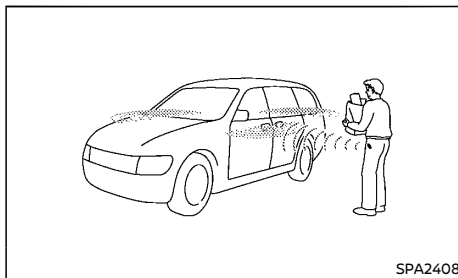

The request switch will not function under the following conditions:

- When the Intelligent Key is left inside the vehicle
- When the Intelligent Key is not within the operational range
- When any door is open or not closed securely
- When the Intelligent Key battery is discharged

- When the ignition switch is in the "ON" position

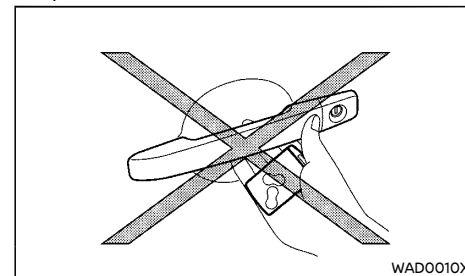

- Do not push the door handle request switch with the Intelligent Key held in your hand as illustrated. The close distance to the door handle will cause the Intelligent Key system to have difficulty recognizing that the Intelligent Key is outside the vehicle.
- After locking the doors using the door handle request switch, make sure that the doors have been securely locked by operating the door handles.
- When locking the doors using the door handle request switch, make sure to have the Intelligent Key in your possession before operating the door handle request switch to prevent the Intelligent Key from being left in the vehicle.
- The door handle request switch is operational only when the Intelligent Key has been detected by the Intelligent Key system.
- To prevent the Intelligent Key from being left inside the vehicle or the luggage room, make sure you are carrying the key with you and then lock the doors.

- Do not pull the door handle before pushing the door handle request switch. The door will be unlocked but will not open. Release the door handle once and pull it again to open the door.

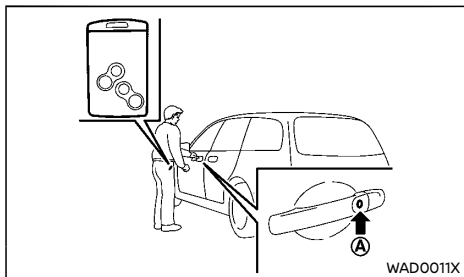

When you carry the Intelligent Key with you, you can lock or unlock all doors and the back door by pushing the door handle request switch (driver's or front passenger's) **A** within the range of operation.

When you lock or unlock the doors, the hazard indicator will flash as a confirmation. For details, see "Hazard indicator operation" (P.3-10).

### Locking doors

- Push the ignition switch to the "LOCK" position.
- Carry the Intelligent Key with you.
- Close all doors.
- Push the door handle request switch **A**.
- All doors and the back door will be locked.
- Operate door handles to confirm that the doors have been securely locked.

### Lockout protection:

To prevent the Intelligent Key from being accidentally locked in the vehicle, lockout protection is equipped with the Intelligent Key system.

- When the Intelligent Key is left in the vehicle while the driver's door is opened and you try to lock the door using the power door lock switch after getting out of the vehicle, all the doors will unlock automatically after the door is closed.



### CAUTION:

The lockout protection may not function under the following conditions:

- When the Intelligent Key is placed on top of the instrument panel.
- When the Intelligent Key is placed on the cargo cover.
- When the Intelligent Key is placed inside of the glove box.
- When the Intelligent Key is placed inside of the door pockets.

The lockout protection may function when the Intelligent Key is outside the vehicle but is too close to the vehicle.

### Unlocking doors

- Carry the Intelligent Key with you.
- Push the door handle request switch **A**.
- All doors and the back door will be unlocked.

If a door handle is pulled while unlocking the doors, that door may not be unlocked. Returning the door handle to its original position will unlock the door. If the door does not unlock, after returning the door handle, push the door

handle request switch to unlock the door.

### Automatic relock:

All doors will be locked automatically unless one of the following operations is performed within 30 seconds after pushing the request switch while the doors are locked.

- Opening any doors.
  - Pushing the ignition switch.
- If during the preset time period the "UNLOCK"  button on the Intelligent Key is pushed, all doors will be locked automatically after the next preset time.



## TROUBLESHOOTING GUIDE

Symptom		Possible cause	Action to take
When pushing the request switch or the "LOCK"  button on the Intelligent Key to lock the door	All the doors unlock.	The Intelligent Key is inside the vehicle or the luggage room.	Carry the Intelligent Key with you.
When pushing the ignition switch to start the engine	The "KEYCARD BATTERY LOW" message appears in the vehicle information display.	The battery charge is low.	Replace the battery with a new one. (See "Intelligent Key battery" (P.8-18).)
	The "PLEASE INSERT KEYCARD" message appears in the vehicle information display.	The Intelligent Key is not in the vehicle or the vehicle could not detect the intelligent key due to the flat battery, etc.	Carry the Intelligent Key with you. To start the engine, insert the Intelligent Key into the Intelligent Key port. (See "Intelligent Key battery discharge" (P.5-7).)

## USING REMOTE KEYLESS ENTRY FUNCTION

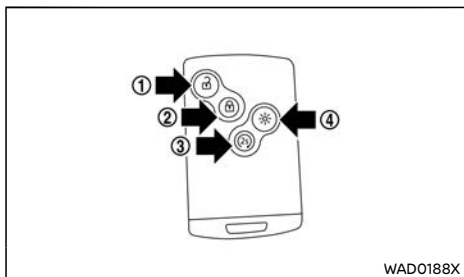

- ① UNLOCK button
- ② LOCK button
- ③ REMOTE ENGINE START button
- ④ \* button

### Operating range

The remote keyless entry system allows you to lock/unlock all doors and start the engine. The operating distance depends upon the conditions around the vehicle. To securely operate the buttons, approach the vehicle to about 1 m (3.3 ft) from the door.

The remote keyless entry system will not function under the following conditions:

- When the Intelligent Key is not within the operational range.
- When the Intelligent Key battery is discharged.

For information regarding the replacement of a battery, see "Intelligent Key battery" (P.8-18).

### Locking doors

1. Place the ignition switch in the "LOCK" position and carry the Intelligent Key.
2. Close all doors (including the back door).
3. Push the "LOCK" button ② on the Intelligent Key.
4. All doors will be locked.
5. Operate the door handles to confirm that the doors have been securely locked.



#### CAUTION:

**After locking the doors using the Intelligent Key, be sure that the doors have been securely locked by operating the door handles.**

### Unlocking doors

1. Push the "UNLOCK" button ① on the Intelligent Key.
2. All doors (including the back door) will be unlocked.

#### Automatic relock:

All doors will be locked automatically unless one of the following operations is performed within 30 seconds after pushing the "UNLOCK" button ① on the Intelligent Key while the doors are locked. If during this 30-second time period, the "UNLOCK" button ① on the Intelligent Key is pushed, all doors will be locked automatically after another 30 seconds.

- Opening any doors.
- Pushing the ignition switch.

### Remote engine start function

The "REMOTE ENGINE START" button ③ is on the Intelligent Key if the vehicle has remote engine start function. This function allows the engine to start from outside the vehicle. See "Remote engine start" (P.3-12) for more details.



### Using lead me to car function

By pushing the \* button ④, you can turn on the room light for a period of time from the outside of the vehicle. For more details, see "Lead me to car function" (P.2-26).

### HAZARD INDICATOR OPERATION

When you lock or unlock the doors or the back door with the request switch or the remote keyless entry function, the hazard indicator will flash as a confirmation.

The following descriptions show how the hazard indicator will activate when locking or unlocking the doors.

<b>Operation</b>	<b>DOOR LOCK</b>	<b>DOOR UNLOCK</b>
<b>Intelligent Key system (using the door handle request switch)</b>	HAZARD - <b>twice</b>	HAZARD - <b>once</b>
<b>Remote keyless entry system (using  or  button)</b>	HAZARD - <b>twice</b>	HAZARD - <b>once</b>

## SECURITY SYSTEM



### WARNING:

- Do not change or modify the security system. Doing so could affect the proper operation of the system.
- Changes or modifications not expressly approved by the party responsible for compliance could void the user's authority to operate the equipment.

Your vehicle is equipped with the NISSAN Anti-Theft System (NATS)\*.

(\* immobilizer)

### NISSAN ANTI-THEFT SYSTEM (NATS)

The NISSAN Anti-Theft System (NATS) will not allow the engine to start without the use of the registered NATS key.

If the engine does not start using the registered NATS key, it may be due to interference caused by:

- Another NATS key.
- Automated toll road device.
- Automated payment device.
- Other devices that transmit similar signals.

Start the engine using the following procedure:

1. Remove any items that may be causing the interference away from the NATS key.
2. Leave the ignition switch in the "ON" position for approximately 5 seconds.
3. Place the ignition switch in the "OFF" or "LOCK" position, and wait approximately 10 seconds.
4. Repeat steps 2 and 3 again.
5. Start the engine.

6. Repeat the steps above until all possible interferences are eliminated.

If this procedure allows the engine to start, NISSAN recommends placing the registered NATS key separate from other devices to avoid interference.

## REMOTE ENGINE START (if equipped)





### WARNING:

To avoid risk of injury or death, do not use the remote engine start function when the vehicle is in an enclosed area such as a garage.

### NOTE:

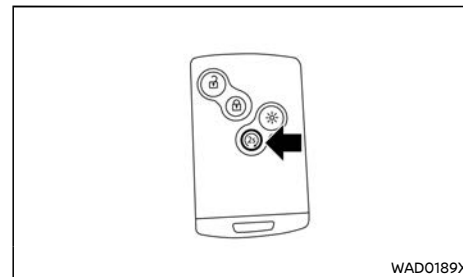
When using the remote engine start function, be sure to turn off the devices, such as wipers, lights, radio and other electrical accessories before leaving the vehicle. Otherwise, they may operate unintentionally.



The "REMOTE ENGINE START"  button is on the Intelligent Key if the vehicle has remote engine start function. This function allows the engine to start from outside the vehicle.

Some systems, such as the air conditioner system, will turn ON during a remote engine start, if the system was ON the last time the ignition switch was turned off.

Laws in some local communities may restrict the use of remote engine starters. For example, some laws require a person using remote engine start to have the vehicle in view. Check local regulations for any requirements.

Other conditions may affect the remote engine

start function. See "Conditions the remote engine start will not work" (P.3-13).

Other conditions can affect the performance of the Intelligent Key transmitter. See "Intelligent Key system" (P.3-5) for additional information.

## REMOTE ENGINE START OPERATING RANGE



### WARNING:



**To help avoid risk of injury or death through unintended operation of the vehicle and/or its systems, do not leave children, people who require the assistance of others or pets unattended in your vehicle. Additionally, the temperature inside a closed vehicle on a warm day can quickly become high enough to cause a significant risk of injury or death to people and pets.**

The remote engine start function can only be used when the Intelligent Key is within the specified operating range from the vehicle.

When the Intelligent Key battery is discharged or other strong radio wave sources are present near the operating location, the Intelligent Key operating range becomes narrower, and the Intelligent Key may not function properly.

The remote engine start operating range is approximately 60 m (197 ft) from the vehicle.

## INITIALIZATION



To activate the remote engine start function for the first time, push the "UNLOCK"  button and then push the "REMOTE ENGINE START"  button twice in succession, for approximately 3 seconds each time. (The time between the two pushes must be less than 5 seconds.) When the function is activated, the hazard indicator flashers illuminate for approximately 3 seconds.

### NOTE:

**Once the function has been activated, it cannot be disabled. Contact a NISSAN dealer for more information.**

## REMOTE STARTING THE ENGINE

To use the remote start function to start the engine, all doors need to be locked and perform the following:

1. Aim the Intelligent Key at the vehicle.
2. Push the "LOCK"  button.
3. Within 2 seconds push and hold the "REMOTE ENGINE START"  button for approximately 3 seconds. The hazard indicator flashers illuminate for approximately 3 seconds and the engine starts.

The following events will occur when the engine starts:

- The doors will be locked and the air conditioner system may turn on.
- The engine will continue to run for about 5 minutes. It is possible to extend the time for an additional 5 minutes. See "Extending engine run time" (P.3-13).

## EXTENDING ENGINE RUN TIME

The remote engine start function can be extended one time by pushing the "REMOTE ENGINE START"  button again. (The hazard indicator flashers illuminate for 3 seconds when the engine run time is extended.) Run time will be calculated as follows:

- The first 5-minute run time will start when the remote engine start function is performed.
- The second 5 minutes will start immediately when the remote engine start function is performed. (The "REMOTE ENGINE START"  button needs to be pushed before the first 5 minutes pass.) For example, if the engine has been running for 4 minutes, and 5 minutes are added, the engine will run for a total of 10 minutes.
- Extending engine run time will count towards the two remote engine start limit.

## CANCELING A REMOTE ENGINE START





The remote engine start will be canceled when the doors are unlocked by pushing the "UNLOCK"  button.

## CONDITIONS THE REMOTE ENGINE START WILL NOT WORK

The remote engine start will not operate if any of the following conditions are present:

- The ignition switch is placed in the "ON" position.
- The hood is not securely closed.
- The hazard indicator flashers are on.
- The engine is still running. The engine must be completely stopped before next engine start by remote engine start. This is not applicable when extending engine run time.

## HOOD

- The "REMOTE ENGINE START"  button is not pushed and held for at least 3 seconds.
- The "REMOTE ENGINE START"  button is not pushed and held within 2 seconds of pushing the "LOCK"  button.
- The doors are not closed and locked.
- The back door is open.
- The Intelligent Key system is malfunctioning.
- An Intelligent Key is inserted in the Intelligent Key port.
- The theft alarm (if equipped) sounds due to illegal entry into the vehicle.
- The shift lever is not in the "P" (Park) position (for CVT model).
- The shift lever is not in the "N" (Neutral) position (for MT model).
- Under extreme weather condition.
- The service indicator light  or the STOP indicator light  illuminates.



### WARNING:

- **The hood must be closed and latched securely before driving. Failure to do so could cause the hood to fly open and result in an accident.**
- **Never open the hood if steam or smoke is coming from the engine compartment to avoid injury.**

## OPENING HOOD

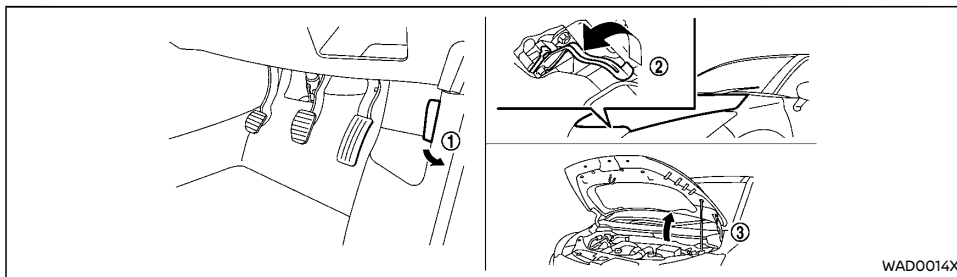

1. Pull the hood lock release handle ① located below the instrument panel until the hood springs up.
2. Locate the lever ② in between the hood and grille and push the lever sideways with your fingertips.
3. Raise the hood ③.
4. Remove the support rod and insert it into the slot.

**Hold the coated parts when removing or resetting the support rod. Avoid direct contact with the metal parts, as they may be hot immediately after the engine has been stopped.**

## CLOSING HOOD

1. While supporting the hood, return the support rod to its original position.
2. Slowly lower the hood to about 20 to 30 cm (8 to 12 in) above the hood lock, then let it drop.
3. Make sure it is securely latched.

## BACK DOOR

### WARNING:

- Make sure the back door has been closed securely to prevent it from opening while driving.
- Do not drive with the back door open. This could allow dangerous exhaust gases to be drawn into the vehicle.

### CAUTION:

- Before opening the back door, be sure to clear away snow, ice or dust that may be stuck to the back door. If the back door is opened while materials are still stuck to it, it may suddenly close again due to the weight of these materials.
- Always be sure to fully open the back door. If it is not fully opened, it may suddenly shut.
- Be especially careful when opening the back door in strong wind. The door could be caught by a gust of wind and may close suddenly.

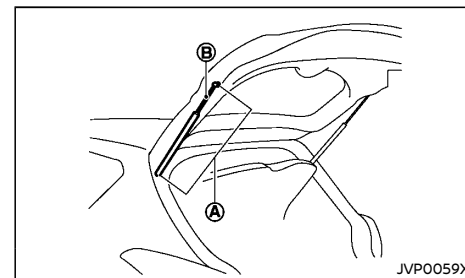

**CAUTION:**

- The back door gas stays **A** are installed in order to support the weight of the back door. In order to prevent the gas stays being damaged or not operating properly, be sure to observe the following points.
  - Do not insert hands or cords into the gas stays **A** or apply any force to them laterally.
  - Do not attach any adhesive foreign materials such as pieces of plastic or stickers to the rod **B** portion.
- Do not close the back door while holding the gas stays or hang anything on them. Doing so may lead to hands or arms becoming trapped in the back door and could result in an injury.

**OPENING BACK DOOR**

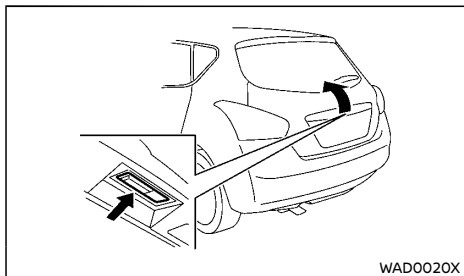

To open the back door, unlock it with one of the following operations, then pull the handle.

- Push the back door opener switch (if equipped). (See "Intelligent Key system" (P.3-5).)

- Push the "UNLOCK" button on the Intelligent Key (if equipped). (See "Intelligent Key system" (P.3-5).)
- Push the "UNLOCK" button on the remote controller (if equipped). (See "Remote keyless entry system" (P.3-4).)
- Push the power door lock switch to unlock all doors.

**CLOSING BACK DOOR**

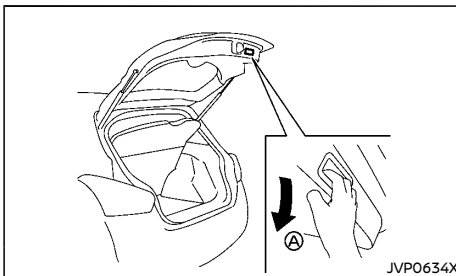

**WARNING:**

- Do not shut the back door with one hand and the other hand remaining on the back door or vehicle body. Doing so may lead to your hand becoming trapped and could result in an injury.
- When closing the back door, do not place your hands near the edge of the back door. Always be sure to close the back door from the outside.
- After closing the back door, be sure to check that it has been closed securely. If the back door opens while the vehicle is being driven, this could result in a serious accident.

To close the back door, hold the grip **A** to pull down the back door and then push it down securely.

**BACK DOOR RELEASE LEVER**

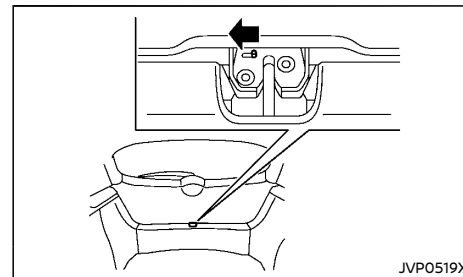

If the back door cannot be unlocked due to a discharged battery, follow these steps.

1. Fold the rear seats down. (See "Rear seats" (P.1-3).)
2. Move the release lever to the left as illustrated to open the back door.

Contact a NISSAN dealer as soon as possible for repair.



## FUEL-FILLER LID



### WARNING:

- Fuel is extremely flammable and highly explosive under certain conditions. You could be burned or seriously injured if it is misused or mishandled. Always stop the engine and do not smoke or allow open flames or sparks near the vehicle when refueling.
- Fuel may be under pressure. Turn the cap a half of a turn, and wait for any “hissing” sound to stop to prevent fuel from spraying out and possibly causing personal injury. Then remove the cap.
- Do not attempt to fill the fuel tank more than twice after the fuel pump nozzle shuts off automatically. Continued refueling may cause fuel overflow, resulting in fuel spray and possible a fire.
- Use only an original equipment type fuel-filler cap as a replacement. It has a built-in safety valve needed for proper operation of the fuel system and emission control system. An incorrect cap can result in a serious malfunction and possible injury.

### OPENING FUEL-FILLER LID

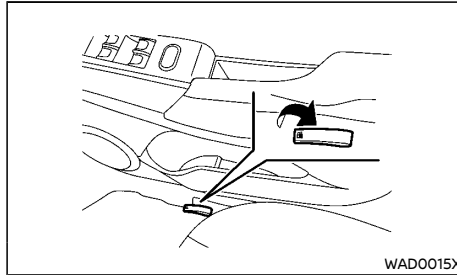

To open the fuel-filler lid, pull the fuel-filler lid opener lever.

### FUEL-FILLER CAP

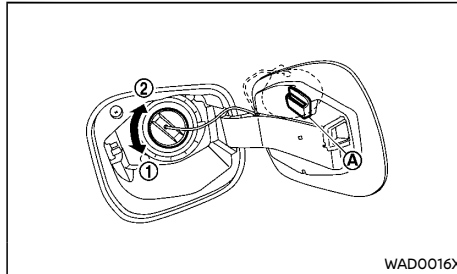

Turn the fuel-filler cap counterclockwise ① to remove. To tighten, turn the fuel-filler cap clockwise ②.

Put the fuel-filler cap on the cap holder ① while refueling.

### NOTE:

For models with Stop/Start System:

Stop the engine with the ignition switch while refueling.



### CAUTION:

If fuel is spilled on the vehicle body, flush it away with water to avoid paint damage.

## STEERING WHEEL

### WARNING:

Never adjust the steering wheel while driving so that full attention may be given to vehicle operation.

### TILT OPERATION

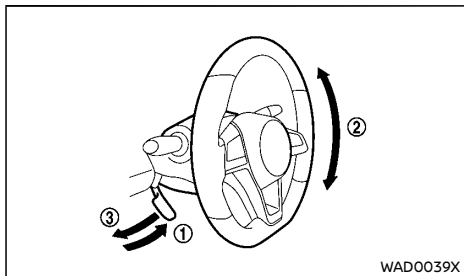

While pulling the lock lever up ①, adjust the steering wheel up or down ② until the desired position is achieved.

Push the lock lever down ③ firmly to lock the steering wheel in place.

## MIRRORS

### WARNING:

Adjust the position of all mirrors before driving. Do not adjust the mirror positions while driving so that full attention may be given to vehicle operation.

### INSIDE REARVIEW MIRROR

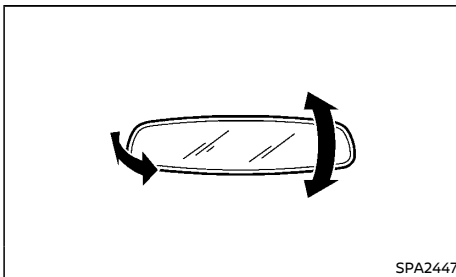

While holding the inside rearview mirror, adjust the mirror angles until the desired position is achieved.

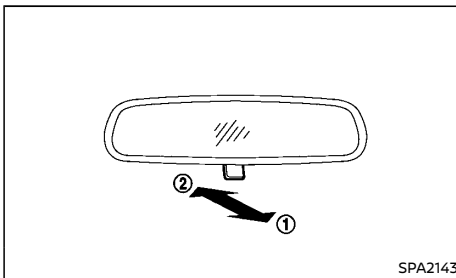

Pull the adjusting lever ① when the glare from the headlights of the vehicle behind you obstructs your vision at night.

Push the adjusting lever ② during the day for the best rearward visibility.

### OUTSIDE REARVIEW MIRRORS

#### WARNING:

- Never touch the outside rearview mirrors while they are in motion. Doing so may pinch your fingers or damage the mirror.
- Never drive the vehicle with the outside rearview mirrors folded. This reduces rear view visibility and may lead to an accident.
- Objects viewed in the outside mirror are closer than they appear (if equipped).
- The picture dimensions and distance in the outside mirrors are not real.

### Adjusting

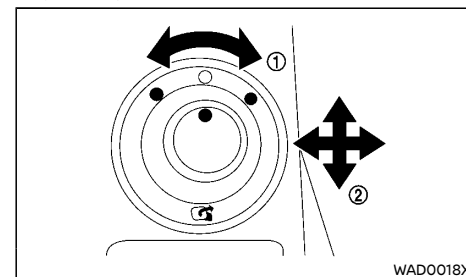

The outside rearview mirror remote control, located on the driver's door armrest, can be operated when the ignition switch is in the "ON" position.

1. Move the switch to select the right or left mirror ①.

- Adjust each mirror until the desired position is achieved ②.

## Folding

### Remote control type (if equipped):

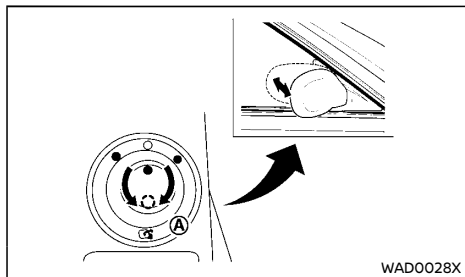

The outside rearview mirror remote control operates when the ignition switch is in the "ON" position.

The outside rearview mirrors automatically fold when the outside rearview mirror folding switch is turned to the ① position. To unfold, turn the switch from ① position to another position.

### CAUTION:

- Continuously performing the fold/unfold operation of the outside rearview mirror may cause the switch to stop the operation.
- Do not touch the mirrors while they are moving. Your hand may be pinched, and the mirror may malfunction.
- Do not drive with the mirrors stored. You will be unable to see behind the vehicle.
- If the mirrors were folded or unfolded by hand, there is a chance that the mirror

will move forward or backward during driving. If the mirrors were folded or unfolded by hand, be sure to adjust them again electrically before driving.

### Manual control type (if equipped):

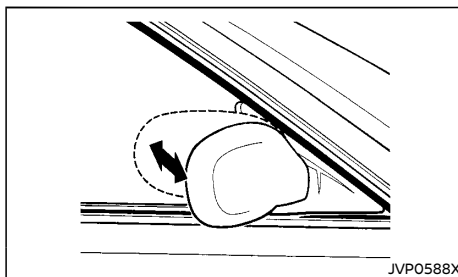

Fold the outside rearview mirror by pushing it toward the rear of the vehicle.

Unfold the outside rearview mirror by pushing it towards the front of the vehicle.

## VANITY MIRROR

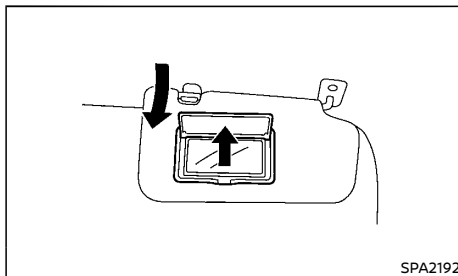

To use the front vanity mirror, pull down the sun visor and pull up the cover.

## PARKING BRAKE

### WARNING:

- Never drive the vehicle with the parking brake applied. The brake will overheat and fail to operate and will lead to an accident.
- Never release the parking brake from outside the vehicle. If the vehicle moves, it will be impossible to push the foot brake pedal and will lead to an accident.
- Never use the shift lever in place of the parking brake. When parking, be sure the parking brake is fully applied.
- To help avoid risk of injury or death through unintended operation of the vehicle and/or its systems, do not leave children, people who require the assistance of others or pets unattended in your vehicle. Additionally, the temperature inside a closed vehicle on a warm day can quickly become high enough to cause a significant risk of injury or death to people and pets.

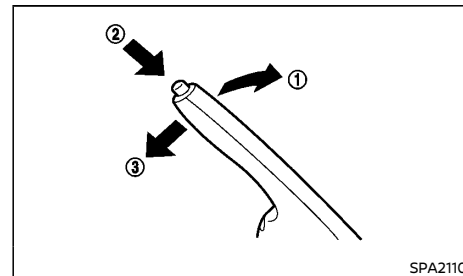

To apply the parking brake, pull the parking brake lever up ①.

To release the parking brake, firmly depress

and hold the foot brake pedal. Pull up the parking brake lever slightly, push the button ② and lower the lever completely ③.

Before driving, be sure that the brake warning light has turned off.

# 4 Monitor, heater and air conditioner, and audio system

NissanConnect Owner's Manual (if equipped) .....	4-2	Side ventilators .....	4-14
Safety precautions .....	4-2	Rear ventilators .....	4-14
Rear view monitor (if equipped) .....	4-3	Heater and air conditioner .....	4-14
Rear view monitor system operation .....	4-3	Operating tips .....	4-15
How to read the displayed lines .....	4-4	Automatic air conditioner and heater .....	4-16
Difference between predictive and actual distances .....	4-4	Servicing air conditioner .....	4-17
Adjusting the screen .....	4-5	Audio system (if equipped) .....	4-17
Rear view monitor system limitations .....	4-6	Audio operation precautions .....	4-17
System maintenance .....	4-6	Antenna .....	4-23
Around View Monitor (if equipped) .....	4-7	FM-AM radio with Compact Disc (CD) player .....	4-23
Around View Monitor system operation .....	4-8	USB (Universal Serial Bus) connection port/AUX (auxiliary) input jack .....	4-28
Difference between predictive and actual distances .....	4-9	CD/USB memory device care and cleaning .....	4-29
How to park with predictive course lines .....	4-11	Car phone or CB radio .....	4-30
How to switch the display .....	4-12	Bluetooth® Hands-Free Phone System (if equipped) .....	4-30
Adjusting the screen .....	4-12	Regulatory information .....	4-31
Around View Monitor system limitations .....	4-12	Control buttons and microphone .....	4-31
System maintenance .....	4-13	Bluetooth® settings .....	4-31
Ventilators .....	4-14	Using the system .....	4-33
Center ventilators .....	4-14		

## NISSANCONNECT OWNER'S MANUAL (if equipped)

For models with NissanConnect System, refer to the NissanConnect Owner's Manual regarding the following information.

- Audio
- Hands-free phone
- Apple CarPlay
- Android Auto
- Voice recognition
- Information and settings viewable on NissanConnect

## SAFETY PRECAUTIONS



### WARNING:

- **Do not adjust the heater and air conditioner controls or audio controls while driving so that full attention may be given to vehicle operation.**
- **If you noticed any foreign objects entering the system hardware, spilled liquid on the system, or noticed smoke or fumes coming out from the system, or any other unusual operation is observed, stop using the system immediately and contact the nearest NISSAN dealer. Ignoring such conditions may lead to an accident, fire or electric shock.**
- **Do not disassemble or modify this system. If you do, it may lead to an accident, fire, or electric shock.**



### CAUTION:

**Do not use the system when the engine is not running for extended periods of time to prevent battery discharge.**

## REAR VIEW MONITOR (if equipped)

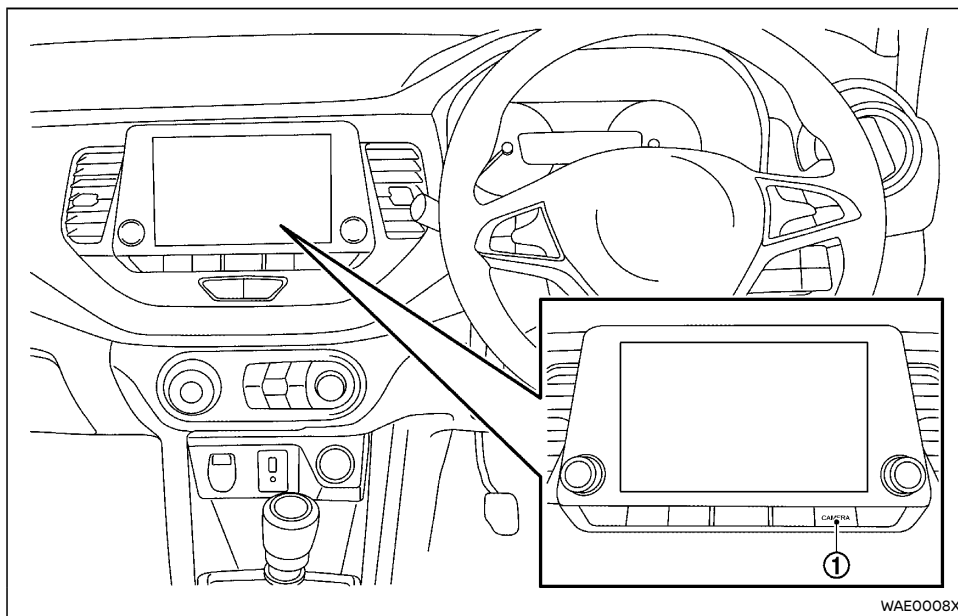

1. CAMERA button



### WARNING:

Failure to follow the warnings and instructions for proper use of the rear view monitor could result in serious injury or death.

- The rear view monitor is a convenience but it is not a substitute for proper backing. Always turn and look out the windows, and check mirrors to be sure that it is safe to move before operating

the vehicle. Always back up slowly.

- The system is designed as an aid to the driver in showing large stationary objects directly behind the vehicle, to help avoid damaging the vehicle.
- The distance guide lines and the vehicle width lines should be used as a reference only when the vehicle is on a level paved surface. The distance viewed on the monitor is for reference only and may be different than the actual distance between the vehicle and displayed ob-

jects.



### CAUTION:

Do not scratch the camera lens when cleaning dirt or snow from the front of the camera.

The rear view monitor system automatically shows a rear view of the vehicle when the shift lever is shifted into the "R" (Reverse) position.

The radio can still be heard while the rear view monitor is active.

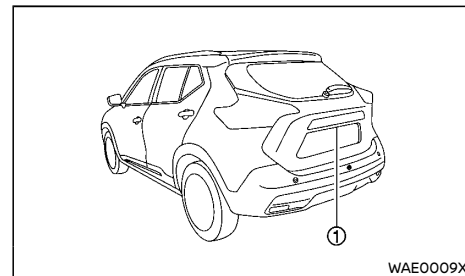

To display the rear view, the rear view monitor system uses a camera ① located just above the vehicle's license plate.

### REAR VIEW MONITOR SYSTEM OPERATION

With the ignition switch in the "ON" position, move the shift lever to the "R" (Reverse) position to operate the rear view monitor.

## HOW TO READ THE DISPLAYED LINES

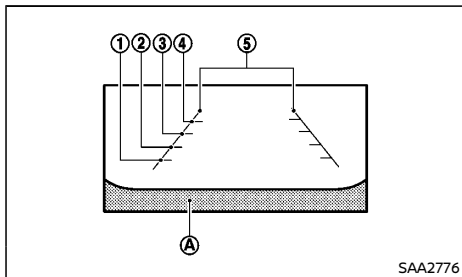

Guiding lines which indicate the vehicle width and distances to objects with reference to the bumper line **A** are displayed on the monitor.

### Distance guide lines:

Indicate distances from the vehicle body.

- Red line ①: approximately 0.5 m (1.5 ft)
- Yellow line ②: approximately 1 m (3 ft)
- Green line ③: approximately 2 m (7 ft)
- Green line ④: approximately 3 m (10 ft)

### Vehicle width guide lines ⑤:

Indicate the vehicle width when backing up.

The vehicle width guide lines are wider than the actual width.

## DIFFERENCE BETWEEN PREDICTIVE AND ACTUAL DISTANCES

The displayed guidelines and their locations on the ground are for approximate reference only. Objects on uphill or downhill surfaces or projecting objects will be actually located at distances different from those displayed in the monitor relative to the guidelines (refer to illustrations). When in doubt, turn around and view the objects as you are backing up, or park

and exit the vehicle to view the positioning of objects behind the vehicle.

## Backing up on a steep uphill

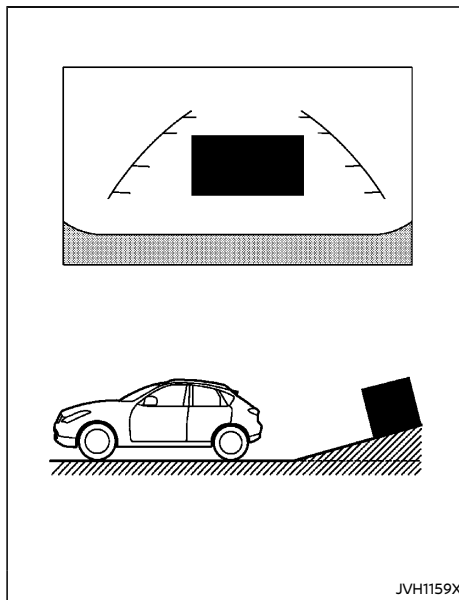

When backing up the vehicle up a hill, the distance guide lines and the vehicle width guide lines are shown closer than the actual distance. Note that any object on steep uphill is farther than it appears on the monitor.

## Backing up on a steep downhill

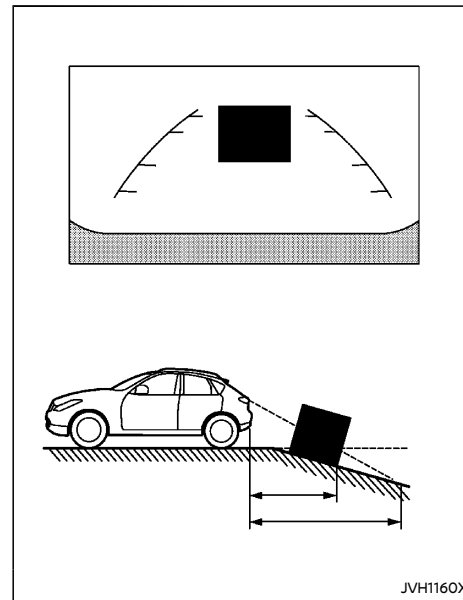

When backing up the vehicle down a hill, the distance guide lines and the vehicle width guide lines are shown farther than the actual distance. Note that any object on steep downhill is closer than it appears on the monitor.



## Backing up near a projecting object

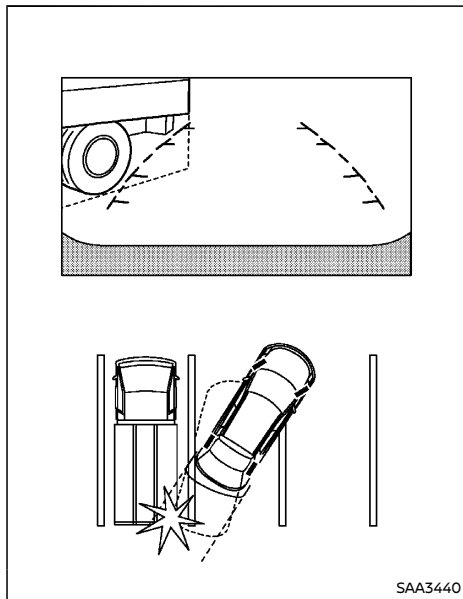

The vehicle may seem to nearly clear the object in the display. However, the vehicle may hit the object if it projects over the actual backing up course.

## Backing up behind a projecting object

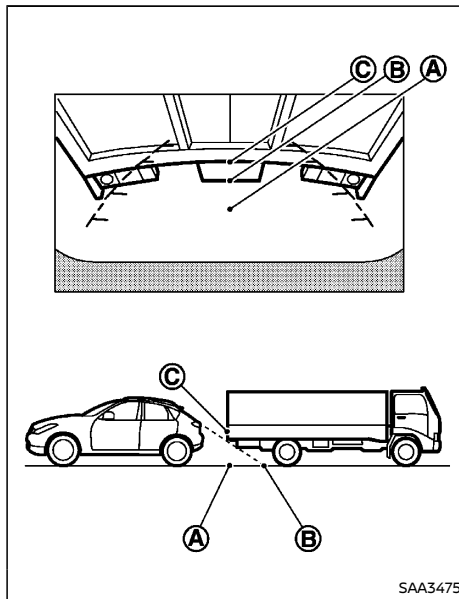

The position © is shown farther than the position © in the display. However, the position © is actually at the same distance as the position ©. The vehicle may hit the object when backing up to the position © if the object projects over the actual backing up course.

## ADJUSTING THE SCREEN

### Operation with touch screen

1. Push the CAMERA button.
2. Select the "Display Settings" key.
3. Select the item you wish to adjust.
  - **Brightness:**  
Adjusts the brightness of the display.
  - **Contrast:**  
Adjusts the level of contrast.
  - **Tint:**  
Adjusts the level of tint.
  - **Colour:**  
Adjusts the level of the color.
  - **Black Level:**  
Adjusts the black level.

### Operation with buttons

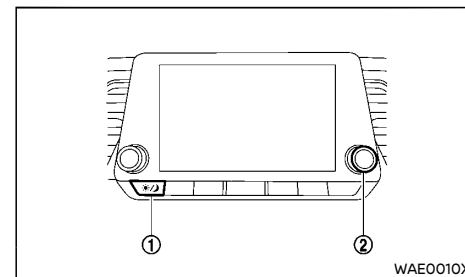

To adjust the screen brightness when the rear view monitor is displayed, push the brightness control/display on-off  button ①.

Adjust brightness to the preferred setting using the TUNE-SCROLL/SOUND dial ②.

## REAR VIEW MONITOR SYSTEM LIMITATIONS



### WARNING:

Listed below are the system limitations for rear view monitor. Failure to operate the vehicle in accordance with these system limitations could result in serious injury or death.

- The system cannot completely eliminate blind spots and may not show every object.
- Underneath the bumper and the corner areas of the bumper cannot be viewed on the rear view monitor because of its monitoring range limitation. The system will not show small objects below the bumper, and may not show objects close to the bumper or on the ground.
- Objects viewed in the rear view monitor differ from actual distance because a wide-angle lens is used.
- Objects in the rear view of the vehicle will appear visually opposite compared to when viewed in the inside rearview mirror, the outside rearview mirrors and the rear view monitor.
- Use the displayed lines as a reference. The lines are highly affected by the number of occupants, fuel level, vehicle position, road conditions and road grade.
- Make sure that the back door is securely closed when backing up.
- Do not put anything on the rear view camera. The rear view camera is installed above the license plate.

- When washing the vehicle with high-pressure water, be sure not to spray it around the camera. Otherwise, water may enter the camera unit causing water condensation on the lens, a malfunction, fire or an electric shock.
- Do not strike the camera. It is a precision instrument. Otherwise, it may malfunction or cause damage resulting in a fire or an electric shock.

The following are operating limitations and do not represent a system malfunction:

- When the temperature is extremely high or low, the screen may not clearly display objects.
- When strong light directly shines on the camera, objects may not be displayed clearly.
- Vertical lines may be seen in objects on the screen. This is due to strong reflected light from the bumper.
- The screen may flicker under fluorescent light.
- The colors of objects on the rear view monitor may differ somewhat from the actual color of objects.
- Objects on the monitor may not be clear in a dark environment.
- There may be a delay when switching to the rear view monitor.
- If dirt, rain or snow accumulates on the camera, the rear view monitor may not display object clearly. Clean the camera.
- Do not use wax on the camera lens. Wipe off any wax with a clean cloth dampened with a diluted mild cleaning agent, then wipe with a dry cloth.

## SYSTEM MAINTENANCE

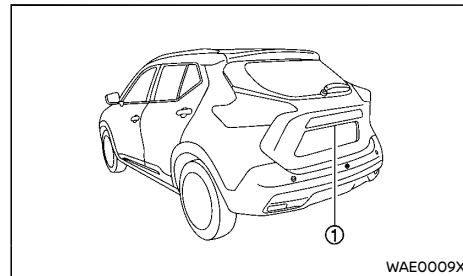

### CAUTION:

- Do not use alcohol, benzine or thinner to clean the camera. This will cause discoloration.
- Do not damage the camera as the monitor screen may be adversely affected.

If dirt, rain or snow accumulates on the camera ①, the rear view monitor may not display objects clearly. Clean the camera by wiping it with a cloth dampened with a diluted mild cleaning agent and then wiping it with a dry cloth.

## AROUND VIEW MONITOR (if equipped)

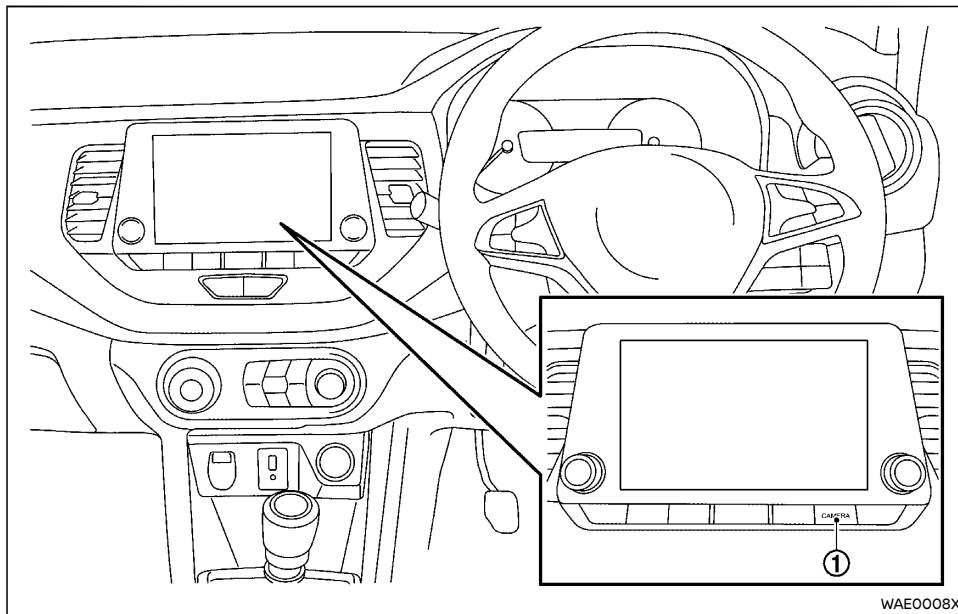

### 1. CAMERA button



#### **WARNING:**

Failure to follow the warnings and instructions for the proper use of the Around View Monitor system could result in serious injury or death.

- The Around View Monitor is a convenient feature but it is not a substitute for proper vehicle operation because it has areas where objects cannot be viewed.

The four corners of the vehicle in particular, are areas where objects do not always appear in the bird's-eye, front, or rear views. Always check your surroundings to be sure that it is safe to move before operating the vehicle. Always operate the vehicle slowly. Always look out the windows and check mirrors to be sure that it is safe to move.

- The driver is always responsible for safety during parking and other maneu-

vers.



#### **CAUTION:**

**Do not scratch the lens when cleaning dirt or snow from the front of the camera.**

The Around View Monitor system is designed as an aid to the driver in situations such as slot parking or parallel parking.

The monitor displays various views of the position of the vehicle in a split screen format. Not all views are available at all times.

#### **Available views:**

- Front view  
The view to the front of the vehicle.
- Rear view  
The view to the rear of the vehicle.
- Bird's-eye view  
The surrounding view of the vehicle from above.
- Front-side view  
The view around and ahead of the front passenger's side wheel.

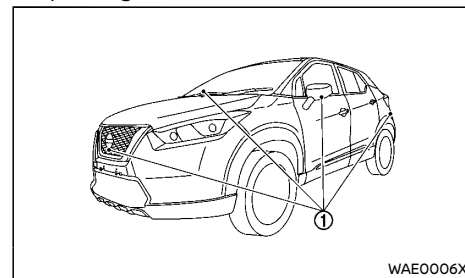

To display the multiple views, the Around View Monitor system uses cameras ① located in the front grill, on the vehicle's outside mirrors and

one just above the vehicle's license plate.

## AROUND VIEW MONITOR SYSTEM OPERATION

With the ignition switch in the "ON" position, move the shift lever to the "R" (Reverse) position or push the CAMERA button to operate the Around View Monitor.

When the camera is first activated with the bird's-eye view in the display, a red icon will flash on the screen.

The screen displayed on the Around View Monitor will automatically return to the previous screen 3 minutes after the CAMERA button has been pushed with the shift lever in a position other than the "R" (Reverse) position.

### Available views



#### WARNING:

- The distance guide lines and the vehicle width guide line should be used as a reference only when the vehicle is on a paved, level surface. The distance viewed on the monitor is for reference only and may be different than the actual distance between the vehicle and displayed objects.
- Use the displayed lines and the bird's-eye view as a reference. The lines and the bird's-eye view are greatly affected by the number of occupants, fuel level, vehicle position, road condition and road grade.
- If the tires are replaced with different sized tires, the predictive course line and the bird's-eye view may be displayed incorrectly.

- When driving the vehicle up a hill, objects viewed in the monitor are further than they appear. When driving the vehicle down a hill, objects viewed in the monitor are closer than they appear.
- Objects in the rear view of the vehicle will appear visually opposite compared to when viewed in the inside rearview mirror, the outside rearview mirrors and the Around View Monitor.
- Use the mirrors or actually look to properly judge distances to other objects.
- On a snow-covered or slippery road, there may be a difference between the predictive course line and the actual course line.
- The vehicle width and predictive course lines are wider than the actual width and course.
- The displayed lines on the rear view will appear slightly off to the right because the rear view camera is not installed in the rear center of the vehicle.

### Front and rear view:

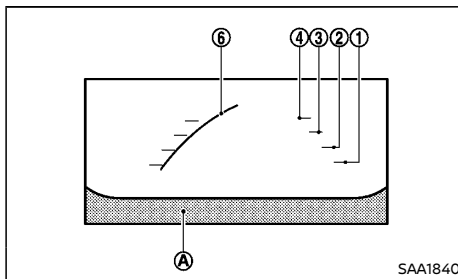

Front view

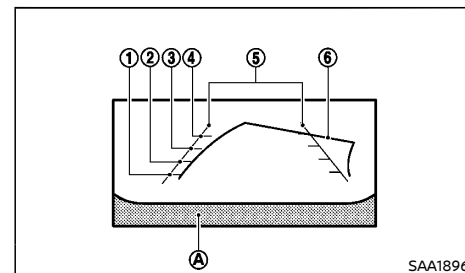

SAA1896

Rear view

Guiding lines that indicate the approximate vehicle width and distances to objects with reference to the vehicle body line (A), are displayed on the monitor.

#### Distance guide lines:

Indicate distances from the vehicle body.

- Red line ①: approximately 0.5 m (1.5 ft)
- Yellow line ②: approximately 1 m (3 ft)
- Green line ③: approximately 2 m (7 ft)
- Green line ④: approximately 3 m (10 ft)

#### Vehicle width guide lines ⑤:

Indicate the vehicle width when backing up.

The vehicle width guide lines are wider than the actual width.

#### Predictive course lines ⑥:

Indicate the predictive course when operating the vehicle. The predictive course lines will be displayed on the monitor when the steering wheel is turned. The predictive course lines will move depending on how much the steering wheel is turned. The predictive course lines in the rear view will not be displayed while the steering wheel is in the straight ahead position.

The Around View Monitor screen will not be displayed when the vehicle speed is above 10

km/h (6 MPH).

**NOTE:**

**When the monitor displays the front view and the steering wheel turns about 90 degrees or less from the straight ahead position, both the right and left predictive course lines ⑥ are displayed. When the steering wheel turns about 90 degrees or more, a line is displayed only on the opposite side of the turn.**

**Bird's-eye view:**

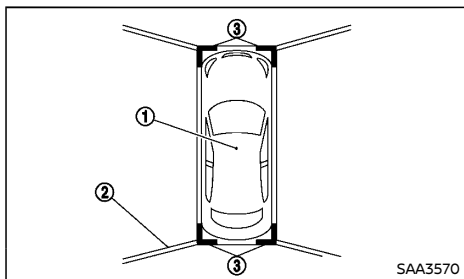

The bird's-eye view shows the overhead view of the vehicle which helps confirm the vehicle position and the predictive course to a parking space.

The vehicle icon ① shows the position of the vehicle. Note that the distance between objects viewed in the bird's-eye view may differ somewhat from the actual distance to the vehicle.

The areas that the cameras cannot cover ② are indicated in black.

The non-viewable area ② is highlighted in yellow for several seconds after the bird's eye view is displayed. It will be shown only the first time after the ignition switch is placed in the "ON" position.

After the ignition switch is placed in the "ON" position, the non-viewable corners ③ will be displayed in red (blink for the first few seconds) to remind the driver to be cautious.



**WARNING:**

- **Objects in the bird's-eye view will appear further than the actual distance.**
- **Tall objects, such as a curb or vehicle, may be misaligned or not displayed at the seam of the views.**
- **Objects that are above the camera cannot be displayed.**
- **The view for the bird's-eye view may be misaligned when the camera position alters.**
- **A line on the ground may be misaligned and is not seen as being straight at the seam of the views. The misalignment will increase as the line proceeds away from the vehicle.**

**Front-side view:**

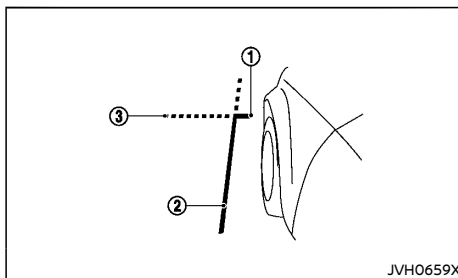

**Guiding lines:**

Guiding lines that indicate the approximate width and the front end of the vehicle are displayed on the monitor.

The front-of-vehicle line ① shows the front part of the vehicle.

The side-of-vehicle line ② shows the approximate vehicle width including the outside mirrors.

The extensions ③ of both the front ① and side ② lines are shown with a green dotted line.

**DIFFERENCE BETWEEN PREDICTIVE AND ACTUAL DISTANCES**

The displayed guidelines and their locations on the ground are for approximate reference only. Objects on uphill or downhill surfaces or projecting objects will be actually located at distances different from those displayed in the monitor relative to the guidelines (refer to illustrations). When in doubt, turn around and view the objects as you are backing up, or park and exit the vehicle to view the positioning of objects behind the vehicle.

### Backing up on a steep uphill

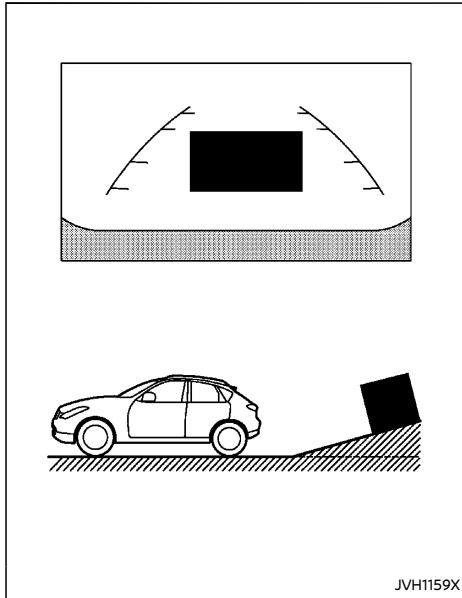

When backing up the vehicle up a hill, the distance guide lines and the vehicle width guide lines are shown closer than the actual distance. Note that any object on steep uphill is farther than it appears on the monitor.

### Backing up on a steep downhill

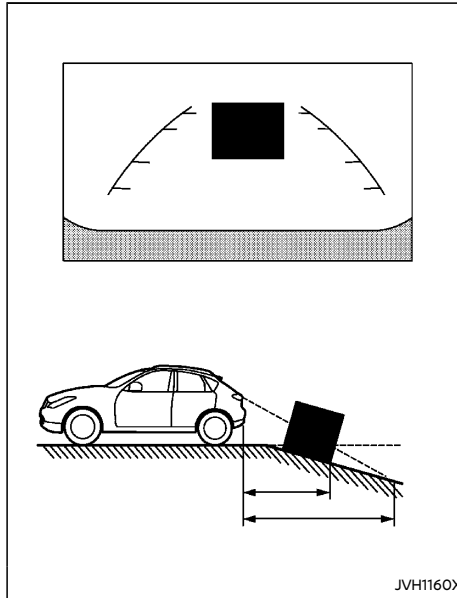

When backing up the vehicle down a hill, the distance guide lines and the vehicle width guide lines are shown farther than the actual distance. Note that any object on steep downhill is closer than it appears on the monitor.

### Backing up near a projecting object

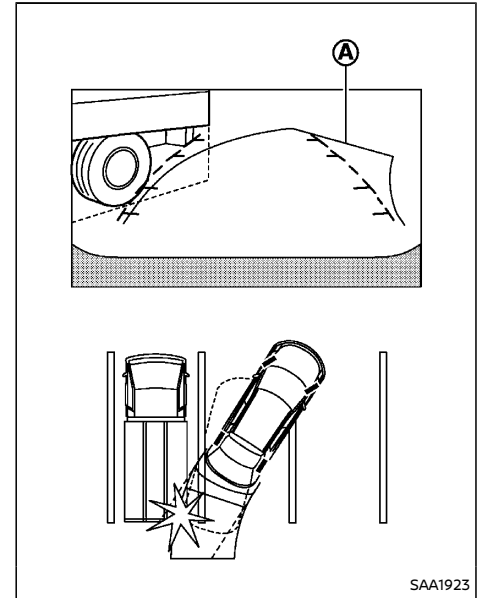

The predictive course lines **A** do not touch the object in the display. However, the vehicle may hit the object if it projects over the actual backing up course.

## Backing up behind a projecting object

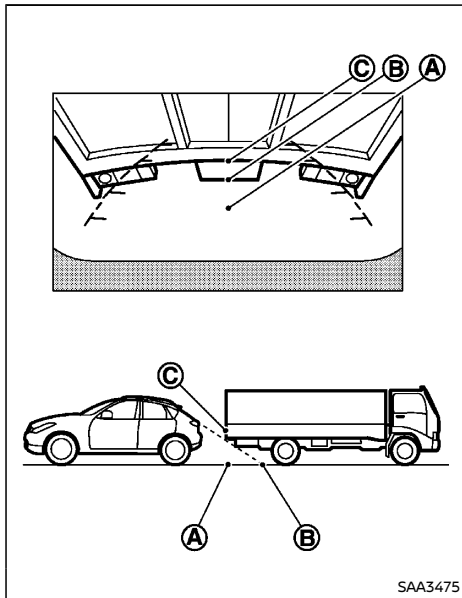

The position ③ is shown farther than the position ② in the display. However, the position ③ is actually at the same distance as the position ①. The vehicle may hit the object when backing up to the position ① if the object projects over the actual backing up course.

## HOW TO PARK WITH PREDICTIVE COURSE LINES

### ⚠ WARNING:

- If the tires are replaced with different sized tires, the predictive course lines may be displayed incorrectly.
- On a snow-covered or slippery road, there may be a difference between the predictive course line and the actual course line.

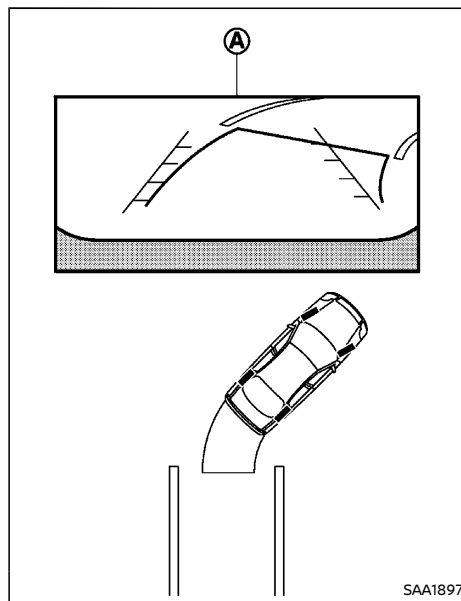

1. Visually check that the parking space is safe before parking your vehicle.
2. The rear view of the vehicle is displayed on the screen ① when the shift lever is moved to the "R" (Reverse) position.

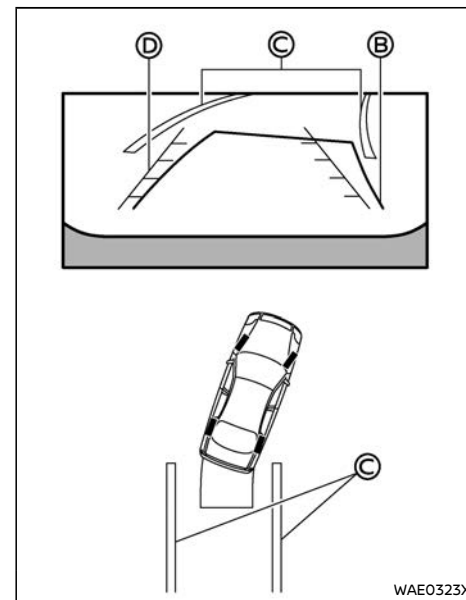

3. Slowly back up the vehicle adjusting the steering wheel so that the predictive course lines ② enter the parking space ③.
4. Maneuver the steering wheel to make the vehicle width guide lines ④ parallel to the parking space ③ while referring to the predictive course lines.

- When the vehicle is located in the space completely, park the vehicle in the correct procedure.

## HOW TO SWITCH THE DISPLAY

With the ignition switch in the "ON" position, push the CAMERA button or move the shift lever to the "R" (Reverse) position to operate the Around View Monitor.

The Around View Monitor displays different split screen views depending on the position of the shift lever. Push the CAMERA button to switch between the available views.

If the shift lever is in the "R" (Reverse) position, the available views are:

- Rear view/bird's-eye view split screen
- Rear view/front-side view split screen

If the shift lever is not in the "R" (Reverse) position, the available views are:

- Front view/bird's-eye view split screen
- Front view/front-side view split screen

The display will switch from the Around View Monitor screen when:

- The shift lever is out of the "R" (Reverse) position and the vehicle speed increases above approximately 10 km/h (6 MPH).
- A different screen is selected (when the shift lever is not in the "R" (Reverse) position).

## ADJUSTING THE SCREEN

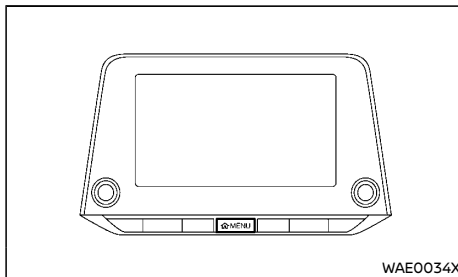

1. Push the MENU button and touch the "Settings" key.
2. Touch the "Camera" key and then touch the "Display Settings" key.
3. Touch the "Brightness", "Contrast", "Tint", "Colour" or "Black Level" key.
4. Adjust the item by touching the "+" or "-" key on the touch screen display.

### NOTE:

**Do not adjust any of the display settings of the Around View Monitor while the vehicle is moving. Make sure the parking brake is firmly applied.**

## AROUND VIEW MONITOR SYSTEM LIMITATIONS

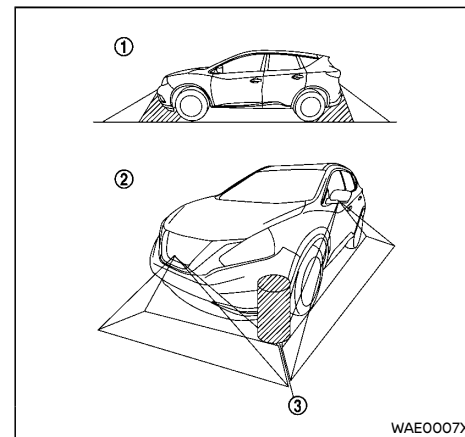

### WARNING:

Listed below are the system limitations for Around View Monitor. Failure to operate the vehicle in accordance with these system limitations could result in serious injury or death.

- Do not use the Around View Monitor with the outside mirrors in the stored position, and make sure that the back door is securely closed when operating the vehicle using the Around View Monitor.
- The apparent distance between objects viewed on the Around View Monitor differs from the actual distance.



- The cameras are installed on the front grille, the outside mirrors and above the rear license plate. Do not put anything on the vehicle that covers the cameras.
- When washing the vehicle with high pressure water, be sure not to spray it around the cameras. Otherwise, water may enter the camera unit causing water condensation on the lens, a malfunction, fire or an electric shock.
- Do not strike the cameras. They are precision instruments. Doing so could cause a malfunction or cause damage resulting in a fire or an electric shock.

There are some areas where the system will not show objects. When in the front or rear view display, an object below the bumper or on the ground may not be viewed ①. When in the bird's-eye view, a tall object near the seam ③ of the camera viewing areas will not appear in the monitor ②.

The following are operating limitations and do not represent a system malfunction:

- There may be a delay when switching between views.
- When the temperature is extremely high or low, the screen may not display objects clearly.
- When strong light directly shines on the camera, objects may not be displayed clearly.
- The screen may flicker under fluorescent light.
- The colors of objects on the Around View Monitor may differ somewhat from the actual color of objects.
- Objects on the Around View Monitor may not be clear and the color of the object may differ in a dark environment.

- There may be differences in sharpness between each camera view of the bird's-eye view.
- Do not use wax on the camera lens. Wipe off any wax with a clean cloth that has been dampened with a diluted mild cleaning agent, then wipe with a dry cloth.

### System temporarily unavailable

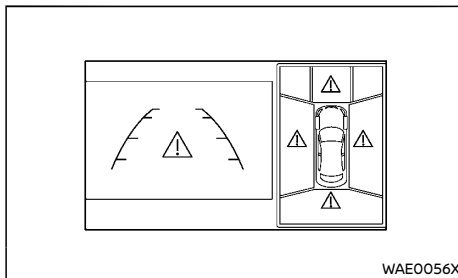

When the "▲" icon is displayed on the screen, there will be abnormal conditions in the Around View Monitor. This will not hinder normal driving operation but the system should be inspected. It is recommended you visit a NISSAN dealer.

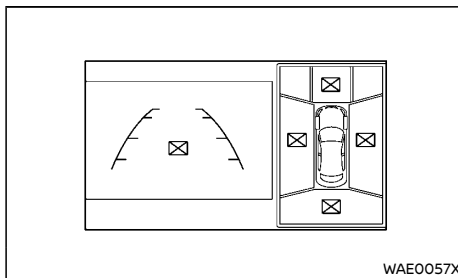

When the "☒" icon is displayed on the screen, the camera image may be receiving temporary electronic disturbances from surrounding devices. This will not hinder normal driving operation but the system should be inspected. It is recommended you visit a NISSAN dealer.

### SYSTEM MAINTENANCE

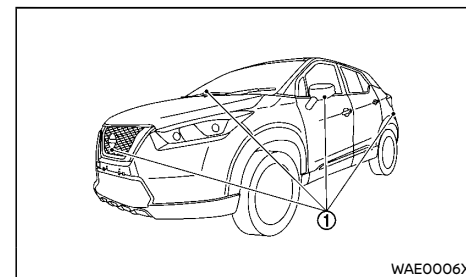

### CAUTION:

- Do not use alcohol, benzene or thinner to clean the camera. This will cause discoloration.
- Do not damage the camera as the monitor screen may be adversely affected.

If dirt, rain or snow accumulates on any of the cameras ①, the Around View Monitor may not display objects clearly. Clean the camera by wiping with a cloth dampened with a diluted mild cleaning agent and then wiping with a dry cloth.

## VENTILATORS

### CENTER VENTILATORS

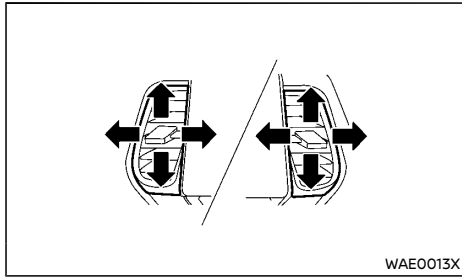

Adjust the air flow direction of the ventilators by moving the center knob (up/down, left/right) until the preferred position is achieved.

### SIDE VENTILATORS

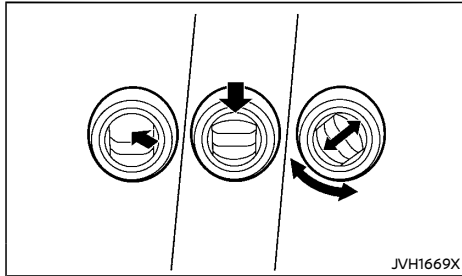

Open or close the ventilators, and adjust the air flow direction as illustrated.

### REAR VENTILATORS

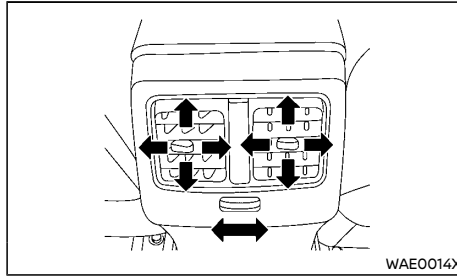

The air blows from the rear ventilators only when the automatic air conditioner is operating in the cooling mode.

Open/close the ventilators by moving the control to either direction.

- ☰ : This symbol indicates that the ventilators are open. Moving the control to this direction will open the ventilators.
- ☒ : This symbol indicates that the ventilators are closed. Moving the control to this direction will close the ventilators.

Adjust the air flow direction of the ventilators by moving the center knob (up/down, left/right) until the desired position is achieved.

## HEATER AND AIR CONDITIONER

### WARNING:

- The heater and air conditioner operate only when the engine is running.
- Children or adults who would normally require supervision should never be left alone in the vehicle. Pets should not be left alone either. They could unknowingly activate switches or controls and inadvertently become involved in a serious accident and injure themselves. On hot, sunny days, temperatures in a closed vehicle could quickly become high enough to cause severe or possibly fatal injuries to people or animals.
- Do not use the recirculation mode for long periods as it may cause the interior air to become stale and the windows to fog up.
- Do not adjust the heating and air conditioning controls while driving so that full attention may be given to vehicle operation.

The heater and air conditioner operate when the engine is running. The air blower will operate even if the engine is turned off and the ignition switch is in the "ON" position.

### NOTE:

- Odors from inside and outside the vehicle can build up in the air conditioner unit. Odor can enter the passenger compartment through the ventilators.
- When parking, set the cooler and air conditioner controls to turn off air recirculation to allow fresh air into the passenger compartment. This should help reduce odors inside the vehicle.

### For models with Stop/Start System:

While the engine is stopped by the Stop/Start System, switching the airflow to the front defogger will cause the engine to automatically restart.

While the engine is running, selecting airflow to the front defogger will prevent the Stop/Start System from automatically stopping the engine.

When the engine is stopped by the Stop/Start System, heater and air conditioner performance may be reduced. To keep full heater and air conditioner performance, restart the engine by pushing the Stop/Start OFF switch, or by placing the ignition switch in the "ON" position. For more details see "Stop/Start System" (P.5-13).

### OPERATING TIPS

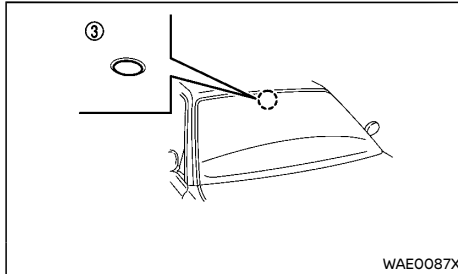
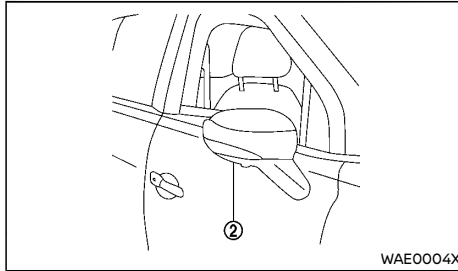
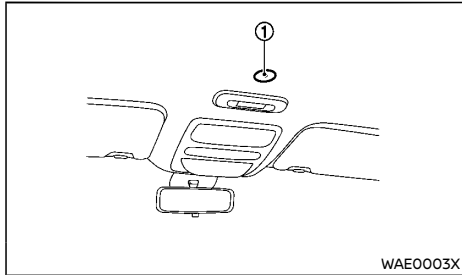

When the engine coolant temperature and outside air temperature are low, the air flow from the foot outlets may not operate. However, this is not a malfunction. After the coolant temperature warms up, the air flow from the foot outlets will operate normally.

The sensors ①, ② and ③ (if equipped) help maintain a constant temperature. Do not cover the sensors or put anything on or around the sensors.

## AUTOMATIC AIR CONDITIONER AND HEATER

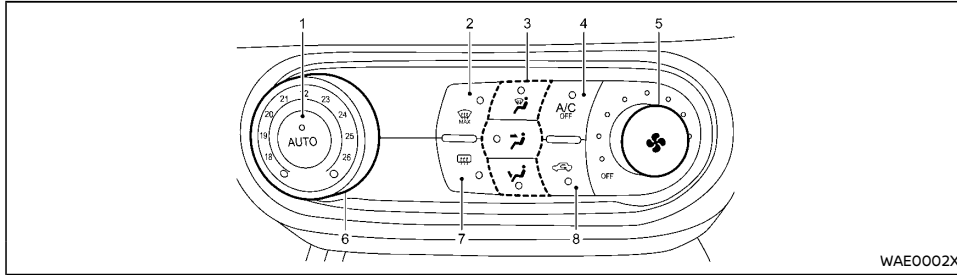

1. "AUTO" button
2. Front defogger "MAX" button
3. Air flow control buttons
4. "A/C OFF" button
5. Fan speed control " " dial
6. Temperature control dial
7. Rear defogger " " button (See "Defogger switch" (P.2-19).)
8. Air recirculation " " button

For models with Stop/Start System:

The Stop/Start System will not activate when the front defogger is turned on.

### Turning system on/off

To turn on the system, turn the fan speed control dial out of the OFF position. Turn the fan speed control dial counterclockwise to the OFF position to turn off the system.

### Automatic operation (AUTO)

The AUTO mode may be used year-round as the system automatically controls the air conditioner to a constant temperature, air flow distribution and fan speed after the desired temperature is set manually.

### Cooling and dehumidified heating:

1. Push the "AUTO" button (the indicator light will turn on).
2. Turn the temperature control dial to set the desired temperature.

A visible mist may be seen coming from the ventilators in hot, humid conditions as the air is cooled rapidly. This does not indicate a malfunction.

### MAX defogging/defrosting:

Push the front defogger "MAX" button to turn on the MAX defogging/defrosting mode and quickly defog/defrost the windshield. When this mode is turned on, the fan will be at its maximum speed, the "A/C OFF" indicator light will turn off or stays off, and the air circulation will be fixed at the outside air circulation mode.

Do not set the temperature too low when the front defogger mode is on (the "MAX" indicator light is illuminated), because doing so may fog up the windshield.

### Manual operation

The manual mode can be used to control the heater and air conditioner to your desired settings.

### Fan speed control:

Turn the fan speed control dial.

### Air flow control:

Push one of the air flow control buttons to select the air flow outlets. More than one air flow control button can be selected at a time.

- Air flows mainly from the front defogger outlets.
- Air flows mainly from the center and side ventilators.
- Air flows mainly from the foot outlets.

### Temperature control:

Turn the temperature control dial to set the desired temperature.

### Air intake control:

The air intake control mode will change each time the air recirculation " " button is pushed.

- When the indicator light is turned on, the air recirculates inside the vehicle.
- When the indicator light is turned off, the air flow is drawn from outside the vehicle.

**NOTE:**

Even if the system is manually set to the air recirculation mode, when outside temperature and coolant temperature are both low, the system may automatically switch to the outside air circulation mode.

**SERVICING AIR CONDITIONER****WARNING:**

The air conditioner system contains refrigerant under high pressure. To avoid personal injury, any air conditioner service should be done only by an experienced technician with the proper equipment.

The air conditioner system in your vehicle is charged with a refrigerant designed with the environment in mind.

**This refrigerant will not harm the earth's ozone layer.** However, it may contribute in a small part to global warming.

Special charging equipment and lubricant are required when servicing your vehicle's air conditioner. Using improper refrigerants or lubricants will cause severe damage to the air conditioner system. See "Air conditioner system refrigerant and lubricant" (P.9-4).

A NISSAN dealer will be able to service your environmentally friendly air conditioner system.

**Air conditioner filter**

The air conditioner system is equipped with an air conditioner filter. To make sure the air conditioner heats defogs and ventilates efficiently, replace the filter in accordance with the specified maintenance intervals listed in the separate maintenance booklet. To replace the filter, contact a NISSAN dealer.

The filter should be replaced if the air flow

decreases significantly or if windows fog up easily when operating the heater or air conditioner.

**AUDIO SYSTEM (if equipped)****AUDIO OPERATION PRECAUTIONS****WARNING:**

**Do not adjust the audio system while driving so that full attention may be given to vehicle operation.**

**Radio**

- Radio reception is affected by station signal strength, distance from radio transmitters, buildings, bridges, mountains and other external influences. Intermittent changes in reception quality normally are caused by these external influences.
- Using a cellular phone in or near the vehicle may influence radio reception quality.

**Compact Disc (CD) player**

- During cold weather or rainy days, the player may malfunction due to the humidity. If this occurs, remove the CD from CD player and dehumidify or ventilate the player completely.
- The player may skip while driving on rough roads.
- The CD player sometimes may not function when the passenger compartment temperature is extremely high. Lower the temperature before use.
- Do not expose the CD to direct sunlight.
- CDs that are of poor quality, or are dirty, scratched, covered with fingerprints, or that have pin holes may not work properly.
- The following CDs may not work properly.
  - Copy control compact discs (CCCD)
  - Recordable compact discs (CD-R)

– Rewritable compact discs (CD-RW)

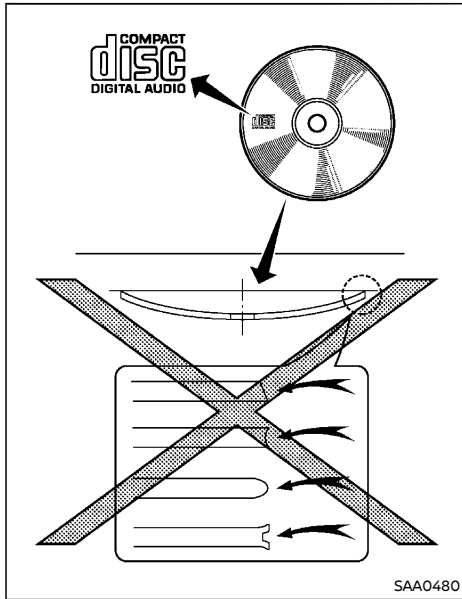

- Do not use the following CDs as they may cause the CD player to malfunction.
  - 8 cm (3.1 in) discs
  - CDs that are not round
  - CDs with a paper label
  - CDs that are warped, scratched or have unusual edges
  - CD lens cleaner discs
- This audio system can only play prerecorded CDs. It has no capabilities to record or burn CDs.

- If the CD cannot be played, one of the following messages will be displayed.

**Check disc/CHK CD/CD ERROR Check Disk:**

- Confirm that the CD is inserted correctly (the label side is facing up, etc.).
- Confirm that the CD is not bent or warped and it is free of scratches.
- Confirm that the disc is a CD and not a DVD.
- Confirm that the disc contains audio files.

**Push eject/Eject CD/CD Ejecting...:**

This is a malfunction due to the temperature inside the player is too high. Remove the CD by pushing the EJECT button, and after a short time reinsert the CD. The CD can be played when the temperature of the player returns to normal.

**Unplayable:**

The file is unplayable in this audio system (only MP3/WMA/AAC CD).

USB (Universal Serial Bus) connection port



**WARNING:**

**Do not connect, disconnect or operate the USB device while driving. Doing so can be a distraction. If distracted you could lose control of your vehicle and cause an accident or serious injury.**



**CAUTION:**

- **Do not force the USB device into the USB connection port. Inserting the USB device tilted or up-side-down into the port may damage the port. Make sure that the USB device is connected correctly into the USB connection port.**

- **Do not grab the USB connection port cover (if equipped) when pulling the USB device out of the port. This could damage the port and the cover.**
- **Do not leave the USB cable in a place where it can be pulled unintentionally. Pulling the cable may damage the port.**

The vehicle is not equipped with a USB device. USB devices should be purchased separately as necessary.

This system cannot be used to format USB devices. To format a USB device, use a personal computer.

This system supports various USB memory devices, USB hard drives and iPod players. Some USB devices may not be supported by this system.

- Partitioned USB devices may not be played correctly.
- Some characters used in other languages (Chinese, Japanese, etc.) are not displayed properly on display. Using English language characters with a USB device is recommended.

**General notes for USB use:**

Refer to your device manufacturer's owner information regarding the proper use and care of the device.

**Notes for iPod use:**

"Made for iPod", "Made for iPhone", and "Made for iPad" mean that an electronic accessory has been designed to connect specifically to iPod, iPhone, or iPad, respectively, and has been certified by the developer to meet Apple performance standards.

Apple is not responsible for the operation of this device or its compliance with safety and regulatory standards.

Please note that the use of this accessory with iPod, iPhone, or iPad may affect wireless performance.

iPad, iPhone, iPod, iPod classic, iPod nano, iPod shuffle, and iPod touch are trademarks of Apple Inc., registered in the U.S. and other countries. Lightning is a trademark of Apple Inc.

- Improperly plugging in the iPod may cause a checkmark to be displayed on and off (flickering). Always make sure that the iPod is connected properly.
- An iPod nano (1st Generation) may remain in fast forward or rewind mode if it is connected during a seek operation. In this case, please manually reset the iPod.
- An iPod nano (2nd Generation) will continue to fast-forward or rewind if it is disconnected during a seek operation.
- An incorrect song title may appear when the Play Mode is changed while using an iPod nano (2nd Generation).
- Audiobooks may not play in the same order as they appear on an iPod.
- If an iPod automatically selects large video files while in the shuffle mode, the touch screen display may momentarily black out, but will soon recover.

## Bluetooth® audio player

- Some Bluetooth® audio devices may not be used with this system. For detailed information about Bluetooth® audio devices that are available for use with this system, contact a NISSAN dealer.
- Before using a Bluetooth® audio system, the initial registration process for the audio device is necessary.
- Operation of the Bluetooth® audio system may vary depending on the audio device that is connected. Confirm the operation

procedure before use.

- The playback of Bluetooth® audio will be paused under the following conditions. The playback will be resumed after the following conditions are completed.
  - while using a hands-free phone
  - while checking a connection with a cellular phone
- The in-vehicle antenna for Bluetooth® communication is built in the system. Do not place the Bluetooth® audio device in an area surrounded by metal, far away from the system or in a narrow space where the device closely contacts the body or the seat. Otherwise, sound degradation or connection interference may occur.
- While a Bluetooth® audio device is connected through the Bluetooth® wireless connection, the battery power of the device may discharge quicker than usual.
- This system is compatible with the Bluetooth® AV profile (A2DP and AVRCP).



Bluetooth® is a trademark owned by Bluetooth SIG, Inc., and licensed to Visteon Corporation.

## Compact Disc/USB memory with MP3/WMA/AAC

### Explanation of terms:

- MP3 — MP3 is short for Moving Pictures Experts Group Audio Layer 3. MP3 is the most well known compressed digital audio file format. This format allows for near “CD quality” sound, but at a fraction of the size of normal audio files. MP3 conversion of an audio track from CD can reduce the file size by approximately 10:1 ratio (Sampling: 44.1 kHz, Bit rate: 128 kbps) with virtually no perceptible loss in quality. MP3 compress-

sion removes the redundant and irrelevant parts of a sound signal that the human ear doesn't hear.

- WMA — Windows Media Audio (WMA) is a compressed audio format created by Microsoft as an alternative to MP3. The WMA codec offers greater file compression than the MP3 codec, enabling storage of more digital audio tracks in the same amount of space when compared to MP3s at the same level of quality.

This product is protected by certain intellectual property rights of Microsoft Corporation and third parties. Use or distribution of such technology outside of this product is prohibited without a license from Microsoft or an authorized Microsoft subsidiary and third parties.
- AAC — Advanced Audio Coding (AAC) is a compressed audio format. AAC offers greater file compression than MP3 and enables music file creation and storage at the same quality as MP3.
- Bit rate — Bit rate denotes the number of bits per second used by a digital music files. The size and quality of a compressed digital audio file is determined by the bit rate used when encoding the file.
- Sampling frequency — The rate at which the samples of a signal are converted from analog to digital (A/D conversion) per second.
- Multisession — Multisession is one of the methods for writing data to media. Writing data once to the media is called a single session, and writing more than once is called a multisession.
- ID3/WMA Tag — The ID3/WMA tag is the part of the encoded MP3 or WMA file that contains information about the digital mu-

sic file such as song title, artist, album title, encoding bit rate, track time duration, etc. ID3 tag information is displayed on the Album/Artist/Song title line on the display.

\* Windows® and Windows Media® are registered trademarks and/or trademarks of Microsoft Corporation in the United States of America and/or other countries.

- The names of folders not containing MP3/WMA/AAC files are not shown in the display.
- If there is a file in the top level of the disc, "Root Folder" is displayed.
- The playback order is the order in which the files were written by the writing software. Therefore, the files might not play in the desired order.

#### Playback order:

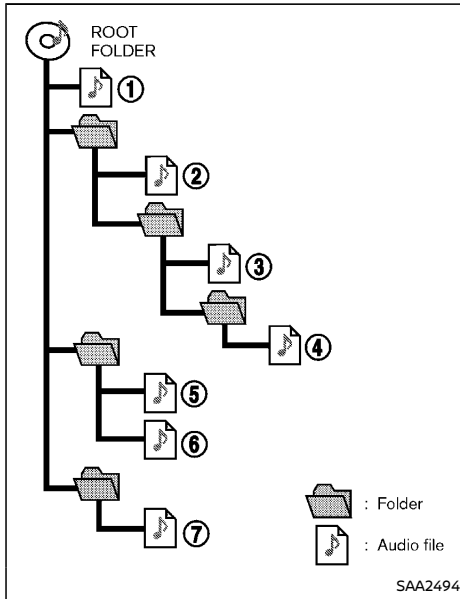

#### Playback order chart

The music playback order of the CD with MP3/WMA/AAC is as illustrated.



**Specification chart:**

Supported media		CD, CD-R, CD-RW, USB2.0	
Supported file systems		ISO9660 LEVEL1, ISO9660 LEVEL2, Romeo, Joliet ISO9660 Level 3 (packet writing) is not supported. Files saved using the Live File System component (on a Windows Vista-based computer) are not supported. USB memory: FAT16, FAT32	
Supported versions*1	MP3	Version	MPEG1, MPEG2, MPEG2.5
		Sampling frequency	32kHz - 44.1 kHz - 48kHz
		Bit rate	32 kbps - 320 kbps VBR*4
	WMA*2	Version	WMA7, WMA8, WMA9
		Sampling frequency	32 kHz - 48 kHz
		Bit rate	48 kbps - 320 kbps, VBR*4
	AAC	Version	MPEG-4 AAC
		Sampling frequency	8 kHz - 48 kHz
		Bit rate	32 kbps - 192 kbps, VBR*4
Tag information (Song title and Artist name)		ID tag VER1.0, VER1.1, VER2.2, VER2.3 (MP3 only) WMA tag (WMA only)	
Folder levels	CD, CD-R, CD-RW	Folder levels: 8, Folders: 255 (including root folder), Files: 512 (Max. 255 files for one folder)	
	USB	Folder levels: 8, Folders 255, Files: 2500 (Max. 255 files for one folder) Memory size: 4GB	
Displayable character codes*3		01: ASCII, 02: ISO-8859-1, 03: UNICODE (UTF-16 BOM Big Endian), 04: UNICODE (UTF-16 Non-BOM Big Endian), 05: UNICODE (UTF-8), 06: UNICODE (Non-UTF-16 BOM Little Endian), 07:SHIFT-JIS	

\*1 Files created with a combination of 48 kHz sampling frequency and 64 kbps bit rate cannot be played.

\*2 Protected WMA files (DRM) cannot be played.

\*3 Available codes depend on what kind of media, versions and information are going to be displayed.

\*4 When VBR files are played, the playback time may not be displayed correctly. WMA7 and WMA8 are not applied to VBR.

## Troubleshooting guide:

Symptom	Cause and Countermeasure
Cannot play	Check if the disc or USB was inserted correctly.
	Check if the disc is scratched or dirty.
	Check if there is condensation inside the player, and if there is, wait until the condensation is gone (about 1 hour) before using the player.
	If there is a temperature increase error, the CD player will play correctly after it returns to the normal temperature.
	If there is a mixture of music CD files (CD-DA data) and MP3/WMA/AAC files on a CD, only the music CD files (CD-DA data) will be played.
	Files with extensions other than ".MP3", ".WMA", ".M4A", ".mp3", ".wma" or ".m4a" cannot be played. In addition, the character codes and number of characters for folder names and file names should be in compliance with the specifications.
	Check if the disc or the file is generated in an irregular format. This may occur depending on the variation or the setting of MP3/WMA/AAC writing applications or other text editing applications.
	Check if the finalization process, such as session close and disc close, is done for the disc.
	Check if the disc or USB is protected by copyright.
Poor sound quality	Check if the disc is scratched or dirty.
It takes a relatively long time before the music starts playing.	If there are many folder or file levels on the disc or USB memory device, some time may be required before the music starts playing.
Music cuts off or skips	The writing software and hardware combination might not match, or the writing speed, writing depth, writing width, etc., might not match the specifications. Try using the slowest writing speed.
Skipping with high bit rate files	Skipping may occur with large quantities of data, such as for high bit rate data.
Move immediately to the next song when playing.	When a non-MP3/WMA/AAC file has been given an extension of ".MP3", ".WMA", ".M4A", ".mp3", ".wma" or ".m4a", or when play is prohibited by copyright protection, the player will skip to the next song.
The songs do not play back in the desired order.	The playback order is the order in which the files were written by the writing software, so the files might not play in the desired order.
	Random/Shuffle may be active on the audio system or on a USB device.

## ANTENNA

### Shark fin antenna

The shark fin antenna is located on the rear part of the vehicle roof.

## FM-AM RADIO WITH COMPACT DISC (CD) PLAYER

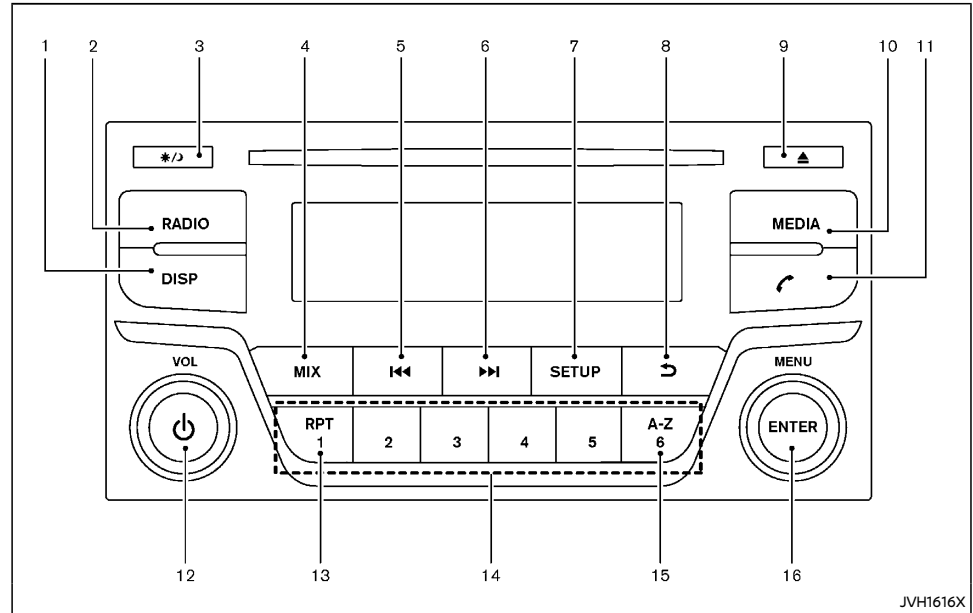

- |                          |                          |
|--------------------------|--------------------------|
| 1. DISP (Display) button | 9. CD eject button       |
| 2. RADIO button          | 10. MEDIA button         |
| 3. Day/Night button      | 11. Phone button         |
| 4. MIX button            | 12. Power/VOL dial       |
| 5. Rewind button         | 13. RPT (repeat) button  |
| 6. Fast forward button   | 14. Radio memory buttons |
| 7. SETUP button          | 15. A-Z button           |
| 8. Back button           | 16. MENU/ENTER dial      |

## Audio main operation

The audio system operates when the ignition switch is placed in the "ON" position.



### Power/VOL dial:

#### Power ON/OFF:

To turn on the audio system, push the Power/VOL dial.

The system will turn on in the mode that was used immediately before the system was turned off.

To turn off the audio system, push the Power/VOL dial.

#### Volume control:

To control the volume, turn the Power/VOL dial. Turn the dial clockwise to make the sound louder.

Turn the dial counterclockwise to make the sound quieter.

#### **SETUP** SETUP button:

To configure audio settings, perform the following procedure.

1. Push the **SETUP** button.
2. Turn the MENU/ENTER dial clockwise or counterclockwise, the display will appear in the following order.  
Audio ⇄ Clock ⇄ Radio ⇄ Language
3. Push the MENU/ENTER dial to select the item.

## Audio adjustments:

Push the **SETUP** button and then select "Audio".

Turn the MENU/ENTER dial, and the mode will change as follows.

Sound ⇄ AUX In ⇄ Audio Default

Push the MENU/ENTER dial to select the setting you want to change. Turn the MENU/ENTER dial to adjust the selected item.

### Sound:

To adjust the sound quality, turn the MENU/ENTER. Push the MENU/ENTER dial to select the setting item. Turn the MENU/ENTER dial to adjust the setting.

- Bass:  
Enhances or attenuates the bass response sound.
- Treble:  
Enhances or attenuates the treble.
- Bal. (Balance):  
Adjusts the balance of the volume between the left and right speakers.
- Fade:  
Adjusts the balance of the volume between the front and rear speakers.

### AUX In:

Adjusts the volume output from the auxiliary source.

### Audio Default:

Resets sound settings (Bass, Treble, Balance and Fade) to the default settings.

## Clock setting:

Push the **SETUP** button to enter the setup menu screen and then select "Clock".

Turn the MENU/ENTER dial, and the mode will change as follows.

Set Time ⇄ ON/OFF ⇄ Format

### Set Time:

Adjusts the clock as follows.

The hour display will start flashing. Turn the MENU/ENTER dial to adjust the hour and push the MENU/ENTER dial. The minute display will start flashing. Turn the MENU/ENTER dial to adjust the minute and push the MENU/ENTER dial to finish the clock adjustment.

### ON/OFF:

Set the clock display between on and off. If "ON" is selected, the clock will be displayed when the audio unit is turned off by pushing the Power/VOL dial.

### Format:

Switch the clock display between 24-hour and 12-hour clock mode.

### Radio setting:

Push the **SETUP** button to enter the setup menu screen and then select "Radio".

This function is used to select the FM frequency band.

### Language setting:

Push the **SETUP** button to enter the setup menu screen and then select "Language".

Select the appropriate language and push the MENU/ENTER dial. Upon completion, the screen will automatically adapt the language setting.

### Day/Night button:

Push the  button to switch the display brightness between the daytime and nighttime modes.

### Phone button:

For operation of the  button, see "Bluetooth® Hands-Free Phone System" (P.4-30).

### MEDIA button:

Push the  button to play a compatible device when it is connected.

Each time the  button is pushed, the audio source will change as follows.

CD → USB/iPod → Bluetooth audio → AUX → CD

A source that is not available will be skipped.

### Radio operation

#### RADIO button:

When the  button is pushed while another audio source is playing, the other audio source will turn off and the radio will turn on.



To change the radio bands, push the  button until the desired band appears.



FM 1 → FM 2 → AM → FM 1

During FM reception, push and hold the  button to update FM list.

Turn the MENU/ENTER dial to select a station from the FM list.

### Fast Forward/Rewind buttons:

When adjusting the broadcasting station frequency manually, push the  or  button until the desired frequency is achieved.





When adjusting the broadcasting station frequency automatically, push and hold the  or  button. When the system detects a broadcasting station, it will stop at the station.

### to Radio memory buttons:

During radio reception, pushing the radio memory button will select the stored radio station.

The audio system can store up to 12 FM station frequencies (6 in each of FM 1, FM 2) and 6 AM station frequencies.

To store the station frequency manually:

1. Tune to the desired broadcasting station frequency by using the   buttons.
2. Push and hold a radio memory button  to  until a beep sounds. (The radio mutes when the memory button is pushed.)
3. The station indicator will display and the radio mute disengages, indicating that the memory is stored properly.
4. Perform steps 1 - 3 for all other memory buttons.

If the battery cable is disconnected, or if the audio fuse blows, the radio memory will be erased. In such a case, reset the desired stations.

### CD player operation

#### Loading:

Insert a CD into the slot with the label side facing up. The CD will be guided automatically into the slot and will start playing. After loading the CD, the number of tracks and the play time will appear on the display.



#### CAUTION:

**Do not force the CD into the slot. This could damage the player.**

#### NOTE:

- The CD player accepts normal audio CDs or CDs containing MP3/WMA/AAC files.
- The audio unit will automatically detect if a CD containing MP3/WMA/AAC files is inserted, and the appropriate file format such as "MP3CD" will be indicated.
- An error notification message will be displayed when inserting an incompatible disc type (e.g., DVD), or if the player cannot read the CD. Eject the disc and insert another disc.

#### MEDIA button:

To change to the CD mode, push the  button with a CD inserted until the CD mode is selected.



#### List view:





While the track is being played, push or turn the MENU/ENTER dial to display the available tracks in a listed view mode. To select a track from the list, or a track to start listening to, turn the MENU/ENTER dial and then push the MENU/ENTER dial.

### Quick search:

In the list view mode, a quick search can be performed to find a track from the list. Push the A-Z button, turn the MENU/ENTER dial to the first alphabetic letter of the song title, and then push the MENU/ENTER dial. When found, a list of the available songs will be displayed. Select a song title, and push the MENU/ENTER dial to play the preferred track.

### Fast forward/Rewind buttons:

Push and hold the  or  button to fast forward or rewind through the track. When the button is released, the track will play at normal playing speed.

By pushing the  or  button once, the track will skip forward to the next track or backward to the beginning of the current track. Push the  or  button more than once to skip through the tracks.

### Folder browsing:

If the recorded media contains folders with music files, pushing the  or  button will play the tracks of each folder in sequence.

To select a preferred folder:

1. Push or turn the MENU/ENTER dial to display a list of tracks in the current folder.
2. Turn the MENU/ENTER dial for the preferred folder.
3. Push the MENU/ENTER dial to access the folder. Push the MENU/ENTER dial again to start playing the first track or turn the MENU/ENTER dial, and push the MENU/ENTER dial to select another track.

If the current selected folder contains sub folders, push the MENU/ENTER dial, and a new screen with a list of sub folders will be

displayed. Turn the MENU/ENTER dial for the sub folder and then push the MENU/ENTER dial to select. Select the root folder item when songs are recorded additionally in the root folder.

### RPT button:

Push the  button and the current track will be played continuously.

### MIX button:

Push the  button and all the tracks will be played in a random order.



### DISP button:

While a CD with title information is being played, the title of the played track is displayed.

When the  button is pushed repeatedly while a CD with MP3/WMA/AAC is playing, further information about the track can be displayed along with the track title as follows.

Playback time → Artist → Album → Playback time

### Track details:

Pushing and holding the  button will turn the display into a detailed overview. Push the  button to return to the display for the main display mode.

### CD Eject button:

When the  button is pushed while a CD is loaded, the CD will be ejected.

When the ignition switch is in the "OFF" or "LOCK" position it is possible to eject the CD currently being played. However the audio unit will not be activated.

If a CD is ejected by pushing the  button, and it is not taken out from the loading slot within 20 seconds, the CD will automatically be reloaded to the slot in order to protect the CD.

USB (Universal Serial Bus) Connection Port

### USB main operation:

#### WARNING:

**Do not connect, disconnect or operate the USB device while driving. Doing so can be a distraction. If distracted you could lose control of your vehicle and cause an accident or serious injury.**

#### CAUTION:

- **Do not force the USB device into the USB connection port. Inserting the USB device tilted or upside-down into the port may damage the port. Make sure that the USB device is connected correctly into the USB connection port.**
- **Do not grab the USB connection port cover (if equipped) when pulling the USB device out of the port. This could damage the port and the cover.**
- **Do not leave the USB cable in a place where it can be pulled unintentionally. Pulling the cable may damage the port.**

Refer to your device manufacturer's owner information regarding the proper use and care of the device.

The USB connection port is located on the lower part of the instrument panel. See "USB (Universal Serial Bus) connection port/AUX (auxiliary) input jack" (P.4-28). When the audio system operates, the system will switch to the USB memory device mode automatically.

If the system has been turned off while the USB memory device was playing, pushing the Power/VOL dial will start the USB memory device.

The following operations are identical to the audio main operation of the Compact Disc (CD) operation. For details, see "CD player operation" (P.4-25).

- List view
- Quick search
- 
- MIX (Random play)
- RPT (Repeat track)
- Folder browsing

#### **MEDIA button:**

To change to the USB mode, push the  button with a USB connected until the USB mode is selected.



#### **DISP button:**

While a track with recorded music information tags (ID3-tags) is being played, the title of the played track is displayed. If the tags are not provided then a notification message is displayed.

When the  button is pushed continuously, further information about the track can be displayed along with the track title as follows.

Playback time → Artist → Album → Playback time

#### **Track details:**

Pushing and holding the  button will turn the display into a detailed overview. Push the  button to return to the display for the main display mode.

## iPod player operation

### **Connecting iPod:**

The USB connection port is located on the lower part of the instrument panel. See "USB (Universal Serial Bus) connection port/AUX (auxiliary) input jack" (P.4-28).

When the iPod is connected to the vehicle, the iPod music library can only be operated by the vehicle audio controls.

### **Compatibility:**

The system unit shall be compatible with all devices (past and future) supporting Apple Accessory Protocol on USB link.

It includes (and not limited to):

- iPod nano 1G (Firmware version 1.3.1 -)
- iPod nano 2G (Firmware version 1.1.3 -)
- iPod nano 3G (Firmware version 1.0.0 -)
- iPod nano 4G (Firmware version 1.0.2 -)
- iPod nano 5G (Firmware version 1.0.1 -)
- iPod nano 6G (Firmware version 1.0 -)
- iPod nano 7G (Firmware version 1.0.0 -)
- iPod 5G (Firmware version 1.2.1 -)
- iPod classic (Firmware version 1.0.0 -)
- iPod Touch (iOS 1.1 -)
- iPod Touch 2G (iOS 2.1.1 -)
- iPod Touch 3G (iOS 3.1 -)
- iPod Touch 4G (iOS 4.1 -)
- iPod Touch 5G (iOS 6.0.0 -)
- iPhone (iOS 1.0.0 - 2.2.1)
- iPhone 3G (iOS 2.1 -)
- iPhone 3GS (iOS 3.0 -)
- iPhone 4/4S (iOS 4.0 -)
- iPhone 5 (iOS 6.0.0 -)

#### **MEDIA button:**

To operate the iPod, push the  button repeatedly until the USB/iPod mode is selected and then push the MENU/ENTER dial.

### **iPod main operation:**

#### **Interface:**

The interface for iPod operation shown on the audio system display is similar to the iPod interface. Use the MENU/ENTER dial to play a track on the iPod.

The following items can be chosen from the menu list screen.

- Playlists
- Artist
- Albums
- Tracks
- more...
  - Composers
  - Genre

For further information about each item, see the iPod owner's manual.

The following operations are identical to the audio main operation of the Compact Disc (CD) operation. For details, see "CD player operation" (P.4-25).

- List view
- Quick search
- 
- MIX (Random play)
- RPT (Repeat track)

### DISP DISP button:

While a track with recorded music information tags (ID3-tags) is being played, the title of the played track is displayed.

When the **DISP** button is pushed repeatedly, further information about the track can be displayed along with the track title as follows:

Playback time → Artist → Album → Playback time

Track details:

Pushing and holding the **DISP** button will turn the display into a detailed overview. To return to the main display, push the **DISP** button.

### Bluetooth® audio player operation

#### Regulatory information:



Bluetooth® is a trademark owned by Bluetooth SIG, Inc. and licensed to Visteon Corporation.

#### CE statement:

Hereby Visteon Corporation declares that this system is in compliance with the essential requirements and other relevant provisions of Directive 1999/5/EC.



#### NOTE:

The audio system only supports Bluetooth® devices with AVRCP (Audio Video Remote Control Profile) version 1.3, or 1.0 or earlier.

### Bluetooth® audio player main operation:

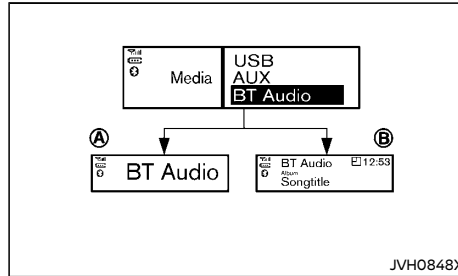

To play Bluetooth® audio, the Bluetooth® audio device needs to be paired to the in-vehicle system. For the pairing operation, see "Pairing device" (P.4-31).

### MEDIA MEDIA button:

To operate the Bluetooth® audio streaming, push the **MEDIA** button repeatedly until "BT Audio" is shown.

The type of display, **A** or **B**, shown on the audio system can vary depending on the Bluetooth® version of the device.

### Fast forward/Rewind buttons:

When **FF** or **RR** button is pushed continuously, the track will be played at high speed. When the button is released, the track will be played at normal playing speed.

By pushing the **FF** or **RR** button once, the track will skip forward to the next track or backward to the beginning of the current track. Push the **FF** or **RR** button more than once to skip through the tracks.

### DISP DISP button:

If the song contains music information tags (ID3- tags), the title of the played song will be displayed. If tags are not provided then the display will not show any messages.

When the **DISP** button is pushed repeatedly, further information about the song can be displayed along with the song title.

A long push on **DISP** button will turn the display into a detailed overview. To return to the main display, push the **DISP** button.

### Auxiliary (AUX) device player operation

The AUX input jack is located on the lower part of the instrument panel. See "USB (Universal Serial Bus) connection port/AUX (auxiliary) input jack" (P.4-28). The AUX input jack accepts any standard analog audio input such as from a portable cassette tape/CD player, MP3 player or laptop computer.

Push the **MEDIA** button repeatedly until the AUX mode is selected, to play a compatible device when it is plugged into the AUX input jack. NISSAN strongly recommends using a stereo mini plug cable when connecting your music device to the audio system. Music may not play properly when a monaural cable is used.

### USB (Universal Serial Bus) CONNECTION PORT/AUX (auxiliary) INPUT JACK

The USB connection port and AUX input jack are located on the lower part of the instrument panel.



### USB connection port:

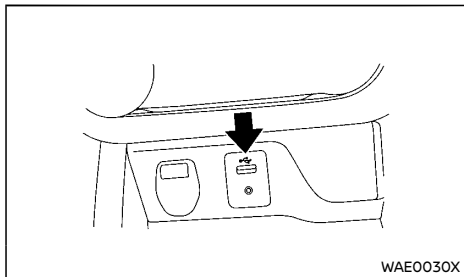

Insert USB devices or iPod connectors into this port.

Refer to your device manufacturer's owner information regarding the proper use and care of the device.

#### **WARNING:**

**Do not connect, disconnect or operate the USB device while driving. Doing so can be a distraction. If distracted you could lose control of your vehicle and cause an accident or serious injury.**

#### **CAUTION:**

- Do not force the USB device into the USB connection port. Inserting the USB device tilted or up-side-down into the port may damage the port. Make sure that the USB device is connected correctly into the USB connection port.
- Do not grab the USB connection port cover (if equipped) when pulling the USB device out of the port. This could damage the port and the cover.

- Do not leave the USB cable in a place where it can be pulled unintentionally. Pulling the cable while it is connected may damage the port.
- The USB connection port can provide 1 A charging circuit for your phone device. If the charging circuit of your device is more than 1 A, it is recommended to charge your device by power outlet converter, or your device will lose power quickly sometimes.

### AUX input jack:

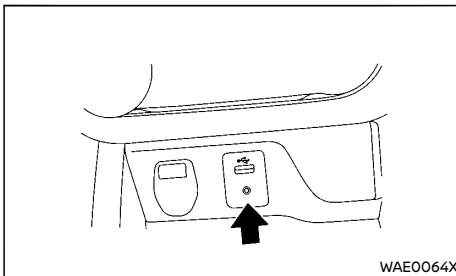

Compatible audio devices, such as some MP3 players, can be connected to the system through the AUX input jack.

#### **WARNING:**

**Do not allow the cable or an external device connected to the AUX terminal to affect your driving.**

#### **NOTE:**

- Depending on the external device, please note that the volume may be louder or quieter than that of the external device.

- When the AUX contacts the plug of the connector cable, noise may be heard.
- The connected external device cannot be operated with the main audio system. The volume and sound quality can be adjusted.
- The song title in the external device cannot be displayed on the audio display/touch screen display.
- For the power source of the external device, use the special battery. The external device cannot be charged with the AUX terminal. Noise may be heard if the radio etc. is operated while charging the battery with the power outlet of the vehicle.

### CD/USB MEMORY DEVICE CARE AND CLEANING

#### CD

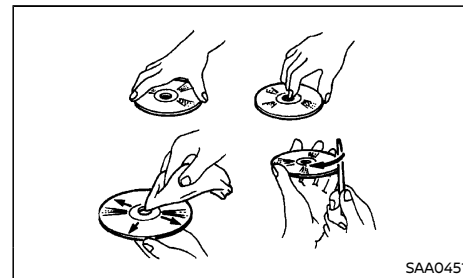

- Handle a disc by its edges. Never touch the surface of the disc. Do not bend the disc.
- Always place the discs in the storage case when they are not being used.

## CAR PHONE OR CB RADIO

When installing a CB, ham radio or a car phone in your vehicle, be sure to observe the following cautions, otherwise the new equipment may adversely affect the Engine Control System and other electronic parts.

### CAUTION:

- **Keep the antenna as far away as possible from the Electronic Control Module.**
- **Keep the antenna wire at least 20 cm (8 in) away from the Engine Control harnesses. Do not route the antenna wire next to any harnesses.**
- **Adjust the antenna standing wave ratio as recommended by the manufacturer.**
- **Connect the ground wire from the radio chassis to the body.**
- **For details, consult a NISSAN dealer.**

- To clean a disc, wipe the surface from the center to the outer edge using a clean, soft cloth. Do not wipe the disc using a circular motion.  
Do not use a conventional record cleaner or alcohol intended for industrial use.
- A new disc may be rough on the inner and outer edges. Remove the rough edges by rubbing the inner and outer edges with the side of a pen or pencil as illustrated.

## USB memory device

- Do not touch the terminal portion of the USB memory device.
- Do not place heavy objects on the USB memory device.
- Do not store the USB memory device in highly humid locations.
- Do not expose the USB memory device to direct sunlight.
- Do not spill any liquids on the USB memory device.

Refer to the USB memory device Owner's Manual for details.

## Bluetooth® HANDS-FREE PHONE SYSTEM (if equipped)

### WARNING:

- **Use a phone after stopping your vehicle in a safe location. If you have to use a phone while driving, exercise extreme caution at all times so full attention may be given to vehicle operation.**
- **If you find yourself unable to devote full attention to vehicle operation while talking on the phone, pull off the road to a safe location and stop your vehicle before using a phone.**

### CAUTION:

**To avoid draining the vehicle battery, use a phone after starting the engine.**

Bluetooth® is a wireless radio communication standard. This system offers a hands-free facility for your cellular phone to enhance driving comfort.

To use the Bluetooth® Hands-Free Phone System, your cellular phone must first be setup. For details, see "Bluetooth® settings" (P.4-31). Once it has been setup, the hands-free mode is automatically activated on the registered cellular phone (via Bluetooth®) when it comes into range.

A notification message appears on the audio display when the phone is connected, when an incoming call is being received, as well as when a call is initiated.

When a call is active, the audio system, microphone, and buttons on the instrument panel enable hands-free communication.

If the audio system is in use at the time, the audio will be muted and will stay muted until the active call has ended.

The Bluetooth® system may not be able to connect with your cellular phone for the following reasons:

- The cellular phone is too far away from the vehicle.
- The Bluetooth® mode on your cellular phone has not been activated.
- Your cellular phone has not been paired with the Bluetooth® system of the audio unit.
- Your cellular phone does not support Bluetooth® technology.

**NOTE:**

- **For details, see your cellular phone's Owner's Manual.**
- **For assistance with your cellular phone integration, please visit your local NISSAN dealer.**

## REGULATORY INFORMATION

### Bluetooth® Trademark



Bluetooth® is a trademark owned by Bluetooth SIG, Inc. and licensed to Visteon Corporation.

### CE statement

Hereby Visteon Corporation declares that this system is in compliance with the essential requirements and other relevant provisions of Directive 1999/5/EC.



**NOTE:**

**The audio system only supports Bluetooth® devices with AVRCP (Audio Video Remote Control Profile) version 1.3, or 1.0 or earlier.**

## CONTROL BUTTONS AND MICROPHONE

### Instrument panel:

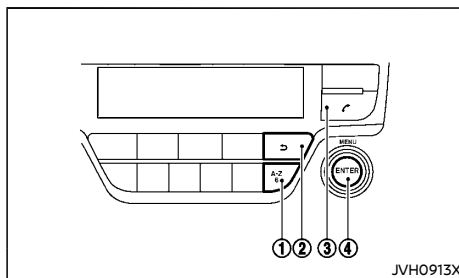

1. A-Z button

2. Back button
3. Phone button
4. MENU/ENTER dial

### Microphone:

Microphone is located near the room light.

## Bluetooth® SETTINGS

### Pairing device

Enter the phone setup menu via the button on the instrument panel, select the "Bluetooth" key, and then check if the Bluetooth® is set to on. (If not, push the MENU/ENTER dial to turn it on.)

To setup the Bluetooth® system to pair (connect or register) your preferred cellular phone, follow the following procedure.

1. To pair a device, use "Scan devices" key or the "Pair device" key on the display.
  2. A notification message will be displayed when the phone is successfully paired.
  3. The display will return to the current audio source status after the connection is complete.
- While the Bluetooth® connection is active, the following icons will appear on the display.
    - Signal strength indicator
    - Battery status indicator\*
    - Bluetooth® connection ON indicator
  - \*: If low battery is indicated, the Bluetooth® device must be recharged soon.
  - Up to 5 different Bluetooth® devices can be connected. However, only one device can be used at a time. If 5 different Bluetooth® registered devices are registered, a new device can only replace one of the 5

- existing paired devices.
- The pairing procedure and operation may vary according to device type and compatibility. See the Bluetooth® device Owner's Manual for further details.

## Setting items

To set up the Bluetooth® system with a device, the following items are available:

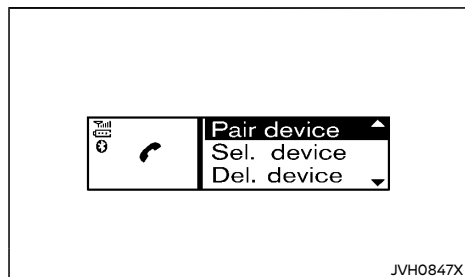

- Scan devices**  
Shows all available visible Bluetooth® devices and initializes Bluetooth® connection from the audio unit. A maximum of 5 Bluetooth® devices can be registered.
- Pair device**  
Bluetooth® devices can be paired with the system. A maximum of 5 Bluetooth® devices can be registered.
- Sel. device**  
Paired Bluetooth® devices are listed and can be selected for connection.
- Del. device**  
A registered Bluetooth® device can be deleted.

- Settings**  
Volume and Ringtone options are listed and can be selected for the Bluetooth® hands-free phone. See "General settings" (P.4-35).
- Bluetooth**  
If this setting is turned off, the connection between the Bluetooth® devices and the in-vehicle Bluetooth® module will be cancelled.

### Scan devices:

- Push the  button on the instrument panel. Select "Scan devices" key. The audio unit searches for the Bluetooth® devices and shows all devices that were found.

Make sure your Bluetooth® device is available at this time.

- Select the device to be paired using the MENU/ENTER dial.
- The pairing procedure depends on the device to be connected:

#### a. Device without PIN code:

The Bluetooth® connection will be automatically connected without any further input.

#### b. Device with PIN code:

Two different ways of pairing are possible depending on the device:

##### • Type A:

The message "To pair" and "Enter Pin" 0000 will be displayed.

Confirm the PIN code on the device. The Bluetooth® connection will be made.

##### • Type B:

The message "Pairing request" and "Confirm password" together with a 6 digit

code will be displayed. The unique and identical code should be displayed on the device. If the code is identical confirm on the device.

The Bluetooth® connection will be made.

### Pair device:

- Turn on the Bluetooth® on the audio unit. See "Setting items" (P.4-32).
- Use the audio unit to pair:

Push the  button on the instrument panel. Select the "Pair device" key.

The pairing procedure depends on the Bluetooth® device to be connected:

#### 1) Device without PIN code:

The Bluetooth® connection will be automatically connected without any further input.

#### 2) Device with PIN code:

Two different ways of pairing are possible depending on the device. For the correct procedure details, see "Setting items" (P.4-32).

- Use the Bluetooth® audio/cellular phone device to pair:

- Switch on the search mode for Bluetooth® devices. If the search mode finds the audio unit it will be shown on the device display.

- Select the unit device shown as "My Car".



- Enter the number code shown on the relevant device with the device's own keypad, and push the confirmation key on the Bluetooth® device.

Refer to the relevant Bluetooth® device Owner's Manual for further details.

### Sel. device:

The paired device list shows which Bluetooth® audio or cellular phone devices have been paired or registered to the system. Select the appropriate device to connect to the system.

The following symbols (if equipped) indicate the capability of the registered device:

-  : Cellular phone integration
-  : Audio streaming (A2DP - Advanced Audio Distribution Profile)

### Del. device:

A registered device can be removed from Bluetooth® system registration. Select a registered device and push the MENU/ENTER dial to confirm to delete.

### Bluetooth:

Turn the vehicle's Bluetooth® system on or off. Push the  button to return to the phone setup menu.

## USING THE SYSTEM

The hands-free mode can be operated using the  button on the instrument panel.

### Receiving a call

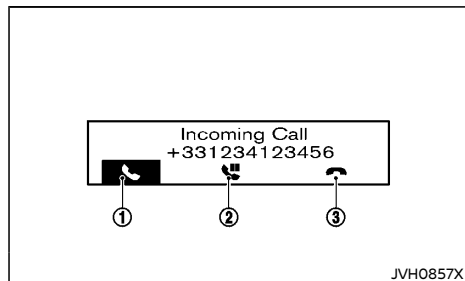





When receiving an incoming call, the display on the audio unit will show the caller's phone number (or a notification message that the caller's phone number cannot be shown) and three operation icons as illustrated. To highlight different icons, turn the MENU/ENTER dial. Push the MENU/ENTER dial to select the highlighted icon.



### ① Answering and during a call:

Answer the call by selecting .

During the call, the following icons are available:

-  : Select this item to end the call.
-  : Select this item to put the call on hold.
-  : Select this item to transfer the call from the hands-free phone system to your cellular phone.
-  : Select this item to transfer the call back to the hands-free phone system from the cellular phone.
- #123: Select this item to enter numbers during a call. For example, use this function when directed by an automated phone system to dial an extension number.

### ② Putting a call on hold:

To put a call on hold, select . Push the MENU/ENTER dial again to take the call. To reject the call, select .

### ③ Rejecting a call:

To reject an incoming call, select .

### Initiating a call



### WARNING:

**Park the vehicle in a safe location, and apply the parking brake before making a call.**



A call can be initiated using one of the following methods:

- Making a call from the phonebook
- Manually dialing a phone number
- Redialing
- Using call history (Call List menu)
  - Dialed
  - Received
  - Missed

### Making a call from the phonebook:

Once the Bluetooth® connection has been made between the registered cellular phone and the hands-free phone system, phonebook data will be transferred automatically to the hands-free phone system. The transfer may take a while before completion.



## NOTE:

### Phonebook data will be erased when:

- Switching to another registered cellular phone.
- Cellular phone is disconnected.
- The registered cellular phone is deleted from the audio system.

1. Push the  button on instrument panel.
2. Turn the MENU/ENTER dial to highlight "Phonebook" and push the MENU/ENTER dial.
3. Scroll down through the list, select the appropriate contact name (highlighted), and push the MENU/ENTER dial.
4. The screen will show the number to be dialed. Push the MENU/ENTER dial to dial the number.

If more than one number is registered, select an appropriate icon.

-  : Home
-  : Cellular phone
-  : Office

### Quick searching the phonebook:

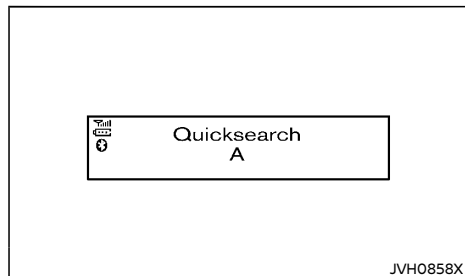

The quick search mode can be used as follows:

1. Push the A-Z button.
2. Turn the MENU/ENTER dial for the first alphabetical or numerical letter of the contact name. Once highlighted, push the MENU/ENTER dial to select the letter.
3. The display will show the corresponding contact name(s). Where necessary, use the MENU/ENTER dial to scroll further for the appropriate contact name to call.
4. The screen will show the number to be dialed. Push the MENU/ENTER dial to dial the number.

### Manually dialing a phone number:

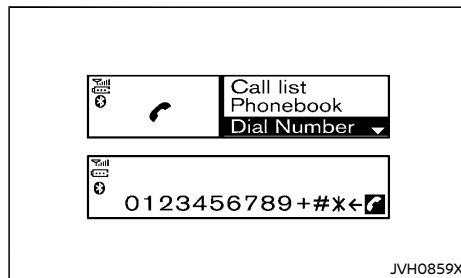

To dial a phone number manually, perform the following operation:

1. Push the  button on the instrument panel and turn the MENU/ENTER dial to highlight "Dial Number".
2. Push the MENU/ENTER dial to select "Dial Number".
3. Turn the MENU/ENTER dial to scroll along and highlight each number of the phone number. Push the MENU/ENTER dial to select the highlighted number.

To delete the last number entered, scroll to the "←" (Backspace symbol) and once highlighted, push the MENU/ENTER dial. The last number will be deleted. Pushing the MENU/ENTER dial repeatedly will delete each subsequent number.

4. After entering the last number, scroll to the "

### Redialing:

To redial or call the last number dialed, push and hold the  button on the instrument panel for more than 2 seconds.

### Using call history (Call list menu):

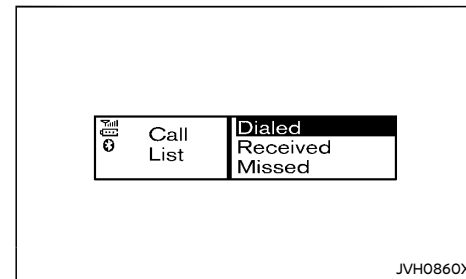

A number from the dialled, received, or missed call lists can also be used to make a call.

1. Push the  button on the instrument panel and select "Call List" on the display.
2. Turn the MENU/ENTER dial and scroll to an item, and push the MENU/ENTER dial to select an item.

### Available items:

- Dialled

Use the dialled call mode to make a call which is based on the list of outgoing

(dialled) calls.

- Received

Use the received call mode to make a call which is based on the list of received calls.

- Missed

Use the missed call mode to make a call which is based on the list of missed calls.

3. Scroll to the preferred phone number and push the MENU/ENTER dial or  button on the instrument panel.

### Second incoming call

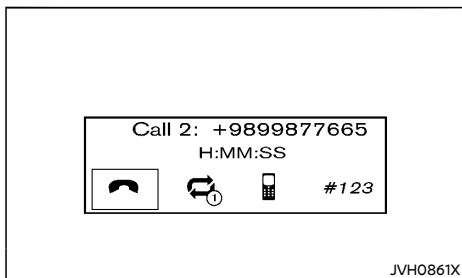

Whenever there is a second incoming call is shown in the display. By selecting the  icon the call is accepted and the current call is put on hold.

Selecting the  icon using the MENU/ENTER dial rejects the second incoming call. When this is done during the conversation it ends the call.

Selecting the  icon using the MENU/ENTER dial switches the call on line between the first and the second call.

### General settings

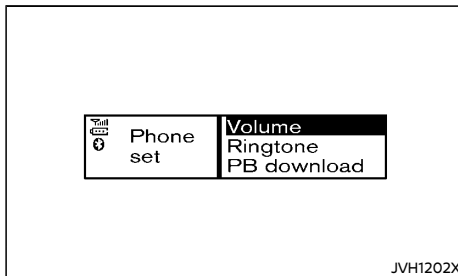

Push the  button on instrument panel.

Using the MENU/ENTER dial, select "Settings".

Volume settings and manually downloading the phonebook can be done using this menu.

#### Menu operation:

Turn the MENU/ENTER dial to change the highlighted item and to change the volume settings.

Push the MENU/ENTER dial to select the highlighted item and to apply the setting.

#### Menu items:

- Volume
  - Ring
    - Set the phone ringing volume.
  - Call
    - Set the volume of the conversation during a call.
- Ringtone
  - Car
    - Switch the ringtone to ring from the vehicle or the cellular phone.

- Phone

Switch the phone ringing volume on or off.

- PB download

Download the phonebook of the mobile device to the audio unit.

**MEMO**



# 5 Starting and driving

Break-in schedule .....	5-2	Stop/Start System (if equipped) .....	5-13
Before starting engine .....	5-2	Stop/Start OFF switch .....	5-15
Precautions when starting and driving .....	5-2	Vehicle Dynamic Control (VDC) system (if equipped) .....	5-15
Exhaust gas (carbon monoxide) .....	5-3	Hill start assist system (if equipped) .....	5-16
Three-way catalyst .....	5-3	Speed limiter (if equipped) .....	5-17
Turbocharger system (if equipped) .....	5-3	Speed limiter operations .....	5-17
Care when driving .....	5-4	Cruise control (if equipped) .....	5-18
Engine cold start period .....	5-4	Precautions on cruise control .....	5-19
Loading luggage .....	5-4	Cruise control operations .....	5-19
Driving in wet conditions .....	5-4	Fuel Efficiency and Carbon Dioxide Reduction driving tips .....	5-20
Driving in winter conditions .....	5-4	Increasing fuel economy and reducing Carbon Dioxide emissions .....	5-21
Ignition switch (model without Intelligent Key system) .....	5-5	Parking .....	5-21
Manual Transmission (MT) .....	5-5	Parking sensor (sonar) system .....	5-23
Key positions .....	5-5	Trailer towing .....	5-24
Steering lock .....	5-5	Power steering .....	5-24
Push-button ignition switch (model with Intelligent Key system) .....	5-5	Hydraulic pump electric power steering type .....	5-24
Precautions on push-button ignition switch operation .....	5-5	Brake system .....	5-24
Intelligent Key system .....	5-5	Brake precautions .....	5-24
Steering lock .....	5-6	Brake assist .....	5-25
Ignition switch positions .....	5-6	Anti-lock Braking System (ABS) .....	5-25
Intelligent Key battery discharge .....	5-7	Vehicle security .....	5-26
Starting engine (model without Intelligent Key system) .....	5-7	Cold weather driving .....	5-26
Starting engine (model with Intelligent Key system) .....	5-8	Battery .....	5-27
Driving vehicle .....	5-9	Engine coolant .....	5-27
Driving with Continuously Variable Transmission (CVT) .....	5-9	Tire equipment .....	5-27
Driving with Manual Transmission (MT) .....	5-12	Special winter equipment .....	5-27
		Parking brake .....	5-27
		Corrosion protection .....	5-27

## BREAK-IN SCHEDULE

During the first 1,000 km (600 miles), follow these recommendations to obtain maximum engine performance and ensure the future reliability and economy of your new vehicle. Failure to follow these recommendations may result in shortened engine life and reduced engine performance.

- Do not drive at a constant speed, either fast or slow, for long periods of time.
- Do not run the engine over 3,000 to 3,500 rpm.
- Do not accelerate at full throttle in any gear.
- Do not start quickly.
- Do not brake hard as much as possible.

## BEFORE STARTING ENGINE



### WARNING:

**The driving characteristics of your vehicle will change remarkably by any additional load and its distribution, as well as by adding optional equipment (roof racks, etc.). Your driving style and speed must be adjusted according to the circumstances. Especially when carrying heavy loads, your speed must be reduced adequately.**

- Make sure the area around the vehicle is clear.
- Visually inspect tires for their appearance and condition. Measure and check the tire pressure for proper inflation.
- Check that all windows and lights are clean.
- Adjust the seat and head restraint positions.
- Adjust the inside and outside rearview mirror positions.
- Fasten your seat belt and ask all passengers to do the same.
- Check that all doors are closed.
- Check the operation of the warning lights when the ignition switch is placed in the "ON" position.
- Maintenance items in the "8. Maintenance and do-it-yourself" section should be checked periodically.

## PRECAUTIONS WHEN STARTING AND DRIVING



### WARNING:

- **Never leave children or adults who would normally require the support of others alone in your vehicle. Pets should not be left alone either. They could unknowingly activate switches or controls and inadvertently become involved in a serious accident and injure themselves. On hot, sunny days, temperatures in a closed vehicle could quickly become high enough to cause severe or possibly fatal illness to people or animals.**
- **Properly secure all luggage to help prevent it from sliding or shifting. Do not place luggage higher than the seatbacks. In a sudden stop or collision, unsecured luggage could cause personal injury.**

### NOTE:

**During the first few months after purchasing a new vehicle, if you smell strong odors of Volatile Organic Compounds (VOCs) inside the vehicle, ventilate the passenger compartment thoroughly. Open all the windows before entering or while in the vehicle. In addition, when the temperature in the passenger compartment rises, or when the vehicle is parked in direct sunlight for a period of time, turn off the air recirculation mode of the air conditioner and/or open the windows to allow sufficient fresh air into the passenger compartment.**

## EXHAUST GAS (carbon monoxide)



### WARNING:

- Do not breathe exhaust gas; it contains colorless and odorless carbon monoxide. Carbon monoxide is dangerous. It can cause unconsciousness or death.
- If you suspect that exhaust fumes are entering the vehicle, drive with all windows fully open, and have the vehicle inspected immediately.
- Do not run the engine in closed spaces such as a garage.
- Do not park the vehicle with the engine running for an extended period of time.
- Keep the back door closed while driving, otherwise exhaust gas could be drawn into the passenger compartment. If you must drive with the back door open, follow these precautions:
  - Open all the windows.
  - Turn the air recirculation mode off and set the fan speed control to the highest level to circulate the air.
- If a special body or other equipment is added for recreational or other usage, follow the manufacturer's recommendation to prevent carbon monoxide entry into the vehicle. (Some recreational vehicle appliances such as stoves, refrigerators, heaters, etc. may also generate carbon monoxide.)
- The exhaust system and body should be inspected by a qualified mechanic whenever:
  - Your vehicle is raised while being serviced.

- You suspect that exhaust fumes are entering into the passenger compartment.
- You notice a change in the sound of the exhaust system.
- You have had an accident involving damage to the exhaust system, underbody, or rear of the vehicle.

## THREE-WAY CATALYST



### WARNING:

- The exhaust gas and the exhaust system are very hot. Keep people, animals and flammable materials away from the exhaust system components.
- Do not stop or park the vehicle over flammable materials such as dry grass, wastepaper or rags. They may ignite and cause a fire.

The three-way catalyst is an emission control device installed in the exhaust system. Exhaust gas in the three-way catalyst is burned at high temperatures to help reduce pollutants.



### CAUTION:

- Do not use leaded gasoline. (See "Recommended fluids/lubricants and capacities" (P.9-2).) Deposits from leaded gasoline seriously reduce the ability of the three-way catalyst to help reduce exhaust pollutants and/or damage the three-way catalyst.
- Keep your engine tuned up. Malfunctions in the ignition, fuel injection, or electrical systems may cause overrich fuel to flow into the three-way catalyst, causing it to overheat. Do not keep driving if the

engine misfires, or if noticeable loss of performance or other unusual operating conditions are detected. Have the vehicle inspected promptly by a NISSAN dealer.

- Avoid driving with an extremely low fuel level. Running out of fuel could cause the engine to misfire, damaging the three-way catalyst.
- Do not race the engine while warming it up.
- Do not push or tow your vehicle to start the engine.

## TURBOCHARGER SYSTEM (if equipped)

The turbocharger system uses engine oil for lubrication and cooling of its rotating components. The turbocharger turbine turns at extremely high speeds and it can reach an extremely high temperature. It is essential to maintain a clean supply of oil flowing through the turbocharger system. A sudden interruption of oil supply may cause a malfunction in the turbocharger.

To ensure prolonged life and performance of the turbocharger, it is essential to comply with the following maintenance procedure.



### CAUTION:

- Change the engine oil according to the recommended intervals shown in a separate maintenance booklet.
- Use only the recommended engine oil. See "Recommended fluids/lubricants and capacities" (P.9-2).
- If the engine has been operating at high rpm for an extended period of time, let it idle for a few minutes prior to turn off.

## CARE WHEN DRIVING

- **Do not accelerate your engine to high rpm immediately after starting it.**

Driving your vehicle to fit the circumstances is essential for your safety and comfort. As a driver, you should be the one who knows best how to drive in the given circumstances.

### ENGINE COLD START PERIOD

Due to the higher engine speeds, when the engine is cold, extra caution must be exercised when selecting a gear during the engine warm-up period after starting the engine.

### LOADING LUGGAGE

Loads and their distribution and the attachment of equipment (coupling devices, roof luggage carriers, etc.) will considerably change the driving characteristics of the vehicle. Your driving style and speed must be adjusted according to the circumstances.

### DRIVING IN WET CONDITIONS

- Avoid accelerating or stopping suddenly.
- Avoid sharp turning or lane changing suddenly.
- Avoid following too close to the vehicle in front.

When water covers the road surface with water puddles, small water streams, etc., reduce speed to prevent hydroplaning which can cause skidding and loss of control. Worn tires will increase this risk.

### DRIVING IN WINTER CONDITIONS

- Drive cautiously.
- Avoid accelerating or stopping suddenly.
- Avoid sharp turning or lane changing suddenly.
- Avoid sudden steering.
- Avoid following too close to the vehicle in front.

## IGNITION SWITCH (model without Intelligent Key system)

### WARNING:

Never remove the key or turn the ignition switch to the "LOCK" position while driving. The steering wheel will lock and could cause the driver to lose control of the vehicle. This could result in serious vehicle damage or personal injury.

## MANUAL TRANSMISSION (MT)

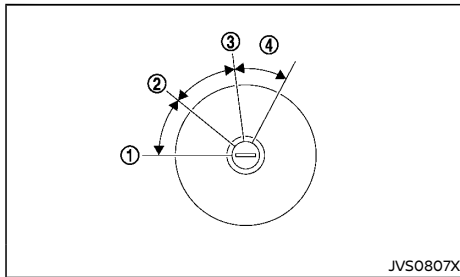

The ignition switch includes a device that helps prevent accidental removal of the key while driving.

The key can only be removed when the ignition switch is in the "LOCK" position ①.

## KEY POSITIONS

### LOCK (1)

- The ignition key can only be removed at this position.
- The steering lock can only be locked at this position.

### OFF (2)

The engine is turned off with the steering wheel unlocked.

### ON (3)

The ignition system and the electrical accessory power activate without the engine turned on.

### START (4)

The engine starter activates and the engine will start. The ignition switch, when released, will automatically turn to the "ON" position.

### CAUTION:

**As soon as the engine has started, release the ignition switch immediately.**

## STEERING LOCK

### To lock steering wheel

1. Turn the ignition switch to the "LOCK" position.
2. Remove the key from the ignition switch.
3. Turn the steering wheel 1/6 of a turn clockwise from the straight up position.

### To unlock steering wheel

1. Insert the key into the ignition switch.
2. Gently turn the ignition switch while rotating the steering wheel slightly right and left.

## PUSH-BUTTON IGNITION SWITCH (model with Intelligent Key system)

### PRECAUTIONS ON PUSH-BUTTON IGNITION SWITCH OPERATION

### WARNING:

**Do not operate the push-button ignition switch while driving the vehicle except in an emergency. (The engine will stop when the ignition switch is pushed 3 consecutive times or the ignition switch is pushed and held for more than 2 seconds.) The steering wheel will lock and could cause the driver to lose control of the vehicle. This could result in serious vehicle damage or personal injury.**

Before operating the push-button ignition switch, be sure to move the shift lever to the "P" (Park) position (for Continuously Variable Transmission (CVT) model) or the shift lever to the "N" (Neutral) position (for Manual Transmission (MT) model).

## INTELLIGENT KEY SYSTEM

The Intelligent Key system can operate the ignition switch without taking the key out from your pocket or bag. The operating environment and/or conditions may affect the Intelligent Key system operation.

### CAUTION:

- **Be sure to carry the Intelligent Key with you when operating the vehicle.**
- **Never leave the Intelligent Key inside the vehicle when you leave the vehicle.**
- **If the vehicle battery is discharged, the ignition switch cannot be switched from the "LOCK" position, and if the steering lock is engaged, the steering wheel cannot be moved. Charge the battery as**

soon as possible. (See “Jump starting” (P.6-7).)

### Operating range

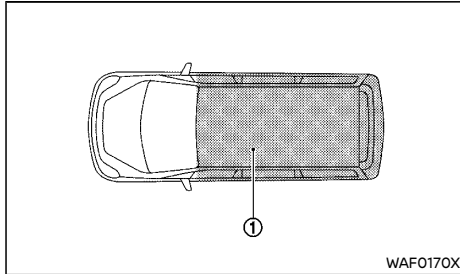

The Intelligent Key can only be used for starting the engine when the Intelligent Key is within the specified operating range ①.

When the Intelligent Key battery is almost discharged or strong radio waves are present near the operating location, the Intelligent Key system's operating range becomes narrower and may not function properly.

If the Intelligent Key is within the operating range, it is possible for anyone, even someone who does not carry the Intelligent Key, to push the ignition switch to start the engine.

- If the Intelligent Key is placed on the instrument panel, inside the glove box, door pocket or the corner of the interior compartment, the Intelligent Key may not function.
- If the Intelligent Key is placed near the door or window outside the vehicle, the Intelligent Key may function.

Continuously Variable Transmission (CVT) model  
If the ignition switch is switched to the “LOCK” position, the shift lever cannot be moved from the “P” (Park) position. The shift lever can be moved if the ignition switch is in the “ON” position with the foot brake pedal depressed.

### STEERING LOCK

The ignition switch is equipped with an anti-theft steering lock device.

#### To lock steering wheel

1. Push the ignition switch to the stop the engine.
2. Open or close the driver's door. The ignition switch turns to the “LOCK” position.
3. Turn the steering wheel 1/6 of a turn to the right or left from the straight up position.

#### To unlock steering wheel

Push the ignition switch, and the steering wheel will be automatically unlocked.

#### CAUTION:

- **If the battery of the vehicle is discharged, the push-button ignition switch cannot be switched from the “LOCK” position.**
- **If the ignition switch position does not change from the “LOCK” position, push the ignition switch again while rotating the steering wheel slightly to the right and left.**

### IGNITION SWITCH POSITIONS

#### WARNING:

**Never push the ignition switch to stop the engine while driving. The steering wheel may lock and cause the driver to lose control of the vehicle, resulting in serious vehicle damage or personal injury.**

#### CAUTION:

- **Do not leave the vehicle for extended periods of time when the ignition switch is in the “ON” position and the engine is not running. This can discharge the battery.**
- **Use electrical accessories with the engine running to avoid discharging the vehicle battery. If you must use accessories while the engine is not running, do not use them for extended periods of time and do not use multiple electrical accessories at the same time.**

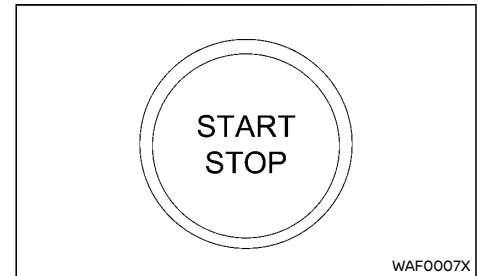

Push the ignition switch once to change to “ON”.

The ignition switch will automatically return to

the "LOCK" position when the driver's door is either opened or closed.

### ON position

The ignition system and the electrical accessory power activate at this position without the engine turned on.

The "ON" position has a battery saver feature that will turn off the ignition if the vehicle is not running for 3 minutes.

### LOCK position

The ignition switch and steering lock can only be locked at this position.

### INTELLIGENT KEY BATTERY DISCHARGE

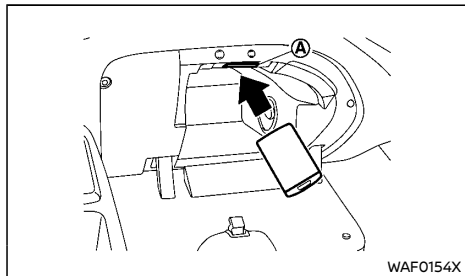

If the battery of the Intelligent Key is almost discharged, the "KEYCARD BATTERY LOW" or "PLEASE INSERT KEYCARD" message appears in the vehicle information display. (See "Vehicle information display" (P.2-11).)

In this case, inserting the Intelligent Key into the port **A** allows you to start the engine. Make sure that the key ring side faces backward as illustrated. Insert the Intelligent Key in the port until it is latched and secured.

To remove the Intelligent Key from the port,

push the ignition switch to stop the engine and pull the Intelligent Key.

### CAUTION:

- **The Intelligent Key port does not charge the Intelligent Key battery. If you see the "KEYCARD BATTERY LOW" or "PLEASE INSERT KEYCARD" message on the vehicle information display, replace the battery as soon as possible. (See "Intelligent Key battery" (P.8-18).)**
- **Never place anything except the Intelligent Key in the Intelligent Key port. Doing so may cause damage to the equipment.**
- **Make sure the Intelligent Key is in the correct direction when inserting it to the Intelligent Key port. The engine may not start if it is in the wrong direction.**
- **Remove the Intelligent Key from the Intelligent Key port after the ignition switch is pushed to stop the engine.**

## STARTING ENGINE (model without Intelligent Key system)

1. Apply the parking brake.
2. Depress the foot brake pedal.
3. Move the shift lever to the "N" (Neutral) position, and depress the clutch pedal to the floor while starting the engine.
4. Crank the engine with your foot off the accelerator pedal by turning the ignition switch to the "START" position.
5. Immediately release the ignition switch when the engine starts. If the engine starts, but fails to run, repeat the above procedures.

If the engine is very hard to start in extremely cold or hot weather, depress the accelerator pedal and hold it to help start the engine.

### CAUTION:

- **Do not operate the starter for more than 15 seconds at a time. If the engine does not start, turn the ignition switch off and wait 10 seconds before cranking the engine again. Otherwise, the starter could be damaged.**
- **After 3 sequence of attempts, if the engine fails to start or requires many attempts to start, contact a NISSAN dealer.**
- **Do not operate the starter if the engine is running or while a gear is engaged. It may damage the starter.**
- **If it becomes necessary to start the engine with a booster battery and jumper cables, the instructions and cautions contained in the "6. In case of emergency" section should be carefully followed.**

## STARTING ENGINE (model with Intelligent Key system)

6. Allow the engine to idle for at least 30 seconds after starting the engine to warm-up. Drive at moderate speeds for a short distance first, especially in cold weather.



### CAUTION:

Do not leave the vehicle unattended while the engine is warming up.

1. Apply the parking brake.
2. **Continuously Variable Transmission (CVT) model:**

Move the shift lever to the "P" (Park) or the "N" (Neutral) position.

**The starter is designed to operate only when the shift lever is in the proper position.**

#### Manual Transmission (MT) model:

Move the shift lever to the "N" (Neutral) position.

**The starter is designed to not operate unless the brake pedal is fully depressed.**

**The Intelligent Key must be carried when operating the ignition switch.**

3. Place the ignition switch in the "ON" position. Firmly depress the brake pedal (CVT model) or the clutch pedal (MT model) and push the ignition switch to start the engine.
4. Immediately release the ignition switch when the engine starts. If the engine starts, but fails to run, repeat the above procedures.

If the engine is very hard to start in extremely cold or hot weather, depress the accelerator pedal and hold it. Push the ignition switch for up to 15 seconds while holding. Release the accelerator pedal when the engine starts.



### CAUTION:

- As soon as the engine has started, release the ignition switch immediately.
- Do not operate the starter for more than 20 seconds at a time. If the engine does not start, wait 20 seconds before cranking the engine again. Otherwise, the

starter could be damaged.

- After 3 sequence of attempts, if the engine fails to start or requires many attempts to start, contact a NISSAN dealer.
  - If it becomes necessary to start the engine with a booster battery and jumper cables, the instructions and cautions contained in the "6. In case of emergency" section should be carefully followed.
5. Allow the engine to idle for at least 30 seconds after starting the engine to warm-up. Drive at moderate speeds for a short distance first, especially in cold weather.



### CAUTION:

Do not leave the vehicle unattended while the engine is warming up.

6. To stop the engine, move the shift lever to the "P" (Park) position (CVT model) or move the shift lever to the "N" (Neutral) position (MT model), apply the parking brake and push the ignition switch to stop the engine.



## DRIVING VEHICLE

### DRIVING WITH CONTINUOUSLY VARIABLE TRANSMISSION (CVT)

The Continuously Variable Transmission (CVT) in your vehicle is electronically controlled to produce maximum power and smooth operation.

The recommended operating procedures for this transmission are shown on the following pages. Follow these procedures for maximum vehicle performance and driving enjoyment.



#### WARNING:

**Do not downshift abruptly on slippery roads. This may cause a loss of control.**



#### CAUTION:

- The cold engine idle speed is high, so use caution when shifting the transmission into a forward or reverse position before the engine has warmed up.
- Avoid revving up the engine while the vehicle is stopped. This could cause unexpected vehicle movement.
- Never shift to either the "P" (Park) or "R" (Reverse) position while the vehicle is moving forward and "P" (Park) or "D" (Drive) position while the vehicle is reversing. This could cause an accident or damage the transmission.
- Start the engine in either the "P" (Park) or "N" (Neutral) position. The engine will not start in any other position. If it does, have your vehicle checked by a NISSAN dealer.
- Except in an emergency, do not shift to the "N" (Neutral) position while driving. Coasting with the transmission in the "N" (Neutral) position may cause serious da-

mage to the transmission.

- Shift into the "P" (Park) position and apply the parking brake when at a standstill for longer than a short waiting period.
- Keep the engine at idling speed while shifting from the "N" (Neutral) position to any driving position.
- When stopping the vehicle on an uphill grade, do not hold the vehicle by depressing the accelerator pedal. The foot brake pedal should be depressed in this situation.

### Starting vehicle

1. After starting the engine, fully depress the foot brake pedal before moving the shift lever out of the "P" (Park) position.
2. Keep the foot brake pedal depressed and move the shift lever to a driving position.
3. Release the parking brake, the foot brake pedal, and then gradually start the vehicle in motion.

The CVT is designed so the foot brake pedal **MUST** be depressed before shifting from the "P" (Park) position to any driving position while the ignition switch is in the "ON" position.

The shift lever cannot be moved out of the "P" (Park) position and into any of the other positions if the ignition switch is placed in the "LOCK" or "OFF" position.



#### CAUTION:

- **DEPRESS THE FOOT BRAKE PEDAL** - Shifting the shift lever to "D" (Drive), "R" (Reverse) or manual shift mode without depressing the foot brake pedal causes the vehicle to move slowly when the

engine is running. Make sure the foot brake pedal is depressed fully and the vehicle is stopped before shifting the shift lever.

- **MAKE SURE OF THE SHIFT LEVER POSITION** - Make sure the shift lever is in the desired position. "D" (Drive) and manual shift mode are used to move forward and "R" to back up.
- **WARM UP THE ENGINE** - Due to the higher idle speeds when the engine is cold, extra caution must be exercised when shifting the shift lever into the driving position immediately after starting the engine.

### Shifting

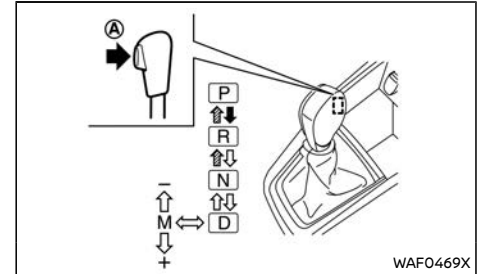

- ➔ Push the button **A** while depressing the foot brake pedal.
- ▨➔ Push the button **A**.
- ⇨➔ Just move the shift lever.



#### WARNING:

- Apply the parking brake if the shift lever is in any position while the engine is not running. Failure to do so could cause the

vehicle to move unexpectedly or roll away and result in serious personal injury or property damage.

- If the shift lever cannot be moved from the “P” (Park) position while the engine is running and the foot brake pedal is depressed, the stop lights may not work. **Malfunctioning stop lights could cause an accident injuring yourself and others.**

After starting the engine, fully depress the foot brake pedal, push the shift lever button and move the shift lever out of the “P” (Park) position.

If the ignition switch is placed in the “OFF” position for any reason while the shift lever is in any positions other than the “P” (Park) position, the ignition switch cannot be placed in the “LOCK” position.

When it is hard to shift the shift lever from the “P” (Park) position to other position, first check that the parking brake is applied, then release the foot brake pedal and depress the foot brake pedal again.

If the ignition switch cannot be placed in the “LOCK” position, perform the following steps:

1. Apply the parking brake.
2. Place the ignition switch in the “ON” position while depressing the foot brake pedal.
3. Move the shift lever to the “P” (Park) position.
4. Place the ignition switch in the “LOCK” position.

#### **P (Park):**

Use this position when the vehicle is parked or when starting the engine. **Make sure that the vehicle is completely stopped and move the shift lever into the “P” (Park) position.** Apply the parking brake. When parking on a hill, first depress the foot brake pedal, apply the parking brake, and then move the shift lever into the “P” (Park) position.

#### **R (Reverse):**

Use this position to back up. Make sure that the vehicle is completely stopped before selecting the “R” (Reverse) position.

#### **N (Neutral):**

Neither the forward nor reverse gear is engaged. The engine can be started in this position. You may shift to the “N” (Neutral) position and restart a stalled engine while the vehicle is moving.

#### **D (Drive):**

Use this position for all normal forward driving.

#### **Manual shift mode**

When the shift lever is shifted from the “D” (Drive) position to the manual shift gate with the vehicle stopped or while driving, the transmission enters the manual shift mode. Shift ranges can be selected manually.

In the manual shift mode, the shift range is displayed on the position indicator in the meter.

Shift ranges up or down one by one as follows:

M1 → M2 → M3 → M4 → M5 → M6 → M7 → M8

- When shifting up, move the shift lever to the + (down) side. (Shifts to higher range.)
- When shifting down, move the shift lever to the – (up) side. (Shifts to lower range.)
- Moving the shift lever to the same side twice will shift the ranges in succession. However, if this motion is rapidly done, the second shifting may not be completed properly.

#### **M7 (Seventh) and M8 (Eighth):**

Use this position for all normal forward driving. However, you need to shift down the gears manually when accelerating or passing another vehicle.

#### **M6 (Sixth) and M5 (Fifth):**

Use these positions when driving up long slopes, or for engine braking when driving down long slopes.

#### **M4 (Fourth), M3 (Third) and M2 (Second):**

Use these positions for hill climbing or engine braking on downhill grades.

#### **M1 (First):**

Use this position when climbing steep hills slowly or driving slowly through deep snow, sand or mud or for maximum engine braking on steep downhill grades.

- Remember not to drive at high speeds for extended periods of time in lower than M7 range. This reduces fuel economy.
- **In the manual shift mode, the transmission automatically shifts down to M1 (First) before the vehicle comes to a stop. When accelerating again, it is necessary to shift up to the desired range.**

- **In the manual shift mode, the transmission may not shift to the selected gear. This helps maintain driving performance and reduces the chance of vehicle damage or loss of control.**
- When canceling the manual shift mode, return the shift lever to the “D” (Drive) position. The transmission returns to the normal driving mode.
- When the CVT fluid temperature is extremely low, the manual shift mode may not work and automatically shift as a drive mode. This is not a malfunction. In this case, return the shift lever to the “D” (Drive) position and drive for a while and then shift to the manual shift mode.
- When the CVT fluid temperature is high, the shift range may upshift in lower rpm than usual. This is not a malfunction.

**Accelerator downshift - in the “D” position -**  
For passing or climbing hills, depress the accelerator pedal to the floor. This shifts the transmission down into a lower gear, depending on the vehicle speed.

### Shift lock release

If the battery is discharged, the shift lever may not be moved from the “P” (Park) position even with the foot brake pedal depressed.

To release the shift lock, perform the following procedure:

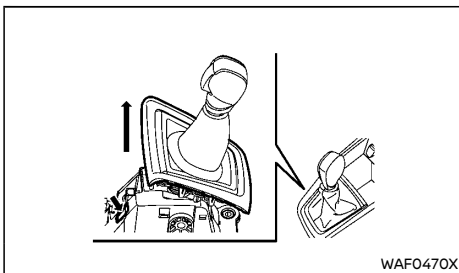

1. Place the ignition switch in the “OFF” or “LOCK” position.
2. Apply the parking brake.
3. Remove the base of the shift lever as shown using a suitable tool.
4. Insert the key, etc. and push down the shift lock release.
5. Push the shift lever button and move the shift lever to the “N” (Neutral) position while holding down the shift lock release. Replace the removed base of the shift lever after the operation.

Place the ignition switch in the “ON” position to release the steering wheel lock.

The vehicle may be moved, by pushing, to the desired location.

If the shift lever cannot be moved out of the “P” (Park) position, have a NISSAN dealer check the CVT system as soon as possible.

### High fluid temperature protection mode

This transmission has a high fluid temperature protection mode. If the fluid temperature becomes too high (for example, when climbing steep grades in high temperature with heavy loads), engine power and, under some conditions, vehicle speed will be decreased automatically to reduce the chance of transmission damage. Vehicle speed can be controlled with the accelerator pedal, but engine and vehicle speed may be limited.

### Fail-safe

When the fail-safe operation occurs, the CVT will not be shifted to the selected driving position.

**If the vehicle is driven under extreme conditions, such as excessive wheel spinning and subsequent hard braking, the fail-safe system may be activated. This will occur even if all electrical circuits are functioning properly. In this case, place the ignition switch in the “OFF” position and wait for 10 seconds. Then place the ignition switch back in the “ON” position. The vehicle should return to its normal operating condition. If it does not return to its normal operating condition, have a NISSAN dealer check the transmission and repair it if necessary.**



### WARNING:

**When the fail-safe operation occurs, vehicle speed may be gradually reduced. The reduced speed may be lower than other traffic, which could increase the chance of a collision. Be especially careful when driving. If necessary, pull to the side of the road at a safe place and allow the transmission to return to normal operation, or have it repaired if necessary.**

## DRIVING WITH MANUAL TRANSMISSION (MT)



### WARNING:

- Do not downshift abruptly on slippery roads. This may cause a loss of vehicle control.
- Do not over-rev the engine when shifting to a lower gear. This may cause a loss of vehicle control or engine damage.



### CAUTION:

- Do not rest your foot on the clutch pedal while driving. This may damage the clutch system.
- Fully depress the clutch pedal before shifting to help prevent transmission damage.
- Stop the vehicle completely before shifting into the "R" (Reverse) position.
- When the vehicle is stopped for a period of time, for example waiting at stoplights, shift to the "N" (Neutral) position and release the clutch pedal with the foot brake pedal depressed.
- Do not shift to the "N" (Neutral) position while driving. Doing so may result in an accident due to loss of engine braking.

## Starting vehicle

1. After starting the engine, depress the clutch pedal to the floor and move the shift lever to the "1" (1st) or "R" (Reverse) position.
2. Slowly depress the accelerator pedal, releasing the clutch pedal and parking brake at the same time.

## Shifting gear

To change gears, or when upshifting or downshifting, fully depress the clutch pedal, shift into the appropriate gear, then slowly and smoothly release the clutch pedal.

To ensure smooth gear changes, fully depress the clutch pedal before operating the shift lever. If the clutch pedal is not fully depressed before the transmission is shifted, a gear noise may be heard. Transmission damage could occur.

Start the vehicle in the "1" (1st) position and shift to the "2" (2nd), "3" (3rd), "4" (4th), "5" (5th) and "6" (6th) (if equipped) gear in sequence according to the vehicle speed.

If it is difficult to move the shift lever into the "R" (Reverse) or "1" (1st) position, shift to the "N" (Neutral) position, and then release the clutch pedal once. Fully depress the clutch pedal again and shift into "R" or "1".

## 5-speed Manual Transmission (MT) model:

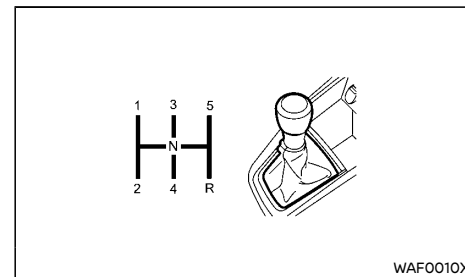

You cannot shift directly from the "5" (5th) position into the R (Reverse) position. First shift into the N (Neutral) position, then shift into the R (Reverse) position.

## 6-speed Manual Transmission (MT) model:

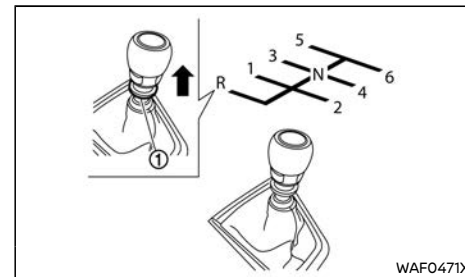

- To reverse, stop the vehicle and move the shift lever into the N (Neutral) position, and then pull the ring ① upward to shift into the R (Reverse) position.
- The ring returns to its original position when the shift lever is moved to the N (Neutral) position.

## Gear shift indicator (if equipped)

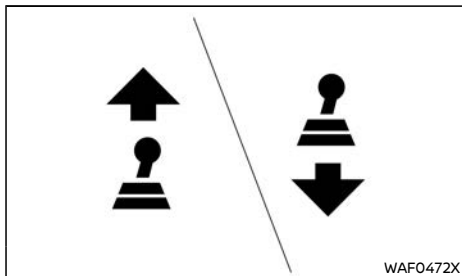

The manual transmission gear shift indicator appears in the meter when the driver should shift into a higher or lower gear as indicated by the up or down arrow. The use of the gear shift indicator will help the driver to upshift or downshift at a constant engine speed from any gear according to the preferred operation or road condition.

When the up arrow appears, upshifting is recommended. When the down arrow appears, downshifting is recommended.

## Suggested maximum speed in each gear

Downshift to a lower gear if the engine is not running smoothly, or if you need to accelerate.

Do not exceed the maximum suggested speed (shown below) in any gear. For level road driving, use the highest gear suggested for that speed. Always observe posted speed limits, and drive according to the road conditions which will ensure safe operation. Do not over-rev the engine when shifting to a lower gear as it may cause engine damage or loss of vehicle control.

## H4K engine model:

	km/h (MPH)
1st	43 (27)
2nd	79 (49)
3rd	123 (76)
4th	— (—)
5th	— (—)

## HR13DDT engine model:

	km/h (MPH)
1st	50 (31)
2nd	88 (55)
3rd	140 (87)
4th	— (—)
5th	— (—)
6th	— (—)

## STOP/START SYSTEM (if equipped)

The Stop/Start System is designed to prevent unnecessary fuel consumption, exhaust emissions, and noise during a journey:

- When you stop the vehicle with the brake pedal depressed firmly and the shift lever in the "N" (Neutral), "D" (Drive) or manual shift mode, the engine is turned off automatically (for Continuously Variable Transmission (CVT) model).
- When the shift lever is in the "N" (Neutral) position, the clutch pedal is released and the vehicle speed is less than approximately 5 km/h (3 MPH), the engine is turned off automatically (for Manual Transmission (MT) model).
- When you release the brake pedal (CVT model) or depress the clutch pedal (MT model), the engine is automatically turned on.
- When the engine is stopped by the Stop/Start system, the Stop/Start indicator light  illuminates on the meter.

### NOTE:

**If you turn off the ignition switch when the engine has been automatically stopped by the Stop/Start System, the Malfunction Indicator Light (MIL)  illuminates for a few seconds (if equipped).**



### CAUTION:

- The engine may restart automatically if required by the Stop/Start System.
- Place the ignition switch in the "OFF" position before opening the hood or performing any maintenance. Failure to do so may result in serious injuries due to automatic engine restart.

- Always place the ignition switch in the "OFF" position before leaving your vehicle, as the system may have turned the engine off, but the ignition will still be on and automatic restart may occur.

Failure to do this may result in a flat battery.

- Keep the vehicle stationary when the Stop/Start System is activated (when the Stop/Start indicator light illuminates).

#### NOTE:

For model with Stop/Start System, use the special battery that is enhanced in regard to the charge-discharge capacity and life performance. Avoid using a non-special battery for the Stop/Start System, as this may cause early deterioration of the battery or a malfunction of the Stop/Start System. For the battery, it is recommended to use Genuine NISSAN parts. For more information, contact a NISSAN dealer.

#### NOTE:

The Stop/Start System will not activate under the following conditions (depending on the condition, the Stop/Start System indicator light  illuminates in the meter):

- when the engine coolant temperature is low.
- when the battery capacity is low.
- when the engine hood is not locked.
- when the driver's seat belt is not fastened (models with Intelligent Key system).
- when the driver's door is open (models with Intelligent Key system).
- when the Stop/Start System indicator light  blinks (for MT model).

- when the fan speed control is in any position other than "OFF" while the air flow control is in the front defogger position.
- when the front defogger switch is on.
- when the outside temperature is too high or low.
- when the temperature inside the vehicle is too high or low.
- when the Stop/Start OFF switch is turned on.
- when the vehicle is traveling at high altitude.
- For Manual Transmission (MT) models
  - when the shift lever is in any position except the "N" (Neutral) position.
  - when the clutch pedal is depressed.
- For Continuously Variable Transmission (CVT) models
  - when the accelerator pedal is depressed.
  - when the shift lever is in the "R" (Reverse) position.
  - when the brake pedal is not firmly depressed.
  - when stopping the vehicle on steep sloping roads.

#### NOTE:

The engine will not restart even if the brake pedal is released (CVT) or clutch pedal is depressed (MT) while the Stop/Start System is activated under the following condition:

- when the shift lever is in the "P" (Park) position (for CVT model).
- when the engine hood is opened.
- when the driver's seat belt is unfastened and the driver's door is opened (models with Intelligent Key system).

- when the clutch pedal is released too quickly while a gear is engaged (for MT model).

#### NOTE:

When the Stop/Start System indicator light  illuminates, the engine starts running automatically under at least one of the following conditions:

- the brake pedal is released with the shift lever in the "D" (Drive) or manual shift mode (for CVT model).
- the brake pedal is released with the shift lever in the "N" (Neutral) position and the parking brake released (for CVT model).
- the brake pedal is depressed again with the shift lever in the "N" (Neutral) position and the parking brake applied (for CVT model).
- in the manual shift mode, the shift lever is moved up or down (for CVT model).
- the shift lever is placed in the "R" (Reverse) position (for CVT model).
- the vehicle speed is above about 5 km/h (3 MPH) (for MT model).
- when the outside temperature is too high or low.
- when the front defogger is turned on.
- when the accelerator pedal is depressed (for CVT model).
- when the battery capacity is low.
- when the clutch pedal is depressed (for MT model).
- when the clutch pedal is slightly depressed with the shift lever in the "N" (Neutral) position (for MT model).

## VEHICLE DYNAMIC CONTROL (VDC) SYSTEM (if equipped)



### CAUTION:

Only engage gear when the clutch pedal is fully depressed (for MT model).

### NOTE:

The following conditions will prevent the Stop/Start System from automatically restarting the engine. Starting the engine with the ignition switch operation is then necessary:

- the driver's seat belt is unfastened, and driver's door is open (models with Intelligent Key system).

Use this system while waiting at stoplight, etc. When the vehicle is stopped for long periods of time, turn off the engine.

When the engine is stopped by the Stop/Start System, heating, cooling and dehumidifying functions will be deactivated. To avoid the air conditioning functions from being deactivated, turn off the Idling Stop mode by pressing the Stop/Start OFF switch.

### STOP/START OFF SWITCH

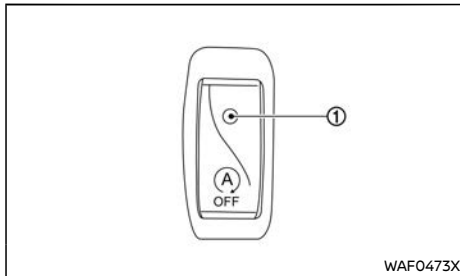





The system can be temporarily deactivated by

pressing the Stop/Start OFF switch. Pressing the switch again or restarting the engine by using the ignition switch will reactivate the Stop/Start System.

- When the Stop/Start System is deactivated while the engine is running, the engine is prevented from automatically stopping.
- When the Stop/Start System is deactivated after the engine has been automatically stopped by the Stop/Start System, the engine will immediately restart if suitable conditions are present. The engine will then be prevented from automatically stopping during the same journey.
- When the Stop/Start System is deactivated, "STOP AND START DEACTIVATED" message appears on the vehicle information display and the indicator light ① on the Stop/Start OFF switch illuminates. In this condition the Stop/Start System cannot prevent unnecessary fuel consumption, exhaust emissions, or noise during your journey.
- When the Stop/Start System is activated using the Stop/Start OFF switch, "STOP AND START ACTIVATED" message appears on the vehicle information display and the indicator light ① on the Stop/Start OFF switch turns off.
- If the Stop/Start System is malfunctioning, "CHECK STOP AND START" message appears on the vehicle information display and the indicator light ① on the Stop/Start OFF switch illuminates.



### WARNING:

- The Vehicle Dynamic Control (VDC) system is designed to help the driver maintain stability but does not prevent accidents due to abrupt steering operation at high speeds or by careless or dangerous driving techniques. Reduce vehicle speed and be especially careful when driving and cornering on slippery surfaces and always drive carefully.
- Do not modify the vehicle's suspension. If suspension parts such as shock absorbers, struts, springs, stabilizer bars, bushings and wheels are not NISSAN recommended for your vehicle or are extremely deteriorated, the VDC system may not operate properly. This could adversely affect vehicle handling performance, and the VDC warning light  may illuminate.
- If brake related parts such as brake pads, rotors and calipers are not NISSAN recommended or are extremely deteriorated, the VDC system may not operate properly and the VDC warning light  may illuminate.
- If engine control related parts are not NISSAN recommended or are extremely deteriorated, the VDC warning light  may illuminate.
- When driving on extremely inclined surfaces such as higher banked corners, the VDC system may not operate properly and the VDC warning light  may illuminate. Do not drive on these types of roads.
- When driving on an unstable surface such as a turntable, ferry, elevator or ramp, the

## HILL START ASSIST SYSTEM (if equipped)

VDC warning light  may illuminate. This is not a malfunction. Restart the engine after driving onto a stable surface.

- If wheels or tires other than the NISSAN recommended ones are used, the VDC system may not operate properly and the VDC warning light  may illuminate.
- The VDC system is not a substitute for winter tires or tire chains on a snow covered road.

The Vehicle Dynamic Control (VDC) system uses various sensors to monitor driver inputs and vehicle motion. Under certain driving conditions, the VDC system helps to perform the following functions.

- Controls brake pressure to reduce wheel slip on one slipping drive wheel so power is transferred to a non slipping drive wheel on the same axle.
- Controls brake pressure and engine output to reduce drive wheel slip based on vehicle speed (traction control function).
- Controls brake pressure at individual wheels and engine output to help the driver maintain control of the vehicle in the following conditions:
  - understeer (vehicle tends to not follow the steered path despite increased steering input)
  - oversteer (vehicle tends to spin due to certain road or driving conditions).

The VDC system can help the driver to maintain control of the vehicle, but it cannot prevent loss of vehicle control in all driving situations.

When the VDC system operates, the VDC warning light  in the instrument panel flashes so note the following:

- The road may be slippery or the system may determine some action is required to help the vehicle on the steered path.
- You may feel a pulsation in the brake pedal and hear a noise or vibration from under the hood. This is normal and indicates that the VDC system is working properly.
- Adjust your speed and driving to the road conditions.

If a malfunction occurs in the system, the VDC warning light  illuminates in the instrument panel. The VDC system automatically turns off.

See "Vehicle Dynamic Control (VDC) warning light" (P.2-8).

The computer has a built-in diagnostic feature that tests the system each time you start the engine and move the vehicle forward or in reverse at a slow speed. When the self-test occurs, you may hear a "clunk" noise and/or feel a pulsation in the brake pedal. This is normal and is not an indication of a malfunction.



### WARNING:

- **Never rely solely on the hill start assist system to prevent the vehicle from moving backward on a hill. Always drive carefully and attentively. Depress the brake pedal when the vehicle is stopped on a steep hill. Be especially careful when stopped on a hill on frozen or muddy roads. Failure to prevent the vehicle from rolling backwards may result in a loss of control of the vehicle and possible serious injury or death.**
- **The hill start assist system is not designed to hold the vehicle at a standstill on a hill. Depress the brake pedal when the vehicle is stopped on a steep hill. Failure to do so may cause the vehicle to roll backwards and may result in a collision or serious personal injury.**
- **The hill start assist system may not prevent the vehicle from rolling backwards on a hill under all load or road conditions. Always be prepared to depress the brake pedal to prevent the vehicle from rolling backwards. Failure to do so may result in a collision or serious personal injury.**

The hill start assist system automatically keeps the brakes applied to help prevent the vehicle from rolling backwards in the time it takes the driver to release the brake pedal and apply the accelerator when the vehicle is stopped on a hill.

The hill start assist system will operate automatically under the following conditions:

- The transmission is shifted to a forward or reverse gear.



## SPEED LIMITER (if equipped)

- The vehicle is stopped completely on a hill by applying the brake.

The maximum holding time is 2 seconds. After 2 seconds the vehicle will begin to roll back and the hill start assist system will stop operating completely.

The hill start assist system will not operate when the transmission is shifted to the "N" (Neutral) (for MT model) or "P" (Park) position (for CVT model), or on a flat and level road.

When the Vehicle Dynamic Control (VDC) warning light illuminates in the meter, the hill start assist system will not operate. (See "Vehicle Dynamic Control (VDC) system" (P.5-15).)

The speed limiter allows you to set the desired vehicle speed limit. While the speed limiter is activated, the driver can perform normal braking and acceleration, but the vehicle will not exceed the set speed.



### WARNING:

- **Always observe posted speed limits. Do not set the speed over them.**
- **Always confirm the setting status of the speed limiter on the instrument panel.**

When the speed limiter is on, the cruise control cannot be operated.

### SPEED LIMITER OPERATIONS

The speed limiter can be set between following speeds.

- 30 to 200 km/h (20 to 124 MPH)

The speed limiter set switches are located on the steering wheel and the right side of the instrument panel.

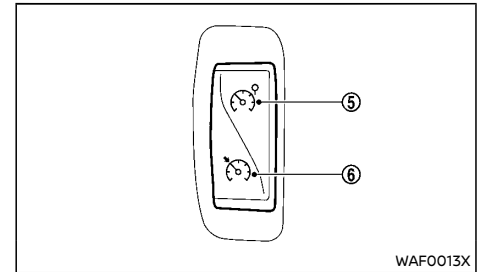
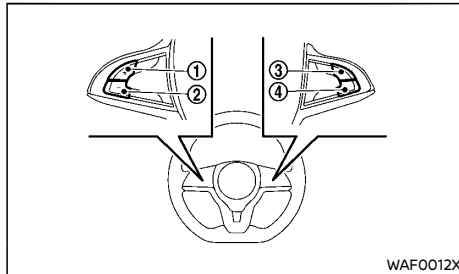

1. + switch
2. - switch
3. RES switch
4. ○ switch
5. Speed limiter MAIN switch

(When this switch is pushed, the speed limiter enters the standby mode. If the cruise control system is on, the system will turn off and the speed limiter enters the standby mode.)

6. Cruise control MAIN switch (For details, see "Cruise control" (P.5-18).)

### Speed limiter display and indicators

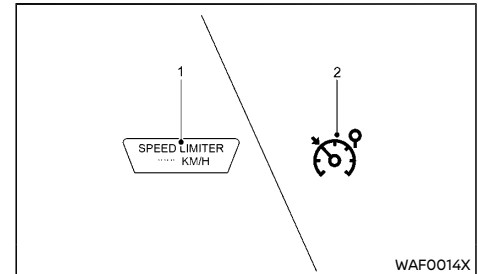

The speed limiter operating condition is shown on the instrument panel.

#### Instrument panel:

1. Speed limiter set speed
2. Speed limiter indicator light

**The speed limiter will not automatically brake the vehicle to the set speed limit.**

#### Turning on speed limiter

Push the speed limiter MAIN switch. The speed limiter indicator (orange) illuminates. The speed limiter set speed shows “- - -”.

#### Setting speed limit

1. Push the + switch.
  - When the vehicle is stopped, the speed will be set at 30 km/h (19 MPH).
  - While driving, the speed limit will be set at the current speed.
2. When the speed limit is set, the speed limiter indicator light and the speed limiter set speed illuminate on the instrument panel.

#### Changing set speed limit:

Use the following operation to change the speed limit.

- Push, then quickly release the + or - switch. Each time you do this, the set speed will increase or decrease by approximately 2 km/h (1.2 MPH).

#### Resuming preset speed limit:

Push the + switch or RES switch. The speed limiter indicator light illuminates, and the speed limiter will resume the last set speed limit. If the vehicle is driven at a speed over the last set speed limit, the speed limiter indicator light will blink.

#### Canceling speed limit

To cancel the speed limiter, push the ○ switch. The speed limiter indicator light will turn off. (The speed limiter set speed will remain on the display.)

If the accelerator pedal is fully depressed (beyond the resistance point), the speed limiter is temporarily suspended and the vehicle speed may be controlled above the set speed. The speed limiter set speed will flash on the vehicle information display.

The vehicle speed returns to the set speed, the speed limiter will activate and limit vehicle speed.

When one of the following operations is performed, the speed limiter will be canceled. The speed limiter set speed and the speed limiter indicator light will turn off. These canceling methods will erase the set speed limit memory.

- Push the speed limiter MAIN switch.
- Push the cruise control MAIN switch.

#### Speed limiter malfunction

If the speed limiter malfunctions, the speed limiter set speed on the instrument panel will blink. Turn the speed limiter MAIN switch off and have the system checked by a NISSAN dealer.

## CRUISE CONTROL (if equipped)



#### WARNING:

- **Always observe the posted speed limits and do not set the speed over them.**
- **Do not use the cruise control when driving under the following conditions. Doing so could cause a loss of vehicle control and result in an accident.**
  - When it is not possible to keep the vehicle at a constant speed
  - When driving in heavy traffic
  - When driving in traffic that varies speed
  - When driving in windy areas
  - When driving on winding or hilly roads
  - When driving on slippery (rain, snow, ice, etc.) roads



#### CAUTION:

**On Manual Transmission (MT) model, do not shift to the “N” (Neutral) position without depressing the clutch pedal when the cruise control is operated. Should this occur, depress the clutch pedal and turn the cruise control MAIN switch off immediately. Failure to do so may cause engine damage.**

## PRECAUTIONS ON CRUISE CONTROL

- If the cruise control system malfunctions, it cancels automatically. The set speed indicator and the cruise control on indicator light will blink to warn the driver.
- If the engine coolant temperature becomes excessively high, the cruise control system will be canceled automatically.
- If the set speed indicator and cruise control indicator light blink, turn off the cruise control MAIN switch and have the system checked by a NISSAN dealer.
- The set speed indicator and cruise control on indicator light may blink when the cruise control MAIN switch is turned on while pushing the RES switch. To properly set the cruise control system, use the following procedures.

## CRUISE CONTROL OPERATIONS

The cruise control allows driving at speeds above 30 km/h (19 MPH) without keeping your foot on the steering wheel and the accelerator pedal.

The cruise control will automatically be canceled if the vehicle slows down more than approximately 13 km/h (8 MPH) below the set speed.

Depressing the clutch pedal will cancel the cruise control and the set speed indicator will turn off.

The cruise control switches are located on the steering wheel and the right side of the instrument panel.

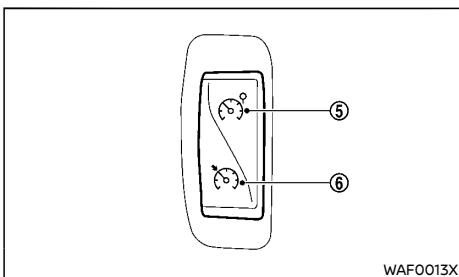
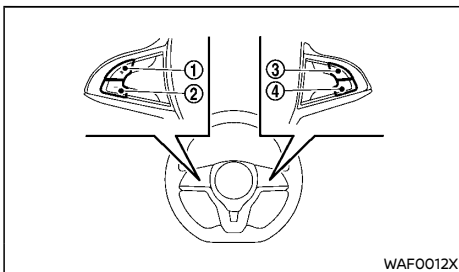

1. + switch
2. - switch
3. RES switch
4. O switch
5. Speed limiter MAIN switch (For details, see "Speed limiter" (P.5-17).)
6. Cruise control MAIN switch

## Cruise control display and indicators

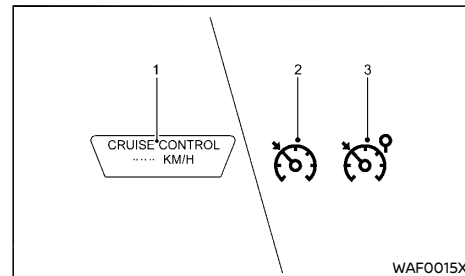

The cruise control operating condition is shown on the instrument panel.

### Instrument panel:

1. Cruise control set speed
2. Cruise control on indicator light
3. Speed limiter indicator light

### Turning on cruise control

Push the cruise control MAIN switch. The speed limiter indicator light (green) illuminates. The cruise control set speed shows "- -".

### Setting cruising speed

1. Accelerate to the desired speed.
2. Push the + switch and release it.
3. The cruise control on indicator light, the speed limiter indicator light and the cruise control set speed illuminate on the meter panel.
4. Take your foot off the accelerator pedal. The vehicle will maintain the set speed.

## FUEL EFFICIENCY AND CARBON DIOXIDE REDUCTION DRIVING TIPS

Follow these easy-to-use Fuel Efficiency and Carbon Dioxide Reduction Driving Tips to help you achieve the most fuel economy from your vehicle and reduce carbon dioxide emissions.

1. Use smooth accelerator and brake pedal application.
  - Avoid rapid starts and stops.
  - Use smooth, gentle accelerator and brake application whenever possible.
  - Maintain constant speed while commuting and coast whenever possible.
2. Maintain constant speed.
  - Look ahead to try and anticipate and minimize stops.
  - Synchronizing your speed with traffic lights allows you to reduce your number of stops.
  - Maintaining a steady speed can minimize red light stops and improve fuel efficiency.
3. Drive at economical speeds and distances.
  - Observing the speed limit and not exceeding 97 km/h (60 MPH) (where legally allowed) can improve fuel efficiency due to reduced aerodynamic drag.
  - Maintaining a safe following distance behind other vehicles reduces unnecessary braking.
  - Safely monitoring traffic to anticipate changes in speed permits reduced braking and smooth acceleration changes.
  - Select a gear range suitable to road conditions.
4. Use cruise control (if equipped).
  - Using cruise control during highway driving helps maintain a steady speed.

### Passing another vehicle:

Depress the accelerator pedal to accelerate. After releasing the accelerator pedal, the vehicle will return to the previously set speed.

The vehicle may not maintain the set speed when going up or down steep hills. In such cases, drive without the cruise control.

### Resetting to slower speed:

Use any one of the following methods to reset to a slower speed.

- Lightly tap the foot brake pedal. When the vehicle reaches the desired speed, push and release the - switch.
- Push and hold the - switch. When the vehicle reaches the desired speed, release the - switch.
- Quickly push and release the - switch. This will reduce the vehicle speed by about 2 km/h (1.2 MPH).

### Resetting to faster speed:

Use any one of the following methods to reset to a faster speed.

- Depress the accelerator pedal. When the vehicle reaches the desired speed, push and release the - switch.
- Push and hold the + switch. When the vehicle reaches the desired speed, release the + switch.
- Quickly push and release the + switch. This will increase the vehicle speed by about 2 km/h (1.2 MPH).

### Resuming at preset speed:

Push and release the RES switch.

The vehicle will resume the last set cruising speed when the vehicle speed is over 30 km/h (19 MPH).

### Canceling cruising speed

To cancel the cruising speed temporarily, push the  switch. The cruise control on indicator light will turn off. (The cruise control set speed will remain on the display.)

To cancel the cruise control, push the cruise control MAIN switch. The cruise control set speed and the cruise control on indicator light will turn off. This canceling method will erase the set cruise control memory.

## INCREASING FUEL ECONOMY AND REDUCING CARBON DIOXIDE EMISSIONS

- Cruise control is particularly effective in providing fuel savings when driving on flat terrains.
5. Plan for the shortest route.
    - Utilize a map or navigation system (if equipped) to determine the best route to save time.
  6. Avoid idling.
    - Shutting off your engine when safe for stops exceeding 30-60 seconds saves fuel and reduces emissions.
  7. Buy an automated pass for toll roads.
    - Automated passes permit drivers to use special lanes to maintain cruising speed through the toll and avoid stopping and starting.
  8. Winter warm up.
    - Limit idling time to minimize impact to fuel economy.
    - Vehicles typically need no more than 30 seconds of idling at start-up to effectively circulate the engine oil before driving.
    - Your vehicle will reach its ideal operating temperature more quickly while driving versus idling.
  9. Keeping your vehicle cool.
    - Park your vehicle in a covered parking area or in the shade whenever possible.
    - When entering a hot vehicle, opening the windows will help to reduce the inside temperature faster, resulting in reduced demand on your A/C system.
  10. Do not carry excessive weight.
    - Remove unnecessary objects from the vehicle to reduce vehicle weight.
- Keep your engine tuned up.
  - Follow the recommended scheduled maintenance.
  - Keep the tires inflated to the correct pressure. Low tire pressure increases tire wear and lowers fuel economy.
  - Keep the wheels in correct alignment. Improper alignment increases tire wear and lowers fuel economy.
  - Use the recommended viscosity engine oil. (See "Recommended fluids/lubricants and capacities" (P.9-2).)

## PARKING



### WARNING:

- **Do not stop or park the vehicle over flammable materials such as dry grass, waste paper or rags. They may ignite and cause a fire.**
- **Safe parking procedures require that both the parking brake be applied and the shift lever placed in the "P" (Park) position (Continuously Variable Transmission (CVT) model) or the shift lever placed in an appropriate gear (Manual Transmission (MT) model). Failure to do so could cause the vehicle to move unexpectedly or roll away and result in an accident.**
- **When parking the vehicle, make sure the shift lever is moved to the "P" (Park) position. The shift lever cannot be moved out of the "P" (Park) position without depressing the foot brake pedal (CVT model).**
- **Never leave the engine running while the vehicle is unattended.**
- **When parking for an extended period of time with Stop/Start System (if equipped) activated, the engine will restart automatically. Never leave the vehicle with the ignition switch in the "ON" position.**
- **Do not leave children unattended inside the vehicle. They could unknowingly activate switches or controls. Unattended children could become involved in serious accidents.**
- **To help avoid risk of injury or death through unintended operation of the vehicle and/or its systems, do not leave children, people who require the assistance of others or pets unattended in**

your vehicle. Additionally, the temperature inside a closed vehicle on a warm day can quickly become high enough to cause a significant risk of injury or death to people and pets.

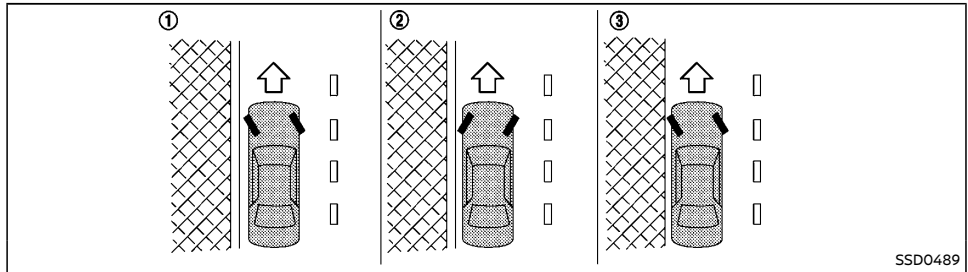

SSD0489

1. Firmly apply the parking brake.
2. Move the shift lever to the "R" (Reverse) position. When parking on an uphill grade, move the shift lever to the "1" (1st) position.
3. To help prevent the vehicle from moving into traffic when parked on an incline, it is a good practice to turn the wheels as illustrated.

#### HEADED DOWNHILL WITH CURB ①

Turn the wheels towards the curb and move the vehicle forward until the curb side wheel gently touches the curb. Then apply the parking brake.

#### HEADED UPHILL WITH CURB ②

Turn the wheels away from the curb and allow the vehicle to move back until the curb side wheel gently touches the curb. Then apply the parking brake.

#### HEADED UPHILL OR DOWNHILL, WITHOUT CURB ③

Turn the wheels toward the side of the road so the vehicle will move away from the center of the road if the vehicle moves. Then apply the parking brake.

#### 4. **Model with Intelligent Key system:**

Place the ignition switch in stop the engine.

#### **Model without Intelligent Key system:**

Place the ignition switch in the "LOCK" position and remove the key.

#### **NOTE:**

#### **For Model with Stop/Start System:**

**Use this system when the vehicle is stopped for a period of time, for example waiting at stoplights.**

**Stop the engine with the ignition switch when parking, etc. for an extended period of time.**

## PARKING SENSOR (sonar) SYSTEM

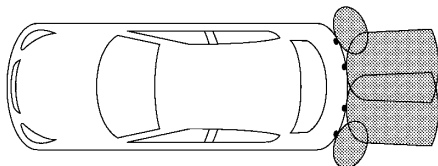

SSD0723

Keep the sonar sensors (located on the bumper fascia) free from snow, ice and large accumulations of dirt (do not clean the sensors with sharp objects). If the sensors are covered, it will affect the accuracy of the parking sensor (sonar) system.

**If the parking sensor (sonar) system malfunctions, the beep sounds for 3 seconds when the shift lever is moved to the "R" (Reverse) position. Have the system checked by a NISSAN dealer.**

### **WARNING:**

- The parking sensor (sonar) system is a convenience but it is not a substitute for proper parking. Always look around and check that it is safe to do so before parking. Always move slowly.
- Read and understand the limitations of the parking sensor (sonar) system as contained in this section. Inclement weather may affect the function of the parking sensor (sonar) system; this may include reduced performance or a false activation.
- This system is not designed to prevent contact with small or moving objects.
- The system is designed as an aid to the driver in detecting large stationary objects to help avoid damaging the vehicle. The system will not detect small objects below the bumper, and may not detect objects close to the bumper or on the ground.
- If your vehicle sustains damage to the bumper fascia, leaving it misaligned or bent, the sensing zone may be altered

causing inaccurate measurement of obstacles or false alarms.

### **CAUTION:**

Keep the interior of the vehicle as quiet as possible to hear the tone clearly.

When the ignition switch is in the "ON" position, the parking sensor (sonar) system is operational.

The parking sensor (sonar) system sounds a tone to warn the driver of obstacles near the bumper. The system detects rear obstacles when the shift lever is in the "R" (Reverse) position. The system may not detect objects at speeds above 10 km/h (6 MPH) and may not detect certain angular or moving objects.

The parking sensor (sonar) system detects obstacles up to 1.2 m (3.9 ft) from the bumper with a decreased coverage area at the outer corners of the bumper (refer to the illustration for approximate zone coverage areas). As you move closer to the obstacle, the rate of the tone increases. When the obstacle is less than 40 cm (15.7 in) away, the tone will sound continuously.

## TRAILER TOWING

Your vehicle was designed to be used to carry passengers and luggage. NISSAN does not recommend trailer towing, because it places additional loads on your vehicle's engine, drive-train, steering, braking and other systems.



### CAUTION:

**Vehicle damage resulting from towing a trailer is not covered by the warranty.**

## POWER STEERING



### WARNING:

**If the engine is not running or is turned off while driving, the power assist for the steering will not work. The steering will be harder to operate.**

## HYDRAULIC PUMP ELECTRIC POWER STEERING TYPE

The hydraulic pump electric power steering is designed to provide power assistance while driving to operate the steering wheel with light force.

When the steering wheel is operated repeatedly or continuously while parking or driving at a very low speed, the power assist for the steering wheel will be reduced. This is to prevent overheating of the hydraulic pump electric power steering and protect it from getting damaged. While the power assist is reduced, steering wheel operation will become heavy. If the steering wheel operation is still performed, the power steering may stop. Stop the engine. The temperature of the hydraulic pump electric power steering will go down and the power assist level will return to normal after starting the engine. Avoid repeating such steering wheel operations that could cause the hydraulic pump electric power steering to overheat.

You may hear a noise from the front of the vehicle when the steering wheel is operated. This is not a malfunction.

## BRAKE SYSTEM

The brake system has two separate hydraulic circuits. If one circuit malfunctions, you will still have braking ability at two wheels.

## BRAKE PRECAUTIONS

### Vacuum assisted brakes

The brake booster aids braking by using engine vacuum. If the engine stops, you can stop the vehicle by depressing the foot brake pedal. However, greater foot pressure on the foot brake pedal will be required to stop the vehicle. The stopping distance will be longer.

If the engine is not running or is turned off while driving, the power assisted brakes will not function. Braking will be harder.



### WARNING:

**Do not coast with the engine stopped.**

When the brake pedal is depressed slowly and firmly, you may hear a clicking noise and feel a slight pulsation. This is normal and indicates that the Brake Assist System is operating.

### Using brakes

Avoid resting your foot on the foot brake pedal while driving. This will overheat the brakes, wear out the brake linings/pads faster, and increase fuel consumption.

To help reduce brake wear and to prevent the brakes from overheating, reduce speed and downshift to a lower gear before going down a slope or long grade. Overheated brakes may reduce braking performance and could result in loss of vehicle control.

While driving on a slippery surface, be careful when braking, accelerating or downshifting. Abrupt braking or acceleration could cause the wheels to skid and result in an accident.



## Wet brakes

When the vehicle is washed or driven through water, the brakes may get wet. As a result, your braking distance will be longer and the vehicle may pull to one side during braking.

To dry the brakes, drive the vehicle at a safe speed while lightly depressing the foot brake pedal to heat up the brakes. Do this until the brakes return to normal. Avoid driving the vehicle at high speeds until the brakes function correctly.

## Parking brake break-in

Break in the parking brake shoes whenever the stopping effect of the parking brake is weakened or whenever the parking brake shoes and/or drums/rotors are replaced, in order to assure the best braking performance.

This procedure is described in the vehicle service manual and can be performed by a NISSAN dealer.

## Driving uphill

When starting on a steep grade, it is sometimes difficult to operate both the brake and clutch (for MT model). Apply the parking brake to hold the vehicle. Do not slip the clutch. When ready to start, slowly release the parking brake while depressing the accelerator pedal and releasing the clutch pedal.

## Driving downhill

The engine braking action is effective for controlling the vehicle while descending hills. For Manual Transmission (MT) model, the shift lever should be placed in the lower speed gear prior to descending. For Continuously Variable Transmission (CVT) model, the manual shift mode should be selected.

## BRAKE ASSIST

When the force applied to the brake pedal exceeds a certain level, the Brake Assist is activated generating greater braking force than a conventional brake booster even with light pedal force.



### WARNING:

**The Brake Assist is only an aid to assist braking operation and is not a collision warning or avoidance device. It is the driver's responsibility to stay alert, drive safely and be in control of the vehicle at all times.**

## ANTI-LOCK BRAKING SYSTEM (ABS)



### WARNING:

- **The Anti-lock Braking System (ABS) is a sophisticated device, but it cannot prevent accidents resulting from careless or dangerous driving techniques. It can help maintain vehicle control during braking on slippery surfaces. Remember that stopping distances on slippery surfaces will be longer than on normal surfaces even with ABS. Stopping distances may also be longer on rough, gravel or snow covered roads, or if you are using tire chains. Always maintain a safe distance from the vehicle in front of you. Ultimately, the driver is responsible for safety.**
- **Tire type and condition may also affect braking effectiveness.**
  - **When replacing tires, install the specified size of tires on all four wheels.**

– **When installing a spare tire, make sure that it is the proper size and type as specified on the tire placard. (See "Tire placard" (P.9-7).)**

– **For detailed information, see "Tires and wheels" (P.8-26).**

The Anti-lock Braking System (ABS) controls the brakes so the wheels do not lock during hard braking or when braking on slippery surfaces. The system detects the rotation speed at each wheel and varies the brake fluid pressure to prevent each wheel from locking and sliding. By preventing each wheel from locking, the system helps the driver maintain steering control and helps to minimize swerving and spinning on slippery surfaces.

## Using system

Depress the brake pedal and hold it down. Depress the brake pedal with firm steady pressure, but do not pump the brakes. The ABS will operate to prevent the wheels from locking up. Steer the vehicle to avoid obstacles.



### WARNING:

**Do not pump the brake pedal. Doing so may result in increased stopping distances.**

## Self-test feature

The ABS includes electronic sensors, electric pumps, hydraulic solenoids and a computer. The computer has a built-in diagnostic feature that tests the system each time you start the engine and move the vehicle at a low speed in forward or reverse. When the self-test occurs, you may hear a "clunk" noise and/or feel a pulsation in the brake pedal. This is normal and does not indicate a malfunction. If the computer senses a malfunction, it switches the ABS

## VEHICLE SECURITY

off and illuminates the ABS warning light on the instrument panel. The brake system then operates normally, but without anti-lock assistance.

If the ABS warning light illuminates during the self-test or while driving, have the vehicle checked by a NISSAN dealer.

### Normal operation

The ABS operates at speeds above 5 to 10 km/h (3 to 6 MPH). The speed varies according to road conditions.

When the ABS senses that one or more wheels are close to locking up, the actuator rapidly applies and releases hydraulic pressure. This action is similar to pumping the brakes very quickly. You may feel a pulsation in the brake pedal and hear a noise from under the hood or feel a vibration from the actuator when it is operating. This is normal and indicates that the ABS is operating properly. However, the pulsation may indicate that road conditions are hazardous and extra care is required while driving.

When leaving your vehicle unoccupied:

- Always take the key with you - even when leaving the vehicle in your own garage.
- Close all windows completely and lock all doors.
- Always park your vehicle where it can be seen. Park in a well lit area during the night.
- If the security system is equipped, use it - even for a short period.
- Never leave children or pets in the vehicle unattended.
- Never leave valuables inside the vehicle. Always take valuables with you.
- Never leave the vehicle documents in the vehicle.
- Never leave articles on a roof rack. Remove them from the rack and keep and lock them inside the vehicle.
- Never leave the spare key in the vehicle.

## COLD WEATHER DRIVING



### WARNING:

- **Whatever the condition, drive with caution. Accelerate and decelerate with great care. If accelerating or decelerating too fast, the drive wheels will lose even more traction.**
- **Allow more stopping distance in cold weather driving. Braking should be started sooner than on dry pavement.**
- **Keep at a greater distance from the vehicle in front of you on slippery roads.**
- **Wet ice (0°C, 32°F and freezing rain), very cold snow and ice can be slick and very difficult to drive on. The vehicle will have a lot less traction or grip under these conditions. Try to avoid driving on wet ice until the road is salted or sanded.**
- **Watch for slippery spots (glaring ice). These may appear on an otherwise clear road in shaded areas. If a patch of ice is seen ahead, brake before reaching it. Try not to brake while actually on the ice, and avoid any sudden steering maneuvers.**
- **Do not use cruise control (if equipped) on slippery roads.**
- **Snow can trap dangerous exhaust gas under your vehicle. Keep snow clear of the exhaust pipe and from around your vehicle.**

## BATTERY

If the battery is not fully charged during extremely cold weather conditions, the battery fluid may freeze and damage the battery. To maintain maximum efficiency, the battery should be checked regularly. For details, see "Battery" (P.8-17).

## ENGINE COOLANT

If the vehicle is to be left outside without anti-freeze, drain the cooling system, including the engine block. Refill before operating the vehicle. For details, see "Changing engine coolant" (P.8-7).

## TIRE EQUIPMENT

1. If you have snow tires installed on the front/rear wheels of your vehicle, they should be of the same size, loading range, construction and type (bias, bias-belted or radial) as the rear/front tires.
2. If the vehicle is to be operated in severe winter conditions, snow tires should be installed on all four wheels.
3. For additional traction on icy roads, studded tires may be used. However, some countries, provinces and states prohibit their use. Check local, state and provincial laws before installing studded tires.

**Skid and traction capabilities of studded snow tires, on wet or dry surfaces, may be poorer than that of non-studded snow tires.**

4. Snow chains may be used if desired. Make sure they are the proper size for the tires on your vehicle and are installed according to the chain manufacturer's instructions. Use chain tensioners when recommended by the tire chain manufacturer to ensure a

tight fit. Loose end links of the tire chains must be secured or removed to prevent the possibility of whipping action damage to the fenders or underbody. In addition, drive at a reduced speed, otherwise, your vehicle may be damaged and/or vehicle handling and performance may be adversely affected.

## SPECIAL WINTER EQUIPMENT

It is recommended that the following items be carried in the vehicle during the winter:

- A scraper and stiff-bristled brush to remove ice and snow from the windows.
- A sturdy, flat board to be placed under the jack to give it firm support.
- A shovel to dig the vehicle out of snow-drifts.

## PARKING BRAKE

When parking in the area where the outside temperature is below 0°C (32°F), do not apply the parking brake, if applied, may freeze in place and may be difficult to release.

For safe parking:

- Place the shift lever in the "P" (Park) position (for Continuously Variable Transmission (CVT) model).
- Place the shift lever in the "1" (1st) or "R" (Reverse) gear (for Manual Transmission (MT) model).
- Securely block the wheels.

## CORROSION PROTECTION

Chemicals used for road surface deicing are extremely corrosive and will accelerate corrosion and the deterioration of underbody components such as the exhaust system, fuel and brake lines, brake cables, floor pan and fenders.

**In the winter, the underbody must be cleaned periodically. For additional information, see "Corrosion protection" (P.7-5).**

For additional protection against rust and corrosion, which may be required in some areas, consult a NISSAN dealer.

**MEMO**

# 6 In case of emergency

Hazard indicator flasher switch .....	6-2	Jump starting .....	6-7
Emergency Stop Signal .....	6-2	Push starting .....	6-10
Flat tire .....	6-2	If your vehicle overheats .....	6-10
Stopping vehicle .....	6-2	Towing your vehicle .....	6-11
Preparing tools and spare tire .....	6-3	Towing precautions .....	6-11
Blocking wheels .....	6-4	Towing recommended by NISSAN .....	6-12
Removing tire .....	6-4	NissanConnect application (if equipped) .....	6-13
Installing spare tire .....	6-6		
Stowing damaged tire and tools .....	6-6		

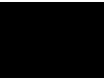

## HAZARD INDICATOR FLASHER SWITCH

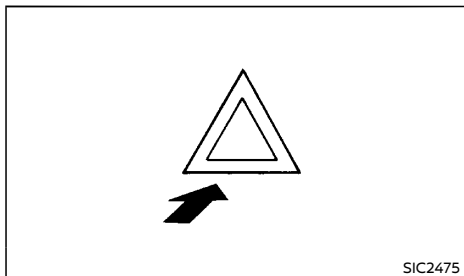

The hazard indicator flasher switch operates regardless of the ignition switch position except when the battery is discharged.

The hazard indicator flasher is used to warn other drivers when you have to stop or park under emergency conditions.

When the hazard indicator flasher switch is pushed, all turn signal lights will flash. To turn off the hazard indicator flasher, push the hazard indicator flasher switch again.

When an impact that could activate the supplemental air bags is detected, the hazard warning flasher lights blink automatically. If the hazard warning flasher switch is pushed, the hazard warning flashers will turn off.



### WARNING:

**Do not turn the hazard warning flasher switch to off until you can make sure that it is safe to do so. Also, the hazard flasher warning may not blink automatically depending on the force of impact.**

## EMERGENCY STOP SIGNAL

The Emergency Stop Signal will blink the hazard indicator flasher to prevent the rear-end collision, when a sudden braking operation is detected. To stop the hazard indicator flasher, push the hazard indicator flasher switch once.

## FLAT TIRE

If you have a flat tire, follow the instructions as follows.

### STOPPING VEHICLE



#### WARNING:

- Be sure to apply the parking brake firmly.
  - Be sure to move the shift lever to the "P" (Park) position (Continuously Variable Transmission (CVT) model) or the shift lever to the "R" (Reverse) position (Manual Transmission (MT) model).
  - Never change tires when the vehicle is on a slope, ice or slippery area. This is hazardous.
  - Never change tires when the oncoming traffic is close to your vehicle. Call for professional road assistance.
1. Safely move the vehicle off the road away from traffic.
  2. Turn on the hazard indicator flasher lights.
  3. Park on a level surface.
  4. Apply the parking brake.
  5. Continuously Variable Transmission (CVT) model: Move the shift lever to the "P" (Park) position.  
Manual Transmission (MT) model: Move the shift lever to the "R" (Reverse) position.
  6. Turn off the engine.
  7. Open the hood:
    - To warn other traffic.
    - To signal professional road assistance personnel that you need assistance.
  8. Have all passengers get out from the vehicle and stand in a safe place, away from other traffic and clear of the vehicle.

## PREPARING TOOLS AND SPARE TIRE

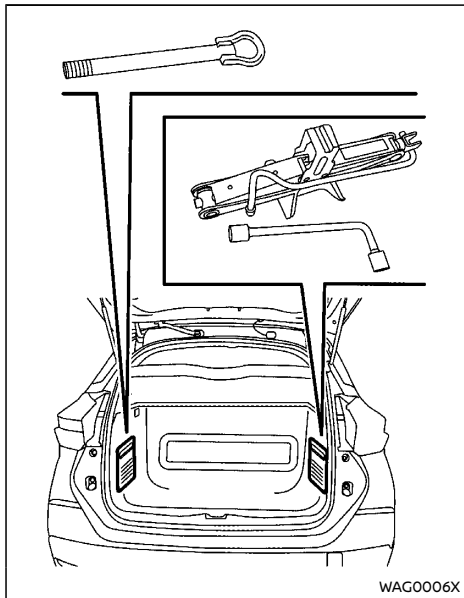

Remove the jack and necessary tools from the storage area.

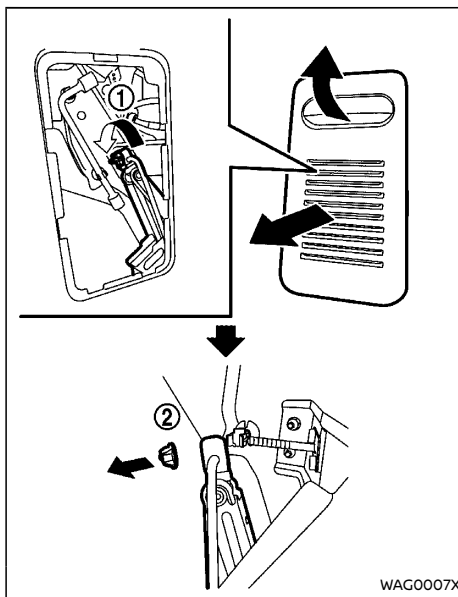

1. Remove the storage door.
2. Unhook the clips restraining the necessary tools, and then remove the necessary tools.
3. Loosen the jack by turning the clamp nut counterclockwise ①.
4. Remove the clamp nut ②, tilt the top of the jack and then remove the jack slowly. To store the jack, perform this in the reverse order and then tighten the clamp nut ② so that it does not rattle.

## ⚠ CAUTION:

- When removing the jack, be careful that your hands do not hit against the vehicle. Otherwise, this could result in personal injury.
- When storing the jack, do not overtighten the jack lever or use a screw driver. Doing so could cause deformation of the installation area for the jack.
- Do not allow the jack to contact the interior parts. Doing so could cause damage to the vehicle.

## Spare tire

The spare tire is located under the rear of the vehicle.

To remove the spare tire, perform the following procedures.

1. Have all passengers get out from the vehicle.
2. Open the back door.
3. Loosen the bolt ①, located near the back door opening, counterclockwise a few turns using the wheel nut wrench.

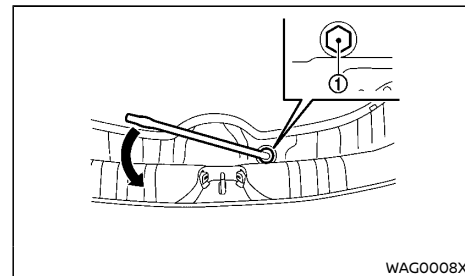

- Push up the spare tire hanger and turn the bolt ① counterclockwise by hand to lower the spare tire.
- Stop turning the bolt when the tire is lowered to the place where the spare tire hanger ② can be removed from the hook ③.

**Do not loosen the bolt excessively, otherwise the spare tire hanger may fall suddenly.**

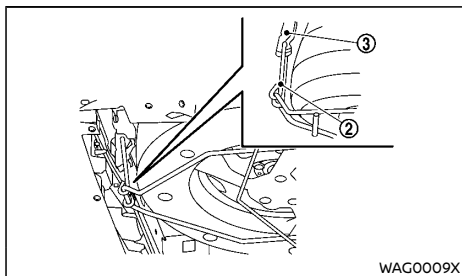

- Hold the spare tire hanger and remove it from the hook by pushing the hanger upward.
- Lower the spare tire hanger slowly to the ground, and then take out the spare tire.

**CAUTION:**

- Be careful not to touch the exhaust pipe while removing the spare tire, as it may be hot.
- Properly stow the spare tire hanger after removing the spare tire.

**BLOCKING WHEELS**

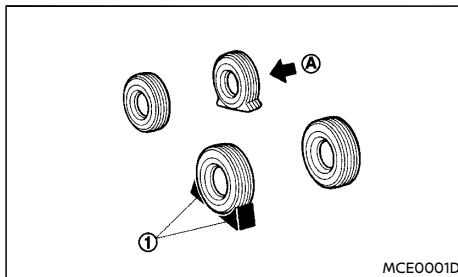

**WARNING:**

**Be sure to block the appropriate wheel to prevent the vehicle from moving, which may cause personal injury.**

Place suitable blocks ① at both the front and back of the wheel diagonally opposite the flat tire ④ to prevent the vehicle from moving when it is jacked up.

**REMOVING TIRE**

**Removing wheel cover**

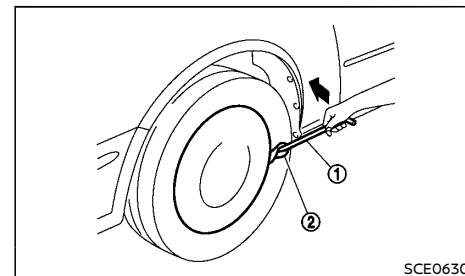

Type A

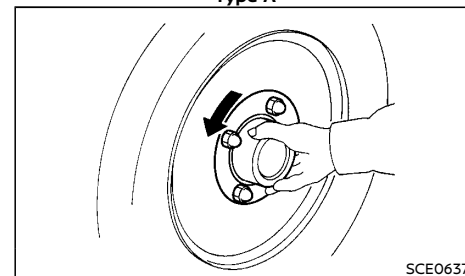

Type B

**Type A:**

**WARNING:**

**Never use your hands to remove the wheel cover. This may cause personal injury.**

To remove the wheel cover, use the jack rod ① as illustrated.

Apply cloth ② between the wheel and jack rod to prevent damaging the wheel and wheel



cover.

### Type B:

Remove the center wheel cap as illustrated.

### Jacking up vehicle

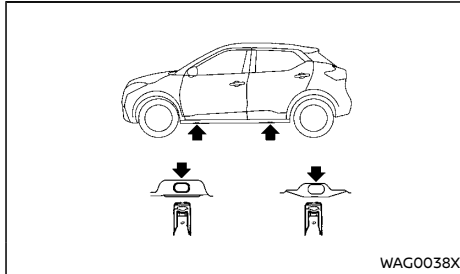

Jack-up points

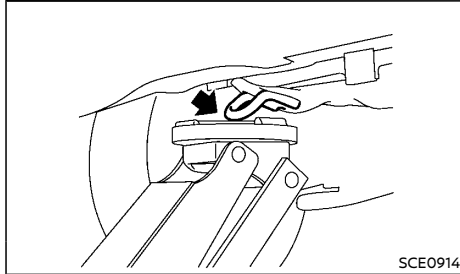

Floor jack-up point

For the rear, never jack up the vehicle at a location other than the floor jack-up point that is specified.

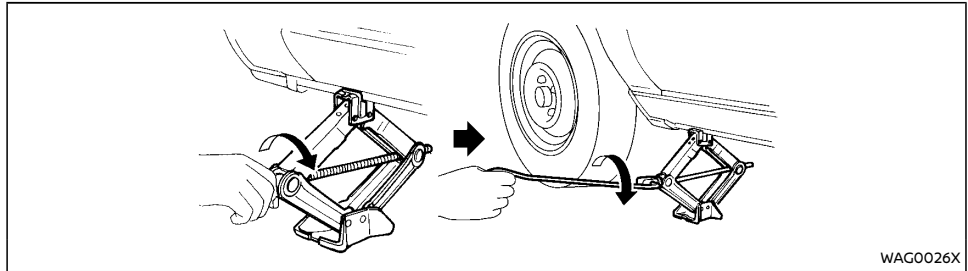

### WARNING:

- Be sure to read and follow the instructions in this section.
- **DO NOT GET UNDER A VEHICLE THAT IS SUPPORTED BY A JACK.**
- Never use a jack which is not provided with your vehicle.
- The jack, which is provided with your vehicle, is designed only to lift your vehicle during a tire change. Do not use the jack provided with your vehicle on other vehicles.
- Never jack up the vehicle at a location other than the jack-up point that is specified.
- Never lift the vehicle more than necessary.
- Never use blocks on or under the jack.
- Never start or run the engine while the vehicle is on the jack. The vehicle may move suddenly, and this may cause an accident.

- Never allow passengers to remain in the vehicle while the tire is off the ground.
- Be sure to read the caution label attached to the jack body before using.

1. Place the jack directly under the jack-up point as illustrated so that the top of the jack contacts the vehicle at the jack-up point.

**The jack should be placed on firm level ground.**

2. Align the jack head between the two notches located at the jack-up point of either the front or the rear section.
3. Fit the groove of the jack head between the notches as shown.
4. Loosen each wheel nut, counterclockwise, one or two turns with the wheel nut wrench.

**Do not remove the wheel nuts until the tire is off the ground.**

5. Carefully raise the vehicle until the clearance between the tire and ground is achieved.

6. To lift the vehicle, securely hold the jack lever and rod with both hands and turn the jack lever.

### Removing tire

1. Remove the wheel nuts.
2. Remove the damaged tire.

### CAUTION:

The tire is heavy. Be sure that your feet are clear from the tire and use gloves as necessary to avoid injury.

### INSTALLING SPARE TIRE

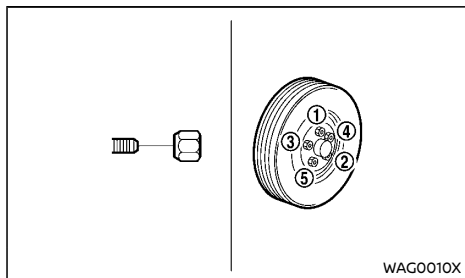

### WARNING:

- Never use wheel nuts which are not provided with your vehicle. Incorrect wheel nuts or improperly tightened wheel nuts may cause the wheel to become loose or come off. This could cause an accident.
- Never use oil or grease on the wheel studs or nuts. This may cause the wheel nuts to become loose.

- **The temporary-use spare tire (if equipped) is designed for emergency use only.**

1. Clean any mud or dirt from the surface between the wheel and hub.
2. Carefully put the spare tire on and tighten the wheel nuts with your fingers. Check that all the wheel nuts contact the wheel surface horizontally.
3. Tighten the wheel nuts alternately and evenly in the sequence illustrated (① - ⑤), more than 2 times with the wheel nut wrench, until they are tight.
4. Lower the vehicle slowly until the tire touches the ground.
5. Tighten the wheel nuts securely, with the wheel nut wrench, in the sequence illustrated.
6. Lower the vehicle completely.

**Tighten the wheel nuts to the specified torque with a torque wrench as soon as possible.**

**Wheel nut tightening torque:  
110 N·m (11 kg·m, 81 ft·lb)**

The wheel nuts must be kept tightened to specification at all times. It is recommended that the wheel nuts be tightened to specification at each lubrication interval.

### WARNING:

Retighten the wheel nuts when the vehicle has been driven for 1,000 km (600 miles) (also in cases of a flat tire, etc.).

### STOWING DAMAGED TIRE AND TOOLS

### WARNING:

**Be sure that the tire, jack and tools used are properly stored after use. Such items can become dangerous projectiles in an accident or sudden stop.**

1. Securely store the jack, tools in the storage area.
2. Close the back door.

### Storing tire on spare tire hanger

To store the tire on the spare tire hanger, perform the following procedures.

1. Place the tire in the spare tire hanger and slightly push it toward the vehicle's front so that it is properly sitting within the spare tire hanger.

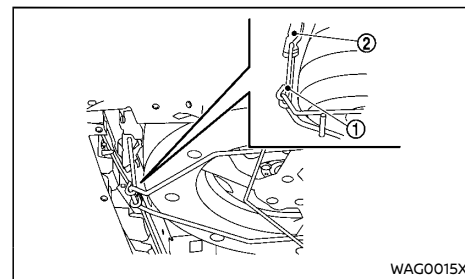

2. Lift the spare tire hanger ① and hang it to the hook ②.

## JUMP STARTING

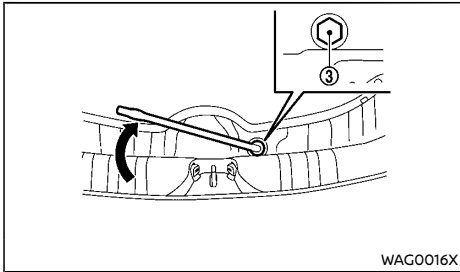

3. Push up the hanger and turn the bolt ③ clockwise by hand to raise the spare tire hanger.
4. Tighten the bolt ③ clockwise using the wheel nut wrench until the spare tire hanger is stored securely.

**Spare tire hanger bolt tightening torque:**

**64 to 86 N·m (6.5 to 8.8 kg·m, 47 to 64 ft·lb)**



### WARNING:

- **Incorrect jump starting can lead to a battery explosion. The battery explosion may result in severe injury or death. It may also result in damage to the vehicle. Be sure to follow the instructions in this section.**
- **Explosive hydrogen gas is always present in the vicinity of the battery. Keep all sparks and flames away from the battery.**
- **Always wear suitable eye protection and remove rings, bracelets, and any other jewelry whenever working on or near a battery.**
- **Never lean over the battery while jump starting.**
- **Never allow battery fluid to come into contact with eyes, skin, clothes or the vehicle's painted surfaces. Battery fluid is a corrosive sulfuric acid which can cause severe burns. If the fluid comes into contact with anything, immediately flush the contacted area with plenty of water.**
- **Keep the battery out of the reach of children.**
- **The booster battery must be rated at 12 volts. Use of an incorrectly rated battery will damage your vehicle.**
- **Never attempt to jump start a frozen battery. It could explode and cause serious injury.**

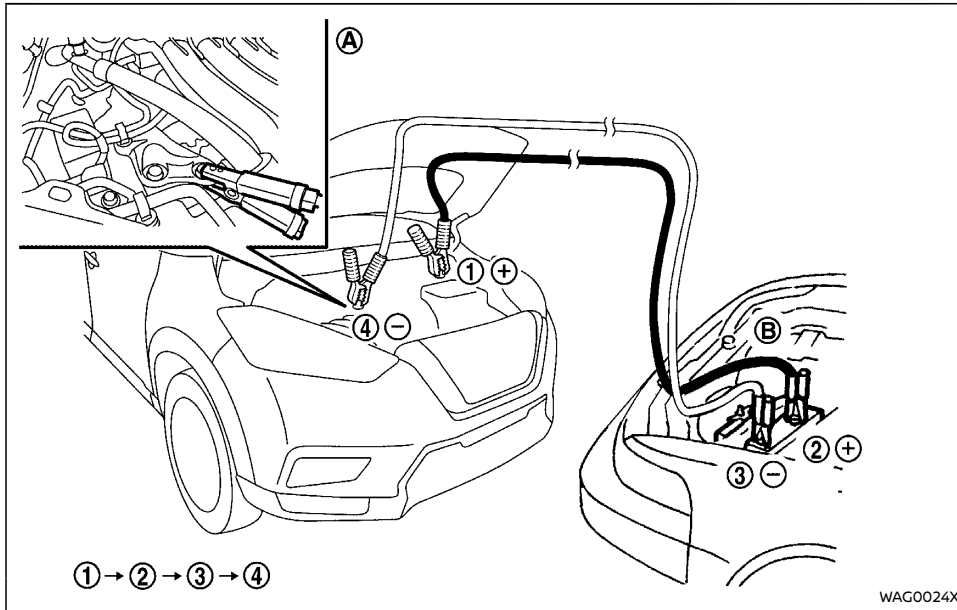

H4K engine models

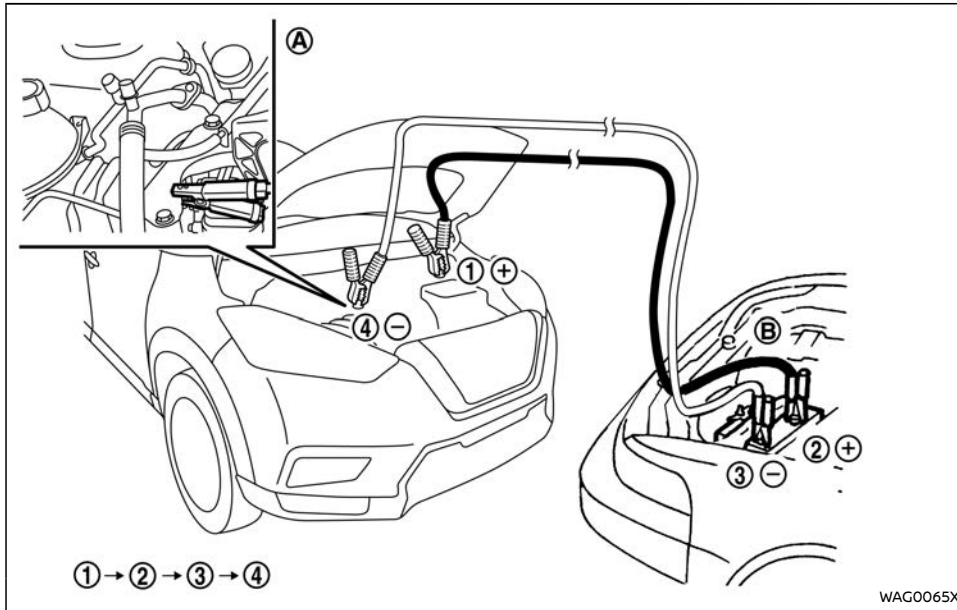

HR13DDT engine models

WAG0065X

1. If the booster battery is in another vehicle **B**, position the two vehicles **A** and **B** to bring the batteries into close proximity to each other.



**CAUTION:**

If the battery of vehicle **A** equipped with the Intelligent Key system is discharged, the ignition switch cannot be moved from the "LOCK" position and, if the steering lock is engaged, the steering wheel cannot be moved. Connect the jumper cables to the

**booster vehicle **B** before turning the ignition switch and disengaging the steering lock.**

2. Apply the parking brake.
3. Continuously Variable Transmission (CVT) model: Move the shift lever to the "P" (Park) position.  
Manual Transmission (MT) model: Move the shift lever to the "N" (Neutral) position.
4. Switch off all unnecessary electrical systems (headlights, heater, air conditioner, etc.).

5. Place the ignition switch in the "LOCK" position.
6. Remove the vent caps, if equipped, on the battery.
7. Cover the battery with a firmly wrung out moist cloth to reduce the hazard of an explosion.
8. Connect the jumper cables in the sequence as illustrated (1, 2, 3, 4).



**CAUTION:**

- Always connect positive **⊕** to positive **⊕** and negative **⊖** to body ground, NOT to the battery's negative **⊖**.
  - Be sure that the jumper cables do not touch moving parts in the engine compartment.
  - Be sure that the jumper cable's clamps do not contact any other metal.
9. Start the engine of the booster vehicle **B** and let it run for a few minutes.
  10. Depress the accelerator pedal of the booster vehicle **B** at about 2,000 rpm.
  11. Start the engine of the jumped vehicle **A** in the normal manner.



**CAUTION:**

**Never keep the starter motor engaged for more than 10 seconds. If the engine does not start right away, wait at least 10 seconds before trying again.**

12. After the engine is started, carefully disconnect the jumper cables in the opposite sequence from that illustrated (4, 3, 2, 1).

13. Remove and dispose of the cloth as it may be contaminated with corrosive acid.
14. Replace the vent caps, if removed.

**NOTE:**

- For model with Stop/Start System, use the special battery that is enhanced in regard to the charge-discharge capacity and life performance. Avoid using a non-special battery for the Stop/Start System, as this may cause early deterioration of the battery or a malfunction of the Stop/Start System. For the battery, it is recommended to use Genuine NISSAN parts. For more information, contact a NISSAN dealer.
- For model with Stop/Start System, it may take some time until Stop/Start System activates when the battery is replaced or the battery terminal is disconnected for extended periods and then reconnected. Also, in the first trip after the jump starting, Stop/Start System will not be activated.

## PUSH STARTING

Do not attempt to start the engine by pushing the vehicle.



**CAUTION:**

- Continuously Variable Transmission (CVT)/Manual Transmission (MT) model cannot be started by pushing. Attempting to do so may cause damage to the transmission.
- Three-way catalyst equipped model should not be started by pushing. Attempting to do so may cause damage to the catalyst.
- Stop/Start System equipped model cannot be started by pushing the vehicle.
- Never try to start the engine by towing. When the engine starts, the forward surge could cause the vehicle to collide with the towing vehicle.

## IF YOUR VEHICLE OVERHEATS



**WARNING:**

- Never continue driving if your vehicle overheats. Doing so could cause engine damage and/or a vehicle fire.
- Never open the hood if steam is coming out.
- Never remove the radiator or coolant reservoir cap while the engine is hot. If the radiator or coolant reservoir cap is removed when the engine is hot, pressurized hot water will spurt out and possibly cause burning, scalding or serious injury.
- If steam or coolant is coming from the engine, stand clear of the vehicle to prevent getting burned.
- The engine cooling fan will start at any time when the coolant temperature exceeds preset degrees.
- Be careful not to allow your hands, hair, jewelry or clothing to come into contact with, or to get caught in the cooling fan or drive belts.

If your vehicle is overheating (indicated by the high temperature indicator), or if you feel a lack of engine power, detect unusual noise, etc., take the following steps:

1. Safely move the vehicle off the road away from traffic.
2. Turn on the hazard indicator flasher lights.
3. Apply the parking brake.
4. Continuously Variable Transmission (CVT) model: Move the shift lever to the "P" (Park) position.

Manual Transmission (MT) model: Move the shift lever to the "N" (Neutral) position.

## TOWING YOUR VEHICLE

### **DO NOT STOP THE ENGINE.**

5. Open all the windows.
6. Turn off the air conditioner. Move the temperature control to maximum hot and the fan control to high speed.
7. Get out from the vehicle.
8. Visually inspect and listen for steam or coolant escaping from the radiator before opening the hood. Wait until no steam or coolant can be seen before proceeding.
9. Open the engine hood.
10. Visually inspect if the cooling fan is running.
11. Visually inspect the radiator and radiator hoses for leakage.  
If the cooling fan is not running or the coolant is leaking, stop the engine.
12. After the engine cools down, check the coolant level in the reservoir with the engine running. **Do not open the radiator cap.**
13. Add coolant to the reservoir if necessary.

Have your vehicle inspected/repared at a NISSAN dealer.

When towing your vehicle, local regulations for towing must be followed. Incorrect towing equipment could damage your vehicle. To assure proper towing and to prevent accidental damage to your vehicle, NISSAN recommends that you have professional road assistance personnel tow your vehicle. It is advisable to have the professional road assistant carefully read the following precautions.

### TOWING PRECAUTIONS

- Be sure that the transmission, steering system, and drivetrain are in working condition before towing. If any units are damaged, the vehicle must be towed using a dolly or flatbed tow truck.
- NISSAN recommends that your vehicle be towed with the driving (front) wheels off the ground.
- Always attach safety chains before towing.

## TOWING RECOMMENDED BY NISSAN

### Two-Wheel Drive (2WD) models

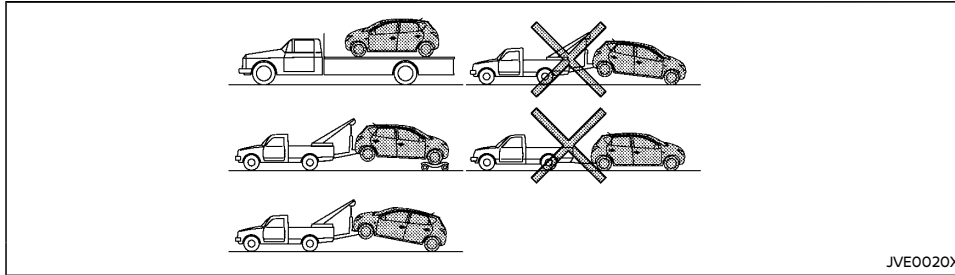

#### Front wheels on the ground:

NISSAN recommends that towing dollies be used under the front wheels when towing your vehicle or the vehicle be placed on a flatbed tow truck as illustrated.



#### CAUTION:

**Never tow Continuously Variable Transmission (CVT) model with the front wheels on the ground. Doing so will cause serious and expensive damage to the drivetrain.**

Manual Transmission (MT) model:

If you have to tow a MT vehicle with front wheel on the ground, perform the following procedures.

1. Place the ignition switch to stop the engine.
2. Secure the steering wheel in a straight ahead position with rope or a similar device.

3. Move the shift lever to the "N" (Neutral) position.
4. Release the parking brake.
5. Attach safety chains whenever towing.

#### Rear wheels on the ground:

1. Place the ignition switch to stop the engine.
2. Secure the steering wheel in a straight-ahead position with rope or a similar device.
3. Move the shift lever to the "N" (Neutral) position.
4. Release the parking brake.
5. Attach safety chains whenever towing.

#### All four wheels on the ground:

NISSAN recommends that the vehicle be placed on a flatbed tow truck as illustrated.



#### CAUTION:

**Never tow CVT model with all four wheels on the ground. Doing so will cause serious and expensive damage to the drivetrain.**

Manual Transmission (MT) model:

If you have to tow a MT vehicle with all four wheels on the ground, perform the following procedures.



#### CAUTION:

**Never tow a MT model backward with all four wheels on the ground.**

1. Place the ignition switch to stop the engine.
2. Move the shift lever to the "N" (Neutral) position.
3. Release the parking brake.

#### Freeing trapped vehicle



#### WARNING:

- **Never allow anyone to stand near the towing line during the pulling operation.**
- **Never spin the tires at high speed. This could cause them to explode and result in serious injury. Parts of the vehicle could also overheat and be damaged.**

In the event that your vehicle's tires become trapped in sand, snow, or mud, and the vehicle is unable to free itself without being pulled, use the recovery hook.

- Use the recovery hook only. Do not attach the pulling device to any other part of the vehicle body. Otherwise, the vehicle body may be damaged.



- Use the recovery hook to free a vehicle only.
- The recovery hook is under tremendous stress when used to free a trapped vehicle. Always pull the pulling device straight out from the vehicle. Never pull on the recovery hook at an angle.

#### Front:

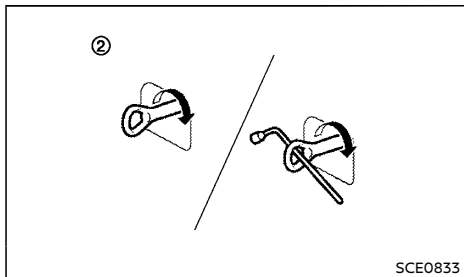
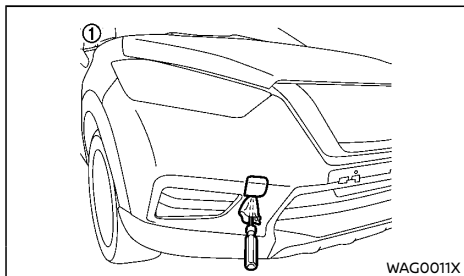

- ① Remove the hook cover from the bumper with a suitable tool.
- ② Securely install the recovery hook as illustrated. (The hook is stored with the jacking tools.)

Make sure that the recovery hook is properly secured in its storage area after use.

#### Rear:

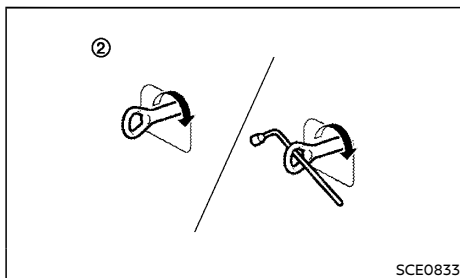
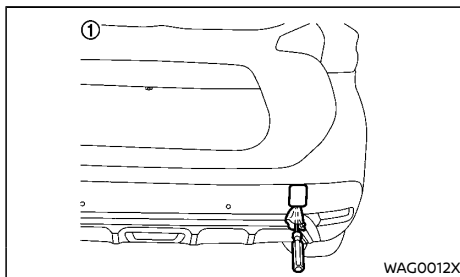

- ① Remove the hook cover from the bumper with a suitable tool.
- ② Securely install the recovery hook as illustrated. (The hook is stored with the jacking tools.)

Make sure that the recovery hook is properly secured in its storage area after use.

## NISSANCONNECT APPLICATION (if equipped)

NissanConnect helps you to get connected to your vehicle through a smartphone application. This app is available for Android, Windows and iOS devices. The steps to be followed for Android device are given for reference.

#### Install procedure:

##### Step 1.

Download the NissanConnect app from the app store of your perspective mobile platform.

##### Step 2.

Contact your nearest Nissan dealers to activate NissanConnect.

##### Step 3.

Also access customer portal at Nissan-connect.in for more info and customize user settings.

For further details visit: <https://www.nissan.in/nissanconnect.html>

Nissan Connect application contains DEMO videos / Quick Reference Videos (QRV) for Customer's easy understanding of its Features.

During emergency, we have an SOS button in the NissanConnect application which triggers the Emergency message/Call to the pre-registered number/email. The number/mail id can be Customer specific.

#### NOTE:

**No support in case connecting OBD dongle or other device.**

**MEMO**

# 7 Appearance and care

Cleaning exterior .....	7-2	Cleaning interior .....	7-3
Washing .....	7-2	Air fresheners .....	7-4
Removing spots .....	7-2	Floor mats .....	7-4
Waxing .....	7-2	Glass .....	7-4
Glass .....	7-2	Seat belts .....	7-4
Underbody .....	7-3	Corrosion protection .....	7-5
Wheels .....	7-3	Most common factors contributing to vehicle corrosion .....	7-5
Aluminum alloy wheels .....	7-3	Environmental factors influence rate of corrosion .....	7-5
Chrome parts .....	7-3	To protect your vehicle from corrosion .....	7-5



## CLEANING EXTERIOR

In order to maintain the appearance of your vehicle, it is important to take proper care of it.

Whenever possible, park your vehicle inside a garage or in a covered area to minimize the chances of damaging the paint surface of your vehicle.

When it is necessary to park outside, park in a shady area or protect the vehicle with a body cover. **Be careful not to scratch the paint surface when putting on or removing the body cover.**

### WASHING

In the following instances, wash your vehicle as soon as possible to protect the paint surface:

- After a rainfall, which may cause the paint surface damage from acid rain.
  - After driving on coastal roads, which may cause rusting from the sea breeze.
  - When contaminants such as soot, bird droppings, tree sap, metal particles or bugs get on the paint surface.
  - When dust or mud builds up on the paint surface.
1. Wash the vehicle surface with a wet sponge and plenty of water.
  2. Clean the vehicle surface gently and thoroughly using a mild soap, a special vehicle soap or a general purpose dishwashing liquid mixed with clean, lukewarm (never hot) water.



#### CAUTION:

- **Do not wash the vehicle with strong household soap, strong chemical detergents, gasoline or solvents.**

- **Do not wash the vehicle in direct sunlight or while the vehicle body is hot, as the paint surface may become water-spotted.**
  - **Avoid using tight-napped or rough cloths, such as washing mitts. Care must be taken when removing caked-on dirt or other foreign substances so the paint surface is not scratched or damaged.**
3. Rinse the vehicle thoroughly with plenty of clean water.
  4. Use a dampened chamois to dry the paint surface and avoid leaving water spots.

When washing the vehicle, take care of the following:

- Inside flanges, joints and folds on the doors, hatches and hood are particularly vulnerable to the effects of road salt. Therefore, these areas must be cleaned regularly.
- Be sure that the drain holes in the lower edge of the doors are not clogged.
- Spray water to the underbody and in the wheel wells to loosen the dirt and/or wash away road salt.

### REMOVING SPOTS

Remove tar and oil spots, industrial dust, insects, and tree sap as quickly as possible from the paint surface to avoid lasting damage or staining. Special cleaning products are available at a NISSAN dealer or any automotive accessory store.

### WAXING

Regular waxing protects the paint surface and helps maintain a new vehicle appearance.

After waxing, polishing is recommended to remove built-up residue and to avoid a weathered appearance.

A NISSAN dealer can assist you in choosing the appropriate waxing products.



#### CAUTION:

- **Wash your vehicle thoroughly and completely before applying wax to the paint surface.**
- **Always follow the manufacturer's instructions supplied with the wax.**
- **Do not use a wax containing any abrasives, cutting compounds or cleaners that may damage the vehicle finish.**

Machine compounding or aggressive polishing on a base coat/clear coat paint finish may dull the finish or leave swirl marks.

### GLASS

Use glass cleaner to remove smoke and dust film from the glass surfaces. It is normal for glass to become coated with a film after the vehicle is parked in the hot sun. Glass cleaner and a soft cloth will easily remove this film.

## UNDERBODY

In areas where road salt is used in the winter, it is necessary to clean the vehicle's underbody regularly in order to prevent dirt and salt from building up and causing the acceleration of corrosion on the underbody and suspension.

Before the winter and again in the spring, the underseal must be checked and, if necessary, re-treated.

## WHEELS

- Wash the wheels when washing the vehicle to maintain their appearance.
- Clean the inner side of the wheels when the wheel is changed or the underside of the vehicle is washed.
- Do not use abrasive cleaners when washing the wheels.
- Inspect wheel rims regularly for dents or corrosion. This may cause loss of pressure or damage the tire bead.
- NISSAN recommends that the road wheels be waxed to protect against road salt in areas where it is used during winter.

## ALUMINUM ALLOY WHEELS

Wash the wheels regularly with a sponge dampened in a mild soap solution, especially during winter in areas where road salt is used. The salt residue from road salt could discolor the wheels if it is not washed off regularly.



### CAUTION:

Follow the directions below to avoid staining or discoloring the wheels:

- Do not use a cleaner that uses strong acid or alkali contents to clean the wheels.

- Do not apply wheel cleaners to the wheels when they are hot. The wheel temperature should be the same as ambient temperature.
- Rinse the wheel to completely remove the cleaner within 15 minutes after the cleaner is applied.

## CHROME PARTS

Clean all chrome parts regularly with a non-abrasive chrome polish to maintain the finish.

## CLEANING INTERIOR

Occasionally remove loose dust from the interior trim, plastic parts and seats using a vacuum cleaner or soft bristled brush. Wipe the vinyl and leather surfaces with a clean, soft cloth dampened in mild soap solution, then wipe clean with a dry, soft cloth.

Regular care and cleaning is required in order to maintain the appearance of the leather.

Before using any fabric protector, read the manufacturer's recommendations. Some fabric protectors contain chemicals that may stain or bleach the seat material.

Use a soft cloth dampened only with water to clean the meter and gauge lens covers.



### CAUTION:

- Never use benzine, thinner or any similar material.
- Small dirt particles can be abrasive and damaging to leather surfaces and should be removed promptly. Do not use saddle soap, car waxes, polishes, oils, cleaning fluids, solvents, detergents or ammonia-based cleaners as they damage the leather natural finish.
- Never use fabric protectors unless recommended by the manufacturer.
- Do not use glass or plastic cleaner on meter or gauge lens covers. It may damage the lens covers.

## AIR FRESHENERS

Most air fresheners use a solvent that could affect the vehicle interior. If you use an air freshener, take the following precautions:

- Hanging-type air fresheners can cause permanent discoloration when they contact vehicle interior surfaces. Place the air freshener in a location that allows it to hang free and not contact an interior surface.
- Liquid-type air fresheners typically clip on the vents. These products can cause immediate damage and discoloration when spilled on interior surfaces.

Carefully read and follow the manufacturer's instructions before using air fresheners.

## FLOOR MATS

The use of genuine NISSAN floor mats (if equipped) can extend the life of your vehicle carpet and make it easier to clean the interior. Regardless of what mats are used, be sure they are fitted for your vehicle and are properly positioned in the foot well to prevent interference with pedal operation. Mats should be maintained with regular cleaning and replaced if they become excessively worn.

## Floor mat positioning aid (driver's side)

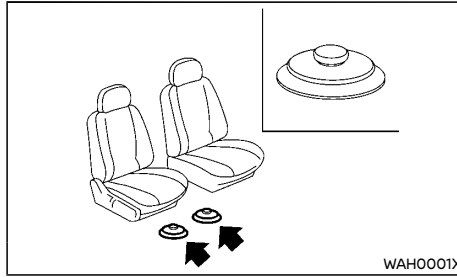

This vehicle includes floor mat brackets to act as a floor mat positioning aid. NISSAN floor mats have been specially designed for your vehicle model.

Position the mat by placing the floor mat bracket hook through the floor mat grommet hole while centering the mat in the foot area.

Periodically check that the mats are properly positioned.

## GLASS

Use glass cleaner to remove smoke and dust film from the glass surfaces. It is normal for glass to become coated with a film after the vehicle is parked in the hot sun. Glass cleaner and a soft cloth will easily remove this film.



### CAUTION:

**When cleaning the inside of the windows, do not use sharp-edged tools, abrasive cleaners or chlorine-based disinfectant cleaners. They could damage the electrical conductors, such as rear window defogger elements.**

## SEAT BELTS



### WARNING:

- **Do not allow wet seat belts to roll up in the retractor.**
- **Never use bleach, dye or chemical solvents to clean the seat belts, since these materials may severely weaken the seat belt webbing.**

The seat belts can be cleaned by wiping them with a sponge dampened in a mild soap solution.

Allow the belts to dry completely in the shade before using them. (See "Seat belts" (P.1-6).)

## CORROSION PROTECTION

### MOST COMMON FACTORS CONTRIBUTING TO VEHICLE CORROSION

- The accumulation of moisture-retaining dirt and debris in body panel sections, cavities, and other areas.
- Damage to the paint surface and other protective coatings caused by gravel and stone chips or minor traffic accidents.

### ENVIRONMENTAL FACTORS INFLUENCE RATE OF CORROSION

#### Moisture

The accumulation of sand, dirt and water on the inside floor of the vehicle can accelerate corrosion. Wet floor carpet/floor mats will not dry completely inside the vehicle. They should be removed and completely dried to avoid floor panel corrosion.

#### Relative humidity

Corrosion will be accelerated in areas of high relative humidity.

#### Temperature

High temperatures accelerate the rate of corrosion to those parts which are not well ventilated.

Corrosion will also be accelerated in areas where the temperatures stay above freezing.

#### Air pollution

Industrial pollution, the presence of salt in the air in coastal areas, or heavy road salt use accelerates the corrosion process. Road salt also accelerates the disintegration of paint surfaces.

### TO PROTECT YOUR VEHICLE FROM CORROSION

- Wash and wax your vehicle often to keep the vehicle clean.
- Always check for minor damage to the paint surface and if any exists, repair it as soon as possible.
- Keep the drain holes in the lower edge of the doors open to avoid water accumulation.
- Check the vehicle underbody for accumulation of sand, dirt or salt. If present, wash with water as soon as possible.



#### CAUTION:

- **Never remove dirt, sand or other debris from the passenger compartment by washing it out with a hose. Remove dirt with a vacuum cleaner.**
- **Never allow water or other liquids to come in contact with electronic components inside the vehicle as this may damage them.**

Chemicals used for road surface deicing are extremely corrosive. They accelerate corrosion and deterioration of underbody components such as the exhaust system, fuel and brake lines, brake cables, floor pan and fenders.

**In the winter, the underbody must be cleaned periodically.**

For additional protection against rust and corrosion, which may be required in some areas, consult a NISSAN dealer.

**MEMO**



# 8 Maintenance and do-it-yourself

General maintenance .....	8-2	Air cleaner filter .....	8-14
Explanation of general maintenance items .....	8-2	Wiper blades .....	8-14
Maintenance precautions .....	8-3	Windshield wiper blades .....	8-14
Maintenance requirements .....	8-4	Rear window wiper blade (if equipped) .....	8-16
Scheduled maintenance .....	8-4	Window washer fluid .....	8-16
General maintenance .....	8-4	Battery .....	8-17
Where to go for service .....	8-5	Vehicle battery .....	8-17
Engine compartment check locations .....	8-5	Remote controller battery .....	8-17
H4K engine model .....	8-5	Intelligent Key battery .....	8-18
HR13DDT engine model .....	8-6	Fuses .....	8-19
Engine cooling system .....	8-6	Engine compartment .....	8-19
Checking engine coolant level .....	8-7	Passenger compartment .....	8-20
Changing engine coolant .....	8-7	Lights .....	8-21
Engine oil .....	8-7	Headlights .....	8-21
Checking engine oil level .....	8-7	Exterior lights .....	8-22
Changing engine oil and oil filter .....	8-8	Interior lights .....	8-22
Drive belt .....	8-10	Light locations .....	8-23
Spark plugs .....	8-11	Tires and wheels .....	8-26
Nickel-tipped spark plugs .....	8-11	Tire inflation pressure .....	8-26
Brakes .....	8-11	Types of tires .....	8-26
Checking parking brake .....	8-11	Tire chains .....	8-27
Checking foot brake pedal .....	8-11	Tire rotation .....	8-27
Brake booster .....	8-12	Tire wear and damage .....	8-27
Brake fluid .....	8-12	Tire age .....	8-28
Clutch fluid (if equipped) .....	8-13	Changing tires and wheels .....	8-28
Continuously Variable Transmission (CVT) fluid (if equipped) .....	8-13	Wheel balance .....	8-28
Power steering fluid .....	8-14	Spare tire .....	8-28
Hydraulic pump electric power steering type .....	8-14		

## GENERAL MAINTENANCE

During normal day-to-day operation of the vehicle, general maintenance should be performed regularly as prescribed in this section. If you detect any unusual sounds, vibrations or smells, be sure to check for the cause or have a NISSAN dealer do it promptly. In addition, you should notify a NISSAN dealer if you think that repairs are required.

When performing any checks or maintenance work, closely observe "Maintenance precautions" (P.8-3).

### EXPLANATION OF GENERAL MAINTENANCE ITEMS

**Additional information on the following items with "" is found later in this section.**

#### Outside vehicle

The maintenance items listed here should be performed from time to time, unless otherwise specified.

#### Doors and hood:

Check that all doors and the hood operate smoothly as well as the back door, trunk lid and hatch. Also make sure that all latches lock securely. Lubricate if necessary. Make sure that the secondary latch keeps the hood from opening when the primary latch is released. When driving in areas using road salt or other corrosive materials, check lubrication frequently.

#### Lights\*:

Clean the headlights on a regular basis. Make sure that the headlights, stop lights, tail lights, turn signal lights, and other lights are all operating properly and installed securely. Also check the aim of the headlights.

#### Tires\*:

Check the pressure with a gauge often and always prior to long distance trips. Adjust the pressure in all tires, including the spare, to the pressure specified. Check carefully for damage, cuts or excessive wear.

#### Tire rotation\*:

In the case that Two-Wheel Drive (2WD) and front and rear tires are same size; tires should be rotated every 10,000 km (6,000 miles). Tires marked with directional indicators can only be rotated between front and rear. Make sure that the directional indicators point in the direction of wheel rotation after the tire rotation is completed.

In the case that Four-Wheel Drive and All-Wheel Drive (4WD/AWD) and front and rear tires are same size; tires should be rotated every 5,000 km (3,000 miles). Tires marked with directional indicators can only be rotated between front and rear. Make sure that the directional indicators point in the direction of wheel rotation after the tire rotation is completed.

In the case that front tires are different size from rear tires; tires cannot be rotated.

The timing for tire rotation may vary according to your driving habits and the road surface conditions.

#### Tire Pressure Monitoring System (TPMS) transmitter components (if so equipped):

Replace the TPMS transmitter grommet seal, valve core and cap when the tires are replaced due to wear or age.

#### Wheel alignment and balance:

If the vehicle should pull to either side while driving on a straight and level road, or if you detect uneven or abnormal tire wear, there may be a need for wheel alignment. If the steering wheel or seat vibrates at normal highway speeds, wheel balancing may be needed.

#### Windshield:

Clean the windshield on a regular basis. Check the windshield at least every six months for cracks or other damage. Repair as necessary.

#### Wiper blades\*:

Check for cracks or wear if not functioning correctly. Replace as necessary.

#### Inside vehicle

The maintenance items listed here should be checked on a regular basis, such as when performing periodic maintenance, cleaning the vehicle, etc.

#### Accelerator pedal:

Check the pedal for smooth operation and make sure that the pedal does not catch or require uneven effort. Keep the floor mats away from the pedal.

#### Brake pedal\*:

Check the pedal for smooth operation and make sure that it is the proper distance from the floor mat when depressed fully. Check the brake booster function. Be sure to keep the floor mats away from the pedal.

### **Parking brake\*:**

Check the parking brake operation regularly. Check that the lever (if so equipped) or the pedal (if so equipped) has the proper travel. Also make sure that the vehicle is held securely on a fairly steep hill when only the parking brake is applied.

### **Seat belts:**

Check that all parts of the seat belt system (for example, buckles, anchors, adjusters and retractors) operate properly and smoothly, and are installed securely. Check the belt webbing for cuts, fraying, wear or damage.

### **Steering wheel:**

Check for changes in the steering condition, such as excessive play, hard steering or strange noises.

### **Warning lights and chimes:**

Make sure that all warning lights and chimes are operating properly.

### **Windshield defogger:**

Check that the air comes out of the defogger outlets properly and in good quantity when operating the heater or air conditioner.

### **Windshield wiper and washer\*:**

Check that the wipers and washer operate properly and that the wipers do not streak.

### **Under hood and vehicle**

The maintenance items listed here should be checked periodically (for example, each time you check the engine oil or refuel).

### **Battery (except for maintenance free batteries)\*:**

Check the fluid level in each cell. It should be between the UPPER and LOWER lines. Vehicles operated in high temperatures or under severe conditions require frequent checks of the battery fluid level.

### **Brake (and clutch) fluid level(s)\*:**

For Manual Transmission (MT) model; make sure that the brake and clutch fluid levels are between the MAX and MIN lines on the reservoirs.

Except for Manual Transmission (MT) model; make sure that the brake fluid level is between the MAX and MIN lines on the reservoir.

### **Engine coolant level\*:**

Check the coolant level when the engine is cold. Make sure that the coolant level is between the MAX and MIN lines on the reservoir.

### **Engine drive belt(s)\*:**

Make sure that drive belt(s) is not frayed, worn, cracked or oily.

### **Engine oil level\*:**

Check the level after parking the vehicle (on a level ground) and turning off the engine.

### **Fluid leaks:**

Check under the vehicle for fuel, oil, water or other fluid leaks after the vehicle has been parked for a while. Water dripping from the air conditioner after use is normal. If you should notice any leaks or if fuel fumes are evident, check for cause and have it corrected immediately.

### **Power steering fluid level and lines\*:**

Check the level when the fluid is cold, with the engine off. Check the lines for proper attachment, leaks, cracks, etc.

### **Windshield washer fluid\*:**

Check that there is adequate fluid in the reservoir.

## **MAINTENANCE PRECAUTIONS**

When performing any inspection or maintenance work on your vehicle, always take care to prevent serious accidental injury to yourself or damage to the vehicle. The following are general precautions which should be closely observed.



### **WARNING:**

- **Park the vehicle on a level surface, apply the parking brake securely and block the wheels to prevent the vehicle from moving. Move the shift lever to the "P" (Park) position (Continuously Variable Transmission (CVT) model) or to the "N" (Neutral) position (Manual Transmission (MT) model).**
- **Be sure the ignition switch is in the "OFF" or "LOCK" position when performing any parts replacement or repairs.**
- **Do not work under the hood while the engine is hot. Always turn off the engine and wait until it cools down.**
- **If you must work with the engine running, keep your hands, clothing, hair and tools away from moving fans, belts and any other moving parts.**
- **It is advisable to secure or remove any loose clothing and any jewelry, such as rings, watches, etc. before working on**

## MAINTENANCE REQUIREMENTS

Some day-to-day and regular maintenance is essential to maintain your vehicle's good mechanical condition, as well as its emission and engine performance.

It is the owner's responsibility to make sure that the specified maintenance, as well as general maintenance, is performed.

As the vehicle owner, you are the only one who can ensure that your vehicle receives the proper maintenance care.

### SCHEDULED MAINTENANCE

For your convenience, the required scheduled maintenance items are described and listed in a separate Warranty Information and Maintenance booklet. You must refer to that booklet to ensure that necessary maintenance is performed on your vehicle at regular intervals.

### GENERAL MAINTENANCE

General maintenance includes those items which should be checked during normal day-to-day operation of the vehicle. They are essential if your vehicle is to continue to operate properly. It is your responsibility to perform these procedures regularly as prescribed.

Performing general maintenance checks requires minimal mechanical skill and only a few general automotive tools.

These checks or inspections can be done by yourself, a qualified technician, or if you prefer, your NISSAN dealer.

your vehicle.

- **If you must run the engine in an enclosed space such as a garage, be sure there is proper ventilation for exhaust gases to escape.**
- **Never get under the vehicle while it is supported by a jack.**
- **Keep smoking materials, flame and sparks away from fuel and the battery.**
- **Never connect or disconnect either the battery or any transistorized component connector while the ignition switch is in the "ON" position.**
- **On gasoline engine models with the Multiport Fuel Injection (MFI) system, the fuel filter and fuel lines should be serviced by a NISSAN dealer because the fuel lines are under high pressure even when the engine is turned off.**
- **Your vehicle is equipped with an automatic engine cooling fan. It may come on at any time without warning, even if the ignition switch is in the "OFF" or "LOCK" position and the engine is not running. To avoid injury, always disconnect the negative battery cable before working near the fan.**
- **Always wear eye protection whenever you work on your vehicle.**
- **Never leave the engine or transmission related component harness connector disconnected while the ignition switch is in the "ON" position.**
- **Avoid direct contact with used engine oil and coolant. Improperly disposed engine oil, engine coolant, and/or other vehicle fluids can hurt the environment. Always conform to local regulations for disposal**

### of vehicle fluids.

This "8. Maintenance and do-it-yourself" section provides instructions regarding only those items which are relatively easy for an owner to perform.

You should be aware that incomplete or improper servicing may result in operating difficulties or excessive emissions, and could affect your warranty coverage. **If in doubt about any servicing, have it done by a NISSAN dealer.**

## ENGINE COMPARTMENT CHECK LOCATIONS

### WHERE TO GO FOR SERVICE

If maintenance service is required or your vehicle appears to malfunction, have the systems checked and tuned by an authorized NISSAN dealer.

### H4K ENGINE MODEL

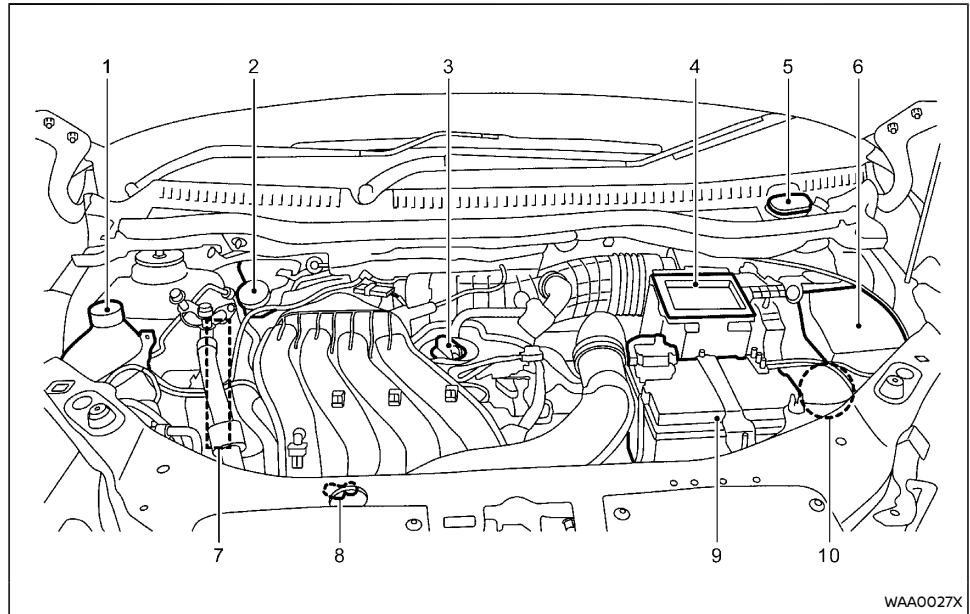

- |                                     |                                    |
|-------------------------------------|------------------------------------|
| 1. Engine coolant reservoir         | 9. Battery                         |
| 2. Brake and clutch fluid reservoir | 10. Power steering fluid reservoir |
| 3. Engine oil filler cap            |                                    |
| 4. Air cleaner                      |                                    |
| 5. Window washer fluid reservoir    |                                    |
| 6. Fuse/fusible link holders        |                                    |
| 7. Engine drive belt location       |                                    |
| 8. Engine oil dipstick              |                                    |

## ENGINE COOLING SYSTEM

### HR13DDT ENGINE MODEL

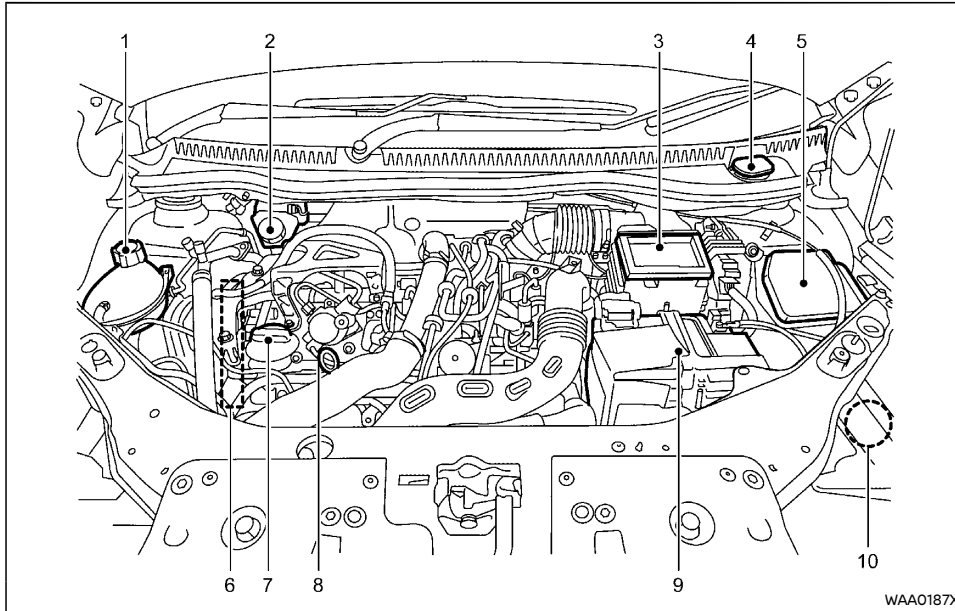

- |                                      |                                       |
|--------------------------------------|---------------------------------------|
| 1. Engine coolant reservoir          | 9. Battery                            |
| 2. Brake and clutch* fluid reservoir | 10. Power steering fluid reservoir    |
| 3. Air cleaner                       | *: For Manual Transmission (MT) Model |
| 4. Window washer fluid reservoir     |                                       |
| 5. Fuse/fusible link holders         |                                       |
| 6. Engine drive belt location        |                                       |
| 7. Engine oil filler cap             |                                       |
| 8. Engine oil dipstick               |                                       |



#### WARNING:

- Never remove the radiator or coolant reservoir cap when the engine is hot. Serious burns could be caused by high-pressure fluid escaping from the radiator. Wait until the engine and radiator cool down.
- Engine coolant is poisonous and should be stored carefully in marked containers out of the reach of children.
- If the engine was stopped soon when the engine is hot, the cooling fan may operate for approximately 10 minutes (HR13DDT engine) after the engine was stopped to cool the components in the engine compartment. When the cooling fan is operating, be sure that hands or other items do not get caught in it.

The engine cooling system is filled at the factory with a high-quality, year-round, anti-freeze coolant solution. The anti-freeze solution contains rust and corrosion inhibitors, therefore additional cooling system additives are not necessary.



#### CAUTION:

- Never use any cooling system additives such as radiator sealer. Additives may clog the cooling system and cause damage to the engine, transmission and/or cooling system.
- When adding or replacing coolant, be sure to use only Genuine NISSAN Engine Coolant or equivalent in its quality with the proper mixture ratio. Examples of the mixture ratio of coolant and water are shown in the following table:

### For HR13DDT engine model

Outside temperature down to		Engine coolant (concentrated)	Demineralized or distilled water
°C	°F		
-15	5	30%	70%

### For H4K engine model

Outside temperature down to		Engine coolant (concentrated)	Demineralized or distilled water
°C	°F		
-23	-9	40%	60%
-35	-30	50%	50%

The use of other types of coolant solutions may damage the engine cooling system.

The radiator is equipped with a pressure cap. To prevent engine damage, use only a Genuine NISSAN radiator cap or its equivalent when replacement is required.

### CHECKING ENGINE COOLANT LEVEL

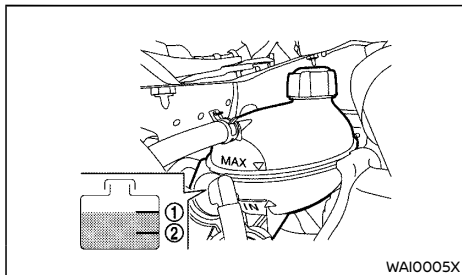

WAI0005X

Check the coolant level in the reservoir when the engine is cold. If the coolant level is below MIN level ②, add coolant up to the MAX level ①.

Tighten the cap securely after adding engine coolant.

**If the cooling system frequently requires coolant, have it checked by a NISSAN dealer.**

### CHANGING ENGINE COOLANT

Contact a NISSAN dealer if replacement is required.

Major engine cooling system repair should be performed by a NISSAN dealer. The service procedures can be found in the appropriate NISSAN Service Manual.

Improper servicing can result in reduced heater performance and engine overheating.



### WARNING:

- **To avoid being scalded, never change the coolant when the engine is hot.**
- **Never remove the radiator or coolant reservoir cap when the engine is hot. Serious burns could be caused by high pressure fluid escaping from the radiator.**
- **Avoid direct skin contact with used coolant. If skin contact is made, wash thoroughly with soap or hand cleaner as soon as possible.**
- **Keep coolant out of the reach of children and pets.**

Engine coolant must be disposed of properly. Check your local regulations.

## ENGINE OIL

### CHECKING ENGINE OIL LEVEL

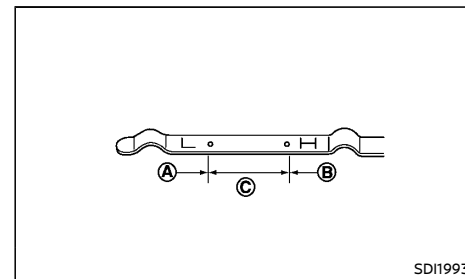

SD11993

H4K engine

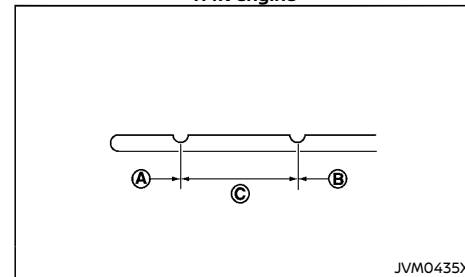

JVM0435X

HR13DDT engine

1. Park the vehicle on a level surface and apply the parking brake.
2. Start the engine and warm it up until the engine temperature reaches the normal operating temperature (approximately 5 minutes).
3. Stop the engine.
4. Wait at least 10 minutes for the engine oil to drain back to the oil pan.

5. Remove the dipstick and wipe it clean.
6. Reinsert the dipstick all the way.
7. Remove the dipstick and check the oil level. It should be within the range **C**.
8. If the oil level is below **A**, remove the oil filler cap and pour the recommended oil into the opening. Do not overfill **B**.

**When filling the engine oil, do not remove the dipstick.**

9. Recheck the oil level with the dipstick.

**It is normal to add some oil between oil maintenance intervals or during the break-in period, depending on the severity of operating conditions.**

**CAUTION:**

The oil level should be checked regularly. Operating your vehicle with an insufficient amount of oil can damage the engine, and such damage is not covered by the warranty.

### CHANGING ENGINE OIL AND OIL FILTER

**WARNING:**

- Used oil must be disposed of properly. Never pour or dump oil into the ground, canals, rivers, etc. It should be disposed of at proper waste facilities. NISSAN recommends having your oil changed by a NISSAN dealer.
- Be careful not to burn yourself, as the engine oil may be hot.
- Prolonged and repeated contact with used engine oil may cause skin cancer.
- Avoid direct skin contact with used oil. If contacted, wash thoroughly with soap or hand cleaner and plenty of water as soon

**as possible.**

- **Store used engine oil in marked containers out of the reach of children.**

1. Park the vehicle on a level surface and apply the parking brake.
2. Start the engine and warm it up until the engine temperature reaches the normal operating temperature (approximately 5 minutes).
3. Stop the engine.
4. Wait at least 10 minutes for the engine oil to drain back to the oil pan.
5. Raise and support the vehicle using a suitable floor jack and safety jack stands.
  - Place the safety jack stands under the vehicle jack-up points.
  - A suitable adapter should be attached to the jack stand saddle.

### Engine oil and filter (H4K engine model)

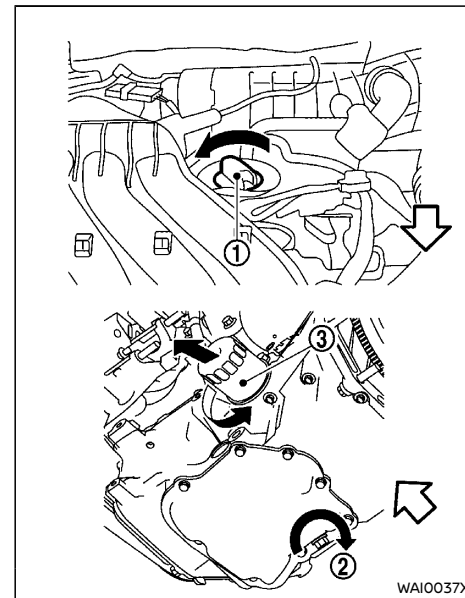

- ① Oil filler cap
- ② Oil drain plug
- ③ Oil filter

1. Place a large drain pan under the drain plug.
2. Remove the drain plug ② with a wrench.
3. Remove the oil filler cap ① and completely drain the oil.

If the oil filter is to be changed, remove and replace it at this time.



**CAUTION:**

**Waste oil must be disposed of properly. Check your local regulations.**

4. Loosen the oil filter ③ with an oil filter wrench.
5. Remove the oil filter by turning it by hand.
6. Wipe the engine oil filter mounting surface with a clean cloth.  
Be sure to remove any old gasket remaining on the mounting surface.
7. Apply new engine oil to the gasket of the new oil filter.
8. Screw in the oil filter until a slight resistance is felt and then tighten an additional 2/3 of a turn to secure the filter.

**Oil filter tightening torque:****15 to 20 N·m****(1.5 to 2.0 kg·m, 11 to 15 ft·lb)**

9. Clean and reinstall the drain plug and new washer. Securely tighten the drain plug with a wrench. Do not use excessive force.

**Drain plug tightening torque:****29 to 39 N·m****(3.0 to 4.0 kg·m, 22 to 29 ft·lb)**

10. Refill the recommended engine oil and quantity. (See "Recommended fluids/lubricants and capacities" (P.9-2).)

**When filling the engine oil, do not remove the dipstick.**

11. Securely install the oil filler cap.
12. Start the engine.
13. Check the drain plug for any sign of leakage.

14. Dispose of the used oil in the proper manner. Check your local regulations.
15. Check the engine oil level according to the proper procedure. (See "Checking engine oil level" (P.8-7).)

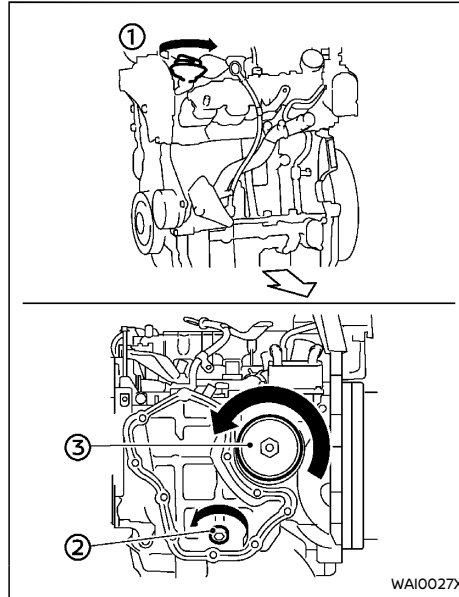
**Engine oil and filter (HR13DDT engine model)**

- ① Oil filler cap
- ② Oil drain plug
- ③ Oil filter

1. Place a large drain pan under the drain plug.

2. Remove the drain plug with a wrench.
3. Remove the oil filler cap and completely drain the oil.

If the oil filter is to be changed, remove and replace it at this time.

**CAUTION:**

**Waste oil must be disposed of properly. Check your local regulations.**

4. Loosen the oil filter with an oil filter wrench.
5. Remove the oil filter by turning it by hand.
6. Wipe the engine oil filter mounting surface with a clean cloth.  
Be sure to remove any old gasket remaining on the mounting surface.
7. Apply new engine oil to the gasket of the new oil filter.
8. Screw in the oil filter until a slight resistance is felt and then tighten an additional 2/3 of a turn to secure the filter.

**Oil filter tightening torque:****20 to 25 N·m****(2.0 to 2.6 kg·m, 15 to 18 ft·lb)**

9. Clean and reinstall the drain plug and new washer. Securely tighten the drain plug with a wrench. Do not use excessive force.

**Drain plug tightening torque:****16 to 24 N·m****(1.6 to 2.4 kg·m, 12 to 18 ft·lb)**

10. Refill the recommended engine oil and quantity. (See "Recommended fluids/lubricants and capacities" (P.9-2).)

**When filling the engine oil, do not remove the dipstick.**

## DRIVE BELT

11. Securely install the oil filler cap.
12. Start the engine.
13. Check the drain plug for any sign of leakage.
14. Dispose of the used oil in the proper manner. Check your local regulations.
15. Check the engine oil level according to the proper procedure. (See "Checking engine oil level" (P.8-7).)

### After the operation

1. Lower the vehicle carefully to the ground.
2. Dispose of waste oil and filter properly.

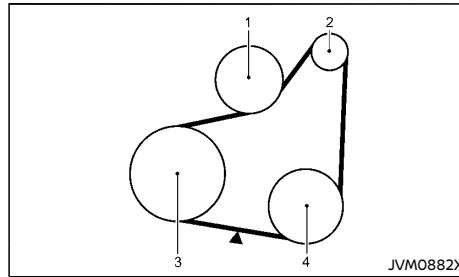

1. Water pump
  2. Alternator
  3. Crankshaft pulley
  4. Air conditioner compressor
- ▼: Tension checking point

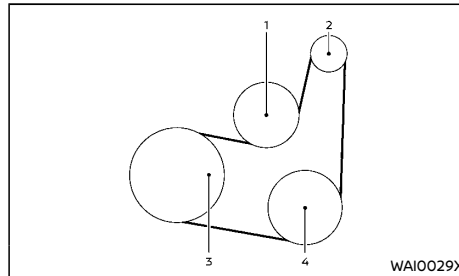

1. Water pump
2. Alternator
3. Crankshaft pulley
4. Air conditioner compressor

Be sure the ignition switch is in the "OFF" or "LOCK" position.

Visually inspect the belt for signs of unusual

wear, cuts, fraying or looseness. Check regularly for condition. If the belt is in poor condition or loose, have it replaced or adjusted by a NISSAN dealer.

## SPARK PLUGS



### WARNING:

Be sure the engine and ignition switch are off and that the parking brake is applied.

Replace the spark plugs according to the maintenance log shown in a separate maintenance booklet.

If replacement is required, contact a NISSAN dealer.

## NICKEL-TIPPED SPARK PLUGS



### CAUTION:

- Do not reuse the nickel-tipped spark plugs by cleaning or re-gapping.
- Always replace with the recommended nickel-tipped spark plugs.

## BRAKES

### CHECKING PARKING BRAKE

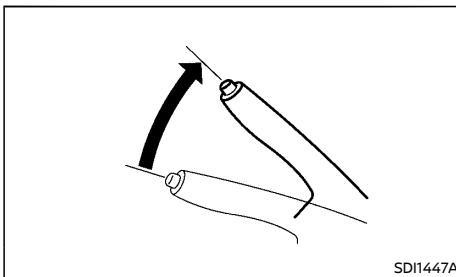

From the released position, pull the parking brake lever up slowly and firmly. If the number of clicks is out of the range listed, see a NISSAN dealer.

**8 to 12 clicks**

**Pulling force 196 N (20 kg, 44 lb)**

### CHECKING FOOT BRAKE PEDAL

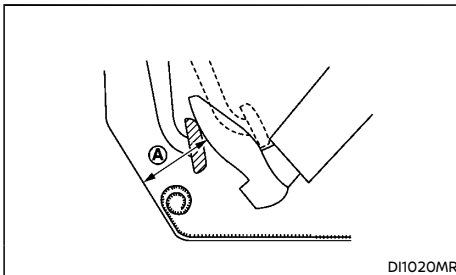

### WARNING:

See a NISSAN dealer for a brake system check if the foot brake pedal height does not return to normal.

With the engine running, check the distance **A** between the upper surface of the pedal and the metal floor. If it is out the range listed, see a NISSAN dealer.

**A: 65 mm (2.56 in) or more**

**Depressing force: 490 N (50 kg, 110 lb)**

### Self-adjusting brakes

Your vehicle is equipped with self-adjusting brakes. The disc-type brakes self-adjust every time the foot brake pedal is applied.

### Brake pad wear warning

#### H4K engine model:

The disc brake pads have audible wear warnings. When a brake pad requires replacement, it will make a high pitched scraping sound when the vehicle is in motion. This scraping sound will first occur only when the brake pedal is depressed. After more wear of the brake pad, the sound will always be heard even if the brake pedal is not depressed. Have the brakes checked as soon as possible if the wear warning sound is heard.

Under some driving or climate conditions, occasional brake squeaks, squeals or other noises may be heard. Occasional brake noise during light to moderate stops is normal and does not affect the function or performance of the brake system.

Proper brake inspection intervals should be followed. For additional information, see a separate maintenance booklet.

## BRAKE FLUID

### HR13DDT engine model:

The disc brake pads have wear inspection hole. Should be checked frequently by owner. Pad replacement is necessary if the pad thickness is around 2.0 mm (0.1 in).

Proper brake inspection intervals should be followed. For additional information, see a separate maintenance booklet.

### BRAKE BOOSTER

Check the brake booster function as follows:

1. With the engine off, depress and release the foot brake pedal several times. When the brake pedal movement (distance of travel) remains the same from one pedal application to the next, continue on to the next step.
2. While depressing the foot brake pedal, start the engine. The pedal height should drop a little.
3. With the foot brake pedal depressed, stop the engine. Keep the pedal depressed for about 30 seconds. The pedal height should not change.
4. Run the engine for 1 minute without depressing the foot brake pedal, then turn it off. Depress the foot brake pedal several times. The pedal travel distance will decrease gradually with each depression as the vacuum is released from the booster.

If the brakes do not operate properly, have the brakes checked by a NISSAN dealer.



#### WARNING:

- Use only new fluid from a sealed container. Old, inferior, or contaminated fluid may damage the brake system. The use of improper fluids can damage the brake system and affect the vehicle's stopping ability.
- Clean the filler cap before removing.
- Brake fluid is poisonous and should be stored carefully in marked containers out of the reach of children.



#### CAUTION:

Do not spill the fluid on painted surfaces. This will damage the paint. If fluid is spilled, wash it off with plenty of water immediately.

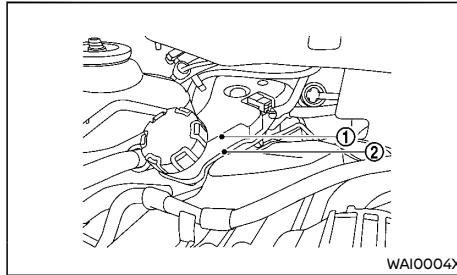

Check the fluid level in the reservoir. If the fluid is below the MIN line ②, the brake warning light will illuminate. Add fluid up to the MAX line ①. (For recommended types of fluid, see "Recommended fluids/lubricants and capacities" (P.9-2).)

If the fluid must be added frequently, the system should be thoroughly checked by a

NISSAN dealer.

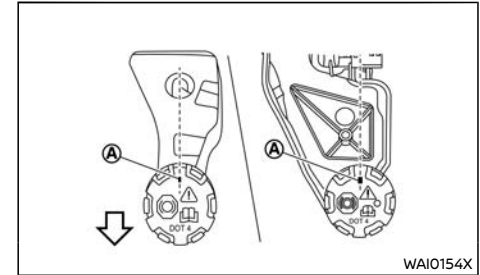

#### NOTE:

When tightening the filler cap, be sure to position the cap as illustrated (the mark ① points toward the rear of the vehicle) to avoid brake fluid leakage.

## CLUTCH FLUID (if equipped)



### WARNING:

- Use only new fluid from a sealed container. Old, inferior, or contaminated fluid may damage the clutch system. The use of improper fluids can damage the clutch system.
- Clean the filler cap before removing.
- Clutch fluid is poisonous and should be stored carefully in marked containers out of the reach of children.



### CAUTION:

Do not spill the clutch fluid on painted surfaces. This will damage the paint. If clutch fluid is spilled, wash it off with plenty of water immediately.

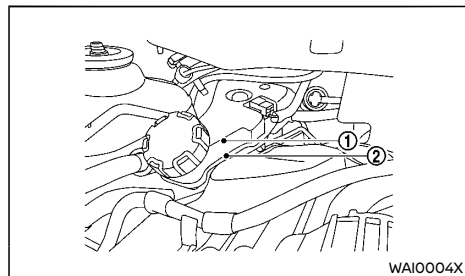

Check the fluid level in the reservoir. The brake fluid reservoir is shared with the clutch system for manual transmissions. If the fluid is below the MIN line ②, add fluid up to the MAX line ①. (For recommended types of fluid, see "Recommended fluids/lubricants and capacities" (P.9-2).)

If the fluid must be added frequently, the clutch

system should be thoroughly checked by a NISSAN dealer.

## CONTINUOUSLY VARIABLE TRANSMISSION (CVT) FLUID (if equipped)

Contact a NISSAN dealer if checking or replacement is required.



### CAUTION:

- Use only Genuine NISSAN CVT Fluid NS-3. Do not mix with other fluids.
- Using transmission fluid other than Genuine NISSAN CVT Fluid NS-3 will damage the CVT, which is not covered by the warranty.

## POWER STEERING FLUID

### HYDRAULIC PUMP ELECTRIC POWER STEERING TYPE

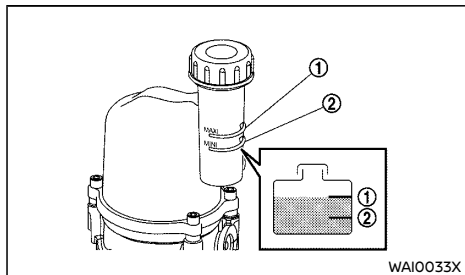

#### WARNING:

Power steering fluid is poisonous and should be stored carefully in marked containers out of the reach of children.

Check the fluid level in the reservoir. The fluid level should be checked when the fluid is cold at fluid temperatures of 0 to 30°C (32 to 86°F). The fluid level should be between ① MAXI and ② MINI line.

If it is necessary to add fluid, contact a NISSAN dealer.

## AIR CLEANER FILTER

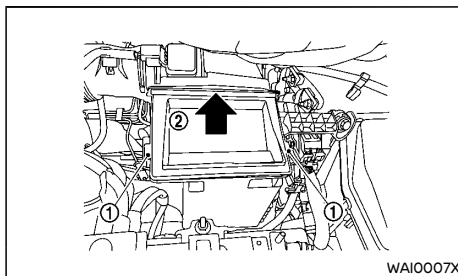

#### WARNING:

Operating the engine with the air cleaner filter off can cause you or others to be burned. The air cleaner filter not only cleans the intake air, it also stops flame if the engine backfires. If the air cleaner filter is not installed and the engine backfires, you could be burned. Never drive with the air cleaner filter off. Be cautious working on the engine when the air cleaner filter is off.

To remove the filter from the air cleaner, release the two retaining clips ①, then release the holders at the back of the unit. Pull the unit upward ②.

The air cleaner filter element may be cleaned and reused. Replace the air filter according to the maintenance log shown in a separate maintenance booklet.

When replacing the air filter, wipe the inside of the air cleaner housing and the cover with a damp cloth.

## WIPER BLADES

### WINDSHIELD WIPER BLADES

#### Cleaning

If the windshield does not become clear after using the windshield washer or if the wiper blades chatter when operating the windshield wipers, wax or other materials may be on the windshield and/or wiper blades.

Clean the outside of the windshield surface with a washer solution or mild detergent. Your windshield is clean if beads do not form when rinsing with water.

Clean the blade by wiping it with a cloth soaked in a washer solution or a mild detergent. Rinse the blade with water. If your windshield is still not clear after cleaning the blades and using the wipers, replace the blades.

#### When a washer nozzle is clogged:

See a NISSAN dealer if a washer nozzle is clogged or any malfunction occurs. Do not attempt to clean the nozzle using a needle or a pin. Doing so may damage the nozzle.

#### Replacing

Replace the wiper blades if they are worn.

1. Hold the wiper arm and blade as shown in the illustration below.

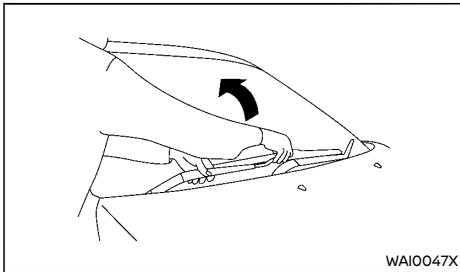

**⚠ CAUTION:**

- After wiper blade replacement, return the wiper arm to its original position. Otherwise the wiper arm or the engine hood may be scratched and may cause damage when the engine hood is opened.
- Worn wiper blades can damage the windshield and impair driver vision.

2. Slightly push the wiper blade towards upside along the windshield by hand (otherwise, the wiper blades may be scratched and may cause damage) and lift the wiper arm.

**When lifting the wiper arm, lift the driver's side first, then the passenger's side.**

3. Pull up the release tab (A), and then move the wiper blade down the wiper arm to remove (1).

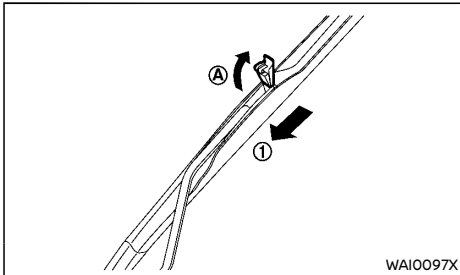

4. Remove the wiper blade.
5. Insert the new wiper blade onto the wiper arm until it clicks into place.

## WINDOW WASHER FLUID

### REAR WINDOW WIPER BLADE (if equipped)

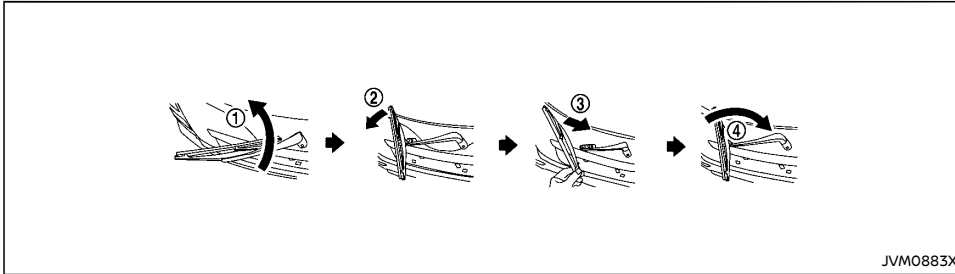

1. Lift the wiper arm away from the rear window.
2. Rotate the wiper blade ① perpendicular to wiper arm.
3. Remove the wiper blade ② gently out from the wiper arm.
4. Set the new wiper blade ③ in the wiper arm in perpendicular position.
5. Rotate the wiper blade ④ in shown direction until it clicks in its place.



#### CAUTION:

After wiper blade replacement, return the wiper arm to its original position.

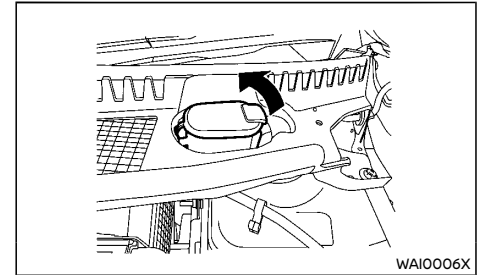

#### WARNING:







Anti-freeze is poisonous and should be stored carefully in marked containers out of the reach of children.

Check the fluid level in the window washer fluid reservoir. If the fluid level is low, add window washer fluid.

Fill the window washer fluid reservoir periodically. Add a washer solvent to the water for better cleaning. In the winter season, add a windshield washer anti-freeze. Follow the manufacturer's instructions for the mixture ratio.



## BATTERY

Caution symbols for battery		⚠ WARNING	
①		No smoking, No exposed flames, No sparks	Never smoke around battery. Never expose battery to open flames or electrical sparks.
②		Shield eyes	Handle the battery cautiously. Always wear eye protection glasses to protect against explosion or battery acid.
③		Keep away from children	Never allow children to handle battery. Keep the battery out of the reach of children.
④		Battery acid	Do not allow battery fluid to contact your skin, eyes, fabrics, or painted surfaces. After handling the battery or battery cap, immediately wash your hands thoroughly. If the battery fluid gets into your eyes, or onto your skin or clothing, flush with water immediately for at least 15 minutes and seek medical attention. Battery fluid is acid. If the battery fluid gets into your eyes or onto your skin, it could cause loss of your eyesight or burns.
⑤		Note operating instructions	Before handling the battery, read this instruction carefully to ensure correct and safe handling.
⑥		Explosive gas	Hydrogen gas, generated by battery fluid, is explosive.

SDI1573

### VEHICLE BATTERY

#### Maintenance free battery

For a maintenance free battery, it is not required to check the fluid level. However, NISSAN recommends to check it periodically at a NISSAN dealer.

#### Jump starting

If jump starting is necessary, see "Jump starting" (P.6-7). If the engine does not start by jump starting or the battery does not charge, the battery may have to be replaced. Contact a NISSAN dealer for replacing the battery.

### REMOTE CONTROLLER BATTERY

#### Battery replacement



#### CAUTION:

- **Be careful not to allow children to swallow the battery and removed parts.**
- **An improperly disposed battery can harm the environment. Always confirm local regulations for battery disposal.**

- When changing batteries, do not let dust or oil get on the components.
- There is danger of explosion if the lithium battery is incorrectly replaced. Replace only with the same or equivalent type.
- Do not expose the battery to excessive heat such as sunshine, fire, etc.

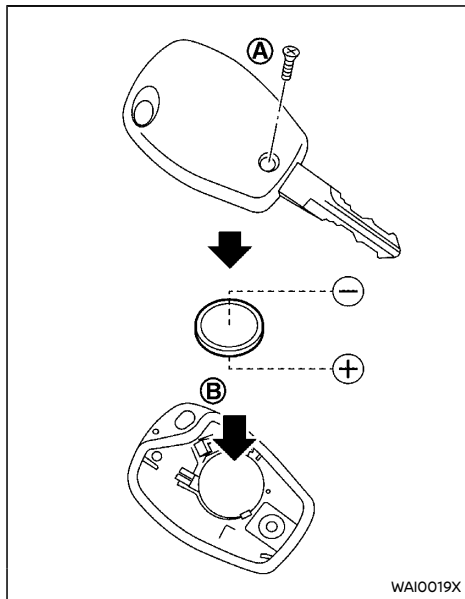

To replace the battery:

1. Remove the screw **A**.
2. Replace the battery with a new one.  
Recommended battery: CR2032 or equivalent.

lent

- Do not touch the internal circuit and electric terminals as doing so could cause a malfunction.
  - Make sure that the  $\oplus$  side faces the bottom of the case **B**.
3. Close the lid securely.
  4. Operate the buttons to check its operation.
- See a NISSAN dealer if you need assistance for replacement.

### INTELLIGENT KEY BATTERY

#### Battery replacement

#### **⚠ CAUTION:**

- Be careful not to allow children to swallow the battery and removed parts.
- An improperly disposed battery can harm the environment. Always confirm local regulations for battery disposal.
- When changing batteries, do not let dust or oil get on the components.
- There is danger of explosion if lithium battery is incorrectly replaced. Replace only with the same or equivalent type.
- Do not expose the battery to excessive heat such as sunshine, fire, etc.

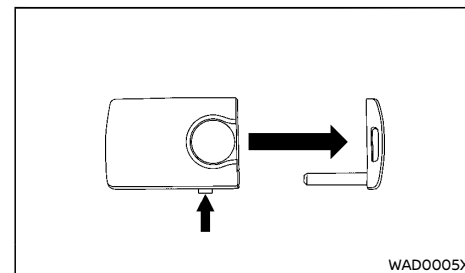

To replace the battery:

1. Release the lock knob at the side of the Intelligent Key and remove the mechanical key.

## FUSES

### ENGINE COMPARTMENT

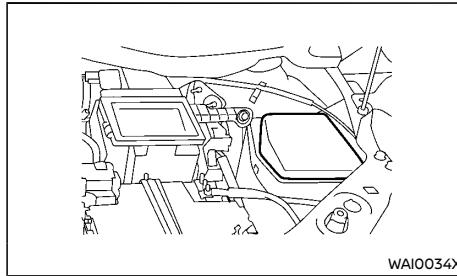

#### CAUTION:

- **Never use a fuse of a higher or lower amperage rating than that specified on the fuse box cover. This could damage the electrical system or cause a fire.**
- **Never use wire or wrapping foil in place of a fuse. This could damage the electrical system or cause a fire.**

For checking and/or replacing, see a NISSAN dealer.

#### Fusible links

If any electrical equipment does not operate and the fuses are in good condition, check the fusible links. If any of these fusible links are melted, replace only with genuine NISSAN parts.

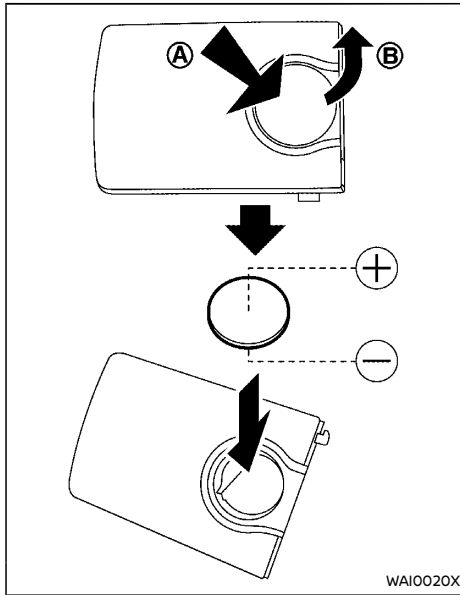

2. Remove the battery by pressing on one side **A** and by lifting the other side **B**.
3. Replace the battery with a new one.
  - Recommended battery: CR2032 or equivalent
  - Do not touch the internal circuit and electric terminals as doing so could cause a malfunction.
  - Make sure that the  $\ominus$  side faces the bottom of the case.

See a NISSAN dealer if you need assistance for replacement.

## PASSENGER COMPARTMENT

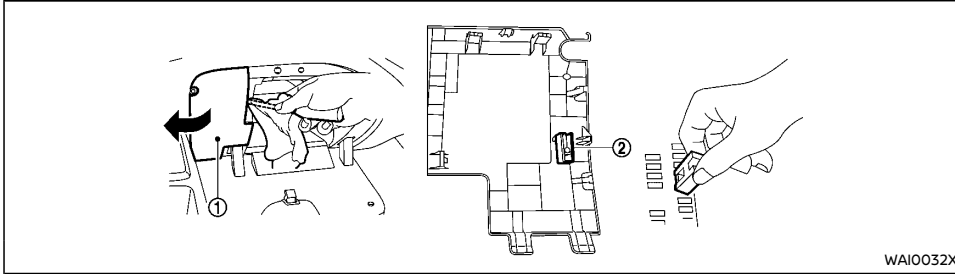

WAI0032X

### CAUTION:

- **Never use a fuse of a higher or lower amperage rating than that specified on the fuse box cover. This could damage the electrical system or cause a fire.**
- **Never use wire or wrapping foil in place of a fuse. This could damage the electrical system or cause a fire.**

If any electrical equipment does not operate, check for an open fuse.

1. Be sure the ignition switch is in the "OFF" or "LOCK" position.
2. Be sure the headlight switch is in the "OFF" position.
3. Remove the fuse box cover ① placed inside of the glove box.
4. Locate the fuse that needs to be replaced.
5. Remove the fuse using the fuse puller ②.

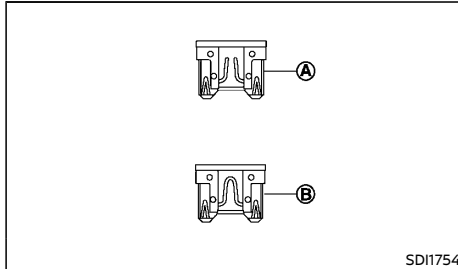

SDI1754

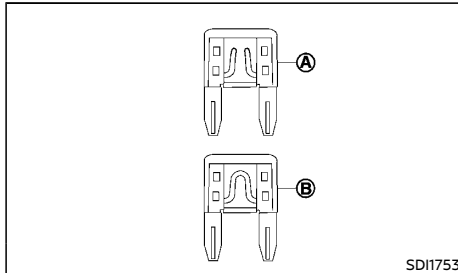

SDI1753

6. If the fuse is open (A), replace it with a new fuse (B).

If the new fuse also opens, after installing, have the electrical system checked, and if necessary repaired, by a NISSAN dealer.

# LIGHTS

## HEADLIGHTS

Fog may temporarily form inside the lens of the exterior lights in the rain or in a car wash. A temperature difference between the inside and the outside of the lens causes the fog. This is not a malfunction. If large drops of water collect inside the lens, contact a NISSAN dealer.

### LED headlight

If replacement is required, contact a NISSAN dealer.

### Halogen headlight bulb

The halogen headlight is a semi-sealed beam type which uses replaceable headlight (halogen) bulbs. They can be replaced from inside the engine compartment without removing the headlight assembly.



#### CAUTION:

High-pressure halogen gas is sealed inside the bulb. The bulb may break if the glass envelope is scratched or the bulb is dropped.

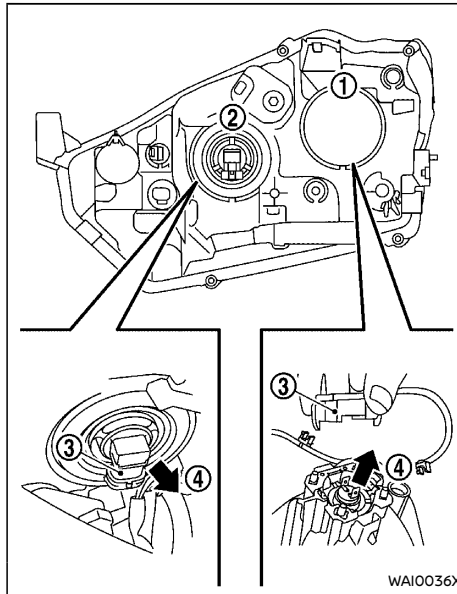

- ① Low-beam (halogen headlight model)
- ② High-beam
1. Disconnect the battery negative cable.
2. Pull off the rubber cap. (if equipped)
3. Disconnect the electrical connector ③ from the rear end of bulb.
4. Remove the bulb ④. Do not shake or rotate the bulb when removing it.
5. Install the new bulb in the reverse order of removal.



#### CAUTION:

- When handling the bulb, do not touch the glass envelope.
- Do not leave the bulb out of the headlight reflector for a long period of time as dust, moisture and smoke may enter the headlight body and affect the performance of the headlight.

Use the same number and wattage as originally installed:

#### Halogen headlight model

Low-beam bulb: 55W (H7)

High-beam bulb: 65W (H9)

#### LED headlight model

High-beam bulb: 65W (H9)

Aiming adjustment is not necessary if only the bulbs are replaced. When aiming adjustment is necessary, contact a NISSAN dealer.

## EXTERIOR LIGHTS

Item	Wattage (W)
Headlight	
Low-beam (halogen headlight model)	55
Low-beam (LED headlight model)*	LED
High-beam	65
Front turn signal light	21
Front clearance light*	LED
Front fog light (if equipped)*	35
Side turn signal light*	5
Rear combination lights	
Turn signal light	21
Stop/tail light	21/5
Tail light	5
Reverse light	16
Rear fog light (if equipped)	21
High-mounted stop light*	LED
License plate light	5

\*: See a NISSAN dealer for replacement.

## INTERIOR LIGHTS

Item	Wattage (W)
Cargo room light	5
Glove box light*	5
Map light	5
Room light	5

\*: See a NISSAN dealer for replacement.

## LIGHT LOCATIONS

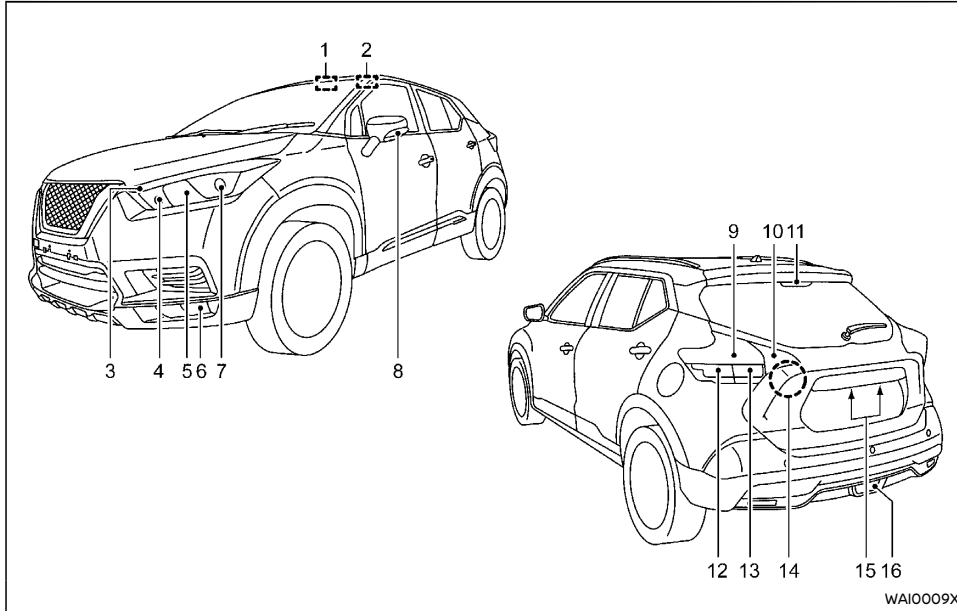

- |                                   |                                  |
|-----------------------------------|----------------------------------|
| 1. Map light and front room light | 9. Stop/Tail light               |
| 2. Rear room light                | 10. Tail light                   |
| 3. Clearance light                | 11. High-mounted stop light      |
| 4. Front turn signal light        | 12. Rear turn signal light       |
| 5. Headlight (high-beam)          | 13. Reverse light                |
| 6. Front fog light (if equipped)  | 14. Cargo room light             |
| 7. Headlight (low-beam)           | 15. License plate light          |
| 8. Side turn signal light         | 16. Rear fog light (if equipped) |

## Replacement procedures

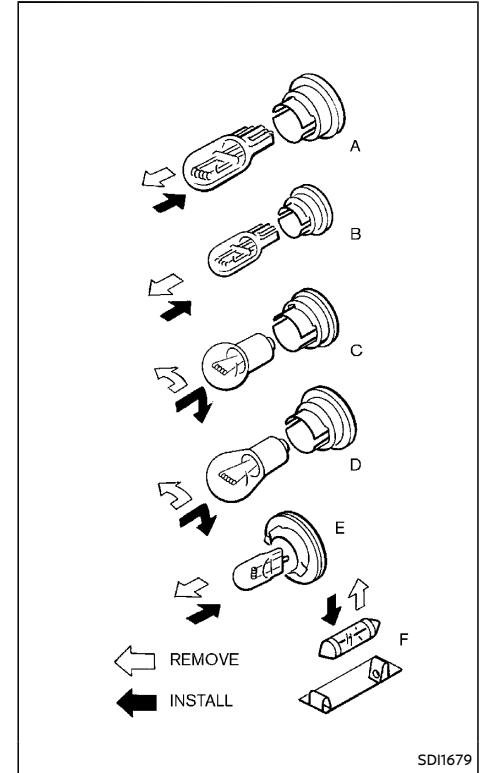

SD11679

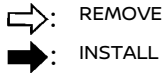

All other lights are either type A, B, C, D, E or F. When replacing a bulb, first remove the lens and/or cover.

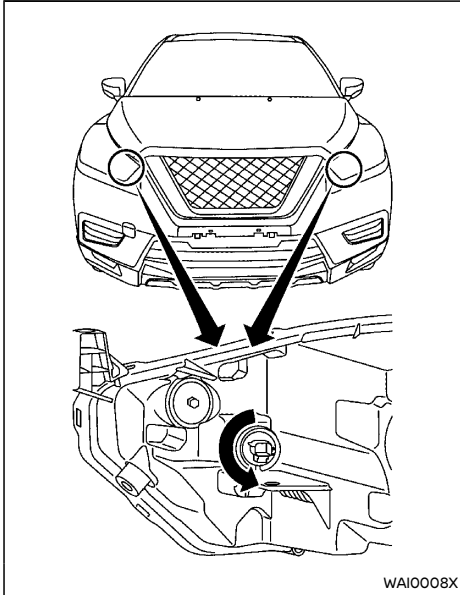

Front turn signal light

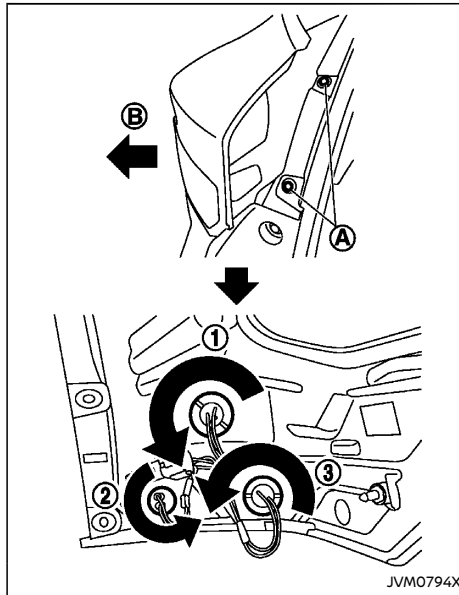

Rear combination light

To replace the rear combination light bulbs:

1. Open the back door.
2. Remove the bolts **A** and move the rear combination light **B** as shown to make a clearance, then carefully pry the light using a suitable tool.
3. Replace the bulbs. (Stop/Tail light **1**, Reverse light **2**, Turn signal light **3**)
4. Install the combination light in the reverse order of removal.

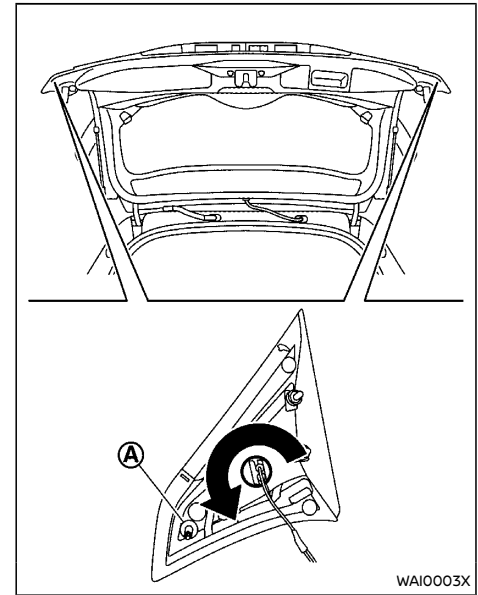

Tail light

To replace the tail light (back door side) bulbs:

1. Open the back door.
2. Remove the back door trim.
3. Remove the nut **A** and move the tail light rearward to make a clearance, then carefully pry the light using a suitable tool.
4. Replace the bulb.
5. Install the tail light in the reverse order of removal.



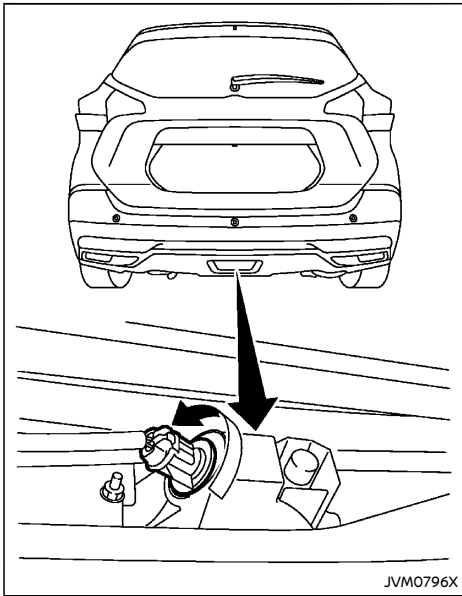

Rear fog light (if equipped)

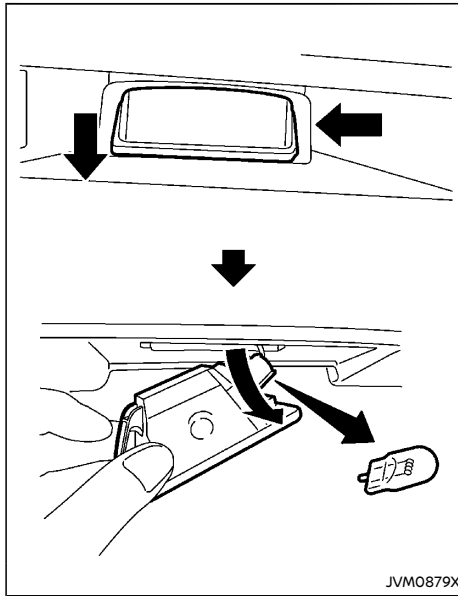

License plate light

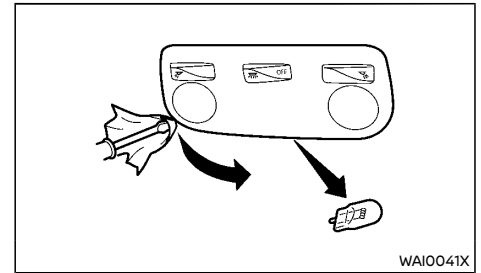

Map light

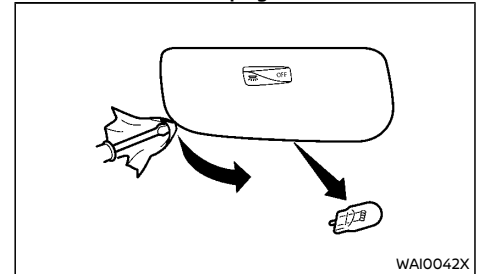

Room light

## TIRES AND WHEELS

If you have a flat tire, see "Flat tire" (P.6-2).

### TIRE INFLATION PRESSURE

Periodically check the pressure of the tires, including the spare. An incorrect tire pressure may adversely affect tire life and vehicle handling. The tire pressure should be checked when tires are COLD. Tires are considered COLD after the vehicle has been parked for 3 or more hours, or driven less than 1.6 km (1 mile). COLD tire pressures are shown on the tire placard.

Insufficient pressure can lead to an overheating of the tire and subsequent internal damage. At high speeds, this could result in tread separation and even bursting of the tire.

### TYPES OF TIRES



#### CAUTION:

**When changing or replacing tires, be sure all four tires are of the same type (that is, summer, all season or snow) and construction. A NISSAN dealer may be able to help you with information about tire type, size, speed rating and availability.**

Replacement tires may have a lower speed rating than the factory equipped tires, and they may not match the potential maximum vehicle speed. Never exceed the maximum speed rating of the tire.

#### All season tires

NISSAN specifies all season tires on some models to provide good performance all year, including snowy and icy road conditions. All season tires are identified by ALL SEASON and/or M&S on the tire sidewall. Snow tires have better snow traction than all season tires and may be more appropriate in some areas.

#### Summer tires

NISSAN specifies summer tires on some models to provide superior performance on dry roads. Summer tire performance is substantially reduced in snow and ice. Summer tires do not have the tire traction rating M&S on the tire sidewall.

If you plan to operate your vehicle in snowy or icy conditions, NISSAN recommends the use of snow or all season tires on all four wheels.

#### Snow tires

If snow tires are needed, it is necessary to select tires equivalent in size and load rating to the original equipment tires. If you do not, it can adversely affect the safety and handling of your vehicle.

Generally, snow tires have lower speed ratings than factory equipped tires and may not match the potential maximum vehicle speed. Never exceed the maximum speed rating of the tire. If you install snow tires, they must be the same size, brand, construction and tread pattern on all four wheels.

For additional traction on icy roads, studded tires may be used. However, some states and provinces prohibit their use. Check local, state and provincial laws before installing studded tires. Skid and traction capabilities of studded snow tires on wet or dry surfaces may be poorer than that of non-studded snow tires.

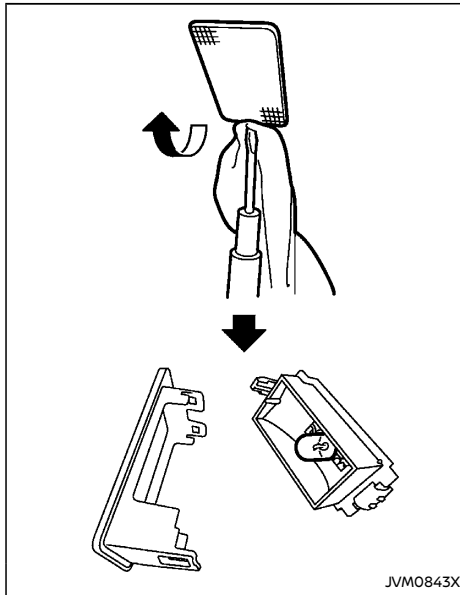

Cargo room light

## TIRE CHAINS

Use of tire chains may be prohibited according to location. Check the local laws before installing tire chains. When installing tire chains, make sure that they are of proper size for the tires on your vehicle and are installed according to the chain manufacturer's instructions.

Use chain tensioners when recommended by the tire chain manufacturer to ensure a tight fit. Loose end links of the tire chains must be secured or removed to prevent the possibility of whipping action damage to the fenders or underbody. If possible, avoid fully loading your vehicle when using tire chains. In addition, drive at a reduced speed. Otherwise, your vehicle may be damaged and/or vehicle handling and performance may be adversely affected.

**Tire chains must be installed only on the front wheels and not on the rear wheels. Do not use the chains on dry roads.**

Never install tire chains on the temporary-use spare tire (if equipped).

Do not drive with tire chains on paved roads which are clear of snow. Driving with chains in such conditions can cause damage to the various mechanisms of the vehicle due to some overstress.

## TIRE ROTATION

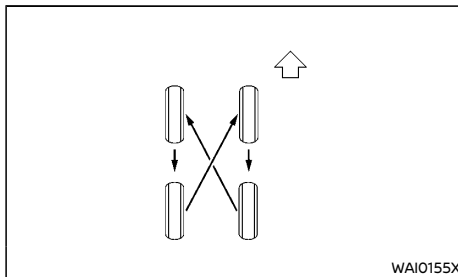

NISSAN recommends that tires be rotated every 10,000 km (6,000 miles). However, the timing for tire rotation may vary according to your driving habits and the road surface conditions. (For the tire replacement, see "Flat tire" (P.6-2).)



### WARNING:

- **After rotating the tires, adjust the tire pressure.**
- **Retighten the wheel nuts when the vehicle has been driven for 1,000 km (600 miles) (also in cases of a flat tire, etc.).**
- **Do not include the temporary-use spare tire (if equipped) in tire rotation.**
- **Incorrect tire selection, fitting, care, or maintenance can affect vehicle safety with risk of accident and injury. If in doubt, consult a NISSAN dealer or the tire manufacturer.**

## TIRE WEAR AND DAMAGE

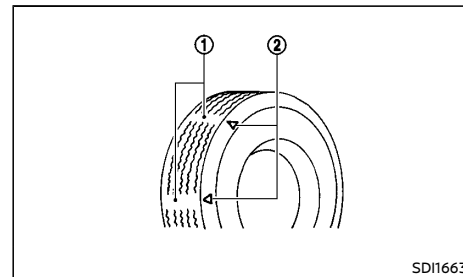

- ① Wear indicator
- ② Wear indicator location marks. The locations are shown by "Δ", "TWI", etc. depending on tire types.

Tires should be periodically inspected for wear, cracking, bulging or objects caught in the tread. If excessive wear, cracks, bulging or deep cuts are found, the tire should be replaced immediately.

The original tires have a built-in tread wear indicator. When the wear indicator is visible, the tire should be replaced.

Improper service of a spare tire may result in serious personal injury. If it is necessary to repair the spare tire, contact a NISSAN dealer.

## TIRE AGE

Never use a tire over six years old, regardless of whether it has been used or not.

Tires degrade with age as well as with the vehicle usage. Have your tires checked and balanced often by a repair shop or, if you prefer, a NISSAN dealer.

## CHANGING TIRES AND WHEELS



### WARNING:

**Do not install a deformed wheel or tire even if it has been repaired. Such wheels or tires could have structural damage and could fail without warning.**

When replacing a tire, use the same size, speed rating and load carrying capacity as originally equipped. (For recommended types and sizes of tires and wheels, see "Tires and wheels" (P.9-5).) The use of tires other than those recommended or the mixed use of tires of different brands, construction (bias, bias-belted, or radial), or tread patterns can adversely affect the ride, braking, handling, ground clearance, body-to-tire clearance, snow chain clearance, speedometer calibration, headlight aim and bumper height. Some of these effects may lead to accidents and could result in serious personal injury.

If the wheels are changed for any reason, always replace with wheels which have the same offset dimension. Wheels of a different offset could cause early tire wear, possibly degraded vehicle handling characteristics and/or interference with the brake discs/drums. Such interference can lead to decreased braking efficiency and/or early brake pad/shoe wear.

## WHEEL BALANCE

Unbalanced wheels may affect vehicle handling and tire life. Even with regular use, wheels can get out of balance. Therefore, they should be balanced as required.

## SPARE TIRE

The spare tire supplied with your vehicle varies depending on the model. See "Tires and wheels" (P.9-5) for applicable spare tire.

### Temporary-use spare tire (if equipped)

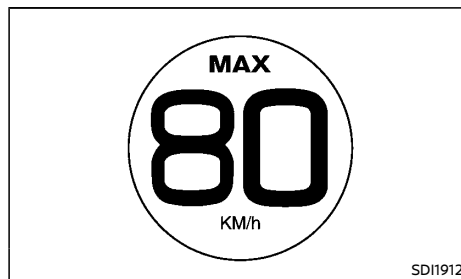

A temporary-use spare tire (different size from the original tire) is supplied with your vehicle.

Observe the following precautions if the spare tire must be used, otherwise your vehicle could be damaged or involved in an accident.



### CAUTION:

- **The spare tire should be used only for emergency. It should be replaced by the standard tire at the first opportunity.**
- **Drive carefully while the spare tire is installed.**

- **Avoid sharp turns and abrupt braking while driving.**
- **Do not drive your vehicle at speeds faster than 80 km/h (50 MPH).**
- **Do not use tire chains on a spare tire. Tire chains will not fit properly on the spare tire and may cause damage to the vehicle.**
- **When driving on roads covered with snow or ice, the spare tire should be used on the rear wheel and the original tire used on the front wheels (drive wheels). Use tire chains only on the front two original tires.**
- **Because the spare tire is smaller than the original tire, ground clearance is reduced. To avoid damage to the vehicle do not drive over obstacles. Also do not drive the vehicle through an automatic car wash since it may get caught.**
- **Do not use the spare tire on other vehicles.**
- **Do not use more than one spare tire at the same time.**

### Conventional spare tire (if equipped)

A standard tire (the same size as the original tire) is supplied with your vehicle.

# 9 Technical information

Recommended fluids/lubricants and capacities .....	9-2	Vehicle identification .....	9-6
Fuel information .....	9-3	Vehicle identification label .....	9-6
Recommended SAE viscosity number .....	9-3	Vehicle Identification Number (VIN) .....	9-6
Air conditioner system refrigerant and lubricant .....	9-4	Engine serial number .....	9-6
Engine .....	9-4	Tire placard .....	9-7
Tires and wheels .....	9-5	Air conditioner specification label .....	9-7
Dimensions .....	9-5	Installation of an RF transmitter .....	9-7
When travelling or registering in another country .....	9-6		



## RECOMMENDED FLUIDS/ LUBRICANTS AND CAPACITIES

The following are approximate capacities. The actual refill quantities may be slightly different. When refilling, follow the procedures instructed in the "8. Maintenance and do-it-yourself" section to determine the proper refill capacity.

Fluid type			Capacity (approximate)			Recommended Fluids/Lubricants
			Metric Measure	US Measure	Imperial Measure	
Fuel			50 L	13-1/4 gal	11 gal	· See "Fuel information" (P.9-3).
Engine oil*  Drain and refill *: For additional information, see "Changing engine oil and oil filter" (P.8-8).	H4K	With oil filter change	4.3 L	4-1/2 qt	3-3/4 qt	<ul style="list-style-type: none"> <li>· Genuine "NISSAN Motor Oil 10W-30 SM or SN" is recommended.</li> <li>· If the above motor oil is not available, use "NISSAN Motor Oil" or equivalent that matches the following grade and viscosity.               <ul style="list-style-type: none"> <li>· Oil grade: API SM or SN, ILSAC GF-4 or GF-5</li> <li>· SAE Viscosity: See "Recommended SAE viscosity number" (P.9-3).</li> </ul> </li> <li>· Genuine "NISSAN Motor Oil 10W-40 ACEA A3/B4" is recommended.</li> <li>· If the above motor oil is not available, use "NISSAN Motor Oil" or equivalent that matches the following grade and viscosity.               <ul style="list-style-type: none"> <li>· Oil grade: ACEA A3/B4</li> <li>· SAE Viscosity: See "Recommended SAE viscosity number" (P.9-3).</li> </ul> </li> </ul>
		Without oil filter change	4.1 L	4-3/8 qt	3-5/8 qt	
	HR13D-DT	With oil filter change	5.4 L	5-3/4 qt	4-3/4 qt	
		Without oil filter change	5.0 L	5-1/4 qt	4-3/8 qt	
Engine coolant (with reservoir)	H4K		4.5 L	4-3/4 qt	4 qt	<ul style="list-style-type: none"> <li>· Genuine NISSAN Engine Coolant (blue) or equivalent</li> <li>· Use Genuine NISSAN Engine Coolant or equivalent in its quality, in order to avoid possible aluminum corrosion within the engine cooling system caused by the use of non-genuine engine coolant.</li> <li>· Note that any repairs for the incidents within the engine cooling system while using non-genuine engine coolant may not be covered by the warranty even if such incidents occurred during the warranty period.</li> </ul>
	HR13DDT		4.5 L	4-3/4 qt	4 qt	
Continuously Variable Transmission (CVT) fluid			—	—	—	<ul style="list-style-type: none"> <li>· Genuine NISSAN CVT Fluid NS-3</li> <li>· Use only Genuine NISSAN CVT Fluid NS-3. Using transmission fluid other than Genuine NISSAN CVT Fluid NS-3 will damage the CVT, which is not covered by the warranty.</li> </ul>
Manual Transmission (MT) gear oil			—	—	—	<ul style="list-style-type: none"> <li>· Manual Transmission Fluid (MTF) TRANSELF NFJ 75W-80, or equivalent</li> <li>· If Manual Transmission Fluid (MTF) TRANSELF NFJ is not available, API GL-4, Viscosity SAE 75W-80 may be used as a temporary replacement. However, use Manual Transmission Fluid (MTF) TRANSELF NFJ as soon as it is available.</li> </ul>
Power steering fluid			—	—	—	· RENAULTMATIC D2 or equivalent
Brake and clutch fluid			Refill to the proper fluid level according to the instructions in the "8. Maintenance and do-it-yourself" section.			<ul style="list-style-type: none"> <li>· Genuine NISSAN Brake Fluid or equivalent DOT3 or DOT4</li> <li>· Never mix different types of fluids (DOT3 and DOT4).</li> </ul>
Multi-purpose grease			—	—	—	· NLGI No. 2 (Lithium soap base)
Air conditioner system refrigerant			—	—	—	· HFC-134a (R-134a)
Air conditioner system lubricants			—	—	—	· SP-10 or equivalent

## FUEL INFORMATION

### Gasoline engine



#### CAUTION:

Do not use leaded gasoline. Using leaded gasoline will damage the three-way catalyst.

Except for Bangladesh: Use UNLEADED REGULAR gasoline with an octane rating of at least 91 (RON).

For Bangladesh: Use UNLEADED PREMIUM gasoline with an octane rating of at least 95 (RON).

## RECOMMENDED SAE VISCOSITY NUMBER

For H4K engine model  
10W-30 is preferable.

If 10W-30 is not available, select the viscosity, from the chart below, that is suitable for the outside temperature range.

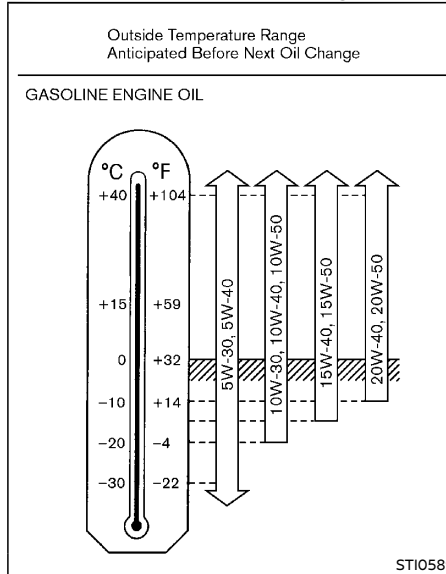

For HR13DDT engine model

10W-40 is preferable.

If 10W-40 is not available, select the viscosity, from the chart below, that is suitable for the outside temperature range.

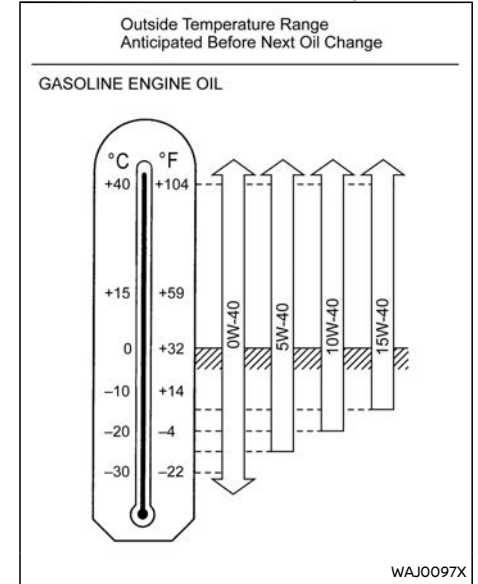

## ENGINE

### AIR CONDITIONER SYSTEM REFRIGERANT AND LUBRICANT

The air conditioner system of your vehicle must be charged with the refrigerant HFC-134a (R-134a) and the lubricant SP-10 or equivalents. Use of any other refrigerants or lubricants will cause severe damage, and you may need to replace your vehicle's entire air conditioner system.

The release of refrigerants into the atmosphere is prohibited in many countries and regions. The refrigerant HFC-134a (R-134a) in your vehicle will not harm the Earth's ozone layer. However, it may contribute in a small part to the global warming effect. NISSAN recommends that the refrigerant be appropriately recovered and recycled. Contact a NISSAN dealer when servicing the air conditioner system.

Engine model		H4K	HR13DDT
Type		Gasoline, 4-cycle, DOHC	Gasoline, 4-cycle
Cylinder arrangement		4-cylinder, in-line	4-cylinder, in-line
Bore × Stroke	mm (in)	78.0 × 78.4 (3.071 × 3.087)	72.2 × 81.3 (2.84 × 3.20)
Displacement	cm <sup>3</sup> (cu in)	1,498 (91.41)	1,330 (81.16)
Idle speed at the "N" (Neutral) position	rpm	700±50	CVT: 850±50 MT: 750±50
Ignition timing (B.T.D.C.) at the "N" (Neutral) position	degree at idle	5±2°	—
Spark plugs			
	Type	Standard	LZKAR7D-9
	Gap	mm (in)	0.8 to 0.9 (0.031 to 0.035)
Camshaft operation		Timing chain	Timing chain



## TIRES AND WHEELS

	Standard	Spare
Tire size	215/65R16 98H	215/65R16 98H
	215/60R17 96H	215/65R16 98H

	Size	Offset mm (in)	
Road wheel	Steel	16 × 6 1/2J	50 (1.97)
	Aluminum	17 × 6 1/2J	50 (1.97)
Spare	Steel	16 × 6 1/2J	50 (1.97)

For India: Tires & tubes fitted in the vehicle, as per clause 3(c) & 3(e) meet the requirement of BIS and comply with the requirements under the Central Motor Vehicle Rules (CMVR), 1989.

## DIMENSIONS

	Unit: mm (in)
Overall length	4,384 (172.6)
Overall width	1,813 (71.4)
Overall height	H4K: 1,656 (65.2) HR13DDT: 1,666 (65.6)
Front tread	1,559 (61.4)
Rear tread	1,566 (61.7)
Wheelbase	2,673 (105.2)

## WHEN TRAVELLING OR REGISTERING IN ANOTHER COUNTRY

When planning to travel in another country or region, find out whether the fuel required for your vehicle is available in that country or region. Using a low octane rated fuel may cause engine damage. Therefore, be sure that the required fuel is available wherever you go. For additional information regarding recommended fuel, see earlier in this section.

When transferring the registration of your vehicle to another country, state, province or district, contact the appropriate authorities to find out that the vehicle complies with the local legal requirements. In some cases, a vehicle cannot meet the legal requirements, and it may be necessary to modify the vehicle to meet local laws and regulations. In addition, there may be possibilities that a vehicle cannot be adapted in certain areas.

The laws and regulations for motor vehicle emission control and safety standards vary according to the country, state, province or district; therefore, the vehicle specification may differ.

When any vehicles are to be taken into another country, state, province or district, its modification, transportation, registration, and any other expenses which may result, are the responsibility of the user. NISSAN is not responsible for any inconveniences that may result.

## VEHICLE IDENTIFICATION

It is prohibited to cover, paint, weld, cut, drill, alter or remove Vehicle Identification Number (VIN).

### VEHICLE IDENTIFICATION LABEL

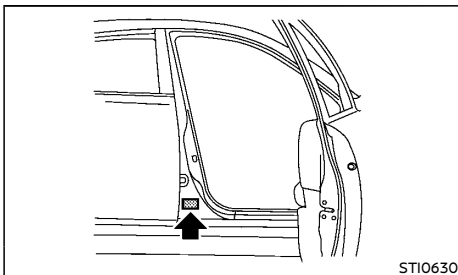

The vehicle identification label is affixed as shown.

### VEHICLE IDENTIFICATION NUMBER (VIN)

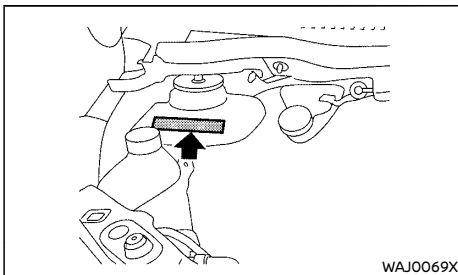

The vehicle identification number is located as shown.

### ENGINE SERIAL NUMBER

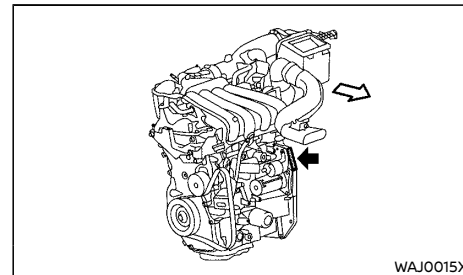

H4K engine

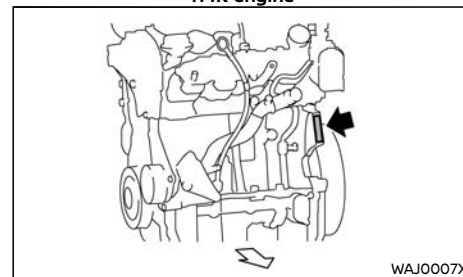

HR13DDT engine

The engine serial number is attached/stamped on the engine as shown.

## INSTALLATION OF AN RF TRANSMITTER

### For countries conforming to UN regulation No.10 or equivalent:

The installation of an RF transmitter in your vehicle could affect electric equipment systems. Be sure to check with your NISSAN dealer for precautionary measures or special instructions regarding installation. Upon request, your NISSAN dealer will provide the detailed information (frequency band, power, antenna position, installation guide, etc.) regarding installation.

### TIRE PLACARD

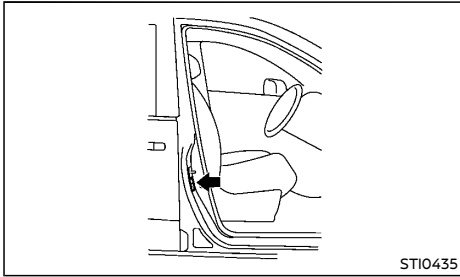

The cold tire pressures are shown on the tire placard affixed to the driver's side center pillar.

### AIR CONDITIONER SPECIFICATION LABEL

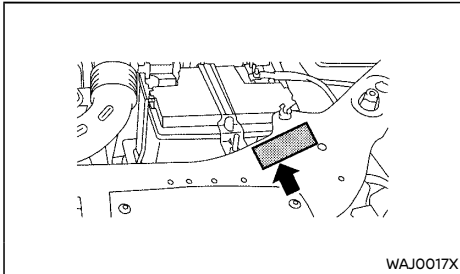

**MEMO**

**MEMO**

**MEMO**

# 10 Index

## A

ABS (Anti-lock Braking System) .....	5-25
Aiming control, Headlights.....	2-15
Air bag system	
Air bag warning labels .....	1-22
Supplemental front-impact air bag system.....	1-19, 1-24
Supplemental side-impact air bag system.....	1-19, 1-24
Air cleaner filter.....	8-14
Air conditioner	
Air conditioner operation.....	4-14
Air conditioner service.....	4-17
Air conditioner specification label.....	9-7
Air conditioning system refrigerant and lubricant recommendations.....	4-17
Air fresheners .....	7-4
Antenna.....	4-23
Anti-lock Braking System (ABS) .....	5-25
Anti-lock Braking system (ABS) warning light.....	2-7
Appearance care	
Exterior appearance care .....	7-2
Interior appearance care.....	7-3
Armrest.....	1-4
Around View Monitor .....	4-7
Audible reminders.....	2-10
Audio operation precautions.....	4-17
Audio system.....	4-17
Automatic air conditioner .....	4-16
Auxiliary input jack.....	4-28

## B

Back door .....	3-15
Battery.....	8-3, 8-17
Battery replacement, Intelligent Key....	8-18
Battery replacement,	
Remote controller .....	8-17

Bluetooth® audio player operation.....	4-28
Bluetooth® Hands-Free Phone System ....	4-30
Brake	
Anti-lock Braking System (ABS).....	5-25
Brake booster.....	8-12
Brake fluid.....	8-12
Brake system.....	5-24
Checking foot brake pedal.....	8-11
Parking brake check.....	8-11
Parking brake operation.....	5-27
Warning light.....	2-7
Break-in schedule .....	5-2
Brightness control, Instrument panel.....	2-5
Bulb check/instrument panel.....	2-7
Bulb replacement.....	8-2, 8-21

## C

Canceling cruising speed .....	5-20
Canceling speed limit.....	5-18
Car phone or CB radio.....	4-30
Card holder.....	2-22
Cargo cover.....	2-23
Cargo room light.....	2-26
Catalytic converter, Three way catalyst .....	5-3
CD player operation.....	4-25
Checking	
Checking engine coolant level.....	8-7
Checking engine oil level.....	8-7
Checking foot brake pedal.....	8-11
Checking lights.....	2-7
Checking parking brake.....	8-11
Child restraints.....	1-10
Child safety.....	1-8
Child safety rear door lock.....	3-4
Chimes, Audible reminders .....	2-10
Circuit breaker, Fusible link .....	8-19
Cleaning exterior and interior.....	7-2, 7-3
Clutch fluid.....	8-13
Cockpit.....	2-2

Cold weather driving.....	5-26
Continuously Variable Transmission (CVT) fluid.....	8-13
Continuously Variable Transmission (CVT) position indicator.....	2-5
Cool box function.....	2-22
Coolant	
Changing engine coolant.....	8-7
Checking engine coolant level.....	8-7
High temperature warning light.....	2-8
Cornering fog light function.....	2-17
Corrosion protection.....	7-5
Cover, Cargo cover.....	2-23
Cruise control.....	5-18
Cruise control display and indicators.....	5-19
Cup holders.....	2-22

## D

Defogger switch.....	2-19
Dimensions.....	9-5
Door open warning light.....	2-7
Drive belt.....	8-10
Driving	
Cold weather driving.....	5-26
Driving with Continuously Variable Transmission (CVT).....	5-9
Driving with Manual Transmission (MT).....	5-12
Precautions when starting and driving.....	5-2

## E

Economy, Fuel.....	5-21
Emergency Stop Signal .....	6-2
Engine	
Break-in schedule .....	5-2
Changing engine coolant.....	8-7
Checking engine coolant level.....	8-7

Checking engine oil level.....	8-7
Engine compartment check locations.....	8-5
Engine cooling system.....	8-6
Engine oil.....	8-7
Engine serial number.....	9-6
Engine specifications.....	9-4
High temperature warning light.....	2-8
If your vehicle overheats.....	6-10
Exhaust gas (carbon monoxide).....	5-3
Explanation of general maintenance items.....	8-2

## F

Flat tire.....	6-2
Floor mat cleaning.....	7-4
Fluid	
Brake fluid.....	8-12
Clutch fluid.....	8-13
Continuously Variable Transmission (CVT) fluid.....	8-13
Engine coolant.....	8-6
Engine oil.....	8-7
Power steering fluid.....	8-14
Window washer fluid.....	8-3, 8-16
FM-AM radio with Compact Disc (CD) player.....	4-23
Fog light switch.....	2-16
Front fog lights.....	2-16
Front map lights.....	2-26
Front room light.....	2-25
Front seat, Front seat adjustment.....	1-2
Fuel	
Fuel economy.....	5-21
Fuel gauge.....	2-5
Fuel information.....	9-3
Fuel octane rating.....	9-3
Fuel-filler cap.....	3-17
Fuel-filler lid.....	3-17
Fuel Efficiency and Carbon Dioxide Reduction driving tips.....	5-20

Fuses.....	8-19
Fusible links.....	8-19

## G

Gauge.....	2-4
Fuel gauge.....	2-5
Speedometer.....	2-4
Tachometer.....	2-4
Trip computer.....	2-13
General maintenance.....	8-2
Glove box.....	2-22

## H

Hands-Free Phone System, Bluetooth®....	4-30
Hazard indicator flasher switch.....	6-2
Head restraints.....	1-4
Headlights	
Aiming control.....	2-15
Bulb replacement.....	8-21
Headlight switch.....	2-15
Heater	
Heater and air conditioner operation.....	4-14
High temperature warning light.....	2-8
Hill start assist system.....	5-16
Hood release.....	3-14
Horn.....	2-19
Hydraulic pump electric power steering.....	5-24

## I

Idling Stop System (See Stop/Start system).....	5-13
Ignition switch	
(with Intelligent Key system).....	5-5
(without Intelligent Key system).....	5-5
Key positions.....	5-5
Indicator lights.....	2-9

Instrument brightness control.....	2-5
Instrument panel.....	2-3
Intelligent Key.....	3-2
Intelligent Key system.....	3-5
Interior lights.....	2-25

## J

Jump starting.....	6-7
--------------------	-----

## K

Key	
NISSAN Anti-Theft System (NATS) key....	3-2
Keyless entry (See remote keyless entry system).....	3-4
Keyless entry (See using remote keyless entry function), Intelligent Key.....	3-10
Keys.....	3-2
For Intelligent Key system.....	3-5

## L

Labels	
Air conditioner specification label.....	9-7
Engine serial number.....	9-6
Vehicle identification.....	9-6
Lead me to car function.....	2-26
Light	
Bulb replacement.....	8-2, 8-21
Fog light switch.....	2-16
Front map lights.....	2-26
Front room light.....	2-25
Headlight switch.....	2-15
Headlights bulb replacement.....	8-21
Indicator lights.....	2-9
Interior lights.....	2-25
Rear room light.....	2-25
Replacement.....	8-2, 8-21
Warning/indicator lights and audible reminders.....	2-7



Lock	
Back door lock.....	3-15
Vehicle speed sensing door lock mechanism.....	3-4
Low fuel warning light.....	2-8
Luggage hooks.....	2-24

## M

Maintenance	
Battery.....	8-3, 8-17
Explanation of general maintenance items.....	8-2
General maintenance.....	8-2
Maintenance precautions.....	8-3
Maintenance requirements.....	8-4
Seat belt maintenance.....	1-10
Maintenance free battery.....	8-17
Malfunction Indicator Light.....	2-9
Manual Transmission (MT).....	5-5
Mechanical key (Intelligent Key system).....	3-3
Meter	
Trip computer.....	2-13
Meters and gauges.....	2-4
Instrument brightness control.....	2-5
Mirror, Vanity mirror.....	3-19
Monitor, Rear view monitor.....	4-3

## N

New vehicle break-in.....	5-2
NISSAN Anti-Theft System (NATS) key.....	3-2

## O

Oil	
Checking engine oil level.....	8-7
Engine oil.....	8-7
Overheat, If your vehicle overheats.....	6-10

## P

Parking	
Brake break-in.....	5-25
Parking brake operation.....	5-27
Parking sensor system.....	5-23
Phone	
Bluetooth® Hands-Free Phone System.....	4-30
Phone, Car phone or CB radio.....	4-30
Power	
Power outlet.....	2-21
Power steering.....	5-24
Power steering fluid.....	8-14
Power windows.....	2-19
Pre-tensioner seat belt system.....	1-22, 1-26
Precautions	
Audio operation.....	4-17
Maintenance.....	8-3
Seat belt usage.....	1-6
Supplemental restraint system.....	1-19
Towing precautions.....	6-11
When starting and driving.....	5-2
Precautions on cruise control.....	5-19
Push starting.....	6-10
Push-button ignition switch.....	5-5

## R

Radio.....	4-17
Car phone or CB radio.....	4-30
FM-AM radio with Compact Disc (CD) player.....	4-23
Rain-sensing auto wiper system.....	2-18
Rear door lock, Child safety rear door lock.....	3-4
Rear fog light.....	2-17
Rear fog light indicator light.....	2-9
Rear room light.....	2-25
Rear seats.....	1-3
Rear view monitor.....	4-3

Rear window wiper and washer switch....	2-18
Remote engine start.....	3-12
Remote keyless entry system.....	3-4
Roof, Roof rack.....	2-24

## S

Safety, Child seat belts.....	1-8
Seat adjustment, Front seats.....	1-2
Seat belt(s)	
Child safety.....	1-8
Injured persons.....	1-9
Pre-tensioner seat belt system.....	1-22, 1-26
Precautions on seat belt usage.....	1-6
Pregnant women.....	1-8
Seat belt cleaning.....	7-4
Seat belt maintenance.....	1-10
Seat belt warning light.....	2-8
Seat belts.....	1-6
Seat(s), Seats.....	1-2
Security system.....	3-12
Setting cruising speed.....	5-19
Setting speed limit.....	5-18
Shark fin antenna.....	4-23
Shift lever	
Shift lock release.....	5-11
Shift lock release	
Transmission.....	5-11
Side-impact air bag system.....	1-19, 1-24
Sonar system.....	5-23
Spare tire.....	8-28
Spark plugs.....	8-11
Speed limiter.....	5-17
Speed limiter display and indicators.....	5-17
Speed limiter malfunction.....	5-18
Speed limiter operations.....	5-17
Speedometer.....	2-4
SRS air bag warning light.....	1-22
Starting	
Jump starting.....	6-7

Precautions when starting and driving.....	5-2
Push starting.....	6-10
<b>Steering</b>	
Power steering.....	5-24
Power steering fluid.....	8-14
Steering lock.....	5-5, 5-6
Tilting steering wheel.....	3-18
Stop/Start System.....	5-13
Sun visors.....	2-25
Supplemental front-impact air bag system.....	1-24
Supplemental side-impact air bag system.....	1-19, 1-24
<b>Switch</b>	
Fog light switch.....	2-16
Headlight aiming control.....	2-15
Headlight switch.....	2-15
Power door lock switch.....	3-3
Turn signal switch.....	2-16

## T

Tachometer.....	2-4
Three-way catalyst.....	5-3
Tilting steering wheel.....	3-18
<b>Tires</b>	
Flat tire.....	6-2
Tire chains.....	8-27
Tire rotation.....	8-2, 8-27
Tires and wheels.....	8-26, 9-5
Types of tires.....	8-26
Tonneau cover (see cargo cover).....	2-23
<b>Towing</b>	
Tow truck towing.....	6-11
Towing precautions.....	6-11
Towing your vehicle.....	6-11
<b>Transmission</b>	
Continuously Variable Transmission (CVT) fluid.....	8-13
Driving with Manual Transmission (MT).....	5-12

Transmission shift lever lock release.....	5-11
Transmitter (See Intelligent Key system).....	3-5
Transmitter (See remote keyless entry system).....	3-4
Trip computer.....	2-13
Turn signal switch.....	2-16
Turning on cruise control.....	5-19
Turning on speed limiter.....	5-18

## U

Underbody cleaning.....	7-3
USB connection port.....	4-28

## V

Vanity mirror.....	3-19
<b>Vehicle</b>	
Dimensions.....	9-5
Information display.....	2-11
Speed sensing door lock mechanism.....	3-4
Vehicle identification.....	9-6
Vehicle Dynamic Control (VDC) system.....	5-15
Vehicle Dynamic Control (VDC) warning light.....	2-8
Vehicle Identification Number (VIN).....	9-6
Ventilators.....	4-14

## W

<b>Warning</b>	
Lights.....	2-7
Warning lights, indicator lights and audible reminders.....	2-6
<b>Warning light</b>	
Anti-lock braking system (ABS) warning light.....	2-7
Brake warning light.....	2-7
Door open warning light.....	2-7
Low fuel warning light.....	2-8
Seat belt warning light.....	2-8

Vehicle Dynamic Control (VDC) warning light.....	2-8
<b>Washer switch</b>	
Rear window wiper and washer switch.....	2-18
Washer switch, Windshield wiper and washer switch.....	2-17
Washing.....	7-2
Waxing.....	7-2
<b>Wheels and tires</b>	
Care of wheels.....	7-3
Cleaning aluminum alloy wheels.....	7-3
Window washer fluid.....	8-3, 8-16
<b>Window(s)</b>	
Cleaning.....	7-2, 7-4
Power windows.....	2-19
Windshield wiper and washer switch.....	2-17
<b>Wiper</b>	
Rain-sensing auto wiper system.....	2-18
Rear window wiper and washer switch.....	2-18
Rear window wiper blade.....	8-16
Windshield wiper and washer switch.....	2-17
Wiper blades.....	8-14

**MEMO**

**MEMO**

**MEMO**

## GAS STATION INFORMATION

### FUEL INFORMATION

Gasoline engine



#### **CAUTION:**

**Do not use leaded gasoline. Using leaded gasoline will damage the three-way catalyst.**

Except for Bangladesh: Use UNLEADED REGULAR gasoline with an octane rating of at least 91 (RON).

For Bangladesh: Use UNLEADED PREMIUM gasoline with an octane rating of at least 95 (RON).

### RECOMMENDED ENGINE OIL

See "Recommended fluids/lubricants and capacities" (P.9-2).

### TIRE COLD PRESSURE

See the tire placard affixed to the driver's side center pillar.

## QUICK REFERENCE

- In case of emergency ... 6-1  
(Flat tire, engine will not start, overheating, towing)
- How to start the engine ... 5-1
- How to read the meters and gauges ... 2-1
- Maintenance and do-it-yourself ... 8-1
- Technical information ... 9-1

## **Nissan Connect**

## FOREWORD

Thank you for purchasing a NISSAN vehicle.

This user's manual is for NissanConnect System offered in your NISSAN vehicle.

Operation instructions for the following systems are included in this manual.

- Audio
- Hands-free phone
- Apple CarPlay
- Android Auto
- Yandex.Auto
- NissanConnect Services
- Navigation
- Voice recognition
- Information and settings viewable on NissanConnect

Please read this manual carefully to ensure safe operation of NissanConnect System.

- Because of possible specification changes and optional equipment, some sections of this manual may not apply to your vehicle.
- All information, specifications and illustrations in this manual are those in effect at the time of printing. NISSAN reserves the right to change specifica-

tions or design at any time without notice.

- Do not remove this manual from the vehicle when selling this vehicle. The next user of the system may need the manual.



# Contents

Introduction	<b>1</b>
Getting started	<b>2</b>
Audio system	<b>3</b>
Hands-Free Phone	<b>4</b>
Information	<b>5</b>
Navigation (if equipped)	<b>6</b>
Voice recognition (if equipped)	<b>7</b>
Troubleshooting guide	<b>8</b>
Index	<b>9</b>



# 1 Introduction

How to use this manual .....	1-2	Trademarks .....	1-6
For safe operation .....	1-2	Legal disclaimer for NissanConnect Services (if equipped for Mexico) .....	1-7
Reference symbols .....	1-2	Licenses .....	1-8
Screen illustrations .....	1-2	Software Licenses (Robert Bosch GmbH) .....	1-8
Safety information .....	1-3	Software Licenses (Clarion Co., Ltd.) .....	1-8
Regulatory information .....	1-4	Telematic Control Unit .....	1-8
Radio approval number and information .....	1-4		

## HOW TO USE THIS MANUAL

This manual uses special words, symbols, icons and illustrations organized by function.

Please refer to the following items and familiarize yourself with them.

### FOR SAFE OPERATION



#### WARNING:

**This is used to indicate the presence of a hazard that could cause death or serious personal injury. To avoid or reduce the risk, the procedures must be followed precisely.**



#### CAUTION:

**This is used to indicate the presence of a hazard that could cause minor or moderate personal injury or damage to your vehicle. To avoid or reduce the risk, the procedures must be followed carefully.**



#### NOTE:

**Indicates items that help you understand and maximize the performance of your vehicle. If ignored, they may lead to a malfunction or poor performance.**

## REFERENCE SYMBOLS



#### INFO:

This indicates information that is necessary for efficient use of your vehicle or accessories.



Reference page:

This indicates the title and page that you should refer to.

< >:

This indicates a button on the control panel, the steering wheel, the steering column or the Display Commander.

[ ]:

This indicates a key/item displayed on the screen.

## SCREEN ILLUSTRATIONS

- The illustrations in this manual are representatives of various models and may not be identical with the design and specifications of your vehicle.
- Icons and menu items displayed on the screen may be abbreviated or omitted from the screen illustrations when appropriate. The omitted icons and menu items are described as dotted lines as illustrated.

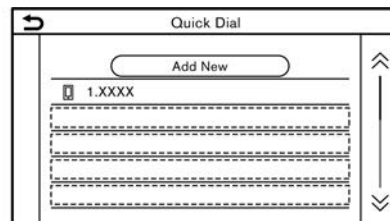

## SAFETY INFORMATION

This system is primarily designed to help you support pleasant driving as outlined in this manual. However, you, the driver, must use the system safely and properly. Information and the availability of services may not always be up to date. The system is not a substitute for safe, proper and legal driving.

Before using the system, please read the following safety information. Always use the system as outlined in this manual.

### WARNING:

- To operate the system, first park the vehicle in a safe location and set the parking brake. Operating the system while driving can distract the driver and may result in a serious accident.
- Exercise extreme caution at all times so full attention may be given to vehicle operation. If the system does not respond immediately, please be patient and keep your eyes on the road. Inattentive driving may lead to a crash resulting in serious injuries or death.
- Do not rely on route guidance (if equipped) alone. Always be sure that all driving maneuvers are legal and safe in order to avoid accidents.
- Do not disassemble or modify this system. If you do, it may result in accidents, fire or electrical shock.

- If you notice any foreign objects in the system hardware, spill liquid on the system or notice smoke or a smell coming from it, stop using the system immediately and it is recommended you contact a NISSAN dealer. Ignoring such conditions may lead to accidents, fire or electrical shock.

### CAUTION:

- Some jurisdictions may have laws limiting the use of video screens while driving. Use this system only where it is legal to do so.
- Extreme temperature conditions [below  $-20^{\circ}\text{C}$  ( $-4^{\circ}\text{F}$ ) and above  $70^{\circ}\text{C}$  ( $158^{\circ}\text{F}$ )] could affect the performance of the system.
- The display screen may break if it is hit with a hard or sharp object. If the display screen breaks, do not touch it. Doing so could result in an injury.

### NOTE:

Do not keep the system running with the engine, hybrid system or e-POWER system stopped. Doing so may discharge the vehicle battery (12V battery). When you use the system, always keep the engine, hybrid system or e-POWER system running.

### Models with NissanConnect Services:

NissanConnect Services may not be available in some regions. Completing the NissanConnect Services registration is necessary to use NissanConnect Services related functions.

## REGULATORY INFORMATION

### RADIO APPROVAL NUMBER AND INFORMATION

#### For Europe

Hereby, Robert Bosch Car Multimedia GmbH declares that the radio equipment type AIVICMFBO, AIVIP32RO, AIVIH60AO and AIVIL42PO is in compliance with Directive 2014/53/EU.

The full text of the EU declaration of conformity is available at the following internet address:

<http://cert.bosch-carmultimedia.net>



#### Frequency Band

2400 MHz - 2480 MHz

#### Radiated Power [EIRP]

Bluetooth < 10 mW

WLAN < 100 mW

#### Hints/Restrictions

Internal Antenna

Internal antenna not accessible by user.  
Any change of the user will violate the legal approval of this product.

#### For Russia



#### For Mexico

La operación de este equipo está sujeta a las siguientes dos condiciones:

- (1) es posible que este equipo o dispositivo no cause interferencia perjudicial y
- (2) este equipo o dispositivo debe aceptar cualquier interferencia, incluyendo la que pueda causar su operación no deseada.

Modelo: AIVIL42PO, AIVIL12FO, AIVIP42MO, AIVIL42NO and AIVICMFBO

Marca: Bosch

#### For Brazil

Este equipamento não tem direito à proteção contra interferência prejudicial e não pode causar interferência em sistemas devidamente autorizados.

Para maiores informações, consulte o site da ANATEL

[www.anatel.gov.br](http://www.anatel.gov.br)



Modelname: AIVICMFBO 05698-18-06541

Modelname: AIVIH60AO 04293-18-06541

#### For Paraguay

Este equipo de Telecomunicaciones cumple con los requerimientos de la CONATEL.



NR: 2018-10-I-000478

For Thailand

Robert Bosch GmbH:

เครื่องวิทยุคมนาคมและอุปกรณ์นี้  
มีความสอดคล้องตามข้อกำหนดของ กทช.

Clarion Co., Ltd.:



nantb.

เครื่องวิทยุคมนาคมนี้ ได้รับยกเว้น ไม่ต้องได้รับ  
ใบอนุญาตให้มี ใช้งานเครื่องวิทยุคมนาคม  
หรือตั้งสถานีวิทยุคมนาคมตามประกาศ กสทช.  
เรื่อง เครื่องวิทยุคมนาคม และสถานีวิทยุ  
คมนาคมที่ได้รับยกเว้นไม่ต้องได้รับใบอนุญาต  
วิทยุคมนาคม ตามพระราชบัญญัติวิทยุ  
คมนาคม พ.ศ. 2498



**nantb.** | โทรคมนาคม  
กำกับดูแลเพื่อประชาชน  
Call Center 1200 ( 1๙๖5 )

## TRADEMARKS

### For Taiwan

經型式認證合格之低功率射頻電機，非經許可，公司、商號或使用者均不得擅自變更頻率、加大功率或變更原設計之特性及功能。

低功率射頻電機之使用不得影響飛航安全及干擾合法通信；經發現有干擾現象時，應立即停用，並改善至無干擾時方得繼續使用。前項合法通信，指依電信法規定作業之無線電通信。低功率射頻電機須忍受合法通信或工業、科學及醫療用電波輻射性電機設備之干擾。

### For Korea

해당 무선설비는 전파혼신 가능성이 있으므로 인명안전과 관련된 서비스는 할 수 없습니다

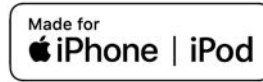

Apple, iPhone, iPod, and iPod touch are trademarks of Apple Inc., registered in the U.S. and other countries. Apple CarPlay is a trademark of Apple Inc. Use of the Apple CarPlay logo means that a vehicle user interface meets Apple performance standards. Apple is not responsible for the operation of this vehicle or its compliance with safety and regulatory standards. Please note that the use of this product with iPhone or iPod may affect wireless performance.



Bluetooth® is a trademark owned by Bluetooth SIG, Inc. and licensed to Robert Bosch GmbH and Clarion Co., Ltd.



HD Radio Technology manufactured un-

der license from iBiquity Digital Corporation. U.S. and Foreign Patents. For patents see <http://dts.com/patents>. HD Radio, Artist Experience, and the HD, HD Radio, and "ARC" logos are registered trademarks or trademarks of iBiquity Digital Corporation in the United States and/or other countries.

### App Store

Apple and the Apple logo are trademarks of Apple Inc., registered in the U.S. and other countries. App Store is a service mark of Apple Inc.

### Siri

Siri is a trademark of Apple Inc., registered in the U.S. and other countries.

### Google/Android/Google Play/Android Auto

Google, Android, Google Play, Android Auto, and other marks are trademarks of Google LLC.



## LEGAL DISCLAIMER FOR NISSANCONNECT SERVICES (if equipped for Mexico)

Feature availability is dependent on vehicle model, trim level, packaging and options. Compatible connected device may be required and feature availability may be dependent on device's capability. Refer to connected device's owner's manual for details. Late availability for some features.

**Driving is serious business and requires your full attention.** Only use features and connected devices when safe and legal to do so. Some features, including automatic crash notification and SOS, are dependent upon the telematics device being in operative condition, its ability to connect to a wireless network, compatible wireless network availability, navigation map data and GNSS signal receptions, the absence of which can limit or prevent the ability to reach Customer Care or receive support. GNSS mapping may not be detailed in all areas or reflect current road status. Never program GNSS while driving.

Only use Remote Engine Start and Remote Horn features in accordance with any laws, rules or ordinances in effect in your vehicle's location.

**Some services and features are provided by independent companies not within NISSAN's control. Should service provider terminate or restrict service or features, service or features may be suspended or terminated without notice or with no liability to NISSAN or its partners or agents.**

Services and features may require compatible cellular network provided by independent companies not within NISSAN or its partners' or agents' control. Cellular network signal strength may vary and may not be available in all areas or at all times. Services and features may not function if cellular network is unavailable, restricted, or terminated.

NISSAN and its partners or agents are not responsible for associated costs or other third party changes that may be required for continued operation due to cellular network unavailability, restriction, or termination (including equipment replacements/upgrades, if available, or roaming charges on alternative networks). Technology is evolving, and changes by independent companies are not within NISSAN's or its partners' or agents' control. Enrollment, owner consent, personal identification number (PIN), and subscription agreement may be required to receive full suite of features and services.

Trial periods (if applicable) begin on the date of vehicle purchase or lease of a new NISSAN. Trial periods may be subject to change at any time and may be subject to early termination without notice. Required subscriptions may be sold separately for each available feature or service after trial period ends, and may continue until you call service provider to cancel. Installation costs, one-time activation fee, other fees and taxes may apply. Fees and programming subject to change. Feature

may be subject to age restrictions in some areas. Subscriptions governed by service provider's subscription agreement, terms and conditions and privacy statements available at service provider's website.

## LICENSES

### SOFTWARE LICENSES (Robert Bosch GmbH)

Open Source Software Licenses

<http://oss.bosch-cm.com/nissan.html>

### SOFTWARE LICENSES (Clarion Co., Ltd.)

- This product use the Source Code of T-Kernel under T-License granted by the TRON Forum ([www.tron.org](http://www.tron.org)).
- This software is based in part on the work of the independent JPEG Group.
- This product includes software developed by the OpenSSL project for use in the OpenSSL Toolkit.  
(<http://www.openssl.org/>)  
Copyright©1998- The OpenSSL Project. All rights reserved.
- Portions of this software are copyright 1996-2002, 2006.  
The FreeType Project ([www.freetype.org](http://www.freetype.org)). All rights reserved.
- This unit include software modules to be licensed under the GUN General Public License (GPL) or GNU Lesser General Public License (LGPL) and other open source software license.  
You can redistribute and/or modify it if under the terms of the each open source license.

To get the source code, refer to the following website.

<https://www.clarion.com/my/en/open-source/nissan/index.html>

### TELEMATIC CONTROL UNIT

<http://opensourceautomotive.com/IC/tZ7T3eE6AiV4>











# 2 Getting started

Control buttons and touch screen display .....	2-2	Basic operation .....	2-9
Buttons on control panel .....	2-2	Selecting menu from Launch Bar .....	2-9
Touch screen display .....	2-3	How to view and operate HOME	
Switches on steering wheel .....	2-4	MENU screen .....	2-10
Steering column switches (if equipped) .....	2-6	Functions disabled while driving	
Display Commander (if equipped) .....	2-7	(if equipped) .....	2-10
USB (Universal Serial Bus) connection port		System settings .....	2-11
and AUX (auxiliary) input jack .....	2-8	Settings menu .....	2-11
Starting system .....	2-9	Connections settings .....	2-13
Start-up screen (if equipped) .....	2-9		

## CONTROL BUTTONS AND TOUCH SCREEN DISPLAY

### BUTTONS ON CONTROL PANEL

The control panel buttons are located at the center of the instrument panel. Available functions, designs, locations, etc. may differ depending on the specifications, switch types and software versions.

Button	Function
<MENU>	Push to display the HOME MENU screen.  "How to view and operate HOME MENU screen" (page 2-10)
<*/>	Push to switch between the day screen (bright) and the night screen (dark) and to adjust the level of screen brightness. Push and hold the button to turn off the display. Push the button again to turn on the display.
<BACK>/< ⏪ >	Depending on the screen, pushing the button will display the previous screen.
<AUDIO>	Push to display the audio screen. When this button is pushed while the audio screen is displayed, a screen to select an audio source will be displayed.  "Selecting audio source" (page 3-13)
<VOL/ ⏻ >/<VOLUME/ ⏻ >	Push to turn the power of the audio system on/off. Turn to adjust the volume.
< ⏮ >/< ⏭ >	Use the buttons for audio operations.  "Audio operations" (page 3-13)
<TUNE SCROLL/SOUND>/ <TUNE SCROLL/ENTER SOUND>/ <TUNE SCROLL/OK>  @ /SOUND>/  @ /ENTER SOUND>/  @ /OK>	Depending on the conditions when a menu screen is displayed, turning the dial can select items on the screen. Push to confirm the selected item or setting. Depending on the models, the button can also be used for audio operations.  "Audio operations" (page 3-13) <b>Models with navigation system:</b> Depending on the models, turning the dial can adjust the map scale on the navigation screen.
<MAP>	Push to display the current location map. When a split map screen is displayed, push this button to display the full map screen. When available, voice guidances can be repeated by pushing and holding this button.  "6. Navigation"
< ▲ >	Push to eject a disc.  "Audio operations" (page 3-13)
< 📞 >	Push to display the phone screen.  "4. Hands-Free Phone"

Button	Function
<SETTING>	Push to display the setting menu screen.  "System settings" (page 2-11)



#### INFO:

For <CAMERA>/<CAMERA/  > (if equipped) operation, refer to the vehicle Owner's Manual. The buttons do not work if the vehicle is not equipped with the functions.

### TOUCH SCREEN DISPLAY

The touch screen display is located at the center of the instrument panel. Various information and operation menus are displayed on the touch screen display. Touch keys and icons on the screen for operation.

#### Liquid crystal display

The touch screen display on this unit is a liquid crystal display and should be handled with care.



#### WARNING:

**Never disassemble the display. Some parts utilize extremely high voltage. Touching them may result in serious personal injury.**

#### Characteristics of liquid crystal display:

- If the temperature inside the vehicle is especially low, the display will stay relatively dim or the movement of the images may be slow. These conditions are normal. The display will function normally when the interior of the vehicle has warmed up.
- Some pixels in the display are darker or brighter than others. This condition is an inherent characteristic of liquid crystal displays, and it is not a malfunction.
- A remnant of the previous display image may remain on the screen. This screen burn is inherent in liquid crystal displays, and it is not a malfunction.
- The screen may become distorted by strong magnetic fields.
- Depending on the condition, brightness may be adjusted automatically to prevent the display from screen burning.

#### Maintenance of display:

To clean the display screen, use a dry, soft cloth. If additional cleaning is necessary, use a small amount of neutral detergent with a soft cloth. Never spray the screen with water or detergent. Dampen the cloth first, then wipe the screen.





















#### CAUTION:

- **Clean the display with the ignition switch or power switch in the OFF position. If the display is cleaned while the ignition switch or power switch is placed in the ON position, unintentional operation may occur.**
- **To clean the display, never use a rough cloth, alcohol, benzene, thinner or any kind of solvent or paper towel with a chemical cleaning agent. They will scratch or deteriorate the panel.**
- **Do not splash any liquid, such as water or car fragrance, on the display. Contact with liquid will cause the system to malfunction.**

## SWITCHES ON STEERING WHEEL

Switches on the steering wheel can be used to perform operations such as taking phone calls, changing volume, and conducting voice operations. Available functions and designs may differ depending on the specifications, switch types and software versions.

Switch	Function
<  >	<p>Push to answer a received call, to end an active call or to read a received text message. Push and hold to reject an incoming call or to ignore a received text message.</p> <p>When no phone call is received or when there is no active call, pushing this switch will display the phone screen.</p> <p>Depending on models and conditions, pushing and holding this switch will start a voice recognition session for making a phone call.</p> <p> "4. Hands-Free Phone"</p>
<  > (TALK)	<p>If your iPhone is connected to the in-vehicle system via Bluetooth®, Siri Eyes Free can be activated by pushing and holding this switch without having to activate Apple CarPlay.</p> <p> "Siri Eyes Free" (page 5-28)</p> <p><b>Models with Voice Recognition System:</b></p> <p>Push to use the Voice Recognition System. Push and hold to end the voice recognition session.</p> <p> "Giving voice commands" (page 7-2)</p> <p>When Apple CarPlay (if equipped), Android Auto (if equipped) or Yandex.Auto (if equipped) is active, pushing and holding this switch will start a Siri, Google Assistant or voice assistant "Alice" voice control session.</p> <p> "Siri operation" (page 5-17)</p> <p> "Google Assistant™ operation" (page 5-21)</p> <p> "Voice assistant "Alice" operation" (page 5-26)</p> <p><b>Models without Voice Recognition System:</b></p> <p>When Apple CarPlay (if equipped), Android Auto (if equipped) or Yandex.Auto (if equipped) is active, pushing this switch will start a Siri, Google Assistant or voice assistant "Alice" voice control session.</p> <p> "Siri operation" (page 5-17)</p> <p> "Google Assistant™ operation" (page 5-21)</p> <p> "Voice assistant "Alice" operation" (page 5-26)</p>
<  >	<p>Push to go back to the previous screen while operating the Voice Recognition System (if equipped). Push and hold to end a voice recognition session.</p>
<  >	<p>Push the + or - side of the switch to adjust the volume.</p>

Switch	Function
< ▲ / ▼ >	Tilt to select the voice command while operating the Voice Recognition System. Tilt to read the previous or next message while a received message is displayed on the screen.  "Hands-free text messaging assistant" (page 4-6) This switch can also be used for audio operations.  "Audio operations" (page 3-13) Depending on models, push to confirm the selected item.
< ▲ >/< ▼ >/< ◀ >/< ▶ >	Push < ▲ >/< ▼ > to select the voice command while operating the Voice Recognition menu screen (if equipped). Push < ▲ >/< ▼ > to read the previous or next message while displaying received message screen.  "Hands-free text messaging assistant" (page 4-6) Push < ◀ >/< ▶ > to switch to the previous or next page while operating the Voice Recognition menu screen (if equipped).  "7. Voice recognition"
<ENTER>	Push to confirm the selected item.
<OK>	Push to confirm the selected item.
<SOURCE>	Push to change the audio source.  "Audio operations" (page 3-13)
< ◀◀ >/< ▶▶ >	This switch can be used for audio operations.  "Audio operations" (page 3-13)

 **INFO:**

Steering wheel switches are mainly for the vehicle information display control and may not be able to operate the touch screen display depending on the conditions. For details of the vehicle information display, refer to the vehicle Owner's Manual.

## STEERING COLUMN SWITCHES (if equipped)

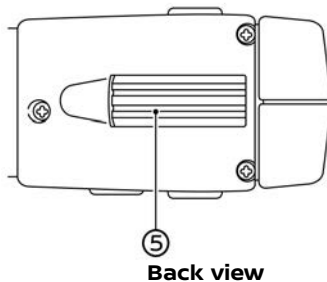
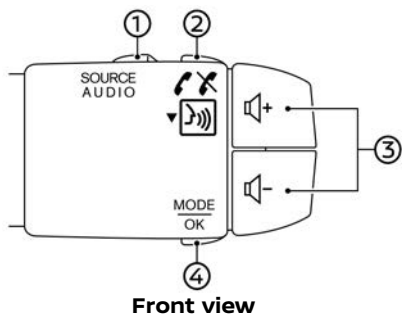





①	<b>&lt;SOURCE/AUDIO&gt;</b>	Push to change the audio source.
②	<    >	Push to answer a received call, to read the text-message or to end an active call. When no phone is received or when there is no active call, pushing this switch will display the phone screen. "4. Hands-Free Phone" Push and hold to use the Voice Recognition System. "Giving voice commands" (page 7-2)
③	<  >	Push the + or - side of the switch from behind to adjust the volume.
④	<b>&lt;MODE/OK&gt;</b>	Push to display the HOME MENU screen. "How to view and operate HOME MENU screen" (page 2-10)
⑤	Tuning wheel	This tuning wheel can be used for audio control. "Audio operations" (page 3-13)



## DISPLAY COMMANDER (if equipped)

The Display Commander is located near the shift lever. With this system, the same operations as those for the control panel are possible using the Display Commander.

Button		Function
<MAP/VOICE>		<p>Push to display the vehicle's current location on the map.            Push and hold to hear the current guidance for a programmed route.   "Navigation screen" (page 6-2)</p>
<AUDIO>		<p>Push to display the audio screen. When this button is pushed while the audio screen is displayed, a screen to select an audio source will be displayed.   "Selecting audio source" (page 3-13)</p>
<MENU>		<p>Push to display the HOME MENU screen.   "How to view and operate HOME MENU screen" (page 2-10)</p>
<BACK>		Pushing the button will display the previous screen.
<OK>		<p>Push to enter the selected item.  <b>Models with navigation system:</b>            If this button is pushed while a map is displayed, the map menu is shown on the display.   "Map Menu screen" (page 6-13)</p>
Center dial/Slide switch	Turning operation	<p>Turn the dial to scroll the highlighted item or to adjust a setting.  <b>Models with navigation system:</b>            While the map screen is displayed, adjust the map scale by turning the dial.</p>
	Sliding operation	<p>Depending on the screen, sliding the slide switch can select areas on the screen or scroll the pages.  <b>Models with navigation system:</b>            While the map screen is displayed, scroll the map screen by sliding the switch.</p>

## USB (Universal Serial Bus) CONNECTION PORT AND AUX (auxiliary) INPUT JACK



### WARNING:

Do not connect, disconnect or operate the USB device while driving. Doing so can be a distraction. If distracted you could lose control of your vehicle and cause an accident or serious injury.



### CAUTION:

- Do not force the USB device into the USB connection port. Inserting the USB device tilted or up-side-down into the port may damage the port. Make sure that the USB device is connected correctly into the USB connection port.
- Do not grab the USB connection port cover (if equipped) when pulling the USB device out of the port. This could damage the port and the cover.
- Do not leave the USB cable in a place where it can be pulled unintentionally. Pulling the cable may damage the port.

The vehicle is equipped with a USB connection port and an AUX input jack. When connected, the in-vehicle audio system can play audio contents from

the compatible device.

The USB connection port and the AUX input jack are located on the lower part of the instrument panel, on the center console or in the center console box.

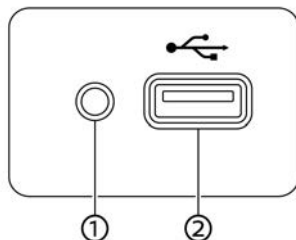

Media hub Type A (example)

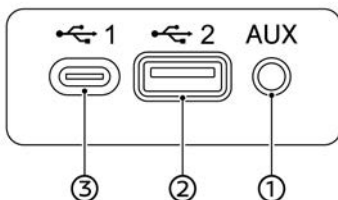

Media hub Type B (example)

### ① AUX (Auxiliary) input jack:

Connect an audio player that accepts a 3.5 mm (1/8 in) TRS connector (such as an MP3 player etc.) to play music.

### ② USB connection port:

Connect a compatible device to play media such as an iPod or a USB memory device.

Connect an iPhone or an Android phone to use Apple CarPlay (if equipped), Android Auto (if equipped) or Yandex.Auto (if equipped).

### ③ USB connection port (for USB Type-C only):

Connect a compatible device to play media such as an iPod or a USB memory device.

Connect an iPhone or an Android phone to use Apple CarPlay (if equipped), Android Auto (if equipped) or Yandex.Auto (if equipped).



### INFO:

- Refer to your AUX and USB device manufacturer's owner information regarding the proper use and care of the device.
- Cables made by Apple Inc. should be used to connect electronic devices marketed by Apple Inc.

## STARTING SYSTEM

The system starts when the ignition switch or power switch is placed in the ACC or ON position.

### START-UP SCREEN (if equipped)

The start-up screen is displayed when the ignition switch or power switch is placed in the ACC or ON position.

After an animated start-up screen is displayed, a message screen will be displayed. Touch [OK] after reading and agreeing to the message displayed on the screen. If you do not agree to the message, some of the functions on the system will be disabled.

### ⚠ NOTE:

**Do not keep the system running with the engine, hybrid system or e-POWER system stopped. Doing so may discharge the vehicle battery (12V battery). When you use the system, always keep the engine, hybrid system or e-POWER system running.**

## BASIC OPERATION

The system can be operated with the touch panel as well as the switches on the control panel, the steering wheel and the Display Commander (if equipped).

This manual mainly describes the touch panel operation.

### SELECTING MENU FROM LAUNCH BAR

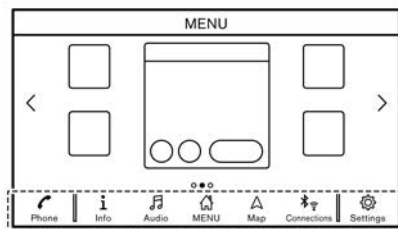

### Example

Various system functions can be accessed by touching the items on the Launch Bar ① which is displayed on most of the main menu screens. (The Launch Bar does not appear on some screens such as scrolled map screen, keyboard screen, etc.)

Touch the item on the Launch Bar to display the corresponding screens.

The items on the Launch Bar differ according to which button on the control panel is pushed.

Models with the Display Commander:

Sliding the slide switch of the Display Commander backwards will enable the center dial operation of the Launch Bar. Slide the switch forward to return to operate Shortcuts with the center dial.

The following menus are available on the Launch Bar. (Displayed items may vary depending on models, specifications and software versions.)

### When pushing <MENU>/<MODE/OK> (if equipped)/<SETTING> (if equipped):

Shortcuts for various functions are displayed.

- [Phone]\*  
☞ "Phone" (page 4-4)
- [Info]  
☞ "Information menu" (page 5-2)
- [Audio]  
☞ "Audio operations" (page 3-13)
- [MENU]  
Touching [MENU] on the Launch Bar will display the center page of the HOME MENU screen.
- [Map]  
☞ "Displaying navigation screen" (page 6-2)
- [Connections]  
☞ "Connections settings" (page 2-13)
- [Settings]  
☞ "System settings" (page 2-11)

\*: [Phone] will be replaced by [CarPlay]

when Apple CarPlay (if equipped) is active, and it will be replaced by [🏠] when Android Auto (if equipped) is active.

[Phone] will be replaced by [Yandex] when Yandex.Auto (if equipped) is active.

### When pushing <AUDIO>:

Shortcuts mainly for the audio functions are displayed.

🔑 "Selecting audio source" (page 3-13)

### When pushing <MAP> (if equipped):

Shortcuts mainly for the navigation functions are displayed.

🔑 "Launch Bar" (page 6-2)

## HOW TO VIEW AND OPERATE HOME MENU SCREEN

Push <MENU>/<MODE/OK> (if equipped) to display the HOME MENU screen.

The HOME MENU consists of 3 pages which can display preferred shortcuts and widgets.

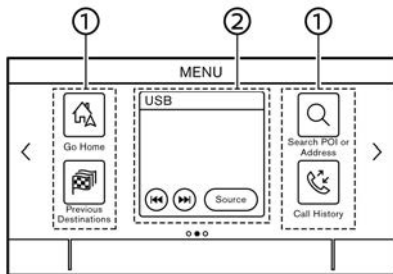

Example

### ① Shortcut icons:

Icons for frequently used menu items can be placed on the HOME MENU screens as shortcuts.

### ② Widget:

Useful information from primary menu functions can be displayed as widgets. Depending on the contents of the widget, keys may be available for operation of the function.

## Customizing HOME MENU screen

The HOME MENU screen can be personalized by selecting which shortcuts and widgets are to be displayed and where to place them on the screen.

### Selecting shortcut or widget:

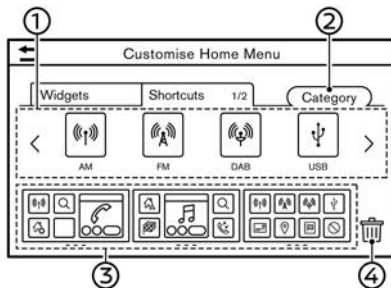

### Example

1. Touch [Customise Home Menu]/[Customize Home Menu] on the setting menu screen.

🔑 "System settings" (page 2-11)

2. Touch [Shortcuts] or [Widgets].

3. Drag the shortcut or widget icon ① to each page layout ③.

If a different shortcut or a widget is already located on the page layout ③, a message will be displayed. Touch [Yes] to replace the shortcut/widget. The page layout ③ can be changed by dragging the icons.

The categories of shortcuts can be changed by touching [Category] ②.

Dragging an icon into the [🗑️] ④ can delete the current shortcut or widget to create a blank spot.

### 📄 INFO:

Touch [🗑️] ④, and then a message will appear. While the message is displayed, touching any icon on the page layout ③ and [Delete] can delete the selected icon. To delete all icons, touch [Select All] and then [Delete].

## FUNCTIONS DISABLED WHILE DRIVING (if equipped)

To ensure safe driving, some functions cannot be operated while driving.

The on-screen functions that are not available while driving will be "grayed-out" or muted. In some cases, certain text will not be displayed on the screen.

To use these functions, first park the vehicle in a safe location and then operate the system.

## SYSTEM SETTINGS







The system settings can be changed for personal convenience.







### SETTINGS MENU

Touch [Settings] on the Launch Bar or push **<SETTING>** (if equipped) on the control panel, and then touch a setting item you wish to adjust.

Available setting items may vary depending on models, specifications and software versions.

#### Available setting items

Setting item	Result
[Connections]	Displays the Bluetooth®, Wi-Fi (if equipped), USB and apps (if equipped) setting screen.  "Connections settings" (page 2-13)
[Phone]	Displays the Phone and text message settings screen.  "Phone and text message settings" (page 4-10)
[Navigation]	Displays the navigation settings screen.  "Navigation settings" (page 6-37)
[Sound]	Displays the audio settings screen.
[Volume & Beeps]	Displays the volume adjustment screen.
[Clock]	Displays the clock adjustment screen.
[Customise Home Menu]/[Customize Home Menu]	Displays the HOME MENU editing screen.
[Customise Audio Sources]/[Customize Audio Sources]	Displays the editing screen for audio source menus on the Launch Bar.  "Selecting from Launch Bar" (page 3-14)
[NissanConnect Services]	Displays the NissanConnect Services settings screen.  "NissanConnect Services (if equipped for Europe and Russia)" (page 5-8)  "NissanConnect Services powered by SiriusXM™ (if equipped for Mexico)" (page 5-9)
[System Voice]	Displays the system voice settings screen.  "System Voice settings" (page 7-5)
[Camera]	Displays the camera settings screen. See the vehicle Owner's Manual for details of the monitor system.

[More Settings]/[Others]	[Display]	Displays the display settings screen.
	[Language]	Displays the language settings screen.
	[Units]	Displays the units settings screen.
	[Keyboard Type]	Keyboard type can be selected.
	[Return All Settings to Default]	This resets all settings to default.
[System Update]	[Software Version]/[Version Information]	Displays the version information screen.
	[Software Update]	The system software can be updated.  "Updating system software" (page 5-6)
	[Map Update]	The map data can be updated.  "How to update map data" (page 6-44)
[Apps]	[Apple CarPlay]	Displays the Apple CarPlay settings screen.  "Apple CarPlay settings" (page 5-18)
	[Android Auto]	Displays the Android Auto settings screen.  "Android Auto settings" (page 5-23)
	Device list	Displays recently connected Apple CarPlay, Android Auto or Yandex.Auto devices.  "Apple CarPlay settings" (page 5-18)  "Android Auto settings" (page 5-23)  "Yandex.Auto settings" (page 5-27)



### INFO:

The system software (if equipped) and map (if equipped) update menus can also be accessed from [System Information] on the information screen, even if the menus are not available from the settings screen.

 "Information menu" (page 5-2)

## CONNECTIONS SETTINGS

Changing the settings and viewing information of Bluetooth®, Wi-Fi (if equipped), USB and apps (if equipped) are available on the Connections settings screen.

### Setting Bluetooth®

Your vehicle is equipped with the Bluetooth® Hands-Free Phone System and Bluetooth® audio device support. If you are an owner of a compatible Bluetooth® enabled cellular phone or Bluetooth® audio device, you can set up the wireless connection between your cellular phone and the in-vehicle phone module or Bluetooth® audio device and in-vehicle audio module. With Bluetooth® wireless technology, you can make or receive a telephone call with your cellular phone in your pocket and listen to Bluetooth® audio.

🔗 "CD, DVD, USB memory device, iPod and Bluetooth® audio player" (page 3-19)

🔗 "Bluetooth® Hands-Free Phone System" (page 4-2)

### Connecting cellular phone/audio device:

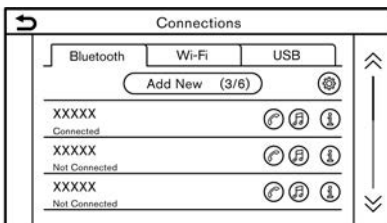

Example

To use the Bluetooth® device with the in-vehicle system for the first time, the device connection operation is required.

1. Touch [Connections] on the setting menu screen.  
🔗 "System settings" (page 2-11)
2. Touch [Bluetooth] and touch [Add New]. A message is displayed.
3. Touch [Yes] to connect a cellular phone. Touch [No] to connect an audio device and operate as guided by the system. (Operations may differ depending on the device.)

### ! NOTE:

**Some cellular phones or other devices may cause interference or a buzzing noise to come from the audio system speakers. Storing the device in a different location may reduce or eliminate the noise.**



### i INFO:

- The paired phone will be added to the list on the Bluetooth® connection screen.
- Touching name of the other device on the list will switch the connected device.
- Touching [📶] will allow the device to be connected via Bluetooth® and be used on the Hands-Free Phone System.
- Depending on the models, specifications and software versions, you can register a favorite hands-free phone. The [📶] by the phone device name selected as a favorite will be marked with "★".  
🔗 "Bluetooth® settings" (page 2-14)
- Touching [📶] will allow the device to be connected via Bluetooth® and be used for Bluetooth® Audio.
- Depending on the models, specifications and software versions, you can register a favorite Bluetooth® audio device. The [📶] by the device name selected as a favorite will be marked with "★".  
🔗 "Bluetooth® settings" (page 2-14)
- Depending on the models, specifications and software versions, touching [📶] (if equipped) will enable Bluetooth® tethering.

- Touching  will display the information of the Bluetooth® device.
- Up to 6 Bluetooth® devices can be registered. If 6 devices are already registered, one of the devices must first be deleted before another device can be registered.
- The pairing procedure of the cellular phone varies according to each cellular phone. See the cellular phone Owner's Manual for the details.
- Consult a NISSAN dealer for information regarding Bluetooth® device connection to your vehicle.

### Bluetooth® settings:

The Bluetooth® settings can be changed according to your preference.

1. Touch [Connections] on the setting menu screen.  
 "System settings" (page 2-11)
2. Touch [Bluetooth].
3. Touch .

Available setting items may vary depending on models, specifications and software versions.

### Available setting items

Setting item	Action
[Bluetooth]	Turns the Bluetooth® connection on/off.
[Allow 2 Phones Simultaneously]	When turned on, up to 2 Bluetooth® devices can be connected as hands-free phones to the in-vehicle system simultaneously.
[Favourite Phone]/[Favorite Phone]	A Bluetooth® device can be registered as a favorite hands-free phone. If the hands-free phone device is within the range with Bluetooth® turned on, the device registered as favorite will automatically be connected to the in-vehicle system with priority upon the system activation.
[Favourite Audio]/[Favorite Audio]	A Bluetooth® device can be registered as a favorite audio device. If the Bluetooth® audio device is within the range with Bluetooth® turned on, the device registered as favorite will automatically be connected to the in-vehicle system with priority upon the system activation.



[Device Name]	The device name can be changed.
[PIN]	The PIN code can be changed.

### INFO:

With [Device Name], the device name that appears on the screen can be changed and be renamed from the name set as default to the preferred name (such as "Steve's Car" for example).

### Deleting cellular phone/audio device:



Paired devices can be deleted from the list.

1. Touch [Connections] on the setting menu screen.  
 "System settings" (page 2-11)
2. Touch [Bluetooth].
3. Touch  by the cellular phone name you wish to delete.
4. Touch [Delete]. Touch [Yes] when a message appears.



## Wi-Fi setting (if equipped)

A Wi-Fi connection can be made by using an available Wi-Fi network near the vehicle or tethering function of smartphone, etc. Wi-Fi connectivity is useful for updating map data (if equipped) and system software (if equipped), or Premium Traffic (if equipped).

-  "Updating system software" (page 5-6)
-  "How to update map data" (page 6-44)
-  "Premium Traffic information" (page 6-27)

### Connecting to a Wi-Fi network:

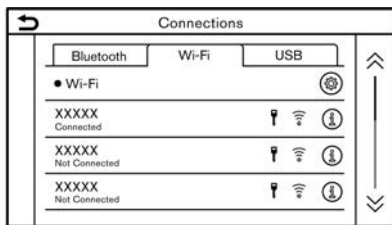



**Example**

To use the Wi-Fi connection for the first time, the following connecting procedures are required.

1. Touch [Connections] on the setting menu screen.
  -  "System settings" (page 2-11)
2. Touch [Wi-Fi].

3. Touch the name of the device you wish to connect.

	Indicates that a password is set.
	Indicates the strength of the signal the Wi-Fi device is receiving.

4. Enter the network password and touch [OK]. The device will be connected.

If a listed device is in a status capable of making Wi-Fi connection, touching the device name on the list will start the connection.

### INFO:



- Enter the password correctly, including capitalization.
- Touching [] will display the network information. Turning [Auto Connect] on will automatically connect the vehicle to the network if the network is available.
- Touch [Vehicle Hotspot]/[Car Hotspot] (if equipped) and turn on the indicator to activate the Wi-Fi hotspot communication. It enables devices such as smartphones to connect to a Wi-Fi network.
- Enabling the Wi-Fi hotspot functionality of your smartphone may incur additional charges from your cellular provider. Consult your cellular provider

contract regarding the communication fee.

- System can connect to only WPA2 security network (not connect WEP, WPA1 network).
- Wi-Fi networks that require a web browser cannot be accessed through this unit.

### Wi-Fi settings:

The Wi-Fi settings can be changed according to your preference.

1. Touch [Connections] on the setting menu screen.
  -  "System settings" (page 2-11)
2. Touch [Wi-Fi].
3. Touch [].
4. Touch a preferred item.

Available setting items may vary depending on models, specifications and software versions.

### Available setting items

Setting item	Action
[Wi-Fi]	Turns the Wi-Fi connection on/off.
[Vehicle Hotspot]/[Car Hotspot]	Turns the vehicle hotspot on/off.
[Network Name (SSID)]	Displays the Wi-Fi network name.

[Password]	Displays the Wi-Fi network password.
[Security]	The used cipher system is displayed.

### Deleting Wi-Fi network:

The stored Wi-Fi network can be deleted from the list.

1. Touch [Connections] on the setting menu screen.  
 "System settings" (page 2-11)
2. Touch [Wi-Fi].
3. Touch by the name of the network you wish to delete.
4. Touch [Delete]. Touch [Yes] when a message appears.

### Displaying USB device information

The information of the connected USB device can be viewed.

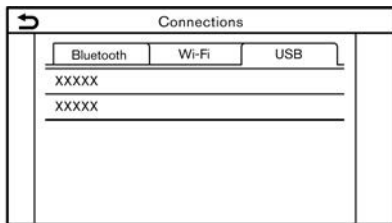

#### Example

1. Touch [Connections] on the setting menu screen.

## 2-16 Getting started

2. Touch [USB].
3. Touch the name of the device you wish to check. The name and the type of the device are displayed.

### Apps settings (if equipped)

A list of devices that have been connected recently for Apple CarPlay (if equipped), Android Auto (if equipped) or Yandex.Auto (if equipped) is displayed, and settings for each device can be changed.

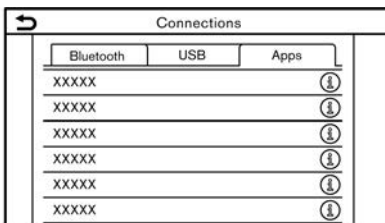

#### Example

The apps settings can be changed according to your preference.

1. Touch [Connections] on the setting menu screen.  
 "System settings" (page 2-11)
2. Touch [Apps].
3. Touch by the name of the device you wish to change the setting.
4. Touch a preferred item.

### INFO:

Displayed items may vary depending on the apps.

- "Apple CarPlay settings" (page 5-18)
- "Android Auto settings" (page 5-23)
- "Yandex.Auto settings" (page 5-27)

# 3 Audio system

Audio operation precautions .....	3-2	CD (if equipped), DVD (if equipped), USB memory device, iPod and Bluetooth® audio player .....	3-19
Radio .....	3-2	Auxiliary (AUX) devices .....	3-28
Compact Disc (CD) player (if equipped) .....	3-3	Smartphone audio (if equipped) .....	3-28
Digital Versatile Disc (DVD) player (if equipped) .....	3-4	Audio settings .....	3-29
USB (Universal Serial Bus) connection port .....	3-6	Audio adjustments with audio adjust bar (if equipped) .....	3-30
Compressed Audio Files (MP3/WMA/AAC) .....	3-7	CD/DVD/USB memory device care and cleaning .....	3-30
Bluetooth® audio .....	3-13	CD/DVD (if equipped) .....	3-30
Audio operations .....	3-13	USB memory device .....	3-31
Audio main operation .....	3-13		
Radio .....	3-14		

## AUDIO OPERATION PRECAUTIONS



### CAUTION:

- Operate the audio system only when the vehicle engine, hybrid system or e-POWER system is running. Operating the audio system for extended periods of time with the engine, hybrid system or e-POWER system turned off can discharge the vehicle battery (12V battery).
- Do not allow the system to get wet. Excessive moisture such as spilled liquids may cause the system to malfunction.
- Park the vehicle in a safe location and apply the parking brake to view movies (if equipped) on the touch screen display.

## RADIO

Place the ignition switch or power switch in the ACC or ON position before turning on the radio. If you listen to the radio with the engine, hybrid system or e-POWER system not running, the ignition switch or power switch should be placed in the ACC position.

Radio reception is affected by station signal strength, distance from radio transmitter, buildings, bridges, mountains and other external influences. Intermittent changes in reception quality normally are caused by these external influences.

### 3-2 Audio system

**Using a cellular phone in or near the vehicle may influence radio reception quality.**

### Radio reception

Your radio system is equipped with state-of-the-art electronic circuits to enhance radio reception. These circuits are designed to extend reception range, and to enhance the quality of that reception.

However there are some general characteristics of both FM and AM radio signals that can affect radio reception quality in a moving vehicle, even when the finest equipment is used. These characteristics are completely normal in a given reception area, and do not indicate any malfunction in your radio system.

Reception conditions will constantly change because of vehicle movement. Buildings, terrain, signal distance and interference from other vehicles can work against ideal reception. Described below are some of the factors that can affect your radio reception.

Some cellular phones or other devices may cause interference or a buzzing noise to come from the audio system speakers. Storing the device in a different location may reduce or eliminate the noise.

### FM radio reception

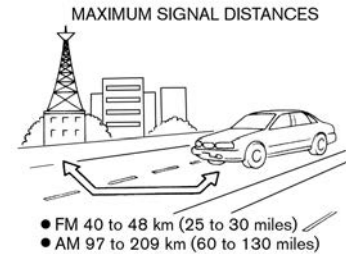

**Range:** FM range is normally limited to 40 to 48 km (25 to 30 miles), with monaural (single station) FM having slightly more range than stereo FM. External influences may sometimes interfere with FM station reception even if the FM station is within 40 km (25 miles). The strength of the FM signal is directly related to the distance between the transmitter and receiver. FM signals follow a line-of-sight path, exhibiting many of the same characteristics as light. For example they will reflect off objects.

**Fade and drift:** As your vehicle moves away from a station transmitter, the signals will tend to fade and/or drift.

**Static and flutter:** During signal interference from buildings, large hills or due to antenna position, usually in conjunction with an increased distance from the station transmitter, static or flutter can be heard. This can be reduced by low-

ering the treble setting to reduce the treble response.

**Multipath reception:** Because of the reflective characteristics of FM signals, direct and reflected signals reach the receiver at the same time. The signals may cancel each other, resulting in momentary flutter or loss of sound.

### AM radio reception

AM signals, because of their low frequency, can bend around objects and skip along the ground. In addition, the signals can bounce off the ionosphere and be bent back to earth. Because of these characteristics, AM signals are also subject to interference as they travel from transmitter to receiver.

**Fading:** Occurs while the vehicle is passing through motorway underpasses or in areas with many tall buildings. It can also occur for several seconds during ionospheric turbulence even in areas where no obstacles exist.

**Static:** Caused by thunderstorms, electrical power lines, electric signs and even traffic lights.

### Digital Audio Broadcast (DAB) (if equipped)

The supported standards for this system are DAB and DAB+.

### HD Radio Technology reception (if equipped)

HD Radio Technology reception needs to be activated to receive HD Radio broadcasts.

☞ "Radio" (page 3-14)

This enables you to receive radio broadcasts digitally (where available), providing a better quality sound with clear reception. When this feature is not activated or HD Radio broadcasts are not available, you will receive analog radio (AM/FM) broadcasts.

### COMPACT DISC (CD) PLAYER (if equipped)

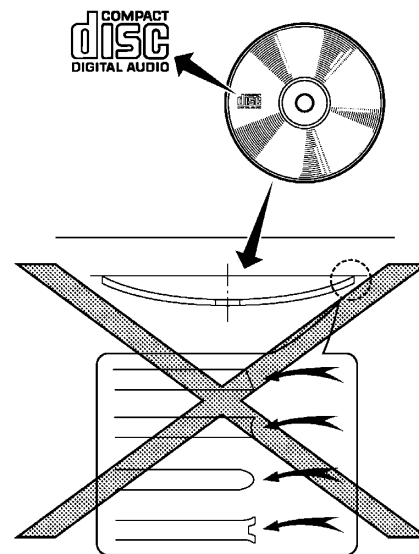

- Do not force a CD into the CD slot. This could damage the CD and/or CD player.
- Trying to load a CD with the CD door closed could damage the CD and/or CD player.
- During cold weather or rainy days, the player may malfunction due to the

humidity. If this occurs, remove the CD and dehumidify or ventilate the player completely.

- The player may skip while driving on rough roads.
- The CD player sometimes cannot function when the passenger compartment temperature is extremely high. Decrease the temperature before use.
- Only use high quality 12 cm (4.7 in) round discs that have the "COMPACT disc DIGITAL AUDIO" logo on the disc or packaging.
- Do not expose the CD to direct sunlight.
- CDs that are of poor quality, dirty, scratched, covered with fingerprints or that have pin holes may not work properly.
- The following CDs may not work properly:
  - Copy control compact discs (CCCD)
  - Recordable compact discs (CD-R)
  - Rewritable compact discs (CD-RW)
- Do not use the following CDs as they may cause the CD player to malfunction.
  - 8 cm (3.1 in) discs

- CDs that are not round
- CDs with a paper label
- CDs that are warped, scratched, or have abnormal edges

- This audio system can only play pre-recorded CDs. It has no capabilities to record or burn CDs.

- If the CD cannot be played, one of the following messages will be displayed.

**Disc read error:**

Indicates a CLV, Focus, TOC or Access error. Check and reinsert the CD. Make sure that it is inserted correctly.

**Please eject disc:**

Indicates a mechanism error. If the CD can be ejected, eject and reinsert the CD. If the CD cannot be ejected, it is recommended you visit a NISSAN dealer for service.

**Unplayable file:**

Indicates that a readable file is not found on the inserted CD. Check the data in your CD.

## DIGITAL VERSATILE DISC (DVD) PLAYER (if equipped)

### Copyright and trademark

- Technology protected by the U.S. patent and other intellectual property rights owned by Macrovision Corporation and other right holders is utilized for this system.
- This copyright protected technology cannot be used without permission from Macrovision Corporation. This is limited to personal use, etc., as long as the permission from Macrovision Corporation is not issued.
- Modifying or disassembling is prohibited.
- Manufactured under license from Dolby Laboratories. Dolby, Dolby Audio and the double-D symbol are trademarks of Dolby Laboratories.
- DTS, the Symbol, DTS and the Symbol together, DTS 2.0 Channel, and the DTS 2.0 Channel logos are registered trademarks or trademarks of DTS, Inc. in the United States and/or other countries.

### Parental level (parental control)

DVDs with the parental control setting can be played with this system. Please use your own judgment to set the parental control with the system.

## Disc selection

You can play the following disc formats with the DVD drive:

- DVD-VIDEO
- DVD-VR
- VIDEO-CD
- DTS-CD

A DVD may not play properly depending on the disc or format.

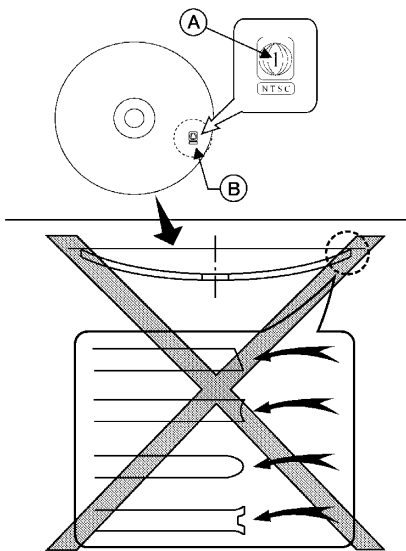

Use DVDs with the region code "ALL" or

the code applicable to your DVD player. (The region code Ⓐ is displayed as a small symbol printed on the DVD Ⓢ.) This vehicle-installed DVD player can only play DVDs with the applicable region code.

**Do not use the following DVDs as they may cause the DVD player to malfunction:**

- 8 cm (3.1 in) discs
- DVDs with incompatible region code
- DVDs that are not round
- DVDs with a paper label
- DVDs that are warped, scratched, or have unequal edges

The following DVDs may not work properly:

- Recordable digital video discs (DVD-R)
- Rewritable digital video discs (DVD-RW)

## Specification chart for DVD

### Playable Media:

The following media can be played on the system.

- DVD+RW
- DVD+R
- DVD+R DL
- DVD-RW (corresponds to CPRM)

- DVD-R (corresponds to CPRM)
- DVD-R DL (corresponds to CPRM)
- DVD-ROM
- Dual DISC (not guaranteed)

### Video codec:

The following video codecs are supported by the system.

Video file format	
DVD Video	
DVD-VR with CPRM	
VIDEO CD*	Ver. 1.0
	Ver. 1.1
	Ver. 2.0
DTS CD	

\*Some VIDEO CD functions may not be supported with this system.

## Audio codec:

The following combinations of audio codecs support video formats.

Sound format	DVD-Video	DVD-VR	VIDEO-CD	DTS-CD
LPCM	Supported	Supported	Not supported	Not supported
Dolby Digital	Supported	Supported	Not supported	Not supported
Dolby Digital EX	Not supported	Not supported	Not supported	Not supported
DTS	Supported	Not supported	Not supported	Supported
DTS-ES	Not supported	Not supported	Not supported	Not supported
DTS 96/24	Not supported	Not supported	Not supported	Not supported
MPEG1 Layer3	Supported	Supported	Supported	Not supported
MPEG2 Layer3	Supported with output limitations *1	Supported with output limitations *1	Not supported *2	Not supported

\*1 A back surround channel of DVD-Video and DVD-VR/MPEG2 is assigned to the LS and RS channels and output.

\*2 MPEG2 Layer3 of VIDEO CD indicates SVCD. SVCD may play but its performance is not guaranteed. The 2ch output is utilized for the audio output of SVCD.

## USB (Universal Serial Bus) CONNECTION PORT



### WARNING:

**Do not connect, disconnect or operate the USB device while driving. Doing so can be a distraction. If distracted you could lose control of your vehicle and cause an accident or serious injury.**



### CAUTION:

- **Do not force the USB device into the USB connection port. Inserting the USB device tilted or up-side-down into the port may damage the port. Make sure that the USB device is connected correctly into the USB connection port.**
- **Do not grab the USB connection port cover (if equipped) when pulling the USB device out of the port. This could damage the port and the cover.**
- **Do not leave the USB cable in a place where it can be pulled unintentionally. Pulling the cable may damage the port.**

The vehicle is not equipped with a USB device. USB devices should be purchased separately as necessary.

This system cannot be used to format USB devices. To format a USB device, use



a personal computer.

This system supports various USB memory devices, USB hard drives and iPod players. Some USB devices may not be supported by this system.

- Partitioned USB devices may not be played correctly.
- Some characters used in other languages (Chinese, Japanese, etc.) are not displayed properly on the display. Using English language characters with a USB device is recommended.

#### **General notes for USB use:**

Refer to your device manufacturer's owner information regarding the proper care of the device.

#### **Notes for iPod use:**

iPod is a trademark of Apple Inc., registered in the U.S. and other countries.

- Improperly plugging in the iPod may cause a checkmark to be displayed on and off (flickering). Always make sure that the iPod is connected properly.
- Audiobooks may not play in the same order as they appear on an iPod.

#### **Compatibility:**

Made for

- iPhone 8 Plus
- iPhone 8
- iPhone 7 Plus

- iPhone 7
- iPhone SE
- iPhone 6s Plus
- iPhone 6s
- iPhone 6 Plus
- iPhone 6
- iPhone 5s
- iPhone 5c
- iPhone 5
- iPod touch (5th generation)
- iPod nano (7th generation)



#### **INFO:**

- Make sure that the iPod firmware is updated.
- The Lightning connector works with iPhone (5 through 8 Plus), iPod touch (5th generation), and iPod nano (7th generation).  
USB works with iPhone (5 through 8 Plus), iPod touch (5th generation) and iPod nano (7th generation).
- Refer to your device manufacturer's owner information regarding the proper use and care of the device.

## **COMPRESSED AUDIO FILES (MP3/WMA/AAC)**

### **Explanation of terms**

- **MP3** — MP3 is short for Moving Pictures Experts Group Audio Layer 3. MP3 is the most well-known compressed digital audio file format. This format allows for near "CD quality" sound, but at a fraction of the size of normal audio files. MP3 conversion of an audio track can reduce the file size by approximately a 10:1 ratio (Sampling: 44.1 kHz, Bit rate: 128 kbps) with virtually no perceptible loss in quality. The compression reduces certain parts of sound that seem inaudible to most people.
- **WMA** — Windows Media Audio (WMA) is a compressed audio format created by Microsoft as an alternative to MP3. The WMA codec offers greater file compression than the MP3 codec, enabling storage of more digital audio tracks in the same amount of space when compared to MP3s at the same level of quality.
- **Bit rate** — Bit rate denotes the number of bits per second used by a digital music file. The size and quality of a compressed digital audio file is determined by the bit rate used when encoding the file.

- Sampling frequency – Sampling frequency is the rate at which the samples of a signal are converted from analog to digital (A/D conversion) per second.
- Multisession – Multisession is one of the methods for writing data to media. Writing data once to the media is called a single session, and writing more than once is called a multisession.
- ID3/WMA tag – The ID3/WMA tag is the part of the encoded MP3 or WMA file that contains information about the digital music file such as song title, artist, album title, encoding bit rate, track time duration, etc. ID3 tag information is displayed on the Album/Artist/Track title line on the display.
- AAC – Advanced Audio Coding (AAC) is a compressed audio format. AAC offers greater file compression than MP3 and enables music file creation and storage at the same quality as MP3.

## Playback order

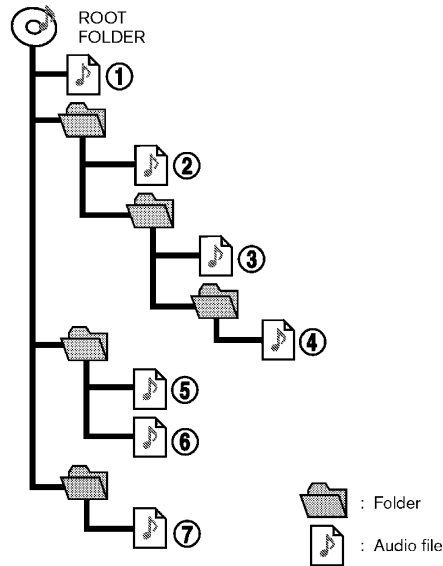

- Names of folders not containing compressed audio files are not shown on the display.
- The playback order is the order in which the files were written by the writing software, so the files might not play in the desired order.
- Music playback order of compressed audio files is as illustrated.

## Specification chart for CD (if equipped)

Supported media		CD, CD-R*5, CD-RW*5	
Supported file systems		CD, CD-R*5, CD-RW*5	
Supported versions*1	MP3	Version	MPEG1 Audio Layer3, MPEG2 Audio Layer3
		Sampling frequency	MPEG1 Audio Layer3: 32kHz, 44.1kHz, 48kHz MPEG2 Audio Layer3: 16kHz, 22.05kHz, 24kHz
		Bit rate	MPEG1 Audio Layer3: 32 kbps - 320 kbps MPEG2 Audio Layer3: 8 kbps - 160 kbps
	WMA*2	Version	WMA7, WMA8, WMA9, WMA9.1, WMA9.2
		Bit rate/Sampling frequency	Bit rate: Ver7, Ver8: 32-192kbps Ver9, Ver9.1, Ver9.2: 32-192kbps, VBR Sampling frequency: Ver7, Ver8: 8k/11.025k/16k/22k/32k/44.1k Ver9, Ver9.1, Ver9.2: 8k/11.025k/16k/22k/32k/44.1k/48 kHz
	AAC*3	Bit rate/Sampling frequency	Bit rate: 8-256 kbps, VBR Sampling frequency: 11.025-48kHz
Tag information (Song title, Artist name and Album name)		ID3 tag VER1.0, VER1.1, VER2.2, VER2.3, VER2.4 (MP3 only) WMA tag (WMA only) AAC tag (AAC only)	
Folder levels		CD, CD-R*5, CD-RW*5: Folder levels: 8, Folders: 255 (including root folder), Files: 510 (Max. 255 files for one folder)	
Displayable character codes*4		01: SHIFT-JIS, ASCII, ISO-8859-1, UTF-8, UTF-16 BOM, UTF-16 Big Endian, UTF-16 Little Endian, 02: UNICODE, 03: UTF-16	

\*1 Files created with a combination of 48 kHz sampling frequency and 64 kbps bit rate cannot be played.

\*2 Protected WMA files (DRM) cannot be played.

\*3 Made by iTunes.

\*4 Available codes depend on what kind of media, versions and information are going to be displayed.

\*5 May not be operated with the Voice Recognition System.

 "7. Voice recognition"

## Specification chart for USB

### Music files (models without <SETTING> on the control panel):

Supported media	USB2.0
Supported file systems	FAT16, FAT32
Folder levels	Folder levels: 8, Files via folder: 255, Folders: 512 (including root folder), Files: 8000
Tag information (Song title, Artist name and Album name)	ID3 tag VER1.0, VER1.1, VER2.2, VER2.3, VER2.4 (MP3 only)
	WMA tag (WMA only)
	AAC tag (AAC only)

Format			Sampling frequency	Supported bitrate
MP3 *1	MPEG1	Layer-3	32, 44.1, 48 kHz	32-320 kbps
	MPEG2		16, 22.05, 24 kHz	8-160 kbps
WMA *2			8, 11.025, 16, 22.05, 32, 44.1, 48 kHz	12-192 kbps
AAC (MPEG4) *3 (Extension "m4a" only)			11.025, 16, 22.05, 32, 44.1, 48 kHz	8-320 kbps
FLAC			8-192 kHz	128-12,288 kbps
WAV			8-192 kHz	128-12,288 kbps

\*1 MPEG2.5 is not supported.

\*2 WMA7, WMA8, WMA9, WMA9.1, WMA9.2 are supported. (WMA9 Professional, Lossless, Voice are not supported.)

\*3 Only AAC files encoded by iTunes are supported. HE-AAC (High-Efficiency) is not supported.

**Music files (models with <SETTING> on the control panel):**

Supported media	USB2.0
Supported file systems	FAT16, FAT32
Folder levels	Folder levels: 8, Files via folder: 255, Folders: 2500 (including root folder), Files: 32000
Tag information (Song title, Artist name and Album name)	ID3 tag VER1.0, VER1.1, VER2.2, VER2.3, VER2.4 (MP3 only)
	WMA tag (WMA only)
	AAC tag (AAC only)

Format			Sampling frequency	Supported bitrate
MP3 *1	MPEG1	Layer-3	32, 44.1, 48 kHz	32-320 kbps
	MPEG2		16, 22.05, 24 kHz	8-160 kbps
WMA *2			8, 11.025, 16, 22.05, 32, 44.1, 48 kHz	12-192 kbps
AAC (MPEG4) *3 (Extension "m4a" only)			11.025, 16, 22.05, 32, 44.1, 48 kHz	8-320 kbps
FLAC			8-192 kHz	128-12,288 kbps
WAV			8-192 kHz	128-12,288 kbps

\*1 MPEG2.5 is not supported.

\*2 WMA7, WMA8, WMA9, WMA9.1, WMA9.2 are supported. (WMA9 Professional, Lossless, Voice are not supported.)

\*3 Only AAC files encoded by iTunes are supported. HE-AAC (High-Efficiency) is not supported.

**Video files (if equipped):**

<b>Video Codec</b>		<b>Max width</b>	<b>Max height</b>	<b>Max bitrate</b>	<b>Max framerate</b>
MPEG-2		1920 px	1080 px	50 Mbps	30 fps
MPEG-4		1920 px	1080 px	40 Mbps	30 fps
H.264	High Profile	1920 px	1080 px	62.5 Mbps	30 fps
	Other	1920 px	1080 px	50 Mbps	30 fps
WMV9, VC-1	Simple Profile	352 px	288 px	384 kbps	15 fps
	Main Profile	1920 px	1080 px	20 Mbps	30 fps
	Advanced Pro- file	1920 px	1080 px	45 Mbps	30 fps

## BLUETOOTH® AUDIO

- Some Bluetooth® audio devices may not be recognized by the in-vehicle audio system.
- It is necessary to set up the wireless connection between a compatible Bluetooth® audio device and the in-vehicle Bluetooth® module before using the Bluetooth® audio.
- The Bluetooth® audio may stop playing when
  - receiving a hands-free call.
  - checking the connection to the hands-free phone.
  - connecting the hands-free phone or the audio device.
  - downloading the phonebook memory from the connected cellular phone.
- Do not place a Bluetooth® audio device in an area surrounded by metal or far away from the in-vehicle Bluetooth® module to prevent tone quality degradation and wireless connection disruption.
- While an audio device is connected through a Bluetooth® wireless connection, the battery of the device may discharge quicker than usual.
- This system supports the Bluetooth® Advanced Audio Distribution Profile





(A2DP) and Audio/Video Remote Control Profile (AVRCP).

- Wireless LAN (Wi-Fi) and the Bluetooth® functions share the same frequency band (2.4 GHz). Using the Bluetooth® and the wireless LAN functions at the same time may slow down or disconnect the communication and cause undesired noise. It is recommended that you turn off the wireless LAN (Wi-Fi) when using the Bluetooth® functions.

## AUDIO OPERATIONS



### AUDIO MAIN OPERATION

#### Turning audio system on/off

The ignition switch or power switch must be in the ACC or ON position to turn on the audio system. Push **<VOL/  >/<VOLUME/  >** or **<AUDIO>** to turn on the last audio source that was playing immediately before the system was turned off. To turn off the audio system, push **<VOL/  >/<VOLUME/  >** again.



#### INFO:

The audio system can also be turned on by turning **<VOL/  >/<VOLUME/  >** when the system is turned off.

#### Selecting audio source

#### Selecting from source menu screen:

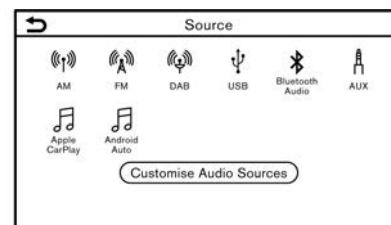

#### Example

1. Push **<AUDIO>** when the audio screen is displayed.

2. Select an audio source you prefer to play.

### INFO:

- Touching [Source] on the upper left corner of the audio screen will also display the audio source menu screen.
- When [Rear Display] (if equipped) is selected, audio source will switch to the Rear Entertainment System (RES) (if equipped). However, the image from the HDMI-connected device cannot be displayed on the touch screen display. For details, see the vehicle Owner's Manual.
- Depending on the models, specifications and software versions, the audio source can also be changed by operating the vehicle information display. Refer to the vehicle Owner's Manual for the detail of the vehicle information display.

### Selecting from Launch Bar:

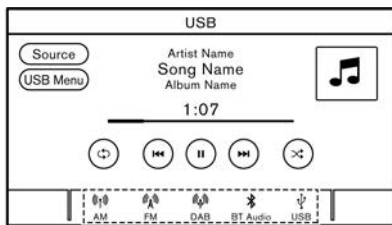

Example

The source icons are displayed on the Launch Bar. Touch the icon to select the preferred audio source.

### Customizing Launch Bar:

The source icons displayed on the Launch Bar can be customized.

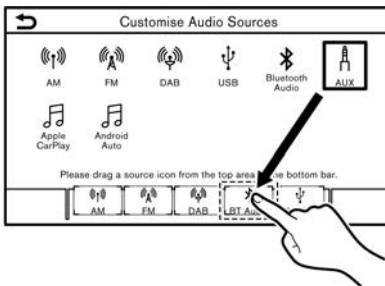

### Example

1. Push **<AUDIO>** or touch [Source], while the Audio screen is displayed.
2. Touch [Customise Audio Sources]/[Customize Audio Sources].
3. Drag the preferred source icon to the Launch Bar.
4. Push **<BACK>/< ⏪ >** on the control panel, **<BACK>** on the Display Commander (if equipped) or touch [**⏪**] to confirm the setting.

### Selecting using steering wheel switch (if equipped):

For models with **<SOURCE>** on the steering wheel, the audio source can be changed by pushing the switch.

### Selecting using steering column switch (if equipped):

For models with **<SOURCE/AUDIO>** on the steering column, the audio source can be changed by pushing the switch.

## RADIO

### Radio operation

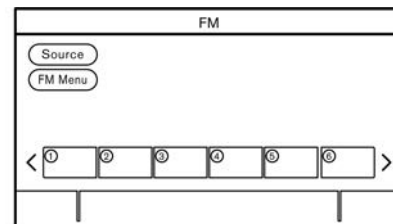

### Radio activation and band selection:

To listen to the radio, turn on the audio system and select a preferred radio band.  "Selecting audio source" (page 3-13)



**INFO:**

When the stereo broadcast signal is weak, the radio will automatically change from stereo to monaural reception.

**AM/FM/DAB (if equipped) radio operation:**

General operations of AM, FM and DAB radio are as follows.

Available functions and buttons/switches may vary depending on the models, specifications, software versions and conditions.

Function	Operation	
	Models with fast tuning	Models without fast tuning
Manual tuning (AM/FM), Selecting service component (DAB)	<ul style="list-style-type: none"> <li>Control panel               <ul style="list-style-type: none"> <li>Turn &lt;TUNE SCROLL/SOUND&gt;/&lt;TUNE SCROLL/ENTER SOUND&gt;/&lt;TUNE SCROLL/OK&gt;.</li> </ul> </li> </ul>	<ul style="list-style-type: none"> <li>Control panel               <ul style="list-style-type: none"> <li>Turn &lt;TUNE SCROLL/SOUND&gt;/&lt;TUNE SCROLL/ENTER SOUND&gt;/&lt;TUNE SCROLL/OK&gt;.</li> <li>Push &lt;◀▶&gt;/&lt;▶▶&gt;.</li> </ul> </li> </ul>
Fast tuning	<ul style="list-style-type: none"> <li>Control panel               <ul style="list-style-type: none"> <li>Push and hold &lt;◀◀▶&gt;/&lt;▶▶&gt;.</li> </ul> </li> </ul>	-
Seek tuning	<ul style="list-style-type: none"> <li>Control panel               <ul style="list-style-type: none"> <li>Push &lt;◀◀▶&gt;/&lt;▶▶&gt;.</li> </ul> </li> <li>Steering wheel switch               <ul style="list-style-type: none"> <li>Push and hold &lt;◀◀▶&gt;/&lt;▶▶&gt;.</li> <li>Tilt and hold &lt;▲ / ▼&gt;.</li> </ul> </li> </ul>	<ul style="list-style-type: none"> <li>Control panel               <ul style="list-style-type: none"> <li>Push and hold &lt;◀◀▶&gt;/&lt;▶▶&gt;.</li> </ul> </li> <li>Steering wheel switch               <ul style="list-style-type: none"> <li>Push and hold &lt;◀◀▶&gt;/&lt;▶▶&gt;.</li> <li>Tilt and hold &lt;▲ / ▼&gt;.</li> </ul> </li> </ul>
Presetting stations	<ul style="list-style-type: none"> <li>Touch screen display               <ol style="list-style-type: none"> <li>Select a radio band.</li> <li>Tune to the station you wish to store.</li> <li>Touch and hold one of the preset numbers in the preset list on the radio screen.</li> </ol> </li> </ul> <p>The information such as frequency etc. will be displayed on the preset list.</p>	

Function	Operation	
	Models with fast tuning	Models without fast tuning
Selecting preset stations	<ul style="list-style-type: none"> <li>● Steering wheel switch <ul style="list-style-type: none"> <li>– Push &lt; ⏪ &gt; / &lt; ⏩ &gt;.</li> <li>– Tilt &lt; ▲ / ▼ &gt;.</li> </ul> </li> <li>● Touch screen display <ul style="list-style-type: none"> <li>– Briefly touch a preferred station on the preset list on the radio screen.</li> </ul> </li> </ul>	

- To turn on the HD Radio mode (if equipped), touch the HD Radio mode on/off key on the radio screen.
- HD Radio reception needs to be enabled to receive HD Radio broadcasts. This enables you to receive radio broadcasts digitally (where available), providing a better quality sound with clear reception. When this feature is not enabled or HD Radio broadcasts are not available, you will receive analog radio (AM/FM) broadcasts.

## Menu items

Touch [FM Menu], [AM Menu] or [DAB Menu] (if equipped) on each radio screen to display the corresponding menu screen. Available menu items may vary depending on models, specifications and software versions.

### [FM Menu]:

[TA]	When this item is turned on, received TA (Traffic Announcement) will interrupt the audio source that is playing.
[REG]	When this item is turned on, the system will switch to regional radio programs when detected.
[SCAN]	When touched, the stations will be tuned from low to high frequencies and stop at each broadcasting station for several seconds. Touching [SCAN] again during this period of several seconds will stop scan tuning and the radio will remain tuned to that station.
[Radio Text]	Displays the radio text information.
[Refresh]	Touch to update the station list displayed on the right side of the FM menu screen.
Station List	Displays the station list on the right side of the FM menu screen.

### [AM Menu]:

[TA]	When this item is turned on, received TA (Traffic Announcement) will interrupt the audio source that is playing.
[SCAN]	When touched, the stations will be tuned from low to high frequencies and stop at each broadcasting station for several seconds. Touching [SCAN] again during this period of several seconds will stop scan tuning and the radio will remain tuned to that station.
[Radio Text]	Displays the radio text information.
[Refresh]	Touch to update the station list displayed on the right side of the AM menu screen.
Station List	Displays the station list on the right side of the AM menu screen.

**[DAB Menu] (if equipped):**

[TA]	When this item is turned on, received TA (Traffic Announcement) will interrupt the audio source that is playing.
[Radio Text]	Touch to display the radio text information.
[Refresh]	Touch to update the station list displayed on the right side of the DAB menu screen.
[DAB-FM]	When this item is turned on, the system searches for and tunes to FM stations when DAB reception is poor.
Station List	Displays the station list on the right side of the DAB menu screen.

CD (if equipped), DVD (if equipped), USB MEMORY DEVICE, iPod AND BLUETOOTH® AUDIO PLAYER



**WARNING:**

**Do not connect, disconnect or operate the USB device while driving. Doing so can be a distraction. If distracted you could lose control of your vehicle and cause an accident or serious injury.**



**CAUTION:**

- **Do not force the USB device into the USB connection port. Inserting the USB device tilted or up-side-down into the port may damage the port. Make sure that the USB device is connected correctly into the USB connection port.**
- **Do not grab the USB connection port cover (if equipped) when pulling the USB device out of the port. This could damage the port and the cover.**
- **Do not leave the USB cable in a place where it can be pulled unintentionally. Pulling the cable may damage the port.**

## Connection and activation

### CD/DVD:

#### Loading

Insert a disc into the slot with the label side facing up. The disc will be guided automatically into the slot and start playing.

#### Activation

Inserting a disc into the slot will activate the CD/DVD mode.

The disc mode can also be selected from the source list with a disc loaded.

 "Selecting audio source" (page 3-13)

### USB memory device:

Availability of video file playing capability depends on models and specifications.

#### Connection

Connect a compatible USB memory device into the port.

 "USB (Universal Serial Bus) connection port and AUX (auxiliary) input jack" (page 2-8)

Refer to your device manufacturer's owner information regarding the proper use and care of the device.

#### Activation

Connecting the USB memory device into the port will start playing the USB memory. USB memory device can also be played by selecting the source on the audio source menu screen.

 "Selecting audio source" (page 3-13)

To play music files, touch [Audio] (if equipped) on the USB Menu screen. Touch [Video] (if equipped) to play video files.

### iPod:

#### Connection

Connect a compatible iPod to the USB connection port via a USB cable.

 "USB (Universal Serial Bus) connection port and AUX (auxiliary) input jack" (page 2-8)

The battery of the iPod will be charged while the device is connected to the vehicle if the iPod supports charging via a USB connection.

Depending on the device and firmware version of the iPod, the display on the iPod shows a NISSAN or Accessory Attached screen when the connection is completed. When the iPod is connected to the vehicle, the iPod music library can only be operated by the vehicle audio controls.

#### Activation

Connecting an iPod to the vehicle via USB cable will activate the iPod mode. The iPod can also be played by selecting the source on the audio source menu screen.

 "Selecting audio source" (page 3-13)

### **Bluetooth® audio:**

Your vehicle is equipped with Bluetooth® Audio. If you have a compatible Bluetooth® device with streaming audio capability (A2DP profile), you can set up a wireless connection between your Bluetooth® device and the in-vehicle audio system. This connection allows you to listen to the audio from the Bluetooth® device using your vehicle speakers. It also may allow basic control of the device for playing and skipping audio files using the AVRCP Bluetooth® profile. Not all Bluetooth® devices have the same level of controls for AVRCP. Please consult the manual for your Bluetooth® device for more details.

### **Connection**

Connect a compatible streaming audio capable Bluetooth® device (A2DP profile) to set up a wireless connection between the Bluetooth® device and the in-vehicle system. Bluetooth® connection can be set up from the Connections screen.

 "Setting Bluetooth®" (page 2-13)



### **INFO:**

- Depending on the Bluetooth® audio device that is connected, it may not be possible to perform audio operations or a delay may occur before music is played back.
- Not all Bluetooth® devices have the same level of controls for AVRCP.

Consult the manual for your Bluetooth® device for more details.

- Wireless LAN (Wi-Fi) and the Bluetooth® functions share the same frequency band (2.4 GHz). Using the Bluetooth® and the wireless LAN functions at the same time may slow down or disconnect the communication and cause undesired noise. It is recommended that you turn off the wireless LAN (Wi-Fi) when using the Bluetooth® functions.

### **Activation**

A Bluetooth® audio device can be played by selecting the source on the audio source menu screen.

 "Selecting audio source" (page 3-13)

## CD, DVD, USB memory device, iPod and Bluetooth® audio operation

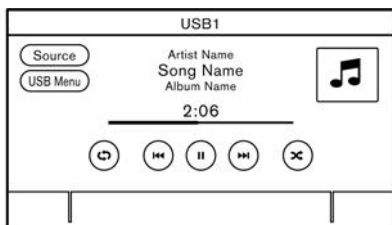

General operations of CD, DVD, USB memory device, iPod and Bluetooth® audio are as follows. Available functions and buttons/switches may vary depending on the models, specifications, software versions and conditions.

Function	Operation	Applicable source
Play	<ul style="list-style-type: none"> <li>● Touch screen display                             <ul style="list-style-type: none"> <li>– Touch [ ▶ ].</li> </ul> </li> </ul>	CD, DVD, USB, iPod, Bluetooth® audio
Pause	<ul style="list-style-type: none"> <li>● Touch screen display                             <ul style="list-style-type: none"> <li>– Touch [    ].</li> </ul> </li> </ul>	CD, DVD, USB, iPod, Bluetooth® audio
Stop playing	<ul style="list-style-type: none"> <li>● Touch screen display                             <ul style="list-style-type: none"> <li>– Touch [ ■ ].</li> </ul> </li> </ul>	DVD
Skipping tracks	<ul style="list-style-type: none"> <li>● Control panel                             <ul style="list-style-type: none"> <li>– Push &lt; ⏮ &gt; / &lt; ⏭ &gt; .</li> <li>– Turn &lt; TUNE SCROLL/SOUND &gt; / &lt; TUNE SCROLL/ENTER SOUND &gt; / &lt; TUNE SCROLL/OK &gt; *.</li> </ul> </li> <li>● Steering wheel switch                             <ul style="list-style-type: none"> <li>– Push &lt; ⏮ &gt; / &lt; ⏭ &gt; .</li> <li>– Tilt &lt; ▲ / ▼ &gt; .</li> </ul> </li> <li>● Steering column switch                             <ul style="list-style-type: none"> <li>– Scroll the tuning wheel.</li> </ul> </li> <li>● Touch screen display                             <ul style="list-style-type: none"> <li>– Touch [ ⏮ ] / [ ⏭ ] .</li> </ul> </li> </ul> <p>*: Depending on the models, turning &lt; TUNE SCROLL/SOUND &gt; / &lt; TUNE SCROLL/ENTER SOUND &gt; / &lt; TUNE SCROLL/OK &gt; may change folders when available.</p>	CD, USB, iPod, Bluetooth® audio

Function	Operation	Applicable source
Skipping chapters	<ul style="list-style-type: none"> <li>Control panel <ul style="list-style-type: none"> <li>Push &lt; ⏮ &gt; / &lt; ⏭ &gt; .</li> </ul> </li> <li>Steering wheel switch <ul style="list-style-type: none"> <li>Push &lt; ⏮ &gt; / &lt; ⏭ &gt; .</li> <li>Tilt &lt; ▲ / ▼ &gt; .</li> </ul> </li> <li>Touch screen display <ul style="list-style-type: none"> <li>Touch [ ⏮ ] / [ ⏭ ] .</li> </ul> </li> </ul>	DVD
Skipping commercial messages	<ul style="list-style-type: none"> <li>Touch screen display <ul style="list-style-type: none"> <li>Touch [ ⏮ ] / [ ⏭ ] .</li> </ul> </li> </ul>	DVD
Skipping titles/groups	<ul style="list-style-type: none"> <li>Steering wheel switch <ul style="list-style-type: none"> <li>Push and hold &lt; ⏮ &gt; / &lt; ⏭ &gt; .</li> </ul> </li> </ul>	DVD
Rewinding/fast-forwarding	<ul style="list-style-type: none"> <li>Control panel <ul style="list-style-type: none"> <li>Push and hold &lt; ⏮ &gt; / &lt; ⏭ &gt; .</li> </ul> </li> <li>Steering wheel switch <ul style="list-style-type: none"> <li>Push and hold &lt; ⏮ &gt; / &lt; ⏭ &gt; * .</li> <li>Tilt and hold &lt; ▲ / ▼ &gt; .</li> </ul> </li> <li>Touch screen display <ul style="list-style-type: none"> <li>Touch and hold [ ⏮ ] / [ ⏭ ] .</li> </ul> </li> </ul> <p>*: Not available for DVD.</p>	CD, DVD, USB, iPod, Bluetooth® audio
Changing play mode	<ul style="list-style-type: none"> <li>Touch screen display <ul style="list-style-type: none"> <li>Touch [ ⏮ ] to change the repeat mode.</li> <li>Touch [ ⏭ ] * to change the random mode.</li> </ul> </li> </ul> <p>*: Not available for DVD.</p>	CD, DVD, USB (music file), iPod, Bluetooth® audio
Changing play speed	<ul style="list-style-type: none"> <li>Touch screen display <ul style="list-style-type: none"> <li>Touch [Speed] to change the play speed.</li> </ul> </li> </ul>	USB (video file)
Ejecting disc	<ul style="list-style-type: none"> <li>Control panel <ul style="list-style-type: none"> <li>Push &lt; ▲ &gt; to eject a disc when the ignition switch or power switch is placed in the ACC or ON position.</li> </ul> </li> </ul>	CD, DVD



## Menu items

Touch [CD Menu], [DVD Menu], [USB Menu], [iPod Menu] and [BT Menu] on each audio screen to display the corresponding audio menu screen. Available setting items may vary depending on models, specifications, software versions and the connected audio device. Depending on the connected Bluetooth® device, [BT Menu] may not be displayed.

### [CD Menu]:

[TA]*	When this item is turned on, received TA (Traffic Announcement) will interrupt the audio source that is playing.
[Now Playing]	Touch to display the CD screen.
Folder and track list	The track list for the selected folder is displayed. The name of sub folder is displayed on the top of the list if the sub folder is included in the selected folder. Touch an item on the list to select the folder or track. Touch [ ⏪ ] and go back to the previous screen.

### [DVD Menu]:

[TA]*	When this item is turned on, received TA (Traffic Announcement) will interrupt the audio-visual source that is playing.
[Top Menu]	Displays the top menu specific to each disc. Refer to the instructions attached to the disc for details.
[Key]/[Control Keys]	Displays the control keys on the screen. Touch < ▲ >< ▼ >< ▶ >< ◀ > to select the items displayed on the screen. Touch [OK] to execute the selected item. Control keys can be moved to the left/right on the screen by touching [Move] in the control key area, and the control keys can be hidden by touching [Hide].
[Title Menu]	Displays the title menu.
[Title List]	Displays the title list.
[Title Search]	Touch [+] or [-] to select the chapter number you wish to search for.
[Select No.]	Displays the keyboard screen. Enter the list number you wish to play.
[10Key Search]	Displays the keyboard screen. Enter the desired chapter and title number and touch [OK]. Touch [<] or [>] to switch the title/chapter.

[Display Settings]/ [Display Adjustment]	[Brightness]	Adjusts the brightness.
	[Contrast]	Adjusts the contrast.
	[Colour]/[Color]	Adjusts the color.
	[Black Level]	Adjusts the black level.
[Display Mode]	Touch to select a display mode from [Normal], [Cinema] and [Full].	
[Voice]	Touch [+] or [-] to select a preferred language.	
[Subtitle]/[Subtitles]	Touch [+] or [-] to select a subtitle setting from the available options.	
[Angle]	Touch [+] and [-] to adjust the angle.	
[Angle Mark]	Turns on/off the angle mark displayed on the screen.	
[Menu Skip]	Turns on/off the menu skip mode.	
[CM Skip]	Touch [+] or [-] to set the length of the CM skip duration.	
[Dynamic Range Control]	Touch [+] or [-] to change the Dynamic Range Control setting. Dynamic Range Control tunes the dynamic range of sound recorded in the Dolby Digital format.	
[DVD Language]	Touch [+] or [-] to change the DVD menu language.	
PG/PL Mode	Touch [▶] or [◀] to switch the PG/PL mode.	

### [USB Menu] (music files):

[TA]*	When this item is turned on, received TA (Traffic Announcement) will interrupt the audio source that is playing.
[Now Playing]	Touch to display the USB screen.
[Folder List]	Touch to display the folder list. Touch an item on the list to select the folder. The sub-folder or track list will be displayed. Select a sub-folder or track from the list.
[Video]	Touch to change the USB memory device player source to video.
[Album Artwork]	Touch to turn on/off the album artwork display on the USB screen.

[Playlists]	Touch to display the list according to the selected item.
[Artists]	
[Albums]	
[Songs]	
[Genres]	
[Composers]	

### [USB Menu] (video files):

[TA]*		When this item is turned on, received TA (Traffic Announcement) will interrupt the audio-visual source that is playing.
[Folder List]		Touch to display the folder list. Touch an item on the list to select the folder. The sub-folder or track list will be displayed. Select a sub-folder or track from the list.
[Audio]		Touch to change the USB memory device player source to audio.
[Display Settings]	[Brightness]	Adjusts the brightness.
	[Contrast]	Adjusts the contrast.
	[Black Level]	Adjusts the black level.
[Aspect Ratio]	[Normal]	Ratio will be same as received from connected device.
	[Full]	Ratio of video will not be modified, and video length/width will occupy complete length/width.
	[Stretched]	Ratio of video will be modified and video will occupy complete screen.

**[iPod Menu]:**

[TA]*	When this item is turned on, received TA (Traffic Announcement) will interrupt the audio source that is playing.
[Now Playing]	Touch to display the iPod screen.
[Current List]	Touch to display the current list. A list of tracks in the currently selected category is displayed.
[Album Artwork]	Touch to turn on/off the album artwork display on the iPod screen.
[Playlists]	Touch to display the list according to the selected item.
[Artists]	
[Albums]	
[Songs]	
[Genres]	
[Composers]	
[Audiobooks]	
[Podcasts]	

**[BT Menu]:**

[TA]*	When this item is turned on, received TA (Traffic Announcement) will interrupt the audio source that is playing.
[Now Playing]	Touch to display the Bluetooth® audio screen.
[Album Artwork]	Touch to turn on/off the album artwork display on the Bluetooth® audio screen.
[Current List]	Touch to display the current list. A list of tracks in the currently selected folder is displayed.
[Connections]	Touch to display the Connections screen.  "Connections settings" (page 2-13)
Folder list	Touch an item on the list to select the folder.

\*: Depending on the models, specifications and software versions, [TA] may be displayed on the main operation screens for some audio sources.

## AUXILIARY (AUX) DEVICES

### Connection and activation

#### Connection:

Connect an AUX device to the AUX input jack via an AUX cable.

AUX input jack location:

-  "USB (Universal Serial Bus) connection port and AUX (auxiliary) input jack" (page 2-8)

The AUX input jack accepts any standard analog audio input such as from a portable cassette player, CD player or MP3 player.



#### INFO:

Insert a 3.5 mm (1/8 in) stereo mini plug in the audio input jack. If a cable with a mono plug is used, the audio output may not function normally.

#### Activation:

Turn on an AUX device and connect the device to the AUX input jack. Select the AUX mode from the audio source menu screen.



-  "Selecting audio source" (page 3-13)

#### Changing volume:

On the AUX screen, touch one of the volume setting menus to select the sound output gain.

#### SMARTPHONE AUDIO (if equipped)

You can also listen to music from your compatible smartphone using Apple CarPlay or Android Auto.



-  "Apple CarPlay" (page 5-16)
-  "Android Auto™" (page 5-20)

#### Connecting smartphone

Connect the iPhone or Android phone to the USB connection port.

-  "USB (Universal Serial Bus) connection port and AUX (auxiliary) input jack" (page 2-8)

#### Smartphone audio operation

1. Connect the iPhone or Android phone to the USB connection port and activate Apple CarPlay or Android Auto.
  -  "Apple CarPlay operation" (page 5-16)
  -  "Android Auto operation" (page 5-21)
2. Push **<AUDIO>**.
3. Touch [Source].
4. Touch [Apple CarPlay] or [Android Auto] in the audio source menu screen, and the smartphone audio starts activating.
  -  "Selecting audio source" (page 3-

## AUDIO SETTINGS

Audio settings can be adjusted or audio related functions can be turned on/off with the following procedure.

Touch [Sound] on the setting menu screen.

 "System settings" (page 2-11)

Available setting items may vary depending on models, specifications and software versions.

Setting items	Action
[Bass]	Adjust the speaker tone quality and sound balance by touching [-]/[+], [L]/[R] or [R]/[F].
[Mid]/[Middle]	
[Treble]	
[Balance]	
[Fader]/[Fade]	
[Bass Enhancer]	When this item is turned on, the system enhances bass sound.
[Speed-Sensitive Volume]/[Speed Sensitive Volume]	Automatically adjusts the volume depending on the vehicle speed. Touch [-]/[+] to change the sensitivity level.
[PersonalSpace]	Adjust the audio settings to best optimize the sound for the driver's listening position.
[Bose Centerpoint]	When this item is turned on, surround sound playback is generated from a traditional stereo recording. Turn on this item to activate Bose Centerpoint and to change its effect level with [Surround Volume].
[Surround Volume]	Touch [+]/[-] to adjust the Surround Volume level if Bose Centerpoint is turned on.

## AUDIO ADJUSTMENTS WITH AUDIO ADJUST BAR (if equipped)

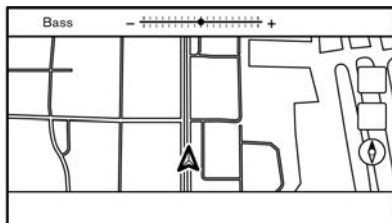

### Example

Sound quality can be adjusted with the following buttons.

- **<TUNE SCROLL/SOUND>\***
- **<TUNE SCROLL/ENTER SOUND>\***
- **<TUNE SCROLL/OK>\***
- **<⏪ 🔊 /ENTER SOUND>\***
- **<⏪ 🔊 /SOUND>\***
- **<⏪ 🔊 /OK>\***

\*: if equipped

When the list screen is not displayed, pushing any of the buttons listed above will display the audio adjustment bar. Each time the button is pushed, the menu will shift to the available setting items.

Turn the button to adjust the level of the selected setting item.

## INFO:

This function may not be available when a menu is highlighted on the screen.

## CD/DVD/USB MEMORY DEVICE CARE AND CLEANING

### CD/DVD (if equipped)

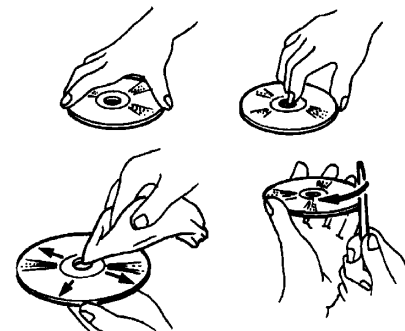

- Handle a disc by its edges. Never touch the surface of the disc. Do not bend the disc.
- Always place the discs in the storage case when they are not being used.
- To clean a disc, wipe the surface from the center to the outer edge using a clean, soft cloth. Do not wipe the disc using a circular motion.  
Do not use a conventional record cleaner or alcohol intended for industrial use.
- A new disc may be rough on the inner and outer edges. Remove the rough edges by rubbing the inner and outer edges with the side of a pen or pencil as illustrated.



## USB MEMORY DEVICE

- Never touch the terminal portion of the USB memory device.
- Do not place heavy objects on the USB memory device.
- Do not store the USB memory device in highly humid locations.
- Do not expose the USB memory device to direct sunlight.
- Do not spill any liquids on the USB memory device.

Refer to the USB memory device Owner's Manual for the details.

**MEMO**

# 4 Hands-Free Phone

Bluetooth® Hands-Free Phone System .....	4-2
Phone screen .....	4-3
Indicators .....	4-3

Phone .....	4-4
Hands-free text messaging assistant .....	4-6
Phone and text message settings .....	4-10



## BLUETOOTH® HANDS-FREE PHONE SYSTEM



### WARNING:

- Use a phone after stopping your vehicle in a safe location. If you have to use a phone while driving, exercise extreme caution at all times so full attention may be given to vehicle operation.
- If you find yourself unable to devote full attention to vehicle operation while talking on the phone, pull off the road to a safe location and stop your vehicle before doing so.



### CAUTION:

To avoid draining the vehicle battery (12V battery), use a phone only after starting the engine, hybrid system or e-POWER system.

Your vehicle is equipped with Bluetooth® Hands-Free Phone System. If you are an owner of a compatible Bluetooth® enabled cellular phone, you can set up the wireless connection between your cellular phone and the in-vehicle phone module. With Bluetooth® wireless technology, you can make or receive a phone call with your cellular phone in your pocket.

Once a cellular phone is connected to the in-vehicle phone module, the procedure for connecting the phone does not need to be performed again. Your phone is automatically selected with the in-vehicle

phone module when the ignition switch or power switch is placed in the ACC or ON position with the selected cellular phone turned on and carried in the vehicle.

You can register up to 6 different Bluetooth® devices in the in-vehicle phone module. However, you can talk on only one cellular phone at a time.

The Voice Recognition System (if equipped) supports phone commands, so dialing a phone number using your voice is possible.

 "Voice recognition" (page 7-2)

Before using the Bluetooth® Hands-Free Phone System, refer to the following notes.

- Wireless LAN (Wi-Fi) and the Bluetooth® functions share the same frequency band (2.4 GHz). Using the Bluetooth® and the wireless LAN functions at the same time may slow down or disconnect the communication and cause undesired noise. It is recommended that you turn off the wireless LAN (Wi-Fi) when using the Bluetooth® functions.
- Set up the wireless connection between a compatible cellular phone and the in-vehicle phone module before using the Bluetooth® Hands-Free Phone System.
- Some Bluetooth® enabled cellular

phones may not be recognized by the in-vehicle phone module.

Consult a NISSAN dealer for phone compatibility.





- You will not be able to use a hands-free phone under the following conditions:
  - Your vehicle is outside of the phone service area.
  - Your vehicle is in an area where it is difficult to receive radio waves; such as in a tunnel, in an underground parking garage, behind a tall building or in a mountainous area.
  - Your cellular phone is locked in order to prevent dialing.
- When the radio wave condition is not ideal or ambient sound is too loud, it may be difficult to hear the other person's voice during a call.
- Immediately after the ignition switch or power switch is placed in the ACC or ON position, it may be impossible to receive a call for a short period of time.
- Do not place the cellular phone in an area surrounded by metal or far away from the in-vehicle phone module to prevent tone quality degradation and wireless connection disruption.
- While a cellular phone is connected through the Bluetooth® wireless connection, the battery power of the

cellular phone may discharge quicker than usual.

- Consult a NISSAN dealer if the Bluetooth® Hands-Free Phone System seems to be malfunctioning.
- Some cellular phones or other devices may cause interference or a buzzing noise to come from the audio system speakers. Storing the device in a different location may reduce or eliminate the noise.
- Refer to the cellular phone Owner's Manual regarding the phone pairing procedure specific to your phone, battery charging, cellular phone antenna, etc.
- The antenna display on the screen may not coincide with the antenna display of some cellular phones.
- The battery display on the screen may not coincide with the battery display of some cellular phones.
- The microphone is located near the map light.
- Keep the interior of the vehicle as quiet as possible to hear the caller's voice clearly as well as to minimize its echoes.
- If reception between callers is unclear, adjusting the outgoing call volume may improve the clarity.  
 "Control buttons and touch screen display" (page 2-2)





## PHONE SCREEN



The phone screen can be displayed by following operations.

- Push <  > on the control panel\*
- Push <  > on the steering wheel\*
- Push <    > on the steering column\*
- Touch [Phone] on the Launch Bar

\*:if equipped

### Available items

Menu item	Action
[Quick Dial]	Displays the Quick Dial screen.  "Making a call" (page 4-4)
[Phone Book]/ [Phonebook]	Displays the phone book screen.  "Making a call" (page 4-4)
[Call History]	Displays the call history screen.  "Making a call" (page 4-4)
[Dial Number]	Displays the phone number entry screen.  "Making a call" (page 4-4)

[Text Message]	Displays the received message list screen.  "Displaying received message list" (page 4-7)
[Connections]	Displays the connection screen.  "Setting Bluetooth®" (page 2-13)
[Volume]	Displays the volume adjustment screen.  "Volume settings" (page 4-12)

### INFO:

Depending on the connected device, some functions cannot be used.

### INDICATORS

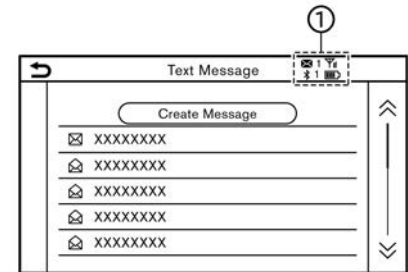





### Example

When a cellular phone is connected through the Bluetooth® wireless connection, indicators ① for phone and text

messaging are displayed on the top of the screen.

Available indicators may vary depending on models, specifications and software versions.

 1	Indicates the number of unread received messages.
 1	Indicates the Bluetooth® device that is currently connected.
	Indicates that Bluetooth® device(s) are connected.
	Indicates the strength of the signal the Bluetooth® device is receiving.
	Indicates the amount of remaining Bluetooth® device battery.

## PHONE

### Connecting Bluetooth® Hands-Free Phone

A cellular phone device must be connected to the Bluetooth® Hands-Free Phone System before operation. Up to 6 Bluetooth® devices can be registered to the system.



 "Setting Bluetooth®" (page 2-13)

### Phone selection

Follow the instructions below to select a connected device for use with the Bluetooth® Hands-Free Phone System:

1. Touch [Phone] on the Launch Bar.
2. Touch [Connections] and touch [Bluetooth]. A list of the connected cellular phones is displayed.
3. Touch one of the connected cellular phones from the list.

When the connection is successful, "Connected" is displayed under the device name.

If  is displayed in gray, touch .

#### INFO:

To select a phone, the Bluetooth® of the cellular phone needs to be turned on.

### Making a call

1. Touch [Phone] on the Launch Bar.
2. Select one of the following methods to make a call.

[Quick Dial]	Select a telephone number registered as a Quick Dial number.  "Quick Dial" (page 4-13)
--------------	--

[Phone book] / [Phonebook]	Select a person and the phone number you wish to call from the phonebook. Depending on the device, the phonebook will be downloaded from the cellular phone automatically when it is connected. If the automatic download does not take place, the telephone number must be transferred to the hands-free phone system from the cellular phone prior to using this method.  "Phone settings" (page 4-10)
[Call History]	Select a telephone number from recent incoming, outgoing or missed calls.
[Dial Number]	Enter the phone number manually using the keypad displayed on the screen.

#### INFO:

With models capable of connecting with two hands-free phones simultaneously via Bluetooth®, either of the connected phone devices can be selected for dialing operation when [Allow 2 Phones Simultaneously] is turned on.

 "Bluetooth® settings" (page 2-14)

## Receiving a call

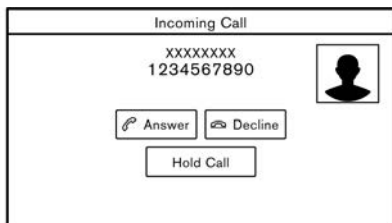

When you receive a phone call, the display switches to the Incoming Call screen and the ringtone is played through the vehicle's audio system.

### Taking a call:

To answer the call, take one of the following actions.

- Push < > (if equipped) on the steering wheel.
- Push < / / > (if equipped) on the steering column.
- Touch [Answer].

### Rejecting a call:

To reject the call, take one of the following actions.

- Push and hold < > (if equipped) on the steering wheel.
- Touch [Decline].

## Holding a call:

To hold the call, touch [Hold Call].



### INFO:

With models capable of connecting with two hands-free phones simultaneously via Bluetooth®, if [Allow 2 Phones Simultaneously] is turned on, two hands-free phone devices can be connected at the same time. If one of the connected devices receives an incoming call while the other device is already online, a pop-up message will appear to inform that answering the call will hang up the line of the other connected device. Touch [Answer] to answer the call and hang up the line on the other device. Touch [Decline] to continue the conversation on the other device.

## During a call

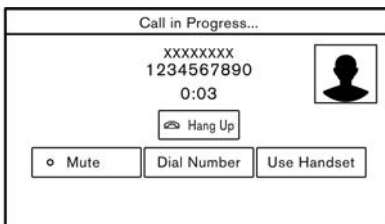

### Example

The Call in Progress screen will appear during a call.

To hang up the phone, touch [Hang Up]/[Hang up].

## Operations during a call:





There are some options available other than hanging up a call or answering/rejecting incoming calls.

Touch one of the following displayed keys on the screen to take action.

Available item	Action
[Use Handset]	Transfer the call to the cellular phone.
[Mute]	When muted, your voice will not be heard by the person on the other end of the line.
[Dial Number]	Using the touch tone, send digits to the connected party for using services such as voicemail.
[Switch Call]*	Answer another incoming call. The person you are talking to will be placed on hold. Touch once more to speak to the person on hold again.

\*: Available when a call is received while on the line with another person. The availability of this function depends on the cellular phone.

## INFO:

To adjust the person's voice to be louder or quieter, push <  > (if equipped) on the steering wheel, push <  > (if equipped) on the steering column from behind or turn <VOL/  >/<VOLUME/  > on the control panel while talking on the phone.





### Call from a second person:



When another phone call is received during a call, the Call Waiting screen will appear.

### Answering call from a second person:

To answer the call from the second person and place the first caller on hold, take one of the following actions.

- Push <  > (if equipped) on the steering wheel.
- Push <  /  /  > (if equipped) on the steering column.
- Touch [Answer].

### Rejecting call from a second person:

To reject a call from the second person and continue the conversation with the first caller, touch [Decline].

### During a call with a second person:

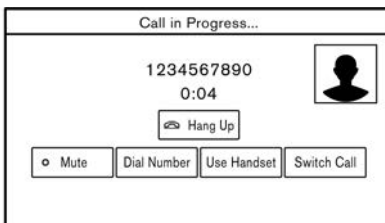

#### Example

To hang up the phone and return to the conversation with the first caller, touch [Hang Up]/[Hang up].

To switch between two calls on line, touch [Switch Call].

## HANDS-FREE TEXT MESSAGING ASSISTANT

### WARNING:

- **Use the text messaging feature after parking your vehicle in a safe location. If you have to use the feature while driving, exercise extreme caution at all times so full attention may be given to vehicle operation.**
- **Laws in some jurisdictions may restrict the use of "Text-to-Speech."**

### Check local regulations before using this feature.

- **Laws in some jurisdictions may restrict the use of some of the applications and features, such as social networking and texting. Check local regulations for any requirements.**
- **If you are unable to devote full attention to vehicle operation while using the text messaging feature, pull off the road to a safe location and stop your vehicle.**

### CAUTION:

**This feature is disabled if the connected device does not support it. See the phone's Owner's Manual for details and instructions.**

The system allows for the sending and receiving of text messages through the vehicle interface.

The availability of the text message function may vary depending on the cellular phone.



## Receiving a message

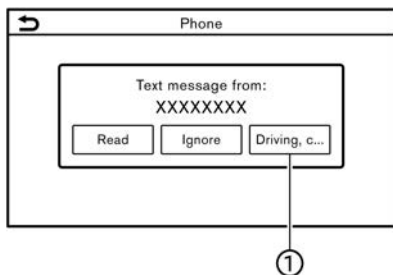

When the cellular phone connected to the vehicle receives a text message, a notification will appear on the touch screen display with a tone. (Depending on the models, the notification will also appear on the vehicle information display.)

To check the message, touch [Read]. Touch [Ignore] to save the message to be checked later.

If you want to respond using a predefined message, touch the message for auto reply ①.

The text message for auto reply can be edited.

"Phone settings" (page 4-10)

### INFO:

- Depending on the cellular phone, the notification display setting may need to be activated on the cellular phone.

- Models with < > on the steering wheel:

Whether to read or ignore the message can be selected operating the switch on the steering wheel. Push < > to read the message. Push and hold the switch to ignore the message.

- Models with < > on the steering column:

Push < > to read the message.

## Displaying received message list

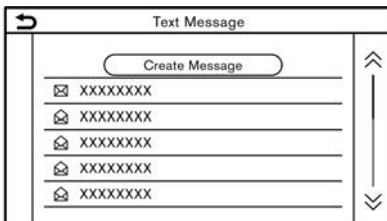

1. Touch [Phone] on the Launch Bar.
2. Touch [Text Message].
3. Touch an item on the list to read or reply to the message.

### INFO:

- Up to 100 messages can be stored in the message list.
- With models capable of connecting with two hands-free phones simulta-

neously via Bluetooth®, either of the connected phone devices can be selected for text message viewing operation when [Allow 2 Phones Simultaneously] is turned on.

"Bluetooth® settings" (page 2-14)

## Received message screen



Touching [Read] on the new message notification screen or selecting a message from the message list will show the details of the received message on the display.

### Available actions:

- [Prev.]: Touch to read the previous message.
- [Next]: Touch to read the next message.
- [Play]/[Stop]: Touch [Play] to have the hands-free phone system read out the received message. Touch [Stop] to stop reading.

- [Call]:  
If the sender of the message is registered in the phonebook, touch this icon to make a call to the sender.
- [Reply]:  
A reply message can be selected from the template.  
☞ "Sending a text message" (page 4-8)

### INFO:

- Push < ▲ >/< ▼ > (if equipped) on the steering wheel or tilt < ▲ / ▼ > (if equipped) on the steering wheel to read the previous or next message.
- Depending on the language setting, the "Text-to-Speech" function may not be available.
- Available keys may vary depending on the situations and models.
- If the sender's name and phone number are registered in the phonebook, the name of the sender is displayed when a message is received.
- To adjust the message reading voice volume, push < 🔊 > (if equipped) on the steering wheel, push < 🔊 > (if equipped) on the steering wheel from behind or turn < VOL / 🔊 >/< VOLUME / 🔊 > on the control panel.

## Sending a text message

This function may not be supported depending on the cellular phone.

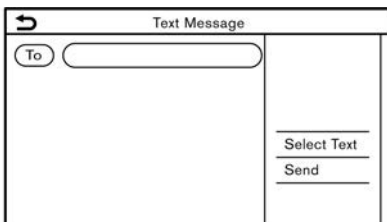

1. Touch [Phone] on the Launch Bar.
2. Touch [Text Message].
3. Touch [Create Message].

### INFO:

With models capable of connecting with two hands-free phones simultaneously via Bluetooth®, either of the connected phone devices can be selected for text message sending operation when [Allow 2 Phones Simultaneously] is turned on.

☞ "Bluetooth® settings" (page 2-14)

The following items are available.

Available item		Action
[To]	[Enter Number with Keypad]/ [Enter Number by Keypad]	Enter the phone number of the recipient using the keypad. Touch [OK] to confirm.
	[Quick Dial]	Select a recipient from the Quick Dial list.
	[Phone Book]/[Phonebook]	Select a recipient from the phonebook.
	[Call History]	Select a recipient/phone number from call history.
[Select Text]	[Fixed]	Touch to display a list of fixed text messages.
	[Customised]/[Customized]	Touch to display a list of custom text message templates. Custom text can be created or edited from the setting menu.  "Phone and text message settings" (page 4-10)
[Send]		Touch to send the message.

## PHONE AND TEXT MESSAGE SETTINGS

### Phone settings



Bluetooth® Hands-Free Phone System settings can be changed according to the user's preference.

Touch [Phone] on the setting menu screen.

 "System settings" (page 2-11).

Available setting items may vary depending on models, specifications and software versions.

#### Available setting items

Setting item		Action
[Connections]		Displays the Connections screen. Phone connection, selection, deletion and other features are available.  "Connections settings" (page 2-13)
[Quick Dial]	[Edit]	Entries in the Quick Dial can be edited. Touch [Add New] to register a new entry.  "Quick Dial" (page 4-13)
	[Delete All]	Deletes all of the phone numbers in the Quick Dial.
[Phone Book]/[Phonebook]	[Download Entire Phone Book]/ [Download Entire Phonebook]	All of the phone numbers that are stored in a phonebook of a cellular phone that is connected to the vehicle are downloaded at once.
	[Auto Download]/[Auto Down- loaded]	Turns on/off automatic downloading of the phonebook from the connected cellular phone.
	[Sort Phone Book by]/[Sort Phone- book by]	Changes the sorted order of contacts in the phonebook.

[Text Message]	[Text Message]	Turns the text messaging function on/off.
	[Text Message Ringtone]	Turns the incoming message sound on/off.
	[Signature]	Turns the signature setting for the outgoing text message on/off.
	[Auto Reply]	Turns on/off the automatic text message reply function.
	[Auto Reply Text Message]	Selects the text message to be used for the automatic reply function.
	[Edit Custom Text]	Creates or edits a customized text message reply.
[Notifications]	[Driver Only]	When this item is turned on, incoming call notification is displayed only in the vehicle information display.
	[Vehicle Ringtone]	Turns the vehicle ringtone on/off.
[Automatic Hold]		When this item is turned on, an incoming phone call will be put on hold automatically.



**INFO:**

The setting of [Driver Only] is unavailable while Apple CarPlay (if equipped), Android Auto (if equipped) or Yandex.Auto (if equipped) is active.

## Volume settings

Volume settings can be adjusted.

1. Touch [Phone] on the Launch Bar.
2. Touch [Volume].

The following volume setting items are available.

Setting items	Action
[Ringtone]	Adjusts the volume level of the ringtone of incoming calls.
[Outgoing Call]	Adjusts the volume level of the outgoing calls.



### INFO:

The volume settings can also be accessed from the setting menu screen.

 "System settings" (page 2-11)

## Quick Dial

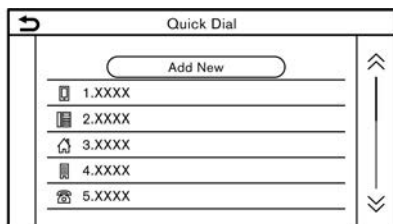

Up to 20 Quick Dial entries can be registered.

Quick Dial entries can be used to quickly make a call or send text messages.

### Registration:

1. Touch [Phone] on the Launch Bar.
2. Touch [Quick Dial].
3. Touch [Edit].
4. Touch [Add New] to register a phone number to the Quick Dial list.
5. Select a method for registration.

### Available methods:

- [Copy from Call History]:  
A phone number can be selected from [All], [Incoming], [Outgoing], or [Missed] call history lists.
- [Copy from Phone Book]/[Copy from Phonebook]:  
A phone number can be selected from the phonebook.

- [Enter Number with Keypad]/[Enter Number by Keypad]:  
A phone number can be entered manually using keypad.



### INFO:

Available methods may vary depending on cellular phone support.

6. When a phone number has been selected, the registration screen is displayed. Enter the phone number and edit the entry information as necessary.
7. Touch [OK] to save the entry.



### INFO:

- Quick Dial entries can also be registered from [Phone] on the setting menu screen.  
☞ "Phone settings" (page 4-10)
- With models capable of connecting with two hands-free phones simultaneously via Bluetooth®, either of the connected phone devices can be selected for dialing operation when [Allow 2 Phones Simultaneously] is turned on.  
☞ "Bluetooth® settings" (page 2-14)

### Voice Tag (if equipped):

A voice tag can be recorded for each of the registered Quick Dial numbers and can be used to dial the number by speaking it.

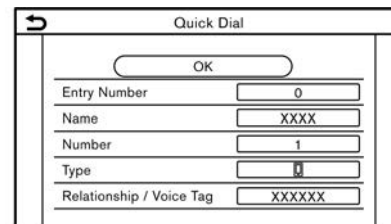

On the Quick Dial registration screen, select [Relationship / Voice Tag].

- Select a preferred relationship from the list.
- Touch [Customise]/[Customize] and touch [Record] to register your original voice tag.



### INFO:

- Touch [Play] to play the recorded voice tag.
- Touch [Delete] to delete the voice tag.

**MEMO**



# 5 Information

Information menu .....	5-2	Apple CarPlay system limitations .....	5-20
Updating system software (if equipped) .....	5-6	Android Auto™ (if equipped) .....	5-20
NissanConnect Services (if equipped for Europe and Russia) .....	5-8	Compatibility .....	5-20
Privacy policy NissanConnect Services .....	5-8	Initial Android Auto settings .....	5-21
NissanConnect Services menus .....	5-8	Android Auto operation .....	5-21
NissanConnect Services settings .....	5-8	Android Auto settings .....	5-23
NissanConnect Services powered by SiriusXM™ (if equipped for Mexico) .....	5-9	Android Auto system limitations .....	5-25
Subscription to NissanConnect Services .....	5-9	Yandex.Auto powered by Bosch (if equipped) .....	5-25
Important information regarding access to NissanConnect Services .....	5-9	Compatibility .....	5-25
NissanConnect Services features .....	5-9	Initial Yandex.Auto settings .....	5-25
NissanConnect Services menus .....	5-12	Yandex.Auto operation .....	5-25
Emergency support .....	5-13	Yandex.Auto settings .....	5-27
NissanConnect Services settings .....	5-15	Yandex.Auto system limitations .....	5-28
Apple CarPlay (if equipped) .....	5-16	Siri Eyes Free (if equipped) .....	5-28
Compatibility .....	5-16	Requirements .....	5-28
Apple CarPlay operation .....	5-16	Siri Eyes Free activation .....	5-28
Apple CarPlay settings .....	5-18	Operating Siri Eyes Free .....	5-28



## INFORMATION MENU





The information screen sets or displays various information.

Push **<MENU>/<MODE/OK>** (if equipped) and then touch [Info] on the Launch Bar to display the Information menu.





Available items may vary depending on models, specifications and software versions. Items displayed on the screen may not function depending on various conditions.

Models with navigation system:

Menu item		Action
[Vehicle]	[Energy Flow]	Displays energy information. Touch [History] to display the Fuel Economy History screen. For details of the Energy Flow, refer to the vehicle Owner's Manual.
	[ECO Drive Report]	Displays the ECO Drive Report screen. Your driving score will be displayed in real time, with 100 points designated as the score for ideal eco-driving. Touch [History] to view the drive report history. Touch [Reset] to clear the past records. To improve your score: <ul style="list-style-type: none"> <li>• When starting off, depress the accelerator gently.</li> <li>• When cruising, accelerate and decelerate as little as possible.</li> <li>• When decelerating, release the accelerator early.</li> </ul>
[NissanConnect Services]		Displays the NissanConnect Services menu screen.  "NissanConnect Services (if equipped for Europe and Russia)" (page 5-8)  "NissanConnect Services powered by SiriusXM™ (if equipped for Mexico)" (page 5-9)
[Traffic Information]/[Premium Traffic]		Displays the Traffic Information screen.  "Viewing traffic information" (page 6-27)
[Where Am I?]		The name and distance of the next/previous street, and other information that indicates the current vehicle location are displayed. Latitude and longitude of the current vehicle location are shown on the bottom right.

Menu item		Action
[Weather]	[Current Conditions]	Current, hourly or 5-day weather information is displayed.
	[Hourly Weather Forecast]	Weather information for nearby location, near the destination and your preferred city set as a Favorite City can be confirmed.
	[5-Day Weather Forecast]	Current, hourly or 5-day weather information can be changed by touching [Current], [Hourly] or [5-Day]. Nearby location, near the destination and your preferred city can be changed by touching [Nearby], [Near Dest.] or [Favourite City]/[Favorite City]. Favorite city can be changed by touching [Change City].
	[Communication Settings]	Turns the TomTom weather data transmission on/off.
[System Information]	[Software Version]/[Version Information]	Displays the version information screen.
	[Software Update]	The system software can be updated.  "Updating system software" (page 5-6)
	[Map Update]	The map data can be updated.  "How to update map data" (page 6-44)
	[Licence Information (OSS)]/[License Information (OSS)]/[Licence Information]/[License Information]	Displays the Open Source Software licenses information.
[GPS Position]	Displays Global Navigation Satellite System (GNSS) information, such as number of satellites, latitude/longitude, and approximate altitude, etc.	
[Vehicle Data Transmission]	When [OK] is touched, data transmission to NISSAN is enabled. Touching [Decline] disables some functions such as Premium Traffic.	
[Apps]/[Smartphone Connection]	[Apple CarPlay]	Displays the Apple CarPlay screen.  "Apple CarPlay" (page 5-16)
	[Android Auto]	Displays the Android Auto screen.  "Android Auto™" (page 5-20)
	[Yandex.Auto]	Displays the Yandex.Auto screen.  "Yandex.Auto powered by Bosch" (page 5-25)

Models without navigation system:

Menu item		Action
[Vehicle]	[Energy Flow]	Displays energy information. Touch [History] to display the Fuel Economy History screen. For details of the Energy Flow, refer to the vehicle Owner's Manual.
	[ECO Drive Report]	Displays the ECO Drive Report screen. Your driving score will be displayed in real time, with 100 points designated as the score for ideal eco-driving. Touch [History] to view the drive report history. Touch [Reset] to clear the past records. To improve your score: <ul style="list-style-type: none"> <li>• When starting off, depress the accelerator gently.</li> <li>• When cruising, accelerate and decelerate as little as possible.</li> <li>• When decelerating, release the accelerator early.</li> </ul>
[NissanConnect Services]		Displays the NissanConnect Services menu screen.  "NissanConnect Services (if equipped for Europe and Russia)" (page 5-8)  "NissanConnect Services powered by SiriusXM™ (if equipped for Mexico)" (page 5-9)
[System Information]	[Software Version]/[Version Information]	Displays the version information screen.
	[Software Update]	The system software can be updated.  "Updating system software" (page 5-6)
	[Licence Information (OSS)]/[License Information (OSS)]/[Licence Information]/[License Information]	Displays the Open Source Software licenses information.
[Vehicle Data Transmission]		When [OK] is touched, data transmission to NISSAN is enabled. Touching [Decline] disables some functions.
[Apps]/[Smartphone Connection]	[Apple CarPlay]	Displays the Apple CarPlay screen.  "Apple CarPlay" (page 5-16)
	[Android Auto]	Displays the Android Auto screen.  "Android Auto™" (page 5-20)

Menu item		Action
	[Yandex.Auto]	Displays the Yandex.Auto screen.  "Yandex.Auto powered by Bosch" (page 5-25)

## UPDATING SYSTEM SOFTWARE (if equipped)



### WARNING:

#### TO AVOID RISK OF DEATH OR SERIOUS PERSONAL INJURY WHEN UPDATING THE SYSTEM SOFTWARE:

If you choose to park the vehicle within range of a Wi-Fi connection (if equipped), park the vehicle in a secure, safe well-ventilated location that is open to the air. During the update process, if you choose to park your vehicle, it should be kept in a well ventilated area to avoid exposure to carbon monoxide. Do not breathe exhaust gases; they contain colorless and odorless carbon monoxide. Carbon monoxide is dangerous. It can cause unconsciousness or death.

1. **Apply the parking brake.**
2. **Remain with the vehicle while the update is in process.**
3. **Do not allow children, pets or people who may need assistance to remain in the vehicle while the software is updating.**



### NOTE:

**The vehicle is not required to be parked during the software update process. If the vehicle disconnects from the Wi-Fi connection (if equipped), it will resume when the vehicle reconnects to a known Wi-Fi connection.**



### INFO:

- The system prioritizes Wi-Fi connection (if equipped) over TCU (Telematics Control Unit) (if equipped) when Wi-Fi network connection is available.
- You will be charged separately when the network communication is made via smartphones.
- The download data size of software updates can vary between 80 MB and 300 MB. If you use your smartphone as a Wi-Fi connection, you may incur data charges from your phone carrier. Please connect to a secure WPA2 Wi-Fi network to avoid potential phone carrier data charges.

### How to update from the pop-up screen

When both of the following conditions are met, the system informs the driver with a pop-up on the screen when system software update is available.

- [Auto] is selected under [Update Method].
    - “How to update from the system menu” (page 5-7)
  - Wi-Fi (if equipped) or TCU (Telematics Control Unit) (if equipped) network connection is available.
    - “Wi-Fi setting” (page 2-15)
1. When the pop-up appears and prompts the driver to perform the system software update, operate the system according to the guides shown on the screen to download the updates. Another pop-up will appear when downloading is complete.
  2. After the system software update is complete, place the ignition switch or power switch in the OFF position and leave the system for 20 minutes without operating the switches on the control panel and the steering wheel. Place the ignition switch or power switch in the ON position and the updated software will be available.



### INFO:

The update may not be reflected if the ignition switch or power switch is placed back in the ON position before the 20-minute period has passed.

## How to update from the system menu



### WARNING:

To operate the system for software update, first park the vehicle in a safe location.

System software updates can be downloaded manually via Wi-Fi (if equipped) or TCU (Telematics Control Unit) (if equipped) from the system menu.

1. Connect to network via Wi-Fi (if equipped) if you wish to perform the software update via Wi-Fi connection.  
☞ “Wi-Fi setting” (page 2-15)
2. Push **<MENU>/<MODE/OK>** (if equipped).
3. Touch [Info] on the Launch Bar and then touch [System Information].
4. Touch [Software Update].

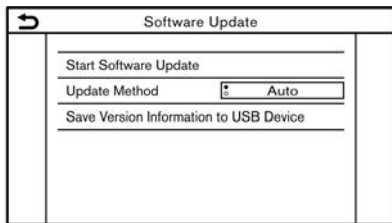

### Example

5. Touch [Start Software Update].



### INFO:

- When [Update Method] is set to [Auto], a notification is made in case that software can be updated.
  - Touch [Check for an Update] (if equipped) to check available updates manually.
6. Touch [Download] to start downloading and updating the system software.
  7. After the system software download is complete, place the ignition switch or power switch in the OFF position and leave the system for 20 minutes without operating the switches on the control panel and the steering wheel. Place the ignition switch or power switch in the ON position and the updated software will be available.



### INFO:

- The update may not be reflected if the ignition switch or power switch is placed back in the ON position before the 20-minute period has passed.
- If updating software is unnecessary, touch [OK] to return to the previous screen.
- [Save Version Information to USB Device] is not available on this system.

- Depending on the models, specifications and software versions, the same operation can be performed from [System Update] on the setting menu screen.  
☞ “System settings” (page 2-11)

## NISSANCONNECT SERVICES (if equipped for Europe and Russia)

This vehicle incorporates a communication device that is called TCU (Telematics Control Unit). The communication connection between this unit and the Nissan Data Center allows for various services.

### For Europe:

For details, refer to the NissanConnect Services app and YOU+Nissan Owners' Portal.

### For Russia:

For details, refer to the NissanConnect Services app and <https://www.nissan.ru>.

## PRIVACY POLICY NISSANCONNECT SERVICES

The transferred personal data will be stored only for period necessary for the processing, and will be then deleted or anonymized.

### For Europe:

For any further information in relation to the retention period and the protection of your personal data, please refer to the Terms and Conditions available in the NissanConnect Services app and YOU+Nissan Owners' Portal.

### For Russia:

For any further information in relation to the retention period and the protection of your personal data, please refer to the Terms and Conditions available in the NissanConnect Services app and <https://www.nissan.ru>.

## NISSANCONNECT SERVICES MENU

With NissanConnect Services, various information can be received and displayed on the screen. The information can also be announced by the system.

## NISSANCONNECT SERVICES SETTINGS

NissanConnect Services settings can be changed.

1. Touch [Info] on the Launch Bar.
2. Touch [NissanConnect Services].
3. Touch [NissanConnect Services Settings].

Available setting items may vary depending on models, specifications and software versions.

### INFO:

[NissanConnect Services] can also be accessed from [Settings] on the Launch Bar.

Setting items	Action
[Information Channel Setting]	Displays the Information Channel Setting screen.
[Unit ID Information]	Displays the Unit ID Information screen.

[Reset all NissanConnect Svcs. Settings to Default]	All NissanConnect Services settings are returned to default.
[Privacy Mode Setting]	Allows you to accept or decline the privacy mode setting.

### INFO:

#### What happens when Privacy Mode is ON?

When Privacy Mode is ON (by declining NissanConnect Services while switching on your vehicle or via the NissanConnect Services settings), your data will not be processed for purposes relating to NissanConnect Services. They might however be processed for the purpose of services other than NissanConnect Services which are (i) either mandatory (such as eCall in Europe, or Glonass in Russia), (ii) that you might have activated independently and manually (such as bCall, concierge service, co-pilot button), or (iii) relating to services that you have subscribed to and remains activated for your safety (SVT, theft/burglar notification).



## NISSANCONNECT SERVICES POWERED BY SiriusXM™ (if equipped for Mexico)

### SUBSCRIPTION TO NISSANCONNECT SERVICES

Subscription is required to use the NissanConnect Services. For the details about the subscription, visit the Nissan Owner Portal or contact a Nissan Mexicana dealer.

NissanConnect Services are offered by SiriusXM™ or other third party vendors in accordance with the terms and conditions and the privacy policies outlined in a Subscription Agreement.

### IMPORTANT INFORMATION REGARDING ACCESS TO NISSANCONNECT SERVICES

Feature availability is dependent on vehicle model, trim level, packaging and options. Compatible connected device may be required and feature availability may be dependent on device's capability. Refer to connected device's owner's manual for details. Late availability for some features.

**Driving is serious business and requires your full attention.** Only use features and connected devices when safe and legal to do so. Some features, including automatic crash notification and SOS, are dependent upon the telematics device being in operative condition, its ability to connect to a wireless network, compatible wireless network availability, navigation map data and GNSS signal receptions, the absence of which can limit or prevent the ability to reach Customer Care or

receive support. GNSS mapping may not be detailed in all areas or reflect current road status. Never program GNSS while driving. Only use Remote Engine Start and Remote Horn features in accordance with any laws, rules or ordinances in effect in your vehicle's location.

**Some services and features are provided by independent companies not within NISSAN's control. Should service provider terminate or restrict service or features, service or features may be suspended or terminated without notice or with no liability to NISSAN or its partners or agents.** Services and features may require compatible cellular network provided by independent companies not within NISSAN or its partners' or agents' control. Cellular network signal strength may vary and may not be available in all areas or at all times. Services and features may not function if cellular network is unavailable, restricted, or terminated. NISSAN and its partners or agents are not responsible for associated costs or other third party changes that may be required for continued operation due to cellular network unavailability, restriction, or termination (including equipment replacements/upgrades, if available, or roaming charges on alternative networks). Technology is evolving, and changes by independent companies are not within NISSAN's or its partners' or agents' control.

Enrollment, owner consent, personal

identification number (PIN), and subscription agreement may be required to receive full suite of features and services. Trial periods (if applicable) begin on the date of vehicle purchase or lease of a new NISSAN. Trial periods may be subject to change at any time and may be subject to early termination without notice. Required subscriptions may be sold separately for each available feature or service after trial period ends, and may continue until you call service provider to cancel. Installation costs, one-time activation fee, other fees and taxes may apply. Fees and programming subject to change. Feature may be subject to age restrictions in some areas. Subscriptions governed by service provider's subscription agreement, terms and conditions and privacy statements available at service provider's website.

### NISSANCONNECT SERVICES FEATURES

NissanConnect Services provides various types of information and services by connecting your vehicle to the NissanConnect Services Data Center and NissanConnect Services Response Center using the TCU (Telematics Control Unit) installed in your vehicle.

If equipped, your vehicle may include NissanConnect connected features and services such as emergency SOS calling, Automatic Collision Notification, Navigation, Bluetooth® and more. For complete

information about your NissanConnect features and services, please visit [www.nissan.com.mx/connect](http://www.nissan.com.mx/connect).



#### **WARNING:**

- **Please note that the Automatic Collision Notification service (if equipped) and Emergency Call function (if equipped) cannot be used in the following conditions:**
  - Emergency functions and services will not be available without a paid subscription to NissanConnect Services.
  - The NissanConnect Services network system is disabled.
  - The vehicle moves outside the service area where the TCU (Telematics Control Unit) is connected to the system.
  - The vehicle is outside the area where the cellular network service is receivable.
  - The vehicle is in a location with poor signal reception such as tunnels, underground parking garages, behind buildings or in mountainous areas.
  - The line is busy.
  - The TCU (Telematics Control Unit) or other systems of your vehicle are not working properly.

– **It may not be possible to make an emergency call depending on the severity of a collision and/or emergency.**

- **Radio waves could adversely affect electric medical equipment. Individuals who use a pacemaker should contact the device manufacturer regarding any possible effects before using the system.**
- **The TCU (Telematics Control Unit) antenna is installed inside the upper central part of the instrument panel. An occupant should not get any closer to the antenna than specified by the pacemaker manufacturer. The radio waves from the TCU antenna may adversely affect the operation of the pacemaker while using the NissanConnect Services.**



#### **INFO:**

- NissanConnect Services features are dependent upon subscription enrollment and the telematics device being in operative condition, cellular connectivity, navigation map data and GNSS signal reception. Terms and conditions of the NissanConnect Services Subscription Agreement apply.
- Enrollment is required in order to use NissanConnect Services. The services

that can be received vary depending on the plan in which you are enrolled.

- All services are complimentary for the trial period.
- After the trial period, use of the service will no longer be complimentary.
- Laws in some jurisdictions may restrict the use of “Text-to-Speech.” Check local regulations before using this feature.

If equipped, your vehicle may include NissanConnect Services features such as emergency SOS calling (if equipped), Automatic Collision Notification (if equipped), Wi-Fi, Remote Services, Navigation, Bluetooth® and more. NissanConnect Services may be updated. The latest detailed information is available on the following website or from the support line.

#### **NissanConnect Services website:**

[www.nissan.com.mx/connect](http://www.nissan.com.mx/connect)

#### **NissanConnect customer support line:**

01-800 9647726

- **Automatic Collision Notification (if equipped):**  
The TCU (Telematics Control Unit) generates a signal automatically to the NissanConnect Services Response Center in the case of an accident severe enough to trigger one of the

vehicle's air bags. Upon the signal, a Response Specialist receives the vehicle location and customer information and notifies the proper authorities in accordance with established policies and procedures.

- **Emergency Call (if equipped):**

The Emergency Call feature provides emergency assistance by connecting to a Response Specialist. In the event of an emergency, by push the in-vehicle <SOS> button to use this feature. The Response Specialist provides various assistance depending on the situation.

 "Emergency support" (page 5-13)

## Notice to Bluetooth® Hands-Free Phone users

The Bluetooth® Hands-Free Phone System will be disabled and not be able to take phone calls while the vehicle is connected to the NissanConnect Services Response Specialists or the emergency support staff at the NISSAN Response Center.

This is to avoid NissanConnect Services Response Specialists and NissanConnect Services emergency support staff from being interrupted by incoming calls. Incoming phone calls received while the vehicle is connected to the Service Center will not be listed in the call history of the Bluetooth® Hands-Free Phone System. However those incoming calls may be

listed in the call history of your mobile phone, depending on its capabilities. After disconnecting communication with the NissanConnect Services Response Specialist or NissanConnect Services emergency support staff, check the incoming call history on your mobile phone when it is safe to do so.

## Service subscription

A separately purchased NissanConnect Services subscription is required. For detailed information, contact a NISSAN dealer or refer to the following NissanConnect Services website:

[www.nissan.com.mx/connect](http://www.nissan.com.mx/connect)



### INFO:

If the vehicle is owned by another person and is resold, the subscription for this service must be canceled and all data stored on the device must be deleted.

## Operating tips



### WARNING:

- **Use the NissanConnect Services after stopping your vehicle in a safe location. If you have to use the NissanConnect Services while driving, exercise extreme caution at all times so full attention may be given to vehicle operation.**

- **If you are unable to devote full attention to vehicle operation while talking with the NissanConnect Services, pull off the road to a safe location and stop your vehicle.**

- Do not use the NissanConnect Services with the engine, hybrid system or e-POWER system stopped. Doing so may discharge the vehicle battery.

- The NissanConnect Services cannot be used under the following conditions:

- The NissanConnect Services subscription has expired.

- The vehicle is outside the area where the cellular network service is receivable.

- The vehicle is in a location with poor signal reception such as tunnels, underground parking garages, behind buildings or in mountainous areas.

- The line is busy.

- The TCU (Telematics Control Unit) or other systems of your vehicle are not working properly.

- The NissanConnect Services network system is disabled.

- Communication with the NissanConnect Services Data Center is related to the data communication mode and may cause occasional difficulty in

receiving signals, and the signal receivable area may be limited compared to regular mobile phones.

- You may hear clicks or experience interruptions while speaking with the NissanConnect Services Response Specialists. This is due to a shift in the connection zone and is not a malfunction.
- Depending on the line used, the sound volume may decrease. Adjust the volume as necessary.
- Received sounds may be distorted or ambient noise may sound like voices of a crowd. This is due to the use of the digital line and is not a malfunction.
- You may hear your own voice from the speaker when talking with the NissanConnect Services Response Specialists due to a network disturbance. When this occurs, reconnect the line after a few minutes or at a different location.
- This vehicle incorporates a communication device that is called a TCU (Telematics Control Unit). The communication connection between this unit and the NissanConnect Services Data Center allows for various services. When the system connects to the NissanConnect Services Data Center, an antenna icon will appear on the screen. Use the service in a location

where the symbol representing good signal reception appears on the screen.

: When the signal reception is good  
: When the signal reception is bad



- The NissanConnect Services use the TCU (Telematics Control Unit) for communications. Even if the signal strength bar of the in-vehicle data communication module indicates good reception, connection to the NissanConnect Services Data Center may be disabled. This does not indicate a malfunction. Operate the system again after a few minutes.

## NISSANCONNECT SERVICES MENU

With NissanConnect Services, various information can be received and displayed on the screen. The information can also be announced by the system.

1. Push **<MENU>** and then touch [Info].
2. Touch [NissanConnect Services].
3. Select an item from the NissanConnect Services menu screens.

Available items may vary depending on models, specifications and software versions. Items displayed on the screen may not function depending on various conditions.

Available items	Content
[History]	Accesses the messages sent to the vehicle from the NissanConnect Services Data Center.  "History" (page 5-12)
[NissanConnect Services Settings]	NissanConnect Services settings can be changed.  "NissanConnect Services settings" (page 5-15)

## History



Messages received from the NissanConnect Services Data Center are displayed.

1. Push **<MENU>** and then touch [Info].
2. Touch [NissanConnect Services].
3. Touch [History].
4. A message list is displayed. Touch preferred message from the list.

## INFO:

- Touch [Stop] during communication with the NissanConnect Services Data Center to cancel the connection.
- A message is displayed when the communication is disconnected while downloading information due to a

poor communication status. Select [Yes] to restart the download.

- Laws in some jurisdictions may restrict the use of "Text-to-Speech". Check local regulations before using this feature.
- Some terminology such as personal names, place names, special terms, symbols, etc. may not be announced correctly. This is not a malfunction.
- The system will pause announcements when interrupted by the voice guidance given by the navigation system (if equipped). When the voice guidance finishes, the system will restart the announcement.
- When the system is making announcements, the volume can be adjusted by turning **<VOL/  >/<VOLUME/  >**.
- The selected content is read out while the vehicle is being driven, or if parked, you can read the content on the display.
- Content settings can be made using the NissanConnect Services website. For more details, refer to the NissanConnect Services website or contact the NissanConnect customer support line.

**NissanConnect Services website:**

[www.nissan.com.mx/connect](http://www.nissan.com.mx/connect)

**NissanConnect customer support line:**

01-800 9647726

**EMERGENCY SUPPORT**

NissanConnect Services provides various services to support dealing with emergencies of the subscribed vehicle and the driver.

For example, in case of an illness or serious injury, you can seek support by pushing the in-vehicle **<SOS>** button and connecting to the NissanConnect Services Response Center. The NissanConnect Services Response Center can specify the location of the vehicle via GNSS, and the information will be sent to the police or other agencies as needed.

For information about other NissanConnect Services emergency support related services, refer to the NissanConnect Services website or contact the NissanConnect customer support line.

**NissanConnect Services website:**

[www.nissan.com.mx/connect](http://www.nissan.com.mx/connect)

**NissanConnect customer support line:**

01-800 9647726



**WARNING:**

- **Please note that the Automatic Collision Notification service (if equipped) and Emergency Call function cannot be used in the following conditions:**
  - **Emergency functions and services will not be available without a paid subscription to NissanConnect Services.**
  - **The NissanConnect Services network system is disabled.**
  - **The vehicle moves outside the service area where the TCU (Telematics Control Unit) is connected to the system.**
  - **The vehicle is outside the area where the cellular network service is receivable.**
  - **The vehicle is in a location with poor signal reception such as tunnels, underground parking garages, behind buildings or in mountainous areas.**
  - **The line is busy.**
  - **The TCU (Telematics Control Unit) or other systems of your vehicle are not working properly.**
  - **It may not be possible to make an emergency call depending on the severity of a collision and/or**

emergency.

- Park the vehicle in a safe location and set the parking brake before operating <SOS>.
- Only use this service in case of an emergency. There may be a penalty for inappropriate use of the service.
- Radio waves could adversely affect electric medical equipment. Individuals who use a pacemaker should contact the device manufacturer regarding any possible effects before using the system.
- The TCU (Telematics Control Unit) antenna is installed inside the upper central part of the instrument panel. An occupant should not get any closer to the antenna than specified by the pacemaker manufacturer. The radio waves from the TCU antenna may adversely affect the operation of the pacemaker while using the NissanConnect Services.

## Making an emergency call



The <SOS> is located near the map light.

1. Push <SOS>.
2. When the line is connected, speak to the Response Specialist.

If you want to cancel the emergency call, push and hold <SOS> for a few seconds.

### INFO:

- If there is a cover on <SOS>, open the cover first.
- After <SOS> is pushed, it may take some time until the system initiates connection, depending on the technical environment and whether the TCU (Telematics Control Unit) is being used by other services.
- An indicator light on <SOS> shows the readiness of the emergency support system. If the indicator light is not illuminated, pushing <SOS> does not

connect your vehicle to the Response Specialist.

The indicator light blinks while connected to the NissanConnect Services Response Center.

- Even when the indicator light is illuminated, connection to the NissanConnect Services Response Center may not be possible. If this occurs in an emergency situation, contact the authorities by other means.
- To avoid disconnecting the line, do not turn off the engine, hybrid system or e-POWER system.

## NISSANCONNECT SERVICES SETTINGS

The NissanConnect Services setting can be changed. Available menus may vary depending on models, specifications and software versions. Menus displayed on the screen may not function depending on various conditions.

1. Push **<MENU>**.
2. Touch [Info] on the Launch Bar.
3. Touch [NissanConnect Services].
4. Touch [NissanConnect Services Settings].



### INFO:

[NissanConnect Services Settings] can also be accessed from [NissanConnect Services] on the settings screen.

"Settings menu" (page 2-11)

Menu		Action
[Delete All Information Feed History]		Deletes contents of information feeds.
[Vehicle Data Sharing]	[Share Vehicle Information]	Turns the vehicle information sharing function on/off.
	[Delete Shared Vehicle Data]	Deletes the shared vehicle information.
[Unit ID Information]		Displays the Unit ID, TCU (Telematics Control Unit) ID, SIM ID and VIN Information necessary for user registration.
[Reset all NissanConnect Svcs. Settings to Default]		All NissanConnect Services settings are returned to default.
[Vehicle Data Transmission Setting]		When [OK] is touched, data transmission to the NissanConnect Services Data Center is enabled. Touch [Decline] to disable the NissanConnect Services, Premium Traffic, etc.

## Apple CarPlay (if equipped)

### WARNING:

- **Stop your vehicle in a safe location and apply the parking brake before connecting your iPhone to the vehicle or operating your connected iPhone for setup.**
- **If you are unable to devote full attention to vehicle operation while using Apple CarPlay, pull off the road to a safe location and stop your vehicle.**

You can use Apple CarPlay by connecting a compatible iPhone to your vehicle via a USB cable.

To connect your iPhone with the in-vehicle system, it is recommended to use the Apple Lightning cable (Mfi certified) that was provided with your iPhone.

With Apple CarPlay, your in-vehicle system can be used as a display and a controller for some of the iPhone functions. Apple CarPlay features Siri which enables operations via voice controls. Visit [apple.com](http://apple.com) for information about the functions that are available and details about Apple's privacy policy.

Certain vehicle information (e.g. location and speed) may be shared with your device while Apple CarPlay is in use. Carrier charges may apply to use Apple CarPlay.

### COMPATIBILITY

Refer to the Apple website for compatible devices.

### INFO:



- In some countries, iPhone in the market may not be supported by Apple CarPlay.
- For best results, always update your device to the latest software version.
- Apple CarPlay will take the place of your Bluetooth® audio and Bluetooth® hands-free phone functionality.
- Phone menu and access to the connected phone through Voice Recognition System (if equipped) will be disabled while Apple CarPlay is connected. To access your phone, use the Siri function or select the phone icon in the Apple CarPlay top menu screen.

### Apple CarPlay OPERATION

1. Connect the iPhone to the USB connection port.
  -  "USB (Universal Serial Bus) connection port and AUX (auxiliary) input jack" (page 2-8)
2. Depending on the setting, a Startup Information screen will appear. Touch [Yes]/[Apple CarPlay] to use Apple CarPlay.

### INFO:

If you do not wish to display the Startup Information screen each time you activate Apple CarPlay, turn on [Don't Ask Any More]/[Don't Ask Any More] on the Startup Information screen. The Startup Information screen will not be displayed from the next Apple CarPlay activation. The Startup Information screen can be set to appear again in the Apple CarPlay setting menu.

-  "Apple CarPlay settings" (page 5-18)
3. The Apple CarPlay screen will appear. The iPhone functions displayed on the screen should now be operable using the in-vehicle system.
4. To return to the Apple CarPlay top menu screen after detailed operation, touch  on the lower corner of the Apple CarPlay screen.
5. To exit the Apple CarPlay screen, push the buttons such as **<MENU>** on the control panel or **<MODE/OK>** (if equipped) on the steering column and display the corresponding screen.

### INFO:

Touching [Nissan] (if equipped) on the Apple CarPlay screen can also exit from the Apple CarPlay screen.

6. To return to the Apple CarPlay screen, take one of the following actions.



- Touch [CarPlay] on the Launch Bar.
- Touch [Apps]/[Smartphone Connection] on the information screen, and then touch [Apple CarPlay].

### INFO:

When your iPhone is locked, Apple CarPlay can still be activated by operating the iPhone and allowing Apple CarPlay activation when asked.



### Siri operation

With Siri, some of the functions in your iPhone can be voice controlled.



Make sure that Siri on your iPhone is turned on.

#### Activation:

Perform one of the following operations to start a Siri session.

- **Models with Voice Recognition System:**  
Push and hold <  > (if equipped) on the steering wheel.
- **Models without Voice Recognition System:**  
Push <  > on the steering wheel.
- Touch and hold [] at the lower corner of the Apple CarPlay screen.

### INFO:

- Push <  > (if equipped) or touch [] to end Siri operation.
- Keep the interior of the vehicle as quiet as possible. Close the windows to eliminate the surrounding noises (traffic noises, vibration sounds, etc.), which may prevent the system from recognizing the voice commands correctly.
- For functions that can be used with Siri, please refer to the Apple website.

### Phone operation

If you wish to use make a call with Apple CarPlay, follow the procedure below:

1. Touch [Phone] on the Apple CarPlay top menu.
2. Operate the screen displayed to make a call, etc.

## Apple CarPlay SETTINGS

1. Touch [Apps] on the setting menu screen.

 "System settings" (page 2-11)

2. **Type A:**

Touch [Apple CarPlay].

**Type B:**

A list of devices is displayed.

Touch  by the name of the Apple CarPlay device you wish to change the setting.

### Available items:

Available setting items may vary depending on models, specifications and software versions.

Setting item 1	Setting item 2	Action
[Select Service]	[Apple CarPlay]	Activates Apple CarPlay when an iPhone is connected to the in-vehicle system.
	[Yandex.Auto]	Activates Yandex.Auto (if equipped) when a smartphone is connected to the in-vehicle system.
	[No service]	Apple CarPlay and Yandex.Auto (if equipped) will not activate even if a smartphone is connected to the in-vehicle system.
[Enable after USB Connection:]	[Always]	Activates Apple CarPlay or Yandex.Auto (if equipped) automatically when an iPhone is connected to the in-vehicle system.
	[Ask]	Displays the Apple CarPlay or Yandex.Auto (if equipped) Startup Information screen when an iPhone is connected to the in-vehicle system.
	[Never]	Apple CarPlay will not activate even if an iPhone is connected to the in-vehicle system.
[Nissan's Help for Apple CarPlay]		Displays helpful tips for Apple CarPlay operation.
[Delete]		Deletes registered iPhone from the list.



**INFO:**

- Access to songs on your iPod via in-vehicle voice recognition system (if equipped) will not be available when connected to Apple CarPlay. To access to your iPod music, use the Siri function or select the music icon in the Apple CarPlay top menu screen.
- Depending on the models, specifications and software versions, Apple CarPlay settings can also be accessed from the Connections screen.  
 "Apps settings" (page 2-16)

## Android Auto™ (if equipped)

### Apple CarPlay SYSTEM LIMITATIONS

For all features of Apple CarPlay to operate correctly, it is necessary to have a compatible iPhone, a cellular connection and a data plan.

When Apple CarPlay is operating, system performance is affected by the strength of the cellular connection or performance of the phone itself. If performance of the system decreases:

- Disconnect and reconnect your phone
- Cycle phone power off/on to restart

Changing government regulations may also affect operation of Apple CarPlay.



#### WARNING:

- **Stop your vehicle in a safe location and apply the parking brake before connecting your Android™ phone to the vehicle or operating your connected Android phone for setup.**
- **If you are unable to devote full attention to vehicle operation while using Android Auto, pull off the road to a safe location and stop your vehicle.**

You can use Android Auto by connecting a compatible Android phone to your vehicle via a USB cable. It is also recommended to use the Android phone OEM cable that was provided with your phone.

With Android Auto, your in-vehicle system can be used as a display and a controller for some of the Android phone functions. Voice control of some of the Android phone functions is also possible with Android Auto. Visit [www.android.com/auto](http://www.android.com/auto) for information about the functions that are available and details about Google's privacy policy.

Certain vehicle information (e.g. location and speed) may be shared with your device while Android Auto is in use. Carrier charges may apply to use Android Auto.

### COMPATIBILITY

Refer to the Android Auto website for compatible devices.



#### INFO:

- In some countries, Android phone in the market may not be supported by Android Auto.
- Download the Android Auto App from Google Play™ to Android phone in advance.
- For best results, always update your device to the latest Android software and Android Auto App version. When you connect the Android phone to the in-vehicle system, it will automatically update the Android software and Android Auto App version.
- Android Auto will take the place of your Bluetooth® audio and Bluetooth® hands-free phone functionality.
- When setting a route with the navigation system (if equipped), if you set a destination with Android Auto, the route setting of the navigation system will be cancelled.
- The Phone menu and access to the connected phone through the Voice Recognition System (if equipped) will be disabled while Android Auto is connected. To access your phone, talk to your Google Assistant or select the

phone icon in the Android Auto top menu screen.

## INITIAL Android Auto SETTINGS

Before using Android Auto, the Android Auto App must be downloaded on your Android phone.

Download the Android Auto App from the Google Play store on your Android phone. It may be necessary to operate the Android phone when connected first.

Depending on the selection, such as approval, some of the features of Android Auto are not available.

## Android Auto OPERATION

Unlock your phone's screen before connecting your Android phone.

1. Connect your Android phone to USB connection port.  
 "USB (Universal Serial Bus) connection port and AUX (auxiliary) input jack" (page 2-8)
2. Depending on the setting, a Startup Information screen will appear. Touch [Yes]/[Android Auto] to use Android Auto.

### INFO:

- If you do not wish to display the Startup Information screen each time you activate Android Auto, turn on [Don't Ask Any More]/[Don't Ask Anymore] on the Startup Infor-

mation screen. The Startup Information screen will not be displayed from the next Android Auto activation. The Startup Information screen can be set to appear again in the Android Auto setting menu.

 "Android Auto settings" (page 5-23)

- Your phone's Bluetooth® will be turned on automatically when Android Auto is activated. Keep the Bluetooth® turned on to use the phone functions.
  - Some functions of Android Auto are not available if the Bluetooth® is not connected.
3. The Android Auto top menu screen will appear. The Android phone functions displayed on the screen should now be operable using the in-vehicle system.
  4. To exit Android Auto screen, touch  and touch the key to return to the original screen.

### INFO:

- If the key to return to the original screen does not appear, touch .
- When pushing the buttons, such as **<MENU>** on the control panel or **<MODE/OK>** (if equipped) on the steering column, the

corresponding display to the button is displayed.

5. To return to the Android Auto screen, take one of the following actions.
  - Touch  on the Launch Bar.
  - Touch [Apps]/[Smartphone Connection] on the information screen, and then touch [Android Auto].

### INFO:

- While Android Auto is activated on the Android phone, the phone operations, such as making or receiving calls, can only be done with Android Auto.
- Depending on the device, an Android phone requires MTP mode to be selected in the USB transfer setting.

## Google Assistant™ operation

Some of the functions on your Android phone can be voice controlled when Android Auto is active.

### Activation:

Perform one of the following operations to start a Google Assistant session.



- **Models with Voice Recognition System:**  
Push and hold  (if equipped) on the steering wheel.  
**Models with Voice Recognition System:**

Push <  > on the steering wheel.

- Touch [] on the Android Auto screen.



#### **INFO:**

- Push <  > (if equipped) or touch [] to end voice operation.
- Keep the interior of the vehicle as quiet as possible. Close the windows to eliminate the surrounding noises (traffic noises, vibration sounds, etc.), which may prevent the system from recognizing the voice commands correctly.
- For functions that can be used with the voice operation, refer to [www.android.com/auto](http://www.android.com/auto).

## Phone operation

If you wish to use your phone while Android Auto is activated, follow the procedure below:

1. Touch [] on the Android Auto screen.
2. Operate the screen displayed to make a call, etc.

## Android Auto SETTINGS

1. Touch [Apps] on the setting menu screen.

 "System settings" (page 2-11)

2. **Type A:**

Touch [Android Auto].

**Type B:**

A list of devices is displayed.

Touch  by the name of the Android Auto device you wish to change the setting.

### Available items:

Available setting items may vary depending on models, specifications and software versions.

Setting item 1	Setting item 2	Action
[Select Service]	[Android Auto]	Activates Android Auto when an Android phone is connected to the in-vehicle system.
	[Yandex.Auto]	Activates Yandex.Auto (if equipped) when a smartphone is connected to the in-vehicle system.
	[No service]	Android Auto and Yandex.Auto (if equipped) will not activate even if a smartphone is connected to the in-vehicle system.
[Enable after USB Connection:]	[Always]	Activates Android Auto or Yandex.Auto (if equipped) automatically when an Android phone is connected to the in-vehicle system.
	[Ask]	Displays the Android Auto or Yandex.Auto (if equipped) Startup Information screen when an Android phone is connected to the in-vehicle system.
	[Never]	Android Auto will not activate even if an Android phone is connected to the in-vehicle system.
[Nissan's Help for Android Auto]		Displays helpful tips for Android Auto operation.
[Delete]		Deletes registered Android phone from the list.

 **INFO:**

Depending on the models, specifications and software versions, Android Auto settings can also be accessed from the Connections screen.

 "Apps settings" (page 2-16)



## YANDEX.AUTO POWERED BY BOSCH (if equipped)

### Android Auto SYSTEM LIMITATIONS

For all features of Android Auto to operate correctly, it is necessary to have a compatible Android phone, a cellular connection and a data plan.

When Android Auto is operating, system performance is affected by the strength of the cellular connection or performance of the phone itself. If performance of the system decreases:

- Disconnect and reconnect your phone
- Close all apps and restart them
- Cycle phone power off/on to restart

It should also be confirmed that the latest version of both Android OS and the Android Auto App are installed on the cellular phone.

Functionality of Android Auto may decrease or be lost if there are changes to operating systems, hardware, software or other technologies central to supporting the system that are outside of NISSAN's control. Changing government regulations may also affect the operation of Android Auto.



#### WARNING:

- **Stop your vehicle in a safe location and apply the parking brake before connecting your smartphone to the vehicle or operating your connected smartphone for setup.**
- **If you are unable to devote full attention to vehicle operation while using Yandex.Auto, pull off the road to a safe location and stop your vehicle.**

You can use Yandex.Auto by connecting a compatible iPhone or Android phone to your vehicle via a USB cable. To connect your iPhone with the in-vehicle system, it is recommended to use the Apple Lightning cable (Mfi certified) that was provided with your iPhone. For Android phones, using the OEM cable that was provided with your phone is recommended.

With Yandex.Auto, your in-vehicle system can be used as a display and a controller for some of the smartphone functions. Voice control of some of the smartphone functions is also possible with Yandex.Auto. Visit [yandex.com](http://yandex.com) for information about the functions that are available and details about Yandex's privacy policy.

Certain vehicle information (e.g. location and speed) may be shared with your device while Yandex.Auto is in use. Carrier charges may apply to use Yandex.Auto.

### COMPATIBILITY

Refer to the Yandex website for compatible devices.



#### INFO:

- In some countries, smartphone in the market may not be supported by Yandex.Auto.
- For best results, always update your device to the latest software version.

### INITIAL YANDEX.AUTO SETTINGS

Before using Yandex.Auto, the Yandex.Auto (launcher app) and Yandex.Navigator (navigation app) must be downloaded on your smartphone from the Apple store or Google Play store. Operate the smartphone as necessary to enable Yandex.Auto.

### YANDEX.AUTO OPERATION

1. Connect the smartphone to the USB connection port.  
 "USB (Universal Serial Bus) connection port and AUX (auxiliary) input jack" (page 2-8)
2. Depending on the setting, a Startup Information screen will appear. Touch [Yandex.Auto] to use Yandex.Auto.

 **INFO:**

- If you do not wish to display the Startup Information screen each time you activate Yandex.Auto, turn on [Don't Ask Any More]/[Don't Ask Anymore] on the Startup Information screen. The Startup Information screen will not be displayed from the next Yandex.Auto activation. The Startup Information screen can be set to appear again in the Yandex.Auto setting menu.  
 "Yandex.Auto settings" (page 5-27)
  - Yandex.Auto requires Bluetooth® connection of your phone. Connect your phone's Bluetooth® to use full functions of Yandex.Auto.
3. The Yandex.Auto screen will appear. The Yandex.Auto functions displayed on the screen should now be operable using the in-vehicle system.
  4. To exit the Yandex.Auto screen, push the buttons such as **<MENU>** on the control panel and display the corresponding screen.
  5. To return to the Yandex.Auto screen, take one of the following actions.
    - Touch [Yandex] on the Launch Bar.
    - Touch [Apps]/[Smartphone Connection] on the information screen, and then touch [Yandex.Auto].

 **INFO:**

Please keep your smartphone unlocked when using Yandex.Auto. Depending on the device, an Android phone requires MTP mode to be selected in the USB transfer setting.

### Voice assistant "Alice" operation

With voice assistant "Alice", some of the functions in your smartphone can be voice controlled.

Make sure that voice assistant "Alice" on your smartphone is turned on.

#### Activation:

- Push and hold **< Ⓜ >** (if equipped) on the steering wheel to start a voice assistant "Alice" session.
- Touch [

 **INFO:**

- Push **< Ⓜ >** (if equipped) to end voice assistant "Alice" operation.
- Keep the interior of the vehicle as quiet as possible. Close the windows to eliminate the surrounding noises (traffic noises, vibration sounds, etc.), which may prevent the system from recognizing the voice commands correctly.

## YANDEX.AUTO SETTINGS

1. Touch [Apps] on the setting menu screen.

 "System settings" (page 2-11)

2. A list of devices is displayed.

Touch  by the name of the Yandex.Auto device you wish to change the setting.

### Available items:

Available setting items may vary depending on models, specifications and software versions.

Setting item 1	Setting item 2	Action
[Select Service]	[Apple CarPlay]	Activates Apple CarPlay when an iPhone is connected to the in-vehicle system.
	[Android Auto]	Activates Android Auto when an Android phone is connected to the in-vehicle system.
	[Yandex.Auto]	Activates Yandex.Auto when a smartphone is connected to the in-vehicle system.
	[No service]	Apple CarPlay, Android Auto and Yandex.Auto will not activate even if a smartphone is connected to the in-vehicle system.
[Enable after USB Connection:]	[Always]	Activates Yandex.Auto automatically when a smartphone is connected to the in-vehicle system.
	[Ask]	Displays the Yandex.Auto Startup Information screen when a smartphone is connected to the in-vehicle system.
[Nissan's Help for Yandex.Auto]		Displays helpful tips for Yandex.Auto operation.
[Delete]		Deletes registered smartphone from the list.



### INFO:

Depending on the models, specifications and software versions, Yandex.Auto settings can also be accessed from the Connections screen.

 "Apps settings" (page 2-16)

## Siri Eyes Free (if equipped)

### YANDEX.AUTO SYSTEM LIMITATIONS

For all features of Yandex.Auto to operate correctly, it is necessary to have a compatible smartphone, a cellular connection and a data plan.

When Yandex.Auto is operating, system performance is affected by the strength of the cellular connection or performance of the phone itself. If performance of the system decreases:

- Disconnect and reconnect your phone
- Cycle phone power off/on to restart

Changing government regulations may also affect operation of Yandex.Auto.

Apple Siri Eyes Free personal assistant can be accessed from the vehicle. Siri Eyes Free can be accessed in Siri Eyes Free mode to reduce user distraction. In this mode, Siri Eyes Free is available for interaction by voice control. After connecting a compatible Apple device via Bluetooth®, Siri Eyes Free can be activated by using <  > on the steering wheel.

Siri is a trademark of Apple Inc., registered in the U.S. and other countries.



#### INFO:

- Some Siri Eyes Free functions, such as opening apps, may not be available during driving.
- For best results, always update your device to the latest software version.
- Keep the interior of the vehicle as quiet as possible. Close the windows to eliminate the surrounding noises (traffic noises, vibration sounds, etc.), which may prevent the system from recognizing the voice commands correctly.
- For functions that can be used in Siri Eyes Free, please refer to the Apple website.

### REQUIREMENTS



Visit Apple's website for details about device compatibility.

Siri must be enabled on the phone. Please check phone settings.

If the device has a lock screen, Siri must be accessible from the lock screen. Please check phone settings.

### Siri Eyes Free ACTIVATION

Siri Eyes Free function can be activated using <  > on the steering wheel.

1. Connect a Siri Eyes Free enabled iPhone to the vehicle.  
 "Setting Bluetooth®" (page 2-13)
2. After the Bluetooth® connection is established, push and hold <  > on the steering wheel to activate the Siri Eyes Free function.

### OPERATING Siri Eyes Free

1. Push and hold <  > on the steering wheel.
2. Speak your command and then listen to the Siri Eyes Free reply.

After starting Siri Eyes Free, push <  > on the steering wheel again within five seconds of the end of the Siri Eyes Free announcement to extend the session.

# 6 Navigation (if equipped)

Safety information .....	6-2	Editing route .....	6-23
Navigation screen .....	6-2	Guidance settings .....	6-26
Displaying navigation screen .....	6-2	Viewing traffic information (if equipped) .....	6-27
Launch Bar .....	6-2	RDS-TMC feature (if equipped) .....	6-27
Map operation .....	6-3	Premium Traffic information (if equipped) .....	6-27
Map types .....	6-3	Viewing available traffic information .....	6-27
Road color .....	6-8	Traffic information settings .....	6-29
Moving map .....	6-8	Storing a location/route .....	6-29
Changing scale of map .....	6-8	Storing location .....	6-29
Map settings .....	6-10	Storing route .....	6-30
Traffic information on map (if equipped) .....	6-13	Storing avoid area .....	6-31
Map Menu screen .....	6-13	Editing stored information .....	6-31
Setting destination .....	6-13	Deleting stored item .....	6-35
Basic operations .....	6-13	Navigation settings .....	6-37
Options before starting the route guidance .....	6-16	General information for navigation system .....	6-39
Route guidance .....	6-16	Current vehicle location .....	6-39
About route guidance .....	6-16	Route calculation .....	6-42
Route menu .....	6-17	Route guidance .....	6-43
Route Preference .....	6-20	How to update map data (if equipped) .....	6-44
Recalculating route .....	6-23		

## SAFETY INFORMATION

The navigation system is primarily designed to help you reach your destination. However, you, the driver, must use the system safely and properly. Information concerning road conditions, traffic signs and the availability of services may not always be up to date. The system is not a substitute for safe, proper, and legal driving.



### WARNING:

**Do not rely on route guidance alone. Always be sure that all driving maneuvers are legal and safe in order to avoid accidents.**

## NAVIGATION SCREEN

### DISPLAYING NAVIGATION SCREEN

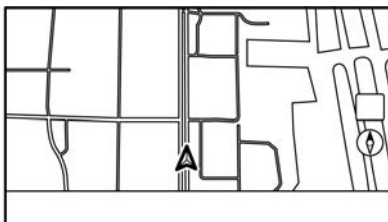

To display the current location map which can be operated, push **<MENU>** and then touch [Map] on the Launch Bar or push **<MAP>**.

### LAUNCH BAR

The Launch Bar related to operating the navigation system is displayed on the current location map screen. Displayed items vary depending on the route settings.

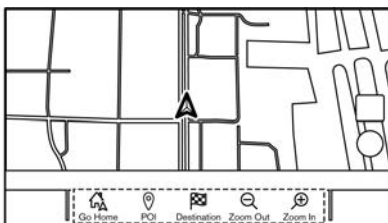

Before setting the destination

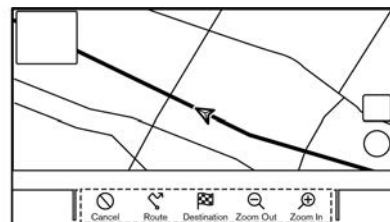

After setting the destination

Menu item	Action
[Add Home]/ [Go Home]	[Add Home]: When the home location is not stored, a home location can be stored in the system. ☞ "Storing home or work location" (page 6-29) [Go Home]: When the home location is stored, sets the home location as a destination.
[POI]	Searches for a Points of Interest to set as a destination.
[Destination]	Displays the destination menu. ☞ "Setting destination" (page 6-13)
[Zoom Out]	Zoom out the map. ☞ "Changing scale of map" (page 6-8)
[Zoom In]	Zoom in the map. ☞ "Changing scale of map" (page 6-8)

## MAP OPERATION

### MAP TYPES

Two types of map views are available: 2D and 3D.

#### 2D map (except for the Middle East)

The 2D map displays the map in a two-dimensional environment similar to a road map.

[Cancel]	Cancels the route guidance.
[Route]	Displays the route menu screen.  "Route menu" (page 6-17)

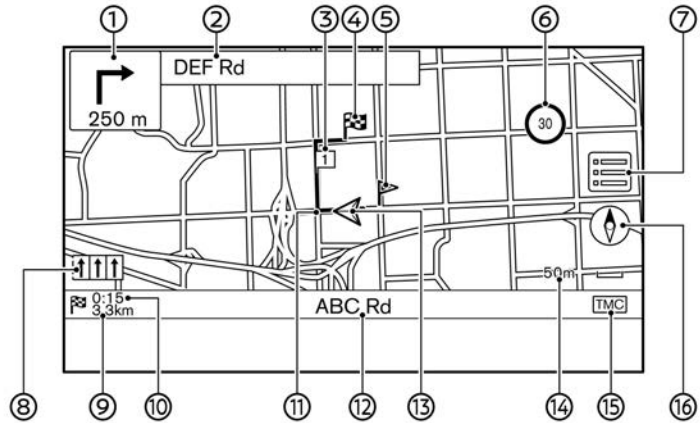

#### Screen information:

①  Arrow and distance:

Indicates the distance to the next guide point and the turning direction at that guide point.

If the current vehicle position is off the road, an arrow indicating the direction to the nearest road may be displayed instead of displaying the next turn arrow/distance.

② Next street name:











Displays the next street name during the route guidance.

③  Waypoint:

Displays the location of the waypoint that the vehicle will stop by before heading to the final destination. A maximum of 20 waypoints can be set.

④  Destination:

Indicates the location of the final destination.

- ⑤ **Stored location:**  
 Displays the locations that are stored in the Address Book.  
 "Storing location" (page 6-29)  
 The icons can be changed according to your preferences.
- ⑥  **Speed limit indicator (if equipped):**  
 Displays the speed limit of the road which the vehicle is on.  
 When the vehicle speed exceeds the limit, the indicator flashes.  
 When the speed limit indicator is not displayed in the unit selected in the Unit settings screen (if equipped), a speed limit in the selected unit may be displayed below the speed limit indicator.  
 The settings for the speed limit indicator can be changed.  
 "Navigation settings" (page 6-37)
- ⑦ :  
 Touch to display the Map Menu.  
 "Map Menu screen" (page 6-13)
- ⑧ **Recommended lane indicator:**  
 When a route is set, the arrow and the recommended driving lane may be displayed depending on the road.  
 Blue: First recommendation  
 White: Secondary recommendation  
 Gray: Not recommended
- ⑨ **Remaining distance to the destination:**  
 Indicates the approximate remaining distance to the destination or the waypoint. This indicator will appear when a destination is set and route guidance is started.
- ⑩ **Remaining time/Time of arrival:**  
 Indicates the remaining time to the destination/waypoint, or it can be set to display the estimated arrival time. This indicator will appear when a destination is set and the route guidance is started.  
 The remaining time or arrival time display can be selected to your preference.  
 "Route Preference" (page 6-20)
- ⑪ **Suggested route:**  
 Appears in bold blue during route guidance.
- ⑫ **Street name:**  
 Displays the name of the street that the vehicle is currently driving on.
- ⑬  **Vehicle icon:**  
 Indicates the current vehicle location and the direction that the vehicle is heading.
- ⑭ **Scale indicator:**  
 Indicates the scale of the map.
- ⑮ **Traffic information reception status indicator (if equipped):**  
 This indicator is displayed in a condition where traffic information can be received.  
 Touch to display the traffic information screen.  
 "Viewing traffic events from list" (page 6-27)  
 [Premium Traffic] (if equipped):  
 Displayed when Premium Traffic information (if equipped) is active and the traffic information is available.  
 "Traffic information settings" (page 6-29)  
 [TMC] (if equipped):  
 Displayed when RDS-TMC (if equipped) is active and the traffic information is available.  
 "Traffic information settings" (page 6-29)
- ⑯ :  
 Indicates the directional setting of the map.  
 Touch to change the map view and the map orientation.



## 2D map (for the Middle East)

The 2D map displays the map in a two-dimensional environment similar to a road map.

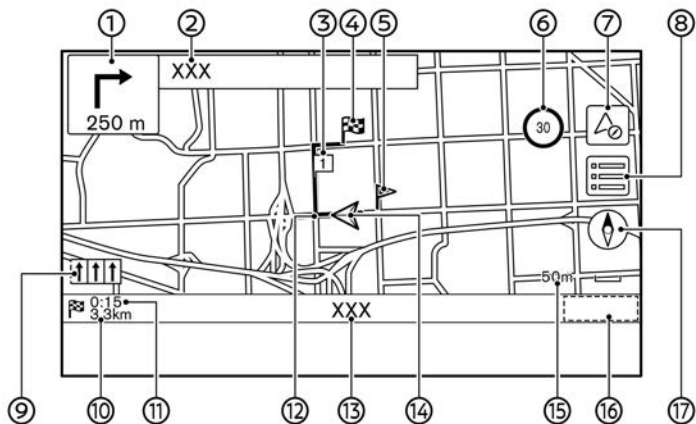









**Example**

The location of the displayed icons and information may vary depending on models, specifications and software versions.

### Screen information:

- ①  Arrow and distance:  
Indicates the distance to the next guide point and the turning direction at that guide point.  
If the current vehicle position is off the road, an arrow indicating the direction to the nearest road may be displayed instead of displaying the next turn arrow/distance.

- ② Next street name:  
Displays the next street name during the route guidance.
- ③  Waypoint:  
Displays the location of the waypoint that the vehicle will stop by before heading to the final destination. A maximum of 20 waypoints can be set.
- ④  Destination:  
Indicates the location of the final destination.

- ⑤ Stored location:  
Displays the locations that are stored in the Address Book.  
 "Storing location" (page 6-29)  
The icons can be changed according to your preferences.
- ⑥  Speed limit indicator:  
Displays the speed limit of the road which the vehicle is on.  
When the vehicle speed exceeds the limit, the indicator flashes.  
The settings for the speed limit indicator can be changed.  
 "Navigation settings" (page 6-37)
- ⑦ :  
Touch to display the compass mode display.  
 "Compass mode display (for the Middle East)" (page 6-7)
- ⑧ :  
Touch to display the Map Menu.  
 "Map Menu screen" (page 6-13)
- ⑨ Recommended lane indicator:  
When a route is set, the arrow and the recommended driving lane may be displayed depending on the road.  
Blue: First recommendation  
White: Secondary recommendation  
Gray: Not recommended

- ⑩ Remaining distance to the destination:

Indicates the approximate remaining distance to the destination or the waypoint. This indicator will appear when a destination is set and route guidance is started.

- ⑪ Remaining time/Time of arrival:

Indicates the remaining time to the destination/waypoint, or it can be set to display the estimated arrival time. This indicator will appear when a destination is set and the route guidance is started.

The remaining time or arrival time display can be selected to your preference.

☞ "Route Preference" (page 6-20)

- ⑫ Suggested route:

Appears in bold blue during route guidance.

- ⑬ Street name:

Displays the name of the street that the vehicle is currently driving on.

- ⑭  Vehicle icon:

Indicates the current vehicle location and the direction that the vehicle is heading.

- ⑮ Scale indicator:

Indicates the scale of the map.

- ⑯ Traffic information reception status indicator:

This indicator is displayed in a condition where traffic information can be received.

Touch to display the traffic information screen.

☞ "Viewing traffic events from list" (page 6-27)

[Premium Traffic] (if equipped):

Displayed when Premium Traffic information (if equipped) is active and the traffic information is available.

☞ "Traffic information settings" (page 6-29)

- ⑰ :

Indicates the directional setting of the map.

Touch to change the map view and the map orientation.

## 3D map

The 3D map displays the map from an elevated perspective. In 3D map, it is easy to recognize an image of the route because it provides a panoramic view over a long distance.

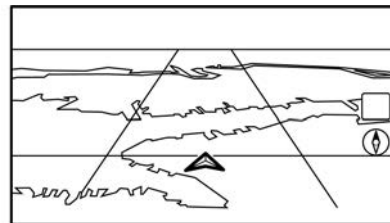

### INFO:

The 3D map always appears with the current forward direction facing up.

## Building graphics

Building graphics are stored in the map data for certain areas, and can be displayed when the map is zoomed in.

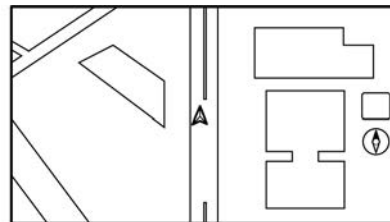

**2D building graphics**

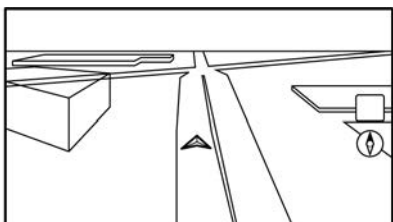

3D building graphics (if equipped)



**INFO:**

In an area where the building graphics are not stored in the map data, the normal map is displayed even when the map is zoomed in.

Compass mode display (for the Middle East)

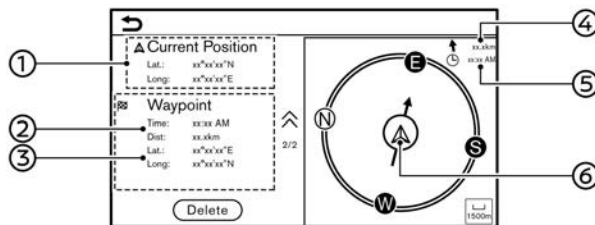

The compass mode can be useful in areas such as deserts where there are no roads or where the area information is not included in the map data. This mode helps the driver to get to the destination by showing the current vehicle location at the center of the map.

Touch  on the map screen to switch to the compass mode screen.

- ① Latitude/longitude of current location
- ② Estimated time of arrival and distance to waypoint/destination
- ③ Latitude/longitude of waypoint/destination
- ④ Direction and straight distance to the destination
- ⑤ Estimated time of arrival at the destination

- ⑥ Current vehicle location and the direction to waypoint/destination

If no destination has been set, only the latitude and longitude of the current location are displayed.



**INFO:**

- When the compass mode is active, route guidance will not be provided.
- Touch [Delete] to delete the information of waypoint/destination. Once deleted, the deleted information cannot be displayed again.
- Details of this function are subject to change.

## ROAD COLOR

The road types are differentiated by color.

### Except for Mexico:

Color	Road type
Yellow and red outline	Motorway
Red or orange	Main road
Yellow or white	Narrow street

### For Mexico:

Color	Road type
Dark red	Freeway
Light brown	Major road
Light green	Secondary road
White	Local road

## MOVING MAP

The map can be scrolled by the touch panel operations. Map scrolling operations may be limited while driving.

### Touch:

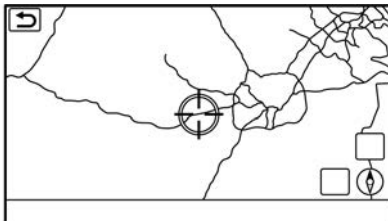

When a point on the map is touched, the cross pointer is displayed and the position touched is moved to the center of the screen.

After moving the map, touch [↵] on the map screen or push <MAP> to display the current location map screen.

### Long touch:

Touch the direction to move to. The map continues to scroll while the screen is touched.

### Drag:

Drag the screen to scroll the map.

### Swipe/flick:

Swipe or flick the screen to scroll the map screen quickly.



### INFO:

Sliding the slide switch on the Display Commander (if equipped) can also operate the map.

## CHANGING SCALE OF MAP

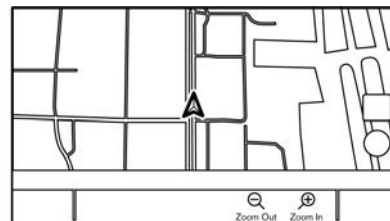

To change the map scale, touch [Zoom Out] or [Zoom In] on the Launch Bar.

### Other operations:

- While the cross pointer is displayed, the scale bar can be displayed by touching the scale indicator on the map.  
Touching [⊖] or [⊕] on the scale bar can change the map scale while the scale bar is displayed.
- Turning the center dial on the Display Commander (if equipped) can also change the map scale.
- Depending on the models, rotating <TUNE SCROLL/SOUND>/<TUNE SCROLL/ENTER SOUND>/<TUNE SCROLL/OK>/<⊖ /ENTER SOUND>/<⊕ /SOUND>/<⊖ /OK>/ (if equipped) can also change the map scale.
- While the cross pointer is displayed, pinching in or out with your fingers on

the map screen can also change the map scale.

Free Zoom:

Depending on the models and setting, rotating **<TUNE SCROLL/SOUND>/<TUNE SCROLL/ENTER SOUND>/<TUNE SCROLL/OK>/<⏪ /ENTER SOUND>/<⏪ /SOUND>/<⏪ /OK>** (if equipped) to change the map scale may adjust the scale normally, or it may engage the free zoom (finer scale adjustment in smaller steps).

 "Map settings" (page 6-10)

### **INFO:**

- While driving, pinch-in and pinch-out operations may be disabled.
- Depending on the map scale, traffic information icons cannot be displayed on the map screen.  
 "Traffic information on map" (page 6-28)

## MAP SETTINGS

The setup for the map view is performed from the Map Menu on the touch screen display.

1. Touch  on the current location map screen.
2. Touch [Map Settings].

Available setting items may vary depending on models, specifications and software versions.

Menu item		Action
[Dual Map View]	[2D Map]	Displays 2D map.
	[3D Map]	Displays 3D map.
	[Split: 2D Map]	Displays 2D map on both left and right side of the split screen. You can see the different scale and settings of 2D maps at the same time.
	[Split: 3D Map]	Displays 2D map on the left side and 3D map on the right side of the split screen.
[Left Side Info]	[Intersection]	Displays the enlarged view of the next intersection on the left side of the screen during route guidance.
	[Turn List]	Displays the turn list on the left side of the screen when a route is set.
	[Drive Report]	Displays your eco drive report on the left side of the screen.
	[Full Map]	Displays full map screen.
[Map Icons]		Select the categories of POI icons to display on the map screen.
[More Settings]/ [Others]	[Map Orientation]	The map orientation can be selected from [North Up] or [Heading Up]. [Map Orientation] is available only when 2D map is displayed.
	[Long Range]	The position of the vehicle icon is located slightly lower than the center of the screen to view a wider area in the traveling direction. Long Range is available only when the map view is in [Heading Up] mode.

Menu item		Action
[Left Split Map Settings]	[Map Orientation]	The map orientation for the left side of split screen can be selected from [North Up] or [Heading Up].
	[Long Range]	With this item turned on, the vehicle position icon on the left screen will be located slightly lower than the center of the screen so that a wider area in the traveling direction can be viewed. Long Range Map View is available only when the left side of split screen is in [Heading Up] mode.
	[Map Scale]	Sets the map scale of the left screen.
[Audio Display on Map]		Turns on/off the audio information displayed at the top of the map screen.
[Map Colour]/[Map Color]		Sets map color from [Standard], [Emphasise Roads]/[Emphasize Roads], [Emphasise Text]/[Emphasize Text] and [Emphasise Traffic]/[Emphasize Traffic] (if equipped).
[Map Text Size]	[Large]	Sets the font size of the text displayed on the map screen.
	[Medium]	
	[Small]	
[Select Text to Display on Map]	[Place Names]	Allows place, facility and road names to be displayed on the map screen.
	[Facility Names]	
	[Road Names]	
[Map Scrolling Information]		Information about the location, on which the center of the cross pointer is placed by scrolling on the map, can be set to be displayed.

Menu item		Action	
	[Tracking Dots Displayed on Map]	[Record & Show Tracking Dots on Map]	Turns the route tracking dots display on/off.
		[Tracking Dot Distance]	Select the interval between tracking dots.
		[Delete Track to Current Location]	Deletes the route tracking dots up to the current location.
	[Small Step Zoom with Dial]		Sets the free zoom function on/off. When this setting is on, it is possible to adjust the scale in smaller steps than with normal scale adjustment.
	[Show all M-way Exits on Route]/[Show all Freeway Exits on Route]		Turns on/off the motorway exit information display.
	[Auto. Show Turn List on M-way]/[Auto. Show Turn List on Freeway]		The turn list can be displayed automatically while driving on a motorway.
	[North Up when Zoomed Out]		When this setting is turned on, the orientation of the map is automatically changed to [North Up] when the widest map scale is selected.
[Back to Map]		Back to the current location map.	



## SETTING DESTINATION

### TRAFFIC INFORMATION ON MAP (if equipped)

Traffic information can be displayed on the map.

☞ “Traffic information on map” (page 6-28)

### MAP MENU SCREEN

Touch  while the current location map screen or a scrolled map screen is displayed to display the menu corresponding to that screen.

This menu can be used to quickly access helpful functions, such as setting a destination or searching for points of interest nearby.

The system can provide route guidance once a destination is set.

### BASIC OPERATIONS

#### Displaying destination setting menu

There are several methods that can be used to set a destination. Select a preferred method for finding and setting a destination.

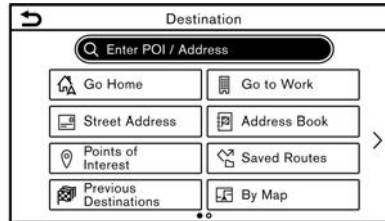

#### Example

Push **<MAP>** and then touch [Destination] on the Launch Bar.

Availability of the destination setting methods varies depending on the models, specifications and software versions. Items displayed on the screen may not function depending on various conditions.

**Available destination setting methods:**



<b>Setting item</b>	<b>Action</b>
[Enter POI / Address]	Searches for a destination by inputting the address or POI names.
[Go Home]	Searches for a route from the current location to the previously stored home location.
[Street Address]	Searches for a destination by address.
[Points of Interest]	Searches for a destination from various categories.
[Previous Destinations]	Searches for the destination from the previous destinations and a previous start point.
[Go to Work]	Searches for a route from the current location to the previously stored work location.
[Address Book]	Searches for a destination from the vehicle Address Book.
[City Centre]/[City Center]	Sets the center of a city as the destination.
[Intersection]	Sets an intersection as a destination.
[Phone Number]	Searches for a point of interest by a phone number.
[Destinations by Google]	Sets a place searched by Google as a destination.
[Saved Routes]	Sets a route from the saved route data.
[By Map]	Searches for a destination by map.
[SXM Travel Link]	This function cannot be used outside the USA and Canada.
[Latitude/Longitude]	Sets a destination from latitude and longitude.
[Door to Door Navigation]/[Smartphone Navigation]	Turns on/off Door to Door Navigation.

 **NOTE:**

**Notice for Point of Interest search:**

**Locations and business hours of facilities are subject to change, which may not be reflected in the map data. Double-check this information before you go to an emergency facility to ensure that you can receive the proper support. Otherwise, you may not receive emergency help when you arrive at the destination. A confirmation message also appears on the navigation screen. Follow the displayed instructions and check the items required.**

 **INFO:**

- After setting a destination, the location of the destination can be adjusted and the location can be stored in the Address Book, etc.  
 "Options before starting the route guidance" (page 6-16)
- The destinations can be canceled and edited/added.  
 "Route menu" (page 6-17)

## OPTIONS BEFORE STARTING THE ROUTE GUIDANCE

Before starting the route guidance, select menus for route details to modify the route, preview the turn list, or store the route.

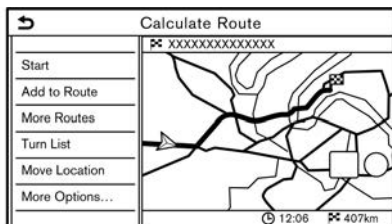

- [Start]: Starts route guidance to the selected destination.
- [Add to Route]: Adds a location to the route previously set.
- [More Routes]: Suggests alternative routes.

### INFO:

Touch [1 Type]/[1type] to display alternative routes calculated with a route search condition selected on the [Basic Route Type] setting screen.

 "Route Preference" (page 6-20)  
Touch [3 Types]/[3types] to display alternative routes calculated in all three route search conditions ([Fastest], [ECO]/[Eco]

and [Shortest]).

- [Turn List]: Displays a detailed turn list. The map can be displayed and the turn can be avoided by touching a turning point.
- [Move Location]: Displays a map screen and allows the location of the destination to be adjusted.
- [More Options...]: Option such as viewing place information and saving locations/routes can be selected.

## ROUTE GUIDANCE

### ABOUT ROUTE GUIDANCE

After setting the route, select [Start] to start the route guidance.

During route guidance, the system navigates you through the guide points using visual and voice guidance.



### WARNING:

- **The navigation system's visual and voice guidance is for reference purposes only. The contents of the guidance may be inappropriate depending on the situation.**
- **Follow all traffic regulations when driving along the suggested route (e.g., one-way traffic).**  
 "Route guidance" (page 6-43)

### Voice guidance during route guidance

#### Basics of voice guidance:

Voice guidance announces which direction to turn when approaching an intersection for which a turn is necessary.



### INFO:

- There may be some cases in which voice guidance and actual road conditions do not correspond. This may occur because of discrepancies between the actual road and the infor-

mation on the map data, or may also be due to the vehicle speed.

- In case voice guidance does not correspond to the actual road conditions, follow the information obtained from traffic signs or notices on the road.
- When approaching a guide point (intersection or corner) or destination/waypoint during route guidance, voice guidance announces the remaining distance and/or turning direction. Push and hold **<MAP>** to repeat voice guidance.

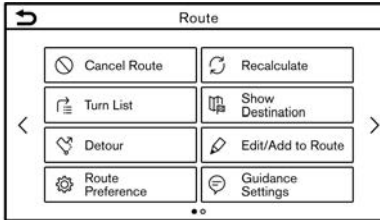

### Example

Push **<MAP>** when a destination is set, and then touch [Route] on the Launch Bar.

The route menu screen is displayed.

## ROUTE MENU



### WARNING:

**Always stop the vehicle in a safe location before modifying the route conditions. Modifying the route conditions while driving may cause an accident.**

During route guidance, the route conditions can be modified and the route information can be confirmed. Set route conditions according to your personal preference.

## Available settings

Menu item		Result
[Cancel Route]		Cancels the current route guidance.
[Turn List]		Displays the details of the suggested route.
[Detour]		A detour of a specified distance can be calculated.
[Route Preference]		Set the route search conditions.
[Recalculate]		Manually search for the route again after changing the search conditions, etc. and have the system calculate a route.
[Show Destination]	[Move Location]	Displays a map screen and allows the location of the destination to be adjusted.
	[Nearby POIs]	Search for points of interest near the destination, such as restaurants and gas stations, etc. The location can be set as a destination or a waypoint.
	[Save Location]	Save the destination in the Address Book.
[Edit/Add to Route]		A destination or waypoint can be edited/added to a route that has already been set.
[Guidance Settings]		Various guidance settings can be customized.
[Save Route]		The current route (a destination and waypoints) can be saved. A maximum of 10 routes can be saved. The saved routes can easily be recalled for future use. Saved route includes only the location information, not the route itself. Route may vary depending on the traffic information (if equipped) or other conditions.
[Map Scroll]		Displays the current map screen which can be scrolled to confirm the location of the destination, waypoints, route, etc.

[Simulation]

Simulates the route guidance. This function provides a detailed image of the route with voice guidance.

The following operations are available:

[ || ]: Pauses the simulation.

[ ▶ ]: Resumes the simulation.

[ ■ ]: Ends the simulation.

: Increases the play speed.

: Decrease the play speed.

## ROUTE PREFERENCE

It is possible to set the conditions of the route search.

1. Touch [Navigation] on the setting menu screen.  
 "System settings" (page 2-11)
2. Touch [Route Preference].
3. Touch the item you would like to set.

Available items may vary depending on models, specifications and software versions.

Setting Item		Action	
[Basic Route Type]	[Fastest Route]	Prioritizes the use of fastest route.	
	[Energy-Saving]	Prioritizes a route which uses less energy.	
	[Shortest Distance]	Prioritizes the shortest route. The route may not be the shortest because the system prioritizes roads that are easy to drive on for safety reasons.	
[Other Routing Choices]	[Minimise Motorways]/[Minimize Freeway]		Minimizes the use of motorways.
	[Minimise Toll Roads]/[Minimize Toll Roads]		Minimizes the use of toll roads.
	[Time Restricted Roads]	[Use Restriction Info]	Calculates route taking time restriction information into consideration.
		[Do Not Use Restriction Info]	Calculates route without taking time restriction information into consideration.
		[Avoid]	Calculates route avoiding the use of time restricted roads.
	[Seasonal Restricted Roads]	[Use Restriction Info]	Calculates route taking seasonal restriction information into consideration.
		[Do Not Use Restriction Info]	Calculates route without taking seasonal restriction information into consideration.
		[Avoid]	Calculates route avoiding the use of seasonal restricted roads.



	[Use Traffic Information]	[Auto]	Calculates the route automatically taking traffic information into consideration.
		[Accept]	If a traffic jam or incident occurs, a confirmation screen will appear before calculation.
		[OFF]	Calculates the route without taking traffic information into consideration.
	[Use Avoid Area Settings]		When enabled, the system avoids the previously defined avoid areas.
	[Use Ferries]		Includes the use of ferries.
	[Use Car-Carrying Trains]		Includes the use of car-carrying trains.
	[Use Unpaved Roads]		Includes the use of unpaved roads.
	[Use HOV Lanes]		This function cannot be used outside the USA and Canada.
	[Use Learned Routes]		Uses the roads that are most frequently traveled with the help of self-learning technology.
[Customise More Routes]/[Customize More Routes]	[3 Types]/[3types]		Calculates 3 types of route when confirming other routes.
	[1 Type]/[1type]		Calculates routes with a route search condition selected on the [Basic Route Type] setting screen.  "Route Preference" (page 6-20)
[Estimated Time]	[Destination]		Displays the estimated time of arrival or remaining time to the destination during route guidance.
	[Waypoint]		Displays the estimated time of arrival or remaining time to the waypoint during the route guidance.
[Time Shown on Map]	[ETA]		Displays the estimated time of arrival.
	[Remaining]		Displays the remaining time to arrival.

**INFO:**

- [Route Preference] can also be accessed from route menu screen.
- If the vehicle greatly deviates from the suggested route, the system calculates a new route.
- Traffic jam information (if equipped) displayed on the map screen is not statistical traffic information.
- If [Do Not Use Restriction Info] is selected for [Time Restricted Roads] setting, the system calculates a route without any consideration of the regulations concerning the time or day of the week. Therefore, the suggested route may include a road subject to traffic regulations concerning the time or day of the week. When driving along the route, always follow all traffic regulations regardless of whether [Time Restricted Roads] is set to be considered or not.
- The system calculates to reduce the time required for the entire route from the start to the destination. If there are no appropriate routes, the system may lead to a route where a traffic jam occurs instead of leading to a detour.
- The system may not lead to a detour if the traffic closure or a traffic jam occurs far from the present location.

## RECALCULATING ROUTE

A route can be manually searched again after changing the search conditions, etc.

1. Push **<MAP>** and then touch [Route] on the Launch Bar.
2. Touch [Recalculate]. A message is displayed and the route is recalculated.
3. Touch [Start] or conduct other operations as necessary.  
 "Options before starting the route guidance" (page 6-16)



### INFO:

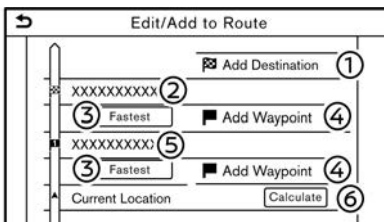

- When a waypoint has been set on the route, the system will search for only one route, even if route recalculation is performed.
- When the vehicle deviates from the suggested route, the route from the current location to the destination is automatically searched again by the Auto Reroute function.

## EDITING ROUTE



1. Push **<MAP>** and then touch [Route] on the Launch Bar.
2. Touch [Edit/Add to Route].
3. Edit the following settings and touch [Calculate].

### Available settings

- ① [Add Destination]:  
Touch to add a new destination.
- ② Current destination:  
Touch to edit or delete the destination.  
 "Editing/deleting destination or waypoint" (page 6-24)
- ③ Criteria for calculating a route to the destination/waypoint:  
Touch to change the conditions for route calculation.  
 "Changing route calculation conditions" (page 6-24)
- ④ [Add Waypoint]:  
Touch to add a waypoint.  
 "Setting destination or waypoint"

(page 6-23)

- ⑤ Current waypoint:  
Touch to edit or delete the waypoint.  
 "Editing/deleting destination or waypoint" (page 6-24)
- ⑥ [Calculate]:  
After editing the route, touch to recalculate a route with new conditions.

## Setting destination or waypoint

A destination or waypoint can be added to a route that has already been set. Up to 20 waypoints besides one destination can be set.

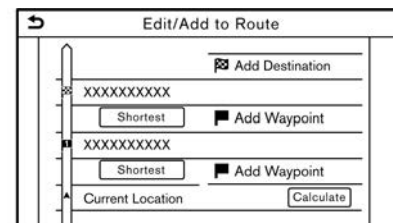

1. Push **<MAP>** and then touch [Route] on the Launch Bar.
2. Touch [Edit/Add to Route].



3. Touch [Add Destination] or [Add Waypoint].

**INFO:**

If [Add Destination] is selected, the current destination changes to a waypoint.

4. Set a destination or waypoint. The method of searching for a waypoint is the same as the one for a destination.  
 "Setting destination" (page 6-13)
5. Touch [Add to Route] to add the location to the route.
6. The route information with the selected location added to the route is displayed. Adjust the route calculation conditions as necessary.  
 "Changing route calculation conditions" (page 6-24)
7. Touch [Calculate] to confirm the route change. The route will be recalculated.

**INFO:**

The prior route will be deleted automatically.

## Editing/deleting destination or waypoint

A destination or waypoint that has already been set can be modified or deleted.

1. Push **<MAP>** and then touch [Route] on the Launch Bar.
2. Touch [Edit/Add to Route].
3. Touch a destination or waypoint that is already set.

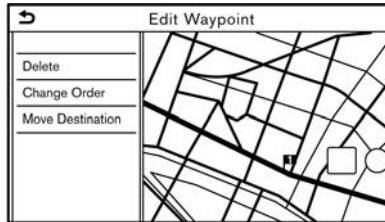

**Example**

4. Touch to edit the following settings:

### Available settings

- [Delete]:  
A selected destination or waypoint that has already been set can be deleted.
- [Change Order]:  
The order of a destination and waypoints that are already set can be changed.
- [Move Destination]/[Move Dest.]:  
The location of the destination or

waypoint can be adjusted by moving the cross pointer across the map on the touch screen display.

5. Touch [Calculate] to apply the change.

**INFO:**

If the destination is deleted, the route guidance will be canceled.

## Changing route calculation conditions

Each section of the route between waypoints can have different route calculation conditions.

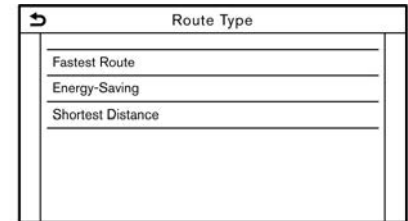

**Example**

1. Push **<MAP>** and then touch [Route] on the Launch Bar.
2. Touch [Edit/Add to Route].
3. Touch the route condition shown on the preferred section of the route to the destination or waypoint.
4. Touch the preferred condition.  
 "Route Preference" (page 6-20)  
The conditions are changed and the

display returns to the edit route screen.

5. Touch [Calculate] to apply the change.

 **INFO:**

The recalculated route may not be the shortest route because the system prioritizes roads that are easy to drive on for safety reasons.

## Changing order of destination and waypoints

The order of a destination and waypoints that are already set can be changed.

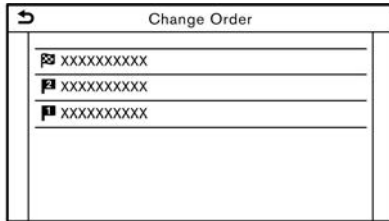

1. Push **<MAP>** and then touch [Route] on the Launch Bar.
2. Touch [Edit/Add to Route].
3. Touch a destination or waypoint that is already set.
4. Touch [Change Order].
5. Touch a preferred destination or waypoint to replace the previously selected destination or waypoint.

6. Touch [Calculate] to apply the change.

## GUIDANCE SETTINGS

Various settings are available to customize the guidance information provided by the system.





1. Touch [Navigation] on the setting menu screen.  
 "System settings" (page 2-11)
2. Touch [Guidance Settings].
3. Touch an item you would like to set.

Available items may vary depending on models, specifications and software versions.

Setting item	Action
[Guidance Volume]	Adjusts the volume level of voice guidance.
[Guidance Voice]	Activates or deactivates voice guidance.
[Traffic Announcement]	Activates or deactivates the traffic announcement. When this item is activated, the system provides an announcement of traffic information or events on the route. The indicator illuminates if traffic announcement is activated.
[Toll Booth Guide]	Activates or deactivates the function to notify that the vehicle is approaching a toll booth.



### INFO:

- [Guidance Settings] can also be accessed from the route menu screen.  
 "Route menu" (page 6-17)
- Even when [Traffic Announcement] is turned on, the traffic information is not announced in the area where traffic information is not broadcast.
- The guidance volume can also be adjusted by turning <VOL/  >/<VOLUME/  >, pushing <  > (if equipped) on the steering wheel or pushing <  > (if equipped) on the steering column from behind while voice guidance is being announced.

## VIEWING TRAFFIC INFORMATION (if equipped)

Two types of traffic information are available on this system, RDS-TMC (Radio Data System - Traffic Message Channel) (if equipped) and Premium Traffic information (if equipped).

To activate RDS-TMC (if equipped), set [Use Premium Traffic] (if equipped) off.

To activate Premium Traffic information (if equipped), set [Use Premium Traffic] on.  "Traffic information settings" (page 6-29)

### RDS-TMC FEATURE (if equipped)

The navigation system receives traffic information from the best available sources and enables the RDS-TMC to broadcast this information for the best possible guidance. The RDS-TMC broadcast is fed by a dedicated FM tuner so that you can still listen to the radio while Traffic Information is being broadcast. Traffic information can be displayed only in areas where RDS-TMC is broadcast. Traffic information is not available in some areas.

### PREMIUM TRAFFIC INFORMATION (if equipped)

Real-time traffic information can also be obtained from Premium Traffic information with more street coverage.

The types of event displayed on the screen are the same as RDS-TMC Information (if equipped).

Premium Traffic information is available

by turning [Use Premium Traffic] on and connecting a Wi-Fi device (if equipped) or connecting a smartphone through Wi-Fi (if equipped).

 "Traffic information settings" (page 6-29)

### INFO:

For models with Door to Door Navigation, you can also use Premium Traffic information when a Door to Door Navigation enabled smartphone is connected to the vehicle.

## VIEWING AVAILABLE TRAFFIC INFORMATION

### Viewing traffic events from list

1. Push **<MENU>** and then touch [Info] on the Launch Bar.
2. Touch [Traffic Information] or [Premium Traffic]. A list of available types of information is displayed.

Available items	Function
[Show Traffic on the Route]	Displays a list of traffic information found on the route from the current vehicle location to the destination. Available only when a route is set.
[Nearby Traffic Info]	Displays a list of available traffic information around the current vehicle location.

### INFO:

[Traffic Information] or [Premium Traffic] is available only when the traffic information is received.

3. Touch the preferred item. A list of available events are displayed.

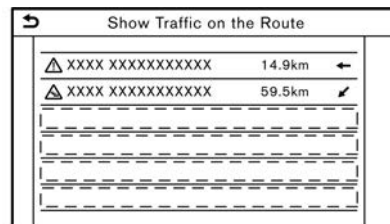

4. Touch an event from the list to check the detailed information and the map. Touch [Avoid] to search for an alternate route.

## Displaying urgent traffic information

When an urgent event is found around the current vehicle location, a message pops up automatically on the touch screen display with a voice announcement.

The message includes the icon, event type, event information and the direct distance from the current location to the event.

**INFO:**

- When there are multiple urgent events, the event with the shortest direct distance from the current location is displayed.
- If the urgent event is on the recommended route, and if a detour is found, the detour route notification screen is displayed when the vehicle approaches the detour point.

**Traffic information on map**

Traffic information is displayed on both 2D and 3D map screens.

**Screen information**

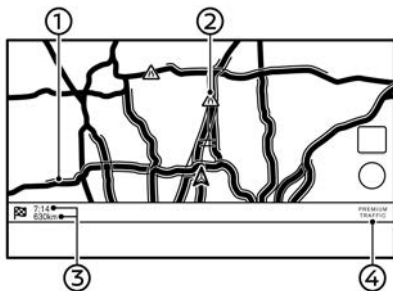

**Example**

- ① Road conditions:

Free Flow	Green
Slow traffic	Yellow
Heavy traffic	Red
Road closed and section affected by serious traffic event	Orange and white stripes
Queuing traffic	Orange (Premium Traffic information (if equipped) only)

- ② Traffic information icon:

If a route is not already set, all of the traffic information icons on the map screen are displayed in gray. When a route is already set, the icons on the route are displayed in color, and the icons outside the route are displayed in gray.

**Except for Mexico:**

	Stationary traffic
	Slow traffic
	Free flowing traffic
	Stretch is closed
	Accident
	Roadworks
	Narrow lanes
	All other events

**For Mexico:**

	Traffic jam
	Slow traffic
	Traffic flowing freely
	Road closed
	Accident
	Road work
	Narrow lanes
	All other events

- ③ Remaining distance and time:

Remaining distance and time calculated with consideration of traffic information on route.

Whether to display the remaining time to the destination or estimated arrival time at the destination can be selected.

"Route Preference" (page 6-20)

- ④ Traffic indicator:

**TMC (if equipped)**

Displayed when there is available RDS-TMC received.

**Premium Traffic (if equipped)**

Displayed when there is available Premium Traffic information received.



## INFO:

Traffic icons are displayed in the scale level of 15 m (1/64 miles) - 12.5 km (7.5 miles) range. Some traffic icons are displayed only on the map at higher detail levels.

## TRAFFIC INFORMATION SETTINGS

Settings for traffic information related functions can be changed.

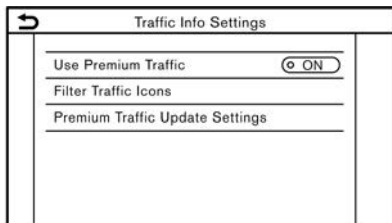

### Example

1. Touch [Navigation] on the setting menu screen.  
 "System settings" (page 2-11)
2. Touch [Traffic Info Settings].
3. Touch the preferred setting. The indicator for the selected setting illuminates.

Available setting items may vary depending on models, specifications and software versions.

## Available setting items

- [Use Premium Traffic]:  
Turns Premium Traffic information (if equipped) on/off.
- [Filter Traffic Icons]:  
Selects which types of traffic incidents (e.g., accident) will be displayed on the map screen.
- [Premium Traffic Update Settings]:  
Sets the update timing of Premium Traffic information (if equipped).

## INFO:

- [Use Premium Traffic] functionality may not be available depending on the models, specifications and software versions.
- [Traffic Info Settings] can also be accessed from current location map screen.
- Even when [Traffic Announcement] is set to off, the route guidance will not be affected. Also, the announcement of emergency information will not be turned off.  
 "Guidance settings" (page 6-26)

## STORING A LOCATION/ROUTE



### STORING LOCATION

Often visited locations can be stored in the Address Book. The stored addresses can be easily retrieved to set them as a destination or waypoint. The Address Book can store up to 200 locations.

### Storing home or work location

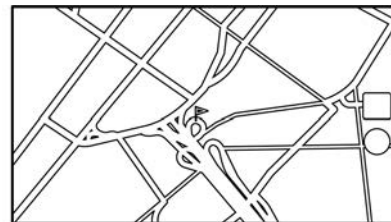
A home or work location can be stored in the system.



1. Touch [Navigation] on the setting menu screen.  
 "System settings" (page 2-11)
2. Touch [Address Book].
3. Touch [Add Home Location] or [Add Work Location].
4. Touch an appropriate method to set a location. Refer to the search methods used for destination setting.  
 "Setting destination" (page 6-13)
5. Touch [OK].
6. A message is displayed, and the address of the location is stored in the Address Book.

- Adjust and edit the contents of the stored item as necessary. Touch [OK] to confirm.  
 "Editing stored location" (page 6-32)

### INFO:



If you touch [Go Home (Save Location)] or [Go to Work (Save Location)] on the destination screen while the home or work location is not stored yet, the system will display a message asking if you wish to store a home or work location. Touch [Yes] to store the home or work location.

### Storing location by searching

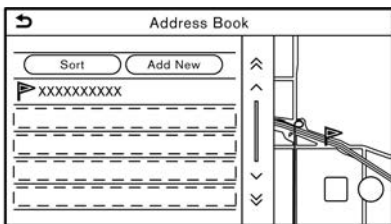
It is possible to store a location by searching in various ways.



- Touch [Navigation] on the setting menu screen.  
 "System settings" (page 2-11)
- Touch [Address Book].
- Touch [Saved Locations].

- Touch [Add New].
- Touch an appropriate method to set a location. Refer to the search methods used for destination setting.  
 "Setting destination" (page 6-13)
- Touch [OK].
- A message is displayed, and the address of the location is stored in the Address Book.
- Adjust and edit the contents of the stored item as necessary. Touch [OK] to confirm.  
 "Editing stored location" (page 6-32)

### INFO:

- When the location is stored in the [Saved Locations], [Address Book] can be used to search for the location.
- When 200 locations are already stored, a new location cannot be stored until a currently stored location is deleted.

### Storing location by moving map

- Move to the preferred location on the map and touch  on the touch screen display.

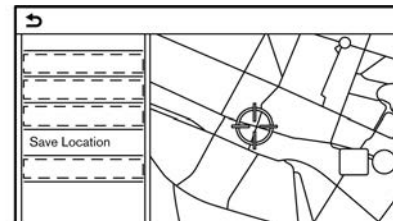

- Touch [Save Location]. A message is displayed.
- The icon representing the stored location is displayed on the map. Push **<MAP>** to return to the current location map screen.

### STORING ROUTE

A maximum of 10 calculated routes can be stored. Stored routes can be easily retrieved and set as the suggested route.

A route requires at least one waypoint in order to be stored.

- Push **<MAP>** and then touch [Route] on the Launch Bar.
- Touch [Save Route]. A confirmation message is displayed. If asked, touch [Yes] to store the current route.

**i** INFO:

- At least 1 waypoint must be set for the route to be stored.
- A stored route includes only locations (destination and waypoints) and route calculation conditions, not the route itself.
- The route is stored in the first available position number in the stored routes list.
- When 10 routes are already stored in the address book, a new route cannot be stored until a route is deleted.  
☞ "Deleting stored item" (page 6-35)

### STORING AVOID AREA

An Avoid Area can be stored. The Avoid Area is an area that can be excluded from a route, such as a road that is always congested. Once Avoid Areas are stored, the system avoids those areas when calculating a route. Up to 10 Avoid Areas can be stored.

1. Touch [Navigation] on the setting menu screen.  
☞ "System settings" (page 2-11)
2. Touch [Address Book].
3. Touch [Avoid Area].

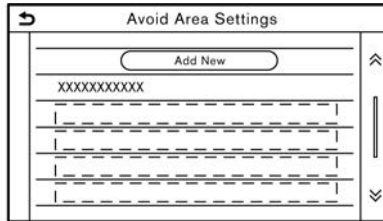

4. Touch [Add New].  
Touch an appropriate method to search for a location.  
☞ "Setting destination" (page 6-13)
5. Touch [OK].
6. Adjust the information of the Avoid Area as necessary.  
☞ "Editing avoid area" (page 6-35)
7. Touch [OK] to store the avoid area information.

**i** INFO:

A maximum of 10 Avoid Areas can be stored. When 10 Avoid Areas are already stored, a new Avoid Area cannot be stored until a currently stored Avoid Area is deleted.

☞ "Deleting stored item" (page 6-35)

### EDITING STORED INFORMATION

Items stored in the system can be edited.

## Editing stored location

1. Touch [Navigation] on the setting menu screen.  
 "System settings" (page 2-11)
2. Touch [Address Book].

Available items may vary depending on models, specifications and software versions.

Setting item		Action	
[Home Location]*	[Edit]	[Show Icon on Map]	Displays the home icon on the map.
		[Icon]	Selects a home icon of a preferred design.
		[Sound]	Sets the type of the alarm that sounds when the vehicle approaches home.
		[Direction]	Sets the alarm to sound when approaching from a specific direction.
		[Distance]	Sets the alarm to sound when reaching a specific distance to home.
	[Phone Number]/[Phone No.]	Stores the home phone number.	
	[Move Location]	Adjusts the stored home location.	
[Delete]	Deletes the stored home location.		
[OK]	Confirms and saves the edited home information.		
[Work Location]*	[Edit]	[Show Icon on Map]	Displays the work icon on the map.
		[Icon]	Selects a work icon of a preferred design.
		[Sound]	Sets the type of the alarm that sounds when the vehicle approaches work.
		[Direction]	Sets the alarm to sound when approaching from a specific direction.
		[Distance]	Sets the alarm to sound when reaching a specific distance to work.

		[Phone Number]/ [Phone No.]	Stores the work phone number.	
	[Move Location]		Adjusts the stored work location.	
	[Delete]		Deletes the stored work location.	
	[OK]		Confirms and saves the edited work information.	
[Saved Locations]	[Sort]	[Sort by Number]	Sorts the saved locations.	
		[Sort by Name]		
		[Sort by Icon]		
		[Sort by Group]		
	[Add New]		Adds a new location.  "Storing location by searching" (page 6-30)	
	Saved Location List	[Edit]	[Show Icon on Map]	Displays the icon of a stored location on the map.
			[Name]	Registers a name of the entry.
			[Voice Tag]	Registers a voice tag for the entry which allows the entry to be used with the Voice Recognition System.
			[Icon]	Selects an icon for the entry.
			[Sound]	Sets the type of the alarm that sounds when the vehicle approaches the location.
[Direction]			Sets the alarm to sound when approaching from a specific direction.	
[Distance]			Sets the alarm to sound when reaching a specific distance to the location.	
[Phone Number]/ [Phone No.]			Registers a phone number for the location.	
[Group]	Registers a group of the entry.			

		[Entry Numbers]	Registers an entry number for the location.
		[Move Location]	Adjusts the stored location information.
		[Delete]	Deletes the stored location information.
		[OK]	Confirms and saves the edited stored location information.

\*: When home or work location has not been stored, [Add Home Location] or [Add Work Location] is displayed and a home or work location can be stored from the menu.

## Editing stored route

1. Touch [Navigation] on the setting menu screen.  
 "System settings" (page 2-11)
2. Touch [Address Book].
3. Touch [Saved Routes].
4. Touch the preferred saved route from the list. Saved Routes settings screen will be displayed.

Setting item	Action
[Rename]	Changes the saved route name.
[Replace]	Overwrites the saved route with the current route.
[Delete]	Deletes the saved route.
[OK]	Applies the edited settings.

## Editing avoid area

1. Touch [Navigation] on the setting menu screen.  
 "System settings" (page 2-11)
2. Touch [Address Book] and then touch [Avoid Area].
3. Touch a preferred Avoid Area from the list. Avoid Area settings screen will be displayed.

Setting item	Action
[Rename]	Changes the name of an Avoid Area.
[Move Location]	Adjusts the Avoid Area location.
[Resize Area]	Adjusts the size of the Avoid Area.
[Motorway]/ [Freeway]	Sets the Avoid Area to include or not include motorways. The color of the Avoid Area changes depending on the setting. Motorway ON: Green Motorway OFF: Blue
[Delete]	Deletes an Avoid Area.
[OK]	Applies the edited setting.

## DELETING STORED ITEM

The locations and routes in the Address Book can be deleted. Deleting an individual item and deleting all stored items are available.



Deleted items cannot be restored. Before deleting an item, always make sure that the item is no longer needed.

## Deleting stored item individually

1. Touch [Navigation] on the setting menu screen.  
 "System settings" (page 2-11)
2. Touch [Address Book].
3. Touch [Delete Saved Items].

Select the preferred item and touch [Yes] to confirm deletion.

Step 1	Step 2	Action
[Delete Home Location]		Deletes home location.
[Delete Work Location]		Deletes work location.
[Delete Address Book]	[Delete All]	Deletes all stored locations.
	[Delete One]	Deletes a selected stored location.
[Delete Saved Routes]	[Delete All]	Deletes all stored routes.
	[Delete One]	Deletes a selected stored route.
[Delete Avoid Areas]	[Delete All]	Deletes all Avoid Areas.
	[Delete One]	Deletes a selected Avoid Area.
[Delete Previous Destinations]	[Delete All Previous Destinations]	Deletes all of the previous destinations.
	[Delete One Previous Destination]	Deletes a selected previous destination.
	[Delete Previous Starting Point]	Deletes the previous starting point.
[Delete Learned Routes]		Deletes the learned routes.

## Deleting individual item on map

1. Align the cross pointer over the stored location to be deleted by moving on the map, and then touch .

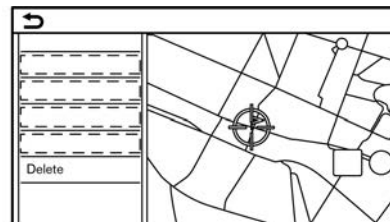

2. Touch [Delete].
3. A confirmation message is displayed. Confirm the contents of the message and touch [Yes].  
The stored item is deleted from the Address Book.



## NAVIGATION SETTINGS

The navigation system can be customized according to the user's preference.

1. Touch [Navigation] on the setting menu screen.

 "System settings" (page 2-11)

2. Touch the item you would like to set.

Available setting items may vary depending on models, specifications and software versions.

### Available items:

- **[Map Settings]**

Sets the display method and direction of the map.

 "Map settings" (page 6-10)

- **[Guidance Settings]**

Sets the various functions for route guidance.

 "Guidance settings" (page 6-26)

- **[Route Preference]**

Changes the routing preferences.





 "Route Preference" (page 6-20)

- **[Traffic Info Settings]**

Sets the various functions of the Traffic information feature.

 "Traffic information settings" (page 6-29)

- **[Safety Guide Settings]**

Setting item	Action
[Speed Limit Indication on Map]	When this item is turned on, the speed limit indicator will appear on the right side of the map screen when there is a speed limit on the road the vehicle is driving on.  "2D map (except for the Middle East)" (page 6-3)  "2D map (for the Middle East)" (page 6-5)
[Speed Limit Warning]	When this item is turned on, the speed limit indicator will blink and warn the driver when the vehicle speed exceeds the speed limit.  "2D map (except for the Middle East)" (page 6-3)  "2D map (for the Middle East)" (page 6-5)
[Speed Limit Sens.]	Adjusts the speed limit sensitivity for [Speed Limit Warning].

- **[Speed Limit Indication on Map]**  
When this item is turned on, the speed limit indicator will appear on the right side of the map screen when there is a speed limit on the road the vehicle is driving on.  
☞ “2D map (except for the Middle East)” (page 6-3)
- **[Speed Limit Warning]**  
When this item is turned on, the speed limit indicator will blink and warn the driver when the vehicle speed exceeds the speed limit.  
☞ “2D map (except for the Middle East)” (page 6-3)
- **[Speed Limit Sens.]**  
Adjusts the speed limit sensitivity for [Speed Limit Warning].
- **[Address Book]**  
Stores locations and routes. Stored items can be edited or deleted.  
☞ “Storing a location/route” (page 6-29)
- **[Customise POIs]/[Customize POIs]**  
Sets the POI categories to be displayed on the Points of Interest screen.
- **[Adjust Current Location]**  
If the vehicle icon indicating the current vehicle location is not in the correct position, the location of the vehicle icon on the map screen can be adjusted.
- **[Delete Saved Items]**  
Deletes a saved location or route.  
☞ “Deleting stored item individually” (page 6-36)
- **[Delete Previous Destinations]**  
Deletes all or one of the previous destinations or the previous start point.  
☞ “Deleting stored item individually” (page 6-36)
- **[Sync with Door to Door Navi]/[Sync with Smartphone Navi.]**  
Turns on/off Door to Door Navigation.
- **[Reset All Navigation Settings to Default]**  
This resets various settings (display, volume level, etc.) to the default settings.

## GENERAL INFORMATION FOR NAVIGATION SYSTEM

### CURRENT VEHICLE LOCATION

#### Display of current vehicle location

This navigation system combines the data obtained from the vehicle (by gyro sensor) and from Global Navigation Satellite System (GNSS) to calculate the current location of the vehicle. This position is then displayed throughout route guidance to a destination.

#### What is Global Navigation Satellite System (GNSS)?

GNSS is a general term for positioning systems that use signals from satellites. This navigation system receives radio signals from three or more different satellites, and detect the position of the vehicle by utilizing the principle of triangulation.

#### Positioning adjustment:

When the system judges that the vehicle position is not accurate based on vehicle speed and gyro sensor data calculations, the system will automatically adjust the position of the vehicle icon using GNSS signals.

#### Receiving signals from GNSS satellites:

The reception of GNSS signals can be weak, depending on the environment. Vehicles in the following areas/environments may not receive GNSS signals.

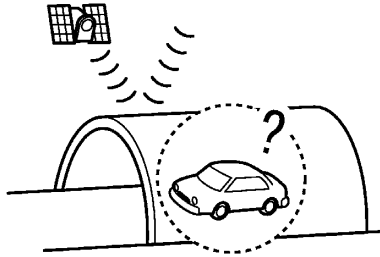

- Inside tunnels or parking garages

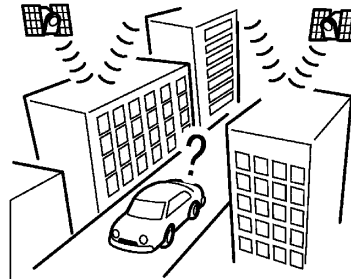

- In areas with numerous tall buildings

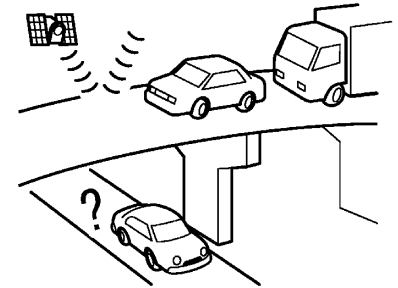

- Under multi-layered highways

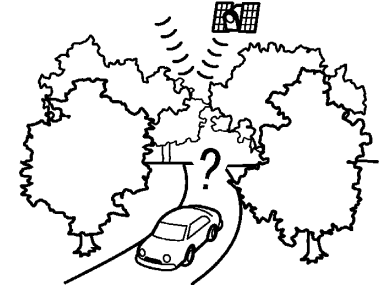

- Areas with numerous tall trees

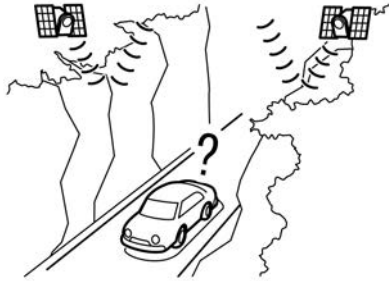

- In canyons

**i** **INFO:**

The GNSS antenna is located on the instrument panel inside the vehicle and/or inside the shark fin antenna (if equipped) on the roof. Do not place any objects, especially cellular phones or transceivers, on the instrument panel. Because the strength of the GNSS signal is weak, phones and transceivers will affect or may totally disrupt the signal.

### Incorrect display of vehicle position

The following cases may affect the display accuracy of the vehicle's position or traveling direction. The accuracy will return to normal if the driving conditions return to normal.

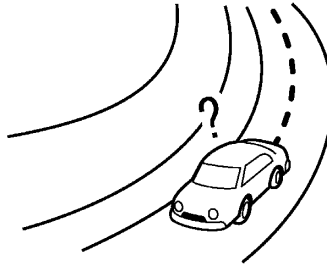

- When there is a similar road nearby.

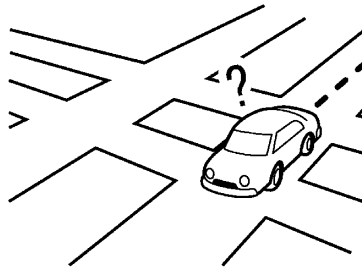

- When the vehicle is traveling in an area with a grid pattern road system.

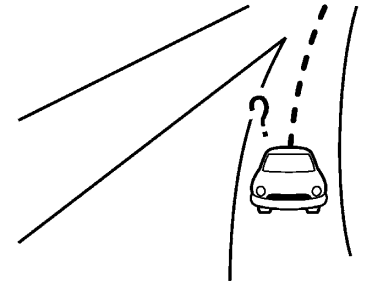

- When the vehicle is passing through a large Y-shaped intersection/junction.

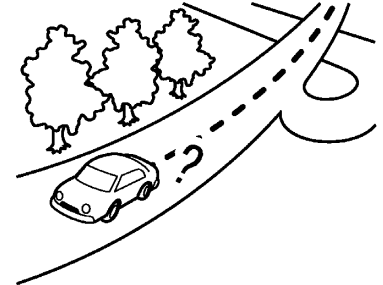

- When the vehicle is traveling on a continuous, slowly curving road.

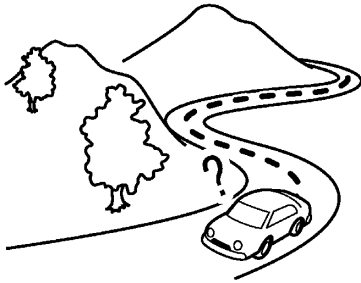

- When the vehicle is traveling on a road with repeating S-shaped curves.



- When the vehicle is on a snow-covered or unpaved road.

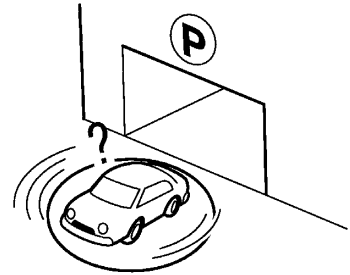

- When the vehicle is rotated on a parking lot turntable while the ignition switch or power switch placed in the OFF position.

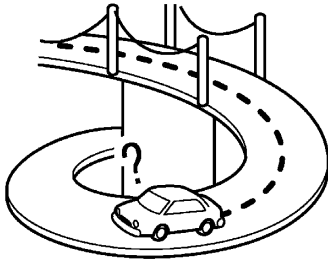

- When the vehicle is on a loop bridge.

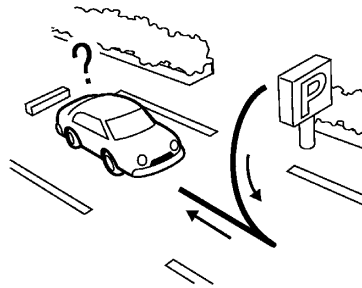

- When repeatedly turning left or right, or driving in zigzags.

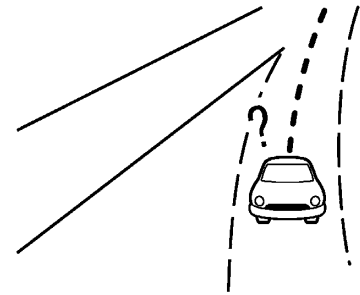

- When driving on a road not displayed on the map screen or a road that has been changed due to additional construction or other reasons.

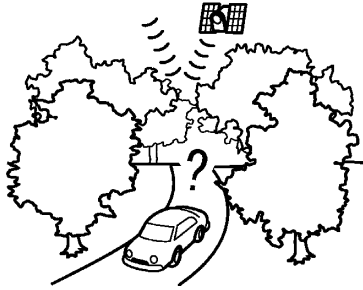

- When the GNSS positioning accuracy is low.

#### INFO:

- The vehicle icon may be misaligned when starting the vehicle just after starting the engine, hybrid system or e-POWER system.
- The vehicle icon may also be misaligned if different sized tires or tire chains are installed.
- The system has a function that automatically corrects the vehicle icon position when it is misaligned from the actual position.
- Vehicle position correction by GNSS may not function when the vehicle is stopped.
- If the vehicle icon position does not return to normal even after driving for

a while, correct the vehicle icon position manually.

### Detailed Map Coverage Areas (MCA) for navigation system

This system is designed to help guiding to the destination, and it also performs other functions as outlined in this manual. However, the system must be used safely and properly. Information concerning road conditions, traffic signs and the availability of services may not always be up-to-date. The system is not a substitute for safe, proper and legal driving.

Map data covers select metropolitan areas.

Map data includes two types of areas: "Detailed coverage areas" providing all detailed road data and other areas showing "Main roads only".

#### INFO:

Detailed map data is not available in many areas and is generally limited to select major metropolitan areas.

### ROUTE CALCULATION

- The suggested route may not be the shortest, nor are other circumstances such as traffic jams considered.
- Because of the inevitable difference in road conditions and circumstances between the time you use this system and the time the information was

produced for the map data, there may be discrepancies in roads and regulations. In such cases, actual road conditions and regulations take precedence over map data information.

- During route calculation, the map will not scroll, however the vehicle icon will move according to the actual vehicle's movement.
- During route calculation, buttons such as **<MAP>** and **<MENU>** will be disabled.
- In some cases, after the calculation is complete, the calculated route may not be immediately displayed.
- Waypoints that have been passed will be disregarded by rerouting calculation.
- If you scroll the map while the suggested route is being drawn, it may take more time to finish drawing.
- Route calculation may not be completed in the following cases.
  - If there is no main road within a range of 2.5 km (1.5 miles) from the vehicle, a message saying so will appear on the screen. Try recalculating when the vehicle is closer to a main road.
  - If there is no main road within a range of 2.5 km (1.5 miles) from the destination or waypoint, a message saying so will appear on the screen.

- Try setting the location closer to a main road.
- If the vehicle is too close to the destination or if there are no roads to the destination, a message saying so will appear on the screen.
- If it is impossible to reach the destination or waypoints because of traffic regulations, etc.
- If the only route to reach the destination or waypoints is extremely complicated.
- The following may occur when the route is displayed.
  - If you calculate a route on a main road, the starting point of the route may not exactly match the current vehicle location.
  - The endpoint of the route may not exactly match the destination.
  - If you calculate a route on a main road, the system may display a route from another main road. This may be because the position of the vehicle icon is not accurate. In this case, park the vehicle in a safe location and reset the vehicle icon, or continue driving to see if the position of the vehicle icon is automatically adjusted before recalculating the route.

- There are cases in which the system shows an indirect route to reach the destination or waypoints, if you set them from stored or facility information. In order to correct this, you must be careful about the traffic direction, especially when lanes with different travel directions are shown separately, such as interchanges and service areas.
- This system makes no distinction between limited traffic control and total control (blockage). It may show an indirect route even if the road is usable.
- Even if the ferry preference is set to OFF, a route that uses a ferry line may be suggested.

## ROUTE GUIDANCE



The system will announce street names when the system language is set to English.

### Repeating voice guidance

This function is available throughout route guidance, from the time after the route calculation is completed until the vehicle arrives at the destination. Push and hold **<MAP>**. Voice guidance will be repeated.

## Notes on voice guidance

- Voice guidance in this system should be regarded as a supplementary function. When driving the vehicle, check the route on the map and follow the actual roads and traffic regulations.
- Voice guidance is activated only for intersections with certain conditions. There may be cases where the vehicle has to turn, but voice guidance is not provided.
- Voice guidance contents may vary, depending on the direction of the turn and the type of intersection.
- The voice guidance timing will vary depending on the situation.
- When the vehicle has deviated from the suggested route, voice guidance is not available. The system will not announce this. Refer to the map and recalculate the route.
  - ☞ "Recalculating route" (page 6-23)
- Voice guidance may not accurately correspond with road numbers and directions at motorway junctions.
- The displayed street names may sometimes differ from the actual names.
- Voice guidance is not available when [Guidance Voice] is turned off.
- Voice guidance will start when the vehicle enters the suggested route.

Refer to the map for directions to the starting point of the route.

- When approaching a waypoint, the voice guidance will announce and inform the driver that the vehicle has reached a waypoint. Voice guidance will switch to the next section of the route. When voice guidance is not available, refer to the map for directions.
- In some cases, voice guidance ends before arrival at the destination. Refer to the destination icon on the map to reach the destination.
- Voice guidance may be partially operational or inoperative due to the angle of roads at an intersection.
- Motorway exit information may differ from the information on the actual exit signs.
- Because it is not possible to consider data concerning roads that are seasonally available or unavailable, a route may be displayed that does not match the actual traffic restrictions. Be sure to follow the actual traffic restrictions while driving.

## HOW TO UPDATE MAP DATA (if equipped)



### WARNING:

#### **TO AVOID RISK OF DEATH OR SERIOUS PERSONAL INJURY WHEN UPDATING THE MAP SOFTWARE:**

**If you choose to park the vehicle within range of a Wi-Fi connection (if equipped) or a TCU (Telematics Control Unit) (if equipped), park the vehicle in a secure, safe well-ventilated location that is open to the air. During the update process, if you choose to park your vehicle, it should be kept in a well ventilated area to avoid exposure to carbon monoxide. Do not breathe exhaust gases; they contain colorless and odorless carbon monoxide. Carbon monoxide is dangerous. It can cause unconsciousness or death.**

1. **Apply the parking brake.**
2. **Remain with the vehicle while the update is in process.**
3. **Do not allow children, pets or people who may need assistance to remain in the vehicle while the software is updating.**



### NOTE:

**The vehicle is not required to be parked during the map update process.**

Map data can be updated via USB (if equipped), Wi-Fi (if equipped) or a TCU (Telematics Control Unit) (if equipped).

Depending on the models, the map data cannot be update via TCU (Telematics Control Unit).

### Updating with USB memory (if equipped)

The navigation map data can be updated with the latest information by downloading a new map database to a USB memory device and installing it in the vehicle.

For map update, use the USB memory with the following specifications:

Supported media: USB2.0

Supported file system: FAT32

1. Push **<MENU>**.
2. Touch [Info] on the Launch Bar and then touch [System Information].
3. **Type A:**  
Touch [Map Update] and then touch [Update via USB Device]/[Update by USB device].

#### **Type B:**

Touch [Map Update].



4. Touch [Save Map Information to USB Device]/[Save Map Information to USB].
5. Insert blank USB memory device into the USB connection port.  
 "USB (Universal Serial Bus) connection port and AUX (auxiliary) input jack" (page 2-8)

 **INFO:**

If data is in the USB memory, it may be deleted.

6. Touch [Start].
7. Touch [OK] after saving the map information to USB.
8. Access to the designated website with your personal computer. Download and install the map update tool in your personal computer. (Consult a NISSAN dealer for details.)
9. Download the updated data and store it in the USB memory with the map update tool.
10. Push <MENU>.
11. Touch [Info] on the Launch Bar and then touch [System Information].
12. **Type A:**  
Touch [Map Update] and then touch [Update via USB Device]/[Update by USB device].  
**Type B:**  
Touch [Map Update].

13. Touch [Install Map Update from USB Device]/[Install Map Update from USB].
14. Insert the USB memory into the USB connection port.  
A confirmation message is displayed. Confirm the contents of the message and touch [Yes].
15. Touch [OK] after completing the update.

 **INFO:**

- The navigation system cannot be operated while the map updates.
- Map data should be updated while the engine, hybrid system or e-POWER system is running to prevent discharge of the vehicle battery (12V battery).
- Depending on the models, specifications and software versions, the same operation can be performed from [System Update] on the setting menu screen.  
 "System settings" (page 2-11)

### Updating using wireless LAN (Wi-Fi) (if equipped)

The map data can be updated using the vehicle Wi-Fi connection. Wi-Fi communications can be made by using a Wi-Fi network, smartphone, etc.  
 "Wi-Fi setting" (page 2-15)

1. Connect the vehicle to an available Wi-Fi network.
2. Push <MENU>.
3. Touch [Info] on the Launch Bar and then touch [System Information].
4. Touch [Map Update].
5. Touch [Update via Wi-Fi]/[Update by Wi-Fi].  
A confirmation message is displayed.
6. **Type A**  
Select an area to be updated, and touch [Start].  
**Type B**  
Touch [Select Area], select the area to be updated, and touch [OK].  
Touch [Yes] to update the selected area.
7. Touch [OK] after completing the update.

 **INFO:**

- When [Cancel] is displayed during the map data update, touching the key can cancel the update.
- The navigation system cannot be operated while the map updates.
- Do not turn off the power source of the smartphone while updating.
- Map data should be updated while the engine, hybrid system or e-POWER system is running to pre-

vent discharge of the vehicle battery (12V battery).

- Touch [Vehicle Hotspot]/[Car Hotspot] (if equipped) and turn on the indicator to activate the Wi-Fi hotspot communication.
- The download data size of map update for one country or one regional zone can vary between 100 MB to 1 GB. Data size in case of updating multiple countries or regional zones can be over 1 GB. Use of Wi-Fi hotspot functionality of your smartphone for map updates may incur additional data charges from your cellular provider. Please connect to your home Wi-Fi network to avoid additional phone data charges.
- Depending on the models, specifications and software versions, the same operation can be performed from [System Update] on the setting menu screen.  
 "System settings" (page 2-11)
- Depending on the models, specifications and software versions, the update is done in the background, and the updates are reflected in the map data the next time the system is started.
- When the vehicle power is shutdown, the map update is suspended. When the map update is

resumed, select the same region to update the map from [Update via Wi-Fi].

### Automatic map update (if quipped)

The map data can be updated using the TCU (Telematics Control Unit).

1. Push **<MENU>**.
2. Touch [Info] on the Launch Bar and then touch [System Information].
3. Touch [Map Update].
4. Touch [Map Update Settings].
5. Select an area of the map you wish to update. A confirmation message is displayed. The next time you start the system, a notification message will be displayed if map data update is available.
6. When the new map data is available after the vehicle power is on, a pop-up message informing that a map update is available will appear. Touch [Yes] to update the map data.



If user selects [No] on the pop-up screen, the automatic map update and software update will not be available forever and user always has to update map and software manually from the next time. When the vehicle power is shutdown, the map update is

suspended. When the map update is resumed, select the same region to update the map from [Update via Wi-Fi].

7. Touch [OK] after completing the update.



- The same operation can be performed by touching [Settings] on the Launch Bar and then touching [System Update].
- The update is done in the background, and the updates are reflected in the map data the next time the system is started.

### Automotive products End User License Provisions

This End-User License Agreement ("**EULA**") is an agreement between you and TomTom International B.V. ("**TomTom**"). You agree that this EULA is enforceable. This EULA applies to your use of the TomTom Map data, software, Traffic and Travel services or any other TomTom products (together the "**Services**").

Please read this EULA carefully. By using the Services you agree to all the terms and conditions of this EULA.

1. GRANT OF LICENSE: In consideration of you agreeing to abide by the terms of this EULA, TomTom hereby grants

to you a non-exclusive, license to use the Services solely in connection with the vehicle. If upgrades, updates or supplements to the Services are provided the use of such upgrades or updates is governed by this EULA.

2. **RESTRICTIONS:** You are prohibited from renting, lending, public presentation, performance or broadcasting or any other kind of distribution of the Services. Other than as permitted by applicable legislation, you will not, and you will not allow any person to, copy or modify the Services or any part thereof or to reverse engineer, decompile or disassemble the Services.
3. **OWNERSHIP:** Copyright and other intellectual, industrial and/or proprietary rights to the Services are owned by TomTom and/or its suppliers. TomTom permits you to use the Services only in accordance with the terms of this EULA. All rights not specifically granted in this EULA are reserved by TomTom. To the extent applicable, you acknowledge that you have no right to have access to the Services in source code or in unlocked coding.
4. **THIRD PARTY SOFTWARE LICENSES:**

The Services may make use of third party software. Notwithstanding Clauses 2 and 3, use of some third party materials included in the Software may be subject to other terms and conditions. The official copyright notices and specific license conditions of these third party software codes and algorithms are to be found via <http://www.tomtom.com>. You hereby agree to the terms and conditions for such third party software.

5. **LIMITED WARRANTY:**
  - YOU ACKNOWLEDGE THAT THE SERVICES HAVE NOT BEEN DEVELOPED TO MEET YOUR INDIVIDUAL REQUIREMENTS AND THAT IT IS THEREFORE YOUR RESPONSIBILITY TO ENSURE THAT THE FACILITIES AND FUNCTIONS OF THE SERVICES MEET YOUR REQUIREMENTS. TOMTOM DOES NOT AND CANNOT WARRANT THAT THE SERVICES OPERATE UNINTERRUPTED OR ERROR-FREE. YOU SHOULD BE PARTICULARLY AWARE OF THE FACT THAT CALCULATION ERRORS MAY OCCUR WHEN USING SOFTWARE IN A NAVIGATION SYSTEM FOR INSTANCE CAUSED BY LOCAL ENVIRONMENTAL CONDITIONS AND/OR INCOMPLETE DATA.
  - TO THE MAXIMUM EXTENT PERMITTED BY APPLICABLE LAW, TOMTOM AND ITS SUPPLIERS PROVIDE

THE SERVICES "AS IS", AND HEREBY DISCLAIM ALL OTHER WARRANTIES AND CONDITIONS, WHETHER EXPRESS, IMPLIED OR STATUTORY, INCLUDING, BUT NOT LIMITED TO, ANY (IF ANY) IMPLIED WARRANTIES, DUTIES OR CONDITIONS OF SATISFACTORY QUALITY, OF FITNESS FOR A PARTICULAR PURPOSE, OF RELIABILITY OR AVAILABILITY, OF ACCURACY OR COMPLETENESS OF RESPONSES, OF RESULTS, WITH REGARD TO THE SERVICES, AND THE PROVISION OF OR FAILURE TO PROVIDE SUPPORT OR OTHER SERVICES, INFORMATION, SOFTWARE, AND RELATED CONTENT THROUGH THE SERVICES OR OTHERWISE ARISING OUT OF THE USE OF THE SERVICES.

**SAFETY: THE SERVICES ARE INTENDED TO BE USED FOR PROVIDING INFORMATION AND NAVIGATION SERVICES RELATED TO YOUR JOURNEY ONLY AND ARE NOT INTENDED TO BE USED AS A SAFETY RELATED TOOL AND CANNOT WARN YOU ABOUT ALL DANGERS AND HAZARDS WITH RESPECT TO THE ROAD YOU ARE DRIVING. THEREFORE, IT REMAINS YOUR DUTY TO DRIVE IN A CAREFUL AND SAFE MANNER (PAYING ALL DUE CARE AND ATTENTION TO THE ROAD) AS WELL AS OBSERVING ALL APPLICABLE TRAFFIC**

**REGULATIONS AND RULES. IT IS YOUR RESPONSIBILITY NOT TO USE THE SERVICES IN A MANNER THAT WOULD DISTRACT YOU FROM DRIVING SAFELY.**

6. LIMITATION OF LIABILITY:

TO THE MAXIMUM EXTENT PERMITTED BY APPLICABLE LAW, NEITHER TOMTOM NOR ITS LICENSORS AND SUPPLIERS, OFFICERS, DIRECTORS OR EMPLOYEES SHALL BE LIABLE TO YOU OR TO ANY THIRD PARTY FOR ANY DAMAGES, WHETHER DIRECT, SPECIAL, INCIDENTAL, INDIRECT OR CONSEQUENTIAL (INCLUDING BUT NOT LIMITED TO, DAMAGES FOR THE INABILITY TO USE OR ACCESS THE SERVICES, LOSS OF DATA, LOSS OF BUSINESS, LOSS OF PROFITS, BUSINESS INTERRUPTION OR THE LIKE) ARISING OUT OF OR RELATED TO THE USE OF, THE INABILITY TO USE OR ACCESS, OR OTHERWISE THE PERFORMANCE OF THE SERVICES, EVEN IF NISSAN HAS BEEN ADVISED OF THE POSSIBILITY OF SUCH DAMAGES.

TO THE EXTENT TOMTOM IS NOT PERMITTED UNDER APPLICABLE LAW TO EXCLUDE ITS LIABILITY PURSUANT TO CLAUSE 6.1 ABOVE, TOMTOM'S TOTAL AGGREGATE LIABILITY TO YOU SHALL BE LIMITED TO THE AMOUNT OF US \$100.00.

THE ABOVE LIMITATIONS OF LIABILITY UNDER THIS CLAUSE 6 DO NOT: (I)

AFFECT YOUR RIGHTS UNDER ANY APPLICABLE MANDATORY NATIONAL LEGISLATION; (II) EXCLUDE OR LIMIT ANY LIABILITY THAT CANNOT BE EXCLUDED OR LIMITED UNDER APPLICABLE LAW.

7. TERMINATION: Without prejudice to any other rights, TomTom may immediately terminate this EULA if you fail to comply with any of its terms and conditions. The provisions of this Agreement, which by their nature are intended to survive termination, will remain in effect after termination of this EULA.

8. LINKS TO THIRD PARTY SITES: TomTom and other third parties involved in making the Services available to you ("Third Parties") are not responsible for the contents of any third-party sites or services, any links contained in third-party sites or services, or any changes or updates to third-party sites or services which are delivered by the Services or otherwise. TomTom (and, as applicable, each of the Third Parties) is providing these links and access to third-party sites and services to you only as a convenience, and the inclusion of any link or access does not imply an endorsement by TomTom or any Third Parties of the third-party site or service. Any use by you of such links or third party sites and the manner in which you use such third party sites and

links shall be your responsibility and at your risk and you shall not use them in any illegal or fraudulent manner.

Should you have any questions concerning this EULA, or if you desire to contact TomTom for any reason, please visit TomTom's website at <http://www.tomtom.com>.

# 7 Voice recognition (if equipped)



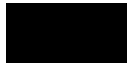

Voice recognition .....	7-2	Giving voice commands .....	7-2
Using Voice Recognition System .....	7-2	System Voice settings .....	7-5
Before starting .....	7-2		



## VOICE RECOGNITION

### USING VOICE RECOGNITION SYSTEM

#### Initialization

When the ignition switch or power switch is in the ACC or ON position, voice recognition is initialized. When the initialization is complete, the system is ready to accept voice commands. If <  > (if equipped) on the steering wheel or <  /  /  > (if equipped) on the steering column is operated before the initialization completes, the display will show a message to wait until the system is ready.





#### BEFORE STARTING

To get the best recognition performance from voice recognition, observe the following items.

- The interior of the vehicle should be as quiet as possible. Close the windows to eliminate the surrounding noises (traffic noise, vibration sounds, etc.) and turn down the fan speed level of the heater/air conditioner to lower the noise which may prevent the system from correctly recognizing the voice commands.
- Wait until the tone sounds before speaking a command.
- Speak in a natural conversational voice without pausing between words.

- The system cannot recognize voice commands spoken from passenger seats.

#### GIVING VOICE COMMANDS

1. Push <  > (if equipped) on the steering wheel or push and hold <  /  /  > (if equipped) on the steering column.

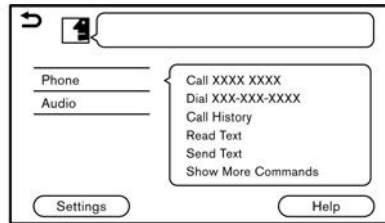

Example















2. A list of commands appears on the screen, and the system provides the voice menu prompt.

Available category commands are displayed on the left side of the screen. Speak or touch a category command from the category command list.





#### INFO:

- Some of the commands for each category are shown on the right side of the screen and they can also be spoken without selecting a category.

- After executing the category command, only the commands related to the selected category can be recognized.



3. After the tone sounds and the icon on the screen changes from  to , speak a command. You can also select a command by directly touching the screen, using <  > / <  > / <  /  > (if equipped) on the steering wheel or using <TUNE SCROLL/SOUND>/<TUNE SCROLL/ENTER SOUND>/<TUNE SCROLL/OK>/<  /  /  /  > / <  /  /  /  > (if equipped) on the control panel or using the Display Commander (if equipped).

#### INFO:







The Voice Recognition System will pause its operation when no command is given after a few prompts. To resume the operation, push <  > (if equipped) on the steering wheel or push and hold <  /  /  > (if equipped) on the steering column.

4. Continue to follow the voice menu prompts and speak the voice commands after the tone sounds until the preferred operation is executed.





## INFO:

- To exit the Voice Recognition System, push and hold <  > (if equipped)/ <  > (if equipped) on the steering wheel.
- Depending on the language setting, the Voice Recognition System cannot be used.





## Operating tips

- Speak a command after the tone.
- If the command is not recognized, the system will prompt you to speak the command again. Repeat the command in a clear voice.
- Touch [  ] on the touch screen display or push <  > (if equipped) on the steering wheel to return to the previous screen.
- To adjust the volume of the system feedback, push <  > (if equipped) on the steering wheel, push <  > (if equipped) on the steering column from behind or turn < VOL/  > / < VOLUME/  > while the system is making an announcement.





## Voice Prompt Interrupt:

In most cases, you can interrupt the voice feedback to speak the next command by pushing <  > (if equipped) on the steering wheel or pushing and holding <  /  /  > (if equipped) on the steering column. After interrupting the system, wait for a tone before speaking your command.

## One Shot Call:

To use the system faster when making a call, you may speak the second level command skipping speaking the first level command. For example, push <  > (if equipped) on the steering wheel or push and hold <  /  /  > (if equipped) on the steering column and say "Redial" after the tone without first saying "Phone".

## How to see voice command screen

1. Push <  > (if equipped) on the steering wheel or push and hold <  /  /  > (if equipped) on the steering column to display the first screen of the voice command list.
2. Speak a command or select an item on the voice command list. The second screen is displayed.
3. Speak a command or select an item on the voice command list. The command is executed or the next screen

for further command is displayed.

4. Follow the prompts to complete the commands.

## Voice command screens:

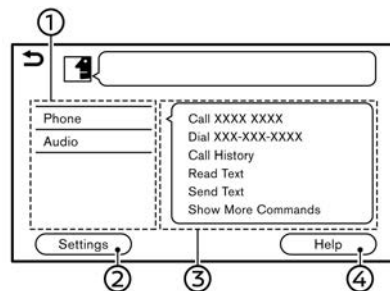

## Example

- ① Shows a list of available categories. Speak a category command or touch the key of the corresponding category.
- ② Touch [Settings] or say "Settings" to display the system voice settings.
- ③ Shows a list of available commands for the selected category. Speak a preferred command.
- ④ Touch [Help] or say "Help" to hear help announcements on how to use the system.

**INFO:**

Push < > (if equipped) on the steering wheel or push and hold < / / > (if equipped) on the steering column to stop the help announcements.

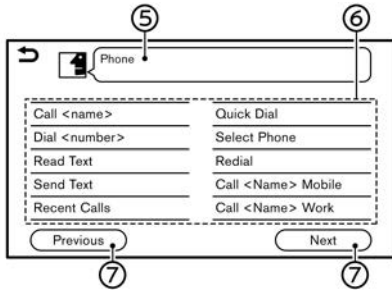

**Example**

⑤ Previously selected command

⑥ Command list

You can speak a command from the list or touch the corresponding key. Preferred words can be spoken for the part of the command enclosed in < >.

⑦ [Previous]/[Next]

Say as a command or touch to go to the previous/next screen.

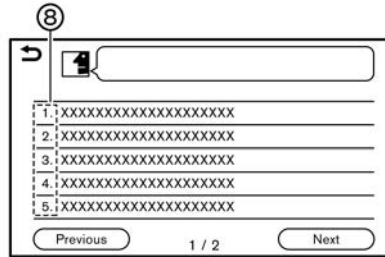

⑧ Speak a number from 1 to 5 or touch an item on the list screen to select the item.

**How to speak numbers**

The Voice Recognition System requires the user to speak numbers in a certain way when giving voice commands.

**General rule:**

Only single digits "0" (zero) to "9" can be used. (For example, for the number "600", speaking "six zero zero" can be recognized by the system, but "six hundred" cannot be recognized.)

**INFO:**

For the best recognition, speak "zero" for the number "0", and "oh" for the letter "o".



## SYSTEM VOICE SETTINGS

The system voice settings can be changed.

1. Touch [System Voice] on the setting menu screen.  
☞ "System settings" (page 2-11)
2. Touch the item you would like to set.

Available setting items may vary depending on models, specifications and software versions.

Available item	Action
[Initial Voice Prompt]	When this item is turned on, voice prompts are announced.
[Short Voice Prompts]	When this item is turned on, short and minimized voice feedback will be provided.
[Best Match Lists]	When these items are turned on, the voice recognition results are displayed on the list in the order of reliable recognition.
[Phone Book]/[Phonebook] [Music Commands]	
[Voice Preference]	Guidance voice setting can be selected from a male or female voice. Depending on the language setting, the guidance voice setting cannot be changed.
[Speech Rate]	Adjusts the speech rate of prompt.

**MEMO**

# 8 Troubleshooting guide

System unit .....	8-2	Bluetooth® Hands-Free Phone System .....	8-18
Liquid crystal display .....	8-2	NissanConnect Services (if equipped) .....	8-21
Audio system .....	8-3	Apple CarPlay (if equipped) .....	8-22
AM radio .....	8-3	Android Auto (if equipped) .....	8-24
DAB radio (if equipped) .....	8-4	Yandex.Auto (if equipped) .....	8-26
HD Radio technology (if equipped) .....	8-6	Siri Eyes Free (if equipped) .....	8-27
Compact Disc (CD) player (if equipped) .....	8-8	Navigation (if equipped) .....	8-28
Digital versatile disc (DVD) player (if equipped) .....	8-10	Basic operations .....	8-28
iPod player .....	8-13	Map screen .....	8-29
USB memory device .....	8-15	Route calculation and visual guidance .....	8-31
Bluetooth® audio .....	8-16	Voice guidance .....	8-33
		Traffic information (if equipped) .....	8-34
		Voice recognition (if equipped) .....	8-35



## SYSTEM UNIT

### LIQUID CRYSTAL DISPLAY

Symptom	Possible cause	Possible solution
The screen is too dark.	The cabin temperature is too low.	Wait until the cabin temperature becomes moderate.
	Screen brightness is set to the maximum darkness.	Adjust the brightness setting of the screen.
The screen is too bright.	Screen brightness is set to the maximum brightness.	Adjust the brightness setting of the screen.
A small black spot or a small bright spot appears on the screen.	This is a typical phenomenon for liquid crystal displays.	This is not a malfunction.
A dot or stripe pattern appears on the screen.	Electromagnetic waves that are generated from neon billboards, high voltage electric power cables, ham radios or other radio devices equipped to other vehicles may adversely affect the screen.	This is not a malfunction.
Image lag appears on the screen.	This is a typical phenomenon for liquid crystal displays.	This is not a malfunction.
Image motion displayed on the screen is slow.	The cabin temperature is less than 10°C (50°F).	Wait until the cabin temperature rises to within 10°C (50°F) and 50°C (122°F).
When looking at the screen from an angle, the screen lightens or darkens.	This is a typical phenomenon for liquid crystal displays.	Adjust the brightness setting of the screen.
The screen turns blue or an error message is displayed on the touch screen display.	A system malfunction has occurred.	It is recommended that you contact a NISSAN dealer for an inspection.

## AUDIO SYSTEM

### AM RADIO

Symptom	Possible cause	Possible solution
AM reception deteriorates at night.	AM stations are required to lower their power at night.	This is not a malfunction.

## DAB RADIO (if equipped)

Symptom	Possible cause	Possible solution
The sound skips, stutters or echoes.	The radio station has not properly aligned digital and analog audio.	Verify correct operation on another station. Report the station with poor performance.
The volume level is unstable.	Level alignment is inappropriate.	Verify correct operation on another station and check the station availability in the area. Report the station with poor alignment.
The sound fades in/out.	DAB-FM is taking place.	Verify transition performance on several stations in the area. Report stations with poor alignment.
Excessive DAB-FM takes place.	The vehicle is located near the edge of the DAB coverage area.	Verify the radio station coverage in your area.
The sound quality of DAB is no better than that of FM/AM.	Audio processing on the digital audio by the station can potentially decrease digital audio sound quality.	Verify correct operation on another station. Report the station with poor performance.
Local stations keep being lost.	Digital coverage is slightly smaller than analog signal coverage.	Verify correct operation on another station.
	Shadowing (Urban/Terrain) can cause reduced digital coverage.	Verify correct operation on another station.
Some data fields are blank.	Text information is sent at the broadcaster's discretion.	Verify correct operation on another station. Report the station issue.
Text information is truncated.	The display is limited to a fixed number of characters and more data is being sent than can be displayed.	This is not a malfunction.
The DAB-FM setting is turned on but an alternative station does not play and the signal does not appear on the display.	The tuner is waiting for the original signal to recover and is seeking an available alternative signal.	Wait for the signal to return or for the tuner to pick up an alternative signal.
A message indicating that service is not available is displayed on the screen.	The selected service or ensemble is not in service.	Select a different service or ensemble.



**INFO:**

- When station presetting is performed while a secondary service is playing, the parent primary service will be registered.
- Secondary services do not appear on the station list.

## HD RADIO TECHNOLOGY (if equipped)

### Sound

Symptom	Possible cause	Possible solution
Delay in digital audio on HD Radio broadcasts.	The radio acquires an analog station first and blends to an digital signal.	This is not a malfunction.
Audio skips, stutters, or echoes.	The radio station has not properly aligned the digital and analog audio.	Verify correct operation on another station. Report any station with poor performance.
Volume changing up/down.	The radio station has not properly aligned digital and analog audio level.	Verify correct operation on another station and check <a href="http://www.hdradio.com">www.hdradio.com</a> for stations in the area. Report any station with poor performance.
Sound fading in and out.	The transition between analog and digital is taking place (blending).	Verify transition performance on several stations in the area. Report any stations with poor alignment.
Excessive blending (transition between analog and digital).	The vehicle is located near the edge of the digital coverage area.	Refer to <a href="http://www.hdradio.com">www.hdradio.com</a> to verify radio stations in your coverage area.
Digital audio is no better than analog audio.	Audio processing on the digital audio at a station can potentially decrease the digital audio sound quality.	Verify correct operation on another station. Report any station with poor performance.



## Functional

Symptom	Possible cause	Possible solution
Keep losing my local stations.	The digital coverage is slightly less than the analog signal coverage.	Verify correct operation on another station. This is an expected behavior.
	Shadowing (urban/terrain) can cause reduced digital coverage.	Verify correct operation on another station. This is an expected behavior.
Some data fields are blank.	Text information is sent at the broadcaster's discretion.	Verify correct operation on another station. Report station issues.
Text information is truncated / there appears to be more available.	The display is limited to a fixed number of characters and more data is being sent than can be shown.	This is an intended behavior.
AM reception changes at night.	AM stations are required to lower their power at night.	This is not a malfunction.

## COMPACT DISC (CD) PLAYER (if equipped)

Symptom	Possible cause	Possible solution
Music cannot be played back.	The disc is inserted upside down.	Insert a CD with the label side facing up.
	Moisture condensation occurs inside the unit.	Wait until the moisture evaporates (approximately 1 hour).
	The cabin temperature is too high.	Wait until the cabin temperature becomes moderate.
	The disc is scratched or dirty. A disc is not always playable if it is scratched.	Wipe off any dirt from the disc.
	Depending on the condition in which they are stored, discs may become unreadable due to deterioration (for example, keeping the discs in the passenger compartment, etc.).	Change the disc with a deterioration-free disc. Do not use a deteriorated disc. The label surface of the disc may crack or chip, and the layer of the label surface may eventually peel off.
The compressed audio files cannot be played back.	If both music CD files (CD-DA data) and compressed audio files (MP3 data, etc.) are mixed on one disc, the audio compression files cannot be played back.	Prepare a disc that includes compressed audio files only.
	The files are not named using characters that are compliant with the specifications.	Use the character codes and the number of characters that are compliant with the specifications for folder names and file names. In addition, always use ".MP3", ".WMA", ".mp3" or ".wma" for file extensions.
It takes a long time before the music starts playing.	The disc contains a large amount of data.	Some time may be required to check the files. It is recommended that unnecessary folders or any files other than compressed audio files should not be recorded in a disc.
The sound quality is poor.	The disc is dirty.	Wipe off any dirt from the disc.

Symptom	Possible cause	Possible solution
No sounds are played though the CD play time is displayed.	The system plays back the first track of the mix mode disc. (Mix mode is a format in which data except music is recorded on the first track and music data is recorded on one other than the first track in a session.)	Play back music data that is recorded on a track other than the first track.
Music cuts off or skips.	The combination of writing software and hardware might not match; or the writing speed, writing depth, writing width, etc. might not match the specifications.	Create a disc using different writing speed settings, etc.
The system skips the selected track and moves to the next track.	A non-MP3/WMA file is given an extension of ".MP3", ".WMA", ".mp3" or ".wma".	Prepare MP3/WMA files.
	The system plays back a file that is prohibited due to copyright protection.	Prepare playable files.
The tracks do not play back in the desired order.	The folder locations in the disc are changed by the writing software while the files are written in the disc.	Check the settings of the writing software, and create a new disc.
The CD cannot be ejected.	The ignition switch or power switch is not placed in the ACC or ON position.	Place the ignition switch or power switch in the ACC or ON position.

## DIGITAL VERSATILE DISC (DVD) PLAYER (if equipped)

Symptom	Possible cause	Possible solution
No image is displayed.	The vehicle is being driven.	Stop the vehicle in a safe location and apply the parking brake.
The system does not behave as operated.	Due to the intentions of the disc maker, there are some DVDs that do not behave as operated.	This is not a malfunction.
A DVD does not respond to operation.	The operation performed is not allowed. (A message may not be displayed depending on the disc.)	Wait until an operable screen is displayed.
The sound cannot be heard.	The volume level is set to the minimum.	Adjust the volume level of the audio.
Playback does not start.	The disc is inserted upside down.	Insert a disc with the label side facing up.
	The volume level is set to the minimum.	Check the volume level of the audio.
	Moisture condensation occurs inside the unit.	Wait until the moisture evaporates (approximately one hour).
	The DVD menu is displayed.	Select the menu item.
	A disc with a different region code has been inserted.	Discs with different region codes cannot be played back. Check the disc.
	Depending on the DVD, and because the standards of the DVD may not be strictly satisfied, this device may not be able to play back some discs.	This is not a malfunction.
Playback skips and the image is distorted.	The disc is scratched.	Depending on the size of the scratch, it may not be possible to correct the error.
	The disc is dirty.	Wipe off any dirt or foreign material on the disc.

Symptom	Possible cause	Possible solution
The subtitles are not displayed.	The subtitle display setting is turned off.	Select [Subtitle]/[Subtitles] from the DVD menu screen and set it to on.  "DVD Menu" (page 3-23)
	The DVD being played back does not have any subtitles recorded on it.	Check the disc.
The audio does not play back in the set audio language.	If the set audio language is not recorded in the disc, the audio will play back in the disc's recommended language.	Check the disc.
The subtitles do not play back the set subtitle language.	If the set subtitle language is not recorded in the disc, the subtitles will play back in the disc's recommended language.	Check the disc.
The angle cannot be changed.	The software being played back does not have multiple-angle information recorded on it.	Check whether the inserted disc supports multiple angles.
The screen display is not normal.	A suitable display mode cannot be selected for the aspect ratio of the DVD.	Change the display mode.
The image is distorted.	The image is being fast-forwarded or re-wound.	This is not a malfunction.
The sound quality is poor.	The disc is dirty.	Wipe off any dirt or foreign material on the disc.
The subtitle language and audio language cannot be switched. (The languages for the subtitles and the audio do not switch to the language set in the system.)	The disc being played back does not have subtitles or audio for multiple languages recorded on it.	The number of subtitle and audio languages recorded varies depending on the disc. In addition, there are some discs for which this can be switched in the menu screen. Check the disc.
	There are default priority language and default priority settings for the disc.	If there are default priority language and default priority settings for the disc, changes set with this device will not be applied.
The menu of the VIDEO CD cannot be used.	The VIDEO CD does not have a playback control feature.	Menu playback is not possible for VIDEO CDs other than those with a playback control feature. Check the disc.

Symptom	Possible cause	Possible solution
The disc playback time is displayed but there is no sound.	The first track of a mixed mode disc (a disc format in which data other than music is recorded in the first track, and music is recorded in the second and subsequent tracks) was played back.	Playback the music data in the second and subsequent tracks.

## iPod PLAYER

Symptom	Possible cause	Possible solution
The system does not recognize an iPod.	A connector cable is not correctly connected, or the iPod does not correctly operate.	Connect the connector cable again. If the system does not recognize the iPod after performing this procedure above, reset the iPod.
	The iPod that is to be connected is not compatible with the system.	Check the iPod model and firmware versions available for the system.
	The connected USB extension cable is not compatible with the system.	Replace the USB extension cable if the system still does not recognize the iPod after reconnecting the cable properly a number of times.
	The cable is rapidly connected to or disconnected from the USB connection port.	Slowly connect or disconnect the USB cable.
An iPod cannot be operated.	The iPod is connected to the in-vehicle audio system while headsets, etc. are connected to the iPod.	Remove all equipment from the iPod after disconnecting the iPod from the system, and then connect it to the system again.
	The iPod is not operating normally.	Disconnect the iPod from the in-vehicle audio system, and then connect it to the system again.
	The system plays back an album/file that includes a particular album art.	Disconnect the iPod from the in-vehicle audio system, and then reset the iPod. Disable the album art, and then connect the iPod to the system.
An iPod does not respond.	There are too many files in a category.	Decrease the number of files in a category (less than 65500 files).
	The shuffle function is turned on.	Turn off the shuffle function if many files are stored on the iPod.
Music cannot be played back.	A connector is not connected to the iPod.	Firmly connect the connector to the iPod.
Playback cuts out.	The sound cuts due to vibration resulting from an unstable location of the iPod.	Place the iPod on a stable location where it does not roll over.

Symptom	Possible cause	Possible solution
Battery charge of an iPod takes longer.	Battery charge of the iPod may take longer while an iPod is playing back.	If the iPod needs to be charged, it is recommended to stop playing the music.
Battery charge of an iPod is unavailable.	The cable that is connected to the iPod may be damaged or improperly connected.	Check the cable currently in use.
Functions cannot be operated using an iPod that is connected to the in-vehicle audio system.	-	The operation of an iPod must be performed using the in-vehicle audio system after the iPod is connected to the system.
Sound skips.	Surrounding circumstances (noise, etc.) may cause the sound to skip.	This does not indicate a malfunction.
	A USB extension cable is used.	Do not use a USB extension cable.



## USB MEMORY DEVICE

Symptom	Possible cause	Possible solution
The system does not recognize a USB device.	A USB extension cable is used.	Do not use a USB extension cable.
	A USB hub is used.	Do not use a USB hub.
	A USB device is rapidly connected to or disconnected from the USB connection port.	Slowly connect or disconnect the USB device.



## BLUETOOTH® AUDIO

Symptom	Possible cause	Possible solution
Registration cannot be performed.	The Bluetooth® audio device is not compatible with the in-vehicle audio system.	Check the Bluetooth® audio device Owner's Manual.
	Bluetooth® is disabled on device.	Check that the Bluetooth® function is enabled on device.
	The PIN code is incorrect.	Check the PIN code for the Bluetooth® audio device that is to be registered.
		Check that the PIN code for the Bluetooth® audio device is consistent with that for the in-vehicle audio system.
Another Bluetooth® device is used in the vehicle.	Turn off the other Bluetooth® device until the registration is completed.	
Music cannot be played back.	The Bluetooth® audio device is not compatible with the in-vehicle audio system.	Check the Bluetooth® audio device Owner's Manual.
	The system is not set to the Bluetooth® audio mode.	Push <b>&lt;AUDIO&gt;</b> and select the Bluetooth® audio mode.  "Selecting audio source" (page 3-13)
	A Bluetooth® adapter is turned off.	Turn on a Bluetooth® adapter when it is used for a Bluetooth® audio device.
Playback stops.	The Bluetooth® audio device is not compatible with the in-vehicle audio system.	Use a device compatible with the system. Ask a NISSAN dealer for information regarding model compatibility.
	A cellular call is active.	This is not a malfunction.
	Sound may cut out when a Bluetooth® audio device is operated.	Push <b>&lt;AUDIO&gt;</b> and select the Bluetooth® audio mode, and then operate a function on the touch screen display of the in-vehicle system instead of conducting the operation on the Bluetooth® audio device.

Symptom	Possible cause	Possible solution
Audio operation cannot be performed.	A Bluetooth® audio device that does not support audio operations is in use.	Use a device compatible with the system. Ask a NISSAN dealer for information regarding model compatibility.
	An error occurs when connecting to a Bluetooth® audio profile.	Turn the power source of the Bluetooth® audio player off and on, and then resume connection with the system.







## BLUETOOTH® HANDS-FREE PHONE SYSTEM

Symptom	Possible cause	Possible solution
A cellular phone cannot be registered.	The cellular phone is not compatible with the in-vehicle hands-free phone system.	Use a cellular phone compatible with the system. Ask a NISSAN dealer for information regarding model compatibility.
	Registration of the cellular phone has been performed incorrectly.	Check the registration procedure, and then register the cellular phone again.
A cellular phone cannot be connected or is disconnected after the registration is completed.	The Bluetooth® setting of the in-vehicle hands-free phone system is turned off.	Turn on the Bluetooth® setting of the system.
	The Bluetooth® setting of the cellular phone is turned off.	Turn on the Bluetooth® setting of the cellular phone.
	The remaining battery level of the cellular phone is low.	Charge the battery of the cellular phone.
	The wireless Bluetooth® connection may be disrupted depending on the location of the cellular phone.	Do not place the cellular phone in an area surrounded by metal or far away from the in-vehicle hands-free phone system. Do not place the cellular phone close to the seats or your body.
	Registration of the cellular phone is not completed.	Perform registration of the cellular phone.
A call to a particular phone number fails.	If the system tries to make a call several times to the same phone number (for example: the party does not respond to the call, the party is out of the service area, or the call is abandoned before the party responds), the system may reject a request to make a call to the phone number.	Turn off the cellular phone and turn it on again to reset the connection.



Symptom	Possible cause	Possible solution
The system does not recognize the connection of a cellular phone. The system does not receive or make a call.	The cellular phone is not compatible with the in-vehicle hands-free phone system.	Use a cellular phone compatible with the system. Ask a NISSAN dealer for information regarding model compatibility.
	The cellular phone is not connected.	Check the registration procedure, and then register the cellular phone again.
	The phone operation is limited by the functions (such as dial lock, etc.) of the registered cellular phone.	Remove any settings that are limiting use of the cellular phone, and then perform registration again.
The other party cannot hear your voice. The other party can hear your voice, but it cracks or cuts out.	Mute function is enabled.	Verify mute function is disabled.
	The cellular phone is not connected.	Check the registration procedure, and then register the cellular phone again.
	The fan speed of the heater/air conditioner is too fast.	Decrease the fan speed of the heater/air conditioner.
	The ambient noise level is excessive. (For example: heavy rain, construction sites, inside a tunnel, oncoming vehicles, etc.)	Close the windows to shut out ambient noise.
	The noise generated by driving the vehicle is too loud.	Reduce the vehicle speed.
	The incoming voice volume is too loud/soft.	Adjust the volume using <VOL/  >/<VOLUME/  > or <  > >.
	The outgoing voice volume is too loud/soft.	Adjust the volume from volume adjustment screen.
The voice is cut out or noise is heard during a call.	The wireless Bluetooth® connection may be disrupted depending on the location of the cellular phone.	Do not place the cellular phone in an area surrounded by metal or far away from the in-vehicle hands-free phone system. Do not place a cellular phone close to the seats or your body.
When a cellular phone is operated to make a call, the hands-free function becomes unavailable.	Some models of a cellular phone do not switch to the hands-free mode when they are operated to make a call.	This is not a malfunction. Make another call using the hands-free function.

Symptom	Possible cause	Possible solution
The other party's voice cannot be heard. There is no ringtone.	The volume level is set to the minimum.	Adjust the volume level.
	A cellular phone is not connected.	Check the registration procedure, and then register the cellular phone again.
Each volume level (ringtone, incoming voice or outgoing voice) is different.	Each volume level is not adjusted properly.	Adjust each volume level properly.
The antenna display is different between the touch screen display and a cellular phone screen. Making or receiving a call is unavailable even though the antenna display shows that it is possible to do so.	The antenna display varies depending on the model of cellular phone.	This does not indicate a malfunction. The antenna display and remaining battery level shown on the touch screen display may be different from those shown on the cellular phone screen. Use them as a reference.
A voice cannot be heard clearly when using a cellular phone behind tall buildings.	Some structures such as tall buildings, etc. may cause irregular reflection of radio waves or completely shut out radio waves that are used for cellular phones.	Move to a place without tall buildings.
Noise is heard when using a cellular phone under/near areas of elevated railroads, high voltage electric power cables, traffic signals, neon billboards, etc.	Electromagnetic waves that are generated from radio devices may adversely affect the cellular phone.	This is not a malfunction.
Noise is heard in the sound from the audio system while using a cellular phone.	Radio waves that are generated from a cellular phone may adversely affect the sound from the audio system.	This is not a malfunction.
Sound skips or stutters.	The cellular phone may have turned on the wireless LAN (Wi-Fi).	Turn off the wireless LAN (Wi-Fi).
Phonebook cannot be downloaded.	An error occurred during the phone pairing process.	Please delete the Bluetooth® pairing information from both the cellular phone and vehicle system before registering it again.
	Phone does not support phonebook download function.	Use a cellular phone compatible with the system. Ask a NISSAN dealer for information regarding model compatibility.



## NISSANCONNECT SERVICES (if equipped)

Symptom	Possible cause	Possible solution
The system cannot connect to the NissanConnect Services Data Center.	A subscription for the NissanConnect Services has not been established.	Sign up for a subscription to the NissanConnect Services. For details about subscriptions, visit the website or contact the support line.  "NissanConnect Services (if equipped for Europe and Russia)" (page 5-8)  "NissanConnect Services powered by SiriusXM™ (if equipped for Mexico)" (page 5-9)
	The communication line is busy.	Try again after a short period of time.
	The vehicle is in a location where it is difficult to receive radio waves.	When the vehicle moves to an area where radio waves can be transmitted sufficiently, communication will be restored. When the icon on the display shows that the vehicle is inside the communication area, the system can be used.
	TCU (Telematics Control Unit) is not turned on.	If the icon does not show that the vehicle is inside the communication area despite the fact that the vehicle is in that location, visit the website or contact the support line.  "NissanConnect Services (if equipped for Europe and Russia)" (page 5-8)  "NissanConnect Services powered by SiriusXM™ (if equipped for Mexico)" (page 5-9)
	Radio wave reception is not sufficient for TCU (Telematics Control Unit) operation.	When the vehicle moves to an area where radio waves can be transmitted sufficiently, communication will be restored. When the icon on the display shows that the vehicle is inside the communication area, the system can be used.
Some of the items that are displayed on the menu screen cannot be selected.	The vehicle is being driven and some menu items are disabled.	Stop the vehicle in a safe location and apply the parking brake before operating the menu screen items.
Some parts of the screen are not displayed.	The vehicle is being driven and some menu items are disabled.	Operate the system after stopping the vehicle in a safe location and applying the parking brake.
The system does not announce information.	The volume level is set to the minimum.	Adjust the volume level by operating <VOL/  >/<VOLUME/  > on the control panel or <  > on the steering wheel switch while the system is announcing information.







## Apple CarPlay (if equipped)

Symptom	Cause and Countermeasure
<p>Cannot start Apple CarPlay though it is tethered to the vehicle.</p>	<p>The USB cable is not connected to the USB connection port. Properly connect the USB cable to the USB connection port.   "USB (Universal Serial Bus) connection port and AUX (auxiliary) input jack" (page 2-8)</p>
	<p>Models without Yandex.Auto:            [Enable after USB Connection:] is set to [Never]. Change the setting to [Always] or [Ask].   "Apple CarPlay settings" (page 5-18)</p>
	<p>Models with Yandex.Auto:            [Select Service] is set to [No service]. Change the setting to [Apple CarPlay].   "Apple CarPlay settings" (page 5-18)</p>
	<p>Use an Apple Lightning cable (Mfi certified) to connect your phone to the USB connection port and check that the cable is not broken.</p>
	<p>Apple CarPlay setting is not active on your iPhone. Turn on "CarPlay" on your iPhone.</p>
	<p>The device is not compatible with Apple CarPlay. Check the compatibility requirements.</p>
<p>Apple CarPlay performance decreases. For example, slow connectivity or slow application functionality.            or            An error message appears when trying to access features of Apple CarPlay. A blank screen appears when trying to access maps.</p>	<p>Confirm you have a compatible iPhone, a cellular connection and an active data plan.</p>
	<p>Use an Apple Lightning cable (Mfi certified) to connect your phone to the USB connection port.</p>
	<p>Phone's performance or cellular connection. Disconnect and reconnect your phone.</p>
	<p>Phone's performance or cellular connection. Cycle phone power off/on to restart.</p>







Cannot access Siri using <  > (if equipped) on the steering wheel.	The USB cable may not be properly connected. Disconnect and reconnect the USB cable.
	Siri setting is not enabled on the phone. Turn on Siri on your phone.
	Models with Voice Recognition System: Check that you are pushing and holding <  > (if equipped) instead of just pushing the switch to initiate Siri operation.

## Android Auto (if equipped)



Symptom	Cause and Countermeasure
<p>Cannot start Android Auto though it is connected to the vehicle.</p>	<p>The USB cable is not connected to the USB connection port. Properly connect the USB cable to the USB connection port.   "USB (Universal Serial Bus) connection port and AUX (auxiliary) input jack" (page 2-8)</p>
	<p>Models without Yandex.Auto:            [Enable after USB Connection:] is set to [Never]. Change the setting to [Always] or [Ask].   "Android Auto settings" (page 5-23)</p>
	<p>Models with Yandex.Auto:            [Select Service] is set to [No service]. Change the setting to [Android Auto].   "Android Auto settings" (page 5-23)</p>
	<p>To activate Android Auto, touch  on the Launch Bar or touch [Apps]/[Smartphone Connection] on the information screen and then touch [Android Auto].   "Selecting menu from Launch Bar" (page 2-9)   "Information menu" (page 5-2)</p>
	<p>The connected device is not compatible with Android Auto. Check the compatibility requirements.</p>
	<p>Your Android phone may not be recognized if its battery is low. Charge your Android phone then try again.</p>
<p>Android Auto performance decreases. For example, slow connectivity or slow application functionality.            or            An error message appears when trying to access features of Android Auto. A blank screen appears when trying to access maps.</p>	<p>Confirm you have a compatible Android phone, a cellular connection and an active data plan.</p>
	<p>Use the Android phone OEM cable to connect your phone to the USB connection port.</p>
	<p>Phone's performance or cellular connection. Disconnect and reconnect your phone.</p>
	<p>Phone's performance or cellular connection. Close all apps and restart them.            Phone's performance or cellular connection. Cycle phone power off/on to restart.</p>

Symptom	Cause and Countermeasure
Cannot start voice operation using < 𐄂 > (if equipped) on the steering wheel.	The USB cable may not be properly connected. Disconnect and reconnect the USB cable.
	Voice operation cannot be performed while driving. Turn on appropriate settings on your Android phone.
	Models with Voice Recognition System: Check that you are pushing and holding < 𐄂 > (if equipped) instead of just pushing the switch to initiate voice operation.

## YANDEX.AUTO (if equipped)

Symptom	Cause and Countermeasure
<p>Cannot start Yandex.Auto though it is tethered to the vehicle.</p>	<p>The USB cable is not connected to the USB connection port. Properly connect the USB cable to the USB connection port.   "USB (Universal Serial Bus) connection port and AUX (auxiliary) input jack" (page 2-8)</p>
	<p>[Select Service] is set to [No service]. Change the setting to [Yandex.Auto].   "Yandex.Auto settings" (page 5-27)</p>
	<p>iPhone:            Use an Apple Lightning cable (Mfi certified) to connect your phone to the USB connection port and check that the cable is not broken.</p>
	<p>The device is not compatible with Yandex.Auto. Check the compatibility requirements.</p>
<p>Yandex.Auto performance decreases. For example, slow connectivity or slow application functionality.            or            An error message appears when trying to access features of Yandex.Auto. A blank screen appears when trying to access maps.</p>	<p>Confirm you have a compatible smartphone, a cellular connection and an active data plan.</p>
	<p>iPhone:            Use an Apple Lightning cable (Mfi certified) to connect your phone to the USB connection port.</p>
	<p>Phone's performance or cellular connection. Disconnect and reconnect your phone.</p>
	<p>Phone's performance or cellular connection. Cycle phone power off/on to restart.</p>
<p>Cannot access voice assistant "Alice" using &lt;  &gt; (if equipped) on the steering wheel.</p>	<p>The USB cable may not be properly connected. Disconnect and reconnect the USB cable.</p>
	<p>Siri setting is not enabled on the phone. Turn on voice assistant "Alice" on your phone.</p>
	<p>Models with Voice Recognition System:            Check that you are pushing and holding &lt;  &gt; (if equipped) instead of just pushing the switch to initiate voice assistant "Alice" operation.</p>

## Siri Eyes Free (if equipped)

Symptom	Cause and Countermeasure
Cannot access Siri Eyes Free using <  > (if equipped) on the steering wheel.	Check if a Bluetooth® connection is established between the iPhone and the system.
	Check if Siri is enabled on the device. On your phone, go to Siri setting.
	Check that Siri can be accessed from the device lock screen. This can be set in the settings menu of your phone.
Audio source does not change automatically to iPod or Bluetooth® Audio mode.	For best results, use the native music app. Performance of music control function while using Podcasts, Audiobook or other third party music apps may vary.
	For best results, play media already stored on your device. Streaming music or playback from cloud storage may degrade performance.
	Switch the source manually.  "Selecting audio source" (page 3-13)
Play, pause, next track, previous track or play timer does not work.	For best results, use the native music app. Performance of music control function while using Podcasts, Audiobook or other third party music apps may vary and is controlled by the device.
Cannot hear any music/audio being played back from a connected iPhone.	Check that the audio source is set to Bluetooth® Audio or iPod mode. A USB connection is required for iPod mode.
Models with navigation system: Cannot hear map turn-by-turn direction guidance from a connected iPhone.	Check that the audio source is set to Bluetooth® Audio or iPod mode. A USB connection is required for iPod mode.
Cannot receive text message notifications on the vehicle audio system.	Check if notification setting is enabled on your phone.
Cannot reply to text message notifications using Siri Eyes Free.	After receiving an incoming text message, follow the on-screen guidance. Push and hold <  > (if equipped) on the steering wheel for Siri Eyes Free operation. After Siri Eyes Free starts, speak an appropriate command to reply to the message using Siri Eyes Free.

## NAVIGATION (if equipped)

### BASIC OPERATIONS

Symptom	Possible cause	Possible solution
No image is displayed.	The brightness is at the lowest setting.	Adjust the brightness of the display.
	The display is turned off.	Push <b>&lt;*/&gt;</b> to turn on the display.
The volume of the voice guidance is too high or too low.	The volume is not set correctly, or the voice guidance setting is turned off.	Adjust the volume of the voice guidance or turn on the voice guidance setting.
No map is displayed on the screen.	A screen other than a map screen is displayed.	Touch [Map] on the Launch Bar or push <b>&lt;MAP&gt;</b> .
The screen is too dim. The movement is slow.	The temperature in the interior of the vehicle is low.	Wait until the interior of the vehicle has warmed up.
Some pixels in the display are darker or brighter than others.	This condition is an inherent characteristic of liquid crystal displays.	This is not a malfunction.
Some menu items cannot be selected.	Some menu items become unavailable while the vehicle is driven.	Park the vehicle in a safe location, and then operate the navigation system.

## MAP SCREEN

Symptom	Possible cause	Possible solution
Names of roads and locations differ between 2D and 3D view.	This is because the quantity of the displayed information is reduced so that the screen does not become too cluttered. There is also a chance that names of the roads or locations may be displayed multiple times, and the names appearing on the screen may be different because of a processing procedure.	This is not a malfunction.
The location of the vehicle icon is misaligned from the actual position.	The vehicle was transported after the ignition switch or power switch was placed in the OFF position, for example, by a ferry or car transporter.	Drive the vehicle for a period of time on a road where Global Navigation Satellite System (GNSS) signals can be received.
	The position and direction of the vehicle icon may be incorrect depending on the driving environments and the levels of positioning accuracy of the navigation system.	This is not a malfunction. Drive the vehicle for a period of time to automatically correct the position and direction of the vehicle icon. ☞ "Current vehicle location" (page 6-39)
	Driving with tire chains or tires that have been replaced may result in an incorrect vehicle location display due to miscalculation by the speed sensor.	Drive the vehicle for a period of time (at approximately 30 km/h (19 MPH) for about 30 minutes) to automatically correct the vehicle icon position. If this does not correct the vehicle icon position, it is recommended you contact a NISSAN dealer.
	The map data has a mistake or is incomplete (the vehicle icon position is always misaligned in the same area).	Updated road information will be included in the next version of the map data. ☞ "How to update map data" (page 6-44)
When the vehicle is traveling on a new road, the vehicle icon is located on another road nearby.	Because the new road is not stored in the map data, the system automatically places the vehicle icon on the nearest road available.	Updated road information will be included in the next version of the map data. ☞ "How to update map data" (page 6-44)
The screen does not switch to the night screen even after turning on the headlights.	The daytime screen was set the last time the headlights were turned on.	Set the screen to the night screen mode using <*/> when turning on the headlights.

Symptom	Possible cause	Possible solution
The map does not scroll even when the vehicle is moving.	The current location map screen is not displayed.	Touch [Map] on the Launch Bar or push <b>&lt;MAP&gt;</b> .
The vehicle icon is not displayed.	The current location map screen is not displayed.	Touch [Map] on the Launch Bar or push <b>&lt;MAP&gt;</b> .



## ROUTE CALCULATION AND VISUAL GUIDANCE



Symptom	Possible cause	Possible solution
Waypoints are not included in the auto reroute calculation.	Waypoints that have been already passed are not included in the auto reroute calculation.	To go to that waypoint again, edit the route.
Route information is not displayed.	Route calculation has not yet been performed.	Set the destination and perform route calculation.
	The vehicle is not on the suggested route.	Drive on the suggested route.
	Route guidance is turned off.	Turn on route guidance.
Route information is not provided for certain types of roads.	Route information is not provided for certain types of roads.	This is not a malfunction.
The auto reroute calculation (or detour calculation) suggests the same route as the one previously suggested.	Route calculations took priority conditions into consideration, but the same route was calculated.	This is not a malfunction.
A waypoint cannot be added.	Twenty waypoints are already set on the route, including ones that the vehicle has already passed.	A maximum of 20 waypoints can be set on the route. To go to 21 or more waypoints, perform route calculations multiple times as necessary.
The suggested route is not displayed.	Roads near the destination cannot be calculated.	Reset the destination to a main or ordinary road, and recalculate the route.
	The starting point and destination are too close.	Set a more distant destination.
	The starting point and destination are too far away.	Divide the trip by selecting one or two intermediate destinations, and perform route calculations multiple times.
	There are time restricted roads (by the day of the week, by time) near the current vehicle location or destination.	Select [Do Not Use Restriction Info] in the [Time Restricted Roads] setting. ] 28 "Route Preference" (page 6-20)
A part of the route is not displayed.	The suggested route includes narrow streets.	This is not a malfunction.

Symptom	Possible cause	Possible solution
The part of the route that the vehicle has already passed is deleted.	A route is managed by sections between waypoints. If the vehicle passed the first waypoint, the section between the starting point and the waypoint is deleted (it may not be deleted depending on the area).	This is not a malfunction.
An indirect route is suggested.	If there are restrictions (such as one-way streets) on roads close to the starting point or destination, the system may suggest an indirect route.	Adjust the location of the starting point or destination.
	The system may suggest an indirect route because route calculation does not take into consideration some areas such as narrow streets.	Reset the destination to a main or ordinary road, and recalculate the route.
The landmark information does not correspond to the actual information.	This may be caused by insufficient or incorrect map data.	Updated information will be included in the next version of the map data.  "How to update map data" (page 6-44)
The suggested route does not exactly connect to the starting point, waypoints or destination.	There is no data for route calculation closer to these locations.	Set the starting point, waypoints and destination on a main road, and perform route calculation.

## VOICE GUIDANCE

Symptom	Possible cause	Possible solution
Voice guidance is not available.	The vehicle has deviated from the suggested route.	Go back to the suggested route or request route calculation again.
	Voice guidance is turned off.	Turn on voice guidance.
	Route guidance is turned off.	Turn on route guidance.
The guidance content does not correspond to the actual road conditions.	The content of voice guidance may vary, depending on the types of intersections at which turns are made.	Follow all traffic rules and regulations.

## TRAFFIC INFORMATION (if equipped)

Symptom	Possible cause	Possible solution
Traffic information is not displayed.	The traffic information setting is turned off.	Turn on the traffic information setting.  "Traffic information settings" (page 6-29)
	The vehicle is in an area where traffic information is not available.	Scroll to an area where traffic information is available.
	The map scale is set at a level where the icons cannot be displayed.	Check that the map scale is set at a level at which the icons can be displayed.  "Traffic information on map" (page 6-28)
The automatic detour route search setting is turned on, but the suggested detour route does not avoid congested areas.	A faster route was not found, based on the road network and traffic information available.	The automatic detour search is not intended for avoiding traffic jams. It searches for the fastest route taking conditions such as traffic jams into consideration. Follow the suggested route.  "Viewing traffic information" (page 6-27)
The route does not avoid a road section with traffic information stating that it is closed due to road construction.	The navigation system does not avoid roads under construction if the day and time of the actual roadwork differs from the one that was declared.	Observe the actual road conditions and follow the instructions on the road to make a detour when necessary. If the road is closed, use the detour function and set the detour distance to avoid the road section that is closed.

## VOICE RECOGNITION (if equipped)

Symptom	Possible cause	Possible solution
The system does not operate or fails to interpret the command correctly.	The interior of the vehicle is too noisy.	Close the windows or have the other occupants be quiet.
	The fan speed of the heater/air conditioner is too fast.	Decrease the fan speed of the heater/air conditioner.
	The noise generated by driving the vehicle is too loud.	Reduce the vehicle speed.
	The voice command is spoken in a low voice.	Speak the command in a louder voice.
	The timing of speaking a command is too early.	Speak the command after confirming the following: a voice guidance is announced, a tone sounds, and an icon on the screen changes from gray to orange.
	The command is spoken too slowly.	Speak in a natural voice without pausing between words.
The system prompts to repeat a command.	Pronunciation is unclear.	Speak clearly.
	The command is spoken too late after the tone.	Speak the command within 5 seconds after confirming the following: a voice guidance is announced, a tone sounds, and an icon on the screen changes from gray to orange.
	An improper command is spoken.	Speak the command or a number that is displayed on the screen.
Speak a command that is shown in the command list.		
The system does not correctly recognize a number spoken.	Too many numbers are spoken at once.	Place a pause between the appropriate digits for correct recognition by the system. When speaking a phone number, place a pause between area codes, dial codes, etc.
USB memory device cannot be operated with voice commands.	Depending on the device, iPhone or iPod may be recognized as a USB memory device.	This is not a malfunction.
The USB/iPod operation screen is grayed out.	The audio device is not connected.	Connect an audio device to the system.

Symptom	Possible cause	Possible solution
An error message is displayed when trying to select a track and operate USB/iPod.	The track information is being processed for registration by the system.	Song information will be loaded into the system when a new audio device is registered for the first time or when the song information in the pre-registered device has been changed. Please wait for the loading to complete which may take a few minutes to up to an hour.
	A number of songs exceeding the amount the device can contain are stored in the connected audio device.	Decrease the number of songs stored in the audio device.
	No song is stored in the audio device.	Store songs in the connected audio device. Storing songs with information such as artist name, album name, song name, playlist, etc., will make voice recognition song search available.

# 9 Index

## Number

2D map ..... 6-3, 6-5  
3D map ..... 6-6

## A

About route guidance ..... 6-16  
Android Auto ..... 5-20  
Apple CarPlay ..... 5-16  
Audio operation precautions ..... 3-2  
Audio operations ..... 3-13  
Automatic map update ..... 6-46  
AUX (auxiliary) input jack ..... 2-8  
Auxiliary (AUX) devices ..... 3-28

## B

Bluetooth® audio ..... 3-13  
Bluetooth® Hands-Free  
Phone System ..... 4-2  
Building graphics ..... 6-6

## C

CD/DVD/USB memory device care  
and cleaning ..... 3-30  
Changing order of destination  
and waypoints ..... 6-25  
Changing scale of map ..... 6-8  
Compact Disc (CD) player ..... 3-3  
Compass mode display ..... 6-7  
Compressed audio  
files (MP3/WMA/AAC) ..... 3-7

Connecting Bluetooth®  
Hands-Free Phone ..... 4-4  
Connections settings ..... 2-13  
Control buttons and touch  
screen display ..... 2-2  
Current vehicle location ..... 6-39

## D

Deleting stored item ..... 6-35  
Destination setting menu ..... 6-13  
Digital Versatile Disc (DVD) player ..... 3-4  
Display Commander ..... 2-7  
Displaying navigation screen ..... 6-2  
During a call ..... 4-5

## E

Editing route ..... 6-23  
Editing stored information ..... 6-31

## F

Functions disabled while driving ..... 2-10

## G

Giving voice commands ..... 7-2

## H

Hands-free text  
messaging assistant ..... 4-6  
How to see voice command screen ... 7-3

## I

Information menu ..... 5-2

## L

Launch Bar ..... 2-9  
Legal disclaimer ..... 1-7  
Licenses ..... 1-8  
Liquid crystal display ..... 2-3

## M

Making a call ..... 4-4  
Map Menu screen ..... 6-13  
Map types ..... 6-3  
Map view settings ..... 6-10  
Moving map ..... 6-8

## N

Navigation screen ..... 6-2  
Navigation settings ..... 6-37  
NissanConnect Services ..... 5-8, 5-9  
NissanConnect  
Services settings ..... 5-8, 5-15

## O

One Shot Call ..... 7-3  
Options before starting the  
route guidance ..... 6-16

**P**

Phone .....	4-4
Phone selection .....	4-4
Phone settings .....	4-10

**Q**

Quick Dial .....	4-13
------------------	------

**R**

Radio .....	3-2, 3-14
Recalculating route .....	6-23
Receiving a call .....	4-5
Route calculation .....	6-42
Route guidance .....	6-16, 6-43

**S**

Safety information .....	1-3, 6-2
Settings menu .....	2-11
Siri Eyes Free .....	5-28
Siri operation .....	5-17
Start-up screen .....	2-9
Starting system .....	2-9
Storing a location/route .....	6-29
Storing avoid area .....	6-31
Storing home location .....	6-29
Storing location .....	6-29
Storing route .....	6-30
System settings .....	2-11
System voice settings .....	7-5

**T**

Text message settings .....	4-10
Touch screen display .....	2-3
Trademarks .....	1-6
Traffic information settings .....	6-29

**U**

USB (Universal Serial Bus) connection port .....	2-8, 3-6
---	----------

**V**

Viewing traffic information .....	6-27
Voice Prompt Interrupt .....	7-3
Voice recognition .....	7-2

**Y**

Yandex.Auto .....	5-25
-------------------	------



**MEMO**



**MEMO**



Printing: February 2020  
Publication No.: OM19E00D15G0  
Printed in India  
T00UM-8HA1E

D15-A