

MAX-PLANCK-GESELLSCHAFT

# Report 2013-2016

Max-Planck-Institut  
für Gravitationsphysik  
Albert-Einstein-Institut



Max-Planck-Gesellschaft  
zur Förderung der Wissenschaften e. V.

**Title image: The first binary black-hole merger observed by LIGO**

The numerical relativity simulation shows the gravitational waves emitted during inspiral and merger of the first black hole binary detected by LIGO on 14th September 2015. The two detected inspiralling black holes merged to form a new black hole. This first direct detection of gravitational waves in the event named GW150914 was the culmination of decades of research in gravitational wave detection in the Max Planck Society going back to the very beginning of the field in the 1960s. The simulation shows the black hole horizons, the strong gravitational field surrounding the black holes, and the gravitational waves produced by the movement of the black holes in space-time.

**Numerical-relativity Simulation:** S. Ossokine, A. Buonanno (Max Planck Institute for Gravitational Physics), Simulating eXtreme Spacetimes project;

**Scientific Visualization:** W. Bengert (Airborne Hydro Mapping Software GmbH)

Everyone is now able to send this image of the Nobel Prize-winning discovery by letter: The German Federal Ministry of Finance issued a 70 cent stamp featuring Einstein's space-time ripples from the collision of two black holes on December 7th. Members of the "Astrophysical and Cosmological Relativity" division led by Prof. Alessandra Buonanno at the Max Planck Institute for Gravitational Physics in Potsdam performed the numerical-relativity simulation.



Stamp design: A. Voß-Acker

## **Preface of the Managing Director**

The Albert Einstein Institute (AEI) was founded in 1995. It is now the largest research institution in the world devoted to the study of gravitation and the general theory of relativity. The two parts, located in Potsdam and Hannover, are composed of about 300 scientific researchers and students, and technical and administrative staff.

This report covers the period from January 2013 to December 2016, and presents an overview of the scientific work at the AEI, and of our current plans and directions. Broadly speaking, the AEI is organized into five independent Divisions, each with its own Director, plus four independent research groups. The report is structured accordingly.

These four years have seen a number of important changes at the AEI. Bernard Schutz, Director of the Astrophysical Relativity Division, retired in 2014, but remains affiliated with the AEI as an Emeritus Director until mid-2018. Alessandra Buonanno joined the AEI in 2014 as a Director of the newly-formed Division of Astrophysical and Cosmological Relativity. New independent research groups were created, led by Holger Pletsch and Maria Rodriguez. Jean-Luc Lehners' group (established in 2010 with the support of a Starting Grant from the European Research Council), has been funded by the Max Planck Society since 2015.

The pioneering open-access on-line journal *Living Reviews in Relativity*, founded by Schutz in 1998, was shifted (along with two other MPS *Living Reviews* titles) to Springer Verlag.

But surely the most dramatic event during the three-year period has been the first direct detection of gravitational waves on 14<sup>th</sup> September 2015, by the advanced LIGO instruments. This discovery was reported in a landmark publication in *Physical Review Letters* (PRL) on 11<sup>th</sup> February 2016, and made headlines around the world. The signal (called GW150914) came from the late inspiral, merger, and ringdown of two black holes, each about thirty times as massive as the sun. While it was visible in the detectors for only a fraction of a second, it was the first time that the amplitude and phase of gravitational waves have been directly observed by humanity. It provides strong evidence for the existence of black holes, and demonstrates that Einstein's theory works correctly in a strong-field dynamical regime where it was previously untested. The first detection was quickly followed by a second one on December 26, 2015 (called GW151226). It was again a collision of two black holes, but this time the signal was weaker and visible for one second, a consequence of the black holes' masses being smaller.

The direct detection of gravitational waves was one of the main scientific targets of Bernard Schutz and Jürgen Ehlers (deceased 2008) when they founded the AEI 21 years ago; in fact about 10% of the PRL authors are from the AEI. Four different Divisions made essential contributions to the instrument, the data analysis, the modeling of the waveforms, and the inference of the sources' properties.

The coming years will see many further discoveries, and the long-awaited transition of this field into a working tool to observe the universe and to study general relativity. The very successful launch and operation of the LISA Pathfinder satellite, testing technology to be used in a future space-based low-frequency gravitational wave detector is a strong sign that also bodes well for the future.

As the AEI matures into adulthood, it will face new challenges, but the scientific landscape is ripe with opportunity. I am confident that the AEI will retain the vibrant and creative edges that have kept it at the forefront for the past two decades.

Bruce Allen



## Content

### Research Overview

Astrophysical and Cosmological Relativity	5
Astrophysical Relativity (2013-2014)	7
Geometric Analysis and Gravitation	10
Laser Interferometry and Gravitational Wave Astronomy	12
Observational Relativity and Cosmology	16
Quantum Gravity and Unified Theories	20
Geometric Measure Theory (Max Planck Research Group)	23
Gravitation and Black Hole Theory (Max Planck Research Group)	26
Pulsar Observation and Data Analysis (Max Planck Research Group)	27
Theoretical Cosmology (Max Planck Research Group)	31

### Research Highlights

#### Astrophysical and Cosmological Relativity Division

Modeling gravitational waves from compact-object binary systems with matter	35
Numerical-relativity simulations and modeling of black-hole binaries for gravitational-wave observations	38
Developing searches and parameter estimation follow-up for gravitational waves from spinning black-hole binaries	41

#### Astrophysical Relativity Division

Astrophysical sources, high-energy astrophysics, planetary science, and dark matter	44
---	----

#### Geometric Analysis and Gravitation Division

The anti-de Sitter stability problem	47
--------------------------------------	----

#### Laser Interferometry and Gravitational Wave Astronomy Division

Gravitational geodesy from space	50
Squeezed light for metrology	54

#### Observational Relativity and Cosmology Division

Developments in gravitational wave searches for binary systems	57
Improving the sensitivity of continuous gravitational-wave searches	59

#### Quantum Gravity and Unified Theories Division

From the atoms of space to cosmology	63
String amplitudes and number theory	66

<b>Research Highlights (contd.)</b>	
Geometric Measure Theory Research Group	
Geometric curvature energies	70
Pulsar Observation and Data Analysis Research Group	
Einstein@Home searches for gamma-ray pulsars	73
Theoretical Cosmology Research Group	
Conflation - a new type of accelerated expansion	77
<b>Through the Eyes of a Visitor</b>	81
<b>IT &amp; Library Highlights</b>	
Activities and highlights of the IT department	83
The library in 2013 - 2016	84
<b>Public Relations</b>	87
<b>IMPRS for Geometric Analysis, Gravitation, and String Theory</b>	91
<b>IMPRS on Gravitational Wave Astronomy</b>	92
<b>Living Reviews</b>	95
<b>Cooperations and Outside Funding</b>	97
<b>Appraisals and Prizes</b>	103
<b>Academic Achievements</b>	105
<b>Lists AEI</b>	
The Scientific Advisory Board	115
The Board of Trustees	116
Scientists and Support Staff	117
Guest Scientists	123
Publications	139
Institute Colloquia	197
Invited Conference Talks	201
Lectures and Lecture Series	214
Popular Talks	223
Events	231
Contacts	236
<b>The Max Planck Society</b>	237
<b>Masthead</b>	238

## Astrophysical and Cosmological Relativity

The Division “Astrophysical and Cosmological Relativity” is led by Alessandra Buonanno and it was established in September 2014. The research focuses on three principal topics: i) Theoretical Gravitational Dynamics and Radiation, ii) Source Modeling and Astrophysics and iii) Observing and Interpreting Gravitational Waves. The division also includes the research group Searching for Continuous Gravitational Waves from Compact Objects led by M.A. Papa. For logistic and scientific reasons Papa’s group is physically located at the AEI in Hannover, where it interacts with Allen’s Observational Relativity and Cosmology Division. Several scientists of the division are members of the LIGO Scientific Collaboration (LSC); some members of the division belong to the European Pulsar Timing Array (EPTA) and the Laser Interferometer Space Antenna (LISA) consortium.

The research in the *Theoretical Gravitational Dynamics and Radiation* group aims at advancing our knowledge of the two-body dynamics and gravitational radiation. The work is primarily conducted within general relativity, but also in modified theories of gravity, and it is particularly relevant for predicting accurate waveform models for gravitational-wave observations on the ground and in space. Scientists carry out calculations within post-Newtonian (PN) theory, the gravitational self-force (GSF) approach, and the effective-one-body (EOB) formalism. Principal results since the inception of the division have been concerned with the computation of higher-order spin effects in PN theory and in the small-mass ratio limit for binary black holes, and dynamical tides in binary neutron stars; self-interaction and extended-body effects in the equations of motion in arbitrary dimensions; perturbative and non-perturbative effects in scalar-tensor theories of gravity, and tests of the equivalence principle in triple pulsar systems.

The *Source Modeling and Astrophysics* group builds on the theoretical gravitational results and develops waveform models (or templates) that combine analytical and numerical relativity. Those templates are then used to observe gravitational waves and infer astrophysical and fundamental physics information upon detection. Astrophysicists in this group study binary formation scenarios, predict event rates, and develop progressively more realistic gravitational-wave source models. The construction of inspiral, merger and ringdown templates relies also on highly-accurate waveforms produced by solving the Einstein equations numerically. Buonanno’s division has joined the Simulating eXtreme Spacetimes (SXS) project, with whom Buonanno has had a very fruitful collaboration since 2007. Main results of this group have been concerned with the development and implementation in the LIGO Algorithm Library of EOBNR waveform models that include black-hole spins and that were used during the first observing run to assess high statistical significance in GW150914 and detect GW151226. Those waveform models were employed also to extract GW150914’s and GW151226’s astrophysical properties and to carry out tests of general relativity. In response to the observations of GW150914 and GW151226, numerical-relativity simulations with parameters close to the events were produced to check the accuracy of waveform models used in follow-up studies and assess possible biases. Furthermore, one hundred spinning binary black-hole simulations

were produced to extend EOBNR templates in more complex or extreme regions of the parameter space and use them in upcoming LIGO observing runs. Binary neutron-star simulations were also produced to improve the modeling of tidal effects during the last stages of coalescence, and predict the final remnant and post-merger signal.

The *Observing and Interpreting Gravitational Waves* group develops analysis algorithms to search for gravitational waves from binary coalescences in instruments' data. They also build methods for the extraction of physical information upon detections using Bayesian statistical theory. To reduce the computational cost of generating waveform models for detection pipelines and (especially) Bayesian analyses, scientists in the division develop reduced-order models. Members of this group were among the most significant contributors to the two analysis algorithms that were able to identify GW150914 and GW151226 as genuine gravitational-wave signals with greater than 5 standard-deviation confidence. They also developed new techniques to be able to optimally choose templates that can cover arbitrarily ranges of black-hole's component masses and spins, and also extended this work to search for compact-object binary coalescences with misaligned spins, which are currently excluded in searches of LIGO data. They were in charge of setting up, coordinating and (with other LSC members) running the parameter-estimation effort for the first observing run. Furthermore, scientists in the division who are members of EPTA used long-term observations of radio pulsars to set upper limits on the strain of individually resolvable supermassive binary black holes. Members of the LISA consortium have provided major inputs to the Gravitational Observatory Advisory Team (GOAT) to advice ESA on possible LISA configurations, and have contributed substantially to the LISA proposal in response to the ESA call for L3 mission concepts.

Lastly, Buonanno purchased in 2016 a new HPC-cluster called Minerva. It consists of 594 compute nodes with a total of 9504 CPU cores. Minerva's primarily usage is in numerical relativity, simulating binaries composed of black holes and neutron stars.

Alessandra Buonanno





## **Astrophysical Relativity 2013-14**

Since the founding of the AEI, the Astrophysical Relativity Division has focussed on the theoretical and data-analysis underpinnings of the first observations of gravitational waves. Predicted by Einstein, these ripples in the gravitational field carry information about the most catastrophic events in the Universe: the mergers of black holes and/or neutron stars with one another. In parallel with the building of the detectors, which is another AEI speciality, we need to be ready to do the difficult job of recognising the signals in the detectors' data, and of extracting and understanding the information these signals contain.

Accordingly, the Division has worked to understand how gravitational waves are generated by black holes and neutron stars, how we detect them, and how we will extract information from the waves we detect. There have been five main divisions of activity: numerical relativity, data analysis for ground-based detectors, data analysis for pulsar timing arrays, preparations for LISA, and astrophysics of gravitational wave sources. This report covers the last 26 months of the activity of the Division, ending with my retirement at the end of August 2014. Work in these fields at the AEI did not stop, however, as is shown in the report of work elsewhere in this volume by my replacement director, Prof. Alessandra Buonanno.

### **Numerical relativity**

Some of our scientists in the Astrophysical Relativity Division perform large supercomputer simulations of the mergers of black holes and neutron stars. Not only were these merger events among the first gravitational wave sources to be directly detected by the LSC and Virgo detectors, but these events are also intrinsically very interesting because they have much to tell us about general relativity and physics under extreme conditions. Numerical simulations of this kind are a kind of laboratory astrophysics: since we can't experiment directly on neutron stars and black holes, and since they are too complex for us to solve the full Einstein equations for with paper and pencil, our approach is to solve the Einstein equations numerically to understand the evolution of systems we believe exist, using as much other physics as we are able to include.

The AEI group has been a world leader in examining the effects of strong magnetic fields on mergers of neutron-stars; we know that neutron stars have such fields, and that they lead to the emission of bursts of gamma-rays when the stars merge, as was shown by the AEI group, among others, some years ago. During this period we worked to put yet more physics into these large numerical simulations, and then to apply this physics to make testable predictions about the correlation between the gravitational waves from the inspiral and merger with the emission of gamma-rays, optical light, and radio waves from the same events. A new understanding has emerged, that there could be abundant X-ray emission from these events even before the gamma-ray burst is seen, but after the gravitational-waves have been received [1]. Astronomers are being encouraged to find ways to locate this increased X-ray activity before the gamma-ray burst is emitted.

Toward the end of this period, the leader of the numerical relativity group, L. Rezzolla, moved to Frankfurt University to take up a full professorship and establish his own group in the field. This is a welcome step that will increase the effort to understand these important and soon-to-be-detected gravitational wave sources.

### **Analysis of data from ground-based detectors**

As members of the GEO project, scientists at AEI/Golm and AEI/Hannover work with our partners elsewhere in Europe, in the USA, and worldwide within the LIGO Scientific Collaboration (LSC). The LSC includes the two large LIGO detectors in the USA and the GEO600 detector operated by AEI/Hannover. The LSC shares its data with that from the large Italian-French Virgo detector in Pisa, performing joint analyses to extract the greatest possible science. During this reporting period, the LIGO and Virgo detectors have been shut down for a major sensitivity upgrade to what are called Advanced detectors, which were to be completed in 2015. The smaller GEO600 meanwhile has been performing “Astrowatch” monitoring of the sky while also upgrading its sensitivity and installing new technologies, like squeezed light. Over a longer timescale two further large detectors are in the planning stages: one in Japan (KAGRA) and another LIGO detector in India.

During this period where no new data was coming in, the data-analysis scientists of the AEI have been mainly engaged in preparing the data analysis software and hardware systems to run with optimum signal-finding capabilities, and to run efficiently, ready for the first new data in 2015. In addition the group finished the analysis of the 2005-10 data for a variety of possible sources. No detections were reported, which is not surprising since the detectors’ sensitivity in that first period was not high enough to give us a good probability of detecting anything.

During this period, the leader of this group, Dr. M.-A. Papa, finished a term as the co-chair of the Data Analysis Council of the whole worldwide LIGO-Virgo collaboration, allowing her to spend more time on her research subject, the detection of gravitational wave pulsars. Dr. Papa made a very significant contribution to the organisation of the collaboration’s data analysis and of the writing of the dozens of research papers that have been published from the first phase of data [2].

### **Preparations for the LISA space-based gravitational wave mission**

Although gravitational waves will first be directly observed by ground-based detectors, it will be important to put a detector system into space if the promise of gravitational wave astronomy is to be realised. This is because the richest frequency range for gravitational waves in astronomy is the milliHertz band, and this is inaccessible to detectors built on the ground. Accordingly, the European Space Agency (ESA) has been developing a project called LISA since 1994. Because the technology is new, it has in parallel been developing a mission called LISA Pathfinder (LPF) to prove the elements of the detector technology that cannot adequately be tested on ground, and LPF was launched in 2015. But because there is confidence in the technology, and because it takes more than a decade to develop a full mission like LISA, ESA also decided during 2013 that its third upcoming major

mission launch (L3) would be dedicated to a gravitational wave observatory, with the science goals set out in the eLISA proposal that was led by the AEI [3].

ESA then constituted a committee to advise it on the appropriate technology, in view of the progress on LPF. This committee, the Gravitational Observatory Assessment Team, began meeting in 2014, and I was invited to become one of its members.

## References

- [1] Siegel, D. M., Ciolfi, R., & Rezzolla, L. (2014). Magnetically driven winds from differentially rotating neutron stars and X-ray afterglows of short gamma-ray bursts. *The Astrophysical Journal Letters*, 785: L6. doi:10.1088/2041-8205/785/1/L6.
- [2] Bizouard, M. A., & Papa, M. A. (2013). Searching for gravitational waves with the LIGO and Virgo interferometers. *Comptes Rendus Physique*, 14(4), 352-365. doi:10.1016/j.crhy.2013.03.001.
- [3] Amaro-Seoane, P., et al (2013). eLISA: Astrophysics and cosmology in the millihertz regime. *GW Notes*, 6, 4-110.
- [4] Sesana, A. (2013). Systematic investigation of the expected gravitational wave signal from supermassive black hole binaries in the pulsar timing band. *Monthly Notices of the Royal Astronomical Society: Letters*, 433(1), L1-L5. doi:10.1093/mnras/ltt034.
- [5] Petiteau, A., Babak, S., Sesana, A., & de Araujo, M. (2013). Resolving multiple supermassive black hole binaries with pulsar timing arrays II: genetic algorithm implementation. *Physical Review D*, 87: 064036. doi:10.1103/PhysRevD.87.064036.
- [6] Amaro-Seoane, P., & Chen, X. (2014). The Fragmenting Past of the Disk at the Galactic Center: The Culprit for the Missing Red Giants. *ApJ Lett*, 781 (1), 18-23.



## Pulsar timing for gravitational wave detection

In the last few years a new and exciting method for detecting gravitational waves has been developed and is now being intensively pursued around the world: using signals from millisecond pulsars to measure gravitational waves that pass through the Earth. These pulsars are, when averaged over a period of several months, excellent clocks, as good as any that we can build. When a gravitational wave passes the Earth, it delays or advances the arrival time of pulses by a very small amount, and the pattern of delays and advances on the sky is very distinctive. By monitoring pulsars over the whole sky regularly, astronomers hope to recognize the characteristic signature of a gravitational wave.

This only works at very low frequencies, say 10-100 nHz, because the pulsar arrival times have to be averaged over several-month periods. This is far below the LISA frequency band. At these frequencies the dominant sources are expected to be binary systems of supermassive black holes of the kind that power quasars. AEI scientist Alberto Sesana, a member of our astrophysics group (next section), is the world-leading expert on the evolution of these systems, and has provided an estimate of the intensity of the random gravitational wave background due to the superposition of millions of such mergers over time [4]. His colleague Stanislav Babak has worked on the opposite question, how to detect single mergers against a background of noise from all of the more distant ones [5].

## Astrophysics

Our astrophysics research group, led by Pau Amaro-Seoane, has been very active, supporting the interests of the data analysis and numerical groups, but also developing its own research on the star clusters surrounding the massive black holes that astronomers have been finding at the centres of galaxies. The nearest massive black hole, the one at the centre of our own Milky Way galaxy, offers an ideal location to try to understand the clusters of stars near it, because these regulate the capture of smaller stars and black holes by the large hole. Out of these studies, Pau and his student Xian Chen have come up with a new and very attractive theory of why there are so many recently formed giant stars near the central black hole [6]. This has been a mystery ever since they were found.

Bernard F. Schutz

## Geometric Analysis and Gravitation

The division “Geometric Analysis and Gravitation” is concerned with foundational and mathematical aspects of gravitational physics. Research on gravitation has throughout its history been driven by fundamental principles and modern mathematics, with the work of Einstein as an inspirational example concerning both of these aspects. In the work of the division, which bridges the topics of the other divisions of the Albert Einstein Institute, ideas from analysis, geometry and physics interact in fascinating and intellectually challenging ways. The methods employed range from differential geometry, nonlinear partial differential equations, calculus of variations and geometric measure theory all the way to discrete approximations and numerical analysis. Special emphasis is given to Einstein’s field equations in classical general relativity, modelling phenomena such as isolated gravitating systems and black holes, gravitational waves and cosmology.

There are close scientific connections with the other divisions at the AEI and to the nearby Universities in Berlin and Potsdam. At the institutional level collaborations exist through collaborative research structures (International Max Planck Research School “Geometric Analysis, Gravitation and String Theory” (“IMPRS”), Special Research Center 647 “Space-Time-Matter” of the German Research Foundation DFG (“SFB647”) and the Berlin Mathematical School in the DFG “excellence initiative” (“BMS”). The IMPRS has attracted excellent students from around the world and intensified the collaboration between this division and the “Quantum Gravity and Unified Theories” division as well as with Potsdam University and Free University Berlin. Some of the students have in addition become members of the BMS leading to new links with the wider Berlin mathematical community. In a joint appointment with Potsdam University an independent Max Planck Research Group was set up in the area of “Geometric Measure Theory”. Methods from geometric measure theory turn out to be crucial in the understanding of positive mass theorems, energy inequalities and marginal outer trapped surfaces. A high level seminar series on these topics has been maintained in collaboration with Potsdam University and the Free University of Berlin.

International collaboration has been supported by the guest program of the institute and has taken place in many directions. Funds from the AEI and from the IMPRS and the BMS allowed many students to participate in conferences and to visit partner institutions. Frequent exchanges take place with the research group of J. Bičak and his colleagues in Prague as well as with the research groups of P. Chruściel in Vienna, and P. Bizon in Krakow.

Outreach activities include the annual vacation course in collaboration with Potsdam University, as well as invited research lecture series at other institutes. Members of the division participated in the organization of international conferences and workshops and helped in the administration and evaluation processes of their research fields. L. Andersson spent the academic year 2014-15 as a Wallenberg Professor at the Royal Institute of Technology in Stockholm. During the fall term of 2015, a research Trimestre on Mathematical General Relativity, with a large number of international visitors was organized at

the Institute Henri Poincaré, Paris, by L. Andersson, P. LeFloch and S. Klainerman. A highlight of the programme was a high level international conference commemorating the centennial of general relativity.

Lars Andersson now leads a core group of researchers in Mathematical Relativity until a new director is appointed while Gerhard Huisken will remain associated with the division as an external scientific member of the AEI. The institute is currently in the process of finding successors for these positions.

One of the major topics of research during the last few years concerns analysis and geometry in black hole space-times. One of the most important open problems in general relativity is the nonlinear stability of the Kerr black hole space-time, which is expected to be the unique vacuum model for a rotating black hole in general relativity. Compact objects such as black holes play a central role in astrophysics. The interactions of black holes are expected to be an essential source of gravitational waves, and it is therefore important to gain a complete understanding of their properties. Major progress has been made in the division towards exploiting the algebraically special nature of the Kerr black hole to prove dispersive behavior of fields on the Kerr background, a major step towards proving stability. In the course of this work, new computer algebra tools have been developed and employed to carry out calculations which would be impossible to do by hand. This opens up many new avenues of research. These techniques have already been employed in a collaborative project with the division on “Quantum Gravity and Unified Theories”.

More generally a wide range of nonlinear phenomena are being investigated, using both numerical and analytical techniques. Here, a close collaboration is maintained with the group of Oliver Rinne, who joined the division in 2012. His group, funded by a Heisenberg fellowship, as well as additional DFG funding, makes use of a combination of analytical numerical techniques to investigate solutions to Einstein's equations, as well as other nonlinear field equations. These studies are important both for numerical simulations of black holes as well as for stable algorithms concerning the behaviour of gravitational fields near spacelike infinity, and provide a close link with the research group on numerical relativity in the division “Astrophysical Relativity”.

A highlight article by Maciej Maliborsky on weak turbulence is presented on page 47 below.



Lars Andersson

## Laser Interferometry and Gravitational Wave Astronomy

The reporting period 2013 – 2016 was a period of great achievements for the division and for gravitational wave astronomy in general. The first detection of gravitational waves from two merging black holes on 14<sup>th</sup> September of 2015 marks the beginning of gravitational wave astronomy. We are proud that many of the technologies that made Advanced LIGO so much more sensitive than initial LIGO and that made this discovery possible, were developed in our GEO collaboration and/or tested in our GEO600 gravitational wave detector. GEO600 itself has been performing well in Astrowatch data taking mode during the downtime of LIGO and Virgo. But we have also further improved the detector, in particular with regard to squeezing and control. In 2013 ESA has selected our proposal for a low-frequency gravitational wave observatory, The Gravitational Universe, as the Science Theme for its L3 large space mission. Technology development for the most pressing items is already beginning and the Phase-A industrial system study will begin in 2018. LISA Pathfinder is the precursor mission demonstrating most technologies in space. It was launched on 3<sup>rd</sup> December of 2015 from Kourou in French Guiana, exactly 100 years after the publication of Einstein's general relativity. At the time of this writing it is in science operations at the Lagrange point L1, and showing superb performance, demonstrating for the first time laser interferometry between free flying test masses in space. The work on the GRACE Follow-On mission to map the spatial and temporal variation of the earth gravity field is proceeding well, with flight hardware being assembled and tested, and the launch is foreseen in early 2018.

### GEO600

GEO600 is the only gravitational wave observatory worldwide employing and exploring squeezed light application in routine gravitational wave observations. To make the operation even more reliable, a novel squeezing phase control scheme was introduced. The sensing errors were lowered, thus reducing losses due to sensing. This enabled the introduction of the first automatic alignment system of squeezed light ever. Both techniques are now foreseen to be installed in Advanced LIGO once it will be ready for squeezing implementation as the next innovative technologies developed at GEO. On GEO600 squeezed light is routinely applied and we have demonstrated the long-term application of squeezed light with >90% up-time of squeezing in normal operations.

### Einstein Telescope

After the conclusion of the large joint European Design Study for the Einstein Telescope in 2011, the work at the AEI has been focussing on detail aspects of the observatory design. This involved the development of a FINESSE model of the detuned, narrow-band ET LF system including radiation pressure effects and squeezed light.

### 10m Prototype

The 10m prototype interferometer construction has remained to be a challenge, but it has made major progress over the last reporting period. The way towards the Standard Quantum Limit (SQL) experiment is now more promising. Laser intensity stabilisation with a photodiode array has been installed and is operating at a level of

### Albert Einstein Institute Hannover

The AEI Hannover grew out of the gravitational wave group of the Max Planck Institute for Quantum Optics in Garching. It came into proper existence in 2002, with the appointment of Karsten Danzmann as the first director in Hannover. In 2007 we have established the second division by appointing Bruce Allen as the second Director.

At AEI Hannover the MPG works closely together with the Leibniz Universität Hannover. The MPG committed to provide stable research funding for both of the planned divisions and the University provided a new building with 4000 m<sup>2</sup> of lab and office space, equipped with basic scientific inventory.

$2 \cdot 10^{-9}$   $\sqrt{\text{Hz}}$  relative intensity noise. The triple suspensions for the 100g SQL mirrors have been designed, built, tested and the first set of two installed.

### **Laser development**

Stabilized high power lasers for gravitational wave detectors are one of the main research topics in the Laser Interferometry and Gravitational Wave Astronomy division. This involves support and maintenance of laser systems installed in GEO-HF (High Frequency), Advanced LIGO and at the 10m prototype as well as the development and test of future light sources and their stabilization. The AEI developed, fabricated and installed the pre-stabilized high power laser systems for Advanced LIGO.

### **High-power lasers**

High-power lasers based on fiber amplifiers are promising concepts for future generation gravitational wave detectors. Laser systems with several hundred watts of output power and low noise performance are reported in literature. Tests of several fiber-based concepts by the Virgo group in Nice showed, however, severe reliability issues such that none of the tested systems is compatible with an operation in gravitational wave detectors. Hence we started an R&D program with the Laserzentrum Hannover to develop a reliable 200W fiber amplifier system.

### **ALPS (Any Light Particle Search)**

The AEI continued its strong support to the ALPS project to search for sub-eV particles beyond the standard model. Several theoretical and astrophysical hints point to the existence of such particles that couple to a strong laser field in the presence of a strong magnetic field. Hence a collaboration led by DESY works towards a light-shining-through-a-wall experiment in which the AEI took responsibility for the optics and the control of high finesse resonators.

### **Quantum Interferometry**

The Quantum Interferometry Group at the AEI researched fundamental aspects of quantum entanglement and developed techniques to reduce the fundamental noise in laser interferometry, i.e. quantum noise and thermal noise. The group is leading in the generation of squeezed light for gravitational wave detectors and in the generation of Einstein-Podolsky-Rosen entangled states for quantum key distribution. Significant expertise also exists in laser interferometry with all-reflective and coating-free nano-structured mirrors, optomechanics with micro-oscillators, and high-precision absorption measurements on potential low-thermal-noise materials for future gravitational wave detectors. After the successful implementation of the squeezed light source in GEO600 in 2010 and its long-term application since then, the AEI collaborated with the ANU (Australian National University) and the MIT to test squeezing of shot noise in LIGO and contributed significantly to the realisation of the squeezed light source.

The AEI proposed and demonstrated the first scheme that uses Einstein-Podolsky-Rosen-entangled (bi-partite squeezed) light for the improvement of laser interferometers. The idea has high potential in

gravitational wave detectors (GWDs). The scheme allows for the simultaneous measurement of the interferometer signal in two non-commuting quadratures of the output field. The measurements could distinguish between the actual interferometer signal and unwanted back-scattered light, providing a potential new veto-channel in GWDs.

We realized the first micro-mechanical interferometer that allowed the observation of interfering dispersive and dissipative coupling and its first detailed analysis. This work is relevant for the optical cooling of large masses with low frequencies and also has a high relevance for GWDs, since we found out that also GWDs have an interfering dispersive and dissipative opto-mechanical coupling due to a non-perfect balancing of the beam splitter.

A major noise source in advanced GW interferometers is given by thermal noise due to Brownian motion in test masses and suspensions and their temperature dependent refractive indices and expansion coefficients. In the past, reflection gratings were proposed to replace conventional cavity couplers. We could experimentally demonstrate that gratings in second order Littrow configuration do not have excess displacement noise due to a lateral grating displacement. Einstein-Podolsky-Rosen (EPR) entangled light is produced when two squeezed states are overlapped on a balanced beam splitter in such a way that the two outputs show large uncertainties in all their field quadratures. The AEI demonstrated the to date strongest EPR entanglement corresponding to more than 10dB of bi-partite squeezing and showed “oneway EPR steering.”

### **Quantum Control**

The Quantum Control group deals with the control of complex quantum-noise-limited systems, systems that exhibit noise at or below the quantum limit. In the context of laser-interferometric gravitational wave detection, this is the standard quantum limit of interferometry. This concerns in particular the experimental realisation of “Coherent Quantum Noise Cancellation” as a promising way to overcome the inherent limitations of the quantum mechanical measurement process, even though a long road lies still ahead.

### **LISA Pathfinder**

After our main contribution, the interferometer, had been finished with tests of the flight model in 2011, the activity slowed down for a while, and ramped up again in 2013 with the preparation of the data analysis tools and experiments to be conducted in orbit. A large part of the activity was the preparation of the software, data infrastructure and team members for the in-flight operations that started after the successful launch on 3<sup>rd</sup> December 2015. As of December 2015, all preparations were concluded very successfully, well-trained teams were in place and everything was ready to optimally use the in-orbit time for the most useful experiments. At the time of this writing, LISA Pathfinder has been in science operations at the Lagrange point L1 for almost a year, the test masses are freely floating with laser interferometry between them, and the performance of the whole system can only be called superb.



## LISA

After NASA pulled out from the 50/50 LISA partnership in 2011 due to budget reasons, all three ESA L mission candidates had to be rescoped as ESA-lead missions. LISA was re-formulated as “eLISA” with somewhat reduced performance to fit the smaller budget, and entered into the L2 and L3 calls for mission proposals in ESA. While for L2 the X-ray observatory Athena was chosen, the Science Theme “The Gravitational Universe” was chosen by ESA for L3. After the spectacular success of LISA Pathfinder, ESA anticipated the call for mission concepts, NASA has rejoined the project, and on 13th January of 2017, we have submitted a LISA mission concept for a three-arm mission, similar to the original concept, but with slightly shorter arms and smaller telescopes. AEI is taking the lead in the preparation of the proposals and has continued its technical work to advance the necessary technology.

## GRACE Follow-On

For the Laser Ranging Interferometer (LRI) used in the U.S. GRACE Follow-On mission (with a significant German contribution led by the GeoForschungsZentrum GFZ in Potsdam), the AEI has the role of Instrument manager in Germany and leads the development of the design, prototypes, industrial requirements and testing, in close cooperation with JPL and industry. Most pieces of the flight hardware have now been manufactured and individually tested and are being delivered for integration into the spacecraft, with more tests upcoming. So far functionality and performance of the LRI seem all good, and the project has been repeatedly praised at reviews for excellent and timely performance and delivery. Launch is planned now for 2018, and if all goes well, this will be the first long-distance inter-spacecraft interferometer ever flown and will be another milestone for LISA, with many shared aspects of the involved technology.



Karsten Danzmann

## Observational Relativity and Cosmology

This AEI Hannover Division was founded in 2007. It has met its initial goal: playing a significant role in the data analysis and discovery process associated with the first direct gravitational-wave observations from ground-based detectors. During the coming years, as the detectors become more sensitive, we intend to stay at the forefront of this activity. In addition to finding new black hole binary systems, and hopefully some very interesting and extreme systems, we also hope to find the first black hole/neutron star and neutron star/neutron star binaries, and perhaps the first continuous gravitational wave sources, or something really exotic and exciting, like bursts from cosmic strings.

### **GW150914: the first direct detection of gravitational waves from merging black holes**

GW150914 was registered by the aLIGO instruments on 14<sup>th</sup> September 2015, shortly before 3am (local time) at the LIGO Observatory in Hanford Washington, and shortly before 5am at the LIGO Observatory in Livingston Louisiana. It was just before noon in Germany, and the first person to see the signal, a coherent WaveBurst (cWB) low-latency burst search trigger, was a postdoc in this division, who is the developer in charge of operating the cWB low-latency real-time pipeline.

About an hour after the event, after having running checks, conducting first analyses, and contacting the LIGO operators on-site, members of this division sent the first email about GW150914 to the LIGO Scientific Collaboration (LSC), alerting everyone in the collaboration to the potential importance of the event. This thorough and measured response is one of the reasons why the LSC responded quickly, locked down the sites and instruments, and was eventually able to establish that the event was genuine.

The cWB generic burst searches are sensitive to these signals because of systematic development in the algorithm and method, to which this division has contributed greatly over the years. In particular, members of the division optimized and tuned cWB to analyze data from the previous LSC scientific run (S6), so that it could efficiently detect intermediate-mass black hole binary systems.

The division is one of the most active contributors to the LSC Compact Binary Coalescence (CBC) group, which looks for such signals. Members of the group contributed many of the results and much of the text in the discovery publication, as well as leading the writing of the CBC companion paper.

A key result presented in the discovery publication is the statistical significance of GW150914 (at least 5.1 standard deviations). Members of the division contributed crucially to all aspects of that result, starting from the software and algorithm development, as well as providing the computational power of the Atlas cluster. These were critical to establish that GW150914 was a real event, and not a detector-noise artifact. Division members also played a leading role in the corresponding detector characterization effort, for example in showing that the LIGO detectors were operating normally during the observation of GW150914.

### **Discovery of the binary black hole GW151226**

The division also played a key role in the discovery of GW151226, the second binary black hole (BBH) merger found in the O1 search. This BBH system was first found by the GST-LAL pipeline (to which a number of Division members have contributed heavily over the years). As with GW150914, much of the careful work to determine the false-alarm probability of this event was carried out with the PyCBC code developed by AEI Hannover and Syracuse University, and run on the Atlas cluster. Members of the group contributed many of the results and much of the text in the discovery paper.

### **Tools and methods for the next BBH discoveries**

It is expected that over the next three years, aLIGO will have observed the gravitational waves from about 100 BBH mergers. Work at the AEI is providing the tools, techniques and computing systems for discovering and analyzing these systems.

A good example of this is PyCBC: a general purpose software toolkit for carrying out CBC analyses, which has seen significant development and optimization, in large part due to the work of division members. PyCBC is now a mature software package and has been extensively used in the detection of GW150914 and in general in the analysis of data from the first Observational run of Advanced LIGO.

Based on observations of lower-mass black holes, our expectation is that some BBH component black holes (BHs) may be spinning near the maximum possible rate. Due in large part to work by this division, current CBC searches now include the effects of aligned spin on the individual components. Effectual template banks have been constructed for the full parameter space of CBC searches (including binary neutron star, neutron star-black hole and binary black hole systems); computational and data analysis issues in such searches have been addressed; the impact of precession has been quantified; and finally, these methods have been applied to the analysis of GW150914.

Members of the division developed a Bayesian parameter-estimation pipeline for quasi-normal mode ringdown, which can be used to measure the mass and spin of the final black hole directly from the data. Neither GW150914 or GW151226 had a large enough signal-to-noise ratio for this, but in the future it will likely be possible to do this with enough precision to directly measure the mass and spin, and (for example) test Hawking's famous Area Theorem of black hole mechanics.

### **Search for intermediate mass black hole binary (IMBHB) coalescences**

IMBHBs occupy the mass range between stellar-mass black holes, originating from core collapse of massive stars, with masses up to  $\sim 30\text{--}50 M_{\odot}$  and massive black holes, exceeding  $10^5$  solar masses, which appear to be generic in galactic centers. IMBHB detections might serve as probes of globular cluster dynamics, and, potentially, as probes of structure formation and growth of massive black holes. They could also inform our understanding of the formation and evolution of the most massive stars. IMBHB can be effectively searched for with both modeled and unmodeled techniques: the IMBHBs merge at low

frequencies and the waveforms are dominated by the late inspiral, merger and ringdown phases.

Earlier work led by division members showed that the burst searches provide a robust methodology for IMBHB detection, which is insensitive to the waveform uncertainties, and could detect sources at Gpc distances. More recently, division members have applied matched filter techniques to the same search within the PyCBC framework.

### **Continuous gravitational wave searches**

One possible contender for the next GW discovery of paramount importance is a continuous gravitational-wave signal emitted by otherwise-invisible rapidly-rotating neutron stars. The most sensitive search methods for such signals have been developed by members of this division in a close collaboration with Dr. M. Alessandra Papa's group in Alessandra Buonanno's division. An LSC-wide comparative study of the performance of various all-sky search pipelines, led by the group, clearly demonstrated that our Einstein@Home pipelines are the most sensitive blind all-sky searches.

Together, we have successfully designed and launched several Einstein@Home searches on LIGO S6 data: a directed search for a signal from Cas A, an all-sky survey and a hierarchy of follow-up searches on 16 million candidates from that survey. None of these searches has revealed a signal, hence upper limits have been set on the gravitational wave amplitude of signals within the searched parameter volume. An all-sky search on aLIGO O1 data is ongoing.

A set of searches on LIGO S5 data were also completed: a high-frequency all-sky survey and a dedicated search for signals from the Galactic centre, and a search for signals from the binary system Scorpius XI.

Members of the division have solved the long-standing problem of finding a well-conditioned and flat approximation to the all-sky template-bank metric for isolated CW sources, for coherent searches. This new metric was then used to build a lattice-based optimal template bank for coherent all-sky searches, and for semi-coherent searches.

An optimisation method was developed to rationally pick targets, parameter space regions, and search set-ups for directed searches. This method has been used to define a directed (targeted) search for CW signal in O1 data, which is currently running on Einstein@Home. It is also being used as a starting point for optimal all-sky searches in O1 data.

### **Operation and extension of the distributed volunteer computing project Einstein@Home**

Einstein@Home is one of the world's four largest volunteer distributed computing projects: it delivers about five times the number of compute cycles as the Atlas cluster (see below). Einstein@Home harvests computer cycles from member of the public who sign up, and whose home or office computers then provide computational power for the searches. Over the years more than 400,000 people have con-

tributed. Einstein@Home is jointly supported by MPG and the US National Science Foundation, and has personnel and infrastructure in several locations.

Einstein@Home was launched in February 2005, to search for continuous gravitational wave (CW) signals in LIGO data, where the sensitivity of the search is limited both by computing power and by the raw sensitivity of the detector.

Since its launch, Einstein@Home has been extended to search for the weak electromagnetic signals from spinning neutron stars, where the sensitivity is also limited by computing power. To date, Einstein@Home has discovered 31 new pulsars in data from the Arecibo Observatory, 24 new pulsars in data from the Parkes Observatory, and 18 new pulsars in data from the Large Area Telescope on board NASA's Fermi Satellite. Over the past years the software and hardware infrastructure of Einstein@Home has been continuously upgraded and extended to host more and more demanding searches and to keep up with the increasing computing power on the volunteers side. All these upgrades were performed under full load with very little or no disruption visible to the participants.

In addition to being one of the most powerful volunteer computing projects in the world and the most powerful computing resource of the LSC, Einstein@Home continues to be an effective focal point for outreach activities also involving social media and distributed searches performed on volunteers' mobile devices.

### **Operation and extension of the Atlas Cluster**

This division operates a large computing cluster (currently 34,000 CPU cores, 2000 GPUs and 10 PB storage) called Atlas. The main use of this cluster is to search for gravitational wave signals within the output of the LIGO, Virgo and GEO600 detectors and analyze any findings. The system has been constructed and upgraded over a period of close to ten years and is currently the largest and most powerful dedicated analysis system used for gravitational wave searches, and as described above, was extensively used in the first two aLIGO BBH detections. At the time of writing, Atlas has contributed 131 million CPU-core hours to the LSC's searches. This is approximately equal to the sum of all the other large computing resources in the LIGO Data Grid.



Improvements and enhancements to Atlas over the report period include the addition of new storage servers and about 2500 new compute nodes (a large fraction of them equipped with GPUs), the replacement of the internal network, connecting all front end nodes and file and data servers directly via 10Gbit/s ethernet to the core switch, and enhancements to the cooling system for automated monitoring and control.

Bruce Allen

## Quantum Gravity and Unified Theories

As in previous years, research in the Quantum Gravity Division over the past three years has been rather diverse, and focused on a number of very different directions. The search for a consistent theory of quantum gravity also unifying the fundamental interactions remains the greatest challenge of modern theoretical physics. In view of the fact that we still have no such theory, the Division has kept to its strategy of approaching the problem in as broad a fashion as possible, by trying to represent the major approaches under one roof. The following is a brief summary of the research highlights and achievements. Further activities of the Division are reviewed in the separate articles by J.L. Lehners, O. Schlotterer and D. Oriti in this report. For its work, the Division has greatly benefited from various third party resources (Humboldt Foundation, DFG, GIF, and others) that it has been able to attract on top of its institutional funding.

### String Theory and hidden symmetries

Considerable research efforts have been devoted to a deeper understanding of how string theory corrects the predictions of Einstein's theory of general relativity. One of the main theoretical problems with general relativity is that it leads to nonsensical results for physical situations involving high energy densities where quantum effects become important (like the Big Bang). This key problem of quantum gravity is potentially solved by string theory which introduces an abundance of new particles and forces in a very specific manner. These new particles and forces can have an impact not only for what is happening at very high energies but also at comparatively low energies where normally Einstein's theory is sufficient to describe physical processes. Understanding the imprint that these new particles and forces leave at low energies is crucial not only for potential tests of string theory as a theory of quantum gravity but also for a better understanding of the structure of string theory itself. String theory has revealed remarkably rich mathematical structures over the course of its almost 50 years of existence and the corrections to general relativity studied at AEI are no exception to this "string of discoveries". The first corrections that string theory predicts compared to Einstein's general relativity have a very deep connection to many branches of mathematics, notably number theory and the representation theory of symmetry groups. The work AEI has shown that these results, though they do not immediately help us to "test" string theory, provide deep and important hints about its underlying structures.

A long-term research line at AEI has been the exploration of new symmetry structures of the equations that govern Einstein's general theory of relativity and its supersymmetric extensions. Establishing new symmetries will lead to powerful ways of solving Einstein's equations and can therefore be of relevance in many contexts related to our Universe and its history. The starting point of current research at AEI is the observation that near the Big Bang a huge "hidden" symmetry arises that is known as an infinite-dimensional Kac-Moody algebra. This insight has triggered many developments in theoretical physics and mathematics. The last few years have revealed new mathematical objects that can be called higher-spin representations of the Kac-Moody structure and that could be relevant for finding even more sym-

metric formulations of our early Universe. Moreover, it has been shown that the representations that are predicted by the Kac-Moody symmetry may be surprisingly closely connected to theory of elementary particles as it is being tested by particle accelerators around the world!

### **Conformal invariance in gravity and string theory**

A central topic of this work during the last three years were theories which are invariant under conformal transformations, i.e. under space-time transformations which preserve angles. The group studied various aspects of this type of theories, which are ubiquitous in theoretical physics and which are relevant for instance for string theory, for systems at second order phase transitions or for the theory of strong interactions at very high energies. One specific question here was the relation between scale and conformal invariance, where the former is a smaller symmetry which in two dimensions is known to imply conformal invariance. By proving that this is generally also true in four space-time dimensions a long standing open question could finally be answered. One of the main tools in this analysis was the conformal anomaly, a subtle but unavoidable breaking of a classical symmetry by quantum effects. In another project, conformal symmetry was used in combination with supersymmetry to establish a relation between a priori separate quantities which are important to characterize these theories, specifically the sphere-partition function and the Kahler potential. Again, the anomaly was the main tool in this investigation.

Clearly conformal symmetry is very special and it is not realized in most physical systems which look different when observed close up or from far away, i.e. they are not even scale invariant. One reason might be that while the equations which describe these systems are symmetric, the particular solution which nature has chosen violates it. In this case the underlying symmetries still go a long way: there is necessarily always a massless particle which accompanies this breaking of the symmetry and which has very special properties which were established and studied. One nice application is the effective hydrodynamical description of conformal field theories. This type of theories is believed to be relevant for the quark-gluon plasma, a state of nuclear matter at very high energies.

### **Higher Spin Gauge Theories**

Important progress has been made in the context of higher-spin gauge theories. Whereas the photon electrodynamics carries spin-1, and gravity can be viewed as a spin-2 gauge theory, higher-spin gauge theories are extensions of gravity by massless fields of spins greater than two. These highly symmetric extensions are interesting for a number of reasons, the most prominent ones being the holographic relation to conformal field theories in one dimension lower (higher-spin AdS/CFT correspondence), and the conjectured relation to string theory in the limit in which the string tension becomes very small. It is conceivable that string theory might be a broken phase of an underlying highly symmetric higher-spin gauge theory.

The formulation of higher-spin gauge theories is extremely involved. The only known construction is the Vasiliev theory that makes use of many auxiliary fields, which obscures its physical features. For example, it is not obvious how to interpret solutions in this theory: what

looks like a black hole in one realisation (gauge), looks like a non-singular space-time in another.

One line of research that was followed during the last years was to extract the physical content of these theories by getting rid of the disturbing auxiliary fields. The metric-like formulation (which is the analogue of the description of gravity in terms of the space-time metric) was studied and worked out the concrete equations of motion perturbatively. In this formulation it is possible to study some of the most puzzling and fascinating aspects of higher-spin theories, in particular the mild non-locality that is inevitable in such theories. Although it may still be a long way to fully understand higher-spin gauge theories, the work at AEI has provided new tools to address some of the most intriguing facets of higher spin gauge theories.

### Conformal Standard Model

Experimental searches at LHC so far (January 2018) have not revealed any evidence of ‘new physics’ beyond the Standard Model (SM) of particle physics, and in particular no signs of low energy supersymmetry, technicolor or large extra dimensions. Of course, this state of affairs may change in the near future with new data, but the possibility that, apart from ‘minor’ modifications, the SM may survive all the way to the Planck scale is by no means excluded. The excellent agreement between SM predictions and several precision experiments indicates that any ‘beyond the SM’ (BSM) scenario must stay as close as possible to the SM as presently understood. Indeed it is a remarkable fact that the SM Lagrangian is classically conformally invariant, except for the scalar mass term introduced to induce electroweak symmetry breaking. By adding a second scalar to generate a Majorana mass term for the right-chiral neutrinos, it has been shown that such a ‘mild’ and minimal extension can potentially solve all outstanding problems of particle physics proper. In particular such a model can be consistent up to the Planck scale, if one imposes the twin requirements of absence of Landau poles and of instabilities of the effective potential over this range of energies. This question was studied both in the context of radiative symmetry breaking (where all mass scales are generated quantum mechanically) and of ‘softly broken conformal symmetry’ (by imposing the vanishing of all quadratic divergences in terms of bare parameters at the Planck scale). The main ‘invariant’ prediction of the model is an extra scalar resonance (‘shadow Higgs boson’) in the 1 TeV range, a prediction that can be tested in upcoming LHC runs. Various other phenomenological aspects of the conformal ansatz as well as an extension with more ‘sterile’ scalars were also investigated.

Hermann Nicolai

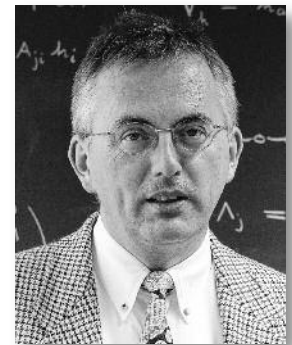



## Max Planck research group “Geometric Measure Theory”

### Main theme

All studies of the research group “Geometric Measure Theory” relate to non-smooth surfaces.

### Why non-smooth surfaces?

There are two obvious reasons to mathematically study non-smooth surfaces. The first is purely mathematical: **understanding by generalisation**. Removing unnecessarily restrictive hypotheses from a theorem until only the truly essential ones remain usually is a good way to identify the underlying core principles. The second reason is of physical nature: **modelling of non-smooth objects**. Certain physical objects might just be more adequately modelled by non-smooth surfaces. Looking for instance at touching soap bubbles, one observes that their bounding surfaces form certain angles where they meet. Hence a good model has to allow for this possibility as well. But there is a third reason which is a bit more delicate to explain, namely the **need for compactness**. Even for problems whose solution is perfectly smooth it is often expedient or even unavoidable to employ non-smooth surfaces in its construction. This principle shall be explained using the example of the following classical problem which had a great impact on the development of the theory of non-smooth surfaces.

### The Plateau problem

The task is to find amongst all surfaces spanning a given smooth boundary contour one with least area. To mathematically formulate this problem, one needs to specify which objects one wishes to admit as surfaces and one needs to define a notion of area for these surfaces and which of them will be considered to span the given boundary contour. Supposing that a nonempty class  $C$  of spanning surfaces and an *area function*  $A$  assigning to each surface  $S$  in  $C$  a nonnegative finite number  $A(S)$ , its area, are given, one defines a notion of convergence of surfaces in  $C$ . That is, one declares what it means that a sequence of surfaces  $S_1, S_2, S_3, \dots$  converges to a limit  $S$  in  $C$ . Once this is done in such a way that  $A$  has the *lower semicontinuity* property meaning that  $A(S)$  does not exceed the limit inferior of  $A(S_1), A(S_2), A(S_3), \dots$  for such sequences, the only remaining difficulty is to verify the following *compactness* property: Given any sequence of surfaces  $S_1, S_2, S_3, \dots$  in  $C$  such that  $A(S_1), A(S_2), A(S_3), \dots$  is bounded there exists a subsequence  $T_1, T_2, T_3, \dots$  of  $S_1, S_2, S_3, \dots$  and a surface  $T$  in  $C$  such that  $T_1, T_2, T_3, \dots$  converges to  $T$ . A subsequence results from a sequence by selecting an infinite subset of indices and enumerating the corresponding elements (surfaces) as new sequence. Then one may argue as follows. Let  $I$  denote the infimum of  $A$  on  $C$ , choose a sequence  $S_1, S_2, S_3, \dots$  in  $C$  such that  $A(S_1), A(S_2), A(S_3), \dots$  converges to  $I$ , and pick a convergent subsequence  $T_1, T_2, T_3, \dots$  of  $S_1, S_2, S_3, \dots$  and a limit surface  $T$  in  $C$ . Then

$$\begin{aligned} I &\leq A(T) \leq \text{limit inferior } A(T_1), A(T_2), A(T_3), \dots \\ &= \text{limit } A(S_1), A(S_2), A(S_3), \dots = I, \end{aligned}$$

hence  $A(T)$  equals  $I$ , that is  $A(T)$  does not exceed  $A(S)$  for all  $S$  in  $C$ .

The crucial point in implementing this scheme is, to define a class and corresponding notion of convergence in such a way that the com-

pactness property holds (lower semicontinuity is often easier). If one were to take the class  $C$  to consist of all smooth surfaces that bound the given smooth contour, one may easily construct a sequence of surfaces with bounded area approaching a non-smooth surface having for instance a cone like tip at some place. As the obvious limit surface is non-smooth, this sequence would not have a convergent subsequence in  $C$  for any meaningful notion of convergence. Therefore one enlarges the class  $C$  by including certain non-smooth surfaces so that a notion of convergence with the desired compactness property can be constructed. Then the procedure described above gives a possibly non-smooth surface of minimal area in the enlarged class. It is then possible to show that a posteriori the surface must in fact be smooth. For instance, it cannot contain a cone like tip at some place as pushing the tip inwards would yield a surface with strictly less area.

Once this procedure is successfully completed one has constructed not only a smooth surface of minimal area bounding the given smooth contour but in fact this surface has also smallest area in the larger class of non-smooth surfaces used in its construction.

Much of this process applies in arbitrary dimensions of surfaces and spaces; only the resulting surfaces need not to be entirely smooth but some lower-dimensional non-smooth parts may persist.

### **Study of non-smooth surfaces**

One main focus of the research of the group “Geometric Measure Theory” is the study of a certain class of non-smooth surfaces, so-called integral varifolds, which occur in variational problems similar to the Plateau problem but requiring continuity of the area function, not just lower semicontinuity. Assuming boundedness conditions on the (directional) derivative of the area, powerful compactness theorems are known for such surfaces. These conditions are very weak, even a surface satisfying merely the first derivative test for minimality of area would have zero derivative. Therefore the question of current interest is to determine which degree of smoothness – even in a correspondingly weak sense – may be obtained from conditions of that type. In this respect Kolasiński and Menne have finished in “Decay rates for the quadratic and super-quadratic tilt-excess of integral varifolds” [1] a series of investigations of Menne by constructing examples as well as by proving positive results yielding a largely complete picture of the degree to which the oscillation of the tangent plane direction is tamed by these conditions.

In a somewhat different vein Menne initiated a theory of classes of non-smooth functions on varifolds in “Weakly differentiable functions on varifolds” [2] and “Sobolev functions on varifolds” [3]. The reason to study non-smooth functions on Euclidean space, or, on smooth surfaces, is conceptionally very similar to the introduction of non-smooth surfaces itself. One would expect that this opens a pathway to completely new ways of studying these non-smooth surfaces. In fact, using this theory, it has already been established in these papers that under fairly general (optimal) conditions locally on these non-smooth surfaces any two points can be joined by a path of finite length lying in the surface and that this length depends continuously on the points.

This yields a well-behaved notion of distance on these varifolds allowing for the first time to study the intrinsic geometry of these highly non-smooth objects.

One may also study the evolution of such non-smooth surfaces by mean curvature (i.e., following locally the steepest descent of area); for two-dimensional surfaces in three-dimensional space this models the evolution of soap films. Whereas the structure of such films (in these dimensions) is well understood in case they are nearly area-minimising, the time-dependent problem is still quite baffling. A first fundamental step in its analysis was completed by Lahiri in “A new version of Brakke's local regularity theorem” [4]. In arbitrary dimensions, his result gives a criterion in terms of the local past behaviour of the evolving non-smooth surface to be in fact smooth near the point considered. This will be a cornerstone for the future development of this theory.

Proceeding to a different type of geometric variational problems, namely those associated to geometric curvature energies, different classes of non-smooth surfaces turn out to be adequate. Fundamental compactness results for some of these classes have only recently been obtained by Kolasiński in joint work with Strzelecki and von der Mosel in “Compactness and isotopy finiteness for submanifolds with uniformly bounded geometric curvature energies” [5]. Other classes, containing even less smooth surfaces, were investigated by Kolasiński in “Higher order rectifiability of rectifiable sets via averaged discrete curvatures” [6]. A more detailed exposition of this important research string may be found in the research highlight “Geometric curvature energies”.

### Asymptotically hyperbolic initial data sets

From the physical perspective it is extremely appealing to conjecture that the total mass of an isolated system in general relativity (with zero cosmological constant) is non-negative. And indeed this is mathematically formulated and proven in the Positive Mass Theorem for asymptotically Euclidean time-slices of asymptotically Minkowskian spacetimes. One key ingredient of its proof by Schoen and Yau is the solution of certain Plateau problems inside these curved spaces. At this point, as explained above, the powerful theory of non-smooth surfaces enters silently in the background despite eventually all surfaces turn out to be smooth. Proceeding to the asymptotically hyperbolic setting, the first of the two steps analogous to the Euclidean setting was successfully completed by Sakovich in joint work with Dahl in “A density theorem for asymptotically hyperbolic initial data satisfying the dominant energy condition” [7]. Related to this, in asymptotically hyperbolic time-slices of asymptotically anti-de Sitter spacetimes (which have a negative cosmological constant), Sakovich showed in joint work with Cederbaum and Cortier in “On the center of mass of asymptotically hyperbolic initial data sets” [8] that three natural notions of center of mass in the asymptotically hyperbolic setting in fact agree; this cleans the picture in analogy to what was known in the asymptotically Euclidean time-slices of asymptotically Minkowskian space-times.

Ulrich Menne

### References

- [1] Kolasiński, S. & Menne, U. (2017). Decay rates for the quadratic and super-quadratic tilt-excess of integral varifolds. *NoDEA Non-linear Differential Equations Appl.*, 24:Art. 17, 56. doi:10.1007/s00030-017-0436-z.
- [2] Menne, U. (2016). Weakly differentiable functions on varifolds. *Indiana Univ. Math. J.*, 65(3), 977-1088. doi:10.1512/iumj.2016.65.5829.
- [3] Menne, U. (2016). Sobolev functions on varifolds. *Proc. Lond. Math. Soc.* (3), 113(6): 725-774. doi:10.1112/plms/pdw023.
- [4] Lahiri, A. (2016). A new version of Brakke's local regularity theorem. arXiv e-print. URL: <https://arxiv.org/pdf/1601.06710v2.pdf>.
- [5] Kolasiński, S., Strzelecki, P., & H. von der Mosel (2019). Compactness and isotopy finiteness for submanifolds with uniformly bounded geometric curvature energies. To appear in *Comm. Anal. Geom.* 27(1).
- [6] Kolasiński, S. (2017). Higher order rectifiability of measures via averaged discrete curvatures. *Rev. Mat. Iberoam.*, 33(3), 861-884. doi: 10.4171/RMI/958.
- [7] Dahl, M. & Sakovich, A. (2015). A density theorem for asymptotically hyperbolic initial data satisfying the dominant energy condition. arXiv e-print. URL: <http://arxiv.org/pdf/1502.07487v1.pdf>.
- [8] Cederbaum, C., Cortier, J., & Sakovich, A. (2016). On the center of mass of asymptotically hyperbolic initial data sets. *Annales Henri Poincaré*, 17(6), 1-24. doi:10.1007/s00023-015-0438-5.



## **Max Planck Research Group “Gravitation and Black Hole Theory”**

This research group is led by Maria J. Rodriguez and is currently funded through the Max Planck Society (MPS). Due to the delay in the provision of funds from the MPS, only in September of 2016, a postdoc (David Chow) joined the group. It is expected that in September 2017 a new postdoc and one graduate student joins the group. Maria J. Rodriguez is a scientific member of the International Max Planck Research School (IMPRS) for Mathematical and Physical Aspects of Gravitation, Cosmology and Quantum Field Theory, and will support the graduate students through this school. The Group has collaborations with research groups at the University of Maryland, Utah State University, University of Pennsylvania, Princeton University and Texas A&M. The members of the Group contributed to four international conferences including the April Meeting of the American Physics Society and were invited have given 12 talks in research Universities around the world.

The research of this Independent Research Group focuses on theoretical aspect of black holes and the astonishing effects they create in the surrounding space-time as detailed below.

### **Main Areas of Scientific Work**

Black holes are among the most fascinating objects in the Universe. These magnificently dense spherical conglomerates of rotating matter, exhibiting strong gravitational effects, are thought to be entailed with event horizons – special regions of space-time from which not even light can escape. Data from a vast number of astrophysical experiments will provide solid evidence (images) of event horizons and hence confirmation that black holes exist. Once thought to be mere static pockets of matter, we now know that black holes lurk at the center of every Galaxy, including the Milky Way, and spin producing the most bewildering effects such as matter accretion and large scale jets. Fully elucidating the mechanisms driving these effects is one of the aims of the group.

Force-free electrodynamics (FFE) is a valid model for energy extraction that has been widely used for magnetospheres around rotating relativistic compact objects such as stars and black holes. Different background metrics in FFE represent these compact objects: for neutron stars surrounded by a magnetized accretion disk flat is a valid approximation and, in the presence of black holes, the curved backgrounds are represented via the Kerr metrics. A systematic mathematical procedure treating the force-free electromagnetic field explicitly instead of scalar variables is still absent except for black holes. As a result, we are still ignorant of the dynamical properties of the force-free electromagnetic field. Moreover, in light of the new results of infinite number of solutions to FFE for extreme Kerr space-times in the proximity of the event horizon (which is neither empty space nor even asymptotically flat) a general action principle formulation for all space-times is indispensable. For all these reasons, employing the method of Lagrange multipliers the group at AEI has developed a Lagrangian encoding of the behavior of electromagnetic fields in plasma filled-magnetosphere for generic (not necessarily asymptotically flat) stationary and axisymmetric metrics. We applied

this action principle to the metric describing the spinning Kerr, NHEK and Anti-de Sitter (AdS) Kerr black hole's environment and showed that from the variation principle of the action the equations of motion correspond to the FFE equations. These findings will appear in a paper that our group wrote jointly with the Princeton University group led by H. Verlinde.

Another focus of the Gravitation and Black Hole Theory Independent Research group is general relativity in more than four dimensions of spacetime. Four-dimensional general relativity leaves room only for spherical event horizon black holes. In more than four space-time dimensions, however, new striking possibilities open up. Besides the spherical configurations, there are non-spherical event horizon topologies and multi-black hole solutions. Higher-dimensional black holes thus have a much richer and still not fully understood phase structure than their four-dimensional counterparts. Recently, in an ambitious effort to elucidate the entire population of black hole configurations many explicit solutions have been unveiled. In spite of the remarkable progress, key explicit examples of conjectured black holes are still missing. Finding these elusive black hole solutions of Einstein's theory, is one of the other research lines of the group. In particular, we have focused in trying to find solutions of five dimensional asymptotically flat spherical black holes of pure Einstein-Maxwell's theory. We hope to publish these results soon.



Combining both topics – force free electrodynamics and gravitational theories in higher/lower dimensions – the group's preliminaries studies also indicate that black hole jets can be envisioned in three and five spacetime dimensions.

Maria J. Rodriguez

### **Max Planck Research Group “Pulsar Observation and Data Analysis”**

This independent research group focuses on observation and computing-intensive data analysis to discover and study pulsars – important key probes for a wide range of fundamental physics and astrophysics. Since the establishment in 2013 under the lead of Holger J. Pletsch, the group has hosted the research projects of several doctoral, master, and bachelor students. The group's main funding is provided by the German Research Foundation (DFG) through the “Emmy Noether” excellence programme. Additional support has been received from the Max Planck Society, the DAAD, and the Federal Ministry of Education and Research. The group also closely cooperates with the MPI for Radio Astronomy and other research groups worldwide, and participates in the Fermi LAT collaboration.

#### **Main areas of scientific work**

Pulsars are fascinating stellar objects and their study provides a wealth of information about fundamental processes in the universe under extreme conditions irreproducible on Earth. These fast spinning and

highly magnetized neutron stars are extremely dense, neutron-packed remnants of supernova explosions. The standard analogy of a pulsar is a lighthouse: In the neutron star's strong magnetic field, charged particles are accelerated to produce beams of electromagnetic radiation, from radio to gamma-ray wavelengths. The star's rotation sweeps these emission beams past our line of sight once per rotation, creating periodic pulsations. Yet many aspects, such as pulsar emission, are still poorly understood after decades of observations, primarily at radio wavelengths. The Fermi Gamma-ray Space Telescope launched in 2008 has opened a new era and revolutionized our understanding of pulsars. The Large Area Telescope (LAT) on board of Fermi detects gamma-ray photons with GeV energies, covering the entire sky every three hours. The significant increase in registered source photons has made the LAT the hitherto most powerful instrument for the discovery and study of gamma-ray pulsars.

Owing to the LAT, the number of known gamma-ray pulsars has increased from just a handful to above 160 recently. The majority of them was detected indirectly. In each case gamma-ray pulsations were revealed only by using parameters obtained beforehand from radio telescopes to assign rotational phases to LAT-detected photons in a straightforward and computationally inexpensive procedure. With the LAT, for the first time pulsars have also been detected in direct searches for periodicity among the gamma-ray photons. In fact, many pulsars found in such "blind" searches are undetected at radio wavelengths, thus inaccessible otherwise. With their broader gamma-ray beams, these pulsars also enable a more unbiased survey of supernovae in our Galaxy. However, blind searches are computationally challenging, because the relevant pulsar parameters are unknown in advance. The challenge is to search a dense grid covering a multidimensional parameter space, with a tremendous number of points to be individually tested. For observations spanning multiple years the finite computing power available makes blind searches with conventional methods impossible. This calls for much more efficient data analysis methods to extract new pulsar populations beyond the "tip of the iceberg" and valuable science yet hidden in several hundreds of LAT-catalogued – but still unidentified – sources.

The research in this group addresses these pressing quests and has been contributing to the above mentioned "pulsar revolution", enabling a fundamentally improved understanding of pulsars and their environments. By developing innovative data analysis methods and exploiting massively increased computing power, including the Einstein@Home volunteer supercomputer, we have been concentrating on two related areas during the reporting period: (1) discovering previously unknown pulsars through blind searches, (2) measuring and studying known pulsars. In what follows, the progress made in both areas will be outlined.

### **Research overview**

Over the past years the group has been remarkably successful in blind pulsar searches with the Fermi LAT. In fact, for over five years all discoveries of new gamma-ray pulsars in blind searches were made at the AEI, continuously lowering the sensitivity level towards weaker (or

more distant) pulsars through several advancements in data analysis and computing.

The computational blind-search problem underlying is in several aspects similar to searches for continuous gravitational waves from neutron stars, also a key area in Bruce Allen's division at the AEI. Hence this has promoted the transfer and adaption of methods from this field to the analysis of LAT data for new gamma-ray pulsars. Initially, the first blind searches for gamma-ray pulsars at the AEI were carried out on the ATLAS cluster. This survey was very successful, revealing eleven new pulsars.

However, as the Fermi mission continued, and the cost of searching for new pulsars increased and but still many hundreds of pulsar-like LAT sources remained unidentified. Therefore, in 2013, we moved the blind search to the volunteer distributed computing system Einstein@Home. Under this scheme, the parameter space that must be searched is split amongst several tens (or even hundreds) of thousands of "work units" each of which can be searched by a volunteer's personal computer within a few hours. This new effort was quickly rewarded, with four new gamma-ray pulsars being found by Einstein@Home volunteers' computers [1].

In a comprehensive optimization study [2] we were able to further enhance the sensitivity of our blind pulsar search at fixed computing budget. We found a set of technical advancements, including e.g efficient multistage and interpolation schemes. We also investigated the pulse profile shapes of all known gamma-ray pulsars and in turn how to utilize this information in a search. Taken together, these optimizations allowed us to significantly improve the blind-search sensitivity by almost 50% at the same computational expense. Thus, to take full advantage of this, we also implemented these improved methodologies on our blind searches on Einstein@Home making this survey more powerful than ever before. As a result, this has enabled several pulsar discoveries, e.g. [3]. Most of these pulsars are otherwise invisible making this an important contribution towards a more complete view of the Galactic population. Further details of this research highlight are presented below in the accompanying article by Colin Clark.

While these exciting discoveries with Einstein@Home were isolated young pulsars (with spin frequencies of a few Hertz), the on-going searches also cover the higher-frequency range of millisecond pulsars (MSPs). With partial orbital constraints from optical data, our improved data analysis techniques also resulted in the first ever detection of a rapidly spinning MSP from its gamma-ray pulsations alone [4]. This unique short-orbital-period system PSR J1311-3430 may provide new insights into irradiation-driven binary stellar evolution and also turned out to have an unusually large mass, likely providing the most important constraints on the neutron-star equation of state. The binary pulsar detection was made possible by efficiently exploiting orbital constraints from prior optical observations of the heated companion. The key features of the new technique included the use of a parameter-space metric and optimized stochastic search grid construction [5]. The first direct detection of such a binary pulsar in gamma-ray data implies that further such extreme systems may exist

among yet unidentified LAT sources, which are too radio-faint or obscured by dense companion winds for typical radio pulsar searches (as we confirmed in this case [6]).

Over the past two years, we therefore further expanded our efforts in searching unidentified gamma-ray sources with optical counterparts that offer hints for being part of a binary system. While the discovery of the compact PSR J1311-3430 system was possible assuming a circular orbit, in other cases the optical data suggested that the binary orbit is eccentric. This fact dramatically increases the computing challenge due to the extra dimensions one has to scan over. In a new method, further trading off sensitivity against computing cost, we were able to develop a first search for such an eccentric binary system. All those methods have been well tested and are currently being implemented on Einstein@Home too. Hence we are optimistic for further discoveries of exotic pulsar binary systems.

While detecting a new pulsar is an important milestone, it is also only half of the story. After the discovery the pulsar is to be precisely measured and carefully studied in order to infer its properties and to eventually learn new scientific insights. This procedure, representing the second core research area of the group, is called “pulsar timing”, since one analyses the photon arrival times from the pulsar that encode a wealth of information about its properties. During the reporting period we developed an improved timing method for gamma-ray pulsars with the LAT. Unlike previous methods that average the arrival times of many gamma-ray photons losing time resolution as a consequence, our method is based on the arrival times of single photons. This allows us to measure the physical properties of the pulsar system to higher precision, especially on shorter time scales.

Our newly developed timing method has been successfully applied to several pulsar systems, e.g. [3,7,8]. To give one outstanding example, based on archival Fermi-LAT data we measured the properties of a binary star system with a gamma-ray MSP more precisely than was possible before [7]. That pulsar binary system, known as PSR J2339–0533, only could be identified through its pulsed radio emission in 2014. However, the observations at radio wavelengths are hampered through the interaction of the pulsar with its stellar partner. The pulsar's radiation heats the companion and slowly vaporizes it. This causes clouds of gas to drift through the binary system, which absorb the radio emission from the pulsar. In contrast, the gamma rays emitted by PSR J2339–0533 penetrate the gas clouds and enable observations of the pulsar over all of the past six years thanks to the contiguous Fermi data. The use of the new analysis algorithms was the key to a very precise measurement of PSR J2339–0533, its companion, and their mutual orbits. This was the first such measurement of an interacting binary system through the gamma-ray emission of a millisecond pulsar, making full use of the Fermi-LAT time resolution, which is a few millionths of a second.

Surprisingly, the results revealed an unexpected cyclic variation of the orbital period. We discovered that the orbital period slowly varies around the mean of 4.6 hours. The variations are a few thousands of a second, but compared to the measurement precision of

## References

- [1] Pletsch, H. J. et al. (2013). Einstein@Home discovery of four young gamma-ray pulsars in Fermi LAT data. *The Astrophysical Journal Letters*, 779: L11. doi:10.1088/2041-8205/779/1/L11.
- [2] Pletsch, H. J., & Clark, C. J. (2014). Optimized Blind Gamma-ray Pulsar Searches at Fixed Computing Budget. *Astrophysical Journal*, 795: 75. doi:10.1088/0004-637X/795/1/75.
- [3] Clark, C. J. et al. (2015). PSR J1906+0722: An Elusive Gamma-ray Pulsar. *The Astrophysical Journal Letters*, 809 (1): L2. doi:10.1088/2041-8205/809/1/L2.
- [4] Pletsch, H. J., et al. (2012). Binary Millisecond Pulsar Discovery via Gamma-Ray Pulsations, *Science* 338, 1314. doi: 10.1126/science.1229054.
- [5] Fehrmann, H., & Pletsch, H. (2014). Efficient generation and optimization of stochastic template banks by a neighboring cell algorithm. *Physical Review D*, 90(12): 124049, pp. 4049-4049. doi:10.1103/PhysRevD.90.124049.
- [6] Ray, P. S. et al. (2013). Radio Detection of the Fermi LAT Blind Search Millisecond Pulsar J1311-3430. *Astrophysical Journal*, 763: L13. doi:10.1088/2041-8205/763/1/L13.
- [7] Pletsch, H., & Clark, C. J. (2015). Gamma-ray Timing of Redback PSR J2339-0533: Hints for Gravitational Quadrupole Moment Changes. *The Astrophysical Journal*, 807(1): 18. doi:10.1088/0004-637X/807/1/18.
- [8] Johnson, T. J. et al. (2015). Discovery of Gamma-ray Pulsations from the Transitional Redback PSR J1227-4853. *The Astrophysical Journal*, 806(1): 91. doi:10.1088/0004-637X/806/1/91.





millionths of a second, this was a significant effect. In comparison, for the Earth's orbit this would mean that some years would be shorter or longer than others by a dozen seconds. These variations are most likely caused by tiny changes in the shape of the companion caused by its magnetic activity. Similar to our Sun the companion might be going through activity cycles. The changing magnetic field interacts with the plasma inside the star and deforms it. As the shape of the star varies its gravitational field also changes, which in turn affects the pulsar orbit. Future simultaneous observations with optical telescopes can help us to prove this causal relationship. These observations can also improve our understanding of the binary system, allowing us to probe the interior of the companion and eventually even to determine the type of magnetic dynamo active in the star.

Holger J. Pletsch

### **Max Planck Research Group “Theoretical Cosmology”**

This research group is led by Jean-Luc Lehners and was funded via a Starting Grant from the European Research Council (ERC Grant 256994: “String Cosmology and Observational Signatures”) from the creation of the group in December 2010 until November 2015. In December 2015 the group was transformed into a Max Planck Research Group. During the period 2013-2016, the group hosted the principal investigator, four postdoctoral researchers (Drs. Lorenzo Battarra, Shane Farnsworth, Rhiannon Gwyn and Michael Koehn) and four doctoral students (Sebastian Bramberger, Dr. Angelika Fertig, Dr. Anna Ijjas and Enno Mallwitz).

The aim of the Theoretical Cosmology research group is to enhance our understanding of the early universe and its most mysterious aspect, the Big Bang. There currently exists no complete theory that satisfactorily explains the early stages of the universe. However, there are promising candidate theories, such as inflationary cosmology and the theory of the cyclic universe. We study and develop these cosmological theories while trying to figure out their relationship with fundamental physics. The big questions guiding our research are: was the Big Bang really the beginning? How did space and time emerge? What was the role of quantum theory in the early universe? Which aspects of the universe are fixed by mathematical requirements, and which are due to historical accidents? And is our universe unique?

#### **Research Overview**

During the period 2013-2016, the Theoretical Cosmology group has pursued research in several complementary topics: the elaboration of early universe models that are in agreement with cosmological observations; attempts to understand/overcome the Big Bang singularity by studying models of classically non-singular bounces, i.e. models where a previous contracting phase smoothly bounces into the current expanding phase; and issues that have to do with quantum mechanics, in par-

ticular the issue of how out of initial quantum fluctuations classical density perturbations were generated, gravitational tunneling by which a region of the universe can make a quantum transition into a physically distinct phase, and the question of initial conditions for the universe.

### **Generating the observed CMB temperature fluctuations**

In order to further our understanding of the early universe, it is imperative to gain a knowledge of what kinds of cosmological models are supported by observational data. The most popular theory of the early universe is inflation. However, inflation leads to a curious situation, in that it can be implemented via an enormous variety of models, a large number of which are in agreement with observations, and an even larger number not. It is interesting to ask whether other types of models exist, which may explain the same data differently. An example of such alternative models are ekpyrotic models, in which one assumes the existence of a contracting phase prior to the current expanding one. We explored a new type of ekpyrotic model, in which there are two scalar fields: the first drives the ekpyrotic phase and the second is responsible for generating perturbations. In older ekpyrotic models, the potential for the second field was assumed to be unstable – this then has the consequence of amplifying perturbations in the second field, which is a desired goal. However, the instability of the potential has a less fortunate consequence in that one must assume special initial conditions for the model to work.

A new type of model was proposed by Li and by Qiu et al., in which the second field is non-minimally coupled to the ekpyrotic scalar. In that case, this coupling can lead to the generation of perturbations, and since no potential for the second field is required, the model is stable and works for a large range of initial conditions. Since interactions between the fields are required for the model to work, one may wonder whether this type of model leads to large non-Gaussian corrections to the primordial perturbations. The data from the Planck satellite now puts strong constraints on non-Gaussianity, and thus this is an important question to address. We analyzed this issue in three papers , finding that the bispectrum parameter  $f_{\text{NL}}$  is naturally small, while the trispectrum parameter  $g_{\text{NL}}$  is predicted to be of a magnitude of several hundred and negative in sign. This is compatible with current bounds, but is significantly different from the predictions of simple inflationary models and thus constitutes an interesting distinguishing feature of these non-minimally coupled ekpyrotic models. These models are further distinguished by having a significant running of the spectral index. It will be interesting to see whether future observations support or refute these prediction.

Inflation and ekpyrosis both have various advantages and disadvantages: inflation for instance typically leads to eternal inflation and the associated measure problem, while ekpyrosis requires a detailed understanding of the bounce connecting the contracting to the expanding phase. It has been proposed by Ijjas (a former student in the group) and Steinhardt that in the context of scalar-tensor theories one may formulate models that combine aspects of both inflation and ekpyrosis. This has led us to come up with the model of conflation, which is described in detail in the Research Highlight attached to this report.

### **Cosmic bounces**

The Big Bang remains a big unsolved problem in cosmology. One interesting possibility is that this singularity in the description of the universe may be replaced by a non-singular bounce. The idea here is that there would have been a prior contracting phase which smoothly goes over into the current expanding phase. Models of this type require special types of matter, and one may wonder whether they make sense from a more fundamental point of view. In this context we achieved significant progress with the elaboration of the first such non-singular bounce model in supergravity (our model was the culmination of a whole series of papers that our group wrote in collaboration with Prof. Ovrut). Our model explicitly demonstrates that supersymmetry and cosmic bounces are compatible. Moreover, this concrete model has allowed us to calculate in detail how the cosmological perturbations cross through the bounce, and we established the important result that in this class of models, the long-wavelength perturbations of observational interest pass through the bounce unchanged. This allows one to follow perturbations generated before the bounce into the current expanding phase in order to compare these with observations.

### **Quantum aspects of cosmology and the question of initial conditions**

A final topic of great interest concerns the importance of quantum effects in cosmology. We studied in detail how in ekpyrotic models quantum perturbations are amplified and end up being equivalently describable via an ensemble of classical density perturbations. We found that the concept of decoherence plays an important role here, and that the necessity of having two scalar fields in ekpyrotic models is highly beneficial in that the interactions between the two scalar fields lead to an efficient process of decoherence, thereby rendering primordial perturbations classical.

We have also investigated the effects of quantum tunneling, whereby one region of the universe can tunnel into a physically distinct phase, effectively creating a new universe inside an existing one. This process is still not fully understood, but we made significant progress in describing this type of tunneling in a mathematically consistent way, while also exploring tunneling in flat potentials and the creation of space-times with wormholes. These works were done in collaboration with Prof. Lavrelashvili.

Finally, we attacked the question of initial conditions for the universe. The best-known theory of the initial conditions is the Hartle-Hawking no-boundary proposal. In this context, we discovered new solutions that describe the emergence of classical contracting universes. These solutions can provide the basis for a fully finite and calculable cosmology. We also managed to establish the interesting result that within gravitational models coupled to a scalar field, only inflation and ekpyrosis manage to explain the emergence of a classical space-time out of an initial quantum state. The full implications of this result are not yet clear at present, but promise to lead to interesting new avenues for discovery in the future.



Jean-Luc Lehnert



### **Modeling gravitational waves from compact-object binary systems with matter**

Gravitational waves from binary systems are largely determined by the initial masses and angular momenta of the constituents. However, as the orbital separation shrinks during the inspiral, the internal composition of the objects starts to play a crucial role: tidal effects cause material objects to deform in response to the gradient in gravity across the matter distribution. The amount of deformation depends on details of the object's internal structure and leads to a distinct imprint in the gravitational waves as the inspiral proceeds. The final fate strongly depends on the objects involved: for example, if their masses are very different, the smaller object can get torn apart by tidal forces, while for comparable masses, the objects will collide and merge, emitting highly complex gravitational wave signals in the process with the details depending on the microphysics involved. Gravitational waves from binaries therefore provide a novel tool to directly probe otherwise inaccessible fundamental physics. Among the most exciting targets for this effort are binaries involving neutron stars.

Neutron stars are extraordinary objects consisting of more than a solar mass of material compressed by their intense gravity to a ball merely 20 km in diameter, where all fundamental forces (gravity, electromagnetism, weak and strong nuclear forces) are simultaneously important. Neutron stars thus provide an exceptional environment to test and advance our knowledge of the nature of matter and fundamental forces. This has remained a longstanding scientific frontier because neutron star interiors represent an entirely different regime than that accessible to terrestrial experiments, even the Large Hadron Collider. Astrophysical observations of neutron stars remain limited to the electromagnetic radiation that is emitted by poorly understood processes involving accretion and nuclear reactions, and is strongly altered by scattering before reaching our telescopes. Moreover, theoretical calculations become exceedingly difficult because the immense gravity in neutron stars causes the familiar structure of matter, even atomic nuclei, to completely dissolve. Does matter form a single quantum mechanical entity of otherwise unstable subatomic particles? An enormous conglomeration of quarks? An exotic phase? What forces besides quantum pressure are supporting the neutron star against complete gravitational collapse to a black hole?

Observations of gravitational waves from neutron star binaries will have a unique potential to shed light on these questions. However, to extract this information from the data requires highly accurate models of the imprint of neutron star matter on the gravitational wave signal. Computing such models is a significant challenge because it requires solving for the dynamical space-time of the binary from Einstein's equations together with the additional complex physics of relativistic neutron stars. Our work addressed this challenge with two approaches: an analytical-relativity model based on the effective-one-body theory and numerical-relativity simulations.

The basis for our analytical waveform model is that of a binary black hole system. If one or both of the black holes is replaced by a neutron star, then the main effect is an accelerated inspiral due to tidal effects. That is, a neutron star is deformed by the inhomogeneous gravitational field of its companion, just like the ocean tides on Earth are produced by the moon. This deformation draws energy from the orbital motion, which makes the orbital separation shrink faster compared to a binary black hole system. The effect can be quantified in terms of a single deformability coefficient for each neutron star, making it an important parameter for our model. While this describes the dominant tidal effects, we find that a more accurate model must include additional physics due to dynamical tides. These effects are associated with the internal oscillation modes of neutron stars that can be resonantly excited by the orbital motion. In particular, we show that, for the neutron stars' fundamental oscillation modes, this leads to a substantial enhancement of the tidal imprint in the gravitational waves, even if the resonance is not fully excited during the inspiral. Measuring the oscillation frequencies of a neutron star might shed light on the internal structure of neutron stars in a similar manner as optical spectrums did for atoms and ordinary stars. We have developed a relativistic description of dynamical tidal effects and also a complete model for signals from non-spinning neutron-star–black-hole binaries that will be implemented for use in data analysis studies [1-3]. To test our model and the conclusions about the importance of dynamical tides we compare it to results from numerical relativity simulations. Such simulations also provide the only way to investigate the highly dynamical regime near the merger.

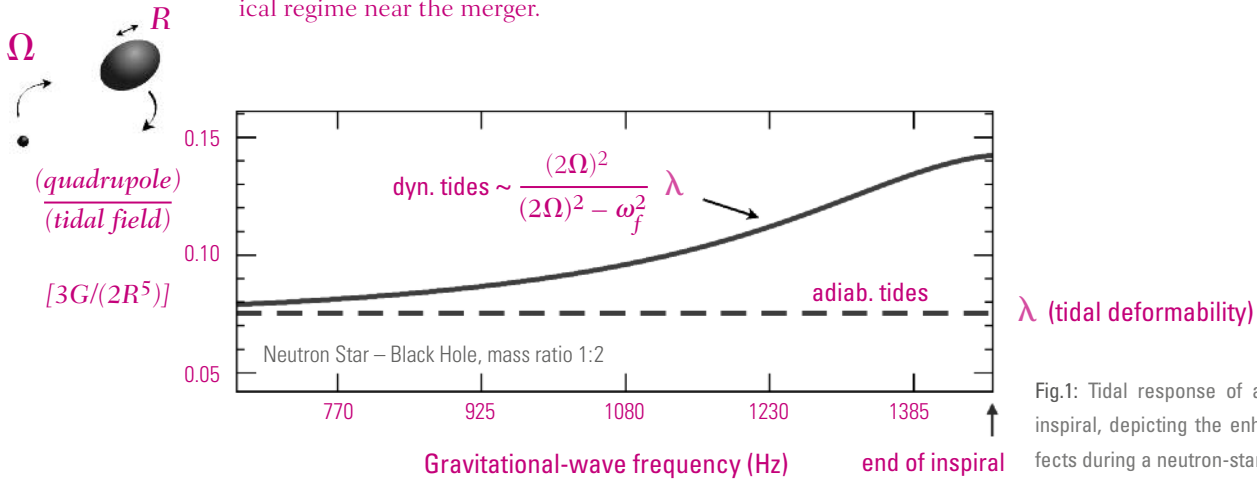
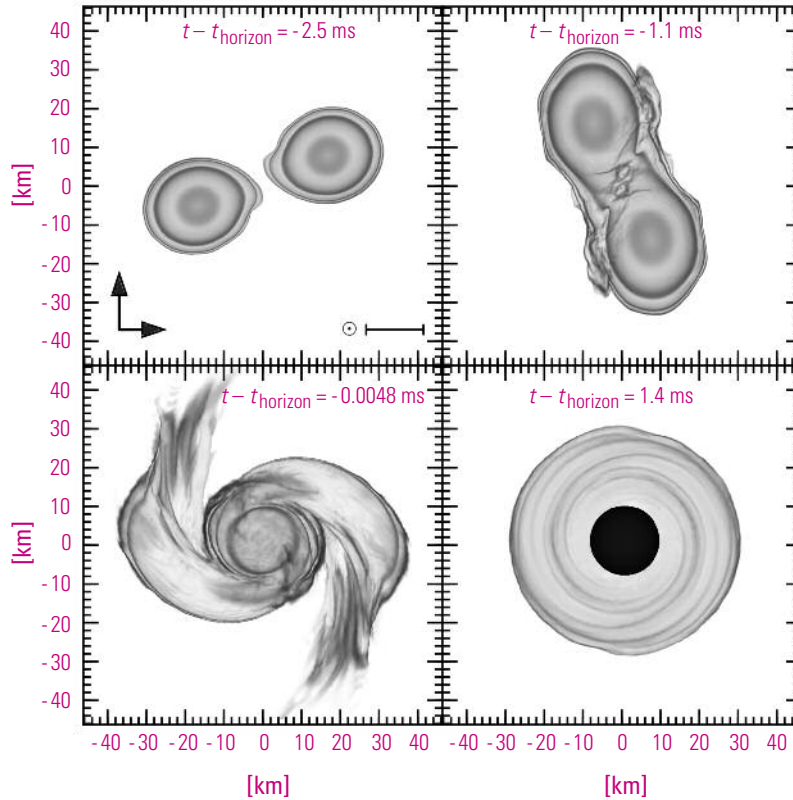

Fig.1: Tidal response of a neutron star during inspiral, depicting the enhancement of tidal effects during a neutron-star–black hole binary inspiral due to the star's fundamental oscillation mode. The quantity shown is the ratio of the neutron star's induced quadrupole moment to the strength of the tidal field due to the black hole as a function of the gravitational wave frequency. In the adiabatic limit, when the objects are widely separated, this ratio is characterized by the tidal deformability coefficient  $\lambda$ . As the frequency of the tides on the neutron star, at twice the orbital frequency  $\Omega$ , approaches the neutron star's fundamental oscillation mode frequency  $\omega^2$ , the tidally induced quadrupole moment is much larger than expected from the adiabatic limit. The behavior is analogous to a forced harmonic oscillator approaching a broad resonance.

Fig.2: Density distribution of a pair of neutron stars 1.7 times the mass of the Sun during their inspiral towards each other. The deformation due to tides is clearly visible 2.5 ms before the stars collide and collapse to a black hole. At 1.1 ms one observes the moment of contact between the two neutron stars, showing the shear layer between them. The bottom panels show the merged neutron star just before collapse to a black hole and the black hole after the accretion disk has fully formed.



#### References

- [1] Hinderer, T., Taracchini, A., Foucart, F., Buonanno, A., Steinhoff, J., Duez, M., Kidder, L. E., Pfeiffer, H. P., Scheel, M. A., Szilagyi, B., Hotokezaka, K., Kyutoku, K., Shibata, M., & Carpenter, C. W. (2016). Effects of neutron-star dynamic tides on gravitational waveforms within the effective-one-body approach. *Physical Review Letters*, 116: 181101. doi:10.1103/PhysRevLett.116.181101.
- [2] Nature Research Highlight: Model predicts Neutron Star signal. *Nature* 533, 294 (2016)
- [3] Steinhoff, J., Hinderer, T., Taracchini, A., & Buonanno, A. (2016). Dynamical tides in general relativity: effective action and effective-one-body hamiltonian. *Physical Review D*, 94: 104028. doi:10.1103/PhysRevD.94.104028.
- [4] Dietrich, T. et al. (2017). Gravitational waves and mass ejecta from binary neutron star mergers: Effect of the mass-ratio. *Phys.Rev. D*95, 024029. doi:10.1103/PhysRevD.95.024029
- [5] Haas, R., Ott, C. D., Szilagyi, B., Kaplan, J. D., Lippuner, J., Scheel, M. A., Barkett, K., Muhlberger, C. D., Dietrich, T., Duez, M. D., Foucart, F., Pfeiffer, H. P., Kidder, L. E., & Teukolsky, S. A. (2016). Simulations of inspiraling and merging double neutron stars using the Spectral Einstein Code. *Physical Review D*, 93: 124062. doi:http://dx.doi.org/10.1103/PhysRevD.93.124062.
- [6] Bernuzzi, S., & Dietrich, T. (2016). Gravitational waveforms from binary neutron star mergers with high-order weighted-essentially-nonoscillatory schemes in numerical relativity. *Physical Review D*, 94(6): 064062. doi:https://doi.org/10.1103/PhysRevD.94.064062.

trinos, thus cooling the merged remnant neutron star and affecting the gravitational wave signal. In addition, during and after the merger, copious amounts of electromagnetic radiation are generated, and joint observations will enable studying the process through multimessenger channels. A study of the characteristics of the electromagnetic counterparts covering a wide range of neutron star parameters and signals at different wavelengths was performed in [4].

SpEC uses a hybrid method that employs a spectral scheme to describe the gravitational field and finite volume algorithms to describe the neutron star fluid. As the neutron star and its companion spiral towards each other the numerical grid follows them such that their bulk motion on the grid is small, increasing the numerical accuracy of the finite volume scheme. This hybrid scheme allows us to track gravitational waves at high accuracy while at the same time capturing shocks and small scale features in the neutron stars [5]. SpEC is designed to provide high quality, very long gravitational waveform predictions that have already been used to calibrate the effective-one-body model developed by AEI group members and now widely used in LIGO when searching for gravitational signals from binary black holes. SpEC contains a module to compute initial data for black hole and neutron star simulations, which we use to start our simulations with the neutron stars on almost circular orbits around each other, as is expected for astrophysically realistic systems. To increase the confidence in our numerical results for the complex physics of neutron star mergers, we perform a number of consistency checks, including a comparison with results obtained with an independent code [5,6].

To date we have focused on long binary neutron star inspiral simulations as well as, in collaboration with other Simulating eXtreme Space-times members, shorter black hole neutron star simulations. The latter

are of particular interest when studying tidal interactions since the mass and size of the black hole can be adjusted to maximize tidal effects on the neutron star.

In future work we will improve both the analytical model and the accuracy of the numerical simulations. Moreover, we will work to include more realistic physics such as the spins of the objects and more detailed microphysics, and the wide range in phenomenology of the signals beyond the inspiral. Our work will provide important inputs to take full advantage of the science potential with gravitational waves from neutron star binaries.

Roland Haas,  
Tanja Hinderer,  
and Jan Steinhoff



### **Numerical-relativity simulations and modeling of black-hole binaries for gravitational-wave observations**

On 15<sup>th</sup> September 2015, for the first time, the Advanced LIGO interferometers directly observed gravitational waves, an event that goes under the name of GW150914. The waves were emitted from the collision of two black holes that had been orbiting each other in a binary configuration. This historic discovery was possible thanks to key contributions from scientists who work in the Astrophysical and Cosmological Relativity division of the AEI. In fact, the primary focus of the division is the prediction of the gravitational-wave emission generated by pairs of compact objects (black holes, neutron stars) according to Einstein's theory of gravity, general relativity. Our scientists employ the tools of analytical and numerical relativity to build accurate models of the waveforms, which are then used to study the output of gravitational-wave detectors. Our binary-black-hole models were used in both the detection and parameter-estimation pipelines for GW150914, as well as for the second event observed by Advanced LIGO, GW151226.

A highlight of the research conducted at the AEI is the development of the only inspiral-merger-ringdown waveform model that accounts for all the physical degrees of freedom of a precessing-spin black-hole binary. A peculiar aspect of the phenomenology of coalescing black-hole binaries is the strong modulation of the emitted gravitational-wave signal due to the precessional motion of the source. In particular, whenever the intrinsic angular momenta (spins) of the holes are not aligned with the orbital angular momentum of the binary, the orbital plane undergoes motion, as seen from an inertial observer, and the spins precess about the total angular momentum. Scientists at the AEI have developed a model for such spin-precessing configurations relying on the fact that, when viewed in an appro-



appropriate frame that tracks the orbital plane (precessing frame), precession-induced amplitude and phase modulations are minimized in the waveforms. In such a frame, one can describe the emission using a non-precessing spin model that has been previously calibrated against numerical solutions of Einstein's equations [1]. Finally, the inertial-frame emission can be obtained from a time-dependent rotation of the precessing-frame waveforms.

In [2] the model was compared to 70 numerical-relativity simulations (full numerical solutions of the Einstein equations run on supercomputers) of black-hole binaries that span mass ratios up to 5, spin magnitudes up to 50% of the maximal value allowed by general relativity, random spin orientations, and lasting for about 20 orbits. The AEI researchers have found that the model on average agrees with numerical relativity better than 97 parts in 100 for binary masses from 10 to 200 solar masses, at least for the portion that has been covered by the simulations, for all the 70 configurations considered. This study has covered the very region of parameter space that includes GW150914, thus increasing our confidence in the applicability of the model for the characterization of such event. The scientists have worked on extrapolating the model throughout the parameter space up to maximal spin magnitudes and very large mass ratios. They have also implemented it in the data-analysis software of the LIGO Scientific Collaboration, thus enabling, for the first time, Bayesian inference on real gravitational-wave events with a fully precessing inspiral-merger-ringdown model [4].

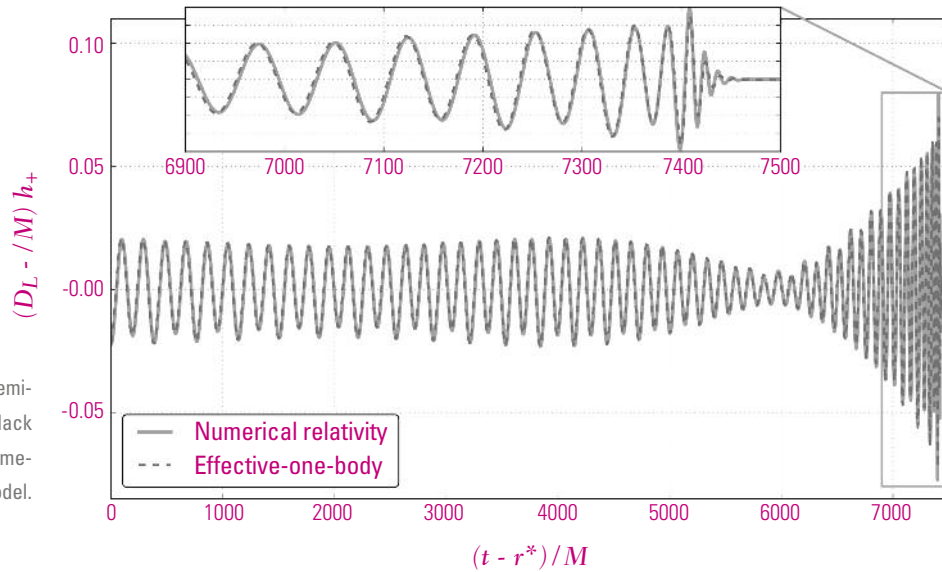

Fig.1: Gravitational waveform emitted by a precessing binary black hole: comparison between numerical relativity and the AEI model.

Following the detection of the GW signals, researchers at the AEI ran numerical-relativity simulations of the detected events on the AEI's 2400-core computer cluster Datura. The simulations were run using the SpEC code, written by members of the Simulating eXtreme Spacetimes collaboration, of which the AEI is a recent member [5]. The waveforms from these simulations were among those used in the LIGO papers, where they were compared against the LIGO data and showed excellent agreement with the experimental measurements. These simulations provide the unique opportunity of visualizing the events observed by LIGO, as shown in the figure on the right.

The astrophysical parameters that describe a compact-object coalescence are inferred by comparing the interferometric data to a large number of plausible general-relativistic signals, and determining the parameters of the best fitting waveform. This procedure can of course be negatively affected by modeling errors. While in the past our waveform models had been tested thoroughly in regions of parameter space close to the detections, additional detailed studies were performed at the AEI – also using new numerical relativity simulations run on the high-performance computer cluster in Potsdam – in order to confirm the absence of significant systematic errors that could bias the measurement of the parameters of the source of GW150914 [3].

Galvanized by the success of Advanced LIGO, the Astrophysical Relativity and Cosmology division at the AEI continues its research in compact-object binaries. Fast spinning binary black hole systems with very different masses are particularly hard to model numerically, and as a result, there are few numerical-relativity simulations available in this region of the parameter space. Since the detection, researchers at the AEI have continued to run numerical relativity simulations, with both the SpEC and Einstein Toolkit/Cactus [6] codes, to extend our knowledge of the waveforms from binary black holes in this challenging region of the parameter space. These simulations will be used to both test and improve our waveform models. In addition to pushing the boundaries of spin and mass ratio for a small number of difficult cases, AEI members have also simulated 120 binary-black-hole systems in which the spins are misaligned with the orbital angular momentum of the binary. On the modeling side, an improved waveform model for non-precessing spin binary black holes has been developed at the AEI to be used in the second observing run of Advanced LIGO.

Ian Hinder, Andrea Taracchini

#### References

- [1] Phys.Rev. D89 (2014) no.6, 061502
- [2] Phys.Rev. D95 (2017) no.2, 024010
- [3] Class.Quant.Grav. 34 (2017) no.10, 104002
- [4] Phys.Rev. X6 (2016) no.4, 041014
- [5] [black-holes.org](http://black-holes.org)
- [6] [einsteintoolkit.org](http://einsteintoolkit.org)

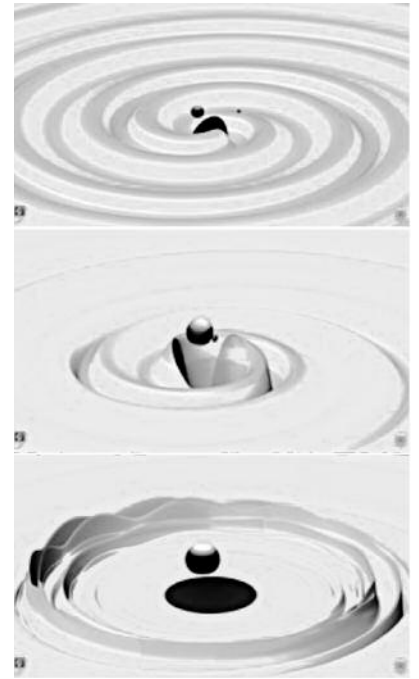

## **Developing searches and parameter estimation follow-up for gravitational waves from spinning black-hole binaries**

Three binary black hole merger signals were observed during the first observing run of the second generation gravitational-wave observatory Advanced LIGO. Scientists from the Max Planck Institute in Potsdam played a significant role in making these observations and in characterizing the observed signals. Specifically, when searching for such systems, one does not know a-priori what the parameters of the system will be, how heavy will the black holes be, or whether we will observe binaries involving much lighter neutron stars. Observing many such systems will allow us to begin to understand the underlying distributions and astrophysical formation scenarios, but to reach that point it is important that search methods are capable of observing any physically possible compact binary merger.

Black holes are described by only two physical parameters, their mass and their intrinsic angular momentum, or spin. Neutron stars depend additionally on parameters defining their unknown internal structure, but this effect can be neglected for our purposes here. It follows then that the gravitational-wave signal emitted by two merging compact objects will depend only on the masses and spins of the two compact objects along with the position and orientation of the binary system with respect to the Earth. Previously, when analyzing data from initial LIGO, we searched a wide range of component masses but the spins of the compact objects were ignored. This was justified because the narrow bandwidth of the initial LIGO instrument meant that a change in the spins was largely indistinguishable from a corresponding change in the masses. Advanced LIGO, however, provides a much larger bandwidth over which to observe compact binary mergers and it is increasingly important that the spins are not ignored when analyzing Advanced LIGO data.

Observing and then extracting information about compact binary mergers in gravitational-wave data is a challenging task. It requires a suite of analysis software to observe signals in the data taken by the gravitational-wave observatories using a technique called “matched-filtering”. Then, a related suite of software tools is applied to extract information about the observed sources using Bayesian inference techniques. Both of these efforts are topics of active research and development within the Astrophysical and Cosmological Relativity division of the AEI. A specific highlight of our research since its inception in fall 2014 has been to include the effect of the compact objects’ spin into these projects and tool kits. This was then used to successfully observe, and infer the parameters of, several binary merger signals.

### **Aligned-spin template bank**

Searching for compact binary mergers with Advanced LIGO requires accurate model waveforms of the waveforms we are looking for. Developing such waveform models is discussed in a companion article. As the emitted gravitational-wave signals vary with the component masses and spins, we require a large set of these waveforms, or a “template bank”, to be able to observe compact binary mergers over a wide range of source parameters. Creating template banks of waveforms neglecting the components’ spins is a problem that has been solved since

2005. In recent years, methods have been developed to construct template banks that do not neglect the spins but do restrict it to be aligned with the plane of the binary's orbit. In the last year, scientists at the AEI have worked to combine these new developments into a single combined method for creating template banks of waveforms covering an arbitrary range of masses and arbitrary range of component spins (restricted to being aligned with the orbit). This new method was used to create the template bank of waveforms that was employed to search Advanced LIGO's data for compact binary mergers [1,2].

### Precessing spin search development

Using the new methods developed by AEI scientists, we are now searching LIGO data employing templates that include component spins aligned with the orbital plane. However, there is no reason to believe that real compact binary mergers will have component spins that are aligned with the orbital plane. If the spins are not aligned with the orbital plane, they will apply a torquing force to the orbit, causing a precessing of the orbital plane. In 2015, we have developed a new method to create template banks, and then search for systems in which the spins are allowed to take any magnitude and any orientation [3]. We find that an order of magnitude more template waveforms, and therefore an order of magnitude more computing power is required to use waveforms with generic spins. However, we also find an improvement in search sensitivity when using these methods. This improvement is much larger for systems in which one body is significantly more massive than the other, for example the case of a neutron star merging with a black hole. For systems in which the masses are comparable there is no noticeable improvement, these systems are already detected efficiently using only aligned-spin waveforms.

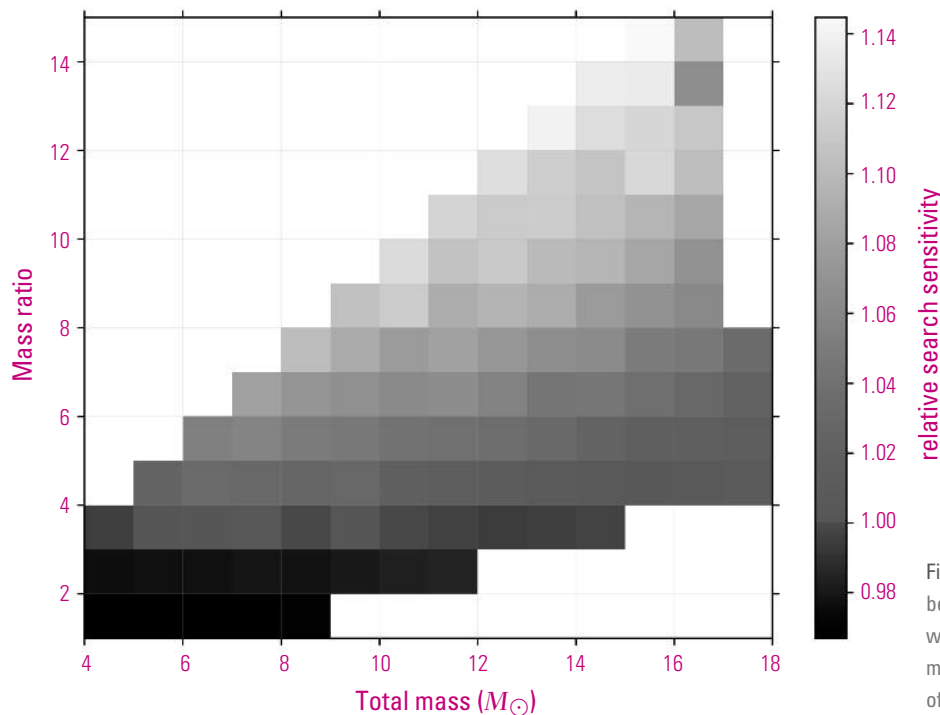

Fig.1: The relative search sensitivity between a search using only signals where the component angular momenta are aligned with the plane of orbit and our new search method allowing the component angular momenta to be in any direction. Plotted as a function of mass ratio and total mass for systems where a neutron star is merging with a black hole.

### Parameter estimation

To extract physical information from compact binary mergers, an accurate set of models of compact merger gravitational waveforms is required. Such models are then combined with a model for the noise

of the observatories to measure the quality of the fit to the observed data. We use Bayesian statistical theory to report multidimensional probability density functions for the model parameters, such as masses and spins. We managed to upgrade the LIGO/Virgo parameter

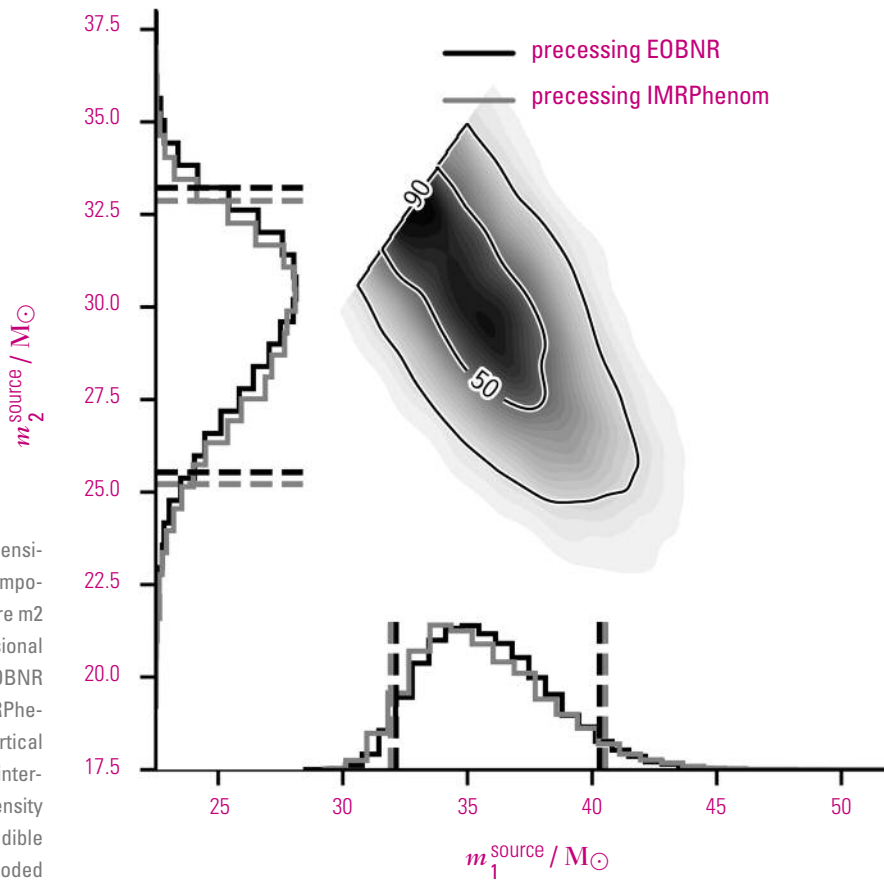

Fig.2: Posterior probability densities for the source-frame component masses  $m_1$  and  $m_2$ , where  $m_2 \leq m_1$ . We show one-dimensional histograms for precessing EOBNR (black) and precessing IMRPhenom (grey); the dashed vertical lines mark the 90% credible intervals. The two-dimensional density plot shows 50% and 90% credible regions plotted over a color-coded posterior density function.



estimation infrastructure to use the latest spin-precessing Effective-One-Body waveform model calibrated to Numerical-Relativity simulations (EOBNR) developed at the AEI. Since it is the first model of the entire gravitational waveform including fully precessing effects of both spins of the binary (incorporating all six spin degrees of freedom), we were able to extract the full spin information of gravitational-wave detections of compact binary mergers. We also confirmed that statistical errors due to finite signal-to-noise-ratio are dominating waveform systematical errors in LIGO's first observing run. This will change in future detections. However, with additional detections in the next observing runs, this measurement capability will enable astrophysicists to unravel the formation history of binary black holes.

Ian Harry, Vivien Raymond

#### References

- [1] C. Capano, I. Harry, Privitera, A. Buonanno, Phys.Rev. D93 (2016) no.12, 124007
- [2] T. Dal Canton and I. Harry, arXiv e-print. URL: <https://arxiv.org/abs/1705.01845>
- [3] I. Harry, S. Privitera, A. Bohe and A. Buonanno, Phys.Rev. D94 (2016) no.2, 024012
- [4] LVC, Phys. Rev. X 6, 041014 (2016)

## Astrophysical Relativity Division

### **Astrophysical sources of gravitational radiation, high-energy astrophysics, planetary science, and dark matter**

The astrophysics group (<http://astro-gr.org>), led by Pau Amaro Seoane, has focused between 2013 and 2016 on gravitational-wave astronomy (eLISA, aLIGO/Virgo and PTA), high-energy astrophysics, our Galactic Centre as a testbed of general relativity, globular clusters, including dark matter and planetary systems. The group has had three postdocs, two PhD students, and a number of visitors, including Prof. H. M. Lee from Seoul for a few months, and undergrad students spending typically a few months on a research project during the summer- or winter semester. The members of our group have been the main organisers of 8 international workshops on Gravitational Waves Astronomy. A postdoc of the group, Xian Chen, has recently obtained a faculty position in the most prestigious Chinese university, his alma mater, the Peking University.

The group has participated in the science article that describes the new physics and astronomy that the Evolved Laser Interferometer Space Antenna mission (eLISA, derived from the previous LISA proposal) will deliver. The mission will survey for the first time the low-frequency gravitational wave band (about 0.1 mHz to 1 Hz), with sufficient sensitivity to detect interesting individual astrophysical sources out to  $z = 15$ . [1].

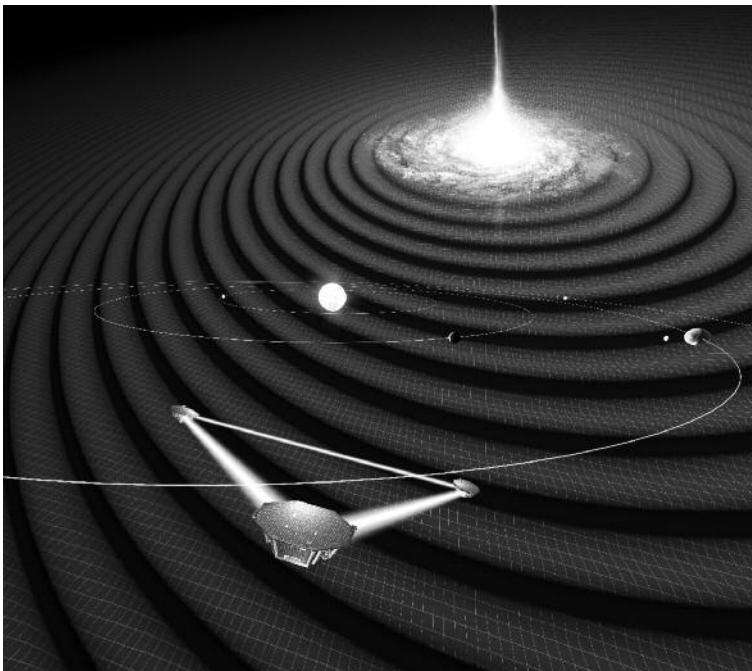

LISA constellation within our solar system in front of gravitational waves emitted by an active galaxy.

Another highlight of the group was a paper sent to the arXiv in 2015 with a prediction of the characteristics of the potential sources that the Advanced ground-based detectors LIGO/Virgo are most likely to see. Due to a selection effect, most binaries of black holes were predicted in the paper to have a large mass, low spin values and a very low eccentricity [2]. These were indeed the features observed

## References

- [1] Amaro-Seoane, P. et al. (2013). eLISA: Astrophysics and cosmology in the millihertz regime. *GW Notes*, 6, 4-110. Retrieved from <http://arxiv.org/abs/1201.3621>.
- [2] Amaro-Seoane, P., & Chen, X. (2016). Relativistic mergers of black hole binaries have large, similar masses, low spins and are circular. *Monthly Notices of the Royal Astronomical Society*, 458(3), 3075-3082. doi:10.1093/mnras/stw503.
- [3] Goicovic, F. G., Cuadra, J., Sesana, A., Staszyn, F., Amaro-Seoane, P., & Tanaka, T. (2016). Infalling clouds on to supermassive black hole binaries – I. Formation of discs, accretion and gas dynamics. *Monthly Notices of the Royal Astronomical Society*, 455(2), 1989-2003. doi:10.1093/mnras/stv2470.
- [4] del Valle, L., Escala, A., Maureira-Fredes, C., Molina, J., Cuadra, J., & Amaro-Seoane, P. (2015). Supermassive black holes in star forming gaseous circumnuclear discs. *Astrophysical Journal*, 811(1): 59. doi:10.1088/0004-637X/811/1/59.
- [5] Amaro-Seoane, P., Glaschke, P., & Spurzem, R. (2014). Hybrid methods in planetesimal dynamics: Formation of protoplanetary systems and the mill condition. *Monthly Notices of the Royal Astronomical Society: Letters*, 445 (4), 3755 -3769. doi:10.1093/mnras/stu1734.
- [6] Glaschke, P., Amaro-Seoane, P., & Spurzem, R. (2014). Hybrid methods in planetesimal dynamics (I): Description of a new composite algorithm. *Monthly Notices of the Royal Astronomical Society*, 445(4), 3620-3649. doi:10.1093/mnras/stu1558.
- [7] Amaro-Seoane, P., & Chen, X. (2014). The fragmenting past of the disk at the Galactic Center: The culprit for the missing red giants. *The Astrophysical Journal Letters*, 781(1): L18. doi:10.1088/2041-8205/781/1/L18
- [8] Chen, X., & Amaro-Seoane, P. (2014). A rapidly evolving region in the Galactic Center: Why S-stars thermalize and more massive stars are missing. *The Astrophysical Journal Letters*, 786(2): L14. doi:10.1088/2041-8205/786/2/L14.
- [9] Amaro-Seoane, P., Casanellas, J., Schödel, R., Davidson, E., & Cuadra, J. (2016). Probing dark matter crests with white dwarfs and IMBHs. *Monthly Notices of the Royal Astronomical Society*, 459(1), 695-700. doi:10.1093/mnras/stw433.

in the first detection by aLIGO, announced in February 2016, GW150914.

There has been a significant effort in the study of binaries of supermassive black holes in circumbinary accretion disks, from the formation down to the coalescence of the binary and consequent emission of gravitational radiation. The group has closely collaborated with researchers leading the field that sent two students, Felipe Garrido and Luciano del Valle to spend a research time with the group. The visits led to the publication of papers that address the formation of mini disks around supermassive black holes due to the infall of gaseous clouds in the galactic center, a process that had never been studied in detail previously. [3].

The study has extended to previous phases, namely to the point in which after two galaxies have merged, the supermassive black holes sink to the center and build a binary in a gaseous environment. Visitor del Valle collaborated with the group in a series of extensive numerical analysis addressing this scenario including, for the first time, realistic accretion prescriptions and stellar formation [4].

The group has extended the interests to the formation and evolution of protoplanetary systems with a novel and very complex hybrid scheme. The code combines statistical methods for the planetesimals with direct-summation integration of protoplanets, including a realistic fragmentation algorithm based on Voronoy tessellation. The new code has led to the publication of two papers in which it is shown that the result on the fragmentation in combination with the effective removal of collisional fragments by gas drag sets an universal upper limit of the protoplanetary mass as a function of the distance to the host star, which we refer to as the mill condition [5, 6].

A recent focus of the group is our own Galactic Center (GC), and how we can use it to test general relativity but also high-energy astrophysics, and its implications. The highlights are the publications that close three big problems related to our GC, one of which has been open for the last 15 years: The fact that we observe less bright giants at the GC than what we expect [7], and the kinematical properties of the group of stars that have allowed us to determine the mass and size of our own supermassive black hole, the «S-stars». By relying on only one sole assumption, the kinematical features of these stars can be well explained, along with the fact that more massive stars, Wolf-Rayet and O-stars, are missing at deeper radii [8].

A completely different line of research has been the search for Dark Matter (DM) via the associated release of energy that some compact objects, in particular white dwarfs (WDs), can release due to the self-annihilation process that takes place in their degenerate cores. These «dark-matter burning stars» are invisible in our Galactic Centre due to the extinction. We put forward the idea that smaller stellar systems which are close enough to us and not heavily

extincted, such as Omega Centauri, could be the perfect testbeds for this process. The detection of DM burning in future observations of dense stellar clusters could allow us to probe different models of DM distributions and characteristics. In a recent publication we prove that the bunching up of WDs at high luminosities would be unique. We predict that DM burning will lead to a truncation of the cooling sequence at the faint end [9].

Pau Amaro-Seoane





## The anti-de Sitter stability problem

### The question

General relativity – a century old, classical theory of space and time – seems to be quite well understood today. However, there are still important questions to be answered within this theory, including the problem of stability of anti-de Sitter space (AdS), one of the most important space-times in general relativity.

The stability analysis is essential for the physical interpretation of a given solution when the theory is supposed to model reality. Such studies are not only driven by pure mathematical curiosity, but provide us with invaluable insight into the structure of the underlying theory. Moreover, from these studies we learn about mechanisms for or against stability.<sup>1</sup>

Introduced by Einstein himself, the cosmological constant term allows a new class of solutions to be considered. Just as in three dimensional Euclidean space one can distinguish surfaces of positive, zero or negative curvature (see Fig. 1) one may consider solutions with different signs of the cosmological constant. We are most familiar with Minkowski space ( $\Lambda = 0$ ), the space of special relativity, which has been proved to be stable [2] and for which a stability mechanism is dispersive dissipation (the excited system radiates excess energy to infinity). The de Sitter space ( $\Lambda > 0$ ) is used as a cosmological model for the early Universe (the expansion phase) and, as it has been proved to be asymptotically stable [3], it is expected to describe an end state of its evolution. For anti-de Sitter space ( $\Lambda < 0$ ) the stability question is still open (as we will try to show there is a good reason for that), even though this solution appears frequently in theoretical considerations. All three spaces are special since they are maximally symmetric solutions (just like the plane, sphere and hyperboloid are in two dimensions) to the vacuum Einstein equation. When one adds matter of any sort to the equation, in order to describe more realistic and time dependent scenarios, one may then still consider solutions as being Minkowski or (anti-)de Sitter like (technically, one considers solutions with corresponding asymptotic behavior).

Asymptotically AdS spaces (solutions which share the same structure of infinity as AdS) play a central role in theoretical physics due to the AdS/CFT correspondence. This correspondence within string theory relates, in a particular limit, classical gravity in the AdS to a conformal quantum field theory with a large number of strongly interacting degrees of freedom, living in the spacetime corresponding to the conformal boundary of AdS.<sup>2</sup> In particular, the black hole solution with AdS asymptotics is dual to a quantum system with finite temperature, which lives on the boundary of such space. The process of a black hole formation itself corresponds to thermalization (an approach to equilibrium) of excited quantum system. On the other hand, the

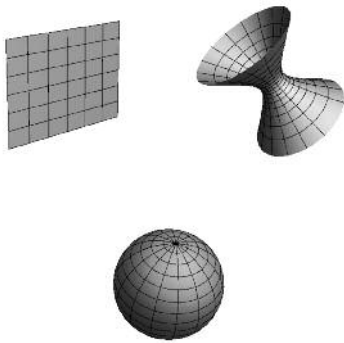

Fig.1: Examples of maximally symmetric two-dimensional spaces: sphere (positive curvature), plane (zero curvature) and hyperboloid (negative curvature).

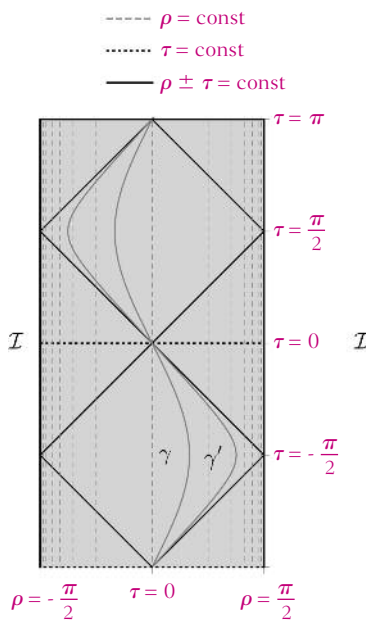

Fig.2: The conformal diagram of AdS space as a part of Einstein static Universe. The conformal boundary located at finite conformal distance ( $\rho = \pi/2$ ) can be reached by light signals in finite coordinate time (contrary to the positive cosmological constant which acts like a “repulsive force”, in AdS, negative  $\Lambda$  provides additional attractive force). For that reason the data at some particular “time” does not suffice to predict the future evolution.

<sup>1</sup> Here we adapt a loose definition of stability: we say that the solution is stable if any small initial perturbation stays small for all times. Additionally, if a perturbation decays over time, we speak about asymptotic stability.  
<sup>2</sup> The expectation is that the former is easier to solve than the latter, even if only numerically.

dynamics of a non-collapsing configuration in the AdS corresponds to an out of equilibrium state. Studying the dynamics of asymptotically AdS solutions, according to the AdS/CFT correspondence, may shed light on the physics of quark-gluon plasmas we currently know little about. Thus, there is no doubt that the answer to the question about stability of AdS is as important as the studies of asymptotically AdS spaces itself.

### The studies

What makes the AdS so different from Minkowski and de Sitter spaces is the presence of a time-like conformal boundary (see Fig. 2 on previous page). To define the evolution one has to impose not only the initial data but also the boundary conditions. For the physically most interesting no-flux boundary conditions there is no mechanism of dispersive dissipation of energy. For this reason the question of stability of AdS space is very challenging.

This question was addressed in the pioneering work [1] on spherically symmetric massless Einstein-Klein-Gordon system with negative cosmological constant<sup>3</sup> where the AdS space was conjectured to be unstable. This conjecture was supported by perturbative and numerical arguments. On the perturbation level, it was shown that resonant interactions between eigenmodes<sup>4</sup> give rise to secular terms at higher orders of the formal perturbation expansion. This shifts the energy spectrum to higher frequencies and causes concentration of energy on finer and finer spatial scales (weak turbulence). Numerical simulations confirmed this scenario (cf. Fig. 3) and showed that nonlinear evolution eventually leads to the black hole formation on the timescale  $1/\varepsilon^2$ , where  $\varepsilon$  is the amplitude of the perturbation.

It should be stressed that the accurate and reliable numerical simulations of turbulent dynamics for Einstein equation, first observed in [1], is difficult by its nature and only a very careful confrontation of results obtained by different methods can make one feel confident about the results.

Already in [1] it was noticed that not all initial perturbations trigger black hole formation. Now we know many examples of non-collapsing solutions, e.g. one-mode solutions, standing waves, time-periodic solutions (a new class of nontrivial smooth solutions constructed by the author and Andrzej Rostworowski). These solutions evade resonant mixing (this is exactly how the time-periodic solutions were constructed – during the construction procedure we were able to remove all of the resonant terms using the free parameters of the solution: frequency and composition in terms of linear eigenmode functions) and enjoy possibly infinite periodic or quasiperiodic oscillations, see Fig. 4. These findings, namely the existence of periodic in time solutions and their properties, were further extended to other spherically symmetric models in the author’s thesis and are a subject of ongoing investigations. These studies indicate that the non-collapsing configurations are stable with respect to finite size perturbations. The co-existence of collapsing and non-collapsing configurations makes the stability prob-

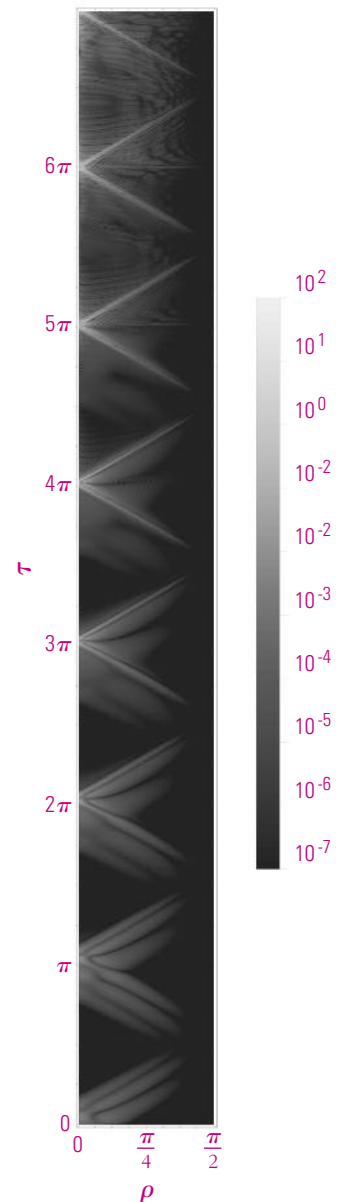

Fig.3: The energy density map for an evolution of spherically symmetric scalar field of [1]. On horizontal axis is the radial distance ( $\rho = 0$  symmetry origin,  $\rho = \pi/2$  conformal boundary), vertical axis is coordinate time of an observer residing at  $\rho = 0$ . Horizon formation is indicated by growing energy concentration at each implosion.

<sup>3</sup> Due to Birkhoff’s theorem, any spherically symmetric vacuum space-time must be static, and in order to generate nontrivial dynamics one needs to couple some kind of matter to gravity.

<sup>4</sup> Solutions to the linear wave equation on a fixed AdS background (see e.g. [4]).

lem particularly challenging (even in spherical symmetry, or other reduced 1 + 1 dimensional settings).

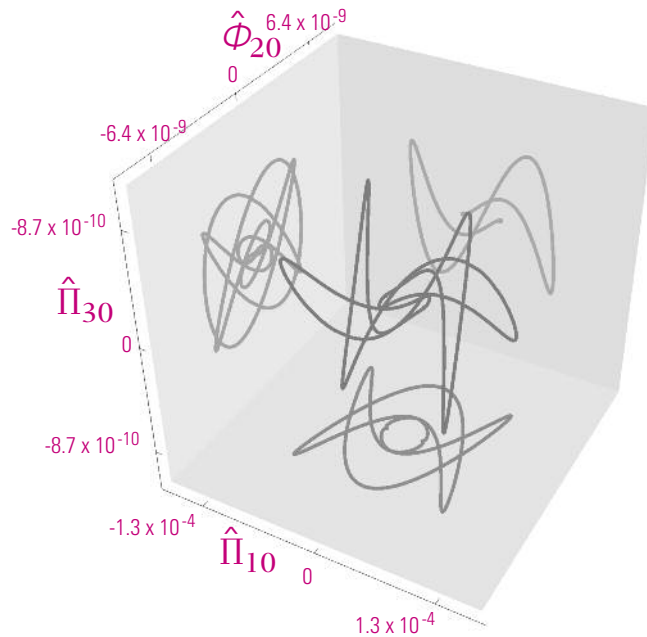

Fig.4: Parametric curves corresponding to a particular time-periodic scalar field perturbation of AdS (see also [5]).

#### References

- [1] Bizoń, P. & Rostworowski, A. (2011). Weakly Turbulent Instability of Anti-de Sitter Spacetime. *Phys. Rev. Lett.* 107, 031102 (2011). doi:10.1103/PhysRevLett.107.031102.
- [2] Christodoulou, D. & Klainerman, S. (1993). *The Global Nonlinear Stability of the Minkowski Space*. Princeton Mathematical Series 41, Princeton University Press.
- [3] Friedrich, H. (1986). On the Existence of n-Geodesically Complete or Future Complete Solutions of Einstein's Field Equations with Smooth Asymptotic Structure. *Comm. Math. Phys.* 107, 587. doi: 10.1007/BF01205488.
- [4] Ishibashi, A. & Wald, R. M. (2004). Dynamics in non-globally-hyperbolic static spacetimes: III. Anti-de Sitter spacetime. *Class. Quant. Grav.* 21, 2981. doi: 10.1088/0264-9381/21/12/012
- [5] Maliborski, M. & Rostworowski, A. (2013). Time-Periodic Solutions in an Einstein AdS-Massless-Scalar-Field System. *Phys. Rev. Lett.* 111, 051102. doi: 10.1103/PhysRevLett.111.051102
- [6] Balasubramanian, V. et al. (2014). Holographic Thermalization, Stability of Anti-de Sitter Space, and the Fermi-Pasta-Ulam Paradox, *Phys. Rev. Lett.*, 113, 071601. doi: 10.1103/PhysRevLett.113.071601
- [7] Craps, B., Evnin, O., and Vanhooft, J. (2014). Renormalization group, secular term resummation and AdS (in)stability. *J. High Energy Phys.*, 10, 48. doi: 10.1007/JHEP10(2014)048



Although computer simulations were instrumental in these findings, they must be supplemented by analytical studies in order to gain good understanding. An important analytical tool, recently developed by two groups [6, 7], is the resonant approximation (known also as multi-scale approach – two time formalism or Galerkin-averaging method). In this approximation one first rewrites the Einstein equation in the generalized Fourier space and then drops all the nonlinear interactions between the modes but the resonant ones. The most important property of the resulting infinite dimensional dynamical system is its scale invariance which allows us to explore solutions in the zero amplitude limit. The resonant approximation was first used to describe quasiperiodic (non-collapsing) solutions and, more recently, also collapsing solutions [8]. In particular, within this approximation the power law energy spectra were calculated. These preliminary studies indicate the important role the resonant approximation may play in our understanding of global dynamics of asymptotically AdS spaces.

#### The answer

Due to the complexity of the problem, current studies of stability of AdS were restricted to spherical symmetry and reflecting boundary conditions. It would be very interesting to relax these simplifying assumptions. Certainly, in further studies computer simulations will play an important role by guiding us toward a full understanding and building up our intuition. This exciting, new, very active path of research connecting general relativity, string theory, theories of partial differential equations and turbulence, and numerical analysis may not only answer the question of stability of AdS space but also uncover new phenomena at the interface of general relativity and turbulence.

Maciej Maliborski

# Laser Interferometry and Gravitational Wave Astronomy Division

## Gravitational geodesy from space

Since its formation, the space group at the AEI develops and advances the laser interferometry for the LISA mission. The LISA constellation employs three satellites in a heliocentric orbit forming a laser interferometer with million km baselines to detect armlength changes caused by low-frequency gravitational waves with characteristic frequencies in the range from 0.1 mHz to 0.1 Hz.

Since 2007, the AEI has been working to transfer the techniques developed for LISA to Earth observation, in particular geodesy, the science of measuring Earth's shape. A pillar of geodesy is the determination of Earth's gravity field. If a pair of satellites orbits the earth then spatial and temporal changes of the Earth's gravity field will change the distance between the satellites. The orbital velocity defines the mapping of the gravity field structure to variations of the inter-satellite distance that can be measured with laser interferometry. It turns out that for a Low Earth Orbit (LEO) detector spatial features of the size of the Earth from thousands down to around a hundred kilometers are mapped to frequencies from 0.18 mHz to 0.1 Hz, which is very similar to the LISA band.

Earth's gravity field in outer space is formed by the integrated mass distribution from Earth's interior, crust, oceans and atmosphere – making it to an invaluable tool in geo-science. The most pronounced feature in the gravity field is due to the oblateness of the Earth, producing a gravitational acceleration difference between the equator ( $9.780 \text{ m/s}^2$ ) and poles ( $9.832 \text{ m/s}^2$ ). If the mean field from the best-fit ellipsoid is subtracted from Earth's actual gravity field, a fine structure remains, which is correlated with the topography. Such gravity field maps are conveniently plotted as an equipotential surface, the so-called geoid, or more precisely as geoid undulation, which is the height difference between geoid and best-fit ellipsoid. Loosely speaking the geoid represents Earth's shape, if Earth would be completely covered by water as the surface of a liquid in equilibrium follows an equipotential surface. The static geoid undulation (height) ranges from -100m to +85m and is shown exaggeratedly in Figure 1. If the static (average) geoid is removed, temporal variations with annual and semi-annual periods and long-term trends become visible, which have a typical magnitude of 0.01% with respect to the static signal. These tiny temporal variations can be used, for example, to deduce the total ice mass loss in Greenland due to global warming [1], to measure the ground-water depletion in Northern India due to excessive agriculture [2] or to analyze continental water storages (hydrology), for example, in the Amazonas region [3].

The first global measurements of Earth's gravity field have been derived from centimeter accurate satellite trajectories. In 2002 the twin-satellite mission GRACE (Gravity Recovery and Climate Experiment) started to measure distance variations between two nearby spacecraft (S/C) with 200 km separation in 480 km height with higher

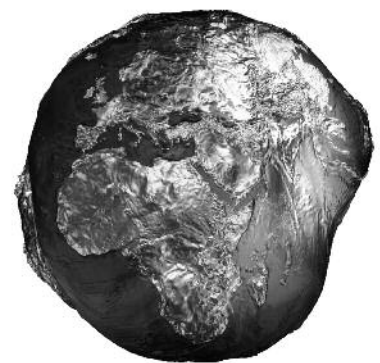

Fig.1: 3-d model of the geoid surface, highly exaggerated in magnitude. Image courtesy of GFZ Potsdam

precision. In a LEO orbit the ranging information contains gravitational as well as non-gravitational contributions from solar radiation pressure, residual atmospheric drag, Lorentz force etc. The non-gravitational contributions are measured by an accelerometer and removed in post-processing, thus yielding the pure differential gravitational acceleration between the spacecraft. After post-processing the data in combination with measurements from precise on-board GNSS receiver and attitude sensors, GRACE delivered monthly snapshots of Earth's gravity field for 15 years. The immense value of this time series was recognized and resulted in the funding of a GRACE Follow-On (GRACE-FO) mission launched in 2018.

GRACE and GRACE-FO use microwaves as primary means to detect distance changes between the two satellites, which is limited to a sensitivity of approx.  $1 \mu\text{m}/\sqrt{\text{Hz}}$  at a Fourier frequency of 0.1 Hz. GRACE-FO is meant as a quick-successor mission, however, with minor modifications and most importantly an additional Laser Ranging Instrument (LRI) as technical demonstrator. The latter is designed to provide a ranging sensitivity of at least  $80 \text{ nm}/\sqrt{\text{Hz}}$  at a Fourier frequency of 0.1 Hz. GRACE-FO has therefore the unique opportunity to compare two different ranging instruments, which leaves several means for inter-calibration and verification. Our group at AEI has designed the interferometer, built and tested prototypes, acts as instrument manager for the German contributions and participates in the ongoing testing of the flight hardware. For future gravimetric missions, commonly abbreviated as NGGM (Next Generation Geodesy Missions), laser ranging is considered as primary instrument. Due to the long development and lead time of space missions, NGGM studies are performed in parallel to current missions [5] [6] to be prepared for mission calls by space agencies.

Key aspects in the design of a space ranging instrument are low complexity and mass, well-defined reference points for the distance measurement, immunity of the distance measurement to rotations, i.e. satellite attitude jitter, to environmental disturbances likes temperature and corresponding structural deformations and to electromagnetic interference. At the same time the interferometric link needs to sustain the typical variations in the inter-satellite separation, i.e. from 170-270 km, relative velocities up to 5 m/s (in most current concepts) and rotations of the satellites with their associated pointing uncertainties.

The S/C separation in the order of 200 km for GRACE FO allows using a design without a large telescope, in contrast to LISA where a telescope is necessary to increase the area to collect light and at the same time to reduce the divergence of the outgoing beam. This inevitable divergence causes in GRACE FO a widening of the initial millimeter sized laser beam to 60m diameter at the distant satellite. The receive aperture of a few millimeters in diameter cuts out a small portion of the beam. As the interferometer schemes developed at AEI allow to operate at very low light levels, a typical single-way power loss between  $10^7$  and  $10^{10}$  is acceptable. If one satellite would be operated as passive retro-reflector, the power loss would be squared. Thus, active transponder concepts are means of choice, where the slave satellite replaces the weak received light by a strong phase-locked beam.

Both S/C operate in continuous mode by tracking the phase of the light, which is to first order proportional to the distance and propagation length. Ideally the slave satellite measures a zero due to the phase-lock, while the master S/C performs a round-trip length measurement.

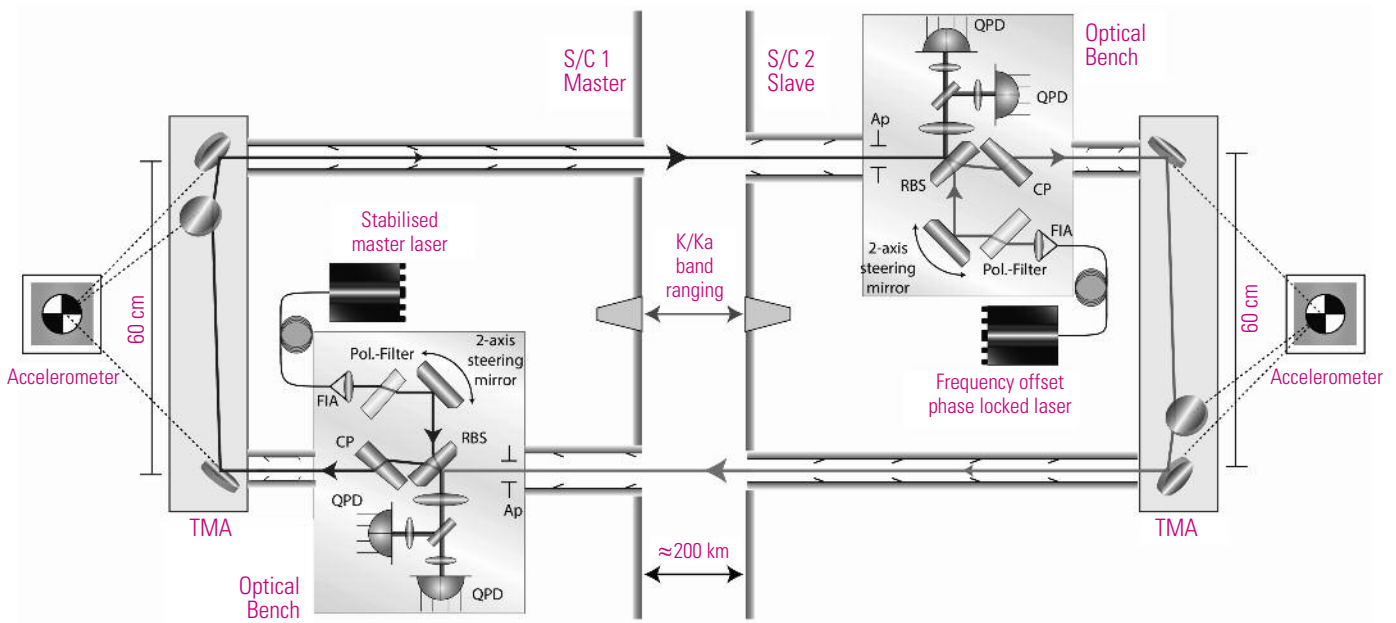

Fig.2: GRACE Follow-On Laser Ranging Interferometer concept consisting of two identical satellites, each equipped with a laser, an optical bench and hollow corner-cube retro-reflector, the vertex of which is co-located with the accelerometer and S/C center-of-mass.

To maintain the link, each satellite needs to send out the light anti-parallel to the received light. This is achieved in GRACE FO with an active retro-reflector concept in racetrack topology, as shown in Figure 2. A large virtual hollow corner-cube retro-reflector on each S/C ensures that the transmit beam is always anti-parallel to the received light. In addition, such retro-reflectors have the advantageous property, that the pathlength through a corner-cube is solely determined by the distance to the vertex, which is the intersection point of all three mirror planes. This virtual point is placed close to the satellite center-of-mass, making the interferometer in first order insensitive to S/C rotations. In GRACE FO, the corner-cube was introduced to obtain a lateral displacement between in- and out-going axis due to space constraints. However, due to its beneficial properties it is now also prioritized in NGGM concepts.

Other main components are the optical benches, which receive the weak light, perform the interferometric readout and emit a strong local field, which is parallel to the received light. If one satellite rotates, for example due to in-orbit disturbance torques, a steering mirror on the optical bench compensates the rotation, such that the emitted light remains parallel to the received light. The steering mirror is controlled with an interferometric technique called Differential Wavefront Sensing, developed for GW detection, which measures the misalignment of the satellite w.r.t. the line-of-sight, thus providing an additional highly sensitive observation channel of spacecraft attitude.

A typical sensitivity curve of a NGGM laser ranging instrument is shown in Figure 3, together with some noise contributors. The noise level of the laser ranging instrument is a sum of the residual spacecraft attitude jitter noise, laser frequency noise, readout noise con-

sisting of relative intensity, electronic and shot noise, atmospheric effects, USO clock noise (shown in Figure 4) and other minor contributors. For comparison, also the microwave noise and the equivalent noise of the accelerometer is provided. The very top curve shows the actual ranging signal.

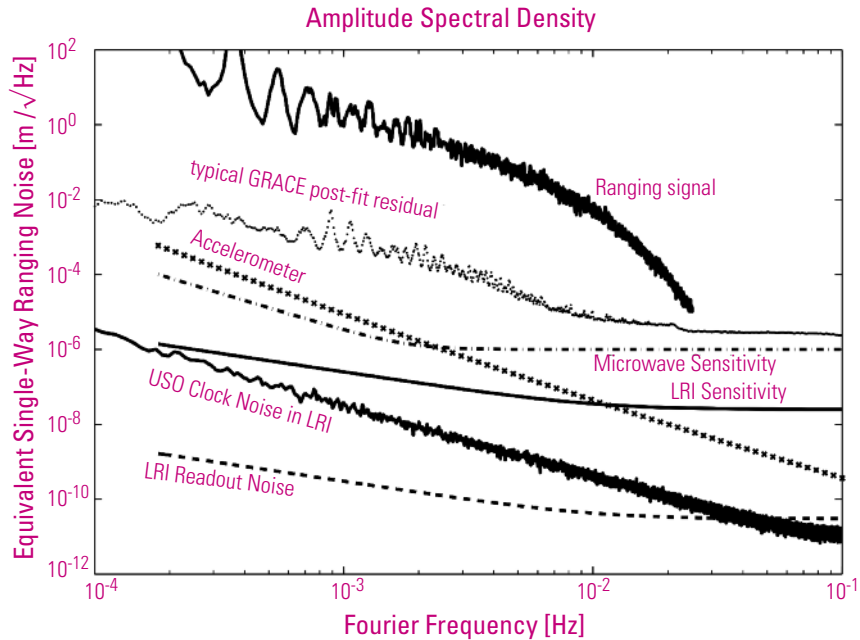

Fig.3: Typical noise and signal curves for a GRACE-like NGGM gravity mission. The ranging signal contains the information on Earth's gravity field.

The gap between post-fit residuals and instrument noise (estimates) for intermediate frequencies in Figure 4 indicates that the GRACE mission is not limited solely by accelerometer and microwave ranging noise, but also by the precision of the orbit determination, attitude errors, gravitational background model errors and other yet unknown contributors. The LRI noise is designed to be well below the other inevitable noise sources, such that the overall performance will not be limited by the laser interferometer, with ample margin even for possible advances in data processing. Due to consideration of learned lessons from GRACE, the additional LRI and steady effort and advances in gravity field modeling, GRACE FO is expected to close the gap and deliver humanity an unprecedented view into our system Earth.



Vitali Müller

**References**

- [1] Velicogna, I., Sutterley, T. C., and van den Broeke, M. R. (2014). Regional acceleration in ice mass loss from Greenland and Antarctica using GRACE time-variable gravity data. *J. Geophys. Res. Space Physics*, 119, 8130–8137. doi:10.1002/2014GL061052.
- [2] Richey, A. S. et al. (2015). Quantifying re-newable groundwater stress with GRACE. *Water Resour. Res.*, 51, 5217–5238. doi:10.1002/2015WR017349
- [3] Güntner, A., Creutzfeldt, B., Dill, R., Barthelmes, F. (2012). Die Variabilität des kontinentalen Wasserkreislaufs in GRACE-Schwerefelddaten. *System Erde*, 2, 1, pp. 26–31. doi:http://doi.org/10.2312/GFZ.syserde.02.01.5
- [4] http://www.geoq.uni-hannover.de/
- [5] Panet, I. et al. (2013). Earth system mass transport mission (e.motion): a concept for future earth gravity field measurements from space. *Surveys in Geo-physics*, 34, 2, pp.141–163. doi:http://doi.org/10.1007/s0712-012-92019-8
- [6] NGGM-D Team (Hrsg.), e2.motion - Earth System Mass Transport Mission (Square) - Concept for a Next Generation Gravity Field Mission - Final Report of Project Satellite Gravimetry of the Next Generation (NGGM-D).http://dggk.badw.de/fileadmin/docs/b-318.pdf

## Squeezed light for metrology

The Max Planck Institute for Gravitational Physics (Albert Einstein Institute / AEI) in cooperation with the Leibniz Universität Hannover, and the British Universities Cardiff and Glasgow, operates the gravitational wave detector GEO600. This measurement device is a Michelson interferometer with 600 m long arms, see Figure 1. The light of a particularly stable high-power laser system is split at a beam splitter and is directed into the two perpendicular arms of the interferometer. On the way back, the light reflected from the two end mirrors recombines on the beam splitter where the two beams interfere. The resulting signal, i.e. the brightness at the output port, varies with the relative phase of the two beams. If now a gravitational wave passes the device, it can stretch the space along one interferometer arm and compress the space along the other. This will lead to a change in the relative phase of the beams and consequently yields a change of the measured light intensity at the interferometer output.

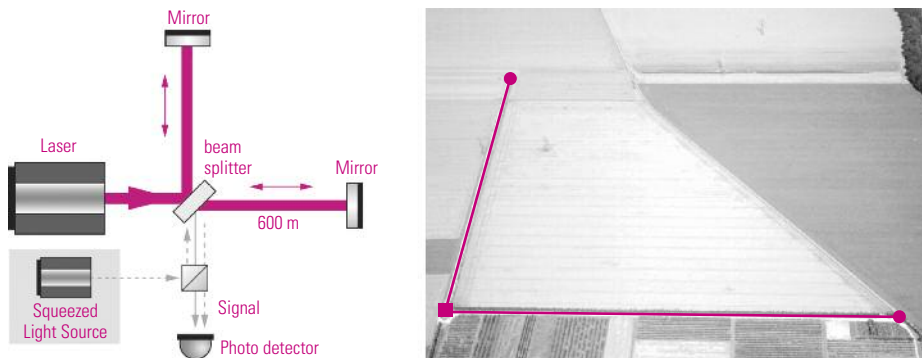

Although the basic measurement principle might seem to be simple, the experimental realization is a technical challenge. The differential length measurement accuracy of GEO600 already exceeds  $10^{-18}$  m, which is one thousandth of a proton diameter. But gravitational wave signals from supernova events or rotating neutron stars, as they are to be expected in the frequency range of hundreds of Hertz to kHz, are still around one order of magnitude smaller. While the environmental influences on the interferometer output signal at these frequencies are sufficiently suppressed, above a measuring frequency of approximately 1 kHz, it is the quantum nature of light, which limits the sensitivity of GEO600. The reason for this is the counting statistics of the light. The photons arrive at the photo detector in irregular time intervals and a measurement at the interferometer output produces a signal whose intensity is stochastically variable. The challenge is to distinguish a weak gravitational wave signal from this background noise, the photon shot-noise.

The output signal strength of a Michelson interferometer is proportional to the light intensity whereas the disturbing shot noise is only proportional to the square root of the light intensity. The classical approach to improve the sensitivity of a gravitational wave detector (i.e. the signal-to-noise ratio) would therefore be to increase the circulating light power. However, gravitational wave detectors are already running close to the maximum available laser power. A further increase would lead to a higher thermal load within the interferometer

Fig.1: Left: The GEO600 gravitational wave detector is based on a Michelson Interferometer topology. The signal-to-noise ratio of the measurement signal on the photo detector can be increased by the injection of squeezed light from the back into the interferometer.

Right: Aerial view of the gravitational wave detector GEO600 near Hannover. The main house (bottom left corner) contains among other components the laser system, the 50/50 beam splitter, photodetector and the squeezed light source. At the end of the 600 meter long vacuum tubes each end station contains the suspended mirrors.



core optics and increasing radiation pressure noise effects. This would again degrade the detector sensitivity. As a result, there is a practical limit for the maximum laser power in a gravitational wave observatory.

Already in 1985 it was proposed that squeezed light can be additionally employed to circumvent the existing shot-noise limitation to further enhance the measurement sensitivity independent of the laser power used. Light, considered as an electromagnetic wave, can be characterized by two quantities: The amplitude and phase, which can be associated with the brightness and color of the light. These two quantities are subject to a Heisenberg uncertainty relation, meaning they can not be simultaneously measured with arbitrary precision. However, this relation does offer the possibility to influence the stochastic distribution of shot-noise. In a squeezed light source, for example, the amplitude noise can be reduced (squeezed) below the shot-noise limit, but as a consequence of the Heisenberg uncertainty this can only happen at the expense of an increased (anti-squeezed) phase noise. Since GEO600 is limited by quantum shot-noise at frequencies above 1 kHz the application of squeezed light, which is equivalent to a reduction of shot-noise, allows to improve the measurement sensitivity of the observatory.

Since the first experimental generation of squeezed light in 1985, the quality and efficiency of squeezed light generation has continuously been improved. Numerous laboratory experiments have been conducted at the AEI Hannover, which have led to the highest squeezing levels reported so far. Furthermore, specific technologies have been developed and demonstrated which paved the way for the application of squeezed light in gravitational wave detectors world-wide.

Fig.2: Photo of the GEO600 squeezed light source. More than one hundred optical components and various electronic control loops are required to prepare squeezed light for the application in a gravitational wave detector. Nevertheless, it is a compact construction with the dimensions of 135 cm x 113 cm at a total mass of about 130kg.



In 2010, a squeezed light source was successfully implemented in GEO600 making it the first ever gravitational wave observatory demonstrating a measurement sensitivity beyond the quantum shot-noise limit. In recent years, the interface between the squeezed light source and the gravitational wave detector was further improved. New technologies have been developed to make squeezed light injection a robust long term application. Squeezing has been in near continuous use since fall of 2011 and in all has operated for 85% of the time dur-

ing which the detector was in science mode. The average observed squeezing level has progressed by several tenths of a dB per year. The record to date is an improvement of the shot-noise-limited strain sensitivity by 4.4dB, the equivalent to a laser power increase by a factor 2.7. Today squeezed light technology has arrived as a permanent application, capable of increasing the astrophysical reach of GEO600. This documents the potential of this quantum technology to become an integral part of all future generations of laser-interferometric gravitational wave observatories world-wide.



Henning Vahlbruch

**Developments in gravitational wave searches for binary systems**

The Compact Binary Coalescence group at the AEI Hannover is part of the LIGO Scientific Collaboration (LSC). One of the main tasks of the LSC is to analyse the data collected by the Advanced LIGO detectors in Hanford and Livingston. The AEI Hannover has played a key role in developing and testing algorithms to perform this data analysis and in the detections of the binary black hole systems GW150914, LVT151012 and GW151226. To make searches for gravitational waves as sensitive as possible matched-filtering of the detector data is used to identify potential signals. This entails searching for matches in the data against a template bank of potential signals that model compact binary coalescences involving either two neutron stars, one neutron star and one black hole, or two black holes. The template bank that was used in the first observing run of Advanced LIGO is displayed in Fig. 1. This template bank found the three binary black hole events and was used to calculate their detection significance, with false alarm rates of less than one per 1.7 million years for GW150914 and GW151226 and one per 2.7 years for LVT151012.

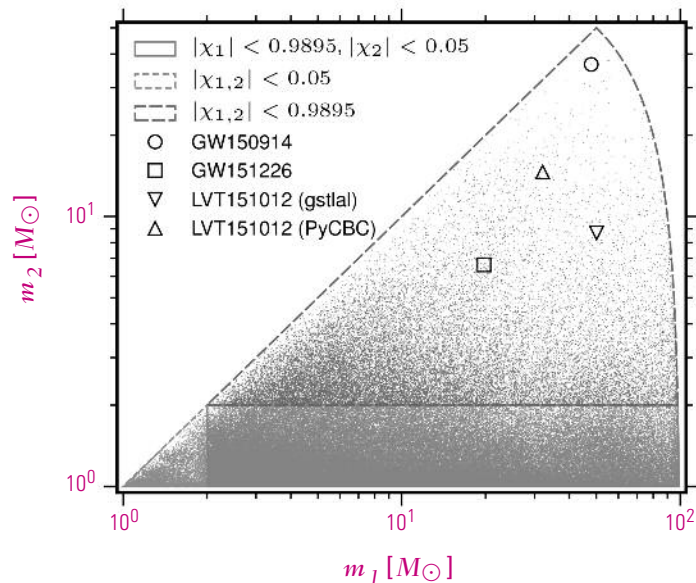

Fig.1: The template bank used for the offline matched filter search in the first observing run of Advanced LIGO and the best-match template locations of the events GW150914, LVT151012 and GW151226. The template bank contains a total of 249,077 templates and is designed to ensure that signals within the target parameter ranges are recovered with at least 97% match. The plot is divided into approximate regions of binary neutron star systems (bottom left corner), neutron star-black hole system (bottom) and binary black hole systems (upper part) and reproduced from the LIGO Scientific and Virgo Collaborations' publication [4].

The algorithms that perform the matched filter analysis are computationally intensive and are run on the Atlas computing cluster at the AEI Hannover. This enables the LIGO data to be searched against hundreds of thousands of templates at a speed that is able to keep up with the data collection rate. A key point is ensuring that searches are as sensitive to likely signals but also that the computing resources are used as efficiently as possible to achieve the desired task. Recent advances have enabled searches to be performed that include the effects of the spin angular momentum of the individual coalescing objects. For the case of binary systems containing one highly spinning black hole and one neutron star [1] and two black holes [2] this can significantly improve the chances of detection with gravitational waves. The computational cost of such matched filtered searches scales roughly with the number of templates that need to be searched

over. Adding the effect of spin adds another dimension, increasing the number of templates, but this increase in computational cost is more than offset by the additional sensitivity obtained and the increased chances of seeing a signal, since previous searches would miss faint signals if the black hole was highly spinning.

If the spin of the black hole is not aligned with the orbital angular momentum of the binary then the orbital plane will precess, leading to distinct effects in the gravitational wave signal. Our recently developed search techniques are also capable of detecting most types of precessing signals even though the templates are all non-precessing [3]. A template bank that covers all precessing signals would contain significantly more templates than the aligned spin template bank displayed in Fig.1 on the previous page. Such a search would have a higher computational cost than current searches. Efforts to develop a precessing search are being investigated by the AEI Compact Binary Coalescence group and would be most relevant for systems composed of one neutron star and one black hole. If the masses of the neutron star and black hole are comparable, or the black hole has considerable spin then the neutron star may be tidally disrupted during its inspiral and form an accretion disk around the black hole. Such an event would potentially give an optical counterpart to the gravitational signal, although no such signals have been detected yet. If the neutron star is not disrupted then it will merge directly with the black hole.

The AEI Hannover group has been busy implementing, testing and running these search strategies for the Advanced LIGO observing run that started in September 2015. A great many decisions need to be made in specifying exactly how the searches should be performed and the AEI Hannover group has run extensive simulations to help inform what the optimal choices are. The choices adopted in the first observing run are further discussed in [4] and [5]. The sensitivity of searches for compact binary signals in LIGO data has also been improved by work at the AEI Hannover to understand the detector characteristics better and to develop data vetoes and detection statistics that reflect the fundamental non-Gaussian nature of the interferometer noise [6], [7]. Together these improvements enable maximum scientific benefit to be made of the upgraded Advanced LIGO detectors.

Alex Nielsen

## References

- [1] Dal Canton, T. et al. (2014). Implementing a search for aligned-spin neutron star-black hole systems with advanced ground based gravitational wave detectors. *Physical Review D*, 90: 082004. doi:10.1103/PhysRevD.90.082004.
- [2] Capano, C., Harry, I., Privitera, S., & Buonanno, A. (2016). Implementing a search for gravitational waves from binary black holes with nonprecessing spin. *Physical Review D*, 93: 124007. doi:http://dx.doi.org/10.1103/PhysRevD.93.124007.
- [3] Dal Canton, T., Lundgren, A., & Nielsen, A. B. (2015). Impact of precession on aligned-spin searches for neutron-star-black-hole binaries. *Physical Review D*, 91: 062010. doi:10.1103/PhysRevD.91.062010.
- [4] LIGO Scientific and Virgo Collaborations (2016). Binary Black Hole Mergers in the first Advanced LIGO Observing Run. *Physical Review X*, 6: 041015. doi:10.1103/PhysRevX.6.041015.
- [5] LIGO Scientific and Virgo Collaborations (2016). GW150914: First results from the search for binary black hole coalescence with Advanced LIGO. *Physical Review D*, 93: 122003. doi:10.1103/PhysRevD.93.122003.
- [6] Dent, T., & Veitch, J. (2014). Optimizing gravitational-wave searches for a population of coalescing binaries: Intrinsic parameters. *Physical Review D*, 89: 062002. doi:10.1103/PhysRevD.89.062002.
- [7] Canton, T. D., Bhagwat, S., Dhurandhar, S. V., & Lundgren, A. (2014). Effect of sine-Gaussian glitches on searches for binary coalescence. *Classical and quantum gravity*, 31: 015016. doi:10.1088/0264-9381/31/1/015016.



## Improving the sensitivity of continuous gravitational-wave searches

The search for continuous gravitational waves from rapidly-rotating, nonaxisymmetrically-deformed neutron stars – gravitational-wave pulsars for short – remains a significant challenge, to which both large-scale computing resources and optimized data analysis methods must be brought to bear. The AEI operates Einstein@Home, a petaflop-scale distributed computing project dedicated to searching for new pulsars in radio, gamma-rays, and gravitational waves. The AEI has also made notable contributions to data analysis methods for continuous gravitational waves, such as search optimization given fixed computing resources, detection statistics which are robust against instrumental noise artefacts, and multi-stage post-processing pipelines capable of following up the large number of candidate signals found by Einstein@Home searches.

This report describes recent work at the AEI on the parameter-space metric of continuous gravitational waves [4–6], which aims to improve the sensitivity of all-sky searches performed by Einstein@Home.

### Continuous gravitational-waves searches and the parameter-space metric

The template of a continuous gravitational-wave signal is described by several parameters: the location of the gravitational-wave pulsar in the sky, the frequency of the emitted gravitational radiation at a given reference time, and the time-derivatives (or spindowns) of the gravitational-wave frequency [1]. The sky position is required to demodulate the gravitational-wave signal due to the rotational and orbital motion of the Earth, while the spindowns account for the loss of rotational energy carried away from the pulsar by gravitational-wave emission, and hence the decrease in the pulsar's rotational (and gravitational-wave) frequency over time.

A search for gravitational-wave pulsars consists of matched filtering calibrated data from e.g. the LIGO interferometers against a bank of templates whose parameters cover the astrophysical parameter-space of interest. For example, a search for gravitational waves from the Crab pulsar would only need to search at the known sky position, frequency and spindowns of the pulsar, while a search for unknown pulsars emitting only gravitational waves would need to search the entire sky and broad ranges of frequencies and spindowns. These latter all-sky searches have been the main focus of Einstein@Home due to their significant computational cost.

The construction of the template bank requires selecting a finite set of points from the parameter space such that, while any real signal in the data will never exactly match any of the templates, it should match at least one template well enough to be recovered with minimal mismatch, i.e. loss of signal-to-noise ratio. The mismatch is quantified by the parameter-space metric tensor, which is defined as follows. Assume that data containing a signal with parameters given by the vector  $\mathbf{p}$  is being searched using a template with parameters given by the vector  $\mathbf{q}$ . The mismatch is then given by the squared distance, with respect to the parameter-space metric, between the signal

parameters  $p$  and template parameters  $q$ . A template bank generation algorithm uses the metric to generate a set of template parameters  $\{q_1, q_2, \dots\}$  such that the mismatch between  $p$  and any one of the  $q_i$  is limited to some maximum, say 50%.

If, in a given coordinate system, the coefficients of the metric tensor are constant, then the density of templates is the same everywhere in the parameter space. In this special case, a template bank can be easily generated by placing templates at the vertices of a lattice. Choosing the hexagonal lattice in 2 dimensions, or the body-centered cubic lattice in 3 dimensions, results in the lowest density of templates, and hence the lowest computational cost of the search; generalisations of these lattices exist for higher dimensions.

### Supersky parameter-space metric for all-sky searches

The main focus of the work reported on here [4–6] was to find a coordinate system with respect to which the metric of the continuous gravitational-wave signal parameters is approximately constant, thus greatly simplifying template placement. The metric is constant with respect to the frequency and spindown parameters, but is not constant with respect to the usual sky position parameters, such as the angles of right ascension and declination. This is illustrated in Figure 1, where the sky parameter space of right ascension and declination is represented by a sphere. At five points on the surface of this sphere, the behaviour of the metric is shown by five bright regions, which represent where the mismatch relative to the respective black point is less than a given constant. The bright regions change shape and orientation over the surface of the sphere, illustrating the fact that the metric with respect to right ascension and declination is not constant, but is instead a function of the current sky position.

The first step [4] towards finding a sky coordinate system with a approximately-constant metric is to extend the metric from the 2-dimensional sky sphere into 3-dimensional space. This is also illustrated in Figure 1; the light-grey regions represent the behaviour of the metric in the 3-dimensional space in which the 2-dimensional sky sphere is embedded. One can see that, unlike the bright regions, the five light-grey regions are of the same shape and orientation; this represents the fact that, with respect to the 3-dimensional Cartesian coordinates  $(x, y, z)$ , the metric is constant. While this is the desired result, we now have 3 sky position parameters, which is undesirable as these parameters are not independent, the sky being fundamentally 2-dimensional. We would therefore like to project out one of the sky position parameters, reducing the sky back to 2 dimensions, while preserving an approximatively-constant metric.

This second step [4] is illustrated in Figure 2. A linear coordinate transform is applied to the metric which, among other effects, aligns the sky metric with new 3-dimensional Cartesian coordinates  $(a, b, c)$ . In this coordinate system, the light-grey regions of Figure 1 are elongated into cylinders along the  $c$  axis, which indicates that the metric is largely insensitive to this coordinate. We can therefore project the metric onto the disk, perpendicular to the  $c$  axis, which represents one hemisphere of the same 2-dimensional sky parameter space shown as the sphere in Figure 1. The bright circles on the disk represent the

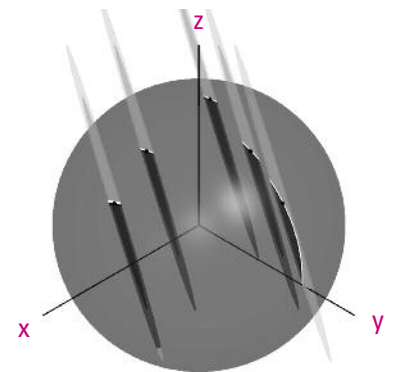

Fig.1: Illustration of the parameter-space metric with respect to the sky parameters.

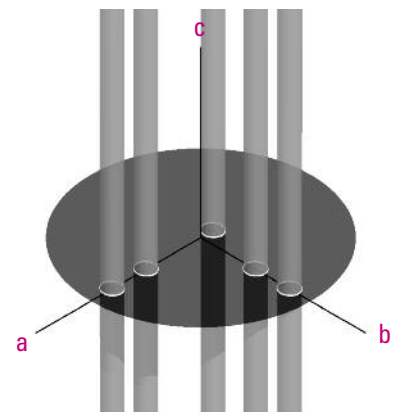

Fig.2: Illustration of the parameter-space metric with respect to the new supersky parameters.

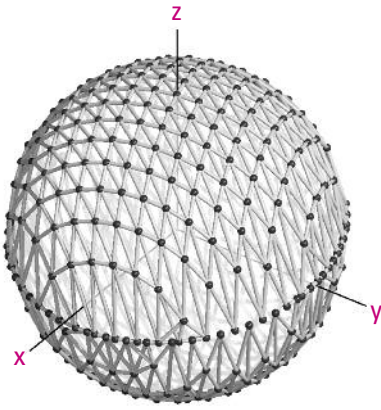

Fig.3: Example of a sky template bank, constructed using the new supersky metric.

metric in this space; that they are all the same shape indicates that the metric is constant on this surface.

We have therefore achieved the desired result: a new set of sky coordinates  $(a, b)$  with respect to which the metric is approximately constant. We refer to these as the supersky coordinates and metric respectively. Extensive Monte-Carlo simulations, detailed in [4], have confirmed that the new metric is a good approximation to the original unapproximated metric. Figure 3 shows an example of a sky template bank constructed using the new metric by a lattice-based template generation algorithm detailed in [5].

### Improving the sensitivity of semicoherent all-sky searches

The computational cost of performing an all-sky search for continuous gravitational waves in year-long datasets is so large, due to the vast number of templates required, that coherent matched filtering of the entire dataset is computationally impossible. Instead, a suboptimal but computationally cheaper method is employed. The data are partitioned into shorter segments, typically spanning a day or so; each segment is searched using coherent matched filtering; and the results of the coherent searches of each segment are combined together using incoherent summing. When computational resources are limited, this semicoherent search method is more sensitive than a fully-coherent search.

A semicoherent search involves two parameter spaces, and hence two parameter-space metrics: the parameter-space and metric of the coherent detection statistic in each data segment, and the semicoherent parameter-space and metric of the incoherent summation of detection statistics from each segment. We have just described a procedure for obtaining a constant metric for a coherent search of a single data segment. The same procedure can be used to obtain a constant metric for the incoherent summation step [6]; the semicoherent supersky metric. The new metric is an improvement over previously-derived semicoherent methods [2,3] in that it involves fewer approximations and assumptions. For example, Figure 4 shows that the new metric predicts, for searches spanning more than 20 days, a much larger number of semicoherent templates than were predicted by previous methods. The neglect of the larger number of templates required in the incoherent summation step by [3] has led to reduced sensitivity of Einstein@Home searches based on this method.

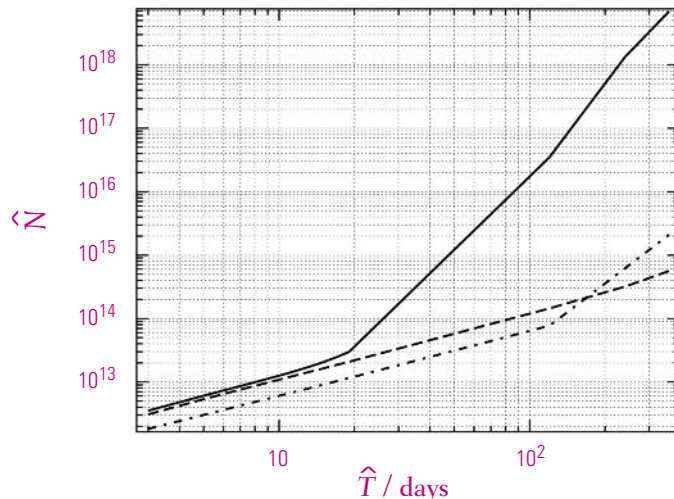

Fig.4: Number of semicoherent templates predicted by the supersky metric (solid line), compared to the number predicted by [3] (dashed line) and [2] (dash-dotted line), as a function of the total time-span of the search.

Finally, the coherent and semicoherent supersky metrics may be used to build a new search code, capable of performing all-sky searches on Einstein@Home. This new code is still under development, however studies of its potential sensitivity suggest that the sensitivity of all-sky searches may be increased by 30–50%. This would correspond to a factor 2 to 3 increase in the volume of space within which the searches are sensitive to gravitational-wave pulsars.

Karl Wette



#### References

- [1] Jaranowski, P., Królak, A., and Schutz, B. F. (1998). Data analysis of gravitational-wave signals from spinning neutron stars: The signal and its detection. *Physical Review D* 58, 063001. doi: 10.1103/PhysRevD.58.063001.
- [2] Brady, P. R. and Creighton, T. (2000). Searching for periodic sources with LIGO. II. Hierarchical searches. *Physical Review D* 61, 082001. doi: 10.1103/PhysRevD.61.082001.
- [3] Pletsch, H. J., (2010). Parameter-space metric of semicoherent searches for continuous gravitational waves. *Physical Review D* 82, 042002. doi: 10.1103/PhysRevD.82.042002.
- [4] Wette, K., & Prix, R. (2013). Flat parameter-space metric for all-sky searches for gravitational-wave pulsars. *Physical Review D*, 88: 123005. doi:10.1103/PhysRevD.88.123005.
- [5] Wette, K. (2014). Lattice template placement for coherent all-sky searches for gravitational-wave pulsars. *Physical Review D*, 90: 122010. doi:10.1103/PhysRevD.90.122010.
- [6] Wette, K. (2015). Parameter-space metric for all-sky semicoherent searches for gravitational-wave pulsars. *Physical Review D*, 92: 082003. doi:10.1103/PhysRevD.92.082003.



# Quantum Gravity and Unified Theories

## From the atoms of space to cosmology

Science and understanding always start with a question and progress by refining and deepening it.

A good part of the research of our group starts with a simple one: What is the universe made of? You would say it is made of stars, planets, galaxies, themselves inhabited by living and non-living beings. True. And all this is in turn made of atoms, small building blocks of all that exists (they are themselves built out of elementary particles, quarks and electrons, but this is another story). Also true. But if we remove all these material objects, what is left? Nothing, one would think, but a more precise answer would be: empty space and time, or, better spacetime.

Here comes the main lesson of our current theory of gravity and spacetime, general relativity: space(time) itself is a physical system, with its own dynamics and itself interacting with the other, more familiar physical systems, i.e. material objects. Thus, the answer to our initial question is: matter, itself made of atoms, and spacetime.

But then, what is space(time) made of?

At first, this question does not make much sense. How can space(time) have a structure, be composed of something? However, it seems inevitable to ask it, after one takes into account the necessity to apply to spacetime itself the laws of quantum mechanics, which is the theoretical framework in which we describe all other physical systems in the universe. On the one hand, in fact, a quantum description of spacetime (a theory of quantum gravity) is commonly believed to be necessary to replace general relativity, and to describe, for example, the very early stages of the evolution of the universe, right after the Big Bang, and the Big Bang itself, where general relativity breaks down and fails to give a consistent picture of what was going on. On the other hand, for all systems we know, quantum mechanics predicts that they are composed of more fundamental atomic constituents.

So, what is the quantum microstructure of space(time)? What are the fundamental quantum building blocks, the “atoms of space(time)”?

This is the first issue we focus on, in our research group: trying to develop models of this microstructure of quantum space(time) itself.

Having one such model, and thus some promising hunch on what the fundamental atoms of space could be, however, another question comes to the forefront: how do such basic constituents end up forming a space as we know it, continuous and regular as it is described by general relativity, in some approximation?

To answer this question is first of all the only way to show that our candidate model is viable as a theory of gravity and spacetime. More-

over, it is tantamount to explaining how our universe could be originated, what could be the physical process, as described by this more fundamental theory, that gives rise to it. On top of this, by telling us how general relativity is recovered in some approximation, such theory will also tell us how it is modified when one looks just outside such approximation, looks a little deeper into the structure of spacetime.

The physical situation where these issues become most important is early cosmology, as said, the very first instants of life of our universe, right after the Big Bang, as well as at the Big Bang itself, its very origin. This is also where, thanks to recent developments in observational cosmology, quantum theories of spacetime have the best chance of being tested.

So, the concluding set of big questions we seek to answer is: how did the universe come into being? What happened at the Big Bang?

The last couple of years have seen tremendous progress towards the answer to the above questions, and our group was at the forefront of these developments.

We focused on the group field theory (GFT) formalism for quantum gravity, an approach closely related to discrete quantum gravity and loop quantum gravity.

In this formalism, the fundamental building blocks of quantum space(time) are associated to purely algebraic and combinatorial data, and can be pictured as abstract graphs or cellular complexes, labelled by elements of the Lorentz group.

What is nice is that these very abstract entities (and they have to be so abstract, since they cannot be understood as standard objects living in any spacetime, being more fundamental than spacetime itself) are however described in the language of quantum field theory (albeit of a peculiar type), the same language by which we describe all material bodies in the universe. In fact, this description of the “atoms of space” is very similar to that of the atoms forming condensed matter systems, and it becomes very convenient to think of spacetime itself using such analogy.

One can think of continuum spacetime as a sort of fluid, made up of the GFT atoms, and then the question of the emergence of space(time) from them can be tackled in a very similar manner as that of the emergence of the usual continuum description of a fluid from an atomic one.

This is what we have done, guided by the more specific hypothesis that the universe or, better, space(time), is a condensate (thus, a quantum fluid) of the GFT atoms, and that the Big Bang, i.e. the “birth of the universe”, corresponds to a process of condensation of its atoms, thus a transition from a phase “before the Big Bang” in which no geometric understanding of spacetime was possible to a “fluid-like” phase “after the Big Bang”, in which the usual description of general relativity applies.

## References

- [1] Oriti, D. (2014). Disappearance and emergence of spacetime in quantum gravity. *Stud.Hist.Philos.Mod.Phys.* 46 (2014) 186-199. arXiv e-print. URL: <https://arxiv.org/abs/1302.2849v1>
- [2] Carrozza, S., Oriti, D., & Rivasseau, V. (2014). Renormalization of an SU(2) Tensorial Group Field Theory in Three Dimensions. *Communications in Mathematical Physics*, 330(2), 581-637. doi:10.1007/s00220-014-1928-x.
- [3] Benedetti, D., Geloun, J. B., & Oriti, D. (2015). Functional Renormalisation Group Approach for Tensorial Group Field Theory: a Rank-3 Model. *Journal of high energy physics: JHEP*, 2015(03): 084. Retrieved from <http://arxiv.org/abs/1411.3180>.
- [4] Lahoche, V., & Oriti, D. (2017). Renormalization of a tensorial field theory on the homogeneous space SU(2)/U(1). *Journal of Physics A*, 50(2): 025201. doi:10.1088/1751-8113/50/2/025201.
- [5] Geloun, J. B., Martini, R., & Oriti, D. (2015). Functional Renormalization Group analysis of a Tensorial Group Field Theory on R3. *EPL*, 112(3): 31001. doi:10.1209/0295-5075/112/31001.
- [6] Geloun, J. B., Martini, R., & Oriti, D. (2016). Functional Renormalisation Group analysis of (gauge invariant) Tensorial Group Field Theories on Rd. arXiv e-print. URL: <https://arxiv.org/abs/1601.08211>
- [7] Gielen, S., Oriti, D., & Sindoni, L. (2013). Cosmology from Group Field Theory Formalism for Quantum Gravity. *Physical Review Letters*, 111: 031301. doi:10.1103/PhysRevLett.111.031301.

In this scenario, the simple cosmological dynamics that we use (coming from general relativity) to model the universe in the early and not-so-early stages of its evolution should arise from the fundamental quantum gravity dynamics as a sort of hydrodynamic approximation of the fundamental atomic dynamics.

We want to realise this fascinating scenario for our universe in concrete and rigorous mathematical terms, and the first step we have taken are at the same time encouraging and exciting.

On the one hand, in fact, we have shown that a transition of the condensation type is indeed realised, at least in some GFT models, those that could be treated analytically with powerful renormalisation group methods (again, as done in condensed matter physics), while adopting various simplifications compared to the more realistic GFT models of quantum space(time).

On the other hand, we have studied in detail condensate states of the GFT atoms, and managed to connect them directly to cosmological spacetimes and to their general relativistic dynamics. In particular, we have shown that condensate states can indeed be interpreted consistently as continuum homogeneous geometries, as used in cosmology, and that their effective hydrodynamics, extracted directly from the fundamental quantum gravity dynamics of realistic GFT models, is a cosmological dynamics that matches, under further approximations, a modified general relativistic dynamics for homogeneous and isotropic universe, i.e. a modified Friedmann equation.

In fact, we were also able to identify some quantum gravity modifications to the classical Friedmann equations, and they appear to be of the type predicting that the Big Bang is replaced by a “Big Bounce”, i.e. that our expanding universe is the result of a previously contracting one “on the other side of the Big Bang” (as it was suggested by simplified approaches to cosmology, like loop quantum cosmology).

This is the very first time that something like this has been achieved in any quantum gravity approach, starting from first principles, i.e. from the fundamental theory, with such level of detail and using purely analytic methods.

Indeed, an encouraging step forward along a long (and winding) road. And we are now ready, and eager, to take the next steps: deriving predictions for early universe, both for in terms of modified dynamics for the background spacetime, and in terms of small perturbations (fluctuations of both matter and geometry) around it, amenable to observational tests).

The goal of this line of research, at the end of this road, is as ambitious as it could get in fundamental physics: understanding the very origin of the universe.

Daniele Oriti



- [8] Gielen, S., Oriti, D., & Sindoni, L. (2014). Homogeneous cosmologies as group field theory condensates. *Journal of high energy physics: JHEP*, 2014(06): 013. doi:10.1007/JHEP06(2014)013.
- [9] Gielen, S., & Oriti, D. (2014). Quantum cosmology from quantum gravity condensates: cosmological variables and latticerefinned dynamics. *New Journal of Physics*, 16: 123004. doi:10.1088/1367-2630/16/12/123004.
- [10] Oriti, D., Pranzetti, D., Ryan, J. P., & Sindoni, L. (2015). Generalized quantum gravity condensates for homogeneous geometries and cosmology. *Classical and quantum gravity*, 32(23): 235016. doi:10.1088/0264-9381/32/23/235016.
- [11] Oriti, D., Sindoni, L., and Wilson-Ewing, E. (2017). Emergent Friedmann dynamics with a quantum bounce from quantum gravity condensates. *Classical and Quantum Gravity*, Volume 33, Issue 22, article id. 224001. doi:10.1088/0264-9381/33/22/224001

## String amplitudes and number theory

Scattering amplitudes are the central quantities for physics on smallest scales. They carry the key information on fundamental interactions as they encode the probability for scattering processes among elementary particles. In particular, amplitudes yield the predictions for collider experiments such as the Large Hadron Collider (LHC) at CERN and set the theoretical foundations of the discovery of the Higgs boson in 2012.

Traditional methods to compute scattering amplitudes are based on Feynman diagrams shown in Figure 1, an intuitive dictionary between different histories how a given scattering process can happen and mathematical expressions. While classical physics is captured by “tree-like” diagrams, quantum corrections correspond to Feynman diagrams with closed loops. Each loop in turn carries a factor of the Planck constant and represents an integration over undetermined momenta and energies of the circulating particles. These integrals lead to special functions some of which are of central interest to mathematicians and mark a fruitful domain of joint activities for particle physicists and number theorists.

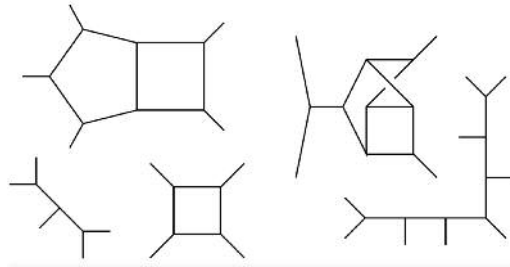

Fig.1: Samples of Feynman diagrams

## String theory

Around 1970, the study of scattering amplitudes among pions lead to the birth of string theory. The key idea is to reinterpret particles as vibration modes of closed and open strings. Even though the scope of string theory changed drastically – from a model of strong interactions towards a candidate theory of quantum gravity – its scattering amplitudes remained of central importance over more than 40 years. Since the ground states of closed and open strings give rise to gravity and gauge interactions similar to those of the Standard Model, the scattering amplitudes of certain field theories follow as a byproduct of string amplitudes. The underlying field-theory limit amounts to shrinking strings to point particles, i.e. to the regime where the fundamental length parameter of string theory vanishes. This string-theory approach yields an elegant viewpoint on point-particle interactions where the combinatorial complexity of Feynman diagrams is bypassed and the simplicity of scattering amplitudes becomes manifest in various respects. The aforementioned loop integrals of field theories are encoded in worldsheet diagrams drawn in Figure 2 which represent possible histories of splitting and joining strings.



Fig.2: String interactions are described by worldsheet diagrams.

Polylogarithms are one class of special functions which prominently appear in Feynman loop integrals are so-called (multiple) polylogarithms. They generalize the logarithm function well-known from high-school mathematics to depend on additional variables. These extra variables enter through repeated or “iterated” integration which occurs naturally in the context of both Feynman integrals and string amplitudes. The family of polylogarithms exhibits rich mathematical structures and thereby attracted a lot of interest and research activity among number theorists. Hence, their appearance in scattering amplitudes of field and string theory initiated rewarding interactions between mathematicians and physicists. The simplest instances of polylogarithms in string amplitudes have been studied at the Albert Einstein Institute (AEI) in ref. [1].

Multiple zeta values are a particularly convenient laboratory to study the appearance of iterated integrals in scattering amplitudes is furnished by multiple zeta values (MZVs). They are real numbers obtained from polylogarithms by specializing their variables to zero or one and can be represented as a nested sum

$$\zeta_{n_1, n_2, \dots, n_r} \equiv \sum_{0 < k_1 < k_2 < \dots < k_r}^{\infty} \frac{1}{k_1^{n_1} k_2^{n_2} \dots k_r^{n_r}}, \quad n_r \geq 2.$$

The positive integers  $n_1, n_2, \dots, n_r$  specify the weight  $n_1 + n_2 + \dots + n_r$  which has crucial impact on the mathematical properties of MZVs. For instance, while even single zeta values  $\zeta_{2n}$  are rational multiples of  $\pi^{2n}$  such as  $\zeta_2 = \frac{\pi^2}{6}$ , the transcendentality and irrationality of generic odd single zeta values  $\zeta_{2n+1}$  belong to the most burning open questions in number theory. Since any known relation among MZVs with rational coefficients preserves their weight, the latter is taken as an organizing principle even though a mathematical proof is still lacking.

### MZVs in string theory

In contrast to their field-theory counterparts, string amplitudes already involve MZVs in their classical “tree-level” approximation which comprises Feynman diagrams without any loops. Hence, tree-level scattering of strings provides an interesting laboratory to encounter iterated integrals in physics without facing the additional complexity caused by quantum corrections. MZVs can be found in the low-energy expansion where the string length-scale is taken to be small and its impact on string amplitudes is studied through a series expansion. Higher orders in the string scale are more and more suppressed if the energies of the scattering states are small in string units, and the  $(2k)$ ’th order of the scale is uniformly accompanied by MZVs of weight  $k$ . The properties of string amplitudes have provided strong support for the currently unproven but widely accepted conjectures on MZVs such as their grading by weight.

### How to expand string amplitudes

The problem to perform the low-energy expansion of amplitudes with many external legs and to express it in terms of MZVs has been exhaustively settled in a recent work [4] involving AEI members. The iterated integrals found in string amplitudes can be deformed such as to satisfy differential equations of Knizhnik-Zamolodchikov type.

Their solutions are governed by the generating series of MZVs, the Drinfeld associator, and it was shown in ref. [4] how the latter recursively determines open-string amplitudes involving an increasing number of scattering states. The method of differential equations is a common theme with modern techniques to evaluate Feynman integrals, see e.g. ref. [5] for recent lecture notes. Accordingly, it would not be surprising to find further applications of the Drinfeld associator to obtain all-order results in field theories.

### Closed strings and single-valued MZVs

While any MZV can be found within tree-level amplitudes of the open string, their closed-string counterparts turn out to obey selection rules, e.g. single zeta values  $\zeta_2$  of even weight are suppressed. A general criterion for MZVs in closed-string amplitudes was conjectured in ref. [2], later on derived in ref. [5], and a rigorous mathematical proof has been recently announced in ref. [6]. These selection rules realized in string amplitudes amount to the so-called “single-valued” projection for MZVs [7, 5, 6] known from a mathematics context. The terminology “single-valued” refers to the origin of MZVs from polylogarithms which are in general multivalued functions unless special combinations are formed to enforce single-valuedness. Specializing the arguments of single-valued polylogarithms only covers a subset of MZVs which are accordingly referred to as “single-valued MZVs”. It is amusing that the mathematical considerations leading to the notion of single-valued MZVs tie in with the comparison of open- and closed-string amplitudes.

### Elliptic MZVs in quantum corrections

The first quantum corrections to string amplitudes are associated with worldsheet diagrams of genus one, i.e. generalizations of Feynman diagrams to the topology of a cylinder or a torus. The open-string instance gives rise to iterated integrals on a cylinder boundary where another striking convergence with recent results in mathematics was reported in ref. [8]. The definition of so-called “elliptic MZVs” (eMZVs) as iterated integrals over a genus-one surface [9] turns out to be tailor-made for the low-energy expansion of one-loop amplitudes of open strings. In contrast to standard MZVs, their elliptic generalizations depend on a complex variable  $\tau$  that characterizes different tori or cylinders. Their appearance in open-string amplitudes motivated further mathematical investigations of eMZVs at AEI [10] where novel insights on their relations and algebraic principles were obtained.

### Single-valued elliptic MZVs?

Since open- and closed-string amplitudes at tree level were found to have a beautiful connection in terms of the single-valued projection [2, 7, 5, 6], analogous properties are expected for their quantum corrections. The low-energy expansion of closed-string amplitudes at one loop has been thoroughly investigated over more than 15 years, and a first connection with single-valued polylogarithms was found in 2015 [11]. Indeed, an “elliptic single-valued” projection for eMZVs which maps one-loop open-string results to their closed-string counterparts [12] was proposed at AEI. This proposal is guided by the differential equations of eMZVs and their closed-string generalizations in the torus parameter  $\tau$  and should play a crucial role in understanding the intriguing web of connections between amplitudes in different string theories.

### References

- [1] J. Broedel, O. Schlotterer and S. Stieberger, “Polylogarithms, Multiple Zeta Values and Superstring Amplitudes,” *Fortsch. Phys.* 61 (2013) 812 [arXiv:1304.7267 [hep-th]].
- [2] O. Schlotterer and S. Stieberger, “Motivic Multiple Zeta Values and Superstring Amplitudes,” *J. Phys. A* 46 (2013) 475401 [arXiv:1205.1516 [hep-th]].
- [3] J. Broedel, O. Schlotterer, S. Stieberger and T. Terasoma, “All order  $\alpha'$ -expansion of superstring trees from the Drinfeld associator,” *Phys. Rev. D* 89 (2014) 066014 [arXiv:1304.7304 [hep-th]].
- [4] J. M. Henn, “Lectures on differential equations for Feynman integrals,” *J. Phys. A* 48 (2015) 153001 [arXiv:1412.2296 [hep-ph]].
- [5] O. Schlotterer and O. Schnetz, “Closed strings as single-valued open strings: A genus-zero derivation,” [arXiv:1808.0071 [hep-th]].
- [6] F. Brown and C. Dupont, “Superstring amplitudes in genus 0 and 1,” talk given by F. Brown in ‘String Math’, Sendai, June 18, 2018.
- [7] S. Stieberger, “Closed superstring amplitudes, single-valued multiple zeta values and the Deligne associator,” *J. Phys. A* 47 (2014) 155401 [arXiv:1310.3259 [hep-th]].
- [8] J. Broedel, C. R. Mafra, N. Matthes and O. Schlotterer, “Elliptic multiple zeta values and one-loop superstring amplitudes,” *JHEP* 1507 (2015) 112 [arXiv:1412.5535 [hep-th]].
- [9] B. Enriquez, “Analogues elliptiques des nombres multi-zetas,” *Bull. Soc. Math. France* 144 (2016) 395 [arxiv:1301.3042 [math.NT]].
- [10] J. Broedel, N. Matthes and O. Schlotterer, “Relations between elliptic multiple zeta values and a special derivation algebra,” *J. Phys. A* 49 (2016) no.15, 155203 [arXiv:1507.02254 [hep-th]].
- [11] E. D’Hoker, M. B. Green, O. Gürdogan and P. Vanhove, “Modular Graph Functions,” *Commun. Num. Theor. Phys.* 11 (2017) 165 [arXiv:1512.06779 [hep-th]].
- [12] J. Broedel, O. Schlotterer and F. Zerbini, “From elliptic multiple zeta values to modular graph functions: open and closed strings at one loop,” [arXiv:1803.00527 [hep-th]].

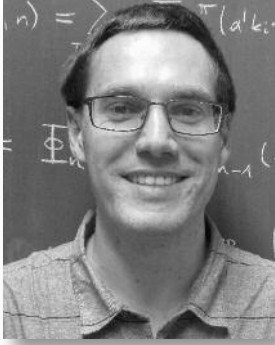

In conclusion, polylogarithms, MZVs and their higher-genus generalizations constitute a vibrant field of research at the interface of particle physics, string theory and number theory. String amplitudes offer the opportunity to encounter iterated integrals in a simpler context as compared to the Feynman integrals in the quantum regime of field theories. Hence, string theory provides an optimal starting point to explore the application of modern mathematical concepts to scattering amplitudes and related quantities. The first appearance of eMZVs in physics [8] calls for a unified language that also captures the steadily growing list of elliptic functions in field theory. It is tempting to envision that higher quantum corrections to open-string amplitudes will inspire an organization scheme for iterated integrals on higher-genus surfaces and that their closed-string counterparts will clarify the associated concept of single-valuedness.

Oliver Schlotterer

## Geometric curvature energies

Curvature is a quantity which measures how fast a given geometric object bends. A sphere of radius  $r > 0$  has curvature  $1/r$  and a plane, since it is flat, has curvature 0. A plane might be considered to be a sphere of radius  $r = \infty$  and then it becomes a special case of a sphere if we agree that  $1/\infty = 0$ . The curvature of more complicated objects will usually be different at different locations – mathematicians say it is a local property. Intuitively, to measure the curvature around some point we should take a small piece of our geometric object and try to approximate it with some sphere.

For the start let us consider a curve  $\gamma$  lying in the usual 3 dimensional Euclidean space. Whenever  $x, y, z \in \gamma$  and  $x \neq y \neq z$  we define  $r(x, y, z)$  to be the radius of the unique circle passing through  $x, y, z$  – if  $x, y, z$  lie on a straight line we set  $r(x, y, z) = \infty$ . The curvature of  $\gamma$  at  $x$  is then defined as the limit of  $r(x, y, z)^{-1}$  as  $y, z \rightarrow x$  with  $y, z \in \gamma$ . Note that this limit might be infinite or even fail to exist at all! Consider a curve with corners, e.g., the graph of the function  $f(t) = |t|$  and let  $x = (0, 0)$  – if  $y$  and  $z$  both lie to the left (or right) of  $x$ , then the limit is 0 but if they lie on opposite sides of  $x$ , the limit might be  $\infty$ . If  $\gamma$  is the graph of a function  $f$  satisfying  $f(t)^2 = |t|^3$  the situation is more subtle – it looks like it were smooth at  $x = (0, 0)$  but the curvature at  $x$  is still  $\infty$  – to see this look at small circles tangent to the horizontal axis at  $(0, 0)$ . The reason is that  $f$  fails to be twice differentiable, i.e., the derivative of the derivative of  $f$  does not exist at  $t = 0$ . This gives evidence that curvature can only be defined for smooth enough objects; namely those which locally coincide with a graph of twice differentiable functions. Subsets of an Euclidean space which coincide locally with a graph (possibly rotated) of some map which is two times differentiable and whose second derivative is continuous are called manifolds of class 2. It is also possible to talk about manifolds of class  $1 + \alpha$ , where  $\alpha \in (0, 1)$  by requiring that the first derivative satisfies, so called, Hölder condition. For example the graph of a nonnegative function satisfying  $f(t)^2 = |t|^3$  is a manifold of class  $1 + 1/2$  but not of class 2.

Things get more complicated when we consider objects of higher dimension. Let  $r(x, y, z, t)$  be the radius of the sphere passing through  $x, y, z, t$  – if  $x, y, z, t$  happen to lie on some plane, we set  $r(x, y, z, t) = \infty$ . We could try to define the curvature of a surface  $\Sigma$  in the same spirit as before. For  $x \in \Sigma$  take sequences of points  $y, z, t \in \Sigma$  which converge to  $x$  and define the curvature to be the limit of  $r(x, y, z, t)^{-1}$ . Unfortunately, this definition is wrong. Let  $\Sigma$  be the, so called, “saddle surface”, i.e., the graph of  $f(u, v) = u \cdot v$ . Note that  $f$  is differentiable infinitely many times but there exist sequences  $y_i, z_i, t_i \in \Sigma$  converging to the point  $x = (0, 0, 0)$  such that  $r(x_i, y_i, z_i, t_i)^{-1} \rightarrow \infty$  – the reader might exercise his or hers imagination and prove this assertion by looking at small spheres passing through the origin  $(0, 0, 0)$  and which are symmetric with respect to the horizontal plane.

A better definition of curvature results from the following: for  $x \in \Sigma$  let  $T$  be the tangent plane to  $\Sigma$  at  $x$  and define  $\rho(x, y)$  to be the radius



of the sphere which passes through  $x$  and  $y$  and such that its tangent plane at  $x$  equals  $T$ . Next, define the curvature of  $\Sigma$  at  $x$  to be the limit of  $\rho(x,y)^{-1}$  as  $y \rightarrow x$  and  $y \in \Sigma$ . It is not hard to see (consider, e.g., a cylinder) that there may be different limits when  $y$  approaches  $x$  from different directions but, at least, all the possible limits will be finite whenever  $\Sigma$  is a manifold of class 2. This defines curvature of a smooth surface at a given point and in a given direction. In fact the dependence on the direction should not be a surprise since  $\Sigma$  might bend with different speeds in different directions (like in the case of a cylinder).

Unfortunately, many geometric objects encountered in real life (of a mathematician) are not smooth enough for the above definition to work. In particular, the surfaces which appear naturally as limits of smooth manifolds in variational problems (e.g. those which minimize area among surfaces with given boundary) might not be manifolds of class 2. Examples are provided also by event horizons of certain black holes. Nonetheless, in such cases one would still like to measure some quantities resembling the curvature and draw conclusions from bounds on them. Among many possibilities one idea is to replace taking limits by taking integrals: for  $u \in [1, \infty]$  and  $x \in \Sigma$  let  $\kappa_u(x)$  be characterized by

$$\begin{aligned} 0 \leq \kappa_u(x)^u &= \int \rho(x,y)^{-u} \, d\Sigma(y) && \text{if } u \in [1, \infty), \\ \kappa_u(x) &= \sup \{ \rho(x,y)^{-1} : y \in \Sigma \} && \text{if } u = \infty \end{aligned}$$

and for  $v \in [1, \infty]$  set

$$\begin{aligned} T_{uv}(\Sigma) &= \int \kappa_u(x)^v \, d\Sigma(x) && \text{if } v \in [1, \infty), \\ T_{uv}(\Sigma) &= \sup \{ \kappa_u(x) : x \in \Sigma \} && \text{if } v = \infty. \end{aligned}$$

The quantity  $\kappa_u(x)$  can be defined for any surface of class 1. Actually, it can be defined almost everywhere on  $\Sigma$  for any  $\Sigma$  which, merely, can be covered by countably many (meaning: they can be enumerated with natural numbers) manifolds of class 1 – these kind of sets  $\Sigma$  are called countably rectifiable of class 1. Chruściel, Fu, Galloway, and Howard [2] proved that event horizons appearing in general relativity are countably rectifiable of class 2. Also certain class of weak limits of smooth manifolds (integral varifolds whose first variation is a Radon measure in the mathematical jargon) are countably rectifiable of class 2; see [6].

Finiteness of  $\kappa_u(x)$  does not imply that  $\rho(x,y)^{-1}$  has a finite limit as  $y \rightarrow x$  but imposes certain restrictions on the speed at which  $\rho(x,y)^{-1}$  may blow-up. If  $T_{uv}(\Sigma) < M$  for some  $M < \infty$ , then  $\kappa_u(x)$  must be comparable with  $M$  for most  $x \in \Sigma$  but there exists a small subset of  $\Sigma$  on which it may be very big. One should also note that the above definitions are meaningful for countably rectifiable sets of arbitrary dimension lying in an Euclidean space of any bigger dimension. They are also good because one can deduce very useful information about the regularity of  $\Sigma$  just from finiteness of  $T_{uv}(\Sigma)$  or from finiteness of  $\kappa_u$  almost everywhere.

If  $u$  is bigger than the dimension of  $\Sigma$  (in case  $\Sigma$  is a surface:  $u > \dim(\Sigma) = 2$ ), then finiteness of  $\kappa_u(x)$  almost everywhere implies that  $\Sigma$  is count-

ably rectifiable of class a bit bigger than 1 and in some cases of class 2; see [3]. If  $u > 2 \cdot \dim(\Sigma)$  and  $\Sigma$  satisfies some mild additional structural hypothesis, which ensure that  $\Sigma$  is bounded, has no holes and no boundary, then finiteness of  $T_{uu}(\Sigma)$  has even more nice consequences. Strzelecki and von der Mosel [7] proved that such  $\Sigma$  must be a manifold of class a bit better than 1. Note that, a priori,  $\Sigma$  could have many self intersections, edges and corners, and at some locations could also oscillate wildly (imagine  $\sin(1/t)$ ) but once we know  $T_{uu}(\Sigma)$  is finite we can be sure  $\Sigma$  is quite nice (usually not of class 2 but, still, of class  $1+\alpha$ ) and we can even control how fast it bends – a property desired from a good notion of curvature. Moreover, it is proven that sets  $\Sigma$  for which  $T_{uu}(\Sigma)$  is finite can be characterized by the property that they coincide locally with graphs of maps belonging to well understood functions spaces (so called Sobolev-Slobodeckij spaces); see Blatt [1] and Strzelecki, von der Mosel, and the author [4]. Finally, the class of sets  $\Sigma$  for which  $T_{uu}(\Sigma)$  is bounded by some fixed constant is stable under taking certain limits (cf. [5]) and, due to the non-local character of  $\kappa_u(x)$ , two such sets which are close must have the same topology. More precisely, this means that if  $\Sigma_1$  and  $\Sigma_2$  are such that  $T_{uu}(\Sigma_1) < E$  and  $T_{uu}(\Sigma_2) < E$  for some  $E < \infty$ , and each point of  $\Sigma_1$  is very close to some point of  $\Sigma_2$  and vice versa, then there exists a continuous one-to-one map between  $\Sigma_1$  and  $\Sigma_2$ . In particular,  $\Sigma_1$  and  $\Sigma_2$  must have the same number of handles. The last described feature makes  $T_{uu}$  an extremely useful tool for applications in calculus of variations where one studies geometric objects of least "energy" obtained usually as limits of smooth approximating manifolds.

Sławomir Kolasiński



#### References

- [1] Simon Blatt. The energy spaces of the tangent point energies. *J. Topol. Anal.*, 5(3):261–270, 2013. URL: <http://dx.doi.org/10.1142/S1793525313500131>.
- [2] Chruściel, P. T. et al. (2002). On fine differentiability properties of horizons and applications to Riemannian geometry. *J. Geom. Phys.*, 41(1-2):1–12. doi: [http://dx.doi.org/10.1016/S0393-0440\(01\)00044-4](http://dx.doi.org/10.1016/S0393-0440(01)00044-4).
- [3] Kolasiński, S. Higher order rectifiability of measures via averaged discrete curvatures. *Rev. Mat. Iberoam.* 33 (2017), no. 3, 861–884.
- [4] Kolasiński, S., Strzelecki, P., and von der Mosel, H. (2013). Characterizing  $W^{2,p}$  submanifolds by  $p$ -integrability of global curvatures. *Geom. Funct. Anal.*, 23(3):937–984. doi: 10.1007/s00039-013-0222-y.
- [5] Kolasiński, S., Strzelecki, P., and von der Mosel, H. (2015). Compactness and isotopy finiteness for submanifolds with uniformly bounded geometric curvature energies. accepted for publication in *Communications in Analysis and Geometry*. arXiv e-print URL: <http://arxiv.org/abs/1504.04538v2>
- [6] Menne, U. (2013). Second order rectifiability of integral varifolds of locally bounded first variation. *Journal of Geometric Analysis*, 23, 709-763. doi:10.1007/s12220-011-9261-5.
- [7] Strzelecki, P. & von der Mosel, H. (2013). Tangent-point repulsive potentials for a class of non-smooth  $m$ -dimensional sets in  $\mathbb{R}^n$ . Part I: Smoothing and self-avoidance effects. *J. Geom. Anal.*, 23(3):1085–1139. doi: 10.1007/s12220-011-9275-z.

### Einstein@Home searches for gamma-ray pulsars

#### Gamma-ray pulsar searches with the Fermi LAT

The study of gamma-ray pulsars was revolutionised by the launch of the Fermi Gamma-ray Space Telescope in 2008. The Large Area Telescope (LAT) on board the Fermi satellite scans the entire sky every 3 hours, observing gamma-ray photons between 20 MeV and 300 GeV. Its wide field of view, large collecting area and excellent angular resolution allow large numbers of photons to be collected from individual pulsars, enough to enable pulsed signals to be detected, often with high significance. The LAT has increased the number of observed gamma-ray pulsars from just six to over 160. Approximately two thirds of these pulsars were first identified in radio observations, from which the pulsar's rotation rate could be deduced and used to test for pulsations in the gamma-ray data.

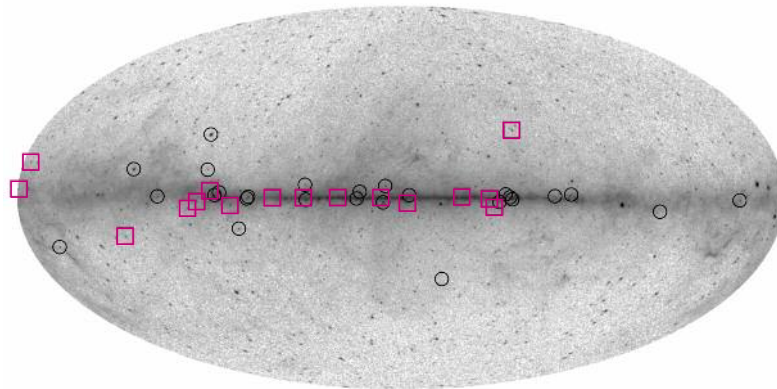

Fig.1: Fermi-LAT sky map of gamma-ray photons above 1GeV, showing the population of gamma-ray pulsars found through blind searches in LAT data. The pulsars found by the AEI group are highlighted.

The remaining gamma-ray pulsars were discovered by blindly searching the LAT data for pulsations, an enormously computationally expensive task. Many of these LAT-discovered pulsars appear to be “radio quiet” in that no radio pulsations have been detected from them, despite extensive observations. Currently, performing a blind search in LAT data is the only way to detect radio-quiet gamma-ray pulsars.

To detect pulsations in LAT data, one must assign rotational phases to each photon based on its arrival time and assumed values of the pulsar's spin frequency and spin-down rate, and test these phases for the presence of a signal. To make matters worse, the arrival times of the pulses are Doppler modulated by the Earth's annual motion around the sun. This modulation depends strongly on the position of the pulsar in the sky; to detect pulsations we must therefore search a fine grid of sky locations.

The length of the time span covered by the Fermi mission means that these parameters must be searched with extremely fine resolution; a small difference between the pulsar's true spin rate and the search model will result in the signal quickly becoming lost as we integrate over the 7 years of available data. Coherently searching this four-dimensional parameter space is completely infeasible with today's

computing hardware; such a search would take several thousands of years on even the fastest supercomputer!

Instead, we perform less sensitive, but more efficient “semicoherent” searches, in which data is only combined coherently over a short time-scale [1]. This vastly reduces the computational cost of a blind search, making it feasible with today’s technology. To increase the sensitivity to weak signals we “follow-up” candidates from this semicoherent stage by performing a fully coherent search of their surrounding parameter space.

Despite these efficient techniques, blindly searching for pulsation in LAT data remains an enormous computational challenge. To meet this cost, we turn to the distributed volunteer computing system, Einstein@Home [2]. During otherwise unused computing cycles, each volunteer’s computer searches a small region of the pulsar parameter space before sending the results back to the AEI. Each day, several thousands of these results are collected and interesting candidates are further analysed by a pipeline developed as part of a summer student’s project.

### **The current Einstein@Home survey for gamma-ray pulsars**

In 2014, we performed an optimisation study in order to improve the sensitivity and efficiency of our blind searches [3]. During this study, we developed a new parameter space metric approximation describing the expected loss of signal-to-noise ratio as a function of the offset between the true signal parameters and the nearest point in our search grid. This allows us to ensure that we search at the right number of points in each parameter; too few and we could risk missing signals due to gaps in our coverage; too many and we would be wasting computing power which could be better spent to improve our sensitivity in other ways.

We also developed new interpolation techniques which allow us to ensure our search sensitivity is more consistent throughout the frequency bands in which we search. A further improvement introduced during this work was the inclusion of a semicoherent refinement stage in between the semicoherent search and the coherent follow-up stage. In this refinement stage, we zoom in on our initial candidates by searching around them with a longer integration time. This stage improves the efficiency of the follow-up by reducing the parameter space which must be searched by a factor of  $\sim 2$  in each dimension, and allows the search to “walk away” from the initial semicoherent candidate if necessary. Using extensive simulations, we were able to show that our optimised methods resulted in searches which could detect signals almost 50% weaker than those that could be found with previous methods

The “Pass 8” reprocessing of the Fermi-LAT data, taking into account several years of improvements to the understanding of the instrument’s response functions, also provided a welcome boost to the number of gamma-ray photons observed by Fermi from each source, giving a significant increase in the sensitivity of our search. In late 2014, we began searching on Einstein@Home for pulsations from a new list of 118 significant unidentified pulsar-like sources from the recent Fermi-

LAT Third Source Catalog (3FGL). As a result of the combination of these new methods and additional data, this survey is currently the most sensitive that we have ever performed.

Fig.2: Results of pulsar search simulations, showing the probability of detecting a given signal as a function of the "pulsed fraction", a measure of the signal amplitude. Our estimate for the sensitivity of the methods implemented in the ongoing Einstein@Home survey is shown in pink, in comparison to that of previous search methods shown in black. The two intermediate grey lines from left-to-right denote the sensitivity of our semi-coherent stage (without follow-ups) with and without the additional interpolation techniques respectively.

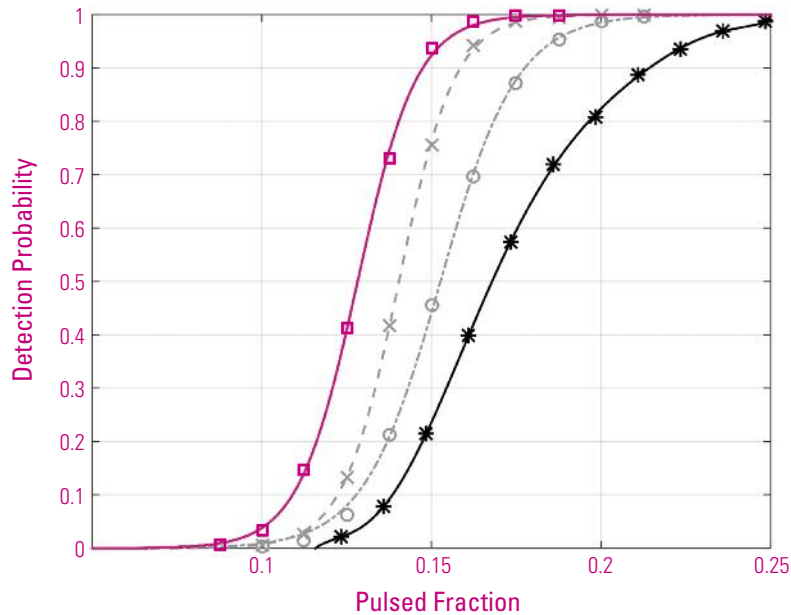

### PSR J1906+0722

One of the first sources on our search list was a mysterious one. Known as 3FGL J1906.6+0720, this source was for many years the most significant unassociated source observed by the LAT. Its highly curved spectrum and non-variable flux made it the most pulsar-like unidentified source in the previous 2FGL catalog. However, despite many attempts, no pulsations had ever been detected from it in either gamma-ray or radio observations.

Shortly after we began our search, an intriguing signal was reported back from this source. Further investigation showed that it belonged to a young, energetic gamma-ray pulsar, now known as PSR J1906+0722 [4].

Like many young pulsars, PSR J1906+0722 exhibits a large degree of “timing noise” (slow variations in the spin-down rate) and suffered a huge “glitch” (a sudden abrupt increase in the spin frequency) in August 2009. These unpredictable effects can not be accounted for in a blind search, and seriously reduce the apparent strength of a signal; in this case we were fortunate that the pulsar's signal was strong enough, and our search sensitive enough, for us to pick up the signal within a small portion of the Fermi-LAT data after the glitch.

An additional complication was the fact that the true sky position of PSR J1906+0722 lay quite far outside of our target search region. After the discovery of this pulsar, an analysis of the unpulsed gamma-ray photons revealed the presence of an additional nearby source of gamma rays, likely being produced by the interaction between a nearby supernova remnant and a cloud of molecular gas. Due to their close proximity, the gamma-ray flux from the pulsar and this new source merged into one apparent source in between the two, and it was here that our search was targeted.

### References

- [1] Pletsch, H. J., et al. (2012). Discovery of Nine Gamma-Ray Pulsars in Fermi Large Area Telescope Data Using a New Blind Search Method. *ApJ* 744, 105. doi:10.1088/0004-637X/744/2/105
- [2] Pletsch, H. J., et al. (2013). Einstein@Home discovery of four young gamma-ray pulsars in Fermi LAT data. *The Astrophysical Journal Letters*, 779: L11. doi:10.1088/2041-8205/779/1/L11.
- [3] Pletsch, H. J., & Clark, C. J. (2014). Optimized Blind Gamma-ray Pulsar Searches at Fixed Computing Budget. *Astrophysical Journal*, 795: 75. doi:10.1088/0004-637X/795/1/75.
- [4] Clark, C. J., et al. (2015). PSR J1906+0722: An Elusive Gamma-ray Pulsar. *The Astrophysical Journal Letters*, 809 (1): L2. doi:10.1088/2041-8205/809/1/L2.

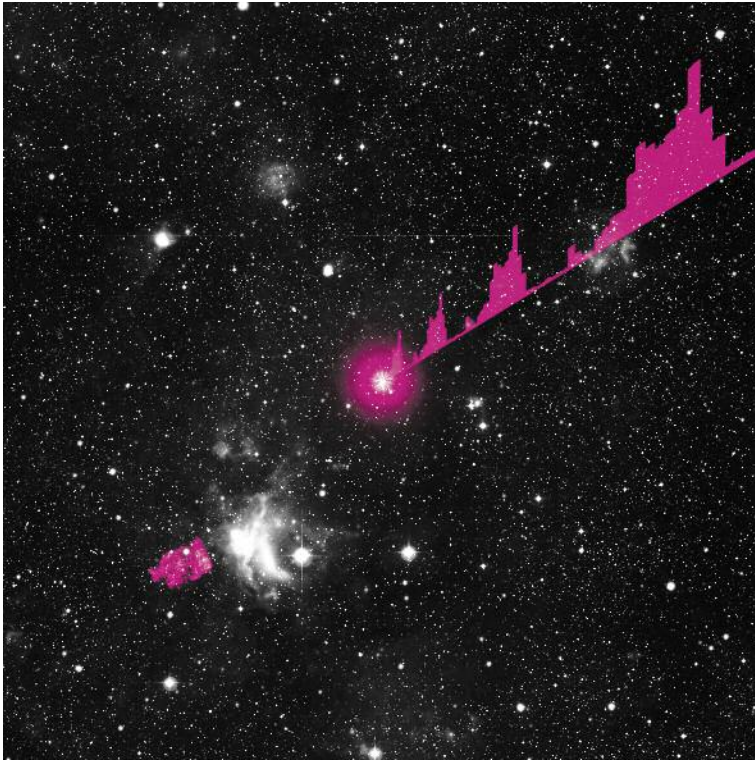

Fig.3: PSR J1906+0722 (artist's impression) in the center of the image and its celestial neighborhood. The supernova remnant nearby is shown (highlighted) towards the bottom left in Chandra space telescope images. The molecular clouds (greyscale) are shown in WISE images. For the Fermi-LAT the supernova remnant and the pulsar merged into a single source which complicated the pulsar discovery.

Without the improvements to our blind search methods, it is possible that this pulsar could have remained undiscovered for far longer. This detection is a promising sign that the current Einstein@Home survey is able to explore the dark corners of the gamma-ray pulsar population that previous searches would struggle to reach.

Colin J. Clark



### **Conflation - a new type of accelerated expansion**

Einstein's theory of general relativity answered many philosophical questions about the universe with a physical theory. The space-time itself is dynamical and the dynamics are described by the Einstein Equations. During the last 20 years measurements of e.g. supernovae, the Large Scale Structure and the Cosmic Microwave Background (CMB) gave us a very detailed picture of the evolution of the universe. Especially the recent CMB measurements of the Planck satellite tell us the features of the universe at large scales to high precision. The universe is remarkably simple: it is nearly flat, homogenous and isotropic. Furthermore the fluctuations in the temperature anisotropies of the CMB are adiabatic, Gaussian and nearly scale invariant. Models of the early universe have to describe the initial conditions, which led to such a simple universe we observe today.

The well-known theory of cosmic inflation explains the initial conditions of the universe by introducing a phase of rapid accelerated expansion. During this phase the universe is driven towards homogeneity and flatness. Inflation can be described by a scalar field, which is minimally coupled to gravity in a flat positive potential. The scalar field dominates the energy density of the universe, such that the universe expands exponentially. Remarkably, the scalar- and tensor-fluctuations get amplified and become classical when leaving the horizon. These quantum fluctuations act as seeds of the structure formation in the universe. Large, rare quantum fluctuations can kick the scalar field back in the evolution such that inflation never ends locally. This process can repeat over and over again leading to eternal inflation.

An alternative model to inflation is the *ekpyrotic model*. During ekpyrosis the universe undergoes a slow contracting phase dominated by a scalar field with a large positive equation of state. The equation of state is the ratio of pressure and energy density. In other words the ekpyrotic phase is a phase of very high pressure, during which time the universe is rendered towards homogeneity and flatness. After the contracting phase the universe undergoes a bounce leading to an expanding Hot Big Bang Cosmology. Ekpyrosis can be described by a scalar field, which is minimally coupled to gravity in a steep negative potential. In contrast to inflation the scalar and tensor perturbations are not amplified and do not become classical. In order to obtain adiabatic fluctuations with a nearly scale invariant spectrum one has to add an additional scalar field. A promising mechanism is the "non-minimal entropic mechanism" where the two scalar fields are coupled in a non-standard kinetic term. Because of this coupling nearly scale invariant and nearly Gaussian entropy perturbations are generated which are converted to adiabatic perturbations in the subsequent evolution.

Both models of the early universe have advantages and disadvantages on their own. Inflation needs special initial conditions to get started, which is in conflict with the very idea of explaining the initial conditions of the universe. Eternal inflation leads to an infinite amount of physically different universes questioning the predictability of the

model. In ekpyrotic models the universe has to bounce from a contracting phase to an expanding phase. During a singular bounce, where the scale factor becomes zero, quantum gravitational effects become important resulting in a breakdown of the effective field theoretic description. Non-singular bounces require a violation of the Null-Energy Condition, which generally causes instabilities.

The basic idea of the model of conflation is to conflate ideas of inflation and ekpyrosis combining features of both models. During conflation the universe expands exponentially like during inflation, but perturbations behave like during ekpyrosis. Hence eternal inflation does not occur during conflation, since there are no large adiabatic fluctuations. The starting point of the construction of conflation is an ekpyrotic model described by a scalar field minimally coupled to gravity in a steep negative potential.

Then this model is transformed to a scalar-tensor theory described by a scalar field non-minimally coupled to gravity where the universe undergoes accelerated expansion. This transformation is achieved by making use of a field redefinition or more precisely by a conformal transformation of the metric. In general relativity the gravitational field is described by the metric tensor. In scalar-tensor theories the gravitational field is described by the metric tensor and a scalar field. This leads to various modifications of the theory of general relativity like a scalar field dependent Newton's gravitational constant. A motivation for studying scalar-tensor theories is that they arise naturally as low energy effective theories of String Theory and Supergravity theories.

During conflation the scalar field rolls up a negative potential due to a "wrong" sign kinetic term and due to the non-minimal coupling to gravity. During this phase the accelerated expansion renders the universe flat and homogenous. The perturbations during conflation and the perturbations during ekpyrosis have the same spectrum. This can be understood due to the fact that both theories are related by a conformal transformation - the physics should not depend on the chosen frame.

Eventually the conflationary phase has to come to an end. Furthermore the scalar field has to stabilise leading to a constant Newton's Gravitational Constant and a subsequent Hot Big Bang Cosmology. This scenario can be achieved by transforming a model where the ekpyrotic phase is followed by a non-singular bounce. The scalar field then stabilises in a dip of the potential leading to a Hot Big Bang Cosmology.

The evolution of the scale factor is shown in Figure 1. During conflation the universe grows rapidly by many orders of magnitude. Afterwards the universe expands slowly for a long period of time. The subsequent evolution is shown in figure 2 where the scalar field oscillates around the dip in the potential; the universe undergoes alternating phases of expansion and contraction until the scalar field stabilises and continuous expansion follows.



Fig.1: The evolution of the scale factor. During conflation the universe grows rapidly by many orders of magnitude. Afterwards the universe expands slowly for a long period of time.

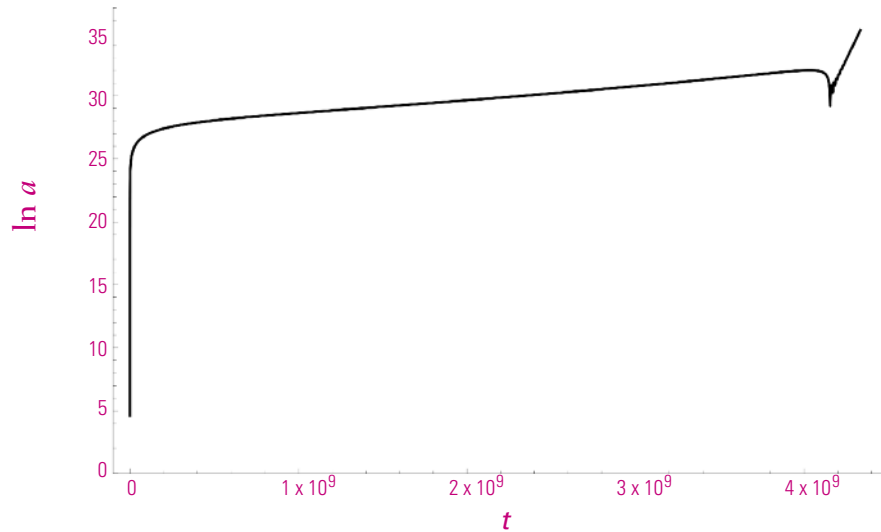
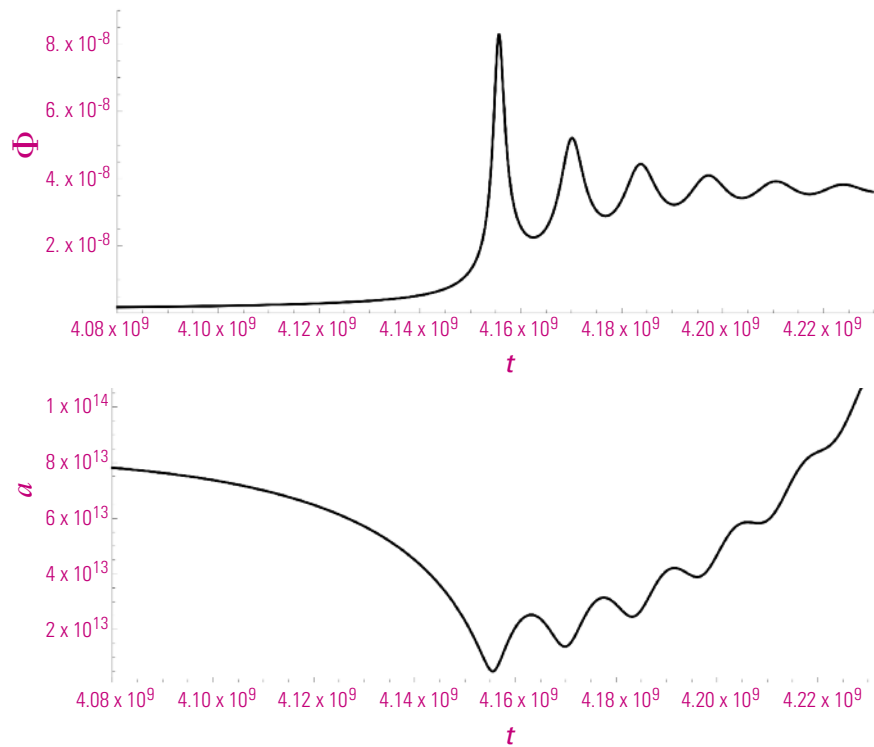

Fig.2: The subsequent evolution where the scalar field oscillates around the dip in the potential; the universe undergoes alternating phases of expansion and contraction until the scalar field stabilises and continuous expansion follows.



Summing up the most important features of the conflationary phase are that accelerated expansion can be obtained by means of negative potentials, which arise naturally in String Theory, and that the multi-verse problem of inflation is absent in this scenario.

Enno Mallwitz



## Through the eyes of a visitor

I first came to the Institute in 2011 for a visit of six months. I had earlier discussed my interest in transitioning from quantum gravity to gravitational wave data-analysis with AEI staff scientist Dr. Badri Krishnan (whom I had known when we were both graduate students of Prof. Ashtekar). Though many had made similar transitions, those I knew of had done so through postdoctoral appointments. I, however, already had a faculty appointment at a predominantly teaching institution, where I was the only person working in any area of gravitational physics. I could neither make such a transition as part of a next career step, nor hope to accomplish it while remaining only where I was.

The Institute proved ideal for this transition. In my first visit of six months, I had both the time to focus on learning the details of a new field, as well as a large group of experts from whom to learn. I was completely removed from the teaching and service obligations of my home institution, and at an institution where everyone else was focused on research, which dictated the rhythm of each week. The regular program of seminars – from researchers from around the world – were instructive, but even more so the steady stream of other visitors such as myself, there for a week, a month, a year. Through these visitors I formed ongoing collaborations extending beyond my continuing connection to the data-analysis group at Hannover.

At the end of that first six months, first Badri and then Prof. Allen asked me if I would be interested in returning, and of course I was. Since that time I have been a long-term visitor, spending generally at least two months each summer, and one other visit of six months as part of a sabbatical year. One summer I was able to find funds to bring with me an undergraduate student, whom the institute also graciously hosted. He too was able to work daily with not only myself, but also the graduate students and postdocs working on our project. After my first visit in 2011, when I returned to my home institution, Prof. Allen then advocated for my application to join the LIGO scientific collaboration, of which I have been a part ever since. My visits to the institute have allowed me to be a core developer on a vital data analysis software project, based at the institute and at Syracuse University. After four years of development, that software has now analyzed the first observing run of the Advanced LIGO detectors, with much of that analysis performed on the Atlas cluster hosted by the institute. My involvement in this project would have been impossible without the continued support of the institute.

Through these visits to Hannover I have of course not only formed scientific collaborations, but also friendships with the other visitors and employees. Indeed, it has been somewhat bittersweet as I have returned year after year, and now others who had been there for many years have moved on to their next appointments. The many students who have successfully defended have also given me several chances to observe an academic custom that was wholly foreign to me: the “hat” that fellow graduates students prepare for their colleagues’ defense. The weeks of planning and ingenuity that go into the construction of those hats, and their associated puzzles to be solved before the prospective doctor can really obtain his or her degree, are remarkable.

My regular visits to Hannover have also been a thoroughly enjoyable immersion in German culture and history. The first time my wife (then fiancée) visited me there, she spent one morning taking the tourist bus around the city; when she returned, she exclaimed: “The place where you’re staying—it’s on the tour!” I was indeed staying (as I have several times) at Leibnizhaus, the restored home of one of Hannover’s most famous residents, which now serves as the guesthouse for the Leibniz Universität Hannover.

On my first visit to Hannover, another visitor was there for only a month, and so had a keener sense of his need to spend every weekend sight seeing. Four weekends in a row he, myself, and other students and postdocs would spend a Saturday on a Niedersachsen Ticket, taking regional trains to see in turn Bremen, Goslar and its Imperial Palace, the museum and palace in Celle, and the nearest castle to Hannover, Marienburg. But perhaps the most unique experience was in the summer of 2014. Many from the institute had gathered to watch the world cup matches at different venues as the tournament progressed; on the night of the final, we were among probably a thousand other fans outdoors in Lindener Marktplatz, watching Germany win the tournament, and then walking home through the spontaneously celebrating city.

I look forward to my next visit to Hannover. The intellectual atmosphere of the institute is unparalleled, not only because of the quality of the researchers who are based there or visit, but because of the complete focus on enabling the scientists there to focus on their work. At least from the perspective of a visitor, the efficiency of the institute in removing distractions is remarkable. It is truly a unique and formative experience for a scientific visitor.

Josh Willis



## Activities and Highlights of the IT Department

Mike Rose moved from Head of IT for the Centre for Mathematical Sciences at the University of Cambridge and followed Christa Hausmann-Jamin as Head of IT at AEI. Dr. Rose started work at the AEI in September 2016.

The IT Department's main task at the AEI is to support the scientific productivity of the institute, therefore one of our aims is to provide easy-to-use IT services that "just work".

Our must-have IT services (Internet, email, printing, scanning, storage, backup, etc.) have been improved and a new IT services and support website (<http://it-support.aei.mpg.de/>) has been released. For example everyone at the AEI can now easily print over Wifi and we want people newly arriving at the AEI to be up and running (Internet, email, printing, storage) within 30 minutes of them starting to use a computer.

The Institute IT Committee (ITC) has been rebooted with responsibility for over-seeing the IT department and giving feedback from each division and department. The ITC has a representative from each scientific division and from administrative services. ITC agendas and minutes are published within the institute, and actions are monitored.

The IT plan is published within the institute for information and feedback.

On the Golm Campus our network connection and security (Internet) is shared by the three Max Planck Institutes on the campus. For AEI Hannover network connectivity is provided by the Leibniz Universität Hannover, and network security from the Golm Campus.

Also on the Golm Campus we have a Web Team that is shared between the three Max Planck Institutes. In principle this is a great initiative as together we can get more good things done, however larger projects were not being finished and the team was experiencing over half of their time going into manual maintenance work.

Large projects are now being finished due to process changes and adoption of Agile software project management methodologies (Scrum), and manual maintenance is being reduced through automation. The project pipeline (backlog) is now under control and we aim to choose new projects that will benefit all three institutes.



Mike Rose

## The Library in 2013 - 2016

The library is a specialized library offering services primarily to scientists working at the institute in Golm and Hannover. Scientists from outside are welcome and usage is possible on appointment. Two librarians manage the library: Mrs. Elisabeth Schlenk (head of the library) and Mrs. Anja Lehmann.

The collection of the library increases continuously. By the end of 2016 our catalog listed 11,667 monographs and conference reports, 19,326 bound journal volumes, 107 printed journal subscriptions (the stock is only Library/Golm). Furthermore, we have online access to journals and eBooks covered by the “Grundversorgung”, i.e. the Max Planck Digital Library (MPDL) secured a permanent right to full text access for more than 34,000 journal titles and 650,000 eBooks.

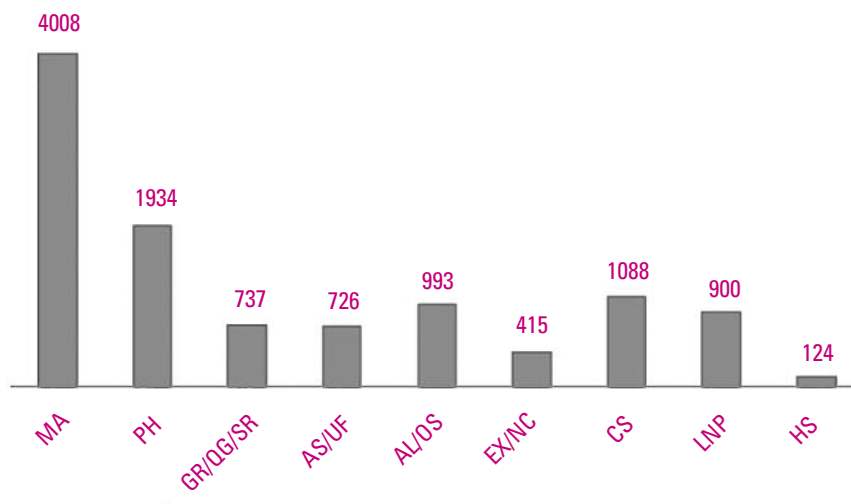

**AL**(General); **AS** (Astronomy, Astrophysics, Cosmology); **CS** (Computer Subjects); **EX** (Exp. Methods Measurements); **GR** (Gravitation & Relativity); **MA** (Mathematics); **NC** (Numerics & Computation); **OS** (Other Sciences); **PH** (Physics); **QG** (Quantum Gravity); **SR** (Special Relativity); **UF** (Unified Field Theory & Other Theories of Gravitation); **LNP** (Lecture Notes Physics); **HS** (Thesis)

We are responsible for the management of the institute's scientific publications. Anja Lehmann is transferring the entries from the AEI database into the PubMan server 'MPG.PuRe'. (<http://pubman.mpg.de/>). She is adding these entries by searching for publications of AEI scientists in other relevant databases (e.g. Web of Science, SPIRES, SAO/NASA).

This refers to 4,978 items since 2010. For most of them this includes a link to the fulltext version. The intention of this electronic document server is to increase the visibility of the intellectual output of the institute as well as of the MPG.

Other topics we actively support are Catalogue Enrichment, e-Books, Virtual Library, Open Access, Document Ordering, Electronic Resource Management and Bibliometric Analysis.



The MPDL is offering a number of new services and we have to find out which of these services is useful for our institute. Of course this took place in close contact with the library commission.

In terms of an embedded library and in addition to the usual tasks of librarians, we are constantly looking for new ways to facilitate and optimize the use and the organization of the library.

Elisabeth Schlenk





## Public Relations Work

The AEI press office and public relations team consists of Dr. Elke Müller, Dr. Benjamin Knispel, and Dr. Peter Aufmuth. The AEI also cooperates with Milde Marketing, a science communication agency in Potsdam, with whom we produce our brochures and films, organize events and develop PR strategies. In the 2013 – 2016 period the team focused on the relaunch of the AEI webpages, the implementation of social media activities, and of course on the communication of the first detection of gravitational waves on Earth.

## Institute webpages

The AEI webpage has been relaunched in July 2013. The new portal allows for the first time to have both the Potsdam-Golm and the Hannover institute webpages in a single webpage. The extended GEO600 webpage has been relaunched in March 2014 and is now also available in German. Einstein Online remains one of the AEI's important outreach projects. It is further developed by its inventor Markus Pössel (now head of the Center for Astronomy Education and Outreach in Heidelberg).

## Social media

In the reporting period, the institute has started to run social media pages for some of its projects to expand its outreach towards the online interaction with members of the general public. At the time of this writing the social media accounts supervised by the press office are:

### Twitter

- The Einstein@Home Twitter account, established in August 2011 has about 4000 followers. <https://twitter.com/EinsteinAtHome>
- The LISACommunity Twitter account, established in March 2013 has about 4300 followers. <https://twitter.com/LISACommunity>
- The AEI Twitter account, established in January 2016 has about 750 followers. [https://twitter.com/mpi\\_grav](https://twitter.com/mpi_grav)



### YouTube

- The LISA Community YouTube channel, established in March 2013 has about 8,700 subscribers and 280,000 views. <https://www.youtube.com/user/LISACommunity>
- The AEI YouTube channel, established in Jan 2016, has about 170 subscribers and 43,000 views. <https://www.youtube.com/channel/UCw6knnFFBhdnwyIMohte45A>

### Facebook

- The LISA Community Facebook page, established in March 2013 has 6,500 likes. <https://www.facebook.com/LISACommunity/>

### First direct detection of gravitational waves

Communicating the first direct detection of gravitational waves was a major undertaking between late 2015 and early 2016. It was comprised of several parallel efforts: helping in the development coordination of the LSC-wide press release, coordinating the creation of a detection dossier with the Max Planck Society press office, the creation of a movie that highlights the AEI contributions to the international enterprise, the coordination and development of accompanying materials and video and picture footage for national and international media, and the preparation and conduction of a press conference at the AEI in Hannover on 11<sup>th</sup> February 2016. Many German print and TV journalists and film teams participated, providing German-wide and international news coverage afterwards. A celebratory event with invited guest from media and politics was held at the AEI in Potsdam-Golm on 19<sup>th</sup> February 2016.



### Second detection of gravitational waves

On 15<sup>th</sup> June 2016, the second LIGO event, GW151226 was announced to the public. The institute issued a press release including a new set of numerical simulation movies, which were distributed worldwide. Again, national and international press covered this topic.

### LISA Pathfinder results press conference at the AEI Hannover

On 7<sup>th</sup> June 2016, a press conference at the AEI Hannover announced the results of the LISA Pathfinder mission, which exceeded all expectations. It successfully demonstrated the technology for a gravitational wave observatory in space such as LISA. The conference was well visited by members of the national press and internationally covered.

### Local Events

The press office team organizes local events at both institute locations on various occasions. The following events are noteworthy:

- Open Days at the GEO600 gravitational-wave detector and at the AEI Potsdam-Golm.
- “November der Wissenschaft” (November of Science), a public lectures series with four popular-science talks open to the general public in November 2013, 2014, 2015 and 2016 at the AEI Hannover.
- “Die Nacht, die Wissen schafft” (open science night) at the AEI in Hannover in November 2014 and 2016, with hourly popular science talks, exhibits and guided Atlas cluster tours.
- Launch Event for the LISA Pathfinder launch on the early morning



(4:45 am) of 3<sup>rd</sup> December 2015 at the AEI in Hannover: live stream of the rocket launch, popular science talk and breakfast with about 100 visitors and members of the institute, as well as several media representatives from newspapers and TV



- Eight additional GEO600 tours for the general public from April to early July 2016
- “Girls' Days” and “Future Days”: to reach young students and especially young girls and to get them excited about science and physics, the AEI in Hannover and Potsdam participates each year in the Girls' Day/Future Day. These half-day events invite about 30 students between 13 and 16 years to the institute, to learn about physics, talk to physicists about their daily work and get a “glimpse behind the curtain”
- Exhibitions: “Einstein inside” - the AEI takes part in this interactive multimedia exhibition about GR that started in November 2015 in Berlin and is now travelling Germany; “Windows to the Universe” – an exhibition about how astronomers discover the Universe in different wavelengths and with gravitational waves by AEI Potsdam and other Potsdam and Brandenburg research institutes (2015/2016).

#### **Popular science talks, laboratory tours, cluster tours and GEO600 tours**

Members of the institute and the press office give (popular) science talks on various occasions: in astronomy clubs, in schools, at teachers' trainings, or at science festivals and others. About two dozen such talks are offered per year. The press office organizes and conducts tours of the institutes and GEO600 including selected laboratories and computer clusters. About two dozen such tours are offered in an average year.

#### **“Einstein macht Schule” (Einstein at schools)**

After the first observation of gravitational waves, a new program has been established in collaboration with Leibniz Universität Hannover. It aims at sending scientists and press office members to local schools in and around Hannover for a short presentation about the detection and the contributions of the AEI and Leibniz Universität Hannover, followed by a discussion with the high school students.

#### **deutschland-geht-ein-licht-auf.de**

deutschland-geht-ein-licht-auf.de was a marketing campaign of the central Max Planck Society press office as part of the International Year of Light in 2015. The campaign was targeted at 20 to 30 year olds

from the general public who are not yet aware of the Max Planck Society and its activities. Several institutes engaging in light-based research were selected to contribute content to this campaign, which used marketing tools to reach out to new audiences. The AEI took part in the initial planning and contributed several articles for an online blog, pictures for an online game and content for the accompanying background webpage [www.forschen-mit-licht.mpg.de](http://www.forschen-mit-licht.mpg.de). The campaign reached the self-set goal of 100,000 unique visitors in the six-month period.

### **GEO600 movies**

A series of three movies about the topics “What is GEO600?”, “Detecting Gravitational Waves”, and “GEO600 Technologies for Advanced LIGO” have been created from interviews with GEO collaboration scientists. Together they have been viewed more than 400 times on YouTube.

At the time of this writing, work is ongoing to produce and updated version of the old (2002) GEO600 impression movie to be shown (with or without) sound at exhibitions and similar events.

A set of six different aerial movies of the GEO600 detector site have been shot and made available to the public via YouTube (250 views). They were created with a quadcopter and are used as press footage, in the GEO600 interview series and in public talks.

### **E10 movies**

Interviews about E10 symmetry have been recorded and published, highlighting work in the Quantum Gravity division. Hermann Nicolai's approach to unifying gravitation and elementary particle effects is based on symmetry E10, a unique infinite-dimensional mathematical structure that is still extremely mysterious, even 50 years after its discovery.

### **International Year of Light 2015 and 100 years of general relativity in 2015**

To celebrate the International Year of Light 2015 and the 100th anniversary of general relativity in 2015, several events highlighted the connection of the AEI to light-based research and General Relativity (Girls' Day/Future Day, Open Day at GEO600, public talks in the “November der Wissenschaft”, several other invited public talks).

At the AEI Hannover, the International Year of Light was also celebrated with an exhibition of 18 photographs created by AEI scientists who also do photography as a hobby or who document their daily work.

B. Knispel, E. Müller



## **IMPRS for Geometric Analysis, Gravitation, and String Theory**

Doctoral training in the two AEI divisions “Quantum Gravity and Unified Theories” and “Geometric Analysis and Gravitation” was strongly supported by two International Max Planck Research Schools (IMPRS).

The first one, the IMPRS for Geometric Analysis, Gravitation and String Theory, was in place from 2004 until the end of 2015. It included the independent Max Planck research groups “Canonical and Covariant Dynamics of Quantum Gravity”, “Microscopic Quantum Structure and Dynamics of Spacetime”, “Theoretical Cosmology” and “Geometric Measure Theory” and was in collaboration with mathematical research groups of the FU Berlin and Potsdam University, and the quantum field theory and string theory groups at Humboldt University. Over the course of its 12 years of existence, the IMPRS has accepted 68 students, some of which were carried over into the new IMPRS. The overall acceptance rate of applications was about 12%. The rate was identical for male and female applicants and women constituted also about 12% of the applications. About 20% of the applications were from Germany, 30% from the rest of the European Union and 50% from the rest of the world.

The new IMPRS for Mathematical and Physical Aspects of Gravitation, Cosmology and Quantum Field Theory has started in January 2016. The university partners of the IMPRS are the QFT and Mathematical Physics groups at Humboldt University and the Differential Geometry group at Potsdam University. At the time of writing (March 2017) it has 23 students, 3 of which are female. 14 are directly funded by the IMPRS and 4 are from non-European countries. The students are based at the partner institute of their principal supervisor. Every student has at least a second supervisor and all students accepted into the new IMPRS have a Thesis Advisory Committee that assists the student and monitors the student’s progress.

The students can benefit from numerous seminars by world-class researchers literally every week at all partner institutions. The curriculum of the IMPRS combines regular courses offered at the participating universities, and specialized lectures that are organized at the AEI or one of the partner universities. The topics of the regular courses include differential geometry, geometric analysis, partial differential equations, supersymmetry, supergravity, general relativity, cosmology, quantum field theory, quantum gravity and string theory. Researchers of the AEI participate regularly in lecturing at the universities. In addition to the regular courses, we have arranged specialized IMPRS lecture series or lecture days at the AEI by invited experts or by members of the institute. Furthermore, the AEI organizes workshops, conferences and schools, in which the students take part.

The students are encouraged to participate in international conferences and schools abroad, for which they are equipped with a travel budget of about 1000,- EUR per person and year. This budget is also available for those students who are not funded by the school but rather through third party funding.

Once a year, the IMPRS organizes an excursion (2-3 days) to a seminar facility outside the institute, where the doctoral students of the program are asked to give a seminar on their research in the presence of the senior members of the IMPRS. The purpose of these seminars is to practice presenting and explaining scientific results, and to stimulate communication among the students. The students get feedback on their talks from the group. These meetings take place outside the Berlin/Potsdam area in order that the students have the opportunity to socialize with each other and continue discussions in the evening.

The IMPRS also offers transferable skill seminars on topics like presentation training, scientific writing or proposal writing. In addition, the students have the opportunity to participate in trainings offered by the Potsdam Graduate School and the Berlin Mathematical School. For foreign students, German language courses are supported.

Applications for the school can be submitted online throughout the whole year, and they are continuously reviewed. We receive approximately 70 applications per year, most of which come from outside Germany (more than 80%).

The School has attracted extremely good students so far, which is also reflected in the grades for the PhD which is always magna cum laude or summa cum laude. Many of the students have taken up postdoctoral positions after the completion of their Ph.D. Some are professors at renowned Universities world-wide and are leading their own research groups by now. Several members or former members of the IMPRS received prestigious prizes, such as the Otto Hahn medal of the Max Planck Society (Niklas Beisert, Bianca Dittrich), the Michelson prize of the University of Potsdam (Kristina Giesel), the JSTAT young scientist prize (Till Bargheer, Niklas Beisert, Florian Loebbert), the “Science interactive” prize of the Stifterverband für die Deutsche Wissenschaft and “Wissenschaft im Dialog” (Carla Cederbaum), and even the Gribov medal (Niklas Beisert).

The spokesperson for the IMPRS is Prof. Hermann Nicolai and the co-ordinators are Hadi Godazgar (since March 2017), Axel Kleinschmidt (since January 2014) and Oliver Schlotterer (since January 2014, until April 2017).

A. Kleinschmidt, O. Schlotterer

IMPRS-Website: <http://www.imprs-gcq.aei.mpg.de>

### **IMPRS on Gravitational Wave Astronomy**

The IMPRS on Gravitational Wave Astronomy (IMPRS-GW) is a joint doctoral program of the AEI (divisions Astrophysical & Cosmological Relativity, Laser Interferometry & Gravitational Wave Astronomy, and Observational Relativity & Cosmology), the Leibniz Universität Hannover (Institute for Gravitational Physics, Institute for Quantum Optics, and Institute for Theoretical Physics), and the Laser Zentrum

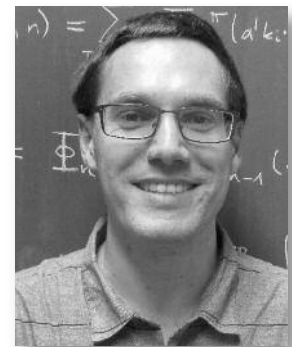

Hannover (division Laser Development). The program combines the different fields of gravitational wave astronomy: from laser development, interferometry and quantum optics to data analysis and numerical simulations of gravitational wave sources.

The IMPRS started in January 2004 and is really flourishing. We have developed an efficient and stable curriculum, a stimulating group spirit and a very productive research environment. Our IMPRS is the dominating institution worldwide in our field and occupies a unique position in the world in covering the complete spectrum of gravitational-wave science from the most abstract theory to experimental applications. The tight integration with the Leibniz Universität Hannover is a great advantage and can serve as a role model for other institutions.

The curriculum of the IMPRS combines specialized lectures offered regularly at Leibniz Universität Hannover, specialized lectures by AEI scientists which are video-transmitted to the other part of the institute, and our “IMPRS Lecture Weeks”, introduced in 2008. This is a week of block lectures in general relativity, data analysis or numerical relativity (alternating), and experimental gravitational wave physics (with changing topics). With this concept, we want to ensure that experimentalists also get some basic knowledge in the theoretical fields of gravitational wave astronomy and theorists learn the basics of the experimental fields. The second important goal of these weeks is to bring the students of the different research fields and of both institute locations together. From 2011 on we are extending this concept to three lecture weeks per year, including basic statistics to the data analysis course and theoretical astrophysics to the numerical relativity course, as well as a one-week project by student teams composed of theorists and experimentalists as well as advanced students and beginners.



It is an ambition of the School that its graduates not only possess first-rate scientific skills but that they also acquire additional competences, ranging from “soft skills” (e.g. scientific writing, presentation skills, proposal writing, etc.) to project or human resources management.

There are currently 57 (as of March, 2017) doctoral students (13 of which are women) in the IMPRS program, 1 of them in Golm and 56 in Hannover. 12 of them are funded by the IMPRS Budget. Currently there are 43 German students and 14 non-Germans. From 2007 the program hosted PhD students from the following countries: Bulgaria, Canada, China, Greece, India, Iran, Italy, North- and South-America, Russia, Spain, UK as well as the Ukraine. Since July 2007, 94 students have successfully completed their PhD within this IMPRS program.



Spokesperson for the IMPRS is Prof. Karsten Danzmann, with Prof. Bruce Allen as Deputy Spokesperson and Sandra Bruns as coordinator.

S. Bruns, M. Hase

IMPRS-Website: <http://imprs-gw.aei.mpg.de>





## Living Reviews

From 1998 to 2015, the AEI published the open access journal *Living Reviews in Relativity*, initiated by Bernard Schutz. The institute also provided the Living Reviews back office in order to support other Living Reviews journals. The development of the Living Reviews journals was based on a collaboration between AEI and the Heinz Nixdorf Center for Information Management, the precursor organization of the Max Planck Digital Library. The unique concept at the heart of Living Reviews is that authors can update the content as needed. The texts remain 'living' and, unlike conventional survey articles, won't inevitably become outdated.

*Living Reviews in Relativity*, launched in 1998, had an impact factor of approximately 19.25 in the year 2015. The journal has held the number one slot in the international ranking of scientific journals in the category "Physics, Particles and Fields" for the past several years. The peer-reviewed articles provide critical overviews of the current state of research in all areas of general relativity theory. The open access journal has become a valuable tool for the scientific community and is one of the first places a researcher looks to for information about current work in relativity.

In order to ensure that the three Living Reviews journals profit from new developments in the publishing world and enjoy long-term success, Max Planck Society transferred three journals to the scientific publisher Springer in June 2015: *LR in Relativity*, *LR in Solar Physics*, and *LR in Computational Astrophysics*. The journals will remain open access and the Max Planck Society will continue to be involved in the makeup of their editorial boards.



## Cooperations and Outside Funding

The years 2013 to 2016 have seen successful collaborations with German and foreign institutions and foundations in both the AEI Hannover and the AEI Potsdam. The following report lists all institutions and foundations (in alphabetical order) as well as the funded projects in detail.

### **Alexander von Humboldt-Stiftung - AvH (Humboldt Foundation)**

In the past four years, the AEI Potsdam hosted several Humboldt Fellows. These include twelve Humboldt Fellowships for Postdoctoral Researchers (Dr. Jianwei Mei, Dr. Jose-Luis Jaramillo, Dr. Evgeny Skvortsov, Dr. Riccardo Ciolfi, Dr. Jordi Casanellas, Dr. Jinhua Wang, Dr. Gustavo Lucena Gomez, Dr. Maciej K. Maliborski, Dr. Mingyi Zhang, Dr. Edvard Musaev, Dr. Yi Pang and Dr. Karapet Mkrtchyan), a Georg Forster Fellowship for Dr. Dine Ousmane Samary, two Humboldt Fellowships for Experienced Researchers for Prof. Kirill Krasnov and Dr. Joseph Ben Geloun and two research visits for Prof. Ruben Manvelyan and Prof. Kirill Krasnov. In addition, the AEI Potsdam was the host institution for the Humboldt Research Award laureate Prof. Piotr Bizon and the Friedrich Wilhelm Bessel Research Award laureate Prof. Harald Pfeiffer.

The Sofja Kovalevskaja Award laureate Dr. Daniele Oriti and his research group were closely cooperating with the Quantum Gravity and Unified Theories Division. Oriti's award was accompanied by 1.400.700 EUR. In December 2016 a new laureate of that prestigious prize, Dr. Michal Heller, started his work in the Quantum Gravity Group. The prize of Dr. Heller is accompanied by 1.649.700 EUR to be spent over a period of five years.

### **Bundesministerium für Bildung und Forschung - BMBF (German Ministry for Education and Research)**

LISA technology is now being used for Earth observation and will improve future satellite geodesy missions. The BMBF supports the Grace Follow-on mission which will observe the critical indicators of climate change through changes in Earth's gravitational field.

### **Chinesisch-Deutsches Zentrum für Wissenschaftsförderung – CDZ (Sino-German Center)**

A Sino-German Symposium on Gravitational Physics in Space was organized at the AEI Hannover from Sept. 14-16, 2015. It was funded by the Sino-German Center. 15 presentations were given by Chinese experts and about 30 presentations by German and international experts. A total of about 100 participants attended, including about 20 students and young scientists from the AEI Hannover as well as leading experts from Italy, France, Spain, UK, Denmark, Switzerland, the Netherlands, ESA and NASA.

## **Deutscher Akademischer Austauschdienst – DAAD (German Academic Exchange Service)**

The AEI Potsdam hosts Dr. Rongxin Miao who obtained a fellowship in the Sino-German (CSC-DAAD) Postdoc Scholarship Program and Isha Kishor Kotecha who obtained a Research Grant in the DAAD Doctoral Programme.

The AEI Hannover and NASA Goddard Space Flight Center (GSFC) in Maryland established a collaboration with the aim to jointly conduct research and development on ultra-low-noise, high-bandwidth photoreceivers for high sensitivity laser interferometry in gravitational physics. This work is relevant, in particular, for scientific space missions in fundamental physics and astronomy such as the conceived space gravitational wave observatory LISA, and geodesy missions like GRACE follow-on. Both projects have strong participation from institutions in Germany and the USA.

## **Deutsche Forschungsgemeinschaft – DFG (German Research Foundation)**

### **I. Sonderforschungsbereiche - SFB (Collaborative Research Centers)**

- *SFB Transregio 7 Gravitationswellen-Astronomie*: The SFB/TR7 aims at the detection and analysis of gravitational waves that reach us from astrophysical sources like black holes, neutron stars, or supernovae. The ‘Transregio’ signifies a collaboration of groups at the Universities of Jena, Tübingen, and Hannover, and at Max Planck Institutes in Garching, Hannover and Potsdam. It was running until December 2014.
- *SFB 647 Raum-Zeit-Materie*: In the SFB 647 entitled Space-Time-Matter the Divisions for Geometric Analysis and Gravitation and Quantum Gravity and Unified Theories at AEI are collaborating with the Humboldt Universität zu Berlin, the Freie Universität in Berlin and the University of Potsdam. In this project mathematicians and physicists explore the exciting research field where theoretical physics, geometry and analysis meet. The DFG started funding this Collaborative Research Center in January 2005 and has extended it until December 2016.

### **II. Sachbeihilfen (Individual Research Grants)**

The DFG approved funds for four Individual Research Grants “Supermassive Schwarze Löcher, Akkretionsscheiben, Stelldynamik und Gezeitenstörungen von Sternen” (Gravitational Waves Group/Astrophysical Relativity Division), “Insight into Gravitation via a Combination of Analytical and Numerical Methods” (Geometric Analysis and Gravitation Division), “String theory, quantum field theory and gauge/gravity duality” (Quantum Gravity and Unified Theories Division) and “Kausalität in der Gravitation, Felder höheren Spins und die AdS/CFT Dualität” (Quantum Gravity and Unified Theories Division). These Individual Research Grants include funding for staff and/or travel and research visits.

### III. Prizes

Dr. Holger Pletsch was awarded the Heinz Maier Leibnitz Prize in 2013. This is the most important prize for early career researchers in Germany and accompanied by 20.000 EUR.

### IV. Emmy Noether Programme

The Emmy Noether Programme supports Dr. Holger Pletsch and his proposal “Hochempfindliche Suchen nach neuen Gammapulsaren mittels öffentlich verteiltem Rechnen und Datenanalyse-Synergien mit der Gravitationswellen-Astronomie.“ His Independent Junior Research Group was granted funding for five years.

### **Deutsches Zentrum für Luft- und Raumfahrt – DLR (German Aerospace Center)**

The DLR supports the following projects:

- *LISA Pathfinder*: an ESA technology test mission for the eLISA mission. It will test most eLISA technologies in space and validate a complete model of all physical noise that can be extrapolated to the full eLISA mission. The AEI Hannover is one of the leading mission partners.
- *LISA (Laser Interferometer Space Antenna)*: a space-based detector with million-kilometer long arms that detects low-frequency gravitational waves that cannot be measured by ground based gravitational wave detectors.
- *Satellite gravimetry next generation (NGGM-D)*: aims to draw up a mission concept for long-term observation of mass variations in the Earth system.

### **EU (European Commission)**

In the reporting period, the European Commission provided funding for six projects:

- *Computing in the dark sector: a Cactus toolkit for modified-gravity cosmologies (COSMOTOOLKIT)*;
  - *String Cosmology and Observational Signatures (STRINGCOSMOS)*;
  - *Integrability, Symmetry and Quantum Space-time (ISAQS)*
  - *ET-LCGT Telescopes: Exchange of Scientists (ELITES)*
  - *Gravitational Wave Initial Training Network (GraWIToN)*
  - *Holographic applications of supergravity (appSG)*
- COSMOTOOLKIT/ Numerical Relativity Group/Astrophysical Relativity Division (Marie Curie Reintegration Grant/ FP7) intended to test cosmologically-relevant proposals using Cactus in order to extend the domain of current codes.
- STRINGCOSMOS/ (ERC Starting Grant J.-L. Lehnert/ FP7) aimed to enhance our understanding of the very early universe and its most mysterious aspect, the big bang. In January 2011 Dr. Jean-Luc Lehnert established his independent research group on String Cosmology

at the AEI Potsdam. The group closely cooperates with the Quantum Gravity and Unified Theories Division.

- ISAQS/ Quantum Gravity and Unified Theories Division (Marie Curie International Research Staff Exchange Team/FP7) brings together leading researchers with broad, complementary expertise: from conformal field theory, gauge theory, supergravity, string theory, to the more mathematical aspects of integrable systems and non-commutative geometry, to form a team with the common goal of understanding the fundamental nature of quantum gravity.
- ELITES/ Laser Interferometry and Gravitational Wave Astronomy Division (Marie Curie International Research Staff Exchange Team/FP7), the Large-scale Cryogenic Gravitational wave Telescope (LCGT) in Japan and the Einstein gravitational-wave Telescope in Europe will adopt new technologies (in cryogenics, mechanics and optics) that necessitate an intense R&D activity and a fully collaborative exchange of know-how between Europe and Japan. ELITES aims to furnish the initial kick-off to this exchange programme.
- GraWIToN/ Laser Interferometry and Gravitational Wave Astronomy Division (Marie Curie Networks for Initial Training/FP7), aimed to train 13 Early Stage Researchers in the gravitational wave search field and in the cutting edge technologies adopted in the gravitational wave detectors. Complex optical apparatuses, high power and low noise lasers, high reflective coatings, optical simulation and modelling using parallel computing systems are the crucial technologies used in gravitational wave detectors that are very interesting in the industrial sector.
- appSG/ Quantum Gravity and Unified Theories Division (Marie Curie International Outgoing Fellowship/FP7), develops supergravity tools to study the strong coupled sectors of High Energy and Condensed Matter systems using the gauge gravity duality.

Furthermore, the Quantum Gravity and Unified Theories Division is partner in the Erasmus Mundus Joint Doctorate Programme in Relativistic Astrophysics funded by the European Commission.

### **European Space Agency (ESA)**

The European Space Agency has concluded a contract with Astrium in order to provide design, development, manufacturing and testing of the "Optical Bench Development for LISA" and to deliver an Elegant Breadboard (EBB) of the Optical Bench (OB) together with related software and documentation. Astrium enters here into a contract with the AEI Hannover, TNO & Science Industry and the University of Glasgow.

### **German-Israeli Foundation for Scientific Research & Development (GIF)**

The German-Israeli Foundation supported two proposals for joint research projects of the Quantum Gravity and Unified Theories Divi-

sion together with the University of Tel Aviv entitled “String Theory Meets Gauge Dynamics” and “When RG flows, fluid-dynamics and entanglement entropy meet holography”.

### **John Templeton Foundation**

The John Templeton Foundation granted a postdoctoral fellowship for the study on Quantum Information before Spacetime in the Quantum Gravity and Unified Theories Division. Another John Templeton Grant supports the project “Close to the Origin, beyond Space and Time” which will realize a new scenario of the Big Bang as a transition between a pregeometric phase with no notion of spacetime, to a phase in which the Universe is described by a smooth spacetime, within a complete Quantum Gravity framework.

### **Max-Planck-Gesellschaft – MPG (Max Planck Society)**

The Max-Planck-Gesellschaft supports collaborative research in target areas which are scientifically promising and innovative. Those Partner Groups enable both the Max Planck Institute and the Head of the Partner Group to continue a sustained scientific interaction. In recent years Partner Groups have been established at the:

- Universidad Nacional de Cordoba, Argentina
- Indian Institute of Science Education and Research Pune, India
- Center for Mathematics, Computation and Cognition of the Universidade Federal do ABC Santo André, Brazil
- Indian Institute of Science Education and Research Thiruvananthapuram, India
- International Centre for Theoretical Sciences, Tata Institute of Fundamental Research Bangalore, India
- Institute of Theoretical Physics of Chinese Academy of Science Beijing, China
- Institute of Physics, Bhubaneswar, India

### **Volkswagen-Stiftung (VW Foundation)**

The VW Foundation is currently funding the R&D programme Advanced LIGO. The objective of that project is the development and delivery of high-power pre-stabilized laser systems for the Advanced LIGO gravitational wave detectors. It is jointly conducted by the AEI Laser Interferometry and Gravitational Wave Astronomy Division and the Laser Zentrum Hannover.

Furthermore, a collaboration of the Numerical Relativity Group and the Uzbek Academy of Sciences has been funded in the field of General-Relativistic Electrodynamics of Astrophysical Compact Objects.

Together with the Yerevan Physics Institute the Quantum Gravity and Unified Theories Division is working on the proposal Infinite-Dimensional Symmetries, Gauge/String Theories and Dualities which is funded by the VW Foundation as well.

The AEI Hannover and LIGO (Laser-Interferometer-Gravitationswellen-Observatorium) share the goals of developing and upgrading the existing LIGO observatories, using them to observe gravitational radiation and subsequently using gravitational radiation as an astrophysical probe. Therefore, AEI Hannover has entered into a research and development contract with the Laser Zentrum Hannover to develop, test and deliver further laser systems related to the gravitational-wave experiment Advanced LIGO.

Constance Münchow





## Appraisals and Prizes



*Bruce Allen, Alessandra Buonanno and Karsten Danzmann* received the *Lower Saxony State Award* for their fundamental contributions to the first detection of gravitational waves.



*Karsten Danzmann* was honoured as an outstanding scientist at a university in Lower Saxony and received the *2016 Lower Saxony Science Award*. He also was awarded the *2016 Fritz Behrens Foundation Science Prize* for his contributions to gravitational-wave astronomy.



*Berit Behnke* has been honoured with the *Max Planck Society's Otto Hahn Medal* for her excellent doctoral dissertation about improved searches for continuous gravitational waves emitted by neutron stars in the Galactic Center.



*Stefan Fredenhagen* received a prize awarded to young scientists for excellent and engaging teaching methods. He was honoured in 2015 by the Student Government Physics (Fachschaftsinitiative Physik) of Humboldt Universität zu Berlin.



*Joseph Ben Geloun* has been awarded the *Young Scientist Prize in Mathematical Physics 2015-2017* of the International Union of Pure and Applied Physics for his pioneering work on the renormalization of tensor field theories and his discovery of their generic asymptotic freedom.



*Oliver Gerberding* was awarded the *2014 Science Prize* of the Leibniz Universitätsgesellschaft Hannover e.V. for his dissertation regarding the development of highly precise measurement methods for future gravitational-wave detectors.



*Hermann Nicolai* was awarded the prestigious *German-French Gay-Lussac-Humboldt-Prize* on 15<sup>th</sup> April 2013 in Paris. He was also given the honorary degree *Doctor of Technology* from Chalmers University of Technology in 2016.



*Maria Alessandra Papa* has been elected as a Fellow of the American Physical Society (APS). She also together with three colleagues accepted the Foreign Policy's *2016 Top 100 Global Thinkers Award* on behalf of the LIGO Scientific Collaboration.

*Harald Pfeiffer* (Canadian Institute for Theoretical Physics, Toronto) was honoured with a *Bessel Award* of the Humboldt Foundation. The award will allow him to stay at the AEI in Potsdam where he will work closely with Alessandra Buonanno's division on the prediction of the gravitational waves that are generated when black holes collide.[1]



[1]

*Holger Pletsch* was awarded the renowned *Heinz Maier-Leibniz Prize* by the German Research Foundation (DFG) and the Federal Ministry of Education and Research for his outstanding work in developing efficient methods to search for unknown neutron stars through their gravitational-wave and gamma-ray emission. He was also voted by the magazine *Capital* as one of the 40 most promising young German scientists of 2014.[2]



[2]

*David Radice* received the *2014 Giulio Rampa Thesis Prize* for outstanding research in honour of his research on relativistic numerical simulations during his doctoral studies at the Max Planck Institute for Gravitational Physics [3]



[3]

*Luciano Rezzolla* is one of the three principal investigators of an European Research Council (ERC) grant of 14 Million Euros. He is part of a team of European astrophysicists to construct the first accurate image of a black hole event horizon. The team will test the predictions of current theories of gravity. The funding is provided in the form of a *Synergy Grant*, the largest and most competitive type of grant of the ERC.[4]



[4]

*Oliver Rinne* received the German Research Foundation's (DFG) *von Kaven Award* 2013 for his excellent work in the field of Einstein's general theory of relativity and related fields of mathematical physics and geometrical analysis.[5]



[5]

*Pablo Antonio Rosado Gonzalez* won the first prize in the science and outreach video competition *Fast Forward Science* 2013 in the Next category. His team also came in second in the *Fast Forward Science* "Super Fast" competition in 2014.[6]



[6]

*Bernard Schutz* was selected as a *Fellow of the International Society on General Relativity and Gravitation* (ISGRG) in 2013.[7]



[7]

*Yan Wang* receives the *2014 Stefano Braccini Thesis Prize* for his innovative and novel doctoral thesis. Wang's thesis covered a variety of topics, among them inter-satellite ranging and clock synchronization for the eLISA mission.[8]

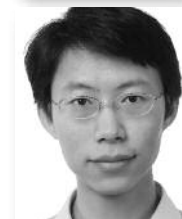

[8]

*More than 100 AEI members* received the *Special Breakthrough Prize in Fundamental Physics* for their contributions to the first direct detection of gravitational waves. The AEI member's contributions to the discovery were also honoured with the *2016 Gruber Cosmology Prize*.

The 90-member *Advanced LIGO engineering team* has been awarded the *Paul F. Forman Team Engineering Excellence Award* 2016 by The Optical Society (OSA). Among the recipients are also six employees of the *Albert Einstein Institute in Hannover* and of the *Laser Zentrum Hannover*.

## **Academic Achievements**

### **New Director at the AEI**

Alessandra Buonanno, physics professor at the University of Maryland, College Park, accepted the position of a director at the AEI and succeeded Bernard Schutz in September 2014. Her division on Astrophysical and Cosmological Relativity aims at improving our ability to detect and extract unique astrophysical and cosmological information from the observed waveforms and test fundamental equations of general relativity.

While at the University of Maryland, Buonanno has been a Fellow of the Alfred P. Sloan Foundation. She was a Radcliffe Fellow at the Radcliffe Institute for Advanced Study at Harvard University. She is a Fellow of the International Society on General Relativity and Gravitation, and a Fellow of the American Physical Society.

### **Professorships at AEI and abroad**

Stefan Fredenhagen was appointed professor in Mathematical Physics at Vienna University in 2016.

In April 2013 Alan Rendall left AEI to take up a professorship at the University of Mainz.

Oliver Rinne was appointed to a professorship in mathematics at the Hochschule für Technik und Wirtschaft (University of Applied Sciences) in Berlin in 2016.

Luciano Rezzolla left AEI for a professorship at Frankfurt University in October 2013. He stayed part-time affiliated to the institute until Summer 2014.

Roman Schnabel was appointed professor in Physics at the University of Hamburg in 2014.

Sascha Skorupka was appointed professor at the University of Applied Sciences in Fulda in 2014.

In January 2013 Amitabh Virmani left AEI to take on an assistant professorship at Bhubaneswar University, India.

### **New Independent Research Groups at AEI**

As of December 2016, Michal P. Heller builds an independent research group on Gravity, Quantum Fields and Information funded by the Alexander von Humboldt Foundation through a Sofja Kovalevskaja Award.

From April 2014 until August 2016, Holger Pletsch led an independent research group which focused on the development of efficient methods for the discovery of unknown gravitational-wave and gamma-ray pulsars. The research was funded by the Emmy Noether program of the Deutsche Forschungsgemeinschaft.

Since September 2015 Maria J. Rodriguez has been setting up a research group on Gravitation and Black Hole Theory at AEI Potsdam.

Her research is funded by the Max Planck Society within the Minerva program for the promotion of excellent female scientists.

### **Habilitation**

Oliver Rinne finished his habilitation thesis on “Numerical and analytical methods for asymptotically flat spacetimes” and was habilitated by Free University Berlin in 2014.

### **Doctoral Theses**

Christoph Affeldt (Leibniz Universität Hannover, 2014): Laser power increase for GEO 600: commissioning aspects towards an operation of GEO 600 at high laser power. Supervisors: Hartmut Grote, Harald Lück

Stefan Ast (Leibniz Universität Hannover, 2015): New approaches in squeezed light generation - Quantum states of light with GHz squeezing bandwidth and squeezed light generation via the cascaded Kerr effect. Supervisor: Roman Schnabel

Heather E. Audley (Leibniz Universität Hannover, 2014): Preparing for LISA pathfinder operations : characterisation of the optical metrology system. Supervisor: Martin Hewitson

Robin Bähre (Leibniz Universität Hannover, 2016): Design and setup of an optical experiment for searching for weakly interacting sub-eV particles (WISPs) that couple to an electro- and/or magnetic field. Supervisor: Benno Willke

Simon Barke (Leibniz Universität Hannover, 2015): Inter-Spacecraft Frequency Distribution for Future Gravitational Wave Observatories. Supervisor: Michael Tröbs

Jöran Bauchrowitz (Leibniz Universität Hannover, 2013): Messung und graphische Darstellung von Ein- und Zwei-Moden-gequetschten Zuständen des Lichts. Supervisor: Roman Schnabel

Christoph Baune (Leibniz Universität Hannover, 2016): Frequency up-conversion of nonclassical states of light. Supervisor: Roman Schnabel

Berit Behnke (Leibniz Universität Hannover, 2013): A Directed Search for Continuous Gravitational Waves from Unknown Isolated Neutron Stars at the Galactic Center. Supervisors: M. Alessandra Papa and B. Krishnan

Christina Bogan (Leibniz Universität Hannover, 2013): Stabilized High Power Lasers and Spatial Mode Conversion. Supervisor: Benno Willke

Patrick Brem (Potsdam University, 2015): Compact Objects in Dense Astrophysical Environments: Numerical Simulations and Implications for Gravitational Wave Astronomy. Supervisors: Pau Amaro-Seoane and Bernard Schutz

Tito Dal Canton (Leibniz Universität Hannover, 2015): Efficient searches for spinning compact binaries with advanced gravitational-wave detectors. Supervisor: Badri Krishnan

Sylvain Carrozza (Université Paris-Sud 11, 2013): Tensorial methods and renormalization in Group Field Theories. Supervisor: Daniele Oriti

Colin Clark (Leibniz Universität Hannover, 2016): A Blind-search Survey for Gamma-ray Pulsars. Supervisor: Holger Pletsch

Katrin Dahl (Leibniz Universität Hannover, 2013): From design to operation: a suspension platform interferometer for the AEI 10m prototype. Supervisor: Stephan Gößler

Christian Diekmann (Leibniz Universität Hannover, 2013): Development of core elements for the LISA optical bench: electro-optical measurement systems and test devices. Supervisor: Gerhard Heinzel

Timo Denker (Leibniz Universität Hannover, 2016): High-precision metrology with high-frequency nonclassical light sources. Supervisor: Michèle Heurs

Kyriaki Dionysopoulou (Potsdam University, 2016): Generalrelativistic magnetohydrodynamics in compact objects (a resistive-magnetohydrodynamics approach). Supervisor: Bernard Schutz

Parikshit Dutta (Free University Berlin, 2013): The DeWitt equation in Quantum Field Theory and its applications. Supervisor: Hermann Nicolai

Tobias Eberle (Leibniz Universität Hannover, 2013): Realization of Finite-Size Quantum Key Distribution based on Einstein-Podolsky-Rosen Entangled Light. Supervisor: Roman Schnabel

Angelika Fertig (Humboldt University, 2016): Alternatives to Inflation - Non-minimal Ekpyrosis and Conflation. Supervisor: Jean-Luc Lehners

Philipp Fleig (Free University Berlin, 2013): Kac-Moody Eisenstein series in string theory. Supervisor: Hermann Nicolai

Rouven Frassek (Humboldt University, 2014):  $Q$ -operators, Yangian invariance and the quantum inverse scattering method. Supervisor: Matthias Staudacher

Joachim Frieben (Potsdam University, 2014): Stable and unstable equilibrium models of relativistic stars. Supervisors: Luciano Rezzolla and Bernard Schutz

Ilmar Gahramanov (Humboldt University, 2016): Superconformal indices, dualities and integrability. Supervisor: Jan Plefka

Filippo Galeazzi (Potsdam University, 2014): Towards realistic modeling of relativistic stars. Supervisors: Luciano Rezzolla and Bernard Schutz

Oliver Gerberding (Leibniz Universität Hannover, 2014): Phase read-out for satellite interferometry. Supervisor: Gerhard Heinzel

Arne Gödeke (Free University Berlin, 2016): The linear instability of uniform black strings. Supervisor: Alan Rendall

Christian Gräf (Leibniz Universität Hannover, 2013): Optical design and numerical modelling of the AEI 10m Prototype Sub-SQL interferometer. Supervisor: Stefan Goßler

Filippo Guarneri (Humboldt University and University „Roma Tre“, 2014): Renormalization group flow of scalar models in gravity. Supervisors: Hermann Nicolai and Orlando Ragnisco

Nishanth Abu Gudapati (Free University Berlin, 2014): On the Cauchy Problem for Energy Critical Self-Gravitating Wave Map. Supervisor: Lars Andersson

Vitus Händchen (Leibniz Universität Hannover, 2016): Experimental Analysis for Einstein-Podolsky-Rosen-Steering for Quantum Information Applications. Supervisor: Roman Schnabel

Martin Heinze (Humboldt University, 2014): Spectrum and Quantum Symmetries of the  $AdS_5 \times S_5$  Superstring. Supervisors: Jan Plefka and Thomas Klose

Anna Ijjas (Humboldt University, 2014): Observational and Theoretical Issues in Early Universe Cosmology. Supervisor: Jean-Luc Lehners

Nils Kanning (Humboldt University, 2016): On the Integrable Structure of Super Yang-Mills Scattering Amplitudes. Supervisor: Matthias Staudacher

Despoina Katsimpouri (Humboldt University, 2015): Integrability in two-dimensional gravity. Supervisor: Axel Kleinschmidt

Henning Kaufer (Leibniz Universität Hannover, 2013): Opto-mechanics in a Michelson-Sagnac interferometer. Supervisor: Roman Schnabel

David Keitel (Leibniz Universität Hannover, 2014): Improving robustness of continuous-gravitational-wave searches against signal-like instrumental artefacts and a concept for an octahedral gravitational-wave detector in space. Supervisor: Reinhard Prix

Pan Kessel (Humboldt University, 2016): The Physics of Higher-Spin Theories. Supervisor: Stefan Fredenhagen

Evgenia Kochkina (Leibniz Universität Hannover, 2013): Stigmatic and astigmatic Gaussian beams in fundamental mode: impact of beam model choice on interferometric pathlength signal estimates. Supervisor: Gerhard Heinzel

Natalia Korsakova (Leibniz Universität Hannover, 2015): Probing low gravity with LISA Pathfinder. Supervisor: Karsten Danzmann, Martin Hewitson

Olaf Krueger (Humboldt University, 2016): The Embedding of Gauged  $N=8$  Supergravity into 11 Dimensions. Supervisor: Hermann Nicolai

Christoph Mahrtdt (Leibniz Universität Hannover, 2013): Laser Link Acquisition for the GRACE Follow-On Laser Ranging Interferometer. Supervisor: Gerhard Heinzel

Giulio Mazzolo (Leibniz Universität Hannover, 2013): Search for intermediate mass black hole binaries with networks of ground-based gravitational-wave detectors. Supervisor: Francesco Salemi, Bruce Allen

Rongxin Miao (University of Science and Technology of China, 2014): Holographic Gravity and Dark Energy. Supervisor: Hermann Nicolai

Christoffer Nerz (University of Tübingen, 2014): Blätterungen asymptotisch flacher Mannigfaltigkeiten und ihre Evolution. Supervisor: Gerhard Huisken

Markus Otto (Leibniz Universität Hannover, 2016): Time-Delay Interferometry Simulations for the Laser Interferometer Space Antenna. Supervisor: Karsten Danzmann

Jan Hendrik Pöld (Leibniz Universität Hannover, 2014): Design, implementation and characterization of the advanced LIGO 200 W laser system. Supervisor: Benno Willke

Matti Raasakka (Free University Berlin, 2014): Non-commutative representation for quantum systems on Lie groups. Supervisor: Daniele Oriti

David Radice (Leibniz Universität Hannover, 2013): Advanced Numerical Approaches in the Dynamics of Relativistic Flows. Supervisor: Luciano Rezzolla

Dennis Rätzel (Potsdam University, 2013): Tensorial spacetime geometries and background independent quantum field theory. Supervisor: Frederic Schuller

Cosimo Restuccia (Humboldt University, 2013): Limit theories and continuous orbifolds. Supervisor: Stefan Fredenhagen

Pablo Antonio Rosado Gonzalez (Leibniz Universität Hannover, 2013): Gravitational Wave Background from Compact Objects and a New Search for Supermassive Black Hole Binaries. Supervisor: Bruce Allen

Dirk Schütte (Leibniz Universität Hannover, 2016): Modern Control Approaches for the Next-Generation Interferometric Gravitational Wave Detectors. Supervisor: Michèle Heurs

Daniel Schütze (Leibniz Universität Hannover, 2014): Intersatellite laser interferometry: test environments for GRACE follow-on. Supervisor: Gerhard Heinzel

Miroslav Shaltev (Leibniz Universität Hannover, 2013): Optimization and Follow-up of Semicohherent Searches for Continuous Gravitational Waves. Supervisor: Bruce Allen

Yu Shang (Leibniz Universität Hannover, 2013): Data analysis and source modelling for LISA. Supervisor: Bernard Schutz

Daniel Siegel (Potsdam University, 2015): Binary neutron-star mergers and short gamma-ray bursts: magnetohydrodynamics and electromagnetic emission. Supervisor: Bernard Schutz

Dmitry Simakov (Leibniz Universität Hannover, 2014): Dynamical tuning of a signal recycled gravitational wave detector: dynamical effects and sensitivity gain of dynamical tuning during detection of a chirp signal from compact binary coalescences. Supervisor: Harald Lück

Sebastian Steinhaus (Potsdam University, 2014): Constructing quantum space time: Relation to classical gravity. Supervisor: Bianca Dittrich

Jessica Steinlechner (Leibniz Universität Hannover, 2013): Absorption measurements for future gravitational wave detectors. Supervisor: Roman Schnabel

Sebastian Steinlechner (Leibniz Universität Hannover, 2013): Quantum Metrology with Squeezed and Entangled Light for the Detection of Gravitational Waves. Supervisor: Roman Schnabel

Gunnar Tackmann (Leibniz Universität Hannover, 2013): Raman interferometry with free-falling and trapped atoms. Supervisor: Ernst Rasel

Johannes Thürigen (Humboldt University, 2015): Discrete quantum geometries and their effective dimension. Supervisors: Daniele Oriti and Gianluca Calcagni

Alexander Volkmann (Free University Berlin, 2015): Free boundary problems governed by mean curvature. Supervisor: Gerhard Huisken

Christina Vollmer (Leibniz Universität Hannover, 2014): Non-classical state engineering for quantum networks. Supervisor: Roman Schnabel

Alexander Wanner (Leibniz Universität Hannover, 2013): Seismic Attenuation System (AEI-SAS) for the AEI 10m Prototype. Supervisor: Kenneth Strain, Stefan Göbner

Yan Wang (Leibniz Universität Hannover, 2014): On inter-satellite laser ranging, clock synchronization and gravitational wave data analysis. Supervisor: Gerhard Heinzel

Tobias Westphal (Leibniz Universität Hannover, 2016): A Coating Thermal Noise Interferometer for the AEI 10m Prototype. Supervisors: Karsten Danzmann, Harald Lück

Maximilian Wimmer (Leibniz Universität Hannover, 2016): Coupled nonclassical systems for coherent backaction noise cancellation. Supervisor: Michèle Heurs

Christof Witte (Humboldt University, 2014): Gravity actions from matter actions. Supervisor: Frederic Schuller

Holger Wittel (Leibniz Universität Hannover, 2015): Active and passive reduction of high order modes in the gravitational wave detector GEO600. Supervisor: Harmut Grote



## Master Theses

Germán Fernández Barranco (Leibniz Universität Hannover, 2013): Development of Ultra-Low Noise High-Bandwidth Photoreceivers. Supervisor: Gerhard Heinzel

Jan Gniesmer (Leibniz Universität Hannover, 2014): Verteilung nicht-klassischer Zustände des Lichts über eine Glasfaser von 1 km Länge. Supervisor: Roman Schnabel

Alexander Görth (Leibniz Universität Hannover, 2013): Development of a Fiber-based Intersatellite Laser Link Simulator for GRACE Follow-On. Supervisor: Gerhard Heinzel

Jan-Simon Hennig (Leibniz Universität Hannover, 2013): Mitigation of Stray Light Effects in the LISA Backlink. Supervisor: Gerhard Heinzel

Clemens Hübner-Worseck (Free University Berlin, 2014): Dynamics near Spacelike Singularities: Cosmological Billiards. Supervisor: Jean-Luc Lehnert

Katharina-Sophie Isleif (Leibniz Universität Hannover, 2013): Investigation of Noise Sources in Digital Interferometry. Supervisor: Gerhard Heinzel

Jonas Junker (Leibniz Universität Hannover, 2016): Laser Power Stabilization for the AEI 10m Prototype. Supervisor: Benno Willke

Esther Kähler (Free University Berlin, 2014): On the dynamics of cyclic universes. Freie Universität. Supervisor: Jean-Luc Lehnert

Robin Kirchhoff (Leibniz Universität Hannover, 2016): Verbesserung der aktiven Seismikisolation für die seismische Isolationsplattform AEI-SAS. Supervisor: Harald Lück

Tim Kittel (Humboldt University, 2014): The Hilbert Spaces of Loop Quantum Gravity and Group Field Theory: A Comparison. Supervisor: Daniele Oriti

Lisa Kleybolte (Leibniz Universität Hannover, 2013): Eine doppelresonante Quetschlichtquelle für optomechanische Experimente bei 1550 nm. Supervisor: Roman Schnabel

Philip Koch: Continuous noise projection of the AEI 10m prototype's reference cavity. Supervisor: Harald Lück

Johannes Lehmann (Leibniz Universität Hannover, 2016): Charakterisierung und Optimierung der Aktuatoren des Single Arm Tests und dessen Installation im AEI 10m-Prototypen. Supervisor: Harald Lück

Enno Mallwitz (Humboldt University, 2013): Non-Gaussianities from Inflationary Models in Preparation for Planck Measurements. Supervisor: Jean-Luc Lehnert

Pablo Marin Jimenez (Leibniz Universität Hannover, 2013): Development of a wide-bandwidth laser frequency noise measurement system. Supervisor: Gerhard Heinzel

Neda Meshksar (Leibniz Universität Hannover, 2015): Optical Simulations for laser interferometry considering polarisation effects. Supervisor: Gerhard Heinzel

Ramon Moghadas Nia (Leibniz Universität Hannover, 2013): Kryogene Laserinterferometrie mit einer SiN-Membran. Supervisor: Roman Schnabel

Vitali Müller (Leibniz Universität Hannover, 2013): Simulations for LISA & GRACE Follow-On: Satellite constellations at Lagrange points for LISA-like missions, Interferometer simulations for the GRACE Follow-On mission. Supervisor: Gerhard Heinzel

Lars Nieder (Leibniz Universität Hannover, 2015): Method Development and Search for an Unknown Gamma-Ray Pulsar in an Eccentric Binary Orbit. Supervisor: Holger Pletsch

Andreas Noack (Leibniz Universität Hannover, 2016): Investigation on a Laser Beam in the Spatial LG<sub>33</sub> Mode. Supervisor: Benno Willke

Amrit Pal-Singh (Leibniz Universität Hannover, 2013): Aufbau eines gefalteten Wanderwellenresonators zur Beobachtung des kaskadierten Kerr-Effekts bei 1550 nm. Supervisor: Roman Schnabel

Dennis Schmelzer (Leibniz Universität Hannover, 2015): Thermally compensated fiber injectors for the three-backlink and hexagon experiments. Supervisor: Gerhard Heinzel

Axel Schönbeck (Leibniz Universität Hannover, 2014): Hochkonversion von einzelnen Photonen im nichtklassischen Regime. Supervisor: Roman Schnabel

Andreas Schreiber (Leibniz Universität Hannover, 2013): Time Delay Interferometry Simulations for Space-Based Gravitational Wave Detectors. Supervisor: Gerhard Heinzel

Bernd Schulte (Leibniz Universität Hannover, 2015): Untersuchungen an mechanischen Aufhängungen und interferometrischen Topologien für zukünftige Gravitationswellendetektoren. Supervisor: Harald Lück

Sönke Schuster (Leibniz Universität Hannover, 2013): Investigation of the coupling between beam tilt and longitudinal pathlength signal in laser interferometers. Supervisor: Gerhard Heinzel

Thomas Sören Schwarze (Leibniz Universität Hannover, 2013): FPGA-based modulation signal synthesis and measurement system for high precision laser interferometry. Supervisor: Gerhard Heinzel

Daniel Steinmeyer (Leibniz Universität Hannover, 2014): Towards Coherent Quantum Noise Cancellation. Supervisor: Michèle Heurs

Markus Strehlau (University of Cologne, 2015): Bartnik conjecture in axisymmetry. Supervisor: Oliver Rinne

Lukas Weymann (Leibniz Universität Hannover, 2016): Long-Term Gamma-Ray Timing of an Extreme Black Widow Binary Pulsar. Supervisor: Holger Pletsch

Andreas Wittchen (Leibniz Universität Hannover, 2013): Noise Investigation on the LISA Pathfinder Optical Bench Ground Setup. Supervisor: Gerhard Heinzel

Petrisa Zell (Leibniz Universität Hannover, 2014): Verschränkung zwischen sichtbarem und nah-infrarotem Licht durch Frequenzhochkonversion. Supervisor: Roman Schnabel

Max Zwetz (Leibniz Universität Hannover, 2016): Non-Gaussian laser beams for the test of the LISA optical bench. Supervisor: Gerhard Heinzel

### **Bachelor Theses**

Lea Bischof (Leibniz Universität Hannover, 2015): Aufbau und Charakterisierung der Laservorbereitung für das 3-Backlink Experiment. Supervisor: Gerhard Heinzel

Felix Bosco (Leibniz Universität Hannover, 2014): Quantitative Charakterisierung und Entkopplung der Bewegungsfreiheitsgrade aufgehängter Testmassen für die Gravitationswellen-Detektion. Supervisor: Michèle Heurs

Daniel Edler (Leibniz Universität Hannover, 2014): Measurement and Modelling of USO Clock Noise in space based applications. Supervisor: Gerhard Heinzel

Felix Frost (Leibniz Universität Hannover, 2014): Vergleichende Untersuchungen an hochfrequenten Homodyndetektoren für die Präzisionsmetrologie. Supervisor: Michèle Heurs

Pia Grupe (Leibniz Universität Hannover, 2015): Statistical Tests for Weak Pulsar Signals in Fermi Gamma-ray Space Telescope Data, Bachelorarbeit. Supervisor: Holger Pletsch

Björn Erik Haase (Leibniz Universität Hannover, 2014): Characterisation and development of stable fibre couplers. Supervisor: Gerhard Heinzel

Elisabeth von Känel (Leibniz Universität Hannover, 2016): Aufbau und Charakterisierung einer fasergekoppelten Frequenzverdopplung bei einer Wellenlänge von 1064 nm. Supervisor: Benno Willke

Robin Kirchhoff (Leibniz Universität Hannover, 2014): Aufbau und Test der Seismischen Isolationsplattform (AEI-SAS). Supervisor: Harald Lück

Philip Koch (Leibniz Universität Hannover, 2014): Kartographierung von Transmission und Reflektion optischer Oberflächen. Supervisor: Harald Lück

Jan Koob (Leibniz Universität Hannover, 2015): Strahl- und Komponentencharakterisierung mittels Intensitätsaufnahmen. Supervisor: Gerhard Heinzel

Johannes Lehmann (Leibniz Universität Hannover, 2014): Aufbau und Test der Dreifach-Aufhängungen für das SQL Interferometer am AEI. Supervisor: Harald Lück

Sebastian Paschel (Leibniz Universität Hannover, 2014): Messung der optischen Absorption und des thermo-optischen Koeffizienten von Saphir. Supervisor: Roman Schnabel

Sebastian Schreiber (Leibniz Universität Hannover, 2014): Implementation and characterization of an acquisition sensor for LISA. Supervisor: Gerhard Heinzel

Morten Steinecke (Leibniz Universität Hannover, 2014): Entwurf und Aufbau eines monolithischen Michelson-Sagnac-Interferometers. Supervisor: Roman Schnabel

Fabian Thies (Leibniz Universität Hannover, 2014): Leistungsstabilisierung eines Faserlasers. Supervisor: Benno Willke

Michael Weber (Leibniz Universität Hannover, 2015): Entwicklung einer Hochpräzisions-Klebertechnik zur Anwendung in optischen Experimenten. Supervisor: Gerhard Heinzel

Hendrik Weißbrich: Charakterisierung von Photodioden für effiziente Homodyndetektion bei 532 nm. Supervisor: Roman Schnabel

Michael Winter (Leibniz Universität Hannover, 2014): Zusammenbau und Test der Sensoren für die Seismische Isolationsplattform des AEI 10m-Prototypen (AEI-SAS). Supervisor: Harald Lück

Max Zwetz: (Leibniz Universität Hannover, 2014): Setup and characterization of a measurement system for the LISA OB. Supervisor: Gerhard Heinzel

### **Diploma Theses**

Daniel Penkert (Leibniz Universität Hannover, 2016): Hexagon - An optical three-signal testbed for the LISA metrology chain. Supervisor: Gerhard Heinzel

## The Scientific Advisory Board of the AEI

The Scientific Advisory Board is the Institute's scientific advisory and assessment Board, made up of internationally renowned physicists. The Board advises the President of the Max Planck Society (MPG) on how effectively the Directors are managing the work of the Institute. Their advice helps the Directors to establish priorities and improve their management. The Board is the main tool used by the MPG to evaluate its research institutes to ensure appropriate and effective development of funds. Every three years the members of the Board meet for several days to evaluate the Institute and to prepare a report to the President of the MPG.

### Current members of the Scientific Advisory Board are:

Prof. Dr. Luis Alvarez-Gaumé  
CERN, Geneva, Switzerland

Prof. Dr. Markus Aspelmeyer  
Quantum Optics, Quantum Nanophysics and Quantum Information,  
University of Vienna, Austria

Prof. Dr. Barry Barish  
California Institute of Technology, Pasadena, USA

Prof. Dr. Beverly K. Berger (Chair)  
Livermore, USA

Prof. Dr. Wilfried Buchmüller  
DESY, Hamburg, Germany

Prof. Dr. Piotr Chruściel  
Gravitational Physics, University of Vienna, Austria

Prof. Dr. Thibault Damour  
Institut des Hautes Études Scientifiques, Bures-sur-Yvette, France

Prof. Dr. Eanna E. Flanagan  
Space Sciences, CRSR, Cornell University, Ithaca, USA

Prof. Dr. Marc Henneaux  
Faculté des Sciences, Université Libre de Bruxelles, Belgium

Prof. Dr. Craig Hogan  
Department of Astronomy and Astrophysics, University of Chicago, USA

Prof. Dr. Vassiliki Kalogera  
Dearborn Observatory, Northwestern University, Evanston, USA

Prof. Dr. Frans Pretorius  
Department of Physics, Princeton University, Princeton, USA

## Members of our Board of Trustees (as of March 2017)

The Board of Trustees is primarily intended to inspire confidence and create good relations between the Institute and the public. After all, a scientific organisation is dependent on the public interest in the opportunities offered by research and even on the public's willingness to bear the burden of research.

Members of our Board of Trustees are representatives of politics, the media, business and of science and research:

Prof. Dr. iur. Volker Epping  
Leibniz Universität Hannover, President

Andrea Hoops  
Secretary of State in Lower Saxony

Prof. Dr. Dr. h.c. Reinhard F. J. Hüttl  
GeoForschungsZentrum Potsdam  
Spokesman of the executive board

Michel Junge  
phæno GmbH, Managing director

Dr. Wilhelm Krull  
Volkswagen Foundation, Secretary General

Prof. Dr.-Ing. Dr. Sabine Kunst  
Humboldt-Universität Berlin, President

Prof. Dr. Gerd Litfin  
Arkadien Verwaltungs KG, Managing partner

Dr. Martina Münch  
Brandenburg Minister of Science, Research and Culture

Dr. Ulf von Rauchhaupt  
Frankfurter Allgemeine Sonntagszeitung Science editor

Prof. Dr. Robert Seckler  
University of Potsdam, Vice president for research and young academics

Prof. Dr. Klaus G. Strassmeier  
Astrophysical Institute Potsdam (AIP)

## Scientists and Support Staff (Potsdam & Hannover) at the AEI and the Leibniz Universität Hannover – based on 1st June 2013

### Directors

Prof. Dr. Bruce Allen	Observational Relativity and Cosmology
Prof. Dr. Alessandra Buonanno	Astrophysical and Cosmological Relativity
Prof. Dr. Karsten Danzmann	Laser Interferometry and Gravitational Wave Astronomy
Prof. Dr. Dr. h.c. Hermann Nicolai	Quantum Gravity and Unified Theories

### Director Emeritus

Prof. Dr. Dr. h.c. Bernard F. Schutz

### External Scientific Members

Prof. Dr. Robert Bartnik	Monash University
Prof. Dr. Dr. h.c. Lars Brink	University of Göteborg
Prof. Dr. Gerhard Huisken	Universität Tübingen & Mathematisches Forschungsinstitut Oberwolfach
Prof. Dr. Dieter Lüst	Max-Planck-Institut für Physik
Prof. Dr. Kenneth Strain	University of Glasgow

### Leaders of Independent Research Groups

Dr. Michal P. Heller	Gravity, Quantum Fields and Information (funded by the Humboldt Foundation)
Dr. Jean-Luc Lehners	Theoretical Cosmology (funded by the Max Planck Society)
Prof. Dr. Ulrich Menne	Geometric Measure Theory (in cooperation with the University of Potsdam; funded by the Max Planck Society)
Dr. Maria Rodriguez	Gravitation and Black Hole Theory (funded by the Max Planck Society)

### Senior Scientists

Dr. Pau Amaro Seoane (AEI Potsdam)  
Prof. Dr. Lars Andersson (AEI Potsdam)  
Dr. Stanislav Babak (AEI Potsdam)  
Dr. Thomas Dent (AEI Hannover: MPG)  
Prof. Dr. Helmut Friedrich (AEI Potsdam)  
Dr. Hartmut Grote (AEI Hannover: MPG)  
Prof. Dr. Klemens Hammerer (AEI Hannover: LUH)  
Apl. Prof. Dr. Gerhard Heinzl (AEI Hannover: MPG)  
Apl. Prof. Dr. Michèle Heurs (AEI Hannover: LUH)  
Dr. Martin Hewitson (AEI Hannover: LUH)  
Dr. Axel Kleinschmidt (AEI Potsdam)  
Dr. Badri Krishnan (AEI Hannover: MPG)  
Dr. Harald Lück (AEI Hannover: LUH)  
Dr. Alex Nielsen (AEI Hannover: MPG)  
Dr. Frank Ohme (AEI Hannover: MPG)  
Dr. Daniele Oriti (AEI Potsdam)  
Dr. Maria Alessandra Papa (AEI Hannover: MPG)  
Dr. Reinhard Prix (AEI Hannover: MPG)  
Dr. Michael Pürrer (AEI Potsdam)  
Albrecht Rüdiger (AEI Hannover: MPG)  
Dr. Francesco Salemi (AEI Hannover: MPG)  
Prof. Dr. Stefan Theisen (AEI Potsdam)  
Dr. Oscar Varela (AEI Potsdam)  
Apl. Prof. Dr. Benno Willke (AEI Hannover: LUH)  
Dr. Walter Winkler (AEI Hannover: MPG)

## Scientists and Support Staff (Potsdam & Hannover) at the AEI and the Leibniz Universität Hannover – based on 1st June 2013

### Junior Scientists and Postdocs

Dr. Christoph Affeldt (AEI Hannover: MPG)  
Dr. Steffen Aksteiner (AEI Potsdam)  
Dr. David Andriot (AEI Potsdam)  
Dr. Gregory Ashton (AEI Hannover: MPG)  
Dr. Stefan Ast (AEI Hannover: MPG)  
Dr. Heather Audley (AEI Hannover: MPG)  
Dr. Stefano Bianco (AEI Potsdam)  
Dr. Ofek Birnholtz (AEI Hannover: MPG)  
Dr. Alejandro Bohé (AEI Potsdam)  
Dr. Michael Born (AEI Hannover: MPG)  
Dr. Richard Brito (AEI Potsdam)  
Dr. Dmitri Bykov (AEI Potsdam)  
Dr. Iouri Bykov (AEI Hannover: MPG)  
Dr. Collin Capano (AEI Hannover: MPG)  
Dr. Goffredo Chirco (AEI Potsdam)  
Dr. David Chow (AEI Potsdam)  
Dr. Colin Clark (AEI Hannover: MPG)  
Dr. Neda Darbeheshti (AEI Hannover: LUH)  
Dr. Timo Denker (AEI Hannover: MPG)  
Dr. Tim Dietrich (AEI Potsdam)  
Dr. Marco Drago (AEI Hannover: MPG)  
Dr. Juan Jose Esteban Delgado (AEI Hannover: LUH)  
Dr. Yangqin Fang (AEI Potsdam)  
Dr. Shane Farnsworth (AEI Potsdam)  
Dr. Ilmar Gahramanov (AEI Potsdam)  
Dr. Hadi Godazgar (AEI Potsdam)  
Dr. Vitus Händchen (AEI Hannover: LUH)  
Dr. Ian Harry (AEI Potsdam)  
Dr. Abraham Harte (AEI Potsdam)  
Dr. Song He (AEI Potsdam)  
Dr. Ian Hinder (AEI Potsdam)  
Dr. Tanja Hinderer (AEI Potsdam)  
Dr. Nikolaos Karnesis (AEI Hannover: LUH)  
Dr. Kai Karvinen (AEI Hannover: MPG)  
Dr. Fumiko Kawazoe (AEI Hannover: LUH)  
Dr. Pan Kessel (AEI Potsdam)  
Dr. Sebastian Khan (AEI Hannover: MPG)  
Dr. Jegors Korovins (AEI Potsdam)  
Dr. Natalia Korsakova (AEI Hannover: MPG)  
Dr. Benjamin Lackey (AEI Potsdam)  
Dr. Ananda Lahiri (AEI Potsdam)  
Dr. Adrian Lewandowski (AEI Potsdam)  
Dr. James Lough (AEI Hannover: MPG)  
Dr. Gustavo Lucena Gomez (AEI Potsdam)  
Dr. Andrew Lundgren (AEI Hannover: MPG)  
Dr. Christoph Mahrtdt (AEI Hannover: MPG)  
Dr. Maciej Maliborski (AEI Potsdam)  
Dr. Sylvain Marsat (AEI Potsdam)  
Dr. Grant David Meadors (AEI Hannover: MPG)  
Dr. Moritz Mehmet (AEI Hannover: MPG)  
Dr. Karapet Mkrtchyan (AEI Potsdam)  
Dr. Matin Mojaza (AEI Potsdam)  
Dr. Edvard Musaev (AEI Potsdam)  
Dr. Alexander Nitz (AEI Hannover: MPG)  
Dr. Joseph Novak (AEI Potsdam)  
Dr. Serguei Ossokine (AEI Potsdam)  
Dr. Dine Ousmane Samary (AEI Potsdam)  
Dr. Yi Pang (AEI Potsdam)  
Dr. Mirko Prijatelj (AEI Hannover: LUH)  
Dr. Stephen Privitera (AEI Potsdam)



## Scientists and Support Staff (Potsdam & Hannover) at the AEI and the Leibniz Universität Hannover – based on 1st June 2013

Dr. Rakibur Rahman (AEI Potsdam)  
Dr. Vivien Raymond (AEI Potsdam)  
Dr. Oliver Schlotterer (AEI Potsdam)  
Dr. Dirk Schütte (AEI Hannover: MPG)  
Dr. Daniel Schütze (AEI Hannover: MPG)  
Dr. Lijing Shao (AEI Potsdam)  
Dr. Jan Steinhoff (AEI Potsdam)  
Dr. Andrea Taracchini (AEI Potsdam)  
Dr. Michael Tröbs (AEI Hannover: MPG)  
Dr. Cédric E.P. Troessaert (AEI Potsdam)  
Dr. Henning Vahlbruch (AEI Hannover: LUH)  
Dr. Justin Vines (AEI Potsdam)  
Dr. Qinglan Wang (AEI Hannover: LUH)  
Dr. Zhi Wang (AEI Hannover: LUH)  
Dr. Gudrun Wanner (AEI Hannover: MPG)  
Dr. Li-Wei Wei (AEI Hannover: LUH)  
Dr. Karl Wette (AEI Hannover: MPG)  
Dr. Edward Wilson-Ewing (AEI Potsdam)  
Dr. Maximilian Wimmer (AEI Hannover: MPG)  
Dr. Holger Wittel (AEI Hannover: LUH)  
Dr. David Wu (AEI Hannover: MPG)  
Dr. Emil Zeuthen (AEI Hannover: LUH)  
Dr. Mingyi Zhang (AEI Potsdam)  
Dr. Sylvia Zhu (AEI Hannover: MPG)  
Dr. Hashem Zoubi (AEI Hannover: LUH)

## Scientific Software Developers and Scientific Cluster Administrators

Dr. Carsten Aulbert (AEI Hannover: MPG)  
Christian Beer (AEI Hannover: MPG)  
Oliver Bock (AEI Hannover: MPG)  
Heinz-Bernd Eggenstein (AEI Hannover: MPG)  
Dr. Henning Fehrmann (AEI Hannover: MPG)  
Dr. Steffen Grunewald (AEI Potsdam)  
Bernd Machenschalk (AEI Hannover: MPG)  
Alexander Post (AEI Hannover: MPG)  
Karsten Wiesner (AEI Hannover: MPG)

## PhD Students

Vaishali Adya (AEI Hannover: LUH)  
Olof Ahlen (AEI Potsdam)  
Melanie Ast (AEI Hannover: LUH)  
Aparna Bisht (AEI Hannover: MPG)  
Sebastian Bramberger (AEI Potsdam)  
Nils Brause (AEI Hannover: MPG)  
Miriam Cabero Müller (AEI Hannover: MPG)  
Ondrej Cernotik (AEI Hannover: LUH)  
Roberto Cotesta (AEI Potsdam)  
Christoph Dreißigacker (AEI Hannover: MPG)  
Germán Fernández Barranco (AEI Hannover: MPG)  
Marco Finocchiaro (AEI Potsdam)  
Jan Erik Gerken (AEI Potsdam)  
Jan Gniesmer (AEI Hannover: LUH)  
Alexander Görth (AEI Hannover: MPG)  
Manuela Hanke (AEI Hannover: MPG)  
Olaf Hartwig (AEI Hannover: MPG)  
Nathaniel Indik (AEI Hannover: MPG)  
Katharina-Sophie Isleif (AEI Hannover: LUH)  
Jonas Junker (AEI Hannover: MPG)  
Kanioar Karan (AEI Hannover: LUH)

## Scientists and Support Staff (Potsdam & Hannover) at the AEI and the Leibniz Universität Hannover – based on 1st June 2013

Steffen Kaufer (AEI Hannover: MPG)  
Brigitte Kaune (AEI Hannover: MPG)  
Alexander Kegeles (AEI Potsdam)  
Robin Kirchhoff (AEI Hannover: MPG)  
Philip Koch (AEI Hannover: MPG)  
Sina Köhlenbeck (AEI Hannover: MPG)  
Isha Kotecha (AEI Potsdam)  
Olaf Krüger (AEI Potsdam)  
Jonas Lammers (AEI Hannover: LUH)  
Seungjin Lee (AEI Potsdam)  
Yongho Lee (AEI Hannover: LUH)  
Johannes Lehmann (AEI Hannover: MPG)  
Mayke Lieser (AEI Hannover: MPG)  
Siyuan Ma (AEI Potsdam)  
Enno Mallwitz (AEI Potsdam)  
Cristián Maureira Fredes (AEI Potsdam)  
Neda Meshksar (AEI Hannover: LUH)  
Jing Ming (AEI Hannover: MPG)  
Ramon Moghadas Nia (AEI Hannover: LUH)  
Vitali Müller (AEI Hannover: MPG)  
Lars Nieder (AEI Hannover: MPG)  
Patrick Oppermann (AEI Hannover: MPG)  
Sarah Paczkowski (AEI Hannover: MPG)  
Claudio Paganini (AEI Potsdam)  
Daniel Penkert (AEI Hannover: MPG)  
David Prinz (AEI Potsdam)  
Julyan Purkart (AEI Potsdam)  
Alexander Roth (AEI Hannover: LUH)  
Mario Santilli (AEI Potsdam)  
Sourav Sarkar (AEI Potsdam)  
Andreas Sawadsky (AEI Hannover: LUH)  
Christian Scharrer (AEI Potsdam)  
Christian Schell (AEI Potsdam)  
Dennis Schmelzer (AEI Hannover: LUH)  
Emil Schreiber (AEI Hannover: MPG)  
Bernd Schulte (AEI Hannover: MPG)  
Marius Schulte (AEI Hannover: LUH)  
Sönke Schuster (AEI Hannover: LUH)  
Thomas Schwarze (AEI Hannover: LUH)  
Noah Sennett (AEI Potsdam)  
Avneet Singh (AEI Hannover: MPG)  
Gunnar Stede (AEI Hannover: MPG)  
Daniel Steinmeyer (AEI Hannover: LUH)  
Fabian Thies (AEI Hannover: MPG)  
Marina Trad Nery (AEI Hannover: MPG)  
Henry Wegener (AEI Hannover: LUH)  
Julyan Westerweck (AEI Hannover: MPG)  
Andreas Wittchen (AEI Hannover: MPG)  
Janis Wöhler (AEI Hannover: MPG)

### Diploma, Bachelor and Master Students

Lea Bischof (AEI Hannover: LUH)  
Nina Bode (AEI Hannover: LUH)  
Gregor Efstratiadis (AEI Hannover: LUH)  
Florian Gerhardt (AEI Potsdam)  
Franz Harke (AEI Hannover: LUH)  
Lisa Kakuschke (AEI Hannover: LUH)  
Stephan Plakity (AEI Hannover: LUH)  
Stefanie Rathe (AEI Hannover: LUH)  
Stina Scheer (AEI Hannover: LUH)

## Scientists and Support Staff (Potsdam & Hannover) at the AEI and the Leibniz Universität Hannover – based on 1st June 2013

Sebastian Schreiber (AEI Hannover: LUH)  
Dennis Schröter (AEI Hannover: LUH)  
Kevin Thieme (AEI Potsdam)  
Christoph Vorndamme (AEI Hannover: LUH)  
Hendrik Weißbrich (AEI Hannover: LUH)  
Michael Winter (AEI Hannover: LUH)  
Lennart Wissel (AEI Hannover: LUH)

### Support Staff

Dr. Peter Aufmuth  
Almuth Barta  
Stefan Bertram  
Simone Beßer-Rausseck  
Marc Brinkmann  
Sandra Bruns  
Ankhi Bhanja Choudhury  
Sebastian Conrady  
Yasmina Darwish  
Rajib Das  
Jan Diedrich  
Marian Dürbeck  
Claus Ebert  
Mara Elste  
Jana Foerste  
Udo Friedrich  
Nicolai Fromm  
Marco Gajardo  
Birgit Gemmeke  
Christian Gößl  
Walter Graß  
Franz Haase  
Melanie Hase  
Klaus-Dieter Haupt  
Stefan Heinich  
Joscha Heinze  
Hans-Jörg Hochecker  
Susanne Holldorf  
Firoz Kabir  
Christian Kanthack  
Hossein Fazeli Khalili  
Dr. Benjamin Knispel  
Alexander Koholka  
Philipp Kormann  
Volker Krügel  
Stefan Krüger  
Heidi Kruppa  
Dr. Gerrit Kühn  
Kirsten Labove  
Marion Laurisch  
Anja Lehmann  
Valentina Levanevskaja  
Oksana Levkivska  
Birger Lüers  
Bianca Lutschick  
Richard Mann  
Michael Meier  
Hans-Joachim Melching  
Gabriele Mensing  
Konrad Mors  
Dr. Kasem Mossavi  
Public Relations Assistant (AEI Hannover: MPG)  
Database Administrator (AEI Potsdam)  
Precision Mechanic (AEI Hannover: LUH)  
Human Resources Administrator (AEI Potsdam)  
Operator GEO600 (AEI Hannover: MPG)  
Coordinator IMPRS (AEI Hannover: MPG)  
Student Assistant (AEI Hannover: MPG)  
Student Assistant (AEI Hannover: MPG)  
International Office Assistant (AEI Potsdam)  
Student Assistant (AEI Hannover: MPG)  
Precision Mechanic (AEI Hannover: LUH)  
Student Assistant (AEI Hannover: LUH)  
System Administrator (AEI Hannover: MPG)  
Human Resources Administrator (AEI Potsdam)  
Assistant to the Head of Administration (AEI Potsdam)  
Facility Manager (AEI Hannover: LUH)  
Trainee (AEI Hannover: LUH)  
Web Developer (AEI Potsdam)  
Secretary (AEI Hannover: LUH)  
Student Assistant (AEI Potsdam)  
Technician (AEI Hannover: MPG)  
System Administrator (AEI Potsdam)  
Assistant (AEI Potsdam)  
Facility Manager (AEI Hannover: MPG)  
Web Developer (AEI Potsdam)  
Student Assistant (AEI Hannover: MPG)  
Electronic Technician (AEI Hannover: LUH)  
Human Resources Administrator (AEI Potsdam)  
Student Assistant (AEI Hannover: MPG)  
Accountant (AEI Potsdam)  
Student Assistant (AEI Hannover: MPG)  
Public Relations Officer (AEI Hannover: MPG)  
System Administrator (AEI Potsdam)  
Electronic Technician (AEI Hannover: MPG)  
Operator GEO600 (AEI Hannover: MPG)  
System Administrator (AEI Potsdam)  
Head of Procurement (AEI Hannover: MPG)  
System Administrator (AEI Hannover: MPG)  
Secretary (AEI Hannover: LUH)  
Student Assistant (AEI Potsdam)  
Librarian (AEI Potsdam)  
Cleaning Person (AEI Hannover: LUH)  
International Office Assistant (AEI Hannover: MPG)  
Student Assistant (AEI Hannover: MPG)  
Procurement Administrator (AEI Potsdam)  
Assistant to the Managing Director (AEI Hannover: MPG)  
Cleaning Person (AEI Hannover: LUH)  
Precision Mechanic (AEI Hannover: LUH)  
Third-Party Funds Manager (AEI Hannover: MPG)  
System Administrator (AEI Hannover: MPG)  
Coordinator (AEI Hannover: LUH)

## Scientists and Support Staff (Potsdam & Hannover) at the AEI and the Leibniz Universität Hannover – based on 1st June 2013

Dr. Elke Müller	Scientific Coordinator (AEI Potsdam)
Karina Müller	Accountant (AEI Potsdam)
Constance Münchow	Third Party Liaison Officer (AEI Potsdam)
Jens Noack	Procurement Administrator (AEI Potsdam)
Christina Pappa	Cleaning Person (AEI Potsdam)
Michaela Pickenpack	Technician (AEI Hannover: LUH)
Dr. Markus Pössel	Adjunct Public Outreach Scientist (AEI Potsdam)
Susann Purschke	General Services Manager (AEI Potsdam)
Anika Rast	Administrative Assistant (AEI Potsdam)
Sabine Rehmert	Administrative Assistant (AEI Hannover: LUH)
Dr. Jens Reiche	LISA Pathfinder Project Manager (AEI Hannover: MPG)
Sven Renas	Student Assistant (AEI Hannover: MPG)
Christiane Roos	Head of Administration (AEI Potsdam)
Dr. Michael Rose	Head of IT Department (AEI Potsdam)
Victoria Rossak	Human Resources Administrator (AEI Potsdam)
Karin Salatti-Tara	Secretary (AEI Hannover: MPG)
Jan Scharein	Web Developer (AEI Potsdam)
Philipp Schauzu	Precision Mechanic (AEI Hannover: LUH)
Dr. André Schirotzek	Scientific Assistant (AEI Potsdam)
Anna Schlegel	Cleaning Person (AEI Hannover: LUH)
Elisabeth Schlenk	Head of the Library (AEI Potsdam)
Matthias Schlenk	Lecture Assistant (AEI Hannover: LUH)
Ute Schlichting	Secretary (AEI Potsdam)
Manuela Schneehufer	Human Resources Manager (AEI Potsdam)
Axel Schnitger	Research Engineer (AEI Hannover: LUH)
Mayk Schwarz	Facility Manager (AEI Hannover: LUH)
Britta Sokol	Human Resources Administrator (AEI Potsdam)
Beatrice Sonntag	Assistant to the Head of Administration (AEI Potsdam)
Dr. Thomas Theeg	Research Engineer (AEI Hannover: LUH)
Andreas Weidner	Electronic Technician (AEI Hannover: MPG)
Britta Weihmann	Assistant (AEI Potsdam)
Michael Weinert	Operator GEO600 (AEI Hannover: MPG)
Ramona Wittwer	Accounting Manager (AEI Potsdam)
Heiko zur Mühlen	Electronic Technician (AEI Hannover: MPG)

MPG: Max-Planck-Gesellschaft

LUH: Leibniz Universität Hannover

## Guest Scientists in Potsdam-Golm and Hannover

### Guest Scientists in Potsdam-Golm (2013)

Abdujabbarov, Ahmadjon – Uzbekistan Academy of Sciences  
Abou Zeid, Mohab – Universität Hannover  
Aganagic, Mina – University of California, Berkeley  
Ahlen, Olof – CERN, Geneva  
Ahmedov, Bobomurat – Uzbekistan Academy of Sciences  
Akhmedov, Emil – ITEP, Moscow  
Aksteiner, Steffen – University Bremen  
Ananth, Sudarshan – IISER, Pune  
Andriot, David – Universität München  
Ansong, Marcus – Helmholtz Zentrum, München  
Aranguiz, Ligeia – Technical University Santa Maria, Valparaiso  
Arcones, Almudena – TU Darmstadt  
Aschieri, Paolo – INFN, Alessandria, Italy  
Assmann, Paulina – Universidad de Chile  
Ast, Stefan – AEI Hannover  
Astefanesei, Dumitru – Universidad Catolica de Valparaiso, Chile  
Atamurotov, Farruh – Uzbekistan Academy of Sciences

Benjamin Bahr – Universität Hamburg  
Baiotti, Luca – Osaka University  
Banados, Maximo – University of Santiago, Chile  
Baratin, Aristide – Perimeter Institute, Waterloo  
Basu, Rudranil – IISER Pune  
Behr, Nicolas – University of Edinburgh  
Bellova, Katarína – Courant Institute, New York, University  
Bernard, Yann – Universität Freiburg  
Berry, Michael – University of Bristol  
Beyer, Florian – University of Otago, New Zealand  
Bianco, Stefano – University of Rome  
Bicák, Jiri – Charles University, Prague  
Biernat, Pawel – Universität Bonn  
Bishop, Nigel – Rhodes University, South Africa  
Blue, Pieter – University of Edinburgh  
Bögelein, Verena – Universität Erlangen  
Bojowald, Martin – Pennsylvania State University  
Boulanger, Nicolas – University of Mons  
Bouso, Raphael – University of California, Berkeley  
Brahma, Suddhasattwa – Pennsylvania State University  
Bunster, Claudio – CECS, Chile  
Buonanno, Alessandra – University of Maryland

Cadoni, Mariano – University of Cagliari  
Campoleoni, Andrea – University of Brussels  
Canto, Rodrigo – Catholic University of Chile  
Carrozza, Sylvain – University of Marseille  
Ceccobello, Chiara – University of Ferrara  
Cederbaum, Carla – Universität Tübingen  
Chen, Yanbei – California Institute of Technology  
Chiodaroli, Marco – University of Pennsylvania  
Chirenti, Cecilia – University of Sao Paulo  
Chrusciel, Piotr – Vienna University  
Cuadra, Jorge – Pontificia Universidad Catolica de Chile

Dain, Sergio – University of Cordoba, Argentina  
Dall'Agata, Gianguido – University of Padova  
De Pietri, Roberto – Parma University  
Devchand, Chand – Universität Potsdam  
Dionysopoulou, Kyriaki – University of Southampton  
Dittrich, Bianca – Perimeter Institute  
Dold, Dominic – University of Cambridge  
Dorigoni, Daniele – University of Cambridge  
Drummond, James – CERN, Geneva

Erlemann, Martina – Free University Berlin  
Espin, Johnny – Ecole Federale Polytechnique, Lausanne  
Evans, Charles – University of North Carolina Chapel Hill

Faddeev, Ludwig – Steklov Institute of Mathematics  
Feingold, Alex – State University of New York at Binghamton  
Feuvrier, Vincent – Toulouse University  
Fleischhack, Christian – Universität Paderborn  
Florakis, Ioannis – Max-Planck-Institut für Physik München  
Font, Anamaria – UCV, Caracas  
Franci, Luca – Parma University  
Frauendiener, Jörg – University of Otago, New Zealand  
Freitag, Marc – Cambridge University  
Futamase, Toshifumi – Tohoku University Sendai

Gahramanov, Ilmar – Humboldt Universität  
Gair, Jonathan – University of Cambridge, UK  
Garfinkle, David – Oakland University  
Germani, Cristiano – Ludwig Maximilian University of Munich  
Gerosa, Davide – Cambridge University  
Ghanem, Sari – Inst. of Math. Jussieu  
Ghosh, Suman – IISER, Trivandrum  
Ghosh, Amit – Saha Institute of Nuclear Physics  
Gielen, Steffen – Imperial College, London  
Glaser, Lisa – Niels Bohr Institute, Copenhagen  
Godazgar, Hadi – DAMTP, Cambridge  
Godazgar, Mahdi – DAMTP, Cambridge  
Gomes, Henrique – UC Davis  
Gomez, Arturo – Catholic University of Valparaiso, Chile  
Gopakumar, Achamveedu – Tata Institute of Fundamental Research Mumbai  
Govindarajan, Thupil Rangachari – The Institute of Mathematical Science, Chennai  
Gregoris, Daniele – Stockholm University  
Gusev, Yuri – IRMACS, Canada

Hadar, Shahar – Racah Institute of Physics Jerusalem  
Halmagyi, Nick – LPTHE, Paris  
Hamber, Herbert – University of California, Irvine  
Han, Muxin – CPT, Marseille  
Hartong, Jelle – Niels Bohr Institute, Copenhagen  
Hellmann, Frank – University of Nottingham  
Henneaux, Marc – University of Brussels

## Guest Scientists in Potsdam-Golm (2013)

Hilditch, David – Universität Jena  
Hirsch, Jonas – University Karlsruhe  
Hnybida, Jeff – Perimeter Institute, Waterloo  
Hohm, Olaf – Massachusetts Institute of Technology  
Höhn, Philipp – Utrecht University  
Hoppe, Jens – Royal Institute of Technology, Stockholm  
Hughes, Spencer T. – University of Cambridge  
Hummel, Quirin – Universität Regensburg

**J**almuzna, Joanna – University of Kraków  
Jezierski, Jacek – Warsaw University  
Jones, Ian – University of Southampton  
Jorjadze, George – A. Razmadze Mathematical Institute, Tbilisi  
Jurco, Brano – Charles University, Prague

**K**aminski, Wojciech – Warsaw University  
Kashani-Poor, Amir-Kian – LPTENS, Paris  
Kaufer, Henning – AEI Hannover  
Khuri, Marcus – State University of New York, Stony Brook  
Kiefer, Claus – Universität Köln  
Kim, Nakwoo – Kyung Hee University, Seoul  
Kittel, Tim – Humboldt Universität  
Kober, Martin – Universität Frankfurt  
Koehl, Ralf – JLU Gießen  
Korovins, Jegors – University of Southampton  
Korsakova, Natalia – AEI Hannover  
Korzynski, Mikolaj – Center for Theoretical Physics of the Polish Academy of Sciences  
Kovacs, Stefano – Trinity College, Dublin  
Krasnov, Kirill – University of Nottingham  
Krishnan, Badri – AEI Hannover  
Krummel, Brian – University of Cambridge

**L**ander, Samuel – Tübingen University  
Lau, Yun Kau – Chinese academy of sciences  
Lavrelashvili, George – A. Razmadze Mathematical Institute, Tbilisi  
Lecian, Orchidea – IHES, Paris  
Lepori, Francesca – University of Trieste  
Lind, Thomas – Queen Mary University of London  
Lucena Gomez, Gustavo – University of Brussels

**M**afra, Carlos – DAMTP, Cambridge  
Mäkinen, Ilkka – University of Jyväskylä  
Magueijo, Joao – Imperial College London  
Majhi, Abhishek – Saha Institute of Nuclear Physics  
Maliborski, Maciej – Jagiellonian University, Krakow  
Manvelyan, Ruben – Yerevan Physics Inst.  
Marini, Antonella – Yeshiva University, New York  
Marquina, Antonio – Universitat de Valencia  
Martin-Benito, Mercedes – Perimeter Institute, Waterloo  
McOrist, Jock – DAMTP, Cambridge  
Meissner, Krzysztof – Warsaw University  
Merbis, Wouter

Mikovic, Aleksandar – Lusophone University of Humanities and Technologies, Lisboa  
Minasian, Ruben – CEA, Saclay  
Mishra, Chandra Kant – Raman Research Institute Bangalore  
Mkrtchyan, Karapet – University of Pisa  
Mkrtchyan, Ruben – Yerevan Physics Inst.  
Moncrief, Vincent – Yale University  
Moraru, Vlad – University of Warwick  
Mösta, Philipp – California Institute of Technology  
Müller, Reto – Imperial College, London

**O**vrut, Burt – University of Pennsylvania  
Oz, Yaron – Tel Aviv University

**P**aetz, Tim-Torben – Universität Wien  
Palmkvist, Jakob – IHES, Bures-sur-Yvette  
Panerai, Rodolfo – Università di Firenze  
Pang, Da-Wei – MPI für Physik, München  
Patil, Subodh – CERN, Geneva  
Perlmutter, Eric – University of Cambridge  
Persson, Daniel – Chalmers University of Technology  
de Philippis, Guido – Hausdorff Center for Mathematics, Bonn  
Pithis, Andreas – Dept. of Physics, Kings College London  
Pizzochero, Pierre – Università degli Studi di Milano  
Plencner, Daniel – LMU München  
Polyakov, Dimitri – Sogang University, Seoul  
Pons, Jose – University of Alicante  
Porayko, Nataliya – MSU Moscow  
Porth, Oliver – University of Leeds

**R**acz, Istvan – Wigner Research Center for Physics Budapest  
Rahman, Rakibur – University of Brussels  
Ramirez, Marcos – Universidad Nacional de Córdoba  
Rampf, Cornelius – RWTH Aachen  
Reffert, Susanne – CERN, Geneva  
Rindler, Filip – University of Cambridge  
Ringström, Hans – Royal Institute of Technology, Stockholm  
Roest, Diederik – Centre for Theoretical Physics, Groningen  
Rollier, Blaise – Universität Bern  
Rosado, Pablo – AEI Hannover  
Rowlett, Julie – MPI für Mathematik

**S**amsonov, Igor – University of Western Australia  
Sathyaprakash, Bangalore – Cardiff University  
Schikorra, Armin – MPI für Mathematik in den Naturwissenschaften  
Schmidt, Bernd – München  
Schmidt, Thomas – Universität Hamburg  
Scholz, Ullika – FU Berlin  
Schwimmer, Adam – Weizmann Institute, Rehovot  
Sedrakian, Armen – Universität Frankfurt am Main  
Sengupta, Sandipan – Raman Research Institute, Bangalore  
Sethi, Savdeep – University of Chicago  
Sivakumar, Muthuswamy – University of Hyderabad

## Guest Scientists in Potsdam-Golm (2013/2014)

Skakala, Jozef – IISER, Trivandrum  
Sopuerta, Carlos – Institute of Space Sciences, Barcelona  
Spadaro, Emanuele – MPI for Mathematics in the Sciences  
Speight, Gareth J. – University of Warwick  
Steinhaus, Sebastian – Perimeter Institute, Waterloo  
Steinwachs, Christian – Universität Köln  
Strehlau, Markus – Universität Köln  
Szpak, Nikodem – Universität Duisburg-Essen

**T**chrakian, Tigran – Dublin Institute for Advanced Studies  
Tibrewala, Rakesh – IISER, Trivandrum  
Tourkine, Piotr – Institute de Physique Théorique Paris  
Tsimpis, Dimitris – Univ. Lyon  
Tursunov, Arman – Astronomical Institute Tashkent

**U**ggla, Claes – Karlstad University, Sweden  
Urbina, Juan Diego – Universität Regensburg

**V**ecchio, Alberto – Birmingham University  
Virmani, Amitabh – Institute of Physics, Bhubaneshwar

**W**all, Aron – University of California, Santa Barbara  
Wang, Chih-Hung – National Central University of Taiwan  
Webb, Natalie – IRAP Toulouse  
Wecht, Brian – University of London  
Whiting, Bernard – University of Florida  
de Wit, Bernard – NIKHEF, Amsterdam  
Wosiek, Jacek – Jagellonian University, Krakow

**Y**ang, Hyun Seok – Sogang University, Seoul

**Z**hiboedov, Alexander – Harvard University

## Guest Scientists in Potsdam-Golm (2014)

Akhmedov, Emil – ITEP, Moscow  
Aksteiner, Steffen – University Bremen  
Alkalaev, Konstantin – Lebedev Institute of Physics, Moscow  
Ansoldi, Stefano – University of Udine  
Argurio, Riccardo – University of Bruxelles  
Assmann, Paulina – Universidad de Chile  
Astafanesei, Dumitru – Universidad Catolica de Valparaiso, Chile

**B**aake, Olaf – Universität Bonn  
Baratin, Aristide – Perimeter Institute, Waterloo  
Barnich, Glenn – University of Brussels  
Belinski, Vladimir – ICRANET, Pescara  
Bellettini, Costante – Cambridge University  
Bentivegna, Eloisa – University of Catania  
Betz, Andre – MPI für Physik, München  
Beyer, Florian – University of Otago, New Zealand

Bhattacharya, Mukul – IISc, Bangalore  
Bhattacharyya, Arpan – Indian Institute of Sciences, Bangalore  
Bicák, Jiri – Charles University, Prague  
Biernat, Pawel – Universität Bonn  
Bishop, Nigel – Rhodes University, South Africa  
Bizoń, Piotr – Cracow University  
Blaum, Klaus – MPI fuer Kernphysik  
Bodendorfer, Norbert – University of Warsaw  
Boulanger, Nicolas – University of Mons  
Brödel, Johannes – Stanford University  
Brahma, Suddhasattwa – Pennsylvania State University  
Brandenberger, Robert – Mc Gill University, Montreal  
Budde, Thea  
Buric, Maja – University of Belgrade  
Burtscher, Annegret – University of Vienna

**C**agnazzo, Alessandra – DESY Hamburg  
Campoleoni, Andrea – University of Brussels  
Carotenuto, Alessandro – University of Naples  
Carrozza, Sylvain – University of Marseille  
Casali, Eduardo – Trinity College  
Cederbaum, Carla – Universität Tübingen  
Celoria, Marco – University of Milan  
Chakraborty, Shankhadeep – IISER, Pune  
Chidambaram, Nitin – Indian Institute of Technology, Madras  
Chirenti, Cecilia – University of Sao Paulo  
Cho, Wonyoung – Sogang University  
Ciolfi, Riccardo – University of Trento  
Cortier, Julyen – ETH Zürich  
Cuadra, Jorge – Pontificia Universidad Catolica de Chile

**D**adhich, Naresh – IUCAA, Pune  
Dafermos, Mihailis – University of Cambridge, UK  
Dahl, Mattias – Royal Institute of Technology, Stockholm  
Dalal, Archismita – Indian Institute of Technology, Kharagpur  
Datta, Shouvik – Indian Inst. of Science, Bangalore  
David, Guy – Université Paris-Sud  
Davidson, Emily – Cambridge University  
Decarli, Roberto – Max-Planck-Institut für Astronomie, Heidelberg  
Devchand, Chand – Universität Potsdam  
Didenko, Vyacheslav – Lebedev Institute, Moscow  
Dittrich, Bianca – Perimeter Institute  
Dotti, Massimo – University of Milano  
Dühr, Claude – University Durham

**E**ichhorn, Astrid – Perimeter Institute, Waterloo  
Empanan, Roberto – University of Barcelona

**F**ang, Yangqin – Université de Paris Sud  
Farakos, Fotis – Masaryk University, Brno  
Faye, Guillaume – Institut d'Astrophysique de Paris  
Feingold, Alex – State University of New York at Binghamton  
Fevrier, Vincent – Toulouse University  
Fine, Joel – University of Brussels

## Guest Scientists in Potsdam-Golm (2014)

Fleig, Philipp – IHES, Paris  
Font, Anamaria – UCV, Caracas  
Frauendiener, Jörg – University of Otago, New Zealand  
Fujitsuka, Masashi – Graduate University for Advanced Studies, KEK  
Furey, Cohl – Perimeter Institute, Canada

**G**air, Jonathan – University of Cambridge, UK  
Galeazzi, Filippo – University of Valencia  
Ganor, Ori – University of California, Berkeley  
Garrido Goicovic, Felipe – Universidad Catolica de Chile  
Ghanem, Sari – Inst. of Math. Jussieu  
Gianniotis, Panagiotis – University of Warwick  
Gicquaud, Romain – Université Tours  
Gielen, Steffen – Imperial College, London  
Godazgar, Hadi – DAMTP, Cambridge  
Godazgar, Mahdi – DAMTP, Cambridge  
Gold, Roman – University of Maryland  
Govil, Karan – Pennsylvania State University  
Govindarajan, Thupil Rangachari – The Institute of Mathematical Science, Chennai  
Gran, Ulf – Chalmers University of Technology  
Gregoris, Daniele – Stockholm University  
Grigoriev, Maksim – Lebedev Institute, Moscow  
Guida, Federica – Università degli Studi di Napoli 'Federico II'  
Gunaydin, Murat – Pennstate University  
Gusev, Yuri – IRMACS, Canada  
Gustafsson, Henrik – Chalmers University of Technology  
Gutperle, Michael – UCLA, Los Angeles

**H**adar, Shoham – Racah Institute of Physics Jerusalem  
Han, Muxin – CPT, Marseille  
Haupt, Alexander – Universität Hannover  
He, Song – Perimeter Institute, Waterloo  
Hejda, Filip – Charles University, Prague  
Henneaux, Marc – University of Brussels  
Hollands, Stefan – University of Leipzig  
Holzger, Gustav – Imperial College, London  
Hoppe, Jens – Royal Institute of Technology, Stockholm  
Huisken, Gerhard – Tübingen University, Mathematisches Forschungsinstitut Oberwolfach  
Hynek, Mariusz – KTH, Stockholm

**I**nverso, Gianluca – Nikhef Amsterdam  
Ivashchuk, Vladimir – Center for Gravitation and Fundamental Metrology

**J**almuzna, Joanna – University of Kraków  
Janka, Hans-Thomas – MPI für Astrophysik  
Johansson, Henrik – CERN, Geneva  
Jorjadze, George – A. Razmadze Mathematical Institute, Tbilisi  
Jottar, Juan – University of Amsterdam  
Joudioux, Jeremie – University of Vienna  
Junghans, Daniel – The Hong Kong University of Science and Technology

**K**aragiorgos, Alexandros – University of Patras  
Karouby, Johanna – MIT  
Kehl, Marcel – Universität Bonn  
Khavkine, Igor – University of Trento  
Kiefer, Claus – Universität Köln  
Kim, Nakwoo – Kyung Hee University, Seoul  
Kittel, Tim – Humboldt Universität  
Ko, Sung Moon – Sogang University  
Kofron, David – Charles University, Prague  
Kokkotas, Kostas – University of Tübingen  
Korotkin, Dimitrii – Concordia University, Montreal  
Korzynski, Mikolaj – Center for Theoretical Physics of the Polish Academy of Sciences  
Koslowski, Tim – University of New Brunswick  
Krasnov, Kirill – University of Nottingham  
Krishnan, Badri – AEI Hannover  
Kumar, Prayush – University of Toronto  
Kuzenko, Sergei – University of Western Australia

**L**ahoche, Vincent – University of Paris-XI Orsay  
Lal, Shailesh – Seoul National University  
Lau, Runqiu – Chinese Academy of Science  
Lavrelashvili, George – A. Razmadze Mathematical Institute, Tbilisi  
Lee, Hyung Mok – Seoul National University  
Lepori, Francesca – University of Trieste  
Lewandowski, Adrian – Warsaw University  
Li, Wen-Liang  
Liang, Xiangyu – University of Warwick  
Lindblom, Lee – California Institute of Technology  
Lüst, Severin – LMU München

**M**ach, Patryk – Jagiellonian University, Krakow  
Mädler, Thomas – University of Cambridge  
Mader, Tomas – Max Planck Digital Library  
Madore, John – University of Paris (South)  
Mafra, Carlos – DAMTP, Cambridge  
Magro, Marc – ENS, Lyon  
Mahapatra, Swapna – Utkal University, Bhubaneswar  
Maharana, Karmadeva – Utkal University, Bhubaneswar  
Maliborski, Maciej – Jagiellonian University, Krakow  
Manvelyan, Ruben – Yerevan Physics Inst.  
Mariusz, Hynek  
Mars, Marc – University of Salamanca  
Marsat, Sylvain – University of Maryland  
Martin-Benito, Mercedes – Perimeter Institute, Waterloo  
Martini, Riccardo – University of Bologna  
Massamba, Fortune – University of KwaZulu-Natal, South Africa  
Matthes, Nils – Universität Hamburg  
Mazzucchelli, Chiara – University of Milano  
Meissner, Krzysztof – Warsaw University  
Mikovic, Aleksandar – Lusophone University of Humanities and Technologies, Lisboa  
Minasian, Ruben – CEA, Saclay  
Mkrtychyan, Karapet – University of Pisa



## Guest Scientists in Potsdam-Golm (2014/2015)

Mkrтчyan, Ruben – Yerevan Physics Inst.  
Moncrief, Vincent – Yale University  
Montuori, Carmen – University of Milano  
Mosig, Johannes – Potsdam University  
Mösta, Philipp – California Institute of Technology  
Mundim, Bruno – University of British Columbia, Canada  
Musaev, Edvard – Queen Mary University of London

Nagy, Silvia – Imperial College, London  
Nungesser, Ernesto – Trinity College, Dublin

Ovrut, Burt – University of Pennsylvania

Paetz, Tim-Torben – Universität Wien  
Palmkvist, Jakob – IHES, Bures-sur-Yvette  
Papadopoulos, George – Kings College, London  
Parikh, Maulik – Arizona State University, Tempe  
Pawelczyk, Jacek – Warsaw University  
Perazzo, Valentina – University of Naples  
Perez, Alfredo – CECS Valdivia, Chile  
Persson, Daniel – Chalmers University of Technology  
Pfeiffer, Harald – Canadian Institute for Theoretical Astrophysics  
Pilch, Krzysztof – University of Southern California  
Pirozzi Palmese, Valentina – University of Naples  
Pletka, Stefan – Universität Wien  
Poghossian, Rubik – Yerevan Physics Institute  
Pomoni, Elli – DESY Hamburg  
Popov, Fedor – ITEP, Moscow  
Possenti, Andrea – Osservatorio Astronomico di Cagliari  
Price, Larry – California Institute of Technology  
Pugh, Harrison – Stony Brook University

Raasakka, Matti – University Paris-Nord  
Racz, Istvan – Wigner Research Center for Physics Budapest  
Radice, David – California Institute of Technology  
Radnaes, Axel – Chalmers University of Technology  
Rahman, Rakibur – University of Brussels  
Rampf, Cornelius – RWTH Aachen  
Ravi, Vikram – University of Melbourne  
Reall, Harvey – DAMTP Cambridge  
Reisswig, Christian – California Institute of Technology  
Rivasseau, Vincent – LPT, Orsay  
Rosquist, Kjell – Stockholm University  
Russo, Rodolfo – Queen Mary, University of London

Samtleben, Henning – ENS, Lyon  
Schmidt, Josef – Technical University, Prague  
Schmidt, Bernd – München  
Schwimmer, Adam – Weizmann Institute, Rehovot  
Sedrakian, Armen – Universität Frankfurt am Main  
Sellaroli, Guisepppe – Perimeter Institute, Canada  
Shang, Yu – Chinese Academy of Sciences Beijing  
Shnir, Yakov – Bogolyubov Laboratory of Theoretical Physics, Dubna

Simon, Walter – Universität Wien  
Sivakumar, Muthuswamy – University of Hyderabad  
Skakala, Jozef – IISER, Trivandrum  
Skrinjar, Vedran – University of Trieste  
Slepukhin, Valentin – ITEP, Moscow  
Smit Vega Garcia, Mariana – Universität Düsseldorf  
Soergel, Wolfgang – University Freiburg  
Speziale, Simone – CPT, Marseille  
Steinhaus, Sebastian – Perimeter Institute, Waterloo  
Stelle, Kellogg – Imperial College, London  
Strehlau, Markus – Universität Köln  
Suh, Yoonji – Sogang University  
Szpak, Nikodem – Universität Duisburg-Essen

Tanaka, Takamitsu – Max-Planck-Institut für Astrophysik  
Taylor, Nicholas – California Institute on Technology  
Tchraikian, Tigran – Dublin Institute for Advanced Studies  
Thornburg, Jonathan – Indiana University  
Toriumi, Reiko – University California Berkeley

Uhlemann, Cora – Universität München

del Valle, Luciano – Universidad de Chile  
Vasiliev, Eugene – Lebedev Physical Institute Moscow  
Vettigli, Ivano – Università degli Studi di Napoli 'Federico II'  
Virmani, Amitabh – Institute of Physics, Bhubaneswar  
Vrzan, Drazen – Universität Wien

Wafu, Roger Tagne  
Wang, Yan – AEI Hannover  
Wesenberg, Lucia  
Wex, Norbert – Max-Planck-Institut für Radioastronomie  
Winicour, Jeffrey – University of Pittsburgh  
de Wit, Bernard – NIKHEF, Amsterdam

Yang, Shiwu – University of Cambridge

Zojer, Thomas – University of Groningen

## Guest Scientists in Potsdam-Golm (2015)

Abbara, Alia – École Normale Supérieure Paris  
Abdikamalov, Ernazar – Nazarbayev University  
Akhmedov, Emil – ITEP, Moscow  
Aspelmeyer, Markus – Universität Wien  
Astefanesei, Dumitru – Universidad Católica de Valparaíso, Chile  
Avohou, Remi Cocou – International Chair in Mathematical Physics and Applications

Bagchi, Arjun – Massachusetts Institute of Technology  
Banados, Maximo – University of Santiago, Chile  
Baratin, Aristide – Perimeter Institute, Waterloo  
Barausse, Enrico – Institut d'Astrophysique de Paris

## Guest Scientists in Potsdam-Golm (2015)

Bastianelli, Fiorenzo – University of Bologna  
Basu, Rudranil – IISER Pune  
Beisert, Niklas  
Belinski, Vladimir – ICRANET, Pescara  
Bentivegna, Eloisa – University of Catania  
Berenstein, David – University of California, Santa Barbara  
Bicák, Jiri – Charles University, Prague  
Biernat, Pawel – Universität Bonn  
Bishop, Nigel – Rhodes University, South Africa  
Bizoń, Piotr – Cracow University  
Blanchet, Luc – Institut d’Astrophysique de Paris  
Bogenstahl, Johanna – ZETT OPTICS GmbH, Braunschweig, Germany  
Bojowald, Martin – Pennsylvania State University  
Bossard, Guillaume – University of Amsterdam  
Boulanger, Nicolas – University of Mons  
Bousso, Raphael – University of California, Berkeley  
Brink, Lars – Chalmers University of Technology  
Brozek, Sascha – KONE, Helsinki, Finland  
Butter, Daniel – University of Utrecht  
Bzowski, Adam – Theoretical Physics Section

**C**alcagni, Gianluca – Pennsylvania State University  
Campoleoni, Andrea – University of Brussels  
Capano, Collin – AEI Hannover  
Caprini, Chiara – Institut de Physique Theorique Saclay  
Caravelli, Francesco – Perimeter Institute, Waterloo  
Cardoso, Gabriel – University of Lisboa  
Carlotto, Alessandro – ETH Zurich  
Carozza, Sylvain – Perimeter Institute  
Carqueville, Nils – Universität Bonn  
Carrozza, Sylvain – University of Marseille  
Cederbaum, Carla – Universität Tübingen  
Chen, Yanbei – California Institute of Technology  
Choe, Jaigyoung – KIAS, Seoul  
Choque, David – Universidad Technica  
Ciolfi, Riccardo – University of Trento  
Compere, Geoffrey – University of Brussels  
Corbett Moran, Christine – California Institute of Technology  
Cuttell, Peter – Dept. of Physics, Kings College London

**D**adhich, Naresh – IUCAA, Pune  
Dain, Sergio – University of Cordoba, Argentina  
Dartois, Stephane – Université Paris-Sud  
Davidson, Aharon – Ben Gurion University  
De Cesare, Marco – Dept. of Physics, Kings College London  
Dennen, Tristan  
Dent, Thomas – AEI Hannover  
Devchand, Chand – Universität Potsdam  
Di Marino, Simone – Université Paris Sud  
Dietrich, Tim  
Dittrich, Bianca – Perimeter Institute  
Donnay, Laura – Free University of Brussels

Erbin, Harold – LPTHE - CNRS - UPMC  
Estes, John – Imperial College London

**F**abre, Ophelia – IISER, Trivandrum  
Fajman, David – Universität Wien  
Farr, Benjamin – Enrico Fermi Institute Chicago  
Faye, Guillaume – Institut d’Astrophysique de Paris  
Feingold, Alex – State University of New York at Binghamton  
Ferrara, Sergio – CERN  
Ferreira, Pedro – University of Oxford  
Fleig, Philipp – IHES, Paris  
Font, Anamaria – UCV, Caracas  
Fusco, Nicola – Università degli studi di Napoli

**G**arrido Goicovic, Felipe – Universidad Catolica de Chile  
Geiller, Marc – Perimeter Institute, Canada  
Ghanem, Sari – Inst. of Math. Jussieu  
Gielen, Steffen – Imperial College, London  
Godazgar, Hadi – DAMTP, Cambridge  
Godazgar, Mahdi – DAMTP, Cambridge  
Govindarajan, Thupil Rangachari – The Institute of Mathematical Science, Chennai  
Grigoriev, Maksim – Lebedev Institute, Moscow  
Gryb, Zachary – University of Florida  
Gusev, Yuri – IRMACS, Canada  
Gustafsson, Henrik – Chalmers University of Technology

**H**e, Song – Kyoto University  
He, Song – Perimeter Institute, Waterloo  
Heller, Michal – Perimeter Institute, Waterloo  
Hencl, Stanislav – Charles University, Prague  
Henneaux, Marc – University of Brussels  
Hohm, Olaf – Massachusetts Institute of Technology  
Hoppe, Jens – Royal Institute of Technology, Stockholm  
Hopper, Seth – Instituto superior Tecnico Lisbon  
Hotokezaka, Kenta – Racah Institute of Physics Jerusalem  
Huisken, Gerhard – Tübingen University, Mathematisches Forschungsinstitut Oberwolfach  
Hung, Ling-Yan – DAMTP, Cambridge

**I**ndik, Nathaniel – AEI Hannover  
Ivashchuk, Vladimir – Center for Gravitation and Fundamental Metrology,

**J**aber, Oussamah  
Jeziński, Jacek – Warsaw University  
Jimenez Forteza, Francisco – University of Balearic Islands Mallorca  
Johansson, Henrik – CERN, Geneva  
Josset, Thibaut – Centre de Physique Theorique Deluminy

**K**alinov, Daniil – Higher School of Economics, Moscow  
Kanno, Sugumi – University of the Basque Country, Spain  
Keeler, Cynthia  
Khanna, Gaurav – University of Massachusetts Dartmouth

## Guest Scientists in Potsdam-Golm (2015)

Kiefer, Claus – Universität Köln  
Kitaura, Francisco – Leibniz-Institut für Astrophysik  
Köhl, Ralf – ILU Giessen  
Köhn, Michael – University of Pennsylvania  
Kosłowski, Tim – University of New Brunswick  
Krasnov, Kirill – University of Nottingham  
Kumar, Prayush – University of Toronto  
Kumar S, Santhosh – IISER - TVM - School of Physics  
Kunst, Daniela – University of Bremen

**L**agraa, Meriem Hadjer – The University of Oran  
Lahoche, Vincent – University of Paris-XI Orsay  
Lammers, Uwe – ESA Madrid  
Lau, Runqiu – Chinese Academy of Science  
Laurain, Paul – Université Paris Diderot  
Lavrelashvili, George – A. Razmadze Mathematical Institute, Tbilisi  
Le Tiec, Alexandre – Observatoire de Paris  
Lekeu, Victor – University of Brussels  
Levi, Michele – Institut Astrophysique de Paris  
Lewandowski, Adrian – Warsaw University  
Li, Yang  
Li, Tjonnie – California Institute of Technology  
Lim, Woei-Chet – University of Waikato  
Lowing, Nicholas  
Lundgren, Andrew – AEI Hannover  
Lynden-Bell, Donald – Cambridge University

**M**ader, Tomas – Max Planck Digital Library  
Mafra, Carlos – DAMTP, Cambridge  
Maharana, Jnanadeva – Institute of Physics, Bhubaneswar  
Majumdar, Parthasarathi – Vivekananda University  
Manvelyan, Ruben – Yerevan Physics Inst.  
Marinelli, Dimitri – Waterloo University, Dept. of Applied Mathematics  
Marsat, Sylvain – University of Maryland  
Martin, Mathieu – ENS Lyon  
Martini, Riccardo – University of Bologna  
Matthes, Nils – Universität Hamburg  
Mazumdar, Anupam – Lancaster University  
Meissner, Krzysztof – Warsaw University  
Meurer, Martin – RWTH Aachen  
Miao, Haixing – University of Birmingham  
Mielczarek, Jakub – Sapienza University, Institute of Physics  
Minasian, Ruben – CEA, Saclay  
Moncrief, Vincent – Yale University  
Mongwane, Bishop – Rhodes University, South Africa  
Monnier, Samuel – University of Zurich  
Monteiro, Ricardo – University of Oxford  
von der Mosel, Heiko – RWTH Aachen  
Mösta, Philipp – California Institute of Technology

**N**andan, Dhritiman – Humboldt Universität Berlin  
Narain, Gaurav – Institute of Fundamental Study (IFS), Thailand  
Ndzinisa, Dumsani – Rhodes University, South Africa

Nicolis, Alberto – Columbia University New York  
Nielsen, Alex – AEI Hannover

**O**liynyk, Todd – Monash University, Australia  
Oz, Yaron – Tel Aviv University  
O’Mullane, William – ESA Madrid

**P**ai, Archana – IISER Trivandrum  
Palmkvist, Jakob – IHES, Bures-sur-Yvette  
Pani, Paolo – Instituto Superior Tecnico Lisboa  
Patrascu, Andrei  
Pavlenko, Kirill  
Peng, Cheng – ETH Zürich  
Perez, Alfredo – CECS Valdivia, Chile  
Persson, Daniel – Chalmers University of Technology  
Petkou, Anastasios – University of Thessaloniki  
Pfeiffer, Harald – Canadian Institute for Theoretical Astrophysics  
Pithis, Andreas – Dept. of Physics, Kings College London  
Poghossian, Rubik – Yerevan Physics Institute  
Pollney, Denis – Rhodes University South Africa  
Pope, Christopher – Institute for Fundamental Physics & Astronomy  
Popov, Fedor – ITEP, Moscow  
Pound, Adam – University of Southampton  
del Pozzo, Walter – University of Birmingham  
Pürrier, Michael – Cardiff University

**R**acz, Istvan – Wigner Research Center for Physics Budapest  
Ramirez, Israel – HU Berlin  
Reisswig, Christian – California Institute of Technology  
Roiban, Radu – Pennsylvania State University  
Rossi, Elena – Leiden Observatory  
Ruba, Blazej Teofil – Jagiellonian University, Krakow  
Rubakov, Valery – Institute for Nuclear Research RAS  
Rupflin, Melanie – Universität Leipzig

**S**akellariadov, Mayri – Kings College London, Physics Dept.  
Salgarkar, Aaditya – Indian Institute of Technology, Kharagpur  
Samsonov, Igor – University of Western Australia  
Saravani, Mehdi – Perimeter Institute, Waterloo  
Sasakura, Naoki – Yukawa Institute for Theoretical Physics, Kyoto  
Sathyaprakash, Bangalore – Cardiff University  
Scharlau, Winfried – Universität Münster  
Schmidt, Bernd – München  
Schmidt, Patricia – California Institute of Technology  
Schnetter, Erik – Perimeter Institute Waterloo  
Schubert, Christian – University Michoacana, Morelia  
Schwimmer, Adam – Weizmann Institute, Rehovot  
Seidel, Jan-Arwed  
Senatore, Leonardo – Stanford University  
Sennett, Noah  
Sesana, Alberto – University of Birmingham  
Shankaranarayanan, Subramaniam – IISER, Trivandrum  
Shibata, Masaru – Yukawa Institute for Theoretical Physics Kyoto  
Shimada, Hidehiko – Okayama Institute for Quantum Physics

## Guest Scientists in Potsdam-Golm (2015/2016)

Shiveshwarkar, Charuhas – IIT Mumbai  
Shnir, Yakov – Bogolyubov Laboratory of Theoretical Physics, Dubna  
Siegel, Daniel – Columbia University  
Simon, Walter – Universität Wien  
Sleight, Charlotte  
Sonnenschein, Jacob – Tel Aviv University  
Sopuerta, Carlos – Institute of Space Sciences, Barcelona  
Spera, Mario – Astronomical Observatory of Padova  
Springel, Volker – Heidelberg Institut für Theoretische Studien  
Steinacker, Harold – Universität München  
Steinhauser, Dominik  
Steinmetz, Matthias – Astrophysikalisches Institut Potsdam  
Strehlau, Markus – Universität Köln  
Strzelecki, Pawel – University of Warsaw

**T**akeshi Morita Gagliardi, Alessandro – École polytechnique Palaiseau

Tonegawa, Yoshihiro – Hokudai University  
Tormo, Joan  
Travaglini, Gabriele – Queen Mary, University of London  
Trejo Espinosa, Maria Anabel – Friedrich-Schiller-Universität Jena  
Turton, David – CEA Saclay

**U**zan, Jean-Philippe – Insitut d´Astrophysique de Paris

**Virmani, Amitabh** – Institute of Physics, Bhubaneshwar

**Waldron, Andrew** – University of California  
Wang, Guofang – Universität Freiburg  
Wetterich, Christof – Universität Heidelberg  
Winckler, Clara  
Winicour, Jeffrey – University of Pittsburgh  
Wiseman, Toby – Imperial College London

**Yamazaki, Masahito**

Yankielowicz, Shimon – Tel Aviv University  
Yin, Ruoxi – Kings College London

**Zerbini, Federico**

Zhiboedov, Alexander – Harvard University

## Guest Scientists in Potsdam-Golm (2016)

**Akhmedov, Emil** – Institute for Theoretical and Experimental Physics, Moscow  
Allen, Gabrielle – NCSA Urbana-Champaign  
Ames, Ellery – Chalmers University of Technology, Göteborg  
Anastasiou, Giorgius  
Andréasson, Hakan – Chalmers University of Technology, Göteborg  
Anza, Fabio – Clarendon Laboratory, University of Oxford  
Aspelmeyer, Markus – Vienna University  
Astefanesei, Dumitru – Universidad Catolica de Valparaiso, Chile

Avohou, Remi Cocou – Cotonou, Benin  
Azzoni, Susanna – Kings College London

**Bäckdahl, Thomas** – Chalmers University of Technology, Göteborg

Bagchi, Arjun – Massachusetts Institute of Technology  
Baker, Paul – West Virginia University Morgantown  
Banados, Maximo – University of Santiago, Chile  
Barnish, Glenn – Université Libre de Bruxelles  
Basak, Abhishek – Indian Institute of Science Education and Research, Thiruvananthapuram  
Bastianelli, Fiorenzo – University of Bologna  
Baulieu, Laurent – Laboratoire de Physique Théorique et Hautes Energies, Paris

Belczynski, Chris – University of Warsaw

Belinski, Vladimir – International Center for Relativistic Astrophysics Network, Pescara

Bernuzzi, Sebastiano – Parma University

Bhattacharya, Swastik

Bianconi, Ginestra – Queen Mary University of London

Bicák, Jiri – Charles University, Prague

Bizoń, Ilya – Kazan Federal University

Bizoń, Piotr – Cracow University

Blackman, Jonathan – California Institute of Technology

Blair, Chris – Vrije Universiteit Brussel

Boels, Rutger – Hamburg University

Bossard, Guillaume – University of Amsterdam

Brünner, Frederic – Technical University Vienna

Brehm, Enrico – LMU München

Brink, Lars – Chalmers University of Technology, Göteborg

Brito, Richard – Institut Superior Tecnico Lisbon

Brizuela, David – University of the Basque Country

Brustein, Ramy – Ben-Gurion University, Israel

Bunster, Claudio – Centro de Estudios Científicos, Chile

Buric, Ilija

**Caballero, Ricardo** – Max Planck Institute for Radio Astronomy

Cardoso, Vitor – Instituto Superior Tecnico Lisbon

Cha, Ye Sle – Freie Universität Berlin

Chakrabarty, Bidisha – Institute of Physics, Bhubaneswar

Chen, Hsin-Yu – University of Chicago

Chirenti, Cecilia – University of Sao Paulo

Cotesta, Roberto – University of Rome

Cropp, Bethan – Indian Institute of Science Education and Research Thiruvananthapuram

**Dadhich, Naresh** – Inter-University Centre for Astronomy and Astrophysics, Pune

Dahl, Mattias – Royal Institute of Technology, Stockholm

Daniil, Kalinov – Institute for Theoretical and Experimental Physics, Moscow

Dawid, Richard – University of Stockholm

Deger, Sadik – Bogazici University Turkey

Desvignes, Gregory – Max Planck Institute for Radio Astronomy

Devchand, Chand – Potsdam University

Dittrich, Bianca – Perimeter Institute, Waterloo

Dolan, Sam – University of Sheffield

## Guest Scientists in Potsdam-Golm (2016)

Drexler, Simon

Duarte, Antonio – Instituto de Física, Rio de Janeiro

Dutz, Christoph – Fachhochschule Potsdam

Ellis, George F.R. – University of Cape Town

Emelyanov, Viacheslav – Karlsruhe Institute of Technology

Fischer, Jonas

Font, Anamaria – Universidad Central de Venezuela, Caracas

Foucart, Francois – Lawrence Berkeley National Laboratory

Fraundniener, Jörg – University of Otago, New Zealand

Fredenhagen, Stefan – Vienna University

Freire, Paulo – Max Planck Institute for Radio Astronomy

Frodden, Ernesto – Centro de Estudios Científicos, Chile

Garrido Goicovic, Felipe – Universidad Católica de Chile

Gerken, Jan Erik – Cambridge University

Gerosa, Davide – Cambridge University

Ghanem, Sari – Institute of Mathematics Jussieu

Gielen, Steffen – Imperial College, London

Gnecchi, Alessandra – Katholieke Universiteit Leuven

Godazgar, Hadi – Cambridge University

Gomberoff, Andres – UAI/Centro de Estudios Científicos, Chile

Gudapati, Nishanth Abu

Gustafsson, Henrik – Chalmers University of Technology, Göteborg

Hanisch, Florian – Potsdam University

He, Song – Institute of Theoretical Physics, Chinese Academy of Science

Heller, Michal – Perimeter Institute, Waterloo

Herfray, Yannick – École normale supérieure de Lyon

Hoppe, Jens – Royal Institute of Technology, Stockholm

Huneau, Cécile – École normale supérieure de Paris

Ivashchuk, Vladimir – Center for Gravitation and Fundamental Metrology,

Jafarzade, Shahriyar – International Centre for Theoretical Physics, Trieste

Jimenez Rosales, Alejandra – Universidad Nacional Autónoma de México

Johansson, Henrik – CERN, Geneva

Joudioux, Jeremie – Vienna University

Kawaguchi, Kyohei – Yukawa Institute for Theoretical Physics, Kyoto

Keimer, Bernhard – Max Planck Institute for Solid State Research Stuttgart

Khanna, Gaurav – University of Massachusetts, Dartmouth

Khavkine, Igor – University of Trento

Khuri, Marcus – State University of New York, Stony Brook

Kilbertus, Niki – Max Planck Institute for Intelligent Systems, Stuttgart

Kloner, Sergei – Technical University, Dresden

Kofron, David – Charles University, Prague

Korotkin, Dimitrii – Concordia University, Montreal

Kourkoulou, Ioanna – Princeton University

Krasnov, Kirill – University of Nottingham

Kupiainen, Antti – University of Helsinki

Kuzenko, Sergei – University of Western Australia

Lagraa, Meriem Hadjer – University of Oran

Laszlo, Andras – Wigner Research Center for Physics, Budapest

Lavrelashvili, George – A. Razmadze Mathematical Institute, Tbilisi

Lehner, Luis – Perimeter Institute, Waterloo

Lentati, Lindley – Cambridge University

Lewandowski, Jerzy – Warsaw University

Lewis, Adam – Canadian Institute for Theoretical Astrophysics, University of Toronto

Li, Danning – Chinese Academy of Sciences

Li, Yang

Lindner, Manfred

Ludewig, Matthias – Max Planck Institute for Mathematics, Bonn

Ma, Yongge – Beijing Normal University

Mach, Patryk – Jagiellonian University, Krakow

Mafra, Carlos – STAG Research Center and Mathematical Sciences, UK

Maggiore, Michele – University of Geneva

Mahapatra, Swapna – Utkal University, Bhubaneswar

Maharana, Jnanadeva – Institute of Physics, Bhubaneswar

Maharana, Karmadeva – Utkal University, Bhubaneswar

Manvelyan, Ruben – Yerevan Physics Institute

Martinelli, Dimitri – Università di Perugia, Italy

Mayer, Lucio – ETH Zürich

Mehra, Aditya Singh – Indian Institute of Technology, Kampur

Meineri, Marco – École polytechnique fédérale de Lausanne

Meissner, Krzysztof – Warsaw University

Mele, Fabio – University of Napoli, Italy

Melville, Scott – University of Cambridge, MA

van de Meent, Maarten – University of Southampton

Metha, Umang Bharat – Tata Institute of Fundamental Research

Miao, Yangang – Nankai University, China

Micol Frassino, Antonia – Frankfurt Institute for Advanced Studies

Mikovic, Aleksandar – Lusophone University of Humanities and Technologies, Lisbon

Minasian, Ruben – CEA, Saclay

Mingarelli, Chiara – Max Planck Institute for Radio Astronomy

Miranda Mello, Cedrick – University of Sao Paulo

Misra, Aalok – Indian Institute of Technology, Roorkee

Mkrtychyan, Ruben – Yerevan Physics Institute

Mogol, Göncü – Heidelberg University

Moncrief, Vincent – Yale University

Monteiro, Ricardo

Mösta, Philipp – University of California at Berkeley

Muir, Alistair – Cardiff University

Nakonieczna, Anna – Wigner Research Center for Physics, Budapest

Nakonieczny, Lukasz – Wigner Research Center for Physics, Budapest

## Guest Scientists in Potsdam-Golm (2016) / Guest Scientists in Hannover (2013)

Nandi, Debottam – Indian Institute of Science Education and Research, Thiruvananthapuram

Nian, Jun – Institut des Hautes Études Scientifiques, Bures-sur-Yvette

Nichols, David – Radboud University Nijmegen

O'Bannon, Andrew – University of Southampton

Oancea, Marius – Babes-Bolyai University

Ochirov, Alexander – University of Edinburgh

Paetz, Tim-Torben – Vienna University

Palmkvist, Jakob – Texas A&M University

Parekh, Pulastya – Indian Institute of Technology, Kampur

Pereira, Raul – Uppsala University

Perera, Benetge – University of Manchester

Petiteau, Antoine – Laboratoire AstroParticle et Cosmologie, Paris

Pfeiffer, Harald – Canadian Institute for Theoretical Astrophysics

Pithis, Andreas – Kings College London

Popov, Fedor – Institute for Theoretical and Experimental Physics, Moscow

Pranzetti, Daniele – SISSA, Trieste

Qiu, Taotao – College of Physical Science & Technology

Racz, Istvan – Wigner Research Center for Physics Budapest

Rahmede, Christoph – Karlsruhe Institute of Technology

Rennert, Julian – University of Waterloo

Rezzolla, Luciano – Goethe University Frankfurt

Ringström, Hans – Royal Institute of Technology, Stockholm

Rosquist, Kjell – Stockholm University

Rosseel, Jan – Bern University

Rosso, Matteo – Humboldt University Berlin

Rostworowski, Andrzej – Kraków University

Roy, Pratik – Institute of Physics, Bhubaneswar

Salzer, Jakob – Technical University Vienna

Sampson, Laura – CIERA-Northwestern University Evanston

Samtleben, Henning – École normale supérieure de Lyon

Schmidt, Bernd – München

Schmidt, Josef – Technical University, Prague

Schubert, Christian – University Michoacana, Morelia

Schwimmer, Adam – Weizmann Institute, Rehovot

Seidel, Edward – NCSA Urbana-Champaign

Semerak, Oldrich – Charles University Prague

Sennett, Noah

Sesana, Alberto – University of Birmingham

Sesar, Branimir – Max Planck Institute for Astronomy, Heidelberg

Sharma, Atul – Indian Institute of Science, Bangalore

Shibata, Masaru – Yukawa Institute for Theoretical Physics, Kyoto

Simon, Joseph – University of Wisconsin-Milwaukee

Simon, Walter – Vienna University

Sotiriou, Thomas – University of Nottingham

Spadaro, Emanuele – Max Planck Institute for Mathematics in the Sciences

Spiridonov, Viacheslav P. – Laboratory of Theoretical Physics

Steinhauer, Jeff – Technion, Israel Institute of Technology

Steinhaus, Sebastian – Perimeter Institute, Waterloo

Steinhauser, Dominik

Stelle, Kellogg – Imperial College, London

Strehlau, Markus – Köln University

Szpak, Nikodem – University of Duisburg-Essen

Takayanagi, Tadeshi – Kyoto University

Talaganis, Spyridon – Lancaster University

Taronna, Massimo – Scuola Normale Superiore, Pisa

Taylor, Stephen – California Institute of Technology

Tchraikian, Tigran – Dublin Institute for Advanced Studies

Tezgin, Kemal – University of Connecticut

Thürigen, Johannes

Thornburg, Jonathan – Indiana University

Tolsa, Xavier – Universitat Autònoma de Barcelona

Toriumi, Reiko – University California Berkeley

Tourkine, Piotr – Institute de Physique Théorique Paris

Vallisneri, Michele – Jet Propulsion Laboratory

Valtorta, Daniele – École Polytechnique fédérale de Lausanne

Vescovi, Edoardo – Humboldt University Berlin

Vincent, Trevor – University of Toronto

Virmani, Amitabh – Institute of Physics, Bhubaneswar

Vreys, Yannick – Katholieke Universiteit Leuven

del Valle, Luciano – Universidad de Chile

Wex, Norbert – Max Planck Institute for Radio Astronomy, Bonn

Whiting, Bernard – University of Florida

Wildemann, Peter – Karlsruhe Institute of Technology

Winicour, Jeffrey – University of Pittsburgh

Wise, Derek – University of Erlangen-Nürnberg

Wosiek, Jacek – Jagellonian University, Krakow

Zhiboedov, Alexander – Harvard University

Zoupanos, George – National Technical University, Athens

## Guest Scientists in Hannover (2013)

Adya, Vaishali B. – Bangalore

Akutsu, Tomo – KAGRA (ICRR Tokyo)

Ali, Asad – Institute of Space Technology, Islamabad, Pakistan

Armand, Michele – ESAC

Aso, Yoichi – KAGRA (ISRR Tokyo)

Astone, Pia – Università di Roma

Bachem, Eberhard – Deutsches Zentrum für Luft- u. Raumfahrt, Bremen

Bassan, Massimo – Università di Roma "Tor Vergata"

Behnke, Berit – AEI, Golm

Bender, Peter L. – JILA University of Colorado

## Guest Scientists in Hannover (2013)

Bergmann, Gerald – Leibniz Universität Hannover

Blair, Carl – University of Western Australia

Bonnand, Romain – EGO/VIRGO

Bork, Rolf – LIGO Lab Caltech, Pasadena

Braam, Ben – TNO

Brandt, Nico – EADS-Astrium GmbH

Brandt, Soeren – National Space Institute, Technical University of Denmark

Brossard, Julyen – Université Paris 7 Denis Diderot Astro Particule et Cosmologie

Brugger, Christina – EADS -Astrium GmbH

Buis, Ernst-Jan – TNO

**C**amp, Jordan – NASA Goddard Space Flight Center

Cernotik, Ondrej – Palachy University

Chiummo, Antonio – EGO/VIRGO

Congedo, Giuseppe – UTN Trento, Italy

Conklin, John – University of Florida

Cutler, Curt – Jet Propulsion Laboratory

**D**amjanic, Marcin – LZH

Debreczeni, Gergely – KFKI Research Institute for Particle and Nuclear Physics of HAS

Di Fiore, Luciano – Università degli Studi di Napoli Federico II

Dolesi, Rita – Università di Trento, Italy

Drolia, Mayank – PS-Laketown, Kalkutta, India

Dwyer, Sheila – LIGO (Caltech+MIT)

**E**nggaard, Anders – Axcon Aps.

**F**afone, Viviana – Università degli Studi di Roma Tor Vergata, Italy

Feili, Davar – Justus-Liebig-Universität, Gießen

Ferraioli, Luigi – Université Paris 7, Denis Diderot

Ferrini, Federico – EGO, Cascina, Italy

Fiori, Irene – EGO/VIRGO

Fitzsimons, Ewan – EADS-Astrium GmbH

Fiurasek, Jaromir – Palacky University, Olomouc

Flechtner, Frank – GFZ Potsdam

Frede, Mayk – LZH

Freise, Andreas – University of Birmingham

Frasinghelli, Karine – University of Trento, Italy

**G**ang, Jin – Chinese Academy of Sciences

Gatto, Alberto – Université Paris 7, Denis Diderot

Genin, Eric – EGO, Cascina, Italy

Gibert Gutierrez, Ferran – ICE Barcelona, Campus UAB, Fac. Ciències

Gilles, Frank – SpaceTech GmbH

Gohlke, Martin – Deutsches Zentrum für Luft- u. Raumfahrt, Bremen

Grado, Aniello – Istituto Nazionale di Astrofisica (INAF)

Grothues, Hans-Georg – Deutsches Zentrum für Luft- u. Raumfahrt, Bremen

Grunewald, Ludwig – GFZ Potsdam

Guenther, Burghard – DLR Bremen

**H**alloin, Hubert – APC Paris, Université Paris 7, Denis Diderot

Harms, Jan – INFN

Heinert, Daniel – Jena University

Henjes-Kunst, Katharina – DESY, Hamburg

Hogenhuis, Harmen – TNO

Hornstrup, Allan – National Space Institute, Technical University of Denmark

**I**nchauspe, Henri – APC Paris, Université Paris 7, Denis Diderot

Iyer, Balasubramanian – Raman Research Institute

**J**ennrich, Oliver – ESTEC

Johann, Ulrich – EADS-Astrium GmbH

**K**arnesis, Nicolaos – IEEC

Karnesis, Nikas – ICE Barcelona, Fac. Ciències

Kato, Jumpei – Tokyo Institute of Technology, Japan

Kemble, Stephen – EADS-Astrium GmbH

Khalili, Farid Ya – Moscow State University

Killow, Christian – University of Glasgow

King, Peter – Caltech, USA

Klimenko, Sergey – University of Florida

Klipstein, Bill – JET Propulsion Laboratory

Kocsis, Alexander – Centre for Quantum Dynamics, Griffith University

Koranda, Scott – University of Wisconsin-Milwaukee

Kroker, Stefanie – Jena University

Kulkarni, Shrinivas – California Institute of Technology

**L**aflamme, Raymond – University of Waterloo, IQC

Leavey, Sean – University of Glasgow

Lentati, Lindley – Department of Physics

Livas, Jeffrey – NASA Goddard Space Flight Center

Lloro Boada, Ivan – ICE - Institute de Ciències de l'Espai

Lo, Fred K. Y. – National Radio Astronomy Observatory

Lucarelli, Stefano – EADS-Astrium GmbH

**M**akabe, Isao – Kings College London

Maliyamveetil Kunjumahmed, Haris – Indian Institute of Sciences and Research

Malvezzi, Valeria – Università degli Studi di Roma "Tor Vergata", Italy

Mangoldt, Thomas – DLR Bremen

Marque, Julyen – EGO/VIRGO

Martynov, Denis – LIGO (Caltech+MIT)

Mateos, Ignacio – ICE - Institute de Ciències de l'Espai

McNamara, Paul – ESTEC

Meacher, Duncan – ARTEMIS, Observatoire de la Côte d'Azur, Nice, France

Moeller Pedersen, Soeren – National Space Institute, Technical University of Denmark

Moerschell, Joseph – HEV Haute école Valaisanne

Mow-Lowry, Conor Malcolm – Uni Birmingham

Mozaffari, Ali – Imperial College London

Müller, Guido – University of Florida

Müller, Jürgen – Jet Propulsion Laboratory

## Guest Scientists in Hannover (2013/2014)

Naticchioni, Luca – Università di Roma “La Sapienza”, Italy  
Nofrarias, Miquel – ICE - Institute de Ciències de l'Espai

O'Shea, Steven – University of Glasgow

Papp, Gábor – Research Centre for Astronomy and Earth Science, Sopron, Hungary

Peters, Achim – Humboldt-Universität zu Berlin

Plagnol, Eric – APC Paris, Université Paris 7, France

Prat, Pierre – APC Paris, Université Paris 7, France

Punturo, Michele – INFN-Sezione di Perugia, Italy

Racz, Istvan – Wigner RCP, Budapest,

Rasmussen, Torben – Axcon Aps.

Regimbau, Tania – Observatoire de la Cote d'Azur, Nice, France

Rievers, Benny – ZARM, Universität Bremen

Robertson, Dave – University of Glasgow

Rocchi, Alessio – INFN, Rome, Italy

Rojas del Rio, Andre – Brussels Office of the Max-Planck-Society

Sanjuan, Josep – DLR, Deutsches Zentrum für Luft- und Raumfahrt

Sarra, Paolo – CGS S. p. A. Compagnia Generale per lo Spazio

Sathyaprakash, Bangalore – Cardiff University

Schnabel, Roman – Universität Hamburg

Schofield, Robert – LIGO (Caltech/MIT)

Schulz, Bastian – LZH

Schutz, Bernard – AEI Golm

Shortt, Brian – ESA, ETEC,

Siemens, Xavier – University of Wisconsin-Milwaukee

Skorupka, Sascha – IQO

Sodnik, Zoran – ESTEC

Sopuerta, Carlos F. – ICE - Institute de Ciències de l'Espai Campus UAB Facultat de Ciències

Stanga, Ruggero M. – Università degli Studi di Firenze, Italy

Stebbins, Tuck – NASA Goddard Space Flight Center

Strain, Ken – University of Glasgow

Sutton, Andrew – The Australian National University

Swinkels, Bas – EGO/VIRGO

Tacca, Matteo – EGO/VIRGO

Tauris, Thomas – University of Bonn, Astronomical Institute

Taylor, Stephen Richard – University of Cambridge

Tevoert, Martijn – TNO

Tokmakov, Kirill – University of Strathclyde, Glasgow

Unnikrishnan, C.S. – TATA Institute of Fundamental Research

Vajente, Gabriele – EGO/VIRGO

Vetruigno, Daniele – UTN

Vitale, Stefano – Università di Trento, Dipartimento di Fisica

Voss, Kai – SpaceTech GmbH

Walsh, Sinead – University of Wisconsin-Milwaukee

Walter, Bastian – Jena University

Ward, Henry – Glasgow University

Wass, Peter – Imperial College of London

Weber, Bill – Università di Trento, Italy

Weise, Dennis – EADS -Astrium GmbH

Weiss, Rainer – MIT

Weiß, Talitha – University of Basel, Switzerland

Weßels, Peter – LZH

Willis, Joshua – Abilene Christian University

Witvoet, Gert – TNO

Zender, Bernd – DLR Bremen

Ziegler, Tobias – EADS-Astrium GmbH

Zuraw, Sarah – Georgia Institute of Technology, Massachusetts, USA

## Guest Scientists in Hannover (2014)

Allen, Gabrielle – University of Illinois

Andersson, Nils – University of Southampton

Armano, Michele – Europäisches Weltraumobservatorium, Madrid, Spain

Ashton, Gregory – University of Southampton

Baig, Mohammed Aftab – India-Based Neutrino Observatory

Bassan, Massimo – Università di Roma Tor Vergata, Italy

Bergmann, Gerald – Leibniz Universität Hannover

Bork, Rolf – LIGO Lab CALTECH, Pasadena

Bose, Sukanta – IUCAA

Brossard, Julyen – APC - Paris Diderot University, France

Calderon Bustillo, Juan – Universitat de les Illes Balears

Campanelli, Manuela – Rochester Institute of Technology

Capano, Collin – University of Maryland

Cesarini, Andrea – University di Trento, Italia

Chandra, Amar Deo – Mumbai University

Coward, David – The University of Western Australia

Creighton, Teviet David – University of Texas at Brownsville

Criswell, Keeley – Thiel College, Greenville USA

Cutler, Curt – Jet Propulsion Laboratory

Damjanic, Marcin – LZH

Darbeheshti, Neda – Australian National University

Del Pozzo, Walter – University of Birmingham

Dhurandhar, Sanjeev – IUCAA, Pune University, India

Dolesi, Rita – University of Trento, Italy

Downes, Tom – University of Wisconsin-Milwaukee

Drago, Marco – INFN

Eda, Kazunari – Research Center for the early Universe

Ferraioli, Luigi – ETH Zürich, Switzerland

Ferroni, Valerio – Sapienza Università degli Studi di Roma, Italy



## Guest Scientists in Hannover (2014)

Finn, Lee Samuel – The Pennsylvania State University, USA  
Fitzsimons, Ewan – EADS Astrium GmbH, Friedrichshafen  
Fort, Stanislav – University of Cambridge, Trinity College  
Frede, Mayk – LZH  
Freschi, Marco – Università di Trento, Italy  
Friedman, John – University of Wisconsin-Milwaukee  
Futamase, Toshifumi – Tohoku University  
Fyffe, Michael – LIGO Livingston Observatory,

**G**ibert, Ferran – Institut d'Estudis Espacials de Catalunya, Spain

Giusteri, Roberta – Università di Trento, Italy  
Gruning, Pierre – University Paris Diderot, Apc Laboratory, France  
Guidi, Gianluca – Istituto di Fisica - DiSBeF  
Gurumurthy, Rajalakshmi – TIFR Center for Interdisciplinary Sciences, Andhra Pradesh, India  
Guzman Cervantes, Felipe – NASA Goddard Space Flight Center, Greenbelt, MD, USA

**H**aloin, Hubert – PC / University Paris Diderot, France

Heinzel, Stefan – Rechenzentrum der MPG am MPI für Plasmaphysik  
Henjes-Kunst, Katharina – DESY, Hamburg  
Henry, Jackson – Rochester Institute of Technology  
Hoelbling, Christian – Bergische Universität Wuppertal  
Hofer, Sebastian – University of Vienna  
Hollands, Stefan – Institute for Theoretical Physics, University of Leipzig  
Hollington, Daniele – APC / University Paris Diderot France  
Hough, Jim – University of Glasgow  
Hueller, Mauro – University of Trento, Italia  
Husa, Sascha – University of the Balearic Islands

**I**nchauspe, Henri – APC, Paris, Frankreich

Itoh, Yousuke – Research Center of the early Universe

**J**ennrich, Oliver – ESTEC, Niederlande

Jimenez, Pablo Marin – CNRS, Paris, France  
Johlander, Bengt – ESA/Estec, Niederlande  
Johlander, Bodil – ESA/Estec, Niederlande

**K**apadia, Shasvath – University of Arkansas, USA

Karvinen, Kai – ETH Zürich  
King, Peter – LIGO Hanford Observatory,  
Klimenko, Sergey – University of Florida, USA  
Kokkotas, Kostas – Universität Tübingen  
Korobko, Mikhail – Faculty of Physics, Moscow  
Krolak, Andrzej – Instytut Matematyczny PAN Warszawa

**L**eavey, Sean – University of Glasgow

Leavy, Sean – University of Glasgow  
Lebigot, Eric O. – Centre National de la Recherche Scientifique (CNRS)  
Lederer, Hermann – Rechenzentrum der MPG am MPI für Plasmaphysik  
Lee, Hyung-Mok – Seoul National University  
Li, Muzi – Beijing, China

Lloro, Ivan – Institut de Ciències de l'Espai (IEEC-CSIC), Spain  
Lough, James Daniel – Syracuse University, USA

**M**ance, Dave – ETH Zürich, Schweiz

Marin Jimenez, Pablo – Laboratoire Astro Particule et Cosmologie  
McNamara, Paul – ESTEC, Niederlande  
Meadors, Grant – University of Michigan  
Messenger, Christopher – Cardiff School of physics and astronomy  
Mittal, Rupal – Rochester Institute of Technology, Center for Imaging Science  
Mow-Lowry, Conor Malcolm – Uni Birmingham  
Mukherjee, Soma – University of Texas

**N**ofrarias, Miquel – Institut de Ciències de l'Espai (IEEC-CSIC), Spain

**P**etiteau, Antoine – APC, France

Piccinni, Ornella Julyana – Università La Sapienza, Rome  
Pivato, Paolo – University of Trento, Italy  
Plagnol, Eric – APC, France  
Porqueras, Fernando Martin – ESAC, Madrid, Spain  
Prins, Nathan – Towson University, Maryland, USA  
Puncken, Oliver – LZH Hannover

**R**ampp, Markus – Rechenzentrum der MPG am MPI für Plasma-physik

Robertson, Dave – University of Glasgow  
Robertson, Noma – University of Glasgow  
Robinet, Florent – LAL Bat 200, Faculté d'Orsay  
Rott, Carsten – Sungkyunkwan University  
Rowan, Sheila – University of Glasgow  
Russano, Giuliana – University of Trento, Italia

**S**athyaprakash, Bangalore – University of Cardiff

Schnabel, Roman – Universität Hamburg  
Schultheiss, Constantin – Universität Hamburg  
Schulz, Bastian – LZH  
Schutz, Bernard – AEI Golm  
Seader, Shawn – SETI Institute, NASA Ames Research Center  
Seidel, Ed – University of Illinois  
Shawhan, Peter – University of Maryland, Dept. of Physics  
Shoemaker, David – California Institute of Technology  
Singh, Avneet – University Rome  
Sintes, Alicia – Universitat de les Illes Balears  
Skorupka, Sascha – IQO  
Slutsky, Jake – UMBC/CRESST, USA  
Sopuerta, Carlos – Institut de ciències de l'espai, Cerdanyola del Vallès  
Strain, Ken – University of Glasgow

**T**aylor, Ian – University of Cardiff

Texier, Damien – École de Technologie Supérieure Montreal, Quebec, Canada  
Thorne, Keith – LIGO Livingston Observatory, USA  
Thorpe, Ira – Goddard Space Flight Center, NASA, USA  
Trenkel, Christian – ASTRIUM, Bremen

## Guest Scientists in Hannover (2014/2015)

Vecchio, Alberto – University of Birmingham

Vedovato, Gabriele – Ist. Nazionale di Fisica Nucleare, Sezione di Padova

Vetrugno, Daniele – University of Trento, Italy

Vitale, Stefano – University of Trento, Italy

Walsh, Sinéad – University of Wisconsin-Milwaukee

Was, Michal – LAPP

Weber, Bill – University of Trento, Italia

Weßels, Peter – LZH

Whelan, John – Rochester Institute of Technology, Center for Computational Relativity & Gravitation

Wild, Lee – UK

Wild, Vivienne – University of St. Andrews

Willis, Joshua – Abilene Christian University

Yeh, Hsieu-Chi – Huazhong University of Science and Technology

Zhang, Yuanhao – Rochester Institute of Technology, Center for Computational Relativity & Gravitation

## Guest Scientists in Hannover (2015)

Achamveedu, Gopakumar – Tata Institute of Fundamental Research

Adams, Thomas – L.A.P.P. Laboratoire d'Annecy Le Vieux de Physique des Particules

Ain, Anirban – IUCAA, Pune University

Ajith, Parameswaran – Tata Institute of Fundamental Research

Ashton, Gregory – University Southampton

Astone, Pia – INFN and University of Rome “La Sapienza”

Baghi, Quentin – ONERA-The French Aerospace Lab, Chatillon

Baig, Mohammed Aftab – India-Based Neutrino Observatory

Beckert, Uwe – Rechenkraft.net.e.V.

Belczynski, Chris – Astronomical Observatory UW

Bergmann, Gerald

Berry, Christopher – University of Birmingham

Blomer, Jakob – CERN

Bork, Rolf – LIGO Lab Caltech, 220 Downs, CA 91125, Pasadena, USA

Bousoo, Raphael – Center for Theor. Phys. and Dept. of Phys. Univ. of California

Brady, Patrick – University of Wisconsin-Milwaukee

Busculic, Damir – L.A.P.P. Laboratoire d'Annecy Le Vieux de Physique des Particules

Bush, Zachary – University of Florida, Dept. of Physics

Calderon Bustillo, Juan – Universitat de les illes balears, Edifici Mateu Orfila

Cao, Song – National Space Science Center, Acad. of Sciences

Caudill, Sarah – University of Wisconsin-Milwaukee

Chandra, Amar Deo – Mumbai University

Chen, Lisheng – Wuhan Institute of Physics and Mathematics, CAS

Chen, Quenfeng – Wuhan Ins. of Physics and Mathematics, CAS

Chen, Yanbei – CALTECH

Creighton, Teviet – Dept. of Physics and Astronomy, Univ. of Texas at Brownsville

Cuesta Lazaro, Carolina – Universidad Autónoma de Madrid

Cutler, Curt – Jet Propulsion Laboratory

Danilishin, Stefan – University of Glasgow

Di Palma, Irene – University of Rome “La Sapienza”, Physics Department

Fairhurst, Steve – School of Physics and Astronomy Cardiff University

Feng, Wei – Inst. of Geodesy and Geophysics, Chinese Acad. Of Sciences

Ferreira, Pedro – University of Oxford

Fitzsimons, Ewan – UK Astronomy Technology Center, Royal Observatory Edinburgh, UK

Flambaum, Victor – The University of New South Wales, Department of Theoretical Physics

Flehtner, Frank – GFZ Potsdam

Flury, Jakob – Inst. f. Erdmessung, LUH

Frede, Mayk – LZH

George, Jogy – Raja Ramanna Centre for Advanced Technology (RRAT) Indore, India

Gerberding, Oliver – NIST

Germain, Vincent – L.A.P.P. Laboratoire d'Annecy Le Vieux de Physique des Particules

Ghosh, Shaon – Radboud University Nijmegen

Gleason, Joe – University of Florida

Goetz, Evan – University of Michigan

Gröblacher, Simon – Delft University of Technology

Gruber, Thomas – TU München, Astronomical and Physical Geodesy

Guidi, Gianluca – Università di Urbino, DiSBef - Sezione di Fisica

Gunn, James – Emmanuel College

Hanna, Chad – Penn State Science Department of Physics

Hesse, Rüdiger – Max Planck Society

Hewitt, Jacqueline – MIT Kavli Institute for Astrophysics and Space Research

Holtkamp, Annette – CERN

Huang, Qing-Guo – Inst. of Theoretical Physics, Chinese Acad. of Sciences

Huesemann, Patrice – Westf. Wilhelms-Universität

Hugentobler, Urs – TU München

Jin, Gang – Institute of Mechanics, Chinese Acad. of Sciences

Kampschulte, Tobias – Universität Basel, Switzerland

Kapadia, Shasvath – University of Arkansas

Kehl, Marcel – Rheinische Friedrich-Wilhelms-Universität Bonn

Keitel, David – Universitat de les Illes Balears

Khalili, Farid – Moscow State University, Moscow, Russia

Khan, Sebastian – Cardiff University

Klimenko, Sergey – University of Florida, USA

Korobko, Mikhail – Faculty of Physics, Moscow

## Guest Scientists in Hannover (2015/2016)

Lahmann, Robert – University Erlangen-Nuremberg

Lämmerzahl, Claus – Uni Bremen, ZARM

Lazzaro, Claudia – INFN

Leavey, Sean – University of Glasgow

Lee, Hyung-Mok – Seoul National University,

Leong, Jonathan – Hannover

Ling, Yi – Institute of High Energy Physics, CAS

Liu, Runqiu – Morningside Centre of Mathematics Beijing

Macas, Ronaldas – University of Glasgow

Marion, Frederique – L.A.P.P. Laboratoire d'Annecy Le Vieux de Physique des Particules

Marton, Tapai – University of Szeged

Miao, Haixing – University of Birmingham

Mittal, Rupal – Rochester Institute of Technology, Center for Imaging Science

Mours, Benoit – L.A.P.P. Laboratoire d'Annecy Le Vieux de Physique des Particules

Mow-Lowry, Conor Malcolm – University of Birmingham

Muir, Alistair – Cardiff University

Mukherjee, Arunava – International Centre for Theoretical Sciences (ICTS)

Müller, Guido – University of Florida, USA

Murböck, Michael – TU München

Nicolis, Alberto – Columbia University

Nissanke, Samaya – Radboud University

Ohme, Frank – Cardiff University

Pail, Roland – TU München

Pannarale, Francesco – Cardiff University

Prodi, Giovanni Andrea – Università di Trento

Puerrer, Michael – Cardiff University

Puncken, Oliver – LZH Hannover

Sathyaprakash, Prof B S – Cardiff University

Schmidt, Piet – PTB Braunschweig

Schnabel, Roman – Universität Hamburg

Schulz, Bastian – LZH

Segal, Ben – CERN, IT-Department

Seoane, Pau Amaro – AEI Golm

Shoemaker, David – Massachusetts Institute of Technology, USA

Skorupka, Sascha – IQO

Srivastava, Varun – IISER

Sterr, Uwe – PTB Braunschweig

Strain, Ken – University of Glasgow

Tauris, Thomas – Universität Bonn,

Tiwari, Shubhanshu – GSSI

Urban, Alex – University of Wisconsin-Milwaukee

Vasuth, Matyas – Hungarian Academy of Sciences

Vecchio, Alberto – University of Birmingham

Vedovato, Gabriele – INFN, Sezione di Padova

Veitch, John – University of Birmingham

Venzl, Hannah – MPG / CPTS

Walker, Marissa – Louisiana State University, USA

Walsh, Sinead – University of Wisconsin Milwaukee, USA

Walton, Rom – Fort Myers, USA

Wang, Zhi – Changchun Institute of Optics, fine Mechanics and Physics, Chinese Acad. of Sciences

Weßels, Peter – LZH

Whelan, John – Rochester Institute of Technology, Center for Computational Relativity & Gravitation

Williamson, Andrew – School of Physics and Astronomy Cardiff University

Willis, Joshua – Abilene Christian Univ. Dept. of Engineering and Physics

Wu, Yueliang – Inst. of Theoretical Physics, CAS, Chinese Acad. of Sciences

Zhang, NZhang-Shuang – Inst. of High Energy Physics

Zhang, Yuanhao – Rochester Institute of Technology, Center for Computational Relativity & Gravitation

Zhu, Sylvia – University of Maryland

## Guest Scientists in Hannover (2016)

Álvarez-Gaumé, Luis – Simons Center for Geometry and Physics

Ashton, Gregory – University of Southampton

Aspelmeyer, Markus – Vienna University

Babak, Stanislav – AEI Potsdam-Golm

Barber, Matthew James – Kings College London

Barish, Barry Clark – California Institute of Technology

Berger, Beverly K.

Bergmann, Gerald

Booker, Phillip – Laser Zentrum Hannover

Brady, Patrick – University of Wisconsin-Milwaukee

Brink, Lars – Chalmers University of Technology, Göteborg

Buchmüller, Wilfried – Deutsches Elektronen-Synchrotron DESY

Calderon Bustillo, Juan – Georgia Institute of Technology

Calmet, Xavier – University of Sussex

Cardoso, Vitor – Instituto Superior Técnico / CENTRA, Lisbon

Chirenti, Cecilia – Federal University of ABC, Brasilia

Chruściel, Piotr T. – Vienna University

Clewa, Frederic – Observatoire de la Côte d'Azur, France

Connaughton, Valerie

Cooper, Sam – University of Birmingham

Damour, Thibault – Institut des Hautes Études Scientifiques, Bures-sur-Yvette

Dergachev, Vladimir – LIGO Laboratory, California Institute of Technology

Dudi, Reetika – Friedrich-Schiller-Universität Jena

Engling, Claudia – Deutsches Elektronen-Synchrotron DESY

## Guest Scientists in Hannover (2016)

**Flanagan, Éanna** – Cornell University

**Fleig, Philipp** – Institut des Hautes Études Scientifiques, Bures-sur-Yvette

**Flörs, Andreas** – Technische Universität München

**Frede, Mayk** – Laser Zentrum Hannover

**Freise, Andreas** – University of Birmingham

**Fu, Yue** – Beijing Normal University

**Fyffe, Mike** – LIGO Livingston Observatory

**Gabbard, Hunter Arthur** – University of Mississippi

**Gerberding, Oliver** – National Institute of Standards and Technology, Gaithersburg, MD

**Gleason, Joe** – University of Florida

**Goetz, Evan** – LIGO Hanford Observatory

**Goldstein, Adam Michael** – Marshall Space Flight Center, NASA

**Gräf, Christian** – Glasgow University

**Greiner, Jochen** – Max Planck Institute for Extraterrestrial Physics

**Hamilton, Hannah Faith** – Abilene Christian University

**Harte, Abraham** – AEI Potsdam-Golm

**Heintze, Matthew** – LIGO, California Institute of Technology

**Henneaux, Marc** – Université Libre de Bruxelles

**Hildebrandt, Stefan** – Wiley-VCH Verlag

**Hochheim, Sven** – Laser Zentrum Hannover

**Hogan, Craig J.** – University of Chicago

**Huarcaya, Victor**

**Huisken, Gerhard** – Mathematisches Forschungsinstitut Oberwolfach

**Jimenez Forteza, Xisco** – Universitat de les Illes Balears

**Joshi, Kunaal** – Indian Institute of Technology

**Kalogera, Vasiliki** – Northwestern University, Dearborn Observatory

**Kaplan, David** – University of Wisconsin-Milwaukee

**Keitel, David** – Universitat de les Illes Balears

**Khan, Sebastian** – Cardiff University

**King, Peter** – LIGO Hanford Observatory

**Kleybolte, Lisa** – Hamburg University

**Korobko, Mikhail** – Faculty of Physics, Moscow

**Kozlowski, Todd** – University of Florida

**Kumar, Sumit** – International Centre for Theoretical Sciences, TIFR

**Kwang, Shawn** – University of Wisconsin

**Lehner, Luis** – Perimeter Institute, Waterloo

**Li, Wei** – Institute of Theoretical Physics, Chinese Academy of Sciences

**Maners, Norbert** – Deutsches Elektronen-Synchrotron DESY

**Mazzolo, Giulio**

**Miller, Dominik** – Deutsches Elektronen-Synchrotron DESY

**Mow-Lowry, Conor Malcolm** – Birmingham University

**Nagar, Alessandro** – Institut des Hautes Études Scientifiques, Bures-sur-Yvette

**O’Toole, Conor** – University College Dublin

**Oberling, Jason** – LIGO Hanford Observatory

**Ohme, Frank** – Cardiff University

**Oliver Almiñana, Miquel** – Universitat de les Illes Balears

**Otto, Markus**

**Pai, Archana** – Indian Institute of Science Education and Research, Thiruvananthapuram

**Parameswaran, Ajith** – International Centre for Theoretical Sciences, TIFR

**Pazhayath Ravi, Aravind** – Indian Institute of Science Education and Research

**Puncken, Oliver** – Laser Zentrum Hannover

**Ringström, Hans** – KTH Royal Institute of Technology

**Schäfer, Gerhard** – Friedrich-Schiller-Universität Jena

**Schnabel, Roman** – Hamburg University

**Schreiber, Andreas** – Max Planck Institute for Astronomy, Heidelberg

**Schulz, Bastian** – Laser Zentrum Hannover

**Schüth, Ferdi** – Max-Planck-Institut für Kohlenforschung

**Schutz, Bernard Frederick** – Cardiff University

**Shibata, Masaru** – Yukawa Institute for Theoretical Physics, Kyoto

**Shoemaker, David** – Massachusetts Institute of Technology

**Shoom, Andrey** – Memorial University

**Singh, Divya** – Indian Institute of Science Education and Research, Thiruvananthapuram

**Smith, David A.** – Centre d’Études Nucléaires de Bordeaux-Grignan

**Stoye, Thorsten** – Deutsches Elektronen-Synchrotron DESY

**Strain, Kenneth** – Glasgow University

**Stromhagen, Richard** – Deutsches Elektronen-Synchrotron DESY

**Subramaniam, Shankaranarayanan** – Indian Institute of Science Education and Research, Thiruvananthapuram

**Tornasi, Zeno** – Glasgow University

**Töyrä, Daniel** – University of Birmingham

**Vivekanathaswamy, Gayathri** – Indian Institute of Science Education and Research, Thiruvananthapuram

**Walsh, Sinead** – University of Wisconsin Milwaukee

**Wanner, Alexander** – Leibniz Universität Hannover

**Weßels, Peter** – Laser Zentrum Hannover

**Zander, Jascha** – Hamburg University

## Publications by AEI Members and Guest Scientists

- Aartsen, M. G., et.al., The IceCube Collaboration, The LIGO Scientific Collaboration, & The Virgo Collaboration (2014). Multimessenger Search for Sources of Gravitational Waves and High-Energy Neutrinos: Results for Initial LIGO-Virgo and IceCube. *Physical Review D*, 90: 102002. doi:10.1103/PhysRevD.90.102002.
- Aasi, J., et.al., The LIGO Scientific Collaboration, & The Virgo Collaboration (2014). Search for gravitational waves associated with gamma-ray bursts detected by the InterPlanetary Network. *Physical Review Letters*, 113: 011102. doi:10.1103/PhysRevLett.113.011102.
- Aasi, J., et.al., The LIGO Scientific Collaboration, & The Virgo Collaboration (2015). Narrow-band search of continuous gravitational-wave signals from Crab and Vela pulsars in Virgo VSR4 data. *Physical Review D*, 91: 022004. doi:10.1103/PhysRevD.91.022004.
- Aasi, J., et.al., The LIGO Scientific Collaboration, & The Virgo Collaboration (2015). Searching for stochastic gravitational waves using data from the two colocated LIGO Hanford detectors. *Physical Review D*, 91: 022003. doi:10.1103/PhysRevD.91.022003.
- Aasi, J., et.al., The LIGO Scientific Collaboration, & The Virgo Collaboration (2014). Improved Upper Limits on the Stochastic Gravitational-Wave Background from 2009-2010 LIGO and Virgo Data. *Physical Review Letters*, 113: 231101. doi:10.1103/PhysRevLett.113.231101.
- Aasi, J., et.al., The LIGO Scientific Collaboration, & The Virgo Collaboration (2014). Search for gravitational radiation from intermediate mass black hole binaries in data from the second LIGO-Virgo joint science run. *Physical Review D*, 89(12): 122003. doi:10.1103/PhysRevD.89.122003.
- Aasi, J., et.al., The LIGO Scientific Collaboration, & The Virgo Collaboration (2014). The NINJA-2 project: Detecting and characterizing gravitational waveforms modelled using numerical binary black hole simulations. *Classical and quantum gravity*, 31: 115004. doi:10.1088/0264-9381/31/11/115004.
- Aasi, J., et.al., The LIGO Scientific Collaboration, & The Virgo Collaboration (2014). Application of a Hough search for continuous gravitational waves on data from the 5th LIGO science run. *Classical and quantum gravity*, 31(8): 085014. doi:10.1088/0264-9381/31/8/085014.
- Aasi, J., et.al., The LIGO Scientific Collaboration, & The Virgo Collaboration (2014). Implementation of an F-statistic all-sky search for continuous gravitational waves in Virgo VSR1 data. *Classical and quantum gravity*, 31(16): 165014. doi:10.1088/0264-9381/31/16/165014.
- Aasi, J., et.al., The LIGO Scientific Collaboration, & The Virgo Collaboration (2014). Constraints on cosmic strings from the LIGO-Virgo gravitational-wave detectors. *Physical Review Letters*, 112: 131101. doi:10.1103/PhysRevLett.112.131101.
- Aasi, J., et.al., The LIGO Scientific Collaboration, & The Virgo Collaboration (2013). Directed search for continuous Gravitational Waves from the Galactic Center. *Physical Review D*, 88(10): 102002. doi:10.1103/PhysRevD.88.102002.
- Aasi, J., et.al., The LIGO Scientific Collaboration, & The Virgo Collaboration (2013). Einstein@Home all-sky search for periodic gravitational waves in LIGO S5 data. *Physical Review D*, 87: 042001. doi:10.1103/PhysRevD.87.042001.
- Aasi, J., et.al., The LIGO Scientific Collaboration (2013). Enhanced sensitivity of the LIGO gravitational wave detector by using squeezed states of light. *Nature Photonics*, 7(8), 613-619. doi:10.1038/nphoton.2013.177.
- Aasi, J., et.al., The LIGO Scientific Collaboration, & The Virgo Collaboration (2014). First Searches for Optical Counterparts to Gravitational-wave Candidate Events. *The Astrophysical Journal. Supplement series*, 211(1): 7. doi:10.1088/0067-0049/211/1/7.
- Aasi, J., et.al., The LIGO Scientific Collaboration, & The Virgo Collaboration (2014). Methods and results of a search for gravitational waves associated with gamma-ray bursts using the GEO600, LIGO, and Virgo detectors. *Physical Review D*, 89: 122004. doi:http://dx.doi.org/10.1103/PhysRevD.89.122004.
- Aasi, J., et.al., The LIGO Scientific Collaboration, & The Virgo Collaboration (2013). Parameter estimation for compact binary coalescence signals with the first generation gravitational-wave detector network. *Physical Review D*, 88: 062001. doi:10.1103/PhysRevD.88.062001.
- Aasi, J., et.al., The LIGO Scientific Collaboration, & The Virgo Collaboration (2014). Search for gravitational wave ringdowns from perturbed intermediate mass black holes in LIGO-Virgo data from 2005-2010. *Physical Review D*, 89: 102006. doi:10.1103/PhysRevD.89.102006.
- Aasi, J., et.al., The LIGO Scientific Collaboration, & The Virgo Collaboration (2013). Search for Gravitational Waves from Binary Black Hole Inspiral, Merger and Ringdown in LIGO-Virgo Data from 2009-2010. *Physical Review D*, 87: 022002. doi:10.1103/PhysRevD.87.022002.
- Aasi, J., et.al., The LIGO Scientific Collaboration, & The Virgo Collaboration (2013). Search for long-lived gravitational-wave transients coincident with long gamma-ray bursts. *Physical Review D*, 88: 122004. doi:10.1103/PhysRevD.88.122004.
- Aasi, J., et.al., The LIGO Scientific Collaboration, & The Virgo Collaboration (2015). A directed search for gravitational waves from Scorpius X-1 with initial LIGO. *Physical Review D*, 91: 062008. doi:10.1103/PhysRevD.91.062008.
- Aasi, J., et.al., The LIGO Scientific Collaboration, & The Virgo Collaboration (2015). Characterization of the LIGO detectors during their sixth science run. *Classical and quantum gravity*, 32 (11): 115012. doi:10.1088/0264-9381/32/11/115012.
- Aasi, J., et.al., The LIGO Scientific Collaboration, & The Virgo Collaboration (2015). Searches for continuous gravitational waves from nine young supernova remnants. *Astrophysical Journal*, 813(1): 39. doi:10.1088/0004-637X/813/1/39.
- Aasi, J., et.al., The LIGO Scientific Collaboration, & The Virgo Collaboration (2014). Gravitational-waves from known pulsars: results from the initial detector era. *Astrophysical Journal*, 785(2): 119. doi:10.1088/0004-637X/785/2/119.

## Publications by AEI Members and Guest Scientists

- Aasi, J., et.al., LIGO Scientific Collaboration (2015). Advanced LIGO. Classical and quantum gravity, 32(7): 074001. doi:10.1088/0264-9381/32/7/074001.
- Aasi, J., et.al., The LIGO Scientific Collaboration, & The Virgo Collaboration (2014). First all-sky search for continuous gravitational waves from unknown sources in binary systems. Physical Review D, 90(6): 062010. doi:10.1103/PhysRevD.90.062010.
- Aasi, J., et.al., The LIGO Scientific Collaboration, & The Virgo Collaboration (2016). Prospects for Observing and Localizing Gravitational-Wave Transients with Advanced LIGO and Advanced Virgo. Living Reviews in Relativity, 19: 1. doi:10.1007/lrr-2016-1.
- Aasi, J., et.al., The LIGO Scientific Collaboration, & The Virgo Collaboration (2016). First low frequency all-sky search for continuous gravitational wave signals. Physical Review D, 93: 042007. doi:10.1103/PhysRevD.93.042007.
- Aasi, J., et.al., The LIGO Scientific Collaboration, & The Virgo Collaboration (2016). A search of the Orion spur for continuous gravitational waves using a "loosely coherent" algorithm on data from LIGO interferometers. Physical Review D, 93: 042006. doi:https://doi.org/10.1103/PhysRevD.93.042006.
- Abbott, B. P., et.al., The LIGO Scientific Collaboration, & The Virgo Collaboration (2016). Astrophysical Implications of the Binary Black-Hole Merger GW150914. Astrophysical Journal, Letters, 818(2): L22. doi:10.3847/2041-8205/818/2/L22.
- Abbott, B., et.al., The LIGO Scientific Collaboration, & The Virgo Collaboration (2016). Properties of the Binary Black Hole Merger GW150914. Physical Review Letters, 116: 241102. doi:http://dx.doi.org/10.1103/PhysRevLett.116.241102.
- Abbott, B., et.al., The LIGO Scientific Collaboration, & The Virgo Collaboration (2016). Characterization of transient noise in Advanced LIGO relevant to gravitational wave signal GW150914. Classical and quantum gravity, 33(13): 134001. doi:http://dx.doi.org/10.1088/0264-9381/33/13/134001.
- Abbott, B., et.al., The LIGO Scientific Collaboration, & The Virgo Collaboration (2016). Tests of General Relativity with GW150914. Physical Review Letters, 116: 221101. doi:http://dx.doi.org/10.1103/PhysRevLett.116.221101.
- Abbott, B., et.al., The LIGO Scientific Collaboration, & The Virgo Collaboration (2016). An all-sky search for long-duration gravitational wave transients with LIGO. Physical Review D, 93: 042005. doi:10.1103/PhysRevD.93.042005.
- Abbott, B., et.al., The LIGO Scientific Collaboration, & The Virgo Collaboration (2016). Observation of Gravitational Waves from a Binary Black Hole Merger. Physical Review Letters, 116: 061102. doi:10.1103/PhysRevLett.116.061102.
- Abbott, B., et.al., The LIGO Scientific Collaboration, & The Virgo Collaboration (2016). Directly comparing GW150914 with numerical solutions of Einstein's equations for binary black hole coalescence. Physical Review D, 94: 064035. doi:https://doi.org/10.1103/PhysRevD.94.064035.
- Abbott, B., et.al., The LIGO Scientific Collaboration, & The Virgo Collaboration (2016). The basic physics of the binary black hole merger GW150914. Annalen der Physik. doi:10.1002/andp.201600209.
- Abbott, B., et.al., The LIGO Scientific Collaboration, & The Virgo Collaboration (2016). GW151226: Observation of Gravitational Waves from a 22-Solar-Mass Binary Black Hole Coalescence. Physical Review Letters, 116: 241103. doi:http://dx.doi.org/10.1103/PhysRevLett.116.241103.
- Abbott, B., et.al., The LIGO Scientific Collaboration, & The Virgo Collaboration & Collaboration, f. t. v. (2016). Localization and broadband follow-up of the gravitational-wave transient GW150914. The Astrophysical Journal Letters, 826(1): L13. doi:http://dx.doi.org/10.3847/2041-8205/826/1/L13.
- Abbott, B., et.al., The LIGO Scientific Collaboration, & The Virgo Collaboration (2016). Results of the deepest all-sky survey for continuous gravitational waves on LIGO S6 data running on the Einstein@Home volunteer distributed computing project. Physical Review D, 94: 102002. doi:https://doi.org/10.1103/PhysRevD.94.102002.
- Abbott, B., et.al., The LIGO Scientific Collaboration, & The Virgo Collaboration (2016). Binary Black Hole Mergers in the first Advanced LIGO Observing Run. Physical Review X, 6: 041015. doi:10.1103/PhysRevX.6.041015.
- Abbott, B., et.al., The LIGO Scientific Collaboration, & The Virgo Collaboration (2016). Supplement: The Rate of Binary Black Hole Mergers Inferred from Advanced LIGO Observations Surrounding GW150914. The Astrophysical Journal Supplement Series, 227(2): 14. doi:10.3847/0067-0049/227/2/14.
- Abbott, B., et.al., The LIGO Scientific Collaboration, & The Virgo Collaboration (2016). A First Targeted Search for Gravitational-Wave Bursts from Core-Collapse Supernovae in Data of First-Generation Laser Interferometer Detectors. Physical Review D, 94: 102001. doi:10.1103/PhysRevD.94.102001.
- Abbott, B., et.al., The LIGO Scientific Collaboration, & The Virgo Collaboration (2016). Improved Analysis of GW150914 Using a Fully Spin-Precessing Waveform Model. Physical Review X, 6: 041014. doi:https://doi.org/10.1103/PhysRevX.6.041014.
- Abbott, B., et.al., The LIGO Scientific Collaboration, & The Virgo Collaboration (2016). The Rate of Binary Black Hole Mergers Inferred from Advanced LIGO Observations Surrounding GW150914. The Astrophysical Journal Letters, 833(1): L1. doi:http://dx.doi.org/10.3847/2041-8205/833/1/L1.
- Abdikamalov, E., Ott, C. D., Radice, D., Roberts, L. F., Haas, R., Reisswig, C., Moesta, P., Klion, H., & Schnetter, E. (2015). Neutrino-driven Turbulent Convection and Standing Accretion Shock Instability in Three-Dimensional Core-Collapse Supernovae. The Astrophysical Journal, 808(1): 70. doi:10.1088/0004-637X/808/1/70.
- Abdo, A. A., Ajello, M., Allafort, A., Baldini, L., Ballet, J., Barbiellini, G., Baring, M. G., Bastieri, D., Belfiore, A., Bellazzini, R., Bhattacharyya, B., Bissaldi, E., Bloom, E. D., Bonamente, E., Bottacini, E., Brandt, T. J., Bregeon, J., Brigida, M., Bruel, P., Buehler, R., Burgay, M., Burnett, T. H., Busetto, G., Buson, S., Caliandro, G. A., Cameron, R.

## Publications by AEI Members and Guest Scientists

- A., Camilo, F., Caraveo, P. A., Casandjian, J. M., Cecchi, C., Çelik, Ö., Charles, E., Chaty, S., Chaves, R. C. G., Chekhtman, A., Chen, A. W., Chiang, J., Chiaro, G., Ciprini, S., Claus, R., Cognard, I., Cohen-Tanugi, J., Cominsky, L. R., Conrad, J., Cutini, S., D'Ammando, F., de Angelis, A., DeCesar, M. E., Luca, A. D., den Hartog, P. R., de Palma, F., Dermer, C. D., Desvignes, G., Digel, S. W., Venere, L. D., Drell, P. S., Drlica-Wagner, A., Dubois, R., Dumora, D., Espinoza, C. M., Falletti, L., Favuzzi, C., Ferrara, E. C., Focke, W. B., Franckowiak, A., Freire, P. C. C., Funk, S., Fusco, P., Gargano, F., Gasparri, D., Germani, S., Giglietto, N., Giommi, P., Giordano, F., Giroletti, M., Glanzman, T., Godfrey, G., Gotthelf, E. V., Grenier, I. A., Grondin, M.-H., Grove, J. E., Guillemot, L., Guiriec, S., Hadasch, D., Hanabata, Y., Harding, A. K., Hayashida, M., Hays, E., Hessels, J., Hewitt, J., Hill, A. B., Horan, D., Hou, X., Hughes, R. E., Jackson, M. S., Janssen, G. H., Jogler, T., Jóhannesson, G., Johnson, R. P., Johnson, A. S., Johnson, T. J., Johnson, W. N., Johnston, S., Kamae, T., Kataoka, J., Keith, M., Kerr, M., Knödseder, J., Kramer, M., Kuss, M., Lande, J., Larsson, S., Latronico, L., Lemoine-Goumard, M., Longo, F., Loparco, F., Lovellette, M. N., Lubrano, P., Lyne, A. G., Manchester, R. N., Marelli, M., Massaro, F., Mayer, M., Mazziotta, M. N., McEnery, J. E., McLaughlin, M. A., Mehault, J., Michelson, P. F., Mignani, R. P., Mitthumsiri, W., Mizuno, T., Moiseev, A. A., Monzani, M. E., Morselli, A., Moskalenko, I. V., Murgia, S., Nakamori, T., Nemmen, R., Nuss, E., Ohno, M., Ohsugi, T., Orienti, M., Orlando, E., Ormes, J. F., Paneque, D., Panetta, J. H., Parent, D., Perkins, J. S., Pesce-Rollins, M., Pierbattista, M., Piron, F., Pivato, G., Pletsch, H., Porter, T. A., Possenti, A., Rainò, S., Rando, R., Ransom, S. M., Ray, P. S., Razzano, M., Rea, N., Reimer, A., Reimer, O., Renault, N., Reposeur, T., Ritz, S., Romani, R. W., Roth, M., Rousseau, R., Roy, J., Ruan, J., Sartori, A., Parkinson, P. M. S., Scargle, J. D., Schulz, A., Sgrò, C., Shannon, R., Siskind, E. J., Smith, D. A., Span- dre, G., Spinelli, P., Stappers, B. W., Strong, A. W., Suson, D. J., Takahashi, H., Thayer, J. G., Thayer, J. G., Thureau, G., Thompson, D. J., Thorsett, S. E., Tibaldo, L., Tibolla, O., Tinivella, M., Torres, D. F., Tosti, G., Troja, E., Uchiyama, Y., Usher, T. L., Vandenbroucke, J., Vasileiou, V., Venter, C., Vianello, G., Vitale, V., Wang, N., Weltevrede, P., Winer, B. L., Wolff, M. T., Wood, D. L., Wood, K. S., Wood, M., & Yang, Z. (2013). The Second Fermi Large Area Telescope Catalog of Gamma-ray Pulsars. *Astrophysical Journal Supplement Series*, 208(2): 17. doi:10.1088/0067-0049/208/2/17.
- Abich, K., Bogan, C., Braxmaier, C., Danzmann, K., Dehne, M., Gohlke, M., Görth, A., Heinzel, G., Herding, M., Mahrdt, C., Müller, V., Nicklaus, K., Sanjuan, J., Schütze, D., Sheard, B., Stede, G., & Voss, K. (2015). GRACE-Follow On Laser Ranging Interferometer: German contribution. *Journal of Physics: Conference Series*, 610: 012010.
- Abramowski, A., Aharonian, F., Benkhali, F. A., Akhperjanian, A. G., Angüner, E., Anton, G., Backes, M., Balenderan, S., Balzer, A., Barnacka, A., Becherini, Y., Tjus, J. B., Bernlöhr, K., Birsin, E., Bissaldi, E., Biteau, J., Böttcher, M., Boisson, C., Bolmont, J., Bordas, P., Brucker, J., Brun, F., Brun, P., Bulik, T., Carrigan, S., Casanova, S., Chadwick, P. M., Chalme-Calvet, R., Chaves, R. C. G., Cheesebrough, A., Chrétien, M., Colafrancesco, S., Cologne, G., Conrad, J., Couturier, C., Cui, Y., Dalton, M., Daniel, M. K., Davids, I. D., Degrange, B., Deil, C., deWilt, P., Dickinson, H. J., Djannati-Ataï, A., Domainko, W., Drury, L. O., Dubus, G., Dutsun, K., Dyks, J., Dyrda, M., Edwards, T., Egberts, K., Eger, P., Espigat, P., Farnier, C., Fegan, S., Feinstein, F., Fernandes, M. V., Fernandez, D., Fiasson, A., Fontaine, G., Förster, A., Fülling, M., Gajdus, M., Gallant, Y. A., Garrigoux, T., Giavitto, G., Giebels, B., Glicenstein, J. F., Grondin, M.-H., Grudzińska, M., Häffner, S., Hahn, J., Harris, J., Heinzlmann, G., Henri, G., Hermann, G., Hervet, O., Hillert, A., Hinton, J. A., Hofmann, W., Hofverberg, P., Holler, M., Horns, D., Jacholkowska, A., Jahn, C., Jamroz, M., Janiak, M., Jankowsky, F., Jung, I., Kastendieck, M. A., Katarzyński, K., Katz, U., Kaufmann, S., Khélifi, B., Kieffer, M., Klepser, S., Klochkov, D., Kluźniak, W., Kneiske, T., Kolitzus, D., Komin, N., Kosack, K., Krakau, S., Krayzel, F., Krüger, P. P., Laffon, H., Lamanna, G., Lefaucheur, J., Lemièrre, A., Lemoine-Goumard, M., Lenain, J.-P., Lohse, T., Lopatin, A., Lu, C.-C., Marandon, V., Marcowith, A., Marx, R., Maurin, G., Maxted, N., Mayer, M., McComb, T. J. L., Méhault, J., Meintjes, P. J., Menzler, U., Meyer, M., Moderski, R., Mohamed, M., Moulin, E., Murach, T., Naumann, C. L., de Naurois, M., Niemiec, J., Nolan, S. J., Oakes, L., Odaka, H., Ohm, S., Wilhelm, E. d. O., Opitz, B., Ostrowski, M., Oya, I., Panter, M., Parsons, R. D., Arribas, M. P., Pekeur, N. W., Pelletier, G., Perez, J., Petrucci, P.-O., Peyaud, B., Pita, S., Poon, H., Pühlhofer, G., Punch, M., Quirrenbach, A., Raab, S., Raue, M., Reichardt, I., Reimer, A., Reimer, O., Renaud, M., Reyes, R. d. I., Rieger, F., Rob, L., Romoli, C., Rosier-Lees, S., Rowell, G., Rudak, B., Rulten, C. B., Sahakian, V., Sanchez, D. A., Santangelo, A., Schlickeiser, R., Schüssler, F., Schulz, A., Schwanke, U., Schwarzburg, S., Schwemmer, S., Sol, H., Spengler, G., Spies, F., Stawarz, Ł., Steenkamp, R., Stegmann, C., Stinzing, F., Stycz, K., Sushch, I., Tavernet, J.-P., Tavernier, T., Taylor, A. M., Terrier, R., Tluczykont, M., Trichard, C., Valerius, K., van Eldik, C., van Soelen, B., Vasileiadis, G., Venter, C., Viana, A., Vincent, P., Völk, H. J., Volpe, F., Vorster, M., Vuillaume, T., Wagner, S. J., Wagner, R. M., Ward, M., Weidinger, M., Weitzel, Q., White, R., Wiercholska, A., Willmann, P., Wörnlein, A., Wouters, D., Yang, R., Zabalza, V., Zacharias, M., Zdziarski, A. A., Zech, A., Zechlin, H.-S., Collaboration, F.-L., Acero, F., Casandjian, J. M., Cohen-Tanugi, J., Giordano, F., Guillemot, L., Lande, J., Pletsch, H., & Uchiyama, Y. (2015). Probing the gamma-ray emission from HESS J1834-087 using H.E.S.S. and Fermi LAT observations. *Astronomy and Astrophysics*, 574: A27. doi:10.1051/0004-6361/201322694.
- Acena, A. E., & Dain, S. (2013). Stable isoperimetric surfaces in super-extreme Reissner-Nordström. *Classical and quantum gravity*, 30(4): 045013. doi:10.1088/0264-9381/30/4/045013.
- Acernese, F., Barone, F., Bell, A. S., Bergmann, G., Blair, D., Born, M., Brown, D., Chen, X., Danilishin, S. L., Degallaix, J., Denker, T., Virgilio, A. D., Frajuca, C., Friedrich, D., Fulda, P., Grote, H., Huttner, S. H., Kato, J., Köhlenbeck, S., Leavey, S., Luck, H., Nakano, M., Palmer, R. N., Punturo, M., Raffai, P., Schuette, D., Simakov, D., Slagmolen, B. J. J., Somiya, K., Steinlechner, S., Steinlechner, J., Tarabrin, S., Wade, A. R., Wang, M., Westphal, T., Zhao, C., Adhikari, R. X., Adier, M., Agatsuma, K., Barr, B. W., Bassiri, R., Bauchrowitz, J., Blair, C., Bond, C., Bongs, K., Bortoli, F. S., Cagnoli, G., Calia, P., Canonico, R., Carbone, L., Chua, S. S. Y., Coccia, E., Cripe, J., Cunningham, L., Danzmann, K., Rosa, R. D., Fafone, V., Fejer, M. M., Flaminio, R., Fontaine, J. P., Forest, D., Freise, A., Furusawa, A., Garufi, F. S., Giordano, G., Gondán, L., Gordon, N., Goßler, S., Gräf, C., Granata, M., Hammerer, K., Heng, I. S., Heurs, M., Hild, S., Hirobayashi, S., Hough, J., Ju, L., Kaufer, H., Kawamura, H., Kawamura, S., Kelecsényi, N., Khalaidovski, A., Khalili, F. Y., Kuroda, K., Loddo, G., Logue, J., Ma, Y., Macarthur, J., Magalhaes, N. S., Majorana, E., Malvezzi, V., Márka, S., Márka, Z., Martin, I., McClelland, D. E., Meinders, M., Michel, C., Miller, J., Morgado, N., Müller-Ebhardt, H., Naticchioni, L., Nguyen, T.-T.-H., Perciballi, M., Pinard, L., Puppo, P., Rapagnani, P., Ricci, F., Rissan, P., Rocchi, A., Rocco, E., Romano, R., Route, R. K., Rowan, S., Sakata, S., Schnabel, R., Shaddock, D. A., Sorazu, B., Stefszky, M. S., Steinmeyer, D., Strain, K. A., Voronchev, N. V., Ward, R. L., & Wimmer, M. (2014). Concepts and research for future detectors. *General Relativity and Gravitation*, 46: 1700. doi:10.1007/s10714-014-1700-8.

## Publications by AEI Members and Guest Scientists

- Adams, T., Leong, J. R., Slutsky, J., Was, M., Affeldt, C., Degallaix, J., Dooley, K., Grote, H., Hild, S., Lueck, H., Macleod, D. M., Nuttall, L. K., Prijatelj, M., Schreiber, E., Sorazu, B., Strain, K. A., Sutton, P. J., Vahlbruch, H., Witte, H., & Danzmann, K. (2015). Cost-benefit analysis for commissioning decisions in GEO600. *Classical and quantum gravity*, 32: 135014. doi:10.1088/0264-9381/32/13/135014.
- Adier, M., Aguilar, F., Akutsu, T., Arain, M. A., Ando, M., Anghinolfi, L., Antonini, P., Aso, Y., Barr, B. W., Barsotti, L., Beker, M. G., Bell, A. S., Bellon, L., Bertolini, A., Blair, C., Blom, M. R., Bogan, C., Bond, C., Bortoli, F. S., Brown, D., Buchler, B. C., Bulten, H. J., Cagnoli, G., Canepa, M., Carbone, L., Cesarini, E., Champagnon, B., Chen, D., Chincarini, A., Chtanov, A., Chua, S. S. Y., Ciani, G., Coccia, E., Conte, A., Cortese, M., Daloisio, M., Damjanic, M., Day, R. A., Ligny, D. D., Degallaix, J., Doets, M., Dolique, V., Dooley, K., Dwyer, S., Evans, M., Factourovich, M., Fafone, V., Farinon, S., Feldbaum, D., Flaminio, R., Forest, D., Frajuca, C., Frede, M., Freise, A., Fricke, T., Friedrich, D., Fritschel, P., Frolov, V. V., Fulda, P., Geitner, M., Gemme, G., Gleason, J., Goßler, S., Gordon, N., Gräf, C., Granata, M., Gras, S., Gross, M., Grote, H., Gustafson, R., Hanke, M., Heintze, M., Hennes, E., Hild, S., Huttner, S. H., Ishidoshiro, K., Izumi, K., Kawabe, K., Kawamura, S., Kawazoe, F., Kasprzack, M., Khalaidovski, A., Kimura, N., Koike, S., Kume, T., Kumeta, A., Kuroda, K., Kwee, P., Lagrange, B., Lam, P. K., Landry, M., Leavey, S., Leonardi, M., Li, T., Liu, Z., Lorenzini, M., Losurdo, G., Lumaca, D., Macarthur, J., Magalhaes, N. S., Majorana, E., Malvezzi, V., Mangano, V., Mansell, G., Marque, J., Martin, R., Martynov, D., Mavalvala, N., McClelland, D. E., Meadors, G. D., Meier, T., Mermet, A., Michel, C., Minkov, Y., Mow-Lowry, C. M., Mudadu, L., Mueller, C. L., Mueller, G., Mul, F., Kumar, D. N., Nardecchia, I., Naticchioni, L., Neri, M., Niwa, Y., Ohashi, M., Okada, K., Oppermann, P., Pinard, L., Poeld, J. H., Prato, M., Prodi, G. A., Puncken, O., Puppo, P., Quetschke, V., Reitze, D. H., Risson, P., Rocchi, A., Saito, N., Saito, Y., Sakakibara, Y., Sassolas, B., Schimmel, A., Schnabel, R., Schofield, R. M. S., Schreiber, E., Sequino, V., Serra, E., Shaddock, D. A., Shoda, A., Shoemaker, D. H., Shibata, K., Sigg, D., Smith-Lefebvre, N., Somiya, K., Sorazu, B., Stefszky, M. S., Strain, K. A., Straniero, N., Suzuki, T., Takahashi, R., Tanner, D. B., Tellez, G., Theeg, T., Tokoku, C., Tsubono, K., Uchiyama, T., Ueda, S., Vahlbruch, H., Vajente, G., Vorvick, C., van den Brand, J. F. J., Wade, A., Ward, R., Wessels, P., Williams, L., Willke, B., Winkelmann, L., Yamamoto, K., & Zendri, J.-P. (2014). Progress and challenges in advanced ground-based gravitational-wave detectors. *General Relativity and Gravitation*, 46(8): 1749. doi:10.1007/s10714-014-1749-4.
- Adrián-Martínez, S., Samarai, I. A., Albert, A., André, M., Anghinolfi, M., Anton, G., Anvar, S., Ardid, M., Astraatmadja, T., Aubert, J.-J., Baret, B., Basa, S., Bertin, V., Biagi, S., Bigongiari, C., Bogazzi, C., Bou-Cabo, M., Bouhou, B., Bouwhuis, M., Brunner, J., Busto, J., Capone, A., Cârloganu, C., Carr, J., Cecchini, S., Charif, Z., Charvis, P., Chiarusi, T., Circella, M., Coniglione, R., Core, L., Costantini, H., Coyle, P., Creusot, A., Curtil, C., Bonis, G. D., Decowski, M., Dekeiser, I., Deschamps, A., Distefano, C., Donzaud, C., Dornic, D., Dorosti, Q., Drouhin, D., Eberl, T., Emanuele, U., Enzenhöfer, A., Ermenwein, J.-P., Escoffier, S., Fehn, K., Fermani, P., Ferri, M., Ferry, S., Flaminio, V., Folger, F., Fritsch, U., Fuda, J.-L., Galatá, S., Gay, P., Geyer, K., Giacomelli, G., Giordano, V., Gómez-González, J., Graf, K., Guillard, G., Hallelwell, G., Hamal, M., van Haren, H., Heijboer, A., Hello, Y., Hernández-Rey, J., Herold, B., Höbl, J., Hsu, C., de Jong, M., Kadler, M., Kalekin, O., Kappes, A., Katz, U., Kavatsyuk, O., Kooijman, P., Kopper, C., Kouchner, A., Kreykenbohm, I., Kulikovskiy, V., Lahmann, R., Lambard, G., Larosa, G., Lattuada, D., Lefèvre, D., Lim, G., Presti, D. L., Loehner, H., Loucatos, S., Louis, F., Mangano, S., Marcelin, M., Margiotta, A., Martínez-Mora, J., Martini, S., Meli, A., Montaruli, T., Morganti, M., Moscoso, L., Motz, H., Neff, M., Nezri, E., Palioselitis, D., Pávlas, G., Payet, K., Petrovic, J., Piattelli, P., Popa, V., Pradier, T., Presani, E., Racca, C., Reed, C., Riccobene, G., Richardt, C., Richter, R., Rivière, C., Robert, A., Roensch, K., Rostovtsev, A., Ruiz-Rivas, J., Rujoiu, M., Russo, G., Samtleben, D., Sánchez-Losa, A., Sapienza, P., Schmid, J., Schnabel, J., Schöck, F., Schuller, J.-P., Schüssler, F., Seitz, T., Shanidze, R., Simeone, F., Spies, A., Spurio, M., Steijger, J., Stolarczyk, T., Taiuti, M., Tamburini, C., Trovato, A., Vallage, B., Vallée, C., Van Eleweyk, V., Vecchi, M., Vernin, P., Visser, E., Wagner, S., Wijnker, G., Wilms, J., de Wolf, E., Yepes, H., Zaborov, D., Zornoza, J., Zúñiga, J., Aasi, J., Abadie, J., Abbott, B. P., Abbott, R., Abbott, T. D., Abernathy, M., Accadia, T., Acernese, F., Adams, C., Adams, T., Addesso, P., Adhikari, R., Affeldt, C., Agathos, M., Agatsuma, K., Ajith, P., Allen, B., Allocca, A., Ceron, E. A., Amariutei, D., Anderson, S. B., Anderson, W. G., Arai, K., Araya, M. C., Ast, S., Aston, S. M., Astone, P., Atkinson, D., Aufmuth, P., Aulbert, C., Aylott, B. E., Babak, S., Baker, P., Ballardín, G., Ballmer, S., Bao, Y., Barayoga, J. C. B., Barker, D., Barone, F., Barr, B., Barsotti, L., Barsuglia, M., Barton, M. A., Bartos, I., Bassiri, R., Bastarrika, M., Basti, A., Batch, J., Bauchrowitz, J., Bauer, T. S., Bebrone, M., Beck, D., Behnke, B., Bejger, M., Beker, M., Bell, A. S., Bell, C., Belopolski, I., Benacquista, M., Berliner, J. M., Bertolini, A., Betzwieser, J., Beveridge, N., Beyersdorf, P. T., Bhabade, T., Bilenko, I. A., Billingsley, G., Birch, J., Biswas, R., Bitossi, M., Bizouard, M. A., Black, E., Blackburn, J. K., Blackburn, L., Blair, D., Bland, B., Blom, M., Bock, O., Bodiya, T. P., Bogan, C., Bond, C., Bondarescu, R., Bondu, F., Bonelli, L., Bonnand, R., Bork, R., Born, M., Boschi, V., Bose, S., Bosi, L., Braccini, S., Bradaschia, C., Brady, P. R., Braginsky, V. B., Branchesi, M., Brau, J. E., Breyer, J., Briant, T., Bridges, D. O., Brillet, A., Brinkmann, M., Brisson, V., Britzger, M., Brooks, A. F., Brown, D. A., Bulik, T., Bulten, H. J., Buonanno, A., Burguet-Castell, J., Buskulic, D., Buy, C., Byer, R. L., Cadonati, L., Cagnoli, G., Calloni, E., Camp, J. B., Campsie, P., Cannon, K., Canuel, B., Cao, J., Capano, C. D., Carbognani, F., Carbone, L., Caride, S., Caudill, S., Cavalià, M., Cavalier, F., Cavalieri, R., Cella, G., Cepeda, C., Cesarini, E., Chalermongsak, T., Charlton, P., Chassande-Mottin, E., Chen, W., Chen, X., Chen, Y., Chincarini, A., Chiummo, A., Cho, H. S., Chow, J., Christensen, N., Chua, S. S. Y., Chung, C. T. Y., Chung, S., Ciani, G., Clara, F., Clark, D. E., Clark, J. A., Clayton, J. H., Cleva, F., Coccia, E., Cohadon, P.-F., Colacino, C. N., Colla, A., Colombini, M., Conte, A., Conte, R., Cook, D., Corbitt, T. R., Cordier, M., Cornish, N., Corsi, A., Costa, C. A., Coughlin, M., Coulon, J.-P., Couvares, P., Coward, D. M., Cowart, M., Coyne, D. C., Creighton, J. D. E., Creighton, T. D., Cruise, A. M., Cumming, A., Cunningham, L., Cuoco, E., Cutler, R. M., Dahl, K., Damjanic, M., Danilishin, S. L., D'Antonio, S., Danzmann, K., Dattilo, V., Daudert, B., Daveloza, H., Davier, M., Daw, E. J., Day, R., Dayanga, T., Rosa, R. D., DeBra, D., Debreczeni, G., Degallaix, J., Pozzo, W. D., Dent, T., Dergachev, V., DeRosa, R., Dhurandhar, S., Fiore, L. D., Lieta, A. D., Palma, I. D., Emilio, M. D. P., Virgilio, A. D., Díaz, M., Dietz, A., Donovan, F., Dooley, K. L., Doravari, S., Dorscher, S., Drago, M., Drever, R. W. P., Driggers, J. C., Du, Z., Dumas, J.-C., Dwyer, S., Eberle, T., Edgar, M., Edwards, M., Effler, A., Ehrens, P., Endrőczy, G., Engel, R., Etzel, T., Evans, K., Evans, M., Evans, T., Factourovich, M., Fafone, V., Fairhurst, S., Farr, B. F., Favata, M., Fazi, D., Fehrmann, H., Feldbaum, D., Ferrante, I., Ferrini, F., Fidecaro, F., Finn, L. S., Fiori, I., Fisher, R. P., Flaminio, R., Foley, S., Forsi, E., Forte, L. A., Fotopoulos, N., Fournier, J.-D., Franc, J., Franco, S., Frasca, S., Frasconi, F., Frede, M., Frei, M. A., Frei, Z., Freise, A., Frey, R., Fricke, T. T., Friedrich, D., Fritschel, P., Frolov, V. V., Fujimoto, M.-K., Fulda, P. J., Fyffe, M., Gair, J., Galimberti, M., Gammaitoni, L., Garcia, J., Garufi, F., Gáspár, M. E., Gelencser, G., Gemme, G., Genin, E., Gennai, A., Gergely, L. Á., Ghosh, S., Giaime, J. A.,



## Publications by AEI Members and Guest Scientists

- Giampanis, S., Giardina, K. D., Giazotto, A., Gil-Casanova, S., Gill, C., Gleason, J., Goetz, E., González, G., Gorodetsky, M. L., Göbber, S., Gouaty, R., Graef, C., Graff, P. B., Granata, M., Grant, A., Gray, C., Greenhalgh, R. J. S., Gretarsson, A. M., Griffo, C., Grote, H., Grover, K., Grunewald, S., Guidi, G. M., Guido, C., Gupta, R., Gustafson, E. K., Gustafson, R., Hallam, J. M., Hammer, D., Hammond, G., Hanks, J., Hanna, C., Hanson, J., Harms, J., Harry, G. M., Harry, I. W., Harstad, E. D., Hartman, M. T., Haughian, K., Hayama, K., Hayau, J.-F., Heefner, J., Heidmann, A., Heintze, M. C., Heitmann, H., Hello, P., Hemming, G., Hendry, M. A., Heng, I. S., Heptonstall, A. W., Herrera, V., Heurs, M., Hewitson, M., Hild, S., Hoak, D., Hodge, K. A., Holt, K., Holtrop, M., Hong, T., Hooper, S., Hough, J., Howell, E. J., Hughey, B., Husa, S., Huttner, S. H., Huynh-Dinh, T., Ingram, D. R., Inta, R., Isogai, T., Ivanov, A., Izumi, K., Jacobson, M., James, E., Jang, Y. J., Jaranowski, P., Jesse, E., Johnson, W. W., Jones, D. I., Jones, R., Jonker, R., Ju, L., Kalmus, P., Kalogera, V., Kandhasamy, S., Kang, G., Kanner, J. B., Kasprzak, M., Kasturi, R., Katsavounidis, E., Katzman, W., Kaufer, H., Kaufman, K., Kawabe, K., Kawamura, S., Kawazoe, F., Keitel, D., Kelley, D., Kells, W., Keppel, D., Keresztes, Z., Khalaidovski, A., Khalili, F. Y., Khazanov, E. A., Kim, B. K., Kim, C., Kim, H., Kim, K., Kim, N., Kim, Y. M., King, P. J., Kinzel, D. L., Kissel, J. S., Klimentenko, S., Kline, J., Kokeyama, K., Kondrashov, V., Koranda, S., Korth, W. Z., Kowalska, I., Kozak, D., Kringel, V., Krishnan, B., Królak, A., Kuehn, G., Kumar, P., Kumar, R., Kurdyumov, R., Kwee, P., Lam, P. K., Landry, M., Langley, A., Lantz, B., Lastzka, N., Lawrie, C., Lazzarini, A., Le Roux, A., Leaci, P., Lee, C. H., Lee, H. K., Lee, H. M., Leong, J. R., Leonor, I., Leroy, N., Letendre, N., Lhuillier, V., Li, J., Li, T. G. F., Lindquist, P. E., Litvine, V., Liu, Y., Liu, Z., Lockerbie, N. A., Lodhia, D., Logue, J., Lorenzini, M., Lorette, V., Lormand, M., Losurdo, G., Lough, J., Lubinski, M., Lück, H., Lundgren, A. P., Macarthur, J., Macdonald, E., Machenschalk, B., MacInnis, M., Macleod, D. M., Magewaran, M., Mayland, K., Majorana, E., Maksimovic, I., Malvezzi, V., Man, N., Mandel, I., Mandic, V., Mantovani, M., Marchesoni, F., Marion, F., Márka, S., Márka, Z., Markosyan, A., Maros, E., Marque, J., Martelli, F., Martin, I. W., Martin, R. M., Marx, J. N., Mason, K., Masserot, A., Matichard, F., Matone, L., Matzner, R. A., Mavalvala, N., Mazzolo, G., McCarthy, R., McClelland, D. E., McGuire, S. C., McIntyre, G., McIver, J., Meadors, G. D., Mehmet, M., Meier, T., Melatos, A., Melissinos, A. C., Mendell, G., Menéndez, D. F., Mercer, R. A., Meshkov, S., Messenger, C., Meyer, M. S., Miao, H., Michel, C., Milano, L., Miller, J., Minenkov, Y., Mingarelli, C. M. F., Mitrofanov, V. P., Mitselmakher, G., Mittleman, R., Moe, B., Mohan, M., Mohapatra, S. R. P., Moraru, D., Moreno, G., Morgado, N., Morgia, A., Mori, T., Morriss, S. R., Mosca, S., Mossavi, K., Mours, B., Mow-Lowry, C. M., Mueller, C. L., Mueller, G., Mukherjee, S., Mullavey, A., Müller-Ebhardt, H., Munch, J., Murphy, D., Murray, P. G., Mytidis, A., Nash, T., Naticchioni, L., Necula, V., Nelson, J., Neri, I., Newton, G., Nguyen, T., Nishizawa, A., Nitz, A., Nocera, F., Nolting, D., Normandin, M. E., Nuttall, L., Ochsner, E., O'Dell, J., Oelker, E., Ogin, G. H., Oh, J. J., Oh, S. H., Oldenberg, R. G., O'Reilly, B., O'Shaughnessy, R., Osthelder, C., Ott, C. D., Ottaway, D. J., Ottens, R. S., Overmier, H., Owen, B. J., Page, A., Palladino, L., Palomba, C., Pan, Y., Pankow, C., Paoletti, F., Paoletti, R., Papa, M. A., Parisi, M., Pasqualetti, A., Passaquietti, R., Passuello, D., Pedraza, M., Penn, S., Perreca, A., Persichetti, G., Phelps, M., Pichot, M., Pickenpack, M., Piergiovanni, F., Piero, V., Pihlaja, M., Pinar, L., Pinto, I. M., Pitkin, M., Pletsch, H. J., Plissi, M. V., Poggiani, R., Pödl, J., Postiglione, F., Poux, C., Prato, M., Predoi, V., Prestegard, T., Price, L. R., Prijatelj, M., Principe, M., Privitera, S., Prix, R., Prodi, G. A., Prokhorov, L. G., Puncken, O., Punturo, M., Puppo, P., Quetschke, V., Quitzow-James, R., Raab, F. J., Rabeling, D. S., Rácz, I., Radkins, H., Raffai, P., Rakhmanov, M., Ramet, C., Rankins, B., Rapagnani, P., Raymond, V., Re, V., Reed, C. M., Reed, T., Regimbau, T., Reid, S., Reitze, D. H., Ricci, F., Riesen, R., Riles, K., Roberts, M., Robertson, N. A., Robinet, F., Robinson, C., Robinson, E. L., Rocchi, A., Roddy, S., Rodriguez, C., Rodruck, M., Rolland, L., Rollins, J. G., Romano, J. D., Romano, R., Romie, J. H., Rosińska, D., Röver, C., Rowan, S., Rüdiger, A., Ruggi, P., Ryan, K., Salemi, F., Sammut, L., Sandberg, V., Sankar, S., Sannibale, V., Santamaría, L., Santiago-Prieto, I., Santostasi, G., Saracco, E., Sassolas, B., Sathyaprakash, B. S., Saulson, P. R., Savage, R. L., Schilling, R., Schnabel, R., Schofield, R. M. S., Schulz, B., Schutz, B. F., Schwinberg, P., Scott, J., Scott, S. M., Seifert, F., Sellers, D., Sentenac, D., Sergeev, A., Shaddock, D. A., Shaltev, M., Shapiro, B., Shawhan, P., Shoemaker, D. H., Sideri, T. L., Siemens, X., Sigg, D., Simakov, D., Singer, A., Singer, L., Sintès, A. M., Skelton, G. R., Slagmolen, B. J. J., Slutsky, J., Smith, J. R., Smith, M. R., Smith, R. J. E., Smith-Lefebvre, N. D., Somiya, K., Sorazu, B., Speirits, F. C., Sperandio, L., Stefszky, M., Steinert, E., Steinlechner, J., Steinlechner, S., Steplewski, S., Stochino, A., Stone, R., Strain, K. A., Strigin, S. E., Stroeer, A. S., Sturani, R., Stuver, A. L., Summerscales, T. Z., Sung, M., Susmithan, S., Sutton, P. J., Swinkels, B., Szeifert, G., Tacca, M., Taffarello, L., Talukder, D., Tanner, D. B., Tarabrin, S. P., Taylor, R., Braack, A. P. M. t., Thomas, P., Thorne, K. A., Thorne, K. S., Thrane, E., Thüring, A., Titsler, C., Tokmakov, K. V., Tomlinson, C., Toncelli, A., Tonelli, M., Torre, O., Torres, C. V., Torrie, C. I., Tourmefier, E., Travasso, F., Traylor, G., Tse, M., Ugolini, D., Vahlbruch, H., Vajente, G., van den Brand, J. F. J., Van Broeck, C. D., van der Putten, S., van Veggel, A. A., Vass, S., Vasuth, M., Vaulin, R., Vavoulidis, M., Vecchio, A., Vedovato, G., Veitch, J., Veitch, P. J., Venkateswara, K., Verkindt, D., Vetrano, F., Viceré, A., Villar, A. E., Vinet, J.-Y., Vitale, S., Vocca, H., Vorvick, C., Vyatchanin, S. P., Wade, A., Wade, L., Wade, M., Waddman, S. J., Wallace, L., Wan, Y., Wang, M., Wang, X., Wanner, A., Ward, R. L., Was, M., Weinert, M., Weinstein, A. J., Weiss, R., Welborn, T., Wen, L., Wessels, P., West, M., Westphal, T., Wette, K., Whelan, J. T., Whitcomb, S. E., White, D. J., Whiting, B. F., Wiesner, K., Wilkinson, C., Willems, P. A., Williams, L., Williams, R., Willeke, B., Wimmer, M., Winkelmann, L., Winkler, W., Wipf, C. C., Wiseman, A. G., Wittel, H., Woan, G., Wooley, R., Worden, J., Yablon, J., Yakushin, I., Yamamoto, H., Yamamoto, K., Yancey, C. C., Yang, H., Yeaton-Massey, D., Yoshida, S., Yvert, M., Zadrożny, A., Zanolin, M., Zendri, J.-P., Zhang, F., Zhang, L., Zhao, C., Zotov, N., Zucker, M. E., Zweizig, J., The ANTARES collaboration, The LIGO scientific collaboration, & The Virgo collaboration (2013). A First Search for coincident Gravitational Waves and High Energy Neutrinos using LIGO, Virgo and ANTARES data from 2007. *Journal of Cosmology and Astroparticles Physics*, 2013(6): 008. doi:10.1088/1475-7516/2013/06/008.
- Adrián-Martínez, S., Albert, A., André, M., Anton, G., Ardid, M., Aubert, J.-J., Avgitas, T., Baret, B., Barrios-Martí, J., Basa, S., Bertin, V., Biagi, S., Bormuth, R., Bouwhuis, M. C., Bruijn, R., Brunner, J., Bustó, J., Capone, A., Caramete, L., Carr, J., Celli, S., Chiarusi, T., Circella, M., Coleiro, A., Coniglione, R., Costantini, H., Coyle, P., Creusot, A., Deschamps, A., De Bonis, G., Distefano, C., Donzaud, C., Dornic, D., Drouhin, D., Eberl, T., Bojaddaini, I. E., Elsässer, D., Enzenhöfer, A., Fehn, K., Felis, I., Fusco, L. A., Galatà, S., Gay, P., Geißelsöder, S., Geyer, K., Giordano, V., Giordano, V., Gleixner, A., Glotin, H., Gracia-Ruiz, R., Graf, K., Hallmann, S., van Haren, H., Heijboer, A. J., Hello, Y., Hernández-Rey, J. J., Höbl, J., Hofestädt, J., Hugon, C., Illuminati, G., James, C. W., de Jong, M., Jongen, M., Kadler, M., Kalekin, O., Katz, U., Kießling, D., Kouchner, A., Kreter, M., Kreykenbohm, I., Kulikovskiy, V., Lachaud, C., Lahmann, R., Lefèvre, D., Leonora, E., Loucatos, S., Marcelin, M., Margiotta, A., Marinelli, A., Martínez-Mora, J. A., Mathieu, A., Melis, K., Michael, T., Migliozi, P., Moussa, A., Mueller, C., Nezi, E., Pávlaš, G. E., Pellegrino, C., Perrina, C., Piattelli, P., Popa, V., Pradier, T., Racca, C., Riccobene, G., Roensch, K., Saldaña, M., Samtleben, D. F. E.,

## Publications by AEI Members and Guest Scientists

Sanguineti, M., Sapienza, P., Schnabel, J., Schüssler, F., Seitz, T., Sieger, C., Spurio, M., Stolarczyk, T., Sánchez-Losa, A., Taiuti, M., Trovato, A., Tselengidou, M., Turpin, D., Tü, C., Vallage, B., Vallée, C., Van Elewyck, V., Vivolo, D., Wagner, S., Wilms, J., Zornoza, J. D., Zúñiga, J., Aartsen, M. G., Abraham, K., Ackermann, M., Adams, J., Aguilar, J. A., Ahlers, M., Ahrens, M., Altmann, D., Anderson, T., Anseau, I., Anton, G., Archinger, M., Argüelles, C., Arlen, T. C., Auffenberg, J., Bai, X., Barwick, S. W., Baum, V., Bay, R., Beatty, J. J., Tjus, J. B., Becker, K.-H., Beiser, E., BenZvi, S., Berghaus, P., Berley, D., Bernardini, E., Bernhard, A., Besson, D. Z., Binder, G., Bindig, D., Bissok, M., Blaufuss, E., Blumenthal, J., Boersma, D. J., Bohm, C., Börner, M., Bos, F., Bose, D., Böser, S., Botner, O., Braun, J., Brayeur, L., Bretz, H.-P., Buzinsky, N., Casey, J., Casier, M., Cheung, E., Chirkin, D., Christov, A., Clark, K., Classen, L., Coenders, S., Collin, G. H., Conrad, J. M., Cowen, D. F., Silva, A. H. C., Daughhetee, J., Davis, J. C., Day, M., de André, J. P. A. M., De Clercq, C., Rosendo, E. d. P., Dembinski, H., De Ridder, S., Desiati, P., de Vries, K. D., de Wasseige, G., de With, M., DeYoung, T., Díaz-Vélez, J. C., di Lorenzo, V., Dujmovic, H., Dumm, J. P., Dunkman, M., Eberhardt, B., Ehrhardt, T., Eichmann, B., Euler, S., Evenson, P. A., Fahey, S., Fazely, A. R., Feintzeig, J., Felde, J., Filimonov, K., Finley, C., Flis, S., Fösig, C.-C., Fuchs, T., Gaisser, T. K., Gaior, R., Gallagher, J., Gerhardt, L., Ghorbani, K., Gier, D., Gladstone, L., Glagla, M., Glüsenkamp, T., Goldschmidt, A., Golup, G., Gonzalez, J. G., Góra, D., Grant, D., Griffith, Z., Ha, C., Haaack, C., Ismail, A. H., Hallgren, A., Halzen, F., Hansen, E., Hansmann, B., Hansmann, T., Hanson, K., Hebecker, D., Heereman, D., Helbing, K., Hellauer, R., Hickford, S., Hignight, J., Hill, G. C., Hoffman, K. D., Hoffmann, R., Holzapfel, K., Homeier, A., Hoshina, K., Huang, F., Huber, M., Huelsnitz, W., Hulth, P. O., Hultqvist, K., In, S., Ishihara, A., Jacobi, E., Japaridze, G. S., Jeong, M., Jero, K., Jones, B. J. P., Jurkovic, M., Kappes, A., Karg, T., Karle, A., Katz, U., Kauer, M., Keivani, A., Kelley, J. L., Kemp, J., Kheirandish, A., Kim, M., Kintschi, T., Kiryluk, J., Klein, S. R., Kohonen, G., Koirala, R., Kolanoski, H., Konietz, R., Köpke, L., Kopper, C., Kopper, S., Koskinen, D. J., Kowalski, M., Krings, K., Kroll, G., Kroll, M., Krückel, G., Kunnen, J., Kunwar, S., Kurahashi, N., Kuwabara, T., Labare, M., Lanfranchi, J. L., Larson, M. J., Lennarz, D., Lesiak-Bzdak, M., Leuermann, M., Leuner, J., Lu, L., Lünemann, J., Madsen, J., Maggi, G., Mahn, K. B. M., Mandelartz, M., Maruyama, R., Mase, K., Matis, H. S., Maunu, R., McNally, F., Meagher, K., Medici, M., Meier, M., Meli, A., Menne, T., Merino, G., Meures, T., Miarecki, S., Middell, E., Mohrmann, L., Montaruli, T., Morse, R., Nahnauer, R., Naumann, U., Neer, G., Niederhausen, H., Nowicki, S. C., Nygren, D. R., Pollmann, A. O., Olivás, A., Omairat, A., O'Murchadha, A., Palczewski, T., Pandya, H., Pankova, D. V., Paul, L., Pepper, J. A., Heros, C. P. d. l., Pfendner, C., Pieloth, D., Pinat, E., Posselt, J., Price, P. B., Przybylski, G. T., Quinnan, M., Raab, C., Rädcl, L., Rameez, M., Rawlins, K., Reimann, R., Relich, M., Resconi, E., Rhode, W., Richman, M., Richter, S., Riedel, B., Robertson, S., Rongen, M., Rott, C., Ruhe, T., Ryckbosch, D., Sabbatini, L., Sander, H.-G., Sandrock, A., Sandroos, J., Sarkar, S., Schatto, K., Schimp, M., Schlunder, P., Schmidt, T., Schoenen, S., Schöneberg, S., Schönwald, A., Schumacher, L., Seckel, D., Seunarine, S., Soldin, D., Song, M., Spiczak, G. M., Spiering, C., Stahlberg, M., Stamatikos, M., Stanev, T., Stasik, A., Steuer, A., Stezelberger, T., Stokstad, R. G., Stöbl, A., Ström, R., Strotzjohann, N. L., Sullivan, G. W., Sutherland, M., Taavola, H., Taboada, I., Tatar, J., Ter-Antonyan, S., Terliuk, A., Tesić, G., Tilav, S., Toale, P. A., Tobin, M. N., Toscano, S., Tosi, D., Tselengidou, M., Turcati, A., Unger, E., Usner, M., Vallecorsa, S., Vandenbroucke, J., van Eijndhoven, N., Vanheule, S., van Santen, J., Veenkamp, J., Vehring, M., Voge, M., Vraeghe, M., Walck, C., Wallace, A., Wallraff, M., Wandkowsky, N., Weaver, C., Wendt, C., Westerhoff, S., Whelan, B. J., Wiebe, K., Wiebusch, C. H., Wille, L., Williams, D. R., Wills, L., Wissing, H., Wolf, M., Wood, T. R., Woschnagg, K., Xu, D. L., Xu, X. W., Xu, Y., Yanez, J. P., Yodh, G., Yoshida, S., Zoll, M., Abbott, B. P., Abbott, R., Abbott, T. D., Abernathy, M. R., Acernese, F., Ackley, K., Adams, C., Adams, T., Addesso, P., Adhikari, R. X., Adya, V. B., Affeldt, C., Agathos, M., Agatsuma, K., Aggarwal, N., Aguiar, O. D., Aiello, L., Ain, A., Ajith, P., Allen, B., Allocca, A., Altin, P. A., Anderson, S. B., Anderson, W. G., Arai, K., Araya, M. C., Arceneaux, C. C., Areeda, J. S., Arnaud, N., Arun, K. G., Ascenzi, S., Ashton, G., Ast, M., Aston, S. M., Astone, P., Aufmuth, P., Aulbert, C., Babak, S., Bacon, P., Bader, M. K. M., Baker, P. T., Baldaccini, F., Ballardín, G., Ballmer, S. W., Barayoga, J. C., Barclay, S. E., Barish, B. C., Barker, D., Barone, F., Barr, B., Barsotti, L., Barsuglia, M., Barta, D., Bartlett, J., Bartos, I., Bassiri, R., Basti, A., Batch, J. C., Baune, C., Baviggadda, V., Bazzan, M., Behnke, B., Bejger, M., Bell, A. S., Bell, C. J., Berger, B. K., Bergman, J., Bergmann, G., Berry, C. P. L., Bersanetti, D., Bertolini, A., Betzwieser, J., Bhagwat, S., Bhandare, R., Bilenko, I. A., Billingsley, G., Birch, J., Birney, R., Biscans, S., Bisht, A., Bitossi, M., Biver, C., Bizouard, M. A., Blackburn, J. K., Blair, C. D., Blair, D. G., Blair, R. M., Bloemen, S., Bock, O., Bodiya, T. P., Boer, M., Bogaert, G., Bogan, C., Bohe, A., Bojtas, P., Bond, C., Bondu, F., Bonnand, R., Boom, B. A., Bork, R., Boschi, V., Bose, S., Bouffanaïs, Y., Bozzi, A., Bradaschia, C., Brady, P. R., Braginsky, V. B., Branchesi, M., Brau, J. E., Briant, T., Brillet, A., Brinkmann, M., Brisson, V., Brockill, P., Brooks, A. F., Brown, D. D., Brown, N. M., Buchanan, C. C., Buikema, A., Bulik, T., Bulten, H. J., Buonanno, A., Buskulic, D., Buy, C., Byer, R. L., Cadonati, L., Cagnoli, G., Cahillane, C., Bustillo, J. C., Callister, T., Calloni, E., Camp, J. B., Cannon, K. C., Cao, J., Capano, C., Capocasa, E., Carbognani, F., Caride, S., Diaz, J. C., Casentini, C., Caudill, S., Cavaglià, M., Cavalier, F., Cavalieri, R., Cella, G., Cepeda, C. B., Baiardi, L. C., Cerretani, G., Cesarini, E., Chakraborty, R., Chalermongsak, T., Chamberlin, S. J., Chan, M., Chao, S., Charlton, P., Chassande-Mottin, E., Chen, H. Y., Chen, Y., Cheng, C., Chincarini, A., Chiummo, A., Cho, H. S., Cho, M., Chow, J. H., Christensen, N., Chu, Q., Chua, S., Chung, S., Ciani, G., Clara, F., Clark, J. A., Cleva, F., Coccia, E., Cohadon, P.-F., Colla, A., Collette, C. G., Cominsky, L., Constanancio, M., Conte, A., Conti, L., Cook, D., Corbitt, T. R., Cornish, N., Corsi, A., Cortese, S., Costa, C. A., Coughlin, M. W., Coughlin, S. B., Coulon, J.-P., Countryman, S. T., Couvares, P., Cowan, E. E., Coward, D. M., Cowart, M. J., Coyne, D. C., Coyne, R., Craig, K., Creighton, J. D. E., Cripe, J., Crowder, S. G., Cumming, A., Cunningham, L., Cuoco, E., Canton, T. D., Danilishin, S. L., D'Antonio, S., Danzmann, K., Darman, N. S., Dattilo, V., Dave, I., Daveloza, H. P., Davier, M., Davies, G. S., Daw, E. J., Day, R., DeBra, D., Debreczeni, G., Degallaix, J., De Laurentis, M., Deléglise, S., Del Pozzo, W., Denker, T., Dereli, H., Dergachev, V., DeRosa, R. T., De Rosa, R., DeSalvo, R., Dhurandhar, S., Díaz, M. C., Di Fiore, L., Di Giovanni, M., Di Lieto, A., Di Pace, S., Di Palma, I., Di Virgilio, A., Dojcinoski, G., Dolique, V., Donovan, F., Dooley, K. L., Doravari, S., Douglas, R., Downes, T. P., Drago, M., Drever, R. W. P., Driggers, J. C., Du, Z., Ducrot, M., Dwyer, S. E., Edo, T. B., Edwards, M. C., Effler, A., Eggenstein, H.-B., Ehrens, P., Eichholz, J., Eikenberry, S. S., Engels, W., Essick, R. C., Etzel, T., Evans, M., Evans, T. M., Everett, R., Factourovich, M., Fafone, V., Fair, H., Fairhurst, S., Fan, X., Fang, Q., Farinon, S., Farr, B., Farr, W. M., Favata, M., Fays, M., Fehrmann, H., Fejer, M. M., Ferrante, I., Ferreira, E. C., Ferrini, F., Fidecaro, F., Fiori, I., Fiorucci, D., Fisher, R. P., Flaminio, R., Fletcher, M., Fournier, J.-D., Franco, S., Frasca, S., Frasconi, F., Frei, Z., Freise, A., Frey, R., Frey, V., Fricke, T., Fritschel, P., Frolov, V. V., Fulda, P., Fyffe, M., Gabbard, H. A. G., Gair, J. R., Gammaitoni, L., Gaonkar, S. G., Garufi, F., Gatto, A., Gaur, G., Gehrels, N., Gemme, G., Gendre, B., Genin, E., Gennai, A., George, J., Gergely, L., Germain, V., Ghosh, A., Ghosh, S., Giaime, J. A., Giardina, K. D., Giazotto, A., Gill, K., Glaefke, A., Goetz, E., Goetz, R., Gondan, L., González, G., Castro, J. M. G., Gopakumar, A., Gordon, N. A., Gorodetsky, M. L., Gossan, S. E., Gos-

## Publications by AEI Members and Guest Scientists

selin, M., Gouaty, R., Graef, C., Graff, P. B., Granata, M., Grant, A., Gras, S., Gray, C., Greco, G., Green, A. C., Groot, P., Grote, H., Grunewald, S., Guidi, G. M., Guo, X., Gupta, A., Gupta, M. K., Gushwa, K. E., Gustafson, E. K., Gustafson, R., Hacker, J. J., Hall, B. R., Hall, E. D., Hammond, G., Haney, M., Hanke, M. M., Hanks, J., Hanna, C., Hannam, M. D., Hanson, J., Hardwick, T., Harms, J., Harry, G. M., Harry, I., Hart, M. J., Hartman, M. T., Haster, C., J., Haughian, K., Heidmann, A., Heintze, M. C., Heitmann, H., Hello, P., Hemming, G., Hendry, M., Heng, I. S., Hennig, J., Heptonstall, A. W., Heurs, M., Hild, S., Hoak, D., Hodge, K. A., Hofman, D., Hollitt, S. E., Holt, K., Holz, D. E., Hopkins, P., Hosken, D. J., Hough, J., Houston, E. A., Howell, E. J., Hu, Y. M., Huang, S., Huerta, E. A., Huet, D., Hughey, B., Husa, S., Huttner, S. H., Huynh-Dinh, T., Idrisy, A., Indik, N., Ingram, D. R., Inta, R., Isa, H. N., Isac, J., M., Isi, M., Islas, G., Isogai, T., Iyer, B. R., Izumi, K., Jacqmin, T., Jang, H., Jani, K., Jaranowski, P., Jawahar, S., Jiménez-Forteza, F., Johnson, W. W., Jones, D. I., Jones, R., Jonker, R. J. G., Ju, L., K. H., Kalaghatgi, C. V., Kalogera, V., Kandhasamy, S., Kang, G., Kanner, J. B., Karki, S., Kasprzack, M., Katsavounidis, E., Katzman, W., Kaufer, S., Kaur, T., Kawabe, K., Kawazoe, F., Kéfélian, F., Kehl, M. S., Keitel, D., Kelley, D. B., Kells, W., Kennedy, R., Key, J. S., Khalaidovski, A., Khalili, F. Y., Khan, I., Khan, S., Khan, Z., Khazanov, E. A., Kijbunchoo, N., Kim, C., Kim, J., Kim, K., Kim, N.-G., Kim, N., Kim, Y.-M., King, E. J., King, P. J., Kinzel, D. L., Kissel, J. S., Kleybolte, L., Klimenko, S., Koehlebeck, S. M., Kokeyama, K., Koley, S., Kondrashov, V., Kontos, A., Korobko, M., Korth, W. Z., Kowalska, I., Kozak, D. B., Kringel, V., Krishnan, B., Królak, A., Krueger, C., Kuehn, G., Kumar, P., Kuo, L., Kutynia, A., Lackey, B. D., Landry, M., Lange, J., Lantz, B., Lasky, P. D., Lazzarini, A., Lazzaro, C., Leaci, P., Leavey, S., Lebigot, E. O., Lee, C. H., Lee, H. K., Lee, H. M., Lee, K., Lenon, A., Leonardi, M., Leong, J. R., Leroy, N., Letendre, N., Levin, Y., Levine, B. M., Li, T. G. F., Libson, A., Littenberg, T. B., Lockerbie, N. A., Logue, J., Lombardi, A. L., Lord, J. E., Lorenzini, M., Lorette, V., Lormand, M., Losurdo, G., Lough, J. D., Lück, H., Lundgren, A., Luo, J., Lynch, R., Ma, Y., MacDonald, T., Machenschalk, B., MacInnis, M., Macleod, D. M., Magaña-Sandoval, F., Magee, R. M., Mageswaran, M., Majorana, E., Maksimovic, I., Malvezzi, V., Man, N., Mandel, I., Mandic, V., Mangano, V., Mansell, G. L., Manske, M., Mantovani, M., Marchesoni, F., Marion, F., Márka, S., Márka, Z., Markosyan, A. S., Maros, E., Martelli, F., Martellini, L., Martin, I. W., Martin, R. M., Martynov, D. V., Marx, J. N., Mason, K., Masserot, A., Massinger, T. J., Masso-Reid, M., Matichard, F., Matone, L., Mavalvala, N., Mazumder, N., Mazzolo, G., McCarthy, R., McClelland, D. E., McCormick, S., McGuire, S. C., McIntyre, G., McIver, J., McManus, D. J., McWilliams, S. T., Meacher, D., Meadors, G. D., Meidam, J., Melatos, A., Mendell, G., Mendoza-Gandara, D., Mercer, R. A., Merilh, E., Merzougui, M., Meshkov, S., Messenger, C., Messick, C., Meyers, P. M., Mezzani, F., Miao, H., Michel, C., Middleton, H., Mikhailov, E. E., Milano, L., Miller, J., Millhouse, M., Minenkov, Y., Ming, J., Mirshekari, S., Mishra, C., Mitra, S., Mitrofanov, V. P., Mitselmakher, G., Mittleman, R., Moggi, A., Mohan, M., Mohapatra, S. R. P., Montani, M., Moore, B. C., Moore, C. J., Moraru, D., Moreno, G., Morris, S. R., Mossavi, K., Mours, B., Mow-Lowry, C. M., Mueller, C. L., Mueller, G., Muir, A. W., Mukherjee, A., Mukherjee, D., Mukherjee, S., Mukund, N., Mullavey, A., Munch, J., Murphy, D. J., Murray, P. G., Mytidis, A., Nardecchia, I., Naticchioni, L., Nayak, R. K., Nacula, V., Nedkova, K., Nelemans, G., Neri, M., Neunzert, A., Newton, G., Nguyen, T. T., Nielsen, A. B., Nissanke, S., Nitz, A., Nocera, F., Nolting, D., Normandin, M. E. N., Nuttall, L. K., Oberling, J., Ochsner, E., O'Dell, J., Oelker, E., Ogin, G. H., Oh, J. J., Oh, S. H., Ohme, F., Oliver, M., Oppermann, P., Oram, R. J., O'Reilly, B., O'Shaughnessy, R., Ottaway, D. J., Ottens, R. S., Overmier, H., Owen, B. J., Pai, A., Pai, S. A., Palamos, J. R., Palashov, O., Palomba, C., Pal-Singh, A., Pan, H., Pankow, C., Pannarale, F., Pant, B. C., Paoletti, F., Paoli, A., Papa, M. A., Paris, H. R., Parker, W., Pascucci, D., Pasqualetti, A., Passaquietti, R., Passuello, D., Patricelli, B., Patrick, Z., Pearlstone, B. L., Pedraza, M., Pedurand, R., Pekowsky, L., Pele, A., Penn, S., Perreca, A., Phelps, M., Piccinni, O., Pichot, M., Piergiovanni, F., Pierro, V., Pillant, G., Pinard, L., Pinto, I. M., Pitkin, M., Poggiani, R., Popolizio, P., Post, A., Powell, J., Prasad, J., Predoi, V., Premachandra, S. S., Prestegard, T., Price, L. R., Prijatelj, M., Principe, M., Privitera, S., Prix, R., Prodi, G. A., Prokhorov, L., Puncken, O., Punturo, M., Puppo, P., Pürner, M., Qi, H., Qin, J., Quetschke, V., Quintero, E. A., Quitzow-James, R., Raab, F. J., Rabeling, D. S., Radkins, H., Raffai, P., Raja, S., Rakhmanov, M., Rapagnani, P., Raymond, V., Razzano, M., Re, V., Read, J., Reed, C. M., Regimbau, T., Rei, L., Reid, S., Reitze, D. H., Rew, H., Reyes, S. D., Ricci, F., Riles, K., Robertson, N. A., Robie, R., Robinet, F., Rocchi, A., Rolland, L., Rollins, J. G., Roma, V. J., Romano, J. D., Romano, R., Romanov, G., Romie, J. H., Rosińska, D., Rowan, S., Rüdiger, A., Ruggi, P., Ryan, K., Sachdev, S., Sadecki, T., Sadeghian, L., Salconi, L., Saleem, M., Salemi, F., Samajdar, A., Sammut, L., Sanchez, E. J., Sandberg, V., Sandeen, B., Sanders, J. R., Sassolas, B., Sathyaprakash, B. S., Saulson, P. R., Sauter, O., Savage, R. L., Sawadsky, A., Schale, P., Schilling, R., Schmidt, J., Schmidt, P., Schnabel, R., Schofield, R. M. S., Schönbeck, A., Schreiber, E., Schuette, D., Schutz, B. F., Scott, J., Scott, S. M., Sellers, D., Sengupta, A. S., Sentenac, D., Sequino, V., Sergeev, A., Serna, G., Setyawati, Y., Seigny, A., Shaddock, D. A., Shah, S., Shahriar, M. S., Shaltev, M., Shao, Z., Shapiro, B., Shawhan, P., Sheperd, A., Shoemaker, D. H., Shoemaker, D. M., Siellez, K., Siemens, X., Sigg, D., Silva, A. D., Simakov, D., Singer, A., Singer, L. P., Singh, A., Singh, R., Singhal, A., Sintés, A. M., Slagmolen, B. J. J., Smith, J. R., Smith, N. D., Smith, R. J. E., Son, E. J., Sorazu, B., Sorrentino, F., Souradeep, T., Srivastava, A. K., Staley, A., Steinke, M., Steinlechner, J., Steinlechner, S., Steinmeyer, D., Stephens, B. C., Stone, R., Strain, K. A., Straniero, N., Stratta, G., Strauss, N. A., Strigin, S., Sturani, R., Stuver, A. L., Summerscales, T. Z., Sun, L., Sutton, P. J., Swinkels, B. L., Szczepańczyk, M. J., Tacca, M., Talukder, D., Tanner, D. B., Tápai, M., Tarabrin, S., Taracchini, A., Taylor, R., Theeg, T., Thirugnanasambandam, M. P., Thomas, E. G., Thomas, M., Thomas, P., Thorne, K. A., Thorne, K. S., Thrane, E., Tiwari, S., Tiwari, V., Tokmakov, K. V., Tomlinson, C., Tonelli, M., Torres, C. V., Torrie, C. I., Töyrä, D., Travasso, F., Traylor, G., Trifirò, D., Tringali, M. C., Trozzo, L., Tse, M., Turconi, M., Tuyenbayev, D., Ugolini, D., Unnikrishnan, C. S., Urban, A. L., Usman, S. A., Vahlbruch, H., Vajente, G., Valdes, G., van Bakel, N., van Beuzekom, M., Brand, J. F. J. v. d., Broeck, C. V. D., VanderHyde, D. C., van der Schaaf, L., van Heijningen, J. V., van Veggel, A. M., Vardaro, M., Vass, S., Vásúth, M., Vaulin, R., Vecchio, A., Vedovato, G., Veitch, J., Veitch, P. J., Venkateswara, K., Verkindt, D., Vetrano, F., Viceré, A., Vinciguerra, S., Vine, D. J., Vinet, J.-Y., Vitale, S., Vo, T., Vocca, H., Vorvick, C., Voss, D., Voudsen, W. D., Vyatchanin, S. P., Wade, A. R., Wade, L. E., Wade, M., Walker, M., Wallace, L., Walsh, S., Wang, G., Wang, H., Wang, M., Wang, X., Wang, Y., Ward, R. L., Warner, J., Was, M., Weaver, B., Wei, L., Weinert, M., Weinstein, A. J., Weiss, R., Welborn, T., Wen, L., Weßels, P., Westphal, T., Wette, K., Whelan, J. T., White, D. J., Whiting, B. F., Williams, R. D., Williamson, A. R., Willis, J. L., Willke, B., Wimmer, M., Winkler, W., Wipf, C. C., Wittel, H., Woan, G., Worden, J., Wright, J. L., Wu, G., Yablon, J., Yam, W., Yamamoto, H., Yancey, C. C., Yap, M. J., Yu, H., Yvert, M., Zadrožny, A., Zangrando, L., Zanolin, M., Zendri, J.-P., Zevin, M., Zhang, F., Zhang, L., Zhang, M., Zhang, Y., Zhao, C., Zhou, M., Zhou, Z., Zhu, X. J., Zucker, M. E., Zuraw, S. E., & Zweizig, J. (2016). High-energy Neutrino follow-up search of Gravitational Wave Event GW150914 with ANTARES and IceCube. *Physical Review D*, 93: 122010. doi:10.1103/PhysRevD.93.122010.

## Publications by AEI Members and Guest Scientists

- Adya, V., Leavey, S., Lück, H., Gräf, C., & Hild, S. (2016). Length sensing and control for Einstein Telescope Low Frequency. *Journal of Physics: Conference Series*, 716: 012030.
- Affeldt, C., Danzmann, K., Dooley, K., Grote, H., Hewitson, M., Hild, S., Hough, J., Leong, J., Lück, H., Prijatelj, M., Rowan, S., Rüdiger, A., Schilling, R., Schnabel, R., Schreiber, E., Sorazu, B., Strain, K. A., Vahlbruch, H., Willke, B., Winkler, W., & Wittel, H. (2014). Advanced techniques in GEO 600. *Classical and quantum gravity*, 31(22): 224002. doi:10.1088/0264-9381/31/22/224002.
- Afonso, J., Casanellas, J., Prandoni, I., Jarvis, M., Lorenzoni, S., Magliocchetti, M., & Seymour, N. (2015). Identifying the first generation of radio powerful AGN in the Universe with the SKA. *Proceedings of Science, AASKA14*: 071. Retrieved from <http://arxiv.org/abs/1412.6040>.
- Ahlen, O. (2015). Instantons in string theory.
- Ahmadiniaz, N., & Schubert, C. (2013). A covariant representation of the Ball-Chiu vertex. *Nuclear Physics B*, 869(3), 417-439. doi:10.1016/j.nuclphysb.2012.12.019.
- Ahmadiniaz, N., Bashir, A., & Schubert, C. (2016). Multiphoton amplitudes and generalized Landau-Khalatnikov-Fradkin transformation in scalar QED. *Physical Review D*, 93(4): 045023. doi:10.1103/PhysRevD.93.045023.
- Ajith, P., Boyle, M., Brown, D. A., Brüggmann, B., Buchman, L. T., Cadonati, L., Campanelli, M., Chu, T., Etienne, Z. B., Fairhurst, S., Hannam, M., Healy, J., Hinder, I., Husa, S., Kidder, L. E., Krishnan, B., Laguna, P., Liu, Y. T., London, L., Lousto, C. O., Lovelace, G., MacDonald, I., Marronetti, P., Mohapatra, S., Mösta, P., Müller, D., Mundim, B. C., Nakano, H., Ohme, F., Paschalidis, V., Pekowsky, L., Pollney, D., Pfeiffer, H. P., Ponce, M., Pürrer, M., Reifenberger, G., Reisswig, C., Santamaría, L., Scheel, M. A., Shapiro, S. L., Shoemaker, D., Sopuerta, C. F., Sperhake, U., Szilágyi, B., Taylor, N. W., Tichy, W., Tsatsin, P., & Zlochower, Y. (2013). The NINJA-2 catalog of hybrid post-Newtonian/numerical-relativity waveforms for non-precessing black-hole binaries The NINJA-2 catalog of hybrid post-Newtonian/numerical-relativity waveforms for non-precessing black-hole binaries (Addendum to vol 29, 124001, 2012). *Classical and quantum gravity*, 30(19): 199401. doi:10.1088/0264-9381/30/19/199401.
- Aksteiner, S., & Andersson, L. (2013). Charges for linearized gravity. *Classical and quantum gravity*, 30(15): 155016. doi:10.1088/0264-9381/30/15/155016.
- Aksteiner, S., & Korovin, Y. (2016). New modes from higher curvature corrections in holography. *Journal of high energy physics: JHEP*, 2016(03): 166. doi:10.1007/JHEP03(2016)166.
- Albin, P., Aldana, C. L., & Rochon, F. (2013). Ricci flow and the determinant of the Laplacian on non-compact surfaces. *Communications in partial differential equations*, 38 (4): 749, pp. 711. doi:10.1080/03605302.2012.721853.
- Albin, P., Aldana, C. L., & Rochon, F. (2015). Compactness of relatively isospectral sets of surfaces via conformal surgeries. *Journal of Geometric Analysis*, 25(2), 1185-1210. doi:10.1007/s12220-013-9463-0.
- Aldana, C. L. (2013). Asymptotics of relative heat traces and determinants on open surfaces of finite area. *Annals of global analysis and geometry*, 44(2), 169-216. doi:10.1007/s10455-012-9362-9.
- Alhulaimi, B., Coley, A., & Sandin, P. (2013). Anisotropic Einstein-aether cosmological models. *Journal of Mathematical Physics*, 54: 042503. doi:<http://dx.doi.org/10.1063/1.4802246>.
- Alic, D., Kastaun, W., & Rezzolla, L. (2013). Constraint-damping of the CCZ4 formulation in simulations of binary neutron stars. *Physical Review D*, 88: 064049. doi:10.1103/PhysRevD.88.064049.
- Alkalaev, K. B., Grigoriev, M., & Skvortsov, E. D. (2015). Uniformizing higher-spin equations. *Journal of Physics A: Mathematical and Theoretical*, 48(1): 015401. doi:10.1088/1751-8113/48/1/015401.
- Allen, B., Knispel, B., Cordes, J. M., Deneva, J. S., Hessels, J. W. T., Anderson, D., Aulbert, C., Bock, O., Brazier, A., Chatterjee, S., Demorest, P. B., Eggenstein, H. B., Fehrmann, H., Gotthelf, E. V., Hammer, D., Kaspi, V. M., Kramer, M., Lyne, A. G., Machenschalk, B., McLaughlin, M. A., Messenger, C., Pletsch, H., Ransom, S. M., Stairs, I. H., Stappers, B. W., Bhat, N. D. R., Bogdanov, S., Camilo, F., Champion, D. J., Crawford, F., Desvignes, G., Freire, P. C. C., Heald, G., Jenet, F. A., Lazarus, P., Lee, K. J., van Leeuwen, J., Lynch, R., Papa, M. A., Prix, R., Rosen, R., Scholz, P., Siemens, X., Stovall, K., Venkataraman, A., & Zhu, W. (2013). The Einstein@Home search for radio pulsars and PSR J2007+2722 discovery. *Astrophysical Journal*, 773(2): 91. doi:10.1088/0004-637X/773/2/91.
- Allen, B. (2016). From Einstein's general theory of relativity to gravitational-wave astronomy. *Annalen der Physik*, 528(3-4), 229-230. doi:10.1002/andp.201600061.
- Alles, A., Buchert, T., Roumi, F. A., & Wiegand, A. (2015). Lagrangian theory of structure formation in relativistic cosmology III: gravitoelectric perturbation and solution schemes at any order. *Physical Review D*, 92: 023512. doi:10.1103/PhysRevD.92.023512.
- Amaro-Seoane, P., Brem, P., & Cuadra, J. (2013). Tidal disruptions in circumbinary discs (I): Star formation, dynamics, and binary evolution. *Astrophysical Journal*, 764(1): 14. doi:10.1088/0004-637X/764/1/14.
- Amaro-Seoane, P., Sopuerta, C. F., & Freitag, M. D. (2013). The role of the supermassive black hole spin in the estimation of the EMRI event rate. *Monthly Notices of the Royal Astronomical Society*, 429(4), 3155-3165. doi:10.1093/mnras/sts572.
- Amaro-Seoane, P., Konstantinidis, S., Brem, P., & Catelan, M. (2013). Mergers of multi-metallic globular clusters: The role of dynamics. *Monthly Notices of the Royal Astronomical Society*, 435(1), 809-821. doi:10.1093/mnras/stt1351.
- Amaro-Seoane, P., Glaschke, P., & Spurzem, R. (2014). Hybrid methods in planetesimal dynamics: Formation of protoplanetary systems and the mill condition. *Monthly Notices of the Royal Astronomical Society: Letters*, 445 (4), 3755 - 3769. doi:10.1093/mnras/stu1734.
- Amaro-Seoane, P., Gair, J. R., Pound, A., Hughes, S. A., & Sopuerta, C. F. (2015). Research Update on Extreme-Mass-Ratio Inspirals. *Journal of Physics: Conference Series*, 610: 012002.

## Publications by AEI Members and Guest Scientists

- Amaro-Seoane, P., & Chen, X. (2016). Relativistic mergers of black hole binaries have large, similar masses, low spins and are circular. *Monthly Notices of the Royal Astronomical Society*, 458(3), 3075-3082. doi:10.1093/mnras/stw503.
- Amaro-Seoane, P., Casanellas, J., Schödel, R., Davidson, E., & Cuadra, J. (2016). Probing dark matter crests with white dwarfs and IMBHs. *Monthly Notices of the Royal Astronomical Society*, 459(1), 695-700. doi:10.1093/mnras/stw433.
- Amaro-Seoane, P., Konstantinidis, S., Freitag, M. D., Miller, M. C., & Rasio, F. A. (2014). Sowing the seeds of massive black holes in small galaxies: Young clusters as the building blocks of Ultra-Compact-Dwarf Galaxies. *The Astrophysical Journal*, 782(2): 97. doi:10.1088/0004-637X/782/2/97.
- Amaro-Seoane, P., & Chen, X. (2014). The fragmenting past of the disk at the Galactic Center: The culprit for the missing red giants. *The Astrophysical Journal Letters*, 781(1): L18.
- Amaro-Seoane, P., Aoudia, S., Babak, S., Binétruy, P., Berti, E., Bohé, A., Caprini, C., Colpi, M., Cornish, N. J., Danzmann, K., Dufaux, J.-F., Gair, J., Jennrich, O., Jetzer, P., Klein, A., Lang, R. N., Lobo, A., Littenberg, T., McWilliams, S. T., Nelemans, G., Petiteau, A., Porter, E. K., Schutz, B. F., Sesana, A., Stebbins, R., Sumner, T., Vallisneri, M., Vitale, S., Volonteri, M., & Ward, H. (2013). eLISA: Astrophysics and cosmology in the millihertz regime. *GW Notes*, 6, 4-110. Retrieved from <http://arxiv.org/abs/1201.3621>.
- Amaro-Seoane, P., Maureira-Fredes, C., Dotti, M., & Colpi, M. (2016). Retrograde binaries of massive black holes in circum-binary accretion discs. *Astronomy & Astrophysics*, 591: A114. doi: <http://dx.doi.org/10.1051/0004-6361/201526172>.
- Ambrozinski, Z. (2013). Tunneling in cosine potential with periodic boundary conditions. *Acta Physica Polonica B*, 44(6), 1261-1272. doi:10.5506/APhysPolB.44.1261.
- Ambroziński, Z., & Wosiek, J. (2013). Resumming Not Summable Perturbative Series. *Acta Physica Polonica B*, 44, 49-58. doi:10.5506/APhysPolB.44.49.
- Anabalon, A., Astefanesei, D., & Martinez, C. (2015). Mass of asymptotically anti-de Sitter hairy spacetimes. *Physical Review D*, 91(4): 041501. doi:10.1103/PhysRevD.91.041501.
- Anabalon, A., Astefanesei, D., Choque, D., & Martinez, C. (2016). Trace Anomaly and Counterterms in Designer Gravity. *Journal of high energy physics: JHEP*, 2016(03): 117. doi:10.1007/JHEP03(2016)117.
- Andersson, L., Bäckdahl, T., & Joudioux, J. (2014). Hertz potentials and asymptotic properties of massless fields. *Communications in Mathematical Physics*, 331, 755-803. doi:10.1007/s00220-014-2078-x.
- Andersson, L., Blue, P., & Nicolas, J.-P. (2013). A decay estimate for a wave equation with trapping and a complex potential. *International Mathematics Research Notices*, 2013(3), 548-561. doi:10.1093/imrn/rnr237.
- Andersson, L., Beig, R., & Schmidt, B. G. (2014). Elastic deformations of compact stars. *Classical and quantum gravity*, 31(18): 185006. doi:10.1088/0264-9381/31/18/185006.
- Andersson, L., Bäckdahl, T., & Blue, P. (2014). Second order symmetry operators. *Classical and quantum gravity*, 31: 135015. doi:10.1088/0264-9381/31/13/135015.
- Andersson, L., & Blue, P. (2015). Hidden symmetries and decay for the wave equation on the Kerr spacetime. *Annals of Mathematics*, 182(3), 787-853. doi:10.4007/annals.2015.182.3.1.
- Andersson, L., & Oliynyk, T. A. (2014). A transmission problem for quasi-linear wave equations. *Journal of Differential Equations*, 256, 2023-2078. doi:10.1016/j.jde.2013.12.014.
- Andersson, L., Bäckdahl, T., & Blue, P. (2015). Spin geometry and conservation laws in the Kerr spacetime. In L. Bieri (Ed.), *One hundred years of general relativity (Surveys in Differential Geometry, 20)* (pp. 183-226). Boston: International Press.
- Andersson, L. (2015). Self-gravitating elastic bodies. In D. Pützfeld (Ed.), *Equations of Motion in Relativistic Gravity (Fundamental Theories of Physics, 179)* (pp. 543-559). Heidelberg u.a.: Springer.
- Andersson, L. (2015). Cosmological models and stability. In J. Bičák, & T. Ledvinka (Eds.), *General Relativity, Cosmology and Astrophysics: Perspectives 100 years after Einstein's stay in Prague (Fundamental Theories of Physics, 177)* (pp. 277-303). Heidelberg u.a.: Springer.
- Andersson, L., Bäckdahl, T., & Blue, P. (2016). Decay of solutions to the Maxwell equation on the Schwarzschild background. *Classical and Quantum Gravity*, 33(8): 085010. doi:10.1088/0264-9381/33/8/085010.
- Andersson, L., & Blue, P. (2015). Uniform energy bound and asymptotics for the Maxwell field on a slowly rotating Kerr black hole exterior. *Journal of Hyperbolic Differential Equations*, 12(4), 689-743. doi:10.1142/S0219891615500204.
- Andersson, L., Oliynyk, T. A., & Schmidt, B. G. (2016). Dynamical compact elastic bodies in general relativity. *Archive for Rational Mechanics and Analysis*, 220(2), 849-887. doi:10.1007/s00205-015-0943-1.
- Andersson, N., Baker, J., Belczynski, K., Bernuzzi, S., Berti, E., Cadonati, L., Cerda-Duran, P., Clark, J., Favata, M., Finn, L. S., Fryer, C., Giacomazzo, B., Gonzalez, J. A., Hendry, M., Heng, I. S., Hild, S., Johnson-McDaniel, N., Kalmus, P., Klimentko, S., Kobayashi, S., Kokkotas, K., Laguna, P., Lehner, L., Levin, J., Liebling, S., MacFadyen, A., Mandel, I., Marka, S., Marka, Z., Neilsen, D., O'Brien, P., Perna, R., Pfeiffer, H., Read, J., Reisswig, C., Rodriguez, C., Ruffert, M., Schnetter, E., Searle, A., Shawhan, P., Shoemaker, D., Soderberg, A., Sperhake, U., Sutton, P., Tanvir, N., Was, M., & Whitcomb, S. (2013). The Transient Gravitational-Wave Sky. *Classical and quantum gravity*, 30(19): 193002. doi:10.1088/0264-9381/30/19/193002.
- Ando, S., Baret, B., Bouhou, B., Chassande-Mottin, E., Kuchner, A., Moscoso, L., Van Elewycy, V., Bartos, I., Márka, S., Márka, Z., Corsi, A., Di Palma, I., Papa, M. A., Dietz, A., Donzaud, C., Eichler, D., Finley, C., Guetta, D., Halzen, F., Jones, G., Sutton, P. J., Kandhasamy, S., Mandic, V., Thrane, E., Kotake, K., Piran, T., Pradier, T., Romero, G. E., & Waxman, E. (2013). Colloquium: Multimessenger astronomy with gravitational waves and high-energy neutrinos. *Reviews of Modern Physics*, 85(4), 1401-1420. doi:10.1103/RevModPhys.85.1401.

## Publications by AEI Members and Guest Scientists

- Andriot, D., & Betz, A. (2014). NS-branes, source corrected Bianchi identities, and more on backgrounds with non-geometric fluxes. *Journal of high energy physics: JHEP*, 2014(7): 059. doi:10.1007/JHEP07(2014)059.
- Andriot, D., & Betz, A. (2015). Supersymmetry with non-geometric fluxes, or a beta-twist in Generalized Geometry and Dirac operator. *Journal of high energy physics: JHEP*, 2015(04): 006. doi:10.1007/JHEP04(2015)006.
- Andriot, D. (2016). New supersymmetric vacua on solvmanifolds. *Journal of high energy physics: JHEP*, 2016(02): 112. doi:10.1007/JHEP02(2016)112.
- Andriot, D. (2016). A no-go theorem for monodromy inflation. *Journal of Cosmology and Astroparticles Physics*, 3: 025. doi:10.1088/1475-7516/2016/03/025.
- Andriot, D., Cacciapaglia, G., Deandrea, A., Deutschmann, N., & Tsimpis, D. (2016). Towards Kaluza-Klein Dark Matter on Nilmanifolds. *Journal of high energy physics: JHEP*, 2016(06): 169. doi:10.1007/JHEP06(2016)169.
- Andriot, D., Blåbäck, J., & Van Riet, T. (2017). Minkowski flux vacua of type II supergravities. *Physical Review Letters*, 118: 011603. doi:10.1103/PhysRevLett.118.011603.
- Angéil, R., Saha, P., Bondarescu, R., Jetzer, P., Schäfer, A., & Lundgren, A. (2014). Spacecraft Clocks and Relativity: Prospects for Future Satellite Missions. *Physical Review D*, 89: 064067. doi:10.1103/PhysRevD.89.064067.
- Ansoldi, S., & Sindoni, L. (2015). Multihorizon regular black holes. In *The Thirteenth Marcel Grossmann Meeting* (pp. 1198-1200). World Scientific.
- Antognini, J. M., Shappee, B. J., Thompson, T. A., & Amaro-Seoane, P. (2014). Rapid Eccentricity Oscillations and the Mergers of Compact Objects in Hierarchical Triples. *Monthly Notices of the Royal Astronomical Society*, 439, 1079-1091. doi:10.1093/mnras/stu039.
- Anzà, F., & Chirco, G. (2016). Typicality in spin-network states of quantum geometry. *Physical Review D*, 94: 084047. doi:https://doi.org/10.1103/PhysRevD.94.084047.
- Armano, M., Audley, H., Auger, G., Baird, J., Binetruy, P., Born, M., Bortoluzzi, D., Brandt, N., Bursi, A., Caleno, M., Cavalleri, A., Cesarini, A., Cruise, M., Danzmann, K., Diepholz, I., Dolesi, R., Dunbar, N., Ferraioli, L., Ferroni, V., Fitzsimons, E., Freschi, M., Gallegos, J., Marirrodiga, C. G., Gerndt, R., Gesa, L. I., Gibert, F., Giardini, D., Giusteri, R., Grimaldi, C., Harrison, I., Heinzl, G., Hewitson, M., Hollington, D., Hueller, M., Huesler, J., Inchauspé, H., Jennrich, O., Jetzer, P., Johlander, B., Karnesis, N., Kaune, B., Korsakova, N., Killow, C., Lloro, I., Maarschalkerweerd, R., Madden, S., Mance, D., Martín, V., Martín-Porqueras, F., Mateos, I., McNamara, P., Mendes, J., Mendes, L., Moroni, A., Nofriarías, M., Paczkowski, S., Perreux-Lloyd, M., Petiteau, A., Pivato, P., Plagnol, E., Prat, P., Ragnit, U., Ramos-Castro, J., Reiche, J., Romera Perez, J. A., Robertson, D., Rozemeijer, H., Russano, G., Sarra, P., Schleicher, A., Slutsky, J., Sopena, C. F., Sumner, T., Texier, D., Thorpe, J., Trenkel, C., Tu, H. B., Vitale, S., Wanner, G., Ward, H., Waschke, S., Wass, P., Wealthy, D., Wen, S., Weber, W., Wittchen, A., Zononi, C., Ziegler, T., & Zweifel, P. (2015). A noise simulator for eLISA: Migrating LISA Pathfinder knowledge to the eLISA mission. *Journal of Physics: Conference Series*, 610: 012036.
- Armano, M., Audley, H., Auger, G., Baird, J., Binetruy, P., Born, M., Bortoluzzi, D., Brandt, N., Bursi, A., Caleno, M., Cavalleri, A., Cesarini, A., Cruise, M., Danzmann, K., Diepholz, I., Dolesi, R., Dunbar, N., Ferraioli, L., Ferroni, V., Fitzsimons, E., Freschi, M., Gallegos, J., Marirrodiga, C. G., Gerndt, R., Gesa, L. I., Gibert, F., Giardini, D., Giusteri, R., Grimaldi, C., Harrison, I., Heinzl, G., Hewitson, M., Hollington, D., Hueller, M., Huesler, J., Inchauspé, H., Jennrich, O., Jetzer, P., Johlander, B., Karnesis, N., Kaune, B., Korsakova, N., Killow, C., Lloro, I., Maarschalkerweerd, R., Madden, S., Mance, D., Martín, V., Martín-Porqueras, F., Mateos, I., McNamara, P., Mendes, J., Mendes, L., Moroni, A., Nofriarías, M., Paczkowski, S., Perreux-Lloyd, M., Petiteau, A., Pivato, P., Plagnol, E., Prat, P., Ragnit, U., Ramos-Castro, J., Reiche, J., Romera Perez, J. A., Robertson, D., Rozemeijer, H., Russano, G., Sarra, P., Schleicher, A., Slutsky, J., Sopena, C. F., Sumner, T., Texier, D., Thorpe, J., Trenkel, C., Tu, H. B., Vitale, S., Wanner, G., Ward, H., Waschke, S., Wass, P., Wealthy, D., Wen, S., Weber, W., Wittchen, A., Zononi, C., Ziegler, T., & Zweifel, P. (2015). Bayesian statistics for the calibration of the LISA Pathfinder experiment. *Journal of Physics: Conference Series*, 610: 012024.
- Armano, M., Audley, H., Auger, G., Baird, J., Binetruy, P., Born, M., Bortoluzzi, D., Brandt, N., Bursi, A., Caleno, M., Cavalleri, A., Cesarini, A., Cruise, M., Danzmann, K., Diepholz, I., Dolesi, R., Dunbar, N., Ferraioli, L., Ferroni, V., Fitzsimons, E., Freschi, M., Gallegos, J., Marirrodiga, C. G., Gerndt, R., Gesa, L. I., Gibert, F., Giardini, D., Giusteri, R., Grimaldi, C., Harrison, I., Heinzl, G., Hewitson, M., Hollington, D., Hueller, M., Huesler, J., Inchauspé, H., Jennrich, O., Jetzer, P., Johlander, B., Karnesis, N., Kaune, B., Korsakova, N., Killow, C., Lloro, I., Maarschalkerweerd, R., Madden, S., Mance, D., Martín, V., Martín-Porqueras, F., Mateos, I., McNamara, P., Mendes, J., Mendes, L., Moroni, A., Nofriarías, M., Paczkowski, S., Perreux-Lloyd, M., Petiteau, A., Pivato, P., Plagnol, E., Prat, P., Ragnit, U., Ramos-Castro, J., Reiche, J., Romera Perez, J. A., Robertson, D., Rozemeijer, H., Russano, G., Sarra, P., Schleicher, A., Slutsky, J., Sopena, C. F., Sumner, T., Texier, D., Thorpe, J., Trenkel, C., Tu, H. B., Vitale, S., Wanner, G., Ward, H., Waschke, S., Wass, P., Wealthy, D., Wen, S., Weber, W., Wittchen, A., Zononi, C., Ziegler, T., & Zweifel, P. (2015). Disentangling the magnetic force noise contribution in LISA Pathfinder. *Journal of Physics: Conference Series*, 610: 012024.
- Armano, M., Audley, H., Auger, G., Baird, J., Binetruy, P., Born, M., Bortoluzzi, D., Brandt, N., Bursi, A., Caleno, M., Cavalleri, A., Cesarini, A., Cruise, M., Cutler, C., Danzmann, K., Diepholz, I., Dolesi, R., Dunbar, N., Ferraioli, L., Ferroni, V., Fitzsimons, E., Freschi, M., Gallegos, J., Marirrodiga, C. G., Gerndt, R., Gesa, L., Gibert, F., Giardini, D., Giusteri, R., Grimaldi, C., Harrison, I., Heinzl, G., Hewitson, M., Hollington, D., Hueller, M., Huesler, J., Inchauspé, H., Jennrich, O., Jetzer, P., Johlander, B., Karnesis, N., Kaune, B., Korsakova, N., Killow, C., Lloro, I., Maarschalkerweerd, R., Madden, S., Maghami, P., Mance, D., Martín, V., Martín-Porqueras, F., Mateos, I., McNamara, P., Mendes, J., Mendes, L., Moroni, A., Nofriarías, M., Paczkowski, S., Perreux-Lloyd, M., Petiteau, A., Pivato, P., Plagnol, E., Prat, P., Ragnit, U., Ramos-Castro, J., Reiche, J., Romera Perez, J. A., Robertson, D., Rozemeijer, H., Russano, G., Sarra, P., Schleicher, A., Slutsky, J., Sopena, C. F., Sumner, T., Texier, D., Thorpe, J., Trenkel, C., Tu, H. B., Vetrugno, D., Vitale, S., Wanner, G., Ward, H., Waschke, S., Wass, P., Wealthy, D., Wen, S., Weber, W., Wittchen, A., Zononi, C., Ziegler, T., & Zweifel, P. (2015). Free-flight experiments in LISA Pathfinder. *Journal of Physics: Conference Series*, 610: 012006.
- Armano, M., Audley, H., Auger, G., Baird, J., Binetruy, P., Born, M., Bortoluzzi, D., Brandt, N., Bursi, A., Caleno, M., Cavalleri, A., Cesarini, A., Cruise, M., Cutler, C., Danzmann, K., Diepholz, I., Dolesi, R., Dunbar, N., Ferraioli, L., Ferroni, V., Fitzsimons, E., Freschi, M., Gallegos, J., Marirrodiga, C. G., Gerndt, R., Gesa, L., Gibert, F., Giardini, D.,

## Publications by AEI Members and Guest Scientists

- Giusteri, R., Grimani, C., Harrison, I., Heinzel, G., Hewitson, M., Hollington, D., Hueller, M., Huesler, J., Inchauspe, H., Jennrich, O., Jetzer, P., Johlander, B., Karnesis, N., Kaune, B., Korsakova, N., Killow, C., Lloro, I., Maarschalkwerd, R., Madden, S., Maghami, P., Mance, D., Martin, V., Martin-Porqueras, F., Mateos, I., McNamara, P., Mendes, J., Mendes, L., Moroni, A., Nofrarias, M., Paczkowski, S., Perreur-Lloyd, M., Petiteau, A., Pivato, P., Plagnol, E., Prat, P., Ragnit, U., Ramos-Castro, J., Reiche, J., Perez, J. A. R., Robertson, D., Rozemeijer, H., Russano, G., Sarra, P., Schleicher, A., Slutsky, J., Sopena, C. F., Sumner, T., Texier, D., Thorpe, J., Trenkel, C., Tu, H. B., Vetrugno, D., Vitale, S., Wanner, G., Ward, H., Waschke, S., Wass, P., Wealthy, D., Wen, S., Weber, W., Wittchen, A., Zanoni, C., Ziegler, T., & Zweifel, P. (2015). A Strategy to Characterize the LISA-Pathfinder Cold Gas Thruster System. *Journal of Physics: Conference Series*, 610: 0120206.
- Armano, M., Audley, H., Auger, G., Baird, J., Binetruy, P., Born, M., Bortoluzzi, D., Brandt, N., Bursi, A., Caleno, M., Cavalleri, A., Cesarini, A., Cruise, M., Danzmann, K., Diepholz, I., Dolesi, R., Dunbar, N., Ferraioli, L., Ferroni, V., Fitzsimons, E., Freschi, M., Gallegos, J., Marirrodriaga, C. G., Gerndt, R., Gesa, L. I., Gibert, F., Giardini, D., Giusteri, R., Grimani, C., Harrison, I., Heinzel, G., Hewitson, M., Hollington, D., Hueller, M., Huesler, J., Inchauspe, H., Jennrich, O., Jetzer, P., Johlander, B., Karnesis, N., Kaune, B., Korsakova, N., Killow, C., Lloro, I., Maarschalkwerd, R., Madden, S., Mance, D., Martín, V., Martin-Porqueras, F., Mateos, I., McNamara, P., Mendes, J., Mendes, L., Moroni, A., Nofrarias, M., Paczkowski, S., Perreur-Lloyd, M., Petiteau, A., Pivato, P., Plagnol, E., Prat, P., Ragnit, U., Ramos-Castro, J., Reiche, J., Perez, J. A. R., Robertson, D., Rozemeijer, H., Russano, G., Sarra, P., Schleicher, A., Slutsky, J., Sopena, C. F., Sumner, T., Texier, D., Thorpe, J., Trenkel, C., Tu, H. B., Vetrugno, D., Vitale, S., Wanner, G., Ward, H., Waschke, S., Wass, P., Wealthy, D., Wen, S., Weber, W., Wittchen, A., Zanoni, C., Ziegler, T., & Zweifel, P. (2015). The LISA Pathfinder Mission. *Journal of Physics: Conference Series*, 610: 012005.
- Armano, M., Audley, H., Auger, G., Baird, J. T., Bassan, M., Binetruy, P., Born, M., Bortoluzzi, D., Brandt, N., Caleno, M., Carbone, L., Cavalleri, A., Cesarini, A., Ciani, G., Congedo, G., Cruise, A. M., Danzmann, K., de Silva, M. D., Rosa, R. D., Diaz-Aguiló, M., Fiore, L. D., Diepholz, I., Dixon, G., Dolesi, R., Dunbar, N., Ferraioli, L., Ferroni, V., Fichter, W., Fitzsimons, E. D., Flatscher, R., Freschi, M., Garcia Marin, A. F., Garcia Marirrodriaga, C., Gerndt, R., Gesa, L., Gibert, F., Giardini, D., Giusteri, R., Guzman, F., Grado, A., Grimani, C., Grynagier, A., Grzymisch, J., Harrison, I., Heinzel, G., Hewitson, M., Hollington, D., Hoyland, D., Hueller, M., Inchauspe, H., Jennrich, O., Jetzer, P., Johann, U., Johlander, B., Karnesis, N., Kaune, B., Korsakova, N., Killow, C. J., Lobo, J. A., Lloro, I., Liu, L., López-Zaragoza, J. P., Maarschalkwerd, R., Mance, D., Martín, V., Martin-Polo, L., Martino, J., Martin-Porqueras, F., Madden, S., Mateos, I., McNamara, P. W., Mendes, J., Mendes, L., Monsky, A., Nicolodi, D., Nofrarias, M., Paczkowski, S., Perreur-Lloyd, M., Petiteau, A., Pivato, P., Plagnol, E., Prat, P., Ragnit, U., Raïs, B., Ramos-Castro, J., Reiche, J., Robertson, D. I., Rozemeijer, H., Rivas, F., Russano, G., Sanjuán, J., Sarra, P., Schleicher, A., Shaul, D., Slutsky, J., Sopena, C. F., Stanga, R., Steier, F., Sumner, T., Texier, D., Thorpe, J. I., Trenkel, C., Tröbs, M., Tu, H. B., Vetrugno, D., Vitale, S., Wand, V., Wanner, G., Ward, H., Warren, C., Wass, P. J., Wealthy, D., Weber, W. J., Wissel, L., Wittchen, A., Zambotti, A., Zanoni, C., Ziegler, T., & Zweifel, P. (2016). Sub-Femto-g Free Fall for Space-Based Gravitational Wave Observatories: LISA Pathfinder Results. *Physical Review Letters*, 116: 231101. doi:<http://dx.doi.org/10.1103/PhysRevLett.116.231101>.
- Armano, M., Audley, H., Auger, G., Baird, J., Binetruy, P., Born, M., Bortoluzzi, D., Brandt, N., Bursi, A., Caleno, M., Cavalleri, A., Cesarini, A., Cruise, M., Danzmann, K., Deus de Silva, M., Desiderio, D., Piersanti, E., Diepholz, I., Dolesi, R., Dunbar, N., Ferraioli, L., Ferroni, V., Fitzsimons, E., Flatscher, R., Freschi, M., Gallegos, J., Marirrodriaga, C. G., Gerndt, R., Gesa, L., Gibert, F., Giardini, D., Giusteri, R., Grimani, C., Grzymisch, J., Harrison, I., Heinzel, G., Hewitson, M., Hollington, D., Hueller, M., Huesler, J., Inchauspe, H., Jennrich, O., Jetzer, P., Johlander, B., Karnesis, N., Kaune, B., Korsakova, N., Killow, C., Lloro, I., Liu, L., Maarschalkwerd, R., Madden, S., Mance, D., Martin, V., Martin-Polo, L., Martino, J., Martin-Porqueras, F., Mateos, I., McNamara, P., Mendes, J., Mendes, L., Moroni, A., Nofrarias, M., Paczkowski, S., Perreur-Lloyd, M., Petiteau, A., Pivato, P., Plagnol, E., Prat, P., Ragnit, U., Raïs, B., Ramos-Castro, J., Reiche, J., Perez, J. A. R., Robertson, D., Rozemeijer, H., Rivas, F., Russano, G., Sarra, P., Schleicher, A., Slutsky, J., Sopena, C., Sumner, T., Texier, D., Thorpe, J., Tomlinson, R., Trenkel, C., Vetrugno, D., Vitale, S., Wanner, G., Ward, H., Wass, P., Wealthy, D., Weber, W., Wittchen, A., Zanoni, C., Ziegler, T., & Zweifel, P. (2016). Constraints on LISA Pathfinder's self-gravity: design requirements, estimates and testing procedures. *Classical and quantum gravity*, 33(23): 235015. doi:[10.1088/0264-9381/33/23/235015](https://doi.org/10.1088/0264-9381/33/23/235015).
- Arzoumanian, Z., Brazier, A., Burke-Spolaor, S., Chamberlin, S. J., Chatterjee, S., Cordes, J. M., Demorest, P. B., Deng, X., Dolch, T., Ellis, J. A., Ferdman, R. D., Garver-Daniels, N., Jenet, F., Jones, G., Kaspi, V. M., Koop, M., Lam, M., Lazio, T. J. W., Lommen, A. N., Lorimer, D. R., Luo, J., Lynch, R. S., Madison, D. R., McLaughlin, M., McWilliams, S. T., Nice, D. J., Palliyaguru, N., Pennucci, T. T., Ransom, S. M., Sesana, A., Siemens, X., Stairs, I. H., Stinebring, D. R., Stovall, K., Swiggum, J., Vallisneri, M., van Haasteren, R., Wang, Y., & Zhu, W. W. (2014). Gravitational Waves from Individual Supermassive Black Hole Binaries in Circular Orbits: Limits from the North American Nanohertz Observatory for Gravitational Waves. *Astrophysical Journal*, 794(2): 141. doi:[10.1088/0004-637X/794/2/141](https://doi.org/10.1088/0004-637X/794/2/141).
- Arzoumanian, Z., Brazier, A., Burke-Spolaor, S., Chamberlin, S. J., Chatterjee, S., Cordes, J. M., Demorest, P. B., Deng, X., Dolch, T., Ellis, J. A., Ferdman, R. D., Garver-Daniels, N., Jenet, F., Jones, G., Kaspi, V. M., Koop, M., Lam, M., Lazio, T. J. W., Lommen, A. N., Lorimer, D. R., Luo, J., Lynch, R. S., Madison, D. R., McLaughlin, M., McWilliams, S. T., Nice, D. J., Palliyaguru, N., Pennucci, T. T., Ransom, S. M., Sesana, A., Siemens, X., Stairs, I. H., Stinebring, D. R., Stovall, K., Swiggum, J., Vallisneri, M., van Haasteren, R., Wang, Y., & Zhu, W. W. (2014). NANOGRAV Limits on Gravitational Waves from Individual Supermassive Black Hole Binaries in Circular Orbits. *The Astrophysical Journal*, 794: 141. doi:[10.1088/0004-637X/794/2/141](https://doi.org/10.1088/0004-637X/794/2/141).
- Aschieri, P., Ferrara, S., & Theisen, S. (2014). Constitutive relations, off shell duality rotations and the hypergeometric form of Born-Infeld theory. In *Breaking of Supersymmetry and Ultraviolet Divergences in Extended Supergravity* (Springer Proceedings in Physics, 153) (pp. 23-41).
- Ashton, G., Jones, D. I., & Prix, R. (2015). The effect of timing noise on targeted and narrow-band coherent searches for continuous gravitational waves. *Physical Review D*, 91: 062009. Retrieved from [10.1103/PhysRevD.91.062009](https://doi.org/10.1103/PhysRevD.91.062009).
- Ashton, G., Jones, D. I., & Prix, R. (2016). Comparing models of the periodic variations in spin-down and beam-width for PSR B1828-11. *Monthly Notices of the Royal Astronomical Society*, 458(1), 881-899. doi:[10.1093/mnras/stw334](https://doi.org/10.1093/mnras/stw334).

## Publications by AEI Members and Guest Scientists

- Ast, S., Mehmet, M., & Schnabel, R. (2013). High-bandwidth squeezed light at 1550 nm from a compact monolithic PPKTP cavity. *Optics Express*, 21(11), 13572-13579. doi:10.1364/OE.21.013572.
- Ast, S. (2015). New approaches in squeezed light generation: Quantum states of light with GHz squeezing bandwidth and squeezed light generation via the cascaded Kerr effect. PhD Thesis.
- Ast, M., Steinlechner, S., & Schnabel, R. (2016). Reduction of Classical Measurement Noise via Quantum-Dense Metrology. *Physical Review Letters*, 117: 180801. doi:10.1103/PhysRevLett.117.180801.
- Ast, S., Ast, M., Mehmet, M., & Schnabel, R. (2016). Gaussian entanglement distribution with gigahertz bandwidth. *Optics Letters*, 41(21), 5094-5097. doi:10.1364/OL.41.005094.
- Astone, P., Weinstein, A., Agathos, M., Bejger, M., Christensen, N., Dent, T., Graff, P., Klimenko, S., Mazzolo, G., Nishizawa, A., Robinet, F., Schmidt, P., Smith, R., Veitch, J., Wade, M., Aoudia, S., Bose, S., Bustillo, J. C., Canizares, P., Capano, C., Clark, J., Colla, A., Cuoco, E., Costa, C. D. S., Dal Canton, T., Evangelista, E., Goetz, E., Gupta, A., Hannam, M., Keitel, D., Lackey, B., Logue, J., Mohapatra, S., Piergiorganni, F., Privitera, S., Prix, R., Pürrer, M., Re, V., Serafinelli, R., Wade, L., Wen, L., Wette, K., Whelan, J., Palomba, C., & Prodi, G. (2015). Gravitational waves: search results, data analysis and parameter estimation: Amaldi 10 Parallel Session C2. *General Relativity and Gravitation*, 47: 11. doi:10.1007/s10714-014-1796-x.
- Baake, O., & Rinne, O. (2016). Superradiance of a charged scalar field coupled to the Einstein-Maxwell equations. *Physical Review D*, 94: 124016. doi:10.1103/PhysRevD.94.124016.
- Babak, S., Biswas, R., Brady, P. R., Brown, D. A., Cannon, K., Capano, C. D., Clayton, J. H., Cokelaer, T., Creighton, J. D. E., Dent, T., Dietz, A., Fairhurst, S., Fotopoulos, N., Gonzalez, G., Hanna, C., Harry, I. W., Jones, G., Keppel, D., McKechnan, D. J. A., Pekowsky, L., Privitera, S., Robinson, C., Rodriguez, A. C., Sathyaprakash, B. S., Sengupta, A. S., Vallisneri, M., Vaulin, R., & Weinstein, A. J. (2013). Searching for gravitational waves from binary coalescence. *Physical Review D*, 87: 024033. doi:10.1103/PhysRevD.87.024033.
- Babak, S., Petiteau, A., Sesana, A., Brem, P., Rosado, P. A., Taylor, S. R., Lassus, A., Hessels, J. W. T., Bassa, C. G., Burgay, M., Caballero, R. N., Champion, D. J., Cognard, I., Desvignes, G., Gair, J. R., Guillemot, L., Janssen, G. H., Karuppusamy, R., Kramer, M., Lazarus, P., Lee, K. J., Lentati, L., Liu, K., Mingarelli, C. M. F., Osłowski, S., Perrodin, D., Posenti, A., Purver, M. B., Sanidas, S., Smits, R., Stappers, B., Theureau, G., Tiburzi, C., van Haasteren, R., Vecchio, A., & Verbiest, J. P. W. (2016). European Pulsar Timing Array Limits on Continuous Gravitational Waves from Individual Supermassive Black Hole Binaries. *Monthly Notices of the Royal Astronomical Society*, 455 (2), 1665-1679. doi:10.1093/mnras/stv2092.
- Babak, S., Taracchini, A., & Buonanno, A. (2017). Validating the effective-one-body model of spinning, precessing binary black holes against numerical relativity. *Physical Review D*, 95: 024010. doi:10.1103/PhysRevD.95.024010.
- Babak, S., Gair, J. R., & Cole, R. H. (2015). Extreme mass ratio inspirals: perspectives for their detection. In *Equations of Motion in Relativistic Gravity. Fundamental Theories of Physics*, 179 (pp. 783-812).
- Bäckdahl, T., & Valiente Kroon, J. A. (2014). How to Measure Deviation from the Kerr Initial Data: Recent Progress. In *Relativity and Gravitation. Springer Proceedings in Physics* (pp. 19-24). Springer.
- Bahr, B., Dittrich, B., Hellmann, F., & Kaminski, W. (2013). Holonomy Spin Foam Models: Definition and Coarse Graining. *Physical Review D*, 87(4): 044048. doi:10.1103/PhysRevD.87.044048.
- Bähre, R., Döbrich, B., Dreyling-Eschweiler, J., Ghazaryan, S., Hodajerdi, R., Horns, D., Januschek, F., Knabbe, E.-A., Lindner, A., Notz, D., Ringwald, A., von Seggern, J. E., Stromhagen, R., Trines, D., & Willke, B. (2013). Any Light Particle Search II -- Technical Design Report. *Journal of Instrumentation*, 8: T09001. doi:10.1088/1748-0221/8/09/T09001.
- Bakhtmatov, I., Kleinschmidt, A., & Musaev, E. T. (2016). Non-geometric branes are DFT monopoles. *Journal of high energy physics: JHEP*, 2016(10): 076. doi:10.1007/JHEP10(2016)076.
- Banados, M., Canto, R., & Theisen, S. (2016). Higher spin black holes in three dimensions: Remarks on asymptotics and regularity. *Physical Review D*, 94: 024002. doi:10.1103/PhysRevD.94.024002.
- Banisch, R., Hellmann, F., & Rätzel, D. (2013). The Unruh-deWitt Detector and the Vacuum in the General Boundary formalism. *Classical and quantum gravity*, 30 (23): 235026. doi:10.1088/0264-9381/30/23/235026.
- Baratin, A., Carrozza, S., Oriti, D., Ryan, J., & Smerlak, M. (2014). Melonic phase transition in group field theory. *Letters in Mathematical Physics*, 104(8), 1003-1017. doi:10.1007/s11005-014-0699-9.
- Barausse, E., Morozova, V., & Rezzolla, L. (2014). On the mass radiated by coalescing black-hole binaries: Erratum *ApJ*, 2012, 758, 63. *The Astrophysical Journal*, 786(1): 76. doi:10.1088/0004-637X/786/1/76.
- Barausse, E., Bellovary, J., Berti, E., Holley-Bockelmann, K., Farris, B., Sathyaprakash, B., & Sesana, A. (2015). Massive Black Hole Science with eLISA. *Journal of Physics: Conference Series*, 610: 012001.
- Barke, S., Brause, N., Bykov, I., Esteban Delgado, J. J., Enggaard, A., Gerberding, O., Heinzel, G., Kullmann, J., Pedersen, S. M., & Rasmussen, T. (2014). LISA Metrology System - Final Report.
- Barke, S., Wang, Y., Delgado, J. J. E., Tröbs, M., Heinzel, G., & Danzmann, K. (2015). Towards a gravitational wave observatory designer: sensitivity limits of spaceborne detectors. *Classical and quantum gravity*, 32(9): 095004. doi:10.1088/0264-9381/32/9/095004.
- Barkett, K., Scheel, M. A., Haas, R., Ott, C. D., Bernuzzi, S., Brown, D. A., Szilágyi, B., Kaplan, J. D., Lippuner, J., Muhlberger, C. D., Foucart, F., & Duez, M. D. (2016). Gravitational waveforms for neutron star binaries from binary black hole simulations. *Physical Review D*, 93: 044064. doi:10.1103/PhysRevD.93.044064.
- Barkett, K., Scheel, M. A., Haas, R., Ott, C. D., Bernuzzi, S., Brown, D. A., Szilágyi, B., Kaplan, J. D., Lippuner, J., Muhlberger, C. D., Foucart, F., & Duez, M. D. (2016). Gravitational waveforms for neutron star binaries from binary black hole simulations. *Physical Review D*, 93: 044064. doi:10.1103/PhysRevD.93.044064.



## Publications by AEI Members and Guest Scientists

- Barrett, S., Hammerer, K., Harrison, S., Northup, T. E., & Osborne, T. J. (2013). Simulating Quantum Fields with Cavity QED. *Physical Review Letters*, 110: 090501. doi:10.1103/PhysRevLett.110.090501.
- Battarra, L., Lavrelashvili, G. V., & Lehnert, J.-L. (2013). Zoology of instanton solutions in flat potential barriers. *Physical Review D*, 88(10): 104012. doi:10.1103/PhysRevD.88.104012.
- Battarra, L., & Lehnert, J.-L. (2014). On the Quantum-To-Classical Transition for Ekpyrotic Perturbations. *Physical Review D*, 89: 063516. doi:10.1103/PhysRevD.89.063516.
- Battarra, L., Lavrelashvili, G. V., & Lehnert, J.-L. (2014). Creation of wormholes by quantum tunnelling in modified gravity theories. *Physical Review D*, 90: 124015. doi:10.1103/PhysRevD.90.124015.
- Battarra, L., & Lehnert, J.-L. (2014). On the No-Boundary Proposal for Ekpyrotic and Cyclic Cosmologies. *Journal of Cosmology and Astroparticle Physics*, 2014(12), 23-23. doi:10.1088/1475-7516/2014/12/023.
- Battarra, L., Köhn, M., Lehnert, J.-L., & Ovrut, B. A. (2014). Cosmological Perturbations Through a Non-Singular Ghost-Condensate/Galileon Bounce. *Journal of Cosmology and Astroparticle Physics*, 2014(7): 007. doi:10.1088/1475-7516/2014/07/007.
- Battarra, L., & Lehnert, J.-L. (2015). On the Creation of the Universe via Ekpyrotic Instantons. *Physics Letters B*, 742, 167-171. doi:10.1016/j.physletb.2015.01.028.
- Bauchrowitz, J., Westphal, T., & Schnabel, R. (2013). A graphical description of optical parametric generation of squeezed states of light. *American Journal of Physics*, 81(10): 767. doi:http://dx.doi.org/10.1119/1.4819195.
- Baune, C., Schönbeck, A., Sambrowski, A., Fiurasek, J., & Schnabel, R. (2014). Quantum non-Gaussianity of frequency up-converted single photons. *Optics Express*, 22(19), 22808-22816. doi:10.1364/OE.22.022808.
- Baune, C., Gniesmer, J., Schönbeck, A., Vollmer, C. E., Fiurasek, J., & Schnabel, R. (2015). Quantum metrology with frequency up-converted squeezed vacuum states. *Optics Express*, 23(12): 16035. doi:10.1364/OE.23.016035.
- Baune, C., Gniesmer, J., Schönbeck, A., Vollmer, C. E., Fiurasek, J., & Schnabel, R. (2015). Strongly squeezed states at 532nm based on frequency up-conversion. *Optics Express*, 23(12), 16035-16041. doi:10.1364/OE.23.016035.
- Baune, C., Gniesmer, J., Kocsis, S., Vollmer, C. E., Zell, P., Fiurasek, J., & Schnabel, R. (2016). Unconditional entanglement interface for quantum networks. *Physical Review A*, 93: 010302. doi:10.1103/PhysRevA.93.010302.
- Behnke, B., Papa, M. A., & Prix, R. (2015). Postprocessing methods used in the search for continuous gravitational-wave signals from the Galactic Center. *Physical Review D*, 91(6): 064007. doi:10.1103/PhysRevD.91.064007.
- Behr, N., & Fredenhagen, S. (2015). Matrix factorisations for rational boundary conditions by defect fusion. *Journal of high energy physics: JHEP*, 2015(05): 055. doi:10.1007/JHEP05(2015)055.
- Belczynski, K., Buonanno, A., Cantiello, M., Fryer, C. L., Holz, D. E., Mandel, I., Miller, M. C., & Walczak, M. (2014). The Formation and Gravitational-Wave Detection of Massive Stellar Black-Hole Binaries. *Astrophysical Journal*, 789(2): 120. doi:10.1088/0004-637X/789/2/120.
- Ben Geloun, J., & Toriumi, R. (2015). Parametric Representation of Rank d Tensorial Group Field Theory: Abelian Models with Kinetic Term  $\sum_s |p_s| + \mu$ . *Journal of Mathematical Physics*, 56: 093503. doi:10.1063/1.4929771.
- Ben Geloun, J. (2016). Renormalizable and asymptotically free tensor field theories. *International Association of Mathematical Physics News Bulletin*, 2016(1), 3-13.
- Benedetti, D. (2013). On the number of relevant operators in asymptotically safe gravity. *EPL*, 102(2): 20007. doi:10.1209/0295-5075/102/20007.
- Benedetti, D., & Guarnieri, F. (2014). Brans-Dicke theory in the local potential approximation. *New Journal of Physics*, 16: 053051. doi:10.1088/1367-2630/16/5/053051.
- Benedetti, D., & Guarnieri, F. (2014). One-loop renormalization in a toy model of Horava-Lifshitz gravity. *Journal of high energy physics: JHEP*, 2014(03): 078. doi:10.1007/JHEP03(2014)078.
- Benedetti, D. (2015). Critical behavior in spherical and hyperbolic spaces. *Journal of Statistical Mechanics: Theory and Experiment*, 2015(1): P01002. doi:10.1088/1742-5468/2015/01/P01002.
- Benedetti, D., Geloun, J. B., & Oriti, D. (2015). Functional Renormalisation Group Approach for Tensorial Group Field Theory: a Rank-3 Model. *Journal of high energy physics: JHEP*, 2015(03): 084. Retrieved from <http://arxiv.org/abs/1411.3180>.
- Benedetti, D., & Henson, J. (2015). Spacetime condensation in (2+1)-dimensional CDT from a Horava-Lifshitz minisuperspace model. *Classical and quantum gravity*, 32(21): 215007. doi:10.1088/0264-9381/32/21/215007.
- Bentivegna, E., & Korzynski, M. (2013). Evolution of a family of expanding cubic black-hole lattices in numerical relativity. *Classical and quantum gravity*, 30(23): 235008. doi:10.1088/0264-9381/30/23/235008.
- Bentivegna, E. (2014). Solving the Einstein constraints in periodic spaces with a multigrid approach. *Classical and quantum gravity*, 31(3): 035004. doi:10.1088/0264-9381/31/3/035004.
- Bentivegna, E. (2014). Black-hole lattices. In *Progress in Mathematical Relativity, Gravitation and Cosmology, Springer Proceedings in Mathematics & Statistics* (pp. 143-146). Berlin Heidelberg: Springer-Verlag.
- Bergner, A., Scharf, F. H., Kühn, G., Ruhmann, C., Hoebing, T., Awakowicz, P., & Mentel, J. (2014). Simulation of the hot core mode of arc attachment at a thoriated tungsten cathode by an emitter spot model. *Plasma Sources Science and Technology*, 23(5): 054005. doi:10.1088/0963-0252/23/5/054005.
- Berman, D. S., Cederwall, M., Kleinschmidt, A., & Thompson, D. C. (2013). The gauge structure of generalised diffeomorphisms. *Journal of high energy physics: JHEP*, 2013(01): 064. doi:10.1007/JHEP01(2013)064.
- Bernard, L., Blanchet, L., Bohé, A., Faye, G., & Marsat, S. (2016). Fokker action of non-spinning compact binaries at the fourth post-Newtonian approximation. *Physical Review D*, 93: 084037. doi:10.1103/PhysRevD.93.084037.

## Publications by AEI Members and Guest Scientists

- Berni, A. A., Gehring, T., Nielsen, B. M., Händchen, V., Paris, M. G. A., & Andersen, U. L. (2015). Ab-initio Quantum Enhanced Optical Phase Estimation Using Real-time Feedback Control. *Nature Photonics*, 9, 577-581. doi:10.1038/nphoton.2015.139.
- Bernuzzi, S., & Dietrich, T. (2016). Gravitational waveforms from binary neutron star mergers with high-order weighted-essentially-nonscillatory schemes in numerical relativity. *Physical Review D*, 94(6): 064062. doi:https://doi.org/10.1103/PhysRevD.94.064062.
- Bertolini, M., Melnikov, I. V., & Plesser, M. R. (2014). Hybrid conformal field theories. *Journal of high energy physics: JHEP*, 2014(5): 043. doi:10.1007/JHEP05(2014)043.
- Bianchi, E., & Hellmann, F. (2013). The Construction of Spin Foam Vertex Amplitudes. *Symmetry, Integrability and Geometry: Methods and Applications (SIGMA)*, 9: 008. doi:10.3842/SIGMA.2013.008.
- Bianco, S. (2015). Phenomenology from the DSR-deformed relativistic symmetries of 3D quantum gravity via the relative-locality framework. *Journal of Physics: Conference Series*, 634: 012003.
- Bicák, J. (2014). On the Effects of Rotating Gravitational Waves. In *Relativity and Gravitation. Springer Proceedings in Physics* (pp. 255-260 ).
- Bicák, J., & Hejda, F. (2015). Near-horizon description of extremal magnetized stationary black holes and Meissner effect. *Physical Review D*, 92: 104006. doi:10.1103/PhysRevD.92.104006.
- Bicák, J., & Schmidt, J. (2016). Energy-momentum tensors in linearized Einstein's theory and massive gravity: The question of uniqueness. *Physical Review D*, 93: 024009. doi:10.1103/PhysRevD.93.024009.
- Biernat, P., & Bizoń, P. (2015). Generic self-similar blowup for equivariant wave maps and Yang-Mills fields in higher dimensions. *Communications in Mathematical Physics*, 338: 1443. doi:10.1007/s00220-015-2404-y.
- Bini, D., Geralico, A., & Gregoris, D. (2013). Dark energy from cosmological fluids obeying a Shan-Chen nonideal equation of state. *Physical Review D*, 88: 063007. doi:10.1103/PhysRevD.88.063007.
- Bini, D., Geralico, A., Gregoris, D., & Succi, S. (2013). Friction forces in cosmological models. *The European Physical Journal C - Particles and Fields*, 73: 2334. doi:10.1140/epjc/s10052-013-2334-9.
- Bini, D., Geralico, A., Gregoris, D., & Succi, S. (2014). Scalar field inflation and Shan-Chen fluid models. *Physical Review D*, 90: 044021. doi:10.1103/PhysRevD.90.044021.
- Bizoń, P., & Friedrich, H. (2013). A remark about wave equations on the extreme Reissner-Nordström black hole exterior. *Classical and quantum gravity*, 30(6): 065001. doi:10.1088/0264-9381/30/6/065001.
- Bizoń, P. (2014). Is AdS stable? *General Relativity and Gravitation*, 46(5): 1724. doi:10.1007/s10714-014-1724-0.
- Bizoń, P., & Jałmużna, J. (2013). Globally Regular Instability of 3-Dimensional Anti-De Sitter Spacetime. *Physical Review Letters*, 111: 041102. doi:10.1103/PhysRevLett.111.041102.
- Bizoń, P., & Kahl, M. (2015). Wave maps on a wormhole. *Physical Review D*, 91: 065003. doi:10.1103/PhysRevD.91.065003.
- Bizoń, P., Maliborski, M., & Rostworowski, A. (2015). Resonant dynamics and the instability of anti-de Sitter spacetime. *Physical Review Letters*, 115: 081103. doi:10.1103/PhysRevLett.115.081103.
- Bizoń, P., & Wasserman, A. (2015). Nonexistence of shrinkers for the harmonic map flow in higher dimensions. *International Mathematics Research Notices*, 2015(17), 7757-7762. doi:10.1093/imrn/rnu176.
- Bizoń, P., & Kahl, M. (2016). A Yang-Mills field on the extremal Reissner-Nordström black hole. *Classical and quantum gravity*, 33(17): 175013. doi:http://dx.doi.org/10.1088/0264-9381/33/17/175013.
- Bizoń, P., & Mach, P. (2017). Global dynamics of a Yang-Mills field on an asymptotically hyperbolic space. *Transactions of the American Mathematical Society*, 369(3), 2029-2048. doi:https://doi.org/10.1090/tran/6807.
- Bizouard, M. A., & Papa, M. A. (2013). Searching for gravitational waves with the LIGO and Virgo interferometers. *Comptes Rendus Physique*, 14(4), 352-365. doi:10.1016/j.crhy.2013.03.001.
- Blanchet, L., Buonanno, A., & Tiec, A. L. (2013). First Law of Mechanics for Black Hole Binaries with Spins. *Physical Review D*, 87(2): 024030. doi:10.1103/PhysRevD.87.024030.
- Blazewicz, M., Hinder, I., Koppelman, D. M., Brandt, S. R., Ciznicki, M., Kierzyńska, M., Löffler, F., Schnetter, E., & Tao, J. (2013). From Physics Model to Results: An Optimizing Framework for Cross-Architecture Code Generation. *Scientific Programming*, 21, 1-16. doi:10.3233/SPR-130360.
- Blumenhagen, R., & Sun, R. (2015). T-duality, Non-geometry and Lie Algebroids in Heterotic Double Field Theory. *Journal of high energy physics: JHEP*, 2015(02): 097. doi:10.1007/JHEP02(2015)097.
- Bogan, C., Kwee, P., Hild, S., Huttner, S. H., & Willke, B. (2015). Novel technique for thermal lens measurement in commonly used optical components. *Optics Express*, 23(12), 15380-15389. doi: 10.1364/OE.23.015380.
- Bogdanovic, T., Cheng, R. M., & Amaro-Seoane, P. (2014). Disruption of a Red Giant Star by a Supermassive Black Hole and the Case of PS1-10jh. *Astrophysical Journal*, 788(2): 99. doi:10.1088/0004-637X/788/2/99.
- Bohé, A., Faye, G., Marsat, S., & Porter, E. K. (2015). Quadratic-in-spin effects in the orbital dynamics and gravitational-wave energy flux of compact binaries at the 3PN order. *Classical and quantum gravity*, 32(9): 195010. doi:10.1088/0264-9381/32/19/195010.
- Bondaescu, R., Schäfer, A., Lundgren, A., Hetényi, G., Houlié, N., Jetzer, P., & Bondaescu, M. (2015). Ground-based optical atomic clocks as a tool to monitor vertical surface motion. *Geophysical journal international*, 202(3), 1770-1774. doi:10.1093/gji/ggv246.
- Bonzom, V., Gurau, R., & Smerlak, M. (2013). Universality in p-spin glasses with correlated disorder. *Journal of Statisti-*

## Publications by AEI Members and Guest Scientists

- cal Mechanics: Theory and Experiment, 2013: L02003. doi:10.1088/1742-5468/2013/02/L02003.
- Bonzom, V., Gurau, R., Ryan, J. P., & Tanasa, A. (2014). The double scaling limit of random tensor models. *Journal of High Energy Physics*, 2014(9): 051. doi:10.1007/JHEP09(2014)05.
- Bose, S., Dhurandhar, S., Gupta, A., & Lundgren, A. (2016). Towards low-latency mitigation of the effect of sine-Gaussian noise transients on searches for gravitational waves from compact binary coalescences. *Physical Review D*, 94: 122004. doi:10.1103/PhysRevD.94.122004.
- Bossard, G., & Kleinschmidt, A. (2015). Supergravity divergences, supersymmetry and automorphic forms. *Journal of high energy physics: JHEP*, 2015(08): 102. doi:10.1007/JHEP08(2015)102.
- Bossard, G., & Kleinschmidt, A. (2016). Loops in exceptional field theory. *Journal of high energy physics: JHEP*, 2016(01): 164. doi:10.1007/JHEP01(2016)164.
- Boulanger, N., Ponomarev, D., & Skvortsov, E. D. (2013). Non-abelian cubic vertices for higher-spin fields in AdS(d). *Journal of high energy physics: JHEP*, 2013(05): 008. doi:10.1007/JHEP05(2013)008.
- Boulanger, N., Ponomarev, D., Skvortsov, E. D., & Taronna, M. (2013). On the uniqueness of higher-spin symmetries in AdS and CFT. *International Journal of Modern Physics A*, 28(31): 1350162. doi:10.1142/S0217751X13501625.
- Boulanger, N., Kessel, P., Skvortsov, E. D., & Taronna, M. (2016). Higher Spin Interactions in Four Dimensions: Vasiliev vs. Fronsdal. *Journal of Physics A*, 49(9): 095402. doi:http://dx.doi.org/10.1088/1751-8113/49/9/095402.
- Bramberger, S. F., Lavrelashvili, G. V., & Lehnert, J.-L. (2016). Quantum tunneling from paths in complex time. *Physical Review D*, 94: 064032. doi:https://doi.org/10.1103/PhysRevD.94.064032.
- Branchesi, M., Woan, G., Astone, P., Bartos, I., Colla, A., Covino, S., Drago, M., Fan, X., Frasca, S., Hanna, C., Haskell, B., Hazboun, J. S., Heng, I. S., Holz, D. E., Johnson-McDaniel, N. K., Jones, I. D., Keer, L., Klimentenko, S., Kostas, G., Larson, S. L., Mandel, I., Mapelli, M., Messenger, C., Mazzolo, G., Melatos, A., Mohanty, S., Necula, V., Normandin, M., Obara, L., Opiela, R., Owen, B., Palomba, C., Prodi, G. A., Re, V., Salemi, F., Sidery, T. L., Sokolowski, M., Schwenzer, K., Tiwari, V., Tringali, M. C., Vedovato, G., Voudsen, W., Yakushin, I., Zadrožny, A., & Ziosi, B. M. (2014). C7 multi-messenger astronomy of GW sources. *General Relativity and Gravitation*, 46: 1771. doi:10.1007/s10714-014-1771-6.
- Braun, S., Friesdorf, M., Hodgman, S. S., Schreiber, M., Ronzheimer, J. P., Riera, A., del Rey, M., Bloch, I., Eisert, J., & Schneider, U. (2015). Emergence of coherence and the dynamics of quantum phase transitions. *Proceedings of the National Academy of Sciences of the United States of America*, PNAS, 112(12), 3641-3646. doi:10.1073/pnas.1408861112.
- Brem, P., Amaro-Seoane, P., & Spurzem, R. (2013). Relativistic mergers of compact binaries in clusters: The fingerprint of the spin. *Monthly Notices of the Royal Astronomical Society*, 434(4), 2999-3007. doi:10.1093/mnras/stt1220.
- Brem, P., Cuadra, J., Amaro-Seoane, P., & Komossa, S. (2014). Tidal disruptions in circumbinary disks. II: Observational signatures in the reverberation spectra. *The Astrophysical Journal*, 792(2): 100. doi:10.1088/0004-637X/792/2/100.
- Brem, P., Amaro-Seoane, P., & Sopuerta, C. F. (2014). Blocking low-eccentricity EMRIs: A statistical direct-summation N-body study of the Schwarzschild barrier. *Monthly Notices of the Royal Astronomical Society*, 437(2), 1259-1267. doi:10.1093/mnras/stt1948.
- Brödel, J., Mafra, C. R., Matthes, N., & Schlotterer, O. (2015). Elliptic multiple zeta values and one-loop superstring amplitudes. *Journal of high energy physics: JHEP*, 2015(07): 112. doi:10.1007/JHEP07(2015)112.
- Brödel, J., Matthes, N., & Schlotterer, O. (2016). Relations between elliptic multiple zeta values and a special derivation algebra. *Journal of Physics A: Mathematical and Theoretical*, 49(15): 155203. doi:http://dx.doi.org/10.1088/1751-8113/49/15/155203.
- Broedel, J., Schlotterer, O., & Stieberger, S. (2013). Polylogarithms, Multiple Zeta Values and Superstring Amplitudes. *Fortschritte der Physik/Progress of Physics*, 61(9), 812-870. doi:10.1002/prop.201300019.
- Broedel, J., Schlotterer, O., Stieberger, S., & Terasoma, T. (2014). All order alpha-expansion of superstring trees from the Drinfeld associator. *Physical Review D*, 89: 066014. doi:10.1103/PhysRevD.89.066014.
- Brown, D., Friedrich, D., Brückner, F., Carbone, L., Schnabel, R., & Freise, A. (2013). Invariance of waveguide grating mirrors to lateral displacement phase shifts. *Optics Letters*, 38(11), 1844-1846. doi:http://dx.doi.org/10.1364/OL.38.001844.
- Buchert, T., Nayet, C., & Wiegand, A. (2013). Lagrangian theory of structure formation in relativistic cosmology II: average properties of a generic evolution model. *Physical Review D*, 87: 123503. doi:10.1103/PhysRevD.87.123503.
- Buchert, T., Carfora, M., Ellis, G. F. R., Kolb, E. W., MacCallum, M. A. H., Ostrowski, J. J., Räsänen, S., Roukema, B. F., Andersson, L., Coley, A. A., & Wiltshire, D. L. (2015). Is there proof that backreaction of inhomogeneities is irrelevant in cosmology? *Classical and quantum gravity*, 32(21): 215021. doi:10.1088/0264-9381/32/21/215021.
- Bugner, M., Dietrich, T., Bernuzzi, S., Weyhausen, A., & Brüggmann, B. (2016). Solving 3D relativistic hydrodynamical problems with weighted essentially nonoscillatory discontinuous Galerkin methods. *Physical Review D*, 94: 084004. doi:https://doi.org/10.1103/PhysRevD.94.084004.
- Bunster, C., & Henneaux, M. (2013). Sources for Generalized Gauge Fields. *Physical Review D*, 88: 085002. doi:10.1103/PhysRevD.88.085002.
- Buonanno, A., Faye, G., & Hinderer, T. (2013). Spin effects on gravitational waves from inspiraling compact binaries at second post-Newtonian order. *Physical Review D*, 87(4): 044009. doi:10.1103/PhysRevD.87.044009.
- Buonanno, A., & Sathyaprakash, B. S. (2014). Sources of Gravitational Waves: Theory and Observations. In *General Relativity and Gravitation: A Centennial Perspective* (pp. 287-346). Cambridge: University Press.
- Bustillo, J. C., Husa, S., Sintes, A. M., & Pürrer, M. (2016). Impact of gravitational radiation higher order modes on single aligned-spin gravitational wave searches for binary black holes. *Physical Review D*, 93: 084019. doi:10.1103/Phys-

## Publications by AEI Members and Guest Scientists

RevD.93.084019.

Butter, D., Kuzenko, S. M., Novak, J., & Theisen, S. (2016). Invariants for minimal conformal supergravity in six dimensions. *Journal of high energy physics: JHEP*, 2016(12): 072. doi:10.1007/JHEP12(2016)072.

Bykov, D. (2014). Geometric aspects of the holographic duality. *Theoretical and mathematical physics*, 181(3), 1499-1508. doi:10.1007/s11232-014-0230-6.

Bykov, D. (2015). Integrable properties of sigma-models with non-symmetric target spaces. *Nuclear Physics B*, 894, 254-267. doi:10.1016/j.nuclphysb.2015.03.005.

Bykov, D. (2016). Classical solutions of a flag manifold sigma-model. *Nuclear Physics B*, 902, 292-301. doi:10.1016/j.nuclphysb.2015.11.015.

Bykov, D. (2015). Branes at toric conical singularities. In B. Dragovic (Ed.), *Proceedings, 8th Mathematical Physics Meeting, Summer School and Conference on Modern Mathematical Physics: Belgrade, Serbia, August 24-31, 2014* (pp. 23-32).

Bykov, D. (2016). Complex structures and zero-curvature equations for sigma-models. *Physics Letters B*, 760, 341-344. doi: <http://dx.doi.org/10.1016/j.physletb.2016.06.071>.

Bykov, D. (2016). Sigma-models with complex homogeneous target spaces. *EPJ Web of Conferences*, 125: 05002. doi:<http://dx.doi.org/10.1051/epjconf/201612505002>.

Bykov, D. (2015). Ricci-flat metrics on cones over toric complex surfaces. In *Proceedings, 18th International Seminar on High Energy Physics (Quarks 2014): Suzdal, Russia, June 2-8, 2014*.

Cabero, M., & Krishnan, B. (2015). Tidal deformations of spinning black holes in Bowen-York initial data. *Classical and quantum gravity*, 32(4): 045009. doi:10.1088/0264-9381/32/4/045009.

Cai, Y.-F., & Wilson-Ewing, E. (2015). A Lambda CDM bounce scenario. *Journal of Cosmology and Astroparticle Physics*, (03): 006. doi:10.1088/1475-7516/2015/03/006.

Cai, Y.-F., Marciano, A., Wang, D.-G., & Wilson-Ewing, E. (2017). Bouncing cosmologies with dark matter and dark energy. *Universe*, 3(1): 1. doi:10.3390/universe3010001.

Calcagni, G., Oriti, D., & Thürigen, J. (2013). Laplacians on discrete and quantum geometries. *Classical and quantum gravity*, 30(12): 125006. doi:10.1088/0264-9381/30/12/125006.

Calcagni, G., Oriti, D., & Thürigen, J. (2014). Spectral dimension of quantum geometries. *Classical and quantum gravity*, 31(13): 135014. doi:10.1088/0264-9381/31/13/135014.

Calcagni, G. (2013). Observational effects from quantum cosmology. *Annalen der Physik*, 525(05): 201200227, pp. 323-338. doi:10.1002/andp.201200227.

Calcagni, G. (2013). Diffusion in multiscale spacetimes. *Physical Review E*, 87: 012123. doi:10.1103/PhysRevE.87.012123.

Calcagni, G., Oriti, D., & Thürigen, J. (2015). Dimensional flow in discrete quantum geometries. *Physical Review D*, 91: 084047. doi:10.1103/PhysRevD.91.084047.

Camanho, X., Edelstein, J. D., Giribet, G., & Gomberoff, A. (2014). Generalized phase transitions in Lovelock gravity. *Physical Review D*, 90(6): 064028. doi:10.1103/PhysRevD.90.064028.

Camanho, X. O., Dadhich, N., & Molina, A. (2015). Pure Lovelock Kasner metrics. *Classical and quantum gravity*, 32(17): 175016. doi:10.1088/0264-9381/32/17/175016.

Camanho, X. O., Edelstein, J. D., & Zhiboedov, A. (2015). Weakly coupled gravity beyond general relativity. *International Journal of Modern Physics D*, 24(12): 1544031. doi:10.1142/S0218271815440319.

Camanho, X. O., Edelstein, J. D., Gomberoff, A., & Sierra-Garcia, J. A. (2015). On AdS to dS transitions in higher-curvature gravity. *Journal of high energy physics: JHEP*, 2015(10): 179. doi:10.1007/JHEP10(2015)179.

Camanho, X. O., & Dadhich, N. (2016). On Lovelock analogues of the Riemann tensor. *The European Physical Journal C*, 76: 149. doi:10.1140/epjc/s10052-016-3891-5.

Camanho, X. O., Edelstein, J. D., Maldacena, J., & Zhiboedov, A. (2016). Causality Constraints on Corrections to the Graviton Three-Point Coupling. *Journal of high energy physics: JHEP*, 2016(02): 020. doi:10.1007/JHEP02(2016)020.

Campoleoni, A., & Francia, D. (2013). Maxwell-like Lagrangians for higher spins. *Journal of high energy physics: JHEP*, 2013(03): 168. doi:10.1007/JHEP03(2013)168.

Campoleoni, A., & Fredenhagen, S. (2013). On the higher-spin charges of conical defects. *Physics Letters B*, 726 (1-3), 387-389. doi:10.1016/j.physletb.2013.08.012.

Campoleoni, A., Fredenhagen, S., Pfenninger, S., & Theisen, S. (2013). Towards metric-like higher spin gauge theories in three dimensions. *Journal of Physics A*, 46(21): 214017. doi:10.1088/1751-8113/46/21/214017.

Campoleoni, A. (2013). Higher Spins in D=2+1. In *Searching for the Unexpected at LHC and the Status of Our Knowledge: Proceedings of the International School of Subnuclear Physics* (pp. 385-396). World Scientific.

Cannon, K., Emberson, J. D., Hanna, C., Keppel, D., & Pfeiffer, H. (2013). Interpolation in waveform space: enhancing the accuracy of gravitational waveform families using numerical relativity. *Physical Review D*, 87: 044008. doi:10.1103/PhysRevD.87.044008.

Cannon, K., Hanna, C., & Keppel, D. (2013). A method to estimate the significance of coincident gravitational-wave observations from compact binary coalescence. *Physical Review D*, 88: 024025. doi:10.1103/PhysRevD.88.024025.

Canton, T. D., Bhagwat, S., Dhurandhar, S. V., & Lundgren, A. (2014). Effect of sine-Gaussian glitches on searches for binary coalescence. *Classical and quantum gravity*, 31: 015016. doi:10.1088/0264-9381/31/1/015016.

## Publications by AEI Members and Guest Scientists

- Cao, Z., Li, L.-F., & Wang, Y. (2014). Gravitational lensing effects on parameter estimation in gravitational wave detection with advanced detectors. *Physical Review D*, 90: 062003. doi:10.1103/PhysRevD.90.062003.
- Cao, L., & Hu, Y.-M. (2016). Beta Rebound in Visuomotor Adaptation: Still the Status Quo? *Journal of Neuroscience*, 36(24), 6365-6367. doi:10.1523/JNEUROSCI.1007-16.2016.
- Capano, C., Pan, Y., & Buonanno, A. (2014). Impact of Higher Harmonics in Searching for Gravitational Waves from Non-Spinning Binary Black Holes. *Physical Review D*, 89(10): 102003. doi:10.1103/PhysRevD.89.102003.
- Capano, C., Harry, I., Privitera, S., & Buonanno, A. (2016). Implementing a search for gravitational waves from binary black holes with nonprecessing spin. *Physical Review D*, 93: 124007. doi:http://dx.doi.org/10.1103/PhysRevD.93.124007.
- Capri, M. A. L., Dudal, D., Fiorentini, D., Guimaraes, M. S., Justo, I. F., Pereira, A. D., Mintz, B. W., Palhares, L. F., Sobreiro, R. F., & Sorella, S. P. (2016). Local and BRST-invariant Yang-Mills theory within the Gibbon horizon. *Physical Review D*, 94: 025035. doi:https://doi.org/10.1103/PhysRevD.94.025035.
- Carbone, L., Bogan, C., Fulda, P., Freise, A., & Willke, B. (2013). Generation of high-purity higher-order Laguerre-Gauss beams at high laser power. *Physical Review Letters*, 110: 251101. doi:10.1103/PhysRevLett.110.251101.
- Carrasco, J. J. M., Chiodarolia, M., Gunaydin, M., & Roiban, R. (2013). One-loop four-point amplitudes in pure and matter-coupled  $N \leq 4$  supergravity. *Journal of high energy physics: JHEP*, 2013(03): 056. doi:10.1007/JHEP03(2013)056.
- Carrozza, S., Oriti, D., & Rivasseau, V. (2014). Renormalization of Tensorial Group Field Theories: Abelian  $U(1)$  Models in Four Dimensions. *Communications in Mathematical Physics*, 327(2), 603-641. doi:10.1007/s00220-014-1954-8.
- Carrozza, S., Oriti, D., & Rivasseau, V. (2014). Renormalization of an  $SU(2)$  Tensorial Group Field Theory in Three Dimensions. *Communications in Mathematical Physics*, 330(2), 581-637. doi:10.1007/s00220-014-1928-x.
- Casanelas, J., & Lopes, I. (2014). The Sun and stars: Giving light to dark matter. *Modern Physics Letters A*, (29): 1440001. doi:10.1142/S021773231440001X.
- Casanelas, J., Brandão, I. M., & Lebreton, Y. (2015). Stellar convective cores as dark matter probes. *Physical Review D*, 91: 103535. doi:10.1103/PhysRevD.91.103535.
- Catino, G., & Mazzieri, L. (2013). Connected sum construction for sigma (k)-Yamabe metrics. *Journal of Geometric Analysis*, 23(2), 709-763.
- Cederbaum, C., Cortier, J., & Sakovich, A. (2015). On the center of mass of asymptotically hyperbolic initial data sets. *Annales Henri Poincaré*, 1-24. doi:10.1007/s00023-015-0438-5.
- Cederbaum, C., Dain, S., & Gabach Clement, M. E. (2013). Area Angular Momentum Charge Inequality. *Living Reviews in Relativity*.
- Černotík, O., & Fiurášek, J. (2014). Transformations of symmetric multipartite Gaussian states by Gaussian local operations and classical communication. *Physical Review A*, 89: 042331. doi:10.1103/PhysRevA.89.042331.
- Černotík, O., Vasilyev, D. V., & Hammerer, K. (2015). Adiabatic Elimination of Gaussian Subsystems from Quantum Dynamics under Continuous Measurement. *Physical Review A*, 92: 012124. doi:10.1103/PhysRevA.92.012124.
- Černotík, O., & Hammerer, K. (2016). Measurement-Induced Long-Distance Entanglement of Superconducting Qubits using Optomechanical Transducers. *Physical Review A*, 94: 012340. doi:10.1103/PhysRevA.94.012340.
- Cervantes, F. G., Flatscher, R., Gerardi, D., Burkhardt, J., Gerdt, R., Nofrarias, M., Reiche, J., Heinzel, G., Danzmann, K., Boté, L. G., Martín, V., Mateos, I., & Lobo, A. (2013). LISA Technology Package Flight Hardware Test Campaign. Cha, Y. S., Khuri, M., & Sakovich, A. (2016). Reduction Arguments for Geometric Inequalities Associated With Asymptotically Hyperboloidal Slices. *Classical Quantum Gravity*, 33: 035009. doi:10.1088/0264-9381/33/3/035009.
- Chakrabarty, B., Turton, D., & Virmani, A. (2015). Holographic description of non-supersymmetric orbifolded D1-D5-P solutions. *Journal of high energy physics: JHEP*, 2015(11): 063. doi:10.1007/JHEP11(2015)063.
- Chankowski, P. H., Lewandowski, A., Meissner, K., & Nicolai, H. (2015). Softly broken conformal symmetry and the stability of the electroweak scale. *Modern Physics Letters A*, 30(2): 1550006. doi:10.1142/S0217732315500066.
- Chankowski, P. H., Lewandowski, A., & Meissner, K. A. (2016). Two-loop RGE of a general renormalizable Yang-Mills theory in a renormalization scheme with an explicit UV cutoff. *Journal of high energy physics: JHEP*, 2016(11): 105. doi:10.1007/JHEP11(2016)105.
- Chen, X., & Amaro-Seoane, P. (2015). Sculpting the Stellar Cusp in the Galactic Center. *Classical and quantum gravity*, 32(6): 064001. doi:10.1088/0264-9381/32/6/064001.
- Chen, X., Amaro-Seoane, P., & Cuadra, J. (2016). Stability of Gas Clouds in Galactic Nuclei: An Extended Virial Theorem. *The Astronomical Journal*, 819(138): 138. doi:10.3847/0004-637X/819/2/138.
- Chen, X., & Amaro-Seoane, P. (2014). A rapidly evolving region in the Galactic Center: Why S-stars thermalize and more massive stars are missing. *The Astrophysical Journal Letters*, 786(2): L14. doi:10.1088/2041-8205/786/2/L14.
- Chiodaroli, M., Jin, Q., & Roiban, R. (2014). Color/kinematics duality for general abelian orbifolds of  $N=4$  super Yang-Mills theory. *Journal of high energy physics: JHEP*, 2014(01): 152. doi:10.1007/JHEP01(2014)152.
- Chiodarolia, M., Gunaydin, M., Johansson, H., & Roiban, R. (2015). Scattering amplitudes in  $N=2$  Maxwell-Einstein and Yang-Mills/Einstein supergravity. *Journal of high energy physics: JHEP*, 2015(01): 081. doi:10.1007/JHEP01(2015)081.
- Chiodarolia, M., Gunaydin, M., Johansson, H., & Roiban, R. (2016). Complete construction of magical, symmetric and homogeneous  $N=2$  supergravities as double copies of gauge theories. *Physical Review Letters*, 117: 011603.

## Publications by AEI Members and Guest Scientists

doi:10.1103/PhysRevLett.117.011603.

Christodoulakis, T., Dimakis, N., Terzis, P. A., & Doulis, G. (2014). Canonical quantization of the BTZ black hole using Noether symmetries. *Physical Review D*, 90(2): 024052. doi:10.1103/PhysRevD.90.024052.

Chu, T., Fong, H., Kumar, P., Pfeiffer, H. P., Boyle, M., Hemberger, D. A., Kidder, L. E., Scheel, M. A., & Szilagyi, B. (2016). On the accuracy and precision of numerical waveforms: Effect of waveform extraction methodology. *Classical and quantum gravity*, 33(16): 165001. doi:10.1088/0264-9381/33/16/165001.

Chua, S. S. Y., Dwyer, S., Barsotti, L., Sigg, D., Schofield, R. M. S., Frolov, V. V., Kawabe, K., Evans, M., Meadors, G. D., Factourovich, M., Gustafson, R., Smith-Lefebvre, N., Vorvick, C., Landry, M., Khalaidovski, A., Stefszky, M. S., Mow-Lowry, C. M., Buchler, B. C., Shaddock, D. A., Lam, P. K., Schnabel, R., Mavalvala, N., & McClelland, D. E. (2014). Impact of backscattered light in a squeezing-enhanced interferometric gravitational-wave detector. *Classical and quantum gravity*, 31: 035017. doi:10.1088/0264-9381/31/3/035017.

Chwalla, M., Danzmann, K., Barranco, G. F., Fitzsimons, E., Gerberding, O., Heinzel, G., Killow, C. J., Lieser, M., Perreux-Lloyd, M., Robertson, D. I., Schuster, S., Schwarze, T. S., Tröbs, M., Ward, H., & Zwest, M. (2016). Design and construction of an optical test bed for LISA imaging systems and tilt-to-length coupling. *Classical and Quantum Gravity*, 33(24): 245015. doi:10.1088/0264-9381/33/24/245015.

Cioffi, R. (2014). Modelling the Magnetic Field Configuration of Neutron Stars. *Astronomische Nachrichten*, 335(6/7), 624-629. doi:10.1002/asna.201412083.

Cioffi, R., & Siegel, D. M. (2015). Short gamma-ray bursts in the "time-reversal" scenario. *The Astrophysical Journal Letters*, 798(2): L36. doi:10.1088/2041-8205/798/2/L36.

Cioffi, R., & Rezzolla, L. (2013). Twisted-torus configurations with large toroidal magnetic fields in relativistic stars. *Monthly Notices of the Royal Astronomical Society: Letters*, 435, L43-L47. doi:10.1093/mnras/slt092.

Cioffi, R. (2014). Magnetic Field Instabilities in Neutron Stars. *Astronomische Nachrichten*, 335(3), 285-290. doi:10.1002/asna.201312033.

Cioffi, R., & Siegel, D. (2015). Short gamma-ray bursts from binary neutron star mergers: the time-reversal scenario. *Proceedings of Science, SWIFT 10*: 108. Retrieved from <http://arxiv.org/abs/1505.01420>.

Clark, J., Evans, H., Fairhurst, S., Harry, I., Macdonald, E., Macleod, D., Sutton, P. J., & Williamson, A. R. (2015). Prospects for joint gravitational wave and short gamma-ray burst observations. *The Astrophysical Journal*, 809: 53. doi:<http://dx.doi.org/10.1088/0004-637X/809/1/53>.

Clark, C. J., Pletsch, H. J., Wu, J., Guillemot, L., Ackermann, M., Allen, B., de Angelis, A., Aulbert, C., Baldini, L., Ballet, J., Barbiellini, G., Bastieri, D., Bellazzini, R., Bissaldi, E., Bock, O., Bonino, R., Bottacini, E., Brandt, T. J., Bregeon, J., Bruel, P., Buson, S., Caliendo, G. A., Cameron, R. A., Caragiulo, M., Caraveo, P. A., Cecchi, C., Champion, D. J., Charles, E., Chekhtman, A., Chiang, J., Chiaro, G., Ciprini, S., Claus, R., Cohen-Tanugi, J., Cuéllar, A., Cutini, S., D'Ammando, F., Desiante, R., Drell, P. S., Eggenstein, H. B., Favuzzi, C., Fehrmann, H., Ferrara, E. C., Focke, W. B., Franckowiak, A., Fusco, P., Gargano, F., Gasparrini, D., Giglietto, N., Giordano, F., Glanzman, T., Godfrey, G., Grenier, I. A., Grove, J. E., Guiriec, S., Harding, A. K., Hays, E., Hewitt, J. W., Hill, A. B., Horan, D., Hou, X., Jogler, T., Johnson, A. S., Jóhannesson, G., Kramer, M., Krauss, F., Kuss, M., Laffon, H., Larsson, S., Latronico, L., Li, J., Li, L., Longo, F., Loparco, F., Lovellette, M. N., Lubrano, P., Machenschalk, B., Manfreda, A., Marelli, M., Mayer, M., Mazzotta, M. N., Michelson, P. F., Mizuno, T., Monzani, M. E., Morselli, A., Moskalenko, I. V., Murgia, S., Nuss, E., Ohsugi, T., Orienti, M., Orlando, E., de Palma, F., Paneque, D., Pesce-Rollins, M., Piron, F., Pivato, G., Rainò, S., Rando, R., Razzano, M., Reimer, A., Parkinson, P. M. S., Schaal, M., Schulz, A., Sgrò, C., Siskind, E. J., Spada, F., Spandre, G., Spinelli, P., Suson, D. J., Takahashi, H., Thayer, J. B., Tibaldo, L., Torne, P., Torres, D. F., Tosti, G., Troja, E., Vianello, G., Wood, K. S., Wood, M., & Yassine, M. (2015). PSR J1906+0722: An Elusive Gamma-ray Pulsar. *The Astrophysical Journal Letters*, 809 (1): L2. doi:10.1088/2041-8205/809/1/L2.

Clark, C. J., Pletsch, H. J., Wu, J., Guillemot, L., Camilo, F., Johnson, T. J., Kerr, M., Allen, B., Aulbert, C., Beer, C., Bock, O., Cuéllar, A., Eggenstein, H. B., Fehrmann, H., Kramer, M., Machenschalk, B., & Nieder, L. (2016). The Breaking Index of a Radio-quiet Gamma-ray Pulsar. *The Astrophysical Journal Letters*, 832(1): L15. doi:10.3847/2041-8205/832/1/L15.

Clark, C. J. (2017). The Einstein@Home Gamma-ray Pulsar Survey: I. Search Methods, Sensitivity and Discovery of New Young Gamma-ray Pulsars. *The Astrophysical Journal*, 834(2): 106. doi:<http://dx.doi.org/10.3847/1538-4357/834/2/106>.

Clement, M. E. G., Jaramillo, J.-L., & Reiris, M. (2013). Proof of the area-angular momentum-charge inequality for axisymmetric black holes. *Classical and quantum gravity*, 30(6): 065017. doi:10.1088/0264-9381/30/6/065017.

Clement, M. E. G., Reiris, M., & Simon, W. (2015). The area-angular momentum inequality for black holes in cosmological spacetimes. *Classical and quantum gravity*, 32(14): 145006. doi:10.1088/0264-9381/32/14/145006.

Clifton, T., Gregoris, D., & Rosquist, K. (2014). Piecewise Silence in Discrete Cosmological Models. *Classical and quantum gravity*, 31: 105012. doi:10.1088/0264-9381/31/10/105012.

Cole, G. D., Yu, P.-L., Gärtner, C., Siquans, K., Nia, R. M., Schmöle, J., Hoelscher-Obermaier, J., Purdy, T. P., Wiecek, W., Regal, C. A., & Aspelmeyer, M. (2014). Strained InxGa1-xP membranes for cavity optomechanics. *Applied Physics Letters*, 104(20): 201908. doi:10.1063/1.4879755.

Coley, A. A., Leon, G., Sandin, P., & Latta, J. (2015). Spherically symmetric Einstein-aether perfect fluid models. *Journal of Cosmology and Astroparticle Physics*, 2015(12): 010. doi:10.1088/1475-7516/2015/12/010.

Colosi, D., & Raetzl, D. (2013). The Unruh effect in general boundary quantum field theory. *SIGMA*, 9: 19. doi:10.3842/SIGMA.2013.019.

Colosi, D., & Raetzl, D. (2013). Quantum field theory on timelike hypersurfaces in Rindler space. *Physical Review D*, 87: 125001. doi:10.1103/PhysRevD.87.125001.

## Publications by AEI Members and Guest Scientists

- Cordero-Carrión, I., Vasset, N., Novak, J., & Jaramillo, J. L. (2014). An excision scheme for black holes in constrained evolution formulations: spherically symmetric case. *Physical Review D*, 90: 044062. doi:10.1103/PhysRevD.90.044062.
- Cornish, N. J., & Sesana, A. (2013). Pulsar Timing Array Analysis for Black Hole Backgrounds. *Classical and quantum gravity*, 30(22): 224005. doi:10.1088/0264-9381/30/22/224005.
- Cortier, J. (2013). Gluing construction of initial data with Kerr-de Sitter ends. *Annales Henri Poincaré*, 14(5), 1109-1134. doi:10.1007/s00023-012-0210-z.
- Coughlin, M., Earle, P., Harms, J., Biscans, S., Buchanan, C., Coughlin, E., Donovan, F., Fee, J., Gabbard, H., Guy, M., Mukund, N., & Perry, M. (2017). Limiting the effects of earthquakes on gravitational-wave interferometers. *Classical and Quantum Gravity*, Volume 34, Number 4, 34(4): 044004. doi:10.1088/1361-6382/aa5a60.
- Coutant, A., & Parentani, R. (2014). Undulations from amplified low frequency surface waves. *Physics of fluids*, 26(4): 044106. doi:10.1063/1.4872025.
- Coutant, A., & Parentani, R. (2014). Hawking radiation with dispersion: the broadened horizon paradigm. *Physical Review D*, 90: 121501. doi:10.1103/PhysRevD.90.121501.
- Coutant, A. (2014). Unitary and non-unitary transitions around a cosmological bounce. *Physical Review D*, 89: 123524.
- Dafermos, M., & Rendall, A. D. (2016). Strong cosmic censorship for surface-symmetric cosmological spacetimes with collisionless matter. *Communications on Pure and Applied Mathematics*, 69(5), 815-908. doi:10.1002/cpa.21628.
- Dafermos, M., & Rendall, A. D. (2016). Strong cosmic censorship for T2-symmetric cosmological spacetimes with collisionless matter. *Communications on Pure and Applied Mathematics*, 69(5), 815-908. doi:10.1002/cpa.21628.
- Dain, S., & Dotti, G. (2013). The wave equation on the extreme Reissner-Nordström black hole. *Classical and quantum gravity*, 30(5): 055011. doi:10.1088/0264-9381/30/5/055011.
- Dal Canton, T., Nitz, A. H., Lundgren, A., Nielsen, A. B., Brown, D. A., Dent, T., Harry, I. W., Krishnan, B., Miller, A. J., Wette, K., Wiesner, K., & Willis, J. L. (2014). Implementing a search for aligned-spin neutron star-black hole systems with advanced ground based gravitational wave detectors. *Physical Review D*, 90: 082004. doi:10.1103/PhysRevD.90.082004.
- Dal Canton, T., Lundgren, A., & Nielsen, A. B. (2015). Impact of precession on aligned-spin searches for neutron-star-black-hole binaries. *Physical Review D*, 91: 062010. doi:10.1103/PhysRevD.91.062010.
- Damour, T., Guercilena, F., Hinder, I., Hopper, S., Nagar, A., & Rezzolla, L. (2014). Strong-Field Scattering of Two Black Holes: Numerics Versus Analytics. *Physical Review D*, 89: 081503. doi:10.1103/PhysRevD.89.081503.
- Danzmann, K. (2013). Introduction to the 9th LISA Symposium.
- Danzmann, K., LISA Pathfinder Team, & eLISA Consortium (2015). LISA and its pathfinder. *Nature Physics*, 11, 613-615-613-615. doi:10.1038/nphys3420.
- Dasgupta, K., Gwyn, R., McDonough, E., Mia, M., & Tatar, R. (2014). de Sitter Vacua in Type IIB String Theory: Classical Solutions and Quantum Corrections. *Journal of high energy physics: JHEP*, 2014(7): 054. doi:10.1007/JHEP07(2014)054.
- de Wit, B., & Nicolai, H. (2013). Deformations of gauged SO(8) supergravity and supergravity in eleven dimensions. *Journal of high energy physics: JHEP*, 2013: 077. doi:10.1007/JHEP05(2013)077.
- del Valle, L., Escala, A., Maureira-Fredes, C., Molina, J., Cuadra, J., & Amaro-Seoane, P. (2015). Supermassive black holes in star forming gaseous circumnuclear discs. *Astrophysical Journal*, 811(1): 59. doi:10.1088/0004-637X/811/1/59.
- Demkowicz-Dobrzanski, R., Banaszek, K., & Schnabel, R. (2013). Fundamental quantum interferometry bound for the squeezed-light-enhanced gravitational-wave detector GEO600. *Physical Review A*, 88: 041802(R). doi:10.1103/PhysRevA.88.041802.
- Denker, T., Schütte, D., Wimmer, M. H., Wheatley, T. A., Huntington, E. H., & Heurs, M. (2015). Utilizing weak pump depletion to stabilize squeezed vacuum states. *Optics Express*, 23: 016517. doi:10.1364/OE.23.016517.
- Dent, T., & Veitch, J. (2014). Optimizing gravitational-wave searches for a population of coalescing binaries: Intrinsic parameters. *Physical Review D*, 89: 062002. doi:10.1103/PhysRevD.89.062002.
- Desvignes, G., Caballero, R. N., Lentati, L., Verbiest, J. P. W., Champion, D. J., Stappers, B. W., Janssen, G. H., Lazarus, P., Osłowski, S., Babak, S., Bassa, C. G., Brem, P., Burgay, M., Cognard, I., Gair, J. R., Graikou, E., Guillemot, L., Hessels, J. W. T., Jessner, A., Jordan, C., Karuppusamy, R., Kramer, M., Lassa, A., Lazaridis, K., Lee, K. J., Liu, K., Lyne, A. G., McKee, J., Mingarelli, C. M. F., Perrodin, D., Petiteau, A., Possenti, A., Purver, M. B., Rosado, P. A., Sanidas, S., Sesana, A., Shaifullah, G., Smits, R., Taylor, S. R., Theureau, G., Tiburzi, C., van Haasteren, R., & Vecchio, A. (2016). High-precision timing of 42 millisecond pulsars with the European Pulsar Timing Array. *Monthly Notices of the Royal Astronomical Society*, 458(03), 3341-3380. doi:10.1093/mnras/stw483.
- Devchand, C. (2014). Oxidation of self-duality to 12 dimensions and beyond. *Communications in Mathematical Physics*, 329(2), 461-482. doi:10.1007/s00220-014-1996-y.
- Devchand, C., & Spiro, A. (2016). On Pseudo-hyperkähler prepotentials. *Journal of Mathematical Physics*, 57: 102501. doi:http://dx.doi.org/10.1063/1.4964750.
- Di Palma, I., ANTARES Collaboration, LIGO Sci Collaboration, & VIRGO Collaboration (2014). Multimessenger astrophysics: When gravitational waves meet high energy neutrinos. *Nuclear Instruments and Methods in Physics Research Section A: Accelerators, Spectrometers, Detectors and Associated Equipment*, 742, 124-129. doi:10.1016/j.nima.2013.10.076.
- Di Palma, I. (2015). The Invisible Messengers: the 2007 Data Search Between Gravitational Waves and High Energy Neutrinos. In K. Rosquist, R. T. Jantzen, & R. Ruffini (Eds.), *Proceedings of the MG13 Meeting on General Relativity* (pp. 2009-2011). World Scientific.
- Di Vecchia, P., Marotta, R., & Mojaza, M. (2016). Soft behavior of a closed massless state in superstring and universality

## Publications by AEI Members and Guest Scientists

- in the soft behavior of the dilaton. *Journal of high energy physics: JHEP*, 2016(12): 020. doi:10.1007/JHEP12(2016)020.
- Didenko, V. E., Mei, J., & Skvortsov, E. D. (2013). Exact higher-spin symmetry in CFT: free fermion correlators from Vasiliev Theory. *Physical Review D*, 88: 046011. doi:10.1103/PhysRevD.88.046011.
- Didenko, V. E., & Skvortsov, E. D. (2013). Towards higher spin holography in ambient space of any dimension. *Journal of Physics A: Mathematical and Theoretical*, 46(21): 214010. doi:10.1088/1751-8113/46/21/214010.
- Didenko, V. E., & Skvortsov, E. D. (2013). Exact higher-spin symmetry in CFT: all correlators in unbroken Vasiliev theory. *Journal of high energy physics: JHEP*, 2013(4): 158. doi:0.1007/JHEP04(2013)158.
- Dionysopoulou, K., Alic, D., Palenzuela, C., Rezzolla, L., & Giacomazzo, B. (2013). General-Relativistic Resistive Magnetohydrodynamics in three dimensions: formulation and tests. *Physical Review D*, 88(4): 044020. doi:10.1103/PhysRevD.88.044020.
- Dionysopoulou, K., Alic, D., & Rezzolla, L. (2015). General-relativistic resistive-magnetohydrodynamic simulations of binary neutron stars. *Physical Review D*, 92: 084064. doi:10.1103/PhysRevD.92.084064.
- Dittrich, B. (2013). How to construct diffeomorphism symmetry on the lattice. Retrieved from <http://arxiv.org/abs/1201.3840>.
- Dittrich, B., Guedes, C., & Oriti, D. (2013). On the space of generalized fluxes for loop quantum gravity. *Classical and quantum gravity*, 3(5): 055008. doi:10.1088/0264-9381/30/5/055008.
- Dittrich, B., Hellmann, F., & Kaminski, W. (2013). Holonomy Spin Foam Models: Boundary Hilbert spaces and Time Evolution Operators. *Classical and quantum gravity*, 30(8): 085005. doi:10.1088/0264-9381/30/8/085005.
- Dittrich, B., & Ryan, J. P. (2013). On the role of the Barbero-Immirzi parameter in discrete quantum gravity. *Classical and quantum gravity*, 30(9): 095015.
- Dolan, S. R., Warburton, N., Harte, A. I., Tiec, A. L., Wardell, B., & Barack, L. (2014). Gravitational self-torque and spin precession in compact binaries. *Physical Review D*, 89: 064011. doi:10.1103/PhysRevD.89.064011.
- Donagi, R., & Wijnholt, M. (2014). Higgs Bundles and UV Completion in F-Theory. *Communications in Mathematical Physics*, 326(2), 287-327. doi:10.1007/s00220-013-1878-8.
- Dong, X., & Miao, R. X. (2015). Generalized Gravitational Entropy from Total Derivative Action. *Journal of high energy physics: JHEP*, 2015(12): 100. doi:10.1007/JHEP12(2015)100.
- Dooley, K., Barsotti, L., Adhikari, R. X., Evans, M., Fricke, T. T., Fritschel, P., Frolov, V., Kawabe, K., & Smith-Lefebvre, N. (2013). Angular control of optical cavities in a radiation pressure dominated regime: the Enhanced LIGO case. *Journal of the Optical Society of America A-Optics Image Science and Vision*, 30(12), 2618-2626. Retrieved from <http://arxiv.org/abs/1310.3662>.
- Dooley, K., Schreiber, E., Vahlbruch, H., Affeldt, C., Leong, J., Wittel, H., & Grote, H. (2015). Phase Control of Squeezed Vacuum States of Light in Gravitational Wave Detectors. *Optics Express*, 23(7), 8235-8245. doi:10.1364/OE.23.008235.
- Dooley, K., & The LIGO Scientific Collaboration (2015). Status of GEO 600. *Journal of Physics: Conference Series*, 610: 012015.
- Dooley, K., Akutsu, T., Dwyer, S., & Puppo, P. (2015). Status of advanced ground-based laser interferometers for gravitational-wave detection. *Journal of Physics: Conference Series*, 610: 012012.
- Dooley, K., Leong, J. R., Adams, T., Affeldt, C., Bisht, A., Bogan, C., Degallaix, J., Graef, C., Hild, S., Hough, J., Khalaidovski, A., Lastzka, N., Lough, J., Lück, H., Macleod, D., Nuttall, L., Prijatelj, M., Schnabel, R., Schreiber, E., Slutsky, J., Sorazu, B., Strain, K. A., Vahlbruch, H., Was, M., Willke, B., Wittel, H., Danzmann, K., & Grote, H. (2016). GEO 600 and the GEO-HF upgrade program: successes and challenges. *Classical and quantum gravity*, 33(7): 075009. doi:10.1088/0264-9381/33/7/075009.
- Doulis, G., & Rinne, O. (2015). Numerical Brill-Lindquist initial data with a Schwarzschildian end at spatial infinity. *Journal of Physics: Conference Series*, 600: 012039.
- Doulis, G., & Rinne, O. (2016). Numerical construction of initial data for Einstein's equations with static extension to space-like infinity. *Classical and Quantum Gravity*, 33(7): 075014. doi:10.1088/0264-9381/33/7/075014.
- Dutta, P., Meissner, K., & Nicolai, H. (2013). DeWitt Equation in Quantum Field Theory. *Physical Review D*, 87(10): 105019. doi:10.1103/PhysRevD.87.105019.
- Dutta, P. (2016). Schwinger-Dyson approach to Liouville Field Theory. *Theoretical and Mathematical Physics*, 187(3), 899-908. doi:10.1134/S0040577916060088.
- Dwyer, S., Barsotti, L., Chua, S. S. Y., Evans, M., Factourovich, M., Gustafson, D., Isogai, T., Kawabe, K., Khalaidovski, A., Lam, P. K., Landry, M., Mavalvala, N., McClelland, D. E., Meadors, G. D., Mow-Lowry, C. M., Schnabel, R., Schofield, R. M. S., Smith-Lefebvre, N., Stefszky, M., Vorvick, C., & Sigg, D. (2013). Squeezed quadrature fluctuations in a gravitational wave detector using squeezed light. *Optics Express*, 21(16), 19047-19060. doi:<http://dx.doi.org/10.1364/OE.21.019047>.
- Dymarsky, A., Komargodski, Z., Schwimmer, A., & Theisen, S. (2015). On Scale and Conformal Invariance in Four Dimensions. *Journal of high energy physics: JHEP*, 2015(10): 171. doi:10.1007/JHEP10(2015)171.
- Eatough, R. P., Lazio, T. J. W., Casanellas, J., Chatterjee, S., Cordes, J. M., Demorest, P. B., Kramer, M., Lee, K. J., Liu, K., Ransom, S. M., & Wex, N. (2015). Observing Radio Pulsars in the Galactic Centre with the Square Kilometre Array. *Proceedings of Science, AASKA14*. Retrieved from <http://arxiv.org/abs/1501.00281>.
- Eberle, T., Händchen, V., Duhme, J., Franz, T., Werner, R. F., & Schnabel, R. (2013). Gaussian Entanglement for Quan-



## Publications by AEI Members and Guest Scientists

- tum Key Distribution from a Single-Mode Squeezing Source. *New Journal of Physics*, 15: 053049. doi:10.1088/1367-2630/15/5/053049.
- Eberle, T., Händchen, V., & Schnabel, R. (2013). Stable control of 10 dB two-mode squeezed vacuum states of light. *Optics Express*, 21, 11546-11553. doi:http://dx.doi.org/10.1364/OE.21.011546.
- Eichler, C., Mlynek, J., Butscher, J., Kurpiers, P., Hammerer, K., Osborne, T. J., & Wallraff, A. (2015). Exploring Interacting Quantum Many-Body Systems by Experimentally Creating Continuous Matrix Product States in Superconducting Circuits. *Physical Review X*, 5: 041044. doi:10.1103/PhysRevX.5.041044.
- Eling, C., Oz, Y., Theisen, S., & Yankielowicz, S. (2013). Conformal Anomalies in Hydrodynamics. *Journal of high energy physics: JHEP*, 2013(05): 037. doi:10.1007/JHEP05(2013)037.
- Eling, C., & Oz, Y. (2013). Holographic Vorticity in the Fluid/Gravity Correspondence. *Journal of high energy physics: JHEP*, 2013(11): 079. doi:10.1007/JHEP11(2013)079.
- Eling, C., Oz, Y., & Theisen, S. (2013). Entanglement and Thermal Entropy of Gauge Fields. *Journal of high energy physics: JHEP*, 2013(11): 019. doi:10.1007/JHEP11(2013)019.
- Eling, C., & Oz, Y. (2014). Horava-Lifshitz Black Hole Hydrodynamics. *Journal of high energy physics: JHEP*, 2014(11): 067. doi:10.1007/JHEP11(2014)067.
- Eling, C., & Oz, Y. (2016). On the Membrane Paradigm and Spontaneous Breaking of Horizon BMS Symmetries. *Journal of high energy physics: JHEP*, 2016(07): 065. doi:10.1007/JHEP07(2016)065.
- Ellis, J., Siemens, X., & van Haasteren, R. (2013). An Efficient Approximation to the Likelihood for Gravitational Wave Stochastic Background Detection Using Pulsar Timing Data. *Astrophysical Journal*, 769: 63. doi:10.1088/0004-637X/769/1/63.
- Etienne, Z. B., Paschalidis, V., Haas, R., Moesta, P., & Shapiro, S. L. (2015). IllinoisGRMHD: An Open-Source, User-Friendly GRMHD Code for Dynamical Spacetimes. *Classical and quantum gravity*, 32(17): 175009. doi:10.1088/0264-9381/32/17/175009.
- Evans, M., Gras, S., Fritschel, P., Miller, J., Barsotti, L., Martynov, D., Brooks, A., Coyne, D., Abbott, R., Adhikari, R., Arai, K., Bork, R., Kells, B., Rollins, J., Smith-Lefebvre, N., Vajente, G., Yamamoto, H., Derosa, R., Effler, A., Kokeyama, K., Betzweiser, J., Frolov, V., Mullavey, A., Dwyer, S., Izumi, K., Kawabe, K., Sigg, D., Ballmer, S., Massinger, T. J., Staley, A., Mueller, C., Grote, H., Ward, R., King, E., Thorne, K., Thomas, M., Adams, C., Aston, S., Romie, J., Pele, A., Heinze, M., Blair, D., Ju, L., & Zhao, C. (2015). Observation of Parametric Instability in Advanced LIGO. *Physical Review Letters*, 114: 161102. doi:10.1103/PhysRevLett.114.161102.
- Falcke, H., & Rezzolla, L. (2014). Fast radio bursts: the last sign of supramassive neutron stars. *Astronomy and Astrophysics*, 562: A137. doi:10.1051/0004-6361/201321996.
- Fang, Z., He, S., & Li, D. (2016). Chiral and Deconfining Phase Transitions from Holographic QCD Study. *Nuclear Physics B*, 907, 187-207. doi:10.1016/j.nuclphysb.2016.04.003.
- Fehrmann, H., & Pletsch, H. (2014). Efficient generation and optimization of stochastic template banks by a neighboring cell algorithm. *Physical Review D*, 90(12): 124049, pp. 4049-4049. doi:10.1103/PhysRevD.90.124049.
- Fernández Barranco, G., Tröbs, M., Müller, V., Gerberding, O., Seifert, F., & Heinzl, G. (2016). Spatially resolved photodiode response for simulating precise interferometers. *Applied Optics*, 55(24), 6688-6693. doi:10.1364/AO.55.006688.
- Feroci, M., den Herder, J. W., Bozzo, E., Barret, D., Brandt, S., Hernanz, M., van der Klis, M., Pohl, M., Santangelo, A., Stella, L., Watts, A., Wilms, J., Zane, S., Ahangarianabari, M., Albertus, C., Alford, M., Alpar, A., Altamirano, D., Alvarez, L., Amati, L., Amoros, C., Andersson, N., Antonelli, A., Argan, A., Artigue, R., Artigues, B., Atteia, J.-L., Azzarello, P., Bakala, P., Baldazzi, G., Balman, S., Barbera, M., van Baren, C., Bhattacharyya, S., Baykal, A., Belloni, T., Bernardini, F., Bertuccio, G., Bianchi, S., Bianchini, A., Binko, P., Blay, P., Bocchino, F., Bodin, P., Bombaci, I., Bonnet Bidaud, J.-M., Boutloukos, S., Bradley, L., Braga, J., Brown, E., Bucciantini, N., Burderi, L., Burgay, M., Bursa, M., Budtz-Jørgensen, C., Cackett, E., Cadoux, F. R., Cañs, P., Caliendo, G. A., Campana, R., Campana, S., Capitanio, F., Casares, J., Casella, P., Castro-Tirado, A. J., Cavazzuti, E., Cerda-Duran, P., Chakrabarty, D., Château, F., Chenevez, J., Coker, J., Cole, R., Collura, A., Cornelisse, R., Courvoisier, T., Cros, A., Cumming, A., Cusumano, G., D'Ai, A., D'Elia, V., Del Monte, E., de Luca, A., de Martino, D., Dercksen, J. P. C., de Pasquale, M., De Rosa, A., Del Santo, M., Di Cosimo, S., Diebold, S., Di Salvo, T., Donnarumma, I., Drago, A., Durant, M., Emmanoulopoulos, D., Erkut, M. H., Esposito, P., Evangelista, Y., Fabian, A., Falanga, M., Favre, Y., Feldman, C., Ferrari, V., Ferrigno, C., Finger, M., Finger, M. H., Fraser, G. W., Frericks, M., Fuschino, F., Gabler, M., Galloway, D. K., Galvez Sanchez, J. L., Garcia-Berro, E., Gendre, B., Gezari, S., Giles, A. B., Gilfanov, M., Giommi, P., Giovannini, G., Giroletti, M., Gogus, E., Goldwurm, A., Goluchová, K., Götz, D., Gouiffes, C., Grassi, M., Groot, P., Gschwendner, M., Gualtieri, L., Guidorzi, C., Guy, L., Haas, D., Haensel, P., Hailey, M., Hansen, F., Hartmann, D. H., Haswell, C. A., Hebel, K., Heger, A., Hermsen, W., Homan, J., Hornstrup, A., Hudec, R., Huovelin, J., Ingram, A., In't Zand, J. J. M., Israel, G., Iwasawa, K., Izzo, L., Jacobs, H. M., Jetter, F., Johannsen, T., Jonker, P., Josè, J., Kaaret, P., Kanbach, G., Karas, V., Karelin, D., Kataria, D., Keek, L., Kennedy, T., Klochkov, D., Kluzniak, W., Kokkotas, K., Korpela, S., Kouveliotou, C., Kreykenbohm, I., Kuiper, L. M., Kuvvetli, I., Labanti, C., Lai, D., Lamb, F. K., Laubert, P. P., Lebrun, F., Lin, D., Linder, D., Lodato, G., Longo, F., Lund, N., Maccarone, T. J., Macera, D., Maestre, S., Mahmoodifar, S., Mayer, D., Malcovati, P., Mandel, I., Mangano, V., Manousakis, A., Marisaldi, M., Markowitz, A., Martindale, A., Matt, G., McHardy, I. M., Melatos, A., Mendez, M., Mereghetti, S., Michalska, M., Migliari, S., Mignani, R., Miller, M. C., Miller, J. M., Mineo, T., Miniutti, G., Morsink, S., Motch, C., Motta, S., Mouchet, M., Mouret, G., Mulačová, J., Muleri, F., Muñoz-Darias, T., Nequeroela, I., Neilsen, J., Norton, A. J., Nowak, M., O'Brien, P., Olsen, P. E. H., Orienti, M., Orío, M., Orlandini, M., Orleañski, P., Osborne, J. P., Osten, R., Ozel, F., Pacciani, L., Paolillo, M., Papitto, A., Paredes, J. M., Patruno, A., Paul, B., Perinati, E., Pellizzoni, A., Penacchioni, A. V., Perez, M. A., Petracek, V., Pittori, C., Pons, J., Portell, J., Possenti, A., Poutanen, J., Prakash, M., Le Provost, P., Psaltis, D., Rambaud, D., Ramon, P., Ramsay, G., Rapisarda, M., Rachevski, A., Rashevskaya, I., Ray, P. S., Rea, N., Reddy, S., Reig, P., Reina Aranda, M., Remillard, R., Reynolds, C., Rezzolla, L.,

## Publications by AEI Members and Guest Scientists

- Ribo, M., de la Rie, R., Riggio, A., Rios, A., Rodríguez-Gil, P., Rodríguez, J., Rohlfs, R., Romano, P., Rossi, E. M. R., Rozanska, A., Rousseau, A., Ryde, F., Sabau-Graziati, L., Sala, G., Salvaterra, R., Sanna, A., Sandberg, J., Scaringi, S., Schanne, S., Schee, J., Schmid, C., Shore, S., Schneider, R., Schwenk, A., Schwöpe, A. D., Seyler, J.-Y., Shearer, A., Smith, A., Smith, D. M., Smith, P. J., Sochora, V., Soffitta, P., Soleri, P., Spencer, A., Stappers, B., Steiner, A. W., Stergioulas, N., Stratta, G., Strohmayer, T. E., Stuchlik, Z., Suchy, S., Sulemainov, V., Takahashi, T., Tamburini, F., Tauris, T., Tenzer, C., Tolos, L., Tombesi, F., Tomsick, J., Torok, G., Torrejon, J. M., Torres, D. F., Tramacere, A., Trois, A., Turolla, R., Turriziani, S., Uter, P., Uttley, P., Vacchi, A., Varniere, P., Vaughan, S., Vercellone, S., Vrba, V., Walton, D., Watanabe, S., Wawrzaszek, R., Webb, N., Weinberg, N., Wende, H., Wheatley, P., Wijers, R., Wijnands, R., Wille, M., Wilson-Hodge, C. A., Winter, B., Wood, K., Zampa, G., Zampa, N., Zampieri, L., Zdunik, L., Zdziarski, A., Zhang, B., Zwart, F., Ayre, M., Boenke, T., Corral van Damme, C., Kuulkers, E., & Lumb, D. (2014). The Large Observatory for x-ray timing. In T. Takahashi, J.-W.-A. den Herder, & M. Bautz (Eds.), *Space Telescopes and Instrumentation 2014: Ultra-violet to Gamma Ray* (pp. 1-20).
- Ferraioli, L., Armano, M., Audley, H., Congedo, G., Diepholz, I., Gibert, F., Hewitson, M., Hueller, M., Karnesis, N., Korsakova, N., Nofrarias, M., Plagnol, E., & Vitale, S. (2015). Kolmogorov-Smirnov like test for time-frequency Fourier spectrogram analysis in LISA Pathfinder. *Experimental Astronomy*, 39(1), 1-10. doi:10.1007/s10686-014-9432-z.
- Ferraioli, L., Porter, E. K., Armano, M., Audley, H., Congedo, G., Diepholz, I., Gibert, F., Hewitson, M., Hueller, M., Karnesis, N., Korsakova, N., Nofrarias, M., Plagnol, E., & Vitale, S. (2014). Improving Bayesian analysis for LISA Pathfinder using an efficient Markov Chain Monte Carlo method. *Experimental Astronomy*, 37(1), 109-125. doi:10.1007/s10686-014-9372-7.
- Ferro, L., Lukowski, T., Meneghelli, C., Plefka, J., & Staudacher, M. (2013). Harmonic R-matrices for Scattering Amplitudes and Spectral Regularization. *Physical Review Letters*, 110: 121602. doi:10.1103/PhysRevLett.110.121602.
- Ferro, L., Lukowski, T., Meneghelli, C., Plefka, J., & Staudacher, M. (2014). A Spectral Parameter for Scattering Amplitudes in N=4 Super Yang-Mills Theory. *Journal of high energy physics: JHEP*, 2014(01): 094. doi:10.1007/JHEP01(2014)094.
- Ferro, L., Lukowski, T., & Staudacher, M. (2014). N=4 Scattering Amplitudes and the Deformed Grassmannian. *Nuclear Physics B*, 889, 192-206. doi:10.1016/j.nuclphysb.2014.10.012.
- Fertig, A., Lehnert, J.-L., & Mallwitz, E. (2014). Ekpyrotic Perturbations With Small Non-Gaussian Corrections. *Physical Review D*, 89: 103537. doi:10.1103/PhysRevD.89.103537.
- Fertig, A., & Lehnert, J.-L. (2016). The Non-Minimal Ekpyrotic Trispectrum. *Journal of Cosmology and Astroparticle Physics*, 2016(01): 26. doi:10.1088/1475-7516/2016/01/026.
- Fertig, A., Lehnert, J.-L., & Mallwitz, E. (2016). Conflation: a new type of accelerated expansion. *Journal of Cosmology and Astroparticle Physics*, 2016(08): 073. doi:http://dx.doi.org/10.1088/1475-7516/2016/08/073.
- Fertig, A., Lehnert, J.-L., Mallwitz, E., & Wilson-Ewing, E. (2016). Converting entropy to curvature perturbations after a cosmic bounce. *Journal of Cosmology and Astroparticle Physics*, 10: 005. doi:10.1088/1475-7516/2016/10/005.
- Fitzsimons, E., Bogenstahl, J., Hough, J., Killow, C., Perreux-Lloyd, M., Robertson, D., & Ward, H. (2013). Precision absolute positional measurement of laser beams. *Applied Optics*, 52 (12), 2527-2530. doi:http://dx.doi.org/10.1364/AO.52.002527.
- Fiurasek, J., Baune, C., Schönbeck, A., & Schnabel, R. (2015). Analysis of counting measurements on narrowband frequency up-converted single photons and the influence of heralding detector dead time. *Physical Review A: Atomic, Molecular, and Optical Physics*, 91: 013829. doi:10.1103/PhysRevA.91.013829.
- Flanagan, É. É., Nichols, D. A., Stein, L. C., & Vines, J. (2016). Prescriptions for measuring and transporting local angular momenta in general relativity. *Physical Review D*, 93: 104007. doi:10.1103/PhysRevD.93.104007.
- Fleddermann, R., Ward, R. L., Elliot, M., Wuchenich, D. M., Gilles, F., Herding, M., Nicklaus, K., Brown, J., Burke, J., Dligatch, S., Farrant, D. I., Green, K. L., Seckold, J. A., Blundell, M., Brister, R., Smith, C., Sheard, B., Heinzel, G., Danzmann, K., Klipstein, B., McClelland, D. E., & Shaddock, D. A. (2014). Testing the GRACE follow-on triple mirror assembly. *Classical and Quantum Gravity*, 31(19): 195004. doi:10.1088/0264-9381/31/19/195004.
- Fleig, P., Kleinschmidt, A., & Persson, D. (2014). Fourier expansions of Kac-Moody Eisenstein series and degenerate Whittaker vectors. *Communications in Number Theory and Physics*, 8(1), 41-100. doi:10.4310/CNTP.2014.v8.n1.a2.
- Fleig, P., & Nicolai, H. (2015). Hidden Symmetries: From bkl to Kac-moody. In K. Rosquist, R. T. Jantzen, & R. Ruffini (Eds.), *Proceedings of the MG13 Meeting on General Relativity* (pp. 80-82). World Scientific.
- Fleig, P., & Kleinschmidt, A. (2015). Perturbative terms of Kac-Moody-Eisenstein series. In *Proceedings of Symposia in Pure Mathematics* (pp. 265-275).
- Fleming, C. H., Hu, B. L., & Roura, A. (2013). Nonequilibrium fluctuation-dissipation inequality and nonequilibrium uncertainty principle. *Physical Review E*, 88(1): 012102. doi:10.1103/PhysRevE.88.012102.
- Flohr, M., & Köhn, M. (2013). What the characters of irreducible subrepresentations of Jordan cells can tell us about LCFT. *Journal of Physics A: Mathematical and Theoretical*, 46(49): 494007. doi:10.1088/1751-8113/46/49/494007.
- Font, A., Quevedo, F., & Theisen, S. (2014). A Comment on Continuous Spin Representations of the Poincare Group and Perturbative String Theory. *Fortschritte der Physik*, 62(10-11), 975-980. doi:10.1002/prop.201400067.
- Foucart, F., O'Connor, E., Roberts, L., Duez, M. D., Haas, R., Kidder, L. E., Ott, C. D., Pfeiffer, H. P., Scheel, M. A., & Szilagyi, B. (2015). Post-merger evolution of a neutron star-black hole binary with neutrino transport. *Physical Review D*, 91: 124021. doi:10.1103/PhysRevD.91.124021.
- Foucart, F., Haas, R., Duez, M. D., O'Connor, E., Ott, C. D., Roberts, L., Kidder, L. E., Lippuner, J., Pfeiffer, H. P., & Scheel, M. A. (2016). Low mass binary neutron star mergers: gravitational waves and neutrino emission. *Physical Review D*, 93: 044019. doi:10.1103/PhysRevD.93.044019.
- Franci, L., De Pietri, R., Dionysopoulou, K., & Rezzolla, L. (2013). Dynamical bar-mode instability in rotating and mag-

## Publications by AEI Members and Guest Scientists

- netized relativistic stars. *Physical Review D*, 88(10): 104028. doi:10.1103/PhysRevD.88.104028.
- Franci, L., De Pietri, R., Dionysopoulou, K., & Rezzolla, L. (2013). Bar-mode instability suppression in magnetized relativistic stars. *Journal of Physics: Conference Series*, 470: 012008. doi:10.1088/1742-6596/470/1/012008.
- Frassek, R., Kanning, N., Ko, Y., & Staudacher, M. (2014). Bethe Ansatz for Yangian Invariants: Towards Super Yang-Mills Scattering Amplitudes. *Nuclear Physics B*, 883, 373-424. doi:10.1016/j.nuclphysb.2014.03.015.
- Frassek, R., & Meneghelli, C. (2013). From Baxter Q-Operators to Local Charges. *Journal of Statistical Mechanics: Theory and Experiment*, 2013(2): P02019. doi:10.1088/1742-5468/2013/02/P02019.
- Frassek, R., Lukowski, T., Meneghelli, C., & Staudacher, M. (2013). Baxter Operators and Hamiltonians for "nearly all" Integrable Closed  $gl(n)$  Spin Chains. *Nuclear Physics B*, 874(2), 620-646. doi:http://dx.doi.org/10.1016/j.nuclphysb.2013.06.006.
- Frassek, R. (2014). Q-operators, Yangian invariance and the quantum inverse scattering method. PhD Thesis.
- Fredenhagen, S., & Restuccia, C. (2013). The geometry of the limit of  $N=2$  minimal models. *Journal of Physics A*, 46(4): 045402. doi:10.1088/1751-8113/46/4/045402.
- Fredenhagen, S., & Kessel, P. (2015). Metric- and frame-like higher-spin gauge theories in three dimensions. *Journal of Physics A*, 48(3): 035402. doi:10.1088/1751-8113/48/3/035402.
- Fredenhagen, S., & Restuccia, C. (2015). The large level limit of Kazama-Suzuki models. *Journal of high energy physics: JHEP*, 2015(04): 015. doi:10.1007/JHEP04(2015)015.
- Fredenhagen, S., Hoppe, J., & Hynek, M. (2015). The Lorentz Anomaly via Operator Product Expansion. *Journal of Mathematical Physics*, 56(10): 4932960, pp. 2302 -2302. doi:10.1063/1.4932960.
- Friebe, J., & Rezzolla, L. (2015). Distortion of neutron stars with a toroidal magnetic field. In *Proceedings of the MG13 Meeting on General Relativity* (pp. 2387-2389). World Scientific.
- Friedrich, H. (2013). Conformal structures of static vacuum data. *Communications in Mathematical Physics*, 321(2), 419-482. doi:10.1007/s00220-013-1694-1.
- Friedrich, H. (2013). The Taylor expansion at past time-like infinity. *Communications in Mathematical Physics*, 324, 263-300. doi:10.1007/s00220-013-1803-1.
- Friedrich, H. (2014). On the AdS stability problem. *Classical and quantum gravity*, 31(10): 105001. doi:10.1088/0264-9381/31/10/105001.
- Friedrich, H. (2015). Smooth non-zero rest-mass evolution across time-like infinity. *Annales Henri Poincaré*, 16, 2215-2238. doi:10.1007/s00023-014-0368-7.
- Friedrich, H. (2015). Geometric Asymptotics and Beyond. In L. Bieri (Ed.), *One hundred years of general relativity (Surveys in Differential Geometry, 20)* (pp. 37-74). Boston: International Press.
- Friedrich, H. (2016). Sharp asymptotics for Einstein-lambda-dust flows. *Communications in Mathematical Physics*, 1-42. doi:10.1007/s00220-016-2716-6.
- Fröb, M., Papadopoulos, D., Roura, A., & Verdaguier, E. (2013). Nonperturbative semiclassical stability of de Sitter spacetime for small metric deviations. *Physical Review D*, 87: 064019. doi:10.1103/PhysRevD.87.064019.
- Gabach Clement, M. E., & Reiris, M. (2013). Shape of rotating black holes. *Physical Review D*, 88(4): 044031. doi:10.1103/PhysRevD.88.044031.
- Gaberdiel, M. R., Taormina, A., Volpato, R., & Wendland, K. (2014). A  $K3$  sigma model with  $Z_2 \times M_{20}$  symmetry. *Journal of high energy physics: JHEP*, 2014(02): 022. doi:10.1007/JHEP02(2014)022.
- Gaberdiel, M. R., Persson, D., Ronellenfisch, H., & Volpato, R. (2013). Generalised Mathieu Moonshine. *Communications in Number Theory and Physics*, 7(1), 145-223. doi:10.4310/CNTP.2013.v7.n1.a5.
- Gaberdiel, M. R., Jin, K., & Li, W. (2013). Perturbations of  $W(\infty)$  CFTs. *Journal of high energy physics: JHEP*, 2013(10): 162. doi:10.1007/JHEP10(2013)162.
- Gaberdiel, M. R., & Volpato, R. (2014). Mathieu Moonshine and Orbifold  $K3$ s. In *Conformal Field Theory, Automorphic Forms and Related Topics (Contributions in Mathematical and Computational Sciences; 8)* (pp. 109-141). Springer.
- Gahramanov, I., & Tezgin, K. (2016). A remark on the Dunne-Unsal relation in exact semi-classics. *Physical Review D*, 93: 065037. doi:https://doi.org/10.1103/PhysRevD.93.065037.
- Gahramanov, I., & Rosengren, H. (2016). Basic hypergeometry of supersymmetric dualities. *Nuclear Physics B*, 913, 747-768. doi:http://dx.doi.org/10.1016/j.nuclphysb.2016.10.004.
- Galeazzi, F., Kastaun, W., Rezzolla, L., & Font, J. A. (2013). Implementation of a simplified approach to radiative transfer in general relativity. *Physical Review D*, 88: 064009. doi:10.1103/PhysRevD.88.064009.
- Gehring, T., Händchen, V., Duhme, J., Furrer, F., Franz, T., Pacher, C., Werner, R. F., & Schnabel, R. (2015). Implementation of continuous-variable quantum key distribution with composable and one-sided-device-independent security against coherent attacks. *Nature Communications*, 6: 8795. doi:10.1038/ncomms9795.
- Geloun, J. B., Martini, R., & Oriti, D. (2015). Functional Renormalization Group analysis of a Tensorial Group Field Theory on  $R^3$ . *EPL*, 112(3): 31001. doi:10.1209/0295-5075/112/31001.
- Geloun, J. B., Martini, R., & Oriti, D. (2016). Functional Renormalisation Group analysis of Tensorial Group Field Theories on  $R^d$ . *Physical Review D*, 94: 024017. doi:10.1103/PhysRevD.94.024017.
- Gerberding, O., Barke, S., Bykov, I., Danzmann, K., Enggaard, A., Esteban, J. J., Gianolio, A., Hansen, T. V., Heinzl, G.,

## Publications by AEI Members and Guest Scientists

- Hornstrup, A., Jennrich, O., Kullmann, J., Pedersen, S. M., Rasmussen, T., Reiche, J., Sodnik, Z., & Suess, M. (2013). Breadboard model of the LISA phasemeter. In Proceedings of 9th International LISA Symposium 2012 (ASP Conference Series) (pp. 271-276).
- Gerberding, O., Sheard, B., Bykov, I., Kullmann, J., Delgado, J. J. E., Danzmann, K., & Heinzel, G. (2013). Phasemeter core for intersatellite laser heterodyne interferometry: modelling, simulations and experiments. *Classical and quantum gravity*, 30(23): 235029. doi:10.1088/0264-9381/30/23/235029.
- Gerberding, O., Diekmann, C., Kullmann, J., Tröbs, M., Bykov, I., Barke, S., Brause, N. C., Delgado, J. J. E., Schwarze, T. S., Reiche, J., Danzmann, K., Rasmussen, T., Hansen, T. V., Engaard, A., Pedersen, S. M., Jennrich, O., Suess, M., Sodnik, Z., & Heinzel, G. (2015). Readout for intersatellite laser interferometry: Measuring low frequency phase fluctuations of HF signals with microradian precision. *Review of Scientific Instruments*, 86: 074501. doi:10.1063/1.4927071.
- Gerosa, D., & Sesana, A. (2015). Missing black holes in brightest cluster galaxies as evidence for the occurrence of superkicks in nature. *Monthly Notices of the Royal Astronomical Society*, 446 (1), 38-55. doi:10.1093/mnras/stu2049.
- Ghanem, S. (2016). The global existence of Yang-Mills fields on curved space-times. *Journal of Hyperbolic Differential Equations*, 13(3), 603-631. doi:10.1142/S0219891616500156.
- Ghosh, A., Ghosh, A., Johnson-McDaniel, N. K., Mishra, C. K., Ajith, P., Del Pozzo, W., Nichols, D. A., Chen, Y., Nielsen, A. B., Berry, C. P. L., & London, L. (2016). Testing general relativity using golden black-hole binaries. *Physical Review D*, 94: 021101. doi:10.1103/PhysRevD.94.021101.
- Giacomazzo, B., Perna, R., Rezzolla, L., Troja, E., & Lazzati, D. (2013). Compact Binary Progenitors of Short Gamma-Ray Bursts. *The Astrophysical Journal Letters*, 762: L18. doi:10.1088/2041-8205/762/2/L18.
- Gibert, F., Nofrarias, M., Karnesis, N., Gesa, L., Martín, V., Mateos, I., Lobo, A., Flatscher, R., Gerardi, D., Burkhardt, J., Gerndt, R., Robertson, D., Ward, H., McNamara, P. W., Guzman, F., Hewitson, M., Diepholz, I., Reiche, J., Heinzel, G., & Danzmann, K. (2015). Thermo-elastic induced phase noise in the LISA Pathfinder spacecraft. *Classical and quantum gravity*, 32(4): 045014. doi:10.1088/0264-9381/32/4/045014.
- Gibert, F., Nofrarias, M., Armano, M., Audley, H., Auger, G., Baird, J., Binetruy, P., Born, M., Bortoluzzi, D., Brandt, N., Bursi, A., Caleno, M., Cavalleri, A., Cesarini, A., Cruise, M., Danzmann, K., Diepholz, I., Dolesi, R., Dunbar, N., Ferraioli, L., Ferroni, V., Fitzsimons, E., Freschi, M., Gallegos, J., Marirrodiga, C. G., Gerndt, R., Gesa, L., Giardini, D., Giusteri, R., Grimani, C., Harrison, I., Heinzel, G., Hewitson, M., Hollington, D., Hueller, M., Huesler, J., Inchauspé, H., Jennrich, O., Jetzer, P., Johlander, B., Karnesis, N., Kaune, B., Korsakova, N., Killow, C., Lloro, I., Maarschalkeweerd, R., Madden, S., Maghami, P., Mance, D., Martín, V., Martín-Porqueras, F., Mateos, I., McNamara, P., Mendes, J., Mendes, L., Moroni, A., Paczkowski, S., Perreur-Lloyd, M., Petiteau, A., Pivato, P., Plagnol, E., Prat, P., Ragnit, U., Ramos-Castro, J., Reiche, J., Perez Romera, J. A., Robertson, D., Rozemeijer, H., Russano, G., Sarra, P., Schleicher, A., Slutsky, J., Sopuerta, C. F., Sumner, T., Texier, D., Thorpe, J., Trenkel, C., Tu, H. B., Vetrugno, D., Vitale, S., Wanner, G., Ward, H., Waschke, S., Wass, P., Wealthy, D., Wen, S., Weber, W., Wittchen, A., Zannoni, C., Ziegler, T., & Zweifel, P. (2015). In-flight thermal experiments for LISA Pathfinder: Simulating temperature noise at the Inertial Sensors. *Journal of Physics: Conference Series*, 610: 012023.
- Gielen, S., Oriti, D., & Sindoni, L. (2013). Cosmology from Group Field Theory Formalism for Quantum Gravity. *Physical Review Letters*, 111: 031301. doi:10.1103/PhysRevLett.111.031301.
- Gielen, S., Oriti, D., & Sindoni, L. (2014). Homogeneous cosmologies as group field theory condensates. *Journal of high energy physics: JHEP*, 2014(06): 013. doi:10.1007/JHEP06(2014)013.
- Gielen, S., & Oriti, D. (2014). Quantum cosmology from quantum gravity condensates: cosmological variables and lattice-refined dynamics. *New Journal of Physics*, 16: 123004. doi:10.1088/1367-2630/16/12/123004.
- Gielen, S. (2014). Quantum cosmology of (loop) quantum gravity condensates: An example. *Classical and quantum gravity*, 31(5): 155009. doi:10.1088/0264-9381/31/5/155009.
- Glaschke, P., Amaro-Seoane, P., & Spurzem, R. (2014). Hybrid methods in planetesimal dynamics (I): Description of a new composite algorithm. *Monthly Notices of the Royal Astronomical Society*, 445(4), 3620-3649. doi:10.1093/mnras/stu1558.
- Godazgar, H., & Godazgar, M. (2013). Duality completion of higher derivative corrections. *Journal of high energy physics: JHEP*, 2013(9): 140. doi:10.1007/JHEP09(2013)140.
- Godazgar, H., Godazgar, M., & Nicolai, H. (2013). Testing the nonlinear flux ansatz for maximal supergravity. *Physical Review D*, 87(8): 085038. doi:10.1103/PhysRevD.87.085038.
- Godazgar, H., Godazgar, M., & Perry, M. J. (2013). E8 duality and dual gravity. *Journal of high energy physics: JHEP*, 2013(6): 044. doi:10.1007/JHEP06(2013)044.
- Godazgar, H., Godazgar, M., & Nicolai, H. (2014). Generalised geometry from the ground up. *Journal of High Energy Physics*, 2014(02): 075. doi:10.1007/JHEP02(2014)075.
- Godazgar, H., Godazgar, M., & Nicolai, H. (2013). Nonlinear Kaluza-Klein theory for dual fields. *Physical Review D*, 88: 125002. doi:10.1103/PhysRevD.88.125002.
- Godazgar, H., Godazgar, M., Hohm, O., Nicolai, H., & Samtleben, H. (2014). Supersymmetric E7(7) Exceptional Field Theory. *Journal of high energy physics: JHEP*, 2014(09): 044. doi:10.1007/JHEP09(2014)044.
- Godazgar, H., Godazgar, M., & Nicolai, H. (2014). The embedding tensor of Scherk-Schwarz flux compactifications from eleven dimensions. *Physical Review D*, 89: 045009. doi:10.1103/PhysRevD.89.045009.
- Godazgar, H., Godazgar, M., & Nicolai, H. (2014). Einstein-Cartan Calculus for Exceptional Geometry. *Journal of high energy physics: JHEP*, 2014(06): 021. doi:10.1007/JHEP06(2014)021.
- Godazgar, H., Godazgar, M., Krüger, O., Nicolai, H., & Pilch, K. (2015). An SO(3) x SO(3) invariant solution of D=11 supergravity. *Journal of high energy physics: JHEP*, 2015(01): 056. doi:10.1007/JHEP01(2015)056.
- Godazgar, M., & Reall, H. (2015). Asymptotic Properties of the Weyl Tensor in Higher Dimensions. In K. Rosquist, R. T.

## Publications by AEI Members and Guest Scientists

- Jantzen, & R. Ruffini (Eds.), *Proceedings of the MG13 Meeting on General Relativity* (pp. 1065-1067). World Scientific.
- Godazgar, H., Godazgar, M., Krüger, O., & Nicolai, H. (2015). Consistent 4-form fluxes for maximal supergravity. *Journal of high energy physics: JHEP*, 2015(10): 169. doi:10.1007/JHEP10(2015)169.
- Goerth, A., Sanjuan, J., Gohlke, M., Rasch, S., Abich, K., Braxmaier, C., & Heinzl, G. (2016). Test environments for the GRACE follow-on laser ranging interferometer. *Journal of Physics: Conference Series (JPCS)*, 716: 012011.
- Goetz, E., & Riles, K. (2016). Coherently combining short data segments for all-sky semi-coherent continuous gravitational wave searches. *Classical and quantum gravity*, 33(8): 085007. doi:10.1088/0264-9381/33/8/085007.
- Goicovic, F. G., Cuadra, J., Sesana, A., Stasyszyn, F., Amaro-Seoane, P., & Tanaka, T. L. (2016). Infalling clouds onto super-massive black hole binaries - I. Formation of discs, accretion and gas dynamics. *Monthly Notices of the Royal Astronomical Society*, 455(2), 1989-2003. doi:10.1093/mnras/stv2470.
- Goicovic, F. G., Cuadra, J., Sesana, A., Stasyszyn, F., Amaro-Seoane, P., & Tanaka, T. (2016). Infalling clouds on to supermassive black hole binaries – I. Formation of discs, accretion and gas dynamics. *Monthly Notices of the Royal Astronomical Society*, 455(2), 1989-2003. doi:10.1093/mnras/stv2470.
- Gomez, G., Kessel, P., Taronna, M., & Skvortsov, E. (2015). Higher Spins and Matter Interacting in Dimension Three. *Journal of high energy physics: JHEP*, 2015(11): 104. doi:10.1007/JHEP11(2015)104.
- Gomis, J., Komargodski, Z., Hsin, P.-S., Schwimmer, A., Seiberg, N., & Theisen, S. (2016). Anomalies, Conformal Manifolds, and Spheres. *Journal of high energy physics: JHEP*, 2016(03): 022. doi:10.1007/JHEP03(2016)022.
- Gong, X., Lau, Y.-K., Xu, S., Amaro-Seoane, P., Bai, S., Bian, X., Cao, Z., Chen, G., Chen, X., Ding, Y., Dong, P., Gao, W., Heinzl, G., Li, M., Li, S., Liu, F., Luo, Z., Shao, M., Spurzem, R., Sun, B., Tang, W., Wang, Y., Xu, P., Yu, P., Yuan, Y., Zhang, X., & Zhou, Z. (2015). Descope of the ALIA mission. *Journal of Physics: Conference Series*, 610: 012011.
- Gotthelf, E. V., Halpern, J. P., Allen, B., & Knispel, B. (2013). X-ray Observations of Disrupted Recycled Pulsars: No Refuge for Orphaned Central Compact Objects. *Astrophysical Journal*, 773(2): 1412013. doi:10.1088/0004-637X/773/2/141.
- Govil, K., & Gunaydin, M. (2014). Deformed Twistors and Higher Spin Conformal (Super-)Algebras in Six Dimensions. *Journal of high energy physics: JHEP*, 2014(7): 004. doi:10.1007/JHEP07(2014)004.
- Gräf, C., Thüring, A., Vahlbruch, H., Danzmann, K., & Schnabel, R. (2013). Length sensing and control of a Michelson interferometer with Power Recycling and Twin Signal Recycling cavities. *Optics Express*, 21(5), 5287-5299. doi:10.1364/OE.21.005287.
- Gräf, C., Barr, B. W., Bell, A. S., Campbell, F., Cumming, A. V., Danilishin, S. L., Gordon, N. A., Hammond, G. D., Hennig, J., Houston, E. A., Huttner, S. H., Jones, R. A., Leavey, S. S., Luck, H., Macarthur, J., Marwick, M., Rigby, S., Schilling, R., Sorazu, B., Spencer, A., Steinlechner, S., Strain, K. A., & Hild, S. (2014). Design of a speed meter interferometer proof-of-principle experiment. *Classical and quantum gravity*, 31(21): 215009. doi:10.1088/0264-9381/31/21/215009.
- Graff, P. B., Buonanno, A., & Sathyaprakash, B. S. (2015). The Missing Link: Bayesian Detection and Measurement of Intermediate-Mass Black-Hole Binaries. *Physical Review D*, 92(2): 022002. doi:10.1103/PhysRevD.92.022002.
- Green, M. B., Mafra, C. R., & Schlotterer, O. (2013). Multiparticle one-loop amplitudes and S-duality in closed superstring theory. *Journal of High Energy Physics*, 2013(10): 188. doi:10.1007/JHEP10(2013)188.
- Grote, H., Danzmann, K., Dooley, K. L., Schnabel, R., Slutsky, J., & Vahlbruch, H. (2013). First Long-Term Application of Squeezed States of Light in a Gravitational-Wave Observatory. *Physical Review Letters*, 110: 181101. doi:10.1103/PhysRevLett.110.181101.
- Grote, H. (2015). On the possibility of Vacuum-QED measurements with gravitational wave detectors. *Physical Review D*, 91: 022002. doi:10.1103/PhysRevD.91.022002.
- Grote, H. (2016). Overview and Status of Advanced Interferometers for Gravitational Wave Detection. *Journal of Physics: Conference Series*, 718: 022009.
- Grote, H., Weinert, M., Adhikari, R. X., Affeldt, C., Kringel, V., Leong, J., Lough, J., Lück, H., Schreiber, E., Strain, K. A., Vahlbruch, H., & Wittel, H. (2016). High power and ultra-low-noise photodetector for squeezed-light enhanced gravitational wave detectors. *Optics Express*, 24(18), 20107-20118. doi:https://doi.org/10.1364/OE.24.020107.
- Grüning, P., Halloin, H., Prat, P., Baron, S., Brossard, J., Buy, C., Petiteau, A., Heinzl, G., & Bykov, I. (2015). Status of the eLISA on table (LOT) electro-optical simulator for space based, long arms interferometers. *Experimental Astronomy*, 39(2), 281-302. doi:10.1007/s10686-015-9448-z.
- Guarino, A., Tarrío, J., & Varela, O. (2016). Romans-mass-driven flows on the D2-brane. *Journal of high energy physics: JHEP*, 2016(08): 168. doi:10.1007/JHEP08(2016)168.
- Guedes, C., Oriti, D., & Raasakka, M. (2013). Quantization maps, algebra representation and non-commutative Fourier transform for Lie groups. *Journal of Mathematical Physics*, 54: 083508. doi:10.1063/1.4818638.
- Guedezounme, S. L., Kanfon, A. D., & Samary, D. O. (2016). Spherically symmetric potential in noncommutative space-time with a compactified extra dimensions. *European Physical Journal C*, 76(9): 505. doi:10.1140/epjc/s10052-016-4359-3.
- Guo, W.-Z., & Miao, R. X. (2016). Entropy for gravitational Chern-Simons terms by squashed cone method. *Journal of high energy physics: JHEP*, 2016(04): 006. doi:10.1007/JHEP04(2016)006.
- Gurau, R., & Ryan, J. P. (2013). Melons are branched polymers. *Annales Henri Poincaré*, 013-0291-3. doi:10.1007/s00023-013-0291-3.
- Gusev, Y. V. (2014). On the Integral Law of Thermal Radiation. *Russian Journal of Mathematical Physics*, 21(4), 460-471. doi:10.1134/S1061920814040049.
- Gusev, Y. (2015). Finite temperature quantum field theory in the heat kernel method. *Russian Journal of Mathematical*

## Publications by AEI Members and Guest Scientists

- Physics, 22, 9-19. doi:10.1134/S1061920815010033.
- Gusev, Y. V. (2016). The field theory of specific heat. *Russian Journal of Mathematical Physics*, 23(1), 56-76. doi:10.1134/S1061920816010040.
- Gustafsson, H. P. A., Kleinschmidt, A., & Persson, D. (2016). Small automorphic representations and degenerate Whittaker vectors. *Journal of Number Theory*, 166, 344-399. doi:10.1016/j.jnt.2016.02.002.
- Gwyn, R., Palma, G. A., Sakellariadou, M., & Sypsas, S. (2013). Effective field theory of weakly coupled inflationary models. *Journal of Cosmology and Astroparticle Physics*, 04: 004. doi:10.1088/1475-7516/2013/04/004.
- Gwyn, R., Rummel, M., & Westphal, A. (2013). Relations between canonical and non-canonical inflation. *Journal of Cosmology and Astroparticle Physics*, (12): 010. doi:10.1088/1475-7516/2013/12/010.
- Gwyn, R., Rummel, M., & Westphal, A. (2013). Resonant non-Gaussianity with equilateral properties. *Journal of Cosmology and Astroparticle Physics*, 4: 040. doi:10.1088/1475-7516/2013/04/040.
- Gwyn, R., Palma, G. A., Sakellariadou, M., & Sypsas, S. (2014). On degenerate models of cosmic inflation. *Journal of Cosmology and Astroparticle Physics*, 10: 005. doi:10.1088/1475-7516/2014/10/005.
- Gwyn, R., & Lehnert, J.-L. (2014). Non-Canonical Inflation in Supergravity. *Journal of High Energy Physics*, 2014: 050. doi:10.1007/JHEP05(2014)050.
- Haas, R., Ott, C. D., Szilagy, B., Kaplan, J. D., Lippuner, J., Scheel, M. A., Barkett, K., Muhlberger, C. D., Dietrich, T., Duez, M. D., Foucart, F., Pfeiffer, H. P., Kidder, L. E., & Teukolsky, S. A. (2016). Simulations of inspiraling and merging double neutron stars using the Spectral Einstein Code. *Physical Review D*, 93: 124062. doi:http://dx.doi.org/10.1103/PhysRevD.93.124062.
- Habibi, H., Zeuthen, E., Ghanaatshoar, M., & Hammerer, K. (2016). Quantum Feedback Cooling of a Mechanical Oscillator Using Variational Measurements: Tweaking Heisenberg's Microscope. *Journal of Optics*, 18(8): 084004. doi:10.1088/2040-8978/18/8/084004.
- Hamber, H. W., Toriumi, R., & Williams, R. M. (2013). Wheeler-DeWitt Equation in 3 + 1 Dimensions. *Physical Review D*, 88(8): 084012. doi:10.1103/PhysRevD.88.084012.
- Hamber, H. W., & Toriumi, R. (2013). Inconsistencies from a Running Cosmological Constant. *International Journal of Modern Physics D*, 22(13): 1330023. doi:10.1142/S0218271813300231.
- Hamber, H. W., & Toriumi, R. (2014). Quantum Gravity and Cosmological Density Perturbations. *Galaxies*, 2(2), 275-291. doi:10.3390/galaxies2020275.
- Hammerer, K., Genes, C., Vitali, D., Tombesi, P., Milburn, G., Simon, C., & Bouwmeester, D. (2014). Nonclassical States of Light and Mechanics. In M. Aspelmeyer (Ed.), *Cavity Optomechanics, Quantum Science and Technology* (pp. 25-56). Berlin Heidelberg: Springer-Verlag.
- Hammerer, K. (2013). Quantum Mechanics Tackles Mechanics. *Science*, 342(6159), 702-703. doi:10.1126/science.1245797.
- Hammerer, K. (2013). Nanomechanical resonators: Spinning oscillators. *Nature Physics*, 9(8), 462-463. doi:10.1038/nphys2674.
- Hammerer, K., & Aspelmeyer, M. (2015). Diamonds take off. *Nature Photonics*, 9(10), 632-633.
- Han, M., & Thiemann, T. (2013). Commuting Simplicity and Closure Constraints for 4D Spin Foam Models. *Classical and quantum gravity*, 30(23): 235024. doi:10.1088/0264-9381/30/23/235024.
- Han, M., & Zhang min, M. (2016). On Spinfoams Near a Classical Curvature Singularity. *Physical Review D*, 94: 104075. doi:https://doi.org/10.1103/PhysRevD.94.104075.
- Händchen, V. (2016). Experimental analysis of Einstein-Podolsky-Rosen steering for quantum information applications. PhD Thesis.
- Hannam, M., Schmidt, P., Bohé, A., Haegel, L., Husa, S., Ohme, F., Pratten, G., & Pürrer, M. (2014). A simple model of complete precessing black-hole-binary gravitational waveforms. *Physical Review Letters*, 113: 151101. doi:10.1103/PhysRevLett.113.151101.
- Haoa, W., Spurzem, R., Naaba, T., Wang, L., Kouwenhovena, M. B. N., Amaro-Seoane, P., & Mardling, R. A. (2016). Resonant motions of supermassive black hole triples.
- Harry, I., Nitz, A. H., Brown, D. A., Lundgren, A., Ochsner, E., & Keppel, D. (2014). Investigating the effect of precession on searches for neutron-star-black-hole binaries with Advanced LIGO. *Physical Review D*, 89: 024010. doi:10.1103/PhysRevD.89.024010.
- Harry, I., Privitera, S., Bohé, A., & Buonanno, A. (2016). Searching for Gravitational Waves from Compact Binaries with Precessing Spins. *Physical Review D*, 94: 024012. doi:10.1103/PhysRevD.94.024012.
- Harte, A. I. (2013). Strong lensing, plane gravitational waves and transient flashes. *Classical and quantum gravity*, 30(7): 075011. doi:10.1088/0264-9381/30/7/075011.
- Harte, A. I. (2013). Tails of plane wave spacetimes: Wave-wave scattering in general relativity. *Physical Review D*, 88(8): 084059. doi:10.1103/PhysRevD.88.084059.
- Harte, A. I. (2015). Optics in a nonlinear gravitational plane wave. *Classical and quantum gravity*, 32(17): 175017. doi:10.1088/0264-9381/32/17/175017.
- Harte, A. I. (2016). Motion in classical field theories and the foundations of the self-force problem. In *Equations of Motion in Relativistic Gravity (Fundamental Theories of Physics, 179)* (pp. 327-398).
- Harte, A. I., Flanagan, É. É., & Taylor, P. (2016). Self-forces on static bodies in arbitrary dimensions. *Physical Review D*,

## Publications by AEI Members and Guest Scientists

- 93(12): 124054. doi:<http://dx.doi.org/10.1103/PhysRevD.93.124054>.
- Harte, A. I., & Vines, J. (2016). Generating exact solutions to Einstein's equation using linearized approximations. *Physical Review D*, 94: 084009. doi:[10.1103/PhysRevD.94.084009](https://doi.org/10.1103/PhysRevD.94.084009).
- Harte, A. I. (2014). Taming the Nonlinearity of the Einstein Equation. *Physical Review Letters*, 113(26): 261103. doi:[10.1103/PhysRevLett.113.261103](https://doi.org/10.1103/PhysRevLett.113.261103).
- Haskell, B., Glampedakis, K., & Andersson, N. (2014). A new mechanism for saturating unstable r modes in neutron stars. *Monthly Notices of the Royal Astronomical Society*, 441(2), 1662-1668. doi:[10.1093/mnras/stu535](https://doi.org/10.1093/mnras/stu535).
- Haskell, B., Ciolfi, R., Pannarale, F., & Rezzolla, L. (2014). On the universality of I-Love-Q relations in magnetized neutron stars. *Monthly Notices of the Royal Astronomical Society: Letters*, 438, L71-L75. doi:[10.1093/mnrasl/slt161](https://doi.org/10.1093/mnrasl/slt161).
- Haskell, B., Pizzochero, P. M., & Seveso, S. (2013). Investigating superconductivity in neutron star interiors with glitch models. *The Astrophysical Journal Letters*, 764(2): L25. doi:[10.1088/2041-8205/764/2/L25](https://doi.org/10.1088/2041-8205/764/2/L25).
- Haupt, A. S., Lechtenfeld, O., & Musaev, E. T. (2014). Order alpha heterotic domain walls with warped nearly Kähler geometry. *Journal of High Energy Physics*, 2014: 152, pp. 11. doi:[10.1007/JHEP11\(2014\)152](https://doi.org/10.1007/JHEP11(2014)152).
- Hayama, K., & Nishizawa, A. (2013). Model-independent test of gravity with a network of ground-based gravitational-wave detectors. *Physical Review D*, 87(6): 062003. doi:[10.1103/PhysRevD.87.062003](https://doi.org/10.1103/PhysRevD.87.062003).
- He, S. (2013). A Link Representation for Gravity Amplitudes. *Journal of high energy physics: JHEP*, 2013(10): 139. doi:[10.1007/JHEP10\(2013\)139](https://doi.org/10.1007/JHEP10(2013)139).
- He, S., Monteiro, R., & Schlotterer, O. (2016). String-inspired BCJ numerators for one-loop MHV amplitudes. *Journal of high energy physics: JHEP*, 2016(01): 171. doi:[10.1007/JHEP01\(2016\)171](https://doi.org/10.1007/JHEP01(2016)171).
- He, S., Li, L.-F., & Zeng, X.-X. (2017). Holographic Van der Waals-like phase transition in the Gauss-Bonnet gravity. *Nuclear Physics B*, 915, 243-261. doi:[http://dx.doi.org/10.1016/j.nuclphysb.2016.12.005](https://doi.org/10.1016/j.nuclphysb.2016.12.005).
- Heinert, D., Craig, K., Grote, H., Hild, S., Luck, H., Nawrodt, R., Simakov, D., Vasilyev, D., Vyatchanin, S., & Wittel, H. (2014). Thermal noise of folding mirrors. *Physical Review D*, 90(4): 042001. doi:[10.1103/PhysRevD.90.042001](https://doi.org/10.1103/PhysRevD.90.042001).
- Heinzel, G., & Danzmann, K. (2014). LISA in 2012 and Beyond: 20 Years After the First Proposal. In J. Bicák (Ed.), *General Relativity, Cosmology and Astrophysics (Fundamental Theories of Physics, 177)* (pp. 477-481).
- Hellmann, F., & Kaminski, W. (2013). Holonomy spin foam models: Asymptotic geometry of the partition function. *Journal of high energy physics: JHEP*, 2013(10): 165. doi:[10.1007/JHEP10\(2013\)165](https://doi.org/10.1007/JHEP10(2013)165).
- Henderson, A., Laddha, A., & Tomlin, C. (2013). Constraint algebra in loop quantum gravity reloaded. II. Toy model of an Abelian gauge theory: Spatial diffeomorphisms. *Physical Review D*, 88(4): 044029. doi:[10.1103/PhysRevD.88.044029](https://doi.org/10.1103/PhysRevD.88.044029).
- Hendry, M., Bradaschia, C., Audley, H., Barke, S., Blair, D. G., Christensen, N., Danzmann, K., Freise, A., Gerberding, O., Knispel, B., Lieser, M., Mandel, I., Moore, T., Stuver, A., & Whiting, B. (2014). Education and public outreach on gravitational-wave astronomy. *General Relativity and Gravitation*, 46(8): 1764. doi:[10.1007/s10714-014-1764-5](https://doi.org/10.1007/s10714-014-1764-5).
- Henneaux, M., Kleinschmidt, A., & Lekeu, V. (2016). Enhancement of hidden symmetries and Chern-Simons couplings. *Romanian Journal of Physics*, 61(1-2), 167-182. Retrieved from <http://arxiv.org/abs/1505.07355>.
- Hinder, I., Buonanno, A., Boyle, M., Etienne, Z. B., Healy, J., Johnson-McDaniel, N. K., Nagar, A., Nakano, H., Pan, Y., Pfeiffer, H. P., Pürrer, M., Reisswig, C., Scheel, M. A., Schnetter, E., Sperhake, U., Szilagyi, B., Tichy, W., Wardell, B., Zenginoglu, A., Alic, D., Bernuzzi, S., Bode, T., Brüggmann, B., Buchman, L. T., Campanelli, M., Chu, T., Damour, T., Grigsby, J. D., Hannam, M., Haas, R., Hemberger, D. A., Husa, S., Kidder, L. E., Laguna, P., London, L., Lovelace, G., Lousto, C. O., Marronetti, P., Matzner, R. A., Mösta, P., Mroué, A., Müller, D., Mundim, B. C., Nerozzi, A., Paschalidis, V., Pollney, D., Reifenberger, G., Rezzolla, L., Shapiro, S. L., Shoemaker, D., Taracchini, A., Taylor, N. W., Teukolsky, S. A., Thierfelder, M., Witek, H., Zlochower, Y., & The NRAR Collaboration (2014). Error-analysis and comparison to analytical models of numerical waveforms produced by the NRAR Collaboration. *Classical and quantum gravity*, 31(2): 025012. doi:[10.1088/0264-9381/31/2/025012](https://doi.org/10.1088/0264-9381/31/2/025012).
- Hinderer, T., Buonanno, A., Mroué, A. H., Hemberger, D. A., Lovelace, G., Pfeiffer, H. P., Kidder, L. E., Scheel, M. A., Szilagyi, B., Taylor, N. W., & Teukolsky, S. A. (2013). Periastron advance in spinning black hole binaries: comparing effective-one-body and Numerical Relativity. *Physical Review D*, 88(8): 084005. doi:[10.1103/PhysRevD.88.084005](https://doi.org/10.1103/PhysRevD.88.084005).
- Hinderer, T., Taracchini, A., Foucart, F., Buonanno, A., Steinhoff, J., Duez, M., Kidder, L. E., Pfeiffer, H. P., Scheel, M. A., Szilagyi, B., Hotokezaka, K., Kyutoku, K., Shibata, M., & Carpenter, C. W. (2016). Effects of neutron-star dynamic tides on gravitational waveforms within the effective-one-body approach. *Physical Review Letters*, 116: 181101. doi:[10.1103/PhysRevLett.116.181101](https://doi.org/10.1103/PhysRevLett.116.181101).
- Hofer, S. G., Vasilyev, D. V., Aspelmeyer, M., & Hammerer, K. (2013). Time-Continuous Bell Measurements. *Physical Review Letters*, 111: 170404. doi:[10.1103/PhysRevLett.111.170404](https://doi.org/10.1103/PhysRevLett.111.170404).
- Hofer, S. G., & Hammerer, K. (2015). Entanglement-enhanced time-continuous quantum control in optomechanics. *Physical Review A*, 91(3): 033822. doi:[10.1103/PhysRevA.91.033822](https://doi.org/10.1103/PhysRevA.91.033822).
- Hofmann, G., Chen, D., Bergmann, G., Hammond, G. D., Hanke, M., Haughian, K., Heinert, D., Hough, J., Khalaidovski, A., Komma, J., Lück, H., Majorana, E., Masso Reid, M., Murray, P. G., Naticchioni, L., Nawrodt, R., Reid, S., Rowan, S., Schmidl, F., Schwarz, C., Seidel, P., Suzuki, T., Tomaru, T., Vine, D., & Yamamoto, K. (2015). Indium joints for cryogenic gravitational wave detectors. *Classical and quantum gravity*, 32(24): 245013. doi:[10.1088/0264-9381/32/24/245013](https://doi.org/10.1088/0264-9381/32/24/245013).
- Hopper, S., & Evans, C. R. (2013). Metric perturbations from eccentric orbits on a Schwarzschild black hole: I. Odd-parity Regge-Wheeler to Lorenz gauge transformation and two new methods to circumvent the Gibbs phenomenon. *Physical Review D*, 87(6): 064008. doi:[10.1103/PhysRevD.87.064008](https://doi.org/10.1103/PhysRevD.87.064008).
- Huang, Y., & Miao, R. X. (2015). A note on the resolution of the entropy discrepancy. *Physics Letters B*, 749, 489-494.

## Publications by AEI Members and Guest Scientists

doi:10.1016/j.physletb.2015.08.039.

Huang, Y.-t., Schlotterer, O., & Wen, C. (2016). Universality in string interactions. *Journal of high energy physics: JHEP*, 2016(09): 155. doi:10.1007/JHEP09(2016)155.

Husa, S., Khan, S., Hannam, M., Pürrer, M., Ohme, F., Forteza, X. J., & Bohé, A. (2016). Frequency-domain gravitational waves from non-precessing black-hole binaries. I. New numerical waveforms and anatomy of the signal. *Physical Review D*, 93: 044006. doi:10.1103/PhysRevD.93.044006.

Ijjas, A., Steinhardt, P. J., & Loeb, A. (2014). Scale-free primordial cosmology. *Physical Review D*, 89: 023525. doi:10.1103/PhysRevD.89.023525.

Ijjas, A., Steinhardt, P. J., & Loeb, A. (2014). Inflationary schism. *Physics Letters B*, 736, 142-146. doi:10.1016/j.physletb.2014.07.012.

Ijjas, A., Lehnert, J.-L., & Steinhardt, P. J. (2014). General mechanism for producing scale-invariant perturbations and small non-Gaussianity in ekpyrotic models. *Physical Review D*, 89: 123520. doi:10.1103/PhysRevD.89.123520.

Isleif, K.-S., Gerberding, O., Köhlenbeck, S., Sutton, A., Sheard, B., Gößler, S., Shaddock, D., Heinzel, G., & Danzmann, K. (2014). Highspeed multiplexed heterodyne interferometry. *Optics Express*, 22(20), 24689-24696. doi:10.1364/OE.22.024689.

Isleif, K.-S., Gerberding, O., Schwarze, T. S., Mehmet, M., Heinzel, G., & Guzman Cervantes, F. (2016). Experimental demonstration of deep frequency modulation interferometry. *Optics Express*, 24(2), 1676-1684. doi:10.1364/OE.24.001676.

Isleif, K.-S., Gerberding, O., Mehmet, M., Schwarze, T. S., Heinzel, G., & Danzmann, K. (2016). Comparing interferometry techniques for multi-degree of freedom test mass readout. *Journal of Physics: Conference Series*, 716(1): 012008.

Janssen, G. H., Hobbs, G., McLaughlin, M., Bassa, C. G., Deller, A. T., Kramer, M., Lee, K. J., Mingarelli, C. M. F., Rosado, P. A., Sanidas, S., Sesana, A., Shao, L., Stairs, I. H., Stappers, B. W., & Verbiest, J. P. W. (2015). Gravitational wave astronomy with the SKA. *Proceedings of Science, PoS(AASKA14)*, 037. Retrieved from <http://arxiv.org/abs/1501.00127>.

Jian, L., Gang, W., Yiming, H., Teng, Z., Ziren, L., Qinglan, W., & Shao, L. (2016). GW150914 and gravitational-wave astronomy. *Chinese Science Bulletin*, 61(14), 1502-1524. doi:10.1360/N972016-00429.

Johnson, T. J., Ray, P. S., Roy, J., Cheung, C. C., Harding, A. K., Pletsch, H. J., Fort, S., Camilo, F., Deneva, J., Bhattacharyya, B., Stappers, B. W., & Kerr, M. (2015). Discovery of Gamma-ray Pulsations from the Transitional Red-back PSR J1227-4853. *The Astrophysical Journal*, 806(1): 91. doi:10.1088/0004-637X/806/1/91.

Joung, E., Taronna, M., & Waldron, A. (2013). A Calculus for Higher Spin Interactions. *Journal of high energy physics: JHEP*, 2013(07): 186. doi:10.1007/JHEP07(2013)186.

Joung, E., Lopez, L., & Taronna, M. (2013). Generating functions of (partially-)massless higher-spin cubic interactions. *Journal of high energy physics: JHEP*, 2013(01): 168. doi:10.1007/JHEP01(2013)168.

Joung, E., Li, W., & Taronna, M. (2014). No-Go Theorems for Unitary and Interacting Partially Massless Spin-Two Fields. *Physical Review Letters*, 113: 091101. doi:10.1103/PhysRevLett.113.091101.

Joung, E., & Taronna, M. (2014). Cubic-interaction-induced deformations of higher-spin symmetries. *Journal of High Energy Physics*, 2014(03): 103. doi:10.1007/JHEP03(2014)103.

Ju, L., Zhao, C., Wen, L., Chu, Q., Fang, Q., Cai, R., Gao, J., Lin, X., Liu, D., Wu, L.-A., Zhu, Z., Reitze, D. H., Arai, K., Zhang, F., Flaminio, R., Zhu, X., Hobbs, G., Manchester, R. N., Shannon, R. M., Baccigalupi, C., Gao, W., Xu, P., Bian, X., Cao, Z., Chang, Z., Dong, P., Gong, X., Huang, S., Ju, P., Luo, Z., Qiang, L., Tang, W., Wan, X., Wang, Y., Xu, S., Zang, Y., Zhang, H., Lau, Y.-K., & Ni, W.-T. (2015). Gravitational wave astronomy: the current status. *Science China Physics*, 58(12): 120402. doi:10.1007/s11433-015-5748-6.

Kahniashvili, T., Maravin, Y., Lavrelashvili, G. V., & Kosowsky, A. (2014). Primordial Magnetic Helicity Constraints from WMAP Nine-Year Data. *Physical Review D*, 90: 083004. doi:10.1103/PhysRevD.90.083004.

Kahniashvili, T., Kar, A., Lavrelashvili, G. V., Agarwal, N., Heisenberg, L., & Kosowsky, A. (2015). Cosmic Expansion in Extended Quasidilaton Massive Gravity. *Physical Review D*, 91: 041301. doi:10.1103/PhysRevD.91.041301.

Kalus, B., Schwarz, D. J., Seikel, M., & Wiegand, A. (2013). Constraints on anisotropic cosmic expansion from supernovae. *Astronomy and Astrophysics*, 553: A56. doi:10.1051/0004-6361/201220928.

Kaminski, W., Oriti, D., & Ryan, J. (2014). Towards a double scaling limit for tensor models: probing sub-dominant orders. *New Journal of Physics*, 16: 063048. doi:10.1088/1367-2630/16/6/063048.

Kanner, J. B., Littenberg, T. B., Cornish, N., Millhouse, M., Khakaj, E., Salemi, F., Drago, M., Vedovato, G., & Klimentko, S. (2016). Leveraging waveform complexity for confident detection of gravitational waves. *Physical Review D*, 93: 022002. doi:http://dx.doi.org/10.1103/PhysRevD.93.022002.

Kanning, N., Lukowski, T., & Staudacher, M. (2014). A Shortcut to General Tree-level Scattering Amplitudes in N=4 SYM via Integrability. *Fortschritte der Physik*, 62(7), 556-572. doi:10.1002/prop.201400017.

Kanning, N., Ko, Y., & Staudacher, M. (2015). Grassmannian Integrals as Matrix Models for Non-Compact Yangian Invariants. *Nuclear Physics B*, 894, 407-421. doi:10.1016/j.nuclphysb.2015.03.011.

Karnesis, N., Nofrarias, M., Sopena, C. F., Gibert, F., Armano, M., Audley, H., Congedo, G., Diepholz, I., Ferraioli, L., Hewitson, M., Hueller, M., Korsakova, N., Plagnol, E., & Vitale, S. (2014). Bayesian Model Selection for LISA Pathfinder. *Physical Review D*, 89: 062001. doi:10.1103/PhysRevD.89.062001.

Kastaun, W., Galeazzi, F., Alic, D., Rezzolla, L., & Font, J. A. (2013). On the black hole from merging binary neutron



## Publications by AEI Members and Guest Scientists

- stars: how fast can it spin? *Physical Review D*, 88: 021501. doi:10.1103/PhysRevD.88.021501.
- Kastaun, W., & Galeazzi, F. (2015). Properties of hypermassive neutron stars formed in mergers of spinning binaries. *Physical Review D*, 91: 064027. doi:10.1103/PhysRevD.91.064027.
- Katsimpouri, D., Kleinschmidt, A., & Virmani, A. (2013). Inverse Scattering and the Geroch Group. *Journal of high energy physics: JHEP*, 2013(02): 011. doi:10.1007/JHEP02(2013)011.
- Katsimpouri, D., Kleinschmidt, A., & Virmani, A. (2014). An inverse scattering formalism for STU supergravity. *Journal of high energy physics: JHEP*, 2014(03): 101. doi:10.1007/JHEP03(2014)101.
- Katsimpouri, D., Kleinschmidt, A., & Virmani, A. (2014). An Inverse Scattering Construction of the JMART Fuzzball. *Journal of high energy physics: JHEP*, 2014(12): 070. doi:10.1007/JHEP12(2014)070.
- Keitel, D., Prix, R., Papa, M. A., Leaci, P., & Siddiqi, M. (2014). Search for continuous gravitational waves: improving robustness versus instrumental artifacts. *Physical Review D*, 89: 064023. doi:10.1103/PhysRevD.89.064023.
- Keitel, D., & Prix, R. (2015). Line-robust statistics for continuous gravitational waves: safety in the case of unequal detector sensitivities. *Classical and quantum gravity*, 32: 035004. doi:10.1088/0264-9381/32/3/035004.
- Keitel, D. (2016). Robust semicoherent searches for continuous gravitational waves with noise and signal models including hours to days long transients. *Physical Review D*, 93: 084024. doi:10.1103/PhysRevD.93.084024.
- Keitel, D. (2016). Distinguishing transient signals and instrumental disturbances in semi-coherent searches for continuous gravitational waves with line-robust statistics. *Journal of Physics: Conference Series*, 716: 012003.
- Kelley, D., Lough, J., Mangaña-Sandoval, F., Perreca, A., & Ballmer, S. W. (2015). Observation of photo-thermal feedback in a stable dual-carrier optical spring. *Physical Review D*, 92: 062003. doi:10.1103/PhysRevD.92.062003.
- Keppel, D., Lundgren, A., Owen, B., & Zhu, H. (2013). Parameter space metric for 3.5 post-Newtonian gravitational waves from compact binary inspirals. *Physical Review D*, 88: 063002. doi:10.1103/PhysRevD.88.063002.
- Keppel, D. (2013). Use of Singular-Value Decomposition in Gravitational-Wave Data Analysis. *International Journal of Modern Physics: Conference Series*, 23, 99-105.
- Keppel, D. (2013). The multi-detector F-statistic metric for short-duration non-precessing inspiral gravitational-wave signals. *Physical Review D*, 86: 123010. doi:10.1103/PhysRevD.86.123010.
- Keppel, D. (2013). The balancing act of template bank construction: inspiral waveform template banks for gravitational-wave detectors and optimizations at fixed computational cost. *Physical Review D*, 87: 124003. doi:10.1103/PhysRevD.87.124003.
- Khalaidovski, A., Steinlechner, J., & Schnabel, R. (2013). Indication for dominating surface absorption in crystalline silicon test masses at 1550nm. *Classical and quantum gravity*, 30(16): 165001. doi:10.1088/0264-9381/30/16/165001.
- Khalaidovski, A., Vahlbruch, H., & Schnabel, R. (2015). Squeezed-light Lasers for Gravitational Wave Observatories. In *Proceedings of the MG13 Meeting on General Relativity* (pp. 2040-2042). World Scientific.
- Khalili, F. Y., Tarabrin, S., Schnabel, R., & Hammerer, K. (2016). Generalized analysis of quantum noise and dynamic back-action in signal-recycled Michelson-type laser interferometers. *Physical Review A*, 94: 013844. doi:10.1103/PhysRevA.94.013844.
- Khan, S., Husa, S., Hannam, M., Ohme, F., Pürrer, M., Forteza, X. J., & Bohé, A. (2016). Frequency-domain gravitational waves from non-precessing black-hole binaries. II. A phenomenological model for the advanced detector era. *Physical Review D*, 93: 044007. doi:10.1103/PhysRevD.93.044007.
- Kim, K., Harry, I., Hodge, K. A., Kim, Y.-M., Lee, C.-H., Lee, H. K., Oh, J. J., Oh, S. H., & Son, E. J. (2015). Application of Artificial Neural Network to Search for Gravitational-Wave Signals Associated with Short Gamma-Ray Bursts. *Classical and Quantum Gravity*, 32(24): 245002. doi:10.1088/0264-9381/32/24/245002.
- Klein, A., Barausse, E., Sesana, A., Petiteau, A., Berti, E., Babak, S., Gair, J., Aoudia, S., Hinder, I., Ohme, F., & Wardell, B. (2016). Science with the space-based interferometer eLISA: Supermassive black hole binaries. *Physical Review D*, 93: 024003. doi:10.1103/PhysRevD.93.024003.
- Kleinschmidt, A., Nutma, T., & Virmani, A. (2013). On unitary subsectors of polycritical gravities. *General Relativity and Gravitation*, 45(4), 727-749. doi:10.1007/s10714-013-1497-x.
- Kleinschmidt, A., & Nicolai, H. (2013). On higher spin realizations of K(E10). *Journal of high energy physics: JHEP*, 2013(08): 041. doi:10.1007/JHEP08(2013)041.
- Kleinschmidt, A., & Palmkvist, J. (2013). Oxidizing Borchers symmetries. *Journal of high energy physics: JHEP*, 2013(03): 044. doi:10.1007/JHEP03(2013)044.
- Kleinschmidt, A., Nicolai, H., & Chidambaram, N. K. (2015). Canonical structure of the E10 model and supersymmetry. *Physical Review D*, 91: 085039. doi:10.1103/PhysRevD.91.085039.
- Kleinschmidt, A., & Nicolai, H. (2015). Standard model fermions and K(E10). *Physics Letters B*, 747, 251-254. doi:10.1016/j.physletb.2015.06.005.
- Kliesch, M., Gogolin, C., Kastoryano, M. J., Riera, A., & Eisert, J. (2014). Locality of temperature. *Physical Review X*, 4: 031019. doi:10.1103/PhysRevX.4.031019.
- Klimenko, S., Vedovato, G., Drago, M., Salemi, F., Tiwari, V., Prodi, G. A., Lazzaro, C., Ackley, K., Tiwari, S., Coste, C. F. D. S., & Mitselmakher, G. (2016). Method for detection and reconstruction of gravitational wave transients with networks of advanced detectors. *Physical Review D*, 93: 042004. doi:10.1103/PhysRevD.93.042004.
- Klose, T., & McLoughlin, T. (2013). Worksheet Form Factors in AdS/CFT. *Physical Review D*, 87(2): 026004. doi:10.1103/PhysRevD.87.026004.
- Knispel, B., Eatough, R. P., Kim, H., Keane, E. F., Allen, B., Anderson, D., Aulbert, C., Bock, O., Crawford, F., Eggen-

## Publications by AEI Members and Guest Scientists

- stein, H.-B., Fehrmann, H., Hammer, D., Kramer, M., Lyne, A. G., Machenschalk, B., Miller, R. B., Papa, M. A., Rastawicki, D., Sarkissian, J., Siemens, X., & Stappers, B. W. (2013). Einstein@Home Discovery of 24 Pulsars in the Parkes Multi-beam Pulsar Survey. *Astrophysical Journal*, 774(2): 93. doi:10.1088/0004-637X/774/2/93.
- Knispel, B., Allen, B., Aulbert, C., Bock, O., Lyne, A. G., Machenschalk, B., & Stappers, B. W. (2015). Einstein@Home Discovery of a PALFA Millisecond Pulsar in an Eccentric Binary Orbit. *The Astrophysical Journal*, 806: 140. doi:10.1088/0004-637X/806/1/140.
- Kochkina, E., Heinzel, G., Wanner, G., Müller, V., Mahrtdt, C., Sheard, B., Schuster, S., & Danzmann, K. (2013). Simulating and Optimizing Laser Interferometers.
- Kochkina, E. (2013). Stigmatic and Astigmatic Gaussian Beams in Fundamental Mode: Impact of Beam Model Choice on Interferometric Pathlength Signal Estimates. PhD Thesis, Technische Informationsbibliothek und Universitätsbibliothek Hannover (TIB), Hannover.
- Kochkina, E., Wanner, G., Schmelzer, D., Tröbs, M., & Heinzel, G. (2013). Modeling of the general astigmatic Gaussian beam and its propagation through 3D optical systems. *Applied Optics*, 52(24), 6030-6040. doi:10.1364/AO.52.006030.
- Kocsis, S., Hall, M. J. W., Bennet, A. J., Saunders, D. J., & Pryde, G. J. (2015). Experimental measurement-device-independent verification of quantum steering. *Nature Communications*, 6: 5886. doi:10.1038/ncomms6886.
- Koehn, M., Lehnert, J.-L., & Ovrut, B. (2013). Ghost Condensate in N=1 Supergravity. *Physical Review D*, 87(6): 065022. doi:10.1103/PhysRevD.87.065022.
- Koehn, M. (2012). Solutions of the Klein-Gordon equation in an infinite square-well potential with a moving wall. *Europhysics Letters*, 100(6): 60008. doi:10.1209/0295-5075/100/60008.
- Koehn, M., Lehnert, J.-L., & Ovrut, B. (2013). Supersymmetric cubic Galileons have ghosts. *Physical Review D*, 88: 023528. doi:10.1103/PhysRevD.88.023528.
- Koehn, M., Lehnert, J.-L., & Ovrut, B. (2014). Scalars with higher derivatives in supergravity and cosmology. In *Breaking of Supersymmetry and Ultraviolet Divergences in Extended Supergravity*, Springer Proceedings in Physics (pp. 115-143).
- Koehn, M., Lehnert, J.-L., & Ovrut, B. A. (2014). Cosmological Super-Bounce. *Physical Review D*, 90(2): 025005. doi:10.1103/PhysRevD.90.025005.
- Koehn, M., Lehnert, J.-L., & Ovrut, B. (2014). Ghost Condensate in N=1 Supergravity. In *Breaking of Supersymmetry and Ultraviolet Divergences in Extended Supergravity*, Springer Proceedings in Physics Volume 153 (pp. 163-178). Springer.
- Koehn, M., Lehnert, J.-L., & Ovrut, B. (2016). Non-Singular Bouncing Cosmology: Consistency of the Effective Description. *Physical Review D*, 93: 103501. doi:10.1103/PhysRevD.93.103501.
- Köhn, M., Lavrelashvili, G. V., & Lehnert, J.-L. (2015). Towards a Solution of the Negative Mode Problem in Quantum Tunnelling with Gravity. *Physical Review D*, 92: 023506. doi:10.1103/PhysRevD.92.023506.
- Kolasiński, S., & Szumańska, M. (2013). Minimal Hölder regularity implying finiteness of integral Menger curvature. *Manuscripta Mathematica*, 141(1-2), 125-147. doi:10.1007/s00229-012-0565-y.
- Kolasiński, S., Strzelecki, P., & von der Mosel, H. (2013). Characterizing  $W_2^p$  submanifolds by  $p$ -integrability of global curvatures. *Geometric and Functional Analysis*, 23(3), 937-984. doi:10.1007/s00039-013-0222-y.
- Kolasiński, S. (2015). Geometric Sobolev-like embedding using high-dimensional Menger-like curvature. *Transactions of the American Mathematical Society*, 367(2), 775-811. doi:10.1090/S0002-9947-2014-05989-8.
- Konstantinidis, S., Amaro-Seoane, P., & Kokkotas, K. D. (2013). Investigating the retention of intermediate-mass black holes in star clusters using N-body simulations. *Astronomy and Astrophysics*, 557: A135. doi:10.1051/0004-6361/201219620.
- Korobko, M., Voronchev, N., Miao, H., & Khalili, F. Y. (2015). Paired carriers as a way to reduce quantum noise of multi-carrier gravitational-wave detectors. *Physical Review D*, 91(4): 042004. doi:10.1103/PhysRevD.91.042004.
- Korovin, Y., Skenderis, K., & Taylor, M. (2013). Lifshitz from AdS at finite temperature and top down models. *Journal of high energy physics: JHEP*, 2013(11): 127. doi:10.1007/JHEP11(2013)127.
- Korovin, Y. (2014). First order formalism for the holographic duals of defect CFTs. *Journal of high energy physics: JHEP*, 2014(04): 152. doi:10.1007/JHEP04(2014)152.
- Korovin, Y., Skenderis, K., & Taylor, M. (2013). Lifshitz as a deformation of Anti-de Sitter. *Journal of high energy physics: JHEP*, 2013(08): 026. doi:10.1007/JHEP08(2013)026.
- Korovin, Y., Kuzenko, S. M., & Theisen, S. (2016). The conformal supercurrents in diverse dimensions and conserved superconformal currents. *Journal of high energy physics: JHEP*, 2016(05): 134. doi:10.1007/JHEP05(2016)134.
- Korsakova, N., Messenger, C., Pannarale, F., Hewitson, M., & Armano, M. (2014). Data Analysis Methods for Testing Alternative Theories of Gravity with LISA Pathfinder. *Physical Review D*, 89: 123511. doi:10.1103/PhysRevD.89.123511.
- Korzynski, M., Hinder, I., & Bentivegna, E. (2015). On the vacuum Einstein equations along curves with a discrete local rotational and reflection symmetry. *Journal of Cosmology and Astroparticle Physics*, 2015(8): 025. doi:10.1088/1475-7516/2015/08/025.
- Kotschwar, B. L. (2014). Ricci flow and the holonomy group. *Journal für die Reine und Angewandte Mathematik*, 2014(690), 133-161. doi:10.1515/crelle-2012-0023.
- Kotschwar, B. (2013). A local version of Bando's theorem on the real-analyticity of solutions to the Ricci flow. *Bulletin of*

## Publications by AEI Members and Guest Scientists

- the London Mathematical Society, 45, 153-158. doi:10.1112/blms/bds074.
- Krueger, O., & Kreimer, D. (2015). Filtrations in Dyson-Schwinger equations: next-to<sup>j</sup>-leading log expansions systematically. *Annals of Physics*, 360, 293-340. doi:10.1016/j.aop.2015.05.013.
- Krueger, O. (2016). Non-linear uplift Ansätze for the internal metric and the four-form field-strength of maximal supergravity. *Journal of high energy physics: JHEP*, 2016(05): 145. doi:10.1007/JHEP05(2016)145.
- Krüger, C., Heinert, D., Khalaidovski, A., Steinlechner, J., Nawrodt, R., Schnabel, R., & Lück, H. (2016). Birefringence Measurements on Crystalline Silicon. *Classical and quantum gravity*, 33(1): 015012. doi:10.1088/0264-9381/33/1/015012.
- Kuhnel, F., & Rampf, C. (2014). Astrophysical Bose-Einstein Condensates and Superradiance. *Physical Review D*, 90: 103526. doi:10.1103/PhysRevD.90.103526.
- Kulaxizi, M., & Rahman, R. (2015). Fermion Dipole Moment and Holography. *Journal of high energy physics: JHEP*, 2015(12): 146. doi:10.1007/JHEP12(2015)146.
- Kumar, P., Chu, T., Fong, H., Pfeiffer, H. P., Boyle, M., Hemberger, D. A., Kidder, L. E., Scheel, M. A., & Szilagy, B. (2016). Accuracy of binary black hole waveform models for aligned-spin binaries. *Physical Review D*, 93: 104050. doi:10.1103/PhysRevD.93.104050.
- Kuzenko, S. M., & Novak, J. (2015). On curvature squared terms in  $N = 2$  supergravity. *Physical Review D*, 92: 085033. doi:10.1103/PhysRevD.92.085033.
- Kuzenko, S. M., Novak, J., & Samsonov, I. B. (2016). The anomalous current multiplet in 6D minimal supersymmetry. *Journal of high energy physics: JHEP*, 2016(02): 132. doi:10.1007/JHEP02(2016)132.
- Lahoche, V., Oriti, D., & Rivasseau, V. (2015). Renormalization of an Abelian Tensor Group Field Theory: Solution at Leading Order. *Journal of high energy physics: JHEP*, 2015(04): 095. doi:10.1007/JHEP04(2015)095.
- Lahoche, V., & Oriti, D. (2017). Renormalization of a tensorial field theory on the homogeneous space  $SU(2)/U(1)$ . *Journal of Physics A*, 50(2): 025201. doi:http://dx.doi.org/10.1088/1751-8113/50/2/025201.
- Lammers, J., Weimer, H., & Hammerer, K. (2016). Open-system many-body dynamics through interferometric measurements and feedback. *Physical Review A*, 94: 052120. doi:10.1103/PhysRevA.94.052120.
- Lang, M., Holley-Bockelmann, K., Bogdanovic, T., Amaro-Seoane, P., Sesana, A., & Sinha, M. (2013). Can a Satellite Galaxy Merger Explain the Active Past of the Galactic Center? *Monthly Notices of the Royal Astronomical Society*, 430, 2574-2584. doi:10.1093/mnras/sts638.
- Lassus, A., van Haasteren, R., Mingarelli, C. M. F., Lee, K. J., & Vecchio, A. (2013). A data analysis library for gravitational wave detection.
- Latosinski, A., Meissner, K., & Nicolai, H. (2013). Neutrino Mixing and the Axion-Gluon Vertex. *Nuclear Physics B*, 868(3), 596-626. doi:10.1016/j.nuclphysb.2012.11.027.
- Latosinski, A., Meissner, K. A., & Nicolai, H. (2013). (B-L) Symmetry vs. Neutrino Seesaw. *The European Physical Journal C - Particles and Fields*, 73: 2336. doi:10.1140/epjc/s10052-013-2336-7.
- Latosinski, A. (2016). Manifestly gauge-covariant representation of scalar and fermion propagators. *Physical Review D*, 93: 025031. doi:10.1103/PhysRevD.93.025031.
- Latosinski, A., Lewandowski, A., Meissner, K., & Nicolai, H. (2015). Conformal standard model with an extended scalar sector. *Journal of high energy physics: JHEP*, 2015(10): 170. doi:10.1007/JHEP10(2015)170.
- Lazarus, P., Brazier, A., Hessels, J. W. T., Karako-Argaman, C., Kaspi, V. M., Lynch, R., Madsen, E., Patel, C., Ransom, S. M., Scholz, P., Swiggum, J., Zhu, W. W., Allen, B., Bogdanov, S., Camilo, F., Cardoso, F., Chatterjee, S., Cordes, J. M., Crawford, F., Deneva, J. S., Ferdman, R., Freire, P. C. C., Jenet, F. A., Knispel, B., Lee, K. J., van Leeuwen, J., Lorimer, D. R., Lyne, A. G., McLaughlin, M. A., Siemens, X., Spitler, L. G., Stairs, I. H., Stovall, K., & Venkataraman, A. (2015). Arecibo Pulsar Survey Using ALFA. IV. Mock Spectrometer Data Analysis, Survey Sensitivity, and the Discovery of 40 Pulsars. *Astrophysical Journal*, 812(1): 81. doi:10.1088/0004-637X/812/1/81.
- Lazarus, P., Tauris, T. M., Knispel, B., Freire, P. C. C., Deneva, J. S., Kaspi, V. M., Allen, B., Bogdanov, S., Chatterjee, S., Stairs, I. H., & Zhu, W. W. (2014). Timing of a Young Mildly Recycled Pulsar with a Massive White Dwarf Companion. *Monthly Notices of the Royal Astronomical Society*, 437 (2), 1485-1494. doi:10.1093/mnras/stt1996.
- Lazarus, P., Freire, P. C. C., Allen, B., Aulbert, C., Bock, O., Bogdanov, S., Brazier, A., Camilo, F., Cardoso, F., Chatterjee, S., Cordes, J. M., Crawford, F., Deneva, J. S., Eggenstein, H.-B., Fehrmann, H., Ferdman, R., Hessels, J. W. T., Jenet, F. A., Karako-Argaman, C., Kaspi, V. M., Knispel, B., Lynch, R., van Leeuwen, J., Machenschalk, B., Madsen, E., McLaughlin, M. A., Patel, C., Ransom, S. M., Scholz, P., Seymour, A., Siemens, X., Spitler, L. G., Stairs, I. H., Stovall, K., Swiggum, J., Venkataraman, A., & Zhu, W. W. (2016). Einstein@Home discovery of a Double Neutron Star Binary in the PALFA Survey. *Astrophysical Journal, Letters*, 831(2): 150. doi:10.3847/0004-637X/831/2/150.
- Leaci, P., & Prix, R. (2015). Directed searches for continuous gravitational waves from binary systems: parameter-space metrics and optimal Scorpius X-1 sensitivity. *Physical Review D*, 91: 102003. doi:10.1103/PhysRevD.91.102003.
- Lee, H., & Rendall, A. D. (2013). The Einstein-Boltzmann system and positivity. *Journal of hyperbolic differential equations*, 77(1), 77-104. doi:10.1142/S0219891613500033.
- Lee, K. J., Stovall, K., Jenet, F. A., Martinez, J., Dartez, L. P., Mata, A., Lunsford, G., Cohen, S., Biwer, C. M., Rohr, M., Flanagan, J., Walker, A., Banaszak, S., Allen, B., Barr, E. D., Bhat, N. D. R., Bogdanov, S., Brazier, A., Camilo, F., Champion, D. J., Chatterjee, S., Cordes, J., Crawford, F., Deneva, J., Desvignes, G., Ferdman, R. D., Freire, P., Hessels, J. W. T., Karuppusamy, R., Kaspi, V. M., Knispel, B., Kramer, M., Lazarus, P., Lynch, R., Lyne, A., McLaughlin, M., Ransom, S., Scholz, P., Siemens, X., Spitler, L., Stairs, I., Tan, M., van Leeuwen, J., & Zhu, W. W. (2013). PEACE: Pulsar Evaluation Algorithm for Candidate Extraction - A software package for post-analysis processing of pulsar survey candidates. *Monthly Notices of the Royal Astronomical Society*, 433, 688-694. doi:10.1093/mnras/stt758.
- Lee, H., & Rendall, A. D. (2013). The spatially homogeneous relativistic Boltzmann equation with a hard potential.

## Publications by AEI Members and Guest Scientists

- Communications in Partial Differential Equations, 38(12), 2238-2262. doi:10.1080/03605302.2013.827709.
- Lee, S., Mafra, C. R., & Schlotterer, O. (2016). Non-linear gauge transformations in D=10 SYM theory and the BCJ duality. *Journal of high energy physics: JHEP*, 2016(03): 090. doi:10.1007/JHEP03(2016)090.
- Lehners, J.-L., & Steinhardt, P. J. (2013). Planck 2013 results support the cyclic universe. *Physical Review D*, 87(12): 123533. doi:10.1103/PhysRevD.87.123533.
- Lehners, J.-L. (2013). Scalars with higher derivatives in supergravity and cosmology. *Proceedings of Science: Proceedings of the Corfu Summer Institute 2012 "School and Workshops on Elementary Particle Physics and Gravity"*, Corfu 2012: 118.
- Lehners, J.-L. (2015). Classical Inflationary and Ekpyrotic Universes in the No-Boundary Wavefunction. *Physical Review D*, 91: 083525. doi:10.1103/PhysRevD.91.083525.
- Lehners, J.-L., & Wilson-Ewing, E. (2015). Running of the scalar spectral index in bouncing cosmologies. *Journal of Cosmology and Astroparticle Physics*, 10: 038. doi:10.1088/1475-7516/2015/10/038.
- Lehners, J.-L. (2015). New Ekpyrotic Quantum Cosmology. *Physics Letters B*, 750, 242-246. doi:10.1016/j.physletb.2015.09.032.
- Leigh, N. W. C., Luetzgendorf, N., Geller, A. M., Maccarone, T. J., Heinke, C. O., & Sesana, A. (2014). On the coexistence of stellar-mass and intermediate-mass black holes in globular clusters. *Monthly Notices of the Royal Astronomical Society*, 444 (1), 29-42. doi:10.1093/mnras/stu1437.
- Lentati, L., Alexander, P., Hobson, M. P., Taylor, S., Gair, J., Balan, S. T., & van Haasteren, R. (2013). Hyper-efficient model-independent Bayesian method for the analysis of pulsar timing data. *Physical Review D*, 87: 104021. doi:10.1103/PhysRevD.87.104021.
- Lentati, L., Alexander, P., Hobson, M. P., Feroz, F., van Haasteren, R., Lee, K., & Shannon, R. M. (2014). TempoNest: A Bayesian approach to pulsar timing analysis. *Monthly Notices of the Royal Astronomical Society*, 437(3), 3004-3023. doi:10.1093/mnras/stt2122.
- Lentati, L., Taylor, S. R., Mingarelli, C. M. F., Sesana, A., Sanidas, S. A., Vecchio, A., Caballero, R. N., Lee, K. J., van Haasteren, R., Babak, S., Bassa, C. G., Brem, P., Burgay, M., Champion, D. J., Cognard, I., Desvignes, G., Gair, J. R., Guillemot, L., Hessels, J. W. T., Janssen, G. H., Karuppusamy, R., Kramer, M., Lasso, A., Lazarus, P., Liu, K., Osłowski, S., Perrodin, D., Petiteau, A., Possenti, A., Purver, M. B., Rosado, P. A., Smits, R., Stappers, B., Theureau, G., Tiburzi, C., & Verbiest, J. P. W. (2015). European Pulsar Timing Array Limits On An Isotropic Stochastic Gravitational-Wave Background. *Monthly Notices of the Royal Astronomical Society*, 453(3), 2576-2598. doi:10.1093/mnras/stv1538.
- Lentati, L., Shannon, R. M., Coles, W. A., Verbiest, J. P. W., van Haasteren, R., Ellis, J. A., Caballero, R. N., Manchester, R. N., Arzoumanian, Z., Babak, S., Bassa, C. G., Bhat, N. D. R., Brem, P., Burgay, M., Burke-Spolaor, S., Champion, D., Chatterjee, S., Cognard, I., Cordes, J. M., Dai, S., Demorest, P., Desvignes, G., Dolch, T., Ferdman, R. D., Fonseca, E., Gair, J. R., Gonzalez, M. E., Graikou, E., Guillemot, L., Hessels, J. W. T., Hobbs, G., Janssen, G. H., Jones, G., Karuppusamy, R., Keith, M., Kerr, M., Kramer, M., Lam, M. T., Lasky, P. D., Lasso, A., Lazarus, P., Lazio, T. J. W., Lee, K. J., Levin, L., Liu, K., Lynch, R. S., Madison, D. R., McKee, J., McLaughlin, M., McWilliams, S. T., Mingarelli, C. M. F., Nice, D. J., Osłowski, S., Pennucci, T. T., Perera, B. B. P., Perrodin, D., Petiteau, A., Possenti, A., Ransom, S. M., Reardon, D., Rosado, P. A., Sanidas, S. A., Sesana, A., Shaifullah, G., Siemens, X., Smits, R., Stairs, I., Stappers, B., Stinebring, D. R., Stovall, K., Swiggum, J., Taylor, S. R., Theureau, G., Tiburzi, C., Toomey, L., Vallisneri, M., van Straten, W., Vecchio, A., Wang, J.-B., Wang, Y., You, X. P., Zhu, W. W., & Zhu, X.-J. (2016). From Spin Noise to Systematics: Stochastic Processes in the First International Pulsar Timing Array Data Release. *Monthly Notices of the Royal Astronomical Society*, 458(2), 2161-2187. doi:10.1093/mnras/stw395.
- Levi, M., & Steinhoff, J. (2015). Leading order finite size effects with spins for inspiralling compact binaries. *Journal of high energy physics: JHEP*, 2015(06): 059. doi:10.1007/JHEP06(2015)059.
- Levi, M., & Steinhoff, J. (2015). Spinning gravitating objects in the effective field theory in the post-Newtonian scheme. *Journal of High Energy Physics*, 2015(09): 219. doi:10.1007/JHEP09(2015)219.
- Levi, M., & Steinhoff, J. (2016). Next-to-next-to-leading order gravitational spin-orbit coupling via the effective field theory for spinning objects in the post-Newtonian scheme. *Journal of Cosmology and Astroparticle Physics*, 2016(01): 011. doi:http://dx.doi.org/10.1088/1475-7516/2016/01/011.
- Levi, M., & Steinhoff, J. (2016). Next-to-next-to-leading order gravitational spin-squared potential via the effective field theory for spinning objects in the post-Newtonian scheme. *Journal of Cosmology and Astroparticle Physics*, 2016(01): 008. doi:10.1088/1475-7516/2016/01/008.
- Li, W., Lin, F.-L., & Wang, C.-W. (2013). Modular Properties of 3D Higher Spin Theory. *Journal of high energy physics: JHEP*, 2013(12): 094. doi:10.1007/JHEP12(2013)094.
- Li, W., & Theisen, S. (2015). Some aspects of holographic W-gravity. *Journal of high energy physics: JHEP*, 2015(8): 035. doi:10.1007/JHEP08(2015)035.
- Li, X., Hu, Y.-M., Fan, Y.-Z., & Wei, D.-M. (2016). GRB/GW association: Long-short GRB candidates, time-lag, measuring gravitational wave velocity and testing Einstein's equivalence principle. *The Astrophysical Journal*, 827(1): 75. doi:10.3847/0004-637X/827/1/75.
- Liebscher, S., Rendall, A. D., & Tchapnda, S. B. (2013). Oscillatory singularities in Bianchi models with magnetic fields. *Annales Henri Poincaré*, 14(5): 012-0207-7, pp. 1043-1075. doi:10.1007/s00023-012-0207-7.
- Lieser, M., d'Arcio, L., Barke, S., Bogenstahl, J., Diekmann, C., Diepholz, I., Fitzsimons, E. D., Gerberding, O., Henning, J.-S., Hewitson, M., Hey, F. G., Hogenhuis, H., Killow, C. J., Lucarelli, S., Nikolov, S., Perreur-Lloyd, M., Pijenburg, J., Robertson, D. I., Sohmer, A., Taylor, A., Tröbs, M., Ward, H., Weise, D., Heinzl, G., & Danzmann, K. (2013). LISA Optical Bench Testbed.
- Lieser, M., Fitzsimons, E., Isleif, K.-S., Killow, C., Perreur-Lloyd, M., Robertson, D., Schuster, S., Tröbs, M., Veith, S.,

## Publications by AEI Members and Guest Scientists

- Ward, H., Heinzl, G., & Danzmann, K. (2016). Construction of an optical test-bed for eLISA. *Journal of Physics: Conference Series*, 716(1): 012029.
- Lim, W. C., Regis, M., & Clarkson, C. (2013). Spherically symmetric cosmological spacetimes with dust and radiation - numerical implementation. *Journal of Cosmology and Astroparticles Physics*, 013(10): 010. doi:10.1088/1475-7516/2013/10/010.
- Lindblom, L., Taylor, N. W., & Rinne, O. (2016). Constructing Reference Metrics on Multicube Representations of Arbitrary Manifolds. *Journal of Computational Physics*, 313, 31-56. doi:10.1016/j.jcp.2016.02.029.
- Littenberg, T. B., Baker, J. G., Buonanno, A., & Kelly, B. J. (2013). Systematic biases in parameter estimation of binary black-hole mergers. *Physical Review D*, 87(10): 104003. doi:10.1103/PhysRevD.87.104003.
- Liu, F. K., & Chen, X. (2013). Enhanced off-center stellar tidal disruptions by supermassive black holes in merging galaxies. *The Astrophysical Journal*, 767: 18. doi:10.1088/0004-637X/767/1/18.
- Livine, E. R., & Martin-Benito, M. (2013). Classical Setting and Effective Dynamics for Spinfoam Cosmology. *Classical and quantum gravity*, 30(3): 035006. doi:10.1088/0264-9381/30/3/035006.
- Lörch, N., & Hammerer, K. (2015). Sub-Poissonian Phonon Lasing in Three-Mode Optomechanics. *Physical Review A*, 91: 061803(R). doi:10.1103/PhysRevA.91.061803.
- Lörch, N., Qian, J., Clerk, A., Marquardt, F., & Hammerer, K. (2014). Laser Theory for Optomechanics: Limit Cycles in the Quantum Regime. *Physical Review X*, 4: 011015. doi:10.1103/PhysRevX.4.011015.
- Lüst, D., Mekareeya, N., Schlotterer, O., & Thomson, A. (2013). Refined partition functions for open superstrings with 4, 8 and 16 supercharges. *Nuclear Physics B*, 876(1), 55-146. doi: http://dx.doi.org/10.1016/j.nuclphysb.2013.08.003.
- Mädler, T., & Winicour, J. (2016). The sky pattern of the linearized gravitational memory effect. *Classical and Quantum Gravity*, 33(17): 175006. doi:http://dx.doi.org/10.1088/0264-9381/33/17/175006.
- Mädler, T., & Winicour, J. (2016). The Bondi-Sachs Formalism. *Scholarpedia*, 11(12): 33528. doi:10.4249/scholarpedia.33528.
- Mafra, C. R., Schlotterer, O., & Stieberger, S. (2013). Complete N-Point Superstring Disk Amplitude II. Amplitude and Hypergeometric Function Structure. *Nuclear Physics B*, 873(3), 461-513. doi:http://dx.doi.org/10.1016/j.nuclphysb.2013.04.022.
- Mafra, C. R., Schlotterer, O., & Stieberger, S. (2013). Complete N-Point Superstring Disk Amplitude I. Pure Spinor Computation. *Nuclear Physics B*, 873(3), 419-460. doi:http://dx.doi.org/10.1016/j.nuclphysb.2013.04.023.
- Mafra, C. R., & Schlotterer, O. (2014). The Structure of n-Point One-Loop Open Superstring Amplitudes. *Journal of High Energy Physics*, 2014(08): 099. doi:10.1007/JHEP08(2014)099.
- Mafra, C. R., & Schlotterer, O. (2015). Towards one-loop SYM amplitudes from the pure spinor BRST cohomology. *Fortschritte der Physik*, 63(2), 105-131. doi:10.1002/prop.201400076.
- Mafra, C. R., & Schlotterer, O. (2014). Multiparticle SYM equations of motion and pure spinor BRST blocks. *Journal of high energy physics: JHEP*, 2014(7): 153. doi:10.1007/JHEP07(2014)153.
- Mafra, C. R., & Schlotterer, O. (2015). Solution to the nonlinear field equations of ten dimensional supersymmetric Yang-Mills theory. *Physical Review D*, 92: 066001. doi:http://dx.doi.org/10.1103/PhysRevD.92.066001.
- Mafra, C. R., & Schlotterer, O. (2015). Two-loop five-point amplitudes of super Yang-Mills and supergravity in pure spinor superspace. *Journal of high energy physics: JHEP*, 2015(10): 124. doi:10.1007/JHEP10(2015)124.
- Mafra, C. R., & Schlotterer, O. (2016). Berends-Giele recursions and the BCJ duality in superspace and components. *Journal of high energy physics: JHEP*, 2016(03): 097. doi:10.1007/JHEP03(2016)097.
- Mafra, C. R., & Schlotterer, O. (2016). One-loop superstring six-point amplitudes and anomalies in pure spinor superspace. *Journal of high energy physics: JHEP*, 2016(04): 148. doi: 10.1007/JHEP04(2016)148.
- Maharana, J. (2015). High Energy Scatterings in Higher Dimensional Theories. *Journal of Mathematical Physics*, 56(10): 4933220. doi:10.1063/1.4933220.
- Maliborski, M., & Schell, C. (2016). Stabil oder nicht stabil? Eine Raumzeit auf dem Prüfstand. doi:10.17617/1.12.
- Maliborski, M. (2014). Dynamics of Nonlinear Waves on Bounded Domains. PhD Thesis.
- Mandel, I., Miller, M. C., Ahmedov, B. J., Bambi, C., Berry, C. P. L., Brink, J., Brown, D., Chaverra, E., Chugunov, A. I., Fairhurst, S., Fryer, C., Gair, J. R., Gondke-Rosinska, D., Gualtieri, L., Gusakov, M. E., Hannam, M., Harry, I., Kantor, E. M., Kluzniak, W., Kucaba, M., Lukes-Gerakopoulos, G., Meheut, H., Melatos, A., Morozova, V. S., Paumard, T., Stergioulas, N., Studzinska, A., Szudlarek, M., Straub, O., Torok, G., Varniere, P., Vincent, F. H., Wisniewicz, M., Wildner, M., Will, C., Yagi, K., Zanotti, O., & Zhou, S.-Y. (2014). Relativistic astrophysics at GR20. *General Relativity and Gravitation*, 46(5): 1688. doi:10.1007/s10714-014-1688-0.
- Manvelyan, R., Mkrchyan, K., Mkrchyan, R., & Theisen, S. (2013). On Higher Spin Symmetries in AdS<sub>5</sub>. *Journal of high energy physics: JHEP*, 2013(10): 185. doi:10.1007/JHEP10(2013)185.
- Marquardt, T. (2013). Inverse Mean Curvature Flow for Star-Shaped Hypersurfaces Evolving in a Cone. *Journal of Geometric Analysis*, 23(3), 1303-1313. doi:10.1007/s12220-011-9288-7.
- Mars, M., & Reiris, M. (2013). Global and uniqueness properties of stationary and static spacetimes with outer trapped surfaces. *Communications in Mathematical Physics*, 322(2), 633-666. doi:10.1007/s00220-013-1739-5.
- Marsat, S., Bohé, A., Blanchet, L., & Buonanno, A. (2014). Next-to-leading tail-induced spin-orbit effects in the gravitational radiation flux of compact binaries. *Classical and quantum gravity*, 31(2): 025023. doi:10.1088/0264-9381/31/2/025023.
- Maselli, A., Gualtieri, L., Pannarale, F., & Ferrari, V. (2015). On the validity of the adiabatic approximation in compact binary inspirals. In *The Thirteenth Marcel Grossmann Meeting* (pp. 951-953). World Scientific.
- Maureira-Fredes, C., & Amaro-Seoane, P. (2014). GraviDy: a modular, GPU-based, direct-summation N-body code. *Pro-*

## Publications by AEI Members and Guest Scientists

ceedings of the International Astronomical Union, 10: S312, pp. 252-253.  
doi: <http://dx.doi.org/10.1017/S1743921315007954>.

Mazzolo, G., Salemi, F., Drago, M., Necula, V., Pankow, C., Prodi, G. A., Re, V., Tiwari, V., Vedovato, G., Yakushin, I., & Klimenko, S. (2014). Prospects for intermediate mass black hole binary searches with advanced gravitational-wave detectors. *Physical Review D*, 90: 063002. doi:10.1103/PhysRevD.90.063002.

Mazzolo, G. (2013). Search for intermediate mass black hole binaries with networks of ground-based gravitational-wave detectors. PhD Thesis.

McNamara, P., Antonucci, F., Armano, M., Audley, H., Auger, G., Benedetti, M., Binétruy, P., Bogenstahl, J., Bortoluzzi, D., Brandt, N., Caleno, M., Cavalleri, A., Congedo, G., Cruise, M., Danzmann, K., De Marchi, F., Diaz-Aguilo, M., Diepholz, I., Dixon, G., Dolesi, R., Dumber, N., Fauste, J., Ferraioli, L., Ferroni, V., Fichter, W., Fitzsimons, E., Freschi, M., García Marín, C., Gerndt, R., Gesa, L., Gibert, F., Giardini, D., Grimaldi, C., Grynagier, A., Guzman, F., Harrison, I., Heinzl, G., Hewitson, M., Hollington, D., Hoyland, D., Hueller, M., Huesler, J., Jennrich, O., Jetzer, P., Johlander, B., Karnesis, N., Korsakova, N., Killow, C., Llamas, X., Llorca, I., Lobo, A., Maarschalk, R., Madden, S., Mance, D., Martin, V., Mateos, I., Mendes, J., Mitchell, E., Nicolodi, D., Nofrarias, M., Perreux-Lloyd, M., Plagnol, E., Prat, P., Ramos-Castro, J., Reiche, J., Romera Perez, J. A., Robertson, D., Rozemeijer, H., Russano, G., Schleicher, A., Shaul, D., Sopuerta, C. F., Sumner, T. J., Taylor, A., Texier, D., Trenkel, C., Tu, H. B., Vitale, S., Wanner, G., Ward, H., Waschke, S., Wass, P., Wealthy, D., Wen, S., Weber, W., Ziegler, T., & Zweifel, P. (2013). The LISA Pathfinder Mission. Meadors, G. D., Goetz, E., & Riles, K. (2016). Tuning into Scorpius X-1: adapting a continuous gravitational-wave search for a known binary system. *Classical and quantum gravity*, 33(10): 105017. doi:10.1088/0264-9381/33/10/105017.

Mei, J. (2013). Fluctuating Black Hole Horizons. *Journal of high energy physics: JHEP*, 2013(10): 195. doi:10.1007/JHEP10(2013)195.

Mei, J. (2014). Emergent Symmetry on Black Hole Horizons. *Physical Review D*, 89(6): 064066. doi:10.1103/PhysRevD.89.064066.

Mei, J. (2014). Conformal Symmetries on the Horizon and Black Hole Entropy in Generic Dimensions. In *Relativity and Gravitation. Springer Proceedings in Physics* (pp. 299-303). Springer.

Meinders, M., Kroker, S., Singh, A. P., Kley, E.-B., Tünnermann, A., Danzmann, K., & Schnabel, R. (2015). Cancellation of lateral displacement noise of 3-port gratings for coupling light to cavities. *Optics Letters*, 40, 2053-2055. doi:10.1364/OL.40.002053.

Meinders, M., & Schnabel, R. (2015). Sensitivity improvement of a laser interferometer limited by inelastic back-scattering, employing dual readout. *Classical and Quantum Gravity*, 32(19): 195004. doi:10.1088/0264-9381/32/19/195004.

Meissner, K., & Nicolai, H. (2013). A narrow scalar resonance at 325 GeV? *Physics Letters B*, 718(3), 943-945. doi:10.1016/j.physletb.2012.11.012.

Meissner, K., & Nicolai, H. (2015). Standard Model Fermions and N=8 supergravity. *Physical Review D*, 91(6): 065029. doi:10.1103/PhysRevD.91.065029.

Melnikov, I. V., Quigley, C., Sethi, S., & Stern, M. (2013). Target Spaces from Chiral Gauge Theories. *Journal of high energy physics: JHEP*, 2013(2): 111. doi:10.1007/JHEP02(2013)111.

Melnikov, I. V., Minasian, R., & Theisen, S. (2014). Heterotic flux backgrounds and their IIA duals. *Journal of High Energy Physics*, 2014(07): 023. doi:10.1007/JHEP07(2014)023.

Menne, U. (2013). Second order rectifiability of integral varifolds of locally bounded first variation. *Journal of Geometric Analysis*, 23, 709-763. doi:10.1007/s12220-011-9261-5.

Menne, U. (2016). Weakly differentiable functions on varifolds. *Indiana University Mathematics Journal*, 65(3), 977-1088. doi:10.1512/iumj.2016.65.5829.

Menne, U. (2016). Sobolev functions on varifolds. *Proceedings London Mathematical Society*, 113(5): 023. doi:10.1112/plms/pdw023.

Messenger, C., Takami, K., Gossan, S., Rezzolla, L., & Sathyaprakash, B. (2014). Source Redshifts from Gravitational-Wave Observations of Binary Neutron Star Mergers. *Physical Review X*, 4: 041004. doi:10.1103/PhysRevX.4.041004.

Messenger, C., Bulten, H. J., Crowder, S. G., Dergachev, V., Galloway, D. K., Goetz, E., Jonker, R. J. G., Lasky, P. D., Meadors, G. D., Melatos, A., Premachandra, S., Riles, K., Sammut, L., Thrane, E. H., Whelan, J. T., & Zhang, Y. (2015). Gravitational waves from Scorpius X-1: A comparison of search methods and prospects for detection with advanced detectors. *Physical Review D*, 92: 023006. doi:10.1103/PhysRevD.92.023006.

Metzger, J. (2013). Surfaces with maximal constant mean curvature. In *Constant Mean Curvature Surfaces with Boundary*. Springer Monographs in Mathematics, 13 (pp. 13-36).

Mewes, V., Galeazzi, F., Font, J. A., Montero, P. J., & Stergioulas, N. (2016). On the dynamics of tilted black hole-torus systems. *Monthly Notices of the Royal Astronomical Society*, 461(3), 2480-2489. doi:https://doi.org/10.1093/mnras/stw1490.

Miao, R. (2014). A Note on Holographic Weyl Anomaly and Entanglement Entropy. *Classical and quantum gravity*, 31(6): 065009. doi:10.1088/0264-9381/31/6/065009.

Miao, R. X., & Guo, W.-z. (2015). Holographic Entanglement Entropy for the Most General Higher Derivative Gravity. *Journal of high energy physics: JHEP*, 2015(08): 031. doi:10.1007/JHEP08(2015)031.

Miao, R. X. (2015). Universal Terms of Entanglement Entropy for 6d CFTs. *Journal of high energy physics: JHEP*, 2015(10): 049. doi:10.1007/JHEP10(2015)049.

Miao, R. X. (2015). A holographic proof of the universality of corner entanglement for CFTs. *Journal of high energy*

## Publications by AEI Members and Guest Scientists

- physics: JHEP, 2015(10): 038. doi:10.1007/JHEP10(2015)038.
- Michishita, Y., & Trzetrzelewski, M. (2013). Towards the Ground State of the Supermembrane. *Nuclear Physics B*, 868(2), 539-553. doi:10.1016/j.nuclphysb.2012.11.013.
- Ming, J., Krishnan, B., Papa, M. A., Aulbert, C., & Fehrmann, H. (2016). Optimal directed searches for continuous gravitational waves. *Physical Review D*, 93: 064011. doi:10.1103/PhysRevD.93.064011.
- Mitrofanov, V. P., Chao, S., Pan, H.-W., Kuo, L.-C., Cole, G., Degallaix, J., & Willke, B. (2015). Technology for the next gravitational wave detectors. *Science China Physics*, 58(12): 120404. doi:10.1007/s11433-015-5738-8.
- Mittal, R., Whelan, J. T., & Combes, F. (2015). Constraining star formation rates in cool-core brightest cluster galaxies. *Monthly Notices of the Royal Astronomical Society*, 450(3), 2564-2592. doi:10.1093/mnras/stv754.
- Moesta, P., Mundim, B. C., Faber, J. A., Haas, R., Noble, S. C., Bode, T., Loeffler, F., Ott, C. D., Reisswig, C., & Schnetter, E. (2014). GRHydro: A new open source general-relativistic magnetohydrodynamics code for the Einstein Toolkit. *Classical and quantum gravity*, 31(1): 015005. doi:10.1088/0264-9381/31/1/015005.
- Moesta, P., Andersson, L., Metzger, J., Szilagyi, B., & Winicour, J. (2015). The Merger of Small and Large Black Holes. *Classical and quantum gravity*, 32(23): 235003. doi:10.1088/0264-9381/32/23/235003.
- Morozova, V. S., Ahmedov, B. J., & Zanotti, O. (2014). Explaining the subpulse drift velocity of pulsar magnetosphere within the space-charge limited flow model. *Monthly Notices of the Royal Astronomical Society*, 444(2), 1144-1156. doi:10.1093/mnras/stu1486.
- Morozova, V. S., Ahmedov, B. J., & Tursunov, A. A. (2013). Gravitational lensing by a rotating massive object in a plasma. *Astrophysics and Space Science*, 346(2), 513-520. doi:10.1007/s10509-013-1458-6.
- Mösta, P., Ott, C. D., Radice, D., Roberts, L. F., Schnetter, E., & Haas, R. (2015). A large scale dynamo and magnetoturbulence in rapidly rotating core-collapse supernovae. *Nature*, 528(7582), 376-379. doi:10.1038/nature15755.
- Mundim, B. C., Nakano, H., Yunes, N., Campanelli, M., Noble, S. C., & Zlochower, Y. (2014). Approximate black hole binary spacetime via asymptotic matching. *Physical Review D*, 89: 084008. doi:10.1103/PhysRevD.89.084008.
- Musaev, E. T. (2016). Exceptional field theory: SL(5). *Journal of high energy physics: JHEP*, 2016(02): 012. doi:10.1007/JHEP02(2016)012.
- Musaev, E. (2016). Exotic branes in Double Field Theory. *EPJ Web of Conferences*, 125: 05017. doi:http://dx.doi.org/10.1051/epjconf/201612505017.
- Muschik, C. A., Hammerer, K., Polzik, E. S., & Cirac, J. I. (2013). Quantum Teleportation of Dynamics and Effective Interactions between Remote Systems. *Physical Review Letters*, 111(2): 020501. doi:10.1103/PhysRevLett.111.020501.
- Nandan, D., Plefka, J., Schlotterer, O., & Wen, C. (2016). Einstein-Yang-Mills from pure Yang-Mills amplitudes. *Journal of High Energy Physics*, 2016(10): 070, pp. 1-29. doi:10.1007/JHEP10(2016)070.
- Narain, G., & Sasakura, N. (2015). An OSP extension of Canonical Tensor Model. *Progress of Theoretical & Experimental Physics*, 2015(123): A05. doi: 10.1093/ptep/ptv169.
- Nguyen, T.-T.-H., Mow-Lowry, C. M., Slagmolen, B. J., Miller, J., Mullavey, A. J., Goßler, S., Altin, P. A., Shaddock, D. A., & McClelland, D. E. (2015). Frequency dependence of thermal noise in gram-scale cantilever flexures. *Physical Review D*, 92: 112004. doi:10.1103/PhysRevD.92.112004.
- Nice, D. J., Altieri, E., Bogdanov, S., Cordes, J. M., Farrington, D., Hessels, J. W. T., Kaspi, V. M., Lyne, A. G., Popa, L., Ransom, S. M., Sanpa-arsa, S., Stappers, B. W., Wang, Y., Allen, B., Bhat, N. D. R., Brazier, A., Camilo, F., Champion, D. J., Chatterjee, S., Crawford, F., Deneva, J. S., Desvignes, G., Freire, P. C. C., Jenet, F. A., Knispel, B., Lazarus, P., Lee, K. J., van Leeuwen, J., Lorimer, D. R., Lynch, R., McLaughlin, M. A., Scholz, P., Siemens, X., Stairs, I. H., Stovall, K., Venkataraman, A., & Zhu, W. (2013). Timing and Interstellar Scattering of Thirty-five Distant Pulsars Discovered in the PALFA Survey. *Astrophysical Journal*, 772: 50. doi:10.1088/0004-637X/772/1/50.
- Nicolai, H. (2014). Quantum Gravity: the view from particle physics. In *General Relativity, Cosmology and Astrophysics: Perspectives 100 years after Einstein's stay in Prague*. *Fundamental Theories of Physics* (pp. 369-387). Springer.
- Nielsen, A. B., & Firouzjaee, J. T. (2013). Conformally rescaled spacetimes and Hawking radiation. *General Relativity and Gravitation*, 45(9), 1815-1838. doi:10.1007/s10714-013-1560-7.
- Nielsen, A. B. (2013). Compact binary coalescence parameter estimations for 2.5 post-Newtonian aligned spinning waveforms. *Classical and quantum gravity*, 30(7): 075023. doi:10.1088/0264-9381/30/7/075023.
- Nielsen, A. B. (2016). On the distribution of stellar-sized black hole spins. *Journal of Physics: Conference Series*, 716(1): 012002. doi:10.1088/1742-6596/716/1/012002.
- Nimmrichter, S., Hornberger, K., & Hammerer, K. (2014). Optomechanical sensing of spontaneous wave-function collapse. *Physical Review Letters*, 113: 020405. doi:10.1103/PhysRevLett.113.020405.
- Nitz, A. H., Lundgren, A., Brown, D. A., Ochsner, E., Keppel, D., & Harry, I. W. (2013). Accuracy of gravitational waveform models for observing neutron-star-black-hole binaries in Advanced LIGO. *Physical Review D*, 88: 124039. doi:10.1103/PhysRevD.88.124039.
- Nofriaris, M., Gibert, F., Karnesis, N., Garcia, A. F., Hewitson, M., Heinzl, G., & Danzmann, K. (2013). Subtraction of temperature induced phase noise in the LISA frequency band. *Physical Review D*, 87: 102003. doi:10.1103/PhysRevD.87.102003.
- Nofriaris, M., Antonucci, F., Armano, M., Audley, H., Auger, G., Benedetti, M., Binetruy, P., Bogenstahl, J., Bortoluzzi, D., Brandt, N., Caleno, M., Cavalleri, A., Congedo, G., Cruise, M., Danzmann, K., De Marchi, F., Diaz-Aguilo, M., Diepholz, I., Dixon, G., Dolesi, R., Dunbar, N., Fauste, J., Ferraioli, L., Ferroni, V., Fichter, W., Fitcher, W., Fitzsimons, E., Freschi, M., García Marirrodiga, C., Gerndt, R., Gesa, L., Gibert, F., Giardini, D., Grimani, C., Grynagier, A., Guzman, F., Harrison, I., Heinzl, G., Hewitson, M., Hollington, D., Hoyland, D., Hueller, M., Huesler, J., Jennrich, O., Jetzer, P., Johlander, B., Karnesis, N., Korsakova, N., Killow, C., Llamas, X., Lloro, I., Lobo, A., Maarschalkerweerd, R., Madden, S., Mance, D., Martin, V., Mateos, I., McNamara, P., Mendes, J., Mitchell, E., Nicolodi, D., Perreux-Lloyd, M., Plagnol, E., Prat, P., Ramos-Castro, J., Reiche, J., Romera Perez, J. A., Robertson, D., Rozemeijer, H., Russano, G., Schleicher, A.,

## Publications by AEI Members and Guest Scientists

- Shaul, D., Sopena, C. F., Sumner, T. J., Taylor, A., Texier, D., Trenkel, C., Tu, H. B., Vitale, S., Wanner, G., Ward, H., Waschke, S., Wass, P., Wealthy, D., Wen, S., Weber, W., Ziegler, T., & Zweifel, P. (2013). State space modelling and data analysis exercises in LISA Pathfinder.
- Nofrarias, M., Karnesis, N., Gibert, F., Armano, M., Audley, H., Danzmann, K., Diepholz, I., Dolesi, R., Ferrarioli, L., Ferroni, V., Hewitson, M., Hueller, M., Inchauspe, H., Jennrich, O., Korsakova, P. W., McNamara, N., Plagnol, E., Thorpe, J. I., Vetrugno, D., Vitale, S., Wass, P., & Weber, W. J. (2016). Optimal design of calibration signals in space borne gravitational wave detectors. *Physical Review D*, 93: 102004. doi:10.1103/PhysRevD.93.102004.
- Notz, T. (2013). Closed Hypersurfaces Driven by Mean Curvature and Inner Pressure. *Communications on Pure and Applied Mathematics*, 66(5), 790-819. doi:10.1002/cpa.21436.
- Novak, J., & Kuzenko, S. (2017). Higher derivative couplings in supergravity. *Physics of Particles and Nuclei Letters*, 14(2): 271.
- Nungesser, E. (2013). Future non-linear stability for reflection symmetric solutions of the Einstein-Vlasov system of Bianchi types II and VI<sub>0</sub>. *Annales Henri Poincaré*, 14, 967-999. doi:10.1007/s00023-012-0201-0.
- Nungesser, E., & Lim, W. C. (2013). The electromagnetic spike solutions. *Classical and quantum gravity*, 30(23): 235020. doi:10.1088/0264-9381/30/23/235020.
- Nungesser, E., Andersson, L., Bose, S., & Coley, A. A. (2013). Isotropization of solutions of the Einstein-Vlasov system with Bianchi V symmetry. *General Relativity and Gravitation*, 46: 1628. doi:10.1007/s10714-013-1628-4.
- Nutma, T. (2014). xTras: a field-theory inspired xAct package for Mathematica. *Computer Physics Communications*, 185(6), 1719-1738. doi:10.1016/j.cpc.2014.02.006.
- Nutma, T., & Taronna, M. (2014). On conformal higher spin wave operators. *Journal of high energy physics: JHEP*, 2014(06): 066. doi:10.1007/JHEP06(2014)066.
- Nuttall, L. K., Massinger, T. J., Areeda, J., Betzwieser, J., Dwyer, S., Effler, A., Fisher, R. P., Fritschel, P., Kissel, J. S., Lundgren, A., Macleod, D. M., Martynov, D., McIver, J., Mullavey, A., Sigg, D., Smith, J. R., Vajente, G., Williamson, A. R., & Wipf, C. C. (2015). Improving the Data Quality of Advanced LIGO Based on Early Engineering Run Results. *Classical and quantum gravity*, 32(24): 245005. doi:10.1088/0264-9381/32/24/245005.
- Ohme, F., Nielsen, A. B., Keppel, D., & Lundgren, A. (2013). Statistical and systematic errors for gravitational-wave inspiral signals: A principal component analysis. *Physical Review D*, 88(4): 042002. doi:10.1103/PhysRevD.88.042002.
- Ohta, N., Percacci, R., & Pereira, A. D. (2016). Gauges and functional measures in quantum gravity I: Einstein theory. *Journal of high energy physics: JHEP*, 2016(6): 115. Retrieved from <http://arxiv.org/abs/1605.00454>.
- Oriti, D. (2013). The quantum geometry of tensorial group field theories. In C. Bai, J.-P. Gazeau, & M.-L. Ge (Eds.), *Symmetries and groups in contemporary physics: proceedings of the XXIX International Colloquium on Group-Theoretical Methods in Physics, ("Group 29")* (pp. 379-385). Singapore: World Scientific.
- Oriti, D., & Raasakka, M. (2014). Asymptotics of the Ponzano-Regge model with non-commutative metric boundary data. *SIGMA*, 10: 067. doi:10.3842/SIGMA.2014.067.
- Oriti, D. (2014). Disappearance and emergence of space and time in quantum gravity. *Studies in History and Philosophy of Science Part B: Studies in History and Philosophy of Modern Physics*, 46, 186-199. doi:10.1016/j.shpsb.2013.10.006.
- Oriti, D., Ryan, J. P., & Thürigen, J. (2015). Group field theories for all loop quantum gravity. *New Journal of Physics*, 17(2): 023042. doi:10.1088/1367-2630/17/2/023042.
- Oriti, D. (2014). Non-commutative quantum geometric data in group field theories. *Fortschritte der Physik*, 62(9-10), 841-854. doi:10.1002/prop.201400038.
- Oriti, D., Pranzetti, D., Ryan, J. P., & Sindoni, L. (2015). Generalized quantum gravity condensates for homogeneous geometries and cosmology. *Classical and quantum gravity*, 32(23): 235016. doi:10.1088/0264-9381/32/23/235016.
- Oriti, D. (2016). Group field theory as the second quantization of loop quantum gravity. *Classical and quantum gravity*, 33(8): 085005. doi:10.1088/0264-9381/33/8/085005.
- Oriti, D., & Kegeles, A. (2016). Generalised conservation laws in non-local field theories. *Journal of Physics A: Mathematical and Theoretical*, 49(13): 135401. doi:10.1088/1751-8113/49/13/135401.
- Oriti, D., Pranzetti, D., & Sindoni, L. (2016). Horizon entropy from quantum gravity condensates. *Physical Review Letters*, 116: 211301. doi:<http://dx.doi.org/10.1103/PhysRevLett.116.211301>.
- Oriti, D. (2016). A quantum field theory for the atoms of space. *Proceedings of Science*, FFP14: 172.
- Osborn, T., Forseth, E., Evans, C., & Hopper, S. (2014). Lorenz gauge gravitational self-force calculations of eccentric binaries using a frequency domain procedure. *Physical Review D*, 90: 104031. doi:10.1103/PhysRevD.90.104031.
- Paik, H. J., Griggs, C. E., Moody, M., Venkateswara, K., Lee, H. M., Nielsen, A. B., Majorana, E., & Harms, J. (2016). Low-frequency terrestrial tensor gravitational-wave detector. *Classical and quantum gravity*, 33(7): 075003. doi:<http://dx.doi.org/10.1088/0264-9381/33/7/075003>.
- Pan, Y., Buonanno, A., Fujita, R., Racine, E., & Tagoshi, H. (2013). Post-Newtonian factorized multipolar waveforms for spinning, nonprecessing black-hole binaries [Erratum: *Phys. Rev. D* 83, 064003 (2011)]. *Physical Review D*, 87(10): 109901. doi:10.1103/PhysRevD.87.109901.
- Pan, Y., Fujita, R., Buonanno, A., Racine, E., & Tagoshi, H. (2011). Post-Newtonian factorized multipolar waveforms for spinning, non-precessing black-hole binaries. *Physical Review D*, 83(6): 064003. doi:10.1103/PhysRevD.83.064003.
- Pan, Y., Buonanno, A., Taracchini, A., Boyle, M., Kidder, L. E., Mroue, A. H., Pfeiffer, H. P., Scheel, M. A., Szilagyi, B., & Zenginoglu, A. (2013). Stability of nonspinning effective-one-body model in approximating two-body dynamics and gravitational-wave emission. *Physical Review D*, 89(6): 061501. doi:10.1103/PhysRevD.89.061501.



## Publications by AEI Members and Guest Scientists

- Pan, Y., Buonanno, A., Taracchini, A., Kidder, L. E., Mroue, A. H., Pfeiffer, H. P., Scheel, M. A., & Szilagy, B. (2014). Inspiral-merger-ringdown waveforms of spinning, precessing black-hole binaries in the effective-one-body formalism. *Physical Review D*, 89(8): 084006. doi:10.1103/PhysRevD.89.084006.
- Pang, Y., & Rong, J. (2016). Evidence for the Holographic dual of N=3 Solution in Massive Type IIA. *Physical Review D*, 93: 065038. doi:10.1103/PhysRevD.93.065038.
- Pang, Y., Rong, J., & Su, N. (2016).  $\phi^3$  theory with  $F_4$  flavor symmetry in  $6-2\epsilon$  dimensions: 3-loop renormalization and conformal bootstrap. *Journal of high energy physics: JHEP*, 2016(12): 057. doi:10.1007/JHEP12(2016)057.
- Pang, Y., Sezgin, E., & Zhu, Y. (2017). One Loop Tests of Supersymmetric Higher Spin AdS4/CFT3. *Physical Review D*, 95: 026008. doi:10.1103/PhysRevD.95.026008.
- Pannarale, F., Berti, E., Kyutoku, K., & Shibata, M. (2013). Nonspinning black hole-neutron star mergers: a model for the amplitude of gravitational waveforms. *Physical Review D*, 88: 084011. doi:10.1103/PhysRevD.88.084011.
- Pannarale, F. (2013). The Black Hole Remnant of Black Hole-Neutron Star Coalescing Binaries. *Physical Review D*, 88(10): 104025. doi:10.1103/PhysRevD.88.104025.
- Papa, M. A., Eggenstein, H.-B., Walsh, S., Di Palma, I., Allen, B., Astone, P., Bock, O., Creighton, T. D., Keitel, D., Machenschalk, B., Prix, R., Siemens, X., Singh, A., Zhu, S., & Schutz, B. F. (2016). Hierarchical follow-up of sub-threshold candidates of an all-sky Einstein@Home search for continuous gravitational waves on LIGO sixth science run data. *Physical Review D*, 94: 122006. doi:10.1103/PhysRevD.94.032006.
- Pereira, A. D., Sobreiro, R. F., & Sorella, S. P. (2016). Non-perturbative BRST quantization of Euclidean Yang-Mills theories in Curci-Ferrari gauges. *European Physical Journal C*, 76(10): 529. doi:https://doi.org/10.1140/epjc/s10052-016-4368-2.
- Perreux-Lloyd, M., Danzmann, K., Fitzsimons, E. D., Heinzl, G., Hennig, J.-S., Killow, C. J., Lieser, M., Robertson, D. I., Schuster, S., Taylor, A., Tröbs, M., Ward, H., & Weise, D. (2015). Sub-system mechanical design for an eLISA optical bench. *Journal of Physics: Conference Series*, 610: 012032.
- Persson, D., & Volpato, R. (2014). Second Quantized Mathieu Moonshine. *Communications in Number Theory and Physics*, 8(3), 403-509. doi:10.4310/CNTP.2014.v8.n3.a2.
- Petiteau, A., Babak, S., Sesana, A., & de Araujo, M. (2013). Resolving multiple supermassive black hole binaries with pulsar timing arrays II: genetic algorithm implementation. *Physical Review D*, 87: 064036. doi:10.1103/PhysRevD.87.064036.
- Pletsch, H. J., Guillemot, L., Allen, B., Anderson, D., Aulbert, C., Bock, O., Champion, D. J., Eggenstein, H. B., Fehrmann, H., Hammer, D., Karuppusamy, R., Keith, M., Kramer, M., Machenschalk, B., Ng, C., Papa, M. A., Ray, P. S., & Siemens, X. (2013). Einstein@Home discovery of four young gamma-ray pulsars in Fermi LAT data. *The Astrophysical Journal Letters*, 779: L11. doi:10.1088/2041-8205/779/1/L11.
- Pletsch, H., & Clark, C. J. (2015). Gamma-ray Timing of Redback PSR J2339-0533: Hints for Gravitational Quadrupole Moment Changes. *The Astrophysical Journal*, 807(1): 18. doi:10.1088/0004-637X/807/1/18.
- Pletsch, H. J., & Clark, C. J. (2014). Optimized Blind Gamma-ray Pulsar Searches at Fixed Computing Budget. *Astrophysical Journal*, 795: 75. doi:10.1088/0004-637X/795/1/75.
- Polzik, E. S., & Hammerer, K. (2015). Trajectories without quantum uncertainties. *Annalen der Physik*, 527, A15-A20. doi:10.1002/andp.201400099.
- Pürrer, M., Hannam, M., & Ohme, F. (2016). Can we measure individual black-hole spins from gravitational-wave observations? *Physical Review D*, 93: 084042. doi:10.1103/PhysRevD.93.084042.
- Pürrer, M. (2016). Frequency domain reduced order model of aligned-spin effective-one-body waveforms with generic mass-ratios and spins. *Physical Review D*, 93: 064041. doi:10.1103/PhysRevD.93.064041.
- Radice, D., & Rezzolla, L. (2013). Universality and intermittency in relativistic turbulent flows of a hot plasma. *The Astrophysical Journal Letters*, 766: L10. doi:10.1088/2041-8205/766/1/L10.
- Radice, D., & Rezzolla, L. (2013). Universality and intermittency in relativistic turbulent flows of a hot gas. In N. Pogorelov, E. Audit, & G. Zank (Eds.), *NUMERICAL MODELING OF SPACE PLASMA FLOWS ASTRONUM-2012* (Astronomical Society of the Pacific Conference Series ) (pp. 25-30).
- Radice, D., Abdikamalov, E., Rezzolla, L., & Ott, C. D. (2013). A New Spherical Harmonics Scheme for Multi-Dimensional Radiation Transport I: Static Matter Configurations. *Journal of Computational Physics*, 242, 648-669. doi:http://dx.doi.org/10.1016/j.jcp.2013.01.048.
- Radice, D., Rezzolla, L., & Galeazzi, F. (2014). High-Order Fully General-Relativistic Hydrodynamics: new Approaches and Tests. *Classical and quantum gravity*, 31(7): 075012. doi:10.1088/0264-9381/31/7/075012.
- Radice, D., Rezzolla, L., & Galeazzi, F. (2014). Beyond second-order convergence in simulations of binary neutron stars in full general-relativity. *Monthly Notices of the Royal Astronomical Society: Letters*, 437, L46-L50. doi:10.1093/mnrasl/slt137.
- Radice, D., Ott, C., Abdikamalov, E., Couch, S. M., Haas, R., & Schnetter, E. (2016). Neutrino-Driven Convection in Core-Collapse Supernovae: High-Resolution Simulations. *The Astrophysical Journal*, 820: 76. doi:10.3847/0004-637X/820/1/76.
- Raetzl, D., Wilkens, M., & Menzel, R. (2016). The effect of entanglement in gravitational photon-photon scattering. *Europhysics Letters*, 115(5): 51002. doi:10.1209/0295-5075/115/51002.
- Rahman, R., & Taronna, M. (2017). Comments on Higher-Spin Fields in Nontrivial Backgrounds. In L. Brink (Ed.), *Higher Spin Gauge Theories* (pp. 381-390). World Scientific.
- Rampf, C. (2014). Frame dragging and Eulerian frames in General Relativity. *Physical Review D*, 89: 063509. doi:10.1103/PhysRevD.89.063509.

## Publications by AEI Members and Guest Scientists

- Rampf, C., & Wiegand, A. (2014). Relativistic Lagrangian displacement field and tensor perturbations. *Physical Review D*, 90: 123503. doi:10.1103/PhysRevD.90.123503.
- Rampf, C., Villone, B., & Frisch, U. (2015). How smooth are particle trajectories in a Lambda CDM Universe? *Monthly Notices of the Royal Astronomical Society*, 452(2), 1421-1436. doi:10.1093/mnras/stv1365.
- Rauer, H., Catala, C., Aerts, C., Appourchaux, T., Benz, W., Brandeker, A., Christensen-Dalsgaard, J., Deleuil, M., Gizon, L., Goupil, M.-J., Güdel, M., Janot-Pacheco, E., Mas-Hesse, M., Pagano, I., Piotto, G., Pollacco, D., Santos, N. C., Smith, A., Suárez, J.-C., Szabó, R., Udry, S., Adibekyan, V., Alibert, Y., Almenara, J.-M., Amaro-Seoane, P., Ammler-von Eiff, M., Asplund, M., Antonello, E., Ball, W., Barnes, S., Baudin, F., Belkacem, K., Bergemann, M., Bihain, G., Birch, A. C., Bonfils, X., Boisse, I., Bonomo, A. S., Borsari, F., Brandão, I. M., Brocato, E., Brun, S., Burleigh, M., Burston, R., Cabrera, J., Cassisi, S., Chaplin, W., Charpinet, S., Chiappini, C., Church, R. P., Csizmadia, S., Cunha, M., Damasso, M., Davies, M. B., Deeg, H. J., Díaz, R. F., Dreizler, S., Dreyer, C., Eggenberger, P., Ehrenreich, D., Eigmüller, P., Erikson, A., Farmer, R., Feltzing, S., de Oliveira Fialho, F., Figueira, P., Forveille, T., Fridlund, M., García, R. A., Giommi, P., Giuffrida, G., Godolt, M., Gomes da Silva, J., Granzer, T., Grenfell, J. L., Grottsch-Noels, A., Günther, E., Haswell, C. A., Hatzes, A. P., Hébrard, G., Hekker, S., Helled, R., Heng, K., Jenkins, J. M., Johansen, A., Khodachenko, M. L., Kislyakova, K. G., Kley, W., Kolb, U., Krivova, N., Kupka, F., Lammer, H., Lanza, A. F., Lebreton, Y., Magrin, D., Marcos-Arenal, P., Marrese, P. M., Marques, J. P., Martins, J., Mathis, S., Mathur, S., Messina, S., Miglio, A., Montalbán, J., Montalto, M., Monteiro, M. J. P. F. G., Moradi, H., Moravveji, E., Mordasini, C., Morel, T., Mortier, A., Nascimbeni, V., Nelson, R. P., Nielsen, M. B., Noack, L., Norton, A. J., Ofir, A., Oshagh, M., Ouazzani, R.-M., Pápics, P., Parro, V. C., Petit, P., Plez, B., Poretti, E., Quirenbach, A., Ragazzoni, R., Raimondo, G., Rainer, M., Reese, D. R., Redmer, R., Reffert, S., Rojas-Ayala, B., Roxburgh, I. W., Salmon, S., Santerne, A., Schneider, J., Schou, J., Schuh, S., Schunker, H., Silva-Valio, A., Silvotti, R., Skillen, I., Snellen, I., Sohl, F., Sousa, S. G., Sozzetti, A., Stello, D., Strassmeier, K. G., Svanda, M., Szabó, G. M., Tkachenko, A., Valencia, D., van Grootel, V., Vauclair, S. D., Ventura, P., Wagner, F. W., Walton, N. A., Weingrill, J., Werner, S. C., Wheatley, P. J., & Zwintz, K. (2014). The PLATO 2.0 Mission. *Experimental Astronomy*, 38(1-2), 249-330. doi:10.1007/s10686-014-9383-4.
- Ray, P. S., Ransom, S. M., Cheung, C. C., Giroletti, M., Cognard, I., Camilo, F., Bhattacharyya, B., Roy, J., Romani, R. W., Ferrara, E. C., Guillemot, L., Johnston, S., Keith, M., Kerr, M., Kramer, M., Pletsch, H., Parkinson, P. M. S., & Wood, K. S. (2013). Radio Detection of the Fermi LAT Blind Search Millisecond Pulsar J1311-3430. *Astrophysical Journal*, 763: L13. doi:10.1088/2041-8205/763/1/L13.
- Read, J., Baiotti, L., Creighton, J. D. E., Friedman, J. L., Giacomazzo, B., Kyutoku, K., Markakis, C., Rezzolla, L., Shibata, M., & Taniguchi, K. (2013). Matter effects on binary neutron star waveforms. *Physical Review D*, 88: 044042. doi:10.1103/PhysRevD.88.044042.
- Reiris, M. (2014). Stationary solutions and asymptotic flatness I. *Classical and quantum gravity*, 31(15): 155012. doi:10.1088/0264-9381/31/15/155012.
- Reiris, M. (2014). Stationary solutions and asymptotic flatness II. *Classical and quantum gravity*, 31(15): 155013. doi:10.1088/0264-9381/31/15/155013.
- Reiris, M. (2014). On the shape of bodies in General Relativistic regimes. *General Relativity and Gravitation*, 47: 1777-0. doi:10.1007/s10714-014-1777-0.
- Reiris, M. (2015). On Ricci curvature and volume growth in dimension three. *Journal of differential geometry*, 99 (2), 313-357. Retrieved from <http://arxiv.org/abs/1212.1317>.
- Reiris, M. (2015). On Perturbations of Extreme Kerr–Newman Black Holes and their Evolution. *Annales Henri Poincaré*, 16(7), 1551-1581. doi:10.1007/s00023-014-0365-x.
- Reiris, M. (2014). On extreme Kerr-throats and zero temperature black-holes. *Classical and Quantum Gravity*, 31(2): 025001. doi:10.1088/0264-9381/31/2/025001.
- Reiris, M. (2015). The asymptotic of static isolated systems and a generalized uniqueness for Schwarzschild. *Classical and quantum gravity*, 32(19): 195001. doi:10.1088/0264-9381/32/19/195001.
- Rendall, A. D., & Velazquez, J. J. L. (2014). Dynamical properties of models for the Calvin cycle. *Journal of dynamics and differential equations*, 26, 673-705. doi:10.1007/s10884-014-9385-y.
- Rendall, A. D. (2014). Construction of oscillatory singularities. In A. García-Parrado (Ed.), *Proceedings of the Spanish Relativity Meeting (ERES 2012) Progress in Mathematical Relativity, Gravitation and Cosmology*, Springer Proceedings in Mathematics & Statistics 60 (pp. 95-105). Berlin Heidelberg: Springer.
- Rendall, A. D. (2013). Multiple steady states in a mathematical model for interactions between T cells and macrophages. *Discrete and Continuous Dynamical Systems - Series B*, 18(3), 769 -782. doi:10.3934/dcdsb.2013.18.769.
- Rezzolla, L., & Takami, K. (2013). Black-hole production from ultrarelativistic collisions. *Classical and quantum gravity*, 30(1): 012001. doi:10.1088/0264-9381/30/1/012001.
- Rezzolla, L., & Zhidenko, A. (2014). New parametrization for spherically symmetric black holes in metric theories of gravity. *Physical Review D*, 90: 084009. doi:10.1103/PhysRevD.90.084009.
- Rezzolla, L. (2014). Three little pieces for computer and relativity. In *General Relativity, Cosmology and Astrophysics (Fundamental Theories of Physics, 177)* (pp. 391-425).
- Rinne, O., & Moncrief, V. (2013). Hyperboloidal Einstein-matter evolution and tails for scalar and Yang-Mills fields. *Classical and quantum gravity*, 30(9): 095009. doi:10.1088/0264-9381/30/9/095009.
- Rinne, O., & Moncrief, V. (2014). Evolution of the Einstein equations to future null infinity. In *Relativity and Gravitation*. Springer Proceedings in Physics (pp. 199-206). Springer.

## Publications by AEI Members and Guest Scientists

- Rinne, O. (2014). Formation and decay of Einstein-Yang-Mills black holes. *Physical Review D*, 90: 124084. doi:10.1103/PhysRevD.90.124084.
- Rinne, O. (2014). Numerical and analytical methods for asymptotically flat spacetimes. Habilitation Thesis. Retrieved from <http://arxiv.org/abs/1407.7407>.
- Roberts, L. F., Ott, C. D., Haas, R., O'Connor, E. P., Diener, P., & Schnetter, E. (2016). General Relativistic Three-Dimensional Multi-Group Neutrino Radiation-Hydrodynamics Simulations of Core-Collapse Supernovae. *The Astrophysical Journal*, 831(1): 98. doi:<http://dx.doi.org/10.3847/0004-637X/831/1/98>.
- Robertson, D. I., Fitzsimons, E. D., Killow, C. J., Perreux-Lloyd, M., Ward, H., Bryant, J., Cruise, A. M., Dixon, G., Hoyland, D., Smith, D., & Bogenstahl, J. (2013). Construction and testing of the optical bench for LISA Pathfinder. *Classical and quantum gravity*, 30(8): 085006. doi:10.1088/0264-9381/30/8/085006.
- Roedig, C., & Sesana, A. (2014). Migration of massive black hole binaries in self-gravitating accretion discs: Retrograde versus prograde. *Monthly Notices of the Royal Astronomical Society*, 439(4), 3476-3489. doi:10.1093/mnras/stu194.
- Rosado, P. A., & Sesana, A. (2014). Targeting supermassive black hole binaries and gravitational wave sources for the pulsar timing array. *Monthly Notices of the Royal Astronomical Society*, 439(4), 3986-4010. doi:10.1093/mnras/stu254.
- Rosado, P. A., Sesana, A., & Gair, J. (2015). Expected properties of the first gravitational wave signal detected with pulsar timing arrays. *Monthly Notices of the Royal Astronomical Society*, 451, 2417-2433. doi:10.1093/mnras/stv1098.
- Rosales, L. (2016). A Holder Estimate for Entire Solutions to the Two-Valued Minimal Surface Equation. *Proceedings of the American Mathematical Society*, 144, 1209-1221. doi:<http://dx.doi.org/10.1090/proc/12774>.
- Roth, A., & Hammerer, K. (2016). Synchronization of Active Atomic Clocks via Quantum and Classical Channels. *Physical Review A*, 94: 043841. doi:10.1103/PhysRevA.94.043841.
- Rupflin, M., Topping, P. M., & Zhu, M. (2013). Asymptotics of the Teichmüller harmonic map flow. *Advances in mathematics*, 244, 874-893. doi:<http://dx.doi.org/10.1016/j.aim.2013.05.021>.
- Rupflin, M., & Topping, P. M. (2014). A uniform Poincaré estimate for quadratic differentials on closed surfaces. *Calculus of Variations and Partial Differential Equations*, 0759. doi:10.1007/s00526-014-0759-0.
- Rupflin, M., & Topping, P. (2014). Flowing maps to minimal surfaces: Existence and uniqueness of solutions. *Annales de l'Institut Henri Poincaré (C) Non Linear Analysis*, 31, 349-368. doi:10.1016/j.anihpc.2013.03.008.
- Rupflin, M., & Topping, P. M. (2016). Flowing maps to minimal surfaces. *American Journal of Mathematics*, 138(4), 1095-1115. doi:<https://doi.org/10.1353/ajm.2016.0035>.
- Sambrowski, A., Vollmer, C. E., Baune, C., Fiurasek, J., & Schnabel, R. (2014). Weak-signal conversion from 1550nm to 532nm with 84% efficiency. *Optics Letters*, 39(10), 2979-2981. doi:10.1364/OL.39.002979.
- Sandin, P., Alhulaimi, B., & Coley, A. (2013). Stability of Einstein-Aether Cosmological Models. *Physical Review D*, 87: 044031. doi:10.1103/PhysRevD.87.044031.
- Sanjuan, J., Gohlke, M., Rasch, S., Abich, K., Görth, A., Heinzel, G., & Braxmaier, C. (2015). Interspacecraft link simulator for the laser ranging interferometer onboard GRACE Follow-On. *Applied Optics*, 54(22), 6682-6689. doi:10.1364/AO.54.006682.
- Sawadsky, A., Kaufer, H., Nia, R. M., Tarabrin, S., Khalili, F. Y., Hammerer, K., & Schnabel, R. (2015). Observation of generalized optomechanical coupling and cooling on cavity resonance. *Physical Review Letters*, 114: 043601. doi:10.1103/PhysRevLett.114.043601.
- Scarinci, C., & Krasnov, K. (2013). The Universal Phase Space of AdS3 Gravity. *Communications in Mathematical Physics*, 322, 167-205. doi:10.1007/s00220-012-1655-0.
- Schärer, A., Angélic, R., Bondarescu, R., Jetzer, P., & Lundgren, A. (2014). Testing scalar-tensor theories and parametrized post-Newtonian parameters in Earth orbit. *Physical Review D*, 90: 123005. doi:10.1103/PhysRevD.90.123005.
- Schell, C., & Rinne, O. (2015). Spectral approach to axisymmetric evolution of Einstein's equations. *Journal of Physics: Conference Series*, 600 (1): 012060. doi:10.1088/1742-6596/600/1/012060.
- Schlotterer, O., & Stieberger, S. (2013). Motivic Multiple Zeta Values and Superstring Amplitudes. *Journal of Physics A: Mathematical and Theoretical*, 46(47): 475401. doi:10.1088/1751-8113/46/47/475401.
- Schlotterer, O., Gomez, H., & Mafra, C. R. (2016). The two-loop superstring five-point amplitude and S-duality. *Physical Review D*, 93: 045030. doi:10.1103/PhysRevD.93.045030.
- Schlotterer, O. (2016). Amplitude relations in heterotic string theory and Einstein-Yang-Mills. *Journal of high energy physics: JHEP*, 2016(11): 074. doi:10.1007/JHEP11(2016)074.
- Schnabel, R., & LIGO Scientific Collaboration (2013). A gravitational wave detector operating beyond the quantum shot-noise limit: Squeezed light in application. *EPJ Web of Conferences*, 57: 02002. doi:10.1051/epjconf/20135702002.
- Schnabel, R. (2015). Einstein-Podolsky-Rosen - entangled motion of two massive objects. *Physical Review A*, 92: 012126. doi:10.1103/PhysRevA.92.012126.
- Schodel, R., Feldmeier, A., Künneriath, D., Stolovy, S., Neumayer, N., Amaro-Seoane, P., & Nishiyama, S. (2014). Surface Brightness Profile of the Milky Way's Nuclear Star Cluster. *Astronomy and Astrophysics*, 566: A47. doi:10.1051/0004-6361/201423481.
- Schoedel, R., Feldmeier, A., Künneriath, D., Stolovy, S., Neumayer, N., Amaro-Seoane, P., & Nishiyama, S. (2015). Surface brightness profile of the Milky Way's nuclear star cluster (Corrigendum). *Astronomy and Astrophysics*, 577: C1. doi:10.1051/0004-6361/201423481e.
- Schoedel, R., Feldmeier, A., Künneriath, D., Stolovy, S., Neumayer, N., Amaro-Seoane, P., & Nishiyama, S. (2015). Surface brightness profile of the Milky Way's nuclear star cluster (Corrigendum2). *Astronomy and Astrophysics*, 583: C1. doi:10.1051/0004-6361/201527565.

## Publications by AEI Members and Guest Scientists

- Scholz, P., Kaspi, V. M., Lyne, A. G., Stappers, B. W., Bogdanov, S., Cordes, J. M., Crawford, F., Ferdman, R. D., Freire, P. C. C., Hessels, J. W. T., Lorimer, D. R., Stairs, I. H., Allen, B., Brazier, A., Camilo, F., Cardoso, R. F., Chatterjee, S., Deneva, J. S., Jenet, F. A., Karako-Argaman, C., Knispel, B., Lazarus, P., Lee, K. J., van Leeuwen, J., Lynch, R., Madsen, E. C., McLaughlin, M. A., Ransom, S. M., Siemens, X., Spitler, L. G., Stovall, K., Swiggum, J. K., Venkataraman, A., & Zhu, W. W. (2015). Timing of five millisecond pulsars discovered in the PALFA survey. *Astrophysical Journal*, 800(2): 123. doi:10.1088/0004-637X/800/2/123.
- Scholz, P., Kaspi, V. M., Lyne, A. G., Stappers, B. W., Bogdanov, S., Cordes, J. M., Crawford, F., Ferdman, R. D., Freire, P. C. C., Hessels, J. W. T., Lorimer, D. R., Stairs, I. H., Allen, B., Brazier, A., Camilo, F., Cardoso, R. F., Chatterjee, S., Deneva, J. S., Jenet, F. A., Karako-Argaman, C., Knispel, B., Lazarus, P., Lee, K. J., van Leeuwen, J., Lynch, R., Madsen, E. C., McLaughlin, M. A., Ransom, S. M., Siemens, X., Spitler, L. G., Stovall, K., Swiggum, J. K., Venkataraman, A., & Zhu, W. W. (2015). ERRATUM: Timing of five millisecond pulsars discovered in the PALFA survey (2015, ApJ, 800, 123). *Astrophysical Journal*, 805(1): 85. doi:10.1088/0004-637X/805/1/85.
- Schreiber, E., Dooley, K. L., Vahlbruch, H., Affeldt, C., Bisht, A., Leong, J., Lough, J., Prijatelj, M., Slutsky, J., Was, M., Wittel, H., Danzmann, K., & Grote, H. (2016). Alignment sensing and control for squeezed vacuum states of light. *Optics Express*, 24(1), 146-152. doi:10.1364/OE.24.000146.
- Schuller, F. P., & Witte, C. (2014). How quantizable matter gravitates: a practitioner's guide. *Physical Review D*, 89: 104061. doi:10.1103/PhysRevD.89.104061.
- Schulte, M., Lörch, N., Leroux, I. D., Schmidt, P. O., & Hammerer, K. (2016). Quantum Algorithmic Readout in Multi-Ion Clocks. *Physical Review Letters*, 116(1): 013002. doi:10.1103/PhysRevLett.116.013002.
- Schuster, S., Wanner, G., Tröbs, M., & Heinzel, G. (2015). Vanishing tilt-to-length coupling for a singular case in two-beam laser interferometers with Gaussian beams. *Applied Optics*, 54(5), 1010-1014. doi:10.1364/AO.54.001010.
- Schuster, S., Tröbs, M., Wanner, G., & Heinzel, G. (2016). Experimental demonstration of reduced tilt-to-length coupling by a two-lens imaging system. *Optics Express*, 24(10), 10466-10475. doi:10.1364/OE.24.010466.
- Schütte, D., Hassen, S. S., Karvinen, K. S., Boyson, T. K., Kallapur, A. G., Song, H., Petersen, I. R., Huntington, E. H., & Heurs, M. (2016). Experimental Demonstration of Frequency Autolocking an Optical Cavity Using a Time-Varying Kalman Filter. *Physical Review Applied*, 5: 014005. doi:10.1103/PhysRevApplied.5.014005.
- Schutz, B. F. (2014). Gravity Talks: Observing the Universe with Gravitational Waves. In *General Relativity, Cosmology and Astrophysics (Fundamental Theories of Physics, 177)* (pp. 459-475).
- Schütze, D., Stede, G., Müller, V., Gerberding, O., Mahrtdt, C., Sheard, B., Heinzel, G., & Danzmann, K. (2013). LISA-like Laser Ranging for GRACE Follow-on.
- Schütze, D., Farrant, D., Shaddock, D., Sheard, B., Heinzel, G., & Danzmann, K. (2014). Measuring coalignment of retroreflectors with large lateral incoming-outgoing beam offset. *Review of Scientific Instruments*, 85: 035103. doi:10.1063/1.4866682.
- Schütze, D., Stede, G., Müller, V., Gerberding, O., Bandikova, T., Sheard, B., Heinzel, G., & Danzmann, K. (2014). Laser beam steering for GRACE Follow-On intersatellite interferometry. *Optics Express*, 22(20), 24117-24132. doi:10.1364/OE.22.024117.
- Schütze, D., Müller, V., & Heinzel, G. (2014). Precision absolute measurement and alignment of laser beam direction and position. *Applied Optics*, 53, 6503-6507. doi:10.1364/AO.53.006503.
- Schütze, D., Müller, V., Stede, G., Sheard, B., Heinzel, G., Danzmann, K., Sutton, A. J., & Shaddock, D. A. (2014). Retroreflector for GRACE follow-on: Vertex vs. point of minimal coupling. *Optics Express*, 22(8), 9324-9333. doi:10.1364/OE.22.009324.
- Schütze, D. (2016). Measuring Earth: Current status of the GRACE Follow-On Laser Ranging Interferometer. *Journal of Physics: Conference Series*, 716: 012005.
- Schwarze, T. S., Gerberding, O., Guzman Cervantes, F., Heinzel, G., & Danzmann, K. (2014). Advanced phasemeter for deep phase modulation interferometry. *Optics Express*, 22(15): 018214, pp. 18214-18223. doi:10.1364/OE.22.018214.
- Schwarze, T., Fernandez Barranco, G., Penkert, D., Gerberding, O., Heinzel, G., & Danzmann, K. (2016). Optical test-bed for the LISA phasemeter. *Journal of Physics: Conference Series*, 716(1): 012004.
- Schwimmer, A., & Theisen, S. (2014). Comments on the Algebraic Properties of Dilaton Actions. *Journal of High Energy Physics*, 2014: 012. doi:10.1007/JHEP05(2014)012.
- Sennett, N., & Buonanno, A. (2016). Modeling dynamical scalarization with a resummed post-Newtonian expansion. *Physical Review D*, 93: 124004. doi:http://dx.doi.org/10.1103/PhysRevD.93.124004.
- Sennett, N., Marsat, S., & Buonanno, A. (2016). Gravitational waveforms in scalar-tensor gravity at 2PN relative order. *Physical Review D*, 94: 084003. doi:10.1103/PhysRevD.94.084003.
- Sesana, A. (2013). Detecting Massive Black Hole Binaries and Unveiling their Cosmic History with Gravitational Wave Observations. In *ASP Conference Series Volumes* (pp. 103-114).
- Sesana, A. (2013). Gravitational wave emission from binary supermassive black holes. *Classical and quantum gravity*, 30(24): 244009. doi:10.1088/0264-9381/30/24/244009.
- Sesana, A., Barausse, E., Dotti, M., & Rossi, E. M. (2014). Linking the spin evolution of massive black holes to galaxy kinematics. *Astrophysical Journal*, 794: 104. doi:10.1088/0004-637X/794/2/104.
- Sesana, A., Weber, W. J., Killow, C. J., Perreux-Lloyd, M., Robertson, D. I., Ward, H., Fitzsimons, E. D., Bryant, J., Cruise, A. M., Dixon, G., Hoyland, D., Smith, D., Bogenstahl, J., McNamara, P. W., Gerndt, R., Flatscher, R., Hechenblaikner, G., Hewitson, M., Gerberding, O., Barke, S., Brause, N., Bykov, I., Danzmann, K., Enggaard, A., Gianolio, A., Hansen, T. V., Heinzel, G., Hornstrup, A., Jennrich, O., Kullmann, J., Møller-Pedersen, S., Rasmussen, T., Reiche, J.,

## Publications by AEI Members and Guest Scientists

- Sodnik, Z., Suess, M., Armano, M., Sumner, T., Bender, P. L., Akutsu, T., Sathyaprakash, B. S., & DECIGO working group (2014). Space-based detectors. *General Relativity and Gravitation*, 46: 1793. doi:10.1007/s10714-014-1793-0.
- Sesana, A. (2013). Gravitational wave science with laser interferometers and pulsar timing. *Brazilian Journal of Physics*, 43(5-6), 314-319. doi:10.1007/s13538-013-0138-x.
- Sesana, A. (2013). Insights on the astrophysics of supermassive black hole binaries from pulsar timing observations. *Classical and quantum gravity*, 30(22): 224014. doi:10.1088/0264-9381/30/22/224014.
- Sesana, A. (2013). Systematic investigation of the expected gravitational wave signal from supermassive black hole binaries in the pulsar timing band. *Monthly Notices of the Royal Astronomical Society: Letters*, 433(1), L1-L5. doi:10.1093/mnrasl/slt034.
- Shaltev, M., & Prix, R. (2013). Fully coherent follow-up of continuous gravitational-wave candidates. *Physical Review D*, 87: 084057. doi:10.1103/PhysRevD.87.084057.
- Shaltev, M., Leaci, P., Papa, M. A., & Prix, R. (2014). Fully coherent follow-up of continuous gravitational-wave candidates: an application to Einstein@Home results. *Physical Review D*, 89: 124030. doi:10.1103/PhysRevD.89.124030.
- Shannon, R. M., Chamberlin, S., Cornish, N. J., Ellis, J. A., Mingarelli, C. M. F., Perrodin, D., Rosado, P., Sesana, A., Taylor, S. R., Wen, L., Bassa, C. G., Gair, J., Janssen, G. H., Karuppusamy, R., Kramer, M., Lee, K. J., Liu, K., Mandel, I., Purver, M., Sidery, T., Smits, R., Stappers, B. W., & Vecchio, A. (2014). Summary of session C1: pulsar timing arrays. *General Relativity and Gravitation*, 46(8): 1765. doi:10.1007/s10714-014-1765-4.
- Shao, L. (2016). Testing the strong equivalence principle with the triple pulsar PSR J0337+1715. *Physical Review D*, 93: 084023. doi:http://dx.doi.org/10.1103/PhysRevD.93.084023.
- Shao, L., & Wex, N. (2016). Tests of Gravitational Symmetries with Radio Pulsars. *Science China Physics, Mechanics & Astronomy*, 59(9): 699501. doi:10.1007/s11433-016-0087-6.
- Shao, L. (2016). Experimental Studies on the Lorentz Symmetry in Post-Newtonian Gravity with Pulsars. *Universe*, 2(4): 29. doi:10.3390/universe2040029.
- Shibata, M., Taniguchi, K., Okawa, H., & Buonanno, A. (2014). Coalescence of binary neutron stars in a scalar-tensor theory of gravity. *Physical Review D*, 89: 084005. doi:10.1103/PhysRevD.89.084005.
- Sidery, T., Aylott, B., Christensen, N., Farr, B., Farr, W., Feroz, F., Gair, J., Grover, K., Graff, P., Hanna, C., Kalogera, V., Mandel, I., O'Shaughnessy, R., Pitkin, M., Price, L., Raymond, V., Roever, C., Singer, L., Van der Sluis, M., Smith, R. J. E., Vecchio, A., Veitch, J., & Vitale, S. (2014). Reconstructing the sky location of gravitational-wave detected compact binary systems: methodology for testing and comparison. *Physical Review D*, 89: 084060. doi:10.1103/PhysRevD.89.084060.
- Siegel, D. M., Ciolfi, R., & Rezzolla, L. (2014). Magnetically driven winds from differentially rotating neutron stars and X-ray afterglows of short gamma-ray bursts. *The Astrophysical Journal Letters*, 785: L6. doi:10.1088/2041-8205/785/1/L6.
- Siegel, D. M., & Roth, M. (2014). An upper bound from helioseismology on the stochastic background of gravitational waves. *Astrophysical Journal*, 784: 88. doi:10.1088/0004-637X/784/2/88.
- Siegel, D. M., & Roth, M. (2015). An upper bound from helioseismology on the stochastic background of gravitational waves [Erratum (2014, ApJ, 784, 88)]. *Astrophysical Journal*, 810(1): 84. doi:10.1088/0004-637X/810/1/84.
- Siegel, D., & Ciolfi, R. (2015). Magnetic field amplification in hypermassive neutron stars via the magnetorotational instability. In P. Nicolini (Ed.), *1st Karl Schwarzschild Meeting on Gravitational Physics (Springer Proceedings in Physics, 170)* (pp. 119-124). Heidelberg u.a.: Springer.
- Siegel, D., & Ciolfi, R. (2016). Electromagnetic emission from long-lived binary neutron star merger remnants I: formulation of the problem. *The Astrophysical Journal*, 819: 14. doi:10.3847/0004-637X/819/1/14.
- Siegel, D., & Ciolfi, R. (2016). Electromagnetic emission from long-lived binary neutron star merger remnants II: lightcurves and spectra. *The Astrophysical Journal*, 819: 15. doi:10.3847/0004-637X/819/1/15.
- Siegel, D. M., Ciolfi, R., Harte, A. I., & Rezzolla, L. (2013). Magnetorotational instability in relativistic hypermassive neutron stars. *Physical Review D*, 87: 121302. doi:10.1103/PhysRevD.87.121302.
- Siegel, D., & Ciolfi, R. (2015). Magnetically-induced outflows from binary neutron star merger remnants. *Proceedings of Science*, 169. Retrieved from <http://arxiv.org/abs/1505.01423>.
- Simakov, D. (2014). Time-domain analysis of a dynamically tuned signal recycled interferometer for the detection of chirp gravitational waves from coalescing compact binaries. *Physical Review D*, 90: 102003. doi:10.1103/PhysRevD.90.102003.
- Sindoni, L. (2013). Horizon thermodynamics in pregeometry. *Journal of Physics: Conference Series*, 410: 012140.
- Sindoni, L. (2013). Horizon thermodynamics and composite metrics. *Journal of Physics: Conference Series*, 410: 012140.
- Singer, L. P., Chen, H.-Y., Holz, D. E., Farr, W. M., Price, L. R., Raymond, V., Cenko, S. B., Gehrels, N., Cannizzo, J., Kasliwal, M. M., Nissanke, S., Coughlin, M., Farr, B., Urban, A. L., Vitale, S., Veitch, J., Graff, P., Berry, C. P. L., Mohapatra, S., & Mandel, I. (2016). Supplement: Going the Distance: Mapping Host Galaxies of LIGO and Virgo Sources in Three Dimensions Using Local Cosmography and Targeted Follow-up (2016, ApJL, 829, L15). *The Astrophysical Journal Supplement Series*, 226(1): 10. doi:http://dx.doi.org/10.3847/0067-0049/226/1/10.
- Singer, L. P., Chen, H.-Y., Holz, D. E., Farr, W. M., Price, L. R., Raymond, V., Cenko, S. B., Gehrels, N., Cannizzo, J., Kasliwal, M. M., Nissanke, S., Coughlin, M., Farr, B., Urban, A. L., Vitale, S., Veitch, J., Graff, P., Berry, C. P. L., Mohapatra, S., & Mandel, I. (2016). Going the Distance: Mapping Host Galaxies of LIGO and Virgo Sources in Three Dimensions Using Local Cosmography and Targeted Follow-up. *The Astrophysical Journal Letters*, 829(1): L15. doi:http://dx.doi.org/10.3847/0067-0049/226/1/10.

## Publications by AEI Members and Guest Scientists

- Singh, A., Papa, M. A., Eggenstein, H.-B., Zhu, S., Pletsch, H., Allen, B., Bock, O., Maschenchalk, B., Prix, R., & Siemens, X. (2016). Results of an all-sky high-frequency Einstein@Home search for continuous gravitational waves in LIGO 5th Science Run. *Physical Review D*, 94: 064061. doi:10.1103/PhysRevD.94.064061.
- Skvortsov, E. D., & Taronna, M. (2015). On Locality, Holography and Unfolding. *Journal of High Energy Physics*, 2015(11): 044. doi:10.1007/JHEP11(2015)044.
- Smerlak, M., & Singh, S. (2013). New perspectives on Hawking radiation. *Physical Review D*, 88(10): 104023. doi:10.1103/PhysRevD.88.104023.
- Smith, R. J. E., Cannon, K., Hanna, C., Keppel, D., & Mandel, I. (2013). Towards Rapid Parameter Estimation on Gravitational Waves from Compact Binaries using Interpolated Waveforms. *Physical Review D*, 87: 122002. doi:10.1103/PhysRevD.87.122002.
- Smith, R., Field, S. E., Blackburn, K., Haster, C.-J., Pürrer, M., Raymond, V., & Schmidt, P. (2016). Fast and Accurate Inference on Gravitational Waves from Preprocessing Compact Binaries. *Physical Review D*, 94: 044031. doi:10.1103/PhysRevD.94.044031.
- Song, H., Yonezawa, H., Kuntz, K. B., Heurs, M., & Huntington, E. H. (2014). Quantum teleportation in space and frequency using entangled pairs of photons from a frequency comb. *Physical Review A: Atomic, Molecular, and Optical Physics*, 90: 042337. doi:10.1103/PhysRevA.90.042337.
- Spallicci, A. D. A. M., Ritter, P., & Aoudia, S. (2014). Self-force driven motion in curved spacetimes. *International Journal of Geometric Methods in Modern Physics*, 11(8): 1450072. doi:10.1142/S0219887814500728.
- Spector, A. D., Pödl, J. H., Bähre, R., Lindner, A., & Willke, B. (2016). Characterization of optical systems for the ALPS II experiment. *Optics Express*, 24(25), 29237-29245. doi:https://doi.org/10.1364/OE.24.029237.
- Spiridonov, V. P., & Vartanov, G. S. (2014). Elliptic hypergeometry of supersymmetric dualities II. Orthogonal groups, knots, and vortices. *Communications in Mathematical Physics*, 325(2), 421-486. doi:10.1007/s00220-013-1861-4.
- Spitler, L. G., Cordes, J. M., Hessels, J. W. T., Lorimer, D. R., McLaughlin, M. A., Chatterjee, S., Crawford, F., Deneva, J. S., Kaspi, V. M., Wharton, R. S., Allen, B., Bogdanov, S., Brazier, A., Camilo, F., Freire, P. C. C., Jenet, F. A., Karako-Argaman, C., Knispel, B., Lazarus, P., Lee, K. J., van Leeuwen, J., Lynch, R., Lyne, A. G., Ransom, S. M., Scholz, P., Siemens, X., Stairs, I. H., Stovall, K., Swiggum, J. K., Venkataraman, A., Zhu, W. W., Aulbert, C., & Fehrmann, H. (2014). Fast Radio Burst Discovered in the Arecibo Pulsar ALFA Survey. *Astrophysical Journal*, 790(2): 101. doi:10.1088/0004-637X/790/2/101.
- Steinhoff, J., & Puetzfeld, D. (2015). Influence of Internal Structure on the Motion of Test Bodies in Extreme Mass Ratio Situations. In K. Rosquist, R. T. Jantzen, & R. Ruffini (Eds.), *Proceedings of the MG13 Meeting on General Relativity* (pp. 978-980). World Scientific.
- Steinhoff, J. (2015). Spin and quadrupole contributions to the motion of astrophysical binaries. In *Equations of Motion in Relativistic Gravity. Fundamental Theories of Physics* (pp. 615-649). Heidelberg u.a.: Springer.
- Steinhoff, J., Hinderer, T., Taracchini, A., & Buonanno, A. (2016). Dynamical tides in general relativity: effective action and effective-one-body hamiltonian. *Physical Review D*, 94: 104028. doi:10.1103/PhysRevD.94.104028.
- Steinlechner, J., Ast, S., Krüger, C., Singh, A. P., Eberle, T., Händchen, V., & Schnabel, R. (2013). Absorption Measurements of Periodically Poled Potassium Titanyl Phosphate (PPKTP) at 775 nm and 1550 nm. *Sensors*, 13(1), 565-573. doi:10.3390/s130100565.
- Steinlechner, S., Bauchrowitz, J., Eberle, T., & Schnabel, R. (2013). Strong Einstein-Podolsky-Rosen steering with unconditional entangled states. *Physical Review A*, 87: 022104. doi:10.1103/PhysRevA.87.022104.
- Steinlechner, S., Bauchrowitz, J., Meinders, M., Müller-Ebhardt, H., Danzmann, K., & Schnabel, R. (2013). Quantum-Dense Metrology. *Nature Photonics*, 7: 150, pp. 626-630. doi:10.1038/nphoton.2013.150.
- Steinlechner, J., Khalaidovski, A., & Schnabel, R. (2014). Optical Absorption Measurement at 1550 nm on a Highly-Reflective Si/SiO<sub>2</sub> Coating Stack. *Classical and quantum gravity*, 31(10): 105005. doi:10.1088/0264-9381/31/10/105005.
- Steinlechner, J., Krüger, C., Lastzka, N., Steinlechner, S., Khalaidovski, A., & Schnabel, R. (2013). Optical Absorption Measurements on Crystalline Silicon at 1550nm. *Classical and quantum gravity*, 30(9): 095007. doi:10.1088/0264-9381/30/9/095007.
- Steinlechner, J., Martin, I. W., Hough, J., Krueger, C., Rowan, S., & Schnabel, R. (2015). Thermal Noise Reduction and Absorption Optimization via Multi-Material Coatings. *Physical Review D*, 91: 042001. doi:10.1103/PhysRevD.91.042001.
- Stovall, K., Allen, B., Bogdanov, S., Brazier, A., Camilo, F., Cardoso, F., Chatterjee, S., Cordes, J. M., Crawford, F., Deneva, J. S., Ferdman, R., Freire, P. C. C., Hessels, J. W. T., Jenet, F., Kaplan, D. L., Karako-Argaman, C., Kaspi, V. M., Knispel, B., Kotulla, R., Lazarus, P., Lee, K. J., van Leeuwen, J., Lynch, R., Lyne, A. G., Madsen, E., McLaughlin, M. A., Patel, C., Ransom, S. M., Scholz, P., Siemens, X., Stairs, I. H., Stappers, B. W., Swiggum, J., Zhu, W. W., & Venkataraman, A. (2016). Timing of Five PALFA-Discovered Millisecond Pulsars. *The Astrophysical Journal*, Volume, 833(2): 192. doi:10.3847/1538-4357/833/2/192.
- Swiggum, J. K., Lorimer, D. R., McLaughlin, M. A., Bates, S. D., Champion, D. J., Ransom, S. M., Lazarus, P., Brazier, A., Hessels, J. W. T., Nice, D. J., Ellis, J., Senty, T. R., Allen, B., Bhat, N. D. R., Bogdanov, S., Camilo, F., Chatterjee, S., Cordes, J. M., Crawford, F., Deneva, J. S., Freire, P. C. C., Jenet, F. A., Karako-Argaman, C., Kaspi, V. M., Knispel, B., Lee, K. J., Van Leeuwen, J., Lynch, R., Lyne, A. G., Scholz, P., Siemens, X., Stairs, I. H., Stappers, B. W., Stovall, K., Venkataraman, A., & Zhu, W. W. (2014). Arecibo Pulsar Survey Using ALFA. III. Precursor Survey and Population Synthesis. *The Astrophysical Journal*, 787(2): 137. doi:10.1088/0004-637X/787/2/137.
- Szilágyi, B., Blackman, J., Buonanno, A., Taracchini, A., Pfeiffer, H. P., Scheel, M. A., Chu, T., Kidder, L. E., & Pan, a. Y. (2015). Approaching the Post-Newtonian Regime with Numerical Relativity: A Compact-Object Binary Simulation Spanning 350 Gravitational-Wave Cycles. *Physical Review Letters*, 115: 031102. doi:10.1103/PhysRevLett.115.031102.

## Publications by AEI Members and Guest Scientists

- Tacik, N., Foucart, F., Pfeiffer, H. P., Haas, R., Ossokine, S., Kaplan, J., Muhlberger, C., Duez, M. D., Kidder, L. E., Scheel, M. A., & Szilágyi, B. (2015). Binary Neutron Stars with Arbitrary Spins in Numerical Relativity. *Physical Review D*, 92: 124012. doi:10.1103/PhysRevD.92.124012.
- Takami, K., Rezzolla, L., & Baiotti, L. (2014). Constraining the Equation of State of Neutron Stars from Binary Mergers. *Physical Review Letters*, 113: 091104. doi:10.1103/PhysRevLett.113.091104.
- Takami, K., Rezzolla, L., & Baiotti, L. (2015). Extracting Information on the Equation of State from Binary Neutron Stars. In *1st Karl Schwarzschild Meeting on Gravitational Physics (Springer Proceedings in Physics, 170)* (pp. 125-131). Heidelberg u.a.: Springer.
- Taniguchi, K., Shibata, M., & Buonanno, A. (2015). Quasiequilibrium sequences of binary neutron stars undergoing dynamical scalarization. *Physical Review D*, 91: 024033. doi:10.1103/PhysRevD.91.024033.
- Tarabrin, S. P., Khalili, F. Y., Kaufer, H., Schnabel, R., & Hammerer, K. (2013). Anomalous dynamic backaction in interferometers. *Physical Review A*, 88: 023809. doi:10.1103/PhysRevA.88.023809.
- Taracchini, A., Buonanno, A., Hughes, S. A., & Khanna, G. (2013). Erratum: Modeling the horizon-absorbed gravitational flux for equatorial-circular orbits in Kerr spacetime [Phys. Rev. D 88, 044001 (2013)]. *Physical Review D*, 88(10): 109903. doi:10.1103/PhysRevD.88.109903.
- Taracchini, A., Buonanno, A., Khanna, G., & Hughes, S. A. (2014). Small mass plunging into a Kerr black hole: Anatomy of the inspiral-merger-ringdown waveforms. *Physical Review D*, 90: 084025. doi:10.1103/PhysRevD.90.084025.
- Taracchini, A., Buonanno, A., Hughes, S. A., & Khanna, G. (2013). Modeling the horizon-absorbed gravitational flux for equatorial-circular orbits in Kerr spacetime. *Physical Review D*, 88(4): 044001. doi:10.1103/PhysRevD.88.044001.
- Taracchini, A., Buonanno, A., Pan, Y., Hinderer, T., Boyle, M., Hemberger, D. A., Kidder, L. E., Lovelace, G., Mroue, A. H., Pfeiffer, H. P., Scheel, M. A., Szilágyi, B., Taylor, N. W., & Zenginoglu, A. (2014). Effective-one-body model for black-hole binaries with generic mass ratios and spins. *Physical Review D*, 89(6): 061502. doi:10.1103/PhysRevD.89.061502.
- Taylor, S. R., Mingarelli, C. M. F., Gair, J. R., Sesana, A., Theureau, G., Babak, S., Bassa, C. G., Brem, P., Burgay, M., Caballero, R. N., Champion, D. J., Cognard, I., Desvignes, G., Guillemot, L., Hessels, J. W. T., Janssen, G. H., Karuppusamy, R., Kramer, M., Lassus, A., Lazarus, P., Lentati, L., Liu, K., Osłowski, S., Perrodin, D., Petiteau, A., Possenti, A., Purver, M. B., Rosado, P. A., Sanidas, S. A., Smits, R., Stappers, B., Tiburzi, C., Haasteren, R. v., Vecchio, A., & Verbiest, J. P. W. (2015). Limits on anisotropy in the nanohertz stochastic gravitational-wave background. *Physical Review Letters*, 115: 041101. doi:10.1103/PhysRevLett.115.041101.
- Terán, M., Martín, V., Gesa, L. I., Mateos, I., Gibert, F., Karnesis, N., Ramos-Castro, J., Schwarze, T. S., Gerberding, O., Heinzl, G., Guzman, F., & Nofrarias, M. (2015). Towards a FPGA-controlled deep phase modulation interferometer. *Journal of Physics: Conference Series*, 610: 012042.
- The LIGO Scientific Collaboration, The Virgo Collaboration, Abbott, B. P., Abbott, R., Abbott, T. D., Abernathy, M. R., Acernese, F., Ackley, K., Adams, C., Adams, T., Addesso, P., Adhikari, R. X., Adya, V. B., Affeldt, C., Agathos, M., Agatsuma, K., Aggarwal, N., Aguiar, O. D., Aiello, L., Ain, A., Ajith, P., Allen, B., Allocca, A., Altin, P. A., Anderson, S. B., Anderson, W. G., Arai, K., Araya, M. C., Arceneaux, C. C., Areeda, J. S., Arnaud, N., Arun, K. G., Ascenzi, S., Ashton, G., Ast, S., Aston, S. M., Astone, P., Aufmuth, P., Aulbert, C., Babak, S., Bacon, P., Bader, M. K. M., Baker, P. T., Baldacci, F., Ballardin, G., Ballmer, S. W., Barayoga, J. C., Barclay, S. E., Barish, B. C., Barker, D., Barone, F., Barr, B., Barsotti, L., Barsuglia, M., Barta, D., Bartlett, J., Bartos, I., Bassiri, R., Basti, A., Batch, J. C., Baune, C., Bavigadva, V., Bazzan, M., Behnke, B., Bejger, M., Bell, A. S., Bell, C. J., Berger, B. K., Bergman, J., Bergmann, G., Berry, C. P. L., Bersanetti, D., Bertolini, A., Betzwieser, J., Bhagwat, S., Bhandare, R., Bilenko, I. A., Billingsley, G., Birch, J., Birney, R., Biscans, S., Bisht, A., Bitossi, M., Biwer, C., Bizouard, M. A., Blackburn, J. K., Blair, C. D., Blair, D. G., Blair, R. M., Bloemen, S., Bock, O., Bodiya, T. P., Boer, M., Bogaert, G., Bogan, C., Bohe, A., Bohémier, K., Bojtos, P., Bond, C., Bondu, F., Bonnand, R., Boom, B. A., Bork, R., Boschi, V., Bose, S., Bouffanais, Y., Bozzi, A., Bradaschia, C., Brady, P. R., Braginsky, V. B., Branchesi, M., Brau, J. E., Briant, T., Brillet, A., Brinkmann, M., Brisson, V., Brockill, P., Brooks, A. F., Brown, D. A., Brown, D. D., Brown, N. M., Buchanan, C. C., Buikema, A., Bulik, T., Bulten, H. J., Buonanno, A., Buskulic, D., Buy, C., Byer, R. L., Cabero, M., Cadonati, L., Cagnoli, G., Cahillane, C., Calderón Bustillo, J., Callister, T., Calloni, E., Camp, J. B., Cannon, K. C., Cao, J., Capano, C., Capocasa, E., Carbognani, F., Caride, S., Diaz, J. C., Casentini, C., Caudill, S., Cavaglià, M., Cavalier, F., Cavalieri, R., Cella, G., Cepeda, C. B., Baiardi, L. C., Cerretani, G., Cesarini, E., Chakraborty, R., Chalermongsak, T., Chamberlin, S. J., Chan, M., Chao, S., Charlton, P., Chassande-Mottin, E., Chen, H. Y., Chen, Y., Cheng, C., Chincarini, A., Chiummo, A., Cho, H. S., Cho, M., Chow, J. H., Christensen, N., Chu, Q., Chua, S., Chung, S., Ciani, G., Clara, F., Clark, J. A., Clayton, J. H., Cleva, F., Coccia, E., Cohadon, P.-F., Cokelaer, T., Colla, A., Collette, C. G., Cominsky, L., Constancio, M., Conte, A., Conti, L., Cook, D., Corbitt, T. R., Cornish, N., Corsi, A., Cortese, S., Costa, C. A., Coughlin, M. W., Coughlin, S. B., Coulon, J.-P., Countryman, S. T., Couvares, P., Cowan, E. E., Coward, D. M., Cowart, M. J., Coyne, D. C., Coyne, R., Craig, K., Creighton, J. D. E., Creighton, T. D., Cripe, J., Crowder, S. G., Cumming, A., Cunningham, L., Cuoco, E., Canton, T. D., Danilishin, S. L., D'Antonio, S., Danzmann, K., Darman, N. S., Dattilo, V., Dave, I., Daveloza, H. P., Davier, M., Davies, G. S., Daw, E. J., Day, R., De, S., DeBra, D., Debreczeni, G., Degallaix, J., De Laurentis, M., Deléglise, S., Del Pozzo, W., Denker, T., Dent, T., Dereli, H., Dergachev, V., DeRosa, R. T., De Rosa, R., DeSalvo, R., Dhurandhar, S., Diaz, M. C., Dietz, A., Di Fiore, L., Di Giovanni, M., Di Lieto, A., Di Pace, S., Di Palma, I., Di Virgilio, A., Dojcinoski, G., Dolique, V., Donovan, F., Dooley, K., Doravari, S., Douglas, R., Downes, T. P., Drago, M., Drever, R. W. P., Driggers, J. C., Du, Z., Ducrot, M., Dwyer, S. E., Edo, T. B., Edwards, M. C., Effler, A., Eggenstein, H.-B., Ehrens, P., Eichholz, J., Eikenberry, S. S., Engels, W., Essick, R. C., Etzel, T., Evans, M., Evans, T. M., Everett, R., Factorovich, M., Fafone, V., Fair, H., Fairhurst, S., Fan, X., Fang, Q., Farinon, S., Farr, B., Farr, W. M., Favata, M., Fays, M., Fehrmann, H., Fejer, M. M., Ferrante, I., Ferreira, E. C., Ferrini, F., Fidecaro, F., Fiori, I., Fiorucci, D., Fisher, R. P., Flaminio, R., Fletcher, M., Fotopoulos, N., Fournier, J.-D., Franco, S., Frasca, S., Frasconi, F., Frei, M., Frei, Z., Freise, A., Frey, R., Frey, V., Fricke, T. T., Fritschel, P., Frolov, V. V., Fulda, P., Fyffe, M., Gabbard, H. A. G., Gair, J. R., Gammaitoni, L., Gaonkar, S. G., Garufi, F., Gatto, A., Gaur, G., Gehrels, N., Gemme, G., Gendre, B., Genin, E., Gennai, A., George, J., Gergely, L., Germain, V., Ghosh, A., Ghosh, S., Giaime, J. A., Giardina, K. D., Giazotto, A., Gill, K., Glaefke, A., Goetz, E., Goetz, R., Goggin, L. M., Gondan, L., González, G., Castro, J. M. G., Gopakumar, A., Gordon, N. A., Gorodetsky, M. L., Gosan, S. E., Gosselin, M., Gouaty, R., Graef, C., Graff, P. B., Granata, M., Grant, A., Gras, S., Gray, C., Greco, G., Green,

## Publications by AEI Members and Guest Scientists

A. C., Groot, P., Grote, H., Grunewald, S., Guidi, G. M., Guo, X., Gupta, A., Gupta, M. K., Gushwa, K. E., Gustafson, E. K., Gustafson, R., Hacker, J. J., Hall, B. R., Hall, E. D., Hammond, G., Haney, M., Hanke, M. M., Hanks, J., Hanna, C., Hannam, M. D., Hanson, J., Hardwick, T., Harms, J., Harry, G. M., Harry, I. W., Hart, M. J., Hartman, M. T., Haster, C.-J., Haughian, K., Heidmann, A., Heintze, M. C., Heitmann, H., Hello, P., Hemming, G., Hendry, M., Heng, I. S., Hennig, J., Heptonstall, A. W., Heurs, M., Hild, S., Hoak, D., Hodge, K. A., Hofman, D., Hollitt, S. E., Holt, K., Holz, D. E., Hopkins, P., Hosken, D. J., Hough, J., Houston, E. A., Howell, E. J., Hu, Y. M., Huang, S., Huerta, E. A., Huet, D., Hughey, B., Husa, S., Huttner, S. H., Huynh-Dinh, T., Idrisy, A., Indik, N., Ingram, D. R., Inta, R., Isa, H. N., Isac, J.-M., Isi, M., Islas, G., Isogai, T., Iyer, B. R., Izumi, K., Jacqmin, T., Jang, H., Jani, K., Jaranowski, P., Jawahar, S., Jiménez-Forsteza, F., Johnson, W. W., Jones, D. I., Jones, G., Jones, R., Jonker, R. J. G., Ju, L., K. H., Kalaghatgi, C. V., Kalogera, V., Kandhasamy, S., Kang, G., Kanner, J. B., Karki, S., Kasprzack, M., Katsavounidis, E., Katzman, W., Kaufer, S., Kaur, T., Kawabe, K., Kawazoe, F., Kéfélian, F., Kehl, M. S., Keitel, D., Kelley, D. B., Kells, W., Keppel, D. G., Kennedy, R., Key, J. S., Khalaidovski, A., Khalili, F. Y., Khan, I., Khan, S., Khan, Z., Khazanov, E. A., Kijbunchoo, N., Kim, C., Kim, J., Kim, K., Kim, N.-G., Kim, N., Kim, Y.-M., King, E. J., King, P. J., Kinzel, D. L., Kissel, J. S., Kleybolte, L., Klimenko, S., Koehlenbeck, S. M., Kokeyama, K., Koley, S., Kondrashov, V., Kontos, A., Korobko, M., Korth, H., Kowalska, I., Kozak, D. B., Kringel, V., Krishnan, B., Królak, A., Krueger, C., Kuehn, G., Kumar, P., Kuo, L., Kutynia, A., Lackey, B. D., Landry, M., Lange, J., Lantz, B., Lasky, P. D., Lazzarini, A., Lazzaro, C., Leaci, P., Leavey, S., Lebigot, E. O., Lee, C. H., Lee, H. K., Lee, H. M., Lee, K., Lenon, A., Leonardi, M., Leong, J. R., Leroy, N., Letendre, N., Levin, Y., Levine, B. M., Li, T. G. F., Libson, A., Littenberg, T. B., Lockerbie, N. A., Logue, J., Lombardi, A. L., Lord, J. E., Lorenzini, M., Lorient, V., Lormand, M., Losurdo, G., Lough, J. D., Lück, H., Lundgren, A., Luo, J., Lynch, R., Ma, Y., MacDonald, T., Machenschalk, B., MacInnis, M., Macleod, D. M., Magana-Sandoval, F., Magee, R. M., Mageswaran, M., Majorana, E., Maksimovic, I., Malvezzi, V., Man, N., Mandel, I., Mandic, V., Mangano, V., Mansell, G. L., Manske, M., Mantovani, M., Marchesoni, F., Marion, F., Márka, S., Márka, Z., Markosyan, A. S., Maros, E., Martelli, F., Martellini, L., Martin, I. W., Martin, R. M., Martynov, D. V., Marx, J. N., Mason, K., Masserot, A., Massinger, T. J., Masso-Reid, M., Matichard, F., Matone, L., Mavalvala, N., Mazumder, N., Mazzolo, G., McCarthy, R., McClelland, D. E., McCormick, S., McGuire, S. C., McIntyre, G., McIver, J., McKechn, D. J. A., McManus, D. J., McWilliams, S. T., Meacher, D., Meadors, G. D., Meidam, J., Melatos, A., Mendell, G., Mendoza-Gandara, D., Mercer, R. A., Merilh, E., Merzougui, M., Meshkov, S., Messaritari, E., Messenger, C., Messick, C., Meyers, P. M., Mezzani, F., Miao, H., Michel, C., Middleton, H., Mikhailov, E. E., Milano, L., Miller, J., Millhouse, M., Minenkov, Y., Ming, J., Mirshekari, S., Mishra, C., Mitra, S., Mitrofanov, V. P., Mitselmakher, G., Mittleman, R., Moggi, A., Mohan, M., Mohapatra, S. R. P., Montani, M., Moore, B. C., Moore, C. J., Moraru, D., Moreno, G., Morriss, S. R., Mossavi, K., Mours, B., Mow-Lowry, C. M., Mueller, C. L., Mueller, G., Muir, A. W., Mukherjee, A., Mukherjee, D., Mukherjee, S., Mukund, N., Mullavey, A., Munch, J., Murphy, D. J., Murray, P. G., Mytidis, A., Nardecchia, I., Naticchioni, L., Nayak, R. K., Necula, V., Nedkova, K., Nelemans, G., Neri, M., Neunzert, A., Newton, G., Nguyen, T. T., Nielsen, A. B., Nisanke, S., Nitz, A., Nocera, F., Nolting, D., Normandin, M. E., Nuttall, L. K., Oberling, J., Ochsner, E., O'Dell, J., Oelker, E., Ogin, G. H., Oh, J. J., Oh, S. H., Ohme, F., Oliver, M., Oppermann, P., Oram, R. J., O'Reilly, B., O'Shaughnessy, R., Ottaway, D. J., Ottens, R. S., Overmier, H., Owen, B. J., Pai, A., Pai, S. A., Palamos, J. R., Palashov, O., Palomba, C., Pal-Singh, A., Pan, H., Pan, Y., Pankow, C., Pannarale, F., Pant, B. C., Paoletti, F., Paoli, A., Papa, M. A., Paris, H. R., Parker, W., Pascucci, D., Pasqualetti, A., Passaquieti, R., Passuello, D., Patricelli, B., Patrick, Z., Pearlstone, B. L., Pedraza, M., Pedurand, R., Pekowsky, L., Pele, A., Penn, S., Perreca, A., Phelps, M., Piccinni, O., Pichot, M., Piergiovanni, F., Pjero, V., Pillant, G., Pinard, L., Pinto, I. M., Pitkin, M., Poggiani, R., Popolizio, P., Post, A., Powell, J., Prasad, J., Predoi, V., Premachandra, S. S., Prestegard, T., Price, L. R., Prijatelj, M., Principe, M., Privitera, S., Prodi, G. A., Prokhorov, L., Puncken, O., Punturo, M., Puppo, P., Pürer, M., Qi, H., Qin, J., Quetschke, V., Quintero, E. A., Quitzow-James, R., Raab, F. J., Rabeling, D. S., Radkins, H., Raffai, P., Raja, S., Rakhmanov, M., Rapagnani, P., Raymond, V., Razzano, M., Re, V., Read, J., Reed, C. M., Regimbau, T., Rei, L., Reid, S., Reitze, D. H., Rew, H., Reyes, S. D., Ricci, F., Riles, K., Robertson, N. A., Robie, R., Robinet, F., Robinson, C., Rocchi, A., Rodriguez, A. C., Rolland, L., Rollins, J. G., Roma, V. J., Romano, R., Romanov, G., Romie, J. H., Rosińska, D., Rowan, S., Rüdiger, A., Ruggi, P., Ryan, K., Sachdev, S., Sadecki, T., Sadeghian, L., Salconi, L., Saleem, M., Salemi, F., Samajdar, A., Sammut, L., Sanchez, E. J., Sandberg, V., Sandeen, B., Sanders, J. R., Santamaría, L., Sassolas, B., Sathyaprakash, B. S., Saulson, P. R., Sauter, O., Savage, R. L., Sawadsky, A., Schale, P., Schilling, R., Schmidt, J., Schmidt, P., Schnabel, R., Schofield, R. M. S., Schönbeck, A., Schreiber, E., Schuette, D., Schutz, B. F., Scott, J., Scott, S. M., Sellers, D., Sengupta, A. S., Sentenac, D., Sequino, V., Sergeev, A., Serna, G., Setyawati, Y., Seigny, A., Shaddock, D. A., Shah, S., Shahriar, M. S., Shaltev, M., Shao, Z., Shapiro, B., Shawhan, P., Sheperd, A., Shoemaker, D. H., Shoemaker, D. M., Siellez, K., Siemens, X., Sigg, D., Silva, A. D., Simakov, D., Singer, A., Singer, L. P., Singh, A., Singh, R., Singhal, A., Sintés, A. M., Slagmolen, B. J. J., Smith, J. R., Smith, N. D., Smith, R. J. E., Son, E. J., Sorazu, B., Sorrentino, F., Souradeep, T., Srivastava, A. K., Staley, A., Steinke, M., Steinlechner, J., Steinlechner, S., Steinmeyer, D., Stephens, B. C., Stone, R., Strain, K. A., Straniero, N., Stratta, G., Strauss, N. A., Strigin, S., Sturani, R., Stuver, A. L., Summerscales, T. Z., Sun, L., Sutton, P. J., Swinkels, B. L., Szczepańczyk, M. J., Tacca, M., Talukder, D., Tanner, D. B., Tápai, M., Tarabrin, S. P., Taracchini, A., Taylor, R., Theeg, T., Thirugnanasambandam, M. P., Thomas, E. G., Thomas, M., Thomas, P., Thorne, K. A., Thorne, K. S., Thrane, E., Tiwari, S., Tiwari, V., Tokmakov, K. V., Tomlinson, C., Tonelli, M., Torres, C. V., Torrie, C. I., Töyrä, D., Travasso, F., Traylor, G., Trifirò, D., Tringali, M. C., Trozzo, L., Tse, M., Turconi, M., Tuyenbayev, D., Ugolini, D., Unnikrishnan, C. S., Urban, A. L., Usman, S. A., Vahlbruch, H., Vajente, G., Valdes, G., van Bakel, N., van Beuzekom, M., Brand, J. F. J. v. d., Broeck, C. V. D., VanderHyde, D. C., van der Schaaf, L., van Heijningen, J. V., van Veggel, A. A., Vardaro, M., Vass, S., Vasúth, M., Vaulin, R., Vecchio, A., Vedovato, G., Veitch, J., Veitch, P. J., Venkateswara, K., Verkindt, D., Vetrano, F., Viceré, A., Vinciguerra, S., Vine, D. J., Vinet, J.-Y., Vitale, S., Vo, T., Vocca, H., Vorvick, C., Voss, D., Vousden, W. D., Vyatchanin, S. P., Wade, A. R., Wade, L. E., Wade, M., Walker, M., Wallace, L., Walsh, S., Wang, G., Wang, H., Wang, M., Wang, X., Wang, Y., Ward, R. L., Warner, J., Was, M., Weaver, B., Wei, L.-W., Weinert, M., Weinstein, A. J., Weiss, R., Welborn, T., Wen, L., Weßels, P., West, M., Westphal, T., Wette, K., Whelan, J. T., White, D. J., Whiting, B. F., Wiesner, K., Williams, R. D., Williamson, A. R., Willis, J. L., Willke, B., Wimmer, M. H., Winkler, W., Wipf, C. C., Wiseman, A. G., Wittel, H., Woan, G., Worden, J., Wright, J. L., Wu, G., Yablon, J., Yam, W., Yamamoto, H., Yancey, C. C., Yap, M. J., Yu, H., Yvert, M., Zadrożny, A., Zangrando, L., Zanelin, M., Zengri, J.-P., Zevin, M., Zhang, F., Zhang, L., Zhang, M., Zhang, Y., Zhao, C., Zhou, M., Zhou, Z., Zhu, X. J., Zucker, M. E., Zuraw, S. E., & Zweigig, J. (2016). GW150914: First results from the search for binary black hole coalescence with Advanced LIGO. *Physical Review D*, 93: 122003. doi:10.1103/PhysRevD.93.122003.



## Publications by AEI Members and Guest Scientists

The LIGO Scientific Collaboration, the Virgo Collaboration, Abbott, B. P., Abbott, R., Abbott, T. D., Abernathy, M. R., Acernese, F., Ackley, K., Adams, C., Adams, T., Addesso, P., Adhikari, R. X., Adya, V. B., Affeldt, C., Agathos, M., Agatsuma, K., Aggarwal, N., Aguiar, O. D., Aiello, L., Ain, A., Ajith, P., Allen, B., Allocca, A., Altin, P. A., Anderson, S. B., Anderson, W. G., Arai, K., Araya, M. C., Arceneaux, C. C., Areeda, J. S., Arnaud, N., Arun, K. G., Ascenzi, S., Ashton, G., Ast, M., Aston, S. M., Astone, P., Aufmuth, P., Aulbert, C., Babak, S., Bacon, P., Bader, M. K. M., Baker, P. T., Baldaccini, F., Ballardin, G., Ballmer, S. W., Barayoga, J. C., Barclay, S. E., Barish, B. C., Barker, D., Barone, F., Barr, B., Barsotti, L., Barsuglia, M., Barta, D., Bartlett, J., Bartos, I., Bassiri, R., Basti, A., Batch, J. C., Baune, C., Bavigadda, V., Bazzan, M., Behnke, B., Bejger, M., Bell, A. S., Bell, C. J., Berger, B. K., Bergman, J., Bergmann, G., Berry, C. P. L., Bersanetti, D., Bertolini, A., Betzwieser, J., Bhagwat, S., Bhandare, R., Bilenko, I. A., Billingsley, G., Birch, J., Birney, R., Biscans, S., Bisht, A., Bitossi, M., Biwer, C., Bizouard, M. A., Blackburn, J. K., Blair, C. D., Blair, D. G., Blair, R. M., Bloemen, S., Bock, O., Bodiya, T. P., Boer, M., Bogaert, G., Bogan, C., Bohe, A., Bojtos, P., Bond, C., Bondu, F., Bonnard, R., Boom, B. A., Bork, R., Boschi, V., Bose, S., Bouffanais, Y., Bozzi, A., Bradaschia, C., Brady, P. R., Braginsky, V. B., Branchesi, M., Brau, J. E., Briant, T., Brillat, A., Brinkmann, M., Brisson, V., Brockill, P., Brooks, A. F., Brown, D. A., Brown, D. D., Brown, N. M., Buchanan, C. C., Buikema, A., Bulik, T., Bulten, H. J., Buonanno, A., Buskulic, D., Buy, C., Byer, R. L., Cadonati, L., Cagnoli, G., Cahillane, C., Bustillo, J. C., Callister, T., Calloni, E., Camp, J. B., Cannon, K. C., Cao, J., Capano, C. D., Capocasa, E., Carbognani, F., Caride, S., Diaz, J. C., Casentini, C., Caudill, S., Cavaglià, M., Cavalier, F., Cavalieri, R., Cella, G., Cepeda, C. B., Baiardi, L. C., Cerretani, G., Cesarini, E., Chakraborty, R., Chalermsoongsak, T., Chamberlin, S. J., Chan, M., Chao, S., Charlton, P., Chassande-Mottin, E., Chen, H. Y., Chen, Y., Cheng, C., Chincarini, A., Chiummo, A., Cho, H. S., Cho, M., Chow, J. H., Christensen, N., Chu, Q., Chua, S., Chung, S., Ciani, G., Clara, F., Clark, J. A., Cleva, F., Coccia, E., Cohadon, P.-F., Colla, A., Collette, C. G., Cominsky, L., Constancio, M., Conte, A., Conti, L., Cook, D., Corbitt, T. R., Cornish, N., Corsi, A., Cortese, S., Costa, C. A., Coughlin, M. W., Coughlin, S. B., Coulon, J.-P., Countryman, S. T., Couvares, P., Coward, D. M., Cowart, M. J., Coyne, D. C., Coyne, R., Craig, K., Creighton, J. D. E., Cripe, J., Crowder, S. G., Cumming, A., Cunningham, L., Cuoco, E., Canton, T. D., Danilishin, S. L., D'Antonio, S., Danzmann, K., Darman, N. S., Dattilo, V., Dave, I., Daveloza, H. P., Davier, M., Davies, G. S., Daw, E. J., Day, R., DeBra, D., Debreczeni, G., Degallaix, J., De Laurentis, M., Deléglise, S., Del Pozzo, W., Denker, T., Dent, T., Dergachev, V., De Rosa, R., DeRosa, R. T., DeSalvo, R., Dhurandhar, S., Díaz, M. C., Di Fiore, L., Di Giovanni, M., Di Girolamo, T., Di Lieto, A., Di Pace, S., Di Palma, I., Di Virgilio, A., Dojcinoski, G., Dolique, V., Donovan, F., Dooley, K. L., Doravari, S., Douglas, R., Downes, T. P., Drago, M., Drever, R. W. P., Driggers, J. C., Du, Z., Ducrot, M., Dwyer, S. E., Edo, T. B., Edwards, M. C., Effler, A., Eggenstein, H.-B., Ehrens, P., Eichholz, J., Eikenberry, S. S., Engels, W., Essick, R. C., Etzel, T., Evans, M., Evans, T. M., Everett, R., Factourovich, M., Fafone, V., Fair, H., Fairhurst, S., Fan, X., Fang, Q., Farinon, S., Farr, B., Farr, W. M., Favata, M., Fays, R. M., Fehrmann, H., Fejer, M. M., Ferrante, I., Ferreira, E. C., Ferrini, F., Fidecaro, F., Fiori, I., Fiorucci, D., Fisher, R. P., Flaminio, R., Fletcher, M., Fournier, J.-D., Frasca, S., Frasconi, F., Frei, Z., Freise, A., Frey, R., Frey, V., Fricke, T., Fritschel, P., Frolov, V. V., Fulda, P., Fyffe, M., Gabbard, H. A. G., Gair, J. R., Gammaitoni, L., Gaonkar, S. G., Garufi, F., Gaur, G., Gehrels, N., Gemme, G., Genin, E., Gennai, A., George, J., Gergely, L., Germain, V., Ghosh, A., Ghosh, S., Giaime, J. A., Giardina, K. D., Giazotto, A., Gill, K., Glaefke, A., Goetz, E., Goetz, R., Gondan, L., González, G., Castro, J. M. G., Gopakumar, A., Gordon, N. A., Gorodetsky, M. L., Gossan, S. E., Gosselin, M., Gouaty, R., Grado, A., Graef, C., Graff, P. B., Granata, M., Grant, A., Gras, S., Gray, C., Greco, G., Green, A. C., Groot, P., Grote, H., Grunewald, S., Guidi, G. M., Guo, X., Gupta, A., Gupta, M. K., Gushwa, K. E., Gustafson, E. K., Gustafson, R., Hacker, J. J., Hall, B. R., Hall, E. D., Hammond, G., Haney, M., Hanke, M. M., Hanks, J., Hanna, C., Hannam, M. D., Hanson, J., Hardwick, T., Harms, J., Harry, G. M., Harry, I. W., Hart, M. J., Hartman, M. T., Haster, C.-J., Haughian, K., Heidmann, A., Heintze, M. C., Heitmann, H., Hello, P., Hemming, G., Hendry, M., Heng, I. S., Hennig, J., Heptonstall, A. W., Heurs, M., Hild, S., Hoak, D., Hodge, K. A., Hofman, D., Hollitt, S. E., Holt, K., Holz, D. E., Hopkins, P., Hosken, D. J., Hough, J., Houston, E. A., Howell, E. J., Hu, Y. M., Huang, S., Huerta, E. A., Huet, D., Hughey, B., Husa, S., Huttner, S. H., Huynh-Dinh, T., Idrisy, A., Idik, N., Ingram, D. R., Inta, R., Isa, H. N., Isac, J.-M., Islas, G., Isogai, T., Iyer, B. R., Izumi, K., Jacqmin, T., Jang, H., Jani, K., Jaranowski, P., Jawahar, S., Jiménez-Forteza, F., Johnson, W. W., Jones, D. I., Jones, R., Jonker, R. J. G., Ju, L., K. H., Kalaghatgi, C. V., Kalogera, V., Kandhasamy, S., Kang, G., Kanner, J. B., Karki, S., Kasprzak, M., Katsavounidis, E., Katzman, W., Kaufer, S., Kaur, T., Kawabe, K., Kawazoe, F., Kéfélian, F., Kehl, M. S., Keitel, D., Kelley, D. B., Kells, W., Kennedy, R., Key, J. S., Khalaidovski, A., Khalili, F. Y., Khan, I., Khan, S., Khan, Z., Khazanov, E. A., Kijbunchoo, N., Kim, C., Kim, J., Kim, K., Kim, N.-G., Kim, N., Kim, Y.-M., King, E. J., King, P. J., Kinzel, D. L., Kissel, J. S., Kleybolte, L., Klimentko, S., Koehlenbeck, S. M., Kokeyama, K., Koley, S., Kondrashov, V., Kontos, A., Korobko, M., Korth, W. Z., Kowalska, I., Kozak, D. B., Kringel, V., Królak, A., Krueger, C., Kuehn, G., Kumar, P., Kuo, L., Kutynia, A., Lackey, B. D., Landry, M., Lange, J., Lantz, B., Lasky, P. D., Lazzarini, A., Lazzaro, C., Leaci, P., Leavey, S., Lebigot, E. O., Lee, C. H., Lee, H. K., Lee, H. M., Lee, K., Lenon, A., Leonardi, M., Leong, J. R., Leroy, N., Letendre, N., Levin, Y., Levine, B. M., Li, T. G. F., Libson, A., Littenberg, T. B., Lockerbie, N. A., Logue, J., Lombardi, A. L., Lord, J. E., Lorenzini, M., Lorette, V., Lormand, M., Losurdo, G., Lough, J. D., Lück, H., Lundgren, A. P., Luo, J., Lynch, R., Ma, Y., MacDonald, T., Machenschalk, B., MacInnis, M., Macleod, D. M., Magaña-Sandoval, F., Magee, R. M., Magewaran, M., Majorana, E., Maksimovic, I., Malvezzi, V., Man, N., Mandic, V., Mangano, V., Mansell, G. L., Manske, M., Mantovani, M., Marchesoni, F., Marion, F., Márka, S., Márka, Z., Markosyan, A. S., Maros, E., Martelli, F., Martellini, L., Martin, I. W., Martin, R. M., Martynov, D. V., Marx, J. N., Mason, K., Masserot, A., Massinger, T. J., Masso-Reid, M., Mastrogiovanni, S., Matichard, F., Matone, L., Mavalvala, N., Mazumder, N., Mazzolo, G., McCarthy, R., McClelland, D. E., McCormick, S., McGuire, S. C., McIntyre, G., McIver, J., McManus, D. J., McWilliams, S. T., Meacher, D., Meadors, G. D., Meidam, J., Melatos, A., Mendell, G., Mendoza-Gandara, D., Mercer, R. A., Merilh, E. L., Merzougui, M., Meshkov, S., Messenger, C., Messick, C., Metzendorf, R., Meyers, P. M., Mezzani, F., Miao, H., Michel, C., Middleton, H., Mikhailov, E. E., Milano, L., Miller, A. L., Miller, J., Millhouse, M., Minenkov, Y., Ming, J., Mirshekari, S., Mishra, C., Mitra, S., Mitrofanov, V. P., Mitselmakher, G., Mittleman, R., Moggi, A., Mohan, M., Mohapatra, S. R. P., Montani, M., Moore, B. C., Moore, C. J., Moraru, D., Moreno, G., Morriss, S. R., Mossavi, K., Mours, B., Mow-Lowry, C. M., Mueller, C. L., Mueller, G., Muir, A. W., Mukherjee, A., Mukherjee, D., Mukherjee, S., Mukund, K. N., Mullavey, A., Munch, J., Murphy, D. J., Murray, P. G., Mytidis, A., Nardecchia, I., Naticchioni, L., Nayak, R. K., Necula, V., Nedkova, K., Nelemans, G., Neri, M., Neunzert, A., Newton, G., Nguyen, T. T., Nielsen, A. B., Nissanke, S., Nitz, A., Nocera, F., Nolting, D., Normandin, M. E. N., Nuttall, L. K., Oberling, J., Ochsner, E., O'Dell, J., Oelker, E., Ogin, G. H., Oh, J. J., Oh, S. H., Ohme, F., Oliver, M., Oppermann, P., Oram, R. J., O'Reilly, B., O'Shaughnessy, R., Ott, C. D., Ottaway, D. J., Ottens, R. S., Overmier, H., Owen, B. J., Pai, A., Pai, S. A., Palamos, J. R., Palashov, O., Palomba, C., Pal-Singh, A., Pan, H., Pankow, C., Pannarale,

## Publications by AEI Members and Guest Scientists

F., Pant, B. C., Paoletti, F., Paoli, A., Papa, M. A., Paris, H. R., Parker, W., Pascucci, D., Pasqualetti, A., Passaquietti, R., Passuello, D., Patricelli, B., Patrick, Z., Pearlstone, B. L., Pedraza, M., Pedurand, R., Pekowsky, L., Pele, A., Penn, S., Pereira, R., Perreca, A., Phelps, M., Piccinni, O. J., Pichot, M., Piergiovanni, F., Pierre, V., Pillant, G., Pinard, L., Pinto, I. M., Pitkin, M., Pletsch, H. J., Poggiani, R., Popolizio, P., Post, A., Powell, J., Prasad, J., Predoi, V., Premachandra, S. S., Prestegard, T., Price, L. R., Prijatelj, M., Principe, M., Privitera, S., Prodi, G. A., Prokhorov, L., Puncken, O., Punturo, M., Puppo, P., Pürner, M., Qi, H., Qin, J., Quetschke, V., Quintero, E. A., Quitzow-James, R., Raab, F. J., Rabeling, D. S., Radkins, H., Raffai, P., Raja, S., Rakhmanov, M., Rapagnani, P., Raymond, V., Razzano, M., Re, V., Read, J., Reed, C. M., Regimbau, T., Rei, L., Reid, S., Reitze, D. H., Rew, H., Ricci, F., Riles, K., Robertson, N. A., Robie, R., Robinet, F., Rocchi, A., Rolland, L., Rollins, J. G., Roma, V. J., Romano, J. D., Romano, R., Romanov, G., Romie, J. H., Rosińska, D., Rowan, S., Rüdiger, A., Ruggi, P., Ryan, K., Sachdev, S., Sadecki, T., Sadeghian, L., Salconi, L., Saleem, M., Salemi, F., Samajdar, A., Sammut, L., Sanchez, E. J., Sandberg, V., Sandeen, B., Sanders, J. R., Sassolas, B., Sathyaprakash, B. S., Saulson, P. R., Sauter, O. E. S., Savage, R. L., Sawadsky, A., Schale, P., Schilling, R., Schmidt, J., Schmidt, P., Schnabel, R., Schofield, R. M. S., Schönbeck, A., Schreiber, E., Schuette, D., Schutz, B. F., Scott, J., Scott, S. M., Sellers, D., Sentenac, D., Sequino, V., Sergeev, A., Serna, G., Setyawati, Y., Sevigny, A., Shaddock, D. A., Shahriar, M. S., Shaltev, M., Shao, Z., Shawhan, P., Sheperd, A., Shoemaker, D. H., Shoemaker, D. M., Siellez, K., Siemens, X., Sieniawska, M., Sigg, D., Silva, A. D., Simakov, D., Singer, A., Singer, L. P., Singh, A., Singh, R., Singhal, A., Sintès, A. M., Slagmolen, B. J. J., Smith, J. R., Smith, N. D., Smith, R. J. E., Son, E. J., Sorazu, B., Sorrentino, F., Souradeep, T., Srivastava, A. K., Staley, A., Steinke, M., Steinlechner, J., Steinlechner, S., Steinmeyer, D., Stephens, B. C., Stiles, D., Stone, R., Strain, K. A., Straniero, N., Stratta, G., Strauss, N. A., Strigin, S., Sturani, S., Stuver, A. L., Summerscales, T. Z., Sun, L., Sutton, P. J., Swinkels, B. L., Szczepańczyk, M. J., Tacca, M., Talukder, D., Tanner, D. B., Tápai, M., Tarabrin, S. P., Taracchini, A., Taylor, R., Theeg, T., Thirugnanasambandam, M. P., Thomas, E. G., Thomas, M., Thomas, P., Thorne, K. A., Thrane, E., Tiwari, S., Tiwari, V., Tokmakov, K. V., Tomlinson, C., Tonelli, M., Torres, C. V., Torrie, C. I., Töyrä, D., Travasso, F., Traylor, G., Trifirò, D., Tringali, M. C., Trozzo, L., Tse, M., Turconi, M., Tuyenbayev, D., Ugolini, D., Unnikrishnan, C. S., Urban, A. L., Usman, S. A., Vahlbruch, H., Vajente, G., Valdes, G., van Bakel, N., van Beuzekom, M., Brand, J. F. J. v. d., Broeck, C. V. D., Vander-Hyde, D. C., van der Schaaf, L., van Heijningen, J. V., van Veggel, A. A., Vardaro, M., Vass, S., Vasúth, M., Vaulin, R., Vecchio, A., Vedovato, G., Veitch, J., Veitch, P. J., Venkateswara, K., Verkindt, D., Vetrano, F., Viceré, A., Vinciguerra, S., Vine, D. J., Vinet, J.-.-Y., Vitale, S., Vo, T., Vocca, H., Vorvick, C., Voss, D. V., Voudsen, W. D., Vyatchanin, S. P., Wade, A. R., Wade, L. E., Wade, M., Walker, M., Wallace, L., Walsh, S., Wang, G., Wang, H., Wang, M., Wang, X., Wang, Y., Ward, R. L., Warner, J., Was, M., Weaver, B., Wei, L.-.-W., Weinert, M., Weinstein, A. J., Weiss, R., Welborn, T., Wen, L., Wessels, P., Westphal, T., Wette, K., Whelan, J. T., Whitcomb, S. E., White, D. J., Whiting, B. F., Williams, R. D., Williamson, A. R., Willis, J. L., Willke, B., Wimmer, M., Winkler, W., Wipf, C. C., Wittel, H., Woan, G., Worden, J., Wright, J. L., Wu, G., Yablon, J., Yam, W., Yamamoto, H., Yancey, C. C., Yap, M. J., Yu, H., Yvert, M., Zny, A. Z., Zangrando, L., Zanolin, M., Zendri, J.-.-P., Zevin, M., Zhang, F., Zhang, L., Zhang, M., Zhang, Y., Zhao, C., Zhou, M., Zhou, Z., Zhu, X. J., Zucker, M. E., Zuraw, S. E., Zweizig, J., Archibald, A. M., Banaszak, S., Berndsen, A., Boyles, J., Cardoso, R. F., Chawla, P., Cherry, A., Darte, L. P., Day, D., Epstein, C. R., Ford, A. J., Flanigan, J., Garcia, A., Hessels, J. W. T., Hinojosa, J., Jenet, F. A., Karako-Argaman, C., Kaspi, V. M., Keane, E. F., Kondratiev, V. I., Kramer, M., Leake, S., Lorimer, D., Lunsford, G., Lynch, R. S., Martinez, J. G., Mata, A., McLaughlin, M. A., McPhee, C. A., Penucci, T., Ransom, S., Roberts, M. S. E., Rohr, M. D. W., Stairs, I. H., Stovall, K., van Leeuwen, J., Walker, A. N., & Wells, B. L. (2016). Search for transient gravitational waves in coincidence with short duration radio transients during 2007-2013. *Physical Review D*, 93: 122008. doi:<http://dx.doi.org/10.1103/PhysRevD.93.122008>.

The LIGO Scientific Collaboration, the Virgo Collaboration, Abbott, B., Abbott, R., Abbott, T., Abernathy, M., Acernese, F., Ackley, K., Adams, C., Adams, T., Addesso, P., Adhikari, R., Adya, V., Affeldt, C., Agathos, M., Agatsuma, K., Aggarwal, N., Aguiar, O., Aiello, L., Ain, A., Ajith, P., Allen, B., Allocca, A., Altin, P., Anderson, S., Anderson, W., Arai, K., Araya, M., Arceneaux, C., Areeda, J., Arnaud, N., Arun, K., Ascenzi, S., Ashton, G., Ast, M., Aston, S., Astone, P., Aufmuth, P., Aubert, C., Babak, S., Bacon, P., Bader, M., Baker, P., Baldaccini, F., Ballardini, G., Ballmer, S., Barayoga, J., Barclay, S., Barish, B., Barker, D., Barone, F., Barr, B., Barsotti, L., Barsuglia, M., Barta, D., Bartlett, J., Bartos, I., Bassiri, R., Basti, A., Batch, J., Baune, C., Bavigadda, V., Bazzan, M., Behnke, B., Bejger, M., Bell, A., Bell, C., Berger, B., Bergman, J., Bergmann, G., Berry, C., Bersanetti, D., Bertolini, A., Betzwieser, J., Bhagwat, S., Bhandare, R., Bilenko, I., Billingsley, G., Birch, J., Birney, R., Biscans, S., Bisht, A., Bitossi, M., Biwer, C., Bizouard, M., Blackburn, J., Blackburn, L., Blair, C., Blair, D., Blair, R., Bloemen, S., Bock, O., Bodiya, T., Boer, M., Bogaert, G., Bogan, C., Bohe, A., Bajt, P., Bond, C., Bondu, F., Bonnard, R., Boom, B., Bork, R., Boschi, V., Bose, S., Bouffanais, Y., Bozzi, A., Bradaschia, C., Brady, P., Braginsky, V., Branchesi, M., Brau, J., Briant, T., Brillet, A., Brinkmann, M., Brisson, V., Brockill, P., Brooks, A., Brown, D., Brown, D., Brown, N., Buchanan, C., Buikema, A., Bulik, T., Bulten, H., Buonanno, A., Buskulic, D., Buy, C., Byer, R., Cadonati, L., Cagnoli, G., Cahillane, C., Bustillo, J. C., Callister, T., Calloni, E., Camp, J., Cannon, K., Cao, J., Capano, C., Capocasa, E., Carbognani, F., Caride, S., Diaz, J. C., Casentini, C., Caudill, S., Cavaglia, M., Cavalier, F., Cavaliere, R., Cella, G., Cepeda, C., Baiardi, L. C., Cerretani, G., Cesarini, E., Chakraborty, R., Chatterji, S., Chalermsoong, T., Chamberlin, S., Chan, M., Chao, S., Charlton, P., Chassande-Mottin, E., Chen, H., Chen, Y., Cheng, C., Chincarini, A., Chiummo, A., Cho, H., Cho, M., Chow, J., Christensen, N., Chu, Q., Chua, S., Chung, S., Ciani, G., Clara, F., Clark, J., Clark, M., Cleva, F., Coccia, E., Cohadon, P.-F., Colla, A., Collette, C., Cominsky, L., Constancio, M., Jr., Conte, A., Conti, L., Cook, D., Corbitt, T., Cornish, N., Corsi, A., Cortese, S., Costa, C., Coughlin, M., Coughlin, S., Coulon, J.-P., Countryman, S., Couvares, P., Cowan, E., Coward, D., Cowart, M., Coyne, D., Coyne, R., Craig, K., Creighton, J., Cripe, J., Crowder, S., Cumming, A., Cunningham, L., Cuomo, E., Canton, T. D., Danilishin, S., D'Antonio, S., Danzmann, K., Darman, N., Dattilo, V., Dave, I., Daveloza, H., Davier, M., Davies, G., Daw, E., Day, R., DeBra, D., Debreczeni, G., Degallaix, J., Laurentis, M. D., Deléglise, S., Pozzo, W. D., Denker, T., Dent, T., Dereli, H., Dergachev, V., DeRosa, R., Rosa, R. D., DeSalvo, R., Dhurandhar, S., Dfaz, M., Fiore, L. D., Giovanni, M. D., Lieta, A. D., Pace, S. D., Di Palma, I., Virgilio, A. D., Dojcinoski, G., Dolique, V., Donovan, F., Dooley, K., Doravari, S., Douglas, R., Downes, T., Drago, M., Drever, R., Driggers, J., Du, Z., Ducrot, H., Dwyer, S., Edo, T., Edwards, M., Effler, A., Eggenstein, H.-B., Ehrens, P., Eichholz, J., Eikenberry, S., Engels, W., Essick, R., Etzel, T., Evans, M., Evans, T., Everett, R., Factourovich, M., Fafone, V., Fair, H., Fairhurst, S., Fan, X., Fang, Q., Farinon, S., Farr, B., Farr, W., Favata, M., Fays, M., Fehrmann, H., Fejer, M., Ferrante, I., Ferreira, E., Ferrini, F., Fidecaro, F., Fiori, I., Fiorucci, D., Fisher, R., Flaminio, R., Fletcher, M., Fournier, J.-D., Franco, S., Frasca, S., Frasconi, F., Frei, Z., Freise, A., Frey, R., Frey, V., Fricke, T., Fritschel, P., Frolov, V., Fulda, P., Fyffe, M., Gabbard, H., Gair, J., Gammaitoni, L., Gaonkar, S., Garufi, F., Gatto, A., Gaur, G., Gehrels, N., Gemme, G., Gendre, B., Genin, E., Gennai, A., George, J.,

## Publications by AEI Members and Guest Scientists

Gergely, L., Germain, V., Ghosh, A., Ghosh, S., Giaime, J., Giardino, K., Giazotto, A., Gill, K., Glaefke, A., Goetz, E., Goetz, R., Gondan, L., González, G., Castro, J. G., Gopakumar, A., Gordon, N., Gorodetsky, M., Gossan, S., Gosselin, M., Gouaty, R., Graef, C., Graff, P., Granata, M., Grant, A., Gras, S., Gray, C., Greco, G., Green, A., Groot, P., Grote, H., Grunewald, S., Guidi, G., Guo, X., Gupta, A., Gupta, M., Gushwa, K., Gustafson, E., Gustafson, R., Haas, R., Hacker, J., Hall, B., Hall, E., Hammond, G., Haney, M., Hanke, M., Hanks, J., Hanna, C., Hannam, M., Hanson, J., Hardwick, T., Harms, J., Harry, G., Harry, I., Hart, M., Hartman, M., Haster, C.-J., Haughian, K., Healy, J., Heidmann, A., Heintze, M., Heitmann, H., Hello, P., Hemming, G., Hendry, M., Heng, I., Hennig, J., Heptonstall, A., Heurs, M., Hild, S., Hinder, I., Hoak, D., Hodge, K., Hofman, D., Hollitt, S., Holt, K., Holz, D., Hopkins, P., Hosken, D., Hough, J., Houston, E., Howell, E., Hu, Y., Huang, S., Huerta, E., Huet, D., Hughey, B., Husa, S., Huttner, S., Huynh-Dinh, T., Idrisy, A., Indik, N., Ingram, D., Inta, R., Isa, H., Isac, J.-M., Isi, M., Islas, G., Isogai, T., Iyer, B., Izumi, K., Jacqmin, T., Jang, H., Jani, K., Jaranowski, P., Jawahar, S., Jiménez-Forteza, F., Johnson, W., Jones, D., Jones, R., Jonker, R., Ju, L., K., H., Kalaghatgi, C., Kalogera, V., Kandhasamy, S., Kang, G., Kanner, J., Karki, S., Kasprzak, M., Katsavounidis, E., Katzman, W., Kaufer, S., Kaur, T., Kawabe, K., Kawazoe, F., Kéfélian, F., Kehl, M., Keitel, D., Kelley, D., Kells, W., Kennedy, R., Key, J., Khalaidovski, A., Khalili, F., Khan, I., Khan, S., Khan, Z., Khazanov, E., Kijbunchoo, N., Kim, C., Kim, J., Kim, K., Kim, N.-G., Kim, N., Kim, Y.-M., King, E., King, P., Kinsey, M., Kinzel, D., Kissel, J., Kleinbolte, L., Klimenko, S., Koehlenbeck, S., Kokeyama, K., Koley, S., Kondrashov, V., Kontos, A., Korobko, M., Korth, W., Kowalska, I., Kozak, D., Kringel, V., Królak, A., Krueger, C., Kuehn, G., Kumar, P., Kuo, L., Kutynia, A., Lackey, B., Laguna, P., Landry, M., Lange, J., Lantz, B., Lasky, P., Lazzarini, A., Lazzaro, C., Leaci, P., Leavey, S., Lebigot, E., Lee, C., Lee, H., Lee, H., Lee, K., Lenon, A., Leonardi, M., Leong, J., Leroy, N., Letendre, N., Levin, Y., Levine, B., Li, T., Libson, A., Littenberg, T., Lockerbie, N., Logue, J., Lombardi, A., Lord, J., Lorenzini, M., Lorette, V., Lormand, M., Losurdo, G., Lough, J., Lück, H., Lundgren, A., Luo, J., Lynch, R., Ma, Y., MacDonald, T., Machenschalk, B., MacInnis, M., Macleod, D., Magaña-Sandoval, F., Magee, R., Mageswaran, M., Majorana, E., Maksimovic, I., Malvezzi, V., Man, N., Mandel, I., Mandic, V., Mangano, V., Mansell, G., Manske, M., Mantovani, M., Marchesoni, F., Marion, F., Márka, S., Márka, Z., Markosyan, A., Maros, E., Martelli, F., Martellini, L., Martin, I., Martin, R., Martynov, D., Marx, J., Mason, K., Maserot, A., Massinger, T., Masso-Reid, M., Matichard, F., Matone, L., Mavalvala, N., Mazumder, N., Mazzolo, G., McCarthy, R., McClelland, D., McCormick, S., McGuire, S., McIntyre, G., McIver, J., McManus, D., McWilliams, S., Meacher, D., Meadors, G. D., Meidam, J., Melatos, A., Mendell, G., Mendoza-Gandara, D., Mercer, R., Merill, E., Merzougui, M., Meshkov, S., Messenger, C., Messick, C., Meyers, P., Mezzani, F., Miao, H., Michel, C., Middleton, H., Mikhailov, E., Milano, L., Miller, J., Millhouse, M., Minenkov, Y., Ming, J., Mirshekari, S., Mishra, C., Mitra, S., Mitrofanov, V., Mitselmakher, G., Mittleman, R., Moggi, A., Mohan, M., Mohapatra, S., Montani, M., Moore, B., Moore, C., Moraru, D., Moreno, G., Morriss, S., Mossavi, K., Mours, B., Mow-Lowry, C., Mueller, C., Mueller, G., Muir, A., Mukherjee, A., Mukherjee, D., Mukherjee, S., Mukund, N., Mullavey, A., Munch, J., Murphy, D., Murray, P., Mytidis, A., Nardecchia, I., Naticchioni, L., Nayak, R., Necula, V., Nedkova, K., Nelemans, G., Neri, M., Neunzert, A., Newton, G., Nguyen, T., Nielsen, A. B., Nissanke, S., Nitz, A., Nocera, F., Nolting, D., Normandin, M., Nuttall, L., Oberling, J., Ochsner, E., O'Dell, J., Oelker, E., Ogin, G., Oh, J., Oh, S., Ohme, F., Oliver, M., Oppermann, P., Oram, R. J., O'Reilly, B., O'Shaughnessy, R., Ottaway, D., Ottens, R., Overmier, H., Owen, B., Pai, A., Pai, S., Palamos, J., Palashov, O., Palomba, C., Pal-Singh, A., Pan, H., Pankow, C., Pannarale, F., Pant, B., Paoletti, F., Paoli, A., Papa, M., Page, J., Paris, H., Parker, W., Pascucci, D., Pasqualetti, A., Passaquietti, R., Passuello, D., Patricelli, B., Patrick, Z., Pearlstone, B., Pedraza, M., Pedurand, R., Pekowsky, L., Pele, A., Penn, S., Perreca, A., Phelps, M., Piccinni, O., Pichot, M., Piergiorgio, F., Pardo, V., Pillant, G., Pinard, L., Pinto, I., Pitkin, M., Poggiani, R., Popolizio, P., Post, A., Powell, J., Prasad, J., Predoi, V., Premachandra, S., Prestegard, T., Price, L., Prijatelj, M., Principe, M., Privitera, S., Prodi, G., Prokhorov, L., Puncken, O., Punturo, M., Puppo, P., Pürrer, M., Qi, H., Qin, J., Quetschke, V., Quintero, E., Quitzow-James, R., Raab, F., Rabeling, D., Radkins, H., Raffai, P., Raja, S., Rakhmanov, M., Rapagnani, P., Raymond, V., Razzano, M., Re, V., Read, J., Reed, C., Regimbau, T., Rei, L., Reid, S., Reitze, D., Rew, H., Reyes, S., Ricci, F., Riles, K., Robertson, N., Robie, R., Robinet, F., Rocchi, A., Rolland, L., Rollins, J., Roma, V., Romano, R., Romanov, G., Romie, J., Rosińska, D., Rowan, S., Rüdiger, A., Ruggi, P., Ryan, K., Sachdev, S., Sadecki, T., Sadeghian, L., Salconi, L., Saleem, M., Salemi, F., Samajdar, A., Sammut, L., Sanchez, E., Sandberg, V., Sandeen, B., Sanders, J., Sassolas, B., Sathyaprakash, B., Saulson, P., Sauter, O., Savage, R., Sawadsky, A., Schale, P., Schilling, R., Schmidt, J., Schmidt, P., Schnabel, R., Schofield, R., Schönbeck, A., Schreiber, E., Schuette, D., Schutz, B. F., Scott, J., Scott, S., Sellers, D., Sengupta, A., Sentenac, D., Sequino, V., Sergeev, A., Serna, G., Setyawati, Y., Sevigny, A., Shaddock, D., Shah, S., Shahriar, M., Shaltev, M., Shao, Z., Shapiro, B., Shawhan, P., Sheperd, A., Shoemaker, D., Shoemaker, D., Siellez, K., Siemens, X., Sigg, D., Silva, A., Simakov, D., Singer, A., Singer, L., Singh, A., Singh, R., Singhal, A., Sintés, A., Slagmolen, B., Smith, J., Smith, N., Smith, R., Son, E., Sorazu, B., Sorrentino, F., Souradeep, T., Srivastava, A., Staley, A., Steinke, M., Steinlechner, J., Steinlechner, S., Steinmeyer, D., Stephens, B., Stone, R., Strain, K., Straniero, N., Stratta, G., Straus, N., Strigin, S., Sturani, R., Stuver, A., Summerscales, T., Sun, L., Sutton, P., Swinkels, B., Szczepańczyk, M., Tacca, M., Talukder, D., Tanner, D., Tápai, M., Tarabrin, S. P., Taracchini, A., Taylor, R., Theeg, T., Thirugnanasambandam, M., Thomas, E., Thomas, M., Thomas, P., Thorne, K., Thorne, K., Thrane, E., Tiwari, S., Tiwari, V., Tokmakov, K., Tomlinson, C., Tonelli, M., Torres, C., Torrie, C., Töyrä, D., Travasso, F., Traylor, G., Trifirò, D., Tringali, M., Trozzo, L., Tse, M., Turconi, M., Tuyenbayev, D., Ugalini, D., Unnikrishnan, C., Urban, A., Usman, S., Vahlbruch, H., Vajente, G., Valdes, G., van Bakel, N., van Beuzekom, M., van den Brand, J., Broeck, C. V. D., Vander-Hyde, D., van der Schaaf, L., van Heijningen, J., van Veggel, A., Vardaro, M., Vass, S., Vasúth, M., Vaulin, R., Vecchio, A., Vedovato, G., Veitch, J., Veitch, P., Venkateswara, K., Verkindt, D., Vetrano, F., Viceré, A., Vinciguerra, S., Vine, D., Vinet, J.-Y., Vitale, S., Vo, T., Vocca, H., Vorvick, C., Voss, D., Voudsen, W., Vyatchanin, S., Wade, A., Wade, L., Wade, M., Walker, M., Wallace, L., Walsh, S., Wang, G., Wang, H., Wang, M., Wang, X., Wang, Y., Ward, R., Warner, J., Was, M., Weaver, B., Wei, L.-W., Weinert, M., Weinstein, A., Weiss, R., Welborn, T., Wen, L., Weßels, P., Westphal, T., Wette, K., Whelan, J. T., White, D., Whiting, B., Williams, D., Williams, R., Williamson, A., Willis, J., Willke, B., Wimmer, M., Winkler, W., Wipf, C., Wittel, H., Woan, G., Worden, J., Wright, J., Wu, G., Yablon, J., Yam, W., Yamamoto, H., Yancey, C., Yap, M., Yu, H., Yvert, M., Zadrožny, A., Zangrando, L., Zanolin, M., Zendri, J.-P., Zevin, M., Zhang, F., Zhang, L., Zhang, M., Zhang, Y., Zhao, C., Zhou, M., Zhou, Z., Zhu, X., Zucker, M., Zuraw, S., & Zweizig, J. (2016). Observing gravitational-wave transient GW150914 with minimal assumptions. *Physical Review D*, 93: 122004. doi:10.1103/PhysRevD.93.122004.

The LIGO Scientific Collaboration, Martynov, D. V., Hall, E. D., Abbott, B. P., Abbott, R., Abbott, T. D., Abernathy, M. R., Ackley, K., Adams, C., Addesso, P., Adhikari, R. X., Adya, V. B., Affeldt, C., Aggarwal, N., Aguiar, O. D., Ain, A., Ajith, P., Allen, B., Altin, P. A., Anderson, R. A., Anderson, S. B., Anderson, W. G., Arai, K., Arain, M. A., Araya, M. C., Arce-neaux, C. C., Areeda, J. S., Arun, K. G., Ashton, G., Ast, M., Aston, S. M., Aufmuth, P., Aulbert, C., Babak, S., Baker, P.

## Publications by AEI Members and Guest Scientists

T., Ballmer, S. W., Barayoga, J. C., Barclay, S. E., Barish, B. C., Barker, D., Barr, B., Barsotti, L., Bartlett, J., Bartos, I., Bassiri, R., Batch, J. C., Baune, C., Belgin, M., Bell, A. S., Belopolski, I., Berger, B. K., Bergmann, G., Berry, C. P. L., Bhagwat, S., Bhandare, R., Bilenko, I. A., Billingsley, G., Birch, J., Birney, R., Biscans, S., Bisht, A., Biver, C., Blackburn, J. K., Blair, C. D., Blair, D. G., Blair, R. M., Bock, O., Bogan, C., Bohe, A., Bond, C., Bork, R., Bose, S., Brady, P. R., Braginsky, V. B., Branco, V., Brau, J. E., Brinkmann, M., Brockill, P., Broida, J. E., Brooks, A. F., Brown, D. A., Brown, D. D., Brown, N. M., Brunett, S., Buchanan, C. C., Buikema, A., Buonanno, A., Byer, R. L., Cabero, M., Cadenati, L., Cahillane, C., Bustillo, J. C., Callister, T., Camp, J. B., Cannon, K. C., Cao, J., Capano, C. D., Caride, S., Caudill, S., Cavaglia, M., Cepeda, C. B., Chan, M., Chao, S., Charlton, P., Cheeseboro, B. D., Chen, H. Y., Chen, Y., Cheng, C., Cho, H. S., Cho, M., Chow, J. H., Christensen, N., Chu, Q., Chung, S., Ciani, G., Clara, F., Clark, J. A., Collette, C. G., Cominsky, L., Constancio, M., Cook, D., Corbitt, T. R., Cornish, N., Corpuz, A. A., Corsi, A., Costa, C. A., Coughlin, M. W., Coughlin, S. B., Countryman, S. T., Couvares, P., Cowan, E. E., Coward, D. M., Cowart, M. J., Coyne, D. C., Coyne, R., Craig, K., Creighton, J. D. E., Cripe, J., Crowder, S. G., Cumming, A., Cunningham, L., Canton, T. D., Damjanic, M., Danilishin, S. L., Danzmann, K., Darman, N. S., Dasgupta, A., Costa, C. F. D. S., Dave, I., Davies, G. S., Daw, E. J., Day, B., De, S., DeBra, D., Del Pozzo, W., Denker, T., Dent, T., Dergachev, V., DeRosa, R. T., DeSalvo, R., Devine, R. C., Dhurandhar, S., Diaz, M. C., Di Palma, I., Donovan, F., Dooley, K. L., Doravari, S., Douglas, R., Downes, T. P., Drago, M., Drever, R. W. P., Driggers, J. C., Dwyer, S. E., Edo, T. B., Edwards, M. C., Effler, A., Eggenstein, H. -B., Ehrens, P., Eichholz, J., Eikenberry, S. S., Engels, W., Essick, R. C., Etzel, T., Evans, M., Evans, T. M., Everett, R., Factourovich, M., Fair, H., Fairhurst, S., Fan, X., Fang, Q., Farr, B., Farr, W. M., Favata, M., Fays, M., Fehrmann, H., Fejer, M. M., Fenyvesi, E., Ferreira, E. C., Fisher, R. P., Fletcher, M., Foley, S., Forsyth, S. S., Frei, Z., Freise, A., Frey, R., Fritschel, P., Frolov, V. V., Fulda, P., Fyffe, M., Gabbard, H. A. G., Gair, J. R., Gaonkar, S. G., Gaur, G., Gehrels, N., Geng, P., George, J., Gergely, L., Ghosh, A., Ghosh, A., Giaime, J. A., Giardina, K. D., Gill, K., Glaefke, A., Goetz, E., Goetz, R., Gondan, L., Gonzalez, G., Gopakumar, A., Gordon, N. A., Gorodetsky, M. L., Gossan, S. E., Graef, C., Graff, P. B., Grant, A., Gras, S., Gray, C., Green, A. C., Greenhalgh, J., Grote, H., Grunewald, S., Guo, X., Gupta, A., Gupta, M. K., Gushwa, K. E., Gustafson, E. K., Gustafson, R., Hacker, J. J., Hall, B. R., Hammond, G., Haney, M., Hanke, M. M., Hanks, J., Hanna, C., Hannam, M. D., Hanson, J., Hardwick, T., Harry, G. M., Harry, I. W., Hart, M. J., Hartman, M. T., Haster, C. -J., Haughian, K., Heefner, J., Heintze, M. C., Hendry, M., Heng, I. S., Hennig, J., Henry, J., Heptonstall, A. W., Heurs, M., Hild, S., Hoak, D., Holt, K., Holz, D. E., Hopkins, P., Hough, J., Houston, E. A., Howell, E. J., Hu, Y. M., Huang, S., Huerta, E. A., Hughey, B., Husa, S., Huttner, S. H., Huynh-Dinh, T., Indik, N., Ingram, D. R., Inta, R., Isa, H. N., Isi, M., Isogai, T., Iyer, B. R., Izumi, K., James, E., Jang, H., Jani, K., Jawahar, S., Jian, L., Jimenez-Forteza, F., Johnson, W. W., Jones, D. I., Jones, R., Ju, L., K. H., Kalaghatgi, C. V., Kalogera, V., Kandhasamy, S., Kang, G., Kanner, J. B., Kapadia, S. J., Karki, S., Karvinen, K. S., Kasprzak, M., Katsavounidis, E., Katzman, W., Kaufer, S., Kaur, T., Kawabe, K., Kehl, M. S., Keitel, D., Kelley, D. B., Kells, W., Kennedy, R., Key, J. S., Khalili, F. Y., Khan, S., Khan, Z., Khazanov, E. A., Kijbunchoo, N., Kim, C.-W., Kim, C., Kim, J., Kim, K., Kim, N., Kim, W., Kim, Y.-M., Kimbrell, S. J., King, E. J., King, P. J., Kissel, J. S., Klein, B., Kleybolte, L., Klimenko, S., Koehlenbeck, S. M., Kondrashov, V., Kontos, A., Korobko, M., Korth, W. Z., Kozak, D. B., Kringel, V., Krishnan, B., Krueger, C., Kuehn, G., Kumar, P., Kumar, R., Kuo, L., Kwee, P., Lackey, B. D., Landry, M., Lange, J., Lantz, B., Lasky, P. D., Laxen, M., Lazarini, A., Leavey, S., Lebigot, E. O., Lee, C. H., Lee, H. K., Lee, H. M., Lee, K., Lenon, A., Leong, J. R., Levin, Y., Lewis, J. B., Li, T. G. F., Libson, A., Littenberg, T. B., Lockerbie, N. A., Loew, K. M., Lombardi, A. L., London, L. T., Lord, J. E., Lormand, M., Luck, H., Lundgren, A. P., Lynch, R., Ma, Y., Machenschalk, B., MacInnis, M., Macleod, D. M., Magana-Sandoval, F., Zertuche, L. M., Magee, R. M., Mandel, I., Mandic, V., Mangano, V., Mansell, G. L., Manske, M., Marka, Z., Markosyan, A. S., Maros, E., Martin, I. W., Marx, J. N., Mason, K., Massinger, T. J., Masso-Reid, M., Matichard, F., Matone, L., Mavalvala, N., Mazumder, N., McCarthy, R., McClelland, D. E., McCormick, S., McGuire, S. C., McIntyre, G., McIver, J., McManus, D. J., McRae, T., McWilliams, S. T., Meadors, G. D., Melatos, A., Mendell, G., Mercer, R. A., Merilh, E. L., Meshkov, S., Messenger, C., Messick, C., Meyer, M., Meyers, P. M., Miao, H., Middleton, H., Mikhailov, E. E., Miller, A. L., Miller, B. B., Miller, J., Miller, T., Nielsen, A. B., Ming, J., Mirshekari, S., Mishra, C., Mitra, S., Mitrofanov, V. P., Mitselmakher, G., Mittleman, R., Mohapatra, S. R. P., Moore, B. C., Moore, C. J., Moraru, D., Moreno, G., Morriss, S. R., Mossavi, K., Mow-Lowry, C. M., Mueller, G., Muir, A. W., Mukherjee, A., Mukherjee, D., Mukherjee, S., Mukund, N., Mullavey, A., Munch, J., Murphy, D. J., Murray, P. G., Mytidis, A., Nayak, R. K., Nedkova, K., Nelson, T. J. N., Neunzert, A., Newton, G., Nguyen, T. T., Nielsen, A. B., Nitz, A., Nolting, D., Normandin, M. E. N., Nuttall, L. K., Oberling, J., Ochsner, E., O'Dell, J., Oelker, E., Ogin, G. H., Oh, J. J., Oh, S. H., Ohme, F., Oliver, M., Oppermann, P., Oram, R. J., O'Reilly, B., O'Shaughnessy, R., Ott, C. D., Ottaway, D. J., Overmier, H., Owen, B. J., Pai, A., Pai, S. A., Palamos, J. R., Palashov, O., Pal-Singh, A., Pan, H., Pankow, C., Pannarale, F., Pant, B. C., Papa, M. A., Paris, H. R., Parker, W., Pascual, D., Patrick, Z., Pearlstone, B. L., Pedraza, M., Pekowsky, L., Pele, A., Penn, S., Perreca, A., Perri, L. M., Phelps, M., Pierre, V., Pinto, I. M., Pitkin, M., Poe, M., Post, A., Powell, J., Prasad, J., Pratt, J., Predoi, V., Prestegard, T., Price, L. R., Prijatelj, M., Principe, M., Privitera, S., Prix, R., Prokhorov, L., Puncken, O., Pürner, M., Qi, H., Qin, J., Qiu, S., Quetschke, V., Quintero, E. A., Quitzow-James, R., Raab, F. J., Rabeling, D. S., Radkins, H., Raffai, P., Raja, S., Rajan, C., Rakhmanov, M., Raymond, V., Read, J., Reed, C. M., Reid, S., Reitze, D. H., Rew, H., Reyes, S. D., Rhoades, E., Riles, K., Rizzo, M., Robertson, N. A., Robie, R., Rollins, J. G., Roma, V. J., Romano, J. D., Romanov, G., Romie, J. H., Rowan, S., Rudiger, A., Ryan, K., Sachdev, S., Sadecki, T., Sadeghian, L., Sakellariadou, M., Saleem, M., Salemi, F., Samajdar, A., Sammut, L., Sanchez, E. J., Sandberg, V., Sandeen, B., Sanders, J. R., Sathyaprakash, B. S., Saulson, P. R., Sauter, O. E. S., Savage, R. L., Sawadsky, A., Schale, P., Schilling, R., Schmidt, E., Schmidt, J., Schmidt, P., Schnabel, R., Schofield, R. M. S., Schonbeck, A., Schreiber, E., Schuette, D., Schulz, B., Schutz, B. F., Schwinberg, P., Scott, J., Scott, S. M., Sellers, D., Sengupta, A. S., Sergeev, A., Shaddock, D. A., Shaffer, T., Shahriar, M. S., Shaltev, M., Shapiro, B., Shawhan, P., Sheperd, A., Shoemaker, D. H., Shoemaker, D. M., Siemens, X., Sigg, D., Silva, A. D., Singer, A., Singer, L. P., Singh, A., Singh, R., Sintes, A. M., Slagmolen, B. J. J., Smith, J. R., Smith, N. D., Smith, R. J. E., Son, E. J., Sorazu, B., Souradeep, T., Srivastava, A. K., Staley, A., Stein, A., Steinke, M., Steinlechner, J., Steinlechner, S., Steinmeyer, D., Stephens, B. C., Stiles, D., Stone, M. C., Stone, R., Strain, K. A., Strauss, N. A., Strigin, S., Sturani, R., Stuver, A. L., Summerscales, T. Z., Sun, L., Sunil, S., Sutton, P. J., Talukder, D., Tanner, D. B., Tapai, M., Tarabrin, S. P., Taracchini, A., Taylor, R., Theeg, T., Thirugnanasambandam, M. P., Thomas, E. G., Thomas, M., Thomas, P., Thorne, K. A., Thorne, K. S., Thrane, E., Tiwari, V., Tokmakov, K. V., Toland, K., Tomlinson, C., Tornasi, Z., Torres, C. V., Torrie, C. I., Toyra, D., Traylor, G., Tri- fi-ro, D., Tse, M., Tuyenbayev, D., Ugolini, D., Unnikrishnan, C. S., Urban, A. L., Usman, S. A., Vahlbruch, H., Vajente, G., Valdes, G., Vander-Hyde, D. C., van Veggel, A. A., Vargas, M., Vass, S., Vaulin, R., Vecchio, A., Veitch, J., Veitch, P. J., Venkateswara, K., Vinciguerra, S., Vine, D. J., Vitale, S., Vo, T., Vorvick, C., Voss, D. V., Vousden, W. D., Vyatchanin,

## Publications by AEI Members and Guest Scientists

S. P., Wade, A. R., Wade, L. E., Wade, M., Waldman, S., Walker, M., Wallace, L., Walsh, S., Wang, H., Wang, M., Wang, X., Wang, Y., Ward, R. L., Warner, J., Weaver, B., Weinert, M., Weinstein, A. J., Weiss, R., Wen, L., Wessels, P., Westphal, T., Wette, K., Whelan, J. T., White, D. J., Whiting, B. F., Willems, P., Williams, R. D., Williamson, A. R., Willis, J. L., Willke, B., Wimmer, M., Winkelmann, L., Winkler, W., Wipf, C. C., Wittel, H., Woan, G., Woehler, J., Worden, J., Wright, J. L., Wu, D. S., Wu, G., Yablon, J., Yam, W., Yamamoto, H., Yancey, C. C., Yu, H., Zanolin, M., Zevin, M., Zhang, L., Zhang, M., Zhang, Y., Zhao, C., Zhou, M., Zhou, Z., Zhu, X. J., Zucker, M. E., Zuraw, S. E., & Zweizig, J. (2016). The Sensitivity of the Advanced LIGO Detectors at the Beginning of Gravitational Wave Astronomy. *Physical Review D*, 93: 112004. doi:10.1103/PhysRevD.93.112004.

The LIGO Scientific Collaboration, The Virgo Collaboration, Abbott, B. P., Abbott, R., Abbott, T. D., Abernathy, M. R., Acernese, F., Ackley, K., Adams, C., Adams, T., Addesso, P., Adhikari, R. X., Adya, V. B., Affeldt, C., Agathos, M., Agatsuma, K., Aggarwal, N., Aguiar, O. D., Aiello, L., Ain, A., Ajith, P., Allen, B., Allocca, A., Altin, P. A., Anderson, S. B., Anderson, W. G., Arai, K., Araya, M. C., Arceneaux, C. C., Areeda, J. S., Arnaud, N., Arun, K. G., Ascenzi, S., Ashton, G., Ast, S., Aston, S. M., Astone, P., Aufmuth, P., Aubert, C., Babak, S., Bacon, P., Bader, M. K. M., Baker, P. T., Baldaccini, F., Ballardin, G., Ballmer, S. W., Barayoga, J. C., Barclay, S. E., Barish, B. C., Barker, D., Barone, F., Barr, B., Barsotti, L., Barsuglia, M., Barta, D., Bartlett, J., Bartos, I., Bassiri, R., Basti, A., Batch, J. C., Baune, C., Bavigadda, V., Bazzan, M., Behnke, B., Bejger, M., Bell, A. S., Bell, C. J., Berger, B. K., Bergman, J., Bergmann, G., Berry, C. P. L., Bersanetti, D., Bertolini, A., Betzwieser, J., Bhagwat, S., Bhandare, R., Bilenko, I. A., Billingsley, G., Birch, J., Birney, R., Biscans, S., Bisht, A., Bitossi, M., Biwer, C., Bizouard, M. A., Blackburn, J. K., Blair, C. D., Blair, D. G., Blair, R. M., Bloemen, S., Bock, O., Bodiya, T. P., Boer, M., Bogaert, G., Bogan, C., Bohe, A., Bohémier, K., Bojtos, P., Bond, C., Bondu, F., Bonnand, R., Boom, B. A., Bork, R., Boschi, V., Bose, S., Bouffanais, Y., Bozzi, A., Bradaschia, C., Brady, P. R., Braginsky, V. B., Branchesi, M., Brau, J. E., Briant, T., Brillet, A., Brinkmann, M., Brisson, V., Brockill, P., Brooks, A. F., Brown, D. A., Brown, D. D., Brown, N. M., Buchanan, C. C., Buikema, A., Bulik, T., Bulten, H. J., Buonanno, A., Buskulic, D., Buy, C., Byer, R. L., Cabero, M., Cadonati, L., Cagnoli, G., Cahillane, C., Calderón Bustillo, J., Callister, T., Calloni, E., Camp, J. B., Cannon, K. C., Cao, J., Capano, C., Capocasa, E., Carbognani, F., Caride, S., Diaz, J. C., Casentini, C., Caudill, S., Cavaglià, M., Cavalier, F., Cavalieri, R., Cella, G., Cepeda, C. B., Baiardi, L. C., Cerretani, G., Cesarini, E., Chakraborty, R., Chalermongsak, T., Chamberlin, S. J., Chan, M., Chao, S., Charlton, P., Chassande-Mottin, E., Chen, H. Y., Chen, Y., Cheng, C., Chincarini, A., Chiummo, A., Cho, H. S., Cho, M., Chow, J. H., Christensen, N., Chu, Q., Chua, S., Chung, S., Ciani, G., Clara, F., Clark, J. A., Clayton, J. H., Cleva, F., Coccia, E., Cohadon, P.-F., Cokelaer, T., Colla, A., Collette, C. G., Cominsky, L., Constancio, M., Conte, A., Conti, L., Cook, D., Corbitt, T. R., Cornish, N., Corsi, A., Cortese, S., Costa, C. A., Coughlin, M. W., Coughlin, S. B., Coulon, J.-P., Countryman, S. T., Couvares, P., Cowan, E. E., Coward, D. M., Cowart, M. J., Coyne, D. C., Coyne, R., Craig, K., Creighton, J. D. E., Creighton, T. D., Cripe, J., Crowder, S. G., Cumming, A., Cunningham, L., Cuoco, E., Canton, T. D., Danilishin, S. L., D'Antonio, S., Danzmann, K., Darman, N. S., Dattilo, V., Dave, I., Daveloza, H. P., Davier, M., Davies, G. S., Daw, E. J., Day, R., De, S., DeBra, D., Debreczeni, G., Degallaix, J., De Laurentis, M., Deléglise, S., Del Pozzo, W., Denker, T., Dent, T., Dereli, H., Dergachev, V., DeRosa, R. T., De Rosa, R., DeSalvo, R., Dhurandhar, S., Diaz, M. C., Dietz, A., Di Fiore, L., Di Giovanni, M., Di Lieto, A., Di Pace, S., Di Palma, I., Di Virgilio, A., Dojcinoski, G., Dolique, V., Donovan, F., Dooley, K., Doravari, S., Douglas, R., Downes, T. P., Drago, M., Drever, R. W. P., Driggers, J. C., Du, Z., Ducrot, M., Dwyer, S. E., Edo, T. B., Edwards, M. C., Effler, A., Eggenstein, H.-B., Ehrens, P., Eichholz, J., Eikenberry, S. S., Engels, W., Essick, R. C., Etzel, T., Evans, M., Evans, T. M., Everett, R., Factourovich, M., Fafone, V., Fair, H., Fairhurst, S., Fan, X., Fang, Q., Farinon, S., Farr, B., Farr, W. M., Favata, M., Fays, M., Fehrmann, H., Fejer, M. M., Ferrante, I., Ferreira, E. C., Ferrini, F., Fidecaro, F., Fiori, I., Fiorucci, D., Fisher, R. P., Flaminio, R., Fletcher, M., Fotopoulos, N., Fournier, J.-D., Franco, S., Frasca, S., Frasca, F., Frei, M., Frei, Z., Freise, A., Frey, R., Frey, V., Fricke, T. T., Fritschel, P., Frolov, V. V., Fulda, P., Fyffe, M., Gabbard, H. A. G., Gair, J. R., Gammaitoni, L., Gaonkar, S. G., Garufi, F., Gatto, A., Gaur, G., Gehrels, N., Gemme, G., Gendre, B., Genin, E., Gennai, A., George, J., Gergely, L., Germain, V., Ghosh, A., Ghosh, S., Giaime, J. A., Giardina, K. D., Giazotto, A., Gill, K., Glaefke, A., Goetz, E., Goetz, R., Goggin, L. M., Gondan, L., González, G., Castro, J. M. G., Gopakumar, A., Gordon, N. A., Gorodetsky, M. L., Gosan, S. E., Gosselin, M., Gouaty, R., Graef, C., Graff, P. B., Granata, M., Grant, A., Gras, S., Gray, C., Greco, G., Green, A. C., Groot, P., Grote, H., Grunewald, S., Guidi, G. M., Guo, X., Gupta, A., Gupta, M. K., Gushwa, K. E., Gustafson, E. K., Gustafson, R., Hacker, J. J., Hall, B. R., Hall, E. D., Hammond, G., Haney, M., Hanke, M. M., Hanks, J., Hanna, C., Hannam, M. D., Hanson, J., Hardwick, T., Harms, J., Harry, G. M., Harry, I. W., Hart, M. J., Hartman, M. T., Haster, C.-J., Haughian, K., Heidmann, A., Heintze, M. C., Heitmann, H., Hello, P., Hemming, G., Hendry, M., Heng, I. S., Hennig, J., Heptonstall, A. W., Heurs, M., Hild, S., Hoak, D., Hodge, K. A., Hofman, D., Hollitt, S. E., Holt, K., Holz, D. E., Hopkins, S., Hosken, D. J., Hough, J., Houston, E. A., Howell, E. J., Hu, Y. M., Huang, S., Huerta, E. A., Huet, D., Hughey, B., Husa, S., Huttner, S. H., Huynh-Dinh, T., Idrisy, A., Indik, N., Ingram, D. R., Inta, R., Isa, H. N., Isac, J.-M., Isi, M., Islas, G., Isogai, T., Iyer, B. R., Izumi, K., Jaqmin, T., Jang, H., Jani, K., Jaranowski, P., Jawahar, S., Jiménez-Forteza, F., Johnson, W. W., Jones, D. I., Jones, G., Jones, R., Jonker, R. J. G., Ju, L., K, H., Kalaghatgi, C. V., Kalogera, V., Kandhasamy, S., Kang, G., Kanner, J. B., Karki, S., Kasprzack, M., Katsavounidis, E., Katzman, W., Kaufer, S., Kaur, T., Kawabe, K., Kawazoe, F., Kéfélian, F., Kehl, M. S., Keitel, D., Kelley, D. B., Kells, W., Keppel, D. G., Kennedy, R., Key, J. S., Khalaidovski, A., Khalili, F. Y., Khan, I., Khan, S., Khan, Z., Khazanov, E. A., Kijbunchoo, N., Kim, C., Kim, J., Kim, K., Kim, N.-G., Kim, N., Kim, Y.-M., King, E. J., King, P. J., Kinzel, D. L., Kissel, J. S., Kleybolte, L., Klimentko, S., Koehlenbeck, S. M., Kokeyama, K., Koley, S., Kondrashov, V., Kontos, A., Korobko, M., Korth, W. Z., Kowalska, I., Kozak, D. B., Kringel, V., Krishnan, B., Królak, A., Krueger, C., Kuehn, G., Kumar, P., Kuo, L., Kutynia, A., Lackey, B. D., Landry, M., Lange, J., Lantz, B., Lasky, P. D., Lazzarini, A., Lazzaro, C., Leaci, P., Leavey, S., Lebigot, E. O., Lee, C. H., Lee, H. K., Lee, H. M., Lee, K., Lenon, A., Leonardi, M., Leong, J. R., Leroy, N., Letendre, N., Levin, Y., Levine, B. M., Li, T. G. F., Libson, A., Littenberg, T. B., Lockerbie, N. A., Logue, J., Lombardi, A. L., Lord, J. E., Lorenzini, M., Lorient, V., Lormand, M., Losurdo, G., Lough, J. D., Lück, H., Lundgren, A., Luo, J., Lynch, R., Ma, Y., MacDonald, T., Machenschalk, B., MacInnis, M., Macleod, D. M., Magana-Sandoval, F., Magee, R. M., Mageswaran, M., Majorana, E., Maksimovic, I., Malvezzi, V., Man, N., Mandel, I., Mandic, V., Mangano, V., Mansell, G. L., Manske, M., Mantovani, M., Marchesoni, F., Marion, F., Márka, S., Márka, Z., Markosyan, A. S., Maros, E., Martelli, F., Martellini, L., Martin, I. W., Martin, R. M., Martynov, D. V., Marx, J. N., Mason, K., Masserot, A., Massinger, T. J., Masso-Reid, M., Matichard, F., Matone, L., Mavalvala, N., Mazumder, N., Mazzolo, G., McCarthy, R., McClelland, D. E., McCormick, S., McGuire, S. C., McIntyre, G., McIver, J., McKechan, D. J. A., McManus, D. J., McWilliams, S. T., Meacher, D., Meadors, G. D., Meidam, J., Melatos, A., Mendell, G., Mendoza-Gandara, D., Mercer,

## Publications by AEI Members and Guest Scientists

R. A., Merilh, E., Merzougui, M., Meshkov, S., Messaritaki, E., Messenger, C., Messick, C., Meyers, P. M., Mezzani, F., Miao, H., Michel, C., Middleton, H., Mikhailov, E. E., Milano, L., Miller, J., Millhouse, M., Minenkov, Y., Ming, J., Mirshekari, S., Mishra, C., Mitra, S., Mitrofanov, V. P., Mitselmakher, G., Mittleman, R., Moggi, A., Mohan, M., Mohapatra, S. R. P., Montani, M., Moore, B. C., Moore, C. J., Moraru, D., Moreno, G., Morriss, S. R., Mossavi, K., Mours, B., Mow-Lowry, C. M., Mueller, C. L., Mueller, G., Muir, A. W., Mukherjee, A., Mukherjee, D., Mukherjee, S., Mukund, N., Mullavey, A., Munch, J., Murphy, D. J., Murray, P. G., Mytidis, A., Nardecchia, I., Naticchioni, L., Nayak, R. K., Necula, V., Nedkova, K., Nelemans, G., Neri, M., Neunzert, A., Newton, G., Nguyen, T. T., Nielsen, A. B., Nisanke, S., Nitz, A., Nocera, F., Nolting, D., Normandin, M. E., Nuttall, L. K., Oberling, J., Ochsner, E., O'Dell, J., Oelker, E., Ogin, G. H., Oh, J. J., Oh, S. H., Ohme, F., Oliver, M., Oppermann, P., Oram, R. J., O'Reilly, B., O'Shaughnessy, R., Ottaway, D. J., Ottens, R. S., Overmier, H., Owen, B. J., Pai, A., Pai, S. A., Palamos, J. R., Palashov, O., Palomba, C., Pal-Singh, A., Pan, H., Pan, Y., Pankow, C., Pannarale, F., Pant, B. C., Paoletti, F., Paoli, A., Papa, M. A., Paris, H. R., Parker, W., Pascucci, D., Pasqualetti, A., Passaquieti, R., Passuello, D., Patricelli, B., Patrick, Z., Pearlstone, B. L., Pedraza, M., Pedurand, R., Pekowsky, L., Pele, A., Penn, S., Perreca, A., Phelps, M., Piccinni, O., Pichot, M., Piergiovanni, F., Pierro, V., Pillant, G., Pinard, L., Pinto, I. M., Pitkin, M., Poggiani, R., Popolizio, P., Post, A., Powell, J., Prasad, J., Predoi, V., Premachandra, S. S., Prestegard, T., Price, L. R., Prijatelj, M., Principe, M., Privitera, S., Prodi, G. A., Prokhorov, L., Puncken, O., Punturo, M., Puppo, P., Pürerer, M., Qi, H., Qin, J., Quetschke, V., Quintero, E. A., Quitzow-James, R., Raab, F. J., Rabeling, D. S., Radkins, H., Raffai, P., Raja, S., Rakhmanov, M., Rapagnani, P., Raymond, V., Razzano, M., Re, V., Read, J., Reed, C. M., Regimbau, T., Rei, L., Reid, S., Reitze, D. H., Rew, H., Reyes, S. D., Ricci, F., Riles, K., Robertson, N. A., Robie, R., Robinet, F., Robinson, C., Rocchi, A., Rodriguez, A. C., Rolland, L., Rollins, J. G., Roma, V. J., Romano, R., Romanov, G., Romie, J. H., Rosińska, D., Rowan, S., Rüdiger, A., Ruggi, P., Ryan, K., Sachdev, S., Sadecki, T., Sadeghian, L., Salconi, L., Saleem, M., Salemi, F., Samajdar, A., Sammut, L., Sanchez, E. J., Sandberg, V., Sandeen, B., Sanders, J. R., Santamaría, L., Sassolas, B., Sathyaprakash, B. S., Saulson, P. R., Sauter, O., Savage, R. L., Sawadsky, A., Schale, P., Schilling, R., Schmidt, J., Schmidt, P., Schnabel, R., Schofield, R. M. S., Schönbeck, A., Schreiber, E., Schuette, D., Schutz, B. F., Scott, J., Scott, S. M., Sellers, D., Sengupta, A. S., Sentenac, D., Sequino, V., Sergeev, A., Serna, G., Setyawati, Y., Seigny, A., Shaddock, D. A., Shah, S., Shahriar, M. S., Shaltev, M., Shao, Z., Shapiro, B., Shawhan, P., Sheperd, A., Shoemaker, D. H., Shoemaker, D. M., Siellez, K., Siemens, X., Sigg, D., Silva, A. D., Simakov, D., Singer, A., Singer, L. P., Singh, A., Singh, R., Singhal, A., Sintés, A. M., Slagmolen, B. J. J., Smith, J. R., Smith, N. D., Smith, R. J. E., Son, E. J., Sorazu, B., Sorrentino, F., Souradeep, T., Srivastava, A. K., Staley, A., Steinke, M., Steinlechner, J., Steinlechner, S., Steinmeyer, D., Stephens, B. C., Stone, R., Strain, K. A., Straniero, N., Stratta, G., Strauss, N. A., Strigin, S., Sturani, R., Stuver, A. L., Summerscales, T. Z., Sun, L., Sutton, P. J., Swinkels, B. L., Szczepeńczyk, M. J., Tacca, M., Talukder, D., Tanner, D. B., Tápai, M., Tarabrin, S. P., Taracchini, A., Taylor, R., Theeg, T., Thirugnanasambandam, M. P., Thomas, E. G., Thomas, M., Thomas, P., Thorne, K. A., Thorne, K. S., Thrane, E., Tiwari, S., Tiwari, V., Tokmakov, K. V., Tomlinson, C., Tonelli, M., Torres, C. V., Torrie, C. I., Töyrä, D., Travasso, F., Traylor, G., Trifirò, D., Tringali, M. C., Trozzo, L., Tse, M., Turconi, M., Tuyenbayev, D., Ugolini, D., Unnikrishnan, C. S., Urban, A. L., Usman, S. A., Vahlbruch, H., Vajente, G., Valdes, G., van Bakel, N., van Beuzekom, M., Brand, J. F. J. v. d., Broeck, C. V. D., Vander-Hyde, D. C., van der Schaaf, L., van Heijningen, J. V., van Veggel, A. A., Vardaro, M., Vass, S., Vasúth, M., Vaulin, R., Vecchio, A., Vedovato, G., Veitch, J., Veitch, P. J., Venkateswara, K., Verkindt, D., Vetrano, F., Viceré, A., Vinciguerra, S., Vine, D. J., Vinet, J.-Y., Vitale, S., Vo, T., Vocca, H., Vorvick, C., Voss, D., Vousden, W. D., Vyatchanin, S. P., Wade, A. R., Wade, L. E., Wade, M., Walker, M., Wallace, L., Walsh, S., Wang, G., Wang, H., Wang, M., Wang, X., Wang, Y., Ward, R. L., Warner, J., Was, M., Weaver, B., Wei, L.-W., Weinert, M., Weinstein, A. J., Weiss, R., Welborn, T., Wen, L., Welbels, P., West, M., Westphal, T., Wette, K., Whelan, J. T., White, D. J., Whiting, B. F., Wiesner, K., Williams, R. D., Williamson, A. R., Willis, J. L., Willke, B., Wimmer, M. H., Winkler, W., Wipf, C. C., Wiseman, A. G., Wittel, H., Woan, G., Worden, J., Wright, J. L., Wu, G., Yablon, J., Yam, W., Yamamoto, H., Yancey, C. C., Yap, M. J., Yu, H., Yvert, M., Zadrožny, A., Zangrando, L., Zanolin, M., Zdziar, J.-P., Zevin, M., Zhang, F., Zhang, L., Zhang, M., Zhang, Y., Zhao, C., Zhou, M., Zhou, Z., Zhu, X. J., Zucker, M. E., Zuraw, S. E., & Zweizig, J. (2016). GW150914: The Advanced LIGO Detectors in the Era of First Discoveries. *Physical Review Letters*, 116: 131103. doi:10.1103/PhysRevLett.116.131103.

The LIGO Scientific Collaboration, The Virgo Collaboration, Abbott, B. P., Abbott, R., Abbott, T. D., Abernathy, M. R., Acernese, F., Ackley, K., Adams, C., Adams, T., Addesso, P., Adhikari, R. X., Adya, V. B., Affeldt, C., Agathos, M., Agatsuma, K., Aggarwal, N., Aguiar, O. D., Aiello, L., Ain, A., Ajith, P., Allen, B., Allocca, A., Altin, P. A., Anderson, S. B., Anderson, W. G., Arai, K., Araya, M. C., Arceneaux, C. C., Areeda, J. S., Arnaud, N., Arun, K. G., Ascenzi, S., Ashton, G., Ast, S., Aston, S. M., Astone, P., Aufmuth, P., Aulbert, C., Babak, S., Bacon, P., Bader, M. K. M., Baker, P. T., Baldaccini, F., Ballardín, G., Ballmer, S. W., Barayoga, J. C., Barclay, S. E., Barish, B. C., Barker, D., Barone, F., Barr, B., Barsotti, L., Barsuglia, M., Barta, D., Bartlett, J., Bartos, I., Bassiri, R., Basti, A., Batch, J. C., Baune, C., Bavigadga, V., Bazzan, M., Behnke, B., Bejger, M., Bell, A. S., Bell, C. J., Berger, B. K., Bergman, J., Bergmann, G., Berry, C. P. L., Bersanetti, D., Bertolini, A., Betzwieser, J., Bhagwat, S., Bhandare, R., Bilenko, I. A., Billingsley, G., Birch, J., Birney, R., Biscans, S., Bisht, A., Bitossi, M., Biwer, C., Bizouard, M. A., Blackburn, J. K., Blair, C. D., Blair, D. G., Blair, R. M., Bloemen, S., Bock, O., Bodiya, T. P., Boer, M., Bogaert, G., Bogan, C., Bohe, A., Bohémier, K., Bojtos, P., Bond, C., Bondu, F., Bonnand, R., Boom, B. A., Bork, R., Boschi, V., Bose, S., Bouffanais, Y., Bozzi, A., Bradaschia, C., Brady, P. R., Braginsky, V. B., Branchesi, M., Brau, J. E., Briant, T., Brillet, A., Brinkmann, M., Brisson, V., Brockill, P., Brooks, A. F., Brown, D. A., Brown, D. D., Brown, N. M., Buchanan, C. C., Buikema, A., Bulik, T., Bulten, H. J., Buonanno, A., Buskulic, D., Buy, C., Byer, R. L., Cabero, M., Cadonati, L., Cagnoli, G., Cahillane, C., Calderón Bustillo, J., Callister, T., Calloni, E., Camp, J. B., Cannon, K. C., Cao, J., Capano, C., Capocasa, E., Carbognani, F., Caride, S., Diaz, J. C., Casentini, C., Caudill, S., Cavaglià, M., Cavalier, F., Cavalieri, R., Cella, G., Cepeda, C. B., Baiardi, L. C., Cerretani, G., Cesarini, E., Chakraborty, R., Chalermongsak, T., Chamberlin, S. J., Chan, M., Chao, S., Charlton, P., Chassande-Mottin, E., Chen, H. Y., Chen, Y., Cheng, C., Chincarini, A., Chiummo, A., Cho, H. S., Cho, M., Chow, J. H., Christensen, N., Chu, Q., Chua, S., Chung, S., Ciani, G., Clara, F., Clark, J. A., Clayton, J. H., Cleva, F., Coccia, E., Cohadon, P.-F., Cokelaer, T., Colla, A., Collette, C. G., Cominsky, L., Constancio, M., Conte, A., Conti, L., Cook, D., Corbitt, T. R., Cornish, N., Corsi, A., Cortese, S., Costa, C. A., Coughlin, M. W., Coughlin, S. B., Coulon, J.-P., Countryman, S. T., Couvares, P., Cowan, E. E., Coward, D. M., Cowart, M. J., Coyne, D. C., Coyne, R., Craig, K., Creighton, J. D. E., Creighton, T. D., Cripe, J., Crowder, S. G., Cumming, A., Cunningham, L., Cuoco, E., Canton, T. D., Danilishin, S. L., D'Antonio, S., Danzmann, K., Darman, N. S., Dattilo, V., Dave, I., Daveloza, H. P., Davier, M., Davies, G. S., Daw, E. J., Day, R., De, S., DeBra, D., Debreczeni, G., Degallaix, J., De Laurentis, M., Deléglise, S., Del Pozzo, W., Denker, T., Dent, T., Dereli, H., Dergachev, V., DeRosa, R. T., De Rosa, R., DeSalvo, R., Dhurandhar, S., Diaz, M. C.,

## Publications by AEI Members and Guest Scientists

Dietz, A., Di Fiore, L., Di Giovanni, M., Di Lieto, A., Di Pace, S., Di Palma, I., Di Virgilio, A., Dojcinovski, G., Dolique, V., Donovan, F., Dooley, K., Doravari, S., Douglas, R., Downes, T. P., Drago, M., Drever, R. W. P., Driggers, J. C., Du, Z., Ducrot, M., Dwyer, S. E., Edo, T. B., Edwards, M. C., Effler, A., Eggenstein, H.-B., Ehrens, P., Eichholz, J., Eikenberry, S. S., Engels, W., Essick, R. C., Etzel, T., Evans, M., Evans, T. M., Everett, R., Factourovich, M., Fafone, V., Fair, H., Fairhurst, S., Fan, X., Fang, Q., Farinon, S., Farr, B., Farr, W. M., Favata, M., Fays, M., Fehrmann, H., Fejer, M. M., Ferrante, I., Ferreira, E. C., Ferrini, F., Fidecaro, F., Fiori, I., Fiorucci, D., Fisher, R. P., Flaminio, R., Fletcher, M., Fotopoulos, N., Fournier, J.-D., Franco, S., Frasca, S., Frascioni, F., Frei, M., Frei, Z., Freise, A., Frey, R., Frey, V., Fricke, T. T., Fritschel, P., Frolov, V. V., Fulda, P., Fyffe, M., Gabbard, H. A. G., Gair, J. R., Gammaitoni, L., Gaonkar, S. G., Garufi, F., Gatto, A., Gaur, G., Gehrels, N., Gemme, G., Gendre, B., Genin, E., Gennai, A., George, J., Gergely, L., Germain, V., Ghosh, A., Ghosh, S., Giaime, J. A., Giardina, K. D., Giazotto, A., Gill, K., Glaefke, A., Goetz, E., Goetz, R., Goggin, L. M., Gondan, L., González, G., Castro, J. M. G., Gopakumar, A., Gordon, N. A., Gorodetsky, M. L., Gosan, S. E., Gosselin, M., Gouaty, R., Graef, C., Graff, P. B., Granata, M., Grant, A., Gras, S., Gray, C., Greco, G., Green, A. C., Groot, P., Grote, H., Grunewald, S., Guidi, G. M., Guo, X., Gupta, A., Gupta, M. K., Gushwa, K. E., Gustafson, E. K., Gustafson, R., Hacker, J. J., Hall, B. R., Hall, E. D., Hammond, G., Haney, M., Hanke, M. M., Hanks, J., Hanna, C., Hannam, M. D., Hanson, J., Hardwick, T., Harms, J., Harry, G. M., Harry, I. W., Hart, M. J., Hartman, M. T., Haster, C.-J., Haughian, K., Heidmann, A., Heintze, M. C., Heitmann, H., Hello, P., Hemming, G., Hendry, M., Heng, I. S., Hennig, J., Heptonstall, A. W., Heurs, M., Hild, S., Hoak, D., Hodge, K. A., Hofman, D., Hollitt, S. E., Holt, K., Holz, D. E., Hopkins, P., Hosken, D. J., Hough, J., Houston, E. A., Howell, E. J., Hu, Y. M., Huang, S., Huerta, E. A., Huet, D., Hughey, B., Husa, S., Huttner, S. H., Huynh-Dinh, T., Idrisy, A., Indik, N., Ingram, D. R., Inta, R., Isa, H. N., Isac, J.-M., Isi, M., Islas, G., Isogai, T., Iyer, B. R., Izumi, K., Jacqmin, T., Jang, H., Jani, K., Jaranowski, P., Jawahar, S., Jiménez-ForTEza, F., Johnson, W. W., Jones, D. L., Jones, G., Jones, R., Jonker, R. J. G., Ju, L., K. H., Kalaghatgi, C. V., Kalogera, V., Kandhasamy, S., Kang, G., Kanner, J. B., Karki, S., Kasprzak, M., Katsavounidis, E., Katzman, W., Kaufer, S., Kaur, T., Kawabe, K., Kawazoe, F., Kéfélian, F., Kehl, M. S., Keitel, D., Kelley, D. B., Kells, W., Koppel, D. G., Kennedy, R., Key, J. S., Khalaidovski, A., Khalili, F. Y., Khan, I., Khan, S., Khan, Z., Khazanov, E. A., Kijbunchoo, N., Kim, C., Kim, J., Kim, K., Kim, N.-G., Kim, N., Kim, Y.-M., King, E. J., King, P. J., Kinzel, D. L., Kissel, J. S., Kleybolte, L., Klimenko, S., Koehlenbeck, S. M., Kokeyama, K., Koley, S., Kondrashov, V., Kontos, A., Korobko, M., Korth, W. Z., Kowalska, I., Kozak, D. B., Kringel, V., Krishnan, B., Królak, A., Krueger, C., Kuehn, G., Kumar, P., Kuo, L., Kutynia, A., Lackey, B. D., Landry, M., Lange, J., Lantz, B., Lasky, P. D., Lazzarini, A., Lazzaro, C., Leaci, P., Leavey, S., Lebigot, E. O., Lee, C. H., Lee, H. K., Lee, H. M., Lee, K., Lenon, A., Leonardi, M., Leong, J. R., Leroy, N., Letendre, N., Levin, Y., Levine, B. M., Li, T. G. F., Libson, A., Littenberg, T. B., Lockerbie, N. A., Logue, J., Lombardi, A. L., Lord, J. E., Lorenzini, M., Loriette, V., Lormand, M., Losurdo, G., Lough, J. D., Lück, H., Lundgren, A., Luo, J., Lynch, R., Ma, Y., MacDonald, T., Machenschalk, B., MacInnis, M., Macleod, D. M., Magana-Sandoval, F., Magee, R. M., Mageswaran, M., Majorana, E., Maksimovic, I., Malvezzi, V., Man, N., Mandel, I., Mandic, V., Mangano, V., Mansell, G. L., Manske, M., Mantovani, M., Marchesoni, F., Marion, F., Márka, S., Márka, Z., Markosyan, A. S., Maros, E., Martelli, F., Martellini, L., Martin, I. W., Martin, R. M., Martynov, D. V., Marx, J. N., Mason, K., Masserot, A., Massinger, T. J., Mastro-Reid, M., Matichard, F., Matone, L., Mavalvala, N., Mazumder, N., Mazzolo, G., McCarthy, R., McClelland, D. E., McCormick, S., McGuire, S. C., McIntyre, G., McIver, J., McKechnan, D. J. A., McManus, D. J., McWilliams, S. T., Meacher, D., Meadors, G. D., Meidam, J., Melatos, A., Mendell, G., Mendoza-Gandara, D., Mercer, R. A., Merilh, E., Merzougui, M., Meshkov, S., Messaritaki, E., Messenger, C., Messick, C., Meyers, P. M., Mezzani, F., Miao, H., Michel, C., Middleton, H., Mikhailov, E. E., Milano, L., Miller, J., Millhouse, M., Minenkov, Y., Ming, J., Mirshekari, S., Mishra, C., Mitra, S., Mitrofanov, V. P., Mitselmakher, G., Mittleman, R., Moggi, A., Mohan, M., Mohapatra, S. R. P., Montani, M., Moore, B. C., Moore, C. J., Moraru, D., Moreno, G., Morriss, S. R., Mossavi, K., Mours, B., Mow-Lowry, C. M., Mueller, C. L., Mueller, G., Muir, A. W., Mukherjee, A., Mukherjee, D., Mukherjee, S., Mukund, N., Mullaney, A., Munch, J., Murphy, D. J., Murray, P. G., Mytidis, A., Nardecchia, I., Naticchioni, L., Nayak, R. K., Necula, V., Nedkova, K., Nelemans, G., Neri, M., Neunzert, A., Newton, G., Nguyen, T. T., Nielsen, A. B., Nissanke, S., Nitz, A., Nocera, F., Nolting, D., Normandin, M. E., Nuttall, L. K., Oberling, J., Ochsner, E., O'Dell, J., Oelker, E., Ogin, G. H., Oh, J. J., Oh, S. H., Ohme, F., Oliver, M., Oppermann, P., Oram, R. J., O'Reilly, B., O'Shaughnessy, R., Ottaway, D. J., Ottens, R. S., Overmier, H., Owen, B. J., Pai, A., Pai, S. A., Palamos, J. R., Palashov, O., Palomba, C., Pal-Singh, A., Pan, H., Pan, Y., Pankov, C., Pannarale, F., Pant, B. C., Paoletti, F., Paoli, A., Papa, M. A., Paris, H. R., Parker, W., Pascucci, D., Pasqualetti, A., Passaquieti, R., Passuello, D., Patricelli, B., Patrick, Z., Pearlstone, B. L., Pedraza, M., Pedurand, R., Pekowsky, L., Pele, A., Penn, S., Perreca, A., Phelps, M., Piccinni, O., Pichot, M., Piergiorganni, F., Pierro, V., Pillant, G., Pinard, L., Pinto, I. M., Pitkin, M., Poggiani, R., Popolizio, P., Post, A., Powell, J., Prasad, J., Predoi, V., Premachandra, S. S., Prestegard, T., Price, L. R., Prijatelj, M., Principe, M., Privitera, S., Prodi, G. A., Prokhorov, L., Puncken, O., Punturo, M., Puppo, P., Pürre, M., Qi, H., Qin, J., Quetschke, V., Quintero, E. A., Quitzow-James, R., Raab, F. J., Rabeling, D. S., Radkins, H., Raffai, P., Raja, S., Rakhmanov, M., Rapagnani, P., Raymond, V., Razzano, M., Re, V., Read, J., Reed, C. M., Regimbau, T., Rei, L., Reid, S., Reitze, D. H., Rew, H., Reyes, S. D., Ricci, F., Riles, K., Robertson, N. A., Robie, R., Robinet, F., Robinson, C., Rocchi, A., Rodriguez, A. C., Rolland, L., Rollins, J. G., Roma, V. J., Romano, R., Romanov, G., Romie, J. H., Rosińska, D., Rowan, S., Rüdiger, A., Ruggi, P., Ryan, K., Sachdev, S., Sadecki, T., Sadeghian, L., Salconi, L., Saleem, M., Salemi, F., Samajdar, A., Sammut, L., Sanchez, E. J., Sandberg, V., Sandeen, B., Sanders, J. R., Santamaría, L., Sassolas, B., Sathyaprakash, B. S., Saulson, P. R., Sauter, O., Savage, R. L., Sawadsky, A., Schale, P., Schilling, R., Schmidt, J., Schmidt, P., Schnabel, R., Schofield, R. M. S., Schönbeck, A., Schreiber, E., Schuette, D., Schutz, B. F., Scott, J., Scott, S. M., Sellers, D., Sengupta, A. S., Sentenac, D., Sequino, V., Sergeev, A., Serna, G., Setyawati, Y., Sevigny, A., Shaddock, D. A., Shah, S., Shahriar, M. S., Shaltev, M., Shao, Z., Shapiro, B., Shawhan, P., Sheperd, A., Shoemaker, D. H., Shoemaker, D. M., Siellez, K., Siemens, X., Sigg, D., Silva, A. D., Simakov, D., Singer, A., Singer, L. P., Singh, A., Singh, R., Singhal, A., Sintès, A. M., Slagmolen, B. J. J., Smith, J. R., Smith, N. D., Smith, R. J. E., Son, E. J., Sorazu, B., Sorrentino, F., Souradeep, T., Srivastava, A. K., Staley, A., Steinke, M., Steinlechner, J., Steinlechner, S., Steinmeyer, D., Stephens, B. C., Stone, R., Strain, K. A., Straniero, N., Stratta, G., Strauss, N. A., Strigin, S., Sturani, R., Stuver, A. L., Summerscales, T. Z., Sun, L., Sutton, P. J., Swinkels, B. L., Szczepańczyk, M. J., Tacca, M., Talukder, D., Tanner, D. B., Tápai, M., Tarabrin, S. P., Taracchini, A., Taylor, R., Theeg, T., Thirugnanasambandam, M. P., Thomas, E. G., Thomas, M., Thomas, P., Thorne, K. A., Thorne, K. S., Thrane, E., Tiwari, S., Tiwari, V., Tokmakov, K. V., Tomlinson, C., Tonelli, M., Torres, C. V., Torre, C. I., Töyrä, D., Travasso, F., Traylor, G., Trifirò, D., Tringali, M. C., Trozzo, L., Tse, M., Turconi, M., Tuyenbayev, D., Ugolini, D., Unnikrishnan, C. S., Urban, A. L., Usman, S. A., Vahlbruch, H., Vajente, G., Valdes, G., van Bakel, N., van Beuzekom, M., Brand, J. F. J. v. d., Broeck, C. V. D., Vander-Hyde, D. C., van der Schaaf, L., van Heijningen, J. V., van Veggel, A. A., Vardaro, M., Vass, S., Vasúth, M., Vaulin, R., Vecchio, A., Vedovato, G., Veitch, J., Veitch, P. J., Venkateswara, K.,

## Publications by AEI Members and Guest Scientists

Verkindt, D., Vetrano, F., Viceré, A., Vinciguerra, S., Vine, D. J., Vinet, J.-Y., Vitale, S., Vo, T., Vocca, H., Vorvick, C., Voss, D., Vousden, W. D., Vyatchanin, S. P., Wade, A. R., Wade, L. E., Wade, M., Walker, M., Wallace, L., Walsh, S., Wang, G., Wang, H., Wang, M., Wang, X., Wang, Y., Ward, R. L., Warner, J., Was, M., Weaver, B., Wei, L.-W., Weinert, M., Weinstein, A. J., Weiss, R., Welborn, T., Wen, L., WeBels, P., West, M., Westphal, T., Wette, K., Whelan, J. T., White, D. J., Whiting, B. F., Wiesner, K., Williams, R. D., Williamson, A. R., Willis, J. L., Willke, B., Wimmer, M. H., Winkler, W., Wipf, C. C., Wiseman, A. G., Wittel, H., Woan, G., Worden, J., Wright, J. L., Wu, G., Yablon, J., Yam, W., Yamamoto, H., Yancey, C. C., Yap, M. J., Yu, H., Yvert, M., Zadrožny, A., Zangrando, L., Zanolin, M., Zendri, J.-P., Zevin, M., Zhang, F., Zhang, L., Zhang, M., Zhang, Y., Zhao, C., Zhou, M., Zhou, Z., Zhu, X. J., Zucker, M. E., Zuraw, S. E., & Zweizig, J. (2016). GW150914: Implications for the stochastic gravitational wave background from binary black holes. *Physical Review Letters*, 116: 131102. doi:10.1103/PhysRevLett.116.131102.

The LIGO Scientific Collaboration, the Virgo Collaboration, Abbott, B. P., Abbott, R., Abbott, T. D., Abernathy, M. R., Acernese, F., Ackley, K., Adams, C., Adams, T., Addesso, P., Adhikari, R. X., Adya, V. B., Affeldt, C., Agathos, M., Agatsuma, K., Aggarwal, N., Aguiar, O. D., Aiello, L., Ain, A., Ajith, P., Allen, B., Allocca, A., Altin, P. A., Anderson, S. B., Anderson, W. G., Arai, K., Araya, M. C., Arceneaux, C. C., Areeda, J. S., Arnaud, N., Arun, K. G., Ascenzi, S., Ashton, G., Ast, M., Aston, S. M., Astone, P., Aufmuth, P., Aulbert, C., Babak, S., Bacon, P., Bader, M. K. M., Baker, P. T., Baldaccini, F., Ballardin, G., Ballmer, S. W., Barayoga, J. C., Barclay, S. E., Barish, B. C., Barker, D., Barone, F., Barr, B., Barsotti, L., Barsuglia, M., Barta, D., Bartlett, J., Bartos, I., Bassiri, R., Basti, A., Batch, J. C., Baune, C., Bavigadda, V., Bazzan, M., Bejger, M., Bell, A. S., Berger, B. K., Bergmann, G., Berry, C. P. L., Bersanetti, D., Bertolini, A., Betzwieser, J., Bhagwat, S., Bhandare, R., Bilenko, I. A., Billingsley, G., Birch, J., Birney, R., Biscans, S., Bisht, A., Bitossi, M., Biwer, C., Bizouard, M. A., Blackburn, J. K., Blair, C. D., Blair, R. M., Bloemen, S., Bock, O., Boer, M., Bogaert, G., Bogan, C., Bohe, A., Bond, C., Bondu, F., Bonnand, R., Boom, B. A., Bork, R., Boschi, V., Bose, S., Bouffanais, Y., Bozzi, A., Bradaschia, C., Brady, P. R., Braginsky, V. B., Branchesi, M., Brau, J. E., Briant, T., Brillet, A., Brinkmann, M., Brisson, V., Brockill, P., Broida, J. E., Brooks, A. F., Brown, D. A., Brown, D. D., Brown, N. M., Brunett, S., Buchanan, C. C., Buikema, A., Bulik, T., Bulten, H. J., Buonanno, A., Buskulic, D., Buy, C., Byer, R. L., Cabero, M., Cadonati, L., Cagnoli, G., Cahillane, C., Bustillo, J. C., Callister, T., Calloni, E., Camp, J. B., Cannon, K. C., Cao, J., Capano, C. D., Capocasa, E., Carbognani, F., Caride, S., Diaz, J. C., Casentini, C., Caudill, S., Cavaglià, M., Cavalier, F., Cavalieri, R., Cella, G., Cepeda, C. B., Baiardi, L. C., Cerretani, G., Cesarini, E., Chan, M., Chao, S., Charlton, P., Chassande-Mottin, E., Cheeseboro, B. D., Chen, H. Y., Chen, Y., Cheng, C., Chincarini, A., Chiummo, A., Cho, H. S., Cho, M., Chow, J. H., Christensen, N., Chu, Q., Chua, S., Chung, S., Ciani, G., Clara, F., Clark, J. A., Cleva, F., Coccia, E., Cohadon, P.-F., Colla, A., Collette, C. G., Cominsky, L., Constancio, M., Conte, A., Conti, L., Cook, D., Corbitt, T. R., Cornish, N., Corsi, A., Cortese, S., Costa, C. A., Coughlin, M. W., Coughlin, S. B., Coulon, J.-P., Countryman, S. T., Couvares, P., Cowan, E. E., Coward, D. M., Cowart, M. J., Coyne, D. C., Coyne, R., Craig, K., Creighton, J. D. E., Creighton, T., Cripe, J., Crowder, S. G., Cumming, A., Cunningham, L., Cuomo, E., Canton, T. D., Danilishin, S. L., D'Antonio, S., Danzmann, K., Darman, N. S., Dasgupta, A., Costa, C. F. D. S., Dattilo, V., Dave, I., Davier, M., Davies, G. S., Daw, E. J., Day, R., De, S., DeBra, D., Debreczeni, G., Degallaix, J., De Laurentis, M., Del'eglise, S., Del Pozzo, W., Denker, T., Dent, T., Dergachev, V., De Rosa, R., DeRosa, R. T., DeSalvo, R., Devine, R. C., Dhurandhar, S., D'iaz, M. C., Di Fiore, L., Di Giovanni, M., Di Girolamo, T., Di Lieto, A., Di Pace, S., Di Palma, I., Di Virgilio, A., Dolique, V., Donovan, F., Dooley, K. L., Doravari, S., Douglas, R., Downes, T. P., Drago, M., Drever, R. W. P., Driggers, J. C., Ducrot, M., Dwyer, S. E., Edo, T. B., Edwards, M. C., Effler, A., Eggenstein, H.-B., Ehrens, P., Eichholz, J., Eikenberry, S. S., Engels, W., Essick, R. C., Etzel, T., Evans, M., Evans, T. M., Everett, R., Factourovich, M., Fafone, V., Fair, H., Fairhurst, S., Fan, X., Fang, Q., Farinon, S., Farr, B., Farr, W. M., Favata, M., Fays, M., Fehrmann, H., Fejer, M. M., Fenyvesi, E., Ferrante, I., Ferreira, E. C., Ferrini, F., Fidecaro, F., Fiori, I., Fiorucci, D., Fisher, R. P., Flaminio, R., Fletcher, M., Fournier, J.-D., Frasca, S., Frasconi, F., Frei, Z., Freise, A., Frey, R., Frey, V., Fritschel, P., Frolov, V. V., Fulda, P., Fyffe, M., Gabbard, H. A. G., Gair, J. R., Gammaitoni, L., Gaonkar, S. G., Garufi, F., Gaur, G., Gehrels, N., Gemme, G., Geng, P., Genin, E., Gennai, A., George, J., Gergely, L., Germain, V., Ghosh, A., Ghosh, A., Ghosh, S., Giaime, J. A., Giardina, K. D., Giazotto, A., Gill, K., Glaefke, A., Goetz, E., Goetz, R., Gondan, L., Gonzalez, G., Castro, J. M. G., Gopakumar, A., Gordon, N. A., Gorodetsky, M. L., Gossan, S. E., Gosselin, M., Gouaty, R., Grado, A., Graef, C., Graff, P. B., Granata, M., Grant, A., Gras, S., Gray, C., Greco, G., Green, A. C., Groot, P., Grote, H., Grunewald, S., Guidi, G. M., Guo, X., Gupta, A., Gupta, M. K., Gushwa, K. E., Gustafson, E. K., Gustafson, R., Hacker, J. J., Hall, B. R., Hall, E. D., Hammond, G., Haney, M., Hanke, M. M., Hanks, J., Hanna, C., Hannam, M. D., Hanson, J., Hardwick, T., Harms, J., Harry, G. M., Harry, I. W., Hart, M. J., Hartman, M. T., Haster, C.-J., Haughian, K., Heidmann, A., Heintze, M. C., Heitmann, H., Hello, P., Hemming, G., Hendry, M., Heng, I. S., Hennig, J., Henry, J., Heptonstall, A. W., Heurs, M., Hild, S., Hoak, D., Hofman, D., Holt, K., Holz, D. E., Hopkins, P., Hough, J., Houston, E. A., Howell, E. J., Hu, Y. M., Huang, S., Huerta, E. A., Huet, D., Hughey, B., Husa, S., Huttner, S. H., Huynh-Dinh, T., Indik, N., Ingram, D. R., Inta, R., Isa, H. N., Isac, J.-M., Isi, M., Isogai, T., Iyer, B. R., Izumi, K., Jacqmin, T., Jang, H., Jani, K., Jaranowski, P., Jawahar, S., Jian, L., Jim'enez-Forteza, F., Johnson, W. W., Jones, D. I., Jones, R., Jonker, R. J. G., Ju, L., K, H., Kalaghatgi, C. V., Kalogera, V., Kandhasamy, S., Kang, G., Kanner, J. B., Kapadia, S. J., Karki, S., Karvinen, K. S., Kasprack, M., Katsavounidis, E., Katzman, W., Kaufer, S., Kaur, T., Kawabe, K., Kefelian, F., Kehl, M. S., Keitel, D., Kelley, D. B., Kells, W., Kennedy, R., Key, J. S., Khalili, F. Y., Khan, I., Khan, S., Khan, Z., Khazanov, E. A., Kijbunchoo, N., Kim, C.-W., Kim, C., Kim, J., Kim, K., Kim, N., Kim, W., Kim, Y.-M., Kimbrell, S. J., King, E. J., King, P. J., Kissel, J. S., Klein, B., Kleybolte, L., Klimentko, S., Koehlenbeck, S. M., Koley, S., Kondrashov, V., Kontos, A., Korobko, M., Korth, W. Z., Kowalska, I., Kozak, D. B., Kringel, V., Krishnan, B., Królak, A., Krueger, C., Kuehn, G., Kumar, P., Kumar, R., Kuo, L., Kutynia, A., Lackey, B. D., Landry, M., Lange, J., Lantz, B., Lasky, P. D., Laxen, M., Lazzarini, A., Lazzaro, C., Leaci, P., Leavey, S., Lebigot, E. O., Lee, C. H., Lee, H. K., Lee, H. M., Lee, K., Lenon, A., Leonardi, M., Leong, J. R., Leroy, N., Letendre, N., Levin, Y., Lewis, J. B., Li, T. G. F., Libson, A., Littenberg, T. B., Lockerbie, N. A., Lombardi, A. L., London, L. T., Lord, J. E., Lorenzini, M., Lorette, V., Lormand, M., Losurdo, G., Lück, H., Lundgren, A. P., Lynch, R., Ma, Y., Machenschalk, B., MacInnis, M., Macleod, D. M., Magana-Sandoval, F., Zertuche, L. M., Magee, R. M., Majorana, E., Maksimovic, I., Malvezzi, V., Man, N., Mandel, I., Mandic, V., Mangano, V., Mansell, G. L., Manske, M., Mantovani, M., Marchesoni, F., Marion, F., M'arka, S., M'arka, Z., Markosyan, A. S., Maros, E., Martelli, F., Martellini, L., Martin, I. W., Martynov, D. V., Marx, J. N., Mason, K., Masserot, A., Massinger, T. J., Masso-Reid, M., Mastrogianni, S., Matichard, F., Matone, L., Mavalvala, N., Mazumder, N., McCarthy, R., McClelland, D. E., McCormick, S., McGuire, S. C., McIntyre, G., McIver, J., McManus, D. J., McRae, T., McWilliams, S. T., Meacher, D., Meadors, G. D., Meidam, J., Melatos, A., Mendell, G., Mercer, R. A., Merilh, E. L., Merzougui, M., Meshkov, S., Messenger, C., Messick, C., Metzdrorf, R., Meyers, P. M., Mezzani, F., Miao, H., Michel, C., Middleton, H., Mikhailov,



## Publications by AEI Members and Guest Scientists

E. E., Milano, L., Miller, A. L., Miller, A., Miller, B. B., Miller, J., Millhouse, M., Minenkov, Y., Ming, J., Mirshekari, S., Mishra, C., Mitra, S., Mitrofanov, V. P., Mitselmakher, G., Mittleman, R., Moggi, A., Mohan, M., Mohapatra, S. R. P., Montani, M., Moore, B. C., Moore, C. J., Moraru, D., Moreno, G., Morriss, S. R., Mossavi, K., Mours, B., Mow-Lowry, C. M., Mueller, G., Muir, A. W., Mukherjee, A., Mukherjee, D., Mukherjee, S., Mukund, N., Mullavey, A., Munch, J., Murphy, D. J., Murray, P. G., Mytidis, A., Nardecchia, I., Naticchioni, L., Nayak, R. K., Nedkova, K., Nelemans, G., Nelson, T. J. N., Neri, M., Neunzert, A., Newton, G., Nguyen, T. T., Nielsen, A. B., Nissanke, S., Nitz, A., Nocera, F., Nolting, D., Normandin, M. E. N., Nuttall, L. K., Oberling, J., Ochsner, E., O'Dell, J., Oelker, E., Ogin, G. H., Oh, J. J., Oh, S. H., Ohme, F., Oliver, M., Oppermann, P., Oram, R. J., O'Reilly, B., O'Shaughnessy, R., Ott, C. D., Ottaway, D. J., Overmier, H., Owen, B. J., Pai, A., Pai, S. A., Palamos, J. R., Palashov, O., Palomba, C., Pal-Singh, A., Pan, H., Pankow, C., Pannarale, F., Pant, B. C., Paoletti, F., Paoli, A., Papa, M. A., Paris, H. R., Parker, W., Pascucci, D., Pasqualetti, A., Passaquieti, R., Passuello, D., Patricelli, B., Patrick, Z., Pearlstone, B. L., Pedraza, M., Pedurand, R., Pekowsky, L., Pele, A., Penn, S., Perreca, A., Perri, L. M., Phelps, M., Piccinni, O. J., Pichot, M., Piergiovanni, F., Pierro, V., Pillant, G., Pinard, L., Pinto, I. M., Pitkin, M., Poe, M., Poggiani, R., Popolizio, P., Post, A., Powell, J., Prasad, J., Predoi, V., Prestegard, T., Price, L. R., Prijatelj, M., Principe, M., Privitera, S., Prix, R., Prodi, G. A., Prokhorov, L., Puncken, O., Punturo, M., Puppo, P., Pürrer, M., Qi, H., Qin, J., Qiu, S., Quetschke, V., Quintero, E. A., Quizow-James, R., Raab, F. J., Rabeling, D. S., Radkins, H., Raffai, P., Raja, S., Rajan, C., Rakhmanov, M., Rapagnani, P., Raymond, V., Razzano, M., Re, V., Read, J., Reed, C. M., Regimbau, T., Rei, L., Reid, S., Reitze, D. H., Rew, H., Reyes, S. D., Ricci, F., Riles, K., Rizzo, M., Robertson, N. A., Robie, R., Robinet, F., Rocchi, A., Rolland, L., Rollins, J. G., Roma, V. J., Romano, J. D., Romano, R., Romanov, G., Romie, J. H., Rosińska, D., Rowan, S., Rüdiger, A., Ruggi, P., Ryan, K., Sachdev, S., Sadecki, T., Sadeghian, L., Sakellariadou, M., Salconi, L., Saleem, M., Salemi, F., Samajdar, A., Sammut, L., Sanchez, E. J., Sandberg, V., Sandeen, B., Sanders, J. R., Sassolas, B., Sathyaprakash, B. S., Saulson, P. R., Sauter, O. E. S., Savage, R. L., Sawadsky, A., Schale, P., Schilling, R., Schmidt, J., Schmidt, P., Schnabel, R., Schofield, R. M. S., Schönbeck, A., Schreiber, E., Schuette, D., Schutz, B. F., Scott, J., Scott, S. M., Sellers, D., Sengupta, A. S., Sentenac, D., Sequino, V., Sergeev, A., Setyawati, Y., Shaddock, D. A., Shaffer, T., Shahriar, M. S., Shaltev, M., Shapiro, B., Shawhan, P., Sheperd, A., Shoemaker, D. H., Shoemaker, D. M., Siellez, K., Siemens, X., Sieniawska, M., Sigg, D., Silva, A. D., Singer, A., Singer, L. P., Singh, A., Singh, R., Singhal, A., Sintés, A. M., Slagmolen, B. J. J., Smith, J. R., Smith, N. D., Smith, R. J. E., Son, E. J., Sorazu, B., Sorrentino, F., Souradeep, T., Srivastava, A. K., Staley, A., Steinke, M., Steinlechner, J., Steinlechner, S., Steinmeyer, D., Stephens, B. C., Stone, R., Strain, K. A., Straniero, N., Stratta, G., Strauss, N. A., Strigin, S., Sturani, R., Stuver, A. L., Summerscales, T. Z., Sun, L., Sunil, S., Sutton, P. J., Swinkels, B. L., Szczepańczyk, M. J., Tacca, M., Talukder, D., Tanner, D. B., T'apai, M., Tarabrin, S. P., Taracchini, A., Taylor, R., Theeg, T., Thiruganasambandam, M. P., Thomas, E. G., Thomas, M., Thomas, P., Thorne, K. A., Thrane, E., Tiwari, S., Tiwari, V., Tokmakov, K. V., Toland, K., Tomlinson, C., Tonelli, M., Tornasi, Z., Torres, C. V., Torrie, C. I., T<sup>oyr</sup>'a, D., Travasso, F., Traylor, G., Trifir'ò, D., Tringali, M. C., Trozzo, L., Tse, M., Turconi, M., Tuyenbayev, D., Ugolini, D., Unnikrishnan, C. S., Urban, A. L., Usman, S. A., Vahlbruch, H., Vajente, G., Valdes, G., van Bakel, N., van Beuzekom, M., Brand, J. F. J. v. d., Broeck, C. V. D., VanderHyde, D. C., van der Schaaf, L., van Heijningen, J. V., van Veggel, A. A., Vardaro, M., Vass, S., Vas'uth, M., Vaubin, R., Vecchio, A., Vedovato, G., Veitch, J., Veitch, P. J., Venkateswara, K., Verkindt, D., Vetrano, F., Vicer'e, A., Vinciguerra, S., Vine, D. J., Vinet, J.-.-Y., Vitale, S., Vo, T., Vocca, H., Vorvick, C., Voss, D. V., Vousden, W. D., Vyatchanin, S. P., Wade, A. R., Wade, L. E., Wade, M., Walker, M., Wallace, L., Walsh, S., Wang, G., Wang, H., Wang, M., Wang, X., Wang, Y., Ward, R. L., Warner, J., Was, M., Weaver, B., Wei, L.-.-W., Weinert, M., Weinstein, A. J., Weiss, R., Wen, L., Wessels, P., Westphal, T., Wette, K., Whelan, J. T., White, D. J., Whiting, B. F., Williams, R. D., Williamson, A. R., Willis, J. L., Willke, B., Wimmer, M. H., Winkler, W., Wipf, C. C., Wittel, H., Woan, G., Woehler, J., Worden, J., Wright, J. L., Wu, D. S., Wu, G., Yablon, J., Yam, W., Yamamoto, H., Yancey, C. C., Yu, H., Yvert, M., zny, A. Z., Zangrando, L., Zanolin, M., Zendri, J.-.-P., Zevin, M., Zhang, L., Zhang, M., Zhang, Y., Zhao, C., Zhou, M., Zhou, Z., Zhu, X. J., Zucker, M. E., Zuraw, S. E., & Zweizig, J. (2016). Comprehensive All-sky Search for Periodic Gravitational Waves in the Sixth Science Run LIGO Data. *Physical Review D*, 94(4): 042002. doi:10.1103/PhysRevD.94.042002.

The LIGO Scientific Collaboration, The Virgo Collaboration, Abbott, B. P., Abbott, R., Abbott, T. D., Abernathy, M. R., Acernese, F., Ackley, K., Adams, C., Adams, T., Addesso, P., Adhikari, R. X., Adya, V. B., Affeldt, C., Agathos, M., Agatsuma, K., Aggarwal, N., Aguiar, O. D., Aiello, L., Ain, A., Ajith, P., Allen, B., Allocca, A., Altin, P. A., Anderson, S. B., Anderson, W. G., Arai, K., Araya, M. G., Arceneaux, C. C., Areeda, J. S., Arnaud, N., Arun, K. G., Ascenzi, S., Ashton, G., Ast, M., Aston, S. M., Astone, P., Aufmuth, P., Aulbert, C., Babak, S., Bacon, P., Bader, M. K. M., Baker, P. T., Baldaccini, F., Ballardin, G., Ballmer, S. W., Barayoga, J. C., Barclay, S. E., Barish, B. C., Barker, D., Barone, F., Barr, B., Barsotti, L., Barsuglia, M., Barta, D., Bartlett, J., Bartos, I., Bassiri, R., Basti, A., Batch, J. C., Baune, C., Bavigadda, V., Bazzan, M., Bejger, M., Bell, A. S., Berger, B. K., Bergmann, G., Berry, C. P. L., Bersanetti, D., Bertolini, A., Betzwieser, J., Bhagwat, S., Bhandare, R., Bilenko, I. A., Billingsley, G., Birch, J., Birney, R., Biscans, S., Bisht, A., Bitossi, M., Biwer, C., Bizouard, M. A., Blackburn, J. K., Blair, C. D., Blair, D. G., Blair, R. M., Bloemen, S., Bock, O., Boer, M., Bogaert, G., Bogan, C., Bohe, A., Bond, C., Bondu, F., Bonnand, R., Boom, B. A., Bork, R., Boschi, V., Bose, S., Bouffanais, Y., Bozzi, A., Bradaschia, C., Brady, P. R., Braginsky, V. B., Branchesi, M., Brau, J. E., Briant, T., Brillet, A., Brinkmann, M., Brisson, V., Brockill, P., Broida, J. E., Brooks, A. F., Brown, D. A., Brown, D. D., Brown, N. M., Brunett, S., Buchanan, C. C., Buikema, A., Bulik, T., Bulten, H. J., Buonanno, A., Buskulic, D., Buy, C., Byer, R. L., Cabero, M., Cadonati, L., Cagnoli, G., Cahillane, C., Bustillo, J. C., Callister, T., Calloni, E., Camp, J. B., Cannon, K. C., Cao, J., Capano, C., Capocasa, E., Carbognani, F., Caride, S., Diaz, J. C., Casentini, C., Caudill, S., Cavagli'a, M., Cavalieri, F., Cavalieri, R., Cella, G., Cepeda, C. B., Baiardi, L. C., Cerretani, G., Cesarini, E., Chamberlin, S. J., Chan, M., Chao, S., Charlton, P., Chassande-Mottin, E., Cheeseboro, B. D., Chen, H. Y., Chen, Y., Cheng, C., Chincarini, A., Chiummo, A., Cho, H. S., Cho, M., Chow, J. H., Christensen, N., Chu, Q., Chua, S., Chung, S., Ciani, G., Clara, F., Clark, J. A., Cleva, F., Coccia, E., Cohadon, P.-.-F., Colla, A., Collette, C. G., Cominsky, L., Constancio, M., Conte, A., Conti, L., Cook, D., Corbitt, T. R., Cornish, N., Corsi, A., Cortese, S., Costa, C. A., Coughlin, M. W., Coughlin, S. B., Coulon, J.-.-P., Countryman, S. T., Couvares, P., Cowan, E. E., Coward, D. M., Cowart, M. J., Coyne, D. C., Coyne, R., Craig, K., Creighton, J. D. E., Cripe, J., Crowder, S. G., Cumming, A., Cunningham, L., Cuoco, E., Canton, T. D., Danilishin, S. L., D'Antonio, S., Danzmann, K., Darman, N. S., Dasgupta, A., Costa, C. F. D. S., Dattilo, V., Dave, I., Davier, M., Davies, G. S., Daw, E. J., Day, R., De, S., DeBra, D., Debreczeni, G., Degallaix, J., De Laurentis, M., Del'eglise, S., Del Pozzo, W., Denker, T., Dent, T., Dergachev, V., De Rosa, R., DeRosa, R. T., DeSalvo, R., Devine, R. C., Dhurandhar, S., D'iaz, M. C., Di Fiore, L., Di Giovanni, M., Di Girolamo, T., Di Lieto, A., Di Pace, S., Di Palma, I., Di Virgilio, A., Dolique, V., Donovan, F., Dooley, K. L., Doravari, S., Douglas, R., Downes, T. P., Drago, M., Drever, R. W. P., Driggers, J. C., Ducrot,

## Publications by AEI Members and Guest Scientists

M., Dwyer, S. E., Edo, T. B., Edwards, M. C., Effler, A., Eggenstein, H.-B., Ehrens, P., Eichholz, J., Eikenberry, S. S., Engels, W., Essick, R. C., Etzel, T., Evans, M., Evans, T. M., Everett, R., Factourovich, M., Fafone, V., Fair, H., Fairhurst, S., Fan, X., Fang, Q., Farinon, S., Farr, B., Farr, W. M., Favata, M., Fays, M., Fehrmann, H., Fejer, M. M., Fenyvesi, E., Ferrante, I., Ferreira, E. C., Ferrini, F., Fidecaro, F., Fiori, I., Fiorucci, D., Fisher, R. P., Flaminio, R., Fletcher, M., Fournier, J.-D., Frasca, S., Frascioni, F., Frei, Z., Freise, A., Frey, R., Frey, V., Fritschel, P., Frolov, V. V., Fulda, P., Fyffe, M., Gabbard, H. A. G., Gair, J. R., Gammaitoni, L., Gaonkar, S. G., Garufi, F., Gaur, G., Gehrels, N., Gemme, G., Geng, P., Genin, E., Gennai, A., George, J., Gergely, L., Germain, V., Ghosh, A., Ghosh, A., Ghosh, S., Giaime, J. A., Giardina, K. D., Giazotto, A., Gill, K., Glaefke, A., Goetz, E., Goetz, R., Gondan, L., Gonzalez, G., Castro, J. M. G., Gopakumar, A., Gordon, N. A., Gorodetsky, M. L., Gossan, S. E., Gosselin, M., Gouaty, R., Grado, A., Graef, C., Graff, P. B., Granata, M., Grant, A., Gras, S., Gray, C., Greco, G., Green, A. C., Groot, P., Grote, H., Grunewald, S., Guidi, G. M., Guo, X., Gupta, A., Gupta, M. K., Gushwa, K. E., Gustafson, E. K., Gustafson, R., Hacker, J. J., Hall, B. R., Hall, E. D., Hammond, G., Haney, M., Hanke, M. M., Hanks, J., Hanna, C., Hannam, M. D., Hanson, J., Hardwick, T., Harms, J., Harry, G. M., Harry, I., Hart, M. J., Hartman, M. T., Haster, C.-J., Haughian, K., Heidmann, A., Heintze, M. C., Heitmann, H., Hello, P., Hemming, G., Hendry, M., Heng, I. S., Hennig, J., Henry, J., Heptonstall, A., Heurs, M., Hild, S., Hoak, D., Hofman, D., Holt, K., Holz, D. E., Hopkins, P., Hough, J., Houston, E. A., Howell, E. J., Hu, Y. M., Huang, S., Huerta, E. A., Huet, D., Hughey, B., Husa, S., Huttner, S. H., Huynh-Dinh, T., Indik, N., Ingram, D. R., Inta, R., Isa, H. N., Isac, J.-M., Isi, M., Isogai, T., Iyer, B. R., Izumi, K., Jacqmin, T., Jiang, H., Jani, K., Jaranowski, P., Jawahar, S., Jian, L., Jimenez-Forteza, F., Johnson, W. W., Jones, D. I., Jones, R., Jonker, R. J. G., Ju, L., K. H., Kalaghatgi, C. V., Kalogera, V., Kandhasamy, S., Kang, G., Kanner, J. B., Kapadia, S. J., Karki, S., Karvinen, K. S., Kasprzak, M., Katsavounidis, E., Katzman, W., Kaufer, S., Kaur, T., Kawabe, K., K'ef'el'ian, F., Kehl, M. S., Keitel, D., Kelley, D. B., Kells, W., Kennedy, R., Key, J. S., Khalili, F. Y., Khan, I., Khan, S., Khan, Z., Khazanov, E. A., Kijbunchoo, N., Kim, C.-W., Kim, C., Kim, K., Kim, N., Kim, W., Kim, Y.-M., Kimbrell, S. J., King, E. J., King, P. J., Kissel, J. S., Klein, B., Kleybolte, L., Klimentko, S., Koehlenbeck, S. M., Koley, S., Kondrashov, V., Kontos, A., Korobko, M., Korth, W. Z., Kowalska, L., Kozak, D. B., Kringel, V., Krishnan, B., Kr'olak, A., Krueger, C., Kuehn, G., Kumar, P., Kumar, R., Kuo, L., Kutynia, A., Lackey, B. D., Landry, M., Lange, J., Lantz, B., Lasky, P. D., Laxen, M., Lazzarini, A., Lazzaro, C., Leaci, P., Leavey, S., Lebigot, E. O., Lee, C. H., Lee, H. K., Lee, H. M., Lee, K., Lenon, A., Leonardi, M., Leong, J. R., Leroy, N., Letendre, N., Levin, Y., Lewis, J. B., Li, T. G. F., Libson, A., Littenberg, T. B., Lockerie, N. A., Lombardi, A. L., London, L. T., Lord, J. E., Lorenzini, M., Lorette, V., Lormand, M., Losurdo, G., Lough, J. D., Lück, H., Lundgren, A., Lynch, R., Ma, Y., Machenschalk, B., MacInnis, M., Macleod, D. M., Magana-Sandoval, F., Zertuche, L. M., Magee, R. M., Majorana, E., Maksimovic, I., Malvezzi, V., Man, N., Mandic, V., Mangano, V., Mansell, G. L., Manske, M., Mantovani, M., Marchesoni, F., Marion, F., M'arka, S., M'arka, Z., Markosyan, A. S., Maros, E., Martelli, F., Martellini, L., Martin, I. W., Martynov, D. V., Marx, J. N., Mason, K., Masserot, A., Massinger, T. J., Masso-Reid, M., Mastrogianni, S., Matichard, F., Matone, L., Mavalvala, N., Mazumder, N., McCarthy, R., McClelland, D. E., McCormick, S., McGuire, S. C., McIntyre, G., McIver, J., McManus, D. J., McRae, T., McWilliams, S. T., Meacher, D., Meadors, G. D., Meidam, J., Melatos, A., Mendell, G., Mercer, R. A., Merilh, E. L., Merzougui, M., Meshkov, S., Messenger, C., Messick, C., Metzdröff, R., Meyers, P. M., Mezzani, F., Miao, H., Michel, C., Middleton, H., Mikhailov, E. E., Milano, L., Miller, A. L., Miller, A., Miller, B. B., Miller, J., Millhouse, M., Minenkov, Y., Ming, J., Mirshekari, S., Mishra, C., Mitra, S., Mitrofanov, V. P., Mitselmakher, G., Mittleman, R., Moggi, A., Mohan, M., Mohapatra, S. R. P., Montani, M., Moore, B. C., Moore, C. J., Moraru, D., Moreno, G., Morris, S. R., Mossavi, K., Mours, B., Mow-Lowry, C. M., Mueller, G., Muir, A. W., Mukherjee, A., Mukherjee, D., Mukherjee, S., Mukund, N., Mullavey, A., Munch, J., Murphy, D. J., Murray, P. G., Mytidis, A., Nardecchia, I., Naticchioni, L., Nayak, R. K., Nedkova, K., Nelemans, G., Nelson, T. J. N., Neri, M., Neunzert, A., Newton, G., Nguyen, T. T., Nielsen, A. B., Nissanke, S., Nitz, A., Nocera, F., Nolting, D., Normandin, M. E. N., Nuttall, L. K., Oberling, J., Ochsner, E., O'Dell, J., Oelker, E., Ogin, G. H., Oh, J. J., Oh, S. H., Ohme, F., Oliver, M., Oppermann, P., Oram, R. J., O'Reilly, B., O'Shaughnessy, R., Ottaway, D. J., Overmier, H., Owen, B. J., Pai, A., Pai, S. A., Palamos, J. R., Palashov, O., Palomba, C., Pal-Singh, A., Pan, H., Pankow, C., Pannarale, F., Pant, B. C., Paoletti, F., Paoli, A., Papa, M. A., Paris, H. R., Parker, W., Pascucci, D., Pasqualetti, A., Passaquietti, R., Passuello, D., Patricelli, B., Patrick, Z., Pearlstone, B. L., Pedraza, M., Pedurand, R., Pekowsky, L., Pele, A., Penn, S., Perreca, A., Perri, L. M., Phelps, M., Piccinni, O. J., Pichot, M., Piergiorgianni, F., Pjero, V., Pillant, G., Pinard, L., Pinto, I. M., Pitkin, M., Poe, M., Poggiani, R., Popolizio, P., Post, A., Powell, J., Prasad, J., Pratt, J., Predoi, V., Prestegard, T., Price, L. R., Prijatelj, M., Principe, M., Privitera, S., Prix, R., Prodi, G. A., Prokhorov, L., Puncture, O., Punturo, M., Puppo, P., Pürner, M., Qi, H., Qin, J., Qiu, S., Quetschke, V., Quintero, E. A., Quitzow-James, R., Raab, F. J., Rabeling, D. S., Radkins, H., Raffai, P., Raja, S., Rajan, C., Rakhmanov, M., Rapagnani, P., Raymond, V., Razzano, M., Re, V., Read, J., Reed, C. M., Regimbau, T., Rei, L., Reid, S., Reitze, D. H., Rew, H., Reyes, S. D., Ricci, F., Riles, K., Rizzo, M., Robertson, N. A., Robie, R., Robinet, F., Rocchi, A., Rolland, L., Rollins, J. G., Roma, V. J., Romano, R., Romanov, G., Romie, J. H., Rosi'nska, D., Rowan, S., Rüdiger, A., Ruggi, P., Ryan, K., Sachdev, S., Sadecki, T., Sadeghian, L., Sakellariadou, M., Salconi, L., Saleem, M., Salemi, F., Samajdar, A., Sammut, L., Sanchez, E. J., Sandberg, V., Sandeen, B., Sanders, J. R., Sassolas, B., Sathyaprakash, B. S., Saulson, P. R., Sauter, O. E. S., Savage, R. L., Sawadsky, A., Schale, P., Schilling, R., Schmidt, J., Schmidt, P., Schnabel, R., Schofield, R. M. S., Schönbeck, A., Schreiber, E., Schuette, D., Schutz, B. F., Scott, J., Scott, S. M., Sellers, D., Sengupta, A. S., Sentenac, D., Sequino, V., Sergeev, A., Setyawati, Y., Shaddock, D. A., Shaffer, T., Shahriar, M. S., Shal'tev, M., Shapiro, B., Shawhan, P., Sheperd, A., Shoemaker, D. H., Shoemaker, D. M., Steliez, K., Siemens, X., Sieniawska, M., Sigg, D., Silva, A. D., Singer, A., Singer, L. P., Singh, A., Singh, R., Singhal, A., Sintès, A. M., Slagmolen, B. J. J., Smith, J. R., Smith, N. D., Smith, R. J. E., Son, E. J., Sorazu, B., Sorrentino, F., Souradeep, T., Srivastava, A. K., Staley, A., Steinke, M., Steinlechner, J., Steinlechner, S., Steinmeyer, D., Stephens, B. C., Stone, R., Strain, K. A., Straniero, N., Stratta, G., Strauss, N. A., Strigin, S., Sturani, R., Stuver, A. L., Summerscales, T. Z., Sun, L., Sunil, S., Sutton, P. J., Swinkels, B. L., Szczepańczyk, M. J., Tacca, M., Talukder, D., Tanner, D. B., T'apai, M., Tarabrin, S. P., Taracchini, A., Taylor, R., Theeg, T., Thirugnanasambandam, M. P., Thomas, E. G., Thomas, M., Thomas, P., Thorne, K. A., Thrane, E., Tiwari, S., Tiwari, V., Tokmakov, K. V., Toland, K., Tomlinson, C., Tonelli, M., Tornasi, Z., Torres, C. V., Torrie, C. I., T'o'y'r'a, D., Travasso, F., Traylor, G., Trifir'o, D., Tringali, M. C., Trozzo, L., Tse, M., Turconi, M., Tuyenbayev, D., Ugolini, D., Unnikrishnan, C. S., Urban, A. L., Usman, S. A., Vahlbruch, H., Vajente, G., Valdes, G., van Bakel, N., van Beuzekom, M., Brand, J. F. J. v. d., Broeck, C. V. D., VanderHyde, D. C., van der Schaaf, L., van Heijningen, J. V., van Veggel, A. A., Vardaro, M., Vass, S., Vas'uth, M., Vaulin, R., Vecchio, A., Vedovato, G., Veitch, J., Veitch, P. J., Venkateswara, K., Verkindt, D., Vetrano, F., Vicer'e, A., Vinciguerra, S., Vine, D. J., Vinet, J.-Y., Vitale, S., Vo, T., Vocca, H., Vorvick, C., Voss, D. V., Voutsden, W. D., Vyatchanin, S. P., Wade, A. R., Wade, L. E.,

## Publications by AEI Members and Guest Scientists

- Wade, M., Walker, M., Wallace, L., Walsh, S., Wang, G., Wang, H., Wang, M., Wang, X., Wang, Y., Ward, R. L., Warner, J., Was, M., Weaver, B., Wei, L.-W., Weinert, M., Weinstein, A. J., Weiss, R., Wen, L., Wessels, P., Westphal, T., Wette, K., Whelan, J., Whiting, B. F., Williams, R. D., Williamson, A. R., Willis, J. L., Willke, B., Wimmer, M., Winkler, W., Wipf, C. C., Wittel, H., Woan, G., Woehler, J., Worden, J., Wright, J. L., Wu, D. S., Wu, G., Yablon, J., Yam, W., Yamamoto, H., Yancey, C. C., Yu, H., Yvert, M., Zny, A. Z., Zangrando, L., Zanolin, M., Zendri, J.-P., Zevin, M., Zhang, L., Zhang, M., Zhang, Y., Zhao, C., Zhou, M., Zhou, Z., Zhu, X. J., Zucker, M. E., Zuraw, S. E., & Zweig, J. (2016). Upper limits on the rates of binary neutron star and neutron-star-black-hole mergers from Advanced LIGO's first observing run. *The Astrophysical Journal Letters*, 832(2): L21. doi:<http://dx.doi.org/10.3847/2041-8205/832/2/L21>.
- Thürigen, J. (2015). Fields and Laplacians on Quantum Geometries. In *The Thirteenth Marcel Grossmann Meeting: On Recent Developments in Theoretical and Experimental General Relativity, Astrophysics and Relativistic Field Theories - Proceedings of the MG13 Meeting on General Relativity* (pp. 2168-2170). World Scientific Publishing.
- Thürigen, J. (2015). Group field theories generating polyhedral complexes. *Proceedings of Science*, FFP14: 177.
- Thürigen, J. (2015). Discrete quantum geometries and their effective dimension. PhD Thesis.
- Tiec, A. L., Buonanno, A., Mroué, A. H., Pfeiffer, H. P., Hemberger, D. A., Lovelace, G., Kidder, L. E., Scheel, M. A., Szilágyi, B., Taylor, N. W., & Teukolsky, S. A. (2013). Periastron Advance in Spinning Black Hole Binaries: Gravitational Self-Force from Numerical Relativity. *Physical Review D*, 88(12): 124027. doi:[10.1103/PhysRevD.88.124027](https://doi.org/10.1103/PhysRevD.88.124027).
- Tiwari, V., Drago, M., Frolov, V., Klimentko, S., Mitselmakher, G., Necula, V., Prodi, G., Re, V., Salemi, F., Vedovato, G., & Yakushin, I. (2015). Regression of Environmental Noise in LIGO Data. *Classical and quantum gravity*, 32(16): 165014. doi:[10.1088/0264-9381/32/16/165014](https://doi.org/10.1088/0264-9381/32/16/165014).
- Tiwari, V., Klimentko, S., Christensen, N., Huerta, E., Mohapatra, S., Gopakumar, A., Haney, M., Parameswaran, A., McWilliams, S., Vedovato, G., Drago, M., Salemi, F., Prodi, G., Lazzaro, C., Tiwari, S., Mitselmakher, G., & Da Silva, F. (2016). A Proposed Search for the Detection of Gravitational Waves from Eccentric Binary Black Holes. *Physical Review D*, 93: 043007. doi:[10.1103/PhysRevD.93.043007](https://doi.org/10.1103/PhysRevD.93.043007).
- Tomlin, C., & Varadarajan, M. (2013). Towards an Anomaly-Free Quantum Dynamics for a Weak Coupling Limit of Euclidean Gravity. *Physical Review D*, 87: 044039. doi:[10.1103/PhysRevD.87.044039](https://doi.org/10.1103/PhysRevD.87.044039).
- Tremblay, G. R., O'Dea, C. P., Baum, S. A., Mittal, R., McDonald, M., Combes, F., Li, Y., McNamara, B., Bremer, M. N., Clarke, T. E., Donahue, M., Edge, A. C., Fabian, A. C., Hamer, S. L., Hogan, M. T., Oonk, R., Quillen, A. C., Sanders, J. S., Salomé, P., & Voit, G. M. (2015). Far Ultraviolet Morphology of Star Forming Filaments in Cool Core Brightest Cluster Galaxies. *Monthly Notices of the Royal Astronomical Society*, 451 (4), 3768-3800. doi:[10.1093/mnras/stv1151](https://doi.org/10.1093/mnras/stv1151).
- Treutlein, P., Genes, C., Hammerer, K., Poggio, M., & Rabl, P. (2014). Hybrid Mechanical Systems. In M. Aspelmeyer (Ed.), *Cavity Optomechanics, Quantum Science and Technology*, 327 (pp. 327-351). Berlin Heidelberg: Springer-Verlag.
- Tröbs, M., d'Arcio, L., Barke, S., Bogenstahl, J., Diekmann, C., Fitzsimons, E. D., Gerberding, O., Hennig, J., Hey, F. G., Hogenhuis, H., Killow, C. J., Lieser, M., Lucarelli, S., Nikolov, S., Perreur-Lloyd, M., Pijnenburg, J., Robertson, D. I., Sohmer, A., Taylor, A., Ward, H., Weise, D., Heinzel, G., & Danzmann, K. (2013). LISA Optical Bench Testing. Tröbs, M., Bogan, C., Barke, S., Kühn, G., Reiche, J., Heinzel, G., & Danzmann, K. (2015). Transportable setup for amplifier phase fidelity measurements. *Journal of Physics: Conference Series*, 610: 012041.
- Trzetrzelewski, M. T. (2013). Dirac equation for embedded four-geometries. *International Journal of Modern Physics D*, 22(6): 13500247. doi:[10.1142/S0218271813500247](https://doi.org/10.1142/S0218271813500247).
- Tursunov, A., Kološ, M., Ahmedov, B., & Stuchlík, Z. (2013). Dynamics of an electric current-carrying string loop near a Schwarzschild black hole embedded in an external magnetic field. *Physical Review D*, 87: 125003. doi:[10.1103/PhysRevD.87.125003](https://doi.org/10.1103/PhysRevD.87.125003).
- Usman, S. A., Kehl, M. S., Nitz, A. H., Harry, I., Brown, D. A., Capano, C. D., Dent, T., Fairhurst, S., Pfeiffer, H. P., Biwer, C. M., Dal Canton, T., Keppel, D., Saulson, P. R., West, M., & Willis, J. L. (2016). An improved pipeline to search for gravitational waves from compact binary coalescence. *Classical and quantum gravity*, 33: 215004, pp. 21. doi:[10.1088/0264-9381/33/21/215004](https://doi.org/10.1088/0264-9381/33/21/215004).
- Vahlbruch, H., Mehmet, M., Danzmann, K., & Schnabel, R. (2016). Detection of 15 dB Squeezed States of Light and their Application for the Absolute Calibration of Photoelectric Quantum Efficiency. *Physical Review Letters*, 117: 110801. doi:<https://doi.org/10.1103/PhysRevLett.117.110801>.
- Valdez-Alvarado, S., Palenzuela, C., Alic, D., & Ureña-López, L. A. (2013). Dynamical evolution of fermion-boson stars. *Physical Review D*, 87: 084040. doi:[10.1103/PhysRevD.87.084040](https://doi.org/10.1103/PhysRevD.87.084040).
- van Haasteren, R. (2013). Gravitational wave detection with pulsar timing.
- van Haasteren, R. (2013). Accelerating pulsar timing data analysis. *Monthly Notices of the Royal Astronomical Society*, 429(1), 55-62. doi:[10.1093/mnras/sts308](https://doi.org/10.1093/mnras/sts308).
- van Haasteren, R., & Levin, Y. (2013). Understanding and analysing time-correlated stochastic signals in pulsar timing. *Monthly Notices of the Royal Astronomical Society*, 428(2), 1147-1159. doi:[10.1093/mnras/sts097](https://doi.org/10.1093/mnras/sts097).
- Vasilyev, D. V., Muschik, C. A., & Hammerer, K. (2013). Dissipative versus Conditional Generation of Gaussian Entanglement and Spin Squeezing. *Physical Review A*, 87: 053820. doi:[10.1103/PhysRevA.87.053820](https://doi.org/10.1103/PhysRevA.87.053820).
- Vega, I., Wardell, B., Diener, P., Cupp, S., & Haas, R. (2013). Scalar self-force for eccentric orbits around a Schwarzschild black hole. *Physical Review D*, 88: 84021. doi:[10.1103/PhysRevD.88.84021](https://doi.org/10.1103/PhysRevD.88.84021).
- Veitch, J., Raymond, V., Farr, B., Farr, W. M., Graff, P., Vitale, S., Aylott, B., Blackburn, K., Christensen, N., Coughlin, M., Del Pozzo, W., Feroz, F., Gair, J., Haster, C.-J., Kalogera, V., Littenberg, T., Mandel, I., O'Shaughnessy, R., Pitkin, M., Rodriguez, C., Röver, C., Sidery, T., Smith, R., Van Der Sluis, M., Vecchio, A., Vousden, W., & Wade, L. (2015). Parameter estimation for compact binaries with ground-based gravitational-wave observations using the LALInference software library. *Physical Review D*, 91(4): 042003. doi:[10.1103/PhysRevD.91.042003](https://doi.org/10.1103/PhysRevD.91.042003).

## Publications by AEI Members and Guest Scientists

- Verbiest, J. P. W., Lentati, L., Hobbs, G., Haasteren van, R., Demorest, P. B., Janssen, G. H., Wang, J.-B., Desvignes, G., Caballero, R. N., Keith, M. J., Champion, D. J., Arzoumanian, Z., Babak, S., Bassa, C. G., Bhat, N. D. R., Brazier, A., Brem, P., Burgay, M., Burke-Spolaor, S., Chamberlin, S. J., Chatterjee, S., Christy, B., Cognard, I., Cordes, J. M., Dai, S., Dolch, T., Ellis, J. A., Ferdman, R. D., Fonseca, E., Gair, J. R., Garver-Daniels, N. E., Gentile, P., Gonzalez, M. E., Graikou, E., Guillemot, L., Hessels, J. W. T., Jones, G., Karuppusamy, R., Kerr, M., Kramer, M., Lam, M. T., Lasky, P. D., Lassus, A., Lazarus, P., Lazio, T. J. W., Lee, K. J., Levin, L., Liu, K., Lynch, R. S., Lyne, A. G., Mckee, J., McLaughlin, M. A., McWilliams, S. T., Madison, D. R., Manchester, R. N., Mingarelli, C. M. F., Nice, D. J., Oslowski, S., Palliyaguru, N. T., Pennucci, T. T., Perera, B. B. P., Perrodin, D., Possenti, A., Petiteau, A., Ransom, S. M., Reardon, D., Rosado, P. A., Sanidas, S. A., Sesana, A., Shaifullah, G., Shannon, R. M., Siemens, X., Simon, J., Smits, R., Spiwak, R., Stairs, I. H., Stappers, B. W., Stinebring, D. R., Stovall, K., Swiggum, J. K., Taylor, S. R., Theureau, G., Tiburzi, C., Toomey, L., Vallisneri, M., van Straten, W., Vecchio, A., Wang, Y., Wen, L., You, X. P., Zhu, W. W., & Zhu, X.-J. (2016). The International Pulsar Timing Array: First Data Release. *Monthly Notices of the Royal Astronomical Society*, 458(2), 1267-1288. doi:10.1093/mnras/stw347.
- Vines, J., Kunst, D., Steinhoff, J., & Hinderer, T. (2016). Canonical Hamiltonian for an extended test body in curved spacetime: To quadratic order in spin. *Physical Review D*, 93: 103008. doi:10.1103/PhysRevD.93.103008.
- Vines, J., & Nichols, D. A. (2016). Properties of an affine transport equation and its holonomy. *General Relativity and Gravitation*, 48(10): 127. doi:10.1007/s10714-016-2118-2.
- Virmani, A., Chakrabarty, B., & Turton, D. (2015). Holographic description of non-supersymmetric orbifolded D1-D5-P solutions. *Journal of high energy physics: JHEP*, 2015(11): 063. doi:10.1007/JHEP11(2015)063.
- Vitale, S., Congedo, G., Dolesi, R., Ferroni, V., Hueller, M., Vetrugno, D., Weber, W. J., Audley, H., Danzmann, K., Diepholz, I., Hewitson, M., Korsakova, N., Ferraioli, L., Gibert, F., Karnesis, N., Nofrarias, M., Inchauspe, H., Plagnol, E., Jennrich, O., McNamara, P. W., Armano, M., Thorpe, J. I., & Wass, P. (2014). Data series subtraction with unknown and unmodeled background noise. *Physical Review D*, 90: 042003. doi:10.1103/PhysRevD.90.042003.
- Vogell, B., Stannigel, K., Zoller, P., Hammerer, K., Rakher, M. T., Korppi, M., Jöckel, A., & Treutlein, P. (2013). Cavity-Enhanced Long-Distance Coupling of an Atomic Ensemble to a Micromechanical Membrane. *Physical Review A*, 87: 023816. doi:10.1103/PhysRevA.87.023816.
- Vogell, B., Kampschulte, T., Rakher, M. T., Faber, A., Treutlein, P., Hammerer, K., & Zoller, P. (2015). Long Distance Coupling of a Quantum Mechanical Oscillator to the Internal States of an Atomic Ensemble. *New Journal of Physics*, 17: 043044. doi:10.1088/1367-2630/17/4/043044.
- Vollmer, C. E., Schulze, D., Eberle, T., Händchen, V., Fiurasek, J., & Schnabel, R. (2013). Experimental entanglement distribution by separable states. *Physical Review Letters*, 111: 230505. doi:10.1103/PhysRevLett.111.230505.
- Vollmer, C. E., Baune, C., Sambrowski, A., Eberle, T., Händchen, V., Fiurasek, J., & Schnabel, R. (2014). Quantum Up-Conversion of Squeezed Vacuum States from 1550 to 532 nm. *Physical Review Letters*, 112: 073602. doi:10.1103/PhysRevLett.112.073602.
- Volpato, R. (2014). On symmetries of  $N=(4,4)$  sigma models on T4. *Journal of High Energy Physics*, 2014(08): 094. doi:10.1007/JHEP08(2014)094.
- Wade, M., Creighton, J. D. E., Ochsner, E., & Nielsen, A. B. (2013). Advanced LIGO's ability to detect apparent violations of the cosmic censorship conjecture and the no-hair theorem through compact binary coalescence detections. *Physical Review D*, 88: 083002. doi:10.1103/PhysRevD.88.083002.
- Wan, Y., Gebert, F., Wübbena, J. B., Schamhorst, N., Amairi, S., Leroux, I. D., Hemmerling, B., Lörch, N., Hammerer, K., & Schmidt, P. O. (2014). Precision spectroscopy by photon-recoil signal amplification. *Nature Communications*, 5: 4096. doi:10.1038/ncomms4096.
- Wang, Q. (2014). Rough solutions of Einstein vacuum equations in CMCSH gauge. *Communications in Mathematical Physics*, 328(3), 1275-1340. doi:10.1007/s00220-014-2015-z.
- Wang, Y., Keitel, D., Babak, S., Petiteau, A., Otto, M., Barke, S., Kawazoe, F., Khalaidovski, A., Müller, V., Schütze, D., Wittel, H., Danzmann, K., & Schutz, B. F. (2013). Octahedron configuration for a displacement noise-cancelling gravitational wave detector in space. *Physical Review D*, 88: 104021. doi:10.1103/PhysRevD.88.104021.
- Wang, Y., Heinzl, G., & Danzmann, K. (2014). First stage of LISA data processing: Clock synchronization and arm-length determination via a hybrid-extended Kalman filter. *Physical Review D*, 90: 064016. doi:10.1103/PhysRevD.90.064016.
- Wang, Y., Heinzl, G., & Danzmann, K. (2015). First stage of LISA data processing II: Alternative filtering dynamic models for LISA. *Physical Review D*, 92: 044037. doi:10.1103/PhysRevD.92.044037.
- Wang, Y. (2015). Fast detection and automatic parameter estimation of a gravitational wave signal with a novel method. *General Relativity and Gravitation*, 47(12): 142. doi:10.1007/s10714-015-1987-0.
- Wang, J., & Yu, P. (2016). A Large Data Regime for non-linear Wave Equations. *Journal of the European Mathematical Society*, 18(3), 575-622. doi:10.4171/JEMS/597.
- Wanner, G., & Heinzl, G. (2014). Analytical description of interference between two misaligned and mismatched complete Gaussian beams. *Applied Optics*, 53(14), 3043-3048. doi:10.1364/AO.53.003043.
- Wanner, G., Schuster, S., Tröbs, M., & Heinzl, G. (2015). A brief comparison of optical pathlength difference and various definitions for the interferometric phase. *Journal of Physics: Conference Series*, 610: 012043.
- Ward, R., Fleddermann, R., Francis, S., Mow-Lowry, C., Wuchenich, D., Elliot, M., Gilles, F., Herding, M., Nicklaus, K., Brown, J., Burke, J., Dligatch, S., Farrant, D., Green, K., Seckold, J., Blundell, M., Brister, R., Smith, C., Danzmann, K., Heinzl, G., Schütze, D., Sheard, B., Klipstein, W., McClelland, D., & Shaddock, D. (2014). The design and construction of a prototype lateral-transfer retro-reflector for inter-satellite laser ranging. *Classical and quantum gravity*, 31: 095015. doi:10.1088/0264-9381/31/9/095015.

## Publications by AEI Members and Guest Scientists

- Was, M., Kalmus, P., Leong, J. R., Adams, T., Leroy, N., Macleod, D. M., Pankow, C., & Robinet, F. (2014). A fixed false alarm probability figure of merit for gravitational wave detectors. *Classical and quantum gravity*, 31(8): 085004. doi:10.1088/0264-9381/31/8/085004.
- Wei li, L.-W., Cleva, F., & Man, a. C. N. (2016). Coherently combined master oscillator fiber power amplifiers for Advanced Virgo. *Optics Letters*, 41(24), 5817-5820. doi:https://doi.org/10.1364/OL.41.005817.
- Wette, K., & Prix, R. (2013). Flat parameter-space metric for all-sky searches for gravitational-wave pulsars. *Physical Review D*, 88: 123005. doi:10.1103/PhysRevD.88.123005.
- Wette, K. (2014). Lattice template placement for coherent all-sky searches for gravitational-wave pulsars. *Physical Review D*, 90: 122010. doi:10.1103/PhysRevD.90.122010.
- Wette, K. (2015). Parameter-space metric for all-sky semicoherent searches for gravitational-wave pulsars. *Physical Review D*, 92: 082003. doi:10.1103/PhysRevD.92.082003.
- Wette, K. (2016). Empirically extending the range of validity of parameter-space metrics for all-sky searches for gravitational-wave pulsars. *Physical Review D*, 94: 122002.
- Whelan, J. T., Prix, R., Cutler, C. J., & Willis, J. L. (2014). New Coordinates for the Amplitude Parameter Space of Continuous Gravitational Waves. *Classical and quantum gravity*, 31(6): 065002. doi:10.1088/0264-9381/31/6/065002.
- Whelan, J. T., Sundaesan, S., Zhang, Y., & Peiris, P. (2015). Model-Based Cross-Correlation Search for Gravitational Waves from Scorpius X-1. *Physical Review D*, 91: 102005. doi:10.1103/PhysRevD.91.102005.
- Wieczorek, W., Hofer, S. G., Hoelscher-Obermaier, J., Riedinger, R., Hammerer, K., & Aspelmeyer, M. (2015). Optimal state estimation for cavity optomechanical systems. *Physical Review Letters*, 114: 223601. doi:10.1103/PhysRevLett.114.223601.
- Wiegand, A., Buchert, T., & Ostermann, M. (2014). Direct Minkowski Functional analysis of large redshift surveys: a new high-speed code tested on the LRG SDSS-DR7 catalogue. *Monthly Notices of the Royal Astronomical Society*, 443(1), 241-259. doi:10.1093/mnras/stu1118.
- Williamson, A. R., Biber, C., Fairhurst, S., Harry, I., Macdonald, E., Macleod, D., & Predoi, V. (2014). Improved methods for detecting gravitational waves associated with short gamma-ray bursts. *Physical Review D*, 90: 122004. doi:10.1103/PhysRevD.90.122004.
- Wilson-Ewing, E. (2015). Loop quantum cosmology with self-dual variables. *Physical Review D*, 92(12): 123536. doi:10.1103/PhysRevD.92.123536.
- Wilson-Ewing, E. (2016). Anisotropic loop quantum cosmology with self-dual variables. *Physical Review D*, 93: 083502. doi:10.1103/PhysRevD.93.083502.
- Wilson-Ewing, E. (2016). Separate universes in loop quantum cosmology: framework and applications. *International Journal of Modern Physics D*, 25(8): 1642002. doi:10.1142/S0218271816420025.
- Wimmer, M., Steinmeyer, D., Hammerer, K., & Heurs, M. (2014). Coherent Cancellation of Backaction Noise in optomechanical Force Measurements. *Physical Review A*, 89: 053836. doi:10.1103/PhysRevA.89.053836.
- Winicour, J. (2014). Global aspects of radiation memory. *Classical and quantum gravity*, 31: 205003. Retrieved from <http://arxiv.org/abs/1407.0259>.
- Winicour, J. (2013). The affine-null metric formulation of Einstein's equations. *Physical Review D*, 87(12): 124027. doi:10.1103/PhysRevD.87.124027.
- Wittel, H., Lück, H., Affeldt, C., Dooley, K., Grote, H., Leong, J., Prijatelj, M., Schreiber, E., Slutsky, J., Strain, K. A., Was, M., Willke, B., & Danzmann, K. (2014). Thermal Correction of Astigmatism in the Gravitational Wave Observatory GEO 600. *Classical and quantum gravity*, 31(6): 065008. doi:10.1088/0264-9381/31/6/065008.
- Wittel, H., Hild, S., Bergmann, G., Danzmann, K., & Strain, K. A. (2015). New Design of Electrostatic Mirror Actuators for Application in High-Precision Interferometry. *Classical and quantum gravity*, 32(17): 175021. doi:10.1088/0264-9381/32/17/175021.
- Wuchenich, D. M. R., Mahrtdt, C., Sheard, B., Francis, S. P., Spero, R. E., Miller, J., Mow-Lowry, C. M., Ward, R. L., Klipstein, W. M., Heinzl, G., Danzmann, K., McClelland, D. E., & Shaddock, D. A. (2014). Laser link acquisition demonstration for the GRACE Follow-On mission. *Optics Express*, 22(9), 11351-11366. doi:10.1364/OE.22.011351.
- Xue-fei, G., Sheng-nian, X., Ye-fei, Y., Shan, B., Xing, B., Zhou-jian, C., Ge-ruì, C., Peng, D., Tian-shu, G., Wei, G., Yu-long, L., Ying, L., Zi-ren, L., Ming-xue, S., Bao-san, S., Wen-lin, T., Pin, Y., Peng, X., Yun-long, Z., Hai-peng, Z., & Yun-kau, L. (2015). Laser Interferometric Gravitational Wave Detection in Space and Structure Formation in the Early Universe. *Chinese Astronomy and Astrophysics*, 36(4), 411-446. doi:10.1016/j.chinastron.2015.10.001.
- Yunes, N., Buonanno, A., Hughes, S. A., Pan, Y., Barausse, E., Miller, M. C., & Throwe, W. (2013). Erratum: Extreme mass-ratio inspirals in the effective-one-body approach: Quasicircular, equatorial orbits around a spinning black hole [Phys. Rev. D 83, 044044 (2011)]. *Physical Review D*, 88(10): 109904. doi:10.1103/PhysRevD.88.109904.
- Zhu, W. W., Berndsen, A., Madsen, E. C., Tan, M., Stairs, I. H., Brazier, A., Lazarus, P., Lynch, R., Scholz, P., Stovall, K., Ransom, S. M., Banaszak, S., Biber, C. M., Cohen, S., Darte, L. P., Flanigan, J., Lunsford, G., Martinez, J. G., Mata, A., Rohr, M., Walker, A., Allen, B., Bhat, N. D. R., Bogdanov, S., Camilo, F., Chatterjee, S., Cordes, J. M., Crawford, F., Deneva, J. S., Desvignes, G., Ferdman, R. D., Freire, P. C. C., Hessels, J. W. T., Jenet, F. A., Kaplan, D., Kaspi, V. M., Knispel, B., Lee, K. J., van Leeuwen, J., Lyne, A. G., McLaughlin, M. A., Siemens, X., Spitler, L. G., & Verkataraman, A. (2014). Searching for pulsars using image pattern recognition. *The Astrophysical Journal*, 781: 117. doi:10.1088/0004-637X/781/2/117.
- Zhu, S. J., Papa, M. A., Eggenstein, H.-B., Prix, R., Wette, K., Allen, B., Bock, O., Keitel, D., Krishnan, B., Machenschalk, B., Shaltev, M., & Siemens, X. (2016). An Einstein@home search for continuous gravitational waves from Cassiopeia A. *Physical Review D*, 94: 082008. doi:10.1103/PhysRevD.94.082008.



## Institute Colloquia 2013-2016 at AEI Potsdam-Golm

**Michael Berry** (Bristol University, UK)

Faster than Fourier: Superoscillation and weak measurement / 23 January 2013

**Bangalore Sathyaprakash** (Cardiff University, UK)

Challenges and scientific goals for the next generation of gravitational wave detectors / 24 April 2013

**Robert Schloegl** (Fritz Haber Institute, Berlin, Germany)

The transformation of our energy system - status and perspectives / 18 December 2013

**Gustav Holzegel & Piotr Bizon** (Imperial College London, UK; Krakow University, Poland)

SFB colloquium - Nonlinear wave equations / 14 October 2014

**Stefan Hollands** (Universität Leipzig, Germany)

Black holes and thermodynamics / 30 October 2014

**Mihalis Dafermos** (Princeton University, USA and Cambridge University, UK)

The stability of the Kerr Cauchy horizon and the strong cosmic censorship conjecture in general relativity / 12 December 2014

**Roberto Emparan** (University of Barcelona, Spain)

The Large-D limit of General Relativity / 18 December 2014

**Winfried Scharlau** (Universität Münster, Germany)

Alexander Grothendieck / 23 January 2015

**Markus Aspelmeyer** (University of Vienna, Austria)

From quantum mechanics to gravitational quantum physics - exploring the next generation of precision interferometry / 13 February 2015

**Valery Rubakov** (Russian Academy of Sciences, Moscow, Russia)

Towards creating a Universe in the laboratory / 27 February 2015

**Pedro Ferreira** (Oxford University, UK)

Testing General Relativity with Cosmology / 17 April 2015

**Donald Lynden-Bell** (Institute of Astronomy and Clare College Cambridge, UK)

Exploring Gravitational Forces via Thought Experiments / 22 May 2015

**Christof Wetterich** (Universität Heidelberg)

Big bang or freeze? / 3 July 2015

**Alberto Nicolis** (Columbia University, New York, USA)

Effective field theories for gravitational systems / 14 July 2015

**Pedro Ferreira** (University of Oxford, UK)

Relativistic Cosmology in the 21st Century / 16 July 2015

**Raphael Bousso** (University of California, Berkeley, USA)

Black holes, Information, and the World as a Hologram / 23 July 2015

**Matthias Steinmetz** (Leibniz Institut für Astrophysik, Potsdam, Germany)

Galactic Archeology with Large Computer Simulations and Spectroscopic Surveys / 4 September 2015

**Shrinivas R. Kulkarni** (California Institute of Technology, USA)

The Dynamic Universe: Palomar Transient Factory / 18 September 2015

**Volker Springel** (Heidelberger Institut für Theoretische Studien, Germany)

Simulating cosmic structure formation in a dark universe / 22 September 2015

**Sergio Ferrara** (CERN, Geneva, Switzerland and University of California, Los Angeles, USA)

The Inflaton in Supergravity / 25 September 2015

**Jürgen Renn & Alexander Blum** (Max Planck Institute for the History of Science, Berlin, Germany)

The Emergence of the Tension between Quantum Theory and Gravity / 2 October 2015

**Niklas Beisert** (ETH Zurich, Switzerland)

Yangian Symmetry in the AdS/CFT Correspondence / 9 October 2015

## Institute Colloquia 2013-2016 at AEI Potsdam-Golm

**Mikhail Shaposhnikov** (EPF Lausanne, Switzerland)  
LHC and Cosmology / 6 November 2015

**Masaru Shibata** (Yukawa Institute for Theoretical Physics, Kyoto University, Japan)  
Predicting neutron-star mergers by numerical relativity / 18 November 2016

**Felix Otto** (Max Planck Institute for Mathematics in the Sciences, Leipzig, Germany)  
Effective behavior of random media: From an error analysis to regularity theory / 11 December 2015

**Lucio Mayer** (University of Zurich, Switzerland)  
The pathway to supermassive black hole mergers; from cosmological scales to milliparsec scales / 22 January 2016

**Thomas Thiemann** (University Erlangen-Nuremberg, Germany)  
Loop Quantum Gravity / 26 February 2016

**Antti Kupiainen** (University of Helsinki, Finland)  
Mandelbrot Cascades: from Turbulence to 2d Quantum Gravity / 22 April 2016

**Rolf-Dieter Heuer** (CERN, Geneva, Switzerland)  
From particle physics to the development of society - the role of large Scientific Institutes like CERN / 27 May 2016

**Luis Lehner** (Perimeter Institute for Theoretical Physics, Waterloo, Canada)  
The strong gravity regime and its key role in physics / 15 August 2016

**Vitor Cardoso** (Instituto Superior Tecnico Lisbon, Portugal)  
The strong-field regime of gravity as a physics laboratory / 22 August 2016

**Bernhard Keimer** (Max Planck Institute for Solid State Research, Stuttgart, Germany)  
High-temperature superconductivity: new insights and perspectives / 7 October 2016

**Hans Ringstroem** (Royal Institute of Technology, Stockholm, Sweden)  
Mathematical Aspects of Cosmology / 14 October 2016

**Jeff Steinhauer** (Technion, Haifa, Israel)  
Observation of quantum Hawking radiation and its entanglement in an analogue black hole / 25 November 2016



## Institute Colloquia 2013-2016 at AEI Hannover

**Thomas Tauris** (University of Bonn, Germany)

The detection rate of merging neutron stars / black holes / 13 June 2013

**Raymond Laflamme** (University of Waterloo, Ontario, Canada)

Overview of quantum information processing / 21 June 2013

**Anuradha Gupta** (Tata Institute of Fundamental Research, Mumbai, India)

New Approach for Constructing Time-Domain Inspiral Templates for Spinning Compact Binaries / 18 July 2013

**Fred K. Y. Lo** (Director-Emeritus, NRAO, Charlottesville, USA)

Mega-masers, Cosmology and the Hubble Constant / 05 August 2013

**S. R. Kulkarni** (California Institute of Technology, Pasadena, USA)

Booms, Burps & Bumps: The Dynamic Universe / 21 November 2013

**Sergey Klimentko** (University of Florida, Gainesville, USA)

Burst Searches for Compact Binary Coalescences / 10 December 2013

**Carsten Rott** (Sungkyunkwan University, Suwon, South Korea)

The Hunt for Dark Matter with Neutrinos / 13 January 2014

**Hyung Mok Lee** (Seoul National University, South Korea)

Black Hole Binaries from Globular Clusters and Galactic Nuclei / 18 February 2014

**Lee Samuel Finn** (The Pennsylvania State University, USA)

Pulsar Timing and Gravitational Wave Astronomy / 27 March 2014

**Walter Del Pozzo** (University of Birmingham, UK)

Measuring the cosmological parameters from gravitational waves observations / 15 May 2014

**David Coward** (The University of Western Australia, Perth)

The detection of on-axis short gamma ray burst optical afterglows triggered by aLIGO/Virgo / 12 June 2014

**Kazunari Eda** (University of Tokyo, Japan)

Gravitational waves as a probe of dark matter mini-spikes / 18 September 2014

**Kai Karvinen** (ETH Zurich, Switzerland)

Control and Estimation Techniques for High-Bandwidth Dynamic Mode Atomic Force Microscopy / 25 September 2014

**Christian Hoelbling** (Bergische Universität Wuppertal, Germany)

How to determine fundamental particle properties with GPUs / 16 October 2014

**Stefan Hollands** (Universität Leipzig, Germany)

Black holes and thermodynamics / 13 November 2014

**Shawn Seader** (SETI Institute, USA)

Kepler: Chasing Shadows / 27 November 2014

**Samaya Nissanke** (Radboud University, Nijmegen, Netherlands)

Follow the chirp: new frontiers on the extreme gravity Universe / 15 January 2015

**Jacqueline N. Hewitt** (Massachusetts Institute of Technology, Cambridge, USA)

Probing the Cosmic Dawn and Cosmology with the 21cm Hydrogen Line / 20 January 2015

**Byron D. Tapley** (University of Texas at Austin, USA)

Non-Linear Parameter Estimation for the Multi-Satellite Mission Configuration / 29 January 2015

**Annette Holtkamp** (CERN Inspire Team, Geneva, Switzerland)

INSPIRE - the High Energy Physics information platform: What's in it for gravitational physicists / 11 June 2015

**Victor Flambaum** (The University of New South Wales, Australia)

Manifestations of Dark Matter in Atomic and Astrophysical Phenomena / 30 June 2015

**Alberto Nicolis** (Columbia University, New York, USA)

Effective field theories for gravitational systems / 15 July 2015

**Pedro Ferreira** (University of Oxford, UK)

Relativistic Cosmology in the 21st Century / 17 July 2015

## Institute Colloquia 2013-2016 at AEI Hannover

**Raphael Bousso** (University of California, Berkeley, USA)  
Black holes, Information, and the World as a Hologram / 20 July 2015

**Haixing Miao** (University of Birmingham, UK)  
Quantum limit of gravitational-wave detectors / 06 August 2015

**Robert Lahmann** (University Erlangen-Nuremberg, Germany)  
Acoustic detection of neutrinos or the search for signals in a sea of noise / 24 September 2015

**Thomas Tauris** (University of Bonn, Germany)  
Ultra-stripped Supernovae and Formation of Double Neutron Star Systems / 12 November 2015

**Simon Gröblacher** (Delft University of Technology, The Netherlands)  
Quantum optomechanics experiments at room temperature / 19 November 2015

**Luis Lehner** (Perimeter Institute for Theoretical Physics, Waterloo, Canada)  
The strong gravity regime and its key role in physics / 16 August 2016

**Vitor Cardoso** (CENTRA/IST, Lisboa, Portugal)  
The strong-field regime of gravity as a physics laboratory / 23 August 2016

**Jochen Greiner** (Max Planck Institute for Extraterrestrial Physics, Garching, Germany)  
On the Fermi/GBM event 0.4s after GW150904 / 25 August 2016

**Hans Ringstroem** (Royal Institute of Technology, Stockholm, Sweden)  
Mathematical Aspects of Cosmology / 13 October 2016

**Abraham Harte** (AEI Potsdam-Golm, Germany)  
Exploring the not-so-nonlinear nonlinearity of Einstein's equation / 27 October 2016

**Masaru Shibata** (Kyoto University, Japan)  
Predicting neutron-star mergers by numerical relativity / 22 November 2016

**Stanislav Babak** (AEI Potsdam-Golm, Germany)  
Searching for gravitational waves with Pulsar Timing Array / 24 November 2016

**Torsten Enßlin** (Max Planck Institute for Astrophysics, Garching, Germany)  
Information field theory - the logic of perception, applied to astrophysics / 08 December 2016

**Xavier Calmet** (University of Sussex, UK)  
Effective Quantum Gravity: Applications to Cosmology, Gravitational Waves and Black Holes / 15 December 2016

## Invited Conference Talks given by AEI members

Allen, B.

5 February 2013 – **Ground-based gravitational wave detectors and their capabilities through 2020**  
Workshop: Realtime Astroparticle Physics, Bonn

4 March 2013 – **Ground-based gravitational-wave detectors through the end of this decade**  
Transients and Timing Meeting, IUCAA, Pune, India

22 April 2013 – **Gravitational Waves**  
2nd PANDA Symposium on Multi-Messenger Astronomy Xian, China

4 June 2013 – **Data Analysis for Ground-based Gravitational Wave Detectors**  
Yukawa International Seminar (YKIS) 2013, Kyoto

10 July 2013 – **Einstein@Home**  
GR20/Amaldi10 Conference, Warsaw

5 February 2014 – **Data-intensive high-throughput computing at the Albert Einstein Institute: The search for gravitational waves and weak astrophysical signals**  
RZG Workshop 'High-performance computing und datengetriebene Anwendungen in der MPG', Schloss Ringberg

18 June 2014 – **The Search for Gravitational Waves**  
Joint theory colloquium of DESY & Hamburg University

3 July 2014 – **Einstein@Home**  
1st Conf. of Polish Society on Relativity, Spala, Poland

24 October 2014 – **Prospects for Gravitational-wave Observations associated with Gamma-ray Bursts**  
5th International Fermi Symposium, Nagoya, Japan

20 June 2015 – **GWPAW 2015 Meeting Summary / Highlights**  
GWPAW Gwangju, South Korea

6 November 2015 – **Einstein's legacy, and the search for gravitational waves**  
AEI/ICTS Joint Workshop on gravitational-wave astronomy Bangalore, India

22 February 2016 – **A new window to the universe / Gravitational waves detected**  
Max Planck Forum Berlin, Berlin-Brandenburgische Akademie der Wissenschaften, Berlin

26 February 2016 – **Direct observation of gravitational waves from the merger and inspiral of two black holes**  
Sitzung der Chemisch-Physikalisch-Technischen Sektion (CPTS) der MPG, Harnack-Haus, Berlin

18 March 2016 – **The Discovery of Gravitational Waves**  
Meeting of the MPG Senate, Zoo Leipzig

23 May 2016 – **Direct observation of gravitational waves from the merger and inspiral of two black holes**  
71st Netherlands Astronomy Conference, Nunspeet, Netherlands

13 September 2016 – **Advanced LIGO observations of gravitational waves from binary black hole mergers**  
TeV Particle Astrophysics 2016, CERN, Geneva, Switzerland

17 October 2016 – **Opening on LIGO results**  
Workshop Gravitational Waves and Cosmology, DESY Hamburg

Andersson, L.

21 February 2013 – **Self-gravitating elastic bodies**  
Equations of motion in relativistic gravity, Bad Honnef

22 May 2013 – **Symmetry operators and conserved quantities**  
Nonlinear wave equations, IHP, Paris

13 June 2013 – **Symmetry operators and conserved quantities**  
Asymptotic Analysis in General Relativity, Cergy-Pontoise

## Invited Conference Talks given by AEI members

18 July 2013 – **Symmetries and conserved quantities** *Geometric Analysis*  
Park City, Utah

12 September 2013 – **Asymptotically deSitter spacetimes**  
Mathematics of CCC, Oxford University

8 October 2013 – **Symmetries and conserved quantities**  
Mathematical General Relativity, MSRI, Berkeley

28 November 2013 – **Hidden symmetries and conservation laws**  
Geometry and physics, IHP, Paris

18 December 2013 – **Hidden symmetries and conservation laws**  
Taiwan International Conference on Geometry, Taipei

14 January 2014 – **Dynamics of self-gravitating bodies**  
Nonlinear Wave Equations and General Relativity, Oxford, Oxford

2 July 2014 – **Hidden symmetries and conservation laws**  
Asymptotic Analysis in General Relativity, Institut Fourier, Grenoble

7 September 2015 – **Symmetries and conservation laws**  
Modern Theory of Wave Equations, ESI, Vienna

8 January 2016 – **Potentials and linearized gravity**  
Mathematical General Relativity, Sanya, China

### Benedetti, D.

21 March 2013 – **Asymptotic safety on an infinite-dimensional coupling space**  
"Workshop "Quantum Gravity in Paris", LPT, Orsay, France"

23 July 2013 – **Asymptotically safe gravity: general ideas and new developments**  
LOOPS 13, at Perimeter Institute, Waterloo, Canada

19 March 2014 – **One-loop renormalization in a toy model of Horava-Lifshitz gravity**  
"Workshop "Quantum Gravity in Paris", LPT, Orsay, France"

24 April 2014 – **One-loop renormalization in a toy model of Horava-Lifshitz gravity**  
"Conference "Renormalization group approaches to quantum gravity", Perimeter Institute, Waterloo, Canada"

### Bengeloun, J.

18 March 2014 – **Tensor Models/Group Field Theories: an overview**  
Plenary speaker in Quantum Gravity in Paris Ed 2014, IHES, Paris

10 April 2014 – **Tensorial Group Field Theory for Quantum Gravity**  
Network Meeting of the Alexander von Humboldt Foundation, Humboldt University

11 September 2014 – **Renormalization in Tensorial Group Field Theories**  
Plenary speaker at Random Geometry and Physics, Steklov Institute of Russian Academy of Science, Moscow

22 July 2015 – **Tensor Models and Renormalization**  
University of San Paulo, San Paulo, Brasil, plenary talk at Operator algebras and quantum physics, satellite conference of the XVIII International Congress of Mathematical Physics, 17 to 23 July 2015.

30 July 2015 – **Tensor Models and Renormalization**  
invited talk at the XVIII International Congress of Mathematical Physics, Santiago de Chile, Chile

21 September 2015 – **Renormalization in Tensorial Group Field Theories**  
Humboldt Kolleg 'Open Problems in Theoretical Physics: the Issue of Quantum Spacetime', Corfu

25 November 2015 – **On a power counting theorem for a  $p=4$  TFT**  
Constructive Field Theory: from CM to QG, Institut Henri Poincare, Paris

## Invited Conference Talks given by AEI members

**Buonanno, A.**

1 May 2013 – **Modeling Gravitational Waves from Compact-Object Coalescences**  
GR Science Workshop, South Padre Island, TX

6 June 2013 – **Closing in on the Shape of Gravitational Waves from Binary Systems**  
YKIS2013, Yukawa Institute, Kyoto, Japan

28 June 2014 – **Learning about Black Holes and Neutron Stars Using Ground-Based Gravitational-Wave Detectors**  
Astroparticle Physics 2014, Amsterdam, Netherlands

5 July 2014 – **Current Status and Unsolved Problems in Gravitational Waves**  
Workshop 'Unsolved Problems in Astrophysics and Cosmology', Eötvös Loránd University, Budapest, Hungary

6 February 2015 – **The Discovery Potential of Gravitational-Wave Experiments**  
Leiden, Netherlands

23 February 2015 – **The Tolman Prize Fellowship: A Turning Point in My Scientific Career**  
Walter Burke Institute for Theoretical Physics, Caltech, CA

24 February 2015 – **Hunting for the Elusive Waves Created by Black Holes and Neutron Stars**  
Walter Burke Institute for Theoretical Physics, Caltech, CA

11 May 2015 – **Measurements of Black-Hole Masses in the Advanced Detector Era**  
Workshop on Black Holes and Gravitational Waves, Cardiff University, Wales, UK

17 June 2015 – **Finalizing Gravitational-Wave Modeling for Searches in the Advanced-Detector Era**  
Gravitational Wave Physics and Astronomy Workshop (GWPAW), Osaka, Japan

9 September 2015 – **Modeling Gravitational Waves from Compact-Object Binaries for the Advanced-Detector Era**  
Stepping into the Second Century, University of the Balearic Islands, Palma de Mallorca, Spain

6 October 2015 – **Gravitational Waves: A New Tool for Observing the Cosmos**  
100 Years of Curved Spacetime, Austrian Academy of Sciences, Vienna, Austria

6 October 2015 – **Gravitational Waves: A New Tool for Observing the Cosmos**  
100 Years of Curved Spacetime, Vienna, Austria

16 December 2015 – **Making Waves: Modeling Gravitational Waves from Coalescing Binary Systems**  
28th Texas Symposium in Relativistic Astrophysics, University of Geneva, Switzerland

12 March 2016 – **Gravitational Waves: A New Tool for Observing the Cosmos**  
General Relativity at One Hundred: The Sixth Biennial Bacon Conference, Pasadena, CA, USA

31 March 2016 – **Properties of GW150914 and Tests of General Relativity**  
Cosmology and Gravity Program Meeting (CIFAR 16), Whistler, British Columbia, Canada

19 April 2016 – **GW150914 Observation: Unveiling Properties and Testing General Relativity**  
Black Holes @ 100, Harvard University, USA

20 May 2016 – **GW150914: The Birth of Gravitational-Wave Astronomy**  
New Frontiers in Theoretical Physics - XXXV Convegno Nazionale di Fisica Teorica and GGI 10th anniversary, Galileo Galilei Institute, Florence, Italy

24 May 2016 – **GW150914 and the next challenges in gravitational-wave observations**  
The first observation of a binary black hole merger, Max Planck Institute for Gravitational Physics, Hannover, Germany

8 August 2016 – **Tests of General Relativity with LIGO's Black Holes**  
Workshop 'Astrophysics from LIGO's First Black Holes', Kavli Institute for Theoretical Physics, University of California, Santa Barbara, CA, USA

## Invited Conference Talks given by AEI members

12 August 2016 – **What did we learn from LIGO's first black holes?**

20th Annual International Conference on Particle Physics and Cosmology (COSMO-16), University of Michigan, Ann Arbor, MI, USA

16 September 2016 – **The New Era of Gravitational-Wave Astronomy**

Annual Meeting of the German Astronomical Society, Ruhr-Universität, Bochum, Germany

9 November 2016 – **Gravitational Waves as Astronomical Messengers**

Workshop 'Astrophysics in the Era of Gravitational Wave and Multimessenger Observations'

Joint Space-Science Institute, Annapolis, MD, USA

2 December 2016 – **Modeling Waveforms from Binary Black Holes**

'Physics At EXtreme' Workshop, Pennsylvania State University, State College, PA

9 December 2016 – **The Next Theoretical Challenges for Gravitational-Wave Observations**

New Frontiers of Gravitational Wave Radiation, University of Pennsylvania, Philadelphia, PA

12 December 2016 – **Analytical Relativity and Gravitational Waves**

Workshop 'GW161212: The Universe Through Gravitational Waves', Simons Centre for Geometry and Physics,

Stony Brook University, NY, USA

**Casanellas, J.**

26 September 2014 – **Dark matter and stars at the Galactic Center**

The Alajar meeting 2014

**Chiodaroli, M.**

9 September 2015 – **Simplifying Amplitudes in  $N = 2$  supergravities**

The String Theory Universe conference, KU Leuven, Belgium

20 March 2016 – **Scattering amplitudes in  $N = 2$  Maxwell-Einstein and Yang-Mills-Einstein supergravities**

PAFT 2016, Vietri sul Mare, Italy

**Danzmann, K.**

14 January 2013 – **LISA as Recognized Experiment at CERN**

Genf, CERN, Recognized Experiment Committee Meeting

10 April 2013 – **LISA, NGO, and eLISA**

HEAD Meeting, Monterey, California, USA

19 July 2013 – **Listening to the Universe with eLISA: A Gravitational Wave Detector in Space**

European Physical Society, High Energy Physics Meeting (EPS-HEP), Stockholm

3 September 2013 – **The Gravitational Universe**

Encuentros Relativistas Espanoles 2013, Benasque, Spain

19 September 2013 – **LISA Technology for Geodesy**

China-Europe Science Meeting in Future Gravity Missions Peking, China

11 November 2013 – **Gravitational Wave Detection from Space**

Wigner Symposium, Budapest

3 December 2013 – **Laserinterferometry for Geodesy Missions**

Understanding Gravity Conference, ISSI, Bern

17 May 2014 – **eLISA as L3-Mission**

LISA10 Conference, Gainesville, Florida

25 August 2014 – **The ESA L3-Mission**

LVC-Meeting, Stanford University, Stanford, CA, USA

9 September 2014 – **Gravitational Wave Physics at the AEI**

Summer School on High-Energy Physics, Maria Laach

## Invited Conference Talks given by AEI members

22 September 2014 – **The Future of Gravitational Wave Astronomy**  
Heraeus Conference on Black Holes, Bad Honnef

18 October 2014 – **Listening to the Universe with Einstein's Gravitational Waves**  
ICALEO Conference, San Diego, USA

1 December 2014 – **Die dunkle Seite des Universums**  
Sonderforschungsbereich TR7 Annual Meeting, Universität Jena, Jena

22 June 2015 – **Multi-Messenger Astronomy with Gravitational Waves**  
European Week of Astronomy and Space Science, Teneriffa

15 July 2015 – **Designing Gravitational Wave Missions in Space**  
ESA Summer School on Gravitational Waves, Alpbach, Austria

11 August 2015 – **Low-Frequency Gravitational Wave Astronomy from Space**  
International Astronomical Union Annual Meeting, Honolulu, Hawaii

14 September 2015 – **Sino-German Symposium on Gravity and Collaborative projects in space**  
Leibniz Universität Hannover, Hannover

5 November 2015 – **The Future of Gravitational Wave Astronomy**  
KAT-Symposium, Bad Honnef

12 November 2015 – **Gravitational Waves**  
QUANOMET Symposium, Leibniz Universität Hannover, Hannover

2 March 2016 – **Gravitational Waves and the Future of Astronomy**  
DPG Annual Meeting, Leibniz Universität Hannover, Hannover

**Dent, T.**

23 April 2014 – **Astrophysics & cosmology with 3rd generation gravitational-wave detectors**  
Sant Cugat Forum on Astrophysics, Casa de Cultura, Sant Cugat, Spain

**Di Palma, I.**

24 May 2013 – **Multi-messenger astrophysics: when gravitational waves meet high energy neutrinos**  
Roma International Conference on AstroParticle Physics, University 'La Sapienza', Rome, Italy

10 August 2015 – **Searches for continuous gravitational waves: recent results in data from the LIGO and Virgo detectors**  
Hot Topic in General Relativity and Gravitation Conference, Quy Nhon

**Dietrich, T.**

23 September 2016 – **Gravitational waves and the prospects for multi-messenger astronomy**  
HAP Workshop: The Non-Thermal Universe, Friedrich-Alexander-Universität, Erlangen, Germany

**Drago, M.**

23 September 2014 – **Gravitational wave transient search in preparation for the Advanced Detector Era**  
100 National Workshop organized by Italian Society of Physics

9 March 2016 – **The LIGO discovery and data analysis**  
Gravitational Waves: The Discovery and Outlook, Bruxelles

18 June 2016 – **From an image to a Binary Black Hole: the History of the first Detected Gravitational Wave**  
Workshop: 'Image as Vortex: An Interdisciplinary Conference on the Question of what an Image is by examining what it does', Oxford University

21 July 2016 – **The first gravitational wave detections**  
Italian-Pakistani Workshop on Relativistic Astrophysics, Lecce

12 September 2016 – **LIGO GW detections: the burst point of view**  
SIGRAV conference, Cefalu

## Invited Conference Talks given by AEI members

24 October 2016 – **LIGO Gravitational wave detections: the transient search**  
The 26th Workshop on General Relativity and Gravitation in Japan, Osaka University

**Fredenhagen, S.**

6 February 2013 – **Metric-like versus frame-like higher-spin gauge fields in three dimensions**  
2nd Solvay Workshop on Higher Spin Gauge Theories, Brussels

1 July 2013 – **On three-dimensional higher-spin gauge theories**  
Itzykson conference, Saclay (France)

29 July 2013 – **On the higher-spin AdS3/CFT2 correspondence**  
Gauge/Gravity Duality conference, Munich

30 July 2014 – **Aspects of the higher-spin AdS3/CFT2 correspondence**  
Sissa (Trieste/Italy), Workshop on String Field Theory and related aspects

5 December 2014 – **On conformal defects in two dimensions**  
Prague (Institute of Physics AS CR), St. Nicolas Meeting on Strings and Higher spins

22 September 2015 – **On defects in conformal field theories and Landau-Ginzburg models**  
Workshop 'Selected topics in Theoretical High Energy Physics', Tbilisi

6 November 2015 – **On higher-spin gravity in three dimensions**  
Workshop 'Strongly interacting field theories', University of Jena

**Friedrich, H.**

10 July 2013 – **Radiation fields and vacuum solutions near past time-like infinity**  
GR 20 and Amaldi 10, Warszawa

9 January 2014 – **On anti-de-Sitter type space-times**  
Conférence en l'honneur d'Yvonne Choquet-Bruhat, Bures-sur-Yvette, IHES

13 April 2015 – **Geometric Asymptotics and Beyond**  
Conference Grav 15, La Falda, Argentina

23 September 2015 – **Some global results and problems for Einstein's field equations**  
DMV Jahrestagung, Universitaet Hamburg

27 November 2015 – **Conformal extensions of Einstein flows**  
2nd Conference of the Polish Society on Relativity, University of Warszawa

9 December 2016 – **Asymptotically simple Einstein-lambda-matter flows with non-vanishing trace of the energy momentum tensor**  
Workshop, University of Warsaw

10 December 2016 – **Gravitational radiation and asymptotic flatness**  
Conference, University of Warsaw

**Grote, H.**

26 May 2014 – **Exploring Advanced Techniques with GEO600**  
GWADW Japan

**Harry, I.**

11 May 2015 – **Observing compact binary coalescences**  
Cwrt Bleddyn Black hole workshop

**Harte, A.**

17 July 2013 – **Self-interaction and extended bodies**  
Capra conference, Dublin

21 May 2015 – **Non-perturbative methods and motion**  
Focus program on 100 years of general relativity, Fields Institute, Toronto



## Invited Conference Talks given by AEI members

He, S.

23 December 2015 – **Entanglement Entropy in String Theory**  
ShangHai

Heurs, M.

15 September 2016 – **Nichtklassische Laserinterferometrie für die Gravitationswellenastronomie**  
Hanopticum, Laseroptik Garbsen, Germany

Joudioux, J.

14 June 2013 – **Hertz potentials and the decay of higher spin fields**  
First meeting of the ANR grant team 'Asymptotic analysis in General relativity', Université de Cergy-Pontoise, France

Kleinschmidt, A.

14 October 2013 – **Whittaker functions and constant terms for Kac-Moody Eisenstein series**  
Workshop on Whittaker functions, Banff, Canada

11 June 2014 – **Automorphic functions and string scattering**  
KITPC, Beijing

11 November 2014 – **Fermions, supersymmetry and hidden symmetries**  
'Exceptional symmetries and emerging space-time' conference, Singapore

6 March 2015 – **K(E10) as R symmetry group**  
Solvay workshop Le charme discret de la symétrie, Brussels

7 July 2015 – **Hidden symmetries in gravity and the standard model**  
Frontiers in Cosmology Solvay Workshop, Brussels

14 July 2015 – **From hidden symmetries in gravity to the standard model of elementary particle physics**  
Marcel Grossmann XIV meeting, Rome

3 August 2015 – **Loops in exceptional field theory**  
'CERN-CKC workshop on 'Duality Symmetries'

14 August 2015 – **Loops in exceptional field theory**  
Benasque workshop on 'Gauge theories, supergravity and superstrings'

14 September 2015 – **Loops in exceptional field theory**  
Conference on 'Stringy Geometry', Mainz

4 November 2015 – **Higher spin representations of K(E10)**  
Conference on 'Higher spin gauge theories', NTU, Singapore

18 November 2015 – **Fourier coefficients and nilpotent orbits for small representations**  
Conference Eisenstein series on Kac Moody groups, KIAS, Seoul

11 April 2016 – **Loops in exceptional field theory**  
Workshop on Duality Symmetries, Supergravity and Branes, A&M University, Texas

27 July 2016 – **Automorphic forms and lattice sums in exceptional field theory**  
Conference on 'Whittaker functions: Number Theory, Geometry and Physics', Banff International Research Station

27 September 2016 – **Hyperbolic Weyl groups**  
Program on Automorphic Forms in String Theory, Simons Center for Geometry and Physics, Stony Brook, USA

Knispel, B.

9 September 2013 – **The Einstein@Home radio pulsar search**  
START meeting, Urumqi, China

Koehn, M.

7 February 2013 – **Scalars with higher derivatives in supergravity and cosmology**  
Nordic String Meeting 2013, DESY, Hamburg

## Invited Conference Talks given by AEI members

28 March 2013 – **Scalars with higher derivatives in supergravity and cosmology**  
Conference 'Breaking of supersymmetry and Ultraviolet Divergences in extended Supergravity'  
National Laboratories of Frascati, Italy

**Kolasiński, S.**  
23 June 2016 – **New solutions to a generalised Plateau problem**  
X Forum of partial differential equations, Banach Center, Bedlewo, Poland

**Krishnan, B.**  
22 February 2013 – **Searching for Gravitational Waves: Status and prospects**  
Conference 'Equations of motion in relativistic gravity', Bad Honnef, Germany

23 September 2015 – **Introduction to gravitational wave searches**  
INFIERI Summer School 2015, Hamburg

6 September 2016 – **Observations of the binary black hole coalescence events GW150914 and GW151226**  
Meeting of the Brazilian Physical Society, Natal, Brazil

4 October 2016 – **Observations of the binary black hole coalescence events GW150914 and GW151226**  
RTG renewal conference: Black Holes, Neutron Stars and the structure of space-time,  
Research Training Group 'Models of Gravity', Oldenburg, Germany

**Lück, H.**  
13 November 2013 – **ET: the Einstein Telescope**  
Wigner Memorial Conference, Wigner Institute, Budapest, Hungary

1 September 2016 – **Status and Goals of Gravitational Wave Detection**  
The Lake Baikal Three Messenger Conference JINR, Listvyanka, Russia

**Maliborski, M.**  
9 September 2016 – **On dynamics of asymptotically AdS spaces**  
Workshop on Numerical and Mathematical Relativity, Oppurg, Germany

**Menne, U.**  
7 May 2013 – **Bericht eines Wissenschaftlers zur Bibliotheksnutzung**  
36. Bibliothekstagung der Max-Planck-Gesellschaft

30 July 2013 – **Weakly differentiable functions on varifolds**  
ICTP Trieste / Conference 'Geometric Measure Theory and Optimal Transport'

7 October 2013 – **Connectedness properties of varifolds**  
Scuola Normale Superiore Pisa / ERC Workshop on Geometric Measure Theory, Analysis in Metric Spaces and Real Analysis

16 June 2015 – **Weakly differentiable functions on varifolds**  
Conference 'Geometric Analysis, Free Boundary Problems and Measure Theory'  
Max Planck Institute for Mathematics in the Sciences

29 June 2015 – **Weakly differentiable functions and Sobolev functions on varifolds**  
Conference 'Geometric Measure Theory and Calculus of Variations: Theory and Applications', Fourier Institute, Grenoble

**Nicolai, H.**  
19 March 2013 – **Quantum gravity and E10 symmetry**  
Quantum Gravity in Paris, LPT Orsay

26 March 2013 – **The non-linear flux ansatz for maximal supergravity**  
Breaking of supersymmetry and UV divergences in extended supergravity, INFN-LNF, Frascati

May 2013 – **Quantum gravity and dark energy**  
AIP Potsdam, Symposium 'Measuring and modelling dark energy'

9 May 2013 – **Non-string approaches to quantum gravity: a brief survey**  
Universidad de Antofagasta, Chile

## Invited Conference Talks given by AEI members

- 12 September 2013 – **Beyond maximal supersymmetry**  
Kallosh Shenker Fest, Stanford University, USA
- 7 January 2014 – **Tensor hierarchies from D=11 Supergravity**  
Aspects of Supergravity, Simons Center, Stony Brook, USA
- 5 May 2014 – **Another look at quadratic divergences**  
LarsBrinkFest, Brussels
- 21 May 2014 – **On exceptional geometry and supergravity**  
'Gravitation, solitons and symmetries', Universite de Tours, France
- 9 June 2014 – **Comments on deformed SO(8) gauged supergravities**  
Workshop 'Quantum Gravity, Black Holes and Strings', KITPC, Beijing, China
- 27 June 2014 – **Another look at quadratic divergences**  
Erice Summer School on Subnuclear Physics, Erice, Sicily
- 21 July 2014 – **Exceptional geometry and supergravity**  
Recent developments in string theory, Centro Stefano Franscini, Ascona, CH
- 31 July 2014 – **On exceptional geometry and supergravity**  
Quantum Cosmology, Bad Honnef, 27 July - 1 August 2014"
- 29 August 2014 – **Quadratic divergences and the Standard Model**  
International Symposium Ahrenshoop, 25 - 29 August 2014
- 10 November 2014 – **Higher spin realizations of K(E10)**  
Workshop 'Exceptional symmetries and emerging spacetime', Nanyang Executive Centre, Singapore
- 5 March 2015 – **N=8 supergravity and standard model fermions**  
'Le charme discret de la symetrie', ULB, Bruxelles
- 8 April 2015 – **Exceptional Geometry and Supergravity**  
Quantum Gravity in Paris, I.H.E.S., Bures-sur-Yvette
- April 2015 – **Approaches to quantum gravity - a brief survey**  
'Le Monde Quantique', I.H.E.S., Bures-sur-Yvette
- 4 May 2015 – **K(E10) as an R symmetry of M theory**  
'Future prospects for fundamental particle physics and cosmology', "SCGP, Stony Brook, New York
- 28 October 2015 – **Comparative Quantum Gravity**  
Windows into Quantum Gravity, UAM-CSIC, Madrid
- 29 October 2015 – **N=8 Supergravity: past, present, future**  
Windows into Quantum Gravity, UAM CSIC, Madrid
- 2 March 2016 – **Standard Model Fermions and N=8 Supergravity**  
DPG Tagung, Hamburg
- 11 April 2016 – **Supersymmetry vs. K(E10)**  
Dualities in Supergravities, Strings and Branes, Mitchell Institute, Texas A&M University, USA
- 7 July 2016 – **Supersymmetry: to be or not to be?**  
SUSY 2016, Melbourne, Australia
- 19 July 2016 – **What has and what has not worked in quantum gravity: a personal view**  
Workshop 'Dashed hopes: what has not worked in quantum gravity and why.', MPI fuer Wissenschaftsgeschichte, Berlin
- 28 September 2016 – **Conformal anomalies and gravitational waves**  
Workshop 'Emergent Space-Time in Quantum Gravity and Fundamental Cosmology', AEI

## Invited Conference Talks given by AEI members

14 October 2016 – **On string duality in D=9 dimensions**

DieterFest, LMU, Muenchen

27 October 2016 – **Conformal anomalies and gravitational waves**

40 years of supergravity: what next?, GGI Florence, Italy

22 November 2016 – **On exceptional geometry and supergravity**

Workshop on Geometry and Physics, in memoriam Ioannis Bakas, Schloss Ringberg

**Orti, D.**

21 March 2013 – **Cosmological dynamics from group field theory**

Conference Quantum Gravity in Paris

27 June 2013 – **Effective cosmological dynamics from group field theory models of quantum gravity**

1st i-Link Conference: Macro-from-Micro: Quantum Gravity and Cosmology, CSIC, Madrid

10 September 2013 – **Group field theory and quantum geometry**

Non-commutative field theory and gravity, Corfu Summer Institute, Corfu, Greece

11 February 2014 – **A 2nd quantized (Fock space) formulation of LQG (and what is can be useful for)**

Second EFI winter conference on Quantum Gravity, Tux, Austria

23 April 2014 – **Renormalization of group field theories: motivations and a brief review**

Conference 'Renormalization group approaches to quantum gravity', Perimeter Institute, Waterloo

9 June 2014 – **Non-commutative geometry tools in loop quantum gravity, spin foam models and group field theory**

Born Symposium: The Planck Scale, Wroclaw, Poland

24 July 2014 – **Group field theory: a quantum field theory for the atoms of space**

Workshop on 'Quantum Gravity', part of Frontiers of Fundamental Physics Symposium, Marseille

4 September 2014 – **The universe as a quantum gravity condensate**

Workshop 'Experimental Search for Quantum Gravity', SISSA, Italy

10 September 2014 – **Group field theory and loop quantum gravity**

Conference 'Conceptual and Technical Challenges for Quantum Gravity', University of Rome La Sapienza

4 September 2014 – **Quantum Gravity: from the atoms of space to cosmology**

Conference 'NEB 16 - Recent developments in gravity', Mykonos, Greece'

0 March 2015 – **Temporal aspects of the geometrogenesis scenario in quantum gravity**

'Time in Quantum Gravity' Conference, Univ. California in San Diego, USA

20 June 2015 – **Cosmology as quantum gravity hydrodynamics**

Conference 'Cosmology and the quantum vacuum', Rhodes, Greece

20 July 2015 – **Cosmology as Quantum Gravity hydrodynamics**

Meeting 'Quantum Gravity: Theory and Phenomenology', Univ. of Rome La Sapienza, Italy

8 September 2015 – **Group field theory renormalisation and effective cosmology**

Conference 'The Planck Scale II', Wroclaw, Poland

6 November 2015 – **Group field theories for the atoms of space and their renormalization**

Friedrich Schiller University Jena

26 November 2015 – **A multi-scale tsunami**

Institute H. Poincare, Paris

16 February 2016 – **Forks on the road, on the way to quantum gravity**

4th Tux Workshop on Quantum Gravity, Tux, Austria

## Invited Conference Talks given by AEI members

21 March 2016 – **Group field theory: foundations and emergent cosmology**  
XVIII meeting 'Current problems in theoretical physics', Vietri sul Mare, Italy

0 March 2016 – **Functional Renormalisation Group approach to the continuum limit of Group Field Theories**  
Conference 'Shapes of Gravity', Raboud University, Nijmegen, The Netherland

**Pang, Y.**

28 October 2016 –  **$N=3$  AdS4 x M6 solution in Massive IIA Supergravity and Holography**  
Conference Supergravity at 40, Galio Galilei Institute, Firenze

**Rezzolla, L.**

19 March 2013 – **Black holes in numerical relativity: from astrophysics to particle physics**  
COST Action on black holes, CERN, Geneve

21 March 2013 – **Using numerical relativity to explore fundamental physics and astrophysics**  
3rd Iberian Gravitational-wave meeting, Valencia

3 April 2013 – **Black holes in numerical relativity**  
The modern radio Universe 2013, Bonn

8 May 2013 – **Electromagnetic counterparts from binary NSs**  
2013 Multimessenger Transient Astrophysics Workshop, Beijing

**Rinne, O.**

1 March 2013 – **Numerical evolution of the Einstein equations to future null infinity**  
Spring Meeting of the German Physical Society, Jena

18 May 2016 – **Numerical approaches to static metric extensions and gluing**  
Static metrics and Bartnik's quasi-local mass conjecture, University of Tübingen

**Sakovich, A.**

28 February 2014 – **A Jang equation approach to positive mass theorem for asymptotically hyperbolic initial data**  
Central European Relativity Seminar/Erwin Schroedinger Institute, Vienna

18 March 2015 – **On the mass of asymptotically hyperbolic initial data sets**  
GAMMP2015, Dortmund

**Schlotterer, O.**

18 September 2014 – **Superstring amplitudes as a laboratory for multiple zeta values**  
Conference Numbers and Physics, Madrid

22 September 2014 – **The anatomy of scattering amplitudes in pure spinor superspace**  
Conference 'New geometric structures in scattering amplitudes', Oxford

9 July 2015 – **Elliptic multiple zeta values and superstring one-loop amplitudes**  
Conference Amplitudes 2015, Zurich

**Schnabel, R.**

7 April 2013 – **Quantum metrology with squeezed and entangled light**  
Photons beyond Qubits Workshop, Olomouc, Czech Republic

23 April 2013 – **Measurement and Observation at the Quantum Limit at the Albert-Einstein Institute Hannover**  
IMPP Kick-off Meeting in Scotland

24 April 2013 – **International Max-Planck Research School (IMPRS) on Gravitational Wave Astronomy**  
IMPP Kick-off Meeting in Scotland

15 May 2013 – **Squeezing and Two-Mode-Squeezing Enhanced Metrology**  
Quantum Metrology Conference, QM2013, in Poznan

## Invited Conference Talks given by AEI members

**Schreiber, E.**

21 May 2014 – **Squeezing at GEO 600**

Virgo Week, Cascina

8 April 2015 – **GEO 600: an advanced techniques detector**

The Next Detectors for Gravitational Wave Astronomy, Beijing

**Steinhoff, J.**

16 October 2014 – **Effective theory for multipoles of compact objects and applications to binary systems**

16th RAGtime workshop, Prague, Czech Republic

14 July 2015 – **Spin effects on the dynamics of compact binaries**

14th Marcel Grossmann Meeting, Rome, Italy

13 July 2016 – **Analytic models for compact binaries: spin and dynamic tides**

GR21 Conference, Columbia University, New York, USA

**Taracchini, A.**

25 November 2014 – **Modeling of coalescing vacuum gravitational-wave sources**

Olomouc Synergy 2014, Olomouc, Czech Republic

13 July 2015 – **Modeling gravitational waves from a small mass plunging into a Kerr black hole**

Marcel Grossman Meeting, Rome

**Taronna, M.**

31 January 2013 – **Higher-Spin Interactions in Constant Curvature Backgrounds**

Bangkok Workshop on Gravity, Gauge Theory, Matrices and Strings

8 May 2013 – **On the non-linear deformations of high-spin gauge symmetric**

Higher Spins, Strings and Duality - Conferenc, (GGI, Florence)

20 June 2013 – **String lessons for and from Higher Spins**

37th Johns Hopkins Workshop, Seoul National University, Korea

7 November 2013 – **Cubic-interaction-induced deformations of higher-spin symmetries**

Workshop on Higher-Spin and Higher-Curvature Gravity, Sao Paulo, Brazil

13 February 2014 – **On Higher-Spin Symmetries, cubic interactions, AdS and CFT**

AEI - Potsdam

9 April 2014 – **On Higher-Spin Symmetries, cubic interactions, AdS and CFT**

Fubini Prize 2014

9 June 2014 – **On Higher-Spin Symmetries, cubic interactions, AdS and CFT**

KITPC

31 July 2014 – **On Higher-Spin Symmetries, cubic interactions, AdS and CFT**

SFT2014, SISSA, Trieste

22 September 2014 – **From Higher Spins to Strings: A constructive approach**

Yerevan: Frontiers in fields and string theory

3 November 2014 – **From Higher Spins to Strings: A constructive approach**

Conference 'New Trends in Field Theories', BHU University, India

15 May 2015 – **Higher Spins and Matter Interactions in Dimension Three**

SFT2015, Chengdu

4 June 2015 – **Remarks on Vasiliev equations to the second order**

Higher Spin Theory and Holography-2, Lebedev Institute

## Invited Conference Talks given by AEI members

Virmani, A.

16 June 2015 – **Inverse Scattering Construction of the JMaRT Fuzzball**  
Workshop, Paris

Volpato, R.

27 August 2013 – **Generalised Mathieu Moonshine**  
Workshop 'Mock Modular Forms, Moonshine, and String Theory', Simons Center for Geometry and Physics  
Stony Brook, New York

Willke, B.

20 April 2015 – **High Power Lasers for Gravitational Astronomy**  
Research Program at the Kavli Institute for Theoretical Physics China, Beijing

23 May 2016 – **The Advanced LIGO Detectors in the Era of First Discoveries**

Conference: The first observation of a binary black hole merger: Status and future prospects (Hannover),  
Hannover, Germany

27 October 2016 – **Observation of Gravitational Waves from a Binary Black Hole Merger  
- Dawn of a New Astronomy**

Keynote talk at EclipseCon Europe conference, Ludwigsburg, Germany

Wilson-Ewing, E.

12 February 2015 – **A  $\Lambda$ CDM Bounce Scenario**  
First Erlangen Workshop on Cosmology and Quantum Gravity

7 July 2015 – **Loop Quantum Cosmology and Alternatives to Inflation**

Loops 15 Conference, Friedrich-Alexander Universität Erlangen-Nürnberg

14 August 2015 – **Bouncing Universes in Loop Quantum Cosmology**

Hot Topics in General Relativity and Gravitation 2 Conference, Quy Nhon, Vietnam

1 June 2016 – **Bouncing Cosmologies from Quantum Gravity Condensates**

Helsinki Workshop on Quantum Gravity, University of Helsinki

14 June 2016 – **Cosmology from Quantum Gravity**

Canadian Association of Physicists Annual Congress, University of Ottawa

29 June 2016 – **Bouncing Cosmologies from Quantum Gravity Condensates**

Singularities of general relativity and their quantum fate workshop, Banach Center, Warsaw

## Lectures, Lecture Series and Courses given by AEI members

**Allen, B.**

06 November 2013 – **The search for gravitational waves**  
University Bern, Switzerland

26 November 2013 – **Einstein@Home Discovery of four young Gamma-Ray pulsars in FERMI LAT Data**  
MIT, Cambridge / USA

18 April 2014 – **The Einstein@Home search for gravitational waves and neutron stars**  
University of Wisconsin-Milwaukee

25 August 2014 – **The search for gravitational waves**  
University Berkeley, USA

04 October 2016 – **The Discovery of Gravitational Waves**  
MPG IT Meeting, Max Planck Campus Göttingen

**Benedetti, D.**

14 November 2013 – **An overview of asymptotic safety**  
PUC, Santiago, Chile

18 November 2013 – **An overview of asymptotic safety**  
CECS, Valdivia, Chile

**Buonanno, A.**

1 April 2013 – **Advances in Solving the Two-Body Problem in General Relativity:  
Implications for the Search of Gravitational Waves**  
John Hopkins University, Baltimore, MD

1 May 2013 – **Advances in Solving the Two-Body Problem in General Relativity:  
Implications for the Search of Gravitational Waves**  
Virginia Tech, VA

24 July 2013 – **Probing the Universe and Fundamental Physics by Detecting Gravitational Waves**  
Summer School 'Post-Planck Cosmology', Les Houches, France

16 September 2014 – **The analytical/numerical relativity interface**  
Heraeus school 'General Relativity@99', Bad Honnef, Germany

24 April 2015 – **Hunting for the Elusive Waves Created by Black Holes and Neutron Stars**  
Queen Mary College, London, UK

24 April 2015 – **Hunting for the Elusive Waves Created by Black Holes and Neutron Stars**  
School of Physics and Astronomy Colloquium, Queen Mary University of London, London, UK

20 May 2015 – **Hunting for the Elusive Waves Created by Black Holes and Neutron Stars**  
HEP-GR Colloquium, Center for Mathematical Sciences, University of Cambridge, Cambridge, UK

3 August 2015 – **Modeling Gravitational Waves: the Analytical/Numerical Relativity Interface**  
School on Gravitational Waves: from data to theory and back, ICTP South American Institute for Fundamental Research, Sao Paulo, Brazil

5 August 2015 – **Hunting for the Elusive Waves Created by Black Holes and Neutron Stars**  
Colloquium, ICTP-SAIFR, Sao Paulo, Brazil

14 January 2016 – **Hunting for the Elusive Waves Created by Black Holes and Neutron Stars**  
Berlin Physics Colloquium, Berlin Physical Society, Magnus House, Berlin, Germany

29 February 2016 – **GravitationalWaves: A New Tool for Observing the Cosmos, Astrophysics Colloquium**  
Department of Physics, Oxford University, Oxford, UK

21 March 2016 – **GW150914: The Birth of Gravitational Wave Astronomy**  
Joint Space-Science Colloquium, University of Maryland, College Park, MD, USA



## Lectures, Lecture Series and Courses given by AEI members

8 April 2016 – **GW150914 and the next challenges for gravitational-wave observations**

General Relativity @ 100+, Princeton University, USA

29 April 2016 – **GW150914 and the Next Challenges in Gravitational-Wave Observations**

Institut Astrophysique de Paris, Paris, France

9 June 2016 – **GW150914 and the Next Challenges in Gravitational-Wave Observations, University of Stockholm, Sweden**

20 October 2016 – **The New Era of Gravitational-Wave Astronomy**

Max Planck Society Section Meeting, Harnack Haus, Berlin, Germany

26 October 2016 – **The New Era of Gravitational-Wave Physics and Astrophysics**

Potsdam University, Potsdam, Germany

4 November 2016 – **The New Era of Gravitational-Wave Astronomy**

NASA Goddard Space Flight Center, MD

7 December 2016 – **The New Era of Gravitational-Wave Physics and Astrophysics**

Department of Physics and Astronomy, University of Pennsylvania, Philadelphia, PA, USA

13 December 2016 – **The New Era of Gravitational-Wave Astronomy**

Workshop 'GW161212: The Universe Through Gravitational Waves', Simons Centre for Geometry and Physics, Stony Brook University, NY, USA

20 December 2016 – **The New Era of Gravitational-Wave Astronomy**

Department Colloquium, Institute for Physics, Humboldt University, Berlin, Germany

**Cabero Mueller, M.**

11 November 2016 – **Gravitationswellen und astronomische Forschung**

Bundesweite WE-Hereaus-Lehrerfortbildung zur Astronomie, Haus der Astronomie, Heidelberg, Deutschland

**Camanho, X.**

20 October 2015 – **Asymptotic causality and hyperbolicity**

Steklov Institute of Mathematics

**Daniele, D.**

22 September 2015 – **Group field theories for the atoms of space**

'Non-commutative field theory and gravity', Corfu Summer Institute, Corfu, Greece

**Danzmann, K.**

Summer Term 2013 – **AEI-Seminar**

Leibniz Universität Hannover

Summer Term 2013 – **Gravitationsphysik**

Leibniz Universität Hannover

Summer Term 2013 – **Institutsseminar**

Leibniz Universität Hannover

Summer Term 2013 – **Studentenseminar**

Leibniz Universität Hannover

13 May 2013 – **Das Universum hören mit Einsteins Gravitationswellen: Präzisionsoptik bei der Arbeit**

DGAO Annual Meeting, Braunschweig

28 June 2013 – **Schwarze Löcher: Monster im Universum**

Akademie der Wissenschaften und Kultur, Mainz

07 July 2013 – **GEO600 and the future**

Gravitational Wave International Committee, Annual Meeting, Warschau

22 July 2013 – **Gravitational Waves in Germany**

Universität Jena, Jena

## Lectures, Lecture Series and Courses given by AEI members

Winter Term 2013 – **AEI-Seminar**

Leibniz Universität Hannover

Winter Term 2013 – **Institutsseminar**

Leibniz Universität Hannover

Winter Term 2013 – **Physik I: Mechanik und Relativität**

Leibniz Universität Hannover

Winter Term 2013 – **Studentenseminar**

Leibniz Universität Hannover

25 October 2013 – **Gravitational Wave Physics at the AEI**

University of Tokyo, Tokyo

18 December 2013 – **International Max-Planck-Partnership Launch**

IMPP , Edinburgh

Summer Term 2014 – **AEI-Seminar**

Leibniz Universität Hannover

Summer Term 2014 – **Elektrizität - Physik II (mit Experimenten)**

Leibniz Universität Hannover

Summer Term 2014 – **Institutsseminar**

Leibniz Universität Hannover

Summer Term 2014 – **Studentenseminar**

Leibniz Universität Hannover

02 April 2014 – **Bald Neues von der dunklen Seite des Universums**

Universität Wien, Littrow-Lecture, Wien

Winter Term 2014 – **AEI-Seminar**

Leibniz Universität Hannover

Winter Term 2014 – **Gravitationsphysik**

Leibniz Universität Hannover

Winter Term 2014 – **Institutsseminar**

Leibniz Universität Hannover

Winter Term 2014 – **Studentenseminar**

Leibniz Universität Hannover

Summer Term 2015 – **AEI-Seminar**

Leibniz Universität Hannover

Summer Term 2015 – **Gravitationsphysik**

Leibniz Universität Hannover

Summer Term 2015 – **Institutsseminar**

Leibniz Universität Hannover

Summer Term 2015 – **Studentenseminar**

Leibniz Universität Hannover

10 April 2015 – **Das dunkle Universum**

Akademie der Wissenschaften, Hamburg

09 November 2015 – **Collaborative opportunities in Germany for laser interferometry in space**

Universität Stuttgart, Stuttgart

## Lectures, Lecture Series and Courses given by AEI members

19 November 2015 – **German Contributions to GRACE2**

Geoforschungszentrum GFZ, Potsdam

07 December 2015 – **Gravitational wave astronomy in the next decade**

Astrophysikalisches Institut Potsdam AIP, Potsdam

12 December 2015 – **The future of LISA**

NASA Mid-Decadal Review in Astrophysics, Irvine, USA

**Dent, T.**

29 May 2013 – **Searching for compact binary coalescence signals with ground-based GW detectors**

School of Astroparticle Physics, Observatoire de Haute Provence, St Michel l, Observatoire, France

20 June 2013 - **Data analysis II: Basic data tools and CBC signals**

IMPRS lecture week, Strandhotel Weisser Berg, Mardorf, Germany

02 July 2014 - **Data analysis III: Basic data tools and CBC signals**

IMPRS lecture week, Strandhotel Weisser Berg, Mardorf, Germany

09 June 2015 – **Data analysis II: Basic data tools and CBC signals**

IMPRS lecture week, Crieff Hydro, Scotland

07 March 2016 – **Data analysis I: Discrete signal processing and data visualization**

IMPRS lecture week, Hotel Am Motzener See, Brandenburg, Germany

07 June 2016 – **A very, very general introduction to LIGO and GW150914**

Workshop 'Dense Stellar Environments', Centro de Ciencias de Benasque Pedro Pascual, Spain

**Devchand, C.**

04 December 2013 – **Instantons and the ADHM Construction**

IMPRS Lecture Day, AEI

**Dietrich, T.**

23 June 2016 – **Simulations of colliding black holes**

"Excellence Cluster Universe" - Munich, Germany

**Dooley, K. L.**

28 January 2013 – **Some examples of effect of thermal distortions on interferometer control**

Livingston, LA USA / Commissioning Workshop

**Fredenhagen, S.**

20 March 2013 – **Higher-spin AdS3/CFT2 correspondence**

School on Higher Spins, Strings and Duality at the GGI (Florence)

01 April 2014 – **General Relativity (lectures and exercises)**

Humboldt University Berlin

25 April 2014 – **General Relativity**

Humboldt University

14 October 2014 – **An introduction to conformal field theory**

Humboldt University Berlin

15 October 2015 – **Lineare Algebra**

Gastprofessur, Humboldt University

**Harte, A.**

19 February 2013 – **Self-interaction and its effects on motion**

Hereaus seminar on equations of motion, Bad Honnef

**Huisken, G.**

27 February 2013 – **Variational Concepts in General Relativity**

DPG-Frühjahrstagung

## Lectures, Lecture Series and Courses given by AEI members

Keitel, D.

15 April 2013 – **Gravitationswellen und Einstein@Home**  
AIfA, Bonn University, Astroclub

Khalaidovski, A.

11 January 2013 – **Application of squeezed light in current and future GW observatories - a review**  
Tokyo Institute of Technology, KAGRA Seminar

Kleinschmidt, A.

11 February 2014 – **Symmetries in Physics**  
IISER Pune

12 November 2015 – **Introduction to string theory**  
KIAS, Seoul

07 December 2015 – **Lie theory for physicists**  
Amsterdam-Brussels-Geneva-Paris doctoral school, CERN, Geneva, Switzerland

Knispel, B.

06 February 2013 – **Gravitationswellen - kann man das Universum hören?**  
MNU-Bundeskongress 2013, Hamburg

04 March 2013 – **Reise an das Ende des Universums**  
Lions Club Hannover, Hannover

18 September 2013 – **Gravitationswellen-Astronomie**  
MNU-Tag 2013 in Niedersachsen, Hannover

25 October 2013 – **Vom Urknall bis heute: die Geschichte des Universums**  
Männerkreis Isernhagener Gespräche, Gemeindehaus der St. Philippus-Gemeinde

06 February 2014 – **Gravitational Wave Astronomy**  
IGS Garbsen

17 February 2014 – **Gravitationswellen**  
Higgs, Masse and all the Rest, Lehrerfortbildung der Physikalischen Fakultät, Universität Marburg

21 August 2014 – **Colleg des Eilenriedestift Hannover**  
Colleg des Eilenriedestift Hannover, Hannover

13 September 2014 – **Meteoriten, sterbende Sterne und Blitze aus den Tiefen des Universums - die Astronomie hinter Katie Patersons Werken**  
Kunstverein und Stiftung Springhornhof, Neuenkirchen

19 June 2015 – **Einstein@Home**  
Astroammtisch Peine, Peine

01 July 2015 – **Gravitationswellen-Astronomie**  
Lehrerfortbildung im Deutschen Museum, München

13 July 2015 – **Gravitationswellen-Astronomie**  
Lehrerfortbildung, Universität Jena

30 August 2015 – **Gravitational-wave Astronomy**  
ESOP34, Hannover

04 September 2015 – **Ground-based gravitational-wave detectors**  
Astronomy from four perspectives, Universität Jena

10 May 2016 – **Gravitationswellen-Astronomie - so klingt die dunkle Seite des Universums**  
Ringvorlesung, Universität Kiel

## Lectures, Lecture Series and Courses given by AEI members

01 September 2016 – **Gravitational-wave Astronomy**

Institute Retreat in Goslar, MHH Hannover

**Kolasiński, S.**

12 September 2016 – **An introduction to varifolds theory**

CIMI Thematic Semester, CIMI – Université de Toulouse, Toulouse, France

**Krishnan, B.**

15 June 2016 – **The coalescence of two black holes and gravitational waves**

Bavarian Elite Academy, Erlangen, Germany

**Lück, H.**

17 January 2013 – **Gravitationswellen, die Suche nach dem Zittern der Raumzeit**

invited talk, Gymnasium Andreanum, Hildesheim

15 April 2013 – **Gravitationswellen, die Suche nach dem Zittern der Raumzeit**

School visit in Ruthe, Gymnasium Josephinum, Hildesheim

07 October 2014 – **Gravitational Waves-observing tiny jitters in space-time**

XXXIII Heidelberg Graduate days

10 October 2014 – **Detektion von Gravitationswellen mit GEO600**

Fachschäftstagung Physik, Cusanuswerk, Cusanuswerk, Wolfenbüttel, Germany

22 July 2015 – **Gravitationswellen**

DPG Lehrerfortbildung, Bad Honneff

17 February 2016 – **Detektion von Gravitationswellen**

Vortrag an Gymnasium, Andreanum Hildesheim

09 June 2016 – **Detektion von Gravitationswellen**

Einladung, Bismarschule Hannover

15 June 2016 – **Detektion von Gravitationswellen**

Einladung, Gymnasium Langenhagen

**Menne, U.**

31 March 2014 – **Plateau type problems using sets**

Minicourse 'Plateau type problems using sets' at AEI

20 February 2015 – **Weakly differentiable functions on varifolds**

Cambridge University / Special Guest Lectures

04 March 2015 – **Varifolds - introduction and regularity**

University of Warwick

**Müller, V.**

27 January 2015 – **Space Laser Interferometry for LISA and GRACE Follow-On**

TU München, ESPACE + Geodesy institute

07 March 2016 – **Introduction to Gravimetric Satellite Missions**

geoQ & IMPRS Lecture Week 1, Motzen, Brandenburg, Germany

21 June 2016 – **Future Gravity Missions**

Lecture Week 2 - geoQ, Mardorf, Germany

**Nicolai, H.**

15 April 2013 – **A la recherche d'une symétrie fondamentale**

Institut de France, Paris, on the occasion of the awarding of the Gay-Lussac-Humboldt Prize

17 June 2013 – **Two Lectures on the Conformal Standard Model**

ERASMUS MUNDUS PhD School, Pescara, Italy

## Lectures, Lecture Series and Courses given by AEI members

09 May 2014 – **Einführung in die Supersymmetrie**

Humboldt University Berlin (together with A. Kleinschmidt)

10 September 2014 – **From cosmological billiards to Kac-Moody algebras: a new look at the BKL paradigm (4 lectures)**

Higher School of Economics, Moscow, Russia

29 December 2014 to 08 January 2015 – **Maximal supergravity and beyond (4 lectures)**

Jerusalem Winter School '100 Years of General Relativity', Jerusalem

5 January 2015 – **Tutorial on BKL and cosmological billiards**

Weizmann Institute, Rehovot

19 February 2015 – **Symmetrie und Vereinheitlichung - lässt sich die Physik auf eine Formel reduzieren?**

Einstein Lecture Dahlem, FU Berlin

20 March 2015 – **Master Class on Supersymmetry and Supergravity**

University of Western Australia, Perth

11 August 2015 – **Approaches to quantum gravity – a brief survey (two talks)**

Rencontres du Vietnam, Quy Nhon, Vietnam

11 July 2016 – **Quantum Gravity: Problems, Puzzles and Perspectives**

Distinguished Guest Lecture, ANU, Canberra, Australia

**Novak, J.**

26 September 2016 – **Minimal conformal supergravity invariants in six dimensions**

Workshop - Supergravity: what next?, The Galileo Galilei Institute for Theoretical Physics

**Orti, D.**

29 November 2013 – **Disappearance and Emergence of Space and Time in Quantum Gravity**

'Physics and Philosophy' series, Laboratoire SPHERE, Univ. Paris VII-Diderot

19 December 2013 – **Loop quantum gravity and group field theory**

IX Avogadro Meeting, SISSA, Trieste

15 April 2014 – **The Bronstein hypercube of Quantum Gravity**

conference 'New Directions in the Foundations of Physics', Mathematical Association of America, Carriage House, Washington, USA

21 July 2014 – **Group field theories: the combinatorics of tensor models, the quantum geometry of loop quantum gravity**

E. Schroedinger Institute for Mathematical Physics, Vienna

12 January 2015 – **A basic introduction to Quantum Gravity: from GR and QFT to a quantum spacetime**

University of Naples Federico II, Italy

21 April 2015 – **Group field theory for Quantum Gravity**

Beijing Normal University, Beijing, China

12 May 2015 – **Group field theories for Quantum Gravity**

Kings College London

28 October 2015 – **If spacetime is emergent, what is cosmology?**

University of Geneva

**Prix, R.**

9 March 2016 – **3 Lectures on Probability & Statistics**

IMPRS Lecture week, Motzen bei Berlin

**Raymond, V.**

25 February 2016 – **GW150914: A new beginning for transient gravitational-wave astrophysics**

Massachusetts Institute of Technology, Cambridge, Massachusetts, USA,

## Lectures, Lecture Series and Courses given by AEI members

**Rinne, O.**

24 February 2014 – **Cosmic censorship in gravitational collapse**

Annual Meeting of the Research Training Group GRK 1523 'Quantum and Gravitational Fields', Oppurg Castle

30 March 2015 – **Putting spacetime on a computer: numerical relativity**

Junior Scientist Andrejewski Days: 100 Years of General Relativity, Gollwitz, Brandenburg, Germany

**Schlotterer, O.**

18 March 2013 – **Superstring Tree Amplitudes Recycling Field Theory Structures**

Workshop 'Beyond the Standard Model, Bad Honnef'

11 April 2013 – **Polylogarithms, Multiple Zeta Values and Superstring Amplitudes**

Workshop 'Grothendieck-Teichmüller-Theory and Multiple Zeta Values', Newton Institute, Cambridge

18 July 2013 – **Closed formulae for disk amplitudes: multiple zeta values and the Drinfeld associator**

Workshop 'Amplitudes, Strings and Branes', CERN

24 September 2013 – **An Introduction to Superstring Theory and its Scattering Amplitudes**

IMPRS Excursion Bollmannsruh

12 November 2013 – **BCJ numerators at one-loop from the superstring: five points and beyond**

Workshop 'Physics and Mathematics of Scattering Amplitudes', Simons Center, Stony Brook

12 November 2014 – **Introduction to the pure spinor formalism**

Mathematical Institute Oxford

09 March 2015 – **Modern approaches to scattering amplitudes**

Juergen Ehlers Spring School 2015

24 April 2015 – **Multiloop super Yang Mills and supergravity amplitudes in pure spinor superspace**

Workshop Superstring Perturbation Theory at Perimeter Institute

26 May 2015 – **Elliptic multiple zeta values and superstring one-loop amplitudes**

Workshop Amplitudes, Motives and beyond, MITP Mainz

05 November 2015 – **Introduction to superstring amplitudes**

Conference 'Amplitudes in Asia 2015', NTU Taipei

16 November 2015 – **Introduction to superstring amplitudes**

Institute of Theoretical Physics, Beijing

02 February 2016 – **SYM amplitudes in pure spinor superspace from first principles**

University Tor Vergata Rome

04 April 2016 – **BCJ gauge for bosons and applications**

Workshop 'QCD meets gravity', Higgs Centre for Theoretical Physics, Edinburgh

**Schreiber, E.**

10 April 2015 – **Quantum noise in gravitational wave detectors**

The Next Detectors for Gravitational Wave Astronomy, Beijing

**Singh, A.**

29 March 2016 – **GW150914: In the era of Gravitational Wave Astronomy**

Indian Institute of Technology, Guwahati, India

**Steinhardt, J.**

09 March 2015 – **General Relativity**

IMPRS Lecture Week No.1, Bad Saarow, Germany

07 March 2016 – **General Relativity**

joined IMPRS and geo-Q Lecture Week No.1, Mittenwalde, OT Motzen, Germany

## Lectures, Lecture Series and Courses given by AEI members

16 June 2016 – **Generation of gravitational waves and spherical stars**  
IMPRS Lecture Week No.2, Mardorf, Germany

22 June 2016 – **Electrodynamics and special relativity**  
geo-Q Lecture Week No.2, Mardorf, Germany

**Taronna, M.**

12 June 2013 – **Introductory Lectures on Higher-Spin Gravity**  
Seoul National University

09 October 2014 – **Elements of Higher-Spin Theories**  
Bollmannsruh, IMPRS Excursion

30 March 2015 – **Higher Spins and Matter Interactions in Dimension Three**  
Tel Aviv/Weizemann

02 April 2015 – **On Higher-Spin Symmetries, Cubic Interactions, AdS and CFT**  
Tel Aviv/TAU

11 June 2015 – **Introduction to Unfolding**  
Chengdu/SFT2015-preschool

**Wanner, G.**

25 November 2013 – **Gravitational Wave Detectors in Space: eLISA/NGO**  
QUEST Lecture Series, Leibniz Universität Hannover, Deutschland

16 December 2013 – **Laser interferometer modeling with IfoCAD**  
PTB, Braunschweig, Deutschland

**Willke, B.**

11 May 2016 – **Gravitationswellenastronomie - Neues von der dunklen Seite des Universums**  
Optence member meeting, Mainz (Germany)

23 June 2016 – **Beobachtung von Gravitationswellen mittels Laserinterferometrie**  
Advanced teacher training, Exzellenzcluster Universe, TU München

27 June 2016 – **Beobachtung von Gravitationswellen zweier verschmelzender schwarzer Löcher**  
German wide advanced teacher training - open evening lecture, Universität Jena

21 July 2016 – **Observation of Gravitational Waves from a Binary Black Hole Merger - Dawn of a New Astronomy**  
Keynote Lecture at 'SYMMETRY FESTIVAL 2016' meeting, Wien (Austria)

16 August 2016 – **Advanced LIGO Pre-stabilized Laser System**  
LIGO-India: The road ahead - meeting, IUCCA, Pune (India)

22 October 2016 – **Gravitationswellen - Ein neues Fenster zum Kosmos**  
Astroseminar 2016, Universität Münster (Germany)

**Wilson-Ewing, E.**

18 August 2016 – **Loop Quantum Cosmology**  
Beijing Normal University International Summer School on Quantum Gravity, Beijing, China



## Popular Talks given by AEI members

Allen, B.

9 April 2013 – **Einsteins Erbe und die Suche nach Gravitationswellen**  
International Scientists in Hannover, Rathaus Hannover

18 June 2013 – **Auf der Suche nach Gravitationswellen**  
Gymnasium Schillerschule Hannover

24 June 2013 – **Auf der Suche nach Gravitationswellen**  
Gymnasium Langenhagen

12 December 2013 – **Einsteins Erbe - Die Suche nach den Gravitationswellen**  
Volkssternwarte Hannover

17 January 2014 – **Einsteins Erbe und die Suche nach Gravitationswellen**  
Kaiser- Wilhelm- und Ratsgymnasium, Hannover

6 March 2014 – **Einsteins Erbe und die Suche nach Gravitationswellen**  
Geschwister-Scholl-Gymnasium, Garbsen

1 April 2014 – **Einsteins Erbe und die Suche nach Gravitationswellen**  
Bismarckschule, Hannover

17 November 2014 – **Schwarze Löcher, Neutronensterne und gekrümmte Raumzeit**  
AEI Hannover

24 November 2014 – **Einsteins Erbe und die Suche nach Gravitationswellen**  
Gymnasium Schillerschule, Hannover

9 July 2015 – **Einsteins Erbe und die Suche nach Gravitationswellen**  
Bismarckschule, Hannover

1 November 2016 – **The Discovery of Gravitational Waves**  
DPG-Magnus-Haus, Berlin

Aufmuth, P.

13 November 2013 – **eLISA - ein Laserinterferometer im All**  
Einstein weiterdenken. Hannover

20 November 2014 – **Die Suche nach dem Higgs-Teilchen - Das Standard-Modell der Materie**  
Vierter November der Wissenschaft. Hannover

Bengeloun, J.

8 March 2016 – **What is spacetime?**  
Next-Einstein Forum, Sciences in Africa, Dakar, Senegal

Buonanno, A.

20 November 2015 – **Le Onde Gravitazionali: Un Nuovo Strumento per Osservare l'Universo**  
University of Parma, Parma, Italy

24 November 2015 – **Sounds of Silence: Listening to the Universe with Gravitational Waves**  
University of Geneva, Switzerland

19 February 2016 – **Celebration of the first detection of gravitational waves by LIGO**  
Max Planck Institute for Gravitational Physics, Potsdam, Germany

22 February 2016 – **A new window on the universe: gravitational waves detected**  
Berlin-Brandenburgische Akademie der Wissenschaften, Berlin, Germany

8 September 2016 – **Sounds of Silence: Listening to the Universe with Gravitational Waves**  
Harvard Leadership Dinner Talk, Harvard University Alumni Club of Berlin, Berlin, Germany

## Popular Talks given by AEI members

1 October 2016 – **Sounds of Silence: Listening to the Universe with Gravitational Waves**  
Science Festival 'Passion for Knowledge', Donostia International Physics Center, Donostia, San Sebastian, Spain

16 November 2016 – **Sounds of Silence: Listening to the Universe with Gravitational Waves**  
Dennis Sciama Memorial Lecture, SISSA, Trieste, Italy

8 December 2016 – **Sounds of Silence: Listening to the Universe with Gravitational Waves**  
Women in Physics Public Lecture, University of Pennsylvania, Philadelphia, PA, USA

### Casanelas, J.

14 February 2014 – **Dark matter and stars**  
Famelab Berlin-Brandenburg, GFZ Potsdam

10 May 2014 – **The music of stars**  
Famelab Germany Final, Bielefeld

16 May 2014 – **The dark music of stars**  
Science Slam Potsdam, Waschhaus

15 November 2014 – **Dark Matter**  
Astro-Slam in der Archenhold-Sternwarte, Treptower Park

20 November 2014 – **Dark Matter**  
Science Slam Berlin Adlershof //Battle den Horst//

1 December 2014 – **Dark Matter**  
7. Science Slam Berlin, SO36 Berlin-Kreuzberg

22 January 2015 – **Dark Matter**  
7. Science Slam Hannover

### Danzmann, K.

21 March 2014 – **Das Universum hören**  
Herrenhausen late, Hannover

9 September 2014 – **Das Universum hören**  
Kloster Maria Laach, Maria Laach

6 March 2015 – **Das Universum hören mit Einstein**  
Planetarium, Hamburg

17 June 2015 – **Hatte Einstein Recht?**  
Universität Bremen, Bremen

11 February 2016 – **We discovered gravitational waves**  
Leibniz Universität Hannover

5 April 2016 – **Töne aus dem dunklen Universum**  
Schloss Herrenhausen, Hannover

7 April 2016 – **Wir können das Universum hören**  
Wirtschaftsempfang der Leibniz Universität Hannover, Hannover

### Dietrich, T.

25 November 2016 – **Gravitational Wave Astronomy**  
Bruno H.-Bürgel Observatory, Berlin, Germany

### Drago, M.

30 April 2016 – **Le onde gravitazionali: una nuova frontiera per lo studio dell'universo** (in Italian)  
TEDxPadova, Padova

## Popular Talks given by AEI members

28 May 2016 – **The discovery of gravitational waves** (in italian)  
Wired Next Fest, Milano

9 September 2016 – **La scoperta delle onde gravitazionali**  
Fucina delle Scienze, Monselice, Italy

22 September 2016 – **La scoperta delle onde gravitazionali**  
Dialoghi di Trani, Trani

8 October 2016 – **La scoperta delle onde gravitazionali**  
Award Niccolo Copernico for Physics, Ferrara

31 October 2016 – **La scoperta delle onde gravitazionali**  
Rovigo

### Heurs, M.

2 February 2016 – **Der Klang des Kosmos**  
Evening event for the inauguration of the 'Hörregion Hannover', Hörregion Hannover, Germany

16 Feb 2016 – **The Gravitational Universe**  
AstroFest London, UK

26 October 2016 – **Gravitationswellen - Neuigkeiten aus dem All**  
Festvortrag zur Verleihung der Wissenschaftspreise, Leibniz Universitätsgesellschaft Hannover, Germany

26 October 2016 – **Gravitationswellen - Neuigkeiten aus dem All**  
Willkommensveranstaltung für neue MitarbeiterInnen, Leibniz Universität Hannover, Germany

12 November 2016 – **In Space no one can hear you scream**  
Nacht der Wissenschaft, Leibniz Universität Hannover, Germany

24 November 2016 – **Gravitationswellen - eine Jahrhundert-Entdeckung**  
November der Wissenschaft, Leibniz Universität Hannover, Germany

30 November 2016 – **Die Jagd nach Einsteins Gravitationswellen**  
Sternwarte Recklinghausen, Germany

### Hinderer, T.

23 April 2015 – **Physik in Extremsituationen**  
Girls' Day 2015, AEI Potsdam

28 April 2016 – **Gravitationswellen: Ein neues Fenster ins Universum**  
Girls' Day 2016 – AEI Potsdam

### Keitel, D.

13 August 2015 – **Auf dem Weg zur Gravitationswellen-Astronomie**  
Astronomisches Sommerlager, St. Andreasberg

### Kleinschmidt, A.

14 April 2015 – **Einsteins allgemeine Relativitätstheorie und ihre Bedeutung für die Forschung heute**  
Industriemuseum Teltow

### Knispel, B.

21 March 2013 – **Listen to the Universe - Gravitationswellen als Klang des Universums**  
DPG-Tagung, Leibniz Universität Hannover

16 May 2013 – **Unsere Sonne**  
Lister Turm, DARC Hannover, Hannover

8 August 2013 – **Unsere Sonne**  
Monatsvortrag in der Volkssternwarte, Hannover

## Popular Talks given by AEI members

9 January 2014 – **Astronomische Jahresvorschau 2014**

Monatsvortrag in der Volkssternwarte, Hannover

9 February 2014 – **Matinee im Foyer - Aliens oder andere Antworten**

Diskussionrunde im Haus der Region, Hannover

12 February 2014 – **Gravitationswellen-Astronomie**

Einladung der Hildesheimer Gesellschaft für Astronomie, Hildesheim

26 February 2014 – **Astrophysik auf dem Heim-PC - mit Einstein@Home Radiopulsare entdecken**

Westfälische Volkssternwarte und Planetarium Recklinghausen, Recklinghausen

10 November 2014 – **The Big Bang Theory - Aktuelle Forschungen zur Entstehung des Kosmos**

Roemer- und Pelizaeus-Museum Hildesheim, Hildesheim

11 December 2014 – **Wellen vom Beginn des Universums?**

Monatsvortrag in der Volkssternwarte, Hannover

21 May 2015 – **The Big Bang Theory - Wie entstand der Kosmos?**

Monatsvortrag in der Volkssternwarte, Hannover

4 June 2015 – **The Big Bang Theory - Wie entstand der Kosmos?**

Wiederholung des Monatsvortrags in der Volkssternwarte, Hannover

27 October 2015 – **Die Jagd auf Einsteins Gravitationswellen**

Österreichische Urania für Steiermark, Graz

3 November 2015 – **Die Jagd auf Einsteins Gravitationswellen**

Westfälisches Landesmuseum mit Planetarium, Münster

12 January 2016 – **Die Jagd auf Einsteins Gravitationswellen**

Planetarium Göttingen, Göttingen

17 February 2016 – **Die Jagd auf Einsteins Gravitationswellen**

Planetarium am Insulaner, Berlin

19 March 2016 – **Die Suche nach Gravitationswellen - und wie jeder helfen kann**

Astronomietag im Museum Schloss Rodenberg, Rodenberg

14 April 2016 – **Gravitationswellen-Astronomie**

Monatsvortrag in der Volkssternwarte, Volkssternwarte Hannover

16 May 2016 – **Gravitationswellen-Astronomie**

Einstein macht Schule, Johannes-Kepler-Gymnasium Garbsen

18 May 2016 – **Gravitationswellen-Astronomie**

Einstein macht Schule, Carl-Bosch-Gymnasium Ludwigshafen

2 June 2016 – **Der Sound der Raumzeit - Stehen wir am Anfang einer neuen Astronomie?**

Gesellschaft für Philosophische Kultur e.V.

3 June 2016 – **Gravitationswellenastronomie - so klingt die dunkle Seite des Universums**

Festvortrag bei Preisverleihung 'Mathematik ohne Grenzen', Schillerschule Hannover

7 June 2016 – **Die Jagd nach Einsteins Gravitationswellen**

Urania Berlin

11 June 2016 – **Auf der Jagd nach Einsteins Gravitationswellen**

Initiativkreis Albert-Einstein-Haus Caputh

29 June 2016 – **Die Jagd nach Einsteins Gravitationswellen**

Planetarium Bochum

## Popular Talks given by AEI members

9 August 2016 – **So klingt die dunkle Seite des Universums**

Rotarier Club Lehrte

7 September 2016 – **Die Jagd nach Einsteins Gravitationswellen**

Wissenschaftstag, Windthorst-Gymnasium Meppen

8 September 2016 – **Gravitationswellen-Astronomie - so klingt die dunkle Seite des Universums**

Urania Eichsfeld

14 September 2016 – **Gravitationswellen-Astronomie - so klingt die dunkle Seite des Universums**

MNU-Tagung 2016 in Niedersachsen, Goetheschule Hannover

13 October 2016 – **Gravitationswellen-Astronomie - so klingt die dunkle Seite des Universums**

Volkssternwarte Hannover

19 October 2016 – **Gravitationswellen-Astronomie - so klingt die dunkle Seite des Universums**

MINT100-Forum, Schillerschule Hannover

19 October 2016 – **Gravitationswellen-Astronomie - so klingt die dunkle Seite des Universums**

Arduino-Treff Hannover, LeineLab Hannover

24 October 2016 – **Gravitationswellen-Astronomie - so klingt die dunkle Seite des Universums**

Volkssternwarte Paderborn

27 October 2016 – **Gravitationswellen-Astronomie - so klingt die dunkle Seite des Universums**

Volkssternwarte Hannover

7 November 2016 – **Einsteins Relativitätstheorie im Universum und im Alltag**

November der Wissenschaft, AEI Hannover

12 November 2016 – **Pulsare mit Einstein@Home entdecken**

Die Nacht, die Wissen schafft, AEI Hannover

15 November 2016 – **Reise an das Ende des Universums**

November der Wissenschaft, AEI Hannover

19 November 2016 – **Gravitationswellen-Astronomie - so klingt die dunkle Seite des Universums**

Guericke-Tagung 2016, Guericke-Zentrum Magdeburg

**Korovins, J.**

14 November 2016 – **The role of high curvature corrections in quantum gravity**

Ministerium für Wissenschaft, Forschung und Kultur, Potsdam

**Lehners, J.**

11 November 2015 – **Das älteste Licht des Universums**

Lunchpaket, Bildungsforum Potsdam

21 November 2015 – **Der Anfang von Raum und Zeit**

G.A.S.-station, Berlin

24 November 2015 – **Der Anfang von Raum und Zeit**

AEI Hannover

**Lück, H.**

23 April 2013 – **Gravitationswellendetektion, aus dem All ins Labor und zurück**

Hanopticum, Laser Optik Garbsen

6 November 2013 – **Einsteins Raumzeitwellen messen**

November der Wissenschaft, AEI, Hannover

2 May 2016 – **Detektion von Gravitationswellen**

Sternwarte Sonneberg

## Popular Talks given by AEI members

11 August 2016 – **Detektion von Gravitationswellen**

Einladung, Rotarier Club Hildesheim

**Nicolai, H.**

2 December 2013 – **Neues vom Higgs-Boson**

Rotary Club Potsdam

13 December 2013 – **Das Higgs Boson**

Rotaract Club Potsdam

23 November 2014 – **Symmetrie - Bauprinzip der Naturgesetze?**

Deutsch/Amerikanisches Zentrum, Heidelberg

24 January 2015 – **Licht ins Dunkel: wie gross ist das Universum?**

Potsdamer Koepfe im Bildungsforum, Potsdam

17 March 2015 – **Symmetries - building blocks of the Laws of Nature?**

University of Western Australia, Perth, Australia

3 June 2015 – **Wie groß ist das Universum?**

Planetarium am Insulaner, Berlin

12 June 2015 – **Licht ins Dunkel: Wie gross ist das Universum?**

Bruno-H.-Bürgel Strenwarte, Spandau

13 June 2015 – **Einsteins Allgemeine Relativitätstheorie - ein Jahrtausendereignis**

Gemeindsaal evang. Kirche, Caputh

20 October 2015 – **Licht ins Dunkel: Wie groß ist das Universum?**

URANIA Graz (Austria)

16 November 2015 – **Die Renaissance der Relativität**

Podiumsdiskussion GV der MPG, Max Planck Forum, München

7 December 2015 – **Alles ist relativ? 100 Jahre Allgemeine Relativitätstheorie**

Podiumsdiskussion, RBB Inforadio, Magnus-Haus Berlin

10 December 2015 – **‘Lässt sich die Physik auf eine Formel reduzieren?’**

URANIA Berlin

17 February 2016 – **After Dinner Speech**

Nilles-Fest, Universität Bonn

1 April 2016 – **Wie groß ist das Universum?**

TH Wildau, Berlin

13 May 2016 – **Einstein's dream - searching for a unified theory**

Award of honorary doctorate, Chalmers University of Technology, Gothenburg, Sweden

1 June 2016 – **Gravitationswellen - das Zittern von Raum und Zeit**

Präsentation für Rotary Club Potsdam, AEI

11 Oct ober2016 – **Der Wissenschaftsstandort Golm: Exzellente Bedingungen für exzellente Forschung**

HighTech Transfer Tag, GO:IN, Golm

**Oriti, D.**

3 March 2013 – **The scientific construction of space and time**

Luca Pozzis personal Art Exhibition, GrimMuseum, Berlin

14 March 2014 – **The nature of space, time and matter**

Public panel discussion, Universite Paris-VII Diderot

## Popular Talks given by AEI members

31 October 2014 – **The relationship between Science and Art**

STATE of Time Festival (a festival for Art and Science), Alte Muenze, Berlin

29 January 2015 – **What is space made of? The quest of quantum gravity**

'Cafe Scientifique', Berlin

**Rinne, O.**

15 July 2014 – **The infinite uses of finite fields**

Habilitation talk, Freie Universität Berlin

**Schlotterer, O.**

26 February 2014 – **String Theorie: Ein roter Faden durch das Naturgeschehen**

Potsdamer Koepfe

30 May 2014 – **String Theorie - Ein roter Faden durch das Naturgeschehen**

Bruno H. Bürgel Sternwarte

6 September 2014 – **String Theorie - Ein roter Faden durch das Naturgeschehen**

Tag der offenen Türen at AEI

24 November 2014 – **String Theorie - Ein roter Faden durch das Naturgeschehen**

Staatliches Seminar fuer Didaktik und Lehrerbildung, Tuebingen

**Schreiber, E.**

2 June 2016 – **Einstein macht Schule: Über die Detektion von Gravitationswellen**

Leibnizschule, Hannover

**Shao, L.**

11 March 2016 – **The First Detection of Gravitational Waves and Related Astrophysics** (in Chinese)

Chinese Embassy in Berlin, Germany

**Siegel, D.**

10 January 2014 – **Kurze Gamma-Blitze und die stärksten Magnetfelder im Universum**

Bruno-H.-Bürgel-Sternwarte Berlin

27 March 2014 – **Kurze Gamma-Blitze und die stärksten Magnetfelder im Universum**

Girls Day 2014 am AEI

6 June 2014 – **Astrophysikalische Relativitätstheorie... mit dem Computer!**

Besuch der Konrad-Adenauer-Stiftung, AEI

6 September 2014 – **Neutronensterne und Schwarze Löcher im Computer:**

**Was numerische Simulationen über Einsteins relativistisches Universum verraten**

Open Day Science Park Golm, AEI

15 December 2014 – **Kurze Gamma-Blitze und die stärksten Magnetfelder im Universum**

Besuch einer Schulklasse am AEI

8 January 2015 – **Kurze Gamma-Blitze und die stärksten Magnetfelder im Universum**

Besuch einer Schulklasse am AEI

**Singh, A.**

8 March 2016 – **Looking into the depths of the Cosmos**

St.-Dominikus-Gymnasium, Karlsruhe, Germany

28 March 2016 – **Looking into the depths of the Cosmos**

Indian Institute of Technology, Guwahati, India

**Wanner, G.**

13 August 2016 – **Gravitationswellen – Burggespräche des Orion**

Loosdorf, Austria

## Popular Talks given by AEI members

5 October 2016 – **Gravitationswellen**

Herbstuni, AEI Hannover

**Willke, B.**

12 November 2016 – **Die Entdeckung der Gravitationswellen**

Nacht die Wissenschaft 2017, Seminar at AEI, AEI Hannover, Germany

**Wilson-Ewing, E.**

7 January 2015 – **The Early Universe and Before**

Bishops University

**Wittchen, A.**

26 November 2014 – **LISA Pathfinder -Technologiedemonstration für das Gravitationswellen-Observatorium eLISA**

November der Wissenschaft, Albert Einstein Institut, Hannover, Germany

3 December 2015 – **LISA Pathfinder startet ins All**

**- Technologiedemonstration für das Gravitationswellen-Observatorium eLISA**

Einstein weiterdenken 2015, Albert Einstein Institut, Hannover, Germany

12 November 2016 – **LISA Pathfinder Technologie für ein Gravitationswellen-Observatorium im All**

Die Nacht, die Wissen schafft, AEI, Hannover, Germany



## Events

**GermanyTopics in geometric analysis, Bi-weekly research seminar, Free University of Berlin, Max Planck Institute for Gravitational Physics, Potsdam, and University of Potsdam, Germany**

Oct. 25, 2012 – today

Organizers: Ulrich Menne, Theodora Bourni, Klaus Ecker, Jan Metzger

**LISA simulation meeting, AEI Hannover**

Feb. 14, 2013

Organizer: Martin Hewitson

**Conference Quantum Gravity and Fundamental Cosmology, AEI Potsdam**

Mar. 5 – 8, 2013

Organizer: Jean-Luc Lehners

**Workshop 'Quantum Gravity in Paris 2013', Paris XI-Orsay and IHES, France**

Mar. 18 – 22, 2013

Organizers: Daniele Oriti with V. Rivasseau (Univ Paris XI, T. Damour (IHES) and R. Gurau (Ecole Polytechnique)

**Geometric measure theory, Reading seminar, Max Planck Institute for Gravitational Physics, Potsdam, Germany**

Apr. 4, 2013 – today

Organizer: Ulrich Menne

**TG7 Meeting, AEI Hannover**

Jun., 05, 2013

Organizer: Gerhard Heinzl

**LRI progress meeting, AEI Hannover**

Jun. 27, 2013

Organizer: Gerhard Heinzl

**LISA modelling workshop, AEI Hannover**

July 04, 2013

Organizer: Martin Hewitson

**TG 7 Meeting, AEI Hannover**

Aug. 19, 2013

Organizer: Gerhard Heinzl

**The Alajar Meeting 2013: Stellar dynamics and growth of massive black holes**

Sep. 16 – 27 2013

Organizers: Pau Amaro Seoane, Roger Blandford, Tal Alexander, Rainer Schoedel, Julian Krolik, and Bernard Schutz

More information: <http://astro-gr.org/alajar-meeting-2013-stellar-dynamics-growth-massive-black-holes/>

**LSC-VIRGO Meeting, AEI Hannover, Hotel Dormero, Hannover**

Sep. 23 – 27, 2013

Organizer: Bruce Allen

**Beyond GEO-HF workshop, AEI Hannover**

Sep. 27, 2013

Organizer: Hartmut Grote

**ET Meeting, AEI Hannover**

Oct. 21 – 24, 2013

Organizer: Harald Lück

**LISA Phasemeter Testreport Presentation, AEI Hannover**

Oct. 25, 2013

Organizer: Oliver Gerberding

**2. Projekttreffen NGGM, AEI Hannover**

Nov. 7 – 8, 2013

Organizer: Vitali Müller

## Events

### **Astro-GR@Atlanta 2013: Formation, growth, and interaction of black holes with their environments**

Nov. 18 – 22, 2013

Organizers: Pau Amaro Seoane, Tamara Bogdanovic, Pablo Laguna, Mike Eracleous

More information: <http://astro-gr.org/astro-gr-atlanta-2013-formation-growth-interaction-black-holes/>

### **Visit Delegation from Chinese Academy of Sciences, AEI Hannover**

Dec. 3, 2013

Organizer: Gerhard Heinzl

### **Test Review Board Meeting, AEI Hannover**

Jan. 29 – 30, 2014

Organizer: Oliver Gerberding

### **LTPDA Developers' meeting, AEI Hannover**

Feb. 18, 2014

Organizers: Hewitson, Nofrarias

### **Workshop series Central European Relativity seminar, ESI, Vienna**

Feb. 27 – Mar. 1, 2014

Organizers: Lars Andersson, co-organizer with Helmut Friedrich, Piotr Bizon, and Piotr Chrusciel

### **Conference Quantum Gravity and Fundamental Cosmology, AEI Potsdam**

Mar. 3 – 6, 2014

Organizer: Jean-Luc Lehners

### **Las Cruces 2014: Super-Massive Black Hole Binaries**

Mar. 4 – 7, 2014

Organizers: Pau Amaro-Seoane (SOC chair), Patricia Arévalo, Jorge Cuadra (LOC chair), Andrés Escala, Stefanie Komossa, Paulina Lira, Alberto Sesana and Taka Tanaka.

More information: <http://astro-gr.org/las-cruces-meeting-2014/>

### **LTPDA Developers' meeting, AEI Hannover**

Mar. 6, 2014

Organizer: Martin Hewitson

### **Workshop 'Quantum Gravity in Paris 2014', Paris XI-Orsay and IHES, France**

Mar. 17 – 20, 2014

Organizers: Daniele Oriti with V. Rivasseau (Univ. Paris XI), T. Damour (IHES), G. Bossard and R. Gurau (Ecole Polytechnique)

### **GEO-ISC meeting, AEI Hannover**

Mar. 26, 2014

Organizer: Hartmut Grote

### **LTPDA Developers' meeting, AEI Hannover**

May 6, 2014

Organizers: Hewitson, Armano

### **LPF Data Analysis and Operations Workshop, AEI Hannover**

Jun. 10 – 12, 2014

Organizer: Hewitson

### **GRACE-FO Fiber OGSE Meeting, AEI Hannover**

Jun. 25 – 26, 2014

Organizer: Christina Bogan

### **LISA simulation meeting, AEI Hannover**

Jul. 8, 2014

Organizer: Martin Hewitson

### **eLISA Final Presentation of the System Consolidation Study by ASD, AEI Hannover**

Jul. 23 – 24, 2014

Organizer: Jens Reiche

## Events

### **Negotiations with TVC, AEI Hannover**

Aug. 4 – 8, 2014

Organizer: Christina Bogan

### **The 2nd Schutz Workshop on Gravitational Waves and Relativistic Astrophysics, AEI Hannover**

Sep. 12, 2014

Organizer: Maria Alessandra Papa

### **The Alajar Meeting 2014: Growth and evolution of the Milky Way's nuclear star cluster and its central black hole**

Sep. 20 – 28, 2014

Organizers: Tal Alexander, Pau Amaro-Seoane, Fabio Antonini, Xian Chen and Rainer Schoedel

More information: <http://astro-gr.org/alajar-meeting-2014-growth-evolution-milky-ways-mbh/>

### **DESY Theory Workshop**

Sep. 23 – 26, 2014

Organizer: Jean-Luc Lehnert (member of the organizing committee)

### **Astro-GR@Rome 2014: Gravitational waves and electromagnetic observations of dense stellar systems**

Jul. 14 – 18, 2014

Organizers: Pau Amaro-Seoane, Raffaella Schneider and Luigi Stella.

More information: <http://astro-gr.org/astro-gr-rome-2014-gw-em-observations-dense-stellar-systems/>

### **First LISA simulation meeting, AEI Hannover**

Jan. 27 – 28, 2015

Organizer: Martin Hewitson

### **LTPDA Developers' meeting, AEI Hannover**

Feb. 17 – 18, 2015

Organizer: Hewitson, Hueller

### **Workshop series Central European Relativity seminar, Academy of Sciences, Budapest**

Feb. 27 – Mar. 1, 2015

Organizers: Lars Andersson, co-organizer with Helmut Friedrich, Piotr Bizon, and Piotr Chrusciel

### **Workshop 'Quantum Gravity in Paris 2015', Paris XI-Orsay and IHES, France**

Apr. 7 – 10, 2015

Daniele Oriti with D. Benedetti (Univ. Paris XI), T. Damour (IHES), V. Rivasseau (Univ. Paris XI), A. Tanasa (Univ Paris XIII)

### **Workshop: 'Renormalization group approaches to Quantum Gravity', Perimeter Institute, Waterloo, Canada**

Apr. 22 – 25, 2015

Daniele Oriti with B. Dittrich, A. Eichhorn (Perimeter Institute) and R. Percacci (SISSA)

### **LISA OB Test Readiness Review, AEI Hannover**

May 22, 2015

Organizer: Michael Tröbs

### **LPF Pipeline development workshop, AEI Hannover**

May 27 – 29, 2015

Organizers: Hewitson, McNamara

### **Meeting of the Max Planck Society electronics engineers, AEI Hannover**

May 28, 2015

Organizer: Andreas Weidner

### **LISA Pathfinder Analysis Procedure Review #1, AEI Hannover**

Jun. 22 – 24, 2015

Organizer: Hewitson

### **Astro-GR@Sao Paulo 2015: LISA and LIGO/Virgo GW Sources**

Aug. 11 – 15, 2015

Organizers: Pau Amaro-Seoane, José de Freitas Pacheco, and Riccardo Sturani

More information: <http://astro-gr.org/astro-gr-sao-paulo-2015-lisa-ligo-virgo-gw-sources/>

## Events

### **Sino-German Symposium on gravitational physics in space, AEI Hannover**

Sep. 13 – 16, 2015

Organizer: Jens Reiche

### **Trimestre on Mathematical General Relativity at the Institute Henri Poincare, Paris**

Sep. 14 – Dec. 18, 2015

Organizers: Lars Andersson with Philippe LeFloch and Sergiu Klainerman

### **Second LISA simulation meeting, AEI Hannover**

Sep. 17 – 18, 2015

Organizer: Martin Hewitson

### **The Alajar Meeting 2015: Galactic nuclei at high resolution in many dimensions**

Oct. 3 – 11, 2015

Organizers: Tal Alexander, Pau Amaro-Seoane, Xian Chen, Nadine Neumayer, Elena Rossi, Rainer Schödel, and Cliff Will

More information: <http://astro-gr.org/alajar-meeting-2015-galactic-nuclei-high-resolution-many-dimensions/>

### **3-day IMPRS Excursion with 22 participants, Bollmannsruh, Germany**

Oct. 5 – 7, 2015

Organizer: Oliver Schlotterer

### **LISA Pathfinder Analysis Procedure Review #2, AEI Hannover**

Oct. 6 – 8, 2015

Organizers: Hewitson, Hueller

### **3-day IMPRS Excursion with 16 participants, Bollmannsruh, Germany**

Oct 8 – 10, 2015

Organizer: Oliver Schlotterer

### **CTP Meeting, AEI Hannover**

Nov. 11, 2015

Organizer: Christoph Mahrtd

### **Eisenstein series and Kac-Moody groups and applications to physic, KIAS, Seoul**

Nov. 12 – 20, 2015

Organizer: Axel Kleinschmidt

### **Conference 'A century of General Relativity', Harnack House in Berlin**

Nov. 30 – Dec. 2, 2015

Organizers: all AEI directors

### **LISA Pathfinder Analysis Procedure Review #3, AEI Hannover**

Dec. 16 – 18, 2015

Organizer: Hewitson

### **Workshop series Central European Relativity seminar, Charles University, Prague**

Jan. 28 – 30, 2016

Organizers: Lars Andersson, co-organizer with Helmut Friedrich, Piotr Bizon, and Piotr Chrusciel

### **Thematic day on 'Loop Quantum Gravity and Group Field Theory' of the Conference 'Current Problems in Theoretical Physics', organized by the Univ. of Naples and Univ. Salerno, Vietri, Italy**

Mar. 20 – 21, 2016

Organizer: Daniele Oriti

### **LISA OB Test Review Board, AEI Hannover**

May 13, 2016

Organizer: Michael Tröbs

### **Conference: The first observation of a binary black hole merger: Status and future prospects, Hotel Crowne Plaza, Hannover**

May 23 – 26, 2016

Organizer: Badri Krishnan

## Events

### **Fourth LISA simulation meeting, AEI Hannover**

Jun. 1 – 3, 2016

Organizer: Martin Hewitson

### **Astro-GR@Benasque 2016: What can we learn from the first GW detection?**

Jun. 5 – 18, 2016

Organizers: Pau Amaro-Seoane and Massimo Dotti

More information: <http://astro-gr.org/astro-gr-benasque-2016-what-can-we-learn-from-first-gw-detection/>

### **Workshop Emergent Space-time in Quantum Gravity and Fundamental Cosmology, AEI Potsdam**

Sep. 26 – 29, 2016

Organizer: Jean-Luc Lehners (co-organizer)

### **CTP Meeting, AEI Hannover**

Aug 17, 2016

Organizer: Christoph Mahrdt

### **Automorphic forms, mock modular forms and string theory (Simons Center for Geometry and Physics, Stony Brook)**

Aug. 29 – Oct 7, 2016

Organizer: Axel Kleinschmidt

### **GraWIToN Lecture Week, AEI Hannover**

Sep. 12 – 16, 2016

Organizer: Harald Lück

### **PyCBC Meeting, AEI Hannover**

Oct. 3 – 7, 2016

Organizer: Alex Nitz

### **IMPRS Softskill Seminar 'Presentation Training', AEI Hannover**

Oct. 25 – 26, 2016

Organizer: Sandra Bruns

### **LISA Consortium structure meeting, AEI Hannover**

Nov. 1 – 2, 2016

Organizer: Martin Hewitson

### **LISA Consortium Meeting, AEI Hannover**

Dec. 7, 2016

Organizer: Martin Hewitson

### **GraWIToN Evaluation, AEI Hannover**

Dec. 15, 2016

Organizers: Benno Willke, Harald Lück

## Contacts

### AEI Potsdam

#### Office:

Anika Rast

phone: (0331) 567-7214

fax: (0331) 567-7297

office@aei.mpg.de

#### Library:

Katharina Klausner

phone: (0331) 567-7400

fax: (0331) 567-7499

library@aei.mpg.de

#### Computer Systems:

Dr. Mike Rose

phone: (0331) 567-7204

fax: (0331) 567-7298

mike.rose@aei.mpg.de

#### Administration:

Dr. Mike Rose

phone: (0331) 567-204

fax: (0331) 567-7699

vw-leiter@aei.mpg.de

#### Scientific Coordination & Public Relations:

Dr. Elke Müller

phone: (0331) 567-7303

fax: (0331) 567-7298

elke.mueller@aei.mpg.de

### AEI Hannover

#### Office:

Gabriele Richardson

phone: (0511) 762-17145

fax: (0511) 762-17182

office-hannover@aei.mpg.de

#### Public Relations:

Dr. Benjamin Knispel

phone: (0511) 762-19104

fax: (0511) 762-2784

benjamin.knispel@aei.mpg.de

Dr. Peter Aufmuth

phone: (0511) 762-2386

fax: (0511) 762-2784

peter.aufmuth@aei.mpg.de

## The Max Planck Society: Profile and Organisation

The Max Planck Society for the Advancement of Science is an independent, non-profit research organization. It was founded on February 26, 1948, and is the successor organization to the Kaiser Wilhelm Society, which was established in 1911. The primary goal of the Max Planck Society is to promote research at its own institutes.

The currently 84 Max Planck Institutes conduct basic research in the service of the general public in the natural sciences, life sciences, social sciences, and the humanities. Max Planck Institutes focus on research fields that are particularly innovative, or that are especially demanding in terms of funding or time requirements. And their research spectrum is continually evolving: new institutes are established to find answers to seminal, forward-looking scientific questions, while others are closed when, for example, their research field has been widely established at universities. This continuous renewal preserves the scope the Max Planck Society needs to react quickly to pioneering scientific developments.

The Max Planck Society maintains 84 institutes and research facilities (as of January 1, 2017), including five institutes and one branch abroad. As of December 31, 2016, the Max Planck Society employed a total of 22,995 staff, of whom 14,036 were scientists, which represents nearly 61 percent of the total number of employees. This includes Directors, Max Planck Research Group leader, academic staff members, postdoctoral students, PhD students, student and graduate assistants, postdoctoral students, visiting scientists, and so research fellowship holders.

This group comprises largely junior scientists: at the beginning of the year, approx. 5,800 Ph.D. students and student and graduate assistants spent a stage of their career at the Max Planck Society. Non-academic personnel includes technical and admin staff as well as apprentices and trainees.

The financing of the Max Planck Society is predominantly comprised of basic financing from the public sector, in the year 2017 the MPG is financed to approximately 1,8 billion euros. In addition, the Max Planck Society and its Institutes receive third party project funding from public and private contributions and from the European Union. The federal and state governments jointly provide the subsidies for the budget of the Max Planck Society.

### Address:

Max-Planck-Gesellschaft zur Förderung der Wissenschaften e.V.  
Postbox 10 10 62  
80084 Munich, Germany  
Phone +49-89-2108-0  
Fax +49-89-2108-1111  
[www.mpg.de](http://www.mpg.de)

## Masthead

### Published:

2018 by the Max-Planck-Institut für Gravitationsphysik (Albert-Einstein-Institut)

### Addresses:

Wissenschaftspark Golm  
Am Mühlenberg 1  
14476 Potsdam-Golm

Callinstraße 38  
30167 Hannover

### Editorial team:

Dr. Benjamin Knispel & Dr. Elke Müller (AEI), Susanne Milde & Sascha Rieger  
(Milde Science Communication)

### Graphic design & Cover:

Milde Science Communication | Sascha Rieger

### Title Image:

Numerical-relativity Simulation: S. Ossokine, A. Buonanno (Max Planck Institute for Gravitational Physics), Simulating eXtreme Spacetimes project;  
Scientific Visualization: W. Benger (Airborne Hydro Mapping Software GmbH)

### Print:

GS Druck und Medien GmbH

### Image credits:

Report: M. Fiorito, N. Fluturel/MPG

Research overview: LIGO/T. Pyle

Research Highlights: LSC/LIGO

IT & Library Highlights: M. Fiorito, N. Fluturel/MPG

Public relations: B. Knispel/AEI

International Max Planck Research Schools: A. Okulla/AEI

Through the Eyes of a Visitor: B. Knispel/AEI

Living Reviews: AEI

Cooperations: S. Rieger/Milde Science Communication

The Max Planck Society: E. Müller/AEI

p. 44 Image by University of Florida / Simon Barke (CC BY 4.0)

p. 50 Image courtesy of GFZ Potsdam

p. 54 Aerial image: Deutsche Luftbild W. Seelmann & Co, GmbH, Hamburg

p. 88 C. Bierwagen/AEI

All other images: Copyright by author

**Note:** Academic Achievements: This page shows Albert Einstein's results in his final school exams. A "6" is the highest possible grade in the Swiss system!





