

AGC Data Book



AGC Inc.

March 2024

Your Dreams, Our Challenge

Table of Contents

Corporate information	3
Product information	
Architectural Glass	10
Automotive	20
Electronics - Display -	31
Electronics - Electronic materials -	42
Chemicals - Essential Chemicals -	57
Chemicals - Performance Chemicals -	64
Life Science	74
New Businesses - Solutions for next-generation high-speed communications -	79
Ceramics/Others	84
Reference Information	91

As of December 30, 2023

Company Name	AGC Inc.
Head Office	〒100-8405 Shin-Marunouchi Bldg., 1-5-1Marunouchi, Chiyoda-ku, Tokyo, JAPAN Tel : +81-(0)3-3218-5741
Incorporated	June 1, 1950 (Founded : September 8, 1907)
Representative	Representative Director, President& CEO Yoshinori Hirai
Book closing date	December 31
Capital	90,873 million yen
Consolidated Revenue	20,193 billion yen
Subsidiaries	Subsidiaries:214 including 173 companies overseas (Consolidated subsidiaries 194 including 156 companies overseas) Affiliate companies: 27 including 16 companies overseas
Employees Consolidated	56,724

Stock Code	5201
Stock Exchange Listings	Tokyo
Minimum Trading Units	100
Number of shares issued	217,434,681
Stock Information	https://www.agc.com/en/ir/stock/stock/index.html
Introduction of Executives	https://www.agc.com/en/company/executive/intd ex.html



Representative
Director, President &
CEO

Yoshinori Hirai, Ph.D.

Year	Education/Business Experience
1978	Graduated from Fukui Prefectural Fujishima High School
1982	Graduated from the University of Tokyo
1987	Ph.D. on Physics from the University of Tokyo
1987	Joined Asahi Glass Co., Ltd. (current AGC Inc.)
1997	LCD Device Group Leader R&D Center for Electronic Technology, Electronics Business Division
2005	Member of the Board and GM, OPTREX
2008	Senior Executive Vice President, OPTREX
2009	GM of Business Planning Office Electronics Company (current AGC Inc.)
2011	GM of Business Development Office
2012	Executive Officer and GM of Business Development Office
2014	Member of the Board Senior Executive Officer GM of Technology General Division
2016	Member of the Board Senior Executive Officer CTO and GM of Technology General Division
2018	Representative Director Executive Vice President and CTO
2021	Representative Director President & CEO

AGC Group Organization Chart

As of April 2023

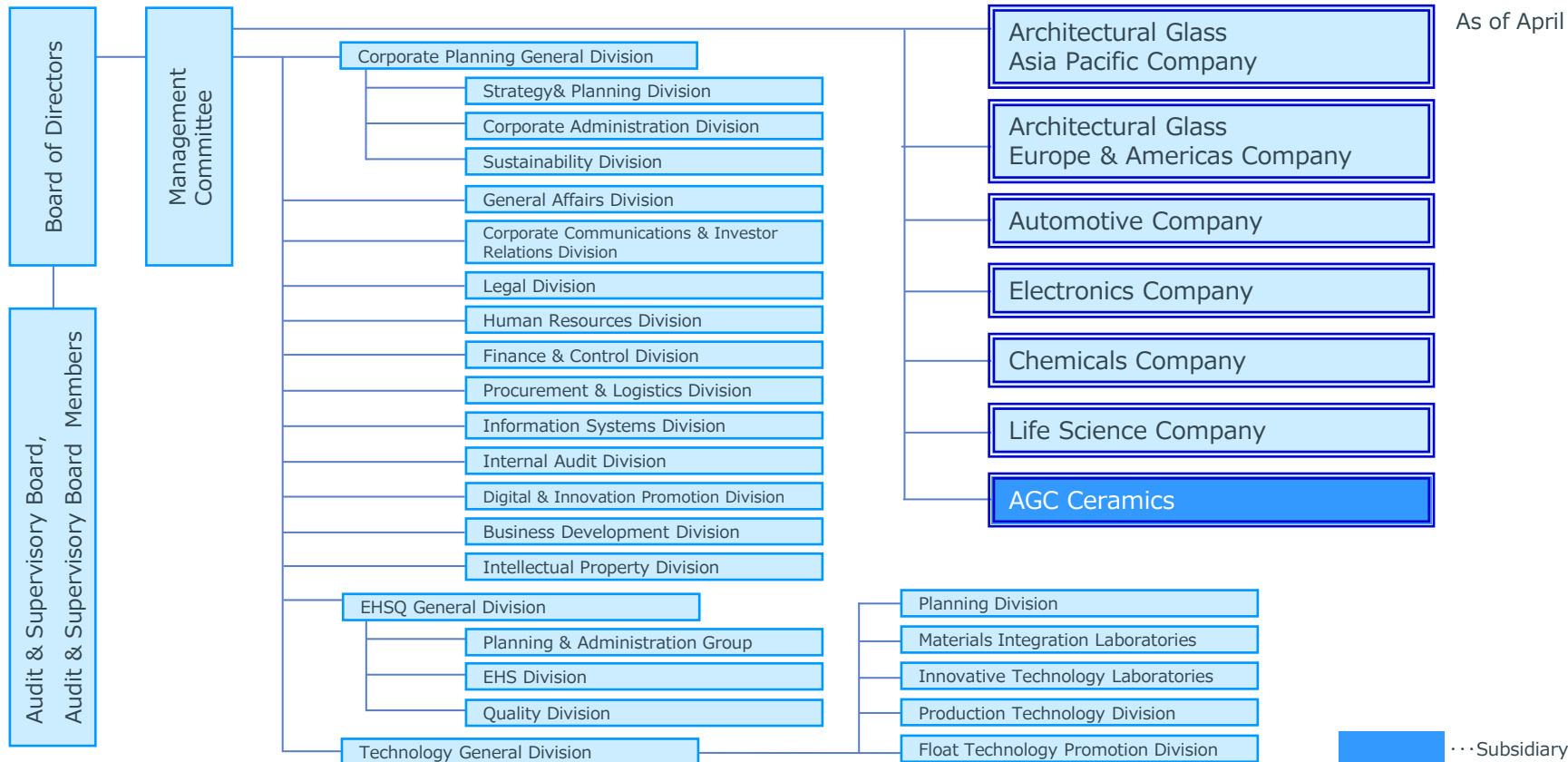

...Subsidiary

AGC's R&D center & Plants in Japan

As of August 2023

Name	Address	Product
Kansai Plant (Amagasaki factory)	〒660-0857 2 Nishimukaijima-cho, Amagasaki-shi, Hyogo Pre.	FPD glass substrates
Kansai Plant (Takasago factory)	〒676-8655 5-6-1 Umei Takasago-shi Hyogo Pre.	FPD glass substrates, Semiconductor production
AGC Yokohama Technical Center (former Keihin Plant)	〒230-0045 1-1 Suehiro-cho, Tsurumi-ku, Yokohama-shi, Kanagawa Pre.	Research & Development Figured glass, Automotive glass
Chiba Plant	〒290-8566 10 Goikaigan, Ichihara-shi, Chiba Pre.	Chlor-alkali, Fluoropolymer, Biopharmaceutical CMO service
Aichi Plant	〒470-2394 1 Asahi, Taketoyo-cho, Chita-gun, Aichi Pre.	Automotive glass and Glass for Solar Cells
Kashima Plant	〒314-0195 25 Higashiwada, Kamisu-shi, Ibaraki Pre.	Flat glass, Fluoropolymer, Sodium bicarbonate
Sagami Plant	〒243-0301 426-1 Sumida, Aikawamachi, Aiko-gun, Kanagawa Pre.	Automotive glass

As of December 31, 2023

The Group operates in approximately 30 countries and regions in the world.

Total 194 consolidated subsidiaries (38 in Japan/156 overseas)

Europe **Japan/Asia** **Americas**
115 **113** **13**

Major subsidiaries

※Subsidiaries and Affiliates Total

Europe		Japan/Asia		Americas	
Company	Region	Company	Region	Company	Region
AGC Glass Europe	Belgium	AGC Ceramics Co., Ltd.	Japan	AGC Flat Glass North America, Inc.	The United States
AGC Automotive Europe	Belgium	AGC Glass Products Co., Ltd.	Japan	AGC Biologics Inc.	The United States
AGC Flat Glass Czech a.s.	Czech Republic	AGC Glass Kenzai Co., Ltd.	Japan	AGC America, Inc.	The United States
AGC Biologics A/S	Denmark	Ise Chemicals Corporation	Japan	AGC Capital, Inc.	The United States
		AGC Display Glass Taiwan Co., Ltd.	Taiwan		
		AGC Automotive (Suzhou) Inc.	China		
		AGC Display Glass(Huizhou)Co., Ltd..	China		
		AGC Fine Techno Korea Co., Ltd.	Korea		
		P.T. Asahimas Chemical	Indonesia		
		Vinythai Public Company Limited	Thailand		

Commands the top-ranking share in many products worldwide

Float flat glass
Top share
worldwide



For TFT LCD/OLED
Glass substrates
No. 2 Worldwide



Caustic soda PVC
No. 1 in Southeast
Asia



(Mountain of salt used
as a raw material)

Automotive glass
Top share
worldwide



Ultra-thin sheet for
electronic equipment
Soda lime glass
No. 1 Worldwide



Fluoropolymer resin
ETFE
No. 1 Worldwide



Cover glass for car-
mounted displays
No. 1 Worldwide

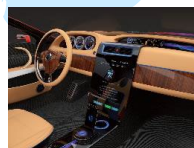

EUV lithography
photomask blanks
No. 2 Worldwide



Fluoropolymer
resin for on-site
coatings
No. 1 Worldwide



*Based on AGC's estimates as of January 2024

AGC Group's Glass Variation

As a comprehensive glass manufacturer, the AGC Group manufactures a wide variety of glass products.

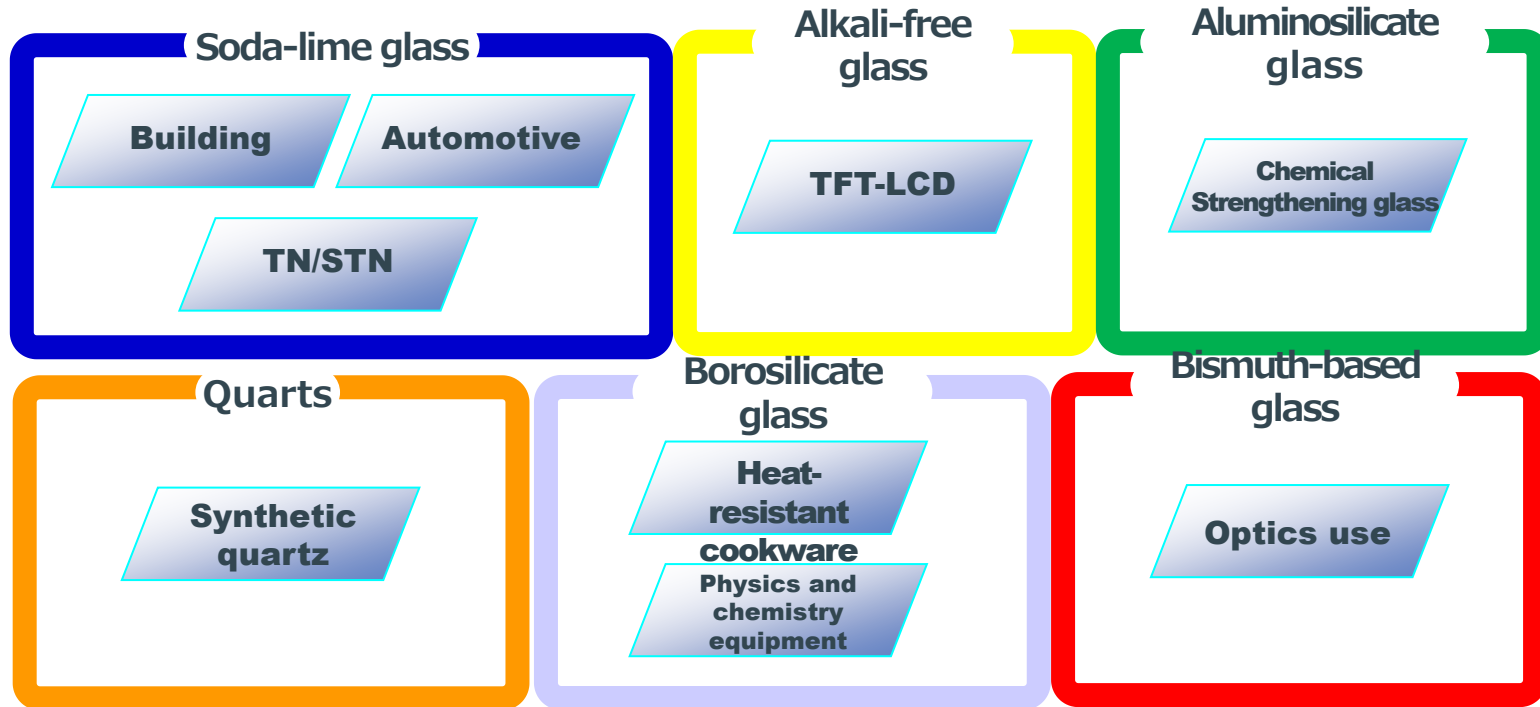

Architectural Glass

General name	Representative product name	Product description
Float glass	Float glass	Transparent flat sheet glass. The most common type of flat glass used for construction purposes. Thickness :from 3mm to 19mm. Maximum size: around 3m in width, around 10m in height (Maximum size vary depending on area and thickness).
Laminated glass	Lamisafe™ Lamisafe Shelter™	Consists of two pieces of glass with an interlayer film inserted in between. Very few fragments scatter even when glass breaks and has excellent penetration resistance. Excellent for disaster/crime prevention. Also has UV blocking properties.
IGU (Insulated Glass Unit)	Pairstyle™ MyMute™ (noise reduction)	Consists of two pieces of glass with dried air and heat-insulating gas enclosed in between. Provides excellent heat insulation, energy conservation and dew condensation prevention.
Low-E IGU	Sunbalance™ Pairplus™ (renovations)	IGU with special metal film coating on the inner surface of one of the glass. Provides enhanced heat insulating/shielding performance.
Tempered glass	Temperlite™/School Temper™ Mistron Ace™/Home Mistron	Safety glass with the strength 3~5 times greater than ordinary glass, produced through special heating and cooling processes. Superior resistance to breakage, and even when breaks, it fragments into small pebble-sized pieces.
Heat-resistant Tempered Glass	Myboka™	Fire-resistant glass with heat-resisting properties, produced through a special tempering process. This non-wired glass provides a clear view.
Mirrors	Sunmirror™G	Environmentally friendly mirror with lead-free back paint coating.
Colored glass	LACOBEL™/MATELUX™	Painted glass produced by adding special paint coating on the back surface of glass. Mainly used as interior glass for commercial facilities.
Figured glass	Kasumi™	Flat glass with a template pattern on one side. Provides privacy while letting light through. Also brings interior effect .
Wired glass	Hishiwire™ /Crosswire	Glass with wire mesh enclosed. Used for fire protection doors.

- Selectively transmit light and heat and helps to improve the energy efficiency of buildings
- Approximately 78% less heat transfer than single pane glass*

Structure of Low-E double glazing glass

Special metal membrane selectively permeable to light and heat (Low-E membrane)

Intermediate layer

Outdoor side

Glass

Moisture absorbent

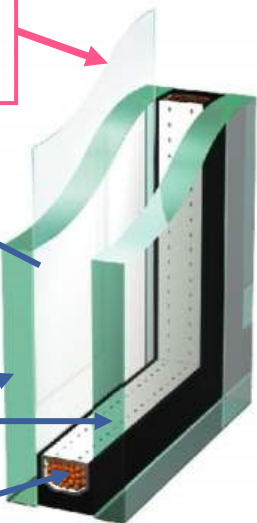

Indoor side

Effect of Low-E double glazing glass

Thermal transmission rate

Amount of heat passing per 1 m² for 1 hour with a temperature difference between inside and outside is 1 °C.

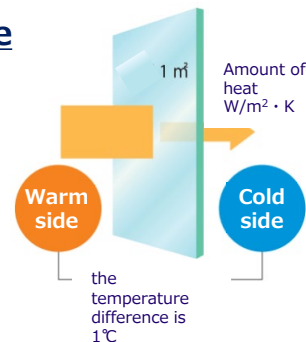

Thermal transmission rate

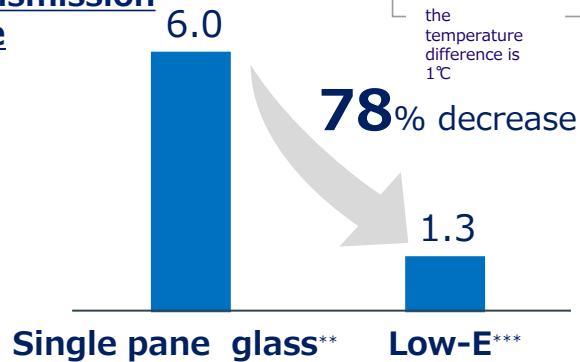

PairPlus™



Heat insulation

Solar control

Anti condensation

This product allows single-pane glass to be replaced with Low-E double-glazing glass without changing the existing sash.

Mado2™



Heat insulation

Solar control

Anti condensation

Noise reduction

Additional layer of glass added to the existing glass/window sash to enhance functionality of the window.

ATTOCH™

ATTOCH®

Heat
insulation

Solar control

Anti
condensation



ATTOCH™ converts single-pane fixed windows of office buildings and stores into energy-saving insulated glass units simply by installing low-E glass from the inside.

Product Lines

WILD ATTOCH™

WILD ATTOCH is enables single-story retail shops to do energy-saving reform without disrupting store operations.



ATTOCH™ SUNJOLE SUDARE

ATTOCH with horizontal-striped PV module creates power while allowing sunlight to shine through.



- Glass that can generate electricity by solar power
- Encapsulates a solar power generation cell in two glass plates
- Realizes both energy creation and design performances and help bring about a carbon-neutral society

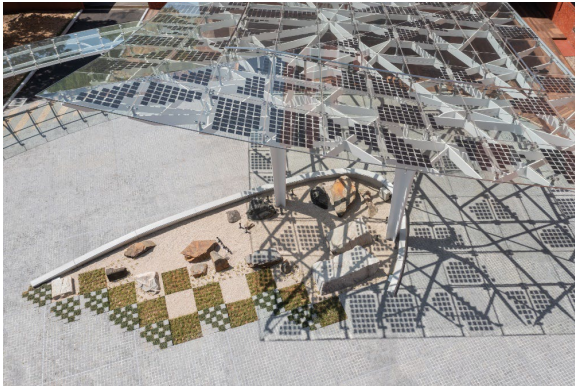

Entrance canopy of
Global Zero Emission Research Center of AIST



New Punggol campus of Singapore Institute of
Technology

Safety Glass (Laminated glass)

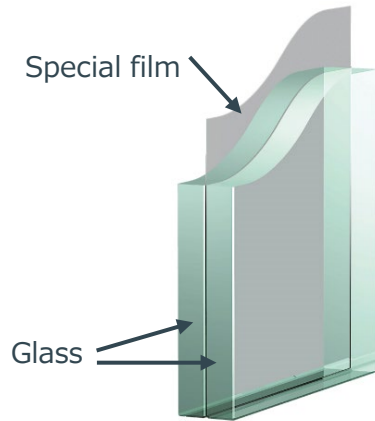

This is a "Disaster Prevention Safety Laminated Glass " with a flexible and tough special film of 60mil (about 1.5mm) or more in thickness sandwiched between two sheets of glass. It has excellent penetration resistance, and the strong adhesion between the special film and glass makes the glass shatterproof.

Fire-resistant Glass

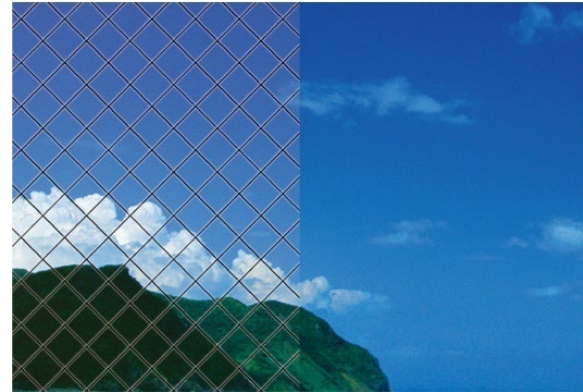

AGC's fire-resistant product lineup consists of wired glass and non-wired heat-resistant tempered glass "Myboka™."

Non-wired heat-resistant tempered glass:

- 1) Provides a clear view
- 2) No thermal breakage (as compared to wired glass)
- 3) Lighter-weight & easier open/close than wired glass

Lacobel™

Colored glass for interior use



Lacobel is painted glass for indoor applications, which is made by applying a layer of special coating onto the back surface of the glass.

This product creates a beautiful color contrast, adding a stylish atmosphere to the room interior.

Clearsight™ II

Anti-reflective Glass Ideal for Outdoor Use



Clearsight™ is anti-reflective glass with special coating applied on both surfaces, thereby reducing light reflectance of the glass surface to 0.9%, whereas normally is about 8.0%. With improved coating durability, Clearightsight™ II can be used outdoor. Also, it can be processed into laminated glass.

Production of Flat Glass -Float Process-

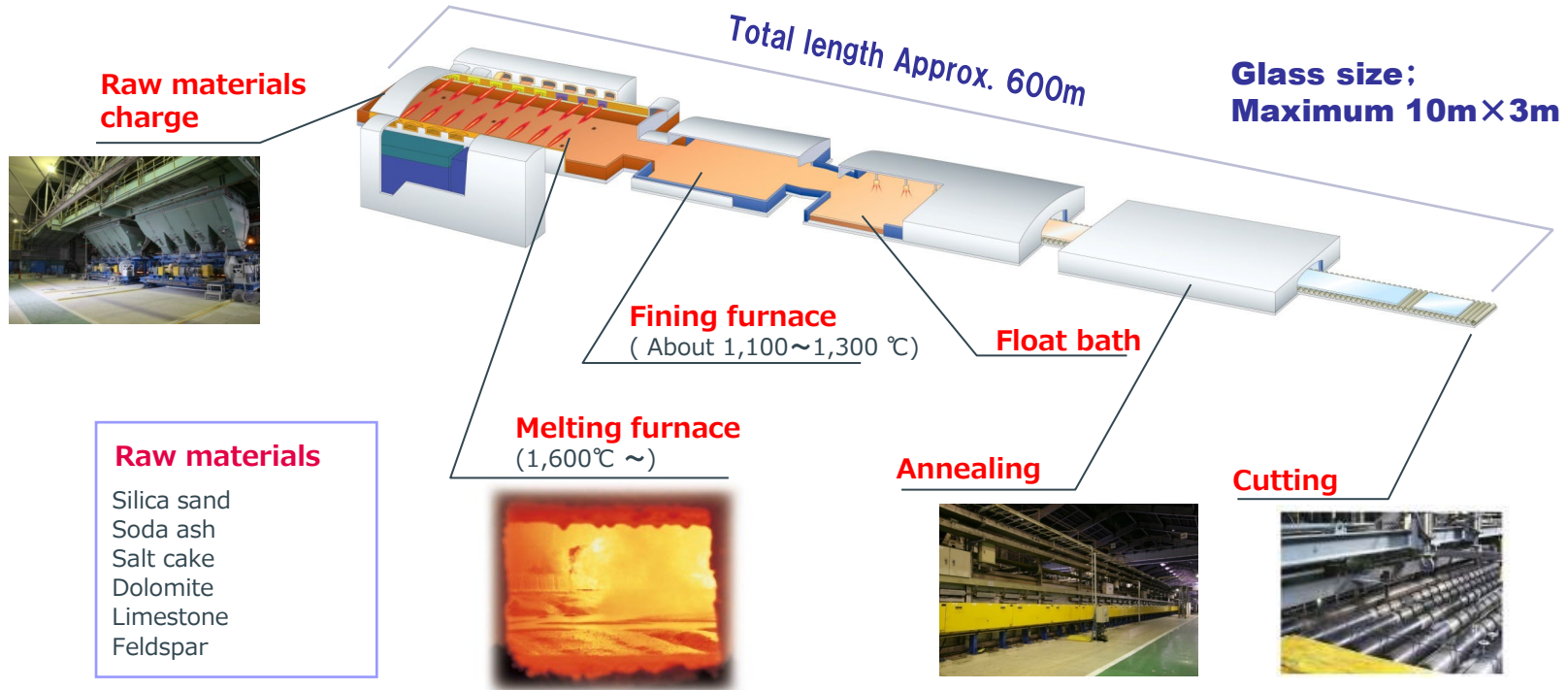

Glass Manufacturing Bases (Float Lines)

Total: 26 float lines (two lines are managed by equity method affiliate)

As of February 2023

Europe (7 plants 11floats)		
City	Country/State	Number of FLs
Moustier	BEL	3
Mol	BEL	1
Seingbouse	FRA	1
Osterweddingen	DEU	1
Cuneo	ITA	1
Sagunto	ESP	1
Retenice	CZE	3

Japan/Asia Pacific (9 plants 12floats)		
City	Country/State	Number of FLs
Kashima	JPN	1
Aichi	JPN	2
Suzhou	CHN	1
Cikampek	IDN	2
Surabaya	IDN	2
Samut Prakarn	THA	1
Chon Buri	THA	1
Taloja (*)	IND	1
Roorkee (*)	IND	1

Americas (1 plant 1 float)		
City	Country/State	Number of FLs
Richmond	U.S.A. / KY	1

South Americas(1 plant 2 floats)		
City	Country/State	Number of FLs
Guaratingueta	Brazil / Sao Paulo	2

(*) Equity method affiliate

Automotive

	General name		Product description
Basic automotive Glass	Laminated glass		Consists of two pieces of glass with an interlayer film in between. Very few fragments scatter even when glass breaks and objects do not penetrate the glass easily. Excellent for crime/disaster prevention.
	Tempered glass		Glass with enhanced strength and safety through heating and cooling processes. Tempered glass gets crumbled into small pebble-sized pieces at the time of breakage.
Value-add automotive glass	Comfort	99% UV cut glass	Cuts over 99% of ultraviolet rays. Effective in preventing sun burn and damage on interior materials.
		IR cut glass	Heat-shielding glass that has good radio transmission and blocks approximately 90% of infrared rays with the special interlayer film between two pieces of glass. Effectively blocks the wavelength that causes frizzling sensations on skin.
			Heat-shielding glass that effectively reflects infrared rays with special coating on the inner surface.
		Privacy glass	Special colorant element added to the glass composition. Provides greater privacy and heat shielding effect.
		Acoustic glass	Laminated glass with improved acoustic insulation. Provides a quieter driving experience.
		Laminated side window	Laminated glass used in side doors. Provides greater crime prevention and acoustic insulation.
		Light Control Glass	A special film is placed between two sheets of glass to freely control light transmission. In transparent mode, the glass provides a sense of openness, while in dimming mode, it provides privacy and blocks sunlight.
	Low-E Glass	Special Low-E coating for automotive use blocks solar heat and provides a cool and comfortable cabin temperature in summer and a warm and comfortable cabin temperature in winter by preventing heat inside the car from escaping outside.	
	Visibility	Water repellent door glass	Automotive door glass with high reactive fluorine and silicone coating. Provides excellent water repellency and strength as well as improved visibility in the rain.
		Snow-melting / Ice-melting front glass	Windshield with conductive ink (heating element) printed on the surface. Provides snow-melting and ice-melting functions using electric current.
		Electro-thermal defogging glass	Rear glass with conductive ink (heating element) printed on the surface, which provides anti-fogging function using electric current.
	Information telecommunications	Printed glass antenna	Automotive antenna with conductive ink printed on the glass surface. Provides flexibility in design and excellent durability.
		Glass for head-up display	Windshield with a speed meter and other indicators displayed on the glass.
	Design	Module assy window	Glass with the peripheral resin parts all integrated in a single unit.

UV Verre Premium™

Protects the skin of the driver, front seat passenger, and rear seat passengers from ultraviolet rays that fall from all directions in the car by approximately 99%*.

- In addition to the ultraviolet (UV) blocking function, which causes sunburn and blotches, it also has an infrared (IR) blocking function, which causes heat from the sun and a feeling of being frizzled, eliminating discomfort such as "it is hot inside the car" and "my arms feel frizzled while driving."
- By relieving the heat and enabling a lower air conditioner setting, the system also contributes to the reduction of CO2 emissions by reducing the cooling load.

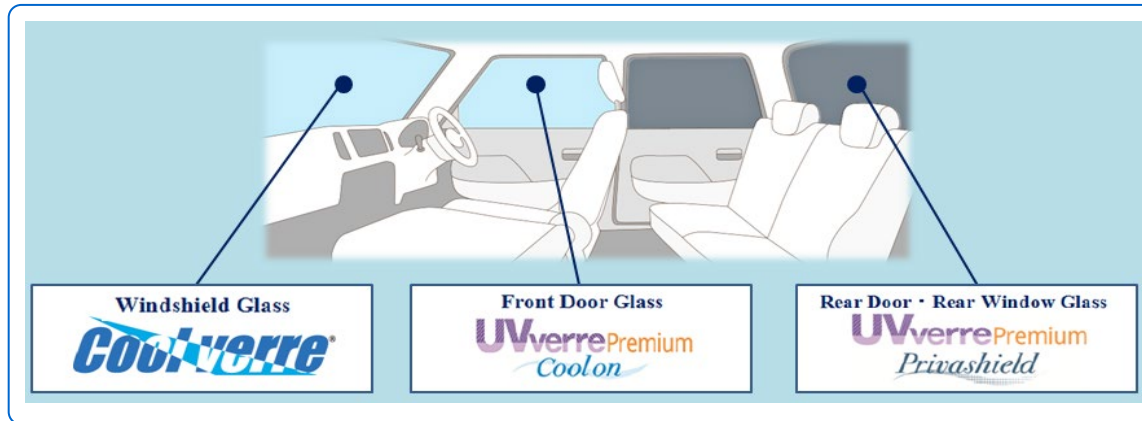

* AGC's survey data, based on ISO9050.

Coolverre™

Increased comfort by cutting both IR & UV rays

- Efficiently blocks middle infrared rays (IR), which cause the skin to feel heat under the sun, and reduces irritations caused by direct sunlight.
- Provides greater interior comfort and improves fuel efficiency by controlling temperature increase inside the vehicle.
- Filters out approximately 99% of UV rays, which can cause aging of the skin
- Good radio-wave transmission



Comparison in the Penetration of Sunrays

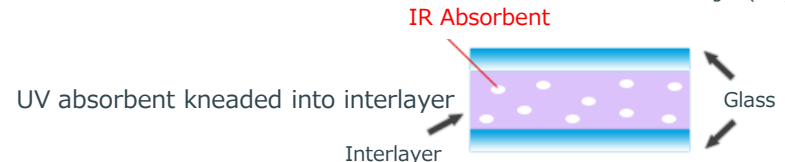
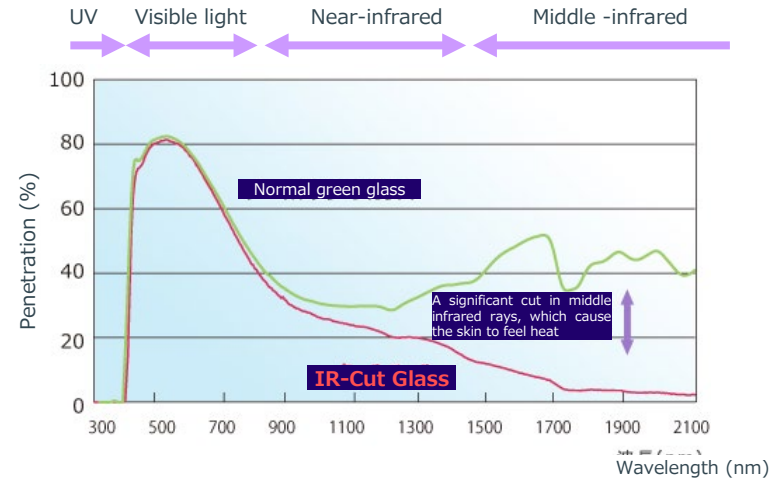

WONDERLITE™ Dx

Structure of laminated glass that sandwiches a special film

The dimming mode (opaque state) mitigates the brightness of sunlight coming in, and the transmission mode (clear state) creates a sense of openness

Realize a comfortable in-vehicle space according to the scene

- World's fastest switch control
- Cuts ultraviolet rays by 99% in both dimming and transmission modes
- Cuts ultraviolet rays to protect the skin of occupants, and contributes to reducing CO₂ emissions by reducing cooling loads

Once arranged into a random pattern, the special material diffuses light from the outside to turn the glass opaque and reduce glare.

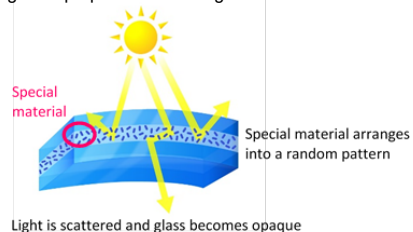

When a voltage is applied to the film, the special material aligns in the same direction, the glass becomes transparent because as light is able to pass through.

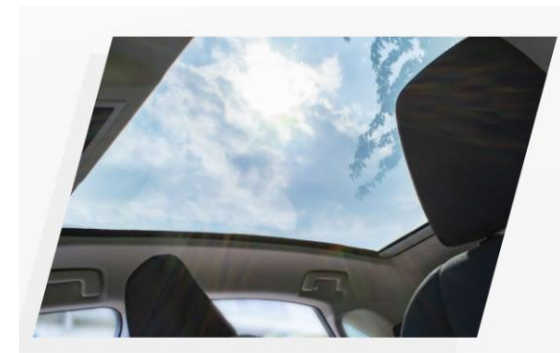
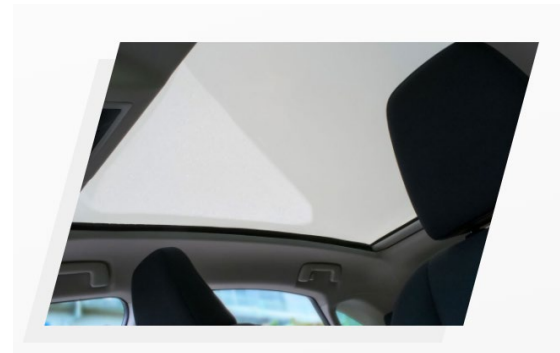
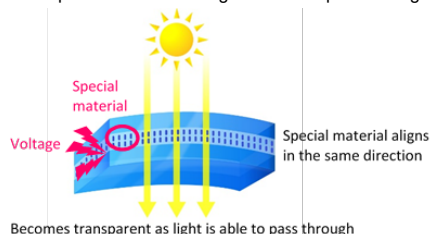

Low-E Glass

Special Low-E coating for automotive use blocks solar heat and provides a cool and comfortable cabin temperature in summer and a warm and comfortable cabin temperature in winter by preventing heat inside the car from escaping outside.

- It reduces CO₂ emissions by reducing the air conditioning load and improving fuel economy, and contributes to extending the cruising range of EVs.
- When used on roof glass, it enables a shade-less setting, contributing to weight reduction of the vehicle body and securing head clearance (the distance from the top of the head to the ceiling when sitting in the seat).

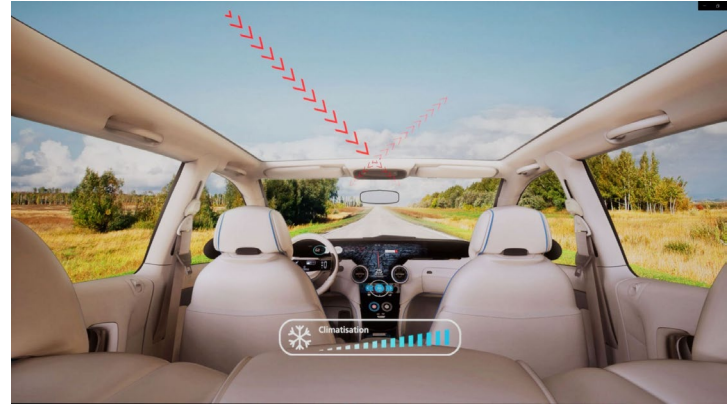

Specialty Glass for Chemical Strengthening

With exceptional strength and high-end appearance, chemically strengthened Dragontrail opens up new possibilities for automotive interior design.

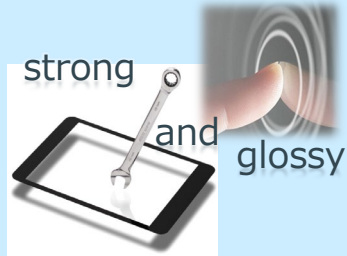

Value added interior with safety + function + design



- Strength and stability of Dragontrail contributes to safe and comfort driving experience.
- High scratch resistancy and various surface treatment options provide long lasting surface beauty, clear display image under all environment and smooth touch surface.



◆ Cross section of a standard cover glass

AFP (Anti-Fingerprint)
AR (Anti-Reflection)
AG (Anti-Glare) on the glass surface
Chemical strengthened Dragontrail
Printing

Cover glass for car-mounted display

- Track record of adoption: Delivered more than 30 million sheets for over 100 vehicle models since the start of production in 2013



- Major adoption cases (excerpts) are as follows

Company	Vehicle model	Announced date
Audi	Audi "A8"	September 14, 2017
TOYOTA	LEXUS "RX"	September 2, 2019
General Motors	Cadillac "Escalade"	September 10, 2020

Production of Automotive Laminated Glass

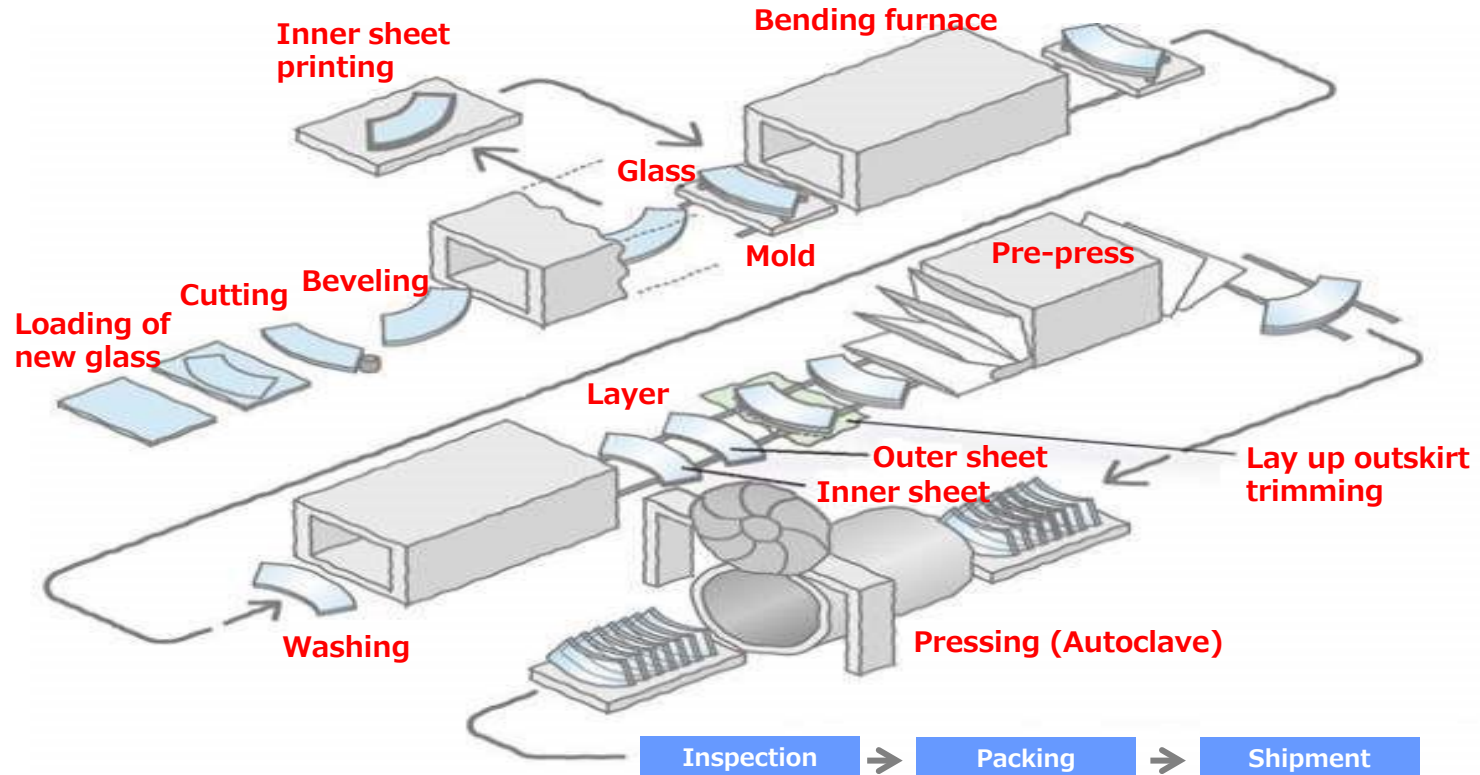

Production of Automotive Tempered Glass

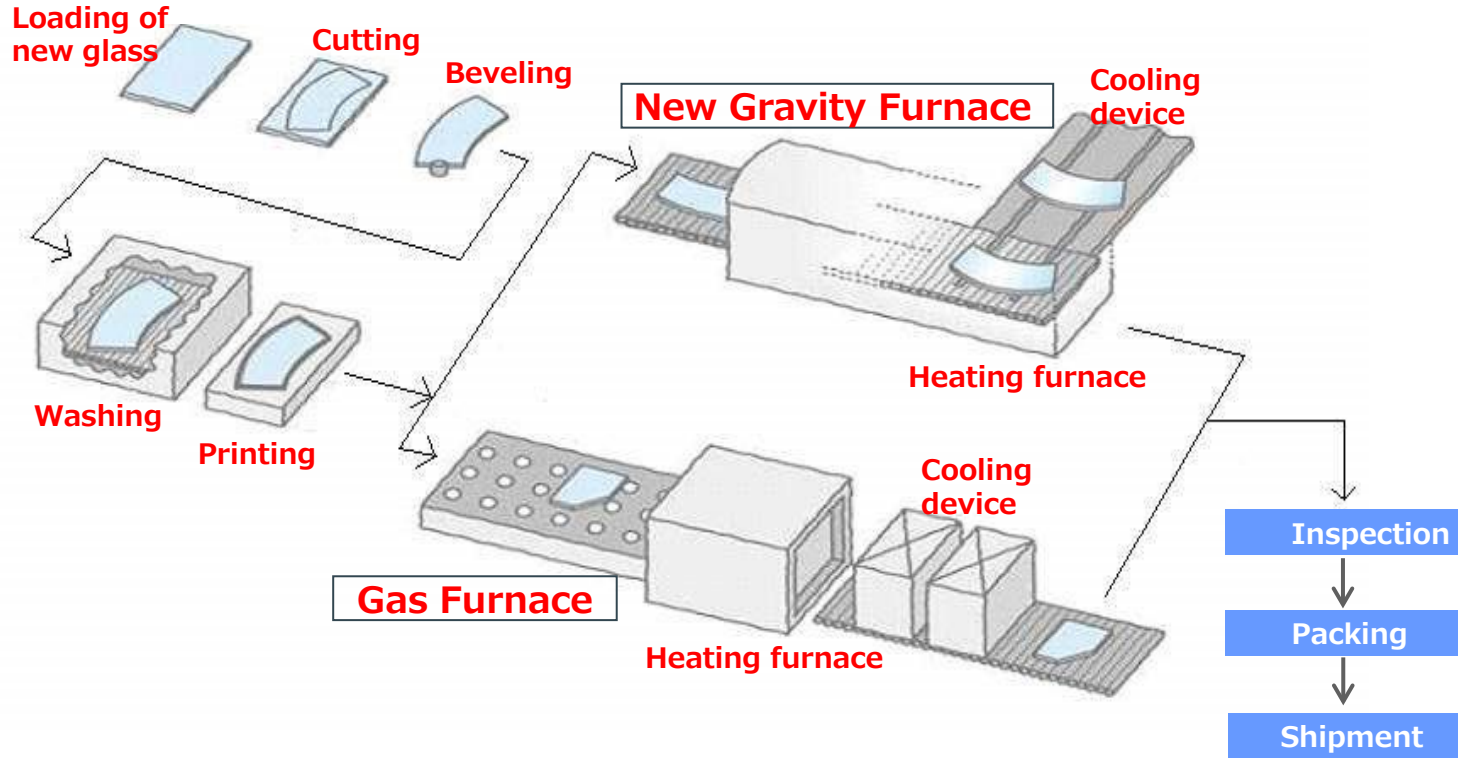

Manufacturing Bases for Automotive Glass

Automotive Glass Plants

As of February 2023

Europe (5 plants)

City	Country
Fleurus	BEL
Aniche	FRA
Roccasecca	ITA
Chuderice	CZE
Tatabanya	HUN

Africa (1 plant)

City	Country
Kenitra	Mar

Japan/Asia Pacific (12 plants)

City	Country
Aichi	JPN
Sagami	JPN
Qinhuangdao	CHN
Foshan	CHN
Suzhou	CHN
Cikampek	IDN
Bangpakong	THA
Rewari (*1)	IND
Chennai (*1)	IND
Roorkee (*1)	IND
Taloja (*1)	IND
Patan Gujarat (*1)	IND

North Americas (3 plants)

City	State	Country
Elizabethtown	KY	USA
Bellefontaine	OH	USA
San Luis Potosí	San Luis Potosí	Mexico

South Americas (1 plant)

City	State	Country
Guaratingueta	Sao Paulo	Brazil

(*1) Equity method affiliate

Electronics Segment Display

Main Products

General name	Product name	Product description
Glass Substrates for TFT-LCD/OLED Displays	AN100	Alkali-free aluminosilicate glass substrates manufactured by the float process. This display material has an exceptionally smooth and flat surface, excellent transparency and thermal resistance.
	AN Wizus™	Glass substrates with the world's lowest level of thermal shrinkage. Optimal for use in high-resolution display panels on smartphones and tablets, etc.
	AN Rezosta™	Large glass substrates for high-definition, large-screen displays with the industry's highest Young's modulus.
Specialty Glass for Chemical Strengthening	Dragontrail™ series	A specialty glass for chemical strengthening used as a cover glass for touchscreens on electronic devices such as smartphones, tablets, PCs, and automotive displays.
High-quality soda-lime glass	AS2	Glass for sensor substrates, various display devices, touch panels for smartphones and tablet PCs, and cover glass.

AN100

< AGC's Strengths >

- Stable production of aluminosilicate glass, which has transparency, smooth and flat surface, and excellent heat resistance.

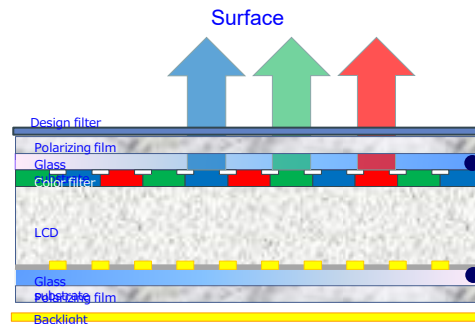

TFT glass substrates: AN100

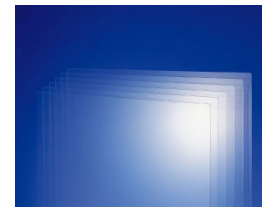

AN100 is alkali-free glass. It does not contain alkaline substances (soda ash) that are harmful to TFTs.

AN WIZUS™

< AGC's Strengths >

- Optimal glass composition design for high-definition panels and production using the float method with a long slow cooling process suitable for producing low thermal shrinkage glass, resulting in overwhelmingly low thermal shrinkage.

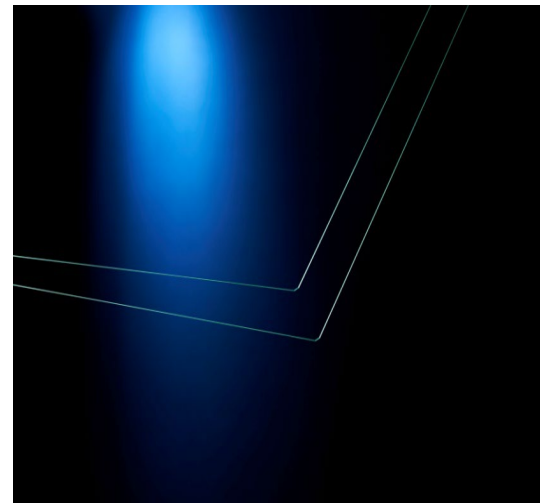
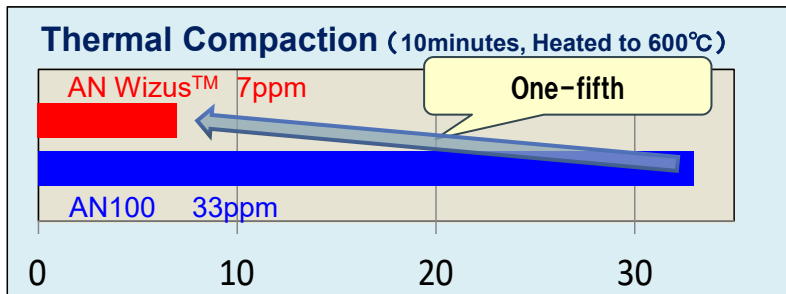
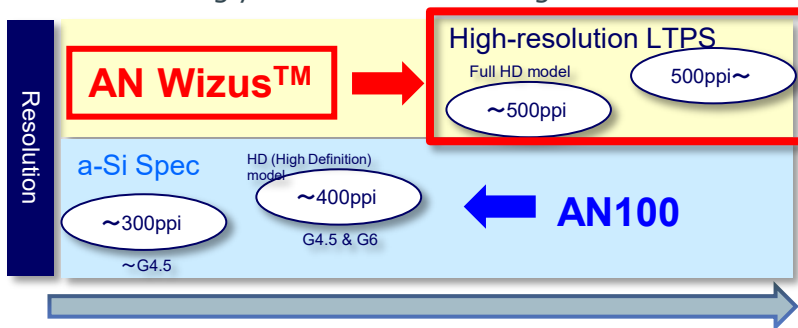

AN Rezosta™

< AGC's Strengths >

- With the industry's highest Young's modulus, low thermal shrinkage, and capability of production of 8th-generation and larger area, "AN Rezosta™" will contribute to improving performance and productivity in the large, ultra-high-resolution, high-refresh-rate panels of its customers.

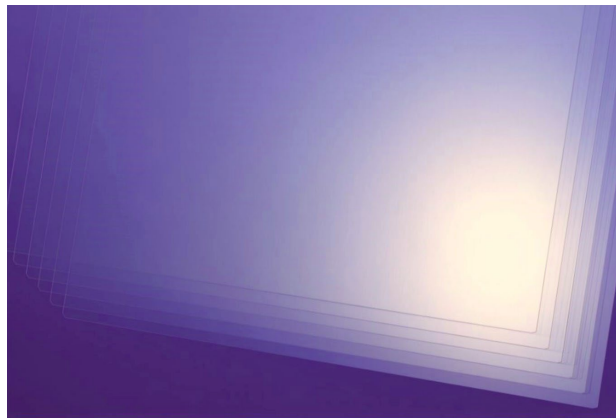

AN Rezosta™

Manufacturing Process for Glass Substrates for TFT-LCD / OLED Displays

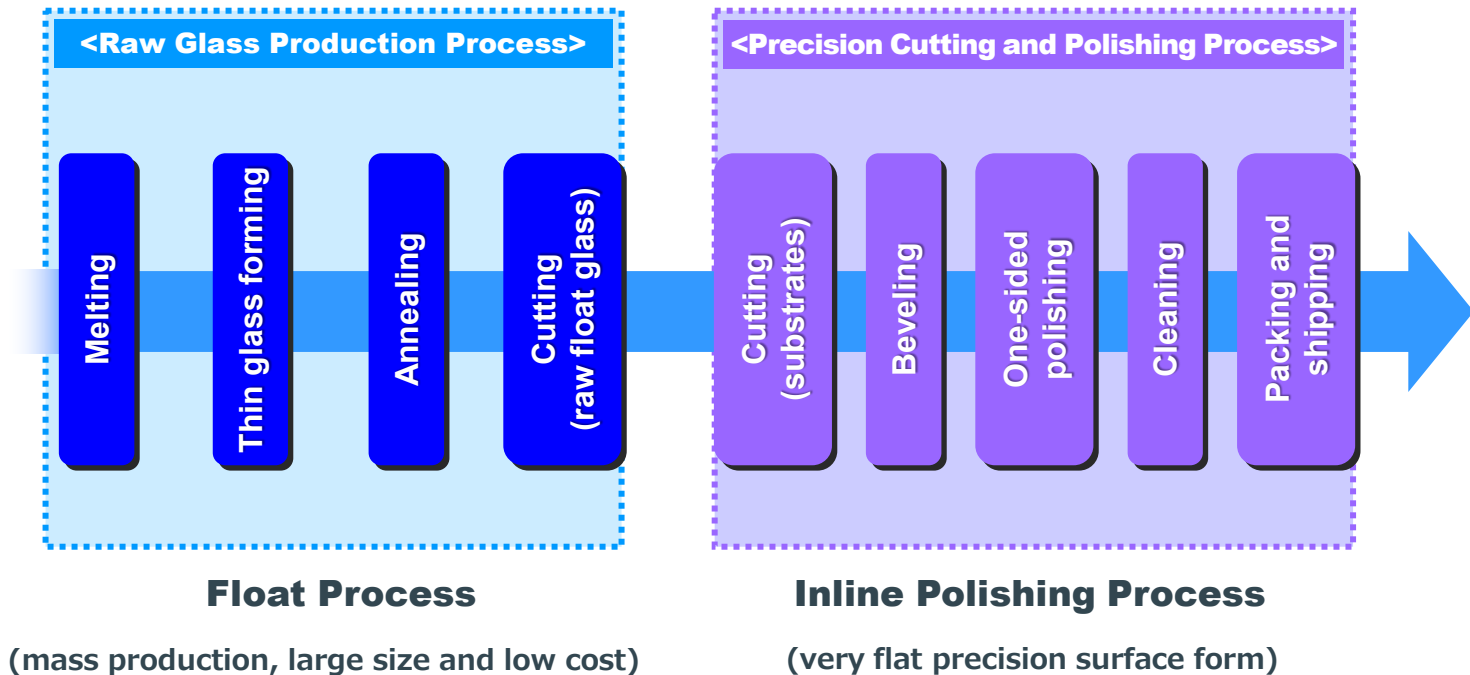

Production Method of Glass Substrates for TFT-LCD/ OLED Displays

Float Process

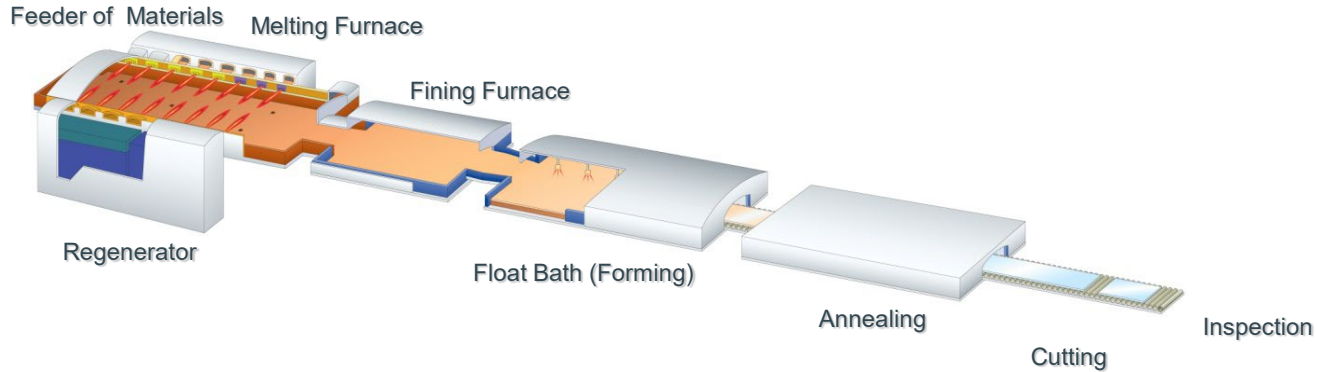

AGC's Float Process Cutting Image

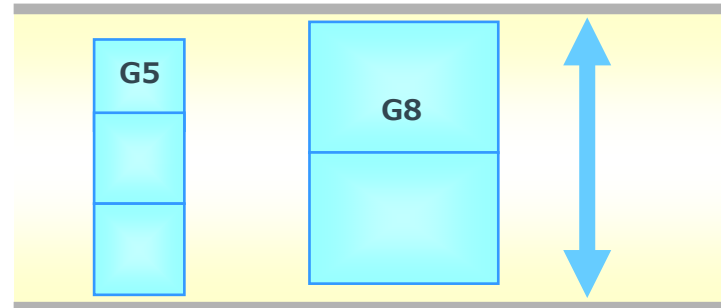

The float process has greater effective width, which allows the production of a multiple number of large-sized glass substrates at a time.

Size Trend of Glass Substrates for TFT-LCD/ OLED Displays

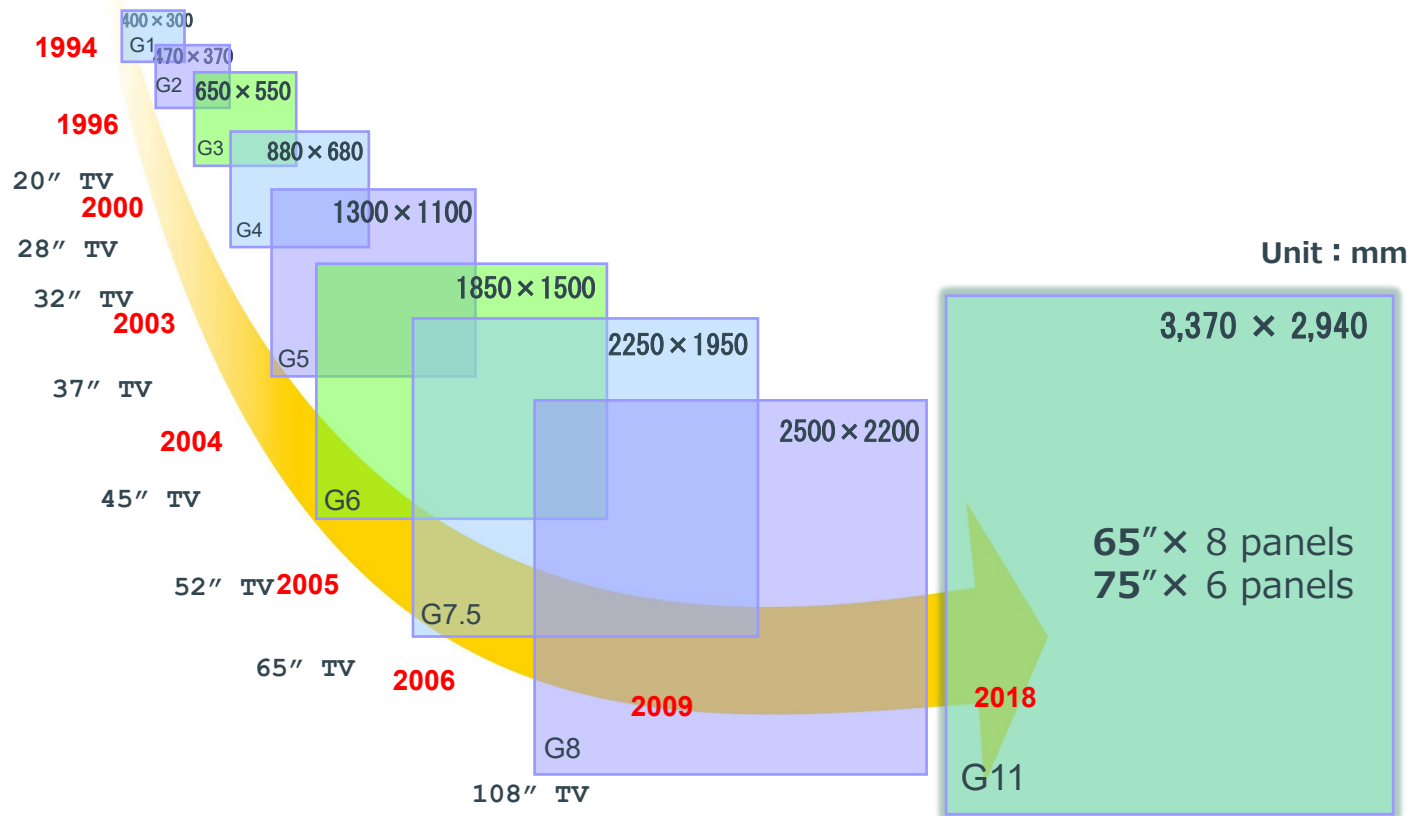

Specialty Glass for Chemical Strengthening

Dragontrail™ series



A specialty glass for chemical strengthening used as a cover glass for touchscreens of smartphones, tablet ,PCs and other electronic devices

< AGC's Strengths >

- Highly resistant to scratches and features a beautiful, pristine finish compared with resin.
- Dragontrail™ is manufactured by using the float method, a highly efficient production method as compared with fusion method and other manufacturing process.

Structure of touchscreen devices

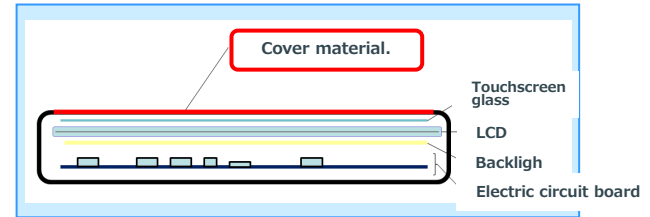

Characteristics of Dragontrail™ series

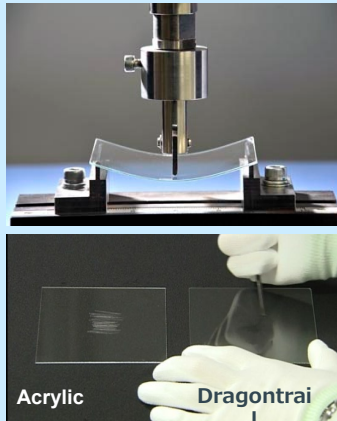

Strength test
(three-point bend test on
1.1 mm-thick glass plate)

Abrasion Test
(Comparison with
acrylic resin)

Acrylic

Dragontrail

Strength Comparison of Dragontrail™ series

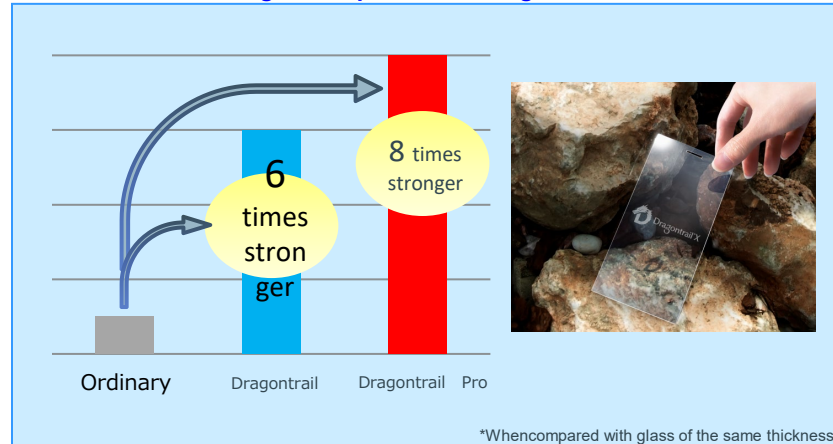

*When compared with glass of the same thickness

High-quality soda-lime glass "AS2" is used in various parts of **display devices and electronic equipment**.

It is manufactured by the float method, which is highly efficient in production, and is available in a variety of thicknesses from 0.23 to 1.1 mm.

We can meet the needs of a wide range of customers.

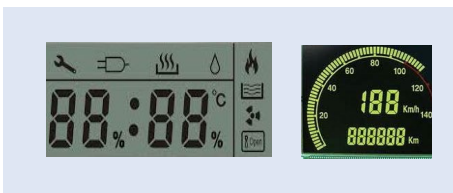

- For TN/STN-LCD

As a substrate for LCD panels, AS2 contributes to the realization of high yields.



- For cover glass

AS2 is used as tempering cover glass for general-purpose devices such as tablets, PCs, car-mounted display and industrial devices.

Comparison of 0.23 mm glass substrate for touchscreens with a coin



- For touch sensor

Taking advantage of the thermal stability of glass, AS2 is used in touch sensors for car-mounted display

As of December 2023

Product	Plants	Region
Glass Substrates for TFT-LCD/OLED Displays	Kansai Plant (Amagasaki factory)	Japan
	AGC Display Glass Yonezawa	Japan
	AGC Display Glass Taiwan	Taiwan
	AGC Fine Techno Korea	Korea
	AGC Display Glass Ochang	Korea
	AGC Display Glass (Kunshan)	China
	AGC Display Glass (Shenzhen)	China
	AGC Display Glass (Keishu)	China
	AGC Advanced Electronics Display Glass (Shenzhen)	China
Specialty glass for display applications	Kansai Plant (Takasago factory)	Japan
	AGC Flat Glass Protech (Shenzhen) Inc.	China
High-quality soda-lime glass	AGC Flat Glass Thailand	Thailand

Electronics Segment

Electronic Materials

Synthetic Fused Silica Glass

Ultra thin glass contributes to thinner and dervisified design for electronics devices with touch-panels

<Product Name>

Synthetic Fused Silica Glass AQ series



Applications

- Lens material for IC/LCD steppers/scanners
- Photo mask substrate
- Other optical material
- Glass wafer

Features

- High transmittance for deep ultraviolet rays with frequencies
- Excellent Compaction/Rarefaction and Polarization Induced Birefringence(PIB) characteristics
- Excellent heat resistance and durability
- Thermal expansion as low as 1/10 that of conventional glass
- High uniformity, Very high purity, very low metal impurity content
- Low OH group content
- Outstanding chemical resistance, Low dielectric loss

Synthetic Quartz

High durability against laser irradiation

<Product Name>

Synthetic Quartz Crystal CQ



Applications

- Prisms, etc.

Features

- This glass reduces deterioration from laser radiation to 1/5 or less relative to that of conventional artificial crystals, and its light resistance against high-intensity lasers, which are used for IC steppers/scanners, etc., has been greatly improved.

Silicon Carbide

High purity, high strength, low thermal expansion Silicon carbide

<Product Name>

ROICERAM™-HS



CMP Slurry

AGC offers slurry and polishing solutions for CMP processes

<Product Name>

CMP Slurry



EUVL mask blanks

Consumable components required for EUV lithography technology

<Product Name>

EUVL mask blanks



Applications

- Material for semiconductor production equipment
- Material for LED manufacturing device
- Material for solar cell production equipment

Features

- The product has characteristics of high purity, high strength, low thermal expansion and excellent acid resistance and heat resistance.
- We have over 30 years of experience as a supplier of parts for semiconductor manufacturing furnaces mainly in high temperature process.

Applications

- Front-end semiconductor process (wafer process)
- Various polishing for back-end process (package process)

Features

- Design and manufacturing of abrasive particles
- Accumulated technology of polishing materials for glasses
- Design and manufacturing of various analyses and chemical liquid
- Polishing material evaluation technology

Applications

- EUV lithography

Features

- Producing high-purity substrates with technology and knowledge cultivated over many years
- We have developed a special polishing method to achieve ultra-high planarization through integrated production of substrate and polishing.
- Responds to customer requirements with optimal film design capabilities for high-definition applications and film formation technologies that reduce defects

High refractive index glass

Glass substrates for next generation displays

<Product Name>

High refractive index glass



Applications

- Glass waveguide used on AR/MR smart glasses
- Glass waveguide for automotive head-up display

Features

- High refractive index
- Low absorption loss
- Flatness
- Smoothness
- Good thermal and chemical reliabilities

DOE · Diffuser

Micro-structured glass components for various consumer electronics and industrial laser applications

<Product Name>

Diffraction optical element(DOE)/Glass diffuser

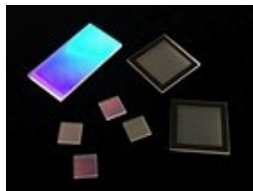

Applications

- Sensing
- AR/VR/MR
- Projector, Optical communications, Lighting
- Laser beam shaping

Features

- One-stop service from design, prototyping through evaluation
- Accumulated skills and experience on DOE processing
- Small 0th order transmission, high efficiency, high durability
- Capabilities of very large FOV and high density dot projection
- Multi-level steps processing

Glass Ceramics Substrate

Products for contributing brightness and high-output of LED and semiconductor laser

<Product Name>

GCHP™

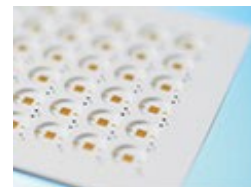

Applications

- Visible LED, IR LED, UV LED
- Semiconductor Laser
- headlamp

Features

- Integrated development from glass material to finished products
- High optical reflectance over a wide range of spectrum (UVC-NIR)
- High heat release efficiency
- Package size reduction capability by 3D circuit integration (multilayer)
- High reliability realized by glass (no color change)
- High hermetic properties of dense glass
- Prevention of solder cracking by glass

Optical Planar Devices

Optical element that greatly increases the performance and design freedom of light-related devices

<Product Name>

Micro lens array, transmission grating, wave plate

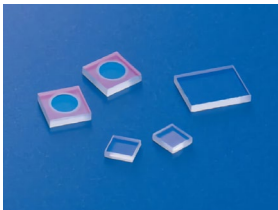

Applications

- Optical pickup for CD/DVD/Blu-ray
- Optical imaging device
- Optical communication device

Features

- The element controls light as intended by using holograms or gratings.
- Customized size-designing
- High efficient polarization filter
- Customized optical beam control

IR cut filter

Visibility compensation filters for cameras

<Product Name>

NF Glass Filter

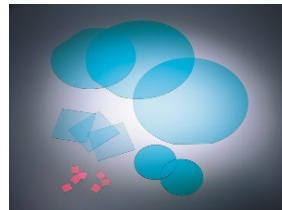

Applications

- Digital single-lens reflex camera, compact camera, smartphone camera, cameras for automobiles, surveillance camera, etc.

Features

- excellent image quality with absorption type
- It reduces ghosting and flares which have a bad influence on the image quality.
- Incident angle dependence of spectral transmittance is small
- integrated production system in a range from glass melting to forming/processing
- The variety of lineups are available so as to meet the spectral characteristics by the customers' requirements, such as anti-reflection coating and UVIR cut film

Aspherical Glass Lenses

Aspherical Glass molded lenses improving the optical performance of precise equipment

<Product Name>

Aspherical Glass Molded Lenses



Applications

- Digital single lens reflex cameras (DSLR), mirrorless interchangeable lens camera, compact camera, surveillance camera, cameras for automobile
- Projectors
- Sensing equipment

Features

- Lens shape: biconvex, meniscus (convex and concave), biconcave, toroidal, etc.
- Lens type: single lens and cemented lens (Doublet, Triplet)
- Size: ϕ 1mm to ϕ 48.5mm or so
- Special processing: I cut, D cut, and rectangular cut, etc.

Aspherical Glass Molded Lenses (Chalcogenide Glass)

Aspherical glass mold lenses made of chalcogenide glass with high transmittance for infrared light

<Product Name>

Aspherical Glass Molded Lenses (Chalcogenide Glass)



Applications

- Surveillance cameras
- Night vision devices for automobiles
- Analyzers using infrared rays

Features

- High infrared light transmittance lenses are realized by chalcogenide glass characteristic.
- High functional anti-reflection coating can be added to the lens surface
- Diffraction grating can be added to the lens surface

Micro Lens Array

Optical Elements with one or two dimensionally arrayed small lenses on a glass substrate

<Product Name>
Micro Lens Array

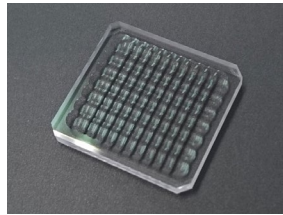

Applications

- Digital cameras, light field cameras
- Projectors
- Light control equipment

Features

- Lenses with submicron level accuracy can be formed.
- High accurate and various lens interval (array pitch) can be arranged.
- Not only single-sided arrays but also double-sided arrays can be manufactured.

Aspherical Glass Molded Lens

Glass mold lens that is excellent in heat resistance and durability

<Product Name>
Glass mold lens(Aspherical/Spherical)



Applications

- Fly-eye lenses for projectors Condenser lenses
- Multi-lens array for laser illumination
- Aspheric lens for illumination

Features

- Borosilicate glass with high weather resistance required for high-luminance projectors is used to create high-precision lenses through precision mold processing and molding technologies.

Fly eye lens / Lens array

Glass mold lens product that is excellent in heat resistance and durability

<Product Name>
Fly eye lens / Multi lens array

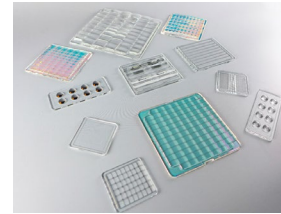

Optical Thin Film/ Polycarbonate Sheet, Thin Sheet, Film

Antireflection Film

Reduce the surface reflection and improves the permeation rate

<Product Name>
Antireflection Film



Applications

- Products using lenses, processing equipment, medical measuring equipment, etc.

Features

- Single- or multi-layer dielectric films are formed on the surface of optical materials to prevent light reflection on the surface and improve transmittance.
- Suppresses ghosting in optical elements.

Beam Splitter

Select an arbitrary wavelength and able to separate polarization components

<Product Name>
Beam Splitter

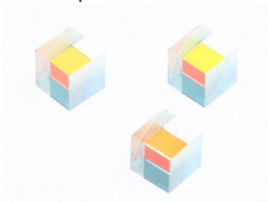

Applications

- Semiconductor and LCD lithography equipment, laser interferometers, measurement equipment, etc.

Features

- Reflects a portion of the single-incident light and also transmits a portion of the single-incident light. Also capable of separating p- and s-polarization components.
- Two types: cube and plate

Interference Filter (Dichroic Mirror)

Adjustment of permeation and reflection depending on the incidence angle is possible.

<Product Name>
Dichroic Mirror/Filter



Applications

- Color TV cameras, LCD projectors, color photo enlargers, color fax machines, lighting, other optical systems, etc.

Features

- AA multilayer film of dielectrics, each with a different refractive index, separates light in two or more wavelength regions. This action makes it possible to extract specific colors.

Optical Thin Film/Polycarbonate Sheet, Thin Sheet, Film

Polycarbonate Sheet

Excellent in processability, flame retardancy, lightweight, and tough transparent material

<Product Name>

CARBOGLASS™,
TWINCARBO™, etc.

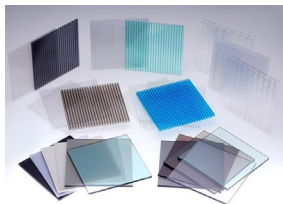

Applications

- Building materials, industrial materials
- Interiors, exteriors, etc.

Features

- High shock resistance
- Lightweight
- Flame retardancy
- Easy processing and forming
- Wide range of working temperature

Polycarbonate thin Film

Polycarbonate Film with excellent in shock resistance and Flame retardancy

<Product Name>

CARBOGLASS™



Applications

- Parts for automobiles, home appliances, office equipment, etc.

Features

- Excellent in shock resistance.
- Excellent in screen printing, and has extraordinary adhesion of UV ink.
- Excellent in transparency and can display printing ink colors reliably.
- Excellent heat resistance/cold resistance, and retains dimensional stability.
- Excellent in electric insulation.
- Easy to process (i.e. heat forming, die cutting, and cutting, etc.).

Glass Frit, Glass Pastes and Low Temperature Hermetic Sealing Parts

Materials for electronics applications used for the purposes of insulation, hermetic sealing

<Product Name>

Glass Frit, Glass Pastes and Low Temperature Hermetic Sealing Parts



Applications

- electronics applications for insulation, hermetic sealing, and protection purposes
- Chip components (capacitors, inductors, MEMS)

Features

- We can provide products in various forms such as powder, paste, and molded products.

Glass substrate for anodic bonding

Glass with an expansion coefficient that is very close to silicon

<Product Name>

SW glass substrate

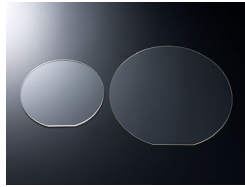

Applications

- Wafer-level packages for MEMS substrates
- Pressure sensors, acceleration sensors, Various automotive and industrial sensors and instruments
- LD/UVC-LED packages

Features

- Very close thermal expansion characteristics to silicon over a wide temperature range, and can be bonded tightly to silicon substrates by anodic bonding
- Metal coating and etching through hole completion and spot facing on substrates are also possible without difficulty.

SW glass substrate

Plastic ware for tissue culture products with reliable "IWAKI" brand

<Product Name>

Tissue Culture Products



Applications

- Drug Discovery Research
- Regenerative Medicine Research
- Various research in cell biology

Features

- Strict quality control
- Sales of general-purpose products as well as unique products with specific functions
- Culture vessels with various culture surfaces
- Dish and plate culture vessels are shaped for easy gripping.

Laboratory Glass Ware(Beaker, Flask,etc.)

High-quality heat resistant glass ware for Laboratories

<Product Name>

Laboratory Glass Ware



Applications

•Various containers (beakers, flasks, etc.) and measuring instruments (scalpels, pipettes, etc.) used in science experiments

Features

•Low-expansion borosilicate glass material with excellent heat resistance, chemical resistance, and transparency
•A lineup of glass products in a wide variety of shapes based on the accumulation of dissolution and processing technologies over many years

Heat Resistant Glassware

Heat resistant glassware usable everyday for food preparation, cooking, dining and storage

<Product Name>

iwaki Heat Resistant Glassware



Applications

•Kitchenware
•Tableware

Features

•Excellent heat resistance allows cooking in ovens and microwaves, and use in dishwashers and dryers.
•Excellent weather resistance, making it easy to clean and resistant to odor transfer.
•Excellent chemical resistance, unaffected by acids, alkalis, and other food components.

Main Products (Multi Material)

General name	Typical product lines	Product description
CCL(Copper Clad Laminate)	Meteorwave	A printed circuit board material composed of copper layers and PPE resin based insulating resin, which has excellent electrical characteristics and processability, and is used for high-speed communication and autonomous driving Radar applications.
	PEFE	A printed circuit board material composed of copper layers and PTFE resin based insulating resin, which has excellent electrical characteristics and processability, and is used for autonomous driving Radar applications.
	hydrocarbon	A printed circuit board material composed of copper layers and Hydrocarbon insulating resin, which has excellent electrical characteristics and stability, and is used in antenna and substrate applications.
Industrial PTFE composite Derivatives	Fabric	A product in which a base material such as glass fabric is impregnated with PTFE resin, which can be used in a wide range of temperatures, has excellent chemical resistance and non-adhesiveness, and is deployed in applications such as solar cell lamination and food processing.
	Tape	A highly functional material coated with a silicone-based or acrylic-based adhesive, which has excellent features, which has excellent heat resistance, electrical insulation, and non-adhesiveness, and has been deployed for FPCB/LCD processing processes and mold release and insulation applications in secondary batteries.
	Belt	A product endlessly processed into a belt using PTFE coated fabric, which has excellent peelability and chemical resistance and can be used for transporting and continuous processing of adhesive materials in a wide temperature and has been deployed for Soldering belt, Printing dryer belt and Food processing belt.
	Architectural Fabric	A product for architectural applications suitable for large membrane structures in which a thin glass fabric is coated with PTFE. The product has excellent weather resistance, flame retardancy, translucency, and self-cleaning properties, and is used in construction applications such as roofing materials, ceiling materials, and interior materials.
	Composite Film	A product in which a fluoropolymer resin such as PTFE or FEP, which has excellent temperature resistance, chemical resistance, electrical insulation and mold release properties, and can be used for electronic parts, semiconductor products, and mold releasing films for fuel cell production processes. Due to its excellent durability, the product can be considered for reuse instead of disposable, contributing to the reduction of waste.

CCL (Copper Clad Laminate)

< AGC's Strengths >

- Wide range of product lineup from digital to RF area.
- Strengths in material development, resin coating technology, electrical characteristics evaluation technology, and various analysis technologies.
- AGC acquired the CCL business and other businesses from Park Electrochemical and Taconic in 2018-2019 and responds to customer needs with global production and sales support.

Rigid CCL cross section

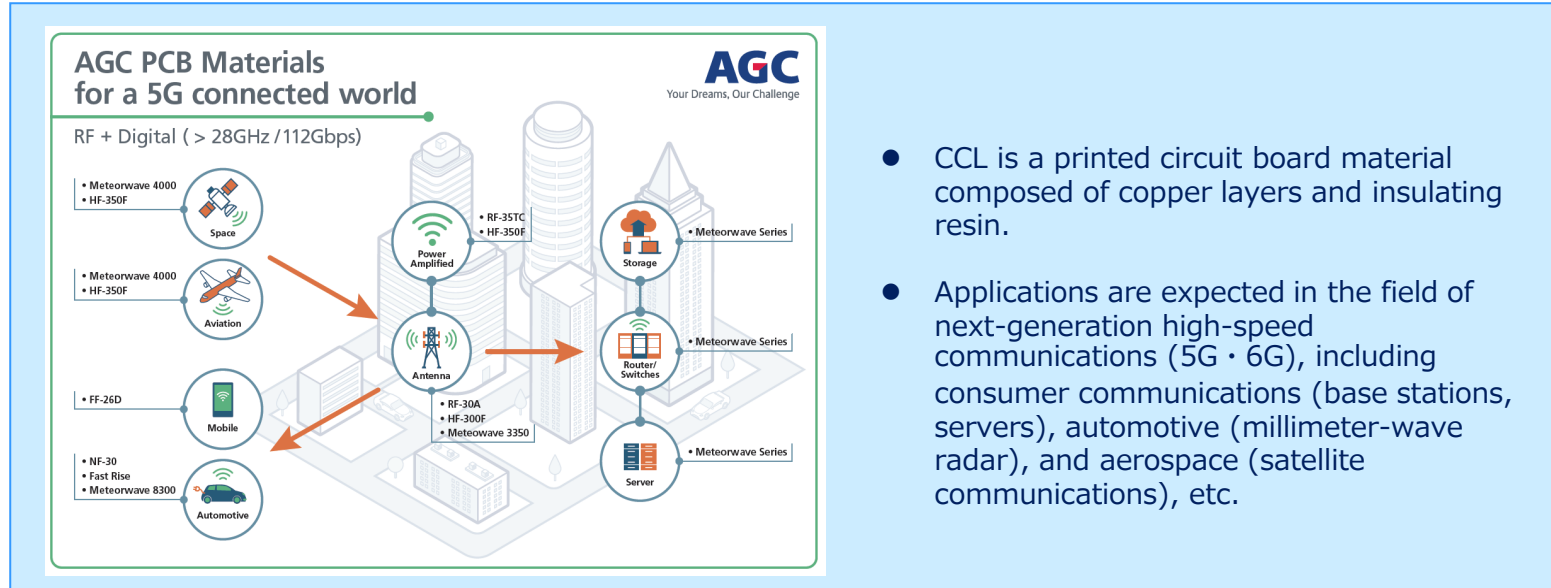
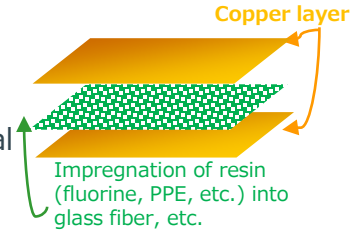

- CCL is a printed circuit board material composed of copper layers and insulating resin.
- Applications are expected in the field of next-generation high-speed communications (5G · 6G), including consumer communications (base stations, servers), automotive (millimeter-wave radar), and aerospace (satellite communications), etc.

Industrial PTFE composite Derivatives

< AGC's Strengths >

- Wide range of product lineup and applications from general industry to advanced functional materials and new energy fields.
- Strengths include unique resin coating technology and customized development capabilities to meet performance requirements and various applications.
- AGC acquired Korea Taconic's IPD business in 2019 and respond to customers' requests with global sales support, demonstrating the synergistic effect of AGC brand on conventional KTC technology.

IPD

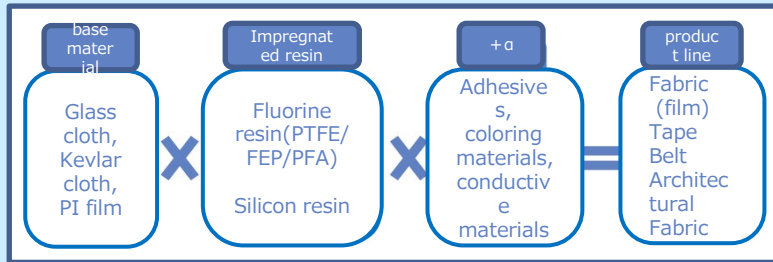

- IPD is a general term for composite materials in which various base materials are impregnated with PTFE. Products such as industrial fabrics, tapes and belts.
- The unique coating technology has the advantage of being able to customize the design to meet various applications and performance requirements.
- Applications are expected in general industry (e.g., food processing and construction applications), electronics and semiconductors (e.g., FPCB/LED/CMOS packaging processes), aviation (CFRP release sheets), automobile (e.g., fuel cell stacks), and new energy (solar cell).

Series/Applications

Series	Applications							
	Mobility	Aviation	Electronics	New Energy	Architecture	Food Processing	Chemical Industry	General Industry
Fabric	○	○	○	○		○	○	○
Tape		○	○				○	○
Belt			○			○	○	○
Architectural Fabric					○			
Composite Film	○	○	○					○

Major manufacturing Bases

As of June 2023

Product	Plants	Region
Semiconductor process materials	Kansai Plant (Takasago factory)	Japan
	AGC Electronics	Japan
	AGC Seimi Chemical	Japan
	AGC Electronics America	USA
Optical materials for cameras	AGC Techno Glass	Japan
	AGC Micro Glass	Japan
	AGC Micro Glass (Thailand)	Thailand
Glass-ceramics substrate for high-power LED/LD lighting	AGC Electronics Taiwan	Taiwan
Glass mold lens	AGC Techno Glass (Thailand)	Thailand
Optical Coating Products	Optical Coatings Japan	Japan
Polycarbonate	AGC Polycarbonate	Japan
Glass frit/paste	AGC Electronics	Japan
Tissue Culture Ware	AGC Techno Glass	Japan
CCL (Copper Clad Laminate)	AGC Multi Material America	USA
	AGC Multi Material Singapore	Singapore
	AGC Multi Material Europe	France
CCL (Copper Clad Laminate) Industrial PTFE composite Derivatives	KOREA TACONIC	Korea

Chemicals

Essential Chemicals Products

Chemical Chain of AGC's Chemical Business

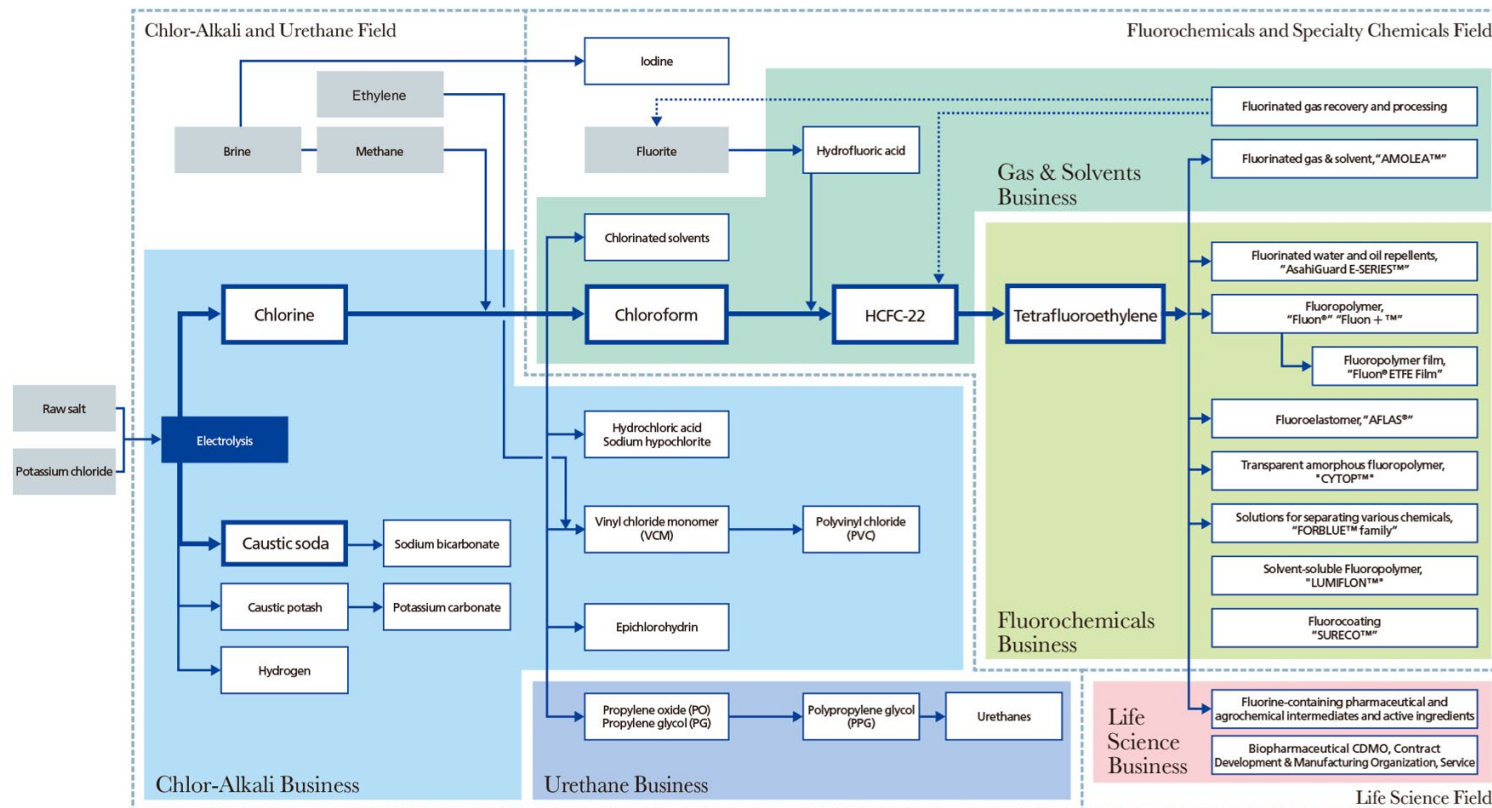

* The Life Science business was transferred from the Chemicals Company to the Life Science Company through a reorganization effective January 1, 2023.

Essential Chemicals Products

General name	Product usage
Caustic Soda	Chemicals, chemical fibers, paper/pulp, etc.
Caustic potash	Chemicals, potassium carbonate raw materials
Potassium carbonate	Food additives, detergent feedstock
Hydrochloric acid	Inorganic chemicals, steel, and chemical seasoning
Sodium hypochlorite	Bleaching pulp and textile, and sterilizing tap water
Liquid chlorine	Bleaching pulp and sterilizing tap water
Vinyl chloride monomer	Polyvinyl chloride raw materials (VCM)
Polyvinyl chloride	Polyvinyl chloride (PVC)
Trichloroethylene, Perchloroethylene	Industrial cleaner, dry-cleaning solvent, fluorinated gas feedstock
Methyl and ethylene chloride	Silicone resin, industrial cleaner, extracting solvent for pharmaceuticals and agrochemicals, paint stripper
Chloroform	Raw materials for fluorochemical products
Epi-chlorohydrin	Epoxy resin
Propylene oxide	Raw materials for propylene glycol, dipropylene glycol and polyols, raw materials for non-ion surfactants
Propylene glycol	Raw materials for unsaturated polyester resins and plasticizers, surfactants, antifreeze and coolants, food additives, perfume and tobacco, toothpaste, cosmetics and medical supplies
Polyols	Rigid and flexible polyurethane foams, coating, adhesives and sealant, elastomers
Sodium bicarbonate	Food additives, pharmaceuticals, bath salts, industrial applications and animal feeds

Caustic Soda, Polyvinyl chloride

- Caustic soda and chlorine are produced from electrolysis of salt.
- Caustic soda is used in a wide range of application as a typical alkaline product for industrial use.
- Chlorine is processed into a variety of products, such as polyvinyl chloride(PVC).



Crude salt, raw material for chlor-alkali products.

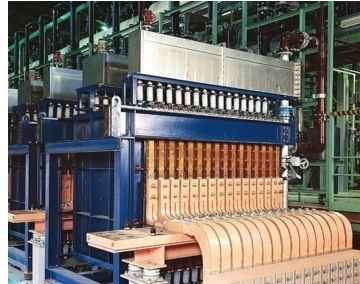

Electrolysis system, using AGC's ion-exchange membrane (Flemion™)

Caustic soda

- ✓ Paper/pulp
- ✓ Alumina refining
- ✓ Soap/detergent
- ✓ Sewer neutralization



Polyvinyl chloride

- ✓ Pipes
- ✓ Window sashes



Polyurethane products

- Polypropylene glycol(PPG) is an indispensable main raw material for producing polyurethanes.
- We have an integrated production system from propylene oxide(PO), the raw material for PPG, to polypropylene glycol(PPG).
- AGC also produces modified silicones with high functionality.
- AGC also offers environment-friendly products, such as PPG suitable for water foaming which enables molding without usage of CFCs, and PPG which can be used with HFO, a new environmentally friendly refrigerant.

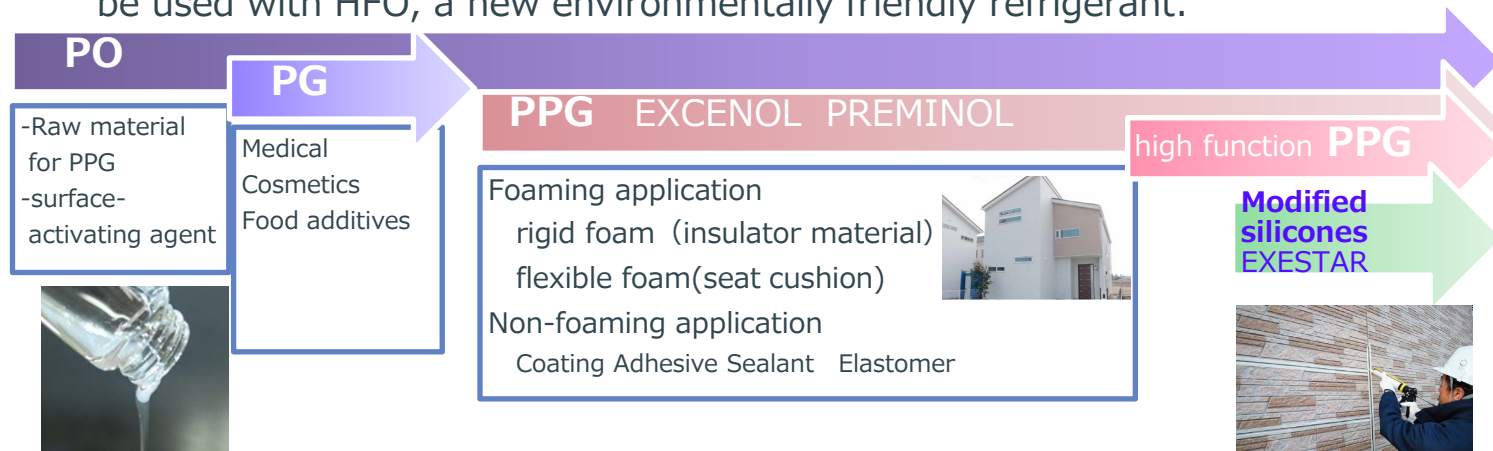

- Sodium bicarbonate is used in various fields, ranging from home products, medical products to advanced technologies.
- As the largest sodium bicarbonate manufacture in Japan, AGC offers a fine selection of grades. AGC is also committed to develop new products to meet wide range of needs.

Applications	
Industrial cleaning	Blast cleaning media, Chemical cleaning new system
Flue gas treatment	Flue gas neutralization
Pharmaceuticals	Stomach medicine (antacid), dialysis
Home products	Cleaners, bath salts, deodorant
Food products	Baking powder, PH control chemicals
Agricultural/ Livestock industries	Formula feed ingredients, Animal pharmaceuticals, Agrochemicals ingredients
Civil engineering/ construction	Liquid glass soil hardening agents
Industry	Fire extinguisher, metal surface treatment agents, neutralizer

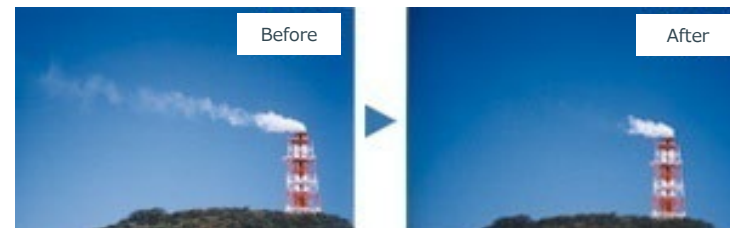

Sodium bicarbonate can also be used as a highly reactive neutralizer for exhaust gas treatment, efficiently removing acidic components in exhaust gas such as HCL, SO_x, sulfuric acid mist, and etc..

Chemicals Manufacturing Bases of Essential Chemicals

Chlor-alkali & urethane

General name	Production base	Country
Caustic Soda (2 million tons) *	Chiba plant	Japan
	Kashima plant	Japan
	Hokkaido Soda	Japan
	P.T.Asahimas Chemical	Indonesia
	AGC Vinythai	Thailand
Caustic potash (130,000 tons) *	Chiba plant	Japan
	AGC Vinythai	Thailand
Potassium carbonate	Chiba plant	Japan
	AGC Vinythai	Thailand
Hydrochloric acid	Chiba plant	Japan
	Kashima plant	Japan
	Hokkaido Soda	Japan
	P.T.Asahimas Chemical	Indonesia
	AGC Vinythai	Thailand
Sodium hypochlorite	Chiba plant	Japan
	Kashima plant	Japan
	Hokkaido Soda	Japan
	P.T.Asahimas Chemical	Indonesia
	AGC Vinythai	Thailand

General name	Production base	Country
Liquid chlorine	Chiba plant	Japan
	Kashima plant	Japan
	P.T.Asahimas Chemical	Indonesia
	AGC Vinythai	Thailand
Vinyl chloride monomer (1.5 million tons) *	Keiyo Monomer	Japan
	P.T.Asahimas Chemical	Indonesia
	AGC Vinythai	Thailand
Polyvinyl chloride (1.2 million tons) *	P.T.Asahimas Chemical	Indonesia
	AGC Vinythai	Thailand
	AGC Chemicals Vietnam	Vietnam
Trichloroethylene, Perchloroethylen	Chiba plant	Japan
Methyl chloride	Kashima plant	Japan
Methylene chloride	Chiba plant	Japan
Chloroform	Chiba plant	Japan
Epi-chlorohydrin (170,000 tons) *	Kashima Chemical Co., Ltd.	Japan
	AGC Vinythai	Thailand
Propylene oxide (110,000 tons) *	Kashima plant	Japan
Propylene glycol (40,000 tons) *	Kashima plant	Japan
Polyols (80,000 tons) *	Kashima plant	Japan
Sodium bicarbonate (50,000 tons) *	Kashima plant	Japan

As of August 2023

*production capacity

Chemicals Performance Chemicals Products

Products of Performance Chemicals

General name "Product name"	Product usage
Fluoropolymers "Fluon [®] ", "Fluon+ [™] "	Tubing, sealing, wire insulation, films, filaments, lining, etc. for various industries
Fluoroelastomers "AFLAS [®] "	Wire insulation, high performance sealing materials for semiconductors, food manufacturing, oil & gas application, etc.
Fluoropolymer film "Fluon [®] ETFE FILM" Green house film "F-CLEAN [®] "	Mold releasing films, roofing and architectural facades, interior finishing and photovoltaics Green houses
Transparent Fluoropolymers "CYTOP [®] "	Optical materials, semiconductor processing, hi-performance
Fluoropolymer resin for coatings "Lumiflon [®] "	Architectural structures, bridges and aircrafts
Fluorinated water and oil repellents "Asahi Guard [™] E SERIES"	Textiles, paper, nonwoven, carpet, and leather
Ion-exchange membranes FORBLUE [™] FLEMION FORBLUE [™] S-SERIES FORBLUE [™] SELEMION FORBLUE [™] sunsep	Ion-exchange membrane for salt electrolysis (for caustic soda/caustic potash/chlorine production) Water electrolysis, redox flow battery, ion-exchange membrane for wide variety of electrolysis and electro dialysis processes Acid recovery, wastewater reclamation, desalination and concentration, desalination of groundwater Dehumidification and humidification of various gases
Fluorine-based electrolyte polymer for fuel cells "FORBLUE [™] i-series"	Material for power-generating system of fuel cell vehicles
Fluorinated gases and solvents "AMOLEA [™] 1234yf", "AMOLEA [™] 1224yd"	Refrigerants for freezer/refrigeration equipment, and air conditioners, working fluid, foaming agent
Fluorinated solvent "AE-3000", "AC-6000" "AMOLEA [™] AS-300"	Cleaning, rinsing and drying agents, dewatering, solvents, dispersant, heat transfer fluid
Fluorosurfactant "SURFLON [™] "	Improved leveling performance for such as floor wax. Resin dispersant, resin surface modifier
Fluorocoating agents "SFCOAT [™] "	Damp-proof coating for electronics devices, oil barrier, anti-flux migration, anti-resin adhesion
Fine silica RESIFA [™] M.S.GEL [™] , RESIFA [™] SUNSPHERE [™] , RESIFA [™] SUNLOVELY [™]	Liquid chromatography packing agent, cosmetic materials

Performance Chemicals : Fluorinated resin Fluon®ETFE

- Fluoropolymers with ease of forming and fabrication while keeping the excellent characteristics of fluorine. Widely used in diverse and specific industrial fields, namely transport equipment, electronics, construction, and energy.
- Extrusion molding, injection molding, and powder coating are possible. Used in severe usage environment where thermal resistance, chemical durability, insulation, etc. are required such as wire coatings, tubes, and coating materials.
- With ETFE, film fabrication is also easy. Used as a mold-releasing film for membrane structure materials and other various fields

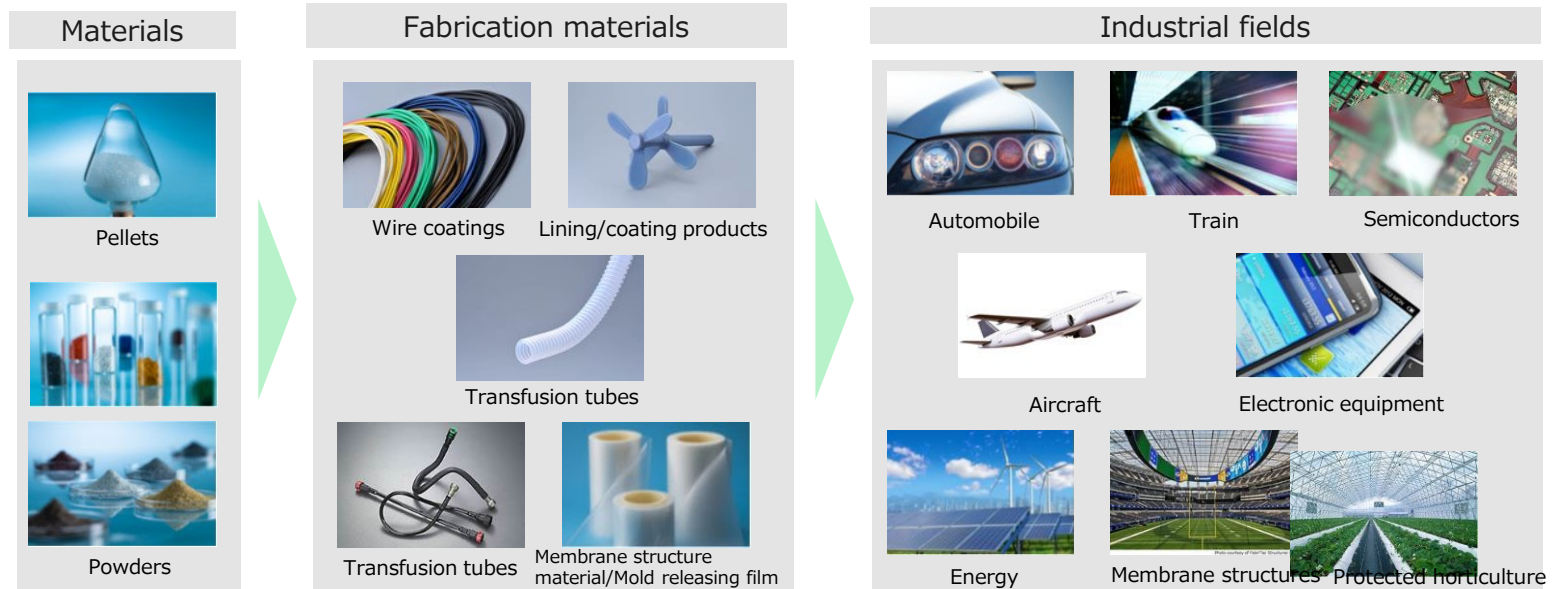

Environmentally friendly refrigerant & solvent AMOLEA™ series



- AGC's AMOLEA™ is a solvent and refrigerant brand developed under the concept of dramatically reducing Global Warming Potential (GWP) while maintaining conventional performance.
- We have the following three products for each application.

General name	Name of the Product	Applications
New environmentally-friendly refrigerant	AMOLEA™ 1234yf	refrigerant for mobile air-conditioners, refrigerators
New environmentally-friendly refrigerant	AMOLEA™ 1224yd	refrigerant for turbo chillers, working fluid, foaming agent
Low GWP Fluorinated Solvent	AMOLEA™ AS-300	Cleaning, solvent

- (American Society of Heating, Under-development AMOLEA 1123 mixed refrigerant is a most promising candidate as a next-generation refrigerant which offers high freezing/heating capacity and low GWP at the same time. It is AGC's unique refrigerant, which is promising to lead market growth mainly for air conditioners for residential, commercial and electric vehicles. ASHRAE Refrigerating and Air-Conditioning Engineers) registration, which authorizes a refrigerant, is to be completed in 2023.

Fluorinated electrolytic polymer for fuel cells (PEMFC ionomer)

- Supplying fluorine-based electrolyte polymer (PEMFC ionomer) for fuel cell membranes, an essential component of fuel cells.
- Demand increase accelerated due to the spread of fuel cell vehicles (FCV) and technological development aimed at realizing a hydrogen society.
- AGC achieved No.1 position based on the excellent performance for high power generation and durability.

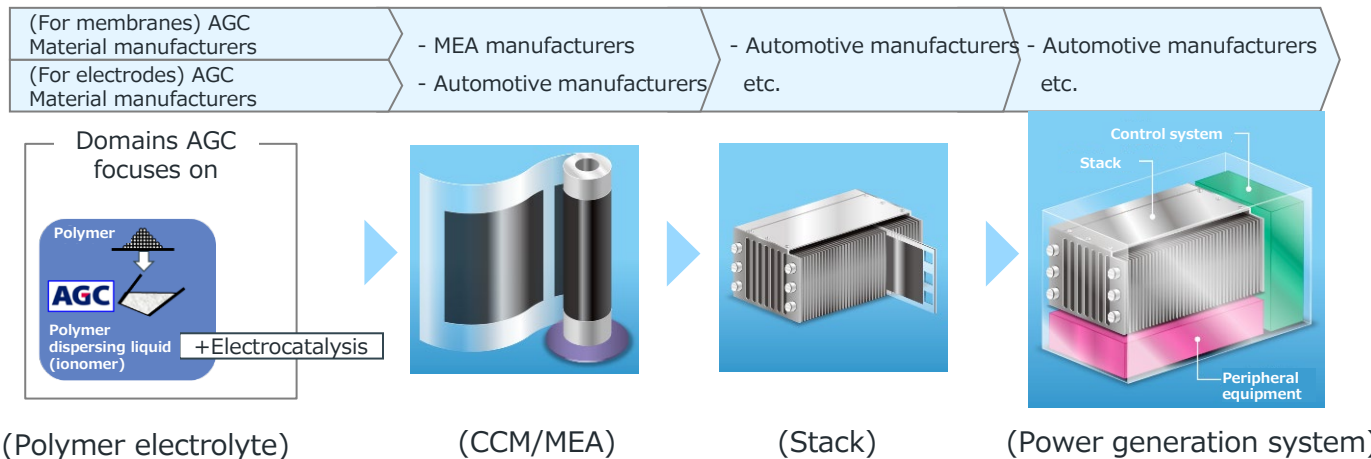

Adhesive fluoropolymer for next generation high speed communication.

- Fluon+™ EA-2000 is a low transmission loss fluoropolymer featuring low dielectric constant and low dielectric loss tangent
- Good adhesion and dispersibility that overturns the concept of existing fluoropolymers.
- Printed circuit boards using this product can reduce transmission loss by 30% or more compared to existing materials.
- Printed circuit board/flexible printed circuit board applications suitable for Fluon+™ EA-2000 are
automotive radar, flexible printed circuit boards for 5G smartphones, millimeter-wave devices.
- Dielectric constant and dielectric tangent

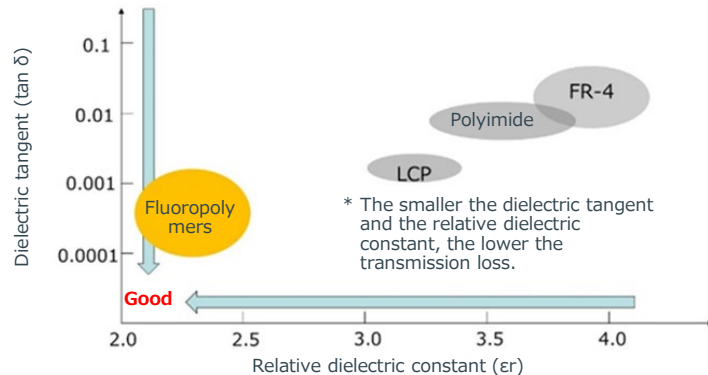

* The smaller the dielectric tangent and the relative dielectric constant, the lower the transmission loss.

Source: Edited by AGC based on data from Nikkei Electronics August 2017 issue

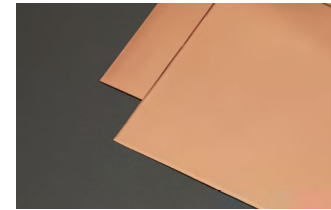

Fluon+™ EA-2000/PPE laminated CCL

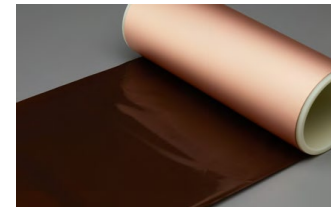

Fluon+™ EA-2000 coat RCC

- Lumiflon® is the world's first solvent-soluble fluoropolymer for coatings, developed by AGC's fluorine technologies, commercialized in 1982.
- Chemically-stable fluoropolymer demonstrates greater weatherability than conventional coating materials.
- Proven credibility based on more than 40 years of experience, used for over 200,000 buildings and facilities.



■ Economic comparison

Lumiflon®'s good weatherability reduces the life-cycle costs

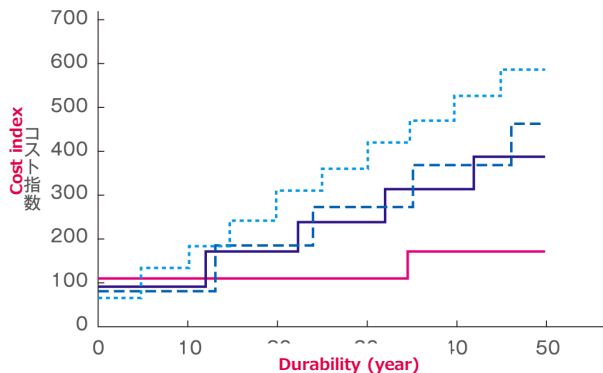

■ Excellent weatherability



Bridge pier without Lumiflon®
(16 years-old)



Bridge pier with Lumiflon coating
(21 years-old)

■ Lumiflon® is used for:



Ping An Finance Centre,
Shenzhen



Akashi Kaikyo Bridge

Fluorinated Water and Oil Repellents

AsahiGuard E-SERIES™

- World's first environmentally friendly fluorinated water and oil repellent launched in 2006.
- Originally developed by AGC.
- Both high performance and improved environmental profiles at the same time.
- Products line ups for applications including textile, paper and non-woven fabrics.



Applications

Textile Living ware	Umbrellas, clothing, sportswear, uniforms, etc.
Architecture Housings	Curtains, sofas, tablecloths, roofs, waterproof sheets, air filters, wall papers, carpets, etc.
Food packaging	Food packages, fast food packaging, cooking sheets, etc.
Automotive Industrial materials	Car seats, sound-absorbing material, oil filters, car waxes, water repellent for glass
Medical Sanitation	Medical gowns, white gowns, masks, surgery cover sheets



■ Treated fabric
with AsahiGuard E-SERIES™

- AGC Si-Tech, as a professional in the silica business for long years, offers silica products suitable for various applications including cosmetics, industry, and pharmaceutical production.
- Silica is attracting attention as a material that contributes to the reduction of environmental risks since it is a material that originally exists in nature. For example, it is expected to be used as an alternative for microplastics, which are concerned to have impact on the ecosystems when discharged into the ocean, and it has also been utilized in the partial purification of COVID-19 vaccine. Thereby contributing to solving various social and environmental issues.



Concept of the new brand RESIFA™

REcycle (to circulate nature) + **SI**lica (with silica) + **Fa** facilitate (contributing to the realization of Customers' dreams)

RESIFA™ Product Lineup

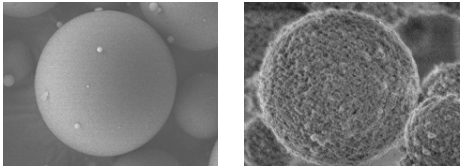
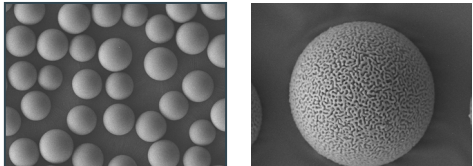
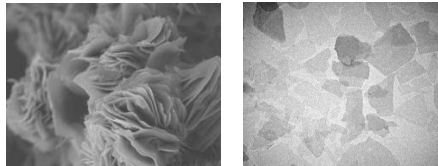
SUNSPHERE™	M.S.GEL™	SUNLOVELY™
 <div data-bbox="214 888 703 1014"> <p>usag e</p> <ul style="list-style-type: none"> -Fillers for cosmetics and antiperspirants -Fillers for resins and films -Carriers for functional materials -Catalyst carriers </div>	 <div data-bbox="730 888 1238 1014"> <p>usag e</p> <ul style="list-style-type: none"> -HPLC column packing material -Purification of pharmaceuticals and natural products -Carriers for functional materials </div>	 <div data-bbox="1265 888 1717 1014"> <p>usag e</p> <ul style="list-style-type: none"> -Binders for coatings -Hydrophilic fillers -Functional particulate binders </div>

Manufacturing Bases of Performance Chemicals

As of March 2023

General name "Product name"	Production base	Country
Fluoropolymers "Fluon®" "Fluon+™"	Chiba plant	Japan
	Kashima plant	Japan
	AGC Engineering Co., Ltd.	Japan
	AGC Chemicals Europe, Ltd.	England
	AGC Chemicals Americas Inc.	Americas
Fluoroelastomers "AFLAS™"	Chiba plant	Japan
Fluoropolymer film "Fluon® ETFE FILM" Green house film "F-CLEAN™"	Chiba plant	Japan
Transparent Fluoropolymers "CYTOP™"	Kashima plant	Japan
Fluoropolymer resin for coatings "Lumiflon™"	Chiba plant	Japan
Fluorinated water and oil repellents "AsahiGuard™ E SERIES"	Chiba plant	Japan
Ion-exchange membranes "FORBLUE™ FLEMION™"	Chiba plant	Japan
Fluorinated gases and solvents "AMOLEA™1234yf", "AMOLEA™1224yd"	Chiba plant	Japan
Fluorinated solvent "AE-3000", "AC-6000" "AMOLEA™AS-300"	Chiba plant	Japan
	Kashima plant	Japan
Fluorosurfactant "SURFLON™", Fluorocoating agents "SFCOAT™"	AGC Seimi Chemical	Japan
Fine silica RESIFA™ M.S.GEL™, RESIFA™ SUNSPHERE™, RESIFA™ SUNLOVELY™	AGC Si-Tech	Japan

Life Science

Life Science : CDMO business in Pharmaceuticals and Agrochemicals

General name "Product name"	Product usage
-Intermediates and active ingredients of synthetic pharmaceutical and agrochemical -biopharmaceuticals	Intermediate and active ingredients of pharmaceutical and agrochemical products

Business domains of AGC's CDMO business

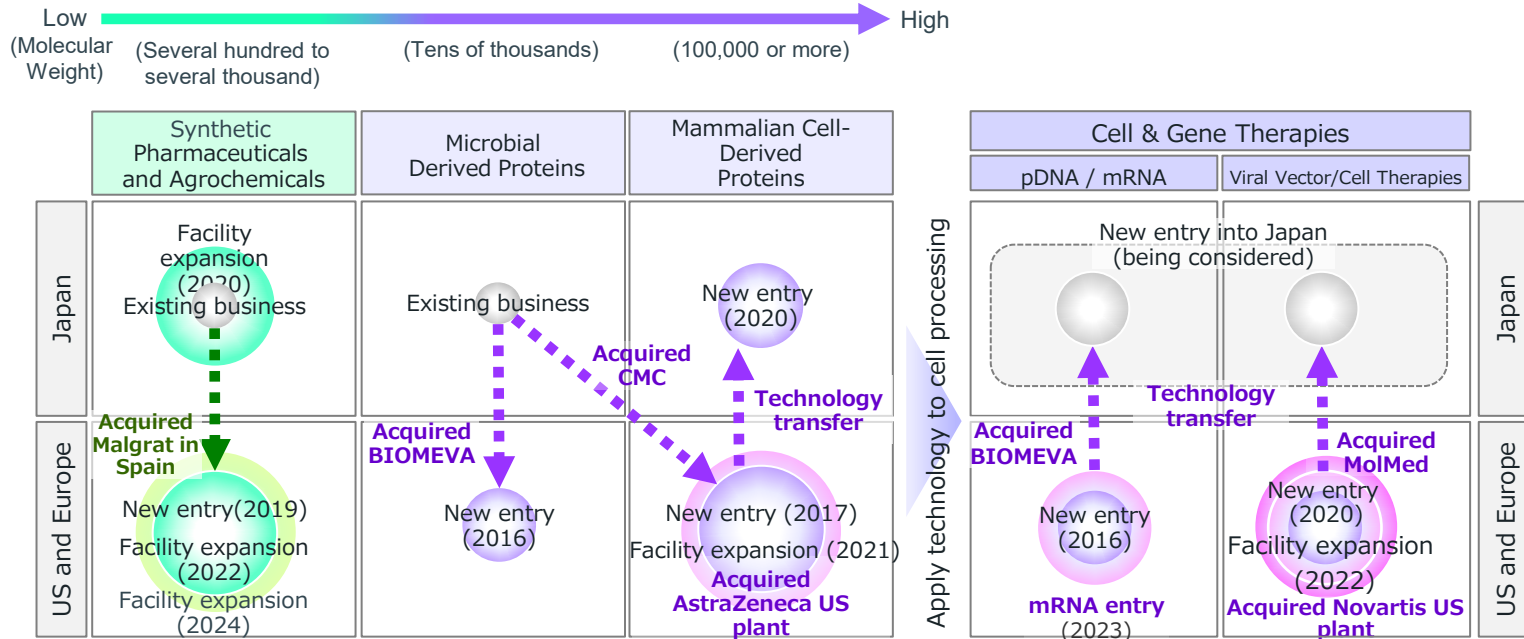

1. Production network catering to customer needs

Offering a wide range of services with high-level cGMP production network in three regions, Japan, the U.S., and Europe

2. Track record in commercial phase manufacturing

With high-level quality and developmental capabilities, have undergone numerous inspections

3. Technological competence

Use of cutting-edge technology to solve manufacturing and development challenges

Life science : Production network catering to customer needs

- One of the few global CDMOs with major operations in Japan
- Offering a **wide range of services** with capabilities in synthetic/microbial/mammalian processes, pDNA, and cell & gene therapies, from clinical through commercial phase, based on high-level **cGMP production network in three regions, Japan, the U.S., and Europe**

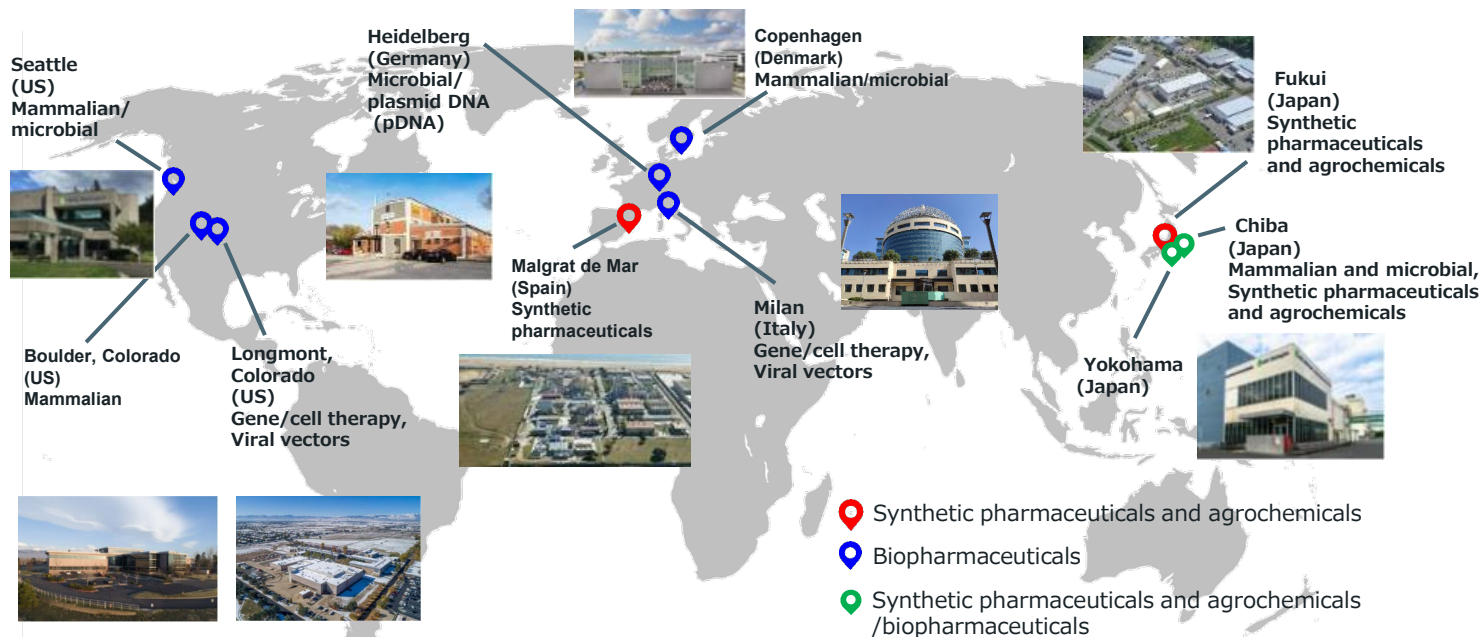

Strengths of the biopharmaceutical CDMO operations

- **Deal with rising needs for low-volume production** based on abundant track records as the pioneer of optimal single use bag(SUB) technologies for low-volume, large-variety production
- We also provide flexible services for **medium to larger scale production needs**, with our SUBs operatable in a **6pack™** configuration, and with our **large-scale SUS bioreactors** located in Boulder, Colorado.
- As **production scale needs shift together with the progression of the development stage**, we provide **consistent services** from early developmental through commercial phase.

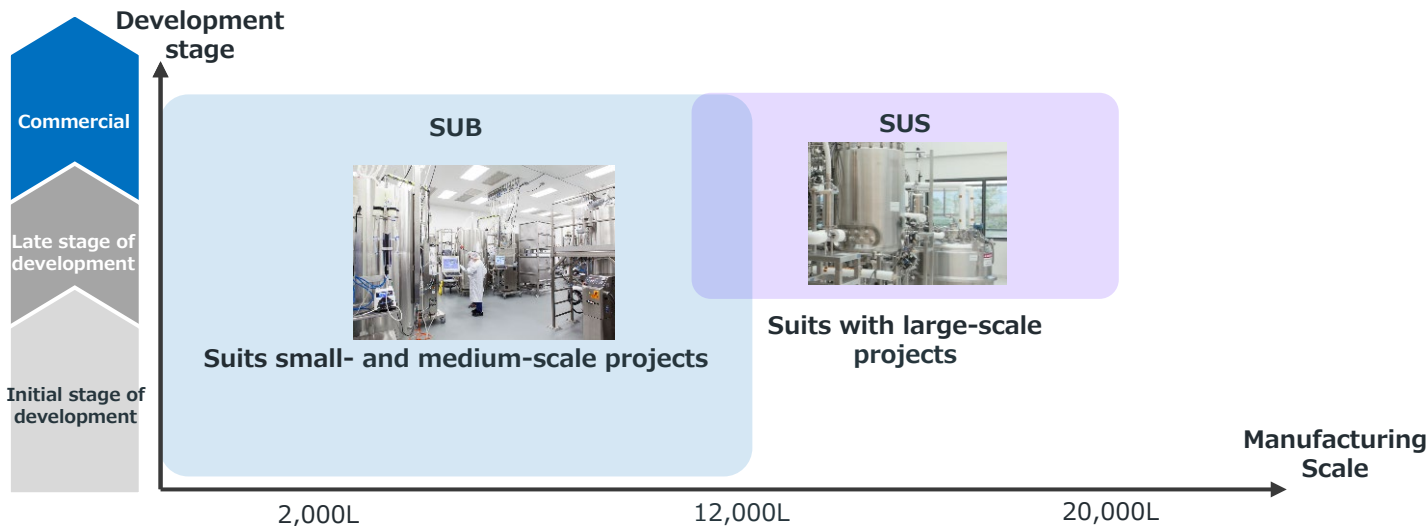

New Businesses (Solutions for next-generation high-speed communications)

AGC's solutions for next-generation high-speed communication antennas

Challenges

Higher frequency radio wave:

- > Shorter distance to transmit -> Huge number of base stations required
- > Difficult to get around obstacle and attenuation become larger
- > Radio waves cannot reach indoors

Development concept

Ultra-low loss material

High designability/
Good appearance

Easy to mount

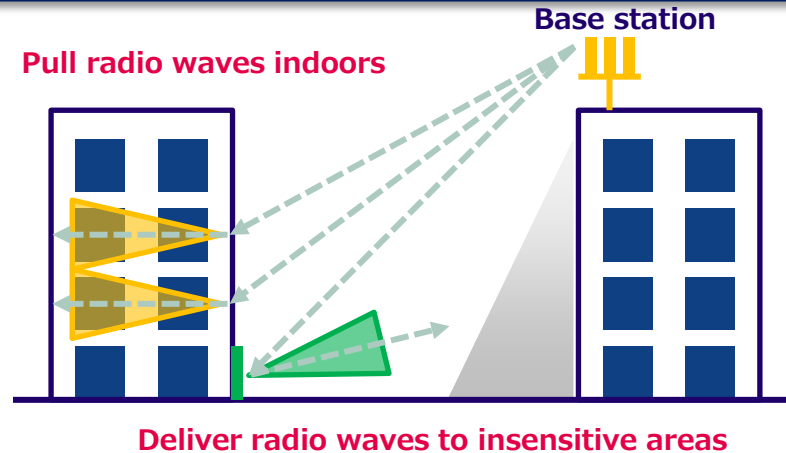

Providing antenna solutions for base stations and terminals

Antenna solutions for base stations

Outdoor



Outdoor

Utility pole mounted antenna



- Flexible antenna mounted on a pole for thin and curved surface installation
- For space saving and good designability of base stations
- Realize 360° omnidirectional antennas

Outdoor



Indoor

Meta-surface technology window glass radio wave lens

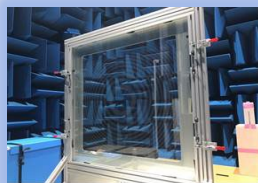

- Collect weak radio waves transmitted through window glass from outdoors to a focal point to aggregate power and achieve efficient area coverage inside buildings

Indoor



Indoor

Active reflector substrate

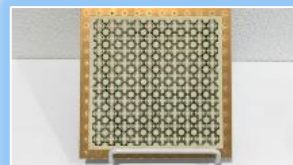

- Capable to control the incident and reflection angle of broadband millimeter wave electrically
- Contribute to improve coverage in various scenes of 5G propagation environments by controlling reflection programmably on a single board

Wall-mounted Massive MIMO sub6 antenna



- Although being Massive MIMO antennas with a wider bandwidth and higher performance compared to conventional dipole antennas, they are lighter and thinner, which greatly improves the flexibility of antenna installation.

AGC develops technology which contributes to expand coverage indoor & outdoor.

For automotive applications



- High speed communication with the base station can be achieved without sacrificing design by mounting antennas on automobile windows.

For IT equipment applications

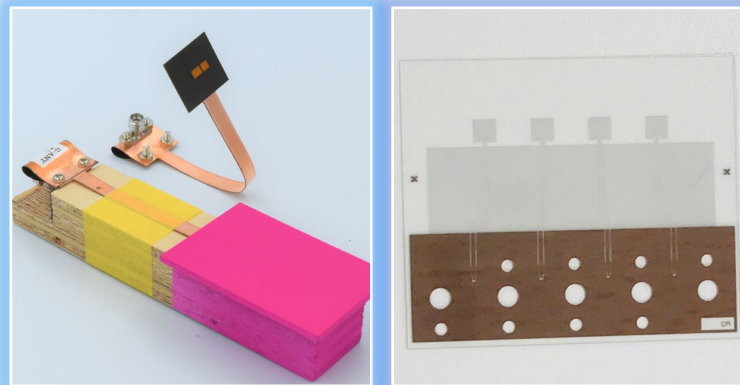

- AGC realizes high-speed communication of mobility, robots and IT devices without impairing the design of the terminals by considering the electrical characteristics of the terminal exterior into the antenna design and mold FPC integrally with the transmission line following the hosing shape.
- AGC has also developed a 5G mmW transparent antenna which will not spoil the display quality of high-definition displays by combining antenna designing technology and material evaluation technology that can achieve sufficient performance even with fine wiring.

**AGC develops solutions to connect mobility and IT devices
with next-generation high-speed communications**

FONTEX®

Double-clad structure of FONTEX®

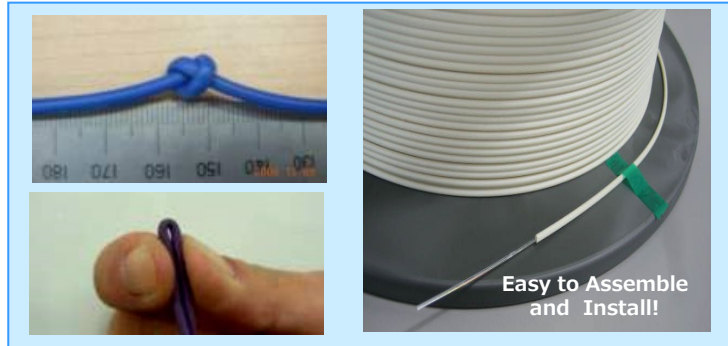
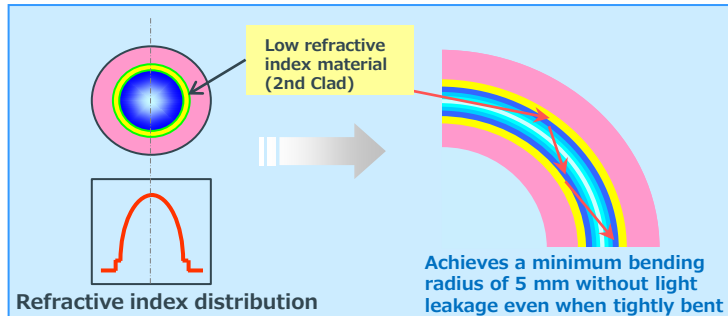

FONTEX

A consumer fluorine-based plastic fiber featuring high transmission speed and ease of handling and connection

- FONTEX® is world's first optical fiber that enables high bandwidth and large capacity data communication with a transmission speed of 10 Gbps or more. The cable features resistance to tight bending, allowing data communication which could not have been achieved with existing silica-based fibers or POFs.
- Double-clad structure successfully prevents light from leaking out of the core. (See the figure in the upper left.) FONTEX® is an incredibly easy to handle optical fiber that doesn't have any kinks that inherently form in plastic and, above all, allows data communication under tight knots or bends. (See the figure in the lower left.)
- FONTEX® adopts a tight cord structure which the cable covering is directly attached to the fiber circumference (See the figure in the lower left.) This leads to cost reduction and simplified terminal treatment processing, allowing anyone to handle the cable with ease.
- FONTEX® is a safe and reliable plastic optical fiber (POF) for general household use. It is suitable for large-volume data transmissions, which are essential for next-generation 4K-TVs, and enables transmission even when it is handled roughly or is tightly bent.

Ceramics / Others

Overview of AGC Ceramics products

Common name	Name of typical product	Product description
Fused cast refractory	ZB-X950 Series	A high-performance refractory made by electro-fusing at an ultra-high temperature of over 1,800°C and casting. It is adopted as a key material for glass melting furnaces by many customers worldwide.
Monolithic refractory	Asahi Caster®/GRAM	Monolithic refractory is made by blending carefully selected refractory raw material through advanced mixing technology. It is used in various high-temperature plants, AGC Ceramics proposes solutions to meet customer needs such as "shorter installation period" and "energy saving".
Bonded refractory	BNC/HAS	A refractory material with both corrosion resistance and thermal shock resistance, made by press forming refractory raw materials and sintering them at a high temperature of 1,500°C or above. It is mainly used in cement kilns and has been adopted by many customers worldwide.
Advanced ceramics	CERAROI-N/CERAROI-C	Ceramics with excellent thermal and corrosion resistance made by forming submicron high-purity raw materials under high pressure and sintering them in a reduction atmosphere. They are used in many fields such as steel, aluminum, and electronics.
Ceramics material for 3D printers	Brightorb	A ceramics material optimized for ink jetting 3D printer that brings together the manufacturing know-how such as ceramics melting technology that we have accumulated over the years. It is attracting attention for shortening the lead time of the casting process and for craft and art applications.
Engineering	Eco-lead furnace	We contribute to energy saving, environmental load reduction, longer service life, and stable operation of glass furnaces by providing our engineering services to meet customer needs, including furnace design, construction support, and remote operation monitoring.

Overview of the AGC Ceramics Group

(Japan)

■ AGC Ceramics Co., Ltd.

- Headquarters: Tokyo
- Takasago Plant (Hyogo Prefecture)
Manufacturing & Development
- Sales Offices: Tokyo, Osaka, and Kitakyushu

■ AGC Plibrico Co., Ltd.

Specialized manufacturer of monolithic refractories and engineering

- Headquarters: Tokyo
- Chigasaki Plant (Kanagawa Prefecture) Manufacturing & Development



(Tokyo) Mita NN Building



AGC Ceramics Takasago Plant office
(Within Takasago Factory of AGC Kansai Plant)

(Overseas sites)

- 淄博艾杰旭刚玉材料有限公司 (China)
- 艾杰旭派力固 (大连) 工业有限公司 (China)
- 江苏恒耐杰旭工业陶瓷有限公司 (China)
- 微瓷科技(江西)有限公司 (China)
- AGC Ceramics Singapore Pte. Ltd.

Fused cast refractory manufacturing process

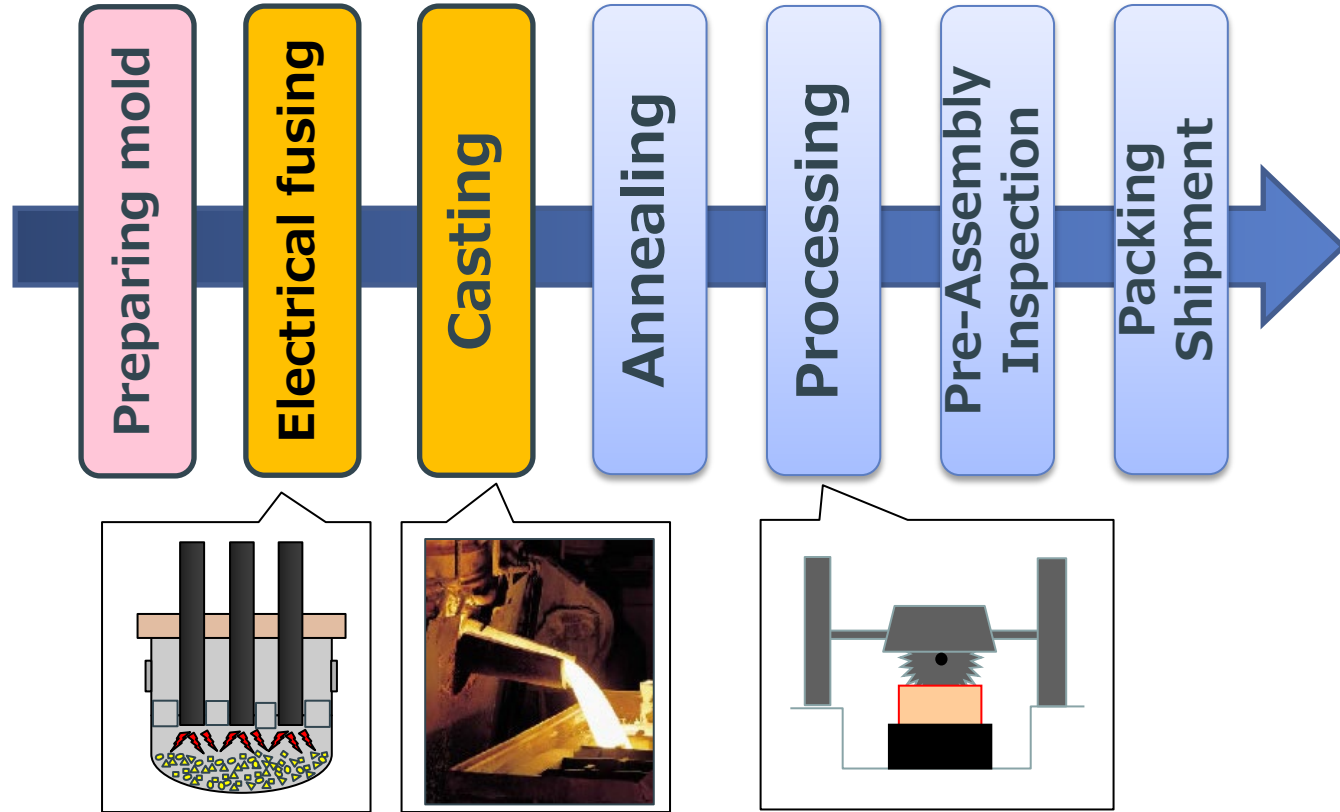

AGC offers a full line-up of fused cast refractories for glass melting furnaces to meet various customer needs.

	Description
ZrO ₂ (zirconia) fused cast refractories ZB-X950 Series	Fused cast refractories with optimal performance against contamination to molten glass and excellent corrosion resistance required for use in glass melting furnace manufacturing high-quality specialty glass.
Al ₂ O ₃ -ZrO ₂ -SiO ₂ (AZS) fused cast refractories Zirconite [□] Series	Fused cast refractories with excellent resistance to corrosion even under high temperatures
Al ₂ O ₃ (alumina) fused cast refractories Marsnite [□] Series	Fused cast refractories with excellent performance against contamination to molten glass

ZB-X950



Zirconite



Marsnite



Dry gunning Low cement monolithic refractory GRAM Series

Dry gunning Low cement monolithic refractory

GRAM Series

To contribute to shortening installation period and reducing installation workers

Unique product that enables to install high-performance low cement monolithic refractory by dry gunning technique

Simple installation method and short heating-up time contribute to shortening installation period.

It contributes to reducing installation workers as it can be installed without complicated wet gunning technique.

■ Image of GRAM construction method

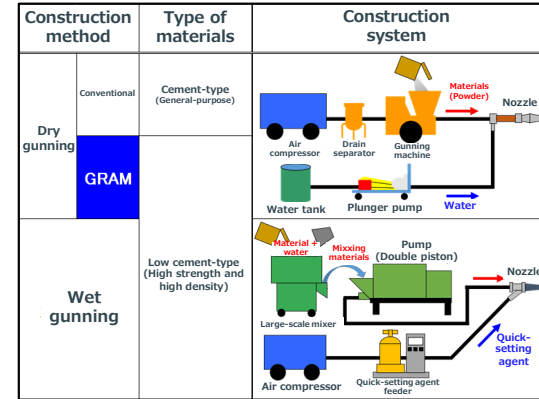

■ Image of GRAM lining

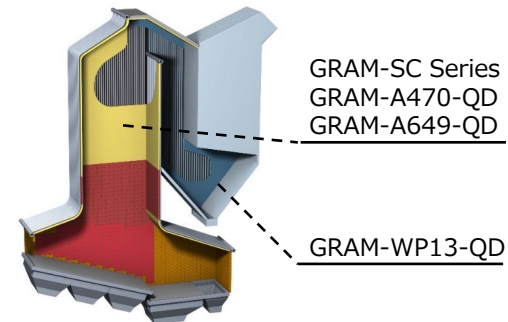

Ceramics material for ink jetting 3D printers(*1)

(*1) AGC Ceramics has a large 3D printer with a 1,000 mm x 600 mm x 500 mm molding box .

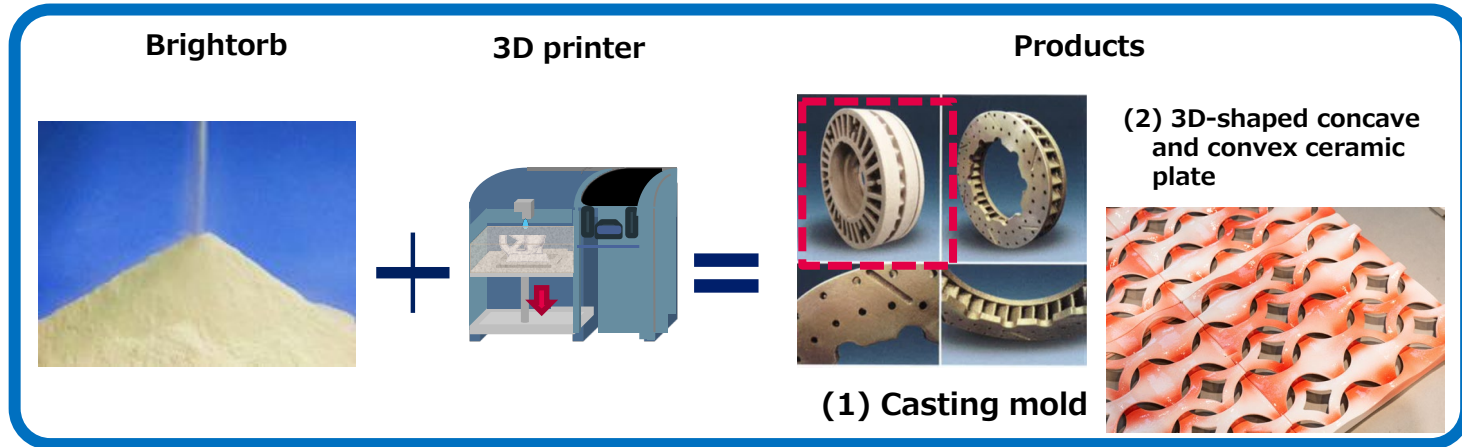

[Brightorb features]

- Applicable to **molds** for cast metals of 1,600°C or higher such as cast-iron.
- **Shrinkage ratio is less than 1% (*2)** after firing at 1,400°C

(*2) Ordinary clay for earthenware has shrinkage of 10% or more and shows shrinkage and deformation after firing.

[Value provided]

- (1) Designing of high-precision ceramics
- (2) Mass customized production
- (3) Shorter casting process for prototyping and development period

Reference Information

Successive Presidents

	Position	Name	Term	Memo
1	President	Toshiya Iwasaki	Sep. 1907 ~ Oct. 1930	
2	Chairman	Sanjiro Yamada	Mar. 1931 ~ Jun. 1939	President position is vacant.
3	President	Masakichi Ono	Jul. 1939 ~ Dec. 1943	
4	President	Kamesaburo Ikeda	Mar. 1943 ~ Mar. 1946	※
5	President	Kanichi Morimoto	Mar. 1946 ~ Dec. 1946	※
6	President	Kikuo Mori	Dec. 1946 ~ Apr. 1950	※
7	President	Tokiichiro Kuwata	Apr. 1950 ~ Jun. 1950	※
8	President	Kiichi Watanabe	Jun. 1950 ~ Feb. 1952	
9	President	Kanichi Morimoto	Feb. 1952 ~ Aug. 1967	
10	President	Motoharu Kurata	Aug. 1967 ~ Feb. 1973	
11	President	Hideaki Yamashita	Feb. 1973 ~ Mar. 1981	
12	President	Takeo Sakabe	Mar. 1981 ~ Jan. 1987	
13	President	Jiro Furumoto	Jan. 1987 ~ Mar. 1992	
14	President	Hiromichi Seya	Mar. 1992 ~ Jun. 1998	
15	President	Shinya Ishizu	Jun. 1998 ~ Mar. 2004	
16	President	Masahiro Kadomatsu	Mar. 2004 ~ Mar. 2008	
17	President	Kazuhiko Ishimura	Mar. 2008 ~ Dec. 2014	
18	President	Takuya Shimamura	Jan. 2015 ~ Dec. 2020	
19	President	Yoshinori Hirai	Jan. 2021 ~	

※ April 1944 ~ May 1950 , (Former) Mitsubishi Kasei Kogyo Co., Ltd

Corporate History (1)

1907	Asahi Glass Company is established.	1972	Sagami Works (now Sagami Plant) is established.
1909	Flat glass production begins at Amagasaki (now Kansai) for the first time in Japan		P.T. Asahimas Flat Glass Co., Ltd. is established and business launches in Indonesia.
1914	Makiyama (now Kitakyushu) Plant is established.	1974	Kashima Plant is established.
1916	Production of refractories begins and ceramics business launches. Tsurumi Plant is established.		Thai Safety Glass Co., Ltd. (now AGC Automotive (Thailand) Co., Ltd.) is established and automotive glass production begins in Asia.
1917	Production of soda ash begins.	1981	Asahi Glass acquires Glaverbel S.A., (AGC Glass Europe) a glass company in Belgium, and launches business in Europe.
1939	Iho (now Takasago) Plant is established.	1985	AP Techno glass Co. is established automotive glass production begins in the USA.
1944	Merges with Nippon Chemical Industries and Mitsubishi Chemical Industries is formed.		Production of synthetic quartz glass begins.
1950	Pursuant to the Company Reconstruction and Improvement Law, Mitsubishi Chemical Industries is divided into Asahi Glass, Nippon Kasei Kogyo (now Mitsubishi Chemical) and Shinko Rayon (now Mitsubishi Rayon). Asahi Glass Company is re-established and lists its stock on the stock exchanges in Japan.	1986	P.T. Asahimas SUBENTRA Chemical (now P.T. Asahimas Chemical) established in Indonesia.
1954	Production of CRT glass bulbs begins.	1988	Makes capital participation into AFG Industries (now AGC Flat Glass North America) and flat glass production begins in the USA.
1956	Production of automotive glass begins. The Indo Asahi Glass Co., Ltd. is established, and business launches in India. Chiba Plant is established.	1991	Makes capital participation into Splintex S.A. (now AGC Automotive Europe Inc) and automotive glass production begins in Europe. Makes capital participation into Glavunion (now AGC Flat Glass Czech a.s. clen AGC Group) and launches business in Czech Republic.
1959	Caustic soda first is produced at Chiba Plant.	1992	Dalian Asahi Float Glass Co., Ltd. (now AGC Flat Glass (Dalian) Co., Ltd.) is established and flat glass production begins in China. Production of TCO glass substrates for LCDs begins at Asahi Glass Fine Techno (now AGC Display Glass Yonezawa Co., Ltd.).
1964	Thai Asahi Glass Public Co., Ltd. is established and business launches in Thailand. Hazawa Research Center (now Research Center) is established.	1995	Production of alkali-free glass for TFT-LCD glass substrates begins. Qinhuangdao Haiyan Safety Glass Co., Ltd. is established and production of automotive glass business begins in China.
1965	Thai Asahi Caustic Soda Co. (now AGC Chemicals (Thailand) Co., Ltd.) is established and production of chemicals products begins in Asia.	1996	Production of glass substrates for Plasma Display Panels (PDPs) begins.
1970	Aichi Plant is established.		

Corporate History (2)

1997	Makes capital participation into Bor Glass Works (now OJSC AGC Bor Glassworks) and launches business in Russia.	2014	Acquires a Vietnamese polyvinyl chloride (PVC) company, Phu My Plastics & Chemicals Co., Ltd. (now AGC Chemicals Vietnam Co., Ltd.) AGC and Obeikan Glass agreed to set up a JV for architectural glass.
1999	Acquires Imperial Chemical Industries PLC's fluoropolymer business and launches production of fluorochemicals in Europe.	2015	Acquires NordGlass, automotive replacement glass company in Poland.
2000	Asahi Glass Fine Techno Taiwan Co., Ltd. (now AGC Display Glass Taiwan Co., Ltd.) is established and production of TFT-LCD glass substrates begins.	2016	AGC's First Automotive Glass Production Base is established in North Africa (Morocco).
2002	Global In-House Company System is introduced.	2017	Acquires Vinythai PCL (shareholding ratio of 58.77%) Bioscience businesses in Japan, the U.S., and Europe consolidated and integrated management as AGC Biologics begins.
2003	Production of PDP glass substrates begins at Hanwook Techno Glass Co., Ltd.	2018	Change of corporate name to AGC Inc. (1 st July)
2004	AGC Automotive Hungary Ltd. is established and automotive glass production begins in Hungary. Asahi Glass Fine Techno Korea Co., Ltd. (now AGC Fine Techno Korea Co., Ltd.) is established and production of TFT-LCD glass substrates begins in South Korea.	2019	Acquires Spanish Synthetic Pharmaceutical Active Ingredient Manufacturing Plant Malgrat Pharma Chemicals Acquires US based Taconic's global operations of the Advanced Dielectric Division
2007	The corporate brand of the AGC Group is unified to AGC. Transfers the shares of Asahi Fiberglass Co., Ltd. and withdraws from glass fiber business.	2020	AGC Acquires Biopharmaceutical Commercial Facility in Colorado, U.S.A. AGC Completes Development of 5G-compatible 'Glass Antenna that Adds Cellular Base Station Capabilities to Windows' AGC to Make Drastic Expansion to Supply System for EUVL Mask Blanks. AGC Biologics Expands Cell and Gene Therapy CDMO Services. AGC Opens New R&D Building.
2008	Transfers the shares of Optrex Corporation and withdraws from LCD display device business.	2022	Established a new company, AGC Vinythai Public Company Limited to integrate and reorganize the chlor-alkali business subsidiaries in Thailand and CLMV markets.
2009	Terminates automotive glass business at Kitakyushu plant. Begins production of specialty glass for chemical strengthening for smart phones, tablet PCs, etc.	2023	Established a new in-house company, Life Science Company. Completed the transfer of its ownership stake in AGC Flat Glass (Dalian) Inc. to Shanghai Yaohua Pilkington Glass Group Co. Ltd. (SYP Group)
2010	AGC Display Glass (Kunshan) Co., Ltd. is established as a production base for TFT-LCD glass substrates in China. Terminates production of CRT glass bulbs at Hankuk Electric Glass Co., Ltd. and withdraws from CRT glass bulb business.		
2011	AGC Glass Brazil inc. is established and business launches in Brazil.		
2012	Strategic partnership with Interpane in Germany.		
2013	AGC Automotive Mexico S. DE R.L. DE C.V. is established.		

AGC's Overseas Business Development

年	Europe/EMEA
1981	[Belgium] Asahi Glass acquires Glaverbel S.A., (AGC Glass Europe S.A.) a glass company in Belgium. First entry into Europe.
1997	[Russia] Capital participation made in Bor Glassworks (OJSC AGC Bor Glassworks). First entry into the Russian market.
1999	[UK] Imperial Chemical Industries PLC's (AGC Chemicals Europe, Ltd.) fluoropolymers business acquired. Production of fluorochemicals begins in Europe.
2004	[Hungary] AGC Automotive Hungary Ltd. established. Production of automotive glass begins in Hungary.
2012	[Germany] Strategic partnership with Interpane in Germany (Became a consolidated subsidiary)
2015	[Poland] AGC acquires NordGlass, automotive replacement glass company in Poland.
2019	[Morocco] Automotive Glass Production Base established in Morocco.
2020	AGC Biologics Expands Cell and Gene Therapy CDMO Services

年	ASIA/Japan
1097	[Japan] 1907 Asahi Glass Company founded.
1956	[India] Glass production begins in India. AGC becomes one of the first Japanese private companies to enter the Indian market.
1964	[Thailand] Thai Asahi Glass Public Co., Ltd. (AGC Flat Glass (Thailand) Public Co., Ltd.) established.
1972	[Indonesia] P.T. Asahimas Flat Glass Co., Ltd. established in Indonesia. First entry into the Indonesian market.
1992	[China] Dalian Asahi Float Glass Co., Ltd. established in China. Production of flat glass begins in China.
2000	[Taiwan] Asahi Glass Fine Techno Taiwan Co., Ltd. (AGC Display Glass Taiwan Co., Ltd.) established. Production of LCD glass substrates begins in Taiwan.
2003	[Korea] At Hanwook Techno Glass Co., Ltd., production of PDP glass substrates begins in Korea.
2003	[Vietnam] AGC acquire a Vietnamese polyvinyl chloride (PVC) company, Phu My Plastics & Chemicals Co., Ltd.
2014	[Saudi Arabia] AGC and Obeikan Glass agreed to set up a JV for architectural glass.
2017	[Thailand] Acquires Vinythai PCL
2022	[Thailand] established a new company, AGC Vinythai Public Company Limited to integrate and reorganize the chlor-alkali business subsidiaries in Thailand and CLMV markets

年	Americas
1985	[USA] AP Technoglass Co. (Automotive glass division in AGC Flat Glass North America, Inc.) established. Production of automotive glass begins in the USA.
2011	[Brazil] AGC Glass Brazil, Inc. established. First entry into the Brazilian market.
2013	[Mexico] AGC Automotive Mexico S. DE R.L. DE C.V. established.
2018	[USA] AGC acquires the electronics business of US-based Park Electrochemical [USA] AGC Biologics, consolidated and integrated management for bioscience business.
2019	[USA] AGC acquires global operations of the Advanced Dielectric Division of US based Taconic
2020	[USA] AGC Acquires Biopharmaceutical Commercial Facility in Colorado, U.S.A.

*This list shows AGC's first entry into the region.



Your Dreams, Our Challenge

AGC Inc.

Shin-Marunouchi Building, 1-5-1,
Marunouchi, Chiyoda-ku, Tokyo

www.agc.com