

OTHER QUALITY PRODUCTS FROM MICROJET®:

FULL FLOW® Compression Fittings

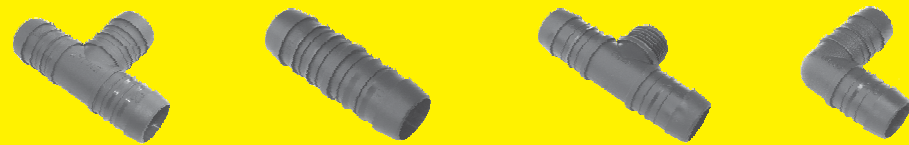

EMJAY® Black Insert Fittings



EMJAY® Poly Threaded Fittings



MICROJET® Jets, Stakes & Accessories



SNAP-ON® Hose Fittings



Microjet Irrigation Systems
P.O. Box 279, Eppindust, 7475
South Africa
Tel: +27 21 535 1310
info@microjet.co.za
www.microjet.co.za

Microjet, Full Flow, Emjay, Snap-on are all registered trademarks
© Microjet Irrigation 2019



EMJAY®

MANIFOLD SYSTEM

By MICROJET®



STRONG, VERSATILE, EASY

WWW.MICROJET.CO.ZA



EMJAY[®] IRRIGATION MANIFOLD

BY MICROJET[®]

The Emjay[®] Manifold is a strong, versatile and easy to use manifold system for irrigation valves.

- It can be used in manual or automatic systems with either manual or electric solenoid valves.
- The unique clip-together system is easy to use, extendable and needs no tools.
- This versatile system has a large range of fittings which allow for numerous configurations and setups.
- It is robust and durable having been extensively tested at 230psi with over 40,000 test cycles completed
- Rated at a **maximum operating pressure of 200psi (14 Bar)**.

How Does it Work?

Emjay[®] Manifold Fittings are assembled by simply inserting the coupling between two fittings, pressing the fittings together and sliding the locking clips over the ends. Each join requires two clips and a coupling, except the inlet and endcap which have built in couplings.

Emjay[®] Manifold Union Fittings have a special BSP/ ACME Nipple for attaching electric valves. The BSP side is screwed tightly against the o'ring which seals against the edge of the valve. The ACME side is tightened against the manifold body which seals against manifold body o'ring.



By using Crosses, Tees, Elbows, Endcaps and Inlets, numerous different configurations of valves are possible. From 2 stations to 20 or more.



The Emjay[®] Manifold can be installed under ground in a valve box, using the standard locking clips or it can be mounted on the wall using the specially designed wall mount clips. The Wall Mount Clips have pre-drilled mounting holes and are designed to keep the manifold far enough away from the wall to allow access to the nut to connect the valves while in place. It is, however, recommended that the manifold is first mounted onto a board or similar rigid material to ensure that it is mounted flat.

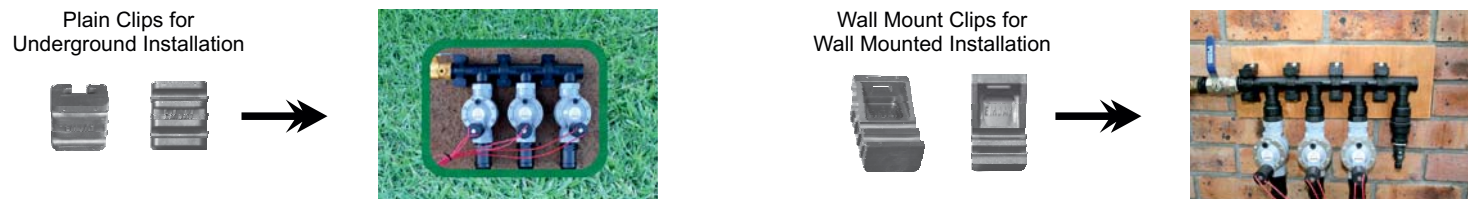

Emjay Manifold System Schematic Drawings

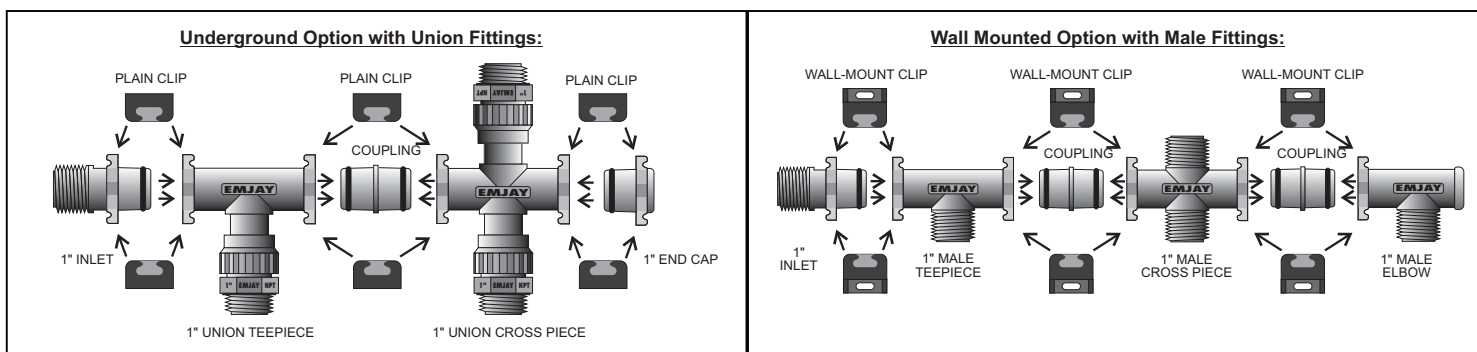

The Range

1. The Male Fittings:

- for direct attachment of female BSP threaded valves or fittings

The Male Manifold Fittings have an accurately tapered male BSP thread which can be screwed directly into the female threaded valve or female threaded fittings such as sockets or bushes. Thread tape should be used as the seal is made on the thread. The Male Tees and Crosspieces are symmetrical which allows for a half turn when tightening valves.

The following Male Manifold Fittings are available:

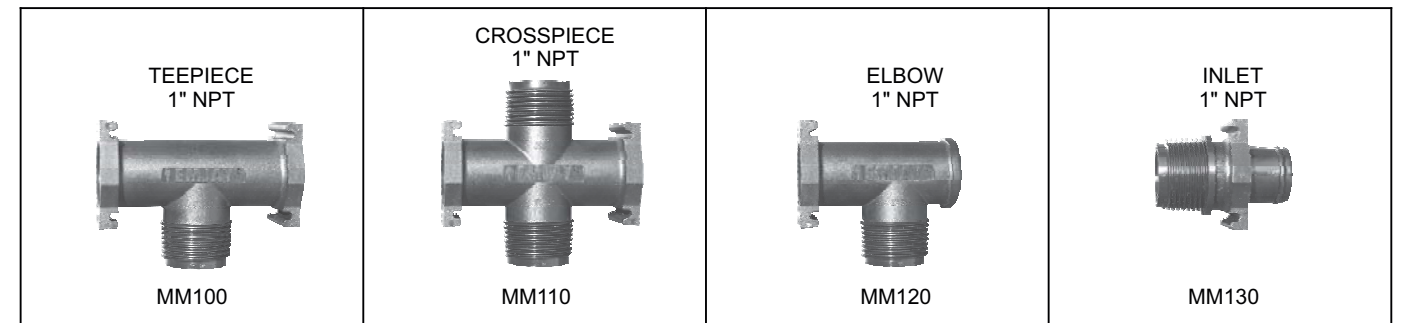

2. The Union Fittings:

- with specially designed BSP/ACME nipple for attachment to female BSP threaded valves or fittings.

The Union Manifold Fittings have a nut and separate nipple in place of the male thread. This enables the user to remove a valve from the manifold by unscrewing the nipple and taking the valve out without disassembling the manifold itself. This is particularly useful in valve boxes or installations where space is tight. The Union fittings have o'rings on the sealing faces of the fittings and the nipple to ensure a leak-proof seal without stressing the female thread of the valve by over tightening. All Union Fittings are supplied complete with the specially designed Manifold Nipple. This nipple has a 1" Male BSP thread on the valve side and a 1" ACME thread on the manifold side. To ensure a leak-proof seal, only this nipple can be used with the Emjay Manifold Union Fittings.

The following Union Manifold Fittings are available:

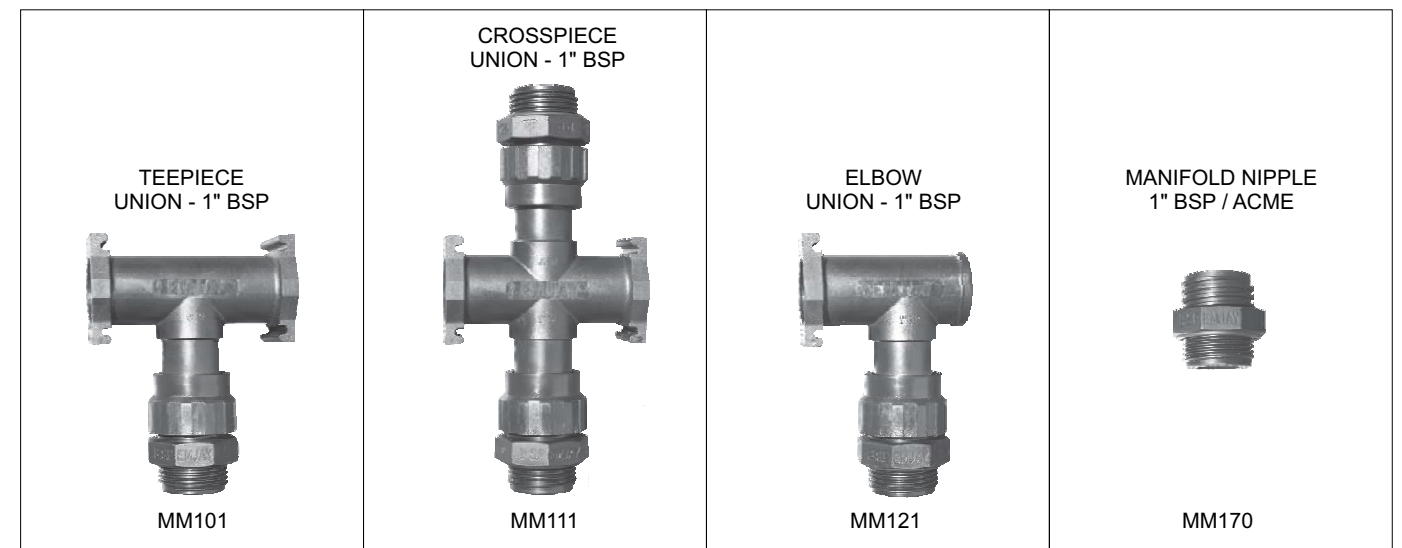

3. The Extra Bits:





- To keep it all together

Two clips and a coupling are needed on each join except for the inlet and end cap which have built-in couplings. An end cap is ideal if the manifold is made up of crosses or tees and no elbow as it closes the end of the line. The valve adaptor is a union fitting to which enables the valve to be removed without affecting the downstream piping.

The following Extra Bits are available:

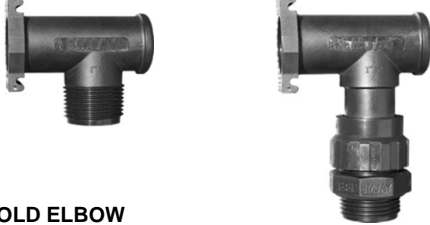



DESCRIPTION	CODE	SIZE	PACK
 <p>MANIFOLD TEE PIECE</p>	MM 100	MALE 1" BSP	20
	MM 101	UNION -1" BSP incl. manifold nipple	20
 <p>MANIFOLD CROSS PIECE</p>	MM 110	MALE 1" BSP	20
	MM 111	UNION -1" BSP incl. manifold nipple	20
 <p>MANIFOLD ELBOW</p>	MM 120	MALE 1" BSP	20
	MM 121	UNION -1" BSP incl. manifold nipple	20
<p>MANIFOLD INLET (MALE - No Coupling Required)</p> 	MM 130	1" BSP - MALE	20
<p>MANIFOLD END CAP (MALE - No Coupling Required)</p> 	MM 140		20
<p>MANIFOLD COUPLING</p> 	MM 150		20
<p>MANIFOLD CLIP</p> 	MM 160	Plain Clip	20
	MM 161	Wall Mount Clip	20
<p>MANIFOLD NIPPLE</p> 	MM 170	1" BSP / ACME	20
<p>MANIFOLD VALVE ADAPTOR</p> 	MM 180	UNION - 1" BSP	20