



BÜROARTIKEL
STATIONERIES

ALCO-Albert GmbH & Co. KG



IHRE ANSPRECHPARTNER IN UNSEREM UNTERNEHMEN

YOUR CONTACT PERSONS IN OUR COMPANY

Zentrale | *General Office*

ALCO-Albert GmbH & Co. KG
T: +49 2932 9748-0 mail@alco-albert.de
F: +49 2932 9748-8800

Verkauf Inland | *National Sales Department*

Ingrid Kaldewey T: +49 2932 974814 kaldewey@alco-albert.de
Stefanie Voss T: +49 2932 974815 voss@alco-albert.de
Silke Wedekind T: +49 2932 974816 wedekind@alco-albert.de

Export | *International Sales Department*

Ingrid Kaldewey T: +49 2932 974814 kaldewey@alco-albert.de
Beate Hecker T: +49 2932 974823 hecker@alco-albert.de

Versand | *Dispatch Department*

Nicole Dumkow T: +49 2932 974813 dumkow@alco-albert.de

Buchhaltung | *Sales Department*

Gerda Lieder T: +49 2932 974812 lieder@alco-albert.de

UNSERE VERTRETUNGEN

Die Kontaktdaten unserer Vertretungen im In- und Ausland finden Sie auf unserer Internetseite www.alco-albert.de

You can find the contact data of our national and international agents on our homepage www.alco-albert.de .



FIXIEREN • HEFTEN • VERBINDEN <i>FIXING • STAPLING • CONNECTING</i>	SEITE <i>PAGE</i>
Reißnägeln / <i>Drawing Pins</i>	4
Pinwandnadeln / <i>Push Pins</i>	4
Hefklammern / <i>Staples</i>	5
Klammerentferner / <i>Staple Remover</i>	6
Briefklammern / <i>Paper Clips</i>	6-8
NORICA	7
Power Clipper / <i>Power Clipper</i>	8
Eckenklammern / <i>Corner Clips</i>	9
Foldback- Klammern / <i>Foldback- Clips</i>	10
Briefklemmer / <i>Metal Pegs</i>	10
Musterbeutelklammern / <i>Paper Fasteners</i>	11
Flachkopfkammern / <i>Paper Fasteners with flat head</i>	11
Bilderhaken / <i>Picture hooks</i>	12
SB- UND GROSSVERBRAUCHER SORTIMENT <i>SELF SERVICE AND BULK CONSUMER RANGE</i>	SEITE <i>PAGE</i>
Büroartikel in Weichplastikdosen / <i>Stationary Articles in Soft Plastic Jar</i>	14-15
Büroartikel für Großverbraucher / <i>Stationery Articles for Bulk Burchaser</i>	16-17
SB-Sortiment / <i>Self-Service Sortiment</i>	18-25
Sortimentsdose / <i>Tidy Box</i>	26
Magnetdosen für Briefklammern / <i>Magnetic Clip Dispenser</i>	26
KONFERENZ • SCHULUNG • PLANUNG <i>MEETING • PRESENTATION • PLANNING</i>	SEITE <i>PAGE</i>
Hakenmagnete / <i>Magnets with a hook</i>	28
Superkraftmagnete Neodym / <i>Neodym Super Power Magnets</i>	29
Magnete / <i>Magnets</i>	29
Wandleisten / <i>Wall Strips</i>	30
Metallhaftband / <i>Flexible Wall Strips</i>	31
Magnetische Wandschienen / <i>Magnetic Racks</i>	31
Glaskopfstecknadel / <i>Corsage Pins</i>	32
Landkartennadeln / <i>Map Pins</i>	32-33
Markierfähnchen / <i>Flag Pins</i>	33
ALCOfix Haftmarker / <i>ALCOfix Page Marker Tabs</i>	34-35
SCHNEIDEGERÄTE • ZEICHENGERÄTE <i>CUTTING EQUIPMENT • DRAWING INSTRUMENTS</i>	SEITE <i>PAGE</i>
Scheren / <i>Scissors</i>	37-39
Messer / <i>Knives</i>	39
Cutter Messer / <i>Cutter Knives</i>	40-41
Lineale, Geometrie Dreiecke / <i>Ruler, Set Squares</i>	42-43
Kurvenlineale / <i>Flexible Curves</i>	42

Zirkel / <i>Compasses</i>	44-45
Schneidematten und Zubehör / <i>Cutting Mats and Accessories</i>	46
Schneidelineale / <i>Cutting Ruler</i>	46
Rollmesser / <i>Rotary Cutter</i>	46

VERSENDEN • VERPACKEN <i>MAILING SUPPLIES</i>	SEITE <i>PAGE</i>
---	-----------------------------

Packbandabroller / <i>Packaging Tape Dispenser</i>	48
Klebeband Tischabroller / <i>Tape Dispenser</i>	49
Gummiringe / <i>Rubber Bands</i>	50
Gummibänder / <i>Elastics</i>	51
Kreuzbänder / <i>Cross Bands</i>	52
Verschlussringe / <i>Hook Bands</i>	52
Anfeuchter / <i>Sponge Damper</i>	52
Blattwender / <i>Finger Cones</i>	52

GELDKASSETTEN SCHLÜSSELSCHRÄNKE • ZUBEHÖR <i>CASH BOXES • KEY CABINETS • ACCESSORIES</i>	SEITE <i>PAGE</i>
--	-----------------------------

Geldkassetten / <i>Cash Boxes</i>	54-56
Münzzählbrett / <i>Coin Counter Tray</i>	56
Geldscheinprüfgerät / <i>Money Detector</i>	57
Schlüsselschränke / <i>Key Cabinets</i>	57-58
Schlüsselkassetten / <i>Key Boxes</i>	58
Schlüsselringe / <i>Key Rings</i>	59
Schlüsselanhänger / <i>Key Hangers</i>	59

SCHREIBTISCH ACCESSOIRES <i>DESK ACCESSORIES</i>	SEITE <i>PAGE</i>
--	-----------------------------

Schreibtisch- Accessoires aus Acryl und Kunststoff / <i>Acrylic and Plastic Desc Accessories</i>	61-63
Zettelspießer / <i>Spike File</i>	64
Buchstützen / <i>Book Stands</i>	64
Schreibtisch- Butler / <i>Desk Tidy</i>	65
Multi Locher / <i>Slim Hole Punch</i>	66
Bleistiftspitzer / <i>Pencil Sharpener</i>	66-68
Kugelschreiberständer / <i>Counter Top Pen</i>	69-70
Brieföffner / <i>Letter Opener</i>	71-72
Klemmbretter / <i>Clipboards</i>	73-75
Klemm- Mappen / <i>Foldover Clipboards</i>	75
Schreibunterlagen / <i>Desk Mats</i>	76
Arbeits- und Bastelunterlagen / <i>Working- and Handicraft Mats</i>	76

LESEGLÄSER <i>READING MAGNIFIERS</i>	SEITE <i>PAGE</i>
--	-----------------------------

Leselupen / <i>Magnifiers</i>	78
Leselupen- Set / <i>Set of Magnifiers</i>	78
Leselupe mit LED- Lampen / <i>Magnifier with LED- Light</i>	79
Rundleuchte, beleuchtet / <i>Round illuminated Magnifier</i>	79
Standlupe / <i>Cylinder Magnifier</i>	79
Rundlupe, beleuchtet zum Anklemmen / <i>Round illuminated Magnifier with Clamp</i>	80

FIXIEREN HEFTEN VERBINDEN

FIXING | STAPLING | CONNECTING



ALCO Reißnägel

Drawing Pins

doppelt vernietet, vermessingt,
 Kopf-Ø 9 mm

*double riveted, brass plated,
 head-Ø 9 mm*

#				
110	N	100	25	
110-750	N	750	1	
112	P	100	50	
115	N	1000	1	



SUN Reißnägel

Drawing Pins

plastiküberzogen, weiß, farbig oder bunt
 gemischt, Kopf-Ø 9,5 mm

*plastic covered, white, in single- or mixed
 colours, head-Ø 9,5 mm*

#				
		10, 11, 12, 13, 14, 15, 16, 17, 18, 19, 20, 26		
151	P	100	25	



GARANT Reißnägel

Drawing Pins

metallüberkapselt, vermessingt,
 Kopf-Ø 9,5 mm

*metal covered, brass plated,
 head-Ø 9,5 mm*

#				
131	F	100	25	
132	P	100	50	



Dreizackstifte

Pins with 3 Shanks

gehärtet, mit 3 Spitzen, plus Heber,
 vernickelt, Kopf-Ø 12 mm)

*hardened with 3 points, nickel plated, with
 1 remover, head-Ø 12 mm*

#				
518	P	100	10	
519	P	50	10	



Pinwandnadeln, Holz

Push Pins, wood

mit Stahlspitze

with steel point

#				
668	P	20	10	
669	P	100	1	



Posternägel

Super Tacks

mit farbigen Kunststoffköpfen
 Kopf-Ø 20 mm, Kopf-Ø 30 mm

*with coloured plastic heads
 Ø 20 mm, Ø 30 mm*

		10, 11, 12, 13, 14, 15, 17, 18, 19, 20, 21, 26		

#				
158	P	10	25	
159	P	10	50	



Stoßnadeln

Special Push Pins

mit geschliffener und gehärteter
 Stahlspitze und Plastikschaft

*with ground and hardened points and plastic
 shaft*

		10, 11, 12, 13, 15, 18, 22, 26, 29		

#				
650	P	50	10	
651	P	25	10	



Pinwandnadeln

Push Pins

einzelfarbig oder bunt gemischt
 in single- or mixed colours

		10, 11, 12, 13, 15, 18, 19, 22, 26		

#				
660	P	20	10	
662	P	40	10	
663	P	100	10	
673	P	200	5	



Heftklammern
Staples

#				
505	verzinkt, Größe 24/6 <i>zinc coated, size 24/6</i>	N	1000	10
515	verzinkt, Größe Nr. 10 <i>zinc coated, size No. 10</i>	N	1000	10
506	verkupfert, Größe 24/6 <i>copper coated, size 24/6</i>	N	1000	10
507	verzinkt, Größe 26/6 <i>zinc coated, size 26/6</i>	N	1000	10 10
508	verzinkt, Größe 6/4 <i>zinc coated, size 6/4</i>	N	2000	10
5106	verzinkt, Größe 23/6 <i>zinc coated, size 23/6</i>	N	1000	10
5108	verzinkt, Größe 23/8 <i>zinc coated, size 23/8</i>	N	1000	10
5110	verzinkt, Größe 23/10 <i>zinc coated, size 23/10</i>	N	1000	10
5113	verzinkt, Größe 23/13 <i>zinc coated, size 23/13</i>	N	1000	10
5115	verzinkt, Größe 23/15 <i>zinc coated, size 23/15</i>	N	1000	10
5117	verzinkt, Größe 23/17 <i>zinc coated, size 23/17</i>	N	1000	10
5120	verzinkt, Größe 23/20 <i>zinc coated, size 23/20</i>	N	1000	10
5123	verzinkt, Größe 23/23 <i>zinc coated, size 23/23</i>	N	1000	10



Klammerentferner

Staple Remover

Klammerentferner Zange, verchromt, für alle Klammergrößen

Staple Remover, chrome, for all staple sizes



6005 N 1 12



Briefklammern, farbig lackiert

Paper Clips, lacquered

eckige Form, 26 mm

angular shape, 26 mm



10, 11, 12, 13, 15, 18, 26, 29



456 P 100 10

458 P 500 1

459 P 1000 1



Klammerentferner Kralle

Staple Extractor

Klammerentferner Kralle, Schwarz, für alle Klammergrößen

Staple Extractor, black, for all staple sizes



6009 N 1 24



Briefklammern, kunststoffüberzogen

Paper Clips, plastic covered

runde Form, 26 mm

round shape, 26 mm



10, 11, 12, 13, 15, 16, 18, 19, 20, 26, 29



256 P 100 10

259 P 1000 1

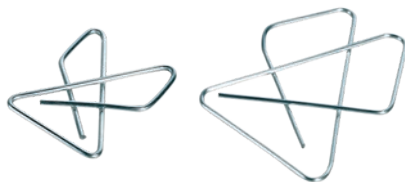

Kreuzklammern

Butterfly Clips

verzinkt

zinc coated



280 P 50 1

Größe 2 /size 2 : 40 x 50 mm

290 P 50 1

Größe 3 /size 3: 45 x 60 mm



Briefklammern, kunststoffüberzogen

Paper Clips, plastic covered

runde Form, 32 mm

round shape, 32 mm



10, 11, 12, 13, 15, 18, 26



243 P 100 10

244 P 1000 10

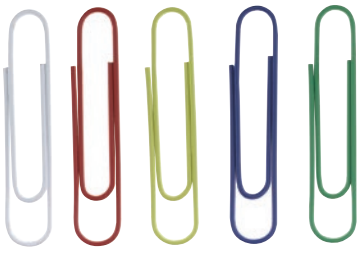

**Aktenklammern,
kunststoffüberzogen**

Paper Clips, plastic covered

50 mm



10, 12, 13, 15, 18, 26



242

P

100

1



Briefklammern „Zebra“

kunststoffüberzogen,
gestreifte Farben 28 mm

plastic covered,
in striped colours 28 mm



2256

P

100

10

2257

P

300

10

2259

P

1000

1

kunststoffüberzogen,
gestreifte Farben 50 mm

plastic covered,
in striped colours 50 mm



2242

P

100

1



- 11 weiß-schwarz/
white-black
- 12 weiß-rot/
white-red
- 13 gelb-schwarz/
yellow-black
- 14 weiß-blau/
white-blue
- 17 gelb-grün/
yellow-green
- 18 weiß-mint/
white-mint
- 19 gelb-orange/
yellow-orange
- 26 gemischt/
mixed colours

NORICA



NORICA Büroklammern

NORICA Paperclip

Die Büroklammern mit dem Kugelende. Zerreit kein Papier und besteht aus vorzglich federndem Material. Sie ist strker als eine handelsbliche Broklammer und hlt Schriftstcke fest zusammen. Sie ist galvanisch behandelt und hinterlsst keine Schmutzrnder und rostet nicht.

The paperclip with balls. It doesn't tear your paper sheets. Out of excellent resilient material. NORICA is stronger than any commercial paper clip. It's zinc plated and rustproof.



2215

N

100

10

24 mm

N

100

10

2210

N

1000

20

24 mm

2225

N

100

10

32 mm

2220

N

1000

25

32 mm

2260

N

100

10

50 mm, glatt

2261

N

100

10

50 mm, gewellt

2262

N

100

10

77 mm, gewellt

2265

N

1000

10

50 mm, glatt

2266

N

1000

10

50 mm, gewellt

2215A

SB

75

10

24 mm

2225A

SB

50

10

32 mm





Aktenklammern, verzinkt

Paper Clips, zinc coated

#	Icon 1	Icon 2	Icon 3
260	N	100	10
50 mm, glatt/smooth			
261	N	100	10
50 mm, gewellt/wavy			
262	N	100	10
77 mm, gewellt/wavy			



Briefklammern, verzinkt

Paper Clips, zinc coated

eckige Form

angular shape

#	Icon 1	Icon 2	Icon 3
200	N	1000	1
21 mm			
205	N	100	20
21 mm			
210	N	1000	1
26 mm			
215	N	100	20
26 mm			
220	N	1000	1
32 mm			
225	N	100	20
32 mm			

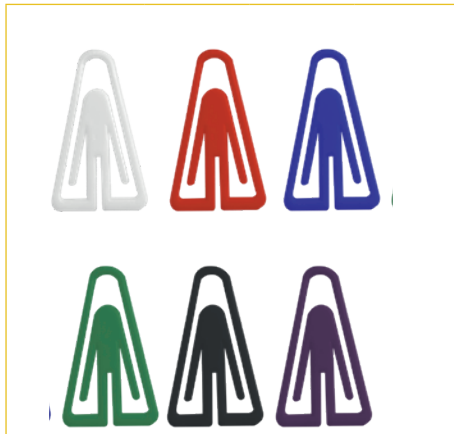

Briefklammern, Plastik

Paper Clips, plastic

#	Icon 1	Icon 2	Icon 3
		10, 11, 12, 13, 15, 18, 26	
213	P	100	10
26 mm dreieckige Form/triangular shape			
211	P	1000	1
26 mm dreieckige Form/triangular shape			

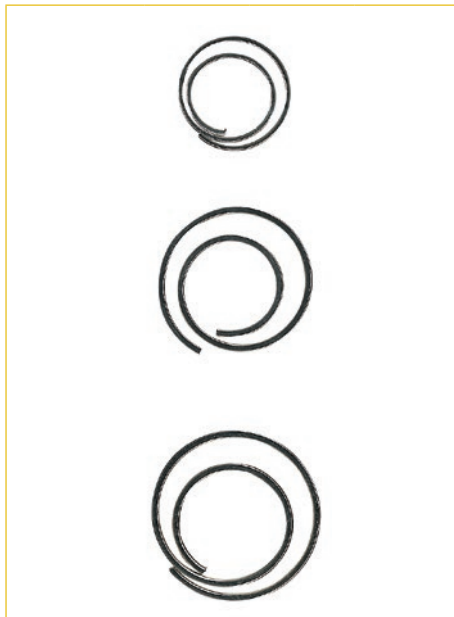

Büroklammer „CIRCULAR“

Paper Clip „CIRCULAR“

spiralförmige Büroklammer, glanzverzinkt

spiral Paper Clip, nickel plated

#	Icon 1	Icon 2	Icon 3
270	P	50	1
Ø 20 mm			
271	P	25	1
Ø 25 mm			
272	P	25	1
Ø 30 mm			

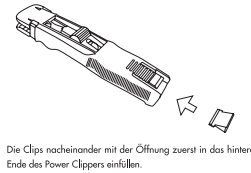

Die Clips nacheinander mit der Öffnung zuerst in das hintere Ende des Power Clippers einfüllen.

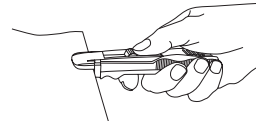

Schieben Sie die Öffnung des Power Clippers an den Rand des Papierstapels und drücken dann den Schieber nach vorn, um den Clip über das Papier zu schieben.



Power Clipper groß

Power Clipper large

Magazin für 8 Klammern, umfasst ca. 60 Blatt

magazin for 8 clips, enfolded about 60 sheets

#	Icon 1	Icon 2	Icon 3
363	E	1	10

Klammern für Power Clipper Art. Nr. 363, Federstahl, rostfrei

Clips for Power Clipper Art. No. 363, spring steel, rustproof

364	P	25	50
------------	---	----	----

Power Clipper klein

Power Clipper small

Magazin für 8 Klammern, umfasst ca. 20 Blatt

magazin for 8 clips, enfolded about 20 sheets

#	Icon 1	Icon 2	Icon 3
263	E	1	10

Klammern für Power Clipper Art. Nr. 263, Federstahl, rostfrei

Clips for Power Clipper Art. No. 263, spring steel, rustproof

264	P	25	50
------------	---	----	----



Eckenklammern Eisen

Corner Clips, steel

blank poliert
polished



521	P	100	10
520	P	1000	1

vermessingt, *brass plated*

531	P	100	10
530	P	1000	1



Mini-Wäscheklammern

Mini Pegs

aus Kunststoff, 32 mm

plastic, 32 mm



265	P	10	10
------------	---	----	----



Klammern für Glückwunschkarten

Mini Pegs for Greeting Cards

Metallfarben, 25 mm

metallic colours, 25 mm



268	P	20	10
269	P	100	1



Eckenklammern Alu

Corner Clips, aluminium

einseitig lackiert
one-side lacquered



541	P	100	10
540	P	1000	1



Briefklemmer

Metal Pegs

aus Metall, farbig lackiert und vernickelt
lacquered and nickel plated



770S	Breite 75 mm, Klemmweite 25 mm <i>breadth 75 mm, width of clamp 25 mm</i>	N	10	1
-------------	--	---	----	---

771 S	Breite 100 mm, Klemmweite 30 mm <i>breadth 100 mm, width of clamp 30 mm</i>	N	10	1
--------------	--	---	----	---

772 S	Breite 125 mm, Klemmweite 40 mm <i>breadth 125 mm, width of clamp 40 mm</i>	N	10	1
--------------	--	---	----	---

773 S	Breite 150 mm, Klemmweite 45 mm <i>breadth 150 mm, width of clamp 45 mm</i>	N	10	1
--------------	--	---	----	---



Büroklammer „EULE“

Paper Clip „OWL“

vernickelte Büroklammer, hält sicher und zerreißt kein Papier mehr

nickel plated, formed like an owl



2275	Gr. 3-22 mm	P	100	1
-------------	-------------	---	-----	---

2295	Gr. 4-27 mm	P	100	1
-------------	-------------	---	-----	---



Foldback-Klammer Sortiment

Assortment of Foldback-Clips

#				
---	--	--	--	--

778

schwarz, in praktischer Tischdose, bestehend aus
black, in a PVC-box, contents:

11	P	27	1
----	---	----	---

10 x 19 mm, 10 x 25 mm,
 5 x 32 mm, 2 x 41 mm

779

farbig gemischt, in praktischer Tischdose:
mixed colours, in practical PVC-box:

26	P	60	1
----	---	----	---

60 x 15 mm

787

schwarz/farbig gemischt,
 in praktischer Tischdose, bestehend aus:
black and mixed colours, in a PVC-box, contents:

26	P	42	1
----	---	----	---

20 x 19 mm,
 farbig gemischt/*mixed colours*
 15 x 25 mm, 5 x 32 mm, 2 x 41 mm
 schwarz/*black*



Foldback-Klammern

Foldback-Clips

mit vernickeltem Bügel und starker Feder,
 schwarz oder farbig

*with nickel plated legs and strong spring,
 black or coloured*

10, 11, 12, 13, 15, 18, 26

+27 780, 781

#			
---	--	--	--

780 S

15 mm	N	12	1
-------	---	----	---

781 S

19 mm	N	12	1
-------	---	----	---

782 S

25 mm	N	12	1
-------	---	----	---

783 S

32 mm	N	12	1
-------	---	----	---

784 S

41 mm	N	12	1
-------	---	----	---

785 S

51 mm	N	12	1
-------	---	----	---



Foldback-Klammer Spender

Magnetic Dispenser with Foldback Clips

Magnetdose mit blauem, grünem oder pinkfarbenem Deckel. Inhalt:
 12 Stk. Klammern 15 mm + 6 Stk. Klammern 19 mm, in 2 getrennten Kammern, bunt ge-
 mischt in Neon-Trendfarben. Lieferung farblich sortiert in Weichplastik-Schachtel.

*With coloured cap, filled with foldback clips as follow:
 12 pcs. 15 mm + 6 pcs. 19 mm, in two different compartments, mixed colours.
 Delivery in assorted colours in soft plastic box.*

#			
---	--	--	--

2222-26

E	1	10
---	---	----



Musterbeutelklammern

Paper Fasteners

Rundkopf, vermessingt, runde Schenkel
round shape, brass plated, round shanks

#							
310							
	1	12 mm	7 mm	P	1000	1	
311							
	1	12 mm	7 mm	P	100	10	
320							
	2	15 mm	7 mm	P	1000	1	
321							
	2	15 mm	7 mm	P	100	10	
330							
	3	17 mm	7 mm	P	1000	1	
331							
	3	17 mm	7 mm	P	100	10	
340							
	4	23 mm	7 mm	P	1000	1	
341							
	4	23 mm	7 mm	P	100	10	
350							
	5	25 mm	5 mm	N	1000	1	
351							
	5	25 mm	5 mm	N	100	10	
360							
	5	30 mm	6 mm	N	1000	1	
361							
	5	30 mm	6 mm	N	100	10	
370							
	7	34 mm		N	1000	1	
371							
	7	34 mm		N	100	10	



Flachkopfklammern

Paper Fasteners with flat head

vermessingt oder eisenblank
brass plated or polished steel

Größe Nr./size No.: 13

Länge/length: 16 mm

Kopf/width: 4

#			
590/4	P	1000	1
590/41	P	100	10



Flachkopfklammern

Paper Fasteners with flat head

vermessingt, starke Ausführung
brass plated, strong type

Größe Nr./size No.: 13

Länge/length: 19 mm

Kopf/width: 4

#			
590/6	P	1000	1
590/61	P	100	10



Briefknöpfe
Plastic Paper Fasteners

aus Kunststoff, zum Verschließen von Briefbögen, Musterbeuteln und zum Basteln, Länge 50 mm

for closing envelopes, plastic, total length 50 mm

10, 11, 12, 13, 15, 20, 26

597	P	1000	10
598	P	100	1



Etiketten-Anhänge-Schlaufen
Label Hangers

oval, 1,4 x 35 mm
 oval, 1,4 x 35 mm

496	N	100	10
------------	---	-----	----



Stahlnadeln für Bilderhaken
Steel Nails

vermessingt, ohne Kapselkopf, Kopf-Ø 1,4 x 25 mm

brass plated, for picture Hooks, head-Ø 1,4 x 25 mm

557	N	100	10
558	N	1000	1



Bilderhaken
Picture Hooks

vermessingt, mit Stahlnadeln

brass plated, with steel nails

550	Größe 0 / size 0		
	P	10	10
551	Größe 1 / size 1		
	P	10	10
552	Größe 2 / size 2		
	P	10	10
553	Größe 3 / size 3		
	P	10	10
554	Größe 4 / size 4		
	P	10	10
555	Sortiment / assortment		
	P	10	10



Dekorationsstecknadeln
Decoration Pins

10, 11

630	Nr./No 105: 30 mm		
	N	500 g	1
635	Nr./No 105: 30 mm		
	N	100 g	10
640	Nr./No 109: 38 mm		
	N	500 g	1
645	Nr./No 109: 38 mm		
	N	100 g	10

SB- UND GROSSVERBRAUCHER SORTIMENT

SELF SERVICE AND BULK CONSUMER RANGE

Weichplastikdose
Soft Plastik Jar

 mit Schraubverschluß, große Öffnung zur leichten Entnahme, gefüllt mit
screw cap, large opening for easy handling, filled with:

 Optische Abweichungen zur Abbildung möglich.
 Optical deviations to the illustration possible.

Wäscheklammern Mini Pegs

680B

 32 mm, verschiedene Farben gemischt
32 mm, mixed colours

26 P 85 20

680K

 32 mm, verschiedene Farben gemischt
32 mm, mixed colours

26 P 60 20

Gummiringe Rubber Bands
267B

 60 mm, verschiedene Farben gemischt
60 mm, mixed colours

26 P 100 g 20

Pinwandnadeln Push Pins
673B26

 verschiedene Farben gemischt
mixed colours

26 P 200 20

Reißnägel Drawing Pins
136B

 GARANT, metallüberzogen, vermessingt
GARANT, metal covered, brass plated

P 750 20

Reißnägel SUN Drawing Pins SUN
156B26

 lackiert, versch. Farben gemischt
lacquered, mixed colours

26 P 750 20

156B10

 lackiert, weiß
lacquered, white

10 P 750 20

Briefklammern Paper Clips
458B26

 26 mm, lackiert, versch. Farben gemischt
26 mm, lacquered, mixed colours

26 P 500 20

Briefklammern „Zebra“ Paper Clips „Zebra“
2257B

 gestreifte Farben, versch. Farben gemischt
in striped colours, mixed colours

26 P 400 20

Briefklammern Paper Clips
219B

 26 mm, verzinkt
26 mm, zinc plated

P 500 20

Aktenklammern „Zebra“ Paper Clips „Zebra“
2242B26

 50 mm, plastiküberzogen, gestreift, glatt, verschiedene Farben gemischt
50 mm, plastic covered, striped, smooth mixed colours

26 P 125 20

Aktenklammern Paper Clips
242B26

 50 mm, lackiert, glatt, verschiedene Farben gemischt
50 mm, lacquered, smooth, mixed colours

26 P 125 20

Weichplastikdose

Soft Plastik Jar

mit Schraubverschluss, große Öffnung zur leichten Entnahme, gefüllt mit
screw cap, large opening for easy handling, filled with:

Musterbeutelklammern *Paper Fasteners*

#				
---	--	--	--	--

333B

Größe 3, vermessing <i>size 3, brass plated</i>	P	500	20
--	---	-----	----

Schlüsselringe *Key Rings*

1751B

aus flexiblem Kunststoff, verschiedene Farben gemischt <i>made of soft plastic, mixed colours</i>	26	P	50	20
--	----	---	----	----

Schlüsselanhänger *Key Hangers*

1851B

aus flexiblem Kunststoff, verschiedene Farben gemischt <i>made of soft plastic, mixed colours</i>	26	P	15	20
--	----	---	----	----

Foldback-Klammern *Foldback-Clips*

781B26

19 mm, verschiedene Farben gemischt <i>19 mm, mixed colours</i>	26	P	35	20
--	----	---	----	----



ALCO - Spezial

Pinwandnadeln *Push Pins*

6600-26

150 Stk., bunt gemischt in Neon-Trendfarben. Bauchdose mit Farbdeckel. <i>150 pcs., NEON-coloured, screw plug box with coloured cap.</i>	26	E	1	12
--	----	---	---	----

Briefklammern *Paper Clips*

2430-26

200 Stk., 26 mm, rund, kunststoffüberzogen, bunt gemischt in Neon-Trendfarben. Bauchdose mit Farbdeckel. <i>200 pcs., 26 mm, round, vinyl covered, NEON-coloured, screw plug box with coloured cap.</i>	26	E	1	12
---	----	---	---	----

Foldback-Klammern *Foldback Clips*

7810-26

25 Stk., 19 mm, bunt gemischt in Neon-Trendfarben. Bauchdose mit Farbdeckel. <i>25 pcs., 19 mm, NEON-coloured, screw plug box with coloured cap.</i>	26	E	1	12
--	----	---	---	----





Reißnägel GARANT

Drawing Pins GARANT

vermessingt

metal covered, brass plated



136G

Ø 9,5 mm P 750 10

Reißnägel SUN

Drawing Pins SUN

plastiküberzogen, weiß

plastic covered, white



156G10

Ø 9,5 mm 10 P 750 10

Reißnägel SUN

Drawing Pins SUN

plastiküberzogen gemischt

plastic covered, mixed colours



156G26

Ø 9,5 mm 26 P 750 10

Schlüsselanhänger

Key Hangers

gemischt, mit beschreibbarem Etikett

with inscribable and changeable label, mixed colours



1851G

26 P 15 10

Briefklammern, eckig

Paper Clips, angular shape

verzinkt

nickel plated



210G

26 mm P 1.500 10

Briefklammern NORICA

Paper Clips NORICA

mit Kugelenden, verzinkt

with balls, zinc plated, rustproof



2210G

24 mm P 400 10

Briefklammern NORICA

Paper Clips NORICA

mit Kugelenden, verzinkt

with balls, zinc plated, rustproof



2220G

32 mm 26 P 300 20

Aktenklammern

Paper Clips

kunststoffüberzogen, bunt

plastic covered, mixed colours



242G26

50 mm 26 P 100 20

Aktenklammern, eckig

Paper Clips, angular shape

verzinkt

nickel plated



261G

50 mm 26 P 125 20



Briefklammern

Paper Clips

lackiert, gemischt, eckige Form

lacquered, mixed colours, angular shape



458G26

26 mm 26 P 500 10

Briefklammern

Paper Clips

vermessingt, eckige Form

brass plated, angular shape



458G28

26 mm P 500 10

Musterbeutelklammern

Paper Fasteners

vermessingt, Nr. 3

brass plated, round shanks, No. 3



333G

17 mm P 500 10

Landkartenandeln

Map Pins

farbig gemischt, Kopf Ø 5 mm x 16 mm

mixed colours, head Ø 5 mm x 16 mm



626G

26 P 750 10

Pinwandnadeln

Push Pins

farbig gemischt

mixed colours



673G

26 P 200 10

Flachkopfklammern

Paper Fasteners with flat head

vermessingt, Länge 16 mm, starke Ausführung

brass plated, 16 mm



594G

16 mm P 300 10

Aktenklammern, gewellt

Paper Clips, wavy

vernickelt

nickel plated



262G

77 mm 26 P 50 20

Gummiringe

Rubber Bands

bunt gemischt, verschiedene Größen

mixed colours, different sizes



267G

26 P 100 g 20

Foldback-Klammern, sortiert

Foldback Clips, sorted

4 x 781-26, 4 x 782-26, 4 x 784-26

4 x 781-26, 4 x 782-26, 4 x 784-26



781G26

26 P 12 10



SB-Aufsteller

Self-Service-Stand



1545 L

Metall, blau lackiert, nicht bestückt
plastic covered metal, blue colour, empty

15 N 1 1

1546

Metall, blau lackiert, bestückt mit je 10 Dosen von 12 Artikeln (=120 Dosen), bestückt nach Wunsch

plastic covered metal, blue colour, filled with 12 different articles, 10 boxes each (= 120 boxes), filled as required

15 N 120 1

#				
Dreizackstifte <i>Pins with 3 shanks</i>				
518A				
	vernickelt, mit 3 Spitzen <i>nickel plated with 3 points</i>		SB	25 10
Posternägel <i>Super Tacks</i>				
	mit farbigen Kunststoffköpfen <i>with coloured plastic heads</i>		SB	25 10
158A26				
	Ø 20 mm	26	SB	4 10
159A26				
	Ø 30 mm	26	SB	4 10
Reißnägel <i>Drawing Pins</i>				
114A				
	ALCO doppelt vernietet, vermessingt <i>ALCO double riveted, brass plated</i>		SB	200 10
153A				
	Reißnägel lackiert <i>Drawing Pins laquered</i>	10	SB	120 10
153A26				
	Reißnägel lackiert <i>Drawing Pins laquered</i>	26	SB	120 10
133A				
	GARANT metallüberkapselt, vermessingt <i>GARANT metal covered, brass plated</i>		SB	120 10
Gummiringe <i>Rubber Bands</i>				
267A				
	20 -50 mm, verschiedene Farben gemischt <i>20-50 mm, mixed colours</i>	26	SB	15 g 20
Markiernadeln <i>Map Pins</i>				
1765A				
	Köpfe rund, quadratisch u. pyramidenförmig gemischt <i>square, pyramid and spherical mixed</i>	26	SB	15 10
Markierfähnchen <i>Flag Pins</i>				
726A				
		26	SB	20 10
Dekorationsnadeln <i>Decoration Pins</i>				
635A10				
	Stecknadeln, vernickelt Nr 105 / 30 mm <i>Pins, nickel-plated No. 105/30 mm</i>		SB	30 g 10
Foldback-Klammern <i>Foldback-Clips</i>				
781A				
	19 mm, bunt gemischt <i>19 mm, mixed colours</i>	26	SB	6 10
781A11				
	19 mm, schwarz <i>19 mm, black colour</i>	11	SB	8 10
782A				
	25 mm, bunt gemischt, <i>mixed colours</i>	26	SB	6 10
782A11				
	25 mm, schwarz, <i>black colour</i>	11	SB	6 10



#				
Briefklammern Paper Clips				
212A	eckige Form, verzinkt, 26 mm <i>angular shape, zinc plated, 26 mm</i>	SB	125	10
216A	eckige Form, vermessingt, 26 mm <i>angular shape, brass plated, 26 mm</i>	SB	125	10
225A	eckige Form, verzinkt, 32 mm <i>angular shape, zinc plated, 32 mm</i>	SB	75	10
456A	eckige Form, lackiert, 26 mm <i>angular shape, lacquered, 26 mm</i>	26	SB	125
256A	runde Form, kunststoffüberzogen, 26 mm <i>round shape, plastic covered, 26 mm</i>	26	SB	100
2256A	ZEBRA, gestreifte Farben, 26 mm <i>ZEBRA, striped colours, 26 mm</i>	26	SB	90
230A	Plastik, dreieckige Form, 26 mm <i>plastic, triangle shape, 26 mm</i>	26	SB	75
2215A	NORICA mit Kugelenden, 24 mm, verzinkt <i>NORICA with balls, 24 mm, zinc plated</i>	SB	75	10
2225A	NORICA mit Kugelenden, 32 mm, verzinkt <i>NORICA with balls, 32 mm, zinc plated</i>	SB	50	10
Kreuzklammern Butterfly Clips				
280A	Kreuzklammern, verzinkt, Größe 2 <i>Butterfly Clips, zinc coated, size 2</i>	SB	6	10
Aktenklammern Paper Clips				
2269A	50 mm glatt, kunststoffüberzogen <i>50 mm, smooth, plastic covered</i>	26	SB	30
2243A	ZEBRA, gestreifte Farben, 50 mm, glatt <i>ZEBRA, striped colours, 50 mm, smooth</i>	26	SB	30
260A	verzinkt, 50 mm, gewellt <i>zinc plated, 50 mm, wavy</i>	SB	40	10
262A	verzinkt, 77 mm, gewellt <i>zinc plated, 77 mm, wavy</i>	SB	12	10
Metallklammern Metal Pegs				
266A	Breite 19 mm <i>width 19 mm</i>	26	SB	5



#



Bildaufhänger *Picture Hangers*

560A

Klappösen mit Dreiecksösen und Nägeln, 11 mm

Hanger, triangular, 11 mm, with 2 nails each, brass plated

SB 10 10

561A

Klappösen mit Dreiecksösen und Nägeln, 15 mm

Hanger, triangular, 15 mm, with 2 nails each, brass plated

SB 10 10

562A

Dreiecksösen mit Klebefläche, weiß Ø 30 mm

Hanger, triangular, with adhesive fixing, white, Ø 30 mm

SB 10 10

556A

Bilderhaken-Sortiment mit Stahlnägeln, vermessingt

assortment of Picture Hooks with steel nails, brass plated

SB 10 10

Musterbeutelklammern *Paper Fasteners*

332A

Runder Kopf Nr. 3, vermessingt

round head No. 3, brass plated

SB 80 10

Flachkopfklammern *Paper Fasteners flat head*

594A

16 mm, vermessingt

16 mm, brass plated

SB 50 10

Mini Wäscheklammern *Mini Pegs*

265A

Länge 32 mm

length 32 mm

26 SB 10 10

Klammern für Glückwunschkarten *Mini Pegs*

268A

Metallfarben, Länge 25 mm

metallic colours, length 25 mm

26 SB 10 10

Glaskopfstecknadeln *Corsage Pins*

628A

mit farbigen Köpfen, 3,5 x 30 mm

with coloured heads, 3,5 x 30 mm

26 SB 80 10

Pinwandnadeln *Push Pins*

661A

verschiedene Farben gemischt

mixed colours

26 SB 25 10

Landkartennadeln *Map Pins*

626A

5 x 16 mm, auch in Einzelfarben erhältlich

5 x 16 mm, available also in single colours

26 SB 60 10

Schlüsselanhänger *Key Hangers*

1852A

mit beschreibbaren und auswechselbaren Etiketten

with describable and changeable label

26 SB 4 10

Schlüsselringe *Key Rings*

1752A

aus flexiblem Kunststoff

made of soft plastic

26 SB 8 10



Haftmagnete rund

Magnets, round shape



10, 11, 12, 13, 15, 18, 26, 29
 Art. Nr. 682 A und 683 A, auch in den Farben 36, 37 erhältlich
 Art. No. 682 A and 683 A, also available in colour 36, 37



681A

Ø 13 mm, Höhe 7 mm, Haftkraft min. 0,1 Kp.
 Ø 13 mm, height 7 mm, power min. 0,1 Kp.

E 8 10

682A

Ø 24 mm, Höhe 7 mm, Haftkraft min. 0,3 Kp.
 Ø 24 mm, height 7 mm, power min. 0,3 Kp.

E 6 10

683A

Ø 32 mm, Höhe 7 mm, Haftkraft min. 0,8 Kp.
 Ø 32 mm, height 7 mm, power min. 0,8 Kp.

E 4 10

685A

Ø 40 mm, Höhe 7 mm, Haftkraft min. 0,8 Kp.
 Ø 40 mm, height 7 mm, power min. 0,8 Kp.

E 2 10

Haftmagnete eckig

Magnets, angular shape



10, 11, 12, 13, 15, 18, 26, 29



686A

13 x 13 mm, Höhe 7 mm, Haftkraft min. 0,1 Kp.
 13 x 13 mm, height 7 mm, power min. 0,1 Kp.

E 8 10

687A

13 x 24 mm, Höhe 7 mm, Haftkraft min. 0,3 Kp.
 13 x 24 mm, height 7 mm, power min. 0,3 Kp.

E 6 10

688A

13 x 40 mm, Höhe 7 mm, Haftkraft min. 0,3 Kp.
 13 x 40 mm, height 7 mm, power min. 0,3 Kp.

E 4 10

689A

23 x 50 mm, Höhe 8 mm, Haftkraft min. 1,0 Kp.
 23 x 50 mm, height 8 mm, power min. 1,0 Kp.

E 2 10

Kraftmagnet

Power Magnet

rund, Höhe 13,5 mm, Haftkraft min. 2,5 Kp.
 round shape height 13,5 mm, power min. 2,5 Kp.



10, 11, 12, 13, 15, 16,
 18, 26, 29



684A

Ø 38 mm

E 2 10



Hakenmagnet

Magnets with a hook

weiß, Haftkraft 8 kg

white, power 8 kg



694A10

Ø 36 mm 10 KE 1 10



Hakenmagnet

Magnets with a hook

weiß, Haftkraft 15 kg

white, power 15 kg



6958A10

Ø 47 mm 10 KE 1 10



Haken-Kraftmagnete Neodym

Neodym Power Magnets with a hook

weiß, Haftkraft 4 kg

white, power 4 kg



6968A10

Ø 15 mm 10 KE 1 10



Haken-Kraftmagnete Neodym

Neodym Power Magnets with a hook

weiß, Haftkraft 11 kg

white, power 11 kg



6978A10

Ø 20 mm 10 KE 1 10



Haken-Kraftmagnete Neodym

Neodym Power Magnets with a hook

weiß, Haftkraft 16 kg

white, power 16 kg



6988A10

Ø 25 mm 10 KE 1 10



Haken-Kraftmagnete Neodym

Neodym Power Magnets with a hook

weiß, Haftkraft 28 kg

white, power 28 kg



6998A10

Ø 30 mm 10 KE 1 10

Neodym



Superkraftmagnete Neodym

Neodym Super Power Magnets

silberfarben gebürstet, Haftkraft 2 kg

silver coloured, brush finished, power 2 kg



7008A27

Ø 16 mm 27 KE 1 10

Neodym



Superkraftmagnete Neodym

Neodym Super Power Magnets

silberfarben gebürstet, Haftkraft 8 kg

silver coloured, brush finished, power 8 kg



7018A27

Ø 22 mm 27 KE 1 10

Neodym



Superkraftmagnete Neodym

Neodym Super Power Magnets

silberfarben gebürstet, Haftkraft 13 kg

silver coloured, brush finished, power 13 kg



7028A27

Ø 25 mm 27 KE 1 10

Neodym



Superkraftmagnet Neodym

Super Power Magnets

silberfarben gebürstet, Haftkraft 21 kg

silver coloured, brush finished, power 21 kg



7038A27

Ø 30 mm 27 KE 1 10

Neodym



Würfelmagnete Neodym

Neodym Cube Magnet

silber, 10 x 10 x 10 mm, 2 Stück

silver, 10 x 10 x 10 mm, 2 pcs.



7048A27

27 KE 1 10

Neodym



Würfelmagnete Neodym

Neodym Cube Magnet Neodym

silber, 10 x 10 x 10 mm, 4 Stück

silver, 10 x 10 x 10 mm, 4 pcs.



7058A27

27 KE 1 10

Neodym



Neodym-Kugelmagnete Neodym
Neodym Ball-Magnets

Haftkraft ca. 1,2 kp, hochglanz-vernickelt,
 Ø 10 mm, 4 Stk. auf Blisterkarte mit
 Eurolochung

*power app. 1,2 kp, nickel-plate,
 Ø 10 mm, 4 pcs. on blister card*



7061A27

Ø 10 mm

E

1

10

Neodym



Neodym-Kugelmagnete Neodym
Neodym Ball-Magnets

Haftkraft ca. 2,9 kp, hochglanz-vernickelt,
 Ø 13 mm, 2 Stk. auf Blisterkarte mit Euro-
 lochung

*power app. 2,9 kp, nickel-plate,
 Ø 13 mm, 2 pcs. on blister card*



7062A27

Ø 13 mm

E

1

10

Neodym



Neodym-Kugelmagnete Neodym
Neodym Ball-Magnets

Haftkraft ca. 5,6 kp, hochglanz-vernickelt,
 Ø 19 mm, 1 Stk. auf Blisterkarte mit Euro-
 lochung

*power app. 5,6 kp, nickel-plated,
 Ø 19 mm, 1 pc. on blister card*



7063A27

Ø 19 mm

E

1

10

Magnetklemmer

Magnet Clips

Metall, verchromt, Breite 38 mm x Länge 45 mm,
 hält ca. 15 Blatt DIN A4 Papier.
 3 Stk. auf Blisterkarte mit Eurolochung

*metal, chrome plated, width 38 mm x length 45 mm,
 power: about 15 pcs. paper format DIN A4,
 3 pcs. on blister card*



7070A27

38 x 45 mm

E

1

10





Kegelmagnete mit hoher Haftkraft
Strong Handle Magnets

Haftkraft ca. 4 kp, Silber, Ø 20 mm, Höhe 25 mm, 2 Stk. auf Blisterkarte mit Eurolochung.

power app. 4 kp, silver, Ø 20 mm, height 25 mm, 2 pcs. on blister card



7060A27

Ø 20 mm E 1 10



Kegelmagnete
Handle Magnets

Haftkraft ca. 2 kp, farbig, Ø 29 mm, Höhe 38,5 mm, 2 Stk. auf Blisterkarte mit Eurolochung. Lieferung farblich sortiert in Grün-Orange, Rot-Blau oder Schwarz-Weiß.

power app. 2 kp, Ø 29 mm, height 38,5 mm, mixed colours: blue/red, green/orange, black/white, 2 pcs. on blister card



7065A26

Ø 29 mm 26 E 1 10



Flachmagnete mit Kunststoffkappe
Magnets with Plastic Cap

Höhe 8 mm, versch. Farben, 12 Stk.

height 8 mm, dif. colours, 12 pcs.



6812A26

Ø 20 mm 26 E 1 10



Flachmagnete mit Kunststoffkappe
Magnets with Plastic Cap

Höhe 8 mm, silberfarben, 10 Stk.,

height 8 mm, silver, 10 pcs.



6810A36

Ø 20 mm E 1 10



Flachmagnete mit Kunststoffkappe
Magnets with Plastic Cap

Höhe 11 mm, silberfarben, 8 Stk.

height 11 mm, silver, 8 pcs.



6811A36

Ø 30 mm E 1 10

Sortimentsdose

Tidy Box

viereckig, gefüllt mit:

angular, contents:

15 g Gummiringe/*Rubber Bands*

120 Briefklammern/*Paper Clips*

50 Pin-Wand-Nadel/*Push Pins*

125 Reißnägeln/*Drawing Pins*



2105

P 1 20



Foldback-Klammer Spender

Magnetic Dispenser with Foldback Clips

Magnetdose mit blauem, grünem oder pinkfarbenem Deckel. Inhalt:

12 Stk. Klammern 15 mm + 6 Stk. Klammern 19 mm, in 2 getrennten Kammern, bunt gemischt in Neon-Trendfarben. Lieferung farblich sortiert in Weichplastik-Schachtel.

With coloured cap, filled with foldback clips as follow:

12 pcs. 15 mm + 6 pcs. 19 mm, in two different compartments, mixed colours.

Delivery in assorted colours in soft plastic box.



2222-26

E 1 10



Magnetdosen für Briefklammern

Magnetic Clip Dispenser



2216

runde Ausführung, gefüllt mit 100 vernickelten Briefklammern 26 mm, Ø 58 x 80 mm, klar, mit schwarzem Deckel

P 1 10

round shape, filled with 100 nickel plated paper clips 26 mm, Ø 58 x 80 mm, transparent with black lid

2216-26

runde Ausführung, gefüllt mit 100 farbig lackierten Briefklammern 26 mm, Ø 58 x 80 mm, klar, mit schwarzem Deckel

P 1 10

round shape, filled with 100 coloured lacquered paper clips 26 mm, Ø 58 x 80 mm, transparent with black lid

2217

eckige Ausführung, gefüllt mit farbig gemischten Briefklammern, 42 x 42 x 70 mm, klar, mit schwarzem Deckel, ca. 30 Klammern

P 1 10

angular shape, filled with coloured paper clips, size 42 x 42 x 70 mm, transparent with black lid

2218

runde Ausführung, gefüllt mit farbig gemischten Briefklammern, Ø 58 x 72 mm, klar, mit schwarzem Deckel, ca. 30 Klammern

P 1 10

round shape, filled with coloured paper clips, Ø 58 x 72 mm, transparent with black lid



KONFERENZ SCHULUNG PLANUNG

MEETING | PRESENTATION | PLANNING



Kraftmagnet

Power Magnet

rund, Ø 38 mm, Höhe 13,5 mm, Haftkraft min. 2,5 kg
round shape, Ø 38 mm, height 13,5 mm, power min. 2,5 kg



10, 11, 12, 13, 15, 18, 19, 26, 29



6848V

N

10

10



Neodym



Haken-Kraftmagnete Neodym

Neodym Power Magnets with a hook



6968

Ø 15 mm, Haftkraft 4 kg, weiß
Ø 15 mm, power 4 kg, white colour

10

N

5

10

6978

Ø 20 mm, Haftkraft 11 kg, weiß
Ø 20 mm, power 11 kg, white colour

10

N

5

10

6988

Ø 25 mm, Haftkraft 16 kg, weiß
Ø 25 mm, power 16 kg, white colour

10

N

5

10

6998

Ø 30 mm, Haftkraft 28 kg, weiß
Ø 30 mm, power 28 kg, white colour

10

N

5

10



Hakenmagnete

Magnets with a hook



10, 27



6938

Ø 25 mm
Haftkraft 3,5 kg
power 3,5 kg

N

5

1

694

Ø 36 mm
Haftkraft 8 kg
power 8 kg

N

5

1

6958

Ø 47 mm
Haftkraft 15 kg
power 15 kg

N

5

1



Haftmagnet Metall

Power Magnet

rund, Ø 22 mm, Höhe 4 mm, Haftkraft min. 0,8 kg
round shape, Ø 22 mm, height 4 mm, power min. 0,8 kg.



6800P27

N

10

10

Neodym

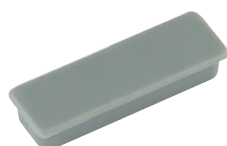

Superkraftmagnete Neodym, silberfarben gebürstet

Neodym Super Power Magnets, silver coloured, brush finished



7008

Ø 16 mm, Haftkraft 2 kg

27 N 5 1

Ø 16 mm, power 2 kg

7018

Ø 22 mm, Haftkraft 8 kg

27 N 5 1

Ø 22 mm, power 8 kg

7028

Ø 25 mm, Haftkraft 13 kg

27 N 5 1

Ø 25 mm, power 13 kg

7038

Ø 30 mm, Haftkraft 21 kg

27 N 5 1

Ø 30 mm, power 21 kg

Haftmagnete rund

Magnets, round shape



10, 11, 12, 13, 15,
18, 26, 29



6818V

Ø 13 mm, Höhe 7 mm, Haftkraft min. 0,1 kg

N 10 12

Ø 13 mm, height 7 mm, power min. 0,1 kg

6828V

Ø 24 mm, Höhe 7 mm, Haftkraft min. 0,3 kg

N 10 30

Ø 24 mm, height 7 mm, power min. 0,3 kg.

6838V

Ø 32 mm, Höhe 7 mm, Haftkraft min. 0,8 kg

N 10 20

Ø 32 mm, height 7 mm, power min. 0,8 kg

6858V

Ø 40 mm, Höhe 7 mm, Haftkraft min. 0,8 kg

N 10 20

Ø 40 mm, height 7 mm, power min. 0,8 kg

Haftmagnete eckig

Magnets, angular shape



10, 11, 12, 13, 15,
18, 26, 29



6868V

13 x 13 mm, Höhe 7 mm, Haftkraft min. 0,1 kg

N 10 30

13 x 13 mm, height 7 mm, power min. 0,1 kg

6878V

13 x 24 mm, Höhe 7 mm, Haftkraft min. 0,3 kg

N 10 20

13 x 24 mm, height 7 mm, power min. 0,3 kg

6888V

13 x 40 mm, Höhe 7 mm, Haftkraft min. 0,3 kg

N 10 24

13 x 40 mm, height 7 mm, power min. 0,3 kg

6898V

23 x 50 mm, Höhe 8 mm, Haftkraft min. 1,0 kg

N 10 12

23 x 50 mm, height 8 mm, power min. 1,0 kg

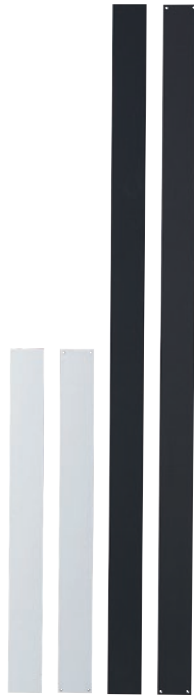

Wandleisten

Wall Strips

lackierte Metallleisten für Magnete
lacquered metal stripes for magnets



690

Größe 50 x 5 cm, selbstklebend, mit Polsterklebeband	10	N	10	1
<i>size 50 x 5 cm, self-adhesive, with soft adhesive tape</i>	11			

691

Größe 100 x 5 cm, selbstklebend, mit Polsterklebeband	10	N	10	1
<i>size 100 x 5 cm, self-adhesive, with soft adhesive tape</i>	11			

692-10

Größe 50 x 5 cm, zum Nageln, mit 4 vorgestanzten Löchern	10	N	10	1
<i>size 50 x 5 cm, for nail fixing, with 4 pre-punched holes</i>				

693

Größe 100 x 5 cm, zum Nageln, mit 4 vorgestanzten Löchern	10	N	10	1
<i>size 100 x 5 cm, for nail fixing, with 4 pre-punched holes</i>	11			

695-10

Größe 150 x 5 cm, zum Nageln, mit 6 vorgestanzten Löchern	10	N	10	1
<i>size 150 x 5 cm, for nail fixing, with 6 pre-punched holes</i>				



Wandleisten

Wall Strips

wie Art. Nr. 690/691, jedoch als SB-Artikel verpackt
as article No. 690/691, but packed as a Self-Service Item



690A

Größe 50 x 5 cm, selbstklebend, mit Polsterklebeband, mit 2 Magneten	10	KE	1	1
<i>size 50 x 5 cm, self-adhesive, with soft adhesive tape, with 2 magnets</i>	11			

691A

Größe 100 x 5 cm, selbstklebend, mit Polsterklebeband, mit 4 Magneten	10	KE	1	1
	11			

*size 100 x 5 cm, self-adhesive,
with soft adhesive tape,
with 4 magnets*



Metallhaftband

Flexible Wall Strips

aus Stahl, flexibel, mit weißer Oberfläche und rückseitigem Schaumpolsterkleber, kann beliebig gekürzt werden, Breite: 35 mm, ohne Magnete

steel, flexible, with white surface and soft adhesive tape, width: 35 mm, without magnets



6910

Länge/length: 1 m 10 N 1 1

6920

Länge/length: 5 m 10 N 1 1

Metallhaftband

Flexible Wall Strips

wie Art. Nr. 6910 / 6920, inklusive 3 Magnete

as article No. 6910 / 6920, including 3 magnets



6910P10

Länge/length: 1 m 10 N 1 1

6920P10

Länge/length: 5 m 10 N 1 1



Magnetische Wandschiene

Magnetic Rack

schwarzer Sockel, incl. Rundkopfschrauben zur Wandbefestigung
black base, including screws for wall fastening



6900-11

360 x 45 x 25 mm

11 N 1 1



Magnetische Wandschiene

Magnetic Rack

schwarzer Sockel, incl. Rundkopfschrauben zur Wandbefestigung
black base, including screws for wall fastening



6901-11

460 x 45 x 25 mm

11 N 1 1



Glaskopfstecknadeln

Corsage Pins

mit farbigen Köpfen, 3,5 x 30 mm
with coloured heads, 3,5 x 30 mm



628

26 P 100 10

Landkartennadeln

Map Pins



10, 11, 12, 13, 14, 15, 16, 17, 18, 19, 20, 21, 22, 23, 24, 25, 26, 29



610 bis/up to 629

Kopf-Ø 5 mm x 16 mm (6 + Farbnummer = Artikelnummer)
size-Ø 5 mm x 16 mm (6 + colour No. = article No.)

P 100 10



Landkartennadeln

Map Pins



10, 11, 12, 13, 14, 15, 16, 17, 18, 19, 20, 21, 22, 23, 24, 25, 26, 29



810 bis/up to 829

Kopf-Ø 8 mm x 16 mm (8 + Farbnummer = Artikelnummer)
size-Ø 8 mm x 16 mm (8 + colour No. = article No.)

P 20 10



Landkartennadeln

Map Pins

 10, 11, 12, 13, 15, 17, 26

#



1760

Kopf-Ø 10 mm, Gesamtlänge 20 mm
size-Ø 10 mm, total length 20 mm

P 20 10



Markierfähnchen

Flag Pins

 10, 11, 12, 13, 14, 15, 17, 18, 19, 20, 21, 23, 24, 25, 26, 29

#



710 bis/up to 729

(7 + Farbnummer = Artikelnummer)

(7 + colour No. = article No.)

P 20 10

726-100

Farben gemischt
mixed colours

P 100 10



ALCOfix Haftmarker, transparent

ALCOfix Page Marker Tabs, transparent

25 x 43 mm, 50 Stück im Spender

25 x 43 mm, 50 pcs. per applicator



6825

12,13,14,17 KE 1 20



ALCOfix Haftmarker, transparent

ALCOfix Page Marker Tabs, transparent

10 verschiedene Farben, 15 x 10 mm,
10 x 50 Stück

10 different colours, 15 x 10 mm,
10 x 50 pcs

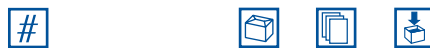

6826

KE 1 20



ALCOfix Haftmarker, transparent

ALCOfix Page Marker Tabs, transparent

10 verschiedene Farben, 6 x 50 mm,
10 x 40 Stück

10 different colours, 6 x 50 mm,
10 x 40 pcs.



6827

KE 1 20



ALCOfix Haftmarker, transparent

ALCOfix Page Marker Tabs transparent

gelb, orange, rot, blau und grün,
12 x 43 mm, 5 x 25 Stück im Spender

yellow, orange, red, blue and green
12 x 43 mm, 5 x 25 pcs. per applicator

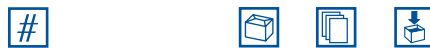

6829

PE 1 20

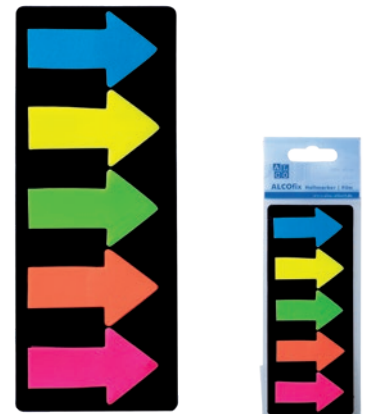

ALCOfix Haftmarker, Film „Pfeile“

ALCOfix Page Marker Tabs Film „Arrows“

gelb, orange, rot, blau und grün,
25 x 45 mm, 5 x 25 Stück

yellow, orange, red, blue and green
25 x 45 mm, 5 x 25 p



6836

PE 1 20



ALCOfix Haftmarker, Neon

ALCOfix Page Marker Tabs, Neon

4 verschiedene Farben, gelb, orange, pink und grün 20 x 50 mm, 4 x 50 Stk.

4 different colours, yellow, orange, pink and green, 20 x 50 mm, 4 x 50 pcs.



6831

KE 1 20

ALCOfix Haftmarker, Film

ALCOfix Page Marker Tabs, Film

4 verschiedene Farben, gelb, orange, pink und blau 20 x 50 mm, 4 x 40 Stk.

4 different colours, yellow, orange, pink and blue, 20 x 50 mm, 4 x 40 pcs.



6832

KE 1 20

ALCOfix Haftmarker, transparent

ALCOfix Page Marker Tabs transparent

4 verschiedene Farben, gelb, rot, blau und grün 20 x 50 mm, 4 x 40 Stk.

4 different colours, yellow, red, blue and green, 20 x 50 mm, 4 x 40 pcs.



6833

PE 1 20

ALCOfix Haftmarker, Film

ALCOfix Page Marker Tabs, Film

5 verschiedene Farben, gelb, orange, pink, grün und blau 12 x 50 mm, 5 x 25 Stk.

5 different colours, yellow, orange, pink green and blue, 12 x 50 mm, 5 x 25 pcs.



6834

KE 1 20



ALCOfix Haftmarker, Film „Pfeile“

ALCOfix Page Marker Tabs, Film „Arrows“

5 verschiedene Farben, gelb, orange, pink, grün und blau 12 x 50 mm, 5 x 25 Stk.

5 different colours, yellow, orange, pink green and blue, 12 x 50 mm, 5 x 25 pcs.



6835

KE 1 20

SCHNEIDGERÄTE ZEICHENGERÄTE

CUTTING EQUIPMENT | DRAWING INSTRUMENTS



Titan-Scheren

Scissors with titanium finish

aus Edelstahl, rostfrei mit Titanbeschichtung, besonders abriebfest, ergonomisch geformte Griffmulden aus schlagfestem ABS-Kunststoff, Schneidflächen mit Präzisionsschliff

stainless steel, rust-proof, with titanium finish, especially abrasion-proof, ergonomically designed handle in unbreakable blue ABS-plastic, for easy precise cutting



1550					
6,3"/16 cm	15	KE	1	12	
1551					
8,5"/21,5 cm	15	KE	1	12	
1552					
10"/25,5 cm	15	KE	1	12	



Bastel-Scheren

Hobby-Scissors

aus Edelstahl, rostfrei, Griffe aus schlagfestem ABS-Kunststoff, mit Millimeterskala, verschiedene Modelle für Rechts- oder Linkshänder, 5,3"/13,5 cm

stainless steel, rust-proof, handle with unbreakable blue ABS-plastic, with mm scale, different models for right handers or lefties, 5,3"/13,5 cm



1405L					
für Linkshänder, rund, zweifarbig Griff	26	KE	1	12	
<i>for lefties, round, two coloured handle</i>					
1405R					
für Rechtshänder, rund	15	KE	1	12	
<i>for right handers, round</i>					
1405R26					
für Rechtshänder, rund, verschiedene Grifffarben gemischt	26	KE	1	12	
<i>or right handers, round different colours of handles assorted</i>					
1407L					
für Linkshänder, spitz, zweifarbig Griff	26	KE	1	12	
<i>for lefties, pointed, two coloured handle</i>					
1407R					
für Rechtshänder, spitz	15	KE	1	12	
<i>for right handers, pointed</i>					
1407R26					
für Rechtshänder, spitz verschiedene Grifffarben gemischt	26	KE	1	12	
<i>for right handers, pointed different colours of handles assorted</i>					



Standard-Scheren

Standard-Scissors

aus Edelstahl, rostfrei, ergonomisch geformte Griffmulden aus schlagfestem ABS-Kunststoff, Farbe blau, Schneidflächen mit Präzisionsschliff

stainless steel, rust-proof, ergonomically designed handle in unbreakable blue ABS-plastic, for easy precise cutting

#					
1406	Qualitätsschere, 16 cm <i>Universal Scissors, 6,3"</i>	15	KE	1	12
1408	Qualitätsschere, 21,5 cm <i>Universal Scissors, 8,5"</i>	15	KE	1	12
1409	Qualitätsschere, für Linkshänder, 21,5 cm <i>Universal Scissors, for lefties, 8,5"</i>	15	KE	1	12
1410	Qualitätsschere, 25,5 cm <i>Universal Scissors, 10"</i>	15	KE	1	12
1429	Scheren Set bestehend aus je 1 Stück Art. Nr. 1406, 1408 und 1410 <i>set of different scissors consisting of 1 piece of Art.No. 1406, 1408 and 1410</i>	15	KE	1 Set	12



Profi-Qualitätsscheren

Professional-Scissors

aus gehärtetem, rostbeständigem Spezialstahl, Griffmulden aus schlagfestem ABS-Kunststoff, Farbe blau, Schneidflächen mit Präzisionsschliff

stainless steel, rust-proof, ergonomically designed cutting features, for easy precise cutting

#					
1416	Haushaltsschere, 6,3"/16 cm <i>Household Scissors 6,3"/16 cm</i>	15	KE	1	12
1417	Allroundschere mit leichtem Wellenschliff, 7,9" / 20 cm <i>Allround Scissors with ergonomically designed cutting feature, 7,9"/20 cm</i>	15	KE	1	12
1418	Papierschere, 8,3"/21 cm <i>Paper Scissors, 8,3"/21 cm</i>	15	KE	1	12
1420	Papierschere, 10,2"/26 cm <i>Paper Scissors, 10,2"/26 cm</i>				
1427	Allroundschere, 7,9"/20 cm <i>Allround Scissors, 7,9"/20 cm</i>				
1428	Allzweckschere, 8,3"/21 cm, mit Kapselheber, schwarz <i>Allpurpose Household Scissors, 8,3"/21 cm, with bottleopener, black</i>	11	KE	1	12



Qualitätsscheren „Comfort Cut“

„Comfort Cut“-Scissors

aus Edelstahl, rostfrei, ergonomisch geformte blaue Kunststoffgriffe aus schlagfestem ABS-Kunststoff mit grau gummierter Griffzone für sicheren Halt, Schneidflächen mit Präzisionsschliff

stainless steel, rust-proof, ergonomically designed handle in unbreakable blue ABS-plastic with rubberized parts, ergonomically designed cutting features, for easy precise cutting

#					
1490	Qualitätsschere mit Softgriffen, 14 cm <i>Metal Scissors with soft handle, 14 cm</i>	15	KE	1	12
1491	Qualitätsschere mit Softgriffen, 17 cm <i>Metal Scissors with soft handle, 17 cm</i>	15	KE	1	12
1492	Qualitätsschere mit Softgriffen, 19 cm <i>Metal Scissors with soft handle, 19 cm</i>	15	KE	1	12
1493	Qualitätsschere mit Softgriffen, 21,5 cm <i>Metal Scissors with soft handle, 21,5 cm</i>	15	KE	1	12
1494	Qualitätsschere mit Softgriffen, 25 cm <i>Metal Scissors with soft handle, 25 cm</i>	15	KE	1	12



ALCO-Messer

ALCO Knives

für Küchen- und Kantinenbedarf, spülmaschinenfest, mit schwarzen, ergonomischen, schlagfesten Kunststoffgriffen, Klingen mit Spezialschliff ohne Nachschärfen

for domestic and canteen purpose, dishwasher safe, with black ergonomical plastic handles, special blades that never need sharpening

#					
1432	Obstmesser, 22,5 cm <i>fruit knife 22,5 cm</i>	11	E	1	12
1434	Universalmesser, 32,5 cm <i>universal knife 32,5 cm</i>	11	E	1	12
1436	Brotmesser, 32,5 cm <i>bread knife, 32,5 cm</i>	15	E	1	12



Hobby-Cutter

Hobby-Cutter

aus Kunststoff, arretierbar, 9 mm Klinge

plastic, lockable, 9 mm blade



120				
	12	KE	1	10
120 A				
	12	E	1	10



Metall-Cutter

Metal-Cutter

vernickelt, arretierbar, 9 mm Klinge

nickel plated, lockable, 9 mm blade



121				
		KE	1	10
121A				
	E	1	10	



Profi-Cutter

Profi-Cutter

aus Kunststoff, Metallführung, arretierbar, 18 mm Klinge

plastic, metal run, lockable, 18 mm blade



122				
	12	KE	1	10
122A				
	12	E	1	10



Profi-Cutter

Profi-Cutter

aus Kunststoff, mit gummiertem Griff, Schieberaster mit Automatik-Stop, Metallführung für sichere Klingenföhrung, Abbrechvorrichtung für Klinge, 18 mm Klinge, inkl. 2 Ersatzklingen

plastic with rubber handle, Automatic-Stop, metal run for security, device to break the blade, 18 mm blade, including 2 spareblades



116				
	13	NE	1	10



Profi-Cutter

Profi-Cutter

aus Kunststoff, mit gummiertem Griff, Schraubenarretierung, Metallführung für sichere Klingenföhrung, Abbrechvorrichtung für Klinge, 18 mm Klinge

plastic with rubber handle, lockable with a screw, metal run for security, device to break the blade, 18 mm blade



117				
	13	NE	1	10



Cutter

Cutter

aus Kunststoff mit Schraubenarretierung und Metallführung, Abbrechhilfe liegt bei, 18 mm Klinge

plastic, lockable with a screw, metal run for security, for suspending, with seperate accessory to break off the blade, 18 mm blade



118				
	13	NE	1	10



Profi-Cutter

Profi-Cutter

aus Kunststoff, arretierbar, 18 mm Klinge

plastic, lockable, 18 mm blade

#				
123				
	12	KE	1	10
123 A				
	12	E	1	10



Sicherheits-Cutter

Security-Cutter

aus Kunststoff, besonders zum Öffnen von Kartons geeignet, Klinge wird durch Zugfeder automatisch in den Griff zurück gezogen

plastic, with automatic spring for drawing back the blad

#				
119				
	13	E	1	10
Ersatzklingen				
<i>Spare Blades</i>				
119/1				
	P	10	25	



Metall-Cutter

Metal-Cutter

Klinge 3-fach verstellbar und einziehba

blade for three different positions

#				
126				
	15	E	1	10
Ersatzklingen				
<i>Spare Blades</i>				
126/1				
	P	10	25	



Ersatzklingen

Spare Blades

#			
128			
9 mm	P	12	24
128A			
9 mm	SB	12	24
129-10			
18 mm	P	10	24
129A-10			
18 mm	SB	10	24

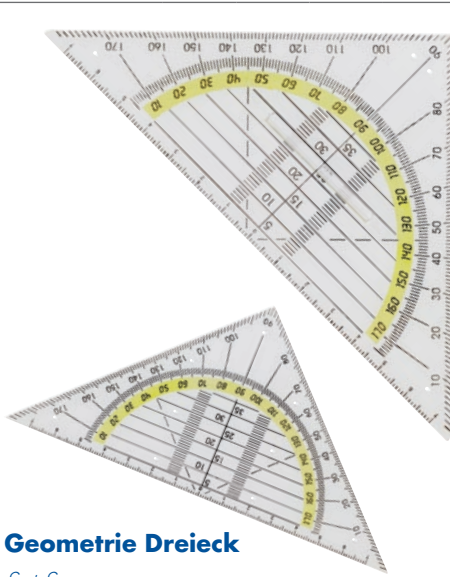

Geometrie Dreieck

Set Square

aus transparentem Kunststoff, mit Facette, farbige hinterlegte gegenläufige Gradskala, mit Tuschenoppen, Länge der Hypotenuse 16 cm

plastic transparent, beveled edged, colour ring, length of hypotenuse 16 cm



1578	ohne Griff	22	KE	1	10
	<i>without handle</i>				
1579	mit Griff	22	KE	1	10
	<i>without handle</i>				

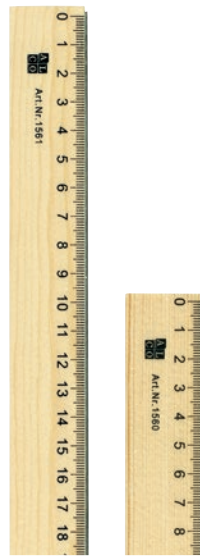

Holz Lineale

Wooden Ruler

naturfarben, abgerundete Tuschkante, mit Stahleinlage, mm-Einteilung

natural coloured, beveled edged, steel edge, mm ruling increment



1560	20 cm	KE	1	10
1561	30 cm	KE	1	10



Alu Lineale

Aluminium Ruler

verschiedene Längen, rutschfest, mit Tuschkante

mit Tuschkante different length, non slip, with ink edge



1450	30 cm	KE	1	12
1450-1	50 cm	KE	1	12
1450-2	70 cm	KE	1	12
1450-3	100 cm	KE	1	12

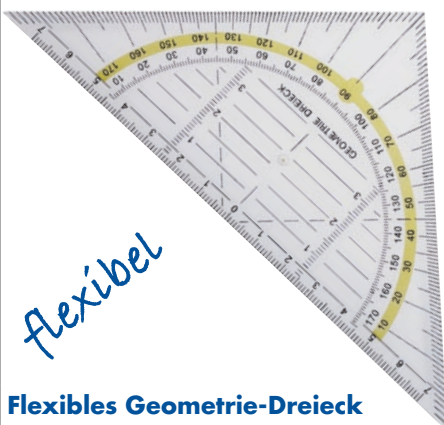

Flexibles Geometrie-Dreieck

Flexible Set Square

transparent, mit Facette, farbige hinterlegte gegenläufige Gradskala, Länge der Hypotenuse 16 cm, ohne Griff

transparent, coloured ring, length of hypotenuse 16 cm, without handle



1586	22	N	1	10
-------------	----	---	---	----

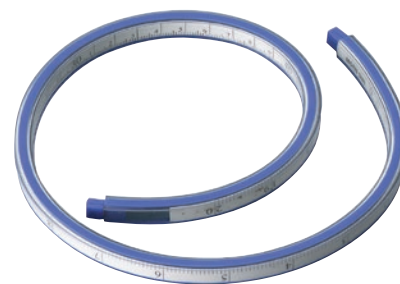

Kurvenlineale

Flexible Curves

flexibles Lineal zum Zeichnen und Formen von Kurven aller Art, Profilkante, für Tinte und Tusche

flexible ruler for drawing and forming curves, raised edges for ink ruling



1460	30 cm	E	1	12
1461	40 cm	E	1	12
1462	50 cm	E	1	12
1463	60 cm	E	1	12

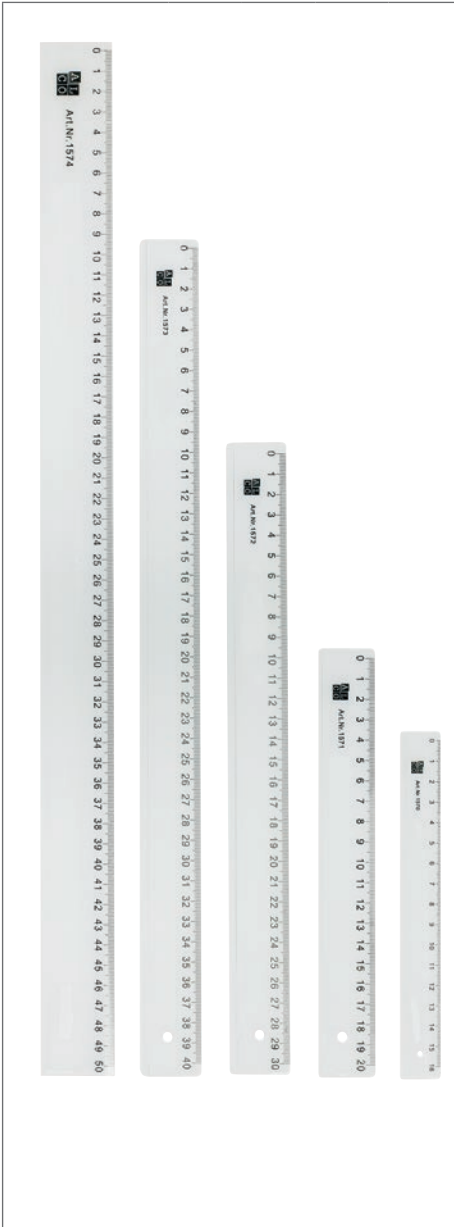

Kunststoff Lineale

Plastic Ruler

Lineal aus transparentem Kunststoff, mit Facette und Tuschekante, mm-Einteilung

transparent, beveled edged, mm ruling increments

#				
1570	16 cm	22	KE	1 10
1571	20 cm	22	KE	1 10
1572	30 cm	22	KE	1 10
1573	40 cm	22	KE	1 10
1574	50 cm	22	KE	1 10

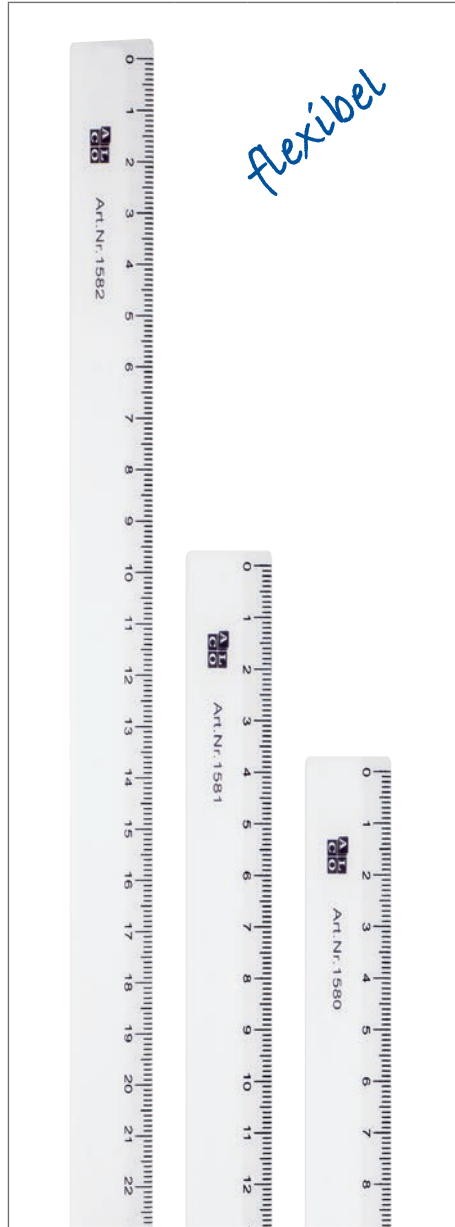

Flexible Lineale

Flexible Ruler

transparent, mm-Einteilung

transparent, beveled edged, mm ruling increments

#				
1580	22 cm	22	KE	1 10
1581	20 cm	22	KE	1 10
1582	30 cm	22	KE	1 10

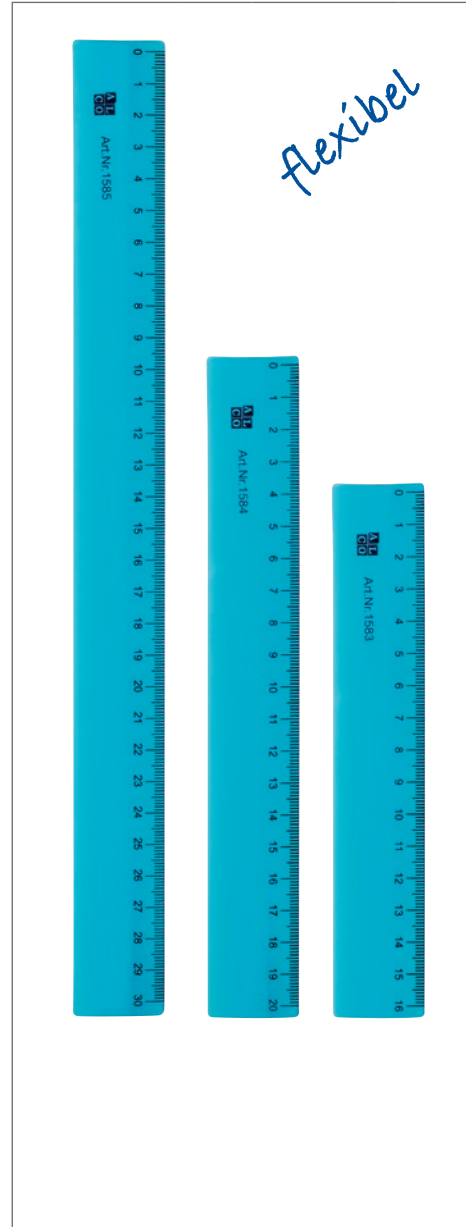

Flexible Lineale

Flexible Ruler

blau transparent, mm-Einteilung

blue transparent colour, mm ruling increments

#				
1583	16 cm	22	KE	1 10
1584	20 cm	22	KE	1 10
1585	30 cm	22	KE	1 10



Schulzirkel, silberfarben

School Compass, silver coloured

Zahnradgeradeführung, Gesamtlänge 125 mm, max. Kreisdurchmesser 340 mm, in transparenter Klarsichtverpackung, farbig sortiert

with quick-setting push-button mechanism and fast and smooth radius adjustment, length 125 mm. Circles up to 340 mm, in transparent plastic tube, assorted colours



1350

KE 1 10



Schulzirkel, silberfarben

School Compass, silver coloured

einfache Ausführung, Zahnradgeradeführung, Knie- und Nadelgelenk abknickbar, Zirkeleinsätze auswechselbar, Gesamtlänge 155 mm, max. Kreisdurchmesser 500 mm, transparentes Hartplastiketui mit Eurolochung

with quick-setting push-button mechanism, fast and smooth radius adjustment, telescopic extension bar, hinged lead and needle legs, interchangeable needle and lead, length 155 mm. Circles up to 500 mm, transparent hard plastic case with hanger



1351

KE 1 10

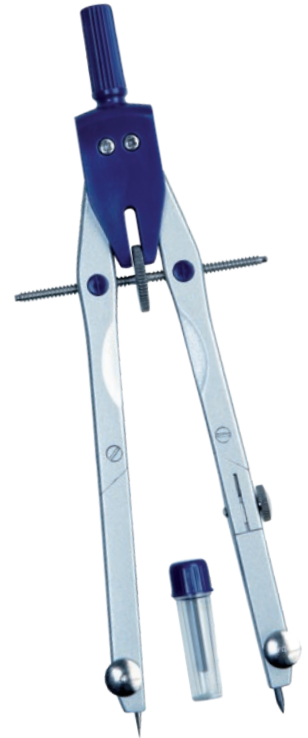

Geometriezirkel, silberfarben

Geometry Compass, silver coloured

mit Feineinstellung durch Mittelradspindel, 2 asymmetrische Kniegelenke, Zirkeleinsätze auswechselbar, Gesamtlänge 170 mm, max. Kreisdurchmesser 380 mm, transparentes Hartplastiketui mit Eurolochung

with quick-setting push-button mechanism, precision radius adjustment through centre wheel, both legs with joint, interchangeable needle and lead, length 170 mm. Circles up to 380 mm, transparent hard plastic case with hanger



1352

KE 1 10



Schnellverstellzirkel, silberfarben
Rapid Adjustment Compass, silver coloured

Mittelradspindel zur Feineinstellung und Schnellverstellung, 2 asymmetrische Kniegelenke, Zirkelinsätze auswechselbar, Gesamtlänge 170 mm, max. Kreisdurchmesser 380 mm, transparentes Hartplastiketui mit Eurolochung

with quick-setting push-button mechanism and centre wheel, hinged lead and needle leg, length 170 mm. Circles up to 380 mm, transparent hard plastic case with hanger



1353 KE 1 10



Schnellverstellzirkel, silberfarben
Rapid Adjustment Compass, silver coloured

mit stabiler Verlängerungsstange, Mittelradspindel zur Feineinstellung und Schnellverstellung, 2 asymmetrische Kniegelenke, Zirkelinsätze auswechselbar, Gesamtlänge 170 mm, max. Kreisdurchmesser 380 mm, max. Kreisdurchmesser mit Verlängerungsstange 620 mm, transparentes Hartplastiketui mit Eurolochung

with quick-setting push-button mechanism and centre wheel, hinged lead and needle leg, interchangeable needle and lead, stable extension bar, technical pen adapter, length 170 mm. Circles up to 380 mm, with extension bar approx. 620 mm, transparent hard plastic case with hange



1354 KE 1 10



Fachschul- Geometriezirkel
Geometry Compass

komplett unifarben, Länge 165 mm, max. Kreisdurchmesser ca. 360 mm, Zahnradradeführung, mit Ersatzmine, Kunststoffverpackung mit Eurolochung, verschiedene Farben *completely single coloured, length: 165 mm, circles up to 360 mm, precision radius adjustment through centrewheel, including spare lead, in different fashion colour*

completely single coloured, length: 165 mm, circles up to 360 mm, precision radius adjustment through centrewheel, including spare lead, in different fashion colour

12,15,18,20



1355 KE 1 10

1356

wie 1355 aber silber, mit farbigen Kunststoffelementen

like 1355 but silver, with coloured plasticparts

KE 1 10

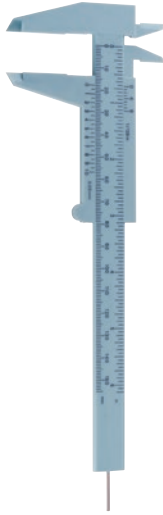

Schieblehre
Slide Calliper Ruler

aus Kunststoff, 155 mm, ideal für die schnelle Messung von Achs-Durchmessern sowie für Tiefen- und Innendurchmesser

plastic, 155 mm, for measuring of center diameter, depth gauge and inside diameter, for exact reading with nonius

#			
1465	29	KE	1 24

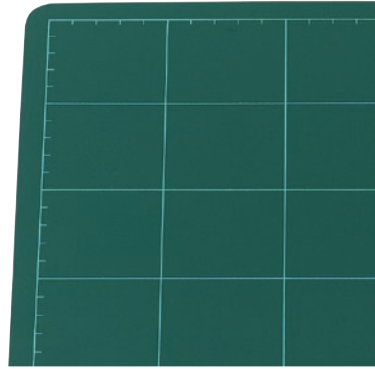

Schneidematten
Cutting Mats

aus Mehrschicht-Material, schwere Ausführung, Stärke 3 mm

heavy type with sandwich material, thickness 3 mm

#				
1451	300 x 200 mm	18	PT	1 10
1452	450 x 300 mm	18	E	1 10
1453	600 x 450 mm	18	PT	1 10
1454	900 x 600 mm	18	PT	1 10



Skalpell
Art Knife

mit rundem, verchromten Stahlgriff und Schutzkappe, incl. 3 Ersatzklingen

with a round metal handle and blade protection cap with 3 spare blades

#			
1445	KE	1	10

Ersatzklingen
Spare Blades

1446	P	5	24
-------------	---	---	----



Schneide-Set
Art Set

1 Alu-Lineal, 30 cm
1 Skalpell mit 3 Ersatzklingen und Klingenschutzkappe
1 Schneidematte aus Mehrschicht-Material, 3 mm stark, Größe: 300 x 200 mm

*1 aluminium ruler, 30 cm
1 art knife with three spare blades and blade protection cap
1 cutting mat with sandwich material, thickness 3 mm, size: 300 x 220 mm*

#			
1440	KE	1	24

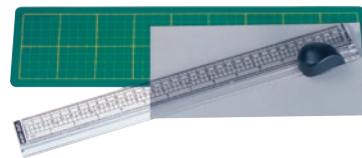

Schneidelineal mit Schneidematte
Cutting Ruler with Cutting Mat

1 Lineal mit integrierter Schneidevorrichtung für exakte Schnitte bis zu 33 cm, 35 cm lang
1 Schneidematte aus Mehrschicht-Material, 3 mm stark, Größe: 380 x 100 mm

*1 cutting ruler, 35 cm
1 cutting mat with sandwich material, thickness 3 mm, size: 380 x 100 mm*

#			
1441	KE	1	24



Rollmesser
Rotary Cutter

zum exakten Schneiden von Papier, Karton, Stoff, etc., Klinge aus rostfreiem Edelstahl, 165 mm, Klinge Ø 45 mm

plastic, for cutting paper, carton, cloth, ect., high grade steel blade, 165 mm, blade Ø 45 mm

#			
1447	KE	1	10

Ersatzklingen
Spare Blades

1447/1	P	1	20
---------------	---	---	----

VERSENDEN VERPACKEN

MAILING SUPPLIES





Sicherheits-Packbandabroller

Safety Tape Dispenser for Parcel Tape

Absoluter Schutz vor Verletzungen durch automatische Rückführung der Metallklinge und dem dadurch verdeckten Messer. Der Griff liegt gut in der Hand und bietet Halt bei der Arbeit. Das Gehäuse des Sicherheits-Handabrollers ist aus Metall, der Griff aus Kunststoff. Geeignet für Packband in 50 mm Breite und 66 m Länge. Lieferung ohne Packband.

Absolute protection against injuries by automatic return of metal blade and therefore covered knife. The handle is comfortable in your hand. The case of the safety tape dispenser is out of metal, the handle is plastic. Suitable for tape size 50 mm width and 66 m length. Delivery without tape.



4482



N 1 24

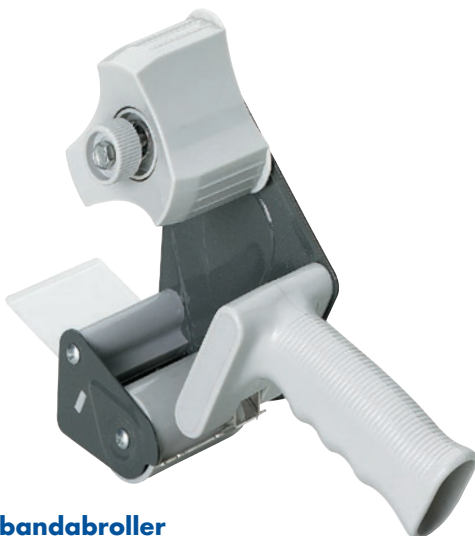

Packbandabroller

Packaging Tape Dispenser

Metallgehäuse mit Kunststoffgriff, für Packband bis 50 mm Breite und 66 m Länge, verstellbare Rollenbremse, gezahnte Abrisskante (ohne Band)

metal casing with plastic handle for packing tape upto 50 mm width and 66 m length



4480



N 1 24



Mini-Packbandabroller

Mini Tape Dispenser

Das Verpackungsklebeband im handlichen Abroller ist optimal für den schnellen Einsatz im Büro und zu Hause.

Für Packband bis 50 mm Breite und 20 m Länge geeignet.

Useful at home and in the office. For packing tape upto 50 mm width and 20 m length.



4485

PE 1 5

Ersatzklebeband

Spare Tape

3 Rollen Ersatzklebeband für Art. Nr. 4485, transparent

3 rolls of spare tape for Art. No. 4485, transparent colour

4485/2

T 3 1



Klebeband Tischabroller

Tape Dispenser

Größe 200 x 75 x 100 mm, schwere Ausführung, für Kleberollen bis 25 mm Breite und 66 m Länge

size 200 x 75 x 100 mm, heavy duty, for spare tape up to 25 mm width and 66 m length



#			
3024	blau / blue	N	1 12
3024-11	schwarz / black	N	1 12



Klebeband Tischabroller

Tape Dispenser

Größe 155 x 70 x 85 mm, für Kleberollen bis 25 mm Breite und 66 m Länge

size 155 x 70 x 85 mm, for spare tape up to 25 mm width and 66 m length



#			
3025	blau / blue	N	1 12
3025-11	schwarz / black	N	1 12



Klebeband Tischabroller

Tape Dispenser

Größe 140 x 60 x 90 mm, für Kleberollen bis 19 mm Breite und 33 m Länge

size 140 x 60 x 90 mm, for spare tape up to 25 mm width and 33 m length



#			
3026	blau / blue	N	1 12
3026-11	schwarz / black	N	1 12



Handabroller

Hand Dispenser

aus Kunststoff, für Klebeband 19 mm x 33 m, mit 1 Rolle Klebeband

plastic, for 19 mm x 33 m tape, including 1 roll of tape



#			
3023	PE	1	10



Ersatzklebeband

Spare Tape

10 Rollen 19 x 33 mm für Art. Nr. 3023

10 rolls 19 x 33 mm for Art. No. 3023



#			
3023-1	T	10	10

50
Gummiringe *Rubber Bands*

#				
2731/2	Ø 25 mm	12	PT	20 g 100
2730	Ø 40 mm	12	PT	20 g 100
2732	Ø 50 mm	12	PT	20 g 100
2734	Ø 65 mm	12	PT	20 g 100
2736	Ø 85 mm	12	PT	20 g 100
2737/1	Ø 100 mm	12	PT	20 g 100
734/2	Ø 65 mm	12	N	25 g 400
736/2	Ø 85 mm	12	N	25 g 400
731/1	Ø 25 mm	12	N	40 g 250
731/2	Ø 25 mm	12	N	50 g 200
730	Ø 40 mm	12	N	50 g 200
731	Ø 40 mm	26	N	50 g 200
732	Ø 50 mm	12	N	50 g 200
733	Ø 50 mm	26	N	50 g 200
734	Ø 65 mm	12	N	50 g 200
735	Ø 65 mm	26	N	50 g 200
735-26	Sofffarben: weiß, gelb, blau, rot, mint soft colours: white, yellow, blue, red, mint			
	Ø 65 mm	26	P	50 g 100
736	Ø 85 mm	12	N	50 g 200
736/1	Ø 85 mm	26	N	50 g 200
737	Ø 100 mm	26	N	50 g 200
737/1	Ø 100 mm	12	N	50 g 100
2736-26	versch. Größen, bunt gemischt, mixed colours			
		26	PT	50 g 400
7300	Ø 40 mm	12	N	100 g 100

Gummiringe *Rubber Bands*

#				
7310	Ø 25 mm	12	N	100 g 100
7320	Ø 50 mm	12	N	100 g 100
7330	Ø 65 mm	12	N	100 g 100
7360	Ø 85 mm	12	N	100 g 100
7370	Ø 100 mm	12	N	100 g 100
791	Ø 40 mm	12	N	250 g 40
792	Ø 50 mm	12	N	250 g 40
793	Ø 65 mm	12	N	250 g 40
794	Ø 85 mm	12	N	250 g 40
795	Ø 100 mm	12	N	250 g 40
737/3	Ø 25 mm	12	N	0,5 kg 20
738	Ø 40 mm	12	N	0,5 kg 20
739	Ø 50 mm	12	N	0,5 kg 20
740	Ø 65 mm	12	N	0,5 kg 20
741	Ø 85 mm	12	N	0,5 kg 20
742	Ø 100 mm	12	N	0,5 kg 20
742/1	Ø 25 mm	12	N	1,0 kg 10
7421	Ø 25 mm	12	PT	1,0 kg 20
743	Ø 40 mm	12	N	1,0 kg 10
7431	Ø 40 mm	12	PT	1,0 kg 20
744	Ø 50 mm	12	N	1,0 kg 10
7441	Ø 50 mm	12	PT	1,0 kg 20
745	Ø 65 mm	12	N	1,0 kg 10
7451	Ø 65 mm	12	PT	1,0 kg 20



Gummiringe *Rubber Bands*



746	Ø 85 mm	12	N	1,0 kg	10
7461	Ø 85 mm	12	PT	1,0 kg	20
747	Ø 100 mm	12	N	1,0 kg	10
7471	Ø 100 mm	12	PT	1,0 kg	20

Rubber Band Ball ca. 320 St.

Rubber Band Ball ca. 320 pcs

Ø ca. 70 mm, ca. 190 g

Ø ca. 70 mm, approx. 190 g

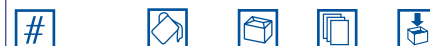

7440	26	T	1	1
-------------	----	---	---	---



Gummibänder *Elastics*

breite und starke Ausführung, flach messend

wide and strong type, measuring flat



748	80x4mm	12	N	50 g	200
749	100x5mm	12	N	50 g	200
750	130x4mm	12	N	50 g	200
751	130x10mm	12	N	50 g	200
752	150x4mm	12	N	50 g	200
7521	200x6mm	12	N	50 g	200
7522	150x10mm	12	N	50 g	200
7523	200x17mm	12	N	50 g	200
753	80 x 4 mm	12	N	0,5 kg	20
754	100 x 5 mm	12	N	0,5 kg	20
755	130 x 4 mm	12	N	0,5 kg	20
756	130x10mm	12	N	0,5 kg	20
757	150x4mm	12	N	0,5 kg	20
757/2	200 x 6 mm	12	N	0,5 kg	20

Gummibänder *Elastics*

breite und starke Ausführung, flach messend

wide and strong type, measuring flat



758	80 x 4 mm	12	N	1,0 kg	10
7581	80 x 4 mm	12	PT	1,0 kg	10
759	100 x 5 mm	12	N	1,0 kg	10
7591	100 x 5 mm	12	PT	1,0 kg	10
760	130 x 4 mm	12	N	1,0 kg	10
7601	130 x 4 mm	12	PT	1,0 kg	10
761	130x10mm	12	N	1,0 kg	10
7611	130x10mm	12	PT	1,0 kg	10
762	150x4mm	12	N	1,0 kg	10
7621	150x4mm	12	PT	1,0 kg	10
763	200 x 6 mm	12	N	1,0 kg	10
7631	200 x 6 mm	12	PT	1,0 kg	10
763/1	150x10mm	12	N	1,0 kg	10
763/2	200x17mm	12	N	1,0 kg	10





Kreuzbänder

Cross Bands

zum Verpacken und Verschnüren von Papierstapeln, Akten, Büchern und Paketen

for packing of paper stocks, files, books, parcels, a.s.o.

#					
2765	80 x 11 mm	26	P	30 g	15
2765/1	80 x 11 mm	26	N	100 g	10
2765/2	80 x 11 mm	26	N	500 g	1
2766	100 x 11 mm	26	P	30g	15
2766/1	100 x 11 mm	26	N	100 g	10
2767	130 x 11 mm	26	P	30 g	15
2768	150 x 11 mm	26	P	30 g	15
2768/1	150 x 11 mm	26	N	100 g	10
2768/2	150 x 11 mm	26	N	500 g	1
2769/2	220 x 11 mm	26	N	500 g	1

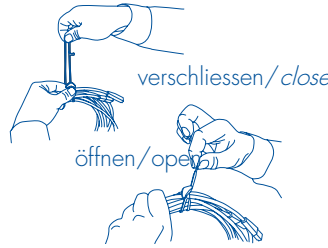

Verschlussringe

Hook Bands

Zum Bündeln von Kabelsträngen und Verschließen von Beuteln, aus Naturkautschuk, leichtes wieder öffnen, wieder verwendbar, kältebeständig bei Gefriergut

For bundling cables and closing bags, material: natural rubber, easy to reopen, usable several times, cold resistant

#					
2770	Ø 32 mm x 4,0 x 1,2 mm	KE	50 g	10	
2771	Ø 40 mm x 4,0 x 1,2 mm	KE	50 g	10	
2772	Ø 50 mm x 3,0 x 1,3 mm	KE	50 g	10	



Anfeuchter *Sponge Damper*

mit rotem Gummischwamm, Ø ca. 10 cm, einfarbig

with red sponge, Ø approx. 10 cm, single colour

#					
769-18	18	T	10	1	
Ersatzschwamm <i>Spare Sponge</i>	für Anfeuchter Art. Nr. 769				
769-12	12	T	10	1	



Anfeuchter, Glycerin

Sponge Damper, Glycerin

nicht fettend, geruchsneutral, hautverträglich, hygienisch

non greasing, odorless, kind to the skin, hygienic

#					
3900	40 g		12		



Blattwender *Finger Cones*

„Igelform“ mit Luftlöchern, Oberfläche mit feinen, engstehenden Gummistiften, weiches Material

with holes for ventilation, soft material

#					
764	Größe 1 Ø 15 mm	18	N	10	40
765	Größe 2 Ø 17 mm	18	N	10	40
766	Größe 3 Ø 19 mm	18	N	10	40
767	Größe 4 Ø 20 mm	18	N	10	40
768	Größe 5 Ø 22 mm	18	N	10	40

GELDKASSETTEN SCHLÜSSELSCHRÄNKE ZUBEHÖR

CASH BOXES | KEY CABINETS | ACCESSORIES



8400



8410



8420



8430



Geldkassetten

Cash Boxes

in einer neuartig ausgefallenen Optik mit gewölbten Seiten und formschönen Deckel, aus Stahlblech, Drehriegelzylinderschloss mit 2 Schlüsseln, Kunststoffeinsatz mit 8 Münzfächern (Art. Nr. 8430 mit 9 Fächern)

in new special design, sheet steel, barrel lock with 2 keys, plastic insert for 8 different coins (Art. No. 8430 with 9 compartments)

#				
8400	(B x H x T) 155 x 80 x 120 mm	10, 11, 12, 15, 36	T	1 1
8410	(B x H x T) 205 x 85 x 160 mm	10, 11, 12, 15, 36	T	1 1
8420	(B x H x T) 255 x 90 x 200 mm	10, 11, 12, 15, 36	T	1 1
8430	(B x H x T) 330 x 90 x 235 mm	10, 11, 12, 15, 36	T	1 1



Geldkassetten

Cash Boxes

Stahlblech, innen und außen kratzfest lackiert, mit 2 Schlüsseln und Kunststoffeinsatz, verchromtes Drehriegel-Zylinderschloss, Maße in mm (B x H x T)

sheet steel, electro painted inside and outside, with 2 keys and plastic insert, chromium-plated lock, measurements in mm (width x height x length)



#	(B x H x T)	10, 11, 12, 15, 18, 29, 36	T	1	1
840	150 x 80 x 115 mm	10, 11, 12, 15, 18, 29, 36	T	1	1
841	200 x 70 x 160 mm	10, 11, 12, 15, 18, 29, 36	T	1	1
842	250 x 70 x 180 mm	10, 11, 12, 15, 18, 29, 36	T	1	1
843	300 x 90 x 240 mm	10, 11, 12, 15, 18, 29, 36	T	1	1
844	200 x 90 x 160 mm	10, 11, 12, 15, 18, 29, 36	T	1	1
845	250 x 85 x 170 mm	10, 11, 12, 15, 18, 29, 36	T	1	1



Mini-Box

Mini Cash Boxes

Kinder-Kassetten mit Einwurf-Schlitz, Maße in mm (B x T x H): 125 x 95 x 60

cash box for children with a slot, measurements in mm (L x W x H): 125 x 95 x 60



#	10, 11, 12, 15, 36	T	1	1
850	10, 11, 12, 15, 36	T	1	1



854

853



874

EURO-Münzzählbrett

EURO-Coin Counter Tray

Zählbrett einteilig
 mit 8 Münzreihen für 1 Cent bis 2 Euro, separates Fach für unsortierte Münzen,
 (B x H x T) 260 x 170 x 20 mm

*Coin Counter Tray one-piece
 for 8 different coins (1 cent to 2 Euro), separate pigeonhole for unsorted coins,
 (B x H x T) 260 x 170 x 20 mm*



854

11 T 1 1

EURO-Geldtransportkassette

EURO Safe Cash Box

herausnehmbarer Euro-Münzeinsatz,
 Schaumstoffeinlage,
 Geldscheinmulde mit 3 Notenfächern,
 Sicherheitszylinderschloss mit 2 Schlüsseln,
 Kunststoffgriff,
 (B x H x T) 355 x 102 x 275 mm

*removable coin tray (including pigeonhole for unsorted coins) and banknote pigeonhole, expanded
 material in the cover, securitylock with 2 keys provided, with plastic handle,
 (w x h x d) 355 x 102 x 275 mm*

853

39 T 1 1

EURO-Zählkassette

EURO Cash Box

herausnehmbarer Euro-Münzeinsatz, Geldscheinmulde mit 3 Notenfächern,
 Sicherheitszylinderschloß mit 2 Schlüsseln, (B x H X T) 250 x 90 x 180 mm

*removable coin tray, banknote pigeonhole, security-lock with 2 keys provided,
 (w x h x d) 250 x 90 x 180 mm*

874

15 T 1 1



Geldscheinprüfgerät

Money Detector

zur Überprüfung der Sicherheitsmerkmale bei Banknoten, Kreditkarten, Ausweisen, Reisepässen und neuen Führerscheinen, mit 6W UV-Lampe in Kunststoffgehäuse, 230 V, 250 x 135 x 70 mm

for security check of Banknotes, passports, credit cards, a.s.o. 6 W, 230 V UV-lamp in a plastic case, 250 x 135 x 70 mm



869



11 N 1 1

Schlüsselschränke

Key Cabinets

Stahlblech, innen und außen kratzfest lackiert, mit 2 Schlüsseln und nummerierten Haken, verchromtes Drehriegel-Zylinderschloss

sheet-steel, lacquered in and outside, with 2 keys and num. hooks, chromiumplated lock



894

390 x 270 x 50 mm, 68 Schlüssel
 390 x 270 x 50 mm, 68 keys



33 N 1 1

895 S

270 x 515 x 52 mm, 105 Schlüssel
 270 x 515 x 52 mm, 105 keys

33 N 1 1

896

270 x 515 x 52 mm, 140 Schlüssel
 270 x 515 x 52 mm, 140 keys

33 N 1 1

897

450 x 680 x 50 mm, 200 Schlüssel
 450 x 680 x 50 mm, 200 keys

33 N 1 1

894-897



879



880



Schlüsselkassetten

Key Boxes

Stahlblech, innen und außen kratzfest lackiert, mit 2 Schlüsseln und nummerierten Haken, verchromtes Drehriegel-Zylinderschloss

sheet-steel, lacquered in and outside, with 2 keys and num. hooks, chromiumplated lock



890

200 x 160 x 80 mm, 20 Schlüssel
 390 x 300 x 60 mm, 20 keys

33 T 1 1

891

200 x 160 x 80 mm, 30 Schlüssel
 200 x 160 x 80 mm, 30 keys

33 T 1 1

892

200 x 160 x 80 mm, 40 Schlüssel
 200 x 160 x 80 mm, 40 keys

33 T 1 1

893

370 x 280 x 60 mm, 80 Schlüssel
 370 x 280 x 60 mm, 80 keys

33 T 1 1

Schlüsselschrank mit Zahlenschloss *Key Box with combination lock*

Schlüsselschrank aus Stahlblech mit Zahlenschloss, anthrazit, für 20 Schlüssel, ohne Schlüsselanhänger
 key box, made of steel, combination lock, anthracite, for 20 keys

879

200 x 160 x 80 mm, ohne Schlüsselanhänger
 200 x 160 x 80 mm, without key hangers

39 N 1 1

Schlüsselschrank mit Zahlenschloss *Key Box with combination lock*

Schlüsselschrank aus Stahlblech mit Zahlenschloss, anthrazit, für 36 Schlüssel, ohne Schlüsselanhänger
 key box, made of steel, combination lock, anthracite, for 36 keys

880

300 x 240 x 80 mm, ohne Schlüsselanhänger
 300 x 240 x 80 mm, without key hangers

39 N 1 1



Schlüsselanhänger

Key Hangers

#					
1851	mit beschreibbaren und auswechselbaren Etiketten <i>with describable and changeable label</i>	10, 11, 12, 13, 15, 18, 19, 21	N	100	1
1850	Sortiment aus den unter Art. Nr. 1851 aufgeführten Farben <i>assortment of the different colours of Art. No. 1851</i>	26	N	200	1
1853	10 Schlüsselanhänger, farbig gemischt, im Klarsichtbeutel 10 key hangers, mixed colours, in a small poly bag	10, 11, 12, 13, 15, 18, 19, 21, 26	PT	10	1
1854	10 Schlüsselanhänger und 6 Schlüsselringe, farbig gemischt, im Klarsichtbeutel 10 key hangers and 6 key rings, mixed colours, in polybag	26	PT	16	10
1855	25 Schlüsselanhänger, farbig gemischt, im Klarsichtbeutel 25 key hangers, mixed colours, in polybag	26	PT	25	10

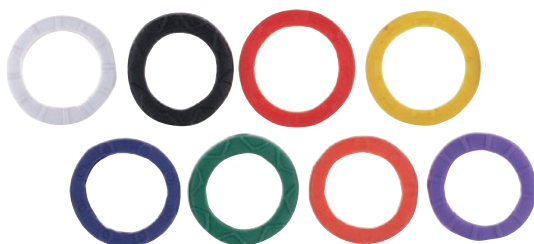

Schlüsselringe

Key Rings

aus flexiblem Kunststoff
made of soft plastic

#					
1751		10, 11, 12, 13, 15, 18, 19, 21, 26	N	100	1

Schlüsselringe

Key Rings

aus Metall

metal

#				
1915-1	Ø 15 mm	P	100	1
1920-1	Ø 20 mm	P	100	1
1925-1	Ø 25 mm	P	100	1
1930-1	Ø 30 mm	P	100	1
1933-1	Ø 33 mm	P	100	1
1936-1	Ø 36 mm	P	100	1

SCHREIBTISCH ACCESSOIRES

DESK ACCESSOIRES

Acryl



Klebebandabroller

Tape Dispenser

aus unserem Büro-Set Art. Nr 4458
(ohne Klebeband)

from Acrylic Desk Set Art. No. 4458
(without Tape)



4461

22 N 1 12

Acryl

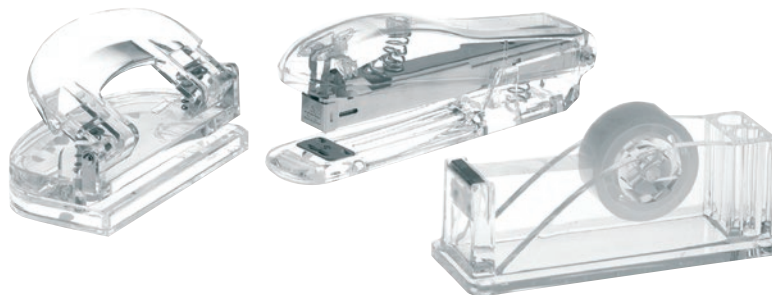

Büro-Set Acryl „glasklar“

Acrylic Desk Set „clear“

bestehend aus Locher mit Anschlagsschiene (80 x 105 x 80 mm),
Klebebandabroller, schwere Ausführung (50 x 125 x 75 mm), ohne Klebeband,
Heftgerät 24/6, 26/6 (30 x 145 x 60 mm)

*1 two holes punch with fence (80 x 105 x 80 mm),
1 heavy tape dispenser (50 x 125 x 75 mm), without tape,
1 stapler 24/6, 26/6 (30 x 145 x 60 mm)*



4458

22 F 1 1

Acryl



Stift Ablage

Pencil Tray

95 x 22 x 35 mm



4463

22 N 1 12

Acryl



Büro-Set Acryl „gefrostet“

Acrylic Desk Set „frosted“

bestehend aus Locher (60 x 110 x 65 mm),
Klebebandabroller (35 x 120 x 50 mm), ohne Klebeband,
Heftgerät 24/6, 26/6 (30 x 145 x 55 mm)

*1 two holes punch (60 x 110 x 65 mm),
1 tape dispenser (35 x 120 x 50 mm), without tape,
1 stapler 24/6, 26/6 (30 x 145 x 55 mm)*



4459-10

10 F 1 1

Acryl



Büro-Set Acryl „gefrostet“

Acrylic Desk Set „frosted“

bestehend aus Locher mit Anschlagschiene (80 x 105 x 80 mm), Klebebandabroller, schwere Ausführung (50 x 125 x 75 mm), ohne Klebeband, Heftgerät 24/6, 26/6 (30 x 145 x 60 mm)

1 two holes punch with fence (80 x 105 x 80 mm),
1 heavy tape dispenser (50 x 125 x 75 mm), without tape,
1 stapler 24/6, 26/6 (30 x 145 x 60 mm)



4459-15

15 F 1 1



Utensilienbox

Multi-Purpose Desk Organizer

4 Fächer für Stifte, Briefständer, 3 Klammerfächer, 155 x 95 x 75 mm

4 parts for pencils, 1 letter holder,
3 parts for clips, 155 x 95 x 75 mm



4452

22 N 1 12



Visitenkartenständer

Name Card Holder

103 x 60 x 30 mm



4456

22 N 1 12

Acryl

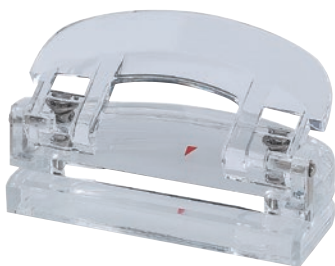

Locher

Two Holes Punch

aus unserem Büro-Set Art. Nr 4458
from Acrylic Desk Set Art. No. 4458



4460

22 N 1 12

Acryl



Stempelhalter

Stamp Holder

für 5 Stempel, 100 x 74 x 60 cm
for 5 stamps, 100 x 74 x 60 cm



4472

22 N 1 12

Acryl



Buchstützen

Book Stands

90 x 136 x 155 mm



4453

22 N 2 12



Utensilienbox

Multi-Purpose Desk Organizer

3 Fächer für Stifte, Utensilien oder Mobiltelefon, 90 x 115 x 115 mm

3 parts for pencils, utilities or mobile phone, 90 x 115 x 115 mm



4454

22 N 1 12



Karteibox

Index Box

mit Registerkarten, 90 x 130 x 105 mm

with Index Cards, 90 x 130 x 105 mm



4469

22 N 1 12

Acryl



Kartei-/Visitenkartenbox

Name Card Holder/Index Box

mit Registerkarten in Führungsschiene, DIN A8, 150 x 110 x 80 mm

with Index Cards, with table track, DIN A8, 150 x 110 x 80 mm



4470

22 N 1 6



Briefklammerschale

Paper Clip Holder

griffig und formschön, 85 x 80 x 65 mm
beautifully designed, 85 x 80 x 65 mm



4455

22 N 1 12

Acryl



Briefständer

Letter Rack

mit 2 Fächern, 75 x 150 x 95 mm
with 2 trays, 75 x 150 x 95 mm



4466

22 N 1 12

Acryl



Zettelbox

Notes Dispenser

mit Zetteln, 100 x 100 x 43 mm
with notes, 100 x 100 x 43 mm



4468

22 N 1 12

Acryl



Stifteköcher

Pen Holder

70 x 75 x 100 mm



4464

22 N 1 12

Acryl



Stiftetui

Pencil Case

45 x 210 x 30 mm



4465

22 N 1 12

Acryl



Brieföffner

Letter Opener

Länge: 240 mm
length: 240 mm



4467

22 N 1 12



Klemmbrett

Clipboard

hochwertige Ausführung, mit starker Federklemme und Aufhänger, 3 mm starker, glasklarer Kunststoff, abgerundete Kanten, 230 x 320 mm

with strong wire clip and hanger, made of 3 mm transparent plastic, rounded edges, 230 x 320 mm



4457

22 N 1 12



Buchstützen

Book Stands

aus Metall, 1 Paar, (B x H x T) Maße in mm

metal, 1 pair, (w x h x d) dimensions in mm



4301

85 x 140 x 140 10, 11, 12, 29 K 1 Paar/ 1 pair 1

4302

125 x 140 x 140 10, 11, 12, 29 K 1 Paar/ 1 pair 1

4303

130 x 240 x 140 10, 11, 12, 29 K 1 Paar/ 1 pair 1

4304

120 x 140 x 145 mm, keilförmig 10, 11, 12, 29 K 1 Paar/ 1 pair 1
120 x 140 x 145 mm, wedge-shaped



Zettelspießer

Spike File

aus Metall, mit rutschfesten Füßen, 100 x 150 mm

metal, non slip, 100 x 150 mm



4308

11 N 1 12

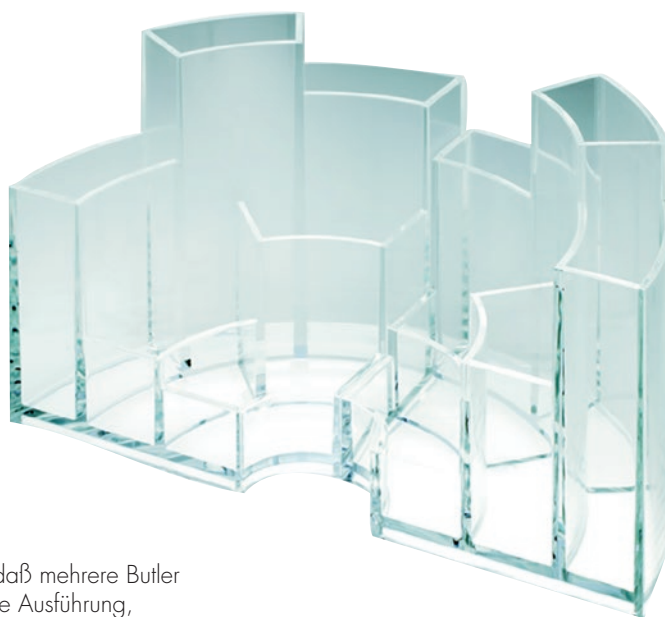
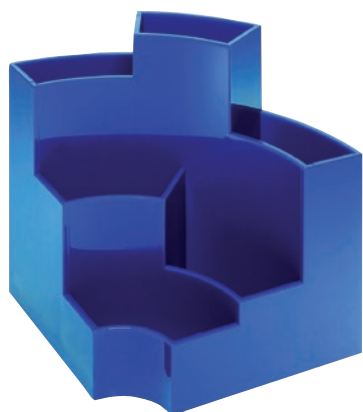

Schreibtisch-Butler

Desk Tidy

mit 6 verschieden hohen Fächern, im Viertelkreis konzipiert, sodaß mehrere Butler miteinander verbunden werden können, sehr stabil, hochwertige Ausführung, exclusives ALCO Design

with 6 different trays, quadrant design to connect multiple Organizers, exclusive designed by ALCO



4473



11, 15, 22

N

1

1

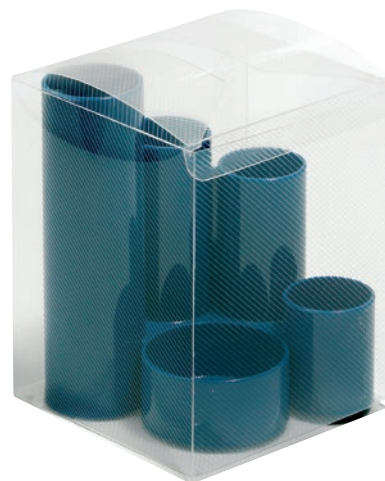

Schreibtisch-Butler

Desk Tidy

Schreibtisch-Butler mit 5 Röhren aus Kunststoff, für die verschiedensten Schreibtisch-Utensilien geeignet

Desk Tidy with 5 tubes, plastic, for different desktop implements



4450



10, 11, 12, 15

K

1

12

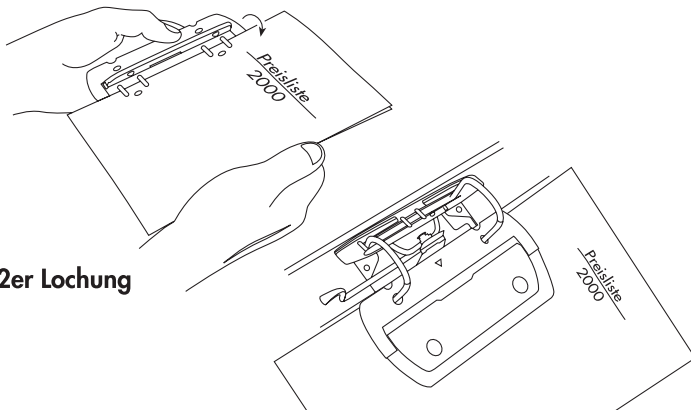

2er Lochung

Im Ordner zur Hand

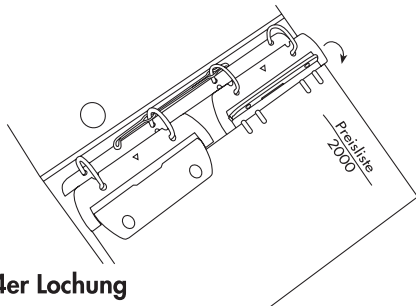

4er Lochung

Multi-Locher

Slim Hole Punch

aus Kunststoff, für 2er und 4er Lochung, zum Abheften

plastic, for 2- or 4 holes, can be filed



4430

26 K 1 25



3013-26

3013-11

3015-11

Dosenbleistiftspitzer

Pencil Sharpener

quadratisch, einfach, verschließbar, Metallspitze

square cube plastic canister, 1-hole, metal sharpener



3013-26

26 K 1 10

3013-11

schwarz 11 K 1 10
black colour

3013-A11

schwarz 11 K 1 10
black colour

quadratisch, doppelt (Ø 7,8 und 11 mm), verschließbar, Metallspitzer

square cube plastiv canister, 2-holes (Ø 7,8 and 11 mm), metal sharpener

3015-11

11 P 1 10



Dosenbleistiftspitzer

Pencil Sharpener

rund, doppelt (Ø 8 u. 11 mm), verschraubt, verschließbar, Metallspitzer

cylindrical shape canister, 2-holes (Ø 8 and 11 mm), screwed to lid, metal sharpener



3012

26 K 1 20



Dosenbleistiftspitzer

Pencil Sharpener

rechteckig, doppelt (Ø 8 u. 11 mm), verschließbar, Kunststoffspitzer

plastic canister, 2-holes (Ø 8 and 11 mm), plastic sharpener



3011

26 K 1 10



Dosenbleistiftspitzer

Pencil Sharpener

rund, einfach, verschließbar, Kunststoffspitzer

round shape flat top, clear transparent, 1-hole, plastic sharpener



3005

26 K 1 10



Dosenbleistiftspitzer

Pencil Sharpener

mondförmig, doppelt (Ø 8 u. 11 mm), verschraubt, verschließbar, Metallspitzer

half moon shape, 2-holes (Ø 8 and 11 mm), screwed to lid, plastic canister, metal sharpener



3010

26 K 1 10

Dosenbleistiftspitzer

Pencil Sharpener

wie 3010, aber Spitzer aus Kunststoff

like 3010, but plastic sharpener



3010-1

26 K 1 10



Bleistiftspitzer

Pencil Sharpener

aus Kunststoff, einfach, in Blockform
plastic, waist shape, 1-hole



3003

26 K 1 20



Bleistiftspitzer

Pencil Sharpener

aus Metall, einfach, in Keilform
metal, wedge shape, zinc, alloy 1-hole



3001

K 1 20

3001 A

E 1 10



Batterie-Bleistiftspitzmaschine

Battery Prepared Pencil Sharpener

für 4 Batterien, 4 X 1,5 V oder Adapter DC 6V, bis 8 mm Ø, Größe: 150 x 45 x 80 mm

battery prepared pencil sharpener, for 4 batteries, 4 X 1,5 V or adapter DC 6V, upto pencils of Ø 8 mm, size: 150 x 45 x 80 mm



3021

29 N 1 1



Bleistiftspitzer

Pencil Sharpener

aus Metall, doppelt (Ø 8 und 11 mm), in Keilform

metal, wedge shape, zinc alloy, 2-holes (Ø 7,8 and 11 mm)



3002

K 1 20

3002 A

E 1 10



Kurbel-Bleistiftspitzer

Crank Operated Sharpener

bis Ø 12 mm, inkl. Tischklemme

for pencils up to Ø 12 mm, incl. clamp



3014

11 K 1 1



Kugelschreiberständer

Counter Top Pen

Kugelschreiber, befestigt an rundem Metallständer mit stabiler verchromter Metall-Kugellkette, flexibler Spiral-Stifthalter incl. Klebepad und rutschfesten Silikon-Noppen zur optionalen Aufstellung auf der Tischoberfläche

- auswechselbare Standardmine in Schwarz inkl.
- Farbe: Schwarz
- H/Ø: 14,5 cm / 8 cm, Kettenlänge ca. 55 cm

ball pen, fixed on round metal stand with solid metal ball chain (chromium plated), flexible spiral pen holder incl. sticky pad for fixing and anti slip silicon knobs for optional using on the table

- incl. interchangeable black standard mine
- colour: black
- h/Ø: 14,5 cm / 8 cm, length of the chain about 55 cm



1510-11

N 1 25



Kugelschreiberständer

Counter Top Pen

Kugelschreiber, befestigt an rundem Metallständer mit stabiler verchromter Metall-Kugellkette, flexibler Spiral-Stifthalter incl. Klebepad und rutschfesten Silikon-Noppen zur optionalen Aufstellung auf der Tischoberfläche

- auswechselbare Standardmine in Schwarz inkl.
- Farbe: Silber
- H/Ø: 14,5 cm / 8 cm, Kettenlänge ca. 55 cm

ball pen, fixed on round metal stand with solid metal ball chain (chromium plated), flexible spiral pen holder incl. sticky pad for fixing and anti slip silicon knobs for optional using on the table

- incl. interchangeable silver standard mine
- colour: silver
- h/Ø: 14,5 cm / 8 cm, length of the chain about 55 cm



1510-28

N 1 25



Kugelschreiberständer

Counter Top Pen

Kugelschreiber, Kunststoff, befestigt an rechteckigem Ständer mit stabiler verchromter Metall-Kugellkette

- Fixierung durch Klebepad an der Fussunterseite möglich
- auswechselbare Standardmine in Schwarz inkl.
- Farbe: Schwarz

ball pen, plastic, fixed on rectangular stand with solid metal ball chain (chromium plated) with sticky pad for fixing on the desk

- incl. interchangeable black standard mine
- colour: black
- h/w/d: 19,5 x 7 x 11,5 cm, length of the chain about 55 cm



1511-11

N 1 25



Kugelschreiberständer

Counter Top Pen

Kugelschreiber, Kunststoff, befestigt an rechteckigem Ständer mit stabiler verchromter Metall-Kugellkette

- Fixierung durch Klebepad an der Fussunterseite möglich
- auswechselbare Standardmine in Schwarz inkl.
- Farbe: Silber

ball pen, plastic, fixed on rectangular stand with solid metal ball chain (chromium plated) with sticky pad for fixing on the desk

- incl. interchangeable black standard mine
- colour: silver
- h/w/d: 19,5 x 7 x 11,5 cm, length of the chain about 55 cm



1511-28

N 1 25



Kugelschreiberständer

Counter Top Pen

Kugelschreiber, Metall, befestigt an ovalem Ständer mit stabiler Metall-Kugelschreiberkette, verchromte Stifthalterung in alle Richtungen schwenkbar incl. Klebepad und rutschfesten Silikon-Noppen zur optionalen Aufstellung auf der Tischoberfläche auswechselbare Standardmine in Schwarz inkl.

- Farbe: Silber • H/Ø: 20,5 cm / 7,5 x 9 cm
- (oval), Kettenlänge ca. 55 cm

ball pen, metal, fixed on oval stand with solid metal chain, chromium plated and rotatable pen holder incl. sticky pad for fixing and anti slip silicon knobs for optional using on the table incl. interchangeable black standard mine

- colour: silver • h/Ø: 20,5 cm / 7,5 x 9 cm
- (oval), length of the chain about 55



1512-1

N 1 25



Kugelschreiberständer

Counter Top Pen

Kugelschreiber, Metall, befestigt an ovalem Ständer mit stabiler Metall-Kugelschreiberkette, verchromte Stifthalterung in alle Richtungen schwenkbar incl. Klebepad und rutschfesten Silikon-Noppen zur optionalen Aufstellung auf der Tischoberfläche auswechselbare Standardmine in Schwarz inkl.

- Farbe: Chrom • H/Ø: 20,5 cm / 7,5 x 9 cm
- (oval), Kettenlänge ca. 55 cm

ball pen, metal, fixed on oval stand with solid metal chain, chromium plated and rotatable pen holder incl. sticky pad for fixing and anti slip silicon knobs for optional using on the table incl. interchangeable black standard mine

- colour: chrome • h/Ø: 20,5 cm / 7,5 x 9 cm
- (oval), length of the chain about 55



1512-2

N 1 25

Kugelschreiberständer

Counter Top Pen

Kugelschreiber, Kunststoff, befestigt an quadratischem Ständer mit flexibler Wendelschnur, Stifthalterung seitlich schwenkbar Fixierung durch Klebepad an der Fussunterseite möglich Mine: Schwarz

- Farbe: Schwarz/Transparent • H/B/T: 14 x 4 x 6 cm
- Auszugslänge bis ca. 100 cm

ball pen, plastic, fixed on square stand with flexible cable, rotatable holder (sideways) with sticky pad for fixing on the desk black mine

- colour: black/transparent • h/w/d: 14 x 4 x 6 cm
- extension length of the cable about 100 cm



1513

N 1 50



Brieföffner

Letter Opener

gekrümmt, aus rostfreiem Edelstahl, mit blauer Gummierung in der Griffmulde, Länge 16,5 cm

engraved handle, all stainless steel, with blue gummed ring inside, length 16,5 cm



1500

KE 1 12



Brieföffner

Letter Opener

gerade, aus rostfreiem Edelstahl, Länge 24 cm

with straight blade and flat handle, all stainless steel, length 24 cm



1502

KE 1 12



Brieföffner

Letter Opener

gerade, aus rostfreiem Edelstahl, mit schwarzem Kunststoffgriff, Länge 21,2 cm

with straight blade and black plastic handle, all stainless steel, length 21,2 cm



1504

KE 1 12



Brieföffner

Letter Opener

gerade, aus rostfreiem Edelstahl, mit aufgebogener Klinge, Länge 24 cm

with straight blade and cranked handle, all stainless steel, length 24 cm



1501

KE 1 12



Brieföffner

Letter Opener

gerade, aus rostfreiem Edelstahl, mit Längsrillen-Gravur am Griff und Aufhängevorrichtung, mit aufgebogener Klinge, Länge 23,2 cm

with straight blade and cranked, engraved handle, all stainless steel, with hole, length 23,2 cm



1503

KE 1 12



Brieföffner

Letter Opener

gerade, aus rostfreiem Edelstahl, mit Holzgriff, Länge 22,6 cm

with straight blade and wooden handle, all stainless steel, length 22,6 cm



1505

KE 1 12



Brieföffner
Letter Opener

gerade, aus rostfreiem Edelstahl, mit aufgebogener Klinge und Holzgriff, Länge 24,8 cm

with straight blade and cranked wooden handle, all stainless steel, length 24,8 cm



1506

KE 1 12



Brieföffner-Set
Letter Opener Set

Set bestehend aus Schere Art. Nr. 1408 und Brieföffner Art. Nr. 1500 (rostfrei, 21,5 cm)

set including scissors Art. No. 1408 and letter opener Art. No. 1500 (rustproof, 21,5 cm)



1508

F 1 12



Buchständer
Book Rest

aus Kunststoff, lichtdurchlässig, Neigung stufenlos einstellbar, 16 x 15,5 x 15 cm

plastic, for school-, office- and home use, 16 x 15,5 x 15 cm



5510

15 KE 1 12



Brieföffner
Letter Opener

gerade, aus rostfreiem Edelstahl, mit aufgebogener Klinge und Holzgriff, Länge 22,6 cm, in Fensterschachtel

with straight blade and cranked wooden handle, all stainless steel, length 22,6 cm



1507

F 1 12



Brieföffner-Set
Letter Opener Set

Set bestehend aus Brieföffner Art. Nr. 1500 (rostfrei, 16,5 cm) und dazu passender Schere (16,5 cm), mit schwarzer Gummierung in der Griffmulde

set including scissors (16,5 cm) and letter opener Art. No. 1500 (16,5 cm) with black gummed ring



1509

F 1 12



Klemmbretter
Clipboards

aus farbigem Kunststoff, lichtdurchlässig, mit starker Federklemme, Aufhängung und abgerundeten Kanten, 23 x 32 cm

in translucent colours, plastic, with a strong clamp and rounded edges, 23 x 32 cm



5511

11, 12, 13, 15

T 1 12

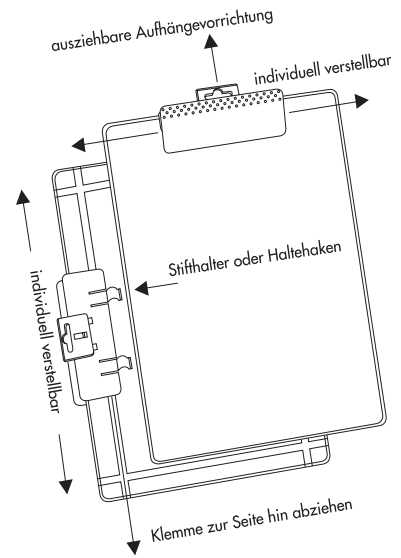

Schreibplatte mit Varioklemme
Clipboard with Relocatable Clamp

Für Büro, Werkstatt, Betriebsabläufe, Klemme seitlich, vertikal und horizontal verschiebbar, individuelle Positionierung durch Rasterung auf der Rückseite, ausziehbarer Aufhängevorrichtung, Patent angemeldet, 32 x 23,5 cm

Ideal for use in the office, workshop or home, it can be used and hung up in portrait or landscape mode, paper clamp can be securely located in any position on the top or side, paper clamps has a retractable hanging hole and pen/pencil holder, patent applied for, 32 x 23,5 cm



5512

11,15,29

K 1 10



Alu Klemmbretter
Aluminium Clipboard

unzerbrechlich, wasser-resistent

unbreakable, water resistant



5516

DIN A5 Format

P 1 12

5517

DIN A4 Format

P 1 12



Klemmbretter

Clipboards

kunststoffüberzogen, mit abgerundeten Kanten, abwaschbar
plastic covered, with rounded edges, washable



5513

geeignet für DIN A4 Format
for DIN A4 format

11, 12, 15 P 1 12

5514

geeignet für DIN A5 Format
for DIN A5 format

11, 12, 15 P 1 12

Klemmbretter A3

Clipboards A3

geeignet für DIN A3 Format, kunststoffüberzogen, mit abgerundeten Kanten, abwaschbar

for DIN A3 format, plastic covered, with rounded edges, washable



5520

11, 12, 15 P 1 10



Klemmbretter A4, quer

Clipboards A4, for cross using

geeignet für DIN A4 Format, kunststoffüberzogen, mit abgerundeten Kanten, abwaschbar

for DIN A4 format, plastic covered, with rounded edges, washable



5519

11, 12, 15 P 1 10



Klemmbretter A3, quer

Clipboards A4, for cross using

geeignet für DIN A3 Format, kunststoffüberzogen, mit abgerundeten Kanten, abwaschbar

for DIN A3 format, plastic covered, with rounded edges, washable



5521

11, 12, 15 P 1 10



Klemmmappen A4

Foldover Clipboard A4

kunststoffüberzogen, mit abgerundeten Kanten, geeignet für DIN A4 Format, abwaschbar

plastic covered, with rounded edges, for DIN A4 format, washable



5515

11, 12, 15 P 1 12



Alu Klemmbretter mit Solarrechner

Clipboards A4 with calculator

für Blattformate bis DIN A4, aus leicht durchsichtigem Kunststoff, an den Längsseiten Maßeinteilungen in cm und inch

DIN A4 format, translucent plastic, with graduation in cm and inch longsides



5518

11, 15 P 1 12

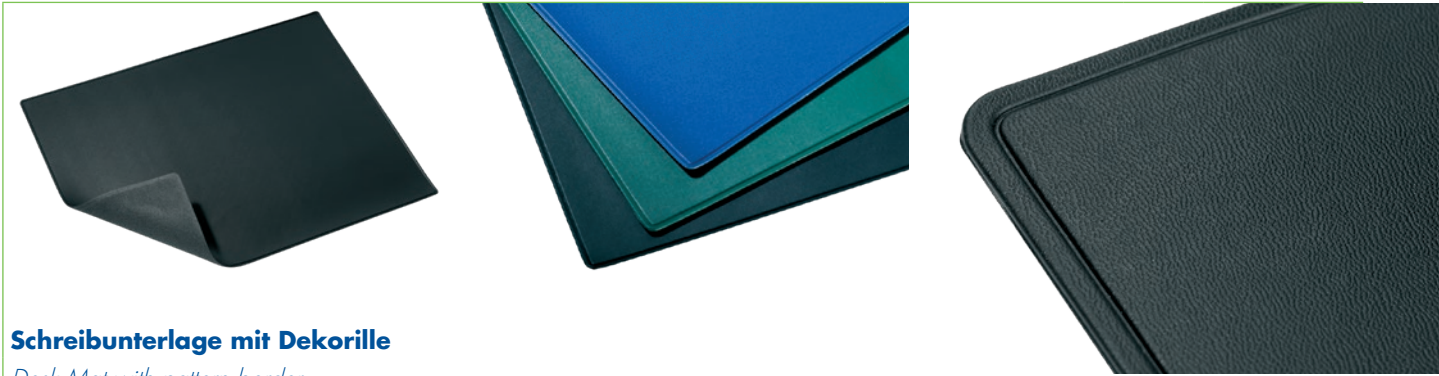

Schreibunterlage mit Dekorille

Desk Mat with pattern border

und abgerundeten Ecken. Gewährleistet besten Schreibkomfort. Die Unterlage ist abwaschbar, rutschfest und strapazierfähig.
washable, antislip, heavy duty. With rounded edges.



5532

Größe 50 x 65 cm / size 50 x 65 cm

11,15,18

P

1

10

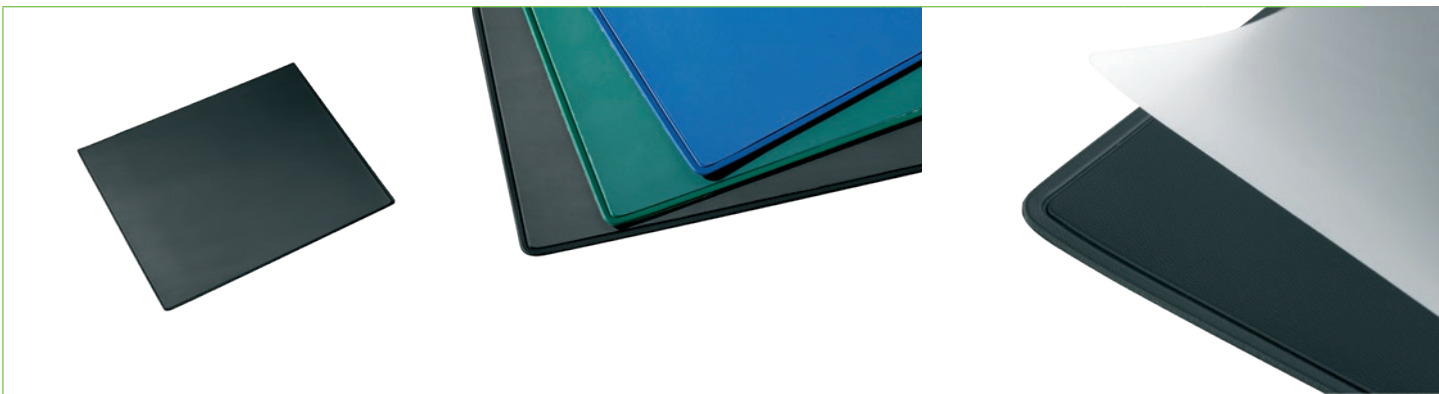

Schreibunterlage mit transparenter Abdeckung

Desk Mat with transparent overlay

zum Unterlegen von Notizen u.a.. Mit abgerundeten Ecken. Für besten Schreibkomfort. Die Unterlage ist abwaschbar, rutschfest und strapazierfähig.

washable, antislip, heavy duty. With rounded edges



5533

Größe 50 x 65 cm / size 50 x 65 cm

18

P

1

10

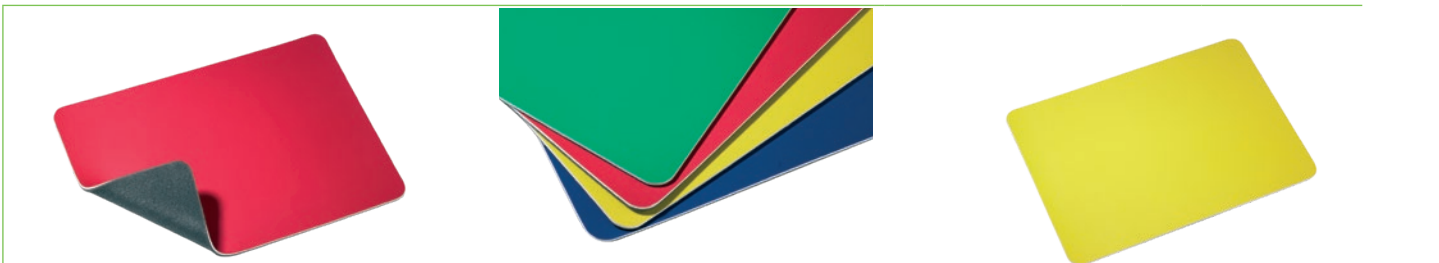

Arbeits- und Bastelunterlagen

Working- and Handicraft Mats

damit bleibt der Tisch sauber und geschützt beim Malen, Basteln, Werkeln und Schreiben. Die Unterlage ist abwaschbar, rutschfest und strapazierfähig

to protect the table during painting, handicraft work and writing. The Mat is washable, antislip and heavy duty. With rounded edges.



5530

12, 13, 18

P

1

10

LESEGLÄSER

READING MAGNIFIERS





Leselupe

Magnifier

mit 2 eingebauten lichtstarken LED-Lampen, Ø 88 mm, Vergrößerung 2,5- und 4-fach, Rand schwarz, Griff silberfarben (Batterien nicht im Lieferumfang enthalten)

with 2 LED lights, Ø 88 mm, 2,5 and 4 x magnification, frame black, handle silver colour (batteries not included)



1276

KE 1 12



Leseglas

Magnifier

Ø 90 mm, Vergrößerung 2-fach, Auge 6-fach

Ø 90 mm, 2x magnification, eye 6x magnification



1270

N 1 10



Rundlupe

Round illuminated Magnifier

beleuchtet, Ø 75 mm, Vergrößerung 3-fach, für 2 Batterien (nicht im Lieferumfang enthalten)

Ø 75 mm, 3 x magnification, for 2 batteries (not included)



1275

KE 1 12



Standlupe

Cylinder Magnifier

Ø 30 mm, Vergrößerung 10-fach

Ø 30 mm, 10 x magnification



1271

N 1 12



LED Rundlupe mit Klemme

Round illuminated Magnifier with clamp

zum Anklebmen, Ø 108 mm, mit flexiblem Schlauch, mit 2 eingebauten lichtstarken LED-Lampen, silberfarben, Vergrößerung 2- und 4-fach (Batterien nicht im Lieferumfang enthalten)

with clamp, Ø 108 mm, with 2 LED lights, silver colour, 2 and 4 x magnification (batteries not included)



1277



N 1 1



Leselupen-Set

Set of Magnifiers

im Aufsteller, bestehend aus: Je 4 Stück Art. 1272, 1273 und 1274
with stand, containing: 4 pieces each of Art. 1272, 1273 and 1274



1278

N 12 1



Leselupe

Magnifier



1272

mit Glaslinse, Ø 50 mm, mit Metallfassung, vernickelt, schwarzer verschraubter Griff, Vergrößerung 5-fach

glas lens, metal frame, black handle, 5 x magnifikation

N 1 12

1273

wie Art. Nr. 1272, Ø 65 mm, Vergrößerung 5-fach

glas lens, metal frame, black handle, 5 x magnifikation

N 1 12

1274

wie Art. Nr. 1272, Ø 75 mm, Vergrößerung 3-fach

same as 1272, 3 x magnifikation

N 1 12



A	SEITE
Aktenklammern	7-8, 14, 16, 17, 19
ALCOfix Haftmarker	34-35
Alu Klemmbretter	73
Alu Lineale	42
Anfeuchter	52
Anfeuchter Glycerin	52
Arbeits- und Bastelunterlagen	76
B	SEITE
Bastel-Scheren	37
Batterie Bleistiftspitzmaschine	68
Bilderhaken	12
Bildaufhänger / Klappösen	20
Blattwender	52
Bleistiftspitzer	68
Briefklammern	6-8, 14-17, 19
Briefklammerschale	63
Briefklemmer	9
Briefknöpfe	12
Brieföffner	63, 70-72
Briefständer	63
Buchständer	72
Buchstützen	62, 64
Büro-Set Acryl	61-62
C	SEITE
CIRCULAR Büroklammer	8
Cutter Messer	40-41
D	SEITE
Dekorationsstecknadeln	12, 18
Dosenbleistiftspitzer	66-67
Dreizackstifte	4, 18
E	SEITE
Eckenklammern	9
Ersatzklebeband	49
Ersatzklingen für Cuttermesser	41
Ersatzschwamm für Anfeuchter	52
Etiketten-Anhängeschlaufen	12
EULE Büroklammer	9

F	SEITE
Flachkopfklammern	11, 17, 20
Flachmagnete	25
Flexible Lineale	43
Foldback-Klammern	10, 15, 17, 18, 26
G	SEITE
Geldkassetten	54-55
Geldscheinprüfgerät	57
Geldtransportkassette	56
Geometrie Dreiecke	42
Geometriezirkel	44-45
Glaskopfstecknadel	20, 32
Gummibänder	51
Gummiringe	14, 17, 18, 50-51
H	SEITE
Haftmarker ALCOfix	34-35
Hakenmagnete	22, 28
Handabroller	49
Hefklammern	5
Holz Lineale	42
I	SEITE
K	SEITE
Karteibox	63
Kegelmagnete	25
Klammerentferner	6
Klebeband Tischabroller	49
Klemmmappen	75
Klemmbretter	73-75
Kraftmagnete	21, 28
Kreuzbänder	52
Kreuzklammern	6, 19
Kugelmagnete	24, 28
Kugelschreiberständer	69-70
Kunststoff Lineale	43
Kurbel-Bleistiftspitzer	68
Kurvenlineale	42

L	SEITE
Landkartennadeln	17, 20, 32-33
Leselupe mit LED- Lampen	78
Leselupen	80
Leselupen-Set	80
Lineale	42-43
Lupen	78-80

M	SEITE
Magnetdosen für Briefklammern	26
Magnete	21-25, 28-29
Magnet Klemmer	24
Magnetische Wandschienen	31
Markierföhnchen	18, 33
Markiernadeln	18, 32-33
Messer	39
Metallhaftband	31
Mini-Box Kassetten	55
Mini-Packbandabroller	48
Mini-Wäscheklammern	9, 14, 20
Multi-Locher	66
Münzzählbretter	56
Musterbeutelklammern	11, 15, 17, 20

N	SEITE
NORICA	7
Neodym-Magnete	22-23, 28,29

P	SEITE
Packbandabroller	48
Pinwandnadeln	4, 14, 15, 17, 20
Posternägel	4, 18
Power Clipper	8
Profi-Qualitätsscheren	38

R	SEITE
Reißnägel	4, 14, 16, 18
Rollmesser	46
Rubber Band Ball	51
Rundlupe, beleuchtet	78
Rundlupe, beleuchtet zum Anklebmen	79

S	SEITE
Scheren, Comfort Cut	39
Scheren, Standard	38
Schieblehre	46
Schlüsselanhänger	15, 20, 59
Schlüsselkassetten	58
Schlüsselringe	15, 20, 59
Schlüsselschränke	57
Schneidelineal	46
Schneidematten und Zubehör	46
Schneide-Set	46
Schnellverstellzirkel	45
Schreibplatte mit Varioklemme	73
Schreibtisch- Accessoires	61-63
Schreibtisch- Butler	65
Schreibunterlagen	76
Schulzirkel	44
Sicherheits-Cutter	41
Sicherheitshandabroller	48
Skalpell	46
Sortimentsdose	26
Stahlnadeln für Bilderhaken	12
Standlupe	78
Stiftetui	63
Stiftablage	61
Stifteköcher	63
Stoßnadeln	4
Superkraftmagnete Neodym	29

T	SEITE
Tischabroller für Klebeband	49
Titan Scheren	37

V	SEITE
Verschlussringe	52
Visitenkartenständer	62

W	SEITE
Wandleisten, magnetisch	30
Wandschienen, magnetisch	31
Würfelmagnete	23

Z	SEITE
Zettelbox	63
Zettelspießer	64
Zirkel	44

A	SITE
Acrylic Desk Set	61, 62
ALCOfix Page Marker Tabs	34-35
Aluminium Clipboards	73
Aluminium Ruler	42
Art Knife	46
B	SITE
Ball Magnets	24
Battery Prepared Pencil Sharpener	68
Book Rest	72
Book Stands	62, 64
Butterfly Clips	6, 19
C	SITE
Calliper Ruler	46
Cash Boxes	54-55
CIRCULAR Paper Clip	8
Clip Board with Relocatable Clamp	73
Clipboards	64, 73-75
Coin Counter Trays	56
Compasses	44
Corner Clips	9
Counter Top Pen	69-70
Corsage Pins	20, 32
Crank Operated Sharpener	68
Cross Bands	52
Cube Magnets	23, 40-41
Cutter Knives	40
Cutting Mats and Accessories	46
Cutting Ruler	46
Cylinder Magnifier	78
D	SITE
Decoration Pins	12, 18
Desk Accessories	61-63
Desk Mats	76
Desk Tidy	65
Drawing Pins	4
E	SITE
Elastics	51
F	SITE
Finger Cones	52
Flag Pins	33

























Flexible Curves	42
Flexible Ruler	43
Flexible Wall Strips	31
Foldback- Clips	10, 15, 17, 18, 26
Foldover Clipboards	75
G	SITE
Geometry Compass	44-45
Glycerin Sponge Damper	52
H	SITE
Hand Dispenser	49
Handle Magnets	25
Hobby Scissors	37
Hook Bands	52
I	SITE
Index Box	63
K	SITE
Key Boxes	58
Key Cabinets	57
Key Hangers	15, 20, 59
Key Rings	15, 20, 59
Knives	39
L	SITE
Label Hangers	12
Letter Opener	63, 71-72
Letter Rack	63
M	SITE
Magnet Clips	24
Magnetic Clip Dispenser	26
Magnetic Racks	31
Magnets	21-25, 28-29
Magnets with a hook	22, 28
Magnifiers	78-80
Map Pins	17, 18, 20, 32, 33
Metal Pegs	9
Metal Cutter	41
Mini Pegs	9, 14, 20

INDEX

<i>Mini Tape Dispenser</i>	48
<i>Mini-Box Cash Boxes</i>	55
<i>Money Detector</i>	57
N	SITE
<i>Name Card Holder</i>	62
<i>Neodym Super Power Magnets</i>	22-24,28,29
<i>NORICA</i>	7
<i>Notes Dispenser</i>	63
O	SITE
<i>OWL Paper Clip</i>	9
P	SITE
<i>Packaging Tape Dispenser</i>	48
<i>Page Marker ALCOfix</i>	34-35
<i>Paper Clip Holder</i>	63
<i>Paper Clips</i>	6-8,14,15,16,17,19
<i>Paper Fasteners</i>	11,15,17,20
<i>Paper Fasteners with flat head</i>	11,17,20
<i>Pen Holder</i>	63
<i>Pencil Case</i>	63
<i>Pencil Sharpener</i>	68
<i>Pencil Sharpener Canister</i>	66-67
<i>Pencil Tray</i>	61
<i>Picture Hooks</i>	12
<i>Pins with 3 Shanks</i>	4,18
<i>Plastic Paper Fasteners</i>	12
<i>Plastic Ruler</i>	43
<i>Power Clipper</i>	8
<i>Power Magnets</i>	21,28
<i>Professional-Scissors</i>	38
<i>Push Pins</i>	14,17,18
R	SITE
<i>Rapid Adjustment Compass</i>	45
<i>Rotary Cutter</i>	46
<i>Round illuminated Magnifier</i>	78
<i>Round illuminated Magnifier with Clamp</i>	80
<i>Rubber Band Ball</i>	51
<i>Rubber Bands</i>	14,17,18,50-51,42,43
<i>Ruler</i>	42,43
S	SITE
<i>Safe Cash Box</i>	56
<i>Safety Tape Dispenser</i>	48
<i>School Compass</i>	44
<i>Scissors, Comfort Cut</i>	39
<i>Scissors, Standard</i>	38
<i>Scissors, titanium finish</i>	37
<i>Security-Cutter</i>	41
<i>Set of Reading Magnifiers</i>	80
<i>Set Squares</i>	42
<i>Spare Blades for Cutter Knives</i>	41
<i>Spare Sponge</i>	52
<i>Spare Tape</i>	49
<i>Special Push Pins</i>	4
<i>Spike File</i>	64
<i>Sponge Damper</i>	52
<i>Staple Remover</i>	6
<i>Staples</i>	5
<i>Slim Hole Punch</i>	66
<i>Steel Nails</i>	12
<i>Super Tacks</i>	4
T	SITE
<i>Tape Dispenser</i>	49
<i>Tidy Box</i>	26
W	SITE
<i>Wall Strips, magnetic</i>	30
<i>Wooden Ruler</i>	42
<i>Working- and Handicraft Mats</i>	76
Z	SITE

FARBSCHLÜSSEL

COLOR INDEX

schwarz • <i>black</i>	11	
weiß • <i>white</i>	10	
rot • <i>red</i>	12	
gelb • <i>yellow</i>	13	
hellblau • <i>light blue</i>	14	
blau • <i>blue</i>	15	
braun • <i>brown</i>	16	
hellgrün • <i>light green</i>	17	
dunkelgrün • <i>dark green</i>	18	
orange • <i>orange</i>	19	
rosa • <i>pink</i>	20	
lila • <i>lilac</i>	21	
glasklar • <i>transparent</i>	22	
bordeauxrot • <i>burgundy</i>	23	
kosmosblau • <i>cosmic blue</i>	24	
ocker • <i>ochre</i>	25	
gemischt • <i>mixed colours</i>	26	
vernickelt • <i>nickel plated</i>	27	
beige • <i>brass plated</i>	28	
grau • <i>grey</i>	29	
lichtgrau • <i>light grey</i>	33	
altrosa ■ <i>old pink</i>	35	
silberfarben • <i>silver</i>	36	
goldfarben • <i>gold</i>	37	
anthrazit • <i>anthracite</i>	39	

Art. Nr. • <i>Art. No.</i>	
Farbe • <i>Colour</i>	
Inhalt • <i>Content</i>	
Verpackungseinheit • <i>Kind of Packing</i>	
Verpackungsart • <i>Packing unit</i>	

Pappschachtel • <i>cardboard box</i>	N
Pappschachtel mit Eurolochung <i>cardboard box with Euro Hole</i>	NE
Pappschachtel mit Klarsichtfenster <i>cardboard box with window</i>	F
Plastikdose • <i>plastic box</i>	P
Klarsichtverpackung • <i>transparent box</i>	K
Klarsichtverpackung mit Eurolochung <i>transparent box with Euro Hole</i>	KE
Schrumpfpackung • <i>shrink wrapped</i>	T
Plastiktüte • <i>poly bag</i>	PT
Pappkarte mit Eurolochung <i>hanging card with Euro Hole</i>	PE
Blisterverpackung mit Eurolochung <i>blister card with Euro Hole</i>	E
Plastikdose mit Eurolochung <i>plastic box with Euro Hole</i>	SB

Weitere Kataloge im Internet:

- ALCO Geschäftsausstattung
- ALCO Büroleuchten
- ALCO Nautik



ALCO-Albert GmbH & Co. KG

Hilsmannweg 9
59755 Arnsberg (Germany)

Postfach | P.O. Box 1108
59701 Arnsberg (Germany)

T: +49 2932 9748-0
F: +49 2932 9748-8800

mail@alco-albert.de
www.alco-albert.de