

HP LaserJet M4345 MFP

User Guide

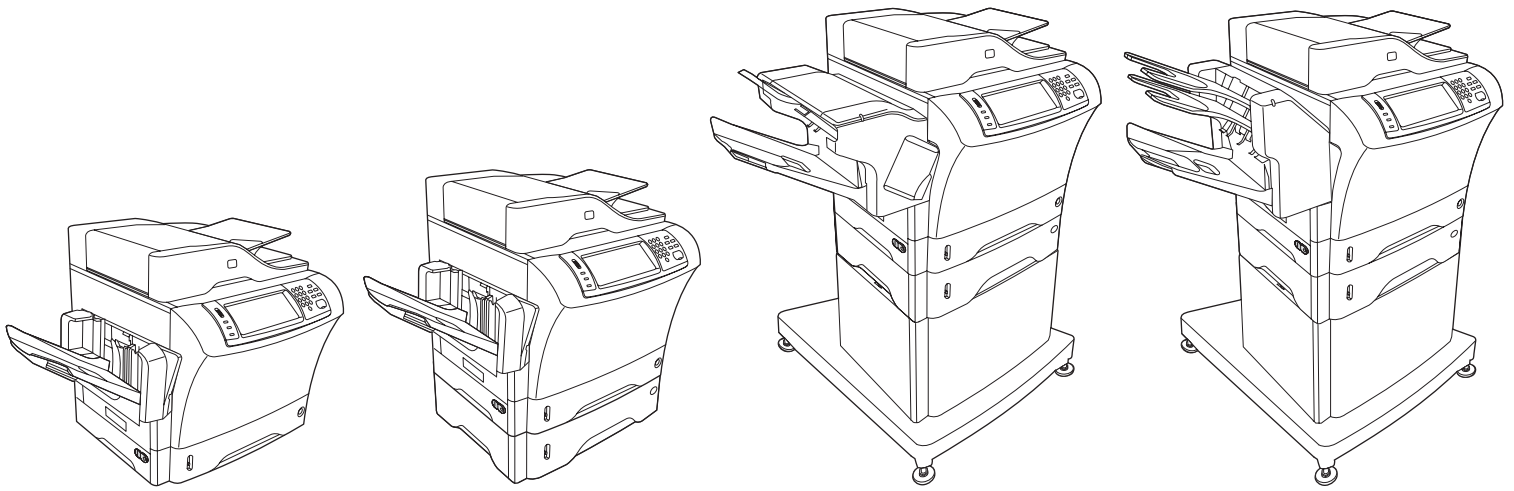

HP LaserJet M4345 Series MFP

User Guide



Copyright and License

© 2006 Copyright Hewlett-Packard Development Company, L.P.

Reproduction, adaptation, or translation without prior written permission is prohibited, except as allowed under the copyright laws.

The information contained herein is subject to change without notice.

The only warranties for HP products and services are set forth in the express warranty statements accompanying such products and services. Nothing herein should be construed as constituting an additional warranty. HP shall not be liable for technical or editorial errors or omissions contained herein.

Part number: CB425-90926

Edition 1, 10/2006

Trademark Credits

Adobe®, Acrobat®, and PostScript® are trademarks of Adobe Systems Incorporated.

Linux is a U.S. registered trademark of Linus Torvalds.

Microsoft®, Windows®, and Windows NT® are U.S. registered trademarks of Microsoft Corporation.

UNIX® is a registered trademark of The Open Group.

ENERGY STAR® and the ENERGY STAR logo® are U.S. registered marks of the United States Environmental Protection Agency.



Table of contents

1 Device basics

Device comparison	2
Features comparison	3
Walkaround	6
Accessories and supplies	7
Interface ports	8
Locking and unlocking optional accessories	9
Device software	10
Supported operating systems	10
Supported printer drivers	10
Select the correct printer driver	11
Universal printer drivers	11
Driver Autoconfiguration	11
Update Now	12
HP Driver Preconfiguration	12
Priority for print settings	12
Open the printer drivers	13
Software for Macintosh computers	14
Remove software from Macintosh operating systems	14
Utilities	15
HP Web Jetadmin	15
Embedded Web server	15
HP Easy Printer Care software	16
Supported operating systems	16
Supported browsers	16
Other components and utilities	16

2 Control Panel

Use the control panel	18
Control-panel layout	18
Home screen	19
Buttons on the touchscreen	20
Control-panel help system	20
Navigate the Administration menu	21
Information menu	22
Default Job Options menu	23
Default Options for Originals	23
Default Copy Options	24
Default Fax Options	25

Default E-mail Options	26
Default Send to Folder Options	27
Default Print Options	28
Time/Scheduling menu	29
Management menu	31
Initial Setup menu	32
Networking and I/O	32
Fax Setup	40
E-mail Setup	43
Send Setup menu	43
Device Behavior menu	44
Print Quality menu	49
Troubleshooting menu	51
Resets menu	55
Service menu	56

3 Input/output (I/O)

USB configuration	58
Network configuration	59
Configure TCP/IPv4 parameters	59
Set an IP address	59
Set the subnet mask	60
Set the default gateway	60
Configure TCP/IPv6 parameters	61
Disable network protocols (optional)	61
Disable IPX/SPX	61
Disable AppleTalk	62
Disable DLC/LLC	62
HP Jetdirect EIO print servers	62

4 Media and trays

General media specifications	64
General guidelines for media	65
Paper to avoid	65
Paper that can damage the device	65
General media specifications	66
Media considerations	67
Envelopes	67
Envelopes with double side seams	67
Envelopes with adhesive strips or flaps	68
Envelope margins	68
Envelope storage	68
Labels	68
Label construction	69
Transparencies	69
Card stock and heavy media	69
Card stock construction	69
Card stock guidelines	70
Letterhead and preprinted forms	70
Select the correct fuser mode	70

Select print media	72
Printing and paper-storage environment	77
Load media	78
Load the flatbed scanner	78
Load the ADF	78
Load tray1	78
Load trays 2, 3, 4 and 5	79
Load special media	83
Load envelopes	83
Load labels	84
Load transparencies	85
Load letterhead, prepunched, or preprinted paper	85
Load paper that has a special finish	86
Load small sizes, custom sizes, or heavy paper	87
Weight and sizes	87
Guidelines for heavy paper	87
Guidelines for custom-size paper	88
Additional guidelines for small or narrow paper	88
Control print jobs	89
Select output bins	90
Select an output location	90
3-bin mailbox output bins	90
Selecting face-up or face-down output for copy jobs	90

5 Use device features

Use the stapler	94
Configure the printer driver to recognize the optional stapler	94
Staple media	94
Load staples	96
Use job storage features	98
Gain access to the job storage features	98
Use the proof and hold feature	98
Create a proof and hold job	98
Print the remaining copies of a proof and hold job	99
Delete a proof and hold job	99
Use the private job feature	100
Create a private job	100
Print a private job	100
Delete a private job	100
Use the QuickCopy feature	101
Create a QuickCopy job	101
Print additional copies of a QuickCopy job	101
Delete a QuickCopy job	101
Use the stored job feature	102
Create a stored copy job	102
Create a stored print job	102
Print a stored job	102
Delete a stored job	103

6 Print

Use features in the Windows printer driver	106
Create and use quick sets	106
Use watermarks	107
Resize documents	107
Set a custom paper size from the printer driver	108
Use different paper and printing covers	108
Print a blank first page	108
Print multiple pages on one sheet of paper	109
Print on both sides of the paper	110
Use automatic duplex printing	110
Print on both sides manually	111
Layout options for printing on both sides	111
Use the Services tab	112
Use features in the Macintosh printer driver	113
Create and use presets	113
Print a cover page	114
Print multiple pages on one sheet of paper	114
Print on both sides of the paper	115
Cancel a print job	116
Stop the current print job from the control panel	116
Stop the current print job from the software program	116

7 Copy

Use the Copy screen	118
Set the default copy options	119
Basic copy instructions	120
Copy from the scanner glass	120
Copy from the document feeder	120
Adjust the copy settings	121
Copy two-sided documents	122
Copying two-sided documents manually	122
Copy two-sided documents automatically (duplex models only)	122
Copy mixed-size originals	124
Change the copy-collation setting	125
Copy photos and books	126
Combine copy jobs by using Job Build	127
Cancel a copy job	128

8 Scan and send to e-mail

Configure e-mail settings	130
Supported protocols	130
Configure e-mail server settings	130
Find gateways	131
Find the SMTP gateway from the device control panel	131
Find the SMTP gateway from an e-mail program	131
Use the Send E-mail screen	132
Perform basic e-mail functions	133
Load documents	133
Send documents	133
Send a document	133

Use the auto-complete function	134
Use the address book	135
Create a recipient list	135
Use the local address book	135
Add e-mail addresses to the local address book	136
Delete e-mail addresses from the local address book	136
Change e-mail settings for the current job	137
Scan to a folder	138
Scan to a workflow destination	139

9 Fax

Analog fax	142
Install the fax accessory	142
Connect the fax accessory to a phone line	144
Configure and use the fax features	145
Digital fax	146

10 Manage and maintain the device

Use information pages	148
Configure e-mail alerts	150
HP Easy Printer Care software	151
Open the HP Easy Printer Care software	151
HP Easy Printer Care software sections	151
Use the embedded Web server	153
Open the embedded Web server by using a network connection	153
Embedded Web server sections	153
Use HP Web Jetadmin software	156
Use the HPPrinter Utility for Macintosh	157
Open the HP Printer Utility	157
HP Printer Utility features	157
Manage supplies	159
Supplies life expectancy	159
Change the print cartridge	159
Manage the print cartridge	159
Print-cartridge storage	159
Use genuine HP print cartridges	159
HP policy on non-HP print cartridges	160
Print-cartridge authentication	160
HP fraud hotline and Web site	160
Clean the device	161
Clean the exterior	161
Clean the scanner glass	161
Clean the scanner lid backing	162
Clean the paper path	162
Clean the document feeder	162
Clean the document feeder delivery system	163
Clean the document feeder-rollers	164
Calibrate the scanner	166

11 Problem solving

Problem-solving checklist	168
Factors that affect performance	168
Problem-solving flowchart	169
Solve general device problems	174
Control-panel message types	177
Control-panel messages	178
Common causes of jams	188
Clear jams	189
Clear jams from the top-cover and print-cartridge areas	190
Clear jams from the optional envelope-feeder area	192
Clear jams from the tray1 area	194
Clear jams from the tray2, 3, 4, or 5 areas	195
Clear jams from the optional duplexer	197
Clear jams from the output areas	198
Clear jams from the fuser	199
Clear jams from the document feeder	202
Solve repeated jams	203
Paper-path test	204
Clear staple jams	205
Solve print-quality problems	207
Print-quality problems associated with media	207
Print-quality problems associated with the environment	207
Print-quality problems associated with jams	207
Image defect examples	207
Light print (partial page)	209
Light print (entire page)	209
Specks	209
Dropouts	210
Lines	210
Gray background	211
Toner smear	211
Loose toner	212
Repeating defects	212
Repeating image	212
Misformed characters	213
Page skew	213
Curl or wave	214
Wrinkles or creases	214
Vertical white lines	215
Tire tracks	215
White spots on black	215
Scattered lines	216
Blurred print	216
Random image repetition	217
Solve network printing problems	218
Solve copy problems	219
Prevent copy problems	219
Image problems	219
Media-handling problems	220

Performance problems	222
Solve fax problems	223
Solve sending problems	223
Solve receiving problems	224
Solve e-mail problems	226
Validate the SMTP gateway address	226
Validate the LDAP gateway address	226
Solve common Windows problems	227
Solve common Macintosh problems	228
Solve Linux problems	231
Solve PostScript problems	232
General problems	232

Appendix A Accessories and consumables

Order parts, accessories, and supplies	234
Order directly from HP	234
Order through service or support providers	234
Order directly through the embedded Web server (for printers that are connected to a network)	234
Order directly through the HP Easy Printer Care software	234
Part numbers	235
Accessories	235
Print cartridges	235
Maintenance kits	236
Memory	236
Cables and interfaces	236
Print media	236

Appendix B Service and support

Hewlett-Packard limited warranty statement	239
Print cartridge limited warranty statement	240
Customer Self Repair Warranty Service	241
HP Customer Care	242
Online Services	242
Telephone support	242
Software utilities, drivers, and electronic information	242
HP direct ordering for accessories or supplies	242
HP service information	242
HP service agreements	242
HP Easy Printer Care software	243
HP support and information for Macintosh computers	243
HP maintenance agreements	244
On-site service agreements	244
Next-day on-site service	244
Weekly (volume) on-site service	244
Repacking the device	244
Extended warranty	245

Appendix C Specifications

Physical specifications	248
Electrical specifications	248
Acoustic specifications	249
Operating environment	250

Appendix D Regulatory information

FCC regulations	252
Environmental product stewardship program	253
Protecting the environment	253
Ozone production	253
Power consumption	253
Toner consumption	253
Paper use	253
Plastics	253
HP LaserJet print supplies	254
HP print supplies returns and recycling program information	254
Paper	254
Material restrictions	255
Disposal of waste equipment by users in private households in the European Union	255
Material Safety Data Sheet (MSDS)	256
For more information	256
Telecom statement	257
Declaration of conformity	258
Safety statements	259
Laser safety	259
Canadian DOC regulations	259
VCCI statement (Japan)	259
Power cord statement (Japan)	259
EMI statement (Korea)	259
Laser statement for Finland	259

Appendix E Working with memory and print server cards

Overview	262
Adding printer memory	263
Installing printer memory	263
Checking DIMM installation	266
Save resources (permanent resources)	267
Enabling memory for Windows	268
Using HPJetdirect print server cards	269
Install an HP Jetdirect print server card	269
Remove an HP Jetdirect print server card	270

Index	271
--------------------	------------

1 Device basics

- [Device comparison](#)
- [Features comparison](#)
- [Walkaround](#)
- [Device software](#)

Device comparison

HP LaserJet M4345 MFP (base model)

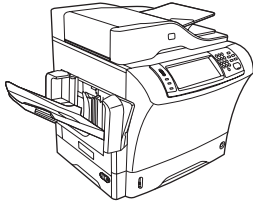

The HP LaserJet M4345 comes standard with the following items:

- 100-sheet input tray (tray1)
- 500-sheet input tray (tray2)
- Automatic document feeder (ADF) that holds up to 50pages
- HPJetdirect embedded print server for connecting to a 10/100Base-T network
- 256megabytes (MB) synchronous dynamic random access memory (SDRAM)

HP LaserJet M4345x MFP

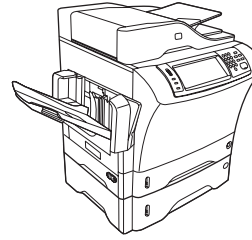

The HP LaserJet M4345x includes all of the features of the base model plus the following items:

- Automatic duplex printing accessory (duplexer)
- Additional 500-sheet feeder (tray3)
- 33.6 kbps analog-fax accessory

HP LaserJet M4345xs MFP



The HP LaserJet M4345xs includes all of the features of the base model plus the following items:

- Automatic duplex printing accessory (duplexer)
- Additional 500-sheet feeder (tray3)
- 33.6 kbps analog-fax accessory
- Stapler/stacker accessory
- Cabinet/stand

HP LaserJet M4345xm MFP

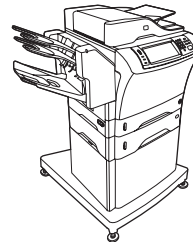

The HP LaserJet M4345xm includes all of the features of the base model plus the following items:

- Automatic duplex printing accessory (duplexer)
 - Additional 500-sheet feeder (tray3)
 - 33.6 kbps analog-fax accessory
 - 3-bin mailbox accessory
 - Cabinet/stand
-

Features comparison

Feature	HP LaserJet M4345
Functions	<ul style="list-style-type: none"> ● Two-sided copying (duplexing) ● Image modification ● Color digital sending ● Document finishing
Speed and throughput	<ul style="list-style-type: none"> ● 45pages per minute (ppm) when scanning and printing on letter-size paper; 43(ppm) when copying and printing on A4-size paper ● 25% to 400% scalability when using the scanner glass ● 25% to 200% scalability when using the automatic document feeder (ADF) ● Less than 10 seconds to print the first page ● Transmit Once, Raster Image Processing (RIP) ONCE technology ● Duty cycle of up to 200,000 pages per month
Resolution	<ul style="list-style-type: none"> ● 1200dots per inch (dpi) with Resolution Enhancement technology (REt) ● FastRes1200 provides 1200dpi quality at full speed ● Up to 220 levels of gray
Memory	<ul style="list-style-type: none"> ● 256megabytes (MB) of random-access memory (RAM), expandable to 512MB by using an industry standard 100-pin double data rate memory module (DDR SDRAM DIMM) ● Memory Enhancement technology (MEt) that automatically compresses data to use RAM more efficiently
User interface	<ul style="list-style-type: none"> ● Graphical touchscreen control panel ● An embedded Web server to gain access to support and order supplies (for network-connected products) ● HPEasy Printer Care software (a Web-based status and troubleshooting tool).
Language and fonts	<ul style="list-style-type: none"> ● HPPCL 6 ● HPPCL5 ● Printer Management Language ● PDF ● XHTML ● 80 scalable TrueType typefaces ● HPPostScript 3 emulation

Copying and sending

- Modes for text, graphics, and mixed text and graphics formats
- A job-interrupt feature (at copy boundaries)
- Xenon lamp for instant-on copying
- Multiple pages per sheet
- Operator attendance animations (for example, jam recovery)
- E-mail compatibility
- A sleep feature that saves energy
- Automatic duplex (two-sided) scanning



NOTE An automatic duplex printing accessory is required for two-sided copying.

NOTE To use e-mail functionality, the device must be connected to an IP-based server that has simple mail transfer protocol (SMTP). This server can be on the local area network or at an outside Internet service provider (ISP). HP recommends that the device be located on the same local area network (LAN) as the SMTP server. If you are using an ISP, you must connect to the ISP by using a digital subscriber line (DSL) connection. If you obtain e-mail services from an ISP, ask the ISP to provide the correct SMTP address.

Dial-up connections are not supported. If you do not have an SMTP server on your network, you can purchase third-party software that allows you to create an SMTP server.

Print cartridge

- Prints up to 18,000 pages at 5% coverage.
- No-shake cartridge design
- Authentic HP print cartridge detection

Paper Input

- **Tray1 (multipurpose tray):** A multipurpose tray for paper, transparencies, labels, and envelopes. Holds up to 100 sheets of paper or 10 envelopes.
 - **Tray2 and optional trays 3, 4, and 5:** 500-sheet trays. These trays automatically detect standard paper sizes up to Legal and accommodate printing on custom-size paper.
 - **Automatic document feeder (ADF):** Holds up to 50 sheets of paper.
 - **Duplex printing and copying:** With the optional duplexing accessory, provides two-sided printing and copying (printing on both sides of the paper).
 - **ADF duplex scanning:** The ADF has an automatic duplex feature for scanning two-sided documents.
 - **Optional envelope feeder:** Holds up to 75 envelopes.
-

Paper output	<ul style="list-style-type: none"> ● Standard output bin: The standard output bin is located on the left side of the device. This bin can hold up to 500sheets of paper. ● ADF output bin: The ADF output bin is underneath the ADF input tray. The bin holds up to 50sheets, and the device automatically stops when this bin is full. ● Optional stapler/stacker: The stapler/stacker staples up to 30sheets and stacks up to 500sheets. ● Optional 3-bin mailbox: One bin stacks up to 500sheets, and two bins stack up to 100sheets each for a total capacity of 700sheets.
Connectivity	<ul style="list-style-type: none"> ● A Foreigninterfaceharness(FIH)connection(AUX) for connecting other devices ● Local area network (LAN) connector (RJ-45) for the embedded HPJetdirect print server ● Optional analog-fax card ● Optional HPDigital Sending Software (DSS) ● High-speed USB 2.0 ● Jetlink for paper handling solutions ● Optional HPJetdirect enhanced input/output (EIO) print server cards: <ul style="list-style-type: none"> ● LocalTalk ● Fast Ethernet 10/100TX ● Ethernet 802.11b wireless ● Bluetooth wireless printer adapter ● Infrared adapter
Environmental features	<ul style="list-style-type: none"> ● The Sleep setting saves energy (meets ENERGY STAR guidelines).
Security features	<ul style="list-style-type: none"> ● Foreign interface harness (FIH) ● Secure Disk Erase ● Security lock ● Job retention ● DSS authentication

Walkaround

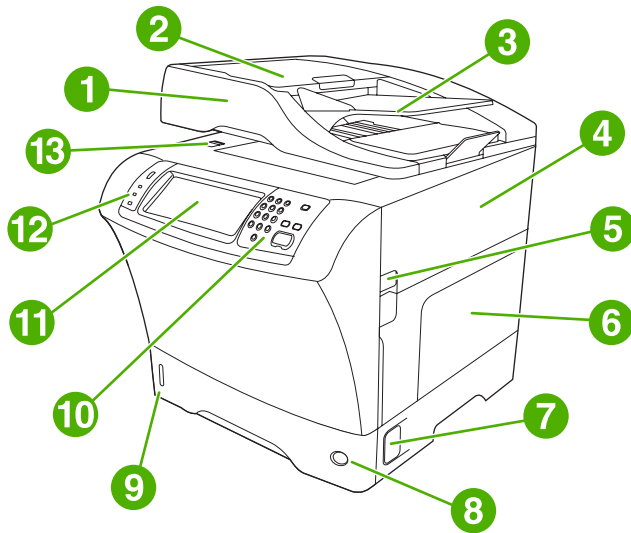

1	Document-feeder assembly
2	Document-feeder top cover
3	Document-feeder input tray
4	Top cover (provides access to the print cartridge)
5	Top-cover lever
6	Tray1 (multipurpose tray)
7	Jam-access lever
8	Tray-number indicator
9	Paper-level indicator
10	Control-panel keypad
11	Control-panel display
12	Control-panel status lights
13	Scanner lock

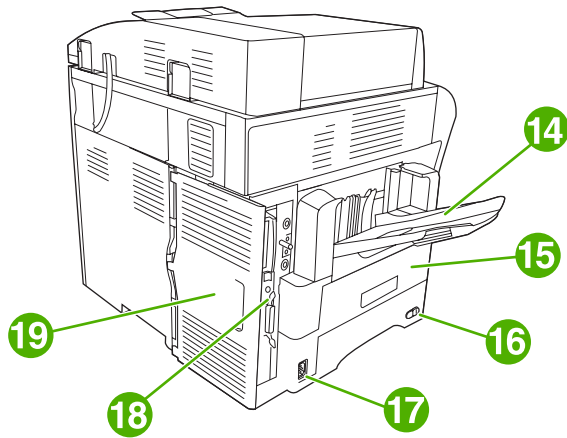

14	Output bin
15	Optional duplexer
16	On/off switch
17	Power connection
18	Interface ports
19	Formatter cover (provides access to the memory DIMM slot, hard disk, and analog-fax accessory)

Accessories and supplies

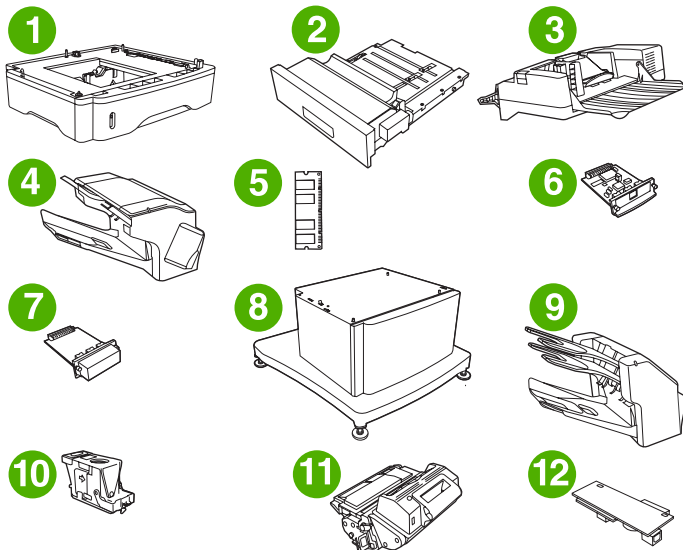

1	500-sheet feeder (Q5968A) (See the note that follows)
2	Duplexer (Q5969A)
3	Envelope feeder (Q2438B)

4	Stapler/stacker (Q5691A)
5	Memory DIMM
6	HPJetdirect print server (EIO card)
7	Hard-disk accessory (EIO card)
8	Storage cabinet/stand (Q5970A)
9	3-bin mailbox (Q5692A)
10	Staple cartridge (C8091A)
11	Print cartridge (Q5945A)
12	HP LaserJet Analog Fax Accessory 300 (Q3701A)

See [Order parts, accessories, and supplies](#) for information about ordering accessories and supplies.



NOTE The device accommodates up to three optional 500-sheet feeders. HP recommends using a cabinet when using the optional 500-sheet feeders.

Interface ports

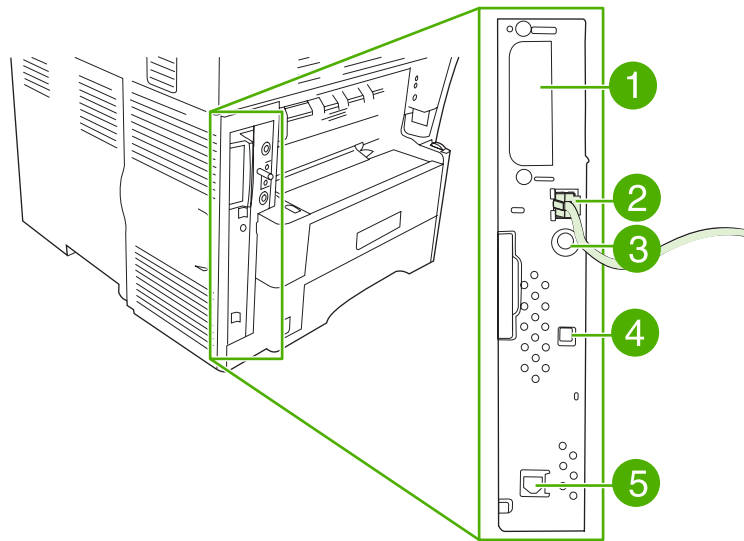

1	EIO slot
2	Network connection (embedded HPJetdirect print server)
3	Foreign interface harness (FIH) port
4	High-speed USB 2.0 device port
5	Telephone-line connection (for the optional analog-fax accessory)

Locking and unlocking optional accessories

For more stability to prevent the device from tipping over, the optional 500-sheet feeders and the cabinet are automatically locked to the bottom of the device. When accessories are installed, verify that the lock on each accessory is in the rear (locked) position.

To unlock the accessories, slide the lever to the forward (unlocked) position.

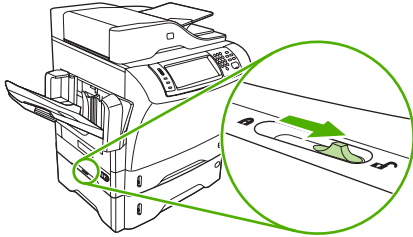

Device software

The printing-system software is included with the device. See the getting started guide for installation instructions.

The printing system includes software for end users and network administrators, and printer drivers for access to the features and communication with the computer.



NOTE For a list of printer drivers and updated software, go to http://www.hp.com/go/M4345_software.

Supported operating systems

The device supports the following operating systems:

Full software installation

- Windows XP (32-bit and 64-bit)
- Windows Server 2003 (32-bit and 64-bit)
- Windows 2000
- Mac OS X V10.2.8, V10.3, V10.4 and later

Printer driver only

- Linux (Web only)
- UNIX model scripts (Web only)



NOTE For Mac OS V10.4 and later, PPC and Intel Core Processor Macs are supported.

Supported printer drivers

Operating system	PCL 5	PCL 6	Postscript level 3 emulation
Windows	✓	✓	✓
Mac OS X V10.2.8, V10.3, V10.4 and later			✓
Linux ¹			✓

¹ For Linux, download the postscript level 3 emulation driver from www.hp.com/go/linuxprinting.

The printer drivers include online Help that has instructions for common printing tasks and also describes the buttons, checkboxes, and drop-down lists that are in the printer driver.

Select the correct printer driver

Printer drivers allow you to gain access to the device features and allow the computer to communicate with the device (using a printer language). Check the installation notes and readme files on the device CD for additional software and languages.

The device uses the PCL 5, PCL 6, and HP postscript level 3 emulation printer description language (PDL) drivers.

- Use the PCL 6 printer driver for the best overall performance.
- Use the PCL 5 printer driver for general office printing.
- Use the HP postscript level 3 emulation driver for printing from postscript level 3 emulation needs, or for postscript flash font support.

Universal printer drivers

The HP Universal Print Driver Series for Windows includes separate HP postscript level 3 emulation and HP PCL 5 versions of a single driver that provides access to almost any HP device while providing system administrator with tools to manage devices more effectively. The Universal Print Driver is included on the device CD, under the Optional Software section. For more information, go to www.hp.com/go/universalprintdriver.

Driver Autoconfiguration

The HP LaserJet PCL 5, PCL 6, and PS level 3 emulation drivers for Windows 2000 and Windows XP feature automatic discovery and driver configuration for device accessories at the time of installation. Some accessories that the Driver Autoconfiguration supports are the duplexing unit, optional paper trays, and dual inline memory modules (DIMMs).

Update Now

If you have modified the device configuration since installation, the driver can be automatically updated with the new configuration. In the **Properties** dialog box (see [Open the printer drivers](#)), on the **Device Settings** tab, click the **Update Now** button to update the driver.

HP Driver Preconfiguration

HP Driver Preconfiguration is a software architecture and set of tools that you can use to customize and distribute HP software in managed corporate printing environments. Using HP Driver Preconfiguration, information technology (IT) administrators can preconfigure the printing and default settings for HP printer drivers before installing the drivers in the network environment. For more information, see the *HP Driver Preconfiguration Support Guide*, which is available at www.hp.com/go/hpdpc_sw.

Priority for print settings

Changes to print settings are prioritized depending on where the changes are made:



NOTE The names of commands and dialog boxes might vary depending on your software program.

- **Page Setup dialog box:** Click **Page Setup** or a similar command on the **File** menu of the program you are working in to open this dialog box. Settings changed here override settings changed anywhere else.
- **Print dialog box:** Click **Print**, **Print Setup**, or a similar command on the **File** menu of the program you are working in to open this dialog box. Settings changed in the **Print** dialog box have a lower priority and do *not* override changes made in the **Page Setup** dialog box.
- **Printer Properties dialog box (printer driver):** Click **Properties** in the **Print** dialog box to open the printer driver. Settings changed in the **Printer Properties** dialog box do not override settings anywhere else in the printing software.
- **Default printer driver settings:** The default printer driver settings determine the settings used in all print jobs, *unless* settings are changed in the **Page Setup**, **Print**, or **Printer Properties** dialog boxes.
- **Printer control panel settings:** Settings changed at the printer control panel have a lower priority than changes made anywhere else.

Open the printer drivers

Operating System	To change the settings for all print jobs until the software program is closed	To change the default settings for all print jobs	To change the device configuration settings
Windows 2000, XP, and Server 2003	<ol style="list-style-type: none"> 1. On the File menu in the software program, click Print. 2. Select the driver, and then click Properties or Preferences. <p>The steps can vary; this procedure is most common.</p>	<ol style="list-style-type: none"> 1. Click Start, click Settings, and then click Printers or Printers and Faxes. 2. Right-click the driver icon, and then select Printing Preferences. 	<ol style="list-style-type: none"> 1. Click Start, click Settings, and then click Printers or Printers and Faxes. 2. Right-click the driver icon, and then select Properties. 3. Click the Device Settings tab.
Mac OS X V10.2.8, V10.3, V10.4 and later	<ol style="list-style-type: none"> 1. On the File menu, click Print. 2. Change the settings that you want on the various pop-up menus. 	<ol style="list-style-type: none"> 1. On the File menu, click Print. 2. Change the settings that you want on the various pop-up menus. 3. On the Presets pop-up menu, click Save as and type a name for the preset. <p>These settings are saved in the Presets menu. To use the new settings, you must select the saved preset option every time you open a program and print.</p>	<ol style="list-style-type: none"> 1. In the Finder, on the Go menu, click Applications. 2. Open Utilities, and then open Print Center (OS X V10.2.8) or Printer Setup Utility. 3. Click on the print queue. 4. On the Printers menu, click Show Info. 5. Click the Installable Options menu.



NOTE Configuration settings might not be available in Classic mode.

Software for Macintosh computers

The HPInstaller provides PostScript Printer Description (PPD) files, Printer Dialog Extensions (PDEs), and the HPPrinter Utility for use with Macintosh computers.

For network connections, use the embedded Web server (EWS) to configure the device. See [Embedded Web server](#).

The printing system software includes the following components:

- **PostScript Printer Description (PPD) files**

The PPDs, in combination with the Apple PostScript printer drivers, provide access to device features. Use the Apple PostScript printer driver that comes with the computer.

- **HPPrinter Utility**

Use the HPPrinter Utility to set up device features that are not available in the printer driver:

- Name the device.
- Assign the device to a zone on the network.
- Assign an internet protocol (IP) address to the device.
- Download files and fonts.
- Configure the device for IP or AppleTalk printing.

You can use the HPPrinter Utility when your device uses a universal serial bus (USB) cable or is connected to a TCP/IP-based network. For more information, see [Use the HPPrinter Utility for Macintosh](#).



NOTE The HPPrinter Utility is supported for Mac OS X 10.2 or later.

Remove software from Macintosh operating systems

To remove the software from a Macintosh computer, drag the PPD files to the trash can.

Utilities

The device is equipped with several utilities that make it easy to monitor and manage the device on a network.

HP Web Jetadmin

HP Web Jetadmin is a browser-based management tool for HP Jetdirect-connected printers within your intranet, and it should be installed only on the network administrator's computer.

To download a current version of HP Web Jetadmin and for the latest list of supported host systems, visit www.hp.com/go/webjetadmin.

When installed on a host server, any client can gain access to HP Web Jetadmin by using a supported Web browser (such as Microsoft® Internet Explorer 4.x or Netscape Navigator 4.x or later) by navigating to the HP Web Jetadmin host.

Embedded Web server

The device is equipped with an embedded Web server, which provides access to information about device and network activities. This information appears in a Web browser, such as Microsoft Internet Explorer or Netscape Navigator.

The embedded Web server resides on the device. It is not loaded on a network server.

The embedded Web server provides an interface to the device that anyone who has a network-connected computer and a standard Web browser can use. No special software is installed or configured, but you must have a supported Web browser on your computer. To gain access to the embedded Web server, type the IP address for the device in the address line of the browser. (To find the IP address, print a configuration page. For more information about printing a configuration page, see [Use information pages](#).)

For a complete explanation of the features and functionality of the embedded Web server, see [Embedded Web server](#).

HP Easy Printer Care software

The HP Easy Printer Care software is a program that you can use for the following tasks:

- Checking the device status
- Checking the supplies status
- Setting up alerts
- Viewing device documentation
- Gaining access to troubleshooting and maintenance tools

You can view the HP Easy Printer Care software when the device is directly connected to your computer or when it is connected to a network. To download the HP Easy Printer Care software, go to www.hp.com/go/easyprintercare.

Supported operating systems

For information about supported operating systems, go to www.hp.com/go/easyprintercare.

Supported browsers

To use the HP Easy Printer Care software, you must have one of the following browsers:

- Microsoft Internet Explorer 5.5 or later
- Netscape Navigator 7.0 or later
- Opera Software ASA Opera 6.05 or later

All pages can be printed from the browser.

Other components and utilities

Windows	Macintosh OS
<ul style="list-style-type: none">● Software installer — automates the printing system installation● Online Web registration	<ul style="list-style-type: none">● PostScript Printer Description files (PPDs) — use with the Apple PostScript drivers that come with the Mac OS● The HP Printer Utility — change device settings, view status, and set up printer-event notification from a Mac. This utility is supported for Mac OS X V10.2 and later.

2 Control Panel

- [Use the control panel](#)
- [Navigate the Administration menu](#)
- [Information menu](#)
- [Default Job Options menu](#)
- [Time/Scheduling menu](#)
- [Management menu](#)
- [Initial Setup menu](#)
- [Device Behavior menu](#)
- [Print Quality menu](#)
- [Troubleshooting menu](#)
- [Resets menu](#)
- [Service menu](#)

Use the control panel

The control panel has a VGA touchscreen that provides access to all device functions. Use the buttons and numeric keypad to control jobs and the device status. The LEDs indicate overall device status.

Control-panel layout

The control panel includes a touchscreen graphical display, job-control buttons, a numeric keypad, and three light-emitting diode (LED) status lights.

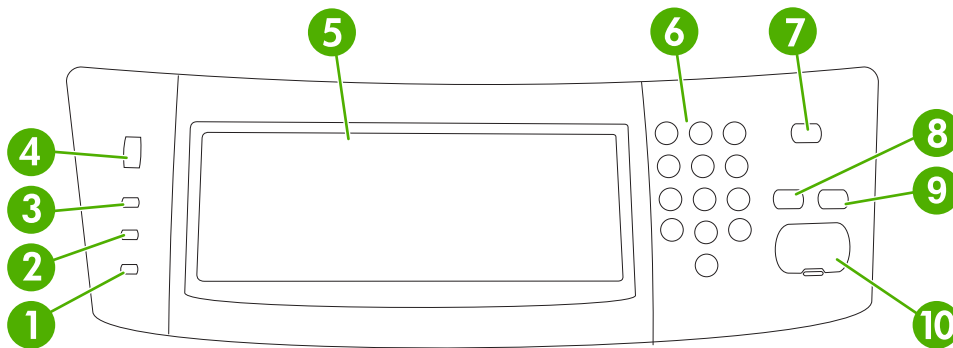

1	Attention light	The Attention light indicates that the device has a condition that requires intervention. Examples include an empty paper tray or an error message on the touchscreen.
2	Data light	The Data light indicates that the device is receiving data.
3	Ready light	The Ready light indicates that the device is ready to begin processing any job.
4	Brightness-adjustment dial	Turn the dial to control the brightness of the touchscreen.
5	Touchscreen graphical display	Use the touchscreen to open and set up all device functions.
6	Numeric keypad	Allows you to type numeric values for number of copies required and other numeric values.
7	Sleep button	If the device is inactive for a long period of time, it automatically enters a sleep mode. To place the device into sleep mode or to reactivate the device, press the Sleep button.
8	Reset button	Resets the job settings to factory or user-defined default values.
9	Stop button	Stops the active job. While stopped, the control panel shows the options for the stopped job (for example, if you press the Stop button while the device is processing a print job, the control panel message prompts you to cancel or resume the print job).
10	Start button	Begins a copy job, starts digital sending, or continues a job that has been interrupted.

Home screen

The home screen provides access to the device features, and it indicates the current status of the device.





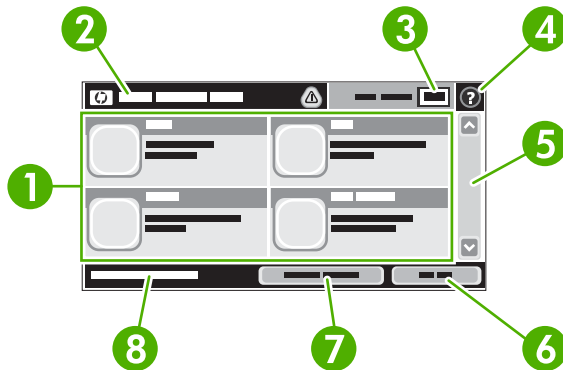



NOTE Depending on how the system administrator has configured the device, the features that appear on the home screen can vary.



1	Features	Depending on how the system administrator has configured the device, the features that appear in this area can include any of the following items: <ul style="list-style-type: none"> • Copy • Fax • E-mail • Secondary E-mail • Network Folder • Job Storage • Workflow • Supplies Status • Administration
2	Device status line	The status line provides information about the overall device status. Various buttons appear in this area, depending on the current status. For a description of each button that can appear in the status line, see Buttons on the touchscreen .
3	Copy count	The copy count box indicates the number of copies that the device is set to make.
4	Help button	Touch the Help button to open the embedded help system.
5	Scroll bar	Touch the up or down arrows on the scroll bar to see the complete list of available features.
6	Sign Out	Touch Sign Out to sign out of the device if you have signed in for access to restricted features. After you sign out, the device restores all options to the default settings.
7	Network Address	Touch Network Address to find information about the network connection.
8	Date and time	The current date and time appear here. The system administrator can select the format that the device uses to show the date and time, for example 12-hour format or 24-hour format.

Buttons on the touchscreen

The status line on the touchscreen provides information about the status of the device. Various buttons can appear in this area. The following table describes each button.

	Home button. Touch the home button to go to the Home screen from any other screen.
	Start button. Touch the Start button to begin the action for the feature that you are using.
	NOTE The name of this button changes for each feature. For example, in the Copy feature, the button is named Start Copy .
	Stop button. If the device is processing a print or fax job, the Stop button appears instead of the Start button. Touch the Stop button to halt the current job. The device prompts you to cancel the job or to resume it.
	Error button. The error button appears whenever the device has an error that requires attention before it can continue. Touch the error button to see a message that describes the error. The message also has instructions for solving the problem.
	Warning button. The warning button appears when the device has a problem but can continue functioning. Touch the warning button to see a message that describes the problem. The message also has instructions for solving the problem.
	Help button. Touch the help button to open the built-in online Help system. For more information, see Control-panel help system .

Control-panel help system

The device has a built-in Help system that explains how to use each screen. To open the Help system, touch the Help button (🔍) in the upper-right corner of the screen.

For some screens, the Help opens to a global menu where you can search for specific topics. You can browse through the menu structure by touching the buttons in the menu.

For screens that contain settings for individual jobs, the Help opens to a topic that explains the options for that screen.

If the device alerts you of an error or warning, touch the error (❗) or warning (⚠️) button to open a message that describes the problem. The message also contains instructions to help solve the problem.

Navigate the Administration menu

From the Home screen, touch **Administration** to open the menu structure. You might need to scroll to the bottom of the Home screen to see this feature.

The Administration menu has several sub-menus, which are listed on the left side of the screen. Touch the name of a menu to expand the structure. A plus sign (+) next to a menu name means that it contains sub-menus. Continue opening the structure until you reach the option that you want to configure. To return to the previous level, touch **Back**.

To exit the Administration menu, touch the Home button (🏠) in the upper-left corner of the screen.

The device has built-in Help that explains each of the features that are available through the menus. Help is available for many menus on the right-hand side of the touchscreen. Or, to open the global Help system, touch the Help button (?) in the upper-right corner of the screen.

The tables in the sections that follow indicate the overall structure of each menu.

Information menu

Use this menu to print information pages and reports that are stored internally on the device.

Table 2-1 Information menu

Menu item	Sub-menu item	Sub-menu item	Values	Description
Configuration/Status Pages	Administration Menu Map		Print (button)	Shows the basic structure of the Administration menu and current administration settings.
	Configuration Page		Print (button)	A set of configuration pages that show the current device settings.
	Supplies Status Page		Print (button)	Shows the status of supplies such as cartridges, maintenance kits, and staples.
	Usage Page		Print (button)	Shows information about the number of pages that have been printed on each paper type and size.
	File Directory		Print (button)	A directory page that contains information for any mass-storage devices, such as flash drives, memory cards, or hard disks, that are installed in this device.
Fax Reports	Fax Activity Log		Print (button)	Contains a list of the faxes that have been sent from or received by this device.
	Fax Call Report	Fax Call Report	Print (button)	A detailed report of the last fax operation, either sent or received.
		Thumbnail on Report	Yes No (default)	Choose whether or not to include a thumbnail of the first page of the fax on the report.
		When to Print Report	Never auto print Print after any fax job Print after fax send jobs Print after any fax error Print after send errors only Print after receive errors only	
		Billing Codes Report	Print	A list of billing codes that have been used for outgoing faxes. This report shows how many sent faxes were billed to each code.
		Blocked Fax List	Print	A list of phone numbers that are blocked from sending faxes to this device.
		Speed Dial List	Print	Shows the speed dials that have been set up for this device.
Sample Pages/Fonts	PCL Font List		Print	A list of printer control language (PCL) fonts that are currently available on the device.
	PS Font List		Print	A list of PostScript (PS) fonts that are currently available on the device.

Default Job Options menu

Use this menu to define the default job options for each function. If the user does not specify the job options when creating the job, the default options are used.

The **Default Job Options** menu contains the following sub-menus:

- Default Options for Originals
- Default Copy Options
- Default Fax Options
- Default E-mail Options
- Default Send To Folder Options
- Default Print Options

Default Options for Originals

Table 2-2 Default Options for Originals menu

Menu item	Values	Description
Paper Size	Select a paper size from the list.	Select the paper size that is most often used for copy or scan originals.
Number of Sides	1 2	Select whether copy or scan originals are most often single-sided or double-sided.
Orientation	Portrait Landscape	Select the orientation that is most often used for copy or scan originals. Select Portrait if the short edge is at the top or select Landscape if the long edge is at the top.
Optimize Text/Picture	Manually Adjust Text Photograph	Use this setting to optimize the output for a particular type of original. You can optimize the output for text, pictures, or a mixture. If you select Manually Adjust , you can specify the mix of text and pictures that will most often be used.
Darkness	Select a value.	

Default Copy Options

Table 2-3 Default Copy Options menu

Menu item	Sub-menu item	Values	Description
Number of Copies		Type the number of copies. The factory default setting is 1.	Set the default number of copies for a copy job.
Number of Sides		1 2	Set the default number of sides for copies.
Staple/Collate	Staple	None (default) One left angled	Set up options for stapling and collating sets of copies.
	Collate	Off On (default)	If collation is selected, the device prints a complete copy before starting on the next copy. If collation is not selected, the device prints page 1 for all copies, then page 2 for all copies, etc.
Image Adjustment	Background Cleanup	Adjust the value within the range.	Increase the Background Cleanup setting to remove faint images from the background or to remove a light background color.
	Sharpness	Adjust the value within the range.	Adjust the Sharpness setting to clarify or soften the image.
Output Bin	Output Bin	<Binname>	Select the default output bin, if applicable, for copies.
	Paper Path	Face-up (straightest path) Face-down (correct order)	Select the default paper path for copies.
Edge-To-Edge		Normal (recommended) (default) Edge-To-Edge Output	If the original document is printed close to the edges, use the Edge-To-Edge feature to avoid shadows that can appear along the edges. Combine this feature with the Reduce/Enlarge feature to ensure that the entire page is printed on the copies.

Default Fax Options

Table 2-4 Fax Send menu

Menu item	Sub-menu item	Values	Description
Resolution		Standard (100x200dpi) (default) Fine (200x200dpi) Superfine (300x300dpi)	Use this feature to set the resolution for sent documents. Higher resolution images have more dots per inch (dpi), so they show more detail. Lower resolution images have fewer dots per inch and show less detail, but the file size is smaller.
Image Adjustment	Background Cleanup	Adjust the value within the range.	Increase the Background Cleanup setting to remove faint images from the background or to remove a light background color.
	Sharpness	Adjust the value within the range.	Adjust the Sharpness setting to clarify or soften the image.
Fax Header		Prepend Overlay	Use this feature to select the position of the fax header on the page. Select Prepend to print the fax header above the fax content and move the fax content down on the page. Select Overlay to print the fax header over the top of the fax content without moving the fax content down. Using this option could prevent a single-page fax from flowing onto another page.

Table 2-5 Fax Receive menu

Menu item	Values	Description
Forward Fax	Fax Forwarding	To forward received faxes to another fax device, select Fax Forwarding and Custom . You can then type the number of the other fax device into the Fax Forwarding Number field. When you select this menu item for the first time, you are prompted to set up a PIN. You will be prompted to enter that PIN every time you try to use this menu. This is the same PIN that is used to access the Fax Printing menu.
	Change PIN	
Stamp Received Faxes	Enabled	Use this option to add the date, time, senders phone number, and page number to each page of the faxes that this device receives.
	Disabled (default)	
Fit to Page	Enabled	Use this feature to shrink faxes that are larger than Letter-size or A4-size so that they can fit onto a Letter-size or A4-size page. If this feature set to Disabled , faxes larger than Letter or A4 will be flow across multiple pages.
	Disabled	
Fax Paper Tray	Select from the list of trays.	Select the tray that holds the size and type of paper that you want to use for incoming faxes.
Output Bin	<Binname>	Select the default output bin, if applicable, to use for faxes.

Default E-mail Options

Use this menu to set default options for e-mails that are sent from the device.

Menu item	Values	Description
Document File Type	PDF (default)	Choose the file format for the e-mail.
	JPEG	
	TIFF	
	M-TIFF	
Output Quality	High (large file)	Choosing higher quality for output increases the size of the output file.
	Medium (default)	
	Low (small file)	
Resolution	75 DPI	Use this feature to select the resolution. Use a lower setting to create smaller files.
	150 DPI (default)	
	200 DPI	
	300 DPI	
Color/Black	Color scan (default)	Specify whether the e-mail will be in black or in color.
	Black/white scan	
TIFF Version	TIFF 6.0 (default)	Use this feature to specify the TIFF version to use when saving scanned files.
	TIFF (Post 6.0)	

Default Send to Folder Options

Use this menu to set default options for scan jobs sent to the computer.

Menu item	Values	Description
Color/Black	Color scan	Specify whether the file will be in black or in color.
	Black/white scan (default)	
Document File Type	PDF (default)	Choose the file format for the file.
	M-TIFF	
	TIFF	
	JPEG	
TIFF version	TIFF 6.0 (default)	Use this feature to specify the TIFF version to use when saving scanned files.
	TIFF (post 6.0)	
Output Quality	High (large file)	Choosing higher quality for output increases the size of the output file.
	Medium (default)	
	Low (small file)	
Resolution	75 DPI	Use this feature to select the resolution. Use a lower setting to create smaller files.
	150 DPI (default)	
	200 DPI	
	300 DPI	
	400 DPI	
	600 DPI	

Default Print Options

Use this menu to set default options for jobs that are sent from a computer.

Table 2-6 Default Print Options menu

Menu item	Sub-menu item	Values	Description
Copies Per Job		Type a value.	Use this feature to set the default number of copies for print jobs.
Default Paper Size		(List of supported sizes.)	Choose a paper size.
Default Custom Paper Size	Unit of measure	Millimeters Inches	Configure the default paper size that is used when the user selects Custom as the paper size for a print job.
	X Dimension		Configure the width measurement for the Default Custom Paper Size .
	Y Dimension		Configure the height measurement for the Default Custom Paper Size .
Output Bin	Output Bin	<binname>	Select the default output bin, if applicable, for print jobs.
	Paper Path	Face-up (straightest path) Face-down (correct order)	Select the default paper path for print jobs.
Print Sides		1-sided 2-sided	Use this feature to select whether print jobs should be single-sided or double-sided by default.
2-Sided Format		Book style Flip style	Use this feature to configure the default style for 2-sided print jobs. If Book style is selected, the back side of the page is printed the right way up. This option is for print jobs that are bound along the left edge. If Flip style is selected, the back side of the page is printed upside-down. This option is for print jobs that are bound along the top edge.

Time/Scheduling menu

Use this menu to set options for setting the time and for setting the device to enter and exit sleep mode.



NOTE Values shown with "(default)" are the factory-default values. Some menu items have no default.

Table 2-7 Time/Scheduling menu

Menu item	Sub-menu item	Sub-menu item	Values	Description	
Date/Time	Date Format		YYYY/MMM/DD (default)	Use this feature to set the current date and time, and to set the date format and time format that are used to time-stamp outgoing faxes.	
			MMM/DD/YYYY		
			DD/MMM/YYYY		
	Date	Month			
		Day			
		Year			
	Time Format		12 hour (AM/PM) (default)		
			24 hour		
	Time	Hour			
Minute					
AM					
	PM				
Sleep Delay			20 minutes	Use this feature to select the time interval that the device should remain inactive before entering Sleep Mode.	
			30 minutes (default)		
			45 minutes		
			1 hour (60 minutes)		
			90 minutes		
			2 hours		
			4 hours		
Wake Time	Monday		Off (default)	Select Custom to set a wake time for each day of the week. The device exits sleep mode according to this schedule. Using a sleep schedule helps conserve energy and prepares the device for use so that users do not have to wait for it to warm up.	
	Tuesday		Custom		
	Wednesday				
	Thursday				
	Friday				
	Saturday				
	Sunday				

Table 2-7 Time/Scheduling menu (continued)

Menu item	Sub-menu item	Sub-menu item	Values	Description
Fax Printing	Fax Printing Mode		Store all received faxes	If you have concerns about the security of private faxes, use this feature to store faxes rather than having them automatically print by creating a printing schedule.
			Print all received faxes	
			Use Fax Printing Schedule	For the fax printing schedule, the control panel prompts you to select days and times to print faxes.
	Change PIN			Select Change PIN to change the PIN number that users must provide to print faxes.

Management menu

Use this menu to set up global device-management options.



NOTE Values shown with "(default)" are the factory-default values. Some menu items have no default.

Table 2-8 Management menu

Menu item	Sub-menu item	Values	Description
Stored Job Management	Quick Copy Job Storage Limit	Select the maximum number of jobs to store	Use this menu to view and manage any jobs that are stored on the device.
	Quick Copy Job Held Timeout	1 Hour	
		4 Hours	
		1 Day	
1 Week			
Sleep mode		Disable	Use this feature to customize the sleep mode settings for this device. Select Use Sleep Delay to set the device to enter sleep mode after the delay that is specified in the Time/Scheduling menu.
		Use Sleep Delay (default)	
Manage Supplies	Supply Low/Order Threshold	Select a value in the range.	Use this menu to carry out administrative supply management tasks such as changing the threshold when supplies should be ordered.
	Replace Black Cartridge	Stop at low	
		Stop at out	
Override at out (default)			

Initial Setup menu

The **Initial Setup** menu contains the sub-menus shown:

- **Networking and I/O** menu
- **Fax Setup** menu
- **E-mail Setup** menu



NOTE Values shown with "(default)" are the factory-default values. Some menu items have no default.

Networking and I/O

Table 2-9 Networking and I/O

Menu item	Sub-menu item	Values	Description
I/O Timeout		Select a value in the range. The factory default setting is 15 seconds.	I/O timeout refers to the elapsed time before a print job fails. If the stream of data that the device receives for a print job gets interrupted, this setting indicates how long the device will wait before it reports that the job has failed.
Parallel Input	High Speed	No Yes (default)	Use the High Speed setting to configure the speed that the parallel port uses to communicate with the host.
	Advanced Functions	Enabled (default) Disabled	Use the Advanced Functions setting to enable or disable bidirectional parallel communication.
Embedded Jetdirect	See Table 2-10 Jetdirect menus for the list of options.		
EIO <X> Jetdirect			



NOTE This item appears only if an EIO accessory is installed.

Table 2-10 Jetdirect menus

Menu item	Sub-menu item	Sub-menu item	Values and Description
TCP/IP	Enable		Off: Disable the TCP/IP protocol. On (default): Enable the TCP/IP protocol.
	Host Name		An alphanumeric string, up to 32 characters, used to identify the device. This name is listed on the HP Jetdirect configuration page. The default host name is NPIxxxxxx, where xxxxxx is the last six digits of the LAN hardware (MAC) address.
	IPV4 Settings	Config Method	Specifies the method that TCP/IPv4 parameters will be configured on the HP Jetdirect print server. Bootp: Use BootP (Bootstrap Protocol) for automatic configuration from a BootP server.

Table 2-10 Jetdirect menus (continued)

Menu item	Sub-menu item	Sub-menu item	Values and Description
			<p>DHCP: Use DHCP (Dynamic Host Configuration Protocol) for automatic configuration from a DHCPv4 server. If selected and a DHCP lease exists, DHCP Release and DHCP Renew menus are available to set DHCP lease options.</p> <p>Auto IP: Use automatic link-local IPv4 addressing. An address in the form 169.254.x.x is assigned automatically.</p> <p>Manual: Use the Manual Settings menu to configure TCP/IPv4 parameters.</p>
		DHCP Release	<p>This menu appears if Config Method was set to DHCP and a DHCP lease for the print server exists.</p> <p>No (default): The current DHCP lease is saved.</p> <p>Yes: The current DHCP lease and the leased IP address are released.</p>
		DHCP Renew	<p>This menu appears if Config Method was set to DHCP and a DHCP lease for the print server exists.</p> <p>No (default): The print server does not request to renew the DHCP lease.</p> <p>Yes: The print server requests to renew the current DHCP lease.</p>
		Manual Settings	<p>(Available only if Config Method is set to Manual) Configure parameters directly from the printer control panel:</p> <p>IP Address: The unique IP address of the printer (n.n.n.n), where n is a value from 0 to 255.</p> <p>Subnet Mask: The subnet mask for the printer (m.m.m.m), where m is a value from 0 to 255.</p> <p>Syslog Server: The IP address of the syslog server used to receive and log syslog messages.</p> <p>Default Gateway: The IP address of the gateway or router used for communications with other networks.</p> <p>Idle Timeout: The time period, in seconds, after which an idle TCP print data connection is closed (default is 270 seconds, 0 disables the timeout).</p>
		Default IP	<p>Specify the IP address to default to when the print server is unable to obtain an IP address from the network during a forced TCP/IP reconfiguration (for example, when manually configured to use BootP or DHCP).</p> <p>Auto IP: A link-local IP address 169.254.x.x is set.</p> <p>Legacy: The address 192.0.0.192 is set, consistent with older HP Jetdirect devices.</p>
		Primary DNS	<p>Specify the IP address (n.n.n.n) of a Primary DNS Server.</p>

Table 2-10 Jetdirect menus (continued)

Menu item	Sub-menu item	Sub-menu item	Values and Description
		Secondary DNS	Specify the IP address (n.n.n.n) of a Secondary Domain Name System (DNS) Server.
	IPV6 Settings	Enable	Use this item to enable or disable IPv6 operation on the print server. Off (default): IPv6 is disabled. On : IPv6 is enabled.
		Address	Use this item to manually configure an IPv6 address. Manual Settings : Use the Manual Settings menu to enable and manually configure a TCP/ IPv6 address.
		DHCPV6 Policy	Router Specified : The stateful auto-configuration method to be used by the print server is determined by a router. The router specifies whether the print server obtains its address, its configuration information, or both from a DHCPv6 server. Router Unavailable : If a router is not available, the print server should attempt to obtain its stateful configuration from a DHCPv6 server. Always : Whether or not a router is available, the print server always attempts to obtain its stateful configuration from a DHCPv6 server.
		Primary DNS	Use this item to specify an IPv6 address for a primary DNS server that the print server should use.
		Manual Settings	Use this item to manually set IPv6 addresses on the print server. Enable : Select this item and choose On to enable manual configuration, or Off to disable manual configuration. Address : Use this item to type a 32 hexadecimal digit IPv6 node address that uses the colon hexadecimal syntax.
	Proxy Server		Specifies the proxy server to be used by embedded applications in the device. A proxy server is typically used by network clients for Internet access. It caches Web pages, and provides a degree of Internet security, for those clients. To specify a proxy server, enter its IPv4 address or fully-qualified domain name. The name can be up to 255 octets. For some networks, you may need to contact your Independent Service Provider (ISP) for the proxy server address.
		Proxy Port	Type the port number used by the proxy server for client support. The port number identifies the port reserved for proxy activity on your network, and can be a value from 0 to 65535.

Table 2-10 Jetdirect menus (continued)

Menu item	Sub-menu item	Sub-menu item	Values and Description
IPX/SPX	Enable		<p>Off: Disable the IPX/SPX protocol.</p> <p>On (default): Enable the IPX/SPX protocol.</p>
		Frame Type	<p>Selects the frame-type setting for your network.</p> <p>Auto: Automatically sets and limits the frame type to the first one detected.</p> <p>EN_8023, EN_II, EN_8022, and EN_SNAP: Frame-type selections for Ethernet networks.</p>
AppleTalk	Enable		<p>Off (default): Disable the AppleTalk protocol.</p> <p>On: Enable the AppleTalk protocol.</p>
DLC/LLC	Enable		<p>Off (default): Disable the DLC/LLC protocol.</p> <p>On: Enable the DLC/LLC protocol.</p>
Security	Print Sec Page		<p>Yes: Prints a page that contains the current security settings on the HP Jetdirect print server.</p> <p>No (default): A security settings page is not printed.</p>
		Secure Web	<p>For configuration management, specify whether the embedded Web server will accept communications using HTTPS (Secure HTTP) only, or both HTTP and HTTPS.</p> <p>HTTPS Required: For secure, encrypted communications, only HTTPS access is accepted. The print server will appear as a secure site.</p> <p>HTTP/HTTPS optional: Access using either HTTP or HTTPS is permitted.</p>
	IPsec or Firewall	<p>Specify the IPsec or Firewall status on the print server.</p> <p>Keep: IPsec/Firewall status remains the same as currently configured.</p> <p>Disable: IPsec/Firewall operation on the print server is disabled.</p>	
	Reset Security	<p>Specify whether the current security settings on the print server will be saved or reset to factory defaults.</p> <p>No*: The current security settings are maintained.</p> <p>Yes: Security settings are reset to factory defaults.</p>	
Diagnostics	Embedded Test		<p>This menu provides tests to help diagnose network hardware or TCP/IP network connection problems.</p> <p>Embedded tests help to identify whether a network fault is internal or external to the device. Use an embedded test to check hardware and communication paths on the print server. After you select and enable a test and set the execution time, you must select Execute to initiate the test.</p>

Table 2-10 Jetdirect menus (continued)

Menu item	Sub-menu item	Sub-menu item	Values and Description
			Depending on the execution time, a selected test runs continuously until either the device is turned off, or an error occurs and a diagnostic page is printed.
		LAN HW Test	 CAUTION Running this embedded test will erase your TCP/IP configuration. This test performs an internal loopback test. An internal loopback test will send and receive packets only on the internal network hardware. There are no external transmissions on your network. Select Yes to choose this test, or No to not choose it.
		HTTP Test	This test checks operation of HTTP by retrieving predefined pages from the device, and tests the embedded Web server. Select Yes to choose this test, or No to not choose it.
		SNMP Test	This test checks operation of SNMP communications by accessing predefined SNMP objects on the device. Select Yes to choose this test, or No to not choose it.
		Select All Tests	Use this item to select all available embedded tests. Select Yes to choose all tests. Select No to select individual tests.
		Data Path Test	This test helps to identify data path and corruption problems on an HP postscript level 3 emulation device. It sends a predefined PS file to the device. However, the test is paperless; the file will not print. Select Yes to choose this test, or No to not choose it.
		Execution Time [H]	Use this item to specify the length of time (in hours) that an embedded test will be run. You can select a value from 1 to 60 hours. If you select zero (0), the test runs indefinitely until an error occurs or device is turned off. Data gathered from the HTTP, SNMP, and Data Path tests is printed after the tests have completed.
		Execute	No* : Do not initiate the selected tests. Yes : Initiate the selected tests.

Table 2-10 Jetdirect menus (continued)

Menu item	Sub-menu item	Sub-menu item	Values and Description
	Ping Test		This test is used to check network communications. This test sends link-level packets to a remote network host, then waits for an appropriate response. To run a ping test, set the following items:
		Dest Type	Specify whether the target device is an IPv4 or IPv6 node.
		Dest IP	<p>IPv4: Type the IPv4 address.</p> <p>IPv6 : Type the IPv6 address.</p>
		Packet Size	Specify the size of each packet, in bytes, to be sent to the remote host. The minimum is 64 (default) and the maximum is 2048.
		Timeout	Specify the length of time, in seconds, to wait for a response from the remote host. The default is 1 and the maximum is 100.
		Count	Specify the number of ping test packets to send for this test. Select a value from 1 to 100. To configure the test to run continuously, select 0.
		Print Results	If the ping test was not set for continuous operation, you can choose to print the test results. Select Yes to print results. If you select No (default), results are not printed.
		Execute	Specify whether to initiate the ping test. Select Yes to initiate the test, or No to not run the test.

Table 2-10 Jetdirect menus (continued)

Menu item	Sub-menu item	Sub-menu item	Values and Description
	Ping Results		Use this item to view the ping test status and results using the control panel display. You can select the following items:
		Packets Sent	Shows the number of packets (0 - 65535) sent to the remote host since the most recent test was initiated or completed.
		Packets Received	Shows the number of packets (0 - 65535) received from the remote host since the most recent test was initiated or completed.
		Percent Lost	Shows the percent of ping test packets that were sent with no response from the remote host since the most recent test was initiated or completed.
		RTT Min	Shows the minimum detected roundtrip- time (RTT), from 0 to 4096 milliseconds, for packet transmission and response.
		RTT Max	Shows the maximum detected roundtrip- time (RTT), from 0 to 4096 milliseconds, for packet transmission and response.
		RTT Average	Shows the average round-trip-time (RTT), from 0 to 4096 milliseconds, for packet transmission and response.
		Ping In Progress	Shows whether a ping test is in progress. Yes indicates a test in progress, and No indicates that a test completed or was not run.
		Refresh	When viewing the ping test results, this item updates the ping test data with current results. Select Yes to update the data, or No to maintain the existing data. However, a refresh automatically occurs when the menu times out or you manually return to the main menu.
Link Speed			<p>The link speed and communication mode of the print server must match the network. The available settings depend on the device and installed print server. Select one of the following link configuration settings:</p> <hr/> <p> CAUTION If you change the link setting, network communications with the print server and network device might be lost.</p> <hr/> <p>Auto (default): The print server uses auto-negotiation to configure itself with the highest link speed and communication mode allowed. If auto-negotiation fails, either 100TX HALF or 10TX HALF is set depending on the detected link speed of the hub/ switch port. (A 1000T half-duplex selection is not supported.)</p> <p>10T Half: 10 Mbps, half-duplex operation.</p> <p>10T Full: 10 Mbps, Full-duplex operation.</p> <p>100TX Half: 100 Mbps, half-duplex operation.</p>

Table 2-10 Jetdirect menus (continued)

Menu item	Sub-menu item	Sub-menu item	Values and Description
			100TX Full: 100 Mbps, full-duplex operation. 100TX Auto: Limits auto-negotiation to a maximum link speed of 100 Mbps. 1000TX Full: 1000 Mbps, full-duplex operation.
Print Protocols			Use this item to print a page that lists the configuration of the following protocols: IPX/SPX, Novell NetWare, AppleTalk, DLC/LLC.

Fax Setup

Table 2-11 Fax Setup menu

Menu item	Sub-menu item	Sub-menu item	Values	Description
Required Settings	Location		(Countries/regions listed)	Configure the settings that are legally required for outgoing faxes.
	Date/Time			
	Fax Header Information	Phone Number		
		Company Name		
PC Fax Send			Disabled Enabled (default)	Use this feature to enable or disable PC Fax Send. PC Fax Send enables users to send faxes through the device from their computers if they have the correct driver installed.

Table 2-11 Fax Setup menu (continued)

Menu item	Sub-menu item	Sub-menu item	Values	Description
Fax Send Settings	Fax Dial Volume		Off	Use this feature to set the volume of the tones that you hear while the device dials the fax number.
			Medium (default)	
			High	
	Error Correction Mode		Enabled (default) Disabled	When Error Correction Mode is enabled and an error occurs during fax transmission, the device sends or receives the error portion again.
	JBIG Compression		Disabled Enabled (default)	The JBIG Compression reduces fax-transmission time, which can result in lower phone charges. However, using JBIG Compression sometimes causes compatibility problems with older fax machines. If this occurs, turn off the JBIG Compression.
	Maximum Baud Rate		Select a value from the list.	Use this feature to set the maximum baud rate for receiving faxes. This can be used as a diagnostic tool for troubleshooting fax problems.
	Dialing Mode		Tone (default) Pulse	Select whether the device should use tone or pulse dialing.
	Redial On Busy		The range is between 0 and 9. The factory default is 3 times.	Type the number of times the device should attempt to redial if the line is busy.
	Redial On No Answer		Never (default) Once Twice	Use this feature to specify the number of times the device should attempt to dial if the recipient fax number does not answer.
				 NOTE Twice is available in locations other than the United States and Canada.
	Redial Interval		The range is between 1 and 5 minutes. The factory default is 5 minutes.	Use this feature to specify the number of minutes between dialing attempts if the recipient number is busy or not answering.
	Detect Dial Tone		Enabled Disabled (default)	Use this feature to specify whether the device should check for a dial tone before sending a fax.
	Dialing Prefix		Off (default) Custom	Use this feature to specify a prefix number that must be dialed when sending faxes from the device.
	Billing Codes		Off (default) Custom	When billing codes are enabled, a prompt appears that asks the user to enter the billing code for an outgoing fax.
		Minimum Length	The range is between 1 and 16 digits. The default is 1 digit.	

Table 2-11 Fax Setup menu (continued)

Menu item	Sub-menu item	Sub-menu item	Values	Description
Fax Receive Settings	Rings To Answer		The range varies by location. The factory default is 2 rings.	Use this feature to specify the number of rings that must occur before the fax modem answers.
		Ring Interval	Default (default) Custom	Use this feature to control the time between rings for incoming faxes.
		Ringer Volume	Off Low (default) High	Set the volume for the fax ring-tone.
Blocked Fax Numbers	Add Blocked Numbers		Type the fax number to add.	Use this feature to add or delete numbers from the blocked fax list. The blocked fax list can contain up to 30 numbers. When the device receives a call from one of the blocked fax numbers, it deletes the incoming fax. It also logs the blocked fax in the activity log along with job-accounting information.
		Remove Blocked Numbers	Select a fax number to remove.	
		Clear All Blocked Numbers	No (default) Yes	

E-mail Setup

Use this menu to enable the e-mail feature and to configure basic e-mail settings.



NOTE To configure advanced e-mail settings, use the embedded Web server. For more information, see [Embedded Web server](#).

Table 2-12 E-mail Setup menu

Menu item	Values	Description
Address Validation	On (default) Off	This option enables the device to check e-mail syntax when you type an e-mail address. Valid e-mail addresses require the "@" sign and a ".".
Find Send Gateways		Search the network for SMTP gateways that the device can use to send e-mail.
SMTP Gateway	Enter a value.	Specify the IP address of the SMTP gateway that is used to send e-mail from the device.
Test Send Gateway		Test the configured SMTP gateway to see if it is functional.

Send Setup menu

Table 2-13 Send Setup menu

Menu item	Values	Description
Replicate MFP	Enter a value (IP Address).	Copy the local Send settings from one device to another.
Allow Transfer to New DSS		Use this feature to allow the transfer of the device from one HP Digital Sending Software (DSS) server to another. HP DSS is a software package that handles digital sending tasks such as faxing, e-mail, and sending a scanned document to a network folder.
Allow Use of Digital Send Service		This feature allows you to configure the device for use with an HP Digital Sending Software (DSS) server.



NOTE This item appears only for the HP LaserJet M4345 MFP models.



NOTE This item appears only for the HP LaserJet M4345 MFP models.

Device Behavior menu



NOTE Values shown with "(default)" are the factory-default values. Some menu items have no default.

Table 2-14 Device Behavior menu

Menu item	Sub-menu item	Sub-menu item	Values	Description
Language			Select the language from the list.	Use this feature to select a different language for control-panel messages. When you select a new language, the keyboard layout might also change.
Key Press Sound			On (default) Off	Use this feature to specify whether you hear a sound when you touch the screen or press buttons on the control panel.
Inactivity Timeout			Type a value between 10 and 300 seconds. The factory default is 60 seconds.	Use this feature to specify the amount of time that elapses between any activity on the control panel and the device resetting to the default settings.
Warning/Error Behavior	Clearable Warnings		On Job (default)	Use this feature to set the amount of time that a clearable warning appears on the control panel.
	Continuable Events		Auto continue (10 seconds) (default) Touch OK to continue	Use this option to configure the device behavior when the device encounters certain errors.
	Jam Recovery		Auto (default) On Off	Use this feature to configure how the device handles pages that are lost during a jam.

Table 2-14 Device Behavior menu (continued)

Menu item	Sub-menu item	Sub-menu item	Values	Description
Tray Behavior	Use Requested Tray		Exclusively (default) First	Use this feature to control how the device handles jobs that have specified a specific input tray.
		Manually Feed Prompt	Always (default) Unless Loaded	
	PS Defer Media		Enabled (default) Disabled	Use this feature to choose either the PostScript (PS) or HP paper-handling model.
	Use Another Tray		Enabled (default) Disabled	Use this feature to turn on or off the control-panel prompt to select another tray when the specified tray is empty.
	Size/Type Prompt		Display Do not display (default)	Use this feature to control whether the tray configuration message appears whenever a tray is opened or closed.
	Duplex Blank Pages		Auto (default) Yes	Use this feature to control how the device handles two-sided jobs (duplexing).
Stapler/Stacker	Staple		None One	If the optional stapler/stacker is installed, use this feature to set stapling characteristics for the device.
		Staples Out	Continue (default) Stop	
MBM-3 Configuration	Operation Mode		Function Separator	Use this feature to configure the optional 3bin mailbox accessory.
			Mailbox	
			Stacker	

Table 2-14 Device Behavior menu (continued)

Menu item	Sub-menu item	Sub-menu item	Values	Description
General Copy Behavior	Scan Ahead		Enabled (default)	Use this feature to turn on no-wait scanning. With Scan Ahead enabled, the pages in the original document are scanned to disk and held until the device becomes available.
			Disabled	
	Auto Print Interrupt		Enabled	When this feature is enabled, copy jobs can interrupt print jobs that are set to print multiple copies. The copy job is inserted into the print queue at the end of one copy of the print job. After the copy job is complete, the device continues printing the remaining copies of the print job.
			Disabled	
Copy Interrupt		Enabled	When this feature is enabled, a copy job that is currently printing can be interrupted when a new copy job is started. You are prompted to confirm that you want to interrupt the current job.	
		Disabled		
First Copy Speed			No early warm up	
			Early warm up	

Table 2-14 Device Behavior menu (continued)

Menu item	Sub-menu item	Sub-menu item	Values	Description
General Print Behavior	Default Paper Size		Select from the list of paper sizes.	Use this feature to configure the default paper size used for print jobs.
	Override A4/Letter		No Yes (default)	Use this feature to print on letter-size paper when an A4 job is sent but no A4-size paper is loaded in the device (or to print on A4 paper when a letter-size job is sent but no letter-size paper is loaded). This option will also override A3 with ledger-size paper and ledger with A3-size paper.
	Manual Feed		Enabled Disabled (default)	When this feature is enabled, the user can select manual feed from the control panel as the paper source for a job.
	Courier Font		Regular (default) Dark	Use this feature to select which version of the Courier font you want to use.
	Wide A4		Enabled Disabled (default)	Use this feature to change the printable area of A4-size paper. If you enable this option, eighty 10-pitch characters can be printed on a single line of A4 paper.
	Print PS Errors		Enabled Disabled (default)	Use this feature to select whether a PostScript (PS) error page is printed when the device encounters a PS error.
	Print PDF Errors		Enabled Disabled (default)	Use this feature to select whether a PDF error page is printed when the device encounters a PDF error.
	Personality		Auto (default) PCL PDF PS	Select the printer language that the device should use. Normally you should not change the language. If you change the setting to a specific language, the device does not automatically switch from one language to another unless specific software commands are sent to the device.

Table 2-14 Device Behavior menu (continued)

Menu item	Sub-menu item	Sub-menu item	Values	Description
	PCL	Form Length	Type a value between 5 and 128 lines. The factory default is 60 lines.	PCL is a set of printer commands that Hewlett-Packard developed to provide access to printer features.
		Orientation	Portrait (default) Landscape	Select the orientation that is most often used print jobs. Select Portrait if the short edge is at the top or select Landscape if the long edge is at the top.
		Font Source	Select the source from the list.	Use this feature to select the font source for the user-soft default font.
		Font Number	Type the font number. The range is between 0 and 999. The factory default is 0.	Use this feature to specify the font number for the user-soft default font using the source that is specified in the Font Source menu item. The device assigns a number to each font and lists it on the PCL font list (available from the Administration menu).
		Font Pitch	Type a value between 0.44 and 99.99. The factory default is 10.00.	If Font Source and Font Number indicate a contour font, then use this feature to select a default pitch (for a fixed-spaced font).
	PCL	Font Point Size	Type a value between 4.00 and 999.75. The factory default is 12.00.	If Font Source and Font Number indicate a contour font, then use this feature to select a default point size (for a proportional-spaced font).
		Symbol Set	PC-8 (default) (50 additional symbol sets from which to choose)	Use this feature to select any one of several available symbol sets from the control panel. A symbol set is a unique grouping of all the characters in a font.
		Append CR to LF	No (default) Yes	Use this feature to configure whether a carriage return (CR) is appended to each line feed (LF) encountered in backwards-compatible PCL jobs (pure text, no job control).
		Suppress Blank Pages	No (default) Yes	This option is for users who are generating their own PCL, which could include extra form feeds that would cause blank pages to be printed. When Yes is selected, form feeds are ignored if the page is blank.
		Media Source Mapping	Standard (default) Classic	Use this feature to select and maintain input trays by number when you are not using the device driver, or when the software program has no option for tray selection.

Print Quality menu



NOTE Values shown with "(default)" are the factory-default values. Some menu items have no default.

Table 2-15 Print Quality menu

Menu item	Sub-menu item	Values	Description
Set Registration	Test Page	Print (button)	Use Set Registration to shift the margin alignment to center the image on the page from top to bottom and from left to right. You can also align the image on the front with the image printed on the back. Print a test page for setting the registration.
	Source	All trays Tray <X>: <contents> (choose a tray)	Select the source input tray for printing the Set Registration page.
	Adjust Tray <X>	Shift from -20 to 20 along the X or Y axes. 0 is the default.	Perform the alignment procedure for each tray. When it creates an image, the device <i>scans</i> across the page from side to side as the sheet <i>feeds</i> from top to bottom into the device. The scan direction is referred to as X. X1 is the scan direction for the first side of a 2-sided page. X2 is the scan direction for the second side of a 2-sided page. The feed direction is referred to as Y.
Fuser Modes	<Paper Type>		Configure the fuser mode associated with each media type.
	Restore Modes	Restore (button)	Restore the fuser modes to the default settings.
Optimize	High Transfer	Normal (default)	Optimizes certain parameters for all jobs rather than (or in addition to) optimizing by paper path.
		Increased	
Resolution	Line Detail	Off (default)	Use this feature to select the print resolution.
		On	
		300	
		600 FastRes 1200 (default) ProRes 1200	
REt		Off	Enable Resolution Enhancement technology (REt), which produces print output with smooth angles, curves, and edges. All print resolutions, including FastRes 1200, benefit from REt.
		Light	
		Medium (default)	
		Dark	
Economode		Enabled	When Economode is enabled, the device prints with a reduced amount of toner per page; however, the print quality of the page is slightly reduced.
		Disabled	

Table 2-15 Print Quality menu (continued)

Menu item	Sub-menu item	Values	Description
Toner Density		Choose from a range of 1 to 5. 3 is the default.	Lighten or darken the print on the page. 1 is the lightest and 5 is the darkest.
Calibration/Cleaning	Auto Cleaning	Enabled	When auto-cleaning is on, the device prints a cleaning page when the page count reaches the value that is set in Cleaning Interval .
		Disabled	
	Cleaning Interval	1000	Set the interval when the cleaning page should be printed. The interval is measured by the number of pages printed.
		2000	
		5000	
		10000	
20000			
Auto Cleaning Size	Letter	Select the size of paper used for the cleaning page.	
	A4		
Process Cleaning Page	Process (button)	Use this feature to create and process a cleaning page for cleaning excess toner off the pressure roller in the fuser. The process takes up to 2.5 minutes.	

Troubleshooting menu



NOTE Values shown with "(default)" are the factory-default values. Some menu items have no default.

Table 2-16 Troubleshooting menu

Menu item	Sub-menu item	Sub-menu item	Values	Description
Event Log			Print (button)	This feature shows the event codes and their corresponding engine cycles on the display, and it allows you to print the full event log.
Calibrate Scanner			Calibrate (button)	Use this feature to compensate for offsets in the scanner imaging system (carriage head) for ADF and flatbed scans. You might need to calibrate the scanner if it is not capturing the correct sections of scanned documents.
Fax T.30 Trace	Print T.30 Report			Use this feature to print or configure the fax T.30 trace report. T.30 is the standard that specifies handshaking, protocols, and error correction between fax machines.
	When to Print Report		Never auto print	
			Print after any fax job	
			Print after fax send jobs	
			Print after any fax error	
			Print after send errors only	
			Print after receive errors only	
Fax Transmit Signal Loss			A value between 0 and 30.	Use this feature to set loss levels to compensate for phone line signal loss. You should not modify this setting unless requested to do so by an HP service representative because it could cause the fax to stop functioning.
Fax V.34			Normal (default) Off	Use this feature to disable V.34 modulations if several fax failures have occurred or if phone line conditions require it.
Fax Speaker Mode			Normal (default) Diagnostic	This feature can be used by a technician to evaluate and diagnose fax issues by listening to the sounds of fax modulations. The factory default setting is Normal.
Paper Path Sensors				Initiate a test of the paper path sensors.

Table 2-16 Troubleshooting menu (continued)

Menu item	Sub-menu item	Sub-menu item	Values	Description
Paper Path Test	Test Page		Print (button)	Generate a test page for testing paper handling features. You can define the path that is used for the test in order to test specific paper paths.
		Source	All trays Tray 1 Tray 2 (Additional trays are shown, if applicable.)	Specify whether the test page will be printed from all trays or from a specific tray.
		Destination	All bins Stacker Bin Standard Output Bin	Select the output option for the test page. You can choose to send the test page to all output bins or only to a specific bin.
		Duplex	Off (default) On	Select whether the duplexer should be included in the Paper Path test.
		Copies	Range: 2-30, Default=2	Select how many pages should be sent from the specified source as part of the Paper Path test.

Table 2-16 Troubleshooting menu (continued)

Menu item	Sub-menu item	Sub-menu item	Values	Description
Finishing Paper Path Test	Staples	Finishing Options	Choose from a list of available options.	Test paper handling features for the finisher. Select the option that you want to test.
		Media Size	Letter Legal A4 Executive (JIS) 8.5 x 13	Select the paper size for the Finishing Paper Path Test.
		Media Type		Select the paper type for the Finishing Paper Path Test.
		Copies	Range: 2-30, Default=2	Select the number of copies to include in the Finishing Paper Path Test.
		Duplex	Off On	Select whether to use the duplexer in the Finishing Paper Path Test.
		Print Test Page	Print (button)	Print a test page to use for the Finishing Paper Path Test.
		Stack	Media Size	Letter Legal A4 Executive (JIS) 8.5 x 13
		Media Type	Select from a list of types.	Select the type of media to use for the Finishing Paper Path Test.
		Copies	1 10 50 100 500	Select the number of copies to include in the Finishing Paper Path Test.
		Duplex	Off On	Select whether to use the duplexer in the Finishing Paper Path Test.
	Print Test Page	Print (button)	Print a test page to use for the Finishing Paper Path Test.	
Manual Sensor Test				Test the device sensors and switches for correct operation. Each sensor is displayed on the control-panel screen, along with its status. Manually trip each sensor and watch for it to change on the screen. Press the Stop button to abort the test.

Table 2-16 Troubleshooting menu (continued)

Menu item	Sub-menu item	Sub-menu item	Values	Description
Component Test				Exercise individual parts independently to isolate noise, leaking, or other issues. To start the test, select one of the components. The test will run the number of times specified by the Repeat option. You might be prompted to remove parts from the device during the test. Press the Stop button to abort the test.
Print/Stop Test			Continuous value from 0 to 60,000 milliseconds. The default is 0 milliseconds.	Isolate faults by stopping the device during the print cycle and observing where in the process the image degrades. To run the test, specify a stop time. The next job that is sent to the device will stop at the specified time in the process.
Scanner Tests				This menu item is used by a service technician to diagnose potential problems with the device scanner.
Control Panel	LEDs			Use this feature to make sure the components of the control panel are functioning correctly.
	Display			
	Buttons			
	Touchscreen			

Resets menu

Table 2-17 Resets menu

Menu item	Values	Description
Clear Local Address Book	Clear (button)	Use this feature to clear all addresses from the address books that are stored on the device.
Clear Fax Activity Log	Yes No (default)	Use this feature to clear all events from the Fax Activity Log.
Restore Factory Telecom Setting	Restore (button)	Use this option to restore the telephone-related settings that are in the Initial Setup menu to factory default values.
Restore Factory Settings	Restore (button)	Use this feature to restore all device settings to their factory defaults.
Clear Maintenance Message	Clear (button)	Clear the Order Maintenance Kit and Replace Maintenance Kit warning messages.
Clear Document Feeder Message	Clear (button)	Use this feature to clear the Order Document Feeder Kit and Replace Document Feeder Kit warning messages.
Reset Supplies	New Maintenance Kit (Yes/No) New Document Feeder Kit (Yes/No)	Notify the device that a new maintenance kit or document feeder kit has been installed.

Service menu

The Service menu is locked and requires a PIN for access. This menu is intended for use by authorized service personnel.

3 Input/output (I/O)

This chapter describes how to configure certain network parameters on the device. The following topics are covered:

- [USB configuration](#)
- [Network configuration](#)

USB configuration

This device supports a USB 2.0 connection. You must use an A-to-B type USB cable for printing.

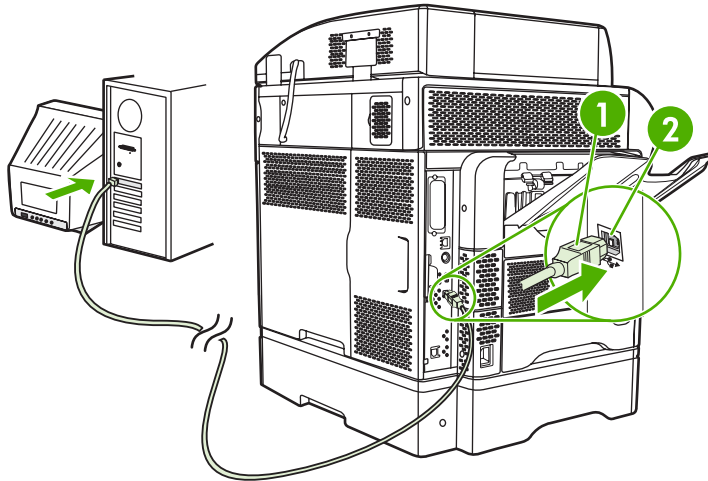

Figure 3-1 USB connection

- | | |
|---|-------------------|
| 1 | USB connector |
| 2 | USB port (type B) |
-

Network configuration

You might need to configure certain network parameters on the device. You can configure these parameters in the following locations:

- Installation software
- Device control panel
- Embedded Web server
- Management software (HP Web Jetadmin or HP LaserJet Utility for Macintosh)



NOTE For more information about using the embedded Web server, see [Embedded Web server](#)

For more information on supported networks and network configuration tools, see the *HP Jetdirect Print Server Administrator's Guide*. The guide comes with printers in which an HP Jetdirect print server is installed.

This section contains the following information about configuring network parameters:

- [Configure TCP/IPv4 parameters](#)
- [Configure TCP/IPv6 parameters](#)
- [Disable network protocols \(optional\)](#)
- [HP Jetdirect EIO print servers](#)

Configure TCP/IPv4 parameters

If your network doesn't provide automatic IP addressing through DHCP, BOOTP, RARP, or another method, you might need to enter the following parameters manually before you can print over the network:

- IP address (4 bytes)
- Subnet mask (4 bytes)
- Default gateway (4 bytes)

Set an IP address

You can view the current IP address of the device from the control-panel Home screen by touching [Network Address](#).

Use the following procedure to change the IP address manually.

1. Scroll to and touch [Administration](#).
2. Scroll to and touch [Initial Setup](#).
3. Touch [Networking and I/O](#).
4. Touch [Embedded Jetdirect](#).
5. Touch [TCP/IP](#).

6. Touch **IPV4 Settings**.
7. Touch **Config Method**.
8. Touch **Manual**.
9. Touch **Save**.
10. Touch **Manual Settings**.
11. Touch **IP Address**.
12. Touch the IP Address text box.
13. Use the touchscreen keypad to type the IP address.
14. Touch **OK**.
15. Touch **Save**.

Set the subnet mask

1. Scroll to and touch **Administration**.
2. Scroll to and touch **Initial Setup**.
3. Touch **Networking and I/O**.
4. Touch **Embedded Jetdirect**.
5. Touch **TCP/IP**.
6. Touch **IPV4 Settings**.
7. Touch **Config Method**.
8. Touch **Manual**.
9. Touch **Save**.
10. Touch **Manual Settings**.
11. Touch **Subnet Mask**.
12. Touch the Subnet Mask text box.
13. Use the touchscreen keypad to type the subnet mask.
14. Touch **OK**.
15. Touch **Save**.

Set the default gateway

1. Scroll to and touch **Administration**.
2. Scroll to and touch **Initial Setup**.
3. Touch **Networking and I/O**.

4. Touch **Embedded Jetdirect**.
5. Touch **TCP/IP**.
6. Touch **IPV4 Settings**.
7. Touch **Config Method**.
8. Touch **Manual**.
9. Touch **Save**.
10. Touch **Manual Settings**.
11. Touch **Default Gateway**.
12. Touch the Default Gateway text box.
13. Use the touchscreen keyboard to type the default gateway.
14. Touch **OK**.
15. Touch **Save**.

Configure TCP/IPv6 parameters

For information about configuring the device for a TCP/IPv6 network, see the *HP Jetdirect Print Server Administrator's Guide*.

Disable network protocols (optional)

By factory default, all supported network protocols are enabled. Disabling unused protocols has the following benefits:

- It decreases device-generated network traffic.
- It prevents unauthorized users from printing to the device.
- It provides only pertinent information on the configuration page.
- It allows the device control panel to display protocol-specific error and warning messages.

Disable IPX/SPX



NOTE Do not disable this protocol in Windows-based systems that print to the printer through IPX/SPX.

1. Scroll to and touch **Administration**.
2. Scroll to and touch **Initial Setup**.
3. Touch **Networking and I/O**.
4. Touch **Embedded Jetdirect**.
5. Touch **IPX/SPX**.
6. Touch **Enable**.

7. Touch **Off**.
8. Touch **Save**.

Disable AppleTalk

1. Scroll to and touch **Administration**.
2. Scroll to and touch **Initial Setup**.
3. Touch **Networking and I/O**.
4. Touch **Embedded Jetdirect**.
5. Touch **AppleTalk**.
6. Touch **Enable**.
7. Touch **Off**.
8. Touch **Save**.

Disable DLC/LLC

1. Scroll to and touch **Administration**.
2. Scroll to and touch **Initial Setup**.
3. Touch **Networking and I/O**.
4. Touch **Embedded Jetdirect**.
5. Touch **DLC/LLC**.
6. Touch **Enable**.
7. Touch **Off**.
8. Touch **Save**.

HP Jetdirect EIO print servers

HP Jetdirect print servers (network cards) can be installed in the EIO slot. These cards support multiple network protocols and operating systems. HP Jetdirect print servers facilitate network management by allowing you to connect a printer directly to your network at any location. HP Jetdirect print servers also support the Simple Network Management Protocol (SNMP), which provides remote printer management and troubleshooting through the HP Web Jetadmin software.



NOTE Configure the card through the control panel, the printer installation software, or HP Web Jetadmin. Refer to the HP Jetdirect print server documentation for more information.

4 Media and trays

This chapter contains the following sections:

- [General media specifications](#)
- [General guidelines for media](#)
- [Media considerations](#)
- [Select print media](#)
- [Printing and paper-storage environment](#)
- [Load media](#)
- [Control print jobs](#)
- [Select output bins](#)

General media specifications

For complete paper specifications for all HP LaserJet devices, see the *HP LaserJet Printer Family Print Media Guide* (available at <http://www.hp.com/support/ljpaperguide>) .

Category	Specifications
Acid content	5.5 pH to 8.0 pH
Caliper	0.094 to 0.18 mm (3.0 to 7.0 mils)
Curl in ream	Flat within 5 mm (0.02 in)
Cut edge conditions	Cut with sharp blades with no visible fray.
Fusing compatibility	Must not scorch, melt, offset, or release hazardous emissions when heated to 200° C (392°F) for 0.1 second.
Grain	Long grain
Moisture content	4% to 6% by weight
Smoothness	100 to 250 Sheffield

General guidelines for media

Before purchasing any paper or specialized forms in quantity, verify that your paper supplier has obtained and understands the print-media requirements that are specified in the *HP LaserJet Printer Family Print Media Guide*.

See [HP Customer Care](#) to order the *HP LaserJet Printer Family Print Media Guide*. To download a copy of the guide, go to <http://www.hp.com/support/ljpaperguide>.

It is possible that paper could meet all of the guidelines in this chapter or the *HP LaserJet Printer Family Print Media Guide* and still not print satisfactorily. This can result from abnormal characteristics of the printing environment or other variables over which HP has no control (for example, extremes in temperature and humidity).

Hewlett-Packard Company recommends testing any paper before buying it in large quantities.



CAUTION Using paper that does not conform to the specifications listed here or in the print media guide can cause problems that require service. This service is not covered by the Hewlett-Packard warranty or service agreements.

Paper to avoid

The product can handle many types of paper. Using paper that does not meet specifications will cause lower print quality and increase the chance of jams.

- Do not use paper that is too rough. Use paper with a tested smoothness rating of 100–250 Sheffield.
- Do not use paper, other than standard 3-hole punched paper, that contains cutouts or perforations.
- Do not use multipart forms.
- Do not use paper that has already been printed on, or that has been fed through a photocopier.
- Do not use paper that contains a watermark if you are printing solid patterns.
- Do not use heavily embossed or raised-letterhead papers.
- Do not use papers that have heavily textured surfaces.
- Do not use offset powders or other materials that prevent printed forms from sticking together.
- Do not use paper that has a colored coating that was added after the paper was produced.

Paper that can damage the device

In rare circumstances, paper can damage the device. The following paper must be avoided to prevent possible damage to the device:

- Do not use paper with staples attached.
- Do not use transparencies, labels, or photo or glossy paper designed for Inkjet printers or other low temperature printers. Use only media that is specified for use with HP LaserJet printers.

- Do not use any media that produces hazardous emissions, or that melts, offsets, or discolors when exposed to the temperature of the fuser.
- Do not use paper that is embossed or coated, or any media that is not designed to withstand the fusing temperature of the device. Do not use letterhead paper or preprinted forms that are made with dyes or inks that cannot withstand the heat of the fuser.

To order HP LaserJet printing supplies, see [Order parts, accessories, and supplies](#).

General media specifications

For complete paper specifications for all HP LaserJet devices, see the *HP LaserJet Printer Family Print Media Guide* (available at <http://www.hp.com/support/ljpaperguide>).

Category	Specifications
Acid content	5.5 pH to 8.0 pH
Caliper	0.094 to 0.18 mm (3.0 to 7.0 mils)
Curl in ream	Flat within 5 mm (0.02 in)
Cut edge conditions	Cut with sharp blades with no visible fray.
Fusing compatibility	Must not scorch, melt, offset, or release hazardous emissions when heated to 200° C (392°F) for 0.1 second.
Grain	Long grain
Moisture content	4% to 6% by weight
Smoothness	100 to 250 Sheffield

Media considerations

Envelopes

Envelope construction is critical. Envelope fold lines can vary considerably, not only between manufacturers, but also within a box from the same manufacturer. Successful printing on envelopes depends upon the quality of the envelopes. When selecting envelopes, consider the following components:

- **Weight:** The weight of the envelope paper should not exceed 105g/m² (28lb) or jamming might occur.
- **Construction:** Prior to printing, envelopes should lie flat with less than 6mm (0.25inch) curl, and should not contain air.
- **Condition:** Envelopes should not be wrinkled, nicked, or otherwise damaged.
- **Temperature:** You should use envelopes that are compatible with the heat and pressure of the printer.
- **Size:** You should use only envelopes within the following size ranges.
 - **Minimum:** 76x127mm (3x5inches)
 - **Maximum:** 216x356mm (8.5x14inches)



NOTE Use only tray1 or the optional envelope feeder to print envelopes. You might experience some jams when using any media with a length less than 178mm(7inches). This might be caused by paper that has been affected by environmental conditions. For optimum performance, make sure you are storing and handling the paper correctly. Also, choose envelopes in the printer driver (see [Supported printer drivers](#)).

Envelopes with double side seams

Double side-seam construction has vertical seams at both ends of the envelope rather than diagonal seams. This style might be more likely to wrinkle. Be sure the seam extends all the way to the corner of the envelope as illustrated below.

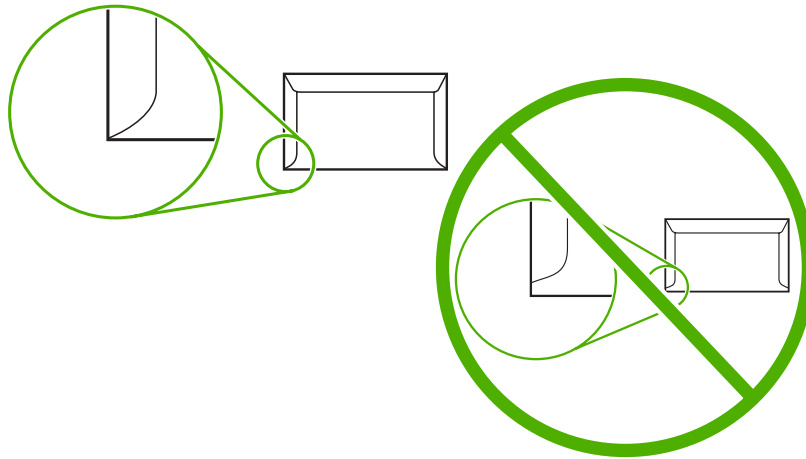

-
- 1 | Acceptable envelope construction
 - 2 | Unacceptable envelope construction
-

Envelopes with adhesive strips or flaps

Envelopes with a peel-off adhesive strip or with more than one flap that folds over to seal must use adhesives compatible with the heat and pressure in the printer. The extra flaps and strips might cause wrinkling, creasing, or even jams and might even damage the fuser.

Envelope margins

The following gives typical address margins for a commercial #10 or DL envelope.

Type of address	Top margin	Left margin
Return address	15mm (0.6inch)	15mm (0.6inch)
Delivery address	51mm (2.0inches)	89mm (3.5inches)



NOTE For the best print quality, position margins no closer than 15mm (0.6inch) from the edges of the envelope. Avoid printing over the area where the envelope's seams meet.

Envelope storage

Proper storage of envelopes helps contribute to print quality. Envelopes should be stored flat. If air is trapped in an envelope, creating an air bubble, then the envelope might wrinkle during printing.

For more information, see [Printing and paper-storage environment](#).

Labels



CAUTION To avoid damaging the MFP, use only labels recommended for laser printers. Never print on the same sheet of labels more than once or print on a partial sheet of labels.

Label construction

When selecting labels, consider the quality of each component:

- **Adhesives:** The adhesive material should be stable at 200C (392F), the printer's fusing temperature.
- **Arrangement:** Only use labels with no exposed backing between them. Labels can peel off sheets with spaces between the labels, causing serious jams.
- **Curl:** Prior to printing, labels must lie flat with no more than 13mm (0.5inch) of curl in any direction.
- **Condition:** Do not use labels with wrinkles, bubbles, or other indications of separation.



NOTE Choose labels in the printer driver (see [Supported printer drivers](#)).

Transparencies

Transparencies used in the printer must be able to withstand 200C (392F), the printer's fusing temperature.



CAUTION To avoid damaging the MFP, use only transparencies recommended for use in HPLaserJet printers, such as HP-brand transparencies.



NOTE Choose transparencies in the printer driver (see [Supported printer drivers](#)).

Card stock and heavy media

You can print many types of card stock from the paper input tray, including index cards and postcards. Some card stock performs better than others because its construction is better suited for feeding through a laser printer.

For optimum printer performance, do not use paper heavier than 157g/m² (42lb). Paper that is too heavy might cause misfeeds, stacking problems, paper jams, poor toner fusing, poor print quality, or excessive mechanical wear.



NOTE You might be able to print on heavier paper if you do not fill the input tray to capacity and if you use paper with a smoothness rating of 100-180Sheffield.

Card stock construction

- **Smoothness:** 135-157g/m² (36-42lb) card stock should have a smoothness rating of 100-180Sheffield. 60-135g/m² (16-36lb) card stock should have a smoothness rating of 100-250Sheffield.
- **Construction:** Card stock should lie flat with less than 5mm (0.2in.) of curl.
- **Condition:** Make sure that the card stock is not wrinkled, nicked, or otherwise damaged.
- **Sizes:** Only use card stock within the following size ranges:
 - **Minimum:** 76x127mm (3x5in.)
 - **Maximum:** 216x356mm (8.5x14.0in.)

Card stock guidelines

Set margins at least 2mm (0.08in.) away from the edges.

Letterhead and preprinted forms

Many manufacturers now offer premium paper advertised as laser-compatible or laser-guaranteed. Some of the rougher surface finishes, such as cockle, laid, or linen, might require the special fuser modes that are available on some printer models in order to achieve adequate toner adhesion.



NOTE Some page-to-page variation is normal when printing with laser printers. This variation cannot be observed when printing on plain paper. However, this variation is obvious when printing on preprinted forms because the lines and boxes are already placed on the page.

To avoid problems when using preprinted forms, embossed paper, and letterhead, observe the following guidelines:

- Avoid using low-temperature inks (the kind used with some types of thermography).
- Use preprinted forms and letterhead paper that have been printed by offset lithography or engraving.
- Use forms that have been created with heat-resistant inks that will not melt, vaporize, or release undesirable emissions when heated to 200C (392F) for 0.1second. Typically, oxidation-set or oil-based inks meet this requirement.
- When the form is preprinted, be careful not to change the moisture content of the paper, and do not use materials that change the paper's electrical or handling properties. Seal the forms in moisture-proof wrap to prevent moisture changes during storage.
- Avoid processing preprinted forms that have a finish or coating.
- Avoid using heavily embossed or raised-letterhead papers.
- Avoid papers that have heavily textured surfaces.
- Avoid using offset powders or other materials that prevent printed forms from sticking together.

Select the correct fuser mode

The device automatically adjusts the fuser mode based on the media type to which the tray is set. For example, heavy paper, such as card stock, might need a higher fuser-mode setting in order to make the toner adhere better to the page, but transparencies need a lower fuser-mode setting to avoid damage to the device. The default setting generally provides the best performance for most print-media types.

The fuser mode can be changed only if the media type has been set for the tray that you are using. See [Control print jobs](#). After the media type has been set for the tray, then the fuser mode for that type can be changed on the [Administration](#) menu in the [Print Quality](#) submenu at the device control panel. See [Print Quality menu](#).



NOTE Using the [High 1](#) or [High 2](#) fuser mode setting improves the ability of the toner to adhere to paper, but it might cause other problems, such as excessive curl. The device might print at a slower speed when the fuser mode is set to [High 1](#) or [High 2](#). The table below describes the ideal fuser mode setting for supported media types.

Media type	Fuser mode setting
Plain	Normal
Preprinted	Normal
Letterhead	Normal
Transparency	Low 2
Prepunched	Normal
Labels	Normal
Bond	Normal
Recycled	Normal
Color	Normal
Light	Low 1
Card stock	Normal
Rough	High 1
Envelope	Normal

To reset the fuser modes to the default settings, touch the [Administration](#) menu at the device control panel. Touch [Print Quality](#), touch [Fuser Modes](#), and then touch [Restore Modes](#).

Select print media

Table 4-1 Supported types of media

Type of media	Tray1	Trays 2, 3, 4, and 5	Optional duplexer	Optional envelope feeder	3-bin mailbox or stacker part of stapler/stacker	Stapler part of stapler/stacker
Plain	X	X	X	X	X	X
Preprinted	X	X	X	X	X	X
Letterhead	X	X	X	X	X	X
Transparency	X	X			X	
Prepunched	X	X		X	X	X
Labels	X	X	X	X	X	
Bond	X	X	X	X	X	X
Recycled	X	X	X	X	X	X
Color	X	X	X	X	X	X
Cardstock	X			X	X ^{1 2}	
Rough	X	X	X	X	X	X
Envelope	X			X	X ¹	

¹ Face-up delivery only.

² If a 3-bin mailbox is installed, select the bottom bin when printing on cardstock. Media weights that are 200g/m² or greater are supported only in the bottom bin.

Table 4-2 Tray1 supported sizes and weights

Size	Dimensions ¹	Weight	Capacity ²
Letter	216x279mm (8.5x11inches)	60to200g/m ² (16to53lb)	100sheets of 75g/m ² (20lb) paper
A4	210x297mm (8.3x11.7inches)		
Legal	216x356mm (8.5x14inches)		
Executive	184x267mm (7.3x10.5inches)		
Statement	140x216mm (5.5x8.5inches)		
8.5x13	216x330mm (8.5x13inches)		
A5	148x210mm (5.8x8.3inches)		
B5 (JIS)	182x257mm (7.2x10.1inches)		
Executive (JIS)	216x330mm (8.5x13inches)		
D Postcard (JIS)	148x200mm (5.8x7.9inches)		
16K	197x273mm (7.75x10.75inches)		
Custom ³	Minimum: 76x127mm (3x5inches) Maximum: 216x356mm (8.5x14inches)		

Table 4-2 Tray1 supported sizes and weights (continued)

Size	Dimensions ¹	Weight	Capacity ²
Envelope Commercial #10	105x241mm (4.1x9.5inches)	75to105g/m ² (20to28lb)	10envelopes
EnvelopeDL ISO	110x220mm (4.3x8.7inches)		
EnvelopeC5 ISO	162x229mm (6.4x9.0inches)		
EnvelopeB5 ISO	176x250mm (6.9x9.8inches)		
EnvelopeMonarch #7-3/4	98x191mm (3.9x7.5inches)		

¹ The MFP supports a wide range of sizes. Check the MFP software for supported sizes.

² Capacity can vary depending on paper weight and thickness, as well as environmental conditions.

³ To print on custom-size paper, see [Load small sizes, custom sizes, or heavy paper.](#)

Table 4-3 Trays 2, 3, 4, and 5 supported sizes and weights

Size	Dimensions ¹	Weight	Capacity ²
Letter	216x279mm (8.5x11inches)	60to120g/m ² (16to32lb)	500sheets of 75g/m ² (20lb) paper
A4	210x297mm (8.3x11.7inches)		
Executive	184x267mm (7.3x10.5inches)		
Legal	216x356mm (8.5x14inches)		
B5 (JIS)	182x257mm (7.2x10.1inches)		
A5	148x210mm (5.8x8.3inches)		
8.5x13	216x330mm (8.5x13inches)		
Executive (JIS)	216x330mm (8.5x13inches)		
16K	197x273mm (7.75x10.75inches)		
Custom ³	Minimum: 148x210mm (5.8x8.3inches)		
	Maximum: 216x356mm (8.5x14inches)		

¹ The MFP supports a wide range of sizes. Check the MFP software for supported sizes.

² Capacity can vary depending on paper weight and thickness, as well as environmental conditions.

³ To print on custom-size paper, see [Load small sizes, custom sizes, or heavy paper.](#)

Table 4-4 Optional duplexer supported sizes and weights

Size	Dimensions	Weight
Letter	216x279mm (8.5x11inches)	60to120g/m ² (16to32lb)
A4	210x297mm (8.3x11.7inches)	
Executive	184x267mm (7.3x10.5inches)	
Legal	216x356mm (8.5x14inches)	
B5 (JIS)	182x257mm (7.2x10.1inches)	
A5	148 x 210 mm (5.8x8.3inches)	
8.5x13	216x330mm (8.5x13inches)	
Executive (JIS)	216x330mm (8.5x13inches)	
16K	197x273mm (7.75x10.75inches)	

Table 4-5 Optional envelope feeder supported sizes and weights

Size	Dimensions	Weight	Capacity
Monarch #7-3/4	98x191mm (3.9x7.5inches)	75to105g/m ² (20to28lb)	75envelopes
Commercial#10	105x241mm (4.1x9.5inches)		
DL ISO	110x220mm (4.3x8.7inches)		
C5 ISO	162x229mm (6.4x9.0inches)		
B5 ISO	176x250mm (6.9x9.8inches)		

Table 4-6 Optional 3-bin mailbox or stacker part of the stapler/stacker supported sizes and weights

Size	Dimensions ¹	Weight	Capacity ²
Letter	216x279mm (8.5x11inches)		For the stacker on the stapler/stacker or the lower bin on the 3-bin mailbox: 500sheets of 75g/m ² (20lb) paper
A4	210x297mm (8.3x11.7inches)		
Executive	184x267mm (7.3x10.5inches)		For the top two bins on the 3-bin mailbox: each can hold 100sheets of 75g/m ² (20lb) paper.
Legal	216x356mm (8.5x14inches)		
B5 (JIS)	182x257mm (7.2x10.1inches)		
A5	148x210mm (5.8x8.3inches)		
Statement	140x216mm (5.5x8.5inches)		
8.5x13	216x330mm (8.5x13inches)		
Executive(JIS)	216x330mm (8.5x13inches)		
DPostcard(JIS)	148x200mm (5.8x7.9inches)		
16K	197x273mm (7.75x10.75inches)		
Envelope #10 ⁴	105x241mm (4.1x9.5inches)		
Envelope Monarch #7-3/4 ⁴	98x191mm (3.9x7.5inches)		
Envelope C5 ISO ⁴	162x229mm (6.4x9.0inches)		
Envelope DL ISO ⁴	110x220mm (4.3x8.7inches)		
Envelope B5 ISO ⁴	176x250mm (6.7x9.8mm)		
Custom ³	Minimum: 76x127mm (3x5inches) Maximum: 216x356mm (8.5x14inches)		

¹ The MFP supports a wide range of sizes. Check the MFP software for supported sizes.

² Capacity can vary depending on paper weight and thickness, as well as environmental conditions.

³ To print on custom-size paper, see [Load small sizes, custom sizes, or heavy paper.](#)

⁴ Face-up delivery only.

Table 4-7 Stapler part of the optional stapler/stacker supported sizes and weights

Size	Dimensions	Weight	Capacity
Letter	216x279mm (8.5x11inches)	For plain media: 60to120g/m ² (16to32lb)	For plain media: 30sheets of 75g/m ² (20lb) paper
A4	210x297mm (8.3x11.7inches)		
Legal	216x356mm (8.5x14inches)	For thick media: 128to199g/m ² (34to53lb)	For glossy media: 20sheets
8.5x13	216x330mm (8.5x13inches)		For thick media: the stack height must not exceed 7mm (0.27inch)
Executive(JIS)	216x330mm (8.5x13inches)		

Table 4-8 ADF supported sizes and weights

Size	Dimensions	Weight	Capacity
Letter	216x279mm (8.5x11inches)	60to120g/m ² (16to32lb)	50sheets of 75g/m ² (20lb) paper
A4	210x297mm (8.3x11.7inches)		
A5	148x210mm (5.8x8.3inches)		
Legal	216x356mm (8.5x14inches)		

Printing and paper-storage environment

Ideally, the printing and paper-storage environment should be at or near room temperature, and not too dry or too humid. Remember paper is hygroscopic; it absorbs and loses moisture rapidly.

Heat works with humidity to damage paper. Heat causes the moisture in paper to evaporate, while cold causes it to condense on the sheets. Heating systems and air conditioners remove most of the humidity from a room. As paper is opened and used, it loses moisture, causing streaks and smudging. Humid weather or water coolers can cause the humidity to increase in a room. As paper is opened and used it absorbs any excess moisture, causing light print and dropouts. Also, as paper loses and gains moisture it can distort. This can cause jams.

As a result, paper storage and handling are as important as the paper-making process itself. Paper storage environmental conditions directly affect the feed operation.

Care should be taken not to purchase more paper than can be easily used in a short time (about 3 months). Paper stored for long periods might experience heat and moisture extremes, which can cause damage. Planning is important to prevent damage to a large supply of paper.

Unopened paper in sealed reams can remain stable for several months before use. Opened packages of paper have more potential for environmental damage, especially if they are not wrapped with a moisture-proof barrier.

The paper-storage environment should be properly maintained to ensure optimum product performance. The required condition is 20° to 24°C (68° to 75°F), with a relative humidity of 45% to 55%. The following guidelines should be helpful when evaluating the paper's storage environment:

- Paper should be stored at or near room temperature.
- The air should not be too dry or too humid (due to the hygroscopic properties of paper).
- The best way to store an opened ream of paper is to rewrap it tightly in its moisture-proof wrapping. If the product environment is subject to extremes, unwrap only the amount of paper to be used during the day's operation to prevent unwanted moisture changes.
- Proper storage of envelopes helps contribute to print quality. Envelopes should be stored flat. If air is trapped in an envelope, creating an air bubble, then the envelope might wrinkle during printing.

Load media

This section contains information about loading standard- and custom-size media into the input trays.

CAUTION To avoid a jam, never add or remove paper from a tray while printing or copying from that tray. To avoid damaging the MFP, print labels and envelopes from tray1 only. Print on only one side of labels, envelopes, and transparencies.

Load the flatbed scanner

Place the document face-down on the scanner glass.

Load the ADF

Load the document face-up in the ADF.

Load tray1

Tray1 holds up to 100 sheets of paper or 10 envelopes. For more information about supported media, see [Select print media](#).

Use the following procedure if tray1 is loaded continually with the same type of media, and the media is not usually removed from tray1 between print jobs. The following procedure can also increase the MFP performance when printing from tray1.

CAUTION To avoid a jam, never add or remove media from a tray while printing from that tray.

1. Touch **Copy**.
2. Touch **Paper Selection**.
3. Touch **Tray 1 Any Size**.
4. Touch the correct media size.



NOTE If you select **Custom** as the media size, also select the unit of measure and the X and Y dimensions.

5. Touch **OK**.
6. Touch **OK** again.
7. Open tray1.

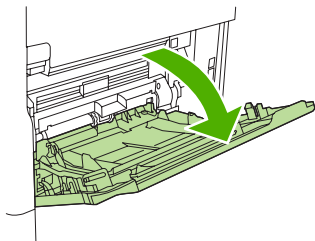

8. Load paper according to size and finishing options. See [Select print media](#) for information about loading preprinted, letterhead, and prepunched paper.



CAUTION To avoid jams, print sheets of labels one sheet at a time.

9. Adjust the media guides so they lightly touch the media stack, but do not bend the media.

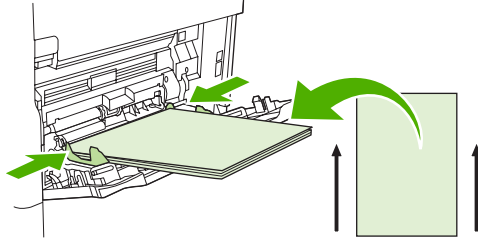

10. Make sure the media fits under the tabs on the guides and not above the load level indicators.



NOTE If printing on long media also pull out the tray extension until it stops.

11. Touch **Start Copy**.

Load trays 2, 3, 4 and 5

Trays 2, 3, 4, and 5 hold up to 500 sheets of standard media. For information about paper specifications, see [Select print media](#).

The following are the *detectable* standard sizes, which are marked inside the tray:

- A4
- Letter
- Legal
- Executive
- B5 (JIS)
- A5

The following are the *undetectable* standard sizes:

- 16K
- Executive (JIS)
- 8.5 x 13 (216 x 330 mm).

When loading undetectable sizes, you need to manually set the size at the control panel. For information about loading custom-size media, see [Load custom-size media in trays 2, 3, 4, and 5](#).



CAUTION To avoid a jam, never add or remove paper from a tray while printing from that tray.

Load standard-size media in trays 2, 3, 4, and 5



NOTE Do not load envelopes in trays 2, 3, 4, or 5. Use only tray1 for printing on envelopes.

1. Open the tray until it stops.

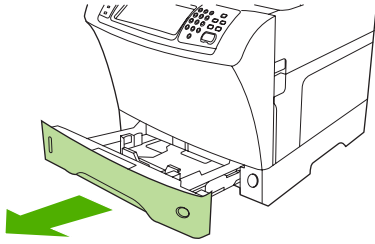

2. Load the media into the tray.

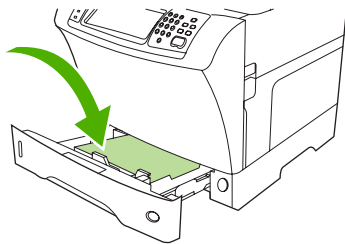

NOTE See [Load letterhead, prepunched, or preprinted paper](#) for information about loading preprinted, letterhead, and prepunched paper.

3. Adjust the media-length guide by pressing the tab on the guide and moving it until it touches the media stack.

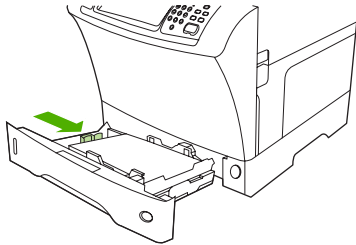

4. Adjust the media-width guide by pressing the tab on the guide and moving it until it touches the media stack.

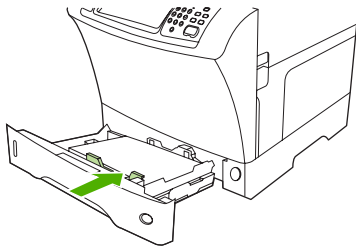

5. Close the tray.

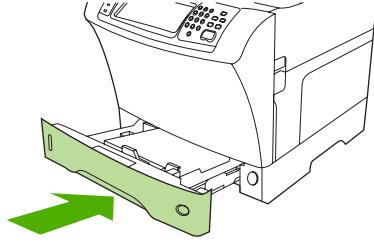

NOTE Depending on the size that you selected, the MFP might prompt you to move the media guides. Follow the instructions on the control panel.

Load custom-size media in trays 2, 3, 4, and 5

1. Open the tray until it stops.

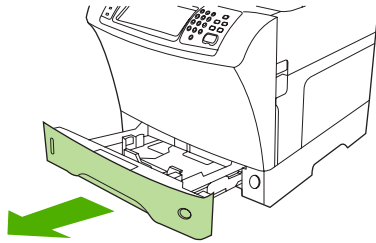

2. Press the tab on the left media guide and slide the guide all the way out.

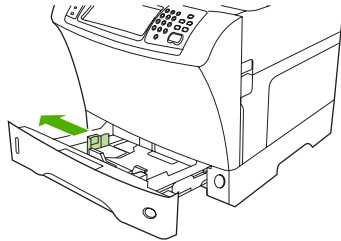

3. Press the tab on the front media guide and slide the guide all the way out.

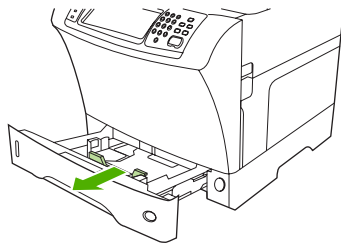

4. Load the media into the tray.

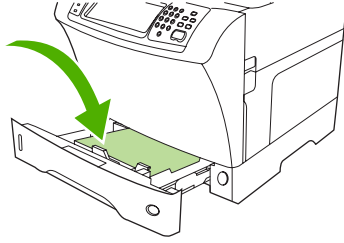

NOTE See [Load letterhead, prepunched, or preprinted paper](#) for information about loading preprinted, letterhead, and prepunched paper.

5. Adjust the left media guide by pressing the tab on the guide and sliding the guide until it gently touches the media stack

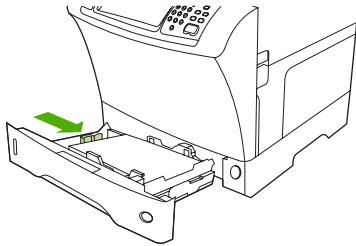

6. Adjust the front media guide by pressing the tab on the guide and sliding the guide until it gently touches the media stack.

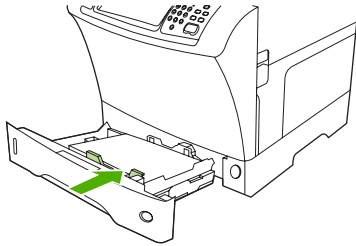

7. Look at the package for the ream of paper. Note the value of the width (X dimension) and the length (Y dimension). You will need this information for a later step.

8. Close the tray.

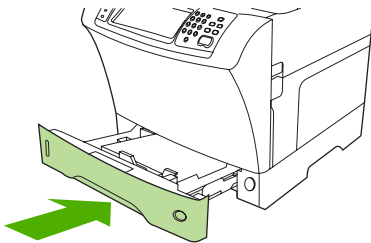

9. If the size that appears on the control panel is **Custom**, then the tray size is set to **ANY CUSTOM**. The tray will match any custom-size print job, even if the print-job dimensions are different from the dimensions of the media that is loaded in the tray. If you prefer, you can

specify the exact dimensions of the custom-size media that is loaded in the tray. When you specify exact dimensions, the dimensions appear as the size, rather than **Custom**.

Touch **Custom**. The **UNIT OF MEASURE** menu appears.



NOTE The MFP might prompt you to move the media guides. Follow the instructions on the control panel.

10. Touch **MILLIMETERS** or touch **INCHES**.
11. Use the numeric keypad to select the X dimension (short edge).
12. Touch **OK**.
13. Use the numeric keypad to select the Y dimension (long edge).
14. Touch **OK**. **SETTING SAVED** appears on the control-panel display for a moment. The tray size then appears.
15. Touch **EXIT** to accept the settings. The tray is ready to use.

Load special media

Load envelopes

You can print on envelopes from tray1 or the optional envelope feeder. Tray1 holds up to 10 envelopes and supports standard or custom sizes. The optional envelope feeder holds up to 75envelopes and supports only standard envelope sizes.

For printing on any size of envelope, make sure to set the margins in your program at least 15mm (0.6inch) from the edge of the envelope.

Printing performance depends on the construction of the envelope. Always test a few sample envelopes before purchasing a large quantity. For envelope specifications, see [Select print media](#).



WARNING! Never use envelopes that contain coated linings, exposed self-stick adhesives, or other synthetic materials. These items can emit noxious fumes.



CAUTION Envelopes that have clasps, snaps, windows, coated linings, exposed self-stick adhesives, or other synthetic materials can severely damage the MFP. To avoid jamming and possible MFP damage, never try to print on both sides of an envelope. Before you load envelopes, make sure that they are flat and are not damaged or stuck together. Do not use envelopes that have pressure-sensitive adhesive.



NOTE The MFP prints at a slower speed when printing on envelopes.

Many types of envelopes can be printed on from tray1. Up to 10can be stacked in the tray. See [Select print media](#) for specifications.

Load envelopes in tray1

1. Open tray1, but do not pull out the extension. Most envelopes feed best without the extension. However, oversized envelopes might need the extension.

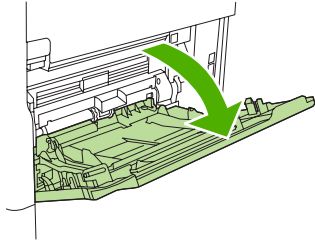

2. Load up to 10 envelopes in the center of tray1 with the front side facing up, and the postage-end toward the MFP. Slide the envelopes into the MFP as far as they will go without forcing them.

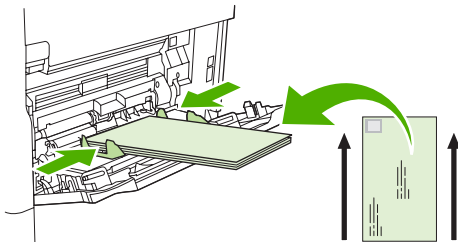

3. Adjust the guides to touch the envelope stack without bending the envelopes. Make sure that the envelopes fit under the tabs and maximum-height indicators on the guides.

Load labels

Use only labels that are recommended for use in laser printers. Make sure that labels meet the correct specifications. See [Labels](#).

Follow these guidelines when printing on labels:

- Print on a stack of up to 50 label sheets from tray1 or a stack of up to 100 label sheets from other trays.
- Load labels in tray1 with the front side facing up, and the top, short edge toward the MFP. For other trays, load media with the front side facing down, and the top edge toward the right.

Do not load or print on labels in the following ways:



CAUTION Failure to follow these instructions can damage the MFP.

- Do not load the trays to maximum capacity, because labels are heavier than paper.
- Do not use labels that are separating from the backing sheet, wrinkled, or damaged in any way.
- Do not use labels that have the backing sheet exposed. (Labels must cover the entire backing sheet, leaving no exposed spaces.)
- Do not feed a sheet of labels through the MFP more than once. The adhesive backing is designed for only one pass through the MFP.

- Do not print on both sides of labels.
- Do not print on sheets from which labels have been removed.

Load transparencies

Use only transparencies that are recommended for use in laser printers. For transparency specifications, see [Transparencies](#).

- At the control panel, scroll to and touch **Administration**, scroll to and touch **Print Quality**, touch **Fuser Modes**, touch **Transparency**, and touch **Low2**.



CAUTION Failure to set the fuser mode to Low2 can permanently damage the MFP and fuser.

- In the printer driver, set the paper type to **Transparency**.
- At the control panel, touch **Copy**, touch **Paper Selection**, select the desired tray, and touch **Transparency**.
- Load transparencies face up in tray1 with the top toward the MFP. Up to 50 transparencies can be loaded in tray1.
- A stack of up to 100 transparencies can be printed from tray2 and the optional trays (although stacking more than 50 at a time is not recommended).
- Because transparencies are heavier than paper, do not load trays to maximum capacity.
- Load transparencies in tray2 or the optional trays with the side to be printed on facing down, and the top, short edge toward the right.
- To prevent transparencies from becoming too hot or from sticking together, remove each transparency from the output bin before printing another.
- Print on only one side of a transparency.
- Place transparencies on a flat surface to cool after removing them from the MFP.
- If two or more transparencies feed at the same time, try fanning the stack.
- Do not feed transparencies through the MFP more than once.

Load letterhead, prepunched, or preprinted paper

When printing on letterhead, prepunched, or preprinted paper, it is important to orient the paper correctly. For most printing situations, follow the guidelines in this section for printing on one side only. For duplexing guidelines, see [Print on both sides of the paper](#).



NOTE If you want to always load letterhead or preprinted paper the same way for all print jobs, whether you are printing on one side of the sheet or on both sides of the sheet, use the **Alternative Letterhead Mode** setting in the printer driver. Load the paper as you would for printing on both sides. When this option is selected, the MFP speed slows to the speed that is required for printing on both sides. The information presented in this section is for printing without using Alternative Letterhead Mode.

NOTE For more information about paper that has a special finish, such as laid or bond paper, see [Load paper that has a special finish](#).

For tray1, load the paper with the front side facing up, and the top, short edge toward the MFP.

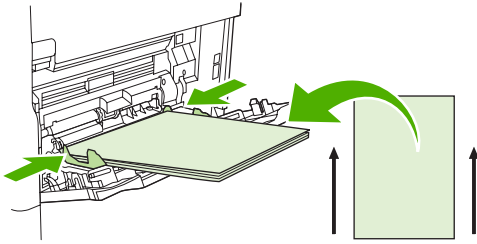

For tray2 and the optional 500-sheet trays, load the paper with the front side facing down, and the top, short edge toward the right.

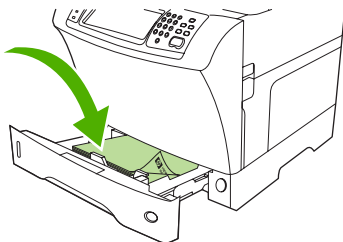

Load paper that has a special finish

Some paper has a special finish, such as laid paper, bond paper, and cockled paper. These types of paper can cause issues in regard to toner adhesion and print quality. Follow these guidelines when printing on paper that has a special finish.

- At the control panel, scroll to and touch **Administration**, touch **Print Quality**, and touch **Fuser Modes**. Touch the paper type that you are using (such as **Bond**). Set the fuser mode to **High1** or **High2**. **High2** provides better toner adhesion and optimal print quality for paper that has a highly textured finish. At the control panel home screen, touch **Copy**, touch **Paper Selection**, select the desired tray, and touch the type of paper that you are using (such as **Bond**) to turn on the appropriate fuser mode.



NOTE The MFP might print at a slower speed when set at **High1** or **High2**. Use the **High1** and **High2** settings only if you are experiencing toner-adhesion problems. The **High1** and **High2** settings might increase problems with curl and jams.

- Some makers of these types of paper are now coating one side of the paper to enhance toner adhesion and print quality. To take advantage of this feature, make sure to load the paper correctly. The side on which you can read the watermark correctly is the front side, or the side to be printed on.

For tray1, load paper with the front side facing up, and the top, short edge toward the MFP.

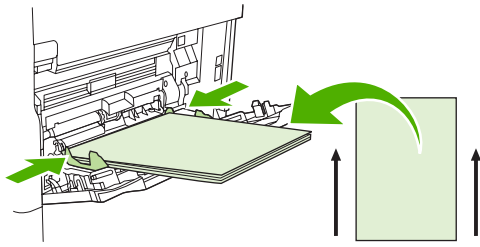

For tray2 and the optional 500-sheet trays, load paper with the front side facing down, and the top, short edge toward the right.

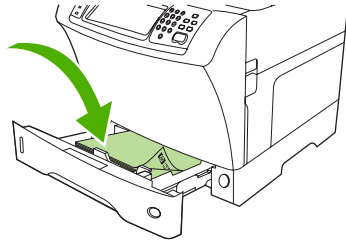

Load small sizes, custom sizes, or heavy paper

Custom-size paper can be printed from tray1, tray2, or an optional 500-sheet tray.



NOTE The MFP might print at a slower speed when printing on small sizes, custom sizes, and heavy paper. For more information about paper that has a special finish, such as laid or bond paper, see [Load paper that has a special finish](#).

Weight and sizes

See the following table for specifications when printing on custom or heavy paper.

Tray	Minimum size	Maximum size	Supported weights
Tray1	76x 127mm (3x5inches)	216x356mm (8.5x14inches)	60to200g/m ² (16to53lb)
Tray2 and optional 500-sheet tray	148x210mm (5.8x8.2inches)	216x356mm (8.5x14inches)	60to120g/m ² (16to32lb)

Guidelines for heavy paper

To help prevent toner from rubbing off of the paper, some heavier paper types should be printed using a higher fuser mode. At the control panel, scroll to and touch **Administration**, touch **Print Quality**, and touch **Fuser Modes**. Touch the paper type that you are using. Set the fuser mode to **High1** or **High2**. Using these modes helps prevent toner from rubbing off the page, but using them might slow the device speed or create other problems, such as increased curl.

Guidelines for custom-size paper

Follow these guidelines when printing on any custom-size paper:

- Feed the paper short-edge first.
- In your program, set page margins at least 4.23mm (0.17inch) away from the edges.
- Set the custom size in the program, in the printer driver, or at the MFP control panel.

Additional guidelines for small or narrow paper

Follow these additional guidelines when printing on small or narrow paper:

- Do not attempt to print on paper smaller than 76mm (3inches) wide or 127mm (5inches) long.
- HP does not recommend printing large quantities of small or narrow paper. This could result in excessive wear on the print-cartridge components that might result in print-quality problems or toner leaking into the MFP.

Control print jobs

When a job is sent to the printer, the printer driver controls what paper tray is used to pull media through the printer. By default, the printer automatically selects the tray, but a specific tray can be chosen based on three user-specified settings: **Source**, **Type**, and **Size**. These settings are available from the **Application Setting** dialog box, the **Print** dialog box, or the printer driver.

Setting	Description
Source	<p>Directs the printer to pull paper from a user-specified tray. The printer tries to print from this tray, no matter what type or size media is loaded in it. To begin printing, load the selected tray with the correct type or size of print media for the print job. After loading the tray, the printer begins printing. If the printer does not begin printing:</p> <ul style="list-style-type: none">• Verify the tray configuration matches the size or type of the print job.• Press OK to have the printer try to print from another tray.
Type or Size	<p>Directs the printer to pull paper or print media from the first tray that is loaded with the type or size that you selected. <i>Always print by Type for special print media such as labels or transparencies.</i></p>

Select output bins

The MFP has two output-bin locations: the ADF output bin and the standard output bin(s) on the output device.

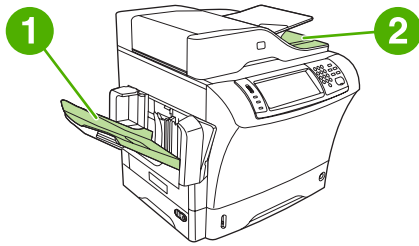

When documents are scanned or copied by using the ADF, the original documents are automatically delivered to the ADF output bin. Copies are delivered to the standard output bin or the output bin(s) on the stapler/stacker or to the 3-bin mailbox.

Documents that are sent to the MFP from a computer are delivered to the standard output bin or the output bin(s) on the stapler/stacker or to the 3-bin mailbox.

Select an output location

It is recommended that you select an output location (bin) through your program or driver. Where and how you make selections depends on your program or driver. If you cannot select an output location from the program or driver, set the default output location from the MFP control panel.

1. Scroll to and touch **Administration**.
2. Touch **Default Job Options**.
3. Touch **Output Bin**.
4. Touch the desired output bin.

3-bin mailbox output bins

If you are using the 3-bin mailbox, three output bins are available. You can configure these bins to act as individual mailboxes, or they can be combined as a single bin to stack documents. You can set up these options in the **Device Behavior** menu, on the **MBM-3 Configuration** submenu. This menu is available only when the 3-bin mailbox is installed.

The top two bins hold up to 100 sheets of paper. A sensor causes the MFP to stop when the bin is full. MFP operation continues when you empty or reduce the amount of media in the bin.

The lower bin holds up to 500 sheets of paper.

Selecting face-up or face-down output for copy jobs

The MFP can deliver pages either face-up or face-down. The default setting is to deliver jobs face-down. Documents that have multiple pages are delivered with the correct page order. Face-down output is the fastest delivery method.

Select face-up output when you want to use the straightest paper path, such as when printing on heavy media. Documents that have multiple pages are delivered with the pages in reverse order.

You can select face-up or face-down output on the **Output** tab in the printer driver. See [Supported printer drivers](#).



NOTE If you select **Face-up (Straightest Path)**, the stapler/stacker cannot staple the job.

5 Use device features

- [Use the stapler](#)
- [Use job storage features](#)

Use the stapler

The optional stapler/stacker can staple jobs of up to 30 sheets of 75g/m² (20lb) paper. The stapler can staple these sizes: A4, Letter, Legal, Executive (JIS), and 8.5x13. It can stack up to 500 sheets of paper.

- Paper weight can range from 60 to 120g/m² (16 to 32lb). Heavier paper might have a stapling limit of fewer than 30 sheets.
- If the job consists of only one sheet, or if it consists of more than 30 sheets, the MFP delivers the job to the bin, but the MFP does not staple the job.
- The stapler supports paper only. Do not try to staple other types of print media, such as envelopes, transparencies, or labels.

When you want the MFP staple a document, select stapling in the software. You can usually select the stapler in your program or printer driver, although some options might be available only in the printer driver. Where and how you make selections depends on your program or printer driver.

If you cannot select the stapler in the program or printer driver, select the stapler at the MFP control panel.

The stapler accepts print jobs if it is out of staples, but it does not staple the pages. The printer driver can be configured to disable the staple option if the staple cartridge is empty.

Configure the printer driver to recognize the optional stapler

You need to configure the printer driver to recognize the optional stapler/stacker. You need to configure this setting only once. The procedure to configure the driver to recognize the accessory depends on the operating system that you are using. For instructions, see [Supported printer drivers](#). Look for the column with the heading "To change the configuration settings," and follow the procedure for the operating system that you are using. Select the HP 500-Sheet Stapler/Stacker as an optional paper destination or accessory.

Staple media

Select the stapler in the software (Windows)

1. On the **File** menu, click **Print**, and then click **Properties**.
2. On the **Output** tab, click the drop-down list under **Staple**, and click **One Staple Angled**.

Select the stapler in the software (Mac)

1. On the **File** menu, click **Print**, and then select **Finishing** from the print options.
2. In the **Output Destination** pop-up menu, select the **Stapler** option.
3. In the **Finishing Options** pop-up menu, select the stapling style that you want to use.

Select the stapler at the control panel for printed jobs

1. Scroll to and touch **Administration**.
2. Touch **Default Job Options**.

3. Touch **Default Copy Options**.
4. Touch **Staple/Collate**.
5. Touch **Staple**.
6. Touch the staple option you want to use.



NOTE Selecting the stapler at the printer control panel changes the default setting to **Staple**. It is possible that all print jobs will be stapled. However, settings that are changed in the printer driver override settings that are changed at the control panel.

Select the stapler in the printer driver for printed jobs (Windows)



NOTE The following procedure changes the default setting to staple all print jobs.

1. Open the printer driver. See [Open the printer drivers](#). Look for the column with the heading "To change the print job default settings."
2. On the **Output** tab, click the drop-down list under **Staple**, and click **One Staple Angled**.



NOTE You can create a Quick Set that has the appropriate settings.

Select the stapler in the printer driver for printed jobs (Mac)

Select the stapler by creating a new preset in the printer driver.

1. Open the printer driver. See [Open the printer drivers](#). Look for the column with the heading "To change the print job default settings," and follow the instructions for the operating system that you are using.
2. Create the new preset.

Set the stapler at the control panel for all copy jobs



NOTE The following procedure changes the default setting for all copy jobs.

1. Scroll to and touch **Administration**.
2. Touch **Default Job Options**.
3. Touch **Default Copy Options**.
4. Touch **Staple/Collate**.
5. Touch **Staple**.
6. Touch the staple option you want to use.

Set the stapler at the control panel for a single copy job



NOTE The following procedure sets the stapling option for only the current copy job.

1. Scroll to and touch **Copy**.
2. Touch **Staple/Collate**.
3. Touch the staple option you want to use.

Configure the device to stop or continue when the staple cartridge is empty

You can specify whether the MFP stops printing when the staple cartridge is empty or if it continues printing but does not staple the jobs.

1. Scroll to and touch **Administration**.
2. Scroll to and touch **Device Behavior**.
3. Scroll to and touch **Stapler Stacker**.
4. Touch **Staples Out**.
5. Touch the option that you want to use:
 - Select **Stop** to stop all printing until the staple cartridge is replaced.
 - Select **Continue** to continue printing jobs without stapling them.

Load staples

Load staples if the printer control-panel display prompts you with a **STAPLER LOW ON STAPLES** message (the stapler has fewer than 20 usable staples left) or a **REPLACE STAPLE CARTRIDGE** message (the stapler is empty, or the remaining staples cannot be used).

You can specify whether the MFP stops printing when the staple cartridge is empty or if it continues printing but does not staple the jobs.

1. Press and hold the release button on the top of the stapler/stacker. Pull the stapler/stacker away from the MFP.

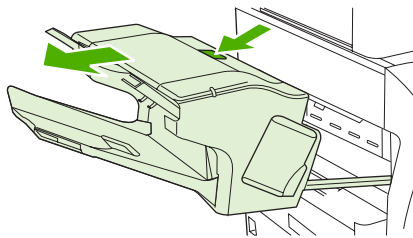

2. Open the staple-cartridge cover.

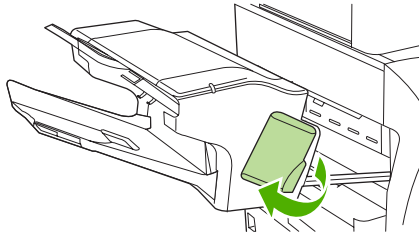

3. Grasp the green staple-cartridge handle and pull the old staple cartridge out of the stapler unit.

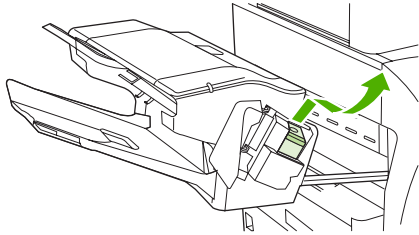

4. Insert the new staple cartridge into the stapler unit and push down on the green handle until the unit snaps into place.

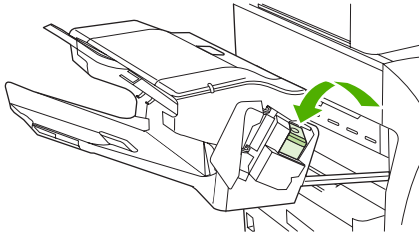

5. Close the staple-cartridge cover, and slide the stapler/stacker into the MFP.

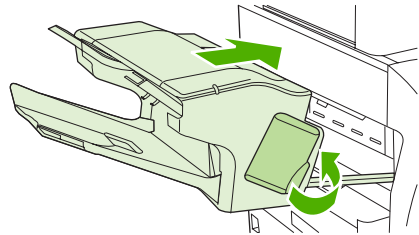

Use job storage features

The following job-storage features are available for this device:

- **Proof and hold jobs:** This feature provides a quick and easy way to print and proof one copy of a job and then print the additional copies.
- **Private jobs:** When you send a private job to the device, the job does not print until you provide the required personal identification number (PIN) at the control panel.
- **QuickCopy jobs:** You can print the requested number of copies of a job and then store a copy of the job on the device hard disk. Storing the job allows you to print additional copies of the job later.
- **Stored jobs:** You can store a job such as a personnel form, time sheet, or calendar on the device and allow other users to print the job at any time. Stored jobs also can be protected by a PIN.

Follow the instructions in this section to gain access to the job storage features at the computer. See the specific section for the type of job that you want to create.



CAUTION If you turn off the device, all QuickCopy, proof and hold, and private jobs are deleted.

Gain access to the job storage features

For Windows

1. On the **File** menu, click **Print**.
2. Click **Properties**, and then click the **Job Storage** tab.
3. Select the job storage mode that you want.

For Macintosh

In newer drivers: Select **Job Storage** in the pull-down menu in the **Print** dialog box. In older drivers, select **Printer Specific Options**.

Use the proof and hold feature

The proof and hold feature provides a quick and easy way to print and proof one copy of a job and then to print the additional copies.

To permanently store the job and prevent the device from deleting it when space is needed for something else, select the **Stored Job** option in the driver.

Create a proof and hold job



CAUTION If the device needs additional space to store newer proof and hold jobs, the device deletes other stored proof and hold jobs, starting with the oldest job. To permanently store a job and prevent the device from deleting it when space is needed, select the **Stored Job** option in the driver instead of the **Proof and Hold** option.

In the driver, select the **Proof and Hold** option and type a user name and job name.

The device prints one copy of the job for you to proof. Then, see [Navigate the Administration menu](#).

Print the remaining copies of a proof and hold job

At the device control panel, use the following procedure to print the remaining copies of a job held on the hard disk.

1. From the Home screen, touch **Job Storage**.
2. Touch the **Retrieve** tab.
3. Scroll to and touch the job storage folder that holds the job.
4. Scroll to and touch the job that you want to print.
5. Touch the **Copies** field to change the number of copies to print. Touch **Retrieve Stored Job** (⌘) to print the document.

Delete a proof and hold job

When you send a proof and hold job, the device automatically deletes your previous proof and hold job.

1. From the Home screen, touch **Job Storage**.
2. Touch the **Retrieve** tab.
3. Scroll to and touch the job storage folder that holds the job.
4. Scroll to and touch the job that you want to delete.
5. Touch **Delete**.
6. Touch **Yes**.

Use the private job feature

Use the private printing feature to specify that a job is not printed until you release it. First, set a 4-digit PIN by typing the PIN in the printer driver. The PIN is sent to the device as part of the print job. After you have sent the print job to the device, you must use the PIN to print the job.

Create a private job

To specify that a job is private, in the driver, select the **Private Job** option, type a user name and job name, and then type a four-digit PIN. The job will not print until you enter the PIN at the device control panel.

Print a private job

You can print a private job at the control panel after the job has been sent to the device.

1. From the Home screen, touch **Job Storage**.
2. Touch the **Retrieve** tab.
3. Scroll to and touch the job storage folder that holds the private job.
4. Scroll to and touch the private job that you want to print.



NOTE A private job will have a  [lock symbol] next to it.

5. Touch the **PIN** field.
6. Use the numeric keypad to type the PIN, and then touch **OK**.
7. Touch the **Copies** field to change the number of copies to print.
8. Touch **Retrieve Stored Job** () to print the document.

Delete a private job

A private job is automatically deleted from the device hard disk after you release it for printing. If you want to delete the job without printing it, use this procedure.

1. From the Home screen, touch **Job Storage**.
2. Touch the **Retrieve** tab.
3. Scroll to and touch the job storage folder that holds the private job.
4. Scroll to and touch the private job that you want to delete.



NOTE A private job will have a  [lock symbol] next to it.)

5. Touch the **PIN** field.
6. Use the numeric keypad to type the PIN, and then touch **OK**.
7. Touch **Delete**.

Use the QuickCopy feature

The QuickCopy feature prints the requested number of copies of a job and stores a copy on the device hard disk. Additional copies of the job can be printed later. This feature can be turned off in the printer driver.

The default number of different QuickCopy jobs that can be stored on the device is 32. At the control panel, you can set a different default number. See [Navigate the Administration menu](#).

Create a QuickCopy job



CAUTION If the device needs additional space to store newer QuickCopy jobs, the device deletes other stored QuickCopy jobs, starting with the oldest job. To permanently store a job and prevent the device from deleting it when space is needed, select the **Job Storage** option in the driver instead of the **QuickCopy** option.

In the driver, select the **QuickCopy** option, and then type a user name and a job name.

When you send the job to print, the device prints the number of copies that you set in the driver. To print more quick copies at the device control panel, see [Print additional copies of a QuickCopy job](#).

Print additional copies of a QuickCopy job

This section describes how to print additional copies of a job stored on the device hard disk at the control panel.

1. From the Home screen, touch **Job Storage**.
2. Touch the **Retrieve** tab.
3. Scroll to and touch the job storage folder that holds the job.
4. Scroll to and touch the job that you want to print.
5. Touch the **Copies** field to change the number of copies to print.
6. Touch **Retrieve Stored Job** (↕) to print the document.

Delete a QuickCopy job

Delete a QuickCopy job at the device control panel when you no longer need it. If the device requires additional space to store new QuickCopy jobs, the device automatically deletes other stored QuickCopy jobs, starting with the oldest job.



NOTE Stored QuickCopy jobs can be deleted at the control panel or in HP Web Jetadmin.

1. From the Home screen, touch **Job Storage**.
2. Touch the **Retrieve** tab.
3. Scroll to and touch the job storage folder that holds the job.
4. Scroll to and touch the job that you want to delete.
5. Touch **Delete**.
6. Touch **Yes**.

Use the stored job feature

You can save a print job to the device hard disk without printing it. You can then print the job at any time at the device control panel. For example, you might want to download a personnel form, calendar, time sheet, or accounting form that other users can print when they need it.

You also can create a stored copy job at the device control panel that can be printed at a later time.

Create a stored copy job

1. Place the original document face-down on the glass or face-up in the ADF.
2. From the Home screen, touch **Job Storage**.
3. Touch the **Create** tab.
4. Specify the name for the stored job in one of these ways:
 - Select an existing folder from the list. Touch **New Job** and type a job name.
 - Touch the box below the existing **Folder Name:** or **Job Name:** on the right-hand side of the screen, and then edit the text.
5. A private stored job has a lock icon next to the name, and it requires that you specify a PIN to retrieve it. To make the job private, select **PIN to Print** and then type the PIN for the job. Touch **OK**.
6. Touch **More Options** to view and change other job storage options.
7. After all the options are set, touch **Create Stored Job** (Ⓢ) in the upper-left corner of the screen to scan the document and store the job. The job is saved on the device until you delete it, so you can print it as often as necessary.

For information about printing the job, see [Print a stored job](#).

Create a stored print job

In the driver, select the **Stored Job** option, and then type a user name and job name. The job does not print until someone requests it at the device control panel. See [Print a stored job](#).

Print a stored job

At the control panel, you can print a job that is stored on the device hard disk.

1. From the Home screen, touch **Job Storage**.
2. Touch the **Retrieve** tab.
3. Scroll to and touch the job storage folder that holds the stored job.
4. Scroll to and touch the stored job that you want to print.
5. Touch **Retrieve Stored Job** (Ⓢ) to print the document.
6. Touch the **Copies** field to change the number of copies to print.
7. Touch **Retrieve Stored Job** (Ⓢ) to print the document.

If the file has  (lock symbol) next to it, the job is a private job and requires a PIN. See [Print a private job](#).

Delete a stored job

Jobs stored on the device hard disk can be deleted at the control panel.

1. From the Home screen, touch [Job Storage](#).
2. Touch the [Retrieve](#) tab.
3. Scroll to and touch the job storage folder that holds the stored job.
4. Scroll to and touch the stored job that you want to delete.
5. Touch [Delete](#).
6. Touch [Yes](#).

If the file has  (lock symbol) next to it, the job requires a PIN to delete it. See [Print a private job](#).

6 Print

- [Use features in the Windows printer driver](#)
- [Use features in the Macintosh printer driver](#)
- [Cancel a print job](#)

Use features in the Windows printer driver

When you print from a software program, many of the product features are available from the printer driver. For complete information about the features that are available in the printer driver, see the printer-driver Help. The following features are described in this section:

- [Create and use quick sets](#)
- [Use watermarks](#)
- [Resize documents](#)
- [Set a custom paper size from the printer driver](#)
- [Use different paper and printing covers](#)
- [Print a blank first page](#)
- [Print multiple pages on one sheet of paper](#)
- [Print on both sides of the paper](#)
- [Use the Services tab](#)



NOTE Settings in the printer driver and software program generally override control-panel settings. Software-program settings generally override printer-driver settings.

Create and use quick sets

Use quick sets to save the current driver settings for reuse. Quick sets are available on most printer-driver tabs. You can save up to 25 Print Task Quick Sets.

Create a quick set

1. Open the printer driver (see [Open the printer drivers](#)).
2. Select the print settings that you want to use.
3. In the **Print Task Quick Sets** box, type a name for the quick set.
4. Click **Save**.

Use quick sets

1. Open the printer driver (see [Open the printer drivers](#)).
2. Select the quick set that you want to use from the **Print Task Quick Sets** drop-down list.
3. Click **OK**.



NOTE To use printer-driver default settings, select **Default Print Settings** from the **Print Task Quick Sets** drop-down list.

Use watermarks

A watermark is a notice, such as "Confidential," that is printed in the background of each page of a document.

1. On the **File** menu in the software program, click **Print**.
2. Select the driver, and then click **Properties** or **Preferences**.
3. From the **Effects** tab, click the **Watermarks** drop-down list.
4. Click the watermark that you want to use. To create a new watermark, click **Edit**.
5. If you want the watermark to appear only on the first page of the document, click **First Page Only**.
6. Click **OK**.

To remove the watermark, click **(none)** in the **Watermarks** drop-down list.

Resize documents

Use the document resizing options to scale a document to a percentage of its normal size. You can also choose to print a document on a different size paper, with or without scaling.

Reduce or enlarge a document

1. On the **File** menu in the software program, click **Print**.
2. Select the driver, and then click **Properties** or **Preferences**.
3. On the **Effects** tab, next to **% of Normal Size**, type the percentage by which you want to reduce or enlarge your document.

You can also use the scroll bar to adjust the percentage.

4. Click **OK**.

Print a document onto a different paper size

1. On the **File** menu in the software program, click **Print**.
2. Select the driver, and then click **Properties** or **Preferences**.
3. On the **Effects** tab, click **Print Document On**.
4. Select the paper size to print on.
5. To print the document without scaling it to fit, make sure that the **Scale to Fit** option is *not* selected.
6. Click **OK**.

Set a custom paper size from the printer driver

1. On the **File** menu in the software program, click **Print**.
2. Select the driver, and then click **Properties** or **Preferences**.
3. On the **Paper** or **Paper/Quality** tab, click **Custom**.
4. On the **Custom Paper Size** window, type the name of the custom paper size.
5. Type the paper-size length and width. If you type a size that is too small or too large, the driver adjusts the size to the minimum or maximum size that is allowed.
6. If necessary, click the button to change the unit of measure between millimeters and inches.
7. Click **Save**.
8. Click **Close**. The name that you saved appears in the paper-size list for future use.

Use different paper and printing covers

Follow these instructions for printing a first page that is different from other pages in the print job.

1. Open the printer driver (see [Open the printer drivers](#)).
2. On the **Paper** or **Paper/Quality** tab, select the appropriate paper for the first page of the print job.
3. Click **Use Different Paper/Covers**.
4. In the list box, click the pages or covers that you want to print on different paper.
5. To print front or back covers, you must also select **Add Blank or Preprinted Cover**.
6. In the **Source is** and **Type is** list boxes, select the appropriate paper type or source for the other pages of the print job.



NOTE The paper size must be the same for all pages of the print job.

Print a blank first page

1. Open the printer driver (see [Open the printer drivers](#)).
2. On the **Paper** or **Paper/Quality** tab, click **Use Different Paper/Covers**.
3. In the list box, click **Front Cover**.
4. Click **Add Blank or Preprinted Cover**.

Print multiple pages on one sheet of paper

You can print more than one page on a single sheet of paper.

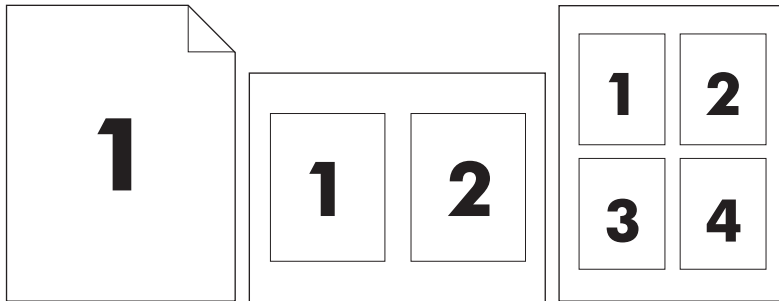

1. On the **File** menu in the software program, click **Print**.
2. Select the driver, and then click **Properties** or **Preferences**.
3. Click the **Finishing** tab.
4. In the section for **Document Options**, select the number of pages that you want to print on each sheet (1, 2, 4, 6, 9, or 16).
5. If the number of pages is greater than 1, select the correct options for **Print Page Borders** and **Page Order**.
 - If you need to change the page orientation, click the **Finishing** tab, and then click **Portrait** or **Landscape**.
6. Click **OK**. The product is now set to print the number of pages per sheet that you have selected.

Print on both sides of the paper

When duplex printing is available, you can automatically print on both sides of a page. If duplex printing is not available, you can manually print on both sides of a page by feeding the paper through the product a second time.



NOTE In the printer driver, **Print on Both Sides (manually)** is available only when duplex printing is not available or when duplex printing does not support the type of print media being used.

To configure the product for automatic or manual duplex printing, open the printer-driver properties, click the **Device Settings** tab, and then select the appropriate settings under **Installable Options**.



NOTE The **Device Settings** tab is not available from within software programs.

NOTE The procedure to open the printer-driver properties depends on the operating system that you are using. For information about opening the printer-driver properties for your operating system, see [Open the printer drivers](#). Look for the column titled "To change the device configuration settings".

Use automatic duplex printing

1. Insert enough paper into one of the trays to accommodate the print job. If you are loading special paper such as letterhead, load it in one of the following ways:
 - For tray 1, load the letterhead paper with the front side up, bottom-edge first.
 - For all other trays, load the letterhead paper with front side down, and the top edge at the back of the tray.



CAUTION To avoid jams, do not load paper that is heavier than 105 g/m² (28 lb bond).

2. Open the printer driver (see [Open the printer drivers](#)).
3. On the **Finishing** tab, click **Print on Both Sides**.
 - If necessary, select **Flip Pages Up** to change the manner in which pages are turned, or select a binding option in the **Booklet Layout** list box.
4. Click **OK**.

Print on both sides manually

1. Insert enough paper into one of the trays to accommodate the print job. If you are loading special paper such as letterhead, load it in one of the following ways:
 - For tray 1, load the letterhead paper with the front side up, bottom-edge first.
 - For all other trays, load letterhead paper with front side down, and the top edge at the back of the tray.



CAUTION To avoid jams, do not load paper that is heavier than 105 g/m² (28 lb bond).

2. Open the printer driver (see [Open the printer drivers](#)).
3. On the **Finishing** tab, select **Print on Both Sides (manually)**.
4. Click **OK**.
5. Send the print job to the product. Follow the instructions in the pop-up window that appears before feeding the output stack into tray 1 for printing the second half.
6. Go to the product. Remove any blank paper that is in tray 1. Insert the printed stack with the printed side up, and the bottom-edge feeding into the product first. You must print the second side from tray 1.
7. If prompted, press a control-panel button to continue.

Layout options for printing on both sides

The four duplex orientation options are shown here. To select option 1 or 4, select **Flip Pages Up** in the printer driver.

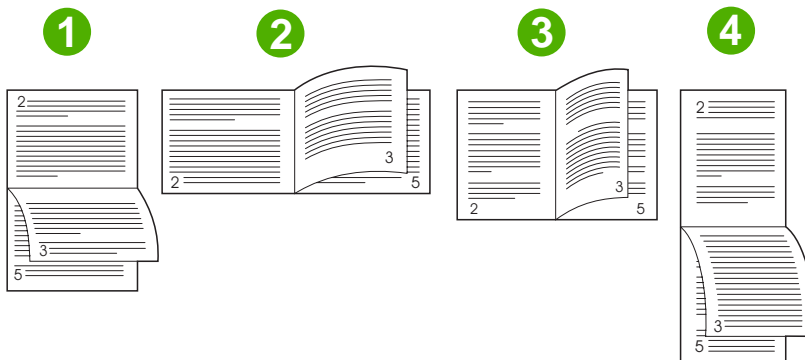

1. Long-edge landscape	Every other printed image is oriented upside-down. Facing pages are read continuously from top to bottom.
2. Short-edge landscape	Every printed image is oriented right-side-up. Facing pages are read from top to bottom.
3. Long-edge portrait	This is the default setting, and the most common layout used. Every printed image is oriented right-side-up. Facing pages are read from top to bottom.
4. Short-edge portrait	Every other printed image is oriented upside-down. Facing pages are read continuously from top to bottom.

Use the Services tab

If the product is connected to a network, use the **Services** tab to obtain product and supply-status information. Click the **Device and Supplies status icon** to open the **Device Status** page of the HP Embedded Web Server. This page shows the current status of the product, the percentage of life remaining for each supply, and information for ordering supplies. For more information, see [Embedded Web server](#).

Use features in the Macintosh printer driver

When you print from a software program, many of the device features are available from the printer driver. For complete information about the features that are available in the printer driver, see the printer-driver Help. The following features are described in this section:

- [Create and use presets](#)
- [Print a cover page](#)
- [Print multiple pages on one sheet of paper](#)
- [Print on both sides of the paper](#)



NOTE Settings in the printer driver and software program generally override control-panel settings. Software-program settings generally override printer-driver settings.

Create and use presets

Use presets to save the current printer driver settings for reuse.

Create a preset

1. Open the printer driver (see [Open the printer drivers](#)).
2. Select the print settings.
3. In the **Presets** box, click **Save As...**, and type a name for the preset.
4. Click **OK**.

Use presets

1. Open the printer driver (see [Open the printer drivers](#)).
2. In the **Presets** menu, select the preset that you want to use.



NOTE To use printer-driver default settings, select the **Standard** preset.

Print a cover page

You can print a separate cover page for your document that includes a message (such as “Confidential”).

1. Open the printer driver (see [Open the printer drivers](#)).
2. On the **Cover Page** or **Paper/Quality** pop-up menu, select whether to print the cover page **Before Document** or **After Document**.
3. In the **Cover Page Type** pop-up menu, select the message that you want to print on the cover page.



NOTE To print a blank cover page, select **Standard** as the **Cover Page Type**.

Print multiple pages on one sheet of paper

You can print more than one page on a single sheet of paper. This feature provides a cost-effective way to print draft pages.

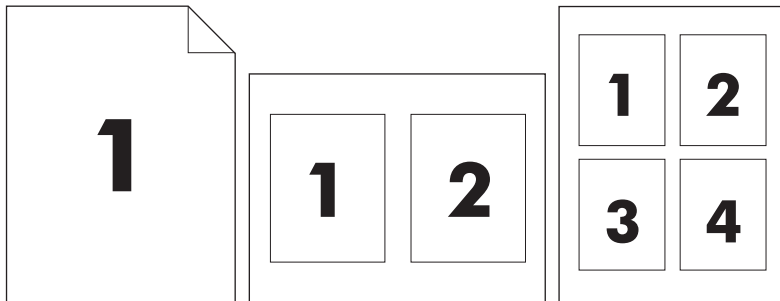

1. Open the printer driver (see [Open the printer drivers](#)).
2. Click the **Layout** pop-up menu.
3. Next to **Pages per Sheet**, select the number of pages that you want to print on each sheet (1, 2, 4, 6, 9, or 16).
4. Next to **Layout Direction**, select the order and placement of the pages on the sheet.
5. Next to **Borders**, select the type of border to print around each page on the sheet.

Print on both sides of the paper

When duplex printing is available, you can automatically print on both sides of a page. Otherwise, you can manually print on both sides of a page by feeding the paper through the device a second time.



CAUTION To avoid jams, do not load paper that is heavier than 105g/m² (28-lb bond).

Use automatic duplex printing

1. Insert enough paper into one of the trays to accommodate the print job. If you are loading special paper such as letterhead, load it in one of the following ways:
 - For tray 1, load the letterhead paper face-up with the bottom edge feeding into the printer first.
 - For all other trays, load the letterhead paper face-down with the top edge at the back of the tray.
2. Open the printer driver (see [Open the printer drivers](#)).
3. Open the **Layout** pop-up menu.
4. Next to **Two Sided Printing**, select either **Long-Edge Binding** or **Short-Edge Binding**.
5. Click **Print**.

Print on both sides manually

1. Insert enough paper into one of the trays to accommodate the print job. If you are loading special paper such as letterhead, load it in one of the following ways:
 - For tray 1, load the letterhead paper face-up with the bottom edge feeding into the printer first.
 - For all other trays, load the letterhead paper face-down with the top edge at the back of the tray.



CAUTION To avoid jams, do not load paper that is heavier than 105 g/m² (28-lb bond).

2. Open the printer driver (see [Open the printer drivers](#)).
3. On the **Finishing** pop-up menu, select the **Manual Duplex** option.



NOTE If the **Manual Duplex** option is not enabled, select **Manually Print on 2nd Side**.

4. Click **Print**. Follow the instructions in the pop-up window that appears on the computer screen before replacing the output stack in tray 1 for printing the second half.
5. Go to the printer, and remove any blank paper that is in tray 1.
6. Insert the printed stack face-up with the bottom edge feeding into the printer first in tray 1. You *must* print the second side from tray 1.
7. If prompted, press the appropriate control-panel button to continue.

Cancel a print job

You can stop a print request by using the control panel or by using the software program. For instructions about how to stop a print request from a computer on a network, see the online Help for the specific network software.



NOTE It can take some time for all printing to clear after you have canceled a print job.

Stop the current print job from the control panel

1. Press **Stop** on the control panel.
2. On the touchscreen, on the **Device Has Been Paused** screen, touch **Cancel current job**.



NOTE If the print job is too far into the printing process, you might not have the option to cancel it.

Stop the current print job from the software program

A dialog box will appear briefly on the screen, giving you the option to cancel the print job.

If several requests have been sent to the device through your software, they might be waiting in a print queue (for example, in Windows Print Manager). See the software documentation for specific instructions about canceling a print request from the computer.

If a print job is waiting in a print queue (computer memory) or print spooler (Windows 2000 or XP), delete the print job there.

Click **Start** and then click **Printers**. Double-click the device icon to open the print spooler. Select the print job that you want to cancel, and then press **Delete**. If the print job is not cancelled, you might need to shut down and restart the computer.

7 Copy

This device can function as a standalone, walk-up copier. It is not necessary to install the printing system software on the computer, nor is it necessary to have the computer turned on to make photocopies. You can adjust the copy settings at the control panel. You can also copy originals by using either the document feeder or the scanner glass. The device can process copying, printing, and digital-sending jobs simultaneously.

This chapter provides information about how to make copies and how to change copy settings, including the following topics:

- [Use the Copy screen](#)
- [Set the default copy options](#)
- [Basic copy instructions](#)
- [Adjust the copy settings](#)
- [Copy two-sided documents](#)
- [Copy mixed-size originals](#)
- [Change the copy-collation setting](#)
- [Copy photos and books](#)
- [Combine copy jobs by using Job Build](#)
- [Cancel a copy job](#)

It is recommended that you review the basic control-panel information before using the device copying functions. See [Use the control panel](#) for more information.

Use the Copy screen

From the Home screen, touch **Copy** to view the Copy screen. The Copy screen is shown in [Figure 7-1 Copy screen](#). Note that only the first six copy features are immediately visible. In order to view additional copy features, touch **More Options**.

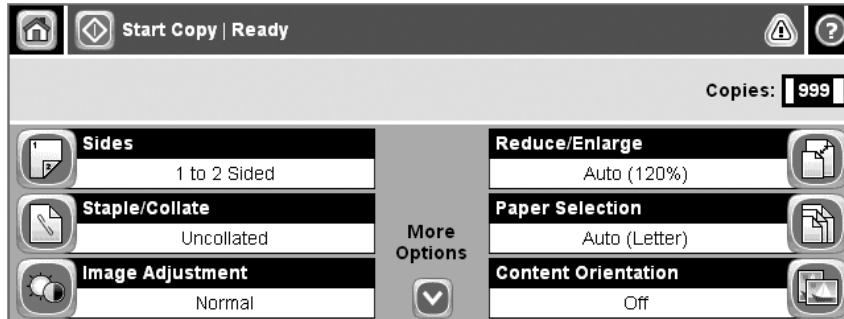

Figure 7-1 Copy screen

Set the default copy options

You can use the administration menu to establish default settings that apply to all copy jobs. If necessary, you can override most settings for an individual job. After that job is complete, the device returns to the default settings.

1. From the Home screen, scroll to and touch [Administration](#).
2. Touch [Default Job Options](#), and then touch [Default Copy Options](#).
3. Several options are available. You can configure defaults for all options, or for only some options.

For information about each option, see [Adjust the copy settings](#). The built-in Help system also provides an explanation of each option. Touch the [Help](#) button (?) in the upper-right corner of the screen.

4. To exit the administration menu, touch the [Home](#) button () in the upper-left corner of the screen.

Basic copy instructions

This section provides the basic instructions for copying.

Copy from the scanner glass

Use the scanner glass to make as many as 999 copies of small, lightweight media (less than 60 g/m² or 16 lb) or heavy media (more than 105 g/m² or 28 lb). This includes media such as receipts, newspaper clippings, photographs, old documents, worn documents, and books.

Place original documents face-down on the glass. Align the corner of the original with the upper-left corner of the glass.

To make copies by using the default copy options, use the numeric keypad on the control panel to select the number of copies, and press **Start**. To use customized settings, touch **Copy**. Specify the settings, and then press **Start**. For more information about using customized settings, see [Adjust the copy settings](#).

Copy from the document feeder

Use the document feeder to make as many as 999 copies of a document that has up to 50 pages (depending on the thickness of the pages). Place the document into the document feeder with the pages facing up.

To make copies by using the default copy options, use the numeric keypad on the control panel to select the number of copies, and press **Start**. To use customized settings, touch **Copy**. Specify the settings, and then press **Start**. For more information about using customized settings, see [Adjust the copy settings](#).

Before starting another copy job, retrieve the original document from the document-feeder output bin that is under the document feeder input tray, and retrieve the copies from the appropriate output bin.

Adjust the copy settings

The device offers several features so you can optimize copied output. These features are all available on the **Copy** screen.

The **Copy** screen consists of several pages. From the first page, touch **More Options** to go to the next page. Then touch the up or down arrow buttons to scroll to other pages.

For details about how to use an option, touch the option, and then touch the help (?) button in the upper-right corner of the screen. The following table provides an overview of the copy options.



NOTE Depending on how the system administrator has configured the device, some of these options might not appear. The options in the table are listed in the order in which they can appear.

Option name	Description
Sides	Use this feature to indicate whether the original document is printed on one or both sides, and whether the copies should be printed on one or both sides.
Staple/Collate or Collate	If the optional HP Stapler/Stacker/Separator is attached, the Staple/Collate option is available. Use this feature to set up options for stapling and assembling the pages in sets of copies. If the optional HP Stapler/Stacker/Separator is not attached, the Collate option is available. Use this feature to assemble each set of copied pages in the same order as the original document.
Paper Selection	Use this feature to select the tray that holds the size and type of paper that you want to use.
Image Adjustment	Use this feature to improve the overall quality of the copy. For example, you can adjust the darkness and sharpness, and you can use the Background Cleanup setting to remove faint images from the background or to remove a light background color.
Content Orientation	Use this feature to specify the way the content of the original page is placed on the page: portrait or landscape.
Output Bin	Use this feature to select an output bin for the copies.
Optimize Text/Picture	Use this feature to optimize the output for a particular type of content. You can optimize the output for text or printed pictures, or you can manually adjust the values.
Pages per Sheet	Use this feature to copy multiple pages onto one sheet of paper.
Original Size	Use this feature to describe the page size of the original document.
Booklet Format	Use this feature to copy two or more pages onto one sheet of paper so you can fold the sheets in the center to form a booklet.
Edge-To-Edge	Use this feature to avoid shadows that can appear along the edges of copies when the original document is printed close to the edges. Combine this feature with the Reduce/Enlarge feature to ensure that the entire page is printed on the copies.
Job Build	Use this feature to combine several sets of original documents into one copy job. Also use this feature to copy an original document that has more pages than the document feeder can accommodate at one time.

Copy two-sided documents

Two-sided documents can be copied manually or automatically.

Copying two-sided documents manually

Copies resulting from this procedure are printed on one side, and need to be hand-collated.

1. Load the documents to be copied into the document feeder input tray with the first page facing up, and with the top of the page leading into the document feeder.
2. Touch **Start Copy**. The odd-numbered pages are copied and printed.
3. Remove the stack from the document feeder output tray and reload the stack with the last page facing up, and with the top of the page leading into the document feeder.
4. Touch **Start Copy**. The even-numbered pages are copied and printed.
5. Collate the odd- and even-numbered printed copies.

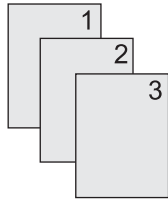

Copy two-sided documents automatically (duplex models only)

The default copy setting is one-sided to one-sided. Use the following procedures to change the setting so you can copy from or to documents that are two-sided.

Make two-sided copies from one-sided documents

1. Load the documents to be copied into the document feeder with the first page facing up, and with the top of the page leading.
2. On the control panel, touch **Copy**.
3. Touch **Sides**.
4. Touch **1-sided original, 2-sided output**.
5. Touch **OK**.
6. Touch **Start Copy**.

Make two-sided copies from two-sided documents

1. Load the documents to be copied into the document feeder with the first page facing up, and with the top of the page leading.



NOTE Two-sided copying from the flatbed scanner glass is not supported.

2. On the control panel, touch **Copy**.
3. Touch **Sides**.
4. Touch **2-sided original, 2-sided output**.
5. Touch **OK**.
6. Touch **Start Copy**.

Make one-sided copies from two-sided documents

1. Load the documents to be copied into the document feeder with the first page facing up, and with the top of the page leading.
2. On the control panel, touch **Copy**.
3. Touch **Sides**.
4. Touch **2-sided original, 1-sided output**.
5. Touch **OK**.
6. Touch **Start Copy**.

Copy mixed-size originals

You can copy original documents that are printed on different sizes of paper as long as the sheets of paper have one common dimension. For example, you could combine letter and legal sizes, or you could combine A4 and A5 sizes.

1. Arrange the sheets in the original document so they all have the same width.
2. Place the sheets face-up into the document feeder, and adjust both paper guides against the document.
3. From the Home screen, touch **Copy**.
4. Touch **Original Size**.



NOTE If this option is not on the first screen, touch **More Options** until the option appears.

5. Select **Mixed Ltr/Lgl**, and then touch **OK**.
6. Touch **Start Copy**.

Change the copy-collation setting

You can set the device to automatically collate multiple copies into sets. For example, if you are making two copies of three pages and the automatic collation is on, the pages print in this order: 1,2,3,1,2,3. If automatic collation is off, the pages print in this order: 1,1,2,2,3,3.

To use the automatic collation, the original document size must fit into the memory. If it does not, the device makes only one copy and a message appears notifying you of the change. If that happens, use one of the following methods to finish the job:

- Split the job into smaller jobs that contain fewer pages.
- Make only one copy of the document at a time.
- Turn off the automatic collation.

The collation setting you select is in effect for all copies until you change the setting. The default setting for automatic copy collation is **On**.

1. On the control panel, touch **Copy**.
2. Touch **Staple/Collate**.
3. Touch **Collate**.

Copy photos and books

Copy a photo



NOTE Photos should be copied from the flatbed scanner, not from the document feeder.

1. Lift the lid and place the photo on the flatbed scanner with the picture-side down and the upper-left corner of the photo in the upper-left corner of the glass.
2. Gently close the lid.
3. Touch **Start Copy**.

Copy a book

1. Lift the lid and place the book on the flatbed scanner with the page that you want to copy at the upper-left corner of the glass.
2. Gently close the lid.
3. Gently press down on the lid to press the book to the flatbed scanner surface.
4. Touch **Start Copy**.

Combine copy jobs by using Job Build

Use the Job Build feature to build a single copy job from multiple scans. You can use either the document feeder or the scanner glass. The settings for the first scan are used for subsequent scans.

1. Touch **Copy**.
2. Scroll to and touch **Job Build**.
3. Touch **Job Build On**.
4. Touch **OK**.
5. If necessary, select the desired copy options.
6. Touch **Start Copy**. After each page is scanned, the control panel prompts you for more pages.
7. If the job contains more pages, load the next page, and then touch **Start Copy**.

If the job contains no more pages, touch **Finished** to print.



NOTE In Job Build, if you scan the first page of a document by using the document feeder, then you must scan all of the pages in that document by using the document feeder. If you scan the first page of a document by using the scanner glass, then you must scan all of the pages in that document by using the scanner glass.

Cancel a copy job

To cancel the copy job that is currently running, touch **Stop** on the control panel. This pauses the device. Then touch **Cancel Current Job**.



NOTE If you cancel a copy job, clear the document from the flatbed scanner or from the automatic document feeder.

8 Scan and send to e-mail

The device offers color-scanning and digital-sending capabilities. By using the control panel, you can scan black-and-white or color documents and send them to an e-mail address as an e-mail attachment. To use digital sending, the device must be connected to a local area network (LAN). The device connects directly to your LAN.



NOTE The device cannot copy or print in color, but it can scan and send color images.

This chapter addresses the following topics:

- [Configure e-mail settings](#)
- [Use the Send E-mail screen](#)
- [Perform basic e-mail functions](#)
- [Use the address book](#)
- [Change e-mail settings for the current job](#)
- [Scan to a folder](#)
- [Scan to a workflow destination](#)

Configure e-mail settings

Before you can send a document to e-mail, you must configure the device for e-mailing.



NOTE The instructions that follow are for configuring the device at the control panel. You can also perform these procedures by using the embedded Web server. For more information, see [Embedded Web server](#).

Supported protocols

The HP LaserJet M4345 MFP models support Simple Mail Transfer Protocol (SMTP). The HP LaserJet M4345 MFP models support SMTP and Lightweight Directory Access Protocol (LDAP).

SMTP

- SMTP is a set of rules that define the interaction between programs that send and receive e-mail. In order for the device to send documents to e-mail, it must be connected to a LAN that has a valid SMTP IP address. The SMTP server must also have Internet access.
- If you are using a LAN connection, contact your system administrator to obtain the IP address for your SMTP server. If you are connecting through a DSL connection, contact the service provider to obtain the SMTP server IP address.

LDAP

- LDAP is used to gain access to a database of information. When the device uses LDAP, it searches a global list of e-mail addresses. As you begin to type the e-mail address, LDAP uses an auto-complete feature that supplies a list of e-mail addresses that match the characters you type. As you type additional characters, the list of matching e-mail addresses becomes smaller.
- The device supports LDAP, but a connection to an LDAP server is not required in order for the device to be able to send to e-mail.



NOTE If you need to change the LDAP settings, you must change them by using the embedded Web server. For more information, see [Embedded Web server](#), or see the *Embedded Web Server User Guide* on the device CD.

Configure e-mail server settings

Consult your system administrator to find the IP address for the SMTP server. Or, find the IP address from the device control panel (see). Then use the following procedures to manually configure and test the IP address.

Configure the SMTP gateway address

1. From the Home screen, touch **Administration**.
2. Touch **Initial Setup**.
3. Touch **E-mail Setup**, and then touch **SMTP Gateway**.
4. Type the SMTP gateway address, either as an IP address or as a fully qualified domain name. If you do not know the IP address or domain name, contact the network administrator.
5. Touch **OK**.

Test the SMTP settings

1. From the Home screen, touch **Administration**.
2. Touch **Initial Setup**.
3. Touch **E-mail Setup**, and then touch **Test Send Gateways**.

If the configuration is correct, **Gateways OK** appears on the control-panel display.

If the first test was successful, send an e-mail to yourself by using the digital-send feature. If you receive the e-mail, you have successfully configured the digital-sending feature.

If you do not receive the e-mail, use these actions to resolve issues with the digital-sending software:

- Check the SMTP and address to make sure that you typed them correctly.
- Print a configuration page. Verify that the SMTP gateway address is correct.
- Make sure that the network is operating correctly. Send an e-mail to yourself from a computer. If you receive the e-mail, the network is operating correctly. If you do not receive the e-mail, contact your network administrator or Internet service provider (ISP).
- Run the DISCOVER.EXE file. This program attempts to find the gateway. You can download the file from the HP Web site at <http://www.hp.com/support/ljm4345mfp>.

Find gateways

If you do not know the SMTP gateway address, you can use one of the following methods to find it.

Find the SMTP gateway from the device control panel

1. From the Home screen, touch **Administration**.
2. Touch **Initial Setup**.
3. Touch **E-mail Setup**, and then touch **Find Send Gateways**.

The touchscreen displays a list of detected SMTP servers.

4. Select the correct SMTP server, and then touch **OK**.

Find the SMTP gateway from an e-mail program

Because most e-mail programs also use SMTP to send e-mail and LDAP to address e-mail messages, you might be able to find the hostname of the SMTP gateway and LDAP server by looking at the settings for your e-mail program.



NOTE The find gateway features might be unable to detect a valid SMTP server on the network if it uses an internet service provider (ISP). To find the ISP e-mail server address, contact the ISP.

Use the Send E-mail screen

Use the touchscreen to navigate through the options on the Send E-mail screen.

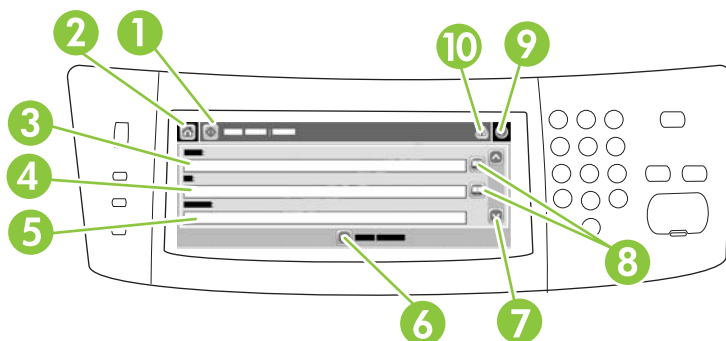

1	Send E-mail button	Touching this button scans the document and sends an e-mail file to the provided e-mail addresses.
2	Home button	Touching this button opens the Home screen.
3	From: field	Touch this field to open the keyboard, and then type your e-mail address. If the system administrator has configured the device to do so, this field might automatically insert a default address.
4	To: field	Touch this field to open the keyboard, and then type the e-mail addresses of those whom you want to receive the scanned document.
5	Subject: field	Touch this field to open the keyboard, and then type a subject title.
6	More Options button	Touch this button to change certain e-mail settings for the current scan job.
7	Scroll bar	Use the scroll bar to view and set up the CC: , BCC: , Message , and File Name fields. Touch any of those fields to open the keyboard and add the necessary information.
8	Address book buttons	Touch these buttons to use the address book to populate the To: , CC: , or BCC: fields. For more information, see Use the local address book .
9	Help button	Touch this button for control-panel help. For more information, see Use the control panel .
10	Error/warning button	This button appears only when there is an error or warning in the status line area. Touch it to open a pop-up screen that will help you resolve the error or warning.

Perform basic e-mail functions

The device e-mail feature offers the following benefits:

- Sends documents to multiple e-mail addresses, saving time and delivery costs.
- Delivers files in black-and-white or in color. Files can be sent in different file formats that the recipient can manipulate.

With e-mail, documents are scanned into the device memory and sent to an e-mail address or multiple addresses as an e-mail attachment. Digital documents can be sent in several graphics formats, such as .TFF and .JPG, which allows recipients to manipulate the document file in various programs to meet their specific needs. Documents arrive in near-original quality, and then can be printed, stored, or forwarded.

In order to use the e-mail feature, the device needs to be connected to a valid SMTP local area network that includes Internet access.

Load documents

You can scan a document by using either the glass or the ADF. The glass and ADF can accommodate Letter-, Executive-, A4-, and A5-size originals. The ADF can also accommodate Legal-size originals. Smaller originals, receipts, irregular and worn documents, stapled documents, previously folded documents, and photographs should be scanned by using the glass. Multiple-page documents can be scanned easily by using the ADF.

Send documents

The device scans both black-and-white and color originals. You can use default settings or change the scanning preferences and file formats. The following are the default settings:

- Color
- PDF (requires the recipient to have an Adobe Acrobat viewer to view the e-mail attachment)

For information about changing the settings for the current job, see [Change e-mail settings for the current job](#).

Send a document

1. Place the document face-down on the scanner glass or face-up in the ADF.
2. From the Home screen, touch **E-mail**.
3. If prompted, type your user name and password.
4. Complete the **From:**, **To:**, and **Subject:** fields. Scroll down and complete the **CC:**, **BCC:**, and **Message** fields if appropriate. Your user name or other default information might appear in the **From:** field. If so, you might not be able to change it.
5. (Optional) Touch **More Options** to change the settings for the document that you are sending (for example, the document's original size). If you are sending a two-sided document, you should select **Sides** and an option with a two-sided original.
6. Press **Start** to begin sending.
7. When you are finished, remove the original document from the scanner glass or ADF.

Use the auto-complete function

When you type characters into the **To:**, **CC:**, or **From:** fields on the Send E-mail screen, the auto-complete function is activated. As you type the required address or name by using the keyboard screen, the device automatically searches the address book list and completes the address or name by using the first match. You can then select that name by touching **Enter**, or continue typing the name until auto-complete finds the correct entry. If you type a character that does not match any entry in the list, the auto-complete text is removed from the display to indicate that you are typing an address that is not in the address book.



Use the address book

You can send e-mail to a list of recipients by using the address book feature of the device. See your system administrator for information about configuring address lists.



NOTE You can also use the embedded Web server to create and manage the e-mail address book. For more information, see [Embedded Web server](#).

Create a recipient list

1. From the Home screen, touch **E-mail**.
2. Complete one of the following steps:
 - Touch **To:** to open the keyboard screen, and then type the recipients' e-mail addresses. Separate multiple e-mail addresses with a semicolon or by touching **Enter** on the touchscreen.
 - Use the address book.
 - a. On the Send E-mail screen, touch the address book button () to open the address book.
 - b. Navigate the entries in the address book by using the scroll bar. Hold down the arrow to scroll quickly through the list.
 - c. Highlight the name to select a recipient, and then touch the add button ().

You can also select a distribution list by touching the drop-down list at the top of the screen and then touching **All**, or add a recipient from a local list by touching **Local** in the drop-down list. Highlight the appropriate names, and then touch  to add the name to your list of recipients.

You can remove a recipient from your list by scrolling to highlight the recipient, and then touching the remove button ().
3. The names in the recipient list are placed in the text line of the keyboard screen. If you want, you can add a recipient that is not found in the address book by typing the e-mail address on the keyboard. After you are satisfied with your recipient list, touch **OK**.
4. Touch **OK**.
5. Finish typing information in the **CC:** and **Subject:** fields on the Send E-mail screen, if necessary. You can check the list of recipients by touching the down arrow in the **To:** text line.
6. Press **Start**.

Use the local address book

Use the local address book to store frequently-used e-mail addresses. The local address book can be shared between devices that use the same server to gain access to the HP Digital Sending software.

You can use the address book when you type e-mail addresses in the **From:**, **To:**, **CC:**, or **BCC:** fields. You can also add or delete addresses in the address book.

To open the address book, touch the address book button ()

Add e-mail addresses to the local address book

1. Touch **Local**.
2. Touch .
3. (Optional) Touch the **Name** field, and in the keyboard that appears type a name for the new entry. Touch **OK**.

The name is the alias for the e-mail address. If you do not type an alias name, the alias will be the e-mail address itself.

4. Touch the **Address** field, and in the keyboard that appears type the e-mail address for the new entry. Touch **OK**.

Delete e-mail addresses from the local address book

You can delete e-mail addresses that you no longer use.



NOTE To *change* an e-mail address, you must first delete the address and then add the corrected address as a new address in the local address book.

1. Touch **Local**.
2. Touch the e-mail address that you want to delete.
3. Touch .

The following confirmation message appears: **Do you want to delete the selected address(es)?**

4. Touch **Yes** to delete the e-mail address(es) or touch **No** to return to the Address Book screen.

Change e-mail settings for the current job

Use the **More Options** button to change the following e-mail settings for the current print job:

Button	Description
Document File Type	Touch this button to change the type of file the device creates after scanning the document.
Output Quality	Touch this button to increase or decrease the print quality of the file being scanned. A higher quality setting produces a larger file size.
Resolution	Touch this button to change the scan resolution. A higher resolution setting produces a larger file size.
Color/Black	Touch this button to determine whether you will scan the document in color or in black-and-white.
Original Sides	Touch this button to indicate if the original document is one-sided or two-sided.
Content Orientation	Touch this button to select either the portrait or landscape orientation for the original.
Original Size	Touch this button to select the size of the document: letter, A4, legal, or mixed letter/legal.
Optimize Text/ Picture	Touch this button to change the scanning procedure based on the type of document that you are scanning.
Job Build	Touch this button to activate or deactivate the Job Build mode, which enables you to scan several small scan jobs and send them as one file.
Image Adjustment	Touch this button to change the darkness and sharpness settings, or to clean up background clutter on the original.

Scan to a folder



NOTE This device feature is supported for the HP LaserJet M4345 MFP models only.

If the system administrator has made the feature available, the device can scan a file and send it to a folder on the network. Supported operating systems for folder destinations include Windows 2000, Windows XP, and Windows Server 2003, and Novell.



NOTE You might be required to supply a user name and password in order to use this option, or to send to certain folders. See your system administrator for more information.

1. Place the document face-down on the scanner glass or face-up in the ADF.
2. From the Home screen, touch **Network Folder**.
3. In the Quick Access Folders list, select the folder in which you want to save the document.
4. Touch the **File Name** field to open the keyboard pop-up screen, and then type the file name.
5. Touch **Send to Network Folder**.

Scan to a workflow destination



NOTE This device feature is provided by the optional Digital Sending Software product and is supported for the HP LaserJet M4345 MFP models only.

If the system administrator has enabled the workflow functionality, you can scan a document and send it to a custom workflow destination. A workflow destination gives you the ability to send additional information, along with the scanned document, to a specified network or file transfer protocol (FTP) location. Prompts for specific information appear on the control-panel display. The system administrator can also designate a printer as a workflow destination, which allows you to scan a document and then send it directly to a network printer for printing.

1. Place the document face-down on the scanner glass or face-up in the ADF.
2. From the Home screen, touch **Workflow**.
3. Select the destination to which you want to scan.
4. In the Text Field field, type the data that you want to accompany the file, and then touch **Send Workflow**.

9 Fax

The HP LaserJet M4345x MFP, HP LaserJet M4345xs MFP, and HP LaserJet M4345xm MFP come with an HPLaserJet Analog Fax Accessory 300 installed. Windows users can also install the optional HP Digital Sending Software (DSS), which provides digital faxing services.

For complete instructions for configuring the fax accessory and using the fax features, see the *HP LaserJet Analog Fax Accessory 300 User Guide*.

This chapter provides a summary of analog and digital fax.

- [Analog fax](#)
- [Digital fax](#)

Analog fax

When the HPLaserJet Analog Fax Accessory 300 is installed, the device can function as a standalone fax machine.



NOTE The HP LaserJet M4345x MFP, HP LaserJet M4345xs MFP, and HP LaserJet M4345xm MFP come with an HPLaserJet Analog Fax Accessory 300 installed.

Install the fax accessory

If your device does not have the HP LaserJet Analog Fax Accessory 300 installed, use the following procedure to install it.

1. Unpack the fax accessory from the box, but do not remove it from the antistatic pouch.
2. Turn off the device, and unplug the power cable.

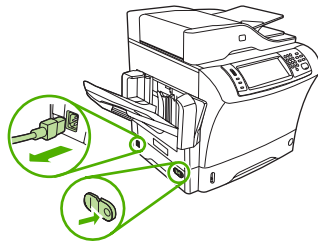

3. At the back of the device, remove the side cover by placing your fingers in the indented area and sliding the cover off.

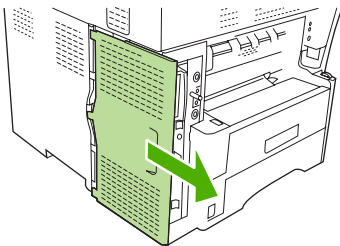

4. If necessary, remove the plastic fax-accessory cover from the formatter. Insert a coin into the groove at the top of the cover, and use it to pry the cover away from the formatter.

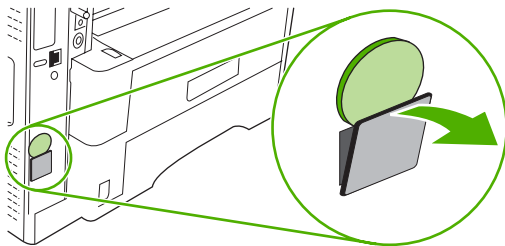

5. Open the formatter-cage door by grasping the metal tab and pulling the door open.

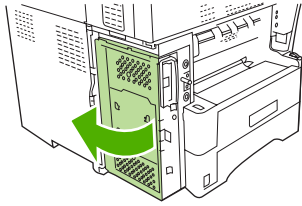

6. If you are replacing an existing fax accessory, remove the old card from the formatter by pulling it out of the slot.
7. Remove the new fax accessory from the antistatic pouch.

 **CAUTION** The fax accessory contains parts that are sensitive to electrostatic discharge (ESD). When handling the fax accessory, use static protection such as a grounding wrist strap that is connected to the metal frame of the device, or touch the metal frame of the device with your other hand.

CAUTION When handling the fax accessory, do not press the yellow component on the card. Doing so can damage the card and cause a fax malfunction.

8. Align the two cutouts on the new fax accessory with the two fax-accessory guides on the formatter.

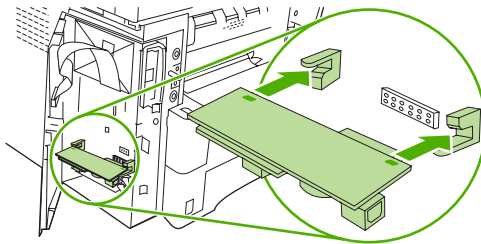

9. Push the fax accessory into place, and then verify that it is securely connected to the formatter. The phone connector on the fax accessory should be aligned with the square opening in the formatter cage.

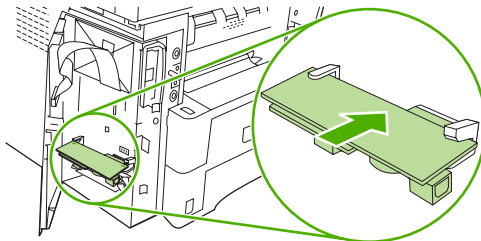

10. Close the formatter-cage door.

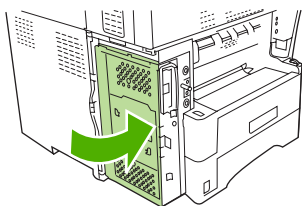

11. Replace the formatter cover.

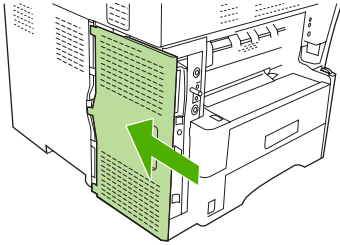

12. Plug the power cable into the device, and turn on the device.

Connect the fax accessory to a phone line

When connecting the fax accessory to a phone line, ensure that the phone line that is being used for the fax accessory is a dedicated line that is not used by any other devices. In addition, this line should be an analog line because the fax will not function correctly if it is connected to some digital PBX systems. If you are not sure whether you have an analog or digital phone line, contact your telecom provider.



NOTE HP recommends using the phone cord that comes with the fax accessory to ensure that the accessory functions correctly.

1. Locate the phone cord that is included in the fax accessory kit. Connect one end of the phone cord to the fax-accessory phone jack on the formatter. Push the connector until it clicks.

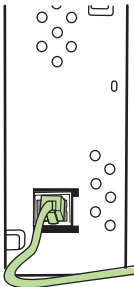

CAUTION Be sure to connect the phone line to the fax-accessory phone jack, which is near the bottom of the formatter. Do not connect the phone line to the HP Jetdirect LAN port, which is closer to the top of the formatter.

2. Connect the other end of the phone cord to the phone jack on the wall. Push the connector until it clicks or until it is securely seated. Because different types of connectors are used in different countries/regions, the connector might not make an audible click.

Configure and use the fax features

Before you can use the fax features, you must configure them in the control-panel menus. For example, you need to specify the following information:

- Date and time
- Location
- Fax header

For complete information about configuring and using the fax accessory, and for information about troubleshooting fax-accessory problems, see the *HP LaserJet Analog Fax Accessory 300 User Guide*, which is provided with the fax accessory.

Digital fax

Digital faxing is available when you install the optional HP Digital Sending Software. For information about ordering this software, go to http://www.hp.com/go/ljm4345mfp_software.

With digital faxing, the device does *not* need to be connected directly to a phone line. Instead, the device can send a fax in one of three ways:

- **LAN fax** sends faxes through a third-party fax provider.
- **Microsoft Windows 2000 fax** is a fax modem and digital sender module that the computer uses to operate as a turnkey gateway fax.
- **Internet fax** uses an Internet fax provider to process faxes. The fax is delivered to a traditional fax machine or sent to the user's e-mail.

For complete information about using digital faxing, see the documentation that is provided with the HP Digital Sending Software.



10 Manage and maintain the device



This chapter describes how to manage the printer:

- [Use information pages](#)
- [Configure e-mail alerts](#)
- [HP Easy Printer Care software](#)
- [Use the embedded Web server](#)
- [Use HP Web Jetadmin software](#)
- [Use the HP Printer Utility for Macintosh](#)
- [Manage supplies](#)
- [Clean the device](#)
- [Calibrate the scanner](#)

Use information pages

From the control panel, print pages that give details about the device and its current configuration. The table below provides the instructions for printing the information pages.

Page description	How to print the page
Menu map Shows the control-panel menus and available settings.	<ol style="list-style-type: none">1. From the Home screen, touch Administration.2. Touch Information.3. Touch Configuration Page.4. Touch Administration Menu Map.5. Touch Print. <p>The content of the menu map varies, depending on the options currently installed in the device.</p> <p>For a complete list of control panel menus and possible values, see Use the control panel.</p>
Configuration page Shows device settings and installed accessories.	<ol style="list-style-type: none">1. From the Home screen, touch Administration.2. Touch Information.3. Touch Configuration Page.4. Touch Configuration Page.5. Touch Print. <hr/>  NOTE If the device contains an HP Jetdirect print server or an optional hard disk drive, additional configuration pages print that provide information about those devices.
Supplies status page Shows print-cartridge toner levels.	<ol style="list-style-type: none">1. From the Home screen, touch Administration.2. Touch Information.3. Touch Configuration Page.4. Touch Supplies Status Page.5. Touch Print. <hr/>  NOTE If you are using non-HP supplies, the supplies status page might not show the remaining life for those supplies. For more information, see HP policy on non-HP print cartridges .
Usage page Shows a page count for each size of paper printed, the number of one-sided (simplex) or two-sided (duplexed) pages, and the average percentage of coverage.	<ol style="list-style-type: none">1. From the Home screen, touch Administration.2. Touch Information.3. Touch Configuration Page.4. Touch Usage Page.5. Touch Print.

Page description	How to print the page
<p>File directory</p> <p>Contains information for any mass storage devices, such as flash drives, memory cards, or hard disks, that are installed in the device.</p>	<ol style="list-style-type: none"> 1. From the Home screen, touch Administration. 2. Touch Information. 3. Touch Configuration Page. 4. Touch File Directory. 5. Touch Print.
<p>Fax reports</p> <p>Five reports show fax activity, fax calls, billing codes, blocked fax numbers, and speed-dial numbers.</p>	<ol style="list-style-type: none"> 1. From the Home screen, touch Administration. 2. Touch Information. 3. Touch Fax Reports. 4. Touch one of the following buttons to print the corresponding report: <ul style="list-style-type: none"> • Fax Activity Log • Fax Call Report • Billing Codes Report • Blocked Fax List • Speed Dial List 5. Touch Print.
<p> NOTE Fax reports are available only on device models that have fax capabilities.</p>	<p>For more information, see the fax guide that came with the device.</p>
<p>Font lists</p> <p>Shows which fonts are currently installed in the device.</p>	<ol style="list-style-type: none"> 1. From the Home screen, touch Administration. 2. Touch Information. 3. Touch Sample Pages/Fonts. 4. Touch either PCL Font List or PS Font List. 5. Touch Print.
<p> NOTE The font lists also show which fonts reside on a hard disk accessory or DIMM.</p>	

Configure e-mail alerts



NOTE If your company does not have e-mail, this feature might not be available.

You can use HP Web Jetadmin or the embedded Web server to configure the system to alert you of problems with the device. The alerts take the form of e-mail messages to the e-mail account(s) that you specify.

You can configure the following:

- The device(s) you want to monitor
- The alerts you want to receive (for example, alerts for paper jams, paper out, supplies status, and cover open)
- The e-mail account(s) to which the alerts should be forwarded

Software	Information location
HP Web Jetadmin	See Use HP Web Jetadmin software for general information about HP Web Jetadmin. See the HP Web Jetadmin Help system for details about alerts and how to set them up.
Embedded Web server	See Embedded Web server for general information about the embedded Web server. See the embedded Web server Help system for details about alerts and how to set them up.

HP Easy Printer Care software

The HP Easy Printer Care software is a program that you can use for the following tasks:

- Check the device status.
- Check supplies status.
- Set up alerts.
- Gain access to troubleshooting and maintenance tools.

You can use the HP Easy Printer Care software when the device is directly connected to your computer or when it is connected to a network. To download the HP Easy Printer Care software, go to www.hp.com/go/easyprintercare.



NOTE You do not have to have Internet access to open and use the HP Easy Printer Care software. However, if you click a Web-based link, you must have Internet access to go to the site associated with the link.

Open the HP Easy Printer Care software

Use one of the following methods to open HP Easy Printer Care software:

- On the **Start** menu, select **Programs**, select **Hewlett-Packard**, and then select **HP Easy Printer Care software**.
- In the Windows system tray (in the lower-right corner of the desktop), double-click the HP Easy Printer Care software icon.
- Double-click the desktop icon.

HP Easy Printer Care software sections

Section	Options
Device List tab	<ul style="list-style-type: none">• Device information, including printer name, make, and model
Shows information about each device in the Devices list	<ul style="list-style-type: none">• An icon (if the View as drop-down box is set to Tiles, which is the default setting)• Any current alerts for the device <p>If you click a device in the list, the HP Easy Printer Care software opens the Overview tab for that device.</p>
Support tab	<ul style="list-style-type: none">• Provides device information, including alerts for items needing attention.
Provides help information and links	<ul style="list-style-type: none">• Provides links to troubleshooting and maintenance tools.
Supplies Ordering window	<ul style="list-style-type: none">• Ordering list: Shows the supplies that you can order for each device. If you want to order a certain item, click the Order check box for that item in the supplies list.
Provides access to online or e-mail supplies ordering	<ul style="list-style-type: none">• Shop Online for Supplies button: Opens the HP SureSupply Web site in a new browser window. If you have checked the Order check box for any items, the information about those items can be transferred to the Web site, where you will receive information on options for purchasing your selected supplies.• Print Shopping List button: Prints the information for the supplies that have the Order check box selected.

Section	Options
<p>Alert Settings window</p> <p>Allows you to configure the device to automatically notify you of device issues</p>	<ul style="list-style-type: none"> Alerts on or off: Activates or deactivates the alerts feature. When alerts appear: Sets when you want alerts to appear—either when you are printing to that particular device, or anytime there is a device event. Alert event type: Sets whether you want alerts for only critical errors, or for any error, including continuable errors. Notification method: Sets what type of alert should appear (pop-up message or desktop alert).
<p>Overview tab</p> <p>Contains basic status information for the device</p>	<ul style="list-style-type: none"> Devices list: Shows the devices that you can select. Device Status section: Shows device status information. This section will indicate device alert conditions, such as an empty print cartridge. It also shows device-identification information, control-panel messages, and print-cartridge levels. After you correct a problem with the device, click the  button to update the section. Supplies Status section: Shows detailed supplies status, such as the percentage of toner remaining in the print cartridge and the status of the media that is loaded in each tray. Supplies Details link: Opens the supplies status page to view more detailed information about device supplies, ordering information, and recycling information.
<p>Find Other Printers window</p> <p>Allows you to add more printers to your printer list</p>	<p>Clicking the Find Other Printers link in the Devices list opens the Find Other Printers window. The Find Other Printers window provides a utility that detects other network printers so that you can add them to the Devices list and then monitor those devices from your computer.</p>

Use the embedded Web server



NOTE When the device is directly connected to a computer, use the HP Easy Printer Care software to view the device status.

- View device control status information
- Set the type of paper loaded in each tray
- Determine the remaining life on all supplies and order new ones
- View and change tray configurations
- View and change the device control panel menu configuration
- View and print internal pages
- Receive notification of device and supplies events
- View and change network configuration
- View support content that is specific to the current state of the device

When the device is connected to the network, the embedded Web server is automatically available. You can open the embedded Web server from Windows 95 and later.

To use the embedded Web server, you must have Microsoft Internet Explorer 4 and later or Netscape Navigator 4 and later. The embedded Web server works when the device is connected to an IP-based network. The embedded Web server does not support IPX-based or AppleTalk printer connections. You do not need Internet access to open and use the embedded Web server.

Open the embedded Web server by using a network connection

1. In a supported Web browser on your computer, type the device IP address or host name in the address/URL field. To find the IP address or host name, print a configuration page. See [Use information pages](#).



NOTE After you open the URL, you can bookmark it so that you can return to it quickly in the future.



2. The embedded Web server has three tabs that contain settings and information about the device: the **Information** tab, the **Settings** tab, and the **Networking** tab. Click the tab that you want to view.

See [Embedded Web server sections](#) for more information about each tab.

Embedded Web server sections

Tab or section	Options
Information tab Provides device, status, and configuration information	<ul style="list-style-type: none">• Device Status: Shows the device status and shows the life remaining of HP supplies, with 0% indicating that a supply is empty. The page also shows the type and size of print paper set for each tray. To change the default settings, click Change Settings.• Configuration Page: Shows the information found on the configuration page.

Tab or section	Options
	<ul style="list-style-type: none"> ● Supplies Status: Shows the life remaining of HP supplies, with 0 percent indicating that a supply is empty. This page also provides supplies part numbers. To order new supplies, click Order Supplies in the Other Links area on the left side of the window. ● Event log: Shows a list of all device events and errors. ● Usage page: Shows a summary of the number of pages the device has printed, grouped by size and type. ● Device Information: Shows the device network name, address, and model information. To change these entries, click Device Information on the Settings tab. ● Control Panel: Shows messages from the device control panel, such as Ready or Sleep mode on. ● Print: Allows you to send print jobs to the device.
<p>Settings tab</p> <p>Provides the ability to configure the device from your computer</p>	<ul style="list-style-type: none"> ● Configure Device: Allows you to configure device settings. This page contains the traditional menus found on devices using a control-panel display. ● E-mail Server: Network only. Used in conjunction with the Alerts page to set up incoming and outgoing e-mail, as well as to set e-mail alerts. ● Alerts: Network only. Allows you to set up to receive e-mail alerts for various device and supplies events. ● AutoSend: Allows you to configure the device to send automated e-mails regarding device configuration and supplies to specific e-mail addresses. ● Security: Allows you to set a password that must be entered to gain access to the Settings and Networking tabs. Enable and disable certain features of the embedded Web server. ● Edit Other Links: Allows you to add or customize a link to another Web site. This link is displayed in the Other Links area on all embedded Web server pages. ● Device Information: Allows you to name the device and assign an asset number to it. Enter the name and e-mail address for the primary contact who will receive information about the device. ● Language: Allows you to determine the language in which to display the embedded Web server information. ● Date & Time: Allows time synchronization with a network time server. ● Wake Time: Allows you to set or edit a wake time for the device. <p> NOTE The Settings tab can be password-protected. If this device is on a network, always consult with the system administrator before changing settings on this tab.</p>

Tab or section	Options
<p>Networking tab</p> <p>Provides the ability to change network settings from your computer</p>	<p>Network administrators can use this tab to control network-related settings for the device when it is connected to an IP-based network. This tab does not appear if the device is directly connected to a computer, or if the device is connected to a network using anything other than an HP Jetdirect print server.</p> <hr/> <p> NOTE The Networking tab can be password-protected.</p>
<p>Other links</p> <p>Contains links that connect you to the Internet</p>	<ul style="list-style-type: none"> • HP Instant Support™: Connects you to the HP Web site to help you find solutions. This service analyzes your device error log and configuration information to provide diagnostic and support information specific to your device. • Order Supplies: Connects to the HP SureSupply Web site, where you will receive information on options for purchasing original HP supplies, such as print cartridges and paper. • Product Support: Connects to the support site for the device, from which you can search for help regarding general topics. <hr/> <p> NOTE You must have Internet access in order to use any of these links. If you use a dial-up connection and did not connect when you first opened the embedded Web server, you must connect before you can visit these Web sites. Connecting might require that you close the embedded Web server and reopen it.</p>

Use HP Web Jetadmin software

HP Web Jetadmin is a Web-based software solution for remotely installing, monitoring, and troubleshooting network-connected peripherals. The intuitive browser interface simplifies cross-platform management of a wide range of devices, including HP and non-HP devices. Management is proactive, allowing network administrators the ability to resolve issues before users are affected. Download this free, enhanced-management software at www.hp.com/go/webjetadmin_software.

To obtain plug-ins to HP Web Jetadmin, click **plug-ins**, and then click the **download** link that is next to the name of the plug-in that you want. The HP Web Jetadmin software can automatically notify you when new plug-ins are available. On the **Product Update** page, follow the directions to automatically connect to the HP Web site.

If installed on a host server, HP Web Jetadmin is available to any client through a supported Web browser, such as Microsoft Internet Explorer 6.0 for Windows or Netscape Navigator 7.1 for Linux. Browse to the HP Web Jetadmin host.



NOTE Browsers must be Java-enabled. Browsing from an Apple PC is not supported.

Use the HP Printer Utility for Macintosh

Use the HP Printer Utility to configure and maintain a printer from a Mac OS X computer.

Open the HP Printer Utility

Open the HP Printer Utility in Mac OS X V10.2.8

1. Open the Finder, and then click **Applications**.
2. Click **Library**, and then click **Printers**.
3. Click **hp**, and then click **Utilities**.
4. Double-click **HP Printer Selector** to open the HP Printer Selector.
5. Select the device that you want to configure, and then click **Utility**.

Open the HP Printer Utility in Mac OS X V10.3, V10.4 and later

1. In the Dock, click the **Printer Setup Utility** icon.



NOTE If the **Printer Setup Utility** icon does not appear in the Dock, open the Finder, click **Applications**, click **Utilities**, and then double-click **Printer Setup Utility**.

2. Select the device that you want to configure, and then click **Utility**.

HP Printer Utility features

The HP Printer Utility consists of pages that you open by clicking in the **Configuration Settings** list. The following table describes the tasks that you can perform from these pages.

Item	Description
Configuration Page	Prints a configuration page.
Supplies Status	Shows the device supplies status and provides links for online supplies-ordering.
HP Support	Provides access to technical assistance, online supplies ordering, online registration, and recycling and return information.
File Upload	Transfers files from the computer to the device.
Upload Fonts	Transfers font files from the computer to the device.
Firmware Update	Transfers updated firmware files from the computer to the device.
Duplex Mode	Turns on the automatic two-sided printing mode.
Economode & Toner Density	Turns on the Economode setting to conserve toner, or adjusts toner density.
Resolution	Changes the resolution settings, including the REt setting.
Lock Resources	Locks or unlocks storage products, such as a hard disk.
Stored Jobs	Manages print jobs that are stored on the device hard disk.
Trays Configuration	Changes the default tray settings.
IP Settings	Changes the device network settings and provides access to the embedded Web server.

Item	Description
Bonjour Settings	Provides the ability to turn on or off Bonjour support or change the device service name that is listed on a network.
Additional Settings	Provides access to the embedded Web server.
E-mail Alerts	Configures the device to send e-mail notices for certain events.

Manage supplies

Monitor the print cartridge to ensure high-quality output.

Supplies life expectancy

The life of the print cartridge depends on the amount of toner that print jobs require and the length of life for the components inside the cartridge. When printing text at approximately 5% coverage (typical for a business letter), the HPprint cartridge lasts an average of 18,000 pages. The page-yield specification that HP provides is a general guideline. Actual yield can vary according to usage conditions.

Change the print cartridge

1. Pull the top-cover release to open the top cover.



2. Grasp the print cartridge by the handle, and remove it from the device.
3. Remove the new print cartridge from the packaging.
4. Remove any protective tape from the print cartridge.
5. Insert the new print cartridge in the device, and close the top cover.

Manage the print cartridge

Print-cartridge storage

Do not remove the print cartridge from its package until you are ready to use it.



CAUTION To prevent damage to the print cartridge, do not expose it to light for more than a few minutes.

Use genuine HP print cartridges

When you use a genuine new HP print cartridge, you can obtain the following supplies information:

- Percentage of supplies remaining
- Estimated number of pages remaining
- Number of pages printed

HP policy on non-HP print cartridges

Hewlett-Packard Company cannot recommend the use of non-HP print cartridges, either new or remanufactured. Because they are not HP products, HP cannot influence their design or control their quality.



NOTE Any damage caused by a non-HP print cartridge is not covered under the HP warranty and service agreements.

To install a new HP print cartridge, see [Change the print cartridge](#). To recycle the used cartridge, follow the instructions included with the new cartridge.

Print-cartridge authentication

The device automatically authenticates the print cartridge when it is inserted into the device. During authentication, the device notifies you whether a cartridge is a genuine HP print cartridge.

If the device control-panel message states that this is not a genuine HP print cartridge and you believe you purchased an HP print cartridge, see [HP fraud hotline and Web site](#).

HP fraud hotline and Web site

Call the HP fraud hotline (1-877-219-3183, toll-free in North America) or go to www.hp.com/go/anticounterfeit when you install an HP print cartridge and the control-panel message says the cartridge is non-HP. HP will help determine if the cartridge is genuine and take steps to resolve the problem.

Your print cartridge might not be a genuine HP print cartridge if you notice the following:

- You are experiencing a high number of problems with the print cartridge.
- The cartridge does not look like it usually does (for example, the orange pull tab is missing, or the packaging differs from HP packaging).

Clean the device

During the printing process, paper, toner, and dust particles can accumulate inside the product. Over time, this buildup can cause print-quality problems, such as toner specks or smearing. This product has a cleaning mode that can correct and prevent these types of problems.

Clean the exterior

Use a soft, damp, lint-free cloth to wipe dust, smudges, and stains off of the exterior of the device.

Clean the scanner glass

Dirty glass, from fingerprints, smudges, hair, and so on, slows down performance and affects the accuracy of special features such as fit-to-page and copy.



NOTE If streaks or other defects appear only on copies produced using the automatic document feeder (ADF), clean the scanner strip (step 3). It is not necessary to clean the scanner glass.

1. Open the scanner lid.
2. Clean the glass by using a damp, lint-free cloth.

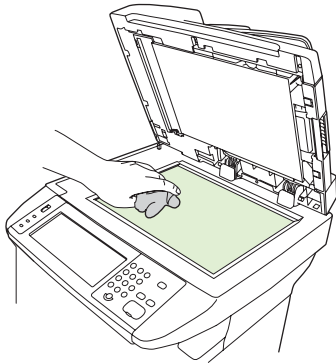

CAUTION Do not use abrasives, acetone, benzene, ammonia, ethyl alcohol, or carbon tetrachloride on any part of the device; these can damage the device. Do not place liquids directly on the glass. They might seep under it and damage the device.

3. Clean the scanner strip by using a damp, lint-free cloth.

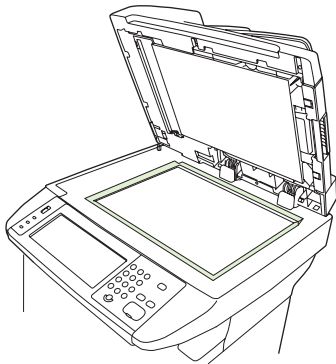

Clean the scanner lid backing

Minor debris can accumulate on the white document lid backing that is located underneath the scanner lid.

1. Open the scanner lid.
2. Clean the white document lid backing by using a soft cloth or sponge that has been moistened with a mild soap and warm water. Also, clean the scanner strip next to the ADF scanner glass.

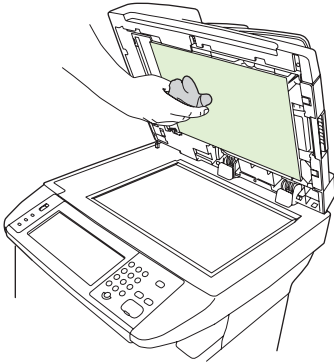

3. Wash the backing gently to loosen debris; do not scrub the backing.
4. Dry the backing by using a chamois or soft cloth.



CAUTION Do not use paper-based wipes because they might scratch the backing.

5. If this does not clean the backing well enough, repeat the previous steps and use isopropyl alcohol to dampen the cloth or sponge, and then wipe the backing thoroughly with a damp cloth to remove any residual alcohol.

Clean the paper path

1. From the Home screen, touch **Administration**.
2. Touch **Print Quality**.
3. Touch **Calibration/Cleaning**.
4. Touch **Create Cleaning Page**.

The device prints a cleaning page.

5. Follow the instructions printed on the cleaning page.

Clean the document feeder

Clean the document feeder only if it is visibly marked or dirty, or if you are experiencing a decrease in copy quality (such as streaking).

Clean the document feeder delivery system

1. Open the scanner lid.

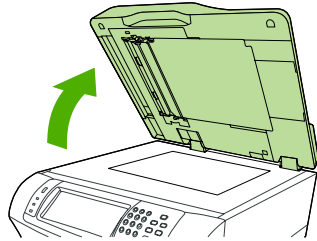

2. Locate the white, vinyl document-feeder backing.

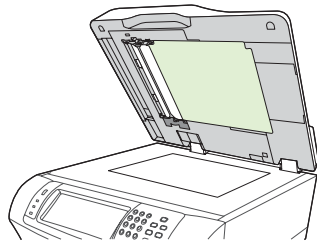

3. Locate the white, vinyl calibration strips.

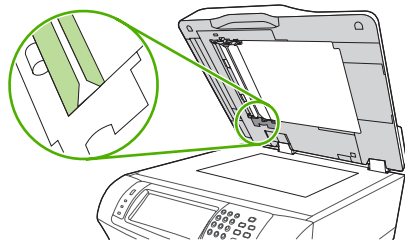

4. Clean the document-feeder backing and the calibration strips by wiping them with a clean, damp, lint-free cloth. Use an ammonia-based surface cleaner only when a water-dampened cloth does not clean the document-feeder components.
5. Clean the scanner glass by wiping it gently with a clean, slightly damp, lint-free cloth. Use an ammonia-based surface cleaner only when a water-dampened cloth does not clean the scanner glass.
6. Close the scanner lid.

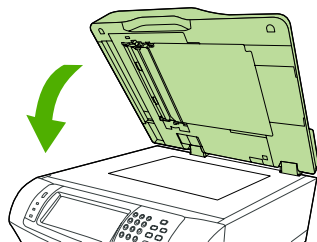

Clean the document feeder-rollers

You should clean the rollers in the document feeder if you are experiencing misfeeds or if your originals show marks as they exit the document feeder.

CAUTION Clean the rollers only if you experience misfeeds or marks on the originals, and you notice dust on the rollers. Cleaning the rollers frequently could introduce dust into the device.

1. Open the scanner lid.

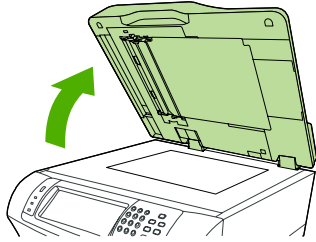

2. Locate the rollers near white, vinyl calibration strips.

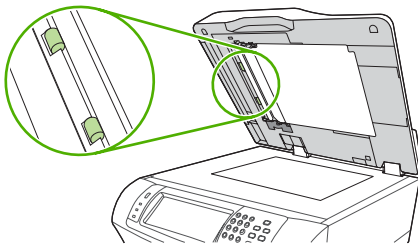

3. Wipe the rollers gently with a clean, water-dampened, lint-free cloth.

CAUTION Do not pour water directly onto the rollers. Doing so might damage the device.

4. Close the scanner lid.

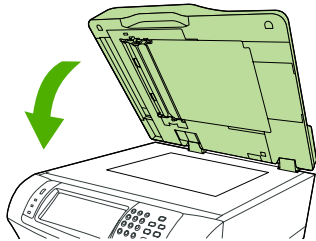

5. Pull the release lever to open the document-feeder cover.

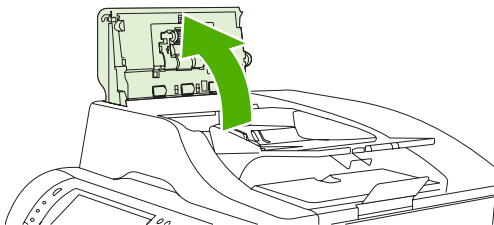

6. Locate the rollers.

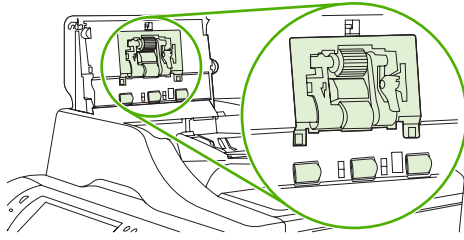

7. Wipe the rollers with a clean, water-dampened, lint-free cloth.



CAUTION Do not pour water directly onto the rollers. Doing so might damage the device.

8. Locate the separation pad.

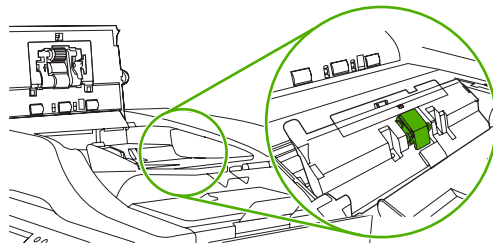

9. Wipe the pad with a clean, water-dampened, lint-free cloth.

10. Close the document-feeder cover.

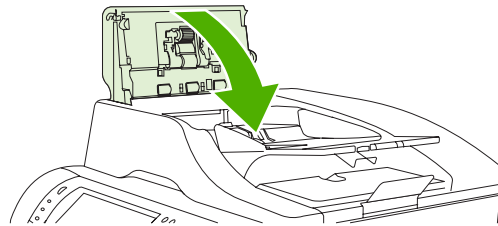

Calibrate the scanner

Calibrate the scanner to compensate for offsets in the scanner imaging system (carriage head) for ADF and flatbed scans. Because of mechanical tolerances, the scanner's carriage head might not read the position of the image accurately. During the calibration procedure, scanner offset values are calculated and stored. The offset values are then used when producing scans so that the correct portion of the document is captured.

Scanner calibration should be carried out only if you notice offset problems with the scanned images. The scanner is calibrated before it leaves the factory. It needs to be calibrated again only rarely.

1. From the Home screen, touch **Administration**.
2. Touch **Troubleshooting**.
3. Touch **Calibrate Scanner** and then follow the instructions in the onscreen dialog box.

The device starts the calibration process, and **Calibrating** appears on the touchscreen status line until the process is complete.

11 Problem solving

This chapter provides information about the following topics.

- [Problem-solving checklist](#)
- [Problem-solving flowchart](#)
- [Solve general device problems](#)
- [Control-panel message types](#)
- [Control-panel messages](#)
- [Common causes of jams](#)
- [Clear jams](#)
- [Clear staple jams](#)
- [Solve print-quality problems](#)
- [Solve network printing problems](#)
- [Solve copy problems](#)
- [Solve fax problems](#)
- [Solve e-mail problems](#)
- [Solve common Windows problems](#)
- [Solve common Macintosh problems](#)
- [Solve Linux problems](#)
- [Solve PostScript problems](#)

Problem-solving checklist

If you are experiencing problems, use the following checklist to identify the cause of the problem:

- Is the device connected to power?
- Is the device on?
- Is the device in the **Ready** state?
- Are all necessary cables connected?
- Do any messages appear on the control panel?
- Are genuine HP supplies installed?
- Was a recently replaced print cartridge installed correctly, and was the pull tab and/or attached tape on the cartridge removed?

For additional information about installation and setup, see the getting started guide.

If you cannot find solutions to problems in this guide, go to <http://www.hp.com/support/ljm4345mfp>.

Factors that affect performance

Several factors affect the time it takes to print a job:

- The use of special paper (such as transparencies, heavy paper, and custom-size paper)
- Device processing and download time
- The complexity and size of graphics
- The speed of the computer you are using
- The USB connection
- The I/O configuration
- The amount of memory installed
- The network operating system and configuration (if applicable)
- Device personality (PCL or PS)



NOTE Although additional memory can resolve memory problems, improve how the device handles complex graphics, and improve download times, it will not increase maximum printing speed (ppm).

Problem-solving flowchart

Symptom	Check	Possible causes	Possible solutions
The control-panel display is blank, no lights are lit, and the device makes no sounds from the motors.	Is the power on?	<p>The power switch might be off.</p> <p>The power cord might be unplugged.</p> <p>The power outlet might not be working correctly.</p> <p>The internal power supply might have failed.</p>	<ol style="list-style-type: none"> 1. Make sure the device is plugged in and the power switch is on. 2. Test the power outlet by plugging the device into an outlet that is known to work. 3. If the problem persists, contact HP Customer Care. See HP Customer Care.
The control panel indicates an error.	Do error messages appear on the control-panel display?	Several conditions can cause an error message to appear.	<ol style="list-style-type: none"> 1. Follow the instructions on the control panel to resolve the problem. 2. For more information, see Control-panel messages. 3. If the problem persists, contact HP Customer Care. See HP Customer Care.
	Are the main features, such as Copy and E-mail , inactive on the touchscreen?	The scanner shipping lock might be in the locked position.	Make sure the scanner shipping lock is unlocked. The scanner lock is on the left side of the device, underneath the scanner.
Paper-feed problems	Do jams occur frequently?	<p>The media does not meet specifications.</p> <p>Paper remains in the device after clearing a previous jam.</p> <p>Some of the shipping tape, cardboard, or shipping locks are still in the device.</p> <p>The maintenance kit items might be ready for replacement.</p>	<ol style="list-style-type: none"> 1. Make sure the media meets specifications for the device. See Select print media. 2. Open all doors and trays and check for jammed media. See Clear jams. 3. Make sure the print cartridge is installed correctly. See Change the print cartridge. 4. Install the device maintenance kit. See Order parts, accessories, and supplies. 5. If the problem persists, contact HP Customer Care. See HP Customer Care.

Symptom	Check	Possible causes	Possible solutions
	Do original documents feed correctly through the ADF?	<p>The original document might be printed on media that is too light or too heavy for the ADF.</p> <p>The ADF rollers and separation pad might be dirty.</p> <p>The ADF maintenance kit parts might need to be replaced.</p>	<ol style="list-style-type: none"> 1. If the original document is printed on very heavy or light media, copy by using the flatbed glass. 2. Clean the ADF rollers and separation pad. See Clean the document feeder. 3. Install the ADF maintenance kit. See Order parts, accessories, and supplies. 4. If the problem persists, contact HP Customer Care. See HP Customer Care.
Copy problems	Are copies blank?	The originals might have been loaded upside-down.	<ol style="list-style-type: none"> 1. In the ADF, load original documents face-up. 2. On the scanner glass, load original documents face-down. 3. If the problem persists, contact HP Customer Care. See HP Customer Care.
	Are copies of poor quality from the ADF and the scanner glass?	The copy settings need to be adjusted for the original document.	<p>See Adjust the copy settings.</p> <p>If the problem persists, contact HP Customer Care. See HP Customer Care.</p>
	Are copies of poor quality only from the ADF?	The ADF glass strip might be dirty.	<p>Clean the scanner glass. See Clean the device.</p> <p>If the problem persists, contact HP Customer Care. See HP Customer Care.</p>
	Are copies of poor quality only from the scanner glass?	The scanner glass might be dirty	<p>Clean the glass strip that is to the left of the scanner glass. See Clean the device.</p> <p>If the problem persists, contact HP Customer Care. See HP Customer Care.</p>
Print-quality problems	<p>Is the overall print quality poor?</p> <p>Is the printing too light?</p> <p>Do lines, streaks, or dots appear on the pages?</p>	<p>The media does not meet specifications.</p> <p>The print cartridge might be empty or damaged.</p> <p>The maintenance kit items might be ready for replacement.</p>	<ol style="list-style-type: none"> 1. Make sure the media meets specifications for the device. See Select print media. 2. Replace the print cartridge. See Change the print cartridge. 3. Install the device maintenance kit. See

Symptom	Check	Possible causes	Possible solutions
			<p>Order parts, accessories, and supplies.</p> <p>4. If the problem persists, contact HP Customer Care. See HP Customer Care.</p>
General printing problems	Can you print documents from a computer?	<p>The computer cable might be defective.</p> <p>The printer driver might need to be reinstalled.</p>	<p>1. Try printing a configuration page at the control panel. Touch Network Address and then touch Print.</p> <p>If the page prints, the problem is with the cable or the driver.</p> <p>2. Reconnect the cables.</p> <p>3. Reinstall the printer driver. The printer driver is on the CD that came with the device.</p> <p>4. If the problem persists, contact HP Customer Care. See HP Customer Care.</p>
	Can you print over the network?	The network might not be configured correctly.	<p>1. Try connecting the computer directly to the device. If you can print, the problem is with the network configuration. See Solve network printing problems.</p> <p>2. If the problem persists, contact HP Customer Care. See HP Customer Care.</p>
	Are you having problems printing from specific software programs?	The problem might be with the software program.	<p>1. Try printing from a different software program. If you can print, the problem is with the original software program.</p> <p>2. See the documentation for the software program.</p>
Stapling problems	Are jobs stapled?	<p>The staple cassette might be jammed.</p> <p>The staple cassette might need to be replaced.</p>	<p>1. Remove the staple cassette and check if it is jammed or empty. See Clear staple jams.</p> <p>2. If the problem persists, contact HP Customer Care. See HP Customer Care.</p>
E-mail problems	Are you able to send e-mail attachments?	The SMTP gateway might need to be reconfigured.	See Solve e-mail problems .

Symptom	Check	Possible causes	Possible solutions
	Does an “E-mail gateway not responding” message appear on the control panel?		
	Are you able to change the “From” e-mail address?	<p>The device might be configured so that the “From” e-mail address cannot be changed.</p> <p>The device might require you to sign in before you can change the “From” e-mail address.</p>	Use the embedded Web server to change these settings. See Embedded Web server .
	Are you able to change the file type or the color setting for e-mail attachments?	Change the settings at the control panel or by using the embedded Web server.	<ol style="list-style-type: none"> At the control panel, touch E-mail, and then touch More Options. See Change e-mail settings for the current job. To change the settings by using the embedded Web server, see Embedded Web server.
	Do you receive a “job failed” e-mail message when you try to send an e-mail attachment?	<p>The e-mail address to which you are sending the document might be incorrect.</p> <p>The file size might be larger than the maximum allowable size for the SMTP gateway.</p>	<ol style="list-style-type: none"> Send a test e-mail from your computer. Use the embedded Web server to change the maximum allowable size for e-mail attachments. See Embedded Web server.
Fax problems	Is the Fax feature on the control panel inactive?	You need to provide required settings before using the Fax feature.	<ol style="list-style-type: none"> At the control panel, touch Administration, touch Initial Setup, and touch Fax Setup. Configure the settings for Location, Date/Time, and Fax Header.
	Is the Fax feature on the control panel completely missing?	The fax accessory might be installed incorrectly.	<ol style="list-style-type: none"> Make sure the fax accessory is installed correctly and that none of the pins are bent. See Install the fax accessory. Print a configuration page and check the modem status. It should indicate “Operational/Enabled”. If the modem status is anything else, the problem is with the fax accessory.

Symptom	Check	Possible causes	Possible solutions
	Is the Fax feature configured correctly but you cannot send faxes?	<p>You must use the phone cord that came with the device.</p> <p>The phone cord might not be connected securely or the telephone line might not be working.</p> <p>You might have connected the device to a digital phone line instead of an analog phone line. The fax accessory requires an analog phone line.</p>	<p>See Solve fax problems.</p> <ol style="list-style-type: none"> 1. Always use the phone cord that came with the device. 2. Test the telephone line by connecting a telephone to it and making a call. 3. Make sure you are connecting the device to an analog phone line.
	Is the Fax feature configured correctly but you cannot receive faxes?	<p>A line splitter or surge-protection device might be interfering with incoming faxes.</p> <p>An answering machine or voice-mail system might be intercepting the incoming fax transmission.</p>	<p>See Solve fax problems.</p> <ol style="list-style-type: none"> 1. Do not use line splitters or surge-protection devices. 2. Disconnect the answering machine or voice-mail system. 3. Set the number of rings-to-answer for the fax accessory to a lower number. See Initial Setup menu. 4. Make sure the device is connected to an a dedicated analog phone line. Do not use a roll-over line.

Solve general device problems

Device selects media from the wrong tray.

Cause	Solution
The tray selection in the software program might be incorrect.	<p>For many software programs, the paper tray selection is found on the Page Setup menu within the program.</p> <p>Remove any media in other trays to make the device select from the correct tray.</p> <p>For Macintosh computers, use the HPPrinter Utility to change the priority of the tray.</p>
The configured size does not match the size of the media that is loaded in the tray.	Adjust the width guides to match the size of the media that is loaded in the tray.

Device does not pull paper from tray.

Cause	Solution
The tray is empty.	Load paper in the tray.
The paper guides are set incorrectly.	<p>To set the guides correctly, see Load media.</p> <p>For tray2, 3, 4, or 5, make sure that the leading edge of the paper stack is even. An uneven edge can prevent the lift plate from rising.</p>

Paper curls when it exits the device.

Cause	Solution
The paper curls when it exits to the top output bin.	<p>Choose the straightest paper path in the printer driver or control panel.</p> <p>Turn over the paper that you are printing on.</p> <p>Reduce the fusing temperature to reduce the curling. (See Print Quality menu.)</p>

Print job is extremely slow.

Cause	Solution
The job might be very complex. The maximum speed of the device cannot be exceeded even when more memory is added. Printing speeds might be automatically reduced when printing on custom-sized media. Note: Slower speeds are expected when printing on narrow paper, when printing from tray 1, or when using the High2 fuser mode.	Reduce the complexity of the page or try adjusting the print-quality settings. If this problem occurs frequently, add memory to the device.
You are printing a PDF or PostScript (PS) file but are using a PCL device driver.	Try using the PS device driver rather than the PCL device driver. (You can usually do this from a software program.)

Print job prints on both sides of the paper.

Cause	Solution
The device is set for duplexing.	See Open the printer drivers to change the setting, or see the online Help.

Print job contains only one page but the device processes the back side of the page as well (the page comes part of the way out, and then goes back into the device).

Cause	Solution
The device is set for duplexing. Even if the print job contains only one page, the device also processes the back side.	See Open the printer drivers to change the setting, or see the online Help. Do not try to pull the page out of the device before duplexing is complete. Jamming might result.

Pages print, but are totally blank.

Cause	Solution
The sealing tape might still be on the print cartridge.	Remove the print cartridge and pull out the sealing tape. Reinstall the print cartridge.
The file might have blank pages.	Check the file to make sure that it does not contain blank pages.

The device prints, but the text is wrong, garbled, or incomplete.

Cause	Solution
The device cable is loose or defective.	Disconnect the device cable and reconnect it. Try a print job that you know works. If possible, attach the cable and device to another computer and try a print job that you know works. Finally, try a new cable.

The device prints, but the text is wrong, garbled, or incomplete.

Cause	Solution
The wrong driver was selected in the software.	Check the software device selection menu to make sure that an HP LaserJet M4345 device is selected.
The software program is malfunctioning.	Try printing a job from another program.

The device does not respond when you select Print in the software.

Cause	Solution
The device is out of media.	Add media.
The device might be in the manual-feed mode.	Change the device from manual-feed mode.
The cable between the computer and the device is not connected correctly.	Disconnect and reconnect the cable.
The device cable is defective.	If possible, attach the cable to another computer and print a job that you know works. You might also try using a different cable.
The wrong device was selected in the software.	Check the software device selection menu to make sure that an HP LaserJet M4345 device is selected.
The device might have a jam.	Clear any jams, paying careful attention to the duplexer area (if your model has a duplexer). See Clear jams .
The software for the device is not configured for the device port.	Check the software device selection menu to make sure that it is using the correct port. If the computer has more than one port, make sure that the device is attached to the correct one.
The device is on a network and is not receiving a signal.	Check cable connections. Reinstall the printing software. Print a job that you know works. Clear any stopped jobs from the print queue.
The device is not receiving power.	If no lights are on, check the power cord connections. Check the power switch. Check the power source.
The device is malfunctioning.	Check the control-panel display for messages and lights to determine if the device is indicating an error. Note any message and see Control-panel messages .

Control-panel message types

Four types of control-panel messages can indicate the status of or problems with the device.

Message type	Description
Status messages	Status messages reflect the current state of the device. They inform you of normal device operation and require no interaction to clear them. They change as the state of the device changes. Whenever the device is ready, not busy, and has no pending warning messages, the status message Ready appears if the device is online.
Warning messages	Warning messages inform you of data and print errors. These messages typically alternate with the Ready or status messages and remain until you touch OK . Some warning messages are clearable. If Clearable Warnings is set to Job on the device Device Behavior menu, the next print job clears these messages.
Error messages	<p>Error messages communicate that some action must be performed, such as adding paper or clearing a jam.</p> <p>Some error messages are auto-continuable. If Auto-Continue is set on the menus, the device will continue normal operation after an auto-continuable error message appears for 10 seconds.</p> <p> NOTE Pressing any button during the 10-second auto-continuable error message overrides the auto-continue feature, and the button function takes precedence. For example, pressing the Stop button pauses printing and offers the option to cancel the print job.</p>
Critical-error messages	Critical error messages inform you of a device failure. Some of these messages can be cleared by turning the device off and then on. These messages are not affected by the Auto-Continue setting. If a critical error persists, service is required.

Control-panel messages

Table 11-1 Control-panel messages

Control panel message	Description	Recommended action
	A duplexed (2-sided) document was requested from a tray that is set to Any Size or Any Custom . Duplexing is not allowed from a tray configured to Any Size or Any Custom .	Select another tray or reconfigure the tray.
	A user name or password is incorrect.	Type the information again.
	A digital send or copy job has been performed from the scanner glass, but the original document needs to be removed.	Remove the original document from the scanner glass and press Start .
	The control panel function that you are trying to use has been locked to prevent unauthorized access.	Contact the network administrator.
10.XX.YY SUPPLY MEMORY ERROR	The MFP cannot read or write to at least one print cartridge e-label or an e-label is missing from a print cartridge.	Reinstall the print cartridge, or install a new HP print cartridge.
11.XX Internal clock error To continue touch OK	The MFP real time clock has experienced an error.	Whenever the MFP is turned off and then turned on again, set the time and date at the control panel. See Use the control panel . If the error persists, you might need to replace the formatter.
13.JJ.NT JAM IN ENVELOPE FEEDER	Media is jammed in the envelope feeder.	Remove the jammed media from the envelope feeder. Follow the instructions in the onscreen dialog box. See Clear jams from the optional envelope-feeder area .
13.JJ.NT JAM IN OUTPUT BIN	Media is jammed in the output bin.	Remove the output bin and gently remove the jammed media. Reattach output bin. Follow the instructions in the onscreen dialog box.
13.JJ.NT JAM IN TRAY 1	Media is jammed in tray 1.	Remove the jammed media from tray 1. Follow the instructions in the onscreen dialog box. See Clear jams from the tray1 area .
13.JJ.NT JAM IN TRAY X	Media is jammed in the specified tray.	Follow the instructions in the onscreen dialog box. See Clear jams from the tray2, 3, 4, or 5 areas .
13.JJ.NT JAM INSIDE DUPLEXER Remove duplexer from lower left area	Media is jammed in the duplexer.	Follow the instructions in the onscreen dialog box. See Clear jams from the optional duplexer .
13.JJ.NT JAM INSIDE LEFT OUTPUT AREA Remove output bin and duplexer	Media is jammed in the output area.	Follow the instructions in the onscreen dialog box. See Clear jams from the output areas .
13.JJ.NT JAM INSIDE RIGHT ACCESS DOOR Open all right access doors ABOVE tray X	Media is jammed inside the jam-access door for the tray that is indicated.	Follow the instructions in the onscreen dialog box.

Table 11-1 Control-panel messages (continued)

Control panel message	Description	Recommended action
13.JJ.NT JAM INSIDE TOP COVER AREA	Media is jammed in the top cover area.	Follow the instructions in the onscreen dialog box. See Clear jams from the top-cover and print-cartridge areas.
13.JJ.NT JAM INSIDE TOP COVER AREA Remove print cartridge	Media is jammed in the top cover area and you must remove the print cartridge to clear the jam.	Follow the instructions in the onscreen dialog box. See Clear jams from the top-cover and print-cartridge areas.
13.JJ.NT JAM INSIDE TRAY 2 AREA	Media is jammed in tray 2.	Follow the instructions in the onscreen dialog box. See Clear jams from the tray2, 3, 4, or 5 areas.
13.JJ.NT JAM INSIDE TRAY 2 RIGHT ACCESS DOOR	Media is jammed inside tray 2 in the jam-access door.	Follow the instructions in the onscreen dialog box.
13.JJ.NT JAMS INSIDE TOP COVER AREA Remove print cartridge	Media is jammed in more than one location inside the top cover area. You must remove the print cartridge to clear the jams.	Follow the instructions in the onscreen dialog box. See Clear jams from the top-cover and print-cartridge areas.
13.JJ.NT PAPER JAM OPEN INPUT TRAYS	Media is jammed inside one or more of the trays.	Follow the instructions in the onscreen dialog box.
20 INSUFFICIENT MEMORY To continue touch OK	The MFP received more data than can fit in the available memory. You might have tried to transfer too many macros, soft fonts, or complex graphics.	Touch OK to print the transferred data (some data might be lost), and then simplify the print job or install additional memory. See Adding printer memory.
21 PAGE TOO COMPLEX To continue touch OK	The page formatting process was not fast enough for the MFP.	Touch OK to print the transferred data. (Some data might be lost.) If this message appears often, simplify the print job.
22 EIO X BUFFER OVERFLOW To continue touch OK	Too much data was sent to the EIO card in the specified slot (x). An incorrect communications protocol might be in use.	Touch OK to print the transferred data. (Some data might be lost.) Check the host configuration. If this message persists, contact an HP-authorized service or support provider. (See the HP support flyer, or go to http://www.hp.com/support/ljm4345mfp .)
22 EMBEDDED I/O BUFFER OVERFLOW To continue touch OK	Too much data was sent to the embedded HP Jetdirect print server.	Touch OK to print the transferred data. (Some data might be lost.)
30.1.YY SCANNER FAILURE	An error has occurred in the scanner.	Check the scanner lock. Turn the MFP off and then on. If this message persists, contact an HP-authorized service or support provider. (See the HP support flyer, or go to http://www.hp.com/support/ljm4345mfp .)
40 BAD EIO X TRANSMISSION To continue touch OK	The connection between the MFP and the EIO card in the specified slot has been broken.	Touch OK to clear the error message and continue printing.
40 BAD SERIAL TRANSMISSION To continue touch OK	A serial data error (parity, framing, or line overrun) occurred as data was being sent by the computer.	Touch OK to clear the error message. (Data will be lost.)
40 EMBEDDED I/O BAD TRANSMISSION To continue touch OK	A temporary printing error has occurred.	Turn the MFP off, and then turn the MFP on. If this message persists, contact an HP-authorized service or support provider. (See the HP support flyer, or go to http://www.hp.com/support/ljm4345mfp .)

Table 11-1 Control-panel messages (continued)

Control panel message	Description	Recommended action
41.3 MEDIA TOO SHORT CANNOT DUPLEX	The MFP cannot print on both sides of the selected media because the media does not meet the minimum length specification.	Select single-sided printing or load a longer-size media. Resend the job. See Select print media .
41.3 MEDIA TOO SHORT CANNOT SEND TO FACE DOWN OUTPUT BIN	The MFP cannot deliver the selected media face-down because the media does not meet the minimum length specification.	Select the face-up output option, or load a longer-size media in the tray. Resend the job. See Select print media .
41.3 UNEXPECTED SIZE IN TRAY XX LOAD TRAY XX <TYPE> <SIZE>	This is typically caused if two or more sheets of media stick together in the MFP or if the tray is not adjusted correctly.	Reload the tray with the correct media size. Reconfigure the size in a tray so that the MFP will use a tray that contains the size required for the print job. Follow the instructions in the onscreen dialog box.
41.3 UNEXPECTED SIZE IN TRAY XX To use another tray touch OK	The specified tray is loaded with media that is longer or shorter in the feed direction than the size adjusted for the tray.	Touch OK to use another tray. Reconfigure the size in a tray so that the MFP will use a tray that is loaded with the size of media required for the print job. If the message does not clear automatically from the control-panel display, turn the MFP off, and then turn the MFP on.
41.X ERROR To continue touch OK	A temporary printing error occurred.	Touch OK to clear the error. If the error is not cleared, turn the MFP off, and then turn the MFP on. If this message persists, contact an HP-authorized service or support provider. (See the HP support flyer, or go to http://www.hp.com/support/ljm4345mfp .)
49.XXXXX ERROR To continue turn off then on	A critical firmware error has occurred.	Remove third-party devices. Turn the MFP off, and then turn the MFP on. If this message persists, contact an HP-authorized service or support provider. (See the HP support flyer, or go to http://www.hp.com/support/ljm4345mfp .)
50.X FUSER ERROR	A fuser error has occurred.	Make sure you have the correct fuser. Re-seat the fuser. Turn the MFP off, and then turn the MFP on. If this message persists, contact an HP-authorized service or support provider. (See the HP support flyer, or go to http://www.hp.com/support/ljm4345mfp .)
51.XY ERROR To continue turn off then on	A temporary printing error has occurred.	Turn the MFP off, and then turn the MFP on. If this message persists, contact an HP-authorized service or support provider. (See the HP support flyer, or go to http://www.hp.com/support/ljm4345mfp .)
52.XY ERROR To continue turn off then on	A temporary printing error has occurred.	Turn the MFP off, and then turn the MFP on. If this message persists, contact an HP-authorized service or support provider. (See the HP support flyer, or go to http://www.hp.com/support/ljm4345mfp .)

Table 11-1 Control-panel messages (continued)

Control panel message	Description	Recommended action
53.XY.ZZ CHECK RAM DIMM SLOT <X> To continue touch OK	A problem exists with the MFP memory. The DIMM that caused the error will not be used. The following are the values of X : X = Device location 0 = Onboard memory 1 = Slot 1	You might need to reseat or replace the specified DIMM. Turn the MFP off, and then replace the DIMM that caused the error. See Adding printer memory . If this message persists, contact an HP-authorized service or support provider. (See the HP support flyer, or go to http://www.hp.com/support/ljm4345mfp .)
55.XX.YY DC CONTROLLER ERROR To continue turn off then on	The print engine is not communicating with the formatter.	Turn the MFP off, and then turn the MFP on. If this message persists, contact an HP-authorized service or support provider. (See the HP support flyer, or go to http://www.hp.com/support/ljm4345mfp .)
56.X ERROR To continue turn off then on	A temporary printing error has occurred.	Turn the MFP off, and then turn the MFP on. If this message persists, contact an HP-authorized service or support provider. (See the HP support flyer, or go to http://www.hp.com/support/ljm4345mfp .)
57.XX ERROR To continue turn off then on	A temporary printing error has occurred.	Turn the MFP off, and then turn the MFP on. If this message persists, contact an HP-authorized service or support provider. (See the HP support flyer, or go to http://www.hp.com/support/ljm4345mfp .)
58.XX ERROR To continue turn off then on	A temporary printing error has occurred.	Turn the MFP off, and then turn the MFP on. If this message persists, contact an HP-authorized service or support provider. (See the HP support flyer, or go to http://www.hp.com/support/ljm4345mfp .)
59.XY ERROR To continue turn off then on	A temporary printing error has occurred.	Turn the MFP off, and then turn the MFP on. If this message persists, contact an HP-authorized service or support provider. (See the HP support flyer, or go to http://www.hp.com/support/ljm4345mfp .)
60.X ERROR To continue turn off then on	The tray specified by X is not lifting correctly.	Follow the instructions in the onscreen dialog box.
62 NO SYSTEM To continue turn off then on	A problem exists with the MFP firmware.	Turn the MFP off, and then turn the MFP on. If this message persists, contact an HP-authorized service or support provider. (See the HP support flyer, or go to http://www.hp.com/support/ljm4345mfp .)
64 ERROR To continue turn off then on	A scan buffer error occurred.	Turn the MFP off, and then turn the MFP on. If this message persists, contact an HP-authorized service or support provider. (See the HP support flyer, or go to http://www.hp.com/support/ljm4345mfp .)

Table 11-1 Control-panel messages (continued)

Control panel message	Description	Recommended action
66.XY.ZZ OUTPUT DEVICE FAILURE	An error occurred in an external paper-handling accessory.	<ol style="list-style-type: none"> 1. Turn the MFP power off. 2. Check that the accessory is properly seated on and connected to the MFP, without any gaps between the MFP and the accessory. If the accessory uses cables, disconnect and reconnect them. 3. Verify that there is no packaging material in or around the output device. 4. Turn the MFP power on. 5. If this message persists, contact an HP-authorized service or support provider. (See the HP support flyer, or go to http://www.hp.com/support/ljm4345mfp.)
68.X PERMANENT STORAGE FULL To continue touch OK	The MFP NVRAM is full. Some settings saved in the NVRAM might have been reset to the factory defaults. Printing can continue, but some unexpected functions might occur if an error occurred in permanent storage.	<p>Touch OK to clear the message. If the message is not cleared, turn the MFP off, and then turn the MFP on.</p> <p>If this message persists, contact an HP-authorized service or support provider. (See the HP support flyer, or go to http://www.hp.com/support/ljm4345mfp.)</p>
68.X PERMANENT STORAGE WRITE FAIL To continue touch OK	The MFP NVRAM is failing to write. Printing can continue, but some unexpected functions might occur if an error occurred in permanent storage.	<p>Touch OK to clear the message. If the message is not cleared, turn the MFP off, and then turn the MFP on.</p> <p>If this message persists, contact an HP-authorized service or support provider. (See the HP support flyer, or go to http://www.hp.com/support/ljm4345mfp.)</p>
68.X STORAGE ERROR SETTINGS CHANGED To continue touch OK	One or more MFP settings are invalid and have been reset to the factory-default settings. Printing can continue, but some unexpected functions might occur if an error occurred in permanent storage.	<p>Touch OK to clear the message. If the message is not cleared, turn the MFP off, and then turn the MFP on.</p> <p>If this message persists, contact an HP-authorized service or support provider. (See the HP support flyer, or go to http://www.hp.com/support/ljm4345mfp.)</p>
69.X ERROR To continue turn off then on	A temporary printing error occurred.	<p>Turn the MFP off, and then turn the MFP on.</p> <p>If this message persists, contact an HP-authorized service or support provider. (See the HP support flyer, or go to http://www.hp.com/support/ljm4345mfp.)</p>
79 ERROR To continue turn off then on	A critical hardware error occurred.	<p>Turn the MFP off, and then turn the MFP on.</p> <p>If this message persists, contact an HP-authorized service or support provider. (See the HP support flyer, or go to http://www.hp.com/support/ljm4345mfp.)</p>

Table 11-1 Control-panel messages (continued)

Control panel message	Description	Recommended action
8X.YYYY EIO ERROR	The EIO accessory card has encountered a critical error, as specified by YYYY .	Try the following actions to clear the message. <ol style="list-style-type: none"> 1. Turn the MFP off, and then turn the MFP on. 2. Turn the MFP off, reseal the EIO accessory, and then turn the MFP on. 3. Replace the EIO accessory.
8X.YYYY INTERNAL JETDIRECT ERROR	The embedded HP Jetdirect print server has encountered a critical error, as specified by YYYY .	Turn the MFP off, and then turn the MFP on. If this message persists, contact an HP-authorized service or support provider. (See the HP support flyer, or go to http://www.hp.com/support/ljm4345mfp .)
Authentication required	Authentication has been enabled for this feature or destination. A username and password are required.	Type the user name and password, or contact the network administrator.
Authentication required to use this feature	A user name and password are required.	Type the user name and password, or contact the network administrator.
Bad duplexer connection	The duplex printing accessory is not connected correctly to the MFP.	Remove and reinstall the duplexer. If this message persists, contact an HP-authorized service or support provider. See the HP support flyer, or go to http://www.hp.com/support/ljm4345mfp .
Bad env feeder connection	The envelope feeder is not connected properly.	Remove and reinstall the envelope feeder. If this message persists, contact an HP-authorized service or support provider. See the HP support flyer, or go to http://www.hp.com/support/ljm4345mfp .
Cartridge failure return for replacement	The print cartridge still contains part of the sealing tape.	Try to remove the remaining sealing tape. If it cannot be removed, insert a new print cartridge and return the faulty print cartridge to receive a replacement. (See Order parts, accessories, and supplies , or go to http://www.hp.com/support/ljm4345mfp .)
Check output device	An error has occurred with the output device.	Remove and reinstall the output device. Observe the LED on the device. If is flashing or is amber, see Solve general device problems .
Chosen personality not available. To continue touch OK.	A print job requested a MFP language (personality) that is not available for this MFP. The job will not print and will be cleared from memory.	Print the job by using a printer driver for a different printer language, or add the requested language to the MFP (if possible). To see a list of available personalities, print a configuration page. (See Use information pages .)
Close right access door <x>	The specified jam-access cover is open.	Close the specified jam-access cover.
Close right access doors	More than one jam-access cover is open.	Close all jam-access covers to continue printing.
Close top cover	The top cover is open.	Close the top cover.

Table 11-1 Control-panel messages (continued)

Control panel message	Description	Recommended action
Digital Send Communication Error	An error has occurred during a digital send task.	Contact the network administrator.
Digital Send server is not responding Contact administrator	The MFP cannot communicate with the server.	Verify the network connection. Contact the network administrator.
Document feeder bin full	The document feeder output bin holds 50 sheets of paper. The MFP stops when the bin is full.	Remove the paper from the document feeder output bin.
Document feeder cover open	The document feeder cover is open.	Close the document feeder cover. Follow the instructions in the onscreen dialog box.
Document feeder pick error	The document feeder experienced an error while picking media.	Make sure that you have not overloaded the document feeder. Do not load more than 50 sheets of 20 lb paper in the document feeder.
Document feeder skew error	Media has become skewed in the document feeder.	Make sure that the paper guides are aligned on the sides of the originals, and that all of the originals are the same size. Remove the remaining media from the document feeder and close the document feeder cover. Follow the instructions in the onscreen dialog box.
DUPLEXER ERROR Remove duplexer Install duplexer with power off	The duplexer has been removed.	Reinstall the duplexer. (Any print jobs at the MFP might be lost.)
E-mail Gateway did not accept the job because the attachment was too large.	The scanned documents have exceeded the size limit of the server.	Send the job again using a lower resolution, smaller file size setting, or fewer pages. See Solve e-mail problems to learn how to reduce the size of the attachment. Contact the network administrator to enable sending the scanned documents by using multiple e-mails.
E-mail Gateway did not respond. Job failed.	A gateway has exceeded the time out value.	Validate the SMTP IP address. See Solve e-mail problems .
E-mail Gateway rejected the job because of the addressing information. Job failed.	One or more of the e-mail addresses is incorrect.	Send the job again with the correct addresses.
Error executing Digital Send job. Job failed.	A digital send job has failed and cannot be delivered.	Try to send the job again.
Folder list is full. To add a folder, you must first delete a folder.	The MFP limits the number of folders that can be established.	Delete an unused folder to add a new folder.
HP Digital Sending: Delivery Error	A digital send job has failed and cannot be delivered.	Try to send the job again.
Insert or close tray XX	The specified tray is missing or open.	Insert or close the specified tray to continue.
Install cartridge	The print cartridge has been removed or has been installed incorrectly.	Replace or reinstall the print cartridge correctly to continue printing.
Insufficient memory to load fonts/data <device> To continue touch OK	The MFP does not have enough memory to load the data (for example, fonts or macros) from the location specified.	Touch OK to continue without this information. If the message persists, add more memory.
JAM IN DOCUMENT FEEDER	Media is jammed in the document feeder.	Remove jammed media from the document feeder. Follow the instructions in the

Table 11-1 Control-panel messages (continued)

Control panel message	Description	Recommended action
		onscreen dialog box. See Clear jams from the document feeder . Also see Solve repeated jams . If the message persists after all jams have been cleared, a sensor might be stuck or broken. Contact an HP-authorized service or support provider. See the HP support flyer, or go to http://www.hp.com/support/ljm4345mfp .
Jam in document feeder	Media is jammed in the document feeder.	Follow the instructions in the onscreen dialog box. See Clear jams from the document feeder . Also see Solve repeated jams .
LDAP Server is not responding Contact administrator	The LDAP server has exceeded the time out value for an address request.	Verify the LDAP server address. See Solve e-mail problems . Contact the network administrator.
Load envelope feeder <type> <size>	The envelope feeder is empty.	Load the envelope feeder.
Load Tray 1 <type> <size>	The tray is empty or configured for a different size than the size requested.	Follow the instructions in the onscreen dialog box.
Manually feed <type> <size>	The specified job requires manual feed from tray 1.	Load the requested media into tray 1. To override the message, touch OK to use a type and size of media that is available in another tray.
Network connection required for Digital Sending. Contact administrator.	A digital-sending feature has been configured, but a network connection is not detected.	Verify the network connection. See Solve network printing problems . Contact the network administrator.
Non HP supply installed Economode disabled	A non-HP supply or a refilled HP supply has been installed.	Follow the instructions in the onscreen dialog box.
Novel login required	Novell authentication has been enabled for this destination.	Enter Novell network credentials to access the requested feature.
Order cartridge	The number of pages remaining for the print cartridge has reached the low threshold. The MFP was set to stop printing when a supply needs to be ordered.	Touch OK to continue printing until the print cartridge is out of toner. To order a new print cartridge, see Order parts, accessories, and supplies .
Output bin <x> full	The specified output bin is full and printing cannot continue.	Empty the bin to continue printing.
Output paper path open	The paper path between the MFP and the output device is open and must be closed before printing can continue.	<ol style="list-style-type: none"> 1. If you have a 3-bin mailbox installed, make sure the jam-access door is closed. 2. If you have a stapler/stacker installed, make sure the staple cartridge is snapped into position and that the staple-cartridge door is closed.
PAPER WRAPPED AROUND FUSER	A jam has occurred because paper has wrapped around the fuser.	Follow the instructions in the onscreen dialog box. See Clear jams .
Password or name is incorrect. Please enter correct login.	The user name or password was typed incorrectly.	Retype the user name and password.

Table 11-1 Control-panel messages (continued)

Control panel message	Description	Recommended action
PIN is incorrect. Please enter a 4-digit number.	The PIN format is incorrect.	Type the 4-digit PIN.
PIN is incorrect. Please re-enter PIN.	The PIN was typed incorrectly.	Retype the PIN.
Please turn device off and install hard disk.	The requested job requires a hard disk, but the MFP does not have a hard disk installed.	Turn the MFP off and install a hard disk. See Order parts, accessories, and supplies .
Reattach output bin	The standard output bin was detached when the MFP was turned on, or the cable on the stapler/stacker or the 3-bin mailbox is not connected to the MFP.	Turn the MFP off. If you are using the stapler/stacker or the 3-bin mailbox, make sure that the cable is connected to the MFP. Reattach the output bin, and then turn the MFP on. Observe the LED on the output device. If it is flashing or amber, see Solve general device problems .
Reinsert duplexer	The duplexer has been removed and must be reinstalled.	Reinsert the duplexer in the MFP.
Reinstall output device	The output device has been removed or is not attached.	Make sure the output bin, 3-bin mailbox, or stapler/stacker is correctly installed on the MFP.
Replace cartridge	The print cartridge has reached the end of its life. Printing cannot continue.	Replace the print cartridge. To order a new print cartridge, see Order parts, accessories, and supplies .
Replace staple cartridge	The stapler is out of staples.	Replace the staple cartridge. For information about replacing the staple cartridge see Order parts, accessories, and supplies .
SANITIZING DISK <X>% COMPLETE Do not power off	The hard disk is being cleaned.	Contact the network administrator.
SCAN FAILURE Press 'Start' to rescan	The scan was unsuccessful and the document needs to be rescanned.	If necessary, reposition the document to rescan it, and then press Start .
SMTP Gateway	The SMTP gateway has exceeded a time out value.	Verify the e-mail server address. See Solve e-mail problems . Contact the network administrator.
STAPLER LOW ON STAPLES	Fewer than 20 staples remain in the staple cartridge. Printing continues when the cartridge runs out of staples unless you have configured the device to stop when staples run out.	Replace the staple cartridge. For information about replacing the staple cartridge see Order parts, accessories, and supplies .
The Digital Sending Service at <IP Address> does not service this MFP. Contact administrator.	The MFP cannot communicate with the specified IP address.	Verify the IP address. Contact the network administrator.
The Digital Sending Service must be upgraded to support this version of the MFP firmware. Contact administrator.	The Digital Sending Service is not supported by the version of the firmware that is currently installed for the MFP.	Check the firmware version. Contact the network administrator.
The folder you have entered is not a valid folder.	The folder name was entered incorrectly, or the folder does not exist.	Re-enter the folder name correctly, or add the folder.
TOO MANY PAGES IN JOB TO STAPLE	The maximum number of sheets the stapler can staple is 30.	For print jobs that have more than 30 pages, staple them manually.
Unable to connect		To temporarily hide this message in order to fax or send to e-mail, touch Hide . If this

Table 11-1 Control-panel messages (continued)

Control panel message	Description	Recommended action
		message persists, contact an HP-authorized service or support provider. (See the HP support flyer, or go to http://www.hp.com/support/ljm4345mfp .)
UNABLE TO COPY	The MFP was unable to copy the document. If this message persists, contact an HP-authorized service or support provider. (See the HP support flyer, or go to http://www.hp.com/support/ljm4345mfp .)	To temporarily hide this message in order to fax or send to e-mail, touch IGNORE .
UNABLE TO SEND		To temporarily hide this message in order to fax or send to e-mail, touch IGNORE . If this message persists, contact an HP-authorized service or support provider. (See the HP support flyer, or go to http://www.hp.com/support/ljm4345mfp .)
Unable to send Fax. Please check fax configuration.	The MFP was unable to send the fax.	Contact the network administrator.
UNABLE TO SEND JOB		To temporarily hide this message in order to fax or send to e-mail, touch IGNORE . If this message persists, contact an HP-authorized service or support provider. (See the HP support flyer, or go to http://www.hp.com/support/ljm4345mfp .)
User name or password is incorrect. Please re-enter.	The user name or password was typed incorrectly.	Retype the user name and password.
User Name, Job Name, or PIN is missing.	One or more of the required items has not been selected or typed.	Select the correct user name and job name, and type the correct PIN.

Common causes of jams

The device is jammed.¹

Cause	Solution
The media does not meet specifications.	Use only media that meets HP specifications. See Select print media .
A component is installed incorrectly.	Verify that the print cartridge is correctly installed.
You are using media that has already passed through a device or copier.	Do not use media that has been previously printed on or copied.
An input tray is loaded incorrectly.	Remove any excess media from the input tray. Make sure that the stack is below the maximum stack height mark in the tray. See Load media .
The media is skewed.	The input-tray guides are not adjusted correctly. Adjust them so they hold the stack firmly in place without bending it.
The media is binding or sticking together.	Remove the media, flex it, rotate it 180°, or flip it over. Reload the media into the input tray.
The media is removed before it settles into the output bin.	Reset the device. Wait until the page completely settles in the output bin before removing it.
During two-sided printing, you removed the paper before the second side of the document was printed.	Reset the device and print the document again. Wait until the page completely settles in the output bin before removing it.
The media is in poor condition.	Replace the media.
The internal tray rollers are not picking up the media.	If the media is heavier than 120 g/m ² (32 lb), it might not be picked from the tray.
The media has rough or jagged edges.	Replace the media.
The media is perforated or embossed.	Perforated or embossed media does not separate easily. Feed single sheets from tray 1.
Device supply items have reached the end of their useful life.	Check the device control panel for messages prompting you to replace supplies, or print a supplies status page to verify the remaining life of the supplies. See Use information pages .
Paper was not stored correctly.	Replace the paper in the trays. Paper should be stored in the original packaging in a controlled environment.
Not all device packing material was removed.	Verify that the packing tape, cardboard, and plastic shipping locks have been removed from the device.

¹ If the device still continues to jam, contact HP Customer Support or your authorized HP service provider.

Clear jams

If a jam message appears on the control-panel display, look for jammed paper or other print media in the locations that are indicated in the following figure.

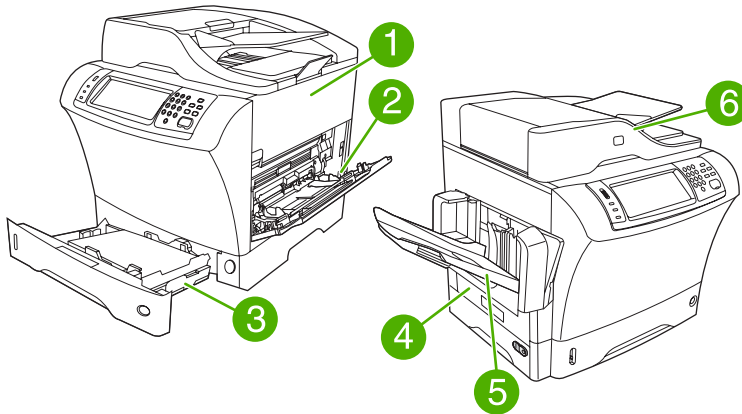

1	Top-cover and print-cartridge areas
2	Envelope-feeder area and tray1 area (the envelope feeder is optional)
3	Tray2 and optional 500-sheet feeder areas
4	Duplexing area (the duplexer is optional)
5	Output area
6	Document feeder

The following table lists the jam messages that might appear on the control-panel display. For information about clearing the jam, see the section that is indicated. You might need to look for media in locations other than those that are indicated in the jam message. If the location of the jam is not obvious, look first in the top-cover area underneath the print cartridge.

Table 11-2 Control-panel messages for jams

Jam message	Procedure for clearing the jam
JAM IN DOCUMENT FEEDER	See Clear jams from the document feeder.
ADF PAPER JAM	See Clear jams from the document feeder.
ADF PICK ERROR	See Clear jams from the document feeder.
13.JJ.NT JAM IN ENVELOPE FEEDER	See Clear jams from the optional envelope-feeder area.
13.JJ.NT JAM IN OUTPUT BIN	See Clear jams from the output areas.
13.JJ.NT JAM IN TRAY 1	See Clear jams from the tray1 area.
13.JJ.NT JAM IN TRAY 2 (or TRAY 3, 4 or 5)	See Clear jams from the tray2, 3, 4, or 5 areas.
13.JJ.NT JAM INSIDE DUPLEXER	See Clear jams from the optional duplexer.
13.JJ.NT JAM INSIDE LEFT OUTPUT AREA	See Clear jams from the output areas.

Table 11-2 Control-panel messages for jams (continued)

Jam message	Procedure for clearing the jam
13.JJ.NT JAM INSIDE RIGHT ACCESS DOOR	See Clear jams from the tray2, 3, 4, or 5 areas.
13.JJ.NT JAM INSIDE TOP COVER AREA	See Clear jams from the top-cover and print-cartridge areas.
13.JJ.NT JAM INSIDE TRAY 2 AREA	See Clear jams from the tray2, 3, 4, or 5 areas.
13.JJ.NT JAM INSIDE TRAY 2 RIGHT ACCESS DOOR	See Clear jams from the tray2, 3, 4, or 5 areas.
13.JJ.NT JAM INSIDE TOP COVER AREA	See Clear jams from the top-cover and print-cartridge areas.
13.JJ.NT PAPER JAM OPEN INPUT TRAYS	See Clear jams from the tray2, 3, 4, or 5 areas.
13.JJ.NT JAM IN STAPLER	See Clear staple jams.

When clearing jams, be very careful not to tear jammed media. If a small piece of media is left in the device, it could cause additional jams. If jams are a recurring problem, see [Solve repeated jams.](#)



NOTE Loose toner might remain in the device after a jam and cause temporary print-quality problems. These problems should clear up within a few pages.

Clear jams from the top-cover and print-cartridge areas

Clear jams that occur during the printing process by using this procedure.

1. Open the top cover and remove the print cartridge.



CAUTION To prevent damage to the print cartridge, do not expose it to light for more than a few minutes. Cover the print cartridge with a sheet of paper while it is outside of the device.

2. Use the green handle to lift the paper-access plate.

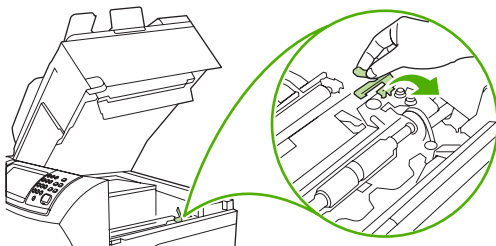

3. Slowly pull the jammed media out of the device. Do not tear the media.

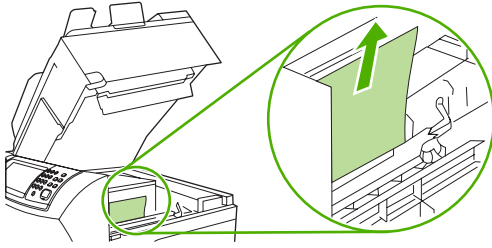

4. If jammed media is difficult to remove, open tray 1 and remove the envelope-entrance cover. If media is present, remove it.

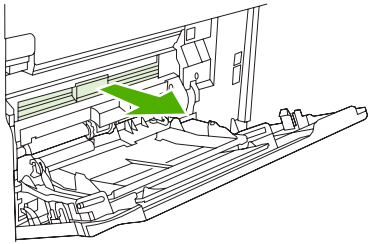

5. Rotate the paper-release guide to check for additional jammed media underneath. If jammed media is present, remove it.

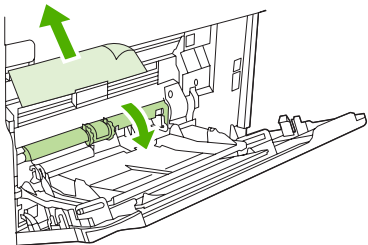

6. Replace the envelope-entrance cover and close tray1.

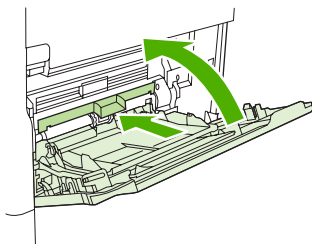

7. Reinstall the print cartridge and close the top cover.



8. If a jam message persists, jammed media is still in the device. Look for the jam in another location.

Clear jams from the optional envelope-feeder area

This section applies only to jams that occur when you are using an optional envelope feeder.

1. Remove any envelopes that are loaded in the envelope feeder. Lower the envelope weight and lift the tray extension up, to the closed position.

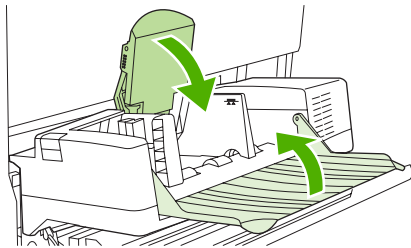

2. Press and hold the release button on the left side of the optional envelope feeder. Grasp both sides of the optional envelope feeder and carefully pull it out of the device.

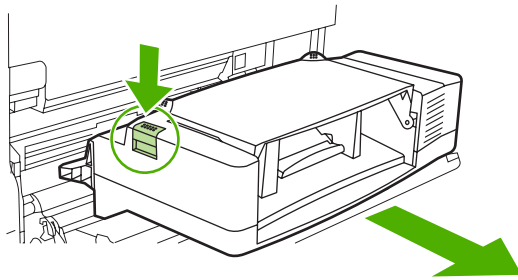

3. Slowly remove any jammed envelopes from the optional envelope feeder and from the device.

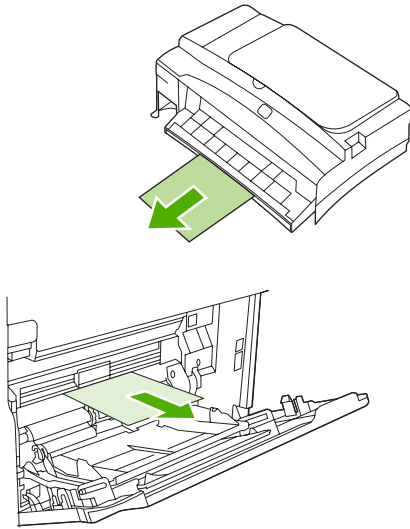

4. Insert the optional envelope feeder into the device until it locks into place. Pull gently on the optional envelope feeder to be sure that it is securely in place.

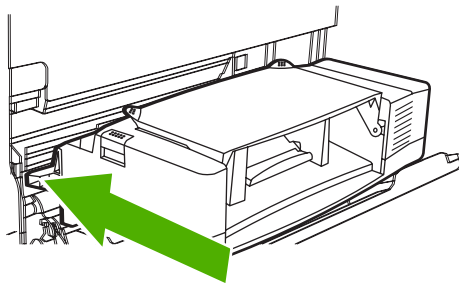

5. Fold down the envelope-feeder tray. Lift the envelope weight.

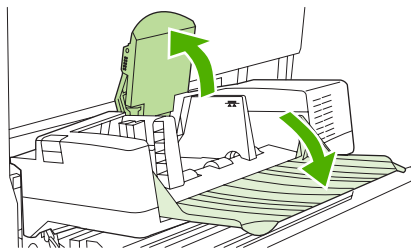

6. Reload the envelopes, making sure that you push the bottom envelopes in slightly farther than the top envelopes.
7. If a jam message persists, jammed media is still in the device. Look for the jam in another location.

Clear jams from the tray1 area

Use this procedure to clear jams that occur in the tray1 input area.

1. Open the top cover, open tray1, and remove the print cartridge.

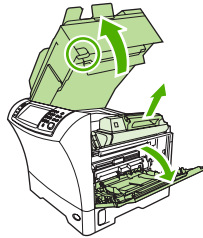

2. Use the green handle to lift the paper-access plate.

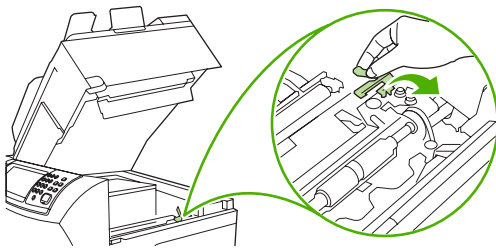

3. Slowly pull any jammed media out of the device. Do not tear the media. If part of the sheet has already been pulled into the device, follow the steps for [Clear jams from the top-cover and print-cartridge areas](#).

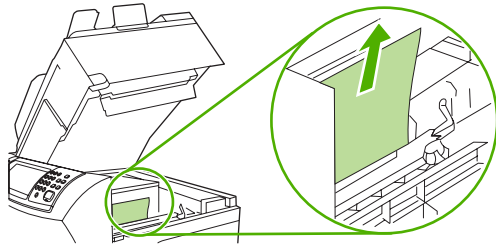

4. If jammed media is difficult to remove, remove the envelope-entrance cover. If media is present, remove it.

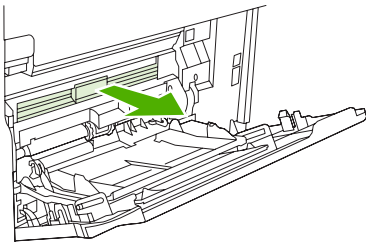

5. Rotate the paper-release guide to check for additional jammed media underneath. If jammed media is present, remove it.

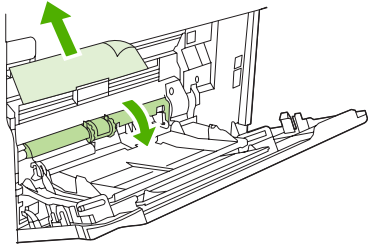

6. Replace the envelope-entrance cover and close tray1.

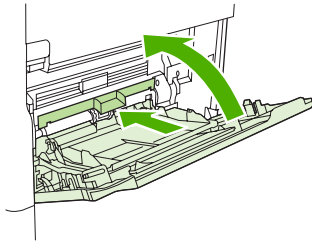

7. Reinstall the print cartridge and close the top cover.



8. If a jam message persists, jammed media is still in the device. Look for the jam in another location.

Clear jams from the tray2, 3, 4, or 5 areas

Use this procedure to clear jams that occur in tray2 or in the optional 500-sheet feeders.

1. Pull the jam-access lever to open the jam-access cover.

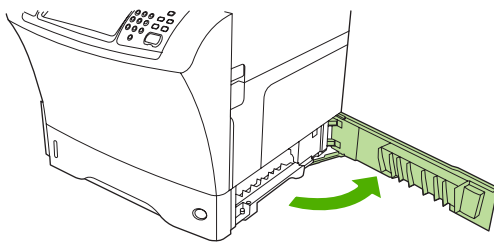

- Carefully pull out any jammed media from either the top or the bottom of the jam-access area.

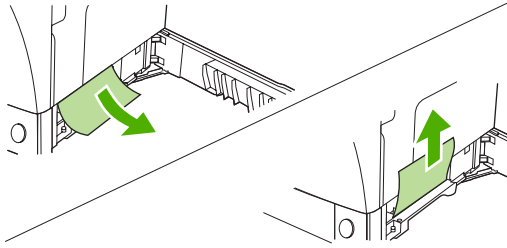

NOTE Use an upward or downward pulling motion to avoid tearing the media and to prevent toner from falling into the device.

- Close the jam-access cover.

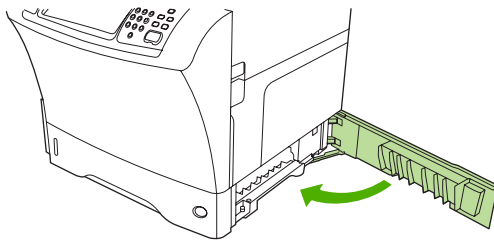

- Slide the tray completely out of the device, and remove any damaged media from the tray.

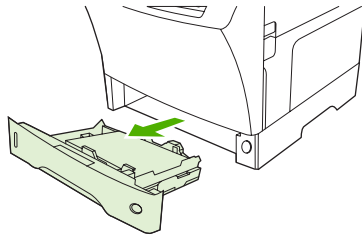

- Slide the tray into the device.

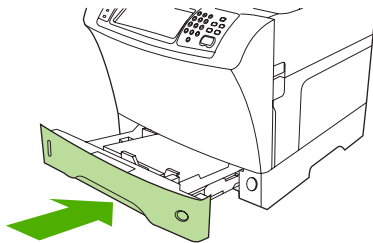

- If a jam message persists, jammed media is still in the device. Look for the jam in another location.

Clear jams from the optional duplexer

If a jam occurs during a duplex printing job, use this procedure to check for the jam and to clear it.

1. Remove the output bin (or remove the stapler/stacker or the mailbox).

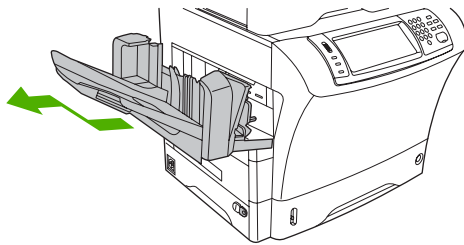

2. Remove the optional duplexer.

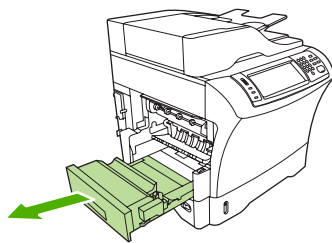

3. Check for jammed paper in the optional duplexer. Carefully pull out the jammed paper.

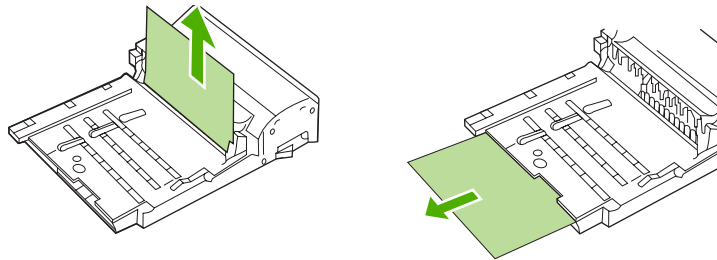

4. Set the duplexer aside.
5. Check for jammed paper inside the device. Carefully pull out the jammed paper.

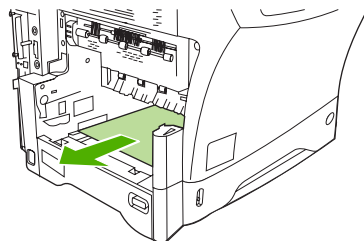

6. Reinstall the duplexer.

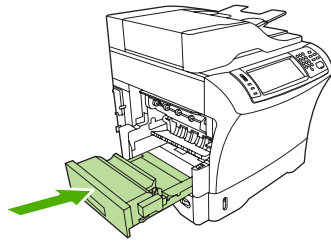

7. Reinstall the output bin (or reinstall the 3-bin mailbox or the stapler/stacker).

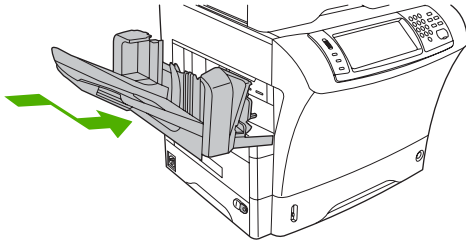

8. If a jam message persists, jammed media is still in the device. Look for the jam in another location.

Clear jams from the output areas

Use this procedure to clear jams that occur in the output bin, the 3-bin mailbox, or the stapler/stacker.

1. If you are using the standard output bin, slide the standard output bin away from the device.

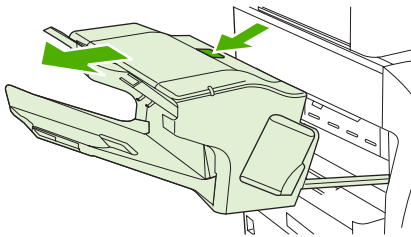

2. If you are using a 3-bin mailbox or a stapler/stacker, remove any media that is stacked, and then press and hold the release button on the top of the accessory. Slide the accessory away from the device.

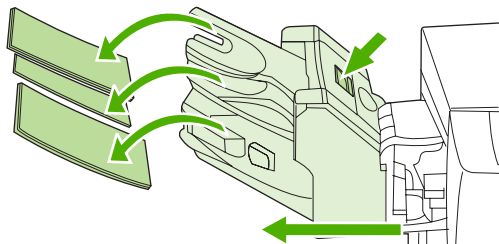

3. If the jammed media is inside the device, carefully pull the jammed media out of the device.

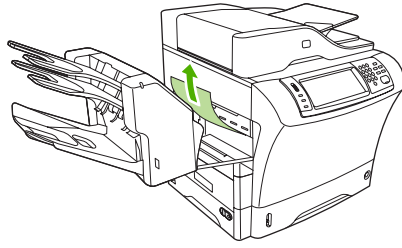

4. If the jammed media is inside the 3-bin mailbox or the stapler/stacker, carefully pull the jammed media up and out of the device.

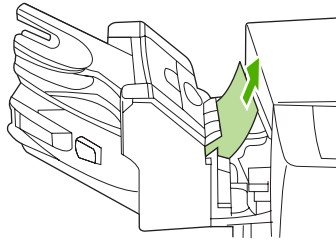

5. If you are using a 3-bin mailbox, the jammed media might be completely inside the device. Open the jam-access cover that is on the top of the 3-bin mailbox, and carefully pull the jammed media out of the mailbox.

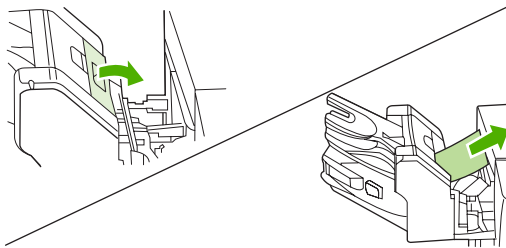

6. Reinstall the output-bin assembly, the 3-bin mailbox, or the stapler/stacker. Insert the device at an angle, and then slide it into the device.
7. If a jam message persists, jammed media is still in the device. Look for the jam in another location.

Clear jams from the fuser

Use this procedure to clear jams that occur in the fuser.

1. Turn the device off and wait 30 minutes for the fuser to cool.



WARNING! The fuser is very hot. To avoid minor burns, wait 30 minutes for the fuser to cool before removing it from the device.

2. If you are using the standard output bin, grasp the handle at the bottom of the output-bin assembly, and pull it out and then up to remove it.

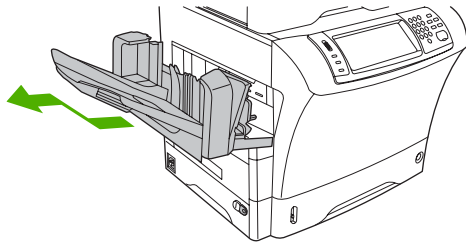

3. If you are using a 3-bin mailbox or a stapler/stacker, remove any media that is stacked, and then press and hold the release button on the top of the device. Pull the device away from the device.

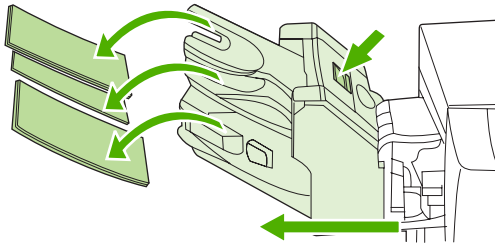

4. Remove the optional duplexer or the duplex cover.

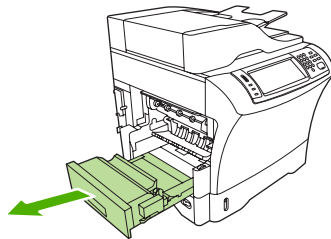

5. If you cannot see the jammed media inside the fuser, skip to step 9.
6. If you can see either the leading edge or the trailing edge of the jammed media inside the fuser, carefully pull it out.

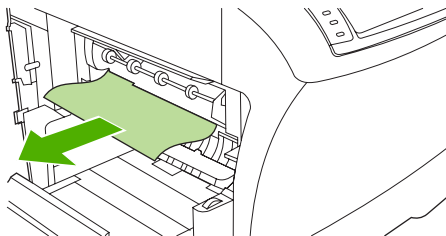

7. If you can see the jammed media, but neither the leading edge nor the trailing edge is visible, gently pull on the sides of the sheet of media until one edge becomes free. Then carefully pull the jammed media out of the fuser.

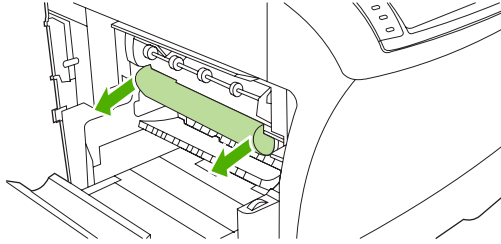

8. If the media tears as you are removing it, turn the green dial on the fuser, and then carefully pull out the jammed media. Go to step 13.

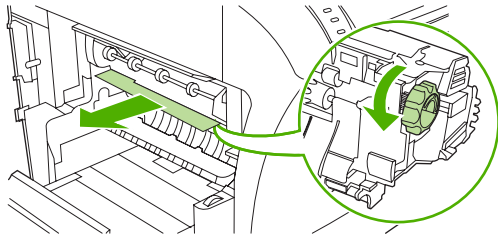

9. To remove the fuser-entrance guide, push inward at the left edge to free the left-side alignment pin. Then lift up slightly on the fuser-entrance guide, and remove it from the device. Place your forefingers on the blue levers on the bottom of each side of the fuser. Place your thumbs on the grip points on the top of each side of the fuser. Squeeze the blue levers up, and remove the fuser from the device.

10. Open the black cover at the top of the fuser, and remove the jammed media.

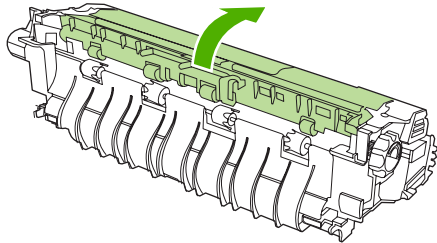

11. Reinstall the fuser. Push on the fuser with your thumbs to be sure it snaps securely into place.

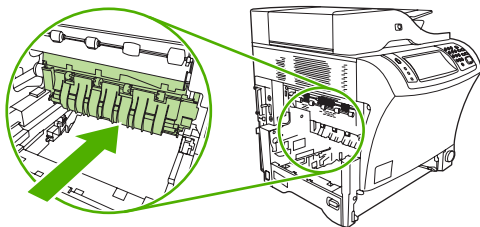

12. To reinstall the fuser-entrance guide, first insert the right-side mounting pin into the hole on the right side, and then lower the left-side mounting pin into the hole on the left side.

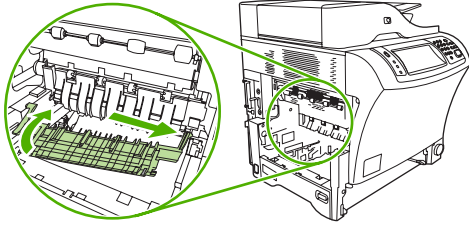

13. Reinstall the duplexer or the duplex cover.

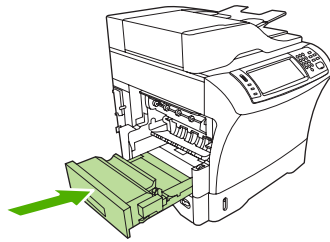

14. Reinstall the output-bin assembly, the 3-bin mailbox, or the stapler/stacker. Insert the device at an angle, and then slide it into the device.

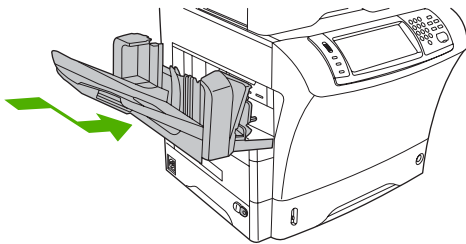

15. If a jam message persists, jammed media is still in the device. Look for the jam in another location.

Clear jams from the document feeder

Use this procedure to clear jams from the document feeder.

1. Lift the document-feeder input tray, and check for jammed media underneath the tray. Carefully remove any jammed media.

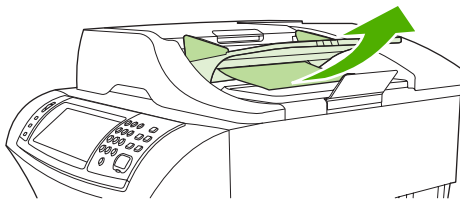

2. Pull up on the document-feeder-cover-release lever, and open the document feeder cover. Carefully remove any jammed media.

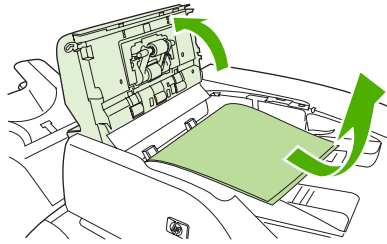

3. Lift the green jam lever on the document guide, and then check for jammed media. Carefully remove any jammed media.

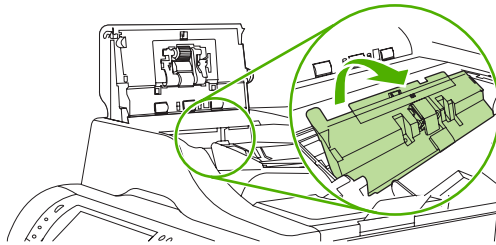

4. Close the document feeder cover.

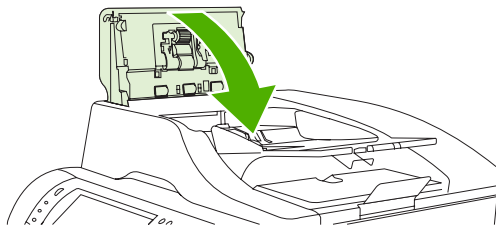

5. If a jam message persists, jammed media is still in the device. Look for the jam in another location.

Solve repeated jams

Situation	Solution
General repeated jam problems	<ol style="list-style-type: none"> 1. Make sure that the media is loaded correctly in the trays and that all width guides are set correctly (see Load media). 2. Make sure that the tray is set for the size of media that is installed and that the tray is not overloaded. 3. Try turning over the stack of media in the tray. If you are using prepunched or letterhead paper, try printing from tray1. 4. Do not use media that has been printed on previously or torn, worn, or irregular media. See Select print media. 5. Check the media specifications. (See Select print media.) If media is outside of the recommended specifications, problems can occur.

Situation	Solution
	<ol style="list-style-type: none"> 6. The device might be dirty. Clean the device as described in Clean the device. 7. Check that all damaged or jammed media is removed from device.
Repeated jams in the document feeder	<ol style="list-style-type: none"> 1. The document feeder might be dirty. Clean the document feeder as described in Clean the document feeder. 2. Make sure that the media is loaded squarely and that the media-width guides are adjusted to the sides of the media stack. 3. Make sure that no more than 50 sheets of 75g/m² (20lb) bond paper are loaded in the document feeder. 4. If the original document that is being copied has been folded or stapled, flatten it as much as you can and smooth any wrinkles. Make sure the pages are not stuck together where the staple was. 5. Media that has been pre-punched or perforated in any way might be difficult to feed through the document feeder. If the leading edge of the document is excessively worn or frayed, try rotating the document 180 degrees before copying.



NOTE If jams continue, contact your HP-authorized service provider. (See the HP support flyer or go to <http://www.hp.com/support/ljm4345mfp>.)

Paper-path test

The paper path test can be used to verify that various paper paths are working correctly or to troubleshoot problems with tray configuration.

1. Scroll to and touch [Administration](#).
2. Scroll to and touch [Troubleshooting](#).
3. Scroll to and touch [Paper Path Test](#).
4. Touch [Print Test Page](#).

Clear staple jams

The stapler is designed to be free of staple jams. To reduce the risk of staple jams, make sure that you observe the following media limits:

- Plain media: 30 sheets of 75 g/m² (20 lb) media

Glossy media: 20 sheets

Thick media (128-199 g/m² [34-53 lb]): Stack height must not exceed 3mm (0.27 inches)

Occasionally, staples become jammed in the optional stapler/stacker. If jobs are not being stapled correctly or are not being stapled at all, use the following procedure to clear staple jams.

1. Turn off the device.
2. Press and hold the release button on the top of the stapler/stacker. Pull the stapler/stacker away from the device.

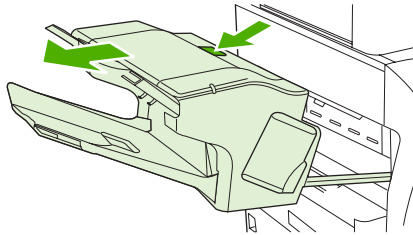

3. Open the staple-cartridge cover.

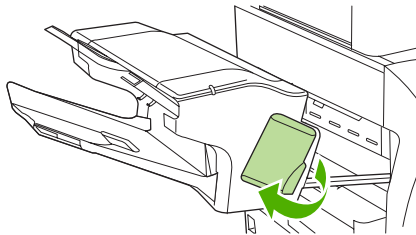

4. To remove the staple cartridge, pull up on the green handle and pull out the staple cartridge.

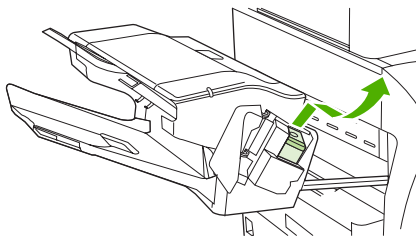

5. Lift up on the small lever at the back of the staple cartridge.

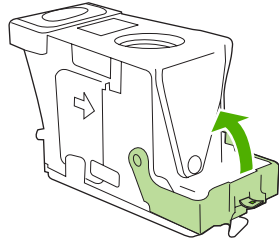

6. Remove the staples that protrude from the staple cartridge.

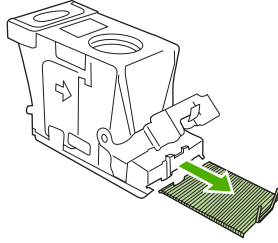

7. Close the lever at the back of the staple cartridge. Be sure that it snaps into place.

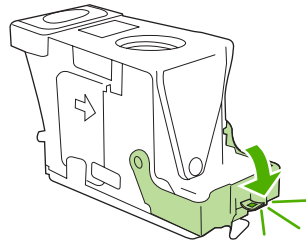

8. Reinsert the staple cartridge into the staple-cartridge holder, and push down on the green handle until it snaps into place.

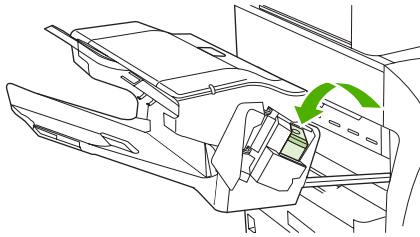

9. Close the staple-cartridge cover, and slide the stapler/stacker into the device.

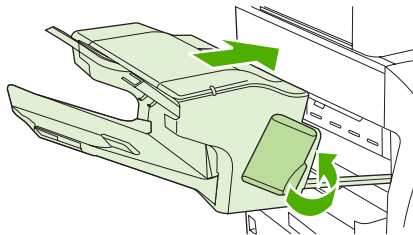

Solve print-quality problems

This section helps you define print-quality problems and what to do to correct them. Often print-quality problems can be handled easily by making sure that the device is correctly maintained, using print media that meets HP specifications, or running a cleaning page.

Print-quality problems associated with media

Some print-quality problems arise from the use of inappropriate media.

- Use media that meets HP specifications. See [Select print media](#).
- The surface of the media is too smooth. Use media that meets HP specifications. See [Select print media](#).
- The moisture content is uneven, too high, or too low. Use media from a different source or from an unopened ream.
- Some areas of the media reject toner. Use media from a different source or from an unopened ream.
- The letterhead you are using is printed on rough media. Use a smoother, xerographic media. If this solves your problem, ask the supplier of your letterhead to use media that meets the specifications for this device. See [Select print media](#).
- The media is excessively rough. Use a smoother, xerographic media.
- The driver setting is incorrect. To change the media type setting, see [Control print jobs](#).
- The media that you are using is too heavy for the media type setting that you selected, and the toner is not fusing to the media.

Print-quality problems associated with the environment

If the device is operating in excessively humid or dry conditions, verify that the printing environment is within specifications. See [Printing and paper-storage environment](#).

Print-quality problems associated with jams

Make sure that all sheets are cleared from the paper path. See [Clear jams](#).

- If the device recently jammed, print two to three pages to clean the device.
- If the sheets do not pass through the fuser and cause image defects on subsequent documents, print three pages to clean the device. If the problem persists, print and process a cleaning page. See [Clean the device](#).

Image defect examples

Use the examples in this image-defect table to determine which print-quality problem you are experiencing, and then see the corresponding reference pages to resolve the problem. These examples identify the most common print-quality problems. If you still have problems after trying the suggested remedies, contact HP Customer Support.

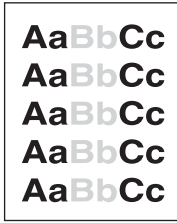

See [Light print \(partial page\)](#)



See [Light print \(entire page\)](#)

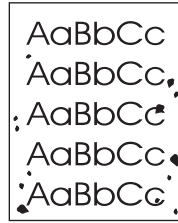

See [Specks](#)

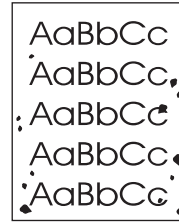

See [Specks](#)



See [Dropouts](#)

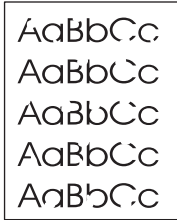

See [Dropouts](#)



See [Dropouts](#)

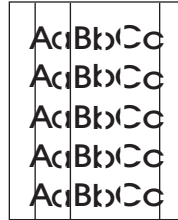

See [Lines](#)



See [Gray background](#)

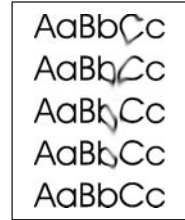

See [Toner smear](#)

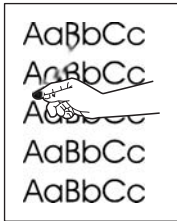

See [Loose toner](#)

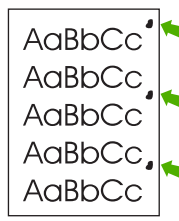

See [Repeating defects](#)

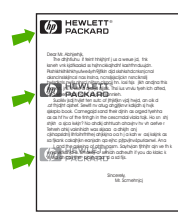

See [Repeating image](#)

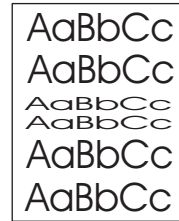

See [Misformed characters](#)

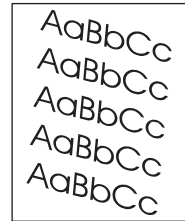

See [Page skew](#)

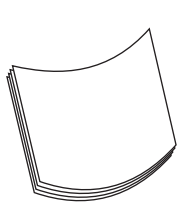

See [Curl or wave](#)

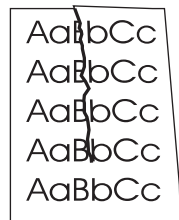

See [Wrinkles or creases](#)



See [Vertical white lines](#)



See [Tire tracks](#)

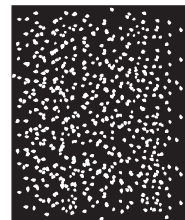

See [White spots on black](#)

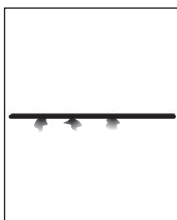

See [Scattered lines](#)

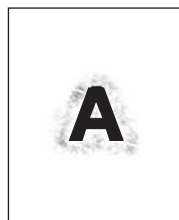

See [Blurred print](#)

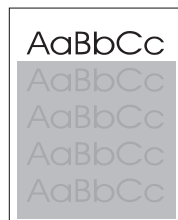

See [Random image repetition \(dark\)](#)

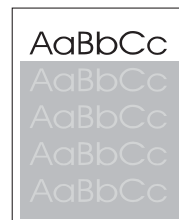

See [Random image repetition \(light\)](#)



NOTE These examples depict letter-size media that has passed through the device.

Light print (partial page)

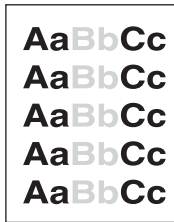

1. Make sure that the print cartridge is fully installed.
2. The toner level in the print cartridge might be low. Replace the print cartridge.
3. The media might not meet HP specifications (for example, the media is too moist or too rough). See [Select print media](#).

Light print (entire page)



1. Make sure that the print cartridge is fully installed.
2. Make sure that the Economode setting is turned off at the control panel and in the printer driver.
3. Open the [Administration](#) menu at the device control panel. Open the [Print Quality](#) menu and increase the [Toner Density](#) setting. See [Print Quality menu](#).
4. Try using a different type of media.
5. The print cartridge might be almost empty. Replace the print cartridge.

Specks

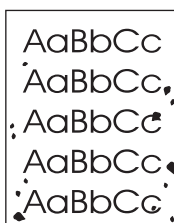

Specks might appear on a page after a jam has been cleared.

1. Print a few more pages to see if the problem corrects itself.
2. Clean the inside of the device and run a cleaning page. See [Clean the device](#).
3. Try using a different type of media.
4. Check the print cartridge for leaks. If the print cartridge is leaking, replace it.

Dropouts



1. Make sure that the environmental specifications for the device are being met. See [Printing and paper-storage environment](#).
2. If the media is rough, and the toner easily rubs off, open the [Administration](#) menu at the device control panel. Open the [Print Quality](#) menu, select [Fuser Modes](#), and then select the media type you are using. See [Print Quality menu](#).
3. Try using a smoother media.

Lines

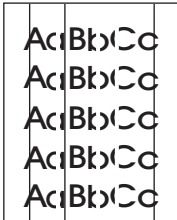

1. Print a few more pages to see if the problem corrects itself.
2. Clean the inside of the device and run a cleaning page. See [Clean the device](#).
3. Replace the print cartridge.

Gray background



1. Do not use media that has already been run through the device.
2. Try using a different type of media.
3. Print a few more pages to see if the problem corrects itself.
4. Turn over the stack in the tray. Also, try rotating the stack 180°.
5. Open the [Administration](#) menu at the device control panel. On the [Print Quality](#) menu, increase the [Toner Density](#) setting. See [Print Quality menu](#).
6. Make sure that the environmental specifications for the device are being met. See [Printing and paper-storage environment](#).
7. Replace the print cartridge.

Toner smear



1. Print a few more pages to see if the problem corrects itself.
2. Try using a different type of media.
3. Make sure that the environmental specifications for the device are being met. See [Printing and paper-storage environment](#).
4. Clean the inside of the device and run a cleaning page. See [Clean the device](#).
5. Replace the print cartridge.

Also see [Loose toner](#).

Loose toner

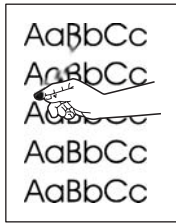

Loose toner, in this context, is defined as toner that can be rubbed off the page.

1. If media is heavy or rough, open the [Administration](#) menu at the device control panel. On the [Print Quality](#) submenu, select [Fuser Modes](#), and then select the media type you are using.
2. If you have observed a rougher texture on one side of your media, try printing on the smoother side.
3. Make sure that the environmental specifications for the device are being met. See [Printing and paper-storage environment](#).
4. Make sure that type and quality of the media you are using meet HP specifications. See [Select print media](#).

Repeating defects

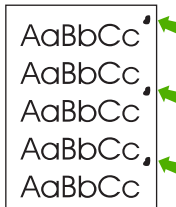

1. Print a few more pages to see if the problem corrects itself.
2. If the distance between defects is 44 mm (1.7 in), 58 mm (2.3 in), or 94 mm (3.7 in), the print cartridge might need to be replaced.
3. Clean the inside of the device and run a cleaning page. See [Clean the device](#).)

Also see [Repeating image](#).

Repeating image



This type of defect might occur when using preprinted forms or a large quantity of narrow media.

1. Print a few more pages to see if the problem corrects itself.
2. Make sure that type and quality of the media you are using meet HP specifications. See [Select print media](#).
3. If the distance between defects is 44 mm (1.7 in), 58 mm (2.3 in), or 94 mm (3.7 in), the print cartridge might need to be replaced.

Misformed characters

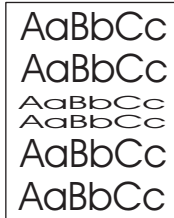

1. Print a few more pages to see if the problem corrects itself.
2. Make sure that the environmental specifications for the device are being met. See [Printing and paper-storage environment](#).

Page skew

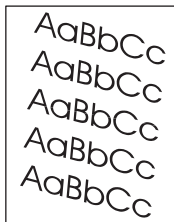

1. Print a few more pages to see if the problem corrects itself.
2. Verify that no torn pieces of media are inside the device.
3. Make sure that media is loaded correctly and that all adjustments have been made. See [Load media](#). Make sure that the guides in the tray are not too tight or too loose against the media.
4. Turn over the stack in the tray. Also, try rotating the stack 180°.
5. Make sure that the type and quality of the media you are using meet HP specifications. See [Select print media](#).
6. Make sure that the environmental specifications for the device are being met. (See [Printing and paper-storage environment](#).)
7. Perform a tray alignment by opening the [Administration](#) menu at the device control panel. On the [Print Quality](#) submenu, touch [Set Registration](#). Choose a tray under [Source](#) and then run a test page. For more information, see [Print Quality menu](#).

Curl or wave

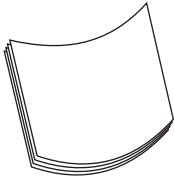

1. Turn over the stack in the tray. Also, try rotating the stack 180°.
2. Make sure that the type and quality of the media you are using meet HP specifications. (See [Select print media](#).)
3. Make sure that the environmental specifications for the device are being met. (See [Printing and paper-storage environment](#).)
4. Try printing to a different output bin.
5. If media is lightweight and smooth, open the **Administration** menu at the device control panel. On the **Print Quality** submenu, touch **Fuser Modes**, and then select the media type you are using. Change the setting to **Low**, which helps reduce the heat in the fusing process.

Wrinkles or creases

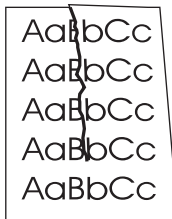

1. Print a few more pages to see if the problem corrects itself.
2. Make sure that the environmental specifications for the device are being met. See [Printing and paper-storage environment](#).
3. Turn over the stack in the tray. Also, try rotating the stack 180°.
4. Make sure that media is loaded correctly and all adjustments have been made. See [Load media](#).
5. Make sure that the type and quality of the media you are using meet HP specifications. See [Select print media](#).
6. If envelopes are creasing, try storing envelopes so that they lie flat.

If the above actions do not improve wrinkles or creases, open the **Administration** menu at the device control panel. On the **Print Quality** submenu, select **Fuser Modes**, and then select the media type you are using. Change the setting to **Low**, which helps reduce the heat in the fusing process.

Vertical white lines

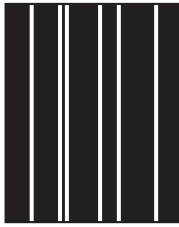

1. Print a few more pages to see if the problem corrects itself.
2. Make sure that the type and quality of the media you are using meet HP specifications. See [Select print media](#).
3. Replace the print cartridge.

Tire tracks

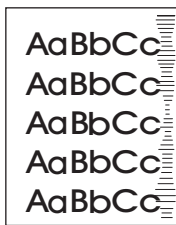

This defect typically occurs when the print cartridge has far exceeded its rated life. For example, if you are printing a very large quantity of pages with very little toner coverage.

1. Replace the print cartridge.
2. Reduce the number of pages that you print with very low toner coverage.

White spots on black

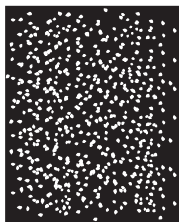

1. Print a few more pages to see if the problem corrects itself.
2. Make sure that the type and quality of the media you are using meet HP specifications. See [Select print media](#).
3. Make sure that the environmental specifications for the device are being met. See [Printing and paper-storage environment](#).
4. Replace the print cartridge.

Scattered lines

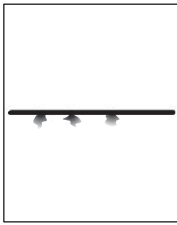

1. Make sure that the type and quality of the media you are using meet HP specifications. See [Select print media](#).
2. Make sure that the environmental specifications for the device are being met. See [Printing and paper-storage environment](#).
3. Turn over the stack in the tray. Also, try rotating the stack 180°.
4. Open the [Administration](#) menu at the device control panel. Open the [Print Quality](#) submenu and change the [Toner Density](#) setting. See [Print Quality menu](#).
5. Open the [Administration](#) menu at the device control panel. On the [Print Quality](#) submenu, open [Optimize](#) and set [Line Detail=On](#).

Blurred print

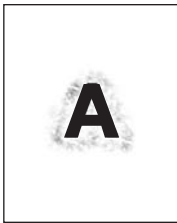

1. Make sure that the type and quality of the media you are using meet HP specifications. See [Select print media](#).
2. Make sure that the environmental specifications for the device are being met. See [Printing and paper-storage environment](#).
3. Turn over the stack in the tray. Also, try rotating the stack 180°.
4. Do not use media that already has been run through the device.
5. Decrease the toner density. Open the [Administration](#) menu at the device control panel. Open the [Print Quality](#) submenu and change the [Toner Density](#) setting. See [Print Quality menu](#).
6. Open the [Administration](#) menu at the device control panel. On the [Print Quality](#) submenu, open [Optimize](#) and set [High Transfer=On](#). See [Print Quality menu](#).

Random image repetition



If an image that appears at the top of the page (in solid black) repeats further down the page (in a gray field), the toner might not have been completely erased from the last job. (The repeated image might be lighter or darker than the field it appears in.)

- Change the tone (darkness) of the field that the repeated image appears in.
- Change the order in which the images are printed. For example, have the lighter image at the top of the page, and the darker image farther down the page.
- From your software program, rotate the whole page 180° to print the lighter image first.
- If the defect occurs later in a print job, turn the device off for 10 minutes, and then turn it on to restart the print job.

Solve network printing problems



NOTE HP recommends using the device CD to install and set up the device on a network.

- Print a configuration page (see [Use information pages](#)). If an HP Jetdirect print server is installed, printing a configuration page also prints a second page that shows the network settings and status.
- See the *HP Jetdirect Embedded Print Server Administrator's Guide* on the device CD for help and for more information about the Jetdirect configuration page. To open the guide, run the CD, click **Printer Documentation**, click **HP Jetdirect Guide**, and then click **Troubleshooting the HP Jetdirect Print Server**.
- Try printing the job from another computer.
- To verify that a device works with a computer, use a USB cable to connect it directly to a computer, and then reinstall the printing software. Print a document from a program that has printed correctly in the past. If this works, a problem with the network might exist.
- Contact a network administrator for assistance.

Solve copy problems

Prevent copy problems

The following are a few simple steps you can take to improve copy quality:

- Copy from the flatbed scanner. This will produce a higher quality copy than copying from the automatic document feeder (ADF).
- Use quality originals.
- Load the media correctly. If the media is loaded incorrectly, it might skew, causing unclear images and problems with the OCR program. See [Load media](#) for instructions.
- Use or make a carrier sheet to protect your originals.



NOTE Verify that the media meets HP specifications. If the media meets HP specifications, recurring feed problems indicate the pickup roller or separation pad is worn. Contact HP Customer Care. See [HP Customer Care](#) or the flyer that came in the device box.

Image problems

Problem	Cause	Solution
Images are missing or faded.	The print-cartridge toner-level might be low.	Replace the print cartridge. See Change the print cartridge .
	The original might be of poor quality.	If your original is too light or damaged, the copy might not be able to compensate, even if you adjust the darkness. If possible, find an original document in better condition.
	The original might have a colored background.	Touch Copy , and then touch Image Adjustment . Adjust the Background Cleanup slider to the right to decrease the background.
Vertical white or faded stripes appear on the copy.	The media might not meet HP specifications.	Use media that meets HP specifications. See Select print media .
	The print-cartridge toner-level might be low.	Replace the print cartridge. See Change the print cartridge .

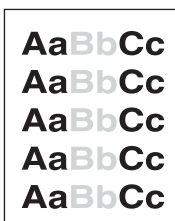

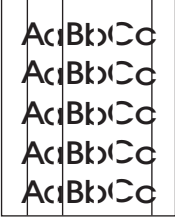
Problem	Cause	Solution
Unwanted lines appear on the copy.	Tray 1 or tray 2 might not be installed correctly.	Verify that the tray is in place.
	The flatbed scanner or the ADF glass might be dirty.	Clean the flatbed scanner or the ADF glass. See Clean the device .
	The photosensitive drum inside the print cartridge might have been scratched.	Install a new HP print cartridge. See Change the print cartridge .
Black dots or streaks appear on the copy.	Ink, glue, correction fluid, or an unwanted substance might be on the automatic document feeder (ADF) or flatbed scanner.	Clean the device. See Clean the device .
Copies are too light or dark.	The darkness setting needs to be adjusted.	Touch Copy , and then touch Image Adjustment . Adjust the Darkness slider to lighten or darken the image.
Text is unclear.	The sharpness setting needs to be adjusted. The image should be optimized for text.	To adjust the sharpness, touch Copy , and then touch Image Adjustment . Adjust the Sharpness slider to the right to increase the sharpness. To optimize the image for text, touch Copy and then touch Optimize Text/Picture . Select Text .

Media-handling problems

Problem	Cause	Solution
Poor print quality or toner adhesion	The paper is too moist, too rough, too heavy or too smooth, or it is embossed or from a faulty paper lot.	Try another kind of paper, between 100 and 250 Sheffield, 4 to 6% moisture content.
Dropouts, jamming, or curl	The paper has been stored incorrectly.	Store paper flat in its moisture-proof wrapping.
	The paper has variability from one side to the other.	Turn the paper over.
Excessive curl	The paper is too moist, has the wrong grain direction, or is of short-grain construction	Open the rear output bin, or use long-grain paper.
	The paper varies from side-to-side.	Turn the paper over.
Jamming, damage to device	The paper has cutouts or perforations.	Use paper that is free of cutouts or perforations.

Problem	Cause	Solution
Problems with feeding	The paper has ragged edges.	Use high-quality paper that is made for laser printers.
	The paper varies from side-to-side.	Turn the paper over.
	The paper is too moist, too rough, too heavy or too smooth, has the wrong grain direction, or is of short-grain construction or it is embossed or from a faulty paper lot.	<ul style="list-style-type: none"> Try another kind of paper, between 100 and 250 Sheffield, 4 to 6% moisture content. Use long-grain paper.
Print is crooked or misaligned on the page.	The media guides might be incorrectly adjusted.	Remove all media from the input tray, straighten the stack, and then load the media in the input tray again. Adjust the media guides to the width and length of the media that you are using and try printing again.
	The scanner might require a calibration.	<p>Perform a tray alignment, and then calibrate the scanner.</p> <ul style="list-style-type: none"> Perform a tray alignment by opening the Administration menu at the device control panel. On the Print Quality submenu, touch Set Registration. Choose a tray under Source and then run a test page. For more information, see Print Quality menu. See Calibrate the scanner for information about calibrating the scanner.
More than one sheet feeds at one time.	The media tray might be overloaded.	Remove some of the media from the tray. See Load media .
	The media might be wrinkled, folded, or damaged.	Verify that the media is not wrinkled, folded, or damaged. Try printing on media from a new or different package.
The device does not pull media from a media tray.	The device might be in manual feed mode.	<ul style="list-style-type: none"> If Manual Feed appears on the control-panel display, press OK to print the job. Verify that the device is not in manual feed mode, and then print your job again.
	The pickup roller might be dirty or damaged.	Contact HP Customer Care. See HP Customer Care or the support flyer that came in the device box.
	The paper-length adjustment control in the tray is set at a length that is greater than the media size.	Adjust the paper-length adjustment control to the correct length.

Performance problems

Problem	Cause	Solution
No copy came out.	The input tray might be empty.	Load media in the device. See Load media for more information.
	The original might have been loaded incorrectly.	Load the original correctly in the ADF or flatbed scanner. See Load media .
Copies are blank.	The sealing tape might not have been removed from the print cartridge.	Remove the print cartridge from the device, pull out the sealing tape, and then reinstall the print cartridge.
	The original might have been loaded incorrectly.	Load the original correctly in the ADF or flatbed scanner. See Load media .
	The media might not meet HP specifications.	Use media that meets HP specifications. See Select print media .
	The print-cartridge toner-level might be low.	Replace the print cartridge. See Change the print cartridge .
The wrong original was copied.	The ADF might be loaded.	Make sure that the ADF is empty.
Copies are reduced in size.	The device software settings might be set to reduce the scanned image.	See the device software Help for more information about changing the settings.

Solve fax problems

Solve sending problems

Faxes quit during sending.

Cause	Solution
The fax machine to which you are sending might be malfunctioning.	Call the recipient to make sure that the receiving fax machine is turned on and ready to receive faxes, or try sending to another fax machine.
Your telephone line might not be working, or the line might be experiencing interference.	Disconnect the fax cable from the telephone jack, and then connect a telephone. Make a phone call to ensure that the telephone line is working. Try using a lower baud rate by adjusting the Maximum Baud Rate setting in the Administration menu. See Initial Setup menu .

The device fax is receiving faxes but is not sending them.

Cause	Solution
If the device is on a PBX system, the PBX system might be generating a dial tone that the fax cannot detect.	Disable the detect dial tone setting. See the fax guide for information about changing the setting.
There might be a poor telephone connection.	Resend the fax later.
The fax machine to which you are sending might be malfunctioning.	Call the recipient to make sure that the receiving fax machine is turned on and ready to receive faxes, or try sending to another fax machine.
Your telephone line might not be working.	Disconnect the fax cable from the telephone jack, and then connect a telephone. Make a phone call to ensure that the telephone line is working.

Outgoing fax calls keep dialing.

Cause	Solution
The fax automatically redials a fax number if either the Redial on Busy feature or the Redial on No Answer feature is enabled.	Disable the Redial on Busy and Redial on No Answer features. See the fax guide for information about changing the settings.

Faxes you send are not arriving at the receiving fax machine.

Cause	Solution
The receiving fax machine might be turned off or might have an error condition, such as being out of paper.	Call the recipient to make sure that the fax machine is turned on and ready to receive faxes.
A fax might be stored in memory because it is waiting to redial a busy number, or there are other jobs ahead of it waiting to be sent.	If a fax job is in memory for either of these reasons, an entry for the job appears in the fax log. Print the fax activity log (see the fax guide), and check the Result column for jobs with a Pending designation.



NOTE If the fax is sending very slowly, see "Faxes are transmitting or being received very slowly" in [Initial Setup menu](#).

Solve receiving problems

Incoming fax calls are not being answered by the fax (no fax detected).

Cause	Solution
The rings-to-answer setting might not be set correctly.	Check the rings-to-answer setting. See the fax guide for information about changing the setting.
The telephone cord might not be connected properly, or the telephone cord is not working.	Check the installation. Make sure you are using the telephone cord that came with the device.
The telephone line might not be working.	Disconnect the fax cable from the telephone jack, and then connect a telephone. Make a phone call to ensure that the telephone line is working.
A voice-messaging service might be interfering with the ability to answer calls.	Do one of the following: <ul style="list-style-type: none">• Discontinue the messaging service.• Get a telephone line dedicated to fax calls.• Decrease the rings-to-answer setting for the fax to a number less than the rings-to-answer for the voice mail. See the fax guide for information about changing the setting.

Faxes are transmitting or being received very slowly.

Cause	Solution
You might be sending or receiving a very complex fax, such as one with many graphics.	Complex faxes take longer to be sent or received.
The receiving fax machine might have a slow modem speed.	The device fax only sends the fax at the fastest modem speed the receiving fax machine can use.

Faxes are transmitting or being received very slowly.

Cause	Solution
The resolution at which the fax was sent or is being received is very high. A higher resolution typically results in better quality, but also requires a longer transmission time.	If you are receiving the fax, call and ask the sender to decrease the resolution and resend the fax. If you are sending, decrease the resolution or change the Page Content mode setting. See the fax guide for information about changing the settings.
A poor telephone-line connection is forcing the device fax and the sending or receiving fax machine to slow down the transmission to adjust for errors.	Cancel and resend the fax. Have the telephone company check the telephone line.

Faxes are not printing at the device.

Cause	Solution
There is no media in the input trays.	Load media. Any faxes received while the input trays are empty are stored and will print after the trays have been refilled.
The Schedule Printing of Faxes mode is enabled. Faxes will not print until it is disabled	Disable the Schedule Printing of Faxes mode. See the fax guide for information about changing the setting.
The device toner level is low, or it has run out of toner.	Replace the print cartridge.
The device stops printing as soon as it is low on toner or runs out of toner. Any faxes received are stored in memory and are printed after the toner has been replaced.	

Solve e-mail problems

If you are unable to send e-mails by using the digital-send feature, you might need to reconfigure the SMTP gateway address or the LDAP gateway address. Print a Configuration page to find the current SMTP and LDAP gateway addresses. Use the following procedures to check if the SMTP and LDAP gateway addresses are valid.

Validate the SMTP gateway address



NOTE This procedure is for Windows operating systems.

1. Open an MS-DOS command prompt: click **Start**, click **Run**, and then type `cmd`.
2. Type `telnet` followed by the SMTP gateway address and then the number `25`, which is the port over which the MFP is communicating. For example, type `telnet 123.123.123.123 25` where "123.123.123.123" represents the SMTP gateway address.
3. Press **Enter**. If the SMTP gateway address is *not* valid, the response contains the message `Could not open connection to the host on port 25: Connect Failed`.
4. If the SMTP gateway address is not valid, contact the network administrator.

Validate the LDAP gateway address



NOTE This procedure is for Windows operating systems.

1. Open Windows Explorer. In the address bar, type `LDAP://` immediately followed by the LDAP gateway address. For example, type `LDAP://12.12.12.12` where "12.12.12.12" represents the LDAP gateway address.
2. Press **Enter**. If the LDAP gateway address is valid, the **Find People** dialog box opens.
3. If the LDAP gateway address is not valid, contact the network administrator.

Solve common Windows problems

Error message:

"General Protection FaultException OE"

"Spool32"

"Illegal Operation"

Cause	Solution
	Close all software programs, restart Windows, and try again.
	Select a different printer driver. If the device PCL 6 printer driver is selected, switch to the PCL 5 or HP postscript level 3 emulation printer driver, which can be done from a software program.
	Delete all temp files from the Temp subdirectory. Determine the name of the directory by opening the AUTOEXEC.BAT file and looking for the statement "Set Temp =". The name after this statement is the Temp directory. It is usually C:\TEMP by default, but can be redefined.
	See the Microsoft Windows documentation that came with the computer for more information about Windows error messages.

Solve common Macintosh problems

In addition to the problems that are listed in [Solve general device problems](#), this section lists problems that can occur when using Mac OS X.



NOTE Setup for USB and IP printing is performed through the **Desktop Printer Utility**. The device will *not* appear in the Chooser.

The printer driver is not listed in the Print Center or Printer Setup Utility.

Cause	Solution
The device software might not have been installed or was installed incorrectly.	Make sure that the PPD is in the following hard drive folder: <code>Library/Printers/PPDs/Contents/Resources/<lang>.lproj</code> , where “<lang>” represents the two-letter language code for the language that you are using. If necessary, reinstall the software. See the getting started guide for instructions.
The Postscript Printer Description (PPD) file is corrupt.	Delete the PPD file from the following hard drive folder: <code>Library/Printers/PPDs/Contents/Resources/<lang>.lproj</code> , where “<lang>” represents the two-letter language code for the language that you are using. Reinstall the software. See the getting started guide for instructions.

The device name, IP address, or Rendezvous host name does not appear in the printer list in the Print Center or Printer Setup Utility.

Cause	Solution
The device might not be ready.	Make sure that the cables are connected correctly, the device is on, and the Ready light is on. If you are connecting through a USB or Ethernet hub, try connecting directly to the computer, or use a different port.
The wrong connection type might be selected.	Make sure that USB, IP Printing, or Rendezvous is selected, depending on the type of connection that exists between the device and the computer.
The wrong device name, IP address, or Rendezvous host name is being used.	Check the device name, IP address, or Rendezvous host name by printing a configuration page. See Use information pages . Verify that the name, IP address, or Rendezvous host name on the configuration page matches the device name, IP address, or Rendezvous host name in the Print Center or Printer Setup Utility.
The interface cable might be defective or of poor quality.	Replace the interface cable. Make sure to use a high-quality cable.

The printer driver does not automatically set up the selected device in the Print Center or Printer Setup Utility.

Cause	Solution
The device might not be ready.	Make sure that the cables are connected correctly, the device is on, and the Ready light is on. If you are connecting through a USB or Ethernet hub, try connecting directly to the computer or use a different port.
The device software might not have been installed or was installed incorrectly.	Make sure that the PPD file is in the following hard drive folder: <code>Library/Printers/PPDs/Contents/Resources/</code>

The printer driver does not automatically set up the selected device in the Print Center or Printer Setup Utility.

Cause	Solution
	<lang>.lproj, where “<lang>” represents the two-letter language code for the language that you are using. If necessary, reinstall the software. See the getting started guide for instructions.
The PPD file is corrupt.	Delete the PPD file from the following hard drive folder: Library/Printers/PPDs/Contents/Resources/<lang>.lproj, where “<lang>” represents the two-letter language code for the language that you are using. Reinstall the software. See the getting started guide for instructions.
The device might not be ready.	Make sure that the cables are connected correctly, the device is on, and the Ready light is on. If you are connecting through a USB or Ethernet hub, try connecting directly to the computer or use a different port.
The interface cable might be defective or of poor quality.	Replace the interface cable. Make sure to use a high-quality cable.

A print job was not sent to the device that you wanted.

Cause	Solution
The print queue might be stopped.	Restart the print queue. Open Print Monitor and select Start Jobs .
The wrong device name or IP address is being used. Another device with the same or similar name, IP address, or Rendezvous host name might have received your print job.	Check the device name, IP address, or Rendezvous host name by printing a configuration page See Use information pages . Verify that the device name, IP address, or Rendezvous host name on the configuration page matches the device name, IP address, or Rendezvous host name in the Print Center or Printer Setup Utility.

An encapsulated PostScript (EPS) file does not print with the correct fonts.

Cause	Solution
This problem occurs with some programs.	<ul style="list-style-type: none">Try downloading the fonts that are contained in the EPS file to the device before printing.Send the file in ASCII format instead of binary encoding.

You are unable to print from a third-party USB card.

Cause	Solution
This error occurs when the software for USB printers is not installed.	When adding a third-party USB card, you might need the Apple USB Adapter Card Support software. The most current version of this software is available from the Apple Web site.

When connected with a USB cable, the device does not appear in the Print Center or Printer Setup Utility after the driver is selected.

Cause	Solution
This problem is caused by either a software or a hardware component.	<p data-bbox="782 304 1053 325">Software troubleshooting</p> <ul data-bbox="782 346 1449 535" style="list-style-type: none">• Check that your Macintosh supports USB.• Verify that your Macintosh operating system is Mac OS X version 10.2.8 or later.• Ensure that your Macintosh has the appropriate USB software from Apple. <p data-bbox="782 556 1053 577">Hardware troubleshooting</p> <ul data-bbox="782 598 1449 1018" style="list-style-type: none">• Check that the device is turned on.• Verify that the USB cable is connected correctly.• Check that you are using the appropriate Hi-Speed USB 2.0 cable.• Ensure that you do not have too many USB devices drawing power from the chain. Disconnect all of the devices from the chain, and connect the cable directly to the USB port on the host computer.• Check to see if more than two nonpowered USB hubs are connected in a row on the chain. Disconnect all of the devices from the chain and connect the cable directly to the USB port on the host computer. <p data-bbox="837 1039 901 1102"></p> <p data-bbox="917 1039 1449 1102">NOTE The iMac keyboard is a nonpowered USB hub.</p>

Solve Linux problems

For information about Linux problem solving, go to the HP Linux support Web site: hp.sourceforge.net/.

Solve PostScript problems

The following situations are specific to the PostScript (PS) language and might occur when several printer languages are being used. Check the control-panel display for messages that might help resolve problems.



NOTE To receive a printed or screen message when PS errors occur, open the **Print Options** dialog box and click the selection next to the PS Errors section that you want.

General problems

The job prints in Courier (the default typeface) instead of the typeface that you requested.

Cause	Solution
The requested typeface is not downloaded.	Download the font that you want and send the print job again. Verify the font type and location. Download the font to the device if applicable. See the software documentation for more information.

A legal page prints with clipped margins.

Cause	Solution
The print job was too complex.	You might need to print your job at 600 dpi, reduce the complexity of the page, or install more memory.

A PS error page prints.

Cause	Solution
The print job might not be a PS job.	Make sure that the print job is a PS job. See whether the software program expected a setup or PS header file to be sent to the device.

A Accessories and consumables

This section provides information about ordering parts, supplies, and accessories. Use only parts and accessories that are specifically designed for this printer.

- [Order parts, accessories, and supplies](#)
- [Part numbers](#)

Order parts, accessories, and supplies

Several methods are available for ordering parts, supplies, and accessories:

- [Order directly from HP](#)
- [Order through service or support providers](#)
- [Order directly through the embedded Web server \(for printers that are connected to a network\)](#)
- [Order directly through the HP Easy Printer Care software](#)

Order directly from HP

You can obtain the following items directly from HP:

- **Replacement parts:** To order replacement parts in the U.S., go to <http://www.hp.com/go/hpparts>. Outside the United States, order parts by contacting your local authorized HP service center.
- **Supplies and accessories:** To order supplies in the U.S., go to <http://www.hp.com/go/ljsupplies>. To order supplies worldwide, go to <http://www.hp.com/ghp/buyonline.html>. To order accessories, go to <http://www.hp.com/support/ljm4345mfp>.

Order through service or support providers

To order a part or accessory, contact an HP-authorized service or support provider.

Order directly through the embedded Web server (for printers that are connected to a network)

Use the following steps to order printing supplies directly through the embedded Web server.

1. In the Web browser on the computer, type the IP address or host name of the device. The status window opens.
2. In the **Other links** area, double-click **Order Supplies**. This provides a URL for a site from which you can purchase consumables.
3. Select the part numbers that you want to order, and follow the instructions on the screen.

Order directly through the HP Easy Printer Care software

HP Easy Printer Care software is a printer management tool designed to make printer configuration, monitoring, supplies ordering, troubleshooting, and updating as simple and efficient as possible. For more information about HP Easy Printer Care software, go to <http://www.hp.com/go/easyprintercare>.

Part numbers

The following list of accessories was current at the time of printing. Ordering information and availability of the accessories might change during the life of the printer.

Accessories

Item	Description	Part number
Optional 500-sheet tray and feeder unit	Optional tray to increase paper capacity. Holds Letter, A4, Legal, A5, B5 (JIS), Executive, and 8.5x13 inch paper sizes. The printer can accommodate up to three optional 500-sheet feeders.	Q5968A
Envelope feeder	Holds up to 75 envelopes.	Q2438A
Duplexer (duplex printing accessory)	Allows automatic printing on both sides of the paper.	Q5969A
3-bin mailbox	Provides three output bins that hold a total of 700 sheets.	Q5692A
500-sheet stapler/stacker	Allows for high-volume output with automatic job finishing. Staples up to 30 sheets of paper.	Q5691A
5,000-staple cartridge	Provides one staple cartridge.	C8091A
Storage cabinet	Raises the height of the MFP and provides room to store paper.	Q5970A
HPLaserJet analog fax accessory 300	Provides fax capability for the mfp. This is included with the HPLaserJet 4345x mfp, 4345xs mfp, and 4345xm mfp models.	Q3701A

Print cartridges

Item	Description	Part number
HPLaserJet print cartridge	18,000-page cartridge	Q5945A

Maintenance kits

Item	Description	Part number
Printer maintenance kit.	110-volt printer maintenance kit	Q5998A
Includes a replacement fuser, a transfer roller, a transfer-roller tool, a pickup roller, eight feed rollers, and one pair of disposable gloves. Includes instructions for installing each component.	220-volt printer maintenance kit	Q5999A
The printer maintenance kit is a consumable item, and its cost is not covered under the warranty or most extended warranty options.		
ADF maintenance kit	Contains maintenance parts for the ADF	Q5997A
Includes a roller assembly, a separation pad, and mylar shields.		
The ADF maintenance kit is a consumable item, and its cost is not covered under the warranty or most extended warranty options.		

Memory

Item	Description	Part number
100-pin DDR memory DIMM (dual inline memory module)	64MB	Q2625A
	128MB	Q2626A
Boosts the ability of the printer to handle large or complex print jobs.	256MB	Q2627A
Hard disk	Greater than 20-GB permanent storage for fonts and forms. Also used for making multiple original prints and for job-storage features.	J6054B

Cables and interfaces

Item	Description	Part number
Enhanced I/O (EIO) cards	HPJetdirect 620n Fast Ethernet (10/100Base-TX) print server	J7934A
HPJetdirect print server multi-protocol EIO network cards	HPJetdirect Connectivity card for USB, serial, and LocalTalk connections	J4135A

Print media

For more information about media supplies, go to <http://www.hp.com/go/ljsupplies>.

Item	Description	Part number
<p>HPLaserJet paper</p> <p>For use with HPLaserJet printers. Good for letterhead, high-value memos, legal documents, direct mail, and correspondence.</p> <p>Specifications: 96bright, 24lb (90g/m²).</p>	Letter (8.5x11inch), 500sheets/ream, 10-ream carton	HPJ1124/North America
	Legal (8.5x14inch), 500sheets/ream, 10-ream carton	HPJ1424/North America
	A Letter (220x280mm), 500sheets/ream, 5-ream carton	Q2398A/Asia-Pacific countries/regions
	A4 (210x297mm), 500sheets/ream, 5-ream carton	Q2400A/Asia-Pacific countries/regions
	A4 (210x297mm), 500sheets/ream	CHP310/Europe
<p>HPPrinting paper</p> <p>For use with HPLaserJet and inkjet printers. Created especially for small and home offices. Heavier and brighter than copier paper.</p> <p>Specifications: 92bright, 22lb.</p>	Letter (8.5x11inch), 500sheets/ream, 10-ream carton	HPP1122/North America and Mexico
	Letter (8.5x11inch), 500sheets/ream, 3-ream carton	HPP113R/North America
	A4 (210x297mm), 500sheets/ream, 5-ream carton	CHP210/Europe
	A4 (210x297mm), 300sheets/ream, 5-ream carton	CHP213/Europe
<p>HPMultipurpose paper</p> <p>For use with all office equipment-laser and inkjet printers, copiers, and fax machines. Created for businesses that want one paper for all their office needs. Brighter and smoother than other office papers.</p> <p>Specifications: 90bright, 20lb (75g/m²).</p>	Letter (8.5x11inch), 500sheets/ream, 10-ream carton	HPM1120/North America
	Letter (8.5x11inch), 500sheets/ream, 5-ream carton	HPM115R/North America
	Letter (8.5x11inch), 250sheets/ream, 12-ream carton	HP25011/North America
	Letter (8.5x11inch), 3-hole, 500sheets/ream, 10-ream carton	HPM113H/North America
	Letter (8.5x11inch), 3-hole, 500sheets/ream, 10-ream carton	HPM1420/North America
	Legal (8.5x14inch), 500sheets/ream, 10-ream carton	

Item	Description	Part number
<p>HPOffice paper</p> <p>For use with all office equipment-laser and inkjet printers, copiers, and fax machines. Good for high-volume printing.</p> <p>Specifications: 84bright, 20lb (75g/m²).</p>	Letter (8.5x11inch), 500sheets/ream, 10-ream carton	HPC8511/North America and Mexico
	Letter (8.5x11inch), 3-hole, 500sheets/ream, 10-ream carton	HPC3HP/North America
	Legal (8.5x14inch), 500sheets/ream, 10-ream carton	HPC8514/North America
	Letter (8.5x11inch), Quick Pack; 2,500-sheet carton	HP2500S/North America and Mexico
	Letter (8.5x11inch), Quick Pack 3-hole; 2,500-sheet carton	HP2500P/North America
	ALetter (220x280mm), 500sheets/ream, 5-ream carton	Q2408A/Asia-Pacific countries/regions
	A4 (210x297mm), 500sheets/ream, 5-ream carton	Q2407A/Asia-Pacific countries/regions
	A4 (210x297mm), 500sheets/ream, 5-ream carton	CHP110/Europe
<p>HPOffice recycled paper</p> <p>For use with all office equipment-laser and inkjet printers, copiers, and fax machines. Good for high-volume printing.</p> <p>Satisfies U.S. Executive Order13101 for environmentally preferable products.</p> <p>Specifications: 84bright, 20lb, 30% post-consumer content.</p>	Letter (8.5x11inch), 500sheets/ream, 10-ream carton	HPE1120/North America
	Letter (8.5x11inch), 3-hole, 500sheets/ream, 10-ream carton	HPE113H/North America
	Legal (8.5x14inch), 500sheets/ream, 10-ream carton	HPE1420/North America
<p>HPLaserJet transparencies</p> <p>For use only with HPLaserJet monochrome printers. For crisp, sharp text and graphics, rely on the only transparencies specifically designed and tested to work with monochrome HPLaserJet printers.</p> <p>Specifications: 4.3-mil thickness.</p>	Letter (8.5x11inch), 50sheets to a carton	92296T/North America, Asia-Pacific countries/regions, and Europe
	A4 (210x297mm), 50sheets to a carton	922296U/Asia-Pacific countries/regions and Europe

B Service and support

Hewlett-Packard limited warranty statement

HP PRODUCT

HP LaserJet M4345 Series MFP

DURATION OF LIMITED WARRANTY

One-year limited warranty

HP warrants to you, the end-user customer, that HP hardware and accessories will be free from defects in materials and workmanship after the date of purchase, for the period specified above. If HP receives notice of such defects during the warranty period, HP will, at its option, either repair or replace products which prove to be defective. Replacement products may be either new or equivalent in performance to new.

HP warrants to you that HP software will not fail to execute its programming instructions after the date of purchase, for the period specified above, due to defects in material and workmanship when properly installed and used. If HP receives notice of such defects during the warranty period, HP will replace software which does not execute its programming instructions due to such defects.

HP does not warrant that the operation of HP products will be uninterrupted or error free. If HP is unable, within a reasonable time, to repair or replace any product to a condition as warranted, you will be entitled to a refund of the purchase price upon prompt return of the product.

HP products may contain remanufactured parts equivalent to new in performance or may have been subject to incidental use.

Warranty does not apply to defects resulting from (a) improper or inadequate maintenance or calibration, (b) software, interfacing, parts or supplies not supplied by HP, (c) unauthorized modification or misuse, (d) operation outside of the published environmental specifications for the product, or (e) improper site preparation or maintenance.

TO THE EXTENT ALLOWED BY LOCAL LAW, THE ABOVE WARRANTIES ARE EXCLUSIVE AND NO OTHER WARRANTY OR CONDITION, WHETHER WRITTEN OR ORAL, IS EXPRESSED OR IMPLIED AND HP SPECIFICALLY DISCLAIMS ANY IMPLIED WARRANTIES OR CONDITIONS OF MERCHANTABILITY, SATISFACTORY QUALITY, AND FITNESS FOR A PARTICULAR PURPOSE. Some countries/regions, states or provinces do not allow limitations on the duration of an implied warranty, so the above limitation or exclusion might not apply to you. This warranty gives you specific legal rights and you might also have other rights that vary from country/region to country/region, state to state, or province to province. HP's limited warranty is valid in any country/region or locality where HP has a support presence for this product and where HP has marketed this product. The level of warranty service you receive may vary according to local standards. HP will not alter form, fit or function of the product to make it operate in a country/region for which it was never intended to function for legal or regulatory reasons.

TO THE EXTENT ALLOWED BY LOCAL LAW, THE REMEDIES IN THIS WARRANTY STATEMENT ARE YOUR SOLE AND EXCLUSIVE REMEDIES. EXCEPT AS INDICATED ABOVE, IN NO EVENT WILL HP OR ITS SUPPLIERS BE LIABLE FOR LOSS OF DATA OR FOR DIRECT, SPECIAL, INCIDENTAL,

CONSEQUENTIAL (INCLUDING LOST PROFIT OR DATA), OR OTHER DAMAGE, WHETHER BASED IN CONTRACT, TORT, OR OTHERWISE. Some countries/regions, states or provinces do not allow the exclusion or limitation of incidental or consequential damages, so the above limitation or exclusion may not apply to you.

THE WARRANTY TERMS CONTAINED IN THIS STATEMENT, EXCEPT TO THE EXTENT LAWFULLY PERMITTED, DO NOT EXCLUDE, RESTRICT OR MODIFY AND ARE IN ADDITION TO THE MANDATORY STATUTORY RIGHTS APPLICABLE TO THE SALE OF THIS PRODUCT TO YOU.

Print cartridge limited warranty statement

This HP product is warranted to be free from defects in materials and workmanship.

This warranty does not apply to products that (a) have been refilled, refurbished, remanufactured or tampered with in any way, (b) experience problems resulting from misuse, improper storage, or operation outside of the published environmental specifications for the device product or (c) exhibit wear from ordinary use.

To obtain warranty service, please return the product to place of purchase (with a written description of the problem and print samples) or contact HP customer support. At HP's option, HP will either replace products that prove to be defective or refund your purchase price.

TO THE EXTENT ALLOWED BY LOCAL LAW, THE ABOVE WARRANTY IS EXCLUSIVE AND NO OTHER WARRANTY OR CONDITION, WHETHER WRITTEN OR ORAL, IS EXPRESSED OR IMPLIED AND HP SPECIFICALLY DISCLAIMS ANY IMPLIED WARRANTIES OR CONDITIONS OF MERCHANTABILITY, SATISFACTORY QUALITY, AND FITNESS FOR A PARTICULAR PURPOSE.

TO THE EXTENT ALLOWED BY LOCAL LAW, IN NO EVENT WILL HP OR ITS SUPPLIERS BE LIABLE FOR DIRECT, SPECIAL, INCIDENTAL, CONSEQUENTIAL (INCLUDING LOST PROFIT OR DATA), OR OTHER DAMAGE, WHETHER BASED IN CONTRACT, TORT, OR OTHERWISE.

THE WARRANTY TERMS CONTAINED IN THIS STATEMENT, EXCEPT TO THE EXTENT LAWFULLY PERMITTED, DO NOT EXCLUDE, RESTRICT OR MODIFY AND ARE IN ADDITION TO THE MANDATORY STATUTORY RIGHTS APPLICABLE TO THE SALE OF THIS PRODUCT TO YOU.

Customer Self Repair Warranty Service

HP products are designed with many Customer Self Repair (CSR) parts to minimize repair time and allow for greater flexibility in performing defective parts replacement. If during the diagnosis period, HP identifies that the repair can be accomplished by the use of a CSR part, HP will ship that part directly to you for replacement. There are two categories of CSR parts: 1) Parts for which customer self repair is mandatory. If you request HP to replace these parts, you will be charged for the travel and labor costs of this service. 2) Parts for which customer self repair is optional. These parts are also designed for Customer Self Repair. If, however, you require that HP replace them for you, this may be done at no additional charge under the type of warranty service designated for your product.

Based on availability and where geography permits, CSR parts will be shipped for next business day delivery. Same-day or four-hour delivery may be offered at an additional charge where geography permits. If assistance is required, you can call the HP Technical Support Center and a technician will help you over the phone. HP specifies in the materials shipped with a replacement CSR part whether a defective part must be returned to HP. In cases where it is required to return the defective part to HP, you must ship the defective part back to HP within a defined period of time, normally five (5) business days. The defective part must be returned with the associated documentation in the provided shipping material. Failure to return the defective part may result in HP billing you for the replacement. With a customer self repair, HP will pay all shipping and part return costs and determine the courier/carrier to be used.

HP Customer Care

Online Services

For 24-hour access to updated HP device-specific software, product information, and support information through an Internet connection, go to the Web site: <http://www.hp.com/support/ljm4345mfp>.

Go to www.hp.com/support/net_printing for information about the HP Jetdirect external print server.

HP Instant Support Professional Edition (ISPE) is a suite of Web-based troubleshooting tools for desktop computing and printing products. Go to instantsupport.hp.com.

Telephone support

HP provides free telephone support during the warranty period. For the telephone number for your country/region, see the flyer that shipped with the device, or visit www.hp.com/support/. Before calling HP, have the following information ready: the product name and serial number, the date of purchase, and a description of the problem.

Software utilities, drivers, and electronic information

http://www.hp.com/go/M4345_software

The Web page for the drivers is in English, but you can download the drivers themselves in several languages.

HP direct ordering for accessories or supplies

- United States: www.hp.com/sbso/product/supplies.
- Canada: www.hp.ca/catalog/supplies
- Europe: www.hp.com/supplies
- Asia-Pacific: www.hp.com/paper/

To order genuine HP parts or accessories, go to the HP Parts Store at www.hp.com/buy/parts (U.S. and Canada only), or call 1-800-538-8787 (U.S.) or 1-800-387-3154 (Canada).

HP service information

To locate HP-Authorized Dealers, call 1-800-243-9816 (U.S.) or 1-800-387-3867 (Canada).

Outside the United States and Canada, call the customer support number for your country/region. See the flyer that shipped in the box with the device.

HP service agreements

Call 1-800-HPINVENT (1-800-474-6836 (U.S.)) or 1-800-268-1221 (Canada). Or, go to the HP SupportPack and Carepaq™ Services Web site at www.hpexpress-services.com/10467a.

For extended service, call 1-800-446-0522.

HP Easy Printer Care software

To check the device status and settings and view troubleshooting information and online documentation, use the HP Easy Printer Care software. You must have performed a full software installation in order to use the HP Easy Printer Care software. See [Open the HP Easy Printer Care software](#).

HP support and information for Macintosh computers

Go to www.hp.com/go/macosex for Macintosh OS X support information and HP subscription service for driver updates.

Go to www.hp.com/go/mac-connect for products that are designed specifically for the Macintosh user.

HP maintenance agreements

HP has several types of maintenance agreements that meet a wide range of support needs. Maintenance agreements are not part of the standard warranty. Support services may vary by area. Check with your local HP dealer to determine the services available to you.

On-site service agreements

To provide you with the level of support best suited to your needs, HP has on-site service agreements with a selection of response times.

Next-day on-site service

This agreement provides support by the next working day following a service request. Extended coverage hours and extended travel beyond HP's designated service zones are available on most on-site agreements (for additional charges).

Weekly (volume) on-site service

This agreement provides scheduled weekly on-site visits for organizations with many HP products. This agreement is designated for sites using 25 or more workstation products, including devices, plotters, computers, and disk drives.

Repacking the device

If HP Customer Care determines that your device needs to be returned to HP for repair, follow the steps below to repack the device before shipping it.



CAUTION Shipping damage as a result of inadequate packing is the customer's responsibility.

To repack the device

1. Remove and retain any DIMMs cards that you have purchased and installed in the device. Do not remove the DIMM that came with the device.



CAUTION Static electricity can damage DIMMs. When handling DIMMs, either wear an antistatic wrist strap, or frequently touch the surface of the DIMM antistatic package and then touch bare metal on the device. To remove the DIMMs, see [Adding printer memory](#).

2. Remove and retain the print cartridge.



CAUTION It is *extremely important* to remove the print cartridge before shipping the device. A print cartridge that remains in the device during shipping will leak and entirely cover the device engine and other parts with toner.

To prevent damage to the print cartridge, avoid touching the roller on it, and store the print cartridge in its original packing material or so that it is not exposed to light.

3. Remove and retain the power cable, interface cable, and optional accessories.

4. If possible, include print samples and 50 to 100 sheets of paper or other print media that did not print correctly.
5. In the U.S., call HP Customer Care to request new packing material. In other areas, use the original packing material, if possible. Hewlett-Packard recommends insuring the equipment for shipment.

Extended warranty

HP Support provides coverage for the HP hardware product and all HP-supplied internal components. The hardware maintenance covers a 1- to 3-year period from date of the HP product purchase. The customer must purchase HP Support within the stated factory warranty. For more information, contact the HP Customer Care Service and Support group.

C Specifications

- [Physical specifications](#)
- [Electrical specifications](#)
- [Acoustic specifications](#)
- [Operating environment](#)

Physical specifications

Table C-1 Product dimensions

Product	Height	Depth	Width	Weight ¹
HPLaserJet M4345 MFP	545mm (21.5inches)	483mm (19.0inches)	762mm (30.0inches)	44.1kg (97.2lb)
HPLaserJet M4345x MFP	667mm (26.3inches)	483mm (19.0inches)	762mm (30.0inches)	52.4kg (115.5lb)
HPLaserJet M4345xs MFP	111.0cm (43.7inches)	483mm (19.0inches)	914mm (36.0inches)	58.4kg (128.7lb)
HPLaserJet M4345xm MFP	111.0cm (43.7inches)	483mm (19.0inches)	914mm (36.0inches)	58.2kg (128.3lb)
Optional 500-sheet feeder	122mm (4.8inches)	483mm (19.0inches)	559mm (22.0inches)	8.3kg (18.3lb)
Optional cabinet	440mm (17.3inches)	762mm (30.0inches)	825.5mm (32.5inches)	41.8kg (92.2lb)
Optional stapler/stacker				6.0kg (13.2lb)
Optional 3-bin mailbox				5.8kg (12.8lb)
Optional Envelope feeder				2.5kg (5.5lb)
Optional duplexer				2.5kg (5.5lb)

¹ Without print cartridge

Table C-2 Product dimensions, with all doors and trays fully opened

Product	Height	Depth	Width
HPLaserJet M4345 MFP	889mm (35.0inches)	876mm (34.5inches)	142.2cm (56.0inches)
HPLaserJet M4345x MFP	101cm (39.8inches)	876mm (34.5inches)	142.2cm (56.0inches)
HPLaserJet M4345xs MFP	145cm (57.0inches)	117cm (46.0inches)	157.5cm (62.0inches)
HPLaserJet M4345xm MFP	145cm (57.0inches)	117cm (46.0inches)	157.5cm (62.0inches)

Electrical specifications



WARNING! Power requirements are based on the country/region where the printer is sold. Do not convert operating voltages. This can damage the printer and void the product warranty.

Table C-3 Power requirements for the HP LaserJet M4345 Series MFP

Specification	110-volt models	230-volt models
Power requirements	110to127volts (10%)	220to240volts (10%)
	50/60Hz (2Hz)	50/60Hz (2Hz)
Rated current	10.0Amps	4.5Amps

Table C-4 Power consumption for the HP LaserJet M4345 Series MFP (average, in watts)¹

Product model	Copying	Printing ²	Ready	Sleep	Off
HPLaserJet M4345 MFP	800W	790W ³	44W	15W	0.25W
HPLaserJet M4345x MFP	800W	790W ³	49W	15W	0.25W
HPLaserJet M4345xs MFP	800W	790W ³	49W	15W	0.25W
HPLaserJet M4345xm MFP	800W	790W ³	49W	15W	0.25W

¹ Values subject to change. See <http://www.hp.com/support/ljm4345mfp> for current information.

² Power numbers are the highest values measured using all standard voltages.

³ HPLaserJet M4345 Series MFP printing and copying speeds are 45ppm Letter size and 43ppm A4 size.

⁴ Default time from Ready mode to Sleep = 60minutes.

⁵ Recovery time from Sleep to start of printing = less than 10seconds.

⁶ Heat dissipation in Ready mode = 167BTU/hour.

Acoustic specifications

Table C-5 Sound power and pressure level for the HP LaserJet M4345 Series MFP¹

Sound power level	Declared per ISO 9296
Printing ²	$L_{WA_d} = 7.0$ Bels (A) [70dB(A)]
Copying	$L_{WA_d} = 7.2$ Bels (A) [72dB(A)]
Ready	$L_{pA_m} = 33$ dB (A)
Sound pressure level	Declared per ISO 9296
Printing ²	$L_{pA_m} = 55$ dB (A)
Copying	$L_{pA_m} = 56$ dB (A)
Ready	$L_{pA_m} = 33$ dB (A)

¹ Values subject to change. See <http://www.hp.com/support/ljm4345mfp> for current information.

² HPLaserJet M4345 Series MFP speed is 43ppm A4 size.

³ Configuration tested (HPLaserJet M4345 MFP): Base model, simplex printing with A4 paper size.

Operating environment

Table C-6 Necessary conditions

Environmental condition	Printing	Storage/standby
Temperature (printer and print cartridge)	15to32.5C (59to89F)	-20to40C (-4to104F)
Relative humidity	10%to80%	10%to90%

D Regulatory information

This section contains the following regulatory information:

- [FCC regulations](#)
- [Environmental product stewardship program](#)
- [Telecom statement](#)
- [Declaration of conformity](#)
- [Safety statements](#)

FCC regulations

This equipment has been tested and found to comply with the limits for a Class B digital device, pursuant to Part 15 of the FCC rules. These limits are designed to provide reasonable protection against harmful interference in a residential installation. This equipment generates, uses, and can radiate radio frequency energy. If this equipment is not installed and used in accordance with the instructions, it may cause harmful interference to radio communications. However, there is no guarantee that interference will not occur in a particular installation. If this equipment does cause harmful interference to radio or television reception, which can be determined by turning the equipment off and on, the user is encouraged to try to correct the interference by one or more of the following measures:

- Reorient or relocate the receiving antenna.
- Increase separation between equipment and receiver.
- Connect equipment to an outlet on a circuit different from that to which the receiver is located.
- Consult your dealer or an experienced radio/TV technician.



NOTE Any changes or modifications to the printer that are not expressly approved by HP could void the user's authority to operate this equipment.

Use of a shielded interface cable is required to comply with the Class B limits of Part 15 of FCC rules.

Environmental product stewardship program

Protecting the environment

Hewlett-Packard Company is committed to providing quality products in an environmentally sound manner. This product has been designed with several attributes to minimize impacts on our environment.

Ozone production

This product generates no appreciable ozone gas (O₃).

Power consumption

Power usage drops significantly while in Ready and Sleep modes, which saves natural resources and saves money without affecting the high performance of this product. This product qualifies for ENERGY STAR® (Version 3.0), which is a voluntary program to encourage the development of energy-efficient office products.



ENERGY STAR® and the ENERGY STAR mark are U.S. registered marks. As an ENERGY STAR partner, Hewlett-Packard Company has determined that this product meets ENERGY STAR Guidelines for energy efficiency. For more information, see www.energystar.gov.

Toner consumption

Economode uses significantly less toner, which might extend the life of the print cartridge.

Paper use

This product's manual/optional automatic duplex feature (two-sided printing, see [Use automatic duplex printing](#) (Windows) or [Use automatic duplex printing](#) (Mac)) and N-up printing (multiple pages printed on one page) capability can reduce paper usage and the resulting demands on natural resources.

Plastics

Plastic parts over 25 grams are marked according to international standards that enhance the ability to identify plastics for recycling purposes at the end of the product's life.

HP LaserJet print supplies

It's easy to return and recycle your empty HP LaserJet print cartridges—free of charge—with HP Planet Partners. HP is committed to providing inventive, high-quality products and services that are environmentally sound, from product design and manufacturing to distribution, operation and recycling processes. We ensure your returned HP LaserJet print cartridges are recycled properly, processing them to recover valuable plastics and metals for new products and diverting millions of tons of waste from landfills. Since this cartridge is being recycled and used in new materials, it will not be returned to you. Your empty HP LaserJet print cartridges are recycled responsibly when you participate in the HP Planet Partners program. Thank you for being environmentally responsible!

In many countries/regions, this product's printing supplies (for example, print cartridges) can be returned to HP through the HP Printing Supplies Returns and Recycling Program. An easy-to-use and free take back program is available in more than 35 countries/regions. Multilingual program information and instructions are included in every new HP LaserJet print cartridge and supplies package.

HP print supplies returns and recycling program information

Since 1992, HP has offered HP LaserJet supplies return and recycling free of charge. In 2004, HP Planet Partners for LaserJet Supplies was available in 85% of the world market where HP LaserJet supplies are sold. Postage-paid and pre-addressed labels are included within the instruction guide in most HP LaserJet print cartridge boxes. Labels and bulk boxes are also available through the Web site: www.hp.com/recycle.

Use the label to return empty, original HP LaserJet print cartridges only. Please do not use this label for non-HP cartridges, refilled or remanufactured cartridges, or warranty returns. Printing supplies or other objects inadvertently sent to the HP Planet Partners program cannot be returned.

More than 10 million HP LaserJet print cartridges were recycled globally in 2004 through the HP Planet Partners supplies recycling program. This record number represents 26 million pounds of print cartridge materials diverted from landfills. Worldwide, in 2004, HP recycled an average of 59% of the print cartridge by weight consisting primarily of plastic and metals. Plastics and metals are used to make new products such as HP products, plastic trays, and spools. The remaining materials are disposed of in an environmentally responsible manner.

- **U.S. returns.** For a more environmentally responsible return of used cartridges and supplies, HP encourages the use of bulk returns. Simply bundle two or more cartridges together and use the single, pre-paid, pre-addressed UPS label that is supplied in the package. For more information in the U.S., call 1-800-340-2445 or visit the HP Web site at www.hp.com/recycle.
- **Non-U.S. returns.** Non-U.S. customers should visit the www.hp.com/recycle Web site for further information regarding availability of the HP Supplies Returns and Recycling Program.

Paper

This product is capable of using recycled papers when the paper meets the guidelines outlined in the *HP LaserJet Printer Family Print Media Guide*. This product is suitable for the use of recycled paper according to EN12281:2002.

Material restrictions

This HP product contains mercury in the fluorescent lamp of the scanner and/or control panel liquid crystal display that may require special handling at end-of-life.

This HP product contains a battery that might require special handling at end-of-life. The batteries contained in or supplied by Hewlett-Packard for this product include the following:

HP LaserJet M4345 device	
Type	Carbon monofluoride lithium battery BR1632
Weight	(1.5 g)
Location	On formatter board
User-removable	No



廢電池請回收

For recycling information, you can go to www.hp.com/recycle, or contact your local authorities or the Electronics Industries Alliance: www.eiae.org.

Disposal of waste equipment by users in private households in the European Union



This symbol on the product or on its packaging indicates that this product must not be disposed of with your other household waste. Instead, it is your responsibility to dispose of your waste equipment by handing it over to a designated collection point for the recycling of waste electrical and electronic equipment. The separate collection and recycling of your waste equipment at the time of disposal will help to conserve natural resources and ensure that it is recycled in a manner that protects human health and the environment. For more information about where you can drop off your waste equipment for recycling, please contact your local city office, your household waste disposal service or the shop where you purchased the product.

Material Safety Data Sheet (MSDS)

Material Safety Data Sheets (MSDS) for supplies containing chemical substances (for example, toner) can be obtained by contacting the HP Web site at www.hp.com/go/msds or www.hp.com/hpinfo/community/environment/productinfo/safety.

For more information

To obtain information about these environmental topics:

- Product environmental profile sheet for this and many related HP products
- HP's commitment to the environment
- HP's environmental management system
- HP's end-of-life product return and recycling program
- Material Safety Data Sheets

Visit <http://www.hp.com/go/environment> or <http://www.hp.com/hpinfo/community/environment/productinfo/safety>.

Telecom statement

The HP LaserJet M4345x, HP LaserJet M4345xs, and HP LaserJet M4345xm models have the HP LaserJet Analog Fax Accessory 300 already installed to provide communication to the public switch telephone network (PSTN) for fax functionality. See the *HP LaserJet Analog Fax Accessory 300 User Guide* for all regulatory approval information and regulatory notices associated with the fax functionality and that device.

Declaration of conformity

Declaration of Conformity

according to ISO/IEC Guide 22 and EN 45014

Manufacturer's Name: Hewlett-Packard Company
Manufacturer's Address: 11311 Chinden Boulevard,
Boise, Idaho 83714-1021, USA

declares, that the product

Product Name: HP LaserJet M4345 series
Regulatory Model Number³⁾: BOISB-0407-00 and BOISB-0407-01

Product Options: Including: CB425A, CB426A, CB427A, CB428A, BOISB-030800⁴
ALL

Toner Cartridges: Q5945A

conforms to the following Product Specifications:

Safety: IEC 60950-1:2001 / EN60950-1: 2001 +A11
IEC 60825-1:1993 +A1 +A2 / EN 60825-1:1994 +A1 +A2 (Class 1 Laser/LED Product)
GB4943-2001

EMC: CISPR 22:1993 +A1 +A2 / EN 55022:1994 +A1 +A2 -- Class B¹⁾
EN 61000-3-2:2000
EN 61000-3-3:1995 +A1
EN 55024:1998 +A1 +A2
FCC Title 47 CFR, Part 15 Class B² / ICES-003, Issue 4²⁾
GB9254-1998, GB17625.1-2003

Supplementary Information:

The product herewith complies with the requirements of the EMC Directive 89/336/EEC and the Low Voltage Directive 73/23/EEC, and carries the CE-Marking accordingly.

- 1) The product was tested in a typical configuration with Hewlett-Packard Personal Computer Systems.
- 2) This Device complies with Part 15 of the FCC Rules. Operation is subject to the following two conditions: (1) this device may not cause harmful interference, and (2) this device must accept any interference received, including interference that may cause undesired operation.
- 3) For regulatory purposes, this product is assigned a Regulatory model number. This number should not be confused with the product name or the product number(s).
- 4) All worldwide modular approvals for analog fax accessory obtained by Hewlett-Packard under the regulatory model number BOISB-030800 incorporate the Multi-Tech Systems MT5634SMI Socket Modem Module.

Boise, Idaho , USA

March 29, 2006

For regulatory topics only:

Australia Contact: Product Regulations Manager, Hewlett-Packard Australia Ltd., 31-41 Joseph Street, Blackburn, Victoria 3130, Australia
European Contact: Your Local Hewlett-Packard Sales and Service Office or Hewlett-Packard GmbH, Department HQ-TRE / Standards Europe, Herrenberger Strasse 140, D-71034 Bblingen, Germany, (FAX: +49-7031-14-3143)
USA Contact: Product Regulations Manager, Hewlett-Packard Company, PO Box 15, Mail Stop 160, Boise, ID 83707-0015, USA, (Phone: 208-396-6000)

Safety statements

Laser safety

The Center for Devices and Radiological Health (CDRH) of the U.S. Food and Drug Administration has implemented regulations for laser products manufactured since August 1, 1976. Compliance is mandatory for products marketed in the United States. The device is certified as a “Class 1” laser product under the U.S. Department of Health and Human Services (DHHS) Radiation Performance Standard according to the Radiation Control for Health and Safety Act of 1968. Since radiation emitted inside the device is completely confined within protective housings and external covers, the laser beam cannot escape during any phase of normal user operation.



WARNING! Using controls, making adjustments, or performing procedures other than those specified in this user guide may result in exposure to hazardous radiation.

Canadian DOC regulations

Complies with Canadian EMC Class B requirements.

« Conforme à la classe B des normes canadiennes de compatibilité électromagnétiques. « CEM ». »

VCCI statement (Japan)

この装置は、情報処理装置等電波障害自主規制協議会（VCCI）の基準に基づくクラスB情報技術装置です。この装置は、家庭環境で使用することを目的としていますが、この装置がラジオやテレビジョン受信機に近接して使用されると、受信障害を引き起こすことがあります。
取扱説明書に従って正しい取り扱いをして下さい。

Power cord statement (Japan)

製品には、同梱された電源コードをお使い下さい。
同梱された電源コードは、他の製品では使用出来ません。

EMI statement (Korea)

B급 기기 (가정용 정보통신기기)

이 기기는 가정용으로 전자파적합등록을 한 기기로서
주거지역에서는 물론 모든지역에서 사용할 수 있습니다.

Laser statement for Finland

Luokan 1 laserlaite

Klass 1 Laser Apparat

HP LaserJet M4345, HP LaserJet M4345x, HP LaserJet M4345xs, HP LaserJet M4345xm, laserkirjoitin on käyttäjän kannalta turvallinen luokan 1 laserlaite. Normaalisissa käytössä kirjoittimen suojakotelointi estää lasersäteiden pääsyn laitteen ulkopuolelle. Laitteen turvallisuusluokka on määritetty standardin EN 60825-1 (1994) mukaisesti.

VAROITUS !

Laitteen käyttäminen muulla kuin käyttöohjeessa mainitulla tavalla saattaa altistaa käyttäjän turvallisuusluokan 1 ylittävälle näkymättömälle lasersäteilylle.

VARNING !

Om apparaten används på annat sätt än i bruksanvisning specificerats, kan användaren utsättas för osynlig laserstrålning, som överskrider gränsen för laserklass 1.

HUOLTO

HP LaserJet M4345, HP LaserJet M4345x, HP LaserJet M4345xs, HP LaserJet M4345xm - kirjoittimen sisällä ei ole käyttäjän huollettavissa olevia kohteita. Laitteen saa avata ja huoltaa ainoastaan sen huoltamiseen koulutettu henkilö. Tällaiseksi huoltotoimenpiteeksi ei katsota väriainekasetin vaihtamista, paperiradan puhdistusta tai muita käyttäjän käsikirjassa lueteltuja, käyttäjän tehtäväksi tarkoitettuja ylläpitotoimia, jotka voidaan suorittaa ilman erikoistyökaluja.

VARO !

Mikäli kirjoittimen suojakotelo avataan, olet alttiina näkymättömälle lasersäteilylle laitteen ollessa toiminnassa. Älä katso säteeseen.

VARNING !

Om laserprinterns skyddshölje öppnas då apparaten är i funktion, utsättas användaren för osynlig laserstrålning. Betrakta ej strålen. Tiedot laitteessa käytettävän laseriodin säteilyominaisuuksista: Aallonpituus 775-795 nm Teho 5 m W Luokan 3B laser.

E Working with memory and print server cards

This section explains the memory features of the printer and provides steps for expansion.

- [Overview](#)
- [Adding printer memory](#)
- [Checking DIMM installation](#)
- [Save resources \(permanent resources\)](#)
- [Enabling memory for Windows](#)
- [Using HPJetdirect print server cards](#)

Overview

Memory is upgradeable by replacing the memory DIMM. DIMMs are available in 32, 48, 64, 128, and 512 MB.

For ordering information, see [Order parts, accessories, and supplies](#)



NOTE Single inline memory modules (SIMMs) used in previous HPLaserJet printers are not compatible with the printer.

The printer also has one EIO slot for expanding the printer networking capabilities. The EIO slot can be used to upgrade the printer with an additional network connection, such as a wireless print server, network card, or a connectivity card for a serial or AppleTalk connection.



NOTE The HP LaserJet M4345 Series MFP comes with a network device already installed. The EIO slot may be used to provide networking capabilities in addition to those already built into the printer.

To find out how much memory is installed in the printer, or to find out what is installed in the EIO slots, print a configuration page. See [Use information pages](#).

Adding printer memory

You might want to add more printer memory to the printer if you often print complex graphics, print PostScript (PS) documents, or use many downloaded fonts. Added memory also gives you more flexibility in supporting job-storage features, such as quick copying.

Installing printer memory

CAUTION Static electricity can damage DIMMs. When handling DIMMs, either wear an antistatic wrist strap or frequently touch the surface of the DIMM antistatic package, then touch bare metal on the printer.

The HP LaserJet M4345 Series MFP comes with one DIMM slot. If desired, you can replace a DIMM installed in the slot with a higher memory DIMM.

If you have not already done so, print a configuration page to find out how much memory is installed in the printer before adding more memory. See [Use information pages](#).

1. After the configuration page has printed, turn the printer off and disconnect the power cord.

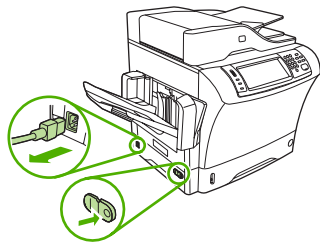

2. Disconnect all interface cables.
3. At the back of the device, remove the side cover by placing your fingers in the indented area and sliding the cover off.

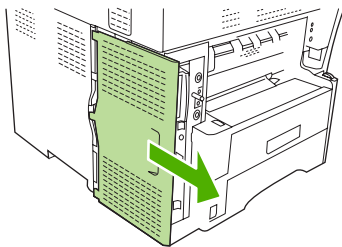

4. Open the formatter-cage door by grasping the metal tab and pulling the door open.

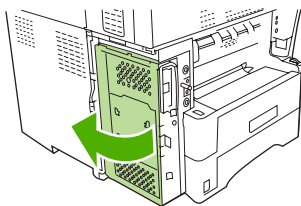

5. Remove the DIMM from the antistatic package.

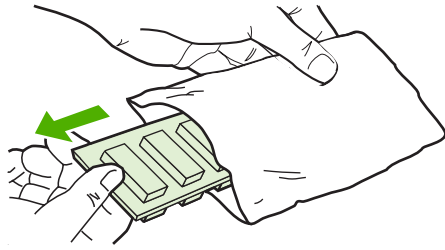

 **CAUTION** To reduce the possibility of damage caused by static electricity, always wear an electrostatic discharge (ESD) wrist strap or touch the surface of the antistatic package before handling DIMMs.

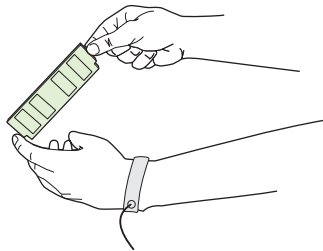

6. Hold the DIMM by the edges, and align the notches on the DIMM with the DIMM slot. (Check that the locks on each side of the DIMM slot are open.)

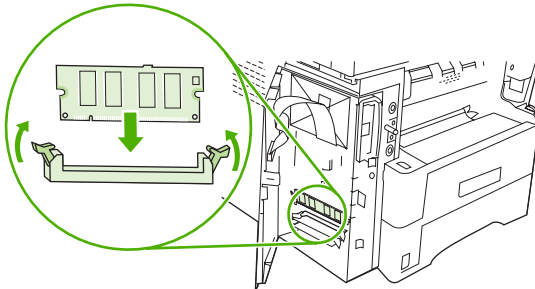

7. Press the DIMM straight into the slot, and press firmly. Make sure the locks on each side of the DIMM snap into place.

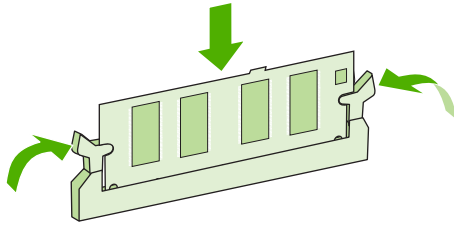

NOTE To remove a DIMM, first release the locks.

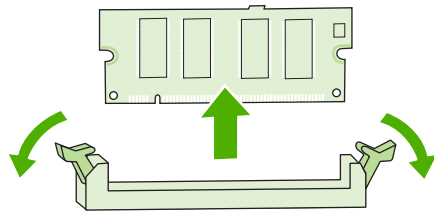

8. Close the formatter-cage door.

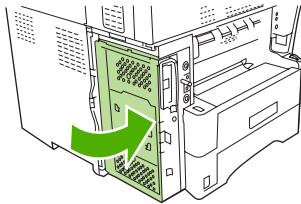

9. Replace the formatter cover.

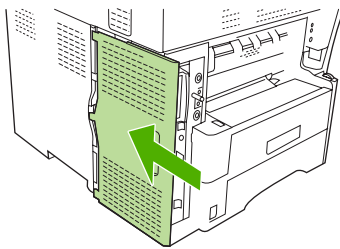

10. Reconnect the interface cable(s).
11. Reconnect the power cord, and turn the device on.

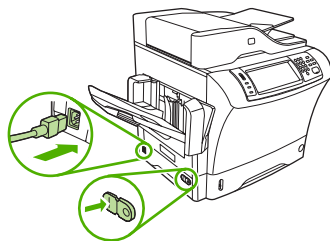

Checking DIMM installation

After installing the DIMM, make sure that the installation was successful.

To verify that the DIMM is installed correctly

1. Turn the printer on. Check that the Ready light is illuminated after the printer has gone through the startup sequence. If an error message appears, the DIMM might have been incorrectly installed. See [Use information pages](#).
2. Print a configuration page (see [Use information pages](#)).
3. Check the memory section on the configuration page and compare it to the configuration page that was printed before the memory installation. If the amount of memory has not increased, the DIMM might not be installed correctly, or the DIMM might be defective. Repeat the installation procedure. If necessary, install a different DIMM.



NOTE If you installed a printer language (personality), check the "Installed Personalities and Options" section on the configuration page. This area should list the new printer language.

Save resources (permanent resources)

Utilities or jobs that you download to the device sometimes include resources (for example, fonts, macros, or patterns). Resources that are internally marked as permanent remain in the device memory until you turn the device power off.

Use the following guidelines if you use the page description language (PDL) ability to mark resources as permanent. For technical details, see an appropriate PDL reference for PCL or PS.

- Mark resources as permanent only when it is absolutely necessary that they remain in memory while the device power is turned on.
- Send permanent resources to the device only at the beginning of a print job and not while the device is printing.



NOTE Overusing permanent resources or downloading them while the device is printing might affect device performance or the ability to print complex pages.

Enabling memory for Windows

1. On the **Start** menu, point to **Settings**, and click **Printers** or **Printers and Faxes**.
2. Select this printer and select **Properties**.
3. On the **Configure** tab, click **More**.
4. In the **Total Memory** field, type or select the total amount of memory that is now installed.
5. Click **OK**.
6. Go to [Checking DIMM installation](#).

Using HPJetdirect print server cards

Follow these procedures to install or remove an EIO card.

Install an HP Jetdirect print server card

1. Turn off the device.
2. Remove the two screws and cover plate from the EIO slot on the back of the device.

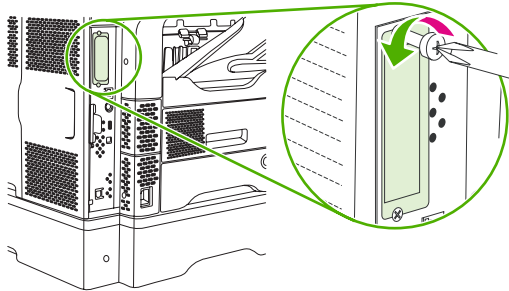

NOTE Do not discard the screws or the cover plate. Save them for future use if you remove the EIO card.

3. Install the EIO card in the EIO slot and tighten the screws.

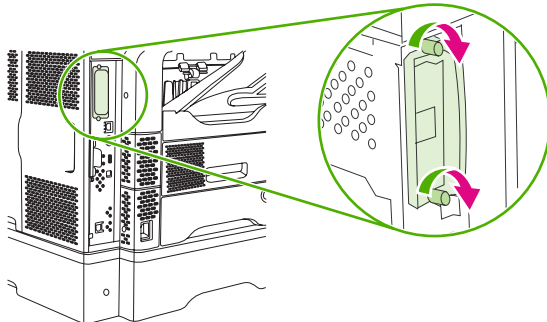

4. Connect the network cable to the EIO card.

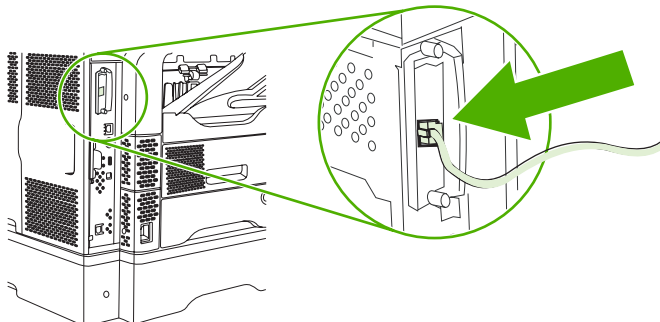

5. Turn on the device, and then print a configuration page to verify that the new EIO device is recognized. See [Use information pages](#).



NOTE When you print a configuration page, an HP Jetdirect configuration page that contains network configuration and status information also prints.

Remove an HP Jetdirect print server card

1. Turn off the device.
2. Disconnect the network cable from the EIO card.
3. Loosen the two screws from the EIO card, and then remove the EIO card from the EIO slot.
4. Place the cover plate from the EIO slot onto the back of the device. Insert and tighten the two screws.
5. Turn on the device.

Index

Symbols/Numerics

- 3-bin mailbox
 - capacity 5
 - jams, clearing 198
 - media specifications 75
 - media types supported 72
 - part number 8, 235
 - reattach error message 186
- 3-bin mailbox
 - selecting 90
- 500-sheet trays
 - adding 8
 - insert or close error message 184
 - jams, clearing 195
 - loading 79
 - locking and unlocking 9
 - media sizes supported 73
 - part numbers 8, 235
 - unexpected size or type error message 180
- 500sheet tray. *See* tray 3

A

- access denied message 178
- accessories
 - locking and unlocking 9
 - ordering 234
 - part numbers 8, 235
- acoustic specifications 249
- activity log, fax 149
- address book, e-mail
 - deleting addresses 136
- address books, e-mail
 - adding addresses 135
 - clearing 55
 - LDAP server errors 185
 - recipient lists 135
 - recipient lists, creating 135

- address books, e-mail
 - auto-complete function 134
 - LDAP support 130
- address, device
 - Macintosh, problem-solving 228
- ADF
 - capacity 4
 - maintenance kit 236
 - media specifications 76
 - sizes supported 133
- ADF output bin
 - capacity 5
 - selecting 90
- adhesive labels. *See* labels
- Administration menu, control panel 21
- Alert Settings window, HP
 - Toolbox 152
- alerts, e-mail 150, 158
- Alternative Letterhead Mode 85
- anticounterfeit supplies 160
- AppleTalk setting 62
- AppleTalk settings 35
- Attention light
 - locating 18
- authentication error messages 178
- authorized dealers 242
- autoconfiguration, drivers 11
- automatic two-sided printing path
 - copying documents 122
- AUX connection 5

B

- batteries included 255
- billing codes report, fax 149
- bins
 - capacities 5
 - full, error messages 185
 - jams, clearing 198

- reattach error message 186
 - selecting 90
- bins, output
 - paper curl, problem-solving 174
- blank copies, problem-solving 222
- blank pages
 - printing 108
 - problem-solving 175
- blocked fax list, printing 149
- blurred print, problem-solving 216
- Bonjour Settings 158
- books
 - copying 126
- both sides, copying 122
- both sides, printing on
 - error messages 178, 180, 183, 184, 186
 - loading paper 115
 - Macintosh settings 157
 - problem-solving 175
- browsers supported, HP
 - Toolbox 16
- buffer overflow errors 179
- buttons, control panel
 - locating 18
 - touchscreen 20

C

- cabinet/stand
 - locking and unlocking 9
 - part number 8, 235
- calibrating scanner 51, 166
- call report, fax 149
- Canadian DOC regulations 259
- canceling
 - copy jobs 128
 - printing 116
- canceling a print request 116

- capacity
 - 3-bin mailbox 5, 75
 - 500-sheet tray 73
 - ADF 4, 76
 - envelope feeder 74
 - output bins 5
 - stacker 75
 - stapler 75
 - stapler/stacker 5
 - tray1 72
- card stock
 - guidelines for using 69
 - output path 90
 - printing on 87
- cartridges
 - authentication 160
 - genuine HP 159
 - management menu 31
 - non-HP 160
 - ordering through embedded
 - Web server 155
 - recycling 254
 - replacing 159
 - status, viewing with HP
 - Toolbox 151
 - storage 159
 - warranty 240
- cartridges, print
 - error messages 183, 184
 - jams, clearing 190
 - part numbers 235
- cartridges, staple
 - empty, stop or continue
 - settings 96
 - jams 205
 - loading 96
 - low error message 186
 - part numbers 8, 235
- characters, misformed 213
- chosen personality not
 - available 183
- cleaning
 - about 164
 - document feeder delivery
 - system 162
 - document feeder rollers 164
 - exterior 161
 - lid backing 162
 - paper path 162
 - scanner glass 161
- clock
 - error message 178
- close door error messages 183
- coated paper 86
- collating copies 125
- configuration page
 - Information menu 22
 - Macintosh 157
 - printing 148
- connectivity features 5
- contacting HP 242
- control panel
 - access denied 178
 - Administration menu 21
 - buttons 18
 - cleaning page, printing 162
 - copy-screen 118
 - E-mail Setup menu 43
 - e-mail screen 132
 - Fax Setup menu 40
 - help 20
 - Home screen 19
 - Information menu 22
 - Initial Setup menu 32
 - jam messages 189
 - lights 18
 - Management menu 31
 - messages, alphabetical list 178
 - messages, numerical list 178
 - messages, types of 177
 - Resets menu 55
 - Send Setup menu 43
 - Service menu 56
 - settings 12
 - Time/Scheduling menu 29
 - touchscreen buttons 20
- copying
 - books 126
 - canceling 128
 - collating 125
 - control-panel navigation 118
 - error messages 187
 - features 4, 117
 - Job Mode 127
 - media, problem-solving 220
 - multiple originals 127
 - photos 126
 - problem-solving 222
 - problems, preventing 219
 - quality, problem-solving 219
 - size, problem-solving 222
 - two-sided documents 122
- counterfeit supplies 160
- Courier font, problem-solving 232
- cover pages 108, 114
- creased paper, problem-solving 214
- crooked pages 213
- curled paper, problem-solving 214, 220
- curly paper, problem-solving 174
- custom-size paper
 - 3-bin mailbox specifications 75
 - 500-sheet tray
 - specifications 73
 - driver settings 108
 - loading 78, 81
 - printing on 87
 - tray 1 specifications 72
 - tray1 specifications 72
- customer support
 - embedded Web server
 - links 155
 - HP Printer Utility pages 157
 - Linux 231
 - online 242
 - repacking device 244
- D**
- dark copying 220
- Data light
 - locating 18
- date, setting 29
- declaration of conformity 258
- default settings
 - Resets menu 55
- density
 - problem-solving 209
 - settings 157
- Device List, HP Toolbox 151
- Device Status, HP Toolbox 152
- diagnostics
 - networks 35
- digital faxing 146
- digital sending
 - about 129, 133
 - address books 135
 - configuring e-mail 130
 - control-panel settings 132

- error
 - messages 184, 185, 186, 187
- folders 138
- job settings 137
- LDAP support 130
- loading documents 133
- recipient lists 135
- sending documents 133
- Setup menu 43
- SMTP support 130
- validating gateway
 - addresses 226
- workflow 139
- DIMMs
 - error messages 181
 - installing 263
 - part numbers 236
 - verifying installation 266
- disk
 - EIO slots 262
 - installing 269
 - removing 270
- disposal, end-of-life 255
- DLC/LLC settings 35
- Document feeder
 - cleaning delivery system 162
 - error messages 184
 - jams, clearing 202
 - jams, frequent 203
- document feeder
 - copying two-sided documents 122
- dots, problem-solving 209, 215, 220
- double-sided copying 122
- double-sided printing
 - error
 - messages 178, 180, 183, 184, 186
 - loading paper 115
 - Macintosh settings 157
 - problem-solving 175
- downloading software 10
- dpi, settings 157
- drivers
 - Macintosh settings 113
 - Macintosh, problem-solving 228
 - operating systems supported 10
- preconfiguration 12
- presets (Macintosh) 113
- quick sets (Windows) 106
- Services tab 112
- settings 12, 13
- universal 11
- Update Now 12
- Windows settings 106
- dropouts, problem-solving 210
- duplex printing accessory
 - error
 - messages 178, 180, 183, 184, 186
 - jams 197
 - media specifications 74
 - media types supported 72
 - part number 8, 235
- duplexer
 - Macintosh settings 157
 - printing with 115
 - problem-solving 175
- duplexing
 - copying documents 122
- E**
- e-mail
 - about 129, 133
 - address books 135
 - configuring 130
 - error
 - messages 184, 185, 186, 187
 - LDAP errors 185
 - sending documents 133
 - e-mail alerts 150, 158
 - E-mail Setup menu 43
 - Easy Printer Care software 16
 - EIO accessory
 - settings 32
 - EIO cards
 - buffer overflow 179
 - errors 183
 - installing 269
 - part numbers 236
 - removing 270
 - slots 262
 - electrical specifications 248
 - embedded Web server 15
 - end-of-life disposal 255
 - energy specifications 248
 - enlarging documents 107
- envelope feeder
 - envelope specifications 74
 - error messages 183
 - jams, clearing 192
 - load error message 185
 - media types supported 72
 - part number 8, 235
 - specifications 83
- envelopes
 - loading 78
 - margins 68, 83
 - specifications 67, 73
 - storing 68, 77
 - wrinkled, problem-solving 214
- environment for device
 - problem-solving 207
- environment for printer
 - specifications 250
- environmental stewardship program 253
- EPS files, problem-solving 229
- Error button, control panel touchscreen 20
- error messages
 - Alert Settings, HP Toolbox 152
 - alphabetical list 178
 - e-mail alerts 150, 158
 - jams 189
 - numerical list 178
 - types of 177
- Ethernet cards 5
- Ethernet cards, part numbers 236
- European Union, waste disposal 255
- extended warranty 245
- e-mail
 - address books 135
 - auto-complete function 134
 - control-panel settings 132
 - job settings 137
 - LDAP support 130
 - loading documents 133
 - recipient lists 135
 - sending documents 133
 - SMTP support 130
 - validating gateway addresses 226
- F**
- face-down output 90

- face-up output 90
 - fax accessory
 - connecting phone line 144
 - installing 142
 - part number 8, 235
 - printing schedule 30
 - user guide 141
 - Fax Activity Log
 - clearing 55
 - fax reports, printing 22, 149
 - Fax Setup menu 40
 - faxes
 - receiving, problem-solving 224
 - sending, problem-solving 223
 - faxing, digital 146
 - feeding problems, media 221
 - file directory, printing 149
 - File Upload, Macintosh 157
 - Find Other Printers window, HP Toolbox 152
 - Finnish laser safety statement 259
 - Firmware Update, Macintosh 157
 - first page
 - blank 108
 - use different paper 108, 114
 - folders
 - error messages 184
 - sending to 138
 - fonts
 - EPS files, problem-solving 229
 - included 3
 - list, printing 22, 149
 - permanent resources 267
 - problem-solving 232
 - Upload Macintosh 157
 - Foreign Interface Harness (FIH) 5
 - fraud hotline 160
 - FTP, sending to 139
 - fuser
 - error messages 180
 - jams, clearing 199
 - paper wrapping errors 185
 - warranty 240
 - fuser modes 70
- G**
- gateways
 - configuring 130
 - error messages 184
 - finding 131
 - testing 131
 - validating addresses 226
 - General Protection FaultException OE 227
 - glass
 - cleaning 161
 - sizes supported 133
 - graphical display, control panel 18
 - gray background, problem-solving 211
- H**
- hard disk
 - part number 236
 - heavy media, guidelines for using 69
 - heavy paper
 - output path 90
 - printing on 87
 - held jobs 98
 - Help button, control panel touchscreen 20
 - help, control panel 20
 - Home button, control panel touchscreen 20
 - Home screen, control panel 19
 - HP Customer Care 242
 - HP Driver Preconfiguration 12
 - HP Easy Printer Care
 - software 16
 - HP fraud hotline 160
 - HP Instant Support Professional Edition (ISPE) 242
 - HP Jetdirect print server
 - configuring 62
 - error messages 183
 - installing 269
 - part numbers 236
 - removing 270
 - settings 32
 - HP media, ordering 236
 - HP Printer Utility 157
 - HP Printer Utility, Macintosh 14
 - HP SupportPack 245
 - HP Toolbox
 - browsers supported 16
 - opening 151
 - options 151
 - HP Universal Print Driver 11
 - HP Web Jetadmin 15, 156
 - HP-Authorized Dealers 242
 - humidity
 - problem-solving 207
 - specifications 250
- I**
- I/O configuration
 - network configuration 59
 - settings 32
 - Illegal Operation errors 227
 - image defects, problem-solving 207
 - image quality
 - copy, improving 219
 - copy, problem-solving 219
 - print, problem-solving 207
 - image reptition, problem-solving 217
 - Information menu 22
 - information pages 148
 - Information tab, embedded Web server 153
 - Initial Setup menu 32
 - input trays. *See* trays
 - insert tray error messages 184
 - install cartridge error message 184
 - installers, Windows 16
 - installing
 - EIO cards 269
 - fax accessory 142
 - memory (DIMMs) 263
 - Instant Support Professional Edition (ISPE) 242
 - insufficient memory 179, 184
 - interface ports
 - included 5
 - internal clock errors 178
 - Internet fax 146
 - IP address
 - Macintosh, problem-solving 228
 - IPX/SPX setting 35, 61
- J**
- jams
 - 3-bin mailbox 198
 - 500-sheet trays 195
 - common causes of 188
 - control-panel messages 189
 - Document feeder 202

- duplex printing accessory 197
- e-mail alerts 150
- envelope feeder 192
- frequent, troubleshooting 203
- fuser 199
- locations 189
- output bin 198
- print quality after 207
- print-cartridge area 190
- print-quality problems 190
- staple 205
- stapler/stacker 198
- top-cover 190
- tray 1 194
- Japanese VCCI statement 259
- Jetadmin, HP Web 15, 156
- Jetdirect print server
 - configuring 62
 - error messages 183
 - installing 269
 - part numbers 236
 - removing 270
 - settings 32
- Job Mode, copying 127
- job storage
 - accessing 98
 - features 98
 - private 100
 - proof and hold 98
 - QuickCopy 101
 - settings 31
 - stored 102
- jobs
 - Macintosh settings 157
- K**
- keys, control panel
 - locating 18
 - touchscreen 20
- kits, maintenance
 - part number 236
- Korean EMI statement 259
- L**
- labels
 - loading 78
 - printing 84
 - specifications 68
- LAN fax 146
- LAN-connector 5
- languages, printer 3
- laser safety statements 259
- LDAP servers
 - connecting to 130
 - error messages 185
 - validating gateway addresses 226
- legal paper
 - clipped margins 232
- letterhead
 - guidelines for using 70
 - printing on 85
- lid, cleaning 162
- light copying 220
- light print
 - problem-solving 209
- lights
 - control panel 18
- lines, problem-solving
 - copies 220
- link speed settings 38
- Linux drivers 10, 231
- loading
 - 500-sheet trays 79
 - coated paper 86
 - custom-size paper 88
 - documents, sizes supported 133
 - error messages 185
 - labels 84
 - preprinted paper 85
 - scanner glass 133
 - sizes supported 133
 - staples 96
 - transparencies 85
 - tray 1 78
 - unexpected size or type error message 180
- Lock Resources, Macintosh 157
- locking
 - accessories 9
- loose toner, problem-solving 212
- loose toner, troubleshooting 190
- low on staples 186
- M**
- Macintosh
 - AppleTalk settings 35
 - driver settings 13, 113
 - drivers supported 10
 - drivers, problem-solving 228
 - HP Printer Utility 157
 - problems, solving 228
 - removing software 14
 - software 14
 - software components 16
 - support 243
 - supported operating systems 10
 - USB card, problem-solving 229
- mailbox, 3-bin
 - capacity 5
 - jams, clearing 198
 - media specifications 75
 - media types supported 72
 - part number 235
 - part numbers 8
 - reattach error message 186
- mailbox, 3-bin
 - selecting 90
- maintenance agreements 244
- maintenance kit
 - part number 236
- Management menu 31
- margins
 - legal paper, problem-solving 232
- margins, envelopes 68, 83
- material restrictions 255
- Material Safety Data Sheet (MSDS) 256
- media
 - 3-bin mailbox specifications 75
 - 500-sheet tray
 - specifications 73
 - ADF specifications 76
 - card stock 69
 - curled 174, 214, 220
 - custom-size 108
 - custom-size, printing 87
 - document size, selecting 107
 - duplexer specifications 74
 - envelope feeder
 - specifications 74
 - first page 108, 114
 - fuser modes 70
 - heavy 69
 - HP, ordering 236
 - legal, clipped margins 232
 - letterhead 70

- loading 78
- pages per sheet 109, 114
- preprinted 85
- preprinted forms 70
- prepunched 85
- problem-solving 207, 220
- problem-solving trays 174
- skewed 213
- small 88
- specifications 64, 66
- stacker specifications 75
- stapler specifications 75
- stapling 94
- storing 77
- tray 1 specifications 72
- types supported 72
- wrinkled 214
- memory
 - autoconfiguration 11
 - DIMM error messages 181
 - included 14
 - installing DIMMs 263
 - insufficient 179, 184
 - part numbers 236
 - permanent resources 267
 - permanent storage error messages 182
 - supply errors 178
 - verifying installation 266
- Menu button 18
- menu map
 - Information menu 22
 - printing 148
- menus, control panel
 - access denied 178
 - Administration 21
 - E-mail Setup 43
 - Fax Setup 40
 - Information 22
 - Initial Setup 32
 - Management 31
 - Resets 55
 - Send Setup 43
 - Service 56
 - Time/Scheduling 29
- mercury-free product 255
- messages
 - Alert Settings, HP Toolbox 152
 - alphabetical list 178
 - e-mail alerts 150, 158
 - jams 189
 - numerical list 178
 - types of 177
- misformed characters, problem-solving 213
- multifeeds 221
- multiple pages per sheet 109, 114
- multipurpose tray. *See* tray 1
- N**
 - n-up printing 109, 114
 - narrow paper, printing on 88
 - Network Folder, scan to 138
 - Networking tab, embedded Web server 155
 - networks
 - AppleTalk settings 35
 - configuring 59
 - configuring gateway addresses 130
 - connectivity features 5
 - default gateway 60
 - diagnostics 35
 - disabling DLC/LLC 62
 - disabling protocols 61
 - DLC/LLC settings 35
 - finding SMTP gateways 131
 - HP Jetdirect print server error messages 183
 - HP Web Jetadmin 156
 - IP address 59
 - IPX/SPX settings 35
 - link speed settings 38
 - Macintosh settings 158
 - problem-solving printing 218
 - protocol configuration page, printing 39
 - security 35
 - SMTP servers 130
 - subnet mask 60
 - TCP/IP parameters 59
 - TCP/IP settings 32
 - testing SMTP settings 131
 - validating gateway addresses 226
 - next-day on-site service 244
 - noise specifications 249
 - non-HP supplies 160
 - not responding, problem-solving 176
- Novell login required 185
- NVRAM errors 182
- O**
 - on-site service agreements 244
 - online help, control panel 20
 - online support 242
 - operating environment specifications 250
 - operating systems supported 10
 - order, page 90
 - ordering
 - media, HP 236
 - part numbers for 235
 - supplies and accessories 234
 - supplies through embedded Web server 155
 - supplies with HP Toolbox 151
 - output bins
 - capacities 5
 - full, error messages 185
 - jams, clearing 198
 - reattach error message 186
 - selecting 90
 - output path open error message 185
 - output quality
 - after jams 190
 - copy, improving 219
 - copy, problem-solving 219
 - print, problem-solving 207
- P**
 - packaging device 244
 - pages per sheet 109, 114
 - paper
 - 3-bin mailbox specifications 75
 - 500-sheet tray specifications 73
 - ADF specifications 76
 - coated 86
 - curled 174, 214, 220
 - custom-size 108
 - custom-size, printing 87
 - document size, selecting 107
 - duplexer specifications 74
 - first page 108, 114
 - fuser modes 70
 - HP, ordering 236
 - legal, clipped margins 232

- loading 78
- pages per sheet 109, 114
- preprinted 85
- prepunched 85
- problem-solving 207, 220
- problem-solving trays 174
- skewed 213
- small 88
- specifications 64, 66
- stacker specifications 75
- stapler specifications 75
- stapling 94
- storing 77
- tray 1 specifications 72
- types supported 72
- wrinkled 214
- paper path
 - cleaning 162
 - testing 204
- parallel port
 - features 5
- part numbers
 - cables 236
 - EIO cards 236
 - maintenance kit 236
 - media, HP 236
 - memory 236
 - print cartridges 235
 - trays 235
- pausing a print request 116
- PCL drivers
 - operating systems supported 10
 - universal 11
- permanent resources 267
- permanent storage errors 182
- phone line, connecting fax
 - accessory 144
- photos
 - copying 126
 - loading 133
- PINs, private jobs 100
- ports
 - included 5
 - problem-solving Macintosh 229
- postcards 87
- PostScript
 - problem-solving 232
 - PostScript Printer Description (PPD) files
 - included 14
 - power
 - specifications 248
 - PPDs
 - included 14
 - preconfiguration, driver 12
 - preprinted forms
 - guidelines for using 70
 - preprinted paper
 - printing on 85
 - prepunched paper
 - printing on 85
 - presets (Macintosh) 113
 - print cartridges
 - authentication 160
 - error messages 183, 184
 - genuine HP 159
 - jams, clearing 190
 - management menu 31
 - non-HP 160
 - ordering through embedded
 - Web server 155
 - part numbers 235
 - recycling 254
 - replacing 159
 - status, viewing with HP
 - Toolbox 151
 - storage 159
 - warranty 240
 - Print Document On 107
 - print quality
 - after jams 190
 - blurred 216
 - dropouts 210
 - environment 207
 - gray background 211
 - image defects 207
 - jams, after 207
 - light print 209
 - lines 210
 - loose toner 212
 - media 207
 - misformed characters 213
 - problem-solving 207
 - repeating defects 212
 - repetitive images 217
 - scattered lines 216
 - smearred toner 211
 - specks 209
 - tire tracks 215
 - white lines 215
 - white spots 215
 - printer drivers. See drivers
 - printer languages 3
 - printer maintenance kit
 - part number 236
 - printing
 - output bin, selecting 90
 - printing system software 10
 - priority, settings 12
 - private jobs 100
 - problem-solving
 - blank pages 175
 - blurred print 216
 - copy quality 219
 - copy size 222
 - copying 219, 222
 - curled paper 174, 214
 - dropouts 210
 - duplexing 175
 - e-mail alerts 150, 158
 - environment 207
 - EPS files 229
 - Error button, control panel
 - touchscreen 20
 - fonts 232
 - gateway addresses 226
 - gray background 211
 - image defects 207
 - legal paper 232
 - light print 209
 - lines 210, 215
 - lines, copies 220
 - Linux 231
 - Macintosh issues 228
 - media 207, 220
 - messages, types of 177
 - network printing 218
 - networks 35
 - output quality 207
 - PostScript problems 232
 - printing 176
 - receiving faxes 224
 - repeating defects 212
 - repetitive images 217
 - scattered lines 216
 - sending faxes 223
 - skewed pages 213

- slow printing 175
 - smear toner 211
 - specks 209
 - text 175
 - text quality 213, 216
 - tire tracks 215
 - trays 174
 - white spots 215
 - Windows issues 227
 - wrinkled paper 214
 - proof and hold jobs 98
 - protocol configuration page, printing 39
 - punched paper printing on 85
- Q**
- quality
 - after jams 190
 - copy, improving 219
 - copy, problem-solving 219
 - print, problem-solving 207
 - quick sets 106
- R**
- Ready light
 - locating 18
 - reattach output bin error message 186
 - receiving faxes
 - problem-solving 224
 - recipient lists 135
 - recycling 254
 - reducing documents 107
 - removing Macintosh software 14
 - repacking device 244
 - repeating defects, problem-solving 212, 217
 - replacing
 - staple cartridges 96
 - replacing printing cartridges 159
 - reset button 18
 - Resets menu, control panel 55
 - resizing documents 107
 - resolution
 - problem-solving quality 207
 - settings 157
 - Resolution Enhancement technology (REt) 157
 - resource saving 267
 - REt (Resolution Enhancement technology) 157
 - retention, job
 - accessing 98
 - features 98
 - private 100
 - proof and hold 98
 - QuickCopy 101
 - stored 102
 - reverse page order 90
 - rollers
 - cleaning document feeder 164
- S**
- safety statements 259
 - saving resources, memory 267
 - scaling documents 107
 - scanner calibration 51, 166
 - scanner glass
 - cleaning 161
 - scanner lid backing, cleaning 162
 - scanning e-mail
 - validating gateway addresses 226
 - scanning to e-mail
 - about 129, 133
 - address books 135
 - configuring 130
 - error messages 184, 185, 186, 187
 - sending documents 133
 - scanning to e-mail
 - address books 135
 - control-panel settings 132
 - job settings 137
 - LDAP support 130
 - loading documents 133
 - recipient lists 135
 - sending documents 133
 - SMTP support 130
 - scanning to folder 138
 - scanning to workflow 139
 - security
 - settings 35
 - security features 5
 - Send Setup menu 43
 - Send to Folder 138
 - Send to Workflow 139
 - sending faxes
 - problem-solving 223
 - sending to e-mail
 - about 129, 130, 133
 - address books 135
 - error messages 184, 185, 186, 187
 - sending documents 133
 - sending to e-mail
 - address books 135
 - job settings 137
 - LDAP support 130
 - loading documents 133
 - recipient lists 135
 - sending documents 133
 - settings 132
 - SMTP support 130
 - validating gateway addresses 226
 - service
 - HP-Authorized Dealers 242
 - repacking device 244
 - service agreements 244
 - Service menu, control panel 56
 - Services tab 112
 - settings
 - driver presets (Macintosh) 113
 - drivers 13
 - priority 12
 - quick sets (Windows) 106
 - Settings tab, embedded Web server 154
 - shipping device 244
 - SIMMs, incompatibility 262
 - size, copy
 - problem-solving 222
 - size, media
 - 3-bin mailbox specifications 75
 - 500-sheet tray specifications 73
 - ADF specifications 76
 - duplexer specifications 74
 - envelope feeder specifications 74
 - printing small or custom 87
 - stacker specifications 75
 - stapler specifications 75
 - tray1 specifications 72
 - unexpected, error message 180
 - sizes, media
 - selecting trays 89

- skewed pages 213
- Sleep button 18
- Sleep mode
 - settings 29, 31
- sleep settings
 - power specifications 248
- slow printing, problem-solving 175
- slow speed, problem-solving
 - fax receiving 224
- small paper, printing on 88
- smear toner, problem-solving 211
- SMTP gateways
 - error messages 186
- SMTP servers
 - configuring gateway
 - address 130
 - connecting to 130
 - finding gateways 131
 - testing 131
 - validating gateway
 - addresses 226
- software
 - embedded Web server 15
 - HP Easy Printer Care 16
 - HP Printer Utility 157
 - HP Toolbox 151
 - HP Web Jetadmin 15
 - Macintosh 14, 16
 - settings 12
 - supported operating systems 10
 - uninstalling Macintosh 14
 - Web sites 10
 - Windows 16
- specifications
 - acoustic 249
 - electrical 248
 - envelopes 67
 - labels 68
 - operating environment 250
 - paper 64, 66
 - transparencies 69
- specifications, media
 - envelope feeder 74
- specks, problem-solving 209, 215
- speed
 - fax receiving, problem-solving 224
 - problem-solving 175
 - troubleshooting 168
- speed dial list, printing 149
- Spool32 errors 227
- spots, problem-solving 209, 215
- standard output bin
 - capacity 5
 - jams, clearing 198
 - reattach error message 186
 - selecting 90
- staple cartridges
 - empty, stop or continue settings 96
 - jams 205
 - loading 96
 - low error message 186
 - part numbers 8, 235
- stapler
 - printing to 94
- stapler/stacker
 - capacity 5
 - empty, stop or continue settings 96
 - loading staples 96
 - media specifications 75
 - media types supported 72
 - paper jams 198
 - part number 8, 235
 - reattach error message 186
 - selecting 90
 - staple jams 205
 - too many pages error message 186
- stapling documents 94
- Start button 18
- Start button, control panel
 - touchscreen 20
- status
 - e-mail alerts 150
 - embedded Web server 153
 - Home screen, control panel 19
 - HP Printer Utility, Macintosh 157
 - HP Toolbox software 151
 - messages, types of 177
- Status button 18
- Stop button 18
- Stop button, control panel
 - touchscreen 20
- stopping a print request 116
- storage cabinet
 - locking and unlocking 9
 - part number 8, 235
- storage, job
 - accessing 98
 - features 98
 - Macintosh settings 157
 - private 100
 - proof and hold 98
 - QuickCopy 101
 - settings 31
 - stored 102
- stored jobs 102
- storing
 - envelopes 68, 77
 - paper 77
 - print cartridges 159
- straight-through paper path 90
- streaks, problem-solving 220
- subnet mask 60
- supplies
 - authentication 160
 - counterfeit 160
 - e-mail alerts 150
 - management menu 31
 - memory errors 178
 - non-HP 160
 - ordering 234
 - ordering through embedded Web server 155
 - ordering with HP Toolbox 151
 - part numbers 8, 235
 - recycling 254
 - replacing print cartridges 159
 - Resets menu 55
 - status page, printing 148
 - status, viewing with embedded Web server 153
 - status, viewing with HP Printer Utility 157
 - status, viewing with HP Toolbox 151
- support
 - embedded Web server links 155
 - HP Printer Utility pages 157
 - Linux 231
 - online 242
 - repacking device 244
 - Support tab, HP Toolbox 151

SupportPack, HP 245

T

TCP/IP settings 32

technical support

Linux 231

online 242

repacking device 244

temperature specifications 250

tests

networks 35

text, problem-solving

blurred 216

blurry 220

dropouts 210

garbled 175

misformed characters 213

time, setting 29

Time/Scheduling menu, control panel 29

timeout settings 32

tire tracks, problem-solving 215

toner

adhesion problems, solving 220

density setting 157

loose, problem-solving 212

smear, problem-solving 211

Toolbox. See HP Toolbox

top cover

jams, clearing 190

transfer unit warranty 240

transparencies

HP, ordering 238

loading 78

printing 85

specifications 69

tray 1

insert or close error message 184

jams, clearing 194

load error message 185

loading 78

media types supported 72

problem-solving 174

unexpected size or type error message 180

tray 2

problem-solving 174

tray 3

problem-solving 174

tray1

envelopes, printing 83

media sizes supported 72

trays

double-sided printing 111, 115

feeding problems, solving 221

insert or close error

message 184

jams, clearing 194, 195

loading 78

Macintosh settings 157

media size specifications 73

media types supported 72

part numbers 235

problem-solving 174

status, viewing with HP

Toolbox 151

unexpected size or type error message 180

troubleshooting

Alert Settings window, HP

Toolbox 152

checklist 168

control panel messages, numerical 178

error messages, alphabetical list 178

error messages, numerical list 178

jams, clearing 189

jams, frequent 203

paper path test 204

speed 168

staple jams 205

TrueType fonts included 3

two-sided copying 122

two-sided printing

error

messages 178, 180, 183, 184, 186

loading paper 115

Macintosh settings 157

problem-solving 175

typefaces

included 3

types, media

selecting trays by 89

U

unable to connect, copy, or send 187

unexpected size or type error messages 180

uninstalling Macintosh software 14

universal print driver 11

unlocking accessories 9

Update Now feature, drivers 12

usage page, printing 148

USB configuration 58

USB port

problem-solving Macintosh 229

Use Different Paper/Covers 108

V

validating gateway

addresses 226

vertical white or faded stripes 219

voltage specifications 248

W

wake time, setting 29

Warning button, control panel touchscreen 20

warranty

extended 245

print cartridge 240

product 239

transfer unit and fuser 240

watermarks 107

wavy paper, problem-solving 174, 214

Web sites

customer support 242

fraud reports 160

HP Easy Printer Care 16

HP Web Jetadmin, downloading 156

Linux support 231

Macintosh customer support 243

Material Safety Data Sheet (MSDS) 256

ordering supplies 234

paper specifications 64, 66

software, downloading 10

universal print driver 11

weekly on-site service 244

- weight, media specifications
 - 3-bin mailbox 75
 - 500-sheet tray 73
 - ADF 76
 - duplexer 74
 - envelope feeder 74
 - stacker 75
 - stapler 75
 - tray1 72
- white lines or spots, problem-solving 215
- white or faded stripes 219
- Windows
 - driver settings 13, 106
 - drivers supported 10
 - problem-solving issues 227
 - software components 16
 - supported operating systems 10
 - universal print driver 11
- Windows 2000 fax 146
- workflow, send to 139
- wrinkled paper, problem-solving 214

© 2006 Hewlett-Packard Development Company, L.P.

www.hp.com



CB425-90926