



ALPHACOOL

ALPHACOOL – THE COOLING COMPANY



ALPHACOOL – THE COOLING COMPANY

Alphacool - the World's No.1 brand in water cooling solutions.

German efficiency, Maximum quality, perfected performance and first-class design.

Get to know our All-in-One and our “Eisbaer Ready“ cooling solutions.

Benefit from our years of experience and find Alphacool to be the perfect business partner.

Alphacool solutions are used in many areas, e.g.: Wind Technology, Medical Equip-

ment, Mechanical Engineering, Data center, Automotive Industry,

LED Technology, Laser Technology, Film & Video Productions.

Alphacool the perfect solution for every need!

Benefits of using liquid cooling systems 6

Our expertise 7

Welcome to the Cooler World

EisbaerReady systems 9

Eisbaer 10

Eisbaer Extreme 12

Eisbaer LT 14

Eiswolf 16

Eiswand 18

Eiswand 20

Eissturm 22

Eissturm 24

Radiators 27

Eisbrecher 28

Eiszeit 30

NexXxoS - parallel flow 32

NexXxoS - X-flow 34

Reservoirs 37

Eisbecher 38

Eisbecher Helix 42

Eisstation 44

Eisfach 46

Cape Coolplex series 48

Pumps and pump tops 51

Eispumpe VPP 52

Eispumpe DC-LT 54

Eisdecke 56

Cooler 59

Eisblock XPX 60

Eisblock XPX - transparent 62

Eisblock GPX 64

NexXxoS GPX 66

Eisblock HDX 68

Eisboard MBX 70

Fittings 73

Eiszapfen 74

Eiszapfen HardTube 76

Eiszapfen Adapter 77

Tubing 79

Eisrohr 80

Thermal interface 83

Eissschicht 84

Accessories 87

Eiswasser 88

Eiskoffer 90

Eiskoffer 92

Eisfluegel 94

Eisteppich 96

Eisplateau 97

Premium Sleeve/Eiskamm 98

Benefits of using liquid cooling systems

High Cooling Capacity

Reduce thermal resistance by a factor of 10 or more

High Heat Flux Density

Remove up to five times as much heat per square area as conventional air cooling systems. Advantageous in densely packed electronics with limited space.

Heat Routing

Allows the integration of small heat exchangers to divert heat away through a liquid circle, which prevents air from being pushed all around the system

Rapid Cool Down

Larger cooling capacities than conventional air cooling methods. Reduces time needed to reach required temperature

Low Noise

Smooth-running level, nearly free from vibration.

Our expertise

- **Strong Engineering Services and Manufacturing in an ISO 9001 and ISO 14001 certified facility**
- **Global Presence and support on product development**
- **Thermal Modeling**
- **Flow Analysis**
- **Mechanical Design**
- **Electrical Design**
- **Rapid Prototyping**
- **In-house testing capabilities & internal Quality inspection:**
 - Noise measurement
 - Cooling Capacity test
 - Pressure & flowrates test
 - High temperature oven storage test
 - Temperature cycling test
 - Continuous running test
 - Electronic drive circuit testing

We work together with different premium suppliers with a proven history of supplying high end components. Benefit from our knowledge, innovation and resources. we are capable to produce 3.000 - 5.000 pcs. All in One water cooling kits per month.

Contact us today for your complete application solutions.

**Welcome to the
Cooler World**

Eisbaer

All-in-One CPU cooler with pump and reservoir

- Cooler, pump and reservoir combo unit
- Compatible with different sockets
- High cooling performance through the cooling fins on the bottom plate
- Fillport is on the upper side of the reservoir
- Easy to fill and upgrade
- Versions available: AiO and Eisbaer (Solo)



AMD 607/771/G34/939
AM2/AM2+/AM3/AM3+/
AM4 (Ryzen)/FM1/FM2

Intel 775/1366/1156/
1155/1150/1151

Intel 2011/2011-3/2066

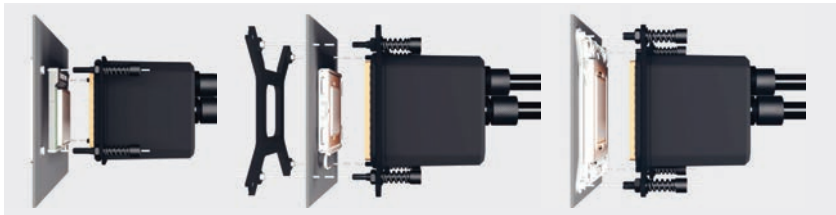

With optional bracket also compatible with Threadripper!



Different radiator sizes



Illuminated Logo



EisbaerReady



Eisbaer Extreme

All-in-One premium CPU Cooler with power pump

- Radiator, pump and reservoir combo unit
- Compatible with different sockets (also Threadripper and AM4)
- High cooling performance through the cooling fins on the bottom plate
- Brilliant RGB lighting in the radiator sides (Compatible with the Aurora RGB series)



RGB LEDs in the side panels



With Eisblock XPX

Eisbaer LT

All-in-One CPU cooler with pump

- Cooler and pump are one unit
- Compatible with different sockets
- High cooling performance through the cooling fins on the bottom plate
- Fillport is on the side of the reservoir
- Easy to fill and upgrade
- Versions available: Eisbaer LT (AiO) and Eisbaer LT (Solo)



AMD 607/771/G34/939/AM2/AM2+/AM3/
AM3+/AM4 (Ryzen)/FM1/FM2

Intel 775/1366/1156/1155/1150/1151/2011/
2011-3/2066

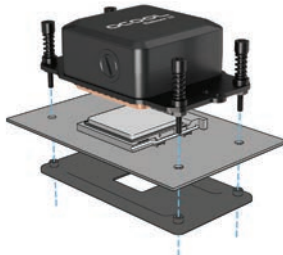

With optional bracket also compatible with Threadripper!



Different radiator sizes and ultra slim with 25mm



Pump include the CPU Cooler



Eisbaer Ready



Eiswolf

All-in-One GPU cooler with pump and reservoir

- HBM Ready
- Cooler, pump and reservoir are one unit
- Expandable open loop system
- Also available without radiator
- Comes with 2 quick release coupling kits
- The modular design allows lots of combinations
- Easy and fast installation

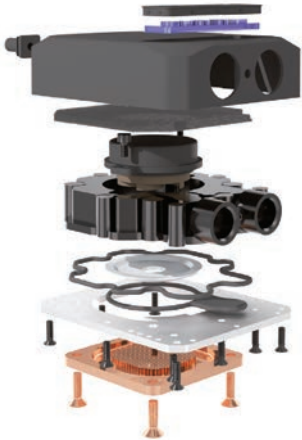
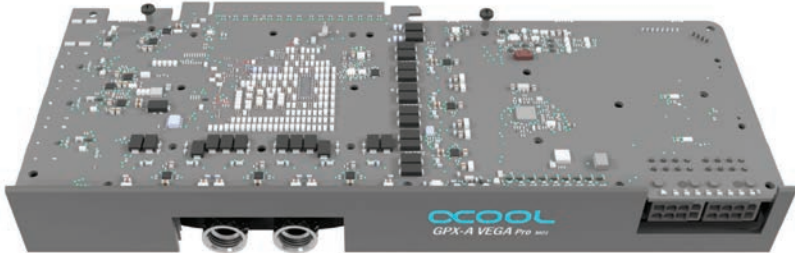

Pump include the GPU cooler



Backplate closed with cooler



Eisbaer Ready



Eiswand

External cooling tower with CPU cooler

- Full cooling system
- Redundant internal pump power in the socket
- 360mm radiator inside
- Illuminated reservoir and logo
- Easy water level overview
- Aluminium Alphacool logo on the top
- Easy to fill
- Simple design

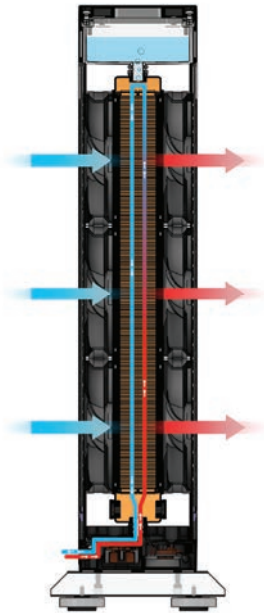

- Connection to radiator part
- Top with electronics + in-/outlet
- 2x pumps
- Illuminated base with feet



- Upper cover with window and fillport
- Mounting frame
- Detachable reservoir top
- Reservoir with connection to radiator part



Illuminated reservoir



Easy to fill



EisbaerReady



Eiswand

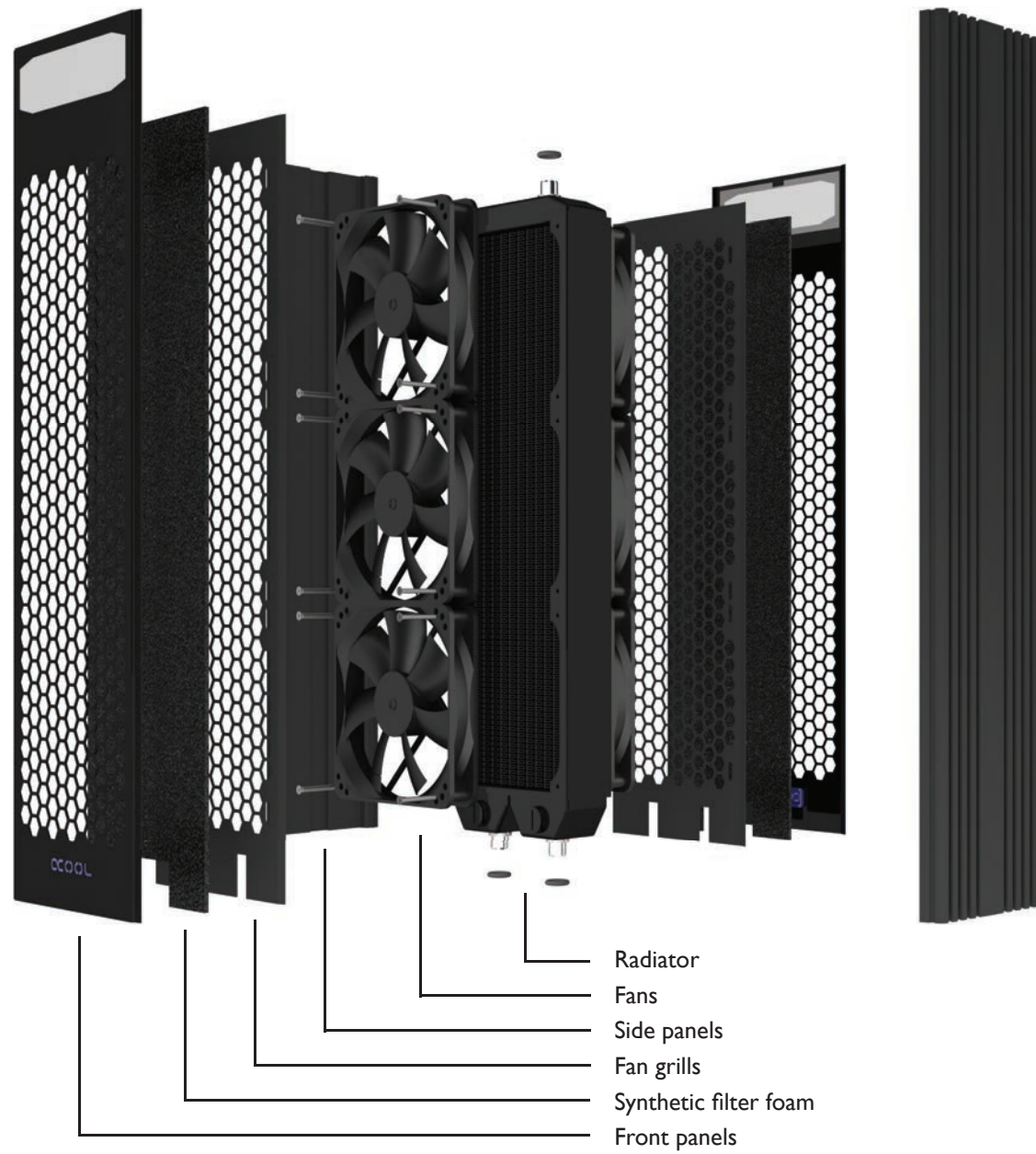

Eissturm

The all-time best products

- **Gaming kits**

- NexXxoS ST30 radiators
(Available in different sizes)
- NexXxoS XP3 or Eisblock XPX
- Eisstation includes DC-LT or DDC pump

- **Hurricane kits**

- NexXxoS XT45 radiators
- All kits includes an Eisblock XPX
- Eisstation or Eisbecher
- Eispumpe or Laing DDC

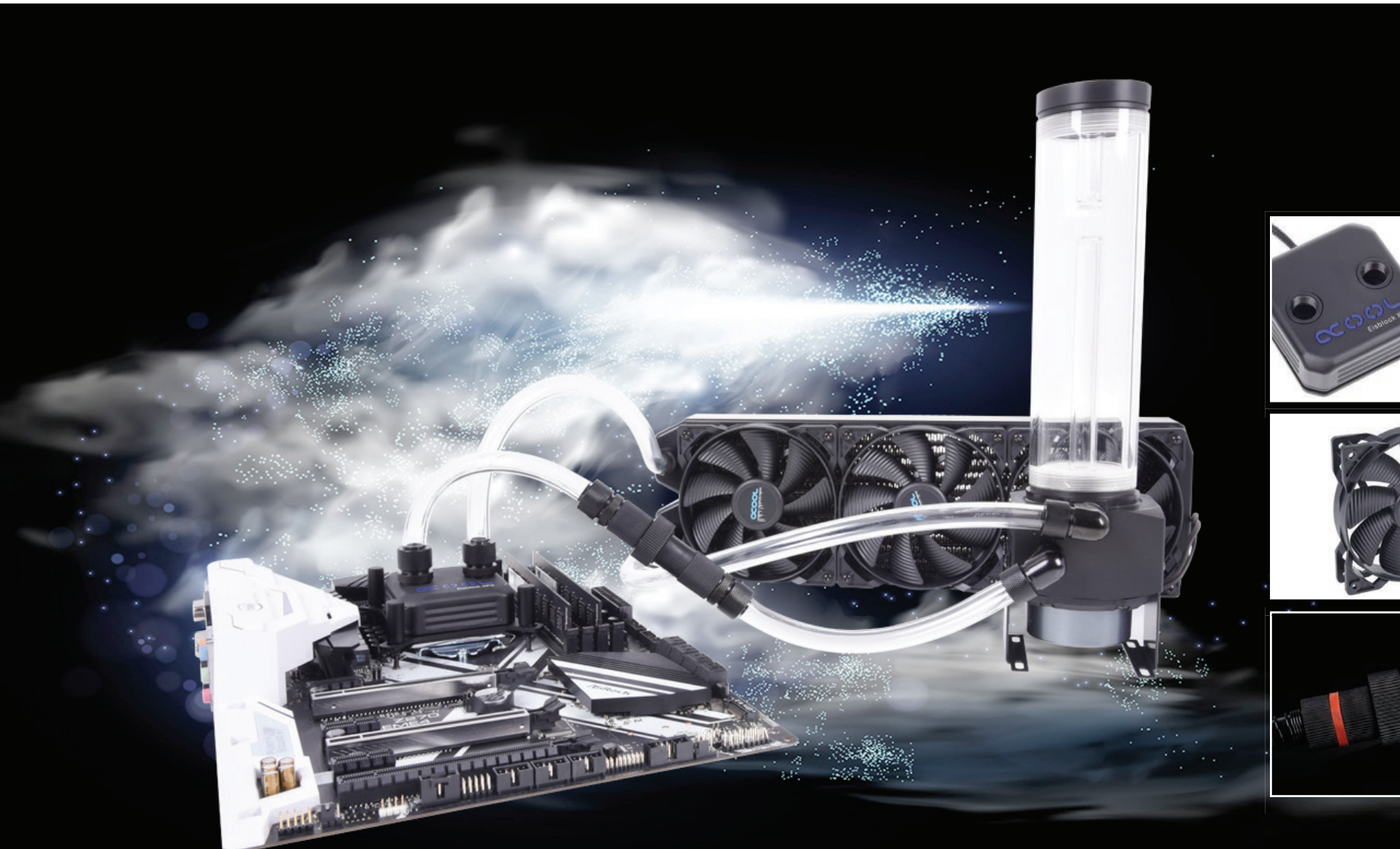

NexXxoS XP3 or Eisblock XPX



Alphacool Eiswind - powered by bequiet!



EisbaerReady



Eissturm

The all-time best products

- **Blizzard kits**

- NexXxoS XT45 radiators
(Available in different sizes)
- All kits includes Eisblock XPX
- Eisstation includes DC-LT or DDC pump

- **Tornado kits**

- NexXxoS UT60 radiators
(Available in different sizes)
- All kits includes Eisblock XPX
- Eisbecher with Eispumpe

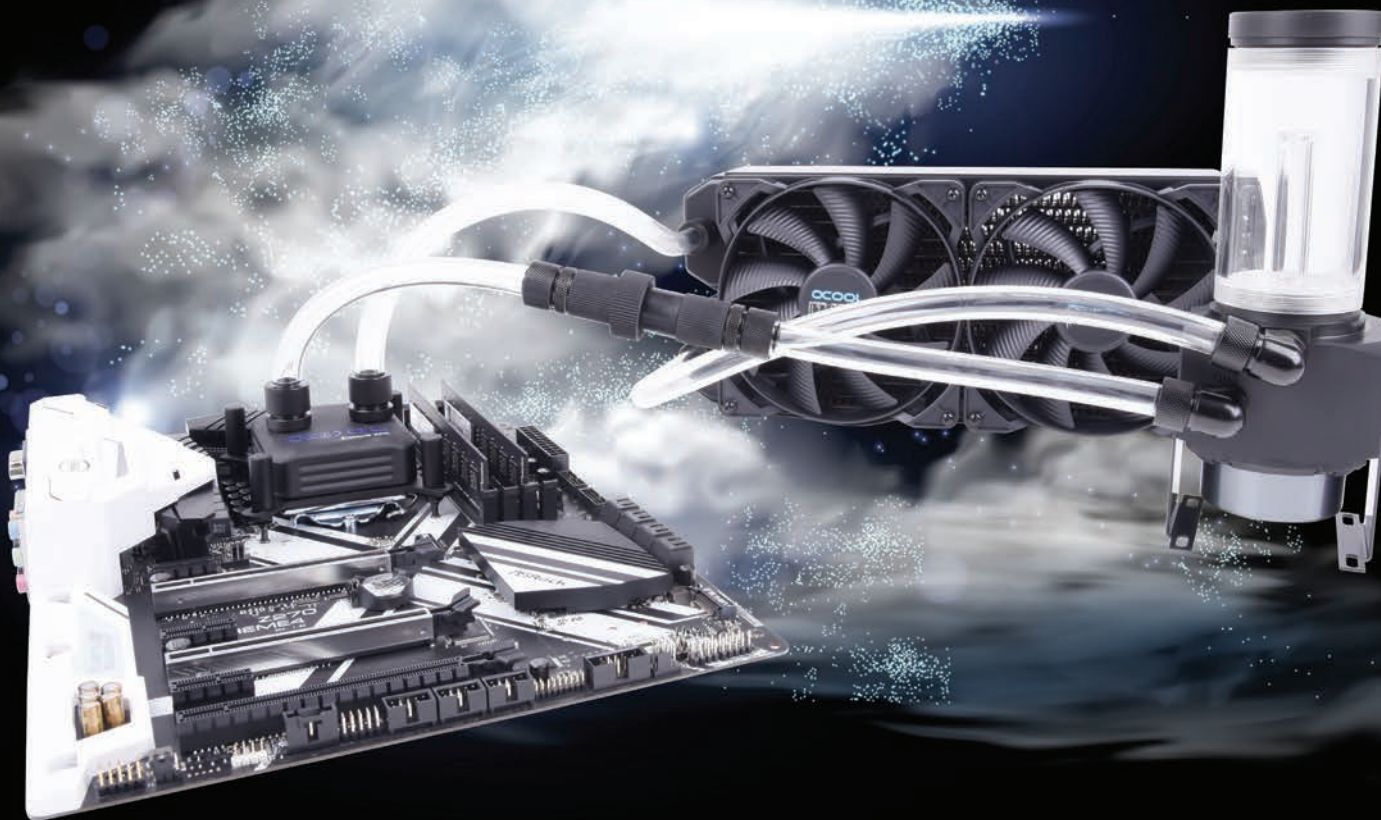

Eisblock XPX



Alphacool Eiswind - powered by bequiet!



Eisbaer Ready



Eisbrecher

Radiator with case

- NexXoS XT45 radiator inside
- Available in 3 different sizes
- Lamellar and cooling channels made of full copper (soldered by hand)
- Case made of aluminium and steel components

- includes:
- Syntetic filter foam
 - Fan grills (steel)
 - 4x G1/4 screw threads for in-/outlet
- Illuminated Alphacool logo on the side panel



120mm

240mm

360mm



Individual fitting option



Three different sizes



Illuminated logo

Eiszeit

High performance Chiller

- Simple matte black design with the Alphacool logo
- Perfect anti-friction and slip-proof properties
- Special thin foam for comfortable support
- Powerful pump inside



With temperature display



Drain port

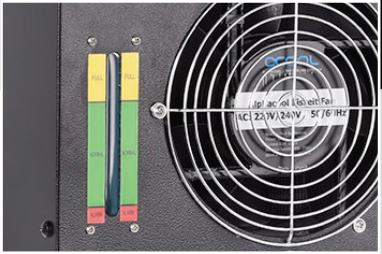

Level indicator for 9L capacity

NexXxoS - parallel flow

The classic

- Available in different sizes
- For 120mm, 140mm, 180mm and 200mm fans
- Up to 7 G1/4" Threads
- Full copper

Monsta - 86mm



UT60 - 60mm



XT45 - 45mm



ST30 - 30mm

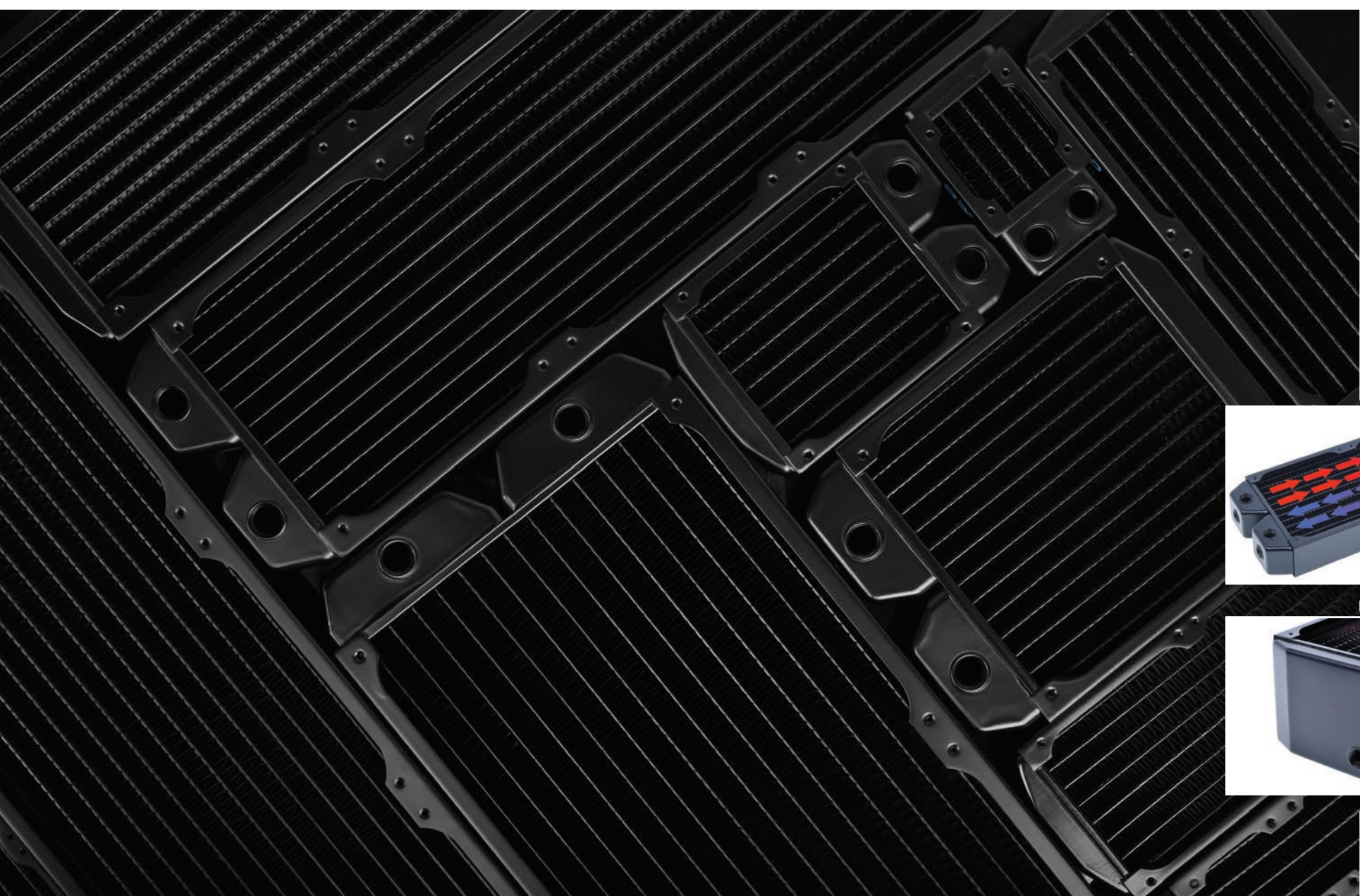

Flow direction



With drain port

NexXxoS - X-flow

The One Way radiator

- Available in the thickness of 30, 45 and 60 mm
- 6 G1/4" Threads (3 each side)
- Full copper

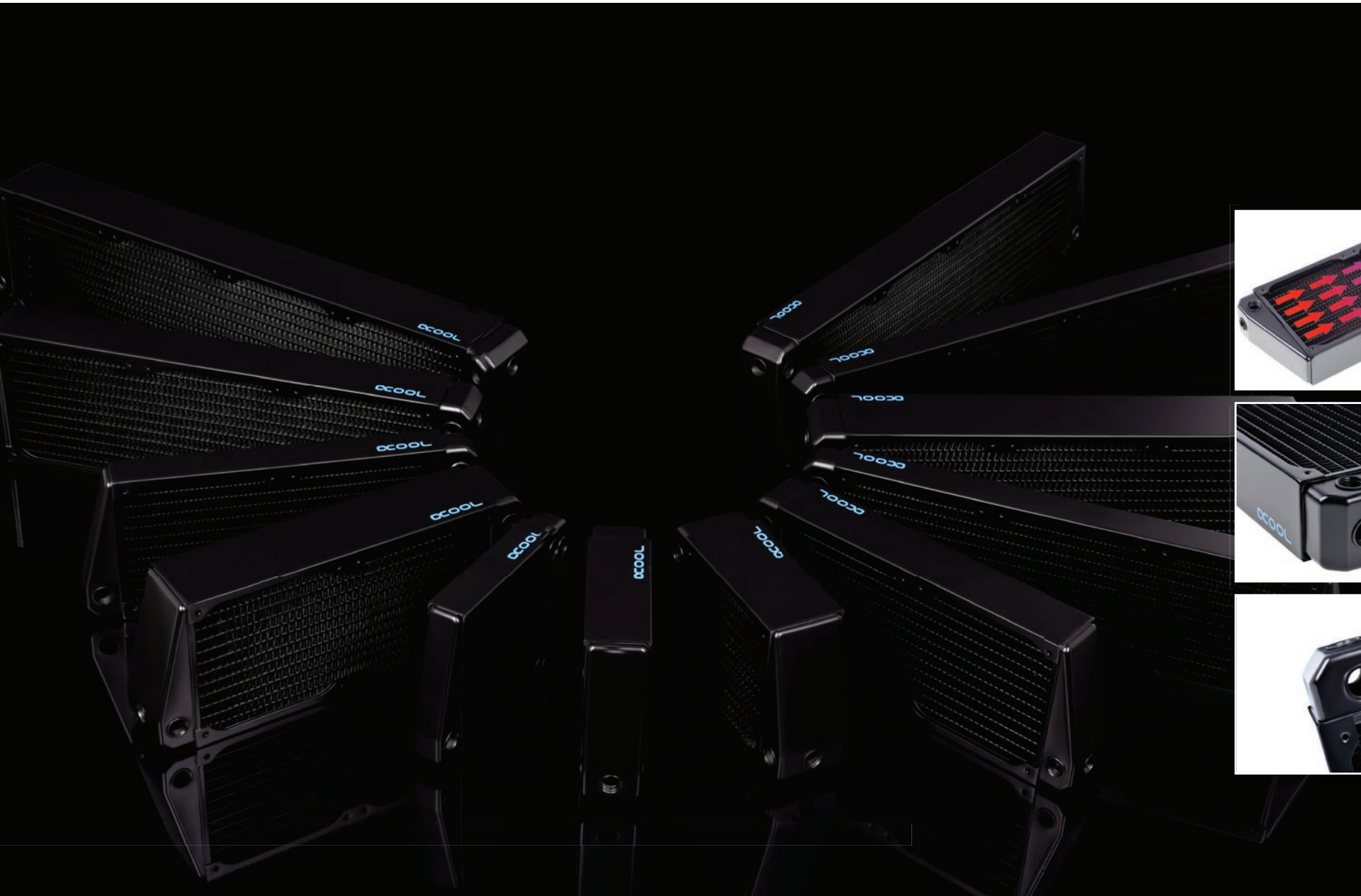

Flow direction



3x 1/4" threads on both sides



Beveled chamber

Eisbecher

The multitalent

- For different pumps
- Lighttower effect
- Two different mounting brackets
- Lighting possible with Aurora Rings and single LEDs

The Eisbecher Series consist of 20 different reservoirs that differ between usage, measurement and appearance. There are ten reservoirs within this series that consist of 99% plexi - totally unique! But the main difference between these reservoirs is within the functionality of the different sockets.

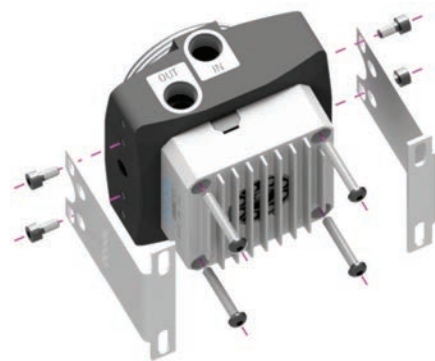
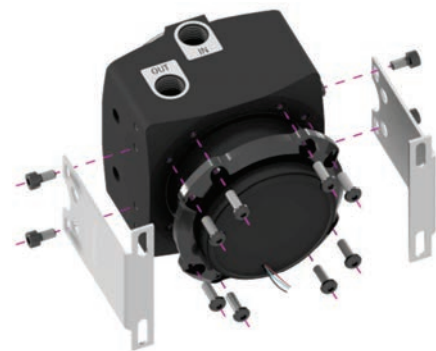

Mounting stands



Different pump sockets



Lighttower effect

Eisbecher

Eisbecher standard



Eisbecher Lite



Eisbecher All-in-One

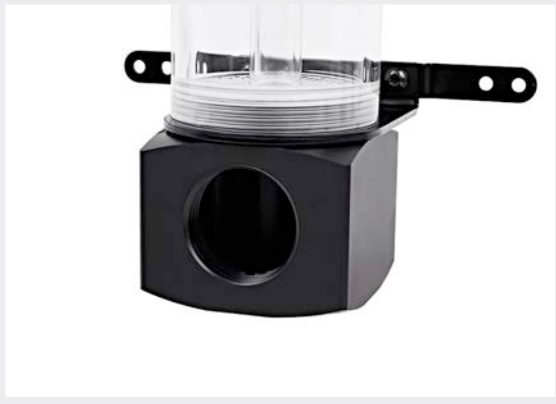

Eisbecher DDC



Eisbecher D5



The universal Eisbecher is ready to use and can be easily installed into any water cooling loop with a G1/4" set up.



Eisbecher Helix

The Eyecatcher

- Two different version: 50mm and 60mm
- The 60mm version with UV cathode inside
- UV reactive Helix
- Four different colors
- Diffenrent mounting options
- G1/4" threads Eisbecher Helix
 - 3x on the top
 - 5x on the bottom
- G1/4" threads Eisbecher Helix Light
 - 2x on top an bottom

The Alphacool Helix Eisbecher captivates with its unique Helix Optic, including elegant aluminium caps for its upper and bottom sides. The 60mm diameter version also offers a UV cathode tube to illuminate UV-reactive water from within.

Eisbecher Helix Light
50mm diameter

Eisbecher Helix
60mm diameter

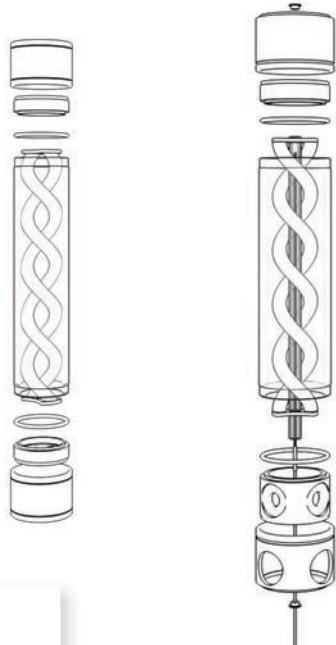

Mounting on radiator

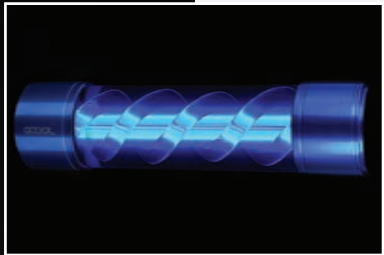

UV cathode



5x G1/4" threads in the bottom

Eisstation

Pump inside re- servoir

- Compatible with Alphacool VPP 755, VPP 655 & D5 pumps
- Soft touch body with mounting holes
- Two fillports on the top side with G1/4" thread
- Made of three different materials
- Coming soon for DDC and DC-LT pumps



Installation DC-LT pump

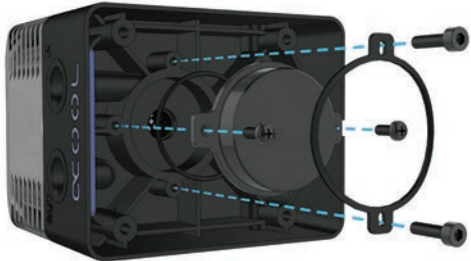

Installation DDC pump

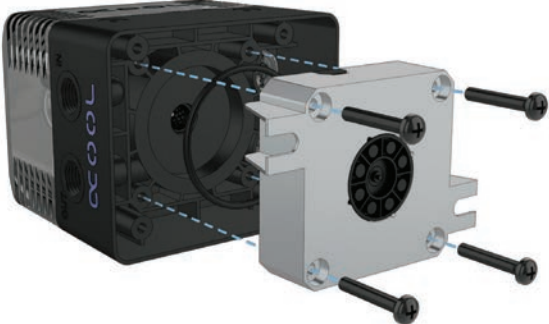

Installation VPP pump

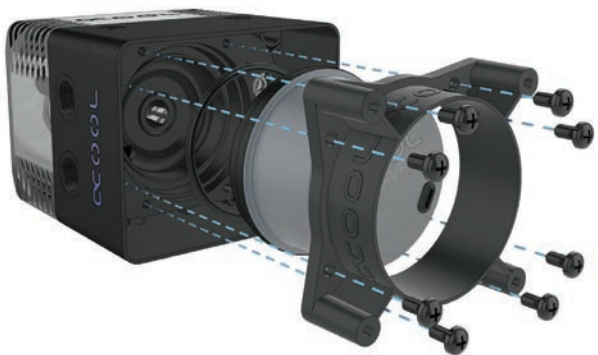

LED and logo lighting



G1/4" and G3/8" fillports; Usable with plexi modules for 5mm LED



Changaeable logo color

Eisfach

Reservoir with pump backpack

- Compatible with Eispumpe, Lanig DDC, Laing D5 (VPP655,) and Dual DC-LT
- Black-matte painted scratch-secure soft-touch surface
- With two holes for 5mm LEDs
- Mounted in two front 5,25" bays
- Light Alphacool logo in the front
- Decoupled

The step towards perfection

The new Alphacool AGB comes in three different models. You can either connect a Laing DDC, the Alphacool DC-LT or the Laing D5/Alphacool VPP655 at the backplate depending on the model which you use.



Installation VPP pump



Installation DDC pump



Installation 2x DC-LT pump

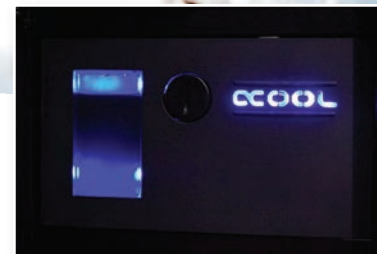

Visible Backlight through the window



Lighting modules on backside



The intelligent fillport

Cape Coolplex series

The compact reservoir

- Reservoir in different lengths: 100, 150 and 250mm
- Silver and black available
- Many different connection options
- Secure holder included
- Lighttower effect
- Base and top completely out of brass

The Alphacool Cape Corp Coolplex HF Metal is the first reservoir from Alphacool which has a base and top made completely out of brass and also has the Lighttower water effect.

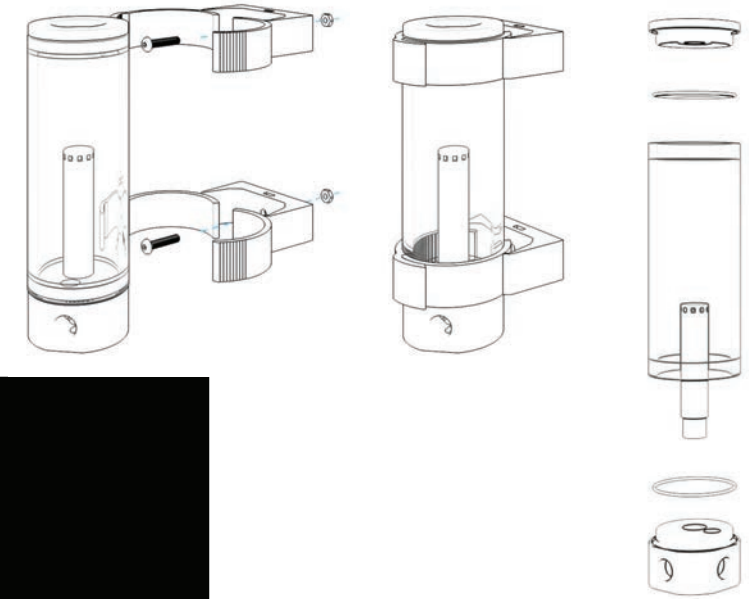

Full Brass Bottom



Different lengths



Fillport on the top

Eispumpe VPP

The Power pump

- Regulated by switches or PWM
- Selected power level is PWM max
- DC Pump is equipped with an electronically commutated ceramic axis
- Increase of bearing play is impossible due to the design
- Runs quietly and smoothly over its whole lifespan
- MTBF 50.000 hours



Compatible with all Laing D5 tops



The perfect combination with the Eisbecher



With PWM plug

Alphacool is announcing the next evolution in pump technology with the VPP755 Eispump. This pump is a completely new development in terms of technology. It throws out all the old problems with the well-known D5 pumps and retains only the compatibility with all current D5 tops and brackets.

Eispumpe DC-LT

The pure power in small

- With two speeds available
- Fits in all small cases
- The smallest pump on the market



Very space saving



Rotor removable for cleaning



Two versions with 2400rpm and 3600rpm



With DC-LT top (optional)

Eisdecke

The perfect pump cover

- Top in plexi and acetal
- Three inlets and two outlets
- Plexi version with four holes for 5mm LEDs
- Bracket for mounting on the case bottom
- Installation in 3,5" drive is possible
- Expandable with Eisdecke reservoir
- Suitable for Eispumpe, Laing D5 or VPP655 and Laing DDC and Alphacool metal bottom
- Include two stands



Alphacool Laing DDC metal bottom - silver and black nickel



Compatible with: Eisbecher, Eisfach, and Eisdecke. (Not with Eisstation)



Eisdecke Plexi with Eispumpe



Eisdecke Acetal with Laing DDC and Alphacool metal bottom



Mounting with the Eisdecke reservoir

Eisblock XPX

The perfect CPU Cooler

- Patented water flow
- Compatible with all watercooling systems with G1/4" connections including Eisbaer and Eiswolf AiO
- Lit Alphacool Logo
- Available in a wide range of brilliant colors
- Easy installation
- Easy changable cover
- Compatible with Intel and AMD processors



AMD 607/771/G34/939
AM2/AM2+/AM3/AM3+/
AM4 (Ryzen)/FM1/FM2

Intel 775/1366/1156/1155/1150/
1151/2011/2011-3/2066



Nickel plated full copper bottom



Brilliant shining logo



Lighting 3 pin plug



Different changable caps

Eisblock XPX - transparent



The Eisblock XPX Satin ClearVersion



The Eisblock XPX Polished Clear version

The Aurora XPX RGB Frame



THE AURORA LED SERIES
RGB



The polished clear version

The satin version



Eisblock GPX

Nothing is better

- Very smooth surface
- Compatible with Alphacool Aurora RGB series
- Backplate included
- Connection Terminal adaptor included for maximum compatibility
- Compatible with Alphacool SLI Bridges

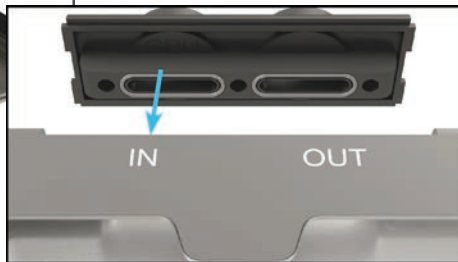
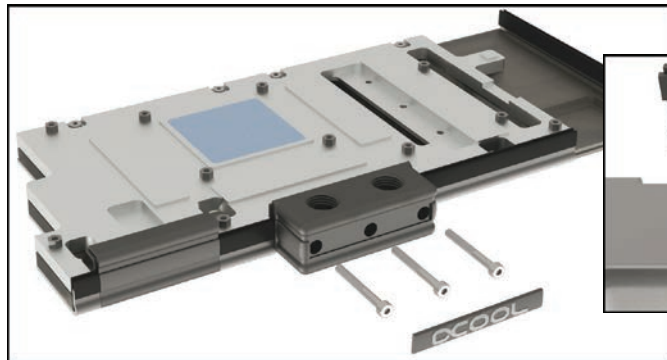
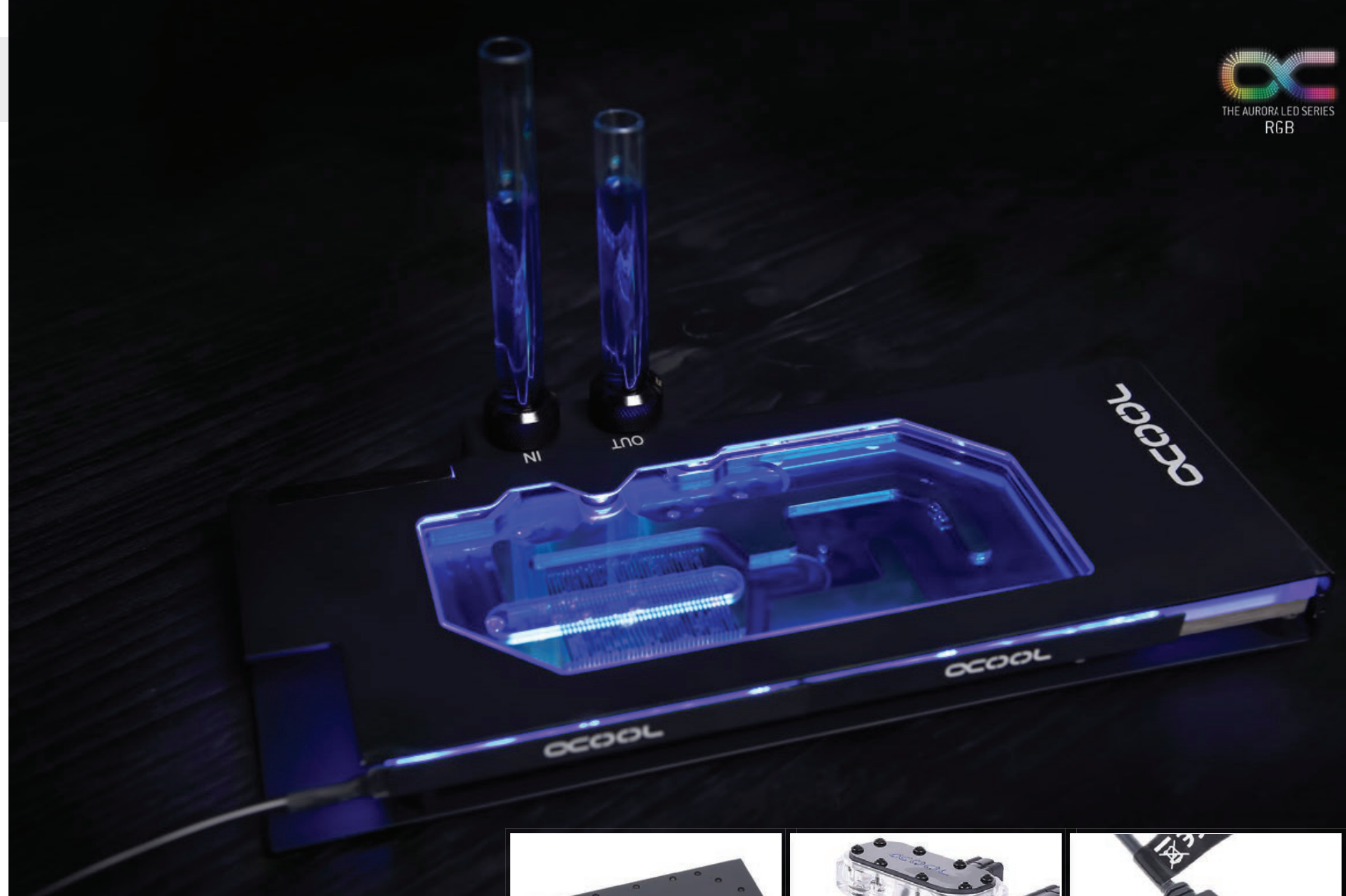

Also available as acetal version



Compatible with Alphacool SLI Bridges



Compatible with the Alphacool Aurora RGB series



Waterblock finder

NexXxoS GPX

The most modular graphic cards cooler

- Compatible with the most graphic cards on the market
- Upgrade kits make it easy to upgrade the graphics card Upgrade kits make it easy to upgrade the graphics card
- Cooling with a combination of air and water cooling
- "Send it and get one cooler for free".

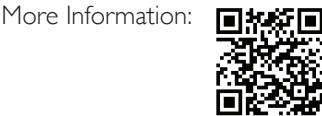

Ready for SLI operation with the optional SLI bridges



Alphacool GPX SLI Connector for triple or dual SLI operation



SLI bridge with asymmetric or symmetric flow in different lengths available



Backplate included



Upgrade kit



Perfect waterflow for optimal cooling performance

Eisblock HDX

M2 SSD cooler for high performance

- Cooling for up to two M2 SSD
- Passive or water cooled cooling blocks
- Enormous cooling surface for optimal cooling performance
- Easy installation in your cooling loop with G1/4" threads
- Possible bandwidth of up to 3900 MB/s.
- Water block provides optimal protection for your SSD

The Alphacool Eisblock HDX-3 water block offers the best cooling for your M.2 SSD. The included PCIe card, on which the water block is mounted, also provides your SSD with an outstanding bandwidth of up to 3900 MB/s.

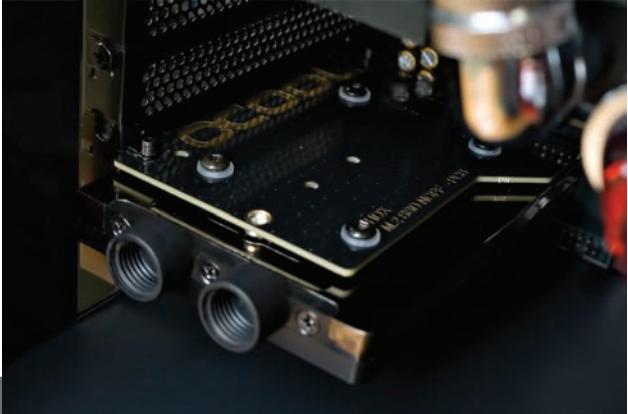

The HDX - M.2 SSD for one M2 SSD - passive cooled



The Eisblock HDX-2 for one M2 SSD - passive cooled



The Eisblock HDX-3 for one M2 SSD - liquid cooled



The Eisblock HDX-5 for two M2 SSD - passive cooled

Eisboard MBX

The modular Motherboard cooling

- Modular system
- 1/4" threads
- Full Copper Terminals
- Special lighting module
- 45° and 90° angel modules

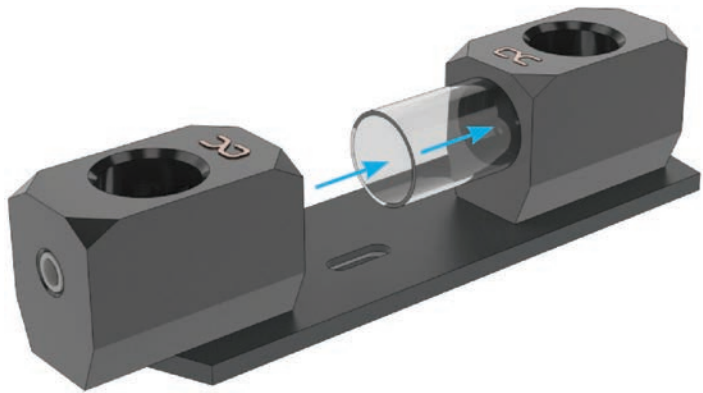
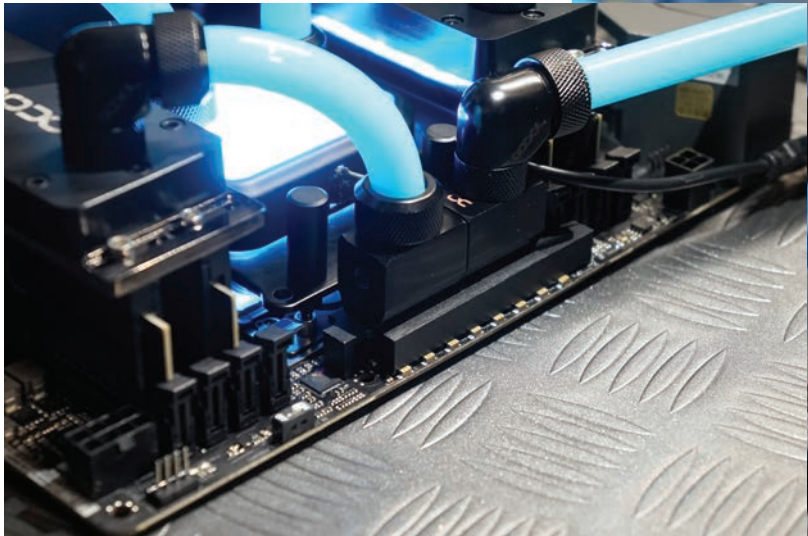

Simply plug the individual modules with a small plastic tube.



Plates for different Motherboards



Full Copper 45° angel



Full Copper connection terminal with lighting module

Eiszapfen

Connect everything

- Many different sizes and angles
- For HardTube and SoftTube
- Many sensors and quick release connectors
- Clean surface for chrome and black fittings
- With lasered Logo
- For optimal handling, the rotatable elements are grooved
- Suitable for many different applications
- High flow rate due to optimal design
- O-rings in different colors included

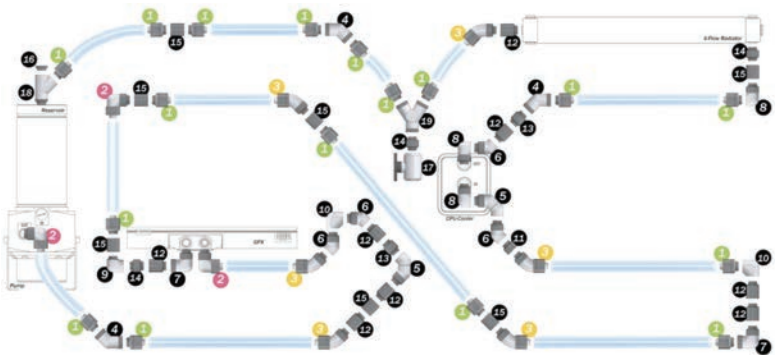

Rotatable 90 degrees



Easy handling thanks to the ribbed surface



Very firm hold

Eiszapfen HardTube



Also available for brass tubes



Different sizes and angles



Also available as a six pack

Eiszapfen modding caps on a XPX Eisblock

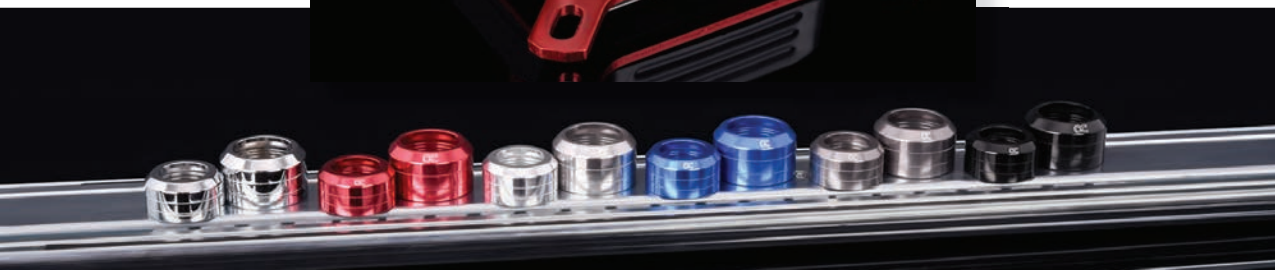

Eiszapfen Adapter

Nothing is impossible



Eisrohr

The new generation of HardTubes

- 4 different materials
- 90 degrees pre-bent angle
- 2 different sizes
- Several lengths
- Extensive accessories and tools
- Available as a pack of 4
- UV reactive

Acrylic



PETG



Borosilicate glass



Brass



Alphacool HeatGun

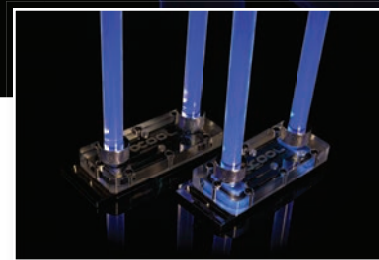

UV-avtice



Pre-bent 90° angel



13mm and 16mm

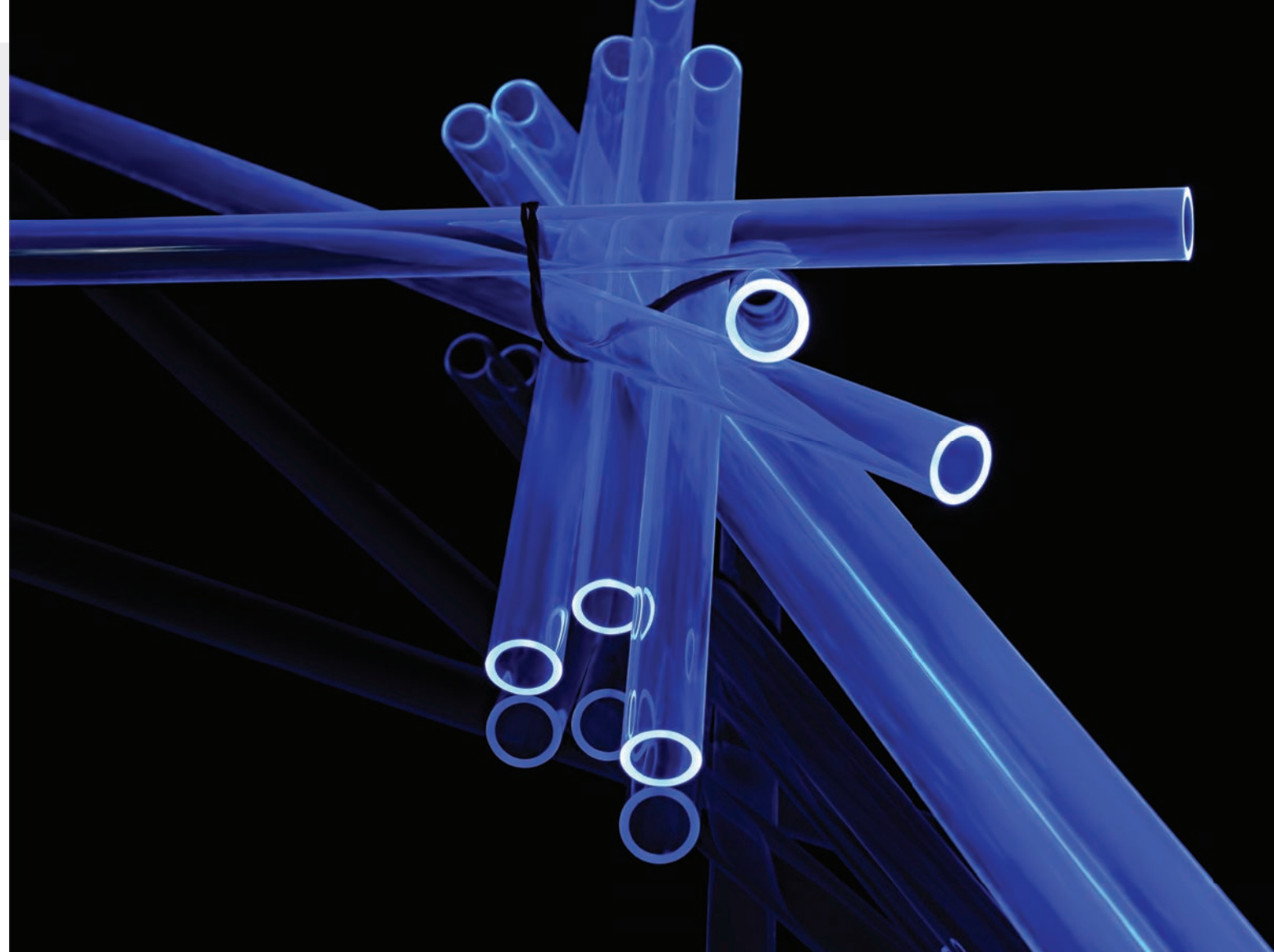

Thermal interface

Eisschicht

Thermal pads

- Impressive cooling performance
- Self-adhesive, elastic, adaptable and more
- Usable with all types of coolers
- Available in different sizes, thicknesses and power levels

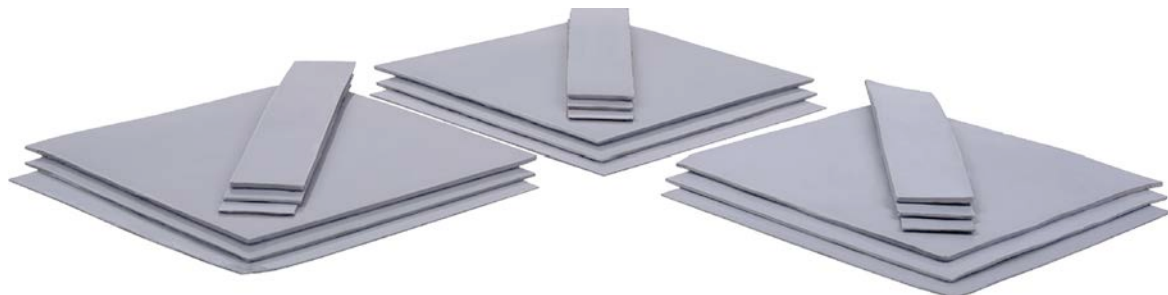
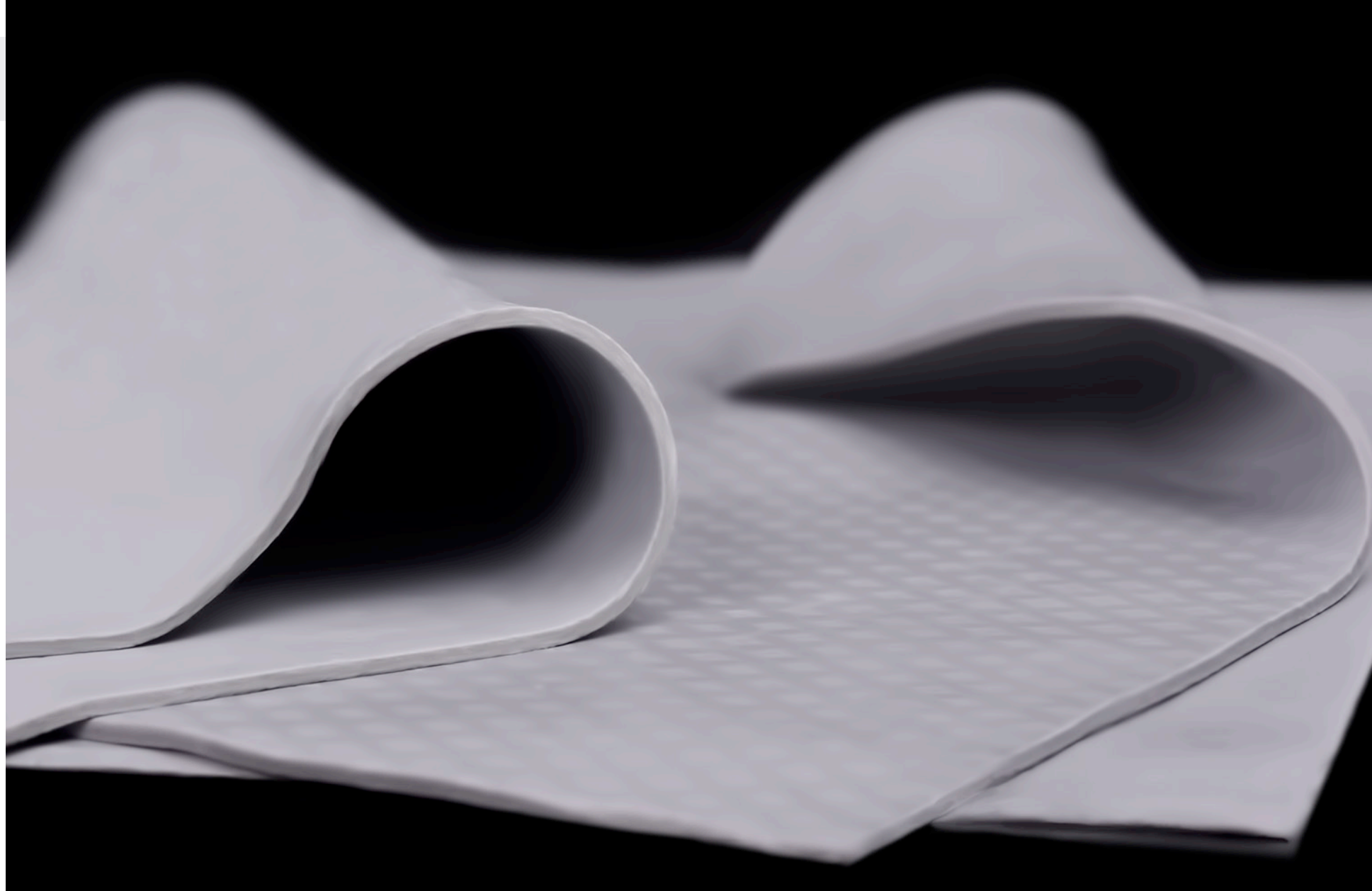
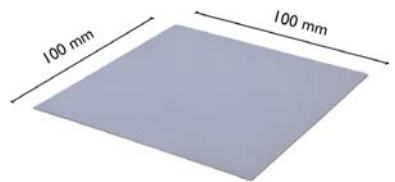

Eiscreme (thermal compound)
Coming soon

























Eiswasser

The modding liquid from Alphacool

- Available in new amazing different colors
- Designed and produced in Germany
- UV reactive
- No salts, metals and contaminants which are in tap water
- (< 0,1 µS/cm, approx 100 times less than in standard distilled water)

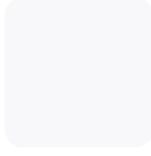

The whole variation of Eiswasser colors

Crystal	 Crystal Blue	 Crystal Blue UV-active	 Crystal Clear UV-active	 Crystal Green	 Crystal Green UV-active
	 Crystal Red	 Crystal Red UV-active	 Crystal Yellow	 Crystal Yellow UV-active	
Galaxy	 Galaxy Blue UV-active	 Galaxy Green UV-active	 Galaxy Red UV-active		
Pastel	 Pastel Black	 Pastel Blue UV-active	 Pastel Green	 Pastel Green UV-active	 Pastel Light Blue
	 Pastel Orange	 Pastel Pink UV-active	 Pastel Red	 Pastel Red UV-active	 Pastel White
	 Pastel Yellow	 Pastel Yellow UV-active			

Eiskoffer

Professional bending

- The complete equipment set for the ambitious HardTube user
- All bending radii can be mounted on the mounting plate
- Unique 3D HardTube bends are possible
- No other tools required, ever again
- Sturdy, elegant case for neat tool organisation
- Compatible with 13 and 16mm HardTube
- Sophisticated measuring system



Bend in all three dimensions

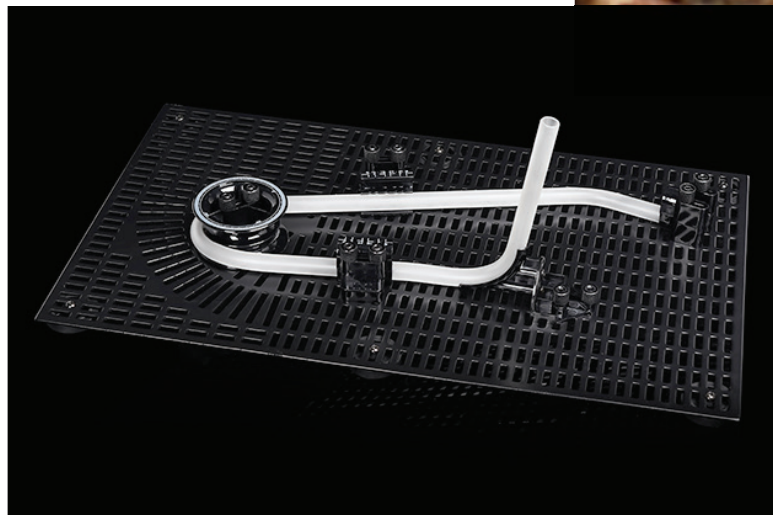

Perfect saw tools



Create impressive curves with the perfect tool



Heat resistant bending plate

Eiskoffer

Eiskoffer Contents

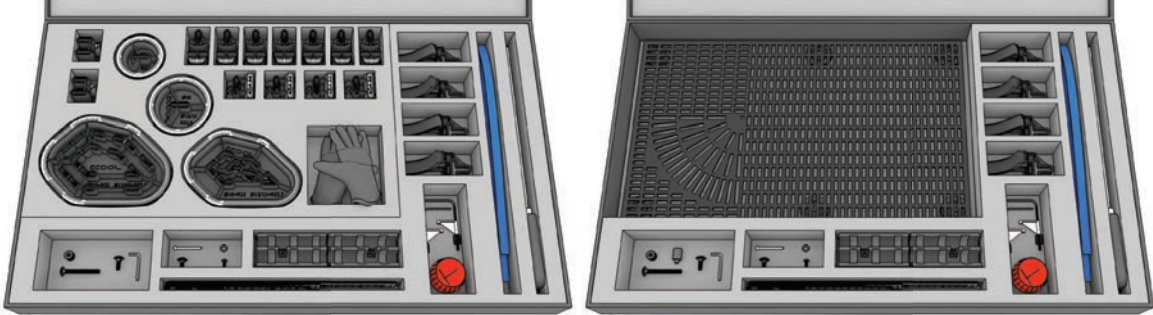

Mounting plate in flexible slotted hole design

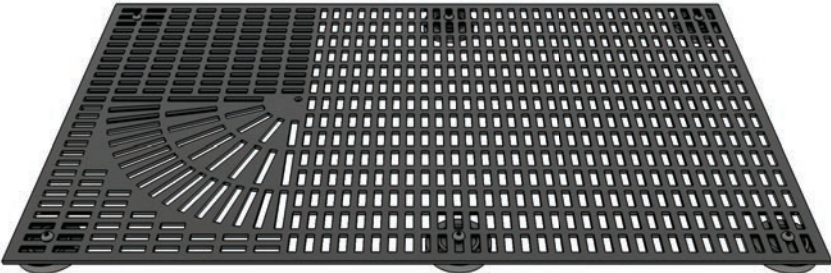

Arc mandrel

Multi mandrel



Flex mandrel

Straight mandrel

Fitting stopper

45° / 90° mandrel

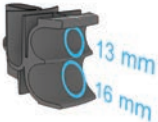

Bending tools



Saw equipment



Measuring tools

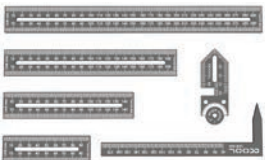
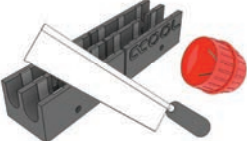

Eisfluegel

- Rotor with six blades of plexiglass
- 3x 1/4" screw threads
- Case combination of acetal and plexiglass
- Silent revolution of fan wheel
- Extra eye-catching

- Different versions
- Dimensions: 44.5 x 32.1 x 48.4mm

More Eisfluegel versions:

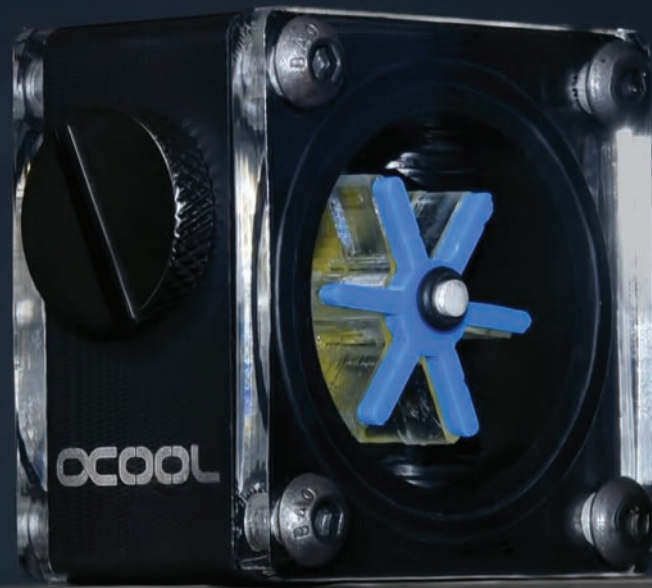

With G1/4" thread



Additional fillport



Two color rotor

Eisteppich



Mousepad

- Simple matte black design with the Alphacool logo
- Perfect anti-friction and slip-proof properties
- Special thin foam for comfortable support

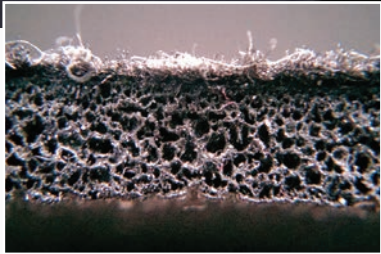

Eisplateau

Anti-static mat

- Dimensions: 1200 x 600 x 4mm
- Material: rubber, printed textile
- Usable as a mousepad
- Antistatic clips to connect an alligator clip and an anti-static wrist strap



Premium Sleeve/Eiskamm



- 12 Colors
- Absolutely opaque
- Fixed without heat shrink

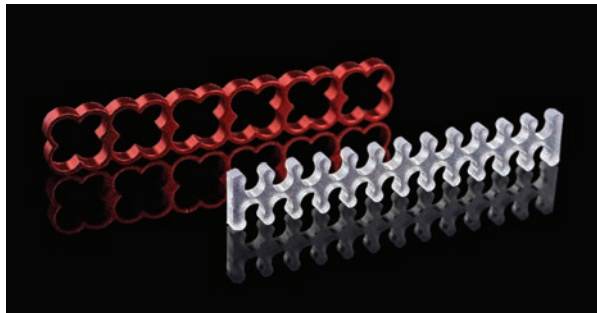

- Cable combs to fit cables from 4 to 28 pins
- Suitable for all 16AWG/18AWG
- UL3239/UL1015/UL1007/3135 wires
- Available in Aluminum and clear plexi
- Available colours: black, blue, red, silver and clear

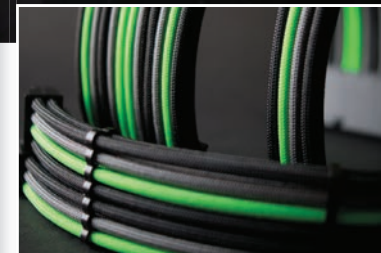



ALPHACOOL – THE COOLING COMPANY

Alphacool International GmbH
Marienberger Str. 1
38122 Braunschweig
Germany

Head Office:

 +49 0 531 28874 - 0

 +49 0 531 28874 - 22

 info@alphacool.com

 www.alphacool.com

All rights reserved. Any unauthorized copying
is strictly prohibited.

Errors and omissions are excluded.