

ARCHITECTURE IN THE DIGITAL AGE • DESIGN AND MANUFACTURING
EDITED BY BRANKO KOLAREVIC



3

**DIGITAL
PRODUCTION**

BRANKO KOLAREVIC

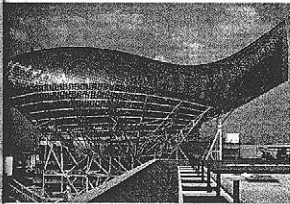

3.1.
Fish Sculpture (1992),
Vila Olimpica,
Barcelona, Spain,
architect Frank Gehry.

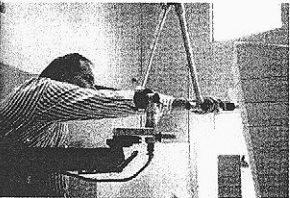

3.2.
Digitizing of a three-
dimensional model in
Frank Gehry's office.

The digital age has radically reconfigured the relationship between conception and production, creating a direct link between what can be conceived and what can be constructed. Building projects today are not only born out digitally, but they are also realized digitally through "file-to-factory" processes of computer numerically controlled (CNC) fabrication technologies.

It was the complexity of "blobby" forms that drew architects, out of sheer necessity, back into being closely involved with the production of buildings. The continuous, highly curvilinear surfaces, which feature prominently in contemporary architecture, brought to the fore the question of how to work out the spatial and tectonic ramifications of such complex forms. It was the challenge of constructability that brought into question the credibility of spatial complexities introduced by the new "digital" avant-garde. But as constructability becomes a direct function of computability, the question is no longer whether a particular form is buildable, but what new instruments of practice are needed to take advantage of the opportunities opened up by the digital modes of production.

One of the first projects to be developed and realized digitally was Frank Gehry's design for the large *Fish Sculpture* at the entrance to a retail complex called Vila Olimpica in Barcelona, Spain (1992, figure 3.1). The project's financial and scheduling constraints led Gehry's partner Jim Glymph to search for a digital design and manufacturing software environment that would make the complex geometry of the project not only describable, but also producible, using digital means in order to ensure a high degree of precision in fabrication and assembly. The solution was found in the three-dimensional modeling and manufacturing program developed for the French aerospace industry (Dassault Systems), called CATIA, an acronym that

stands for *Computer Aided Three-dimensional Interactive Application*. Thus, the software made for the design and manufacture of airplanes was used to develop and construct a built structure. Three-dimensional digital models were used in the design development, for structural analysis, and as a source of construction information, in a radical departure from the normative practices of the profession. The bellwether of digital revolution for architecture had finally arrived.

THREE-DIMENSIONAL SCANNING: FROM PHYSICAL TO DIGITAL

For some designers, such as Frank Gehry, the direct tactility of a physical model is a much preferred way of designing than a "flat" digital manipulation of surfaces on a computer screen. In Gehry's case, the digital technologies are not used as a medium of conception but as a medium of *translation* in a process that takes as its input the geometry of the physical model (figure 3.2) and produces as its output the digitally-encoded control information which is used to drive various fabrication machines (figures 3.3a–c). As it will be demonstrated in this chapter, digital representations of geometry can be used in ways the original physical models cannot.

The process of translation from the physical to the digital realm is the inverse of computer-aided manufacturing. From a physical model a digital representation of its geometry can be created using various three-dimensional scanning techniques in a process often referred to as "reverse engineering." A pattern of points, called the "point cloud" (figure 3.4a), is created from the physical model through scanning, and is then interpreted by the conversion software to produce a close approximation of the model's geometry. Typically, patterns of scanned points (figure 3.4b) are used to generate profile NURBS (Non-Uniform Rational B-Splines) curves (figure 3.4c), which

3.3a–c.
The *translation* process
in Gehry's office: (a)
digitized points; (b)
digital surface
reconstruction; and (c)
digitally fabricated
model.

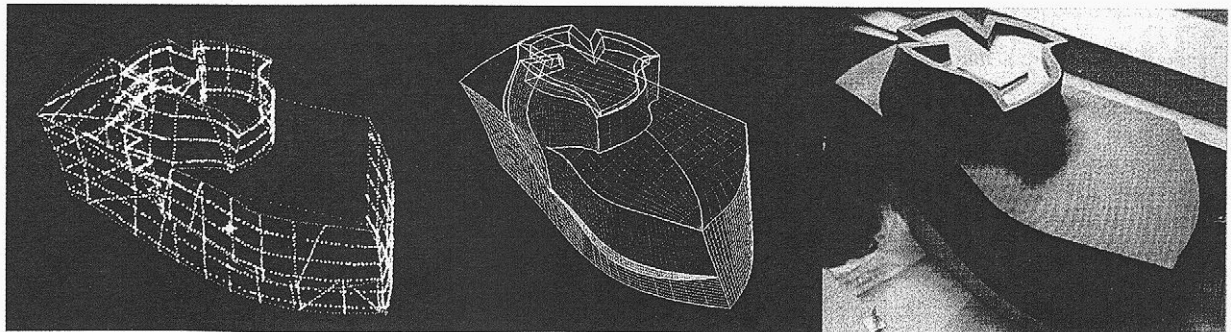

3.4a-e.

The reverse engineering process: (a) point cloud from three-dimensional scanning; (b) and (c) cross-sectional curve generation; (d) surface lofting, and (e) comparison with the point cloud.

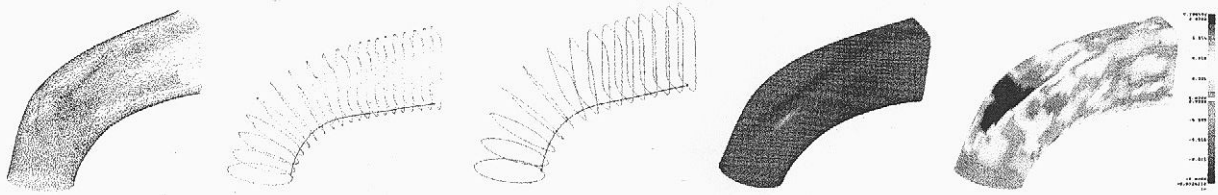

are then used to generate lofted NURBS surfaces (figure 3.4d). The resulting surfaces can be compared to the scanned point cloud for an analysis of deviations from the original physical model (figure 3.4e).

A common method for three-dimensional scanning involves the use of a digitizing position probe to trace surface features of the physical model. This procedure can be done manually using three-dimensional digitizing arms (figure 3.5) or automatically using a Coordinate Measuring Machine (CMM), which has a digitizing position sensor that is mechanically kept in contact with the surface of the scanned object.

An alternative is to use *non-contact* scanning methods, which require more expensive scanning devices, but are faster, more accurate, less labor intensive, and often more effective when scanning small-scale objects. These devices commonly use laser light to illuminate the surface of a scanned object (figure 3.6) in a step-by-step fashion, producing patterns of bright dots or lines, which are captured by digital cameras (two are often used). The recorded images are processed using optical recognition techniques to construct the three-dimensional geometric model of the scanned object, which can then be exported in a desired data format for use in digital analysis or modeling applications.

Three-dimensional scanning techniques can be used to digitally capture not only the physical models, but also existing or as-built conditions, or even entire landscapes. Laser scanning technologies, based on different measurement techniques, are commonly used in surveying on construction sites worldwide (figure 3.7). In each of the different devices available on the

market, a laser beam is emitted by the scanner and the reflected beam is captured, and its properties analyzed to calculate the distances to the measured object. Four pieces of information are captured for each individual point measurement: X, Y and Z coordinates plus the intensity of the reflected beam, which can be used to assign different light intensities or even colors to the point cloud.

Laser scanning technologies can create very accurate three-dimensional models of existing objects.¹ Today, they are used increasingly on construction sites in place of conventional measuring devices to quickly measure distances and to precisely determine locations for the installation of various building components. It is conceivable that the laser scanning will also be used to continuously scan the building's structure as it is erected and to immediately detect deviations from the geometry of the digital model. The "point cloud" is already in the builder's vocabulary, and the laser scanning has already rendered the tape measure obsolete on numerous construction sites.

DIGITAL FABRICATION: FROM DIGITAL TO PHYSICAL

The long tradition of Euclidean geometry in building brought about drafting instruments, such as the straightedge and the compass, needed to draw straight lines and circles on paper, and the corresponding extrusion and rolling machinery to produce straight lines and circles in material. The consequence was, as William Mitchell observed, that architects drew what they could build, and built what they could draw.² This reciprocity between the means of representation and production has not disappeared entirely in the digital age. Knowing the production capabilities and availability of

3.5.

The *Microscribe* three-dimensional digitizer.

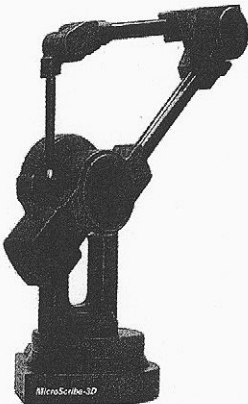

3.6.

Three-dimensional laser scanner.

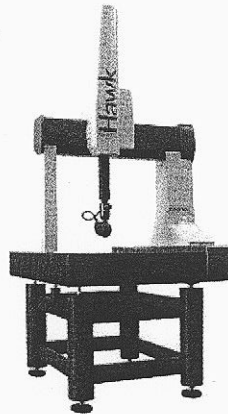

3.7.

Three-dimensional laser scanner for site surveying.

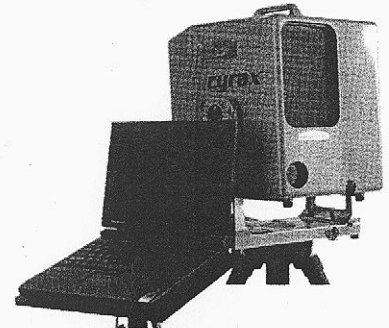

3.8a–b.

Nationale-Nederlanden Building (1996), Prague, Czech Republic, architect Frank Gehry: irregularly-shaped glass panels were cut using digitally-driven cutting machines.

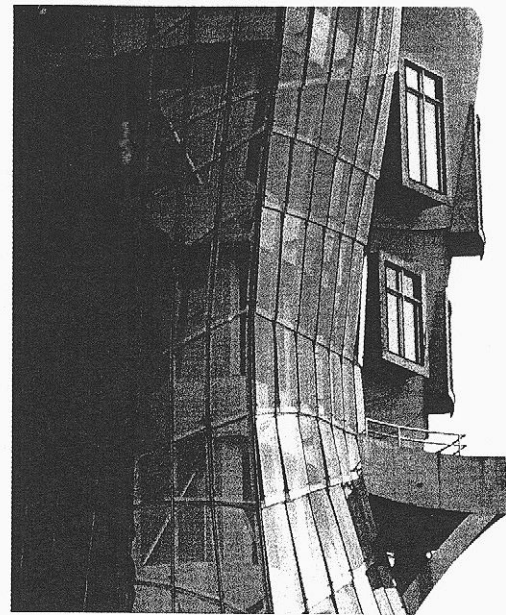
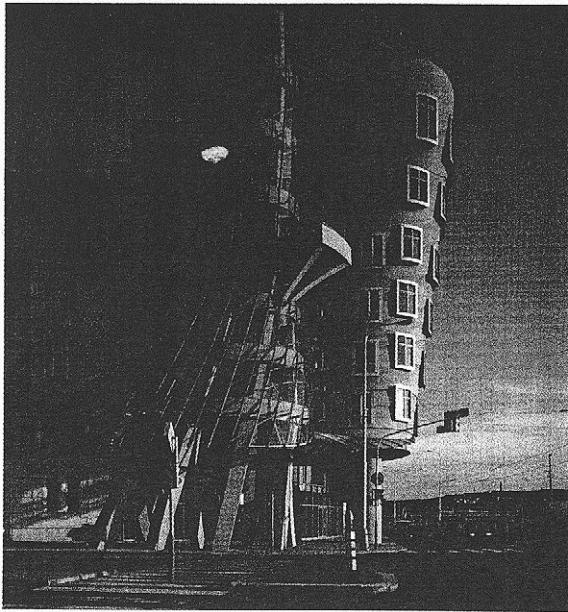

particular digitally-driven fabrication equipment enables architects to design specifically for the capabilities of those machines. The consequence is that architects are becoming much more directly involved in the fabrication processes, as they create the information that is translated by fabricators directly into the control data that drives the digital fabrication equipment. For instance, the irregularly-shaped glass panels on Frank Gehry's *Nationale-Nederlanden Building* in Prague, Czech Republic, (1996, figures 3.8a–b), were cut using digitally-driven cutting machines from the geometric information extracted directly from the digital model, as was also the case with more than 21,000 differently shaped metal shingles for the exterior of the *Experience Music Project* (EMP) in Seattle, also designed by

Frank Gehry (2000, figures 3.9a–b). A growing number of successfully completed projects, which vary considerably in size and budgets, demonstrate that digital fabrication can offer productive opportunities within schedule and budget frameworks that need not be extraordinary.

The new digitally-enabled processes of production imply that the constructability in building design becomes a direct function of computability. The fact that complex geometries are described precisely as NURBS curves and surfaces, and, thus, computationally possible, also means that their construction is attainable by means of CNC fabrication processes. Production processes based on cutting, subtractive, additive and formative fabrication, which are described in more detail in this chapter, offer rich opportunities for the tectonic exploration of new geometries.³

3.9a–b.

Experience Music Project (EMP) (2000), Seattle, USA, architect Frank Gehry: 21,000 differently shaped metal shingles for the exterior were cut digitally.

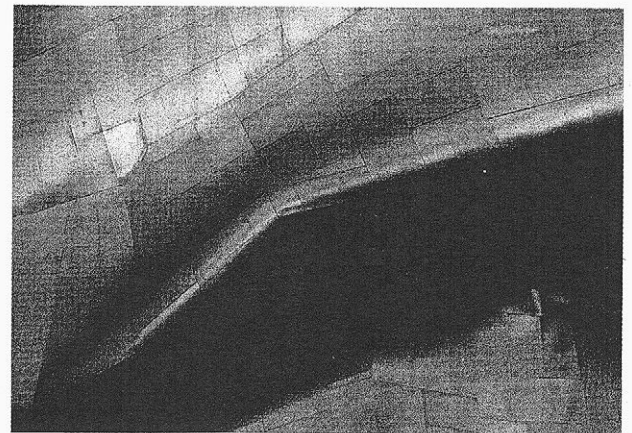
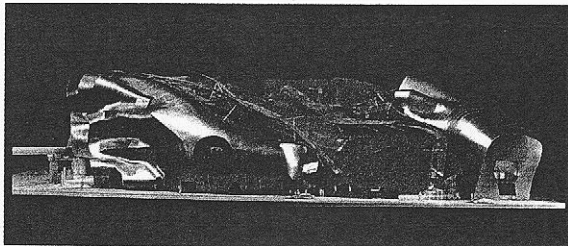

3.10.
Plasma-arc CNC
cutting of steel supports
for masonry walls in
Frank Gehry's *Zollhof
Towers* (2000) in
Düsseldorf, Germany.

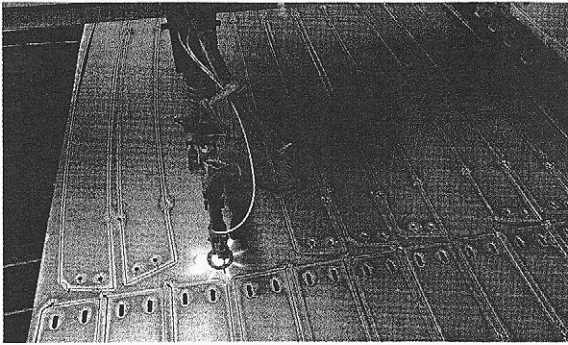

TWO-DIMENSIONAL FABRICATION

CNC cutting, or two-dimensional fabrication, is the most commonly used fabrication technique. Various cutting technologies, such as plasma-arc, laser-beam and water-jet, involve two-axis motion of the sheet material relative to the cutting head, and are implemented as a moving cutting head, a moving bed or a combination of the two. In plasma-arc cutting, an electric arc is passed through a compressed gas jet in the cutting nozzle, heating the gas into plasma with a very high temperature (25,000°F), which converts back into gas as it passes the heat to the cutting zone (figure 3.10). In water-jets, as their name suggests, a jet of highly pressurized water is mixed with solid abrasive particles and is forced through a tiny nozzle in a highly focused stream (figure 3.11), causing the rapid erosion of the material in its path and producing very clean and accurate cuts (figure 3.12). Laser-cutters use a high-intensity focused beam of infrared light in combination with a jet of highly pressurized gas (carbon dioxide) to melt or burn the material that is being cut. There are, however, large differences between these technologies in the kinds of materials or maximum thicknesses that could be cut. While laser-cutters can only cut materials that can absorb light energy, water-jets can cut almost any material. Laser-cutters can cut material up to 5/8 inches (16 mm) cost-effectively, while water-jets can cut much thicker materials, for example, up to 15 inches (38 cm) of thick titanium.

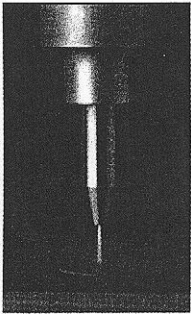

3.11.
A water-jet nozzle.

3.12.
The "*Bubble*" (1999),
BMW Pavilion,
Frankfurt, Germany,
architects Bernhard
Franken and ABB
Architekten: the
aluminum frame is cut
directly from digital
data using CNC
water-jet technology.

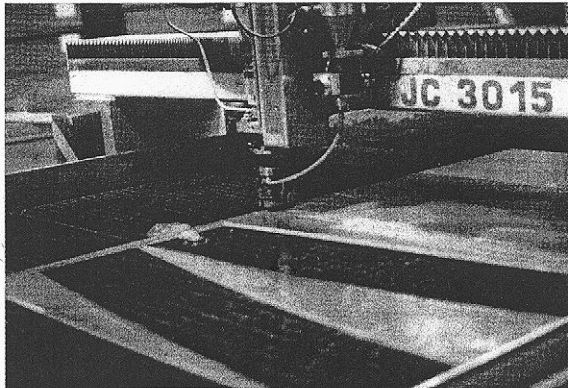

SUBTRACTIVE FABRICATION

Subtractive fabrication involves the removal of a specified volume of material from solids (hence the name) using electro-, chemically- or mechanically-reductive (multi-axis milling) processes. The milling can be axially, surface or volume constrained. In axially constrained devices, such as lathes, the piece of material that is milled has one axis of rotational motion, and the milling head has two axes of translational motion. Surface constrained milling machines are conceptually identical to the cutting machines discussed previously. In two-axis milling routers, the rotating drill-bit is moved along X and Y axes to remove two-dimensional patterns of material.

The milling of three-dimensional solids is a straightforward extension of two-dimensional cutting. By adding the ability to raise or lower the drill-bit, i.e. to move it along the third, Z axis, the three-axial milling machines could remove material volumetrically. Because of the inherent limitations of three-axial milling, the range of forms that could be produced with these machines is limited. For example, undercuts as shown in figure 3.13 cannot be accomplished with three-axis milling devices. For such shapes, a four- or five-axis machines are used. In four-axis systems, an additional axis of rotation is provided, either for the cutting head or the cutting bed that holds the piece (the A-axis), and in five-axis systems one more axis of rotation (the B-axis) is added (figure 3.14). In this fashion, the cutting head can perform the "undercuts" and can substantially increase the range of forms that can be produced using milling.

The drill bits inserted into the cutting heads can be of different sizes, i.e. diameters. Large bits are used for the coarse removal of material, and smaller bits for finishing. The milling itself can be done at different rotational speeds, depending on the hardness or other properties of the material that is milled.

3.15.
A simple CNC
program.

```

O0001
N005 G54 G90 S400 M03
N010 G00 X1. Y1.
N015 G43 H01 Z.1 M08
N020 G01 Z-1.25 F3.5
N025 G00 Z.1
N030 X2.
N035 G01 Z-1.25
N040 G00 Z.1 M09
N045 G91 G28 Z0
N050 M30

```

3.13.
Undercuts cannot be milled with three-axis milling machines.

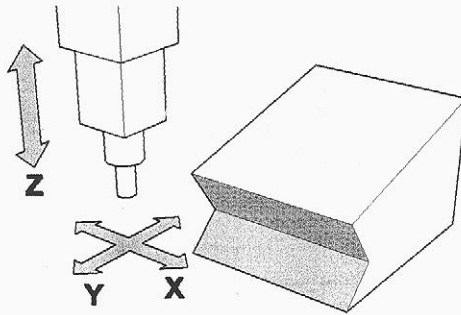

In CNC milling, a dedicated computer system performs the basic controlling functions over the movement of a machine tool using a set of coded instructions. The geometry is imported into so-called post-processing software that generates the CNC instructions which are transmitted to the milling machine. The CNC instructions control the motion, the feedrate, operation of the spindle drive, coolant supply, tool changes, and other operational parameters. As milling of shapes can be accomplished in a variety of ways, generating an appropriate "tool path" is not a trivial task, especially for four- or five-axis machines, which is often executed by skilled operators. The tool path itself is expressed as a CNC program, which is nothing more than a sequence of coded instructions for the machine to execute (figure 3.15). The CNC programs are made of commands that consist of words, each of which has a letter address and an associated numerical value. The so-called preparatory functions that, for example, control the motion of the machining tool, are often designated with a "G" letter. In a typical CNC program, the majority of "words" are these preparatory functions. Because of this, the CNC code is often referred to as "G-code" among CAM (computer-aided manufacturing) operators.

3.16a-c.
The double-curved acrylic glass panels for Bernhard Franken's "Bubble" BMW pavilion (1999) were produced using CNC-milled molds.

The CNC multi-axis milling is one of the oldest digital fabrication technologies. Early experiments in using CNC milling machines to produce architectural models were carried out in

3.14.
Five-axis milling system.

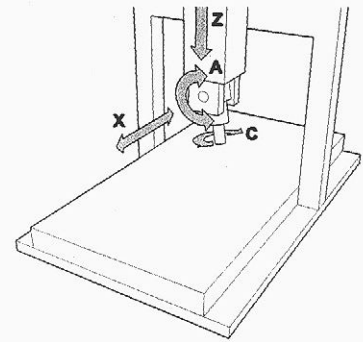

early 1970s in the United Kingdom. Large architectural firms in the United States, such as Skidmore, Owings and Merrill's (SOM) office in Chicago, have used CNC milling machines and laser cutters extensively in the production of architectural models and studies of construction assemblies. Automated milling machines were used in the late 1980s and in the 1990s to produce construction components,⁴ such as stones for New York's *Cathedral of Saint John the Divine* and columns for the *Sagrada Familia Church* in Barcelona. Frank Gehry's project for the *Walt Disney Concert Hall* in Los Angeles represents the first comprehensive use of CAD/CAM to produce architectural stonework (before that project was redesigned with a metal skin). For the initial 1:1 scale model, the stone panels with double-curved geometry were CNC milled in Italy and then shipped to Los Angeles, where they were positioned and fixed in place on steel frames. Gehry's office used this same fabrication technique for the stone cladding in the Bilbao project.

The CNC milling has recently been applied in new ways in the building industry – to produce the formwork (molds) for the off-site and on-site casting of concrete elements with double-curved geometry, as was done in one of Gehry's office buildings in Düsseldorf, Germany, in 2000, and for the production of the laminated glass panels with complex curvilinear surfaces, as in Gehry's *Condé Nast Cafeteria* project in New York (2000) and Bernhard Franken's "Bubble" BMW pavilion (1999, figures 3.16a-c).

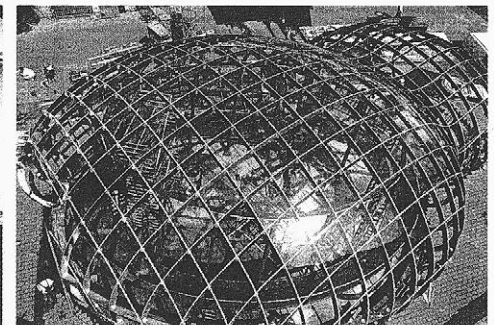
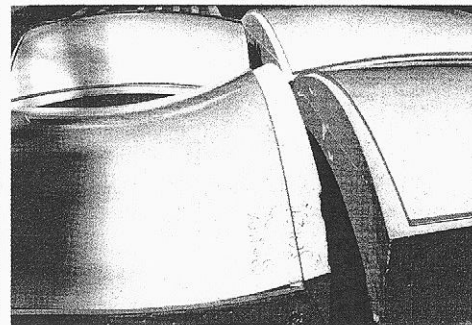
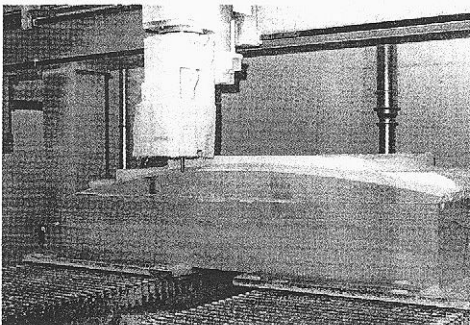

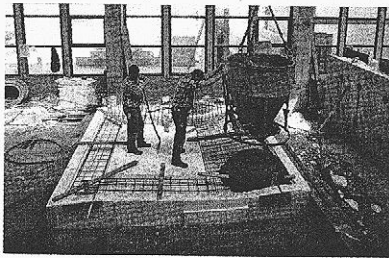
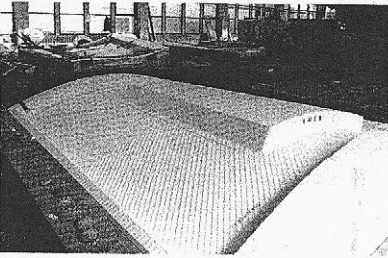
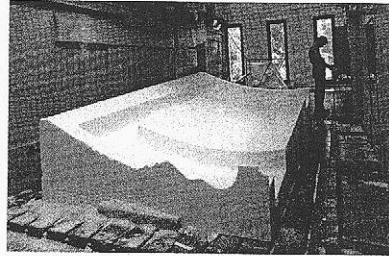
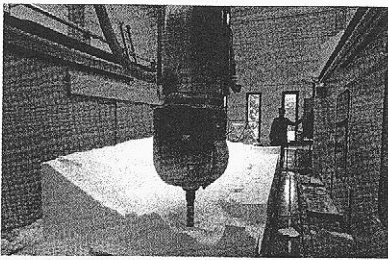

3.17a–f.

The reinforced concrete panels for Gehry's *Zollhof Towers* (2000) in Düsseldorf, Germany, were precast in CNC-milled Styrofoam molds.

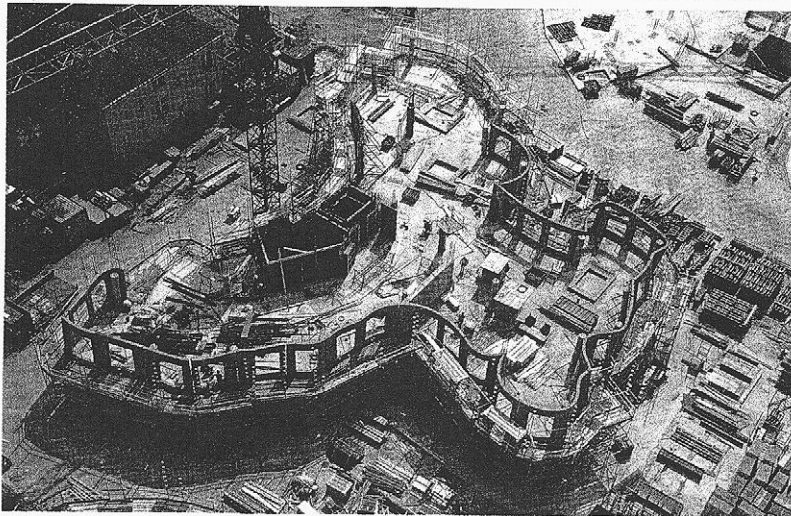
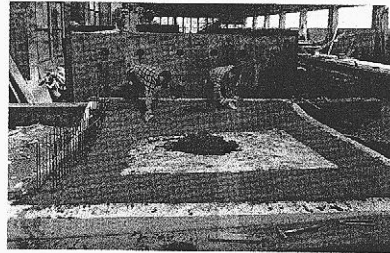

In Gehry's project in Düsseldorf (*Zollhof Towers*), the undulating forms of the load-bearing external wall panels, made of reinforced concrete, were produced using blocks of lightweight polystyrene (Styrofoam), which were shaped in CATIA and were CNC milled (figures 3.17a–f) to produce 355 different curved molds that became the forms for the casting of the concrete.⁵

ADDITIVE FABRICATION

Additive fabrication involves incremental forming by adding material in a layer-by-layer fashion, in a process which is the converse of milling. It is often referred to as *layered manufacturing*, *solid freeform fabrication*, *rapid prototyping*, or *desktop manufacturing*. All additive fabrication technologies share the same principle in that the digital (solid) model is sliced into two-dimensional layers (figure 3.18). The information of each layer is then transferred to the processing head of the manufacturing machine and the physical product is generated incrementally in a layer-by-layer fashion.

Since the first commercial system based on stereolithography was introduced by *3D Systems* in 1988 (figure 3.19), a number of competing technologies have emerged on the market, utilizing a variety of materials and a range of curing processes based on light, heat, or chemicals.⁶ *Stereolithography* (SLA) is based on liquid polymers that solidify when exposed to laser light. A laser beam traces a cross-section of the model in a vat of light-sensitive liquid polymer. A thin solid layer is produced in the areas hit by the laser light. The solidified part, which sits on a submerged platform, is then lowered by a small increment into the vat, and the laser beam then traces the next layer, i.e. the cross-section of the digital model. This process is repeated until the entire model is completed. At the end of the process, the platform with the solidified model is raised from the vat, and the model is then cured to remove extraneous liquid and to give it greater rigidity.

In *Selective Laser Sintering* (SLS), the laser beam melts layer by layer of metal powder to create solid objects. In *3D Printing* (3DP), layers of ceramic powder are glued to form objects (figure 3.20). Sheets of material (paper or plastic), either precut or on a roll, are glued (laminated) together and laser cut in the *Laminated Object Manufacture* (LOM) process. In *Fused Deposition Modeling* (FDM), each cross-section is produced by melting a plastic filament that solidifies upon cooling. *Multi-jet manufacture* (MJM) uses a modified printing head to deposit melted thermoplastic wax material in very thin layers, one layer at a time, to create three-dimensional solids (figure 3.21).

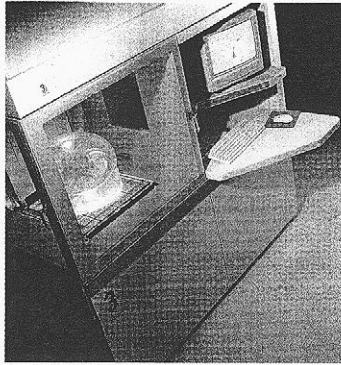

3.19.
The SLA 250 stereolithography system by 3D Systems.

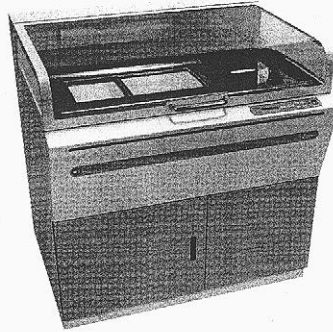

3.20.
ZCorp's Z406 3D printer.



3.21.
Thermojet printer by 3D Systems.



3.18.
Layered manufacturing.

Because of the limited size of the objects that could be produced, costly equipment and lengthy production times, the additive fabrication processes have a rather limited application in building design and production. In design, they are used mainly for the fabrication of (massing) models with complex, curvilinear geometries (figure 3.22). In construction, they are used to produce components in series, such as steel elements in light truss structures, by creating patterns that are then used in investment casting (figures 3.23a–b).

Recently, however, several experimental techniques based on sprayed concrete were introduced to manufacture large-scale building components directly from digital data. A fairly recent additive technology called *contour crafting*, invented and

patented by Behrokh Khoshnevis from the University of Southern California, allows fairly quick layered fabrication of highly finished buildings.⁷ Contour crafting is a hybrid automated fabrication method that combines extrusion for forming the surface shell of an object and a filling process based on pouring or injection to build the object's core. Computer-controlled trowels, the flat blades used for centuries to shape fluid materials such as clay or plaster, are used to shape the outside edges (rims) of each cross-section on a given layer, which are then filled with concrete or some other filler material. Since material deposition is computer-controlled, accurate amounts of different materials can be added precisely in desired locations, and other elements, such as various sensors, floor and wall heaters, can be built into the structure in a fully automated fashion.

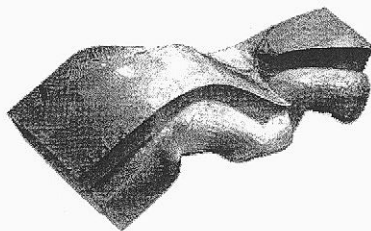

3.22.
The stereolithography model of the *House Prototype in Long Island* project by Greg Lynn.

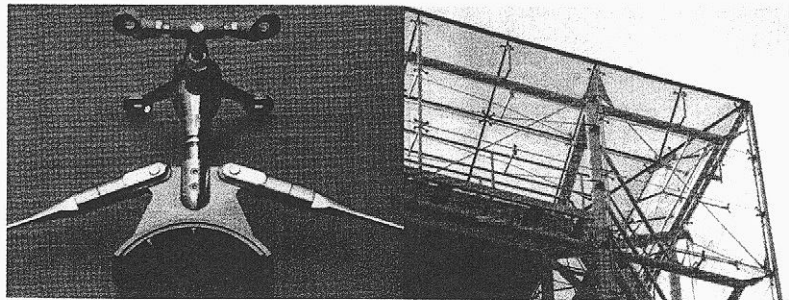

3.23a–b.
TriPyramid, a fabricator in New York, used rapid prototyping to manufacture truss elements for Polshek's *Rose Center for Earth and Sciences* (2000) in New York.

FORMATIVE FABRICATION

In formative fabrication mechanical forces, restricting forms, heat or steam are applied to a material so as to form it into the desired shape through reshaping or deformation, which can be axially or surface constrained. For example, the reshaped material may be deformed permanently by such processes as stressing metal past the elastic limit, heating metal and then bending it while it is in a softened state, steam-bending boards, etc. Double-curved, compound surfaces can be approximated by arrays of height-adjustable, numerically-controlled pins, which could be used for the production of molded glass and plastic sheets and for curved stamped metal. Plane curves can be fabricated by the numerically-controlled bending of thin rods, tubes or strips of elastic material, such as steel or wood, as was done in several exhibition pavilions designed by Bernhard Franken for BMW (figures 3.24a–b).

ASSEMBLY

After the components are digitally fabricated, their assembly on site can be augmented with digital technology. Digital three-dimensional models can be used to precisely determine the location of each component, move each component to its location and, finally, fix each component in its proper place.

Traditionally, builders took dimensions and coordinates from paper drawings and used tape measures, plumb-bobs and other devices to locate the building components on site. New digitally-driven technologies, such as electronic surveying and laser positioning (figure 3.25), are increasingly being used on construction sites around the world to precisely determine the location of building components. For example, as described by Annette LeCuyer, Frank Gehry's *Guggenheim Museum* in Bilbao "was built without any tape measures. During fabrication, each structural component was bar coded and marked with the nodes of intersection with adjacent layers of structure. On site bar codes were swiped to reveal the coordinates of each piece in the CATIA model. Laser surveying equipment linked to CATIA enabled each piece to be precisely placed in its position as defined by the computer model."⁸ Similar processes were used on Gehry's EMP project in Seattle (figures 3.26a–c).⁹ As LeCuyer notes, these processes are common practice in the aerospace industry, but relatively new to building.¹⁰

The geometric data extracted from the digital three-dimensional model can be used to control construction robots that can automatically carry out a variety of tasks on construction sites. In Japan, a number of robotic devices for the moving and fixing of components were developed, such as Shimizu's *Mighty Jack* for heavy steel beam positioning, Kajima's *Reinforcing Bar Arranging Robot*, Obayashi-Gumi's *Concrete Placer* for pouring

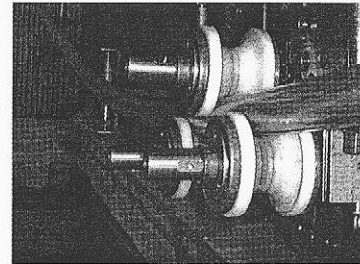
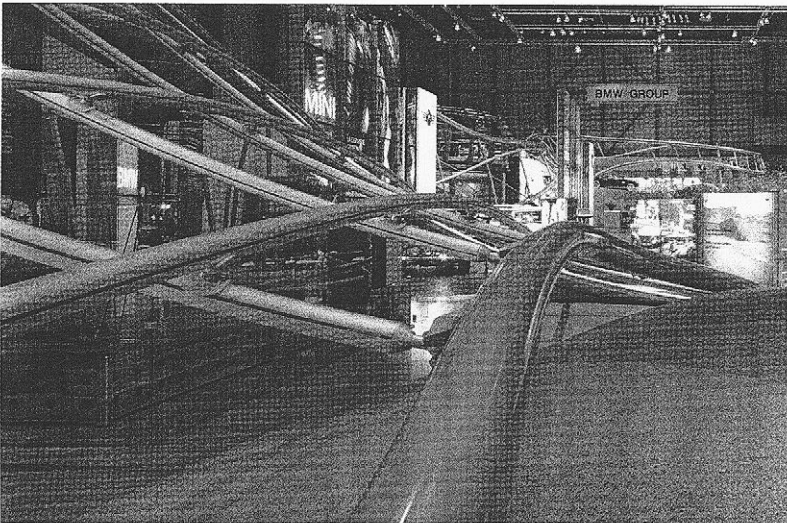

3.24a–b.
The CNC bending of the aluminum profiles for the "Brandscape" BMW Pavilion at the 2000 Auto Show in Geneva, Switzerland, architects Bernhard Franken and ABB Architekten.



3.25.
Trimble's 5600 Series
Total Station advanced
surveying system.

3.26a-c.
Global Positioning
System (GPS)
technology was used on
Frank Gehry's
*Experience Music
Project* in Seattle (EMP)
(2000) to verify the
location of components.

concrete into forms, Takenaka's *Self-Climbing Inspection Machine*, Taisei's *Pillar Coating Robot* for painting, and Shimizu's *Insulation Spray Robot* (figure 3.27).

It is conceivable that in the not so distant future architects will directly transmit the design information to a construction machine that will automatically assemble a complete building. The SMART system, which stands for *Shimizu Manufacturing system by Advanced Robotics Technology*, is the world's first digitally-driven, automated construction system that was actually applied to a full-scale building project. In the 20-storey *Juroku Bank Building* in Nagoya, Japan, Shimizu's SMART construction machine automatically erected and welded the structural steel frame and placed and installed the concrete floor panels and exterior and interior walls. The SMART system showed that it is possible to fully automate the identification, transport and installation of building components using a computerized information management system.

These experiments by Japanese construction companies are harbingers of the inevitable digital evolution in the building industry. A radical reconceptualization of building practices is technologically possible today; the realities of economic and social constraints in the building industry simply mean that the processes of change will be evolutionary rather than revolutionary, and will most likely occur over several decades.

SURFACE STRATEGIES

Architects today digitally create and manipulate NURBS surfaces, producing building skins that result not only in new expressive and aesthetic qualities, but also in new tectonic and geometric complexities. It is the surface and not necessarily the structure that preoccupies the work of the digital avant-garde in its exploration of new formal territories. The exterior surface of a building – its skin – becomes necessarily emphasized due to the logics of formal conception inherent in the NURBS-based software, as discussed in the previous chapter.

The explorations in constructability of geometrically complex envelopes in the projects of the digital avant-garde have led to a rethinking of surface tectonics. The building envelope is increasingly being explored for its potential to reunify the skin and the structure in opposition to the binary logics of the Modernist tectonic thinking. The structure becomes embedded or subsumed into the skin, as in *semi-monocoque* and *monocoque* structures, in which the skin absorbs all or most of the stresses. The principal idea is to conflate the structure and the skin into one element, thus creating self-supporting forms that require no armature. That, in turn, prompted a search for "new" materials, such as high-temperature foams, rubbers, plastics and composites, which were, until recently, rarely used in the building industry. As observed by Joseph Giovannini, "the idea of a structural skin not only implies a new material, but also geometries, such as curves and folds that would enable the continuous skin to act

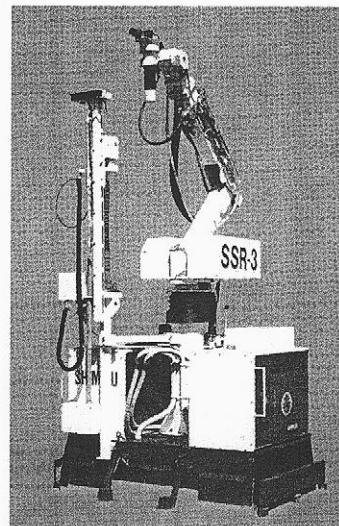
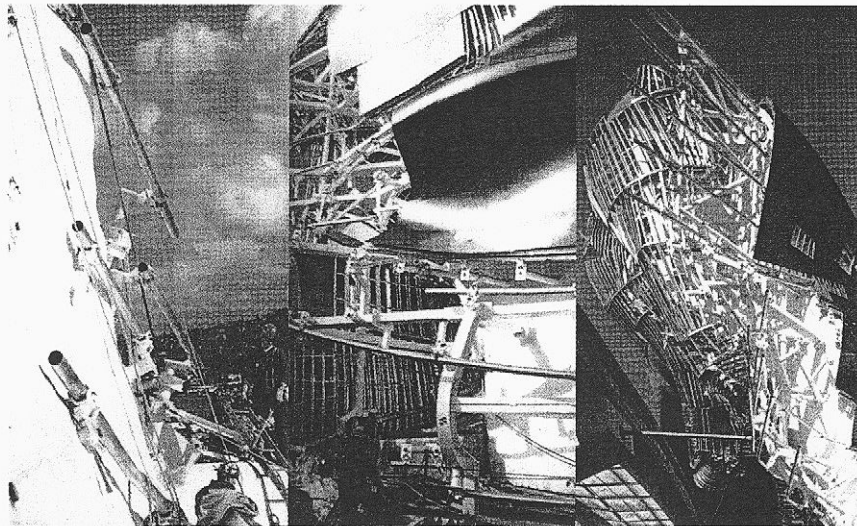

3.27.
Shimizu's *Insulation
Spray Robot*.

structurally, obviating an independent static system: The skin alone does the heavy lifting."¹¹ Thus, an interesting reciprocal relationship is established between the new geometries and new materialities: new geometries opened up a quest for new materials and vice versa. Kolatan and Mac Donald's *Raybould House* addition (2003) project in Connecticut (figure 3.28) nicely illustrates that reciprocity – the building is to be made of polyurethane foam sprayed over an egg-crate plywood armature that should be CNC cut (figure 3.29); the resulting monocoque structure is structurally self-sufficient without the egg-crate, which should remain captured within the monocoque form.

The fusion of the structure and the skin in monocoque and semi-monocoque envelopes is already having a considerable impact on the design of structures and cladding in particular. The new thin, layered building envelopes are made of panels that provide not only enclosure and structural support, but also contain other systems typically placed into ceilings or floors. These developments in cladding are driven in part by technologies and concepts from other industries, such as the "stressed skins" long used in automotive, aerospace, and shipbuilding production. For example, in airplanes, the cage-like structure called *airframe* (figure 3.30), made from

aluminum alloys, is covered by aluminum panels to form a semi-monocoque envelope in which the structure and skin are separate tectonic elements but act in unison to absorb stresses.

The "blobby" shell of the *NatWest Media Centre* (1999) building (figure 1.21) at Lord's Cricket Ground in London was designed by Future Systems and built as an aluminum semi-monocoque structure in a boatyard. Aluminum was the material of choice because it does not corrode and it can be formed to make a waterproof skin; the skin is also structural in this case, thus making a separate framing structure or cladding unnecessary. The shell was manufactured from CNC cut, 6 and 12 mm thick aluminum plates and was pre-assembled in a boatyard (figure 1.22). It was then divided into 26, 3 m wide sections (figure 3.31) and transported to the site, where it was reassembled on two giant concrete pillars. Aluminum semi-monocoque structures were also used by Jakob and MacFarlane in the *Georges Restaurant* (2000), at Centre Pompidou, Paris, France (figures 3.32 and 33a–b). The structural elements were digitally cut out of 10 mm thick aluminum; the skin was made from 4 mm thick sheets of aluminum that were bent into doubly-curved shapes using traditional boat building methods.

The implications of these new structural skins are significant, as noted by Joseph Giovannini, because they signify a radical departure from Modernism's ideals:

3.28.
Kolatan and Mac
Donald's *Raybould
House* addition (2003)
in Connecticut.

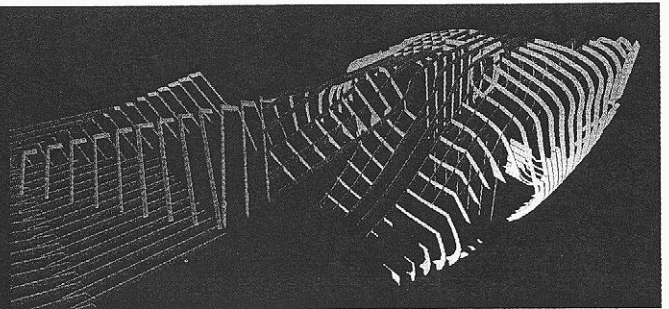
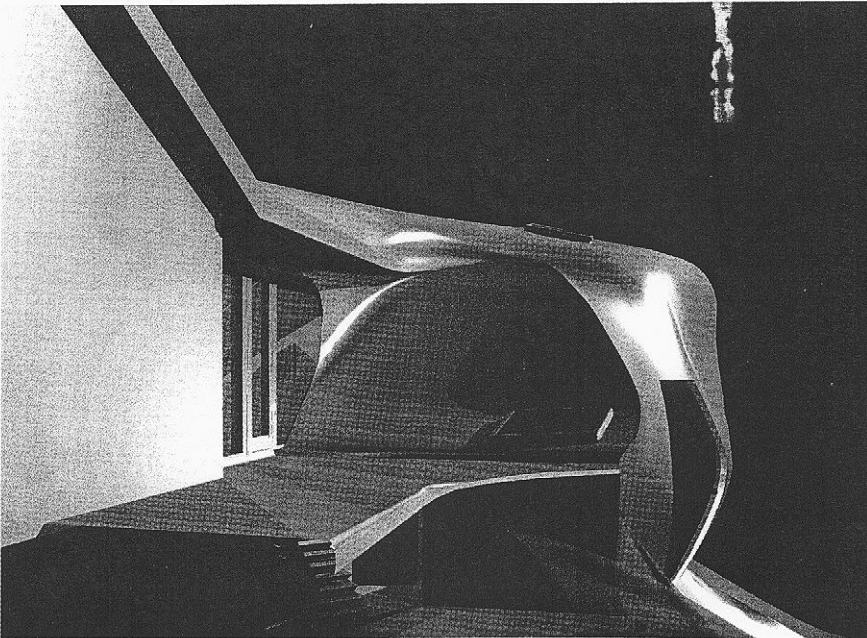

3.29.
Raybould House: egg-
crate armature for the
polyurethane shell.

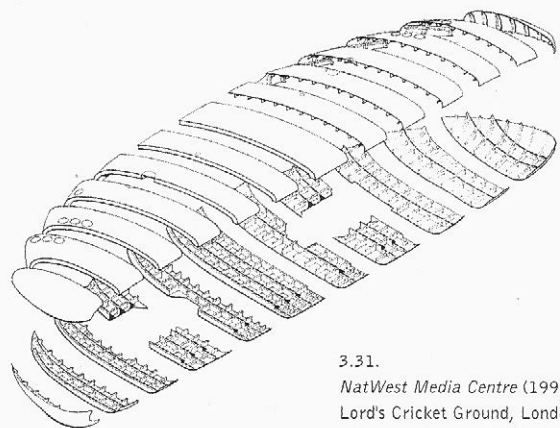
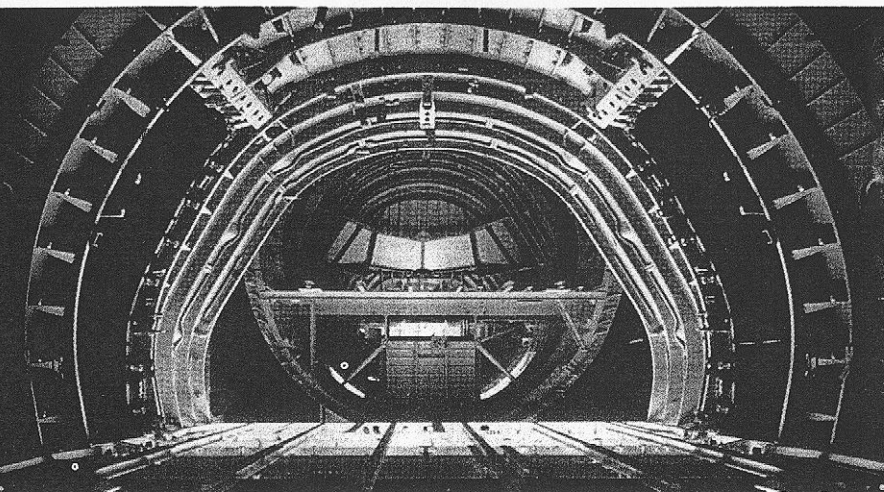

3.31.
NatWest Media Centre (1999),
 Lord's Cricket Ground, London,
 UK, architect Future Systems: the
 semi-monocoque aluminum shell
 was made from 26 segments.

3.30.
 In airplanes the structure
 and the skin act in unison
 to absorb stresses.

3.32.
Restaurant Georges
 (2000), Centre Pompidou,
 Paris, France, architects
 Jakob + MacFarlane.

"In some ways the search for a material and form that unifies structure and skin is a counterrevolution to Le Corbusier's *Domino House*, in which the master separated structure from skin. The new conflation is a return to the bearing wall, but one with freedoms that Corb never imagined possible. Architects could build many more exciting buildings on the *Statue of Liberty* paradigm, but complex surfaces with integrated structures promise a quantum leap of engineering elegance and intellectual satisfaction."¹²

Other less radical strategies involve offsetting the structure from the skin into its own layer (figure 3.34), which is the approach Frank Gehry has applied to most of his recent projects. The process of working from the skin to the structure is a common practice in automotive and aerospace industries, where the spatial envelope is fixed early on. Such an approach is a relative novelty in architecture, a clear departure from the "primacy of structure" logics of the Modernism. Another approach is a distinct separation of the skin and the structure, where the spatial juxtaposition can produce potent

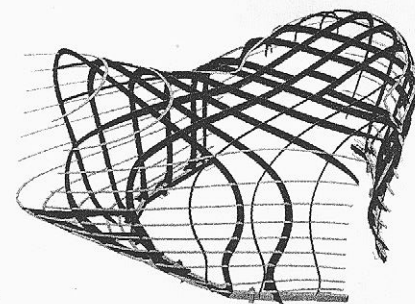
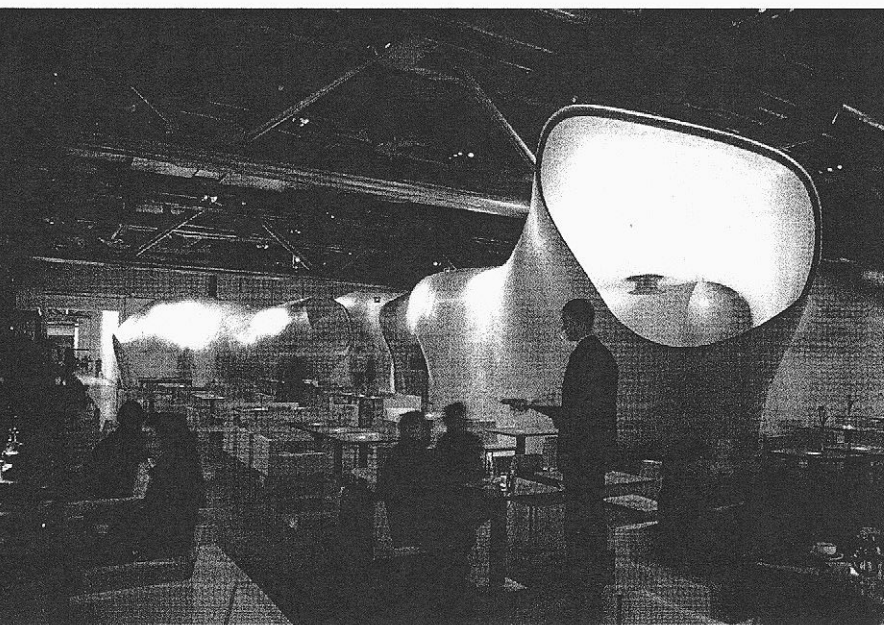

3.33a-b.
Restaurant Georges:
 model of the monocoque
 shell for the "bar"
 volume.

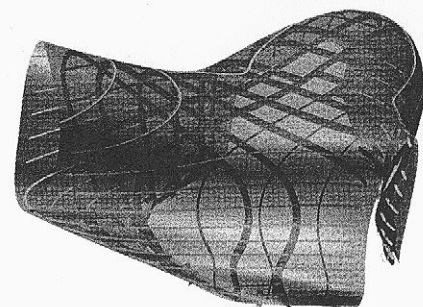

3.34.
Assembly of the
structural frame for
the *Disney Concert
Hall* (2003), Los
Angeles, architect
Frank Gehry.

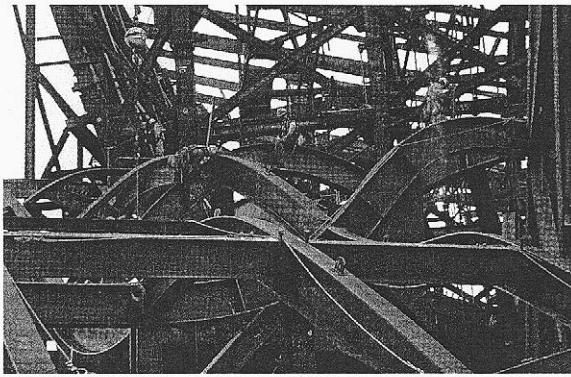

visual interplays. Gustave Eiffel's structural frame for Auguste Bartholdi's contoured skin for the *Statue of Liberty* (figure 3.35) provides a telling precedent that demonstrates clearly the possibilities that open up by such an approach to surface tectonics. There is also a conventional approach in which the sinuous skin is attached to a conventionally-conceived structural grid, which, if carefully applied, can produce interesting results. Each of these approaches to skin and structure is perfectly valid and each has different repercussions for the development of the project relative to its overall cost and desired spatial qualities.

The strategies for articulating the tectonics of NURBS-based envelopes are driven by their geometric complexity, possibilities and resistances offered by the intended material composition, and structural considerations, all of which could have significant implications for the overall cost of the project. These "rules of constructability" often demand rationalizations in the geometry of tectonic components, which could be ordered according to their cost (from lower to higher) into straight or flat, radially bent, doubly curved, and highly shaped (or distorted, often by stretching). The digital technologies enable architects to attain exact control over the budget by precisely controlling the geometry.

3.36a–b.
Structural frames in
Frank Gehry's
*Experience Music
Project* (2000) in
Seattle were produced
by contouring.

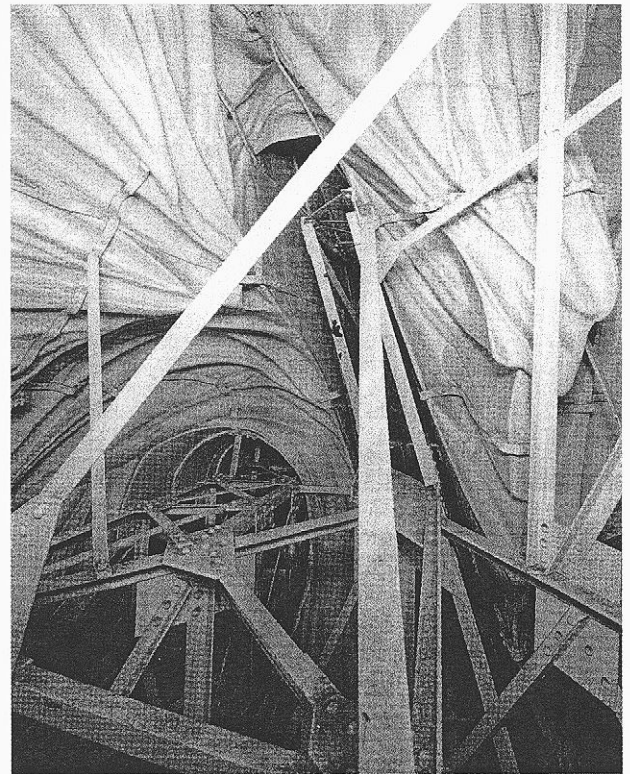
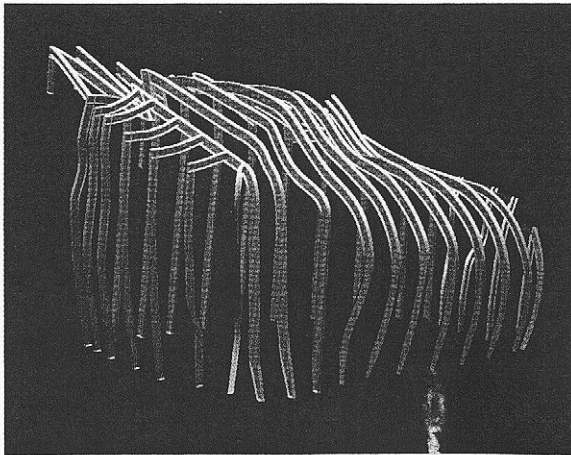

3.35.
Statue of Liberty
(1886), New York,
architects Gustave Eiffel
and Auguste Bartholdi:
folds, armature and
bracing.



3.37.
Structural framework
for Bernhard Franken's
"Bubble" BMW
Pavilion produced by bi-
directional contouring.

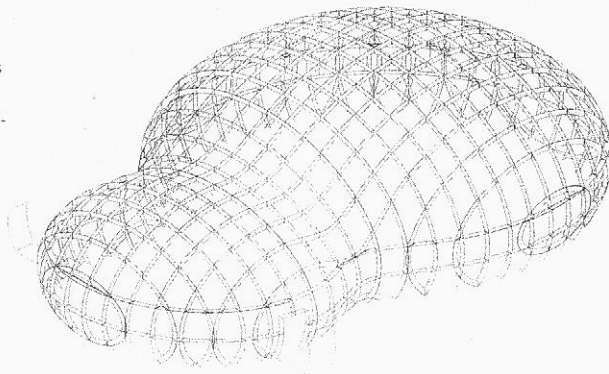

3.38.
Structural framework
for a ship's hull.

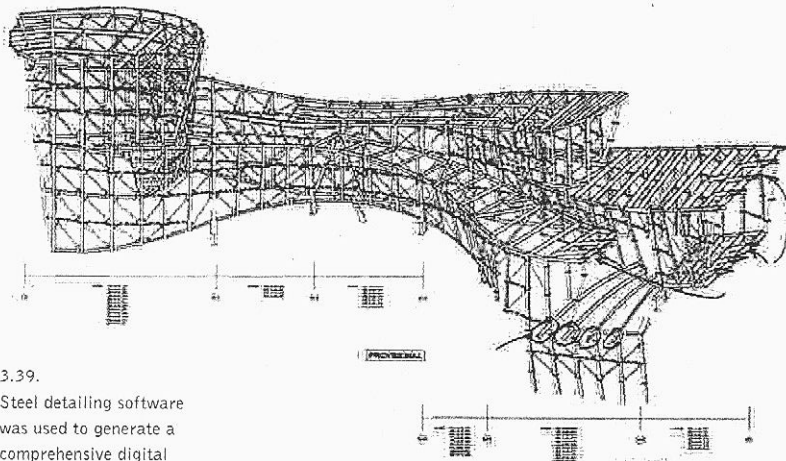
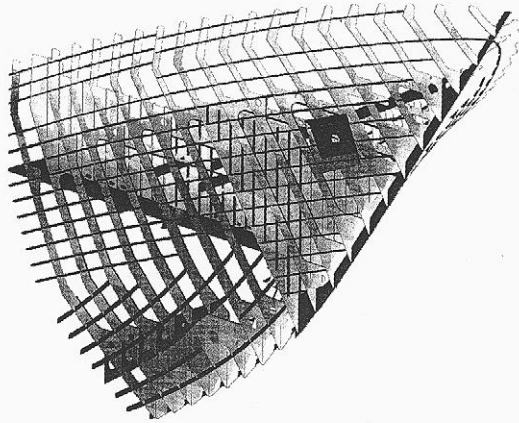

3.39.
Steel detailing software
was used to generate a
comprehensive digital
model of the steel
structure for Gehry's
Guggenheim Museum
(1997) in Bilbao, Spain.

PRODUCTION STRATEGIES

The production strategies used for two-dimensional fabrication often include *contouring*, *triangulation* (or *polygonal tessellation*), use of *ruled, developable surfaces*, and *unfolding*. They all involve the extraction of two-dimensional, planar components from geometrically complex surfaces or solids comprising the building's form. The challenge in the two-dimensional interpretation, of course, is to choose an appropriate geometric approximation that will preserve the essential qualities of the initial three-dimensional form. Which of the production strategies is used depends on what is being defined tectonically: structure, envelope, a combination of the two, etc.

In contouring, a sequence of planar sections, often parallel to each other and placed at regular intervals, are produced automatically by modeling software from a given form and can be used directly to articulate structural components of the building, as was the case in a number of recently completed projects (figures 3.36a–b and 3.37). Contouring is conceptually identical to a process called *lofting* in shipbuilding, in which the shape of a ship's hull is defined by a sequence of planar lateral cross-sections that become "ribs" mounted on a "spine" that runs lengthwise (figure 3.38).

The wireframe cross-sections, produced by contouring, can be further manipulated to create a complete abstraction of the building's structural framework, which could then be processed by the structural analysis software to generate the precise definition of all structural members. In Gehry's Bilbao project, the contractor used a software program from Germany called *Bocad* to automatically generate a comprehensive digital model of the structural steel, including the brace-framed and secondary steel structures for the museum (figure 3.39).¹³ More importantly, that same program was used to automatically produce the fabrication drawings, or CNC data, to precisely cut and pre-assemble the various components.¹⁴ Similar structural steel detailing software (and fabrication) were used on the *Walt Disney Concert Hall* and other recent projects by Gehry's office.

A potentially interesting contouring technique involves the extraction of the isoparametric curves ("isoparms") used to aid in visualizing NURBS surfaces through contouring in the "U" and "V" direction, as discussed in the previous chapter. For example, the tubular members for the "*Brandscape*" BMW Pavilion (figure 3.40), designed by Bernhard Franken in association with ABB Architekten for the 2000 Autoshow in Geneva, featured CNC-formed, doubly-curved geometry extracted as isoparms from the complex NURBS surface (figure 3.41). Sometimes, due to budgetary or other production-related constraints, the complex geometry of the NURBS curves can be approximated with circular, radial geometry, which can be inexpensively manufactured using rolling machines (figure 3.42). In this approach, the complexity lies in the precise connection among different pieces and the required temporary structures for assembly. This approximation, using radial geometry, was also used by Franken and his team for the production of structural members in the "*Brandscape*" BMW Pavilion.

3.40.

Assembly of the
"Brandscape" BMW
Pavilion at the 2000
Auto Show in Geneva,
Switzerland, architects
Bernhard Franken and
ABB Architekten.

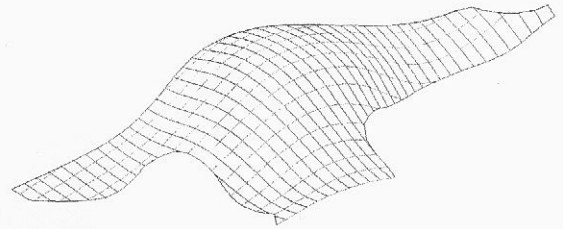
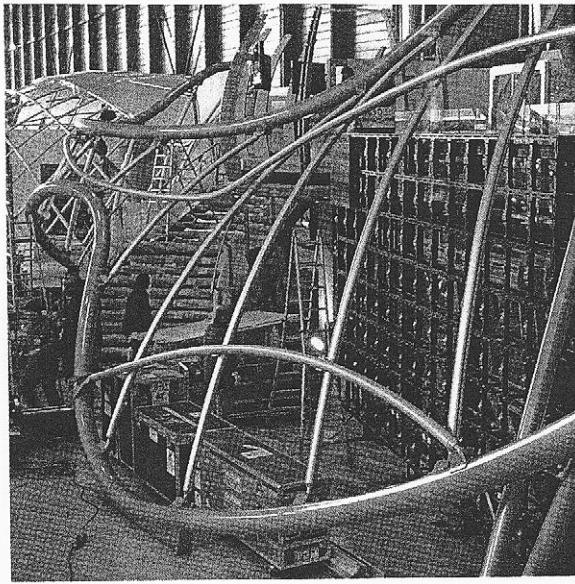

3.41.

"Brandscape": the frame
members' geometry was
derived from the NURBS
surface isoparms.

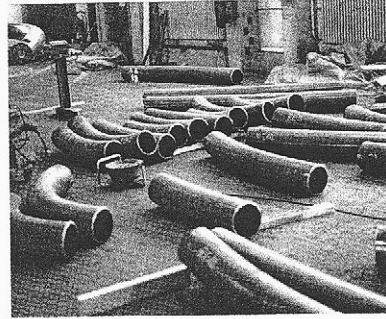

3.42.

"Brandscape": the
geometry of the perimeter
tubes was rationalized into
tangent circular arcs.

While isoparms can lead to a "true" tectonic expression of the three-dimensional form, they pose non-trivial production challenges, as fabrication of doubly-curved structural members requires expensive equipment and temporary egg-crate (created through planar contouring) or other structures for the precise positioning in the construction assembly. The use of NURBS isoparms may also lead to suboptimal structural solutions; instead, isoparametric curves produced by structural analysis could be used for defining the geometry of structural components.

Complex, curvilinear surface envelopes are often produced by either *triangulation* (figure 3.43) or some other planar tessellation, or by the conversion of double-curved into *ruled* surfaces, which are generated by linear interpolation between two curves (figure 3.44). Triangulated or ruled surfaces are then unfolded into planar strips (figures 3.45 and 3.46), which are laid out in some optimal fashion as two-dimensional shapes on a sheet (in a process called *nesting*), which is then used to cut the corresponding pieces of the sheet material using one of the CNC cutting technologies.

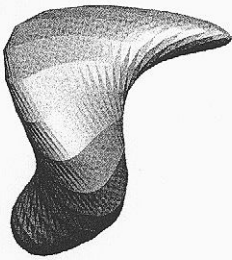

3.43.

Triangulation of a
doubly-curved surface.

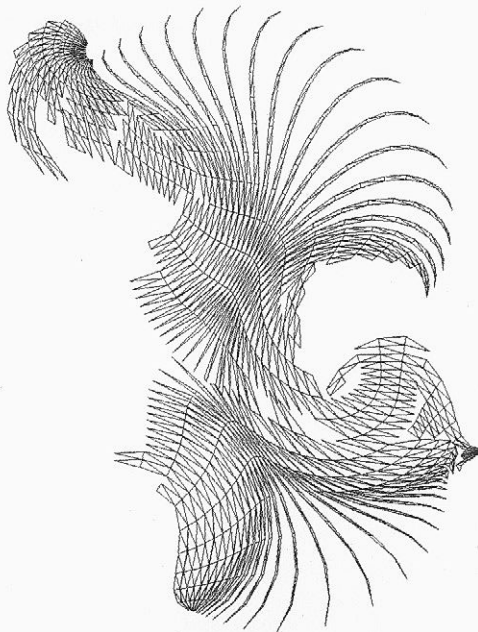

3.45.

Unfolded triangulated
surface (shown in 3.43).

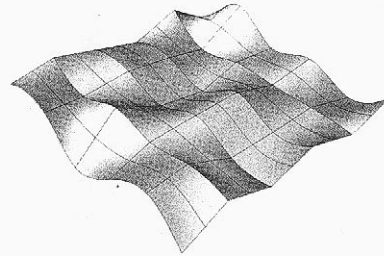

3.44.

Ruled surface.

3.46.

Unfolded ruled surface
(shown in 3.44).

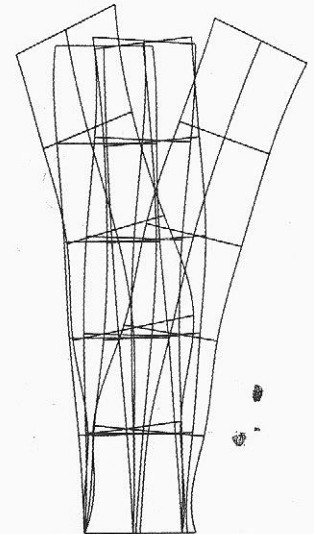

3.47.
Tessellated roof shell of
the *Sydney Opera House*
(1973), architect Jørn
Utzon.

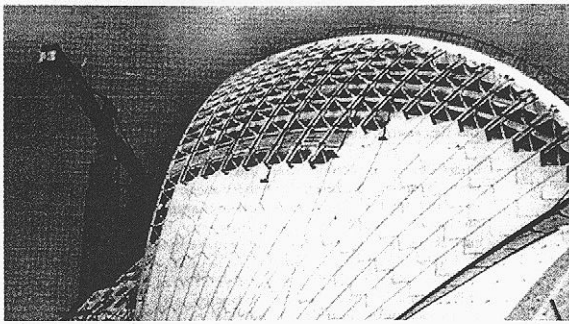

3.48.
Triangulated complex
surfaces in Frank
Gehry's *DG Bank*
(2000) building in
Parizer Platz, Berlin,
Germany.

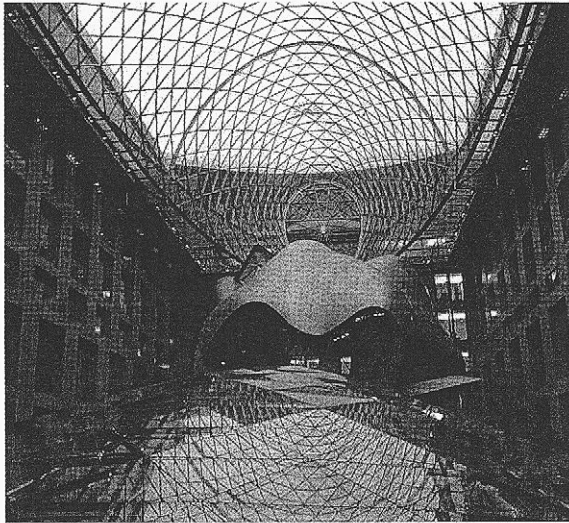

3.49.
The triangulated
toroidal surface of the
*British Museum Great
Court* (2000), London,
UK, architect Foster
and Partners.

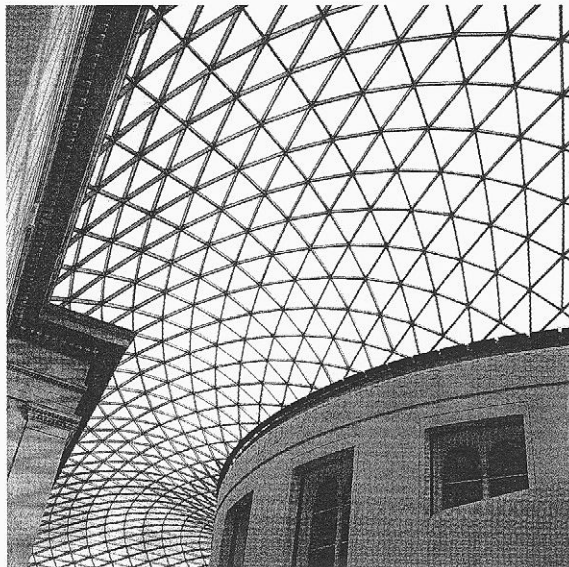

One of the best known examples of polygonal tessellation are the roof forms of the *Sydney Opera House* (1973) designed by Jørn Utzon. The initial freeform shapes sketched by Utzon were first approximated by surface segments extracted from spheres of varying radii, and were then subdivided into flat patches (figure 3.47). Triangulation is the most commonly applied form of planar tessellation. It was used, for example, in the glass roof of the *DG Bank* (2001) building (figure 3.48) that Frank Gehry designed at Parizer Platz in Berlin, Germany. The triangulated space frame was constructed from solid stainless steel rods that meet at different angles at six-legged star-shaped nodal connectors, each of which was unique and was CNC cut from 70 mm thick stainless steel plate. The frame was infilled by approximately 1,500 triangular glazing panels, which were also CNC cut. A similar production strategy was used in the glass roof of the *Great Court* in the British Museum in London, designed by Foster and Partners (figure 3.49). The irregularly-shaped and deformed "sliced" torus form of the roof was rationalized as a triangulated frame network consisting of 4,878 hollow rods and 1,566 connector nodes, all of them different from each other and all of them CNC cut. The frame was then filled with 3,312 glass panes, each of which was unique, due to the irregular geometry of the roof's perimeter.

In some of their recent projects, Foster's office has created designs with complex geometries that are based on parameterized, concatenated torus patches that smoothly transition to each other. As with complex curves, rationalizations based on the radial geometry of spheres, cones, cylinders or tori, are often deployed to approximate complexly-curved surfaces. The roof structure of the *Music Centre* (2003) in Gateshead, UK, designed by Foster's office, consists of a series of torus patches, which curve in both directions and are mutually dependent (figure 3.50). Each of the patches is subdivided into bands of identical four-sided flat panels, whose size can be parametrically varied to match the specific production and construction constraints.

Other multi-sided tessellation patterns are also possible. More sophisticated modeling programs often provide a rich repertoire of tessellation options, allowing designers to choose not only the geometry of the patches but also their minimum and maximum size. By varying the tessellation parameters, designers could interactively explore various approximation strategies to match various cost and production scenarios. Other surface subdivision algorithms can be used to divide a complex surface into a collection of patches, which are not necessarily flat. Sometimes, custom surface subdivision procedures are developed, as was done by Dennis Shelden in Gehry's office for the definition of the geometry of some 21,000 different metal shingles on the EMP project in Seattle (figure 3.51).

Another method of "rationalizing" double-curved surfaces is to convert them into "rule-developable" surfaces. Ruled surfaces are generated by linear interpolation between two curves in space, i.e.

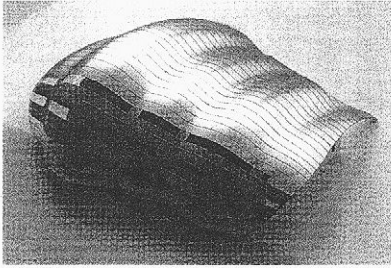

3.50.
The toroidal geometry
of Foster and Partner's
Music Centre (2003),
Gateshead, UK.

by connecting pairs of curves with straight, "ruling" lines that are placed at regular intervals (figure 3.44). A wide variety of surfaces can be generated in this fashion. The simplest ones are cones and cylinders; the more interesting forms from an architectural point of view are saddle-shaped hyperbolic paraboloids (figure 3.52) and hyperboloids (figure 3.53), a common form for the cooling towers of nuclear power stations.

The ruled surfaces are fairly easy to construct using conventional construction techniques. Relatively simple formwork is required for concrete structures. Stonemasons, for example, have used templates to cut complex ruled surface forms out of stones for centuries. For some architects, such as the well-known Uruguayan architect Eladio Dieste, the ruled surfaces were a preferred means of architectural expression in a number of his building designs (figure 3.54).

3.52.
Ruled surface:
hyperbolic paraboloid.

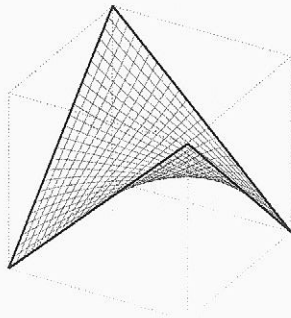

3.53.
Ruled surface:
hyperboloid.

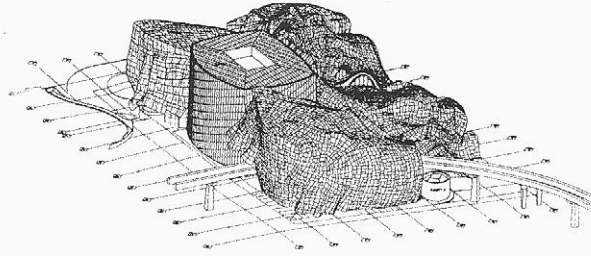
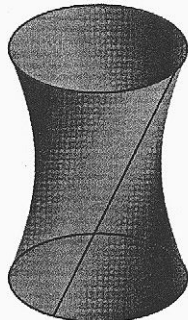

3.51.
Surface subdivision
of the exterior envelope in
EMP (2000), Seattle,
architect Gehry
Partners.

Ruled surfaces are used extensively in contemporary architectural practice because they can be "developed," i.e. unfolded into flat shapes in modeling software (figure 3.46), and digitally fabricated out of flat sheets. "Developable" surfaces can be formed by rolling a flat sheet of material without deformation, i.e. with no stretching, tearing or creases. They curve only in one isoparametric direction, i.e. they are linear in the other direction (figure 3.55a–c), unlike the doubly-curved NURBS surfaces.

Frank Gehry's office relies extensively on the use of ruled, developable surfaces to ensure the buildability of his sinuous designs within reasonable schedule and budgetary constraints (figures 3.56a–b). Gehry physically models his conceptual designs by shaping into desired forms the "developable" strips of paper or metal. These forms are digitized and the resulting surfaces are then analyzed in CATIA software and converted into digitally developable surfaces.

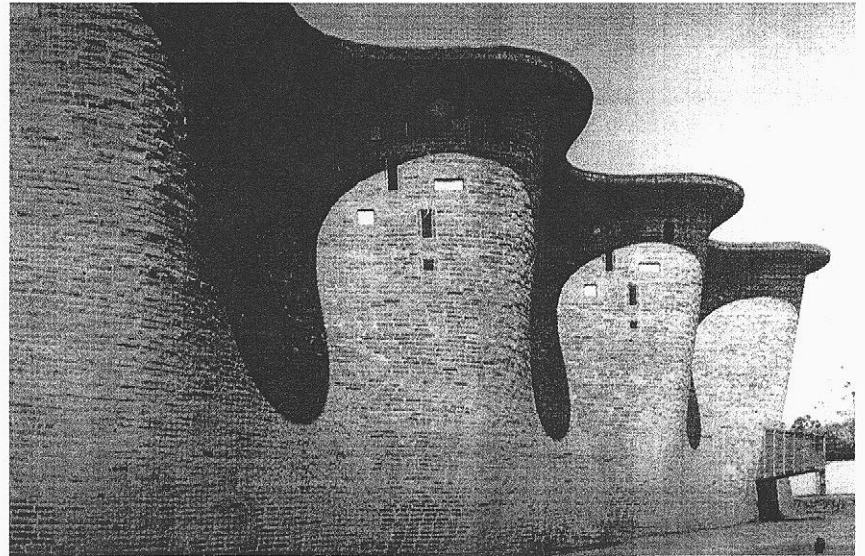

3.54.
Atlantida Church (1958),
Uruguay, architect
Eladio Dieste.

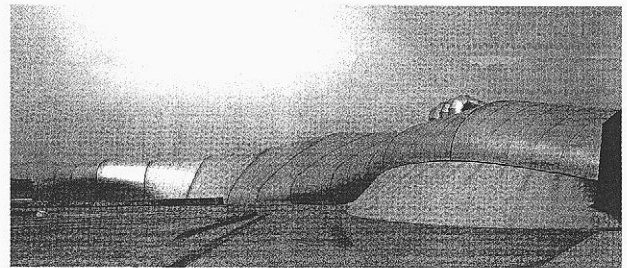
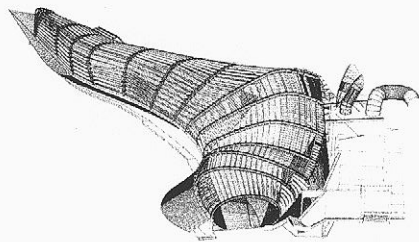
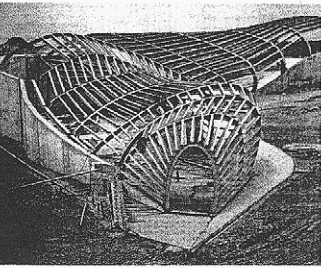

3.55a–c.
Use of ruled surfaces in the *Water Pavilion* (1998), the Netherlands, architect Lars Spuybroek/NOX Architects.

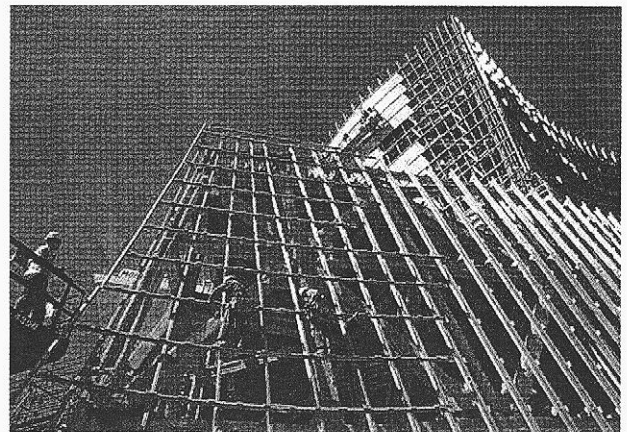
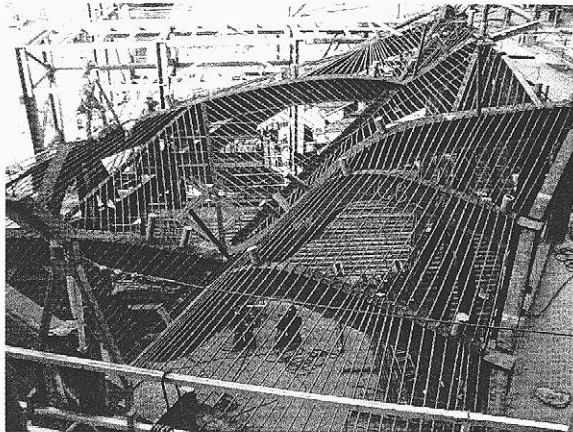

3.56a–b.
Use of ruled surfaces in the *Walt Disney Concert Hall* (2003), Los Angeles, architect Gehry Partners.

3.57.
The doubly curved steel plates for the conference chamber of the *DG Bank* (2000), Berlin, Germany, architect Gehry Partners.

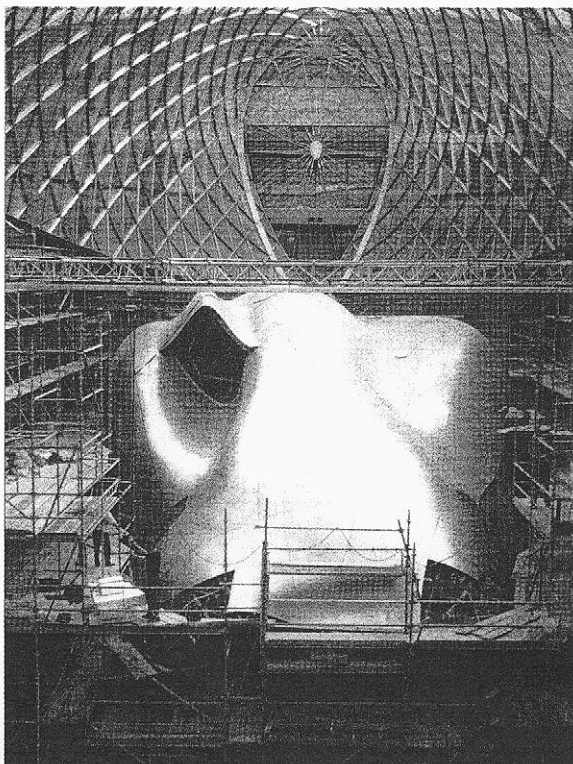

The fabrication technologies allow the production of non-developable doubly-curved surfaces, albeit at a higher cost. As discussed earlier, doubly-curved concrete elements can be formed in CNC-milled Styrofoam molds, as was done for the *Zollhof Towers* (2000) designed by Gehry in Düsseldorf, Germany (figures 3.17a–f). Glass panels with complex curvature can be produced in a similar fashion, by heating the flat sheets of glass over CNC-milled molds in high-temperature ovens (figures 3.16a–d). CNC-driven pin-beds can be used to shape metal panels into doubly-curved forms. For example, the large stainless steel plates (2 m x 4 m) for the conference chamber of the *DG Bank* (2000) building, designed by Gehry at the Parizer-Platz in Berlin, were shaped by boatbuilders to produce its complex doubly-curved form (figure 3.57).

Whether a particular section of the building's envelope is produced as a developable or doubly-curved surface can be determined by applying the *Gaussian* analysis to the surface model. The Gaussian analysis evaluates the degree of curvature in complexly-shaped elements and produces a colored image that indicates, through various colors, the extent of the surface curvature – a blue color indicates areas of no or minimum curvature, red is applied to maximum values, and green is used for areas with a median curvature (figure 3.58). Developable surfaces, for example, have zero Gaussian curvature at every point on the surface, because they are linear in one direction (figure 3.59).

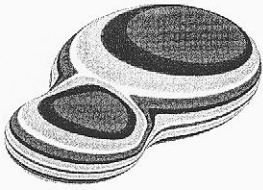

3.58.
Gaussian analysis of a doubly-curved surface.

In designing the *Guggenheim Museum* in Bilbao, Gehry's office used the Gaussian analysis to determine the areas of excessive curvature (figure 3.60), as there are limits as to how much the sheets of metal could be bent in two directions – the same technique was used on other projects by Gehry. For example, Gaussian analysis was used in the *EMP* in Seattle to determine which of the apparently double-curved surface patches can be converted into developable ones (figure 3.61) and which ones need to be complexly shaped, thus providing Gehry's office with an important ability to determine and control the overall cost of manufacturing elements of a particularly complex envelope.

3.60.
Guggenheim Museum:
Gaussian analysis.

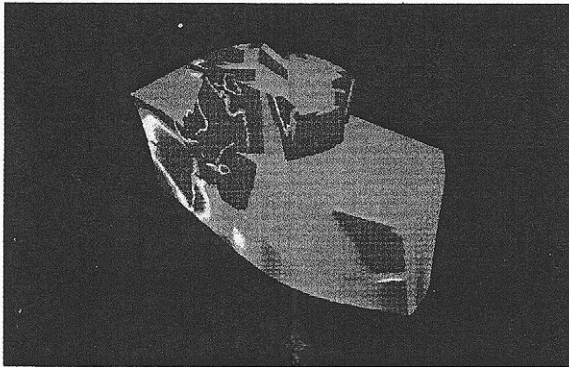

3.61.
Experience Music Project:
Gaussian analysis.

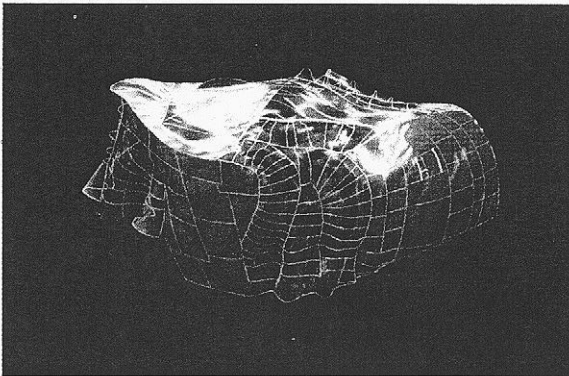

3.59.
Gaussian analysis of a developable surface.

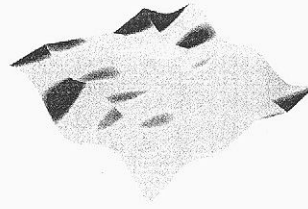

NEW MATERIALITY

New forms of architectural expression and advances in material science have led to a renewed interest among architects in materials, their properties and their capacity to produce desired aesthetic and spatial effects. As was often the case in the past, a formal departure from the basic, normative geometries would often coincide with the development of new materials. Freely formable materials, such as concrete and plastics, have led, for example, to renewed interest into "blobby" forms in the 1950s and 1960s, as discussed in Chapter 1.

The contemporary emphasis on surface articulation is fundamentally related to the possibilities and resistances offered by the intended material composition. New materials for architectural skins are offering the unprecedented thinness, dynamically-changing properties, functionally-gradient composition, and an incredible repertoire of new surface effects. For example, the titanium sheets that cover the exterior of Gehry's *Guggenheim Museum* in Bilbao have the thickness of only 0.38 mm. But it is not this thinness that is driving the increasing interest in new materials. The building skins are also acquiring a new complexity as new digital and mechanical networks become embedded into their composite layers. Structural skins with dynamic behavior are challenging the prevalent assumptions about the tectonics and the permanence of the material conditions.

The old, familiar materials, such as brick, are today being used in novel ways, as shown by the sinuous masonry wall of the *Crawford Municipal Art Gallery* (2000) in Cork, Ireland (figure 3.62), designed by Erick van Egeraat Architects, which emphasizes the new addition while adhering to the local vernacular. Van Egeraat's design is a contemporary version of the smooth, fluid forms of Eladio Dieste's buildings constructed from bricks and mortar (figure 3.54). Beneath the plastered, curving exterior walls in one of the three office towers designed by Frank Gehry in Düsseldorf, Germany, is a framework construction of CNC cut steel rules with in-fill masonry (figure 3.63), a distant contemporary antecedent of Erich Mendelsohn's *Einsteinturm* (1921, figure 1.4) in Potsdam, Germany, whose fluid shapes, conceived in concrete, were also realized in bricks and plaster.

3.62.

Crawford Municipal Art Gallery (2000), Cork, Ireland, architect Erick van Egeraat Architects.

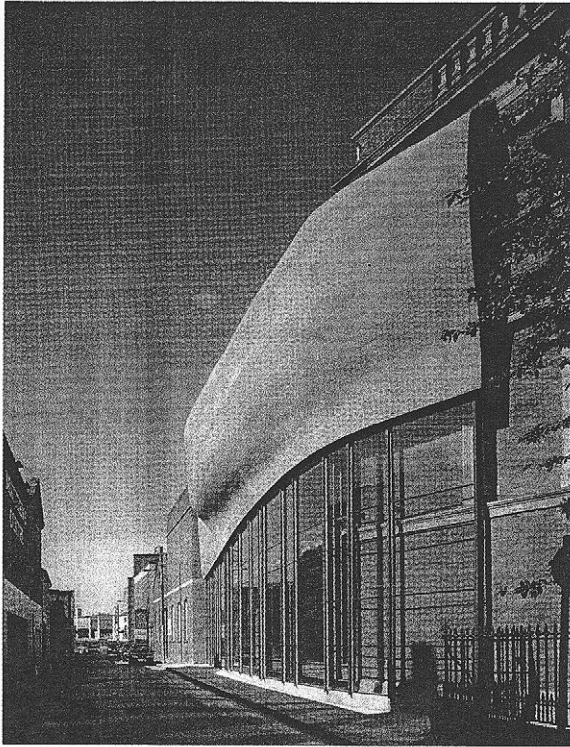

3.63.

Masonry walls in one of the *Zollhof Towers* (2000), Düsseldorf, Germany, architect Gehry Partners.

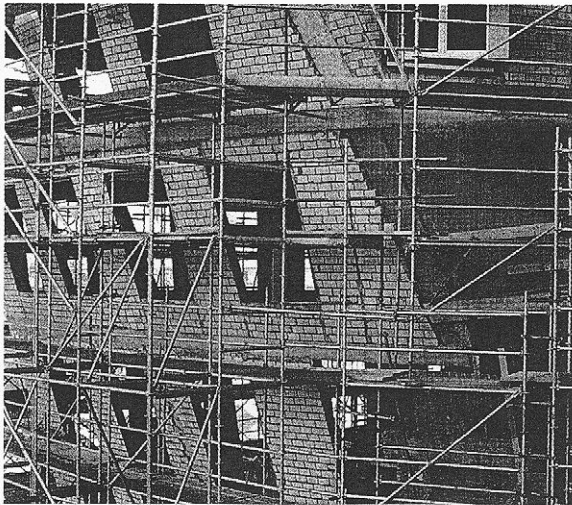

Conventional materials are being reconceptualized in new ways. For instance, the conventional steel rebar grid in reinforced concrete can be replaced with a non-corroding carbon fiber grid, producing concrete structures that are lighter and considerably stronger than steel reinforced concrete. Carbon fibers made from carbon *nanotubes* could even become the building material of the twenty-first century, replacing steel as the material of choice for the skeletal systems in buildings. Carbon atoms can create tiny spheres, which, with an appropriate catalyst, can form tiny, nano-scale edgeless tubes – “nanotubes” (figure 3.64) – that have very high strength and are much stronger than steel: a single nanotube (figure 3.65) can support more than a billion times its own weight! Once the bulk manufacturing of nanotubes becomes a reality in a decade or so, we will probably start to see some incredibly thin, but exceptionally strong, beams and walls. Nanotubes could form “gossamer structures that open up spatial realms far beyond anything we could imagine,” according to Antoine Predock,¹⁵ who says that “blobs would seem heavy-handed by comparison,” as “nanoscale structures would be like clouds.”

While new construction materials made of carbon nanotubes are still in the realm of the “not-yet” future, other commonly available materials, such as fiberglass, polymers and foams, offer several advantages over materials commonly used in current building practice. They are lightweight, have high strength, and can be easily shaped into various forms. For example, the physical characteristics of fiberglass make it particularly suitable for the

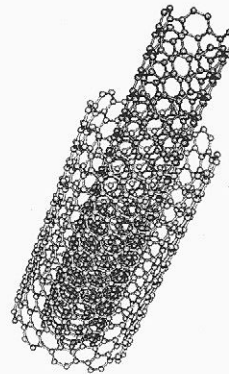

3.64.
Digital model of a
double nanotube.

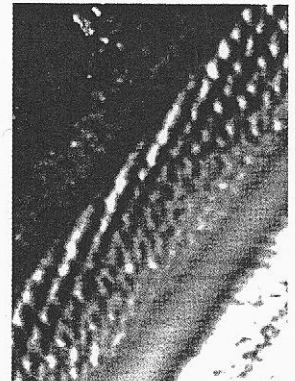

3.65.
Microscopic image of
a carbon nanotube.

fabrication of complex forms. It is cast in liquid state, so it can conform to a mold of any shape and produce a surface of exceptional smoothness – a liquid, fluid materiality that produces liquid, fluid spatiality, as manifested in Kolatan and Mac Donald's design for the *Ost/Kuttner Apartments* in New York (figure 2.26).

The "liquid" materials that have aroused particular interest among architects today are *composites* whose composition can be engineered precisely to meet specific performance criteria, and whose properties can vary across the section to achieve, for example, a different structural capacity in the relationship to local stress conditions and surface requirements. These layered materials, commonly used in automotive, aerospace, shipbuilding and other industries (figure 3.66), are experimented with for possible architectural applications, as they offer the unprecedented capability to design material effects by digitally controlling the production of the material itself.

Composites are actually solid materials created, as their name suggests, by combining two or more different constituent material components, often with very different properties. The result is a new material that offers a marked qualitative improvement in performance, with properties that are superior

to those of the original components. A composite material is produced by combining two principal components – the *reinforcement* and the *matrix*, to which other filler materials and additives could be added. The matrix is, typically, a metallic, ceramic or polymer material, into which multiple layers of reinforcement fibers, made from glass, carbon, polyethylene or some other material, are embedded. Lightweight fillers are often used to add volume to the composites with minimal weight gain, while various chemical additives are typically used to attain a desired color or to improve fire or thermal performance.

The actual components made from composite materials are usually formed over CNC-milled molds, as in boatbuilding, to produce boat hulls or large interior components, or in closed moulds by injecting the matrix material under pressure or by partial vacuum, as is done in the automotive industry for the production of smaller-scale components. In the building industry, composite panels are produced either through continuous lamination or by using the resin transfer molding.

Among composites, the polymer composite materials, or simply "plastics," are being considered with renewed interest by architects, primarily because of their high formability, relatively low cost, minimum maintenance, and a relatively high strength-to-weight ratio. Plastics were used with great enthusiasm in the 1960s and 1970s because of their novelty as a material and their ability to take any shape, but the poor weathering capabilities, the shifting aesthetics of the late 1970s and early 1980s, and the ubiquity of plastic products, led to their second-class status later on.

It is the *functionally gradient* polymer composite materials that offer the promise of enclosures in which structure, glazing, and mechanical and electrical systems are synthesized into a single material entity. By optimizing material variables in composites for local performance criteria, entirely new material and tectonic possibilities open up in architecture. For example, transparency can be modulated in a single surface, and structural performance can be modulated by varying the quantity and pattern of reinforcement fibers, etc.¹⁶

Other possibilities are opened up by materials that change their properties dynamically in direct response to external and internal stimuli, such as light, heat and mechanical stresses. Kolatan and Mac Donald are exploring, in their speculative projects, materials such as "plastics that undergo molecular restructuring with stress," "smart glass that responds to light and weather conditions," "anti-bacterial woven-glass-fiber wall covering" and "pultruded fiberglass-reinforced polymer structural components."

3.66.
Closeup of a bicycle
frame made of a carbon
fiber composite
material.

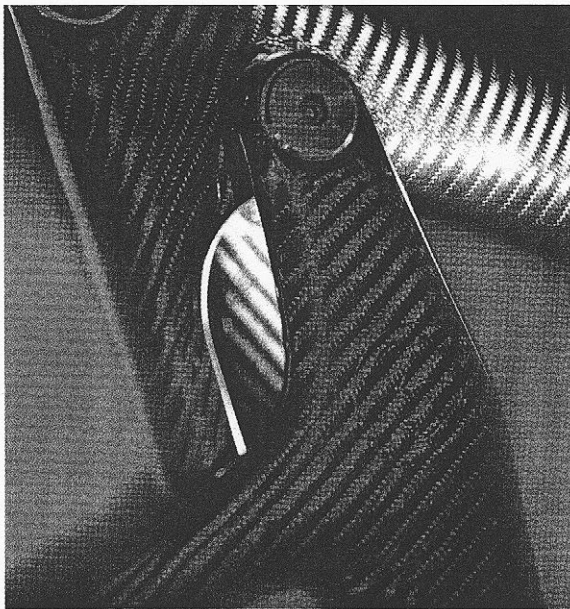

New skins begin to change not only their transparency and color, but also their shape in response to various environmental influences, as the *Aegis Hyposurface* project by Mark Goulthorpe shows. This project was developed initially as a competition entry for an interactive art piece to be exhibited in the Birmingham Hippodrome Theater foyer. The developed construct is a highly faceted metallic surface, which is actually a deformable, flexible rubber membrane covered with tens of thousands of triangular metal shingles (figure 3.67), and which can change its shape in response to electronic stimuli resulting from movement and changes in sound and light levels in its environment, or through parametrically-generated patterns. It is driven by an underlying mechanical apparatus that consists of several thousand pistons, which are controlled digitally, providing a real-time response. According to Goulthorpe, this project "marks the transition from autoplastic (determinate) to alloplastic (interactive, indeterminate) space;" it "utterly radicalize[s] architecture by announcing the possibility of dynamic form."

Goulthorpe's *Aegis Hyposurface* dynamic skin, a highly complex, electromechanical hybrid structure, whose sensors, pneumatic actuators, and computational and control systems provide it with what could be called "intelligent" behavior, points

to a material future in which it could become a fairly thin, single "intelligent" composite material with a "neural" system fully integrated into its layers.

"Intelligent," "smart," "adaptive" and other terms are used today to describe a higher form of composite materials that have sensing, actuation, control and intelligence capabilities. These composites have their own sensors, actuators, and computational and control firmware built into their layers. According to another definition, intelligent materials are those materials that possess adaptive capabilities to external stimuli through built-in "intelligence." This "intelligence" of the material can be "programmed" through its composition, its microstructure, or by conditioning to adapt in a certain manner to different levels of stimuli. The "intelligence" of the material can be limited to sensing or actuation only. For example, a sensory material is capable of determining particular material states or characteristics and sending an appropriate signal; an adaptive material is capable of altering its properties, such as volume, opacity, color, resistance, etc. in response to external stimuli. An active material, however, contains both sensors and actuators, with a feedback loop between the two, and is capable of complex behavior – it can not only sense a new condition, but can also respond to it.

Some of the early "intelligent" materials, for example, were capable of sensing stress and temperature change through embedded sensors. The complexity, capacities, and utility of the "intelligent" materials, however, have increased dramatically over the past decade, with most of the research efforts concentrated on aerospace applications. Piezoelectric and optical sensors, for example, are embedded into composite material used as a skin in high-performance airplanes. These materially-integrated sensors continually measure stress and chemical changes within an airplane's skin, detecting damage and transmitting an appropriate signal. Similar sensory mechanisms, for example, are being embedded into "smart" concrete via tiny optical fibers, to monitor stresses and to detect potential damage. By producing materials in a digitally-controlled layer-by-layer fashion, as in additive fabrication, it is possible to embed various functional components, thus making them an integral part of a single, complex composite material.

The developing materials and technologies of the twenty-first century will radically redefine the relationship between architecture and its material reality. Future digital architecture, in its conception and its realization, will respond dynamically to the internal logics and external influences of the environment. Designs are already "alive" – the buildings will soon be as well.

3.67.

Aegis Hyposurface
(1999), architect Mark
Goulthorpe/dECOi.

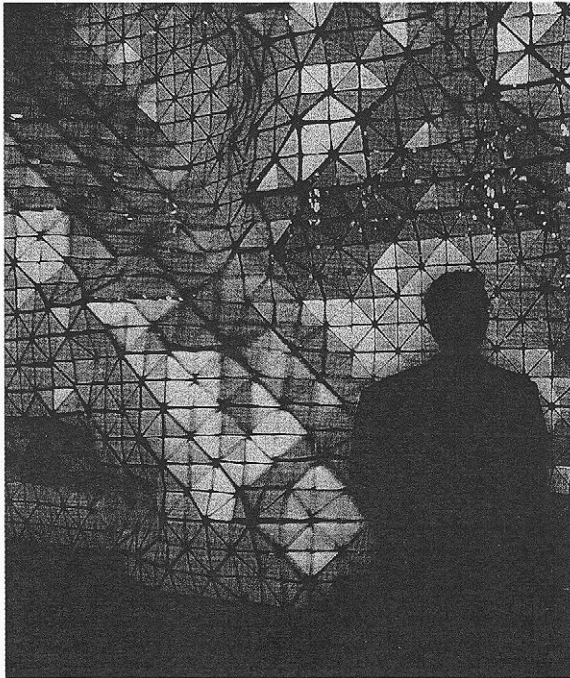

MASS-CUSTOMIZATION

The sparse geometries of the twentieth century Modernism were, in large part, driven by Fordian paradigms of industrial manufacturing, imbuing the building production with the logics of standardization, prefabrication and on-site installation. The rationalities of manufacturing dictated geometric simplicity over complexity and the repetitive use of low-cost mass-produced components. But these rigidities of production are no longer necessary, as digitally-controlled machinery can fabricate unique, complexly-shaped components at a cost that is no longer prohibitively expensive. Variety, in other words, no longer compromises the efficiency and economy of production.

The ability to mass-produce one-off, highly differentiated building components with the same facility as standardized parts, introduced the notion of "mass-customization" into building design and production (it is just as easy and cost-effective for a CNC milling machine to produce 1,000 unique objects as to produce 1,000 identical ones). Mass-customization, the post-Fordian paradigm for the economy of the twenty-first century, was defined by Joseph Pine¹⁷ as the mass production of individually-customized goods and services, thus offering a tremendous increase in variety and customization without a corresponding increase in costs. It was anticipated as a technological capability in 1970 by Alvin Toffler in *Future Shock* and was delineated, as well as named, in 1987 by Stan Davis in *Future Perfect*.¹⁸

Almost every segment of the economy, and industrial production in particular, has been affected by mass-customization, sometimes in very radical ways. Levi's, for example, offers customized jeans, manufactured from body measurements taken by a scanner in one of its stores, at a cost slightly more than a standard pair. Motorola's Paging Products Group lets its customers design their own pagers by choosing the desired frequency, tone, color, software, clips and other components (more than 29 million combinations are possible), and sells them at the same cost as their off-the-shelf predecessors. In Japan, Panasonic sells bicycles that are built to individual rider's measurements, with customized color combinations and other options (with some 11 million possible variations), creating truly mass-produced, built-to-fit, i.e. mass-customized machines.

Mass-customization is a particularly suitable production paradigm for the building industry, since buildings are mostly one-off, highly customized products. A "custom" house will become available to a broader segment of society. Eventually, the technologies and "customization" methods that are developed in the consumer products industry will be applied to building products as well. In buildings, individual components could be mass-customized to allow for optimal variance in response to differing local conditions in buildings, such as uniquely shaped and sized structural components that address different structural loads in the most optimal way, variable window shapes and sizes that correspond to differences in orientation and available views. The digitally-driven production processes will introduce a different logic of seriality in architecture,

3.68.
Embryologic Houses (2000),
architect Greg
Lynn.

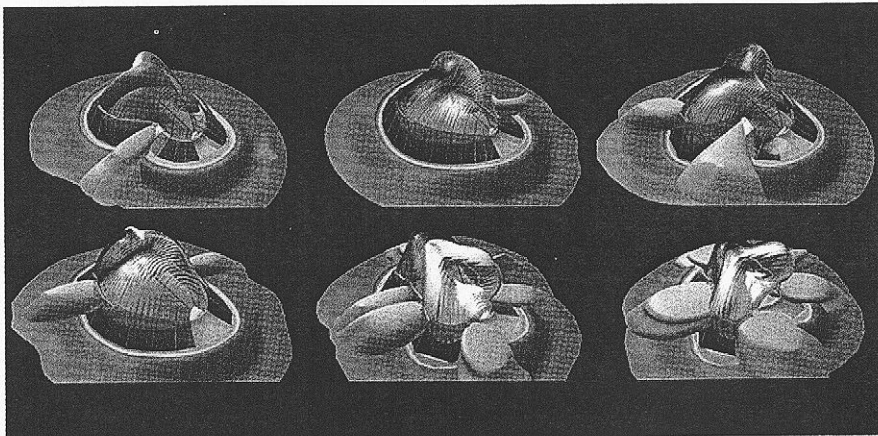

one that is based on local variation and differentiation in series. It is now possible to produce "series-manufactured, mathematically coherent but differentiated objects, as well as elaborate, precise and relatively cheap one-off components," according to Peter Zellner,¹⁹ who argues that in the process the "architecture is becoming like 'firmware,' the digital building of software space inscribed in the hardwares of construction." That is precisely what Greg Lynn's *Embryologic Houses* (figure 3.68) manifest: mass-customizable individual house designs produced by differentiation achieved through parametric variation in non-linear dynamic processes.

For Bernard Cache, "objects are no longer designed but calculated,"²⁰ allowing the design of complex forms with surfaces of variable curvature and laying "the foundation for a nonstandard mode of production." His *objectiles* (figure 3.69) are non-standard objects, mainly furniture and paneling, which are procedurally calculated in modeling software and are industrially produced with numerically-controlled machines. For Cache, it is the modification of parameters of design, often random, that allows the manufacture of different shapes in the same series, thus making the mass-customization, i.e. the industrial production of unique objects, possible.

The implications of mass-customization for architecture and the building industry in general are profound. As Catherine Slessor observed, "the notion that uniqueness is now as economic and easy to achieve as repetition, challenges the

simplifying assumptions of Modernism and suggests the potential of a new, post-industrial paradigm based on the enhanced, creative capabilities of electronics rather than mechanics."²¹ In the Modernist aesthetic, the house was to be considered a manufactured item ("machine for living"). Mass production of the house would bring the best designs to a wide market and design would not no longer cater to the elite. That goal remains, albeit reinterpreted. The industrial production no longer means the mass production of a standard product to fit all purposes, i.e. one size fits all. The technologies and methods of mass-customization allow for the creation and production of unique or similar buildings and building components, differentiated through digitally-controlled variation.

3.69.
Objectiles, designer
Bernard Cache.

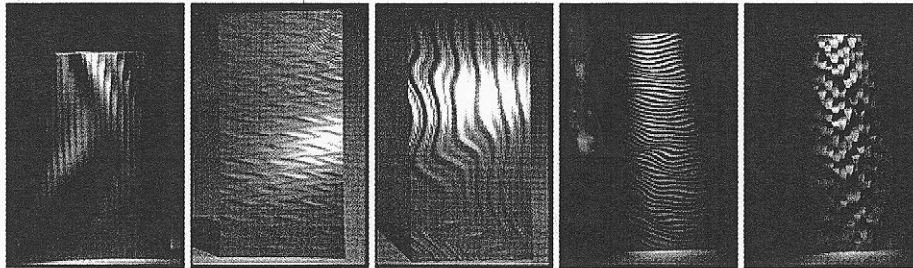

NOTES

- 1** For more information about large-scale scanning, see Edward H. Goldberg, "Scan Your World with 3D Lasers" in *Cadalist*, February 2001 (online at <http://www.cadalist.com/features/0201cyra/index.htm>).
- 2** William J. Mitchell. "Roll Over Euclid: How Frank Gehry Designs and Builds" in J. Fiona Ragheb (ed.), *Frank Gehry, Architect*. New York: Guggenheim Museum Publications, 2001, pp. 352–363.
- 3** For more information about various fabrication technologies, see W. Mitchell and M. McCullough, "Prototyping" (Chapter 18) in *Digital Design Media*, 2nd edition. New York: Van Nostrand Reinhold, 1995, pp. 417–440.
- 4** W. Mitchell and M. McCullough, "Prototyping" (Chapter 18) in *Digital Design Media*, 2nd edition. New York: Van Nostrand Reinhold, 1995, pp. 417–440.
- 5** For more information about this project, see Thomas Rempfen, *Frank O. Gehry: der Neue Zollhof Düsseldorf*. Essen, Germany: Bottrop, 1999; and Catherine Slessor, "Digitizing Düsseldorf" in *Architecture*, September 2000, pp. 118–125.
- 6** For more information about various rapid prototyping technologies, see Chee Kai Chua and Leong Kah Fai, *Rapid Prototyping: Principles & Applications in Manufacturing*. New York: Wiley, 1997; and Detlef Kochan. *Solid Freeform Manufacturing: Advanced Rapid Prototyping*. Amsterdam: Elsevier, 1993.
- 7** Behrokh Khoshnevis. "Innovative Rapid Prototyping" in *Material Technology*, vol. 13(2), 1998, pp. 53–56.
- 8** Annette LeCuyer. "Building Bilbao" in *Architectural Review*, December 1997, vol. 102, no. 1210, pp. 43–45.
- 9** Charles Linn. "Creating Sleek Metal Skins for Buildings" in *Architectural Record*, October 2000, pp. 173–178.
- 10** Annette LeCuyer. "Building Bilbao." *op cit*.
- 11** Joseph Giovannini. "Building a Better Blob" in *Architecture*, September 2000, vol. 89, no. 9, pp. 126–128.
- 12** *Ibid*.
- 13** S. Stephens. "The Bilbao Effect" in *Architectural Record*, May 1999, pp. 168–173.
- 14** Annette LeCuyer. "Building Bilbao." *op cit*.
- 15** See Erik Baard, "Unbreakable" in *Architecture*, June 2001, p. 52.
- 16** See Johan Bettum, "Skin Deep: Polymer Composite Materials in Architecture" in Ali Rahim (ed.), *AD Profile 155: Contemporary Techniques in Architecture*. London: Wiley, 2002, pp. 72–76.
- 17** Joseph B. Pine. *Mass Customization: The New Frontier in Business Competition*. Boston: Harvard Business School Press, 1993.
- 18** *Ibid*.
- 19** Peter Zellner. *Hybrid Space: New Forms in Digital Architecture*. New York: Rizzoli, 1999.
- 20** Bernard Cache. *Earth Moves: The Furnishing of Territories*. Cambridge: MIT Press, 1995.
- 21** Catherine Slessor. "Digitizing Düsseldorf." *op cit*.