



SALT- & FRESHWATER



CATALOGUE 2018

AQUA MEDIC

Valid from: 07/2018

	page
Aquaria	5 – 13
Seasalt	14 – 15
Hydrometer	15 – 16
Saltwater supplements	17 – 22
Freshwater supplements	23 – 24
Special nutrition	25 – 26
Algal resources	26
Plankton	27
Cooling	28 – 29
Pumps	30 – 38
Protein skimmer	39 – 45
Filter systems	46 – 51
Filter components	52 – 54
Filter material	55 – 57
UV-C sterilizer	58 – 59
Light	60 – 77
Measurement and control technology	78 – 86
Reverse osmosis	87 – 89
CO ₂	90 – 92
aqua tools	93 – 104

AQUA MEDIC recommends:

-  suitable for saltwater
-  suitable for freshwater
-  suitable for salt- and freshwater

Subject to technical changes and errors.

	page		page		page
AC Runner-series	34	fishknob	13	Qube control LEDspot	70
Adapter union AM	103	Fish trap	94	reactor+	92
aminovit	25	floreal + iod	24	reactor 100	92
angel LED 200	67	flow kit	51	reactor 1000	92
antiphos Fe	55	Fluidized bed filter FB 5000	52	Reducing T-piece	103
aqua +GH	23	frag board	99	Reef Construct	98
aqua +KH	23	heat controller duo	78	REEF LIFE antired	26
aquabiovit	25	Helix Max	58	REEF LIFE OptiClean	20
aquabreed complete	27	hopstop	13, 99	REEF LIFE-series	17 – 20
aqua divider	103	hose clip	37, 99	Reef Salt	14
aquafit-series	76	hot construct	98	Reef Station	46
aqua grid	100	Hydrocarbonat	22	reefdoser add 4	37
aqualife + Vitamine	23	hydroquick	16	reefdoser EVO 4	37
aqualine T5	72 – 73	Kalkwasserpowder	18	refill depot	50
aqualine-series	74 – 75	Kalkwasser stirrer KS 1000	54	Refill System pro	50
Aqua Medic seasalt	15	Kauderni	12	refractometer	16
aquaniveau	82	K-series	40	regular	92
aquapHloor	24	LEDspot	68 – 70	Regulation valve	104
aquarius	60	LF controller	80	Reverse osmosis accessories	88 – 89
aquarius control	62	magnetscraper	97	Round grate	102
aquarius holder	62	Magnifica	10 – 11	rubber sucker twin	94
aquarius plant	61	Mega Mag	96	Saddle with thread	103
aqua smoothy	98	Merlin plus (PRF-RO)	88	salimeter	16
aquasunlight NG	74	midifloter	44	scissors 60	93
arctic breeze	29	Mini-Deniballs	57	scissors 60 curved	93
Armatus	5	minifloter	44	scraper	97
BactoBalls	56	Mistral-series	36	Silencer	45
Bali Sand	21	multi reactor-series	52	Silicagel	83
biobacter	57	mV computer-Set	81	SP 3000 Niveumat	38
Blenny	9	mV controller	80	sulfur pearls	56
blue	94	M-ventil	84	Systemfilter-series	47 – 49
Calciumreactor KR 5000	53	Nitratereducator NR 5000	53	T computer-Set	82
carbolit	55	Non-return valve	104	T controller	80
CO ₂	90 – 92	Ocean Light LED Control	77	T controller twin	78
combfix	101	Outlet strainer	103	T5 reflector	71
Coral Construct	98	Overflow comb	102	T5 tubes	72 – 73
coral fit	26	Overflow box OFB	51	Tank union	102
Coral holder	100	Ozone	82	Test fluids	86
coral pins	99	Ozone Booster	83	Titan cooler	28 – 29
Coral Sand	21	Ozoniser	83	Titanium Heater	78
Coral strap	100	pH computer-Set	81	T-meter	80
counter	92	pH controller	79	T-meter twin	81
Cubicus	7 – 8	pH-control-Set	79	t-rail 60	93
DC Runner-series	32	pH monitor	79	Trap-pest	95
defroster+	99	phosphatfilter Fe	53	Trickle filter T 5000	42
Deniballs	57	pipette 35	26	Trickle filter T 10000 & 20000	43
Denigran	56	plancto	25	Tri Complex	17
denimar	57	plankton light reactor	27	Turbofloter 5000-series	42
DensiMeter	15	plankton reactor	27	Turbofloter 10000	43
DensiTower	15	platinum line plus	87	Turbofloter 20000	43
Dosing pump SP 3000	38	plexipad	97	tweezers 60	93
easy line	88	power floter-series	39	UV-C Professional	59
EcoDrift-series	30	power pad	104	valve	104
EcoDrift Wireless Master Controller	30	prefilter bag	54, 95	variocare	31
Electrodes	85	premium line	87	Wooden airstones	45
Electrode holder	85	Pumps NK-/OK-series	35	Xenia	6
EVO-series	41	Qube 30	63	Y-cable aquarius	62
ferreal + spureal	24	Qube 50	64	Zeolith	55
Filter accessories 15 x 15	100 – 101	Qube 50 plant	65		
filter bag	54, 95	Qube control	66		

Armatus 250/300/400/450**Rimless saltwater aquarium incl. cabinet filter system**

- aquarium without brace bars made from ultra clear (low iron) glass with polished edges
- integrated safety bottom seam
- silent operation due to the "easy drain system"
- filter tank with adjustable water level and automatic refill
- fine filter area with replaceable filter bags
- transportable refill tank
- glass cabinet filter with prefilter chamber, two clear water chambers for use with additional biological and mechanical filters (e. g. skimmer, multi reactor, etc.) and filter media
- integrated emergency overflow
- elegant glass duct cover
- high-quality cabinet with softclose, white high gloss
- large base cabinet with aeration and ventilation
- incl. drip pan
- the cabinet is supplied flat packed for easy transportation and home assembly with few parts

Armatus	Armatus 250	Armatus 300	Armatus 400	Armatus 450
Dimensions aquarium (l x w x h) app.	75 x 50 x 55 cm	100 x 50 x 55 cm	125 x 50 x 55 cm	150 x 50 x 55 cm
Glass thickness front pane	10 mm	12 mm	15 mm	15 mm
Glass thickness side pane	8 mm	10 mm	10 mm	12 mm
Glass thickness back wall	8 mm	10 mm	10 mm	12 mm
Glass thickness bottom pane	10 mm	10 mm	12 mm	12 mm
Volume aquarium app.	190 l	250 l	315 l	375 l
Water level app.	50 cm	50 cm	50 cm	50 cm
Dimensions filter cabinet (l x w x h) app.	60 x 42 x 34 cm	60 x 42 x 34 cm	90 x 42 x 34 cm	90 x 42 x 34 cm
Water level filter cabinet max.	16 – 23 cm	16 – 23 cm	16 – 23 cm	16 – 23 cm
Dimensions skimmer compartment	43 x 27 cm	43 x 27 cm	51 x 40 cm	51 x 40 cm
Dimensions pump compartment	43 x 11 cm	43 x 11 cm	40 x 20 cm	40 x 20 cm
Volume filter cabinet app.	55 l	55 l	85 l	85 l
Total volume	245 l	305 l	400 l	460 l
Volume refill l tank	10 l	10 l	16 l	16 l
Dimensions incl. cabinet (l x w x h) app.	75 x 50 x 145 cm	100 x 50 x 145 cm	125 x 50 x 145 cm	150 x 50 x 145 cm

Item code	Item
510.014	Armatus 250 white NEW
510.114	Armatus 300 white NEW
510.214	Armatus 400 white NEW
510.314	Armatus 450 white NEW



Armatus 250



Armatus 300



Armatus 400



Armatus 450



Xenia 65



Xenia

Frameless saltwater aquaria incl. cabinet filter system

- aquarium without support made from float glass with polished edges, front and side panes in premium white glass
- incl. glass cabinet filter with four-chamber system for putting up biological and mechanical filters
- incl. assembled inlet and outlet piping and emergency overflow
- quiet and adjustable overflow
- incl. empty conduit for hidden cable duct
- high-quality cabinet with softclose, completely mounted, white high gloss or graphite/black



Xenia 100



Xenia 130



Xenia 160



Xenia	Xenia 65	Xenia 100	Xenia 130	Xenia 160
Dimensions aquarium (l x w x h) app.	65 x 60 x 55 cm	100 x 65 x 55 cm	130 x 65 x 55 cm	160 x 65 x 55 cm
Water level app.	50 cm	50 cm	50 cm	50 cm
Volume aquarium app.	195 l	325 l	425 l	525 l
Glass thickness front pane	10 mm	12 mm	15 mm	19 mm
Glass thickness side pane	10 mm	10 mm	12 mm	12 mm
Glass thickness back wall	8 mm	10 mm	10 mm	12 mm
Glass thickness bottom pane	10 mm	10 mm	12 mm	12 mm
Dimensions incl. cabinet (l x w x h) app.	65 x 60 x 140 cm	100 x 65 x 140 cm	130 x 65 x 140 cm	160 x 65 x 140 cm
Dimensions filter cabinet (l x w x h) app.	50 x 50 x 45 cm	50 x 50 x 45 cm	65 x 50 x 45 cm	84 x 50 x 45 cm
Water level filter cabinet max.	32 cm	32 cm	32 cm	32 cm
Volume filter cabinet app.	75 l	75 l	97 l	130 l
Circulation pump	DC Runner 2.2	DC Runner 3.2	DC Runner 3.2	DC Runner 5.2

Water volume calculated before gravel or decoration.

Item code	Item
509.014	Xenia 65 white
509.084	Xenia 65 graphite-black
509.114	Xenia 100 white
509.184	Xenia 100 graphite-black
509.214	Xenia 130 white
509.284	Xenia 130 graphite-black
509.314	Xenia 160 white
509.384	Xenia 160 graphite-black

Cubicus Qube

Complete saltwater aquarium

Energy saving complete saltwater aquarium in stylish design. By the use of perfect and efficient elements for current, filter technique and illumination this complete aquarium guarantees durable and easy care functionality plus a lot of fun in keeping saltwater animals. The design is perfectly configured to direct the focus of the observer to the saltwater wildlife and to let the technique disappear in the background. The appearance is completed through the use of 8 mm prime white glass which guarantees the observer the colour rendering of the animals at its best.

Equipment:

- current: EcoDrift 4.1 (24 V, 3 – 10 W), integrated into the rear panel
- skimmer: EVO 500 (24 V, max. 7 W)
- filter technique: integrated filter tank, separated by a high quality glass rear panel with adjustable surface flow
- illumination: 2 x Qube 50 - High power LED spot. Five different light colours with high energy density specially designed for strong coral growth (24 V, max. 50 W). Colour and light intensity are adjustable manually via 2 channels. Integrated 0 – 10 V connection for using external controllers.

Dimensions (l x w x h): app. 50 x 60 x 50 cm

Water level app. 47 cm, volume app. 140 l

Item code	Item
570.20	Cubicus Qube



Cubicus Qube



Cubicus Stand

Cabinet for Cubicus

Cabinet can be used for aquaria with dimensions of around 50 x 60 cm. The cabinet is designed especially for the Cubicus nano reef tank. It is built to support the weight of a full aquarium. The cabinet is of a modern and stylish design, to complement many different styles of living areas. The cabinet is supplied flat packed for easy transportation and home assembly with few parts.

Dimensions (l x w x h): app. 50 x 60 x 100 cm

Item code	Item
570.01	Cubicus Stand white
570.08	Cubicus Stand graphite-black



Cubicus Stand



Cubicus CF Qube

Cubicus CF Qube

Saltwater aquarium incl. cabinet filter system

- aquarium made of 8 mm prime white glass front pane
- incl. glass cabinet filter, four-chamber system, prefilter chamber, two clear water chambers for putting up biological and mechanical filters (e. g. skimmer) and filter media, settling chamber
Dimensions (l x w x h): app. 40 x 47 x 45 cm, water level max. 32 cm, volume max. 54 l
- illumination: 2 x Qube 50 - High power LED spot. Five different light colours with high energy density specially designed for strong coral growth (24 V, max. 50 W). Colour and light intensity are adjustable manually via 2 channels. Integrated 0 – 10 V connection for using external controllers.
- circulation pump DC Runner 2.2 (24 V, max. 20 W)
- protein skimmer EVO 500 (24 V, max. 7 W)
- high-quality cabinet with softclose, completely mounted, white high gloss or graphite/black

Options:

- Aqua Medic Refill System pro (see page 50)
- Helix Max UV-C sterilizer 9 W (see page 58)

Dimensions (l x w x h): app. 50 x 60 x 150 cm

Water level app. 45 cm, volume app. 135 l

Item code	Item
571.20	Cubicus CF Qube white
571.28	Cubicus CF Qube graphite-black



Overflow Cubicus CF Qube



Water volume calculated before gravel or decoration.

Aquaria can be produced with alternative lighting, please inquire.

Blenny Qube

Saltwater aquarium

Ready to go with proven technology and high quality components. Blenny combines the full functionality of a reef aquarium in a compact design. The integrated filter compartment guarantees easy maintenance. Made with 6 mm prime white glass.

Equipment:

- current: EcoDrift 4.1, located in the back wall, easily adjustable for desired water moment (800 – 4,000 l/hr, 24 V, 3 – 10 W).
- protein skimmer: EVO 500 (24 V, max. 7 W), efficient and near silent operation
- light: Qube 50-High power LED spot with balanced light spectrum. Five different light colours with high energy density specially designed for strong coral growth (24 V, max. 50 W). Colour and light intensity are adjustable manually via 2 channels. Integrated 0 – 10 V connection for using external controllers.

Dimensions: (l x w x h): app. 40 x 50 x 40 cm

Water level: app. 38 cm, volume: app. 76 l

Item code	Item
565.20	Blenny Qube



Blenny Qube



Blenny Stand

Cabinet for Blenny

Cabinet can be used for aquaria with dimensions of around 40 x 50 cm. The cabinet is designed especially for the Blenny nano reef tank. It is built to support the weight of a full aquarium. The cabinet is of a modern and stylish design, to complement many different styles of living areas. The cabinet is supplied flat packed for easy transportation and home assembly with few parts.

Dimensions (l x w x h): app. 40 x 50 x 100 cm

Item code	Item
565.01	Blenny Stand white

Water volume calculated before gravel or decoration.



Blenny Stand



Magnifica 100



aquarius 90



Magnifica 100

Integrated saltwater aquarium system complete with filtration system (real panel filter), lights & cabinet

- aquarium made of 10 mm float glass, front pane with 12 mm and side panes with 10 mm, both made of prime white glass
- high-quality aluminium cover (powder-coated) including adjustable active ventilation
- illumination: 1 x LED light aquarius 90
- filter: filter compartment incl. protein skimmer EVO 1000 (24 V/max. 9 W)
- two internal baskets for adding further filter media like antiphos Fe or carbolit
- circulation pump: DC Runner 2.2 (24 V, max. 20 W)
- current pumps: 2 x EcoDrift 4.1 (800 – 4,000 l, 24 V, 3 – 10 W, adjustable)
- high-quality cabinet with softclose, completely mounted, white high gloss

Options:

- aquarius control (see page 62)

Dimensions (l x w x h): app. 100 x 65 x 145 cm
(aquarium dimensions app. 100 x 65 x 60 cm).

Water level app. 49.5 cm, volume app. 320 litres.

Item code	Item
507.314	Magnifica 100 white

Water volume calculated before gravel or decoration.

Aquaria can be produced with alternative lighting, please inquire.

Magnifica 100 CF / Magnifica 130 CF**Saltwater aquarium incl. cabinet filter system**

- aquarium made from float glass, front and side panes in premium white glass
- incl. glass cabinet filter, four-chamber system, prefilter chamber, two clear water chambers for putting up biological and mechanical filters (e. g. skimmer) and filter media, settling chamber
- high-quality aluminium cover including adjustable active ventilation
- illumination: 1 x LED light aquarius
- filter: filter compartment incl. protein skimmer EVO 1000 (24 V/max. 9 W)
- high-quality cabinet with softclose, completely mounted, white high gloss or graphite/black

Options:

- aquarius control (see page 62)
- Aqua Medic Refill System pro (see page 50)
- Helix Max UV-C sterilizer 36 W (see page 58)

Magnifica CF	Magnifica 100 CF	Magnifica 130 CF
Dimensions aquarium (l x w x h) app.	100 x 65 x 60 cm	130 x 65 x 60 cm
Water level app.	50 cm	50 cm
Volume aquarium app.	325 l	425 l
Glass thickness front pane	10 mm	12 mm
Glass thickness side pane	10 mm	10 mm
Glass thickness back wall	10 mm	10 mm
Glass thickness bottom pane	10 mm	12 mm
Dimensions incl. cabinet (l x w x h) app.	100 x 65 x 145 cm	130 x 65 x 145 cm
Dimensions filter cabinet (l x w x h) app.	50 x 50 x 45 cm	65 x 50 x 45 cm
Water level filter cabinet max.	32 cm	32 cm
Volume filter cabinet app.	75 l	97 l
Circulation pump	DC Runner 3.2	DC Runner 3.2
Protein skimmer	EVO 1000	EVO 1000
Illumination	1 x aquarius 90	1 x aquarius 120

Item code	Item
507.414	Magnifica 100 CF white
507.484	Magnifica 100 CF graphite-black
508.414	Magnifica 130 CF white
508.484	Magnifica 130 CF graphite-black

Water volume calculated before gravel or decoration.
Aquadria can be produced with alternative lighting, please inquire.



Magnifica 100 CF



aquarius 90



Filter Magnifica 100 CF



Magnifica 130 CF



aquarius 120



Filter Magnifica 130 CF





Kauderni CF

Kauderni CF white

Saltwater aquarium incl. cabinet filter system

- aquarium 8 mm float glass, front pane and side panes 8 mm made of prime white glass
- incl. glass cabinet filter, four-chamber system, prefilter chamber, two clear water chambers for putting up biological and mechanical filters (e. g. skimmer) and filter media, settling chamber
Dimensions (l x w x h): app. 40 x 47 x 45 cm, water level max. 32 cm, volume max. 54 l
- illumination: 1 x LED light aquarius 60
- circulation pump DC Runner 2.2 (24 V, max. 20 W)
- protein skimmer EVO 500 (24 V, max. 7 W)
- high-quality cabinet with softclose, completely mounted, white high gloss

Options:

- aquarius control (see page 62)
- Aqua Medic Refill System pro (see page 50)
- Helix Max UV-C sterilizer 11 W (see page 58)

Dimensions (l x w x h): 65.5 x 60 x 146 cm (aquarium app. 65.5 x 60 x 60 cm)

Water level app. 50 cm, volume app. 195 l



aquarius 60



Item code	Item
523.044	Kauderni CF white

Water Volume calculated before gravel or decoration.

Aquaria can be produced with alternative lighting, please inquire.

hopstop

Hop protection for open top aquaria

Helps prevent nocturnal fish from jumping out.
Content: 6 holders (combfix) and 3 plastic plates each app. 480 x 50 mm.

Item code	Item
418.12	hopstop



hopstop

aquarius holder

Mounting bracket for aquarius LED-lights

Item code	Item
87706	aquarius holder / pair



aquarius holder

Modifying set for Ocean Light LED/aquarius

For modifying from Ocean Light LED to the aquarius light, it is also necessary in addition to the holder.

Item code	Item
87708	Modifying set for Ocean Light LED/aquarius



Modifying set for Ocean Light LED/aquarius

fishknob

Attractive door-knobs

Item code	Item
511.10	fishknob Angel / pair
511.11	fishknob Discus / pair
511.12	fishknob Seahorse / pair



fishknob



Reef Salt



Reef Salt

Aquarium salt for all modern reef aquaria

Reef Salt is a dynamic new formulation, specifically designed for the needs of the modern reef aquarium. Reef Salt is blended from chemically pure raw materials, continuously quality controlled, achieves elevated levels of calcium and alkalinity reserve without resorting to harmful chelating agents, contains all the essential trace elements and enhanced levels of Strontium and Iodine, dissolves easily and leaves no residue.

Item code	Item
301.25	Reef Salt Nano 1020 g can
301.10	Reef Salt 4 kg bucket
301.00	Reef Salt 20 kg carton
301.01	Reef Salt 25 kg bucket



Reef Salt coral



Reef Salt coral

Aqua Medic Reef Salt coral is a specially made high quality formulation suitable for all modern reef aquaria.

- contains vitamin B complex for the supply of corals with the vital vitamin B12 (according to scientific investigations)
- provides ideal nature-like conditions for growth and coloration of SPS and LPS corals
- with pH buffer and high calcium and magnesium content
- contains all the essential trace elements
- blended from chemically pure raw materials, continuously quality controlled
- dissolves easily and leaves no residue, so can be used quickly

Item code	Item
301.03	Reef Salt coral 20 kg bucket NEW

Aqua Medic seasalt

Synthetic seasalt for aquaria

Aqua Medic seasalt is a top quality product, fulfilling all the requirements of a modern synthetic seasalt. It is formulated from highly purified compounds, and contains a pH buffer and all the essential trace elements needed for saltwater aquaria. It dissolves quickly, leaving no residue, and can be used very shortly after being mixed. Its quality has been proven by its selection by numerous public aquaria, many leading wholesalers of saltwater fish, and thousands of coral reef and fish aquaria. It is the economic solution for large scale applications.



Aqua Medic seasalt

Item code	Item
300.00	Aqua Medic seasalt 20 kg bag

DensiMeter

Hydrometer to determine the density [g/ml] Tp. 25/4 °C in saltwater aquaria

Allow the hydrometer to float freely in sufficiently deep water for highly precise measurement, e.g. DensiTower. In this case, the water temperature of the sample should be, if possible, exactly 25 °C.

Maximum discrepancy at 25 °C: 0.001 g/ml

Measuring range: 1,018 to 1,028 g/ml

Resolution: 0.0001 g/ml

Dimensions: length app. 35,5 cm

Item code	Item
65905	DensiMeter

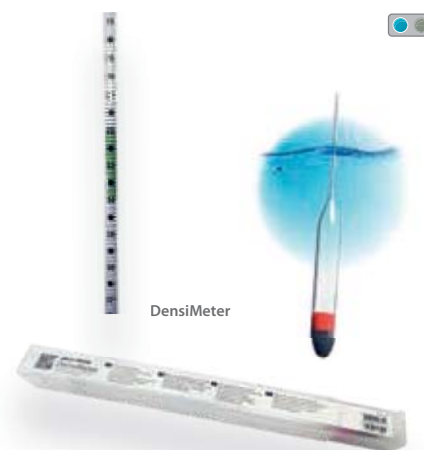

DensiMeter

DensiTower

Hydrometer cylinder with overflow to determine the exact density by using a hydrometer (not included)

Fill the DensiTower to the top of the inner tube with the water to be tested, place the hydrometer into the water slowly. Excess water flows into the outer ring.

After use, remove the hydrometer and empty the DensiTower.

To determine the exact density, we recommend the use of Aqua Medic DensiMeter.

Ø app. 45 mm, height app. 355 mm

Item code	Item
65906	DensiTower



DensiTower



salimeter

salimeter

Density meter (hydrometer)

salimeter is a density meter (hydrometer) allowing easy measurement of the specific gravity of saltwater in aquaria. salimeter has a measuring range of 1,000 to 1,040, with graduations at every 0.001 and an accuracy of ± 0.0005 at 25 °C (77 °F). Dimensions: length app. 27 cm, \varnothing app. 2 cm

Item code	Item
65900	salimeter



refractometer

Test fluid 35 ppt

refractometer

Temperature compensated refractometer for the determination of salinity

The refractometer is a precision optical instrument used to determine the salt concentration in saltwater aquaria. Its exact value can be determined in seconds and can be read either as absolute salt concentration (‰, ppt) or as specific density (kg/l). When a beam of light enters the refractometer it is bent or "refracted" by the water in the test panel. This refraction is proportional to the salinity of the sample and can be directly read by viewing the internal scale. As salinity varies in inverse proportion to temperature refractometer is fully temperature compensated. The strong plastic carrying case contains the refractometer, a pipette for the water sample, a screw driver for calibration and full instructions.

Item code	Item
65910	refractometer
65920-1	Test fluid 35 ppt for refractometer 60 ml



hydroquick



hydroquick

For measuring specific density in saltwater

- easy to use, the density can be easily measured
- precise water inlet helps prevent air bubbles, increasing accuracy of measurement

Item code	Item
65911	hydroquick

Tri Complex

Complete solution for all reef aquaria

It is really important that corals receive a balanced ratio of calcium and all vital trace elements. Tri Complex was developed according to the latest research and helps offer optimal conditions for healthy and steady coral growth. Ideal for use in dispensing systems, e.g. reefdoser EVO 4 (see page 37)

Features:

- no mixing necessary
- easy dosage
- highly concentrated
- developed according to latest research results
- calcium supply without ion shift
- helps reduce water changes
- including all vital trace elements
- optimum coral growth

Item code	Item
353.000	Tri Complex 3 x 2 l
353.005	Tri Complex 3 x 5 l NEW



Tri Complex



REEF LIFE System Coral

The complete solution for supplying reef aquaria with calcium and trace elements without ion shift.

The 3 component system consists of the following components:

- calcium (System Coral A) for increasing the calcium content
- KH Buffer (System Coral B) for increasing the carbonate hardness
- trace (System Coral C) provides essential trace elements

For each dosing spoon of KH Buffer, 2 ml of the other two components have to be added.

REEF LIFE System Coral A

Highly concentrated calcium additive for enhanced coral growth

Provides optimum calcium content in the aquarium that can be maintained simply with REEF LIFE System Coral Calcium.

Item code	Item
350.001	REEF LIFE System Coral A Calcium 100 ml
350.002	REEF LIFE System Coral A Calcium 250 ml
350.010	REEF LIFE System Coral A Calcium 1000 ml
350.050	REEF LIFE System Coral A Calcium 5000 ml



REEF LIFE System Coral A



REEF LIFE System Coral B KH BUFFER

REEF LIFE System Coral B KH BUFFER

Carbonate buffer stabilizes the pH value for a healthy aquarium

REEF LIFE System Coral B KH Buffer for increasing the alkalinity.

Item code	Item
351.001	REEF LIFE System Coral B KH Buffer 300 g/315 ml can
351.010	REEF LIFE System Coral B KH Buffer 1000 g/1000 ml can



REEF LIFE System Coral C Trace

REEF LIFE System Coral C Trace

Contains vital trace elements for fish, corals and invertebrates

Provides saltwater aquaria with vital trace elements such as boron, chrome, cobalt, copper, fluoride, iron, manganese, molybdenum and zinc.

REEF LIFE System Coral Trace does not contain any chelating agents.

Item code	Item
350.201	REEF LIFE System Coral C Trace 100 ml
350.202	REEF LIFE System Coral C Trace 250 ml
350.210	REEF LIFE System Coral C Trace 1000 ml
350.250	REEF LIFE System Coral C Trace 5000 ml



Kalkwasserpowder

Kalkwasserpowder

For enhanced calcium supply during water top up

The addition of Kalkwasser has several positive effects on the water in a reef aquarium. The calcium level increases, the phosphate concentration is reduced by precipitation and the pH value increases. The growth of hair algae is decreased and the development of calcareous algae is encouraged.

Item code	Item
351.310	Kalkwasserpowder 350 g/1000 ml can

REEF LIFE Iodine**3 component iodine for healthy coral growth and bright colours**

REEF LIFE Iodine is an iodide additive especially developed for saltwater aquaria. It supplies both fresh and saltwater aquaria with iodide and organic and elementary iodine. Whereas iodide and elementary iodine are immediately available for the animals and plants, the organic bond releases iodine slowly and ensures a long term supply. Iodine is an essential trace element for all invertebrates and especially for crustacea which require iodide to assist in sloughing off their shell. When provided with iodine, corals show better growth and more intense colouring.

Item code	Item
350.401	REEF LIFE Iodine 100 ml
350.402	REEF LIFE Iodine 250 ml
350.410	REEF LIFE Iodine 1000 ml
350.450	REEF LIFE Iodine 5000 ml



REEF LIFE Iodine

REEF LIFE Strontium**For healthy structure of skeleton of hard corals**

REEF LIFE Strontium contains strontium ions in a form that can be easily assimilated by all invertebrates. It is essential for the production and the maintenance of the skeleton of hard corals, the shells of reef mussels and calcareous algae. In the sea, the strontium concentration is about 8 mg/l. There can be a lack of strontium in the aquarium if it isn't re-dosed regularly.

Item code	Item
350.501	REEF LIFE Strontium 100 ml
350.502	REEF LIFE Strontium 250 ml
350.510	REEF LIFE Strontium 1000 ml
350.550	REEF LIFE Strontium 5000 ml



REEF LIFE Strontium

REEF LIFE Magnesium**For natural structure of skeleton of corals and calcareous algae**

For regular supply of saltwater aquaria with normal magnesium need.
For aquaria with heavy magnesium consumption, we recommend REEF LIFE Magnesium compact.

Item code	Item
350.601	REEF LIFE Magnesium 100 ml
350.602	REEF LIFE Magnesium 250 ml
350.610	REEF LIFE Magnesium 1000 ml
350.650	REEF LIFE Magnesium 5000 ml



REEF LIFE Magnesium



REEF LIFE Magnesium compact

REEF LIFE Magnesium compact

For natural structure of skeleton of corals and calcareous algae

Concentrated magnesium additive for saltwater aquaria.

Item code	Item
351.601	REEF LIFE Magnesium compact 250 g/315 ml can
351.610	REEF LIFE Magnesium compact 800 g/1000 ml can



REEF LIFE Calciumbuffer compact

REEF LIFE Calciumbuffer compact

To increase the calcium level and alkalinity

The perfect solution for calcium supply. The Calciumbuffer compact contains calcium and carbonate buffer in an optimum relation.

Item code	Item
351.101	REEF LIFE Calciumbuffer compact 250 g/315 ml can
351.110	REEF LIFE Calciumbuffer compact 800 g/1000 ml can



REEF LIFE Balance

REEF LIFE Balance

Avoids ion shift

The use of calcium chloride and sodium hydrogen carbonate will lead to sodium chloride as a by-product that will cause an ion shift on a long-term basis. In order to avoid this, sea salt containing no sodium chloride has to be added according to the originated quantity sodium chloride so that pure sea salt arises beside the desired lime.

Item code	Item
351.201	REEF LIFE Balance 250 g/315 ml can
351.210	REEF LIFE Balance 800 g/1000 ml can



REEF LIFE OptiClean

REEF LIFE OptiClean

Liquid filter medium applicable for salt and freshwater aquaria – the quick troubleshooter

OptiClean contains effective activated micro particles from highly pure Clinoptilolite, a natural mineral. Contaminants such as heavy metals and pesticides attach to that mineral and then they can be removed with a fine filter from the water. In the saltwater aquarium, they are also removed with the skimmer. The result is extremely clear and low-pollution water. The animals feel again well.

Item code	Item
350.101	REEF LIFE OptiClean 100 ml
350.102	REEF LIFE OptiClean 250 ml
350.110	REEF LIFE OptiClean 1000 ml

Aqua Medic Coral Sand

Coral Sand (natural substrate)

Natural substrate, cleaned and without additives. Suitable for all saltwater- and malawi aquaria.

Since this is a natural product, the grain sizes may vary.

Item code	Item
420.25-1	Coral Sand 0 – 1 mm, 5 kg (11 lbs) bag
420.25-2	Coral Sand 2 – 5 mm, 5 kg (11 lbs) bag
420.25-3	Coral Sand 10 – 29 mm, 5 kg (11 lbs) bag
420.20-1	Coral Sand 0 – 1 mm, 10 kg (22 lbs) bag
420.20-2	Coral Sand 2 – 5 mm, 10 kg (22 lbs) bag
420.20-3	Coral Sand 10 – 29 mm, 10 kg (22 lbs) bag



Aqua Medic Coral Sand

Aqua Medic Bali Sand

- high-quality white substrate
- natural product, without additives
- supports the biodegradation of Detritus
- suitable for use in all saltwater aquaria

Aqua Medic Bali Sand is a very pure limestone that consists of about 98% of calcium carbonate as well as some zeolite-like minerals. Aqua Medic Bali Sand, like the coral reef, is a fossil natural material and is not removed from the oceans. This substrate is an alternative, producing the optimal biological effect for all aquarium inhabitants and preserving nature.

Item code	Item
420.30-1	Aqua Medic Bali Sand 0,5 – 1,2 mm, 5 kg (11 lbs) bag
420.30-2	Aqua Medic Bali Sand 2 – 3 mm, 5 kg (11 lbs) bag
420.31-1	Aqua Medic Bali Sand 0,5 – 1,2 mm, 10 kg (22 lbs) bag
420.31-2	Aqua Medic Bali Sand 2 – 3 mm, 10 kg (22 lbs) bag



Aqua Medic Bali Sand



Hydrocarbonat



fine



medium



coarse

Hydrocarbonat

Highly pure calcium carbonate

It is used in calciumreactors and may be used in filters to increase the hardness of water, and as a substrate material in saltwater- or Malawi/Tanganyika aquaria. A natural calcium-carbonic acid equilibrium is created in all aquaria with an alkaline pH value and in a calciumreactor supplied with CO₂. The Hydrocarbonat is completely dissolved to calcium bicarbonate, becoming available for assimilation by hard and many soft corals, sponges, echinoderms, etc. Hydrocarbonat is available in 3 grain sizes and 3 packaging sizes: fine (1 – 2 mm) for “hardening” filters, medium (3 – 5 mm) for calciumreactors, coarse (12 – 15 mm) as filter material.

Item code	Item
410.91-1	Hydrocarbonat 1 l can fine (app. 0.25 gal)/1 kg
410.91-2	Hydrocarbonat 1 l can medium (app. 0.25 gal)/1 kg
410.91-3	Hydrocarbonat 1 l can coarse (app. 0.25 gal)/1 kg
410.92-1	Hydrocarbonat 5 l bucket fine (app. 1.3 gal)/8 kg
410.92-2	Hydrocarbonat 5 l bucket medium (app. 1.3 gal)/8 kg
410.92-3	Hydrocarbonat 5 l bucket coarse (app. 1.3 gal)/8 kg
410.93-1	Hydrocarbonat 15 l bucket fine (app. 3.9 gal)/21 kg
410.93-2	Hydrocarbonat 15 l bucket medium (app. 3.9 gal)/21 kg
410.93-3	Hydrocarbonat 15 l bucket coarse (app. 3.9 gal)/21 kg

aqua + GH

Increases the total hardness of aquarium water

aqua + GH increases the total hardness in freshwater aquaria. In connection with aqua + KH you can produce from reverse osmosis water or too soft water suitable water for fishes and plants.



aqua + GH

Item code	Item
123.001	aqua + GH 250 g can

aqua + KH

Increases the carbonate hardness of aquarium water

Through a correct adjusted carbonate hardness you could avoid harmful pH up- and downturns. By using aqua + KH the pH level could be stabilized and the carbonate hardness could be increased. In combination with aqua + GH you can produce from reverse osmosis water fish and plant suitable water.



aqua + KH

Item code	Item
123.101	aqua + KH 300 g can

aqualife + Vitamine

High effective water treatment preparation for freshwater aquaria

Tap water often contains heavy metal and chlorine that harms the fishes, it causes diseases and symptoms of poisoning. aqualife + Vitamine contains suitable chelates and reducer that binds the harmful substances respectively transfers it in harmless compounds. Special protective colloids that have been approved since many years, strengthens the protective function of the mucosa and keep the sensitive craw/intestinal tract of the animals from damages. Useful vitamins improve the body's defences of the fishes and enhance their well-being.



aqualife + Vitamine

Item code	Item
120.001	aqualife + Vitamine 100 ml
120.002	aqualife + Vitamine 250 ml
120.010	aqualife + Vitamine 1000 ml
120.050	aqualife + Vitamine 5000 ml



ferreal + spureal

ferreal + spureal

Intensive iron fertilizer for freshwater aquaria

ferreal + spureal is a combination compound. It contains beside iron more essential micro elements such as manganese, molybdenum, boron, zinc and cobalt. ferreal + spureal prevents with continuous application reduced growth, the yellowing of the leaves and strengthens the plants. The colours of the plants become an intensive glow.

Item code	Item
121.001	ferreal + spureal 100 ml
121.002	ferreal + spureal 250 ml
121.010	ferreal + spureal 1000 ml
121.050	ferreal + spureal 5000 ml



floreal + iod

floreal + iod

High effective compound fertilizer for freshwater aquaria

floreal + iod is an indispensable instrument to ferreal + spureal that adjust the mineral balance of the plants and beyond supplies them with iodine and fluorine. Through this the growth of the plants will be increased. Furthermore iodine increases the vitality and the willingness to spawn of the fish. The contained iodine will be released slowly over several days whereby it is continued available.

Item code	Item
122.001	floreal + iod 100 ml
122.002	floreal + iod 250 ml
122.010	floreal + iod 1000 ml
122.050	floreal + iod 5000 ml



aquapHloor



aquapHloor

Nutritious substrate, decreases the pH value

aquapHloor substrate is especially suitable for plant aquaria and shrimp tanks. It is not suitable for aquaria with strong digging inhabitants. aquapHloor has pH-decreasing and stabilizing features that are preferred by many plants and animals from the soft water areas of the world. The substrate doesn't need to be washed before putting it into the aquarium. If the water is cloudy then, it will be clear again soon. It's a nutritious substrate, ensuring strong plant growth. The shape of granules with a grain size of 2 – 3 mm ensures good oxygen supply of the plant roots and also serves as a settlement substrate for vital bacteria.

Item code	Item
21135	aquapHloor 3,5 kg - Soil

plancto**Concentrated food for corals and invertebrates**

plancto is a pH stabilized, high-quality concentrated food for the nutrition of plankton and saltwater invertebrates. Its unique composition and its particle size of 25 – 200 µm makes it especially suitable for plankton feeders. It is also an excellent single food source for rearing artemia. The inclusion of high taste elements results in visible stimulation of feeding tentacles to encourage high nutrient take up. Even if overdosed it is impossible to effect the animals digestive systems.

Item code	Item
340.001	plancto 100 ml
340.002	plancto 250 ml
340.010	plancto 1000 ml
340.050	plancto 5000 ml



plancto

aquabiovit**Vital vitamins for fish and invertebrates**

aquabiovit is a multi vitamin compound for use in fresh and saltwater. Its formulation is suited to both, fish and invertebrates. Its regular use enhances growth, strengthens the immune system and increases the willingness to spawn.

Item code	Item
342.001	aquabiovit 100 ml
342.002	aquabiovit 250 ml



aquabiovit

aminovit**Contains all vital amino acids and vitamins**

Amino acid concentrate for coral reef aquaria. Additional food for invertebrates, in particular for LPS, but also for gorgonians, tube worms and sponges. The animals ingest directly – the colours improve and the tissue growth is accelerated. aminovit is also ideal for enriching the dry or frozen food. Or soak the food in an equivalent quantity prior to feeding.

Item code	Item
342.101	aminovit 100 ml
342.102	aminovit 250 ml



aminovit



coral fit
Coral food

coral fit is a natural coral food suitable for SPS, LPS and soft corals. coral fit contains shell-less artemia eggs and is easily absorbed by corals.
Content: app. 210 g

coral fit

Item code	Item
343.000	coral fit 210 g NEW

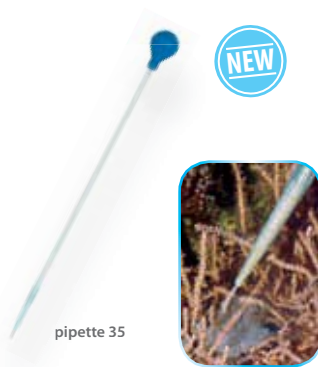

pipette 35
Pipette

The pipette is the ideal choice for precise feeding of fish and corals. Medications can also be dosed selectively.
Length: app. 35 cm

pipette 35

Item code	Item
39040	pipette 35 NEW

ALGAL RESOURCES



REEF LIFE antired

REEF LIFE antired
Eliminates red slime algae

antired will successfully eliminate red slime algae in saltwater aquaria. antired is safe with invertebrates, is not harmful to nitrifying bacteria and enhances macro algae growth. During treatment, the skimmer has to remain switched on and the carbon filter has to be switched off. The dead algae should be removed rapidly by a power filter.

Item code	Item
420.001	REEF LIFE antired 100 ml
420.002	REEF LIFE antired 250 ml
420.010	REEF LIFE antired 1000 ml
420.050	REEF LIFE antired 5000 ml

aquabreed complete

Artemia cultivation unit

A cultivation unit for hatching larger quantities of artemia cysts. The unit can be installed inside or outside of the aquarium if positioned in a warm environment. The hatch time depends on the ambient temperature. Capacity app. 2,000,000 cysts per hatch. After about 2 weeks, the animals are fully grown and can be used as food. The unit may also be used for the breeding of artemia.

A stable wall holder and a pump for ventilation are included. A drain valve with a large diameter prevents clogging during emptying. The optimal installed outlet valve allows a measured removal of hatched artemia whilst the shells remain in the culture unit. The push to open lid makes filling the hatchery easier.

Contents: aquabreed complete reactor (app. volume 1 litre), support plate Ø app. 8 cm (app. 3.24")

Length: app. 52 cm (app. 17")

Hose connection: 6 mm (app. 1/4"), air pump Mistral 50 ECO

Item code	Item
35020	aquabreed complete

plankton reactor

Zooplankton cultivation unit

Many species of salt- and freshwater zooplankton can be cultivated in the plankton reactor. The zooplankton is fed with micro-algae from the plankton light reactor. The zooplankton has great growth potential: under optimal algal nutrition the number of rotifers (*Brachionus*) may double over four days. *Brachionus* is the ideal food for raising many saltwater fish larvae and invertebrates in the saltwater aquarium.

Contents: plankton reactor app. volume 2.5 litre (app. 0.65 gal), wall bracket and connections for air pump. Ø 8 cm (app. 3.2"). Length: 80 cm (app. 32").

Hose connection: 6 mm (app. 1/4")

Item code	Item
35005	plankton reactor

plankton light reactor

Phytoplankton (Micro-algae) cultivation unit

The plankton light reactor is a simple system for producing plankton in a natural food chain. Within the plankton light reactor, micro-algae are produced with light, fertiliser and CO₂. The micro-algae can be fed directly to many filter-feeding invertebrates, especially to zooplankton. The growth rate of the micro-algae in the plankton light reactor is enormous. If the supply of light, CO₂ and nutrients is continuous, the biomass of the algae may increase four-fold within 24 hours. Both fresh- and saltwater species of phytoplankton can be cultivated.

Contents: plankton light reactor app. volume 2.5 l (app. 0.65 gal), wall bracket, connections for air pump, lighting unit with fluorescent lamp (18 W), special reflector and fixing clamps. Ø app. 8 cm (app. 3.2").

Length: app. 80 cm (app. 32"). Hose connection: 6 mm, (app. 1/4")

Item code	Item
35000	plankton light reactor



aquabreed complete



plankton reactor



plankton light reactor



Titan 150



Titan 4000

Titan

Titan	150	500	1500	2000	4000
For aquaria up to	100 – 250 l	250 – 500 l	700 – 1.500 l	1.500 – 2.500 l	3.000 – 4.000 l
Compressor power	0,1 PS	0,25 PS	0,5 PS	1 PS	2 PS
Power supply	220 – 240 V/50 Hz				
Power uptake	150 W	190 W	375 W	550 W	1.500 W
Cooling power	200 W	395 W	790 W	1.650 W	4.000 W
Recommended water flow (l/h)	200 – 1.500	500 – 2.000	800 – 2.500	2.000 – 4.000	3.000 – 6.000
Connections	14 mm 1/2" or 20 mm 3/4"	20 mm 3/4" or 25 mm 1"			32 mm 1 1/4" or 37 mm 1 1/2"
Max. dB/ at a distance of 1 metre	49	52	53	58	69
Housing material	ABS/powder-coated metal				
Heat exchanger material	Titanium				
Cooling gas	R134a				R407c
Dimensions (l x w x h) mm, app.	350 x 300 x 350	390 x 340 x 390		400 x 500 x 440	540 x 700 x 650
Weight	13 kg	14,7 kg	16,4 kg	28,1 kg	60,5 kg

Item code	Item
105.015	Titan 150
105.050	Titan 500
105.150	Titan 1500
105.200	Titan 2000
105.400	Titan 4000

Titan Professional

Titan Professional	6000	8000	15000
For aquaria up to	3.000 – 6.000 l	4.000 – 8.000 l	7.500 – 15.000 l
Compressor power	2 PS	3 PS	5 PS
Power supply	220 – 240 V/50 Hz		380 V; 3 Ph.
Power uptake: cooling	1.780 W	2.340 W	3.950 W
Power uptake: heating	1.400 W	1.750 W	2.900 W
Cooling/heating power	5.200 W	7.200 W	14.900 W
Recommended flow rate (l/h)	3.000 – 12.000	4.000 – 16.000	8.000 – 32.000
Connections	1 1/2"		
Max. dB/at a distance of 1 metre	85		
Housing material	X5CrNiMo 17-12-2 corrosion-resistant steel (V4A)		
Cooling gas	R410A		
Dimensions (l x w x h) mm, app.	710 x 435 x 670	735 x 460 x 720	850 x 550 x 950
Weight	68 kg	78 kg	150 kg



Titan 6000 Professional

Item code	Item
108.060	Titan 6000 Professional
108.080	Titan 8000 Professional
108.150	Titan 15000 Professional

Larger cooling units on demand!

arctic breeze

Silent long life fans, with real ball bearing and brush free motor. 12 V low voltage with adjustable transformer (3 – 12 V) for speed control. By this, the cooling power can be adjusted. High capacity fans, adjustable from 80,000 l/h (double unit at 12 V) to 240,000 l/h (6 fold unit at 12 V). Power uptake only 0.5 – 3 W per fan.

arctic breeze aquarium fans can easily be fixed at the aquarium frame. It cools down the water by increasing the evaporation. The complete construction is made from corrosion proof plastic and aluminium.

For temperature-dependent control we recommend optional the use of our T controller twin.

Dimensions (l x w x h):

arctic breeze 2-pack: app. 16 x 4 x 15 cm

arctic breeze 4-pack: app. 28 x 4 x 15 cm

arctic breeze 6-pack: app. 40 x 4 x 15 cm

Item code	Item
107.102	arctic breeze 2-pack
107.104	arctic breeze 4-pack
107.106	arctic breeze 6-pack



arctic breeze 2-pack



arctic breeze 4-pack



arctic breeze 6-pack



EcoDrift



EcoDrift Controller



EcoDrift

High-performance current pump with RC-Controller* for adjusting the flow power and wave frequency

- 0 – 10 V connection for external control options
- *RC Controller: allows control via the optional EcoDrift Wireless Master Controller
- magnetic holder with vibration-reducing rubber dampers; variable flow direction
- light sensor for reducing the current automatically at night
- 24 V safety tension, incl. transformer 110 – 240 V/50 – 60 Hz
- available as an option: extension cord 1.8 m, for cable extension between pump and controller.

EcoDrift	EcoDrift 4.1	EcoDrift 8.1	EcoDrift 15.1	EcoDrift 20.1
For aquaria up to	300 l	800 l	1.500 l	2.000 l
Capacity adjustable	800 – 4.000 l/h	1.600 – 8.000 l/h	3.000 – 15.000 l/h	4.000 – 20.000 l/h
Power consumption	3 – 10 watts	8 – 20 watts	10 – 35 watts	20 – 60 watts
Power supply	110 – 240 V/50 – 60 Hz			
Dimensions, app.	90 mm, Ø 70 mm	106 mm, Ø 84 mm	136 mm, Ø 110 mm	136 mm, Ø 110 mm
Glass thickness	15 mm	15 mm	15 mm	15 mm

Item code	Item
103.604	EcoDrift 4.1
103.608	EcoDrift 8.1
103.615	EcoDrift 15.1
103.620	EcoDrift 20.1



EcoDrift Wireless Master Controller



EcoDrift Wireless Master Controller

Wireless control for EcoDrift current pumps of the x.1 series

- two separately or parallel controllable channels for connecting any number of circulation pumps of the EcoDrift x.1 series
- timer function allows the mutual alternate control of the channels in an interval of 1 – 59 minutes
- each channel can be individually adjusted for wave simulation, pulse rate and flow intensity
- 0 – 10 V connection for external control options
- feed function for deactivating the flow for 10 min
- 24 V safety tension, incl. transformer 110 – 240 V/50 – 60 Hz

Item code	Item
103.600	EcoDrift Wireless Master Controller

variocare

Concentrate for cleaning pumps and other fresh and saltwater aquarium equipment

Mix 100 ml of variocare with 1,000 ml water. For heavy impurities, the dose can be increased or can even be used without diluting.

Depending on the degree of soiling, the equipment to be cleaned can left for several hours in variocare, the maximum application time is 24 hours. Then rinse under running water and brush off residues. Repeat the procedure for persistent dirt. The cleaner must not enter the aquarium.

Can be used multiple times, the solution is exhausted when the colour changes from red to yellow.

Item code	Item
100.900	variocare 1000 ml



variocare



DC Runner 9.2



DC Runner x.2

Powerful, adjustable universal pumps for aquaria
“ultra silent” due to optimized control electronics

- for use as a circulation or current pump in salt or freshwater aquaria
- incl. controller for adjusting the water output
- 0–10 V-connection for external control
- rugged pump housing
- power-saving D/C motor 24 V, high efficiency
- polished ceramic shaft and bearings for quiet operation and low maintenance
- submerged and non-submerged use is possible
- including prefilter basket and hose connections



DC Runner x.2 series



DC Runner	1.2	2.2	3.2	5.2	9.2
Power supply pump	24 V				
Power supply transformer	100 – 240 V / 50 – 60 Hz				
Pump power	up to 1.200 l/h	up to 2.000 l/h	up to 3.000 l/h	up to 5.000 l/h	up to 9.000 l/h
max. head	up to 1,5 m	up to 2,2 m	up to 2,7 m	up to 3,5 m	up to 4,8 m
Power consumption	max. 12 watts	max. 20 watts	max. 25 watts	max. 50 watts	max. 65 watts
Connection suction side	25 mm / 1 inch	25 mm / 1 inch	32 mm / 1¼ inch	32 mm / 1¼ inch	40 mm / 1½ inch
Connection pressure side	20 mm / 0,8 inch	25 mm / 1 inch	25 mm / 1 inch	32 mm / 1¼ inch	40 mm / 1½ inch
Protection rating	IP X8				
Dimensions in mm app.	125 x 60 x 85	135 x 67 x 67	200 x 90 x 120	190 x 105 x 130	200 x 105 x 180

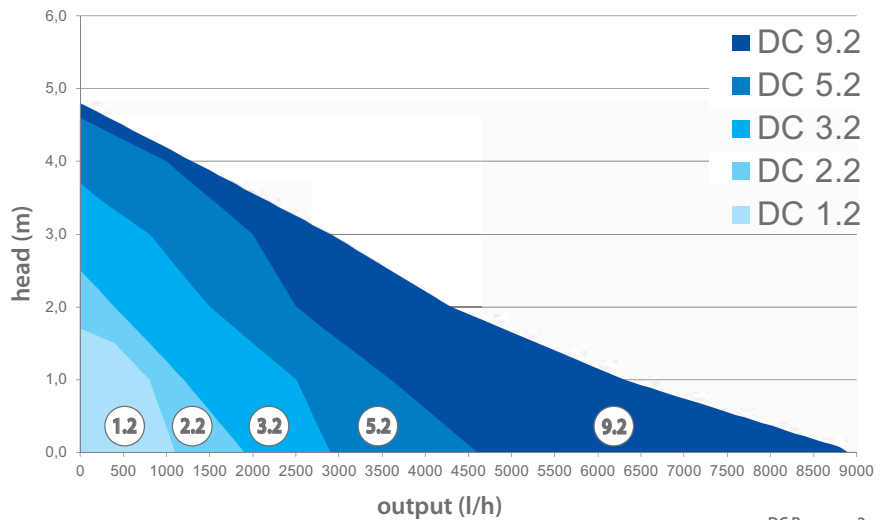

DC Runner x.2 series

Item code	Item
100.812	DC Runner 1.2 NEW
100.822	DC Runner 2.2 NEW
100.832	DC Runner 3.2 NEW
100.852	DC Runner 5.2 NEW
100.892	DC Runner 9.2 NEW

Extension cord 1.8 m DC Runner/EcoDrift

For cable extension between pump and controller

Please note: Only one extension cord per controller may be used. If several extension cables are connected to a controller, a proper function cannot be guaranteed.



Extension cord DC Runner/EcoDrift

Item code	Item
100.301	Extension cord 1.8 m



AC Runner 9.0

AC Runner

Powerful universal pump for aquaria

220 V – 240 V / EU-Plug only

- for use as a circulation or current pump in salt or freshwater aquaria
- rugged pump housing
- polished ceramic shaft and bearings for quiet operation and low maintenance
- submerged and non-submerged use is possible
- including prefilter basket and hose connections (AC Runner 3.0 + 5.0)
- including hose connections (AC Runner 9.0 + 12.0)



AC Runner series

AC Runner	3.0	5.0	9.0	12.0
Pump power - l/h	up to 3.000	up to 5.000	up to 9.000	up to 12.000
Max. head	up to 2,7 m	up to 4,2 m	up to 5 m	up to 5,5 m
Total power consumption	max. 27 W	max. 44 W	max. 78 W	max. 92 W
Power supply pump	220 V – 240 V / 50 Hz			
Suction side Ø	32 mm/ 1 1/4 inch	32 mm/ 1 1/4 inch	40 mm/ 1 1/2 inch	40 mm/ 1 1/2 inch
Pressure side Ø	25 mm/ 1 inch	32 mm/ 1 1/4 inch	40 mm/ 1 1/2 inch	40 mm/ 1 1/2 inch
Protection rating	IP X8			
Dimensions in mm (l x w x h), app.	155 x 90 x 115 (195 x 90 x 115)	175 x 105 x 125 (195 x 105 x 125)	195 x 115 x 130 (basket not included)	195 x 115 x 130 (basket not included)

Dimensions are indicated without fittings / dimensions within brackets mean including basket



Impeller AC Runner

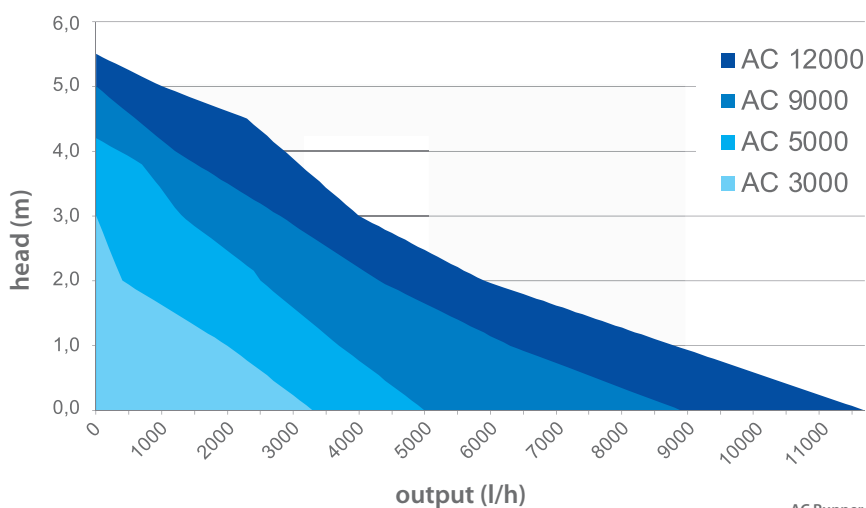

AC Runner series

Item code	Item
100.430	AC Runner 3.0
100.450	AC Runner 5.0
100.490	AC Runner 9.0
100.520	AC Runner 12.0

Pump NK/ OK, motor protection switch

Circulation pump OK/ NK

The OK and NK-series circulation pumps are powerful units having a capacity between 13 and 33 m³/h. With the housing moulded in plastic, the pumps are completely saltwater resistant. To improve the operating characteristics OK and NK pumps have an integrated prefilter and the impeller shaft has a rotating seal.



Pump NK / OK	NK 25	NK 33	OK 33	OK 51	OK 71	OK 100
m ³ /h at 10 m	–	4,0	4,8	6,6	10,0	14,5
Max. flow at 5 m	8.000 l*	11.000 l*	9.600 l	11.000 l	13.900 l	20.000 l
Max. head	9,25 m	11 m	12 m	14 m	15,5 m	15 m
Power (watts)	0,27	0,30	0,45	0,58	0,75	1,00
A			2,45	2,65	4,00	4,70
V	230	230	230	230	230	230
Dimensions cm (l x w x h), app.	43 x 21 x 27		47,5 x 24 x 31			50 x 24 x 31

* max. flow at 3 m

Connections: 1 1/2" and/or adhesive connection (inside Ø 50 mm, outside Ø 63 mm)

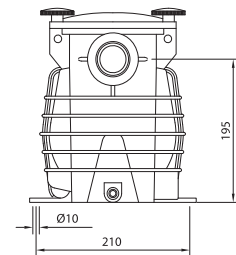
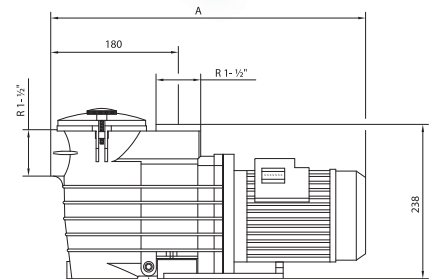
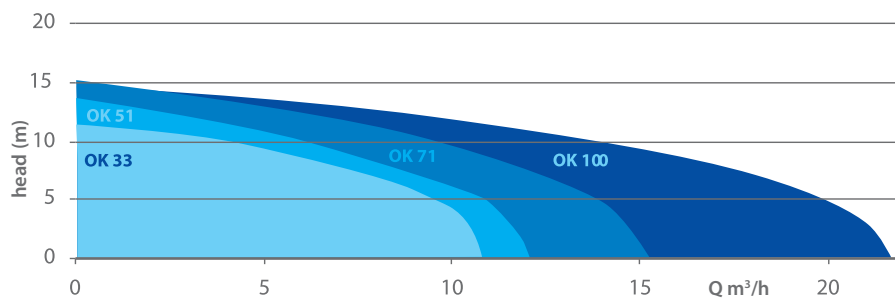

Item code	Item
400.00-19	pump NK 25.B
400.00-20	pump NK 33.B
400.00-21	pump OK 33.B
400.00-22	pump OK 51.B
400.00-23	pump OK 71.B
400.00-24	pump OK 100.B
400.01	motor protection switch pump NK 25, 1,45 A
400.02	motor protection switch pump NK 33/OK 33, 1,9 A
400.03	motor protection switch pump OK 51, 2,7 A
400.04	motor protection switch pump OK 71, 3,8 A
400.06	motor protection switch pump OK 100, 4,8 A

(Necessary to use with any NK or OK pump!)

Warranty is void, if pumps are used without motor protection switch!



Mistral 50 ECO



Mistral 200



Mistral 300



Mistral 2000



Mistral 4000

Mistral

Diaphragm air pump

This family of powerful diaphragm air pumps has a cast aluminium housing (plastic at Mistral 50 ECO) to ensure long life and silent operation. The output of the Mistral 300 is adjustable with a slide control which alters the magnetic circuit. All units have integrated replaceable air filters and are of low maintenance design. They are ideally suited to supplying air lift filters (under-gravel and box), air stones and protein skimmers using either ceramic or wooden air diffusers.

Mistral	Mistral 50 ECO	Mistral 200	Mistral 300
Power requirements	220 V, 50/60 Hz	220 – 240 V~/50 Hz	
Power uptake	1,8 watts	4 watts	8 watts
Maximum capacity	78 l/h (19.5 gph)	300 l/h (75 gph)	380 l/h (95 gph) magnetically adjustable by a slide system
Capacity at 1 m (3 ft) depth (100 mbar, 1.45 psi)	50 l/h (12.5 gph)	200 l/h (50 gph)	300 l/h (75 gph)
Maximum pressure	120 mbar (1.73 psi)	250 mbar (3.6 psi)	470 mbar (6.8 psi)
Connection pressure side	air tube 4/6 mm (1/4")		
Max. dB/ at a distance of 1 metre	35	40	48
Cable length in m	1,4	3	
Weight	0,23 kg (app. 0,53 lbs)	1,36 kg (app. 3.1 lbs)	1,75 kg (app. 3.7 lbs)
Housing	plastic	cast aluminium	
Dimensions in cm (l x w x h), app.	8,8 x 6,0 x 5,3	17,5 x 7,5 x 9,5	19 x 8,5 x 10

Mistral	Mistral 2000	Mistral 4000
Power requirements	220 – 240 V~/50 Hz	
Power uptake	25 watts	35 watts
Maximum capacity:	2.500 l/h	4.000 l/h
Capacity at 1 m (3 ft) depth (100 mbar, 1.45 psi)	1.600 l/h (400 gph)	2.900 l/h (750 gph)
Maximum pressure	> 300 mbar, 4.35 psi	
Connection pressure side	air tube 12 mm (1/2")	
Max. dB/ at a distance of 1 metre	41	46
Cable length in m	3	
Weight	3,5 kg (7.8 lbs)	5,6 kg (12.4 lbs)
Housing	cast aluminium	
Dimensions in cm (l x w x h), app.	17,5 x 16 x 13	19,5 x 18 x 15

Item code	Item
101.005	Mistral 50 ECO
101.020	Mistral 200
101.030	Mistral 300
101.200	Mistral 2000
101.400	Mistral 4000

reefdoser EVO 4

4-channel dosing pump incl. external controller

The Aqua Medic reeferdoser EVO 4 can independently control the four dosing pumps included in the package. The dispensing of the food or additive can be achieved either manually or automatically; all pumps can be calibrated individually. The interval control allows for adjustment of the duration of the on/off cycle for each pump over a broad time span – from seconds to days. reeferdoser EVO 4 can automate many tasks in an aquarium:

- regular dispensing of trace elements and fertilizers in salt- and fresh water aquarium
- controlled addition of calcium and bicarbonate into coral reef aquaria
- accurate dosing of Kalkwasser
- automatic feeding with live zoo plankton
- the external controller can be placed in a position away from the pumps to make it easy to use and allow for very simple programming

Incl. 4 m inlet hose (can be adjusted individually) to connect the dosing pumps to the containers with the dosing liquids.

Dimensions: app. 25 x 13 x 6.4 cm (l x w x h)

Item code	Item
104.144	reeferdoser EVO 4

accessories:

104.144-3	pump head
-----------	-----------

reeferdoser add 4

reeferdoser EVO 4 - Expandable to eight dosing pumps

Incl. 4 m inlet hose (can be adjusted individually) to connect the dosing pumps to the containers with the dosing liquids.

Dimensions: app. 14 x 6.5 x 3.6 cm (l x w x h)

Item code	Item
104.145	reeferdoser add 4

6-tubes

Acrylic tube holder to attach up to six tubes (max. Ø 6 mm) on to the glass edge.

Item code	Item
410.37	6-tubes

hose clip

Plastic clip

Flexible plastic clip designed for the safe fastening of hoses.

Item code	Item
410.38	hose clip Ø 5 – 6 mm
410.39	hose clip Ø 6 – 7 mm





Dosing pump

Dosing pump SP 3000

The SP 3000 is a hose pump for pumping small amounts of water. It can be used for bypass filters such as the Nitratoreductor and the Calciumreactor, to top up evaporated water when combined with an aquaniveau and for the automatic dosing of fertilizers and minerals. In freshwater aquaria, the iron fertilizer ferreal can be added daily. The pump is supplied with a long life Santoprene® hose.

SP 3000: 3.0 l/h (app. 0.08 gph), 4.5 watts

Item code	Item
104.030	Dosing pump SP 3000



SP 3000 Niveumat

SP 3000 Niveumat

Automatic top up unit with peristaltic pump and float switch

The SP 3000 Niveumat will automatically top up evaporated water in fresh and saltwater aquaria. It comprises a Niveumat SP 3000 peristaltic pump with a directly connected float switch. The float switch is installed in the aquarium or filter tank at the desired level using its holding unit. As the level drops the Niveumat SP 3000 automatically tops up the tank with water from a reservoir (not supplied).

Technical data Niveumat:

Capacity: 3 l/h pump, hose: Santoprene®, power consumption: 4.5 watts

Item code	Item
104.031	SP 3000 Niveumat

power flotor

Compact and adjustable skimmer for sump use

We offer the power flotor skimmer in three different sizes: S for aquaria up to 300 litres, M for aquaria up to 400 litres, L for aquaria up to 500 litres.

Equipment:

- integrated, adjustable 24 V pump DC Runner incl. controller with button to allow skimmer to pause for feeding. 0 – 10 V connection enabled
- optimum bubble size and shape due to the effective Power Wheel
- near silent operation with the adjustable water outlet positioned on the bottom of the housing
- silencer that can be positioned freely
- foaming is adjustable both electronically and manually
- compact design allows for use in small areas
- can be completely dismantled for easy cleaning



power flotor S

power flotor	S	M	L
For aquaria	up to 300 l	up to 400 l	up to 500 l
Total consumption	max. 13 watts	max. 13 watts	max. 13 watts
Pump	DC Runner	DC Runner	DC Runner
Air power	max. 350 l/h	max. 400 l/h	max. 450 l/h
Total height	app. 42 cm	app. 45 cm	app. 48 cm
Required space	app. 15 x 15 cm	app. 15 x 15 cm	app. 15 x 15 cm
Optimum water level in the filter sump	app. 14 – 18 cm	app. 14 – 18 cm	app. 16 – 20 cm

Item code	Item
411.210	power flotor S NEW
411.220	power flotor M NEW
411.230	power flotor L NEW



power flotor M

power flotor L



K1



K2



K3

K1 / K2 / K3

Motor driven skimmer

Adjustable and very powerful skimmer for the sump

- adjustable 24 V-pump DC Runner incl. controller with button to allow skimmer to pause for feeding. 0 – 10 V connection enabled
- high air entry, optimum bubble size and shape due to the Power Wheel
- near silent operation with the adjustable water outlet positioned on the bottom of the housing
- silencer that can be positioned freely
- foaming is adjustable both electronically and manually
- compact design allows for use in small areas
- can be completely dismantled for easy cleaning

	K1	K2	K3
For aquaria	100 – 500 l	200 – 1.000 l	300 – 1.500 l
Total consumption	max. 18 W	max. 31 W	max. 58 W
Pump	DC Runner K1	DC Runner K2	DC Runner K3
Air power	max. 1.000 l/h	max. 1.800 l/h	max. 3.100 l/h
Total height	app. 45 cm	app. 48 cm	app. 54 cm
Height foam cup	app. 48 cm	app. 51 cm	app. 57 cm
Required space	app. 20 x 24 cm	app. 35 x 24 cm	app. 40 x 25 cm
Opt. water level in filter sump	app. 14 – 18 cm	app. 18 – 23 cm	app. 18 – 23 cm

Item code	Item
412.210	K1
412.220	K2
412.230	K3



Controller



Power Wheel

EVO 500

Motor driven adjustable internal skimmer

The power driven EVO 500 is especially characterized by the power-saving and efficient pump DC Runner 1.1 (incl. DC motor) with power consumption of max. 7 watts. The pump power can be continuously adjusted by the included controller. Two holding systems for individual fixing, adjustable in height making it suitable for many different styles of aquarium. 3D needle wheel will provide a large amount of air and optimum bubble structure. High skimming capacity is achieved by the special water flow with a patented conical foam cup.

EVO	EVO 500
For aquaria up to	250 l
Pump	DC Runner 1.1
Power supply pump	24 V
Power supply transformer	110 – 240 V/50 – 60 Hz
Power consumption	max. 7 W
Total height	app. 36.5 cm
Dimensions (l x w x h):	app. 14 x 8 x 36.5 cm (app. 5.6" x 3.2" x 14.6")
Immersion depth	app. 23 cm

Item code	Item
410.005	EVO 500

EVO 1000 / EVO 3000

Motor driven adjustable internal and external skimmer

The power driven skimmers are especially characterized by the power-saving and efficient DC Runner pump (incl. DC motor). The pump power can be continuously adjusted by the included controller. The skimmers are designed for installation in any mode: as a "hang on", it is simply hung over the edge of the aquarium. Only the venturi pump is inside the tank. The 3D needle wheel will provide a large amount of air and optimum bubble structure.

EVO	EVO 1000	EVO 3000
For aquaria up to	500 l	500 – 1.500 l
Pump	DC Runner 1.1	DC Runner 3.2
Power supply pump	24 V	
Power supply transformer	110 – 240 V/50 – 60 Hz	
Power consumption	max. 9 W	max. 20 W
Total height	app. 46 cm	app. 56 cm
Required space	app. 25 x 11 cm	app. 35 x 17 cm

Item code	Item
410.010	EVO 1000
410.030	EVO 3000



EVO 500



EVO 1000



EVO 3000



Turboflotor 5000 Shorty Compact



Turboflotor 5000 Shorty II

Turboflotor 5000 Shorty

Powerful skimmers for in cabinet installation

The "Shorties" are manufactured in 2 sizes to fit into most aquarium cabinets. They are supplied with a venturi pump and our patented needle wheel. The water supply to the skimmer requires a second pump with a capacity of minimum 2,000 l/h (app. 500 gph). The skimmer may also be directly connected to the overflow of the aquarium. In this case it is recommended to install a bypass to control the water flow to the skimmer, especially if powerful return pumps are used.

Total height with foam cup:

Shorty Compact: app. 62.5 cm (footprint app. 30 x 40 cm)

Shorty II: app. 73 cm (footprint app. 30 x 50 cm)

Item code	Item
410.16	Turboflotor 5000 Shorty Compact for aquaria up to 1,500 l
410.17	Turboflotor 5000 Shorty II for aquaria up to 1,500 l



Turboflotor 5000 baby ECO



Turboflotor 5000 single 6.0

Turboflotor 5000

Powerful skimmer with longer contact time for aquaria from 1,500 – 5,000 l (app. 375 – 1,250 gal)

The skimmer 5000 series were developed for larger aquaria. The reaction pipe has a diameter of 200 mm. A separate pump (2,000 – 3,500 l/h) is required for the water supply, e. g. DC Runner 5.2 or AC Runner 3.0. The venturi pumps of our DC Runner-series with Power wheel have a high skimming power, are very quiet in operation and have a low power consumption.

T 5000 baby ECO: Total height app. 107 cm, required space app. 50 x 29 cm (without outlet D40). Venturi pump - app. 60 watts

T 5000 single 6.0: Total height app. 185 cm, required space app: app. 50 x 29 cm (without outlet D40). Venturi pump - app. 60 watts

Item code	Item
400.015	Turboflotor 5000 baby ECO for aquaria up to 2,000 l
400.021	Turboflotor 5000 single 6.0 for aquaria up to 5,000 l



Trickle filter T 5000 single 6.0

Tricklefilter

for Turboflotor 5000 single 6.0

The trickle filter is suitable for the connection at the Turboflotor 5000 single 6.0, filled with BactoBalls, app. 20 cm Ø. Height: app. 155 cm, footprint: app. 30 x 35 cm

Item code	Item
410.026	Trickle filter for Turboflotor 5000 single 6.0

Turboflotor 10000

It is made of an acrylic pipe and is designed for flow rates up to 10,000 l/h (app. 2,500 gph). It is recommended for larger aquaria up to 10,000 litres (app. 2,500 gallons) and professional aquaculture systems.

Technical data: Reaction chamber Ø: 50 cm (app. 20"), total height including foam cup: 200 cm (app. 80"), injector pump power consumption incl. motor protection switch: 500 watts, max. water flow: 10,000 l/h (app. 2,500 gph)

Item code	Item
400.05	Turboflotor 10000
400.15	Turboflotor 10000 w/o pump



Turboflotor 10000

Turboflotor 20000

Protein Skimmer for large aquaria

With the production of this skimmer Aqua Medic enters the area of water treatment for large professional aquaria. A powerful pump is combined with a venturi to provide an injection of app. 3,500 l/h. The maximum water flow rate is 20,000 litres (5,000 gallons) per hour. The Turboflotor 20000 is designed for larger tanks in public aquaria and for commercial use for pet fish importers and distributors.

Technical data: Reaction chamber Ø: 50 cm (app. 20"), total height including foam collection cup: 310 cm (app. 122"), injector pump power consumption incl. motor protection switch: 900 watts, max. water flow: 20,000 l/h (app. 5,000 gph).

Item code	Item
400.00	Turboflotor 20000
400.10	Turboflotor 20000 w/o pump



Turboflotor 20000

Trickle filter for Turboflotor

Item code	Item
401.01	Trickle filter for Turboflotor 10000, with BactoBalls
401.01-1	Trickle filter for Turboflotor 10000, w/o BactoBalls

Total height app. 135 cm, required space app. 52 x 70 cm

401.00	Trickle filter for Turboflotor 20000, with BactoBalls
401.00-1	Trickle filter for Turboflotor 20000, w/o BactoBalls

Total height app. 235 cm, required space app. 52 x 70 cm



Trickle filter T 10000



miniflotor

miniflotor

Air driven internal skimmer for aquaria up to 200 litres (app. 50 gal)

The miniflotor is a small but powerful air-driven internal protein skimmer. A lime wood air diffuser producing very fine air bubbles is also included. The outer reaction tube is replaceable. A second shorter reaction tube is included in shipment. For the air supply, we recommend the Mistral 200 membrane air pump.

Ø app. 5 cm (app. 2"), length: with long tube app. 45 cm (app. 18") - with short tube app. 32 cm (app. 12.8"), total width: app. 15 cm (app. 6"), immersion depth: long tube app. 33 cm (app. 13.2"), short tube app. 20 cm (app. 8")

Item code	Item
410.50	miniflotor



midiflotor

midiflotor

Air driven internal skimmer for aquaria up to 400 litres (app. 100 gal)

The midiflotor is an air-driven counter current internal protein skimmer. The strong holding system allows movement of the skimmer vertically to adjust the foam production zone. A lime wood air diffuser, producing very fine air bubbles, is included. For the air supply, we recommend the Mistral 300 membrane air pump.

Ø app. 57.5 cm (app. 3"), length: app. 52 cm (app. 21"), total width: app. 15 cm (app. 6"), immersion depth: app. 30 – 35 cm (app. 12" – 14")

Item code	Item
410.55	midiflotor

Wooden airstones

For air driven protein skimmers

Wooden airstones are produced from lime wood with very fine pores. To keep the skimmer running at its optimum performance level, the bubbles have to be monitored regularly, and it is recommended that they are changed every 6 – 8 weeks. In an attractive blister pack.

Item code	Item
410.59	Wooden airstones Mini 2 pcs., app. 15 x 15 x 57 mm (l x w x h)
410.58	Wooden airstones Midi 2 pcs., app. 18 x 18 x 78 mm (l x w x h)
410.57	Wooden airstones Maxi 1 pc., app. 30 x 30 x 110 mm (l x w x h)



Silencer

Silencer for protein skimmer

The Silencer 100 and the Silencer 200 reduce the noise of the air intake of a protein skimmer. The noise may be avoided by the use of the Silencers. At the fitting of the Silencer you can attach tubes with a diameter of 6/8 mm without any problems.

Item code	Item
410.610	Silencer 100 up to a capacity of 200 l air/h
410.620	Silencer 200 for a capacity higher than 200 l air/h





Reef Station

Reef Station

A complete filtration system for Reef aquaria up to 1,000 litres

It comprises the following components: closed glass filter sump with sliding doors and removable cover, a prefilter for taking up activated carbon, phosphate absorbers or bioballs, the K2 protein skimmer and DC Runner 3.2 circulation pump. Pipework connections to the aquarium (left side): 32 mm flow, return 40 mm. All components are inside the filter sump.

Dimensions of the filter: app. 75.5 x 47.5 x 62 cm (l x w x h)

Item code	Item
501.010	Reef Station

optional filter features:

80818	Helix Max 18 watts
502.76	Refill System pro

Systemfilter 2000

A complete filter system for saltwater aquaria and holding tanks up to 5,000 litres (app. 1,319 gallons)

Systemfilter 2000 is a modular filter system delivered ready for use. It is designed for use as a centralized filter system for food fish holding tanks and for aquaria up to 5,000 l (app. 1,319 gallons).

The standard version comprises the following:

- protein skimmer Turboflotor 5000 single 6.0 incl. venturi pump, connection for external ozone supply
- prefilter chamber, post-switched biofilter, prepared to receive various filter materials
- UV-C clarifier, 1 x 80 watts, firmly integrated in the internal water cycle
- plastic vessel as filter sump, dimensions: app. 1,100 x 550 x 1,175 mm (l x w x h)
- cooling unit Titan 2000
- internal circulation pump
- recirculating pump

All components are already piped.

Total required space: app. 1,400 x 800 x 1,900 mm (l x w x h)

optional:

- cooling unit (max. Titan 4000)
- other pump combinations upon request
- the filter is also available without UV-C unit

Item code	Item
405.80	Systemfilter 2000 NEW



Systemfilter 2000

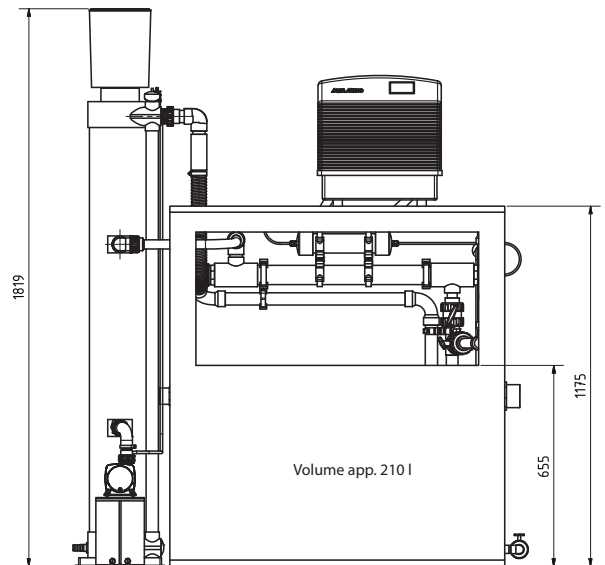

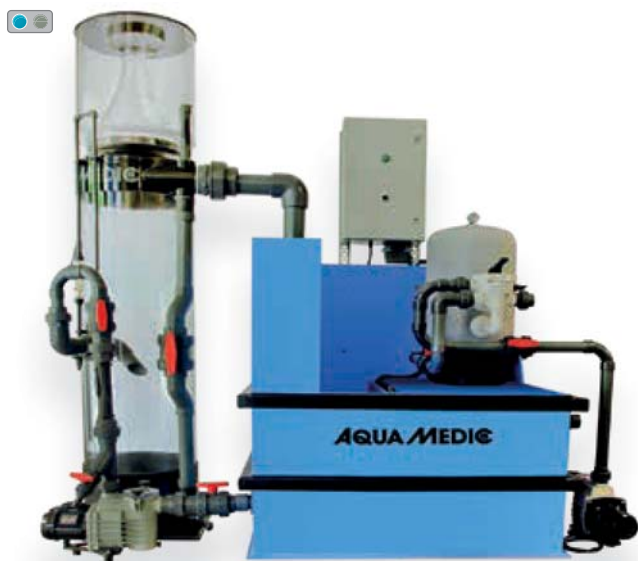

Systemfilter Skim

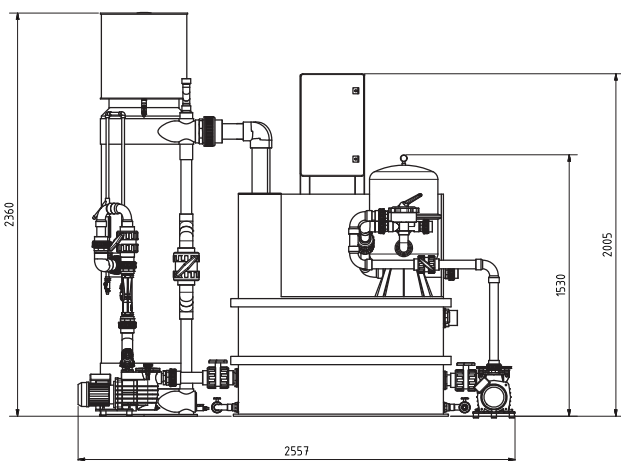

Systemfilter Skim

A complete filter system for saltwater aquaria and holding tanks up to 20,000 litres (app. 5,277 gallons)

Systemfilter Skim is a modular filter system delivered ready for use. It is designed for use as a centralized filter system for food fish holding tanks and for aquaria up to 20,000 l (app. 5,277 gallons).

The standard version comprises the following:

- protein skimmer Turboflotor 15000 incl. venturi pump, connection for external ozone supply
- trickle filter for biological filtration (filled with BactoBalls)
- pressurized sand filter as final mechanic filter with back-flush valve
- plastic vessel as filter sump, dimensions: app. 1,290 x 940 x 1,300 mm (l x w x h). The tank is equipped with an underwater retaining system with 12 pcs. UV-C tubes with 20 watts each. With external switchboard for controlling.
- preparation for receiving a heat exchanger
- circulation pump capacity 12 m³/h (app. 3,000 gph)
- all components are already piped

Total required space: app. 260 x 95 x 255 cm (l x w x h)

optional:

- a second trickle filter and/or fine filter unit
- installation of a titanium heat exchanger for cooling or heating
- the filter is also available without UV-C unit

Equipment selectable upon agreement.

Item code	Item
406.50	Systemfilter Skim
406.51	Systemfilter Skim w/o UV

Systemfilter

A complete filter system for fresh- and saltwater aquaria and holding tanks up to 20,000 litres (app. 5,277 gallons)

Systemfilter is a modular filter system delivered ready for use. It is designed for use as a centralized filter system for food fish holding tanks and for aquaria up to 20,000 l (app. 5,277 gallons).

The standard version comprises the following:

- trickle filter for biological filtration (filled with BactoBalls)
- pressurized sand filter as final mechanic filter with back-flush valve
- plastic vessel as filter sump, dimensions: app. 1,290 x 940 x 1,300 mm (l x w x h). The tank is equipped with an underwater retaining system with 12 pcs. UV-C tubes with 20 watts each. With external switchboard for controlling.
- preparation for receiving a heat exchanger
- circulation pump capacity 12 m³/h (app. 3,000 gph)
- all components are already piped.

Total required space: app. 190 x 95 x 165 cm (l x w x h)

optional:

- a second trickle filter and/or fine filter unit
- installation of a titanium heat exchanger for cooling or heating.
- the filter is also available without UV-C unit

Equipment selectable upon agreement.

Item code	Item
405.50	Systemfilter
405.51	Systemfilter w/o UV



Systemfilter

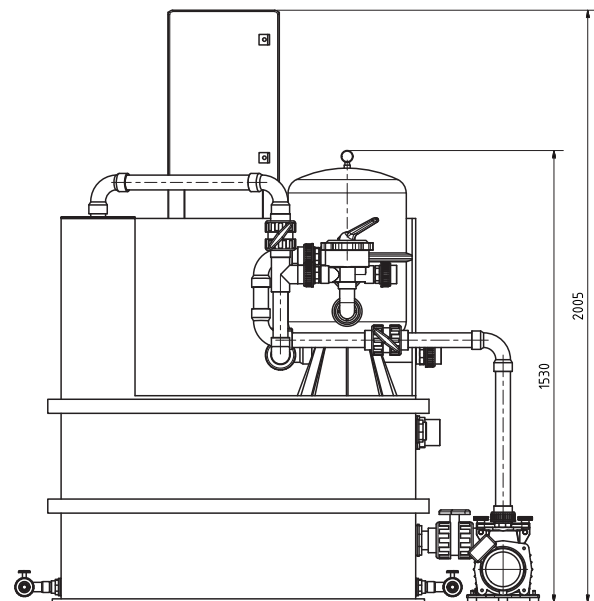

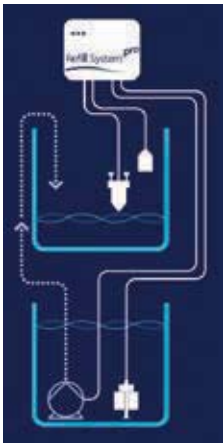

Refill System pro

Refill System with safety circuit

Easy and safe refilling of evaporated water in the aquarium

- permanent monitoring of the water level in the aquarium with an infrared sensor incl. delay circuit
- automatic refilling of evaporated aquarium water
- adjustable minimum and maximum water levels in the aquarium or filter sump
- dry-running protection of the refilling pump – optical and acoustic alarm
- there is a warning for low water level of the refill tank
- easy installation and maintenance, plug connections on all cables (incl. cable protection against unintentional release)
- safety shutdown circuit in case of a defective level sensor
- 12 V low voltage, incl. transformer 100 – 240 V / 50 – 60 Hz

Refill System pro



Item code	Item
502.76	Refill System pro



refill depot

refill depot

Canister with cap and tap

Dimensions (l x w x h): app. 32 x 17 x 31 cm
total height incl. cap: app. 38 cm

Item code	Item
502.79-1	refill depot 16 l (1) für Refill System pro, Canister with cut-out and cap
502.79-2	refill depot 16 l (2) für Refill System pro Canister with cap and tap

Overflow box

For connecting to an under tank filter system

The Aqua Medic Overflow box hangs over the outside of the aquarium. A constant water level is maintained after the start of the overflow. Water circulation is achieved by pumping the water from the sump into the aquarium, and then via the Overflow box back into the sump. This makes it possible to connect aquaria to under the tank filter systems without having to drill holes in the aquarium.

The Overflow box is manufactured from acrylic and is available in two capacities:

OFB 2500 for up to 2,500 l/h (app. 625 gph),

OFB 5000 for up to 5,000 l/h (app. 1,250 gph) Connection: 32 mm

OFB 2500 (l x w x h): app. 19 x 18 x 25 cm (app. 8" x 7.2" x 10"),

OFB 5000 (l x w x h): app. 19 x 25 x 25 cm (app. 8" x 10" x 10")



Overflow box OFB 5000 I

Item code	Item
501.70	Overflow box OFB 2500 I
501.75	Overflow box OFB 5000 I

flow kit

Stainless steel connection set for external filter
(suction and pressure side)

The set consists of a stainless steel tube with suction basket and variable surface skimming for water drainage as well as a stainless steel pressure pipe for water supply. The pipes are manufactured with a 3.2 cm – 3.5 cm gap to allow installation on many different styles of aquarium, even those with internal glass bracing. High quality materials guaranteeing a long service life.

Supplied with two suction cups for each tube for easy installation.

Suction side: Ø 13 mm for hose of 12/16 mm

Length of the external tube: 21 cm

Length of the internal tube: 19 cm

Internal distance: 3.5 cm

Pressure side: Ø 13 mm for hose of 12/16 mm

Length of the external tube: 21 cm

Length of the internal tube: 10 cm

Internal distance: 3.2 cm



flow kit

Item code	Item
590.000	flow kit



multi reactor S



multi reactor

All-In-One filter system

- for use in the aquarium or sump filter
- highly efficient filtration due to high flow through your chosen filter media
- adjustable water flow
- high-quality, precision made using quality acrylic
- very simple maintenance due to removable filling tube, the filter housing can remain in the aquarium for refilling and maintenance
- space-saving installation in the aquarium or sump filter with internal pump
- low maintenance double O-ring seal
- universal application by using various filter media such as activated carbon (carbolit), phosphate absorber (antiphos FE), zeolithes, fine filter, etc. (filter media not included)
- incl. pump and flexibly adjustable mounting system



multi reactor M

multi reactor L

multi reactor	S	M	L
Dimensions (l x w x h), app.	60 x 50 x 315 mm	80 x 60 x 380 mm	100 x 100 x 465 mm
Filling quantity	app. 150 ml	app. 350 ml	app. 650 ml
Voltage	220 – 240 V/50 – 60 Hz		
Total power consumption	12 V/app. 4 watts	12 V/app. 8 watts	12 V/app. 14 watts
Pump power	app. 200 l/h	app. 350 l/h	app. 450 l/h
For aquaria	up to 350 l	up to 500 l	up to 800 l

Item code	Item
410.930	multi reactor S
410.940	multi reactor M
410.950	multi reactor L



FB 5000

Fluidized bed filter FB 5000

Fluidized bed sand filter

The FB 5000 fluidized bed sand filter is a powerful but compact biological sand filter. The water enters the filter from the bottom and keeps the small quartz sand grains fluidized – a huge surface area is created and is optimally supplied with water and nutrients. FB 5000 can work as biological filter for aquarium systems up to 10,000 litres (app. 2,500 gallons).

Incl. 20 kg Quartz sand

Dimensions: Ø 20 cm (app. 8"), total height: 170 cm (app. 67")

Item code	Item
410.600	Fluidized bed filter FB 5000

phosphatfilter Fe

Bypass filter for the elimination of phosphate

The phosphatfilter Fe is a compact chemical filtration chamber for aquarium use. It can be installed in line with any standard canister filter or fed via a separate pump. The phosphatfilter Fe contains 400 ml of antiphos Fe. This reduces the level of phosphate and thereby curtails the growth of filamentous algae. Depending on the phosphate level, one filling of antiphos may be sufficient for an aquarium up to 600 litres (app. 150 gallons) for between 3 – 6 months. The phosphatfilter Fe can be used for fresh- and saltwater aquaria.

Ø app. 8 cm (app. 3.2"), length app. 24 cm (app. 9.45"),
hose connection: 12 and 16 mm



phosphatfilter Fe

Item code	Item
65024	phosphatfilter Fe

Nitratreductor NR 5000

Denitrification filter for aquaria up to 3,000 litres [app. 800 gallons]

The Nitratreductor NR 5000 is an anaerobic biological reactor for removing nitrates from fresh- and saltwater aquaria. It has a volume of 30 l (app. 7.5 gal) and is supplied with an internal circulation pump plus the connection for a pressurized redox probe with a PG 13.5 thread. Feeding the bacteria can be performed manually with denimar or automatically using Deniballs in conjunction with an mV (ORP) controller. The Nitratreductor NR 5000 is a closed system and should be supplied with feed water via a bypass or a dosing pump at a rate of 12 – 30 l/h (app. 3 – 8 gph).

Dimensions excluding electrode (l x w x h): app. 50 x 30 x 96 cm (app. 20" x 12" x 38.5"). Recommended accessories: denimar-powder and Deniballs to feed the anaerobic bacteria, pressure resistant mV (Redox or ORP) probe with PG 13.5 threaded connection.



NR 5000

Item code	Item
410.850	Nitratreductor NR 5000

Calciumreactor KR 5000

For the supply of dissolved calcium to reef aquaria up to 5,000 litres (app. 1,250 gallons)

The Calciumreactor KR 5000 is designed as a closed system. An integral pump provides internal water circulation. A PG 13.5 threaded port accepts an electrode for measuring and controlling the pH within the vessel. The reactor has a volume of 30 litres (app. 8 gallons) and is supplied with a 15 l bucket of Hydrocarbonat. Dimensions (l x w x h): app. 50 x 30 x 96 cm (app. 20" x 20" x 38.5").

Recommended accessories:
pressure resistant pH probe threaded PG 13.5, Hydrocarbonat as refill.



KR 5000

Item code	Item
410.450	Calciumreactor KR 5000



KS 1000

Kalkwasser stirrer KS 1000

For the production of Kalkwasser for saltwater aquaria

Kalkwasser stirrers automatically produce Kalkwasser to replace the evaporated water in saltwater aquaria. They should be used in conjunction with an automatic refill device, e.g. the Niveumat. The top up water is pumped from a reverse osmosis or a reservoir through the Kalkwasser stirrer. Inside the unit a sediment of Calciumhydroxide powder is slowly stirred so it is kept in suspension.

For aquaria up to 1,500 litres (app. 400 gal); dimensions: app. 11 cm Ø x 50 cm high, (app. 4.3" Ø x app. 20"), connection: 4/6 mm (app. 1/4") hose

Recommended accessories:

Niveumat or aquaniveau with dosing pump SP 3000

Item code	Item
410.510	Kalkwasser stirrer KS 1000



filter bag

filter bag

Zip up media bag

Filter bags are designed to contain fine filter media, such as activated carbon, antiphos Fe or other granular media. The filter bag is fitted with a zip fastener for quick and easy replacement of the media.

Item code	Item
429.01	filter bag 1, 2 pcs., 22 x 15 cm (app. 8.6" x 5.9")
429.02	filter bag 2, 2 pcs., 22 x 30 cm (app. 8.6" x 11.8")
429.03	filter bag 3, 2 pcs., 22 x 45 cm (app. 8.6" x 17.7")

FILTER MATERIAL



prefilter bag



filter bag 4

prefilter bag

Filter bag (Ø app. 12 cm) with 200 µm for use as a prefilter in a cabinet filter. Incl. acrylic holder for max. 14 mm glass.

Item code	Item
429.10	prefilter bag
429.11	filter bag 4 (2 pcs.) - replacement Ø app. 90 mm, length app. 300 mm

antiphos Fe

For the control of algal growth

Phosphate and silicate remover for freshwater and saltwater aquaria. antiphos Fe is an ideal medium for selectively extracting phosphate and silicate from aquarium water, thus counteracting unwanted algal growth. antiphos Fe is a highly active iron based product containing no aluminium and is completely non toxic to aquarium plants and animals. The binding capacity of antiphos Fe is app. 10 g phosphate/kg. Subject to the conditions 500 ml of antiphos Fe will treat a normally populated 300 l aquarium for app. 3 – 6 months.



Item code	Item
11650	antiphos Fe 300 g/app. 500 ml
12650	antiphos Fe 600 g/app. 1000 ml
12653	antiphos Fe 3000/app. 5000 ml

carbolit

For the removal of toxins and colours

Activated carbon pellets for fresh- and saltwater aquaria. carbolit comprises of highly efficient activated carbon pellets. carbolit quickly clears aquarium water and removes colouring substances, turbidity and medication residues. Yellowing substances such as phenols and tannins that can accumulate in the water are also removed. carbolit may also be used as a long-term filter material.



Item code	Item
11512	carbolit 500 g/1,25 l, 1,5 mm Pellets (app. 1.1 lbs/125 gal)
12513	carbolit 400 g/1.25 l, 4 mm Pellets (app. 0.9 lbs/100 gal)
11517	carbolit 5 l/3.5 kg, 1.5 mm Pellets (app. 7.7 lbs/1 gal)
12517	carbolit 5 l/3 kg, 4 mm Pellets (app. 6.6 lbs/1 gallons)
11516	carbolit 25 kg/62.5 l, 1.5 mm Pellets (app. 55 lbs)
12516	carbolit 25 kg/62.5 l, 4 mm Pellets (app. 55 lbs)

Zeolith

For use in salt- and freshwater aquaria and ponds

Natural zeolite rock with a highly porous surface.



Item code	Item
13001	Zeolith 900 g 10 – 25 mm/1 l can
13003	Zeolith 6 kg 10 – 25 mm/5 l bucket
13006	Zeolith 25 kg 10 – 25 mm/bag



BactoBalls

BactoBalls

Biological filter media

BactoBalls are the optimum filter medium for biological filters. They can be used in trickle filters and denitrification reactors and in larger aquaculture systems. The large surface area of 300 m²/m³ allows a high concentration of active bacterial biomass.

Item code	Item
410.80	BactoBalls 25 l box (app. 6.25 gal)
410.81	BactoBalls 5 l bucket (app. 1.3 gal)
410.82	BactoBalls 15 l bucket (app. 3.75 gal)

Larger quantities on request!



sulfur pearls

sulfur pearls

Filter medium for Sulphur denitrification reactors

sulfur pearls are sulphur beads formed from pure sulphur. They are used in sulphur nitratereductors as the filter medium and energy source for the bacteria. They have to be replaced from time to time as they are slowly consumed by the bacteria.

Caution:

Use only in nitrate removing anaerobic filters having a low water flow rate.

Item code	Item
410.79	sulfur pearls app. 1000 g/app. 1000 ml can
410.79-1	sulfur pearls app. 5000 g/app. 5000 ml bucket



Denigran

Denigran

Supports the natural decomposition of nitrate in salt- & freshwater aquaria, also helps clear algae problems

Denigran is a type of granular media made of special plastic material to enhance the settlement of nitrate removing bacteria. The main nutrient, nitrate is removed from the algae without any chemical additives; additional feeding of the bacteria is not required. The optimal designed mesh bag gives the best possible water flow past the media. Depending on the population, Denigran will be effective for up to 12 months.

Content: 4 mesh bags of 50 g each

Application: 1 – 2 bags per 50 liters of aquarium water

Item code	Item
411.76	Denigran 4 x 50 g

Deniballs

A filter material and bacteria feed for the Nitratereducator

Deniballs are manufactured from a unique biologically based plastic. One to three packages of 0.8 litres (app. 0.2 gal) is enough to supply the Nitratereducator as the sole food source for 12 months. For the Nitratereducator NR 5000, about 5 litres (1.3 gal) are required. Changing the Deniballs after approximately 12 months is recommended to ensure safe and maintenance free denitrification in fresh- and saltwater aquaria.

Item code	Item
410.78	Deniballs 0,8 l (app. 0.2 gal)
410.78-1	Deniballs 5 l bucket
410.78-3	Deniballs 25 l box



Deniballs

Mini-Deniballs

A filter material and bacteria feed for the Nitratereducator

Mini-Deniballs are manufactured from a unique biologically based plastic. One package of 0.5 litres (app. 0.2 gal) is enough to supply a Nitratereducator as the sole food source for 12 months. Changing the Mini-Deniballs after approximately 12 months is recommended to ensure safe and maintenance free denitrification in fresh- and saltwater aquaria.

Item code	Item
411.78	Mini-Deniballs 0,5 l

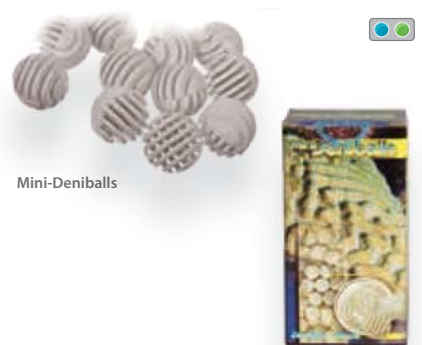

Mini-Deniballs

denimar

Nutrient powder for the Nitratereducator

The bacteria within an anaerobic biofilter need organic nutrients as their energy source to remove nitrate. If denimar is dosed daily, high nitrate removal rates can be achieved in the Nitratereducator. denimar is suited for salt- and freshwater aquaria. It contains no fertilizers and does not foster the growth of algae.

Item code	Item
410.76-1	denimar 150 g



denimar

biobacter

bacteria culture for improving nitrification and de-nitrification in aquaria

biobacter is a compound containing freeze-dried living bacteria. It is used to start new biological filters, revitalise filters after using medication, and to improve nitrification in existing aquaria. biobacter comprises a glass vial of bacteria and bacteria feed.

1 carton for 250 litres (app. 60 gallons).

Item code	Item
12411	biobacter



biobacter



Helix Max 18 W



Helix Max

Water clarifier for fresh- and saltwater aquaria and garden ponds

Helix Max UV sterilizers can eliminate single cell algae giving crystal clear water in aquaria and ponds. The water is directed in a spiral path around the quartz tube resulting in more efficient use of the UV radiation than in standard units. The inlet and outlet fittings can be rotated through 360° for easy mounting at any angle. All Helix Max are equipped with a rubber cable and high frequency electronic ballast, for garden ponds, salt- and freshwater aquaria. The electronic ballasts increase the lifetime and the efficacy of the UV lamps.

Helix Max	5 W	9 W	11 W	18 W	36 W	55 W
Saltwater aquarium	25 – 125 l	125 – 250 l	150 – 350 l	250 – 500 l	500 – 1.000 l	up to 1.500 l
Recommended max. flow	100 l/h	200 l/h	300 l/h	500 l/h	1.000 l/h	1.500 l/h
Freshwater aquarium	50 – 250 l	250 – 500 l	350 – 750 l	500 – 1.000 l	1.000 – 2.000 l	up to 3.000 l
Recommended max. flow	200 l/h	500 l/h	700 l/h	1.000 l/h	2.000 l/h	3.000 l/h
Capacity	1,8 W/ UVC	2,4 W/ UVC	3,6 W/ UVC	5,5 W/ UVC	12 W/ UVC	17 W/ UVC
Cable length	2 m	2 m	2 m	10 m	10 m	10 m
Lamp type	PL-S-5 watts	PL-S-9 watts	PL-S-11 watts	PL-L-18 watts	PL-L-36 watts	PL-L-55 watts
Max. pressure	0,3 bar					
Power connection	230 V~/50 Hz					
Dimensions l x w in mm, app.	160 x 75	240 x 75	290 x 75	380 x 120	510 x 120	650 x 120

Item code	Item
80805	Helix Max 5 W
80809	Helix Max 9 W
80811	Helix Max 11 W
80818	Helix Max 18 W
80836	Helix Max 36 W
80855	Helix Max 55 W



UVC-Max

Spare bulbs for Helix Max

Item code	Item
80805-8	UVC-Max 5 W
80809-8	UVC-Max 9 W
80811-8	UVC-Max 11 W
80818-8	UVC-Max 18 W
80836-8	UVC-Max 36 W
80855-8	UVC-Max 55 W

UV-C Professional

Modular UV-C system

Aqua Medic water clarifiers are suitable for fresh and saltwater aquaria. Helix Max can eliminate single cell algae giving crystal clear water in aquaria. The water is directed in a spiral path around the quartz tube resulting in more efficient use of the UV radiation than in standard units. This system consists of modules with 80 watts lamps. The housing consists of solid blue PVC tubes. The electronic ballast is placed in a switchbox together with an hour meter.



UV-C Professional

UV-C Professional	2 x 80 W	4 x 80 W	8 x 80 W	12 x 80 W
Saltwater aquarium	5 – 10 m ³	10 – 20 m ³	25 – 35 m ³	35 – 55 m ³
Recommended max. flow	10 m ³ /h	20 m ³ /h	30 m ³ /h	60 m ³ /h
Freshwater aquarium	10 – 20 m ³	20 – 40 m ³	50 – 70 m ³	70 – 110 m ³
Recommended max. flow	15 m ³ /h	30 m ³ /h	50 m ³ /h	75 m ³ /h
Capacity	520 mW/cm ²	1040 mW/cm ²	2080 mW/cm ²	3120 mW/cm ²
Lamp type	80 W T5			
Power connection	230 V~/50 Hz			
Dimensions l x w in mm, app.	920 x 365	1055 x 545	982 x 787	1055 x 585

Item code	Item
81828	UV-C Professional 2 x 80 W
81848	UV-C Professional 4 x 80 W
81888	UV-C Professional 8 x 80 W
81898	UV-C Professional 12 x 80 W

Spare bulb for UV-C Professional 80 W

Item code	Item
80891-8	Spare bulb for UV-C Professional 80 W



Spare bulb for UV-C Professional 80 W



aquarius

LED aquarium light for saltwater aquaria

The aquarius light is made of high quality aluminium in a slim design which offers even illumination of your aquarium. The compilation of the six individual light colours can be specifically adjusted to the needs of saltwater aquaria. The light has preparation for connecting a 6-channel controller which makes individual adjustment of light colour, light intensity and light settings possible.

Equipment:

- LED light with 6 colours
- prepared for connecting a 6-channel controller (aquarius control)
- anodized housing made of aluminum for cooling passively (no fans)
- for safety 24 V with external transformer (100 – 240 V / 50 – 60 Hz)
- adjustable holder for fixing onto the aquarium

optional:

- aquafit 2 steel wire suspension
- aquarius control
- Y-cable
- aquarius holder

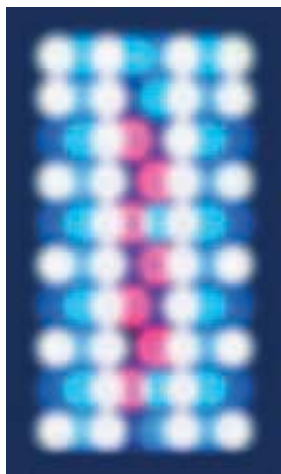

aquarius LED Module



aquarius	30	60	90	120
Total consumption max./W	32	65	95	128
Total Lumen app./lm	2080	4160	6240	8320
Dimensions (l x w x h) app./mm	320 x 210 x 25	580 x 210 x 25	840 x 210 x 25	1100 x 210 x 25
For aquarium with length app./mm	350 – 600	600 – 900	850 – 1100	1150 – 1350
Light colours – Colour temperature	white 6000 – 6500 K red 620 – 625 nm blue 460 – 465 nm	royal blue 450 – 455 nm purple 395 – 405 nm UV 365 – 370 nm		

Item code	Item
87711	aquarius 30
87712	aquarius 60
87713	aquarius 90
87714	aquarius 120

aquarius plant

LED aquarium light for freshwater aquaria

The aquarius plant light is made of high quality aluminium in a slim design which offers even illumination of your aquarium. The compilation of the six individual light colours can be specifically adjusted to the needs of freshwater aquaria. The light has preparation for connecting a 6-channel controller which makes individual adjustment of light colour, light intensity and light settings possible.

Equipment:

- LED light with 6 colours
- prepared for connecting a 6-channel controller
- anodized housing made of aluminum for cooling passively (no fans)
- for safety 24 V with external transformer (100 – 240 V / 50 – 60 Hz)
- adjustable holder for fixing onto the aquarium

optional:

- aquafit II steel wire suspension
- aquarius control
- Y-cable
- aquarius holder

aquarius plant	60	90	120
Total consumption max./W	65	95	128
Total Lumen app./lm	4550	6825	9110
Dimensions (l x w x h) app./mm	580 x 210 x 25	840 x 210 x 25	1100 x 210 x 25
For aquarium with length app./mm	600 – 900	850 – 1100	1150 – 1350
Light colours – Colour temperature	daylight white 6000 – 6500 K warm white 2800 – 3200 nm red 640 – 660 nm		ruby red 620 – 630 nm green 520 – 530 nm blue 460 – 470 nm

Item code	Item
87812	aquarius plant 60 NEW
87813	aquarius plant 90 NEW
87814	aquarius plant 120 NEW



aquarius LED-Module



aquarius holder

aquarius holder

Mounting bracket for aquarius LED-lights

Item code	Item
87706	aquarius holder / pair



aquarius control

aquarius control

6-channel controller for aquarius

- six independently programmable / dimmable channels, e. g. for sunrise, sunset and moonlight
- optional Y-cable is available meaning several aquarius lights can be controlled simultaneously
- programming is done via the aquarius control timer interface. It's not necessary to connect it to the computer
- power (24 V low voltage) is supplied via the aquarius connection on the light fixture itself, no additional power supply is required

Dimensions (l x w x h): app. 110 x 60 x 25 mm

Cable length: app. 1,800 mm

Item code	Item
87700	aquarius control



Y-cable aquarius

Y-cable aquarius

For connecting two aquarius lights to an aquarius control

The Y cables can also be plugged into each other to connect a further aquarius to the control unit.

Cable length: app. 50 cm

Item code	Item
87701	Y-cable aquarius

Qube 30

LED-Spot light for saltwater aquaria

Features:

- LED Cluster chip consisting of 12 individual LED elements with balanced light spectrum
- high energy density specially designed for strong coral growth (PAR = 790 $\mu\text{mol m}^{-2}\text{s}^{-1}$)
- colour and light intensity are adjustable manually via 2 channels
- the compact design allows for an ideal illumination of nano aquaria as well as dark edge areas in larger aquaria.
- silent-running internal fan for reliable cooling of the LED chip
- a flexible gooseneck ensures a firm hold and easy alignment
- integrated cable feedthrough for power supply in the gooseneck

LED	cool white	12.000 K	4 pcs.
	royal blue	450 nm	4 pcs.
	sky blue	470 nm	2 pcs.
	violet	420 nm	1 pc.
	UV	395 nm	1 pc.

There is a lense with 90° scattering angle installed.

Technical data:

Dimensions (housing)	app. 80 x 80 x 25 mm
Weight incl. holder	app. 290 g
Number of light channels	2
Number of light colours	5
Illuminated area max.	app. 300 x 300 mm
PAR value	790 $\mu\text{mol m}^{-2}\text{s}^{-1}$
Total consumption	30 watts max.
Power supply transformer	100 – 240 V / 50 – 60 Hz
Power supply light	24 V

Item code	Item
83216030	Qube 30 NEW



Qube 30





Qube 50

Qube 50

High Power LED-Spot light for saltwater aquaria

- LED Cluster chip consisting of 24 individual LED elements with balanced light spectrum
- high energy density specially designed for strong coral growth (PAR = 1.250 $\mu\text{mol m}^{-2}\text{s}^{-1}$)
- colour and light intensity are adjustable manually via 2 channels
- integrated 0 – 10 V connection for using external controllers
- the compact design allows for an ideal illumination of nano aquaria as well as dark edge areas in larger aquaria
- silent-running internal fan for reliable cooling of high-power LED chips
- a flexible goose neck ensures a firm hold and easy alignment, a wire suspension system for mounting on the ceiling is included

LED	cool white	12.000 K	9 pcs.
	royal blue	450 – 455 nm	9 pcs.
	sky blue	465 – 470 nm	2 pcs.
	violet	420 – 430 nm	2 pcs.
	UV	400 – 405 nm	2 pcs.

There is a lense with 90° scattering angle installed.



Technical data:

Dimensions (housing)	app. 80 x 80 x 65 mm
Weight incl. holder	app. 725 g
Number of light channels	2
Number of light colours	5
Illuminated area max.	app. 500 x 500 mm
PAR value	1.250 $\mu\text{mol m}^{-2}\text{s}^{-1}$
Total lumen	834 lm
Total consumption	50 watts max.
Power supply transformer	100 – 240 V/50 – 60 Hz
Power supply light	24 V

Item code	Item
83216050	Qube 50



Qube 50 plant

High Power LED-Spot light for freshwater aquaria

- LED Cluster chip consisting of 24 individual LED elements with balanced light spectrum
- high energy density specially designed for strong growth (PAR = 1.410 $\mu\text{mol m}^{-2}\text{s}^{-1}$)
- colour and light intensity are adjustable manually via 2 channels
- integrated 0 – 10 V connection for using external controllers
- the compact design allows for an ideal illumination of nano aquaria as well as dark edge areas in larger aquaria
- silent-running internal fan for reliable cooling of high-power LED-chips
- a flexible goose neck ensures a firm hold and easy alignment, a wire suspension system for mounting on the ceiling is included

LED	daylight white	8.000 K	10 pcs.
	warm white	3.000 K	4 pcs.
	red	660 nm	2 pcs.
	green	520 nm	1 pc.
	royal blue	450 nm	6 pcs.
	blue	420 nm	1 pc.

There is a lense with 90° scattering angle installed.

Technical data:

Dimensions (housing)	app. 80 x 80 x 65 mm
Weight incl. holder	app. 725 g
Number of light channels	2
Number of light colours	6
Illuminated area max.	app. 500 x 500 mm
PAR value	1.410 $\mu\text{mol m}^{-2}\text{s}^{-1}$
Total lumen	app. 1364 lm
Total consumption	50 watts max.
Power supply transformer	100 – 240 V/50 – 60 Hz
Power supply light	24 V

Item code	Item
83217050	Qube 50 plant



Qube 50 plant

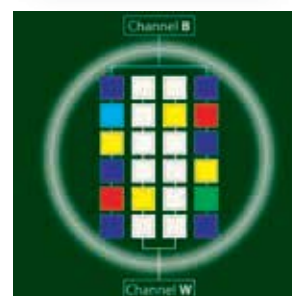



Qube control

Qube control

2-channel light control for Qube

- two independently programmable / dimmable channels for blue phase, sunrise, sunset and moonlight
- by using a connecting cable (included in shipment) several Qubes can be connected in series to be controlled simultaneously
- programming is completed via the supplied remote control from the Qube control by timer. No connection to the PC is therefore necessary.
- power (24 V low voltage) is supplied via the Qube lights power pack, no additional power supply is required
- can be used with all 0 – 10 volt control lamps (if necessary, separate power supply required)

Dimensions (l x w x h): app. 74 x 74 x 15 mm

Cable length: app. 1,400 mm

Item code	Item
83216000	Qube control

angel LED 200

Revolutionary LED aquarium lighting system "Light in colour"

- WiFi Control
- Touch-Key technology
- multiple LED lights controllable
- second generation density matrix LED chips
- optical quartz lens
- steel wire suspension (incl.)
- powerful cooling
- top-quality power supply

Technical data:

Total power consumption	max. 200 watts
Power supply transformer	100 – 240 V/50 – 60 Hz
Power supply light	24 V DC
Dimensions (l x w x h)	app. 520 x 180 x 33 mm
Weight (light without holder)	app. 2,600 g
Light channels	6
Light colours	8
Illumination area	max. 1,200 x 600 mm
Total LED Lumen	app.15,500 max.
PAR	app. 500 max.

Recommended for aquaria: 100 x 60 x 60 cm (l x w x h)
 Suitable for a max. aquarium size: 120 x 60 x 60 cm (l x w x h)

Item code	Item
83501200	angel LED 200 black NEW
83502200	angel LED 200 white NEW
83501201	angel LED holder black NEW
83502201	angel LED holder silver NEW



angel LED 200

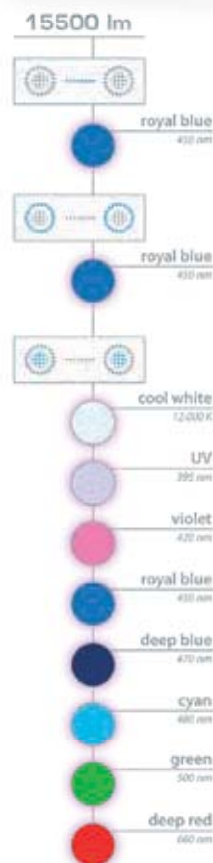



LEDspot 100 W



LEDspot 200 W

LEDspot 100 W/200 W

Splash-proof LED-spotlight (IP65)

The lights are equipped with 100 W respectively 200 LED chips (Epistar). The light beam is bundled with a lense to 90°. The luminous flux of the 100 W light is app. 10.000 lumen and of the 200 W light app. 20.000 lumen. These lights could replace metal halogen damp lights from 250 W respectively from 400 W. The control gear unit is placed in a splash-proof body on the light. The control gear (Meanwell) could be dimmed with a 0 – 10 V control e.g. with the Aqua Medic Qube control LEDspot. The LEDspots will be cooled passively by a massive corrosion resistant alu-minium cooling element. It can be hang up on the central loop with a chain or attached with a holder out of polished stainless steel on the ceiling. Then you can adjust the angle. Without feed as standard.

Technical data:

LEDspot 100 W: Ø 32 cm, height: app. 38 cm, app. 8 kg

LEDspot 200 W: Ø 32 cm, height: app. 48 cm, app. 11.2 kg

Item code	Item
83414100	LEDspot 100 W 12K 90°
83414150	LEDspot 100 W 12K 60°
83414160	LEDspot 100 W 12K 120°
83416100	LEDspot 100 W blue 90°
83416150	LEDspot 100 W blue 60°
83416160	LEDspot 100 W blue 120°
83415100	LEDspot 100 W 6.5K 90°
83415150	LEDspot 100 W 6.5K 60°
83415160	LEDspot 100 W 6.5K 120°
83414200	LEDspot 200 W 12K 90°
83414250	LEDspot 200 W 12K 60°
83414260	LEDspot 200 W 12K 120°
83416200	LEDspot 200 W blue 90°
83416250	LEDspot 200 W blue 60°
83416260	LEDspot 200 W blue 120°
83415200	LEDspot 200 W 6.5K 90°
83415250	LEDspot 200 W 6.5K 60°
83415260	LEDspot 200 W 6.5K 120°



Power Supply LEDspot

Item code	Item
83414000	Power Supply/2.5 m

Different lengths on request.



FlapSet LEDspot



FlapSet LEDspot

Flaps suitable for Aqua Medic LEDspots 100 W/200 W and LEDspots flex 200 W incl. mounting ring.

Item code	Item
83414108	FlapSet LEDspot

Control cable

Control cable (app. 1.5 m) for connecting the Aqua Medic LEDspots to the Qube control
 Special lengths are available on request.
 Manifold for control on request.



Control cable

Item code	Item
83400001	Control cable LEDspot and LEDspot flex

Lens 60°/90°/120°

Lenses to change the beam angle of LEDspots

Item code	Item
83414105	Lens 90° LEDspot 100 W
83414104	Lens 60° LEDspot 100 W
83414106	Lens 120° LEDspot 100 W
83414205	Lens 90° LEDspot 200 W/LEDspot 200 W flex
83414204	Lens 60° LEDspot 200 W/LEDspot 200 W flex
83414206	Lens 120° LEDspot 200 W/LEDspot 200 W flex



Lens LEDspot

LEDspot 200 W flex

Splash-proof LED spotlight (IP65)

The LEDspot 200 W flex is equipped with a two-coloured LED chip (white and blue). Both colours can be dimmed separately. Two control gears (Meanwell) guarantee for a reliable and safe power supply. The light beam is bundled with a lense to 90°. By an optional manual dimming, the Potentiometer (incl. approx. 7.50 m cable) or Qube control (control cable LEDspot is also required) both light channels can be adjusted optimal to the individual needs.

A holder for the ceiling is included.

Without feed as standard.

Further colour variations can be found in the table below.

Technical data:

Dimensions	Ø 280 mm, height app. 400 mm
Weight	app. 12 kg
Luminous flux	white: 10,000 Lm, blue: 3000 Lm
Light colour	white: 12.000 K, blue: 455 – 460 nm
Beam angle	90°, optional 60°/120°

Item code	Item
83418200	LEDspot 200 W flex 90°
83418250	LEDspot 200 W flex 60°
83418260	LEDspot 200 W flex 120°
83419200	LEDspot 200 W flex red/blue 90° NEW
83419250	LEDspot 200 W flex red/blue 60° NEW
83419260	LEDspot 200 W flex red/blue 120° NEW
83420200	LEDspot 200 W flex 90° white 3,5 k / 6,5 k NEW
83420250	LEDspot 200 W flex 60° white 3,5 k / 6,5 k NEW
83420260	LEDspot 200 W flex 120° white 3,5 k / 6,5 k NEW



LEDspot 200 W flex





LEDspot 400 W flex

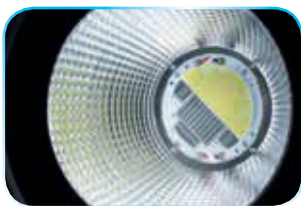

LEDspot 400 W flex

Splash-proof LED spotlight (IP65)

The LEDspot 400 W is equipped with a two-coloured LED chip (white and blue). Both colours can be dimmed separately. The control gear (Meanwell) guarantees for a reliable and safe power supply. The pre-installed reflector provides a viewing angle of about 60°. Optional, the reflector supplied incl. diffuser can be mounted with an angle of about 90°. By an optional manual dimming, the Potentiometer (incl. approx. 7.50 m cable) or Qube control (control cable LEDspot is also required) both light channels can be adjusted optimal to the individual needs. A holder for the ceiling is included. Without feed as standard.

Technical data:

Dimensions	Ø 390 mm, height app. 500 mm
Weight	app. 13.5 kg
Luminous flux	white: 21,895 Lm, blue: 6087 Lm
Light colour	white: 12,000 K, blue: 455 – 460 nm
Beam angle	60° / 90°

Item code	Item
83418450	LEDspot 400 W flex



Potentiometer

Potentiometer

Manual dimming for LEDspot flex

By the potentiometer (incl. 7.5 m cable) both light channels of the LEDspots flex can be adjusted independently optimal to the individual needs. Special lengths are available on request.

Item code	Item
83414210	Potentiometer LEDspot flex



Qube control LEDspot



Qube Control LEDspot

2-channel light control for LEDspot

- two independently programmable/dimmable channels for blue phase, sunrise, sunset and moonlight
- by using an optional splitter (not included in shipment) several LEDspots can be controlled by one Qube Control simultaneously
- programming is completed via the supplied remote control of the Qube control by timer. No connection to the PC is therefore necessary
- power (24 V low voltage) is supplied via the included power pack

Dimensions (l x w x h): app. 74 x 74 x 15 mm

Cable length: app. 1,400 mm

Manifold for control on request.

Item code	Item
83416000	Qube control LEDspot NEW

Ocean Blue power compact 24 W

Blue actinic power compact lamp for saltwater aquaria

For combination with metal halide lamps and Ocean White 24 W.

Item code	Item
80909	Ocean Blue power compact 24 W



Ocean Blue power compact 24 W

Ocean White power compact 24 W

Blue-white power compact lamp with a colour temperature of 10000 K

For fresh- and saltwater aquarium.

Item code	Item
81909	Ocean White power compact 24 W



Ocean White power compact 24 W

T5 Reflector

Item code	Item
83221	T5 reflector 24 W incl. clip, length app. 51,1 cm
83231	T5 reflector 39 W incl. clip, length app. 81,1 cm
83251	T5 reflector 54 W incl. clip, length app. 109,5 cm
83281	T5 reflector 80 W incl. clip, length app. 140,5 cm
83220	Clip for reflector T5 (stainless steel)



T5 Reflector

T5 Tubes, 16 mm Ø, FQ-series



aqualine T5 Reef Blue

aqualine T5 Reef Blue

Actinic blue fluorescent lamp to increase the percentage of blue light in saltwater aquaria

aqualine T5 Reef Blue is intended for use in saltwater aquaria with the lamp emitting, almost exclusively, blue light in the spectrum between 400 nm and 500 nm, peaking at 420 nm. These wavelengths enhance the growth of many coral species. In addition, when combined with Reef White 10K or 15K they give the aquarium a most natural appearance.

Item code	Item
88700	aqualine T5 Reef Blue 24 W 55 cm (app. 22") B* 26 kWh/1.000 h
88701	aqualine T5 Reef Blue 39 W 85 cm (app. 34") B* 44 kWh/1.000 h
88702	aqualine T5 Reef Blue 54 W 115 cm (app. 46") B* 60 kWh/1.000 h
88703	aqualine T5 Reef Blue 80 W 145 cm (app. 58") B* 85 kWh/1.000 h

*Power efficiency category



aqualine T5 Reef White 15 K

aqualine T5 Reef White 15 K

A blue/white lamp for the illumination of saltwater aquaria

This lamp emits an extremely bright blue/white light, providing ideal illumination for the saltwater aquarium. The spectrum is chosen to encourage strong coral growth. aqualine T5 Reef White 15K can be used as the sole light source for an aquarium as well as in combination with aqualine T5 Reef Blue.

Item code	Item
88710	aqualine T5 Reef White 15K 24 W 55 cm (app. 22") B* 26 kWh/1.000 h
88711	aqualine T5 Reef White 15K 39 W 85 cm (app. 34") B* 44 kWh/1.000 h
88712	aqualine T5 Reef White 15K 54 W 115 cm (app. 46") B* 60 kWh/1.000 h
88713	aqualine T5 Reef White 15K 80 W 145 cm (app. 58") B* 85 kWh/1.000 h

*Power efficiency category

aqualine T5 Reef White 10 K

Bright white lamp for salt- and freshwater aquaria

aqualine T5 Reef White 10K is a bright white lamp with a colour temperature of 10000 K. The lamp simulates tropical sunlight and is the ideal basic illumination for saltwater as well as freshwater aquaria. For saltwater aquaria, we recommend combining aqualine T5 Reef White 10K with aqualine T5 Reef Blue to increase the blue spectrum whilst for freshwater the combination of aqualine T5 Reef White 10K with aqualine T5 Plant Grow will enhance plant growth.

Item code	Item
88720	aqualine T5 Reef White 10K 24 W 55 cm (app. 22") A* 26 kWh/1.000 h
88721	aqualine T5 Reef White 10K 39 W 85 cm (app. 34") A* 44 kWh/1.000 h
88722	aqualine T5 Reef White 10K 54 W 115 cm (app. 46") A* 60 kWh/1.000 h
88723	aqualine T5 Reef White 10K 80 W 145 cm (app. 58") A* 85 kWh/1.000 h

*Power efficiency category



aqualine T5
Reef White 10 K

aqualine T5 Plant Grow

Growth lamp for plants in freshwater aquaria

The lamp accentuates the red and blue parts of the spectrum and comes close to the absorption spectrum of water plants. These wave lengths stimulate photosynthesis and so create excellent condition for luxuriant plant growth. In addition the colours become more vibrant in any fish with red pigmentation (e.g. Cardinal tetra). Combined with aqualine T5 Reef White 10K, Plant Grow gives the aquarium a brilliant natural appearance.

Item code	Item
88730	aqualine T5 Plant Grow 24 W 55 cm (app. 22") B* 26 kWh/1.000 h
88731	aqualine T5 Plant Grow 39 W 85 cm (app. 34") B* 44 kWh/1.000 h
88732	aqualine T5 Plant Grow 80 W 145 cm (app. 58") B* 85 kWh/1.000 h
88733	aqualine T5 Plant Grow 80 W 145 cm (app. 58") B* 85 kWh/1.000 h

*Power efficiency category



aqualine T5
Plant Grow

Please add the luminaire part number to complete confirmation:
-1 black, -3 RAL-number from our colour card, -4 silver.



aquasunlight NG

aquasunlight NG

The aquasunlight NG combines all the benefits of metal halide lamps with the technology of the T5 fluorescent lamps. Of course, the fixture is made of saltwater resistant powder coated aluminium and supplied with high purity aluminium reflectors. For long term reliability, the electronic components are all manufactured by the leading European manufacturers. Incl. LED-moonlight. The steel wire suspension aquafit is included in delivery.

Dimensions (l x w x h):

aquasunlight NG 60 cm: app. 60 x 41 x 9.5 cm

aquasunlight NG 120 cm: app. 120 x 41 x 9.5 cm

aquasunlight NG 180 cm: app. 180 x 41 x 9.5 cm

Item code	Item
85512-1	aquasunlight NG 60 cm 1x150 W + 2xT5 24 W
85612-1	aquasunlight NG 60 cm 1x150 W + 4xT5 24 W
85513-1	aquasunlight NG 60 cm 1x250 W + 2xT5 24 W
85613-1	aquasunlight NG 60 cm 1x250 W + 4xT5 24 W
85522-1	aquasunlight NG 120 cm 2x150 W + 2xT5 54 W
85622-1	aquasunlight NG 120 cm 2x150 W + 4xT5 54 W
85523-1	aquasunlight NG 120 cm 2x250 W + 2xT5 54 W
85623-1	aquasunlight NG 120 cm 2x250 W + 4xT5 54 W
85532-1	aquasunlight NG 180 cm 3x150 W + 2xT5 80 W
85632-1	aquasunlight NG 180 cm 3x150 W + 4xT5 80 W
85533-1	aquasunlight NG 180 cm 3x250 W + 2xT5 80 W
85633-1	aquasunlight NG 180 cm 3x250 W + 4xT5 80 W



aqualine 10000

aqualine 10000

Metal halide lamp for saltwater aquaria

The aqualine 10000 lamp has a colour temperature of 13000° Kelvin and a high percentage of the light output is at the blue end of the spectrum. aqualine 10000 was the first metal halide lamp to simulate the lighting conditions on a coral reef and the new lamp gives an even more realistic looking aquarium as the improved twin getters give long term colour stability. The corals show their natural colours and the lighting intensity encourages excellent growth. aqualine 10000 helps to transform your aquarium into a perfect reef tank.

Item code	Item
80941	aqualine 10000 70 W 13K
80942	aqualine 10000 150 W 13K
80950	aqualine 10000 175 W E39 13K
80943	Bulb 250 W 14K
80951	aqualine 10000 250 W E40 13K
80944	aqualine 10000 400 W E40 13K
80945	Bulb 1000 W E40 13K

aqualine 16000

A blue/white full spectrum metal halide lamp for saltwater aquaria

The aqualine 16000 lamp simulates the light spectrum in deeper waters. It is best used in combination with aqualine 10000, but as it is a full spectrum lamp it can also be used as the sole light source, if a high percentage of blue light is required. In these circumstances, there is no need for blue fluorescent lamps and the efflorescing colours of the corals are enhanced.

Item code	Item
80982	aqualine 16000 150 W 16K
80983	aqualine 16000 250 W 16K



aqualine 16000

aqualine 20000

A blue metal halide lamp for saltwater aquaria

The aqualine 20000 blue lamp emits light strongly in the blue end of the spectrum. The use of this "actinic" lamp enhances the fluorescent blue and green colours of many corals. The lamp should be used in combination with aqualine 10000. This combination gives the aquarium a beautiful bluish hue.

Item code	Item
80971	aqualine 20000 70 W 20K
80972	aqualine 20000 150 W 20K
80973	aqualine 20000 250 W 20K



aqualine 20000

aqualine 5000

Daylight metal halide lamp for freshwater aquaria

aqualine 5000 is a metal halide lamp with a colour temperature of 5000° Kelvin – attenuated sunlight. This lamp was specially developed for the illumination of freshwater aquaria with its a high percentage of red light and a high intensity – 11000 lumens per watts. It gives planted aquaria a natural appearance and enhances plant growth.

Item code	Item
81912	aqualine 5000 150 W 5K
81913	aqualine 5000 250 W 5K



aqualine 5000

Suspension	Aqua Medic light system
aquafit	aquaspacelight 400 aquasunlight NG aquastarlight T5 Ocean Light T5 sunbeam
aquafit 2	aquareefLED aquasunLED Ocean Light T5 aquarius
aquafit 3	Ocean Light LED Ocean Light LED twin ECOplant LED ECOplant LED twin



aquafit

aquafit Steel Wire Suspension

The wire suspension system aquafit provides a neat and simple method of ceiling mounting of Aqua Medic and other suitable lights. The suspension system contains 2 pcs. of the following: ceiling plate with retaining bush, stainless steel, top screw fitting, wire with ferrule, light fixing incl. top cap, plastic washer, screws and wall fixings and clips to secure the wire's end.

Item code	Item
80400	aquafit



aquafit 2

aquafit 2 Steel Wire Suspension

Universal suspension kit for use with all suspended lighting units, provided that the screws in the housing's end plates are of adequate length & not too wide (max. Ø 4 mm). aquafit 2 consists of 2 pieces of: 2 metre stainless steel wire with stopper, ceiling plate with retaining bush, steel wire with height and angle adjustment unit attached, screws and plugs. The suspension kit allows fixing of the lighting unit to the ceiling and provides easy adjustment in both height and angle of unit.

Item code	Item
80401	aquafit 2



aquafit 3

aquafit 3 Steel Wire Suspension

Suitable for Aqua Medic Ocean Light LED-, ECOplant-series, may also be suitable for other lights that have Ø M3 thread fixings to attach the cable holder onto the top of the light housing. aquafit 3 consists of 2 pieces of 2 metre stainless steel wire with stopper, ceiling plate with retaining bush, steel wire with height and angle adjustment unit attached, screws and plugs. The suspension kit allows fixing of the light unit to a suitable ceiling and provides easy adjustment in both height and angle of the unit.

Item code	Item
80402	aquafit 3

Ocean Light LED Control

Programmable controller for Ocean Light LED light fixtures

- two independently programmable/dimmable channels, for daylight and warm white LEDs (sunrise, sunset and moonlight)
- optional Y-cable is available meaning up to 3 Ocean Light LED light fixtures can be controlled simultaneously
- programming is via the Ocean Light LED control timer interface
- power (24 V low voltage) is supplied via the Ocean Light LED connection on the light fixture itself, no additional power supply is required

Dimensions (l x w x h): app. 90 x 50 x 18 mm / 3.5 x 2 x 0.75 in

Cable length: app. 1800 mm / 70 in

Item code	Item
83200001	Ocean Light LED Control



Ocean Light LED Control

Y-cable

Y-cable for connecting several Ocean Light LED lamps to just one Ocean Light LED Control.

Cable length: 1,2 m

Item code	Item
86608	Y-cable



Y-cable



T controller twin

T controller twin

Digital temperature monitor and controller, for the control and monitoring of heating systems and cooling units simultaneously

The temperature controller T controller twin is used for controlling both heating systems and cooling units. Measuring and switching accuracy is 0.1°C. The control range varies from 16 – 40°C, and the set value is in 0.1 °C increments. **The maximum load for heating systems is 1,200 watts and 460 watts for cooling units.** Because of the integrated double socket it is possible to connect a heating system and cooling unit simultaneously. The T controller twin is supplied with a waterproof temperature probe. The LCD display provides instant information on the current temperature. The minimum and maximum values can be easily adjusted.

Item code	Item
200.25	T controller twin



heat controller duo

heat controller duo

The temperature controller heat controller duo is used for controlling heaters and under gravel heating systems at the same time. Measuring and switching accuracy is 0.1 °C. The control range varies from 0 – 50 °C, the set value is in 0.1 °C increments and is controlled exactly to 1 °C. The maximum load for the heating systems and under gravel heater is 1,200 watts. Because of the integrated double socket it is possible to connect a heater and an under gravel heating system simultaneously. The heat controller duo is supplied with a temperature probe attached. The LCD display provides instant information on the current temperature, time and state of the connected units. The heating cable is controlled by a timer, the on/off time can be programmed. If the set value is not reached, the under gravel heater is switched on. To avoid overheating, both sockets switch off as soon as the set value is reached.

Item code	Item
200.30	heat controller duo



Titanium Heater

Titanium Heater

Titan Aquarium Heater

Titanium heaters are the safe alternative to glass heaters in both fresh- and saltwater aquaria. The unbreakable titanium housing is saltwater resistant and the heaters have both overheat and dry running protection cutouts. The heaters must be used in combination with a temperature controller. For temperature-dependent control we recommend optional the use of our T controller twin. Ø 20 mm

Item code	Item
110.010	Titanium heater 100 W, for aquaria up 100 – 250 l, length: app. 27 cm (app. 10.6")
110.020	Titanium heater 200 W, for aquaria up 250 – 500 l, length: app. 28 cm (app. 11")
110.030	Titanium heater 300 W, for aquaria up 500 – 1,000 l, length: app. 30 cm (app. 11.8")
110.050	Titanium heater 500 W, for aquaria up 1,000 – 1,500 l, length: app. 32 cm (app. 12.6")

pH controller

pH monitor and controller

The pH controller is a precision instrument for controlling the pH value in aquaria. In combination with a CO₂ system and a solenoid valve the pH can be maintained at a constant level, and the CO₂ supply to aquatic plants or into a Calciumreactor can be controlled. The unit is supplied with a large LED display and the control range is digitally adjustable from pH 3.5 to 10.5. **The direction of adjustment can be set up or down.** The pH controller has a BNC connection for pH electrodes. The use of an original Aqua Medic plastic shafted electrode is recommended.



pH controller

Item code	Item
200.00	pH controller without probe

pH monitor

pH meter for exact measuring of the pH value

The pH monitor is a precision instrument for controlling permanently the pH value in aquaria. The LED display continuously shows the current pH value of the aquarium water. The measuring range covers pH-values from 0.00 to 14.00. The test liquids included in delivery allow an exact calibration of the electrode that is connected to the pH monitor via a BNC connection.

Included:
pH monitor, pH electrode with BNC fitting, test liquids for calibration

Item code	Item
203.00	pH monitor NEW



pH monitor

pH-control-Set

Includes: controller, pH-sensor, sensor holder, pH-test fluid and solenoid valve

Item code	Item
200.50	pH-control-Set



pH-control-Set



mV controller

mV controller

Redox-potential (ORP) monitor and controller

The mV controller is designed for monitoring and controlling the redox potential (or ORP - oxidation-reduction potential) in aquaria. The unit has a broad controlling range from -500 to a +500 mV, and a measuring range from -1000 to +1000 mV. It can be used to control the supply of ozone in saltwater aquaria and/or for the control of nitrate removal in anaerobic biological filters (Nitrate-reductor). The unit is supplied with a BNC connection for a mV probe. The use of an original Aqua Medic plastic shafted electrode is recommended.

Item code	Item
200.05	mV controller without probe



LF controller

LF controller

Conductivity monitor and controller

The salt content of water can be determined by measuring the electrical conductivity. A special feature of the LF controller conductivity monitor and controller is the broad measurement and control range which is divided into 2 bands: from 0 to 2000 μ S, the unit is used for monitoring desalinated water and freshwater, and in the range 0 to 200 mS, it is used for brackish and saltwater. The unit can therefore be used for the control of reverse osmosis units, for monitoring breeding tanks with soft water, and for the control of the salt content in saltwater aquaria. The unit is supplied with a directly connected, saltwater resistant graphite electrode.

Item code	Item
200.10	LF controller with probe



T controller

T controller

Temperature monitor and controller

The T controller is available in 2 versions: T controller HC for the control of heating systems and T controller CC for the control of cooling units. The control range varies from 0 to 50 °C, with an accuracy of ± 0.1 °C. The maximum load is 1000 watts for heaters and 600 watts for coolers. The units are supplied with a waterproof temperature probe.

Item code	Item
200.15	T controller CC with probe
200.20	T controller HC with probe



T-meter

T-meter

Submersible digital thermometer incl. rubber sucker and battery.

Item code	Item
203.20	T-meter

T-meter twin

External double-display thermometer

Large double LCD display simultaneously showing aquarium and ambient temperature. Selectable temperature unit: °C or °F. With adhesive tape at back side for easy putting on aquarium tank.

- Ambient: -10 ~ +50 °C (-14~+122 °F)
- Aquarium: -50 ~ +70 °C (-58 ~ +158 °F)
- Resolution: 0.1 °C / 0.1 °F
- Accuracy: ±1 °C (2 °F)
- Power supply: 1.5 V (AG10)



T-meter twin

Item code	Item
203.10	T-meter twin

pH computer-Set

Microprocessor controlled pH monitor and controller

The pH computer-Set utilises a modern microprocessor, which provides high precision measurement and control. The pH computer-Set is used to control precise values of pH in the aquarium or the calciumreactor. The direction of control can be set upwards or downwards. The computer can switch up to 500 watts using the supplied external electrical socket. When the calibration key has been selected the unit will automatically calibrate itself to the electrode. A plastic shafted pH electrode with BNC fitting and the correct calibration fluids are included.



pH computer-Set

Item code	Item
201.00	pH computer-Set

mV computer-Set

Microprocessor controlled redox-potential (ORP) monitor and controller

The mV computer-Set uses the same microprocessor technique as the pH computer-Set. Waterproof touch keys are used to set the required values and calibrate the electrode. The mV computer-Set is ideal for controlling anaerobic biological filters such as the Nitratoreductor which have negative redox potential or can control the supply of ozone to the aquarium, or monitor the aquarium water's redox potential. All these functions are possible due to the computer's broad measurement and control range of -500 to +1000 mV. The direction of control can be set upwards or downwards. The status of the direction of control and the output are shown on LED's. A plastic shafted mV electrode with a BNC fitting and calibration fluid is included.



mV computer-Set

Item code	Item
201.05	mV computer-Set



T computer-Set

T computer-Set

Microprocessor controlled temperature monitor and controller

The T computer-Set is a precise multi-functional temperature controller and is complete with a digital temperature sensor. The mode of operation can be set using the function keys, either as a heater or cooler controller. In "heating" mode, the temperature is controlled to the set value using a proportional pulse system with an accuracy of ± 0.1 °C. In the "cooling" mode, the accuracy is ± 0.5 °C. The maximum operating power is 1,000 watts for heaters and 600 watts for coolers.

Item code	Item
201.20	T computer-Set



aquaniveau

aquaniveau

Electronic level and refill controller

The aquaniveau electronic level controller may be used in 2 different modes: As a top up controller with one or two float switches to control the replacement of evaporated water. It is possible to control dosing pumps (e.g. SP 3000) or circulation pumps (max. 200 W). If circulation pumps shall be controlled, a second sensor can be used as dry running protection for the pump. In order to fill a storage tank by an osmosis unit, the operation with solenoid valve and two float switches as maximum/minimum control is possible.

Item code	Item
77114	aquaniveau with 2 switches



Ozone

Ozone

The injection of ozone into the water can improve the efficiency of protein skimming and raise the ORP (redox potential). The decomposition of toxic nitrite is enhanced whilst the bacteria in the water decreases, minimising the risk of illness of the animals. The compounds that produce yellow colouring in the aquarium are broken down and the water stays crystal clear. The ozone generators in the ozone-series utilise low voltage technology for safety and reliability. Various models are available with capacities from 25 – 300 mg/h.



Ozone	Ozone 25	Ozone 50	Ozone 100	Ozone 200	Ozone 300
Ozone output in mg/h	2 – 25	5 – 50	10 – 100	50 – 200	50 – 300
Continuously adjustable %	0 – 100	0 – 100	0 – 100	0 – 100	0 – 100
Power consumption/watts	3	3,6	4,8	6	10
Air flow rate l/h	30 – 500	30 – 500	50 – 500	100 – 500	200 – 500
Freshwater amount up to/l	500	1.000	2.000	4.000	6.000
Saltwater amount up to/l	250	500	1.000	2.000	3.000
Outlet/connection in mm	4	4	4	4	4

Item code	Item
202.00	Ozone 25
202.05	Ozone 50
202.10	Ozone 100
202.15	Ozone 200
202.20	Ozone 300

Ozonizer

Ozonizer

The wear-resistant components offer high-power ozone production with optimum power consumption. The ceramic electrode can be easily cleaned, if necessary. The ozone quantity can be adjusted continuously via a potentiometer. The XT 2000 is equipped with a large touch display that allows convenient operation and precise adjustment of all operating parameters.

Ozonizer	Ozonizer S 500	Ozonizer S 1000	Ozonizer XT 2000
Ozone output - mg/h	0 – 500	0 – 1.000	0 – 2.000
Continuous adjustment - %	0 – 100	0 – 100	0 – 100
Power consumption - watts	12	24	42
Air flow - l/h	200 – 1.000	200 – 1.000	50 – 1.000
Freshwater quantity up to - l	10.000	20.000	40.000
Saltwater quantity up to - l	5.000	10.000	20.000

Item code	Item
202.905	Ozonizer S 500 - Sander
202.910	Ozonizer S 1000 - Sander
202.920	Ozonizer XT 2000 - Sander

Ozone Booster

Air dryer

The air dryer is for use with any Aqua Medic Ozone Generators. Ozone output can decrease dramatically if the supply air is very humid. Ozone Booster should be used to dry the air, particularly if a protein skimmer is supplied with ozone using the humid air present in the aquarium cabinet. In some circumstances ozone production can be almost doubled. The unit utilises silicagel as drying component. The silicagel should be changed as soon as the indicator beads change their colour from orange to blue.

Item code	Item
65027	Ozone Booster

Silicagel

Ozone Booster - Refill

Dry granulate with high de-hydration capacity. The indication pearls changing colour from orange to blue if wet.

Item code	Item
12730	Silicagel 600 g/app. 1000 ml



Ozonizer S 500

Ozonizer XT 2000



Ozone Booster

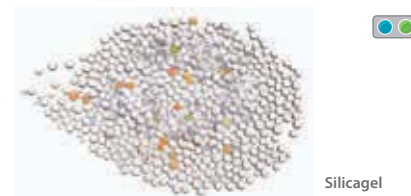

Silicagel



M-ventil ECO



M-ventil ECO

Electronic shut-off valve for CO₂, Eco

The M-ventil Eco is a quality valve with pressure fittings for 6 mm flexible hose with a maximum operating pressure of 1 bar. The power consumption is only 5 watts of electrical energy to prevent overheating. The valve can be connected to the corresponding CO₂ units. In conjunction with a pH controller, automatic control of the CO₂ supply and pH can be achieved. If used with a timer, the valve will provide a night shut off system. Only suitable for gases.

Item code	Item
230.32	M-ventil ECO NEW



M-ventil Standard

M-ventil Standard

Electronic shut off valve for CO₂-Standard

M-ventil Standard has a high quality nickel plated brass body with a maximum operating pressure of 6 bar, pressure fittings for 6 mm flexible hose and can be connected to all our CO₂ units. The solenoid coil consumes only 2.5 watts of electric energy to prevent overheating.

Item code	Item
230.30	M-ventil Standard, nickel plated, 1/8", 2.5 watts



M-ventil 1/2"

M-ventil 1/2"

Water shut off valve

M-ventil 1/2" for water is intended for automatic control of reverse osmosis units. The brass body has connections for 1/2" BSP male fittings and is recommended only for use with tap water. The power uptake is 6 watts.

Item code	Item
230.35	M-ventil 1/2" for tap water, brass

Electrodes

Aqua Medic pH- and mV-electrodes (Redox-potential) are quality products designed for both accurate measurement and long, trouble free use. Both types of electrodes are available in three versions: Standard electrodes – with plastic shaft, glass electrodes – laboratory standard for extended performance. Electrodes with plastic shaft and PG 13.5 thread – pressure resistant up to 3 bar, and can be used in plumbing fittings or in a closed version of Nitratereductors and Calciumreactors.

Electrode	Length up to the top	Length incl. top
Plastic probe pH	127 mm	159 mm
Glass probe pH	120 mm	160 mm
Plastic probe pH PG 13.5	70 mm	110 mm
Plastic probe mV	120 mm	160 mm
Glass probe mV	120 mm	160 mm
Plastic probe mV PG 13.5	70 mm	110 mm

Item code	Item
220.10	Plastic probe pH
220.11	Glass probe pH
220.13	Plastic probe pH PG 13.5
220.16	Plastic probe mV
220.17	Glass probe mV
220.19	Plastic probe mV PG 13.5



Electrodes

Electrode holder 2 / 4

For use with up to 2 or 4 electrodes, easily attaches to the aquarium. The level of submergence of the electrodes is fully adjustable.

Item code	Item
230.62	Electrode holder 2
230.64	Electrode holder 4

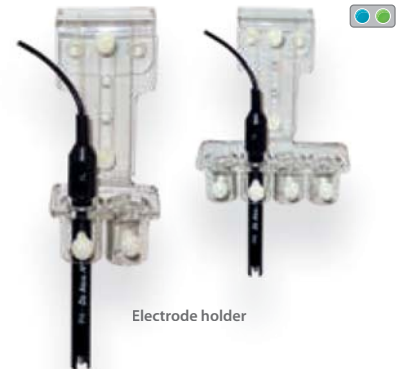

Electrode holder

Electrode holder

An electrode holder is available as an option. It can hold up to four electrodes and can be attached to the horizontal stress bars inside the aquarium or directly over the edge of the aquarium glass.

Item code	Item
230.00	Electrode holder



Electrode holder



Test fluids

Test fluids

Electrode calibration fluids

The accuracy of all electrodes is dependent on their calibration. To ensure accurate readings, all electrodes need to be calibrated at regular intervals. To ensure that the fluid values used to calibrate the electrodes remain constant, regular replacement of these fluids should occur.

Item code	Item
230.004	pH 4 test fluid 60 ml
230.007	pH 7 test fluid 60 ml
230.009	pH 9 test fluid 60 ml
230.300	KCL-solution for pH + mV sensors 60 ml
230.230	230 mV test fluid 60 ml
230.400	Cleaning solution 60 ml
230.250	250 μ S test fluid 60 ml
230.050	50 mS test fluid 60 ml

platinum line plus

Reverse osmosis unit

- reverse osmosis unit incl. high pressure pump for producing up to 400 litres of purified water per day
- for the production of soft water with low-salt content for fresh- and saltwater aquaria, for spraying terrariums and many other applications

The reverse osmosis system platinum line plus is a compact and versatile superior unit. It is supplied with three large 10" filter housings. The filter cartridges (activated carbon, fine filter and demineralization resin) can easily be replaced. The supplied pressure gauge will display the operation pressure at any time. All components, the prefilter housings and the membrane module are mounted onto a stable powder-coated bracket. The unit has a high pressure pump and a flushing valve and therefore, can achieve a high ratio of pure to waste water output up to 1:1. The salt removal rate is up to 99%. Due to the fully automatic back flushing and continuous monitoring of the pure water, the unit requires very little maintenance.

Dimensions (l x w x h): app. 38 x 22 x 47 cm
 Tube's diameter: 1/4" - 4/6
 Filling capacity for resin: app. 600 ml



platinum line plus

Item code	Item
U800.60	platinum line plus

premium line

For producing 190 – 580 litres (app. 50 – 153 gal) of purified tap water per day

The premium line reverse osmosis units are compact and versatile superior grade products. They are supplied with two large (10") prefilter housings and their activated carbon and 5µ sediment cartridges can easily be replaced. The membrane, the heart of the unit, is offered in 3 sizes: 190 l/day and 300 l/day as well as a double membrane of 580 l/day. The membrane housing includes a combined flushing valve and flow restrictor and the system can achieve a concentrate to permeate recovery ratio of 3 to 1 with a rejection rate of app. 95%. The prefilter housings and the membrane module are mounted onto a strong powder coated wall mounting bracket.



premium line 190/300

premium line 580

Item code	Item
U800.25	premium line 190, 190 l/day
U800.30	premium line 300, 300 l/day
U800.35	premium line 580, 580 l/day



easy line

easy line

For producing purified tap water, app. 190/300 l/day

easy line 190 and easy line 300 reverse osmosis units are compact and powerful. A sediment filter retains all particles larger than 5 µm and a carbon filter protects the membrane by removing chlorine. In our units, only TFC (Polyamide / Polysulfone) membranes are used to provide the highest quality treated water, providing a recovery ratio of approximately 3 – 4 concentrate : 1 permeate, and a rejection rate of up to 98%.

Item code	Item
U700.25	easy line 190, 190 l/day
U700.30	easy line 300, 300 l/day



Merlin plus (PRF-RO)

Merlin plus (PRF-RO)

Reverse osmosis unit with a capacity of app. 2,000 l/day (app. 500 gpd)

The Merlin plus (PRF-RO) reverse osmosis unit operates using just the mains pressure of the tap water (3 – 4 bar), without the need for a high pressure pump. It has 2 high flow membranes and a combined activated carbon/sediment prefilter. Salt rejection is app. 90 – 95% and the recovery ratio (purewater:wastewater) is 3 – 4 : 1. We recommend using an aquaniveau level control with an M-ventil ½" to give automatic control of the unit.

Item code	Item
U600.71	Merlin plus (PRF-RO)

ACCESSORIES FOR REVERSE OSMOSIS



Demineralisation filter

Demineralisation filter

Used to remove the last remaining pollutants using a special ion exchange resin, and is placed after the reverse osmosis unit. It reduces the growth of diatom, if silicate level of tap water is too high.

Item code	Item
U601.10	Demineralisation filter 10"
U601.11	Demineralisation filter 600 g/app. 1000 ml can
U601.12	Demineralisation filter 3000 g/app. 5000 ml bucket

resin

Ion exchange resin

Used to remove the last remaining pollutants using a special ion exchange resin, and is placed after the reverse osmosis unit. It reduces the growth of diatom, if silicate level of tap water is too high



resin

Item code	Item
U601.11	Demineralisation filter 600 g/app. 1000 ml can
U601.12	Demineralisation filter 3000 g/app. 5000 ml bucket

Membrane, filter, filter cartridges

Item code	Item
U605.60	Membrane 90 l / day
U605.65	Membrane 150 l / day
U605.80	Membrane 200 l / day for platinum line
U605.01	Activated carbon prefilter w. fittings for easy line
U605.06	Sediment 5 µm prefilter w. fittings for easy line
U606.17	Sediment filter 5 µm 10" housing for premium line/platinum line plus
U606.10	Combined filter cartridge carb./sed. 10" housing for premium line/platinum line plus
U606.15	Activated carbon filter cartridge 10" housing for premium line



Activated carbon prefilter cartridge



Sediment filter

PE-tube

Item code	Item
U630.00	PE-tube 4/6 mm / 1 m



PE-tube



CO₂ Box

CO₂ Box

For the constant supply of carbon dioxide to aquatic plants in the aquarium

Complete set for aquaria up to 200 liters. The set consists of a 250 g aluminum CO₂ bottle (filling capacity: app. 250 g) including holder, pressure regulator with bottle pressure display and needle valve, CO₂ hose, diffuser with built-in bubble counter and non-return valve (reactor compact) and a CO₂ indicator for indicating the carbon dioxide level within the aquarium.

Item code	Item
71600	CO ₂ Box



CO₂ cylinder ALU

CO₂ cylinder ALU

250 g CO₂-bottle made from aluminium

Filling capacity: app. 250 g/refillable

Item code	Item
71620	CO ₂ cylinder ALU 250 g



cylinder base

cylinder base

Holder for use with aluminium CO₂-bottle

Ø 60 – 80 mm

Item code	Item
71601	cylinder base



station 2 kg

station

CO₂ storage bottle

station is a steel CO₂ storage bottle with an external shut off valve. The cylinder will be supplied with a safety cage and a base stand.

Item code	Item
71413	station 2 kg (app. 4.4 lb.) with cage



reactor compact

reactor compact

CO₂-reactor with integrated non-return valve and bubble counter for aquaria up to 200 liters.

Item code	Item
71630	reactor compact

regular mini

Pressure regulator with bottle pressure display and needle valve to use with CO₂-bottles. Connecting thread W21,8 x 1/14".

Item code	Item
71610	regular mini



regular mini

**CO₂ pipe 4/6 mm, 5 m**

4/6 mm hose, 5 meter

Item code	Item
71614	CO ₂ pipe 4/6 mm - 5 m

CO₂ pipe**pipe holder**

Holder for 6 mm CO₂-hose to fit onto glass of up to 10 mm thickness.

Item code	Item
71615	pipe holder



pipe holder

**bubble counter plus**

Bubble counter for use with CO₂-systems for the supply of water plants.

Item code	Item
71650	bubble counter plus



bubble counter plus

**CO₂ indicator**

Indicator for showing the carbon dioxide content in freshwater aquaria. Incl. 10 ml CO₂ indicator solution.

Item code	Item
71640	CO ₂ indicator

CO₂ indicator**CO₂ indicator solution**

Inject 1 ml of CO₂ indicator solution into CO₂ indicator directly. It is recommended to change the CO₂ indicator solution once a month. Compare the color of the CO₂ solution with the included scala and determine the CO₂ content of your aquarium water.

Item code	Item
71641	CO ₂ indicator solution 10 ml

CO₂ indicator solution



reactor 100

reactor 100

Passive CO₂-reactor for aquaria up to 250 litres (app. 62.5 gallons)

reactor 100 is operated without an additional pump. The CO₂ is forced through a ceramic diaphragm. This creates tiny bubbles that rise slowly in the water and dissolve on their way up.

Item code	Item
71130	reactor 100



reactor 1000

reactor 1000

Closed CO₂-reactor for external use for aquaria up to 2,000 litres (app. 500 gallons)

reactor 1000 is a hermetically sealed unit for introducing CO₂ into larger aquaria. The universal mounting plate enables it to be mounted outside the aquarium or inside the cabinet. This powerful unit can supply aquaria up to 2,000 litres (app. 500 gallons) with CO₂. With 12/16 mm hose.

Required pump power: 1,500 – 2,000 l/h. (app. 375 – 500 gal.)

Total height: app. 37 cm (app. 15"); Ø app. 8 cm (app. 3")

Item code	Item
71113	reactor 1000



reactor+

reactor+

Motor-driven, highly efficient CO₂ reactor for use in planted aquaria up to 1,000 liters. Easy fitting within the aquarium with the supplied suction cups.

Item code	Item
71710	reactor+



regular

regular

Pressure regulator for precise control of CO₂ dosing into the aquarium

regular is chrome plated and offers: a fixed working pressure of app. 1.5 bar, a needle valve for fine adjustment, two pressure gauges to show both the cylinder and working pressures. regular fits industry standard CO₂ cylinders having an external valve. Connecting thread W21,8 x 1/14".

Item code	Item
71011	regular with 2 pressure gauges



counter

counter

CO₂-bubble counter incl. check valve

High-quality material allows longer operation life and a reliable operation. Bubble counter with combined check valve. The backflow is effectively prevented by the check valve. Suitable for hose connection 4/6 mm.

Item code	Item
71850	counter

megatools**scissors 60**

Straight stainless steel scissors for pruning plants in the aquarium.
Length app. 60 cm

Item code	Item
39010	scissors 60 NEW

**scissors 60 curved**

Curved stainless steel scissors, for easy trimming of ground covering plants.
Length app. 60 cm

Item code	Item
39011	scissors 60 curved NEW

**t-rail 60**

Straight stainless steel pliers with clip, for effortless planting of aquarium plants.
Length app. 60 cm

Item code	Item
39020	t-rail 60 NEW

**tweezers 60**

Straight stainless steel tweezers to assist in the planting of aquarium plants in inaccessible areas of the aquarium. Length app. 60 cm

Item code	Item
39030	tweezers 60 NEW

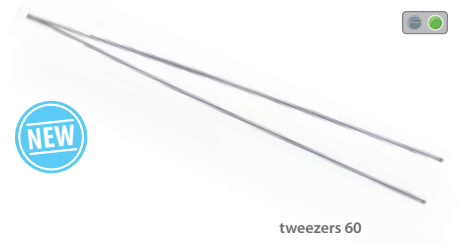



blue

blue

LED aluminium torch

The Aqua Medic blue makes corals fluoresce in darkness, the actinic blue colour is particularly well reflected by the natural colours of the corals. Thus, it seems like they are fluorescing. The Aqua Medic blue is ideal for watching corals feeding at nighttime as many corals show their feeding tentacles during that time.

3 watts Cree LED, app. 220 – 240 lm, app. 450 – 465 nm

Shock resistant and weatherproof, adjustable focus, incl. belt clip and wrist strap. The individual modes can be accessed by pressing the on-off switch.

3 x Micro AAA (LR03) 1.5 V batteries are required (not included).

Item code	Item
65950	blue



Fish trap

Fish trap

Trap for catching a particular fish in an aquarium

Aquaria can have many hiding places making catching an individual fish extremely difficult without being time consuming and stressful to both yourself and the aquarium inhabitants and can also cause damage to invertebrates when trying to use a net.

Fish trap is baited with some food and as soon as the desired fish has entered the trap the closing mechanism is simply released – by hand. The Fish trap is constructed in such a way that when it is removed from the aquarium with the fish inside it remains half full of water. This method considerably reduces the stress on the fish. Incl. rubber sucker twin

The double sucker is made of a highly quality flexible material and is particularly suitable for fixing our Fish trap to the inside glass of an aquarium.

We recommend using three double suckers to ensure safe fixing of the fish trap. By using this type of fixing, the fish trap does not have to be in contact with the base of the aquarium, making it easier to catch fish than was possible before.

Dimensions (l x w x h): app. 27.5 x 17 x 17 cm

Item code	Item
501.80	Fish trap

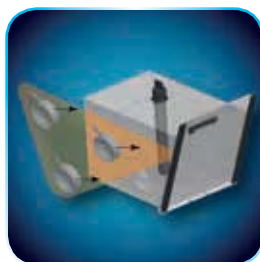

rubber sucker twin

rubber sucker twin

The double sucker is made of a highly quality flexible material and is particularly suitable for fixing our Fish trap to the inside glass of an aquarium.

We recommend using three double suckers to ensure safe fixing of the Fish trap. By using this type of fixing, the Fish trap does not have to be in contact with the base of the aquarium, making it easier to catch fish than was possible before.

You can also use the double sucker to connect other items with smooth surfaces to each other. (Ø app. 45 mm)

Item code	Item
418.11	rubber sucker twin 3 pcs.

Trap-pest

Universal trap for crabs, snails and bristle worms – for fresh- and saltwater

Trap-pest is an automatic trap for removing undesirable bristle worms, crabs or snails from an aquarium. Bristle worms crawl through a funnel into the trap and cannot find their way out whilst crabs and snails pass through a one way curtain which blocks their return path. The Trap-pest is simply baited from the outside.

Dimensions (l x w x h): app. 27.5 x 17 x 17 cm



Trap-pest

Item code	Item
501.81	Trap-pest

filter bag

Zip up media bag

Filter bags are designed to contain fine filter media, such as activated carbon, antiphos Fe or other granular media. The filter bag is fitted with a zip fastener for quick and easy replacement of the media.

Item code	Item
429.01	filter bag 1, 2 pcs., 22 x 15 cm (app. 8.6" x 5.9")
429.02	filter bag 2, 2 pcs., 22 x 30 cm (app. 8.6" x 11.8")
429.03	filter bag 3, 2 pcs., 22 x 45 cm (app. 8.6" x 17.7")



filter bag

prefilter bag

Filter bag (Ø app. 12 cm) with 200 µm for use as a prefilter in a cabinet filter. Incl. acrylic holder for max. 14 mm glass.

Item code	Item
429.10	prefilter bag
429.11	filter bag 4 (2 pcs.) - replacement Ø app. 90 mm, length app. 300 mm



prefilter bag

filter bag 4



Mega Mag

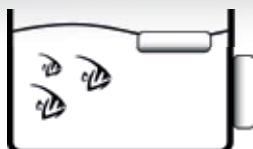

Mega Mag

Magnetic glass cleaners for panes between 6 and 18 mm (app. 0.24 and 0.72")

Mega Mag magnetic glass cleaners are waterproof, corrosion-resistant and suitable for use in fresh and saltwater aquaria, removes debris and algae from the aquarium glass. The floating half of the magnet that is placed within the aquarium can be easily attached to help avoid scratching due to sand and gravel being trapped between the two halves.

Mega Mag	Mega Mag S	Mega Mag M	Mega Mag L
Glass thickness up to	6 mm	12 mm	18 mm
Cleaning surface	app. 62 x 33 mm	app. 98 x 36 mm	app. 85 x 67 mm

Item code	Item
67021	Mega Mag S
67022	Mega Mag M
67023	Mega Mag L



Mega Mag 1



Spare pads

Mega Mag 1 + 2

Magnetic glass cleaners for panes between 10 and 32 mm (app. 0.4" and 1.25")

Mega Mag glass cleaners are completely sealed and corrosion protected and are suitable for use in fresh- and saltwater aquaria. The cleaning pads of the inner magnet and the felt pads of the outer magnet can be easily replaced. Mega Mag glass cleaners contain extremely strong magnets and have to be handled with care. Cleaning surface 8 x 11 cm.

Mega Mag 1 for glass from 10 – 19 mm (app. 0.4" – 0.75")

Mega Mag 2 for glass from 15 – 32 mm (app. 0.6" – 1.25")

Item code	Item
67000	Mega Mag 1
67001	Mega Mag 2
67101	Spare pads Mega Mag 1 & 2, 2 pcs.



Mega Mag 3

Mega Mag 3

Magnetic glass cleaner for large aquaria

Mega Mag 3 is a powerful magnetic cleaner for large aquaria with panel thicknesses up to 55 mm. As with the smaller models in the Mega Mag range, the cleaning pads are easily renewed or a plexipad can be fitted for the cleaning of acrylic aquaria. Cleaning surface 10 x 14 cm.

Item code	Item
67002	Mega Mag 3
67103	Spare pads Mega Mag 3, 2 pcs.

plexipad Mega Mag**Cleaning pad for Mega Mag to protect acrylic**

When using Mega Mag cleaners on acrylic aquaria the existing glass cleaning pad should be replaced with plexipad. This material is specially selected for cleaning acrylic and is fixed on the inner magnet to protect the acrylic panels from scratching. plexipad can be easily changed when worn.

Item code	Item
67100	plexipad Mega Mag 1 + 2
67102	plexipad Mega Mag 3



plexipad

magnetscraper**Blade accessory for Mega Mag**

magnetscraper is an accessory for the Mega Mag glass cleaner. It converts the Mega Mag from a simple magnet into a bladed cleaner. Now, even the most resistant algae can be removed. The magnetscraper simply snaps onto the Mega Mag 1 or Mega Mag 2 and is secured with a single screw. It can easily be removed if required.

Item code	Item
67010	magnetscraper



magnetscraper

magnetscraper blades**Spare blades for Mega Mag**

Item code	Item
67011	magnetscraper blades, package 5 pcs.



magnetscraper blades

scraper**Aquarium glass cleaner**

scraper is a multiple use blade cleaner. The 150 mm wide blade makes it easy to remove even the most resistant calcareous algae from the aquarium glass. Extended durability with stainless steel anti-corrosive coating – specially made sharp blade. The removable blade protector also acts as a squeegee for cleaning the outside of the aquarium glass. A unique feature of the scraper is the hinge which allows the blade head to be turned through 180°. This facility allows the user to clean the aquarium even when the tank decoration, such as rocks or roots, are very close to the glass.

Item code	Item
66000	scraper
66001	scraper blades 5 pcs.



scraper





aqua smoothy



aqua smoothy

Superfine micro porous fibre cloths, for smear free cleaning of the outside glass of the aquarium, lint-free. The aqua smoothy is very absorbent and can be used either wet or dry. It will safely and gently remove salt encrustation or fatty residues without the use of aggressive cleaning agents. Can also be used on most other smooth surfaces.

Contents: 2 x cloths, each approximately 40 x 40 cm

Microfiber: 80% polyester, 20% polyamide.

Item code	Item
66100	aqua smoothy



Reef Construct

Reef Construct

Two-component resin

For safe and easy attachment of stones and corals in the aquarium.

A two-part epoxy putty to secure rock and hard and soft corals in the aquarium. Reef Construct solves many of the problems encountered during the aqua-scaping of fresh- and saltwater aquaria. Reef Construct is a fast curing, two-part epoxy putty that can even be used underwater. It adheres to rock, wood, metal, glass, plastic, concrete and most other materials.

Item code	Item
420.60	Reef Construct, 2 x 56 g (2 x app. 2 oz) sticks
420.61	Reef Construct, 1008 g, 18 x 56 g (18 x app. 2 oz) sticks



Coral Construct

Coral Construct

Under water glue

For safe and easy attachment of coral frags inside and outside the aquarium. Harden quickly in and outside of the water.

Item code	Item
420.71	Coral Construct - 5 g
420.70	Coral Construct - 20 g



hot construct



hot construct

Coral glue

hot construct is an easy-to-use glue for synthetic material for quick and easy gluing of coral fragments (layers). It is free from solvents. Unused material can be reactivated in hot water and reused. Suitable for use above and under water.

Item code	Item
420.80	hot construct NEW

defroster+

For defrosting of frozen food and enrichment with amino acids and vitamins

For salt- and freshwater fish. The frozen food is thawed in the defroster box, protected from light and vitamin saving. With the defroster+ sieve, it is separated from the nitrate and phosphate enriched thawing water and can be enriched with essential vitamins and amino acids (aminovit).
Incl. defroster+ box with lid and sieve.



defroster+

Item code	Item
68000	defroster+

frag board

Retaining plate (app. 15 x 15 cm) for holding several coral pins

By using the supplied suction cups, the retaining plate can be placed anywhere on the inner side of the aquarium. Thereby, the frags can be put in an optimal position for illumination. Thus, optimal growth of the frags can be significantly stimulated. Incl. 10 x coral pins.



frag board

Item code	Item
230.04	frag board

coral pins

Frag stones

Item code	Item
230.06	coral pins (10 pcs.)



coral pins

hopstop

Hop protection for open top aquaria

Helps prevent nocturnal fish from jumping out.
Content: 6 holders (combfix) and 3 plastic plates each app. 480 x 50 mm.

Item code	Item
418.12	hopstop



hopstop

hose clip

Plastic clip

Flexible plastic clip designed for the safe fastening of hoses.

Item code	Item
410.38	hose clip Ø 5 – 6 mm
410.39	hose clip Ø 6 – 7 mm



hose clip



Coral strap

Coral strap

Secure strap for soft corals and live rock

Extra wide strap with rounded and thickened edges that do not cut into the tissue of the corals. For vegetative propagation of the soft corals. Saltwater resistant and PVC-free. Re-usable! Length app. 31 cm

Item code	Item
39520	Coral strap (5 pcs.)



Coral holder

Coral holder

The Aqua Medic Coral holder is the solution to present invertebrates and clams in shop systems. The holder has a flexible system, adjustable on the dimensions of the animals. With a water-resistant marker, the holder can be signed with name of the species and price.

Item code	Item
230.03	Korallenhalter



aqua grid

aqua grid

Grid plate

The aqua grid is a versatile plastic grid that can be used in many applications in the aquarium itself or within a sump/filter system. A unique highly stable plug-in system in the form of slot and key on all sides allowing multiple grids to inter-connect to form a smooth surface of varying sizes depending on your needs. The aqua grid is an excellent base for live rock and can also be used on the base of the aquarium, in filtration systems or for displaying corals in the retail environment.

Dimensions: app. 305 x 305 x 10 mm, grid size: 13 x 13 mm

Item code	Item
415.80	aqua grid



PVC-quadratic pipe

PVC-quadratic pipe

This pipe can be used for the construction of filter components, including trickle filters, denitrifying reactors, calcium reactors, etc.

Item code	Item
416.00	PVC-quadratic pipe 15 x 15 cm transp./ max. length 200 cm

Trickle plate

Trickle plate, 15 x 15 cm (app. 6" x 6"). Can be mounted on the rectangular pipe to evenly distribute the water.

Item code	Item
415.00	Trickle plate 15 x 15 cm



Trickle plate

Lid for trickle plate

Top lid for trickle plate, 15 x 15 cm (app. 6" x 6"). With a connection for 20 mm Ø pipe.

Item code	Item
415.20	Lid for trickle plate 15 x 15 cm



Lid for trickle plate

Bottom plate

Base for rectangular pipe, 15 x 15 cm (app. 6" x 6"). Can be glued to the bottom of the rectangular pipe.

Item code	Item
415.25	Bottom plate 15 x 15 cm



Bottom plate

Grid for quadratic pipe

Grate 15 x 15 cm (app. 6" x 6"). Grate for rectangular pipe, useful for holding filter material in place.

Item code	Item
415.30	Grid for quadratic pipe 15 x 15 cm



Grid for quadratic pipe

combfix

Holder for overflow comb

Optional support for fixing the overflow comb to the aquaria without the need for gluing.

Item code	Item
418.06	combfix 6 pcs.



combfix





Overflow comb with holder 32 cm

Overflow comb with holder 32 cm

Overflow comb, for the construction of aquarium overflows

The water flows evenly and fish, plant matter and coarse detritus are prevented from entering the overflow chamber. The holder is glued on the overflow chamber and the overflow comb is pressed securely into the holder whilst leaving it easy to remove for cleaning and maintenance.

Length: app. 32 cm, (app. 12.8"), height: app. 6 cm (app. 2.4"), length of teeth: app. 2,2 cm (app. 0,88")

Item code	Item
418.00	Overflow comb with holder 32 cm



Overflow comb with holder 50 cm

Overflow comb with holder 50 cm

With extra long teeth. Holder can be glued to the aquarium or is designed to also be used with combfix (not included).

Length: app. 50 cm (app. 20"), height: app. 8 cm (app. 3,2"), length of teeth: app. 3,7 cm (app. 1,28")

Item code	Item
418.05	Overflow comb with holder 50 cm



Round grate

Round grate

Ideal for preventing larger detritus flowing through. They are manufactured in three sizes. Ø 40 mm, 50 mm and 63 mm (app. 1.6", 2" and 2.5")

Item code	Item
415.31	Round grate 40 mm black
415.41	Round grate 40 mm transparent
415.32	Round grate 50 mm black
415.42	Round grate 50 mm transparent
415.33	Round grate 63 mm black
415.43	Round grate 63 mm transparent



Tank union

Tank union

Tank union from ABS for the connection of aquaria to PVC hard pipes.

	D1	D2	G	L1	L2	L3	glass drilling
D 25	55	25	1"	46	22	19.5	35
D 32	65	32	1 1/4"	46	22	18	45
D 40	80	40	1 3/4"	55	26	20	55

Item code	Item
417.25	Tank union D 25
417.32	Tank union D 32
417.40	Tank union D 40

Adapter union

Adapter union AM from ABS for pipe 25/32, 32/40 mm and 40/50 mm.

Item code	Item
416.125	Adapter union AM 25 mm
416.132	Adapter union AM 32 mm
416.140	Adapter union AM 40 mm



Adapter union AM

Saddle with thread 32 x 1/4"

Adhesive bridge with external thread 32 x 1/4", for sticking to a 32 mm PVC pipe to produce a 1/4" branch.

Item code	Item
410.44-1	Saddle with thread 32 x 1/4"



Saddle with thread 32 x 1/4"

aqua divider

With aqua divider it is possible to mount a glass sheet into an aquarium or terrarium without using any glue. The groove is holding a 4 mm glass sheet. The fastening is done by the rubber suckers. With aqua divider you can separate animals inside of the aquarium.

Item code	Item
418.10	aqua divider 4 pcs.



aqua divider

Outlet strainers

Outlet strainers are manufactured out of ABS pipe and have slits to prevent coarse detritus passing through. Available in the following diameter pipe sizes: 20 mm, 25 mm, 32 mm, 40 mm, 50 mm, 63 mm

Item code	Item
418.21	Outlet strainer 20 mm, length app. 82 mm NEW
418.20	Outlet strainer 20 mm, length app. 160 mm
418.25	Outlet strainer 25 mm, length app. 160 mm
418.32	Outlet strainer 32 mm, length app. 200 mm
418.40	Outlet strainer 40 mm, length app. 200 mm
418.50	Outlet strainer 50 mm, length app. 240 mm
418.63	Outlet strainer 63 mm, length app. 240 mm



Outlet strainers

Reducing T-piece

Reducing T-pieces are used for the connection of bypass filters like the Nitrate-reductor and the Calciumreactor.

Item code	Item
410.41	Reducing T-piece 9/12 - 4/6
410.40	Reducing T-piece 12/16 - 4/6
410.42	Reducing T-piece 16/22 - 4/6



Reducing T-piece



valve

valve

The regulation valve can be used for both air and water. High quality plastic ensures a long service life.
2 pcs. per package

Item code	Item
411.40	valve 4 – 6 mm
411.41	valve 8 – 9 mm
411.42	valve 12 – 14 mm
411.43	valve 16 – 18 mm
411.44	valve 20 – 22 mm



Regulation valve FBS

Regulation valve FBS

High quality regulation valve for hose inlet diameter in 4/6 mm and 6/8 mm – outlet diameter 4/6 mm. Connection fittings can be changed. Durable materials ensure low wear for constant adjustment. The regulation valve can be used for air and for water (e. g. Nitratereducator and Calciumreactor).

Item code	Item
410.44	Regulation valve FBS



Regulation valve 4/6



Regulation valve 4/6

Regulation valve for tube diameter of 4/6 mm. The regulation valve can be used for both air and water (Nitratereducator and Calciumreactor). High quality plastic ensures a long service life. The flow can be easily adjusted by the fine thread. In an attractive blister pack.

Item code	Item
410.47	Regulation valve 4/6 mm 2 pcs.



Non-return valve 4/6



Non-return valve 4/6

Check valve for a tube of 6 mm. Suitable for gas and water. In an attractive blister pack

Item code	Item
410.43	Non-return valve 4/6 mm 2 pcs.



power pad



power pad

Double-sided adhesive pad
Dimensions: 60 x 40 mm

Item code	Item
66200	power pad NEW

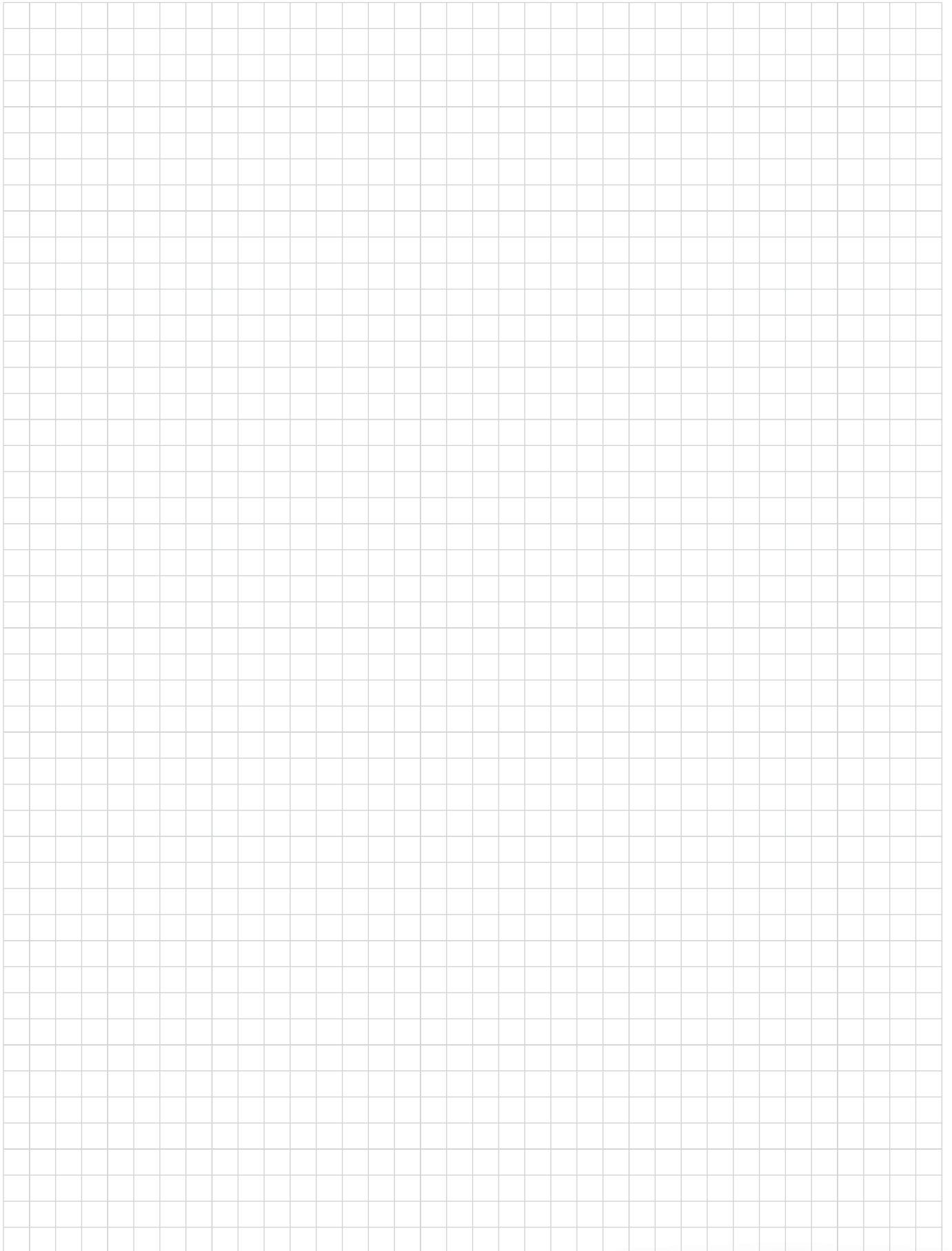

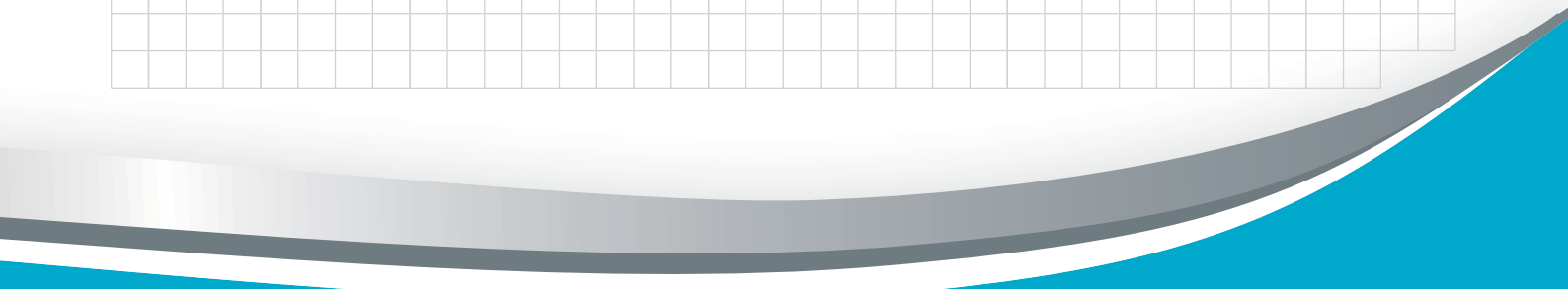
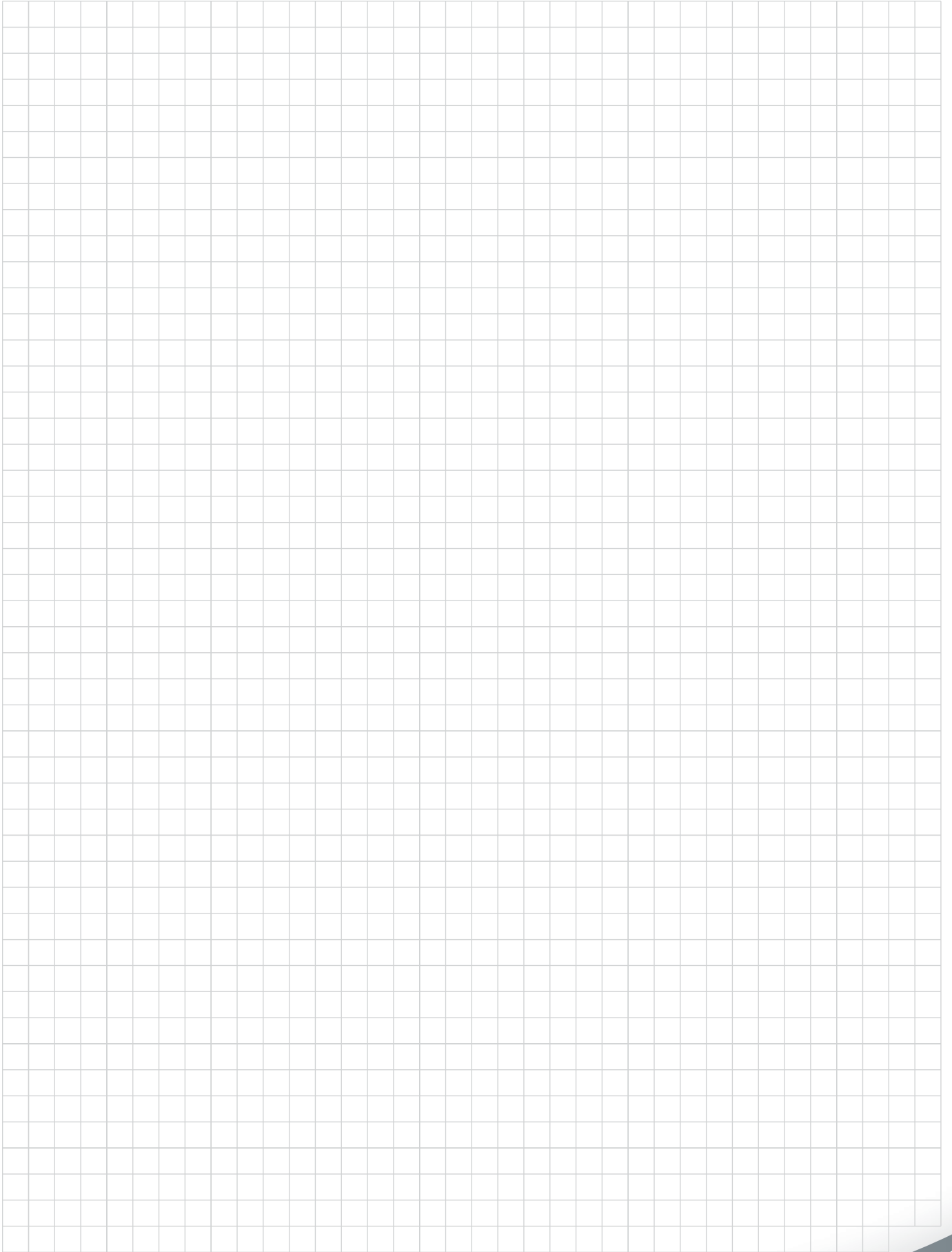



AQUA MEDIC

E-Mail: info@aqua-medic.de
Managing Director: Dipl.-Ing. Oliver Wehage

HRB 16246 AG Osnabrück
Tax No.: 65/200/41142
VAT No.: DE 117575590
WEEE-Reg.-No.: DE 88550220

AB Aqua Medic GmbH

Gewerbepark 24 | 49143 Bissendorf, Germany | Phone +49 5402 99110 | Fax +49 5402 991119

Technical changes reserved

www.aqua-medic.de