

Surgical Instruments

... high class
instruments



 **DUFNER**[®]
Instruments

DUFNER Hauptkatalog
DUFNER General catalogue
Catálogo principal de DUFNER
Le catalogue DUFNER général
Catalogo Generale DUFNER



DUFNER Hauptkatalog

Der vorliegende Katalog ist unter der obigen Identifikationsnummer auf Ihren Namen registriert und bleibt grundsätzlich Eigentum der Dufner Medizintechnik GmbH, D-78532 Tuttlingen.
Die im Katalog enthaltenen Darstellungen unterliegen dem Urheberrecht. Reproduktionen sind daher grundsätzlich untersagt. Unsere Geschäftsbedingungen entnehmen Sie bitte der jeweils gültigen Preisliste.

DUFNER General catalogue

This catalogue is registered in your name under the above identification number and remains our property. The illustrations in the catalogue are copyrighted. Reproductions are not permitted. Our business terms can be found in the respective price list.

Catálogo principal de DUFNER

El presente catálogo está registrado bajo el número de identificación arriba mencionado en su nombre y naturalmente queda de nuestra propiedad. Las explicaciones que se encuentran en el catálogo están sujetos a la propiedad intelectual. Reproducciones sin autorización nuestra está completamente prohibido. Por favor, enterense de nuestras condiciones de negocio en la lista de precios correspondiente.

Le catalogue DUFNER général

Le présent catalogue, par son numéro d'identification, est enregistré à votre nom, mais nous sommes toujours le possesseur. Dans ce catalogue contient la présentation réelle du créateur. Les reproductions sont formellement interdites. Vous trouverez nos conditions générales de vente sur nos listes de prix actuelles.

Catalogo Generale DUFNER

Il presente catalogo, pure restando di nostra proprietà, è stato registrato a suo nome con il numero sopra impresso. Le immagini contenute nel catalogo sono coperte da diritto d'autore e pertanto ne è vietata ogni riproduzione. Vi preghiamo di notare le condizioni di vendita contenute nel listino prezzi in vigore.



DUFNER Instrumente GmbH
Fabrik ärztlicher Instrumente · Medizintechnik
Föhrenstraße 9 · Postfach 4149
D-78532 Tuttlingen / Germany
Telefon ++49(0)7461-3697
Telefax ++49(0)7461-79419
E-mail: info@dufner-tuttlingen.de
www.dufner-tuttlingen.de

DUFNER Hauptkatalog

Der DUFNER Hauptkatalog präsentiert in übersichtlicher Form ein praxisbewährtes Instrumentarium der üblichen offenen Chirurgiedisziplinen. Die gruppenweise Zusammenfassung nach anwendungstechnischen Gesichtspunkten wird mittels entsprechender Symbole signalisiert und ist auf den folgenden Seiten als Inhaltsübersicht dargestellt.

DUFNER Instrumente sind handwerklich gefertigte Qualitätserzeugnisse. Jedes Instrument unterliegt einer sorgfältigen Kontrolle auf einwandfreie Funktionsfähigkeit, Material und Oberflächenbeschaffenheit. Voraussetzung für optimale Handhabung, Belastbarkeit und hohe Lebensdauer.

DUFNER - Qualität für Anspruchsvolle - Instrumente der Spitzenklasse.

DUFNER General catalogue

The DUFNER main catalogue presents a clearly laid out insight into a well-established instrumentarium for all the general surgical disciplines. The collection in groups, according to the technical usage, is indicated by a corresponding symbol and is displayed in the following pages in the form of a summary of contents.

DUFNER instruments are quality products, the result of skilled workmanship. Every instrument is subjected to a rigorous control of its functionality, material and surface working: the conditions for ease of handling and operative strength.

DUFNER - quality for the sophisticated - instruments of the highest class.

Catálogo principal de DUFNER

El catálogo de DUFNER presenta en forma muy clara un instrumentario conocido por su práctica en todas las disciplinas de cirugía. La combinación pro grupos de su uso técnico pro su punto de vista se ve simbólicamente y enseña el contenido en las paginas siguientes.

Los instrumentos de DUFNER son verdaderamente instrumentos de calidad superior, hechos por expertos. Cada instrumento sumite un control preciso respecto a su función, material y su superficie, suposición para su manejo.

Los instrumentos de DUFNER son instrumentos para los exigentes y son de primera calidad.

Le catalogue DUFNER général

Le grand catalogue DUFNER présente, sous forme d'ensemble, des instruments authentique concernent toutes les disciplines chirurgicales.

Les instruments DUFNER c'est une fabrication qualité finition artisanale. Tous les instruments sont soumis à un sérieux contrôle. Le conditionnement et une bonne manipulation sont nos conditions optimales.

DUFNER c'est l'exigence - qualité de l'instrument de première classe.

Catalogo Generale DUFNER

Il catalogo generale DUFNER presenta lo strumentario usato nelle varie specialità chirurgiche. Le pagine seguenti illustrano il piano del catalogo con opportuni simboli atto ad individuare le diverse specialità.

Lo strumentario DUFNER è un prodotto di altissima qualità rifinito a mano.

Ogni strumento viene sottoposto ad un triplice controllo per quanto riguarda la sua idoneità. Il materiale e la rifinitura esterna - caratteristiche che garantiscono un uso e una durata ottimali.

DUFNER - la qualità per strumenti prestigiosi di classe superiore.



DUFNER-Fachkataloge

Für die einzelnen Produktparten stehen Fachkataloge zur Verfügung, die das jeweilige Leistungsspektrum übersichtlich darstellen. Ständige Aktualisierung gewährleistet Information nach neuestem technologischen Stand.

Informieren Sie uns über die für Sie interessanten Instrumente. Sie erhalten dann die gewünschten Fachkataloge zu Ihrem Spezialgebiet aus der offenen oder endoskopischen Chirurgie.

DUFNER technical catalogues

There are technical catalogues for all the different product ranges which show very clearly the features offered by our products. Our policy of continuous updating ensures that our information always reflects the latest state of technology available.

Just let us know the instruments of your interest. You will then be forwarded a selection of our technical catalogues according to your special field of open or endoscopic surgery.

DUFNER catálogos técnicos

Para cada producto hay catálogos técnicos que muestran claramente la capacidad de rendimiento. Nuestra política de actualización garantiza que la información de los productos siempre refleje la última tecnología disponible.

Informenos que instrumentos les interesa. Les enviaremos enseguida el catálogo especializado. En vuestro sector de cirugía abierta y cirugía endoscópica.

DUFNER catalogues spéciaux

De tous les secteurs de produits il y a des catalogues spéciaux qui montrent la capacité de rendement bien disposé. Notre politique d'actualité assure l'information qui montre en permanence le dernier état de la technique disponible.















Informez-nous des instruments qui vous intéressent. Ensuite vous allez recevoir les catalogues souhaités de votre secteur spécial de chirurgie ouverte ou celio chirurgie.





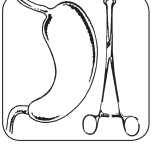
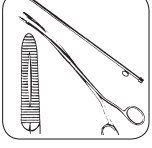

DUFNER cataloghi speciali

Per tutti i settori dei prodotti abbiamo a disposizione cataloghi speciali che mostrano chiaramente la capacità di rendimento. La nostra politica di continua attualizzazione garantisce le ultime informazioni della tecnologia.

Vi preghiamo di informarci su quali strumenti siete interessati. Da parte nostra avrete automaticamente i cataloghi speciali del Vostro settore desiderato, sia per la divisione chirurgia aperta e sia quella endoscopica.

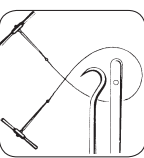
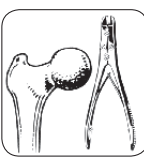
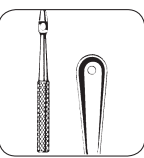

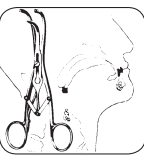
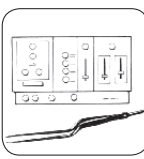
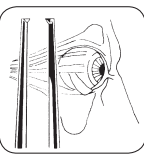
	Seite/Page		Seite/Page
00 Diagnostik Diagnostics Diagnóstico Diagnostic Diagnostica	1-7		
01 Anatomie Anatomy Anatomia Anatomie Anatomia	8-13		
02 Skalpelle Scalpels Bisturies Bistouris Bisturi	14-21		
04 Scheren Scissors Tijeras Ciseaux Forbici	22-42		
06 Pinzetten Forceps Pinzas Pincés Pinze	43-54		
08 Arterienklemmen Artery Forceps Pinzas hemostáticas Pincés hemostatiques Pinze emostatiche	55-81		
10 Sterilisation, Korn- u. Tupferzangen Sterilization, Sponge- and Dressing Forceps Esterilización, Pinzas para curaciones y pinzas porta-esponjas Stérilisation, Pincés à pansements et pincés porte-coton Sterilizzazione, Pinze per bende e pinze porta-cotone	82-87		
12 Wundhaken Retractors Separadores Ecarteurs Divaricatori	88-144		
14 Sonden, Watteträger, Spatel Probes, Cotton Applicators, Spat. Sondas, Porta- algodones, Espát. Sondes, Porta-cotons, Spatules Specilli, Portacotone, Spatole			145-149
16 Trokare, Saugrohre, Saugkanülen Trocars, Suction Tubes Trócares, Tubos aspiradores Trocars, Tubes d'aspiration Tre quarti, Cannule per aspirazione			150-155
18 Naht-Instrumente Suture Instruments Instrumental para suturas Intruments à suture Strumenti per sutura			156-182
20 Thorax- und Lungen-Chirurgie Thoracic and Lung Surgery Cirurgia torácica y pulmonar Chirurgie thoracique et pul- monaire			183-196
22 Cardiovascular Chirurgie Cardiovascular Surgery Cirugia cardiovascular Chirurgie cardio-vasculaire Chirurgia cardiovascolare			197-202
24 Darm, Magen, Mastdarm Intestines, Stomach, Rectum Intestinos, Estómago, Recto Intestins, Estomac, Rectum Intestino, Stomaco, Retto			203-223
26 Leber, Galle, Niere Liver, Gall, Kidney Hígado, Bilis, Rinón Foie, Bile, Rein Fegato, Bile, Rene			224-236
28 Gynäkologie Gynecology Ginecologia Gynécologie Ginecologia			237-258

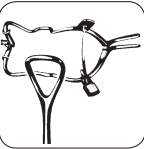
<p>30 Geburtshilfe Obstetrics Obstetricia Accouchements Ostericia</p>	<p style="text-align: right;">Seite/Page</p>  <p style="text-align: right;">259-262</p>	<p>50 Verband, Gips Dressing Vendajes Pansements, Appareils plâtrés Bendaggi, Gessature</p>	<p style="text-align: right;">Seite/Page</p>  <p style="text-align: right;">274-276</p>
<p>32 Neurochirurgie Neurosurgery Neurocirugia Neurochirurgie Neurochirurgia</p>	<p style="text-align: right;">Seite/Page</p>  <p style="text-align: right;">263-264</p>	<p>52 Knochenchirurgie Bone Surgery Cirugia ósea Chirurgie osseuse Chirurgia ossea</p>	<p style="text-align: right;">Seite/Page</p>  <p style="text-align: right;">277-283</p>
<p>34 Dermatologie Dermatology Dermatologia Dermatologie Dermatologia</p>	<p style="text-align: right;">Seite/Page</p>  <p style="text-align: right;">265</p>	<p>54 Knochenchirurgie Bone Surgery Cirugia ósea Chirurgie osseuse Chirurgia ossea</p>	<p style="text-align: right;">Seite/Page</p>  <p style="text-align: right;">284-300</p>
<p>36 Tracheotomie Tracheotomy Traqueotomia Trachéotomie Tracheotomie</p>	<p style="text-align: right;">Seite/Page</p>  <p style="text-align: right;">266</p>	<p>00/08/12/28 Instrumente für die Elektrochir. Instruments for Electro Surgery Instrumentos para la electrocirugia Instruments pour l'électrochirurgie Strumenti per l'elettrochirurgia</p>	<p style="text-align: right;">Seite/Page</p>  <p style="text-align: right;">301</p>
<p>38 Ophtalmologie Ophtalmologiy Oftalmologia Ophtalmologie Oftalmologia</p>	<p style="text-align: right;">Seite/Page</p>  <p style="text-align: right;">267</p>		
<p>42 Otologie Otology Otologia Otologie Otologia</p>	<p style="text-align: right;">Seite/Page</p>  <p style="text-align: right;">268-269</p>		
<p>44 Rhinologie Rhinology Rinologia Rhinologie Rinologia</p>	<p style="text-align: right;">Seite/Page</p>  <p style="text-align: right;">270-271</p>		
<p>46/48 Mund, Zunge Mouth, Tongue Boca, Lengua Bouche, Langue Bocca, Lingua</p>	<p style="text-align: right;">Seite/Page</p>  <p style="text-align: right;">272-273</p>		

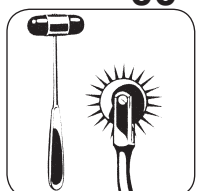

$\frac{1}{2}$ **BABINSKY**
00097-25
25 cm / 10"



$\frac{1}{2}$ **RABINER**
00122-23
23 cm / 9"



$\frac{1}{2}$ **BUCK**
00127-18
18 cm / 7"



$\frac{1}{2}$ **TROEMNER**
00142-24
24 cm / 9 1/2"



$\frac{1}{2}$ **DÉJERINE**
00156-20
20 cm / 8"



$\frac{1}{2}$ **DÉJERINE**
00157-21
21 cm / 8 1/4"



$\frac{1}{2}$ **TAYLOR**
00162-20
20 cm / 8"

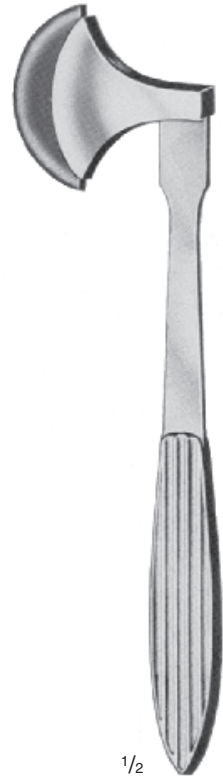

$\frac{1}{2}$ **BERLINER**
00166-20
20 cm / 8"



Sensibilitäts-Instrumente
Sensibility Instruments
Instrumentos para examinar la sensibilidad
Instruments pour mesurer la sensibilité
Strumenti per esaminare la sensibilità



1/2

ALY
00177-18
18 cm / 7"



1/2

WARTENBERG
00182-19
19 cm / 7 1/2"

Stethoskope
Stethoscopes
Estetoscopios
Stéthoscopes
Stetoscopi



1/2

PINARD
00214-18
18 cm / 7"

Holz
wood
madera
bois
legno



1/2

PINARD
00220-15
15 cm / 6"

Aluminium
aluminium
aluminio
aluminium
alluminio

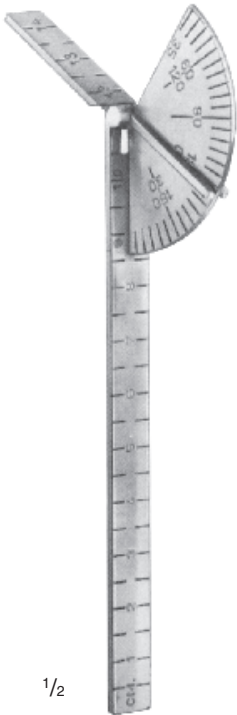

1/2

CARROLL
00376-01
Winkelmesser
Goniometer
Goniómetro
Rapporteur
Goniometro



1/2

00382-01
für Kinder
for children
para niños
pour enfants
per bambini

COLLIN

00382-02
für Erwachsene
for adults
para adultos
pour adultes
per adulti



1/3

MOELTGEN
00386-01
Winkelmesser
Goniometer
Goniómetro
Rapporteur
Goniometro



1/2

00387-21
Schieblehre
Caliper
Calibrador
Calibre
Calibro

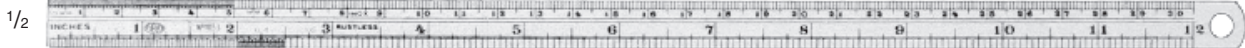

1/2

mm / in

00390-20 = 200 mm / 8"
00390-30 = 300 mm / 12"
00390-50 = 500 mm / 20"



1/2

00391-50
500 mm / 20"

Röntgenfähig
X-ray
Rayos x
Règle radiologique
Regolo radiologico



1/2

REGOLO
00394-15
15 cm / 6"



00397-15
150 cm / 60"
Stahlmaßband
Steel tape measure
Cinta métrica de acero
Ruban métrique en acier
Nastro metrico di acciaio



Diagnostik-Bestecke
 Diagnostic Sets
 Juegos para diagnóstico
 Nécessaires à diagnostic
 Set per diagnostica



00412-02

Otoskop-Besteck, komplett
 Otoscope Set, complete
 Juego para otoscopia, completo
 Trousse d'otoscope, complète
 Trousse per otoscopia, completa



00413-03

Ophthalmoskop-Besteck, komplett
 Ophthalmoscope Set, complete
 Juego para oftalmoscopia, completo
 Trousse d'ophtalмосcope, complète
 Trousse per oftalmoscopia, completa



00415-03

Ophthalmoskop- und Otoskop-Besteck, komplett
 Ophthalmoscope- and Otoscope Set, complete
 Juego para oftalmoscopia y otoscopia, completo
 Trousse d'ophtalмосcope et otoscope, complète
 Trousse per oftalmoscopia e otoscopia, completa



Ohrtrichter, Kunststoff
 Ear Specula, plastic
 Espéculos auriculares, plástico
 Spécula auriculaires, plastique
 Specoli auricolari, plástico



00412-23
Ø 2,5 mm



00412-26
Ø 4 mm

grau, Einmalgebrauch
 grey, disposable
 gris, desechable
 gris, à usage unique
 grigio, monouso



00412-12
Ø 2 mm



00412-14
Ø 3 mm



00412-16
Ø 4 mm



00412-18
Ø 5 mm

schwarz, wiederverwendbar
 black, reusable
 negro, reutilizable
 noir, réutilisable
 nero, riutilizzabile



00419-01

Batteriegriff
 Battery handle
 Mango a pila
 Poignée à pile
 Impugnatura a pila

HL 2,5 V



00420-04

6 Ersatzbirnen für Otoskop
 6 Spare bulbs for otoscope
 6 Bombillos de repuesto para otoscopia
 6 Lampes de rechange pour otoscope
 6 Lampadine di ricambio per otoscopia

HL 2,5 V



00420-05

6 Ersatzbirnen für Ophtalmoskop
 6 Spare bulbs for ophtalmoscope
 6 Bombillos de repuesto para oftalmoscopia
 6 Lampes de rechange pour ophtalmoscope
 6 Lampadine di ricambio per oftalmoscopia



Stirnspiegel
Head Mirrors
Espejos frontales
Miroirs frontaux
Specchi frontali



ZIEGLER

00422-09 = 90 mm Ø

00422-10 = 100 mm Ø

komplett - complete -

completo - complète - completa



ZIEGLER

00443-01

ZIEGLER

00427-09 = 90 mm Ø

00427-10 = 100 mm Ø

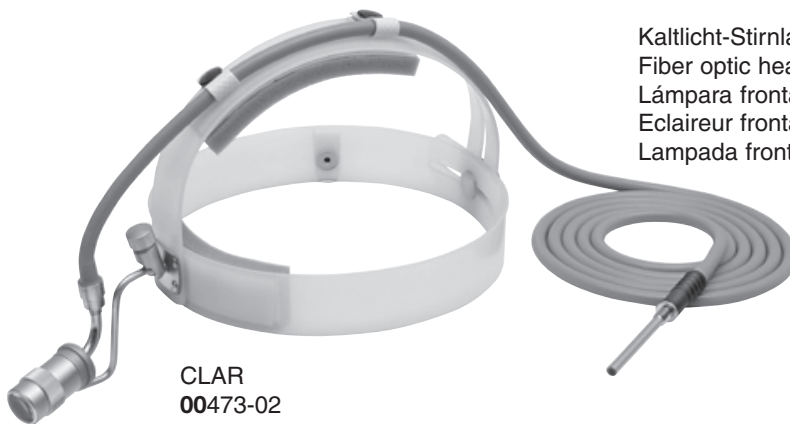

Kaltlicht-Stirnlampe, fokussierbar

Fiber optic head lamp, focussing

Lámpara frontal de luz fría, enfocable

Eclaireur frontal à lumière froide, réglable

Lampada frontale a luce fredda, regolabile

CLAR

00473-02

komplett - complete - completo - complète - completa



00480-00

LED-Hochleistungsbatteriestirnleuchte

LED High-power battery head lamp



Miniatur Kaltlicht-Stirnlampe

Miniature Fiber optic head lamp

Lámpara frontal de luz fría

Eclaireur frontal à lumière froide

Lampada frontale a luce fredda

CLAR 73

00478-00

komplett - complete - completo - complète - completa



00482-00
Xenon-Batteriestirnleuchte
Xenon Battery head lamp



CLAR 55
00489-06
komplett - complete - completo -complète - completa



CLAR
00489-08
komplett - complete - completo -complète - completa



00490-01
55 mm



CLAR
00495-06
komplett - complete - completo -complète - completa



00499-01

Transformator
Transformer
Transformador
Transformateur
Transformatore



00550-01
220 Volt



Anatomie
Anatomy
Anatomia
Anatomie
Anatomia

Anatomische Skalpelle
Dissecting knives
Bisturios para disección anatomica
Bistouris anatomiques
Bisturi anatomici

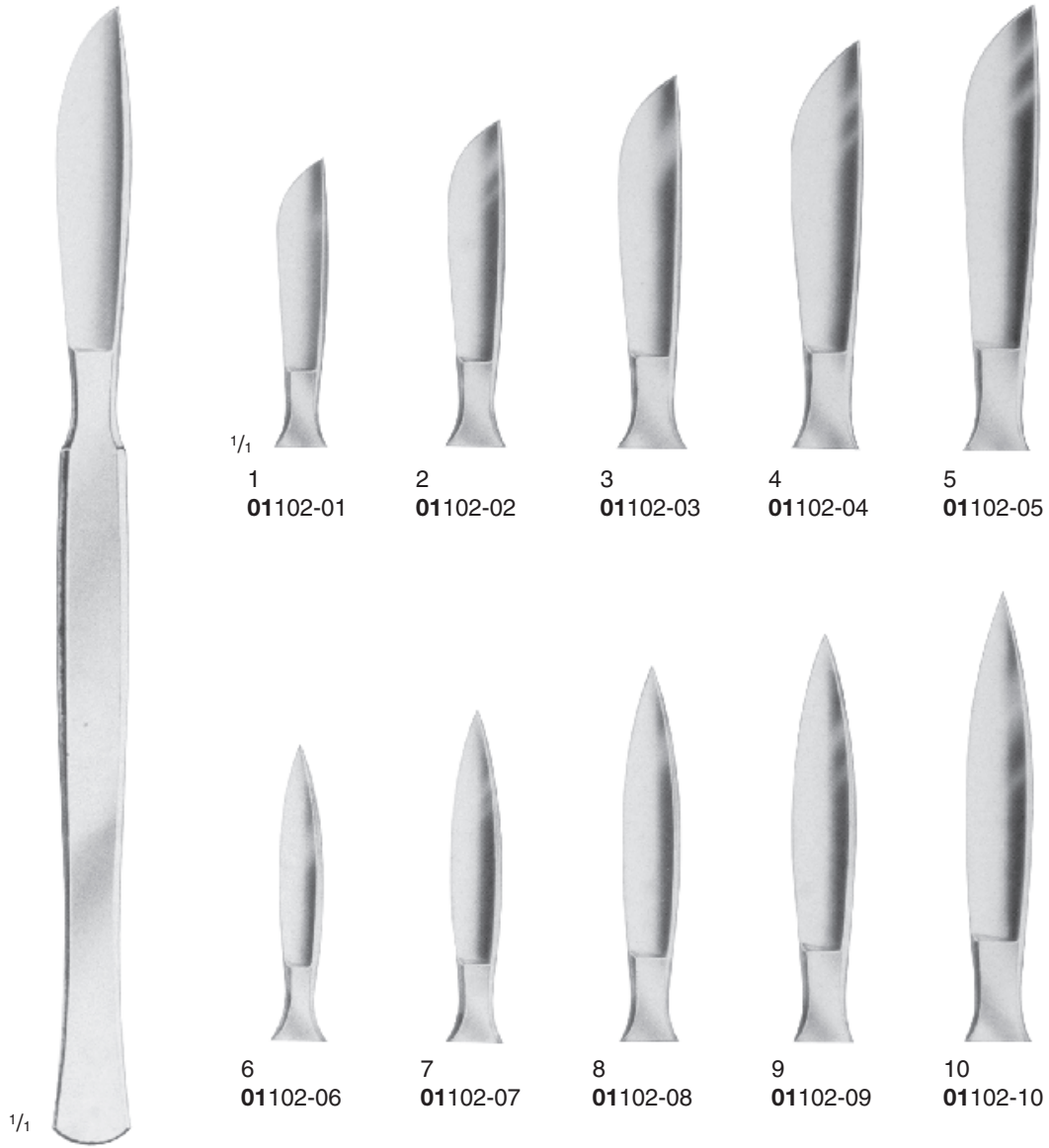

01102-01 – 10
Fig. 1 – 10



mit Holzheft
with wooden handle
con mango de madera
avec manche bois
con manico di legno

mit Holzheft
with wooden handle
con mango de madera
avec manche bois
con manico di legno



1/2

01110-05



1/2

01111-05



1/2

VIRCHOW
01120-09



1/2

VIRCHOW
01121-09



1/2

VIRCHOW
01130-08



1/2

VIRCHOW
01136-10

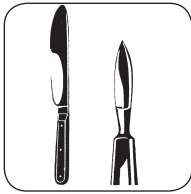

Anatomie
Anatomy
Anatomia
Anatomie
Anatomia

Organmesser
Post Mortem knives
Cuchillos para órganos
Bistouri post mortem
Coltelli per organi

mit Holzheft
with wooden handle
con mango de madera
avec manche bois
con manico di legno



$\frac{1}{2}$
WALB
01150-11

mit Holzheft
with wooden handle
con mango de madera
avec manche bois
con manico di legno



$\frac{1}{2}$
WALB
01150-14

mit Holzheft
with wooden handle
con mango de madera
avec manche bois
con manico di legno



$\frac{1}{2}$
WALB
01150-17

Schnittlänge
Length of blade
Largo de hojas
Longueur de lame
Lunghezza della lama

11 cm / 4 $\frac{1}{4}$ "

14 cm / 5 $\frac{1}{2}$ "

17 cm / 6 $\frac{3}{4}$ "



$\frac{1}{2}$
01160-19



$\frac{1}{2}$
**VIRCHOW
01164-16**



$\frac{1}{2}$
**VIRCHOW
01164-20**



$\frac{1}{2}$
**VIRCHOW
01164-24**

Schnittlänge
Length of blade
Largo de hojas
Longueur de lame
Lunghezza della lama

19,5 cm / 7³/₄"

16 cm / 6¹/₄"

20 cm / 8"

24 cm / 9¹/₂"

01



Anatomie
Anatomy
Anatomia
Anatomie
Anatomia

Rachiotomie
Rachiotomes
Raquiótomos
Rachiotomes
Rachiotomi

Knochenmeißel
Bone chisels
Cinceles para huesos
Ciseaux-burins
Scalpelli



1/3
01172-22
22 cm / 8³/₄"



1/3
BRUNETTI
01178-28
28,5 cm / 11¹/₄"



1/3
BRUNETTI
01179-28
28,5 cm / 11¹/₄"



1/3
01195-24

Hammer
Mallets
Martillos
Maillets
Martelli



1/3
01200-15 mm
01200-18 mm
01200-22 mm

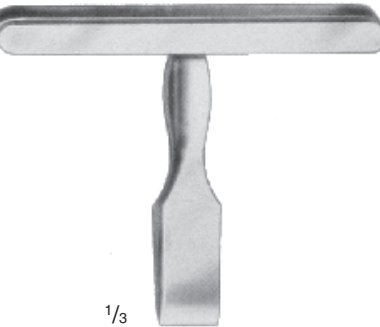

1/3
VIRCHOW
01206-00

Schädelspalter
Skull breakers
Cinzel rompe-cráneo
Burin pour le crâne
Scalpello taglia cranio



1/3
01210-14



1/2

04754-21
21 cm / 8 1/2"



1/2

04756-21
21 cm / 8 1/2"



1/2

20073-22
22 cm / 8 3/4"

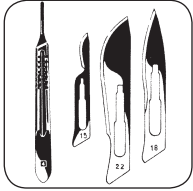

Skalpelli
 Scalpel Handles
 Mangos de bisturís
 Manches pour bistouris
 Manici per bisturi



abgewinkelt
 angled on flat
 angulada
 coudé sur le plat
 angolato



1/1

02072-04
 No. 4
 massiv
 solid
 macizo
 solide
 solido



1/1

02076-41
 No. 4L
 massiv
 solid
 macizo
 solide
 solido



1/1

02076-45
 No. 4LA
 massiv
 solid
 macizo
 solide
 solido



1/1

COLLIN
02080-08
 No. 8



1/1

hohl
 hollow
 hueco
 creux
 cavo

COLLIN
02081-09
 No. 9

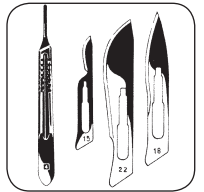

abgewinkelt
angled on flat
angulada
coudé sur le plat
angolato

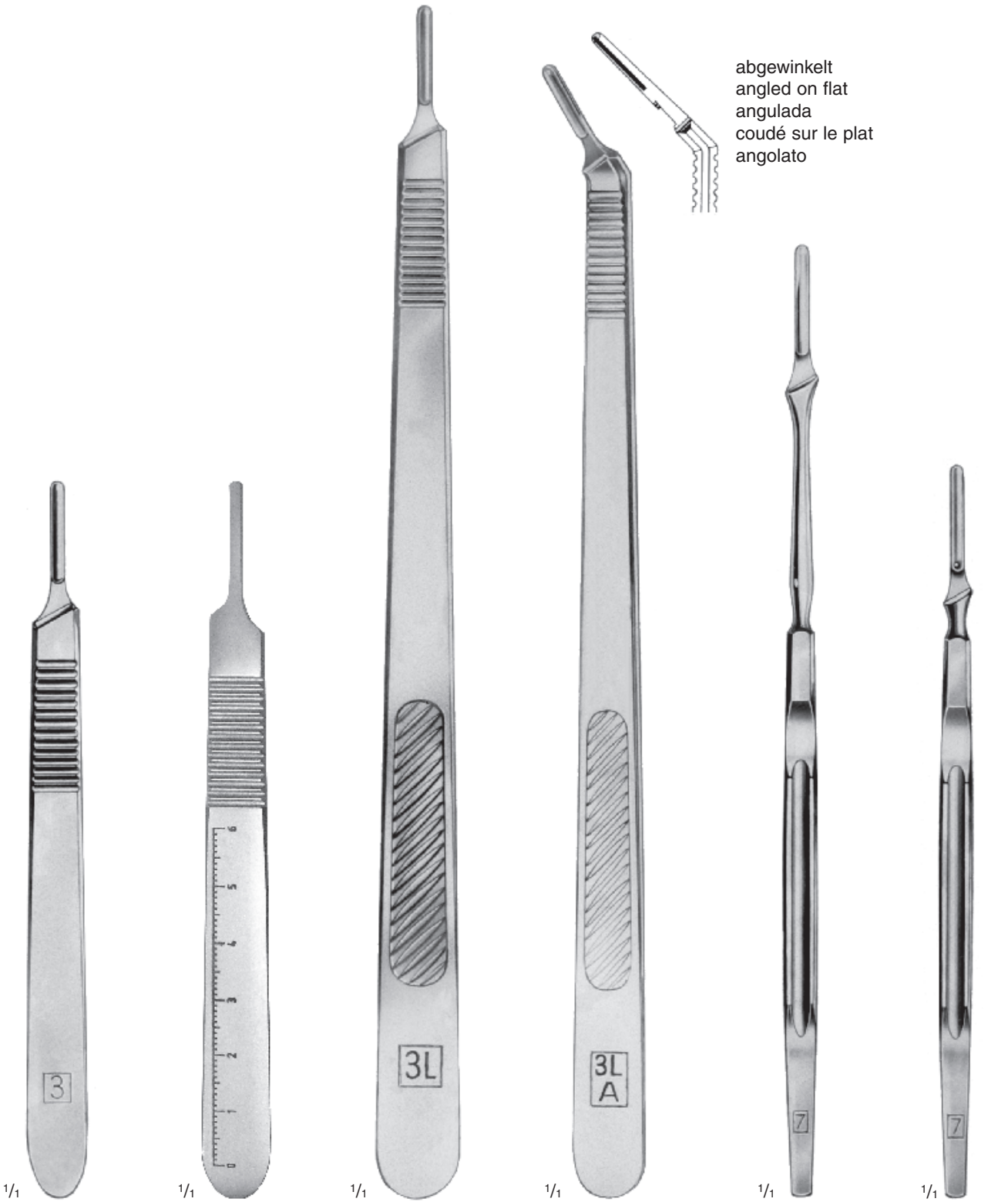

02102-03
No. 3
massiv
solid
macizo
solide
solido

02102-05
No. 3
massiv
solid
macizo
solide
solido

02105-31
No. 3L
massiv
solid
macizo
solide
solido

02105-35
No. 3LA
massiv
solid
macizo
solide
solido

02109-07
No. 7
massiv
solid
macizo
solide
solido

02109-71
No. 7K
massiv
solid
macizo
solide
solido

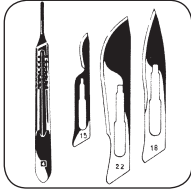

Skalpellsklingen, steril
 Scalpel Blades, sterile
 Hojas de bisturíes, estériles
 Lames de bistouri, stériles
 Lame per bisturi, sterili



passend für die Griffe
 for handles
 para los mangos
 pour manches
 per manici

02102-03 – 02109-71



Fig. 10
02127-10



Fig. 11
02127-11



Fig. 12
02127-12



Fig. 13
02127-13



Fig. 15
02127-15



Fig. 16
02127-16



Fig. 17
02127-17



Fig. 18
02127-18



Fig. 19
02127-19



Fig. 20
02127-20



Fig. 21
02127-21



passend für die Griffe
 for handles
 para los mangos
 pour manches
 per manici

02072-04 – 02081-09



Fig. 22
02127-22



Fig. 23
02127-23



Fig. 24
02127-24



Fig. 25
02127-25

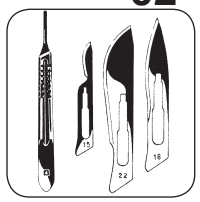

1/1
 Fig. 3 02272-03
 Fig. 14 02272-14
 Fig. 15 02272-15
 Fig. 16 02272-16
 Fig. 17 02272-17
 Fig. 18 02272-18
 Fig. 26 02272-26
 Fig. 27 02272-27
 Fig. 32 02272-32

1/1
 Fig. 40 02272-40
 Fig. 60 02272-60
 Fig. 61 02272-61
 Fig. 62 02272-62
 Fig. 63 02272-63

1/1
 17 cm, 6 3/4"
 02272-03 – 63

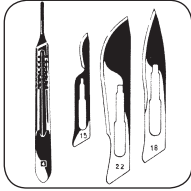

Skalpelle
Scalpels
Bisturies
Bistouris
Bisturi



Fig. 1
02372-01

Fig. 3
02372-03

Fig. 9
02372-09



Fig. 16
02372-16

1/1

DIEFFENBACH
02372-01
02372-03
02372-09
02372-16
16 cm / 6 1/4"



Fig. 2
02392-02

Fig. 3
02392-03

Fig. 4
02392-04

1/1

BERGMANN
02392-02 - 04
14 cm / 5 1/2"



Schnittlänge
 Length of blade
 Largo de hojas
 Longueur de lame
 Lunghezza della lama

cm	in.	COLLIN	CATLIN	LISTON	LANGENBECK
9,5	3 3/4"				02502-09
11,0	4 1/2"				02512-11
12,0	4 3/4"				02492-12
13,0	5"	02472-13			
16,0	6 1/4"	02472-16	02478-16		
17,0	6 3/4"			02482-17	
19,0	7 1/2"	02472-19	02478-19		
20,0	8"			02482-20	
22,0	8 3/4"	02472-22	02478-22		
28,0	11"	02472-28			

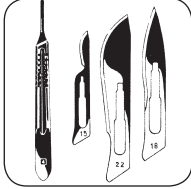

Resektionsmesser, Fistelmesser
 Resection Knives, Fistula Knives
 Cuchillos para resección, Bisturie para fistulas
 Couteaux à résection, Bistouris à fistules
 Coltelli per resezione, Bisturi per fistole



1/2
 LANGENBECK
 02542-05



1/2
 LANGENBECK
 02544-05



1/2
 WILLIGER
 02548-03



1/2
 NÉLATON
 02552-03



1/2
 NÉLATON
 02554-03



1/2
 ADAMS
 02672-01 – 04
 Fig. 1-4
 13 cm / 5"



1/1
 Fig. 1
 02672-01



1/1
 Fig. 3
 02672-03



Fig. 2
 02672-02



Fig. 4
 02672-04



1/2
 PARKER
 02682-01 – 04
 Fig. 1, 2, 4
 13 cm / 5"



1/1
 Fig. 1
 02682-01



Fig. 2
 02682-02



1/1
 Fig. 4
 02682-04



1/2
 SIMON
 20 cm, 8"
 02722-01 – 04



1/1
 02722-01



02722-02



02722-03



02722-04



1/2
 ULRICH
 02726-01
 23 cm / 9"



1/2

02772-00



1/2

THIERSCH
02793-00



1/2

REHN
02796-00



1/2

SCHINK
02852-00



1/2

02852-01



1/2

02852-02



1/2

SILVER
02856-00
19 cm / 7 1/2"



02856-01
Ersatzklinge für Silver, nicht steril
Spare blade for Silver, non sterile
Hoja de repuesto para Silver, no estéril
Lame de rechange pour Silver, non-stérile
Lama di ricambio per Silver, non sterile



HUMBY
02857-00
30 cm / 12"



WATSON
02857-10
30 cm / 12"



COBBETT
02857-20
30 cm / 12"



02857-01
Ersatzklinge allein, nicht steril
Spare blade only, non sterile
Hoja de repuesto suelta, no estéril
Lame de rechange seule, non-stérile
Lama di ricambio sola, non sterile

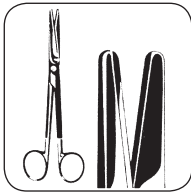

Chirurgische Scheren
 Operating Scissors
 Tijeras para cirugía
 Ciseaux à chirurgie
 Forbici per chirurgia



STANDARD
 Fig. 1 – 3

gerade
 straight
 rectas
 droites
 rette



STANDARD
 Fig. 1 – 3

gebogen
 curved
 curvas
 courbes
 curve

cm	in.	Fig.1	Fig.2	Fig.3
11,5	4 1/2"	04072-11	04074-11	04076-11
13,0	5"	04072-13	04074-13	04076-13
14,5	5 1/2"	04072-14	04074-14	04076-14
15,5	6"	04072-15	04074-15	04076-15
16,5	6 1/2"	04072-16	04074-16	04076-16
18,5	7 1/4"	04072-18	04074-18	04076-18
20,0	8"	04072-20	04074-20	04076-20

cm	in.	Fig.1	Fig.2	Fig.3
11,5	4 1/2"	04077-11	04079-11	04081-11
13,0	5"	04077-13	04079-13	04081-13
14,5	5 1/2"	04077-14	04079-14	04081-14
15,5	6"	04077-15	04079-15	04081-15
16,5	6 1/2"	04077-16	04079-16	04081-16
18,5	7 1/4"	04077-18	04079-18	04081-18
20,0	8"	04077-20	04079-20	04081-20



graziles Modell
 delicate pattern
 modelo delgado
 modèle délicat
 modello delicato



graziles Modell
 delicate pattern
 modelo delgado
 modèle délicat
 modello delicato



Incisionsschere
 Incision Scissors
 Tijeras de incision
 Ciseaux á incision
 Forbici per incisione

cm	in.	Fig.1	Fig.2	Fig.3
13,0	5"	04092-13	04094-13	04096-13
14,5	5 1/2"	04092-14	04094-14	04096-14

cm	in.	Fig.1	Fig.2	Fig.3
13,0	5"	04097-13	04099-13	04101-13
14,5	5 1/2"	04097-14	04099-14	04101-14
16,5	6 1/2"			04108-16



cm	in.	DEAVER	DEAVER	MAYO	MAYO	MAYO-HARRINGTON	MAYO-HARRINGTON
14,5	5 1/2"	04112-14	04113-14	04142-14	04143-14		
15,0	6"			04142-15	04143-15		
17,0	6 3/4"			04142-17	04143-17		
20,0	8"					04146-20	04147-20
23,0	9"			04142-23	04143-23	04146-23	04147-23
30,0	12"						04147-30



cm	in.	MAYO-STILLE	MAYO-STILLE	MAYO-NOBLE	MAYO-NOBLE
15,0	6"	04152-15	04153-15		
17,0	6 3/4"	04152-17	04153-17	04162-17	04163-17
19,0	7 3/4"	04152-19	04153-19		
21,0	8 1/4"	04152-21	04153-21		

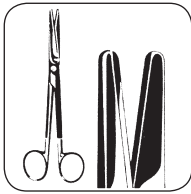

Gynäkologische Scheren
 Gynecological Scissors
 Tijeras para ginecología
 Ciseaux à gynécologie
 Forbici per ginecologia

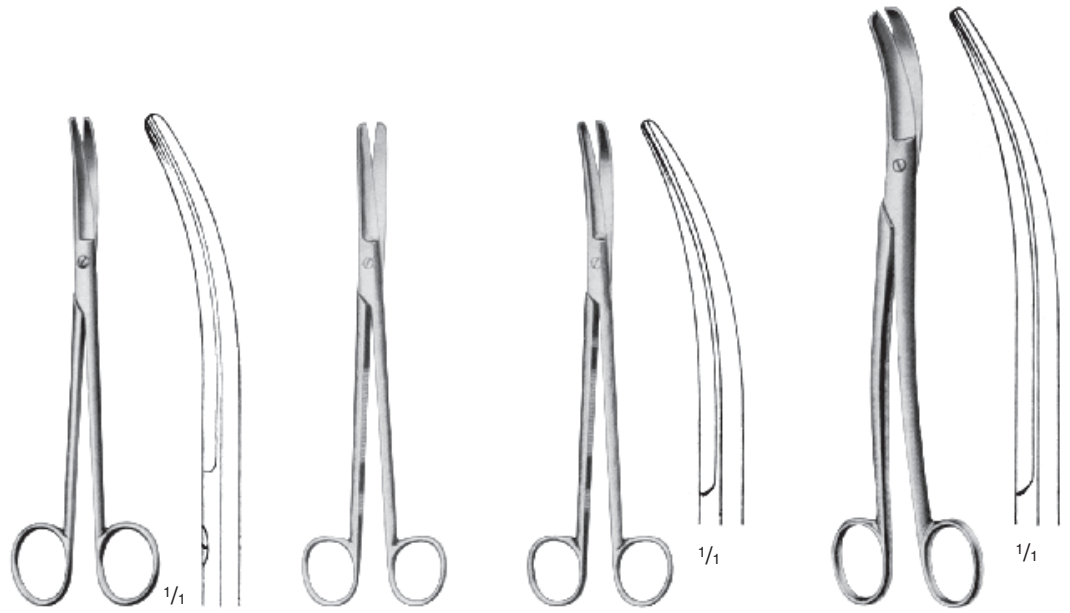

cm	in.	WERTHEIM	SIMS	SIMS	SIEBOLD
14,5	5 1/2"	04167-14			
19,5	7 3/4"	04167-19			
20,0	8"		04172-20	04175-20	
22,5	9"	04167-22			
23,0	9"		04172-23	04175-23	
24,0	9 1/2"				04183-24



cm	in.	DUBOIS	DUBOIS	KELLY	KELLY	DOYEN	DOYEN
16,0	6 1/2"			04198-16	04199-16		
17,5	7"					04202-17	04203-17
18,0	7"			04198-18	04199-18		
27,0	10 1/2"	04192-27	04193-27				

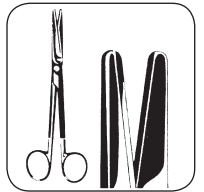

cm	in.	MINI-METZENBAUM		METZENBAUM			METZENBAUM		
				Fig. 1	Fig. 2	Fig.3	Fig.1	Fig.2	Fig.3
11,5	4 1/2"	04220-11	04221-11						
14,5	5 1/2"			04222-14	04224-14	04226-14	04227-14	04229-14	04231-14

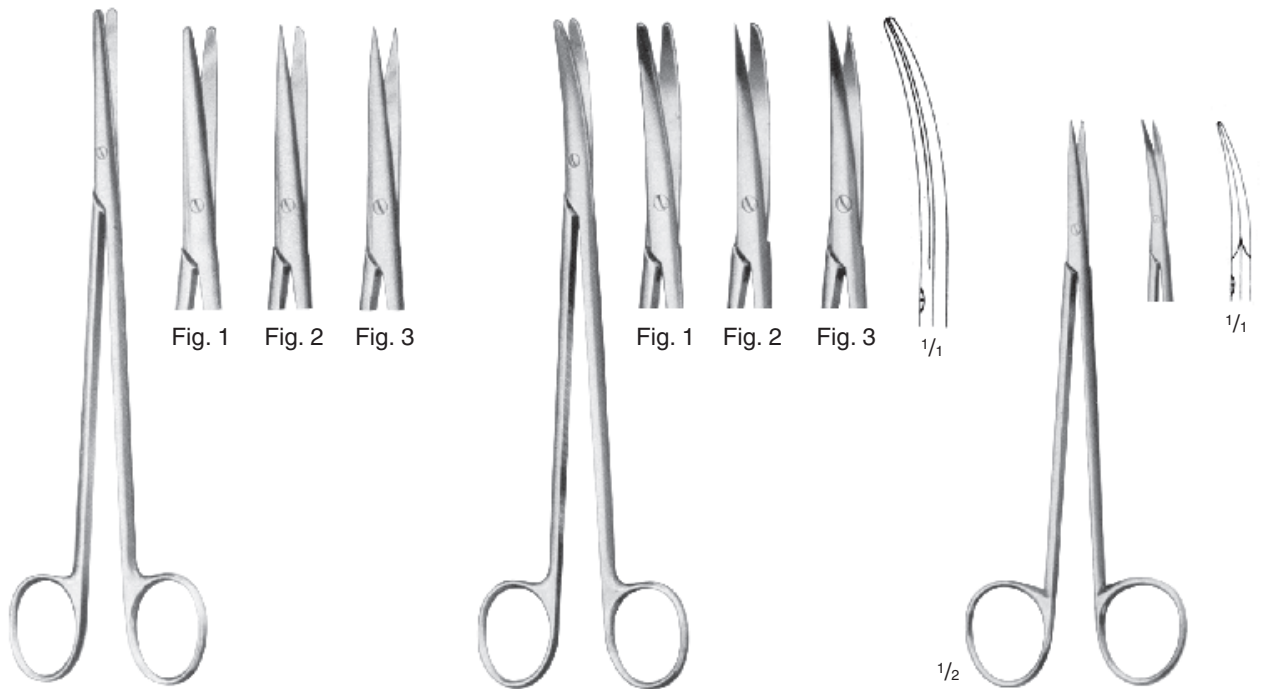

cm	in.	METZENBAUM-NELSON			METZENBAUM-NELSON			Nerv-Präparierschere Nerve dissecting scissors	
		Fig. 1	Fig. 2	Fig.3	Fig.1	Fig.2	Fig.3		
15,0	6"							04272-15	04273-15
18,0	7"	04252-18	04254-18	04256-18	04257-18	04259-18	04261-18		
20,0	8"	04252-20	04254-20	04256-20	04257-20	04259-20	04261-20		
23,0	9"	04252-23	04254-23	04256-23	04257-23	04259-23	04261-23		
25,0	10"	04252-25	04254-25	04256-25	04257-25	04259-25	04261-25		
28,0	11"	04252-28	04254-28	04256-28	04257-28	04259-28	04261-28		
30,0	12"	04252-30	04254-30	04256-30	04257-30	04259-30	04261-30		

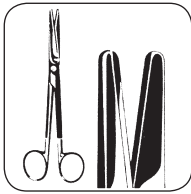

Präparierscheren
Dissecting Scissors
Tijeras de disección
Ciseaux à dissection
Forbici per dissezione



LEXER 04282-16 = 16 cm / 6 1/2" 04282-21 = 21 cm / 8 1/2"	LEXER 04283-16 = 16 cm / 6 1/2" 04283-21 = 21 cm / 8 1/2"	FOMON 04289-14 13,5 cm / 5 1/4"	THOREK 04291-19 = 19 cm / 7 3/4" 04291-25 = 25,5 cm / 10"	LEXER-BABY 04292-10 = 10 cm / 4" 04292-12 = 12 cm / 4 3/4"	LEXER-BABY 04293-10 = 10 cm / 4" 04293-12 = 12 cm / 4 3/4"
--	--	--	--	---	---



cm	in.	LEXER slimline	METZENBAUM slimline	METZENBAUM slimline	METZENBAUM slimline	METZENBAUM slimline
14,5	5 1/2"		04302-14	04303-14	04304-14	04305-14
16,0	6 1/2"	ger. 04296-16				
16,0	6 1/2"	geb. 04297-16				
18,0	7"		04302-18	04303-18	04304-18	04305-18
20,0	8"		04302-20	04303-20	04304-20	04305-20
23,0	9"		04302-23	04303-23	04304-23	04305-23



SANVENERO
04313-14
14 cm / 5 1/2"



04316-11
11 cm / 4 1/3"

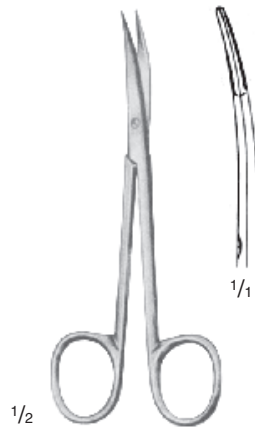

04317-11
11 cm / 4 1/3"

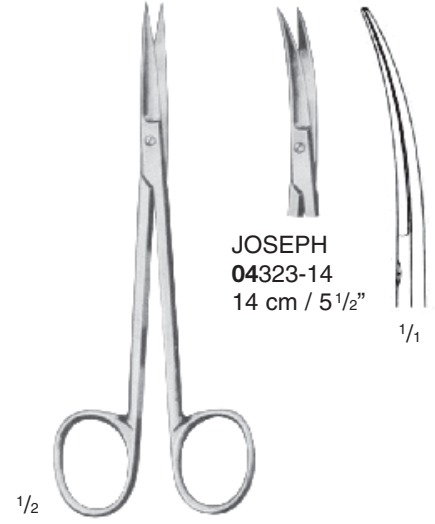

JOSEPH
04323-14
14 cm / 5 1/2"

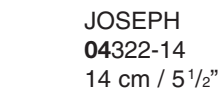

JOSEPH
04322-14
14 cm / 5 1/2"

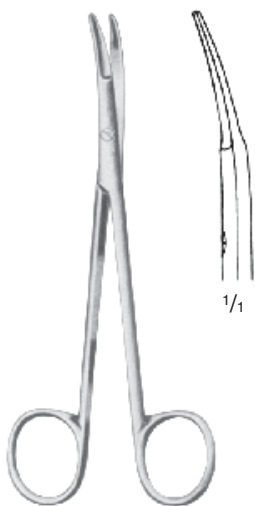

RAGNELL-KILNER
04331-12 = 12 cm / 4 3/4"
04331-15 = 15 cm / 6"



04335-14
14 cm / 5 1/2"

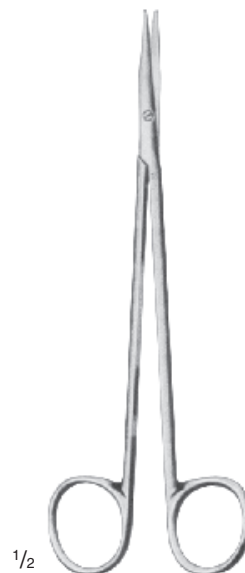

REYNOLDS
04336-15
15 cm / 6"

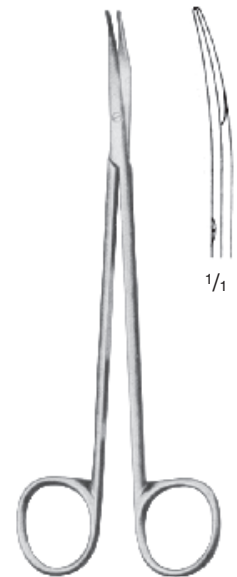

REYNOLDS
04337-15 = 15 cm / 6"
04337-18 = 18 cm / 7"

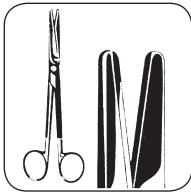

Gefäßscheren
 Vascular Scissors
 Tijeras vasculares
 Ciseaux vasculaires
 Forbici vascolari



SATINSKY
 04347-18 = 18 cm / 7"
 04347-24 = 24,5 cm / 10"

DIETRICH
 04364-01
 19 cm / 7³/₄"

HEGEMANN-DIETRICH
 19 cm / 7³/₄"

POTTS-SMITH
 19 cm / 7¹/₂"

Technical specifications for Diethrich and Hegemann-Diethrich:
 25° 04363-25
 45° 04363-45
 60° 04363-60
 90° 04363-90
 125° 04364-12
 Dimensions: 3,9 mm, 12,5 mm, 1,15 mm, 125°

POTTS-DE-MARTEL
 04369-21 = 21 cm / 8¹/₄"
 04369-24 = 24 cm / 9¹/₂"

STRULLY
 04417-22
 22 cm / 8³/₄"

DANDY
 04423-17
 17 cm / 6³/₄"

SCHMIEDEN-TAYLOR
 04427-17
 17 cm / 6³/₄"

TOENNIS-ADSON
 04431-17
 17,5 cm / 7"



Tonsillenscheren
Tonsil Scissors
Tijeras para amígdalas
Ciseaux pour les amygdales
Forbici per tonsille

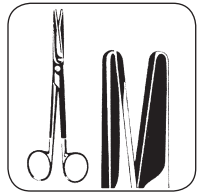

gezahnt
saw edge
dentada
denté
dentata



TOENNIS
04438-18
18 cm / 7"

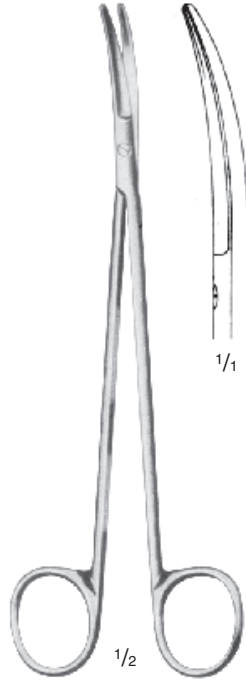

TOENNIS
04439-18
18 cm / 7"

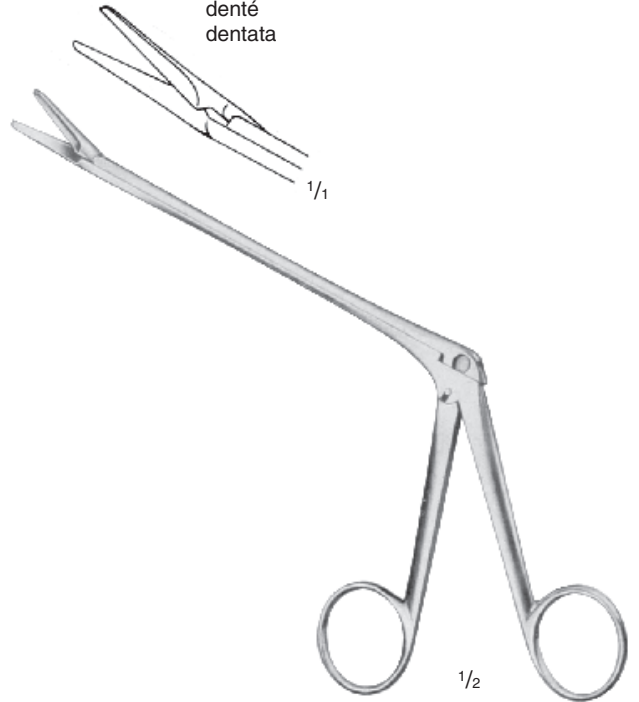

OLIVECRONA
04447-23
23 cm / 9"

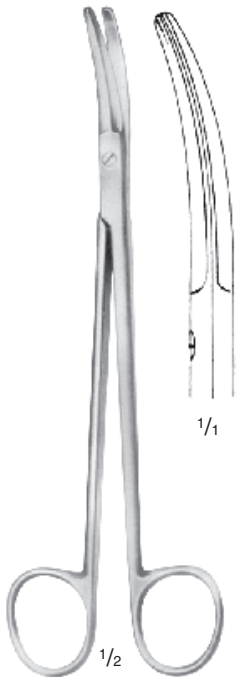

BOETTCHER
04457-18
18 cm / 7"

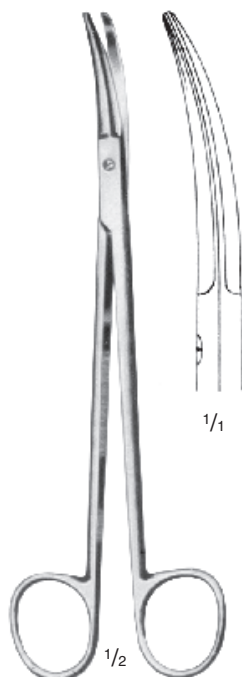

PRINCE
04461-17
17,5 cm / 7"

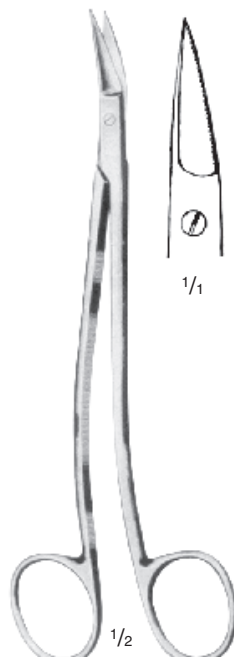

DEAN
04467-17
17 cm / 6³/₄"



04469-17
gezahnt
saw edge
dentada
denté
dentata



GOOD
04471-19
19 cm / 7¹/₂"



FOMON
04479-15
15 cm / 6"

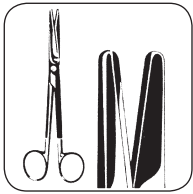

Chirurgische und gynäkologische Scheren
 Operating and Gynecological Scissors
 Tijeras para cirugía y gynecología
 Ciseaux à chirurgie et à gynécologie
 Forbici per chirurgia e ginecologia



COTTLE
 04481-16
 16 cm / 6 1/2"

HEYMANN
 04483-18
 18 cm / 7"

WALDMANN
 04503-18
 18 cm / 7"

EPISCHERE
 04505-19
 19 cm / 7 1/2"

BRAUN-STADLER
 04507-14 = 14,5 cm / 5 1/2"
 04507-22 = 22 cm / 8 3/4"

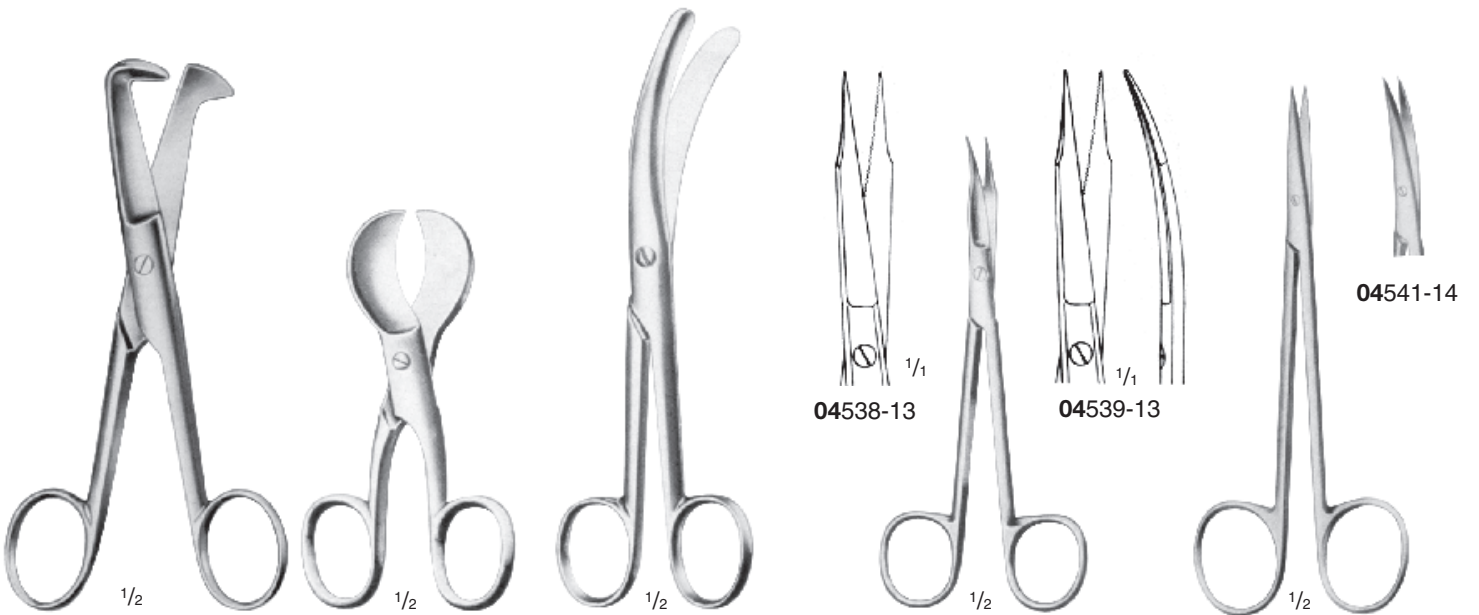

SCHUMACHER
 04509-15
 15 cm / 6"

MOD. USA
 04517-10
 10,5 cm / 4 1/4"

BUSCH
 04523-13 = 13 cm / 5"
 04523-16 = 16 cm / 6 1/4"

04538-13

04539-13

GOLDMAN-FOX
 13 cm / 5"

04541-14

BROPHY
 04540-14
 14 cm / 5 1/2"

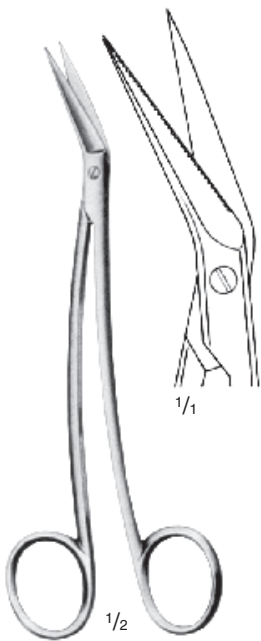
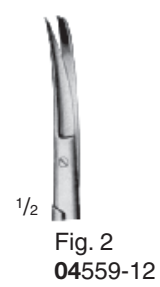
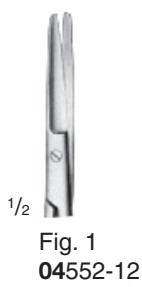
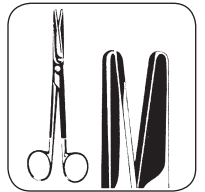

LOCKLIN
04579-16
16 cm / 6¹/₄"

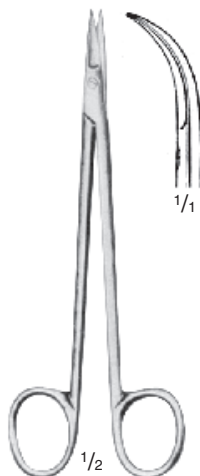

QUINBY
04583-12
12,5 cm / 5"





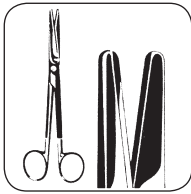







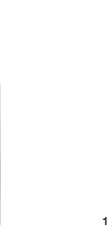

cm	in.		
9,0	3 ¹ / ₂ "	04602-09	04603-09
10,0	4"	04602-10	04603-10
11,5	4 ¹ / ₂ "	04602-11	04603-11 04605-11 04607-11



Feine Scheren
 Fine Scissors
 Tijeras finas
 Ciseaux fins
 Forbici fini



 STEVENS $\frac{1}{2}$	 $\frac{1}{1}$ gerade straight rectas droites rette	 $\frac{1}{1}$ gebogen curved curvas courbés curve	 $\frac{1}{1}$ gerade straight rectas droites rette	 $\frac{1}{1}$ gebogen curved curvas courbés curve	 04663-11 $\frac{1}{2}$	 04677-11 $\frac{1}{2}$	
					04662-11 11,5 cm / 4 1/2"	11 cm / 4 1/2"	
cm	in.						
11,0	4 1/2"	04652-11	04653-11	04654-11	04655-11		

 $\frac{1}{2}$ 18,5 cm / 7 1/4"	 $\frac{1}{1}$ YASARGIL 04708-19	 $\frac{1}{1}$ JACOBSON 04709-19	 $\frac{1}{1}$ POTTS-YASARGIL 04711-19	 $\frac{1}{2}$ WESTCOTT 04712-11 11,5 cm / 4 1/2"	 $\frac{1}{1}$ WESTCOTT 04713-11 11,5 cm / 4 1/2"
--	--	--	--	---	--



Darmscheren, Ligaturscheren
 Enterotomy Scissors, Ligature Scissors
 Tijeras-enterotomos, Tijeras para ligaduras
 Ciseaux-entérotomes, Ciseaux à ligatures
 Forbici per enterotomia, Forbici per legature



cm	in.			NORTHBENT	SPENCER
9,0	3 1/2"			04791-09	04798-09
10,5	4 1/4"				04798-10
13,0	5"		04788-13	04791-13	04798-13
15,0	6"		04788-15		
21,0	8 1/2"	04754-21	04756-21		

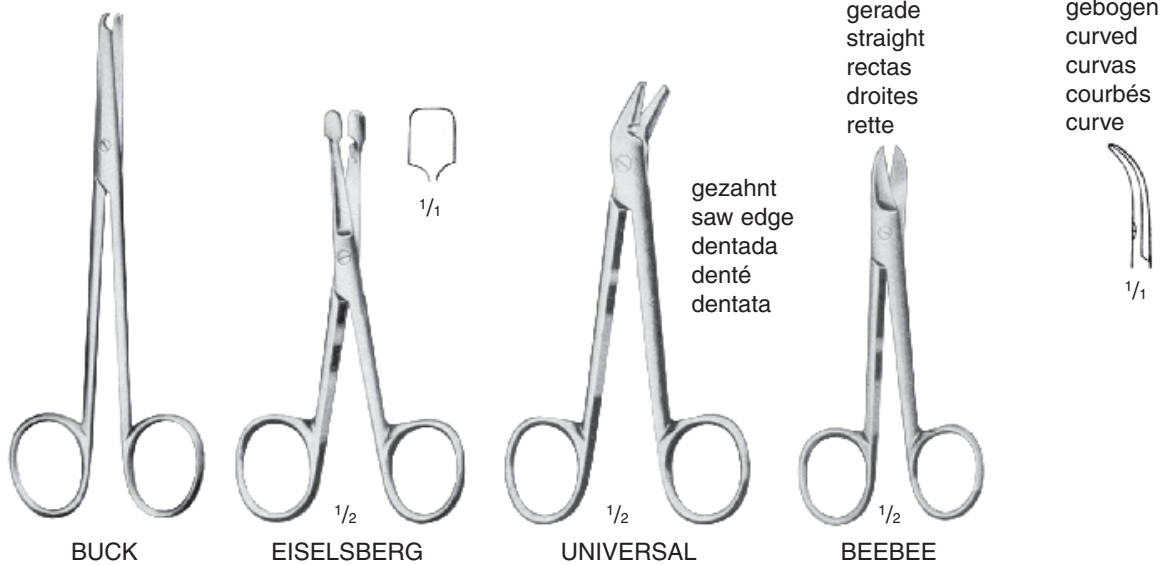

cm	in.				
10,0	4"			04846-10	04847-10
12,0	4 3/4"		04812-12	04837-12	
14,5	5 1/2"	04802-14			
18,0	7"	04802-18			

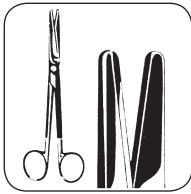

TOP DUR Scheren mit Hartmetalleinsätzen
 TOP DUR Scissors with Tungsten Carbide Inserts
 TOP DUR Tijeras con filos de carburo de tungsteno
 TOP DUR Ciseaux avec plaquettes en carbure de tungstène
 TOP DUR Forbici con taglio di carburo di tungsteno

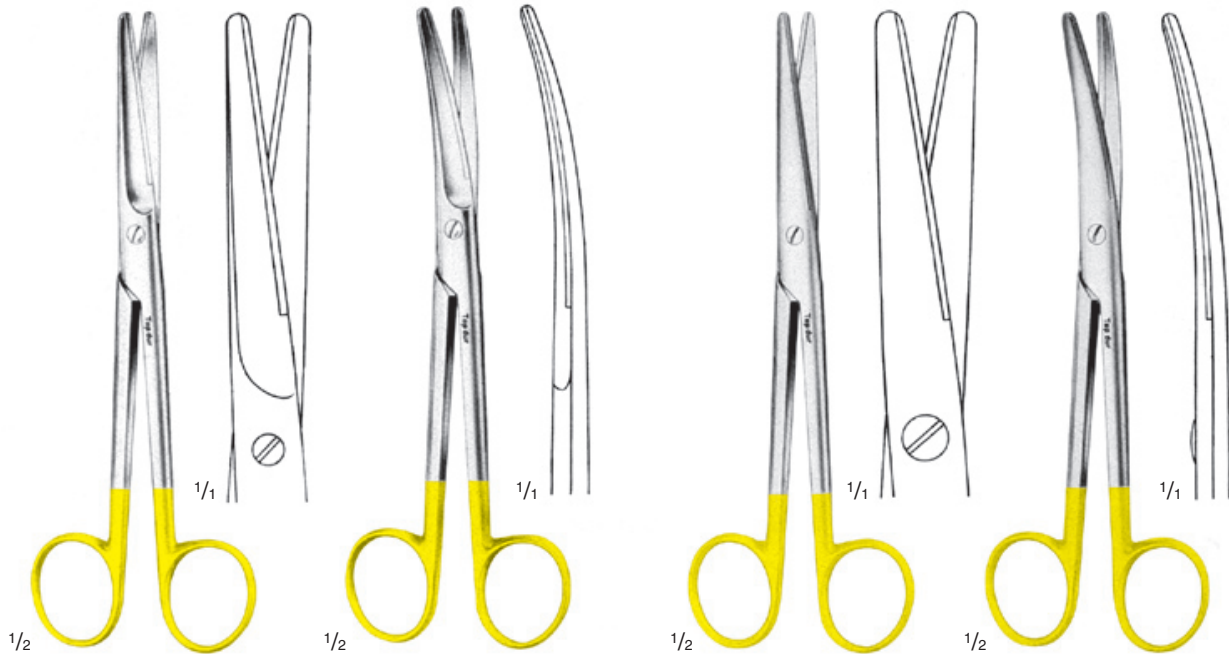
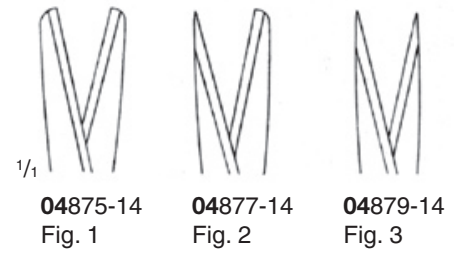
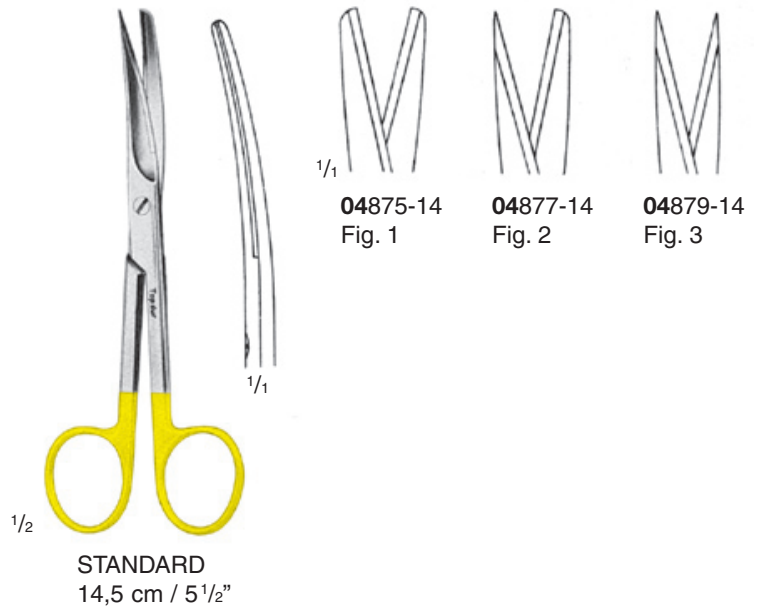
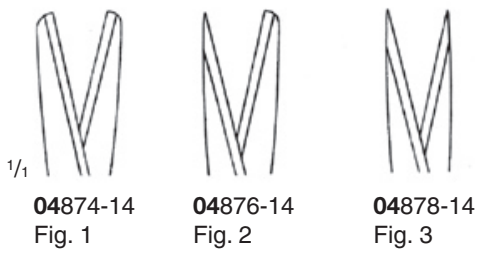

cm	in.	MAYO	MAYO	MAYO-STILLE	MAYO-STILLE
14,5	5 1/2"	04882-14	04883-14		
15,0	6"			04902-15	04903-15
17,0	6 3/4"	04882-17	04883-17	04902-17	04903-17
20,0	8"	04882-20	04883-20		
21,0	8 1/4"			04902-21	04903-21
23,0	9"	04882-23	04883-23		

TOP DUR Präparierscheren mit Hartmetalleinsätzen
 TOP DUR Dissecting Scissors with Tungsten Carbide Inserts
 TOP DUR Tijeras de disección con fillos de carburo de tungsteno
 TOP DUR Ciseaux à dissection avec plaquettes en carbure de tungstène
 TOP DUR Forbici con taglio di carburo di tungsteno

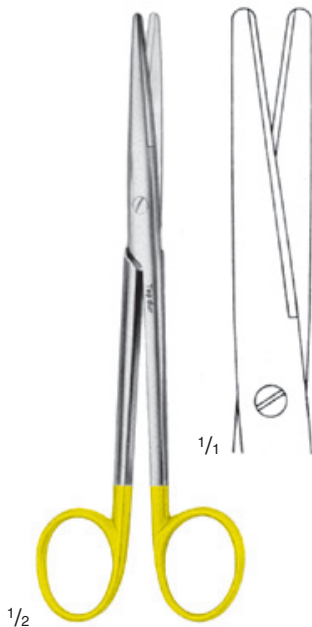

MAYO-LEXER
04904-16 = 16 cm / 6 1/4"
04904-21 = 21 cm / 8 1/4"



MAYO-LEXER
04905-16 = 16 cm / 6 1/4"
04905-21 = 21 cm / 8 1/4"



BABY-LEXER
04908-11
 11 cm / 4 1/2"



BABY-LEXER
04909-11
 11 cm / 4 1/2"



METZENBAUM
04910-14 = 14 cm / 5 1/2"
04910-18 = 18 cm / 7"
04910-20 = 20 cm / 8"

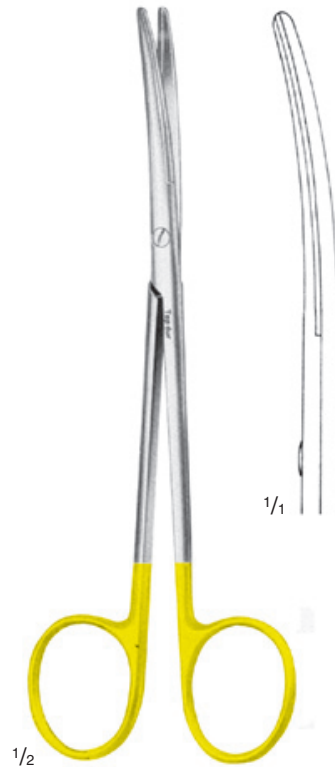

METZENBAUM
04911-14 = 14 cm / 5 1/2"
04911-18 = 18 cm / 7"
04911-20 = 20 cm / 8"

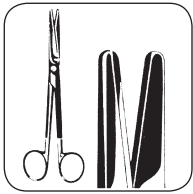

TOP DUR Scheren mit Hartmetalleinsätzen
 TOP DUR Scissors with Tungsten Carbide Inserts
 TOP DUR Tijeras con filos de carburo de tungsteno
 TOP DUR Ciseaux avec plaquettes en carbure de tungstène
 TOP DUR Forbici con taglio di carburo di tungsteno

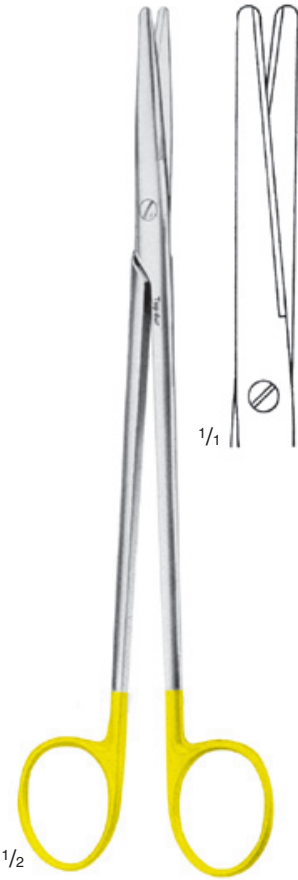

NELSON-METZENBAUM
 04914-23 = 23 cm / 9"
 04914-25 = 25 cm / 10"
 04914-28 = 28 cm / 11"
 04914-30 = 30 cm / 12"

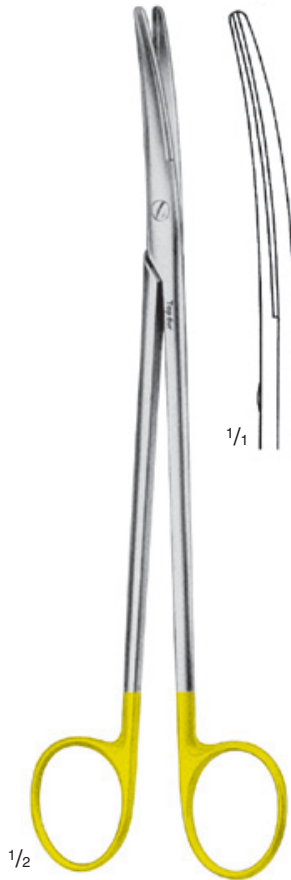

NELSON-METZENBAUM
 04915-23 = 23 cm / 9"
 04915-25 = 25 cm / 10"
 04915-28 = 28 cm / 11"
 04915-30 = 30 cm / 12"

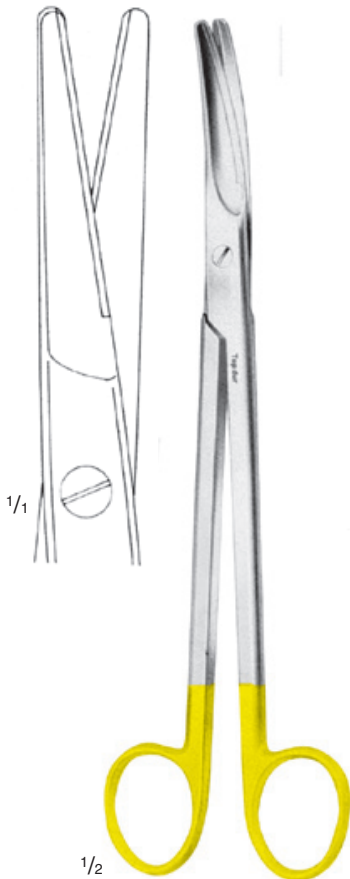

04922-23 23 cm / 9"	04924-23 23 cm / 9"	04923-23 23 cm / 9"
04922-26 26 cm / 10"	04924-26 26 cm / 10"	04923-26 26 cm / 10"
04922-30 30 cm / 12"	04924-30 30 cm / 12"	04923-30 30 cm / 12"

PARAMETRIUM

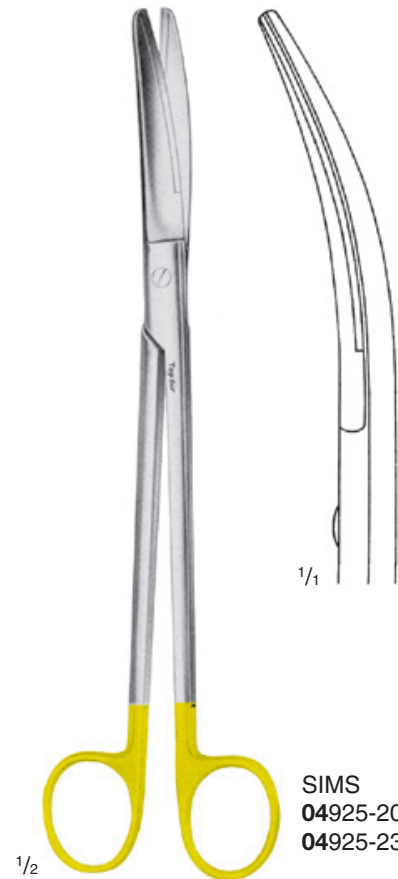

SIMS
 04925-20 = 20 cm / 8"
 04925-23 = 23 cm / 9"



TOP DUR Feine Scheren mit Hartmetalleinsätzen
 TOP DUR Fine Scissors with Tungsten Carbide Inserts
 TOP DUR Tijeras finas con filos de carburo de tungsteno
 TOP DUR Ciseaux fins avec plaquettes en carbure de tungstène
 TOP DUR Forbici fini con taglio di carburo di tungsteno

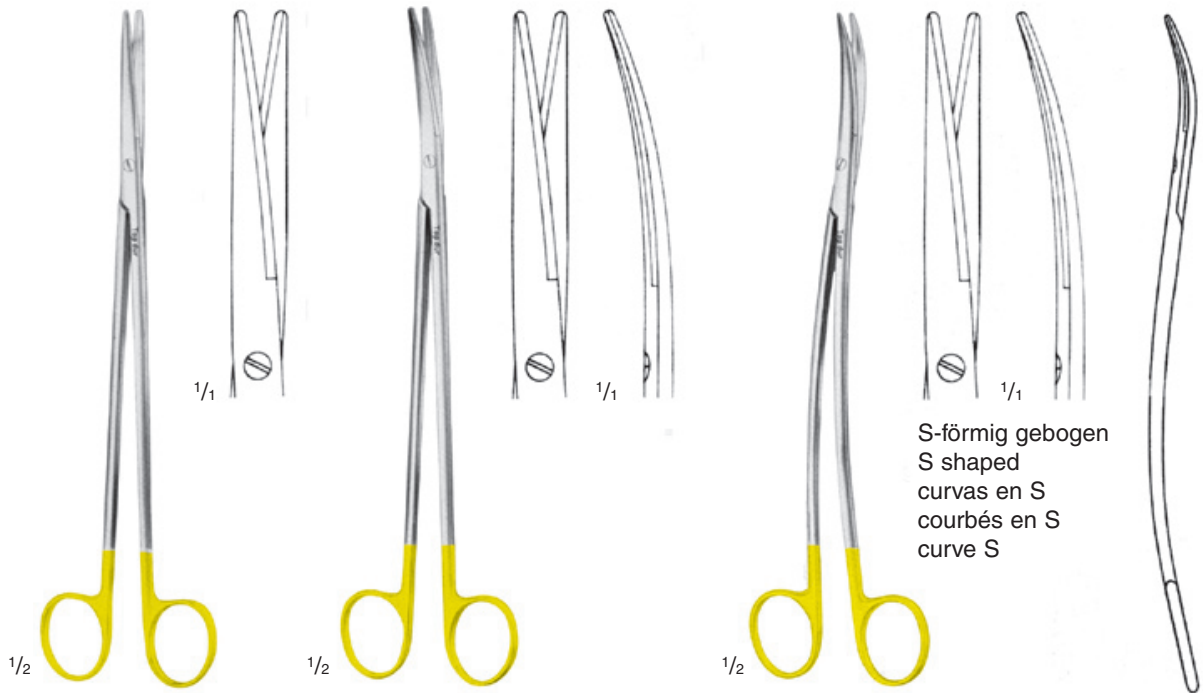

S-förmig gebogen
 S shaped
 curvas en S
 courbés en S
 curve S

cm	in.	METZENBAUM slimline	METZENBAUM slimline	METZENBAUM slimline
14,0	5 ³ / ₄ "	04926-14	04927-14	04928-14
18,0	7"	04926-18	04927-18	04928-18
20,0	8"	04926-20	04927-20	04928-20
23,0	9"	04926-23	04927-23	04928-23

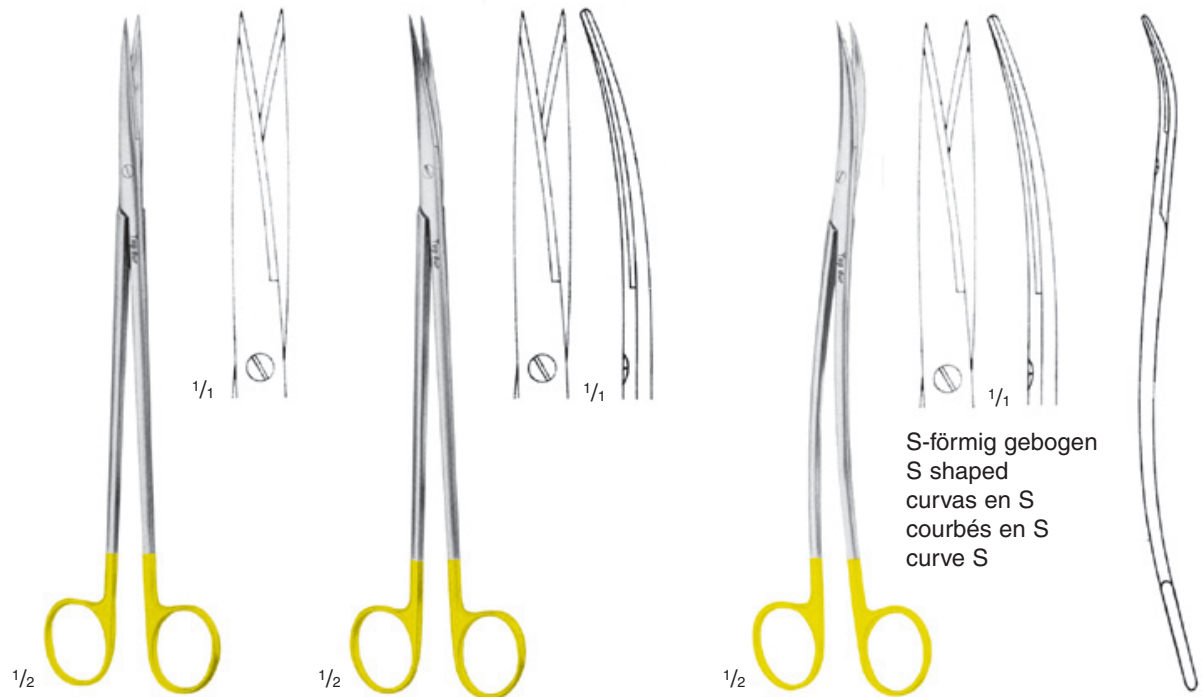

S-förmig gebogen
 S shaped
 curvas en S
 courbés en S
 curve S

cm	in.	METZENBAUM slimline	METZENBAUM slimline	METZENBAUM slimline
14,0	5 ³ / ₄ "	04934-14	04935-14	04936-14
18,0	7"	04934-18	04935-18	04936-18
20,0	8"	04934-20	04935-20	04936-20
23,0	9"	04934-23	04935-23	04936-23

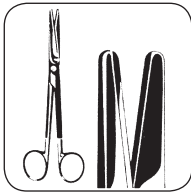

TOP DUR Feine Scheren, Drahtscheren
 TOP DUR Fine Scissors, Wire Cutting Scissors
 TOP DUR Tijeras finas, Cizalla para cortar alambre
 TOP DUR Ciseaux fins, Ciseaux pour couper les fils métalliques
 TOP DUR Forbici fini, Forbici per fili metallici



TOENNIS-ADSON
 04937-17
 17,5 cm / 7"

METZ

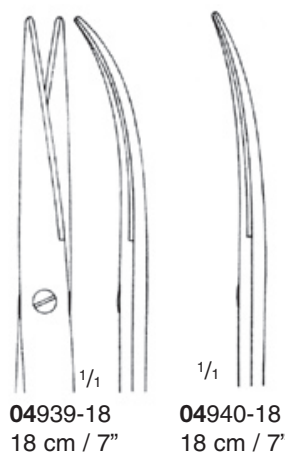

04939-18
 18 cm / 7"

04940-18
 18 cm / 7"

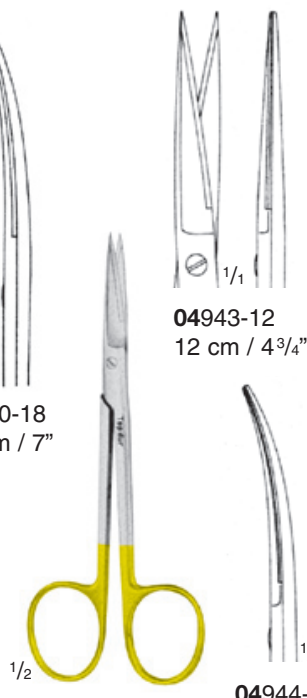

WAGNER

04944-12
 12 cm / 4 3/4"

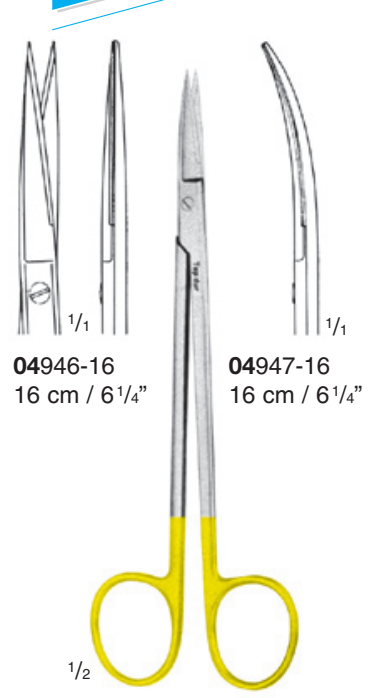

KELLY

04946-16
 16 cm / 6 1/4"

04947-16
 16 cm / 6 1/4"



- 1 Schneide gezahnt
- 1 Blade serrated
- 1 Hoja dentada
- 1 Lame denté
- 1 Lama dentata

LIGATURSCHERE
 04949-14 = 14,5 cm / 5 3/4"
 04949-18 = 18 cm / 7"
 04949-20 = 20 cm / 8"
 04949-23 = 23 cm / 9"
 04949-25 = 25 cm / 10"



FOX
 04952-13
 13 cm / 5"



IRIS
 04954-11
 11 cm / 4 1/2"



UNIVERSAL
 04967-12
 12 cm / 4 3/4"



TOP DUR Feine Scheren
 TOP DUR Fine Scissors
 TOP DUR Tijeras finas
 TOP DUR Ciseaux fins
 TOP DUR Forbici fini



POTTS-SMITH
 19 cm / 7 1/2"

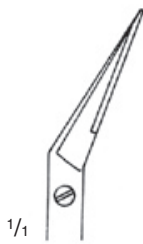

04968-25
 25°

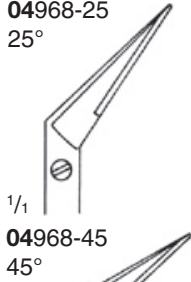

04968-45
 45°

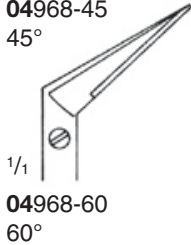

04968-60
 60°



DE BAKEY



04970-17
 17 cm / 6 3/4"
 25°



04970-23
 23 cm / 9"
 25°



04970-28
 28 cm / 11"
 25°

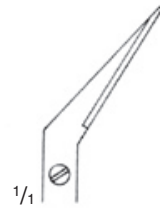

04971-17
 17 cm / 6 3/4"
 45°



04971-23
 23 cm / 9"
 45°



04971-28
 28 cm / 11"
 45°

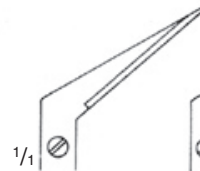

04972-17
 17 cm / 6 3/4"
 60°

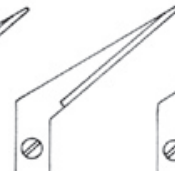

04972-23
 23 cm / 9"
 60°

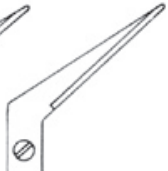

04972-28
 28 cm / 11"
 60°

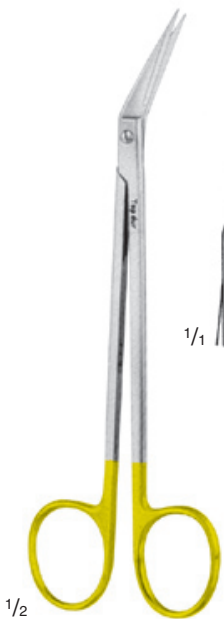

LOCKLIN
04974-16
 16 cm / 6 1/4"

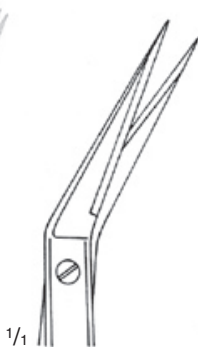

LOCKLIN
04975-16
 16 cm / 6 1/4"





TOP DUR-IPERCUT Präparierscheren für plastische Chirurgie
 TOP DUR-IPERCUT Dissecting Scissors for Plastic Surgery
 TOP DUR-IPERCUT Tijeras de disección
 TOP DUR-IPERCUT Ciseaux à dissection
 TOP DUR-IPERCUT Forbici per preparazioni

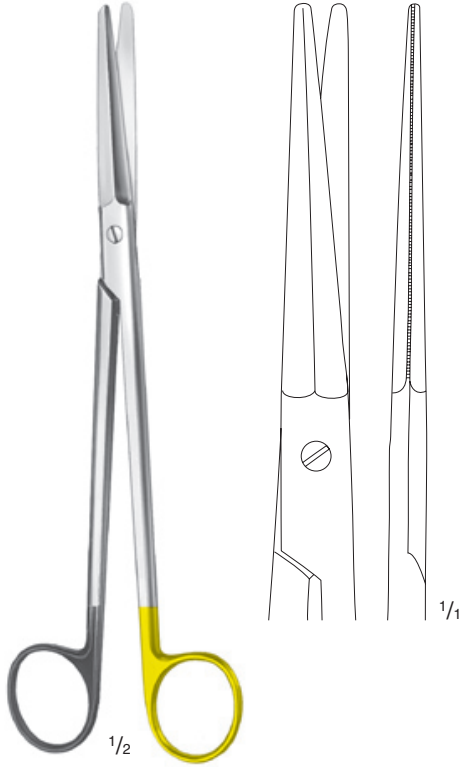

GORNEY
04299-51
 20 cm / 8"

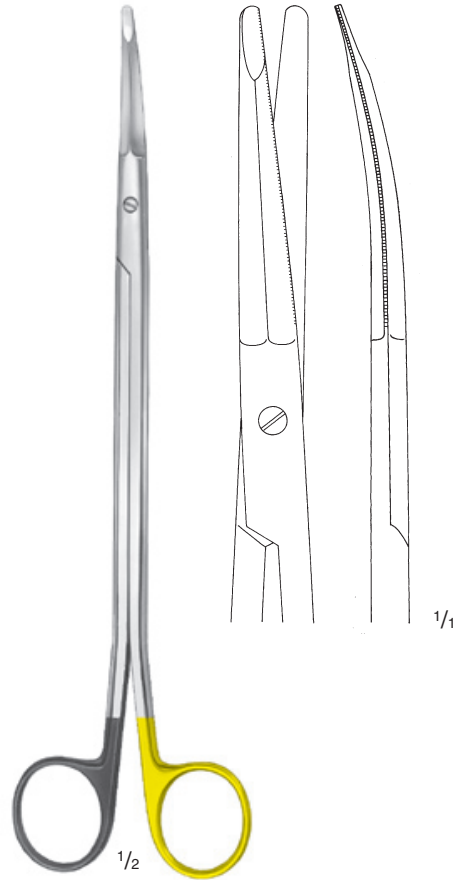

GORNEY FACE-LIFT
04300-52
 23 cm / 9"

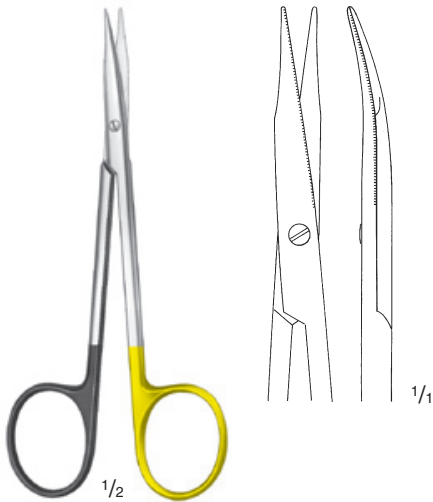

STEVENS
04317-51
 12,5 cm / 5"

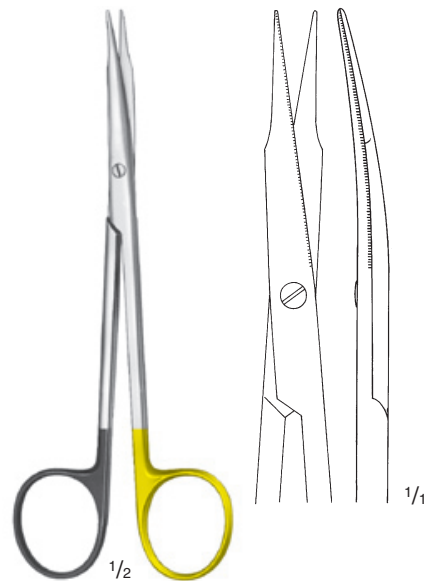

JAMESON
04337-50
 15 cm / 6"

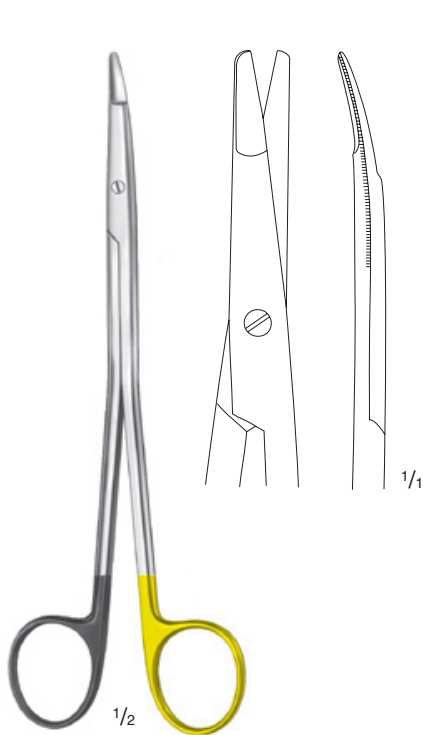

FREEMAN
04331-50
 18 cm / 7"

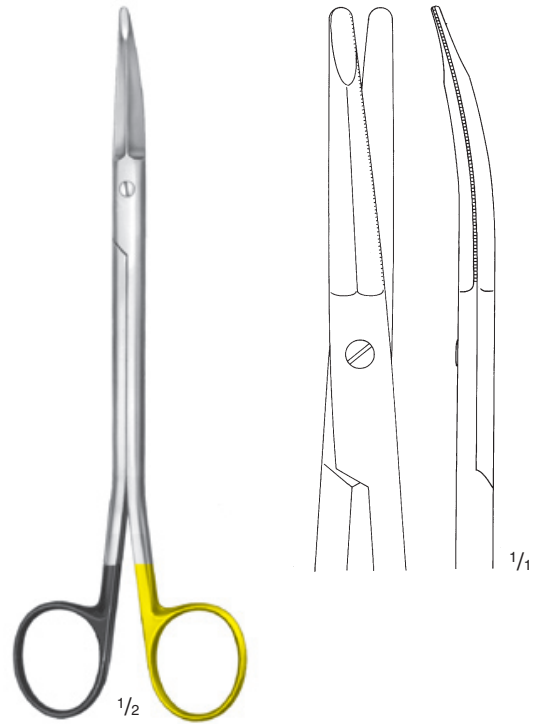

FREEMAN KAYE
04335-50
 19 cm / 7 1/2"

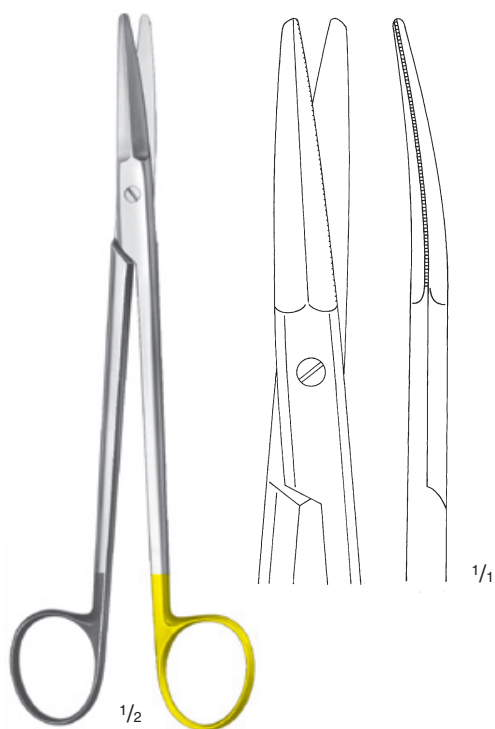

GORNEY (BÖTTCHER)
04457-50
 18,5 cm / 7 1/4"

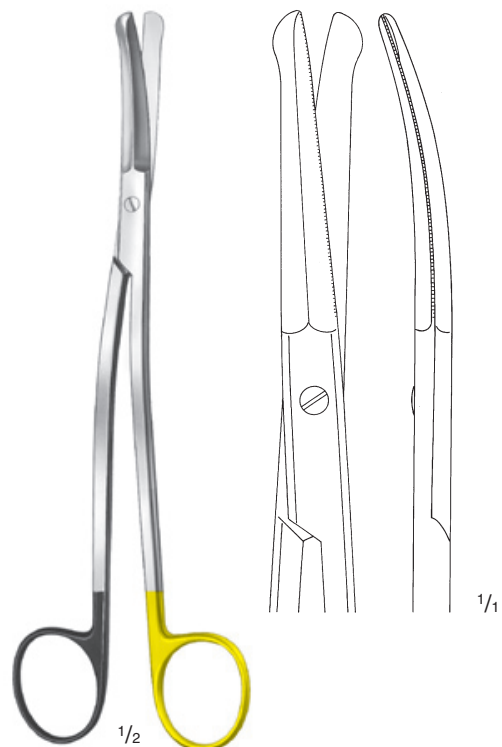

GOOD TONSILLEN SCHERE
04471-50
 19,5 cm / 7 1/2"



TOP DUR-IPERCUT Präparierschere, Episiotomiescheren
 TOP DUR-IPERCUT Dissecting Scissors, Episiotomy Scissors
 TOP DUR-IPERCUT Tijeras de disección, Tijeras para episiotomia
 TOP DUR-IPERCUT Ciseaux à dissection, Ciseaux à épisiotomie
 TOP DUR-IPERCUT Forbici per preparazioni, Forbici per episiotomia



1/2

04505-50
 19 cm / 7 1/2"
 TOP DUR-IPERCUT
 Episiotomieschere
 Episiotomy scissors



1/1

04505-10
 19 cm / 7 1/2"
 TOP DUR
 Episiotomieschere
 Episiotomy scissors

04505-11
 19 cm / 7 1/2"
 TOP DUR
 Episiotomieschere mit Mikroverzahnung
 Episiotomy scissors with micro teeth

04505-19
 19 cm / 7 1/2"
 STANDARD
 Episiotomieschere
 Episiotomy scissors

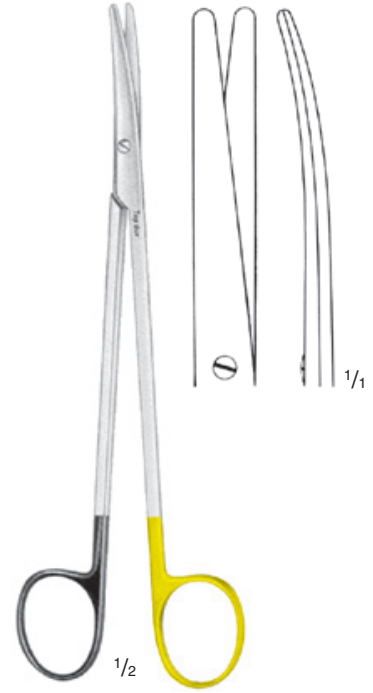

1/2

METZENBAUM
04911-64 = 14 cm / 5 1/2"
04911-68 = 18 cm / 7"
04911-70 = 20 cm / 8"

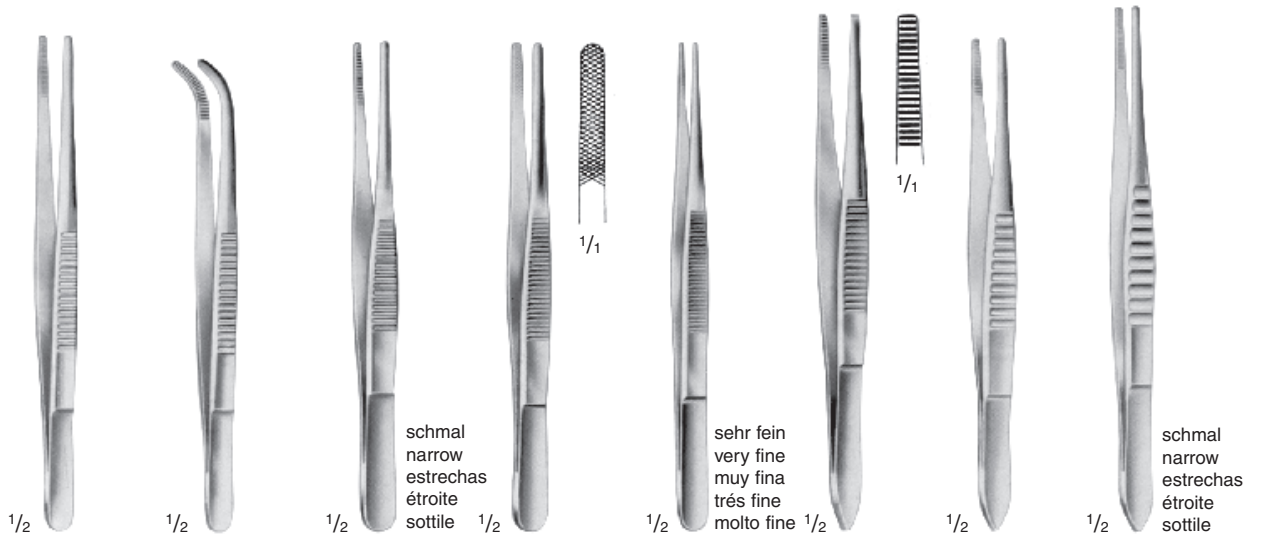

cm	in.	STANDARD	STANDARD			STILLE	USA		
10,5	4 1/4"	06072-10							
11,5	4 1/2"	06072-11	06073-11	06092-11		06102-11			
12,0	4 3/4"						06112-12	06118-12	
13,0	5"	06072-13	06073-13	06092-13	06096-13	06098-13	06102-13	06112-13	06118-13
14,5	5 1/2"	06072-14	06073-14	06092-14	06096-14	06098-14		06112-14	06118-14
15,0	6"						06102-15	06112-15	06118-15
16,0	6 1/4"	06072-16	06073-16	06092-16	06096-16				
17,0	6 3/4"					06102-17			
18,0	7"	06072-18	06073-18	06092-18				06112-18	
20,0	8"	06072-20	06073-20	06092-20		06102-20			
21,0	8 1/4"							06112-21	
25,0	10"	06072-25		06092-25				06112-25	
30,0	12"	06072-30		06092-30					
31,0	12 1/4"							06112-31	

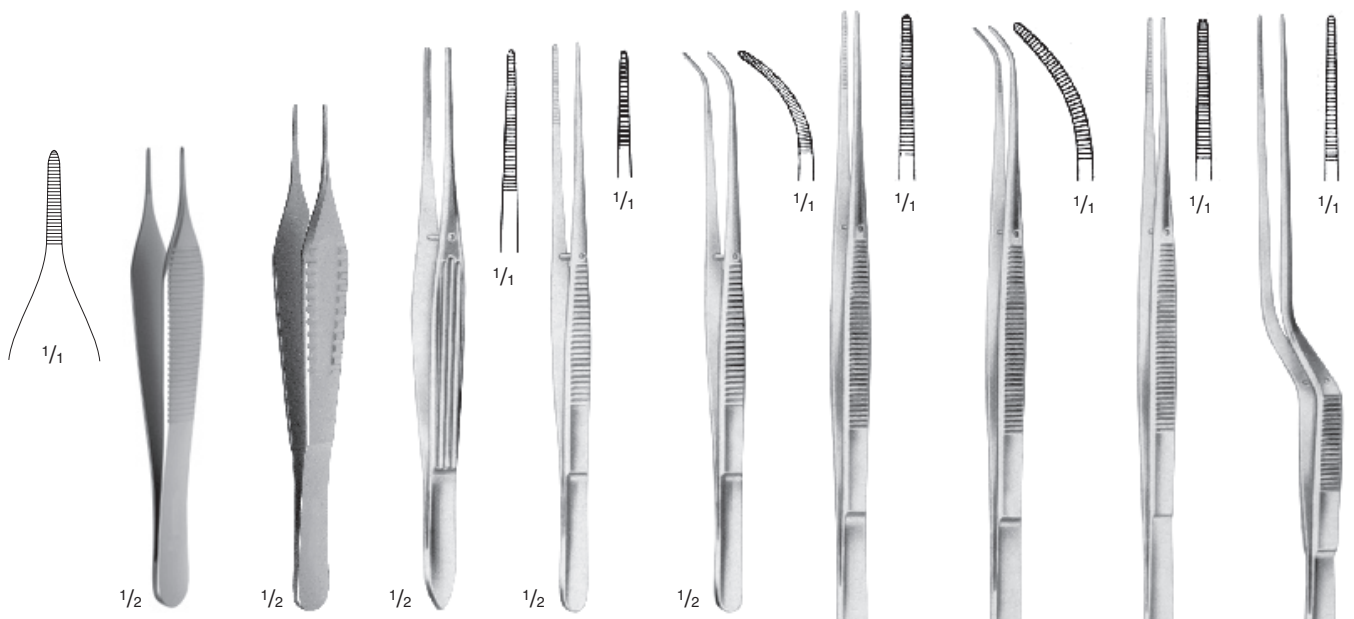

cm	in.	ADSON	ADSON	MC INDOE	SEMKEN	SEMKEN	TAYLOR	TAYLOR	TAYLOR	TAYLOR
12,0	4 3/4"	06140-12		06144-12	06145-12					
13,0	5"		06140-13							
15,0	6"	06140-15		06142-15	06144-15	06145-15	06146-17	06147-17	06152-17	06155-17
17,5	7"									

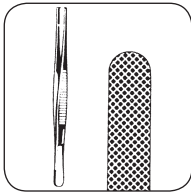

Anatomische Pinzetten
 Dressing Forceps
 Pinzas de disección
 Pincés à dissection
 Pinze anatomiche

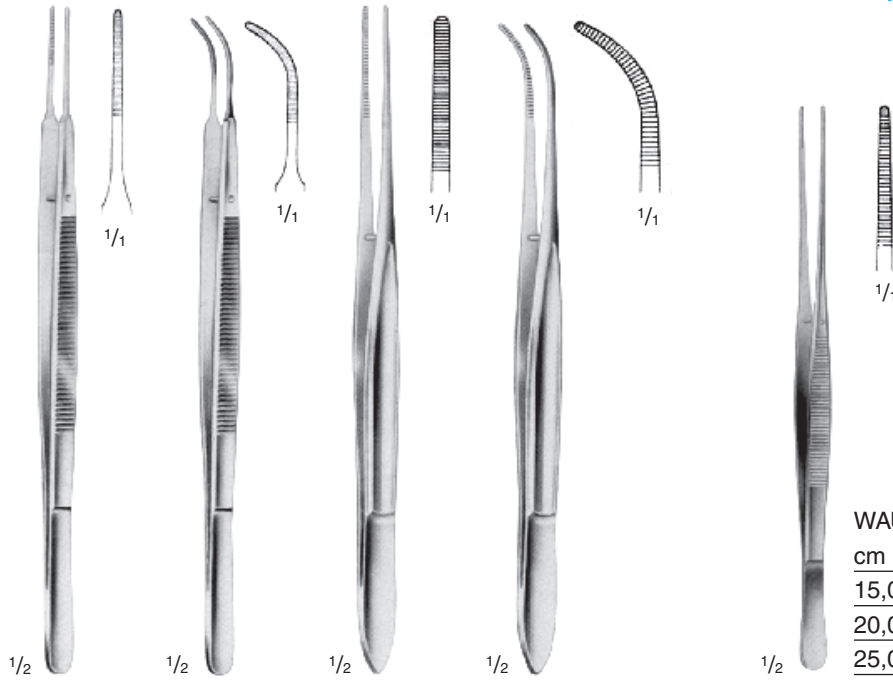

cm	in.	GERALD	GERALD	CUSHING	CUSHING
17,5	7"	06158-18	06159-18	06160-17	06161-17

WAUGH

cm	in.	
15,0	6"	06163-15
20,0	8"	06163-20
25,0	10"	06163-25

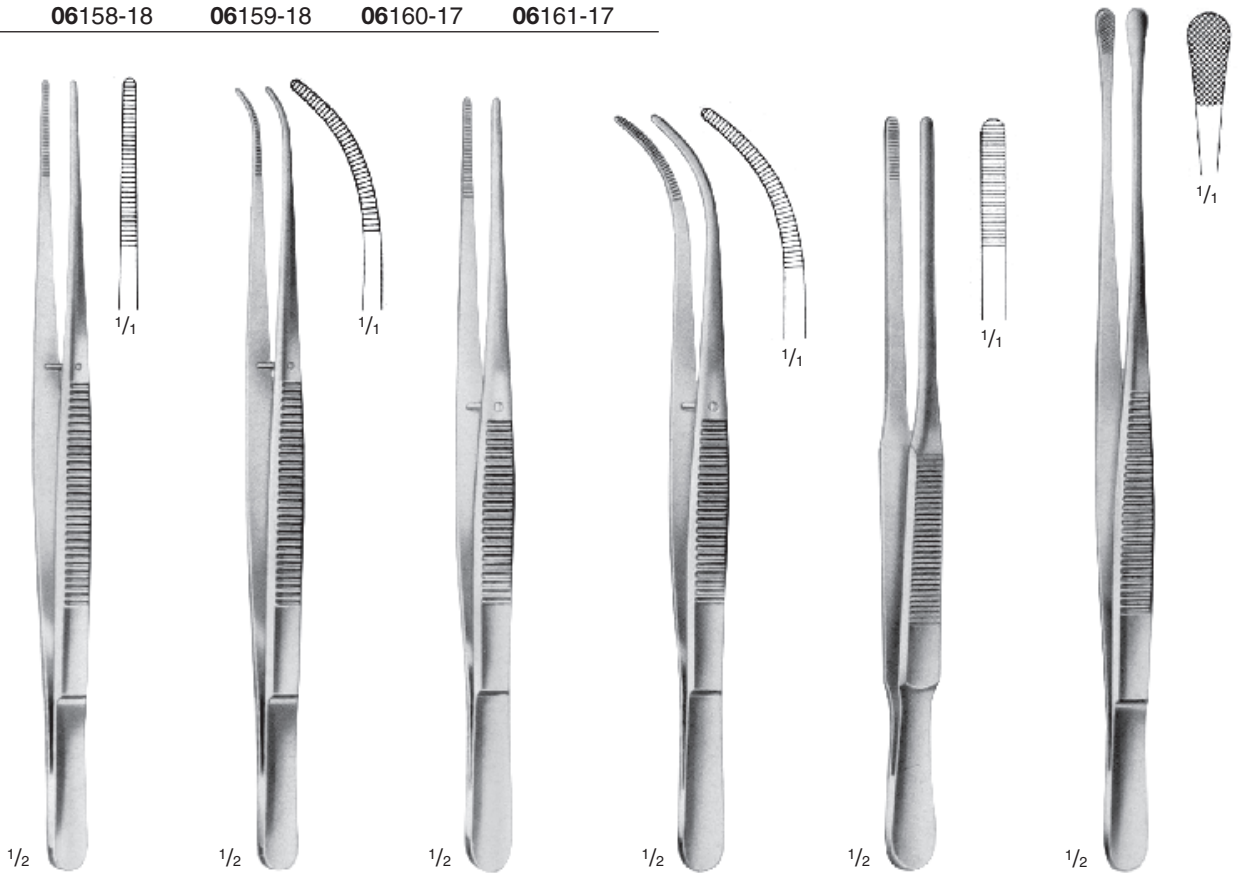

cm	in.	POTTS-SMITH	BROPHY	BROPHY	DUEHRSSSEN	WANGENSTEEN
18,0	7"	06164-18	06165-18			
20,0	8"		06168-20	06169-20	06182-20	
21,0	8 1/4"	06164-21	06165-21			
23,0	9"					06192-23
25,0	10"	06164-25	06165-25			

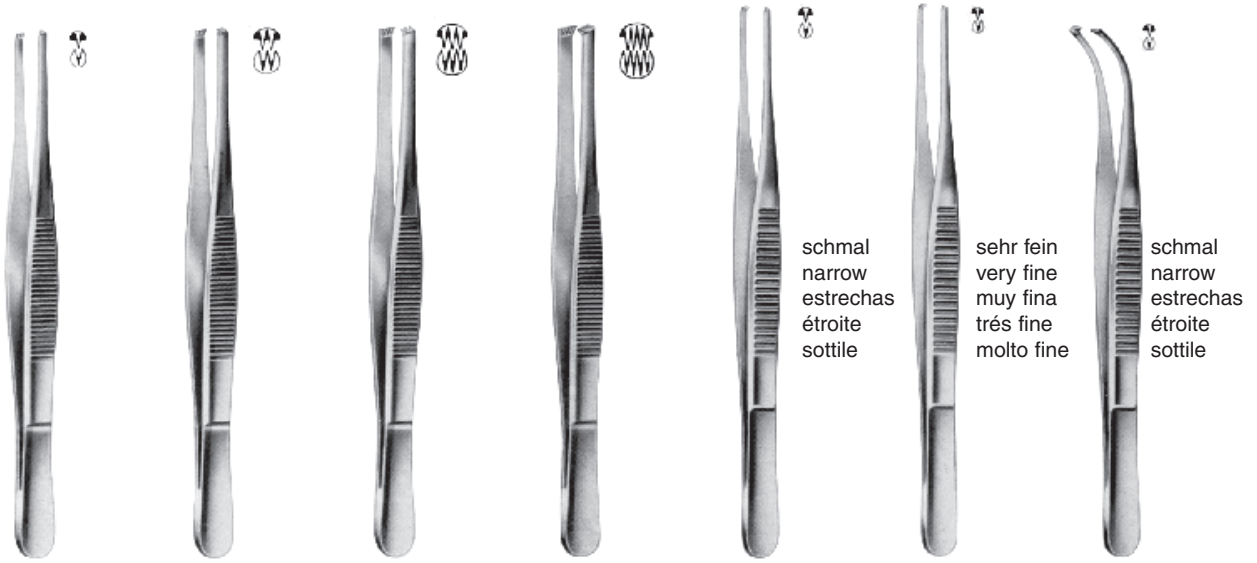

schmal
narrow
estrechas
étroite
sottile

sehr fein
very fine
muy fina
très fine
molto fine

schmal
narrow
estrechas
étroite
sottile

cm	in.	1 x 2	2 x 3	3 x 4	4 x 5	1 x 2	1 x 2	1 x 2
10,5	4 1/4"	06273-10						
11,5	4 1/2"	06273-11	06274-11			06293-11		
13,0	5"	06273-13	06274-13	06275-13	06276-13	06293-13	06298-13	06301-13
14,5	5 1/2"	06273-14	06274-14	06275-14	06276-14	06293-14	06298-14	06301-14
16,0	6 1/4"	06273-16	06274-16	06275-16	06276-16	06293-16		
18,0	7"	06273-18	06274-18			06293-18		
20,0	8"	06273-20	06274-20	06275-20		06293-20		
25,0	10"	06273-25	06274-25			06293-25		
30,0	12"	06273-30	06274-30					

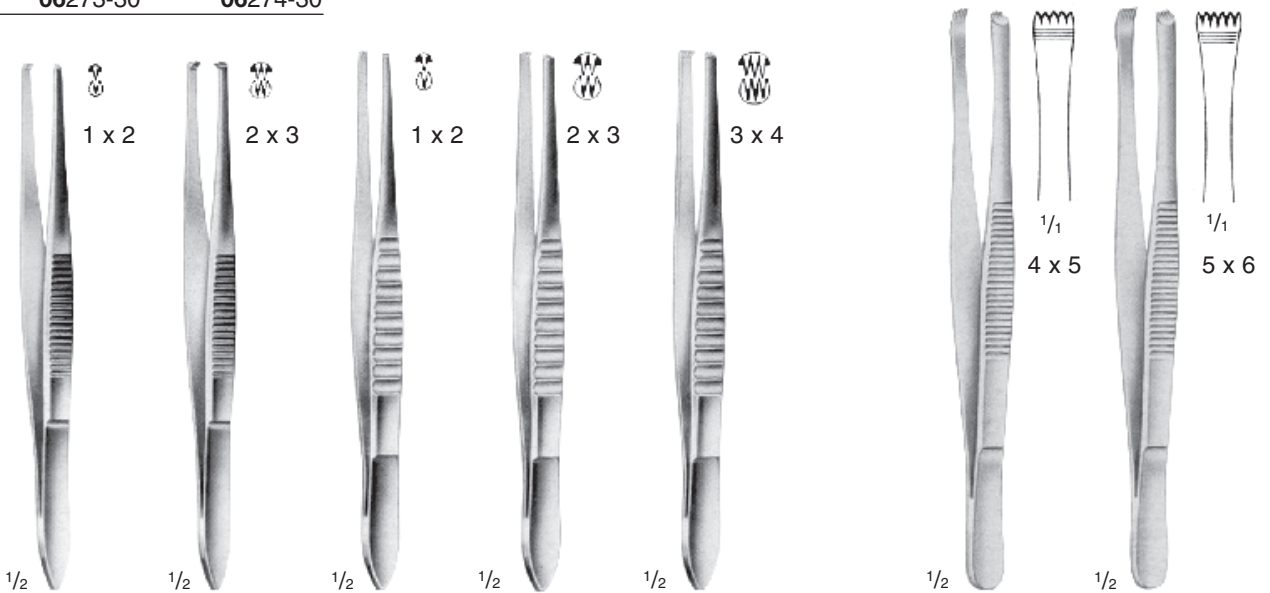

cm	in.	1 x 2	2 x 3	1 x 2	2 x 3	3 x 4	1/1	1/1
		1/2	1/2	1/2	1/2	1/2	4 x 5	5 x 6
		STILLE	STILLE		MOD. USA		STONE	LERCHE
12,0	4 3/4"			06313-12				
13,0	5"			06313-13	06314-13			
14,5	5 1/2"			06313-14	06314-14	06315-14		
15,0	6"	06303-15	06304-15	06313-15	06314-15		06336-15	06337-15
18,0	7"			06313-18				
21,0	8 1/4"			06313-21				
25,0	10"			06313-25				
31,0	12 1/4"			06313-31				

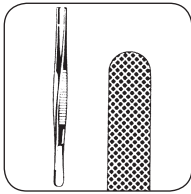

Chirurgische Pinzetten
 Tissue Forceps
 Pinzas de disección con dientes
 Pincés à dissection à griffes
 Pinze chirurgiche

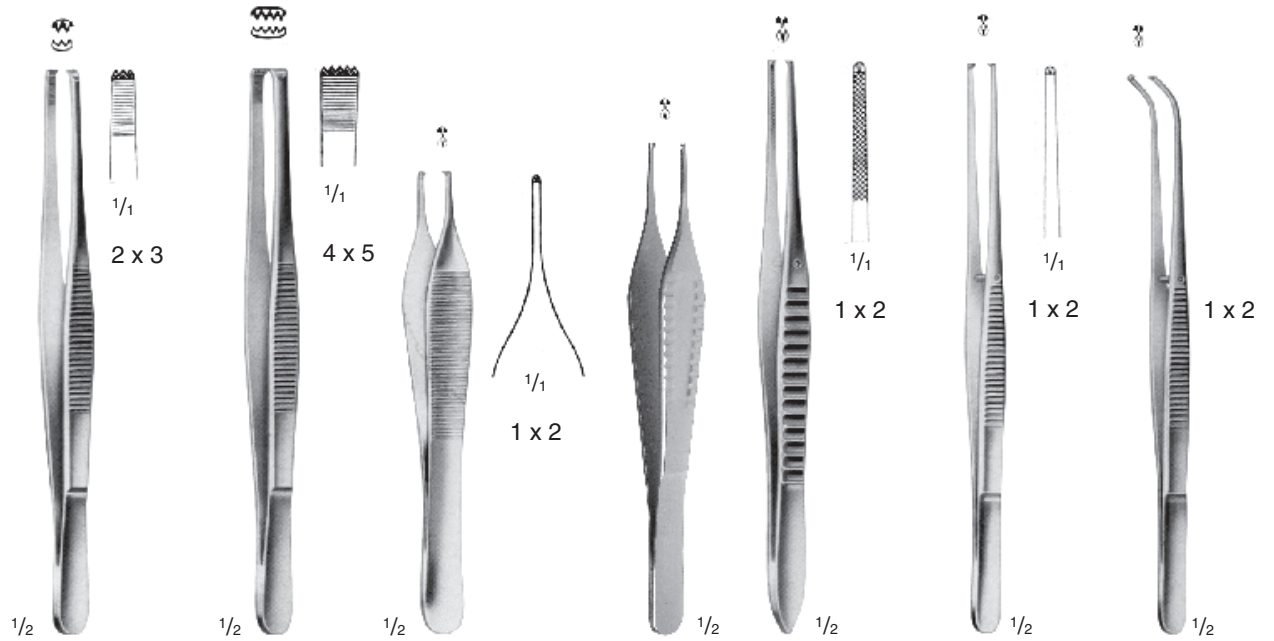

cm	in.	ADLERKREUTZ	ADSON	GILLIES	SEMKEN	SEMKEN
12,0	4 3/4"		06340-12		06344-12	06345-12
13,0	5"			06340-13		
15,0	6"	06338-15	06339-15	06340-15	06342-15	06344-15
20,0	8"	06338-20	06339-20			

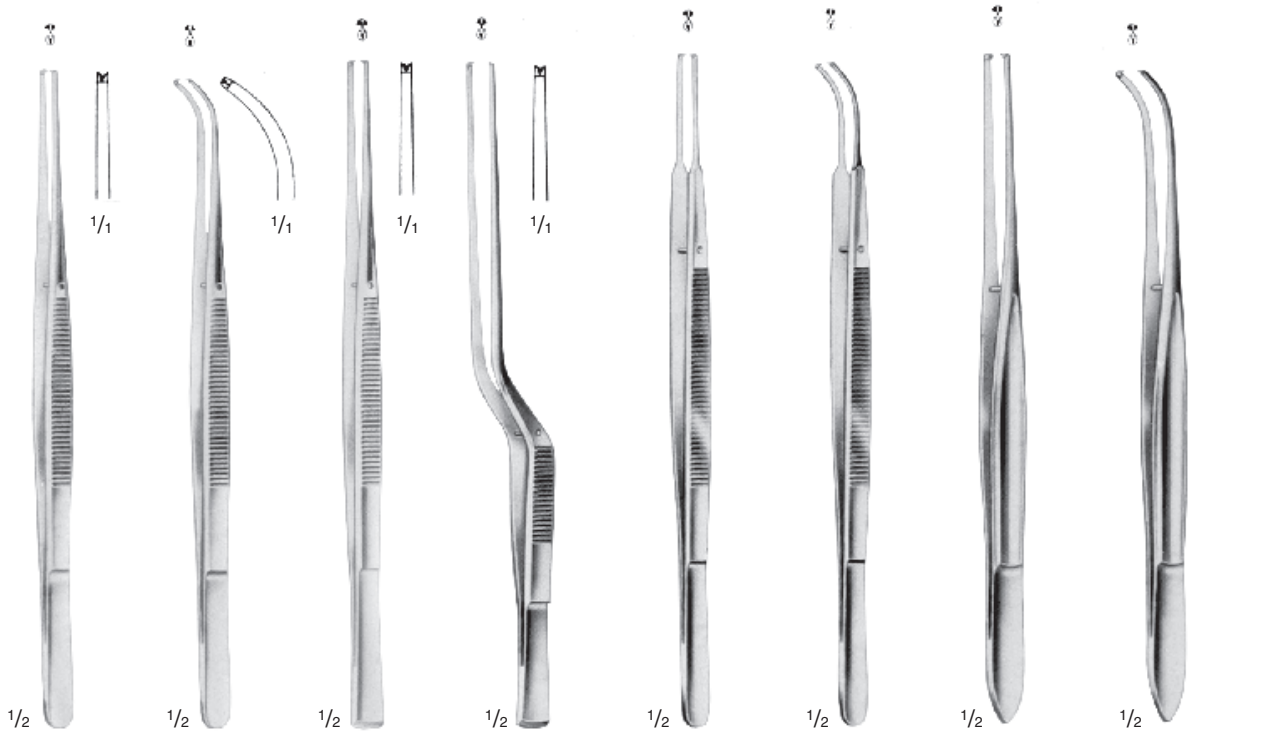

cm	in.	TAYLOR	TAYLOR	TAYLOR	TAYLOR	GERALD	GERALD	CUSHING	CUSHING
17,5	7"	06346-17	06347-17	06352-17	06355-17	06358-17	06359-17	06360-17	06361-17

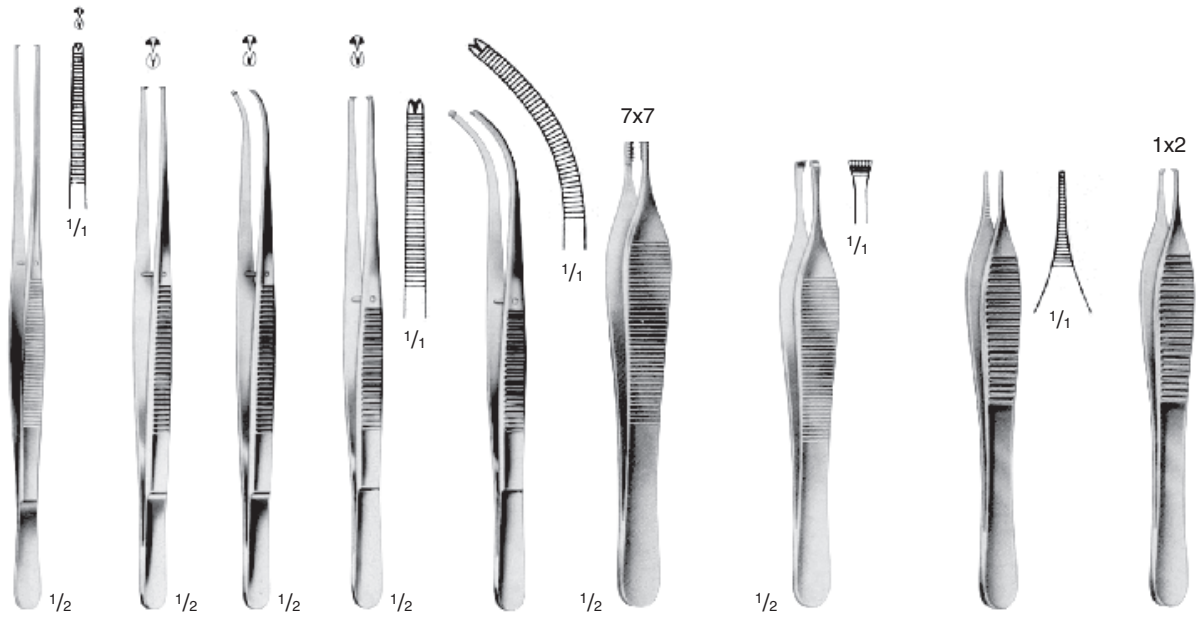

cm	in.	WAUGH	POTTS-SMITH	BROPHY	BROPHY	ADSON-BROWN	ADSON-GRAEFE	MICRO-ADSON	MICRO-ADSON
12,0	4 ³ / ₄ "					06372-12	06374-12	06376-12	06378-12
15,0	6"	06363-15						06376-15	06378-15
18,0	7"		06364-18	06365-18					
20,0	8"	06363-20		06368-20	06369-20				
21,0	8 ¹ / ₄ "		06364-21	06365-21					
25,0	10"	06363-25	06364-25	06365-25					

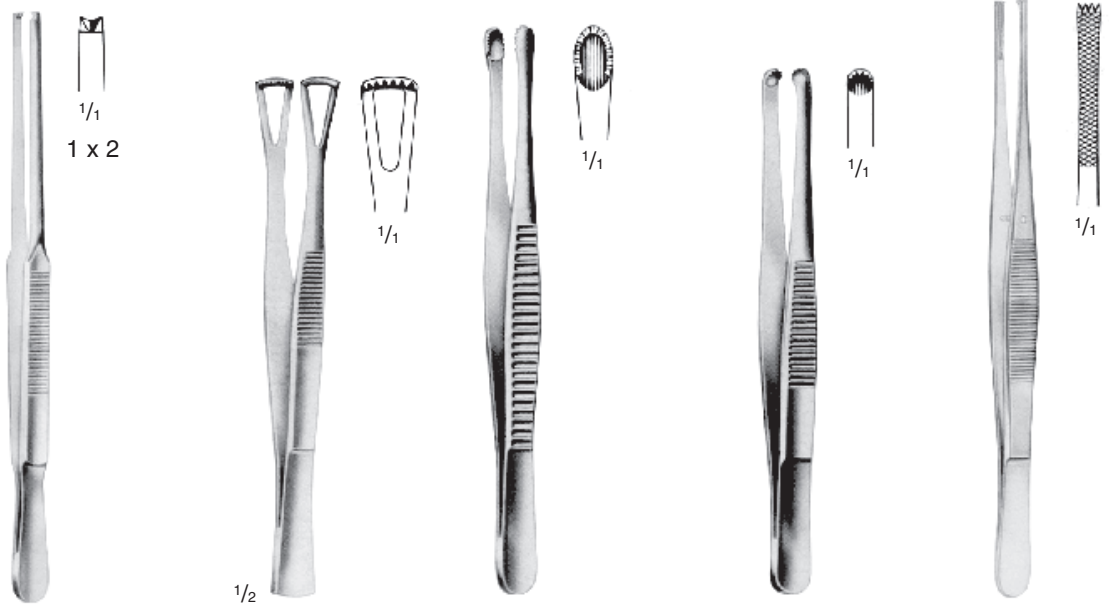

cm	in.	DUEHRSSSEN	DUVAL	RUSS. MODELL	DURANTE	STILLE-BARRAYA
14,5	5 ¹ / ₂ "		06388-14		06398-14	
15,0	6"			06392-15		
16,0	6 ¹ / ₄ "				06398-16	
18,0	7"					06416-18
20,0	8"	06383-20		06392-20	06398-20	06416-20
25,0	10"			06392-25		06416-25
26,0	10 ¹ / ₄ "				06398-26	

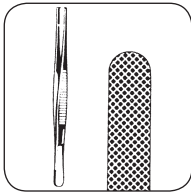

Faßpinzetten
Grasping Forceps
Pinzas para coger
Pinces pour saisir les tissus
Pinze per afferrare tessuti



MAYO-RUSS.
06428-23
23 cm / 9"



DAVIS
06430-25
25 cm / 10"



SINGLEY-TUTTLE
06432-18 = 18 cm / 7"
06432-23 = 23 cm / 9"



NELSON
06438-23
23 cm / 9"

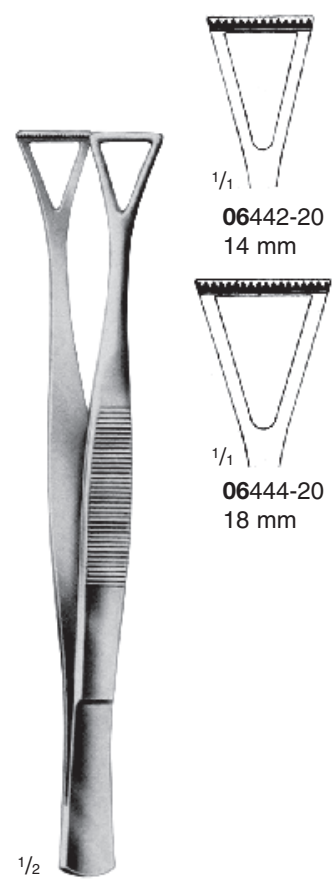

COLLIN-DUVAL
20 cm / 8"

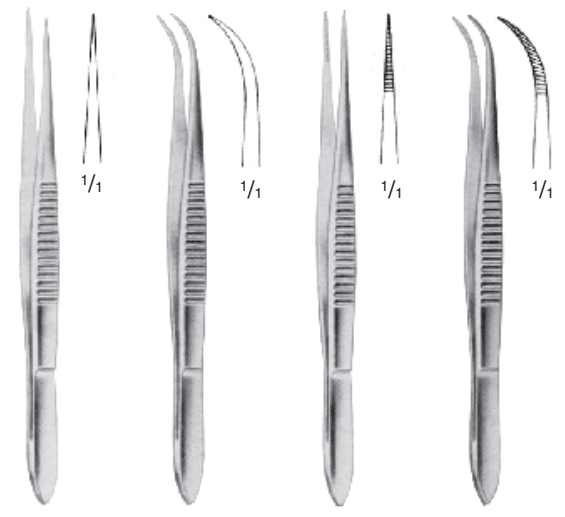
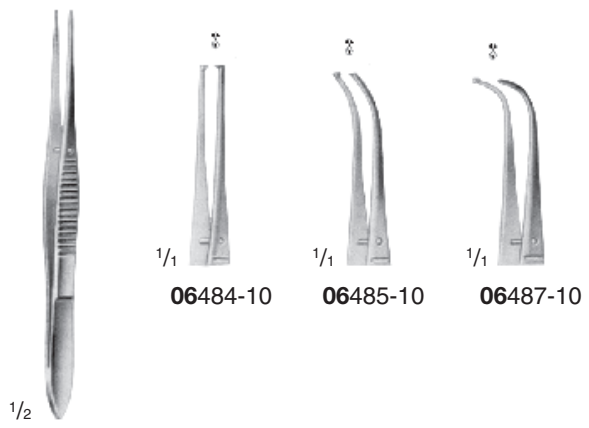

cm	in.				
8,0	3 1/4"			06576-08	06577-08
9,0	3 1/2"	06572-09	06573-09	06576-09	06577-09
10,5	4 1/4"	06572-10	06573-10	06576-10	06577-10
11,5	4 1/2"	06572-11	06573-11	06576-11	06577-11
12,5	5"	06572-12	06573-12	06576-12	06577-12

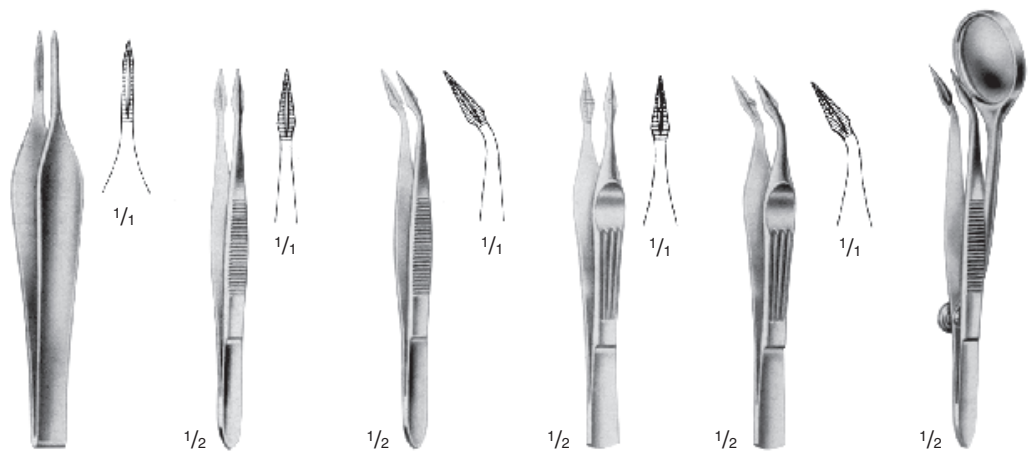

cm	in.	FEILCHENFELD	HUNTER	HUNTER	WALTER	WALTER
7,5	3"	06602-07				
9,0	3 1/2"	06602-09				
10,0	4"		06612-10	06613-10	06622-10	06623-10
11,5	4 1/2"	06602-11				
12,0	4 3/4"					06626-12



Cilienpinzetten und Splitterzangen
 Cilia Forceps and Splinter Forceps
 Pinzas depilación y Pinzas para espina
 Pincès à épiler le cils et Pincès à échardes
 Pinze depilatorie e Pinze per schegge



$\frac{1}{2}$
LITTAUER
06636-08
 8,5 cm / 3 $\frac{1}{2}$ "



$\frac{1}{2}$
06638-09
 9 cm / 3 $\frac{1}{2}$ "



$\frac{1}{2}$
DOUGLAS
06646-09
 9 cm / 3 $\frac{1}{2}$ "

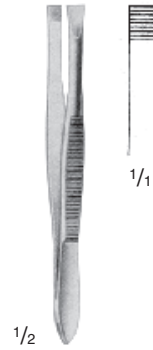

$\frac{1}{2}$
DOUGLAS
06648-09
 9 cm / 3 $\frac{1}{2}$ "

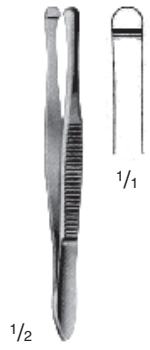

$\frac{1}{2}$
BEER
06652-09
 9 cm / 3 $\frac{1}{2}$ "

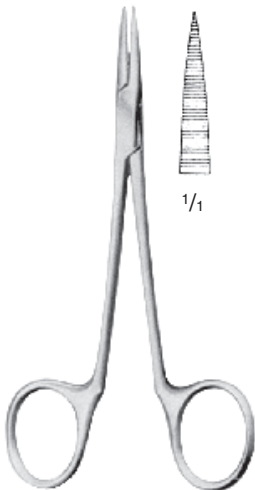

$\frac{1}{2}$
RAPP
06672-13
 13 cm / 5"

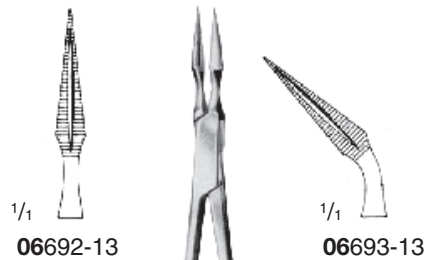

$\frac{1}{2}$
STIEGLITZ
 13,5 cm / 5 $\frac{1}{4}$ "



$\frac{1}{2}$
PEET
06697-11
 11,5 cm / 4 $\frac{1}{2}$ "

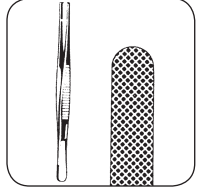

06500-12
12 cm / 4³/₄"

06500-15
15 cm / 6"

06501-12
12 cm / 4³/₄"

06501-15
15 cm / 6"

06502-12
12 cm / 4³/₄"

06502-15
15 cm / 6"

ADSON

MICRO-ADSON

ADSON-BROWN
06503-12
 12 cm / 4³/₄"



STANDARD

06504-13 = 13 cm / 5"

06504-14 = 14 cm / 5¹/₂"

06504-16 = 16 cm / 6¹/₂"

STANDARD

06505-18 = 18 cm / 7"

06505-20 = 20 cm / 8"

06505-25 = 25 cm / 10"

POTTS-SMITH

06507-15 = 15 cm / 6"

06507-18 = 18 cm / 7"

06507-20 = 20 cm / 8"

06507-25 = 25 cm / 10"

mit Dissektor-Ende
 with dissector end
 con cabo disecador
 avec bout dissecteur
 con dissettore



TOP DUR Pinzetten mit Hartmetalleinsätzen
 TOP DUR Dissecting Forceps with Tungsten Carbide Inserts
 TOP DUR Pinzas de disección con bocas de carburo de tungsteno
 TOP DUR Pinces à dissection avec mors en carbure de tungstène
 TOP DUR Pinze a molla con punte di carburo di tungsteno



mit Dissektor-Ende
 with dissector end
 con cabo disecador
 avec bout dissecteur
 con dissettore

1/2

LUCAE
 06509-18
 18 cm / 7"



1/1

MERIAM
 06510-16
 16 cm / 6 1/2"



1/1

CUSHING
 06511-17
 17 cm / 6 3/4"



1/1

CUSHING
 06512-18
 18 cm / 7"

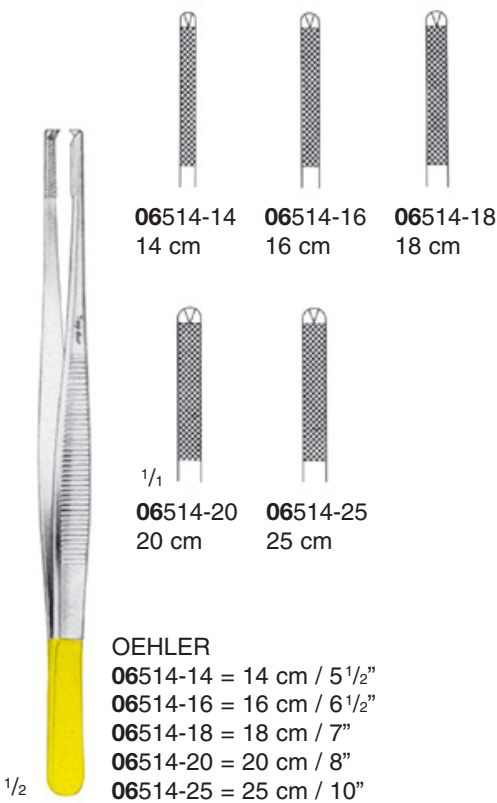

06514-14 14 cm
 06514-16 16 cm
 06514-18 18 cm

06514-20 20 cm
 06514-25 25 cm

1/2

OEHLER
 06514-14 = 14 cm / 5 1/2"
 06514-16 = 16 cm / 6 1/2"
 06514-18 = 18 cm / 7"
 06514-20 = 20 cm / 8"
 06514-25 = 25 cm / 10"

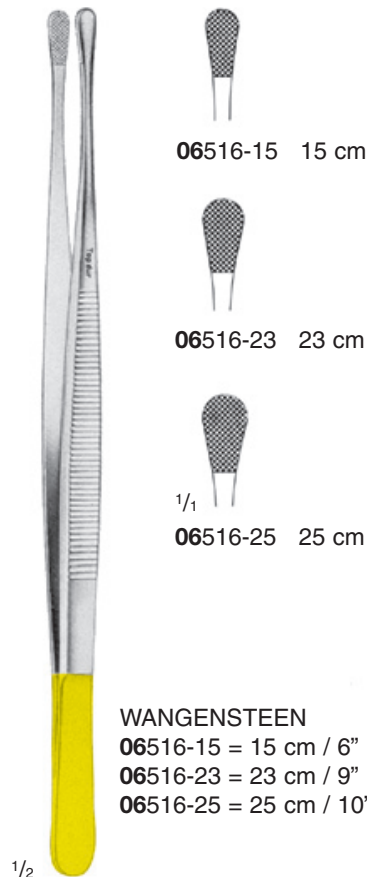

06516-15 15 cm

06516-23 23 cm

06516-25 25 cm

1/2

WANGENSTEEN
 06516-15 = 15 cm / 6"
 06516-23 = 23 cm / 9"
 06516-25 = 25 cm / 10"



TOP DUR Pinzetten mit Hartmetalleinsätzen
 TOP DUR Dissecting Forceps with Tungsten Carbide Inserts
 TOP DUR Pinzas de disección con bocas de carburo de tungsteno
 TOP DUR Pinces à dissection avec mors en carbure de tungstène
 TOP DUR Pinze a molla con punte di carburo di tungsteno



 1,5 mm $\frac{1}{1}$ 2 x 4 $\frac{1}{2}$	 1,5 mm $\frac{1}{1}$ 6 x 12 $\frac{1}{2}$		 2 mm $\frac{1}{1}$ 6 x 12 $\frac{1}{2}$	 2 mm $\frac{1}{1}$ 2 x 4 $\frac{1}{2}$
DE BAKEY 06517-15 = 15 cm / 6" 06517-20 = 20 cm / 8" 06517-24 = 24 cm / 9 1/2"	DE BAKEY 06518-15 = 15 cm / 6" 06518-20 = 20 cm / 8" 06518-24 = 24 cm / 9 1/2"		DE BAKEY 06519-15 = 15 cm / 6" 06519-20 = 20 cm / 8" 06519-24 = 24 cm / 9 1/2"	DE BAKEY 06522-15 = 15 cm / 6" 06522-20 = 20 cm / 8" 06522-24 = 24 cm / 9 1/2"
			 2,7 mm $\frac{1}{1}$ 6 x 12 $\frac{1}{2}$	 2,7 mm $\frac{1}{1}$ 2 x 4 $\frac{1}{2}$
			DE BAKEY 06520-15 = 15 cm / 6" 06520-20 = 20 cm / 8" 06520-24 = 24 cm / 9 1/2"	DE BAKEY 06523-15 = 15 cm / 6" 06523-20 = 20 cm / 8" 06523-24 = 24 cm / 9 1/2"
			 3,5 mm $\frac{1}{1}$ 6 x 12 $\frac{1}{2}$	 3,5 mm $\frac{1}{1}$ 2 x 4 $\frac{1}{2}$
			DE BAKEY 06521-15 = 15 cm / 6" 06521-20 = 20 cm / 8" 06521-24 = 24 cm / 9 1/2"	DE BAKEY 06524-15 = 15 cm / 6" 06524-20 = 20 cm / 8" 06524-24 = 24 cm / 9 1/2"

 $\frac{1}{1}$ $\frac{1}{2}$	 $\frac{1}{1}$ 06530-17 17 cm / 6 3/4"	 $\frac{1}{1}$ 06531-17 17 cm / 6 3/4"	 $\frac{1}{1}$ $\frac{1}{2}$	 $\frac{1}{1}$ 06540-17 17 cm / 6 3/4"	 $\frac{1}{1}$ 06541-17 17 cm / 6 3/4"
BONNEY			GERALD		

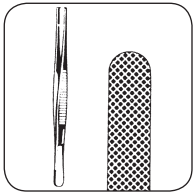

Knüpfpinzetten mit Plateau
 Suture Tying Forceps with platform
 Pinzas de ligadura con plataforma
 Pincès à ligature avec plate-forme
 Pinze per ligature con piattaforma



1/1

06902-00
 12 cm / 4³/₄"



06902-06
 12 cm / 4³/₄"



1/1

06902-01
 15 cm / 6"



06902-07
 15 cm / 6"



1/1

06902-02
 18 cm / 7"



06902-08
 18 cm / 7"



Bulldogklemmen, Arterienklemmen
 Serrefines, Haemostatic Forceps
 Serrafinas, Pinzas hemostáticas
 Serre-fines, Pinces hémostatiques
 Bulldog, Pinze emostatiche

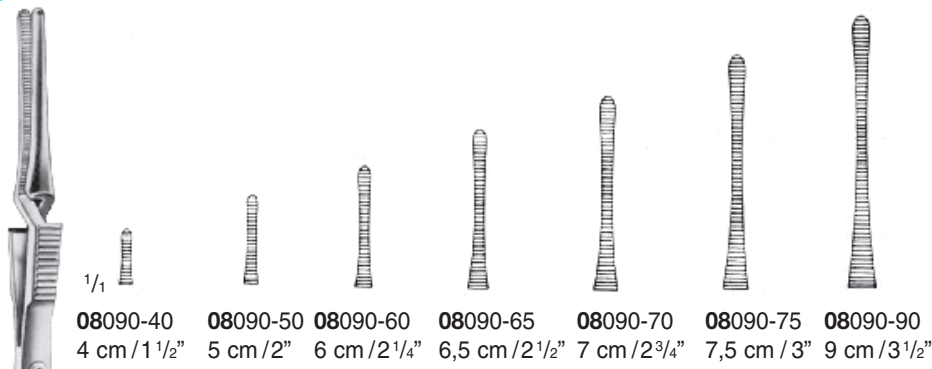
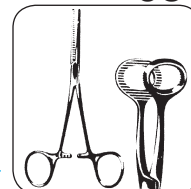

08090-40 08090-50 08090-60 08090-65 08090-70 08090-75 08090-90
 4 cm / 1 1/2" 5 cm / 2" 6 cm / 2 1/4" 6,5 cm / 2 1/2" 7 cm / 2 3/4" 7,5 cm / 3" 9 cm / 3 1/2"

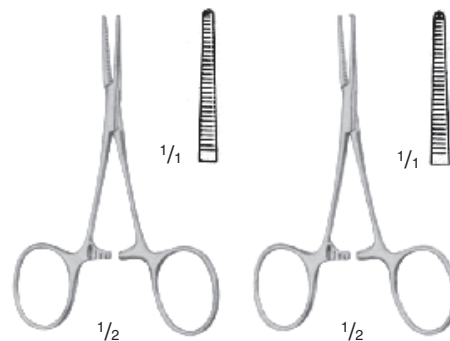

CARREL
 08122-08
 8,5 cm / 3 1/2"
TERRIER
 08126-08
 8,5 cm / 3 1/2"

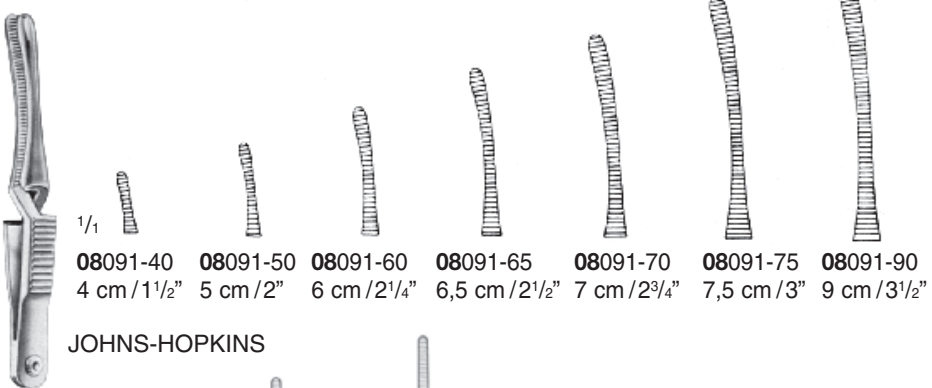

08091-40 08091-50 08091-60 08091-65 08091-70 08091-75 08091-90
 4 cm / 1 1/2" 5 cm / 2" 6 cm / 2 1/4" 6,5 cm / 2 1/2" 7 cm / 2 3/4" 7,5 cm / 3" 9 cm / 3 1/2"

JOHNS-HOPKINS

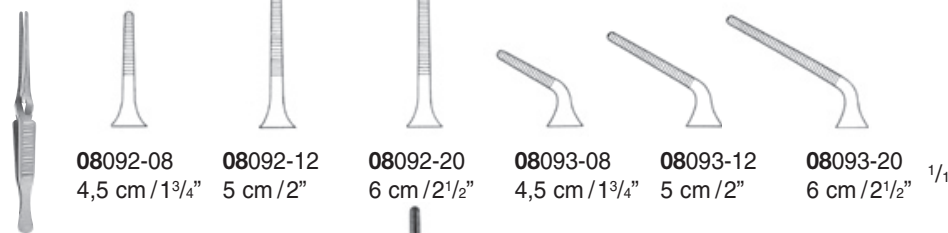

08092-08 08092-12 08092-20 08093-08 08093-12 08093-20
 4,5 cm / 1 3/4" 5 cm / 2" 6 cm / 2 1/2" 4,5 cm / 1 3/4" 5 cm / 2" 6 cm / 2 1/2"

DIETRICH



08094-10 08094-14 08094-20 08095-10 08095-14 08095-20
 4,5 cm / 1 3/4" 5 cm / 2" 6 cm / 2 1/2" 3,5 cm / 1 1/2" 4,5 cm / 1 3/4" 6 cm / 2 1/2"

DE BAKEY-DIETRICH

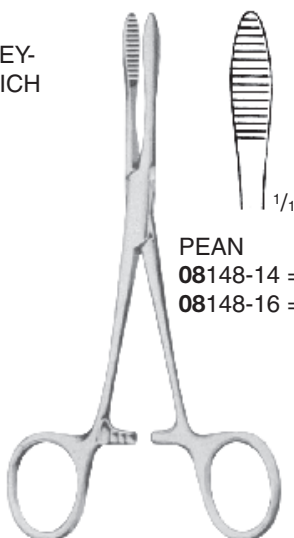

PEAN
 08148-14 = 14 cm / 5 1/2"
 08148-16 = 16 cm / 6 1/4"

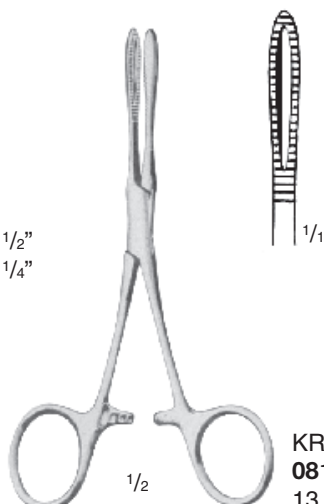

KROENLEIN
 08154-13
 13 cm / 5"

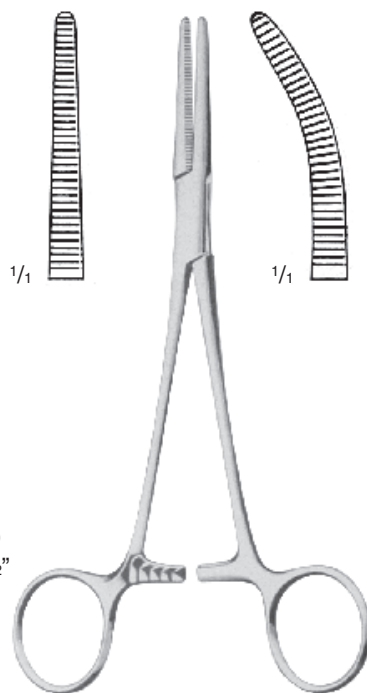

SPENCER-WELLS

	gerade straight rectas droites rette		gebogen curved curvas courbes curve
	cm	in.	
08220-13	13,0	5"	08221-13
08220-14	14,0	5 1/2"	08221-14
08220-15	15,5	6"	08221-15
08220-18	18,0	7"	08221-18
08220-20	20,0	8"	08221-20

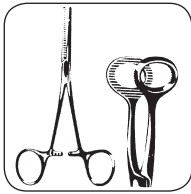

Arterienklemmen
 Haemostatic Forceps
 Pinzas hemostáticas
 Pinces hémostatiques
 Pinze emostatiche

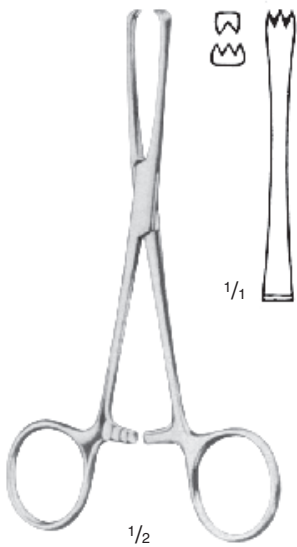

CHAPUT
08228-13
 13 cm / 5"

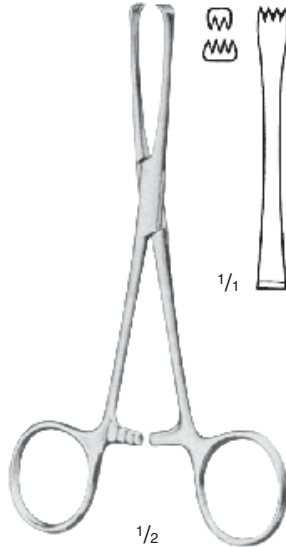

TUFFIER
08230-13
 13 cm / 5"

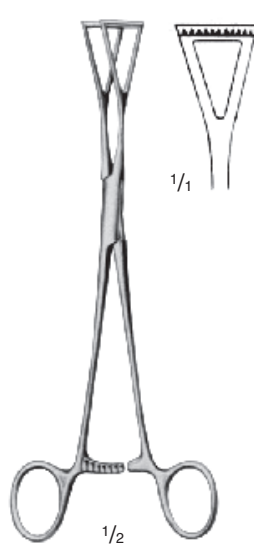

COLLIN-DUVAL
08240-14
 14 cm / 5 1/2"



COLLIN
08242-16
 16 cm / 6 1/4"



COLLIN
08250-17
 16,5 cm / 6 1/2"

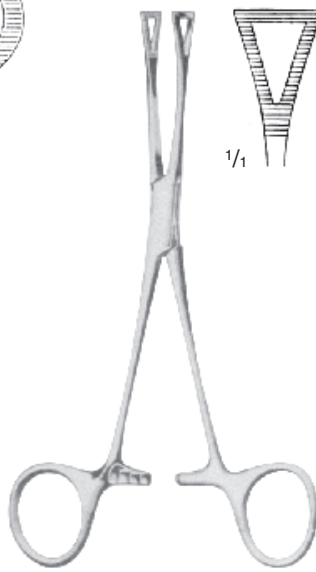

PENNINGTON
08252-15 = 15,5 cm / 6"
08252-20 = 20 cm / 8"



PRATT
08254-15
 15 cm / 6"

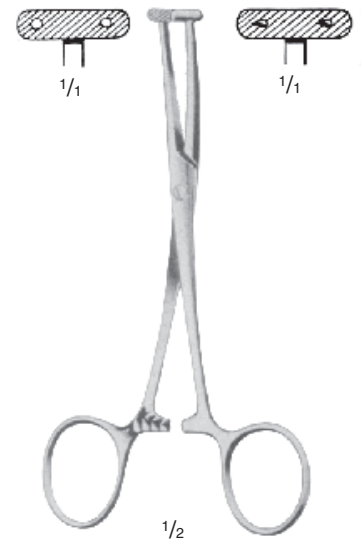

MARTEL
08262-14
 14 cm / 5 1/2"

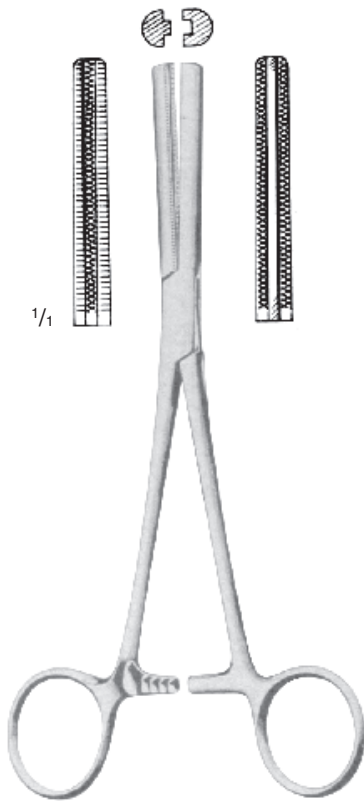

FERGUSSON
08272-16 = 16 cm / 6 1/4"
08272-20 = 20 cm / 8"

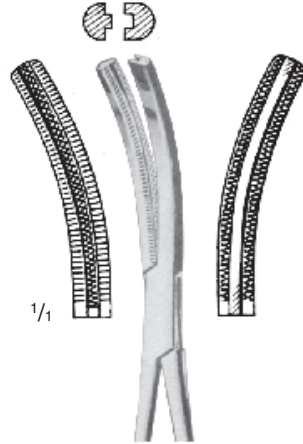

08273-16 = 16 cm / 6 1/4"
08273-20 = 20 cm / 8"

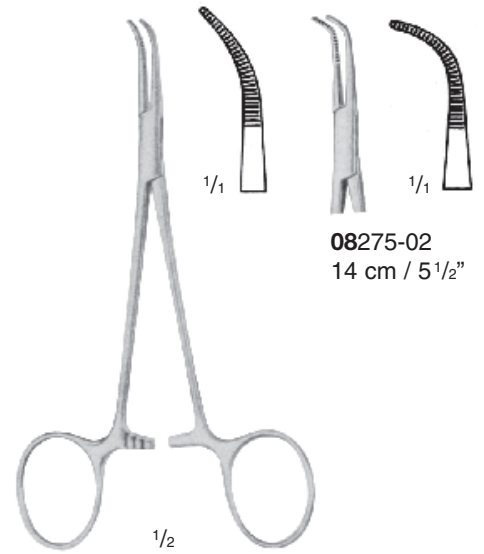

BABY-MIXTER
08275-01
14 cm / 5 1/2"

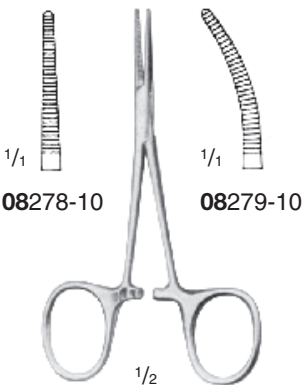

08278-10 08279-10
HARTMANN
10 cm / 4"

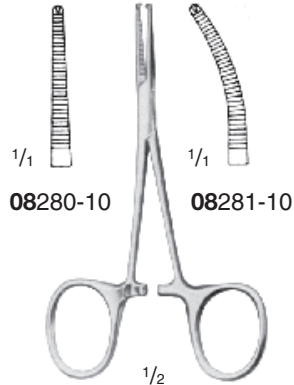

08280-10 08281-10
HARTMANN
10 cm / 4"

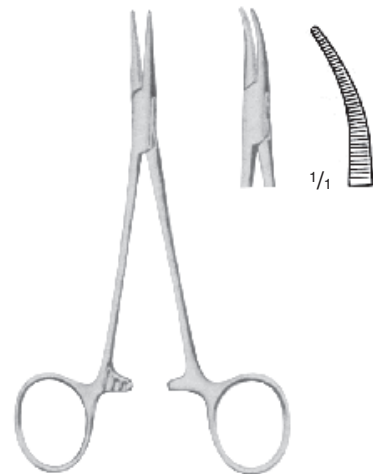

HALSTED-MOSQUITO

gerade straight rectas droites rette	cm	in.	gebogen curved curvas courbes curve
08282-12	12,5	5"	08283-12
08282-14	14,0	5 1/2"	08283-14

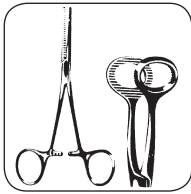

Arterienklemmen
Haemostatic Forceps
Pinzas hemostáticas
Pincas hémostatiques
Pinze emostatiche



HALSTED-MOSQUITO



gerade straight rectas droites rette	1 x 2		gebogen curved curvas courbes curve
	cm	in.	
08284-12	12,5	5"	08285-12
08284-14	14,0	5 1/2"	08285-14



HALSTED-MOSQUITO

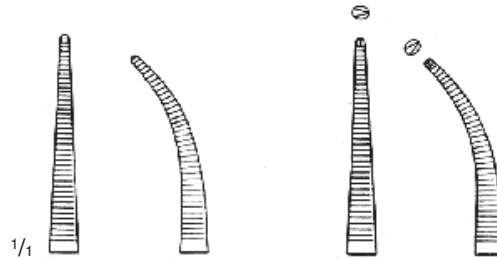

cm	in.	gerade straight rectas droite rette	gebogen curved curvas courbes curve	gerade straight rectas droite rette	gebogen curved curvas courbes curve
		18,0	7"	08288-18	08289-18

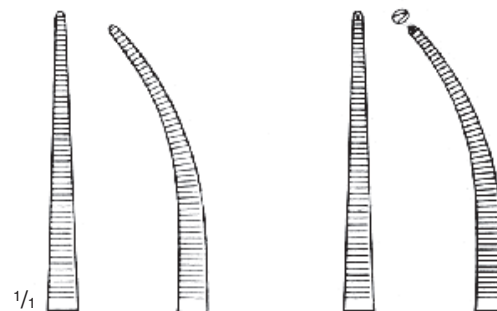

cm	in.	gerade straight rectas droite rette	gebogen curved curvas courbes curve	gerade straight rectas droite rette	gebogen curved curvas courbes curve
		21,0	8 1/4"	08288-21	08289-21

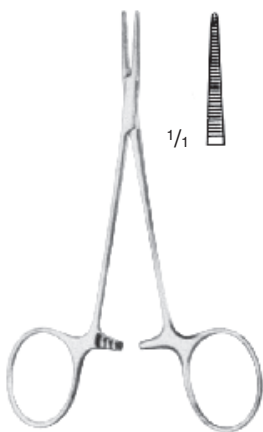
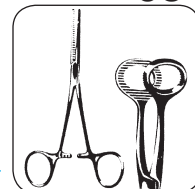

MICRO-MOSQUITO
08292-10 = 10 cm / 4"
08292-12 = 12 cm / 4³/₄"



MICRO-MOSQUITO
08293-10 = 10 cm / 4"
08293-12 = 12 cm / 4³/₄"

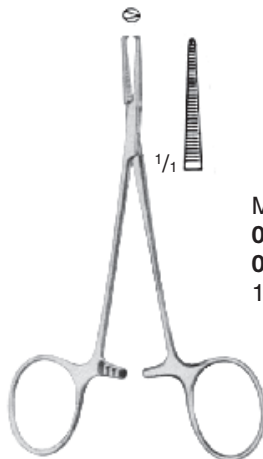

MICRO-MOSQUITO
08294-10 = 10 cm / 4"
08294-12 = 12 cm / 4³/₄"
1:2 Zähne • Teeth • Dientes • Dents • Denti



MICRO-MOSQUITO
08295-10 = 10 cm / 4"
08295-12 = 12 cm / 4³/₄"
1:2 Zähne • Teeth • Dientes • Dents • Denti

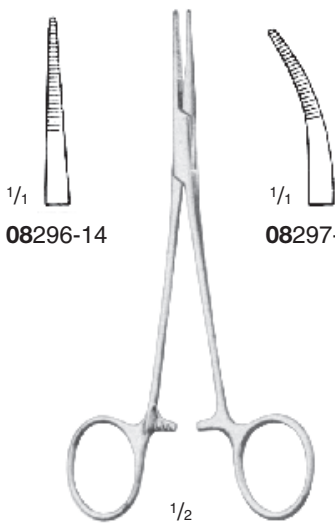

PROVIDENCE-HOSPITAL
14 cm / 5¹/₂"

08296-14

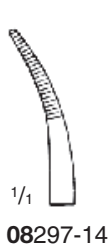

08297-14

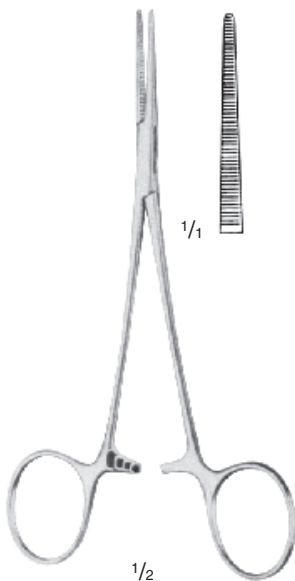

LERICHE
08298-15
15 cm / 6"

08299-15



08299-15
15 cm / 6"

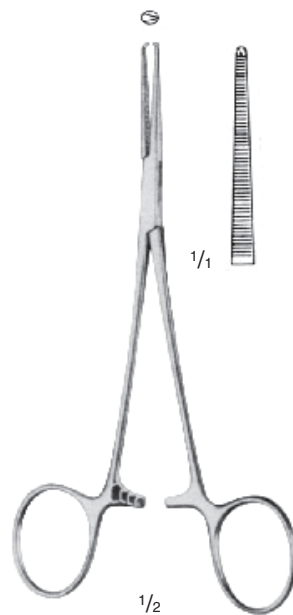

LERICHE
08300-15
15 cm / 6"
1:2 Zähne • Teeth • Dientes • Dents • Denti

08301-15



08301-15
15 cm / 6"
1:2 Zähne • Teeth • Dientes • Dents • Denti

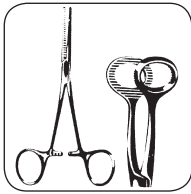

Arterienklemmen
Haemostatic Forceps
Pinzas hemostáticas
Pinces hémostatiques
Pinze emostatiche

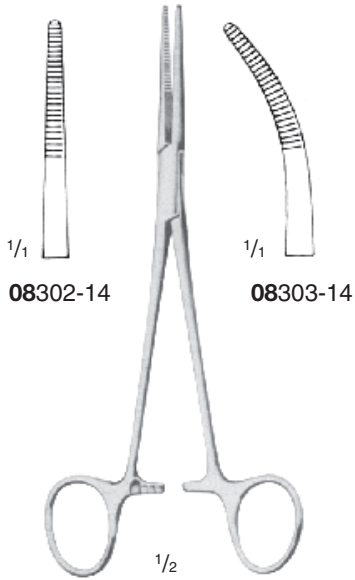

08302-14

08303-14

KELLY
14 cm / 5 1/2"

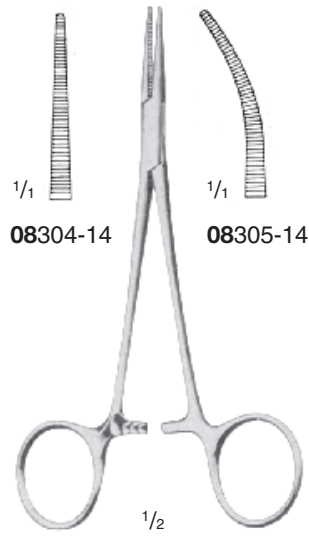

08304-14

08305-14

BABY-CRILE
14 cm / 5 1/2"

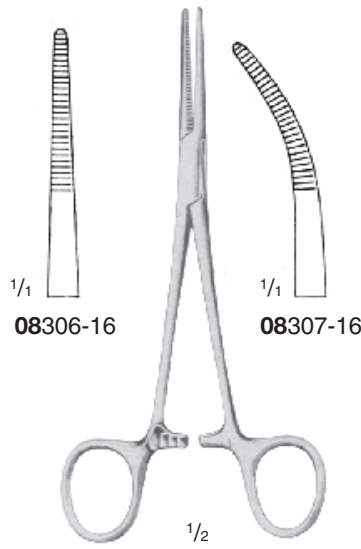

08306-16

08307-16

KELLY-RANKIN
16 cm / 6 1/4"

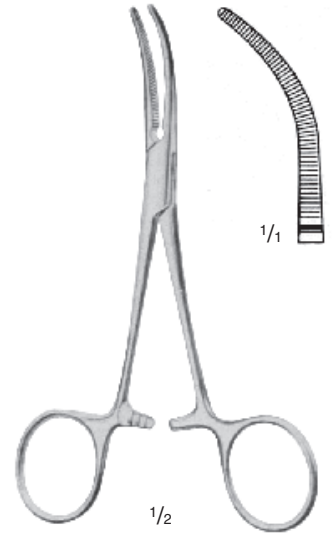

1/1

BABY-OVERHOLT
08311-14
13,5 cm / 5 1/4"

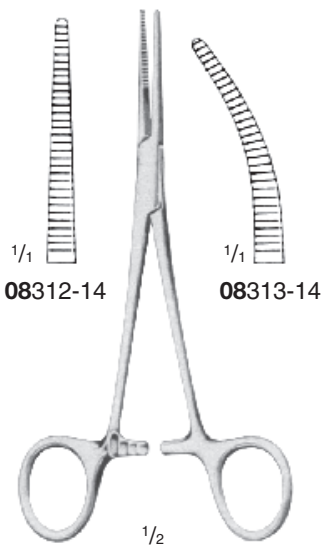

08312-14

08313-14

CRILE
14 cm / 5 1/2"

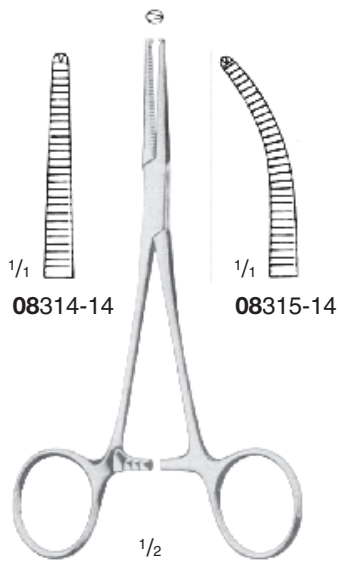

08314-14

08315-14

CRILE
14 cm / 5 1/2"
1:2 Zähne • Teeth
Dientes • Dents • Denti

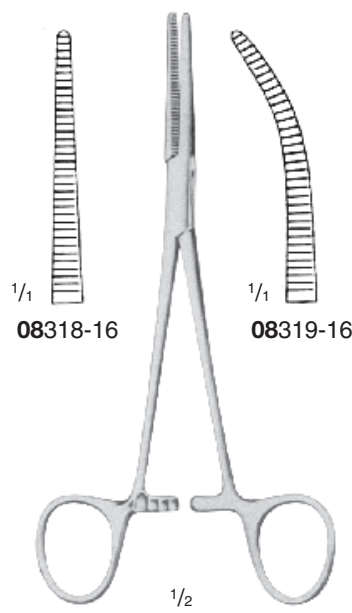

08318-16

08319-16

CRILE-RANKIN
16 cm / 6 1/4"

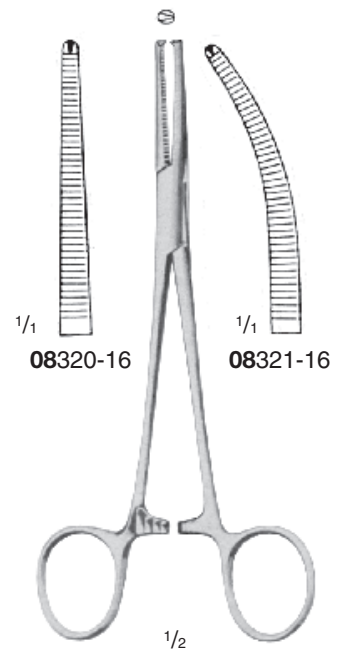

08320-16

08321-16

CRILE
16 cm / 6 1/4"
1:2 Zähne • Teeth
Dientes • Dents • Denti

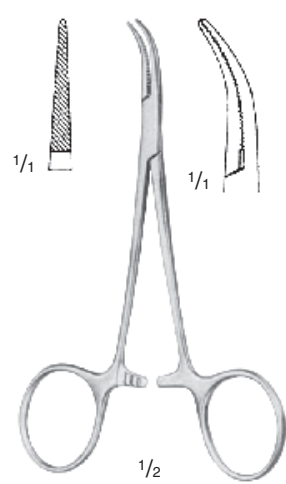
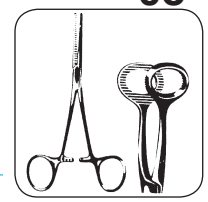

MOSQUITO-DANDY
08323-12
12 cm / 4³/₄"

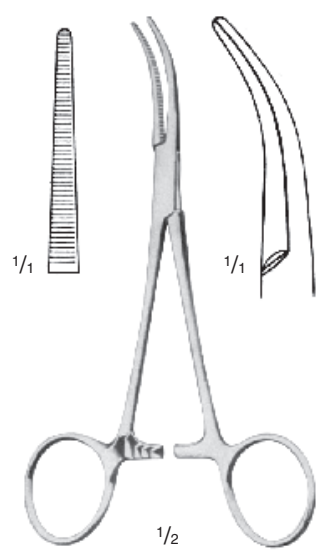

DANDY
08327-14
14 cm / 5¹/₂"

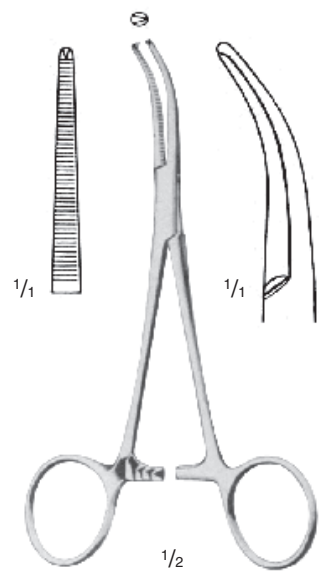

DANDY
08329-14
14 cm / 5¹/₂"
1:2 Zähne • Teeth • Dientes • Dents • Denti



BAINBRIDGE



gerade
straight
rectas
droites
rette



gebogen
curved
curvas
courbes
curve

	cm	in.	
08330-15	15,0	6"	08331-15
08330-18	18,5	7 ¹ / ₄ "	08331-18



SCHNIDT
19 cm / 7¹/₂"



08335-19

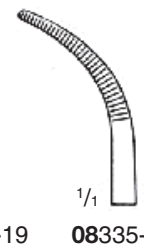

08335-18

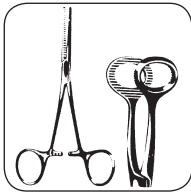

Arterienklemmen
Haemostatic Forceps
Pinzas hemostáticas
Pincas hémostatiques
Pinze emostatiche

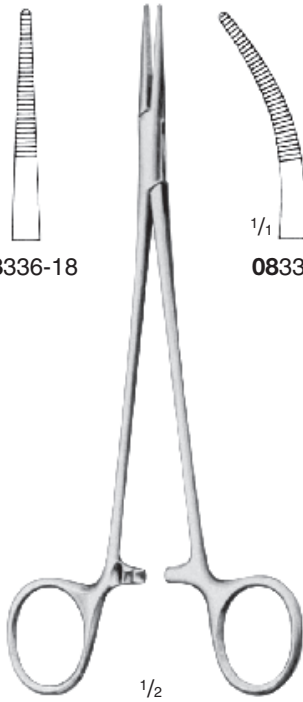

ADSON
18,5 cm / 7 1/4"

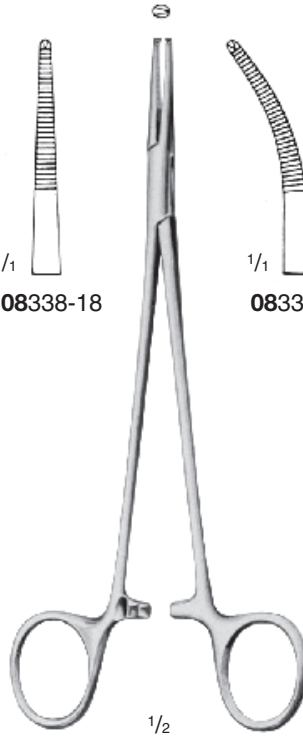

ADSON
18,5 cm / 7 1/4"
1:2 Zähne • Teeth
Dientes • Dents • Denti

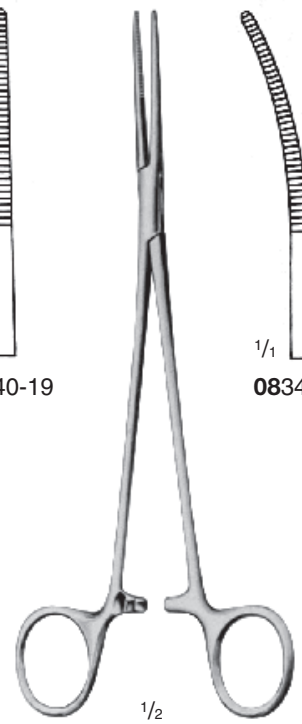

BIRKETT
19 cm / 7 1/2"

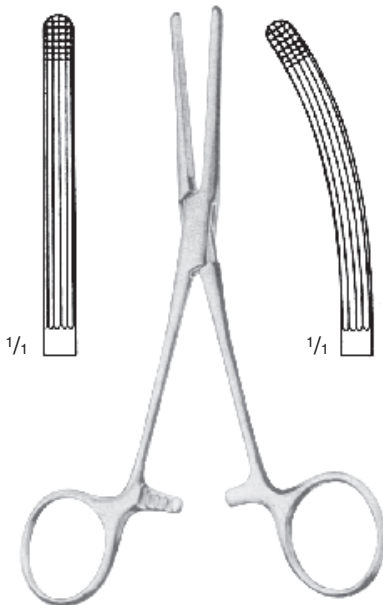

ROCHESTER-CARMALT

gerade straight rectas droites rette			gebogen curved curvas courbes curve
	cm	in.	
08342-16	16,0	6 1/4"	08343-16
08342-20	20,0	8"	08343-20

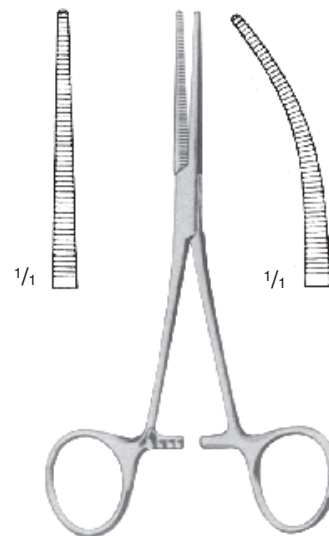

PEAN

gerade straight rectas droites rette			gebogen curved curvas courbes curve
	cm	in.	
08346-13	13,0	5"	08347-13
08346-14	14,0	5 1/2"	08347-14
08346-16	16,0	6 1/4"	08347-16

graziles Modell
delicate pattern
modelo delgado
modèle délicat
modello delicato

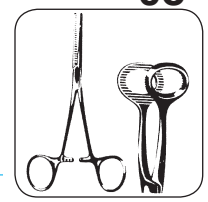

KOCHER

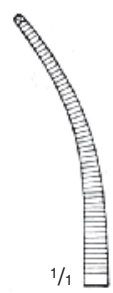
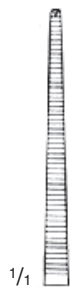

graziles Modell
 delicate pattern
 modelo delgado
 modèle délicat
 modello delicato

	1:2		
	cm	in.	
gerade straight rectas droites rette			gebogen curved curvas courbes curve
08356-13	13,0	5"	08357-13
08356-14	14,0	5 1/2"	08357-14
08356-16	16,0	6 1/4"	08357-16

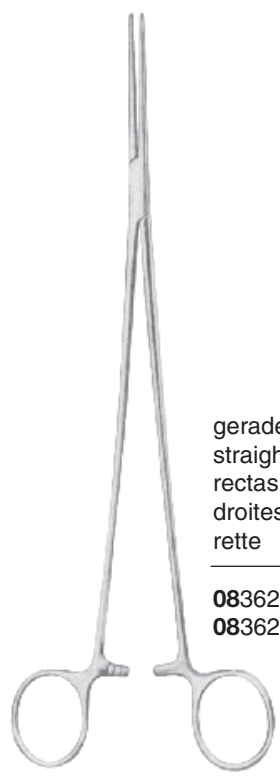

BENGOLEA
 08362-22 - 08363-26



	cm	in.	
08362-22	22,0	8 3/4"	08363-22
08362-26	26,0	10 1/2"	08363-26

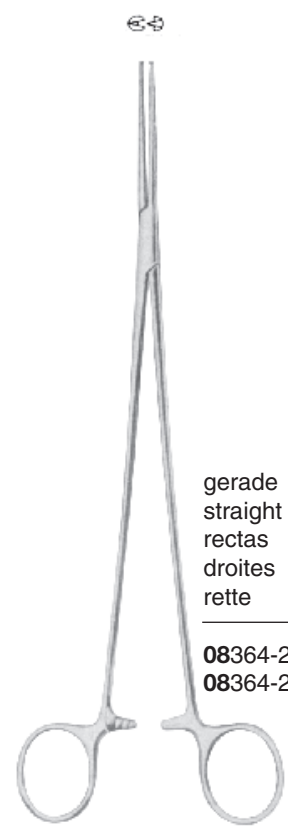

BENGOLEA
 08364-22 - 08365-26

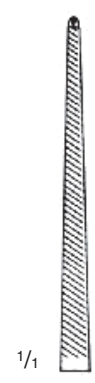

	cm	in.	
08364-22	22,0	8 3/4"	08365-22
08364-26	26,0	10 1/2"	08365-26

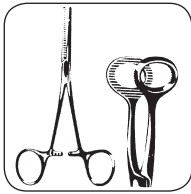

Arterienklemmen
Haemostatic Forceps
Pinzas hemostáticas
Pinces hémostatiques
Pinze emostatiche



1/2

PEAN (ROCHESTER)

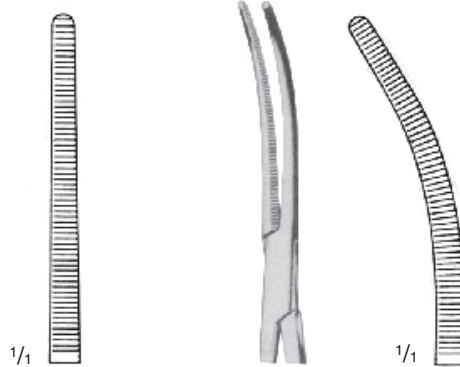

1/1

1/1

	gerade straight rectas droites rette			gebogen curved curvas courbes curve	
	cm	in.		cm	in.
08382-14	14,0	5 1/2"	08383-14		
08382-16	16,0	6 1/4"	08383-16		
08382-18	18,0	7"	08383-18		
08382-20	20,0	8"	08383-20		
08382-22	22,0	8 3/4"	08383-22		
08382-24	24,0	9 1/2"	08383-24		
08382-26	26,0	10 1/4"	08383-26		
08382-30	30,0	12"	08383-30		



1/2

KOCHER (OCHSNER)

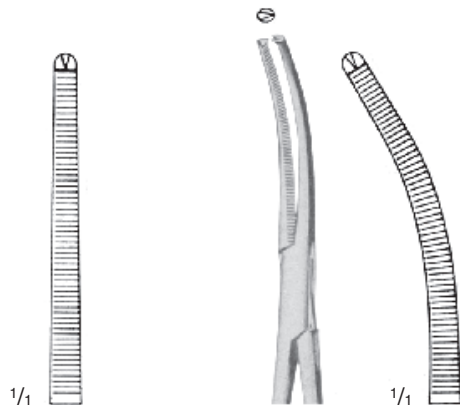

1/1

1/1

	gerade straight rectas droites rette			gebogen curved curvas courbes curve	
	cm	in.		cm	in.
08386-14	14,0	5 1/2"	08387-14		
08386-16	16,0	6 1/4"	08387-16		
08386-18	18,0	7"	08387-18		
08386-20	20,0	8"	08387-20		
08386-22	22,0	8 3/4"	08387-22		
08386-24	24,0	9 1/2"	08387-24		
08386-26	26,0	10 1/4"	08387-26		
08386-30	30,0	12"	08387-30		

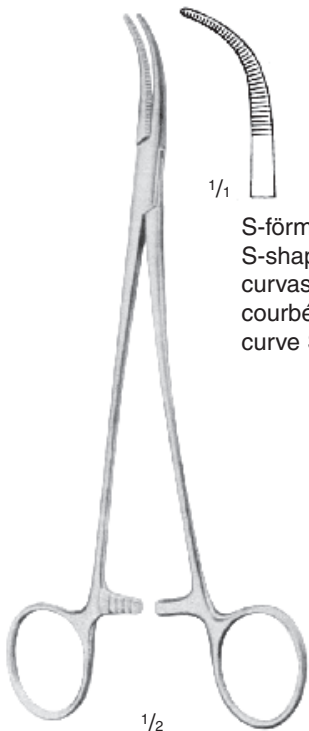

1/1

S-förmig gebogen
 S-shaped
 curvas en S
 courbés en S
 curve S

1/2

OVERHOLT-S
 08389-01
 18,5 cm / 7 1/2"

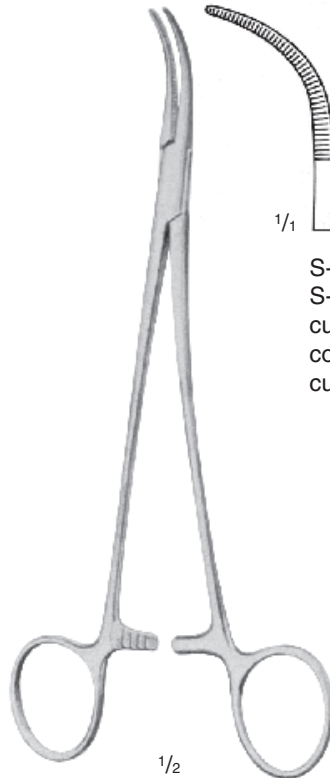

1/1

S-förmig gebogen
 S-shaped
 curvas en S
 courbés en S
 curve S

1/2

OVERHOLT-S
 08389-02
 20,5 cm / 8"

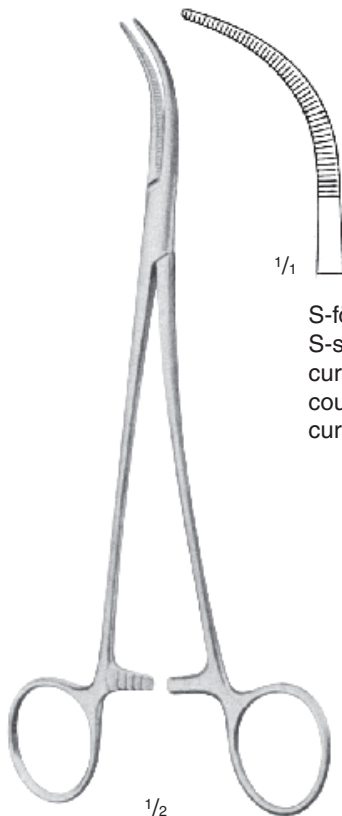

1/1

S-förmig gebogen
 S-shaped
 curvas en S
 courbés en S
 curve S

1/2

OVERHOLT-S
 08389-03
 21 cm / 8 1/4"

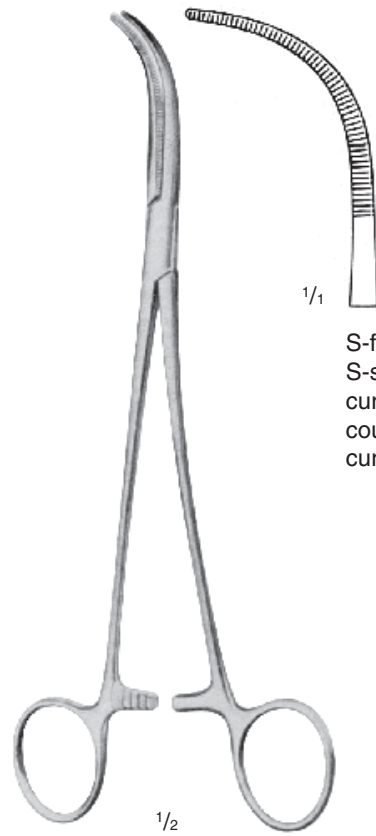

1/1

S-förmig gebogen
 S-shaped
 curvas en S
 courbés en S
 curve S

1/2

OVERHOLT-S
 08389-04
 21,5 cm / 8 1/2"

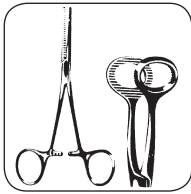

Präparier- und Ligaturklemmen
 Dissecting and Ligature Forceps
 Pinzas para preparaciones y para ligaduras
 Pincès à dissection et à ligatures
 Pinze per dissezione e per legature



BABY-MIXTER
08391-18
 18 cm / 7"

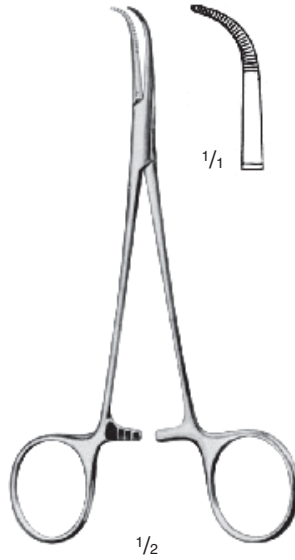

BABY-ADSON
08393-14
 14 cm / 5 1/2"



BABY-ADSON
08393-18
 18 cm / 7"

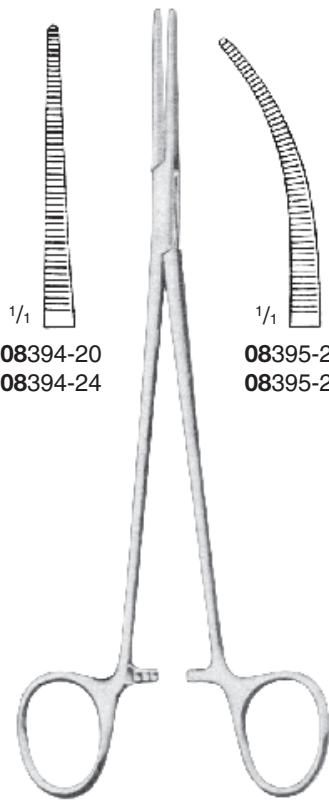

08394-20
08394-24

08395-20
08395-24

08396-20
08396-24

HEISS
 20 cm / 8"
 24 cm / 9 1/2"



OVERHOLT-MIXTER
 21 cm / 8 1/4"

08399-21

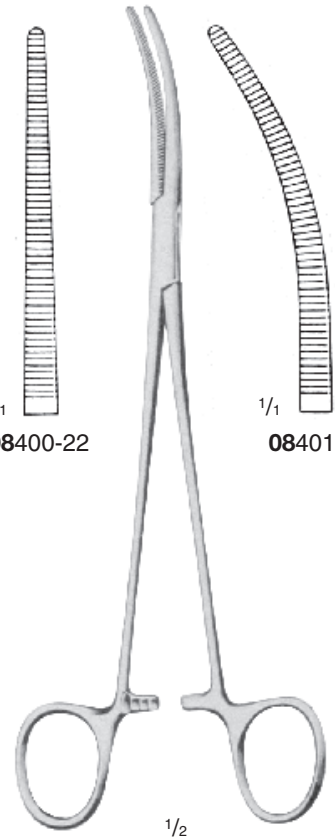

08400-22

08401-22

ROBERTS
 22 cm / 8 3/4"

Arterienklemmen, Bronchusklemmen
Haemostatic Forceps, Bronchus Forceps
Pinzas hemostáticas, Pinzas para bronquios
Pinces hémostatiques, Pinces pour bronches
Pinze emostatiche, Pinze per bronchi

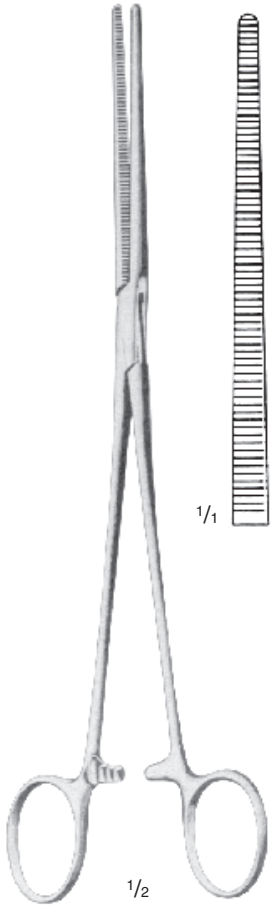

SAROT
08404-24
24 cm / 9 1/2"

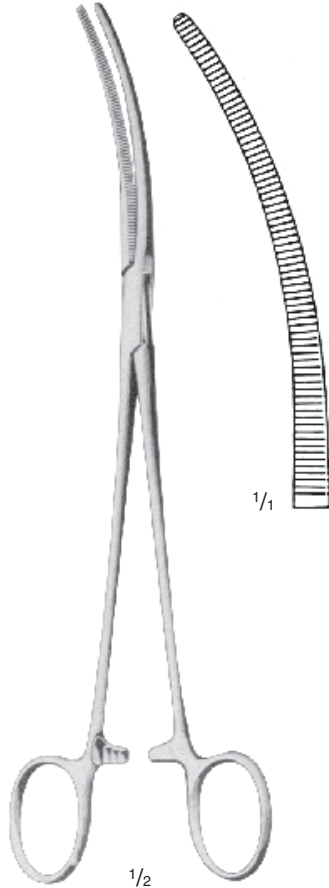

SAROT
08405-24
24 cm / 9 1/2"

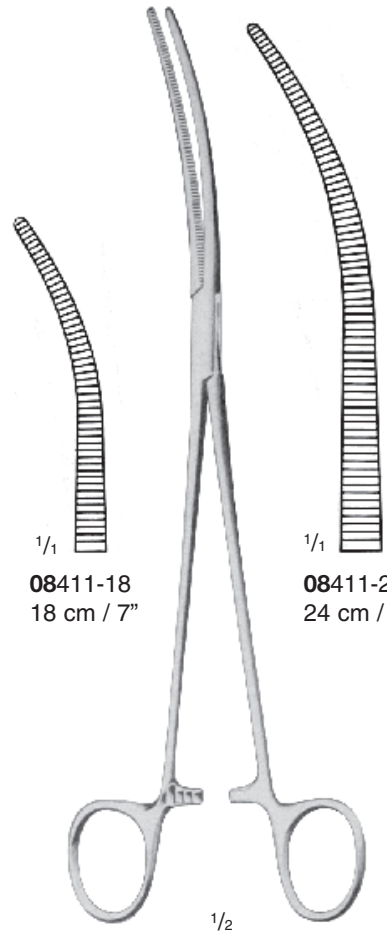

08411-18
18 cm / 7"

08411-24
24 cm / 9 1/2"

CRAFOORD

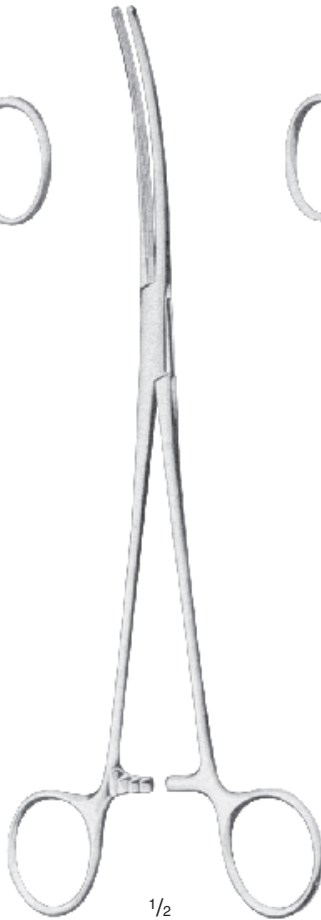

CRAFOORD-SELLORS
24 cm / 9 1/2"



08413-24



08413-23



08413-22

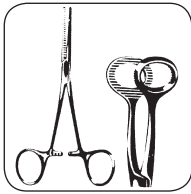

Präparier- und Ligaturklemmen
 Dissecting and Ligature Forceps
 Pinzas para preparaciones y para ligaduras
 Pincès à dissection et à ligatures
 Pinze per dissezione e per legature



1/2

OVERHOLT-GEISSENDOERFER
 08415-01 – 08415-07
 21 cm / 8 1/4"



1/2

OVERHOLT-GEISSENDOERFER
 08419-01 – 08419-07
 27 cm / 10 3/4"

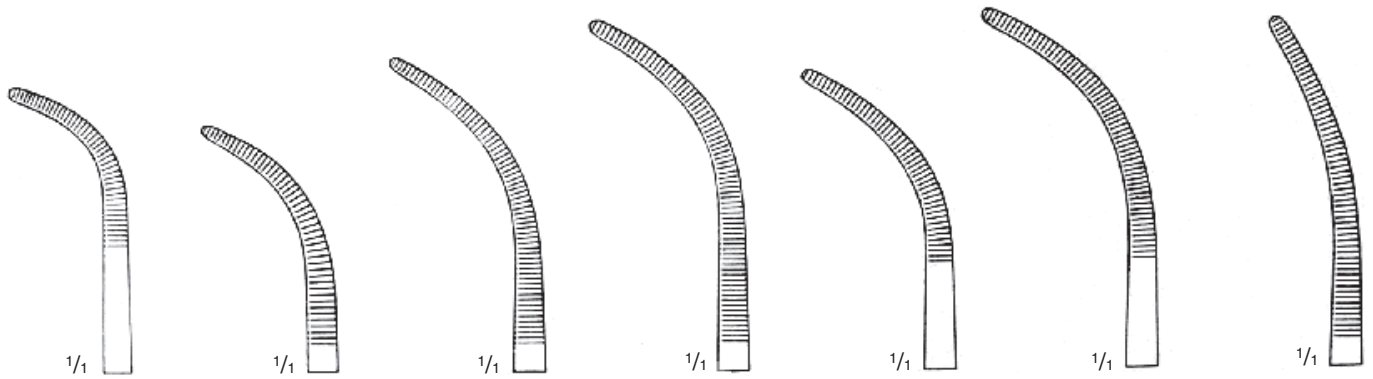

1/1

1/1

1/1

1/1

1/1

1/1

1/1

Fig. 1

08415-01
 21 cm / 8 1/4"

Fig.2

08415-02

Fig.3

08415-03

Fig. 4

08415-04

Fig. 5

08415-05

Fig. 6

08415-06

Fig.7

08415-07

08419-01
 27 cm / 10 3/4"

08419-02

08419-03

08419-04

08419-05

08419-06

08419-07

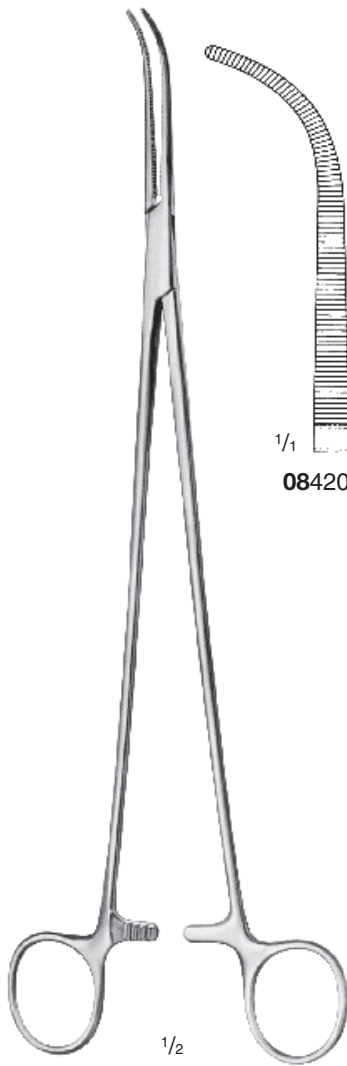

1/2

OVERHOLT
08420-00 – 02
29,5 cm / 11 1/2"

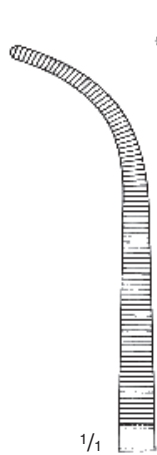

1/1

08420-00



1/1

08420-01

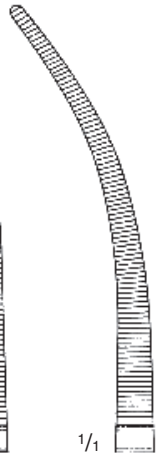

1/1

08420-02



1/2

OVERHOLT-MINI



1/1

08420-15
15 cm / 6"



1/1

08420-20
20 cm / 8"



1/2

RUMEL
08433-01 – 05
23 cm / 9"



1/1

08433-01



1/1

08433-02



1/1

08433-03



1/1

08433-04



1/1

08433-05

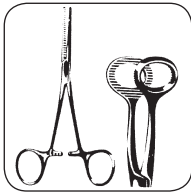

Präparier- und Ligaturklemmen
 Dissecting and Ligature Forceps
 Pinzas para preparaciones y para ligaduras
 Pincas à dissection et à ligatures
 Pinze per dissezione e per legature

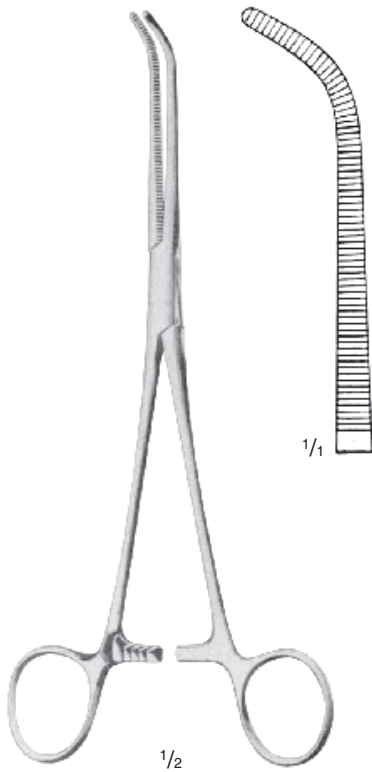

JOHNS HOPKINS
08439-20
 20 cm / 8"



ZENKER
 29,5 cm / 11 1/2"

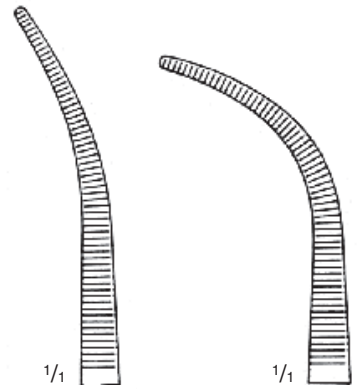

08441-01

08441-02

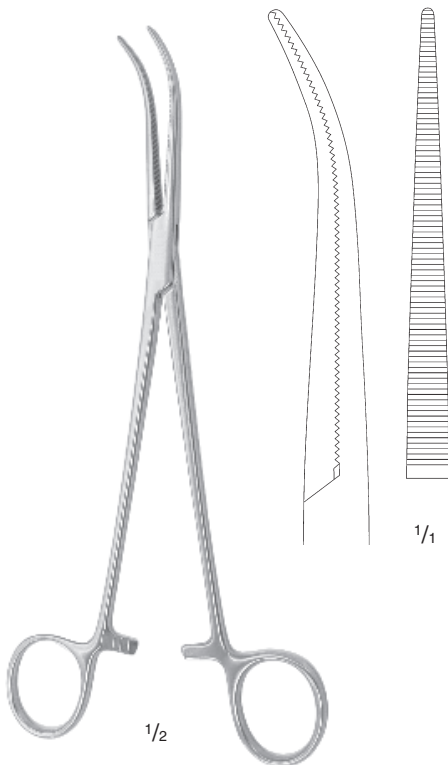

BRUNSCHWIG
08440-01 = 23 cm / 9"
08440-02 = 29 cm / 11 1/2"



MIXTER-BABY

08443-14

14 cm / 5 1/2"

08443-16

16 cm / 6 1/4"

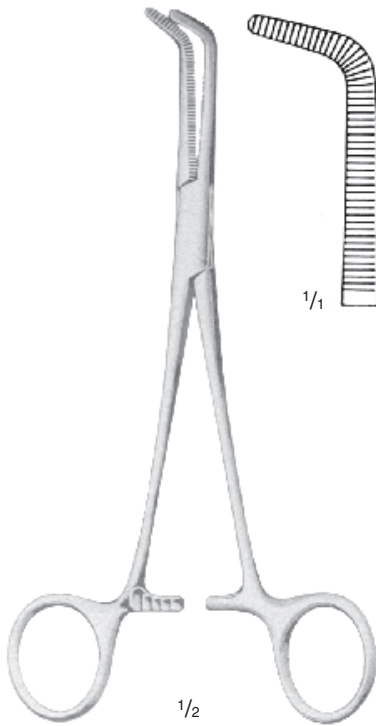

MIXTER
08445-15 = 15,5 cm / 6"
08445-19 = 19 cm / 7 1/2"



MIXTER-O'SHAUGHNESSY
08451-19
18 cm / 7"

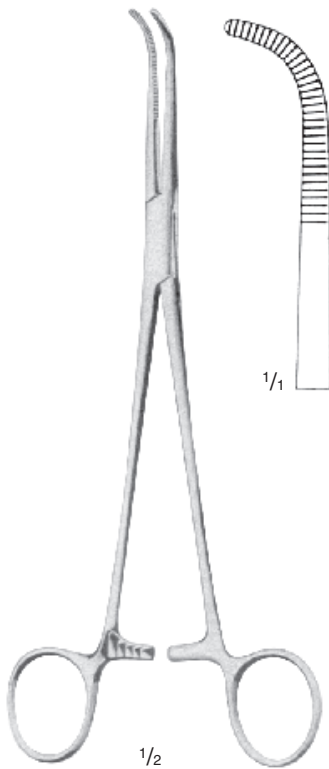

MIXTER
08455-22
22 cm / 8 3/4"



MIXTER
08457-23
23 cm / 9"



Arterienklemmen, Gallenkanalklemmen
 Haemostatic Forceps, Gall Duct Clamps
 Pinzas hemostáticas, Pinzas-clamps para conducto biliar
 Pincas hémostatiques et pour le canal biliaire
 Pinze emostatiche e per canale biliare



MIXTER

1/1
08463-22
 22 cm / 8 3/4"



1/1
08465-25
 25 cm / 10"



1/1
08467-28
 28 cm / 11"

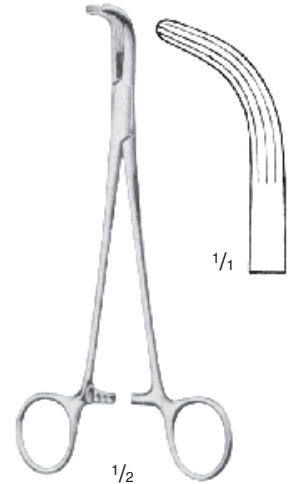

LOWER
08473-18
 18 cm / 7"

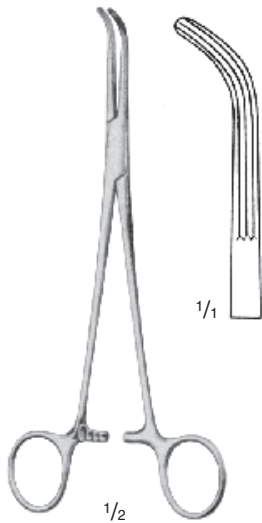

LAHEY
08483-19
 19 cm / 7 1/2"

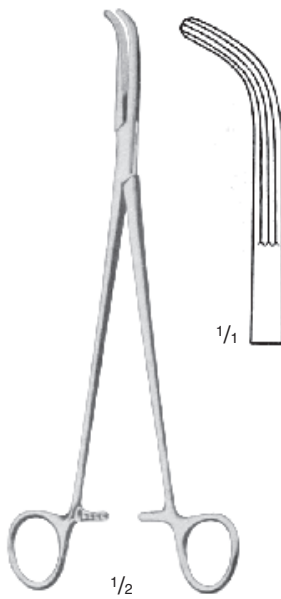

LAHEY
08485-23
 23 cm / 9"



FINOCHIETTO
08493-24
 24 cm / 9 1/2"



DE BAKEY
08495-13 – 08495-28



08495-13
13 cm / 5"



08495-16
16 cm / 6 1/4"



08495-18
18 cm / 7"



08495-20
20 cm / 8"



08495-23
23 cm / 9"



08495-25
25 cm / 10"

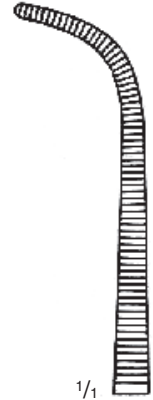

08495-28
28 cm / 11"



Präparier- und Ligaturklemmen
 Dissecting and Ligature Forceps
 Pinzas para preparaciones y para ligaduras
 Pinces à dissection et à ligatures
 Pinze per dissezione e per legature



KANTROWITZ



1/1

08496-20
20 cm / 8"



1/1

08496-24
24 cm / 9 1/2"



1/1

08496-28
28 cm / 11"



GEMINI (MIXTER)



1/1

08497-18
18 cm / 7"



1/1

08497-22
22 cm / 8 3/4"



1/1

08497-25
25 cm / 10"



1/1

08497-28
28 cm / 11"

Nierenstielklemmen
Kidney Pedicle Clamp Forceps
Pinzas-clamps para pedúnculos renales
Pincés pour pédicules renaux
Pinze per peduncoli renali



$\frac{1}{2}$
GUYON-PEAN

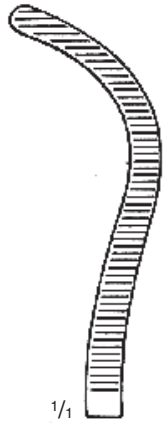

$\frac{1}{1}$
08503-20
20 cm / 8"

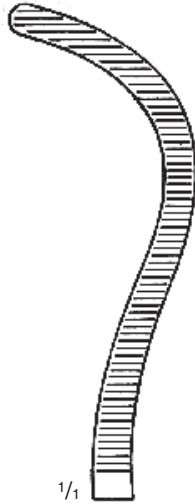

$\frac{1}{1}$
08503-22
22 cm / 8 $\frac{3}{4}$ "



$\frac{1}{1}$
08503-24
24 cm / 9 $\frac{1}{2}$ "



$\frac{1}{2}$
GUYON
08505-23
23 cm / 9"

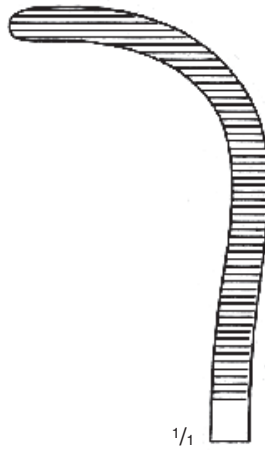

$\frac{1}{1}$

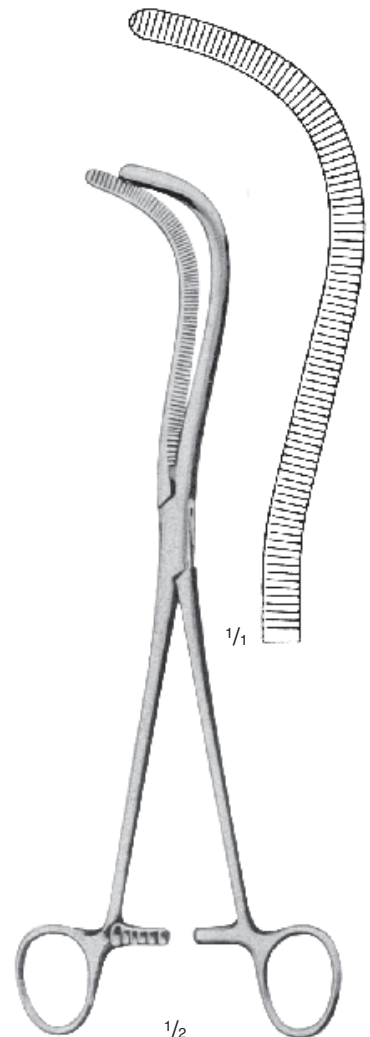

$\frac{1}{2}$
MAYO-GUYON
08517-23
23 cm / 9"

$\frac{1}{1}$

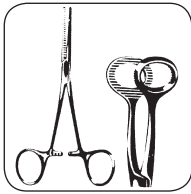

Arterienklemmen, Gallenkanalklemmen
 Haemostatic Forceps, Gall Duct Clamps
 Pinzas hemostáticas, Pinzas-clamps para conducto biliar
 Pincas hémostatiques et pour le canal biliaire
 Pinze emostatiche e per canale biliare

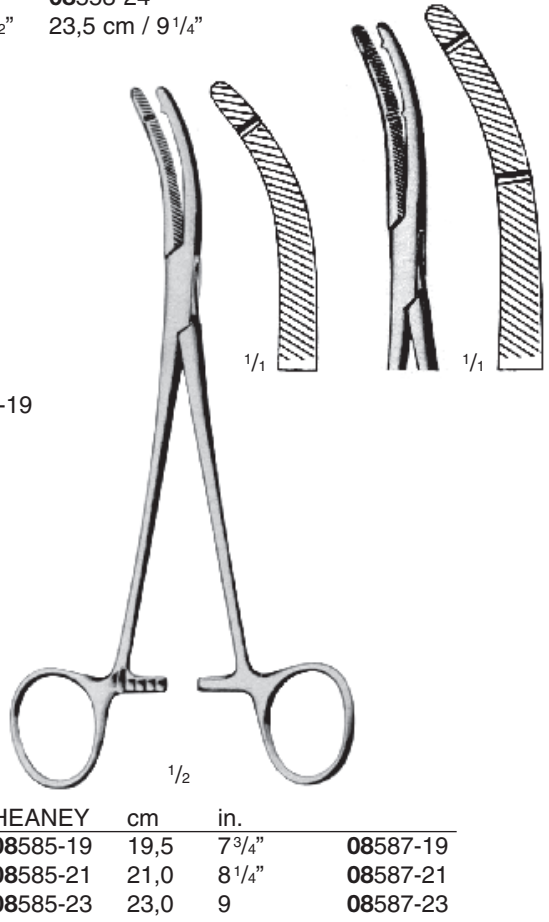
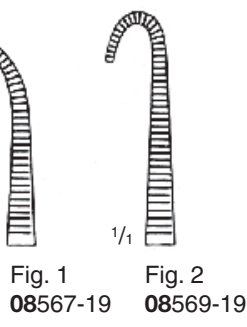
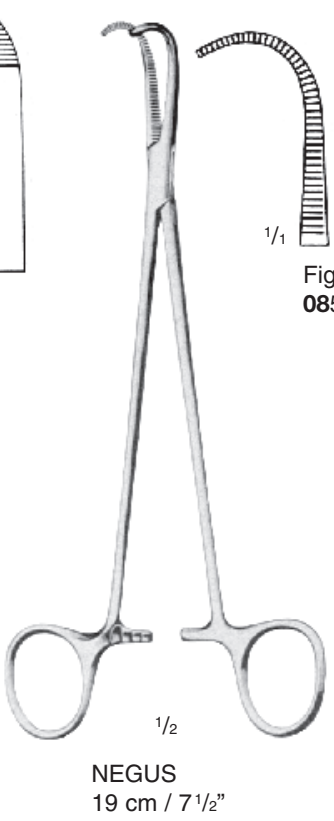
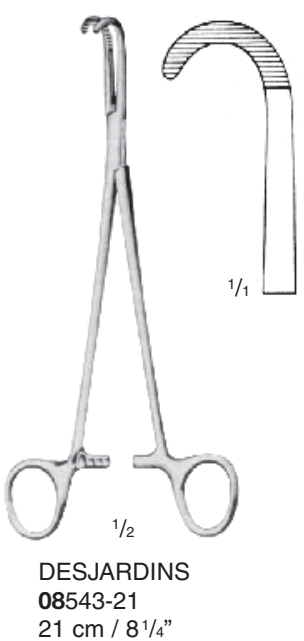
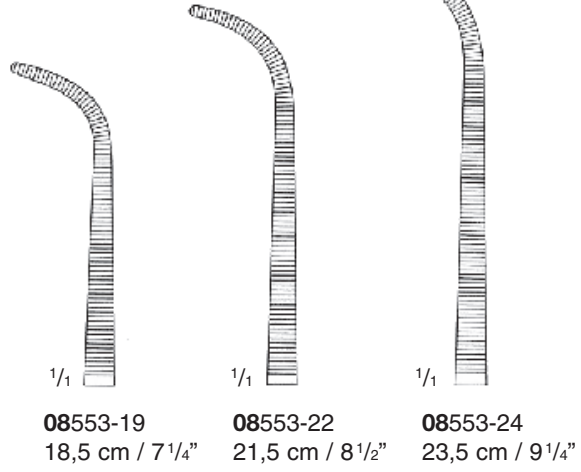
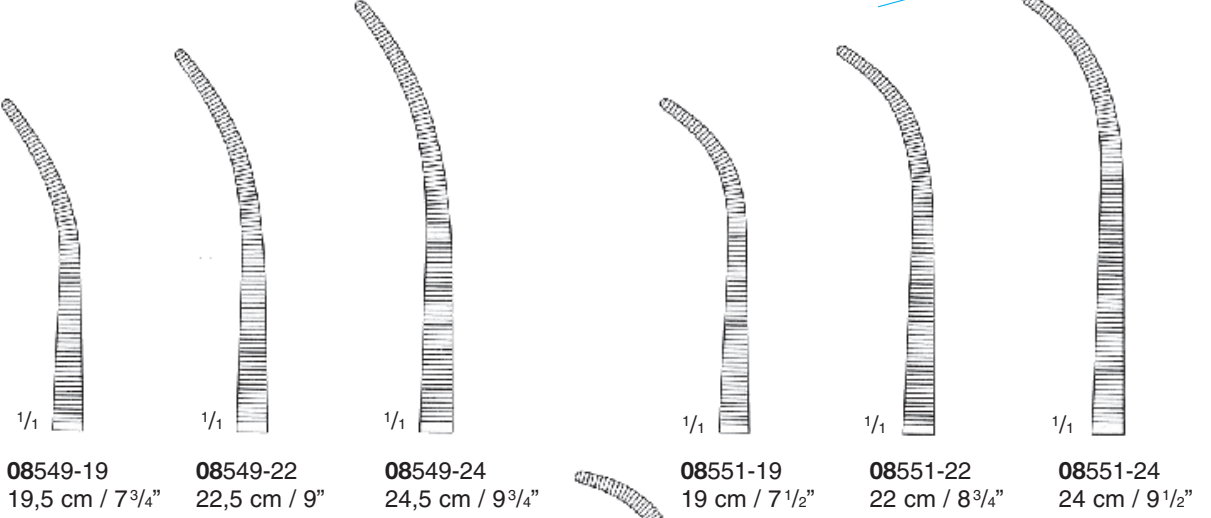
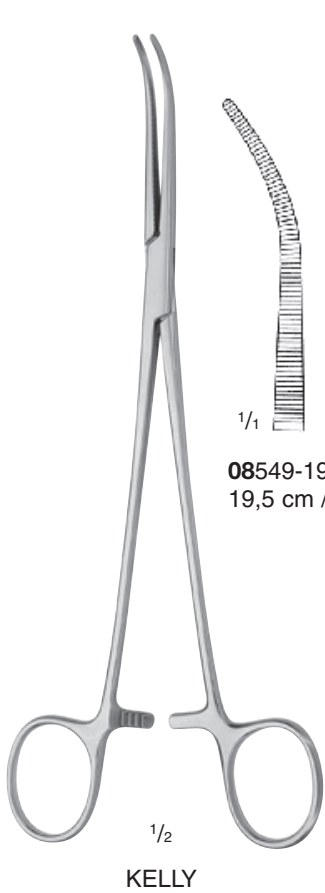

Hysterektomieklemmen, Vaginalklemmen
Hysterectomy and Vaginal Forceps
Pinzas-clamps para histerectomía y pinzas vaginales
Pinces à hysterectomie et pinces vaginales
Pinze per isterectomia e pinze vaginali



ATRAUMATICO

1/1

08607-01 21 cm / 8 1/4"	08607-02 21 cm / 8 1/4"	08607-03 21 cm / 8 1/4"	08607-04 21 cm / 8 1/4"	08609-01 24 cm / 9 1/2"	08609-02 24 cm / 9 1/2"	08609-03 24 cm / 9 1/2"	08609-04 24 cm / 9 1/2"

PARAMETRIUM
08607-01 – 08609-04

1/1

08643-23 23 cm / 9"	08645-24 24 cm / 9 1/2"	08648-24 24 cm / 9 1/2"	08649-24 24 cm / 9 1/2"

MOYNIHAN

1/2

SEKOND-LANDAU

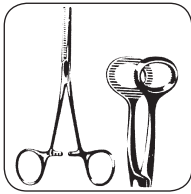

Hysterektomieklemmen, Vaginalklemmen
 Hysterectomy and Vaginal Forceps
 Pinzas-clamps para histerectomía y pinzas vaginales
 Pincès à hysterectomie et pincès vaginales
 Pinze per isterectomia e pinze vaginali



schweres Modell
 heavy pattern
 modelo fuerte
 modèle robuste
 modello robusto

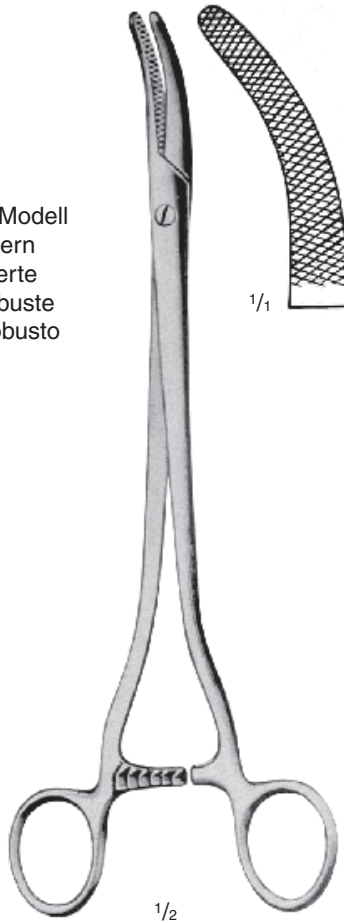

$\frac{1}{2}$
WERTHEIM
08667-25
 25 cm / 10"

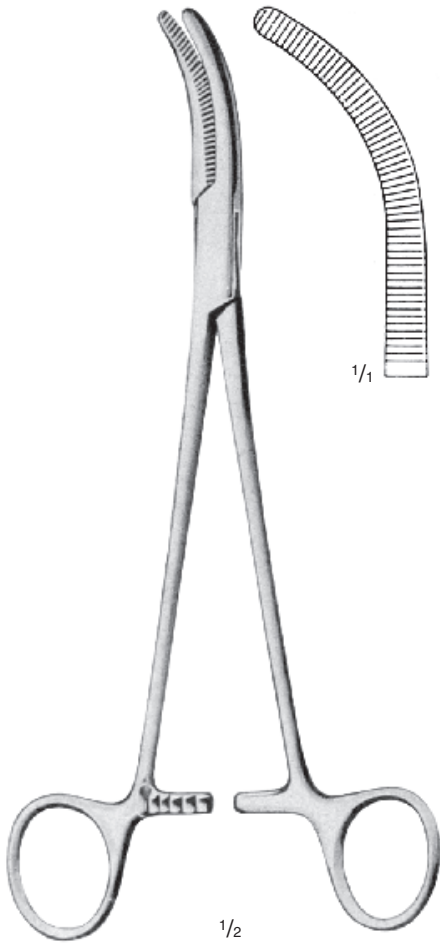

$\frac{1}{2}$
WERTHEIM
08669-25
 25 cm / 10"

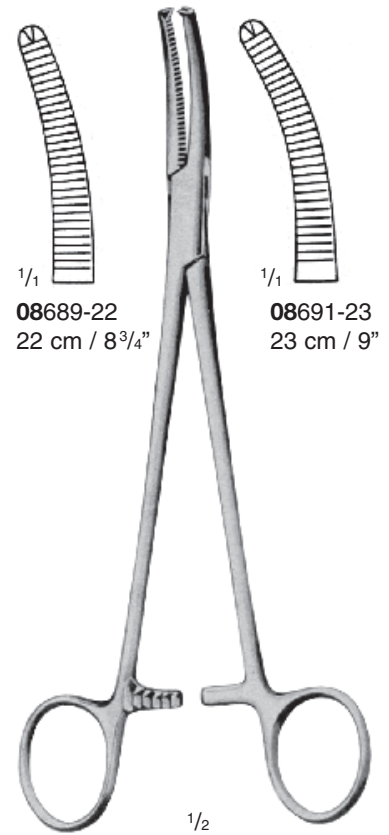

$\frac{1}{1}$
08689-22
 22 cm / 8 $\frac{3}{4}$ "

$\frac{1}{1}$
08691-23
 23 cm / 9"

$\frac{1}{2}$
WERTHEIM

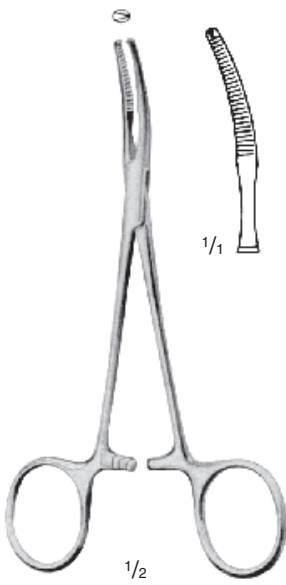

BABY-MIKULICZ
08693-14
14 cm / 5 1/2"
1:2 Zähne • Teeth
Dientes • Dents • Denti



MIKULICZ
08709-18
18 cm / 7"
1:2 Zähne • Teeth
Dientes • Dents • Denti

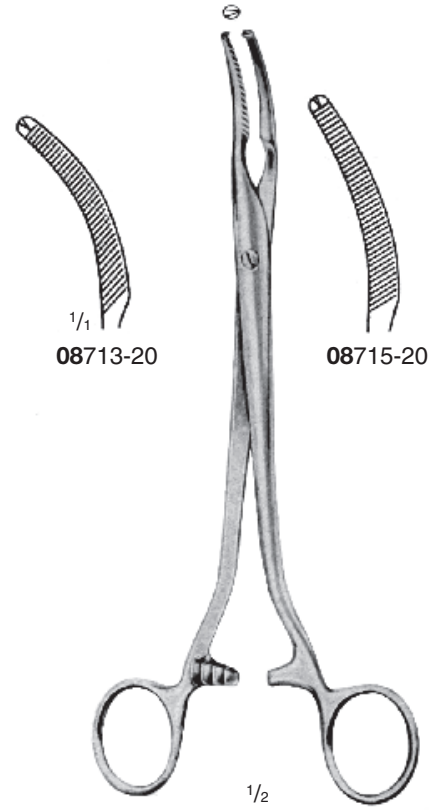

MIKULICZ
20 cm / 8"
1:2 Zähne • Teeth
Dientes • Dents • Denti

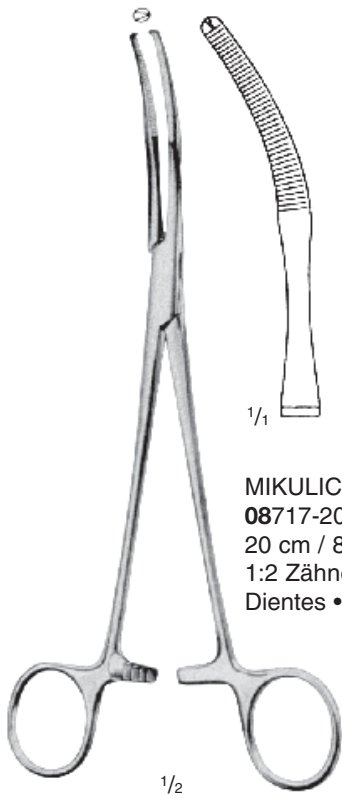

MIKULICZ
08717-20
20 cm / 8"
1:2 Zähne • Teeth
Dientes • Dents • Denti

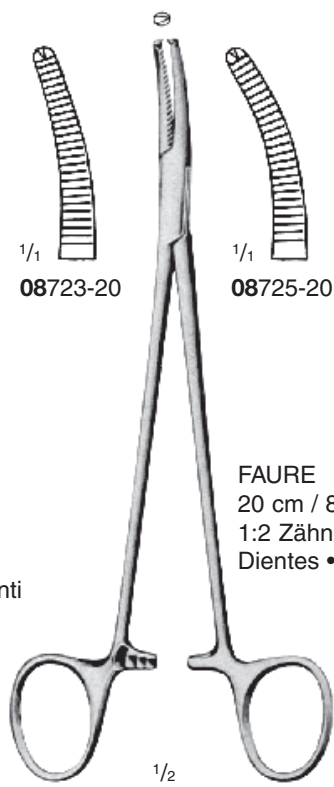

FAURE
20 cm / 8"
1:2 Zähne • Teeth
Dientes • Dents • Denti



SCHINDLER
08730-20
20 cm / 8"
1:2 Zähne • Teeth
Dientes • Dents • Denti

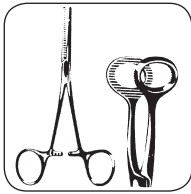

Tuchklemmen
Towel Forceps
Pinzas para compresas, Pinzas de campo
Pinces à compresses, Pinces à champs
Fermateli



1/2

SCHAEDEL
08847-09
9 cm / 3 1/2"



1/2

ENGL. MODELL
08849-09
9 cm / 3 1/2"



JONES
08853-05 = 5 cm / 2"
08853-09 = 9 cm / 3 1/2"



1/2

JONES-MARTIN
08855-09
9 cm / 3 1/2"



1/2

DOYEN
08865-18
18 cm / 7"

mit Schlauch- oder Kabelhalter
with clip for tubing or cable
con porta-tubo o porta-cable
avec porte-tube ou porte-cordon
con porta-tubo o porta-cavo

mit Schlauch- oder Kabelhalter
with clip for tubing or cable
con porta-tubo o porta-cable
avec porte-tube ou porte-cordon
con porta-tubo o porta-cavo



1/2

BACKHAUS
08885-11
11 cm / 4 1/2"

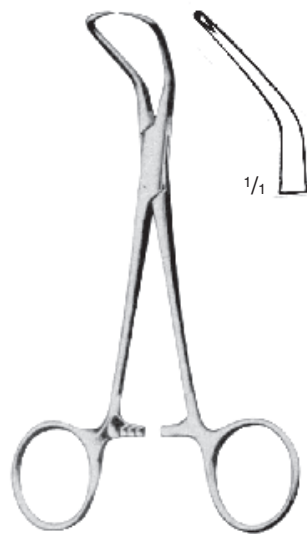

1/1

BACKHAUS
08887-08 = 8 cm / 3 1/4"
08887-11 = 11 cm / 4 1/2"
08887-13 = 13 cm / 5"
08887-15 = 15 cm / 6"



BACKHAUS-ROEDER
08889-13 = 13 cm / 5"
08889-15 = 15 cm / 6"

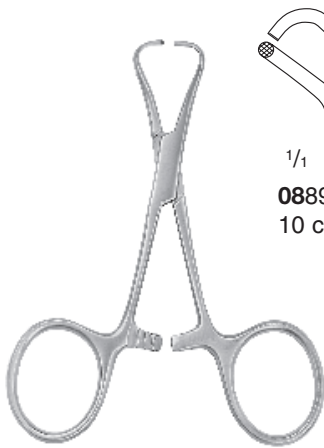

TOHOKU



1/1
08890-10
10 cm / 4"



1/1
08890-13
13 cm / 5"

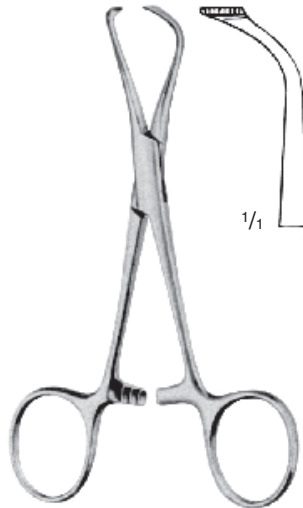

LORNA
08891-10 = 10 cm / 4"
08891-13 = 13 cm / 5"



1/1

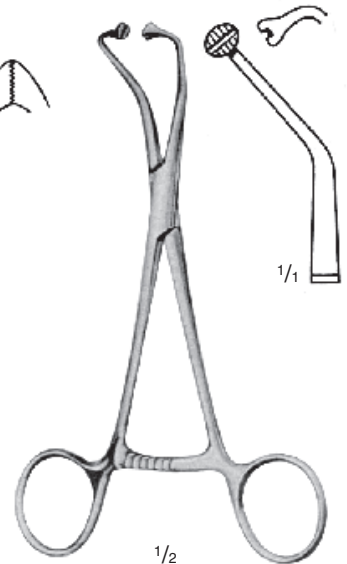

PEERS
08892-14
14,5 cm / 5 3/4"

1/2

1/1



BERNHARD
08893-16
16,5 cm / 6 1/2"

1/2



08897-14
14 cm / 5 1/2"

1/2

Kugel / Pfanne
Ball / Socket
Bola / Cojinete
Boule / Coussinet
Palla / Cuscinetto



LANE
08907-20
20 cm / 8"

1/2



Schlauchklemmen, Sterilisierpinzetten, Sterilisierzangen
 Tubing Clamps, Sterilizing Forceps
 Pinzas para tubos, Pinzas para esterilizacion
 Pincas presse-tube, Pincas à stérilisation
 Pinze per tubi, Pinze per sterilizzare

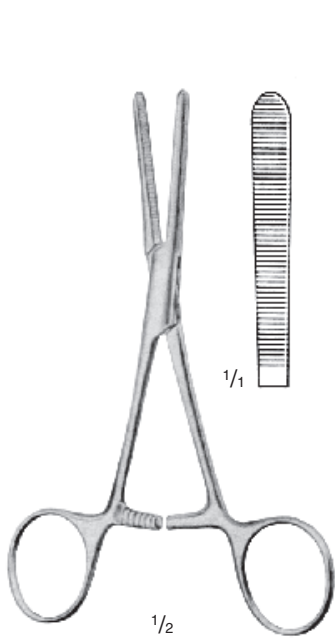

KLINIKUM BERLIN
08912-14
 14,5 cm / 5³/₄"

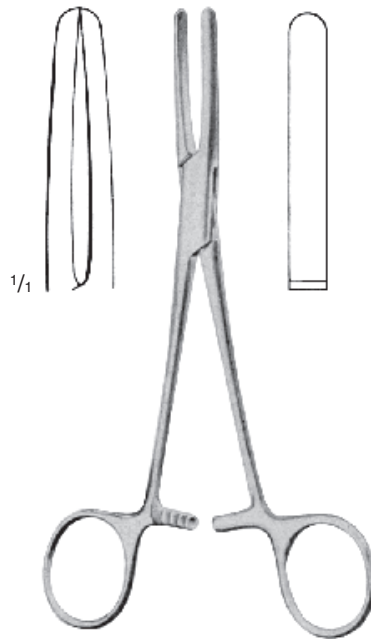

PRESBYTERIAN-HOSPITAL
08914-16 = 16,5 cm / 6¹/₂"
08914-18 = 18 cm / 7"
08914-20 = 20 cm / 8"

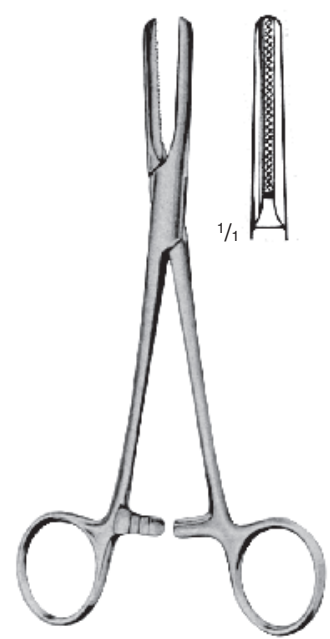

08920-16 = 16 cm / 6¹/₄"
08920-18 = 18 cm / 7"
08920-20 = 20 cm / 8"



DAVIS
10043-16 = 16 cm / 6¹/₄"
10043-20 = 20 cm / 8"
10043-24 = 24 cm / 9¹/₂"



CHEATLE
10049-27
 27 cm / 10³/₄"

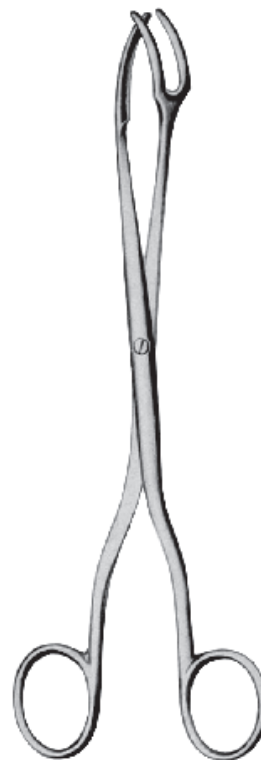

10051-20 = 20 cm / 8"
10051-30 = 30 cm / 12"



ROGGE
10053-23
 23 cm / 9"

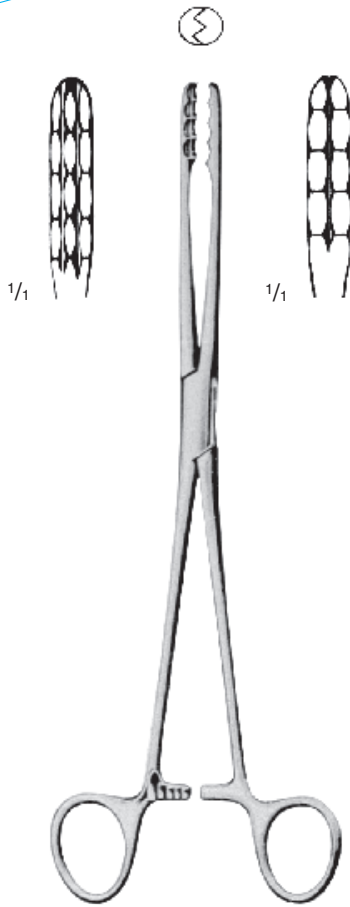

ULRICH
10072-18 = 18 cm / 7"
10072-20 = 20 cm / 8"
10072-22 = 22 cm / 8³/₄"
10072-25 = 25 cm / 10"

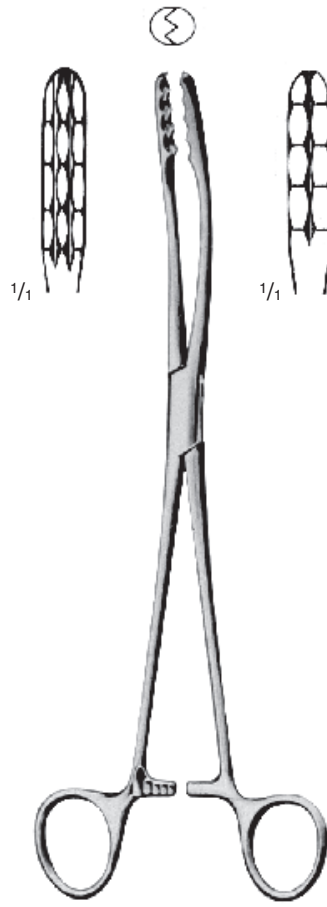

ULRICH
10073-18 = 18 cm / 7"
10073-20 = 20 cm / 8"
10073-22 = 22 cm / 8³/₄"
10073-25 = 25 cm / 10"

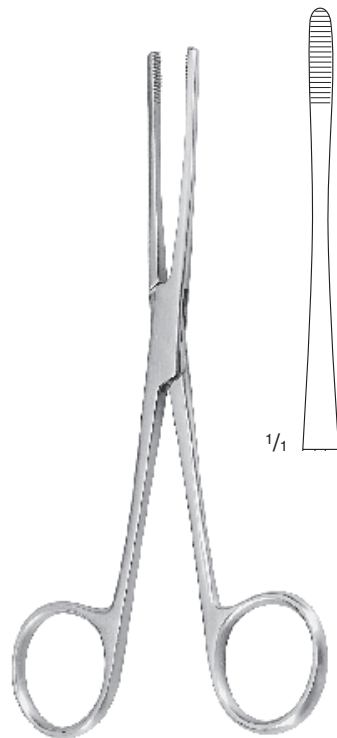

LISTER
10074-13 = 13 cm / 5"
10074-16 = 16 cm / 6¹/₄"
10074-18 = 18 cm / 7"

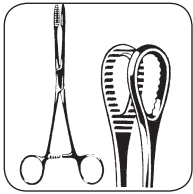

Korn- und Tupferzangen
 Sponge- and Dressing Forceps
 Pinzas para curaciones y pinzas porta-esponjas
 Pincès à pansements et pincès porte-coton
 Pinze per bende e pinze porta-cotone



GROSS-MAIER



gerade
 straight
 rectas
 droites
 rette

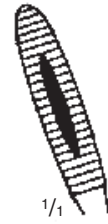

gebogen
 curved
 curvas
 courbes
 curve

	cm	in.	
10194-20	20,0	8"	10195-20
10194-22	22,0	8 ³ / ₄ "	10195-22
10194-25	25,0	10"	10195-25

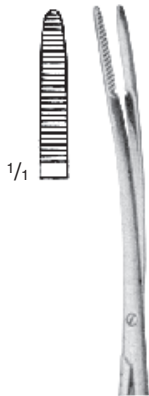

10233-25

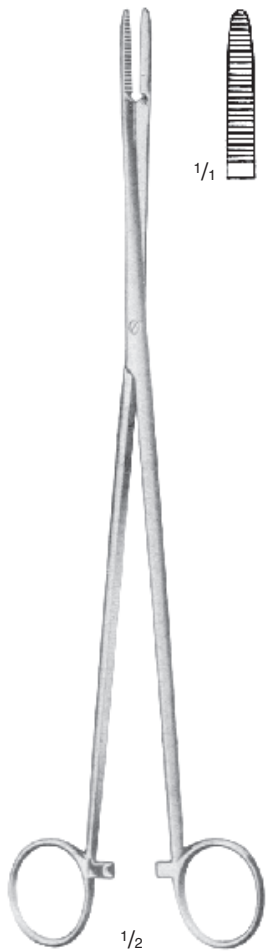

PELKMANN
 10232-25
 25 cm / 10"

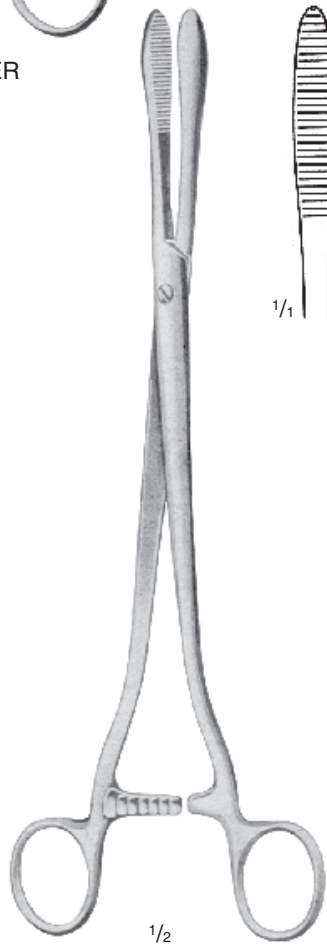

COLLIN
 10258-25
 25 cm / 10"



CHERON
 10262-25
 25 cm / 10"



BOZEMANN
10282-26
26 cm / 10 1/4"

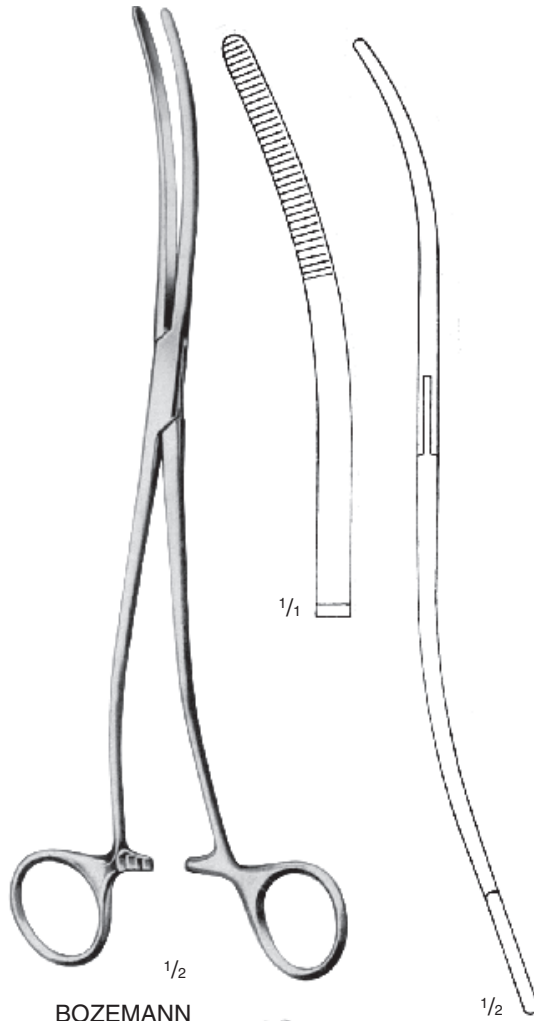

BOZEMANN
10285-26
26 cm / 10 1/4"

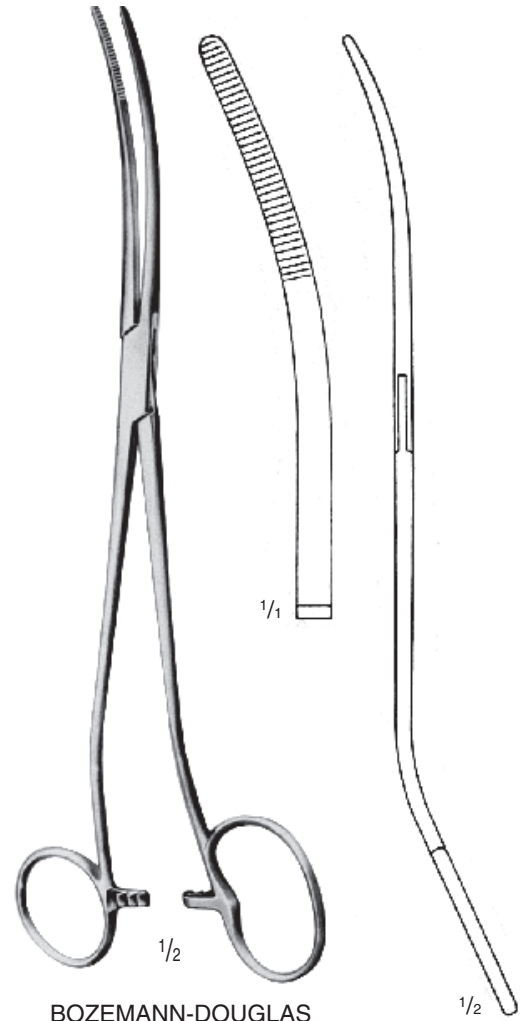

BOZEMANN-DOUGLAS
10287-26
26 cm / 10 1/4"

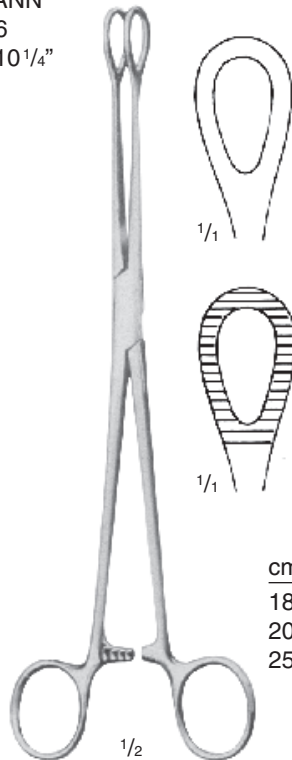

FOERSTER

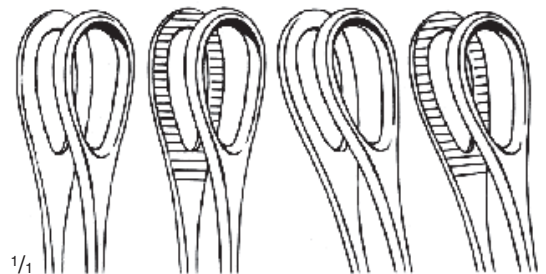

cm	in.				
18,0	7"		10324-18		10327-18
20,0	8"		10324-20		10327-20
25,0	10"	10322-25	10324-25	10325-25	10327-25

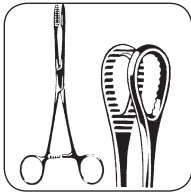

Tupfer- und Schwammzangen
 Dressing- and Sponge Holding Forceps
 Pinzas para tapones y pinzas porta- esponjas
 Pincès à pansements et pincès porte-coton
 Pinze per bende e pinze porta-cotone



^{1/2}
FOERSTER
 25 cm / 10"

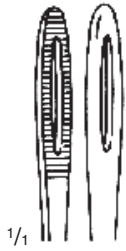

^{1/1}
10332-25

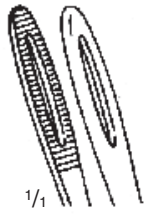

^{1/1}
10333-25

schmal
 narrow
 estrechas
 étroites
 strette

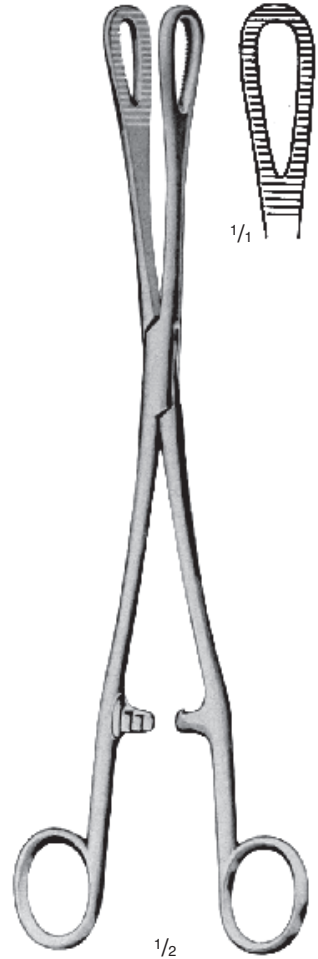

^{1/2}
RAMPLEY
10342-25
 25 cm / 10"



^{1/1}



^{1/1}



^{1/2}
FLETCHER
10350-24
 24 cm / 9 1/2"



^{1/2}
FLETCHER
10351-24
 24 cm / 9 1/2"



MARTIN
10444-58
58 cm / 22³/₄"



SAUERBRUCH
10446-55
55 cm / 21¹/₂"



¹/₂
BUNT
10772-12
12 cm / 4³/₄"



¹/₂
MAYO
10777-14
14 cm / 5¹/₂"



¹/₂
MAYO
10780-14
14 cm / 5¹/₂"

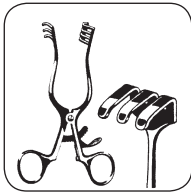

Wundhaken
Retractors
Separadores
Ecarteurs
Divaricatori



1/2

GRAEFE
16 cm / 6 1/4"



1/1

12038-01

scharf
sharp
agudo
pointu
acuto



12038-02

stumpf
blunt
romo
mousse
smusso



1/2

16 cm / 6 1/4"



1/1

12040-01



1/1

12040-02



1/1

12040-03



1/1

12040-04



1/2

O'CONNOR
12042-16
16 cm / 6 1/4"



1/1



1/2

GUTHRIE
16 cm / 6 1/4"



1/1

12044-01



1/1

12044-02



1/2

16 cm / 6 1/4"



1/1

12046-01



1/1

12046-02



1/1

12046-03



1/1

12046-04

scharf
sharp
agudo
pointu
acuto



1/1

12047-01



1/1

12047-02



1/1

12047-03



1/1

12047-04

stumpf
blunt
romo
mousse
smusso





Wundhaken
Retractors
Separadores
Ecarteurs
Divaricatori



				scharf sharp agudo pointu acuto
	1/1 12050-02	1/1 12050-03	1/1 12050-04	
	flexibel flexible flexible flexible flessibile			
				stumpf blunt romo mousse smusso
	1/1 12051-02	1/1 12051-03	1/1 12051-04	

1/2
16 cm / 6 1/4"

		scharf sharp agudo pointu acuto
	1/1 12058-04	
		stumpf blunt romo mousse smusso
	1/1 12059-04	

1/2
16 cm / 6 1/4"

1/2

MOLDESTAD
12060-12
12 cm / 4 3/4"

	1/1 10 x 10 mm 12062-16	1/1 8 mm 12063-08	1/1 10 mm 12063-10	1/1 12 mm 12063-12			1/1 12 mm 12065-12		1/1 14 mm 12065-14				
								1/1 14 mm 12063-14	1/1 16 mm 12063-16	1/1 18 mm 12063-18			
									1/1 16 mm 12065-16	1/1 18 mm 12065-18			

1/2
16 cm / 6 1/4"

CUSHING-KOCHER
12062-16
16 cm / 6 1/4"

DESMARRES
16 cm / 6 1/4"



Wundhaken
Retractors
Separadores
Ecarteurs
Divaricatori



MINI-LANGENBECK
16 cm / 6 1/4"



1/1
12067-10
10 x 6 mm

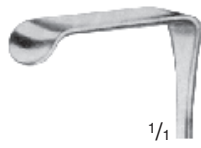

1/1
12067-17
17 x 5 mm



1/1
12067-20
20 x 6 mm



1/1
12067-22
22 x 8 mm



LANGENBECK-GREEN
16 cm / 6 1/4"



1/1
12070-01

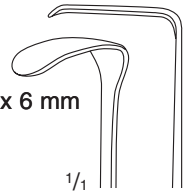

16 x 6 mm
1/1
12070-03

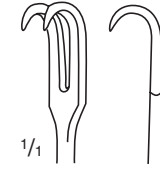

1/1
12070-02

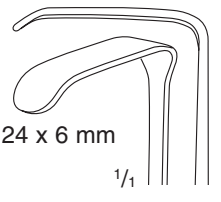

24 x 6 mm
1/1
12070-04

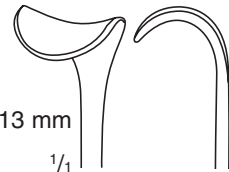

10 x 13 mm
1/1
12070-05



1/2
12071-16
16 cm / 6 1/4"



1/1
12072-01



1/1
12072-02



1/1
12072-03



1/1
12072-04

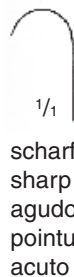

1/1
scharf
sharp
agudo
pointu
acuto



1/1
12073-01



1/1
12073-02



1/1
12073-03



1/1
12073-04

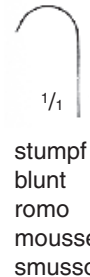

1/1
stumpf
blunt
romo
mousse
smusso



1/1
12074-01



1/1
12074-02



1/1
12074-03



1/1
12074-04

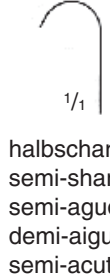

1/1
halbscharf
semi-sharp
semi-agudo
demi-aigus
semi-acuto



Wundhaken
Retractors
Separadores
Ecarteurs
Divaricatori



	1/1	1/1	1/1	1/1	
	12082-01	12082-02	12082-03	12082-04	
			flexibel flexible flexible flexible flessibile		
	1/1	1/1	1/1	1/1	
	12083-01	12083-02	12083-03	12083-04	
1/2					1/2
16 cm / 6 1/4"					17 cm / 6 3/4"

				scharf sharp agudo pointu acuto
1/1	1/1	1/1	1/1	
12092-01	12092-02	12092-03	12092-04	
				stumpf blunt romo mousse smusso
1/1	1/1	1/1	1/1	
12093-01	12093-02	12093-03	12093-04	

				scharf sharp agudo pointu acuto
	1/1	1/1	1/1	
	12112-02	12112-03	12112-04	
				stumpf blunt romo mousse smusso
	1/1	1/1	1/1	
	12113-02	12113-03	12113-04	
1/2				
VOLKMANN 11,5 cm / 4 1/2"				

				18 x 7 mm
	1/1	1/1	1/1	
	12123-01	12123-02	12123-03	
				10 x 3 mm
	1/1	1/1	1/1	
	12123-04	12123-05	12123-06	7 x 4 mm
				10 x 4 mm
1/2				
MEYERDING 18 cm / 7"				

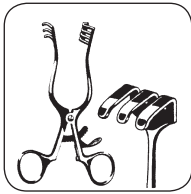

Wundhaken
Retractors
Separadores
Ecarteurs
Divaricatori



SENN-GREEN
15 cm / 6"

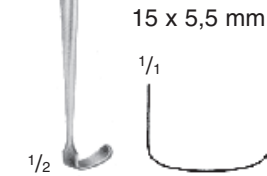
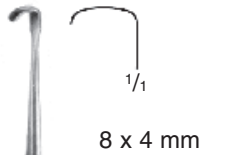

RAGNELL-DAVIS
12136-14
14 cm / 5 1/2"

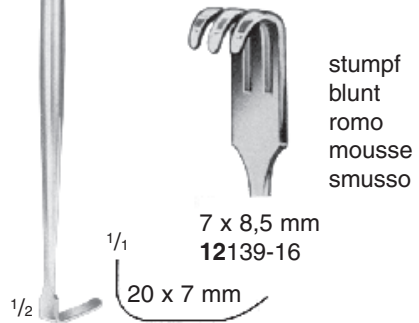

SENN-MILLER
16 cm / 6 1/4"

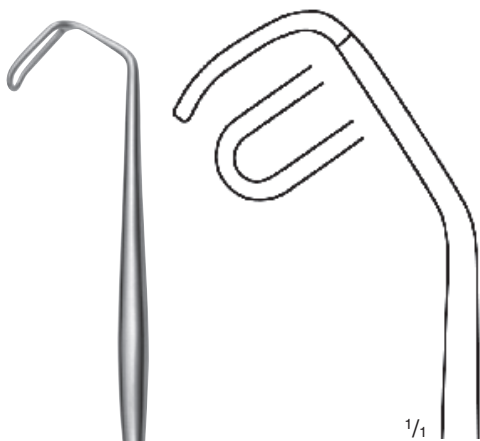

CUSHING
12142-20
20,5 cm / 8"

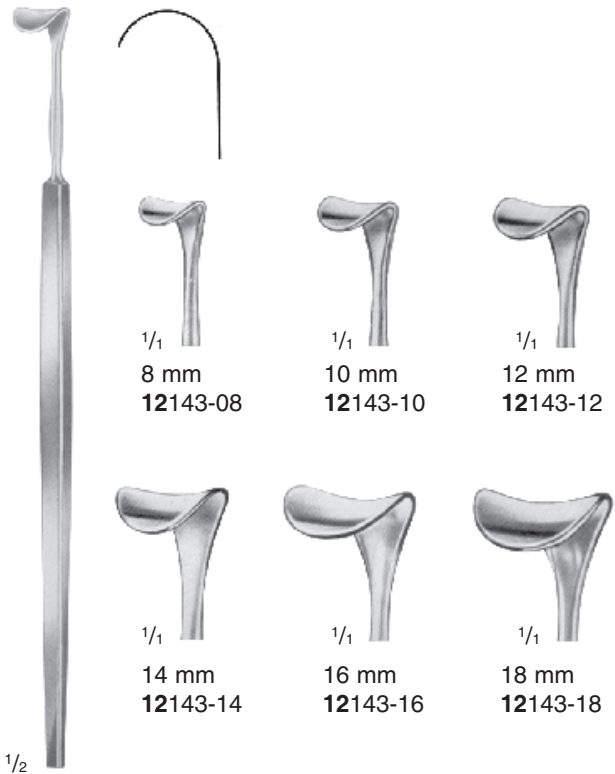

CUSHING
20 cm / 8"



CUSHING
24 cm / 9 1/2"

1/2



1/1
8 mm
12144-08



1/1
10 mm
12144-10



1/1
12 mm
12144-12



1/1
14 mm
12144-14



1/1
16 mm
12144-16



1/1
18 mm
12144-18



KÖNIG
17 cm / 6 3/4"

1/2



1/1
13 x 13 mm
12149-13



1/1
13 x 16 mm
12149-16



1/2

KLAPP
17,5 cm / 7"



1/1
12153-02



1/1
12153-03



1/1
12153-04

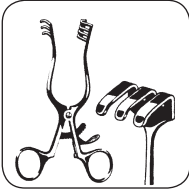

Wundhaken
Retractors
Separadores
Ecarteurs
Divaricatori



STRANDELL-STILLE
19 cm / 7 1/2"



1/1
12163-01



1/1
12163-02

gezahnt
toothed
dentado
dentelé
dentato

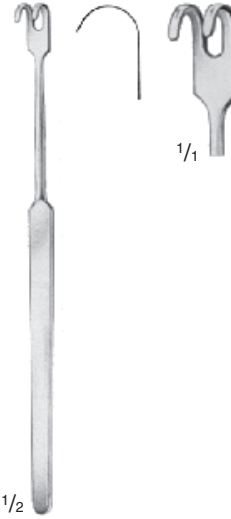

12169-02
13,5 cm / 5 1/4"

1/1



1/2
16 cm / 6 1/4"



1/1
12172-04



1/1
12173-04

scharf
sharp
agudo
pointu
acuto

stumpf
blunt
romo
mousse
smusso



1/2
VOLKMANN
23 cm / 9"



1/1



1/2

12182-01



1/2

12182-02

scharf
sharp
agudo
pointu
acuto



1/2

12182-03



1/2

12182-04



1/2

12182-06



1/1



1/2

12183-01



1/2

12183-02

stumpf
blunt
romo
mousse
smusso



1/2

12183-03



1/2

12183-04

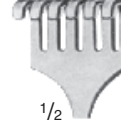

1/2

12183-06



1/2

VOLKMANN
21,5 cm / 8 1/2"



1/2 12192-01 1/2 12192-02 1/2 12192-03 1/2 12192-04 1/2 12192-06 1/2 12192-08

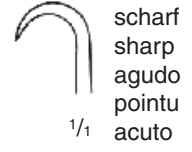

scharf
sharp
agudo
pointu
acuto



1/2 12193-01 1/2 12193-02 1/2 12193-03 1/2 12193-04 1/2 12193-06 1/2 12193-08

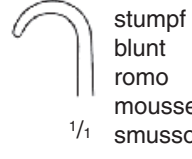

stumpf
blunt
romo
mousse
smusso



1/2 12194-01 1/2 12194-02 1/2 12194-03 1/2 12194-04 1/2 12194-06 1/2 12194-08

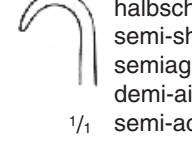

halbscharf
semi-sharp
semiagudo
demi-aigus
semi-acuto



1/2

VOLKMANN
12202-01
21,5 cm / 8 1/2"



VOLKMANN
12203-01
21,5 cm / 8 1/2"



12204-13 – 12205-25
23 cm / 9"

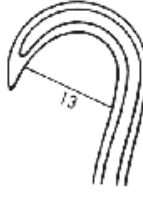

12204-13

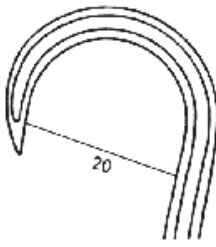

12204-20

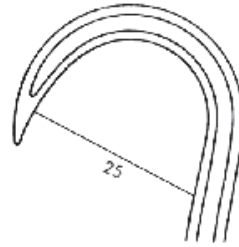

12204-25

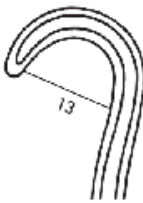

12205-13

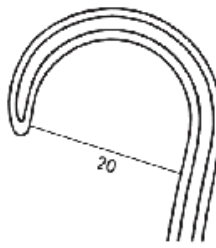

12205-20

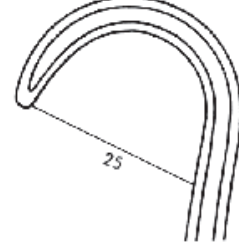

12205-25

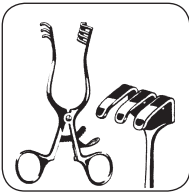

Wundhaken
Retractors
Separadores
Ecarteurs
Divaricatori



1/2

KOCHER
22 cm / 8³/₄"

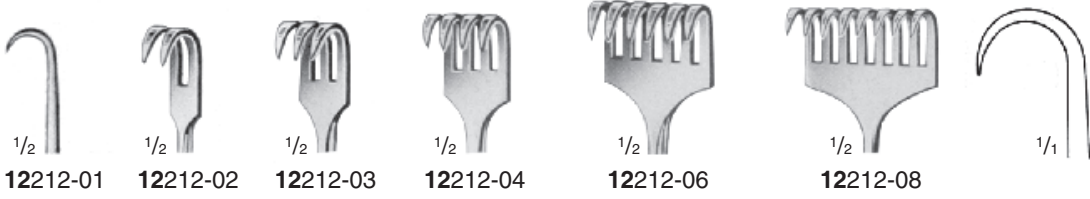

scharf
sharp
agudo
pointu
acuto

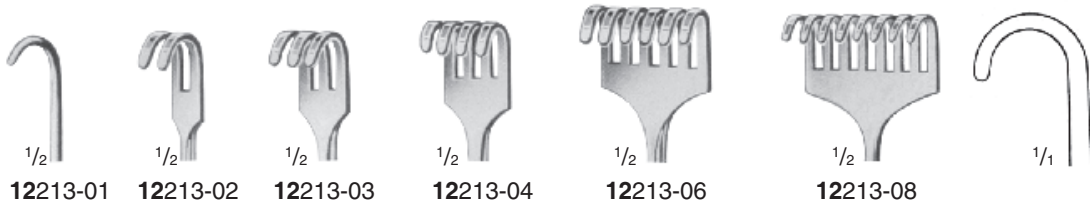

stumpf
blunt
romo
mousse
smusso

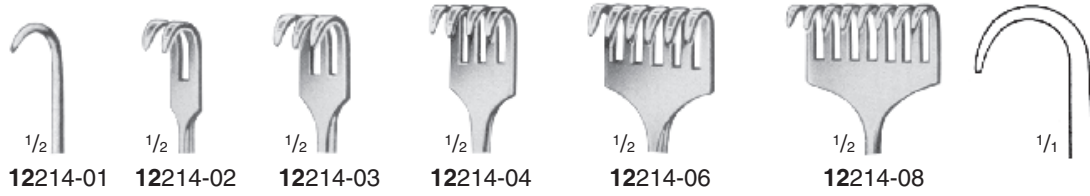

halbscharf
semi-sharp
semiagudo
demi-aigus
semi-acuto



36 x 60 mm

36 x 30 mm

OLLIER
12223-03

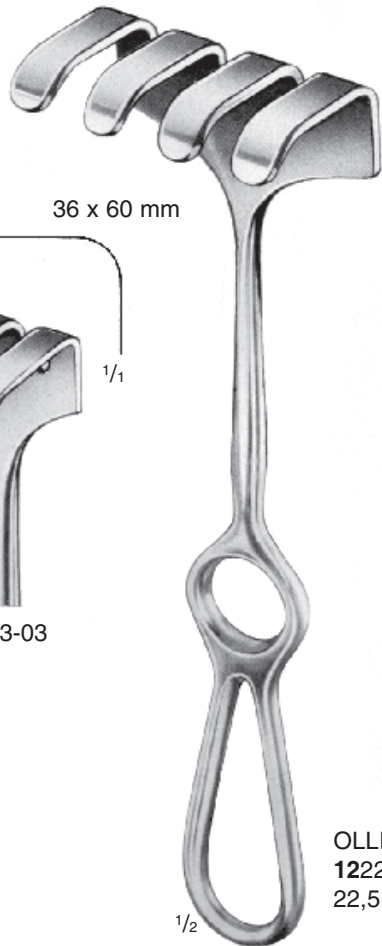

1/2

OLLIER
12225-04
22,5 cm / 9"



1/2

WASSMUND
12233-02
20 cm / 8"

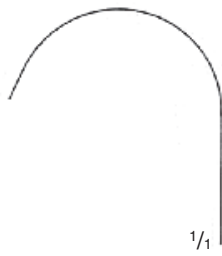

1/1

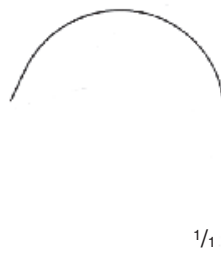

1/1

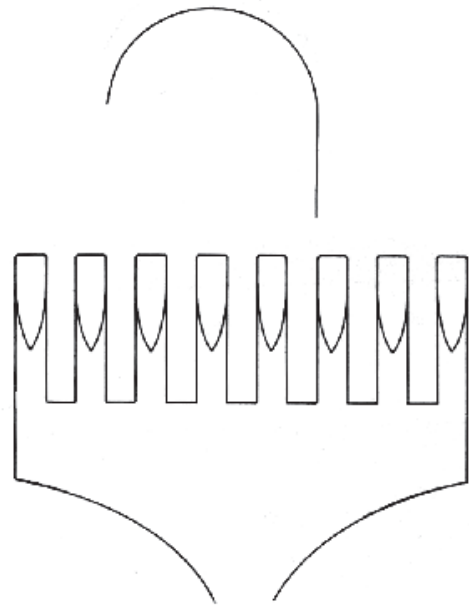

26 x 60 mm

40 x 30 mm



1/2

KOERTE
12238-08
23,5 cm / 9 1/4"

40 x 30 mm



1/2

KOERTE
12239-08
23,5 cm / 9 1/4"



1/2

12240-08
25 cm / 10"



Wundhaken
Retractors
Separadores
Ecarteurs
Divaricatori



$\frac{1}{2}$
ISRAEL
25 cm / 10"

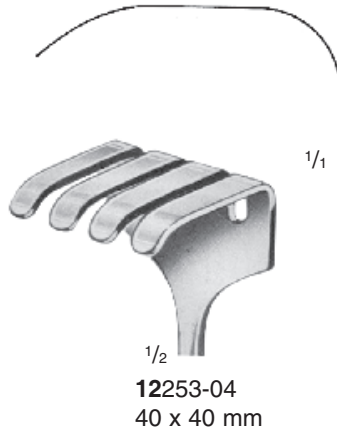

$\frac{1}{2}$
12253-04
40 x 40 mm

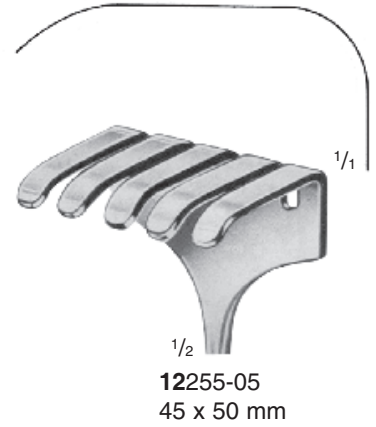

$\frac{1}{2}$
12255-05
45 x 50 mm

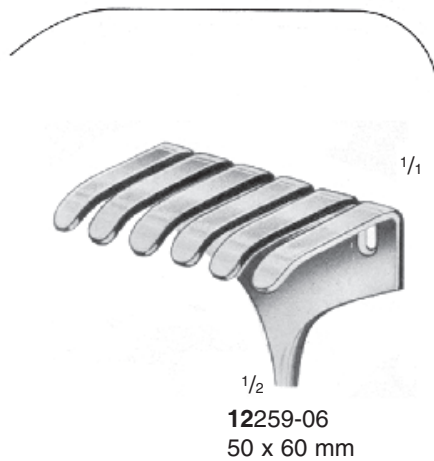

$\frac{1}{2}$
12259-06
50 x 60 mm

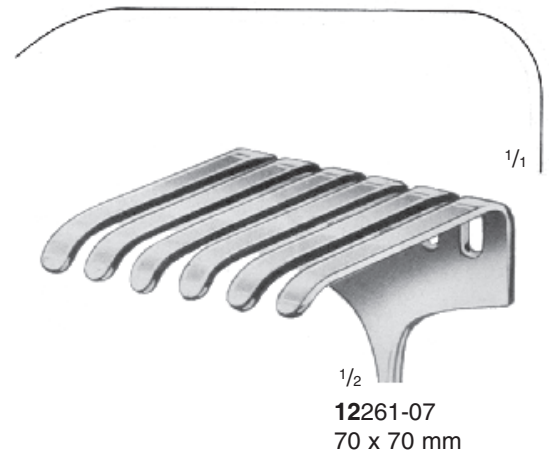

$\frac{1}{2}$
12261-07
70 x 70 mm



20 x 7 mm ^{1/1}
12265-00

30 x 11 mm ^{1/1}
12263-01
12265-01

30 x 14 mm ^{1/1}
12263-02
12265-02

30 x 16 mm ^{1/1}
12263-03
12265-03

40 x 11 mm ^{1/1}
12263-04
12265-04

40 x 15 mm ^{1/1}
12263-05
12265-05

50 x 11 mm ^{1/1}
12263-06
12265-06



^{1/2}
LANGENBECK
12263-01 – 12263-06
22 cm / 8 3/4"



^{1/2}
LANGENBECK
12265-00 – 12265-06
21 cm / 8 1/2"

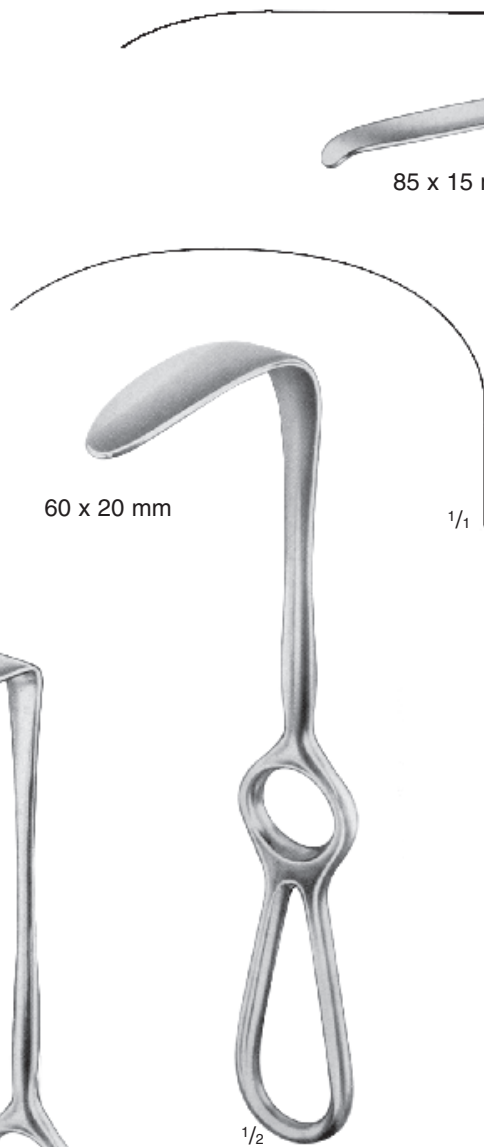

60 x 20 mm ^{1/1}

^{1/2}
LANGENBECK
12267-21
21 cm / 8 1/4"

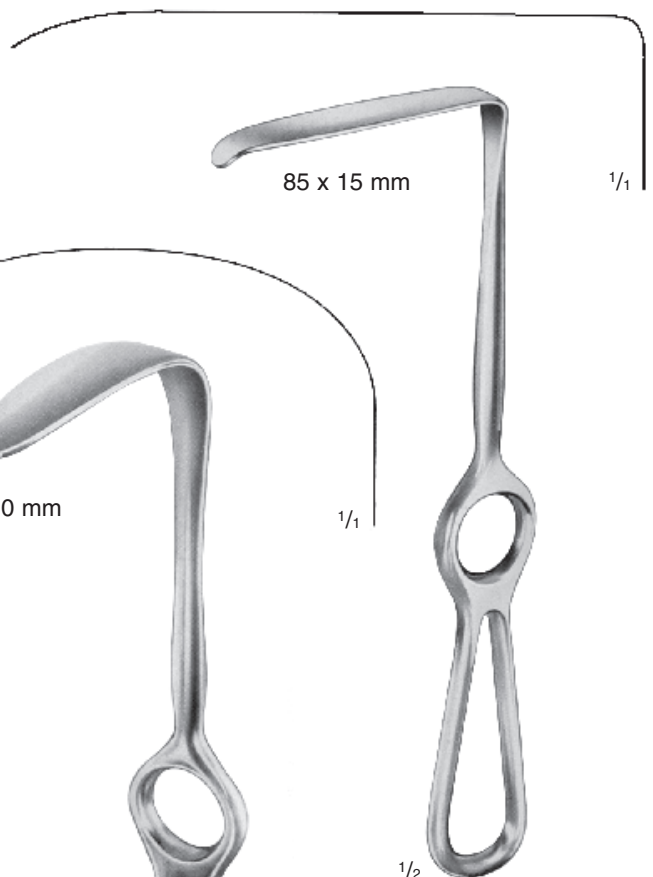

85 x 15 mm ^{1/1}

^{1/2}
LANGENBECK
12269-21
21 cm / 8 1/4"

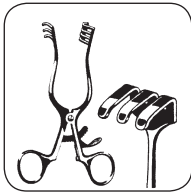

Wundhaken
Retractors
Separadores
Ecarteurs
Divaricatori



KOCHER
12287-03
78 x 40 mm
23 cm / 9 1/4"

1/2

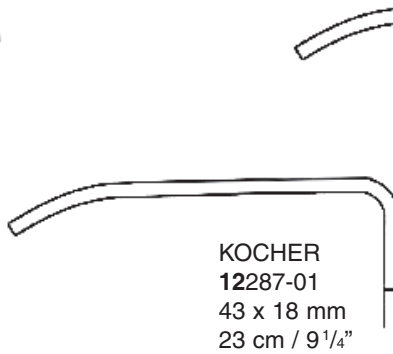

KOCHER
12287-01
43 x 18 mm
23 cm / 9 1/4"



KOCHER
12287-02
63 x 25 mm
23 cm / 9 1/4"

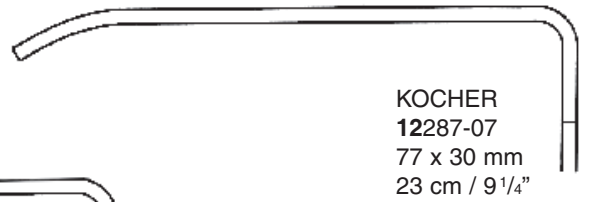

KOCHER
12287-07
77 x 30 mm
23 cm / 9 1/4"

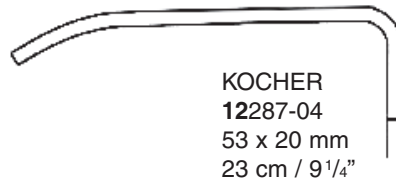

KOCHER
12287-04
53 x 20 mm
23 cm / 9 1/4"



28 x 6 mm

1/2

LAHEY
12279-19
19 cm / 7 1/2"



12 x 14 mm

1/2

LITTLE
12285-20
20 cm / 8"

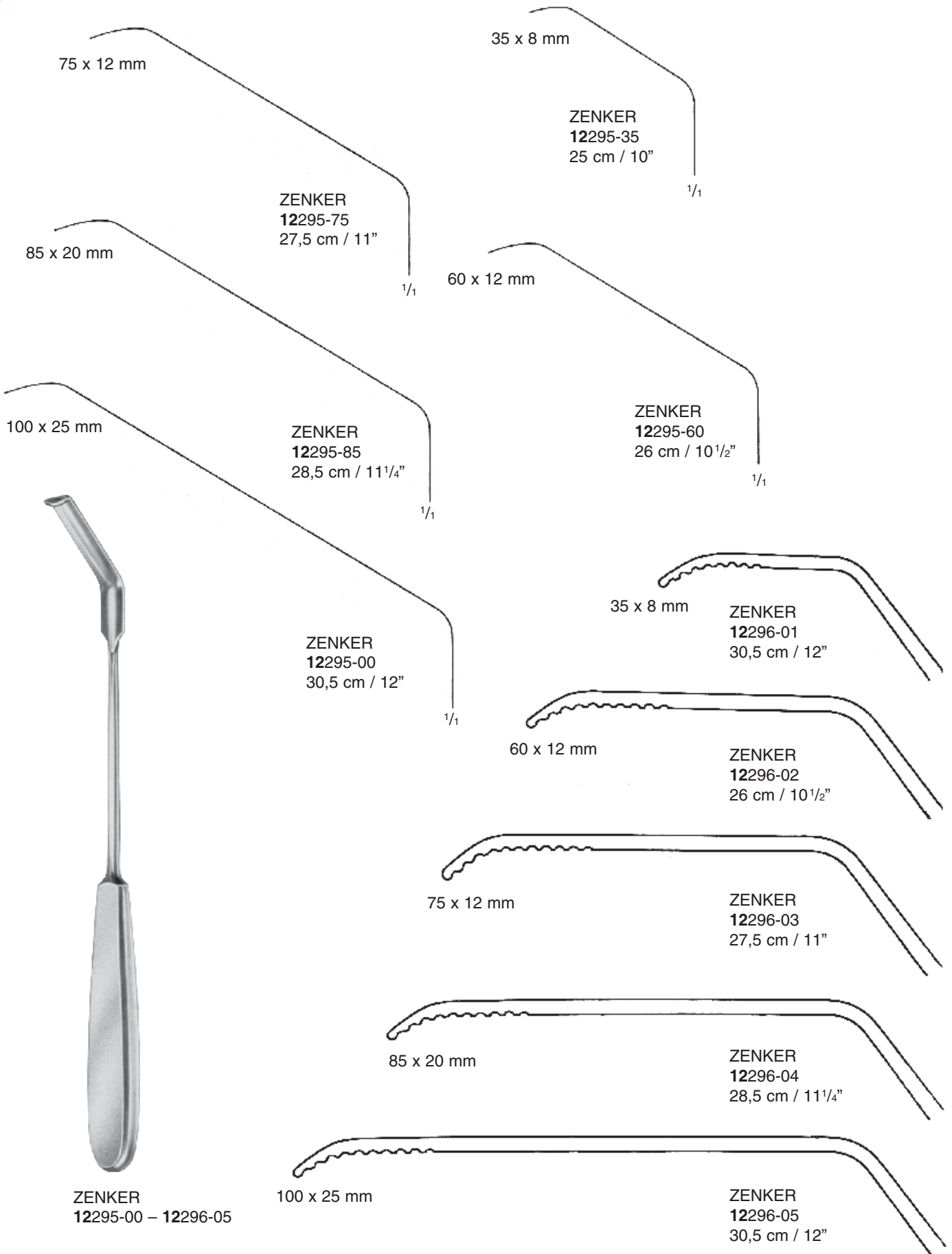

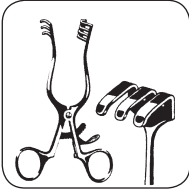

Wundhaken
Retractors
Separadores
Ecarteurs
Divaricatori



KOCHER
19 cm / 7 1/2"



12297-01
19 x 12 mm



12297-02
21 x 14 mm



KOCHER-LANGENBECK
12319-02 – 12319-20

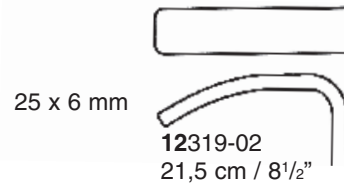

25 x 6 mm
12319-02
21,5 cm / 8 1/2"

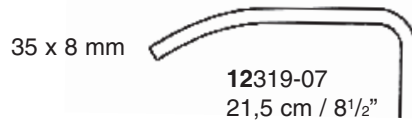

35 x 8 mm
12319-07
21,5 cm / 8 1/2"

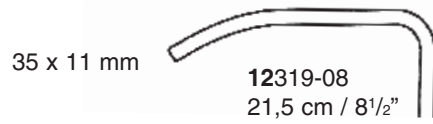

35 x 11 mm
12319-08
21,5 cm / 8 1/2"

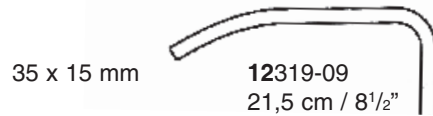

35 x 15 mm
12319-09
21,5 cm / 8 1/2"



40 x 11 mm
12319-10
21,5 cm / 8 1/2"

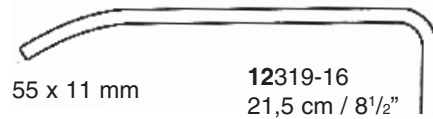

55 x 11 mm
12319-16
21,5 cm / 8 1/2"

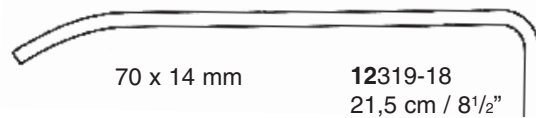

70 x 14 mm
12319-18
21,5 cm / 8 1/2"

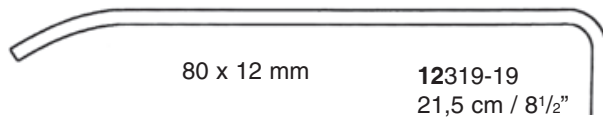

80 x 12 mm
12319-19
21,5 cm / 8 1/2"

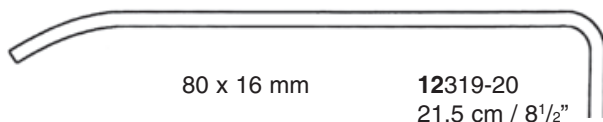

80 x 16 mm
12319-20
21,5 cm / 8 1/2"



1/2

KOCHER-LANGENBECK
12320-01 – 12320-08

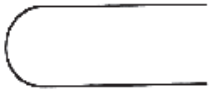
- 

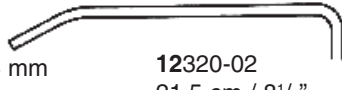
25 x 10 mm **12320-01**
21,5 cm / 8 1/2"
- 

40 x 13 mm **12320-02**
21,5 cm / 8 1/2"
- 

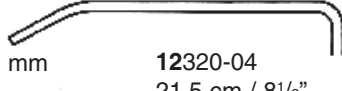
60 x 13 mm **12320-03**
21,5 cm / 8 1/2"
- 

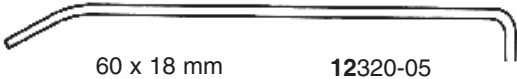
40 x 18 mm **12320-04**
21,5 cm / 8 1/2"
- 

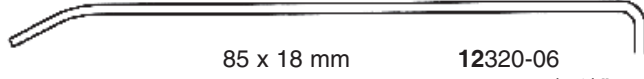
60 x 18 mm **12320-05**
21,5 cm / 8 1/2"
- 

85 x 18 mm **12320-06**
21,5 cm / 8 1/2"
- 

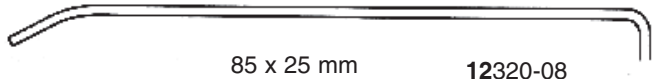
60 x 25 mm **12320-07**
21,5 cm / 8 1/2"
- 

85 x 25 mm **12320-08**
21,5 cm / 8 1/2"

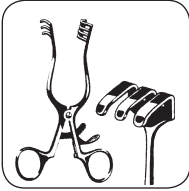

Wundhaken
Retractors
Separadores
Ecarteurs
Divaricatori



1/2

KOCHER
22 cm / 8³/₄"

- 12323-01 = 40 x 10 mm
- 12323-02 = 40 x 15 mm
- 12323-03 = 40 x 20 mm



1/2

MIDDELDORPF
12333-01 – 12333-03

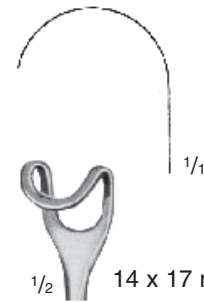

1/1

1/2 14 x 17 mm

12333-01
21,5 cm / 8¹/₂"



1/2 20 x 22 mm

12333-02
22 cm / 8³/₄"



1/2 26 x 30 mm

12333-03
23,5 cm / 9¹/₄"



Fig. 1

Fig. 2

36 x 28 mm
63 x 49 mm

1/2

RICHARDSON-EASTMAN

12353-00 = Satz – set – juego – jeu – serie

12353-01 = Fig. 1 = 26 cm / 10 1/4"

12353-02 = Fig. 2 = 28 cm / 11"

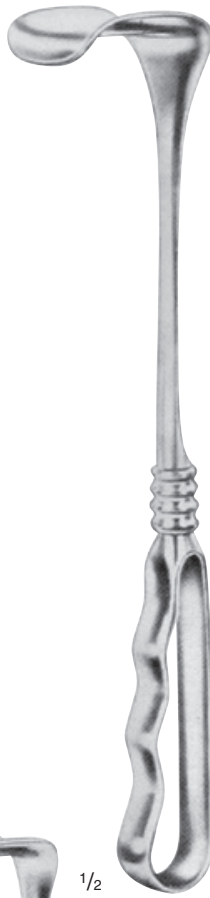

28 x 20 mm

1/2

12363-01



36 x 28 mm

1/2

12363-02



44 x 38 mm

1/2

12363-03



52 x 22 mm

1/2

RICHARDSON
24 cm / 9 1/2"

1/2

RICHARDSON
12367-24
24 cm / 9 1/2"

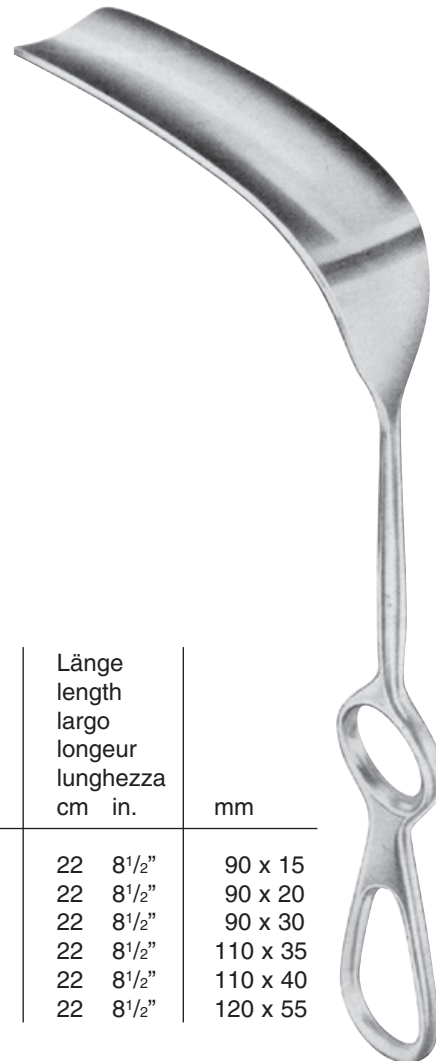

65 x 50 mm

1/2

KELLY
12369-26
26 cm / 10 1/4"

1/2

DOYEN-STILLE

	Länge length largo longeur lunghezza cm in.	mm
12374-01	22 8 1/2"	90 x 15
12374-02	22 8 1/2"	90 x 20
12374-03	22 8 1/2"	90 x 30
12374-04	22 8 1/2"	110 x 35
12374-05	22 8 1/2"	110 x 40
12374-06	22 8 1/2"	120 x 55



Wundhaken
Retractors
Separadores
Ecarteurs
Divaricatori

60 x 20 mm

12376-01
26,0 cm / 10¹/₄"

80 x 30 mm

12376-02
26,0 cm / 10¹/₄"

100 x 30 mm

12376-03
26,0 cm / 10¹/₄"

120 x 30 mm

12376-04
26,0 cm / 10¹/₄"

140 x 30 mm

12376-05
26,0 cm / 10¹/₄"

140 x 40 mm

12376-06
26,0 cm / 10¹/₄"

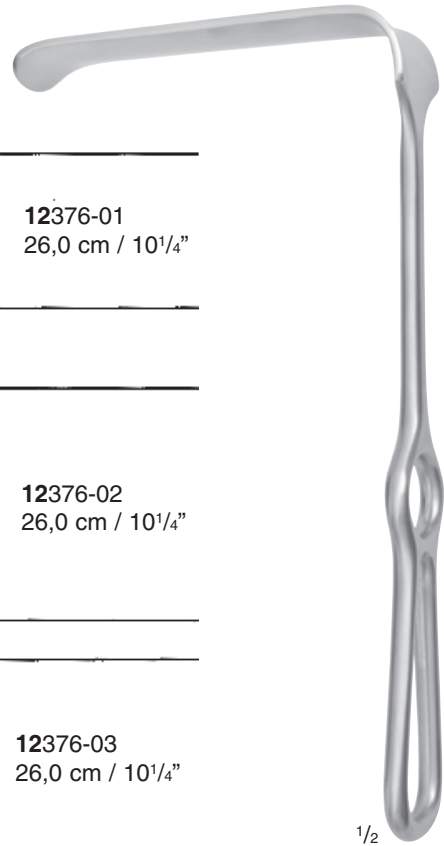

1/2

HÖSEL
12376-01 – 12376-06

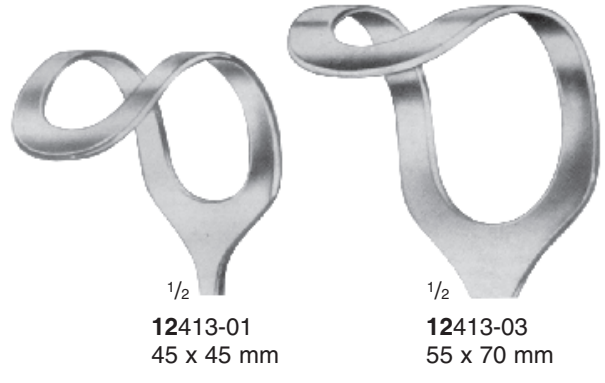

$\frac{1}{2}$
12413-01
45 x 45 mm

$\frac{1}{2}$
12413-03
55 x 70 mm



$\frac{1}{2}$
MIDDELDORPF
12413-02
25,5 cm / 10"
45 x 50 mm



$\frac{1}{2}$
FRITSCH

	Länge		mm
	length	largo	
12425-01	24	9 $\frac{1}{2}$ "	45 x 40
12425-02	24	9 $\frac{1}{2}$ "	45 x 50
12425-03	24	9 $\frac{1}{2}$ "	45 x 60
12425-04	24	9 $\frac{1}{2}$ "	45 x 75

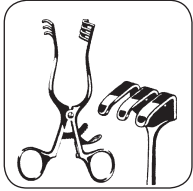

Scheidenhalter und Wundhaken
 Vaginal- and Wound Retractors
 Valvas vaginales, Separadores
 Valves et écarteurs vaginaux
 Divaricatori, Divaricatori per parete abdominale



DOYEN
12433-25
 25 cm / 10"



KOCHER
12441-22
 22,5 cm / 9"

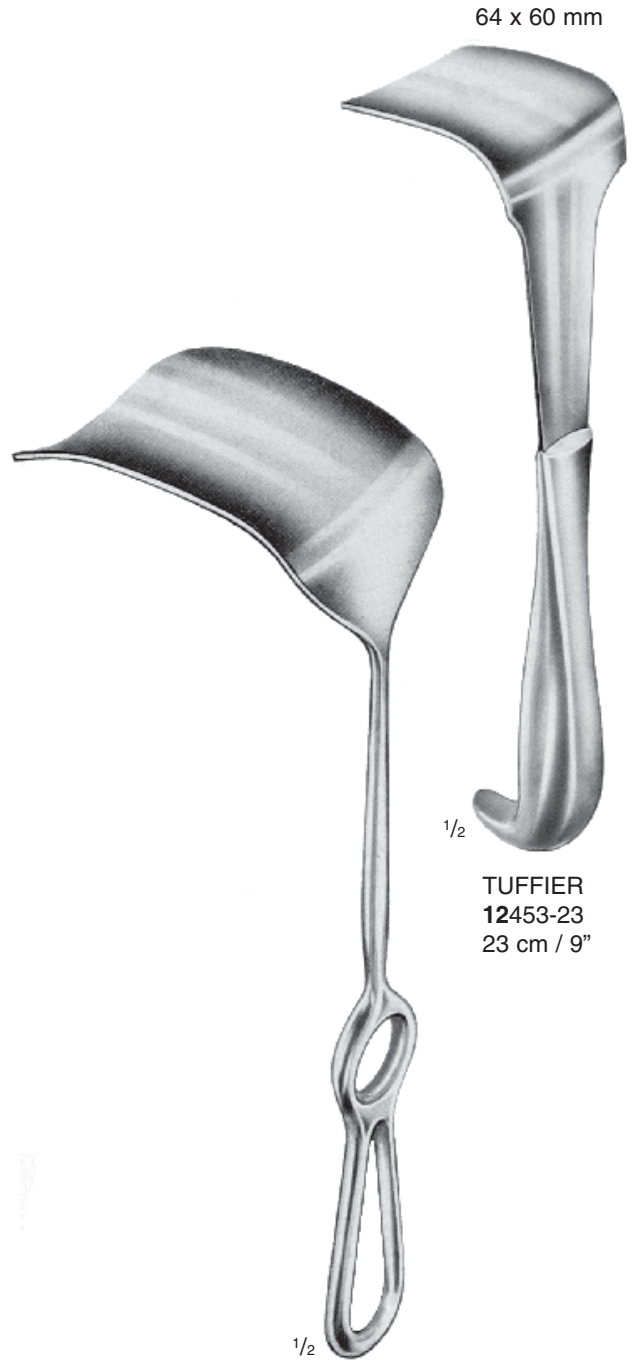

TUFFIER
12453-23
 23 cm / 9"

KOCHER

	Länge length largo longeur lunghezza		mm
	cm	in.	
12443-01	25	10"	80 x 45
12443-02	25	10"	80 x 55
12443-03	25	10"	80 x 65

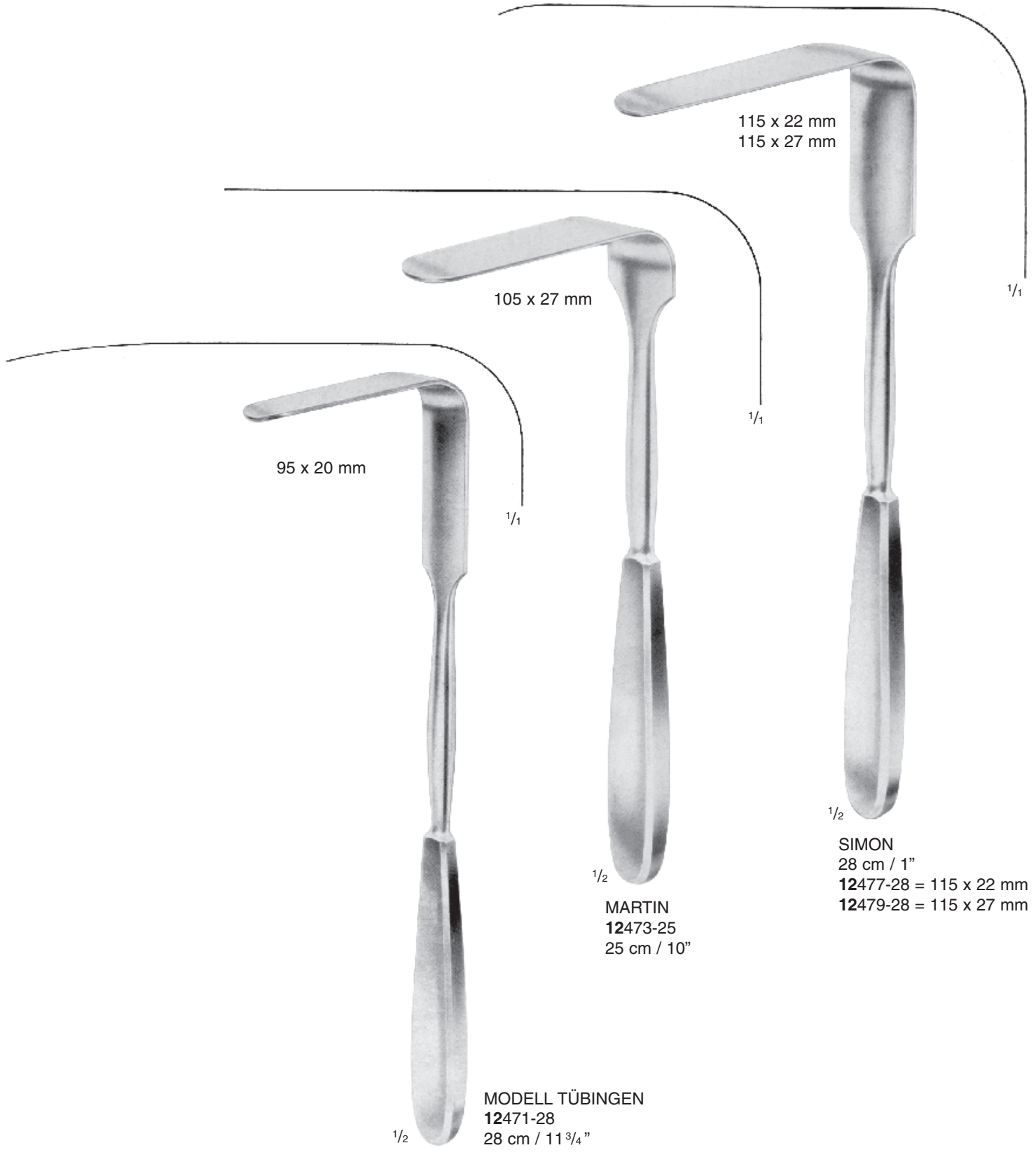

95 x 20 mm

105 x 27 mm

115 x 22 mm
115 x 27 mm

1/2

MODELL TÜBINGEN
12471-28
28 cm / 11 3/4"

1/2

MARTIN
12473-25
25 cm / 10"

1/2

SIMON
28 cm / 1"
12477-28 = 115 x 22 mm
12479-28 = 115 x 27 mm

1/1

1/1

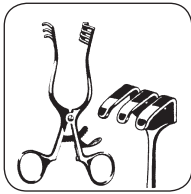

Wundhaken
Retractors
Separadores
Ecarteurs
Divaricatori





DAVIDSON
16 cm / 6 1/4"



1/2

12517-01
75 x 50 mm

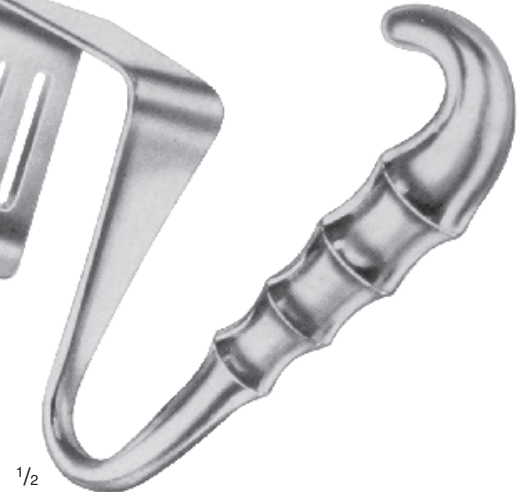

1/2

12517-02
75 x 90 mm



1/1

125 x 37 mm

SAUERBRUCH
12523-25
25 cm / 10"

1/2

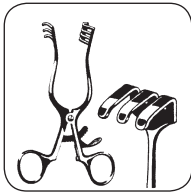

Wundhaken
Retractors
Separadores
Ecarteurs
Divaricatori

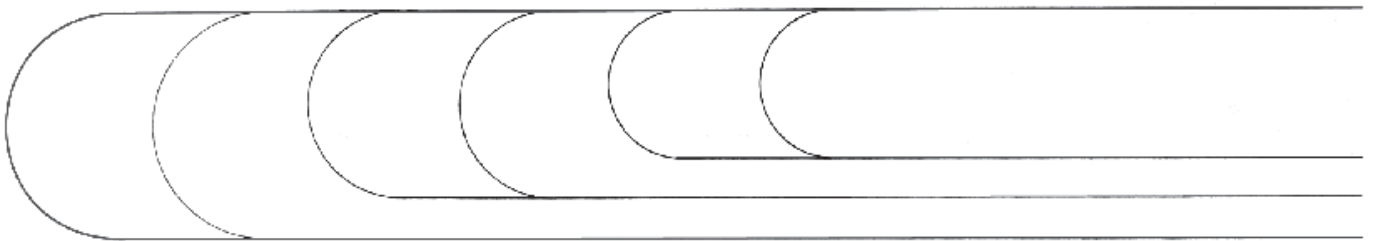
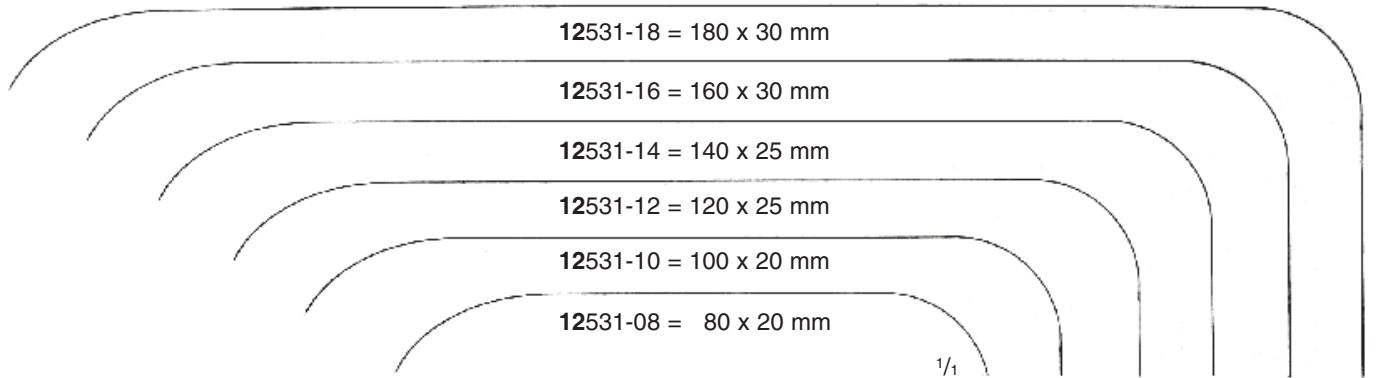

BRUNNER
12531-08 - 18
25 cm / 10"

1/2



SAUERBRUCH
22,5 cm / 9"

1/2



12533-01
45 x 15 mm

1/2

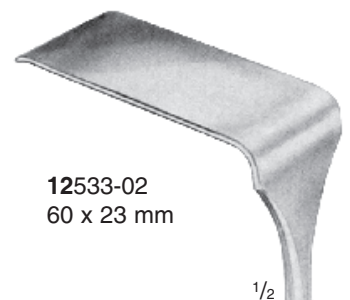

12533-02
60 x 23 mm

1/2

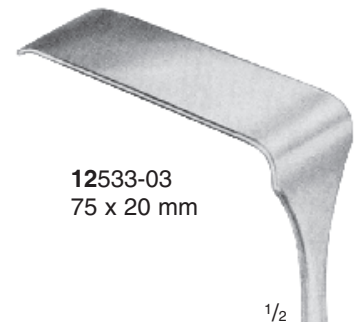

12533-03
75 x 20 mm

1/2

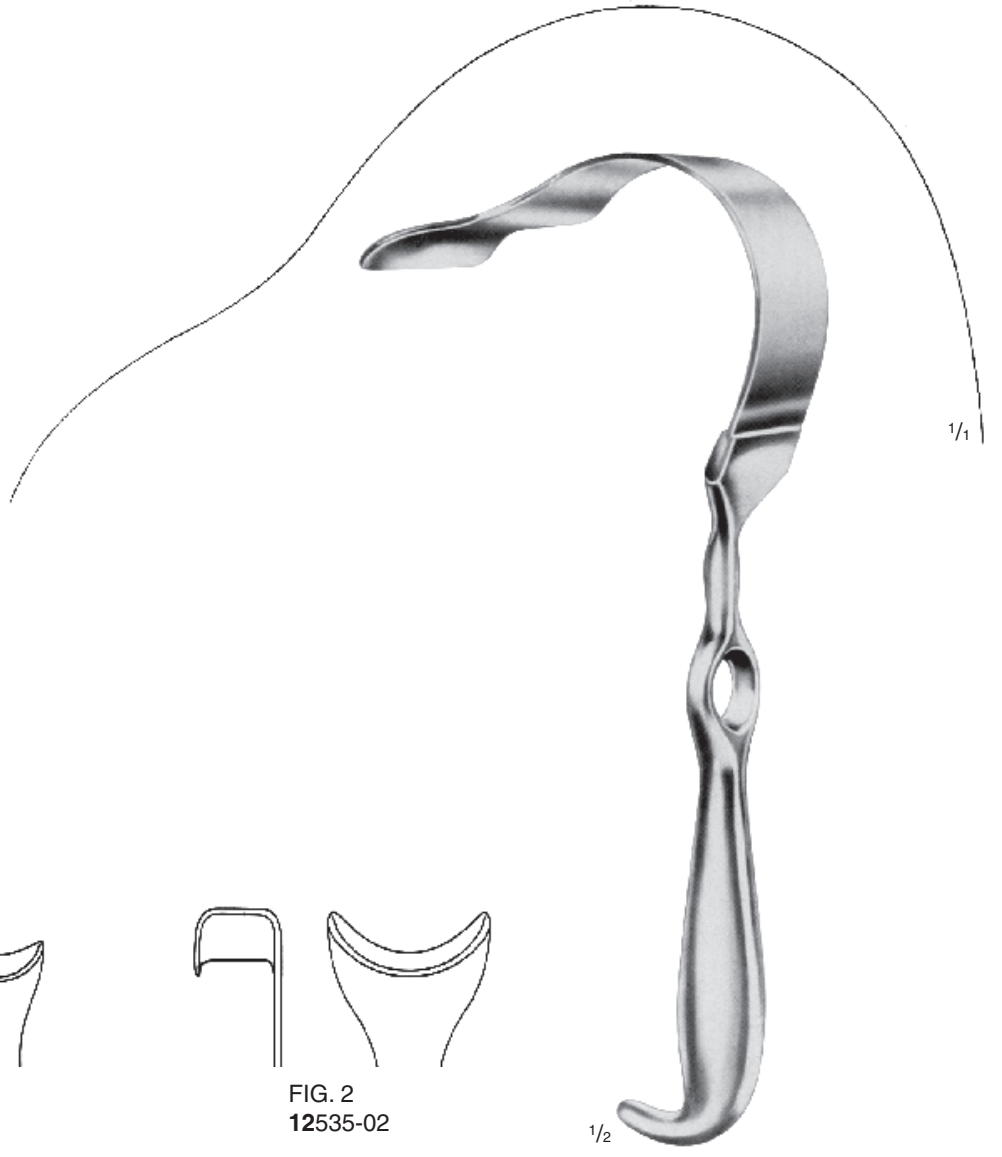

flexibel
flexible
flexible
flexible
flessibile

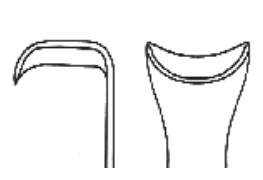

FIG. 1
12535-01

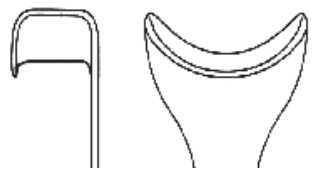

FIG. 2
12535-02



FIG. 3
12535-03

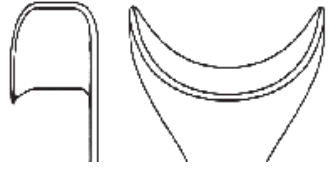

FIG. 4
12535-04

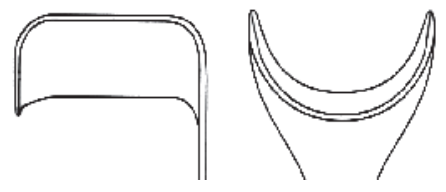

FIG. 5
12535-05

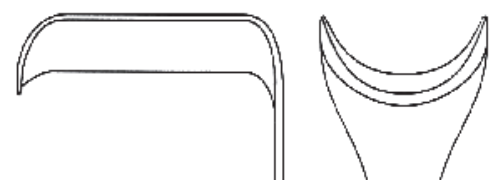
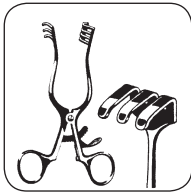

FIG. 6
12535-06

POLLOSON
12549-27
27 cm / 10³/₄"

ROSS
12535-01 – 12535-06
25,5 cm / 10"



Wundhaken
Retractors
Separadores
Ecarteurs
Divaricatori

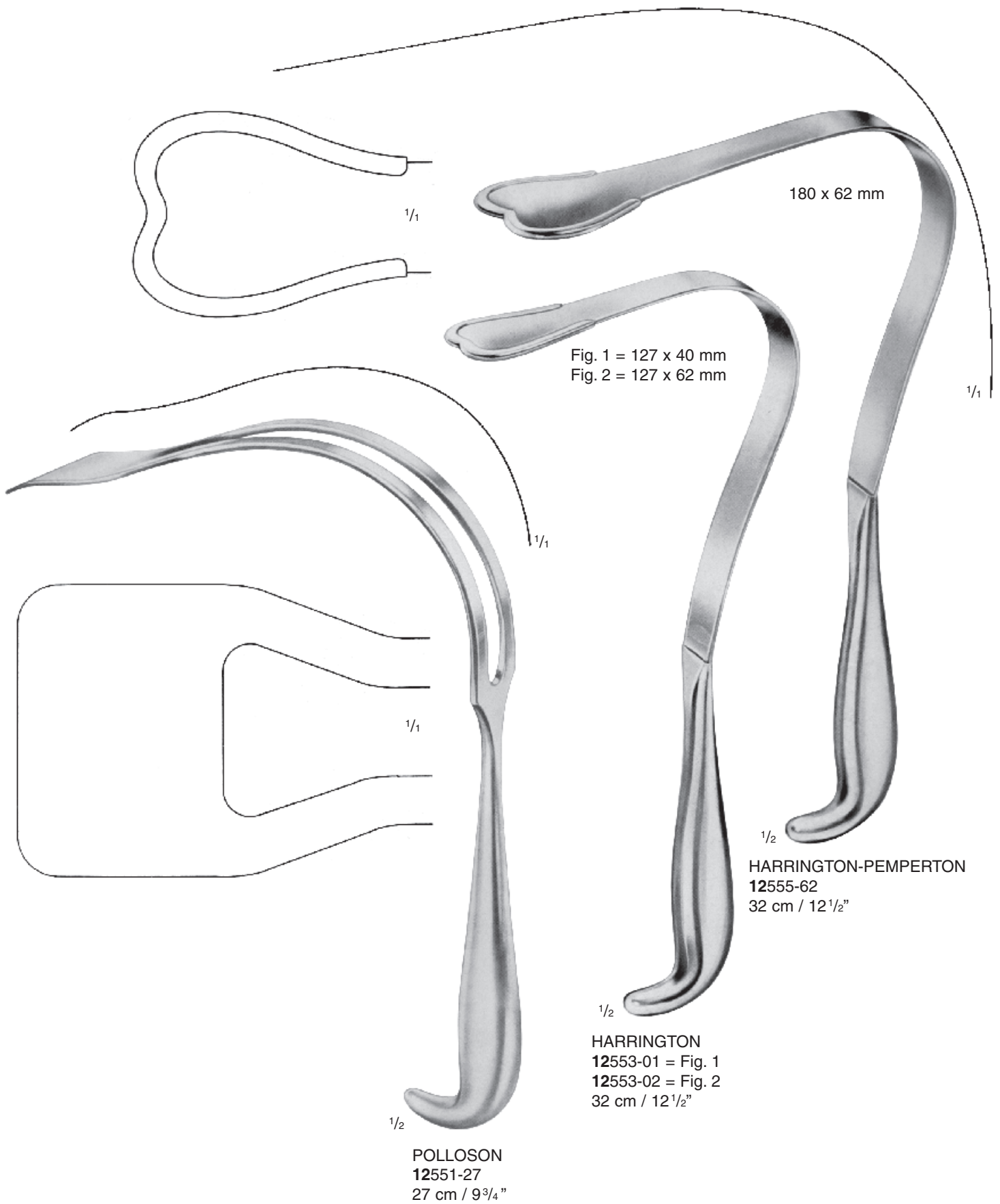

POLLOSON
12551-27
27 cm / 9³/₄"

HARRINGTON
12553-01 = Fig. 1
12553-02 = Fig. 2
32 cm / 12¹/₂"

HARRINGTON-PEMPERTON
12555-62
32 cm / 12¹/₂"



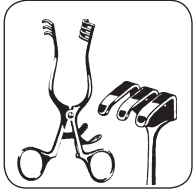

Wundhaken, Lungenspatel
 Retractors, Lung Spatulas
 Separadores, Espátulas pulmonares
 Ecarteurs et valves pour le poumon
 Divaricatori e spatole polmonari



38 mm

75 mm

50 mm

1/2

DEAVER
 12563-07
 30 cm / 12"

1/2

DEAVER
 12563-09
 30 cm / 12"

1/2

DEAVER
 12563-08
 30 cm / 12"

1/2

DEAVER
 12565-25 25 mm
 12565-35 35 mm
 12565-50 50 mm
 32 cm / 12 1/2"



rechts
right
derecho
droit
destra

COOLEY
12567-01
25,0 cm / 9³/₄"
48 x 48 mm



rechts gerieft
right, serrated
derecho, estriado
droit, avec stries
destra, con striatura

COOLEY
12567-02
25,0 cm / 9³/₄"
48 x 48 mm



links
left
izquierdo
gauche
sinistra

COOLEY
12567-03
25,0 cm / 9³/₄"
30 x 48 mm



Wundhaken
Retractors
Separadores
Ecarteurs
Divaricatori

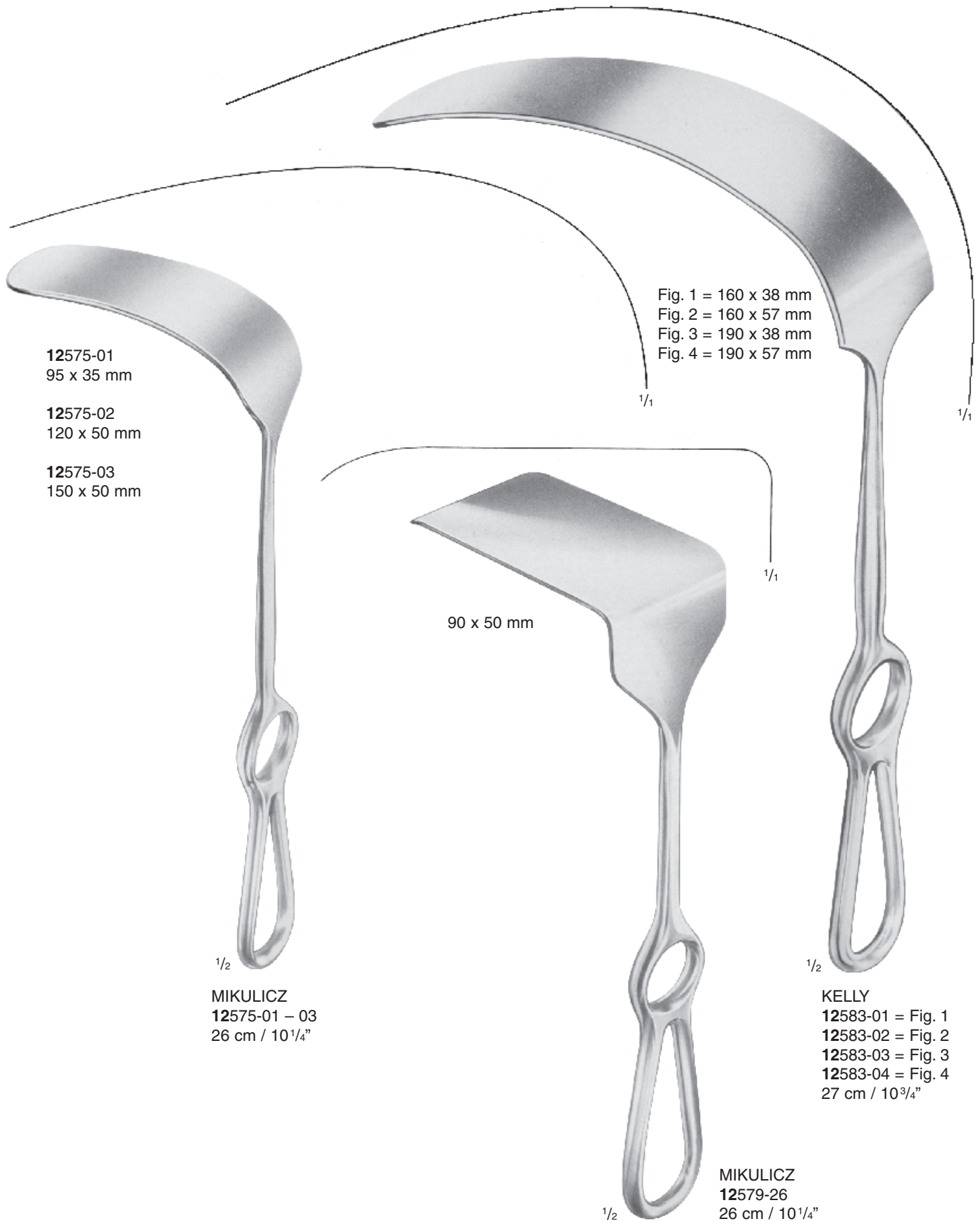

12575-01
95 x 35 mm

12575-02
120 x 50 mm

12575-03
150 x 50 mm

Fig. 1 = 160 x 38 mm
Fig. 2 = 160 x 57 mm
Fig. 3 = 190 x 38 mm
Fig. 4 = 190 x 57 mm

90 x 50 mm

MIKULICZ
12575-01 - 03
26 cm / 10 1/4"

KELLY
12583-01 = Fig. 1
12583-02 = Fig. 2
12583-03 = Fig. 3
12583-04 = Fig. 4
27 cm / 10 3/4"

MIKULICZ
12579-26
26 cm / 10 1/4"



flexibel
flexible
flexible
flexible
flessibile

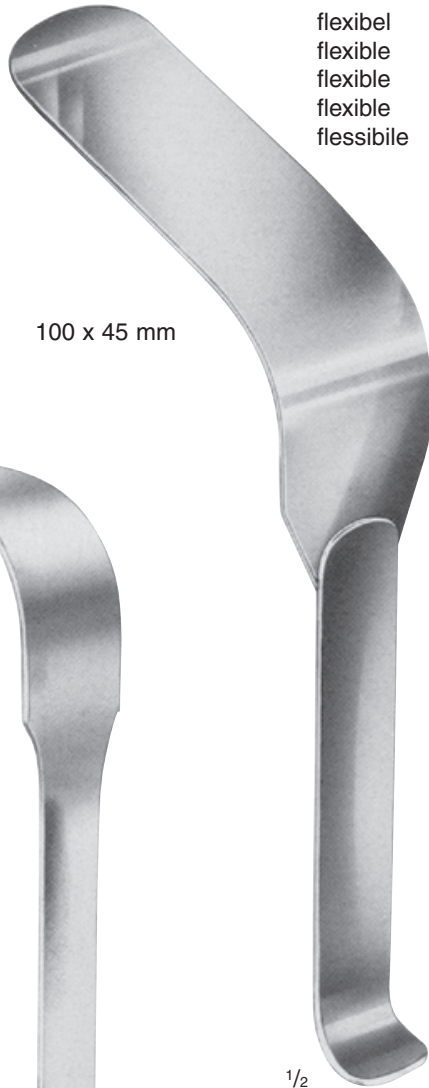

100 x 45 mm

120 x 45 mm

1/2

KUEMMEL
12593-28
28 cm / 11"

1/2

KOERTE
12589-28
28 cm / 11"

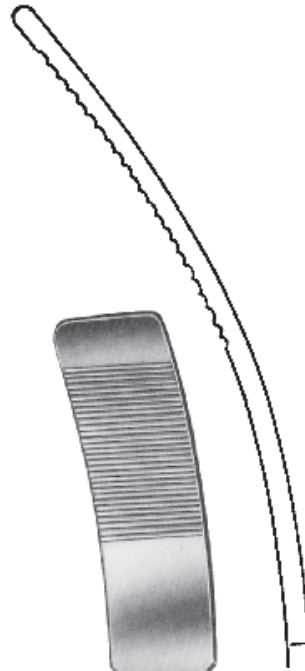

1/2

KADER
12595-20 – 12595-40
28,0 cm / 11"

20 mm



12595-20
28,0 cm / 11"

30 mm



12595-30
28,0 cm / 11"

40 mm



12595-40
28,0 cm / 11"

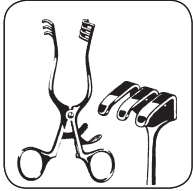

Wundhaken
Retractors
Separadores
Ecarteurs
Divaricatori



34 x 26 mm
52 x 33 mm



30 x 21 mm
38 x 30 mm

1/2

COLLIN-HARTMANN
12623-01 = 14 cm / 5 1/2"
12623-02 = 16 cm / 6 1/4"



Fig. 1 = 24 x 20 mm
Fig. 2 = 29 x 26 mm
Fig. 3 = 35 x 29 mm

Fig. 1 = 30 x 28 mm
Fig. 2 = 36 x 36 mm
Fig. 3 = 38 x 43 mm

1/1

ROUX
12627-00 = Satz – set – juego – jeu – serie

Fig. 1 = 26 x 10 mm
Fig. 2 = 30 x 10 mm

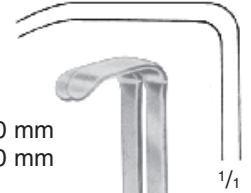

1/1

Fig. 1 = 30 x 13 mm
Fig. 2 = 34 x 13 mm

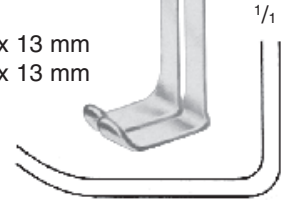

1/1

FARABEUF
12 cm / 4 3/4"
12635-00 = Satz – set – juego – jeu – serie

Fig. 1 = 23 x 16 mm
Fig. 2 = 27 x 16 mm

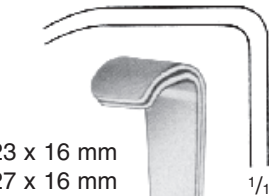

1/1

Fig. 1 = 26 x 16 mm
Fig. 2 = 30 x 16 mm

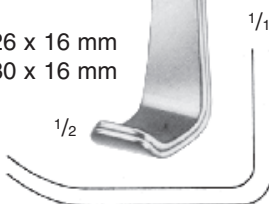

1/2

FARABEUF
15 cm / 6"
12637-00 = Satz – set – juego – jeu – serie

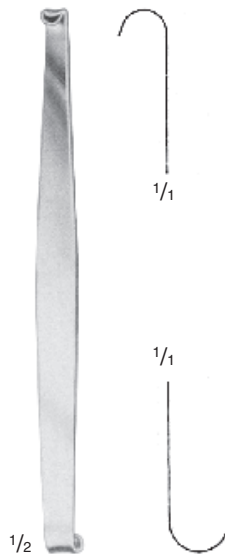

1/1

1/1

1/2

MINI-ROUX
12639-06
14 cm / 5 1/2"



1/1

1/1

1/2

BABY-ROUX
12641-13
13 cm / 5 1/4"

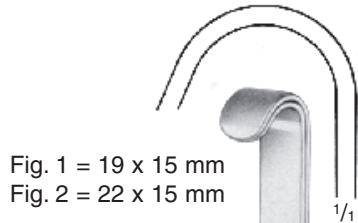

Fig. 1 = 19 x 15 mm
Fig. 2 = 22 x 15 mm

Fig. 1 = 19 x 15 mm
Fig. 2 = 22 x 15 mm

PARKER
13,5 cm / 5 1/4"
12645-01 = Satz – set – juego – jeu – serie

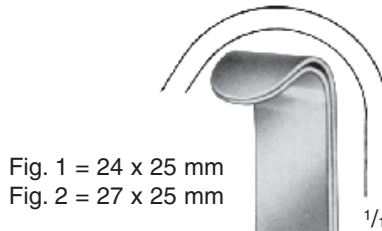

Fig. 1 = 24 x 25 mm
Fig. 2 = 27 x 25 mm

Fig. 1 = 26 x 25 mm
Fig. 2 = 29 x 25 mm

PARKER
18 cm / 7"
12645-02 = Satz – set – juego – jeu – serie

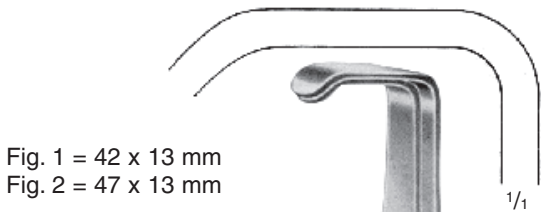

Fig. 1 = 42 x 13 mm
Fig. 2 = 47 x 13 mm

MATHIEU
20 cm / 8"
12655-00 = Satz – set –
juego – jeu – serie

Fig. 1 = 42 x 26 mm
Fig. 2 = 46 x 26 mm

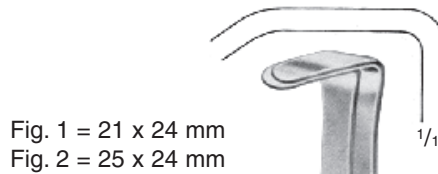
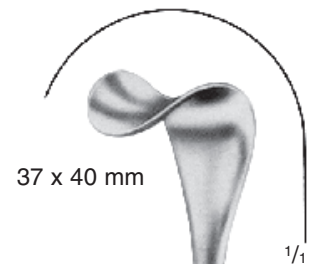
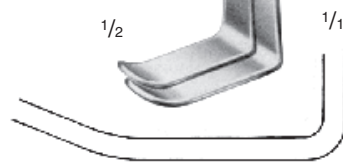

Fig. 1 = 21 x 24 mm
Fig. 2 = 25 x 24 mm

PARKER-LANGENBECK
21 cm / 8 1/4"
12659-00 = Satz – set –
juego – jeu – serie

Fig. 1 = 40 x 15 mm
Fig. 2 = 40 x 15 mm



37 x 40 mm

GOELET
12667-00
19 cm / 7 1/2"

30 x 31 mm

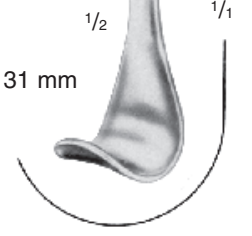

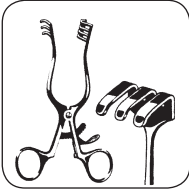

Wundspreizer
Retractors
Separadores
Ecarteurs
Divaricatori

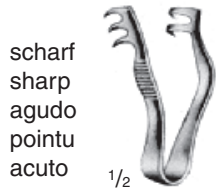

scharf
sharp
agudo
pointu
acuto

1/2

stumpf
blunt
romo
mousse
smusso

FINSEN

12672-05
5 cm / 2"



scharf
sharp
agudo
pointu
acuto

1/2

stumpf
blunt
romo
mousse
smusso

FINSEN

12674-07
7 cm / 2 3/4"



scharf
sharp
agudo
pointu
acuto

1/2

stumpf
blunt
romo
mousse
smusso

FINSEN

12676-07
7 cm / 2 3/4"

12677-07
7 cm / 2 3/4"

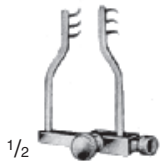

1/2

LOGAN
12680-04
4 cm / 1 1/2"



1/2

scharf
sharp
agudo
pointu
acuto

BUCKLEY
12682-06
6 cm / 2 1/4"



1/2

scharf
sharp
agudo
pointu
acuto

stumpf
blunt
romo
mousse
smusso

ALM

12686-07
7 cm / 2 3/4"
12686-10
10 cm / 4"

12687-07
7 cm / 2 3/4"
12687-10
10 cm / 4"



scharf
sharp
agudo
pointu
acuto

1/2

stumpf
blunt
romo
mousse
smusso

HOLTZHEIMER

12694-10
10 cm / 4"

12695-10
10 cm / 4"



scharf
sharp
agudo
pointu
acuto

1/2

stumpf
blunt
romo
mousse
smusso

JANSEN

12698-10
10 cm / 4"

12699-10
10 cm / 4"

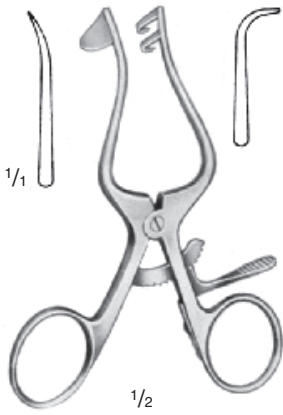

PLESTER
12710-11
11 cm / 4 1/4"

stumpf
blunt
romo
mousse
smusso

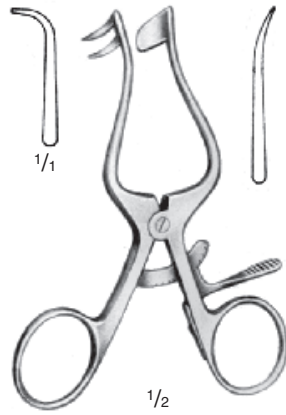

PLESTER
12712-11
11 cm / 4 1/4"

stumpf
blunt
romo
mousse
smusso

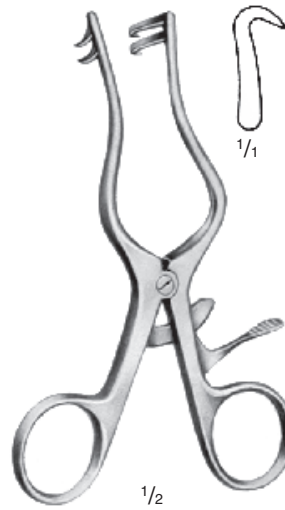

PLESTER
12714-11
11 cm / 4 1/4"

12714-13
13 cm / 5"
scharf
sharp
agudo
pointu
acuto

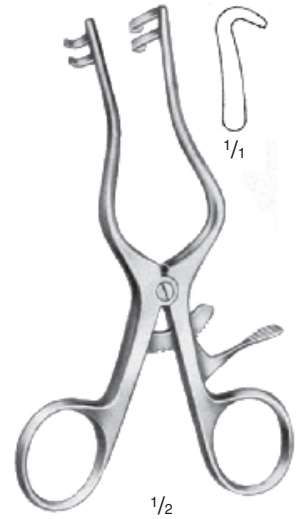

PLESTER
12716-11
11 cm / 4 1/4"

12716-13
13 cm / 5"
stumpf
blunt
romo
mousse



WEITLANER
12720-10 **12721-10**
10,5 cm / 4" 10,5 cm / 4"

scharf stumpf
sharp blunt
agudo romo
pointu mousse
acuto smusso



WEITLANER
12722-13 **12723-13**
13 cm / 5" 13 cm / 5"

scharf stumpf
sharp blunt
agudo romo
pointu mousse
acuto smusso



WEITLANER
12724-16 **12725-16**
16 cm / 6 1/4" 16 cm / 6 1/4"

scharf stumpf
sharp blunt
agudo romo
pointu mousse
acuto smusso

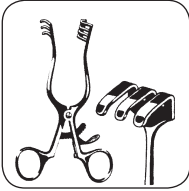

Wundspreizer
Retractors
Separadores
Ecarteurs
Divaricatori

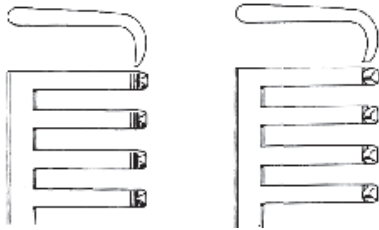

komplett mit 3 Mittelvalven
Art.-Nr. 12726-19/12726-25/12726-32

complete with 3 central blades
ref. 12726-19/12726-25/12726-32

completo con 3 valvas centrales
ref. 12726-19/12726-25/12726-32

complet avec 3 valves centrales
ref. 12726-19/12726-25/12726-32

completo con 3 valve centrali
rif. 12726-19/12726-25/12726-32

HENLEY

12726-00
16 cm / 6¹/₄"

12726-01
16 cm / 6¹/₄"

scharf
sharp
agudo
pointu
acuto

stumpf
blunt
romo
mousse
smusso



¹/₂

HENLEY
12726-00 – 12726-01

19 x 16 mm

25 x 16 mm

32 x 16 mm

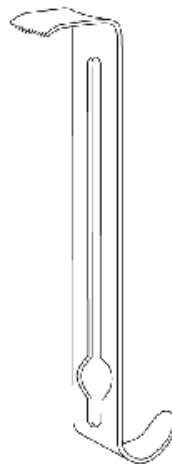

12726-19

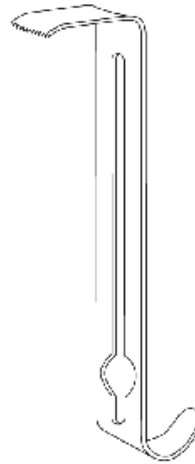

12726-25

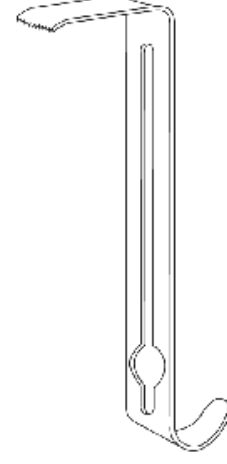

12726-32

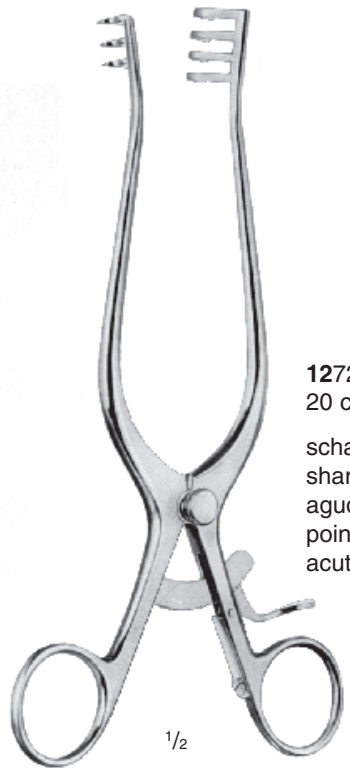

WEITLANER
12728-20 20 cm / 8"
 scharf
 sharp
 agudo
 pointu
 acuto
12729-20 20 cm / 8"
 stumpf
 blunt
 romo
 mousse
 smusso



WEITLANER
12732-24 24 cm / 9 1/2"
 scharf
 sharp
 agudo
 pointu
 acuto
12733-24 24 cm / 9 1/2"
 stumpf
 blunt
 romo
 mousse
 smusso

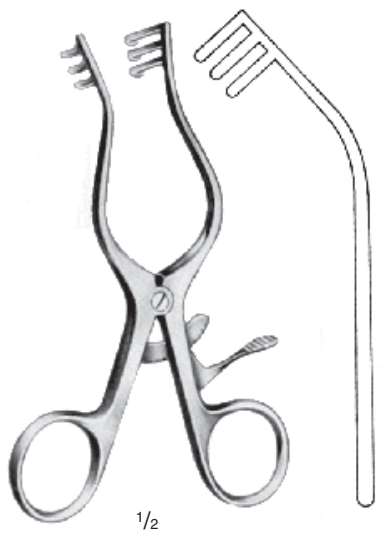

WULLSTEIN
12738-10 10 cm / 4"
12739-10 10 cm / 4"
12738-13 13 cm / 5"
12739-13 13 cm / 5"
 scharf
 sharp
 agudo
 pointu
 acuto
 stumpf
 blunt
 romo
 mousse
 smusso



MILLIGAN
12742-13 13 cm / 5"
 stumpf
 blunt
 romo
 mousse
 smusso



WEITLANER-BABY
12745-14 14 cm / 5 1/2"

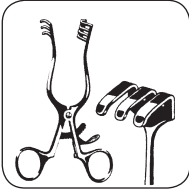

Wundspreizer
Retractors
Separadores
Ecarteurs
Divaricatori



12746-40

40 mm



12746-45

45 mm



12746-50

50 mm



12746-55

55 mm



12746-60

60 mm



12747-40

40 mm



12747-45

45 mm



12747-50

50 mm



12747-55

55 mm



12747-60

60 mm



$\frac{1}{2}$

CLOWARD
12746-00
25,0 cm / 9 $\frac{3}{4}$ "

komplett, mit je 2 Steckvalven (**12746-40 + 12746-60**)
complete, with 2 each plug-in blades (**12746-40 + 12746-60**)
completo, con 2 valvas enchufables (**12746-40 + 12746-60**)
complet, chacun avec deux valves (**12746-40 + 12746-60**)
completo, con 2 valve ad innesto (**12746-40 + 12746-60**)

CLOWARD
12746-25
25,0 cm / 9 $\frac{3}{4}$ "
Sperrer allein
Spreader only
Separador suelto
Ecarteur seul
Divaricatore solo



$\frac{1}{2}$

CLOWARD
12747-00
15,0 cm / 6"

komplett, mit je 2 Steckvalven (**12747-40 + 12747-60**)
complete, with 2 each plug-in blades (**12747-40 + 12747-60**)
completo, con 2 valvas enchufables (**12747-40 + 12747-60**)
complet, chacun avec deux valves (**12747-40 + 12747-60**)
completo, con 2 valve ad innesto (**12747-40 + 12747-60**)

CLOWARD
12747-15
15,0 cm / 9 $\frac{3}{4}$ "
Sperrer allein
Spreader only
Separador suelto
Ecarteur seul
Divaricatore solo



ADSON

12750-20
20 cm / 8"

12751-20
20 cm / 8"

scharf
sharp
agudo
pointu
acuto

stumpf
blunt
romo
mousse
smusso



ADSON

12754-20
20 cm / 8"

12755-20
20 cm / 8"

scharf
sharp
agudo
pointu
acuto

stumpf
blunt
romo
mousse
smusso



ADSON

12760-26
26 cm / 10 1/4"

12761-26
26 cm / 10 1/4"

scharf
sharp
agudo
pointu
acuto

stumpf
blunt
romo
mousse
smusso



Wundspreizer
Retractors
Separadores
Ecarteurs
Divaricatori



ADSON

12764-27 **12765-27**
27 cm / 10³/₄" 27 cm / 10³/₄"

scharf	stumpf
sharp	blunt
agudo	romo
pointu	mousse
acuto	smusso



ADSON

12766-27 **12767-27**
27 cm / 10³/₄" 27 cm / 10³/₄"

scharf	stumpf
sharp	blunt
agudo	romo
pointu	mousse
acuto	smusso



ADSON

12768-27 **12769-27**
27 cm / 10³/₄" 27 cm / 10³/₄"

scharf	stumpf
sharp	blunt
agudo	romo
pointu	mousse
acuto	smusso



12772-14
14 cm / 5 1/2"

scharf
sharp
agudo
pointu
acuto



12773-14
14 cm / 5 1/2"

stumpf
blunt
romo
mousse
smusso



12776-20
20 cm / 8"

scharf
sharp
agudo
pointu
acuto



12777-20
20 cm / 8"

stumpf
blunt
romo
mousse
smusso



12778-25
25 cm / 10"

scharf
sharp
agudo
pointu
acuto



12779-25
25 cm / 10"

stumpf
blunt
romo
mousse
smusso

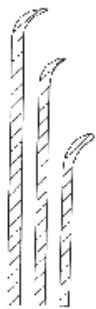

mit 3 Paar Valven
with 3 pairs of blades
con 3 pares de valvas
avec 3 paires de valves
con 3 paia di valve

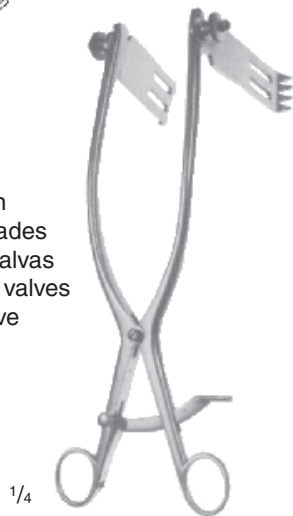

CHANDLER
12806-25
25 cm / 10"

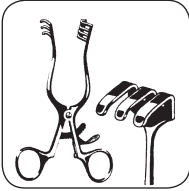

Bauchdeckenhalter
Abdominal Retractors
Separadores abdominales
Ecarteurs à paroi abdominale
Divaricatori addominali

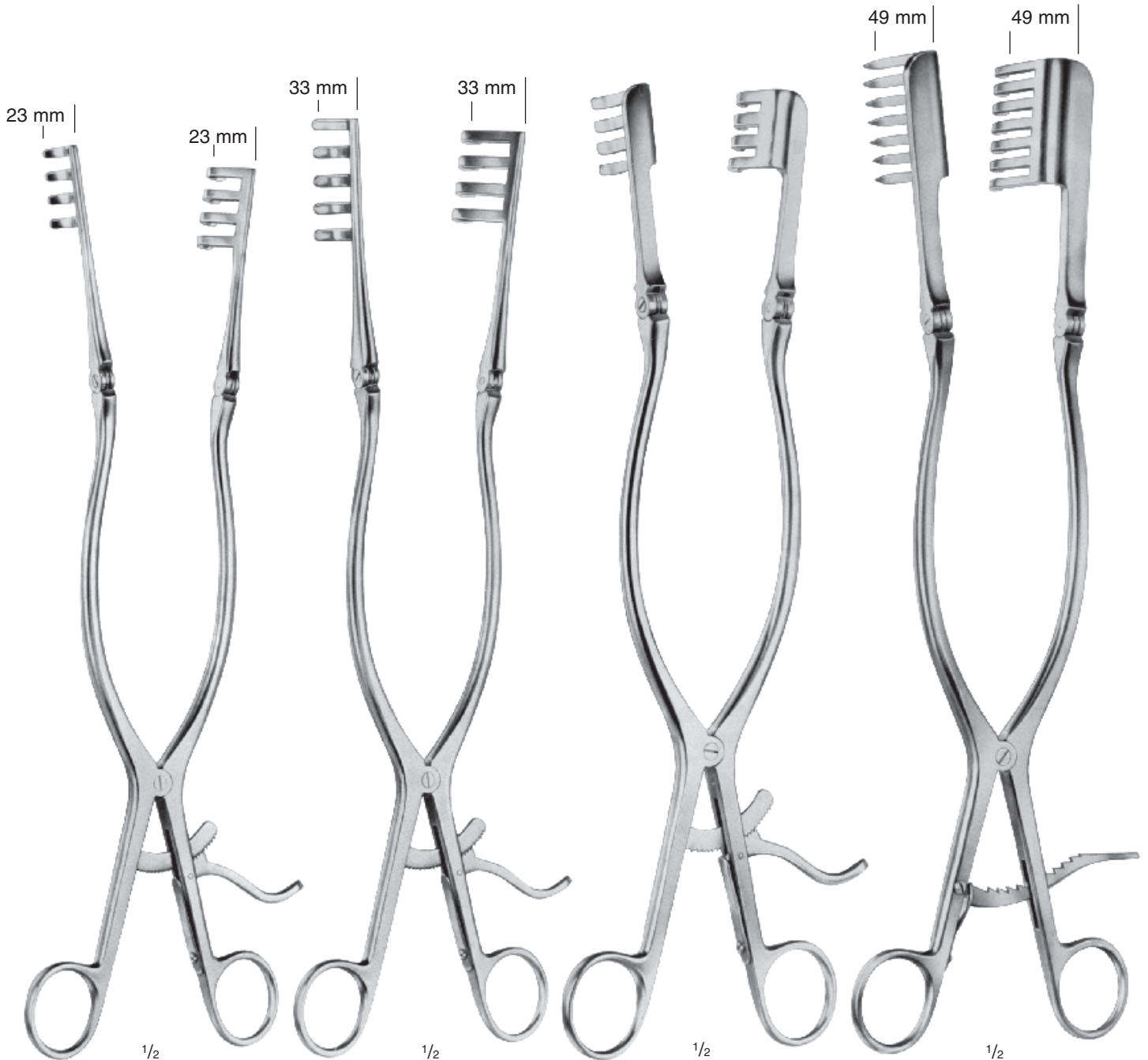

BECKMANN
12782-31 31 cm / 12 1/4"
12783-31 31 cm / 12 1/4"
scharf
sharp
agudo
pointu
acuto

12783-31
stumpf
blunt
romo
mousse
smusso

BECKMANN
12784-33 33 cm / 13"
scharf
sharp
agudo
pointu
acuto

12785-33 33 cm / 13"
stumpf
blunt
romo
mousse
smusso

BECKMANN-ADSON
12789-33 25 x 25 mm, 1" x 1"
12790-33 25 x 31 mm, 1" x 1 1/4"
12791-33 25 x 40 mm, 1" x 1 1/2"
12792-33 25 x 45 mm, 1" x 1 3/4"
33 cm / 13"
halbscharf, semi-sharp,
semi-agudo, demi-pointu,
semi-acuto

BECKMANN-EATON
12795-33 33 cm / 13"
scharf
sharp
agudo
pointu
acuto



1/2

GELPI
12806-13
13,5 cm / 5 3/8"



1/2

GELPI
12806-19
19 cm / 7 1/2"



mit Kugel
with stop
con alto
avec stop
con arresti

1/2

GELPI
12808-19
19 cm / 7 1/2"



1/2

HUSTINX
12806-22
22 cm / 8 3/4"



1/2

TÜBINGER MODELL
12812-16
16,5 cm / 6 1/2"



1/2

MAYO-ADAMS
12816-17
17 cm / 6 3/4"



1/2

MAYO-ADAMS
12817-17
17 cm / 6 3/4"



1/2

RIGBY, 18 cm / 7 1/2"
12820-18 35 x 20 mm
1 3/8" x 3/4"
12821-18 60 x 20 mm
2 3/8" x 3/4"
12822-18 65 x 15 mm
2 9/16" x 9 1/16"

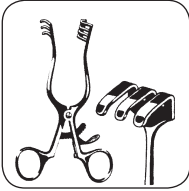

Bauchdeckenhalter
Abdominal Retractors
Separadores abdominales
Ecarteurs à paroi abdominale
Divaricatori addominali



1/2

COLLIN-BABY
12825-18
18 cm / 7"
mit 2 Paar Valven
with 2 pair of blades
con 2 pares valvas
avec 2 paires de valves
con 2 paia di valve



1/2

COLLIN
12828-22
22 cm / 8³/₄"
32 mm x 62 mm
1¹/₂" x 2³/₈"



1/2

COLLIN, 22 cm / 8³/₄"
12830-22 32 x 62 mm 55 x 55 mm
1¹/₂" x 2³/₈" 2¹/₈" x 2¹/₈"
12831-22 38 x 80 mm 55 x 65 mm
1¹/₂" x 3¹/₈" 2¹/₈" x 2¹/₂"
12832-22 38 x 100 mm 55 x 75 mm
1¹/₂" x 4" 2¹/₈" x 3"
seitl. Valven Mittelvalve
latral blades center blade
valvas laterales valva central
valves latérales valve centrale
valve laterali valva centrale

**RICARD**

12834-01	60 x 80 mm 2 1/4" x 3 1/4"	55 x 70 mm 2 1/8" x 2 3/4"
12834-02	72 x 85 mm 2 3/4" x 3 3/8"	80 x 90 mm 3 1/4" x 3 1/2"
	seitl. Valven latral blades valvas laterales valves latérales valve laterali	Mittelvalve center blade valva central valve centrale valva centrale

ROBIN-MASSE

12836-25	38 x 64 mm 1 1/2" x 2 1/2"	40 x 64 mm 1 5/8" x 2 1/2"
	seitl. Valven latral blades valvas laterales valves latérales valve laterali	Mittelvalve center blade valva central valve centrale valva centrale

HOLZBACH

12838-30	62 x 80 mm 2 1/2" x 3 1/4"	80 x 80 mm 3 1/4" x 3 1/4"
	seitl. Valven latral blades valvas laterales valves latérales valve laterali	Mittelvalve center blade valva central valve centrale valva centrale

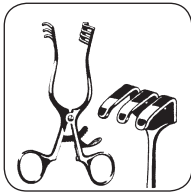

Bauchdeckenhalter
 Abdominal Retractors
 Separadores abdominales
 Ecarteurs à paroi abdominale
 Divaricatori addominali



GOSSET	A	B	C
12840-10	38 mm	19 mm	100 mm

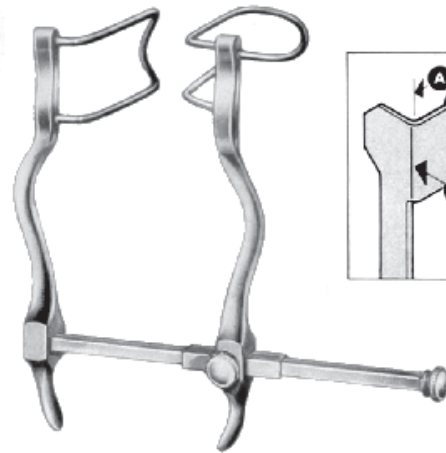

GOSSET	A	B	C
12842-10	38 mm	19 mm	100 mm



GOSSET	A	B	C
12844-14	64 mm	25 mm	140 mm



GOSSET	A	B	C
12846-14	64 mm	25 mm	160 mm



HERTZLER	A	B	C
12848-70	25 mm	25 mm	70 mm

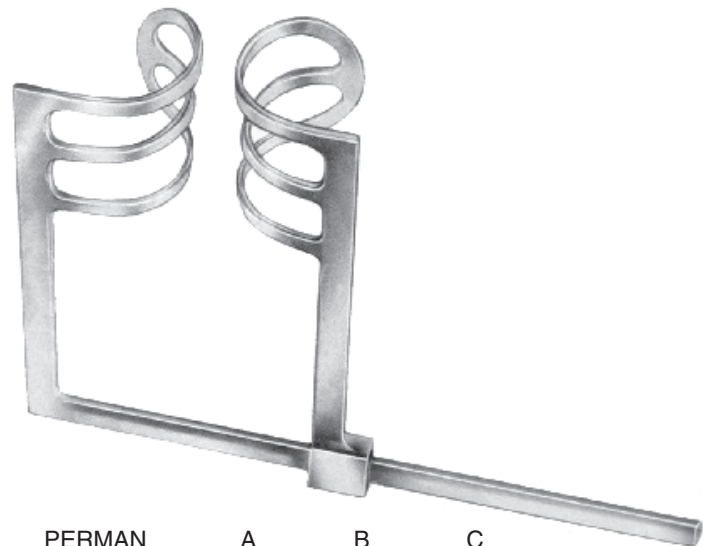

PERMAN	A	B	C
12850-20	65 mm	65 mm	180 mm



Bauchdeckenhalter
Abdominal Retractors
Separadores abdominales
Ecarteurs à paroi abdominale
Divaricatori addominali

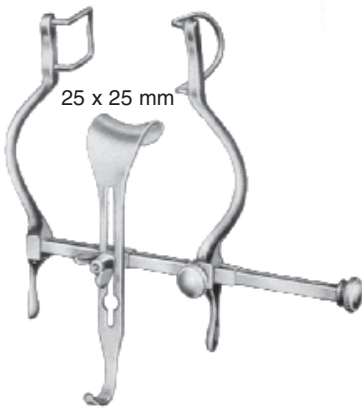

BALFOUR-BABY	A	B	C
12854-90	36 mm	25 mm	95 mm

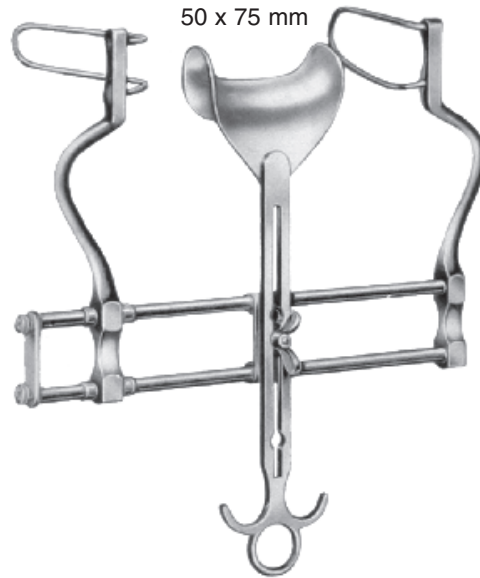

BALFOUR	A	B	C
12858-18	50 mm	38 mm	180 mm

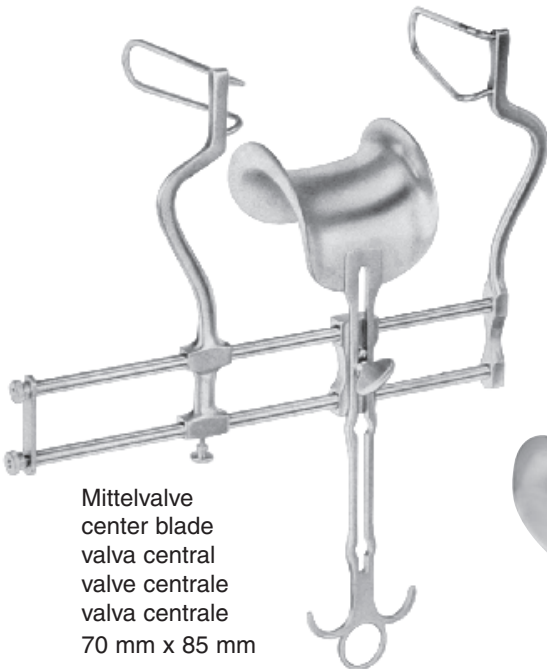
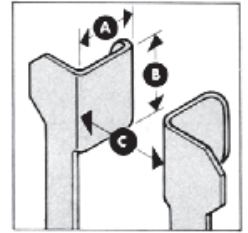

BALFOUR	A	B	C
12860-25	100 mm	40 mm	250 mm

Mittelvalve
center blade
valva central
valve centrale
valva centrale
70 mm x 85 mm

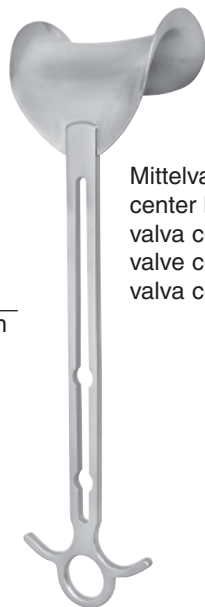

Mittelvalve
center blade
valva central
valve centrale
valva centrale



BALFOUR US	C
12869-00	180 mm

Drahtvalven (Paar)
Fenestrated blades
Valvas de alambre
Valves en fil
Valve di filo

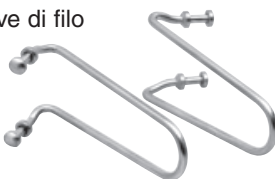

	C
12869-06	60 mm
12869-08	80 mm

12869-01	68 x 85 mm
12869-02	40 x 68 mm

mit je 1 Paar Seitenvlaven 12869-06 +12869-08
und 1 Mittelvalve 12869-01

with 1 pairs of each lateral blades 12869-06 +12869-08
and 1 central blade 12869-01

con 1 par de c. u. valves laterales 12869-06 +12869-08
y 1 valva centrale 12869-01

avec chacun 1 paire de valves laterales 12869-06 +12869-08
et 1 valve centrale 12869-01

con ognuno 1 paio di valve laterali 12869-06 +12869-08
e 1 valva centrale 12869-01

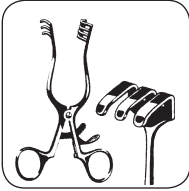

Bauchdeckenhalter
 Abdominal Retractors
 Separadores abdominales
 Ecarteurs à paroi abdominale
 Divaricatori addominali



BALFOUR	A	B	C
12862-20	70 mm	35 mm	180 mm



BALFOUR	A	B	C
12864-20	100 mm	35 mm	180 mm

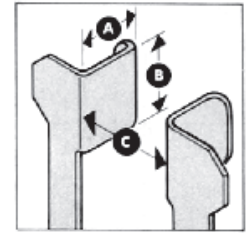

BALFOUR
 12865-45 = 50 x 75 mm
 12865-60 = 70 x 85 mm
 12865-80 = 80 x 80 mm

biegsam
 flexible
 flexibles
 malléables
 malleabile

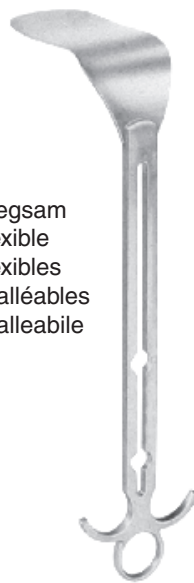

HORGAN
 12866-50
 50 x 125 mm



BALFOUR
 12867-70
 70 x 100 mm



12875-01

12875-02
70 x 100 mm12875-03
45 x 90 mm**O'SULLIVAN-O'CONNOR**

12874-00 komplett, complete, completo, complet, completo
bestehend aus: consisting of, compuesto de,
composé de, composto da

12875-01 = 1 Rahmen mit 2 Valven, frame with 2 blades, cuadro con
2 valvas, cadre avec 2 valves, telaio con 2 valve

12875-02 = 1 Valve, blade, valva, valve, valva 70 x 100 mm

12875-03 = 2 Valven, blades, valvas, valves, valve 45 x 90 mm

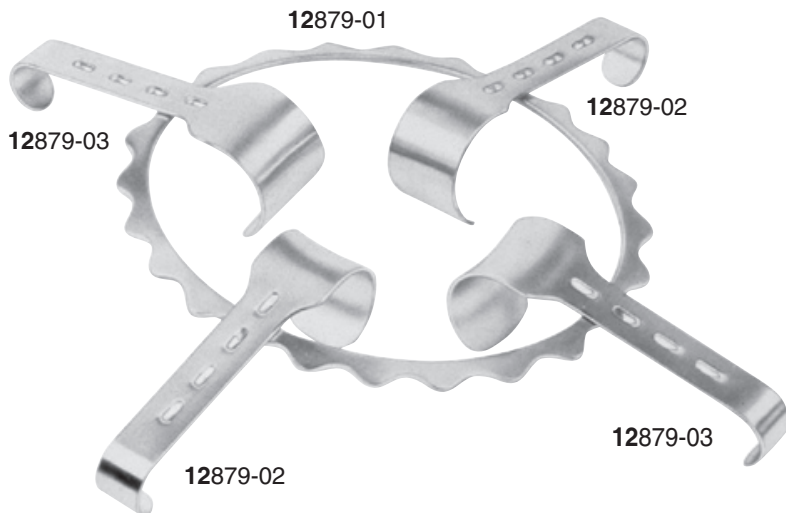

12879-01

12879-02

12879-03

12879-02

12879-03

DENIS-BROWNE

12878-00 komplett, complete, completo, complet, completo
bestehend aus: consisting of, compuesto de,
composé de, composto da

12879-01 = 1 Rahmen, frame, cuadro, cadre, telaio 180 x 150 mm

12879-02 = 2 Valven, blades, valvas, valves, valve 40 x 30 mm

12879-03 = 2 Valven, blades, valvas, valves, valve 40 x 40 mm

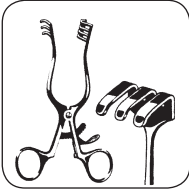

Bauchdeckenhalter
Abdominal Retractors
Separadores abdominales
Ecarteurs à paroi abdominale
Divaricatori addominali

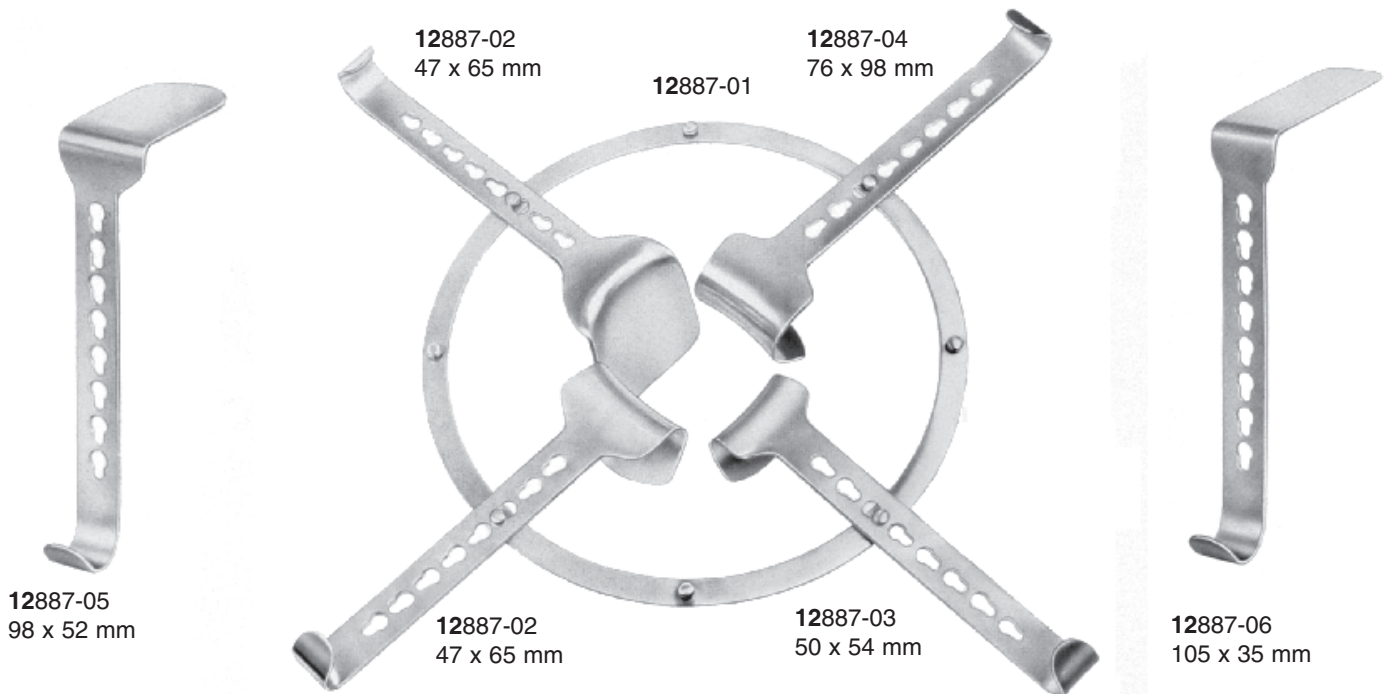

SEMM

12886-00 komplett, complete, completo, complet, completo
bestehend aus: consisting of, compuesto de, composé de, composto da
12887-01 = 1 Rahmen, frame, cuadro, cadre, telaio 275 x 250 mm
12887-02 = 2 Valven, blades, valvas, valves, valve 47 x 65 mm
12887-03 = 1 Valve, blade, valva, valve, valva 50 x 54 mm
12887-04 = 1 Valve, blade, valva, valve, valva 76 x 98 mm
12887-05 = 1 Valve, blade, valva, valve, valva 98 x 52 mm
12887-06 = 1 Valve, blade, valva, valve, valva 105 x 35 mm

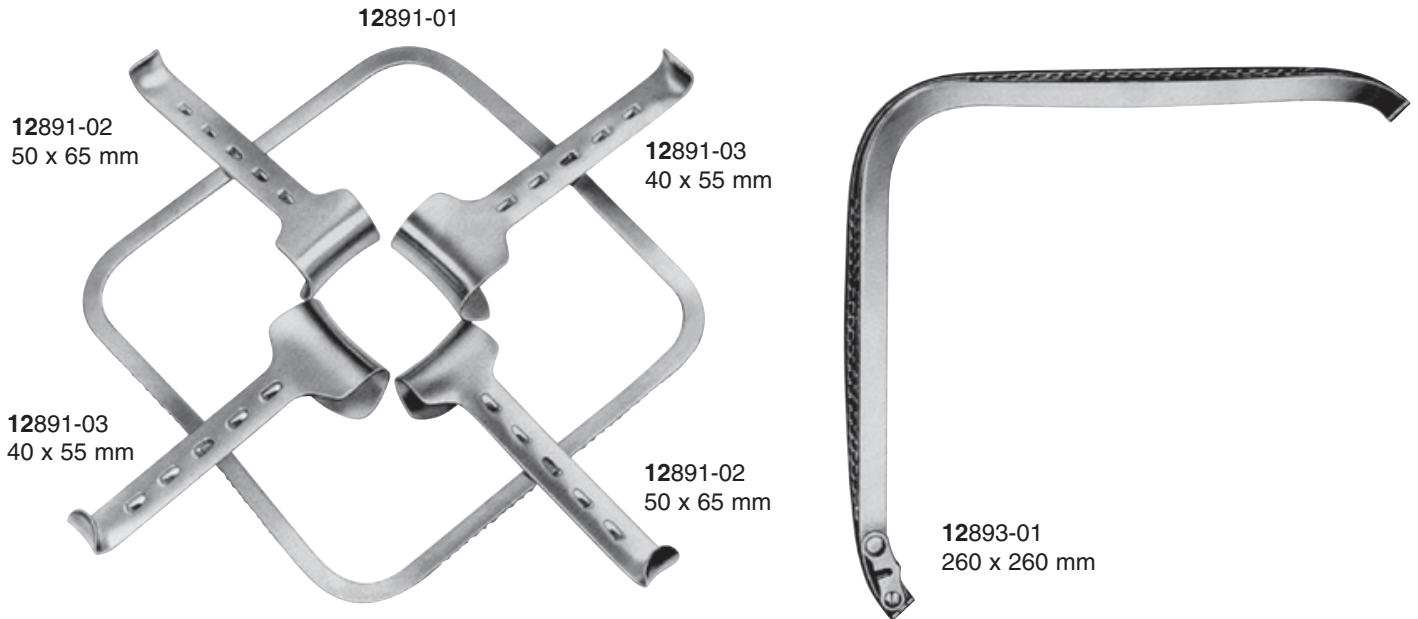
**KIRSCHNER**

12890-00 komplett, complete, completo, complet, completo
bestehend aus: consisting of, compuesto de,
composé de, composto da,
12891-01 = 1 Rahmen fest, frame rigid, cuadro sólido, cadre rigide,

telaio rigido 240 x 240 mm

12891-02 = 2 Valven, blades, valvas, valves, valve 50 x 65 mm

12891-03 = 2 Valven, blades, valvas, valves, valve 40 x 55 mm

KIRSCHNER

12892-00 komplett, complete, completo, complet, completo
bestehend aus: consisting of, compuesto de,
composé de, composto da,

12893-01 = 1 Rahmen zusammenlegbar, folding frame,
cuadro plegable, cadre pliant, telaio pieghevole
260 x 260 mm

12891-02 = 2 Valven, blades, valvas, valves, valve 50 x 65 mm

12891-03 = 2 Valven, blades, valvas, valves, valve 40 x 55 mm



12891-04
65 x 80 mm
2 1/4" x 3 1/4"



12891-06
90 x 65 mm
3 1/2" x 2 1/2"

12891-05
80 x 80 mm
3 1/4" x 3 1/4"

12891-07
90 x 90 mm
3 1/2" x 3 1/2"



Mittelblatt allein
Centre blade only
Valva central suelta
Valve centrale seule
Valva centrale solo

DOYEN
12897-01 = 55 x 95 mm
12897-02 = 55 x 105 mm
12897-03 = 55 x 115 mm
12897-04 = 55 x 120 mm



Bauchdeckenhalter
Abdominal Retractors
Separadores abdominales
Ecarteurs à paroi abdominale
Divaricatori addominali

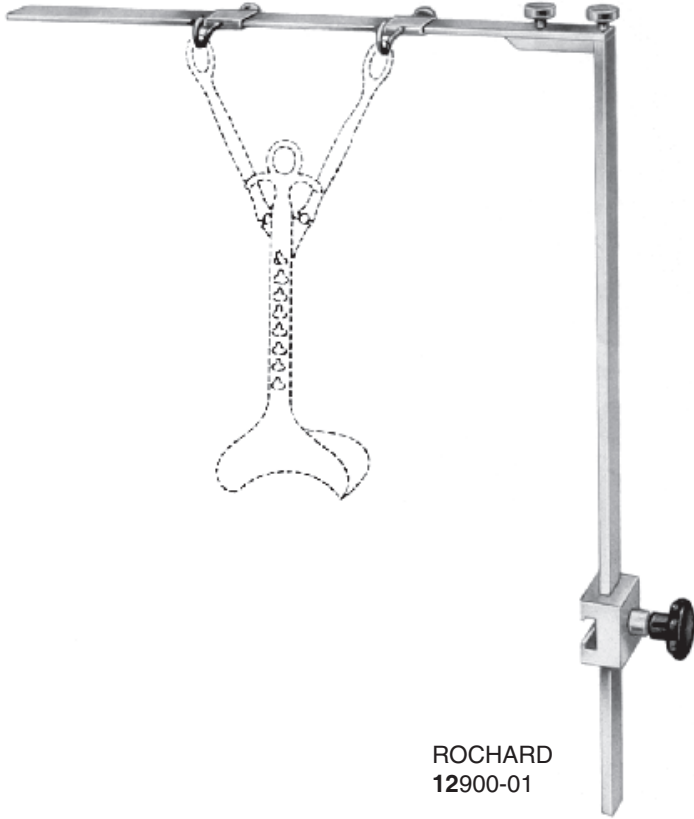

ROCHARD
12900-01

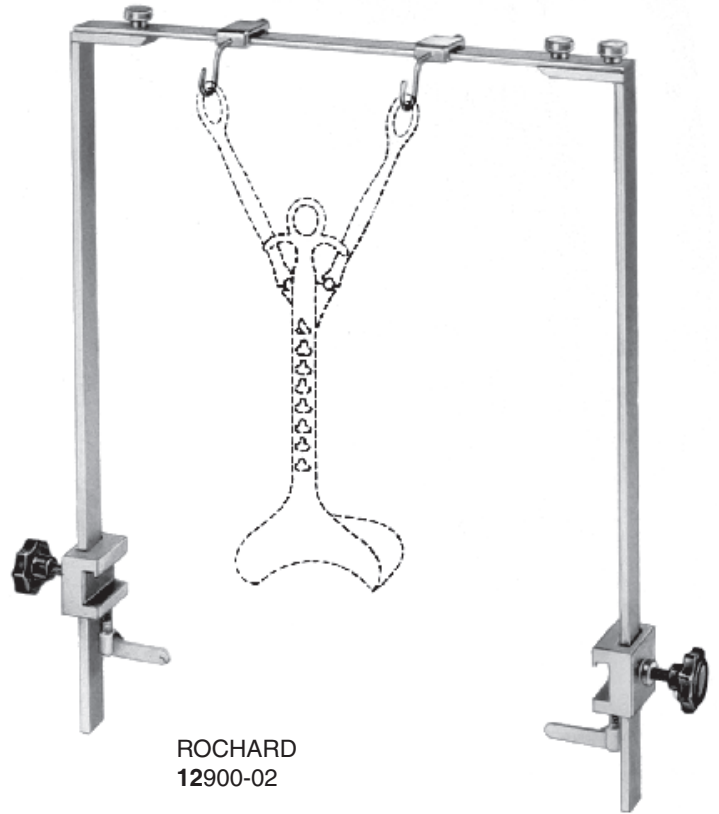

ROCHARD
12900-02



ROCHARD, 27 cm, 10 1/2 "
12901-01 = 50 x 95 mm, 2" x 3 3/4"
12901-02 = 50 x 105 mm, 2" x 4 1/8"
12901-03 = 60 x 120 mm, 2 3/8" x 4 3/4"
12901-04 = 60 x 135 mm, 2 3/8" x 5 1/4"
12901-05 = 60 x 155 mm, 2 3/8" x 6 1/8"



ROCHARD
12902-00
19 cm / 7 3/4"

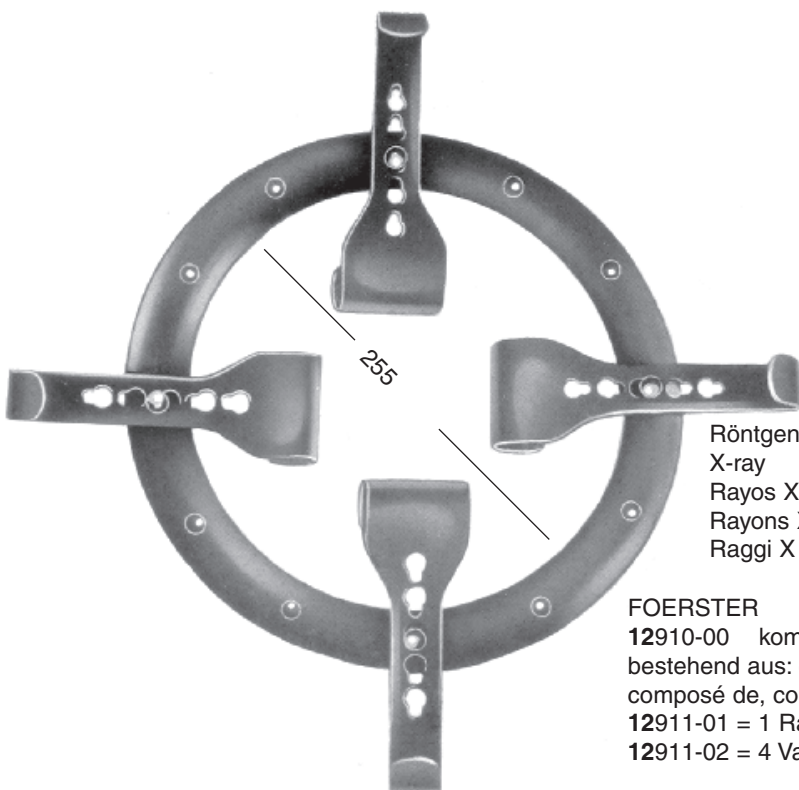

12911-02
52 x 65 mm



12911-03
65 x 80 mm

12911-04
45 x 105 mm

12911-05
45 x 155 mm

Röntgenfähig
X-ray
Rayos X
Rayons X
Raggi X

FOERSTER

12910-00 komplett, complete, completo, complet, completo
bestehend aus: consisting of, compuesto de,
composé de, composto da

12911-01 = 1 Rahmen, frame, cuadro, cadre, telaio

12911-02 = 4 Valven, blades, valvas, valves, valve 52 x 65 mm



Laminektomiesperrer
Laminectomy Retractors
Separdores para laminectomia
Ecarteurs pour laminectomie
Divaricatori per laminectomia



SCOVILLE
12927-00
Spreizweite 150 mm
spreading 150 mm
extensión 150 mm
écartement 150 mm
apertura 150 mm



SCOVILLE
12928-50
Spreizweite 150 mm
spreading 150 mm
extensión 150 mm
écartement 150 mm
apertura 150 mm

Rahmen allein, mit Gelenk
frame only, with joint
bastidor suelto, con articulación
cadre seul, avec articulation
telaio solo, con articolazione



SCOVILLE
12928-01 50 mm
12928-02 70 mm

SCOVILLE
12928-06 50 mm
12928-07 70 mm

Hakenvalven, stumpf
Hooks, blunt
Ganchos, romo
Valves á griffes, mousse
Uncini, smusso

Hakenvalven, spitz
Hooks, sharp
Ganchos, agudo
Valves á griffes, pointu
Uncini, acuto



SCOVILLE
12928-11 60 x 25 mm
12928-12 64 x 50 mm
12928-13 88 x 25 mm

Blattvalven, gezahnt
Blades, toothed
Valvas, dentado
Valves, dentelé
Valve, dentato



TAYLOR
12928-41 48 x 50 mm
12928-42 64 x 50 mm
12928-43 64 x 64 mm
12928-44 80 x 57 mm

Hakenvalven, spitz
Hooks, sharp
Ganchos, agudo
Valves á griffes, pointu
Uncini, acuto



SCOVILLE
12928-46 41 x 38 mm
12928-47 67 x 44 mm

Hakenvalven, spitz
Hooks, sharp
Ganchos, agudo
Valves á griffes, pointu
Uncini, acuto



Bauchspatel, Blutschöpflöffel
 Abdominal Spatulas, Blood Scoops
 Espátulas abdominales, Chucharones para sangre
 Spatules abdominales, Puisseirs à sang
 Spatole addominali, Cucchiali per sangue

**TUFFIER**

12930-12 = 200 x 12 mm
12930-17 = 200 x 17 mm
12930-25 = 250 x 25 mm
 biegsam, flexible, flexibles,
 malléables, malleabili

**HABERER**

12932-25 = 20 cm / 8", 17/25 mm
12932-30 = 28 cm / 11", 17/25 mm
12932-45 = 30 cm / 12", 37/45 mm
 biegsam, flexible, flexibles,
 malléables, malleabili

**12934-30** = 30 mm**12934-40** = 40 mm**12934-50** = 50 mm

33 cm / 13"

biegsam, flexible, flexibles,
 malléables, malleabili

**REVERDIN****12938-28**

28 cm / 11"



cm	in.	1 mm Ø	1,5 mm Ø	2 mm Ø	2 mm Ø
10,5	4"			14072-10	
11,5	4 1/2"	14068-11		14072-11	
13,0	5"	14068-13	14070-13	14072-13	14080-13
14,5	5 3/4"	14068-14	14070-14	14072-14	14080-14
16,0	6 1/4"	14068-16	14070-16	14072-16	14080-16
18,0	7"	14068-18	14070-18	14072-18	
20,0	8"	14068-20	14070-20	14072-20	
25,0	10"		14070-25	14072-25	
30,0	12"			14072-30	

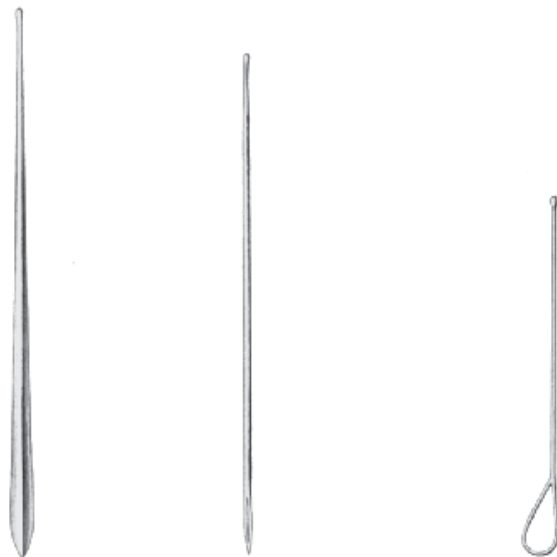

Silber
silver
plata
argent
argento

cm	in.	2 mm Ø		STACKE
10,5	4"			14096-10
11,5	4 1/2"			14096-11
13,0	5"		14090-13	
14,5	5 3/4"	14088-14	14090-14	
16,0	6 1/4"	14088-16	14090-16	

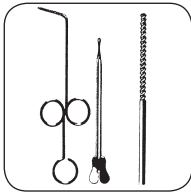

Sonden, Gefäßstripper,
 Probes, Vein Stripper
 Sondas, Desobliterador
 Sondes, Tire-veines,
 Specilli, Triavene



cm	in.			DOYEN	NÉLATON
11,5	4 1/2"	14132-11			
13,0	5"	14132-13	14142-13		14157-13
14,5	5 3/4"	14132-14	14142-14	14147-14	14157-14
16,0	6 1/4"	14132-16	14142-16	14147-16	14157-16
18,0	7"	14132-18	14142-18		
20,0	8"	14132-20	14142-20		14157-20

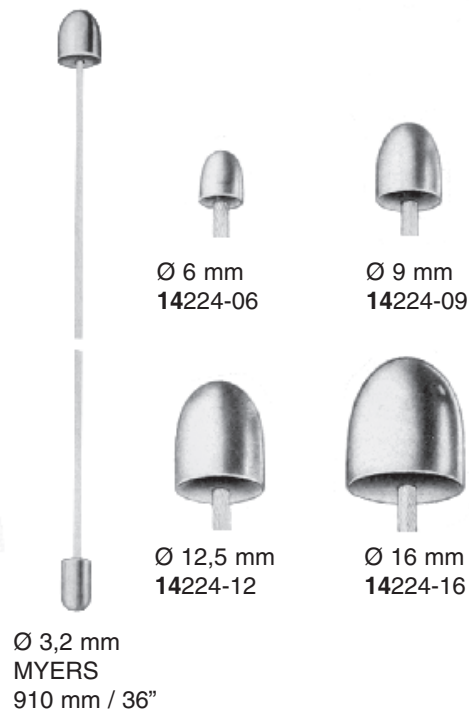



Gefäßstripper, Krampfader-Besteck
 Vein Stripper, Varicose Vein Probe Set
 Desobliterador, sonda para várices
 Tire-veines, Trousse à varices
 Triavene, Astuccio per varici

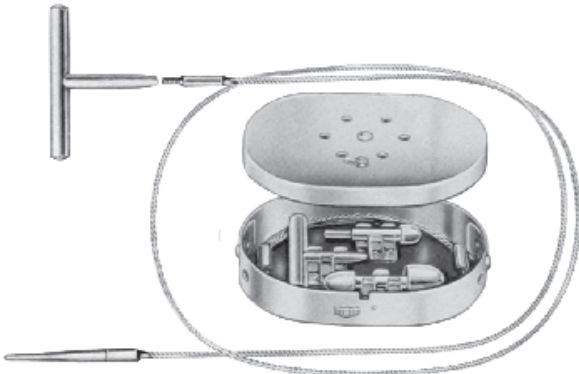

NABATOFF
 14226-00

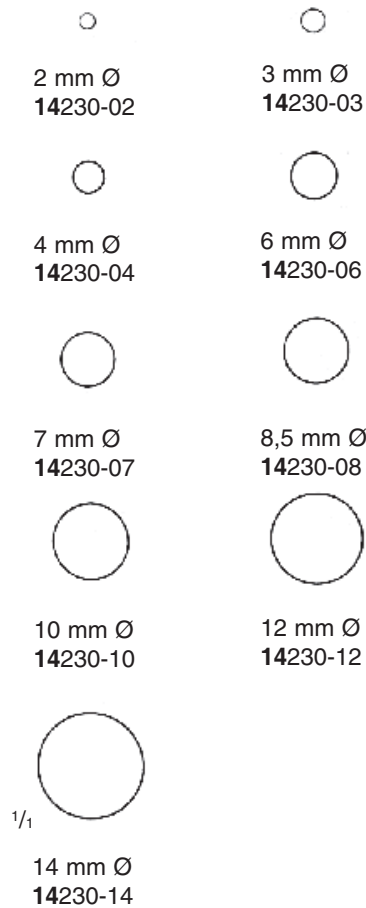
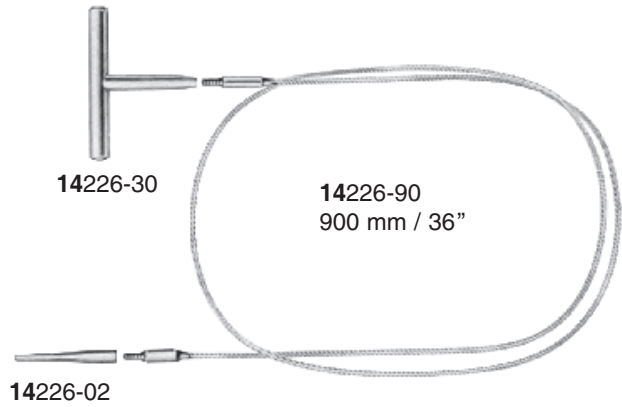

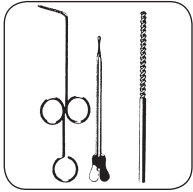

Pflasterspatel, Watteträger
 Plaster Spatulas, Cotton Applicators
 Espátulas, Porta-algodones
 Spatules, Porte-cotons
 Spatole, Portacotone

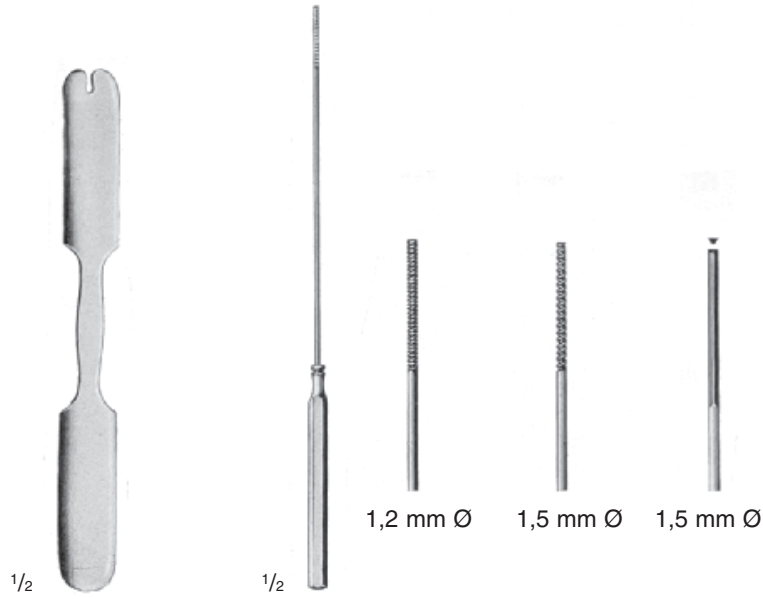

cm	in.	MOD. MARTIN		
12,0	4 ³ / ₄ "	14382-12	14384-12	14386-12
14,0	5 ¹ / ₂ "	14382-14	14384-14	14386-14
14,5	5 ³ / ₄ "	14272-14		
16,0	6 ¹ / ₄ "	14382-16	14384-16	14386-16
18,0	7"	14382-18	14384-18	14386-18



cm	in.	mm Ø	FARRELL	
12,0	4 ³ / ₄ "	0,9	14392-12	14398-12
14,0	5 ¹ / ₄ "	0,9	14392-14	14398-14
16,5	6 ¹ / ₂ "	1,1	14392-16	14398-16
18,0	7"	1,2	14392-18	14398-18
23,0	9"	1,3	14392-23	14398-23

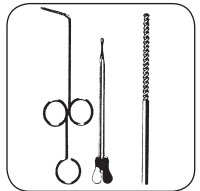

1/4
FEIN
14472-28
28 cm / 11 "



1/4
14482-45
45 cm / 17 3/4"



1/1



1/4
EDER
14483-38
38 cm / 15"



1/1



1/2
14512-28
28 cm / 11"
2,5 mm Ø



1/2
14514-28
28 cm / 11"
2,5 mm Ø

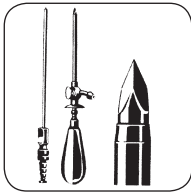

Impfanzetten, Trokare
 Vaccinating Lancets, Trocars
 Lancetas para vacunación, Trócares
 Lancettes à vacciner, Trocarts
 Lancette per vaccinazione, Trequarti



1/2
16072-13
 13 cm / 5"



1/2
16082-12
 12 cm / 5"



1/2
16274-04



Ø 6 4,5 3,0 1,75 mm

Satz zu 4 Stück
 Set of 4 pieces
 Juego de 4 piezas
 Jeu de 4 pièces
 Serie di 4 pezzi



1/2
16278-04



Ø 6 4,5 3,0 1,75 mm

UNIVERSAL



STANDARD
 11 cm / 4 1/2"



STANDARD
 12 cm / 4 3/4"



STANDARD
 12 cm / 4 3/4"

Ø mm	16280-30	16290-30	16300-30
3,0	16280-30	16290-30	16300-30
3,5	16280-35	16290-35	16300-35
4,0	16280-40	16290-40	16300-40
4,5	16280-45	16290-45	16300-45
5,0	16280-50	16290-50	16300-50
5,5	16280-55	16290-55	16300-55
6,0	16280-60	16290-60	16300-60



1/2

NELSON
21 cm / 8 1/4"

Außen Ø
outside Ø
exterior Ø
extérieureur Ø
esterno Ø

lichte Weite
inside diameter
interior anchura
diamètre intérieur
diámetro interno



1/1

16320-06
Fig. 1

7,5 mm

6 mm



16320-08
Fig. 2

9,5 mm

8 mm



16320-10
Fig. 3

11 mm

9,5 mm



16320-11
Fig. 4

12 mm

11 mm



1/2

DUKE
16316-55
11 cm / 4 1/2"
5,5 mm Ø



Für die Gallenblase
for gall bladder
para vesicula biliar
pour la vésicule biliaire
per las vescichette biliare

OCHSNER	Ø Charr.	Charr./Catheter
16372-10	10	6
16372-12	12	8
16372-14	14	10
16372-16	16	12
16372-18	18	14
16372-20	20	16
16372-22	22	18
16372-24	24	20
16372-26	26	22

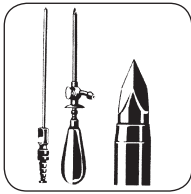

Trokare
Trocars
Trócares
Trocarts
Trequarti

für Beckenabszesse
for pelvic abscesses
para abscesos pelvianos
pour abcés perlvians
per accessi pelvici

1/2

LANDAU
16442-20
16 cm / 6 1/4"
2 mm Ø

1/2

LANDAU
16446-20
19 cm / 7 1/2"
2 mm Ø

1/2

LICHTWITZ
16462-18
1,8 mm Ø

1/2

PIERCE mm Ø
16469-30 = 3,0
16469-40 = 4,0
16469-50 = 5,0

1/2

KRAUSE
16477-55
5,5 mm Ø

1/2

COAKLEY
16487-22
2,5 mm Ø

Kieferhöhlentrokare, Antrum Puncture Trocars, Trócares para punción del seno maxilar,
Trocarts pour sinus maxillaire, Trequarti per puntura del seno mascellare

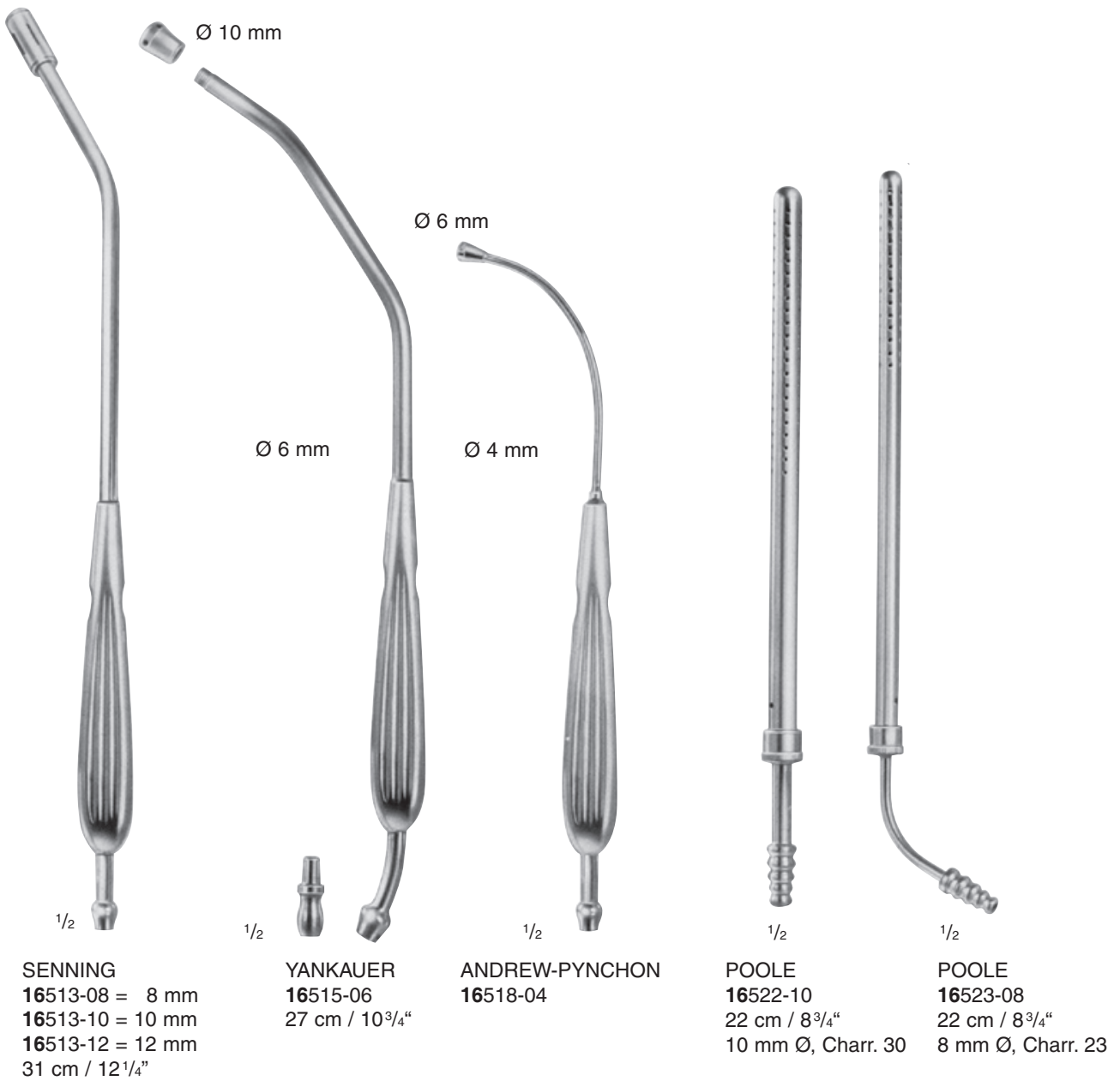
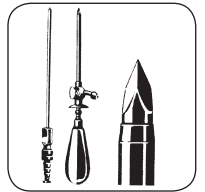

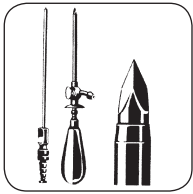

Saugrohre
Suction Tubes
Tubos aspiradores
Tubes d'aspiration
Cannule per aspirazione



1/3

COOLEY
16528-08
36,0 cm / 14¹/₄
8 mm Ø



1/3

COOLEY
16528-10
31,0 cm / 12¹/₄
10 mm Ø
mit perforierter Schraubspitze
with perforated screw tip
con punta perforada y roscada
avec pointe perforée et filetée
con punta perforata e filettata



1/3

COOLEY
16529-00
31,0 cm / 12¹/₄
8 mm Ø
mit perforierter Schraubspitze
with perforated screw tip
con punta perforada y roscada
avec pointe perforée et filetée
con punta perforata e filettata



1/3

COOLEY
16529-30
31,0 cm / 12¹/₄
8 mm Ø
mit perforierter Schraubspitze
with perforated screw tip
con punta perforada y roscada
avec pointe perforée et filetée
con punta perforata e filettata

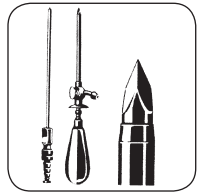

ADSON
16530-40
21 cm / 8 1/4", 4 mm Ø



ADSON
16533-40
21 cm / 8 1/4", 4 mm Ø



FRAZIER
16536-27 = 2,7 mm Ø
16536-33 = 3,3 mm Ø
16536-40 = 4,0 mm Ø
17 cm / 6 3/4"



FRAZIER
16537-20 = 2,0 mm Ø
16537-27 = 2,7 mm Ø
16537-33 = 3,3 mm Ø
16537-40 = 4,0 mm Ø
17 cm / 6 3/4"



FERGUSSON
16539-20 = 2,0 mm Ø
16539-23 = 2,3 mm Ø
16539-27 = 2,7 mm Ø
16539-33 = 3,3 mm Ø
16539-40 = 4,0 mm Ø
17 cm / 6 3/4",



BARON
16541-10 = 1,0 mm Ø
16541-15 = 1,5 mm Ø
16541-20 = 2,0 mm Ø
13 cm / 5",



16545-18 = Suction 1,8 mm
Irrigation 1,8 mm
16545-25 = Suction 2,5 mm
Irrigation 2,0 mm
16545-30 = Suction 3,0 mm
Irrigation 2,0 mm



TOP DUR Nadelhalter mit Hartmetalleinsätzen
 TOP DUR Needle holders with Tungsten Carbide Inserts
 TOP DUR Porta-agujas con bocas de carburo de tungsteno
 TOP DUR Porte-aiguilles à mors en carbure de tungstène
 TOP DUR Portaghi con placche di carburo di tungsteno



1/2

TOENNIS
18000-

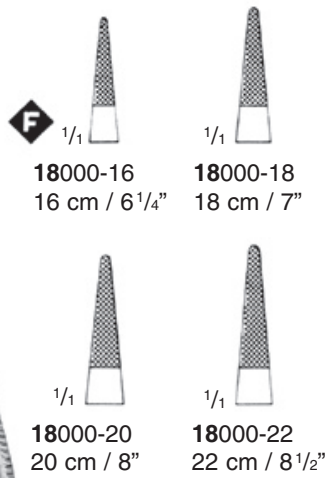

1/2

TOENNIS-RYDER
18001-
slimline

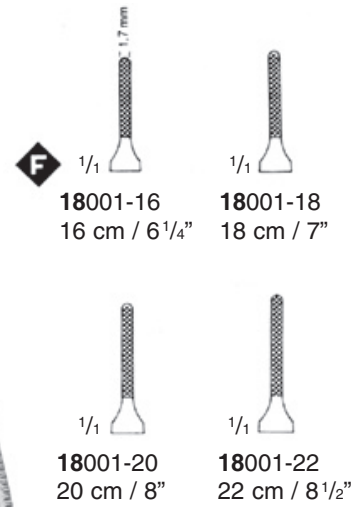

1/2

LICHTENBERG
18004-

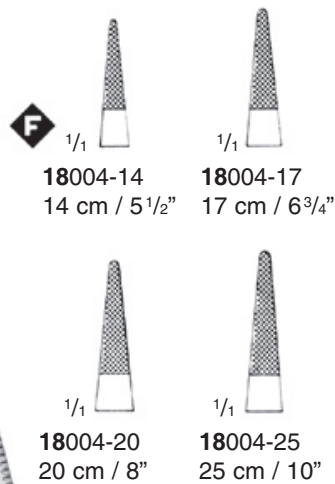

1/2

LICHTENBERG-RYDER
18005-
slimline

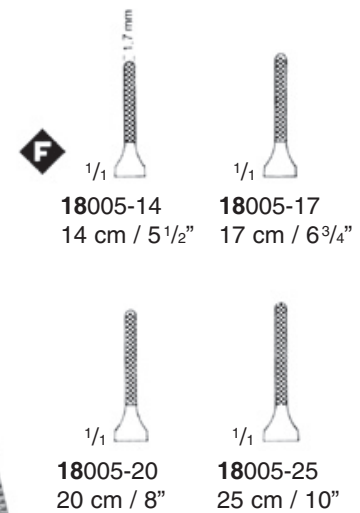

TOP DUR Nadelhalter mit Hartmetalleinsätzen
 TOP DUR Needle holders with Tungsten Carbide Inserts
 TOP DUR Porta-agujas con bocas de carburo de tungsteno
 TOP DUR Porte-aiguilles à mors en carbure de tungstène
 TOP DUR Portaghi con placche di carburo di tungsteno

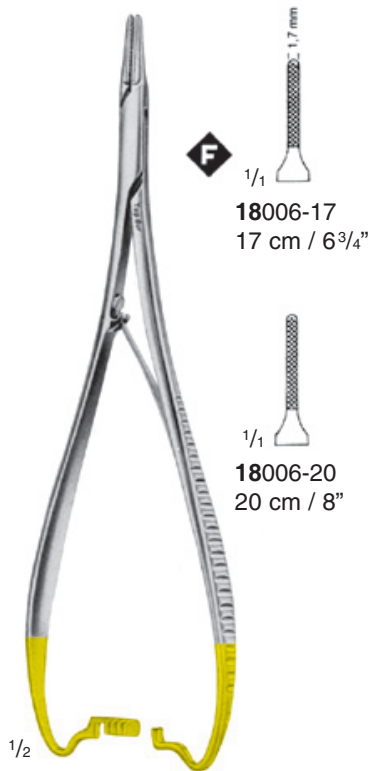

F $\frac{1}{1}$
18006-17
 17 cm / 6³/₄"

$\frac{1}{1}$
18006-20
 20 cm / 8"

$\frac{1}{2}$

MATHIEU-RYDER
18006-
 slimline

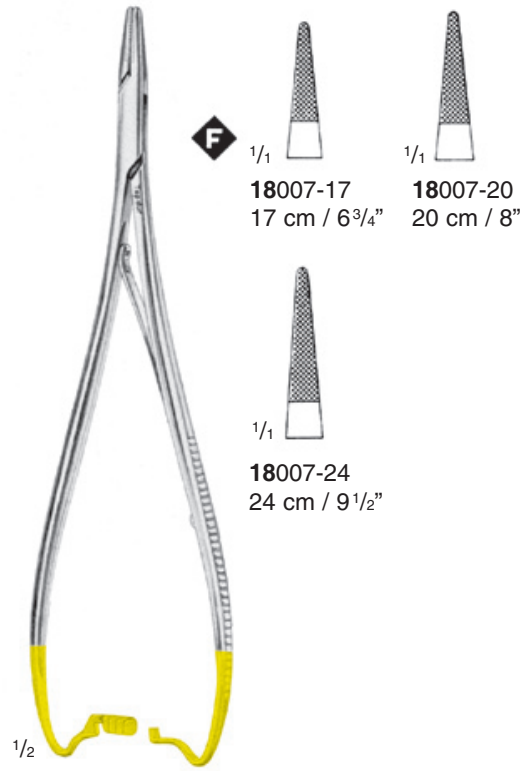

F $\frac{1}{1}$ $\frac{1}{1}$
18007-17 **18007-20**
 17 cm / 6³/₄" 20 cm / 8"

$\frac{1}{1}$
18007-24
 24 cm / 9¹/₂"

$\frac{1}{2}$

LICHTENBERG
18007-
 slimline



$\frac{1}{1}$ $\frac{1}{1}$
18008-17 **18008-20**
 17 cm / 6³/₄" 20 cm / 8"

$\frac{1}{1}$
18008-24
 24 cm / 9¹/₂"

$\frac{1}{2}$

LICHTENBERG
 VASCULAR
18008-
 slimline



TOP DUR Nadelhalter mit Hartmetalleinsätzen
 TOP DUR Needle holders with Tungsten Carbide Inserts
 TOP DUR Porta-agujas con bocas de carburo de tungsteno
 TOP DUR Porte-aiguilles à mors en carbure de tungstène
 TOP DUR Portaghi con placche di carburo di tungsteno

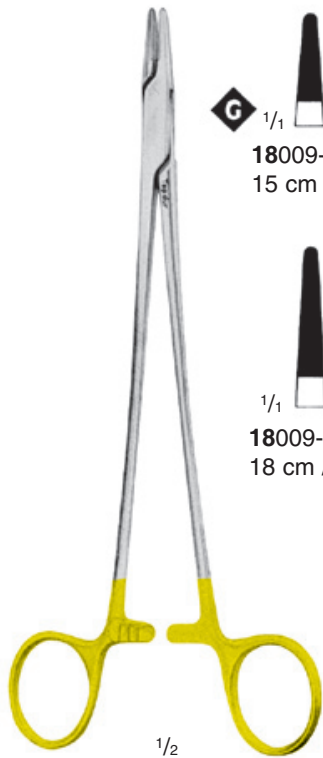

G 1/1
18009-15
 15 cm / 6"

1/1
18009-18
 18 cm / 7"

CRILE-WOOD
18009-



F 1/1
18010-18
 18 cm / 7"

1/1
18010-20
 20 cm / 8"

1/1
18010-23
 23 cm / 9"

CRILE-WOOD
18010-



F 1/1
18011-13
 13 cm / 5"

1,7 mm

1/1
18011-15
 15 cm / 6"

1/1
18011-18
 18 cm / 7"

1/1
18011-20
 20 cm / 8"

1/1
18011-23
 23 cm / 9"

CRILE-WOOD
 RYDER
18011-

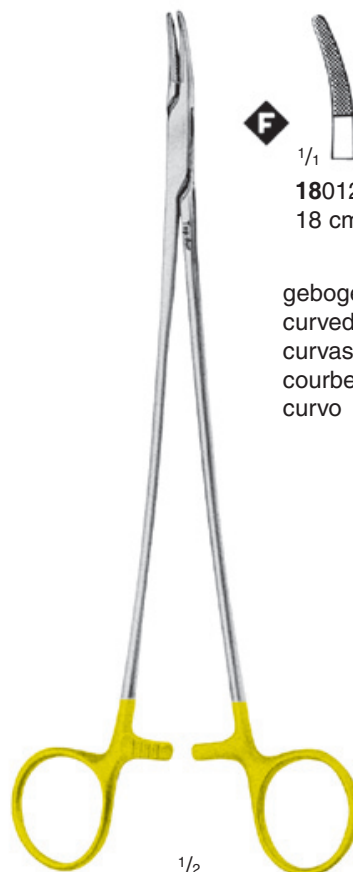

F 1/1
18012-18
 18 cm / 7"

1/1
18012-20
 20 cm / 8"

gebogen
 curved
 curvas
 courbes
 curvo

1/1
18012-23
 23 cm / 9"

CRILE-WOOD
18012-



TOP DUR Nadelhalter mit Hartmetalleinsätzen
 TOP DUR Needle holders with Tungsten Carbide Inserts
 TOP DUR Porta-agujas con bocas de carburo de tungsteno
 TOP DUR Porte-aiguilles à mors en carbure de tungstène
 TOP DUR Portaghi con placche di carburo di tungsteno

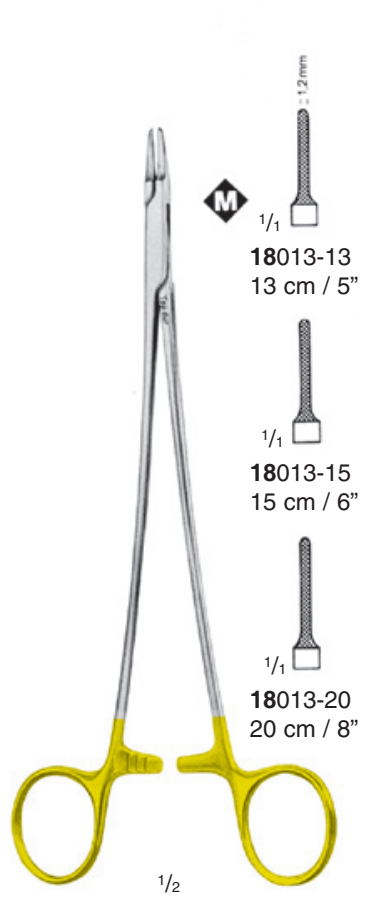

RYDER-VASCULAR
18013-
 slimline

M 1.2 mm
 1/1
18013-13
 13 cm / 5"

1/1
18013-15
 15 cm / 6"

1/1
18013-18
 18 cm / 7"

1/1
18013-20
 20 cm / 8"

1/1
18013-23
 23 cm / 9"



DIETHRICH
18014-
 slimline

M 1.2 mm
 1/1
18014-18
 18 cm / 7"

1/1
18014-20
 20 cm / 8"

1/1
18014-23
 23 cm / 9"



SENNING
18015-

F 1/1
18015-15
 15 cm / 6"

1/1
18015-17
 17 cm / 6³/₄"



TOP DUR Nadelhalter mit Hartmetalleinsätzen
 TOP DUR Needle holders with Tungsten Carbide Inserts
 TOP DUR Porta-agujas con bocas de carburo de tungsteno
 TOP DUR Porte-aiguilles à mors en carbure de tungstène
 TOP DUR Portaghi con placche di carburo di tungsteno



1/1
18016-15
 15 cm / 6"



1/1
18016-18
 18 cm / 7"



1/1
18016-20
 20 cm / 8"

MICRO-VASCULAR
18016-
 slimline

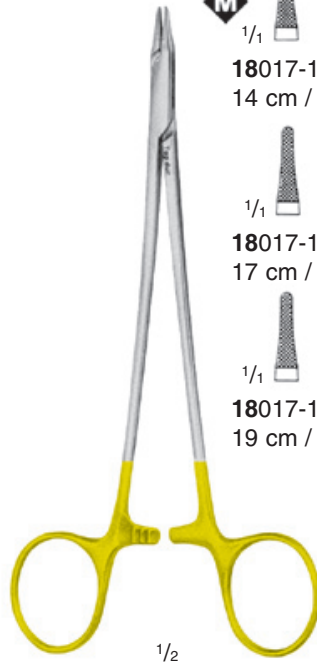

1/1
18017-14
 14 cm / 5 1/2"

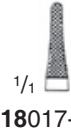

1/1
18017-17
 17 cm / 6 3/4"

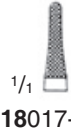

1/1
18017-19
 19 cm / 7 1/2"

LEMMON
18017-

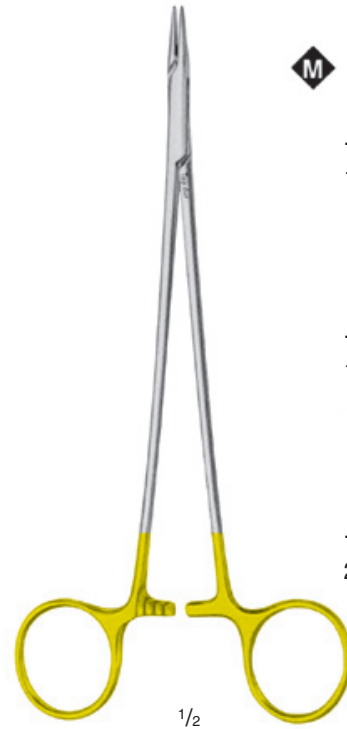

1/1
18020-16
 16 cm / 6 1/4"



1/1
18020-19
 19 cm / 7 1/2"



1/1
18020-22
 22 cm / 8 1/2"

DUFNER-VASCULAR
18020-
 slimline



1/1
18019-01
 20 cm / 8"

ALAN-PARKS
18019-01



1/1
18019-02
 20 cm / 8"

ALAN-PARKS
18019-02



TOP DUR Nadelhalter mit Hartmetalleinsätzen
 TOP DUR Needle holders with Tungsten Carbide Inserts
 TOP DUR Porta-agujas con bocas de carburo de tungsteno
 TOP DUR Porte-aiguilles à mors en carbure de tungstène
 TOP DUR Portaghi con placche di carburo di tungsteno



1/2

MIKRO
 18021-
 18026-

	1,2 mm	1,5 mm	1,8 mm	2,5 mm	1,2 mm	1,5 mm	1,8 mm	2,5 mm
M								
15 cm / 6"	18021-04	18021-05	18021-06	18021-07	18021-34	18021-35	18021-36	18021-37
18 cm / 7"	18021-09	18021-10	18021-11	18021-12	18021-39	18021-40	18021-41	18021-42
21 cm / 8 1/4"	18021-14	18021-15	18021-16	18021-17	18021-44	18021-45	18021-46	18021-47

	1,2 mm	1,5 mm	1,8 mm	2,5 mm	1,2 mm	1,5 mm	1,8 mm	2,5 mm
G								
15 cm / 6"	18026-04	18026-05	18026-06	18026-07	18026-34	18026-35	18026-36	18026-37
18 cm / 7"	18026-09	18026-10	18026-11	18026-12	18026-39	18026-40	18026-41	18026-42
21 cm / 8 1/4"	18026-14	18026-15	18026-16	18026-17	18026-44	18026-45	18026-46	18026-47



1/2

MIKRO
 18022-
 18027-

	1,2 mm	1,5 mm	1,8 mm	2,5 mm	1,2 mm	1,5 mm	1,8 mm	2,5 mm
M								
15 cm / 6"	18022-04	18022-05	18022-06	18022-07	18022-34	18022-35	18022-36	18022-37
18 cm / 7"	18022-09	18022-10	18022-11	18022-12	18022-39	18022-40	18022-41	18022-42
21 cm / 8 1/4"	18022-14	18022-15	18022-16	18022-17	18022-44	18022-45	18022-46	18022-47

	1,2 mm	1,5 mm	1,8 mm	2,5 mm	1,2 mm	1,5 mm	1,8 mm	2,5 mm
G								
15 cm / 6"	18027-04	18027-05	18027-06	18027-07	18027-34	18027-35	18027-36	18027-37
18 cm / 7"	18027-09	18027-10	18027-11	18027-12	18027-39	18027-40	18027-41	18027-42
21 cm / 8 1/4"	18027-14	18027-15	18027-16	18027-17	18027-44	18027-45	18027-46	18027-47



TOP DUR Nadelhalter mit Hartmetalleinsätzen
 TOP DUR Needle holders with Tungsten Carbide Inserts
 TOP DUR Porta-agujas con bocas de carburo de tungsteno
 TOP DUR Porte-aiguilles à mors en carbure de tungstène
 TOP DUR Portaghi con placche di carburo di tungsteno



1/2
 CASTROVIEJO
 18026-

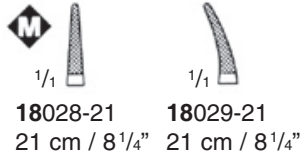
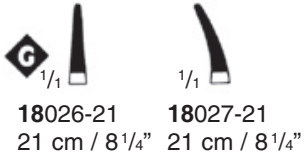

1/2
 KALT
 18030-14

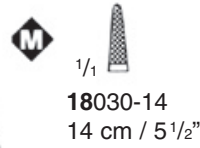

1/2
 CASTROVIEJO
 18032-

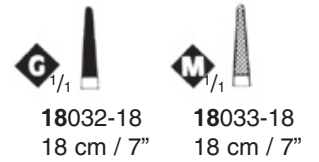
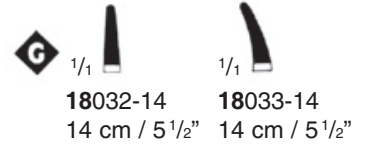

1/2
 CASTROVIEJO
 18034-13

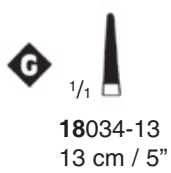

1/2
 BOYTON
 18035-12

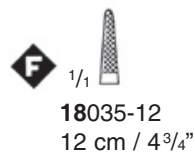

1/2
 ARRUGA
 18036-16





TOP DUR Nadelhalter mit Hartmetalleinsätzen
 TOP DUR Needle holders with Tungsten Carbide Inserts
 TOP DUR Porta-agujas con bocas de carburo de tungsteno
 TOP DUR Porte-aiguilles à mors en carbure de tungstène
 TOP DUR Portaghi con placche di carburo di tungsteno



F 1/1
18037-13
 13 cm / 5"

1/2
KILNER
18037-13



F 1/1
18038-13
 13 cm / 5"

1/2
NEIVERT
18038-13



F 1/1
18039-12
 12 cm / 4 3/4"
G 1/1
18039-62
 12 cm / 4 3/4"

1/2
DERF
18039-12



G 1/1
18040-13
 13 cm / 5"

1/2
HALSEY
18040-13



F 1/1
18041-13
 13 cm / 5"

1/2
BAUMGARTNER
18041-13



F 1/1
18042-15
 15 cm / 6"

1/2
CRILE-WOOD
18042-15



TOP DUR Nadelhalter mit Hartmetalleinsätzen
 TOP DUR Needle holders with Tungsten Carbide Inserts
 TOP DUR Porta-agujas con bocas de carburo de tungsteno
 TOP DUR Porte-aiguilles à mors en carbure de tungstène
 TOP DUR Portaghi con placche di carburo di tungsteno



F

$\frac{1}{1}$

18043-18
18 cm / 7"

$\frac{1}{1}$

18043-20
20 cm / 8"

$\frac{1}{2}$

SAROT
18043-

F

$\frac{1}{1}$

18044-15
15 cm / 6"

$\frac{1}{1}$

18044-18
18 cm / 7"

$\frac{1}{1}$

18044-20
20 cm / 8"

$\frac{1}{1}$

18044-23
23 cm / 9"

$\frac{1}{1}$

18044-26
26 cm / 10 $\frac{1}{4}$ "

$\frac{1}{1}$

18044-30
30 cm / 12"

$\frac{1}{2}$

DE BAKEY
18044-
slimline

F

$\frac{1}{1}$

18045-14
14,5 cm / 5 $\frac{3}{4}$ "

N

$\frac{1}{1}$

18045-16
16 cm / 6 $\frac{1}{4}$ "

$\frac{1}{1}$

18045-18
18 cm / 7"

$\frac{1}{1}$

18045-20
20 cm / 8"

$\frac{1}{1}$

18045-23
23 cm / 9"

$\frac{1}{1}$

18045-26
26 cm / 10 $\frac{1}{4}$ "

$\frac{1}{1}$

18045-30
30 cm / 12"

$\frac{1}{2}$

MAYO-HEGAR
18045-

N

$\frac{1}{1}$

18046-20
20 cm / 8"

$\frac{1}{1}$

18046-23
23 cm / 9"

$\frac{1}{1}$

18046-26
26 cm / 10 $\frac{1}{4}$ "

$\frac{1}{1}$

18046-30
30 cm / 12"

$\frac{1}{2}$

BOZEMANN
18046-



TOP DUR Nadelhalter mit Hartmetalleinsätzen
 TOP DUR Needle holders with Tungsten Carbide Inserts
 TOP DUR Porta-agujas con bocas de carburo de tungsteno
 TOP DUR Porte-aiguilles à mors en carbure de tungstène
 TOP DUR Portaghi con placche di carburo di tungsteno



1/1
18047-20
 20 cm / 8"

1/1
18047-24
 24 cm / 9 1/2"

HEGAR
 18047-



1/1
18048-20
 20 cm / 8"

1/1
18048-24
 24 cm / 9 1/2"

BOZEMANN
 18048-



1/1
18049-20
 20 cm / 8"

1/1
18049-23
 23 cm / 9"

1/1
18049-26
 26 cm / 10 1/4"

HEANEY
 18049-

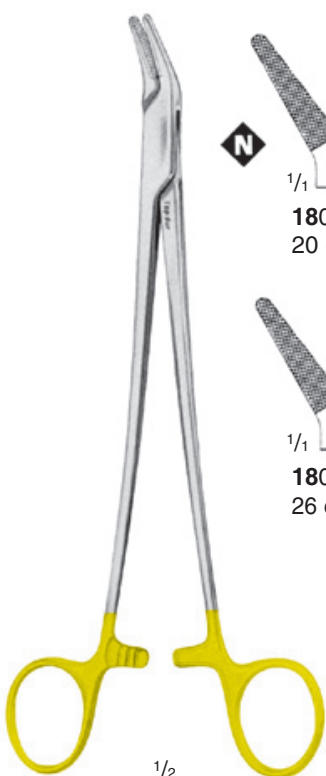

1/1
18050-20
 20 cm / 8"

1/1
18050-26
 26 cm / 10 1/4"

FINOCHIETTO
 18050-



TOP DUR Nadelhalter mit Hartmetalleinsätzen
 TOP DUR Needle holders with Tungsten Carbide Inserts
 TOP DUR Porta-agujas con bocas de carburo de tungsteno
 TOP DUR Porte-aiguilles à mors en carbure de tungstène
 TOP DUR Portaghi con placche di carburo di tungsteno

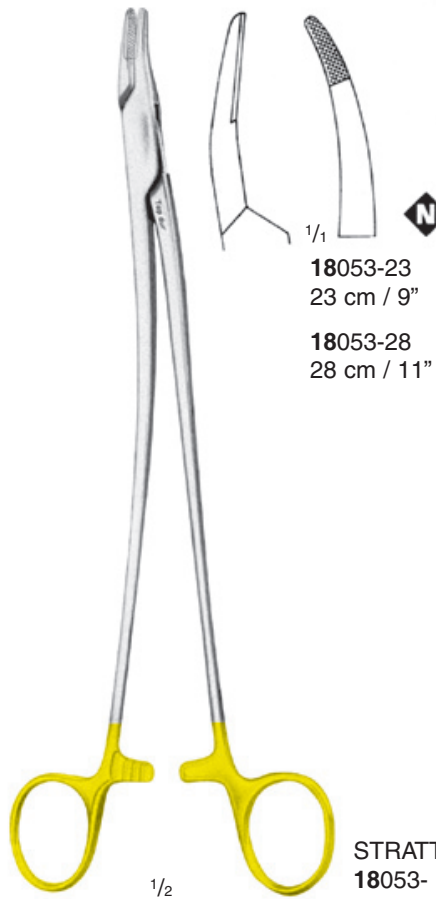
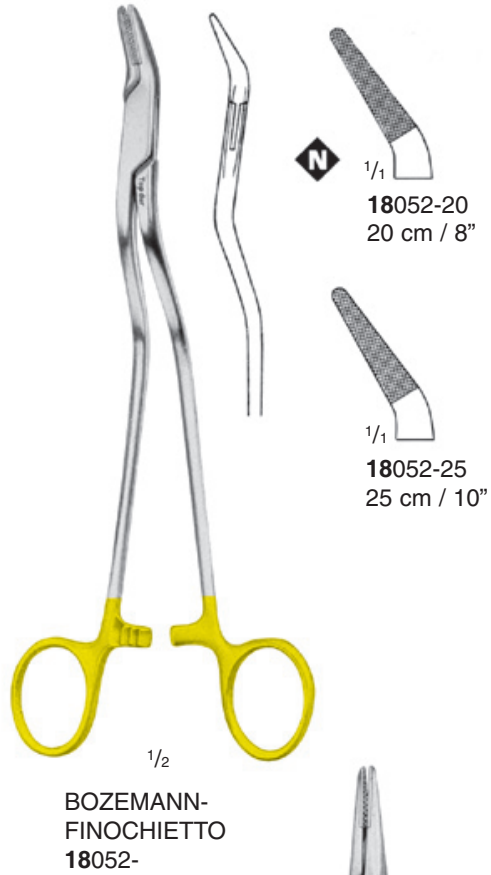
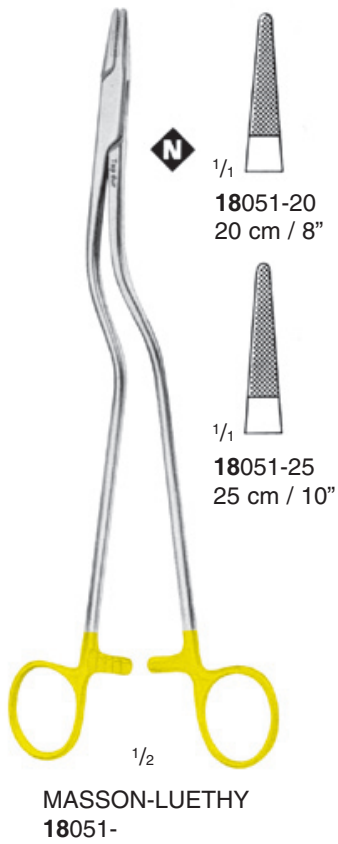



TOP DUR Nadelhalter mit Hartmetalleinsätzen
 TOP DUR Needle holders with Tungsten Carbide Inserts
 TOP DUR Porta-agujas con bocas de carburo de tungsteno
 TOP DUR Porte-aiguilles à mors en carbure de tungstène
 TOP DUR Portaghi con placche di carburo di tungsteno

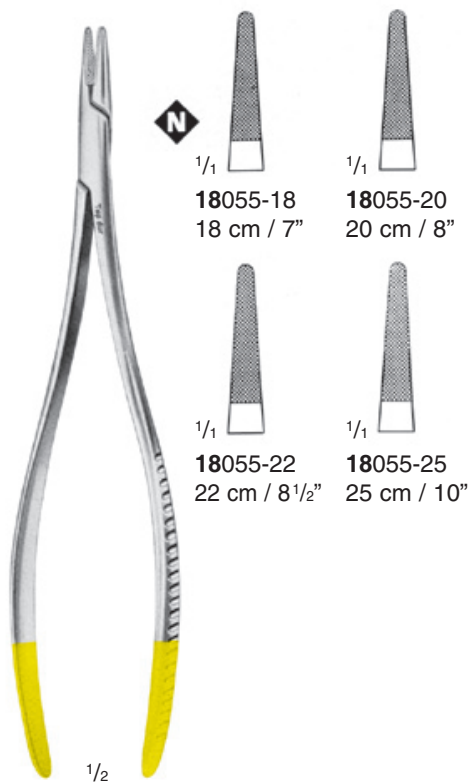

1/1
18055-18
 18 cm / 7"



1/1
18055-20
 20 cm / 8"

1/1
18055-22
 22 cm / 8 1/2"

1/1
18055-25
 25 cm / 10"

LANGENBECK
18055-



1/1
18056-20
 20 cm / 8"

LANGENBECK-RYDER
18056-20



1/1
18057-17
 17 cm / 6 3/4"

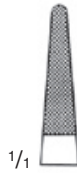

1/1
18057-20
 20 cm / 8"

1/1
18057-23
 23 cm / 9"

MATHIEU
18057-



1/1
18060-14
 14 cm / 5 1/2"



1/1
18060-17
 17 cm / 6 3/4"

1/1
18060-20
 20 cm / 8"

MATHIEU
18060-



TOP DUR Nadelhalter mit Hartmetalleinsätzen
 TOP DUR Needle holders with Tungsten Carbide Inserts
 TOP DUR Porta-agujas con bocas de carburo de tungsteno
 TOP DUR Porte-aiguilles à mors en carbure de tungstène
 TOP DUR Portaghi con placche di carburo di tungsteno





Z $\frac{1}{1}$
18061-17
 17 cm / 6³/₄"

$\frac{1}{1}$
18061-19
 19 cm / 7³/₄"

$\frac{1}{2}$

METZENBAUM
18061-



F $\frac{1}{1}$ $\frac{1}{1}$
18062-20 **18062-23**
 20 cm / 8" 23 cm / 9"

$\frac{1}{1}$
18062-25
 25 cm / 10"

$\frac{1}{2}$

HOESEL
18062-



Z $\frac{1}{1}$ $\frac{1}{1}$
18063-20 **18063-23**
 20 cm / 8" 23 cm / 9"

$\frac{1}{1}$
18063-25
 25 cm / 10"

$\frac{1}{2}$

LUETHY-BECK
18063-



Z $\frac{1}{1}$
18064-20
 20 cm / 8"

$\frac{1}{1}$
18064-23
 23 cm / 9"

$\frac{1}{2}$

ZWEIFEL
18064-



TOP DUR Nadelhalter mit Hartmetalleinsätzen
 TOP DUR Needle holders with Tungsten Carbide Inserts
 TOP DUR Porta-agujas con bocas de carburo de tungsteno
 TOP DUR Porte-aiguilles à mors en carbure de tungstène
 TOP DUR Portaghi con placche di carburo di tungsteno



F
 $\frac{1}{1}$
18065-18
 18 cm / 7"

$\frac{1}{2}$
 EISELSBERG-MATHIEU
18065-18



N $\frac{1}{1}$ **18066-14** 14 cm / 5 $\frac{1}{2}$ "
 $\frac{1}{1}$ **18066-16** 16 cm / 6 $\frac{1}{4}$ "

$\frac{1}{1}$ **18066-18** 18 cm / 7"

$\frac{1}{2}$
 OLSEN-HEGAR
18066-



M $\frac{1}{1}$ **18067-12** 12,5 cm / 5"

$\frac{1}{2}$
 OLSEN-HEGAR
18067-12
 slimline



N $\frac{1}{1}$ **18068-16** 16 cm / 6 $\frac{1}{4}$ "

$\frac{1}{2}$
 GILLIES
18068-16



F $\frac{1}{1}$ **18069-14** 14,5 cm / 5 $\frac{3}{4}$ "

$\frac{1}{2}$
 GILLIES
18069-14
 slimline



Mikro-Nadelhalter
Micro-Needle Holders
Micro-porta-agujas
Micro-porte-aiguilles
Micro-Portaghi



BARRAQUER-TROUTMAN
18260-10
10 cm / 4"



BARRAQUER-TROUTMAN
18261-10
10 cm / 4"



BARRAQUER-TROUTMAN
18270-10
10 cm / 4"



BARRAQUER-TROUTMAN
18271-10
10 cm / 4"



CASTROVIEJO
18274-09
9 cm / 3 1/2"

18274-14
14 cm / 5 1/2"



CASTROVIEJO
18275-09
9 cm / 3 1/2"

18275-14
14 cm / 5 1/2"



CASTROVIEJO
18278-09
9 cm / 3 1/2"

18278-14
14 cm / 5 1/2"



CASTROVIEJO
18279-09
9 cm / 3 1/2"

18279-14
14 cm / 5 1/2"



DERF
18298-12
12 cm / 4 3/4"



DERF-CONVERSE
18300-12
12,5 cm / 5"

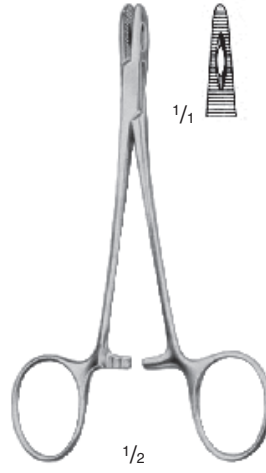

COLLIER
18304-12
12,5 cm / 5"



Maul glatt
Smooth jaws
Bocas lisas
Mors lisses
Morsi lisci

WEBSTER
18306-13
13 cm / 5"

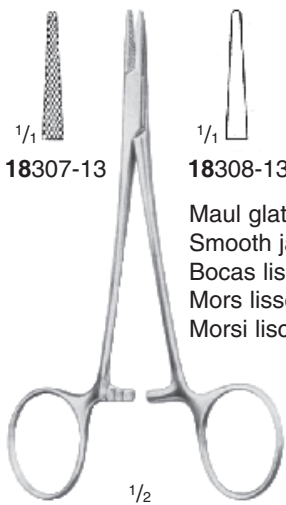

18307-13

18308-13

Maul glatt
Smooth jaws
Bocas lisas
Mors lisses
Morsi lisci

HALSEY
13 cm / 5"



HEGAR-BAUMGARTNER
18312-14
14 cm / 5 1/2"



CRILE-MURRAY
18320-15
15 cm / 6"



CRILE-WOOD
18322-15
15 cm / 6"



Nadelhalter
Needle Holders
Porta-agujas
Porte-aiguilles
Portaghi



ADSON
18332-18
18 cm / 7"



MAYO-HEGAR



cm	in.	
14	5 1/2"	18362-14
16	6 1/4"	18362-16
18	7"	18362-18
20	8"	18362-20
24	9 1/2"	18362-24
26	10 1/2"	18362-26
30	12"	18362-30

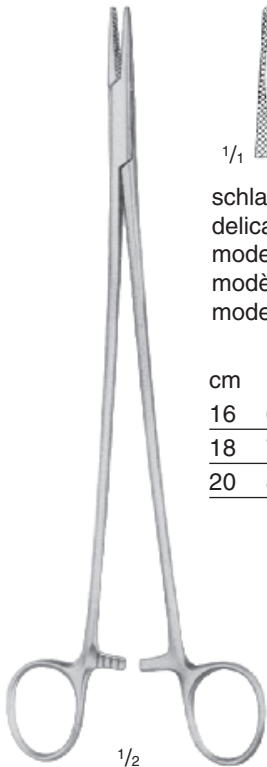

MAYO-HEGAR

schlankes Modell
delicate pattern
modelo delgado
modèle fin
modello fino

cm	in	
16	6 1/4"	18368-16
18	7"	18368-18
20	8"	18368-20



HEANEY
18375-21
21 cm / 8 1/4"



JAMISON
18376-23
23,5 cm / 9 1/4"



MASSON
18380-27
27 cm / 10 1/2"



FINOCHIETTO
18387-27
27 cm / 10 1/2"



WANGENSTEEN
18394-27
27 cm / 10 1/2"

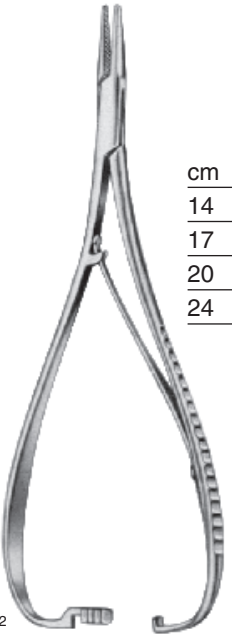

MATHIEU

cm	in.		
14	5 1/2"	18488-14	18490-14
17	6 3/4"	18488-17	18490-17
20	8"	18488-20	18490-20
24	9 1/2"	18488-24	18490-24



schlankes Modell
slender jaws
boca fina
mors étroits
morso stretto

MATHIEU

18498-14	= 14 cm / 5 1/2"
18498-17	= 14 cm / 6 3/4"
18498-20	= 20 cm / 8"



Reverdin-Nadeln
 Reverdin Needles
 Aguja de Reverdin
 Aiguilles de Reverdin
 Aghi di Reverdin e per legature



¹/₂
 REVERDIN
 14 cm / 5 1/2"

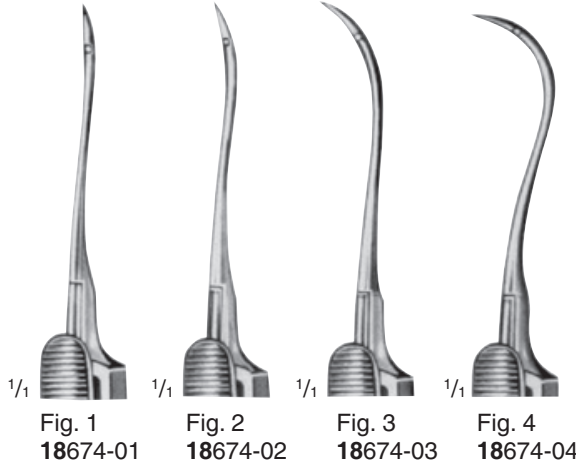
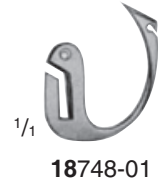

Fig. 1 18674-01 Fig. 2 18674-02 Fig. 3 18674-03 Fig. 4 18674-04



¹/₂
 YOUNG
 18747-25
 25 cm / 10"



¹/₁
 18748-01

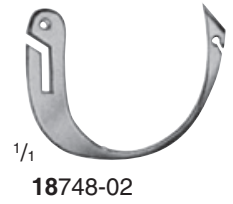

¹/₁
 18748-02



¹/₁
 18748-03



¹/₂
 REVERDIN

Fig. 1	Fig. 2	Fig. 3	Fig. 4
19,5 cm / 7 3/4"	18694-01	18694-02	18694-03
22,5 cm / 8 3/4"	18714-01	18714-02	18714-03
			18714-04

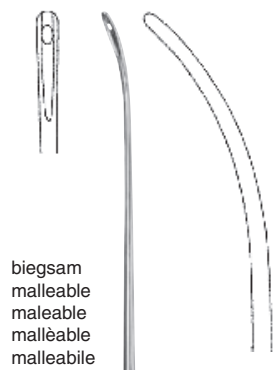

biegsam
malleable
maleable
malléable
malleabile

1/2

18797-20
20,5 cm / 8"



1/2

COOPER
18804-19
18,5 cm / 7 1/4"



Unterbindungs-nadeln
Ligature Needles
Agujas para Ligaduras
Aiguilles à ligatures
Aghi per legatura



KRONECKER **KRONECKER**
18807-13 **18809-13**
13 cm / 5" 13 cm / 5"

links gebogen
für die rechte Hand

rechts gebogen
für die linke Hand

curved to left
for the right hand

curved to right
for the left hand

curva a izquierda
para la mano derecha

curva a derecha
para la mano izquierda

courbé à gauche
pour la main droite

courbé à droite
pour la main gauche

curvato a sinistra
per la mano destra

curvato a destra
per la mano sinistra



DESCHAMPS
18813-20 **18814-20**
20 cm / 8" 20 cm / 8"
stumpf, blunt, roma,
mousse, smusso

links gebogen
für die rechte Hand

rechts gebogen
für die linke Hand

curved to left
for the right hand

curved to right
for the left hand

curva a izquierda
para la mano derecha

curva a derecha
para la mano izquierda

courbé à gauche
pour la main droite

courbé à droite
pour la main gauche

curvato a sinistra
per la mano destra

curvato a destra
per la mano sinistra



DESCHAMPS
18815-20 **18816-20**
20 cm / 8" 20 cm / 8"
scharf, sharp, aguda,
pointue, acuto

links gebogen
für die rechte Hand

rechts gebogen
für die linke Hand

curved to left
for the right hand

curved to right
for the left hand

curva a izquierda
para la mano derecha

curva a derecha
para la mano izquierda

courbé à gauche
pour la main droite

courbé à droite
pour la main gauche

curvato a sinistra
per la mano destra

curvato a destra
per la mano sinistra



Unterbindungsnadeln
 Ligature Needles
 Agujas para Ligaduras
 Aiguilles à ligatures
 Aghi per legatura

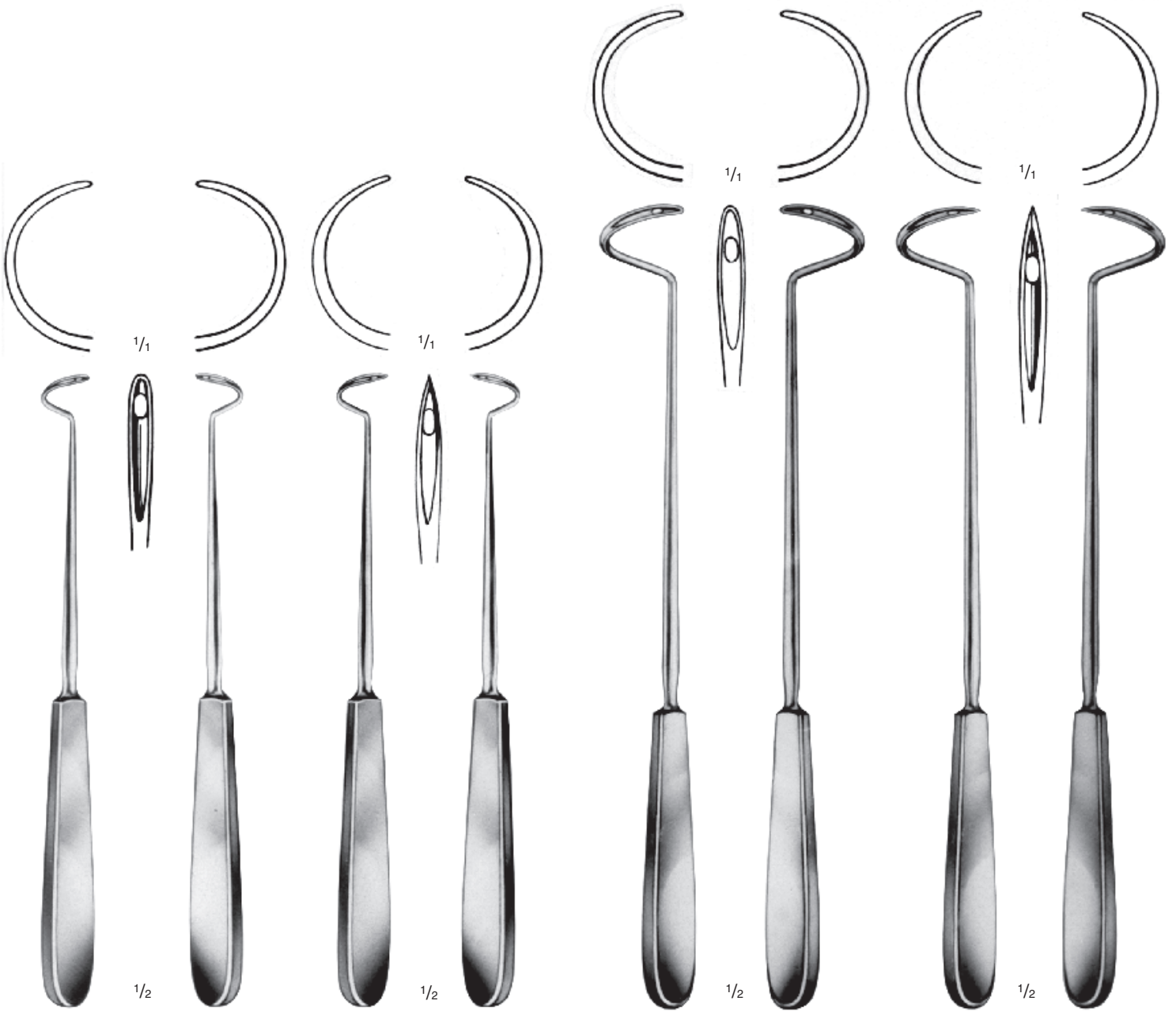

DESCHAMPS
 18817-21 18818-21
 21 cm / 8 1/4" 21 cm / 8 1/4"
 stumpf, blunt, roma,
 mousse, smusso

DESCHAMPS
 18819-21 18820-21
 21cm / 8 1/4" 21 cm / 8 1/4"
 scharf, sharp, aguda,
 pointue, acuto

DESCHAMPS
 18821-27 18822-27
 27cm / 10 1/2" 27 cm / 10 1/2"
 stumpf, blunt, roma,
 mousse, smusso

DESCHAMPS
 18823-27 18824-27
 27 cm / 10 1/2" 27 cm / 10 1/2"
 scharf, sharp, aguda,
 pointue, acuto

links gebogen für die rechte Hand	rechts gebogen für die linke Hand	links gebogen für die rechte Hand	rechts gebogen für die linke Hand	links gebogen für die rechte Hand	rechts gebogen für die linke Hand	links gebogen für die rechte Hand	rechts gebogen für die linke Hand
curved to left for the right hand	curved to right for the left hand	curved to left for the right hand	curved to right for the left hand	curved to left for the right hand	curved to right for the left hand	curved to left for the right hand	curved to right for the left hand
curva a izquierda para la mano derecha	curva a derecha para la mano izquierda	curva a izquierda para la mano derecha	curva a derecha para la mano izquierda	curva a izquierda para la mano derecha	curva a derecha para la mano izquierda	curva a izquierda para la mano derecha	curva a derecha para la mano izquierda
courbé à gauche pour la main droite	courbé à droite pour la main gauche	courbé à gauche pour la main droite	courbé à droite pour la main gauche	courbé à gauche pour la main droite	courbé à droite pour la main gauche	courbé à gauche pour la main droite	courbé à droite pour la main gauche
curvato a sinistra per la mano destra	curvato a destra per la mano sinistra	curvato a sinistra per la mano destra	curvato a destra per la mano sinistra	curvato a sinistra per la mano destra	curvato a destra per la mano sinistra	curvato a sinistra per la mano destra	curvato a destra per la mano sinistra



Führungshohlsonden
 Ligature Conductors
 Sondas cundutoras
 Sondes conductrices
 Sonde conduttrici



$\frac{1}{2}$
 BRUNNER
 30 cm / 12"



$\frac{1}{1}$
 18834-01



$\frac{1}{1}$
 18834-02



$\frac{1}{2}$

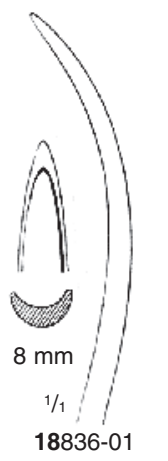

8 mm
 $\frac{1}{1}$
 18836-01



8 mm
 $\frac{1}{1}$
 18836-02

BRUNNER
 30 cm / 12"



$\frac{1}{2}$

KIRSCHNER
 18837-25
 25 cm / 10"



5 mm
 $\frac{1}{1}$



$\frac{1}{2}$

18838-28
 28 cm / 11"

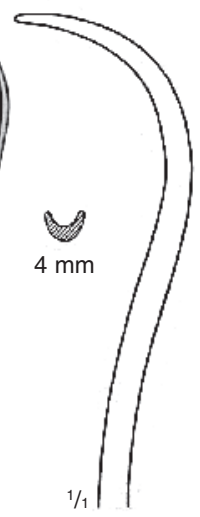

4 mm
 $\frac{1}{1}$



1/2

BRUNNER-FERROZELL
18840-18 = 18 cm / 7"
18840-27 = 27 cm / 10 1/2"



1/2

KIRSCHNER-FERROZELL
18841-27
27 cm / 10 1/2"



1/2

FERROZELL
18842-19
19 cm / 7 1/2"



1/2

FERROZELL
19 cm / 7 1/2"

18842-01
gebogen
curved
curvas
courbes
curvo

18842-02
gerade
straight
recta
droite
retta









1/2

FERROZELL
18842-24
24 cm / 9 1/2"

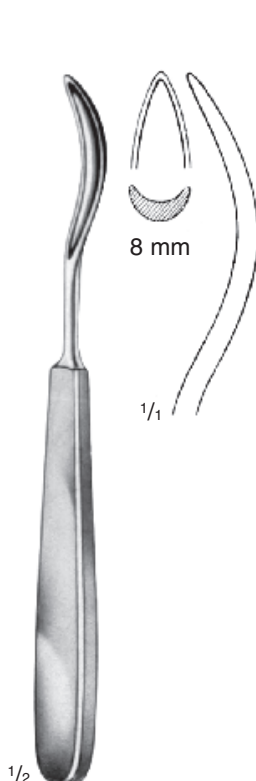
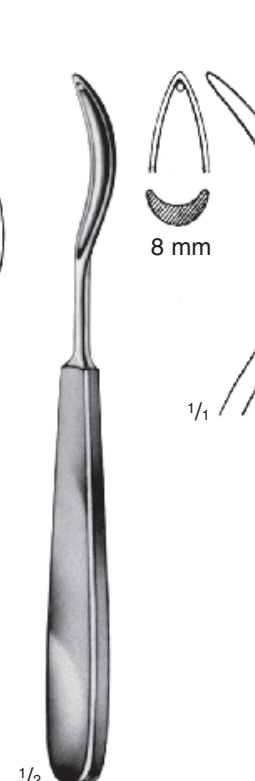

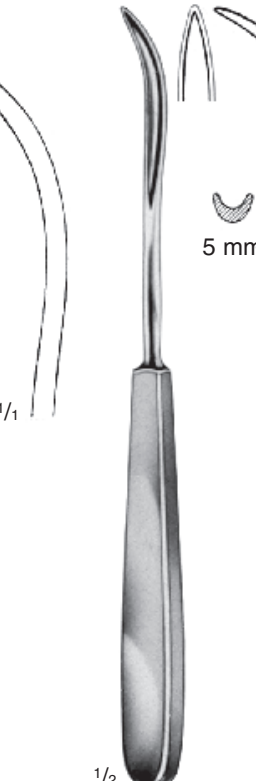
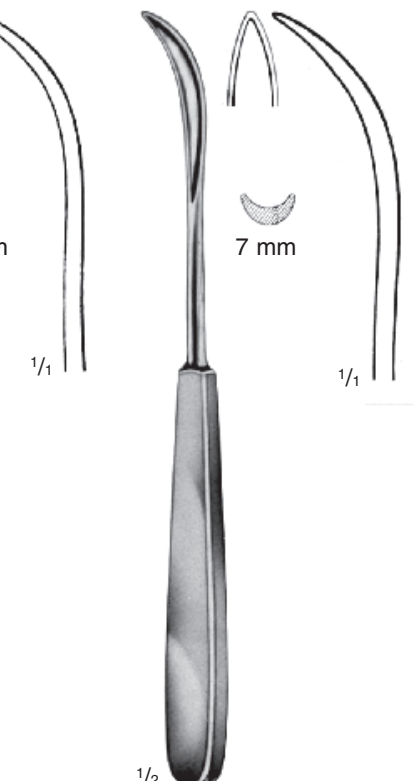
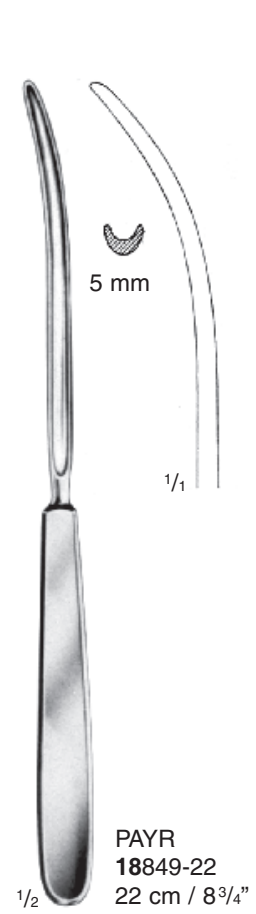
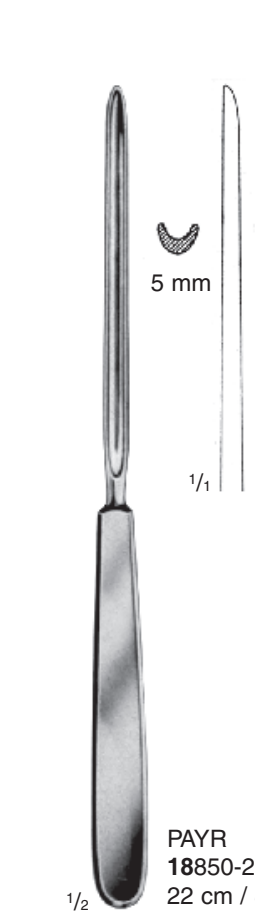
Führungshohlsonden, Nahtinstrumente
 Ligature Conductors, Suture Instruments
 Sondas cundutoras, Instrumental para suturas
 Sondes conductrices, Instruments à suture
 Sonde conduttrici, Strumenti per sutura



 <p>1/2</p>	 <p>1/2</p>	 <p>1/2</p>	 <p>1/2</p>	 <p>1/2</p>
<p>SCHMIEDEN 18843-19 19 cm / 7 1/2"</p>	<p>SCHMIEDEN-PAYR 18844-19 19 cm / 7 1/2"</p>	<p>KÖNIG 18847-03 19,5 cm / 7 3/4"</p>	<p>KÖNIG 18847-05 19,5 cm / 7 3/4"</p>	<p>KÖNIG 18847-07 20 cm / 8"</p>
 <p>1/2</p>	 <p>1/2</p>	 <p>1/2</p>	 <p>1/2</p>	 <p>1/2</p>
<p>PAYR 18849-22 22 cm / 8 3/4"</p>	<p>PAYR 18850-22 22 cm / 8 3/4"</p>	<p>MOD. WIEN 18854-23 23,5 cm / 9 1/4"</p>	<p>BOZEMANN 18856-21 21,5 cm / 8 1/4"</p>	<p>18858-23 23 cm / 9"</p>



kräftig, mit Klammerschiene
heavy pattern, with clip holder
modelo fuerte, con barra para agrafes
modèle fort, avec porte-agrafe
modello forte, con portaagrafes

1/2

CHILDE
18882-18
17,5 cm / 7"
Wundrandpinzette
Approximation Forceps
Pinza aproximadora
Pincès à poser les agrafes
Pinza per i margini della ferita



1/2

MICHEL
18888-12
12 cm / 4 3/4"



1/2

HEGENBARTH
18894-12
12,5 cm / 5"



1/2

WACHENFELDT
18896-12
12,5 cm / 5"



1/2

MICHEL
18900-12
12 cm / 4 3/4"



1/2

COLLIN
18906-13
13 cm / 5"



1/2

RICHTER-HEATH
18907-14
14 cm / 5 1/2"



Wundklammern
Suture Clips
Agrafes (Grapas)
Agrafes
Agrafes

Größen
sizes
tamaños
tailles
mesure

Katalog-Nr.	mm	$\frac{1}{1}$
18912-01	7,5 x 1,75	
18912-02	11 x 2	
18912-04	12 x 3	
18912-05	14 x 3	
18912-06	16 x 3	
18912-07	18 x 3	
18912-08	20 x 3	
18912-09	22 x 3	$\frac{1}{1}$

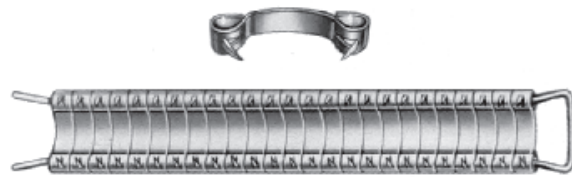

MICHEL

Verkaufseinheit: 10 Packungen = 1000 Stück
Unit for Sale: 10 packages = 1000 ea.
Unidad de venta: 10 paquetes = 1000 piezas
Unité de vente: 10 paquets = 1000 pièces
Unità di vendita: 10 pacchetti = 1000 pezzi

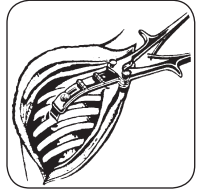
 $\frac{1}{2}$

20072-23
23 cm / 9"

 $\frac{1}{2}$

20073-22
22 cm / 8 $\frac{3}{4}$ "

 $\frac{1}{2}$

GLUCK
20079-19 = 19 cm / 7 $\frac{1}{2}$ "
20079-22 = 22 cm / 8 $\frac{3}{4}$ "

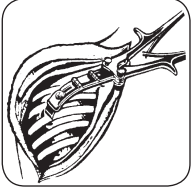

Rippenscheren
Rib Shears
Costótomos
Costotomes
Costotomi

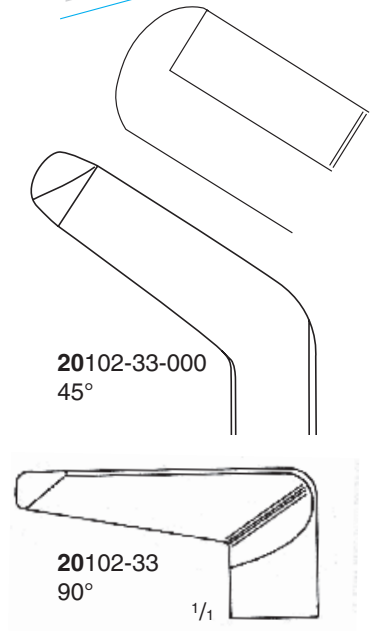
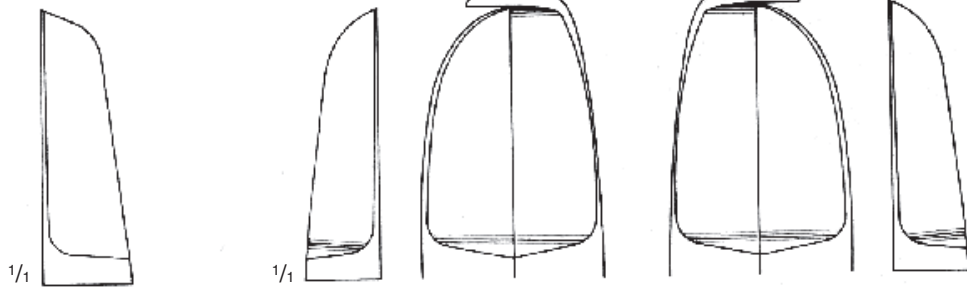

20102-33-000
45°

20102-33
90°



1/3

BETHUNE
20098-35
35 cm / 13³/₄"



1/3

CORYLLOS-BETHUNE
20100-35
35 cm / 13³/₄"
für die linke Hand
for the left hand
para la mano izquierda
pour la main gauche
per la mano sinistra



1/3

CORYLLOS-BETHUNE
20101-35
35 cm / 13³/₄"
für die rechte Hand
for the right hand
para la mano derecha
pour la main droite
per la mano destra



1/3

ROOS
20102-33
33 cm / 13"
90°

ROOS
20102-33-000
33 cm / 13" 45°
Haken an linker
Schneide
Hook on left edge

20102-33-001
33 cm / 13" 45°
Haken an rechter
Schneide
Hook on right edge

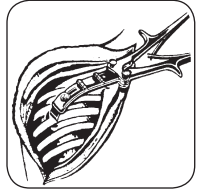

1/3

SAUERBRUCH
20103-26
 26 cm / 10 1/4"



1/3

GIERTZ-STILLE
20109-27
 27 cm / 10 1/2"



1/3

20121-32
 für die linke Hand
 for the left hand
 para la mano izquierda
 pour la main gauche
 per la mano sinistra

BRUNNER
20119-32
 32 cm / 12 1/2"
 für die rechte Hand
 for the right hand
 para la mano derecha
 pour la main droite
 per la mano destra



1/2

LEBSCHE
20123-24
 24,5 cm / 9 3/4"

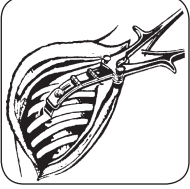

Rippensperrer aus Leichtmetall
 Rib Spreaders from Aluminium
 Separadores costales de aluminio
 Ecarteurs des côtes en aluminium
 Divaricatori sternali an alluminio

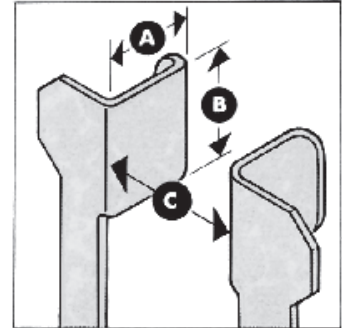

COOLEY	ALUMINIUM		
	A	B	C
20126-75	14 mm	16 mm	85 mm



für Säuglinge
 for babies
 para bebés
 pour bébés
 per neonati

COOLEY	ALUMINIUM		
	A	B	C
20127-10	16 mm	30 mm	115 mm
20127-15	21 mm	44 mm	150 mm



für Kinder
 for children
 para niños
 pour enfants
 per bambini

Rippensperrer aus Leichtmetall
Rib Spreaders from Aluminium
Separdores costales de aluminio
Ecarteurs des côtes en aluminium
Divaricatori sternali an alluminio

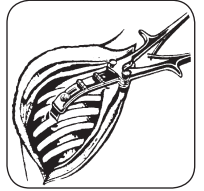

COOLEY	ALUMINIUM		
	A	B	C
20127-20	37 mm	49 mm	200 mm

für Erwachsene
for adults
para adultos
pour adultes
per adulti

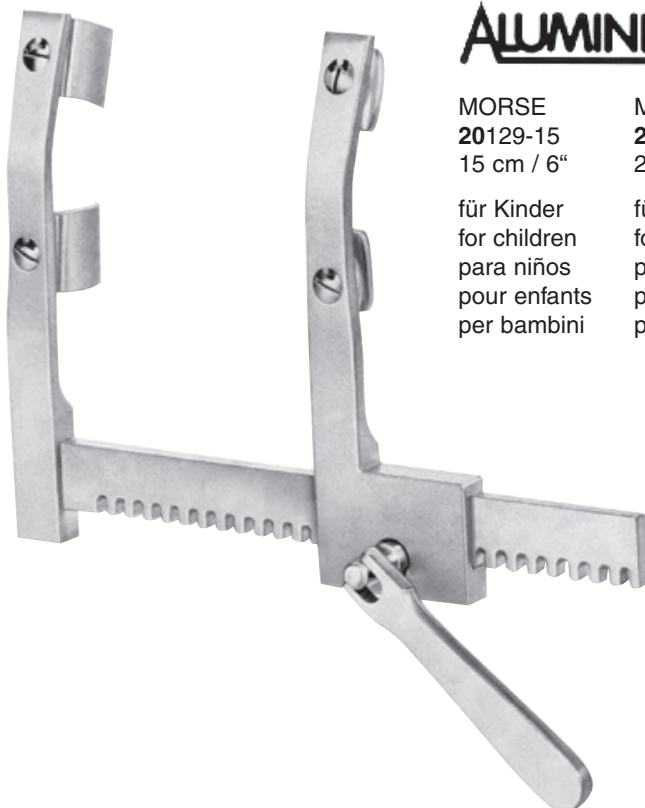
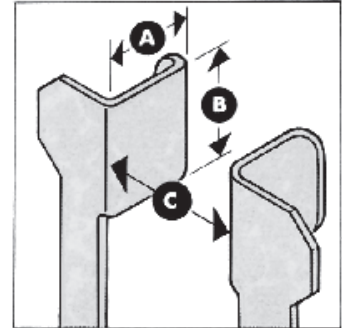

ALUMINIUM

MORSE	MORSE
20129-15	20129-20
15 cm / 6"	20 cm / 8"

für Kinder
for children
para niños
pour enfants
per bambini

für Erwachsene
for adults
para adultos
pour adultes
per adulti

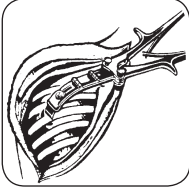

Rippensperrer aus Leichtmetall
 Rib Spreaders from Aluminium
 Separdores costales de aluminio
 Ecarteurs des côtes en aluminium
 Divaricatori sternali an allumnio



für Säuglinge
 for babies
 para bebés
 pour b b s
 per neonati

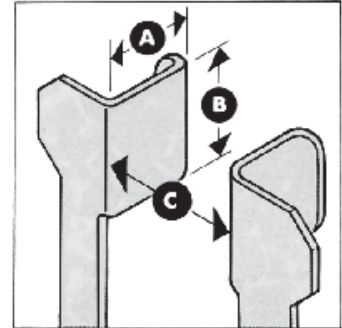

ALUMINIUM

FINOCHIETTO-INFANT	A	B	C
20133-75	15 mm	15 mm	75 mm



Kindergr  e
 child size
 para ni o
 pour enfants
 per bambini



ALUMINIUM

FINOCHIETTO-BABY-HAIGHT	A	B	C
20134-00	31 mm	31 mm	100 mm

ALUMINIUM

FINOCHIETTO	A	B	C
20135-01	38 mm	44 mm	135 mm
20135-02	52 mm	62 mm	175 mm
20135-03	85 mm	65 mm	175 mm

Rippensperrer aus Leichtmetall
Rib Spreaders from Aluminium
Separadores costales de aluminio
Ecarteurs des côtes en aluminium
Divaricatori sternali an alluminio

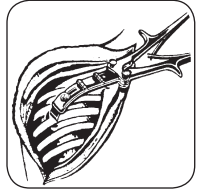

BURFORD	ALUMINIUM		
	A	B	C
20136-00	48 mm 34 mm	42 mm 42 mm	135 mm

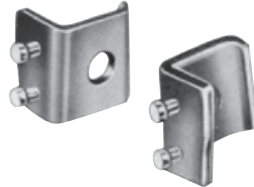

mit 2 Paar Valven
with 2 pairs of blades
con 2 pares de valvas
avec 2 paires de valves
con 2 paia di valve

für Kinder
for children
para niños
pour enfants
per bambini

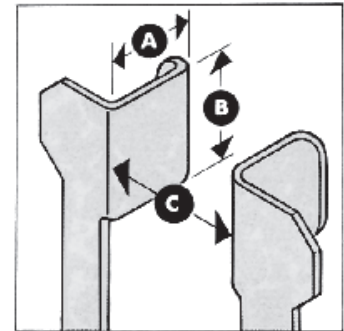

mit 2 Paar Valven
with 2 pairs of blades
con 2 pares de valvas
avec 2 paires de valves
con 2 paia di valve

BURFORD	ALUMINIUM		
	A	B	C
20137-01	65 mm 47 mm	62 mm 62 mm	180 mm
20137-02	65 mm 47 mm	62 mm 62 mm	260 mm
20137-03	65 mm 47 mm	62 mm 62 mm	300 mm

für Erwachsene
for adults
para adultos
pour adultes
per adulti

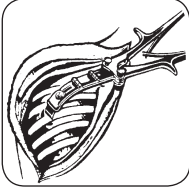

Rippensperrer
Rib Spreaders
Separadores costales
Ecarteurs de côtes
Divaricatori sternali e costali

ALUMINIUM

Seitenvalven 10,5 x 32 mm
lateral blades 10,5 x 32 mm
hojas laterales 10,5 x 32 mm
valves latérales 10,5 x 32 mm
valve laterali 10,5 x 32 mm



für Säuglinge
for babies
para recién nacidos
pour nourissons
per neonati

CASTAÑEDA

A

20138-01 65 mm

Seitenvalven 12 x 45 mm
lateral blades 12 x 45 mm
hojas laterales 12 x 45 mm
valves latérales 12 x 45 mm
valve laterali 12 x 45 mm



für Kleinkinder
for infants
para bébes
pour petits enfants
per bambini piccoli

CASTAÑEDA

A

20138-02 70 mm

Seitenvalven 15 x 60 mm
lateral blades 15 x 60 mm
hojas laterales 15 x 60 mm
valves latérales 15 x 60 mm
valve laterali 15 x 60 mm

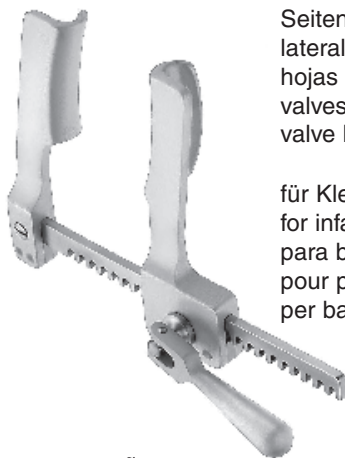

für Kleinkinder
for infants
para bébes
pour petits enfants
per bambini piccoli

CASTAÑEDA

A

20138-03 120 mm

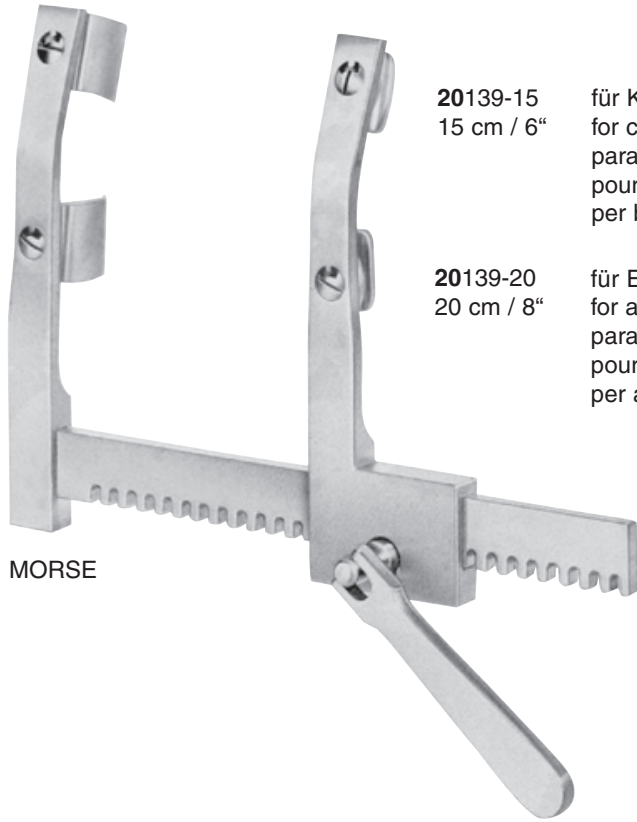
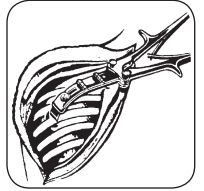

MORSE

20139-15
15 cm / 6"

für Kinder
for children
para niños
pour enfants
per bambini

20139-20
20 cm / 8"

für Erwachsene
for adults
para adultos
pour adultes
per adulti

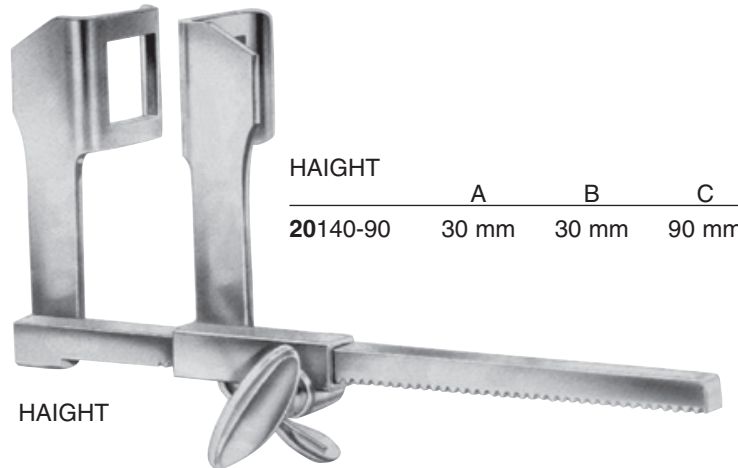
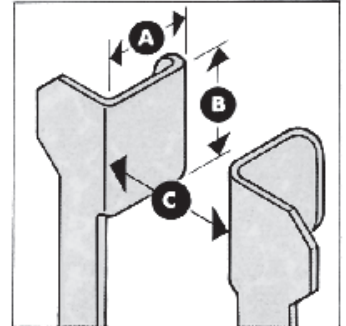

HAIGHT

HAIGHT	A	B	C
20140-90	30 mm	30 mm	90 mm

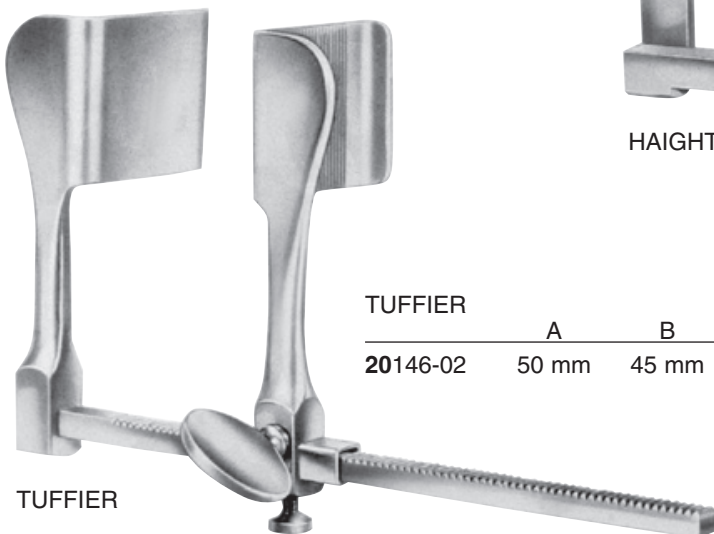

TUFFIER

TUFFIER	A	B	C
20146-02	50 mm	45 mm	165 mm

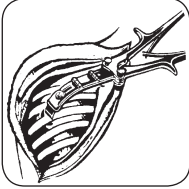

Rippensperrer
 Rib Spreaders
 Separadores costales
 Ecarteurs de côtes
 Divaricatori sternali e costali

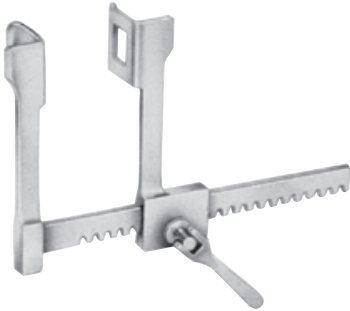

FINOCHIETTO-BABY			
	A	B	C
20149-75	18 mm	20 mm	75 mm

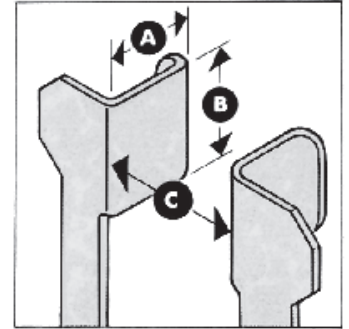
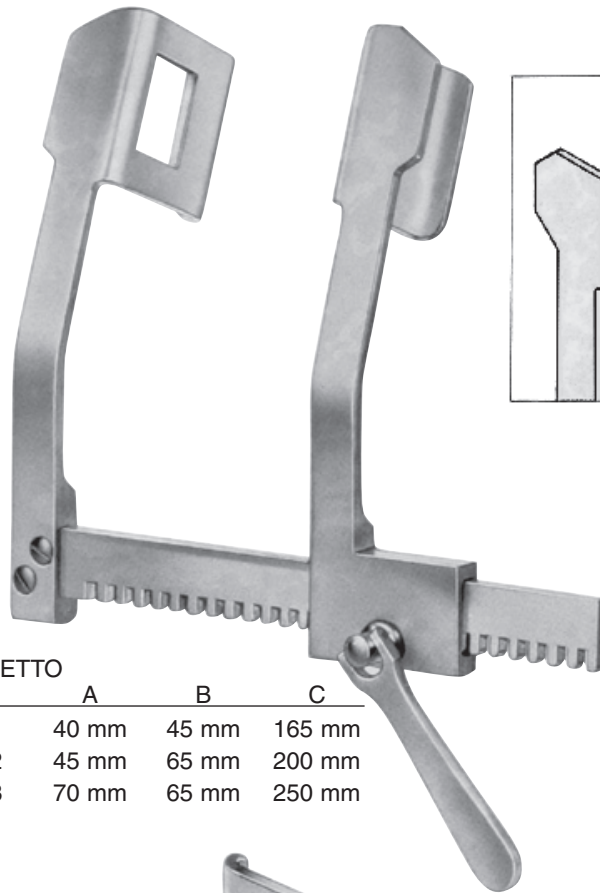

FINOCHIETTO			
	A	B	C
20150-01	40 mm	45 mm	165 mm
20150-02	45 mm	65 mm	200 mm
20150-03	70 mm	65 mm	250 mm



mit 2 Paar Valven
 with 2 pairs of blades
 con 2 pares de valvas
 avec 2 paires de valves
 con 2 paia di valve

BURFORD-FINOCHIETTO			
	A	B	C
20154-02	65 mm	62 mm	250 mm
	47 mm	62 mm	

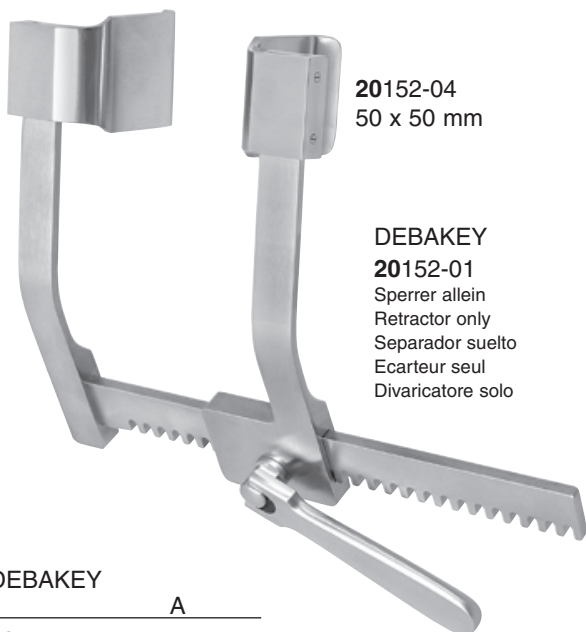
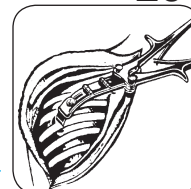

20152-04
50 x 50 mm

DEBAKEY
20152-01
Sperrer allein
Retractor only
Separador suelto
Ecarteur seul
Divaricatore solo



20152-02
30 x 30 mm



20152-03
40 x 40 mm

DEBAKEY

A

20152-00 150 mm

mit 3 Paar Valven
with 3 pairs of blades
con 3 pares de valvas
avec 3 paires de valves
con 3 paia di valve

20152-02 - 20152-04

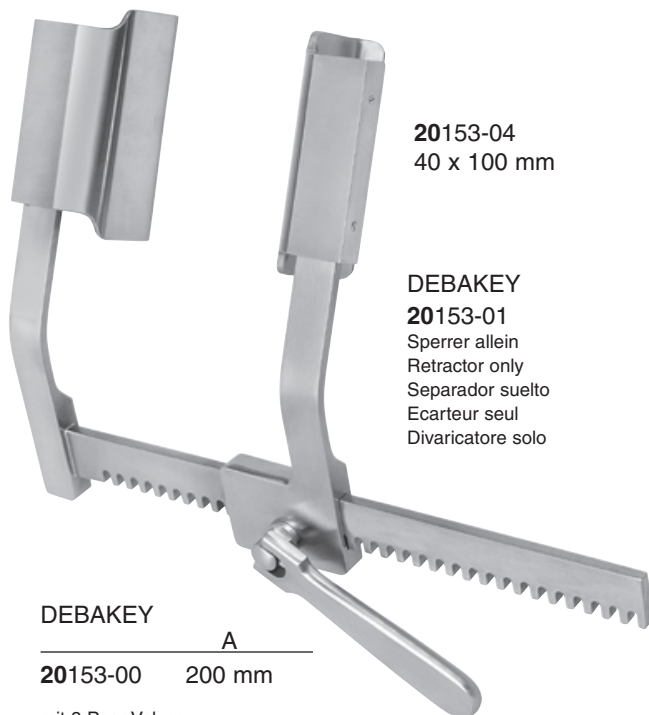

20153-04
40 x 100 mm

DEBAKEY
20153-01
Sperrer allein
Retractor only
Separador suelto
Ecarteur seul
Divaricatore solo



20153-02
60 x 60 mm



20153-03
50 x 80 mm

DEBAKEY

A

20153-00 200 mm

mit 3 Paar Valven
with 3 pairs of blades
con 3 pares de valvas
avec 3 paires de valves
con 3 paia di valve

20153-02 - 20153-04

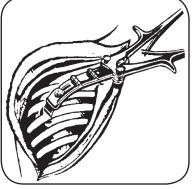

Rippensperrer, Rippenkontraktoren
 Rib Spreaders, Rib Contractors
 Separadores costales, Aproximadores para costillas
 Ecarteurs de côtes, Rapprocheurs de côtes
 Divaricatori sternali e costali, Avvicinatori costali



$\frac{1}{2}$
SELLORS
20190-19
 19 cm / 7 $\frac{1}{2}$ "



$\frac{1}{2}$
BAILEY-BABY
20192-14
 14,5 cm / 5 $\frac{3}{4}$ "



$\frac{1}{2}$
BAILEY
20196-16
 16 cm / 6 $\frac{1}{4}$ "



$\frac{1}{2}$
BAILEY-GIBBON
20198-16
 16 cm / 6 $\frac{1}{4}$ "

Lungenspatel, Bronchusklemmen
Lung Spatulas, Bronchus Clamps
Espátulas pulmonares, Pinzas para bronquios
Spatules pulmonaires, Pinces bronchiques
Spatole polmonari, Pinze per bronchi

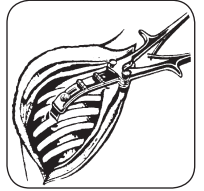

$\frac{1}{3}$
ALLISON
20203-27
27 cm / 10 $\frac{1}{2}$ "



$\frac{1}{3}$
ALLISON
20203-32
32 cm / 12 $\frac{1}{2}$ "



$\frac{1}{3}$
NIEDER
20205-26
26 cm / 12 $\frac{1}{2}$ "

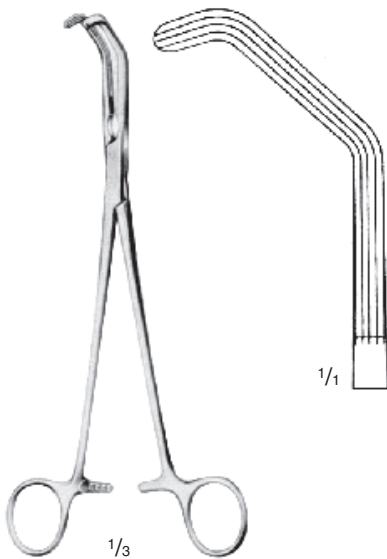

$\frac{1}{3}$
PRICE-THOMAS
20213-22
22 cm / 8 $\frac{3}{4}$ "

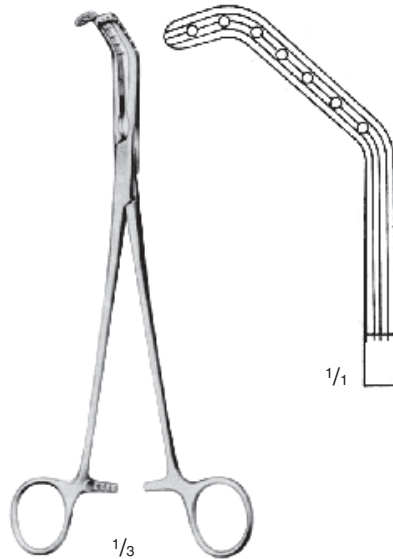

$\frac{1}{3}$
PRICE-THOMAS
20215-22
22 cm / 8 $\frac{3}{4}$ "

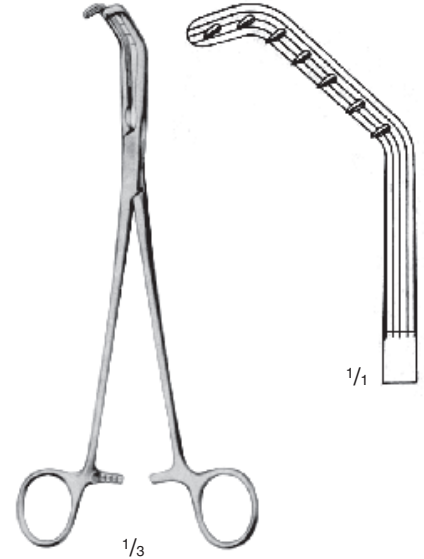

$\frac{1}{3}$
PRICE-THOMAS
20217-22
22 cm / 8 $\frac{3}{4}$ "

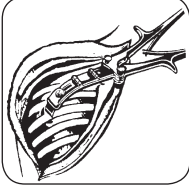

Bronchusklemmen, Gefäßklemmen
 Bronchus Clamps, Blood Vessel Clamps
 Pinzas para bronquios, Clamps para vasos
 Pincès bronchiques, pincès vasculaires
 Pinze per bronchi, Pinze polmonari e vascolari

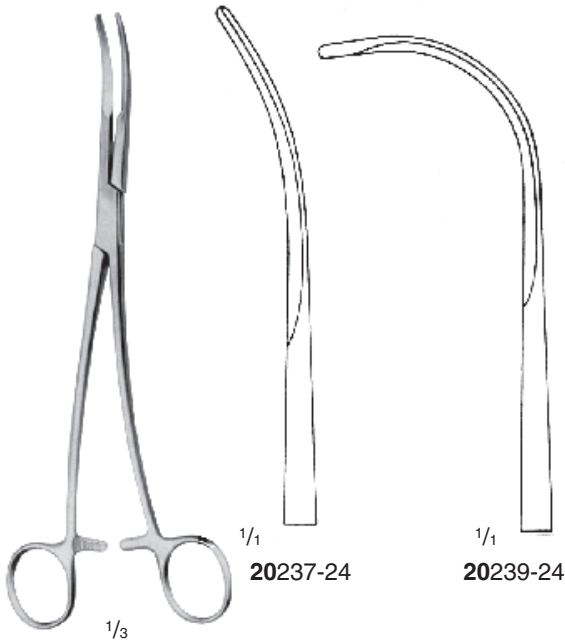

SEMB
 20237-24 / 20239-24
 24 cm / 9 1/2"

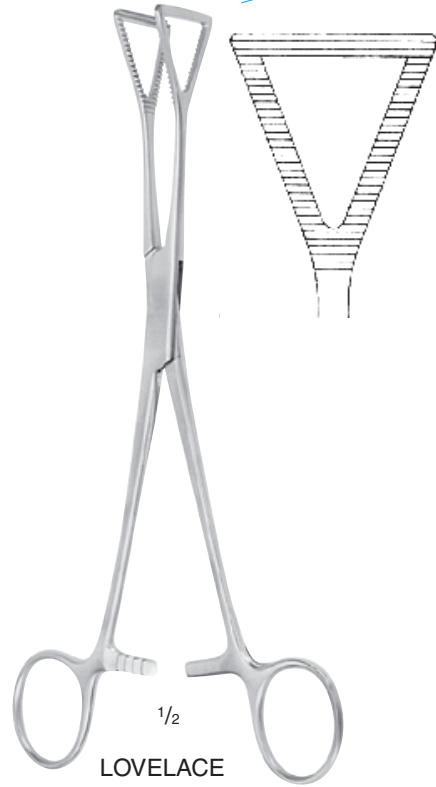

LOVELACE
 20258-20
 20,5 cm / 8"

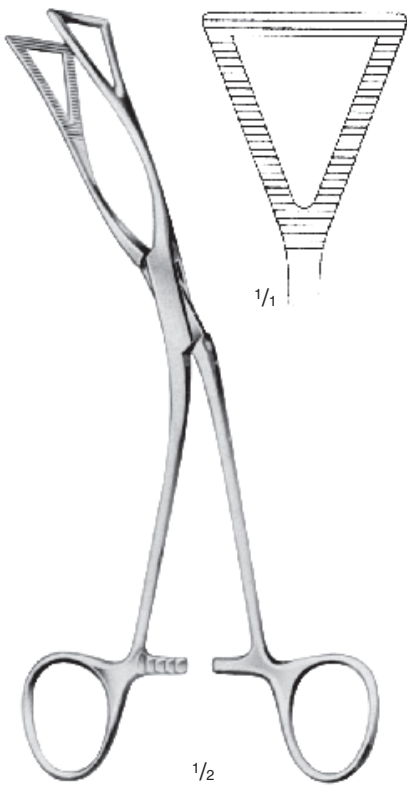

LOVELACE
 20259-20
 20 cm / 8"

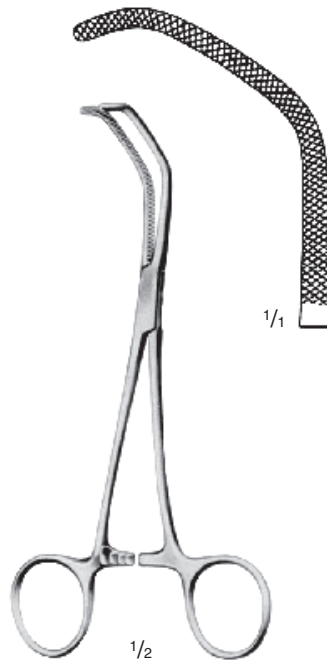

BABY-SATINSKY
 20297-15
 15 cm / 6"

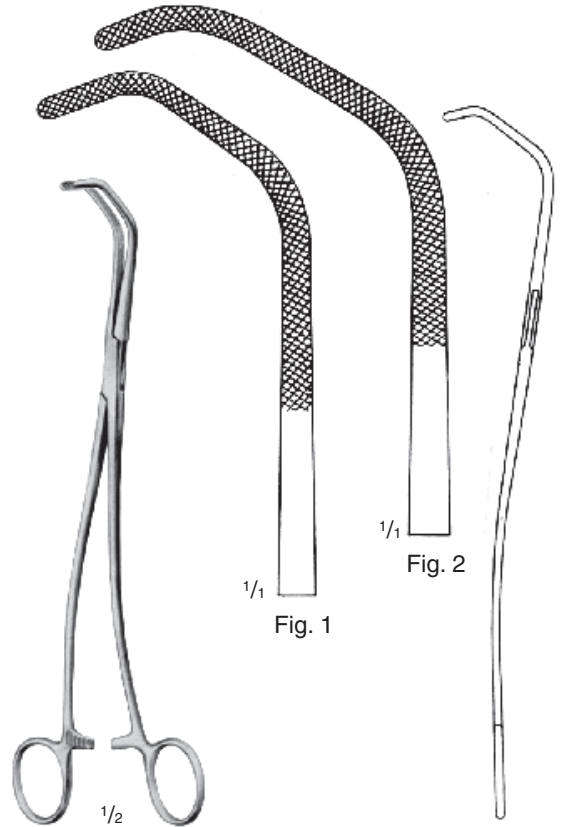

SATINSKY
 20299-26 = Fig. 1
 20300-26 = Fig. 2
 26,5 cm / 10 1/2"



Atraumatische Gefäßpinzetten
 Non-traumatic Vessel Forceps
 Pinzas vasculares con bocas atraumáticas
 Pincas vasculaires à mors non traumatisants
 Pinze vascolari con morso atraumatico

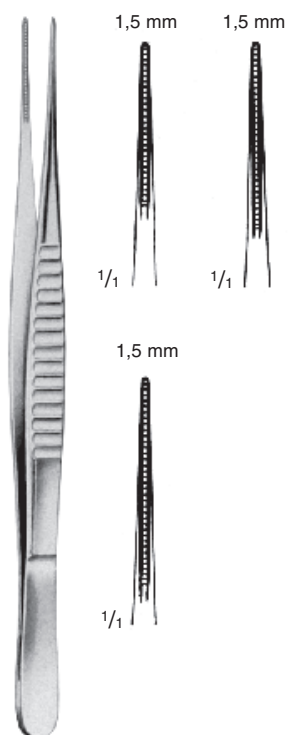
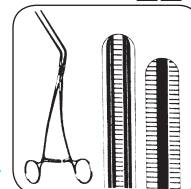

DE BAKEY
 22358-16 = 16 cm / 6 1/4"
 22358-20 = 20 cm / 8"
 22358-24 = 24 cm / 9 1/2"

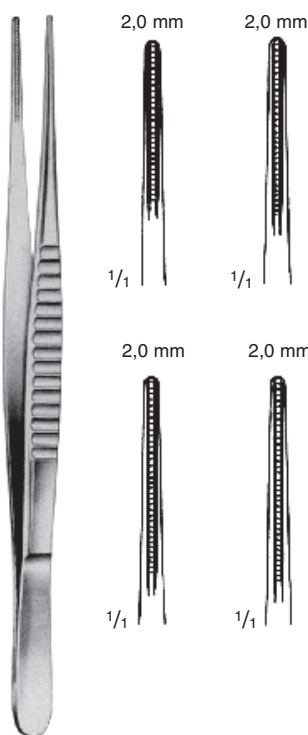

DE BAKEY
 22360-16 = 16 cm / 6 1/4"
 22360-20 = 20 cm / 8"
 22360-24 = 24 cm / 9 1/2"
 22360-30 = 30 cm / 12"

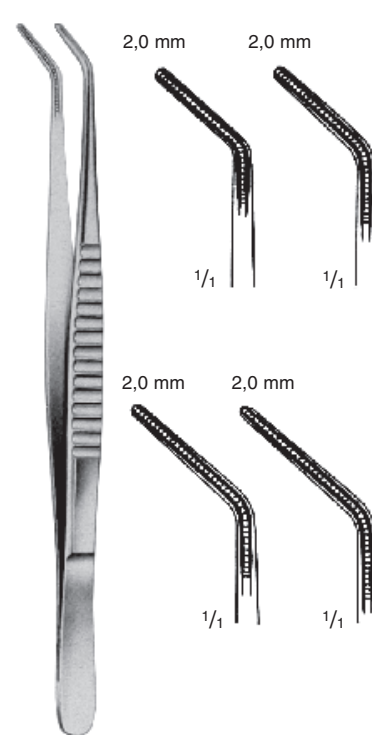

DE BAKEY
 22361-16 = 16 cm / 6 1/4"
 22361-20 = 20 cm / 8"
 22361-24 = 24 cm / 9 1/2"
 22361-30 = 30 cm / 12"

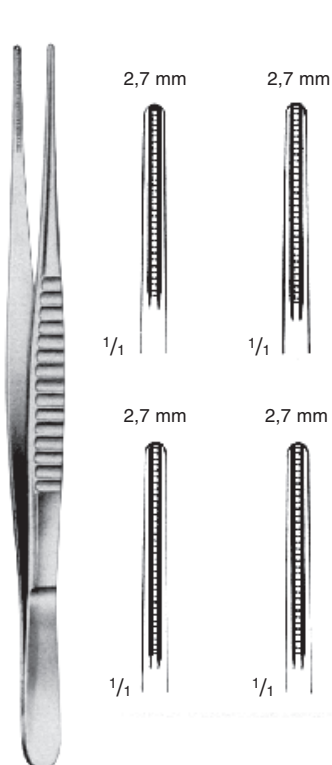

DE BAKEY
 22362-16 = 16 cm / 6 1/4"
 22362-20 = 20 cm / 8"
 22362-24 = 24 cm / 9 1/2"
 22362-30 = 30 cm / 12"

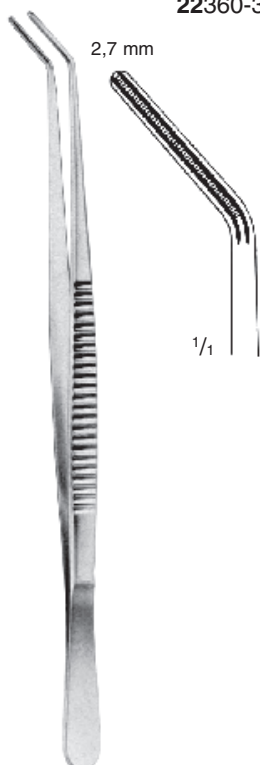

DE BAKEY
 22362-00
 30 cm / 12"

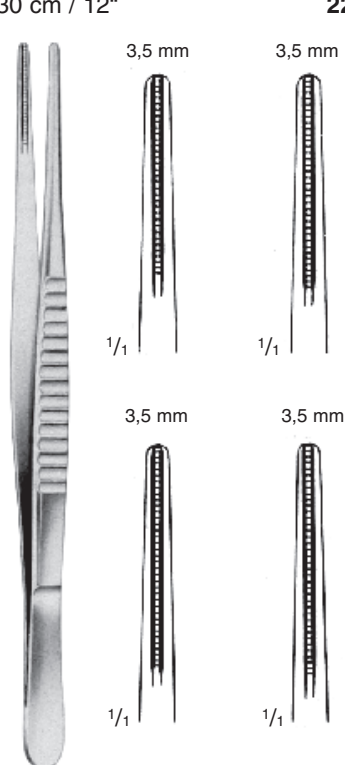

DE BAKEY
 22363-16 = 16 cm / 6 1/4"
 22363-20 = 20 cm / 8"
 22363-24 = 24 cm / 9 1/2"
 22363-30 = 30 cm / 12"

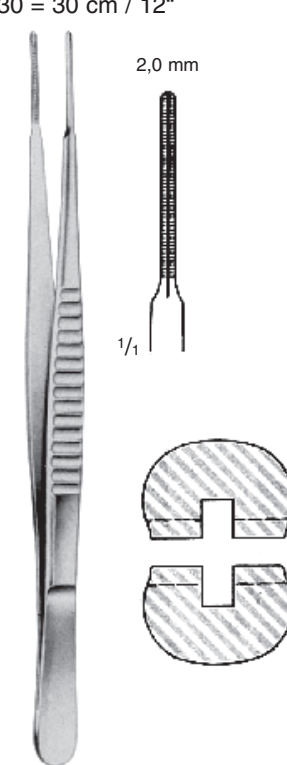

COOLEY
 22436-16 = 16 cm / 6 1/4"
 22436-20 = 20 cm / 8"
 22436-24 = 24 cm / 9 1/2"

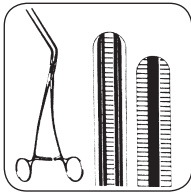

Atraumatische Bulldogklemmen
 Non-traumatic Bulldog Clamps
 Clamps Bulldog con bocas atraumáticas
 Clamps Bulldog à mors non traumatisants
 Clamps Bulldog con morso atraumatico



1/1
DE BAKEY



1/1
22364-07
7,5 cm / 3"



1/1
22364-08
8,5 cm / 3 1/2"



1/1
22364-10
10,5 cm / 4 1/4"



1/1
22364-12
12 cm / 4 3/4"

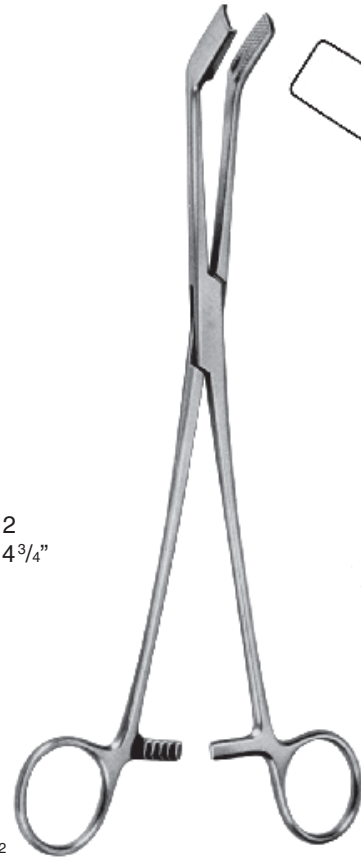

1/2
22367-23
23 cm / 9"



1/1
DE BAKEY



1/1
22365-07
7 cm / 2 3/4"



1/1
22365-08
8 cm / 3 1/4"



1/1
22365-10
10 cm / 4"



1/1
22365-12
11,5 cm / 4 3/4"

Atraumatische Bulldogklemmen
Non-traumatic Bulldog Clamps
Clamps Bulldog con bocas atraumáticas
Clamps Bulldog à mors non traumatisants
Clamps Bulldog con morso atraumatico

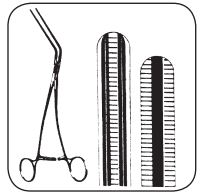

1/1

GLOVER
22370-06 – 22370-11



1/1
22370-06
6,0 cm / 2 1/4"



1/1
22370-07
7,0 cm / 2 3/4"



1/1
22370-09
9,0 cm / 3 1/2"



1/1
22370-11
11,0 cm / 4 1/4"



1/1

GLOVER
22371-06 – 22371-11



1/1
22371-06
5,5 cm / 2"



1/1
22371-07
6,5 cm / 2 1/2"



1/1
22371-09
8,5 cm / 3 1/4"



1/1
22371-11
10,5 cm / 4"

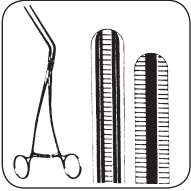

Atraumatische Gefäßklemmen
 Non-traumatic Vascular Clamps
 Pinzas vasculares con bocas atraumáticas
 Pincès vasculaires à mors non traumatisants
 Pinze vascolari con morso atraumatico



DE BAKEY
 22397-35 - 22397-75

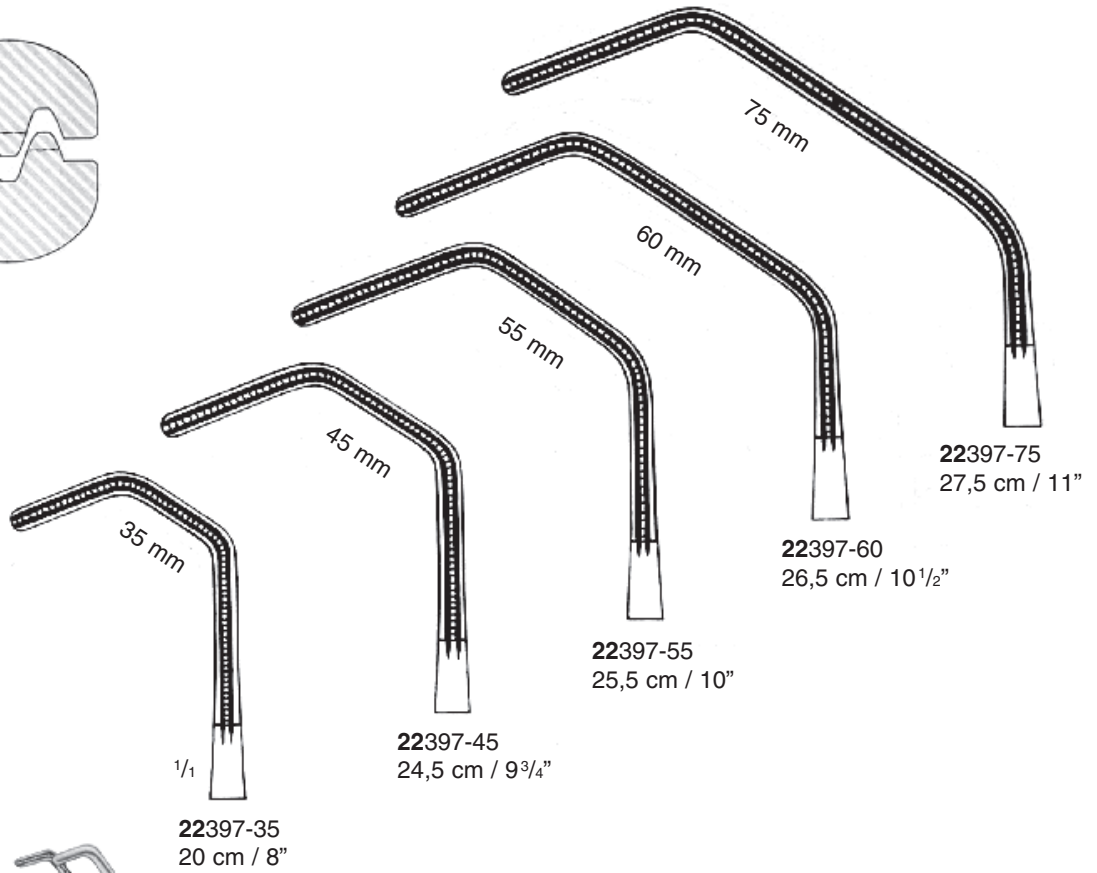

22397-35
 20 cm / 8"

22397-45
 24,5 cm / 9³/₄"

22397-55
 25,5 cm / 10"

22397-60
 26,5 cm / 10¹/₂"

22397-75
 27,5 cm / 11"

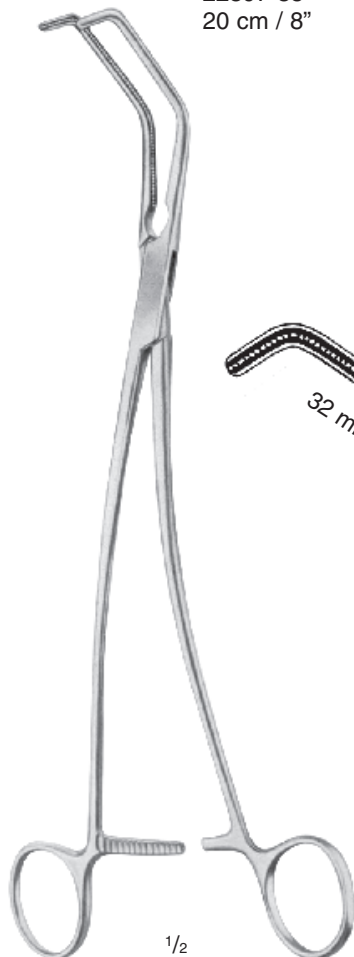

SATINSKY
 22400-32 - 22400-50

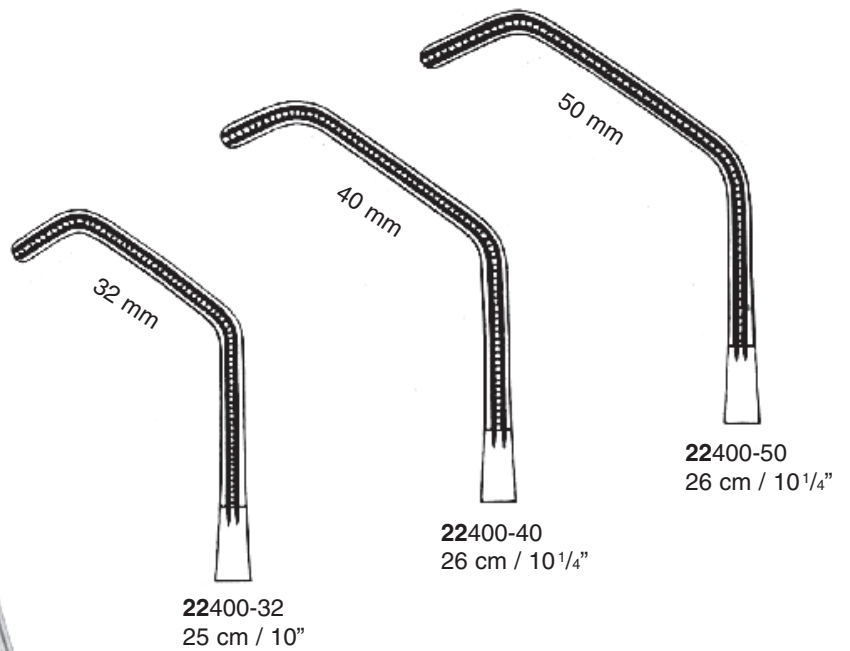

22400-32
 25 cm / 10"

22400-40
 26 cm / 10¹/₄"

22400-50
 26 cm / 10¹/₄"



Atraumatische Gefäßklemmen
 Non-traumatic Vascular Clamps
 Pinzas vasculares con bocas atraumáticas
 Pincas vasculaires à mors non traumatisants
 Pinze vascolari con morso atraumatico

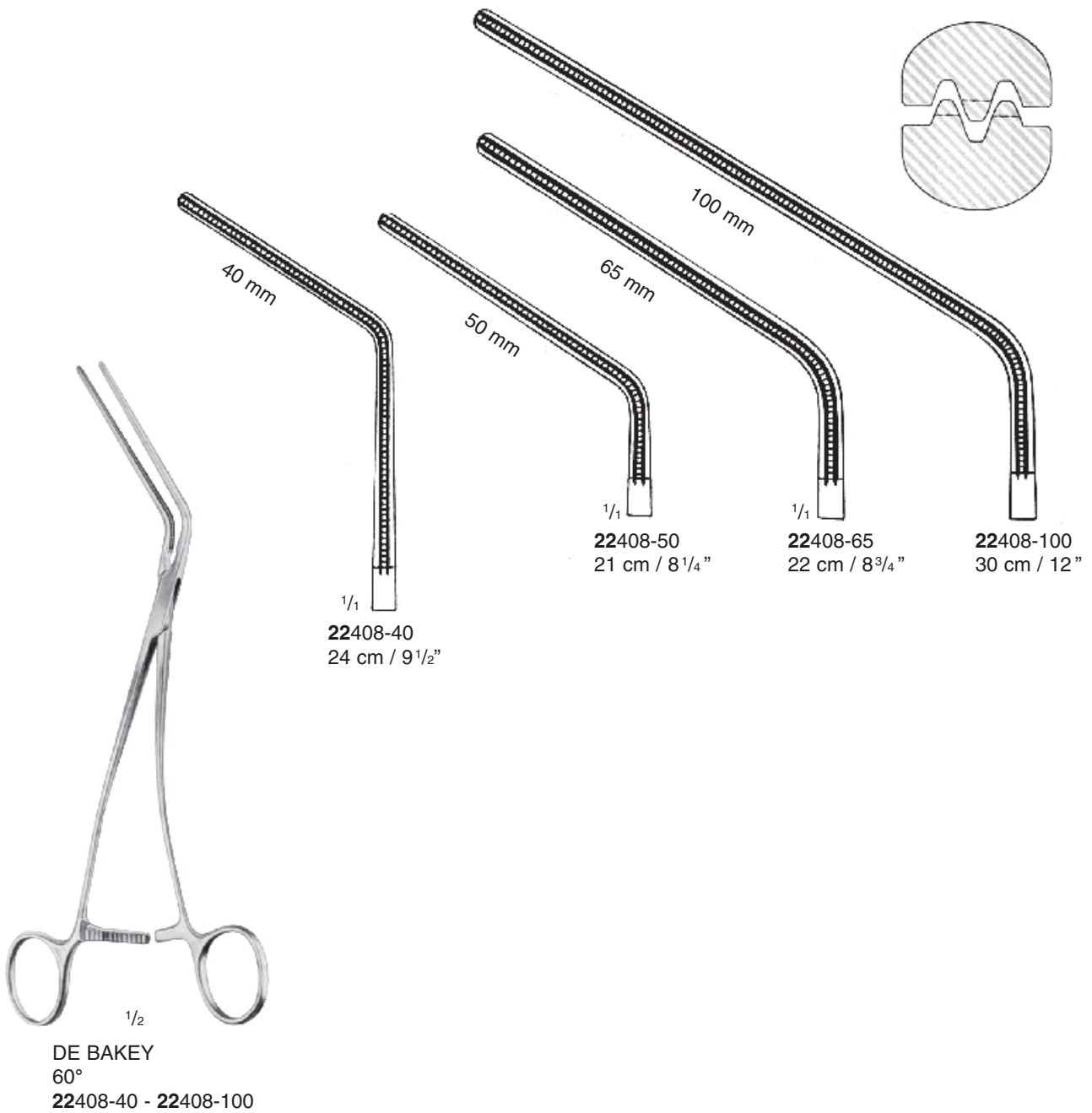

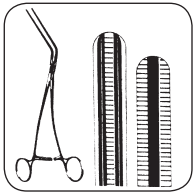

Atraumatische Gefäßklemmen
 Non-traumatic Vascular Clamps
 Pinzas vasculares con bocas atraumáticas
 Pincas vasculaires à mors non traumatisants
 Pinze vascolari con morso atraumatico

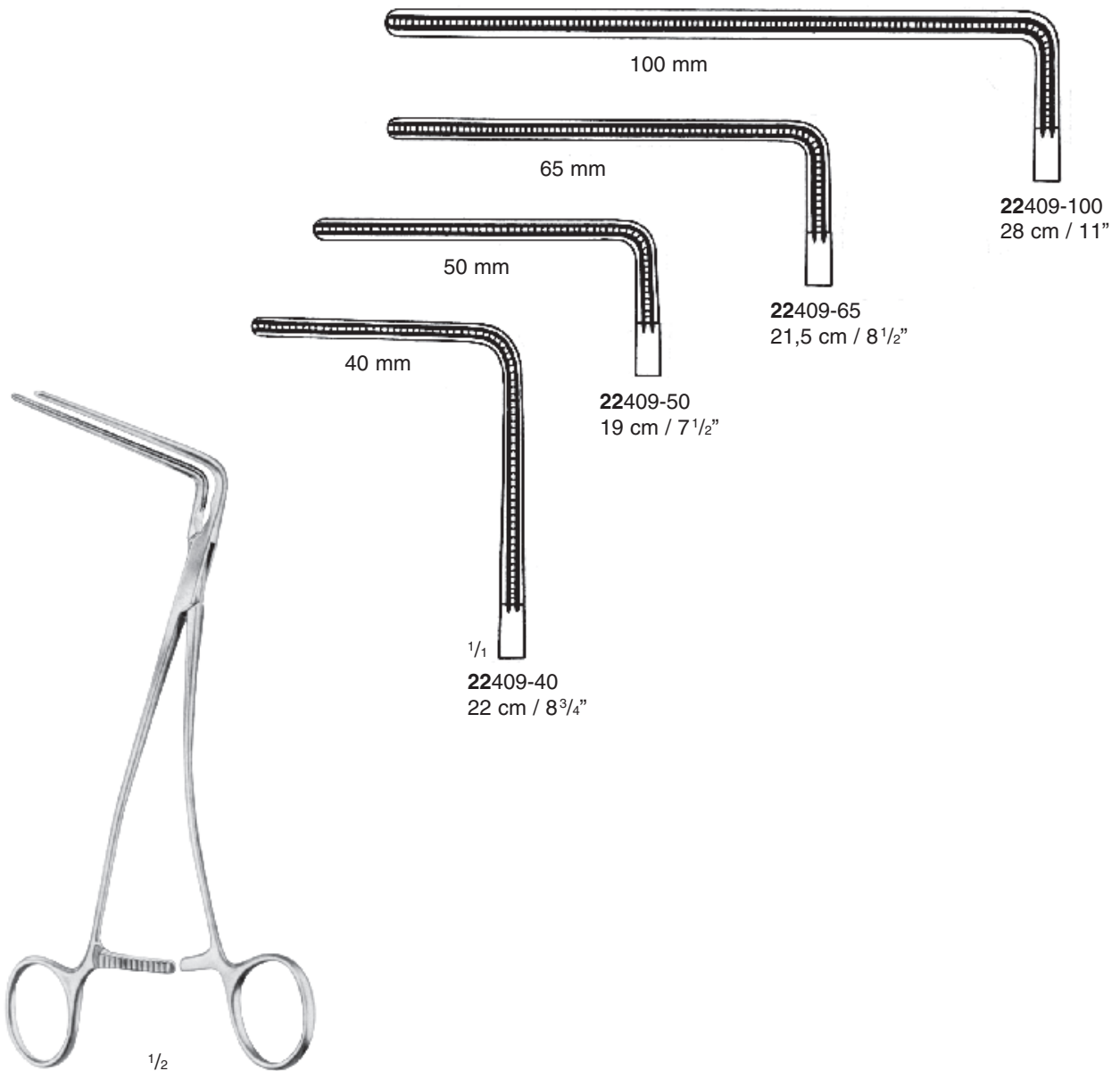

DE BAKHEY
 90°
 22409-40 - 22409-100



Gewebefasszängchen, Darmfasszangen
 Tissue Seizing Forceps, Intestinal Tissue Forceps
 Pinzas para coger tejidos e intestinos
 Pincers pour saisir le tissu et l'intestin
 Pinze per tessuti e intestino

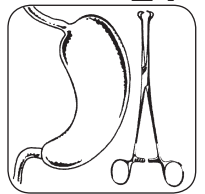

ALLIS-BABY
 24102-12
 12 cm / 4 1/2"



4:5	cm	in.	5:6
24104-15	15	6"	24106-15
24104-19	19	7 1/2"	24106-19
24104-23	23	9"	24106-23
24104-25	25	10"	24106-25



ALLIS ATRALUMICO
 24108-15 = 15 cm / 6"
 24108-20 = 20 cm / 8"
 24108-25 = 25 cm / 10"
 24108-30 = 30 cm / 12"



ALLIS-ADAIR
 24110-15
 15,5 cm / 6"



BOYS-ALLIS
 24114-15
 15 cm / 6"



JUDD-ALLIS
 24120-15 = 15 cm / 6"
 24120-19 = 19 cm / 7 1/2"

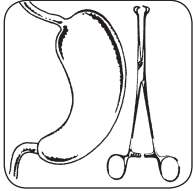

Darmfazzangen
 Intestinal Tissue Forceps
 Pinzas para coger tejidos e intestinos
 Pince pour saisir l'intestin
 Pinze per tessuti e intestino



THOMS-ALLIS
 24122-20
 20 cm / 8"



LOCKWOOD
 24142-20
 20 cm / 8"



WILLIAMS
 24158-16
 16 cm / 6 1/4"



ALLIS
 24160-
Topdur

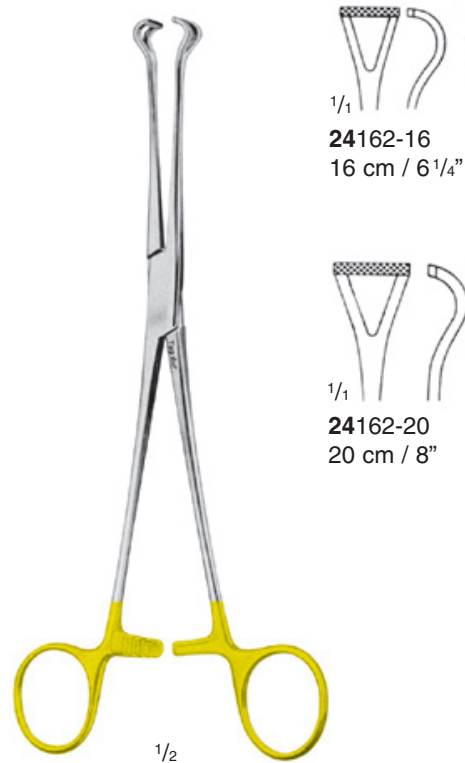

BABCOCK
 24162-
Topdur

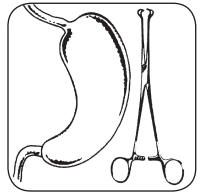

BABCOCK

24164-16 = 16 cm / 6 1/4"

24164-18 = 18 cm / 7"

24164-20 = 20 cm / 8"

24164-24 = 24 cm / 9 1/2"



BABCOCK ATRAUMATICO

24168-16 = 16 cm / 6 1/4"

24168-20 = 20 cm / 8"

24168-23 = 23 cm / 9"

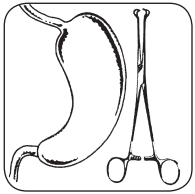

Darmfazzangen
 Intestinal Tissue Forceps
 Pinzas para tejidos e intestinos
 Pince pour saisir l'intestin
 Pinze per tessuti e intestino



DUVAL
 24178-20
 20 cm / 8"

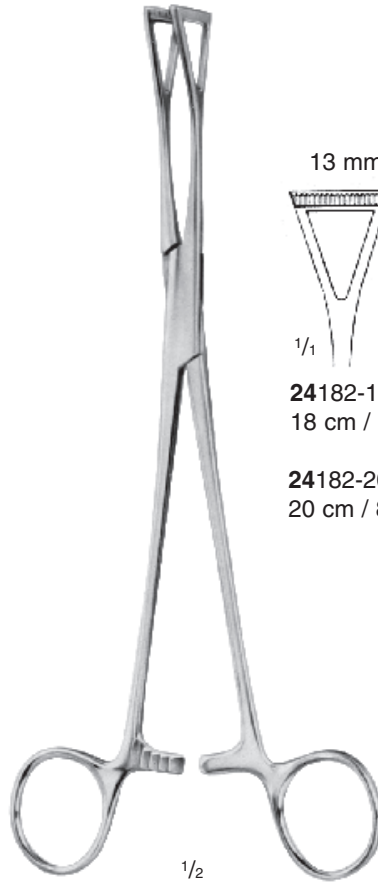

DUVAL

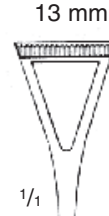

24182-18
 18 cm / 7"

 24182-20
 20 cm / 8"

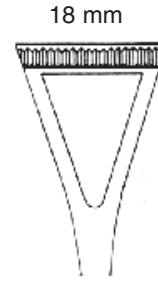

24183-20
 20 cm / 8"

 24183-23
 23 cm / 9"

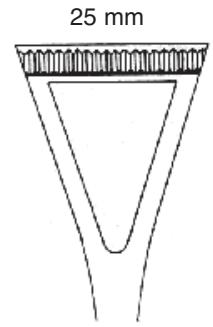

24184-20
 20 cm / 8"

 24184-23
 23 cm / 9"

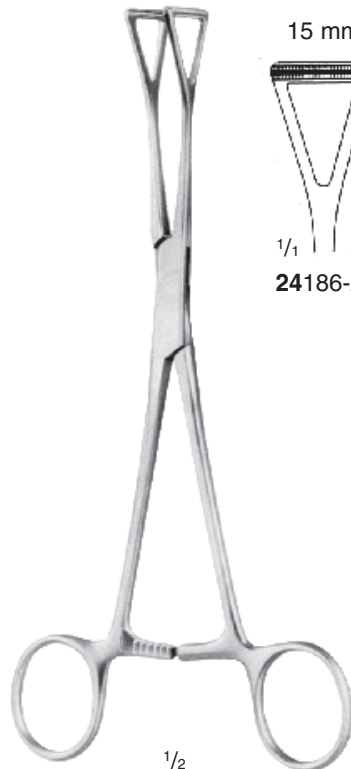

DUVAL ATRAUMATICO
 20 cm / 8"



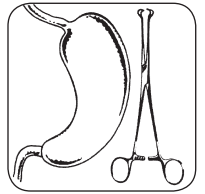

24242-15 = 15 cm / 6"
24242-18 = 18 cm / 7"



24243-15 = 15 cm / 6"
24243-18 = 18 cm / 7"



BABY-DOYEN

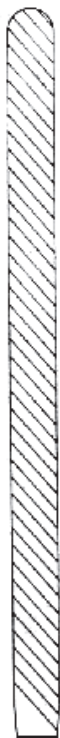

24246-23 1/1



DOYEN
23 cm / 9"

24247-23 1/1



24260-25 1/1



MAYO-ROBSON
25 cm / 10"



24261-25 1/1

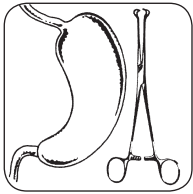

Darmklemmen
 Intestinal Clamp Forceps
 Pinzas intestinales
 Pinces pour l'intestin
 Pinze intestinali

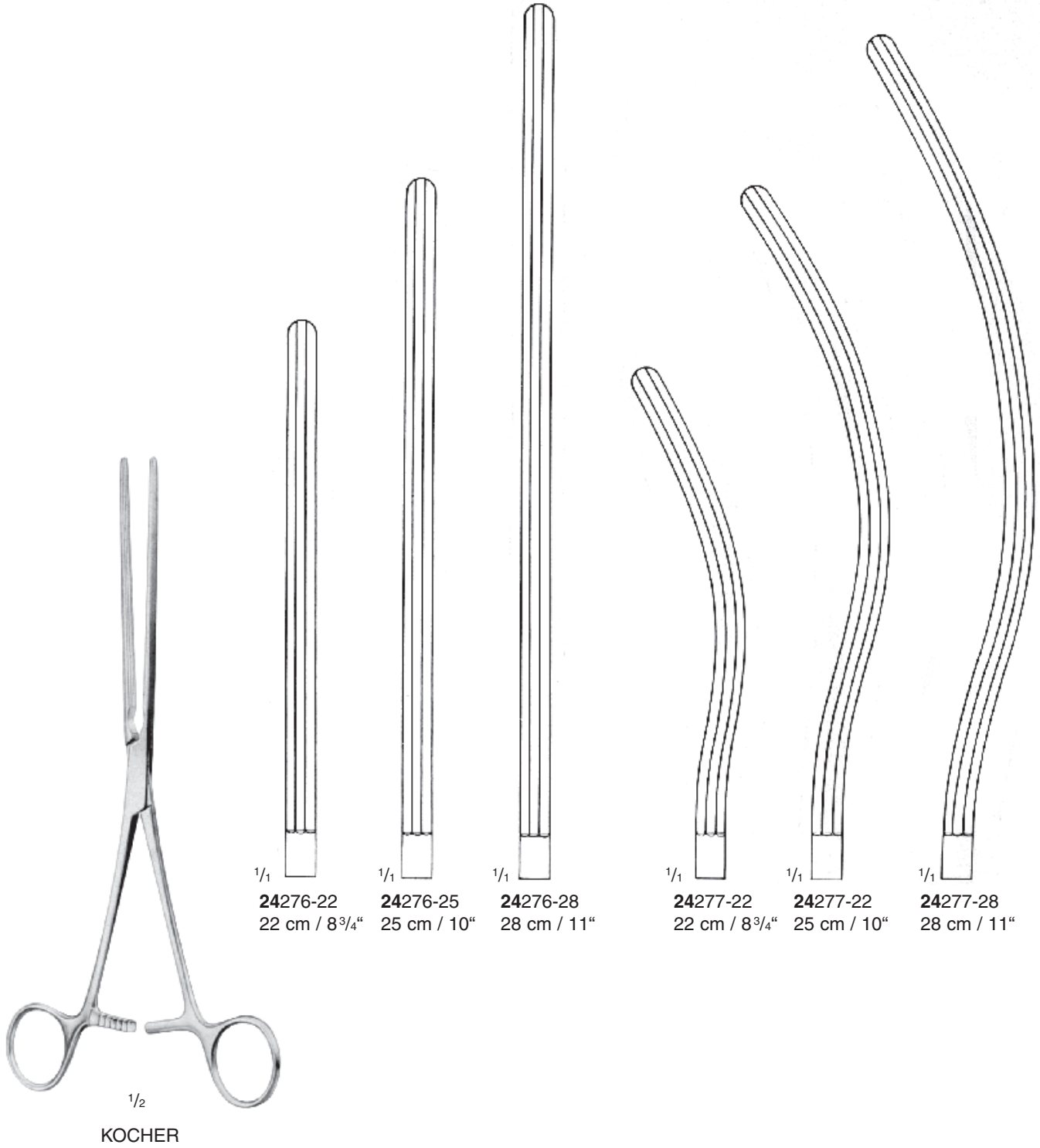

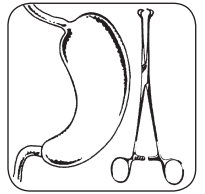

1/2

PAYR-BABY
15 cm / 6"



1/1

24385-15



24387-15



PAYR

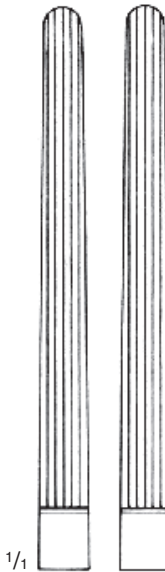

1/1

24389-21

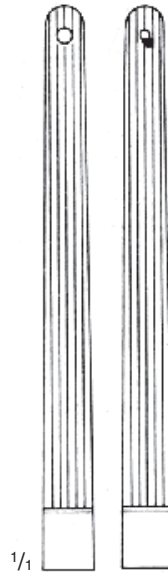

1/1

24391-21

21 cm / 8 1/4"

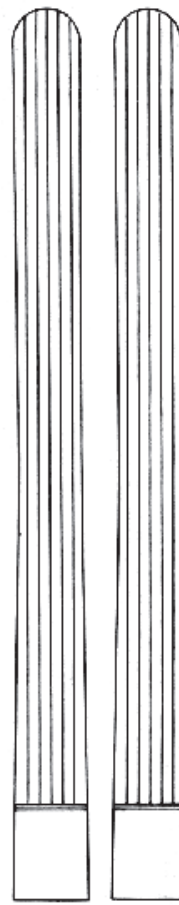

1/1

24395-29

29 cm / 11 1/2"

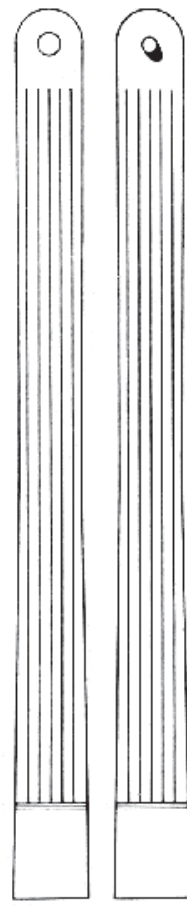

1/1

24397-29

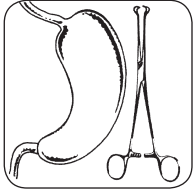

Darm- und Magenquetschklemmen
 Intestinal and Stomach Clamps
 Pinzas intestinales y estomacales
 Pincas et Ecraseurs pour l'intestin et l'estomac
 Pinze per intestino e stomaco

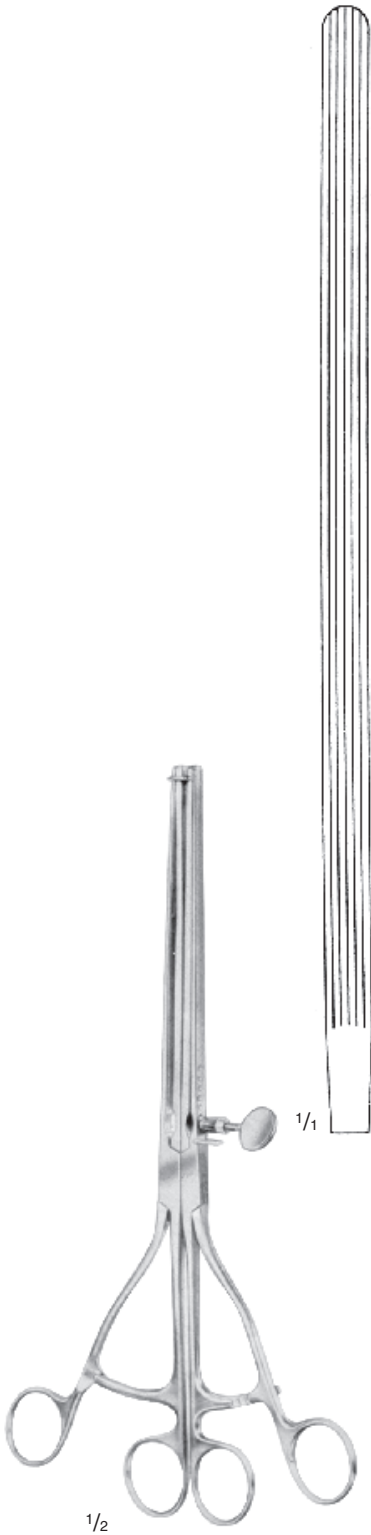

LANE
 24446-30
 30 cm / 12"



LANE
 24447-30
 30 cm / 12"

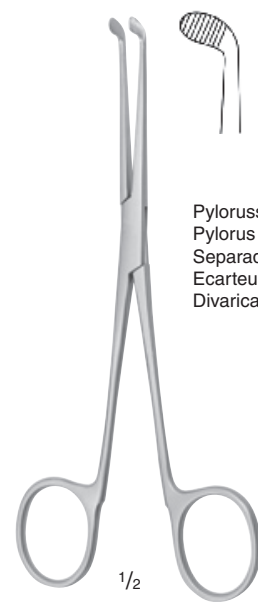

BENSON
 24498-15
 15,0 cm / 6"

Pylorusspreizer
 Pylorus spreader
 Separador para piloro
 Ecarteur pour pylore
 Divaricatore pilorico

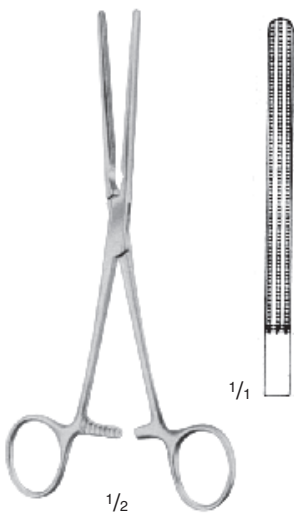
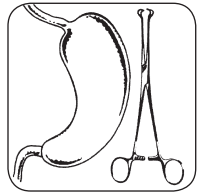

BABY-DOYEN ATRAUMATICO
24522-13
13 cm / 5 1/4"



DOYEN ATRAUMATICO



24522-16
16 cm / 6 1/4"



24522-18
18 cm / 7"

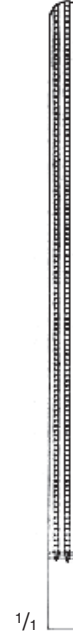

24522-21
21 cm / 8 1/2"

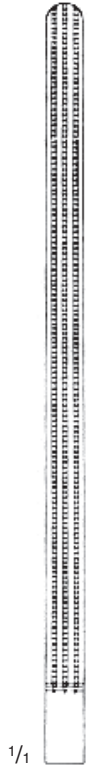

24522-23
23 cm / 9"

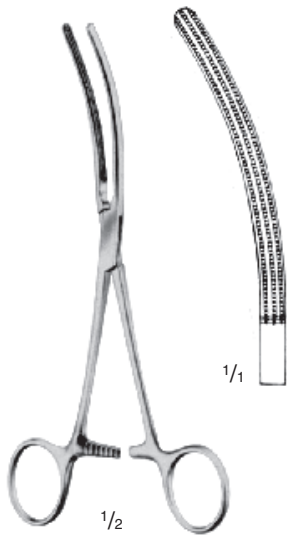

BABY-DOYEN ATRAUMATICO
24523-13
13 cm / 5 1/4"



DOYEN ATRAUMATICO



24523-16
16 cm / 6 1/2"



24523-18
18 cm / 7"



24523-21
21 cm / 8 1/2"



24523-23
23 cm / 9"

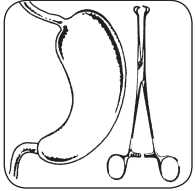

Darmklemmen
 Intestinal Clamp Forceps
 Pinzas intestinales
 Pinces pour l'intestin
 Pinze intestinali



1/2

KOCHER ATRAUMATICO

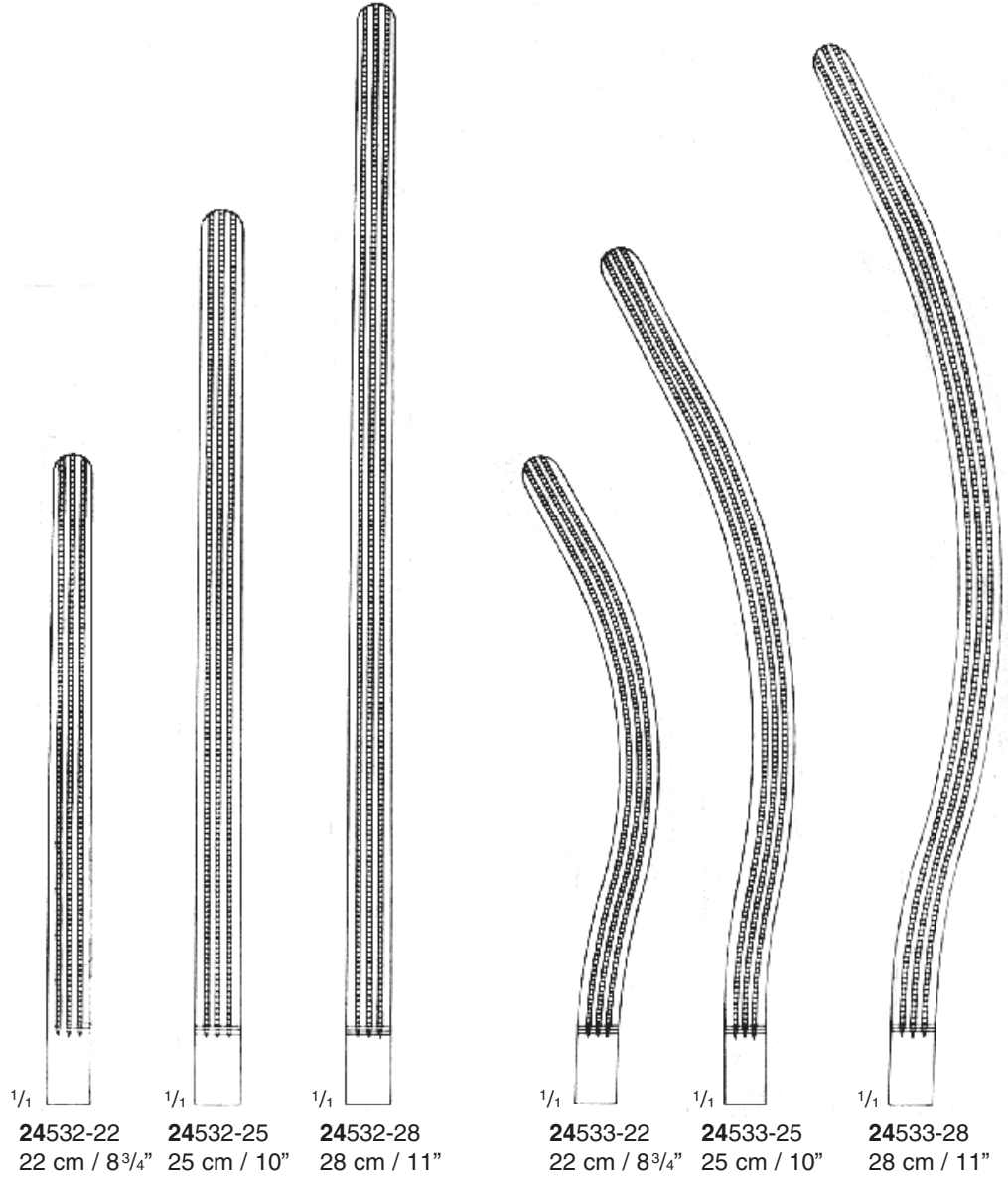

1/1	1/1	1/1	1/1	1/1	1/1	1/1
24532-22	24532-25	24532-28	24533-22	24533-25	24533-28	24533-28
22 cm / 8 ³ / ₄ "	25 cm / 10"	28 cm / 11"	22 cm / 8 ³ / ₄ "	25 cm / 10"	28 cm / 11"	28 cm / 11"

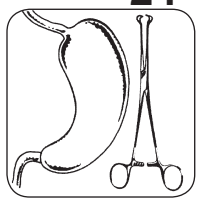

SCUDDER ATRAUMATICO

1/2



24542-33
33,5 cm / 13 1/4"

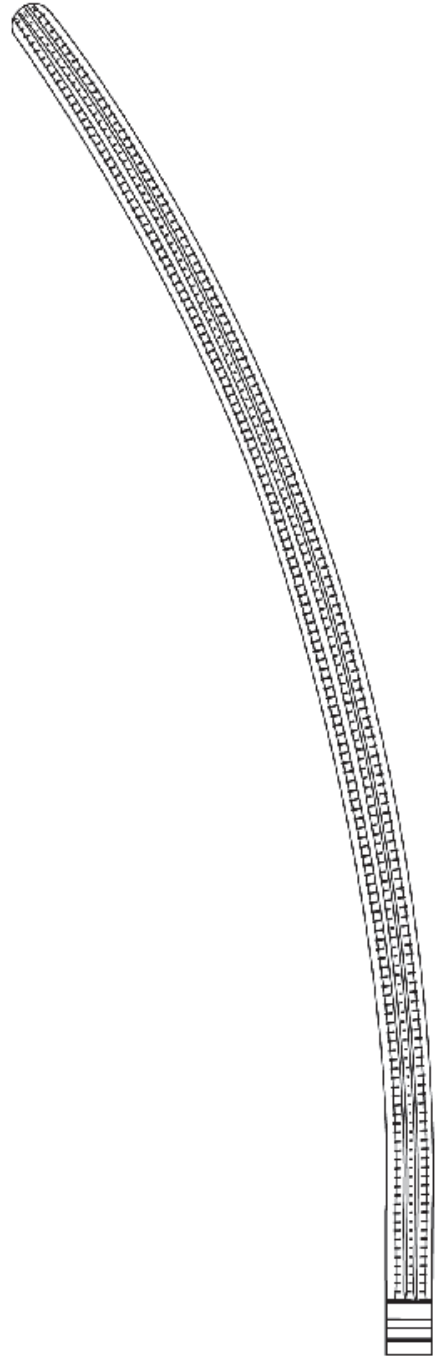

24543-33
32,5 cm / 12 3/4"

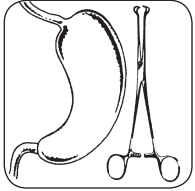

Darmklemmen
 Intestinal Clamp Forceps
 Pinzas intestinales
 Pinces pour l'intestin
 Pinze intestinali

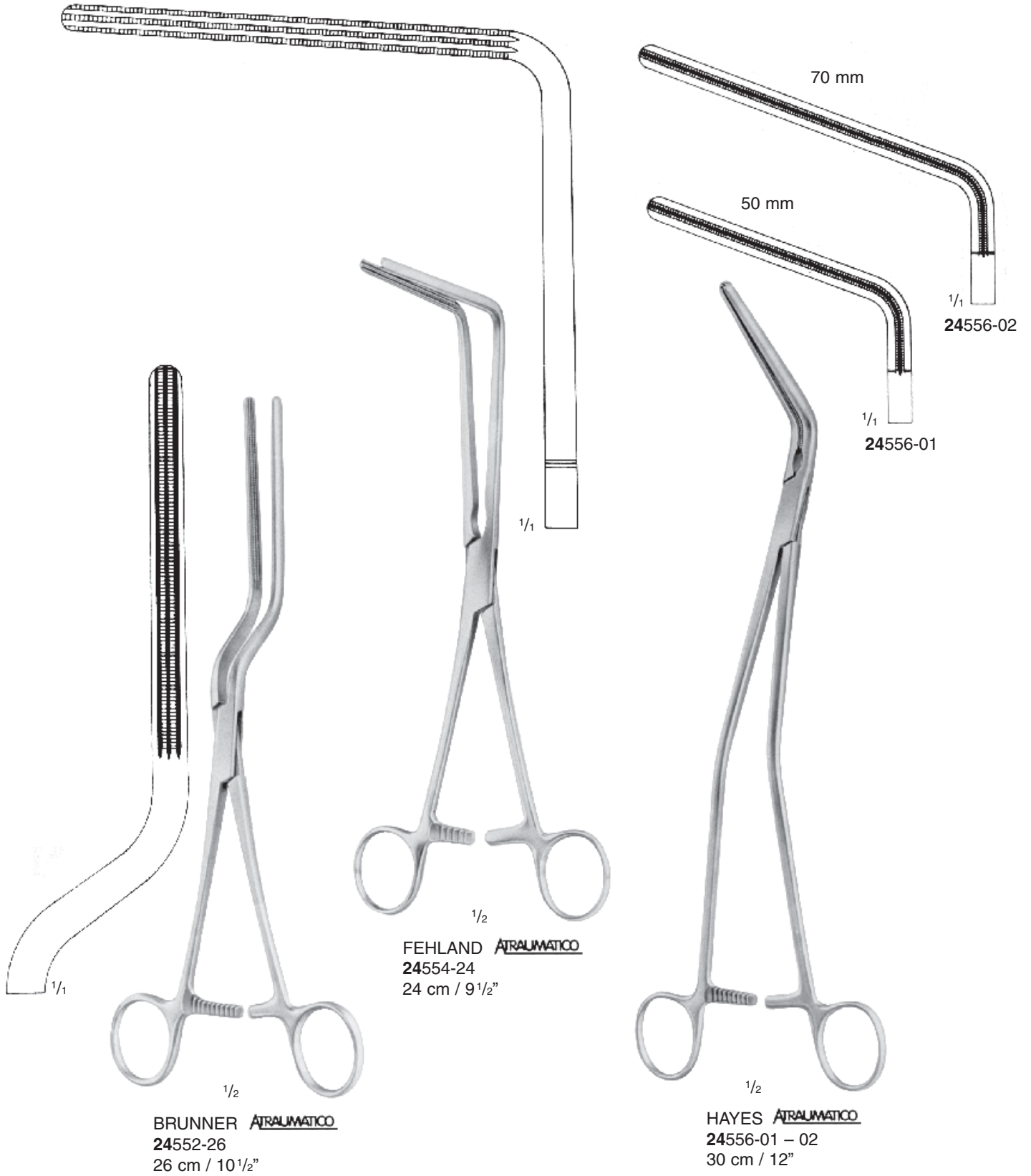

BRUNNER ATRAUMATICO
 24552-26
 26 cm / 10 1/2"

FEHLÄND ATRAUMATICO
 24554-24
 24 cm / 9 1/2"

HAYES ATRAUMATICO
 24556-01 - 02
 30 cm / 12"

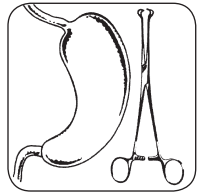

1/2

SIMS (BODENHAMMER)
24585-15
15 cm / 6"



1/2

SIMS
24587-15
15 cm / 6"



1/2

PRATT
24590-22
22 cm / 8³/₄"

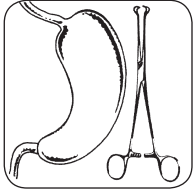

Mastdarm-Spekula
 Rectal Specula
 Espécules rectales
 Spéculums rectaux
 Specoli rettali



$\frac{1}{2}$
 SCHULZE-BERGMANN
 24593-06 - 24593-15

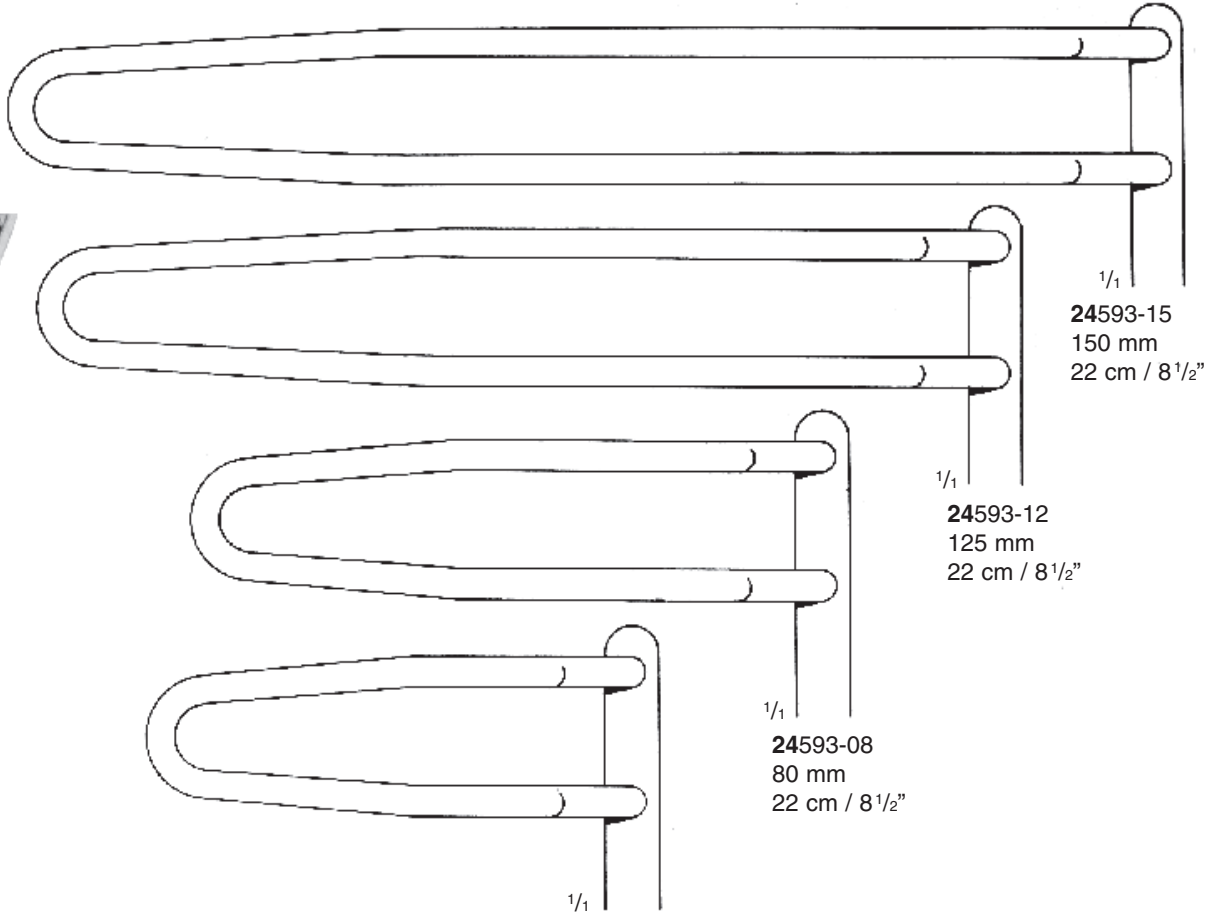

$\frac{1}{1}$
 24593-15
 150 mm
 22 cm / 8 $\frac{1}{2}$ "

$\frac{1}{1}$
 24593-12
 125 mm
 22 cm / 8 $\frac{1}{2}$ "

$\frac{1}{1}$
 24593-08
 80 mm
 22 cm / 8 $\frac{1}{2}$ "



$\frac{1}{2}$
 MATHIEU
 24597-19
 19,5 cm / 7 $\frac{3}{4}$ "

$\frac{1}{1}$
 24593-06
 60 mm
 17 cm / 6 $\frac{1}{2}$ "



$\frac{1}{2}$
 SMITH-BUIE
 24600-15
 15 cm / 6"

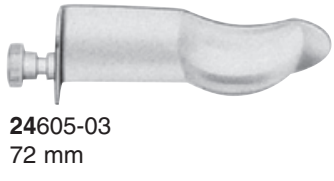
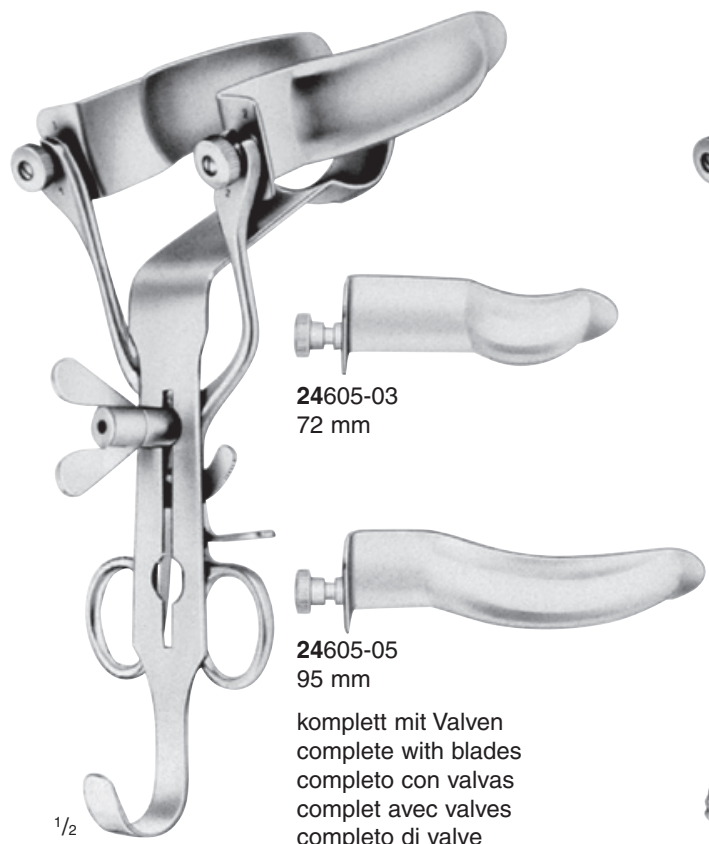
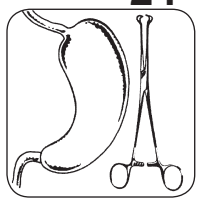

komplett mit Valven
complete with blades
completo con valvas
complet avec valves
completo di valve

1/2

ALAN PARKS
24605-00

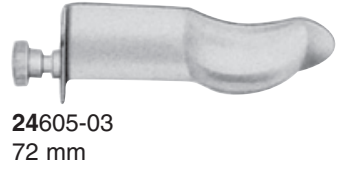
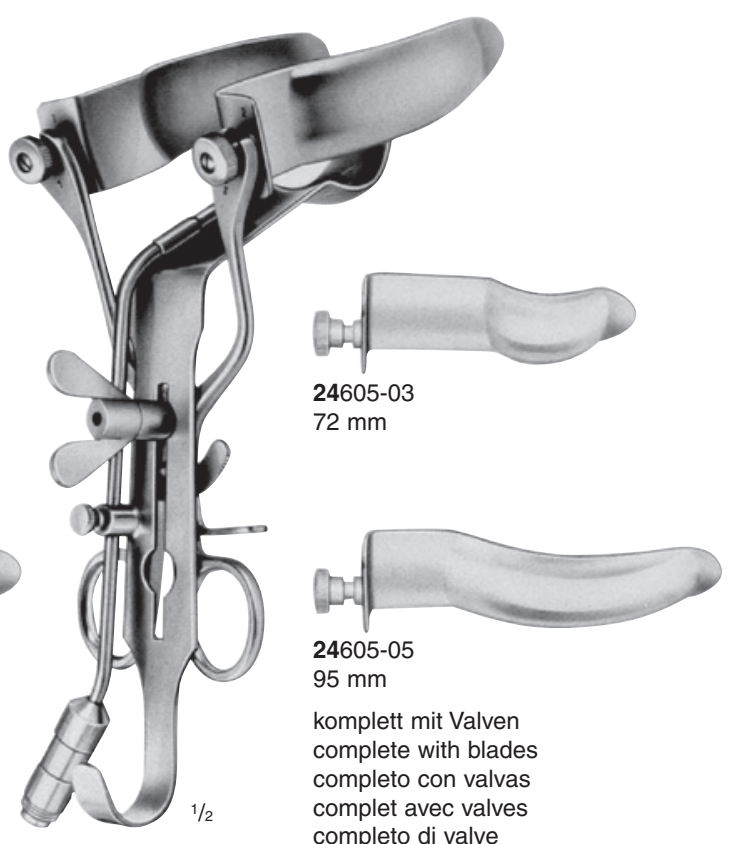

komplett mit Valven
complete with blades
completo con valvas
complet avec valves
completo di valve

1/2

ALAN PARKS
24605-10

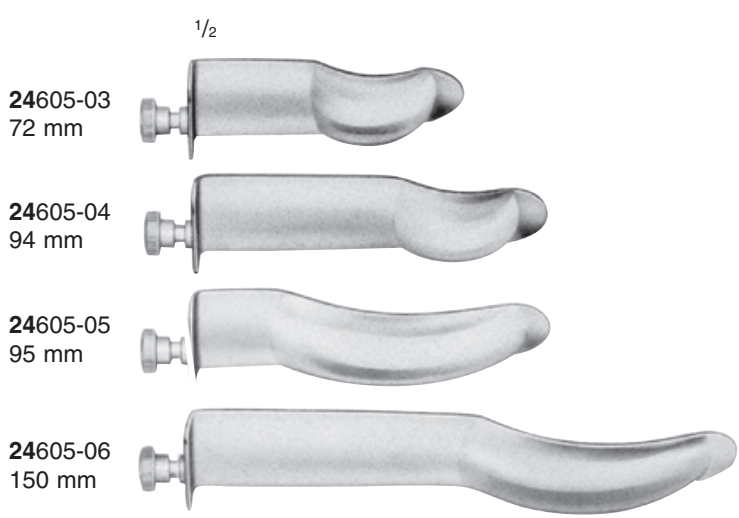

1/2



1/2

ALAN PARKS
24607-00

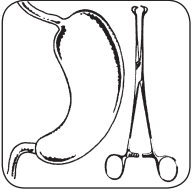

Mastdarm-Spekula
Rectal Specula
Espéculos rectales
Spéculums rectaux
Specoli rettali



BRINKERHOFF

24615-01 13/25 mm Ø x 90 mm
24615-02 15/25 mm Ø x 100 mm
24615-03 19/32 mm Ø x 115 mm

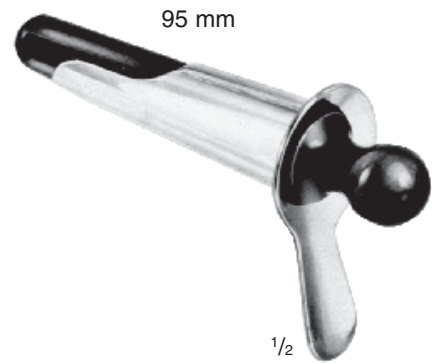

IVES-FANSLER

24623-15
22 cm Ø



HIRSCHMANN

24627-01 16 mm Ø x 65 mm
24627-02 19 mm Ø x 65 mm
24627-03 22 mm Ø x 65 mm



BENSAUDE

24631-01 19 mm Ø x 70 mm
24631-02 22 mm Ø x 70 mm

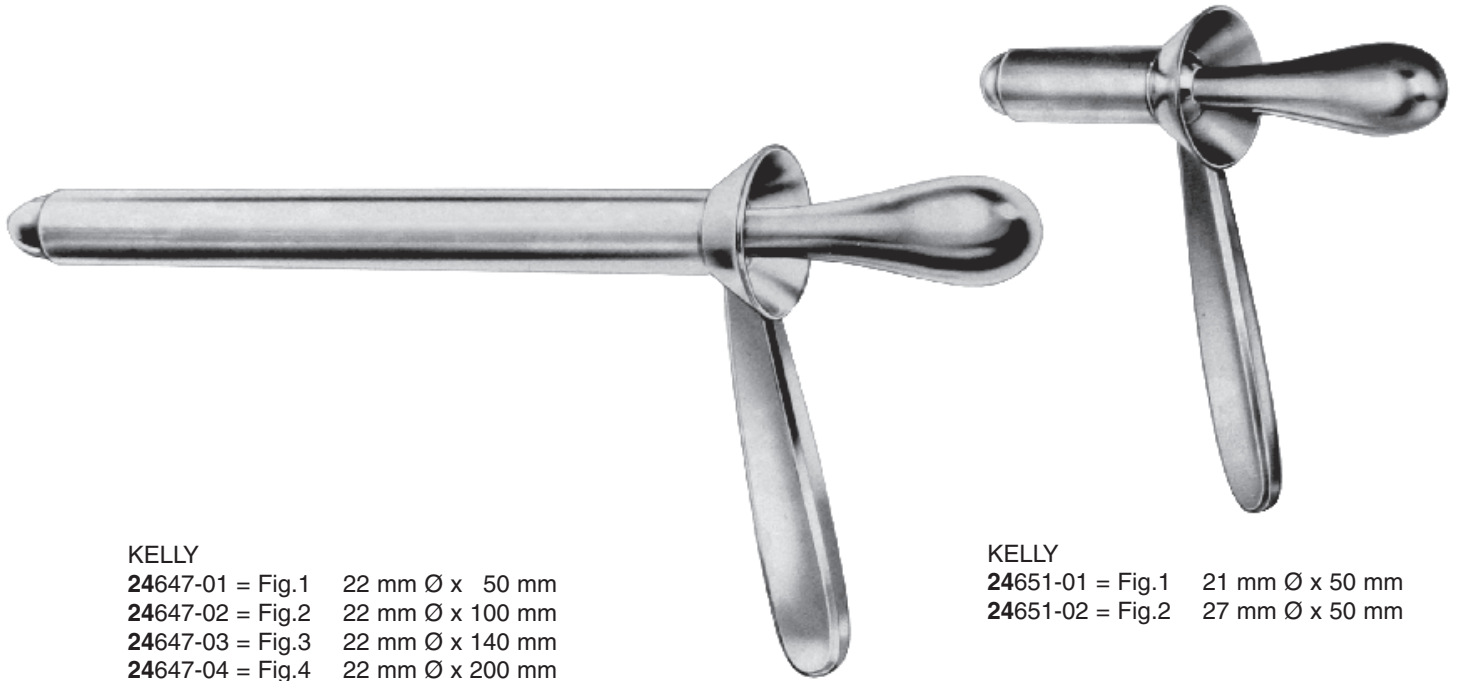
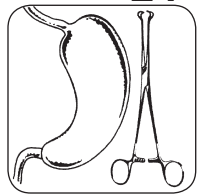

KELLY

- 24647-01 = Fig.1 22 mm Ø x 50 mm
- 24647-02 = Fig.2 22 mm Ø x 100 mm
- 24647-03 = Fig.3 22 mm Ø x 140 mm
- 24647-04 = Fig.4 22 mm Ø x 200 mm

KELLY

- 24651-01 = Fig.1 21 mm Ø x 50 mm
- 24651-02 = Fig.2 27 mm Ø x 50 mm

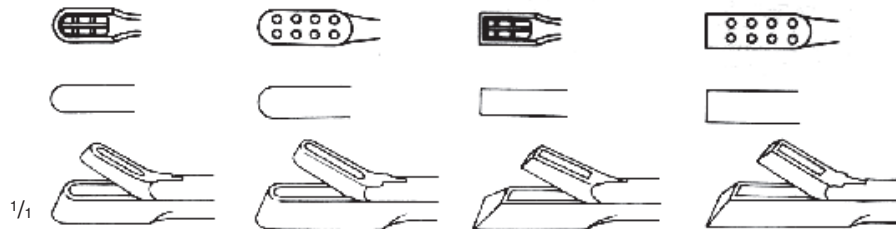

	1	2	3	4
28 cm / 11"	24660-28	24662-28	24664-28	24666-28
35 cm / 13 ³ / ₄ "	24660-35	24662-35	24664-35	24666-35
42 cm / 16 ¹ / ₂ "	24660-42	24662-42	24664-42	24666-42

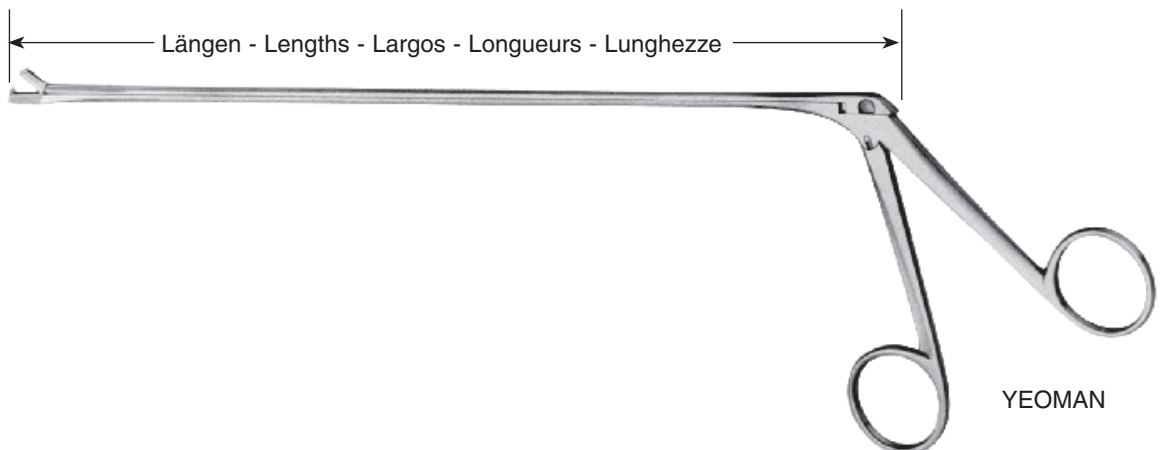

YEOMAN

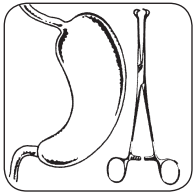

Rektal-Instrumente
 Rectal Instruments
 Instrumentos rectales
 Instruments rectals
 Strumenti per retto



1/2

LOCKHART-MUMMERY
 24680-01
 Fig. 1



1/2

LOCKHART-MUMMERY
 24680-02
 Fig. 2
 45°



1/2

LOCKHART-MUMMERY
 24680-03
 Fig. 3
 90°

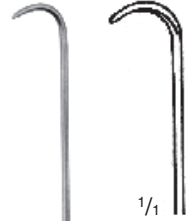

1/1

LOCKHART-MUMMERY
 24680-04
 Fig. 4



1/2

BUIE
 24682-16
 16 cm / 6 1/4"



1/2

BRODIE
 24684-18
 18 cm / 7"



1/2

PRATT
 24686-20
 20 cm / 8"

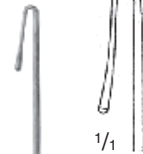

1/1

24688-01
 Fig. 1



24688-02
 Fig. 2



24688-03
 Fig. 3

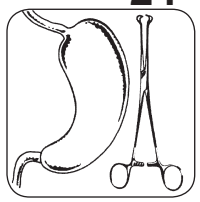

$\frac{1}{3}$
ST. MARKS
24700-30
30 cm / 12"
45/60 x 130 mm

$\frac{1}{3}$
ST. MARKS
24700-33
33 cm / 13"
45/60 x 180 mm

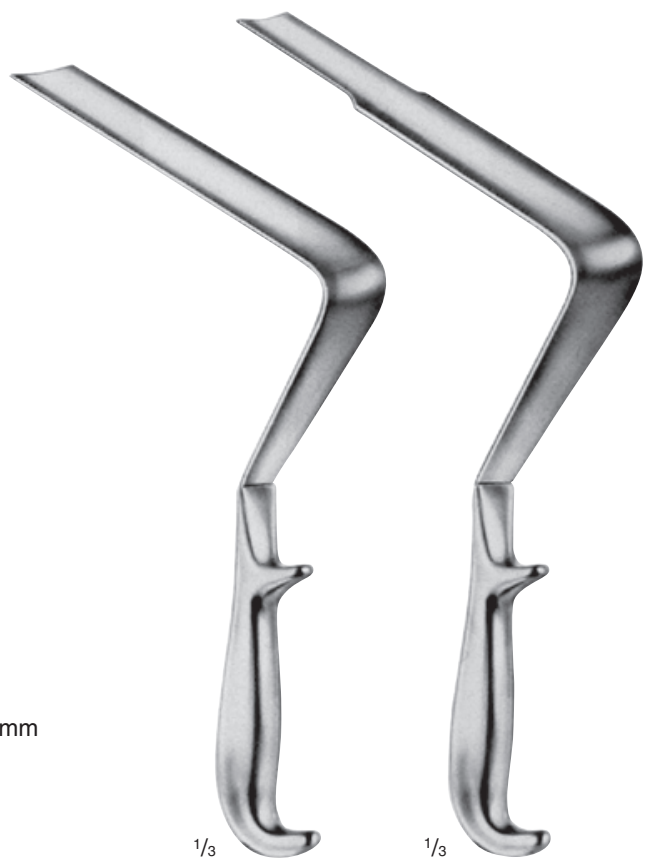

$\frac{1}{3}$
ST. MARKS
24702-30
30 cm / 12"
60 x 130 mm

$\frac{1}{3}$
ST. MARKS
24702-33
33 cm / 13"
45/60 x 130 mm

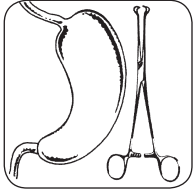

Hämorrhoidalzangen
 Haemorrhoidal Forceps
 Pinzas-clamps hemorroidales
 Pincés-clamps pour hémorroïdes
 Pinze per emorroidi

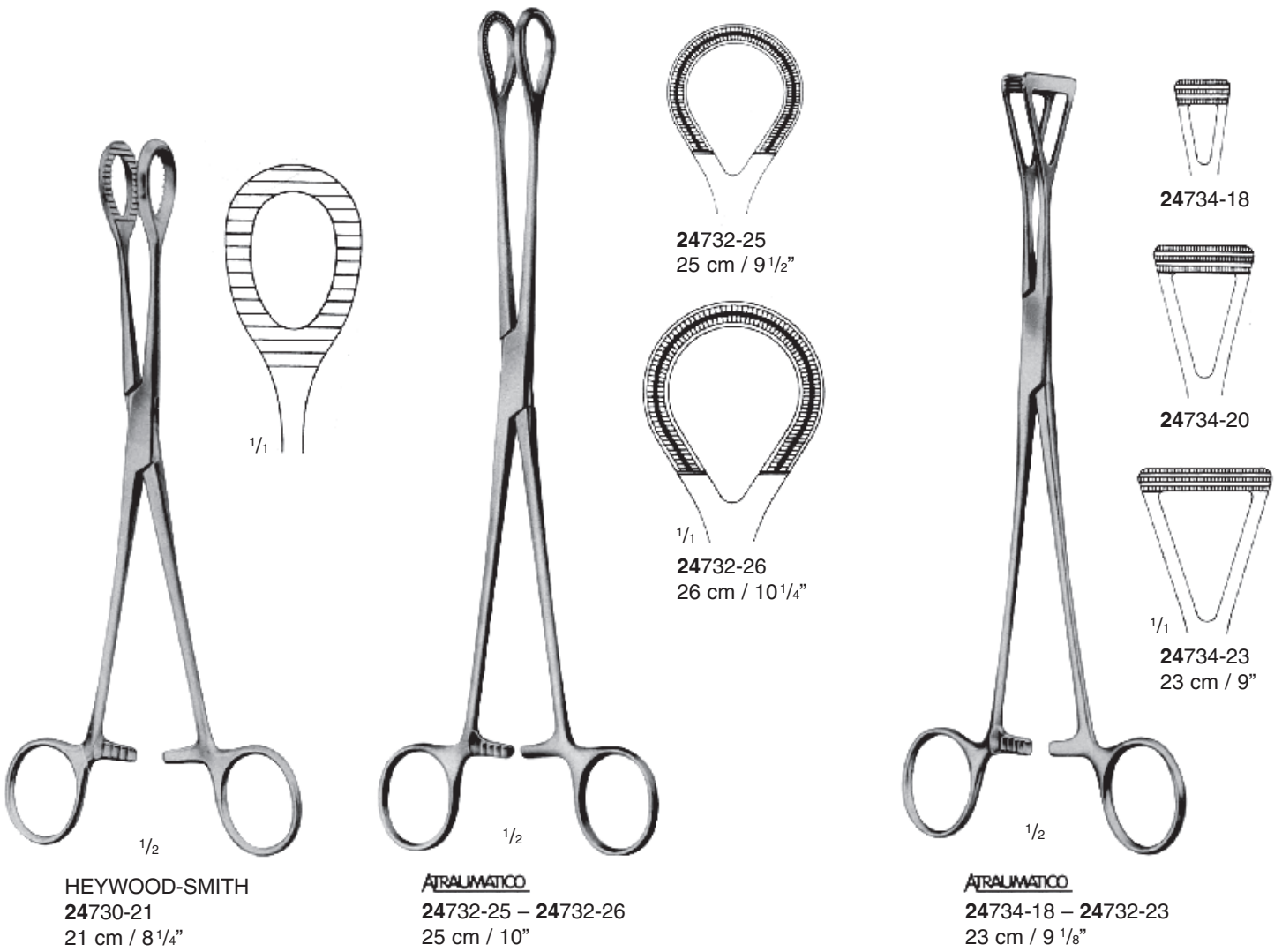

HEYWOOD-SMITH
 24730-21
 21 cm / 8 1/4"

ATRAUMATICO
 24732-25 – 24732-26
 25 cm / 10"

ATRAUMATICO
 24734-18 – 24732-23
 23 cm / 9 1/8"

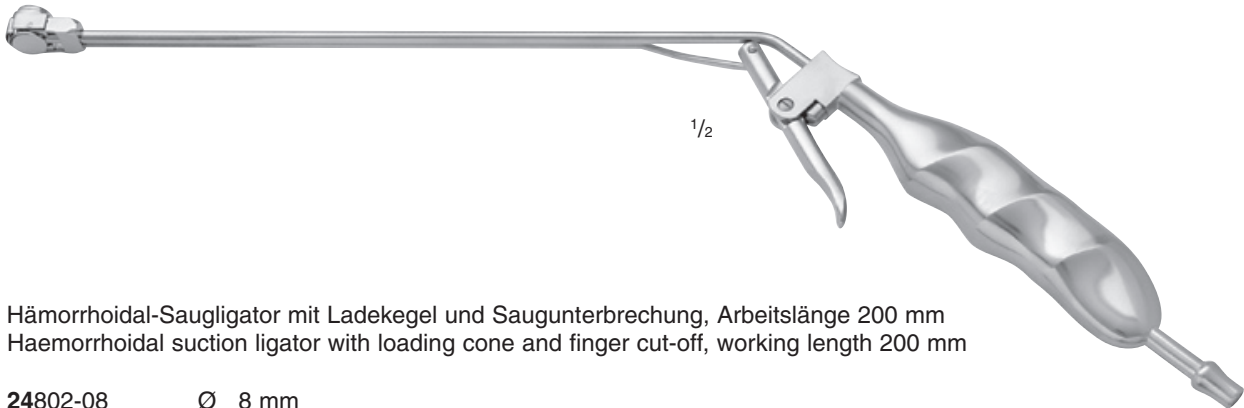
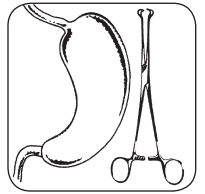

Hämorrhoidal-Saugligator mit Ladekegel und Saugunterbrechung, Arbeitslänge 200 mm
Haemorrhoidal suction ligator with loading cone and finger cut-off, working length 200 mm

24802-08 Ø 8 mm
24802-10 Ø 10 mm

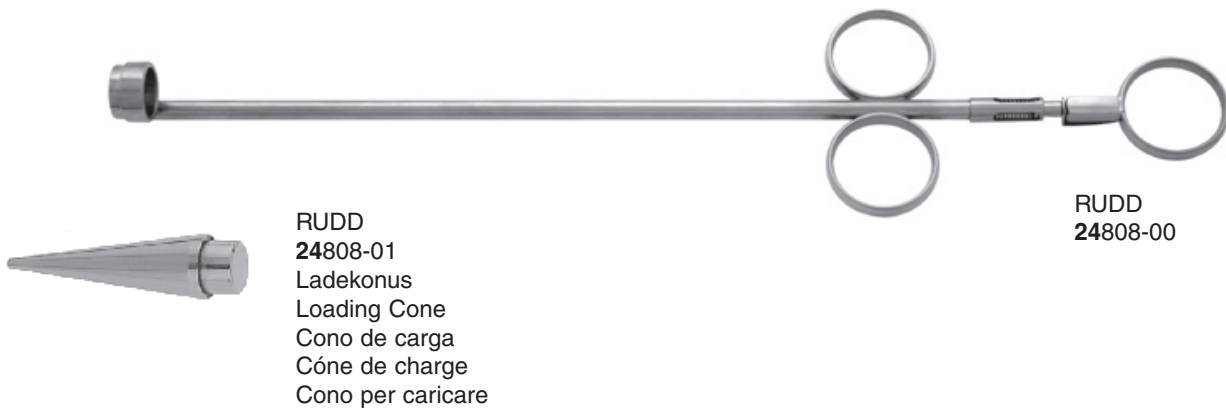

RUDD
24808-01
Ladekonus
Loading Cone
Cono de carga
Cône de charge
Cono per caricare

RUDD
24808-00

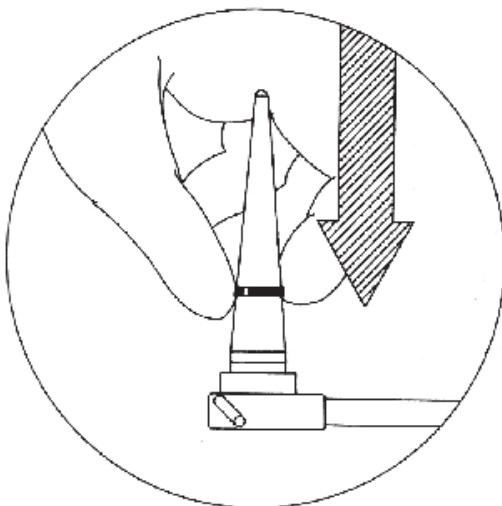

 24806-00
Ligaturgummiringe / 100 Stk. Verpackung
Elastic ligature bands / in packs of 100
ligaduras elásticas / en paquetes de 100
ligatures élastiques / en paquets de 100
legature elastiche / in pacchetti da 100



Nierensteinzangen
 Kidney Stone Forceps
 Pinzas para cálculos renales
 Pinces pour les calculs du bassin
 Pinze per calcoli renali

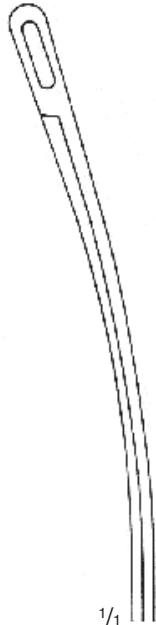
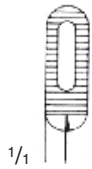

Fig. 1

26073-23
 23 cm / 9"

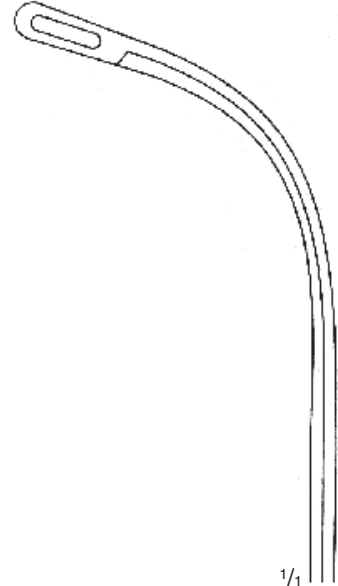

Fig. 2

26075-22
 22 cm / 8 3/4"

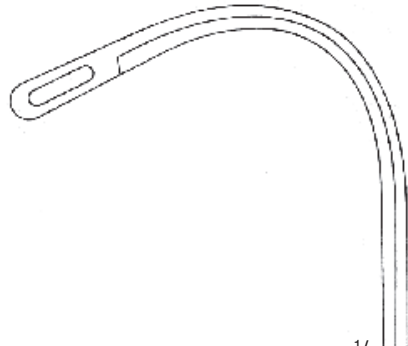

Fig. 3

26077-22
 22 cm / 8 3/4"

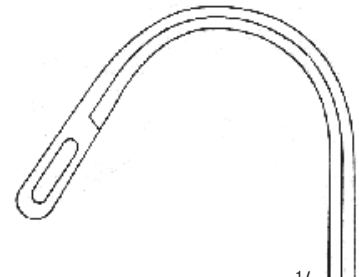

Fig. 4

26079-22
 22 cm / 8 3/4"

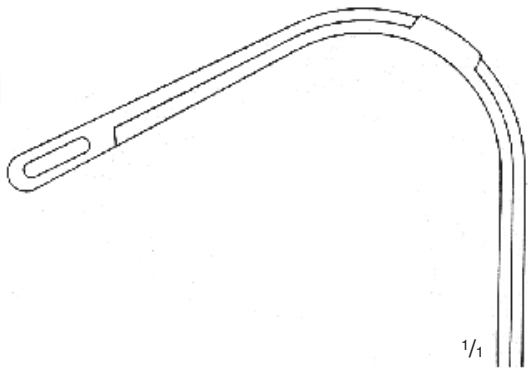

Fig. 5

26081-19
 19 cm / 7 1/2"

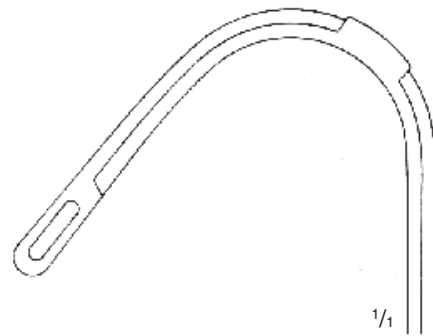

Fig. 6

26083-19
 19 cm / 7 1/2"

Nierenfistelzangen, Gallensteinsonden
Nephrostomy Forceps, Gall Stone Probes
Pinza para nefrostomia, Exploradores para cálculos biliares
Pinces à néphrostomie, Explorateurs à calculs biliaires
Strumenti per il rene



1/2
ELSÄSSER
26087-01
20 cm / 8"



1/2
ELSÄSSER
26087-02
20 cm / 8"



1/4
OCHSNER
26110-38
38 cm / 15"



1/4 1/1
MOYNIHAN
26114-34
34 cm / 13 1/2"

biegsam
malleable
maleables
malléable
malleabile



Gallenkanal-Dilatoren
 Gall Duct Dilators
 Dilatadores para conductos biliares
 Dilatateurs à voies biliaires
 Strumenti biliari

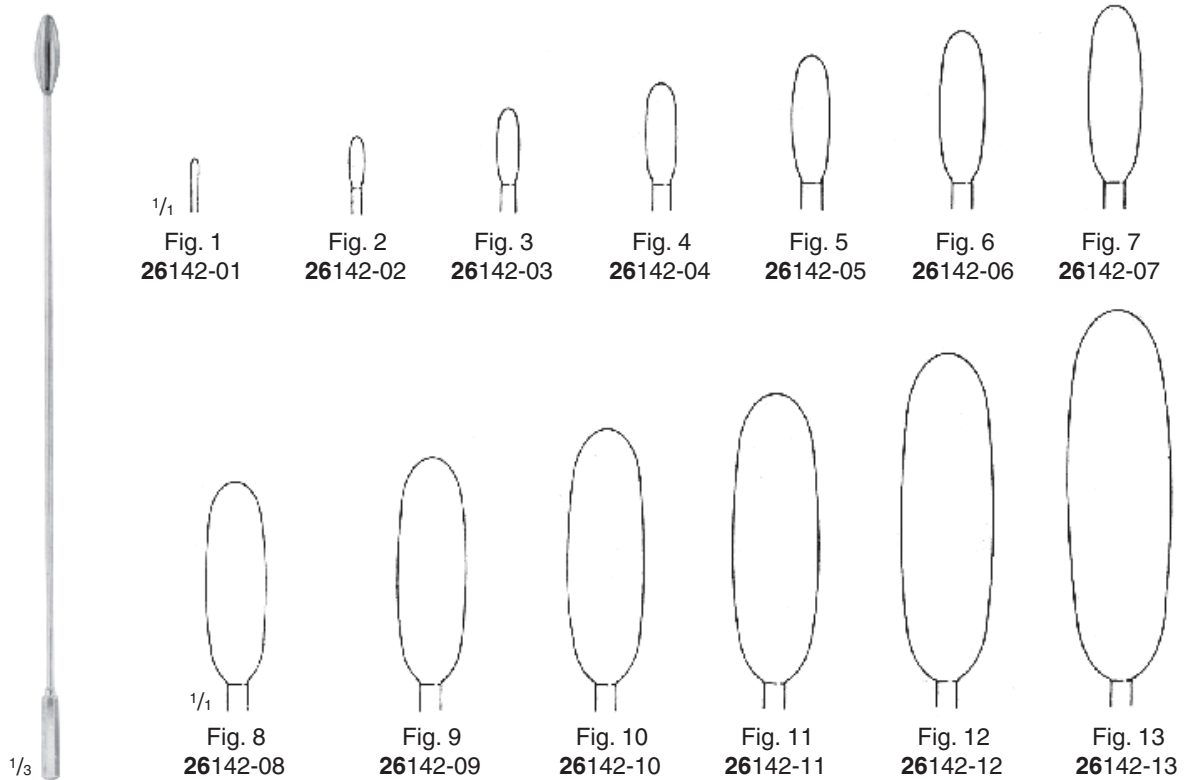
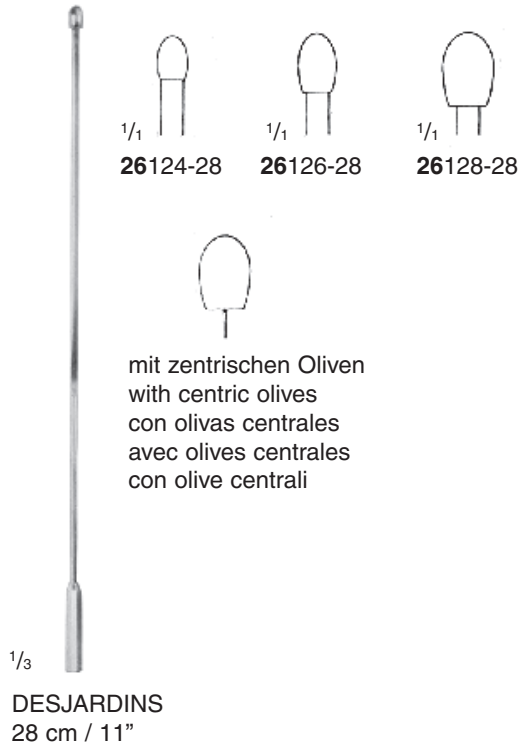

Schaft biegsam, malleable shaft, vástago maleable,
 tige malléable, asta malleabile



Gallensteinzangen
 Gall Stone Forceps
 Pinzas para cálculos biliares
 Pincès pour calculs biliaires
 Pinze per calcoli biliari

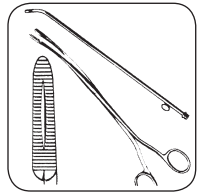

BLAKE
26176-20
 20 cm / 8"



BLAKE
26177-20
 20 cm / 8"



MAYO-BLAKE
26186-20
 20 cm / 8"



MAYO-BLAKE
26187-20
 20 cm / 8"



MIXTER
26189-22
 22 cm / 8³/₄"

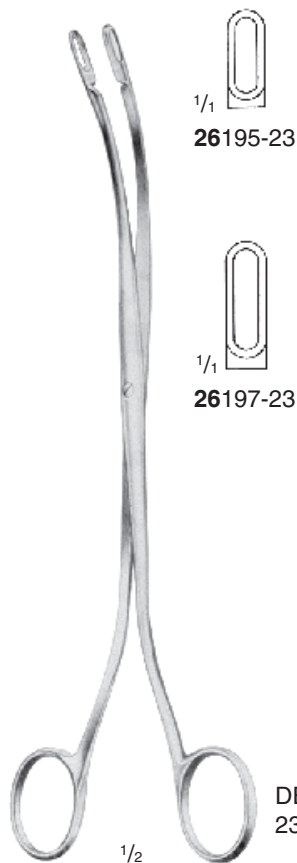

26195-23

26197-23

DESJARDINS
 23 cm / 9"



Galleinsteinlöffel
 Gall Stone Scoops
 Cucharillas para coger cálculos biliares
 Curettes pour calculs biliaires
 Cucchiari biliari

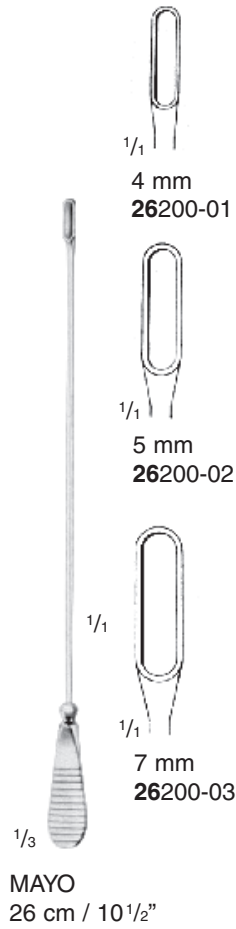

DEJARDINS
 30 cm / 12"
 federnd, elastic, elásticas,
 élastiques, elastiche

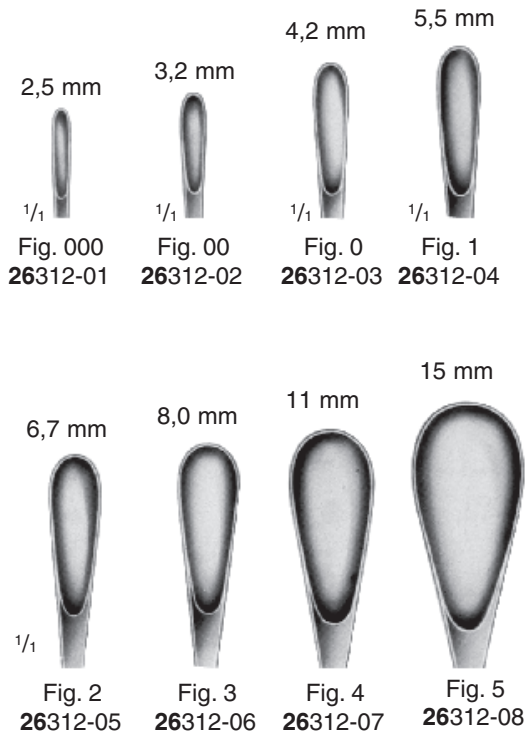

LUER-KOERTE
 26312-01 - 08
 32 cm / 12 3/4"



MAYO
 26330-27
 28 cm / 11"

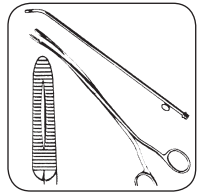

$\frac{1}{3}$
YOUNG
26373-21
21 cm / 8 1/4"



$\frac{1}{3}$
YOUNG
26375-22
22 cm / 8 3/4"



$\frac{1}{3}$
YOUNG
26377-21
21 cm / 8 1/4"



$\frac{1}{3}$
YOUNG
26379-22
22 cm / 8 3/4"



$\frac{1}{2}$
26398-16
16 cm / 6 1/4"



$\frac{1}{2}$
26400-14
14,5 cm / 5 1/2"

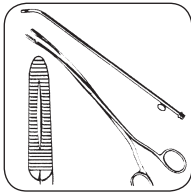

Instrumente für Prostata-Operationen
 Prostatectomy Instruments
 Instrumentos para prostatectomia
 Instruments pour prostatectomie
 Divaricatori e pinze per urologia



MILLIN
26433-23
 23 cm / 9"



MILLIN
26435-23
 23 cm / 9"



MILLIN
26437-24
 23 cm / 9 1/2"



MILLIN
26439-28
 28,5 cm / 11 1/4"



MILLIN
26440-10

komplett mit je 2 Seitenvälven 57 x 25 mm und 80 x 25 mm,
 sowie 1 Mittelvalve 120 x 45 mm

Complete, with 2 pairs of lateral blades 57 x 25 mm and 80 x 25 mm
 and 1 central blade 120 x 45 mm

Completo con 2 pares de valvas laterales 57 x 25 mm, y 80 x 25 mm,
 y una valva central 120 x 45 mm

Complèt, avec 2 paires de valves latérales 57 x 25 mm et 80 x 25 mm,
 ainsi qu'une valve centrale 120 x 45 mm

Completo, con 2 paia di valve laterali 57 x 25 mm e 80 x 25 mm,
 in più 1 valva centrale 120 x 45 mm

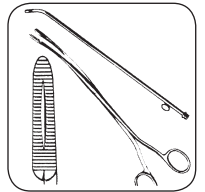

THOMSON-WALKER
26475-00

35 mm



LEGUEU
26499-27
27 cm / 10 1/2"



GIL-VERNET
26524-09
26524-11
26524-13
26524-15
26524-18
24 cm / 9 1/2"



1/1
9 mm



1/1
11 mm



1/1
13 mm



1/1
15 mm

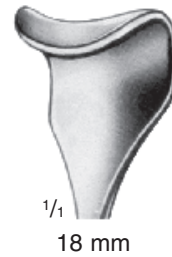

1/1
18 mm

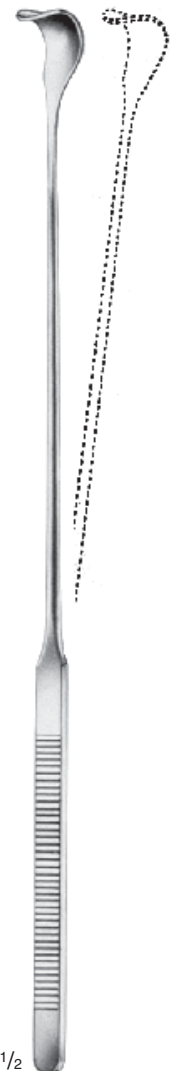

GIL-VERNET
26528-09
26528-11
26528-13
26528-15
26528-18
28 cm / 11"

biegsam
malleable
maleables
malléable
malleabile

1/2

1/2

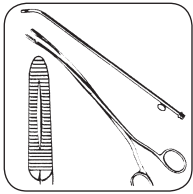

Wundhaken
Retractors
Separadores
Ecarteurs
Divaricatori renali



²/₃
MARBERGER
24 cm / 9 1/2"

Hilushaken
biegsam
malleable
maleables
malléable
malleabile



8 mm
26530-08



11 mm
26530-11



15 mm
26530-15



17 mm
26530-17



20 mm
26530-20



23 mm
26530-23



mm Ø	Char. (French)	DITTEL Charrière No.6-30	VAN BUREN Charrière No.6-36	GUYON Charrière No.10-30 ohne Innengewinde	GUYON Charrière No.10-30 mit Innengewinde
2	6		26571-06		
2 ² / ₃	8	26552-08	26571-08		
3	9	26552-09			
3 ¹ / ₃	10	26552-10	26571-10	26577-10	26579-10
3 ² / ₃	11	26552-11		26577-11	26579-11
4	12	26552-12	26571-12	26577-12	26579-12
4 ¹ / ₃	13	26552-13		26577-13	26579-13
4 ² / ₃	14	26552-14	26571-14	26577-14	26579-14
5	15	26552-15		26577-15	26579-15
5 ¹ / ₃	16	26552-16	26571-16	26577-16	26579-16
5 ² / ₃	17	26552-17		26577-17	26579-17
6	18	26552-18	26571-18	26577-18	26579-18
6 ¹ / ₃	19	26552-19		26577-19	26579-19
6 ² / ₃	20	26552-20	26571-20	26577-20	26579-20
7	21	26552-21		26577-21	26579-21
7 ¹ / ₃	22	26552-22	26571-22	26577-22	26579-22
7 ² / ₃	23	26552-23		26577-23	26579-23
8	24	26552-24	26571-24	26577-24	26579-24
8 ¹ / ₃	25	26552-25		26577-25	26579-25
8 ² / ₃	26	26552-26	26571-26	26577-26	26579-26
9	27	26552-27		26577-27	26579-27
9 ¹ / ₃	28	26552-28	26571-28	26577-28	26579-28
9 ² / ₃	29	26552-29		26577-29	26579-29
10	30	26552-30	26571-30	26577-30	26579-30
10 ² / ₃	32		26571-32		
11 ¹ / ₃	34		26571-34		
12	36		26571-36		
Satz			26571-00	26577-00	26579-00
Set			Charr. 8–36	Charr. 10–30	Charr. 10–30
Juego					
Jeu					
Serie					

 FILFORM
 26582-03 – 06
 33 cm / 13"

 Char.
 (French)
 3 26582-03
 4 26582-04
 5 26582-05
 6 26582-06

 Gleitsonde (Filiformbougies) zum
 Aufschrauben auf Bougies
 26579-10 – 30

 Filiform bougie to be screwed on
 bougies 26579-10 – 30

 Bujia conductora (bujia filiforme)
 atorniliándose sorbe las bujías
 dilatadoras 26579-10 – 30

 Bougie conctrice à être vissée sur les
 bougies 26579-10 – 30

 Candeletta filiforme da avvitarisi sulle
 candetette 26579-10 – 30

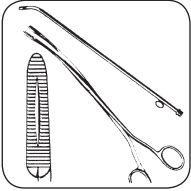

Dilatationsbesteck, Metall-Katheter
 Set of Dilating Sondes, Metal Catheters
 Juego de bujias dilatadoras, Sondas metálicas
 Trousse de cathéters dilatateurs, Sondes métalliques
 Set dilatatori uretrali, Sonde metalliche

Set Charrière 10 – 30 + 4 Filiformbougies
 Charrière 3,4,5,6



GUYON
 26584-00
 420 x 175 x 40 mm



1/2

26673-06 – 24
 Charrière No. 6 – 24
 27 cm / 10 1/2"

	mm Ø	Char. (French)	
26673-06	2	6	26693-06
26673-07	2 1/3	7	26693-07
26673-08	2 2/3	8	26693-08
26673-09	3	9	26693-09
26673-10	3 1/3	10	26693-10
26673-11	3 2/3	11	26693-11
26673-12	4	12	26693-12
26673-13	4 1/3	13	26693-13
26673-14	4 2/3	14	26693-14
26673-15	5	15	26693-15
26673-16	5 1/3	16	26693-16
26673-17	5 2/3	17	26693-17
26673-18	6	18	26693-18
26673-19	6 1/3	19	26693-19
26673-20	6 2/3	20	26693-20
26673-21	7	21	26693-21
26673-22	7 1/3	22	26693-22
26673-23	7 2/3	23	26693-23
26673-24	8	24	26693-24



1/2

26693-06 – 24
 Charrière No. 6 – 24
 15 cm / 6"



Circumcisionsgerät
Circumcision Instrument
Instrumento para circuncisión
Instrument de circoncision
Strumento per circoncisione



26737-08	8 mm Ø
26737-11	11 mm Ø
26737-13	13 mm Ø
26737-16	16 mm Ø
26737-21	21 mm Ø
26737-26	26 mm Ø
26737-32	32 mm Ø

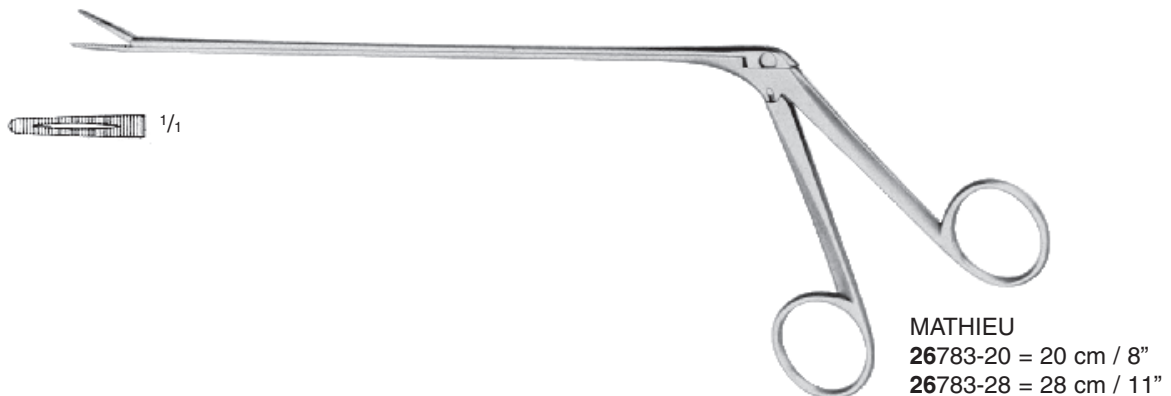
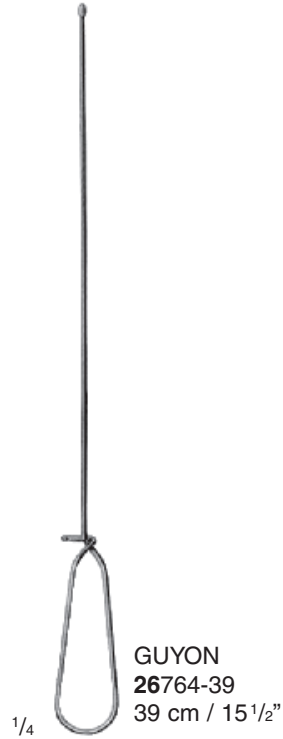

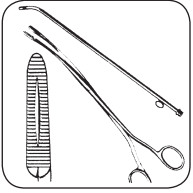

Sekretlöffel, Penisklemmen
 Secretion Scoops, Penis seizing Forceps
 Cucharillas para sacar secreciones, Pinza para coger el penis
 Cuillers à sécrétions, Pince pour saisir le pénis
 Cucciai, Spatola, Pinze serrapene



GUTTMANN
26812-26
 26,5 cm / 10 1/2"
 Per secrezioni
 Vescicali



STOCKMANN
26847-08



STOCKMANN
26849-08

mit Raste
 with catch
 con trinquete
 avec cliquet
 con serratura



STRAUSS
26853-11



Maßschema für Spekula
Scheme of dimensions for specula
Ssquema de dimensiones para los especulos
Schéma de dimensions pour les spéculums
Schema di dimensioni per specoli

Blattlänge
length of valves
anchura de valvas
longueurs de valves
lunghezza delle valve

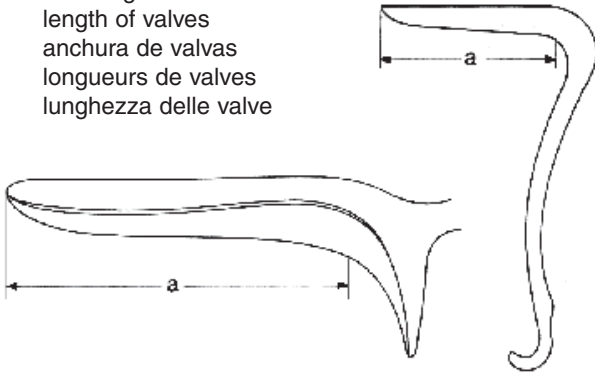

Blattbreite
width of blades
anchura de valvas
largeurs des valves
larghezza delle valve



COLLIN-BABY
28074-00
55 x 10 mm

1/2

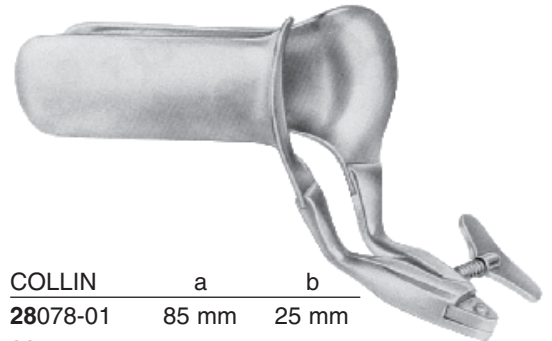

COLLIN	a	b
28078-01	85 mm	25 mm
28078-02	100 mm	35 mm
28078-03	110 mm	40 mm



CUSCO	a	b
28082-01	75 mm	32 mm
28082-02	85 mm	35 mm
28082-03	100 mm	35 mm



1/2

CUSCO	a	b
28084-01	75 mm	17 mm

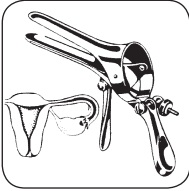

Scheidenspekula
Vaginal Specula
Espécules vaginales
Spéculums vaginaux
Specoli vaginali

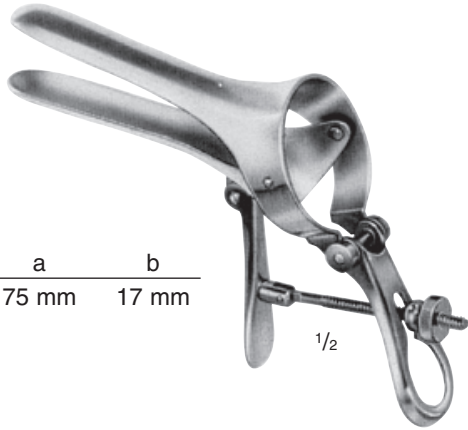

CUSCO	a	b
28084-02	75 mm	17 mm

1/2

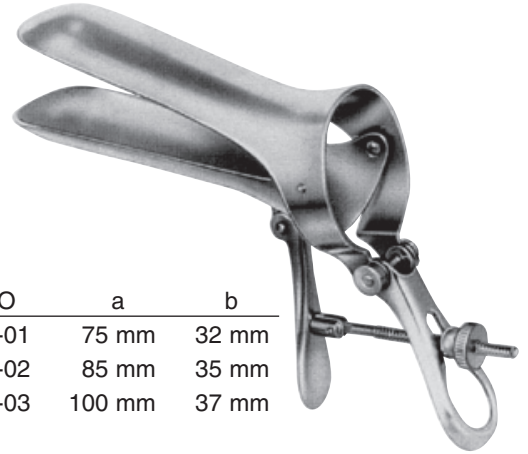

CUSCO	a	b
28088-01	75 mm	32 mm
28088-02	85 mm	35 mm
28088-03	100 mm	37 mm

Schweizer Modell
Swiss pattern
modelo suizo
modèle suisse
modello svizzero

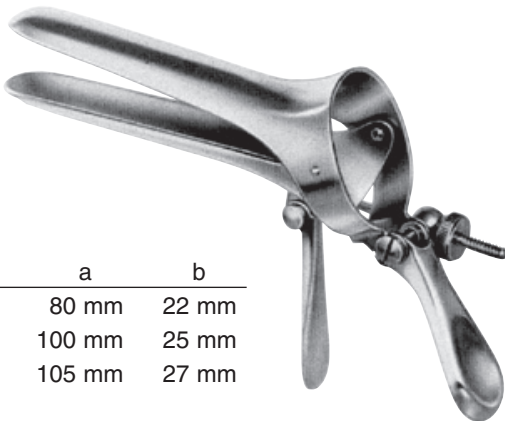

CUSCO	a	b
28090-01	80 mm	22 mm
28090-02	100 mm	25 mm
28090-03	105 mm	27 mm

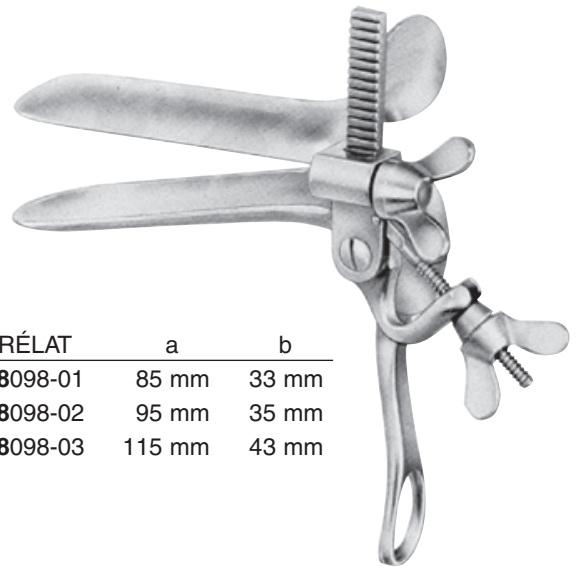

TRÉLAT	a	b
28098-01	85 mm	33 mm
28098-02	95 mm	35 mm
28098-03	115 mm	43 mm

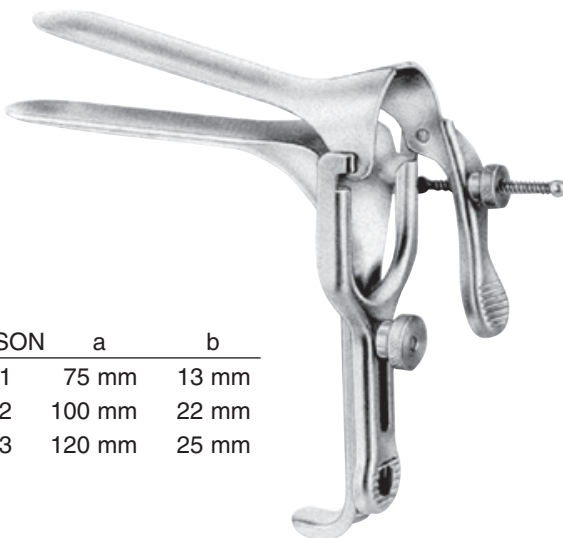

PEDERSON	a	b
28100-01	75 mm	13 mm
28100-02	100 mm	22 mm
28100-03	120 mm	25 mm

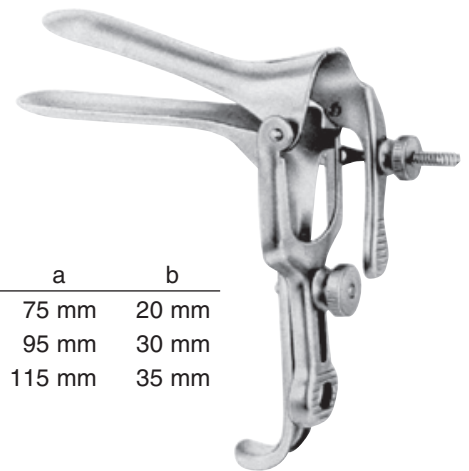

GRAVE	a	b
28102-01	75 mm	20 mm
28102-02	95 mm	30 mm
28102-03	115 mm	35 mm



Scheidenspekula
 Vaginal Specula
 Espécules vaginales
 Spéculums vaginaux
 Specoli vaginali

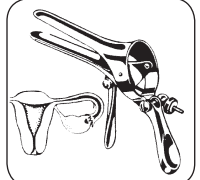

SEMM	a	b
28104-01	100 mm	17 / 20 mm
28104-02	100 mm	25 / 30 mm



28116-00
 Bügel Spekulum



SIMS, 18,5 cm / 7 1/4"	Fig.	a	b
28130-01	1	90 mm	27 mm
28130-02	2	75 mm	30 mm
28130-03	3	90 mm	36 mm



SIMS	Fig.	a	b
28132-01	1	60 mm	25 / 30 mm
28132-02	2	70 mm	30 / 35 mm
28132-03	3	80 mm	36 / 40 mm



JACKSON	Fig.	a	b
28136-01	1	75 mm	35 mm
28136-02	2	90 mm	35 mm
28136-03	3	100 mm	35 mm

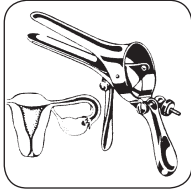

Scheidenspekula und -halter
 Vaginal Specula and Retractors
 Espéculos y Valvas vaginales
 Spéculums et Valves vaginaux
 Specoli e Valve vaginali



Spekula
 Specula
 Espéculo
 Spéculum
 Specolo

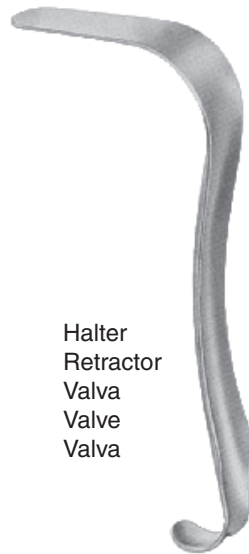

Halter
 Retractor
 Valva
 Valve
 Valva



Satz
 Set
 Juego
 Jeu
 Serie

KRISTELLER	Fig.	a	b
28154-00	0	70 mm	15 mm
28154-01	1	70 mm	27 mm
28154-02	2	75 mm	30 mm
28154-03	3	90 mm	36 mm

KRISTELLER	Fig.	a	b
28155-00	0	75 mm	10 mm
28155-01	1	75 mm	23 mm
28155-02	2	80 mm	26 mm
28155-03	3	95 mm	32 mm

KRISTELLER	Fig.	a	b
28157-00	0	70 mm	15 mm
28157-01	1	70 mm	27 mm
28157-02	2	75 mm	30 mm
28157-03	3	90 mm	36 mm



Spekula
 Specula
 Espéculo
 Spéculum
 Specolo

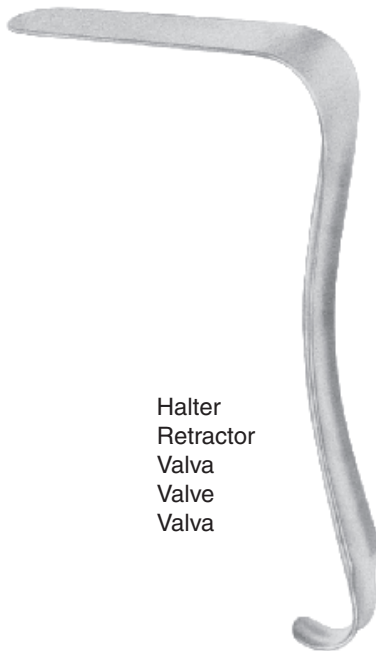

Halter
 Retractor
 Valva
 Valve
 Valva



Satz
 Set
 Juego
 Jeu
 Serie

KRISTELLER	Fig.	a	b
28174-00	00	110 mm	18 mm
28174-01	0	110 mm	20 mm
28174-02	1	110 mm	27 mm
28174-03	2	110 mm	30 mm
28174-04	3	110 mm	36 mm

KRISTELLER	Fig.	a	b
28175-00	00	115 mm	14 mm
28175-01	0	115 mm	17 mm
28175-02	1	115 mm	23 mm
28175-03	2	115 mm	26 mm
28175-04	3	115 mm	32 mm

KRISTELLER	Fig.	a	b
28177-00	00	110 mm	18 mm
28177-01	0	110 mm	20 mm
28177-02	1	110 mm	27 mm
28177-03	2	110 mm	30 mm
28177-04	3	110 mm	36 mm



Scheidenspekula
Vaginal Specula
Espéculo vaginal
Spéculum vaginal
Specolo

KALLMORGEN	Fig.	a	b
28204-01	1	70 mm	40 mm
28204-02	2	90 mm	40 mm

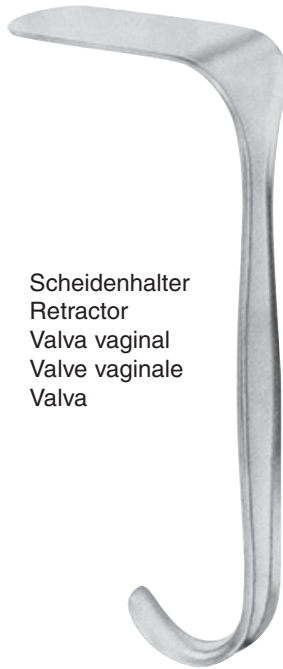

Scheidenhalter
Retractor
Valva vaginal
Valve vaginale
Valva

KALLMORGEN	Fig.	a	b
28205-01	1	70 mm	33 mm
28205-02	2	90 mm	33 mm



Satz
Set
Juego
Jeu
Serie

KALLMORGEN	Fig.	a	b
28207-01	1	70 mm	40 mm
28207-02	2	90 mm	40 mm



Scheidenspekula
Vaginal Specula
Espéculo vaginal
Spéculum vaginal
Specolo

MATHIEU	Fig.	a	b
28214-01	1	100 mm	13 / 23 mm
28214-02	2	100 mm	16 / 30 mm



Scheidenhalter
Retractor
Valva vaginal
Valve vaginale
Valva

MATHIEU	Fig.	a	b
28215-01	1	100 mm	11 / 21 mm
28215-02	2	100 mm	14 / 27 mm

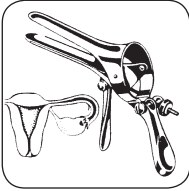

Scheidenspekula
Vaginal Specula
Espécules vaginales
Spéculums vaginaux
Specoli vaginali

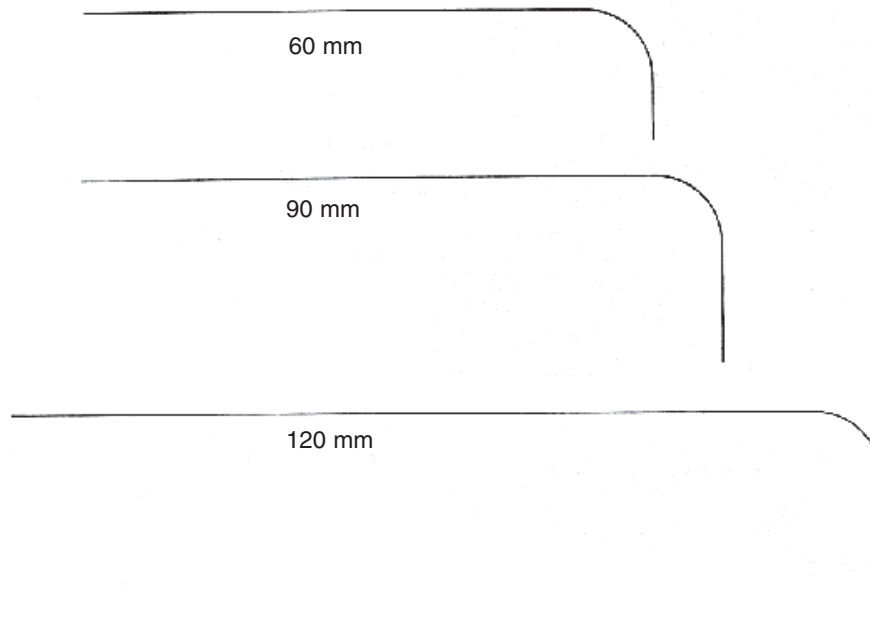

leichtohhl
slightly-concave
ligeramente concavas
légèrement concaves
leggermente concava

28221-01	Fig. 1	60 x 35 mm
28221-02	Fig. 2	90 x 35 mm
28221-03	Fig. 3	120 x 35 mm
28221-04	Fig. 4	140 x 35 mm
28221-05	Fig. 5	160 x 35 mm
28221-06	Fig. 6	180 x 35 mm
28222-01	Fig. 1	60 x 45 mm
28222-02	Fig. 2	90 x 45 mm
28222-03	Fig. 3	120 x 45 mm
28222-04	Fig. 4	140 x 45 mm
28222-05	Fig. 5	160 x 45 mm
28222-06	Fig. 6	180 x 45 mm
28223-01	Fig. 1	60 x 60 mm
28223-02	Fig. 2	90 x 60 mm
28223-03	Fig. 3	120 x 60 mm
28223-04	Fig. 4	140 x 60 mm
28223-05	Fig. 5	160 x 60 mm
28223-06	Fig. 6	180 x 60 mm

halbhohl
medium-concave
semi-cóncavas
demi-concaves
semiconcava

28231-01	Fig. 1	60 x 35 mm
28231-02	Fig. 2	90 x 35 mm
28231-03	Fig. 3	120 x 35 mm
28231-04	Fig. 4	130 x 35 mm
28232-01	Fig. 1	60 x 45 mm
28232-02	Fig. 2	90 x 45 mm
28232-03	Fig. 3	120 x 45 mm
28232-04	Fig. 4	130 x 45 mm
28233-01	Fig. 1	60 x 60 mm
28233-02	Fig. 2	90 x 60 mm
28233-03	Fig. 3	120 x 60 mm
28233-04	Fig. 4	130 x 60 mm

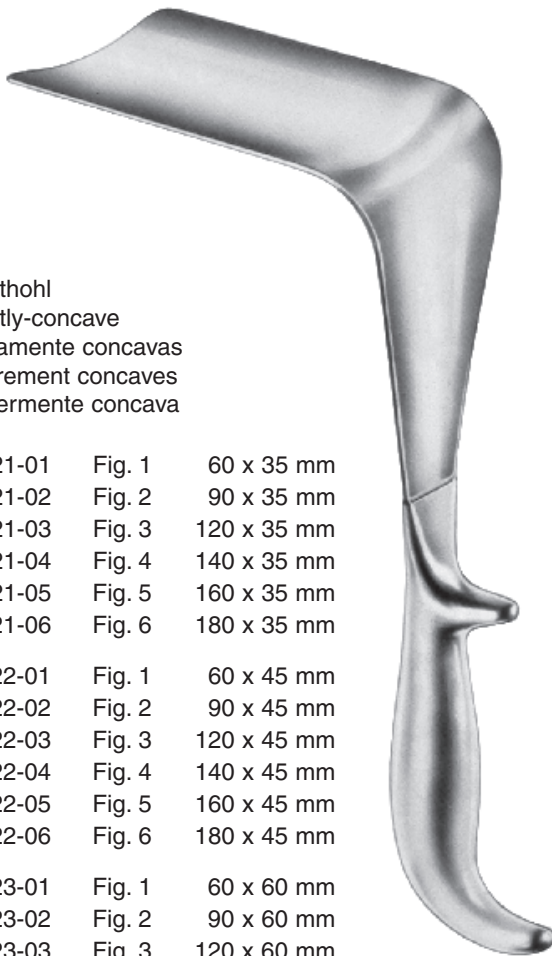

DOYEN

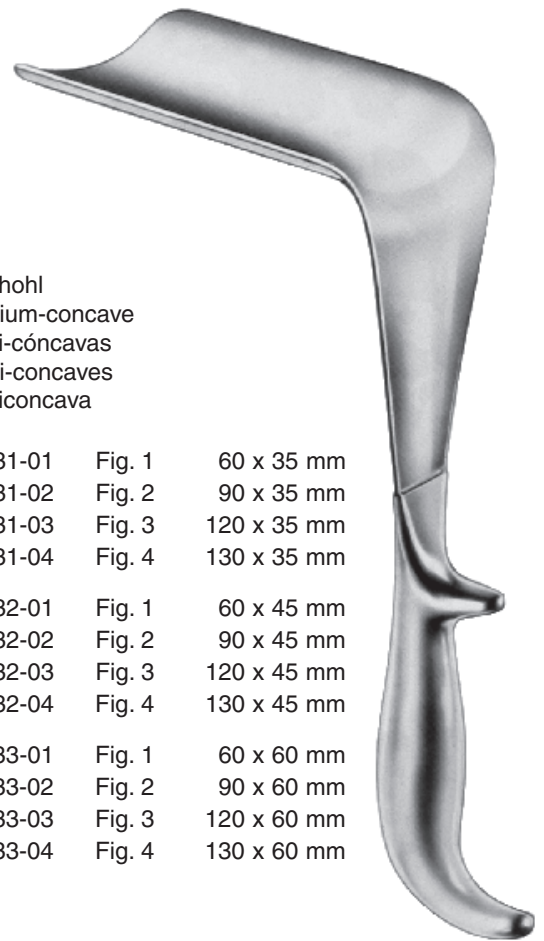

DOYEN



Gewicht, leicht, 400g.
Weight, light, 400 grs.
Pesa, liviana, 400 grs.
Poids, léger, 400 grs.
Peso, leggero, 400 gr.

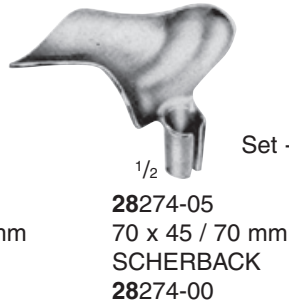
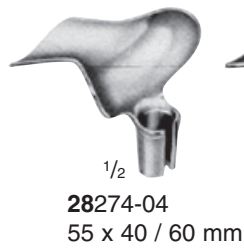

Set -01, -02, -03, -04, -05, -10, -14

komplett
complete
completo
complet
completo

28274-12
Gewicht, schwer, 800 g.
Weight, heavy, 800 grs.
Pesa, pesada, 800 grs.
Poid, lourd, 800 grs.
Peso, pesante, 800 gr.



AUVARD
28282-22
22 cm / 8³/₄"



WEISSBARTH
28286-24
24 cm / 9¹/₂"

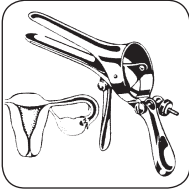

Scheidenspekula
Vaginal Specula
Espéculos vaginales
Spéculums vaginaux
Specoli vaginali



1/2

BREISKY

28295-01	70 x 25 mm
28295-02	80 x 25 mm
28295-03	90 x 25 mm
28295-04	100 x 10 mm
28295-05	100 x 15 mm
28295-06	100 x 20 mm
28295-07	100 x 25 mm
28295-08	100 x 30 mm
28295-09	100 x 35 mm
28295-10	100 x 40 mm

27 – 30 cm
10³/₄" – 12"



1/2

BREISKY

28296-01	130 x 20 mm
28296-02	130 x 25 mm
28296-03	130 x 30 mm
28296-04	130 x 35 mm
28296-05	130 x 40 mm
28296-06	160 x 30 mm
28296-07	160 x 40 mm
28296-08	180 x 40 mm

32 – 35 cm
12³/₄" – 13³/₄"



1/2

LANDAU

28298-01	100 x 28 mm
28298-02	110 x 38 mm

29 cm / 11¹/₂"



Fig. 3

70 x 30 mm



1/2

DOYEN
28314-24
24 cm / 9 1/2"



Fig. 2



Fig. 1 1/2

Fig.	a	b
1	45 mm	17 mm
2	90 mm	37 mm
3	90 mm	45 mm



1/2

O'SULLIVAN- O'CONNOR
28323-00
completo di Valve
Fig. 1 • 2 • 3



1/2

KOGAN
28355-24
24 cm / 9 1/2"

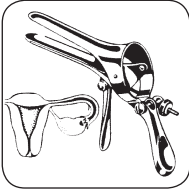

Uterus-Dilatatoren
Uterine Dilators
Dilatadores uterinos
Dilatateurs du col de l'utérus
Dilatatori uterini



1/2

HEGAR

28372-01 – 30

28373-01 – 20

28372-01	1 mm Ø	28372-16	16 mm Ø	28373-01	1,5 mm Ø	28373-16	16,5 mm Ø
28372-02	2 mm Ø	28372-17	17 mm Ø	28373-02	2,5 mm Ø	28373-17	17,5 mm Ø
28372-03	3 mm Ø	28372-18	18 mm Ø	28373-03	3,5 mm Ø	28373-18	18,5 mm Ø
28372-04	4 mm Ø	28372-19	19 mm Ø	28373-04	4,5 mm Ø	28373-19	19,5 mm Ø
28372-05	5 mm Ø	28372-20	20 mm Ø	28373-05	5,5 mm Ø	28373-20	20,5 mm Ø
28372-06	6 mm Ø	28372-21	21 mm Ø	28373-06	6,5 mm Ø		
28372-07	7 mm Ø	28372-22	22 mm Ø	28373-07	7,5 mm Ø		
28372-08	8 mm Ø	28372-23	23 mm Ø	28373-08	8,5 mm Ø		
28372-09	9 mm Ø	28372-24	24 mm Ø	28373-09	9,5 mm Ø		
28372-10	10 mm Ø	28372-25	25 mm Ø	28373-10	10,5 mm Ø		
28372-11	11 mm Ø	28372-26	26 mm Ø	28373-11	11,5 mm Ø		
28372-12	12 mm Ø	28372-27	27 mm Ø	28373-12	12,5 mm Ø		
28372-13	13 mm Ø	28372-28	28 mm Ø	28373-13	13,5 mm Ø		
28372-14	14 mm Ø	28372-29	29 mm Ø	28373-14	14,5 mm Ø		
28372-15	15 mm Ø	28372-30	30 mm Ø	28373-15	15,5 mm Ø		



28372-84

Satz mit 14 Dilatatoren (4 – 17 mm Ø) im Metalletui
Set of 14 dilators (4 – 17 mm Ø) im metal case
Juego de 14 dilatadores (4 – 17 mm Ø) en estuche de metal
Jeu de 14 dilatateurs (4 – 17 mm Ø) en boîte métal
Serie di 14 dilatatori (4 – 17 mm Ø) in scatola metallica



28372-94

Satz mit 26 Dilatatoren (1 – 26 mm Ø) im Metalletui
Set of 26 dilators (1 – 26 mm Ø) im metal case
Juego de 26 dilatadores (1 – 26 mm Ø) en estuche de metal
Jeu de 26 dilatateurs (1 – 26 mm Ø) en boîte métal
Serie di 26 dilatatori (1 – 26 mm Ø) in scatola metallica

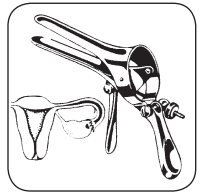

1/2

SIMS, 32 cm / 12 1/2"

28555-32 28556-32

fest
 rigid
 rigido
 rigide
 rigido

biegsam
 malleable
 maleable
 malléable
 malleabili

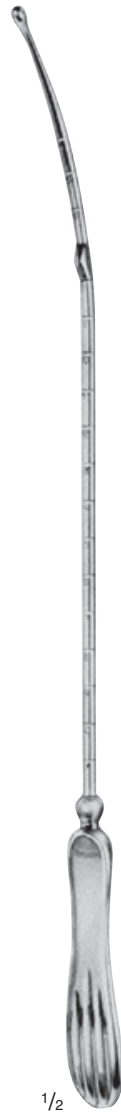

1/2

MARTIN, 30 cm / 12"

28557-30 28558-30

fest
 rigid
 rigido
 rigide
 rigido

biegsam
 malleable
 maleable
 malléable
 malleabili



1/2

VALLEIX

28565-25
25 cm / 10"

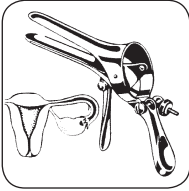

Hakenzangen
Vulsellum Forceps
Pinzas para coger el cuello del útero
Pincas pour abaissement du col de l'utérus
Pinze uterine



$\frac{1}{3}$
BARRET-POZZI
28588-18
18 cm / 7"

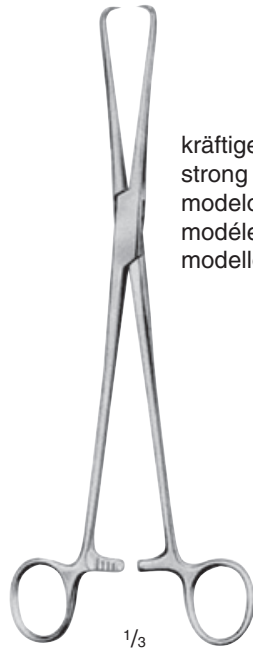

$\frac{1}{3}$
POZZI
28590-26
25,5 cm / 10 $\frac{1}{2}$ "

kräftiges Modell
strong pattern
modelo fuerte
modèle fort
modello forte



$\frac{1}{3}$
SCHROEDER
28594-25
25 cm / 10"



$\frac{1}{3}$
BRAUN
28600-25
25 cm / 10"



$\frac{1}{3}$
DUPLAY
28617-25
25 cm / 10"



$\frac{1}{3}$
SKENE
28635-24
24 cm / 9 $\frac{1}{2}$ "



$\frac{1}{3}$
ABEL
28642-27
27 cm / 10 $\frac{1}{2}$ "



$\frac{1}{3}$
SCHROEDER
28654-20 = 20 cm / 8"
28654-20 = 24 cm / 9 $\frac{1}{2}$ "



$\frac{1}{3}$
SCHROEDER
28655-20 = 20 cm / 8"
28655-24 = 24 cm / 9 $\frac{1}{2}$ "
aufgebogen
curved on flat
curva sobre el plano
courbe vers le haut
curva sul piatto



Hakenzangen
 Vulsellum Forceps
 Pinzas para coger el cuello del útero
 Pincas pour abaissement du col de l'utérus
 Pinze uterine



TEALE
 28669-23
 23 cm / 9"

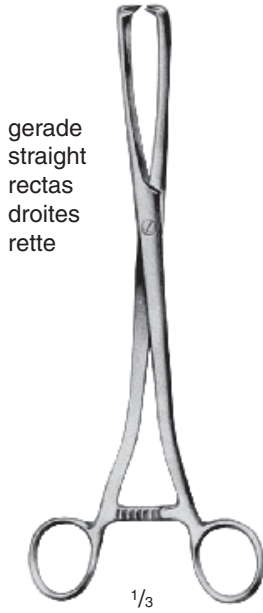

MUSEUX, 24 cm / 9 1/2"
 28674-06
 28674-08
 28674-10

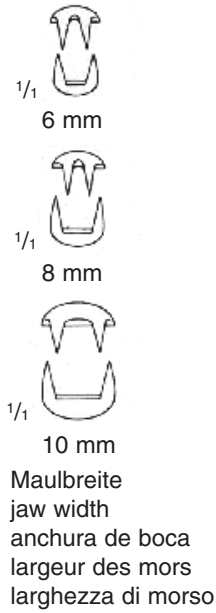

6 mm
 8 mm
 10 mm
 Maulbreite
 jaw width
 anchura de boca
 largeur des mors
 larghezza di morso

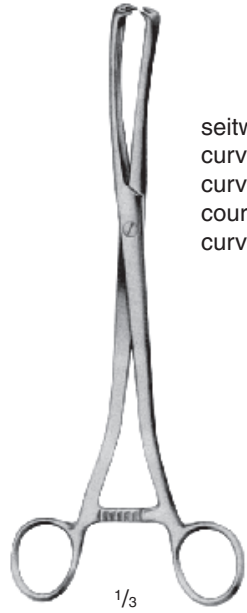

MUSEUX, 24 cm / 9 1/2"
 28675-06
 28675-08
 28675-10

gerade
 straight
 rectas
 droites
 rette

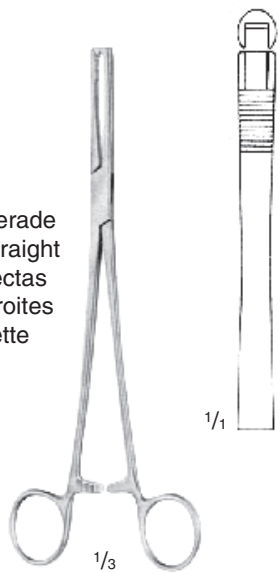

JACOBS
 28700-21
 21 cm / 8 1/4"

seitwärts gebogen
 curved sideways
 curva lateral
 courbes sur le côté
 curve sul fianco

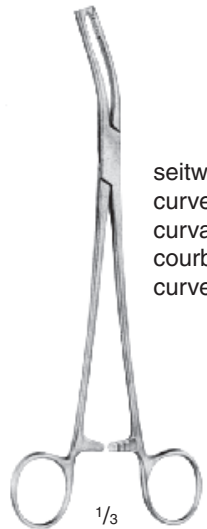

JACOBS
 28701-21
 21 cm / 8 1/4"

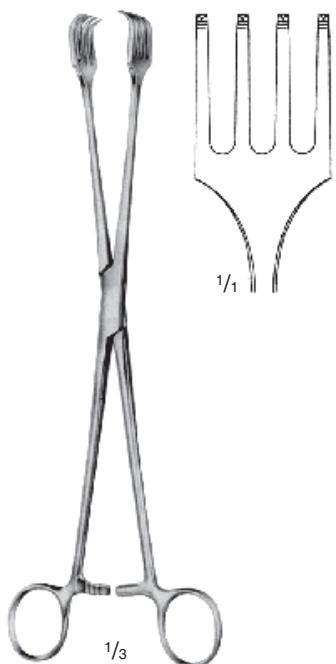

PRATT
 28706-26
 26 cm / 10 1/4"

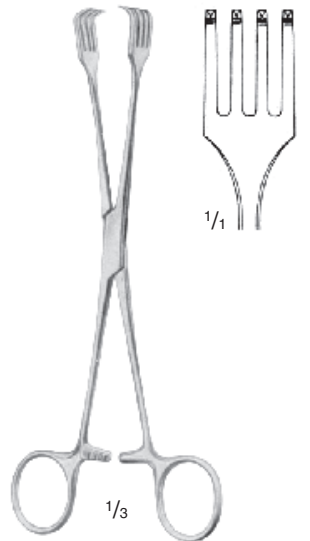

CZERNY
 28712-21
 20,5 cm / 8"

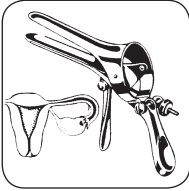

Uterus-Polypenzangen, Myomheber
 Uterine Polypus Forceps, Myoma Screw
 Pinzas para pólipos uterinos, Tirabuzónes para fibromas
 Pincès à polypes utérins, Tracteur hélicoïdal pour fibromes
 Pinze Uterine Tiramiomi



KELLY
28713-32
 32 cm / 12 1/2"

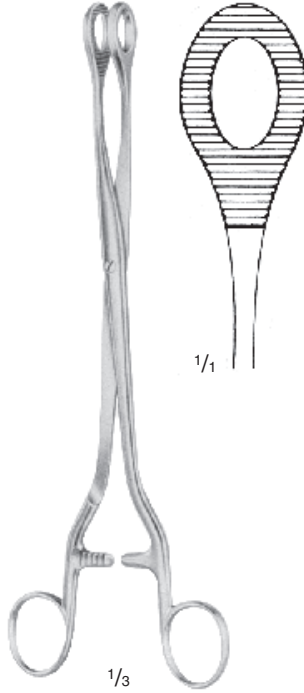

NOTO
28716-27
 27 cm / 10 1/2"

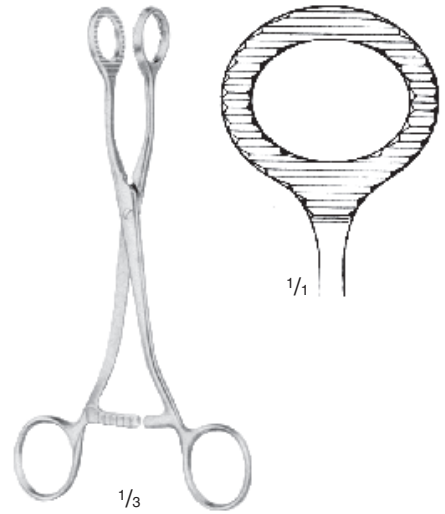

DOYEN
28728-20
 20 cm / 8"



DOYEN
28729-17
 17 cm / 6 3/4"



DOYEN
28731-17
 17 cm / 6 3/4"

Uterus - Faßzangen, Konusmesser, Biopsieküretten
 Uterine Elevating Forceps, Cone Knives, Biopsy Curettes
 Pinzas para el útero, Bisturi para conos de atracción, Curetas para biopsia
 Pincès hystérolabes, Bistouri pour le cône d'attraction, Curettes pour biopsie
 Pinze per afferare l'utero, Bisturi per conizzazione, Curette per biopsia



$\frac{1}{3}$
DARTIGUES
28745-27
 27 cm / 10 1/2"



$\frac{1}{3}$
SOMER
28751-23
 23 cm / 9"

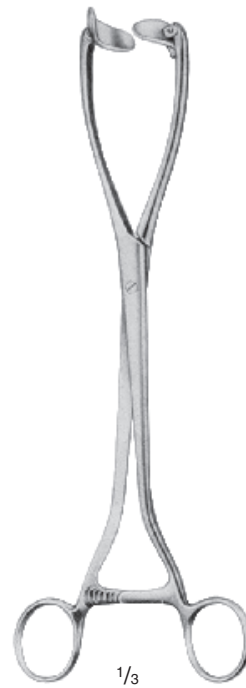

$\frac{1}{3}$
COLLIN
28765-25
 25 cm / 10"



$\frac{1}{3}$
COLLIN
28766-25
 25 cm / 10"

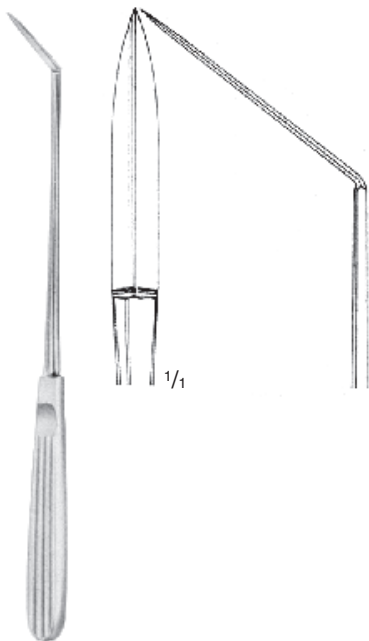

$\frac{1}{1}$
AYRE
28773-23
 23 cm / 9"



$\frac{1}{1}$
RANDALL
28793-24
 4 mm Ø
 23 cm / 9 1/2"



$\frac{1}{1}$
NOVAK
28797-23
 4 mm Ø
 23 cm / 9"



$\frac{1}{1}$
MOD. MÜNCHEN
28801-27
 27 cm / 10 1/2"

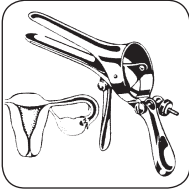

Biopsieküretten, Probeexzisionszangen
 Biopsy Curettes, Biopsy Forceps
 Curetas para biopsia, Pinzas para biopsia
 Curettes pour biopsie, Pincès à biopsie
 Curette per biopsia, Pinze per biopsia

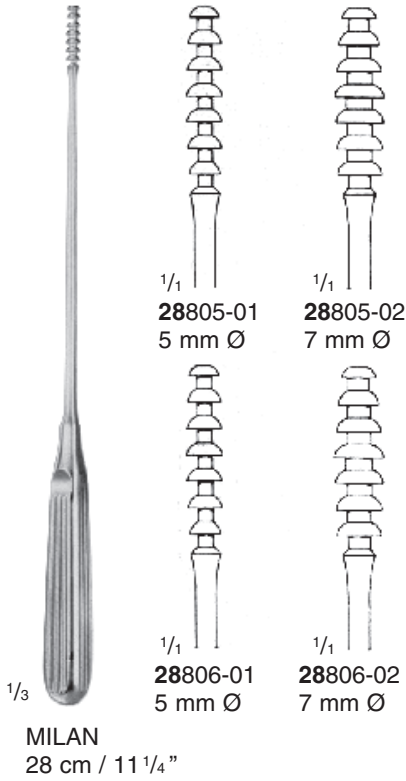

biegsam
 malleable
 maleable
 malléable
 malleabile

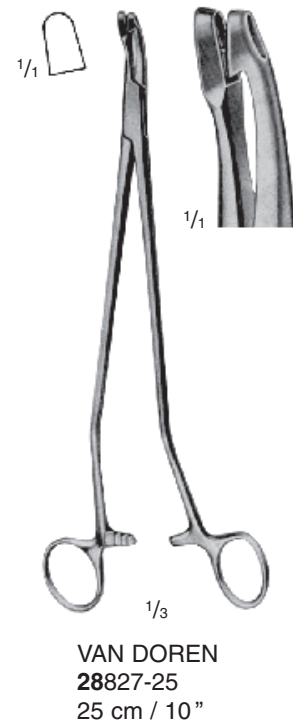
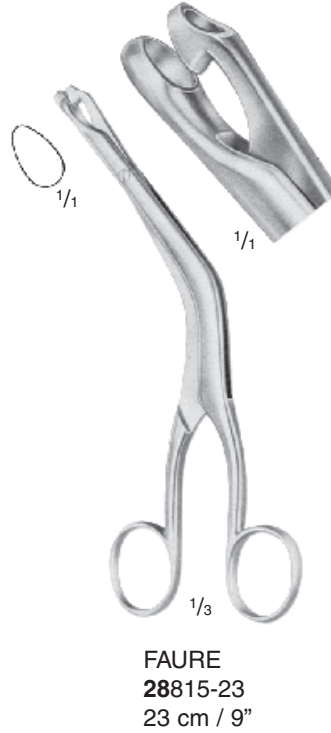

Probeexzisionszangen
Biopsy Forceps
Pinzas para biopsia
Pinces à biopsie
Pinze per biopsia

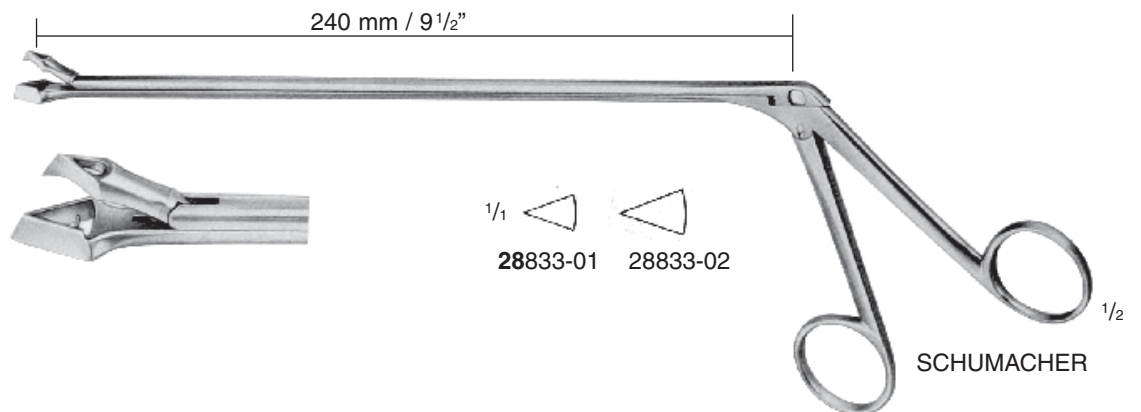
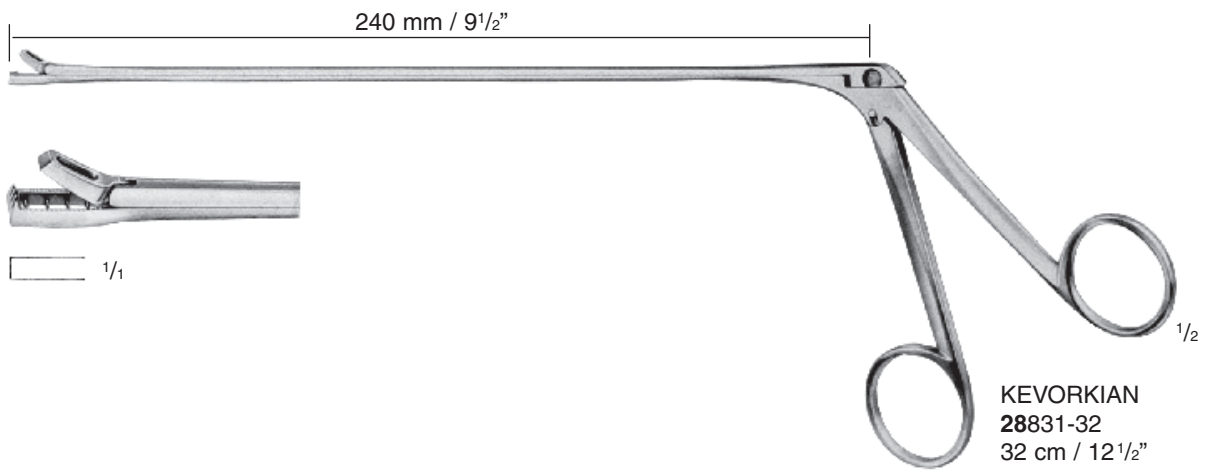
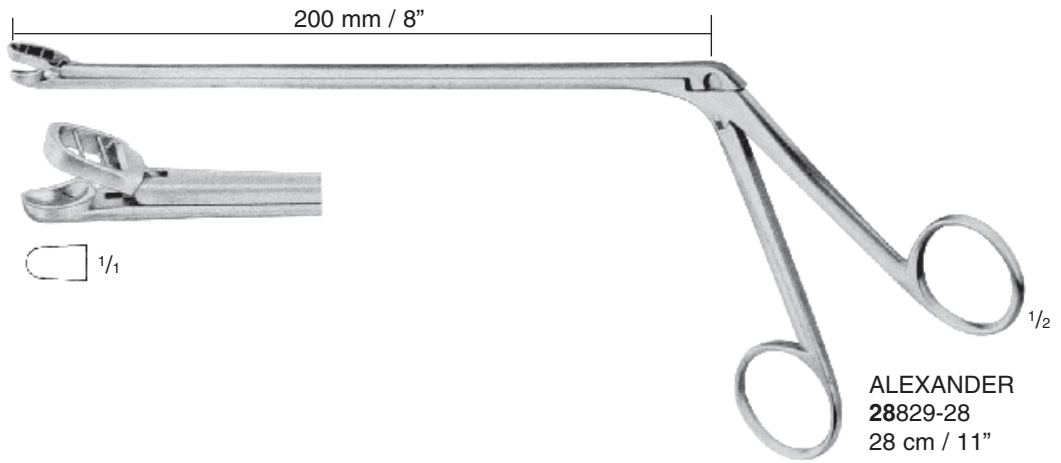



Probeexzisionszangen
 Biopsy Forceps
 Pinzas para biopsia
 Pincès à biopsie
 Pinze per biopsia

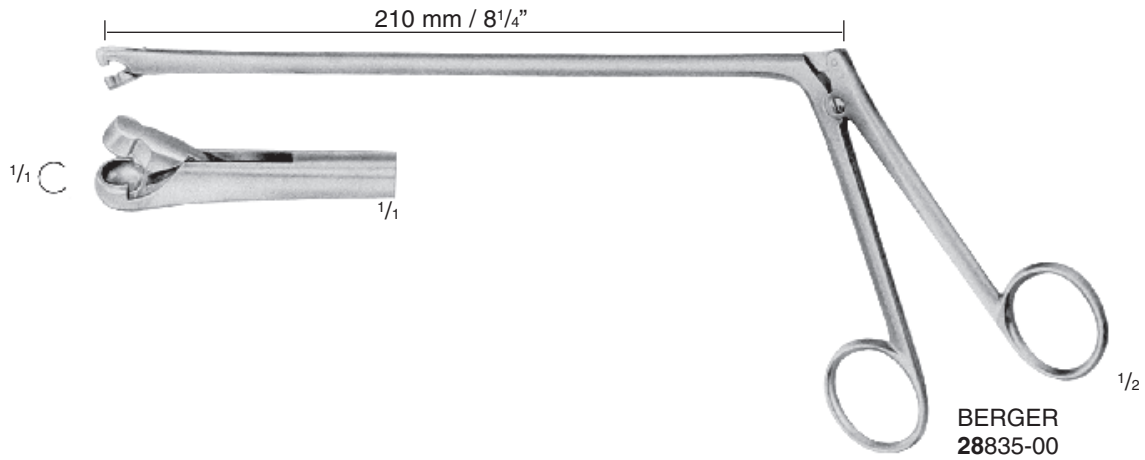

BERGER
28835-00

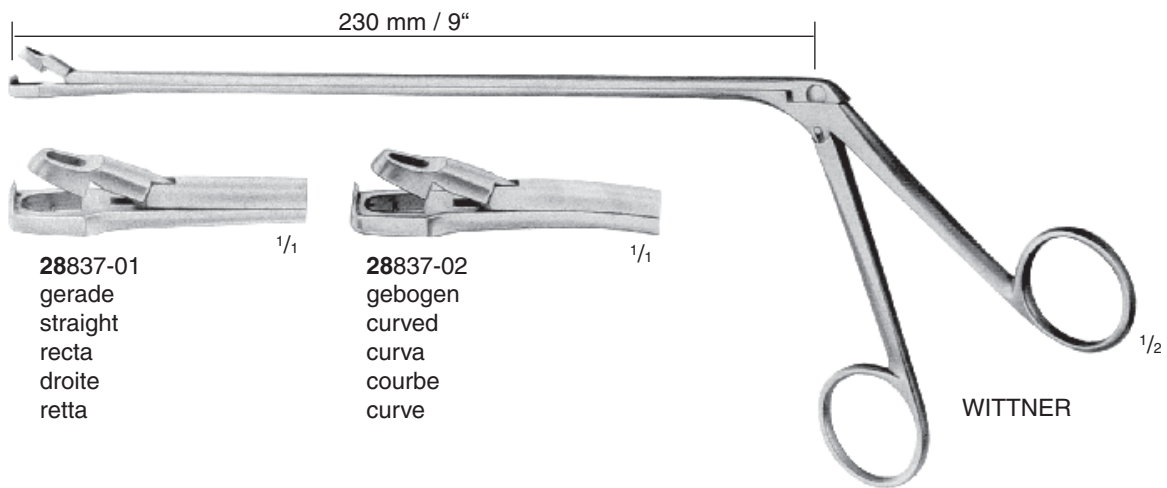

28837-01
gerade
straight
recta
droite
retta

28837-02
gebogen
curved
curva
courbe
curve

WITTNER

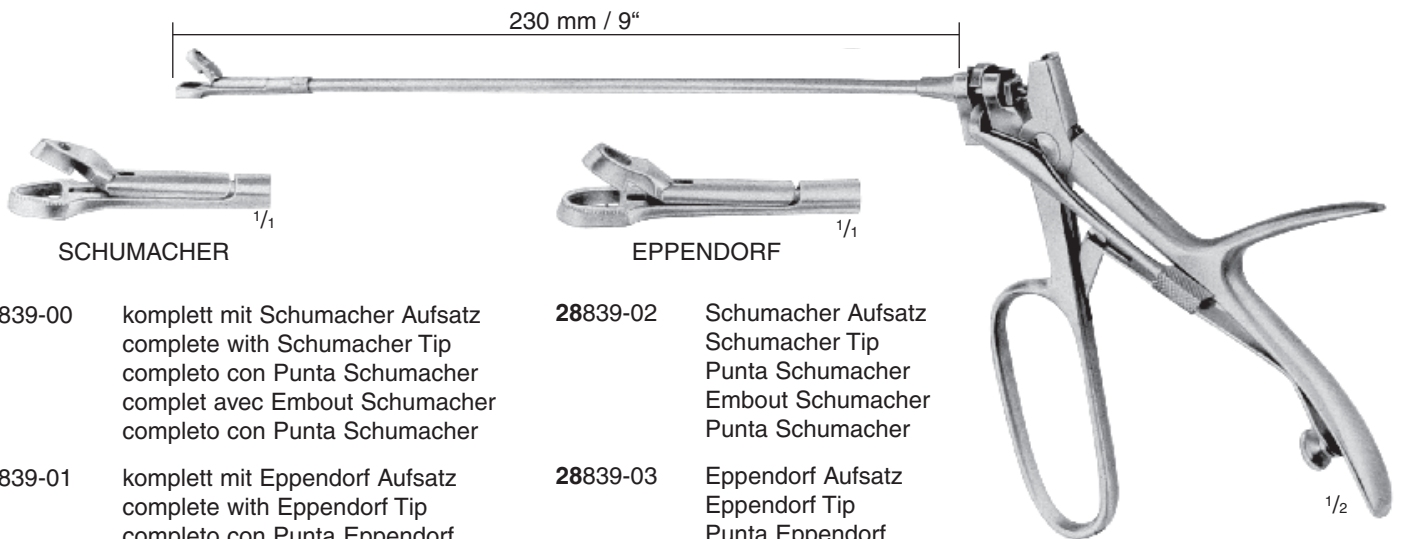

SCHUMACHER

EPPENDORF

28839-00 komplett mit Schumacher Aufsatz
 complete with Schumacher Tip
 completo con Punta Schumacher
 complet avec Embout Schumacher
 completo con Punta Schumacher

28839-02 Schumacher Aufsatz
 Schumacher Tip
 Punta Schumacher
 Embout Schumacher
 Punta Schumacher

28839-01 komplett mit Eppendorf Aufsatz
 complete with Eppendorf Tip
 completo con Punta Eppendorf
 complet avec Embout Eppendorf
 completo con Punta Eppendorf

28839-03 Eppendorf Aufsatz
 Eppendorf Tip
 Punta Eppendorf
 Embout Eppendorf
 Punta Eppendorf

28839-10 Universalgriff
 Universal handle
 Mango universal
 Manche universel
 Manico universale

28839-20 Verlängerungsrohr
 Extension cannula
 Tubo de extensión
 Tube rallonge
 Tubo allungo

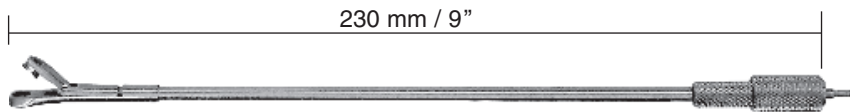
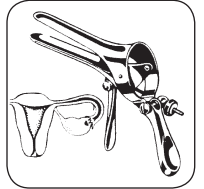

drehbar 360°
 turnable 360°
 giratorio 360°
 pivotant 360°
 girevole 360°

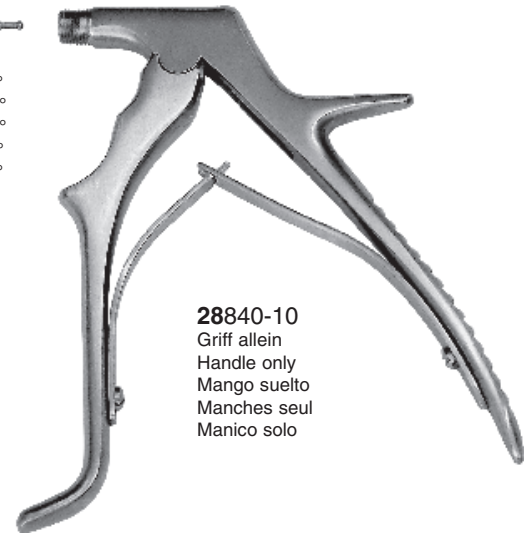

28840-10
 Griff allein
 Handle only
 Mango suelto
 Manches seul
 Manico solo

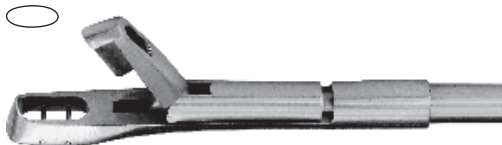

TISCHLER-MORGAN
28840-00
 komplett
 complete
 completo
 complet
 completo

TISCHLER-MORGAN
28840-20
 Aufsatz
 Tip
 Punta
 Embout
 Punta



KEVORKIAN
28840-02
 komplett
 complete
 completo
 complet
 completo

KEVORKIAN
28840-22
 Aufsatz
 Tip
 Punta
 Embout
 Punta



EPPENDORF
28840-04
 komplett
 complete
 completo
 complet
 completo

EPPENDORF
28840-24
 Aufsatz
 Tip
 Punta
 Embout
 Punta



TOWNSEND-MINI
28840-06
 komplett
 complete
 completo
 complet
 completo

TOWNSEND-MINI
28840-26
 Aufsatz
 Tip
 Punta
 Embout
 Punta

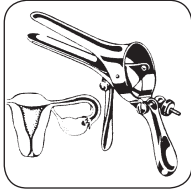

Uteruslöffel, Uterusküretten
 Uterine Scoops, Uterine Curettes
 Cucharillas y Curetas uterinas
 Curettes utérines
 Curette uterine

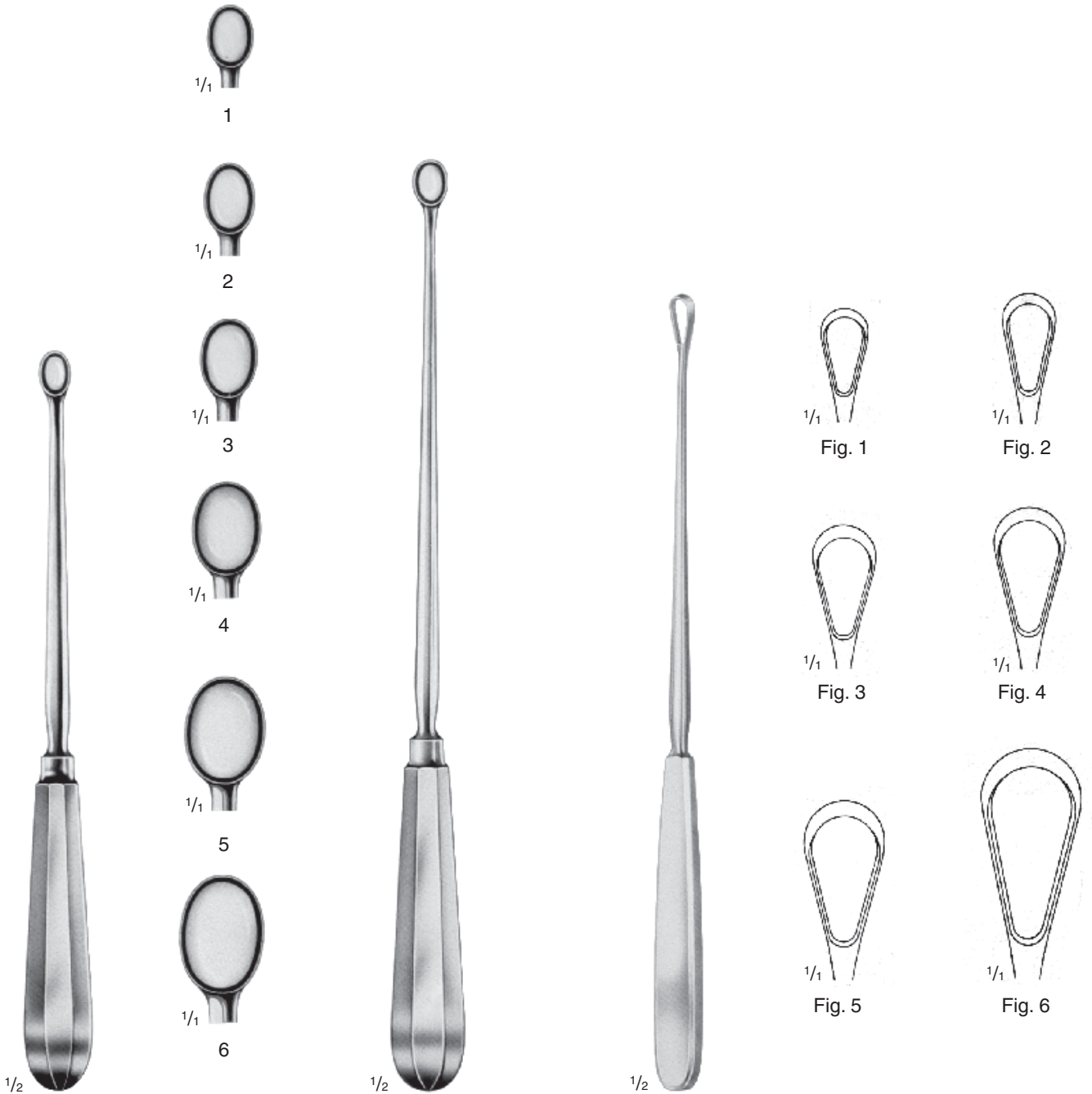

SIMON
 25 cm / 10"
 fest, scharf
 rigid, sharp
 rigidas, cortantes
 rigides, tranchantes
 rigide, taglienti

SCHROEDER
 30 cm / 12"
 fest, scharf
 rigid, sharp
 rigidas, cortantes
 rigides, tranchantes
 rigide, taglienti

SIMS
 26 cm / 10 1/4"
 fest, scharf
 rigid, sharp
 rigidas, cortantes
 rigides, tranchantes
 rigide, taglienti

fest, stumpf
 rigid, blunt
 rigidas, romas
 rigides, mousses
 rigide, smusse

Fig. 1	28872-01	28878-01	28880-01	28882-01
Fig. 2	28872-02	28878-02	28880-02	28882-02
Fig. 3	28872-03	28878-03	28880-03	28882-03
Fig. 4	28872-04	28878-04	28880-04	28882-04
Fig. 5	28872-05	28878-05	28880-05	28882-05
Fig. 6	28872-06	28878-06	28880-06	28882-06

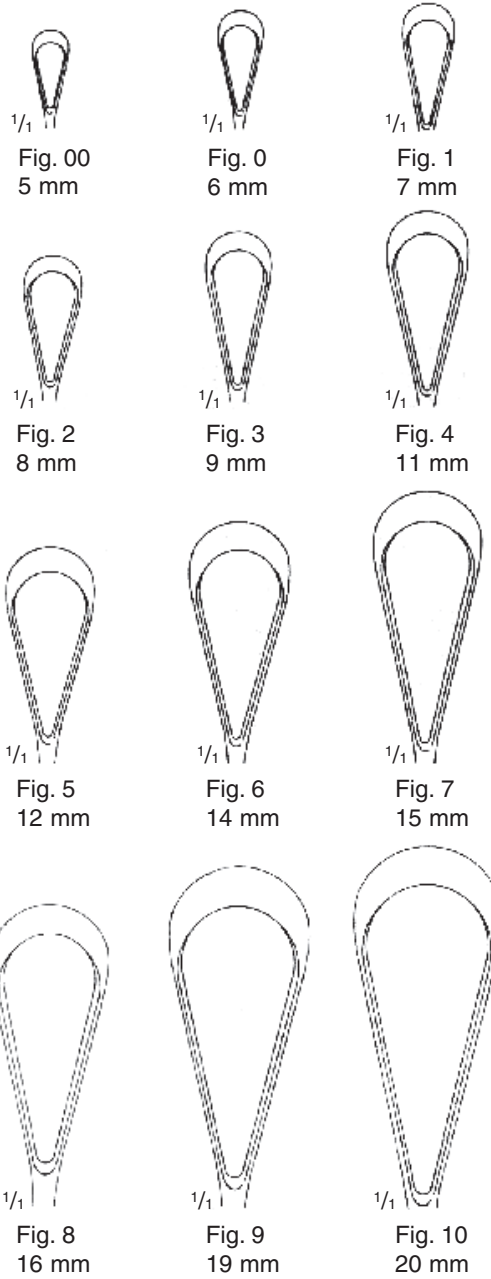

RECAMIER
28892-05 – 20 28898-05 – 20
28893-05 – 20 28899-05 – 20
31 cm / 12 1/2"

fest, scharf
rigid, sharp
rigidas, cortantes
rigides, tranchantes
rigide, taglienti

biegsam
malleable
maleables
malléables
malleabili

fest, stumpf
rigid, blunt
rigidas, romas
rigides, mousses
rigide, smusse

biegsam
malleable
maleables
malléables
malleabili

Fig. 00	28892-05	28893-05	28898-05	28899-05
Fig. 0	28892-06	28893-06	28898-06	28899-06
Fig. 1	28892-07	28893-07	28898-07	28899-07
Fig. 2	28892-08	28893-08	28898-08	28899-08
Fig. 3	28892-09	28893-09	28898-09	28899-09
Fig. 4	28892-11	28893-11	28898-11	28899-11
Fig. 5	28892-12	28893-12	28898-12	28899-12
Fig. 6	28892-14	28893-14	28898-14	28899-14
Fig. 7	28892-15	28893-15	28898-15	28899-15
Fig. 8	28892-16	28893-16	28898-16	28899-16
Fig. 9	28892-19	28893-19	28898-19	28899-19
Fig. 10	28892-20	28893-20	28898-20	28899-20



Uterusküretten
 Uterine Curettes
 Curetas uterinas
 Curettes utérines
 Curette uterine

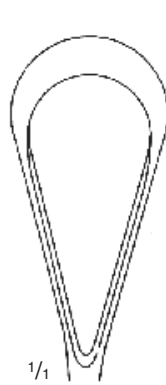
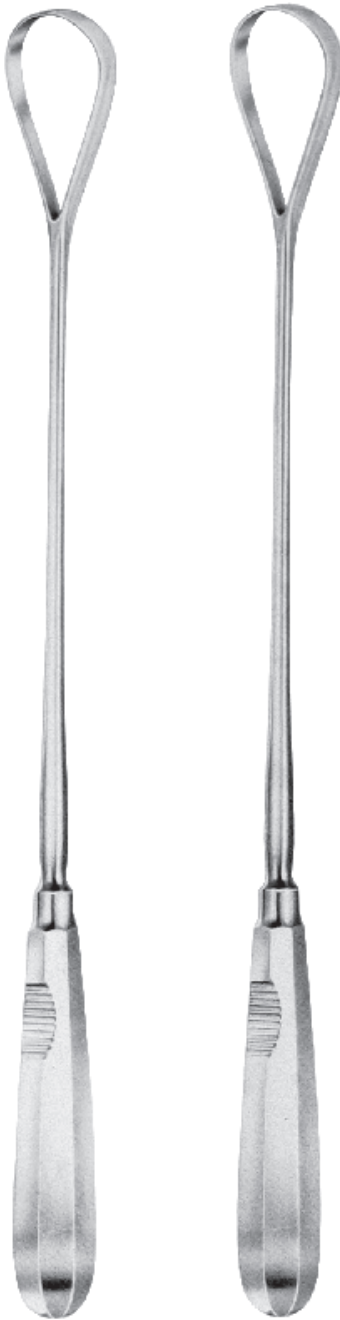

Fig.11
21 mm



Fig.12
23 mm

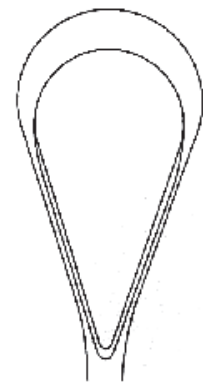

Fig.13
25 mm

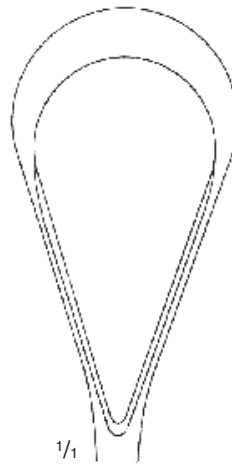

Fig.14
30 mm

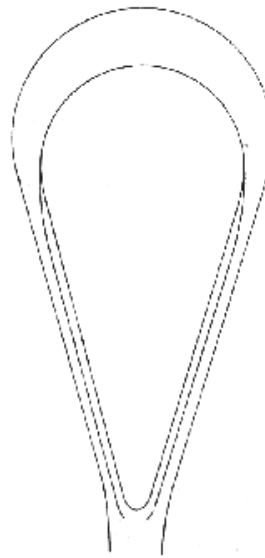

Fig.15
35 mm

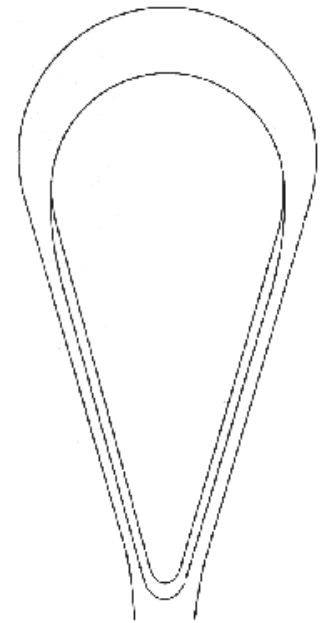

Fig.16
40 mm

RECAMIER
 BUMM

28892-21 – 23 28898-21 – 23
 28893-21 – 23 28899-21 – 23
 31 cm / 12 1/2"

28892-25 – 40 28898-25 – 40
 28893-25 – 40 28899-25 – 40
 34 cm / 13 1/2"

	fest, scharf rigid, sharp rigidas, cortantes rigides, tranchantes rigide, taglienti	biegsam malleable maleables malléables malleabili	fest, stumpf rigid, blunt rigidas, romas rigides, mousses rigide, smusse	biegsam malleable maleables malléables malleabili
Fig. 11	28892-21	28893-21	28898-21	28899-21
Fig. 12	28892-23	28893-23	28898-23	28899-23
Fig. 13	28892-25	28893-25	28898-25	28899-25
Fig. 14	28892-30	28893-30	28898-30	28899-30
Fig. 15	28892-35	28893-35	28898-35	28899-35
Fig. 16	28892-40	28893-40	28898-40	28899-40

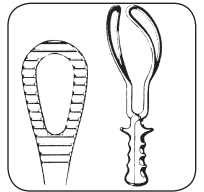

1/4

MARTIN, 34 cm / 13 1/2"

30073-34

cm-Skala
cm scale
escala en cm
échelle en cm
scala in cm

30075-34

cm-Zoll-Skala
cm-inch scale
escala en cm-pulg.
échelle en cm-pouces
scala in cm / pollici

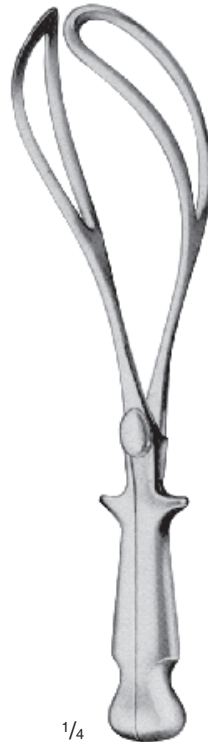

1/4

NAEGELE

30113-36 = 36 cm / 14"

30113-40 = 40 cm / 15 3/4"



1/4

SIMPSON

30117-30

30 cm / 11 3/4"

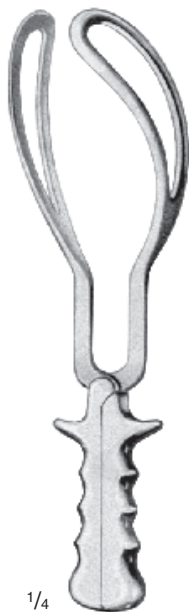

1/4

SIMPSON-BRAUN

30121-36 = 36 cm / 14"



1/4

KIELLAND

30167-41
41 cm / 16"



1/4

WRIGLEY

30187-00
28 cm / 11"



1/4

PIPER

30197-44
44 cm / 17 1/4"

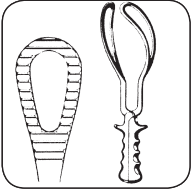

Salpingograph, Kopfschwartzangen, Geburtslöffel
 Salpingograph, Scalp Flap Forceps, Elevating Spoon
 Salpinógrafo, Pinza para pericráneo, Separador para la salida de cabeza
 Salpingographe, Pince pour le cuir chevelu, Levier pour abaisser la tête
 Salpingografo, Pinza per cuoio capelluto, Cucchiario ostetrico

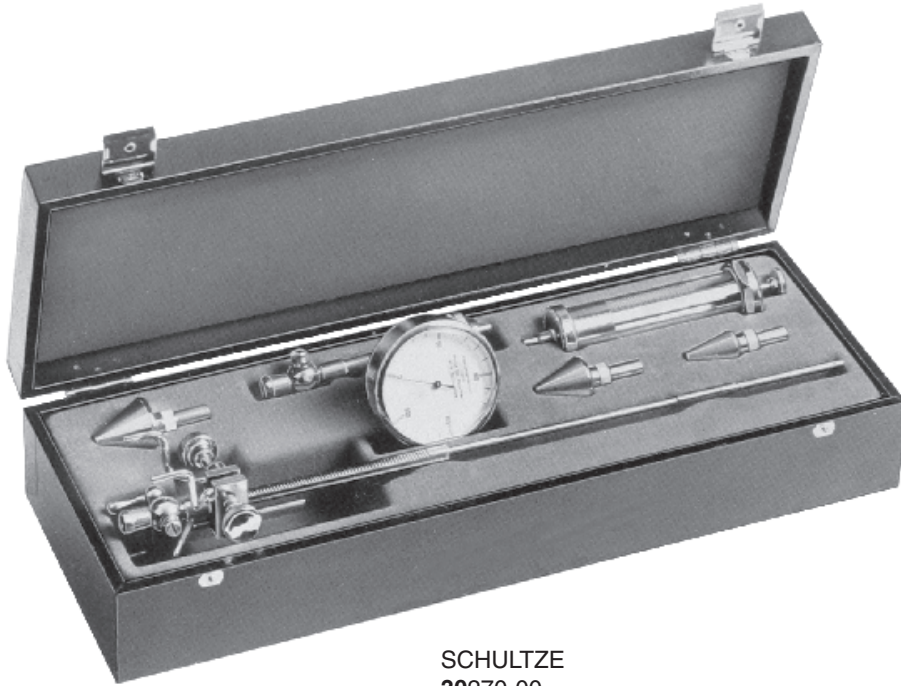

SCHULTZE
30270-00



GREEN-ARMYTAGE
30272-21
21 cm / 8 1/4"



SELLHEIM
30281-28
28 cm / 11"



SAENGER
30300-27
24 cm / 10 1/2"



SAENGER
30301-27
24 cm / 10 1/2"



WINTER
30316-01
30316-02
28 cm / 11"



Fig. 1



Fig. 2



WINTER
30317-01
30317-02
28 cm / 11"

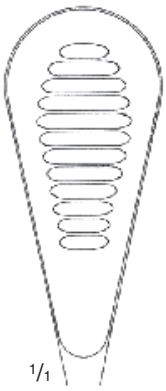

1/1



CUZZI
30354-01
30 cm / 12"



1/1

30354-01
14,5 mm



1/1

30354-02
18 mm



1/1

30354-03
21 mm

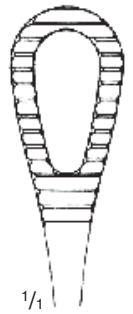

1/1



PESTALOZZA
30358-30
30 cm / 12"

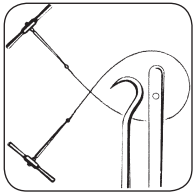

Instrumente zur Schädelöffnung
 Instruments for Cranial Opening
 Instrumentos para abertura craneana
 Instruments pour l'ouverture du crâne
 Chirurgia cerebrale, Strumenti per l'apertura del cranio

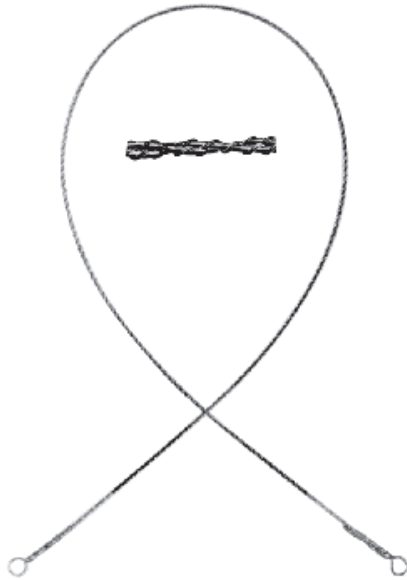

OLIVECRONA / GIGLI
 cm in.
 32572-30 = 30 12
 32572-40 = 40 16
 32572-50 = 50 20
 32572-60 = 60 24
 32572-70 = 70 28



$\frac{1}{2}$
 GIGLI
 32574-01



$\frac{1}{2}$
 DE MARTEL
 32590-33
 33 cm / 13"



$\frac{1}{3}$
 CONE
 32620-23 = 23 cm / 9"



$\frac{1}{2}$
 DAHLGREN
 32626-20
 20 cm / 8"

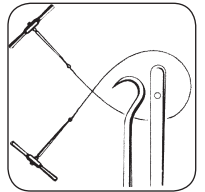

TOENNIS
32652-25
26 cm / 10 1/4"



PENFIELD
32662-01
Fig. 1
17,5 cm / 7"



PENFIELD
32662-02
Fig. 2
19,5 cm / 7 3/4"



PENFIELD
32662-03
Fig. 3
19,5 cm / 7 3/4"

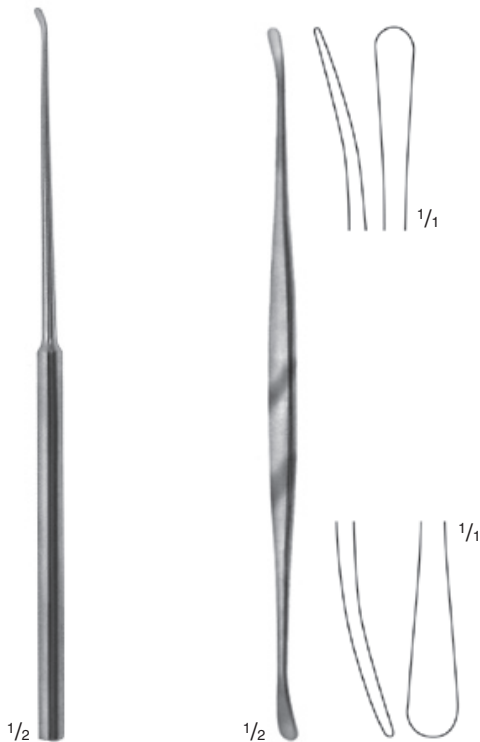

PENFIELD
32662-04
Fig. 4
20,5 cm / 8"



PENFIELD
32662-05
Fig. 5
18,5 cm / 7 1/4"



LOVE
32666-19
19 cm / 7 3/4"



LOVE
32667-19

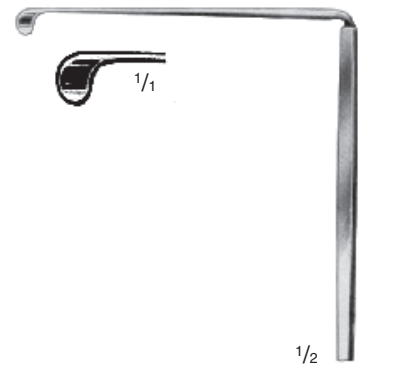

LOVE
32669-19

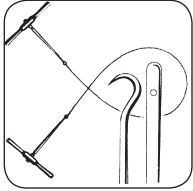

Instrumente zur Schädelöffnung
 Instruments for Cranial Opening
 Instrumentos para abertura craneana
 Instruments pour l'ouverture du crâne
 Chirurgia cerebrale, Strumenti per l'apertura del cranio

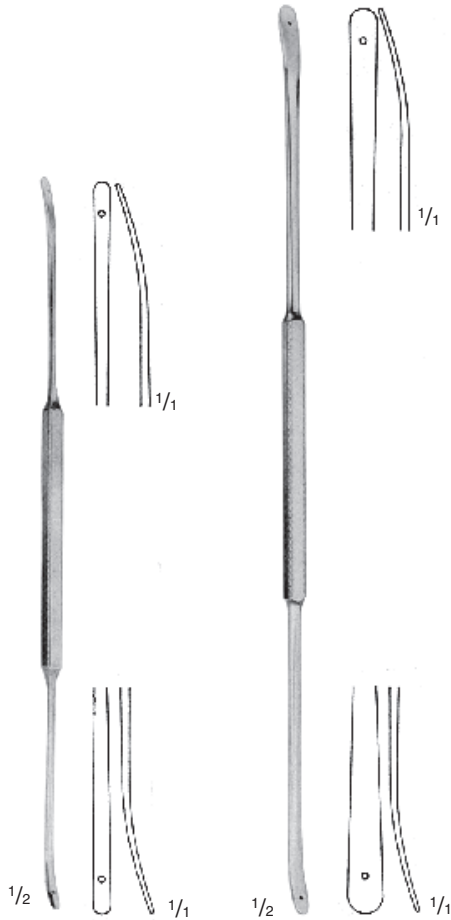

OLIVECRONA
 32672-18 18 cm / 7" 32673-18
 32672-24 24 cm / 9 1/2" 32673-24



SCOVILLE
 32699-19
 16,5 cm / 6 1/2"



CUSHING
 32716-19 = 19 cm / 7 3/4"
 32716-28 = 28 cm / 11"



GRAHAM 32797-16 17,0 cm / 6 3/4"
SACHS 32799-18 18,5 cm / 7 1/4"



CUSHING 32805-14 14 cm / 5 1/2"

spitz
 sharp
 agudos
 pointus
 acuti

FRAZIER
 32807-13 13 cm / 5"
 32807-18 18 cm / 7"



stumpf
 blunt
 romos
 mousses
 smussi

FRAZIER
 32809-13
 32809-18



Häkchen, Trephinen, Komedoneninstrumente
 Hooks, Trephines, Comedo Extractors
 Ganchos, Trépanos, Saca-comedones
 Crochets, Trépan, Tire-comédons
 Uncini, Trefine, Schiaccia-comedoni

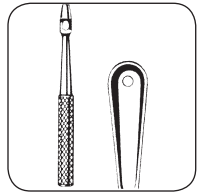

MONCORPS
34096-14
 14 cm / 5 1/2"



KILNER
34175-15
 15 cm / 6"



GILLIES
34179-18 / Fig. 1
34181-18 / Fig. 2
 18 cm / 7"

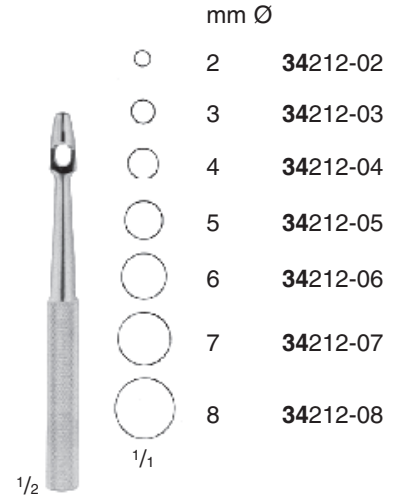

KEYES
34212-02 - 34212-08

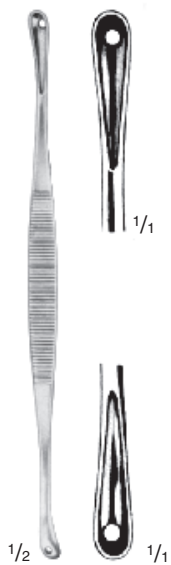

UNNA
34233-14
 14 cm / 5 1/2"



UNNA
34235-14
 14 cm / 5 1/2"



SAALFELD
34243-10
 10 cm / 4"



SAALFELD
34247-14
 14 cm / 5 1/2"

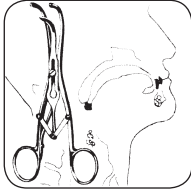

Dilatatoren, Tracheal-Häkchen
 Dilators, Trachea Retractors
 Dilatadores, Separadores para la tráquea
 Dilatateurs, Ecarteurs pour trachéotomie
 Dilatatori tracheali, Uncini



LABORDE
 36085-14
 14 cm / 5 1/2"



TROSSEAU
 36087-14
 14 cm / 5 1/2"

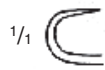

links
 left
 izquierdo
 à gauche
 sinistro



BOSE
 36103-16
 16 cm / 6 1/4"

scharf
 sharp
 agudo
 pointu
 acuto



BOSE
 36105-16
 16 cm / 6 1/4"



rechts
 right
 derecho
 à droite
 destro

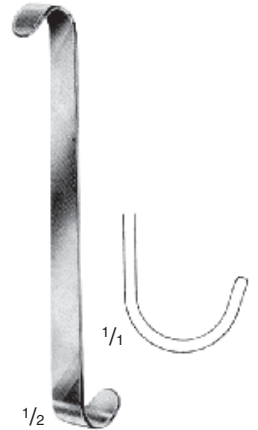

LUER
 36117-11
 11 cm / 4 1/2"



LUKENS
 36123-17
 17 cm / 6 3/4"



JACKSON
 36127-17
 17 cm / 6 3/4"

stumpf
 blunt
 romo
 mousse
 smusso



JACKSON
 36129-18
 18 cm / 7"

scharf
 sharp
 agudo
 pointu
 acuto

JACKSON
 36131-18
 18 cm / 7"



36383-15
 15 cm
 36383-16
 16 cm



36385-15
 15 cm
 36385-16
 16 cm



KOCHER

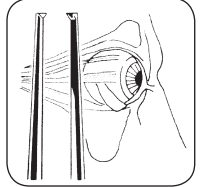

1/1

38542-13



1/1

38543-13



1/1

**WALTON
38574-12**



1/1

**WALTON
38576-12**



1/1

**MEYER
38580-12**



**STANDARD
38630-12**



1/1

**GRAEFE
40332-10
10 cm / 4"**



1/1

40333-10



1/1

40335-10



1/1

40336-10



1/1

40337-10



1/1

40339-10



Ohrspekula, Stimmgabeln
 Ear Specula, Tuning Forks
 Espéculos auriculares, Diapasones
 Spéculums auriculaires, Diapasons
 Specoli auricolari, Diapason



Ø = 3,0 mm



HARTMANN
42084-10

HARTMANN

für Säuglinge
 for babies
 para lactantes
 pour nourrissons
 per lattanti

für Erwachsene
 for adults
 para adultos
 pour adultes
 per adulti

- ① = 4,5 mm Ø
42084-11
- ② = 5,5 mm Ø
42084-12
- ③ = 6,5 mm Ø
42084-13
- ④ = 7,5 mm Ø
42084-14

Stück	Fig.	
pieces	Fig.	
piezas	Fig.	
pièces	Fig.	
pezzi	Fig.	
3	2 - 4	42086-03
4	1 - 4	42087-04



HARTMANN
42227-00

Satz zu 5 Stimmgabeln
 42147-10, 42149-11, 42166-12
 42168-13, 42170-14, im Samtetui

Set of 5 Tuning Forks
 42147-10, 42149-11, 42166-12
 42168-13, 42170-14, un velvet-lined case

Juego de 5 Diapasones
 42147-10, 42149-11, 42166-12
 42168-13, 42170-14,
 en estuche forrado de terciopelo

Jeu de 5 Diapasons
 42147-10, 42149-11, 42166-12
 42168-13, 42170-14, en boîte garnie
 de velours intérieurement

Serie di 5 Diapason
 42147-10, 42149-11, 42166-12
 42168-13, 42170-14, in scatola rivestita
 internamente di velluto

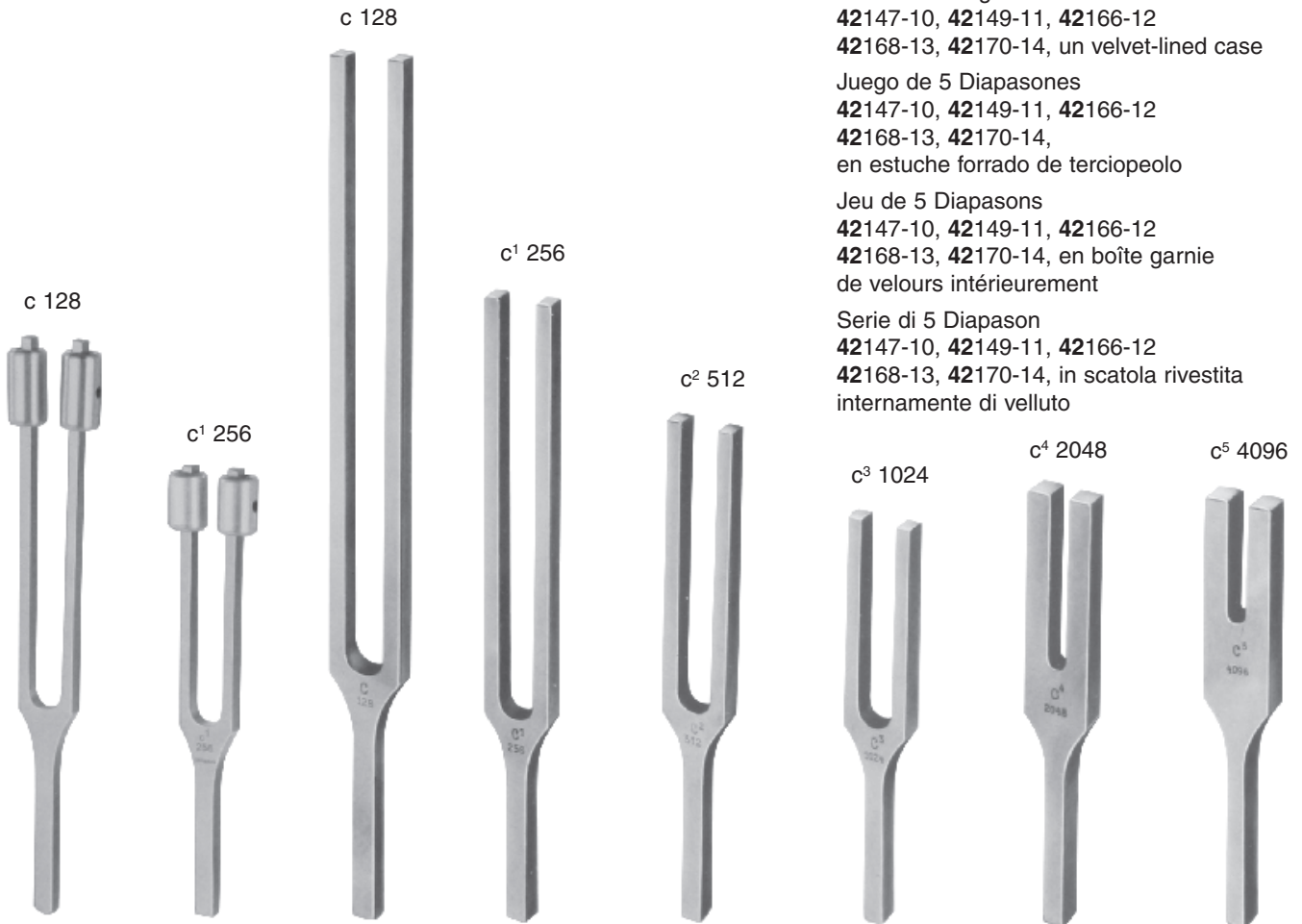

HARTMANN

- 42147-10
- 42149-11
- 42161-10
- 42164-11
- 42166-12
- 42168-13
- 42170-14
- 42172-15



Ohrpinzetten, Polypenzängchen, Fremdkörper-Instrumente
 Ear Dressing Forceps, Polypus Forceps, Foreign Body Instruments
 Pinzas auriculares, Pinzas para pólipos, Instrumentos para cuerpos extraños
 Pincès auriculaires, Pincès pour polypes, Instruments à corps étrangers
 Pinze auricolari, Anse, Uncini per corpi estranei



1/2
TROELTSCH (WILDE)
42347-12
 12 cm / 4³/₄"



1/2
LUCAE
42363-14
 14 cm / 5¹/₂"



1/2
JANSEN
42367-16 = 16 cm / 6¹/₄"
42367-20 = 20 cm / 8"



1/2
HARTMANN
42377-12
 12 cm / 4³/₄"



1/2
HARTMANN
42379-14
 14 cm / 5¹/₂"



1/2
BILLEAU
42526-01 – 03
 16,5 cm / 6¹/₂"



1/2
HARTMANN
42542-16
 16 cm / 6¹/₄"



1/2
LUCAE
42549-01 – 03
 14 cm / 5¹/₂"



1/2
WAGENER
 14 cm / 5¹/₂"

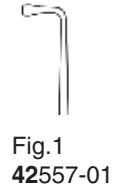

Fig.1
42557-01



Fig.2
42557-02

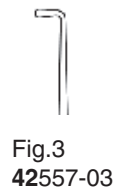

Fig.3
42557-03

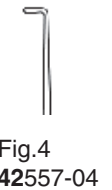
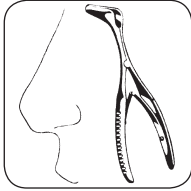

Fig.4
42557-04



Fig.5
42557-05



Nasenspekula, Tamponzange, Elevatorium
 Nasal Specula, Tampon Forceps, Elevators
 Espéculos nasales, Pinzas a taponamientos, Elevatores
 Spéculums nasaux, Pincas à tamponements, Elévateurs
 Specoli nasali, Pinze per medicazione, Scollatori



42817-01



42817-02



42817-03

1/2

HARTMANN-HALLE
 42817-01 – 03
 15 cm / 6"



1/2

TIECK-HALLE
 42824-13
 13,0 cm / 5 1/8"



42824-13
 Fig.1



42824-23
 Fig.2



1/2

KILLIAN
 14,0 cm / 5 1/2"



42828-04
 Fig.4



42828-03
 Fig.3



42828-02
 Fig.2



42828-01
 Fig.1



Nasenspekula, Tamponzange, Elevatorium
 Nasal Specula, Tampon Forceps, Elevators
 Espéculos nasales, Pinzas a taponamientos, Elevatores
 Spéculums nasaux, Pinces à tamponements, Elévateurs
 Specoli nasali, Pinze per medicazione, Scollatori

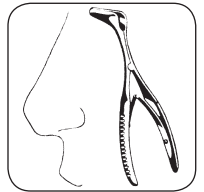

WESTMACOTT
 44093-20
 20 cm / 8"

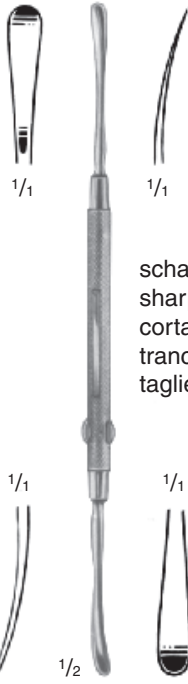

FREER
 44518-18
 18 cm / 7"

scharf / stumpf
 sharp / blunt
 cortante / romo
 tranchant / mousse
 tagliente / smusso



JOSEPH
 44656-15
 15,5 cm / 6"
 Schleimhauthäkchen
 Mucosa Hooklet
 Ganchito para mucosa
 Crochet pour la muqueuse
 Uncino per mucosa

scharf
 sharp
 cortante
 tranchant
 tagliente

scharf
 sharp
 cortante
 tranchant
 tagliente



FREER
 44674-15
 15,0 cm / 6"



JOSEPH
 16,5 cm / 6 1/2"



44676-02
 2 mm



44676-05
 5 mm



44676-07
 7 mm



44676-10
 10 mm

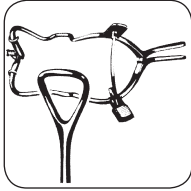

Mundsperrer, Zungendrucker
 Mouth Gags, Tongue Depressors
 Abre-bocas, Abaja-lengua
 Ouvre-bouches, Abaisse-langues
 Apribocca, Abbassalingua



1/2

MAUNDER
 46092-10
 aus Holz
 of wood
 de madera
 en bois
 di legno



1/2

ROSER-KÖNIG
 46151-16 = 16 cm / 6 1/4"

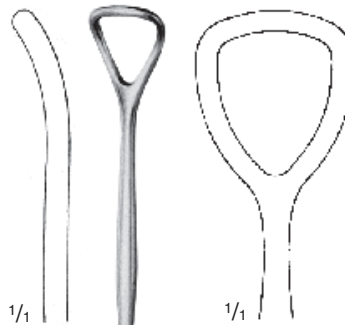

1/1

1/1



1/2

JENNINGS
 46209-09 = 9 cm / 3 1/2"
 46209-11 = 11 cm / 4 1/2"
 46209-13 = 13 cm / 5"
 46209-15 = 15 cm / 6"



1/2

MORITZ-SCHMIDT
 46237-19
 19 cm / 7 1/2"

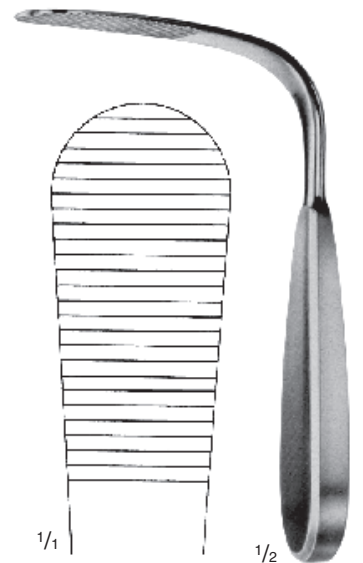

1/1

1/2

TOBOLD
 46253-14
 14,5 cm / 5 1/2"

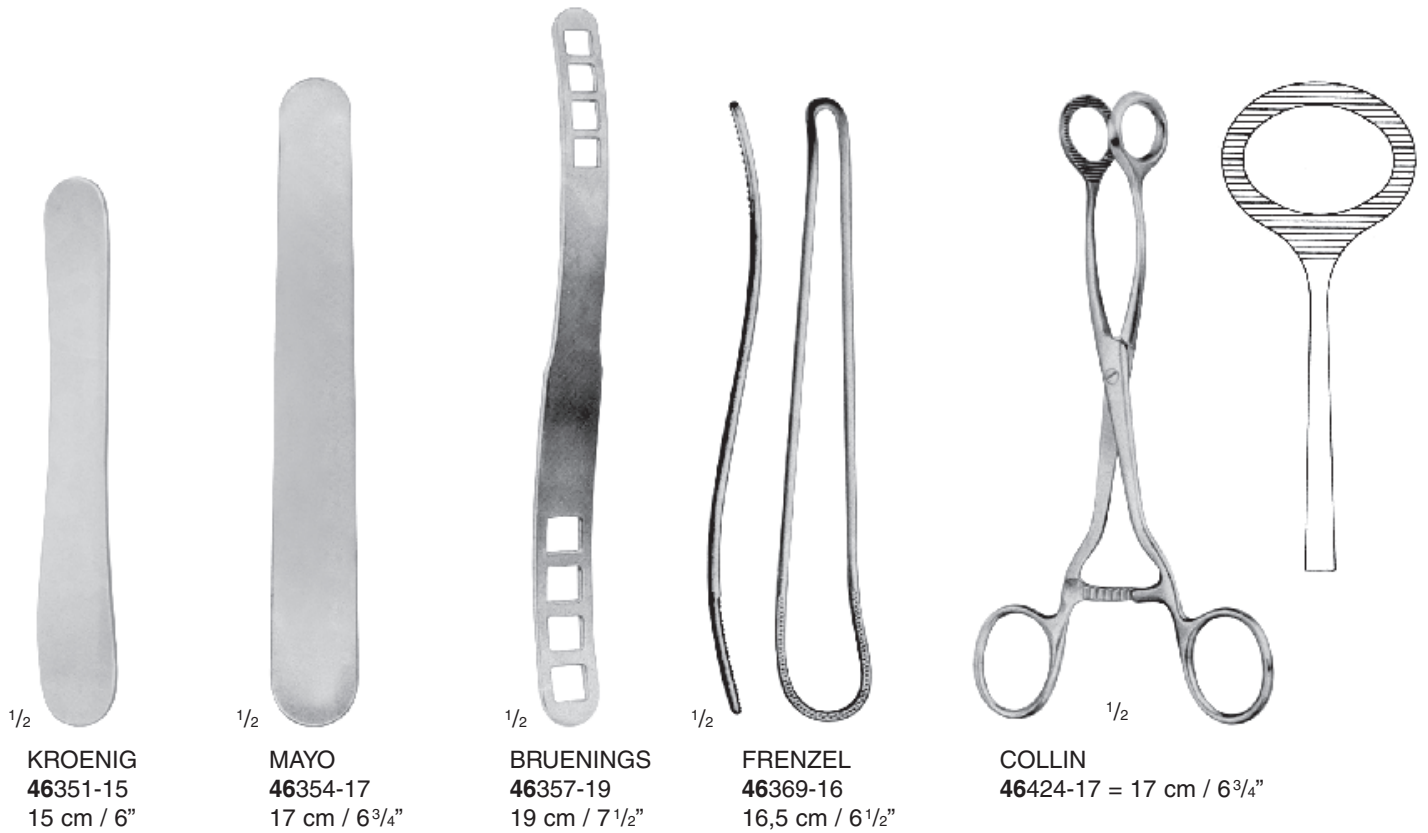
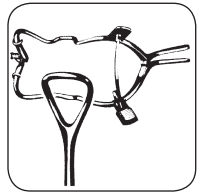

YOUNG
46439-17
17 cm / 6³/₄"

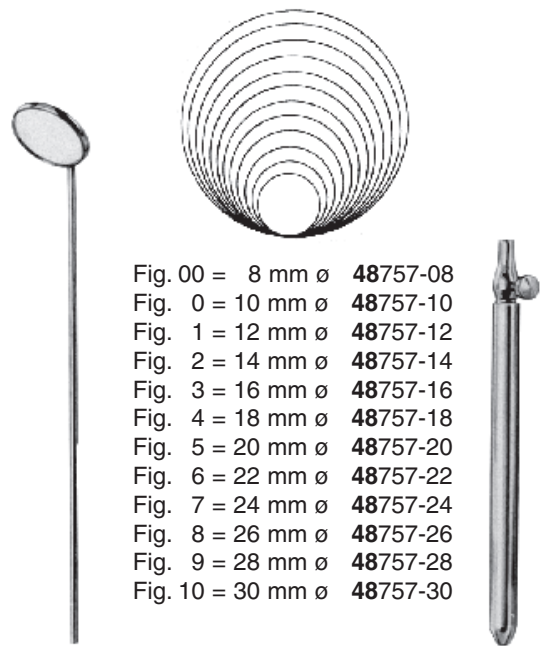



Verband- und Gipsscheren
 Bandage Scissors, Plaster-of-Paris Shears
 Tijeras para vendajes, Cizallas para vendajes enyesados
 Cizailles pour pansements et appareils plâtrés
 Cesioie per bendaggi ed apparecchi gessati



für Finger
 for fingers
 para dedos
 pour doigts
 per dita



LORENZ
50127-23
 23 cm / 9"



KNOWLES
50132-14
 14 cm / 5 1/2"



LISTER
50137-09 = 9 cm / 3 1/2"
50137-11 = 11 cm / 4 1/2"
50137-14 = 14 cm / 5 1/2"
50137-18 = 18 cm / 7"
50137-20 = 20 cm / 8"



BERGMANN
50167-23
 23 cm / 9"



ESMARCH
50177-20 = 20 cm / 8"
50177-22 = 22 cm / 8 3/4"



UNIVERSAL
50179-15 = 15 cm / 6"
50179-18 = 18 cm / 7"



1/2

BRUNS
50193-24
24 cm / 9 1/2"



1/2

BRUNS
50195-24
24 cm / 9 1/2"

gezahnt
toothed
dentada
dentelée
dentellata



1/2

STILLE
50247-20 = 20 cm / 8"
50247-23 = 23 cm / 9"
50247-26 = 26 cm / 10 1/4"
50247-37 = 37 cm / 14 1/2"



1/2

HOPKINS
50373-20
20 cm / 8"



1/2

ESMARCH
50392-18
18 cm / 7"



1/2

ENGEL
50452-14



Gipsspreizer, Gipsabreißzangen
 Plaster Cast Instruments
 Instrumentos para vendajes enyesados
 Pinces pour les appareils plâtrés
 Divaricatori, Pinze per gessi



HAGLUND-STILLE
 50474-28
 28 cm / 11"

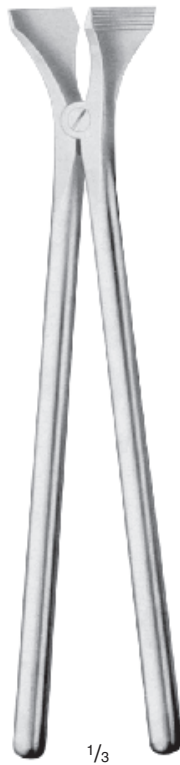

BEESON
 50482-30
 30 cm / 12"



HENNING
 50492-28
 28 cm / 11"

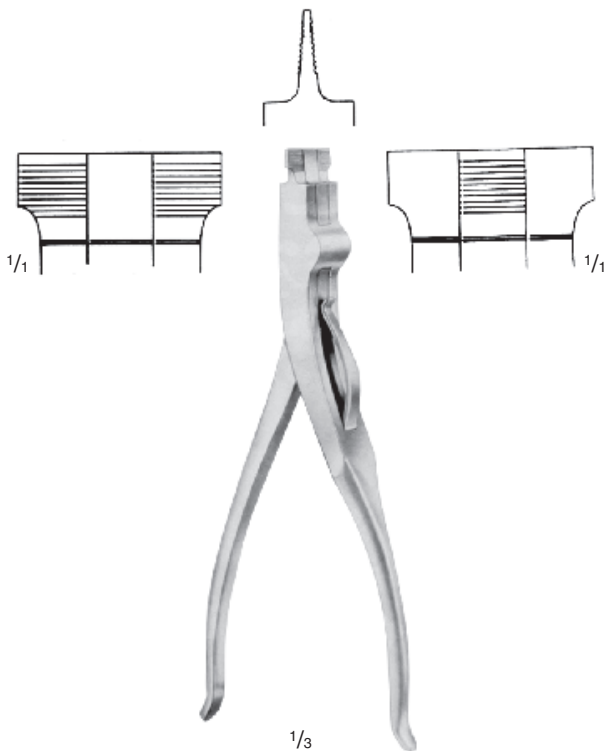

MOD. USA
 50494-23
 23 cm / 9"



WOLFF
 50513-18
 18 cm / 7"

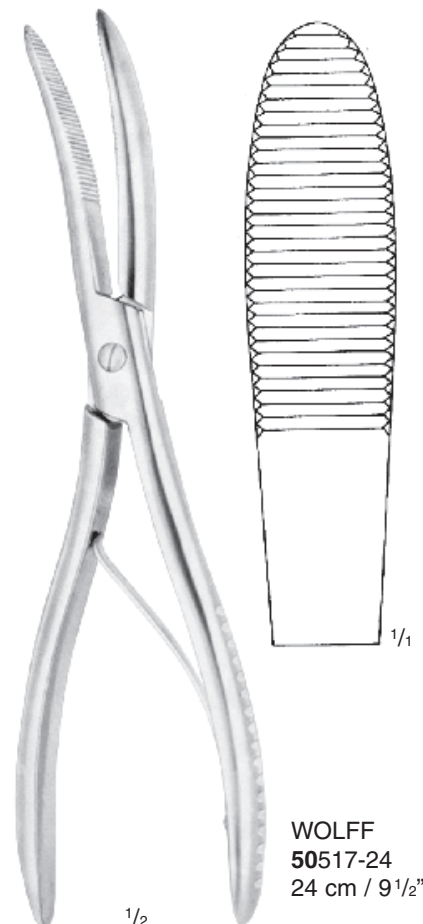

WOLFF
 50517-24
 24 cm / 9 1/2"

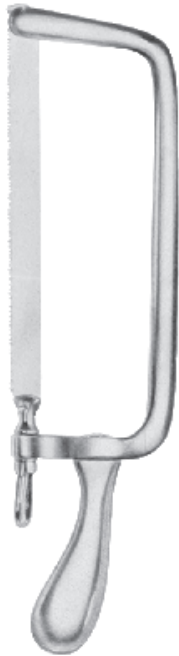

Ersatzsägeblatt
Spare saw blade
Hoja de sierra de repuesto
Lame de scie de rechange
Lama di sega di ricambio

52073-52 = 12 mm
52073-55 = 15 mm

CHARRIÈRE
52073-35
35 cm / 14"



Ersatzsägeblatt
Spare saw blade
Hoja de sierra de repuesto
Lame de scie de rechange
Lama di sega di ricambio

52073-63 = 4 mm
52073-65 = 6 mm
52073-67 = 8 mm

HELFERICH-BIER
52075-39
39 cm / 15 1/2"



1/3

LANGENBECK
52082-23
23 cm / 9"



CHARRIÈRE
52084-27 = 27 cm / 10 1/2"
52084-30 = 30 cm / 12"



SATTERLEE
52086-31
31 cm / 12 1/4"



TOP DUR Drahtzangen
 TOP DUR Wire Twisting Forceps
 TOP DUR Pinzas para torcer hilos
 TOP DUR Pinces à torsader le fil
 TOP DUR Pinze per torcere fili

Draht-Kneifzangen
 Wire Cutting Pliers
 Alicates para cortar alambre
 Pinces à couper le fil
 Tenaglie taglia fili



N 1/1
 52471-20
 20 cm / 8"



N 1/1
 52472-15
 15 cm / 6"

N 1/1
 52473-15
 15 cm / 6"



N
 52474-20
 20 cm / 8"

BERRY



52480-25
 24 cm / 9 1/2"

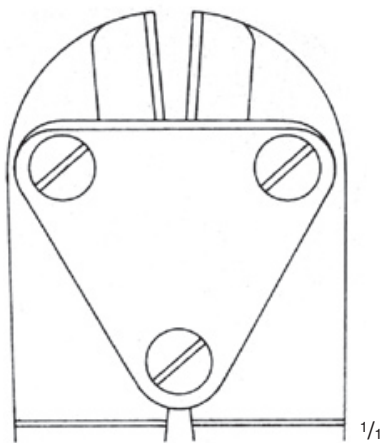

1/1

spezialvergütete
 Schneiden

specially heat-treated
 cutting edges

bocas de acero
 especial de gran dureza

Mors d'acier

Tronchese con taglio à
 tempra speciale



1/2

52484-15 - 52486-18

N
 52484-15
 15 cm / 6"

N
 52484-18
 18 cm / 7"

N
 52485-18
 18 cm / 7"

N
 52486-18
 18 cm / 7"

TOP DUR Draht-Kneifzangen
TOP DUR Wire Cutting Pliers
TOP DUR Alicates para cortar alambre
TOP DUR Pinces à couper le fil
TOP DUR Tenaglie taglia fili

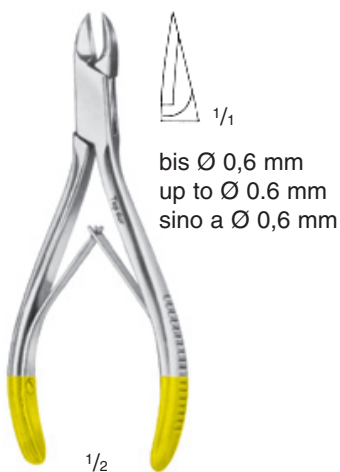
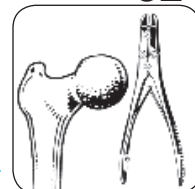

bis Ø 0,6 mm
up to Ø 0.6 mm
sino a Ø 0,6 mm

52495-12
12 cm / 4³/₄"

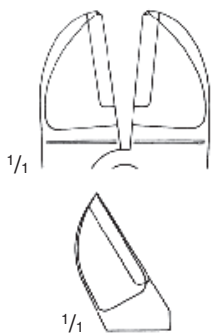

bis Ø 1,7 mm
up to Ø 1.7 mm
sino a Ø 1,7 mm

52495-18
18 cm / 7"

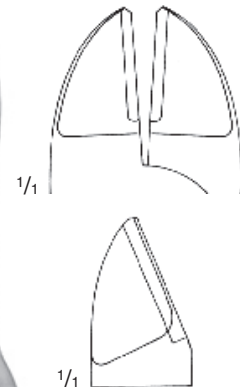

bis Ø 1,5 mm
up to Ø 1.5 mm
sino a Ø 1,5 mm

52495-20
20 cm / 8"

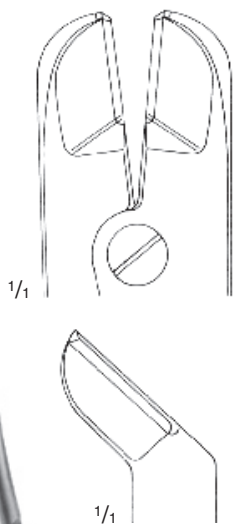

bis Ø 2,5 mm
up to Ø 2.5 mm
sino a Ø 2,5 mm

52495-22
22 cm / 8³/₄"

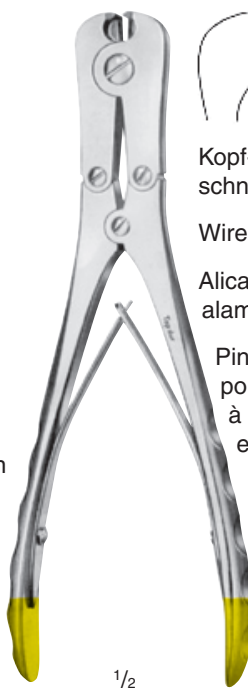

bis Ø 1,7 mm
up to Ø 1.7 mm
sino a Ø 1,7 mm



Kopf- und Seiten-
schneider
Wire Cutting Pliers
Alicates para cortar
alambre

Pinces courpantes
pour fil métallique
à trancher latéral
et frontal

Tenaglie tagliafi-
li,
taglio laterale
e frontale

52532-18
18 cm / 7"

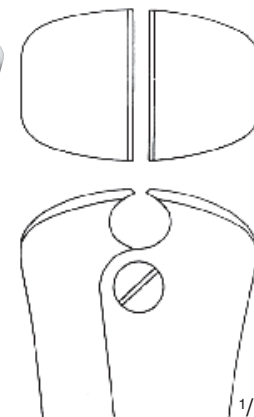
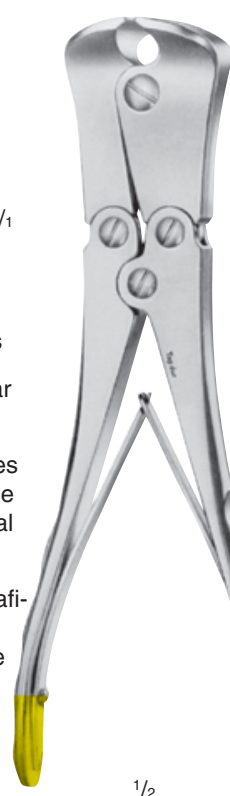

spezialvergütete
Schneiden
specially heat-treated
cutting edges
bocas de acero
especial de gran dureza
Mors d'acier
Tronchese con taglio à
tempra speciale

52535-22
22 cm / 8³/₄"



TOP DUR Bolzenschneider
 TOP DUR Wire Cutting Pliers
 TOP DUR Alicates para cortar alambre
 TOP DUR Pinces pour couper les broches
 TOP DUR Tenaglie taglia fili



Bolzenschneider mit spezialvergüteten Schneiden zum Abzwicken von Kirschner-Drähten, Tibia-Kopf-Schrauben und Nägeln bis zu Ø 6 mm.

Cutter with specially harden edges for cutting of Kirschner wires, Tibia head screws, bolts, pins drilling wires, up to diameter 6 mm.

corta-bulones con corte de dureza para alambres de Kirschner, pernos roscados para tibia, y clavos hasta un diametro de 6 mm.

Coupe-boulons pour couper les boulons filetés, les clous et broches, jusqu'à un diamètre de 6 mm.

Tronchese con taglio a tempra speciale per tagliare bulloni, chiodi e fili metallici sino al diam. di 6 mm.

52495-47
 47 cm / 18 1/2"

52495-54
 54 cm / 21"



TOP DUR Flachzangen, Draht-Kneifzangen
 TOP DUR Flat Pliers Wire Cutting Pliers
 TOP DUR Alicates planos, Alicates para cortar calambre
 TOP DUR Pinces serre-fil, Pinces à couper le fil
 TOP DUR Tenaglie piatte, Tenaglie taglia fili

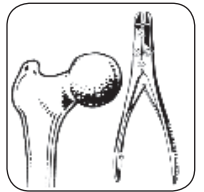

2 mm
 1/1
52521-18
 18 cm / 7"



5 mm
 1/1

52524-20
 20 cm / 8"



1/1

52525-17
 17 cm / 6 3/4"

4 mm
 1/1
52522-18
 18 cm / 7"

6 mm
 1/1
52523-18
 18 cm / 7"



52528-16
 16 cm / 6 1/4"



52530-18
 18 cm / 7"

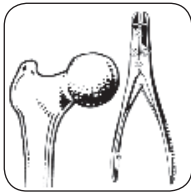

Bohrdrähte
Wire Drills
Broches
Agujas de Kirschner
Fili perforatori di Kirschner



mit Trokarspitze
with trocar point
puntas de trocar
à pointe trocar
con punta a trequarti

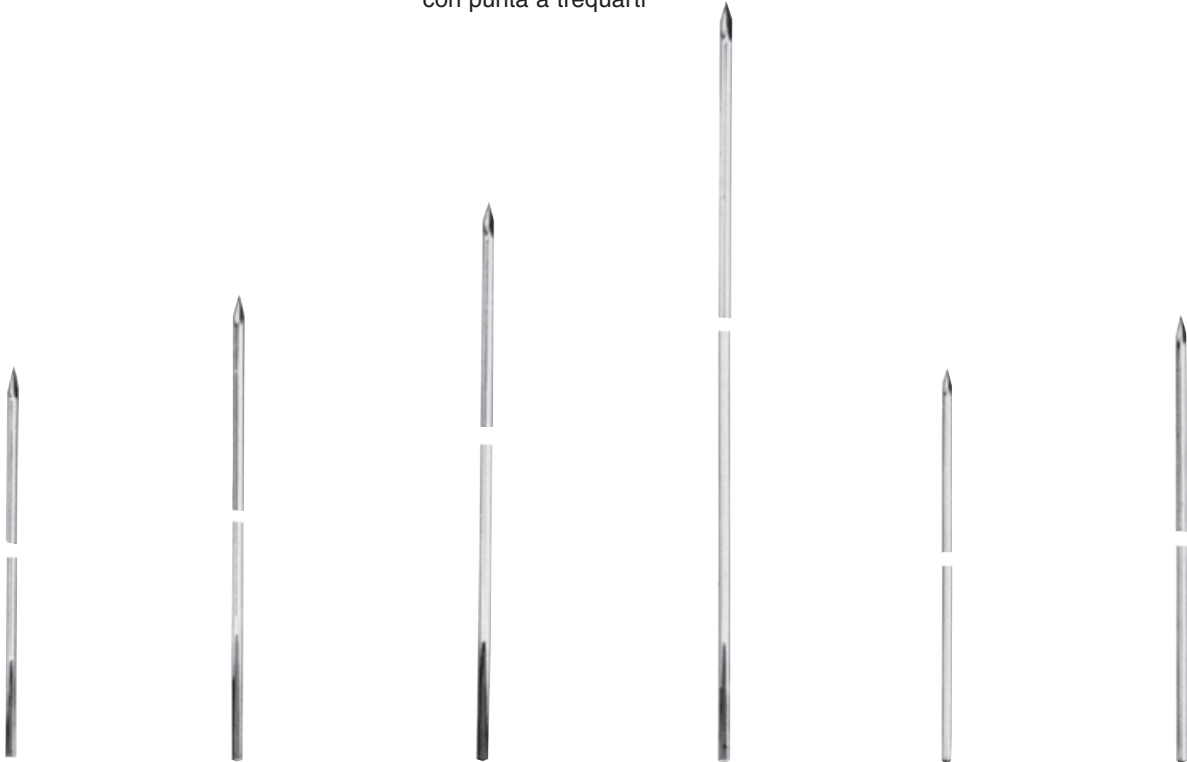

mit flachem Ende
with flat shaft
con término plano
à extrémité plate
con estremitá piatta

mit rundem Ende
with round shaft
con vástago rodondo
à extrémité ronde
con estremitá rotonda

KIRSCHNER

mm ø	6 cm / 2 1/4"	10 cm / 4"	15,5 cm / 6"	31 cm / 12 3/4"	6 cm / 2 1/4"	10 cm / 4 3/4"
0,8	52594-08	52595-08	52596-08	52597-08	52598-08	52599-08
0,9	52594-09	52595-09	52596-09	52597-09	52598-09	52599-09
1,0	52594-10	52595-10	52596-10	52597-10	52598-10	52599-10
1,1	52594-11	52595-11	52596-11	52597-11	52598-11	52599-11
1,2	52594-12	52595-12	52596-12	52597-12	52598-12	52599-12
1,3	52594-13	52595-13	52596-13	52597-13	52598-13	52599-13
1,4	52594-14	52595-14	52596-14	52597-14	52598-14	52599-14
1,5	52594-15	52595-15	52596-15	52597-15	52598-15	52599-15
1,6	52594-16	52595-16	52596-16	52597-16	52598-16	52599-16
1,7	52594-17	52595-17	52596-17	52597-17	52598-17	52599-17
1,8	52594-18	52595-18	52596-18	52597-18	52598-18	52599-18
1,9	52594-19	52595-19	52596-19	52597-19	52598-19	52599-19
2,0	52594-20	52595-20	52596-20	52597-20	52598-20	52599-20
2,2	52594-22	52595-22	52596-22	52597-22	52598-22	52599-22
2,4	52594-24	52595-24	52596-24	52597-24	52598-24	52599-24
2,5	52594-25	52595-25	52596-25	52597-25	52598-25	52599-25
2,8	52594-28	52595-28	52596-28	52597-28	52598-28	52599-28
3,0	52594-30	52595-30	52596-30	52597-30	52598-30	52599-30

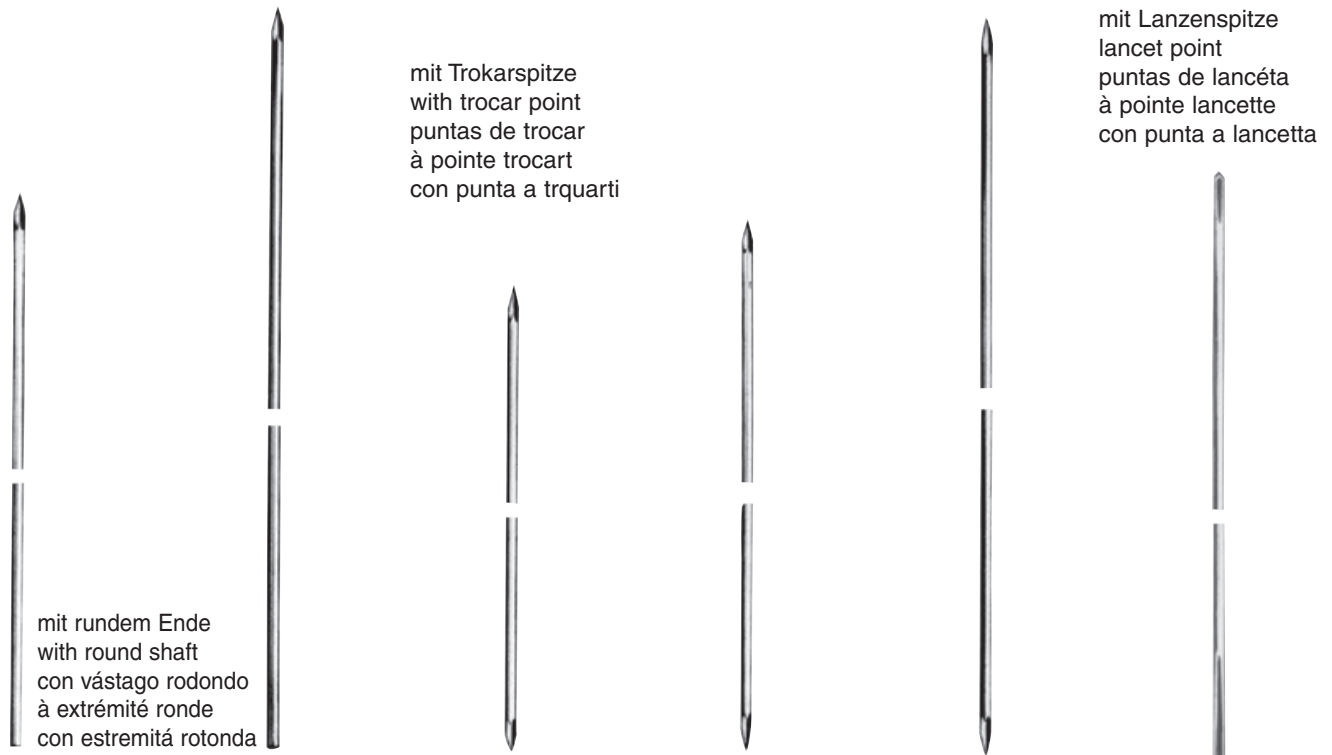
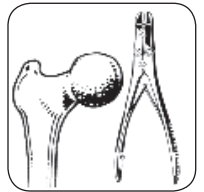

KIRSCHNER

mm ø	15,5 cm / 6"	31 cm / 12 ³ / ₄ "	10 cm / 4"	15 cm / 6"	31 cm / 12 ³ / ₄ "	31 cm / 12 ³ / ₄ "
0,8	52600-08	52601-08	52602-08	52604-08	52606-08	52610-08
0,9	52600-09	52601-09	52602-09	52604-09	52606-09	52610-09
1,0	52600-10	52601-10	52602-10	52604-10	52606-10	52610-10
1,1	52600-11	52601-11	52602-11	52604-11	52606-11	52610-11
1,2	52600-12	52601-12	52602-12	52604-12	52606-12	52610-12
1,3	52600-13	52601-13	52602-13	52604-13	52606-13	52610-13
1,4	52600-14	52601-14	52602-14	52604-14	52606-14	52610-14
1,5	52600-15	52601-15	52602-15	52604-15	52606-15	52610-15
1,6	52600-16	52601-16	52602-16	52604-16	52606-16	52610-16
1,7	52600-17	52601-17	52602-17	52604-17	52606-17	52610-17
1,8	52600-18	52601-18	52602-18	52604-18	52606-18	52610-18
1,9	52600-19	52601-19	52602-19	52604-19	52606-19	52610-19
2,0	52600-20	52601-20	52602-20	52604-20	52606-20	52610-20
2,2	52600-22	52601-22	52602-22	52604-22	52606-22	52610-22
2,4	52600-24	52601-24	52602-24	52604-24	52606-24	52610-24
2,5	52600-25	52601-25	52602-25	52604-25	52606-25	52610-25
2,8	52600-28	52601-28	52602-28	52604-28	52606-28	52610-28
3,0	52600-30	52601-30	52602-30	52604-30	52606-30	52610-30

Sämtliche Bohrdrähte auch in anderen Längen lieferbar!
On request, available in any other length needed!
Entregable en otras medidas!
Livrables, sur demande, dans toute autre longueur!
Fornibili anche in lunghezze diverse!

Lieferbar in Packungen zu je 10 Stück (ausgenommen ø 3 mm)
Available in packages of 10 pieces (except 3 mm ø)
Paquete de 10 piezas
Livrables par paquets de 10 pièces (sauf 3 mm ø)
Fornibili in pacchetti a 10 pezzi (all'infuori 3 mm di ø)

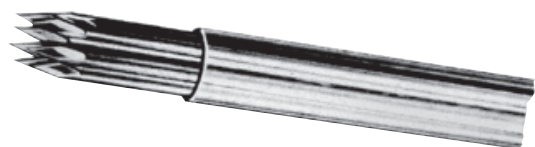



Knochenmeißel
Bone Chisels and Gouges
Cinceles y Gubias para huesos
Ciseaux-burins et Gouges
Osteotomi, Scalpelli, Sgorbie



breit width ancho largeur largh. mm				
	1/2	1/2	1/2	
	JANSEN			
	13,5 cm / 5 1/4"			
	4	54072-04	54073-04	54074-04
	6	54072-06	54073-06	54074-06
	8	54072-08	54073-08	54074-08
10	54072-10	54073-10	54074-10	
12	54072-12	54073-12	54074-12	
14	54072-14	54073-14	54074-14	
16	54072-16	54073-16	54074-16	

← 25 mm →



54093-50
 13,5 cm / 5 1/4"
 r = 50 mm

54093-60
 13,5 cm / 5 1/4"
 r = 60 mm

54093-70
 13,5 cm / 5 1/4"
 r = 70 mm

Hohlmeißelklingen, auswechselbar
 Gouge blades, interchangeable
 Hojas de gubia, intercambiables
 Lames-gouges, interchangeables
 Lame intercambiabili, concavo

54094-05
 8,5 cm / 3 1/3"
 5 mm

54094-10
 8,5 cm / 3 1/3"
 10 mm

54094-16
 8,5 cm / 3 1/3"
 16 mm

54094-25
 8,5 cm / 3 1/3"
 25 mm

Meißelklingen, auswechselbar
 Chisel blades, interchangeable
 Hojas de cincel, intercambiables
 Lames-ciseaux-burin, interchangeables
 Lame intercambiabili,



1/2

54094-00
 18,5 cm / 7 1/4"
 Griff, allein
 Handle, only
 Mango, suelto
 Manche, seul
 Manico, solo



54094-01
 9,0 cm / 3 1/2"
 Spanschlüssel
 Key
 Llave
 Clé
 Chiave



54094-90
 Ersatzschraube
 Spare Screw
 Tornillo de repuesto
 Vis de rechange
 Vite di ricambio

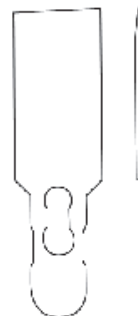

54094-55
 8,5 cm / 3 1/3"
 5 mm

54094-60
 8,5 cm / 3 1/3"
 10 mm

54094-66
 8,5 cm / 3 1/3"
 16 mm

54094-85
 8,5 cm / 3 1/3"
 25 mm

Osteotomklingen, auswechselbar
 Osteotome blades, interchangeable
 Hojas de osteotomo, intercambiables
 Lames per osteotomia, interchangeables
 Lame per osteotomia, intercambiabili,



	breit width ancho largeur largh. mm		STILLE 20 cm / 8"	
1/2	4	54095-04	54096-04	54099-04
	6	54095-06	54096-06	54099-06
	8	54095-08	54096-08	54099-08
	10	54095-10	54096-10	54099-10
	12	54095-12	54096-12	54099-12
	15	54095-15	54096-15	54099-15
	20	54095-20	54096-20	54099-20
	25	54095-25	54096-25	54099-25

	breit width ancho largeur largh. mm		
1/2	4	54104-04	54105-04
	6	54104-06	54105-06
	8	54104-08	54105-08
	10	54104-10	54105-10
	12	54104-12	54105-12

MINI-LEXER
 54104 – 54105
 18 cm / 7"

	breit width ancho largeur largh. mm		
1/2	7	54106-07	54107-07
	10	54106-10	54107-10
	12	54106-12	54107-12
	15	54106-15	54107-15
	20	54106-20	54107-20
	25	54106-25	54107-25
	30	54106-30	54107-30

LEXER
 54106 – 54107
 22 cm / 8 3/4"



Knochenmeißel, Knochenfeilen
Bone Chisels and Gouges, Bone File
Cinceles y Gubias para huesos, Lima para huesos
Ciseaux-burins et Gouges, Lime à os
Osteotomi, Scalpelli, Sgorbie, Raspe



breit
width
ancho
largeur
largh.
mm

3	54108-03
4	54108-04
6	54108-06
8	54108-08
10	54108-10
12	54108-12
15	54108-15

MINI-LAMBOTTE
54108-
12,5 cm / 5"

breit
width
ancho
largeur

LAMBOTTE
54110-54111

largh. mm	24 cm / 9 1/2"	23 cm / 9"
4	54110-04	54111-04
6	54110-06	54111-06
8	54110-08	54111-08
10	54110-10	54111-10
12	54110-12	54111-12
15	54110-15	54111-15
20	54110-20	54111-20
25	54110-25	54111-25
30	54110-30	54111-30
38	54110-38	54111-38
44	54110-44	54111-44

breit
width
ancho
largeur
largh.
mm

HIBBS
24 cm / 9 1/2"

6	54142-06	54144-06	54148-06
13	54142-13	54144-13	54148-13
19	54142-19	54144-19	54148-19
25	54142-25	54144-25	54148-25
32	54142-32	54144-32	54148-32

PUTTI
54153-30
30 cm / 12"

54155-27
27 cm / 10 1/2"



30 mm ø
510 g



Stahl, massiv
steel, solid
acero, macizo
acier, solide
acciaio, pieno

1/3

54190-22
22,5 cm / 9"

26 mm ø
180 g

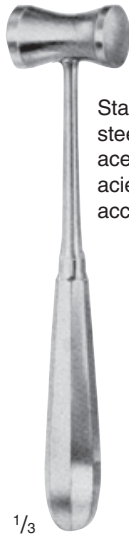

Stahl, massiv
steel, solid
acero, macizo
acier, solide
acciaio, pieno

1/3

HÄJEK
54194-21
21 cm / 8 1/4"

42 mm ø



Kunststoff, bleigefüllt
plastic, lead filled
plástico, relleno de plomo
matière plastique
garni de plomb
materia plastica,
guarnito di piombo

1/3

54208-01 26 cm / 10 1/4" **54208-02**
400 g 250 g



Kopf
head
cebeza
tête
testa
Ø 30 mm

Gewicht
weight
pesp
poids
peso
675 gr.

1/3

54212-29
26,5 cm / 10 1/2"
plan (Nylon)/konvex (Stahl) Kunststoffgriff
Plane (Nylon)/convex (steel) plastic handle
plano (nilon)/convexo (acero) mango de
plastico
plan (nylon)/convexe (acier) manche en
matière plastique
plano (nilon)/convesso (acciaio) manico
in materia plastica

30 mm ø
480 g



Stahl, massiv
mit Kunststoffstiel
steel, solid
with plastic handle
acero, macizo
mango de materia plástica
acier, solide, manche
en matière plastique
acciaio, pieno, con manico
in materia plastica

1/3

54216-24
24 cm / 9 1/2"



54227-00
Ersatzbacken (Paar)
Spare Facings (pair)

Kopf
head
cebeza
tête
testa
Ø 37 mm

Gewicht
weight
pesp
poids
peso
370 gr.

1/3

54226-22
24,0 cm / 9 1/2"
Backen und Griff aus Kunststoff
dicks and handle of plastic
Mango y tapas de plástico
Manche et plaques en matière plastique
Manico e placche in materia plastica



Stahl, massiv
steel, solid
acero, macizo
acier, solide
acciaio, pieno

1/3

54232-01 Fig. 1 450 g
54232-02 Fig. 2 900 g
26,5 cm / 10 1/2"

40 mm ø
510 g



massiv
solid
macizo
solide
pieno

1/3

BERGMANN (HIBBS)
54234-23
22,5 cm / 9"



Scharfe Löffel
Bone Curettes
Cucharillas cortantes
Curettes
Cucchiai taglienti



1/2
SCHEDE
17 cm / 6 3/4"

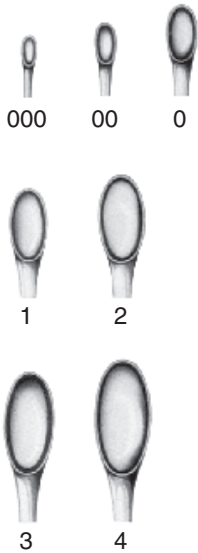

SCHEDE	Fig.	VOLKMANN
	0000	54276-40
54272-30	000	54276-30
54272-20	00	54276-20
54272-10	0	54276-10
54273-01	1	54277-01
54273-02	2	54277-02
54273-03	3	54277-03
54273-04	4	54277-04
	5	54277-05
	6	54277-06

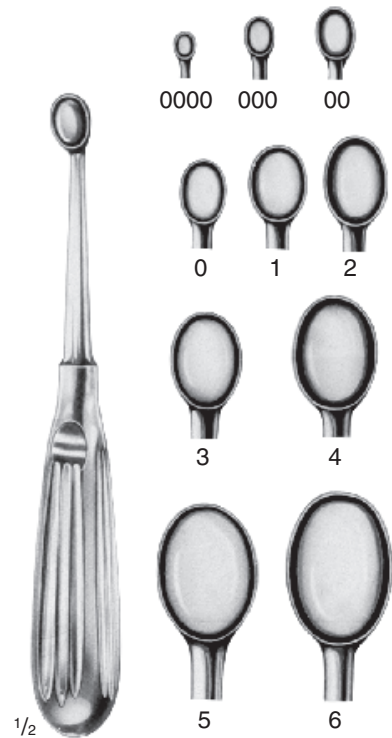

1/2
VOLKMANN
17 cm / 6 3/4"

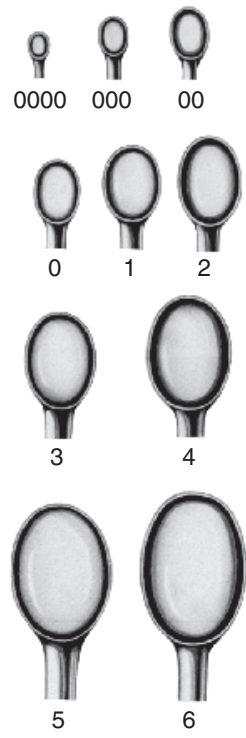

1/2
STILLE
18 cm – 22 cm
7" - 8 3/4"

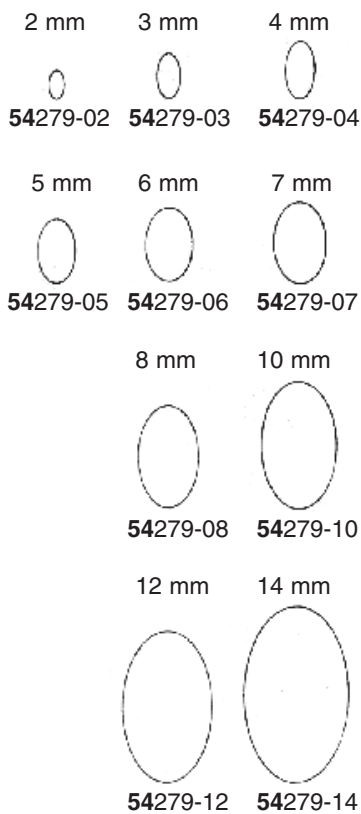

BRUNS	Fig.
54280-30	000
54280-20	00
54280-10	0
54281-01	1
54281-02	2
54281-03	3
54281-04	4
54281-05	5
54281-06	6

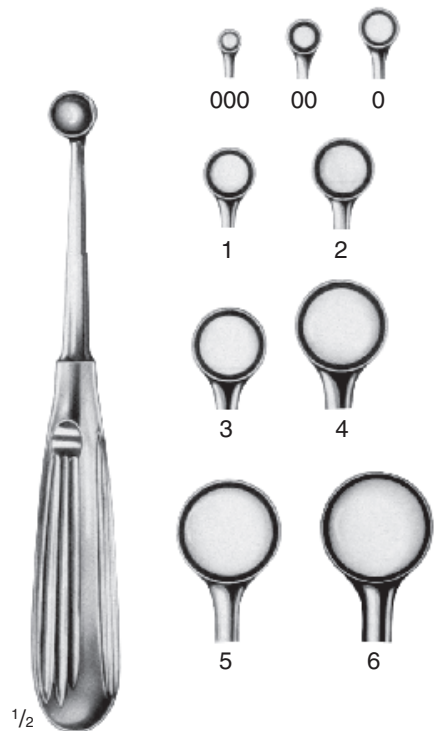

1/2
BRUNS
16 cm / 6 1/4"





Scharfe Löffel, Raspatorien
 Bone Curettes, Periosteal Raspatories
 Cucharillas cortantes, Legras-Periostótomos
 Curettes, Rugines-raspatoires
 Cucchiari taglienti Periostotomi

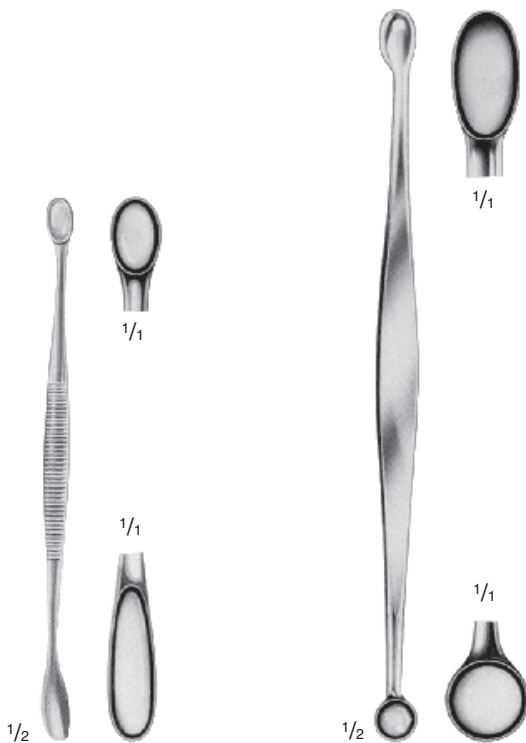

VOLKMANN	cm	in.
54324-13	13	5"
54324-14	14	5 1/2"
	16	6 1/4"
54324-17	17	6 3/4"
	20	8"

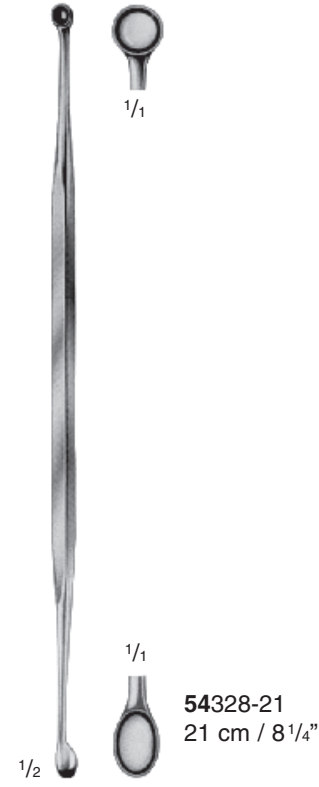

54328-21
 21 cm / 8 1/4"



LANGENBECK
 54374-19
 19 cm / 7 1/2"

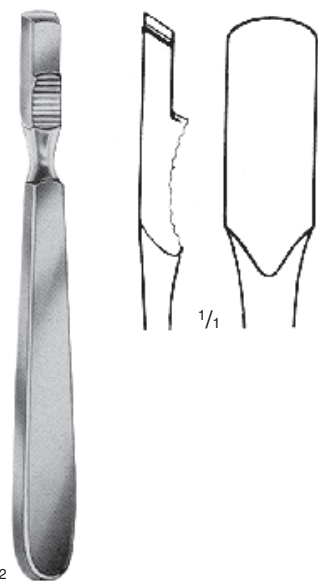

FARABEUF
 54390-15
 15 cm / 6"

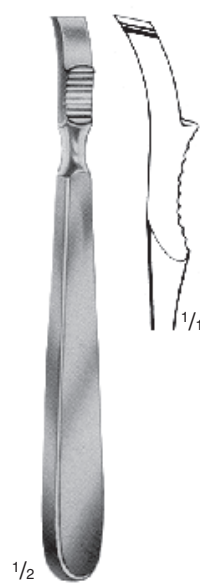

FARABEUF
 54391-15
 15 cm / 6"

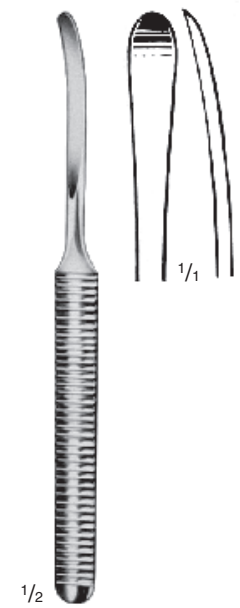

WILLIGER
 54408-16
 16 cm / 6 1/4"



Raspatorien
 Periosteal Raspatories
 Legras-Periostótomos
 Rugines-raspatoires
 Periostotomi costali



1/2

DOYEN
 54413-17
 54417-17
 17 cm / 6³/₄"



1/2

DOYEN
 54415-17
 54419-17
 17 cm / 6³/₄"

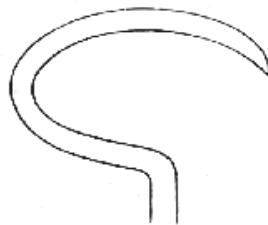

54413-17

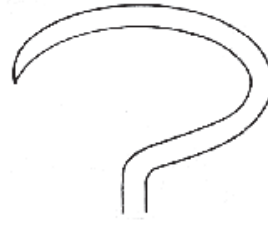

54415-17



54417-17



54419-17



1/2

LAMBOTTE
 21 cm / 8¹/₄"

Breite
 width
 ancho
 largeur
 larghezza
 mm

54433-10	10
54433-15	15
54433-20	20
54433-25	25



1/2

SEMB



54422-01
 18,5 cm / 7¹/₄"



54422-02
 21 cm / 8¹/₄"



54422-03
 18,5 cm / 7¹/₄"



54422-04
 21 cm / 8¹/₄"



54422-05
 20,5 cm / 8"



54422-06
 20,5 cm / 8"



54422-07
 22,5 cm / 9"



Knochenfeilen, Elevatorien, Meniskotome
 Bone File, Elevators, Meiskotomy Knives
 Lima para huesos, Elevadores, Bisturios para meniscos
 Lime à os, Relévateurs, Bistouris à ménisques
 Raspe, Lime, Leve per ossa, Meniscotomi, Scollatendini

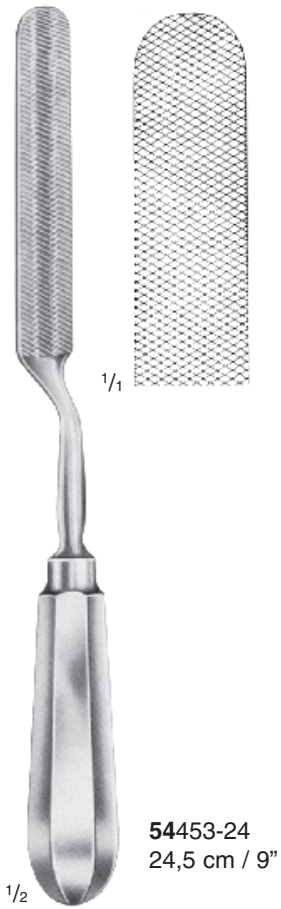

54453-24
24,5 cm / 9"

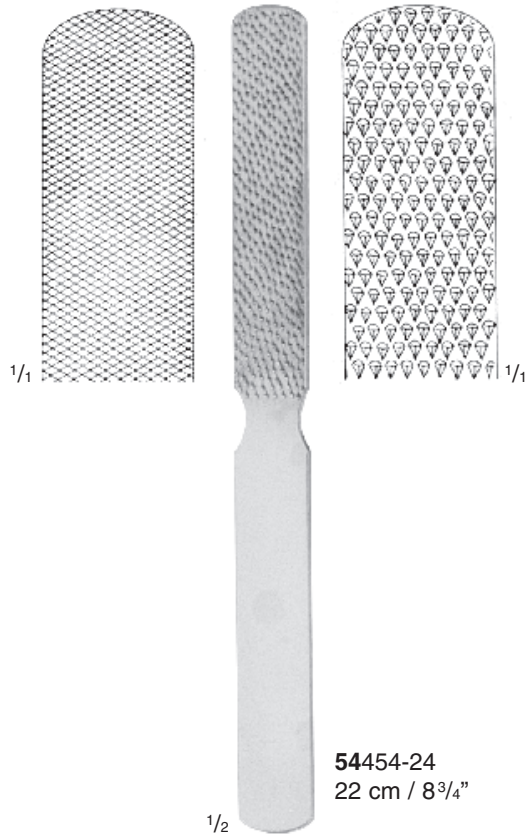

54454-24
22 cm / 8³/₄"



LANGENBECK
54467-20
20 cm / 8"



LANGENBECK
54469-20
20 cm / 8"



SMILLE
54602-17
17 cm / 6³/₄"



SMILLE
54603-17
17 cm / 6³/₄"



SMILLE
54605-17
17 cm / 6³/₄"

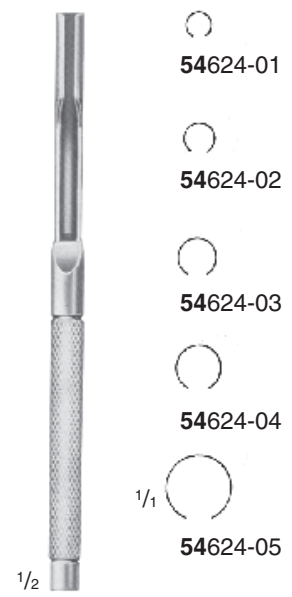

BUNNELL
54624-
15 cm / 6"



Knochenhaltezaugen, Retraktor
 Bone Holding Forceps, Retractors
 Pinzas para huesos, Retractores
 Daviers porte-os, Rétracteur
 Tenaglie per ossa, Pinze per Menisco, Retrattore per Amputazioni



1/2
CARROLL
54651-11
 11,5 cm / 4 1/2"

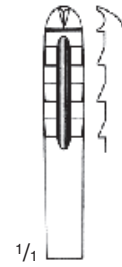

1/1
54682-20
 20 cm / 8"

gerade
 straight
 recta
 droite
 retta



1/1
54683-20
 20 cm / 8"

aufgebogen
 curved-on-flat
 curva sobre el plano
 courbe sur le plat
 curva sul piatto

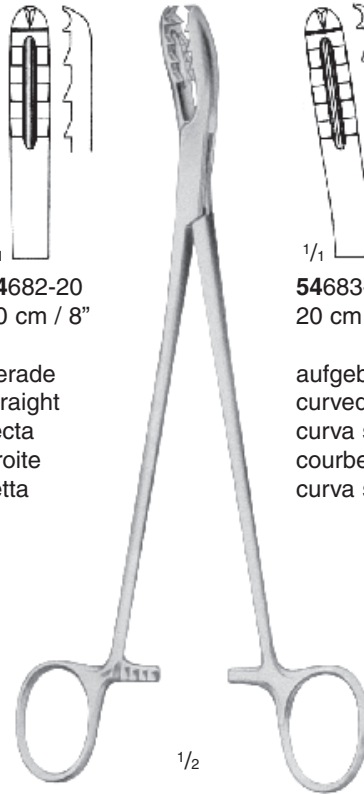

1/2
BIRCHER-GANSKE
54682-20 – 54683-20
 20 cm / 8"

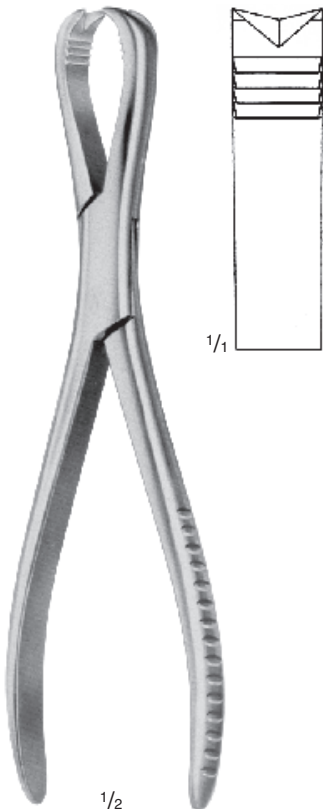

1/2
LANGENBECK
54694-21
 21 cm / 8 1/4"

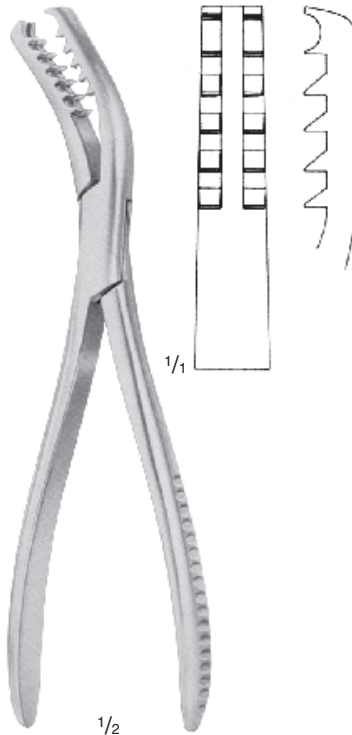

1/2
SEMB
54703-19
 19 cm / 7 1/2"



1/3
 einfaches Modell, Griffe abnehmbar
 simple pattern, handles detachable
 modelo sencillo, mangos removibles
 modèle simple, manches à détacher
 modello semplice, manici smontabili
PERCY
54734-30



MINI-FRIEDMAN
54771-12
12 cm / 5"



FRIEDMAN
54773-14
14 cm / 5 1/2"



MEAD
54787-16
16,5 cm / 6 1/2"

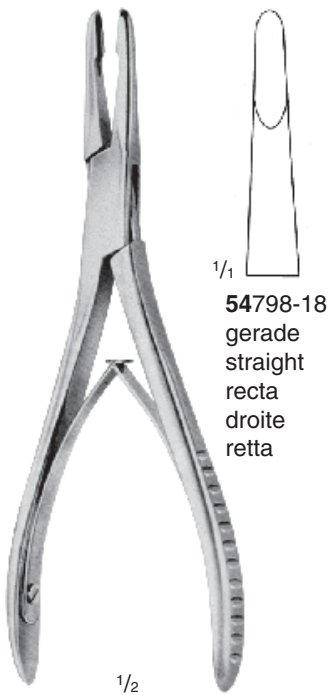

JANSEN
54798-18 – 54799-18
18 cm / 7"

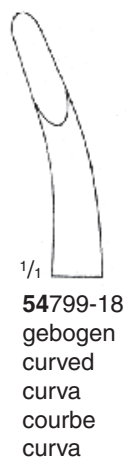

54799-18
gebogen
curved
curva
courbe
curva

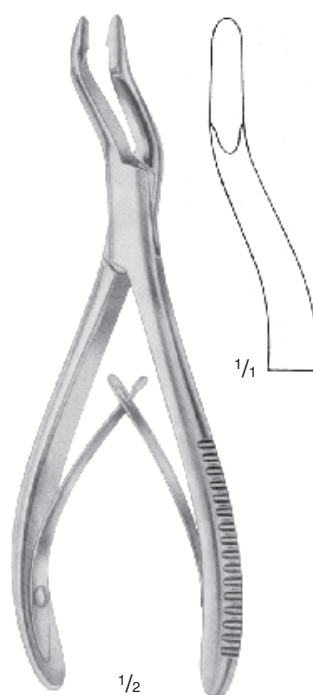

JANSEN
54802-19
19 cm / 7 1/2"

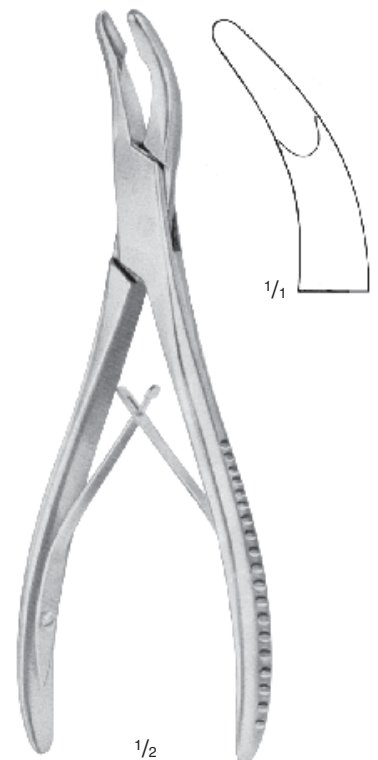

OLIVECRONA
54803-20
20 cm / 8"



Hohlmeißelzangen
 Bone Rongeur Forceps
 Pinzas-gubias
 Pincès-gouges
 Pinze-sgorbie



54805-02
2 mm



54805-03
3 mm

BEYER
54805-02 – 54805-03
 17 cm / 6³/₄"



BLUMENTHAL
54807-15
 15,5 cm / 6"



54818-17
 gerade
 straight
 recta
 droite
 retta



54819-17
 gebogen
 curved
 curva
 courbe
 curva

LUER
54818-17 – 54819-17
 17 cm / 6³/₄"



LUER
54825-15
 15 cm / 6"

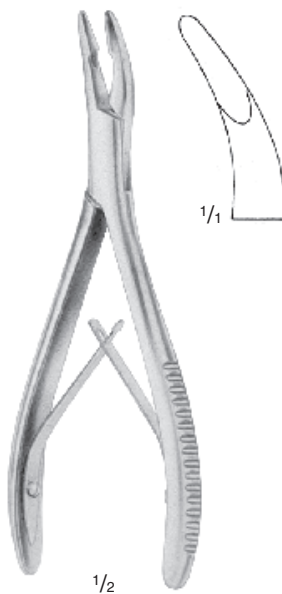

LUER
54836-15
 15 cm / 6"



BACON
54838-20
 20 cm / 8"

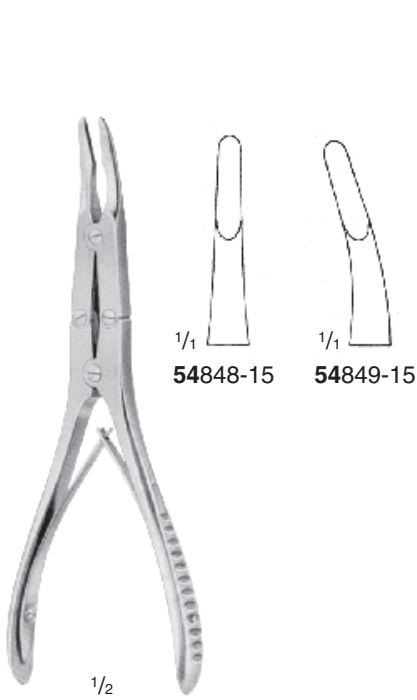

MINI-RUSKIN
54848-15 – 54849-15
15 cm / 6"



BEYER
54851-18
18 cm / 7"



ZAUFAL-JANSEN
54853-18
18 cm / 7"

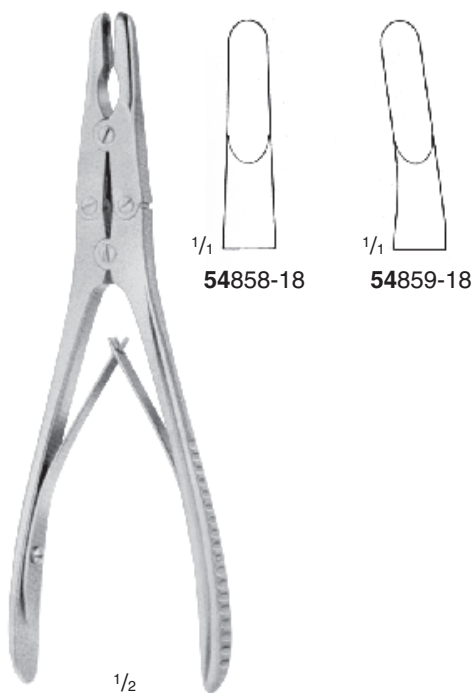

RUSKIN
54858-18 – 54859-18
18 cm / 7"



RUSKIN
54865-23
23 cm / 9"



Hohlmeißelzangen
 Bone Rongeur Forceps
 Pinzas-gubias
 Pincès-gouges
 Pinze-sgorbie

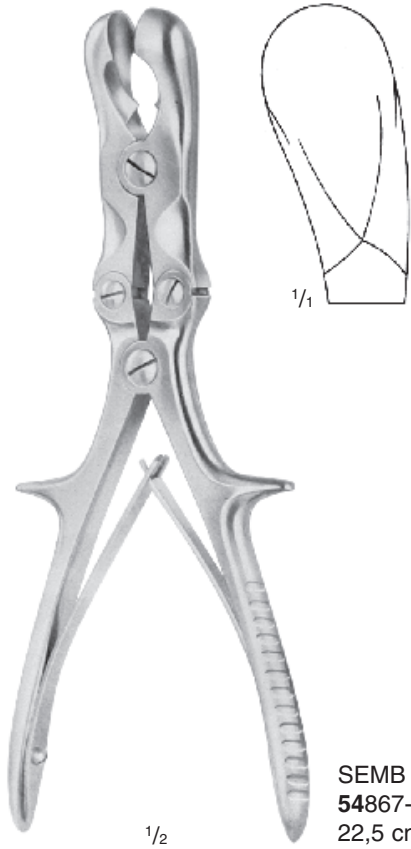

SEMB
 54867-22
 22,5 cm / 9"



STILLE
 54869-23
 23 cm / 9"



ECHLIN
 54870-23 – 54872-23
 23 cm / 9"

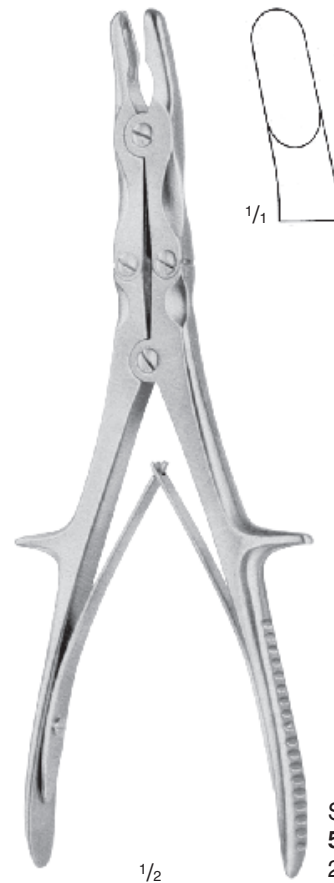
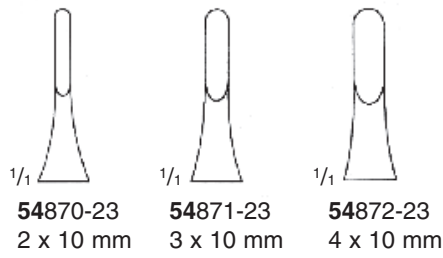

STILLE-RUSKIN
 54873-23
 23 cm / 9"

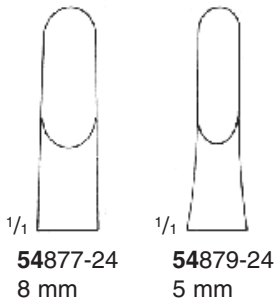

1/2

LEKSELL-STILLE
54877-24 – 54879-24
24 cm / 9 1/2"

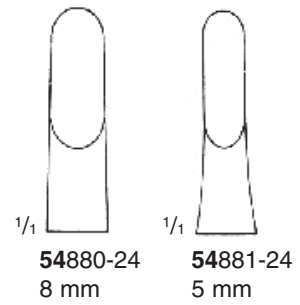

1/2

LEKSELL-STILLE
54880-24 – 54881-24
24 cm / 9 1/2"

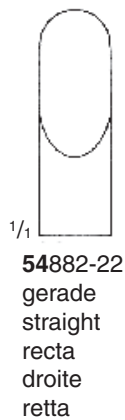

1/2

STILLE-LUER
54882-22 – 54883-22
22 cm / 8 3/4"



Knochensplitterzangen
 Bone Cutting Forceps
 Pinzas cortantes para huesos
 Pinces coupantes à os
 Cesioie per ossa



gerade
 straight
 rectas
 droites
 rette

	cm	in.	
54906-14	14	5 1/2"	54907-14
54906-17	17	6 3/4"	54907-17
54906-19	19	7 1/2"	54907-19
54906-22	22	8 3/4"	54907-22



gebogen
 curved
 curvas
 courbes
 curve



LISTON
 54906-14 – 54907-22

MC INDOE
 54910-17
 17,5 cm / 7"



54916-15



54917-15

MINI-LISTON
 54916-15 – 54917-15
 15 cm / 5 3/4"



54922-18



54923-18

RUSKIN-LISTON
 54922-18 – 54923-18
 18,5 cm / 7 1/4"



54926-27



54927-27

 $\frac{1}{3}$

STILLE-LISTON
54926-27 – 54927-27
27 cm / 10 $\frac{1}{2}$ "

 $\frac{1}{1}$ $\frac{1}{3}$

LISTON-KEY
54929-27
27 cm / 10 $\frac{1}{2}$ "

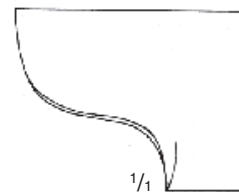
 $\frac{1}{1}$ $\frac{1}{3}$

SEMB
54931-24
24 cm / 9 $\frac{1}{2}$ "



Bleihände, Fingerringssägen
 Lead Hands, Finger Ring Saws
 Manoplas de plomo, Sierras para abrir anillos
 Manches en plomb, Scies pour bagues
 Mani di piombo, Strumenti per unghie, Seghe per anelli



54932-01
 für Kinder
 child size
 para niños
 pour enfants
 per bambini

54932-02
 für Erwachsene
 adult size
 para adultos
 pour adultes
 per adulti



$\frac{1}{2}$
FELDHEIM
54936-10
 10 cm / 4"

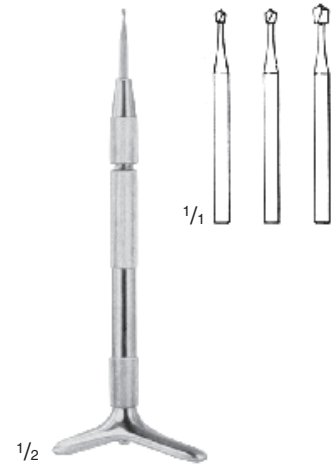

$\frac{1}{2}$
54939-10
 10 cm / 4"



$\frac{1}{2}$
54947-17
 17 cm / 6 $\frac{3}{4}$ "

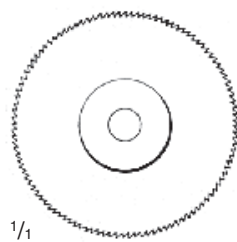

$\frac{1}{1}$
54948-01

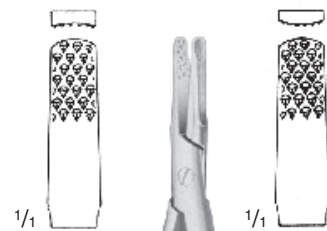

$\frac{1}{1}$
 $\frac{1}{2}$
RADOLF
54950-13
 13,5 cm / 5 $\frac{1}{4}$ "

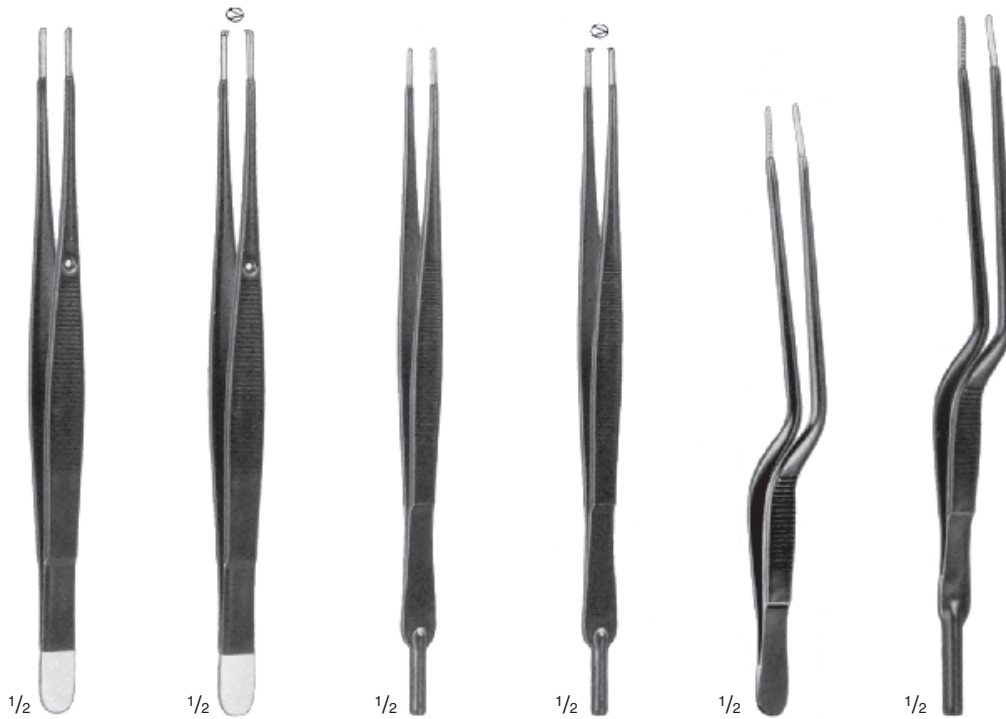
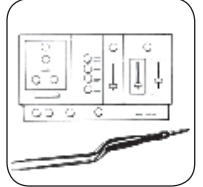

cm	in.						
14	5 1/2"						06248-14 06250-14
16	6 1/4"						06248-16 06250-16
18	7"	06240-18	06242-18	06244-18	06246-18		
20	8"					06248-20	06250-20
21	8 1/4"	06240-21	06242-21	06244-21	06246-21		
25	10"	06240-25	06242-25	06244-25	06246-25		



KRISTELLER

28254-03
90 x 36 mm
28255-03
110 x 36 mm
Scheidenspekula
Vaginal Specula
Espéculos vaginales
Spéculum vaginaux
Specoli vaginali

28256-03
95 x 32 mm
28257-03
115 x 32 mm
Scheidenhalter
Vaginal Retractors
Separadores vaginales
Valves vaginales
Valve vaginali

28258-00
90 x 36 mm
28259-00
110 x 36 mm
Satz
Set
Juego
Jeu
Serie

A		Seite				
ABEL Hakenzangen		248	Atriumhaken	117	Beckenzirkel	259
Abfallzangen		87	Auswechselbare Zangenaufsätze	254	BECKMANN Wundsperrer	130
Abortuslöffel		261	AUVARD Scheidenspekula	243	BECKMANN-ADSON Wundspreizer	130
Abortuszangen		261	AYRE Konusmesser	251	BECKMANN-EATON Wundspreizer	130
ADAMS Tenotomiemesser		20			BEEBEE Drahtscheren	33
ADLERKREUTZ					BEER Cilienpinzetten	50
chirurgische Pinzetten		45, 46	B	Seite	BEESON Gipsspreizer	276
ADSON anatomische Pinzetten		43	BABCOCK ATRAUMATICO	205	BENGOLEA Arterienklemmen	63
ADSON Arterienklemmen		62	Darmfaßzangen	205	BENSAUDE Anuskop	218
ADSON chirurgische Pinzetten		46	BABCOCK Darmfaßzangen	205	BENSON Pylorusspreizer	211
ADSON Nadelhalter mit Sperre		172	BABCOCK Gewebefaßzangen	204	BERGER Biopsiezangen	254
ADSON Pinzetten			BABINSKY Perkussionshammer	1	BERGMANN Gipsscheren	274
mit Hartmetalleinsätzen / Top dur		52	BABY-ADSON Arterienklemmen	66	BERGMANN Hammer	287
ADSON Saugkanülen		155	BABY-CRILE Arterienklemmen	60	BERGMANN Skalpelle	18
ADSON Wundsperrer		127, 128	BABY-DOYEN ATRAUMA	211	BERLINER Reflexhammer	1
ADSON-BROWN Pinzetten		52	Darmklemmen	211	BERNHARD Tuchklemmen	81
ADSON-GRAEFE chirurgische Pinzetten		47	BABY-DOYEN Darmklemmen	207	BERRY Sternumnadelhalter	
ALAN PARKS Analretraktor		217	BABY-LEXER Scheren	35	mit Hartmetalleinsätzen / Top dur	278
ALAN PARKS Nadelhalter			BABY-LEXER Scheren	35	Beschneidungsinstrumente	235
mit Hartmetalleinsätzen / Top dur		160	mit Hartmetalleinsätzen / Top dur	35	BETHUNE Rippenscheren	184
ALAN PARKS Sphincterivalve		217	BABY-MIKULICZ	79	BEYER Hohlmeißelzangen	294, 295
ALEXANDER Probeexzisionszangen		253	Peritoneumklemmen	79	BILLEAU Ohrschlingen	269
ALLEN Plasterspatel		148	BABY-MIXTER Arterienklemmen	66	Biopsieküretten	251, 252
ALLIS ATRAUMATICO Darmfaßzangen		203	BABY-MIXTER Präparierklemmen	57	Biopsieküretten	252
ALLIS Darmfaßzangen		203	BABY-OVERHOLT Arterienklemmen	60	Biopsiezangen	252-255
ALLIS Gewebefaßzangen		204	BABY-ROUX Wundhaken	120	BIRCHER-GANSKE	
ALLIS-ADAIR Darmfaßzangen		203	BABY-SATINSKY	196	Knochenhalte-zangen	292
ALLIS-BABY Darmfaßzangen		203	Bronchusklemmen	196	BIRKETT Arterienklemmen	62
ALLISON Lungenspatel		195	BACKHAUS ROEDER	80	BLAKE Gallensteinzangen	227
ALM Wundsperrer		122	Tuchklemmen	80	Blattsägen	277
ALY Sensibilitätsinstrument		2	BACKHAUS Tuchklemmen	80	Bleihände	300
Amputationsmesser		19	BACON Hohlmeißelzangen	294	BLUMENTHAL Hohlmeißelzangen	294
Amputationssägen		277	BAILEY Rippenkontraktor	194	BOETTCHER Tonsillen-Schere	29
Analretraktor		217	BAILEY-BABY Rippenkontraktor	194	Bohrdrähte	282, 283
Anatomische Pinzetten		43, 44	BAILEY-GIBBON Rippenkontraktor	194	Bolzenschneider	280
Anatomische Pinzetten			BAINBRIDGE Arterienklemmen	61	BONNEY Pinzetten	
mit Hartmetalleinsätzen / Top dur		52-54	BAKES Gallenkanal-Dilatatore	226	mit Hartmetalleinsätzen / Top dur	54
Anatomische Skalpelle		8	BALFOUR Bauchdeckenhalter	135	BOSE Tracheal-Häkchen	266
ANDERSON-ADSON Wundsperrer		127	BALFOUR Mittelblatt	136	BOYS-ALLIS Darmfaßzangen	203
ANDREW-PYNCHON Saugrohre		153	BALFOUR US-Type Bauchdeckenhalter	135	BOYTON Nadelhalter	
Anlegezange für Bulldogklemmen		198	BALFOUR-BABY Bauchdeckenhalter	135	mit Hartmetalleinsätzen / Top dur	162
Anuskope		219	Bandmaße	3	BOZEMANN Fadenschlingendreher	180
Aortahaken		113	BARON Saugkanülen	155	BOZEMANN Nadelhalter	
ARRUGA Nadelhalter			BARRAQUER-TROUTMAN	170	mit Hartmetalleinsätzen / Top dur	164, 165
mit Hartmetalleinsätzen / Top dur		162	Nadelhalter	170	BOZEMANN Schwammzangen	85
Arterienklemmen		55-64, 67, 71, 72, 76	BARRETT-POZZI Hakenzangen	248	BOZEMANN-DOUGLAS	
Aspirationsrohre		153	Batteriegriff	5	Schwammzangen	85
ATRAUMATICO Hämorrhoidalzangen		222	Bauchdeckenhalter	107, 130-141	BOZEMANN-FINOCHIETTO	
Atraumatische Bulldogklemmen		198-202	Bauchdeckenschere	30	Nadelhalter mit	
Atraumatische Gefäßpinzetten		197	Bauchspateln	144	Hartmetalleinsätzen / Topdur	166
			Bauchstichtrokare	150, 151	BRAUN Hakenzangen	248
			BAUMGARTNER Nadelhalter		BRAUN-STADLER Dammschere	30
			mit Hartmetalleinsätzen / Top dur	163		

BREISKY Scheidenspekula	244	Chirurgische Scheren		CZERNY Hakenzangen	249
BRINKERHOFF Mastdarmspekula	218	mit Hartmetalleinsätzen / Top dur	34		
BRODIE Rektal Sonden	220	Cilienpinzetten	50	D	Seite
Bronchusklemmen	67, 195, 196	CLAR Kaltlicht-Stirnlampen	6	DAHLGREN Schädelzangen	262
BROPHY anatomische Pinzetten	44	CLAR Stirnlampen	7	Dammscheren	30
BROPHY chirurgische Pinzetten	47	CLOWARD Wundsperrerr und Valven	126	DANDY Arterienklemmen	61
BROPHY Scheren	30	COBBETT Dermatom	21	DANDY neurochirurgische Scheren	28
BRUENINGS Zungenspatel	273	COLLIER Nadelhalter	171	Darmfaßzangen	203-206
BRUNETTI Knochenmeißel	12	COLLIN Amputationsmesser	19	Darmklemmen	207-214
BRUNNER ATRAUMA Darmklemmen	214	COLLIN Bauchdeckenhalter	132	Darmquetschklemmen	209
BRUNNER Führungshohlsonden	178	COLLIN Dynamometer	3	Darmscheren	13, 33
BRUNNER Rippenscheren	185	COLLIN Faßzangen	55, 56	DARTIGUES Uterus-Faßzangen	251
BRUNNER Unterbindungsnadeln	178	COLLIN Scheidenspekula	237	DAVIDSON Wundhaken	111
BRUNNER Wundhaken	112	COLLIN Skalpgriffe	14	DAVIS Faßpinzetten	48
BRUNNER-FERROZELL Hohlsonden	179	COLLIN Tupferzangen	84	DE BAKEY atrauma Bulldogklemmen	198
BRUNS Gipsscheren	275	COLLIN Uterus-Faßzangen	251	DE BAKEY atrauma Gefäßklemmen	200, 202
BRUNS Löffel	288	COLLIN Wundklammerzangen	181	DE BAKEY atrauma Pinzetten	197
BRUNSCHWIG (Tunneler) Klemmen	70	COLLIN Zungenzangen	273	DE BAKEY Pinzetten	
BUCK Ligaturscheren	33	COLLIN-BABY Bauchdeckenhalter	132	mit Hartmetalleinsätzen / Top dur	54
BUCK Perkussionshammer	1	COLLIN-BABY Scheidenspekula	237	DE BAKEY Präparierklemmen	73
BUCKLEY Wundspreizer	122	COLLIN-DUVAL Faßpinzetten	48	DE BAKEY Rippensperrerr	193
Bügelpekula	239	COLLIN-DUVAL Faßzangen	56	DE BAKEY Scheren	
BUIE Rektalsonden	220	COLLIN-HARTMANN Wundhaken	120	mit Hartmetalleinsätzen / Top dur	39
Bulldogklemmen	55	CONE Schädelstanzzangen	262	De Bakey Slim Nadelhalter	
Bulldogklemmen atraumatisch	198, 199	CONE Wundspreizer	129	mit Hartmetalleinsätzen / Top dur	164
BUNNELL Sehnenstripper	291	COOLEY Rippensperrerr ALU	186, 187	DE BAKEY-DIETRICH Bulldogklemmen	55
BUNT Sterilisierklammern	87	COOLEY Saugrohre	154	DE MARTEL Einführungssonden	262
BURFORD Rippensperrerr	189	COOLEY Wundhaken	117	DEAN Tonsillen-Scheren	29
BURFORD-FINOCHIETTO		COOPER Unterbindungsnadeln	175	DEAVER chirurgische Scheren	23
Rippensperrerr	192	CORYLLOS Wundhaken	110	DEAVER Wundhaken	115-117
BUSCH Nabelschnur-Scheren	30	CORYLLOS-BETHUNE Rippenscheren	184	DÉJERINE Reflexhammer	1
		COTTLE Nasenscheren	30	DENIS-BROWNE Bauchdeckenhalter	137
C	Seite	CRAFOORD Arterienklemmen	67	DENIS-BROWNE Rahmen	137
CARREL Arterienklemmen	55	CRAFOORD-SELLORS		DENIS-BROWNE Valven	137
CARROL Sehnenfaßzängchen	292	Bronchusklemmen	67	DERF Nadelhalter	
CARROLL Finger Goniometer	3	CRILE Arterienklemmen	60	mit Hartmetalleinsätzen / Top dur	163
CASTANEDA Rippensperrerr Alu	190	CRILE-MURRAY Nadelhalter	171	DERF-CONVERSE Nadelhalter	171
CASTROVIEJO Nadelhalter	170	CRILE-RANKIN Arterienklemmen	60	Dermatome	21
CASTROVIEJO Nadelhalter		CRILE-WOOD Nadelhalter	171	DESCHAMPS Unterbindungsnadeln	176, 177
mit Hartmetalleinsätzen / Top dur	162	CRILE-WOOD Nadelhalter		DESJARDINS Gallenkanalklemmen	76
CATLIN Amputationsmesser	19	mit Hartmetalleinsätzen / Top dur	158, 163	DESJARDINS Gallensteinlöffel	228
CHAPUT Arterienklemmen	56	CUSCO Scheidenspekula	237, 238	DESJARDINS Gallensteinsonden	226
CHARRIERE Amputationssägen	277	CUSHING anatomische Pinzetten	44	DESJARDINS Gallensteinzangen	227
CHARRIERE Blattsägen	277	CUSHING chirurgische Pinzetten	46	DESMARRES Sattelhäkchen	89
CHERON Tupferzangen	84	CUSHING Durahaken	263	Diagnostik-Bestecke	4, 5
CHILDE Wundrand-Faßpinzetten	181	CUSHING Nervhaken	264	DIEFFENBACH Skalpelle	18
Chirurgische Pinzetten	45-47	CUSHING Pinzetten		DIETRICH Bulldogklemmen	55
Chirurgische Pinzetten		mit Hartmetalleinsätzen / Top dur	53	DIETRICH Scheren	28
mit Hartmetalleinsätzen / Top dur	52-54	CUSHING Wundhaken	92, 93	DIETRICH Slim Nadelhalter	
Chirurgische Scheren	22, 30	CUSHING-KOCHER Wundhaken	89	mit Hartmetalleinsätzen / Top dur	159
		CUZZI Abortuslöffel	261	Dilatationsbesteck	234

Dilatationsbougies	233	ENGEL Gipssägen	275	FINOCHIETTO-BABY-HAIGHT	
Dilatatoren	226, 266	ENGL. MODELL Tuchklemmen	80	Rippensperrerr	188
DITTEL Harnröhren-Bougie	233	Enukleationsscheren	32	FINOCHIETTO-INFANT Rippensperrerr	188
DOUGLAS Cilienpinzetten	50	Episiotomiescheren	42	FINSEN MARTIN Wundsperrerr	122
DOYEN ATRAUMATICO Darmklemmen	211	Episiotomiescheren mit Hartmetalleinsätzen / Top dur	42	Fistelmesser	20
DOYEN Bauchdeckenhaken	139	EPPENDORF Aufsatz	254, 255	Flachmeißel	284-286
DOYEN Bauchdeckenhalter	108	EPPENDORF Biopsiezangen	255	Flachzangen	278
DOYEN Bauchdeckenscheren	24	Ersatzbirnen für Ophthalmoskop	5	Flachzangen mit Hartmetalleinsätzen / Top dur	281
DOYEN Darmklemmen	207	Ersatzbirnen für Otoskop	5	FLETCHER Schwammzangen	86
DOYEN Hohlsonden	146	Ersatzklingen	21	FOERSTER Bauchdeckenhalter	141
DOYEN Myomheber	250	Ersatzsägeblätter	277	FOERSTER Schwammzangen	85, 86
DOYEN Ovarienzangen	250	Ersatzschrauben	284	FOMON Nasenscheren	29
DOYEN Raspatorien	290	Ersatz-Spiegelglas	7	FOMON Präparierscheren	26
DOYEN Scheidenhalter	245	ESMARCH Gipsmesser	275	FOX Scheren	38
DOYEN Scheidenspekula	242	ESMARCH Gipsscheren	274	FOX Scheren mit Hartmetalleinsätzen / Top dur	38
DOYEN Tuchklemmen	80			FRAZIER Durahaken	264
DOYEN-STILLE Wundhaken	105	F	Seite	FRAZIER Saugkanülen	155
Drahtbiegezangen mit Hartmetalleinsätzen / Top dur	281	Fadenfänger	180	FREEMAN KAYE Präparierscheren	41
Drahtkneifzangen mit Hartmetalleinsätzen / Top dur	278, 279, 281	Fadengabeln	180	FREEMAN Präparierscheren mit Hartmetalleinsätzen / Top dur	41
Drahtsägen	262	Fadenpinzetten	181	FREER Schleimhauthaken	271
Drahtscheren mit Hartmetalleinsätzen / Top dur	38	Fadenscheren	33	FREER Septum-Elevator	271
Drahtspannzangen mit Hartmetalleinsätzen / Top dur	278	FARABEUF Raspatorien	289	Fremdkörper-Instrumente	267, 269
Drahtvalven	135	FARABEUF Wundhaken	120	Fremdkörpernadeln	267
DUBOIS Kephalotomscheren	24	FARREL Watteträger	148	FRENZEL Zungenspatel	273
DUEHRSSSEN anatomische Pinzetten	44	Faßpinzetten	48	FRIEDMANN Hohlmeißelzangen	293
DUEHRSSSEN chirurgische Pinzetten	47	FAURE Biopsiezangen	252	FRITSCH Bauchdeckenhalter	107
DUFNER ADSON anatomische Pinzetten	43	FAURE Peritoneumklemmen	79	Führungshohlsonden	178-180
DUFNER ADSON chirurgische Pinzetten	46	Federhäkchen	89		
DUFNER-Vascular Slim Nadelhalter mit Hartmetalleinsätzen / Top dur	160	FEHLAND atrauma Darmklemmen	214	G	Seite
DUKE Trokare	151	FEILCHENFELD Splitterpinzetten	49	Gallenkanal-Dilatatoren	226
DUPLAY Hakenzangen	248	Feilen	291	Gallenkanalklemmen	71, 72, 76
Duradissektoren	263	FEIN Watteträger	149	Gallensteinlöffel	228
DURANTE chirurgische Pinzetten	47	Feine chirurgische Pinzetten	49	Gallensteinsonden	225
DUVAL Darmfaßzangen	206	Feine chirurgische Scheren	31, 32	Gallensteinzangen	227
DUVAL Gewebefaßzangen	206	Feine Scheren mit Hartmetalleinsätzen / Top dur	37-39	Geburtshilfe	259, 260
DUVAL Pinzette	47	FELDHEIM Kompressorium	300	Gefäßklemmen	196
		FERGUSSON Arterienklemmen	57	Gefäßklemmen atraumatisch	200-202
		FERGUSSON Saugkanülen	155	Gefäßpinzetten atraumatisch	197
		FERROZELL Hohlsonden	179	Gefäßscheren	28
E	Seite	FILIFORM Gleitsonden	233	Gefäßstripper	147
ECHLIN Hohlmeißelzangen	296	FILIFORM Spitze	147	GELPI Wundspreizer	131
EDER Watteträger	149	Fingernagelbohrer	300	GEMINI (MIXTER) Präparierklemmen	74
EISELSBERG Ligatursscheren	33	Fingerringsägen	300	GERALD anatomische Pinzetten	44
EISELSBERG-MATHIEU Nadelhalter mit Hartmetalleinsätzen / Top dur	169	FINOCHIETTO Arterienklemmen	72	GERALD chirurgische Pinzetten	46
Elevatorien	270, 271, 291	FINOCHIETTO Nadelhalter	173	GERALD Pinzetten mit Hartmetalleinsätzen / Top dur	54
ELSAESSER Nierenfistelzangen	225	FINOCHIETTO Nadelhalter mit Hartmetalleinsätzen / Top dur	165	Gewebefaßzängchen	203
Endospekula	245	FINOCHIETTO Rippensperrerr	188, 192	GIERTZ-STILLE Rippenscheren	185
		FINOCHIETTO-BABY Rippensperrerr	192		

GIGLI Hakengriff	262	Hammer für Anatomie	12	I	Seite
GILLIES chirurgische Pinzetten	46	Hämorrhoidal Saugligatur-Instrumente	223	Impfanzetten	150
GILLIES Hauthäkchen	265	Hämorrhoidalzangen	222	Instrumente für Prostata-Operationen	229-231
GILLIES Nadelhalter	169	HARRINGTON PEMBERTON Wundhaken	114	Instrumente zur Schädelöffnung	262, 264
GILLIES Slim Nadelhalter mit Hartmetalleinsätzen / Top dur	169	HARRINGTON Wundhaken	114	Inzisionsscheren	22
GIL-VERNET Wundhaken	231	HARTMANN Arterienklemmen	57	Irispinzetten	267
Gipsabreißzangen	276	HARTMANN Häkchen	269	Irisscheren	31, 38
Gipsmesser	275	HARTMANN Ohrpolypenzangen	269	Isolierte Instrumente	301
Gipssägen	275	HARTMANN Ohrspekula	268	ISRAEL Wundhaken	98
Gipsscheren	274, 275	HARTMANN Stimmgabeln	268	IVES-FANSLER Anuskop	218
Gipsspreizer	276	HARTMANN-HALLE Nasenspekula	270	J	Seite
GLOVER atrauma Bulldogklemmen	199	HAYES Atrauma Darmklemmen	214	JACKSON Scheidenspekula	239
GLUCK Rippenscheren	183	HEANEY Klemmzangen	76	JACKSON TRACHEAL -Haken	266
GOELET Wundhaken	121	HEANEY Nadelhalter	172	JACOBS Hakenzangen	249
GOLDMAN-FOX chirurgische Scheren	30	HEANEY Nadelhalter mit Hartmetalleinsätzen / Top dur	165	JACOBSON Scheren	32
GOOD Tonsillen Scheren	29, 41	HEANEY Wundhaken	110	JAMESON Präparierscheren	40
GORNEY (BÖTTCHER) Präparierscheren	41	HEGAR Nadelhalter mit Hartmetalleinsätzen / Top dur	165	JAMISON Nadelhalter	172
GORNEY Präparierscheren mit Hartmetalleinsätzen / Top dur	40	HEGAR Uterusdilatoren	246	JANSEN Flachmeißel	284
GOSSET Bauchdeckenhalter	134	HEGAR-BAUMGARTNER Nadelhalter	171	JANSEN Hohlmeißel	284
GRAEFE Irispinzetten	267	HEGAR Uterusdilatoren	246	JANSEN Hohlmeißelzangen	293
GRAEFE Mikrohäkchen	88	HEGEMANN DIETHRICH Scheren	28	JANSEN Ohrpinzetten	269
GRAHAM Durahaken	264	HEGENBARTH Wundklammerpinzetten	181	JANSEN Wundsperrerr	122
GRAVE Scheidenspekula	238	HEISS Arterienklemmen	65, 66	JENNINGS Mundsperrerr	272
GREEN-ARMYTAGE Uterus Klemmzangen	260	HELFERICH-BIER Amputationssäge	277	JOHNS HOPKINS Arterienklemmen	70
Griff für Kehlkopfspiegel	273	HENLEY Wundsperrerr	124	JOHNS-HOPKINS Bulldogklemmen	55
GROSS-MAIER Kornzangen	84	HENNIG Gipsspreizer	276	JONES Tuchklemmen	80
GUTHRIE Häkchen	88	HERTZLER Bauchdeckenhalter	134	JONES-MARTIN Tuchklemmen	80
GUTTMANN Sekretlöffel	236	HEYMANN Nasenscheren	30	JOSEPH Scheren	27
GUYON Dilatationsbesteck	234	HEYWOOD-SMITH Hämorrhoidalzangen	222	JOSEPH Schleimhauthäkchen	271
GUYON Harnröhren Bougies	233	HIBBS Flachmeißel	286	JUDD-ALLIS Darmfaßzangen	203
GUYON Katheterspanner	235	HIBBS Hohlmeißel	286	K	Seite
GUYON Nierenstielklemmen	75	Hirnmesser	11	KADER Spateln	119
GUYON-PEAN Nierenstielklemmen	75	HIRSCHMANN Anuskope	218	KALLMORGEN Scheidenhalter	241
Gynäkologische Scheren	24, 3	HOESEL Nadelhalter mit Hartmetalleinsätzen / Top dur	168	KALLMORGEN Scheidenspekula	241
H	Seite	Hohlmeißel	284-286	KALT Nadelhalter mit Hartmetalleinsätzen / Top dur	162
HABERER Spateln	144	Hohlmeißelzangen	293-297	KANTROWITZ Präparierklemmen	74
HAGLUND-STILLE Gipsspreizer	276	Hohlsonden	146	Katheter-Einführungsinstrumente	235
HAIGHT Rippensperrerr	191	HOLTZHEIMER Wundspreizer	122	Kehlkopfspiegel	273
HAJEK Hammer	287	HOLZBACH Bauchdeckenhalter	133	KELLY Arterienklemmen	60
Haken für den Samenstrang	229	HOPKINS Gipsmesser	275	KELLY Bauchdeckenhalter	118
Hakenzangen	248, 249	HORGAN Mittelblatt	136	KELLY Fistel-Scheren	24
HALSEY Nadelhalter	171	HÖSEL Wundhaken	106	KELLY Präparierklemmen	76
HALSEY Nadelhalter mit Hartmetalleinsätzen / Top dur	163	HUMBY Dermatome	21	KELLY Proktoskope	219
HALSTED-MOSQUITO Arterienklemmen	57, 58	HUNTER Splitter-Pinzetten	49	KELLY Scheren mit Hartmetalleinsätzen / Top dur	38
Hämmer	287	HUSTINX Wundspreizer	131	KELLY Sphinkteroskop	219
		Hysterektomieklammen	77, 78	KELLY Uterus-Polypenzangen	250

KELLY Wundhaken	105	KRONECKER Unterbindungsadeln	176	LITTAUER Cilienpinzetten	50
KELLY-RANKIN Arterienklemmen	60	KUEMMEL Spatel	119	LITTLE Wundhaken	100
KEVORKIAN Biopsiezangen	255	L	Seite	LOCKKLIN Feine chirurgische Scheren	31
KEVORKIAN Probeexzisionszangen	253	LABORDE Trachealdilatatore	266	LOCKKLIN Scheren mit Hartmetalleinsätzen / Top dur	39
KEYES Haut-Trephinen	265	LAHEY Gallenkanalklemmen	72	LOCKWOOD Darmfaßzangen	204
Kieferhöhlentrokar	152	LAHEY Wundhaken	100	LOGAN Wundsperrerr	122
KIELLAND Geburtszangen	259	LAMBOTTE Osteotome	286	LORENZ Verbandschere	274
KILLIAN Nasenspekula	270	LAMBOTTE Flachmeißel	286	LORNA Tuchklemmen	81
KILNER Hautkäckchen	265	LAMBOTTE Raspatorien	290	LOVE Nervwurzelhaken	264
KILNER Nadelhalter mit Hartmetalleinsätzen / Top dur	163	Laminektomiesperrerr	142	LOVELACE Lungenfaßzangen	196
KIRSCHNER Bauchdeckenhalter	139	LANDAU Scheidenspekula	244	LOWER Arterienklemmen	72
KIRSCHNER Bohrdrähte	282, 283	LANDAU Trokare	152	LUCAE Knopfhäkchen	269
KIRSCHNER Führungshohlsonden	178	LANE Magenklemmen	210, 211	LUCAE Ohrpinzetten	269
KIRSCHNER-FERROZELL Hohlsonden	179	LANE Tuchklemmen	81	LUCAE Pinzetten mit Hartmetalleinsätzen / Top dur	52
KLAPP Wundhaken	93	LANGENBECK Knochenhalte	292	LUER Hohlmeißelzangen	294
KLINIKUM BERLIN Schlauchklemmen	82	LANGENBECK Lappenmesser	19	LUER Tracheal-Häkchen	266
Knochenfeilen	285, 286, 291	LANGENBECK Nadelhalter mit Hartmetalleinsätzen / Top dur	167	LUER-KOERTE Gallensteinlöffel	228
Knochenhalte	292	LANGENBECK Periost-Elevatore	291	LUETHY-BECK Nadelhalter mit Hartmetalleinsätzen / Top dur	168
Knochenmeißel	12, 284-286	LANGENBECK Raspatorien	289	LUKENS Thymus-Haken	266
Knochenschere	13, 183	LANGENBECK Resektionsmesser	20	Lungenspateln	115, 116, 195
Knochensplitterzangen	298, 299	LANGENBECK Stichsäge	277	M	Seite
Knopfsonden	145, 147	LANGENBECK Wundhaken	99	Magenquetschklemmen	209, 210
Knorpelmesser	9	LANGENBECK Wundhaken	90	MARBERGER Wundhaken	232
KNOWLES Schere	274	LANGENBECK-GREEN Wundhaken	90	MARTEL Kopfhautklemmen	56
KOCHER (OCHSNER) Arterienklemmen	63, 64	LANGENBECK-RYDER Nadelhalter mit Hartmetalleinsätzen / Top dur	167	MARTIN Abfallzangen	87
KOCHER Bauchdeckenhalter	108	LEBSCHKE Sternummeißel	185	MARTIN Beckenzirkel	259
KOCHER Darmklemmen	208	LEGUEU Blasenspateln	231	MARTIN Uterussonden	247
KOCHER Kropfsonden	266	LEKSELL-STILLE Hohlmeißelzangen	297	MARTIN Wundhaken	109
KOCHER LANGENBECK Wundhaken	103	LEMMON Nadelhalter mit Hartmetalleinsätzen / Top dur	160	MARTIN-FERROZELL Hammer	287
KOCHER Wundhaken	96, 100, 102, 104	LERCHE chirurgische Pinzetten	45	MASSON Nadelhalter	173
KOCHER-ATRAUMA Darmklemmen	212	LERICHE Arterienklemmen	59	MASSON-LUETHY Nadelhalter mit Hartmetalleinsätzen / Top dur	166
KOCHER-LANGENBECK Wundhaken	102	LEXER Flachmeißel	285	Maßstäbe	3
KOENIG Führungshohlsonden	180	LEXER Hohlmeißel	285	Mastdarm-Biopsiezangen	219
KOERTE Darmspateln	119	LEXER Präparierschere	26	Mastdarm-Spekula	215, 216, 218
KOERTE Wundhaken	97	LEXER-BABY Präparierschere	26	MATHIEU Fremdkörperzangen	235
KOGAN Éndospekulum	245	LICHTENBERG Nadelhalter mit Hartmetalleinsätzen / Top dur	156, 157	MATHIEU Mastdarm-Spekula	216
Komedoneninstrumente	265	LICHTWITZ Trokar	152	MATHIEU Nadelhalter	173
KÖNIG Wundhaken	93	Ligaturgummiringe	223	MATHIEU Nadelhalter mit Hartmetalleinsätzen / Top dur	167
Konusmesser	251	Ligaturklemmen	65-66, 68-70, 73, 74	MATHIEU Scheidenhalter	241
Kopf- und Seitenschneider mit Hartmetalleinsätzen / Top dur	278, 279	Ligaturschere	33	MATHIEU Scheidenspekula	241
Kopfhautklemme	56	Ligaturschere mit Hartmetalleinsätzen / Top dur	38	MATHIEU Wundhaken	121
Kopfschwartzangen	260	LISTER Sinusklemmen	83	MATHIEU-RYDER Slim Nadelhalter mit Hartmetalleinsätzen / Top dur	157
Kornzangen	83-85	LISTER Verbandschere	274	MAUNDER Mundkeile	272
Krampfader-Besteck	147	LISTON Amputationsmesser	19	MAYO Gallensteinlöffel	228
KRAUSE Kieferhöhlentrokar	152	LISTON Knochensplitterzangen	298		
KRISTELLER Scheidenhalter	240, 301	LISTON-KEY Knochensplitterzangen	299		
KRISTELLER Scheidenspekula	240, 301				
KROENIG Zungenspateln	273				
KROENLEIN Arterienklemmen	55				

P		Seite			Seite
Parametriumklemmen		77	PRATT Hakenzangen		249
Parametriumscheren			PRATT Mastdarm-Spekula		215
mit Hartmetalleinsätzen / Top dur		36	PRATT Rektalsonden		220
PARKER Tenotomiemesser		20	PRESBYTERIAN-HOSPITAL		
PARKER Wundhaken		121	Schlauchklemmen		82
PARKER-LANGENBECK Wundhaken		121	PRICE-THOMAS Bronchusklemmen		195
PAYR Darmquetschklemmen		209	PRINCE Tonsillen-Scheren		29
PAYR Führungshohlsonden		180	Probeexzisionszangen		252-255
PAYR-BABY Darmquetschklemmen		209	Prostata Instrumente		230-231
PEAN (ROCHESTER)			Prostata Wundhaken		229
Arterienklemmeny		55, 62-64	PROVIDENCE-HOSPITAL		
PEDERSON Scheidenspekula		238	Arterienklemmen		59
PEERS Tuchklemmen		81	PUTTI Knochenraspeln		286
PEET Splitterzangen		50			
PELKMANN Tupferzangen		84	Q		Seite
PENFIELD Duradisektoren		263	QUINBY Scheren		31
Penisklemmen		236			
PENNINGTON Arterienklemmen		56	R		Seite
PERCY Retraktoren		292	RABINER Perkussionshammer		1
Peritoneumklemmen		79	RADOLF Nagelauseizangen		300
Perkussionshmmer		1	RAGNELL-DAVIS Wundhaken		92
PERMAN Bauchdeckenhalter		134	RAGNELL-KILNER Scheren		27
PESTALOZZA Abortuskretten		261	RAMPLEY Schwammzangen		86
Pflasterspatel		148	RANDALL Nierensteinzangen		224
Phalangenmesser		19	RANDALL Saugkretten		251
PIERCE Oberkiefertrokare		152	RAPP Splitterzangen		50
PINARD Stethoskope		2	Rasiermesser		21
Pinzetten anatomisch		43, 44	Raspatorien		289, 290
Pinzetten anatomisch			RECAMIER Kretten		257, 258
mit Hartmetalleinstzen / Top dur		52-54	REGOLO Mastab		3
Pinzetten chirurgisch		45-57	REHN Transplantationsmesser		21
Pinzetten chirurgisch			Rektal-Instrumente		220, 221
mit Hartmetalleinstzen / Top dur		52-54	Rektal-Sonden		220
PIPER Geburtszangen		259	Resektionsmesser		20
PLESTER Wundspreitser		123	Resektionssgen		277
POLLOSON Wundhaken		113, 114	Retraktor		292
Polypenzngchen		269	REVERDIN Bauchspatel		144
POOLE Aspirationsrohre		153	REVERDIN Nadeln		174
POTTS-DE MARTEL Scheren		28	REYNOLDS Prparierscheren		27
POTTS-SMITH anatomische Pinzetten		44	RICARD Bauchdeckenhalter		133
POTTS-SMITH chirurgische Pinzetten		47	RICHARDSON Wundhaken		105
POTTS-SMITH Pinzetten			RICHARDSON-EASTMAN		
mit Hartmetalleinstzen / Top dur		52	Wundhaken		105
POTTS-SMITH Scheren		28	RICHTER-HEATH Wundklammerzangen		181
POTTS-SMITH Scheren			RIGBY Bauchdeckenhalter		131
mit Hartmetalleinstzen / Top dur		39	Rippenkontraktoren		194
POTTS-YASARGIL Microscheren		32	Rippenscheren		13, 183-185, 190-194
POZZI Hakenzangen		248	Rippensperrerr aus Alu		186-189
Prparierklemmen		65-66, 68-70, 73-74	ROBERTS Arterienklemmen		66
Prparierscheren		23, 25-27, 40-42	ROBIN-MASSE Bauchdeckenhalter		133
			ROCHARD Bauchdeckenhalter		140
			ROCHARD Fixiervorrichtung		140
			ROCHESTER-CARMALT		
			Arterienklemmen		62
			ROOS Aorta Haken		113
			ROOS Rippenscheren		184
			ROSER KOENIG Mundsperrerr		272
			ROUX Wundhaken		120
			RUDD Hmorrhoidal-Ligatur		223
			RUDD Ladekonus		223
			RUMEL Prparierklemmen		69
			RUSKIN Hohlmeielzangen		295
			RUSKIN-LISTON Knochensplitterzangen		298
			RUSS.MODELL chirurgische Pinzetten		47
			RYDER Vascular Slim Nadelhalter		
			mit Hartmetalleinstzen / Top dur		159
			S		Seite
			SAALFELD Komedonenquetscher		265
			SACHS Durahaken		264
			SAENGER Abortuszangen		261
			Sgeblatt zu Fingerringssge		300
			Salpingograph		260
			SANVENERO chirurgische Scheren		27
			SAROT Arterienklemmen		67
			SAROT Nadelhalter		
			mit Hartmetalleinstzen / Top dur		164
			SATINSKY Atrauma-Gefklemmen		200
			SATINSKY Bronchusklemmen		196
			SATINSKY Gefscheren		28
			Sattelhkchen		89
			SATTERLEE Blattsge		277
			SAUERBRUCH Abfallzangen		87
			SAUERBRUCH Rippenscheren		185
			SAUERBRUCH Wundhaken		111, 112
			Saugkanlen		155
			Saugkretten		251
			Saugrohre		153-155
			Schdel Instrumente		262, 264
			Schdelspalter		12
			SCHAEDEL Tuchklemmen		80
			Scharfe Lffel		288, 289
			SCHEDE Lffel		288
			Scheidenhalter		108, 109, 240, 242
			Scheidenspekula		237-245
			SCHERBACK Scheidenspekula		243
			Scheren chirurgisch		3, 22
			Scheren fein		32
			Scheren fein chirurgisch		31
			Scheren fein		
			mit Hartmetalleinstzen / Top dur		37-39
			Scheren gynkologisch		3, 24

Scheren		SIMPSON Geburtszangen	259	STILLE-RUSKIN Hohlmeißelzangen	296
mit Hartmetalleinsätzen / Top dur	34, 36	SIMPSON-BRAUN Geburtszangen	259	Stimmgabeln	269
Schieblehre Alu	3	SIMS Gynäkologische Scheren	24	Stirnlampen	7
SCHINDLER Peritoneumklemmen	79	SIMS Mastdarm-Spekulum	215	Stirnspiegel	6
SCHINK Dermatom	21	SIMS Scheidenspekulum	239	STOCKMANN Penisklemmen	236
Schlauchklemmen	82	SIMS Scheren	36	STONE chirurgische Pinzetten	45
SCHMIEDEN Führungshohlsonden	180	SIMS Uterusküretten	256	Strabismusscheren	32
SCHMIEDEN-PAYR		SIMS Uterussonden	247	STRANDELL-STILLE Wundhaken	94
Führungshohlsonden	180	SINGLEY-TUTTLE Faßpinzetten	48	STRATTE Nadelhalter	166
SCHMIEDEN-TAYLOR Durascheren	28	Skalpelle	8, 18	STRAUSS Penisklemmen	236
SCHNIDT Arterienklemmen	61	Skalpellgriffe	14, 15	STRULLY neurochirurgische Scheren	28
SCHRÖDER Hakenzangen	248	Skalpellklingen	16		
SCHROEDER Uteruslöffel	256	SKENE Hakenzangen	248	T	Seite
SCHUBERT Probeexzisionszangen	252	SMILLIE Meniskotom	291	Tamponzangen	270, 271
SCHULTZE Salpingograph	260	SMITH-BUIE Mastdarm-Spekulum	216	TAYLOR anatomische Pinzetten	43
SCHULZE-BERGMANN		SOMER Uterus-Faßzangen	251	TAYLOR chirurgische Pinzetten	46
Mastdarm-Spekula	216	Sonden	145, 146	TAYLOR Reflexhammer	1
SCHUMACHER Aufsatz	254	SPENCER Fadenscheren	33	TEALE Hakenzangen	249
SCHUMACHER Nabelschnurscheren	30	SPENCER Ligaturscheren	33	Tenotomiemesser	20
SCHUMACHER		SPENCER-WELLS Arterienklemmen	55	TERRIER Arterienklemmen	55
Probeexzisionszangen	252, 253	Splitterpinzetten	49	THIERSCH Transplantationsmesser	21
Schwammhalter	149	Splitterzangen	50	THOMS-ALLIS Darmfaßzangen	204
Schwammzangen	86	ST.MARKS Rektalinstrumente	221	THOMS-GAYLOR	
SCOVILLE Laminektomiesperrerr	142	STACKE Ohrsonden	145	Probeexzisionszangen	252
SCOVILLE Valven	142	STANDARD anatomische Pinzetten	43, 52	THOMSON-WALKER	
SCUDDER-ATRAUMA Darmklemmen	213	STANDARD anatomische Pinzetten		Blasen-Wundspreizer	231
SEGOND Hysterektomieklemmen	77	mit Hartmetalleinsätzen / Top dur	52	THOREK Präparierscheren	26
Sekretlöffel	236	STANDARD Augenmagnet	267	TIECK-HALLE Nasenspekula	270
SELLHEIM Geburtslöffel	260	STANDARD Scheren	22, 34	TISCHLER-MORGAN Biopsiezangen	255
SELLORS Rippenkontraktoren	194	STANDARD Scheren		TOBOLD Zungendrücker	272
SEMB Bronchusklemmen	196	mit Hartmetalleinsätzen / Top dur	34	TOENNIS Duradisektoren	263
SEMB Hohlmeißelzangen	296	STANDARD Trokare	150	TOENNIS Nadelhalter	
SEMB Knochenhalte-zangen	292	Sterile Skalpelle	16	mit Hartmetalleinsätzen / Top dur	156
SEMB Knochensplitterzangen	299	Sterilisierklammern	87	TOENNIS Präparierscheren	29
SEMB Rippen-Raspatorien	290	Sterilisierpinzetten	82	TOENNIS-ADSON Präparierscheren	28
SEMKEN anatomische Pinzetten	43	Sterilisierzangen	82	TOENNIS-ADSON Scheren	38
SEMKEN chirurgische Pinzetten	46	Sternummeißel	185	TOENNIS-RYDER Slim Nadelhalter	
SEMM Bauchdeckenhalter	138	Sternumscheren	185	mit Hartmetalleinsätzen / Top dur	156
SEMM Scheidenspekula	239	STEVENS Präparierscheren	40	TOHOKU Tuchklemmen	81
SENN-GREEN Wundhaken	92	STEVENS Sehenscheren	32	Tonsillenscheren	29
SENNING Nadelhalter		STIEGLITZ Splitterzangen	50	TOWNSEND-MINI Biopsiezangen	255
mit Hartmetalleinsätzen / Top dur	159	STILLE anatomische Pinzetten	43	Tracheal-Dilatatoren	266
SENNING Saugrohre	153	STILLE chirurgische Pinzetten	45	Tracheal-Häkchen	266
SENN-MUELLER Wundhaken	92	STILLE Flachmeißel	285	Transformator	7
Sensibilitätsinstrumente	2	STILLE Hohlmeißel	285	TRELAT Scheidenspekula	238
Seziermesser	9, 11	STILLE Hohlmeißelzangen	296	Trephinen	265
SIEBOLD Gynäkologische Scheren	24	STILLE Hohlmeißelzangen	288	TROELTSCH (WILDE) Ohrpinzetten	269
SILVER Dermatom	21	STILLE Löffel	288	TROEMNER Perkussionshammer	1
SIMON Fistelmesser	20	STILLE-BARRAYA chirurgische Pinzetten	47	Trokare	150-152
SIMON Uterus-Löffel	256	STILLE-LISTON Knochensplitterzangen	299	TROUSSEAU Trachael-Dilatatoren	266
SIMON Wundhaken	109	STILLE-LUER Hohlmeißelzangen	297	Tuchklemmen	80, 81
		STILLE-MOD.MARTIN Gipsscheren	275		

TUFFIER Arterienklemmen	56	WANGENSTEEN Nadelhalter	166, 173	ZWEIFEL Nadelhalter	
TUFFIER Bauchspateln	144	WANGENSTEEN Pinzetten	53	mit Hartmetalleinsätzen / Top dur	168
TUFFIER Rippensperrerr	191	WARTENBERG Nadelrad	2	Zwischenknorpelmesser	19
Tupferzangen	83-86	WASSMUND Wundhaken	96		
U	Seite	WATSON Dermatome	21		
ULRICH Fistelmesser	20	Watteträger	148, 149		
ULRICH Tupferhalte-zangen	83	WAUGH anatomische Pinzetten	44		
UNIVERSAL Drahtscheren	33	WAUGH Pinzetten	47		
UNIVERSAL Trokare	150	WEBSTER Nadelhalter	171		
UNIVERSAL Verbandsscheren	274	WEISSBARTH Scheidenspekula	243		
Universalgriffe	254	WEITLANER Wundsperrerr	123, 125		
UNNA Komedonenquetscher	265	WERTHEIM chirurgische Scheren	24		
Unterbindungsnadeln	175-177	WERTHEIM Klemmzangen	78		
USA anatomische Pinzetten	43	WESTCOTT Strabismusscheren	32		
Uterusbiopsiezangen	254	WESTMACOTT Nasen-Tamponzangen	271		
Uterus-Dilatatoren	246	WILLIAMS Darmfaßzangen	204		
Uterus-Faßzangen	251	WILLIGER Raspatorien	289		
Uterusküretten	256-258	WILLIGER Resektionsmesser	20		
Uteruslöffel	256	Winkelmesser	3		
Uterus-Polypenzangen	250	WINTER Abortuszangen	261		
Uterussonden	247	WITTNER Probeexzisionszangen	254		
Uterus-Tamponstopfer	247	WOLFF Gipsabreißzangen	276		
V	Seite	WRIGLEY Geburtszangen	259		
Vaginalklemmen	77, 78	WULLSTEIN Wundsperrerr	125		
VALLEIX Uterussonden	247	Wundhaken	88-116, 118-121, 232		
VAN BUREN Hamnröhren Bougie	233	Wundklammern	182		
VAN DOREN Probeexzisionszangen	252	Wundklammerpinzetten	181		
Verbandsscheren	274	Wundklammerzangen	181		
Verlängerungsrohr	254	Wundsperrerr	122-129, 143		
VIRCHOW Hirnmesser	11	X	Seite		
VIRCHOW Knorpelmesser	9	Xenon-Batteriestirnleuchte	7		
VIRCHOW Schädelspalter	12	Y	Seite		
VIRCHOW Seziermesser	9	YANKAUER Aspirationsrohre	153		
VOLKMANN Löffel	288, 289	YASARGIL Scheren	32		
VOLKMANN Wundhaken	91, 94, 95	YEOMAN Mastdarm-Biopsiezangen	219		
W	Seite	YOUNG Nahtinstrumente	174		
WACHENFELDT		YOUNG Prostatahaken	229		
Wundklammerpinzetten	181	YOUNG Zungenzangen	273		
WAGENER Knopfhäkchen	269	Z	Seite		
WAGNER Scheren		ZAUFAL-JANSEN Hohlmeißelzangen	295		
mit Hartmetalleinsätzen / Top dur	38	ZENKER Präparierklemmen	70		
WALB Organmesser	10	ZENKER Wundhaken	101		
WALDMANN Episiotomiescheren	30	ZIEGLER Stirnspiegel	6		
WALTER-CARMALT		Zugseile	147		
Splitterpinzetten	49	Zugendrücker	272		
WALTON Fremdkörper Hohlmeißel	267	Zungenspatel	273		
WANGENSTEEN		Zungenzangen	273		
Anatomische Pinzetten	44				

A	page			
Abdominal puncture trocars	150, 151	ARRUGA needle holders		BECKMANN retractors
Abdominal retractors	107, 130-141	with tungsten carbide inserts / Top dur	162	BECKMANN-ADSON retractors
Abdominal scissors	30	Aspiration tubes	153	BECKMANN-EATON retractors
Abdominal spatulas	144	Atraumactical Bulldog forceps	198-202	BEEBEE wire scissors
ABEL vulsellum forceps	248	Atraumactical tissue forceps	197	BEER cilia forceps
Abortion forceps	261	ATRAUMATICO haemorrhoidal forceps	222	BEESON plaster cast instruments
Abortion scoops	261	Atrium hooks	117	BENGOLEA artery forceps
ADAMS tenotomy knives	20	Autopsy knives	9, 11	BENSAUDE anoscope
ADLERKREUTZ		AUVARD vaginal specula	243	BENSON pylorus spreader
surgical tissue forceps	45, 46	AYRE Cone knives	251	BERGER biopsy forceps
ADSON anatomical tissue forceps	43			BERGMANN mallets
ADSON artery forceps	62	B	page	BERGMANN plaster-of-Paris shears
ADSON needle holders with ratchet	172	BABCOCK ATRAUMATICO		BERGMANN scalpels
ADSON retractors	127, 128	intestinal forceps	205	BERLINER reflex mallets
ADSON suction cannulas	155	BABCOCK intestinal forceps	205	BERNHARD towel forceps
ADSON surgical tissue forceps	46	BABCOCK tissue seizing forceps	204	BERRY sternum needle holders
ADSON tissue forceps		BABINSKY percussion mallets	1	with tungsten carbide inserts / Top dur
with tungsten carbide inserts / Top dur	52	BABY-ADSON artery forceps	66	BETHUNE rib scissors
ADSON-BROWN dressing forceps	52	BABY-CRILE haemostatic forceps	60	BEYER bone rongeur forceps
ADSON-GRAEFE		BABY-DOYEN ATRAUMA		BILLEAU ear loops
surgical dressing forceps	47	intestinal forceps	211	Biopsy curettes
ALAN PARKS anal retractors	217	BABY-DOYEN intestinal forceps	207	Biopsy forceps
ALAN PARKS needle holders		BABY-LEXER scissors	35	
with tungsten carbide inserts / Top dur	160	BABY-LEXER scissors		BIRCHER-GANSKE
ALAN PARKS sphinctervalves	217	with tungsten carbide inserts / Top dur	35	bone seizing forceps
ALEXANDER biopsy forceps	253	BABY-MIKULICZ peritoneum forceps	79	BIRKETT artery forceps
ALLEN plaster spatulas	148	BABY-MIXTER artery forceps	66	Blade saws
ALLIS ATRAUMATICO		BABY-MIXTER dissecting forceps	57	BLAKE gall stone forceps
intestinal forceps	203	BABY-OVERHOLT artery forceps	60	BLUMENTHAL bone rongeur forceps
ALLIS intestinal forceps	203	BABY-ROUX retractors	120	BOETTCHER tonsil scissors
ALLIS tissue seizing forceps	204	BABY-SATINSKY bronchus forceps	196	Bone chisels
ALLIS-ADAIR intestinal forceps	203	BACKHAUS ROEDER towel forceps	80	
ALLIS-BABY intestinal forceps	203	BACKHAUS towel forceps	80	Bone cutting forceps
ALLISON lung spatulas	195	BACON bone rongeur forceps	294	Bone files
ALM retractors	122	BAILEY rib contractor	194	
ALY sensibility instruments	2	BAILEY-BABY rib contractor	194	Bone holding forceps
Amputating knives	19	BAILEY-GIBBON rib contractor	194	Bone rongeur forceps
Amputating saws	277	BAINBRIDGE artery forceps	61	Bone scissors
Anal retractors	217	BAKES gall duct dilators	226	
Anatomical dressing forceps	43, 44	BALFOUR abdominal retractors	135	BONNEY tissue forceps
Anatomical scalpels	8	BALFOUR centre blades	136	with tungsten carbide inserts / Top dur
Anatomical tissue forceps		BALFOUR US-Type abdominal retractors	135	BOSE tracheal retractors
with tungsten carbide inserts / Top dur	52-54	BALFOUR-BABY abdominal retractors	135	Bow speculum
ANDERSON-ADSON retractors	127	Bandage scissors	274	BOYS-ALLIS intestinal forceps
ANDREW-PYNCHON suction tubes	153	BARON suction cannulas	155	BOYTON needle holders with
Antrum puncture trocars	152	BARRAQUER-TROUTMAN		tungsten carbide inserts / Top dur
Anuscopes	219	needle holders	170	
Aorta hooks	113	BARRETT-POZZI vulsellum forceps	248	BOZEMANN loop twister
Applicators for bulldog forceps	198	Battery handle	5	BOZEMANN needle holders with
		BAUMGARTNER needle holders		tungsten carbide inserts / Top dur
		with tungsten carbide inserts / Top dur	163	
				BOZEMANN sponge and dressing forceps
				BOZEMANN-DOUGLAS
				sponge and dressing forceps
				BOZEMANN-FINOCHIETTO
				needle holders with
				tungsten carbide inserts / Topdur

DIETRICH scissors	28	Enucleations scissors	32	sponge and dressing forceps	85, 86
DIETRICH Slim needle holders		Episiotomy scissors	30, 42	FOMON dissecting scissors	26
with tungsten carbide inserts / Top dur	159	Episiotomy scissors		FOMON nose scissors	29
Dilating bougies	233	with tungsten carbide inserts / Top dur	42	Forceps	83-86
Dilators	226, 266	EPENDORF biopsy forceps	255	Forceps anatomical	43, 44
Dissecting forceps	65-66, 68-70, 73-74	EPENDORF tip	254, 255	Forceps anatomical with	
Dissecting scissors	23, 25-27, 40-42	ESMARCH plaster-of-Paris knives	275	tungsten carbide inserts / Top dur	52-54
DITTEL dilating bougie	233	ESMARCH plaster-of-Paris scissors	274	Forceps surgical	45-57
DOUGLAS cilia forceps	50	Extension cannula	254	Forceps surgical with	
DOYE myoma screws	250	F	page	tungsten carbide inserts / Top dur	52-54
DOYEN abdominal retractors	108, 139	Face lift forceps	56	Foreign body instruments	267, 269
DOYEN abdominal scissors	24	FARABEUF raspatories	289	Foreign body needles	267
DOYEN ATRAUMATICO		FARABEUF retractors	120	FOX scissors	38
intestinal forceps	211	FARRELL cotton applicators	148	FOX scissors with	
DOYEN hollow probes	146	FAURE biopsy forceps	252	tungsten carbide inserts / Top dur	38
DOYEN intestinal forceps	207	FAURE peritoneum forceps	79	FRAZIER dura hooks	264
DOYEN ovarian forceps	250	FEHLAND atrauma intestinal forceps	214	FRAZIER suction cannulas	155
DOYEN raspatories	290	FEILCHENFELD splinter forceps	49	FREEMAN dissecting scissors	
DOYEN towel forceps	80	FEIN cotton applicators	149	with tungsten carbide inserts / Top dur	41
DOYEN vaginal specula	242, 245	FELDHEIM		FREEMAN KAYE dissecting scissors	41
DOYEN-STILLE retractors	105	tourniquets for finger and toes	300	FREER mucous hook	271
DUBOIS cephalotomy scissors	24	FERGUSON haemostatic forceps	57	FREER septum elevator	271
DUEHRSEN anatomical dressing forceps	44	FERGUSON suction cannulas	155	FRENZEL tongue depressors	273
DUEHRSEN surgical dressing forceps	47	FERROZELL hollow probes	179	FRIEDMANN bone rongeur forceps	293
DUFNER ADSON		Files	291	FRITSCH abdominal retractors	107
anatomical dressing forceps	43	FILIFORM bougies	233	G	page
DUFNER ADSON		FILIFORM probe tips	147	Gall duct dilators	226
surgical dressing forceps	46	Fine scissors with		Gall duct forceps	71, 72, 76
DUFNER-Vascular		tungsten carbide inserts / Top dur	37-39	Gall stone forceps	227
Slim needle holders with		Fine surgical dressing forceps	49	Gall stone probes	225
tungsten carbide inserts / Top dur	160	Fine surgical scissors	31, 32	Gall stone scoops	228
DUKE trocars	151	Finger nail drill	300	GELPI retractors	131
DUPLAY hook forceps	248	Finger ring saws	300	GEMINI (MIXTER) dissecting forceps	74
Duradissectors	263	FINOCHIETTO artery forceps	72	GERALD anatomical dressing forceps	44
DURANTE surgical dressing forceps	47	FINOCHIETTO needle holders	173	GERALD surgical dressing forceps	46
DUVAL intestinal forceps	206	FINOCHIETTO needle holders		GERALD tissue forceps	
DUVAL tissue forceps	47	with tungsten carbide inserts / Top dur	165	with tungsten carbide inserts / Top dur	54
DUVAL tissue seizing forceps	206	FINOCHIETTO rib spreader	188, 192	GIERTZ-STILLE rib scissors	185
E	page	FINOCHIETTO-BABY rib spreader	192	GIGLI hook handles	262
Ear speculas	5, 268	FINOCHIETTO-BABY-HAIGHT		GILLIES cutaneous hooklets	265
ECHLIN bone rongeur forceps	296	rib spreader	188	GILLIES needle holders	169
EDER cotton applicators	149	FINOCHIETTO-INFANT rib spreader	188	GILLIES Slim needle holders	
EISELSBERG ligature scissors	33	FINSEN MARTIN retractors	122	with tungsten carbide inserts / Top dur	169
EISELSBERG-MATHIEU		Fistula knives	20	GILLIES surgical dressing forceps	46
needle holders with		Flat pliers	278	GIL-VERNET retractors	231
tungsten carbide inserts / Top dur	169	Flat pliers		GLOVER atrauma Bulldog forceps	199
Elevators	270, 271, 291	with tungsten carbide inserts / Top dur	281	GLUCK rib scissors	183
ELSAESSER nephrostomy forceps	225	FLETCHER sponge and dressing forceps	86	GOELET retractors	121
Endospeculas	245	FOERSTER abdominal retractors	141	GOLDMAN-FOX surgical scissors	30
ENGEL plaster-of-Paris saws	275	FOERSTER			
ENGL.MODELL towel forceps	80				

Goniometer	3	Head mirrors	6	J	page
GOOD tonsil scissors	29, 41	HEANEY clamp forceps	76	JACKSON trachea retractors	266
GORNEY (BÖTTCHER) dissecting scissors	41	HEANEY needle holders	172	JACKSON vaginal specula	239
GORNEY dissecting scissors with tungsten carbide inserts / Top dur	40	HEANEY needle holders with tungsten carbide inserts / Top dur	165	JACOBS hook forceps	249
GOSSET abdominal retractors	134	HEANEY retractors	110	JACOBSON scissors	32
GRAEFE Iris forceps	267	HEGAR needle holders with tungsten carbide inserts / Top dur	165	JAMESON dissecting scissors	40
GRAEFE micro hooks	88	HEGAR uterine dilators	246	JAMISON needle holders	172
GRAHAM dura hooks	264	HEGAR-BAUMGARTNER needle holders	171	JANSEN bone chisels	284
Grasping forceps	48	HEGEMANN DIETRICH scissors	28	JANSEN bone rongeur forceps	293
GRAVE vaginal specula	238	HEGENBARTH suture instruments	181	JANSEN ear dressing forceps	269
GREEN-ARMYTAGE uterine forceps	260	HEISS dissecting and ligature forceps	65, 66	JANSEN retractors	122
GROSS-MAIER dressing forceps	84	HELFERICH-BIER amputating saws	277	JENNINGS mouth gags	272
GUTHRIE retractors	88	HENLEY retractors	124	JOHNS HOPKINS haemostatic forceps	70
GUTTMANN secretion scoops	236	HENNIG plaster-of-Paris instruments	276	JOHNS-HOPKINS Bulldog forceps	55
GUYON bougies	233	HERTZLER abdominal retractors	134	JONES towel forceps	80
GUYON catheters	75, 235	HEYMANN nasal scissors	30	JONES-MARTIN towel forceps	80
GUYON kidney pedicle clamp forceps	75	HEYWOOD-SMITH haemorrhoidal forceps	222	JOSEPH mucous hooks	271
GUYON set of dilating probes	234	HIBBS bone chisel	286	JOSEPH scissors	27
GUYON-PEAN kidney pedicle clamp forceps	75	HIRSCHMANN anoscope	218	JUDD-ALLIS intestinal forceps	203
Gynaecological scissors	24, 3	HOESEL needle holders with tungsten carbide inserts / Top dur	168	K	page
H	page	Hollow probes	146	KADER spatulas	119
HABERER spatulas	144	HOLTZHEIMER retractors	122	KALLMORGEN vaginal specula	241
Haemorrhoidal forceps	222	HOLZBACH abdominal retractors	133	KALT needle holders with tungsten carbide inserts / Top dur	162
Haemorrhoidal suction ligators	223	Hook forceps	248, 249	KANTROWITZ dissecting forceps	74
Haemostatic forceps	55-64, 67, 71, 72, 76	HOPKINS plaster-of-Paris knives	275	KELLY abdominal retractors	118
HAGLUND-STILLE plaster-of-Paris instruments	276	HORGAN middle valve	136	KELLY artery forceps	60
HAIGHT rib spreader	191	HÖSEL retractors	106	KELLY dissecting forceps	76
HAJEK mallets	287	HUMBY dermatomes	21	KELLY fistula scissors	24
HALSEY needle holders	171	HUNTER splinter forceps	49	KELLY proctoscope	219
HALSEY needle holders with tungsten carbide inserts / Top dur	163	HUSTINX retractors	131	KELLY retractors	105
HALSTED-MOSQUITO haemostatic forceps	57, 58	Hysterectomy forceps	77, 78	KELLY scissors with tungsten carbide inserts / Top dur	38
Hammer for anatomy	12	I	page	KELLY sphincteroscope	219
Handle for laryngeal mirrors	273	Incision scissors	22	KELLY uterine polypus forceps	250
HARRINGTON PEMBERTON retractors	114	Instruments for cranial opening	262, 264	KELLY-RANKIN artery forceps	60
HARRINGTON retractors	114	Insulated instruments	301	KEVORKIAN biopsy forceps	253, 255
HARTMANN ear polypus forceps	269	Interchangeable forceps tips	254	KEYES trephines	265
HARTMANN ear specula	268	Interosseous knife	19	Kidney pedicle clamp forceps	75
HARTMANN haemostatic forceps	57	Intestinal forceps	207-214	Kidney stone forceps	224
HARTMANN retractors	269	Intestinal grasping forceps	203-206	KIELLAND obstetrical forceps	259
HARTMANN tuning forks	268	Intestinal scissors	13, 33	KILLIAN nasal specula	270
HARTMANN-HALLE nasal specula	270	Intestinal stomach forceps	209	KILNER cutaneous hooklets	265
HAYES Atrauma intestinal forceps	214	Iris forceps	267	KILNER needle holders with tungsten carbide inserts / Top dur	163
Head lamps	7	Iris scissors	31, 38	KIRSCHNER abdominal retractors	139
		ISRAEL retractors	98	KIRSCHNER ligature conductors	178
		IVES-FANSLER anoscope	218	KIRSCHNER wire drills	282, 283

Measure instruments	3	MORITZ-SCHMIDT		OLSEN-HEGAR needle holders	
Meniscotomes	291	tongue depressors	272	with tungsten carbide inserts / Top dur	169
MERIAM tissue forceps		MORSE rib spreader	191	Operation scalpels	17
with tungsten carbide inserts / Top dur	53	MORSE rib spreader Alu	187	Ophthalmoscopes	4
Metall catheter for men	234	MOSQUITO-DANDY artery forceps	61	Osteotome blades interchangeable	284
Metall catheter for women	234	Mouth gags	272	O'SULLIVAN-O`CONNOR	
METZ scissors		Mouth spreader	272	abdominal retractors	137
with tungsten carbide inserts / Top dur	38	MOYNIHAN gall stone probes	225	O'SULLIVAN-O`CONNOR	
METZENBAUM		MOYNIHAN hysterectomy forceps	77	vaginal specula	245
dissecting scissors with		MUSEUX vulsellum forceps	249	Otoscope sets, complete	4
tungsten carbide inserts / Top dur	35-37, 42	MYERS vein stripper	146	OVERHOLT dissecting forceps	69
METZENBAUM needle holders	168	Myoma screw	250	OVERHOLT S-shaped forceps	65
METZENBAUM scissors	25, 26	Myrtle blade probes	145	OVERHOLT-GEISENDOERFER	
METZENBAUM Slim scissors	37			artery forceps	68
MEYER				OVERHOLT-MINI dissecting forceps	69
foreign body bone rongeur forceps	267			OVERHOLT-MIXTER forceps	66
MEYERDING retractors	91				
MICHEL suture clips	182	N	page	P	page
MICHEL suture clips forceps	181	NABATOFF varicose vein probes	147	Parametrium forceps	77
MICHEL suture clips tweezers	181	NAEGELE obstetrical forceps	259	Parametrium scissors	
MICRO-ADSON dressing forceps	47	Nail splitting scissors	33	with tungsten carbide inserts / Top dur	36
MICRO dressing forceps	51	Nasal specula	270, 271	PARKER retractors	121
MICRO needle holders	170	Needle holders	171-173	PARKER tenotomy knives	20
MICRO needle holders with		Needle holders with		PARKER-LANGENBECK retractors	121
tungsten carbide inserts / Top dur	160, 161	tungsten carbide inserts / Top dur	156-169	PAYR intestinal clamps	209
MICRO-ADSON tissue forceps		NEGUS gall duct forceps	76	PAYR ligature conductors	180
with tungsten carbide inserts / Top dur	52	NEIVERT needle holders		PAYR-BABY intestinal forceps	209
MICRO-MOSQUITO artery forceps	59	with tungsten carbide inserts / Top dur	163	PEAN (ROCHESTER)	
MIDDELDORPF abdominal retractors	107	NELATON hollow probes	146	haemostatic forceps	55, 62-64
MIDDELDORPF retractors	104	NELATON resection knives	20	PEDERSON vaginal specula	238
MIKULICZ abdominal retractors	118	NELSON grasping forceps	48	PEERS towel forceps	81
MIKULICZ peritoneum clamp forceps	79	NELSON trocars	151	PEET splinter forceps	50
MILAN biopsy curettes	252	NELSON-METZENBAUM scissors	36	PELKMANN forceps	84
MILLIGAN retractors	125	Nephrostomy forceps	225	Pelvimeters	259
MILLIN bladder retractor	230	Nerve dissecting scissors	25	PENFIELD dura dissectors	263
MILLIN capsule forceps	230	NIEDER lung spatulas	195	Penis seizing forceps	236
MILLIN ligature carrying forceps	230	NORTHBENT ligature scissors	33	PENNINGTON artery forceps	56
MINI-FRIEDMAN bone rongeur forceps	293	NOTO uterine polypus forceps	250	Percussion mallets	1
MINI-LAMBOTTE osteotomes	286	NOVAK suction biopsy curettes	251	PERCY retractors	292
MINI-LANGENBECK retractors	90			Peritoneal clamp forceps	79
MINI-LEXER osteotomes	285	O	page	PERMAN abdominal retractors	134
MINI-LISTON bone cutting forceps	298	OAKLEY antrum puncture trocars	152	PESTALOZZA ovum curettes	261
MINI-METZENBAUM scissors	25	Obstetrics	259, 260	Phalangeal knife	19
MINI-ROUX retractors	120	OCHSNER gall stone probes	225	PIERCE antrum trocars	152
MINI-RUSKIN bone rongeur forceps	295	OCHSNER trocars	151	PINARD stethoscope	2
MIXTER artery forceps	71, 72	O`CONNOR retractors	88	PIPER obstetrical forceps	259
MIXTER gall stone forceps	227	OEHLER tissue forceps		Plaster spatulas	148
MIXTER-BABY artery forceps	70	with tungsten carbide inserts / Top dur	53	Plaster-of-Paris instruments	275, 276
MIXTER-O`SHAUGNESSY		OLIVECRONA bone rongeur forceps	293	PLESTER retractors	123
artery forceps	71	OLIVECRONA dura hooks	264	POLLOSON retractors	113, 114
MOELTGEN goniometers	3	OLIVECRONA trigeminal scissors	29	Polypus forceps	269
MONCORPS knives	265	OLIVECRONA wire saws	262		
		Olives	147		
		OLLIER retractors	96		

POOLE suction tubes	153	Retractors	292	SAUERBRUCH waste forceps	87
Post mortem knives	10	REVERDIN abdominal spatulas	144	Saw blade for finger ring saw	300
POTTS-DE MARTEL scissors	28	REVERDIN needles	174	Scalp flap forceps	260
POTTS-SMITH		REYNOLDS dissecting scissors	27	Scalpel blades	16
anatomical dressing forceps	44	Rib contractors	194	Scalpel handles	14, 15
POTTS-SMITH scissors	28	Rib scissors	13, 183-185, 190-194	Scalpels	8, 18
POTTS-SMITH scissors		Rib spreader alu	186-189	SCHAEDEL towel forceps	80
with tungsten carbide inserts / Top dur	39	RICARD abdominal retractors	133	SCHEDE spoon	288
POTTS-SMITH		RICHARDSON retractors	105	SCHERBACK vaginal specula	243
surgical dressing forceps	47	RICHARDSON-EASTMAN		SCHINDLER peritoneal forceps	79
POTTS-SMITH tissue forceps		retractors	105	SCHINK dermatome	21
with tungsten carbide inserts / Top dur	52	RICHTER-HEATH suture instruments	181	SCHMIEDEN ligature conductors	180
POTTS-YASARGIL micro scissors	32	RIGBY abdominal retractors	131	SCHMIEDEN-PAYR ligature conductors	180
POZZI hook forceps	248	ROBERTS artery forceps	66	SCHMIEDEN-TAYLOR dura scissors	28
PRATT hooks	249	ROBIN-MASSE abdominal retractors	133	SCHNIDT artery forceps	61
PRATT rectal probes	220	ROCHARD abdominal retractors	140	SCHRÖDER hooks forceps	248
PRATT rectal specula	215	ROCHARD fixation	140	SCHROEDER uterine scoops	256
PRESBYTERIAN-HOSPITAL		ROCHESTER-CARMALT		SCHUBERT biopsy forceps	252
tubing clamps	82	artery forceps	62	SCHULTZE salpingograph	260
PRICE-THOMAS bronchus clamps	195	ROOS aorta hooks	113	SCHULZE-BERGMANN	
PRINCE tonsil scissors	29	ROOS rib scissors	184	rectal specula	216
Probes	145-147	ROSER KOENIG mouth gags	272	SCHUMACHER biopsy forceps	252, 253
Prostatectomy instruments	229-231	ROUX retractors	120	SCHUMACHER scissors	30
PROVIDENCE-HOSPITAL		RUDD haemorrhoidal suction ligators	223	SCHUMACHER tips	254
artery forceps	59	RUDD loading cone	223	Scissors fine	32
PUTTI bone rasps	286	RUMEL dissecting forceps	69	Scissors fine surgical	31
		RUSKIN bone rongeur forceps	295	Scissors fine with	
Q	page	RUSKIN-LISTON		tungsten carbide inserts / Top dur	37-39
QUINBY scissors	31	bone cutting forceps	298	Scissors gynecological	3, 24
		RUSS.MODELL		Scissors surgical	3, 22
R	page	surgical dressing forceps	47	Scissors with	
RABINER percussion mallets	1	RYDER vascular		tungsten carbide inserts / Top dur	34, 36
RADOLF forceps		Slim needle holders		SCOVILLE blades	142
for tearing toe and finger nails	300	with tungsten carbide inserts / Top dur	159	SCOVILLE retractors	142
RAGNELL-DAVIS retractors	92			SCUDDER-ATRAUMA	
RAGNELL-KILNER scissors	27	S	page	intestinal forceps	213
RAMPLEY sponge and dressing forceps	86	SAALFELD comedo extractors	265	Secretion scoops	236
RANDALL kidney stone forceps	224	SACHS dura hooks	264	SEGOND hysterectomy forceps	77
RANDALL suction curettes	251	SAENGER ovum forceps	261	SELLHEIM elevating spoon	260
RAPP splinter forceps	50	Safety pins	87	SELLORS rib contractors	194
Raspatories	289, 290	Salpingograph	260	SEMB bone cutting forceps	299
Razor	21	SANVENERO surgical scissors	27	SEMB bone holding forceps	292
RECAMIER curettes	257, 258	SAROT artery forceps	67	SEMB bone rongeur forceps	296
Rectal biopsy specimen forceps	219	SAROT needle holders		SEMB bronchus forceps	196
Rectal biopsy specimen speculas	215, 216, 218	with tungsten carbide inserts / Top dur	164	SEMB rib raspatories	290
Rectal instruments	220, 221	SATINSKY atrauma vessel forceps	200	SEMKEN anatomical dressing forceps	43
Rectal probes	220	SATINSKY bronchus forceps	196	SEMKEN surgical dressing forceps	46
REGOLO metal ruler	3	SATINSKY vessel scissors	28	SEMM abdominal retractors	138
REHN transplantation knives	21	SATTERLEE blade saw	277	SEMM vaginal specula	239
Resection knives	20	SAUERBRUCH retractors	111, 112	SENN-GREEN retractors	92
Resection saws	277	SAUERBRUCH rib scissors	185		

SENNING needle holders					
with tungsten carbide inserts / Top dur	159				
SENNING suction tubes	153				
SENN-MUELLER retractors	92				
Sensibility instruments	2				
Set of dilating probes	234				
Sharp spoon	288, 289				
SIEBOLD gynecological scissors	24				
SILVER dermatomes	21				
SIMON fistula knives	20				
SIMON retractors	109				
SIMON uterine scoops	256				
SIMPSON obstetrical forceps	259				
SIMPSON-BRAUN					
obstetrical forceps	259				
SIMS gynecological scissors	24				
SIMS rectal specula	215				
SIMS scissors	36				
SIMS uterine curettes	256				
SIMS uterine probes	247				
SIMS vaginal specula	239				
SINGLEY-TUTTLE grasping forceps	48				
SKENE hook forceps	248				
Skull breakers	12				
SMILLIE menisectome	291				
SMITH-BUIE rectal specula	216				
SOMER uterine forceps	251				
Spare blades	21				
Spare lamps for ophthalmoscope	5				
Spare lamps for otoscope	5				
Spare mirror	7				
Spare saw blades	277				
Spare screws	284				
SPENCER ligature scissors	33				
SPENCER-WELLS artery forceps	55				
Spermatic cord hook	229				
Splinter forceps	49, 50				
Sponge and dressing forceps	86				
Sponge forceps	83-85				
Sponge holders	149				
ST.MARKS rectal instruments	221				
STACKE ear probes	145				
STANDARD					
anatomical dressing forceps	43, 52				
STANDARD					
anatomical tissue forceps					
with tungsten carbide inserts / Top dur	52				
STANDARD magnetic eye probes	267				
STANDARD scissors	22, 34				
STANDARD scissors					
with tungsten carbide inserts / Top dur	34				
STANDARD trocars	150				
Sterile scalpels	16				
Sterilizing forceps	82				
Sternum chisel	185				
Sternum scissors	185				
STEVENS dissecting scissors	40				
STEVENS tenotomy scissors	32				
STIEGLITZ splinter forceps	50				
STILLE anatomical dressing forceps	43				
STILLE bone rongeur forceps	296				
STILLE chisels	285				
STILLE spoon	288				
STILLE surgical dressing forceps	45				
STILLE-BARRAYA					
surgical dressing forceps	47				
STILLE-LISTON bone cutting forceps	299				
STILLE-LUER bone rongeur forceps	297				
STILLE-MOD.MARTIN					
plaster-of-Paris scissors	275				
STILLE-RUSKIN bone rongeur forceps	296				
STOCKMANN meatus clamps	236				
Stomach clamps	209, 210				
STONE surgical dressing forceps	45				
Strabismus scissors	32				
STRANDELL-STILLE retractors	94				
STRATTE needle holders	166				
STRAUSS meatus clamps	236				
STRULLY neurosurgical scissors	28				
Suction biopsy curettes	251				
Suction canulas	155				
Suction tubes	153-155				
Surgical dressing forceps	45-47				
Surgical scissors	22, 30				
Surgical scissors					
with tungsten carbide inserts / Top dur	34				
Surgical tissue forceps					
with tungsten carbide inserts / Top dur	52-54				
Suture clips	182				
Suture clips forceps	181				
Suture instruments	180, 181				
T					page
Tampon forceps	270, 271				
Tape measure	3				
TAYLOR anatomical dressing forceps	43				
TAYLOR reflex hammer	1				
TAYLOR surgical dressing forceps	46				
TEALE tenaculum forceps	249				
Tenotomy knives	20				
TERRIER artery forceps	55				
THIERSCH transplantation knives	21				
THOMS-ALLIS intestinal forceps	204				
THOMS-GAYLOR biopsy forceps	252				
THOMSON-WALKER					
bladder retractors	231				
THOREK dissecting scissors	26				
TIECK-HALLE nasal specula	270				
TISCHLER-MORGAN biopsy forceps	255				
Tissue seizing forceps	203				
TOBOLD tongue depressors	272				
TOENNIS dissecting scissors	29				
TOENNIS dura dissectors	263				
TOENNIS needle holders					
with tungsten carbide inserts / Top dur	156				
TOENNIS-ADSON dissecting scissors	28				
TOENNIS-ADSON scissors	38				
TOENNIS-RYDER					
Slim needle holders					
with tungsten carbide inserts / Top dur	156				
TOHOKU towel forceps	81				
Tongue holding forceps	273				
Tongue spatula	273				
Tonsil scissors	29				
Towel forceps	80, 81				
TOWNSEND-MINI biopsy forceps	255				
Trachea retractors	266				
Transformer	7				
TRELAT vaginal specula	238				
Trephines	265				
Trocars	150-152				
TROELTSCH (WILDE)					
dressing forceps	269				
TROEMNER percussion mallets	1				
TROUSSEAU trachea dilators	266				
Tube forceps	82				
TUFFIER abdominal spatulas	144				
TUFFIER artery forceps	56				
TUFFIER rib spreader	191				
U					page
ULRICH fistula knives	20				
ULRICH sponge- and dressing forceps	83				
Umbilical scissors	30				
UNIVERSAL bandage scissors	274				
UNIVERSAL handles	254				
UNIVERSAL trocars	150				
UNIVERSAL wire scissors	33				
UNNA comedo extractors	265				
USA anatomical dressing forceps	43				
Uterine biopsy forceps	254				
Uterine curettes	256-258				
Uterine dilators	246				

Uterine gauze packers	247
Uterine grasping forceps	251
Uterine polypus forceps	250
Uterine probes	247
Uterine scoops	256

V page

Vaccinating lancets	150
Vaginal forceps	77, 78
Vaginal retractors	108, 109, 240, 242
Vaginal specula	237-245
VALLEIX uterine probes	247
VAN BUREN bougies	233
VAN DOREN biopsy forceps	252
Varicos vein probe set	147
Vessel forceps	196
Vessel forceps atraumatic	197, 200-202
Vessel scissors	28
Vessel stripper	147
VIRCHOW autopsy knives	9, 11
VIRCHOW skull breakers	12
VOLKMANN bone curettes	288, 289
VOLKMANN retractors	91, 94, 95

V page

WACHENFELDT suture clips	181
WAGENER hook probe	269
WAGNER scissors	
with tungsten carbide inserts / Top dur	38
WALB organ knives	10
WALDMANN episiotomy scissors	30
WALTER-CARMALT splinter forceps	49
WALTON foreign body chisel	267
WANGENSTEEN	
anatomical dressing forceps	44
WANGENSTEEN dressing forceps	53
WANGENSTEEN needle holders	166, 173
WARTENBERG pin wheels	2
WASSMUND retractors	96
Waste forceps	87
WATSON dermatomes	21
WAUGH anatomical dressing forceps	44
WAUGH dressing forceps	47
WEBSTER needle holders	171
WEISSBARTH vaginal specula	243
WEITLANER retractors	123, 125
WERTHEIM clamps forceps	78
WERTHEIM surgical scissors	24
WESTCOTT strabismus scissors	32
WESTMACOTT nasal tampon forceps	271

WILLIAMS intestinal tissue forceps	204
WILLIGER raspatories	289
WILLIGER resection knives	20
WINTER abortus forceps	261
Wire bending pliers with tungsten carbide inserts / Top dur	281
Wire cutting pliers	280
Wire cutting pliers with tungsten carbide inserts / Top dur	278, 279, 281
Wire cutting scissors with tungsten carbide inserts / Top dur	38
Wire drills	282, 283
Wire saws	262
Wire twisting forceps with tungsten carbide inserts / Top dur	278
Wire valves	135
WITTNER biopsy forceps	254
WOLFF plaster cast instruments	276
WRIGLEY obstetrical foreps	259
WULLSTEIN retractors	125

X page

Xenon battery head lamp	7
-------------------------	---

Y page

YANKAUER suction tubes	153
YASARGIL scissors	32
YEOMAN rectal biopsy forceps	219
YOUNG prostata forceps	229
YOUNG suture instruments	174
YOUNG tongue holder forceps	273

Z page

ZAUFAL-JANSEN	
bone rongeur forceps	295
ZENKER dissecting forceps	70
ZENKER retractors	101
ZIEGLER head mirrors	6
ZWEIFEL needle holders	
with tungsten carbide inserts / Top dur	168