

Ay 122a, Fall 2012

Spectrographs and Spectroscopy (UV/visible/IR)

*S. G. Djorgovski
(Some slides today c/o M. Bolte)*

The Purposes of Spectroscopy

- To measure accurate wavelengths of emission and absorption lines
 - Get velocities, redshifts
- To measure the relative strengths and/or equivalent widths of emission or absorption lines
 - Abundances, ionization states, temperatures...
- To measure shapes of emission or absorption lines
 - Pressure, density, rotation, magnetic fields ...
- To measure the spectral energy distribution of the continuum radiation
 - Physical mechanisms, temperature ...
- In other words, spectroscopy enables *astrophysics!*

Types of Spectrographs

- By type of dispersing element:
 - Grating (transmission or reflection)
 - Prism (rare, except as a cross-dispersor)
 - Grism = grating on a prism
 - Narrow-band imaging
 - Interferometry

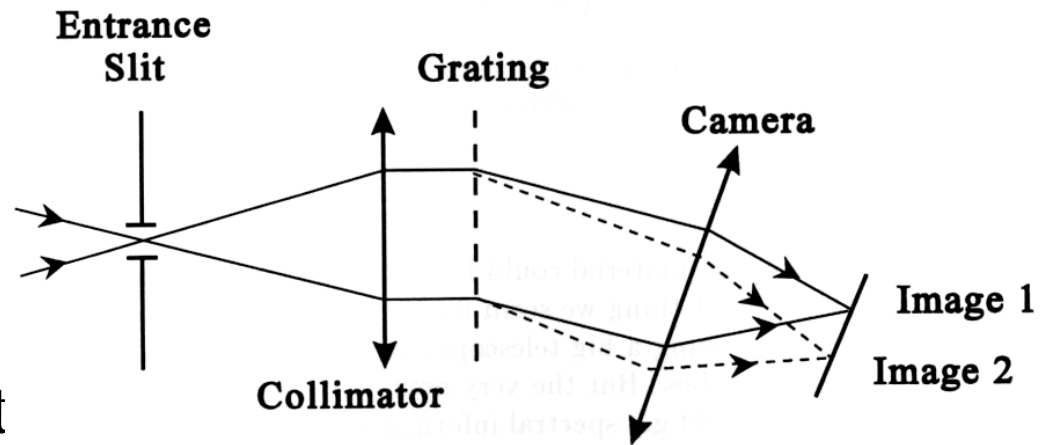

- By geometry:
 - Long-slit or multislit
 - Aperture of multi-fiber
 - Integral field units (IFU): lenslets or fiber bundles
 - Tunable imagers (e.g., Fabry-Perot)

Diffraction Gratings

- The principal device used to generate wavelength-dependent interference patterns at UV/Opt/IR (and even X-ray) wavelengths
- A diffraction grating acts as a set of equally spaced slits in an otherwise opaque screen
- Each slit can be considered as radiating secondary waves (Huygens' secondary wavelets)
- The amplitude at any point on the image side of the slit can be calculated by summing the amplitude contributed by each set of secondary wavelets

Diffraction Gratings

- Most common is probably the *reflecting diffraction grating*.
- Grating equation: $m\lambda = d[\sin(\alpha) + \sin(\beta)]$
 ↑ ↑
 order groove spacing

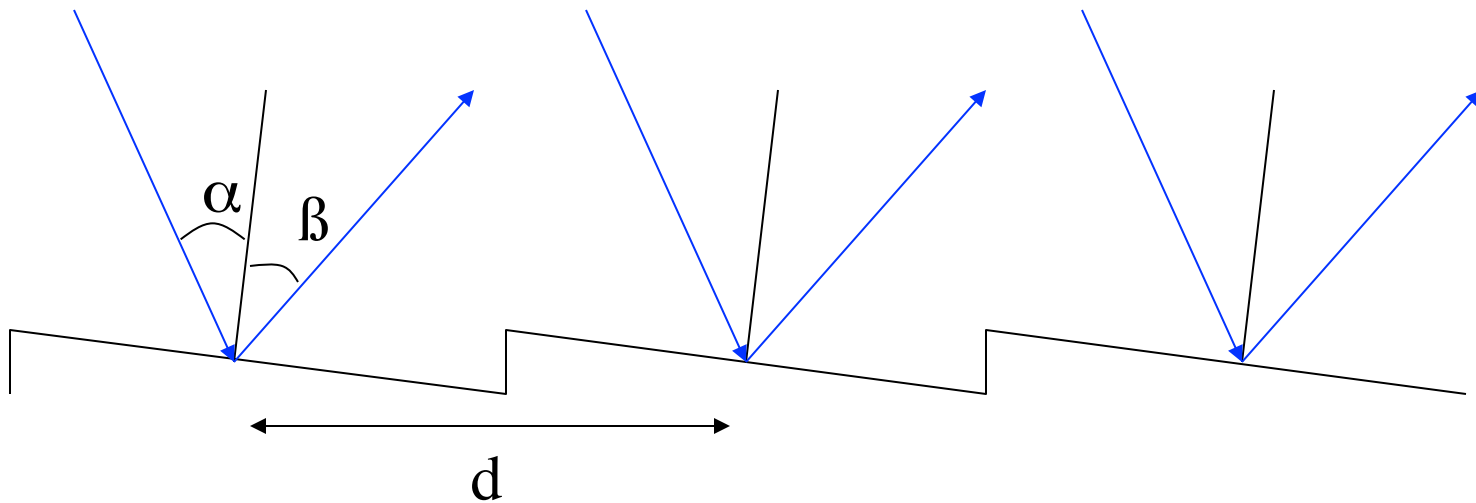

Diffraction Gratings

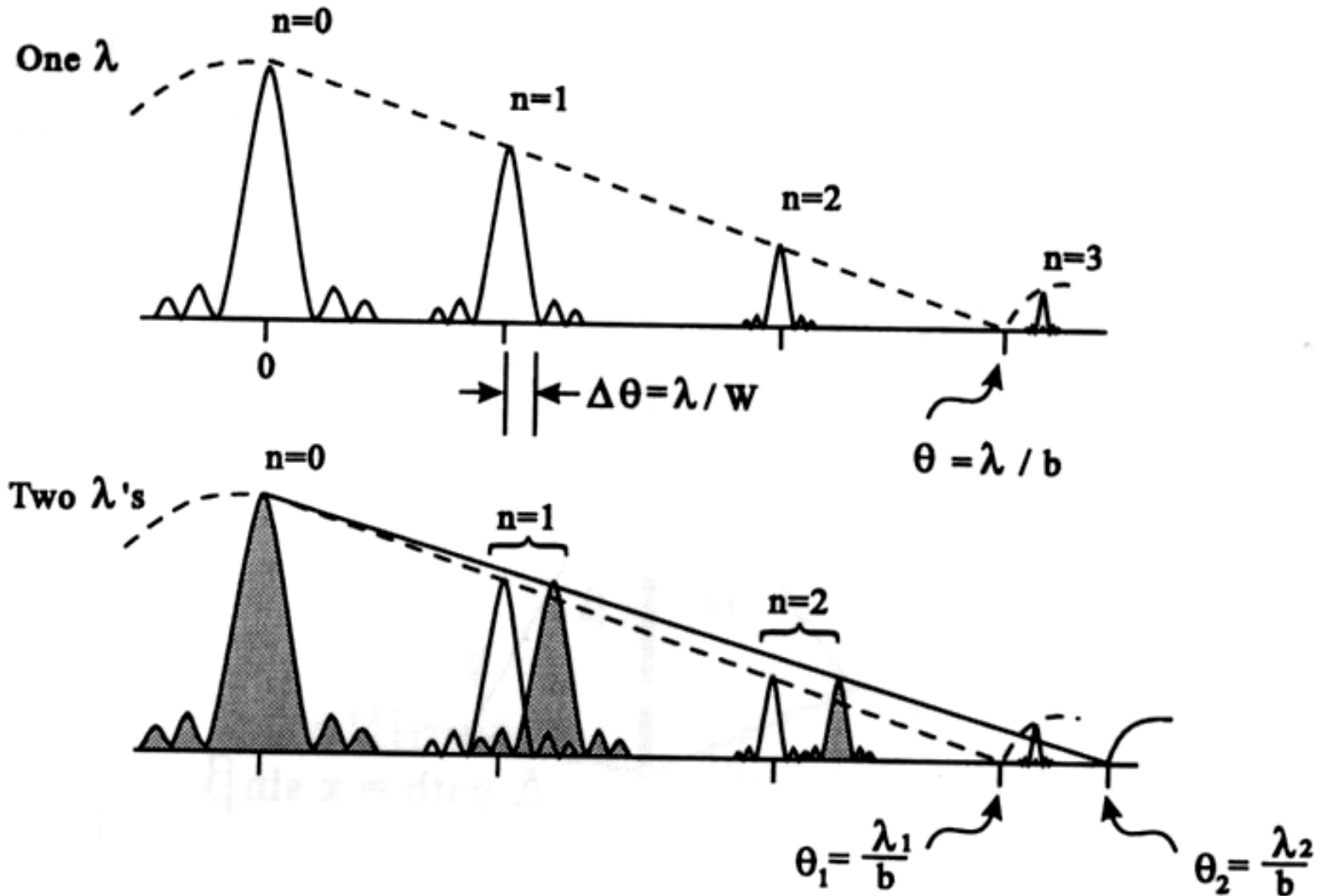

Diffraction Gratings

- The single slit diffraction pattern modifies this by affecting the heights of the maxima, the strongest being at $m = 0$
- This “zeroth order” maximum is of no use, because it does not provide any discrimination in wavelength, it is at the same angle for any λ
- Gratings are designed to concentrate radiation in orders with $m \neq 0$ (note that positive and negative m are equivalent)

Diffraction Gratings

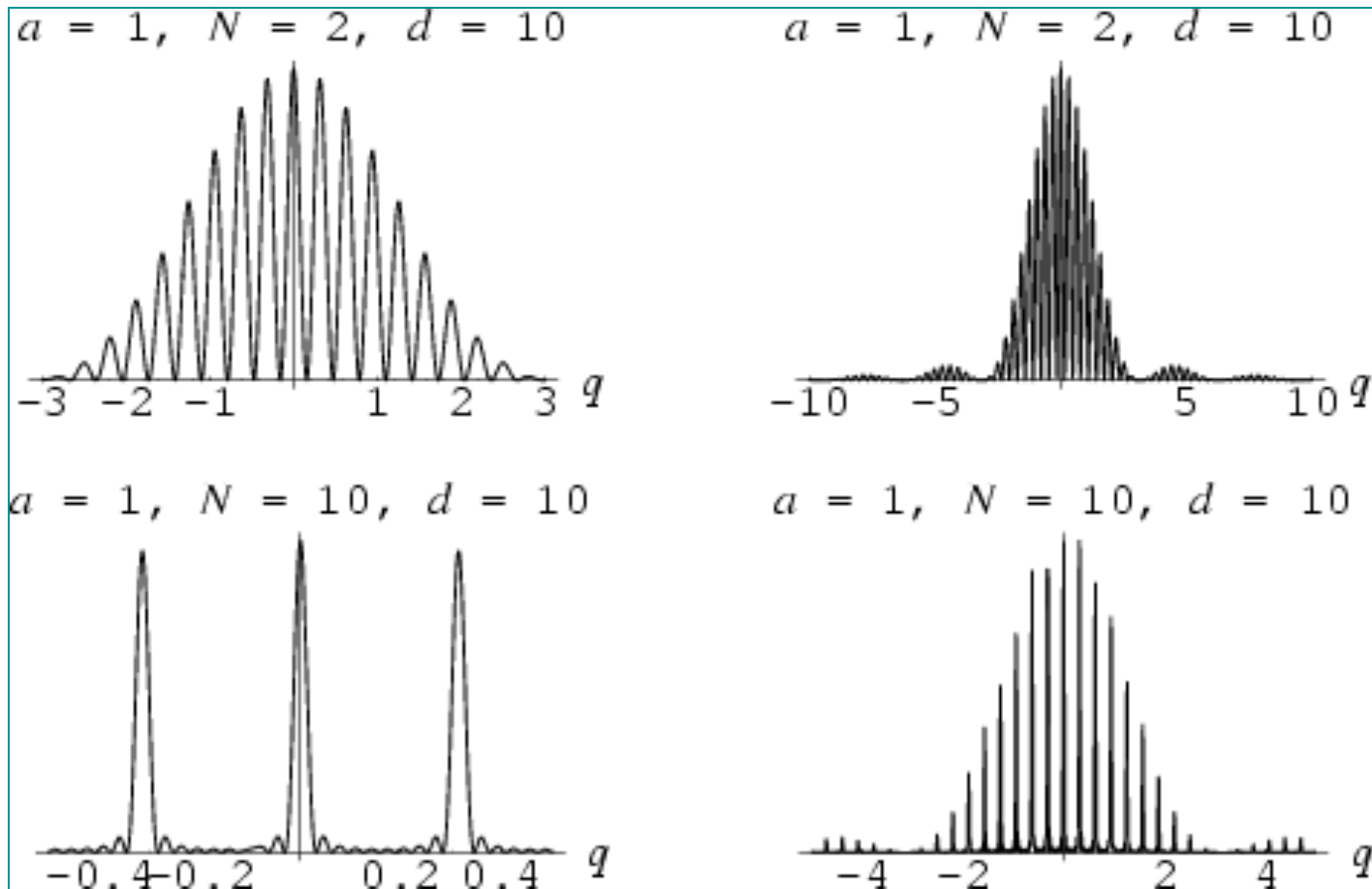

Monochromatic diffraction patterns from one and 10 slits

Intensity Profile From an Unblazed Grating

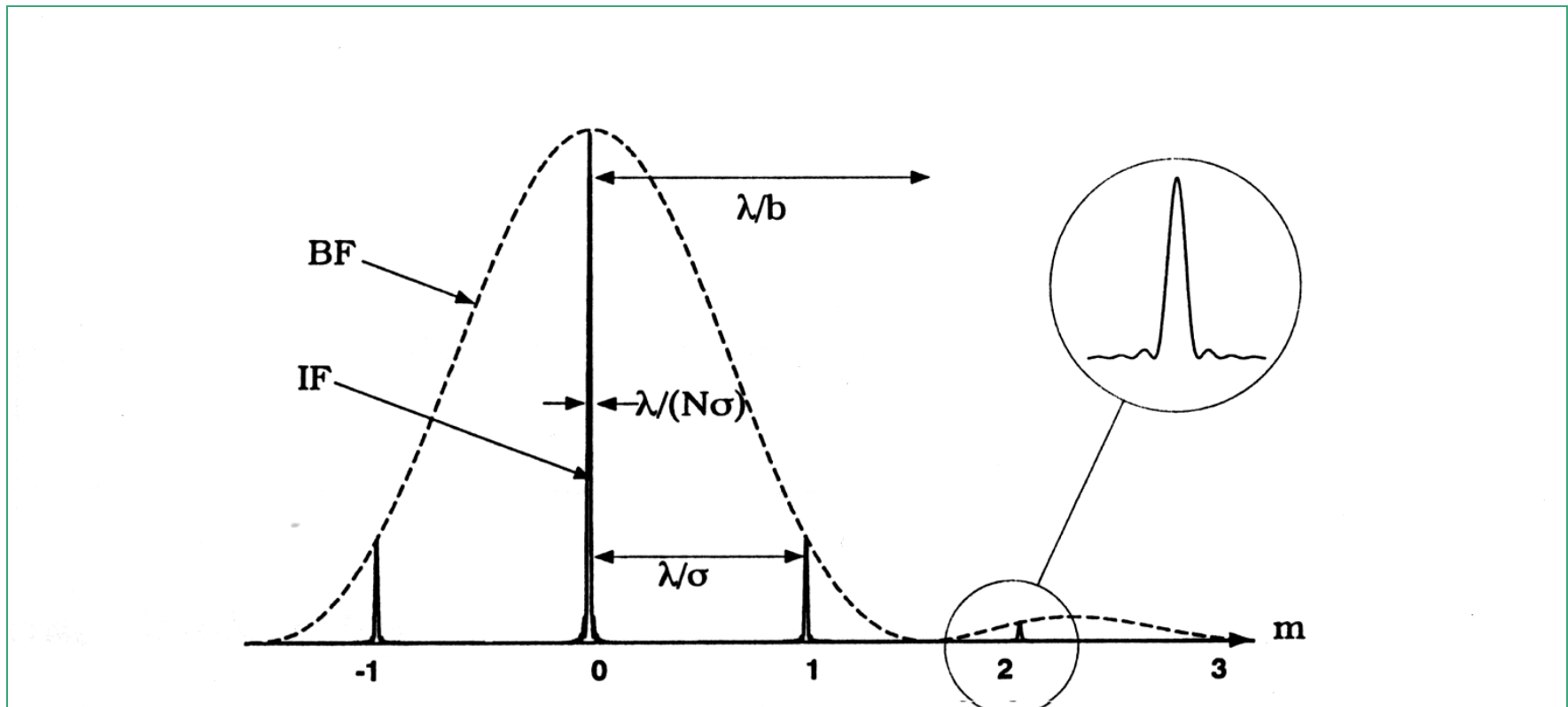

- Differentiate the grating equation wrt outgoing angle and get the *angular dispersion*

$$\frac{d\beta}{d\lambda} = \frac{m}{d \cos(\beta)}$$

- The *linear dispersion* is:

$$\frac{d\lambda}{dx} = \frac{d\lambda}{d\beta} \frac{d\beta}{dx} = \frac{d \cos(\beta)}{m F_{\text{camera}}}$$

in camera
focal plane

order

$\text{\AA}/\text{mm} \propto d/m$

lines/mm

$$F_{\text{camera}} = \frac{dx}{d\beta} \equiv \text{camera focal length}$$

Diffraction Gratings

- There are three principal methods of grating fabrication:
 - Diamond ruling on a low expansion glass substrate
 - Epoxy resin cast of a diamond ruled master
 - Imaging the interference pattern of a laser interferometer onto photosensitive emulsion, then etching away the unexposed regions; these are holographic gratings (not to be confused with Volume Phase Holographic gratings)
- Most practical gratings are *reflection gratings*, they are not composed of a screen with equally spaced slits, but of alternating reflecting and non-reflecting strips, made by ruling on a reflecting surface
- Note: ruling gratings is not easy! Spacing tolerance is $\sim 1\text{nm}$. Grating ruling machines are used in rooms kept a constant temperature to 0.01°C

Blazed Gratings

- To concentrate light away from zero order to higher orders, gratings are blazed
- The reflecting surfaces are now oriented at some angle with respect to the surface of the grating, reflecting light preferentially in that direction
- Blaze shifts the peak of the grating efficiency envelope towards higher orders
- An additional advantage is that the whole surface can now be reflecting, since the step where two facets join provides a phase difference to allow diffraction to occur
- But if a grating is blazed to be efficient at a particular wavelength with $m=1$, then it is also efficient at half that wavelength with $m=2$, so order overlap can be a problem

Grating Blaze

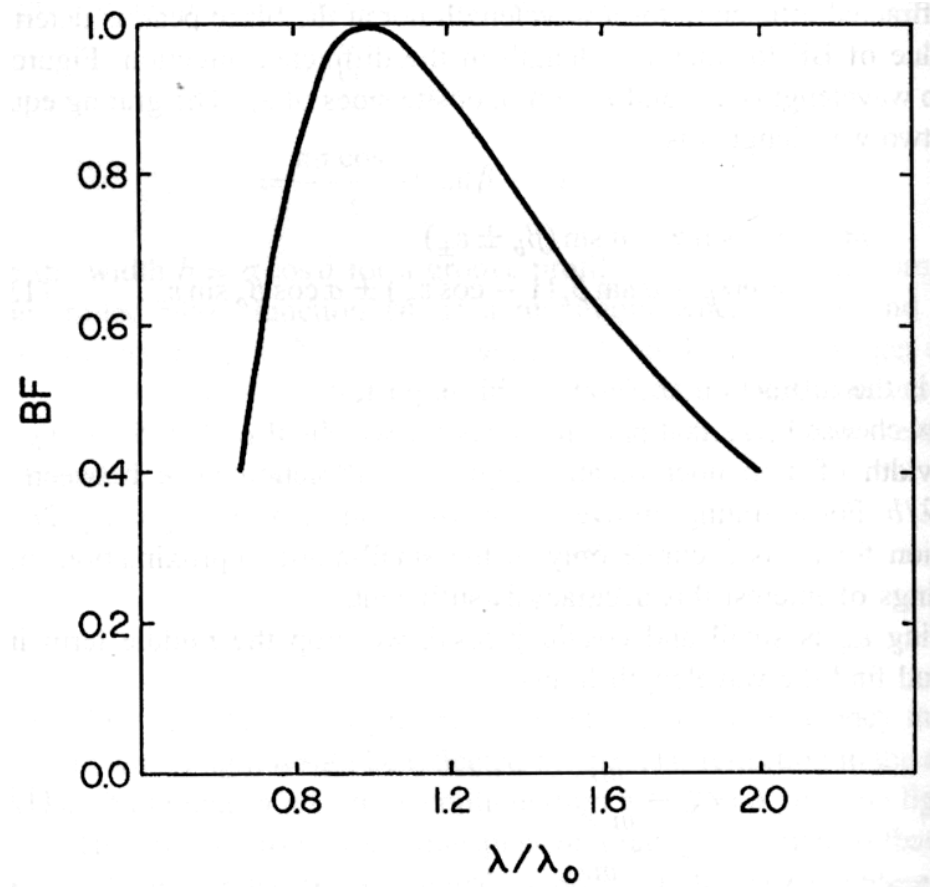
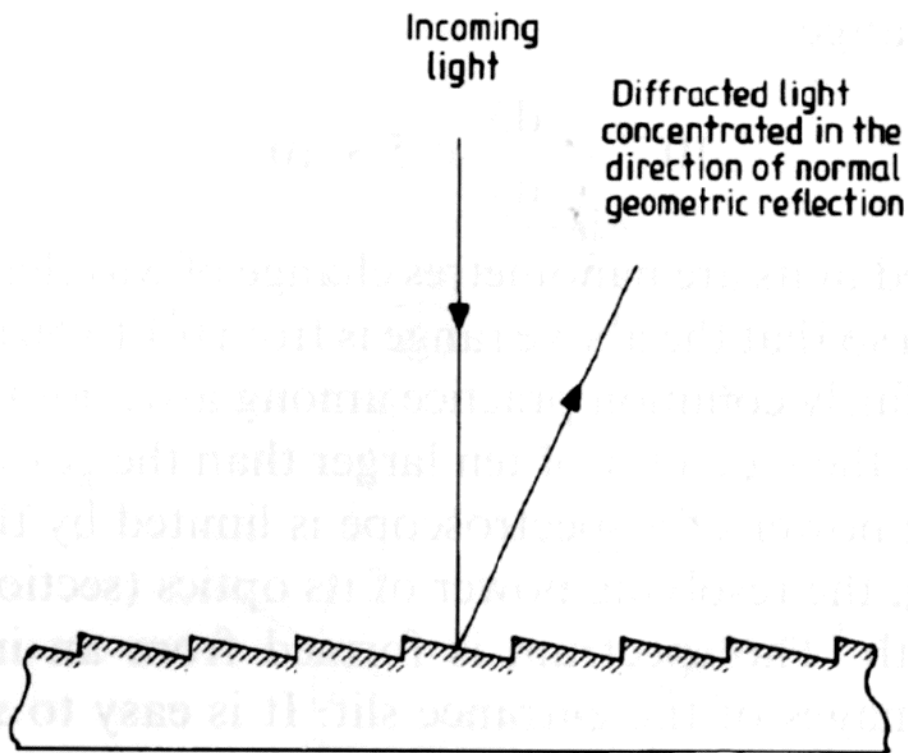

Low-resolution Gratings LRIS Spectral Efficiency

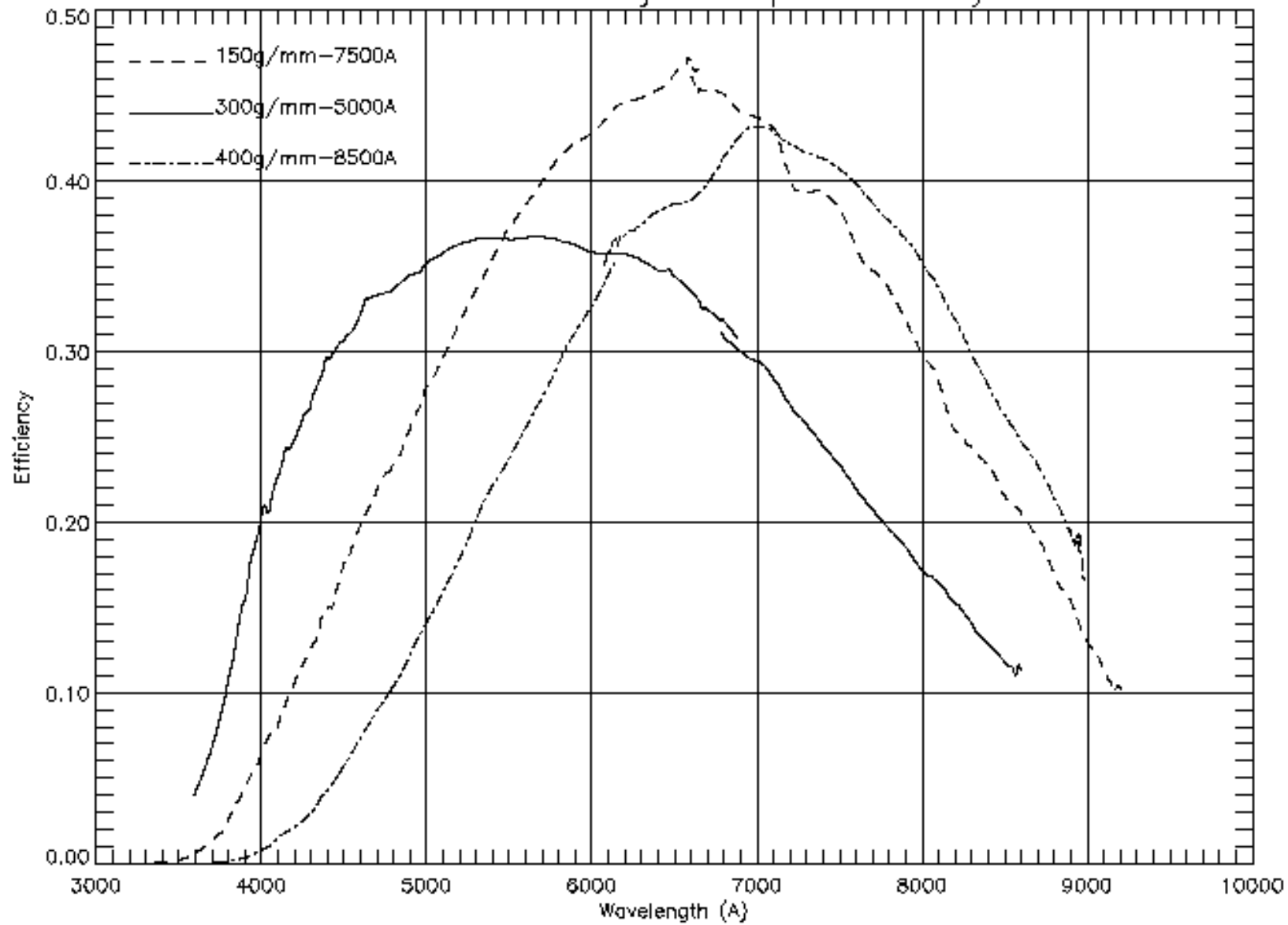

Example: LRIS Gratings

(From Keck Obs. WWW page)

Grating Name	Grooves (l/mm)	Blaze (Å)	Disp. (Å/pix)	Spec. coverage (Å/2048 pix)
150/7500	150	7500	4.8	9830
300/5000	300	5000	2.55	5220
400/8500	400	8500	1.86	3810
600/5000	600	5000	1.28	2620
600/7500	600	7500	1.28	2620
600/10000	600	10000	1.28	2620
831/8200	831	8200	0.93	1900
900/5500	900	5500	0.85	1740
1200/7500	1200	7500	0.64	1310

Transmission Gratings

There are also different versions of transmission gratings:

- Transmission gratings
- *Grisms* - add a prism for *zero-deviation* transmission dispersion
- *Volume Phase Holographic Gratings*: VPH - use modulations of the index of refraction rather than surface structures to produce dispersion. High efficiency!

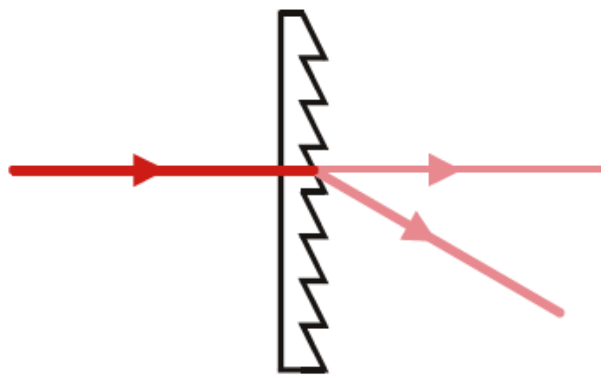

Relief Diffraction Grating

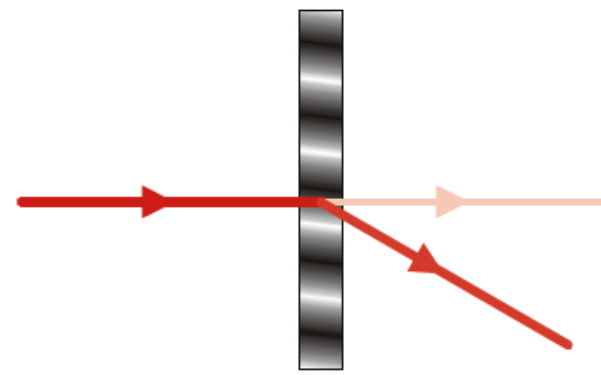

VPH Diffraction Grating

Volume Phase Holographic Gratings

- They work by a mechanism similar to Bragg diffraction
- The planes are provided by refractive index modulations in a volume of gelatin, set up by a holographic process
 - If the fringes are parallel to the grating surface, the grating acts as a reflecting monochromator as in the Bragg crystal
 - If the fringes are nearly parallel to the grating surface, it acts as a reflection grating
 - If the fringes are perpendicular to the grating surface, or nearly so it acts as a transmission grating
- Transmission gratings with very low fringe spacings can be made, much lower than the ruling spacing on a conventional grating

Spectrometers

- Gratings require collimated (parallel beam) light so the basic long-slit spectrometer:

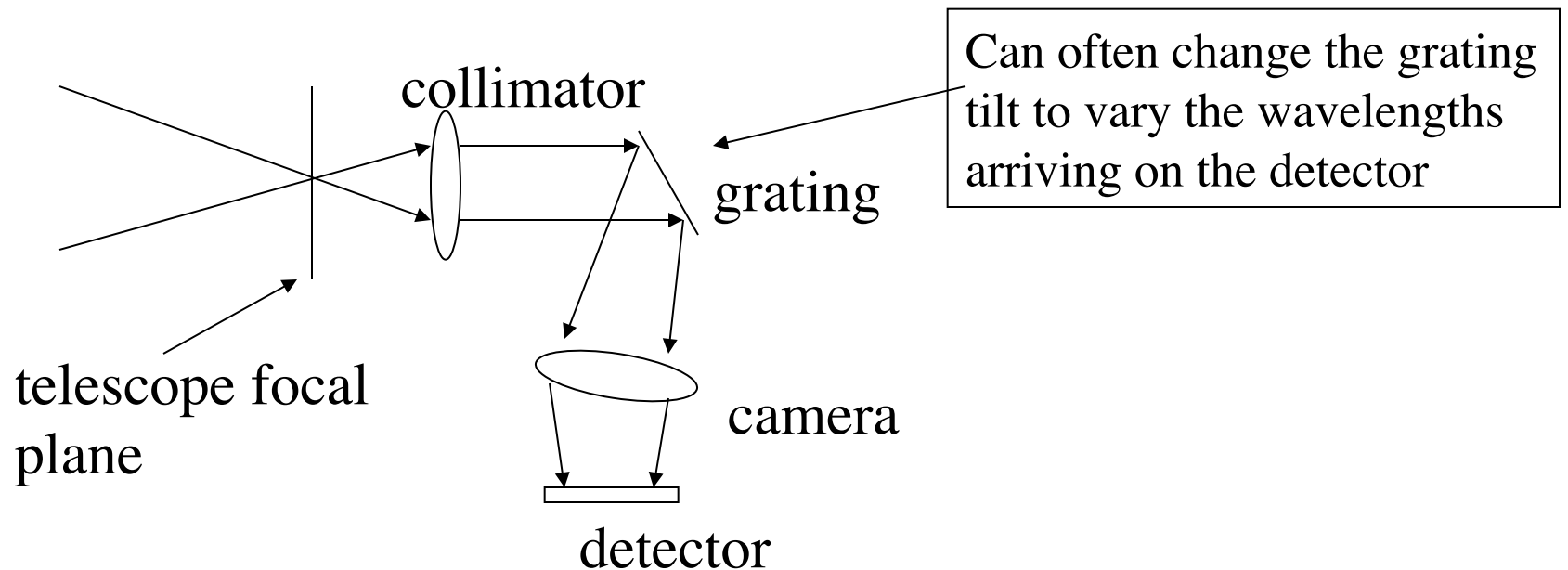

Diffraction Grating Spectrograph

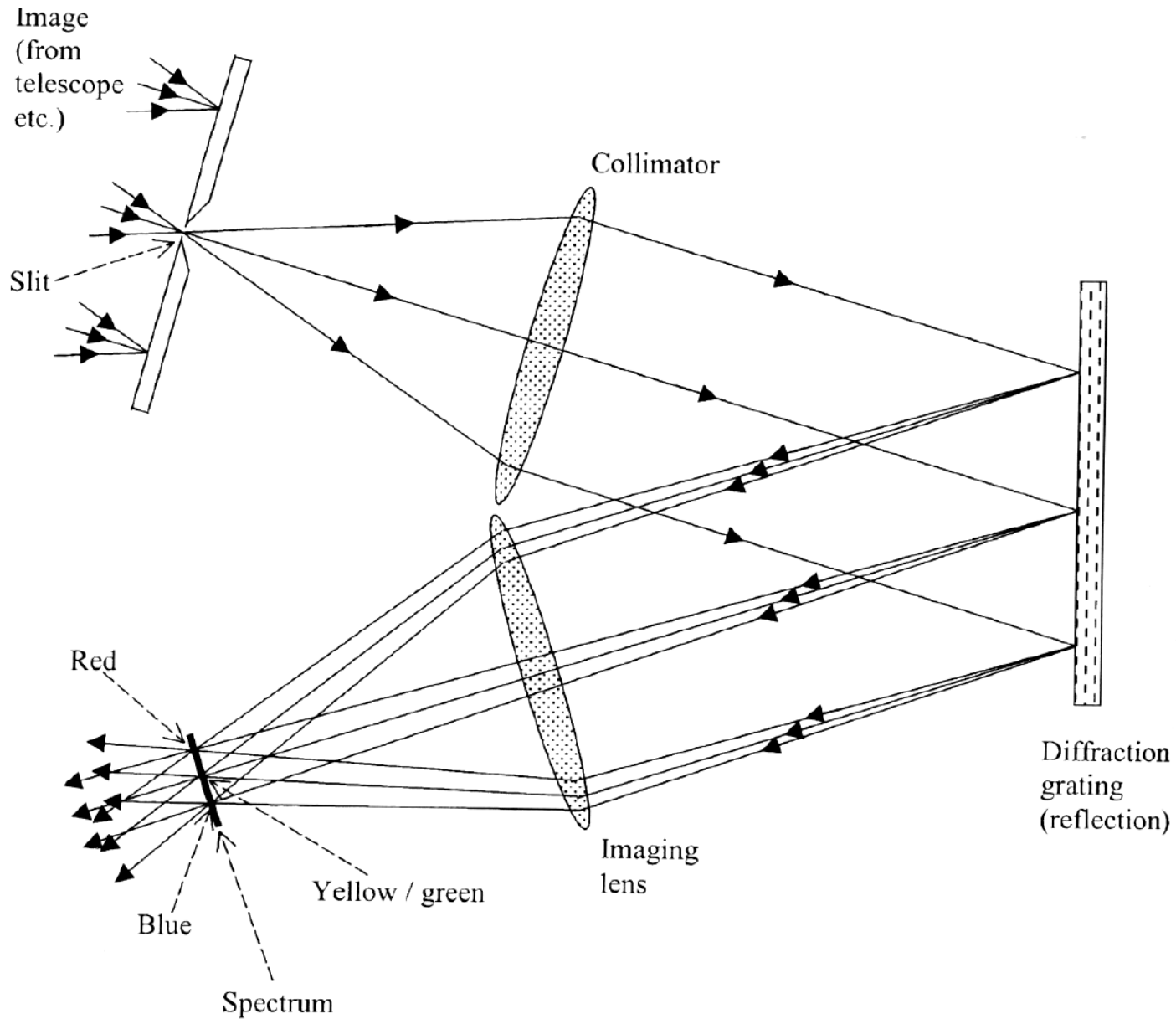

Long-slit Spectra Geometry

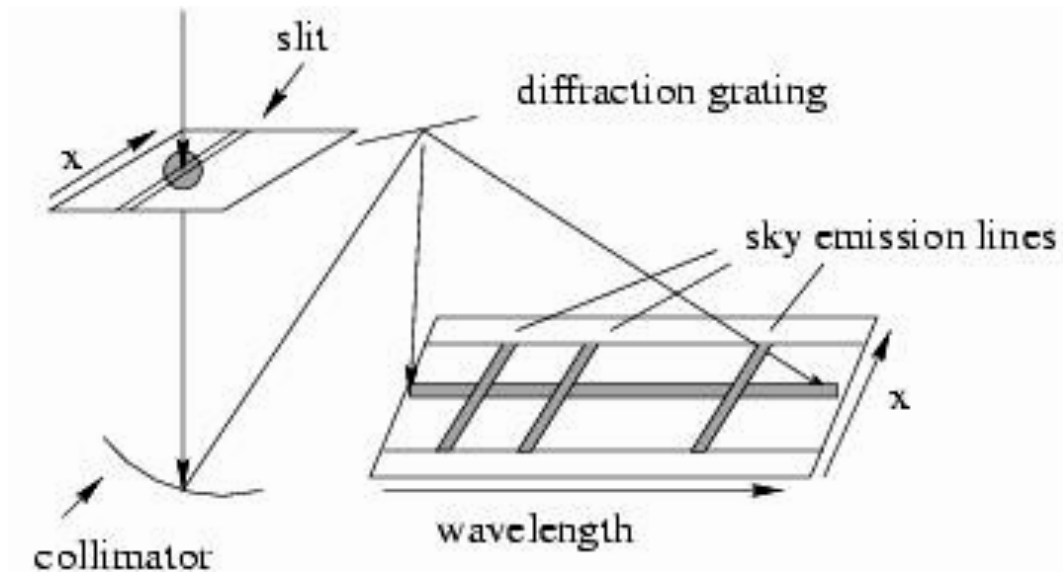

In the *camera* focal plane there is the *dispersion direction* perpendicular to the slit and the *spatial direction* along the slit.

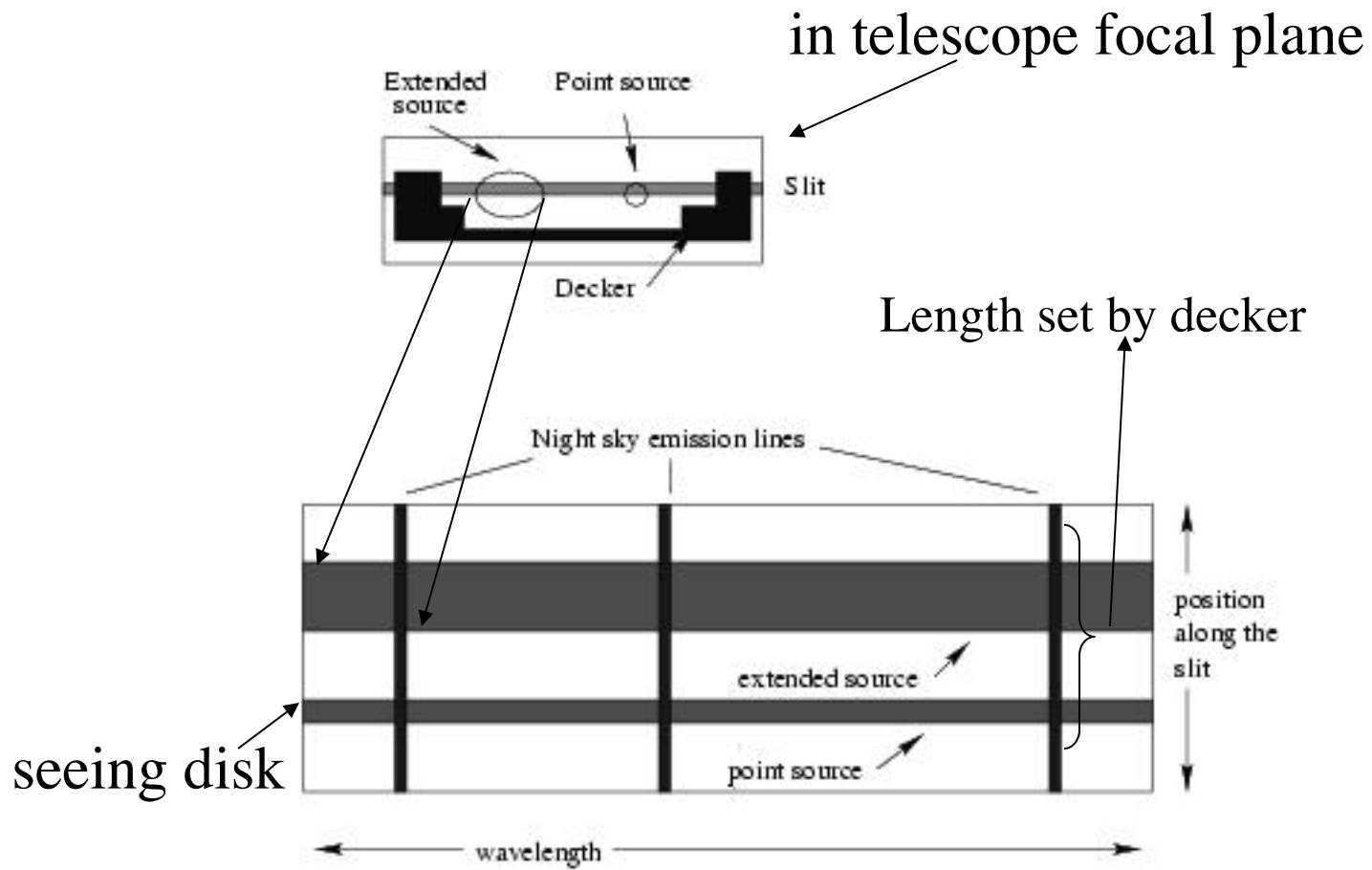

An Example: P200 DBSP

Night sky OH emission bands

.....

s
p
a
t
i
a
l

Raw data

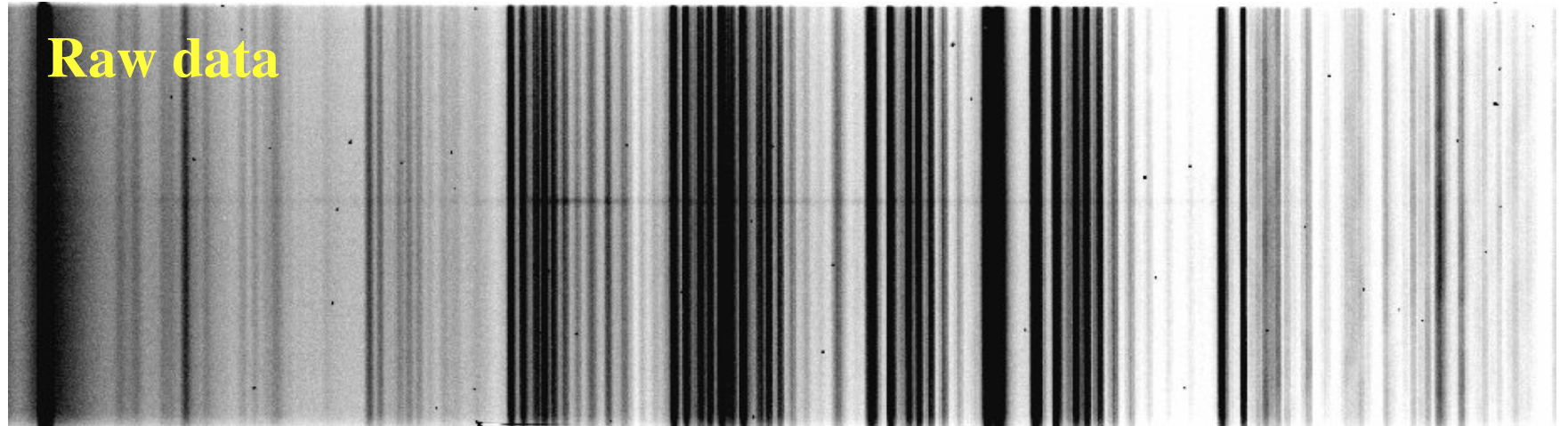

Sky subtracted

Object spectrum

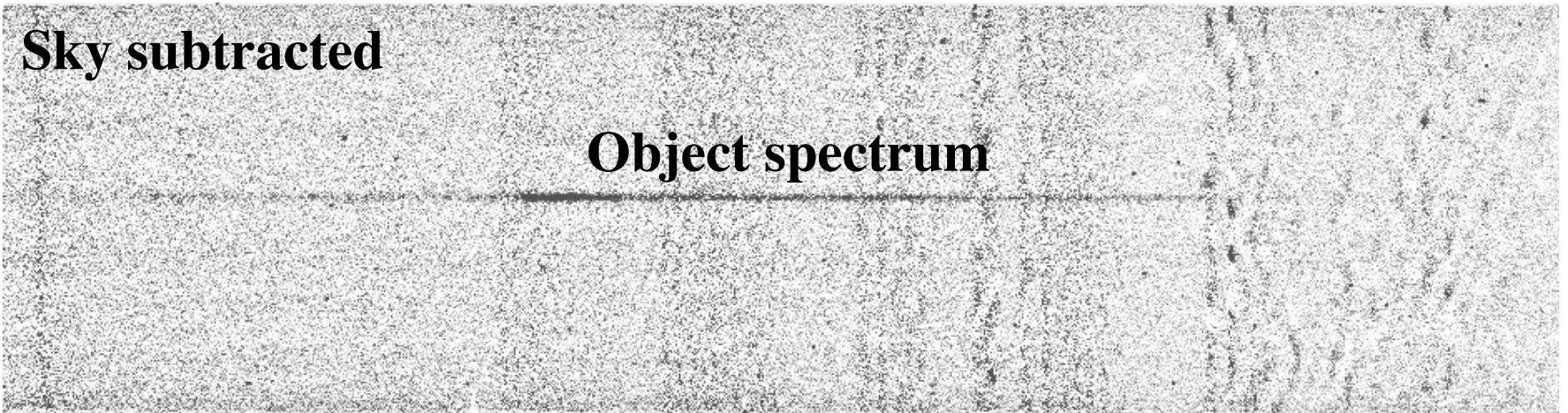

Spectral Resolution

- $R = \lambda / \Delta\lambda$
- For slit spectral, depends on slit width and grating choice.
- Examples:
 - V filter: $5500\text{\AA} / 1000\text{\AA} = 5.5$
 - LRIS-R: $1'' \sim 4$ pixels FWHM
 - 150 l/mm grating: $R \sim 6500 / 20 \sim 325$
 - 600 l/mm grating: $R \sim 6500 / 5 \sim 1300$
 - 1200 l/mm grating: $R \sim 6500 / 2.6 \sim 2600$

Higher Resolution → Better Sky Subtraction

Because fewer pixels are covered by the bright night sky lines

P200 DBSP
158 lines/mm
Grating →



Keck ESI →

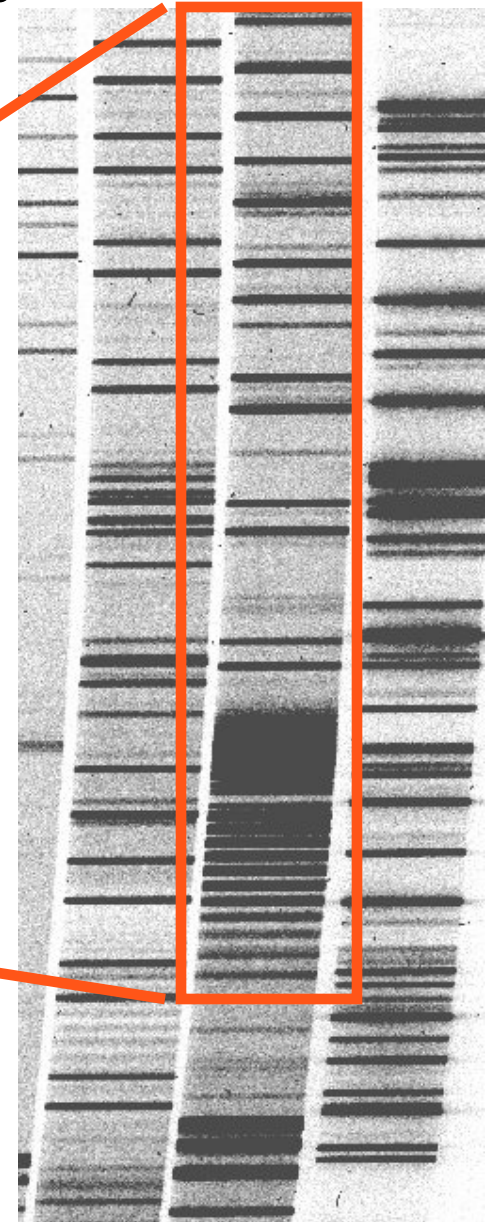

Orders and blocking filters

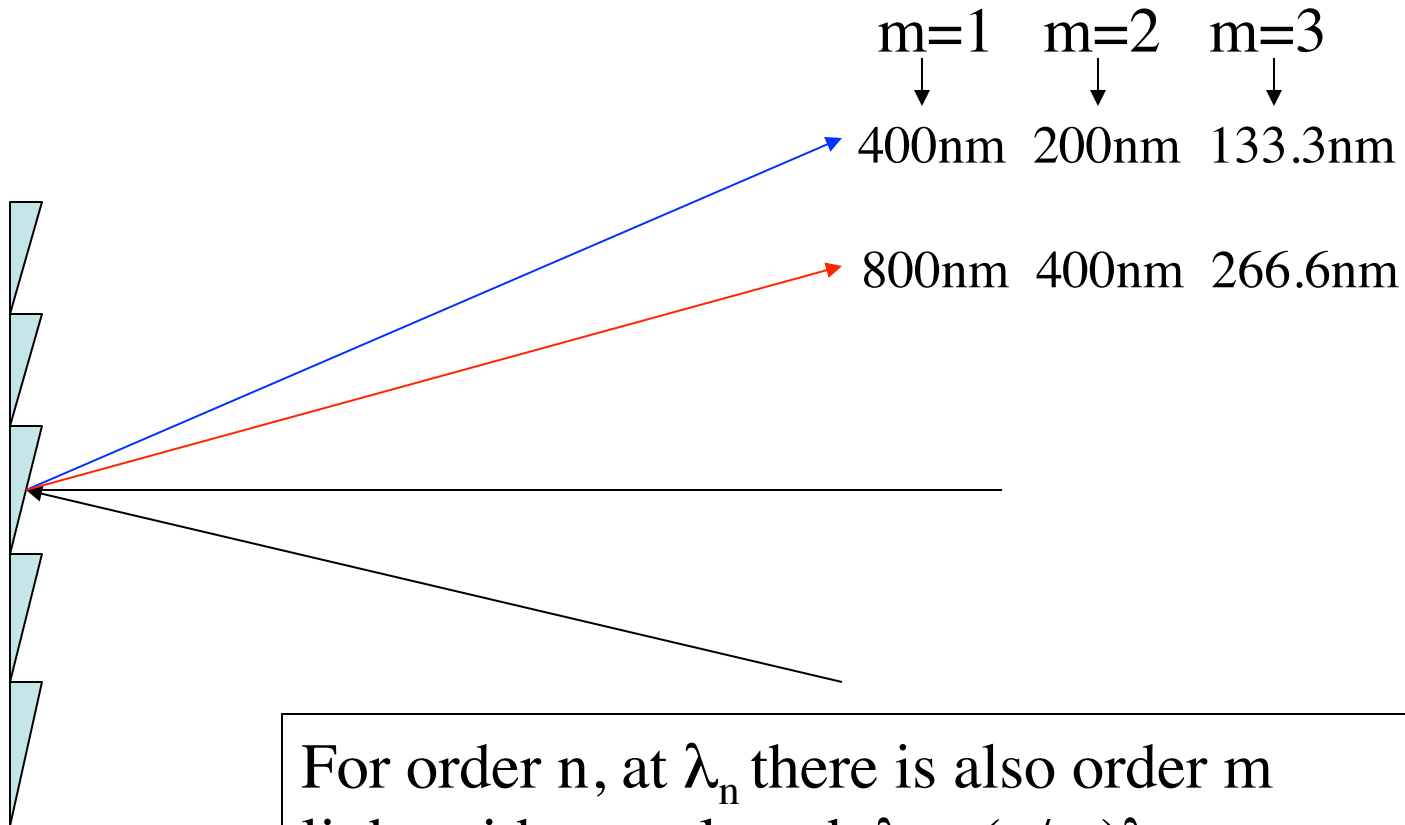

Grating Orders

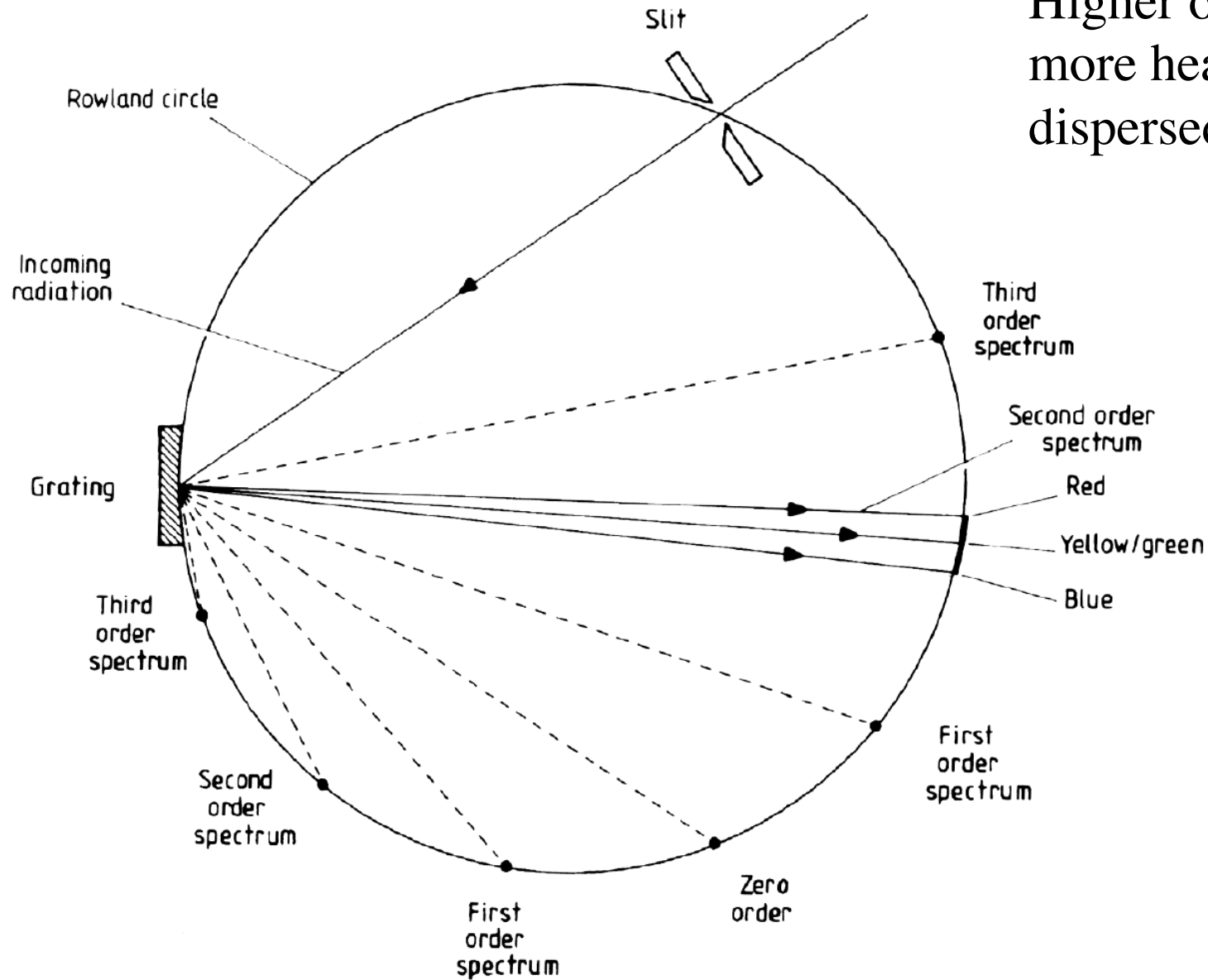

Higher orders are more heavily dispersed

- For higher orders with $\lambda < 310\text{nm}$ it's not an issue as the atmosphere cuts out all the light (can still be an issue for calibration sources).
- But, if you are working in the red ($>640\text{nm}$) in 1st order, you need to block the 2nd order light.
- If you are working in a higher order, may need to block red light from lower orders.

KPNO 2.1m Goldcam blue blocking filters

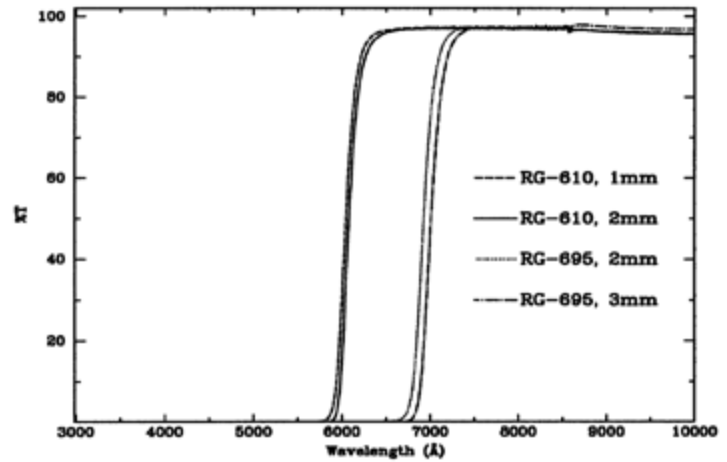
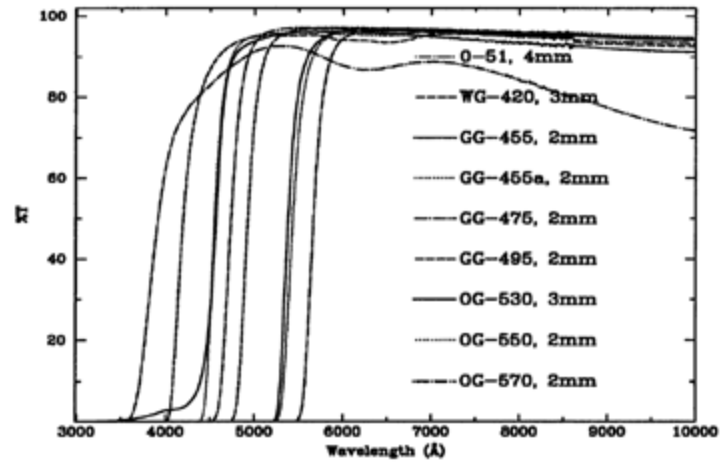
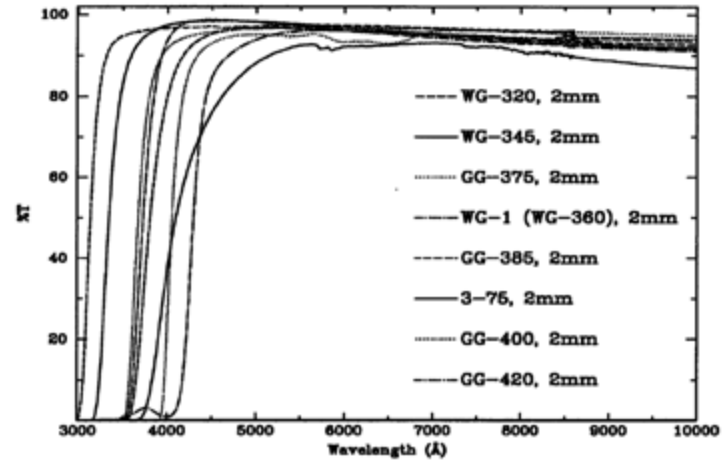

Echelle Spectrometers: The Modern Way To Achieve A High Spectral Resolution

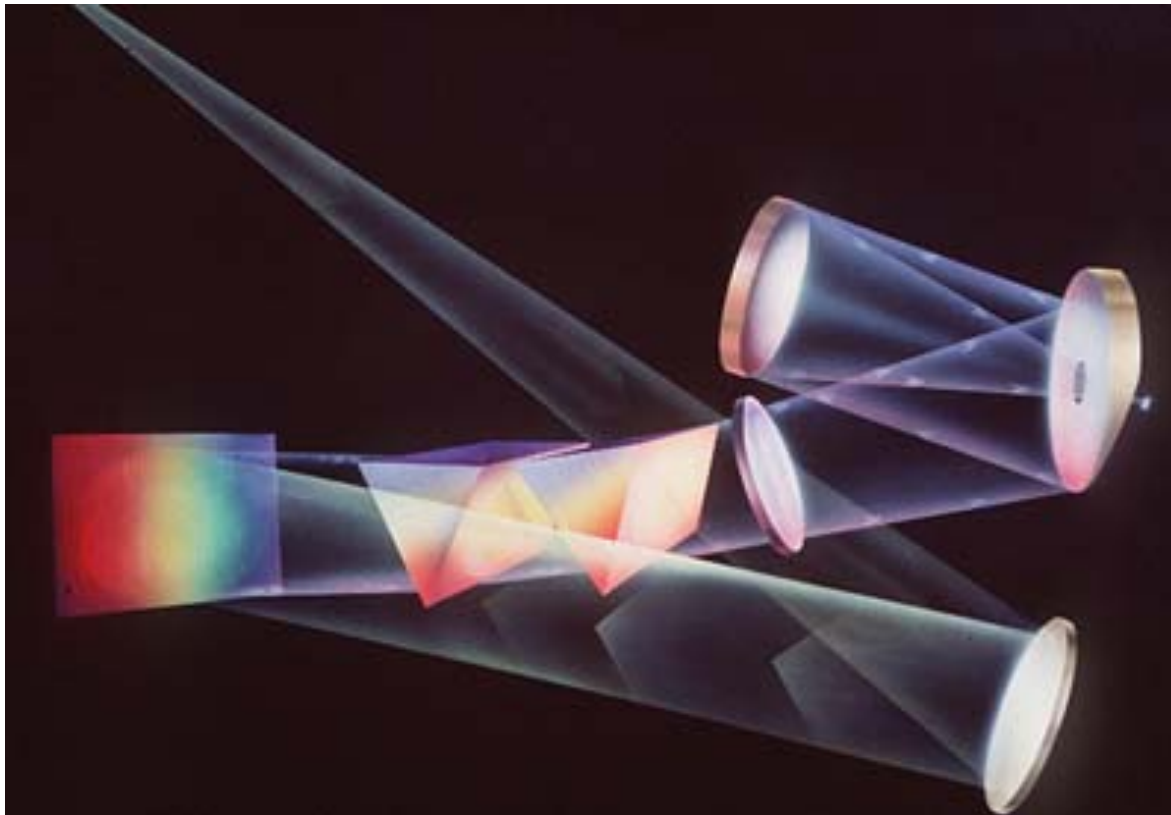

If after grating dispersion you “cross disperse” the spatially coincident orders you can separate the orders in the camera focal plane.

Usually do the initial dispersion with a fine ruled grating and the cross dispersing with a prism.

- Keck examples: HIRES, ESI

Echelle Gratings

- Echelle grating is more extremely blazed, to high angles and therefore high order m - could be tens or even hundreds!
- Order overlap is much worse, because adjacent orders differ in wavelength by small amounts (e.g. Order 6 @ 500nm is coincident with order 5 @ 600nm, order 7 @ 429nm, order 8 @ 375nm etc)
- Must separate these orders by *cross-dispersion*, usually dispersing with a prism at right angles to the grating dispersion
- Echelle spectrum consists of a number of spectral orders arranged side by side on the detector

Keck HIRES Outline

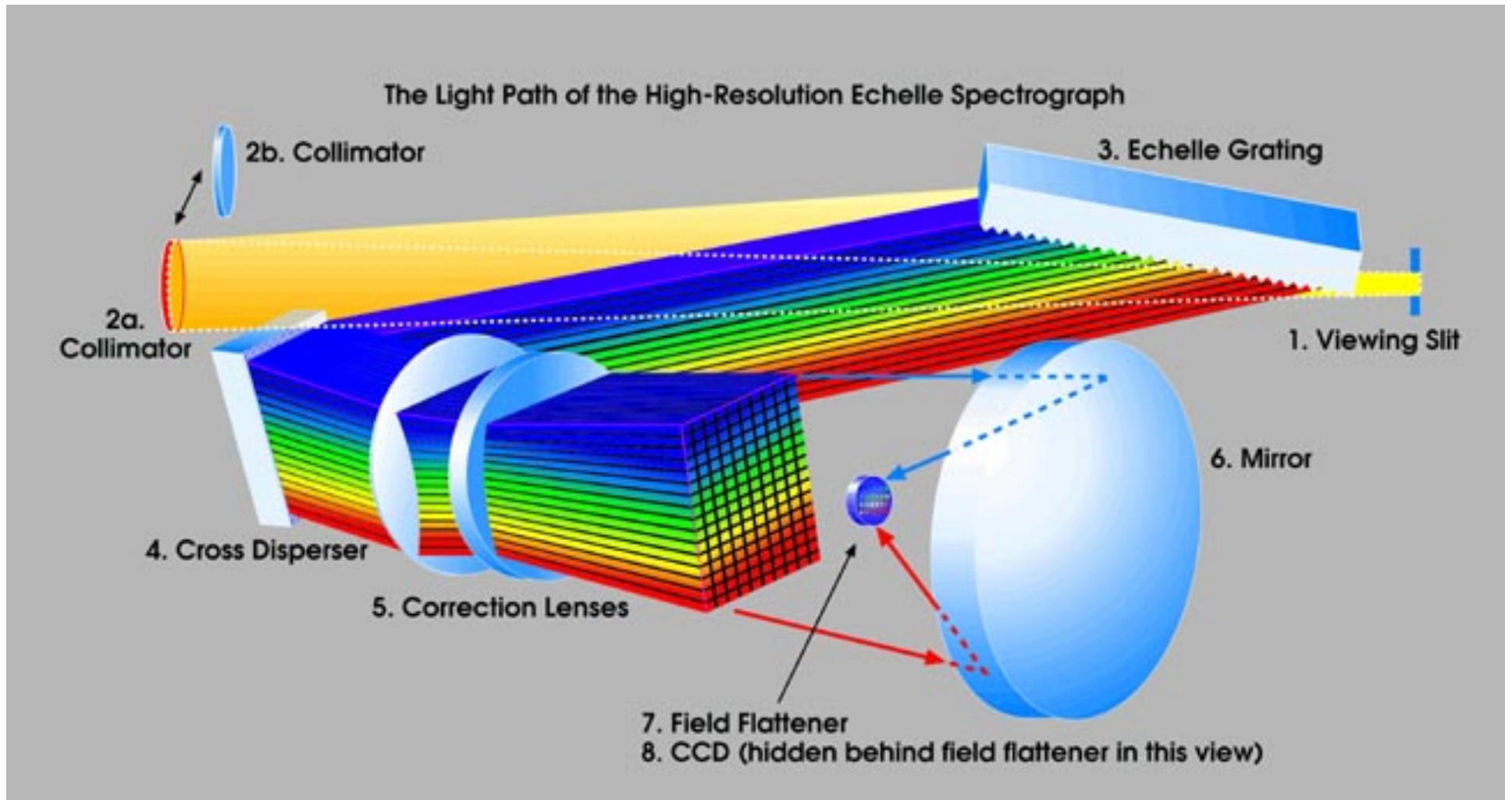

A Schematic View of an Echelle Spectrograph (HIRES)

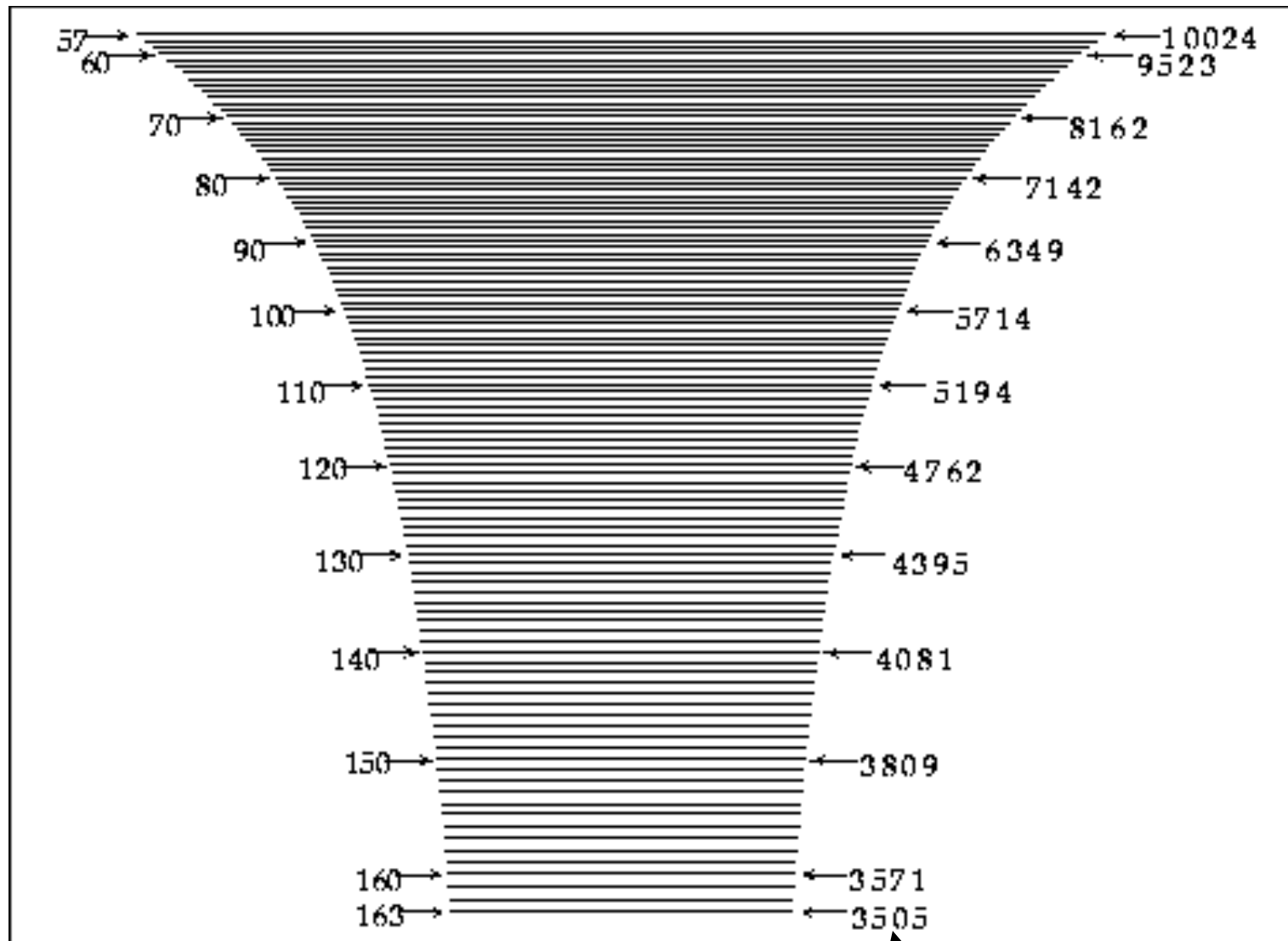

Order#

wavelength

Echelle Example: Keck ESI

Note curved orders,
with the spacing
getting tighter towards
the longer wavelengths

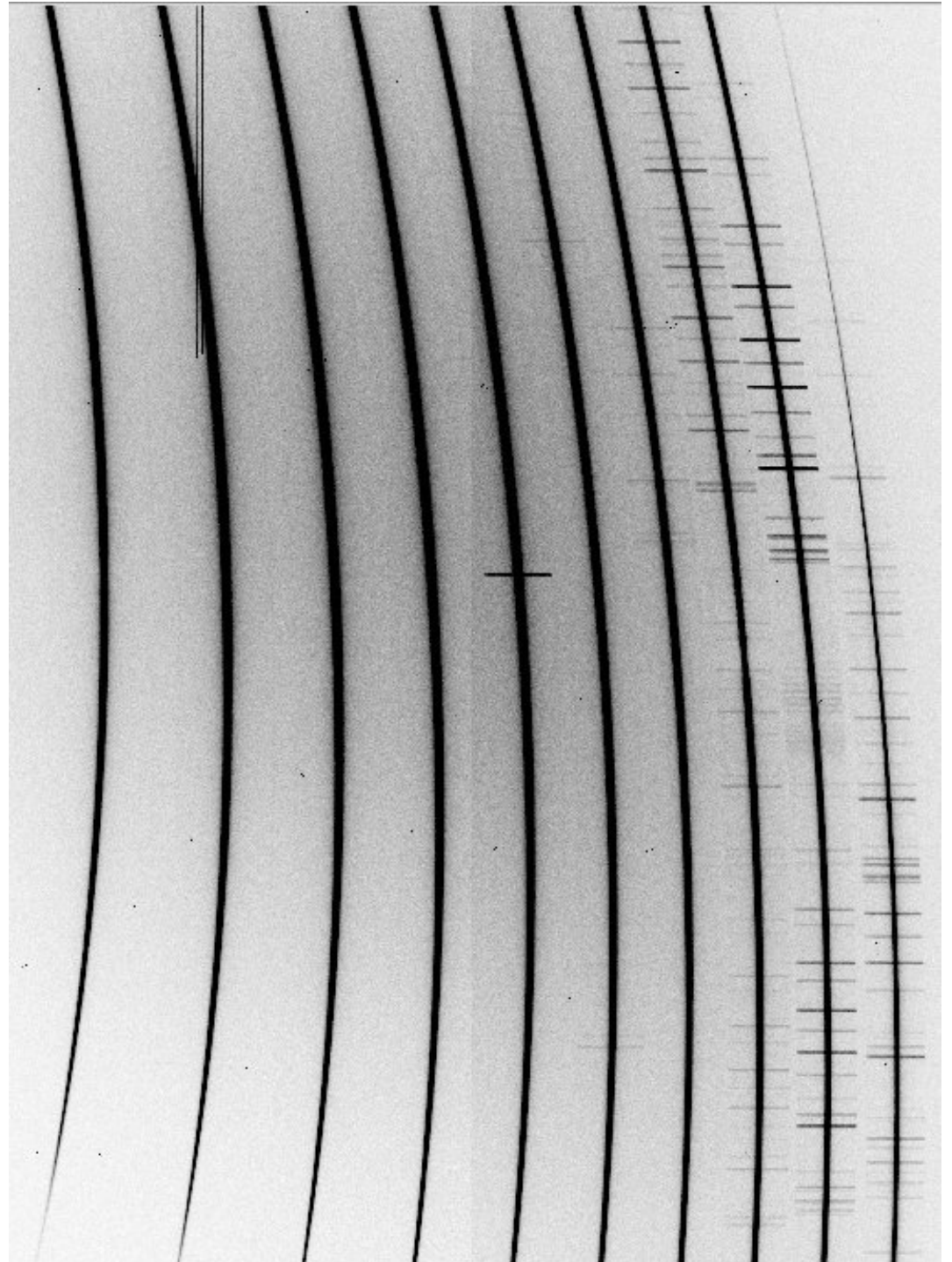

Solar Spectrum Taken With An Echelle

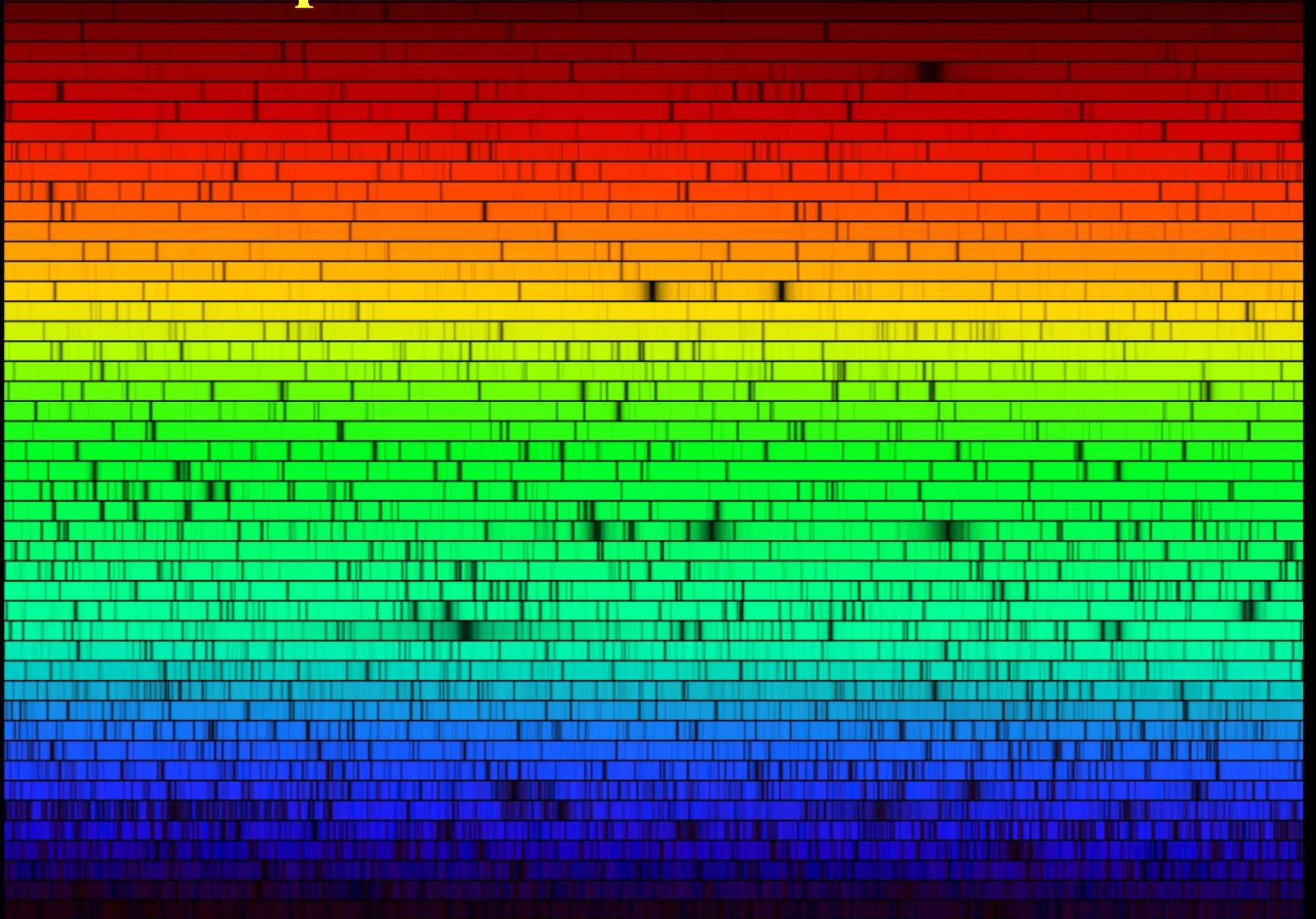

Dichroics and Double Spectrometers

Telescope focal plane

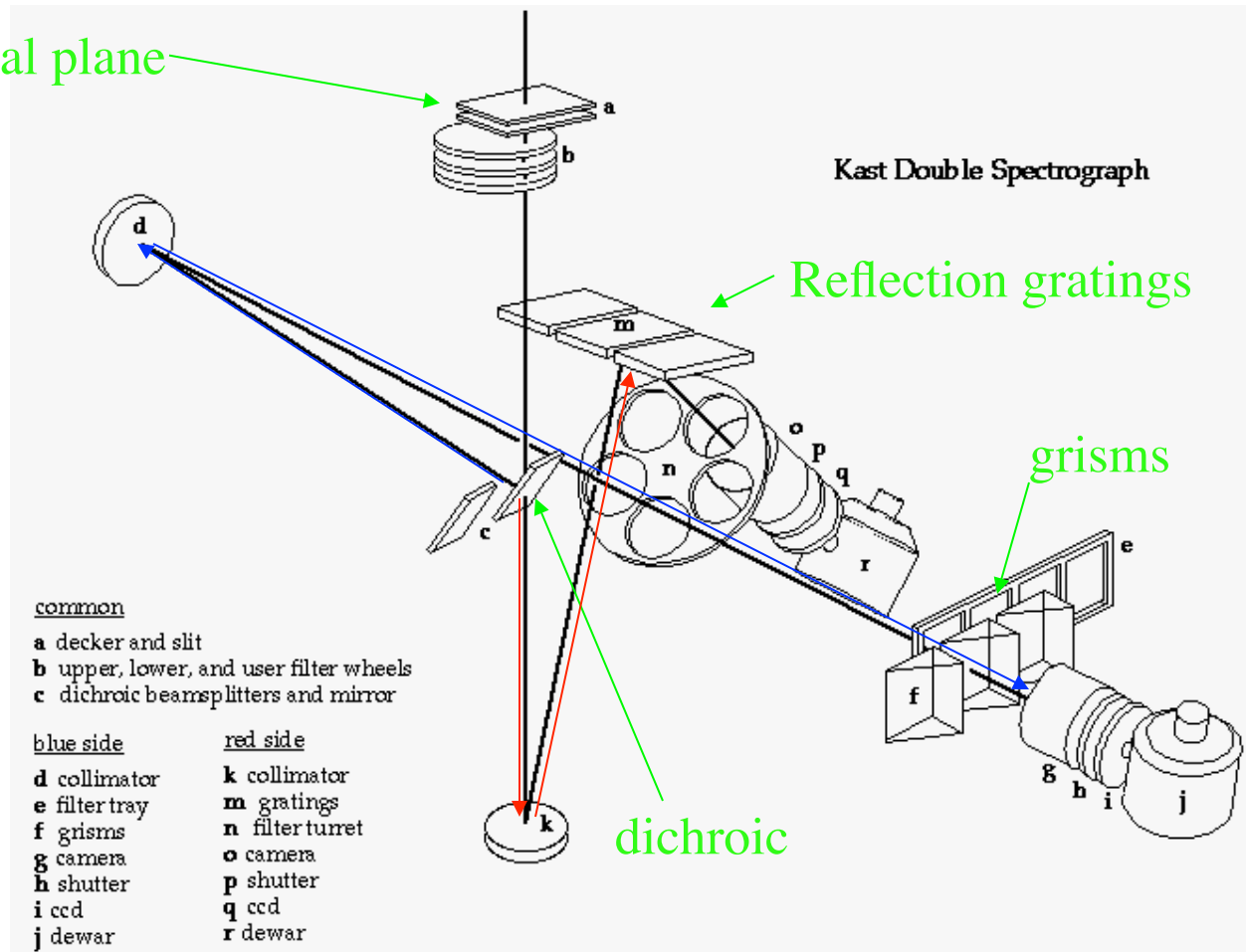

Spectrometer Throughput

- Spectrometer throughput ranges from a few percent to ~50%. The losses accumulate fast. Dispersing elements are usually a big hit, then the losses at multiple surfaces go like (transmission)^{*n*} where *n* is the number of surfaces in the collimator and camera elements (*n* can be pretty big)

$$0.98^8 \times 0.7 \times 0.8 = 0.47$$

Camera/collim.
with 8 surfaces
(pretty good!)

Grating CCD

... and then there is
the telescope optics

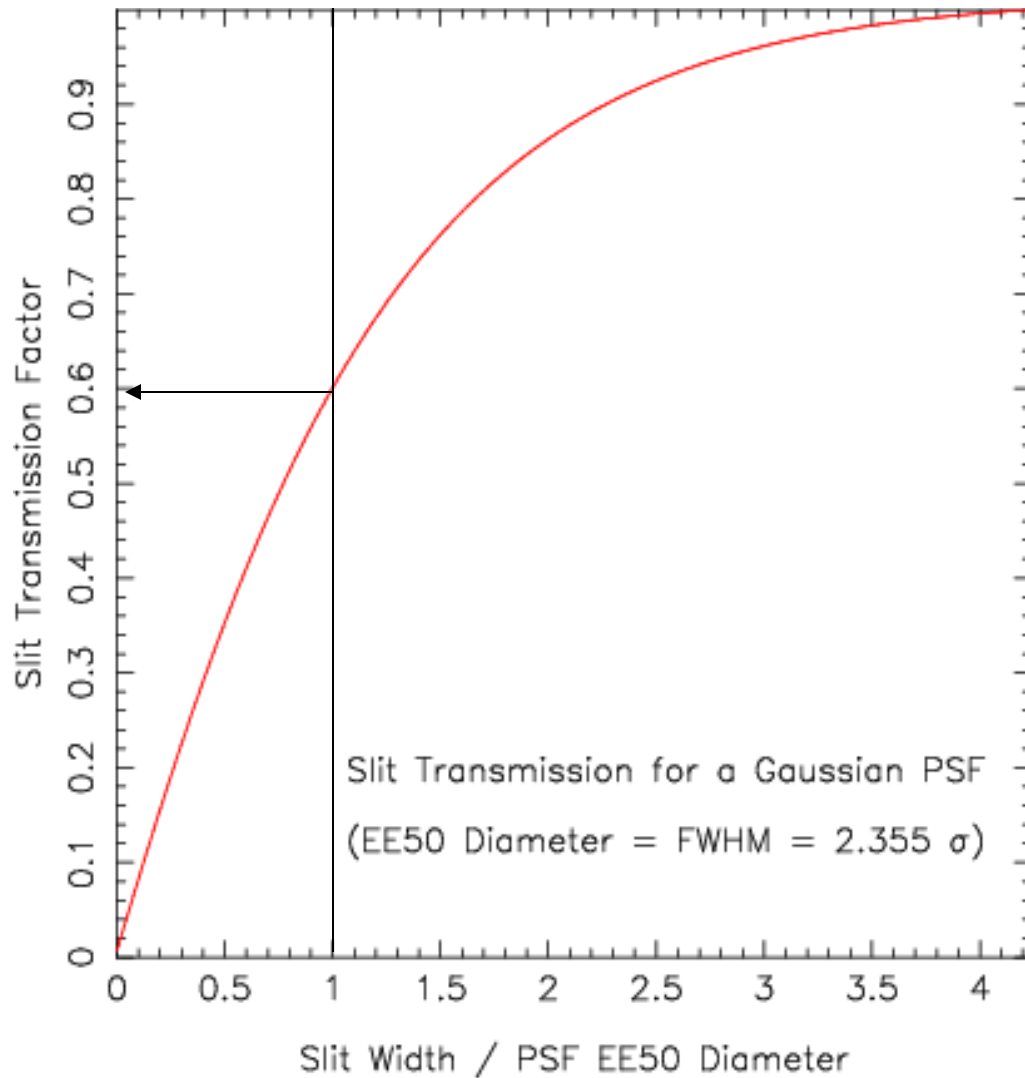

Another (major!)
throughput issue:
slit losses can be
very significant!

Spectrometer Observing Considerations

- On-chip binning:

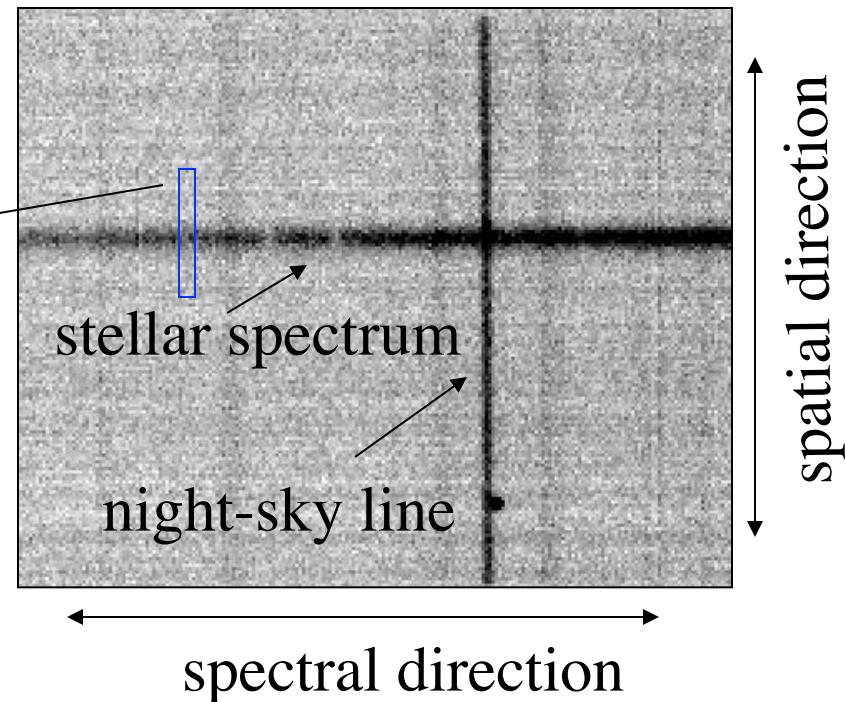
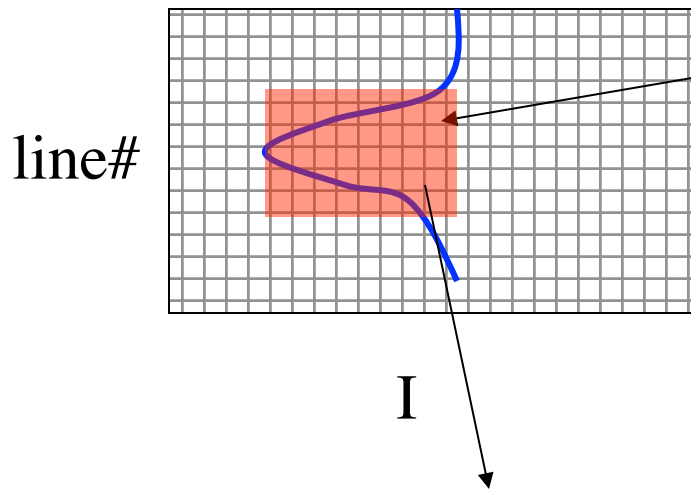

You are going to sum over these lines in the extraction anyway. On-chip binning will reduce $RN \times \#pixels$

For LRIS-B, 0.15 arcsec/pixel in the spatial direction

Should You Bin the Data?

- In the *spectral direction*, binning can reduce spectral resolution. If the FWHM of arclamp lines ≥ 5 pixels, you can start to think about binning. Lots of time you are interested in accurate line centers and higher moments of the spectral line profiles in which case, well sampled features are a good idea.

S/N for Spectral Observations

- On-chip binning:

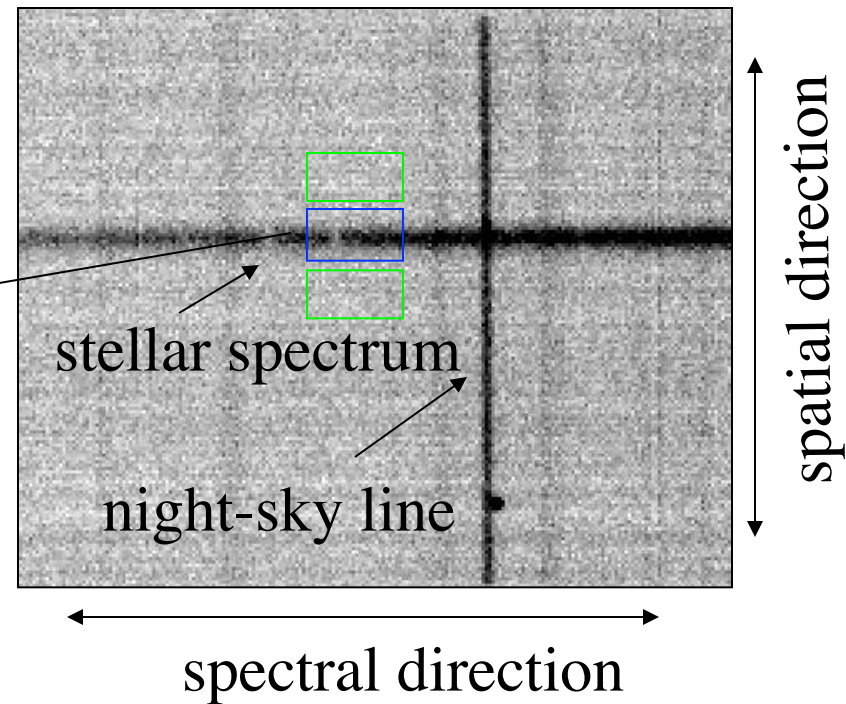
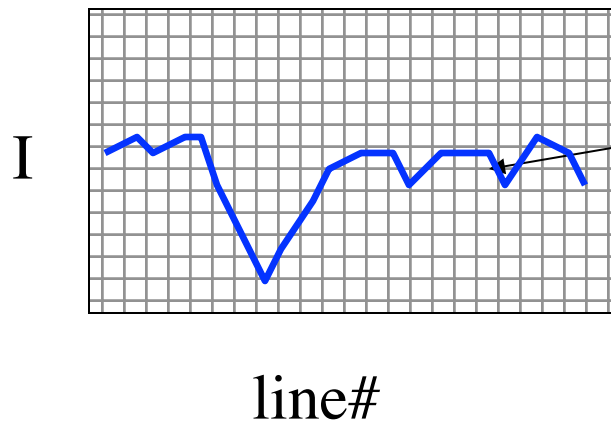

$$S_{\text{spectral pixel}} = \sum_{\text{lines}} R_{\text{object}} \times t$$

$$N_{\text{spectral pixel}} = \sum_{\text{lines}} \left[(R_{\text{object}} \times t) + (R_{\text{sky}} \times t) + RN^2 \right]^{\frac{1}{2}}$$

S/N for Spectral Observations

- Often sum counts again in the spectral direction to determine S/N per resolution element.
- Note! Assumes sky noise is at the shot noise limit. Imperfectly modeled and subtracted sky lines are worse than this.
- For spectra the S/N usually varies considerably with wavelength:
 - Absorption, emission, continuum
 - Sky lines
 - System efficiency with wavelength

More Spectral Considerations

- Differential Atmospheric Dispersion (Filippenko, 1982, PASP, 94 715)
- Dispersion in the atmosphere causes chromatic distortion of images that gets larger at blue wavelengths at fixed airmass and larger with airmass at fixed central wavelength.

$$\Delta\theta = 206265 \times [(n_{\lambda_1} - 1) - (n_{\lambda_2} - 1)] \times \tan(ZD)$$

index of refraction

zenith distance

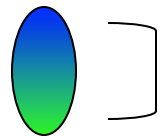

@X=1.5, 1.3" separation
between 350nm and 550nm

[H=30% (=> Pw=368.0849304 Pa)] [P=77500 Pa] [T=283.1499939 K] [$\lambda_w=450$ nm] [D(fib)=1.799999952 "] [1" FWHM]

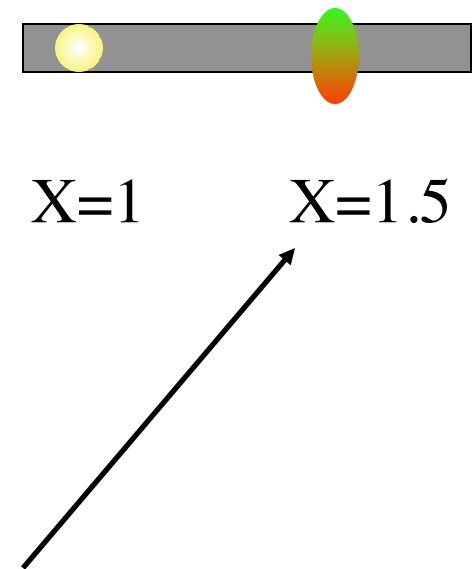
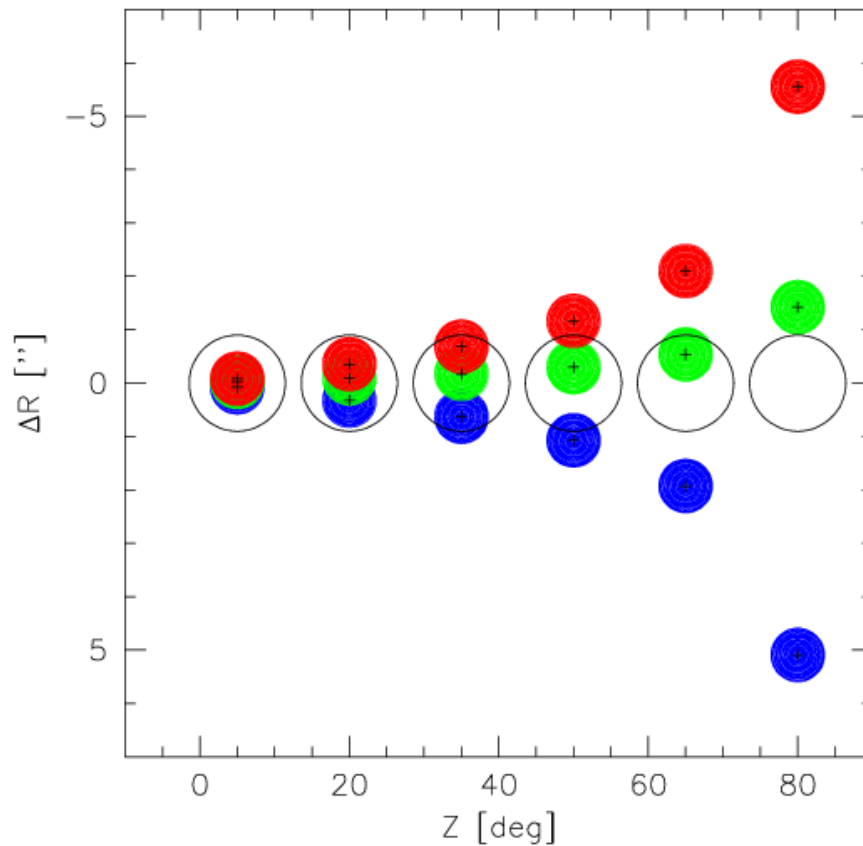

Two problems:

1) Preferentially lose red (or blue) light out of the slit.

2) If guiding on a particular wavelength of light, the object at other wavelengths will move out of the slit.

- Two solutions:
 1. Align slit along the *parallactic angle*

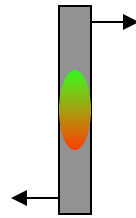
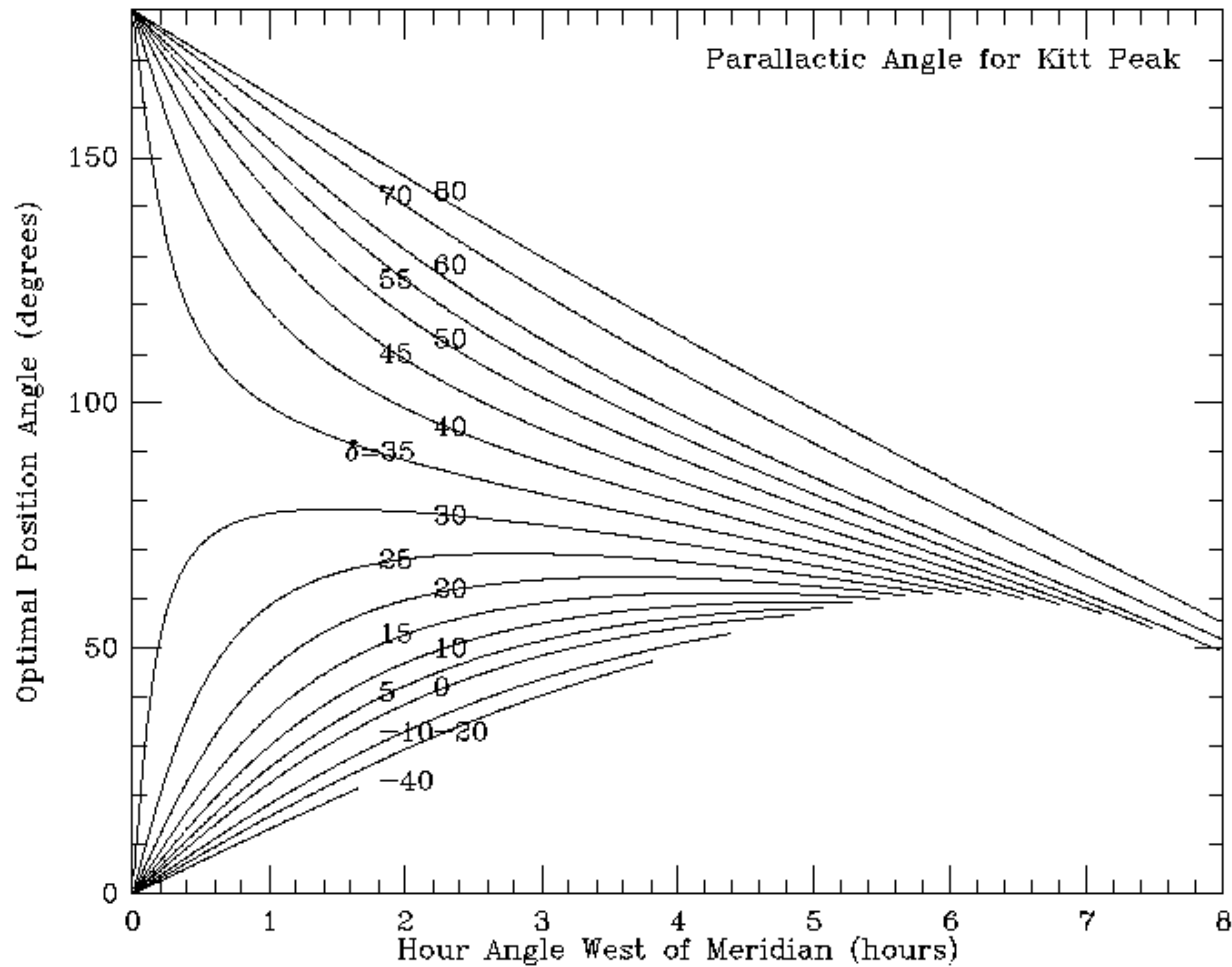

2. Build an Atmospheric Dispersion Compensator

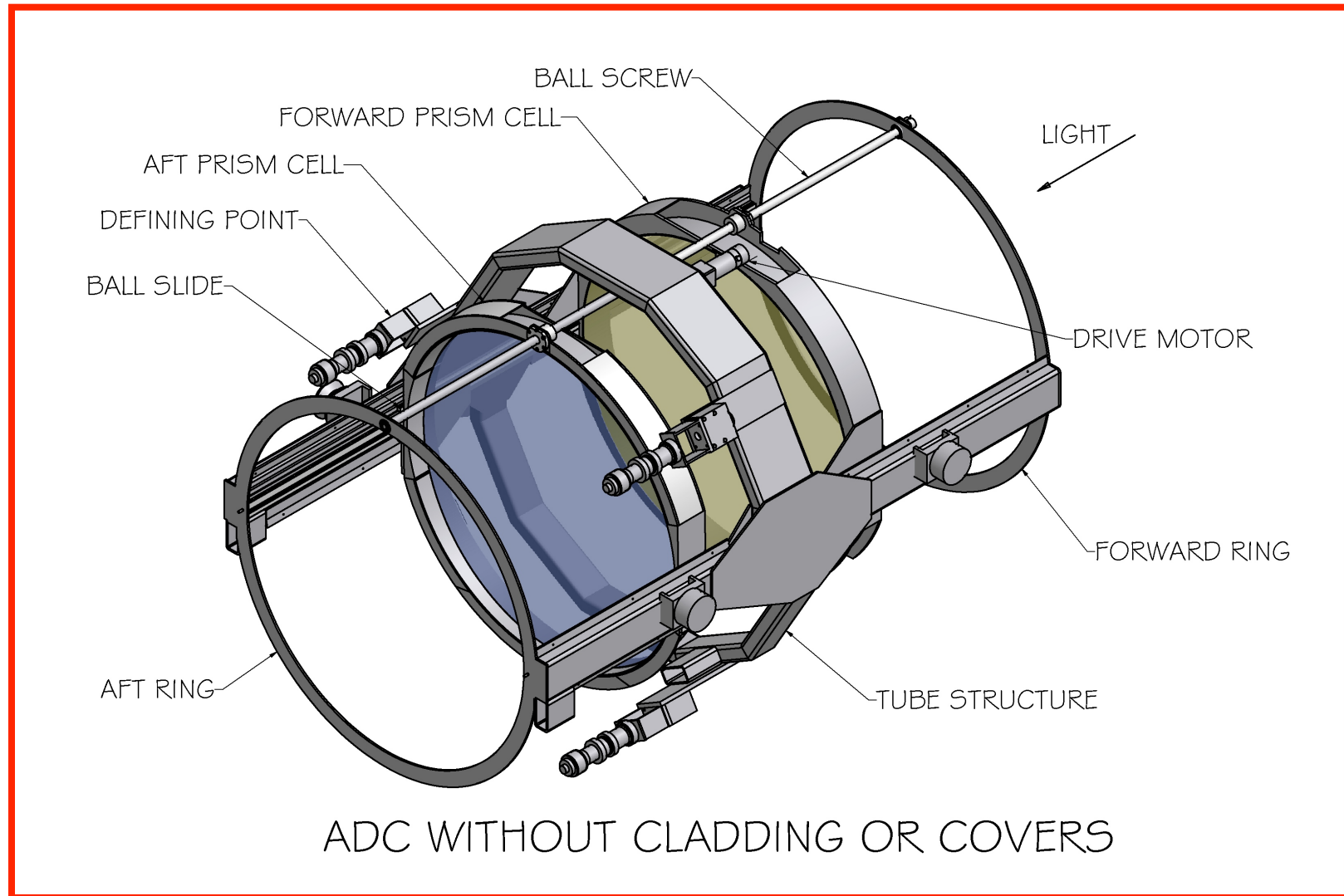

Uncorrected

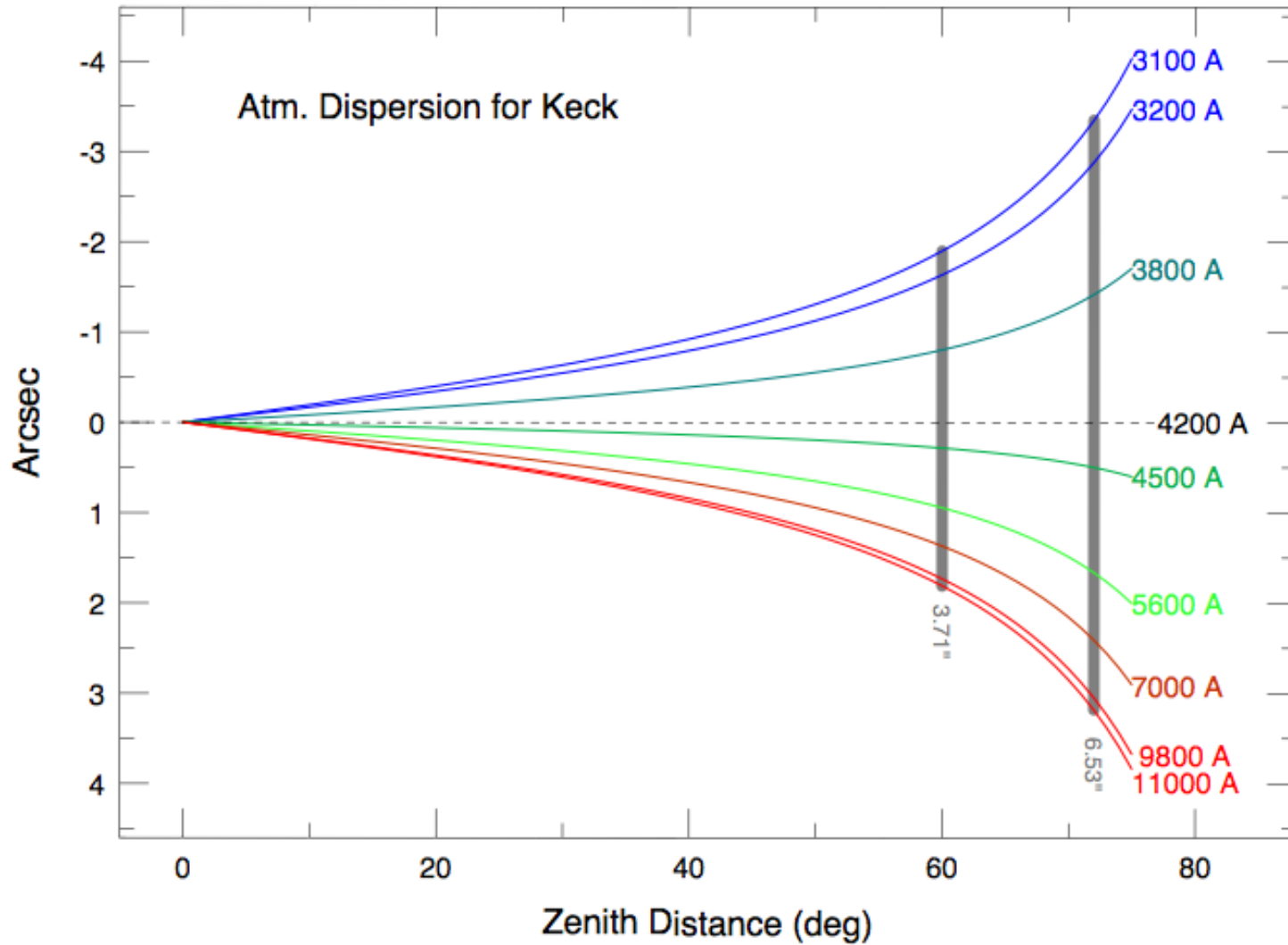

Corrected with ADC

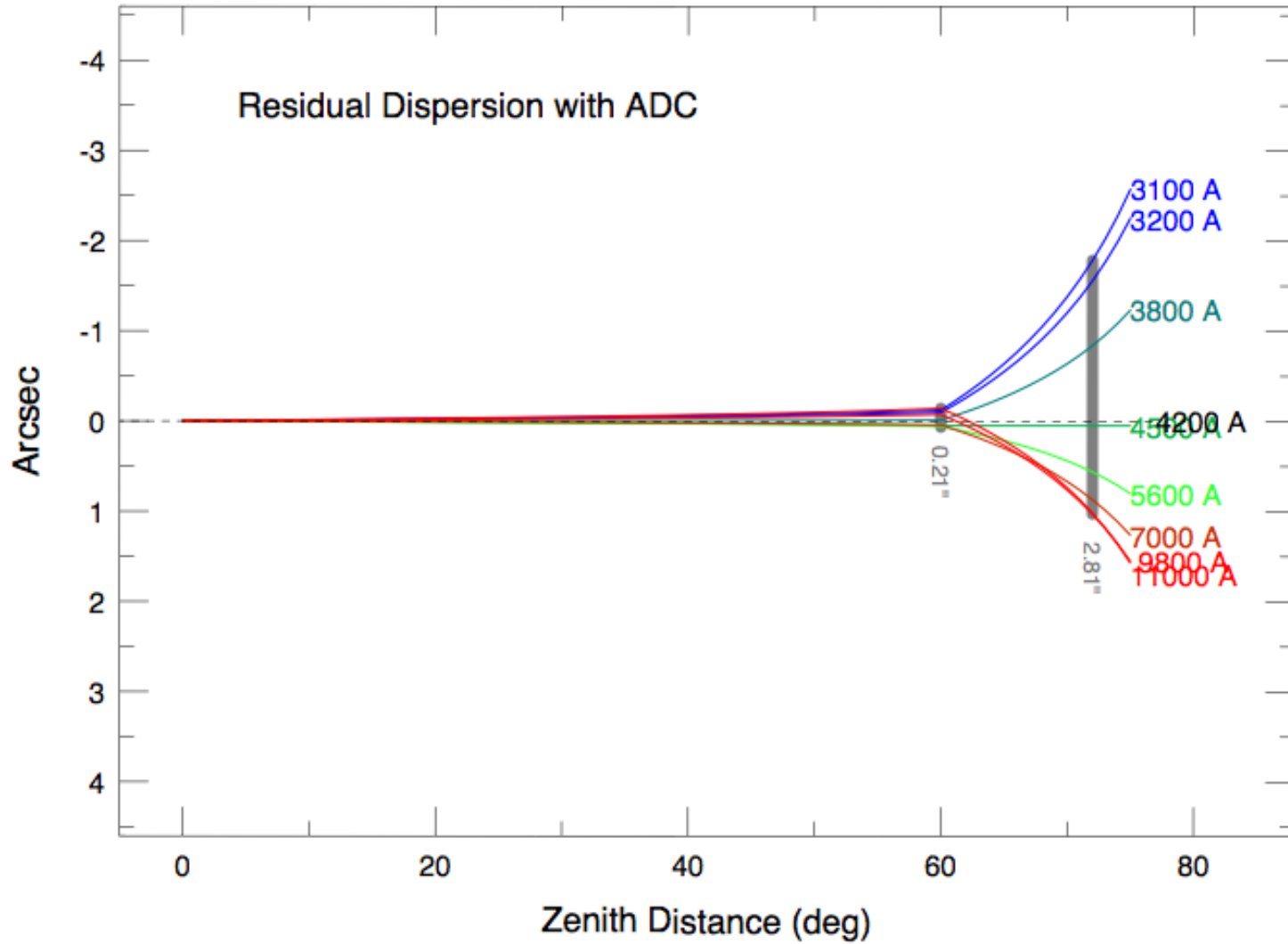

Multiobject Spectroscopy

- Very popular option for many projects, whenever the surface density of targets is high (e.g., surveys)
- Various implementations:
 - Multislit
 - Fiber-fed
 - Fabry-Perot tunable filter imaging
 - Integral Field Units (IFUs)

- Remember the simple case: carefully rotated long slit. Note: better have an ADC.

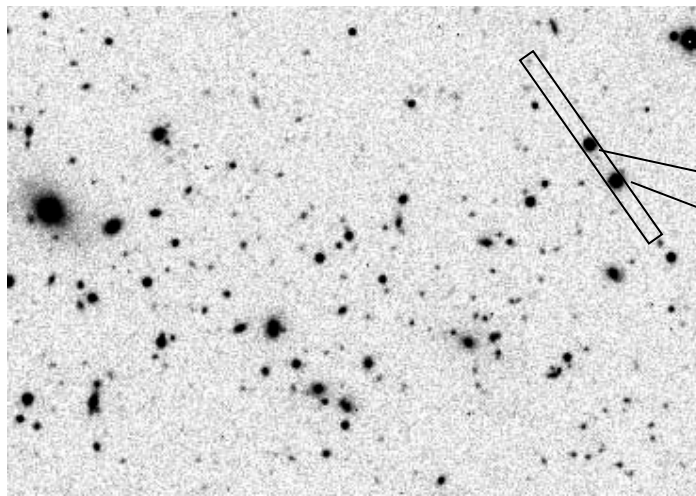

Telescope focal plane

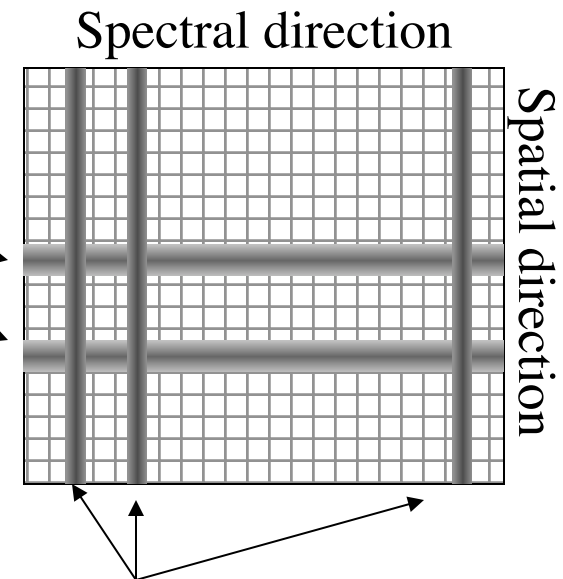

Night sky lines

Spectrometer camera focal plane

Multislit spectroscopy

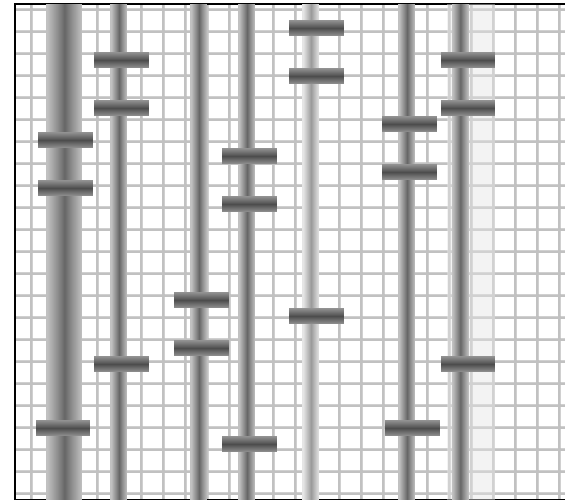
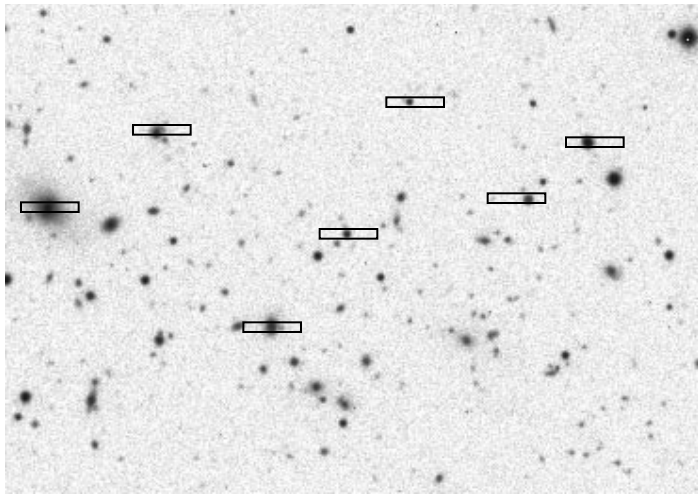

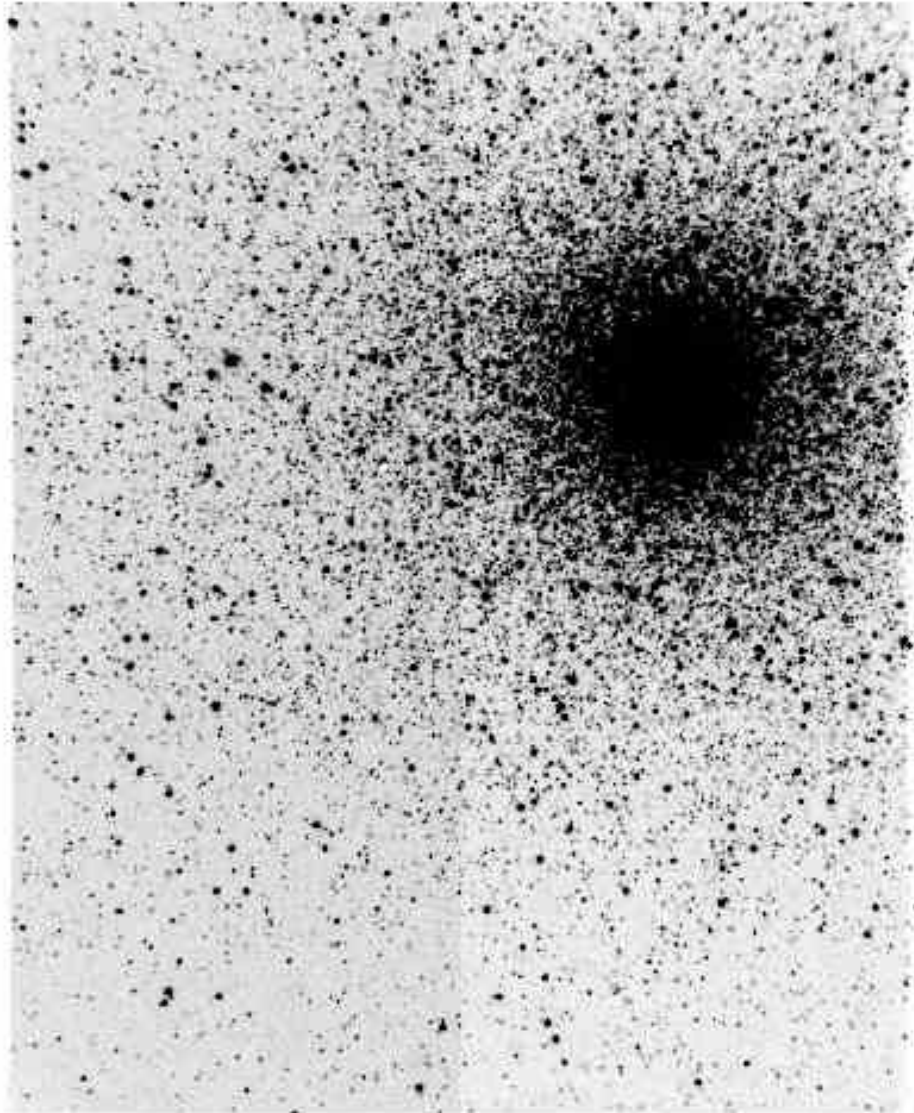

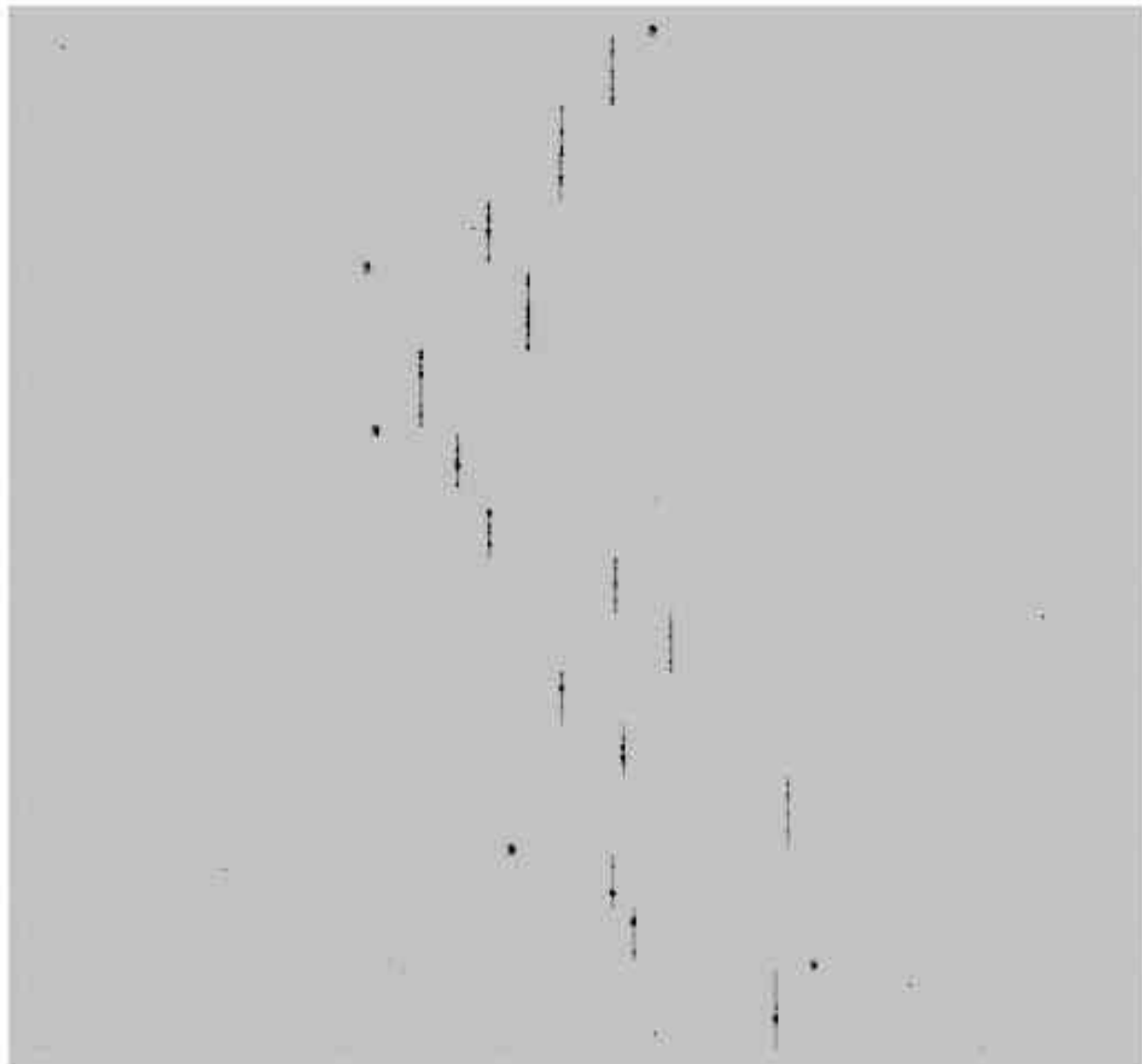

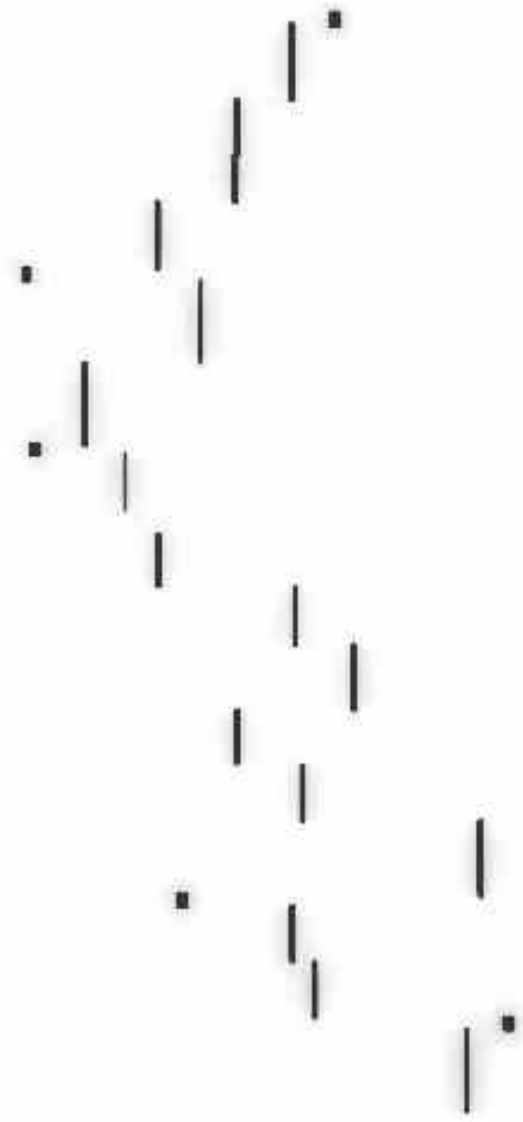

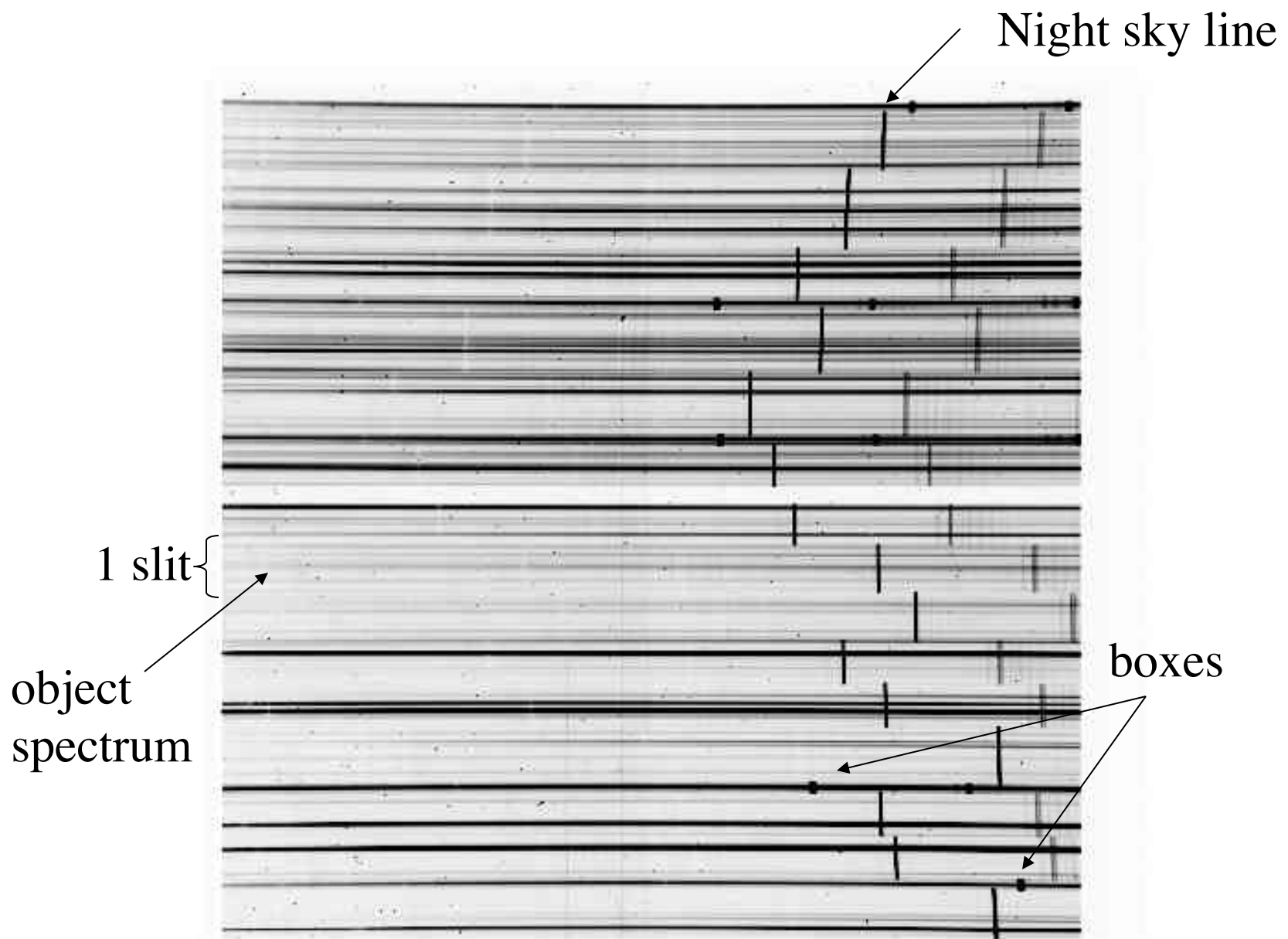

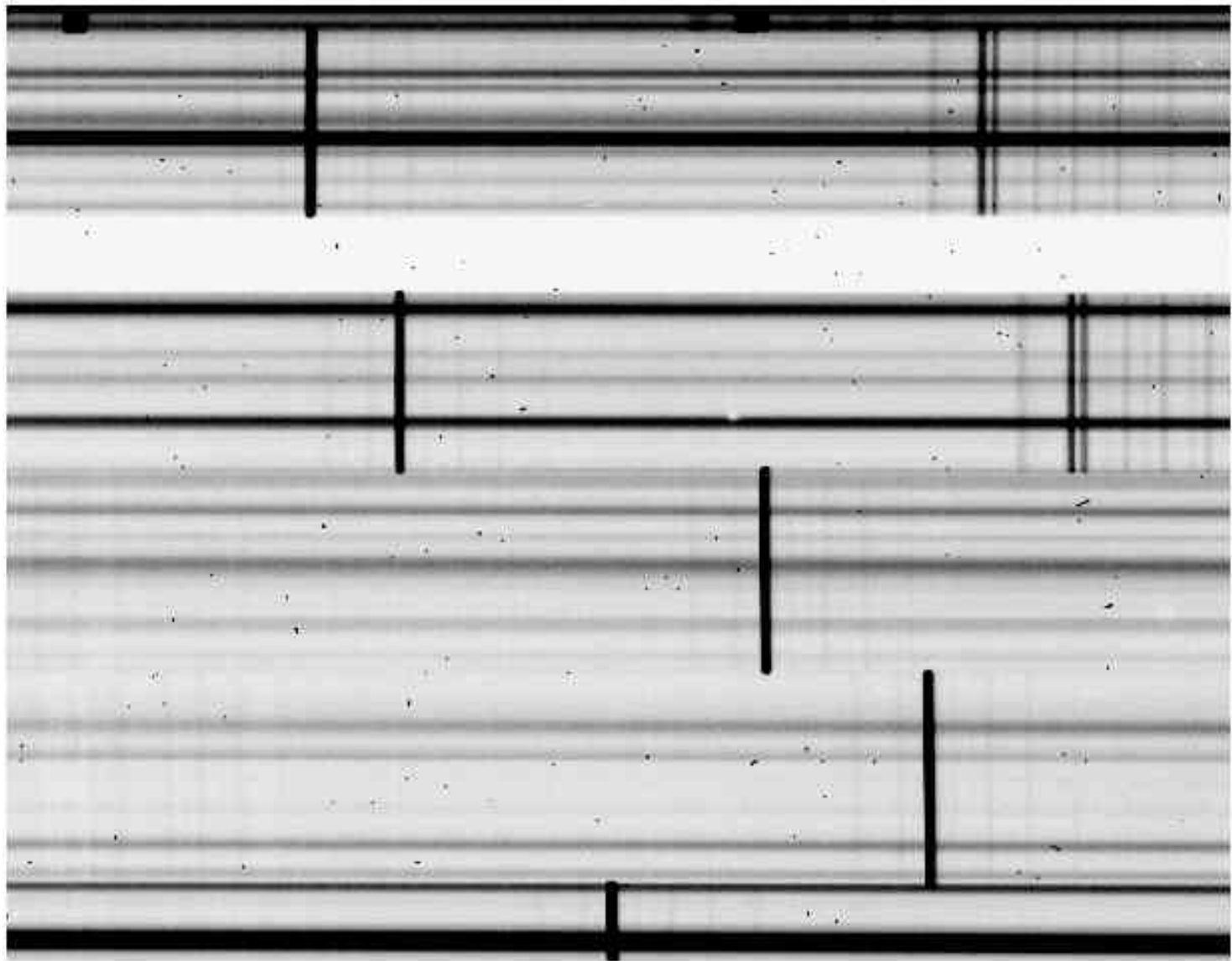

- Advantages of multislits:
 - High throughput
 - Can choose slit width and length
 - Good sky subtraction
 - Can place slits close together in telescope focal plane
- Disadvantages of multislits:
 - wavelength coverage varies with the slit position
 - do not always use the detector area efficiently.

Fiber-Fed Multi-Object Spectrographs (MOS)

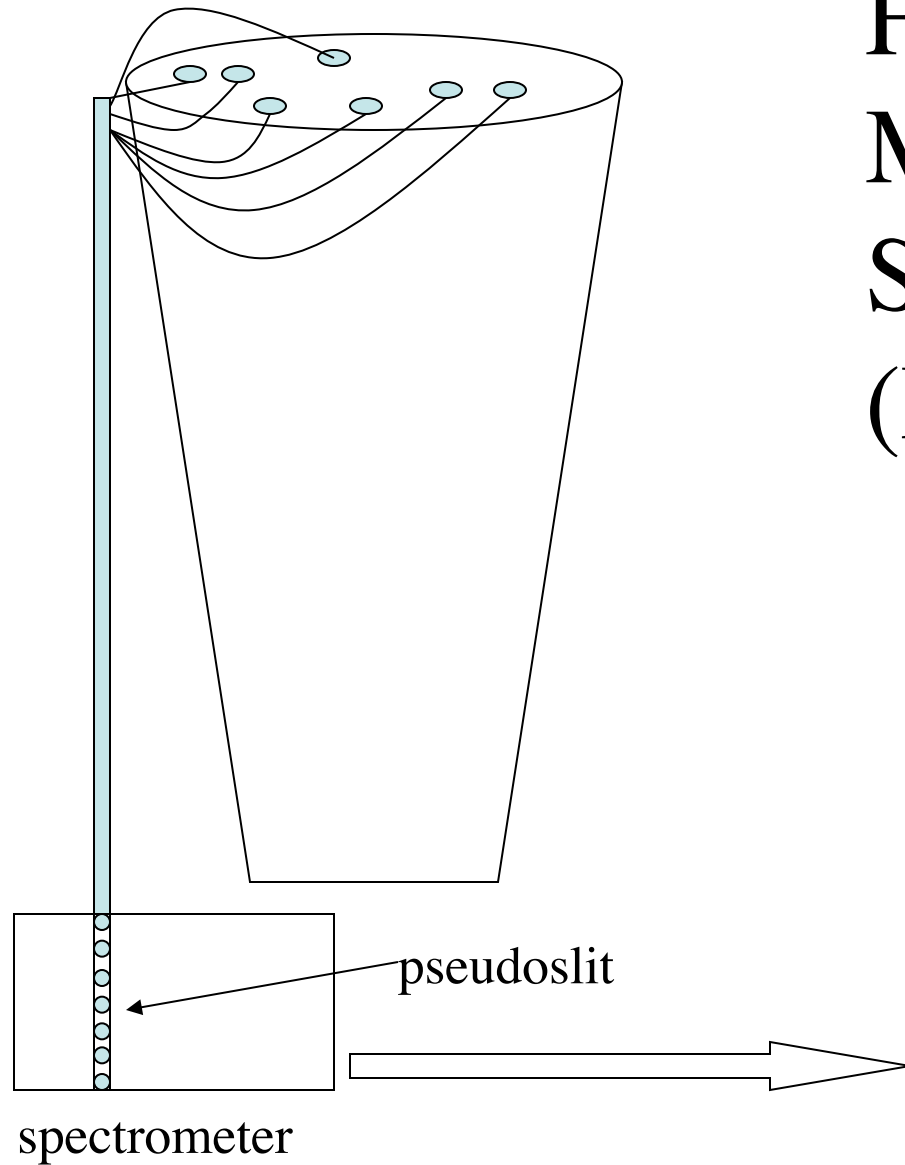

Spectra on CCD

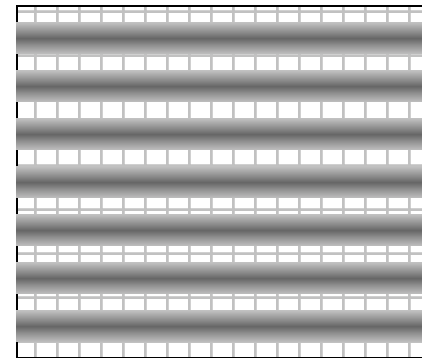

An Example of a MOS: 2DF

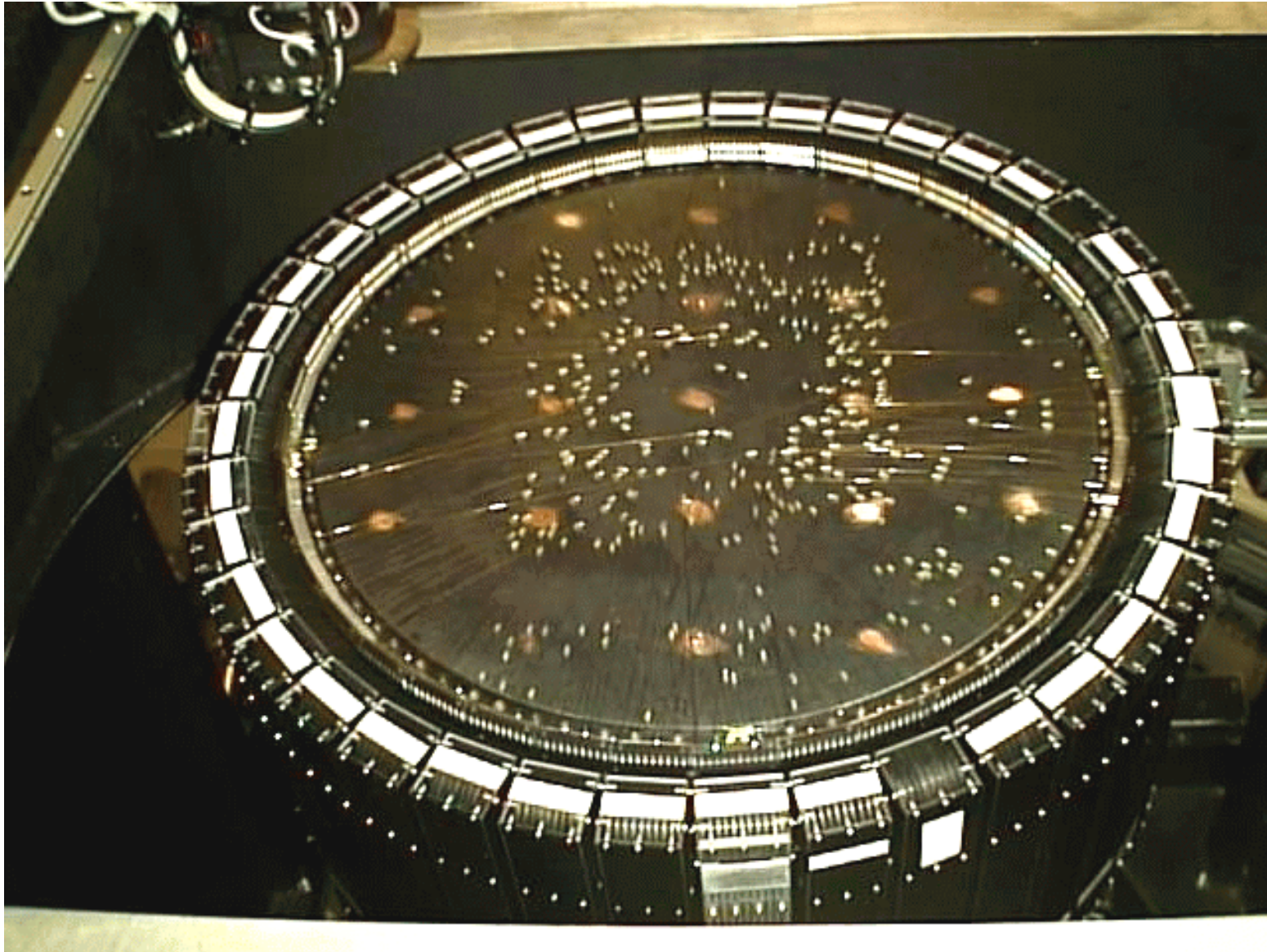

2DF buttons+fibers

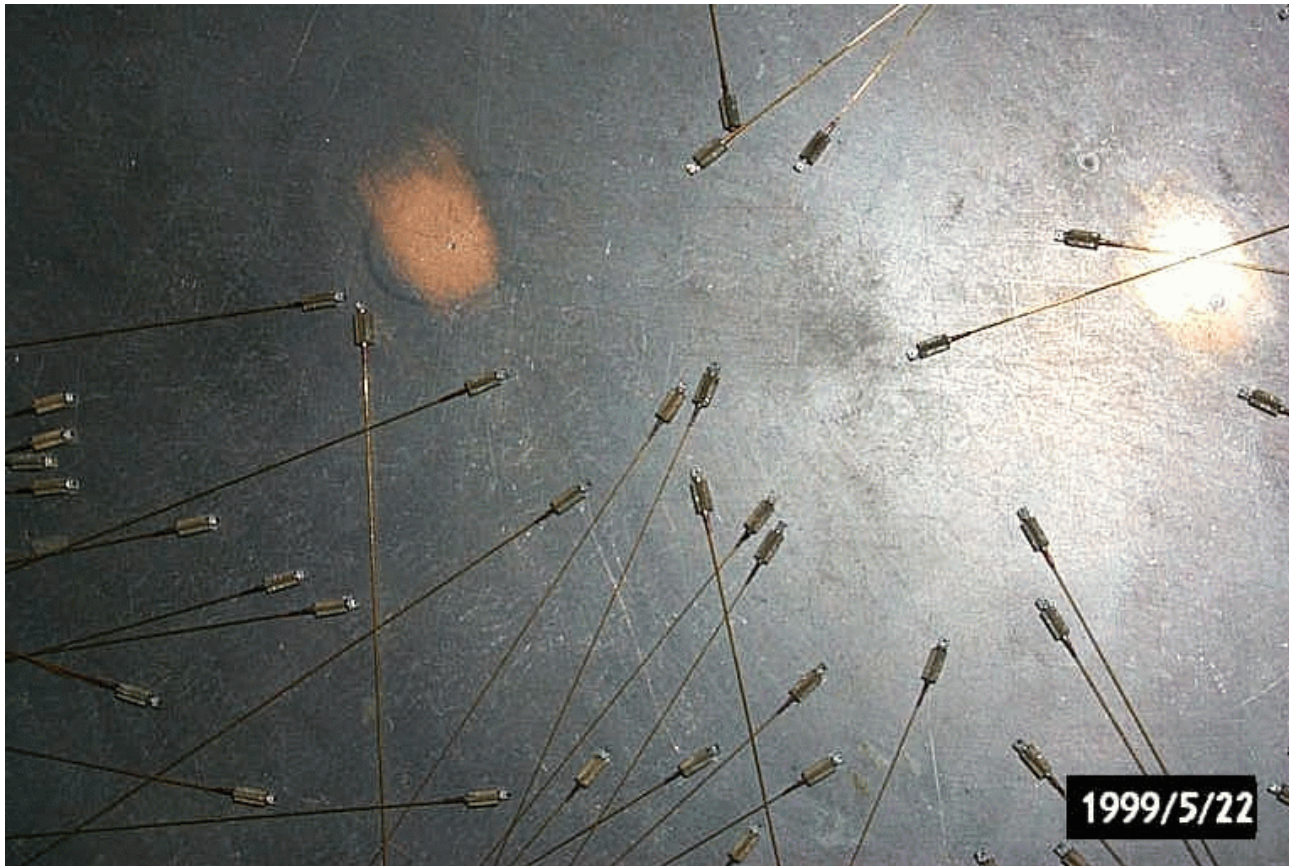

- Advantages of multi-fiber systems
 - Large fields
 - Uniform wavelength coverage
 - Efficient use of detector area
- Disadvantages
 - Minimum separation is between a few and 10+ arcseconds
 - Fiber losses are significant and grow with time (fiber are delivate)
 - Sky subtraction difficulties
 - Setup times can be long

Integral Field Units

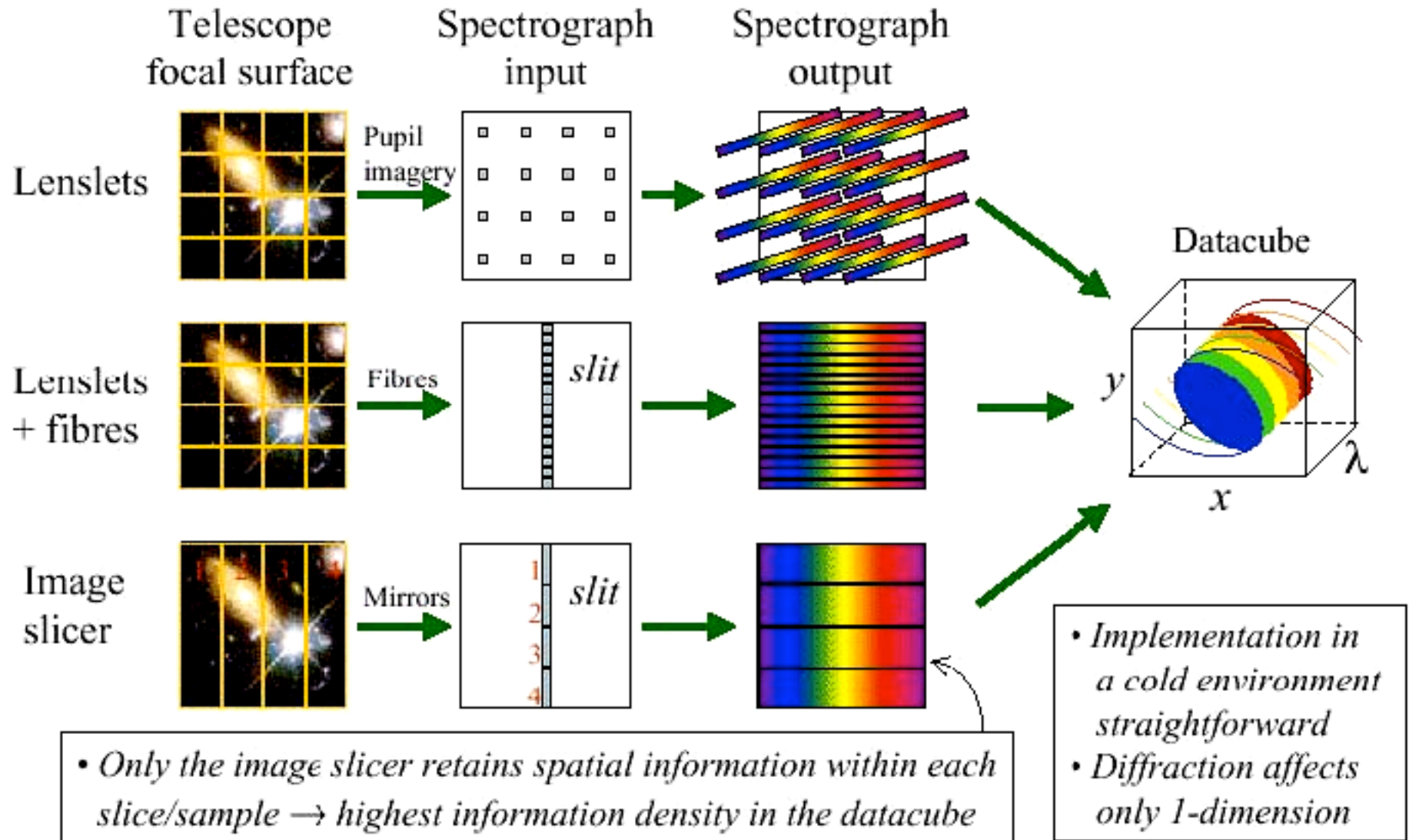

IFU Example: SAURON on WHT

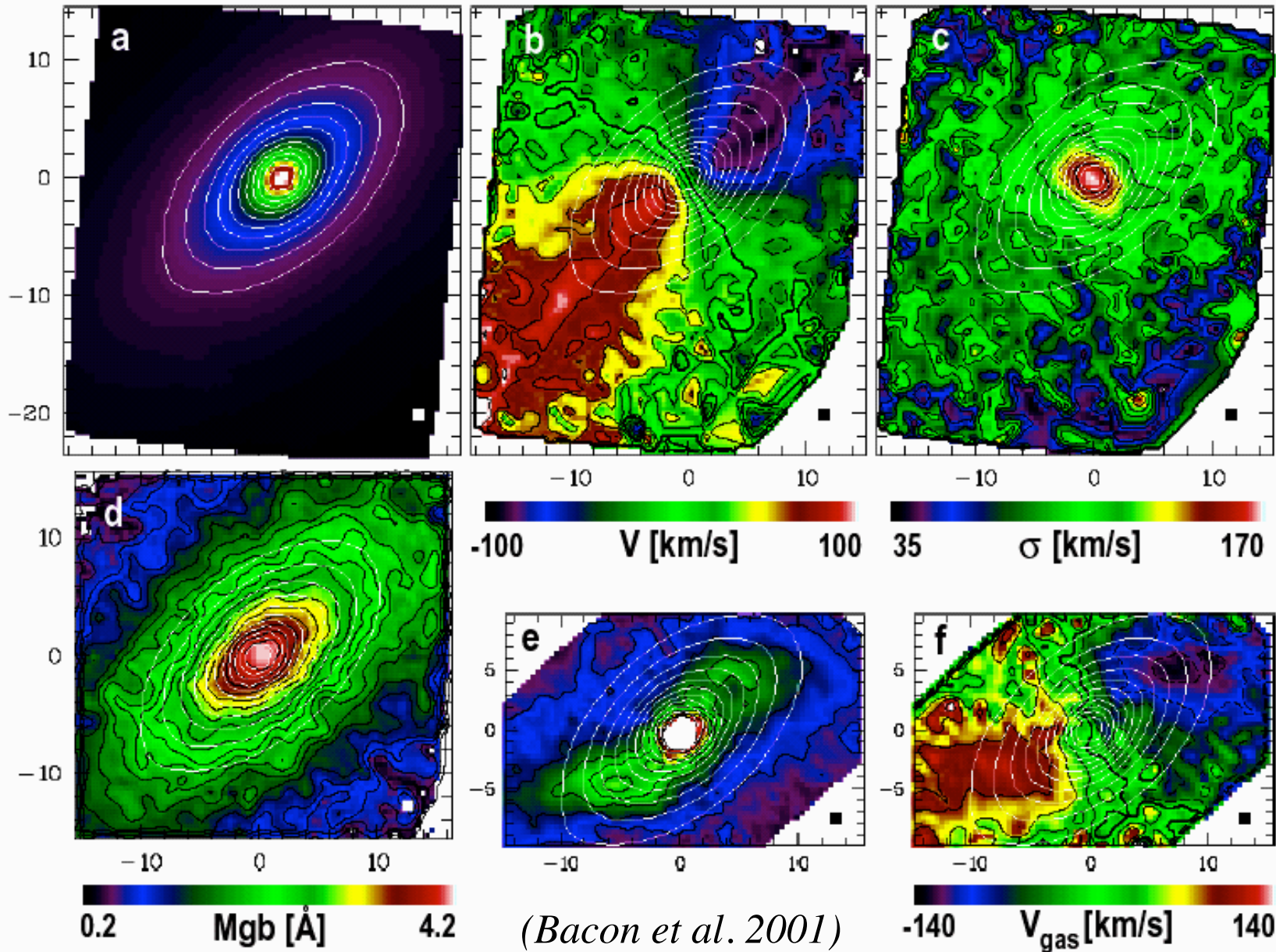

Narrow-Band Imaging: Interference Filters, Fabry-Perot

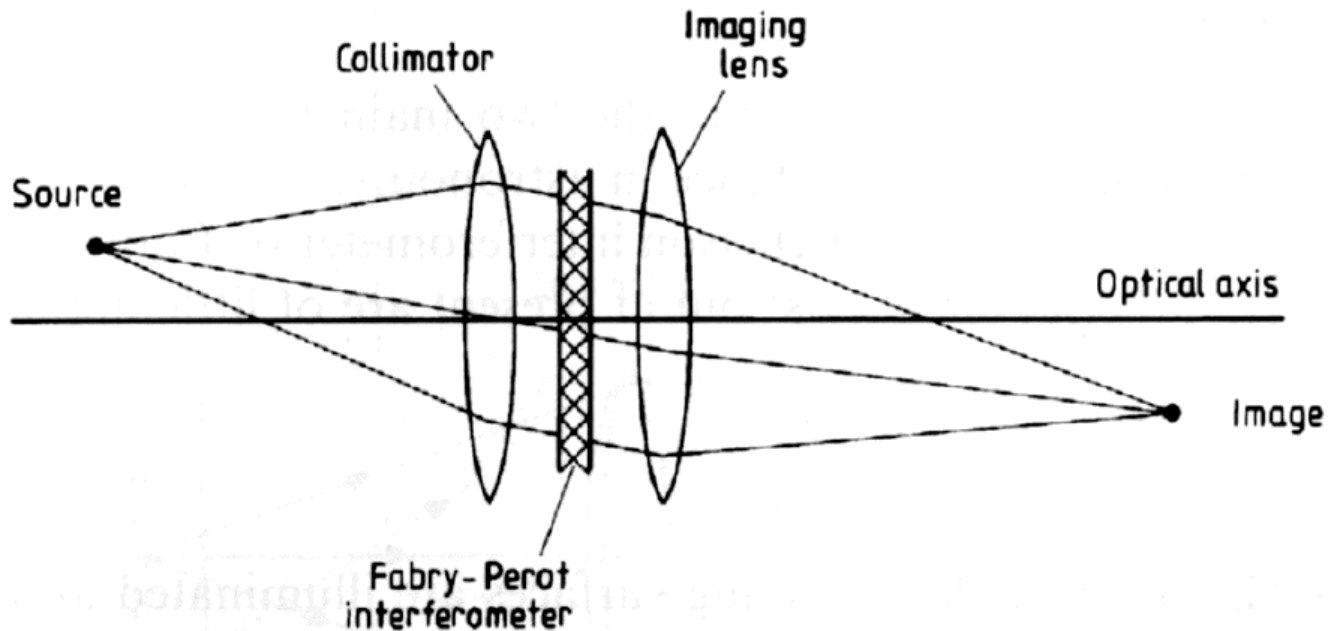

Using a filter which is a resonant cavity (thickness = $n \times \lambda$).
Coatings or order-sorting filter can be used to isolate 1 order.
If made of a piezoelectric material → tunable Fabry-Perot etalon.

Fabry-Perot Imager

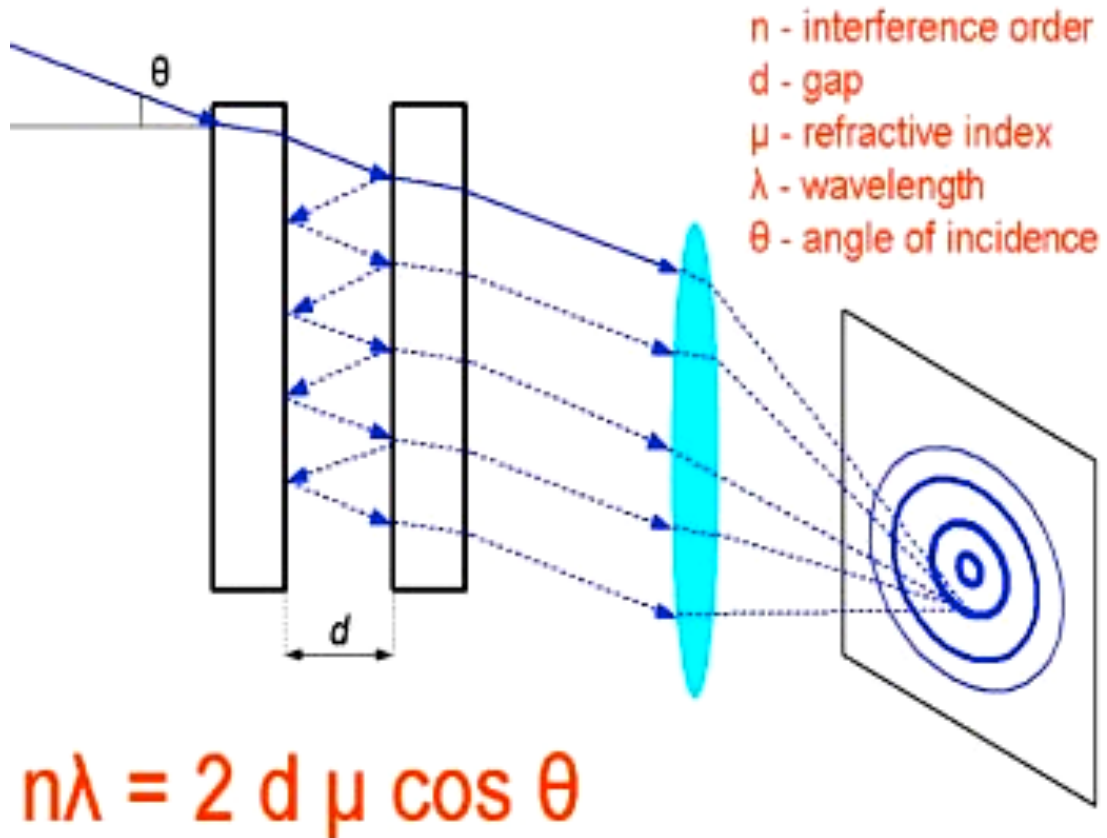

Loci of a constant wavelength in the focal plane are circles: a curved data cube!

An Example of a F-P Data Cube

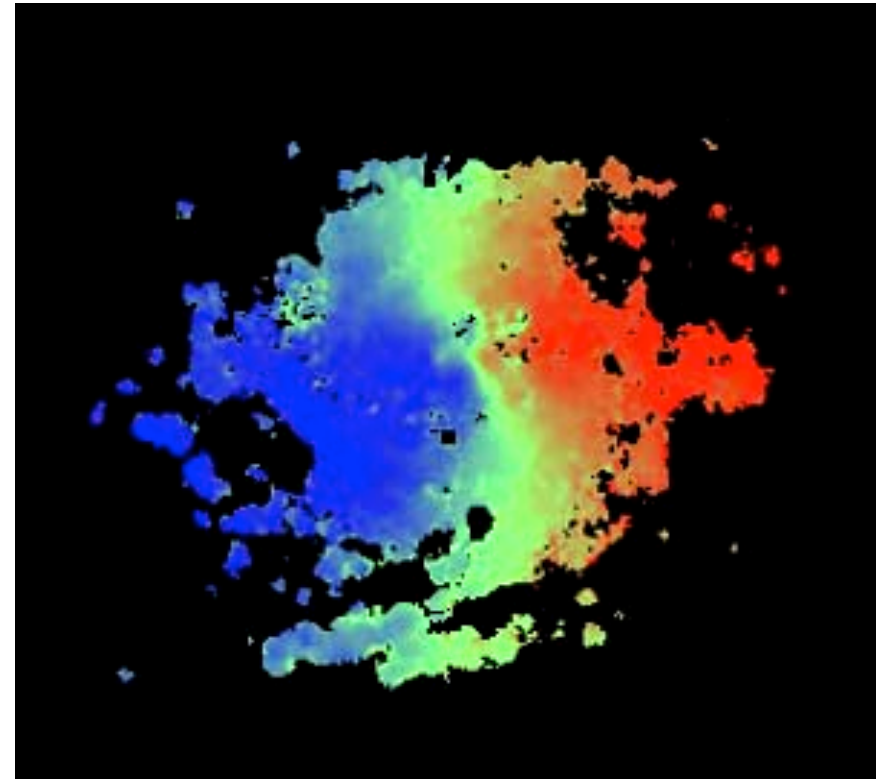
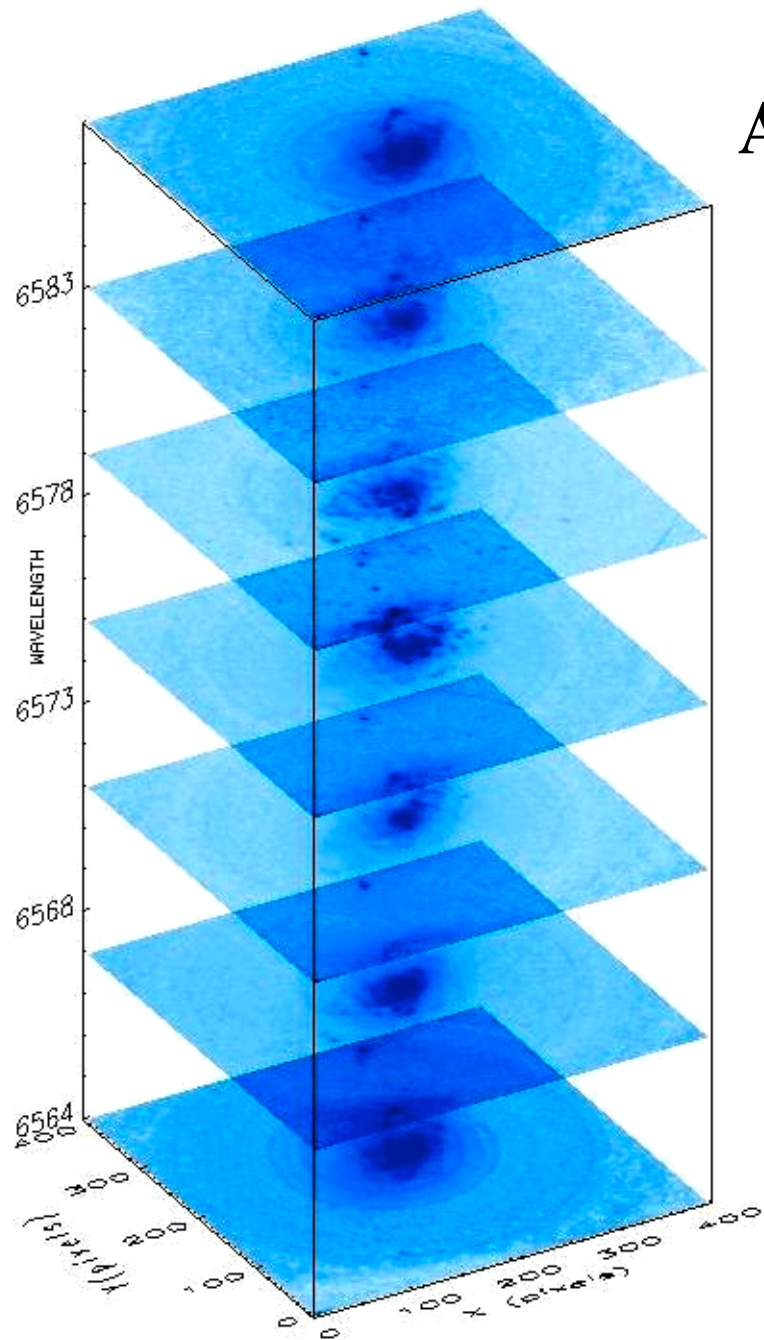

Color-coded
velocity map

Slitless Spectroscopy

Place a dispersing element in the front of the telescope/camera:
Each source has a dispersed image (generally a low disp.)

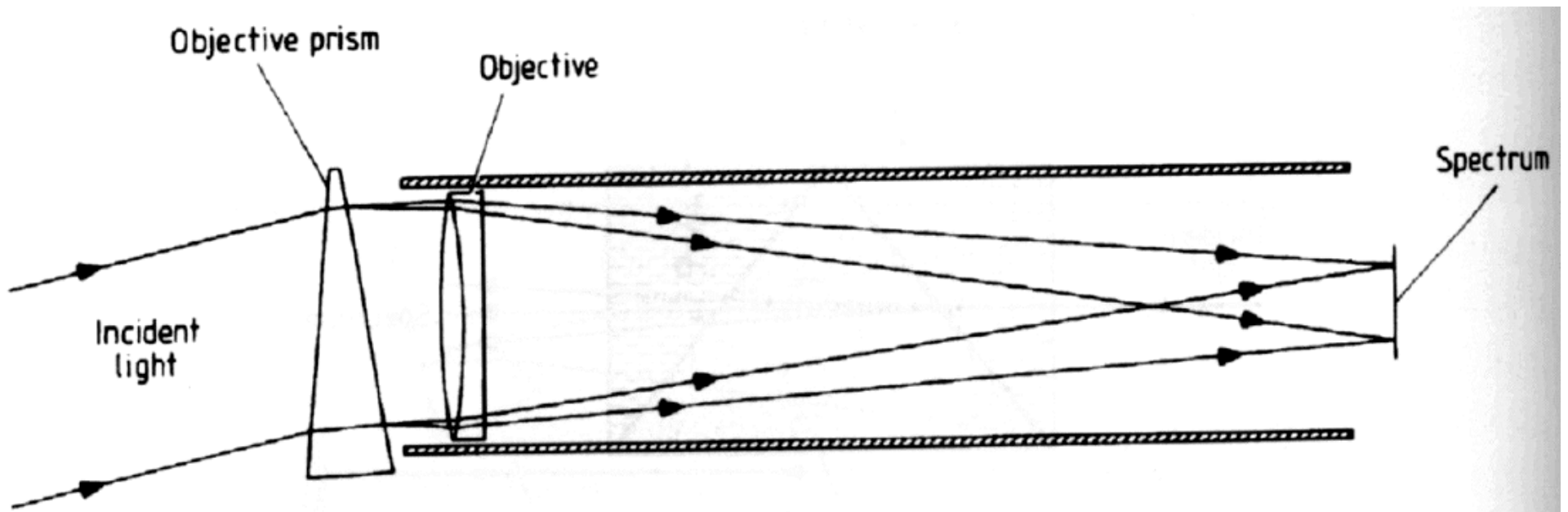

Good for wide-field surveys, but only for bright sources:
the sky foreground still has the light from all wavelengths

Slitless Spectroscopy Example:

From
KISS
Survey

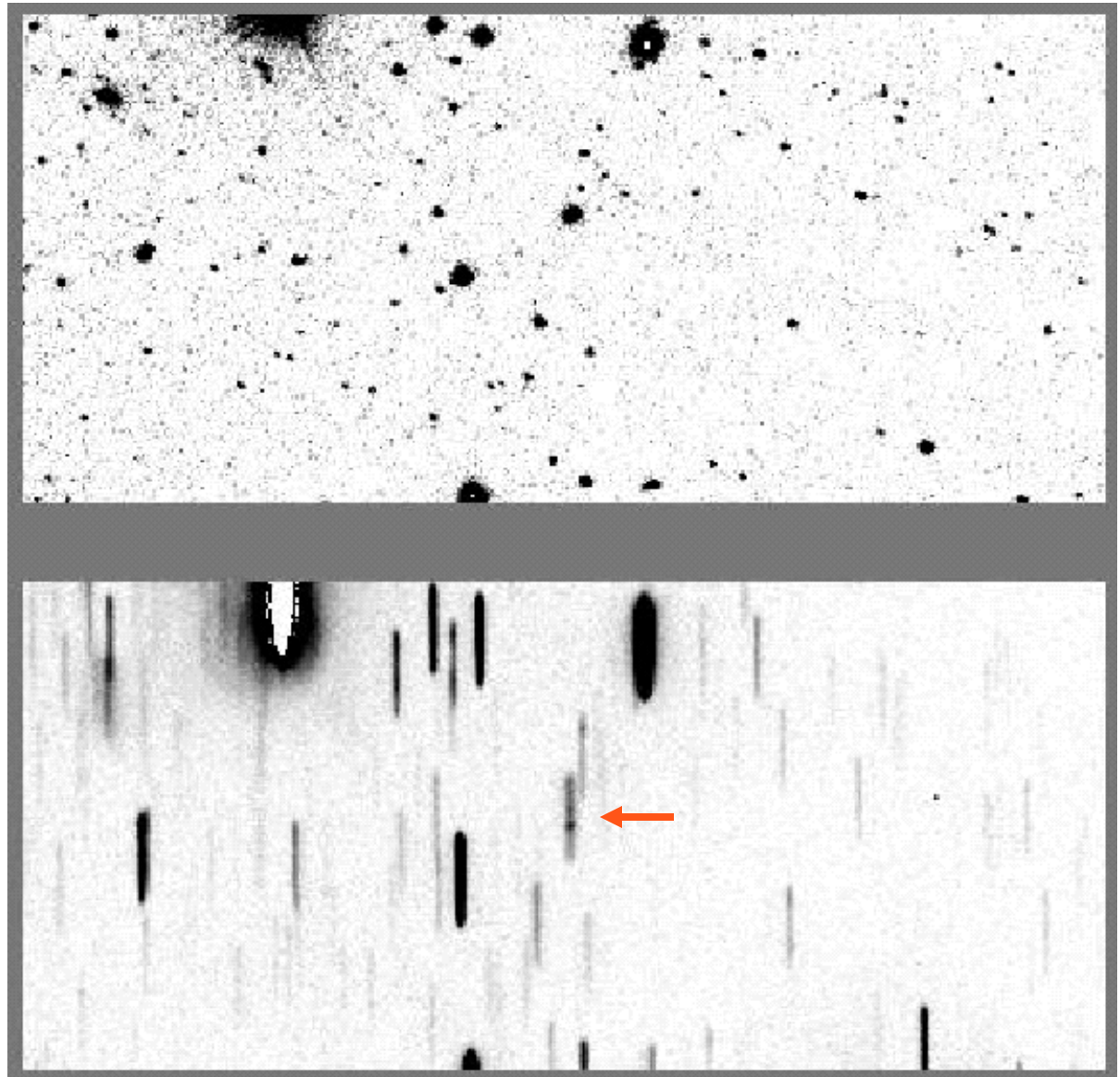

Fourier-Transform Spectrometer

Really a Michelson Interferometer

Baseline scans $\rightarrow \lambda_{\text{peak}}$

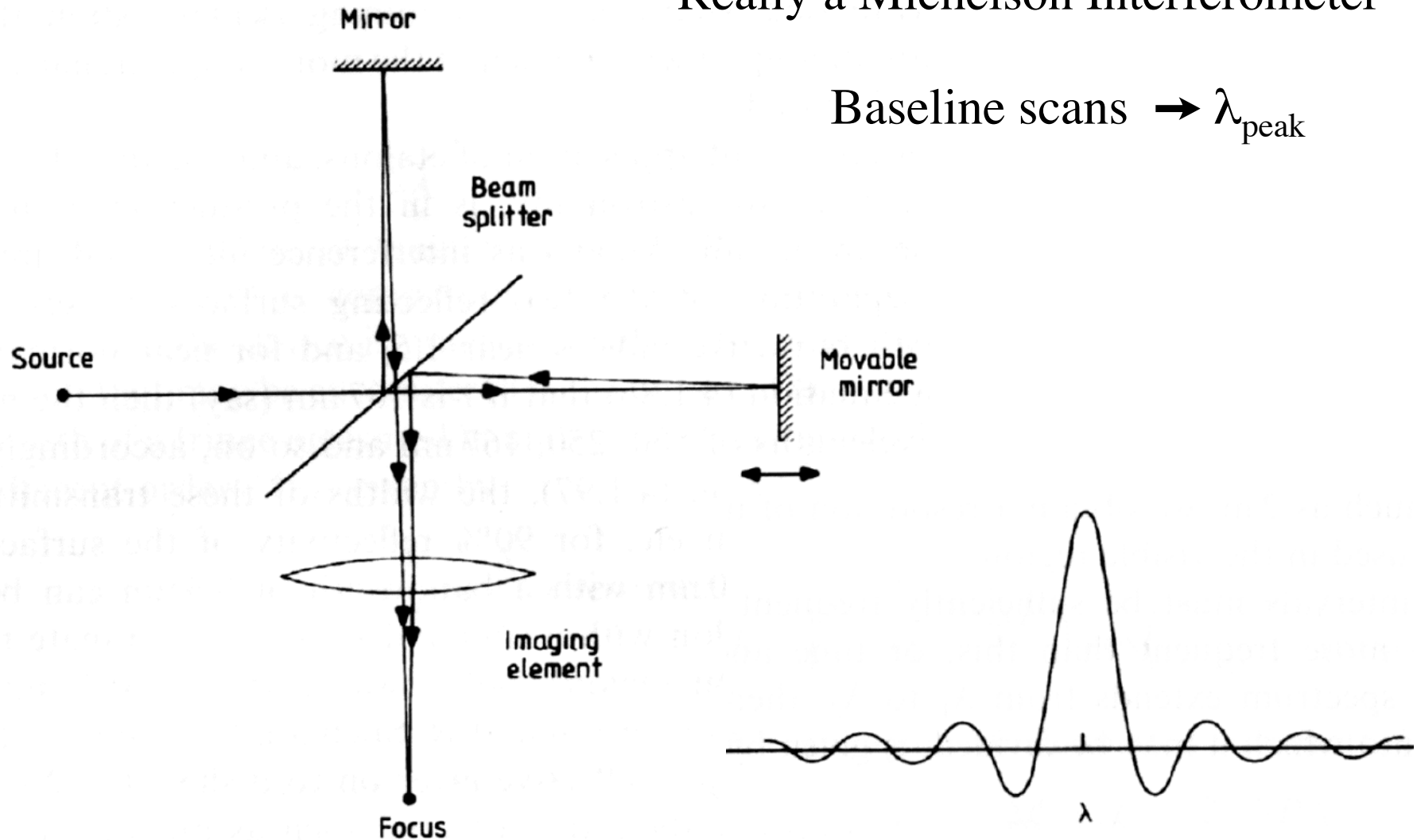

Spectroscopic Observing

- If spectrometer is not flexure compensated, the usual procedure is to obtain a line lamp spectrum (or two) and flat-field spectrum (or two) at the position of your program object. Sometimes even bracket the program exposures with arcs and flats.
- Depending on program, observe:
 - Flux standard
 - Radial velocity standard
 - Hot rapid rotator to identify terrestrial atmospheric absorption
- If no ADC, pay attention to position angle!

Star+sky

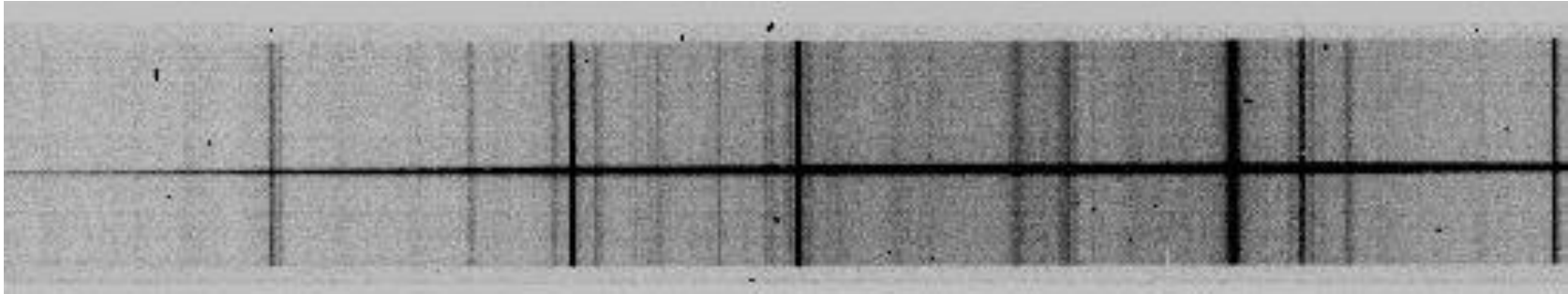

Quartz lamp flat



HgCdNe line lamps

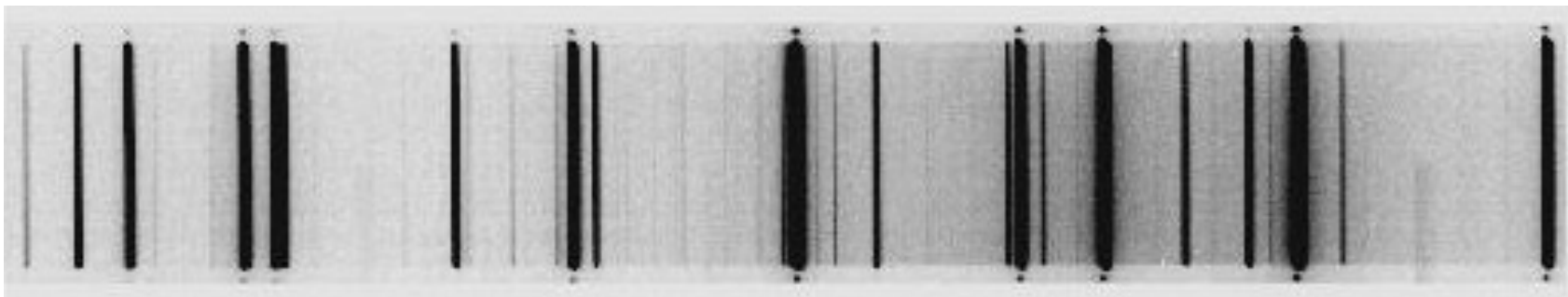

Spectroscopic Data Reduction Steps:

- Bias and overscan correction
- Flat-fielding
 - Note: need to remove large-scale variations in the spectral dimension
- Identify location of the spectrum
- Identify location of sky samples
- Extract spectrum
 - Trace
 - Collapse lines
 - Interpolate sky and subtract
- Use stellar aperture to extract arc spectrum
- Fit pixel-wavelength map and apply to spectrum
 - May need heliocentric/other velocity correction
- Derive flux calibration and apply to spectrum
 - Correct for atmospheric and sometimes also interstellar absorption

Spectroscopic Flatfields

- Can flatfield original frames in 2-D format, or extract flatfield with the same aperture as the program object
- You would like a source that is uniform in the spatial direction *and* has a flat spectrum. In practice, all flat-field lamps (usually a hot quartz lamp) have a strong spectral (continuum) signature
- So, usually extract flat, then fit a function in the spectral direction and divide this out to leave the pixel-to-pixel response
- Note: CCD pixel response varies with wavelength!

Quartz lamp

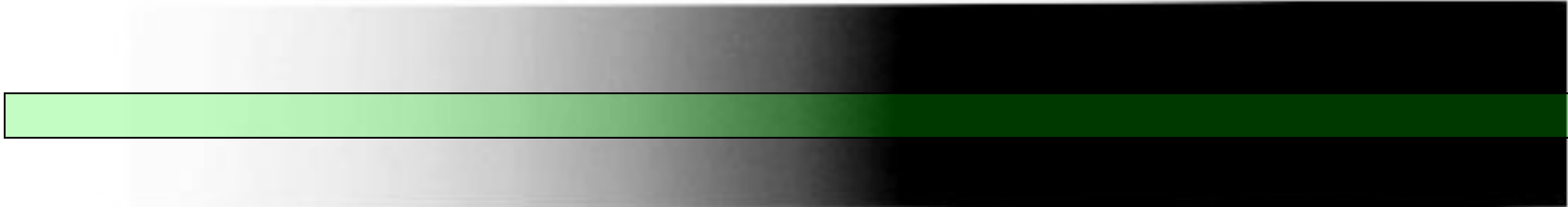

Blue

Red

NOAO/IRAF V2.12.2-EXPORT bolte@Michael-Boltes-Computer.local Tue 10:38:35 18-M
b71: flat@F9H-19 - Aperture 1

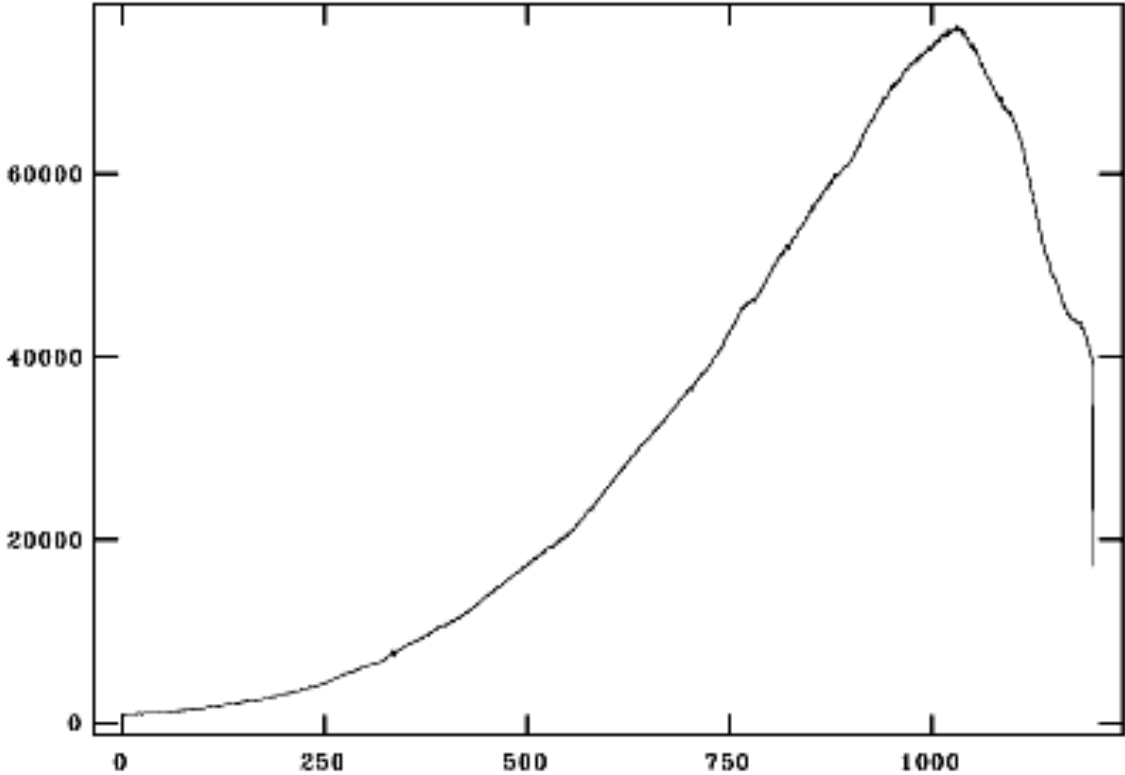

To “flatten the flatfield”, evaluate the low spatial frequency shape along the dispersion directions (poly fit, or a spatially filtered surface) and divide by it.

NOAO/IRAF V2.12.2-EXPORT bolte@Michael-Boltes-Computer.local Tue 10:38:35 18-M
b71: flat@F9H-19 - Aperture 1

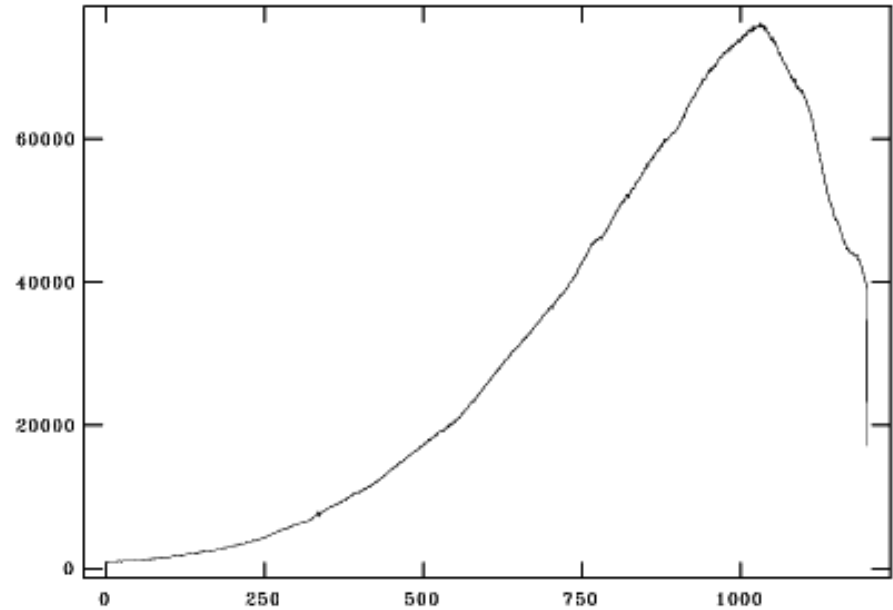

NOAO/IRAF V2.12.2-EXPORT bolte@Michael-Boltes-Computer.local Tue 11:01:49 18-M
Line 100 of n71
flat@F9H-19

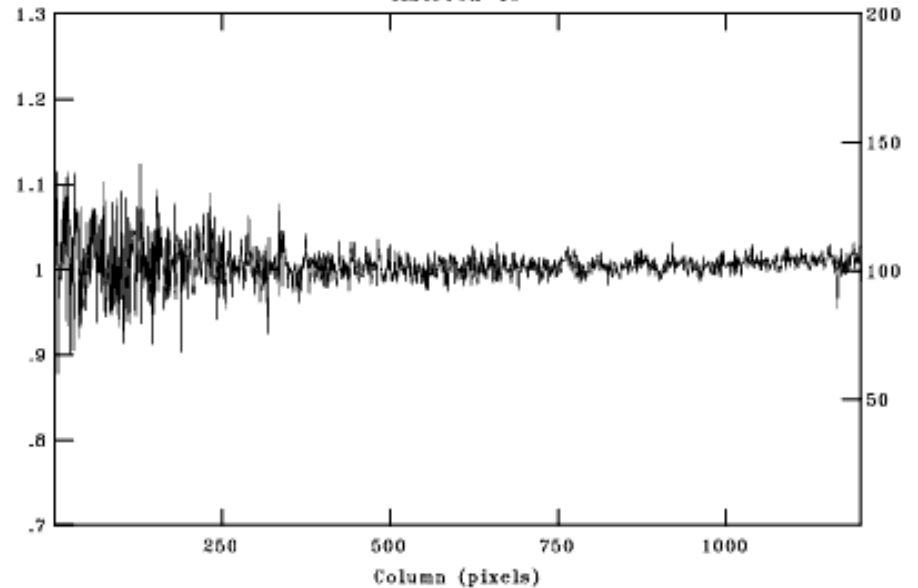

Two Major Problems

(especially for the faint object work)

1. Fringing (in the red)
2. Slit function: uneven slit width and illumination

Both are greatly aggravated by spectrograph flexure

DBSP spectroscopic flatfield divided by a smoothed version

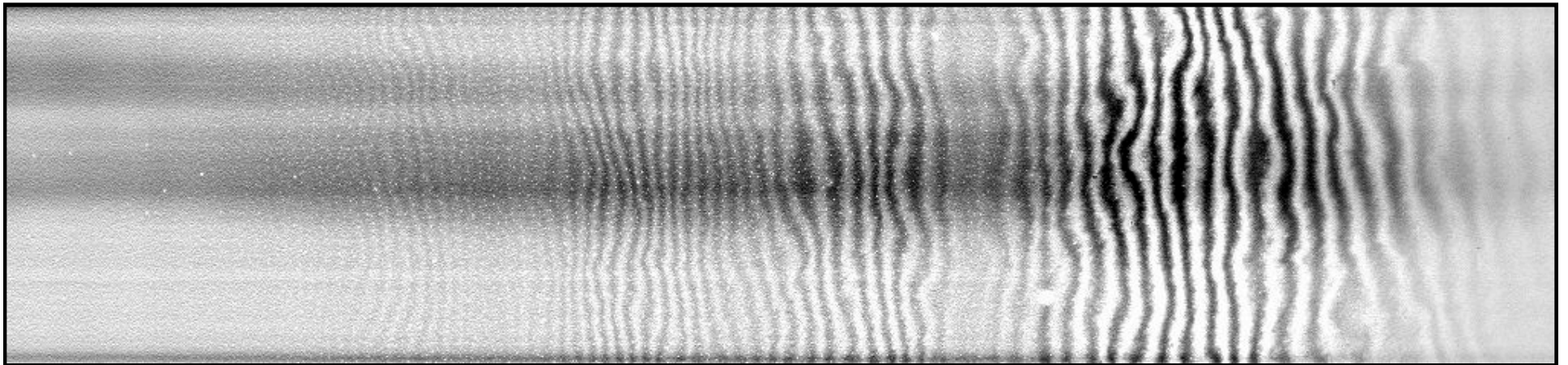

→ λ

Extracting the Spectrum: 2-D to 1-D

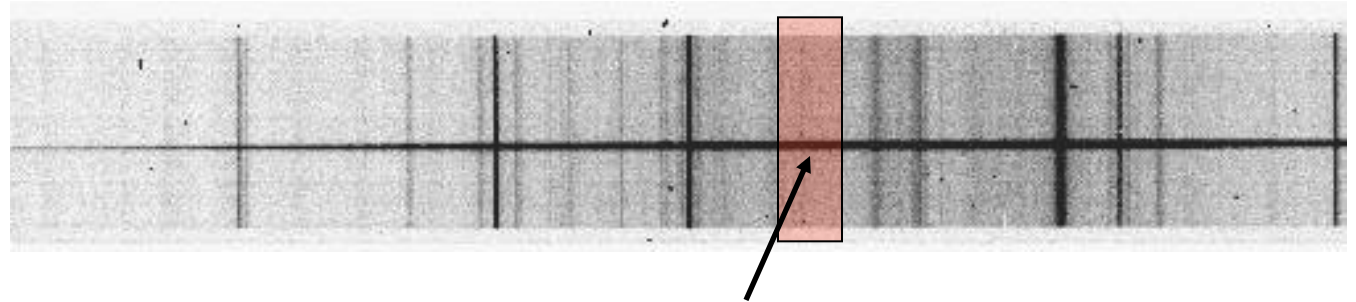

First, you need to determine the approximate position of the object spectrum to get its trace (extraction band)

NOAO/IRAF V2.12.2-EXPORT bolte@Michael-Boltes-Computer.local Sun 21:37:37 16-M
Image=test, Sum of columns 595-604
Define and Edit Apertures

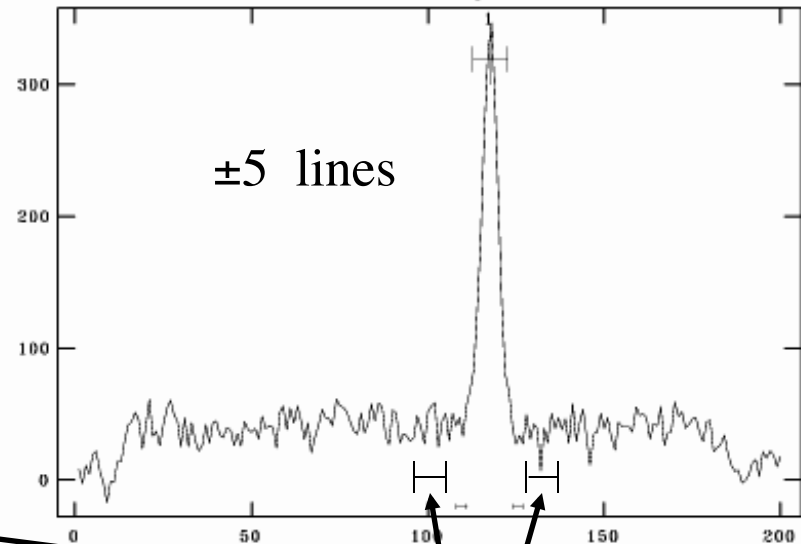

Then you need to determine the sky measurement bands

Trace: order 2 fit

NOAO/IRAF V2.12.2-EXPORT bolte#Michael-Boltes-Computer.local Mon 23:17:19 17-M
func=legendre, order=2, low_rej=3, high_rej=3, niterate=0, grow=0
total=120, sample=120, rejected=0, deleted=0, RMS= 0.1014
Aperture 1 of b188

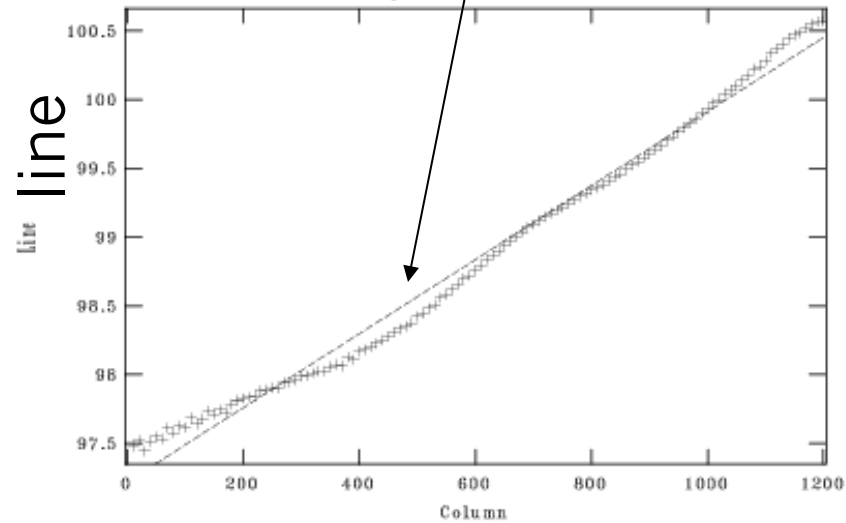

column



order 7 fit

NOAO/IRAF V2.12.2-EXPORT bolte#Michael-Boltes-Computer.local Mon 23:18:00 17-M
func=legendre, order=7, low_rej=3, high_rej=3, niterate=0, grow=0
total=120, sample=120, rejected=0, deleted=0, RMS=0.02567
Aperture 1 of b188

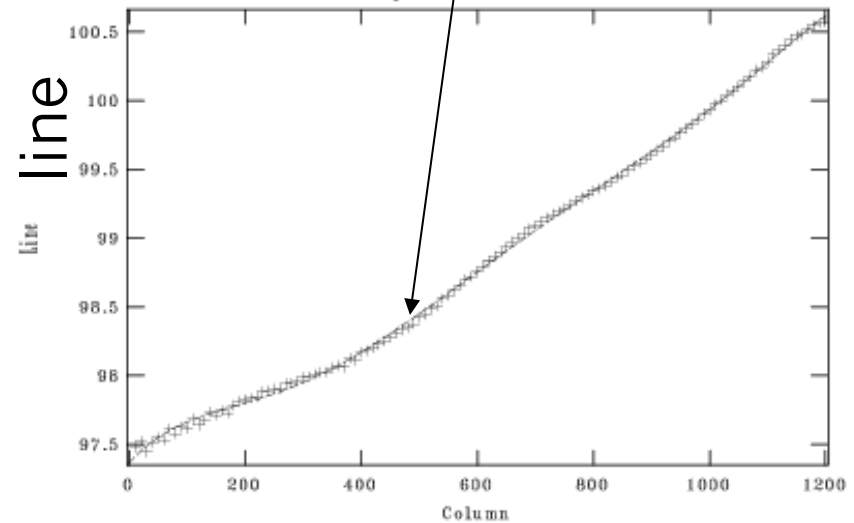

column

Spectroscopic Extraction

- The simplest approach is just to somehow subtract the sky under your object, and add up the flux over some band
- A better approach is to do optimal, S/N-based weighting of the fluxes from individual pixels. To do that, you need to approximate the object intensity profile (\sim PSF), which may vary along the dispersion direction. In practice, a fixed-sigma Gaussian is good enough for point sources or faint galaxies

Sky Subtraction

- Critical when crossing the sky lines (which are often tilted and unevenly illuminated)
- Many approaches:
 1. Fit a low-order poly to the sky bands, subtract
 2. Get a (possibly sigma-clipped) median in the sky bands, subtract
 3. Use a sliding-window, sigma-clipped median, and subtract

 This is usually the best!

Wavelength Calibration

- Identify the lines in your lamp-line spectrum
- Fit line centers, derive function to map pixel scale to wavelength scale
- Associate arc+solution with program spectra
- Apply the dispersion solution to the data

Arc Line Lamps

- Common types: He, Ne, Ar, Hg (+Cd), sometimes Xe, Zn; for high resolution (Echelle), Cu+Ar or Fe+Ar (hollow cathode)
- Use a pre-defined aperture, trace for extracting arcs. Lines are often tilted or curved

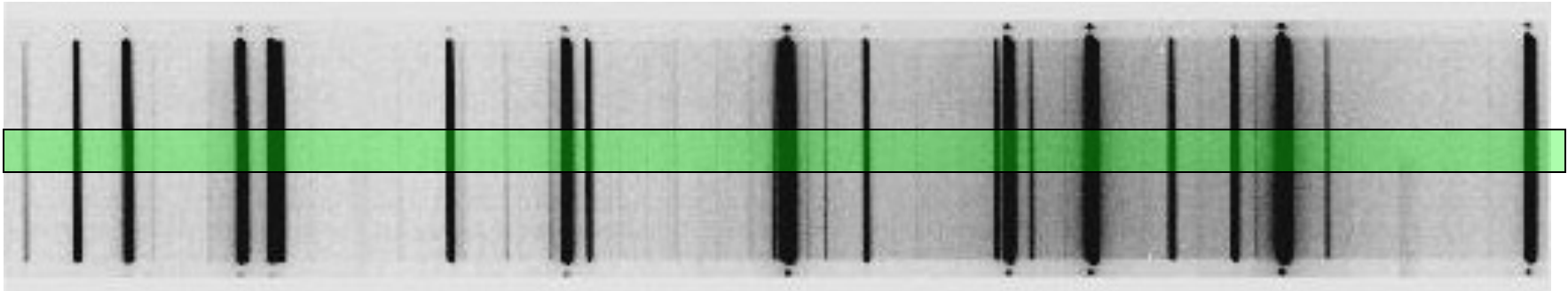

NOAO/IRAF V2.12.2-EXPORT bolte@Michael-Boltes-Computer.local Tue 09:01:30 18-M
b9: HgHeCd arc - Aperture 1

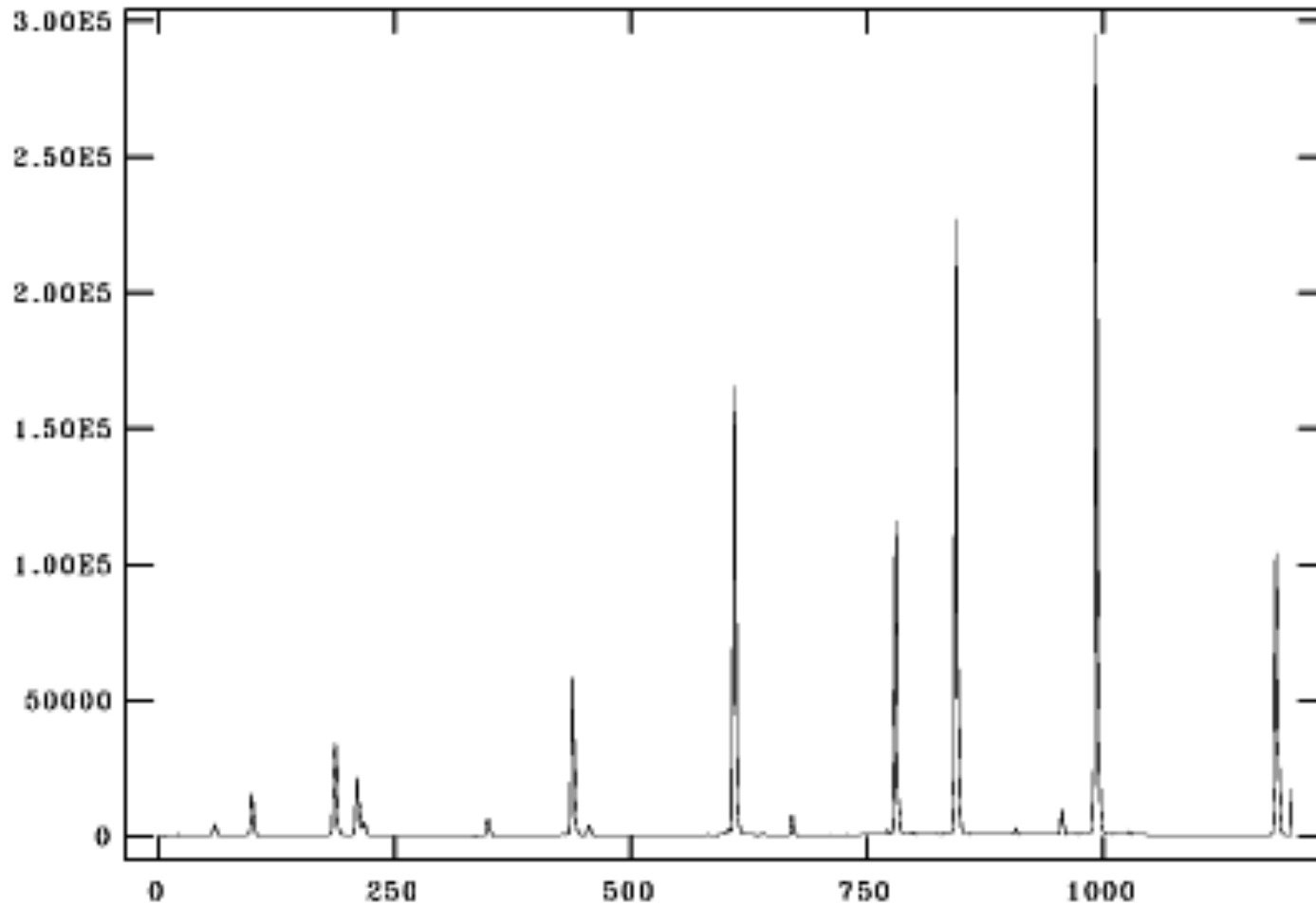

Sometimes fit a master arc taken in the afternoon and use arcs taken adjacent to program objects to make a zeropoint shift to the wavelength solution.

Flux Calibration

There are lists of spectrophotometric standard stars:

Faint spectrophotometric standard stars

Oke, J. B. 1990, AJ, 99, 1621 [[table](#) | [paper](#)]

Spectral energy distributions of standard stars of intermediate brightness. II.

Stone, R. P. S. 1977, ApJ, 218, 767 [[table](#) | [paper](#)]

Spectrophotometry of Flux Calibration Stars for Hubble Space Telescope

Stone, R. P. S. 1996, ApJS, 107, 423 [[table](#) | [paper](#)]

Southern spectrophotometric standards for large telescopes

Stone, R. P. S., & Baldwin, J. A. 1983, MNRAS, 204, 347 [[table](#) | [paper](#)]

Spectrophotometric standards

Massey, P. et al. 1988, ApJ, 328, 315 [[table](#) | [paper](#)]

The Kitt Peak spectrophotometric standards – Extension to 1 μ m

Massey, P., & Gronwall, C. 1990, ApJ, 358, 344 [[table](#) | [paper](#)]

Usual zeropoint is based on Vega:

$$F_{5556\text{\AA}} = 3.52 \times 10^{-20} \text{ erg/cm}^2/\text{s/Hz} \quad (V=0.048 \text{ mag})$$

An Example of a Spectrophotometric Standard

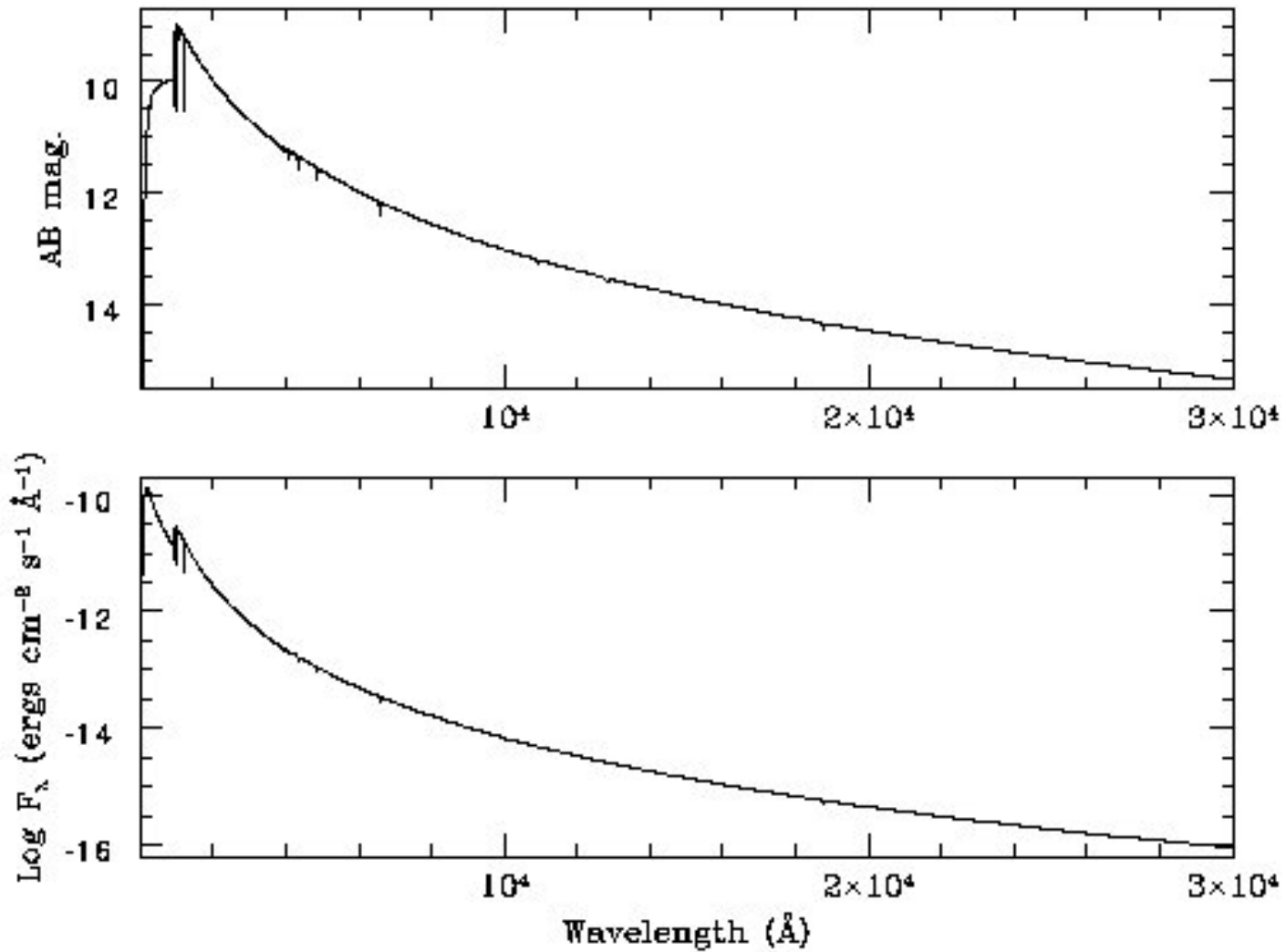

NOAO/IRAF V2.12.2-EXPORT bolte@Michael-Boltes-Computer.local Sat 22:46:46 22-M
[bz14.ms[*],1,1]: HZ 14 600. ap:1 beam:1

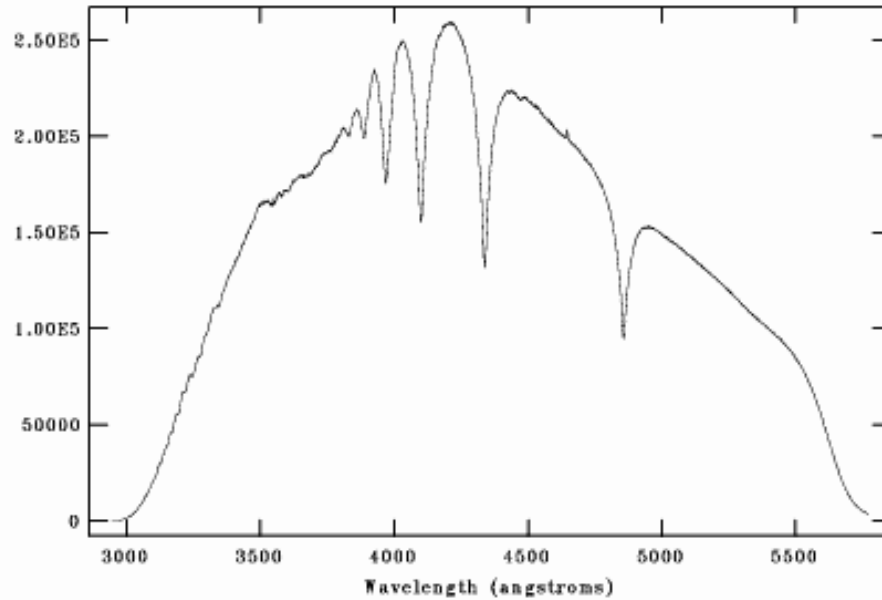

Raw extracted
Spectrum

NOAO/IRAF V2.12.2-EXPORT bolte@Michael-Boltes-Computer.local Sat 22:46:02 22-M
[chz14.ms[*],1,1]: HZ 14 600. ap:1 beam:1

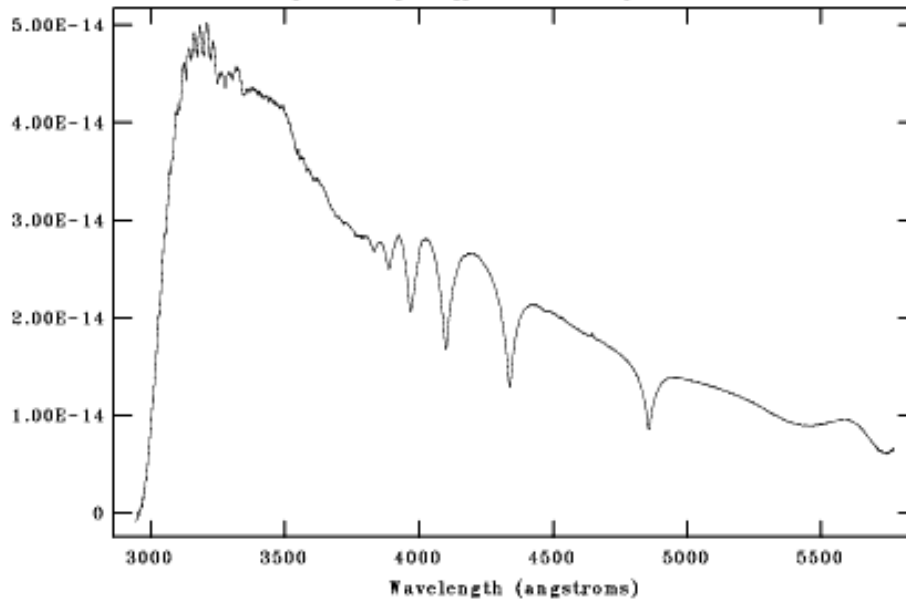

Flux calibrated

Echelle format spectra

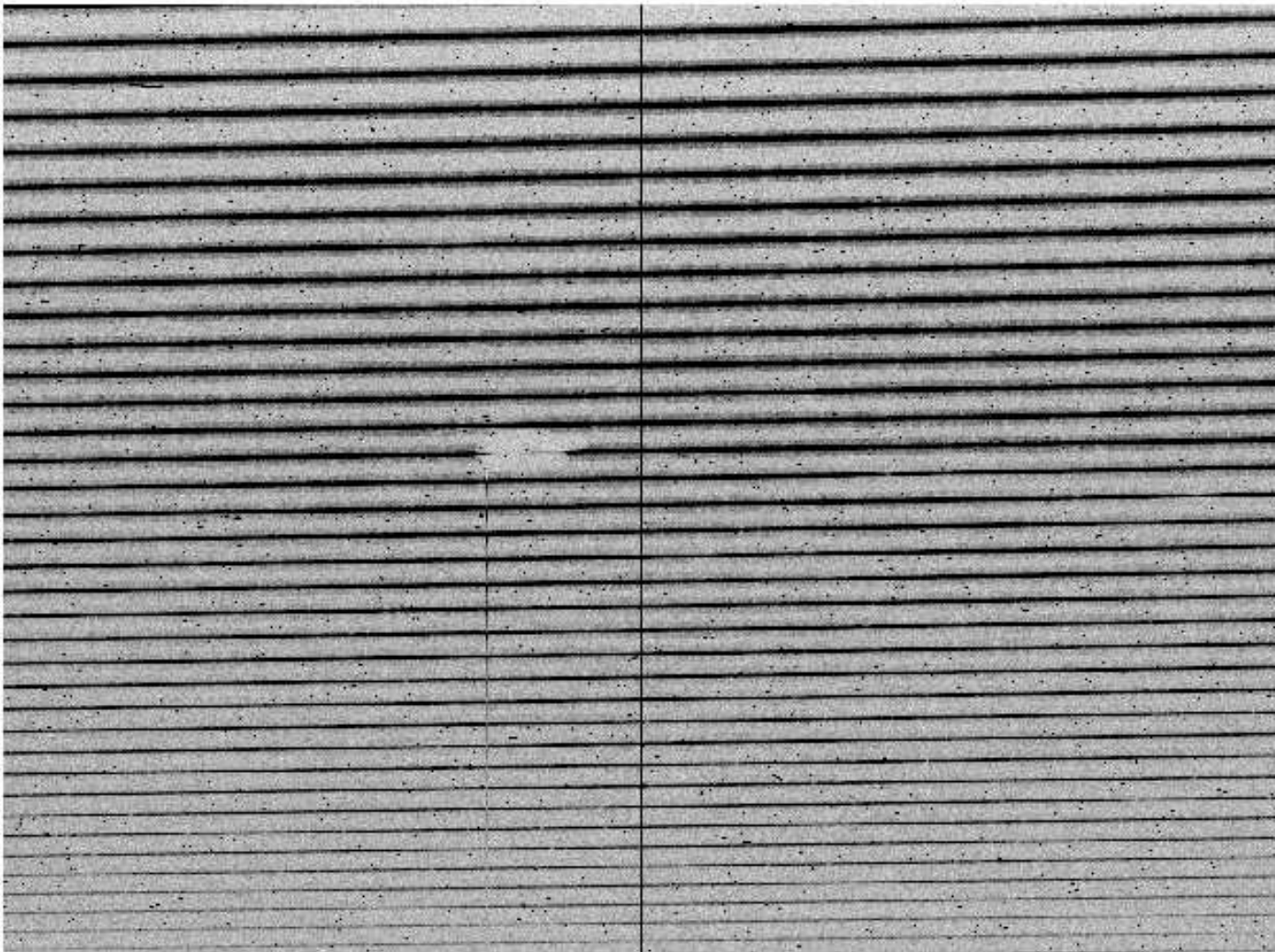

Each order
has to be
traced,
extracted,
and
calibrated
separately,
then
combined

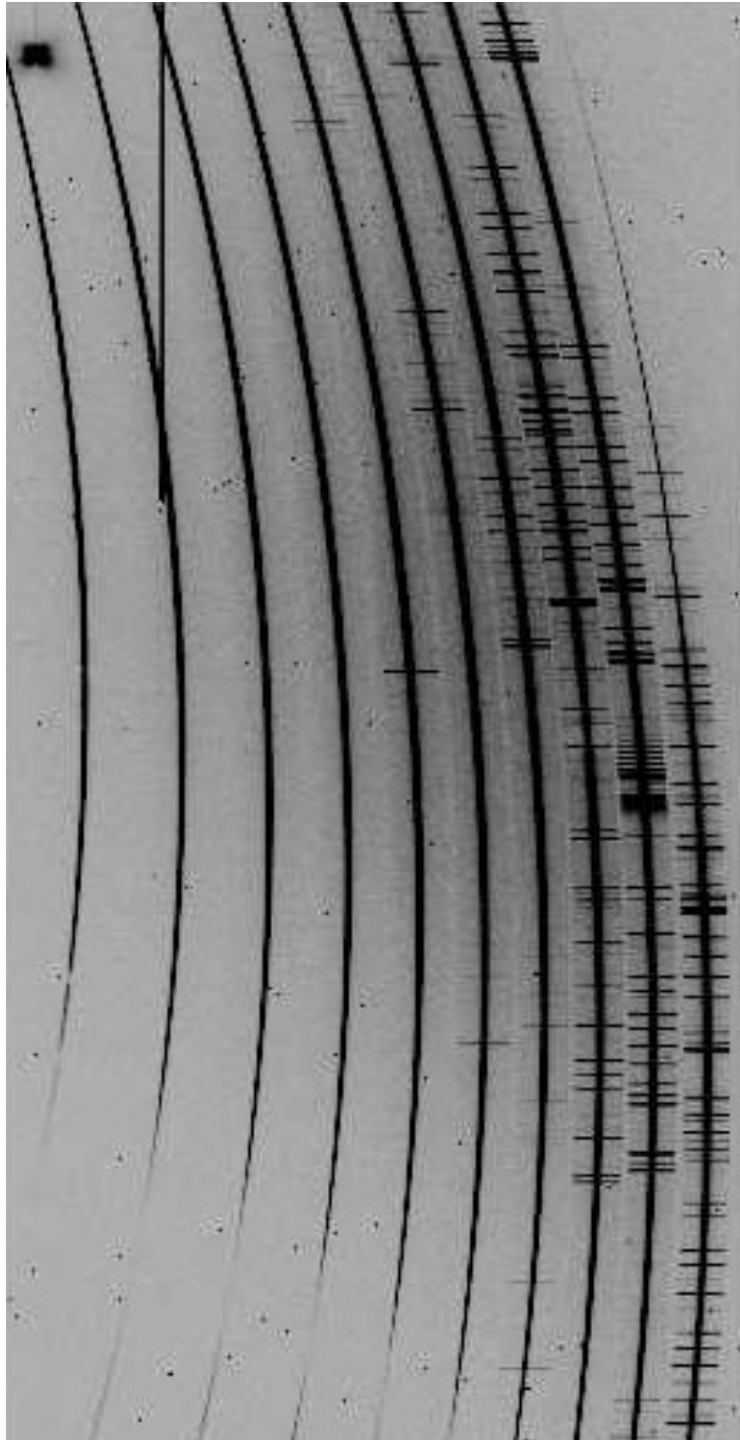

ESI spectra

Inner order regions

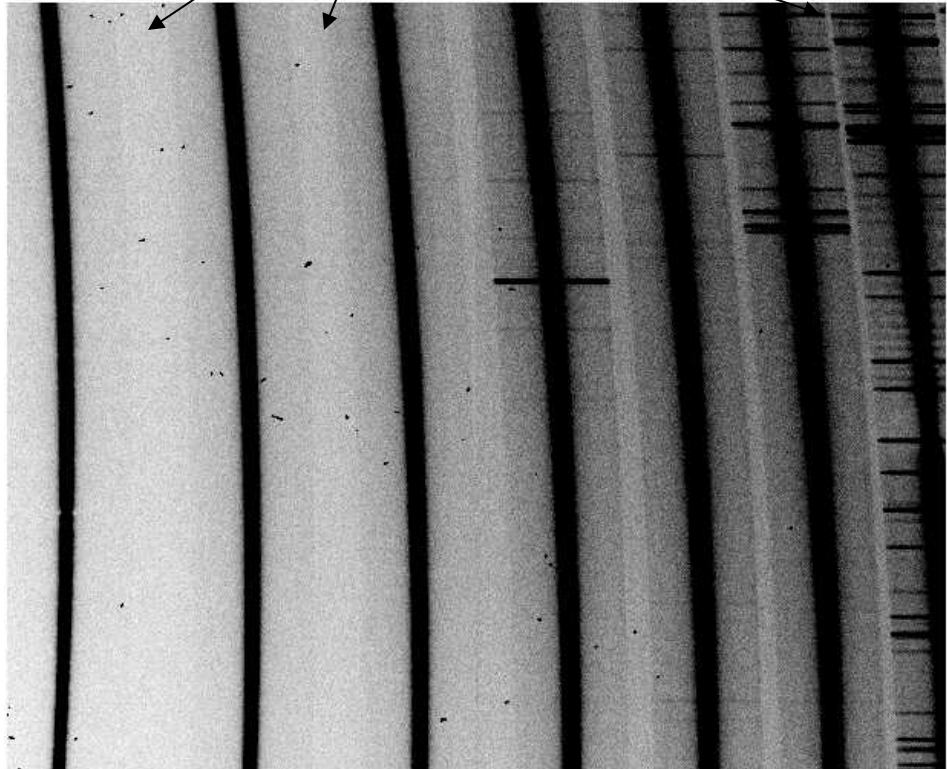

Radial velocity precision/accuracy:

$$R \equiv \frac{\lambda}{\Delta\lambda} = \frac{c}{v}$$

$$v = \frac{c}{R}$$

- $R = 2500$ (e.g., LRIS): 120km/s
- Centroid to 1/20 resolution element gives a precision of 5 km/s (ignoring wavelength calibration uncertainties)
- HIRES at $R = 50000$ and 1/20th: 0.3 km/sec

- For most spectrometers, systematic errors dominate by ~ 2 km/sec. Flexure, illumination differences between sky and lamp paths, asymmetric line profiles due to detector and spectrometer optics shortcomings, spectrometer focal-plane scale shifts due to refocus/temperature changes, etc.
- Sun reflex motion due to Jupiter is 12.4 m/sec - planet searching is a new ballgame. At this level you even need to worry about the barycentric corrections: 1 m/sec corresponds to determining the mid-time of an observation to 30 seconds.

- Solutions for really high precision work are to environment control stationary spectrometers (coude or Nasmyth platform) and to use a stable, in-spectrum wavelength calibration source.
- Campbell & Walker (1979, PASP, 91, 540) proposed hydrogen-fluoride in a cell in front of the spectrometer slit to superpose narrow lines at zero velocity on the spectrum. Showed 15 m/sec precision was possible. HF was described as “obnoxious”

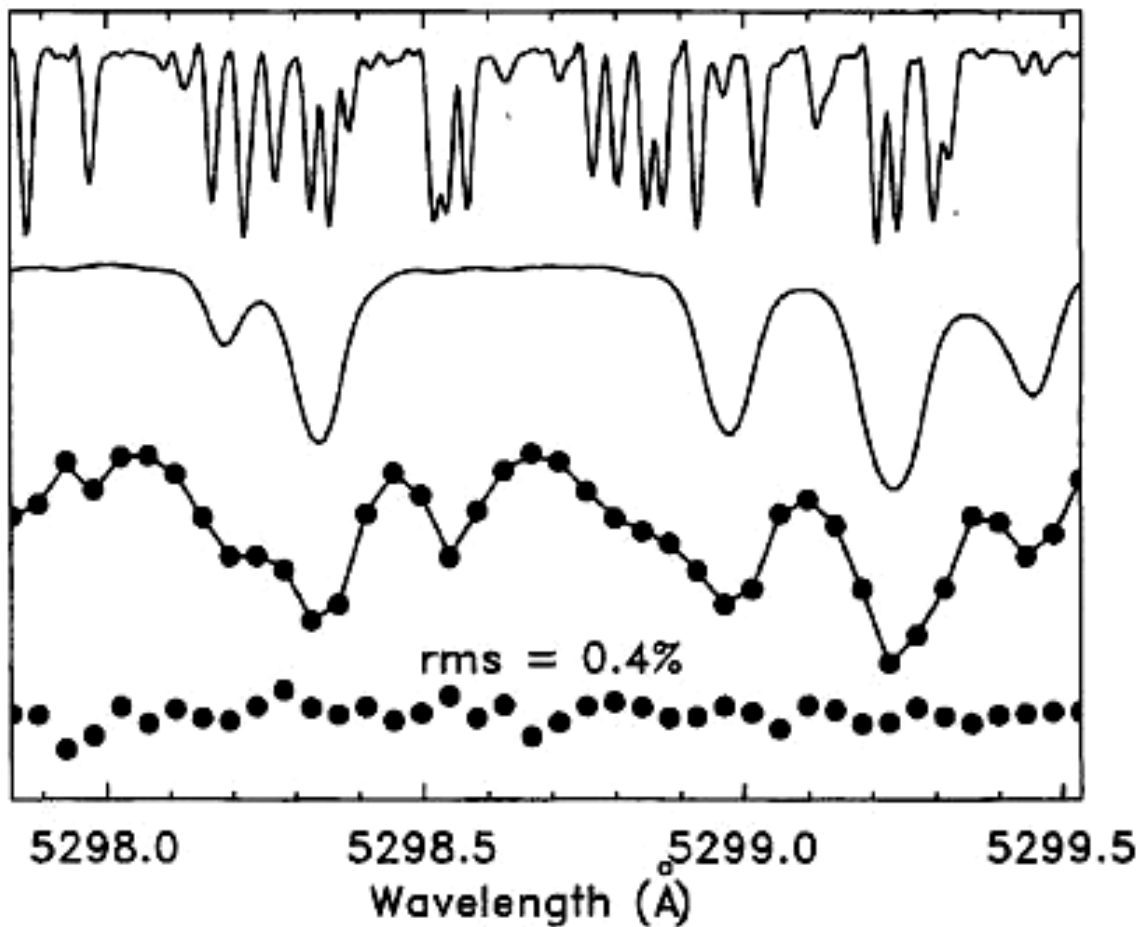

3m/s Precision With An Iodine Cell:

*Butler et al. 1996,
PASP, 108, 500*

FIG. 1—The modeling process. Top: The template iodine cell spectrum. Second: The template stellar spectrum (τ Ceti, G8 V). Third: The points are an observation of τ Ceti made through the iodine absorption. The solid line is a model of the observation. The model is composed of the template iodine and stellar spectra. The free parameters consist of the spectrograph PSF and the Doppler shift of the template star relative to the template iodine. Bottom: 10 times the difference between the model and the observation. The model and observation differ by 0.4% rms.