

# CNC Vision Measuring System Quick Vision Series

Catalog No. E14007(2)



# Quick Vision Evolves Toward Ideal Solution

With sophisticated edge detection capabilities, an illumination wizard and advanced, user-friendly software the Quick Vision Series satisfies the demand for compactness, high accuracy and high throughput in the field of non-contact dimensional measurement.

## Continuous Evolution

Mitutoyo has marketed CNC vision measuring machines, including the Quick Vision Series, since the mid-1980s and is proud of its superb delivery record in Japan.

Today, measurement professionals are becoming more and more sophisticated, demanding higher accuracy, compactness and a smaller footprint. Mitutoyo has recently relaunched the Quick Vision Series, which already has a good reputation, to address such demands. The new Quick Vision Series highly integrates the advanced optical, sensing, software and vision measuring technologies which Mitutoyo has developed to help customers solve the challenges they face.

## Traceability

Mitutoyo is the accredited company for the calibration of three main types of length standard (laser sources, end standards, and line standards).

Also, being the manufacturer of the most comprehensive range of precision measuring instruments available, Mitutoyo provides a number of measuring instruments traceable to national standards, such as coordinate measuring machines, optical measuring instruments, and form measuring instruments, as well as vision measuring machines.



Production of linear scales



Iodine absorption stabilized He-Ne (633nm) laser for length measurement

## Optical

The optical system employed in the Quick Vision Series is based on optical technology that Mitutoyo has accumulated over many years. This is a practically ideal optical system where the image is flat across the field of view with little flare.



Design and production of lenses

## Software

### Knowledge-Based Software to Control Quick Vision

QVPAK is a constantly evolving software package. In combination with various other applications, QVPAK delivers multifunctional analysis along with high-speed processing and simple operation.

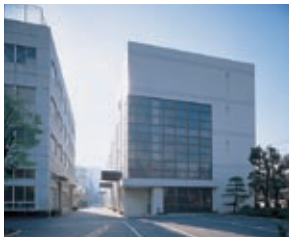

Kawasaki Plant (Japan)



## Quick Scope



## Quick Image

Functionality

**Mitutoyo**

# Lineup of Vision Measuring Systems

Accuracy ↑



**ULTRA Quick Vision**



**M-NanoCoord**



**Quick Vision Apex  
Hyper Quick Vision**



**UMAP Vision System**



**Hyper Quick Vision WLI**



**Quick Vision ELF**



**Quick Vision ACCEL**

# Multi-Probe Versatility Enriches the Functionality of Vision Measurement According to Individual Customer's Needs

## Touch Trigger Probe

Quick Vision Series models can also use touch-trigger probes to support measurement of workpiece features that cannot be inspected with vision alone. This capability is also useful when the most precise height measurements are required.



## Magnified Vision

A magnified image is taken by a CCD camera, and then dimensional measurements can be performed by way of edge detection and auto focus, which use image processing technology.

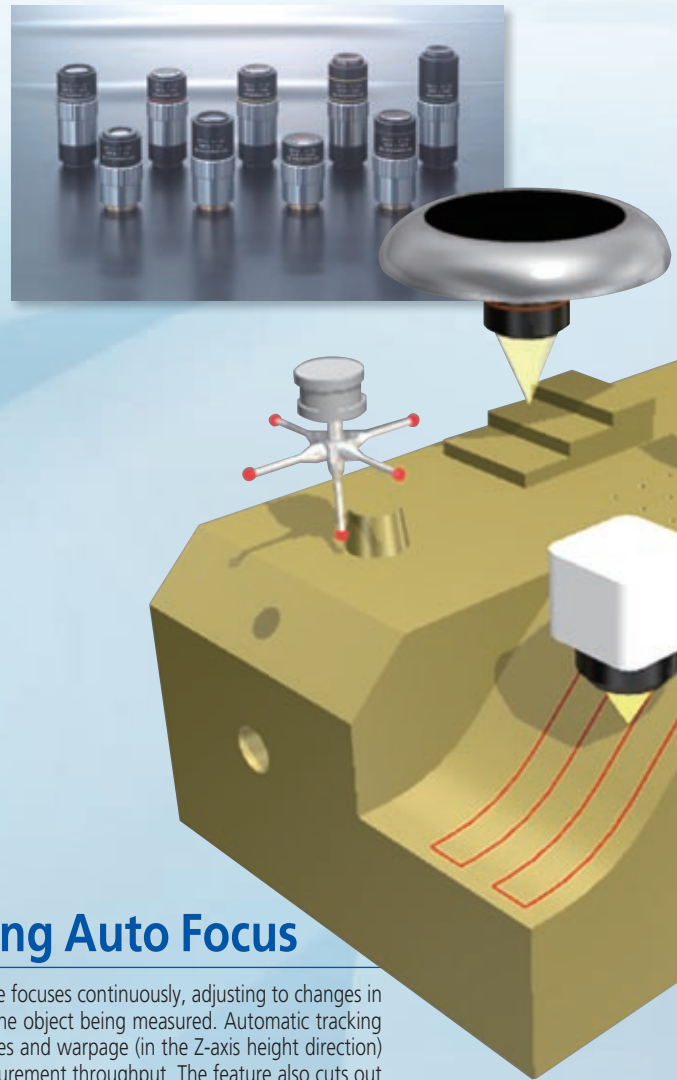

## Laser Probe

Utilizing this non-contact displacement sensor that uses a laser focusing point method, the Quick Vision Series can use its scanning function to measure very small steps and curved planes at high speed.



## CPS Probe

Thanks to its wavelength confocal format, non-contact displacement sensor that uses the epaxial chromatic aberration of the white light source, the Quick Vision Series can use its scanning function to measure very small steps and curved planes at high speed.

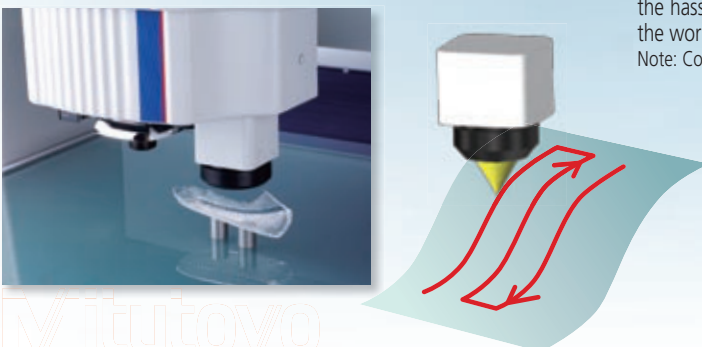

## Tracking Auto Focus

The TAF feature focuses continuously, adjusting to changes in the height of the object being measured. Automatic tracking of surface waves and warpage (in the Z-axis height direction) improves measurement throughput. The feature also cuts out the hassle of focusing during manual measurement, reducing the work burden for measuring system operators.

Note: Continuous measurement of displacement is not performed.

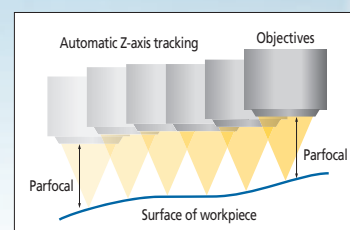

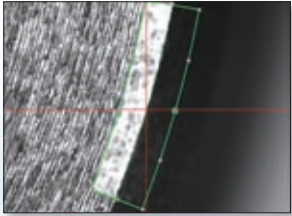

Image edge detection using a filter



Highly accurate height measurement thanks to image auto focus

## UMAP Probe

By using an extremely small stylus with a high aspect ratio, made possible by our proprietary sensing technology, the Quick Vision Series can perform contact measurements on small or narrow parts.

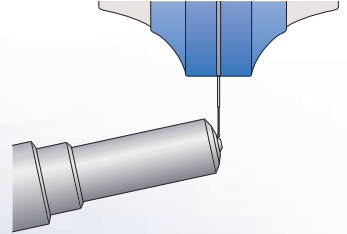
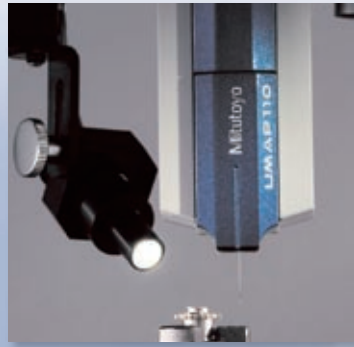

Measurement of a fuel injection nozzle hole's shape

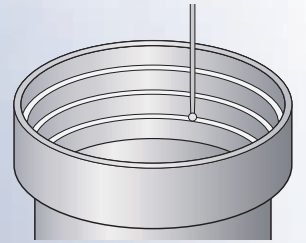

Measurement of a lens barrel's shape

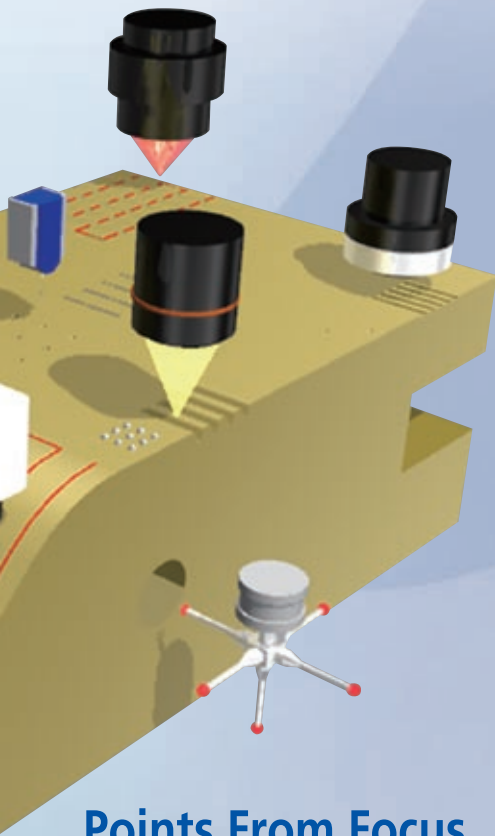

## White Light Interferometer

Using its white light interferometer, the Quick Vision Series can perform highly accurate 3D measurements in microscopic areas for surface analysis, small-diameter hole depth, and line and space measurements on circuit boards.

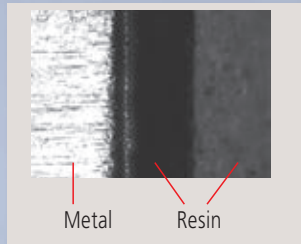
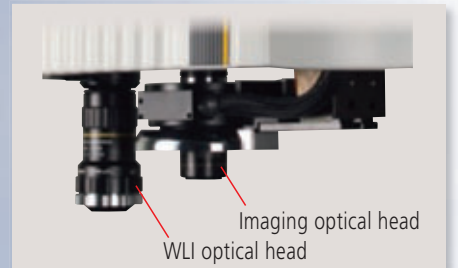

Metal Resin



## Points From Focus

Contrast information can be used to obtain 3D-form data from images at different heights that have been taken by the Quick Vision Series.

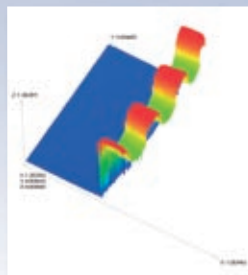

## QV Index

Using the QV index to rotate the workpiece makes it possible to automatically measure multiple surfaces without having to dismount/remount the workpiece.

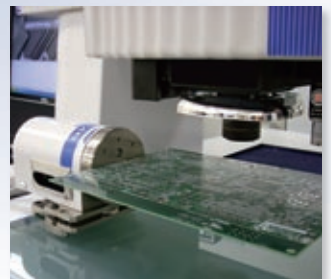

# Main Unit Structure Enables High Accuracy and High-Performance 3D Non-Contact Measurements

## Quick Vision Series Features

The Quick Vision Series is a non-contact dimension measurement system. It uses its CCD camera to take images magnified by its optical lens, and then uses image processing technology to detect the edges of the workpiece.

- The dimensions of microscopic features can be measured because the Quick Vision Series performs measurements on images that have been highly magnified by its optical system. The Quick Vision Series is extremely well suited to measurements of microscopic workpieces such as are found in electronics, semiconductor components, precision machinery, and medical equipment components.
- Because the Quick Vision Series performs non-contact measurements, there is no risk of the workpiece being damaged, deformed, or stained. In addition to measurements of electronic and semiconductor components that must be kept clean, the Quick Vision Series is also suited to measurements of workpieces such as soft resin-molded products and thin press-molded products.
- The Quick Vision Series can perform high-speed measurements of multiple points from within the captured image. The image processing technology and high-speed stage control enable high-throughput measurements, which makes the Quick Vision Series the optimal solution for workpieces that have many features to be measured and for manufacturing process management of mass-produced products.
- The Quick Vision Series uses its image auto focus function and non-contact displacement sensor to perform highly accurate height measurements.

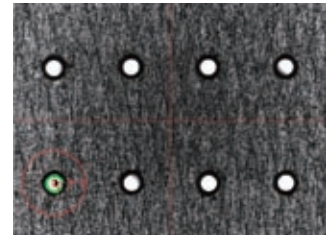

Vision measuring machine



Contact-type measuring machine

## Main Unit Structure Optimized for Highly Accurate Measurements

Structural deformation caused by movement along each axis has been minimized, which ensures that the Quick Vision Series can be used to perform highly accurate measurements with minimal spatial coordinate distortions.

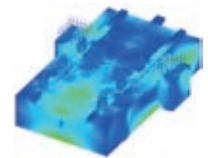
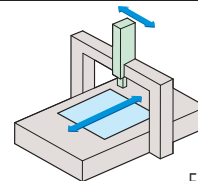

FEM structure analysis simulation

## Lineup Offers Choice of Measuring Range and Accuracy

The QV Series consists of a diverse lineup that includes models ranging from compact to large-range models and from models with general-purpose accuracy to models with extremely high accuracy. The QV Series can meet all the varied measurement needs for manufacturing industry.

Name	Size	Measurement range(mm)
QV ELF	202	250 × 200 × 200
QV Apex	302	300 × 200 × 200
Hyper QV	404	400 × 400 × 250
QV STREAM PLUS	606	600 × 650 × 250
	808	800 × 800 × 150
QV ACCEL	1010	1000 × 1000 × 150
	1212	1250 × 1250 × 100
	1517	1500 × 1750 × 100

## Highly Functional and Versatile Illumination Unit

- QV-PROs use LEDs for all of their light sources: contour, surface, and programmable ring light.
- Lighting uniformity has been achieved at a high level, which leads to excellent part program compatibility between multiple QVs.
- LED light sources have excellent responsiveness, which improves measurement throughput.
- LED light sources have longer lives than halogen types, which reduces illumination fluctuations and thereby minimizes any errors caused by changes in light intensity.

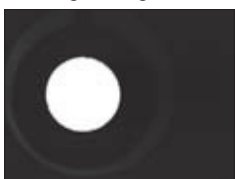

Contour illumination



Vertical surface illumination



Programmable ring light illumination

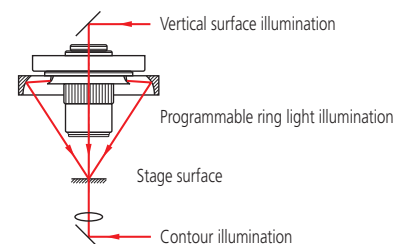

# Highly Functional Lighting Supports Positive Edge Detection and Automatic Measurements

## Tracking Auto Focus (TAF)

The TAF feature focuses continuously, adjusting to changes in the height of the object being measured. Automatic tracking of surface waves and warpage (in the Z-axis height direction) improves measurement throughput. The feature also cuts out the hassle of focusing during manual measurement, reducing the work burden for measuring system operators.

Note: Continuous measurement of displacement is not performed.

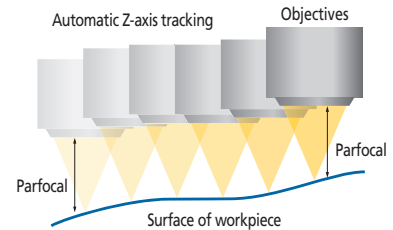

<b>Laser source</b>	Semiconductor laser (peak wavelength: 690nm)				
<b>Laser safety</b>	Class 2 (JIS C6802:2011, EN/IEC 60825-1:2007)				
<b>Auto focus system</b>	Objective coaxial autofocusing (knife-edge method)				
<b>Applicable objectives</b>	QV-HR1X	QV-SL1X	QV-HR2.5X	QV-SL2.5X	QV-5X
<b>Tracking range *</b>	6.3mm (±3.15mm)	6.3mm (±3.15mm)	1mm (±0.5mm)	1mm (±0.5mm)	0.25mm (±0.125mm)

\* When using Tracking Auto Focus, be sure to set upper and lower limits in the software to prevent the objective colliding with the workpiece.  
The tracking range depends on the surface texture and reflectance of a workpiece.

## Programmable Ring Light (PRL)

Changing the positions of the two curved mirrors sets the ring light's obliquity to any chosen value between 30° and 80°. This is effective for enhancing the edges of inclined surfaces or very small steps. Furthermore, the PRL light's illumination can be controlled independently in every direction, front and back, right and left. This makes it possible to configure highly variable lighting settings to match measurement locations.



### Measuring the top and bottom widths of metallization patterns on an IC package

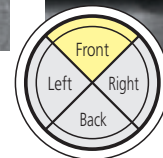
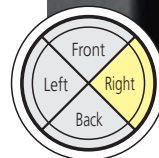
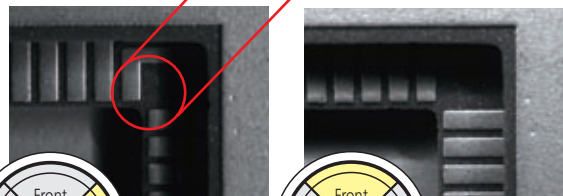
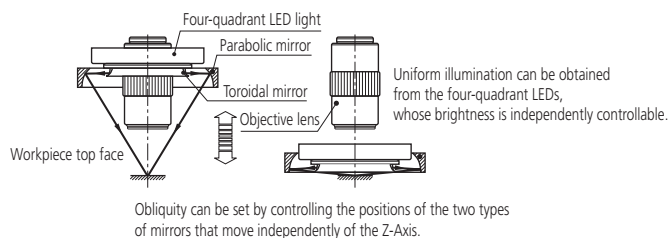
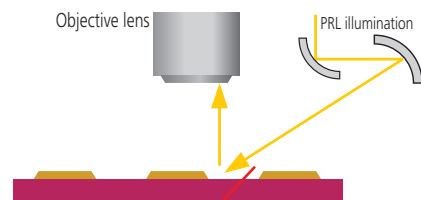

# Powerful Vision Sensor with High Flexibility due to Mitutoyo's High Performance Lenses

## Programmable Power Turret

The QV's programmable power turret has excellent magnification repeatability which makes it suited to highly accurate measurements.

The standard specification permits three steps of magnification: 1X, 2X and 6X.

The customized specification permits three or four steps of magnification: 1X, 2X and 4X; or 1X, 2X, 4X and 6X.

Furthermore, the rich lineup of objectives contains lenses with magnifications ranging from 0.5X to 25X, which makes it possible to select the optimal optical system to match the measurement target.

It is easy to install new objectives by using the optional calibration chart and compensation chart, so additional objectives can be purchased at a later date.

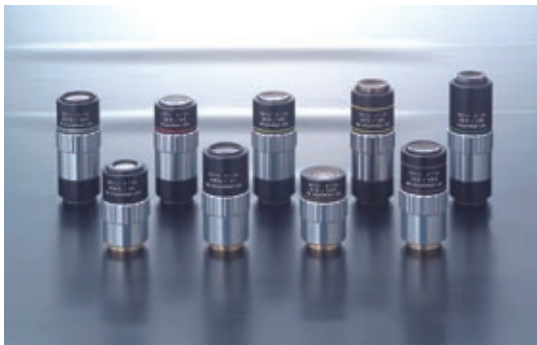

Various objectives for the QVs

### Objectives

#### QV-HR1X

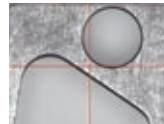

PPT1X  
Field of View: 6.27 x 4.70 mm

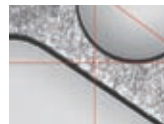

PPT2X  
Field of View: 3.13 x 2.35 mm



PPT6X  
Field of View: 1.04 x 0.78 mm

#### QV-HR2.5X



PPT1X  
Field of View: 2.49 x 1.86 mm

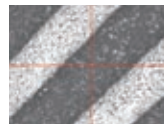

PPT2X  
Field of View: 1.24 x 0.93 mm

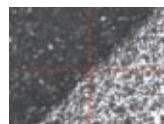

PPT6X  
Field of View: 0.41 x 0.31 mm

#### QV-5X

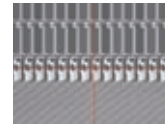

PPT1X  
Field of View: 1.24 x 0.93 mm



PPT2X  
Field of View: 0.62 x 0.47 mm



PPT6X  
Field of View: 0.20 x 0.15 mm

#### QV-HR10X



PPT1X  
Field of View: 0.62 x 0.47 mm



PPT2X  
Field of View: 0.31 x 0.23 mm



PPT6X  
Field of View: 0.10 x 0.07 mm

	Monitor magnification*1	15X	29X	58X	72X	87X	144X	173X	290X	430X	580X	720X	870X	1440X	1730X	4300X
	Field of View (mm)	12.54x9.4	6.27x4.7	3.13x2.35	2.49x1.86	2.09x1.56	1.24x0.93	1.04x0.78	0.62x0.47	0.41x0.31	0.31x0.23	0.25x0.18	0.20x0.15	0.12x0.09	0.10x0.07	0.04x0.03
PRO model programmable power turret	0.5x objective	●	●	●	●	●										
	1x objective		●	●	●	●	●	●								
	2.5x objective				●	●	●	●	●	●						
	5x objective						●	●	●	●	●	●	●			
	10x objective*2								●	●	●	●	●	●	●	●
25x objective*2											●	●	●	●	●	

\*1: With QVPAK version 10 or later, the size of the video window can be changed. Monitor magnification shown in the above table is a reference value at the same display magnification when using 22-inch wide LCD monitor.

\*2: When the 10x objective or 25x objective is used in combination with the 2X or 6X magnification of the power turret, the brightness may be insufficient depending on the workpiece.

\*3: For the PRO3 models, the monitor magnifications are 1.34 times and the field of view are approximately 0.75 times those of the PRO model.



## Color Camera Specifications That Improve The Observation Function (PRO3 Model)

To improve the observation function, Mitutoyo offers the PRO3 model that is equipped with a color CCD camera. A high-resolution CCD camera has been used to achieve the specifications of the PRO3, so highly accurate measurements, in which there is no decrease in the resolution of the screen, can be performed.

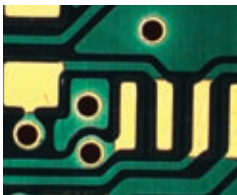

Printed circuit board

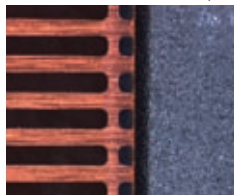

QFP package leads

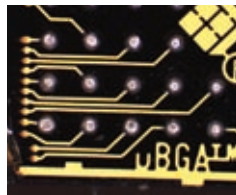

IC package



LCD color filter

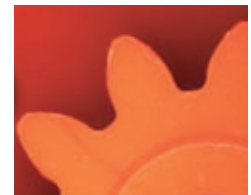

Resin-molded product

## High-Performance Multi-Auto Focus

The QV Series is equipped with a high-performance image auto focus function as standard. Image auto focus is used to guarantee accuracy. Thanks to the availability of various auto focus tools, the optimal focus for each surface texture and measured feature can be selected, which makes it possible to perform highly reliable height measurements.

Furthermore, auto focus operates at high speed, which increases total measurement throughput.

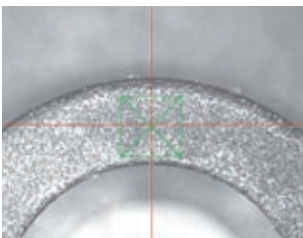

### Surface focus

Image auto focus can be used to measure the height of a chosen area, which makes it possible to perform stable height measurements that are minimally affected by the roughness of machined surfaces and other similar surfaces.

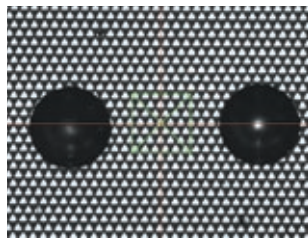

### Pattern focus

Auto focus can be performed on low-contrast transparent objects, such as film, glass and mirrored surfaces by projecting onto the object surface a pattern placed within the light path.

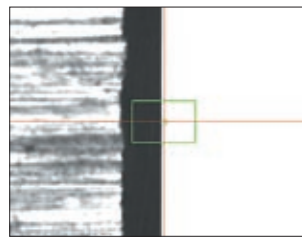

### Edge focus

Edge focus is suited to focusing edges that have been chamfered or that have a corner radius. Using this focus tool prior to performing edge detection improves edge detection reproducibility.

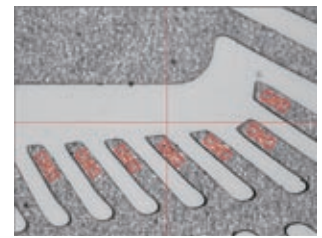

### Multi-point auto focus

Multi-point auto focus can be used to set multiple focus positions, sizes, and angles to arbitrary values. This tool can be used to obtain multiple sets of height information with a single focus operation, which makes it possible to perform highly efficient height and flatness measurements.

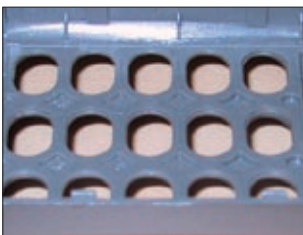

Resin-molded product



IC package



Chamfered part of a machined surface



## Capable of Supporting ISO10360-7 Guaranteed Accuracy

Some models in the Quick Vision Series support the ISO10360-7 guaranteed accuracy specifications.

Contact Mitutoyo for details on applicable models.

### Guaranteed accuracies

- Length measurement error  $E_{U,MPE}$
- Probing error  $P_{F2D,MPE}$

Length measurement error E

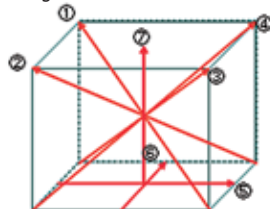

## Multi-Function Control Box

This multi-function control box has been developed for maximum ease of use.



# Compact CNC Vision Measuring System QV ELF



QV ELF

## QV ELF

- The edge detection capability and the functions of measurement software QVPAK are as powerful as those of the higher model QV Apex, which enables the QV ELF to surpass the conventional image of a compact model.
- While the QV ELF is a compact model, it has a more than adequate Z-Axis stroke of 200 mm.
- Each lighting unit employs long-life white LEDs that have low power consumption. The LED light sources have excellent responsiveness, which improves measurement throughput.
- This model can support ISO10360-7:2011 guaranteed accuracy (specifications on request).

## Specifications

Model		QV ELF Series
Optical system		PRO
Order No.		363-107
Measuring range (XxYxZ)		250x200x200mm
Resolution of scale / Scale type		0.1μm / Linear Encoder
Observation Unit *1		PPT1X -2X -6X
Imaging Device		B&W CCD
Illumination Unit	Co-axial Light	White LED
	Transmitted Light	White LED
	PRL	White LED
Accuracy *2	E1x, E1y	(2+3L/1000)μm
	E1z	(3+5L/1000)μm
Operating Temperature range	Ambient temperature	20±1°C
	Temperature variation	2°C/8H
Stage glass size		311x269mm
Maximum stage loading *3		15kg
Main unit external dimensions		586x847x1528mm
Main unit mass (including the sub-base)		270kg

\*1 The specific combination of 1X, 2X and 4X or 1X, 2X, 4X and 6X is available by custom order.

\*2 Determined by Mitutoyo's inspection method. L is the measured length (mm).

The optical condition for accuracy assurance is to be (QV-HR2.5X or QV-SL2.5X) + Middle magnification of the tube lens.

\*3 An excessively biased or concentrated load is excluded.

\* The Laser Auto Focus (LAF) specification is available by custom order.

\* Append "S" to the end of code number to order a QV machine compatible with ISO10360-7:2011 Accuracy Assurance.

# Standard CNC Vision Measuring System QV Apex



QV Apex 302PRO

## QV Apex

- QV Series standard models range in size from compact to large.
- The model equipped with the tracking focus function that allows continuous focusing in response to change in workpiece height is also available, achieving improvement in measurement throughput.
- The lineup, including the PRO3 models equipped with a color CCD camera, can satisfy a wide range of needs.
- The QV Apex404 and QV Apex606 X-Axis and Y-Axis drive speeds reach 400 mm/second. This greatly contributes to throughput improvement, particularly for workpieces that involve a large range of travel.
- This model (PRO type only) can support ISO10360-7:2011 guaranteed accuracy (specifications on request).

## Specifications

Model	QV Apex 302				QV Apex 404				QV Apex 606			
	PRO		PRO3		PRO		PRO3		PRO		PRO3	
Optical system	—		●		—		●		—		●	
Tracking Auto Focus device	—		●		—		●		—		●	
Order No.	363-170	363-174	363-171	363-175	363-180	363-184	363-181	363-185	363-190	363-194	363-191	363-195
Measuring range (X×Y×Z)	300×200×200mm				400×400×250mm				600×650×250mm			
Resolution of scale / Scale type	0.1μm/Linear Encoder											
Observation Unit*1	PPT1X-2X-6X											
Imaging Device	B&W CCD		3CCD Color		B&W CCD		3CCD Color		B&W CCD		3CCD Color	
Illumination Unit*2	Co-axial light				White LED				White LED			
	Transmitted Light				White LED				White LED			
	PRL				White LED				White LED			
Accuracy*3	E <sub>1x</sub> , E <sub>1y</sub>				(1.5+3L/1000)μm				(1.5+3L/1000)μm			
	E <sub>1z</sub>				(1.5+4L/1000)μm				(1.5+4L/1000)μm			
	E <sub>2xy</sub>				(2+4L/1000)μm				(2+4L/1000)μm			
Operating Temperature range	Ambient temperature				20±1°C				20±1°C			
	Temperature variation				2°C/8H				2°C/8H			
Stage glass size	399×271mm				493×551mm				697×758mm			
Maximum stage loading*4	20kg				40kg				50kg			
Main unit external dimensions	859×951×1609mm				1027×1407×1778mm				1309×1985×1794mm			
Main unit mass (including the sub-base)	360kg				579kg				1450kg			

\*1 The specific combination of 1X, 2X and 4X or 1X, 2X, 4X and 6X is available by custom order.

\*2 The color LED lighting or halogen lighting specification is available by custom order.

\*3 Determined by Mitutoyo's inspection method. L is the measured length (mm).

The optical condition for accuracy assurance is to be (QV-HR2.5X or QV-SL2.5X) + Middle magnification of the tube lens.

\*4 An excessively biased or concentrated load is excluded.

\* The Laser Auto Focus (LAF) specification is available by custom order.

\* Append "S" to the end of code number to order a QV machine compatible with ISO10360-7:2011 Accuracy Assurance. (PRO machine only)

# High-accuracy CNC Vision Measuring System Hyper QV



Hyper QV 404PRO

## Hyper QV

- The Hyper QV is a highly accurate model that is equipped with a high-resolution/accuracy scale.
- A lineup, similar to the QV Apex, containing models that range in size from compact to large means that a model ideally suited to the size of the workpiece can be selected.
- The model equipped with the tracking focus function that allows continuous focusing in response to change in workpiece height is also available, achieving improvement in measurement throughput.
- This model is standard-equipped with an automatic temperature compensation function that uses a temperature sensor on the main unit of the measuring machine and a temperature sensor for the workpiece, thus guaranteeing the stated accuracy specification applies over the temperature range 18 to 23°C for stable measurement results.
- This model can support ISO10360-7:2011 guaranteed accuracy (specifications on request).

## Specifications

Model	Hyper QV 302		Hyper QV 404		Hyper QV 606	
Optical system	PRO					
Tracking Auto Focus device	—	●	—	●	—	●
Order No.	363-173	363-177	363-183	363-187	363-193	363-197
Measuring range (X×Y×Z)	300×200×200mm		400×400×250mm		600×650×250mm	
Resolution of scale / Scale type	0.02μm/Linear Encoder					
Observation Unit *1	PPT1X-2X-6X					
Imaging Device	B&W CCD					
Illumination Unit *2	Co-axial light		White LED			
	Transmitted Light		White LED			
	PRL		White LED			
Accuracy *3	E <sub>1x</sub> , E <sub>1y</sub>		(0.8+2L/1000)μm			
	E <sub>1z</sub>		(1.5+2L/1000)μm			
	E <sub>2xy</sub>		(1.4+3L/1000)μm			
Operating Temperature range	Ambient temperature		18 ~ 23°C			
	Temperature variation		0.5°C/1H and 1°C/24H			
Stage glass size	399×271mm		493×551mm		697×758mm	
Maximum stage loading *4	15kg		30kg		40kg	
Main unit external dimensions	859×951×1609mm		1027×1407×1778mm		1309×1985×1794mm	
Main unit mass (including the sub-base)	360kg		579kg		1450kg	
Temperature compensation function	Automatic					

\*1 The specific combination of 1X, 2X and 4X or 1X, 2X, 4X and 6X is available by custom order.

\*2 The color LED lighting or halogen lighting specification is available by custom order.

\*3 Determined by Mitutoyo's inspection method. L is the measured length (mm).

The optical condition for accuracy assurance is to be (QV-HR2.5X or QV-SL2.5X) + Middle magnification of the tube lens.

\*4 An excessively biased or concentrated load is excluded.

\* The Laser Auto Focus (LAF) specification is available by custom order.

\* Append "S" to the end of code number to order a QV machine compatible with ISO10360-7:2011 Accuracy Assurance.

# Non-stop CNC Vision Measuring System

## QV STREAM PLUS



QV STREAM PLUS 606PRO

## QV STREAM PLUS

• The QV STREAM PLUS is an innovative vision measuring machine that acquires images without stopping the stage. This is accomplished by synchronizing the main unit's X-Axis and Y-Axis traversal with the strobe illumination. Conventional vision measuring machines repeat the displacement, stop, measurement, and displacement cycle, which hinders the improvement of throughput. In contrast, the QV STREAM PLUS realizes non-stop vision measurement (stream mode) by eliminating acceleration, deceleration, and stop times. Consequently, this dramatically reduces the overall measurement time needed.

- The model equipped with the tracking focus function that allows continuous focusing in response to change in workpiece height is also available, achieving improvement in measurement throughput.
- A lineup, similar to the QV Apex, and containing models that range in size from compact to large, means that a model ideally suited to the size of the workpiece can be selected.

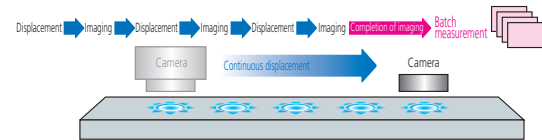

## Specifications

Model	QV STREAM PLUS 302		QV STREAM PLUS 404		QV STREAM PLUS 606	
Optical system	PRO					
Tracking Auto Focus device	—	●	—	●	—	●
Order No.	363-172	363-176	363-182	363-186	363-192	363-196
Measuring range (XxYxZ)	300x200x200mm		400x400x250mm		600x650x250mm	
Resolution of scale / Scale type	0.1μm/Linear Encoder					
Observation Unit*1	PPT1X-2X-6X					
Imaging Device	B&W CCD					
Illumination Unit*2	Co-axial light*3		Color LED			
	Transmitted Light		Blue LED			
	PRL*3		Color LED			
Accuracy*4	E <sub>1x</sub> , E <sub>1y</sub>		(1.5+3L/1000)μm			
	E <sub>1z</sub>		(1.5+4L/1000)μm			
	E <sub>2xy</sub>		(2+4L/1000)μm			
Operating Temperature range	Ambient temperature		20±1°C			
	Temperature variation		2°C/8H			
Stage glass size	399x271mm		493x551mm		697x758mm	
Maximum stage loading*5	20kg		40kg		50kg	
Main unit external dimensions	859x951x1609mm		1027x1407x1778mm		1309x1985x1794mm	
Main unit mass (including the sub-base)	360kg		579kg		1450kg	

\*1 The specific combination of 1X, 2X and 4X or 1X, 2X, 4X and 6X is available by custom order.

\*2 Only one of the illumination functions (reflected, transmitted, and PRL illumination) can be set in STREAM mode. The 4-way PRL illumination can be set to the entire lighting (4-direction lighting) or single-direction lighting.

\*3 Enable to use cyan only while using STREAM mode.

\*4 Determined by Mitutoyo's inspection method. L is the measured length (mm).

The optical condition for accuracy assurance is to be (QV-HR2.5X or QV-SL2.5X) + Middle magnification of the tube lens.

\*5 An excessively biased or concentrated load is excluded

\* The Laser Auto Focus (LAF) specification is available by custom order.

# Large CNC Vision Measuring System QV ACCEL



## QV ACCEL

- The QV ACCEL is a moving-bridge type. Because the stage remains stationary, the fixtures used to hold workpieces in place can be simplified. This leads to a reduction in the amount of work required to create these fixtures. In addition, the QV ACCEL is suited to measurements of workpieces that have short life cycles and to measurements of thin and light-weight workpieces.
- The QV ACCEL is optimal for measurements of printed circuit boards, whose density and resolution continue to increase, as well as metal masks and screen plates. The QV ACCEL is also optimal for measurements on glass circuit boards, film, and other components of display panels.
- By using highly functional edge detection and image auto focus, the QV ACCEL can perform highly accurate height measurements. The QV ACCEL is standard-equipped with a pattern focus function that can be used to perform image auto focusing even on transparent objects such as film and glass.
- The model equipped with the tracking focus function that allows continuous focusing in response to change in workpiece height is also available, achieving improvement in measurement throughput.

## Specifications

Model	QV ACCEL 808		QV ACCEL 1010		QV ACCEL 1212		QV ACCEL 1517		
	PRO	PRO3	PRO	PRO3	PRO	PRO3	PRO	PRO3	
Optical system									
Standard Machine	363-315	363-316	363-335	363-336	363-355	363-356	363-375	363-376	
Tracking Auto Focus device	363-321	363-322	363-341	363-342	363-361	363-362	363-381	363-382	
Measuring range (XxYxZ)	800x800x150mm		1000x1000x150mm		1250x1250x100mm		1500x1750x100mm		
Resolution of scale / Scale type	0.1µm/Linear Encoder								
Observation Unit *1	PPT1X-2X-6X								
Imaging Device	B&W CCD	Color CCD	B&W CCD	Color CCD	B&W CCD	Color CCD	B&W CCD	Color CCD	
Illumination Unit *2	Co-axial light	White LED							
	Transmitted Light	White LED							
	PRL	White LED							
Accuracy *3	E <sub>ix</sub> , E <sub>iy</sub>	(1.5+3L/1000)µm				(2.2+3L/1000)µm			
	E <sub>iz</sub>	(1.5+4L/1000)µm				(2.5+5L/1000)µm			
	E <sub>2xy</sub>	(2.5+4L/1000)µm				(3.5+4L/1000)µm			
Repeatability *3	Short dimension	3σ=0.2µm				3σ=1.5µm			
	Long dimension	3σ=0.7µm				3σ=1.5µm			
Operating Temperature range	Ambient temperature	20±1°C							
	Temperature variation	2°C/8H							
Stage glass size	883x958mm		1186x1186mm		1440x1440mm		1714x1968mm		
Maximum stage loading *4	10kg		30kg		30kg		30kg		
Main unit external dimensions	1475x1860x1578mm		1912x2141x1603mm		2166x2370x1554mm		2440x2898x1554mm		
Main unit mass (not including the sub-base)	2050kg		2950kg		3600kg		4500kg		

\*1 The specific combination of 1X, 2X and 4X or 1X, 2X, 4X and 6X is available by custom order.

\*2 The color LED lighting or halogen lighting specification is available by custom order.

\*3 Determined by Mitutoyo's inspection method. L is the measured length (mm).

The optical condition for accuracy assurance is to be (QV-HR2.5X or QV-SL2.5X) + Low magnification of the tube lens.

\*4 An excessively biased or concentrated load is excluded.

\* The Laser Auto Focus (LAF) specification is available by custom order.

# Ultra-high Accuracy CNC Vision Measuring System ULTRA QV 404



ULTRA QV 404PRO

## ULTRA QV 404

- The ULTRA QV 404 is an ultra-precise CNC vision measuring machine that achieves measurement accuracy of  $E_{iXY}: (0.25 + L/1000)\mu\text{m}$ .
- To improve the maneuverability of each axis, Mitutoyo has employed aerostatic bearings, which Mitutoyo developed in our highly accurate 3D measuring machines, as the guidance systems for the X-, Y-, and Z-axes.
- This model is standard-equipped with an automatic temperature compensation function that uses a temperature sensor on the main unit of the measuring machine and a temperature sensor

for the workpiece, thus guaranteeing the stated accuracy specification applies over the temperature range 19 to 23°C for stable measurement results.

- The model equipped with the tracking focus function that allows continuous focusing in response to change in workpiece height is also available, achieving improvement in measurement throughput.
- This model can support ISO10360-7:2011 guaranteed accuracy (specifications on request).

## Specifications

Model		ULTRA QV 404
Optical system		PRO
Tracking Auto Focus device		—
Order No.		363-518
Measuring range (X×Y×Z)		400×400×200mm
Resolution of scale / Scale type		0.01 $\mu\text{m}$ / Linear Encoder
Observation Unit *1		PPT1X-2X-6X
Imaging Device		B&W CCD
Illumination Unit	Co-axial light	Halogen
	Transmitted Light	Halogen
	PRL	Halogen
Accuracy *2	$E_{iX}, E_{iY}$	$(0.25 + L/1000)\mu\text{m}$
	$E_{iZ}$ (50mm stroke)*3	$(1 + 2L/1000)\mu\text{m}$
	$E_{iZ}$ (Full stroke)	$(1.5 + 2L/1000)\mu\text{m}$
	$E_{2XY}$	$(0.5 + 2L/1000)\mu\text{m}$
On-screen repeatability		$3\sigma = 0.2\mu\text{m}$
Auto focus repeatability		$\sigma = 0.4\mu\text{m}$
Operating Temperature range	Ambient temperature	19 ~ 23°C
	Temperature variation	0.5°C/1H and 1°C/24H
Stage glass size		493×551mm
Maximum stage loading *4		40kg
Main unit external dimensions		1172×1735×1910mm
Main unit mass (including the sub-base)		2150kg
Operating air pressure		0.4 MPa*5
Required air flow rate		300L/min(ANR)*6
Temperature compensation function		Automatic

\*1 The specific combination of 1X, 2X and 4X or 1X, 2X, 4X and 6X is available by custom order.

\*2 Determined by Mitutoyo's inspection method. L is the measured length (mm).

The optical condition for accuracy assurance is to be QV-5X + Middle magnification of the tube lens.

\*3 Verified at shipment from factory.

\*4 An excessively biased or concentrated load is excluded.

\*5 Air supply pressure to be in range 0.5 - 0.9MPa.

\*6 Indicates the flow rate under normal conditions.

\* The Laser Auto Focus (LAF) specification is available by custom order.

\* Append "S" to the end of code number to order a QV machine compatible with ISO10360-7:2011 Accuracy Assurance.

# CNC Vision Measuring System equipped with a Touch Trigger Probe QV TP



QVTP Apex 302PRO

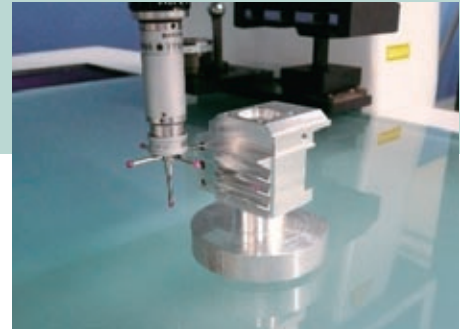

## QV Touch Trigger Probe

- The QVTP Series enables non-contact measurements and contact measurements on the same machine.  
The QVTP Series has a vision measurement function and can also perform contact measurements by way of its touch trigger probe.
- The QVTP Series can support measurements of 3D workpieces.  
The QVTP Series can perform 3D measurements of workpieces, such as press-molded products, resin-molded products, and machined products, that could not be measured with conventional image processing alone.
- The QV TP Series is equipped with a probe module change rack.  
Using the probe module change rack makes it possible to switch between vision measurement and touch trigger probe measurement during a sequence of automatic measurements.  
Furthermore, storing the characteristics of different styli makes it possible to perform measurements on multiple surfaces.
- This model (excluding QV ACCEL type) can support ISO 10360-7:2011 guaranteed accuracy (specifications on request).

## Specifications

### QVTP ELF

Model		QVTP ELF Series
Optical system		PRO
Order No.		364-107
Measuring range by vision probe*1 (X×Y×Z)		250×200×200mm
Measuring range by touch probe*1 (X×Y×Z)		184×200×200mm
Resolution of scale / Scale type		0.1μm / Linear Encoder
Observation Unit*2		PPT1X-2X-6X
Imaging Device		B&W CCD
Illumination Unit	Co-axial Light	White LED
	Transmitted Light	White LED
	PRL	White LED
Measuring Accuracy*3 (Vision)	E1x, E1y	(2+3L/1000)μm
	E1z	(3+5L/1000)μm
TP measuring accuracy*3	E1x, E1y, E1z	(2.4+3L/1000)μm
Operating Temperature range	Ambient temperature	18 ~ 23°C
	Temperature variation	0.5°C / 1H and 1°C / 24H
Stage glass size		312×269mm
Maximum stage loading*4		15kg
Main unit external dimensions		586×847×1528mm
Main unit mass (including the sub-base)		270kg
Temperature compensation function		Manual

\*1 Measuring range is smaller than the dimension in the specifications table above when the machine is equipped with module change rack, master ball and calibration ring.

\*2 The specific combination of 1X, 2X and 4X or 1X, 2X, 4X and 6X is available by custom order.

\*3 Determined by Mitutoyo's inspection method. L is the measured length (mm).

The optical condition for accuracy assurance is to be (QV-HR2.5X or QV-SL2.5X) + Middle magnification of the tube lens.

\*4 An excessively biased or concentrated load is excluded.

\* The Laser Auto Focus (LAF) specification is available by custom order.

\* Append "S" to the end of code number to order a QV machine compatible with ISO10360-7:2011 Accuracy Assurance.



## Specifications

### QVTP Apex

Model	QVTP Apex 302		QVTP Apex 404		QVTP Apex 606	
	PRO	PRO3	PRO	PRO3	PRO	PRO3
Optical system						
Standard machine	364-170	364-171	364-180	364-181	364-190	364-191
Tracking Auto Focus device	364-174	364-175	364-184	364-185	364-194	364-195
Measuring range by vision probe*1 (XxYxZ)	300x200x200mm		400x400x250mm		600x650x250mm	
Measuring range by touch probe*1 (XxYxZ)	234x200x200mm		334x400x250mm		534x650x250mm	
Resolution of scale / Scale type	0.1µm/Linear Encoder					
Observation unit*2	PPT1X-2X-6X					
Imaging Device	B&W CCD	3CCD Color	B&W CCD	3CCD Color	B&W CCD	3CCD Color
Illumination Unit*3	Co-axial light	White LED				
	Transmitted Light	White LED				
	PRL	White LED				
Measuring Accuracy*4 (Vision)	E1X, E1Y	(1.5+3L/1000)µm				
	E1Z	(1.5+4L/1000)µm				
	E2XY	(2+4L/1000)µm				
TP measuring accuracy*4	E1X, E1Y, E1Z	(1.8+3L/1000)µm				
Operating Temperature range	Ambient temperature	18 ~ 23°C				
	Temperature variation	0.5°C/1H and 1°C/24H				
Stage glass size	399x271mm		493x551mm		697x758mm	
Maximum stage loading*5	20kg		40kg		50kg	
Main unit external dimensions	859x951x1609mm		1027x1407x1778mm		1309x1985x1794mm	
Main unit mass (including the sub-base)	360kg		579kg		1450kg	
Temperature compensation function	Manual					

\*1 Measuring range is smaller than the dimension in the specifications table above when the machine is equipped with module change rack, master ball and calibration ring.

\*2 The specific combination of 1X, 2X and 4X or 1X, 2X, 4X and 6X is available by custom order.

\*3 The color LED lighting or halogen lighting specification is available by custom order

\*4 Determined by Mitutoyo's inspection method. L is the measured length (mm).

The optical condition for accuracy assurance is to be (QV HR2.5X or QV SL2.5X) + Middle magnification of the tube lens.

\*5 An excessively biased or concentrated load is excluded.

\* The Laser Auto Focus (LAF) specification is available by custom order.

\* Append "S" to the end of code number to order a QV machine compatible with ISO10360-7:2011 Accuracy Assurance. (PRO machine only)

### Hyper QVTP

Model	Hyper QVTP302		Hyper QVTP404		Hyper QVTP606	
	PRO	PRO3	PRO	PRO3	PRO	PRO3
Optical system						
Tracking Auto Focus device	—	●	—	●	—	●
Order No.	364-173	364-177	364-183	364-187	364-193	364-197
Resolution of scale / Scale type	0.02µm/Linear Encoder					
Measuring Accuracy*1 (Vision)	E1X, E1Y	(0.8+2L/1000)µm				
	E1Z	(1.5+2L/1000)µm				
	E2XY	(1.4+3L/1000)µm				
TP measuring accuracy*1	E1X, E1Y, E1Z	(1.7+3L/1000)µm				
Operating Temperature range	Ambient temperature	18 ~ 23°C				
	Temperature variation	0.5°C/1H and 1°C/24H				
Maximum stage loading*2	15kg		30kg		40kg	
Temperature compensation function	Automatic					

\*1 Determined by Mitutoyo's inspection method. L is the measured length (mm).

The optical condition for accuracy assurance is to be (QV HR2.5X or QV SL2.5X) + Middle magnification of the tube lens.

\*2 An excessively biased or concentrated load is excluded.

Note: For other specifications, refer to QVTP Apex.

### QVTP ACCEL

Model	QVTP ACCEL 808		QVTP ACCEL 1010		QVTP ACCEL 1212		QVTP ACCEL 1517	
	PRO	PRO3	PRO	PRO3	PRO	PRO3	PRO	PRO3
Order No.	364-315	364-316	364-335	364-336	364-355	364-356	364-375	364-376
Measuring range by vision probe*2 (XxYxZ)	800x800x150mm		1000x1000x150mm		1250x1250x100mm		1500x1750x100mm	
Measuring range by touch probe*2 (XxYxZ)	734x800x150mm		934x1000x150mm		1184x1250x100mm		1434x1750x100mm	
Measuring Accuracy*1 (Vision)	E1X, E1Y	(1.5+3L/1000)µm				(2.2+3L/1000)µm		
	E1Z	(1.5+4L/1000)µm				(2.5+5L/1000)µm		
	E2XY	(2.5+4L/1000)µm				(3.5+4L/1000)µm		
TP measuring accuracy*1	E1X, E1Y, E1Z	(1.8+3L/1000)µm	(3+4L/1000)µm		(6+7L/1000)µm			
Repeatability*1	Short dimension	XY		3σ = 0.2µm				
	Long dimension	axis		3σ = 0.7µm		3σ = 1.5µm		
Operating Temperature range	Ambient temperature	18 ~ 23°C						
	Temperature variation	0.5°C/1H and 1°C/24H						
Temperature compensation function	Automatic							

\*1 Determined by Mitutoyo's inspection method. L is the measured length (mm).

The optical condition for accuracy assurance is to be (QV-HR2.5X or QV-SL2.5X) + Low magnification of the tube lens.

\*2 Measuring range is smaller than the dimension in the specifications table above when the machine is equipped with module change rack, master ball and calibration ring.

Note: For other specifications, refer to QV ACCEL.

NOTE: Machines in this series are equipped with the main unit deactivating system (relocation detection system) that prevents the machine from operating if it is subjected to an unexpected vibration or if it is relocated.  
Be sure to contact your nearest Mitutoyo sales office prior to relocating this machine after initial installation.

# Non-contact Laser Probe-equipped CNC Vision Measuring System QV HYBRID TYPE1



**HYBRID  
TYPE 1**

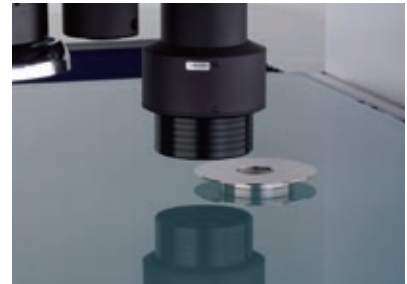

Hyper QVH1 404PRO

## QV HYBRID TYPE 1

- The QV HYBRID TYPE1 is a hybrid measuring machine that has a vision measurement function and can use the scanning function of its non-contact displacement sensor to measure very small steps and curved surfaces at high speeds.
- Mitutoyo's proprietary double-pinhole technique is used for the displacement sensor's detection method. Compared to the knife-edge and triangulation techniques, this method has the advantage of lower laser directivity.
- Because a focusing point method is used, the QV HYBRID TYPE1 has the advantage that it is minimally affected by factors such as the color of the workpiece.
- The small laser spot diameter of approximately 2 $\mu$ m makes it possible to perform measurements with high horizontal resolution.

- The displacement sensor alone has a wide measuring range of  $\pm 0.5$  mm, which makes it possible to perform form measurements with a wide dynamic range. For displacements outside this range, scanning can be performed by moving the Z-axis.
- This model (excluding QV ACCEL and QV STREAM PLUS type) can support ISO 10360-7:2011 guaranteed accuracy (specifications on request).

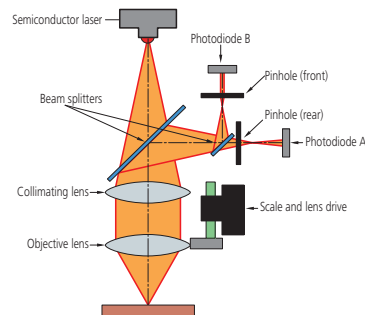

## Applications

### Viewer Function

The QV HYBRID series is provided as standard with the viewer function that allows you to easily set filter parameters and calculation items for laser scanning measurement while visual inspection is in progress.

### A Variety of Laser Scanning Tools

A variety of scanning tools including line, cross, circle, and area are provided as standard for both Type 1 and 4.

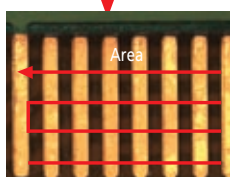

Workpiece: Printed circuit board

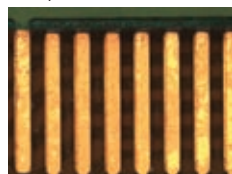

Prior confirmation with Viewer



Profile assessment analysis with FORMPAK-QV

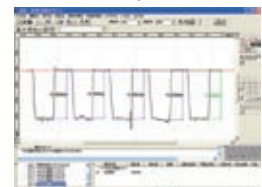

Form analysis with FORMTRACEPAK-PRO

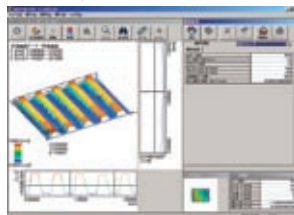

QV TraceMaker 7000

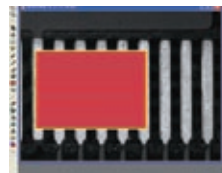

Trace Route Creation from Image

This tool can create a trace route from a captured image. It is appropriate for measurement of complicated areas.

**Mitutoyo**

# Specifications

## QV Apex HYBRID TYPE1

Model	QVH1 Apex 302		QVH1 Apex 404		QVH1 Apex 606	
	PRO	PRO3	PRO	PRO3	PRO	PRO3
Optical system						
Order No.	365-170	365-171	365-180	365-181	365-190	365-191
Measuring range by vision probe (XxYxZ)	300x200x200mm		400x400x250mm		600x650x250mm	
Measuring range by displacement sensor (XxYxZ)	180x200x200mm		280x400x250mm		480x650x250mm	
Resolution of scale / Scale type	0.1µm / Linear Encoder					
Observation Unit *1	PPT1X-2X-6X					
Imaging Device	B&W CCD	3 CCD Color	B&W CCD	3 CCD Color	B&W CCD	3 CCD Color
Illumination unit *2	Co-axial Light		White LED			
	Transmitted Light		White LED			
	PRL		White LED			
Measuring Accuracy *3 (Vision)	E <sub>1x</sub> ,E <sub>1y</sub>		(1.5+3L/1000)µm			
	E <sub>1z</sub>		(1.5+4L/1000)µm			
	E <sub>2xy</sub>		(2+4L/1000)µm			
Displacement sensor Measuring Accuracy *3	E <sub>1z</sub>		(1.5+4L/1000)µm			
	Detecting range of probe itself		±0.5mm			
Displacement sensor	Vertical resolving power		10nm			
	Spot diameter		About ø2µm			
	Working distance (including the collision sensor)		5mm			
	Ambient temperature		20±1°C			
Operating Temperature range	Temperature variation		2°C/8H			
	Stage glass size		399x271mm		493x551mm	
Maximum stage loading *4	20kg		40kg		50kg	
Main unit external dimensions	859x951x1609mm		1027x1407x1778mm		1309x1985x1794mm	
Main unit mass (including the sub-base)	370kg		589kg		1460kg	

\*1 The specific combination of 1X, 2X and 4X or 1X, 2X, 4X and 6X is available by custom order.

\*2 The color LED lighting or halogen lighting specification is available by custom order.

\*3 Determined by Mitutoyo's inspection method. L is the measured length (mm). The optical condition for accuracy assurance is to be (QV-HR2.5X or QV-SL2.5X) + Middle magnification of the tube lens.

\*4 An excessively biased or concentrated load is excluded.

\* Append "S" to the end of code number to order a QV machine compatible with ISO10360-7:2011 Accuracy Assurance. (PRO machine only)

## Hyper QV HYBRID TYPE 1

Model	Hyper QVH1 302		Hyper QVH1 404		Hyper QVH1 606	
	PRO	PRO	PRO	PRO	PRO	PRO
Optical system						
Order No.	365-173		365-183		365-193	
Resolution of scale / Scale type	0.02µm / Linear Encoder					
Measuring Accuracy *1 (Vision)	E <sub>1x</sub> ,E <sub>1y</sub>		(0.8+2L/1000)µm			
	E <sub>1z</sub>		(1.5+2L/1000)µm			
	E <sub>2xy</sub>		(1.4+3L/1000)µm			
Displacement sensor Measuring Accuracy *1	E <sub>1z</sub>		(1.5+2L/1000)µm			
	Ambient temperature		18 ~ 23°C			
Operating Temperature range	Temperature variation		0.5°C/1H and 1°C/24H			
	Temperature Compensation function		Automatic			
Maximum stage loading *2	15kg		30kg		40kg	

\*1 Determined by Mitutoyo's inspection method. L is the measured length (mm). The optical condition for accuracy assurance is to be (QV-HR2.5X or QV-SL2.5X) + Middle magnification of the tube lens.

\*2 An excessively biased or concentrated load is excluded. Other specifications are the same as those of the QVH1 Apex. For details, refer to above table.

## QV STREAM PLUS HYBRID TYPE1

Model	QVH1 STREAM 302		QVH1 STREAM 404		QVH1 STREAM 606	
	PRO	PRO	PRO	PRO	PRO	PRO
Optical system						
Order No.	365-172		365-182		365-192	
Imaging Device			B&W CCD			
Illumination unit	Co-axial Light		Color LED			
	Transmitted Light		Blue LED			
	PRL		Color LED			
Measuring Accuracy *1 (Vision)	E <sub>1x</sub> ,E <sub>1y</sub>		(1.5+3L/1000)µm			
	E <sub>1z</sub>		(1.5+4L/1000)µm			
	E <sub>2xy</sub>		(2+4L/1000)µm			
Displacement sensor Measuring Accuracy *1	E <sub>1z</sub>		(1.5+4L/1000)µm			
	Ambient temperature		20±1°C			
Operating Temperature range	Temperature variation		2°C/8H			

\*1 Determined by Mitutoyo's inspection method. L is the measured length (mm). The optical condition for accuracy assurance is to be (QV-HR2.5X or QV-SL2.5X) + Middle magnification of the tube lens. Other specifications are the same as those of the QVH1 Apex. For details, refer to above table.

## QV ACCEL HYBRID TYPE1

Model	QVH1 ACCEL 808		QVH1 ACCEL 1010		QVH1 ACCEL 1212		QVH1 ACCEL 1517	
	PRO	PRO3	PRO	PRO3	PRO	PRO3	PRO	PRO3
Optical system								
Order No.	365-315	365-316	365-335	365-336	365-355	365-356	365-375	365-376
Measuring range by vision probe (XxYxZ)	800x800x150mm		1000x1000x150mm		1250x1250x100mm		1500x1750x100mm	
Measuring range by displacement sensor (XxYxZ)	680x800x150mm		880x1000x150mm		1130x1250x100mm		1380x1750x100mm	
Measuring Accuracy *1 (Vision)	E <sub>1x</sub> ,E <sub>1y</sub>		(1.5+3L/1000)µm		(2.2+3L/1000)µm			
	E <sub>1z</sub>		(1.5+4L/1000)µm		(2.5+5L/1000)µm			
	E <sub>2xy</sub>		(2.5+4L/1000)µm		(3.5+4L/1000)µm			
Displacement sensor Measuring Accuracy *1	E <sub>1z</sub>		(2.5+4L/1000)µm		(3.5+5L/1000)µm			
	Detecting range of probe itself				±0.5mm			
Displacement sensor	Vertical resolving power				10nm			
	Spot diameter				About ø2µm			
	Working distance (including the collision sensor)				5mm			
	Ambient temperature				20±1°C			
Operating Temperature range	Temperature variation				2°C/8H			

\*1 Determined by Mitutoyo's inspection method. L is the measured length (mm). The optical condition for accuracy assurance is to be (QV-HR2.5X or QV-SL2.5X) + Low magnification of the tube lens. Other specifications are the same as those of the QV ACCEL. For details, refer to page 14.

NOTE: Machines in this series are equipped with the main unit deactivating system (relocation detection system) that prevents the machine from operating if it is subjected to an unexpected vibration or if it is relocated. Be sure to contact your nearest Mitutoyo sales office prior to relocating this machine after initial installation.

**CLASS 1 LASER PRODUCT**

### Safety Precautions for Laser Beam

These systems uses a low-power invisible laser beam (780nm) which corresponds to Class 1 (invisible light) of JIS C 6802 Safety Standard of Laser Radiation Products\*. The class 1 laser warning label as shown above is attached to the main unit.

# CNC Vision Measuring System equipped with Non-contact Scanning Sensor QV HYBRID TYPE4



HYBRID  
TYPE 4

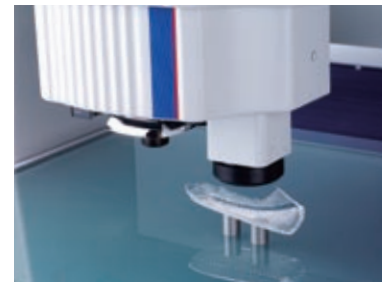

Hyper QVH4 606PRO

## QV HYBRID TYPE4

- QV HYBRID TYPE 4 is equipped with CPS (Chromatic Point Sensor) that employs confocal method. This method uses the axial chromatic aberration to detect Z-axis direction position.
- The QV HYBRID TYPE4 is a hybrid measuring machine that has a vision measurement function and can use the scanning function of its non-contact displacement sensor to measure very small steps and curved surfaces at high speeds.
- The displacement sensor detection method employs the wavelength confocal method that uses the axial chromatic aberration of the white light source. The sensor itself has a wide measuring range and has a high inclined-surface-following performance for both mirrored and diffusive surfaces.
- This system uses LEDs as light sources. Thanks to Auto-brightness control, the sensor makes it possible to perform measurements that are minimally affected by reflectivity variations on the workpiece.
- The heights of two surfaces within the measuring range can be detected simultaneously, which makes it possible to support measurements of the thickness of thin, transparent objects.
- This model can support ISO 10360-7:2011 guaranteed accuracy (specifications on request).

### Measurement principle

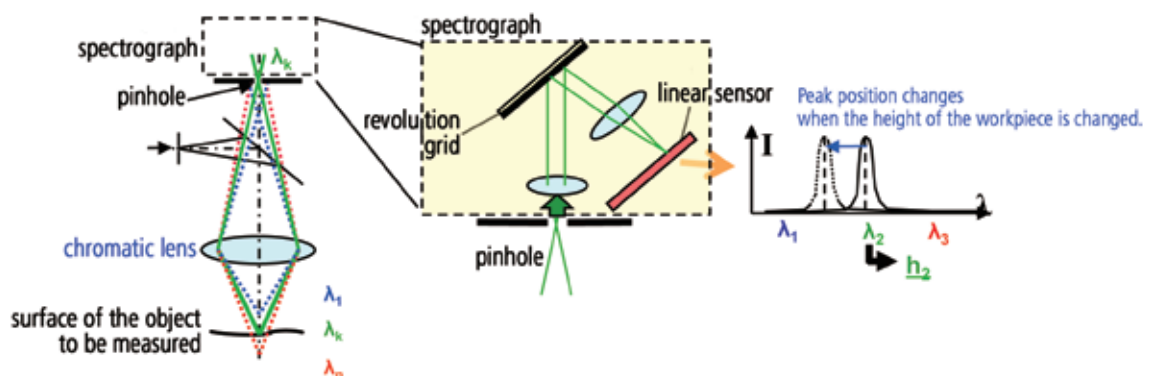

## Scanning measurement with automatic movement of the Z-axis

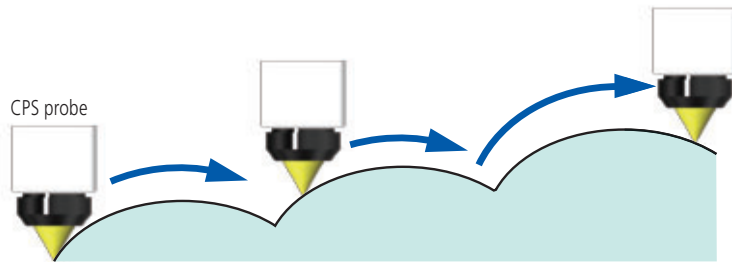

## FORMTRACEPAK-PRO Analysis Example

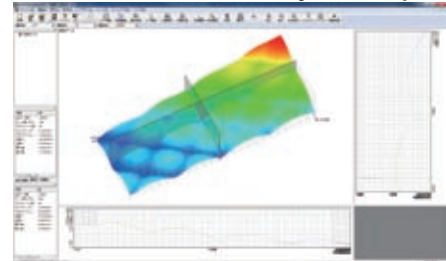

Color-coded 3D display

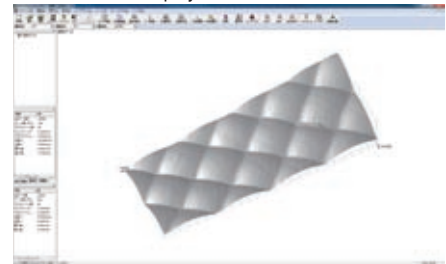

Shaded display

## Specifications

### QV Apex HYBRID TYPE 4

Model	QVH4 Apex 302 PRO	QVH4 Apex 404 PRO	QVH4 Apex 606 PRO
Order No.	365-413	365-433	365-453
Measuring range by vision probe (X×Y×Z)	300×200×200mm	400×400×250mm	600×650×250mm
Measuring range by displacement sensor (X×Y×Z)	176×200×200mm	276×400×250mm	476×650×250mm
Resolution of scale / Scale type	0.1μm / Linear Encoder		
Observation Unit *1	PPT1X-2X-6X		
Imaging Device	B&W CCD	B&W CCD	B&W CCD
Illumination unit *2	Co-axial Light	White LED	
	Transmitted Light	White LED	
	PRL	White LED	
Measuring Accuracy *3 (Vision)	E <sub>1x</sub> , E <sub>1y</sub>	(1.5+3L/1000)μm	
	E <sub>1z</sub>	(1.5+4L/1000)μm	
	E <sub>2xy</sub>	(2+4L/1000)μm	
Displacement sensor Accuracy	E <sub>1z</sub>	(1.5+4L/1000)μm	
Displacement sensor	Detecting range of probe itself	±0.6mm	
	Vertical resolving power	25nm	
	Spot diameter	About ø4μm	
	Working distance (including the collision sensor)	21.0mm	
Operating Temperature range	Ambient temperature	20±1°C	
	Temperature variation	2°C/8H	
Stage glass size	399×271mm	493×551mm	697×758mm
Maximum stage loading *4	20kg	40kg	50kg
Main unit external dimensions	859×951×1609mm	1027×1407×1778mm	1309×1985×1794mm
Main unit mass (including the sub-base)	370kg	589kg	1460kg

\*1 The specific combination of 1X, 2X and 4X or 1X, 2X, 4X and 6X is available by custom order.

\*2 The color LED lighting or halogen lighting specification is available by custom order.

\*3 Determined by Mitutoyo's inspection method. L is the measured length (mm). The optical condition for accuracy assurance is to be (QV-HR2.5X or QV-SL2.5X) + Middle magnification of the tube lens.

\*4 An excessively biased or concentrated load is excluded.

\* Append "S" to the end of code number to order a QV machine compatible with ISO10360-7:2011 Accuracy Assurance. (PRO machine only)

### Hyper QV HYBRID TYPE4

Model	Hyper QVH4 302 PRO	Hyper QVH4 404 PRO	Hyper QVH4 606 PRO
Order No.	365-416	365-436	365-456
Resolution of scale / Scale type	0.02μm / Linear Encoder		
Measuring Accuracy *1 (Vision)	E <sub>1x</sub> , E <sub>1y</sub>	(0.8+2L/1000)μm	
	E <sub>1z</sub>	(1.5+2L/1000)μm	
	E <sub>2xy</sub>	(1.4+3L/1000)μm	
Displacement sensor Accuracy	E <sub>1z</sub>	(1.5+2L/1000)μm	
Operating Temperature range	Ambient temperature	18 ~ 23°C	
	Temperature variation	0.5°C / 1H and 1°C / 24H	
Temperature compensation function	Automatic		
Maximum stage loading *2	15kg	30kg	40kg

\*1 Determined by Mitutoyo's inspection method. L is the measured length (mm). The optical condition for accuracy assurance is to be (QV-HR2.5X or QV-SL2.5X) + Middle magnification of the tube lens.

\*2 An excessively biased or concentrated load is excluded. Other specifications are the same as those of the QVH4 Apex. For details, refer to the table above.

NOTE: Machines in this series are equipped with the main unit deactivating system (relocation detection system) that prevents the machine from operating if it is subjected to an unexpected vibration or if it is relocated. Be sure to contact your nearest Mitutoyo sales office prior to relocating this machine after initial installation.

# Microscopic Form Measurement System UMAP Vision System TYPE2

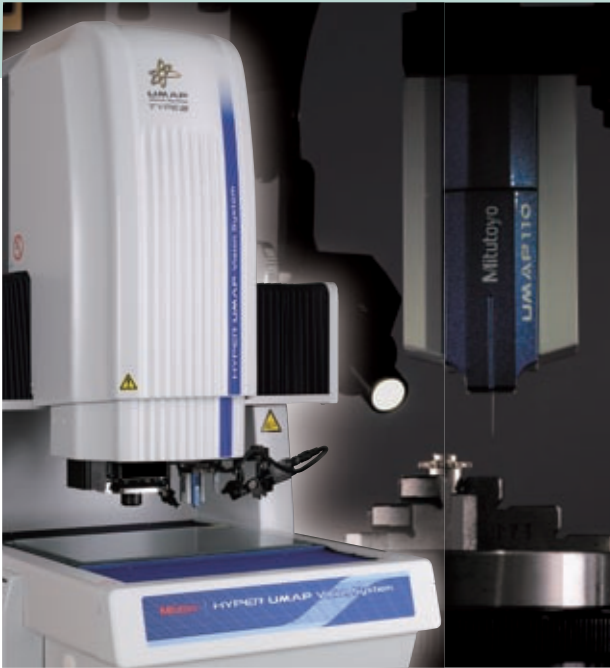

## Stylus lineup

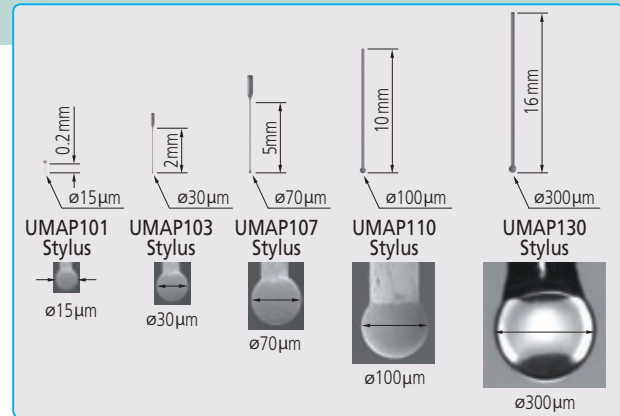

## Measurement examples

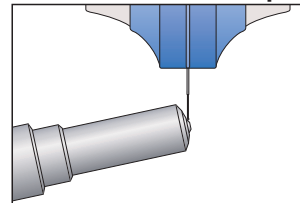

Measurement of the shape of the holes in a fuel injection nozzle

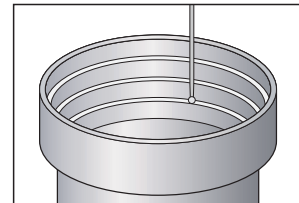

Measurement of the shape of a lens barrel

## UMAP Vision System TYPE2

- The UMAP Vision System uses Mitutoyo's proprietary sensing technology and is equipped with an ultra low-force probe. The utilization of extremely small styli with high aspect ratios (styli with a diameter between 15µm and 300µm), makes dimension measurements of microscopic forms possible. These measurements cannot be made using conventional contact measurement sensors.

## Specifications

Model	Hyper UMAP 302		ULTRA UMAP 404	
Optical system			PRO	
Order No.	364-713		364-717	
Measuring range (X×Y×Z)	300×200×200mm		400×400×200mm Effective measuring range on glass surface: 360×400×200 mm*1	
Effective measuring range (common between images and UMAP103)	185×200×175mm		285×400×175mm	
Resolution of scale / Scale type	0.02µm/Linear Encoder		0.01µm/Linear Encoder	
Observation unit*2	PPT1X-2X-6X B&W CCD			
Imaging Device				
Illumination unit	Co-axial Light	White LED	Halogen	
	Transmitted Light	White LED	Halogen	
	PRL	White LED	Halogen	
Measuring accuracy*3	Vision	E <sub>1x</sub> , E <sub>1y</sub>	(0.8+2L/1000)µm	(0.25+L/1000)µm
		E <sub>1z</sub> (50mm stroke)*4	—	(1+2L/1000)µm
		E <sub>1z</sub> (full stroke)	(1.5+2L/1000)µm	(1.5+2L/1000)µm
		E <sub>2xy</sub>	(1.4+3L/1000)µm	(0.5+2L/1000)µm
	Optical condition for accuracy assurance	QV-HR2.5X or QV-SL2.5X + Middle magnification tube lens	QV-5X + Middle magnification tube lens	
UMAP	E <sub>1x</sub> , E <sub>1y</sub> (UMAP 110)*5	(1.7+3L/1000)µm	(1.5+3L/1000)µm	
UMAP repeatability*3	UMAP101, 103, 107	σ=0.1µm	σ=0.08µm	
UMAP110, 130	σ=0.15µm	σ=0.12µm		
Operating Temperature range	Ambient temperature	18 ~ 23°C	19 ~ 23°C	
Temperature variation	0.5°C/1H and 1°C/24H			
Maximum stage loading*6	15kg		40kg	
Operating air pressure			0.4MPa	
Required air flow rate	—		300L/min (ANR)	
Temperature compensation function	Automatic			

\*1 Effective measuring range when contour light is used.

\*2 The specific combination of 1X, 2X and 4X or 1X, 2X, 4X and 6X is available by custom order.

\*3 Determined by Mitutoyo's inspection method. L is measured length (mm).

\*4 Verified at shipment from factory.

\*5 The assured accuracy of UMAP is specific to that of UMAP110 in the case of a measuring speed of 10µm/s.

\*6 An excessively biased or concentrated load is excluded.

\* The Laser Auto Focus (LAF) specification is available by custom order.

\* Append "S" to the end of code number to order a QV machine compatible with ISO10360-7:2011 Accuracy Assurance. (PRO machine only)

# Non-contact 3D Measuring System Hyper QV WLI

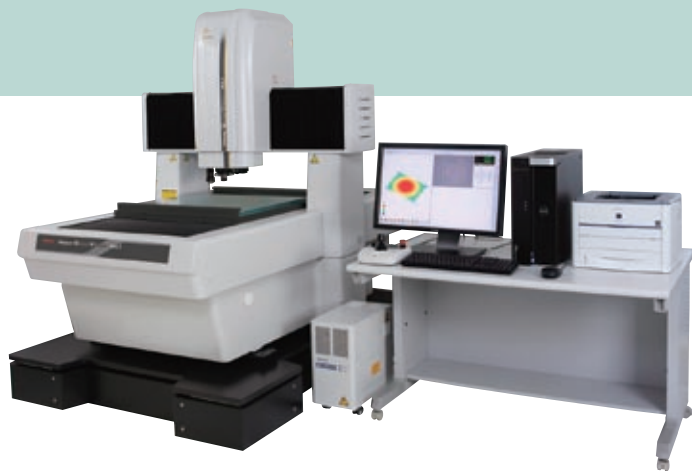

## Principle of WLI measurement

White light is split into two beams, one for the reference mirror within the interference objective and the other for the measurement sample. When the interference objective is swept in the Z-direction, white interference fringes are generated only for the area of the measurement sample that is in focus. The 3D shape of the object being measured is calculated by detecting the peak position of the interference fringe intensity at each pixel position of the CCD camera.

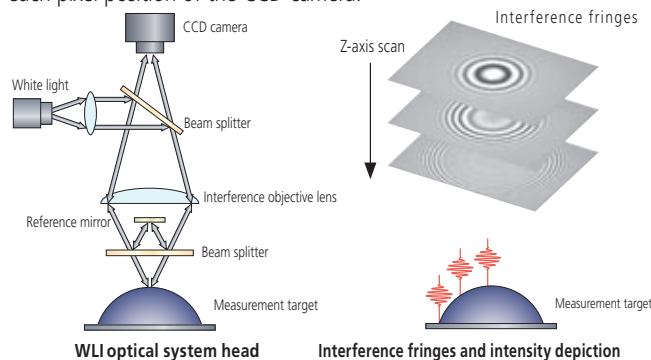

## Hyper QV WLI

- The Hyper Quick Vision WLI is Mitutoyo's leading, highly accurate dual-head measurement system equipped with a white light interferometer (WLI) optical head.
- Equipping a vision measuring machine with a WLI head makes it possible for the machine to perform measurements ranging from 2D coordinate and dimension measurements to highly accurate 3D measurements on microscopic areas in applications such as surface analysis, small-diameter hole depth, and circuit board wiring dimensions.

## Specifications

Model	Hyper QV WLI 302	Hyper QV WLI 404 PRO	Hyper QV WLI 606
Optical system			
Order No.	363-713	363-714	363-715
WLI optical head unit			
Measuring range *1 (X×Y×Z)	215×200×190mm	315×400×240mm	515×650×220mm
Imaging Device		B&W CCD	
Illumination Unit	Co-axial Light	Halogen	
Z-axis scanning range *2		170μm	
Z-axis Repeatability		2σ ≤ 0.08μm	
Vision optical head unit			
Measurement range (X×Y×Z)	300×200×190mm	400×400×240mm	600×650×220mm
Resolution of scale / Scale type		0.01μm / Linear Encoder	
Observation unit		PPT 1X-2X-6X	
Imaging Device			
Illumination Unit	Co-axial Light	White LED	
	Transmitted Light	White LED	
	PRL	White LED	
Measuring accuracy *3	E <sub>x</sub> , E <sub>y</sub>	(0.8+2L/1000)μm	
	E <sub>z</sub>	(1.5+2L/1000)μm	
	E <sub>zxy</sub>	(1.4+3L/1000)μm	
Operating Temperature range	Ambient temperature	20±1°C	
	Temperature variation	0.5°C/1H	
Stage glass size	399×271mm	493×551mm	697×785mm
Maximum stage loading*4	15kg	25kg	35kg
Main unit external dimensions	859×950×1606mm	1027×1407×1781mm	1309×1985×1792mm
Main unit mass (including the sub-base)	490kg	1160kg	2275kg
Operating air pressure		0.4Mpa	
Temperature compensation function		Automatic	

\*1 Movable range of WLI optical head. Three dimensional shape measurement using WLI is allowed within one field of vision.

\*2 In case of standard mode. Applicable to max. 200μm by modifying scan pitch.

\*3 Determined by Mitutoyo's inspection method. L is measured length (mm).

The optical condition for accuracy assurance is to be (QV-HR2.5X or QV-SL2.5X) + Middle magnification of the tube lens.

\*4 An excessively biased or concentrated load is excluded.

\* Append "S" to the end of code number to order a QV machine compatible with ISO10360-7:2011 Accuracy Assurance.

\* Hyper QV WLI is not compatible with the Easy Editor function of QVPAK.

# Dimensions

## QV302

Unit:mm

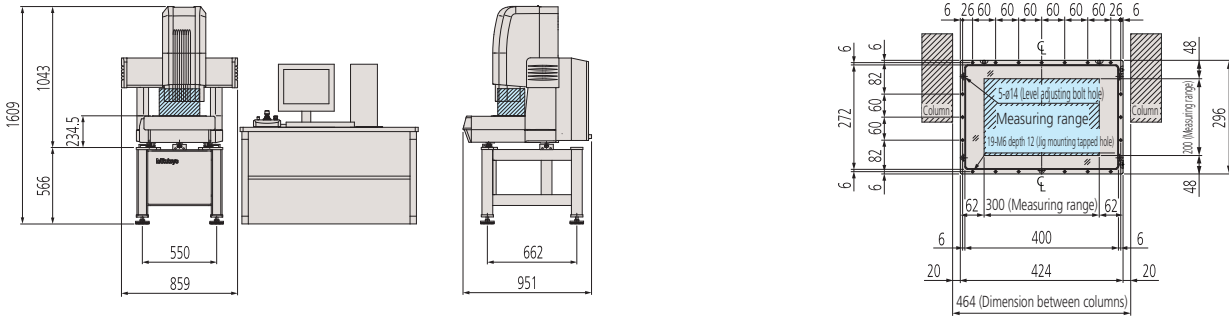

## QV404

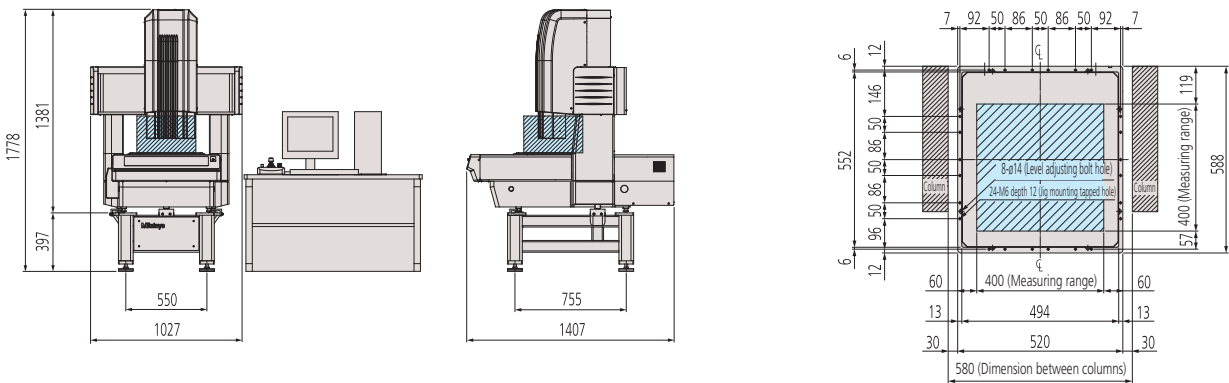

## QV606

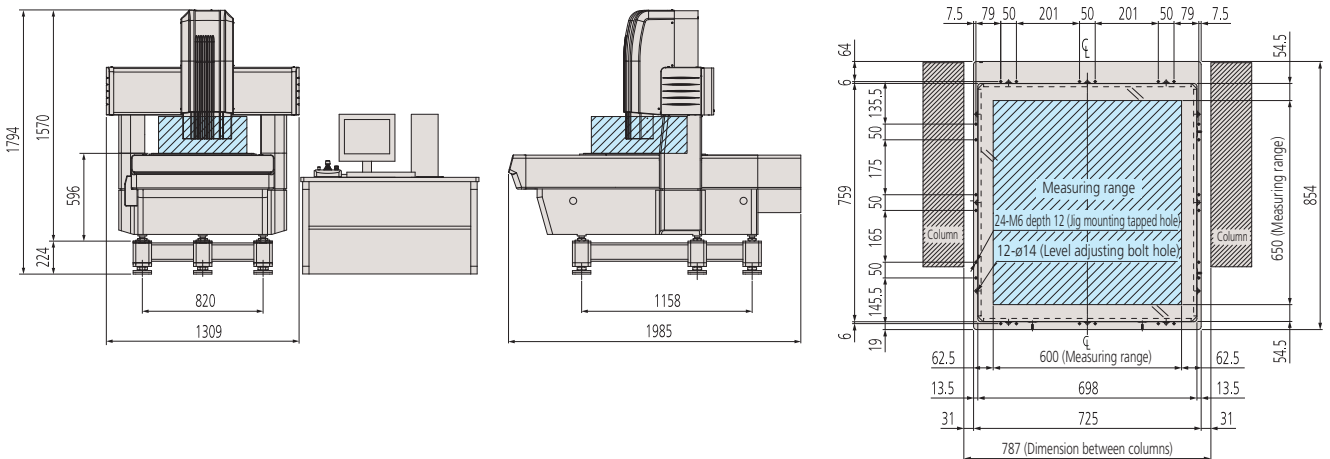

For more information about dimensions of the PC table, please contact your local Mitutoyo sales office.





# Dimensions

## ULTRA QV

Unit:mm

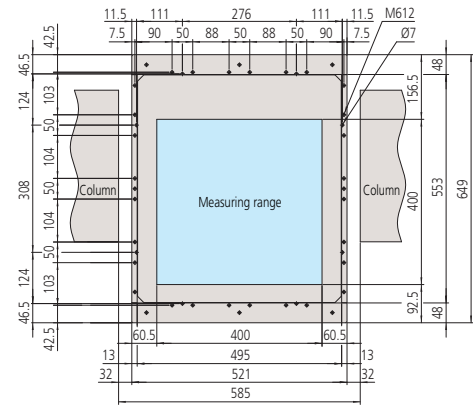
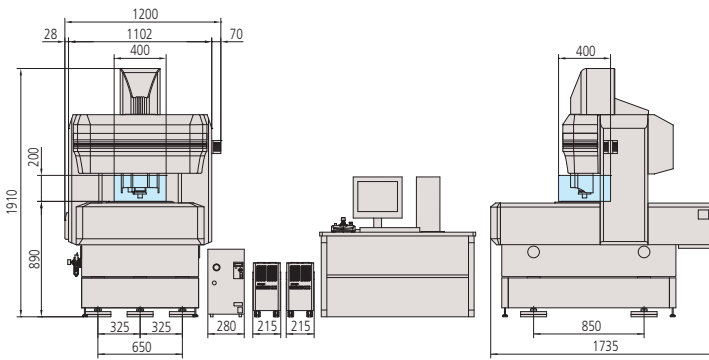

## QV ELF

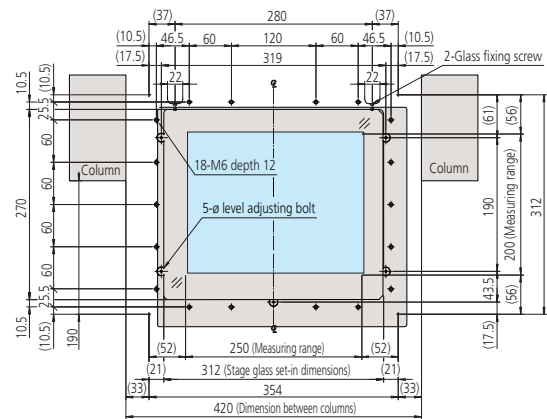
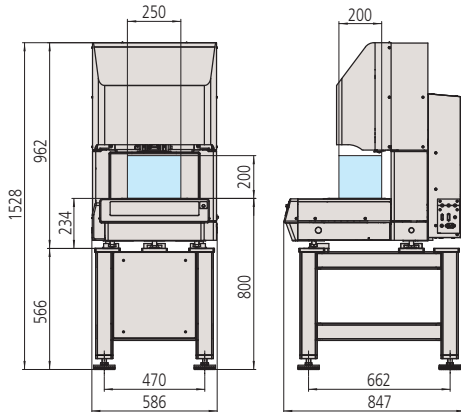

Dimensions in parentheses apply to LAF-equipped machines.  
For more information about dimensions of the PC table, please contact your local Mitutoyo sales office.

# Optional Hardware / Objectives

## Calibration Chart and QV Compensation Chart

### Calibration chart

A calibration chart is used to compensate for the pixel size of the CCD chip and for the auto focus accuracy and optical axis offset at each magnification of the variable magnification unit (PPT).



\* There are limitations on what functions can be used, depending on the lens.  
For details, contact your Mitutoyo sales office.

### QV compensation chart\*

This glass chart is used to perform compensation for distortions within the screen caused by the optical system, and auto focus compensation, which reduces auto focus variations that are caused by differences between the workpiece pattern and texture.



\* There are limitations on what functions can be used, depending on the lens.  
For details, contact your Mitutoyo sales office.

## QV Index

Consecutive measurements of the sides and bottom of a workpiece can be made without having to perform refixturing.

This leads to a decrease in the production costs related to fixturing, which results in an improvement in measurement efficiency.

Supported models: QV302, 404, 606

Supported QVPAK versions: version 7.356 or later

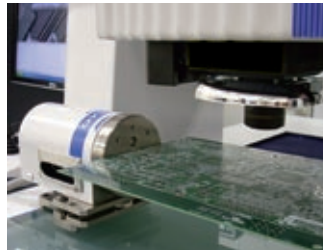

Item	Specifications
Maximum workpiece size	ø140mm (Max)
Maximum faceplate loading	2kg (Max)
Resolution	0.1°
Rotational positioning accuracy	±0.5°
Rotational speed	10 r.p.m
External dimensions (WxDxH)	118x150x105mm

## QV Objectives

### QV objectives

Objective	QV-SL0.5x*	QV-HR1x	QV-SL1x	QV-HR2.5x	QV-SL2.5x	QV-5x	QV-HR10x*	QV-10x*	QV-25x*
Order No.	02AKT199	02AKT250	02ALA150	02AKT300	02ALA170	02ALA420	02AKT650	02ALG010	02ALG020
Optical magnification	0.5X	1X		2.5X		5X	10X		25X
Working distance	30.5mm	40.6mm	52.5mm	40.6mm	60mm	33.5mm	20mm	30.5mm	13mm
PRO model imaging FOV [(H) mmx (V) mm]	Turret 1x	12.54x9.4	6.27x4.7	2.49x1.86		1.24x0.93	0.62x0.47		0.25x0.18
	Turret 2x	6.27x4.7	3.13x2.35	1.24x0.93		0.62x0.47	0.31x0.23		0.10x0.07
	Turret 6x	2.09x1.56	1.04x0.78	0.41x0.31		0.20x0.15	0.10x0.07		0.04x0.03
PRO3 model imaging FOV [(H) mmx (V) mm]	Turret 1x	9.4x7.04	4.7x3.52	1.87x1.41		0.93x0.7	0.46x0.34		0.18x0.14
	Turret 2x	4.7x3.52	2.35x1.76	0.09x0.7		0.47x0.35	0.23x0.17		0.09x0.07
	Turret 6x	1.56x1.17	0.78x0.59	0.31x0.24		0.16x0.12	0.08x0.06		0.03x0.02

\* When the QV-SL0.5x, QV-HR10x, QV-10x, or QV-25x objective is used, some limitations, such as the illumination being insufficient depending on the workpiece, may occur.

### Set of objectives that support PFF

Objective Sets	QV-HR2.5(Set)	QV-5X(Set)	QV-HR10X(Set)	QV-25X(Set)
Order No.	02AKX895	02AKX900	02AKX905	02AKX910
Optical magnification	2.5X	5X	10X	25X
Working distance	40.6mm	33.5mm	20mm	13mm
PRO model imaging FOV [(H) mmx (V) mm]	Turret 1x	2.49x1.86	1.24x0.93	0.62x0.47
	Turret 2x	1.24x0.93	0.62x0.47	0.31x0.23
	Turret 6x	0.41x0.31	0.20x0.15	0.10x0.07

\* For details of applicable models, refer to "About the PFF (Points From Focus) Function" on page 38.

\* This set of objectives supports the PFF function and normal measurement.



High-performance QV objectives

# Software

Secure Edge Detection by Advanced Image Processing.

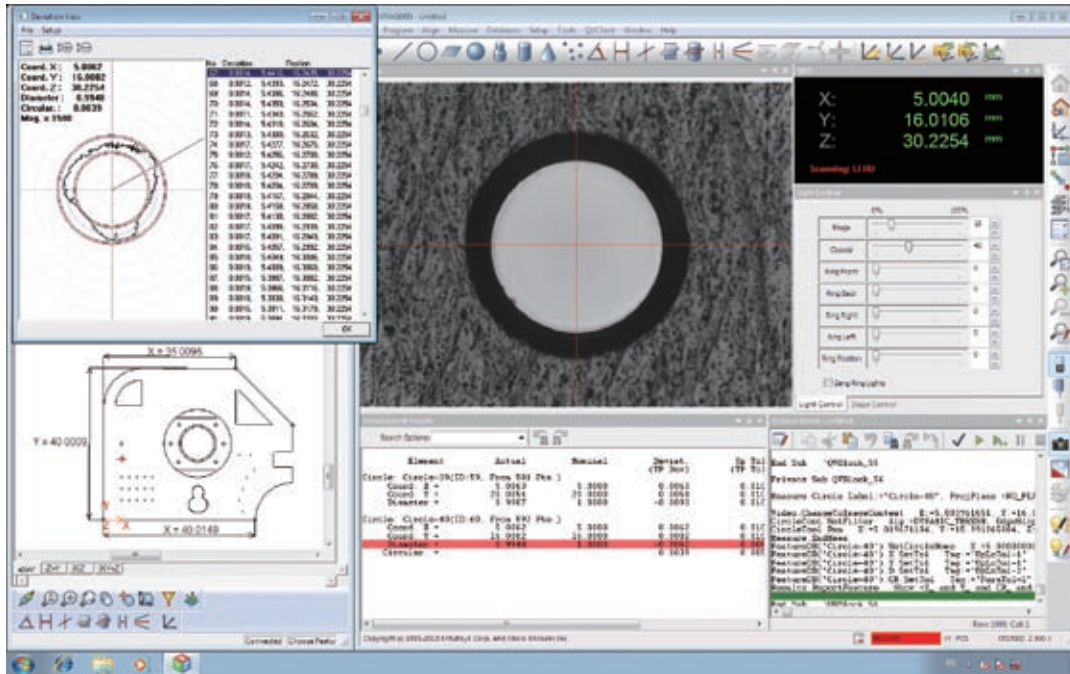

## Edge Detection Tools

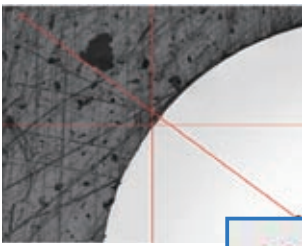

### Point Tool

This is a basic tool for detecting one point.

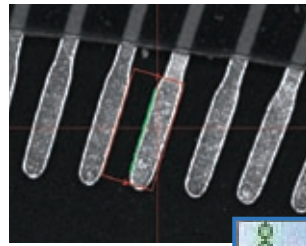

### Line Tool

This tool detects linear edges with a minimum of one pixel space. Compared to the point tool, the line tool can perform averaging and remove abnormal points, which enables stable measurements.

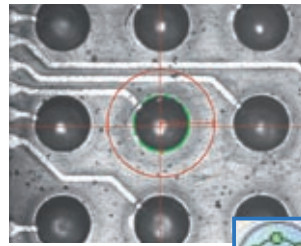

### Circle Tool

This tool detects circular edges with a minimum of one pixel space. Edges can be specified easily with a single click.

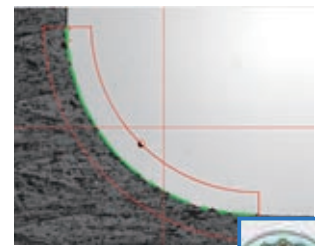

### Arc Tool

This tool is suited to detection of arcs and corner radii.

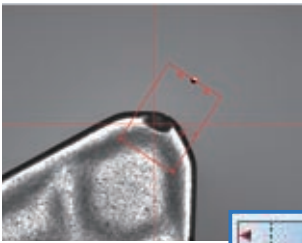

### Maximum/Minimum Tool

This tool detects the maximum or minimum point within the range.



### Area Centroid Tool

This tool detects the position of a form's centroid, and is suited to the positioning of different forms.

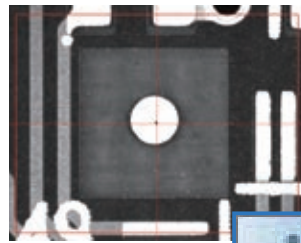

### Pattern Search Tool

This tool performs pattern matching to detect a position, and is optimal for positioning alignment marks and similar tasks.

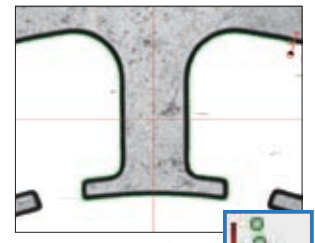

### Auto Trace Tool

This is a shape-measuring tool that automatically tracks a contour with input consisting only of a start point and end point.



## Equipped with Powerful Auto Focus Functions as Standard

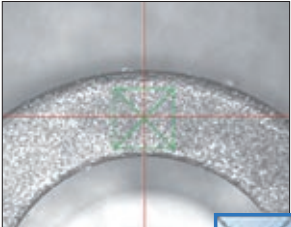

**Surface Focus Tool**

Image auto focus can be performed on a chosen area specified with the mouse. Highly accurate height measurements that are minimally affected by surface roughness can be performed even on objects such as resin-molded products and machined surfaces.

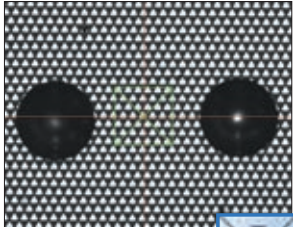

**Pattern Focus Tool**

Even low-contrast mirrored surfaces and transparent objects can be brought into focus by the use of pattern focus, which projects onto the workpiece surface a pattern placed within the light path. This is useful when performing height measurements of flexible printed circuit boards and film.



**Edge Focus Tool**

This is the optimal tool for focusing chamfered parts.

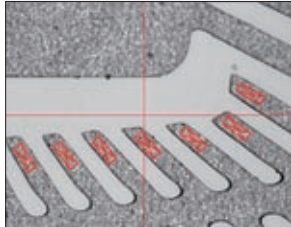

**Multi-point auto focus**

Multi-point auto focus can be used to set multiple focus positions, sizes, and angles to chosen values. This tool can be used to obtain multiple sets of height information with a single focusing operation, which makes it possible to perform highly efficient height and flatness measurements.

## One-click Measuring Tool Set-up

The tool size, orientation, and threshold of a measuring tool are automatically set with one click of the mouse in the vicinity of the measurement location.

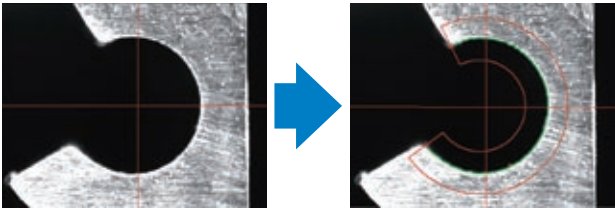

## AI Illumination Tools

There are two tools: the dual area contrast tool, which can adjust the light intensity to the optimal value at procedure creation time, and the brightness tool, which automatically compensates the light intensity at program creation time. These tools stabilize the light intensity during repeat measurements, which increases edge detection repeatability and reduces the occurrence of edge detection errors caused by light intensity fluctuations.



**Brightness Tool**

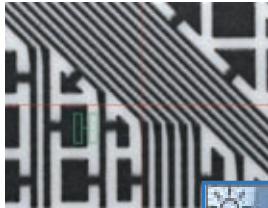

**Dual Area Contrast Tool**



## Increase in Edge Detection Capability

Workpieces that have been machined often have optically 'noisy' surfaces produced by cutter marks and marks caused by abrasive blasting of outer surfaces. There are times when conventional image processing alone is not enough to perform accurate measurements when such noise is present. QVPAK's filter function removes this noise to make highly accurate measurements possible.

Preview screen of morphological filter

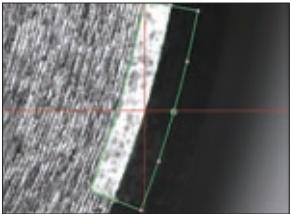

Edge detection using morphological filter

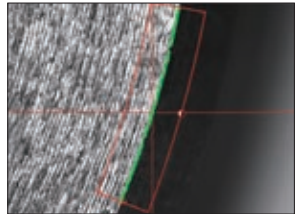

Brightness analysis

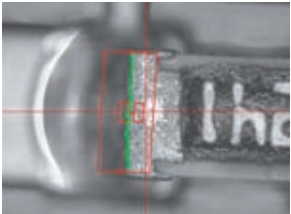

Texture analysis

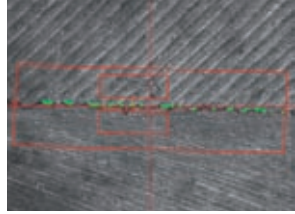

## Illumination Wizard

This tool automatically sets the optimal illumination conditions from among multiple combinations of illumination types such as contour illumination and surface illumination and the illumination direction and angle of PRL illumination.

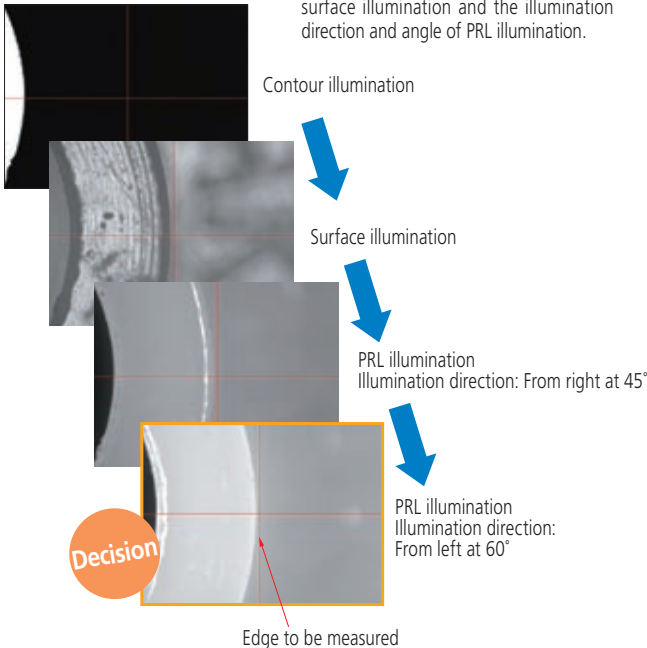

# Software

Equipped with the Easy Editor, QVPAK Has Evolved to the Most Easy to use and Most Powerful Version Ever.

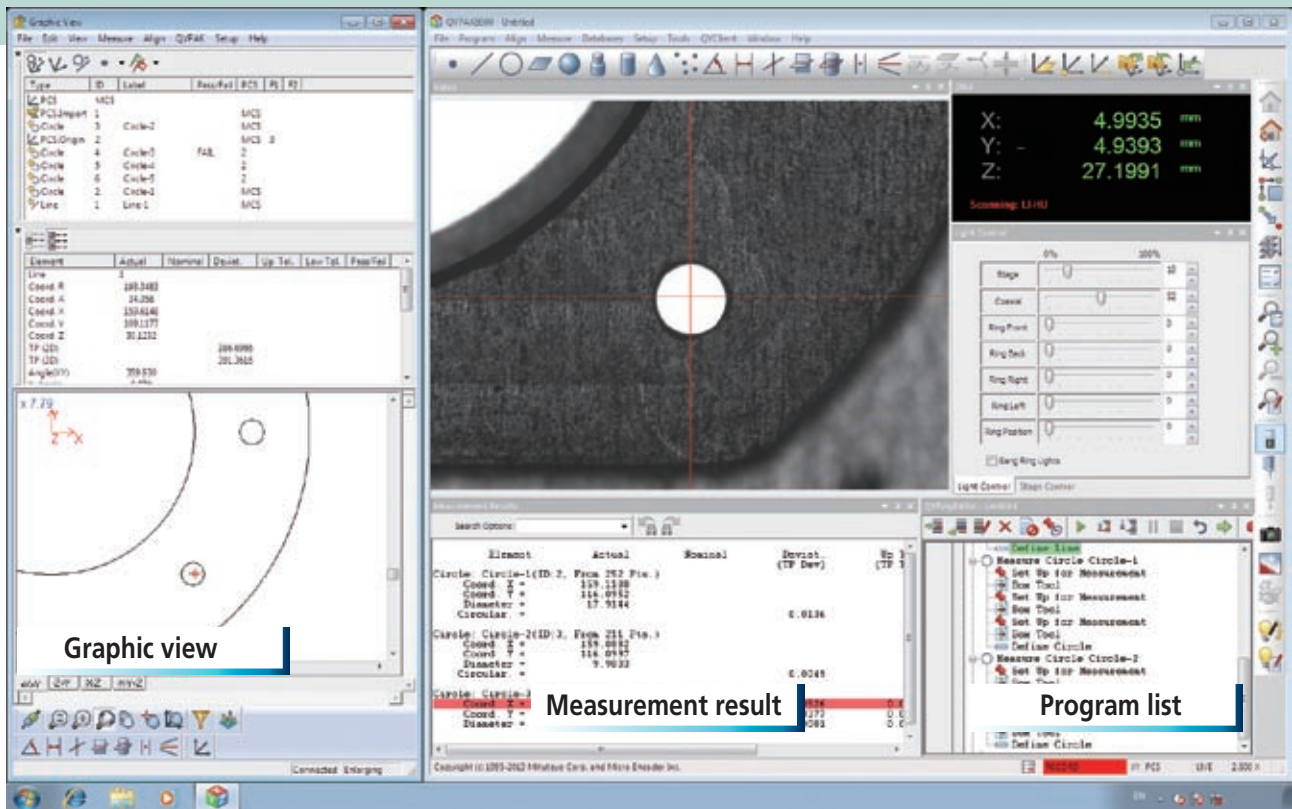

## The Most Powerful Software Combining Ease of Use and Intelligence

QVPAK has evolved to the most powerful version yet with both QV EasyEditor, which is easy to operate and requires no specialized knowledge, and QV BasicEditor, which has all the functions necessary to satisfy software developers.

Program creation example: measuring the distance between two circles

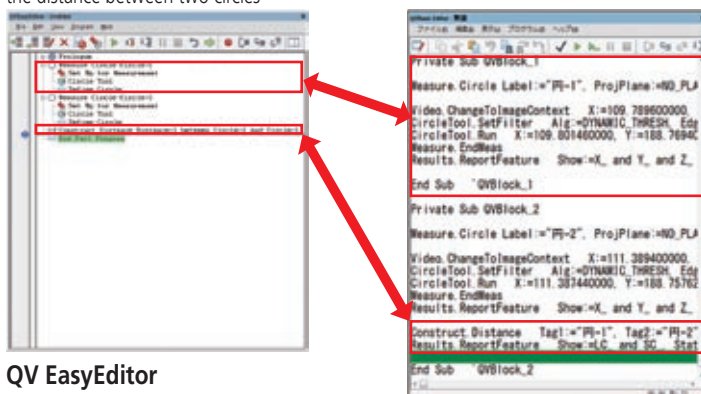

### QV EasyEditor

- No specialized programming language knowledge is required.
- The procedure adjustments associated with changes to the workpiece form can be done easily.
- Edge detection tool corrections can be made from the video window.
- Mistakes during program creation can be fixed on the spot.
- Errors during repeat execution can also be fixed on the spot easily.

### QV BasicEditor

- Both subroutines, which have arguments and return values, and local variables can be used, which makes QV BasicEditor suited to high-level programming.
- All flow control statements, such as IF, THEN, and ELSE, can be used.
- Data can be read from and written to text files.
- User-designed dialog boxes can be created.

## Error Icons and the Auto Scroll Function Quickly Indicate the Areas that Need to be Fixed in the Program

Error icons are displayed in the program list, which makes it possible to quickly identify the areas that need to be fixed.

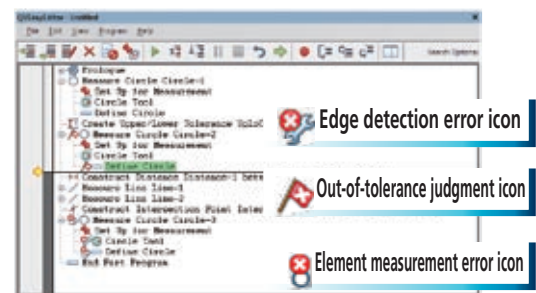

The program list, measurement result, and graphic view are linked together through the auto scroll function. This is useful in identifying the areas that need to be fixed in the program.

On the measurement result window, out-of-tolerance measurement results are highlighted in red, which is useful in identifying problems.

## Easy Program Correction When Errors Occur during Recording Mode and during Part Program Execution

It's easy to insert, delete, and change procedures even during recording mode.

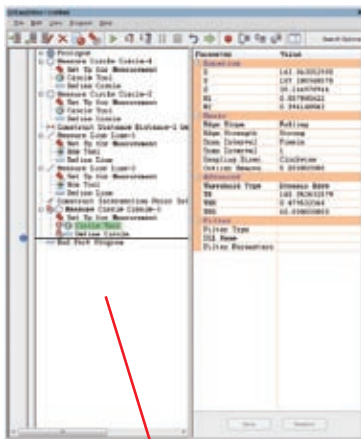

Editing Tools

If an edge detection error or auto focus error occurs during part program execution, error recovery mode can be used to update the program.

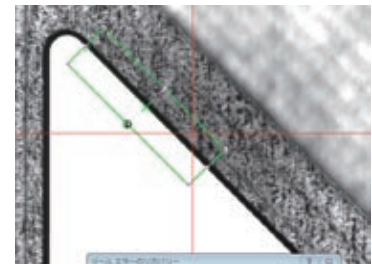
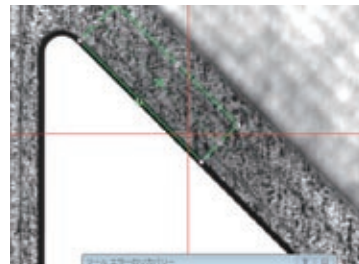

An error occurs during program execution due to an issue such as a mistake during program creation or a workpiece design change.

The details corrected in error recovery mode are updated.

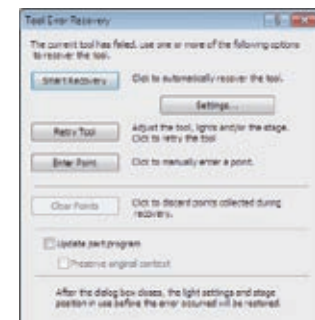

## Partial Execution of Measurement Programs Is Possible

It is even possible to reduce the measurement time of part programs that have a large number of elements by partially executing the program.

This function is effective in identifying the cause of failures, as it makes it possible to execute only the parts of a program that are failing, such as the parts in which out-of-tolerance values are present.

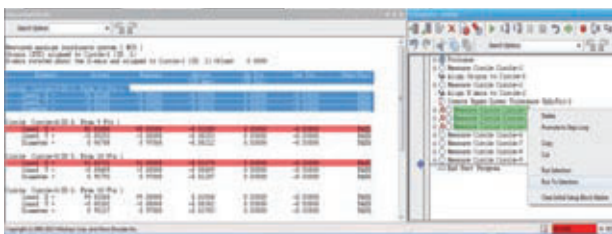

## Repeated Execution (Step and Repeat) Can Be Easily Programmed

The repeat command can easily be set on the graphic display. Furthermore, even if parts of the workpiece are missing, steps can be easily deleted.

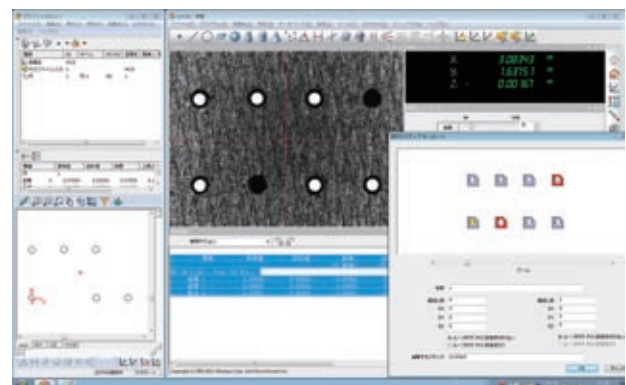

## Calculation function examples

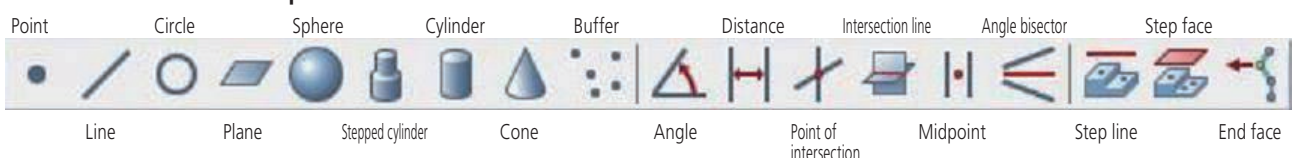

# Software

Powerful Software Solutions Increase Easy Operability.

## QV Graphics

Not only can this feature be used for reports of measurement results but also high-level calculations such as calculations between elements and PCD measurements can be performed by selecting diagrams with the mouse. In addition, effective use of the graphics function makes it possible to easily edit part programs and is also useful in checking the coordinate system of the current workpiece and in checking for any forgotten measurements.

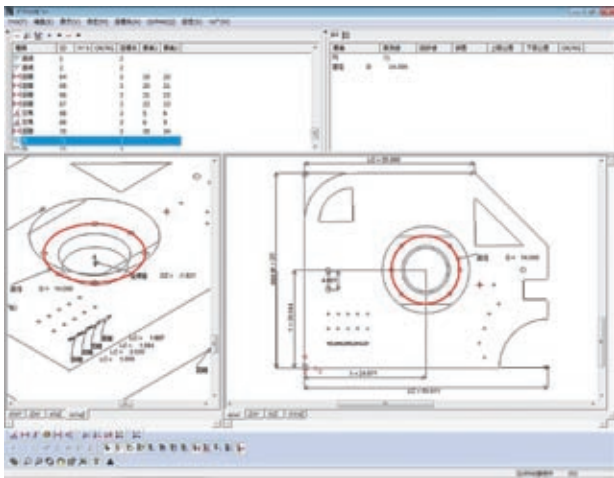

Furthermore, QV graphics has a function for drawing geometric deviations of lines, circles, planes, cylinders, and spheres.

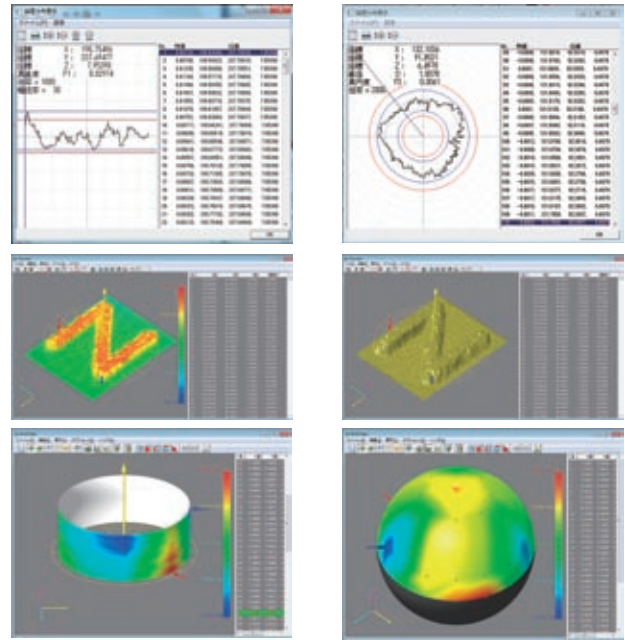

## Image Composition

This function combines multiple images of surfaces at different heights to create a complete focal point image in focus over a wide range.

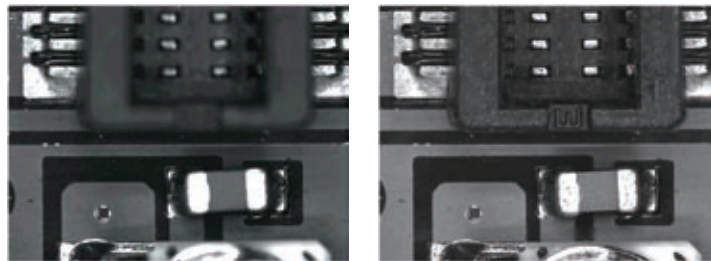

Original data

Image data after composition

## QV Navigator

This function provides a navigated display of the procedures for calculations between elements and for coordinate system setup patterns. The user macro creation function can be used to freely customize even complex patterns. Also, part programs can be registered together with workpiece images, which improves the operability of repeat measurements.

### User macro creation function

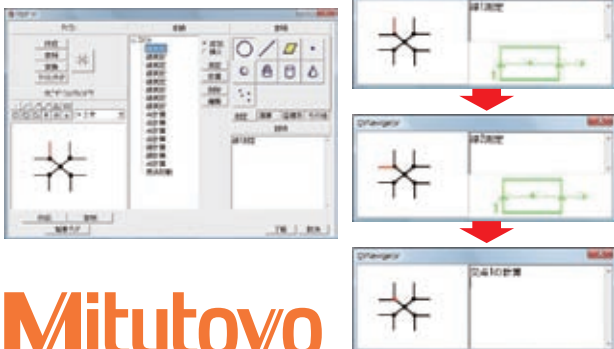

### Part program registration example



Mitutoyo



## QV Trace Planner

QV Trace Planner is application software that uses edge detection to measure contour forms. This software can easily generate trace routes even for forms that have varying heights and for forms that require multiple illumination conditions. Furthermore, after measurements are complete, FORMPAK-QV (optional) can start automatically and can automatically perform analysis, which achieves seamless operability.

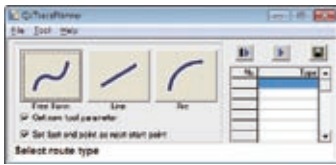

Trace route image generated by QV Trace Planner  
(The actual operations are performed by executing one tool at a time.)

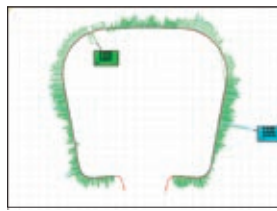

Actual example of FORMPAK-QV analysis

## Function for Removing Abnormal Points at the Element Level

In addition to removing abnormal points per tool, abnormal points can also be removed from specific elements. Even when measurements are being performed on multiple screens, the abnormal point removal settings can easily be configured while viewing the graphic screen.

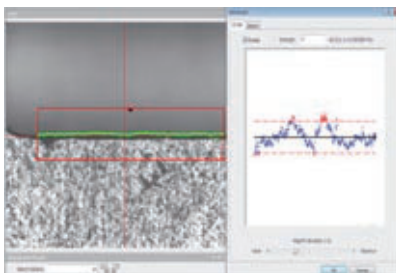

## Multi-Point Auto Focus

The auto focus tool has been subdivided. Chosen sizes, positions, and angles can be set for multiple auto focus tools. Multiple data points can be obtained with a single focus operation. It is possible to not only perform efficient height measurements but also to determine the maximum point, minimum point, and average point from among the acquired data.

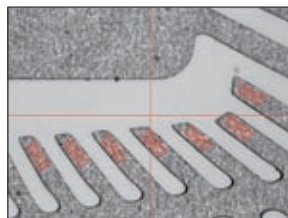
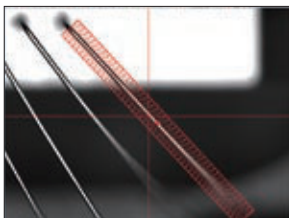

## Help Function

The Help function has been enhanced through the utilization of a great number of graphics. Searches can be easily made by topic to provide operators with quick solutions to their queries.



## Best Fit Function

The best fit function considers items such as the skew and elasticity of the workpiece, and then sets the coordinate system accordingly. The origin and reference axes are determined from multiple elements, so measurements can be performed with a coordinate system that is more optimized than with conventional coordinate system settings.

### Conventional coordinate system setting

Mark that is not considered when setting the coordinate system

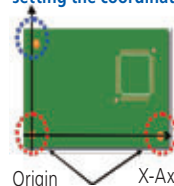

The origin and the axis are determined to be separate elements.

### Coordinate system setting using best fit

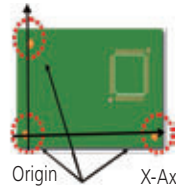

The coordinate system is set so that the alignment mark position offset errors are minimized.

## Smart Recovery Function

When edge detection or auto focus errors, which are caused by variations in the workpieces or setting errors, occur, the smart recovery function automatically corrects the illumination conditions and tool position, and then performs the measurement again.

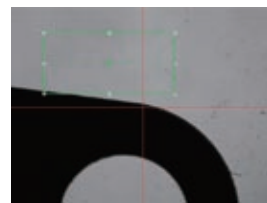

The workpiece is not located at the conventional measurement position.

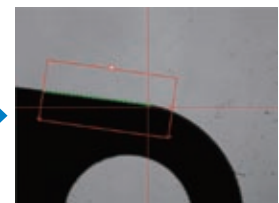

The tool is automatically corrected, and the measurement is then performed again.

# Optional Application Software

## Form Evaluation and Analysis Software

### FORMPAK-QV

FORMPAK-QV performs tolerancing and form analysis from data obtained with the QV's auto trace tool, non-contact displacement sensor, QV-WLI, and PFF.

#### Contour Tolerancing Function

- Design data creation  
CAD data conversion, master workpiece conversion, function specification, text file conversion, and aspherical surface design value creation
- Tolerancing  
Normal vector direction tolerancing, axial direction tolerancing, and best-fit tolerancing
- Result display  
Result list display, error graph, error developed view, error coordinate display function, and analysis result display

#### Report Creation Function

- Measurement result, error graph, and error developed view

#### Other Functions

- Recording and executing analysis procedures
- External output function:  
CSV, text or DXF/IGES format output
- Fairing processing
- Quadratic curve fitting function
- Pseudo-roughness analysis function

#### Microscopic Form Analysis

- Analyzed items: point measurement, line measurement, circle measurement, distance measurement, intersection measurement, angle measurement, origin setting, and axial rotation
- Calculated items: maximum, minimum, average, standard deviation, and area

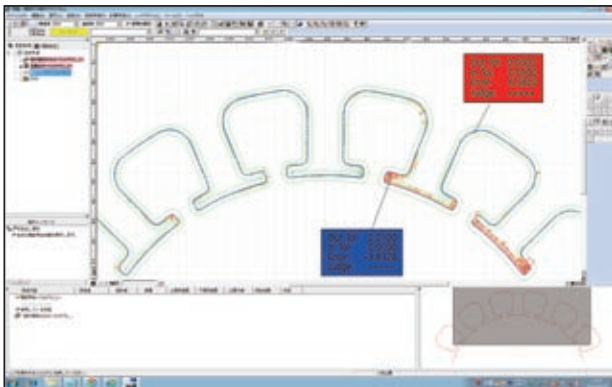

Tolerancing example

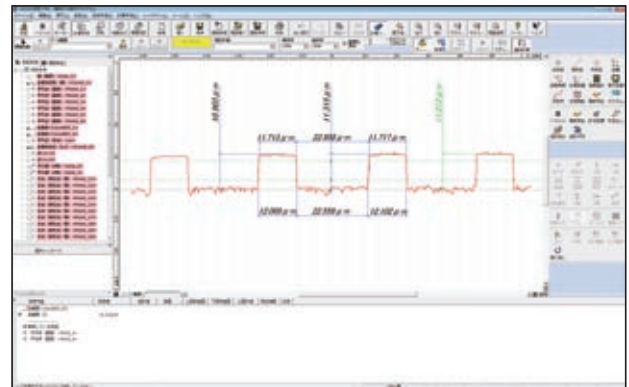

Example of using QV-WLI to perform line and space and conductor thickness measurements on a printed circuit board

### QV Trace Maker

QV Trace Maker is a software application that creates scanning routes for the non-contact displacement sensor based on the images acquired by Quick Vision. Using this software together with FORMTRACEPAK-PRO and MSHAPE-QV makes it possible to perform highly accurate 3D form measurements.

Automatic image composition outside the field of view can be performed when acquiring images, which not only makes it possible to create wide-area trace routes but also enables the easy creation of trace routes of complicated and unusual form areas.



Target area image composition



Measuring area specification

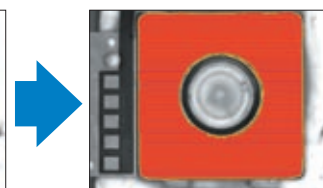

Trace condition setup

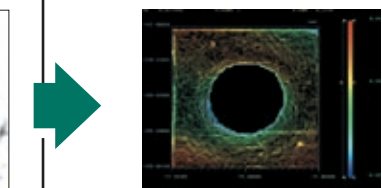

MSHAPE-QV evaluation example

## FORMTRACEPAK-PRO

FORMTRACEPAK-PRO is a software application that performs 3D analysis processing on the data obtained with the non-contact displacement sensor, QV-WLI, and PFF.

### Main Functions

- **3D display**  
Wire frame, shading, contour line, contour line filling
- **Trend compensation and filter processing**  
Trend compensation using flat surfaces, spherical surfaces, cylindrical surfaces, and polyhedrons  
1D and 2D digital filters for each profile
- **Digitization of a rich variety of surface textures**  
Relative load curves and area distribution curves can be used to evaluate wear and oil accumulation areas.  
Spectral analysis, cutoff area and volume analysis, angle of inclination calculations at peaks and valleys, and histogram calculations of numbers of valleys can be performed.
- **Function for extracting features from measurement data**  
Extraction of a chosen cross section, slope enhancement, and simultaneous analysis of the peaks and valleys of the cutoff surface can be performed.

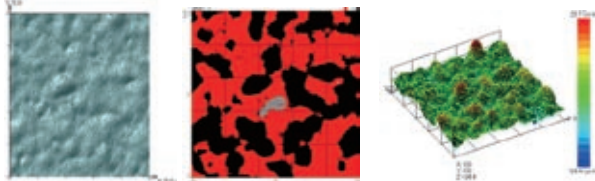

Shading display      Cutoff surface analysis example      Wire frame display

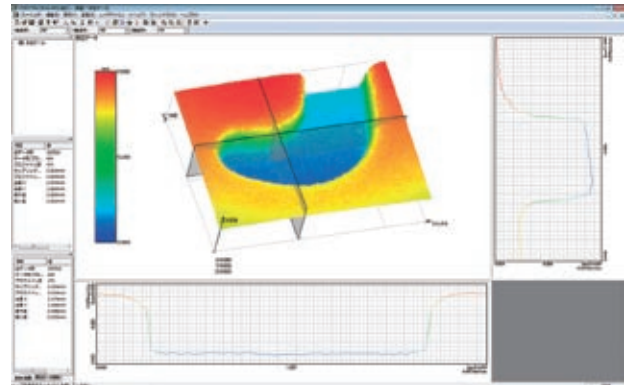

Example of using PFF to measure a molded component

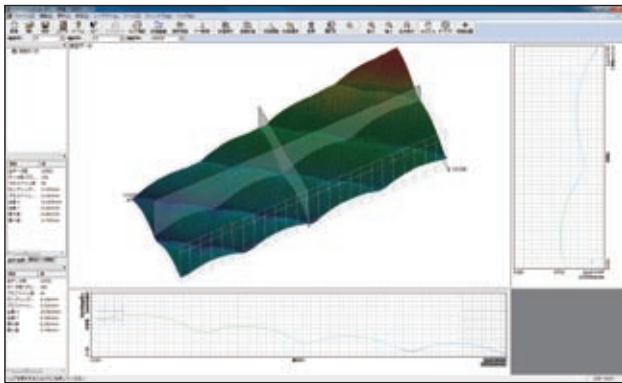

Example of using QVH4 to perform acrylic lens eye measurements

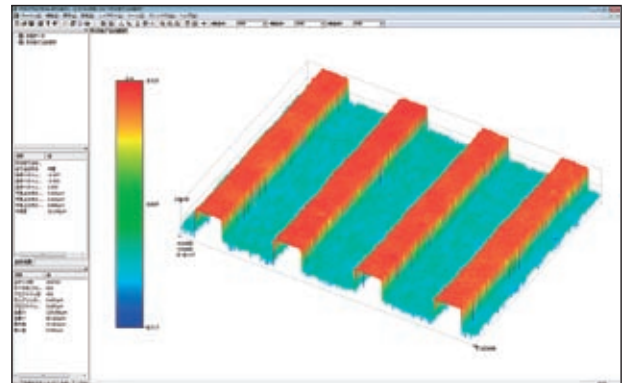

Example of using QV-WLI to perform line and space measurements on a circuit board

## MSHAPE-QV

MSHAPE-QV is a software application that performs 3D analysis processing on the data obtained with the non-contact displacement sensor, QV-WLI, and PFF.

### Main Functions

- Display functions
- 2D/3D contour line display
  - 2D/3D fill display
  - Curved plane analysis
- Form analysis
- Curved plane analysis
  - Cross-section curve analysis, etc.

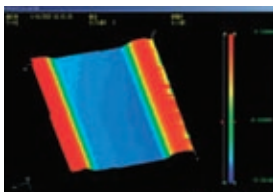

3D fill display



Shadow graph

# Optional Application Software

## Inspection Certificate Creation

### Measure Report-QV

#### Features

- This software package, which is based on MS Excel, can easily produce a customized inspection certificate.
- Data from multiple instruments such as calipers and micrometers can be used in addition to Quick Vision data.



### MeasurLink STATMeasure PLUS

Many types of statistical calculations can be performed on the measurement results. It is also possible to display control charts in real time.

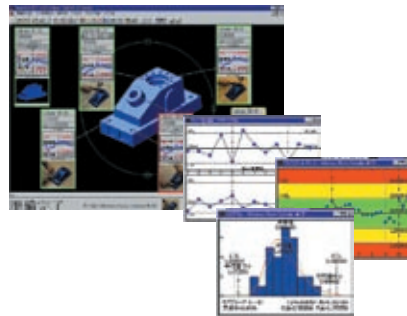

## Offline Teaching Software

### EASYPAG-PRO

DXF IGES GERBER data

EASYPAG-PRO can use 2D CAD data to create QVPAK part programs in an offline manner. This reduces the number of man-hours required to create part programs, which results in a decrease in lead time.

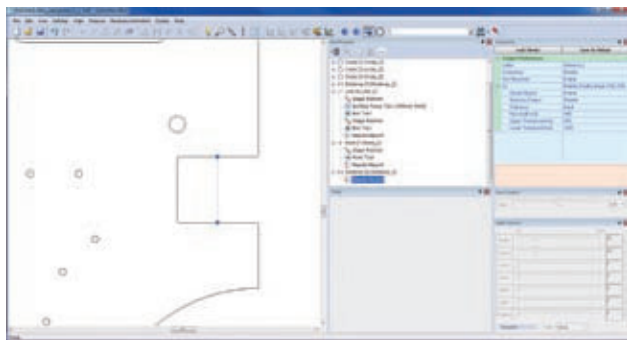

Line-to-arbitrary point distance measurement

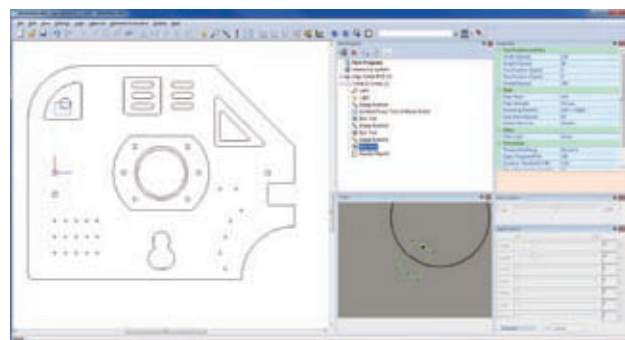

Off-line teaching operation display

# Online Teaching Software

## QV3DCAD-OnLine

QV3DCAD-OnLine uses 3D CAD models to easily create QVPAK part programs. QV measurements can be performed by specifying an element in the CAD data. This improves program creation efficiency more than using a joystick to perform teaching.

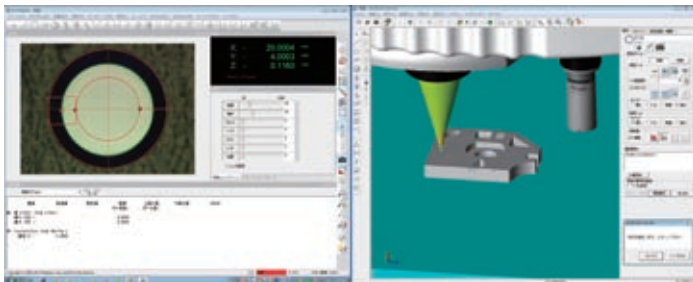

Primary display: QVPAK

Secondary display: QV3DCAD-OnLine

### Reliable Online Teaching of Illumination Conditions and Edge Detection Thresholds

QV3DCAD-OnLine can be used to teach correct illumination conditions and edge detection thresholds from actual images. The operation of the created program path can be checked immediately. This minimizes the operation check and program editing work that needs to be performed after the program is completed.



### Supported CAD formats

Format	Supported version
SAT	Up to version 19
STEP*	AP203 and AP214 (graphics only)
VDAFS*	Up to version 2.0 of VDA-FS
IGES*	Up to version 5.3 of IGES
CATIA V4*	Version 4.1.9 to version 4.2.4 of CATIA V4
CATIA V5*	Release 2 to 17 of CATIA V5
Pro/E*	Version 16 of Pro/E to WildFire2 and WildFire3
Parasolid*	Version 10 to version 18 of Parasolid
Unigraphics*	V11 to V18 of Unigraphics and NX1 to NX7
SolidWorks*	SolidWorks 98 to 2006

\* This is optional.

### Simulations and Checks for Interference Provide Accurate Operation

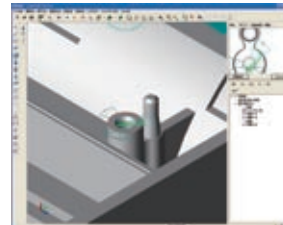

Edge detection tool simulations can be performed from the pseudo-video window.

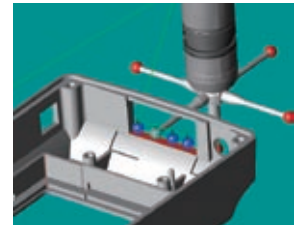

The interference check function can be used to prevent problems caused by the probe or objective colliding with the workpiece.

## QV-CAD I/F

DXF IGES

QV-CAD I/F improves the measurement operability by displaying CAD data in the graphic window.

### Features

- A navigation function that uses CAD data (the Import function) and a function for generating measurement result data (the Export function) are available.
- Design value information can be referenced from CAD data, which eliminates the need for key entry of design values during nominal tolerancing.
- The 3D CAD Import function can be used to display 3D CAD data and to configure flatness display area settings.

### CAD Export function

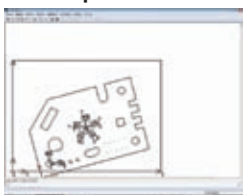

Drawing a graphic of the measurement result

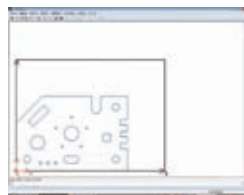

Generated CAD data

### 3D CAD Import function

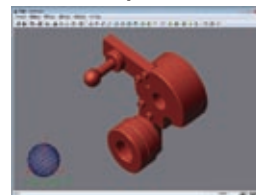

3D CAD data display

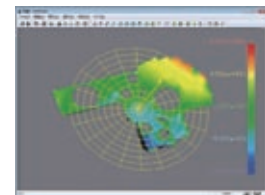

Illustrating flatness using 3D CAD data

# Optional Application Software

## QV3DPAK

QV3DPAK is a software application that composes 3D forms from PFF (points from focus) or WLI (white light interferometer) data.

### Main Functions

#### 3D Form Data Composition

- QV-WLI 3D form data composition
- PFF 3D form data composition
- Form data noise elimination
- Form data Gaussian filter processing

#### 3D Form Data External Output

- Transfer of extracted data to QVPAK
- Transfer of extracted data to FORMPAK-QV
- Transfer of extracted data to FORMTRACEPAK-PRO

### 3D Profile Stitching

If a measuring target area cannot be covered with a single FOV (field of view) measurement, this function allows stitching of 3D profile data in multiple FOVs. 3D profile stitching enables an extensive range of measurement and analysis as a high resolving power is maintained.

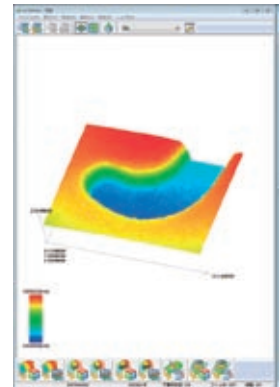
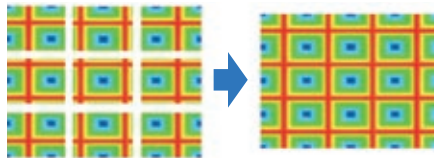

QV3DPAK

## About the PFF (points from Focus) Function

PFF (points from focus) is an application that can use the image contrast of the Quick Vision Series to perform non-contact 3D form measurements. The Mitutoyo inspection method guarantees the Z-direction repetition accuracy, so it is possible to perform highly accurate form measurements.

### PFF Principle

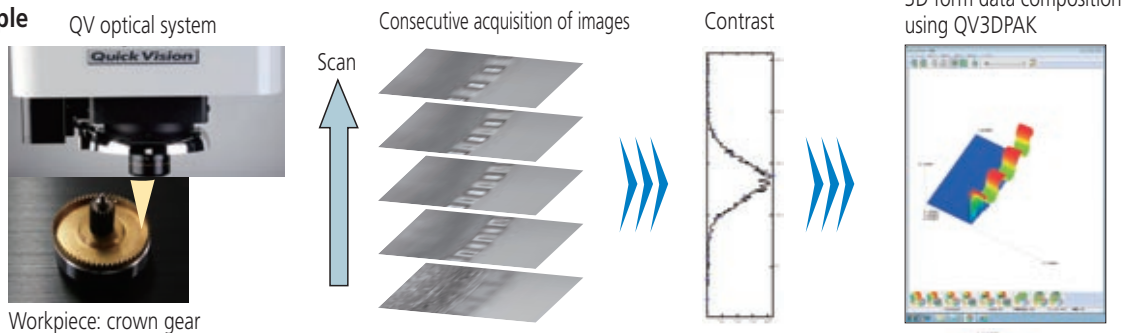

### PFF Measurement Example

Partition line of a molded product

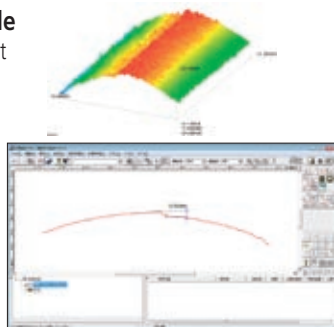

IC package BGA

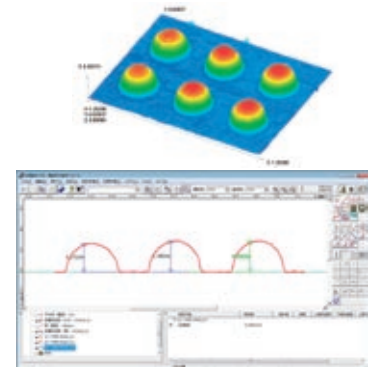
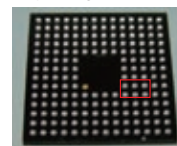

### PFF Measurement Performance

PFF guarantees, by way of the Mitutoyo inspection method, the Z-direction repetition accuracy.

	QV ELF	QV Apex/QV ACCEL	Hyper QV	ULTRA QV
Z-direction repetition accuracy	$2\sigma \leq 2.0\mu\text{m}$	$2\sigma \leq 1.5\mu\text{m}$	$2\sigma \leq 1.5\mu\text{m}$	$2\sigma \leq 0.7\mu\text{m}$
Optical magnification guaranteed to be accurate	QV-HR2.5X + PT2X	QV-HR2.5X + PT2X	QV-HR2.5X + PT2X	QV-5X + PT2X

\* When using the PFF function, employ the QV3DPAK software and a PFF-compatible objective (described on page 27).

\* The PFF-compatible models are the PRO versions of the machines listed in the table above (including TP, HYBRID and UMAP machines).

## QV Part Manager

QV Part Manager is the part program execution management software for multiple workpieces arranged on the measuring stage. It is possible to create mapped displays of execution conditions and approval/rejection judgment results for each measurement workpiece. A retry function and a pass function are available for use when tolerances are exceeded or when an error occurs. These functions are effective in simplifying operations during repeat execution.

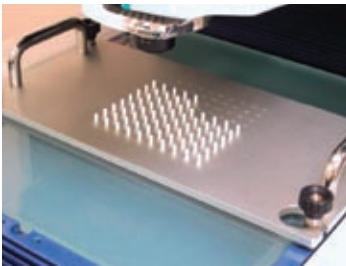

Workpieces arranged on a dedicated fixture



QV Part Manager screen

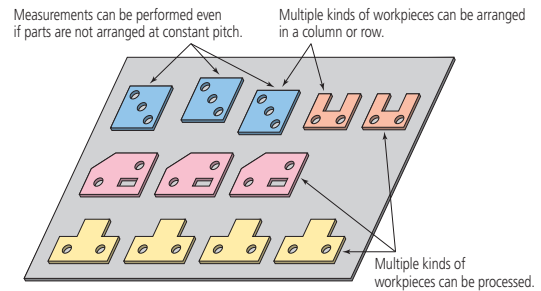

## QV Eio

QV Eio is client application software for performing external control of the QV. The software contains three types of program function: QV Eio-PLC, QV Eio-PC and QV Eio-Signal.

## QV Eio-PLC

QV Eio-PLC is a software that can perform execution commands sent to the QV from an external source and provide status notifications in response to received commands by way of RS-232C communication with a PLC. Using this software makes it easy to construct a QV automated system such as by making a connection to an automatic conveyance robot.

### Main Control Commands

- |                                   |   |  |
|-----------------------------------|---|--|
| <b>PLC</b>                        |   | <b>QV Eio-PLC</b>                            |
| • ABS start command               | ⇔ | • ABS complete                               |
| • Measurement start command       | ⇔ | • Measurement complete                       |
| • Measurement stop command        | ⇔ | • Measurement stop complete                  |
|                                   | ⇔ | • Measurement result judgment (pass or fail) |
| • X-, Y-, Z-Axis movement command | ⇔ | • X-, Y-, Z-Axis movement complete           |
|                                   | ⇔ | • Reading or writing device information*     |
- \* This function uses QVBasic language commands.

### QV Eio-PLC supported example

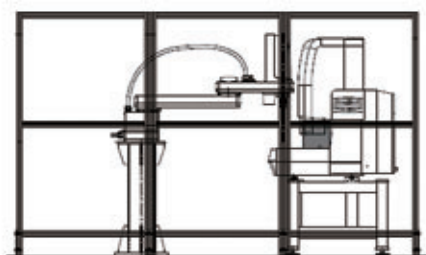
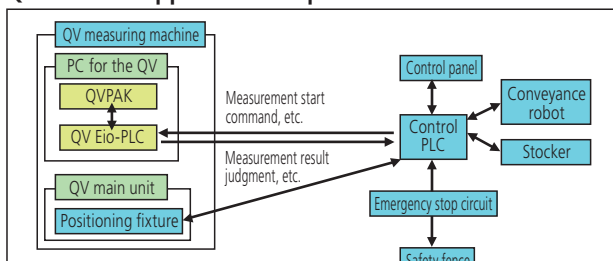

## QV Eio-PC

Not only can QV Eio-PC be used to perform control through RS-232C communication with an external PC but it can also be used to output measurement results and the status of errors that occur on the QV. This makes it possible to control the QV efficiently. QV Eio-PC is optimal for controlling the QV from a dedicated GUI on an external PC.

### Main Control Commands

- |  |   |   |
|--|---|---|
| <b>External PC</b>                       |   | <b>QV Eio-PC</b>  |
| • Reading the operation status of the QV | ⇔ | • Operation status output   |
| • ABS execution command                  | ⇔ | • ABS execution in progress or ABS complete                               |
| • Measurement start command              | ⇔ | • Measurement in progress or measurement complete                         |
| • Reading measurement result file        | ⇔ | • Measurement result file output  |
| • X-, Y-, Z-Axis movement command        | ⇔ | • X-, Y-, Z-Axis movement in progress or X-, Y-, Z-Axis movement complete |
| • Reading stage position information     | ⇔ | • Stage position information output                                       |
| • Each command                           | ⇔ | • Error code output   |

### QV Eio-PC supported example

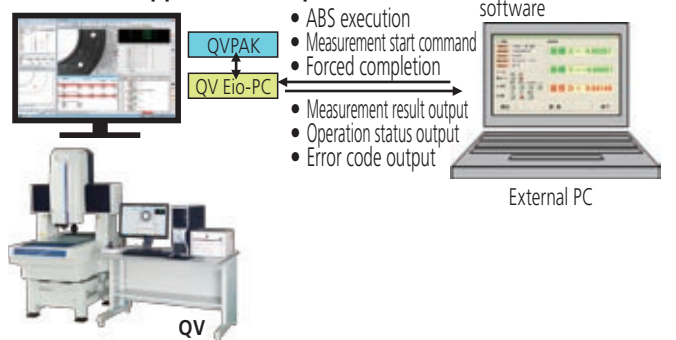

## QV Eio-Signal

QV Eio-Signal notifies a PLC of the QV's operation status. QV Eio-Signal is optimal for using a signal tower or similar device to display the operation status of the QV.

### Measurement status output examples

- Measurement complete (standby)
- Measurement processing in progress
- Error occurrence
- Measurement complete message display
- Emergency stop error occurrence
- Reading or writing bit device data

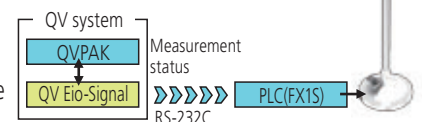



Export permission by the Japanese government may be required for exporting our products according to the Foreign Exchange and Foreign Trade Law. Please consult our sales office near you before you export our products or you offer technical information to a nonresident.

- Coordinate Measuring Machines
- Vision Measuring Systems
- Form Measurement
- Optical Measuring
- Sensor Systems
- Test Equipment and Seismometers
- Digital Scale and DRO Systems
- Small Tool Instruments and Data Management

Note: All information regarding our products, and in particular the illustrations, drawings, dimensional and performance data contained in this pamphlet, as well as other technical data are to be regarded as approximate average values. We therefore reserve the right to make changes to the corresponding designs, dimensions and weights. The stated standards, similar technical regulations, descriptions and illustrations of the products were valid at the time of printing. Only quotations submitted by ourselves may be regarded as definitive. Our products are classified as regulated items under Japanese Foreign Exchange and Foreign Trade Law. Please consult us in advance if you wish to export our products to any other country. If the purchased product is exported, even though it is not a regulated item (Catch-All controls item), the customer service available for that product may be affected. If you have any questions, please consult your local Mitutoyo sales office.

**Mitutoyo Corporation**  
 20-1, Sakado 1-Chome,  
 Takatsu-ku, Kawasaki-shi,  
 Kanagawa 213-8533, Japan  
 T +81 (0) 44 813-8230  
 F +81 (0) 44 813-8231  
<http://www.mitutoyo.co.jp>

