



# Ignitor-6 LED Strobe

ORDERCODE 40291



Highlite International B.V.  
Vestastraat 2  
6468 EX Kerkrade  
The Netherlands  
Phone: +31 45-5667700

**SHOWELECTRONICS FOR PROFESSIONALS**

## **Congratulations!**

You have bought a great, innovative product from Showtec.  
The Showtec Ignitor-6 LED Strobe brings excitement to any venue.

You can rely on Showtec, for more excellent lighting products.  
We design and manufacture professional light equipment for the entertainment industry.  
New products are being launched regularly. We work hard to keep you, our customer, satisfied.  
For more information: [iwant@showtec.info](mailto:iwant@showtec.info)

You can get some of the best quality, best priced products on the market from Showtec.  
So next time, turn to Showtec for more great lighting equipment.  
Always get the best -- with Showtec !

Thank you!



|  |    |
|--|----|
| <b>Warning</b> .....                                       | 2  |
| Safety-instructions.....                                   | 2  |
| Operating Determinations.....                              | 4  |
| Rigging.....   | 4  |
| Return Procedure.....                                      | 5  |
| Claims.....  | 5  |
| <b>Description</b> .....                                   | 6  |
| Features and Overview .....                                | 6  |
| Backside.....  | 6  |
| <b>Installation</b> .....                                  | 7  |
| <b>Set Up and Operation</b> .....                          | 7  |
| Control Modes.....   | 7  |
| One Ignitor-6 LED Strobe (Built-in Programs).....          | 7  |
| One Ignitor-6 LED Strobe (Auto Run Mode).....              | 7  |
| One Ignitor-6 LED Strobe (Sound Control).....              | 7  |
| Multiple Ignitor-6 LED Strobes (Master/Slave control)..... | 7  |
| Multiple Ignitor-6 LED Strobes (DMX control).....          | 8  |
| Fixture Linking.....                                       | 9  |
| Data Cabling.....  | 9  |
| Control Panel.....   | 10 |
| Control Mode.....  | 10 |
| DMX addressing.....  | 10 |
| MENU OVERVIEW .....  | 11 |
| Main Menu Options.....                                     | 11 |
| - 1. DMX Mode.....   | 12 |
| - 2. Brightness.....                                       | 12 |
| - 3. Built-in Programs .....                               | 12 |
| - 4. Auto Run Mode.....                                    | 12 |
| - 5. Sound control Mode 1.....                             | 12 |
| - 6. Sound control Mode 2.....                             | 12 |
| - 7. Master/Slave Mode.....                                | 12 |
| DMX Channel Setting.....                                   | 13 |
| - 7 Channels.....  | 13 |
| <b>Maintenance</b> .....                                   | 14 |
| Replacing the Fuse.....                                    | 14 |
| <b>Troubleshooting</b> .....                               | 15 |
| No Light.....  | 15 |
| No Response to DMX .....                                   | 15 |
| <b>Product Specifications</b> .....                        | 17 |

**FOR YOUR OWN SAFETY, PLEASE READ THIS USER MANUAL CAREFULLY  
BEFORE YOUR INITIAL START-UP!**

## Unpacking Instructions

Immediately upon receiving this product, carefully unpack the carton and check the contents to ensure that all parts are present, and have been received in good condition. Notify the dealer immediately and retain packing material for inspection if any parts appear damaged from shipping or the carton itself shows signs of mishandling. Save the carton and all packing materials. In the event that a fixture must be returned to the factory, it is important that the fixture be returned in the original factory box and packing.

Your shipment includes:

- Ignitor-6 LED Strobe with IEC cable 1,5m
- User manual



## LED Expected Lifespan

LEDs gradually decline in brightness over time. HEAT is the dominant factor that leads to the acceleration of this decline. Packaged in clusters, LEDs exhibit higher operating temperatures than in ideal or singular optimum conditions. For this reason when all color LEDs are used at their fullest intensity, life of the LEDs is significantly reduced. It is estimated that a viable lifespan of 40,000 to 50,000 hours will be achieved under normal operational conditions. If improving on this lifespan expectancy is of a higher priority, place care in providing for lower operational temperatures. This may include climatic-environmental and the reduction of overall projection intensity.

## WARNING



**CAUTION!**  
**Keep this device away from rain and moisture!**  
**Unplug mains lead before opening the housing!**



**FOR YOUR OWN SAFETY, PLEASE READ THIS USER MANUAL CAREFULLY  
BEFORE YOUR INITIAL START-UP!**

## SAFETY INSTRUCTIONS

Every person involved with the installation, operation and maintenance of this device have to:

- be qualified
- follow the instructions of this manual



**CAUTION! Be careful with your operations.**  
**With a dangerous voltage you can suffer**  
**a dangerous electric shock when touching the wires!**



Before your initial start-up, please make sure that there is no damage caused by transportation. Should there be any, consult your dealer and do not use the device.

To maintain perfect condition and to ensure a safe operation, it is absolutely necessary for the user to follow the safety instructions and warning notes written in this manual.

Please consider that damages caused by manual modifications to the device are not subject to warranty.

This device contains no user-serviceable parts. Refer servicing to qualified technicians only.

## **IMPORTANT:**

*The manufacturer will not accept liability for any resulting damages caused by the non-observance of this manual or any unauthorized modification to the device.*

- Never let the power-cord come into contact with other cables! Handle the power-cord and all connections with the mains with particular caution!
- Never remove warning or informative labels from the unit.
- Never use anything to cover the ground contact.
- Never leave any cables lying around.
- Do not insert objects into air vents.
- Do not connect this device to a dimmerpack.
- Do not open the device and do not modify the device.
- Never use the device during thunderstorms, unplug the device immediately.
- Never look directly into the light source.
- Do not switch the device on and off in short intervals, as this would reduce the system's life.
- Do not shake the device. Avoid brute force when installing or operating the device.
- Only use device indoor, avoid contact with water or other liquids.
- Only operate the fixture after having checked that the housing is firmly closed and all screws are tightly fastened.
- Avoid flames and do not put close to flammable liquids or gases.
- Always allow free air space of at least 50 cm around the unit for ventilation.
- Always disconnect power from the mains, when device is not used or before cleaning! Only handle the power-cord by the plug. Never pull out the plug by tugging the power-cord.
- Make sure that the device is not exposed to extreme heat, moisture or dust.
- Make sure that the available voltage is not higher than stated on the rear panel.
- Make sure that the power-cord is never crimped or damaged. Check the device and the power-cord from time to time.
- If the external cable is damaged, it has to be replaced by a qualified technician.
- If the lens is obviously damaged, it has to be replaced. So that its functions are not impaired, due to cracks or deep scratches.
- If device is dropped or struck, disconnect mains power supply immediately. Have a qualified engineer inspect for safety before operating.
- If the device has been exposed to drastic temperature fluctuation (e.g. after transportation), do not switch it on immediately. The arising condensation water might damage your device. Leave the device switched off until it has reached room temperature.
- If your Showtec device fails to work properly, discontinue use immediately. Pack the unit securely (preferably in the original packing material), and return it to your Showtec dealer for service.
- For adult use only. Light effect must be installed out of the reach of children. Never leave the unit running unattended.
- For replacement use fuses of same type and rating only.
- The user is responsible for correct positioning and operating of the Ignitor-6 LED Strobe. The manufacturer will not accept liability for damages caused by the misuse or incorrect installation of this device.
- This device falls under protection class I. Therefore it is essential to connect the yellow/green conductor to earth.
- During the initial start-up some smoke or smell may arise. This is a normal process and does not necessarily mean that the device is defective.
- Repairs, servicing and electric connection must be carried out by a qualified technician.
- WARRANTY: Till one year after date of purchase.



**CAUTION ! EYEDAMAGES !**  
**Avoid looking directly into the light source.**  
**(meant especially for epileptics) !**



## OPERATING DETERMINATIONS

This device is not designed for permanent operation. Consistent operation breaks will ensure that the device will serve you for a long time without defects.

The minimum distance between light-output and the illuminated surface must be more than 0.5 meter.

The maximum ambient temperature  $t_a = 45^\circ\text{C}$  must never be exceeded.

The relative humidity must not exceed 50 % with an ambient temperature of  $45^\circ\text{C}$ .

If this device is operated in any other way, than the one described in this manual, the product may suffer damages and the warranty becomes void.

Any other operation may lead to dangers like short-circuit, burns, electric shock, crash etc.

*You endanger your own safety and the safety of others!*

## Rigging

*Please follow the European and national guidelines concerning rigging, trussing and all other safety issues.*

*Do not attempt the installation yourself !*

*Always let the installation be carried out by an authorized dealer !*

### Procedure:

- If the Ignitor-6 LED Strobe is lowered from the ceiling or high joists, professional trussing systems have to be used.
- Use a clamp to mount the Ignitor-6 LED Strobe, with the mounting-bracket, to the trussing system.
- The Ignitor-6 LED Strobe must never be fixed swinging freely in the room.
- The installation must always be secured with a safety attachment, e.g. an appropriate safety net or safety-cable.
- When rigging, derigging or servicing the device, always make sure, that the area below the installation place is blocked and staying in the area is forbidden.

*Improper installation can cause serious damage to people and property !*

## Connection with the mains

Connect the device to the mains with the power-plug.

Always pay attention, that the right color cable is connected to the right place.

| International   | EU Cable     | UK Cable | US Cable      | Pin   |
|---|--------------|----------|---------------|-------|
| L   | BROWN        | RED      | YELLOW/COPPER | FASE  |
| N   | BLUE         | BLACK    | SILVER        | NUL   |
|  | YELLOW/GREEN | GREEN    | GREEN         | EARTH |

Make sure that the device is always connected properly to the earth!

## **⚠ Return Procedure ⚠**

Returned merchandise must be sent prepaid and in the original packing, call tags will not be issued. Package must be clearly labeled with a Return Authorization Number (RMA number). Products returned without an RMA number will be refused. Highlite will not accept the returned goods or any responsibility. Call Highlite 0031-455667723 or mail [aftersales@highlite.nl](mailto:aftersales@highlite.nl) and request an RMA prior to shipping the fixture. Be prepared to provide the model number, serial number and a brief description of the cause for the return. Be sure to properly pack fixture, any shipping damage resulting from inadequate packaging is the customer's responsibility. Highlite reserves the right to use its own discretion to repair or replace product(s). As a suggestion, proper UPS packing or double-boxing is always a safe method to use.

**Note: If you are given an RMA number, please include the following information on a piece of paper inside the box:**

- 1) Your name
- 2) Your address
- 3) Your phone number
- 4) A brief description of the symptoms

## **Claims**

The client has the obligation to check the delivered goods immediately upon delivery for any shortcomings and/or visible defects, or perform this check after our announcement that the goods are at their disposal. Damage incurred in shipping is the responsibility of the shipper; therefore the damage must be reported to the carrier upon receipt of merchandise.

It is the customer's responsibility to notify and submit claims with the shipper in the event that a fixture is damaged due to shipping. Transportation damage has to be reported to us within one day after receipt of the delivery.

Any return shipment has to be made post-paid at all times. Return shipments must be accompanied with a letter defining the reason for return shipment. Non-prepaid return shipments will be refused, unless otherwise agreed in writing.

Complaints against us must be made known in writing or by fax within 10 working days after receipt of the invoice. After this period complaints will not be handled anymore.

Complaints will only then be considered if the client has so far complied with all parts of the agreement, regardless of the agreement of which the obligation is resulting.



# Description of the device

## Features

The Showtec Ignitor-6 LED Strobe is a light effect with high output and great effects.

- LED System: Cool White
- Power Supply: 100-240V AC
- Peak Power 87 Watt
- Continuous Power 46 Watt
- Drive Current: 340mA
- Refresh rate: 500Hz
- Power Connectors: IEC
- 3-pin DMX In and 3-pin DMX Out
- Clear LCD display for all settings
- Beam Angle: 62 degrees
- DMX-controlled
- DMX channels: 7
- Dimmer: 0-100%
- Strobe: 0-20Hz
- Compact strong metal housing
- Cooling: Aluminum Housing
- Control: Auto, Built-in Programs, Sound-controlled, Master/Slave, DMX
- Music-controlled via built-in microphone
- Fuse 1A / 250V

## Overview



Fig. 1

## Backside

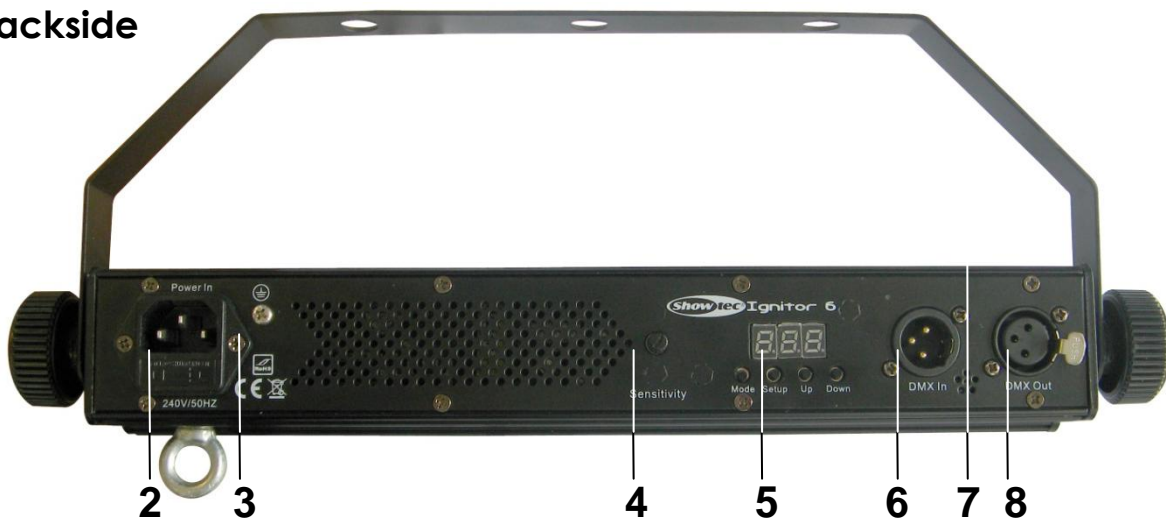

Fig. 2

- 1) Mountingbracket
- 2) IEC Powerconnector + Fuse 1A/250V
- 3) Earth connection
- 4) Sensitivity

- 5) LCD Display + Menu Buttons
- 6) 3-pin DMX In
- 7) Safety Eye
- 8) 3-pin DMX Out



## Installation

Remove all packing materials from the Ignitor-6 LED Strobe. Check that all foam and plastic padding is removed. Connect all cables.

**Always disconnect from electric mains power supply before cleaning or servicing.**  
**Damages caused by non-observance are not subject to warranty.**

## Set Up and Operation

Before plugging the unit in, always make sure that the power supply matches the product specification voltage. Do not attempt to operate a 120V specification product on 230V power, or vice versa.

Connect the device to the main power supply. The device can be music-controlled by its built-in microphone.

## Control Modes

There are 5 modes:

- Built-in programs
- Auto run (visual effects)
- Sound-controlled
- Master/Slave
- DMX512

### One Ignitor-6 LED Strobe (Built-in Programs)

1. Fasten the effect light onto firm trussing. Leave at least 0,5 meter on all sides for air circulation.
2. When the Ignitor-6 LED Strobe is not connected by a DMX-cable, it functions as a stand-alone device. Please see page 12 for more information about the built-in programs.

### One Ignitor-6 LED Strobe (Auto run visual effects)

1. Fasten the effect light onto firm trussing. Leave at least 0,5 meter on all sides for air circulation.
2. When the Ignitor-6 LED Strobe is not connected by a DMX-cable, it functions as a stand-alone device. Please see page 12 for more information about the Auto run visual effects.

### One Ignitor-6 LED Strobe (Sound-control)

1. Plug the end of the electric mains power cord into a proper electric power supply socket.
2. Turn on the music. If the device is set to **5d1** or **5d2**, then the Ignitor-6 LED Strobe will react to the beat of the music. Please see page 12 for more information about the sound-control options.

### Multiple Ignitor-6 LED Strobes (Master/Slave control)

1. Fasten the effect light onto firm trussing. Leave at least 0,5 meter on all sides for air circulation.
2. Use a 3-p XLR cable to connect the Ignitor-6 LED Strobe.

The pins:



1. Earth
2. Signal -
3. Signal +

3. Link the units as shown in (Fig. 3), Connect a DMX signal cable from the first unit's DMX "out" socket to the second unit's "in" socket. Repeat this process to link the second, third, and fourth units. You can use the same functions on the master device as described on page 12 (Brightness, Built-in Programs, Autorun or Music control Mode 1+2). This means on the master device you can set your desired operation Mode and all slave devices will react the same as the master device.

### Multiple Ignitor-6 LED Strobes (Master/Slave control)

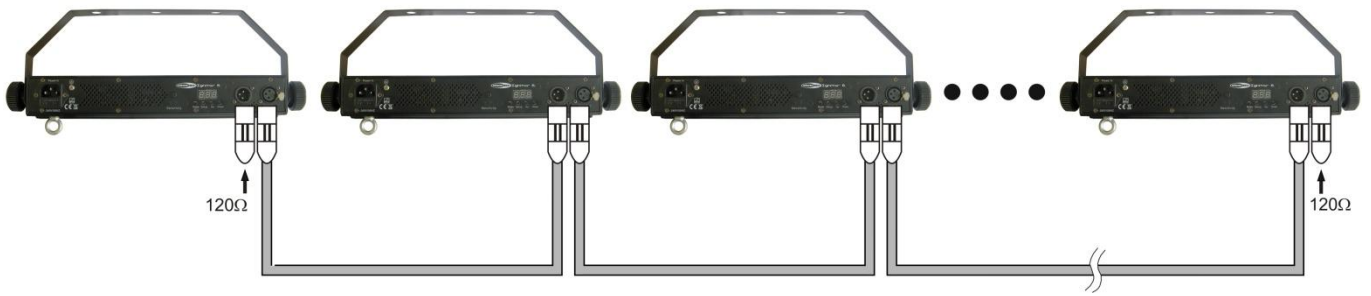

Fig. 3

### Multiple Ignitor-6 LED Strobe (DMX Control)

1. Plug the end of the electric mains power cord into a proper electric power supply socket.
2. Use a 3-p XLR cable to connect the Ignitor-6 LED Strobes.
3. Link the units as shown in (figure 4), Connect a DMX signal cable from the first unit's DMX "out" socket to the second unit's "in" socket. Repeat this process to link the second, third, and fourth units.
4. Supply electric power: Plug the end of the mains power cord into proper electric power supply sockets. Do so for all units and the controller.

### Multiple Ignitor-6 LED Strobes Pro Set Up



Max. 30 Ignitor-6 LED Strobes

Fig. 4

**Note : Link all DMX cables and set dip switches before connecting electric power**

5. Do not supply power before the whole system is set up and connected properly. Design your show according to your DMX controller functions. See page 12 for more about DMX programming.

## Fixture Linking

You will need a serial data link to run light shows of one or more fixtures using a DMX-512 controller or to run synchronized shows on two or more fixtures set to a master/slave operating mode. The combined number of channels required by all the fixtures on a serial data link determines the number of fixtures the data link can support.

**Important:** Fixtures on a serial data link must be daisy chained in one single line. To comply with the EIA-485 standard no more than 30 devices should be connected on one data link. Connecting more than 30 fixtures on one serial data link without the use of a DMX optically isolated splitter may result in deterioration of the digital DMX signal.



Maximum recommended DMX data link distance: 100 meters  
Maximum recommended number of Ignitor-6 LED Strobes on a DMX data link: 30 fixtures

## Data Cabling

To link fixtures together you must obtain data cables. You can purchase DAP Audio certified DMX cables directly from a dealer/distributor or construct your own cable. If you choose to create your own cable please use data-grade cables that can carry a high quality signal and are less prone to electromagnetic interference.

### DAP Audio Certified DMX Data Cables

- DAP Audio Basic microphone cable for allround use. bal. XLR/M 3 p. > XLR/F 3 p.  
**Ordercode** FL01150 (1,5m.), FL013 (3m.), FL016 (6m.), FL0110 (10m.), FL0115 (15m.), FL0120 (20m.).
- DAP Audio cable for the demanding user with exceptional audio-qualities and connector made by Neutrik®. **Ordercode** FL71150 (1,5m.), FL713 (3m.), FL716 (6m.), FL7110 (10m.).

## Control Panel

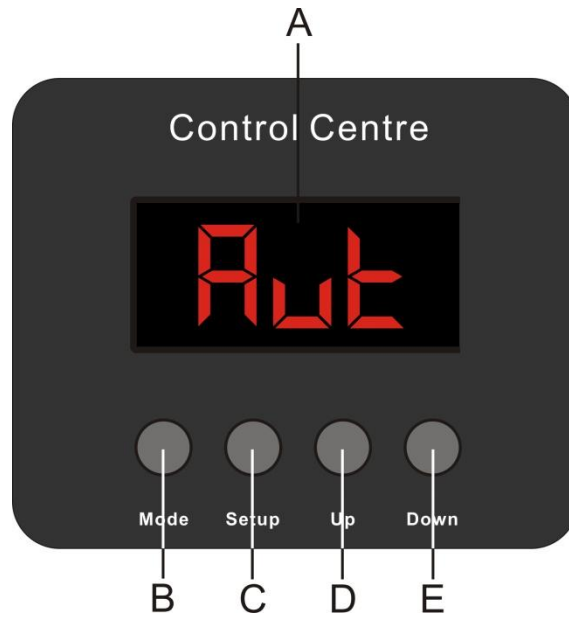

Fig. 5

- A. LED Display
- B. MODE Button
- C. SETUP Button

- D. Up Button
- E. Down Button

## Control Mode

The fixtures are individually addressed on a data-link and connected to the controller. The fixtures respond to the DMX signal from the controller.

### DMX Addressing

The control panel on the front side of the base allows you to assign the DMX fixture address, which is the first channel from which the Ignitor-6 LED Strobe will respond to the controller.

Please note when you use the controller, the unit has max. **7** channels.

When using multiple Ignitor-6 LED Strobe's, make sure you set the DMX addresses right.

Therefore, the DMX address of the first Ignitor-6 LED Strobe should be **1(001)**; the DMX address of the second Ignitor-6 LED Strobe should be **1+7=8**; the DMX address of the third Ignitor-6 LED Strobe should be **8+7=15**, etc.

Please, be sure that you don't have any overlapping channels in order to control each Ignitor-6 LED Strobe correctly. If two or more Ignitor-6 LED Strobe's are addressed similarly, they will work similarly. For address settings, please refer to the instructions under "Addressing" (menu d - -).

### Controlling:

After having addressed all Ignitor-6 LED Strobes, you may now start operating these via your lighting controller.

**Note:** After switching on, the Ignitor-6 LED Strobe will automatically detect whether DMX 512 data is received or not.

The problem may be:

- The XLR cable from the controller is not connected with the input of the Ignitor-6 LED Strobe.
- The controller is switched off or defective, the cable or connector is defective, or the signal wires are swapped in the input connector.

**Note:** It's necessary to insert a XLR termination plug (with 120 Ohm) in the last fixture in order to ensure proper transmission on the DMX data link.

### **⚠ Display Off after 20 seconds ⚠**

When no button is pressed for 20 seconds, the display will dim. The display will light up, when one of the four buttons is pressed again.

## Menu Overview

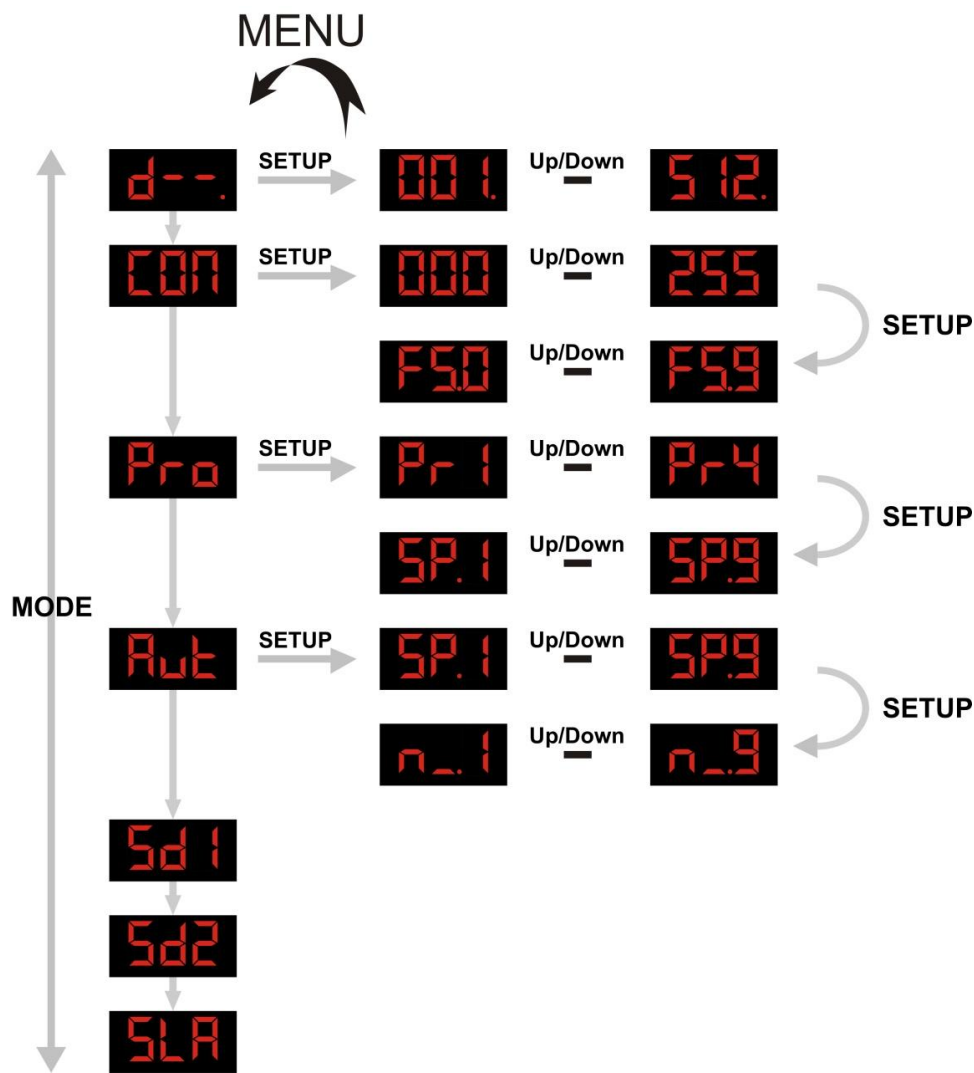

## Main Menu Options

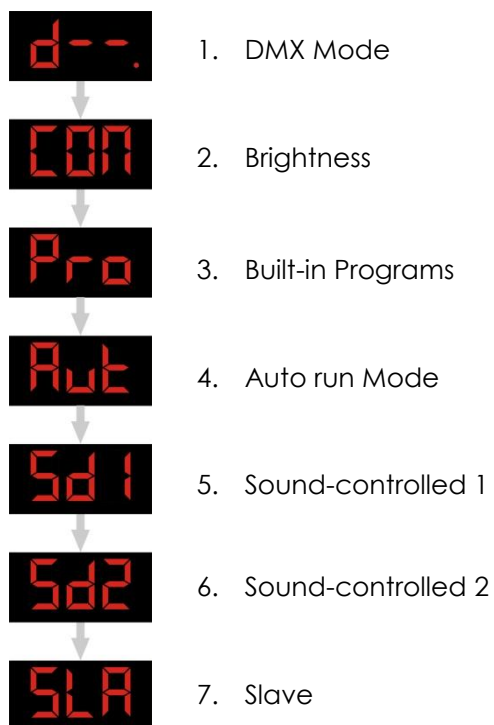

The Ignitor 6 will only show its version number at start-up ! 

### 1. DMX Mode

With this menu you can set the DMX address.

1) Press the **MODE** button, until the display shows .

2) You can choose 512 different DMX addresses.

Use the Up / Down buttons to select the required address from  Up/Down .

### 2. Brightness

With this menu you can set the Brightness of the Ignitor.

1) Press the **MODE** button on the device, until the display shows .

2) Press **Setup** to enter the BRIGHTNESS Menu. You can choose 2 different sub menus.

 Up/Down  Brightness from 000-255

 Up/Down  Strobe Speed from 0-9

Use the **Setup** button to scroll through the menu.

Use the Up / Down buttons to select the value of the brightness or the strobe speed.

### 3. Built-in Programs

1) Press the **MODE** button on the device, until the display shows .

2) With this menu you can set the Built-in Program Mode of the Ignitor-6 LED Strobe.

You can choose 4 built-in programs  Up/Down , by using the Up / Down buttons.

3) Press **Setup** to enter the desired built-in programs Menu. You can choose the speed of each program.

 Up/Down  Speed from 1-9

Use the Up / Down buttons to select the required speed.

### 4. Auto Run Program

1) Press the **MODE** button on the device, until the display shows .

2) With this menu you can set the Auto Mode of the Ignitor-6 LED Strobe.

3) Press **Setup** to enter the AUTO Menu. You can choose 2 different sub menus.

 Up/Down  Number of Loops from 1-9

 Up/Down  Speed from 1-9

Use the **Setup** button to scroll through the menu.

Use the Up / Down buttons to select the number of loops or the strobe speed.

### 5. Sound control Mode 1

1) Press the **MODE** button on the device, until the display shows . Turn on the music and the LED Ignitor-6 LED Strobe will react to the beat of the music.

2) Use the sensitivity control on the backside to adjust the sensitivity of the Ignitor-6 LED Strobe.

In **Sound Mode 1**, the Ignitor-6 LED Strobe will carry out one single step. If there is no sound for 5 seconds, the light will dim.

### 6. Sound control Mode 2

1) Press the **MODE** button on the device, until the display shows . Turn on the music and the LED Ignitor-6 LED Strobe will react to the beat of the music.

2) Use the sensitivity control on the backside to adjust the sensitivity of the Ignitor-6 LED Strobe.

In **Sound Mode 2**, the Ignitor-6 will strobe once. The louder the music, the more the Ignitor-6 LED will strobe.

### 7. Slave Mode

When the display shows : , the device is a slave device. It will now react the same as its master.

# DMX Channel Setting

## DMX Protocol 7 Channels

**Channel 1 – Dimmer Part 1 (when CH7 is set between 0-34 ⚠ )**

|       |                           |
|-------|---------------------------|
| 0-255 | Brightness from 0 to 100% |
|-------|---------------------------|

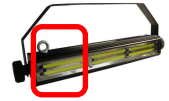

**Channel 1 – Master Dimmer Part 1, 2 and 3 (when CH7 is set between 35-69 ⚠ )**

|       |                           |
|-------|---------------------------|
| 0-255 | Brightness from 0 to 100% |
|-------|---------------------------|



**Channel 1 – Speed (when CH7 is set between 70-209 ⚠ )**

|       |                         |
|-------|-------------------------|
| 0-255 | Speed from slow to fast |
|-------|-------------------------|

**Channel 1 – No Function (when CH7 is set between 210-255 ⚠ )**

**Channel 2 – Strobe Part 1 (when CH7 is set between 0-34 ⚠ )**

|       |                                   |
|-------|-----------------------------------|
| 0-255 | Flash frequency from slow to fast |
|-------|-----------------------------------|



**Channel 2 – Strobe Part 1, 2 and 3 (when CH7 is set between 35-69 ⚠ )**

|       |                                   |
|-------|-----------------------------------|
| 0-255 | Flash frequency from slow to fast |
|-------|-----------------------------------|



**Channel 2 – No Function (when CH7 is set between 70-255 ⚠ )**

**Channel 3 – Dimmer Part 2 (when CH7 is set between 0-34 ⚠ )**

|       |                           |
|-------|---------------------------|
| 0-255 | Brightness from 0 to 100% |
|-------|---------------------------|



**Channel 3 – No Function (when CH7 is set between 35-255 ⚠ )**

**Channel 4 – Strobe Part 2 (when CH7 is set between 0-34 ⚠ )**

|       |                                   |
|-------|-----------------------------------|
| 0-255 | Flash frequency from slow to fast |
|-------|-----------------------------------|



**Channel 4 – No Function (when CH7 is set between 35-255 ⚠ )**

**Channel 5 – Dimmer Part 3 (when CH7 is set between 0-34 ⚠ )**

|       |                           |
|-------|---------------------------|
| 0-255 | Brightness from 0 to 100% |
|-------|---------------------------|



**Channel 5 – No Function (when CH7 is set between 35-255 ⚠ )**

**Channel 6 – Strobe Part 3 (when CH7 is set between 0-34 ⚠ )**

|       |                                   |
|-------|-----------------------------------|
| 0-255 | Flash frequency from slow to fast |
|-------|-----------------------------------|



**Channel 6 – No Function (when CH7 is set between 35-255 ⚠ )**

### Channel 7 – Built-in Programs

|         |   |
|---------|---|
| 0-34    | Dimmer & Strobe Mode (part1, 2 and 3 controlled separately) |
| 35-69   | Dimmer & Strobe Mode (part1, 2 and 3 controlled together)   |
| 70-104  | Program 1   |
| 105-139 | Program 2   |
| 140-174 | Program 3   |
| 175-209 | Program 4   |
| 210-244 | Sound-controlled Mode 1                                     |
| 245-255 | Sound-controlled Mode 2                                     |

**Note:**

When CH7 is set to 0-34, CH1, CH3 and CH5 control the dimmer of all 3 Ignitor parts separately from closed to open.

When CH7 is set to 0-34, CH2, CH4 and CH6 control the strobe of all 3 Ignitor parts separately from slow to fast.

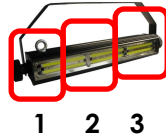

When CH7 is set to 35-69, CH1 controls the dimmer of the entire Ignitor 6 from closed to open.  
When CH7 is set to 35-69, CH2 controls the strobe of the entire Ignitor 6 from slow to fast.



## Maintenance

The Showtec Ignitor-6 LED Strobe requires almost no maintenance. However, you should keep the unit clean. Otherwise, the fixture's light-output will be significantly reduced. Disconnect the mains power supply, and then wipe the cover with a damp cloth. Do not immerse in liquid. Wipe lens clean with glass cleaner and a soft cloth. Do not use alcohol or solvents. Keep connections clean. Disconnect electric power, and then wipe the connections with a damp cloth. Make sure connections are thoroughly dry before linking equipment or supplying electric power.

The operator has to make sure that safety-relating and machine-technical installations are to be inspected by an expert after every four years in the course of an acceptance test.

The operator has to make sure that safety-relating and machine-technical installations are to be inspected by a skilled person once a year.

The following points have to be considered during the inspection:

1. All screws used for installing the device or parts of the device have to be tightly connected and must not be corroded.
2. There may not be any deformations on housings, fixations and installation spots.
3. Mechanically moving parts like axles, eyes and others may not show any traces of wearing.
4. The electric power supply cables must not show any damages or material fatigue.

## Replacing a Fuse

Power surges, short-circuit or inappropriate electrical power supply may cause a fuse to burn out. If the fuse burns out, the product will not function whatsoever. If this happens, follow the directions below to do so.

1. Unplug the unit from electric power source.
2. Insert a screwdriver into the slot in the fuse cover. Gently pry up the fuse cover. The fuse will come out.
3. Remove the used fuse. If brown or unclear, it is burned out.
4. Insert the replacement fuse into the holder where the old fuse was. Reinsert the fuse cover. Be sure to use a fuse of the same type and specification. See the product specification label for details.



## Troubleshooting

This troubleshooting guide is meant to help solve simple problems.

If a problem occurs, carry out the steps below in sequence until a solution is found. Once the unit operates properly, do not carry out following steps.

1. If the device does not operate properly, unplug the device.
2. Check the power from the wall, the fuse, all cables etc.
3. If all of the above appears to be O.K., plug the unit in again.
4. If you are unable to determine the cause of the problem, do not open the Ignitor-6 LED Strobe, as this may damage the unit and the warranty will become void.
5. Return the device to your Showtec dealer.

## No Light

This troubleshooting guide is meant to help solve simple problems. If a problem occurs, carry out the steps below in sequence until a solution is found. Once the unit operates properly, do not carry out following steps.

If the light effect does not operate properly, refer servicing to a technician.

Response: Suspect three potential problem areas: the power supply or the LEDs.

1. Power supply. Check that the unit is plugged into an appropriate power supply.
2. The LEDs. Return the Ignitor-6 LED Strobe to your Showtec dealer.
3. The fuse. Replace the fuse. See page 14 for replacing the fuse.

## No Response to DMX

Response: Suspect the DMX cable or connectors, a controller malfunction, a light effect DMX card malfunction.

1. Check the DMX cable: Unplug the unit; change the DMX cable; then reconnect to electrical power. Try your DMX control again.
2. Determine whether the controller or light effect is at fault. Does the controller operate properly with other DMX products ? If not, take the controller in for repair. If so, take the DMX cable and the light effect to a qualified technician.

| <b>Problem</b>  | <b>Probable cause(s)</b>   | <b>Remedy</b>   |
|---|--|---|
| One or more fixtures are completely dead.   | No power to the fixture  | · Check that power is switched on and cables are plugged in.  |
|   | Primary fuse blown.  | · Replace fuse.   |
| Fixtures reset correctly, but all respond erratically or not at all to the controller.  | The controller is not connected.   | · Connect controller.   |
|   | 3-pin XLR Out of the controller does not match XLR Out of the first fixture on the link (i.e. signal is reversed). | · Install a phase reversing cable between the controller and the first fixture on the link.   |
| Fixtures reset correctly, but some respond erratically or not at all to the controller. | Poor data quality  | · Check data quality. If much lower than 100 percent, the problem may be a bad data link connection, poor quality or broken cables, missing termination plug, or a defective fixture disturbing the link. |
|   | Bad data link connection   | · Inspect connections and cables. Correct poor connections. Repair or replace damaged cables.   |
|   | Data link not terminated with 120 Ohm termination plug.  | · Insert termination plug in output jack of the last fixture on the link.   |
|   | Incorrect addressing of the fixtures.  | · Check address setting.  |
|   | One of the fixtures is defective and disturbs data transmission on the link.                                       | · Bypass one fixture at a time until normal operation is regained: unplug both connectors and connect them directly together.<br>· Have the defective fixture serviced by a qualified technician.         |
|   | 3-pin XLR Out on the fixtures does not match (pins 2 and 3 reversed).  | · Install a phase-reversing cable between the fixtures or swap pin 2 and 3 in the fixture, that behaves erratically.  |
| No light  | The power supply settings do not match local AC voltage and frequency.   | · Disconnect fixture. Check settings and correct if necessary.  |
|   | LEDs damaged   | · Disconnect fixture and return to your dealer.   |
|   | The power supply settings do not match local AC voltage and frequency.   | · Disconnect fixture. Check settings and correct if necessary.  |

## Product Specification

Model: Showtec Ignitor-6 LED Strobe

LED System: Cool White

Power Supply: 100-240V AC

Peak Power 87 Watt

Continuous Power 46 Watt

Drive Current: 340mA

Refresh rate: 500Hz

Power Connectors: IEC

3-pin DMX In and 3-pin DMX Out

Clear LCD display for all settings

Beam Angle: 62 degrees

Control Mode: DMX 512

DMX-controlled

DMX channels: 7

Dimmer: 0-100%

Strobe: 0-20Hz

Compact strong metal housing

Cooling: Aluminum Housing

Control: Auto, Built-in Programs, Sound-controlled, Master/Slave, DMX

Music-controlled via built-in microphone

Fuse 1A / 250V

Dimensions: 385 x 142 x 60 mm

Weight: 1,26 kg

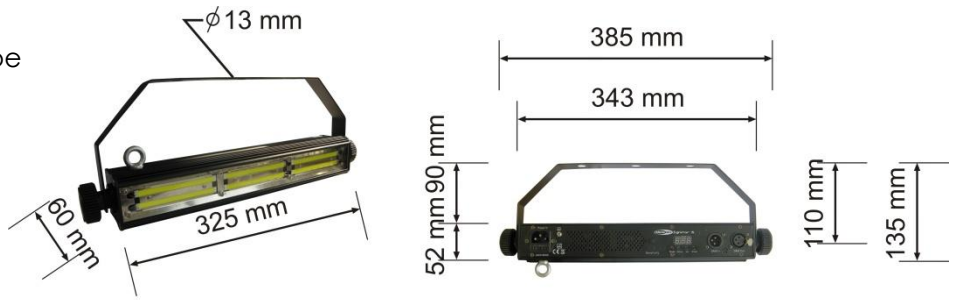

### Minimum distance:

Minimum distance from flammable surfaces: 0.5m

Minimum distance to lighted object: 0.8m

Design and product specifications are subject to change without prior notice.



Website: [www.Showtec.info](http://www.Showtec.info)

Email: [service@highlite.nl](mailto:service@highlite.nl)



© 2012 Showtec.