

mULTIDROP

YOU DREAM IT
MULTIDROP CREATES IT

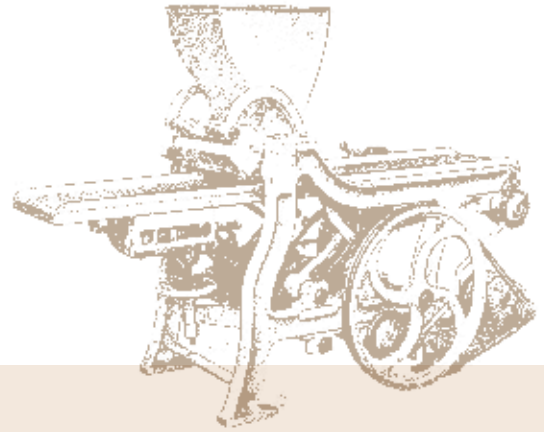

MODELS



For decades, the Multidrop has served bakers worldwide. The models (Classic and Compact) are available in a range of versions to accommodate individuals' unique needs. Some of the greatest pastry chefs the world choose the Multidrop for its versatility, consistency, reliability, and ability to create new ideas.



CLASSIC MODEL C

CLASSIC FAST

COMPACT



VERSIONS

FCC

FIXED TABLE
(adjustable by hand)

**Classic Models only*

DIE:
• FIXED
• WIRE CUT

FE

DIE:
• FIXED

FET

DIE:
• FIXED
• WIRE CUT

FR

DIE:
• FIXED
• TWISTING

FL

DIE:
• FIXED
• TWISTING
• WIRE CUT

Fixed die



Twisting die

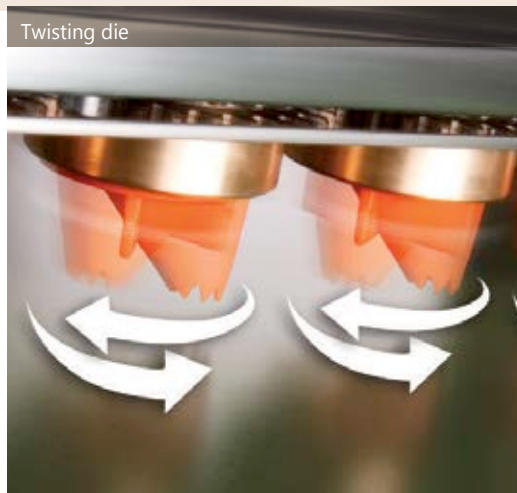

Wire-cut

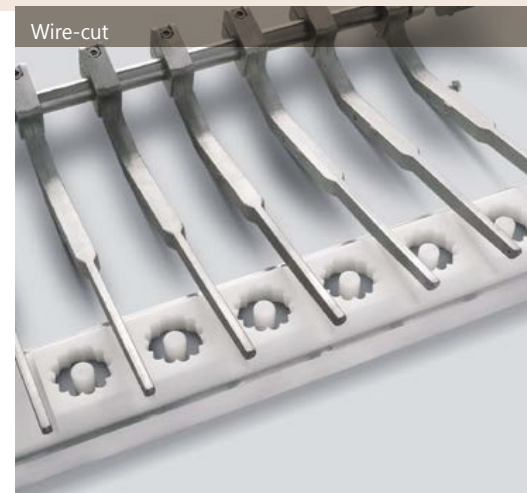

FXL

DIE:

- FIXED
- TWISTING
- WIRE CUT



The Multidrop at its best.

In addition to the varieties offered with the three types of dies, the ability to control the table's vertical motion as well as movement of the nozzles enables limitless creativity. You'll be able to invent the most creative shapes you wished, copying not only the horizontal movements of piping bag but also vertical ones. Release your creative energy.

COMPUTERISED MANAGEMENT OF MOTION:

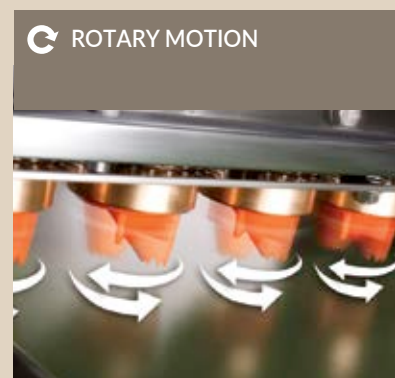
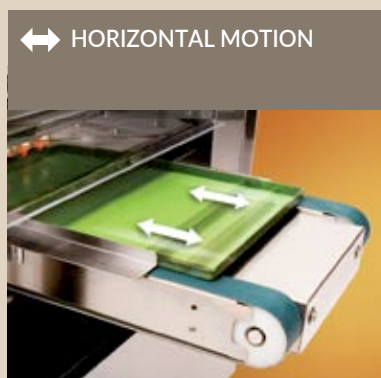
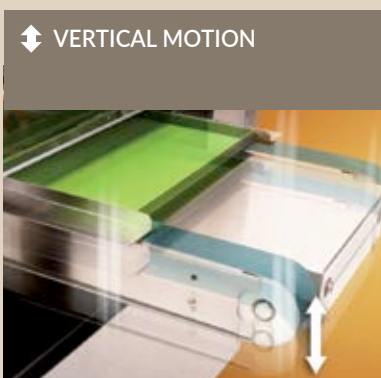

DOSING HEADS & DIES

HEADS

WITH ROLLERS FOR HARD DOUGHS



Fixed die



Twisting die



Wire cut

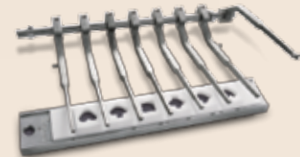

WITH ROLLERS WITH SIDE PANELS FOR SOFT DOUGHS



Fixed die



Twisting die

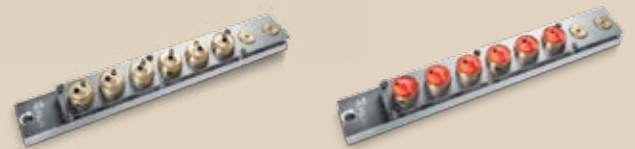

PUMP FOR SOFT AND LIQUID DOUGHS

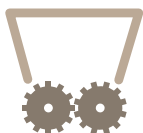

Fixed die



For sponge cake



VOLUMETRIC PUMP FOR SOFT AND LIQUID DOUGHS

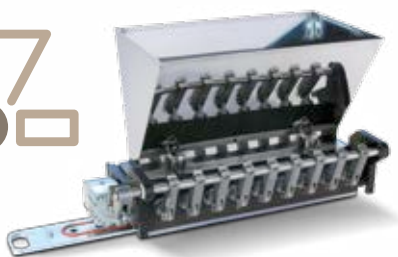

Fixed die



EQUIPMENT

HOPPERS: light, ergonomic, easy to handle, disassemble and clean.

ROLLERS HARD DOUGH HEAD: strengthened aluminium shoulders, grooved rollers in stainless steel. Equipped with self-lubricating teflon bushings which are easy to replace.

PUMP SOFT DOUGH HEAD: head jacket in strengthened aluminium, toothed gears in metal alloy.

VOLUMETRIC PUMP SOFT DOUGH HEAD: strengthened aluminium single piece with st/st independent cylinders. When weight precision must be perfect even with small particulates (e.g. fruit pieces, candied fruits, chocolate chips).

Rollers head for hard dough



Pump head for soft dough

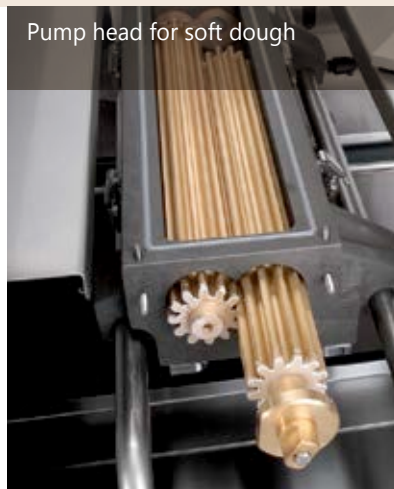

Volumetric pump head for soft dough



FULL CONTROL

INTUITIVE AND EASY-TO-USE TOUCH SCREEN DISPLAY

The Multidrop is equipped with advanced computer software which allows the creation and storing of many recipes. The computer, comprehensive but user friendly, allows you to control with precision every function of the machine.



USB CONNECTION

To download stored menus and back-up functional parameters.

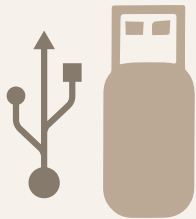

DISCOVER OUR GREAT RANGE OF PRODUCTS!



Cream injection die



Filler block



Belts



COMPACT
FE
FET
FR
FL
FXL

FAST
FE
FET
FR
FL
FXL



ROLLER HEAD FOR HARD DOUGH

Different nozzles and wire cut dies can be made on demand

FIXED DIE



P7



P8



P9



DR10



DR45



M22



M46



M60



M59



M61



M469



M450



M451



M452

FXL



M453 ⇕



M454 ⇕



M455 ⇕ ⇔



M456 ⇕ ⇔

Motion: ⇕ ⇔





FIXED DIE



P4



M32



DR33



DR34



M62



M63



M64



M457



M458

FXL



M459 ⇕



M460 ⇕



M461 ⇕ ↔



M462 ⇕ ↔

Motion: ⇕ ↔

FIXED DIE



P1 star



P1 smooth



P2 star



P2 smooth



P6 star



P6 smooth



P14 star right
P14 star left



P14 smooth right
P14 smooth left



P18 left
P18 right



P5



M75



M76



COMPACT
FE
FET
FR
FL
FXL

FAST
FE
FET
FR
FL
FXL

FIXED DIE



M77



M78



M79



M80



M81



M82



M83



M84



M85



M86



M88 star



M88 smooth



COMPACT
FE
FET
FR
FL
FXL

FAST
FE
FET
FR
FL
FXL

FIXED DIE



M89



M90



M302



M303



M304



M305



M306



M87



M313



M314



M402A



M404A



TWISTING DIE



P13



M65



M66



M67



M68



M69



M70



M463



M464



M465



M466



TWISTING DIE



M467



M15



M71



M468

TWISTING DIE



DR52



M469



M72

FXL



M470 ⇕ ↻



M471 ⇕ ↻



M472 ↔ ↻

Motion: ⇕ ↔ ↻



COMPACT
FET
FL
FXL

FAST
FET
FL
FXL

MODEL C
FCC



WIRE CUT

WIRE CUT



DR27



DR41



M100



M101



M102



M103



M130



M131



M133



M134



M135



M136



M135



M136



COMPACT
FET
FL
FXL

FAST
FET
FL
FXL

MODEL C
FCC

WIRE CUT



M137



M138



M139



M140



M144



M145



M146



M148



M149



M155



M159



M160



M159



M160



WIRE CUT

COMPACT
FET
FL
FXL

FAST
FET
FL
FXL

MODEL C
FCC



WIRE CUT

WIRE CUT



M161



M163



M164



M165



M166

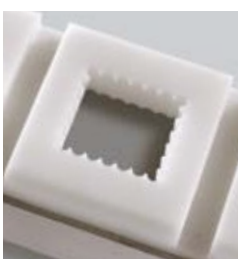

M167



M168



M169



M170



M171



M172



M173



M174



M175



COMPACT
FET
FL
FXL

FAST
FET
FL
FXL

MODEL C
FCC

WIRE CUT



M180



DR36



DR58 (Ø40)



DR58 (Ø40)



DR25 (Ø50)



DR25 (Ø50)

IF YOU MATCH SHAPES TOGETHER YOU CAN ACHIEVE ENDLESS CREATIVE SOLUTIONS...

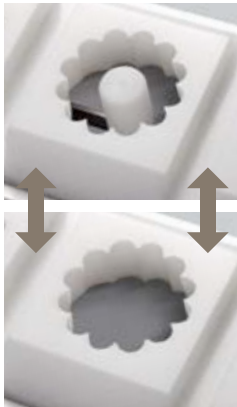

Matching
DR58 (Ø40)

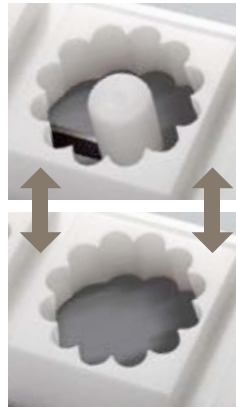

Matching
DR25 (Ø50)

DISCOVER ALL
THE OTHER
SHAPES



WWW.MULTIDROP.IT



WIRE CUT



ROLLER HEAD

with side panels for soft dough

Different nozzles and wire cut dies can be made on demand

COMPACT
FE
FET
FR
FL
FXL

FAST
FE
FET
FR
FL
FXL

FIXED DIE



P3



P27



P28



P29



P30



P19



M28



M38



M104



M473



COMPACT
FE
FET
FR
FL
FXL

FAST
FE
FET
FR
FL
FXL

MODEL C
FCC



M105



M106



M107



M108



M109



M110

FXL



M200 ⇕



M201 ⇕



M202 ⇕



M203 ⇕



M204 ⇕



M205 ⇕



M474 ⇕



M475 ⇕



M476 ⇕



M477 ⇕ ⇔



M478 ⇕ ⇔

Motion: ⇕ ⇔



FIXED DIE



P10



M111



M112



M479

FXL



M206 ↔



M207 ↔



M208 ⇕



M211 ⇕ ↔



M480 ⇕ ↔



M481 ⇕



M482 ⇕ ↔

*NO JUNIOR



M483 ⇕

Motion: ⇕ ↔

TWISTING DIE



M12



M484



M113



M116



M114



M117



M115

FXL



M209 ⇕ ⌚



M210 ⇕ ⌚



M485 ⇕ ⌚



M486 ⇕ ⌚ ⇔



M487 ⇕ ⌚ ⇔



M488 ⇕ ⌚ ⇔

Motion: ⇕ ⇔ ⌚





TWISTING DIE

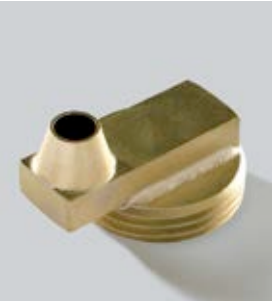

M121



M489

FXL



M212 ⇕ ⌚



M214 ⇕ ⌚



M213 ⇕ ⌚



M490 ⇕ ⌚



M491 ⇕ ⌚

Motion: ⇕ ⇔ ⌚

COMPACT

FR
FL
FXL

FAST

FR
FL
FXL

TWISTING DIE



P11



M118



M119



M120



M122



M494

FXL



M215 ⇕ ↻



M216 ⇕ ↻



M217 ⇕ ↻



M218 ⇕ ↻



M495 ⇔ ↻

Motion: ⇕ ⇔ ↻



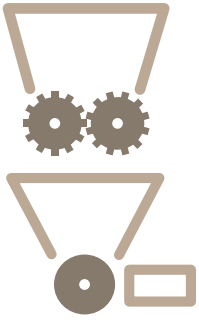

PUMP HEAD AND VOLUMETRIC PUMP HEAD FOR SOFT AND LIQUID DOUGHS

Different nozzles and wire cut dies can be made on demand

FIXED DIE



P20



M496



P21



M497



M498



P49



P25



M126





M499



P23



M17



M123



M124



M125



P37



M127

DIE FOR SPONGE CAKE



M4

TECHNICAL FEATURES

COMPACT

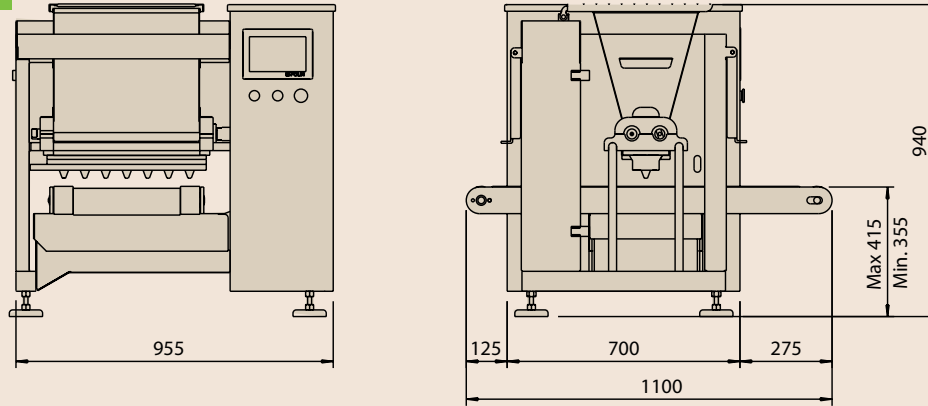

| | TRAY SIZE | | TECHNICAL FEATURES | | | | | PERFORMANCE | | DIMENSIONS AND WEIGHT | | |
|------------|-------------|--------------|--------------------|-------------|--------------|---------------|-------------------------|---------------------------|----------|-------------------------|-----|--|
| | Width mm | Length mm | Tension Volt | Power kW | Weight Kg | Capacity l | Noise level decibels | Depositing strokes/min | Wire-cut | Packaging | | |
| | | | | | | | | | | mm | kg | |
| FE | 400-460 | 400-700 | 220/3N~/60 | 1,1 | 190 | 35 | <70 | 20 | - | 1300 1200 h. 1250 | 260 | |
| FET | 400-460 | 400-700 | 220/3N~/60 | 1,1 | 200 | 35 | <70 | 20 | 30 | 1300 1200 h. 1250 | 270 | |
| FR | 400-460 | 400-700 | 220/3N~/60 | 1,3 | 200 | 35 | <70 | 20 | - | 1300 1200 h. 1250 | 270 | |
| FL | 400-460 | 400-700 | 220/3N~/60 | 1,3 | 210 | 35 | <70 | 20 | 30 | 1300 1200 h. 1250 | 280 | |
| FXL | 400-460 | 400-700 | 220/3N~/60 | 1,3 | 220 | 35 | <70 | 20 | 30 | 1300 1200 h. 1250 | 290 | |

CLASSIC TIPO C

CLASSIC FAST

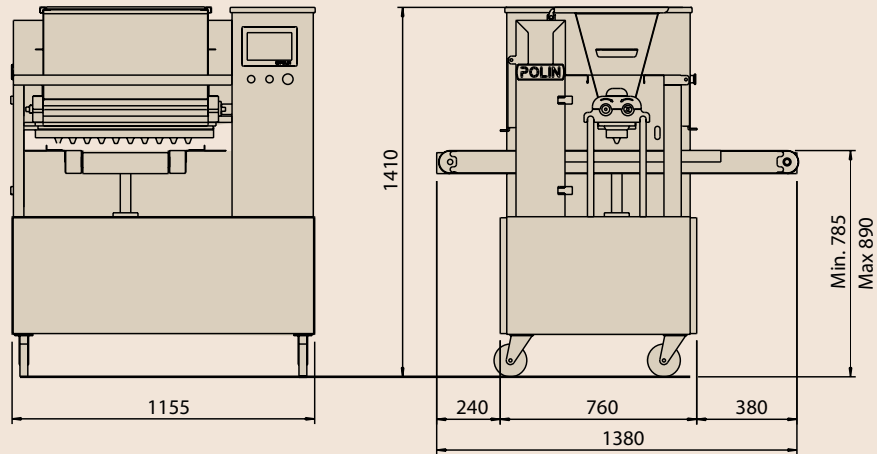

| | TRAY SIZE | | TECHNICAL FEATURES | | | | | PERFORMANCE | | DIMENSIONS AND WEIGHT | | |
|-----------------|-------------|--------------|--------------------|-------------|--------------|---------------|-------------------------|---------------------------|----------|-----------------------|---------|-----|
| | Width mm | Length mm | Tension Volt | Power kW | Weight Kg | Capacity l | Noise level decibels | Depositing strokes/min | Wire-cut | Packaging | | |
| | | | | | | | | | | mm | kg | |
| CLASSIC MODEL C | FCP | 400-460 | 400-800 | 220/3N~/60 | 0,6 | 235 | 35 | <70 | 20 | - | 1550 | 350 |
| | | 600-660 | | | | 1300 | | | | | | |
| | FCM | 400-460 | 400-800 | 220/3N~/60 | 0,6 | 240 | 35 | <70 | 20 | - | h. 1600 | 355 |
| | | 600-660 | | | | 1550 | | | | | | |
| | FCC | 400-460 | 400-800 | 220/3N~/60 | 0,6 | 240 | 35 | <70 | 20 | 30 | 1300 | 355 |
| | | 600-660 | | | | 1550 | | | | | | |
| CLASSIC FAST | FE | 400-460 | 400-800 | 220/3N~/60 | 1,7 | 300 | 35 | <70 | 26 | - | 1550 | 450 |
| | | 600-660 | | | | 305 | | | | | 1300 | |
| | FET | 400-460 | 400-800 | 220/3N~/60 | 1,7 | 310 | 35 | <70 | 26 | 35 | h. 1600 | 460 |
| | | 600-660 | | | | 315 | | | | | 1300 | |
| | FR | 400-460 | 400-800 | 220/3N~/60 | 2,0 | 310 | 35 | <70 | 26 | - | h. 1600 | 460 |
| | | 600-660 | | | | 315 | | | | | 1300 | |
| | FL | 400-460 | 400-800 | 220/3N~/60 | 2,0 | 320 | 35 | <70 | 26 | 35 | h. 1600 | 470 |
| | | 600-660 | | | | 325 | | | | | 1300 | |
| | FXL | 400-460 | 400-800 | 220/3N~/60 | 2,1 | 325 | 35 | <70 | 26 | 35 | h. 1600 | 475 |
| | | 600-660 | | | | 330 | | | | | 1300 | |
| | | | | | | | | | | | h. 1600 | 480 |

CARATTERISTICHE / FEATURES / CARACTERISTIQUES

| | JUNIOR | CLASSIC FAST | CLASSIC MODEL C |
|---|-------------------------|----------------|-----------------|
| Head width | 40-46 | 40-46-60-66 | 40-46-60-66 |
| St/st frame and pivoting wheels with brake | optional only with rack | ● | ● |
| Table easy and fast to disassemble | ● | ● | ● |
| Head easy to disassemble and clean | ● | ● | ● |
| St/st rollers head with adaptors for soft doughs | ● | ● | ● |
| Touch screen with TFT display 7" | ● | ● | ● |
| CE conformity declaration | ● | ● | ● |
| It's possible to use different heads to make different products | ● | ● | ● |
| Electronic speed variation of rollers rotation speed | ● | ● | ● |
| Nozzles rotation device | FR - FL - FXL | FR - FL - FXL | |
| Wire cut device | FET - FL - FXL | FET - FL - FXL | FCC |
| Automatic trays advancing with electronic | ● | | |
| High performing motor for trays advancing | | ● | ● |
| Motorised table positioning | | | |
| Automatic and motorised table positioning | ● | ● | |
| Back&Forth Drive System | FXL | FXL | |
| Reduced length table with foldable extensions | | | |

* Decorations, toppings, matchings are hand-made / Lady fingers are dropped into trays with moulds / Madeleinettes and plum cakes are dropped into trays with moulds

The art of baking since 1929

We represent the largest Italian industrial market in building ovens and machinery for bread pastries and cookies.

We entirely produce the most complete high quality range for the modern "Art of Baking" laboratory. We have introduced important technological innovations for over eightyfive years worldwide.



Immagini, misure e dati, tecnici non sono impegnativi, quindi soggetti a modifiche senza obbligo di preavviso. / Images, measurements and specifications are not binding and therefore subject to changes without obligation of notice. / Les images, les dimensions et les données techniques n'engagent pas la société Polin et sont donc sujettes à des modifications sans obligation de préavis.



ProBAKE, Inc.

2057 East Aurora Road - Twinsburg, OH 44087 - Tel. 330 425 4427 - Fax 330 425 9742

www.probake.com - probake@probake.com