

### Overview

### HPE ProLiant ML350 Generation9 (Gen9)

The ML350 Gen9 is the 2P premium server which delivers a class-leading combination of performance, availability, expandability, manageability, reliability and serviceability making it the choice for remote offices, growing businesses and data centers.

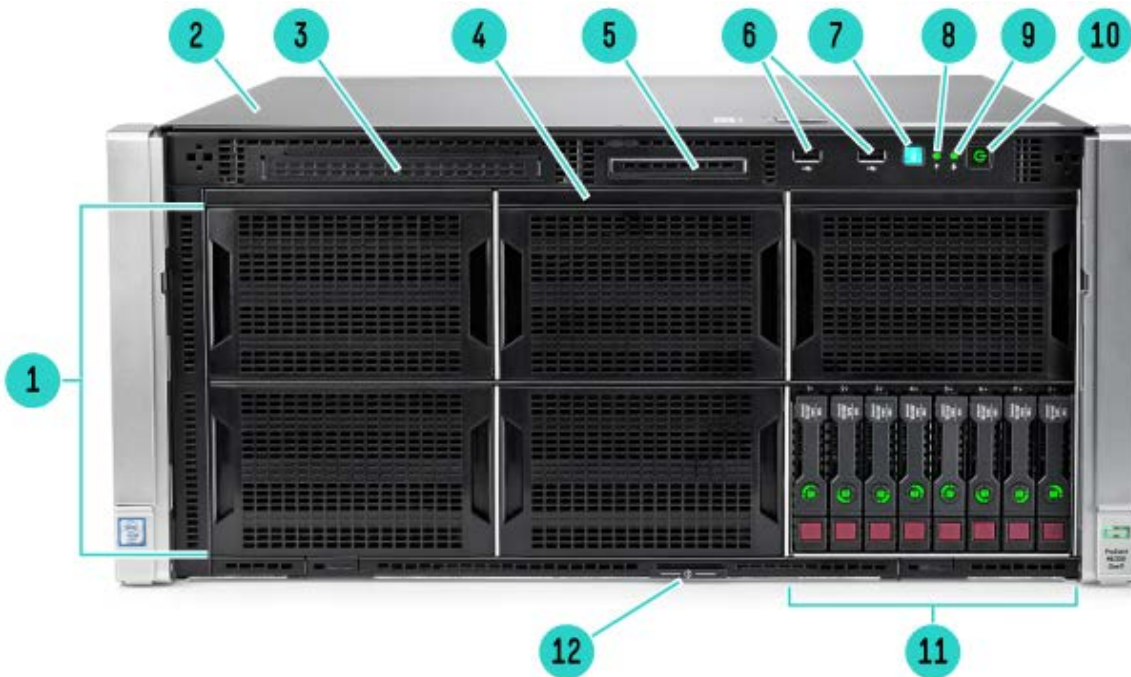

### Front View Rack Model (SFF)

- |    |  |    |  |
|----|--|----|--|
| 1  | Optional HDD cage Drive Cage Bays (Rack shown with blanks. Tower shown with 16 LFF Optional drives)  | 2  | Quick removal access panel   |
| 3  | Slim Height Drive Bay for Optional Slim Height SATA DVD-ROM or DVD RW Optical Drive (shown on Tower) | 4  | Media Drive Cage Bays – (Rack supports two half height or one full height device; Tower supports one half height device) |
| 5  | Systems Insight Display Bay for Optional SID (Rack models only)                                      | 6  | Two (2) USB 2.0 connectors   |
| 7  | Unit ID LED button   | 8  | Health LED   |
| 9  | NIC Activity LED   | 10 | Power On /Standby button & system power LED button   |
| 11 | Eight (8) SFF (Rack)/LFF (Tower) SAS/SATA HDD cage   | 12 | Serial label pull tab  |

## Overview

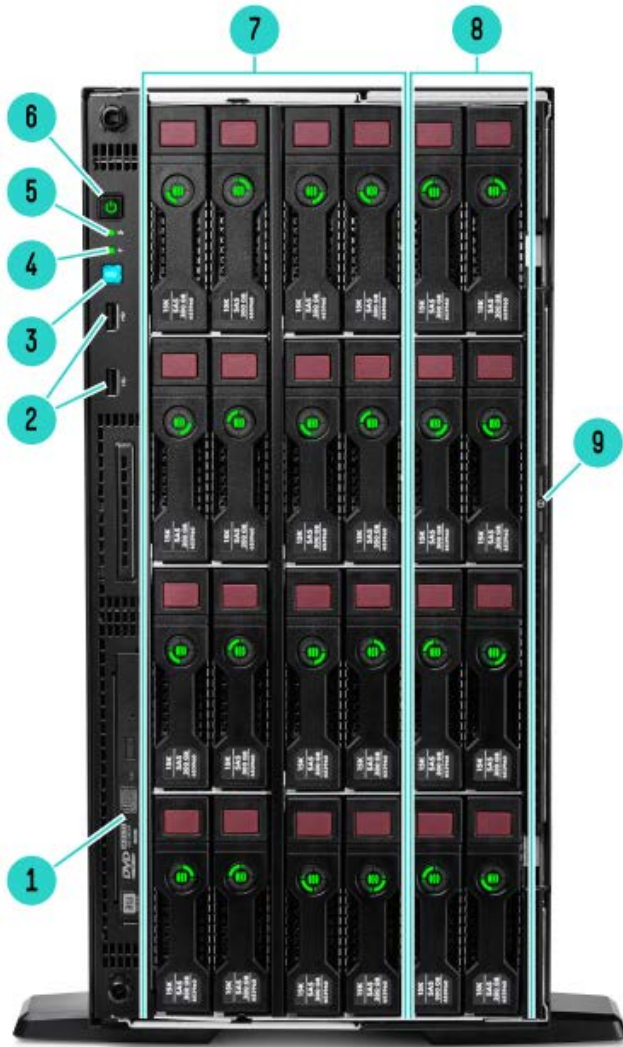

### Front View Tower Model (LFF)

- |   |   |   |  |
|---|---|---|--|
| 1 | Slim Height Drive Bay for Optional Slim Height SATA DVD-ROM or DVD RW Optical Drive                 | 2 | Two (2) USB 2.0 connectors                         |
| 3 | Unit ID LED button  | 4 | Health LED   |
| 5 | NIC Activity LED  | 6 | Power On /Standby button & system power LED button |
| 7 | Optional HDD cage Drive Cage Bays (Rack shown with blanks. Tower shown with 16 LFF Optional drives) | 8 | Eight (8) SFF (Rack)/LFF (Tower) SAS/SATA HDD cage |
| 9 | Serial label pull tab   |   |  |

## Overview

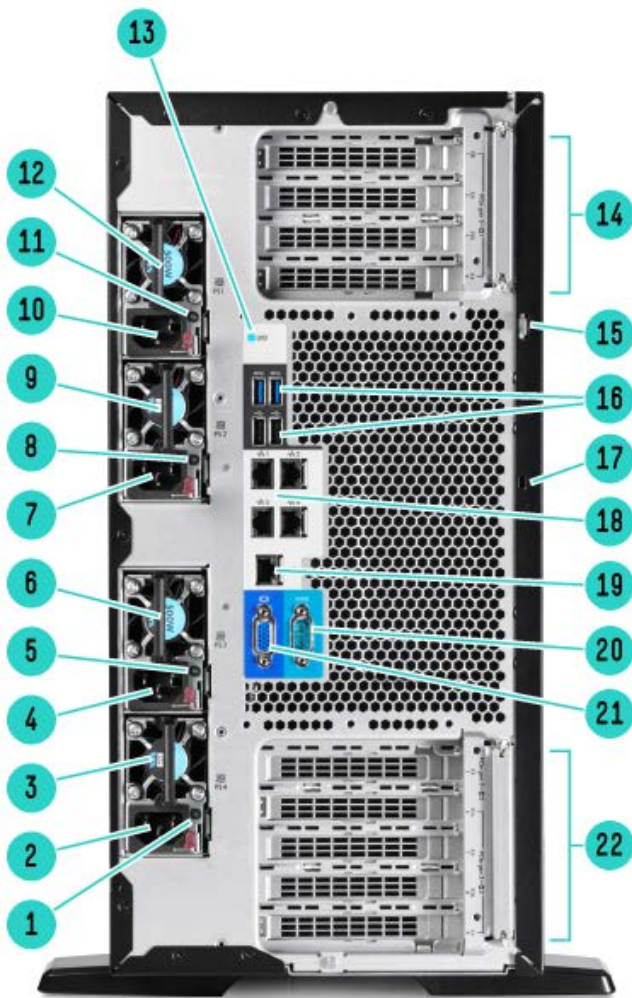

## Rear View (Tower Model)

- |    |  |    |  |
|----|--|----|--|
| 1  | Power supply Power LED   | 2  | Power supply Power connection  |
| 3  | HPE Flexible Slot 4 Power Supply (Optional - 500w Power Supply shown)  | 4  | Power supply Power connection  |
| 5  | Power supply Power LED   | 6  | HPE Flexible Slot 3 Power Supply (Optional - 500w Power Supply shown)                          |
| 7  | Power supply Power connection  | 8  | Power supply Power LED   |
| 9  | HPE Flexible Slot 2 Power Supply (Optional - 500w Power Supply shown)  | 10 | Power supply Power connection  |
| 11 | Power supply Power LED   | 12 | HPE Flexible Slot 1 Power Supply (Standard Entry Model - 500w Power Supply shown)              |
| 13 | Unit ID LED  | 14 | PCI Slots (Slots 1-4) Slot 1 and 3 can support Optional GPU                                    |
| 15 | Padlock  | 16 | USB 3.0 Connectors (2) top & USB 2.0 Connectors (2) bottom                                     |
|    | <b>NOTE: Chassis mechanical feature only to support Padlock.</b>   | 18 | Embedded 4 x 1GbE Network Adapter  |
|    | <b>NOTE: HPE do not offer padlock options or provide qualified part numbers. Customers will need to source from other 3rd party vendors to get this Hardware security feature enabled.</b> | 20 | Serial Connector   |
|    |  | 22 | PCI Slots (Slots 5-9) requires Optional second processor-Slot 6 and 8 can support Optional GPU |

## Overview

### 17 Kensington Security Lock

**NOTE:** Chassis mechanical feature only to support Kensington Security lock.

**NOTE:** HPE do not offer Kensington security lock options or provide qualified part numbers. Customers will need to source from other 3rd party vendors to get this Hardware security feature enabled.

### 19 Dedicated iLO Connector

### 21 Video Connector

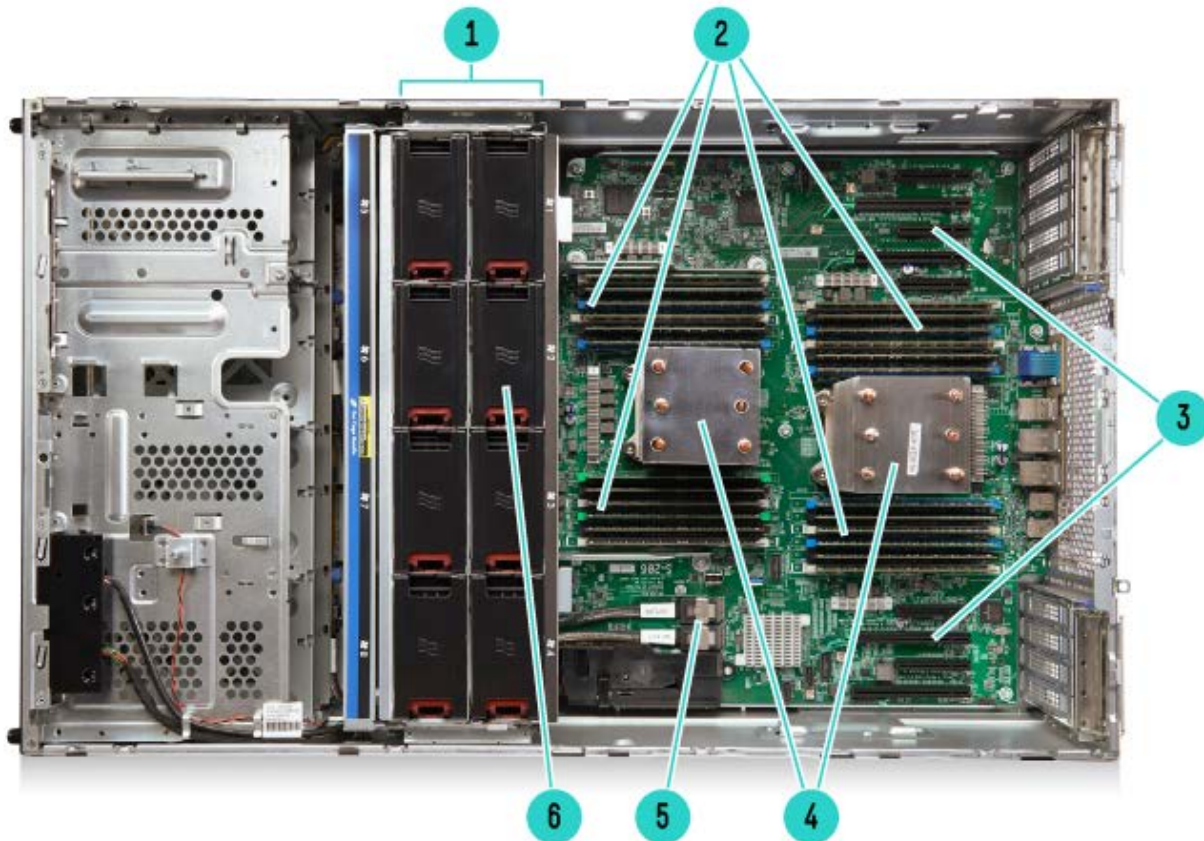

### Internal View (Rack Model)

- |   |  |   |  |
|---|--|---|--|
| 1 | System fans: Three (3) fans are standard Optional Five (5) systems fans are shown. | 2 | Twenty four DIMM slots: DDR4 Registered (RDIMM) or Load Reduced Registered (LRDIMM) memory |
| 3 | Nine (9) PCIe expansion slots (8 PCIe Gen3 and 1 PCIe Gen2)                        | 4 | Two (2) processors and heatsinks (Second Processor is Optional)                            |
| 5 | Optional HPE Flexible Smart Array or Smart HBA (not shown here)                    | 6 | Optional HPE Smart Storage Battery is under the system fans                                |

### What's New

- New 12 TB SAS and SATA LFF HDD option offering, maximum internal storage capacity up to 288 TB

## Standard Features

**NOTE:** For more information regarding Intel Xeon processors, please see the following <http://www.intel.com/xeon>.

**Processor**  
One of the following  
depending on model

Model	CPU frequency	Cores	L3 Cache	Power	QPI	DDR4 Hz
E5-2699v3	2.3GHz	18	45MB	145W	9.6GT/s	2133
E5-2698v3	2.3GHz	16	40MB	135W	9.6GT/s	2133
E5-2697v3	2.6GHz	14	35MB	145W	9.6GT/s	2133
E5-2695v3	2.3GHz	14	35MB	120W	9.6GT/s	2133
E5-2690v3	2.6GHz	12	30MB	135W	9.6GT/s	2133
E5-2683v3	2.0GHz	14	35MB	120W	9.6GT/s	2133
E5-2680v3	2.5GHz	12	30MB	120W	9.6GT/s	2133
E5-2670v3	2.3GHz	12	30MB	120W	9.6GT/s	2133
E5-2667v3	3.2GHz	8	20MB	135W	9.6GT/s	2133
E5-2660v3	2.6GHz	10	25MB	105W	9.6GT/s	2133
E5-2650v3	2.3GHz	10	25MB	105W	9.6GT/s	2133
E5-2650Lv3	1.8GHz	12	30MB	65W	9.6GT/s	2133
E5-2643v3	3.4GHz	6	20MB	135W	9.6GT/s	2133
E5-2640v3	2.6GHz	8	20MB	90W	8.0GT/s	1866
E5-2637v3	3.5GHz	4	15MB	135W	9.6GT/s	2133
E5-2630v3	2.4GHz	8	20MB	85W	8.0GT/s	1866
E5-2630Lv3	1.8GHz	8	20MB	55W	8.0GT/s	1866
E5-2623v3	3.0GHz	4	10MB	105W	8.0GT/s	1866
E5-2620v3	2.4GHz	6	15MB	85W	8.0GT/s	1866
E5-2609v3	1.9GHz	6	15MB	85W	6.4GT/s	1600
E5-2603v3	1.6GHz	6	15MB	85W	6.4GT/s	1600
E5-2699v4	2.2GHz	22	55MB	145W	9.6GT/s	2400
E5-2698v4	2.2GHz	20	50MB	135W	9.6GT/s	2400
E5-2697v4	2.3GHz	18	45MB	145W	9.6GT/s	2400
E5-2697Av4	2.6GHz	16	40MB	145W	9.6GT/s	2400
E5-2695v4	2.1GHz	18	45MB	120W	9.6GT/s	2400
E5-2690v4	2.6GHz	14	35MB	135W	9.6GT/s	2400
E5-2683v4	2.1GHz	16	40MB	120W	9.6GT/s	2400
E5-2680v4	2.4GHz	14	35MB	120W	9.6GT/s	2400
E5-2667v4	3.2GHz	8	25MB	135W	9.6GT/s	2400
E5-2660v4	2.0GHz	14	35MB	105W	9.6GT/s	2400
E5-2650v4	2.2GHz	12	30MB	105W	9.6GT/s	2400
E5-2650Lv4	1.7GHz	14	35MB	65W	9.6GT/s	2400
E5-2643v4	3.4GHz	6	20MB	135W	9.6GT/s	2400
E5-2640v4	2.4GHz	10	25MB	90W	8.0GT/s	2133
E5-2637v4	3.5GHz	4	15MB	135W	9.6GT/s	2400
E5-2630v4	2.2GHz	10	25MB	85W	8.0GT/s	2133
E5-2630Lv4	1.8GHz	10	25MB	55W	8.0GT/s	2133
E5-2623v4	2.6GHz	4	10MB	85W	8.0GT/s	2133
E5-2620v4	2.1GHz	8	20MB	85W	8.0GT/s	2133
E5-2609v4	1.7GHz	8	20MB	85W	6.4GT/s	1866
E5-2603v4	1.7GHz	6	15MB	85W	6.4GT/s	1866

## Standard Features

<b>Chipset</b>	Intel® C610 Series Chipset Intel® E5-2600v3 Processor Family Intel® E5-2600v4 Processor Family <b>NOTE:</b> For more information regarding Intel® chipsets, please see the following URL: <a href="http://www.intel.com/products/server/chipsets/">http://www.intel.com/products/server/chipsets/</a>	
<b>On System Management Chipset</b>	HPE iLO (Firmware HPE iLO4 2.0 or later) 4GB NAND <b>NOTE:</b> 1GB USB user space configurable via UEFI and accessible via iLO. Read and learn more in the <a href="#">iLO QuickSpecs</a> .	
<b>Memory</b>	Type: One of the following HPE SmartMemory depending on model	
	DDR4 Registered (RDIMM) or Load Reduced (LRDIMM) <b>NOTE:</b> The following shows the support with E5-2600v3 processors.	
	DIMM Slots Available	24 (12 DIMM slots per processor, 4 channels per processor, 3 DIMMs per channel)
	Maximum Capacity (LRDIMM)	1.5TB (24 x 64GB LRDIMM)
	Maximum Capacity (RDIMM)	768GB 24 x 32GB RDIMM
	<b>NOTE:</b> Refer to the Memory section in this document for more memory support detail.	
	Type: <b>NOTE:</b> The following shows the support with E5-2600v4 processors.	
	DIMM Slots Available	24 (12 DIMM slots per processor, 4 channels per processor, 3 DIMMs per channel)
	Maximum Capacity (LRDIMM)	3TB (24 x 128GB LRDIMM)
	Maximum Capacity (RDIMM)	768GB 24 x 32GB RDIMM
	<b>NOTE:</b> Refer to the Memory section in this document for more memory support detail.	
	<b>NOTE:</b> Mixing of 2133 and 2400MHz memory is not supported.	
<b>Memory Protection</b>	Advanced ECC	Advanced ECC uses single device data correction to detect and correct single and all multibit error that occurs within a single DRAM chip.
	Online spare	Memory online spare mode detects a rank that is degrading and switches operation to the spare rank.
<b>Network Controller</b>	HPE 1Gb Ethernet 4-port 331i Adapter	

### Expansion Slots

Expansion Slots #	Expansion Technology	Bus Width	Connector Width	Bus Number	Form Factor	Notes
9	PCIe 3.0	x4	x8		Full-height, full-length slot	For processor 2
8	PCIe 3.0	x16	x16		Full-height, full-length slot	For processor 2
7	PCIe 3.0	x4	x8		Full-height, full-length slot	For processor 2
6	PCIe 3.0	x16	x16		Full-height, full-length slot	For processor 2

## Standard Features

5	PCIe 2.0	x4	x8		Full-height, half-length slot	For processor 2
4	PCIe 3.0	x4	x8	0	Full-height, full-length slot	For processor 1
3	PCIe 3.0	x16	x16	0	Full-height, full-length slot	For processor 1
2	PCIe 3.0	x4	x8	0	Full-height, full-length slot	For processor 1
1	PCIe 3.0	x8	x16	0	Full-height, full-length slot	For processor 1

**NOTE:** Bus number - Default bus assignment (in decimal). Inserting cards with PCI bridges may alter the actual bus assignment number.

**NOTE:** Nine total expansion slots. Three PCIe 3.0 x16 (x16 speed); One PCIe 3.0 x16 (x8 speed); Four PCIe 3.0 x8 (x4 speed); One PCIe 2.0 x8 (x4 speed).

<b>Storage Controller</b> One of the following depending on model	Entry Models	HPE Dynamic Smart Array B140i Embedded SATA controller
	Base Models	HPE Flexible Smart Array P440ar/2GB
	Performance Models	HPE Flexible Smart Array P440ar/2GB

<b>Internal Storage Devices</b> One of the following depending on model	Optical Drive	Optional SATA 9.5mm DVD-ROM Optical Drive Optional SATA 9.5mm DVD RW Optical Drive <b>NOTE: Optical is optional in entry, base and performance BTO models.</b>
	Hard Drive Bays	8 Hot plug SFF SAS/SATA HDD bays; upgradable to 48 8 Hot plug LFF SAS/SATA HDD Bays; upgradable to 24 <b>NOTE: All Pre-configured Models come populated with some hard drive blanks installed. Should the customer need additional hard drive blanks, they can order more using either HPE SFF HDD Blank Kit (666987-B21) or HPE LFF HDD Blank Kit (666986-B21). These part numbers for single HDD blanks below are also provided should the customer require replacement HDD blanks for their server.</b>
	Hard Drives	None ship standard

Maximum Internal Storage	CAPACITY	CONFIGURATION	
One of the following depending on model	Hot Plug LFF SAS	288TB	24 x 12TB
	Hot Plug LFF SATA	288TB	24 x 12TB
	Hot Plug LFF SAS SSD	38.4TB	24 x 1.6TB
	Hot Plug LFF SATA SSD	92.16TB	24 x 3.84TB
	Hot Plug SFF SAS	96TB	48 x 2TB
	Hot Plug SFF SATA	96TB	48 x 2TB
	Hot Plug SFF SAS SSD	184.32TB	48 x 3.84TB
	Hot Plug SFF SATA SSD	184.32TB	48 x 3.84TB
	Hot Plug SFF NVMe PCIe SSD	7.2TB	6 x 1.2TB

<b>Power Supply</b> One of the following depending on model	HPE 500W Flex Slot Platinum Hot Plug Power Supply	<b>NOTE: The 500W Flex Slot PSU was not qualified or supported with the X4 RPS Enablement Kit.</b>
	HPE 800W Flex Slot Platinum Hot Plug Power Supply	
	HPE 1400W Flex Slot Platinum Plus Hot Plug Power Supply	
	HPE Flexible Slot (Flex Slot) Power Supplies share a common electrical and physical design that allows for hot plug, tool-less installation into HPE ProLiant Gen9 Performance Servers. Flex Slot power supplies	

## Standard Features

are certified for high-efficiency operation, allowing users to "right-size" a power supply for specific server configurations. This flexibility helps to reduce power waste, lower overall energy costs, and avoid "trapped" power capacity in the data center.

To review the power requirements for your selected system, please use the HPE Power Advisor Tool located at <http://www.hpe.com/info/hppoweradvisor>.

Power specifications and technical content for all HPE Server power supplies can be found at <http://www.hp.com/go/proliant/powersupply>.

System Fans	Non-redundant	Redundant
One of the following depending on model	3 fans	6 fans
1P model	3 fans	6 fans
	<b>NOTE:</b> Fan Redundancy is standard in performance model. ML350 Gen9 Redundant Fan option kit (725878-B21) consists of four system fans and two PCIe air baffles.	
	Non-redundant	Redundant
2P model	4 fans	8 fans
	<b>NOTE:</b> Refer to ML350 Gen9 User Guide for fan configuration rules.	

Interfaces		
Serial	1	
Video	1 (rear)	
Network RJ-45 (Ethernet)	4	
HPE iLO Remote Management Network Port	1 Gb Dedicated	
SD Slot	1 (internal)	
	<b>NOTE:</b> The Micro-SD slot is not a hot-pluggable device. Customers should not attempt to plug a Micro-SD card into the Micro-SD slot while the server is powered.	
USB 2.0 Ports	5 (2 front, 2 rear, 1 internal)	
USB 3.0	3 (2 rear, 1 internal)	

Operating Systems and Virtualization Software Support for ProLiant Servers	Microsoft Windows Server
	<b>Canonical Ubuntu</b>
	<b>Red Hat Enterprise Linux (RHEL)</b>
	<b>SUSE Linux Enterprise Server (SLES)</b>
	<b>VMware</b>
	<b>Citrix XenServer</b>
	<b>ClearOS</b>

**NOTE:** ClearOS allows you to build a fully functional server that is just right for you at no upfront cost. It is available via CTO preload, Intelligent Provisioning or via download. For more information on ClearOS, please visit <http://www.hpe.com/servers/clearos>.

**NOTE:** For more information on Hewlett Packard Enterprise Certified and Supported ProLiant Servers for OS and Virtualization Software and latest listing of software drivers available for your server, please visit our Support Matrix at: <http://www.hpe.com/info/ossupport> and our [driver download page](#)

Upgradeability	
	Upgradeable to 2 processors (up to 22 cores)
	<b>NOTE:</b> Total 4, 6, 8, 10, 12, 14, 16, 18, 20 & 22 cores.
	Up to 24 DIMM slots available for higher Memory capacity
	Up to 48 SFF Hard Drive Bays; Or 24 LFF Hard Drive Bays
	Up to 6 SFF NVMe PCIe SSD drives



## Standard Features

**NOTE:** The ML350 Gen9 6SFF Express Bay kit **MUST** be installed and it takes up one SFF drive cage space. For detail, refer to Express Bay kit and NVMe SSD section.

8 PCIe 3.0 and 1 PCIe 2.0 I/O slots for additional communications and storage expansion

4 redundant hot-plug power supplies

Redundant Fan

Optional optical drive (up to 1)

**NOTE:** Support of 9.5mm DVD-RW or DVD-ROM.

Optional SFF or LFF media bay kit to support RDX or tape device(s)

Tower to rack conversion

Optional System Insight Display

**NOTE:** Rack model only.

---

<b>Industry Standard Compliance</b>	<p>ACPI 2.0b Compliant</p> <p>PCIe 3.0 Compliant</p> <p>PXE Support</p> <p>WOL Support</p> <p>Novell Certified</p> <p>IPMI 2.0, SMASH CLP, DCMI 1.0 compliant</p> <p>Microsoft® Logo certifications</p> <p>USB 3.0 Support</p> <p>SMBIOS 2.7.1</p> <p>ASHRAE A3/A4</p> <p>Energy Star</p>
-------------------------------------	---

---

<b>Graphics</b>	<p>16 bit color: maximum resolution of 1920 x 1200</p> <p>Integrated Matrox G200 video standard</p> <p>32 bit color: maximum resolution of 1280 x 1024</p> <ul style="list-style-type: none"> <li>• 16 MB Flash</li> <li>• 256 MB DDR3</li> </ul>
-----------------	---

---

<b>HPE Server UEFI/Legacy ROM</b>	<p>Unified Extensible Firmware Interface (UEFI) is an industry standard that provides better manageability and more secured configuration than the legacy ROM while interacting with your server at boot time. HPE ProLiant Gen9 platform defaults to UEFI and can be factory or field configured for Legacy BIOS Boot Mode.</p>
-----------------------------------	--

**NOTE:** The UEFI System Utilities function is analogous to the HPE ROM-Based Setup Utility (RBSU) of legacy BIOS. For more information, please visit <http://www.hpe.com/servers/uefi>

UEFI enables numerous new capabilities specific to HPE ProLiant servers such as:

- Secure Boot
- Operating system specific functionality
- Support for > 2.2 TB (using GPT) boot drives
- USB 3.0 Stack
- Embedded UEFI Shell
- Mass Configuration Deployment Tool using RESTful API for iLO 4
- PXE boot support for IPv6 networks
- Boot support for option cards that only support a UEFI option ROM

## Standard Features

- Network Stack configurations

**NOTE:** For UEFI Boot Mode, boot environment and OS image installations should be configured properly to support UEFI.

**NOTE:** UEFI FIO Setting (758959-B22) can be selected to configure the system in Legacy mode in the factory for your HPE ProLiant Gen9 Server.

---

**Form Factor** Tower or Rack (5U)

---

**Embedded Management** **HPE Integrated Lights-Out (HPE iLO)** Monitor your servers for ongoing management, service alerting, reporting and remote management with HPE iLO. Learn more at <http://www.hpe.com/info/ilo>.

**UEFI** Configure and boot your servers securely with industry standard Unified Extensible Firmware Interface (UEFI). Learn more at <http://www.hpe.com/servers/uefi>.

**RESTful API** RESTful API for iLO 4 is Redfish 1.0 conformance for simplified server management such as configuration and maintenance tasks based on modern industry standards. Learn more at <http://www.hpe.com/info/restfulapi>.

**Intelligent Provisioning** Hassle free server and OS provisioning for 1 or few servers with Intelligent Provisioning. Learn more at <http://www.hpe.com/servers/intelligentprovisioning>.

**Embedded Remote Support** The Hewlett Packard Enterprise embedded remote support, when used with Insight Online direct connect or HPE Insight Remote Support, allows HPE ProLiant servers to transmit hardware events directly to Hewlett Packard Enterprise or a Hewlett Packard Enterprise Authorized Partner for automated phone home support. Learn more at <http://www.hpe.com/info/insightonline/explore>.

---

**Server utilities** **Smart Updates** Optimize firmware and driver updates with Smart Update solutions including Smart Update Manager (SUM) and Service Pack for ProLiant (SPP). Learn more at <http://www.hpe.com/servers/smartupdatemanager>.

**HPE Systems Insight Manager (HPE SIM)** HPE SIM allows you to monitor the health of your HPE ProLiant Servers and HPE Integrity Servers, and also provides you with basic support for non-HPE servers. HPE SIM also integrates with Smart Update Manager to provide quick and seamless firmware updates. Learn more at <http://www.hpe.com/servers/hpsim>.

**Scripting Tool Kit and Windows PowerShell** Provision 1 to many servers using your own scripts to discover and deploy them with Scripting Tool Kit (STK) for Windows and Linux or Scripting Tools for Windows PowerShell. Learn more at <http://www.hpe.com/servers/proliant/stk> or <http://www.hpe.com/servers/powershell>.

**RESTful Interface Tool** RESTful Interface tool is a scripting tool to provision using RESTful API for iLO 4 to discover and deploy servers at scale. Learn more at <http://www.hpe.com/info/resttool>.

## Standard Features

**HPE iLO Mobile Application** Enables the ability to access, deploy, and manage your server anytime from anywhere from select smartphones and mobile devices. For additional information please visit: <http://www.hpe.com/info/ilo/mobileapp>.

**HPE Insight Online** HPE Insight Online, available at no additional cost as part of your Hewlett Packard Enterprise warranty or contractual support agreement with Hewlett Packard Enterprise, is a personalized dashboard for simplified tracking of IT operations and support information from anywhere, anytime. Learn more at <http://www.hpe.com/info/insightonline/explore>.

**NOTE:** The Service Pack for ProLiant (which includes SUM) can be downloaded from <http://www.hpe.com/servers/spp/download>. More information can be found on: <http://www.hpe.com/info/smartupdate>, <http://www.hpe.com/servers/spp> and <http://www.hpe.com/servers/hpsum>.

---

### Security

Power-on password  
Setup password  
Serial interface control  
Power switch security  
Administrator's password  
UEFI  
TPM 1.2

**NOTE:** Refer to Additional Options section in this document for detail.

TPM 2.0

**NOTE:** Need to upgrade BIOS before using the TPM 2.0. Refer to Additional Options section in this document for detail.

Security Front Bezel

**NOTE:** Refer to Additional Options section in this document for detail.

Chassis mechanical support of padlock and Kensington Security lock (located at system rear)

**NOTE:** HPE do not offer padlock or Kensington security lock options or provide qualified part numbers. Customers will need to source from other 3rd party vendors to get these Hardware security features enabled.

---

### Warranty

This product is covered by a global limited warranty and supported by HPE Services and a worldwide network of HPE Authorized Channel Partners resellers. Hardware diagnostic support and repair is available for three years from date of purchase. Support for software and initial setup is available for 90 days from date of purchase. Enhancements to warranty services are available through HPE Pointnext operational services or customized service agreements. Hard drives have either a one year or three year warranty; refer to the specific hard drive QuickSpecs for details.

**NOTE:** Server Warranty includes 3-Year Parts, 3-Year Labor, 3-Year Onsite support with next business day response. Warranty repairs may be accomplished through the use of Customer Self Repair (CSR) parts. These parts fall into two categories: 1) Mandatory CSR parts are designed for easy replacement. A travel and labor charge will result when customers decline to replace a Mandatory CSR part; 2) Optional CSR parts are also designed for easy replacement but may involve added complexity. Customers may choose to have HPE replace Optional CSR parts at no charge. Additional information regarding worldwide limited warranty and technical support is available at: <http://h17007.www1.hpe.com/us/en/enterprise/servers/warranty/>.

## Optional Features

<b>Embedded Management</b>	<b>iLO Advanced</b>	HPE iLO Advanced licenses offer smart remote functionality without compromise, for all HPE ProLiant servers. The license includes the full integrated remote console, virtual keyboard, video, and mouse (KVM), multi-user collaboration, console record and replay, and GUI-based and scripted virtual media and virtual folders. You can also activate the enhanced security and power management functionality. Learn more about HPE iLO Advanced at <a href="http://www.hpe.com/servers/iloadvanced">http://www.hpe.com/servers/iloadvanced</a> .
<b>Server Management</b>	<b>HPE Insight Control</b>	HPE Insight Control, lets you deploy, migrate, monitor, remote control, and optimize your IT infrastructure through a single, simple management console. For more information, see <a href="http://www.hpe.com/info/insightcontrol">http://www.hpe.com/info/insightcontrol</a> .
	<b>HPE Insight Cluster Management Utility (CMU)</b>	HPE Insight Cluster Management Utility is a HyperScale management framework that includes software for the centralized provisioning, management and monitoring of nodes and infrastructure. Learn more at <a href="http://www.hpe.com/info/cmu">http://www.hpe.com/info/cmu</a> .
<b>Rack and Power Infrastructure</b>	HPE Rack and Power Infrastructure products and services create highly efficient and intelligent solutions for existing or new IT data centers. HPE Rack and Power infrastructure solutions – rack infrastructure, power protection and management, performance optimized data centers (PODs) – are the foundation you are looking for to help secure your long-term IT success. These products are designed to help you react to changes in the industry. They deliver efficient, easy-to-use capabilities to manage, monitor, deploy and provision infrastructure from entry to enterprise. As an industry leader, Hewlett Packard Enterprise is uniquely positioned to address the key concerns of power, cooling, cable management and system access. Learn more at <a href="#">HPE Rack and Power Infrastructure</a> .	
<b>High Performance Clusters</b>	HPE Cluster Platforms are specifically engineered, factory-integrated large-scale ProLiant clusters optimized for High Performance Computing, with a choice of servers, networks and software. Operating system options include specially priced offerings for Red Hat Enterprise Linux and SUSE Linux Enterprise Server, as well as Microsoft Windows HPEC Server. A Cluster Platform Configurator simplifies ordering. <a href="http://www.hp.com/go/clusters">http://www.hp.com/go/clusters</a> . HPE Insight Cluster Management Utility (CMU) is a Hewlett Packard Enterprise licensed and supported suite of tools that are used for lifecycle management of hyperscale clusters of Linux ProLiant systems. CMU includes software for the centralized provisioning, management and monitoring of nodes. CMU makes the administration of clusters user friendly, efficient, and effective. <a href="http://www.hp.com/go/cmu">http://www.hp.com/go/cmu</a> . <b>NOTE:</b> High Performance Computing (HPC) interconnect technologies are available for this server as part of the HPE Cluster Platform portfolio. These high-speed InfiniBand and Gigabit interconnects are fully supported by Hewlett Packard Enterprise when integrated within a Hewlett Packard Enterprise cluster. Flexible, validated solutions can be defined with the help of configuration tools. <a href="http://www.hp.com/techservers/clusters/ucp/index.html">http://www.hp.com/techservers/clusters/ucp/index.html</a> .	
<b>HPC Interconnects</b>	<b>NOTE:</b> High Performance Computing (HPC) interconnect technologies are available for this server under the HPE Cluster Platform product portfolio. These high-speed interconnects are fully supported by Hewlett Packard Enterprise when they are part of these configure to order clusters. Solutions can be defined with a lot of flexibility with the help of configuration tools. Please visit the following URL to configure HPEC Clusters with InfiniBand Interconnects: <a href="http://www.hp.com/techservers/clusters/ucp/index.html">http://www.hp.com/techservers/clusters/ucp/index.html</a> .	
<b>Storage Software</b>	Whether you need to solve a specific data protection, archiving, or storage command and control challenge, or deliver on strategic consolidation, compliance, or continuity initiatives, look no further	

## Optional Features

than Hewlett Packard Enterprise storage software. Our storage software helps you reduce costs, simplify storage infrastructure, protect vital assets and respond faster to business opportunities. Storage software that gets the job done:

- **Data Protection and Recovery Software**  
Whether you're a large enterprise or a smaller business, Hewlett Packard Enterprise data protection and recovery software will cost-effectively protect you against disaster and ensure business continuity.
- **Data Archive and Migration Software**  
Hewlett Packard Enterprise storage software enables you to comply with data retention and retrieval requirements, improve application performance, and reduce costs by efficiently migrating infrequently accessed or less valuable data to lower cost storage.
- **Storage Resource Management Software (SRM)**  
Hewlett Packard Enterprise storage resource management software reduces operational costs and provides the command and control foundation you need to efficiently manage and visualize your physical and virtual environments.
- **Data Replication Software**  
Hewlett Packard Enterprise offers array-based and host-based replication software for use in disaster recovery, testing, application development and reporting.
- **Storage Device Management Software**  
Maximize your investment in Hewlett Packard Enterprise storage and networking with software that enables hardware-specific configuration, performance tuning and connectivity management.
- **HPE StoreVirtual VSA**  
Make the move to virtualized storage with HPE StoreVirtual VSA. Transform unused capacity inside your servers into a virtual storage array. Add StoreVirtual VSA to multiple servers, manage it as a single pool of shared storage capacity, and scale it to match your evolving needs. HPE ProLiant Gen9 servers include a 3-year limited license for HPE software-defined storage at no extra cost. You have the option to install free 1TB-capacity StoreVirtual VSA software during server setup within Intelligent Provisioning. More information, instructional videos, and free management software are available at <http://www.hpe.com/storage/tryVSA>.

**NOTE:** For more information about Storage Software including QuickSpecs, please see: <http://www.hp.com/go/storage/software>.

---

### ClearOS

HPE and ClearCenter will help you lower the cost of building on-premise solutions without sacrificing security and ease of use. HPE ProLiant servers with ClearOS give you a simple, secure, and affordable operating system with an intuitive web based graphical user interface that provides a cloud-like experience on- premise, and an Application Marketplace with over 100 apps and growing. Whether you're starting out or scaling, you decide what applications you need and pay as you grow.

**NOTE:** For more information on ClearOS, please visit <http://www.hpe.com/servers/clearos>.

---

### One Config Simple (SCE)

SCE is a guided self-service tool to help sales and non-technical people provide customers with initial configurations in 3 to 5 minutes. You may then send the configuration on for configuration help, or use in your existing ordering processes. If you require "custom" rack configuration or configuration for products not available in SCE, please contact Hewlett Packard Enterprise Customer Business Center or an Authorized Partner for assistance. <http://ocs.ext.hpe.com/>.

## Service and Support

### HPE Support Services

HPE Technology Services delivers confidence, reduces risk and helps customers realize agility and stability. Connect to Hewlett Packard Enterprise to help prevent problems and solve issues faster. HPE Support Services enable you to choose the right service level, length of coverage and response time as you purchase your new server, giving you full entitlement to the support for need for your IT and business.

### Connect your devices

Unlock all of the benefits of your technology investment by connecting your products to Hewlett Packard Enterprise. Achieve up to 77%<sup>1</sup> reduction in down time, near 100%<sup>2</sup> diagnostic accuracy and a single consolidated view of your environment. By connecting, you will receive 24x7 monitoring, pre-failure alerts, automatic call logging, and automatic parts dispatch. HPE Proactive Care Service and HPE Datacenter Care Service customers will also benefit from proactive activities to help prevent issues and increase optimization. All of these benefits are already available to you with your server storage and networking products, securely connected to Hewlett Packard Enterprise support.

1- IDC 2 - HP CSC reports 2014 - 2015

### Recommended Support

#### **Standard: HPE Proactive Care\* with 24x7 coverage, three year Support Service**

HPE Proactive Care gives customers an enhanced call experience. When your products are connected to Hewlett Packard Enterprise, Proactive Care helps prevent problems and maintains IT stability by utilizing personalized proactive reports with recommendations and advice. This service combines three years proactive reporting and advice with our 24x7 coverage, four hour hardware response time when there is a problem. This service also includes collaborative software support for Independent Software Vendors (ISVs), (Red Hat, VMWare, Microsoft, etc.) running on your HPE servers.

<https://www.hpe.com/h20195/v2/GetPDF.aspx/4AA3-8855ENW.pdf>

#### **Optimized HPE Proactive Care\* with 6 hour call-to-repair commitment, three year Support Service**

HPE Proactive Care gives customers an enhanced call experience. When your products are connected to Hewlett Packard Enterprise, Proactive Care helps prevent problems and maintains IT stability by utilizing personalized proactive reports with recommendations and advice. This service combines three years' proactive reporting and advice with our highest level of hardware support – Hewlett Packard Enterprise 24x7, six hour hardware call-to-repair. Hewlett Packard Enterprise is the only leading manufacturer who makes this level of coverage available as a standard service offering for your most valuable servers. This service also includes collaborative software support for Independent Software Vendors (ISVs), (Red Hat, VMWare, Microsoft, etc.) running on your HPE servers.

<https://www.hpe.com/h20195/v2/GetPDF.aspx/4AA3-8855ENW.pdf>

### Parts and Materials

Hewlett Packard Enterprise will provide Hewlett Packard Enterprise-supported replacement parts and materials necessary to maintain the covered hardware product in operating condition, including parts and materials for available and recommended engineering improvements.

Parts and components that have reached their maximum supported lifetime and/or the maximum usage limitations as set forth in the manufacturer's operating manual, product QuickSpecs, or the technical product data sheet will not be provided, repaired, or replaced as part of these services.

The defective media retention service feature option applies only to Disk or eligible SSD/Flash Drives replaced by Hewlett Packard Enterprise due to malfunction.

### Related Services

#### **HPE Server Hardware Installation**

Provides for the basic hardware installation of Hewlett Packard Enterprise branded servers, storage devices and networking options to assist you in bringing your new hardware into operation in a timely and professional manner.

<https://www.hpe.com/h20195/V2/GetPDF.aspx/5981-9356EN.pdf>

#### **HPE Installation and Startup Service**

Provides for the installation and startup of Hewlett Packard Enterprise technology including BladeSystems, C-Class enclosure, HPE ProLiant c-Class and Integrity server blades, storage blades, SAN switch blades, HPE Virtual Connect modules (Ethernet and Fibre Channel), Ethernet network interconnects, and InfiniBand, as well as the installation of one supported operating system type (Windows® or Linux).

## Service and Support

### HPE Technology Services Support Credits

Offer flexible services and technical skills to meet your changing IT demands. With a menu of service that is tailored to suit your needs, you get additional resources and specialist skills to help you maintain peak performance of your IT. Offered as annual credits, you can plan your budgets while proactively responding to your dynamic business.

---

### HPE Education Services

Keep your IT staff trained making sure they have the right skills to deliver on your business outcomes. Book on a class today and learn how to get the most from your technology investment. <http://www.hpe.com/ww/learn>

---

**HPE Support Center** The HPE Support Center is a personalized online support portal with access to information, tools and experts to support Hewlett Packard Enterprise business products. Submit support cases online, chat with Hewlett Packard Enterprise experts, access support resources or collaborate with peers.

Learn more <http://www.hpe.com/support/hpesc>

The Hewlett Packard Enterprise Support Center Mobile App\* allows you to resolve issues yourself or quickly connect to an agent for live support. Now, you can get access to personalized IT support anywhere, anytime.

HPE Insight Remote Support and HPE Support Center are available at no additional cost with a Hewlett Packard Enterprise warranty, HPE Support Service or Hewlett Packard Enterprise contractual support agreement.

\*HPE Support Center Mobile App is subject to local availability.

For more information: <http://www.hpe.com/services>

## Pre-configured Models

For the Standard Features shipped in the "Factory Integrated Models", please see the "Configuration Information - Factory Integrated Models" section.

1. Pre-configured models ship with the configurations below. Options can be selected from the Core or Additional options section of this QuickSpecs.
2. Hewlett Packard Enterprise does not allow factory integration of options into pre-configured models. Any additional options purchased will be shipped separately.
3. If you desire a custom configuration please see "Configuration Information - Factory Integrated Models" section of this QuickSpecs.

**NOTE:** All Pre-configured Models come populated with some hard drive blanks installed. Should the customer need additional hard drive blanks, they can order more using either P/N 666987-B21: HPE SFF Hard Drive Blank Kit or P/N 666986-B21: HPE LFF Hard Drive Blank Kit.

**NOTE:** All pre-configured servers ship with a country-specific AC power cord in Tower models; while in the Rack model, a standard 6-foot IEC C-13/C-14 jumper cord (AOK02A) is included. This jumper cord is also included with each standard AC power supply option kit. If a different power cord is required, please check the [ProLiant Power Cables](#) web page.

**CAUTION:** Hewlett Packard Enterprise recommends that a minimum of two people are required for all Rack Server installations. Please refer to your installation instructions for proper tools and number of people to use for any installation.

	Entry Models	Base Models
<b>[SKU Number]</b>	835262-001	835263-001
<b>Model Name</b>	HPE ProLiant ML350 Gen9 E5-2609v4 1P 8GB-R B140i 8LFF 500W PS Entry Server	HPE ProLiant ML350 Gen9 E5-2620v4 16GB-R P440ar 8SFF 500W PS Base Server
<b>Processor</b>	Intel® Xeon® E5-2609v4	Intel® Xeon® E5-2620v4
<b>Number of Processors</b>	One	
<b>Memory</b>	8GB (1x8GB Registered DIMMs, 2400 MHz)	16GB (1x16GB Registered DIMMs, 2400 MHz)
<b>Network Controller</b>	HPE Embedded 1Gb Ethernet 4-port 331i Adapter	
<b>Storage Controller</b>	HPE Dynamic Smart Array B140i	HPE Smart Array P440ar/2G Controller
<b>Hard Drive</b>	None ship standard; includes 6 LFF hard drive blanks	None ship standard; includes 6 SFF hard drive blanks
<b>Internal Storage</b>	8 LFF HDD Bays (upgradable to 24)	8 Hot plug SFF SAS/SATA HDD Bays; upgradeable to 48
<b>Optical Drive Bay</b>	Optional LFF Media Cage Kit (726561-B21)	Optional SFF Media Cage Kit (726545-B21)
<b>Optical Drive</b>	Optional Slim Optical Bay (SATA DVD-RW/ROM Optical Drive)	
<b>PCI-Express Slots</b>	9 PCIe slots	
<b>Power Supply</b>	(1) HPE 500W Flex Slot Platinum Power Supply	
<b>Fans</b>	3 hot swap fans, non-redundant	
<b>Management</b>	iLO Management (standard), Intelligent Provisioning (standard), iLO Advanced (optional), Insight Control (optional), HPE OneView (optional)	
<b>Energy Star</b>	Meets Energy Star requirements	
<b>Form Factor</b>	Tower (5U)	
<b>Warranty</b>	Server Warranty includes 3-Year Parts, 3-Year Labor, 3-Year Onsite support with next business day response	

	Performance Rack Models	Performance Models
<b>[SKU Number]</b>	835264-001	835265-001
<b>Model Name</b>	HPE ProLiant ML350 Gen9 2xE5-2630v4 2P 32GB-R P440ar 8SFF 2x800W PS Perf ES Rack Server	HPE ProLiant ML350 Gen9 E5-2650v4 2P 32GB-R P440ar 8SFF 2x800W PS Perf Server
<b>Processor</b>	Intel® Xeon® E5-2630v4	Intel® Xeon® E5-2650v4



## Pre-configured Models

<b>Number of Processors</b>	Two	
<b>Memory</b>	32GB (2x16GB Registered DIMMs, 2400 MHz)	32GB (2x16GB Registered DIMMs, 2400 MHz)
<b>Network Controller</b>	HPE Embedded 1Gb Ethernet 4-port 331i Adapter	
<b>Storage Controller</b>	HPE Smart Array P440ar/2G Controller	
<b>Hard Drive</b>	None ship standard; includes 6 SFF hard drive blanks	
<b>Internal Storage</b>	8 Hot plug SFF SAS/SATA HDD Bays; upgradeable to 48	
<b>Optical Drive Bay</b>	Optional SFF Media Cage Kit (726545-B21)	
<b>Optical Drive</b>	Optional Slim Optical Bay (SATA DVD-RW/ROM Optical Drive)	
<b>PCI-Express Slots</b>	9 PCIe slots	
<b>Power Supply</b>	(2) HPE 800W Flex Slot Platinum Power Supply	
<b>Fans</b>	8 hot plug fans, redundant	
<b>Management</b>	iLO Management (standard), Intelligent Provisioning (standard), iLO Advanced (optional), Insight Control (optional), HPE OneView (optional)	
<b>Energy Star</b>	Meets Energy Star requirements	
<b>Accessories</b>	Rack Kit included	
<b>Form Factor</b>	Rack (5U) HPE Easy Install Rails with CMA	Tower (5U)
<b>Warranty</b>	Server Warranty includes 3-Year Parts, 3-Year Labor, 3-Year Onsite support with next business day response	

## Smart Buy Models

	E5-2600v4 Smart Buy Models		
<b>[SKU Number]</b>	835850-S01	835851-S01	835852-S01
<b>Model Name</b>	HPE ProLiant ML350 Gen9 E5-2609v4 LFF US Svr/S-B	HPE ProLiant ML350 Gen9 E5-2620v4 SFF US Svr/S-B	HPE ProLiant ML350 Gen9 E5-2640v4 SFF US Svr/S-B
<b>Processor</b>	Intel® Xeon® E5-2609v4	Intel® Xeon® E5-2620v4	Intel® Xeon® E5-2640v4
<b>Number of Processors</b>	one		
<b>Memory</b>	8GB (1x8GB Registered DIMMs, 2400MHz) <b>NOTE: DIMMs will operate at 1866MHz with this processor.</b>	8GB (1x8GB Registered DIMMs, 2400MHz) <b>NOTE: DIMMs will operate at 2133MHz with this processor.</b>	16GB (1x16GB Registered DIMMs, 2400MHz) <b>NOTE: DIMMs will operate at 2133MHz with this processor.</b>
<b>Network Controller</b>	HPE Embedded 1Gb Ethernet 4-port 331i Adapter		
<b>Storage Controller</b>	HPE Smart Array P440ar/2G Controller + Smart Storage Battery		
<b>Hard Drive</b>	None ship standard		
<b>Internal Storage</b>	Up to 8 LFF	Up to 8 SFF	Up to 8 SFF
<b>Optical Drive</b>	HP 9.5mm SATA DVD ROM Jb Kit		
<b>PCI-Express Slots</b>	9 PCIe slots		
<b>Power Supply</b>	(1) HPE 500W Flex Slot Platinum Power Supply		(2) HPE 800W Flex Slot Platinum Power Supplies
<b>Fans</b>	3 hot plug fans, non-redundant		
<b>Management</b>	Standard: iLO Management Optional: iLO Advanced, Insight Control, HP OneView		
<b>Form Factor</b>	Tower (5U)		
<b>Warranty</b>	3-Year Parts, 3-Year Labor, 3-Year Onsite support with next business day response		

## Configuration Information - Factory Integrated Models

This section lists some of the steps required to configure a Factory Integrated Model. To ensure only valid configurations are ordered, Hewlett Packard Enterprise recommends the use of an HPE approved configurator. Contact your local sales representative for information on configurable product offerings and requirements.

1. Factory Integrated Models must start with a CTO Server.
2. FIO indicates that this option is only available as a factory installable option.
3. All Factory Integrated Models will be populated with sufficient hard drive blanks based on the number of initial hard drives ordered with the server.
4. Some options may not be integrated at the factory. Contact your local sales representative for additional information.

### Step 1: Base Configuration (choose one of the following configurable models)

<b>CTO Server</b>	HPE ProLiant ML350 Gen9 Hot Plug 8SFF Configure-to-order Rack Server	HPE ProLiant ML350 Gen9 Hot Plug 8SFF Configure-to-order Tower Server	HPE ProLiant ML350 Gen9 Hot Plug 8LFF Configure-to-order Tower Server
<b>SKU Number</b>	754534-B21	754536-B21	754537-B21
<b>Processor</b>	2 (optional) x HPE Smart Socket Guide		
<b>DIMM Slots</b>	24 DIMM slots for RDIMM, LRDIMM DDR4 Memory		
<b>Storage Controller</b>	HPE Dynamic Smart Array B140i		
<b>PCIe</b>	9 Standard (8 FH/FL, 1 FH/HL)		
<b>Drive Cage</b>	8SFF Hot Plug	8LFF Hot Plug	
<b>Network Controller</b>	HPE Embedded 1Gb Ethernet 4-port 331i Adapter		
<b>Fans</b>	3 hot swap fans, non-redundant		
<b>Management</b>	iLO Management (standard), Intelligent Provisioning (standard)		
<b>USB</b>	2 front, 2 internal, 4 rear		

### Step 2: Choose Required Options (only one of the following from each list unless otherwise noted)

<b>HPE Processors</b>	<b>E5-2600v4 series Processors</b>	
	HPE ML350 Gen9 Intel® Xeon® E5-2620v4 (2.1GHz/8-core/20MB/85W) FIO Processor Kit	801232-L21
	HPE ML350 Gen9 Intel® Xeon® E5-2609v4 (1.7GHz/8-core/20MB/85W) FIO Processor Kit	801233-L21
	HPE ML350 Gen9 Intel® Xeon® E5-2603v4 (1.7GHz/6-core/15MB/85W) FIO Processor Kit	801234-L21
	HPE ML350 Gen9 Intel® Xeon® E5-2650Lv4 (1.7GHz/14-core/35MB/65W) FIO Processor Kit	801250-L21
	HPE ML350 Gen9 Intel® Xeon® E5-2630Lv4 (1.8GHz/10-core/25MB/55W) FIO Processor Kit	801251-L21
	HPE ML350 Gen9 Intel® Xeon® E5-2643v4 (3,4GHz/6-core/20MB/135W) FIO Processor Kit	801255-L21
	HPE ML350 Gen9 Intel® Xeon® E5-2637v4 (3.5GHz/4-core/15MB/135W) FIO Processor Kit	801256-L21
	HPE ML350 Gen9 Intel® Xeon® E5-2623v4 (2.6GHz/4-core/10MB/85W) FIO Processor Kit	801258-L21
	HPE ML350 Gen9 Intel® Xeon® E5-2690v4 (2.6GHz/14-core/35MB/135W) FIO Processor Kit	801225-L21
	HPE ML350 Gen9 Intel® Xeon® E5-2680v4 (2.4GHz/14-core/35MB/120W) FIO Processor Kit	801226-L21
	HPE ML350 Gen9 Intel® Xeon® E5-2660v4 (2GHz/14-core/35MB/105W) FIO Processor Kit	801228-L21

## Configuration Information - Factory Integrated Models

HPE ML350 Gen9 Intel® Xeon® E5-2650v4 (2.2GHz/12-core/30MB/105W) FIO Processor Kit	801229-L21
HPE ML350 Gen9 Intel® Xeon® E5-2640v4 (2.4GHz/10-core/25MB/90W) FIO Processor Kit	801230-L21
HPE ML350 Gen9 Intel® Xeon® E5-2697v4 (2.3GHz/18-core/45MB/145W) FIO Processor Kit	801252-L21
HPE ML350 Gen9 Intel® Xeon® E5-2695v4 (2.1GHz/18-core/45MB/120W) FIO Processor Kit	801253-L21
HPE ML350 Gen9 Intel® Xeon® E5-2667v4 (3,2GHz/8-core/25MB/135W) FIO Processor Kit	801254-L21
HPE ML350 Gen9 Intel® Xeon® E5-2683v4 (2.1GHz/16-core/40MB/120W) FIO Processor Kit	801257-L21
HPE ML350 Gen9 Intel® Xeon® E5-2699v4 (2.2GHz/22-core/55MB/145W) FIO Processor Kit	801259-L21
HPE ML350 Gen9 Intel® Xeon® E5-2698v4 (2.2GHz/20-core/50MB/135W) FIO Processor Kit	801271-L21
HPE ML350 Gen9 Intel® Xeon® E5-2697Av4 (2.6GHz/16-core/40MB/145W) FIO Processor Kit	839989-L21
HPE ML350 Gen9 Intel® Xeon® E5-2630v4 (2.2GHz/10-core/25MB/85W) FIO Processor Kit	801231-L21

**NOTE:** If two processors are desired, select one xxxxxx-L21 and one xxxxxx-B21.

**NOTE:** Up to 2 processors supported. Mixing different processor models is not supported.

**NOTE:** DDR4 speed is the maximum memory speed of the processor. Actual memory speed may depend on the quantity and type of DIMMs installed.

**NOTE:** When v4 Processor is selected, then only PC4-2400T Memory Kit can be selected.

**NOTE:** For the Intel® C600 Chipset E5-2600 Series, the letter preceding the model number indicates the Product Line (E3, E5, E7); 2600x v#, 2= number of CPUs in a Node, 6 is socket/segment designation, 00= Processor SKU, x= L for low power SKUs and v# (not yet designated)= version number.

### HPE Memory

**NOTE:** Select one or more memory kits from below.

**NOTE:** LRDIMM, RDIMM are all distinct memory technologies and cannot be mixed within a server. The majority of ProLiant Gen9 servers support LRDIMM and RDIMM

**NOTE:** HPE memory from previous generation servers are not qualified or warranted with this HPE ProLiant Server. HPE SmartMemory is required to realize the memory performance improvements and enhanced functionality listed in this document for Gen9.

**NOTE:** Kits described as LP include Low Power DIMMs. For more information on ProLiant Energy Efficient Features, see: <http://www.hp.com/go/proliant-energy-efficient>

**NOTE:** Depending on the memory configuration and processor model, the memory speed may run at 2400MHz, 2133MHz, 1866MHz, 1600MHz or 1333MHz. Please see Memory Population Table or the Online Memory Configuration Tool at: [Online Memory Configuration Tool](#)

#### Registered DIMMs (RDIMMs) for E5-2600v4 Series

HP 8GB (1x8GB) Single Rank x8 DDR4-2400 CAS-17-17-17 Registered Memory Kit	805347-B21
HP 16GB (1x16GB) Single Rank x4 DDR4-2400 CAS-17-17-17 Registered Memory Kit	805349-B21
HP 32GB (1x32GB) Dual Rank x4 DDR4-2400 CAS-17-17-17 Registered Memory Kit	805351-B21
HP 16GB (1x16GB) Dual Rank x4 DDR4-2400 CAS-17-17-17 Registered Memory Kit	836220-B21

#### Load Reduced DIMMs (LRDIMMs) for E5-2600v4 Series

HP 32GB (1x32GB) Dual Rank x4 DDR4-2400 CAS-17-17-17 Load Reduced Memory Kit	805353-B21
HP 64GB (1x64GB) Quad Rank x4 DDR4-2400 CAS-17-17-17 Load Reduced Memory Kit	805358-B21

## Configuration Information - Factory Integrated Models

### HPE Power Supplies

**NOTE:** Mixing of power supplies in the same server is not supported. All power supplies must be of the same input voltage, output rating, and efficiency rating. If non-matching power supplies are installed, you may receive an error message and/or experience operational issues with your server.

**NOTE:** Prior to selecting a power supply option, it is highly recommended that you review your server configuration in the HP Power Advisor Tool to determine the right size power supply for your server configuration. The HP Power Advisor is located at: [HPE Power Advisor Online](#)

#### HPE Flex Slot Hot-Plug Power Supplies

HP 500W Flex Slot Platinum Hot Plug Power Supply Kit	720478-B21
HP 800W Flex Slot Platinum Hot Plug Power Supply Kit	720479-B21
HP 1400W Flex Slot Platinum Plus Hot Plug Power Supply Kit	720620-B21
HP 800W Flex Slot -48VDC Hot Plug Power Supply Kit	720480-B21
HP 800W Flex Slot Titanium Hot Plug Power Supply Kit	720482-B21
HP 800W Flex Slot Universal Hot Plug Power Supply Kit	720484-B21

#### Enablement Kit

HP ML350 Gen9 X4 Redundant Power Supply Enablement FIO Kit	725870-B21
--	------------

**NOTE:** If more than quantity two of 800W or 1400W Power Supplies are ordered, then X4 Redundant Power Supply FIO Kit must be selected. This kit does not support the 500W Power Supply.

## Step 3: Choose Additional Factory Integratable Options (only one from each category unless otherwise noted)

### HPE Storage Controllers

**NOTE:** The embedded B140i controller will be used as the primary controller if no controller has been selected from the list below. Embedded SATA controller can support up to 8 SATA hard drives.

#### HPE Smart Array Controllers

HP Smart Array P440ar/2GB FBWC 12Gb 2-ports Int FIO SAS Controller	749974-B21
--	------------

**NOTE:** Supports up to 8 internal SAS/SATA drives without using a PCIe slot.

**NOTE:** Includes the HP Smart Storage Battery

HP Smart Array P440/4GB FBWC 12Gb 1-port Int FIO SAS Controller	761872-B21
---	------------

**NOTE:** Includes the HP Smart Storage Battery

HP Smart Array P840/4GB FBWC 12Gb 2-ports Int FIO SAS Controller	761874-B21
--	------------

**NOTE:** Includes the HP Smart Storage Battery

#### HPE Smart Host Bus Adapters

HP H240ar 12Gb 2-ports Int FIO Smart Host Bus Adapter	749976-B21
---	------------

**NOTE:** Supports up to 8 internal SAS/SATA drives without using a PCIe slot.

HP H240 12Gb 2-ports Int FIO Smart Host Bus Adapter	761873-B21
---	------------

#### Expander Kits

HP 12Gb SAS Expander Card for ML350 Gen9	769635-B21
--	------------

**NOTE:** Does not support H240ar or P440ar. It contains three cables from expander card to HDD backplanes, and one cable from Smart Array or HBA to expander card.

HP ML350 Gen9 Second Expander FIO Kit	769637-B21
---------------------------------------	------------

**NOTE:** Cannot be selected when HP 12Gb SAS Expander Card for ML350 Gen9 (769635-B21) is not in order. If selected, 2<sup>nd</sup> processor and X4 RPS Enablement FIO Kit (725870-B21) and P840 controller (761874-B21) must also be ordered.

#### HPE Cable Options

HP ML350 Gen9 Host Bus Adapter Mini-SAS Cable Kit	765648-B21
---	------------

**NOTE:** If HP H240 12Gb 2-ports Int FIO Smart Host Bus Adapter (761873-B21) is selected then this option kit must be selected. One card per kit.

HP ML350 Gen9 Smart Array Cable Kit	765650-B21
-------------------------------------	------------

## Configuration Information - Factory Integrated Models

	<b>NOTE:</b> If HP Smart Array P440/4GB FBWC 12Gb 1-port Int FIO SAS Controller (761872-B21) or HP H240ar 12Gb 2-ports Int FIO Smart Host Bus Adapter (749976-B21) is selected, this option kit must be selected. One card per kit.	
	HP ML350 Gen9 Flexible Smart Array Controller Mini-SAS Cable Kit	765652-B21
	<b>NOTE:</b> If HP Smart Array P440ar/2GB FBWC 12Gb 2-ports Int FIO SAS Controller (749974-B21) or HP H240ar 12Gb 2-ports Int FIO Smart Host Bus Adapter (749976-B21) is selected, this option kit must be selected.	
	HP ML350 Gen9 Mini-SAS Cable FIO Kit	765654-B21
	<b>NOTE:</b> If no SAS controller is selected and using B140i as primary, this option kit is required.	
<b>BIOS Mode</b>	HP Legacy FIO Mode Setting	758959-B22
	<b>NOTE:</b> If selected, then B140i will not be supported and can no longer be a primary controller therefore, SAS internal controller must be selected to be the primary controller.	
<b>Controller State</b>	HP FIO Enable B140i Setting	784308-B21
	<b>NOTE:</b> Must be selected when B140i is used as the primary controller and RAID is desired.	
	HP Mfg FIO Enable HBA Mode Setting	792962-B21
	<b>NOTE:</b> When selected if H240ar/H240 are used as the primary controller then RAID is not allowed.	
<b>HPE Insight Software</b>	HP Insight Controller including 1yr 24x7 Support ProLiant ML/DL/BL-bundle Single Server FIO License	C6N36A
<b>HPE Converged Infrastructure Management Software</b>	<b>HPE OneView Advanced (with HPE iLO Advanced)</b> HPE OneView for ProLiant DL Server including 3yr 24x7 Support FIO Bundle Physical 1-server LTU	E5Y43A
	<b>HPE OneView Advanced (without HPE iLO Advanced)</b> HPE OneView w/o iLO including 3yr 24x7 Support 1-server FIO LTU	P8B31A
<b>Rail Kits</b>	HP ML350 Gen9 5U FIO Rail Kit	790357-B21
<b>HPE Location Discovery Service</b>	HP ML350 Gen9 Discovery Service FIO Kit	726549-B21

### Step 4: Choose Additional Options for Factory Integration from Core and Additional Options sections below.

**CAUTION:** Hewlett Packard Enterprise recommends that a minimum of two people are required for all Rack Server installations. Please refer to your installation instructions for proper tools and number of people to use for any installation.

## Core Options

**NOTE:** Some options may not be integrated at the factory. To ensure only valid configurations are ordered, Hewlett Packard Enterprise recommends the use of an HPE approved configurator. Contact your local sales representative for additional information.

<b>HPE Unique Options</b>	HP ML350 Gen9 8LFF Hot Plug Drive Cage Kit	726547-B21
	<b>NOTE:</b> Additional 8LFF Hard Drive Cage/backplane assembly, allowing for up to 24FF Drive Bays.	
	HP ML350 Gen9 8SFF Hard Drive Cage Kit	778157-B21
	<b>NOTE:</b> Additional 8SFF Hard Drive Cage/Backplane assembly, allowing for up to 48SFF Drive Bays.	
	HP ML350 Gen9 Redundant Fan Kit	725878-B21
	<b>NOTE:</b> This kit consists of four additional system fans and two PCIe air baffles to support fan redundancy.	
	HP ML350 Gen9 LFF Media Cage Kit	726561-B21
	<b>NOTE:</b> Cage for converting LFF drive bays to a media device. Supports 1*Half-Height tape storage/ Disk-Based Backup device. (RDX)	
	HP ML350 Gen9 SFF Media Cage Kit	726545-B21
	<b>NOTE:</b> Cage for converting SFF drive bays to a media device. Supports 2*Half-Height/ 1*Full-Height tape storage/ Disk-Based Backup device (RDX).	
	HP ML350 Gen9 Flexible Smart Array Controller Mini-SAS Cable Kit	765652-B21
	<b>NOTE:</b> Mini-SAS Cable Kit for Flexible Smart Array Controller (AROC).	
	HP ML350 Gen9 Smart Array Cable Kit	765650-B21
<b>NOTE:</b> Mini-SAS Cable Kit for stand-up P-series Smart Array Card.		
HP ML350 Gen9 Host Bus Adapter Mini-SAS Cable Kit	765648-B21	
<b>NOTE:</b> Mini-SAS Cable kit for Host Bus Adapter.		
HP ML350 Gen9 Graphic Card Support Kit	726565-B21	
<b>NOTE:</b> Required to support graphic accelerators except for K2200.		
HP ML350 Gen9 Tower to Rack Conversion Kit	726567-B21	
<b>NOTE:</b> For converting a tower model to a rack model. It is consist of a 5U rail kit, cable management arm (CMA) and rack enablement kit (rack ear, rack handle, SID blank etc).		
HP ML350 Gen9 System Insight Display Kit	726563-B21	
<b>NOTE:</b> For rack model only.		
HP Security Bezel Kit	660584-B21	
<b>NOTE:</b> For ML350 Rack model only.		
HP 12Gb SAS Expander Card for ML350 Gen9	769635-B21	
<b>NOTE:</b> The SAS Expander card supports 24 drives. The SAS Expander card must be used in conjunction with an HPE Smart Array P840 or P440 controller, or an H240 Host Bus Adapter. The SAS Expander card cannot be connected to H240ar or P440ar Flexible Smart Array Controller cards.		
<b>NOTE:</b> The SAS Expander kit includes two cables to connect from the Smart Array controller or HBA to the SAS Expander and the other to connect from the Expander to the HDD backplane.		
<b>NOTE:</b> It DOES NOT support tape storage/ Disk-Based Backup device (RDX).		
HP ML350 Gen9 X4 RPS Enablement Kit	802988-B21	
<b>NOTE:</b> ML350 Gen9 supports max. four Power Supply slots. If Power supply selection quantity is more than two, then X4 RPS Enablement Kit must be selected - to support the 3rd and 4th Power Supply Units. Minimum Power Supply quantity selection to configure with X4 RPS Enablement Kit is three.		

## Core Options

**NOTE:** And this option is not supported with 720478-B21 (HPE 500W FS Plat Ht Plg Pwr Supply Kit).

**NOTE:** If hard drive cage selection quantity is more than three, this X4 RPS Enablement Kit must be selected - to get proper quantity of HDD backplane power connectors.

**NOTE:** If DW GPU card selection quantity is more than two, this X4 RPS Enablement Kit MUST be selected - in order to get proper quantity of GPU external power connectors.

HP ML350 Gen9 NVMe 6 Solid State Drive Express Bay Enablement Kit 726551-B21

**NOTE:** Support for SFF model only. Maximum installation of NVMe express bay in ML350 Gen9 is one - installation limited to Box 1 or Box 4 for optimized cooling, which supports up to 6 SFF NVMe PCIe SSDs.

**NOTE:** One express bay bridge card is included in the enablement kit, with installation limited to PCIe slot 3, 6 or 8. If slot 6 or 8 is selected, a 2nd processor must be installed.

**NOTE:** For NVMe PCIe SSD selection, refer to drive section in this document.

---

HPE Processors	E5-2600v4 series Processors	
	HPE ML350 Gen9 Intel® Xeon® E5-2609v4 (1.7GHz/8-core/20MB/85W) Processor Kit	801233-B21
	HPE ML350 Gen9 Intel® Xeon® E5-2603v4 (1.7GHz/6-core/15MB/85W) Processor Kit	801234-B21
	HPE ML350 Gen9 Intel® Xeon® E5-2650Lv4 (1.7GHz/14-core/35MB/65W) Processor Kit	801250-B21
	HPE ML350 Gen9 Intel® Xeon® E5-2630Lv4 (1.8GHz/10-core/25MB/55W) Processor Kit	801251-B21
	HPE ML350 Gen9 Intel® Xeon® E5-2620v4 (2.1GHz/8-core/20MB/85W) Processor Kit	801232-B21
	HPE ML350 Gen9 Intel® Xeon® E5-2643v4 (3.4GHz/6-core/20MB/135W) Processor Kit	801255-B21
	HPE ML350 Gen9 Intel® Xeon® E5-2637v4 (3.5GHz/4-core/15MB/135W) Processor Kit	801256-B21
	HPE ML350 Gen9 Intel® Xeon® E5-2623v4 (2.6GHz/4-core/10MB/85W) Processor Kit	801258-B21
	HPE ML350 Gen9 Intel® Xeon® E5-2690v4 (2.6GHz/14-core/35MB/135W) Processor Kit	801225-B21
	HPE ML350 Gen9 Intel® Xeon® E5-2680v4 (2.4GHz/14-core/35MB/120W) Processor Kit	801226-B21
	HPE ML350 Gen9 Intel® Xeon® E5-2660v4 (2.0GHz/14-core/35MB/105W) Processor Kit	801228-B21
	HPE ML350 Gen9 Intel® Xeon® E5-2650v4 (2.2GHz/12-core/30MB/105W) Processor Kit	801229-B21
	HPE ML350 Gen9 Intel® Xeon® E5-2640v4 (2.4GHz/10-core/25MB/90W) Processor Kit	801230-B21
	HPE ML350 Gen9 Intel® Xeon® E5-2697v4 (2.3GHz/18-core/45MB/145W) Processor Kit	801252-B21
	HPE ML350 Gen9 Intel® Xeon® E5-2695v4 (2.1GHz/18-core/45MB/120W) Processor Kit	801253-B21



## Core Options

HPE ML350 Gen9 Intel® Xeon® E5-2667v4 (3.2GHz/8-core/25MB/135W) Processor Kit	801254-B21
HPE ML350 Gen9 Intel® Xeon® E5-2683v4 (2.1GHz/16-core/40MB/120W) Processor Kit	801257-B21
HPE ML350 Gen9 Intel® Xeon® E5-2699v4 (2.2GHz/22-core/55MB/145W) Processor Kit	801259-B21
HPE ML350 Gen9 Intel® Xeon® E5-2698v4 (2.2GHz/20-core/50MB/135W) Processor Kit	801271-B21
HPE ML350 Gen9 Intel® Xeon® E5-2697Av4 (2.6GHz/16-core/40MB/145W) Processor Kit	839989-B21
HPE ML350 Gen9 Intel® Xeon® E5-2630v4 (2.2GHz/10-core/25MB/85W) Processor Kit	801231-B21
<b>E5-2600v3 series Processors</b>	
HP ML350 Gen9 Intel® Xeon® E5-2609v3 (1.9GHz/6-core/15MB/85W) Processor Kit	726661-B21
HP ML350 Gen9 Intel® Xeon® E5-2603v3 (1.6GHz/6-core/15MB/85W) Processor Kit	726664-B21
HP ML350 Gen9 Intel® Xeon® E5-2640v3 (2.6GHz/8-core/20MB/90W) Processor Kit	726651-B21
HP ML350 Gen9 Intel® Xeon® E5-2630v3 (2.4GHz/8-core/20MB/85W) Processor Kit	726654-B21
HP ML350 Gen9 Intel® Xeon® E5-2620v3 (2.4GHz/6-core/15MB/85W) Processor Kit	726658-B21
HP ML350 Gen9 Intel® Xeon® E5-2630Lv3 (1.8GHz/8-core/20MB/55W) Processor Kit	726671-B21
HP ML350 Gen9 Intel® Xeon® E5-2623v3 (3GHz/4-core/10MB/105W) Processor Kit	779834-B21
HP ML350 Gen9 Intel® Xeon® E5-2637v3 (3.5GHz/4-core/15MB/135W) Processor Kit	726686-B21
HP ML350 Gen9 Intel® Xeon® E5-2690v3 (2.6GHz/12-core/30MB/135W) Processor Kit	726636-B21
HP ML350 Gen9 Intel® Xeon® E5-2680v3 (2.5GHz/12-core/30MB/120W) Processor Kit	726639-B21
HP ML350 Gen9 Intel® Xeon® E5-2670v3 (2.3GHz/12-core/30MB/120W) Processor Kit	726642-B21
HP ML350 Gen9 Intel® Xeon® E5-2660v3 (2.6GHz/10-core/25MB/105W) Processor Kit	726645-B21
HP ML350 Gen9 Intel® Xeon® E5-2650v3 (2.3GHz/10-core/25MB/105W) Processor Kit	726648-B21
HP ML350 Gen9 Intel® Xeon® E5-2650Lv3 (1.8GHz/12-core/30MB/65W) Processor Kit	726668-B21
HP ML350 Gen9 Intel® Xeon® E5-2697v3 (2.6GHz/14-core/35MB/145W) Processor Kit	726674-B21
HP ML350 Gen9 Intel® Xeon® E5-2695v3 (2.3GHz/14-core/35MB/120W) Processor Kit	726677-B21
HP ML350 Gen9 Intel® Xeon® E5-2667v3 (3.2GHz/8-core/20MB/135W) Processor Kit	726680-B21

## Core Options

HP ML350 Gen9 Intel® Xeon® E5-2643v3 (3.4GHz/6-core/20MB/135W) Processor Kit	726683-B21
HP ML350 Gen9 Intel® Xeon® E5-2683v3 (2GHz/14-core/35MB/120W) Processor Kit	765794-B21
HP ML350 Gen9 Intel® Xeon® E5-2699v3 (2.3GHz/18-core/45MB/145W) Processor Kit	781828-B21
HP ML350 Gen9 Intel® Xeon® E5-2698v3 (2.3GHz/16-core/40MB/135W) Processor Kit	781830-B21

### HPE Memory

#### Registered DIMMs (RDIMMs) for E5-2600v3 Series

HP 4GB (1x4GB) Single Rank x8 DDR4-2133 CAS-15-15-15 Registered Memory Kit	726717-B21
HP 8GB (1x8GB) Single Rank x4 DDR4-2133 CAS-15-15-15 Registered Memory Kit	726718-B21
HP 8GB (1x8GB) Dual Rank x8 DDR4-2133 CAS-15-15-15 Registered Memory Kit	759934-B21
HP 16GB (1x16GB) Dual Rank x4 DDR4-2133 CAS-15-15-15 Registered Memory Kit	726719-B21
HP 32GB (1x32GB) Dual Rank x4 DDR4-2133 CAS-15-15-15 Registered Memory Kit	728629-B21

**NOTE:** Depending on Processor selected this memory will run at 1600, 1866 or 2133MHz.

**NOTE:** Mixing of DIMM types is not supported.

**NOTE:** Mixing of 2133 and 2400MHz DIMMs is not supported.

#### Load Reduced DIMMs (LRDIMMs) for E5-2600v3 Series

HP 16GB (1x16GB) Dual Rank x4 DDR4-2133 CAS-15-15-15 Load Reduced Memory Kit	726720-B21
HP 32GB (1x32GB) Quad Rank x4 DDR4-2133 CAS-15-15-15 Load Reduced Memory Kit	726722-B21
HP 64GB (1x64GB) Quad Rank x4 DDR4-2133 CAS-15-15-15 Load Reduced Memory Kit	726724-B21

**NOTE:** Depending on Processor selected this memory will run at 1600, 1866 or 2133MHz.

**NOTE:** Mixing of DIMM types is not supported.

**NOTE:** Mixing of 2133 and 2400MHz DIMMs is not supported.

#### Registered DIMMs (RDIMMs) for E5-2600v4 Series

**NOTE:** The following memory is supported by the E5-2600v4 series Processor only.

HP 8GB (1x8GB) Single Rank x8 DDR4-2400 CAS-17-17-17 Registered Memory Kit	805347-B21
HP 16GB (1x16GB) Single Rank x4 DDR4-2400 CAS-17-17-17 Registered Memory Kit	805349-B21
HP 32GB (1x32GB) Dual Rank x4 DDR4-2400 CAS-17-17-17 Registered Memory Kit	805351-B21
HPE 16GB (1x16GB) Dual Rank x4 DDR4-2400 CAS-17-17-17 Registered Memory Kit	836220-B21

**NOTE:** Depending on Processor selected this memory will run at 1866, 2133 or 2400MHz.

**NOTE:** Mixing of DIMM types is not supported.

**NOTE:** Mixing of 2133 and 2400MHz DIMMs is not supported.

#### Load Reduced DIMMs (LRDIMMs) for E5-2600v4 Series

**NOTE:** The following memory is supported by the E5-2600v4 series Processor only.

## Core Options

HPE 32GB (1x32GB) Dual Rank x4 DDR4-2400 CAS-17-17-17 Load Reduced Memory Kit	805353-B21
HPE 64GB (1x64GB) Quad Rank x4 DDR4-2400 CAS-17-17-17 Load Reduced Memory Kit	805358-B21
HPE 128GB (1x128GB) Octal Rank x4 DDR4-2400 CAS-20-18-18 Load Reduced Memory Kit	809208-B21

**NOTE:** Depending on Processor selected this memory will run at 1866, 2133 or 2400MHz.

**NOTE:** Mixing of DIMM types is not supported.

**NOTE:** Mixing of 2133 and 2400MHz DIMMs is not supported.

---

<b>HPE Optical Drives</b> HP 9.5mm SATA DVD-ROM JackBlack Gen9 Optical Drive	726536-B21
HP 9.5mm SATA DVD-RW JackBlack G9 Optical Drive	726537-B21

---

### HPE Drives

**NOTE:** For a complete list of the drive, controller and cable options please check the compatibility

matrix: <https://www.hpe.com/h20195/V2/GetDocument.aspx?docname=4AA5-4154ENW&cc=us&lc=en>

#### 12G SAS Hot Plug LFF (3.5-inch) Enterprise (ENT) Drives

HPE 600GB SAS 12G Enterprise 15K LFF (3.5in) SC 3yr Wty HDD	765424-B21
HPE 300GB SAS 12G Enterprise 15K LFF (3.5in) SCC 3yr Wty HDD	737261-B21

#### 12G SAS Hot Plug LFF (3.5-inch) Midline (MDL) Drives

HPE 12TB SAS 12G Midline 7.2K LFF (3.5in) SC 1yr Wty Helium 512e Digitally Signed Firmware HDD	881779-B21
HPE 10TB SAS 12G Midline 7.2K LFF (3.5in) SC 1yr Wty Helium 512e Digitally Signed Firmware HDD	857644-B21
HPE 8TB SAS 12G Midline 7.2K LFF (3.5in) SC 1yr Wty Helium 512e Digitally Signed Firmware HDD	861590-B21
HPE 8TB SAS 12G Midline 7.2K LFF (3.5in) SC 1yr Wty 512e Digitally Signed Firmware HDD	819201-B21
HPE 6TB SAS 12G Midline 7.2K LFF (3.5in) SC 1yr Wty 512e HDD	861754-B21
HPE 6TB SAS 12G Midline 7.2K LFF (3.5in) SC 1yr Wty Digitally Signed Firmware HDD	846514-B21
HPE 4TB SAS 12G Midline 7.2K LFF (3.5in) SC 1yr Wty 512e HDD	861756-B21
HPE 4TB SAS 12G Midline 7.2K LFF (3.5in) SC 1yr Wty Digitally Signed Firmware HDD	872487-B21
HPE 4TB SAS 12G Midline 7.2K LFF (3.5in) SC 1yr Wty Digitally Signed Firmware HDD	872487-B21
HPE 2TB SAS 12G Midline 7.2K LFF (3.5in) SC 1yr Wty Digitally Signed Firmware HDD	872485-B21
HPE 2TB SAS 12G Midline 7.2K LFF (3.5in) SC 1yr Wty Digitally Signed Firmware HDD	872485-B21
HPE 1TB SAS 12G Midline 7.2K LFF (3.5in) SC 1yr Wty Digitally Signed Firmware HDD	846524-B21

#### 6G SATA Hot Plug LFF (3.5-inch) Midline (MDL) Drives

HPE 12TB SATA 6G Midline 7.2K LFF (3.5in) SC 1yr Wty Helium 512e Digitally Signed Firmware HDD	881785-B21
HPE 10TB SATA 6G Midline 7.2K LFF (3.5in) SC 1yr Wty Helium 512e Digitally Signed Firmware HDD	857648-B21

## Core Options

HPE 8TB SATA 6G Midline 7.2K LFF (3.5in) SC 1yr Wty Helium 512e Digitally Signed Firmware HDD	861594-B21
HPE 8TB SATA 6G Midline 7.2K LFF (3.5in) SC 1yr Wty 512e Digitally Signed Firmware HDD	819203-B21
HPE 6TB SATA 6G Midline 7.2K LFF (3.5in) SC 1yr Wty 512e HDD	861750-B21
HPE 6TB SATA 6G Midline 7.2K LFF (3.5in) SC 1yr Wty Digitally Signed Firmware HDD	846510-B21
HPE 6TB SATA 6G Midline 7.2K LFF (3.5in) SC 1yr Wty 512e HDD	861750-B21
HPE 4TB SATA 6G Midline 7.2K LFF (3.5in) SC 1yr Wty Digitally Signed Firmware HDD	872491-B21
HPE 4TB SATA 6G Midline 7.2K LFF (3.5in) SC 1yr Wty Digitally Signed Firmware HDD	872491-B21
HPE 3TB SATA 6G Midline 7.2K LFF (3.5in) SC 1yr Wty Digitally Signed Firmware HDD	861693-B21
HPE 2TB SATA 6G Midline 7.2K LFF (3.5in) SC 1yr Wty Digitally Signed Firmware HDD	872489-B21
HPE 2TB SATA 6G Midline 7.2K LFF (3.5in) SC 1yr Wty Digitally Signed Firmware HDD	872489-B21
HPE 1TB SATA 6G Midline 7.2K LFF (3.5in) SC 1yr Wty HDD	861691-B21
<b>6G SATA Hot Plug LFF (3.5-inch) Mixed Use Solid State Drives</b>	
HPE 1.92TB SATA 6G Mixed Use LFF (3.5in) SCC 3yr Wty Digitally Signed Firmware SSD	875480-B21
HPE 960GB SATA 6G Mixed Use LFF (3.5in) SCC 3yr Wty Digitally Signed Firmware SSD	872350-B21
HPE 480GB SATA 6G Mixed Use LFF (3.5in) SCC 3yr Wty Digitally Signed Firmware SSD	872346-B21
<b>12G SAS Hot Plug SFF (2.5-inch) Enterprise (ENT) Drives</b>	
HPE 2.4TB SAS 12G Enterprise 10K SFF (2.5in) SC 3yr Wty 512e Digitally Signed Firmware HDD	881457-B21
HPE 1.8TB SAS 12G Enterprise 10K SFF (2.5in) SC 3yr Wty 512e Digitally Signed Firmware HDD	872481-B21
HPE 1.2TB SAS 12G Enterprise 10K SFF (2.5in) SC 3yr Wty Digitally Signed Firmware HDD	872479-B21
HPE 900GB SAS 12G Enterprise 15K SFF (2.5in) SC 3yr Wty Digitally Signed Firmware HDD	870759-B21
HPE 900GB SAS 12G Enterprise 15K SFF (2.5in) SC 3yr Wty 512e Digitally Signed Firmware HDD	870765-B21
HPE 600GB SAS 12G Enterprise 15K SFF (2.5in) SC 3yr Wty Digitally Signed Firmware HDD	870757-B21
HPE 600GB SAS 12G Enterprise 10K SFF (2.5in) SC 3yr Wty Digitally Signed Firmware HDD	872477-B21
HPE 300GB SAS 12G Enterprise 15K SFF (2.5in) SC 3yr Wty Digitally Signed Firmware HDD	870753-B21
HPE 300GB SAS 12G Enterprise 10K SFF (2.5in) SC 3yr Wty Digitally Signed Firmware HDD	872475-B21
<b>12G SAS Hot Plug SFF (2.5-inch) Midline (MDL) Drives</b>	
HPE 2TB SAS 12G Midline 7.2K SFF (2.5in) SC 1yr Wty 512e HDD	765466-B21
HPE 1TB SAS 12G Midline 7.2K SFF (2.5in) SC 1yr Wty 512e Digitally Signed Firmware HDD	765464-B21

## Core Options

HPE 1TB SAS 12G Midline 7.2K SFF (2.5in) SC 1yr Wty Digitally Signed Firmware HDD	832514-B21
<b>6G SATA Hot Plug SFF (2.5-inch) Midline (MDL) Drives</b>	
HPE 2TB SATA 6G Midline 7.2K SFF (2.5in) SC 1yr Wty 512e Digitally Signed Firmware HDD	765455-B21
HPE 1TB SATA 6G Midline 7.2K SFF (2.5in) SC 1yr Wty Digitally Signed Firmware HDD	655710-B21
HPE 1TB SATA 6G Midline 7.2K SFF (2.5in) SC 1yr Wty 512e Digitally Signed Firmware HDD	765453-B21
<b>12G SAS Hot Plug SFF (2.5-inch) Read Intensive Solid State Drives</b>	
HPE 7.68TB SAS 12G Read Intensive SFF (2.5in) SC 3yr Wty Digitally Signed Firmware SSD	870144-B21
HPE 3.84TB SAS 12G Read Intensive SFF (2.5in) SC 3yr Wty Digitally Signed Firmware SSD	872394-B21
HPE 3.84TB SAS 12G Read Intensive SFF (2.5in) SC 3yr Wty Digitally Signed Firmware SSD	875330-B21
HPE 1.92TB SAS 12G Read Intensive SFF (2.5in) SC 3yr Wty Digitally Signed Firmware SSD	872392-B21
HPE 1.92TB SAS 12G Read Intensive SFF (2.5in) SC 3yr Wty Digitally Signed Firmware SSD	875326-B21
HPE 960GB SAS 12G Read Intensive SFF (2.5in) SC 3yr Wty Digitally Signed Firmware SSD	872390-B21
HPE 960GB SAS 12G Read Intensive SFF (2.5in) SC 3yr Wty Digitally Signed Firmware SSD	875313-B21
HPE 480GB SAS 12G Read Intensive SFF (2.5in) SC 3yr Wty Digitally Signed Firmware SSD	875311-B21
<b>12G SAS Hot Plug SFF (2.5-inch) Write Intensive Solid State Drives</b>	
HPE 1.6TB SAS 12G Write Intensive SFF (2.5in) SC 3yr Wty Digitally Signed Firmware SSD	873357-B21
HPE 800GB SAS 12G Write Intensive SFF (2.5in) SC 3yr Wty Digitally Signed Firmware SSD	873355-B21
HPE 400GB SAS 12G Write Intensive SFF (2.5in) SC 3yr Wty Digitally Signed Firmware SSD	873351-B21
<b>12G SAS Hot Plug LFF (3.5-inch) Mixed Use Solid State Drives</b>	
HPE 800GB SAS 12G Mixed Use LFF (3.5in) SCC 3yr Wty Digitally Signed Firmware SSD	872378-B21
<b>12G SAS Hot Plug SFF (2.5-inch) Mixed Use Solid State Drives</b>	
HPE 3.2TB SAS 12G Mixed Use SFF (2.5in) SC 3yr Wty Digitally Signed Firmware SSD	873367-B21
HPE 3.2TB SAS 12G Mixed Use SFF (2.5in) SC 3yr Wty Digitally Signed Firmware SSD	872386-B21
HPE 1.6TB SAS 12G Mixed Use SFF (2.5in) SC 3yr Wty Digitally Signed Firmware SSD	873365-B21
HPE 1.6TB SAS 12G Mixed Use SFF (2.5in) SC 3yr Wty Digitally Signed Firmware SSD	872382-B21
HPE 800GB SAS 12G Mixed Use SFF (2.5in) SC 3yr Wty Digitally Signed Firmware SSD	873363-B21
HPE 800GB SAS 12G Mixed Use SFF (2.5in) SC 3yr Wty Digitally Signed Firmware SSD	872376-B21

## Core Options

HPE 400GB SAS 12G Mixed Use SFF (2.5in) SC 3yr Wty Digitally Signed Firmware SSD	873359-B21
HPE 400GB SAS 12G Mixed Use SFF (2.5in) SC 3yr Wty Digitally Signed Firmware SSD	872374-B21
<b>6G SATA Hot Plug WI-3 SFF (2.5-inch) SC Solid State Drives</b>	
HPE 400GB SATA 6G Write Intensive SFF (2.5in) SC 3yr Wty Digitally Signed Firmware SSD	872355-B21
<b>6G SATA Hot Plug SFF (2.5-inch) Mixed Use Solid State Drives</b>	
HPE 1.92TB SATA 6G Mixed Use SFF (2.5in) SC 3yr Wty Digitally Signed Firmware SSD	877788-B21
HPE 1.92TB SATA 6G Mixed Use SFF (2.5in) SC 3yr Wty Digitally Signed Firmware SSD	875478-B21
HPE 1.92TB SATA 6G Mixed Use SFF (2.5in) SC 3yr Wty Digitally Signed Firmware SSD	872352-B21
HPE 960GB SATA 6G Mixed Use SFF (2.5in) SC 3yr Wty Digitally Signed Firmware SSD	877782-B21
HPE 960GB SATA 6G Mixed Use SFF (2.5in) SC 3yr Wty Digitally Signed Firmware SSD	875474-B21
HPE 960GB SATA 6G Mixed Use SFF (2.5in) SC 3yr Wty Digitally Signed Firmware SSD	872348-B21
HPE 480GB SATA 6G Mixed Use SFF (2.5in) SC 3yr Wty Digitally Signed Firmware SSD	877776-B21
HPE 480GB SATA 6G Mixed Use SFF (2.5in) SC 3yr Wty Digitally Signed Firmware SSD	875470-B21
HPE 480GB SATA 6G Mixed Use SFF (2.5in) SC 3yr Wty Digitally Signed Firmware SSD	872344-B21
HPE 240GB SATA 6G Mixed Use SFF (2.5in) SC 3yr Wty Digitally Signed Firmware SSD	880295-B21
HPE 240GB SATA 6G Mixed Use SFF (2.5in) SC 3yr Wty Digitally Signed Firmware SSD	875483-B21
<b>6G SATA Hot Plug LFF (3.5-inch) Mixed Use Solid State Drives</b>	
HPE 1.92TB SATA 6G Mixed Use LFF (3.5in) SCC 3yr Wty Digitally Signed Firmware SSD	877790-B21
HPE 960GB SATA 6G Mixed Use LFF (3.5in) SCC 3yr Wty Digitally Signed Firmware SSD	877784-B21
HPE 960GB SATA 6G Mixed Use LFF (3.5in) SCC 3yr Wty Digitally Signed Firmware SSD	875476-B21
HPE 480GB SATA 6G Mixed Use LFF (3.5in) SCC 3yr Wty Digitally Signed Firmware SSD	875472-B21
<b>Mixed Use - 6G SATA - M.2 - Solid State Drives</b>	
HPE 960GB SATA 6G Mixed Use M.2 2280 3yr Wty Digitally Signed Firmware SSD	875492-B21
HPE 480GB SATA 6G Mixed Use M.2 2280 3yr Wty Digitally Signed Firmware SSD	875490-B21
HPE 240GB SATA 6G Mixed Use M.2 2280 3yr Wty Digitally Signed Firmware SSD	875488-B21
<b>6G SATA Hot Plug LFF (3.5-inch) SC Read Intensive Solid State Drives</b>	
HPE 1.92TB SATA 6G Read Intensive LFF (3.5in) SCC 3yr Wty Digitally Signed Firmware SSD	877760-B21

## Core Options

HPE 960GB SATA 6G Read Intensive LFF (3.5in) SCC 3yr Wty Digitally Signed Firmware SSD 877754-B21

HPE 480GB SATA 6G Read Intensive LFF (3.5in) SCC 3yr Wty Digitally Signed Firmware SSD 877748-B21

### **6G SATA Hot Plug SFF (2.5-inch) SC Read Intensive Solid State Drives**

HPE 3.84TB SATA 6G Read Intensive SFF (2.5in) SC 3yr Wty Digitally Signed Firmware SSD 877764-B21

HPE 3.8TB SATA 6G Read Intensive SFF (2.5in) SC 3yr Wty Digitally Signed Firmware SSD 868830-B21

HPE 1.92TB SATA 6G Read Intensive SFF (2.5in) SC 3yr Wty Digitally Signed Firmware SSD 877758-B21

HPE 1.92TB SATA 6G Read Intensive SFF (2.5in) SC 3yr Wty Digitally Signed Firmware SSD 868826-B21

HPE 1.92TB SATA 6G Read Intensive SFF (2.5in) SC 3yr Wty Digitally Signed Firmware SSD 875513-B21

HPE 960GB SATA 6G Read Intensive SFF (2.5in) SC 3yr Wty Digitally Signed Firmware SSD 877752-B21

HPE 960GB SATA 6G Read Intensive SFF (2.5in) SC 3yr Wty Digitally Signed Firmware SSD 868822-B21

HPE 960GB SATA 6G Read Intensive SFF (2.5in) SC 3yr Wty Digitally Signed Firmware SSD 875511-B21

HPE 480GB SATA 6G Read Intensive SFF (2.5in) SC 3yr Wty Digitally Signed Firmware SSD 877746-B21

HPE 480GB SATA 6G Read Intensive SFF (2.5in) SC 3yr Wty Digitally Signed Firmware SSD 868818-B21

HPE 480GB SATA 6G Read Intensive SFF (2.5in) SC 3yr Wty Digitally Signed Firmware SSD 875509-B21

HPE 240GB SATA 6G Read Intensive SFF (2.5in) SC 3yr Wty Digitally Signed Firmware SSD 877740-B21

HPE 240GB SATA 6G Read Intensive SFF (2.5in) SC 3yr Wty Digitally Signed Firmware SSD 868814-B21

HPE 240GB SATA 6G Read Intensive SFF (2.5in) SC 3yr Wty Digitally Signed Firmware SSD 875503-B21

### **Read Intensive - 6G SATA - M.2 - Solid State Drives**

HPE 960GB SATA 6G Read Intensive M.2 2280 3yr Wty Digitally Signed Firmware SSD 875500-B21

HPE 480GB SATA 6G Read Intensive M.2 2280 3yr Wty Digitally Signed Firmware SSD 875498-B21

### **HPE NVMe PCIe Read Intensive SFF (2.5 inch) Solid State Drives**

HPE 1.92TB NVMe x4 Lanes Read Intensive SFF (2.5in) SCN 3yr Wty Digitally Signed Firmware SSD 875591-B21

HPE 960GB NVMe x4 Lanes Read Intensive SFF (2.5in) SCN 3yr Wty Digitally Signed Firmware SSD 875589-B21

HPE 480GB NVMe x4 Lanes Read Intensive SFF (2.5in) SCN 3yr Wty Digitally Signed Firmware SSD 875587-B21

**NOTE:** ML350 Gen9 6SFF Express Bay Enablement Kit (726551-B21) is required to support these drives.

**NOTE:** HPE has qualified the NVMe drive portfolio using the Operating System inbox drivers, full detail on the [HPE Solid State Drive QuickSpecs](#).

### **HPE NVMe PCIe Mixed Use SSDs**

## Core Options

HPE 1.6TB NVMe x4 Lanes Mixed Use SFF (2.5in) SCN 3yr Wty Digitally Signed Firmware SSD 875597-B21

HPE 800GB NVMe x4 Lanes Mixed Use SFF (2.5in) SCN 3yr Wty Digitally Signed Firmware SSD 875595-B21

HPE 400GB NVMe x4 Lanes Mixed Use SFF (2.5in) SCN 3yr Wty Digitally Signed Firmware SSD 875593-B21

**NOTE:** ML350 Gen9 6SFF Express Bay Enablement Kit (726551-B21) is required to support these drives.

**NOTE:** HPE has qualified the NVMe drive portfolio using the Operating System inbox drivers, full detail on the [HPE Solid State Drive QuickSpecs](#).

### M.2 SSD

HPE Universal SATA HHHL 3yr Wty M.2 Kit 878783-B21

**NOTE:** M.2 SSD ML-DL Enablmt Kit can be used to build RAID 0, 1 by using B140i controller.

- When HPE 120GB or 340GB M.2 SSD ML-DL Dual Enablmt Kit is ordered, it can support RAID 0, 1.

- When HPE 120GB or 340GB M.2 SSD ML-DL Sngl Enablmt Kit is ordered, it can support RAID 0.

**NOTE:** M.2 SSD ML-DL Enablmt Kit CANNOT support RAID setting when AROC card (P440ar or H240ar) is selected. Embedded B140i controller CANNOT be used when AROC is ordered.

### Hard Drive Blank Kits

HPE Large Form Factor Hard Drive Blank Kit 666986-B21

HPE Small Form Factor Hard Drive Blank Kit 666987-B21

### Hard Drive Kits

HP ML350 Gen9 SFF Media Cage Kit 726545-B21

HP ML350 Gen9 8LFF Hot Plug Drive Cage Kit 726547-B21

HP ML350 Gen9 LFF Media Cage Kit 726561-B21

HP ML350 Gen9 8SFF Hard Drive Cage Kit 778157-B21

HP ML350 Gen9 NVMe 6 Solid State Drive Express Bay Enablement Kit 726551-B21

**NOTE:** The ML350 Gen9 6SFF Express Bay kit is consist of one x6 SFF NVMe drive cage assembly, one Express Bay Bridge card, etc.

## HPE Networking

### 1 Gigabit Ethernet adapters

HP Ethernet 1Gb 4-port 331T Adapter 647594-B21

HP Ethernet 1Gb 2-port 361T Adapter 652497-B21

HP Ethernet 1Gb 2-port 332T Adapter 615732-B21

HP Ethernet 1Gb 4-port 366T Adapter 811546-B21

### 10 Gigabit Ethernet adapters

HP Ethernet 10Gb 2-port 560SFP+ Adapter 665249-B21

HP Ethernet 10Gb 2-port 530T Adapter 656596-B21

HP Ethernet 10Gb 2-port 530SFP Adapter 652503-B21

HP Ethernet 10Gb 2-port 561T Adapter 716591-B21

HP Ethernet 10Gb 2-port 546SFP+ Adapter 779793-B21

HP Ethernet 10Gb 2-port 557SFP+ Adapter 788995-B21

HPE Ethernet 10Gb 2-port 562SFP+ Adapter 727055-B21

### 25 Gigabit Ethernet adapters



## Core Options

HPE Ethernet 10/25Gb 2-port 640SFP28 Adapter	817753-B21
HPE Ethernet 4x25Gb 1-port 620QSFP28 Adapter	817762-B21

**NOTE:** The ML350 Gen9 ships with 4x1Gb ports Embedded.

**NOTE:** Direct Attach Cable (DAC) for copper environments or fiber transceivers and cables for fiber-optic environments must be purchased separately. Please see the related NIC QuickSpecs for Technical Specifications and additional information: <http://www.hp.com/go/ProLiantNICs>.

---

<b>HPE InfiniBand</b>	HP InfiniBand FDR 2-port 545QSFP Adapter	702211-B21
-----------------------	--	------------

### HPE Power Supplies

#### HPE Flex Slot Platinum Hot-plug Power supplies

HPE 500W Flex Slot Platinum Hot Plug Power Supply Kit	720478-B21
HPE 800W Flex Slot Platinum Hot Plug Power Supply Kit	720479-B21
HPE 1400W Flex Slot Platinum Plus Hot Plug Power Supply Kit	720620-B21
HPE 800W Flex Slot -48VDC Hot Plug Power Supply Kit	720480-B21
HPE 800W Flex Slot Titanium Hot Plug Power Supply Kit	720482-B21
HPE 800W Flex Slot Universal Hot Plug Power Supply Kit	720484-B21
HP ML350 Gen9 X4 RPS Enablement Kit	802988-B21

**NOTE:** If Power supply selection quantity is more than two, then X4 RPS Enablement Kit must be selected (minimum Power Supply qty. selection to configure with X4 RPS Enablement Kit is three).

**NOTE:** And this option is not supported with 720478-B21 (HPE 500W FS Plat Ht Plg Pwr Supply Kit).

**NOTE:** If hard drive cage selection quantity is more than three, this X4 RPS Enablement Kit must be selected - to get proper quantity of HDD backplane power connectors.

**NOTE:** If DW GPU card selection quantity is more than two, this X4 RPS Enablement Kit MUST be selected - in order to get proper quantity of GPU external power connectors.

### HPE Computation and Graphics Accelerators

---

HP ML350 Gen9 Graphic Card Support Kit	726565-B21
--	------------

**NOTE:** One Graphic Card Support Kit- 726565-B21 is required for each computation or graphics accelerator except for K2200 or M2000.

NVIDIA Tesla K40C 12GB Computational Accelerator	753960-B21
--	------------

**NOTE:** A maximum of four of these cards can be selected. Each requires one Graphic Card Support Kit (726565-B21).

**NOTE:** If this SKU is selected then minimum quantity = 2 of 800W Power Supply Kit (725870-B21) must be selected.

HP AMD FirePro W7100 Accelerator Kit	J0H10A
--------------------------------------	--------

**NOTE:** A maximum of four of these cards can be selected. Each requires one Graphic Card Support Kit (726565-B21).

HPE NVIDIA Quadro M4000 Graphics Accelerator	M9X58A
--	--------

**NOTE:** A maximum of four of these cards can be selected. Each requires one Graphic Card Support Kit (726565-B21).

**NOTE:** Only supported with E5-2600v4 processors.

HP NVIDIA Quadro M5000 Graphics Accelerator	M9R60A
---	--------

**NOTE:** A maximum of four of these cards can be selected. Each requires one Graphic Card Support Kit (726565-B21).

**NOTE:** Only supported with E5-2600v4 processors.

## Core Options

HPE NVIDIA Quadro M2000 Graphics Accelerator	P8Y48A
HPE NVIDIA Quadro P2000 Graphics Accelerator	Q0V77A
HPE NVIDIA Quadro P4000 Graphics Accelerator	Q0V78A

**NOTE:** A maximum of four of these cards can be selected.

**NOTE:** Only supported with E5-2600v4 processors.

**NOTE:** If more than two Double Wide Graphics options are selected, then HPE ML350 Gen9 X4 RPS Enablement Kit must be selected in order to get the third and fourth supporting power connectors to supply power to the GPU cards.

**NOTE:** Only the above listed Graphics cards are HPE standard supported options in this server.

**NOTE:** The NVIDIA Quadro modules are supported only on 64-bit versions of Linux and Windows operating systems as well as on Virtual Machine client operating systems. The supported bare metal operating systems are RHEL6, SLES 11 and Windows Server 2012 R2.

**NOTE:** Please see the HPE Power Advisor for estimated power consumption of your individual system configuration prior to installing GPUs. The HPE Power Advisor is located

at: <http://www.hpe.com/info/hppoweradvisor>.

**NOTE:** All GPU Accelerators are restricted to equal less than 1024GB for system HOST memory.

---

## HPE Cooling Options

HP ML350 Gen9 Redundant Fan Kit	725878-B21
---------------------------------	------------

**NOTE:** This kit consists of four system fans and two PCIe air baffles.

## Additional Options

**NOTE:** Some options may not be integrated at the factory. To ensure only valid configurations are ordered, Hewlett Packard Enterprise recommends the use of an HPE approved configurator. Contact your local sales representative for additional information.

<b>HPE Insight Software</b>	<b>HPE Insight Control</b>	
	HPE Insight Control including 1yr 24x7 Technical Support and Updates 1-server LTU	C6N27A
	HPE Insight Management Media Kit	C6N31A

<b>Embedded Management</b>	<b>HPE iLO Advanced</b>	
	HPE iLO Advanced including 3yr 24x7 Tech Support and Updates 1-server LTU	BD505A
	HPE iLO Advanced including 1yr 24x7 Technical Support and Updates E-LTU	E6U59ABE
	HPE iLO Advanced including 1yr 24x7 Technical Support and Updates 1-server LTU	512485-B21
	HPE iLO Advanced including 3yr 24x7 Technical Support and Updates E-LTU	E6U64ABE

<b>HPE Converged Infrastructure Management Software</b>	<b>HPE OneView Advanced (with HPE iLO Advanced)</b>	
	HPE OneView including 3yr 24x7 Support Physical 1-server LTU	E5Y34A
	HPE OneView including 3yr 24x7 Support Flexible Quantity E-LTU	E5Y35AAE
	<b>HPE OneView Advanced (without HPE iLO Advanced)</b>	
	HPE OneView w/o iLO including 3yr 24x7 Support 1-server LTU	P8B24A
	HPE OneView w/o iLO including 3yr 24x7 Support Flexible Quantity E-LTU	P8B26AAE
	HPE OneView Physical Media Kit LTU	E5Y37A

**NOTE:** Full licenses of HPE OneView Advanced also provide the right-to-use HPE Insight Control without additional charge.

**NOTE:** Server provisioning (via 'HPE Insight Control server provisioning') is licensed as part of HPE OneView Advanced and provides multi-server OS and driver provisioning. Media kit #BD883A can be ordered for a physical copy of this software (USB flash drive).

**NOTE:** Licenses ship without media. The HPE OneView Media Kit can be ordered separately, or can be downloaded at: <http://www.hpe.com/info/hpeoneview>

**NOTE:** HPE OneView 3.1 Advanced simplifies Lifecycle Operations with Proactive Insight and Automated Updates.

**NOTE:** HPE OneView delivers proactive insights into the health of your entire infrastructure. An intuitive dashboard provides an at-a-glance view of the status of your servers, storage pools and enclosures. Color-coded icons clearly show which systems are functioning properly and which ones need attention.

**NOTE:** Integrated remote support automatically logs hardware failures with Hewlett Packard Enterprise support to speed problem resolution and accelerate parts or service technician dispatch.

<b>High Performance Clusters</b>	<b>HPE Cluster Management Utility</b>	
	HPE Insight Cluster Management Utility 1yr 24x7 Flexible LTU	QL803B
	HPE Insight Cluster Management Utility 3yr 24x7 Flexible LTU	BD476A
	<b>NOTE:</b> These part numbers can be used to purchase one certificate for multiple licenses and support with a single activation key. Each license is for one node (server). Customer will receive a printed end user license agreement and license entitlement certificate via physical shipment. The license entitlement certificate must be redeemed online in order to obtain a license key. Customer also will receive a support agreement.	
	HPE Insight Cluster Management Utility Media	BD477A

## Additional Options

<b>HPE PCIe Workload Accelerator Options</b>	<b>Light Endurance (LE) PCIe Workload Accelerators</b> HPE 5.2TB FH/HL Light Endurance (LE) PCIe Workload Accelerator	775672-B21
<b>HPE Security</b>	HP Security Bezel Kit <b>NOTE:</b> Rack model only. HP Trusted Platform Module Option <b>NOTE:</b> The HPE Trusted Platform Module Option (488069-B21) is the TPM 1.2 version. Compatible server platforms include Gen8 and Gen9 servers. <b>NOTE:</b> HPE server systems can have a TPM module (of any type) installed only once. It cannot be replaced with any other TPM module. <b>NOTE:</b> The TPM (Trusted Platform Module) is a microcontroller chip that can securely store artifacts used to authenticate the server platform. These artifacts can include passwords, certificates and encryption keys. Windows® BitLocker™ Drive Encryption (BitLocker) is a data protection feature available in Windows Server® 2008. BitLocker leverages the enhanced security capabilities of a Trusted Platform Module (TPM) version 1.2. The TPM works with BitLocker to help protect user data and to ensure that a server running Windows Server 2008 has not been tampered with while the system was offline. For more information about TPM, go to: <a href="https://www.hpe.com/h20195/v2/gethtml.aspx?docname=c04939549">https://www.hpe.com/h20195/v2/gethtml.aspx?docname=c04939549</a> . <b>NOTE:</b> ProLiant OS pre-installed units will come with the partition required for TPM deployment. <b>NOTE:</b> The TPM key is unique to every TPM deployed server and must be retained. Misplacing or losing the key could result in data loss.	660584-B21
	HP Trusted Platform Module 2.0 Kit <b>NOTE:</b> HPE Trusted Platform Module 2.0 Option works with Gen9 servers with UEFI Mode not Legacy Mode. It is not compatible with HPE ProLiant Gen8 servers or earlier generation variants. <b>NOTE:</b> HPE Gen9 servers purchased earlier may need the latest firmware update to be compatible with the TPM 2.0 Option. <b>NOTE:</b> HPE server systems can have a TPM module (of any type) installed only once. It cannot be replaced with any other TPM module. <b>NOTE:</b> ML350 Gen9 supports both TPM 1.2 (488069-B21) and TPM 2.0 (745823-B21). However, once the TPM version 1.2 is installed on the system board, it can no longer be upgraded to TPM version 2.0. <b>NOTE:</b> A new TPM (1.2 or 2.0) can only be installed on a Gen9 server if there is no TPM already installed. Once a TPM is installed with the security rivet, it is not designed to be removed. This means that if a customer already has a TPM 1.2 module riveted down on their Gen9 server, they cannot remove it and change it to a TPM 2.0 module. <b>NOTE:</b> For more information about TPM, go to: <a href="https://www.hpe.com/h20195/v2/gethtml.aspx?docname=c04939549">https://www.hpe.com/h20195/v2/gethtml.aspx?docname=c04939549</a> .	745823-B21
<b>HPE Storage Controllers</b>	<b>SAS Controllers</b> <b>HPE Flexible Smart Array Controllers</b> HP Smart Array P440ar/2GB FBWC 12Gb 2-ports Int SAS Controller <b>NOTE:</b> Provides support for up to 8 internal SAS/SATA drives without using a PCIe slot. <b>NOTE:</b> Includes the HPE Smart Storage Battery.	726736-B21

## Additional Options

### HPE Smart Array Controllers

HP Smart Array P440/4GB FBWC 12Gb 1-port Int SAS Controller 726821-B21

**NOTE:** Provides support for up to 8 internal SAS/SATA drives, consumes 1 PCIe slot.

HP Smart Array P840/4GB FBWC 12Gb 2-ports Int SAS Controller 726897-B21

HP Smart Array P441/4GB FBWC 12Gb 2-ports Ext SAS Controller 726825-B21

HP Smart Array P841/4GB FBWC 12Gb 4-ports Ext SAS Controller 726903-B21

### HPE Smart Host Bus Adapters

HP H240ar 12Gb 2-ports Int Smart Host Bus Adapter 726757-B21

**NOTE:** Provides support for up to 8 internal SAS/SATA drives without using a PCIe slot.

HP H240 12Gb 2-ports Int Smart Host Bus Adapter 726907-B21

HP H241 12Gb 2-ports Ext Smart Host Bus Adapter 726911-B21

### Optional Upgrades

HP 12Gb SAS Expander Card for ML350 Gen9 769635-B21

**NOTE:** The SAS Expander card supports 24 drives. The SAS Expander card must be used in conjunction with an HPE Smart Array P440 or P840 controller, or an H240 Host Bus Adapter. The SAS Expander card cannot be connected to H240ar or P440ar Flexible Smart Array Controller (AROC) cards. The SAS Expander kit includes two cables to connect from the Smart Array controller or HBA to the SAS Expander and the other to connect from the Expander to the HDD backplane.

**NOTE:** It DOES NOT support tape storage/ Disk-Based Backup device (RDX).

HP ML350 Gen9 2nd Expander Card 811216-B21

**NOTE:** The ML350 Gen9 2nd Expander Card must be used in conjunction with ML350 Gen9 SAS Expander kit (769635-B21, see config. guideline described in above item), a 2nd processor kit, ML350 Gen9 x4 RPS enablement kit (802988-B21) and P840 controller. This configuration can support maximum 48 drives in SFF chassis system.

**NOTE:** This kit DOES NOT support tape storage or disk-based backup devices (RDX) either.

HPE 96W Smart Storage Battery 145mm Cbl for DL/ML/SL Servers P01366-B21

**NOTE:** New part number P01366-B21 to replace the older part 727258-B21.

HPE SmartCache No Media 24x7 Technical Support 1-server LTU D7S26A

HPE SmartCache No Media 24x7 Technical Support Flexible LTU D7S27A

HPE SmartCache No Media 24x7 Technical Support E-LTU D7S27AAE

### HPE Cable Options

HP ML350 Gen9 Flexible Smart Array Controller Mini-SAS Cable Kit 765652-B21

**NOTE:** Mini-SAS Cable Kit for Flexible Smart Array (AROC) Controller.

HP ML350 Gen9 Smart Array Cable Kit 765650-B21

**NOTE:** Mini-SAS Cable Kit for stand-up P-series Smart Array Card.

HP ML350 Gen9 Host Bus Adapter Mini-SAS Cable Kit 765648-B21

**NOTE:** Mini-SAS Cable kit for Host Bus Adapter.

HP ML350 Gen9 Mini SAS Cable FIO Kit 765654-B21

**NOTE:** Required to support B140i embedded SATA controller.

**NOTE:** FIO indicates factory integrated option for CTO order.

---

**HPE Tape Backup** **NOTE:** For the complete range of tape drives, autoloaders, libraries and media see: <http://www.hp.com/go/tape>. For hardware and software compatibility of Hewlett Packard

## Additional Options

Enterprise tape backup products see: <http://www.hp.com/storage/SPOCK> and <http://www.hp.com/go/ebs>.

### Tape Drives

HPE StoreEver LTO-4 Ultrium 1760 SAS External Tape Drive	EH920B
HPE StoreEver LTO-4 Ultrium 1760 SAS Internal WW Tape Drive	EH919B
HPE StoreEver LTO-5 Ultrium 3000 SAS External Tape Drive	EH958B
HPE StoreEver LTO-5 Ultrium 3000 SAS Internal Tape Drive	EH957B
HPE StoreEver LTO-5 Ultrium 3000 SAS Tape Drive in a 1U Rack Mount Kit	EJ014B
HPE StoreEver LTO-6 Ultrium 6250 External Tape Drive	EH970A
HPE StoreEver LTO-6 Ultrium 6250 Internal Tape Drive	EH969A
HPE StoreEver 1/8 G2 LTO-6 Ultrium 6250 Fibre Channel Tape Autoloader	COH19A
HPE StoreEver LTO-6 Ultrium 6250 Tape Drive in a 1U Rack Mount Kit	COL99A
HPE StoreEver Mini-SAS High Density to 4-lane Mini-SAS External Fanout 2m Cable	K2R09A
HPE StoreEver Mini-SAS High Density to 4-lane Mini-SAS External Fanout 4m Cable	K2R10A
HPE StoreEver LTO-7 Ultrium 15000 Internal Tape Drive	BB873A
HPE StoreEver LTO-7 Ultrium 15000 External Tape Drive	BB874A
HPE LTO-8 Ultrium 30750 Int Tape Drive	BC022A

### HPE Tape Storage Systems

#### HPE StoreEver MSL6480

HPE StoreEver MSL6480 Scaleable Expansion Module	QU626A
<b>NOTE:</b> Please see the <a href="#">HPE StoreEver MSL6480 Tape Library QuickSpecs</a> for Technical Specifications and additional information.	
HPE StoreEver MSL6480 Scalable Base Module	QU625A
HPE StoreEver MSL2024 0-drive Tape Library	AK379A
HPE StoreEver MSL4048 0-drive Tape Library	AK381A

## HPE Disk Backup

### HPE RDX Removable Disk Backup Systems USB

HPE RDX500 USB3.0 Internal Disk Backup System	B7B64A
HPE RDX1000 USB3.0 Internal Disk Backup System	B7B67A
HPE RDX 2TB USB3.0 Internal Disk Backup System	E7X52A
HP RDX+ 500GB External Backup System	B7B66B
HP RDX+ 1TB External Backup System	B7B69B
HP RDX 2TB USB3.0 External Disk Backup System	E7X53B
HPE RDX+ External Docking System	C8S07B
HPE RDX USB 3.0 Internal Docking Station	C8S06A
HPE RDX 3TB USB 3.0 Internal Disk Backup System	P9L71A
HPE RDX+ 3TB USB 3.0 External Disk Backup System	P9L72A

**NOTE:** For the complete range of RDX drives and media see: <http://www.hp.com/go/rdx>. For hardware and software compatibility of HPE disk backup products see: <http://www.hp.com/storage/SPOCK>.

## HPE Storage Options

**NOTE:** The following is a list of all Fibre Channel Host Bus Adapters for Windows and Linux. For detailed compatibility information please

see: <http://h18006.www1.hp.com/storage/saninfrastructure/hba.html>.

### Emulex Fibre Channel HBAs

HPE 81E 8Gb 1-port PCIe Fibre Channel Host Bus Adapter	AJ762B
HPE 82E 8Gb 2-port PCIe Fibre Channel Host Bus Adapter	AJ763B
HPE StoreFabric SN1100E 16Gb Single Port Fibre Channel Host Bus Adapter	C8R38A

## Additional Options

HPE StoreFabric SN1100E 16Gb Dual Port Fibre Channel Host Bus Adapter	C8R39A
HPE StoreFabric SN1600E 32Gb Single Port Fibre Channel Host Bus Adapter	Q0L11A
HPE StoreFabric SN1600E 32Gb Dual Port Fibre Channel Host Bus Adapter	Q0L12A
HPE StoreFabric SN1200E 16Gb Single Port Fibre Channel Host Bus Adapter	Q0L13A
HPE StoreFabric SN1200E 16Gb Dual Port Fibre Channel Host Bus Adapter	Q0L14A
<b>QLogic Fibre Channel HBAs</b>	
HPE 81Q 8Gb 1-port PCIe Fibre Channel Host Bus Adapter	AK344A
HPE 82Q 8Gb 2-port PCIe Fibre Channel Host Bus Adapter	AJ764A
HPE StoreFabric SN1000Q 16GB 1-port PCIe Fibre Channel Host Bus Adapter	QW971A
HPE StoreFabric SN1000Q 16GB 2-port PCIe Fibre Channel Host Bus Adapter	QW972A
HPE StoreFabric 84Q 4-port 8Gb Fibre Channel Host Bus Adapter	P9D91A
HPE StoreFabric SN1100Q 16Gb Single Port Fibre Channel Host Bus Adapter	P9D93A
HPE StoreFabric SN1100Q 16Gb Dual Port Fibre Channel Host Bus Adapter	P9D94A
HPE StoreFabric SN1600Q 32Gb Single Port Fibre Channel Host Bus Adapter	P9M75A
HPE StoreFabric SN1600Q 32Gb Dual Port Fibre Channel Host Bus Adapter	P9M76A
<b>Converged Network Adapter</b>	
HPE StoreFabric CN1100R Dual Port Converged Network Adapter	QW990A
HPE StoreFabric CN1200E 10Gb Converged Network Adapter	E7Y06A
HPE StoreFabric CN1100R 10GBASE-T Dual Port Converged Network Adapter	N3U52A
HPE StoreFabric CN1200E 10GBASE-T Dual Port Converged Network Adapter	N3U51A

### HPE Data Center Racks

#### HPE Advanced Series Racks

HPE 11648 1075mm Pallet Universal Rack	H6J87A
HPE 11648 1075mm Shock Universal Rack	H6J88A
HPE 11642 1075mm Pallet Universal Rack	H6J65A
HPE 11642 1075mm Shock Universal Rack	H6J66A
HPE 11642 1200mm Pallet Universal Rack	H6J67A
HPE 11642 1200mm Shock Universal Rack	H6J68A
HPE 11636 1075mm Pallet Universal Rack	H6J77A
HPE 11636 1075mm Shock Universal Rack	H6J78A
HPE 11622 G2 1075mm Pallet Universal Rack	H6J83A
HPE 11622 G2 1075mm Shock Universal Rack	H6J84A
HPE 11614 1075mm Shock Universal Rack	H6J82A

**NOTE:** Please see the [HPE Advanced Series Racks QuickSpecs](#) for information on additional racks options and rack specifications.

#### HPE Enterprise Series Racks

HPE 647 1075mm Pallet Intelligent Series Rack	BW911A
HPE 647 1075mm Shock Intelligent Series Rack	BW912A
HPE 647 1200mm Pallet Intelligent Series Rack	BW913A
HPE 647 1200mm Shock Intelligent Series Rack	BW914A
HPE 642 1075mm Pallet Intelligent Series Rack	BW903A
HPE 642 1075mm Shock Intelligent Series Rack	BW904A
HPE 642 1200mm Pallet Intelligent Series Rack	BW907A
HPE 642 1200mm Shock Intelligent Series Rack	BW908A
HPE 636 1075mm Pallet Intelligent Series Rack	BW895A
HPE 636 1075mm Shock Intelligent Series Rack	BW896A
HPE 842 1075mm Pallet Intelligent Series Rack	BW917A
HPE 842 1075mm Shock Intelligent Series Rack	BW918A

**NOTE:** Please see the [HPE Enterprise Series Racks QuickSpecs](#) for information on additional racks options and rack specifications.

## Additional Options

<b>HPE Power Distribution Units (PDUs)</b>	<b>HPE Basic Power Distribution Units (PDU)</b>	
	HPE Basic Modular 4.9kVA/L6-30P 24A/208V Outlets (4) C19/Horizontal NA/JP Core Only PDU	252663-D74
	HPE Basic Modular 8.3kVA/CS8265C 40A/208V Outlets (4) C19/Horizontal NA/JP PDU	252663-D75
	HPE Basic Modular 3Ph 17.3kVA/60309 60A 4-wire 48A/208V Outlets (6) C19/Horizontal NA/JP PDU	AF511A
	HPE Basic 3.6kVA/60320 C20 Detachable 16A/230V Outlets (12) C13/Horizontal WW PDU	H5M56A
	HPE Basic 4.9kVA/L6-30P 24A/208V Outlets (20) C13/Vertical NA/JP PDU	H5M58A
	<b>NOTE: Please see the <a href="#">HPE Basic Power Distribution Units (PDU) QuickSpecs</a> for information on additional options and product specifications.</b>	
	<b>HPE Metered Power Distribution Units (PDU)</b>	
	HPE Metered 2.8kVA/L5-30P 24A/120V Outlets (12) 5-20R/Horizontal NA/JP PDU	D9N43A
	HPE Metered 3.6kVA/60320 C20 Detachable 16A/230V Outlets (16) C13/Vertical WW PDU	D9N45A
	HPE Metered 4.9kVA/L6-30P 24A/208V Outlets (20) C13 (4) C19/Vertical NA/JP PDU	D9N47A
	HPE Metered 3Ph 17.3kVA/60309 60A 4-wire 48A/208V Outlets (12) C13 (12) C19/Vertical NA/JP PDU	D9N59A
<b>NOTE: Please see the <a href="#">HPE Metered Power Distribution Units (PDU) QuickSpecs</a> for information on additional options and product specifications.</b>		
<b>HPE Intelligent Power Distribution Unit (PDU)</b>		
HPE Intelligent Modular 4.9kVA/L6-30P 24A/208V Outlets (6) C19/Horizontal NA/JP PDU	AF520A	
HPE Intelligent Modular 8.3kVA/CS8265C 40A/208V Outlets (6) C19/Horizontal NA/JP PDU	AF521A	
HPE Intelligent Modular 3Ph 8.6kVA/L15-30P 24A/208V Outlets (6) C19/Horizontal NA/JP PDU	AF522A	
HPE Intelligent Modular 3Ph 17.3kVA/60309 60A 4-wire 48A/208V (6) C19/Horizontal NA/JP PDU	AF523A	
HPE Intelligent Modular 3Ph 17.3kVA/IEC 60309 60A 4-wire 48A/208V (12) C19/Horizontal NA/JP PDU	AF535A	
HPE Intelligent Modular 4.9kVA/L6-30P 24A/208V Outlets (20) C13 (6) C19/Horizontal NA/JP PDU	AF531A	
HPE Intelligent Modular 3Ph 8.6kVA/L15-30P 24A/208V Outlets (20) C13 (6) C19/Horizontal NA/JP PDU	AF532A	
<b>NOTE: Please see the <a href="#">HPE Intelligent Power Distribution Unit (PDU) QuickSpecs</a> for information on additional options and product specifications.</b>		
<b>HPE Rack Mount Consoles, KVM Switches, and Keyboards</b>	<b>Rack location options</b>	
	HP ML350 Gen9 System Insight Display Kit	726563-B21
	HPE 36U Location Discovery Kit	BW945A
	HPE 42U Location Discovery Kit	BW946A
	HPE 47U Location Discovery Kit	BW947A
	HPE Location Discovery Services LCD8500 Kit	TL052A
	<b>Rail Kits</b>	
HP ML350 Gen9 Tower to Rack Conversion Kit	726567-B21	



## Additional Options

**NOTE:** For converting a tower model to a rack model. It is consist of a 5U rail kit, cable management arm (CMA) and rack enablement kit (rack ear, rack handle, SID blank etc).

### HPE Rack Mount Consoles

HP LCD8500 1U US Rackmount Console Kit	AF630A
HP LCD8500 1U US TAA Rackmount Console Kit	AF645A

### HPE KVM Switches

**NOTE:** To learn more, please visit the [HPE KVM Switches web page](#).

HP 1x1Ex8 KVM IP Console Switch G2 with Virtual Media CAC Software	AF620A
HP 2x1Ex16 KVM IP Console Switch G2 with Virtual Media CAC Software	AF621A
HP 0x2x16 KVM Server Console Switch G2 with Virtual Media CAC Software	AF618A
HP 1x4 USB/PS2 KVM Console Switch	AF611A
HP 0x2x32 KVM Server Console Switch G2 with Virtual Media CAC Software	AF619A
HP 4x1Ex32 KVM IP Console Switch G2 with Virtual Media CAC Software	AF622A
HP KVM Console USB Interface Adapter	AF628A
HP KVM Console USB 2.0 Virtual Media CAC Interface Adapter	AF629A
HP USB Remote Access Key for G3 KVM Console Switches	AF650A
HP 0x1x8 G3 KVM Console Switch	AF651A
HP 0x2x16 G3 KVM Console Switch	AF652A
HP TAA 0x2x16 G3 KVM Console Switch	AF653A

### HPE USB Keyboard and Mouse

HP USB BFR with PVC Free US Keyboard/Mouse Kit	631341-B21
--	------------

**NOTE:** Please see the [HPE USB Keyboard and Mouse QuickSpecs](#) for information on additional options and product specifications.

## HPE Uninterruptible HPE Tower UPS

### Power Systems (UPS)

HPE T750 G4 NA/JP Uninterruptible Power System	J2P85A
HPE T1000 G4 NA/JP Uninterruptible Power System	J2P86A
HPE T1500 G4 NA/JP Uninterruptible Power System	J2P87A
HPE R5000 3U L630 High Voltage NA/JP Uninterruptible Power System	AF460A

### HPE Rack-mountable UPS

HPE R7000 4U 50A High Voltage NA/JP Uninterruptible Power System	AF462A
--	--------

**NOTE:** To learn more, please visit the [HPE Uninterruptible Power Systems \(UPS\) web page](#).

## HPE USB and SD Options

HPE 32GB microSD Mainstream Flash Media Kit	700139-B21
HPE 8GB microSD Enterprise Mainstream Flash Media Kit	726116-B21
HP 8GB USB Enterprise Mainstream Flash Media Drive Key Kit	737953-B21
HP Dual 8GB microSD Enterprise Midline USB Kit	741279-B21

## HPE Support Services

### Installation & Start-up Services

HPE Install ProLiant ML350(p) Service	U4522E
HPE Installation and Startup ML350(p) Service	U4523E

### Proactive Care

HPE 3 year Proactive Care 24x7 ML350 Gen9 Service	U7BG4E
HPE 3 year Proactive Care Call to Repair ML350 Gen9 Service	U7BH0E
HPE 3 year Proactive Care 24x7 with DMR ML350 Gen9 Service	U7BG5E
HPE 3 year Proactive Care 24x7 with CDMR ML350 Gen9 Service	U7BG6E
HPE 3 year Proactive Care Call to Repair 24x7 with DMR ML350 Gen9 Service	U7BH1E

## Additional Options

HPE 3 year Proactive Care Call to Repair with CDMR ML350 Gen9 Service

U7BH2E

## Memory

### Memory Population Guidelines

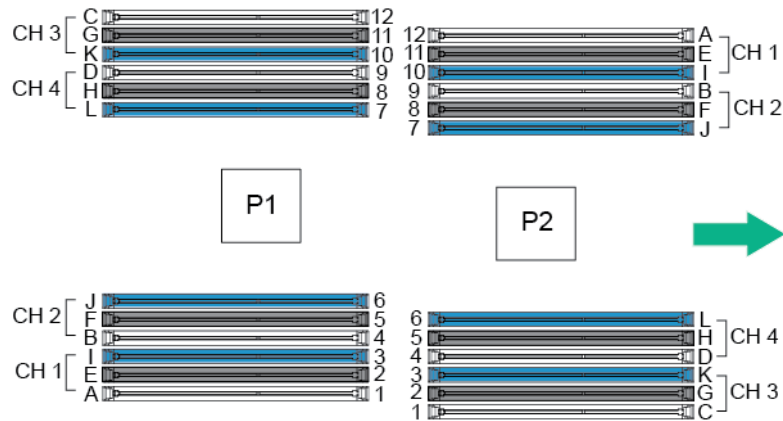

DIMM population order			
	1st slot of channel	2nd slot of channel	3rd slot of channel
	A B C D	E F G H	I J K L
Number of DIMMs to install	4	8	12

#### General Memory Population Rules and Guidelines:

- . A minimum of one DIMM is required per server.
- . White DIMM slots denote the first slot to be populated in a channel.
- . Install DIMMs only if the corresponding processor is installed.
- . If only one processor is installed in a two processor system, only half of the DIMM slots are available.
- . To maximize performance, it is recommended to balance the total memory capacity between all installed processors and load the channels similarly whenever possible.
- . When two processors are installed, balance the DIMMs across the two processors.
- . Place the DIMMs with the highest number of ranks in the white slot when mixing DIMMs of different ranks on the same channel.
- . Do not mix RDIMMs or LRDIMMs.
- . Quad rank RDIMMs are not supported in HPE ProLiant ML350 Gen9 servers.
- . Quad rank LRDIMMs are capable of up to three DIMMs per channel.
- . RDIMMs operating at 1.2V
- . DIMMs of different speeds may be mixed in any order; the server will select a common optimal speed.
- . The maximum memory speed is a function of the memory type, memory configuration, and processor model.
- . The maximum memory capacity is a function of the memory type and number of installed processors.
- . To realize the performance memory capabilities listed in this document, HPE SmartMemory is required. For additional information, please see the HPE SmartMemory QuickSpecs at: <https://www.hpe.com/h20195/v2/GetHTML.aspx?docname=c04111535>.
- . For memory population rules and additional memory guidelines, please see the ML350 Gen9 user guide at <https://www.hpe.com/h20195/v2/GetHTML.aspx?docname=c04431235>
- . There are four (4) channels per processor; eight (8) channels per server. There are three (3) DIMM slots for each memory channel; twenty-four (24) total slots Memory channels1 and 3 consists of the

## Memory

three (3) DIMMs that are furthest from the processor Memory channel 2 and 4 consists of the three (3) DIMMs that are closest to the processor

All GPU Accelerators are restricted to equal less than 1024GB for system HOST memory.

### Intel Gen9 Supported Memory Bandwidth for HPE ProLiant Gen9 Intel® Xeon® E5-2600v3 Series Processor Family

Memory Bandwidth and Capacity								
[DIMM Type]	Registered DIMMs (RDIMMs)					Load Reduced (LRDIMMs)		
HPE SKU P/N	726717-B21	726718-B21	759934-B21	726719-B21	728629-B21	726720-B21	726722-B21	726724-B21
DIMM Rank	Single Rank	Single Rank	Dual Rank	Dual Rank	Dual Rank	Dual Rank	Quad Rank	Quad Rank
DIMM Capacity	4GB	8GB	8GB	16GB	32GB	16GB	32GB	64GB
Voltage	Std Voltage 1.2V	Std Voltage 1.2V	Std Voltage 1.2V	Std Voltage 1.2V	Std Voltage 1.2V	Std Voltage 1.2V	Std Voltage 1.2V	Std Voltage 1.2V
DRAM Depth [bit]	512M	1G	512M	1G	1G	2G	2G	2G
DRAM Width [bit]	x8	x4	x8	x4	x4	x4	x4	x4
DRAM Density	4Gb	4Gb	4Gb	4Gb	4Gb	8Gb	8Gb	8Gb
CAS Latency	15-15-15	15-15-15	15-15-15	15-15-15	15-15-15	15-15-15	15-15-15	15-15-15
DIMM Native Speed (MT/s)	2133	2133	2133	2133	2133	2133	2133	2133
SLOTS THAT CAN BE POPULATED								
24 slot servers	24	24	24	24	24	24	24	24
MAXIMUM CAPACITY (GB)								
	96	192	192	384	768	384	768	1536
POPULATED DIMM SPEED (MT/s)								
1 DIMM Per Channel	2133	2133	2133	2133	2133	2133	2133	2133
2 DIMM Per Channel	2133	2133	2133	2133	2133	2133	2133	2133
3 DIMM Per Channel	1600	1600	1600	1600	1866	1600	1866	1866

### Intel Gen9 Supported Memory Bandwidth for HPE ProLiant Gen9 Intel® Xeon® E5-2600v4 Series Processor Family

Memory Bandwidth and Capacity							
[DIMM Type]	Registered DIMMs (RDIMMs)				Load Reduced (LRDIMMs)		
HPE SKU P/N	805347-B21	805349-B21	836220-B21	805351-B21	805353-B21	805358-B21	809208-B21
DIMM Rank	Single Rank	Single Rank	Dual Rank	Dual Rank	Dual Rank	Quad Rank	Octal Rank
DIMM Capacity	8GB	16GB	16GB	32GB	32GB	64GB	128GB

## Memory

<b>Voltage</b>	Std Voltage 1.2V	Std Voltage 1.2V	Std Voltage 1.2V	Std Voltage 1.2V	Std Voltage 1.2V	Std Voltage 1.2V	Std Voltage 1.2V
<b>DRAM Depth [bit]</b>	1G	2G	1G	2G	2G	2G	2G
<b>DRAM Width [bit]</b>	x8	x4	x4	x4	x4	x4	x4
<b>DRAM Density</b>	8Gb	8Gb	4Gb	8Gb	8Gb	8Gb	8Gb
<b>CAS Latency</b>	17-17-17	17-17-17	17-17-17	17-17-17	17-17-17	17-17-17	20-18-18
<b>DIMM Native Speed (MT/s)</b>	2400	2400	2400	2400	2400	2400	2400
<b>SLOTS THAT CAN BE POPULATED</b>							
24 slot servers	24	24	24	24	24	24	24
<b>MAXIMUM CAPACITY (GB)</b>							
	192	384	384	768	768	1536	3072
<b>POPULATED DIMM SPEED (MT/s)</b>							
<b>1 DIMM Per Channel</b>	2400	2400	2400	2400	2400	2400	2400
<b>2 DIMM Per Channel</b>	2133	2133	2400	2400	2400	2400	2400
<b>3 DIMM Per Channel</b>	1866	1866	1866	1866	2133	2133	2133

## DIMM slot and configuration diagram

## DIMM slot and configuration diagrams

- Population order; start with "A" first, "B" second, "C" third, etc.
- When one processor is installed, install DIMMs in sequential alphabetic order: A, B, C, D, E, F.
- When two processors are installed, install DIMMs in sequential alphabetic order: CPU1-A, CPU2-A, CPU1-B, CPU2-B, CPU1-C, CPU2-C

	CPU 1		CPU 2		
	Slot #	population order	Slot #	population order	
Chnl 1	1	A	1	C	Chnl 4
	2	E	2	G	
	3	I	3	K	
	CPU 1		CPU 2		
	Slot #	population order	Slot #	population order	
Chnl 2	4	B	4	D	Chnl 3
	5	F	5	H	
	6	J	6	L	
	CPU 1		CPU 2		
	Slot #	population order	Slot #	population order	
Chnl 3	7	L	7	J	Chnl 2
	8	H	8	F	
	9	D	9	B	

## Memory

	CPU 1		CPU 2		
	Slot #	population order	Slot #	population order	
Chnl 4	10	K	10	I	Chnl 1
	11	G	11	E	
	12	C	12	A	

### Memory Speed by Processor Model

Processor Models	Supported Memory Speeds
E5-2609v3, E5-2603v3	1600MT/s
E5-2640v3, E5-2630v3, E5-2620v3, E5-2630Lv3, E5-2623v3	1866MT/s
E5-2637v3, E5-2690v3, E5-2680v3, E5-2670v3, E5-2660v3, E5-2650v3, E5-2650Lv3, E5-2697v3, E5-2695v3, E5-2667v3, E5-2643v3, E5-2683v3, E5-2699v3, E5-2698v3	2133MT/s
E5-2609v4, E5-2603v4	1866MT/s
E5-2630Lv4, E5-2620v4, E5-2623v4, E5-2640v4, E5-2630v4	2133MT/s
E5-2650Lv4, E5-2643v4, E5-2637v4, E5-2690v4, E5-2680v4, E5-2660v4, E5-2650v4, E5-2697v4, E5-2695v4, E5-2667v4, E5-2683v4, E5-2699v4, E5-2698v4, E5-2697Av4	2400MT/s

### Standard and Maximum Memory Capacity (Pre-configured Models)

Pre Configured Models	Standard Memory	Maximum Memory Plus Optional Memory	Standard Memory Replaced with Optional Memory
E5-2650v4, E5-2650v3, E5-2630v4, E5-2630v3	32GB (2x16GB)	736GB (22x32GB, 2x16GB)	1536GB (24x64GB)
E5-2620v4, E5-2620v3	16GB (1x16GB)	752GB (23x32GB, 1x16GB)	1536GB (24x64GB)
E5-2609v4, E5-2609v3	8GB (1x8GB)	744GB (23x32GB, 1x8GB)	1536GB (24x64GB)

### DDR4 memory options part number decoder

**NOTE:** Capacity references are rounded to the common gigabyte (GB) values.

- 2GB = 2,048MB
- 4GB = 4,096MB
- 8GB = 8,192MB
- 16GB = 16,384MB
- 32GB = 32,768MB
- 64GB = 65,536MB

# Memory

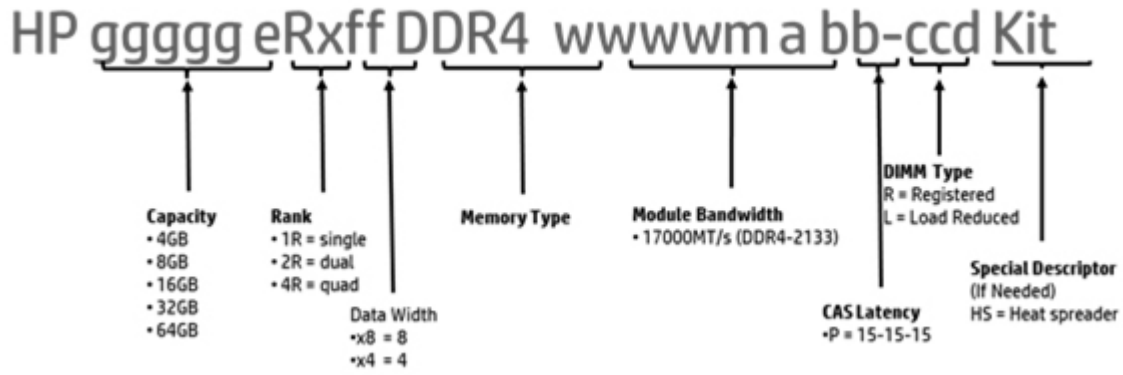

Storage

48 SFF hot-plug drive model (Tower)

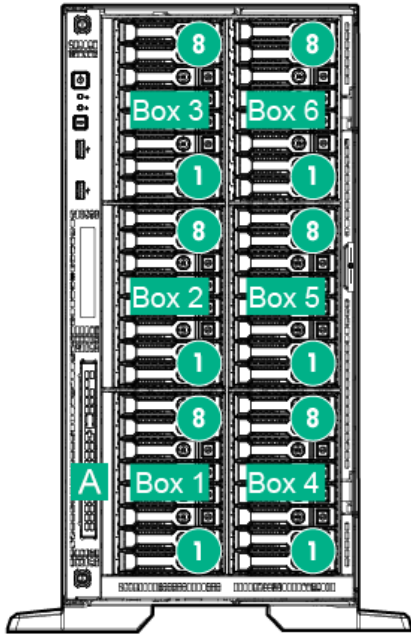

A

Optional Slim DVD-ROM/DVD-RW

1-6

8 x SFF SATA/SAS/SSD Hot Pluggable Hard Drive Bays

48 SFF hot-plug drive model (Rack)

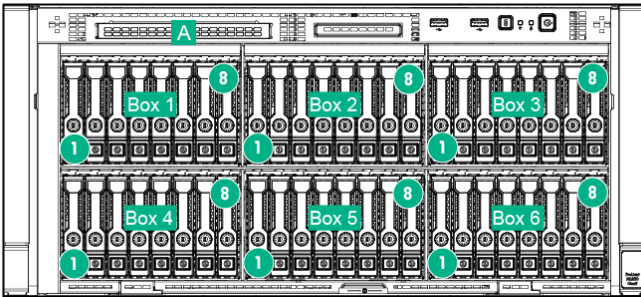

A

Optional Slim DVD-ROM/DVD-RW

1-6

8 x SFF SATA/SAS/SSD Hot Pluggable Hard Drive Bays

24 LFF hot-plug drive model (Tower)

A

Optional Slim DVD-ROM/DVD-RW

1-3

8 x LFF SATA/SAS/SSD Hot Pluggable Hard Drive Bays



Storage

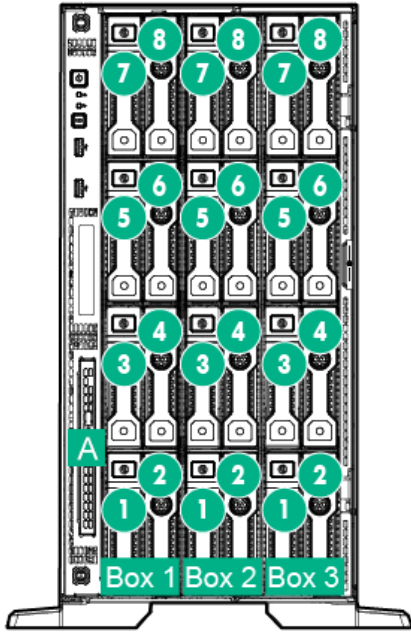

24 LFF hot-plug drive model (Rack)

A

Optional Slim DVD-ROM/DVD-RW

1-3

8 x LFF SATA/SAS/SSD Hot Pluggable Hard Drive Bays

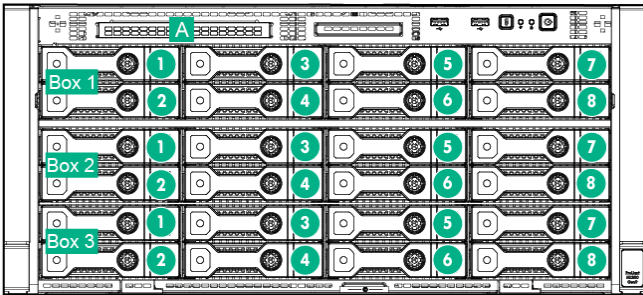

32 SFF hot-plug drives with SFF media cage

A

Optional Slim DVD-ROM/DVD-RW

B

SFF Media Cage

1-4

Remark: Support up to 2 RDX or Tape devices.  
8 x SFF SATA/SAS/SSD Hot Pluggable Hard Drive Bays  
Image shown a ML350 Gen9 Rack model

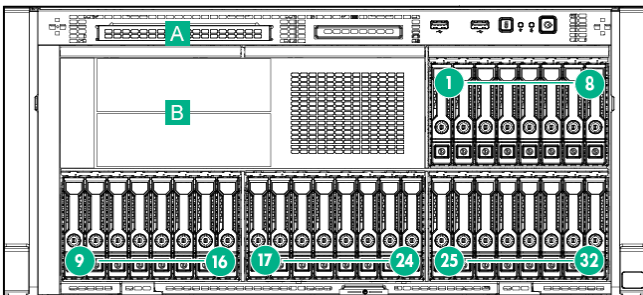

16 LFF hot-plug drives with LFF media cage

A

Optional Slim DVD-ROM/DVD-RW

B

LFF Media Cage

1-2

8 x LFF SATA/SAS/SSD Hot Pluggable Hard Drive Bays  
Image shown a ML350 Gen9 Rack model

## Storage

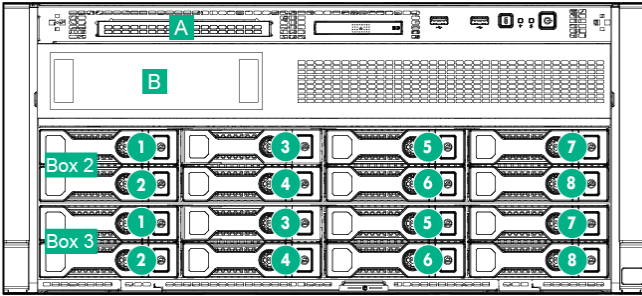

40 SFF hot-plug drives with 6 SFF NVMe SSD

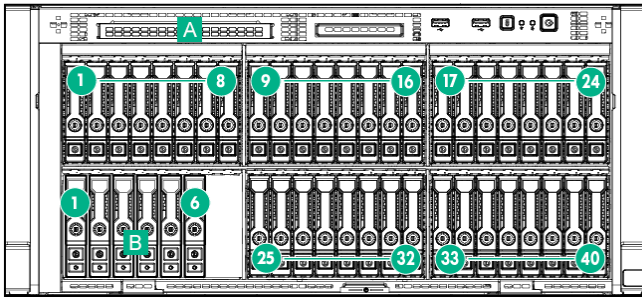

- A Optional Slim DVD-ROM/DVD-RW
- B 1 SFF Express Bay to support 6 x SFF PCIe NVMe SSDs
- 1-5 8 x SFF SATA/SAS/SSD Hot Pluggable Hard Drive Bays  
Image shown a ML350 Gen9 Rack model

**NOTE:** For additional storage configuration guidelines, please see the ML350 Gen9 user guide at <https://www.hpe.com/h20195/v2/GetHTML.aspx?docname=c04431235>

**NOTE:** For maximum storage capacity information with different types of drives installation, refer to the "Standard Features" section in this document.

**NOTE:** For drive options and part numbers supported by ML350 Gen9, refer to the "Core Options" section in this document.

**NOTE:** For controller options and part numbers supported by ML350 Gen9, refer to the "Additional Options" section in this document.

## Technical Specifications

<b>System Unit</b>	<b>Tower Dimensions</b>	18.27(H) x 8.62(W) x 30.28(D) in (46.4 x 21.9 x 76.9 cm)	
	<b>Rack Dimensions</b>	8.58(H) x 17.51(W) x 29.37(D) in (21.8 x 44.5 x 74.6 cm)	
	<b>Tower Weight</b>	Minimum:	66.14lb(30kg)
		Maximum:	121.30lb (55kg)
	<b>Rack Weight</b>	Minimum:	57.3lb(26kg)
		Maximum:	112.4lb(51kg)
	<b>Input Requirements</b>	Range Line	100 to 120 VAC
		Voltage	200 to 240 VAC
	<b>BTU Rating</b>	Maximum	For 1400W Power Supply: 5459 BTU/hr (at 200 VAC), 5459 BTU/hr (at 240 VAC), 5459 BTU/hr (at 240 VAC) for China Only
			For 800W Power Supply: 3207 BTU/hr (at 100 VAC), 3071 BTU/hr (at 200 VAC), 3112 BTU/hr (at 240 VAC) for China Only
<b>Power Supply Output</b>	Rated Steady-State Power	For 1400W Power Supply: 1400W (at 240 VAC), 1400W (at 240 VAC)	
		For 800W Power Supply: 800W (at 100 VAC), 800W (at 240 VAC), 800W (at 240 VAC) input for China only	
<b>System Inlet Temperature</b>	Standard Operating Support	For 500W Power Supply: 500W (at 100 VAC), 500W (at 240 VAC), 500W (at 240 VAC) input for China only	
		For 1400W Power Supply: 1400W (at 200 to 240 1VAC), 1400W (at 240 VAC) input for China only	
<b>System Inlet Temperature</b>	Non-operating	For 800W Power Supply: 800W (at 100 to 127 VAC), 800W (at 200 to 240 1VAC), 800W (at 240 VAC) input for China only	
		For 500W Power Supply: 500W (at 100 to 127 VAC), 500W (at 200 to 240 VAC), 500W (at 240 VAC) input for China only	

## Technical Specifications

<b>Relative Humidity</b>	Operating	Minimum to be the higher (more moisture) of -12°C (10.4°F) dew point or 8% relative humidity. Maximum to be the lower (less moisture) of 24°C (75.2°F) dew point or 90% relative humidity.
	Non-operating	5 to 95% relative humidity (Rh), 38.7°C (101.7°F) maximum wet bulb temperature, non-condensing.
<b>Altitude</b>	Operating	3050 m (10,000 ft). This value may be limited by the type and number of options installed. Maximum allowable altitude change rate is 457 m/min (1500 ft/min).
	Non-operating	9144 m (30,000 ft). Maximum allowable altitude change rate is 457 m/min (1500 ft/min).
<b>Acoustic Noise</b>	Listed are the declared A-Weighted sound power levels (LWAd) and declared average bystander position A-Weighted sound pressure levels (LpAm) when the product is operating in a 23°C ambient environment. Noise emissions were measured in accordance with ISO 7779 (ECMA 74) and declared in accordance with ISO 9296 (ECMA 109).	
	<b>Idle</b>	
	L WAd	3.6 Bels (1P LFF Entry) 3.5 Bels (1P SFF Base) 3.6 Bels (2P SFF E-star Rack) 3.4 Bels (2P SFF E-star Tower)
	L pAm	21 dBA (1P LFF Entry) 21 dBA (1P SFF Base) 20 dBA (2P SFF E-star Rack) 19 dBA (2P SFF E-star Tower)
	<b>Operating</b>	
	L WAd	3.7 Bels (1P LFF Entry) 3.6 Bels (1P SFF Base) 4.5 Bels (2P SFF E-star Rack) 4.5 Bels (2P SFF E-star Rack)
	L pAm	21 dBA (1P LFF Entry) 22 dBA (1P SFF Entry) 28 dBA (2P SFF E-star Rack) 28 dBA (2P SFF E-star Tower)
	<b>NOTE:</b> Configurations tested for 1P LFF Entry models included two (2) 500GB LFF SATA Midline HDD and Windows 2012 Enterprise 64-bit.	
	<b>NOTE:</b> Configurations tested for 1P and 2P SFF models included two (2) 500GB SFF SATA Midline HDD and Windows 2012 Enterprise 64-bit.	
	<b>NOTE:</b> The Listed sound levels apply to standard shipping configurations. Additional options may result in increased sound levels.	
<b>Emissions Classification</b>	FCC Rating	Class A
	Normative Standards	CISPR 22; EN55022; EN55024; FCC CFR 47, Pt 15; ICES-003; CNS13438; GB9254; K22;K24; EN 61000-3-2; EN 61000-3-3; EN 60950-1; IEC 60950-1
	<b>NOTE:</b> Product conformance to cited product specifications is based on sample (type) testing, evaluation, or assessment. This product or family of products is eligible to bear the appropriate compliance logos and statements.	

## Technical Specifications

<b>HPE Dynamic Smart Array B140i Controller</b>	<b>Number of PCI links</b>	Four	
	<b>PCI link rate</b>	4Gb/s	
	<b>Storage protocol support</b>	SATA	
	<b>SAS/SATA peak data transfer rate</b>	6Gb/s	
	<b>Number of SAS/SATA links</b>	10 links	
	<b>SAS/SATA connectivity</b>	2x4 connectors; 2x1 connectors	
	<b>Expander support</b>	No	
	<b>Drives supported (max)</b>	Up to 10 Internal Drives	
	<b>RAID support</b>	0, 1, 10, 5 SATA	
	<b>Software management</b>	HPE SSA, SMH, SIM	
	<b>Warranty</b>	Server warranty	
	<b>HPE Secure Encryption license</b>	Not Supported	
	<b>HPE SmartCache License</b>	Not Supported	
	<b>HPE Smart Storage Administrator</b>	Supported	
	<b>HPE Ethernet 1Gb 4-port 331i Adapter</b>	<b>Network Interface</b>	10Base-T/100Base-TX/1000Base-TX
		<b>Compatibility</b>	IEEE 802.3 10Base-T IEEE 802.3ab 1000Base-T IEEE 802.3u 100Base-TX
<b>Data Transfer Method</b>		PCI Express, two lanes (x2)	
<b>Controller</b>		BCM5719	
<b>Network Transfer Rate</b>		10Base-T (Half-Duplex)	10 Mb/s per port, 40 Mb/s combined
		10Base-T (Full-Duplex)	20 Mb/s per port, 80 Mb/s combined
		100Base-TX (Half-Duplex)	100 Mb/s per port, 400 Mb/s combined
		100Base-TX (Full-Duplex)	200 Mb/s per port, 800 Mb/s combined
		100Base-TX (Half-Duplex)	1000 Mb/s per port, 4000 Mb/s combined
		100Base-TX (Full-Duplex)	2000 Mb/s per port, 8000 Mb/s combined
<b>Connector</b>	RJ-45		

## Technical Specifications

<b>Cable Support</b>	10 Base-T	Categories 3, 4 or 5 UTP; up to 328 ft (100 m)
	10/100/1000 Base-TX	Category 5 or higher UTP; up to 328 ft (100 m)

---

**Environment-friendly Products and Approach - End-of-life Management and Recycling**

Hewlett Packard Enterprise offers end-of-life product return, trade-in, and recycling programs, in many geographic areas, for our products. Products returned to Hewlett Packard Enterprise will be recycled, recovered or disposed of in a responsible manner.

<http://www.hpe.com/recycle>

The EU WEEE directive (2002/95/EC) requires manufacturers to provide treatment information for each product type for use by treatment facilities. This information (product disassembly instructions) is posted on the Hewlett Packard Enterprise web site. These instructions may be used by recyclers and other WEEE treatment facilities as well as Hewlett Packard Enterprise OEM customers who integrate and re-sell Hewlett Packard Enterprise equipment.

<http://www.hpe.com/recycle>

## Summary of Changes

Date	Version History	Action	Description of Change
2-Apr-2018	Version 31	Added	New LTO-8 tape drive, new Smart Battery part number
		Changed	SKU description were revised..
		Removed	Obsolete SKUs were removed from the QuickSpecs.
4-Dec-2017	Version 30	Added	Added new 12 TB SAS and SATA LFF HDD option offering. Added a few new LFF HDD options.
23-Oct-2017	Version 29	Changed	Care Pack naming and Service and Support- Parts and Materials updated.
25-Sep-2017	Version 28	Added	Added new Solid State Drives offering to the HPE Drives section.
		Changed	Core Options section was revised.
7-Aug-2017	Version 27	Added	Added new Solid State Drives offering to the HPE Drives section.
11-Jul-2017	Version 26	Added	Added support for HPE OneView 3.1 and new GPU offering.
5-Jun-2017	Version 25	Added	Added new HPE Digitally Signed (DS) Firmware Solid State Drive and Hard Disk Drive options.
8-May-2017	Version 24	Added	Added support for ClearOS.
		Changed	Operating Systems and Virtualization Software Support for ProLiant Servers and HPE Drives were revised.
		Removed	Obsolete SKUs were removed from the QuickSpecs.
27-Mar-2017	Version 23	Added	Added new Hard Drives.
13-Feb-2017	Version 22	Added	Added new HDD and SSD offering to the HPE Drives section.
		Changed	HPE StoreVirtual VSA content was revised.
28-Nov-2016	Version 21	Added	Added new Hard Drives offering.
		Changed	Maximum Internal Storage and HPE Storage Options were revised.
		Removed	Obsolete SKUs were removed from the QuickSpecs.
28-Oct-2016	Version 20	Removed	Obsolete Hard Drives were removed from the QuickSpecs.
26-Sep-2016	Version 19	Added	Added new SATA & SAS LFF HDD offering and 16Gb/32Gb FC HBAs. Added new 128GB LRDIMM memory.
		Changed	Standard features was revised to reflect the system support with the new option offering eg. 128GB DIMM, max memory capacity 3TB, etc. What's new and memory table were updated.
15-Aug-2016	Version 18	Added	Added new Networking and Storage option offering.
		Changed	PCIe expansion slot 5 support revised to support FH/HL cards in Standard Features section.
		Removed	Removed K4200 & K5200 from the Computation and Graphics Accelerators section along with a few PCIe workload accelerators for option EOL.
24-Jun-2016	Version 17	Changed	Expansion Slot 5 under the Standard Features section was revised.
6-Jun-2016	Version 16	Added	New option offering incl. NVIDIA Quadro M2000, 340GB M.2 kits, LTO-7, new HDD options, dual 32GB micro-SD USB kit, RDX 3TB.
		Changed	Updated 2400MHz memory table in the Standard Features section. Updated memory speed, memory configuration guidelines in the memory section. Added notes to the storage section.
		Removed	Removed EOL drive options.
22-Apr-2016	Version 15	Changed	Part numbers for the E5-2600v4 Smart Buy Models in the NA version were revised.
8-Apr-2016	Version 14	Changed	HPE Processors section was revised.
31-Mar-2016	Version 13	Added	New E5-2600 v4 CPU, new 2400MHz DIMM, new M4000 & M5000 GPU, new networking cards, TPM2.0 and new drives added. Added mechanical features for HW security: padlock, Kensington lock. Added new E5-2600 v4 BTO SKUs.

## Summary of Changes

		Changed	Internal Storage Devices, Upgradeability, Embedded Management, Service and Support, Pre-configured Models, HPE Security, HPE Tape Backup, and Memory sections were revised. Storage section - added additional front views of different storage configuration among HDD/SSD, SFF/LFF media cage, NVMe SSD.
		Removed	Obsolete SKUs were removed from the QuickSpecs.
26-Feb-2016	Version 12	Removed	340GB M.2 options (835563-B21 & 835565-B21) were removed from Core Options.
16-Feb-2016	Version 11	Added	New 12G SAS Drives and M.2 offering was added to HPE Drives.
1-Dec-2015	Version 10	Added	New HDD offering was added to HPE Drives. New options added to HPE Unique Options, HPE Security, HPE Tape Backup, and HPE Disk Storage Systems.
		Changed	On System Management Chipset, Maximum Internal Storage, Embedded Management, and Server utilities were revised. Product images were updated.
		Removed	Obsolete SKUs were removed from the QuickSpecs.
16-Nov-2015	Version 9	Added	New Solid State Drives offering was added to HPE Drives.
		Changed	Maximum Internal Storage, and Additional Options were updated. X4 RPS Enablement Kit note was updated. iLO FW updated to iLO4 2.3
17-Aug-2015	Version 8	Added	New Solid State Drives offering was added to HPE Drives. New graphic options were added to HPE Computation and Graphics Accelerators.
		Changed	Memory, Maximum Internal Storage, and Additional Options were updated.
		Removed	Obsolete SKUs were removed from QuickSpecs.
1-Jun-2015	Version 7	Added	New Hard Drives were added to QuickSpecs. New RDX+ external backup options were added.
		Changed	Number of fans for Energy Star Models and Performance Models were revised. HPE Memory was revised.
		Removed	Obsolete SKUs were removed from QuickSpecs.
30-Mar-2015	Version 6	Added	New Hard Drives offering. Optional Software added to HPE Storage Controllers.
		Changed	HPE Power Supplies, HPE Storage Controllers, HPE Disk Storage Systems, Micro SD Options were updated.
9-Feb-2015	Version 5	Added	Added new HPE Drives, HPE Disk Backup, and new G4 UPS models. HPE Drives, HPE Computation and Graphics Accelerators, HPE Tape Backup, HPE Rack Mount Consoles, KVM Switches, and Keyboards, and HPE Uninterruptible Power Systems (UPS) sections were revised.
1-Dec-2014	Version 4	Changed	Changes made throughout the entire QuickSpecs.
13-Oct-2014	Version 3	Added	6G SATA Enterprise Value G1 Solid State Drives were added to Core Option section. High Performance Clusters, HPE PCIe Workload Accelerator Options, HPE USB and SD options, and HPE Pointnext operational services were added to the Additional Options section.
		Changed	Standard Features, Optional Features, Core Options, Additional Options, and Memory sections were revised.
19-Sep-2014	Version 2	Changed	Changes made throughout the entire QuickSpecs.
9-Sep-2014	Version 1	New	New QuickSpecs.



## Summary of Changes



[hpe.com/qref/ml350gen9](http://hpe.com/qref/ml350gen9)



**Sign up for updates**

---

© Copyright 2018 Hewlett Packard Enterprise Development LP. The information contained herein is subject to change without notice. The only warranties for Hewlett Packard Enterprise products and services are set forth in the express warranty statements accompanying such products and services. Nothing herein should be construed as constituting an additional warranty. Hewlett Packard Enterprise shall not be liable for technical or editorial errors or omissions contained herein.

Intel® and Xeon® are registered trademarks of Intel Corporation in the U.S. and other countries.

Microsoft®, Windows®, and Windows Server® are U.S. registered trademarks of the Microsoft group of companies.

For hard drives, 1GB = 1 billion bytes. Actual formatted capacity is less

c04375628 - 15035 – North America - V31 - 2-April-2018

