



Ironwood
ELECTRONICS
www.ironwoodelectronics.com



Products, Services & Capabilities



B.C.E. s.r.l.
Via Regina Pacis, 54/c - 41049 SASSUOLO (MO) Italy
Tel. +39 0536 811.616 r.a. - Fax +39 0536 811.500
www.bce.it - E-mail: bce@bce.it



● Company Overview

- Founded 1986
- Over 10,000 catalog products
- High Performance Adapters and Sockets
- Many Custom Designs & Turn-Key Solutions
- Engineering – Electrical and Mechanical
- ISO9001:2015 Registration
- World wide distribution
- Customers – Engineering and OEM
- 57 Employees

● Capabilities Overview

- Simulation
 - QFIN for heat sink design
 - Microwave Studio for electrical
- 3D Solid Modeling CAD & CAM
 - ProEngineer, Solid Works
 - Gibbs cam
- PCB Technology
 - PADS Layout, PADS Router
 - Controlled Impedance, Embedded Resistors, Laser Micro Vias, Filled Via in Pad, 3/3 traces, Rigid-flex PCBs
- State of the art CNC machines - Tight Tolerance 3D Machining (e.g. $\pm 0.0127\text{mm}$), Swiss screw machine, Print, Pick, Place & Reflow assembly line, High speed PCB drilling, Laser cutting/drilling, Automated Optical Inspection, Impedance test, FDR test.

Product Overview

- Elastomer Sockets
- Spring Pin Sockets
- Manual Socket Lids
- Clamshell/Lever Actuation
- Zero footprint Sockets
- Near Zero footprint Sockets
- SMT Adapter Sockets
- SMT Package Emulation
- Package Convertors
- Prototype, Probing & Analysis Adapters
- Electronic Modules

Engineering Sockets

Continuous improvement

Proven Capability

Development

20 Years

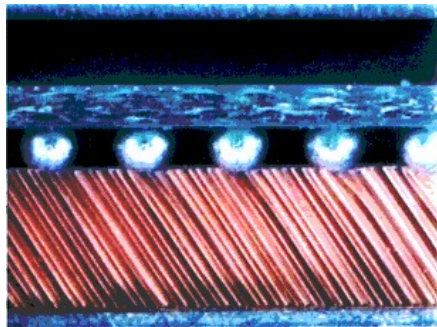

BGA compressed on Elastomer

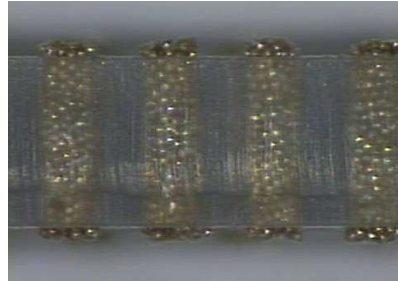

Silver particle
Elastomer

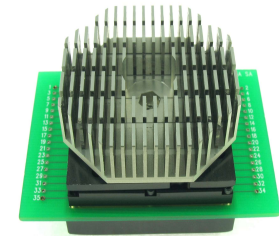
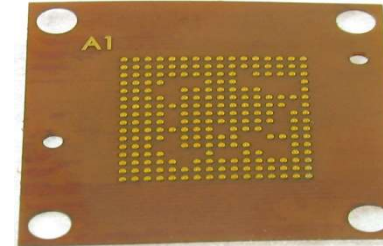

Heat sink lid

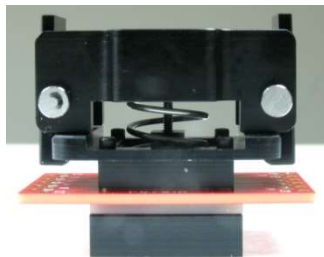

Double latch lid

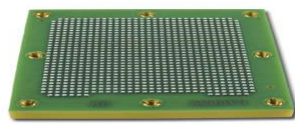

Surface mount adapter

Capabilities

- 0.3mm to 1.27mm pitch
- 1x1mm to 60x60mm device
- BGA, LGA, QFN, QFP, SOIC, WLP
- 4000 pin count
- 75GHz
- Heat sink options
- Easy chip replacement
- Custom support plate options
- Custom mounting options
- Industry's smallest footprint

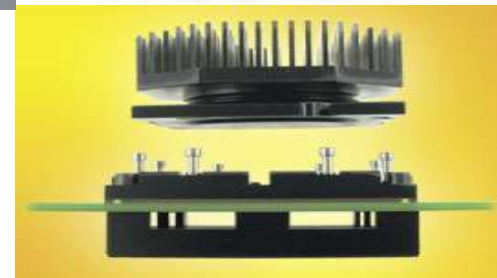

Swivel lid socket with decaps
accommodated back plate



Torque indicator

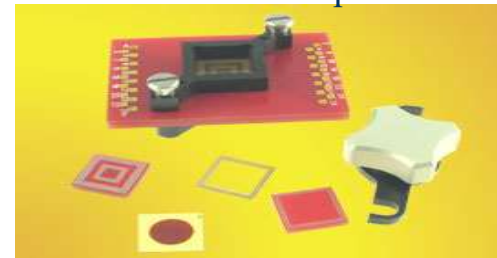

PoP socket with two elastomers



Back-to-back socket



Clamshell lid
IP, 10/23/2019

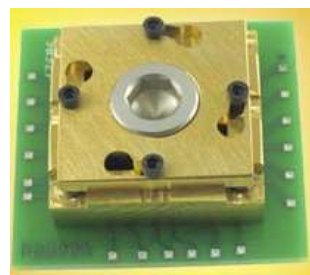

Gold RF socket



Open top lid

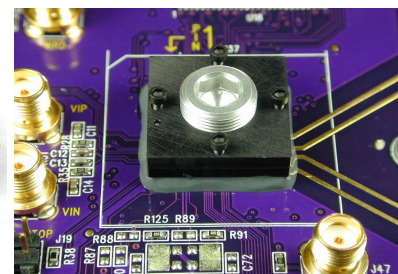

No mounting hole socket

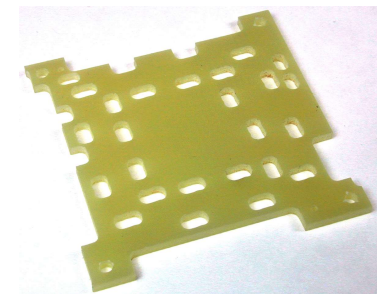

Custom insulation plate

Production & Burn-in Sockets

Continuous improvement

Proven Capability

Development

13 Years



Stamped LGA pogo pin



Stamped BGA pogo pin

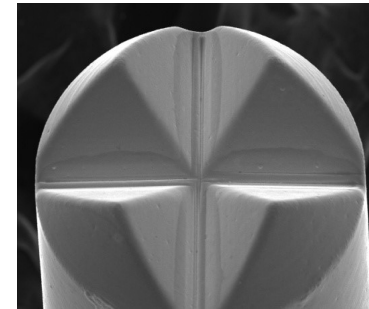

Self cleaning Pogo pin crown



Ceramic QFP socket with center E-pad



Short 3piece Pogo pin

- Capabilities
- 0.2mm to 1.27mm pitch
 - 1x1mm to 60x60mm device
 - BGA, LGA, QFN, QFP, SOIC, WLP
 - 4000 pin count
 - 45 GHz, 500K cycles
 - Consistent contact resistance throughout life
 - Low cleaning frequency
 - High current & extreme temperature

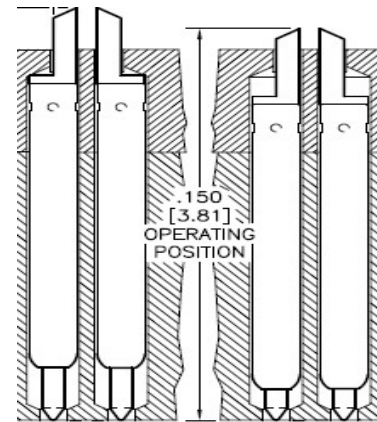

Offset plunger Kelvin pogo pin

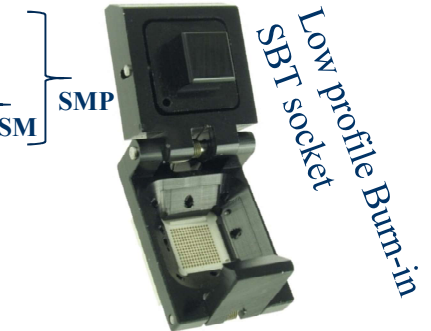
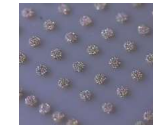
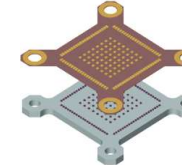
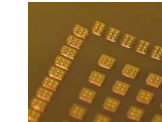

SOIC production socket

IP, 10/23/2019

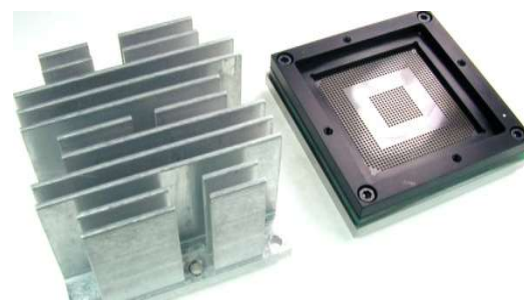

BGA production socket with heat sink lid

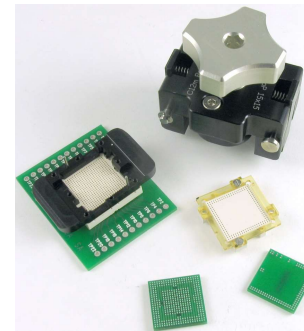

Multi Level SBT socket

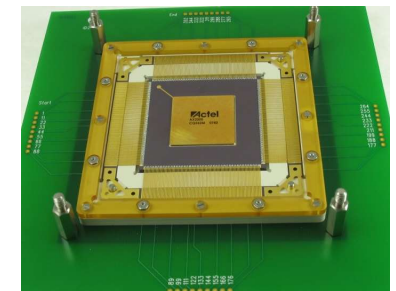

Flat lead Ceramic QFP production socket

Socket Lid Options

Swivel Lid Socket

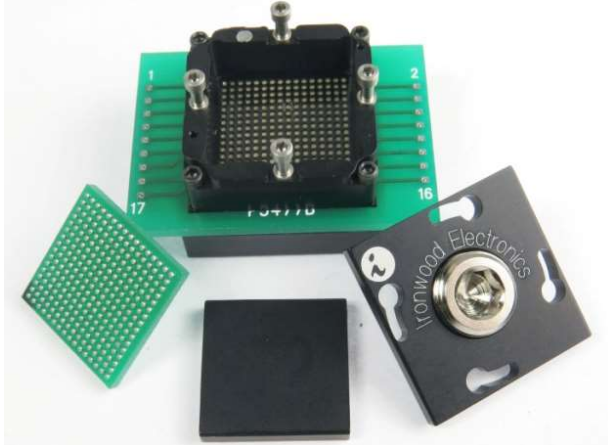

Screw Top Socket w/Center Open

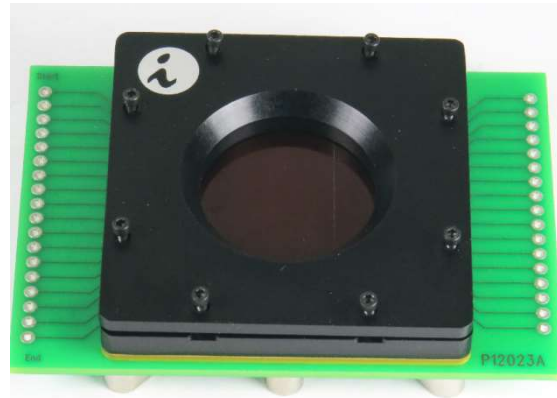

Snap Lid Socket w/Center Open

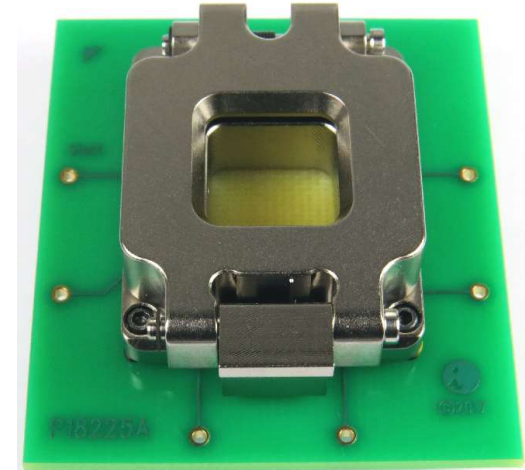

Double Latch Socket w/Center Open



Double Latch Socket w/Handle

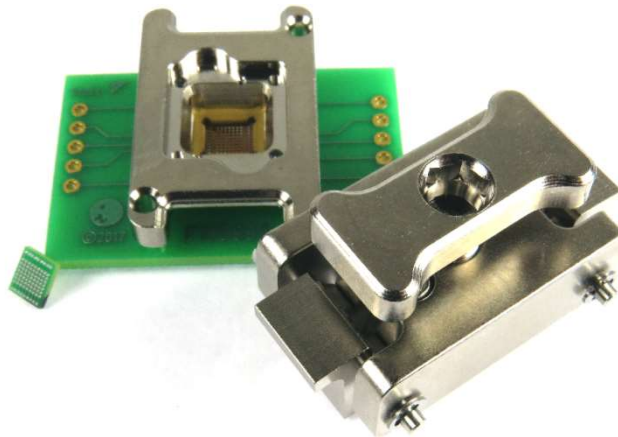

Snap Lid with adjustable pressure screw Socket

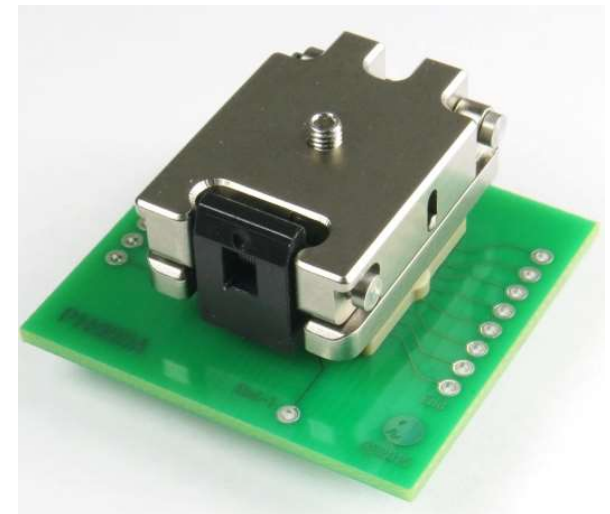

Socket Lid Options

Clamshell Socket w/Center Open

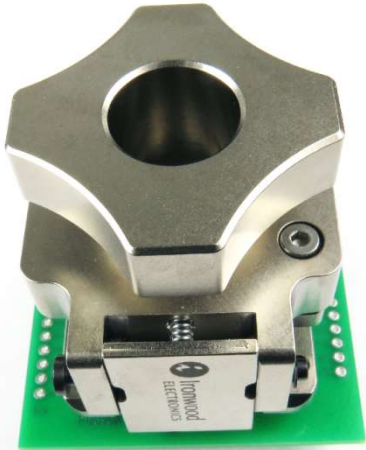

Clamshell Adjustable Hard Stop Socket



Clamshell Socket w/Heat Sink

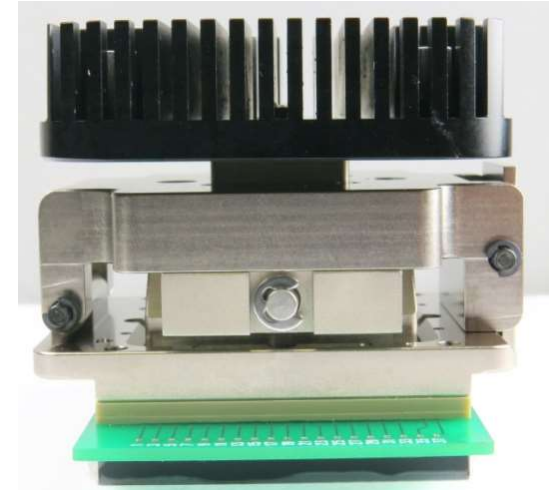

Lever Lid Socket

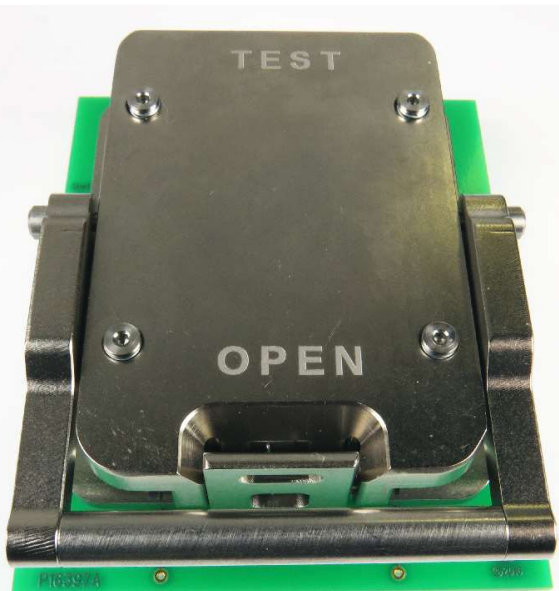

Lever Lid Socket w/Center Open



Lever Lid Socket
w/Fan and Heat Sink

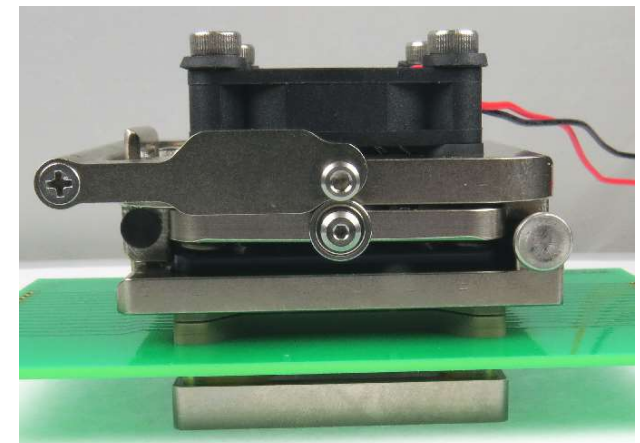

Contact Technology Summary

<u>Characteristics</u>	<u>Embedded Wire Elastomer (SG)</u>	<u>Stamped spring pins (SBT)</u>	<u>Embedded Silver Ball Elastomer Matrix (SM/SMP)</u>	<u>Silver Button Elastomer (GT/GTL)</u>
Bandwidth, GHz	27 to 56.8	4.15 to 31.7	44.8	75**
Endurance, Cycles*	2K	500K	5K/500K	1K
Resistance, mΩ	20	15	15	20
Self Inductance, nH	0.11 to 0.28	0.88 to 0.98	0.1	0.04
Max Current, Amp	2	8	7.8	5
Temp Range, °C	-35 to +125	-55 to +180	-55 to +155	-55 to +160
Pitch, mm	0.3 to 1.27	0.3 to 1.27	0.25 to 1.27	0.25 to 1.27
Package Types	BGA, QFN, QFP, SOIC	BGA, LGA, QFN, QFP, SOIC	BGA, LGA, QFN	BGA
Lab test	√	√	√	√
Production test		√	√	
Field upgrade	√	√	√	√
Temperature test	√	√	√	√
Kelvin test	√	√	√	√
Burn-in test		√		

*Cycle life shown at room temperature. Reduced cycle life is expected when used at extreme temperatures, thermal cycling, improper force, cleaning and handling.

** Simulated value; measured value >40GHz

Pin Datasheet

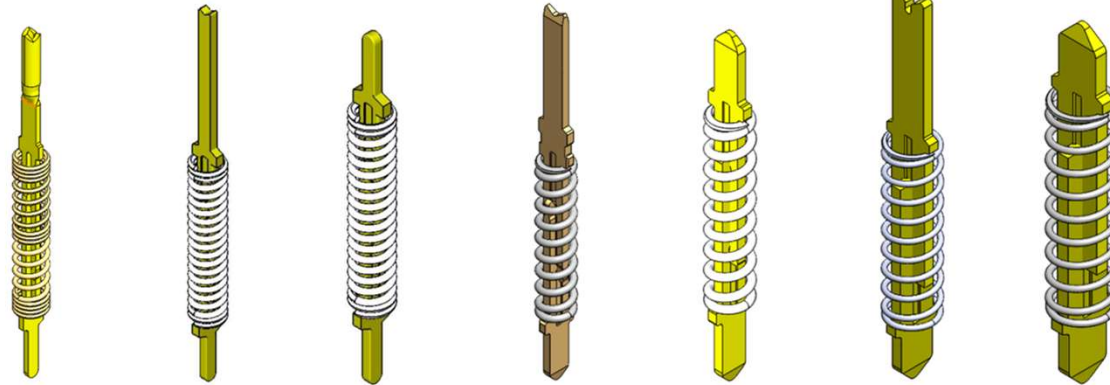

Pin Family	SBT	SBT	SBT	SBT	SBT	SBT	SBT
Part Number	P-P204A	P-P185A	P-P184A	P-P196A	P-P150A	P-P151A	P-P152A
Minimum Pitch (mm)	0.35	0.4	0.4	0.5	0.5	1.0	1.0
Pin Type	BGA	BGA	LGA	BGA	LGA	BGA	LGA
Length (mm)	3.46	3.81	2.9	3.86	2.95	5.69	4.45
DUT Side Tip Shape	Crown	V Shape	Radius Cone	V Shape	Radius Cone	Notched V	Radius Cone
DUT Side Tip Dimension (mm)	0.17	0.14	0.12	0.2	0.06	0.54	0.1
PCB Side Tip Shape	Radius Cone	Radius Cone	Radius Cone	Radius Cone	Radius Cone	Radius Cone	Radius Cone
PCB Side Tip Dimension (mm)	0.12	0.12	0.12	0.04	0.06	0.1	0.1
DUT Side Travel (mm)	0.3	0.5	0.3	0.33	0.33	0.6	0.6
PCB Side Travel (mm)	0.1	0.1	0.1	0.1	0.1	0.1	0.1
Force (g)	8.7	17	14.5	30	30	19	19
Cres (mOhms)	< 70	< 50	< 50	< 30	< 30	< 15	< 15
CCC @ ambient (Amps)	1	1.8	1.8	4.0	6.0	8.0	8.0
Bandwidth (GHz @ -1dB)**	23.5 - 26.1	20.5 - 31.7	20.5 - 31.7	5.2 - 15.7	5.2 - 15.7	14.1 - 21.9	14.1 - 21.9
Self inductance (nH)	0.92	0.98	0.98	0.88	0.88	0.93	0.93
Temperature (deg C)	-55 to +180C	-55 to +180C	-55 to +180C	-55 to +180C	-55 to +180C	-55 to +180C	-55 to +180C
Insertion Cycles	50K	50K	50K	500K	500K	500K	500K

* 0.4mm/0.5mm pitch SBT pins are used in 0.65mm and 0.8mm pitch applications

** Bandwidth range is based on pin location (corner, edge, field). See report for test conditions and setup.

IP, 10/23/2019

Zero Footprint Sockets

- No lid required
- Socket same size as device
- device simply snaps in for test
- Allows test on platform boards

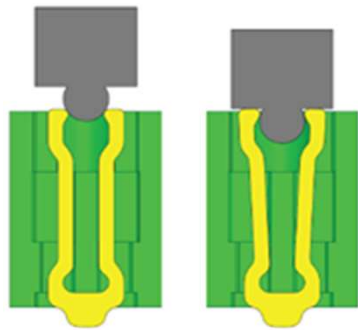

Grypper

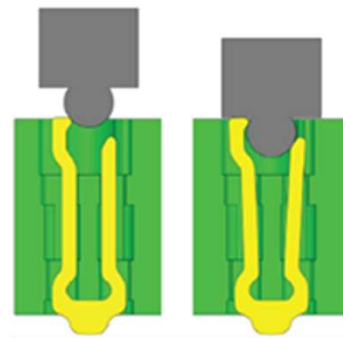

G80

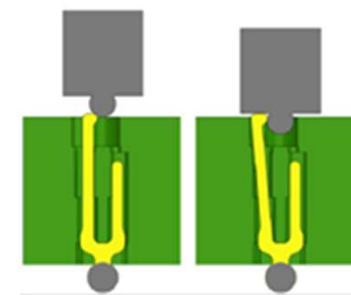

G35/40

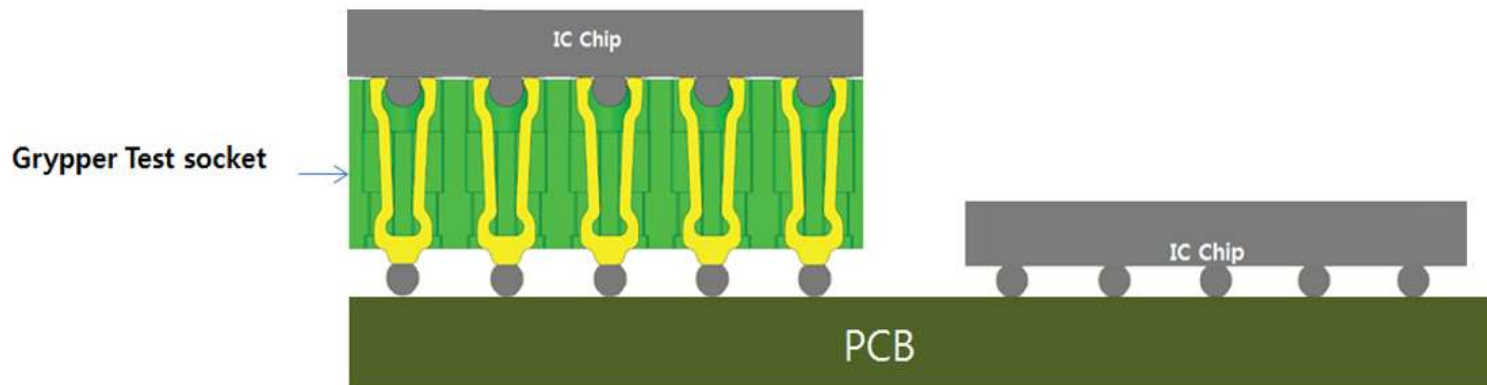

Near Zero Footprint Sockets

- “Y” contact technology:
 - Does have a cover
 - Great for vibration testing
 - Still near zero footprint
 - Test same device up to 200+ times with little mark on the ball
- Zero footprint spring pins
 - Same attributes of “Y” solution.
 - Longer life out of the socket
 - Low volume ATE applications
 - LGA, BGA, small ball.

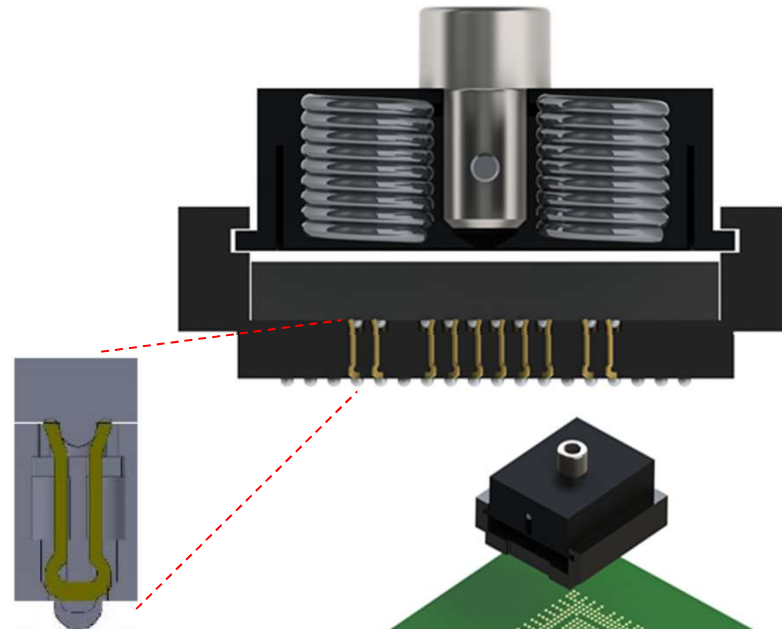

METHODOLOGY

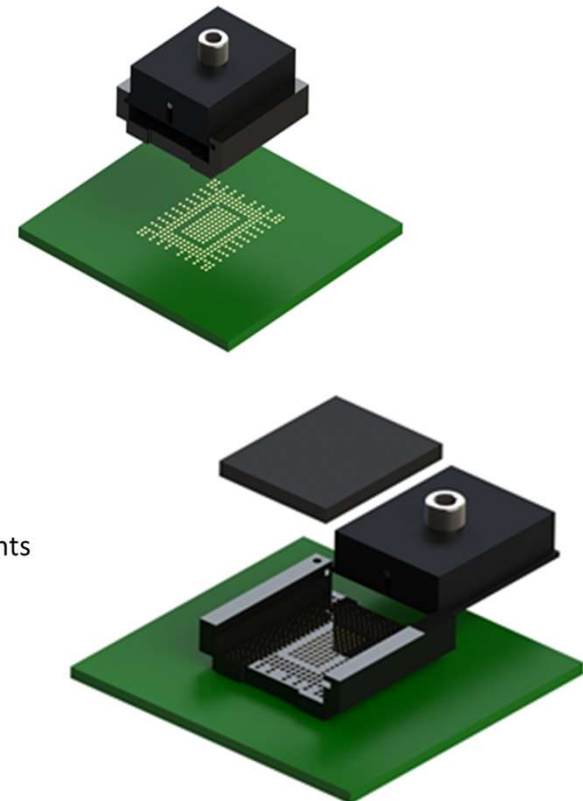
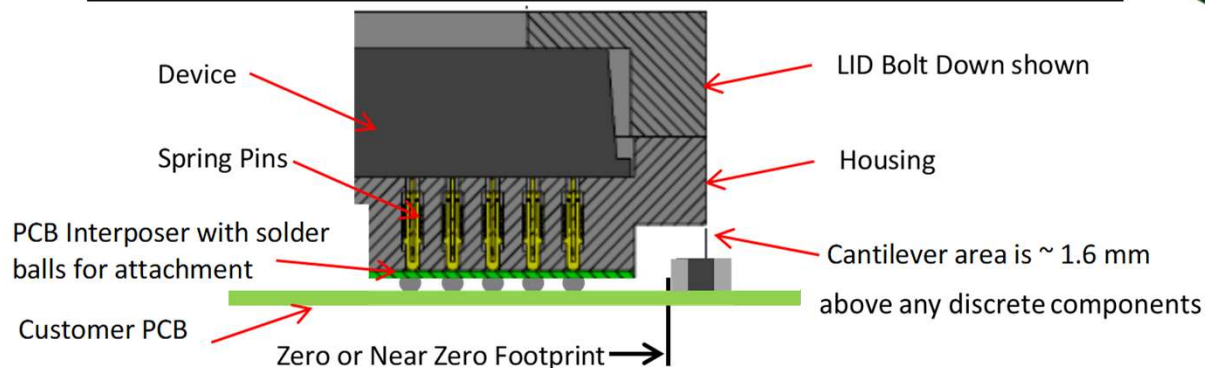

Engineering Adapters

Continuous improvement

Proven Capability

Development

27 Years

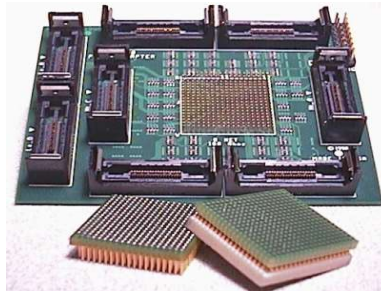

Power PC BGA device interfaced to Logic analyzer and motherboard for functional analysis



SOIC, PLCC adapter



0.5mm pitch 21x21 array 289 position BGA solder balls to AMP 104068 connectors using rigid flex PCB with socket fixture

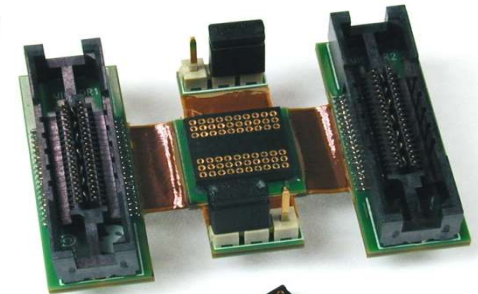

60 pin, 0.8mm pitch BGA rigid-flex probing adapter with AMP mictor and BGA surface mount foot

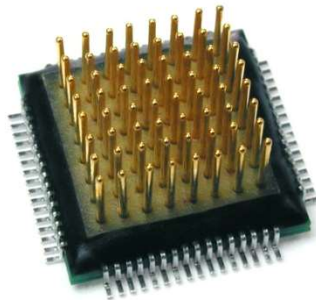

Gull-wing QFP Emulator foot

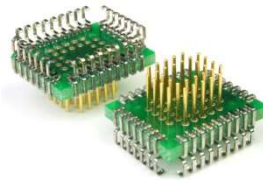

J-led PLCC Emulator foot

Capabilities

- 0.4mm to 1.27mm pitch
- 2x2mm to 50x50mm device
- BGA, LGA, QFN, SOIC, PLCC, QFP, DIP, PGA, etc
- 2000 pin count
- RoHS compatible
- Agilent, Tektronix compatible
- Rigid & flex options

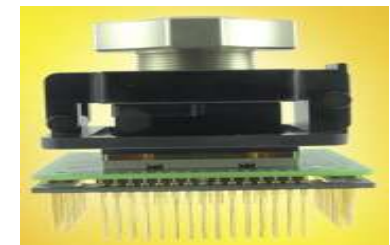

BGA proto adapter with Clamshell pogo pin socket

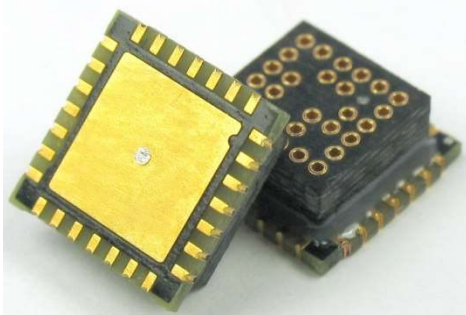

Leadless QFN emulator
IP, 10/23/2019

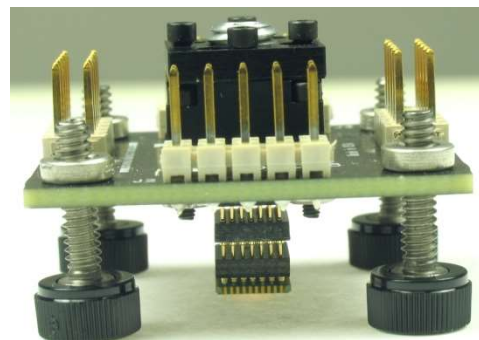

Allows QFN device to be socketed to motherboard with signals brought out to test pins



Flex emulator - 125 position AMP Z pack connector to 80 position female interface

Production Adapters

Continuous improvement

Proven Capability

Development

27 Years



Daughter card module
Interfaced to QFP footprint

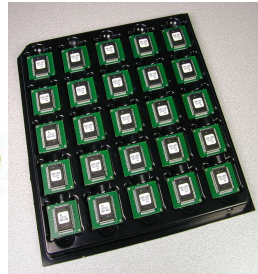

QFP device mounted to PLCC Footprint
on target board with shortest trace length



BGA to BGA conversion with
complex signal swap due to
device enhancement without
additional real estate



SoC module with high
density connector

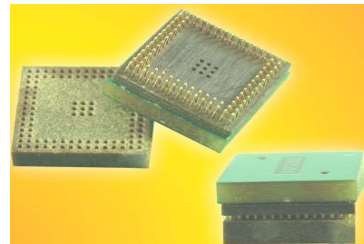

0.5mm pitch BGA
Pluggable adapter system

- Capabilities
- 0.4mm to 2.54mm pitch
 - 2x2mm to 50x50mm device
 - BGA, LGA, QFN, SOIC, PLCC, QFP, DIP, PGA, etc
 - 3 mil trace/space
 - Laser micro vias
 - Embedded caps & resistors
 - Lead free options
 - Tray, Tape & Reel options
 - Turnkey solutions



SOIC device mounted
to PLCC footprint
using solder column
technology for high
volume production

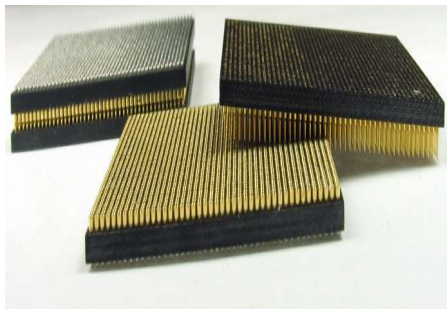

2000 pin count BGA adapter
system plugged together
IP, 10/23/2019



SOIC to DIP converter
using blind hole technology

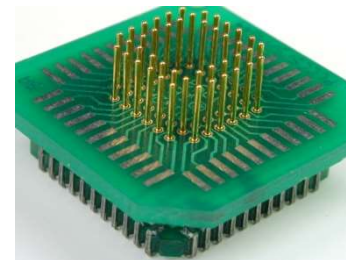

PLCC plug connects
Daughter card to socket

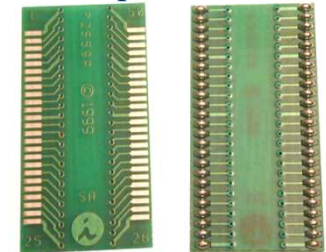

SOIC pitch converter

Facility Overview

24000 Sq. Ft Building



Production area



Machining area



ESD Automated Assembly area

Custom Capabilities

- Custom designs in 2 days
- Match customer's PCB footprint
- Custom manufacturing in 10 days
- Multiple contactor technologies
- Heat sink simulation and design
- Contactor signal integrity simulation
- In-house automated optical inspection
- In-house machining
- Quick turn production

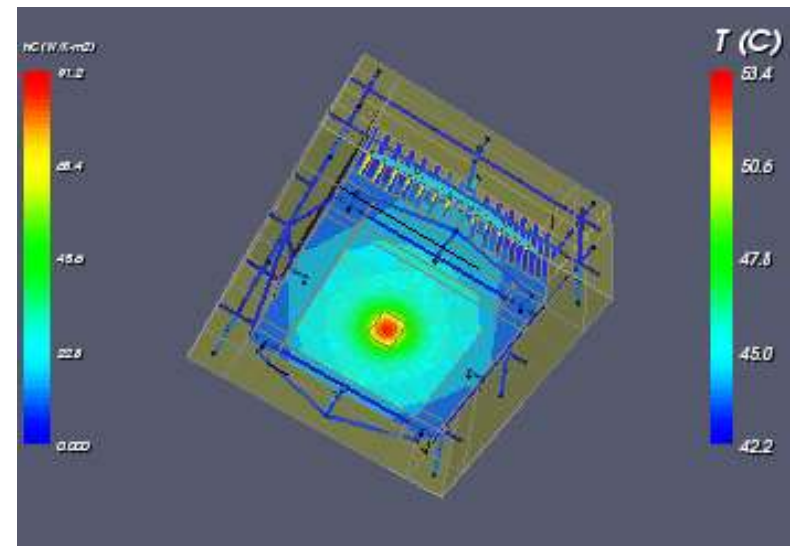
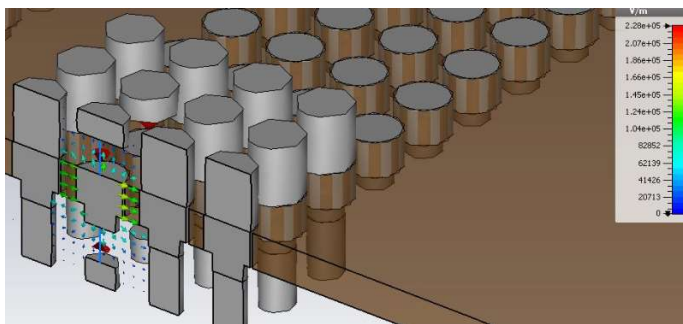
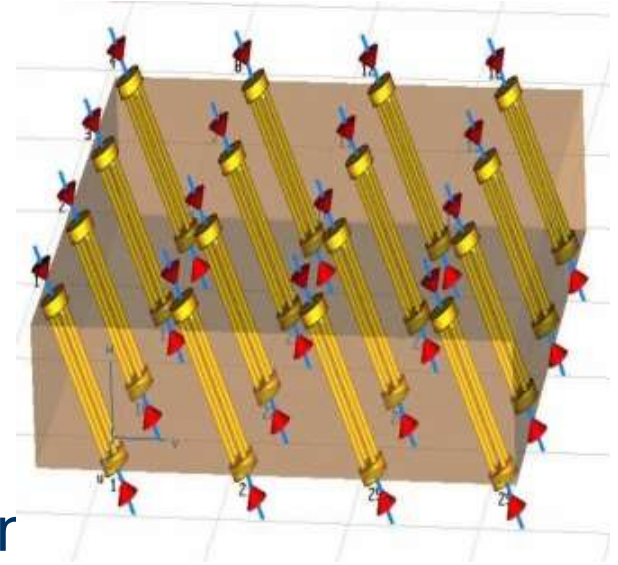

IP, 10/23/2019





B.C.E. s.r.l.

Via Regina Pacis, 54/c - 41049 SASSUOLO (MO) Italy
Tel. +39 0536 811.616 r.a. - Fax +39 0536 811.500
www.bce.it - E-mail: bce@bce.it



Thank you