







EUROP LCAC change

May , 2021

Product lines

Series	Picture	12	18	24	30	36 (1phase)	36 (3phase)	42	48 (1phase)	48 (3phase)	60 (3 phase)
Compact Cassette		●	●								
New Cassette				●	●	●	●	●		●	●
Ceiling & Floor			●	●		●	●			●	●
A6 Duct		●	●	●	●	●	●	●		●	●
Console		●	●								
Floor&Standing									● GD	● GD	

Contents

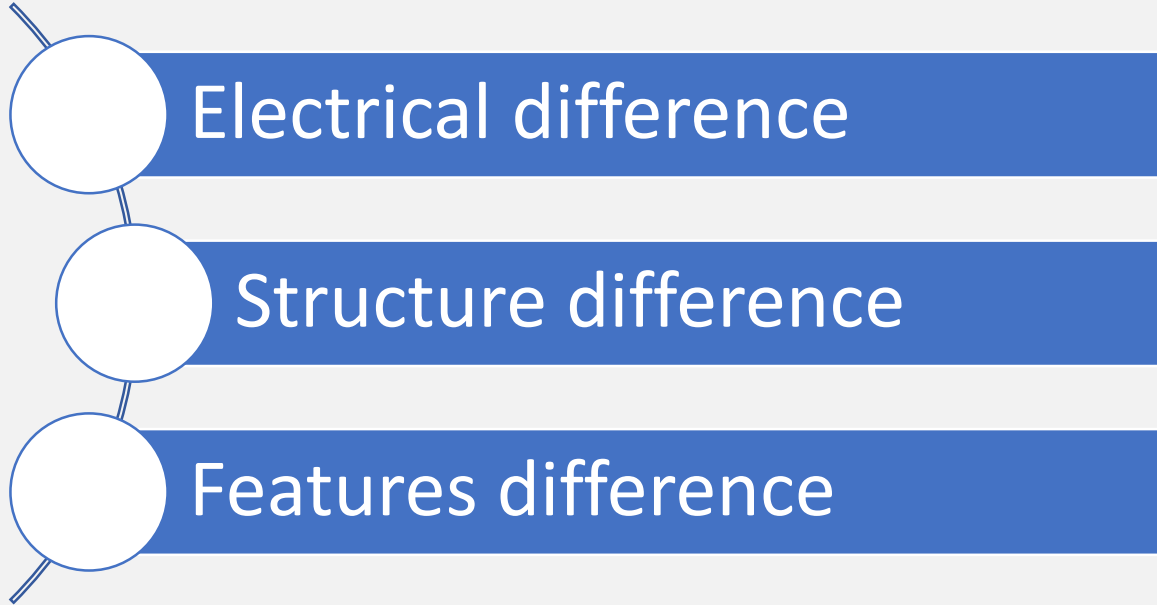
- 
- Electrical difference
 - Structure difference
 - Features difference

Electrical difference

- PCB function
- New refrigerant cool stream inverter technology
- Communication way

Electrical difference

+ PCB standard function -New cassette

New cassette

	Functions	Standard	Optional
Standard	Infrared WRC	Y	/
Standard	2 WIRES WC	Y	/
Customized	4 WIRES WC	N	Y
Standard	CCM WC	Y	Y
Standard	WIFI	Y	Y
Standard	ON-OFF	Y	Y
Standard	ALARM	Y	Y



Standard is 2 core wired controller 120G/120X port and 12B wired controller port

Super slim cassette

	Functions	Standard	Optional
NA	Infrared WRC	N	N
Customized	2 WIRES WC	N	Y
Standard	4 WIRES WC	Y	/
Standard	CCM WC	Y	Y
Standard	WIFI	Y	Y
Standard	ON-OFF	Y	Y
Standard	ALARM	Y	Y



Standard is 4 core wired controller Port 120G2/120X2

Note ,
 2 WIRES WC(2 core non-polarity Wired controller) and 4 WIRES WC(485 communication Wired controller) can not exist at same time.

Electrical difference

PCB function - **New Cassette**

New Cassette Main control PCB	Wired controller port	Wifi port	Central control port
PCB1(standard) 24/30K 17122500004213 36~60K 17122500004211	120X(2core wired controller port	yes	yes
PCB2(optional) 24/30K 17122500A02909 36~60K 17122500A02907	120X2/120G2 (4core wired controller) port	yes	yes

Note ,

TWINS and Central controller use same terminal X/Y/E, so these two functions you can just choose one

Electrical difference

+ PCB standard function -New cassette

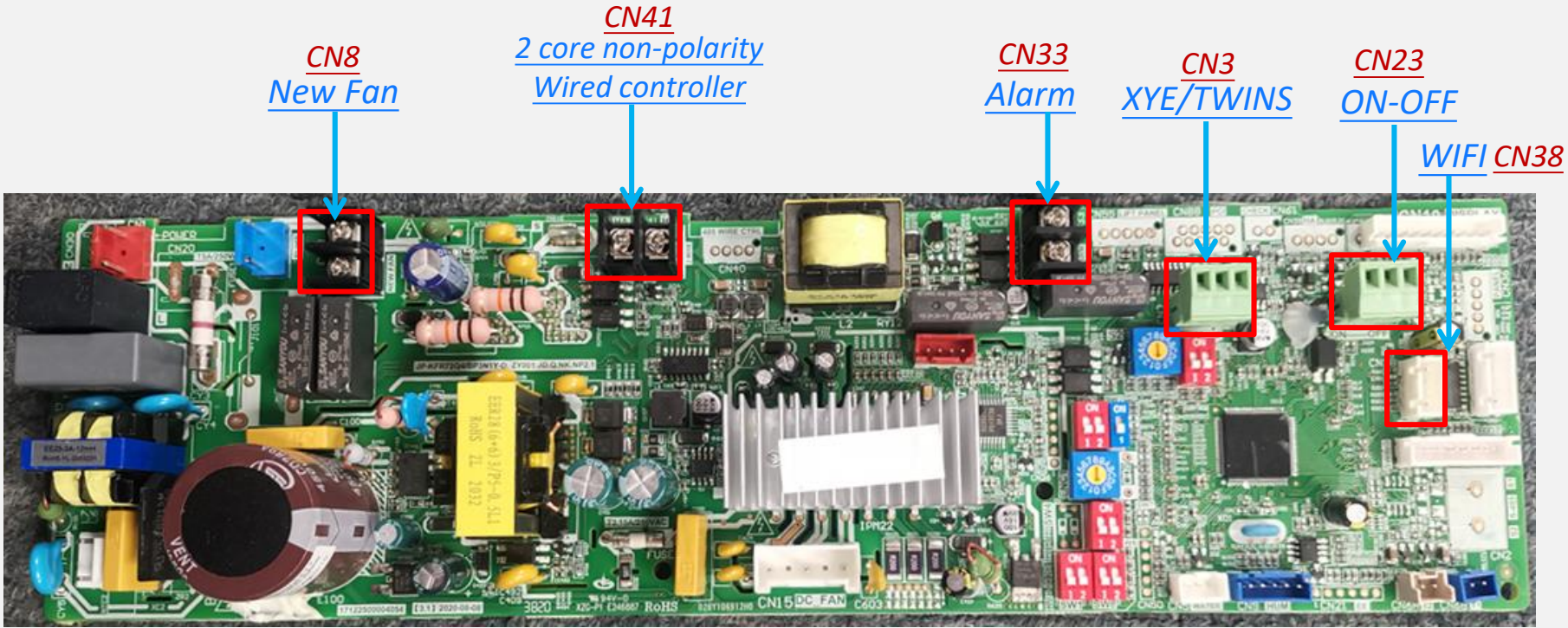

Electrical difference

PCB standard function -New cassette

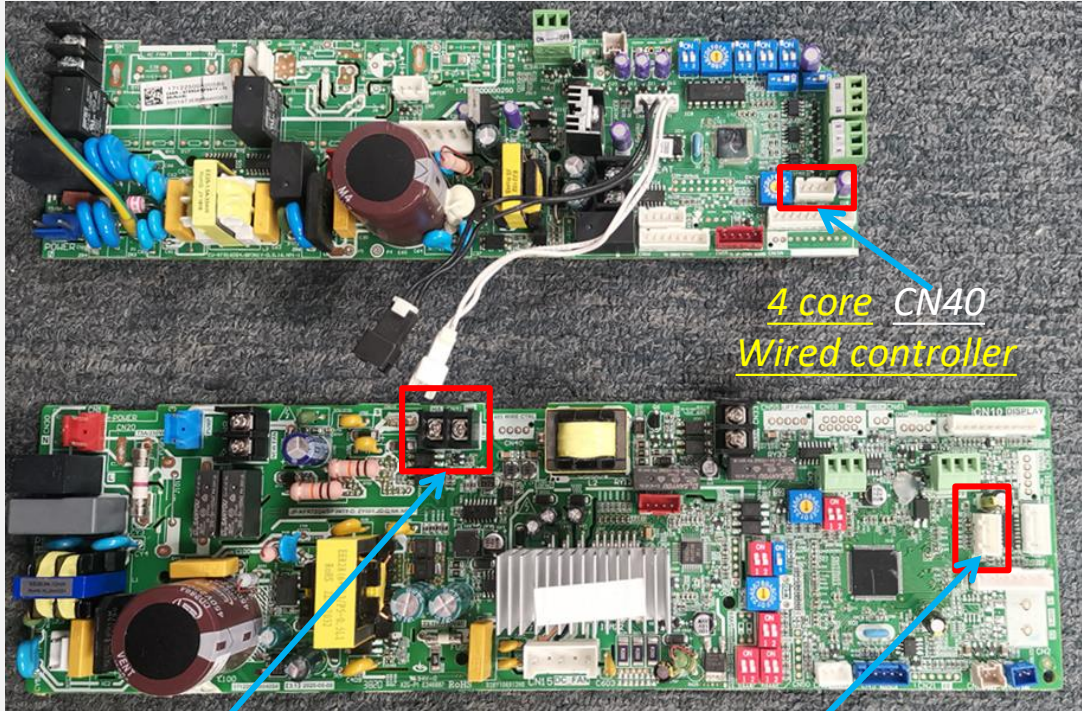

Super Slim cassette PCB

4 core CN40
Wired controller

New cassette PCB

CN41
2 core non-polarity
Wired controller

WIFI CN38

Electrical difference

WIFI connection -New cassette wifi connection

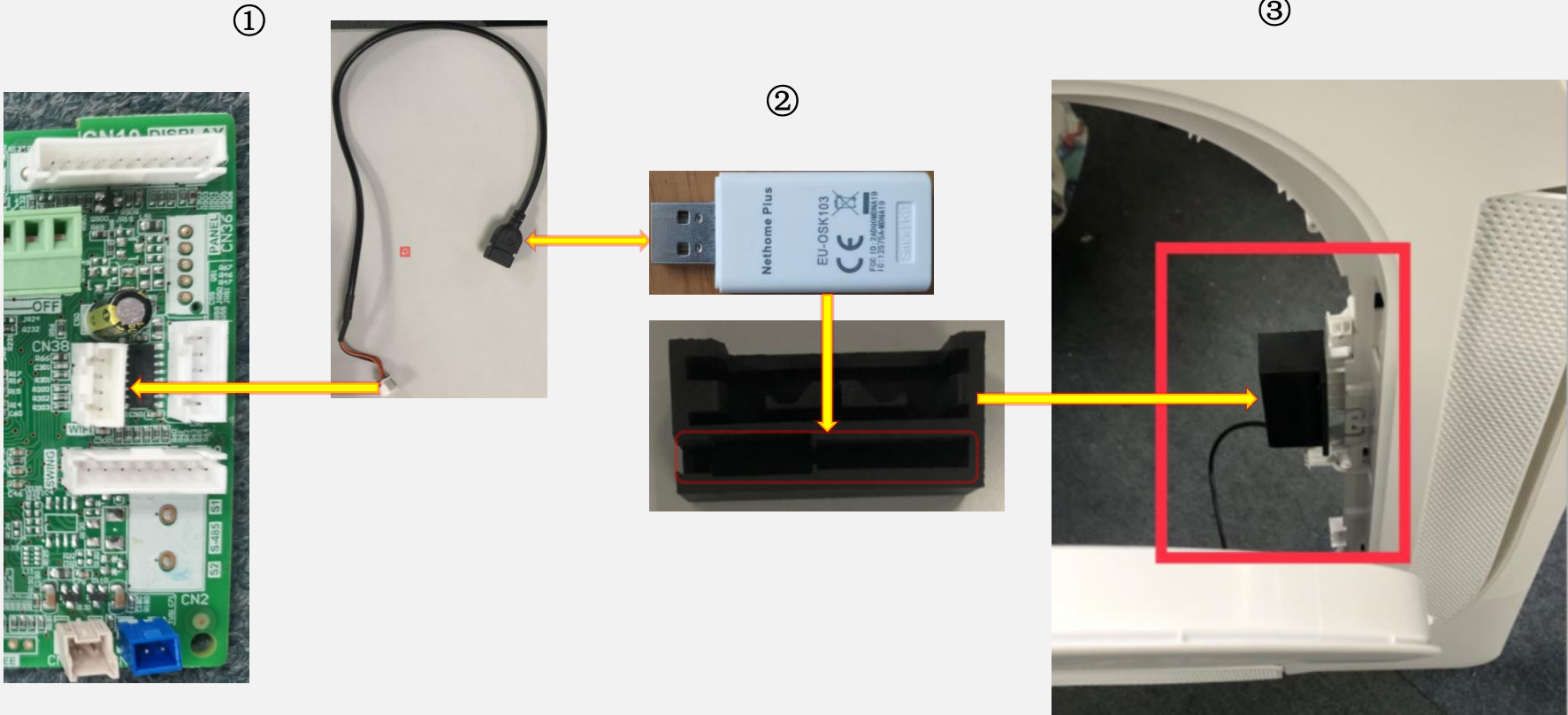

Electrical difference

WIFI connection -New cassette wifi connection

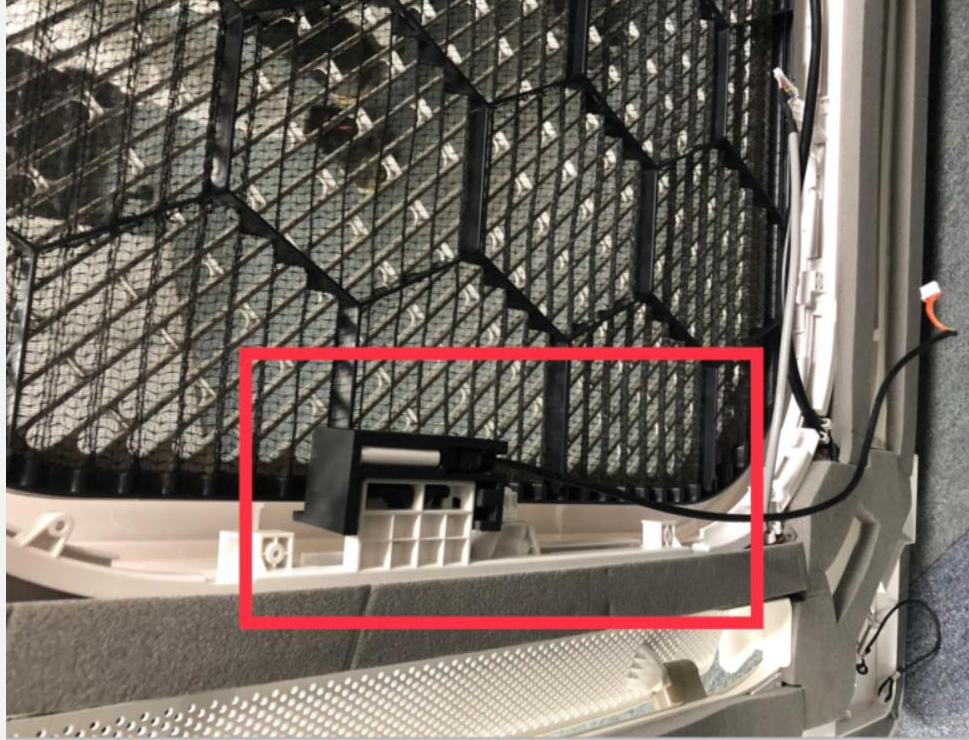

PCB standard function - New Duct and Under&Ceiling

New Duct and Under&Ceiling

	Functions	Standard	Optional
Standard	Infrared WRC	Y	/
Standard	2 WIRES WC	Y	N
Customized	4 WIRES WC	N	Y
Standard	CCM WC	Y	/
Customized	WIFI	N	Y
Standard	ON-OFF	Y	/
Standard	ALARM	Y	/

Old Duct and Under&Ceiling

	Functions	Standard	Optional
Standard	Infrared WRC	Y	/
Customized	2 WIRES WC	N	Y
Standard	4 WIRES WC	Y	N
Standard	CCM WC	Y	/
Standard	WIFI	Y	N
Standard	ON-OFF	Y	/
Standard	ALARM	Y	/

Note ,

1. 2 WIRES WC (2 core non-polarity Wired controller) and 4 WIRES WC (485 communication Wired controller) can not exist at same time.
2. 2 WIRES WC (2 core non-polarity Wired controller) +wifi and Central control(X,Y,E) can not exist at same time.

✚ PCB function - Duct and Under & Ceiling

New Duct and under&ceiling	Wired controller port	Wifi port	Central control port
PCB1(standard)	120X(2core wired controller port	No	yes
PCB2(optional)	120X(2core wired controller)port	yes	No
PCB3(optional)	120X2/120G2 (4core wired controller) port	yes	yes

Note ,

1. 2 WIRES WC(2 core non-polarity Wired controller) +wifi and TWINS and Central controller port all use the XYE terminal port so these three functions you can just choose one

✚ PCB function - Duct and Under & Ceiling

Series	Size	Standard main PCB1 board 120X(2core wired controller port	Optional main PCB2 board 120X(2core wired controller)port+Wifi Port	Optional main PCB3 board 120X2/120G2 (4core wired controller) port
R32 IDU New Under-ceiling	18K-HP	17122700001915	17122700A02648	17122700A02688
	24K-HP	17122700001915	17122700A02648	17122700A02688
	36K-HP	17122700001895	17122700A02647	17122700A02686
	48K-HP	17122700001895	17122700A02647	17122700A02686
	60K-HP	17122700001895	17122700A02647	17122700A02686
R32 IDU New Ducted	12K-HP	17123000007398	17123000A03227	17123000A03307
	18K-HP	17123000007299	17123000A03225	17123000A03305
	24K-HP	17123000007299	17123000A03225	17123000A03305
	30K-HP	17123000007299	17123000A03225	17123000A03305
	36K-HP	17123000007305	17123000A03245	17123000A03308
	42K-HP	17123000007305	17123000A03245	17123000A03308
	48K-HP	17123000007305	17123000A03245	17123000A03308
	60K-HP	17123000007305	17123000A03245	17123000A03308

Electrical difference

✚ PCB1 standard function- **Duct and Under&Ceiling**

PCB1 – standard 2 WIRES WC

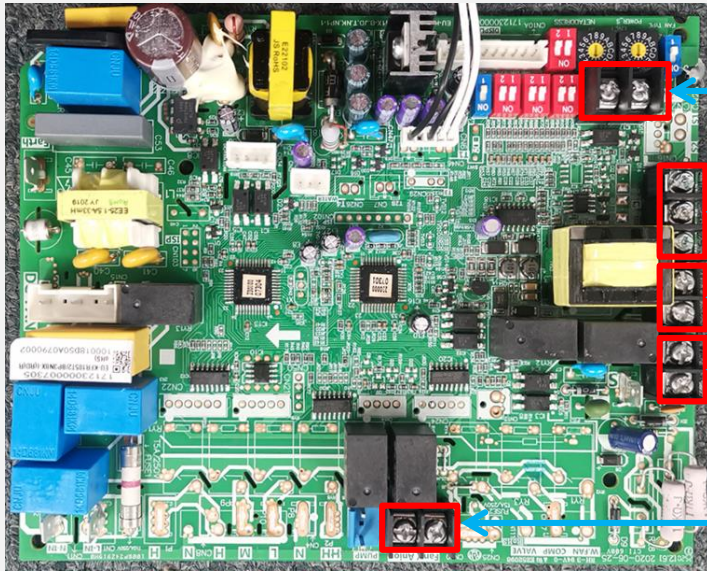

CN23 ON-OFF

CN9 XYE(Central controller)/TWINS

CN45 2 core non-polarity Wired controller

CN33 Alarm

CN43 New Fan

Electrical difference

- PCB2 standard function- **Duct and Under&Ceiling**
PCB2 - customize wifi port

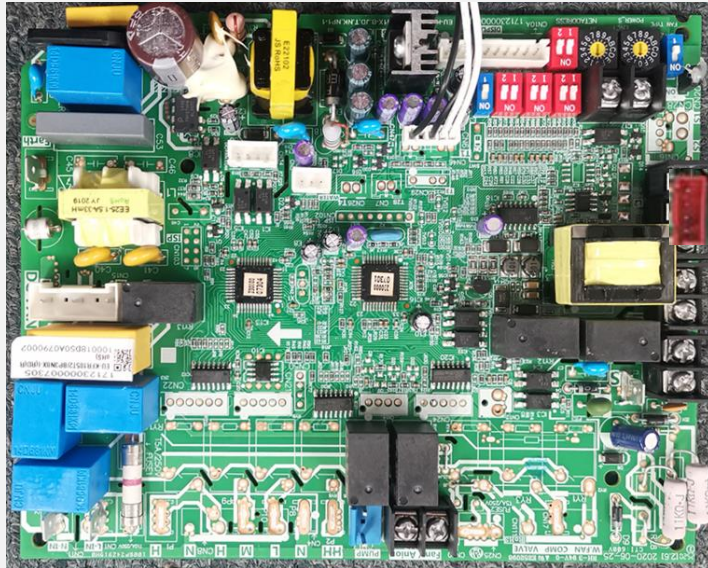

CN23 ON-OFF

CN49 Wifi

CN45 2 core non-polarity Wired controller

CN33 Alarm

CN43 New Fan

Electrical difference

- PCB3 standard function- **Duct and Under&Ceiling**
PCB3 - customize 4 WIRES WC

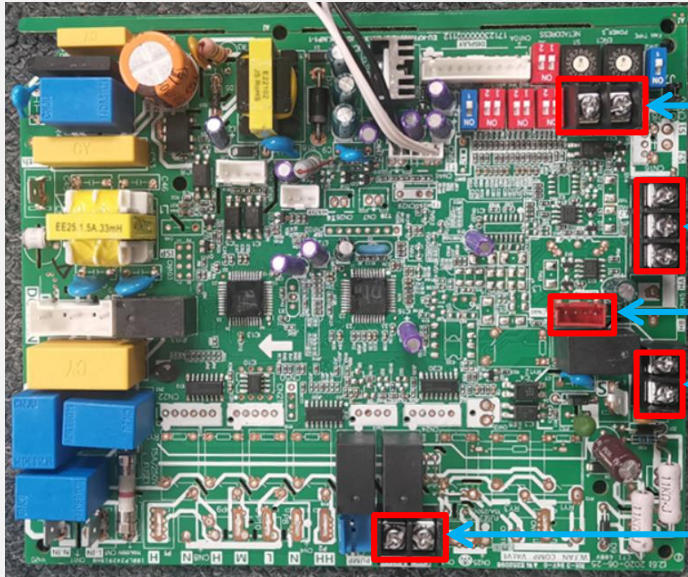

CN23 ON-OFF

CN9 XYE(Central controller)/TWINS

CN40 4 WIRES(485) WC/WIFI

CN33 Alarm

CN43 New Fan

Electrical difference

PCB standard function - Duct and Under&Ceiling

CN45 2 core non-polarity Wired controller

New DUCT PCB

Old DUCT PCB

Electrical Part for 2 core wired controller

CN40 4 core Wired controller

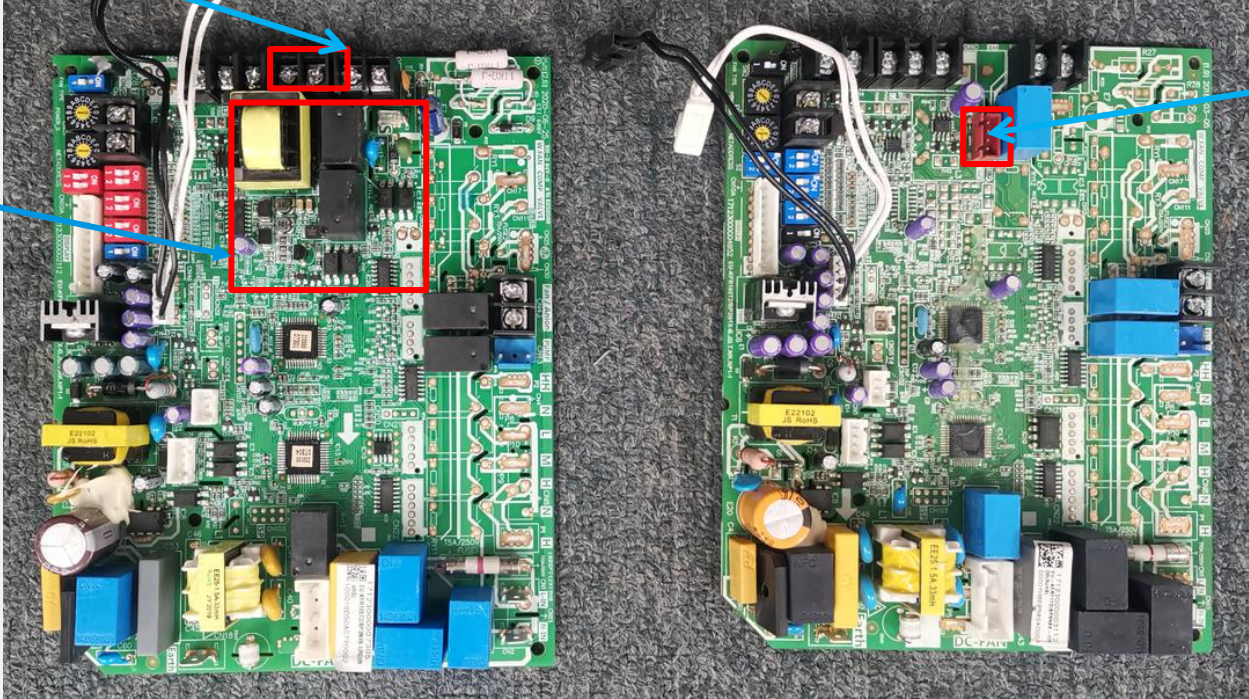

Electrical difference

WIFI connection - DUCT and under&ceiling wifi connection

Note , for DUCT and U&C type the original PCB don' t have **wifi or CN40** terminal , so it can not connect wifi module . If you want to connect wifi , you must customize .



Connection wire to LCAC product

USB Connection

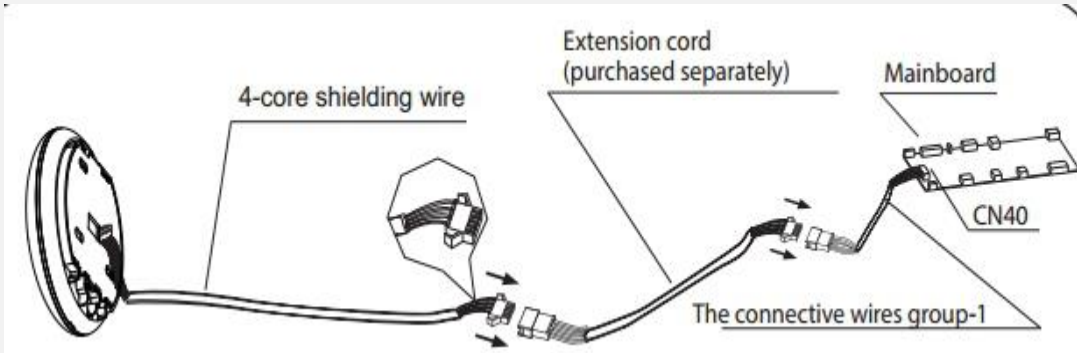

Electrical difference

PCB function - Console

New Console

Functions	Standard	Optional
Infrared WRC	N	N
2 WIRES WRC	N	N
4 WIRES WRC	Y	N
CCM WC	N	N
WIFI	N	N
ON-OFF	Y	N
ALARM	N	N

Connect
120G1/120X1 WRC

Old Console

Functions	Standard	Optional
Infrared WRC	Y	N
2 WIRES WRC	N	N
4 WIRES WRC	N	Y
CCM WC	N	N
WIFI	N	N
ON-OFF	Y	N
ALARM	N	N

Connect to
display board

Connect 12B WRC

Electrical difference

PCB function - Console

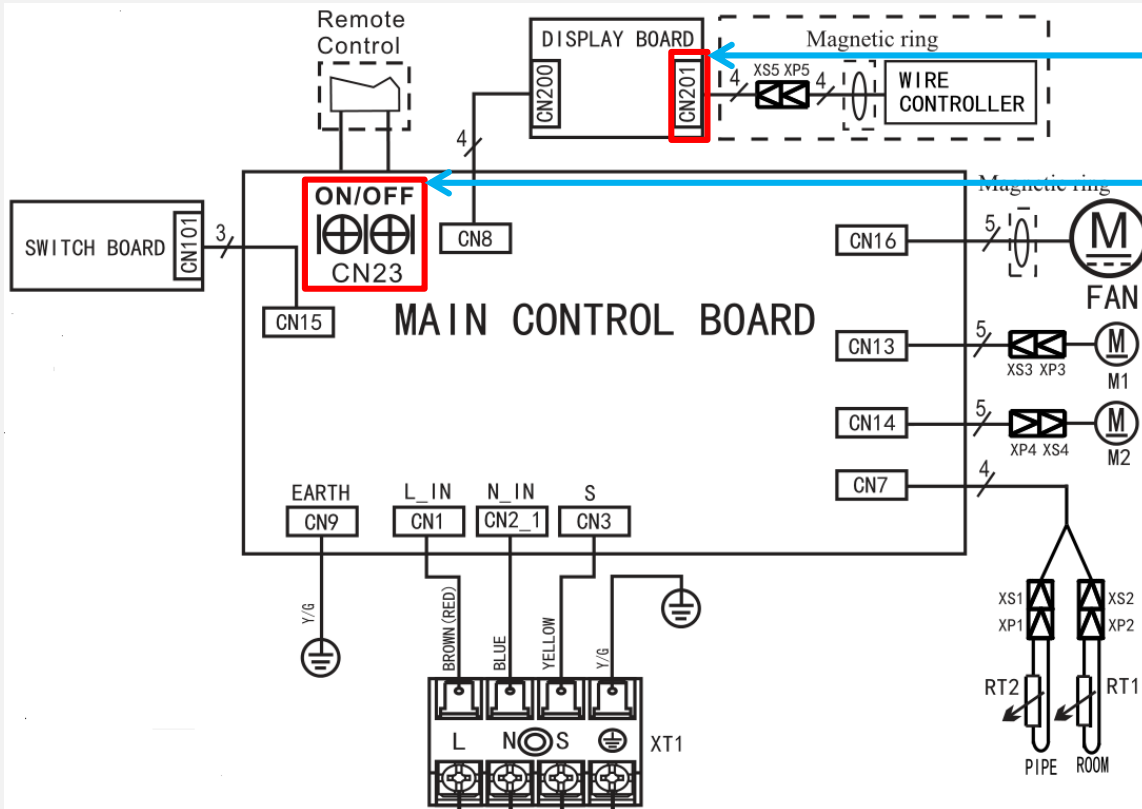

CN201 4 WIRES(485) WRC
Connect to 120G1/X1

CN23 ON-OFF

Electrical difference

PCB function - Console

Old display

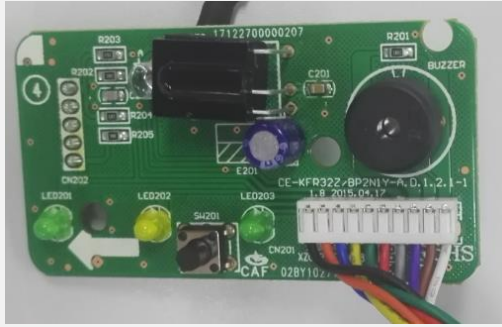

New display

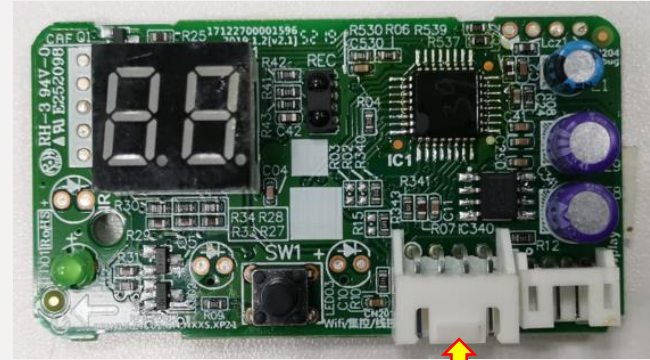

Infrared WRC connection

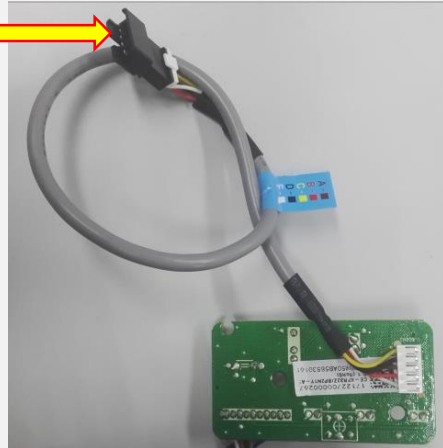

12B(5 core)

Connect 485 WRC



120G1/120X1(4 core)

Electrical difference

✚ New refrigerant cool stream inverter technology

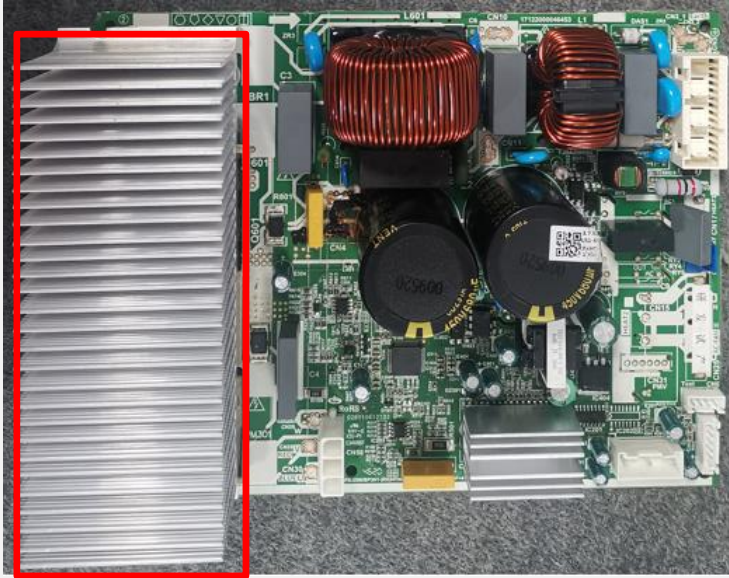

old: Fan cool inverter technology

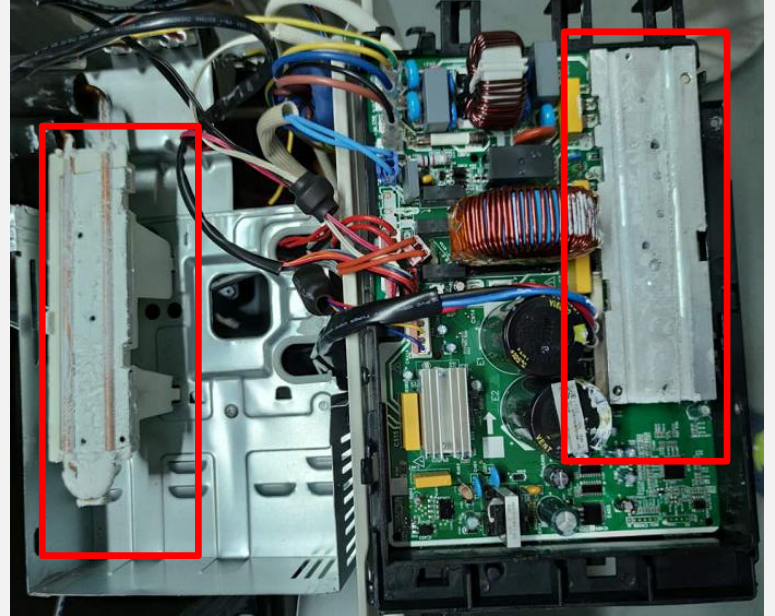

New: Refrigerant cool stream inverter technology

Electrical difference

+ New refrigerant cool stream inverter technology

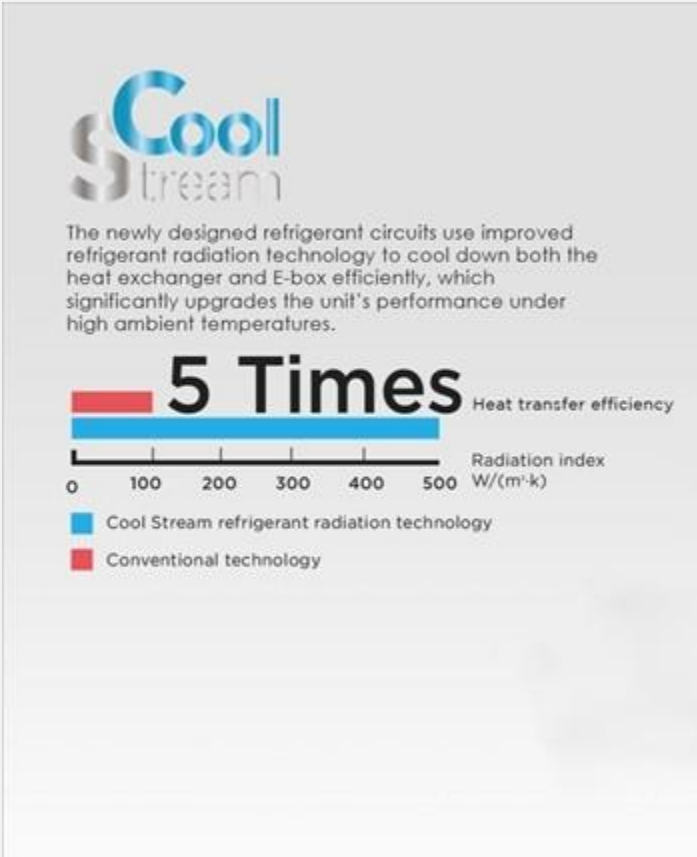

Electrical difference

Communication way

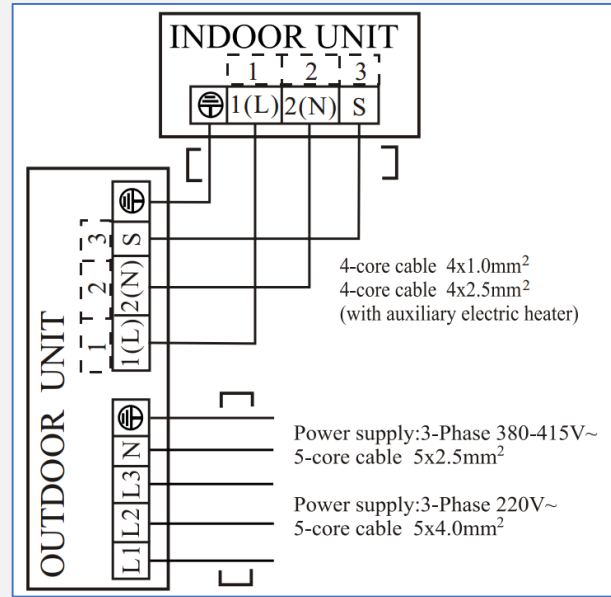
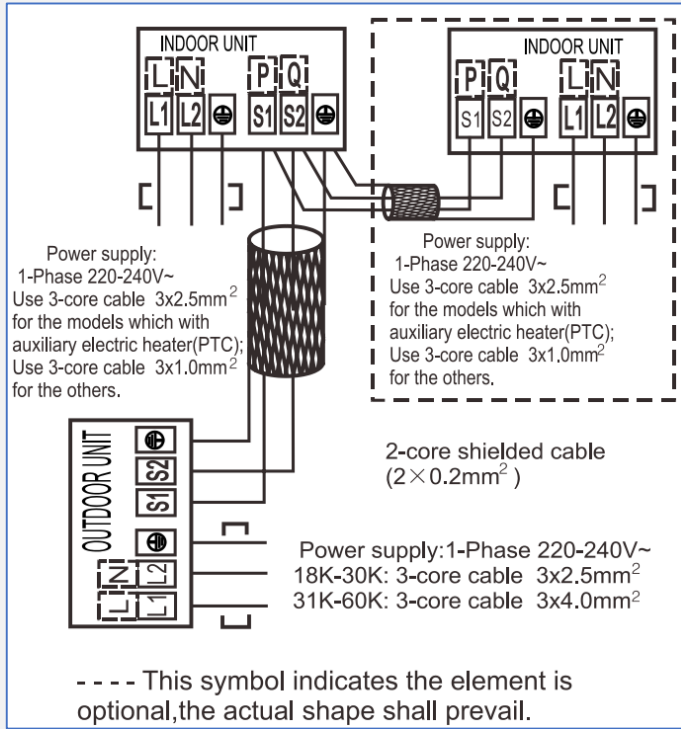

Old: 485 communication: L1/N/E+S1/S2
Same as CAC products

New current loop: L/N/S/E
Same as RAC split and multi

Note ,

Because of the communication way difference , new LCAC ERP and Old LCAC ERP are not compatible .

New LCAC ERP IDU just match new LCAC ERP ODU.

Old LCAC ERP IDU just match Old LCAC ERP ODU.

Structure difference

- **Drainage Pump built out**
- **High Lift Water Pump**
- **Materials**
- **Fireproof and Anti-Rat E-box**
- **Bigger Air Outlet Dimension**
- **Bigger Evaporator**
- **Drainage Pipe Diameter**
- **Package**
- **Installation paperboard**
- **Panel**

Structure difference

+ New cassette -Drainage Pump

Old Cassette | New Cassette

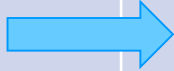
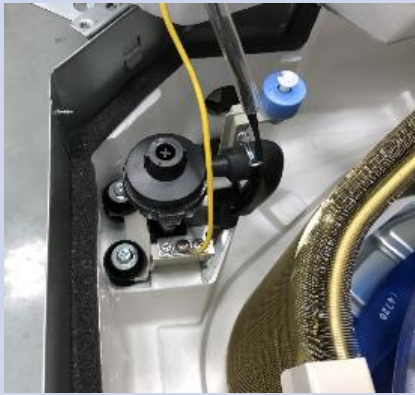

Key optimization :
Water drainage pump is built-out. It takes only 10min to replace the pump, saving up to half an hour for the aftersales man.

Structure difference

+ New cassette -High Lift Water Pump

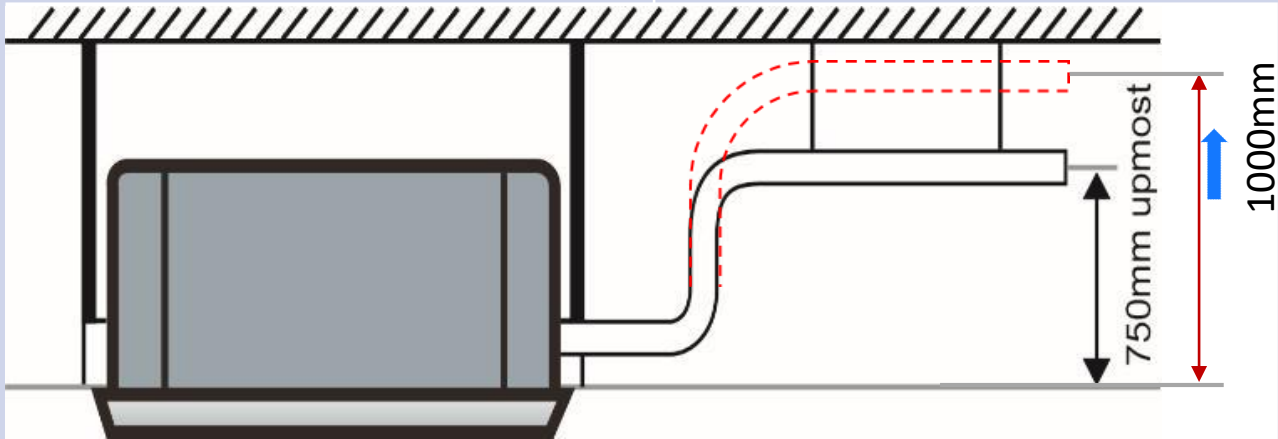

Key optimization :
The lift of the water drainage pump increases from 750mm to **1000mm**, water drainage capacity is higher. It's convenient to install drainage piping under more space condition.

Structure difference

New cassette **-Materials**

Old Cassette **New Cassette**



water collector :
0.8mm
absorbing-
plastics molding



water collector :
2.4mm ABS

Key optimization :
The materials of the water collector is ABS, 2.4mm in thickness, more reliable comparing to previous 0.8mm absorbing-plastics molding type.

Structure difference

+ New cassette -Fireproof and Anti-Rat E-box

Old Cassette



New Cassette

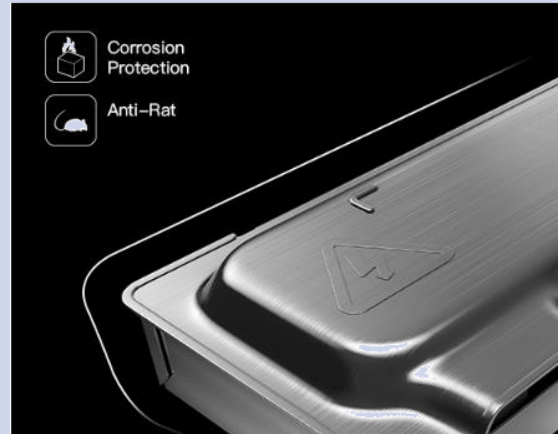

Key optimization :
The electrical box are all-metal, and the dimension of the electrical outlet are designed Anti-Rat, preventing effectively the rats from entering in.

Structure difference

+ New cassette - Bigger Air Outlet Dimension

Old Cassette



New Cassette

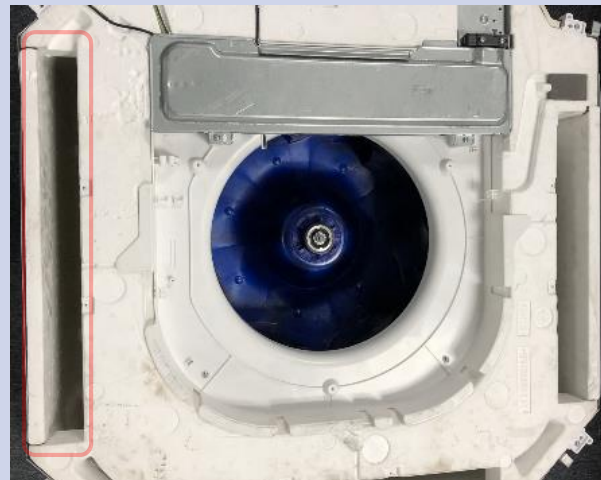

Key optimization :

The area of air outlet is 23% bigger than previous, air velocity and noise is lower.

Structure difference

+ New cassette -Bigger Evaporator

Old Cassette

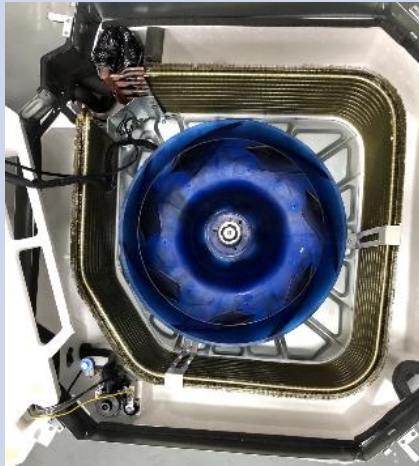

New Cassette

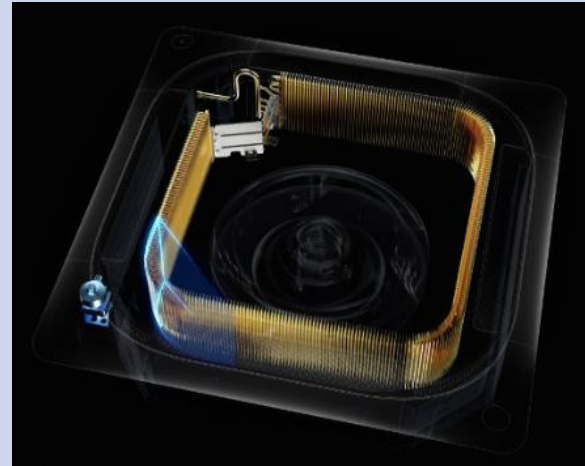

Key optimization :

With optimized evaporator, heat exchange area and capacity is increased, and the air flow is improved.

Structure difference

+ New cassette -Drainage Pipe Diameter

Old Cassette

New Cassette



Key optimization :
The diameter of drainage pipe is changed from 32mm to the mainstream 25mm.

Structure difference

+ New cassette -Package

Old Cassette

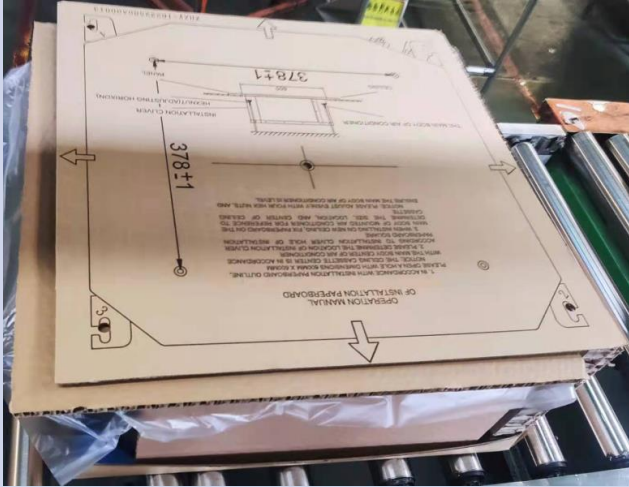

New Cassette



Key optimization :
Brand-new package design for the new cassette, real drop test height is bigger than previous.

Structure difference

 New cassette -Installation paperboard

Old Cassette	New Cassette
--------------	--------------

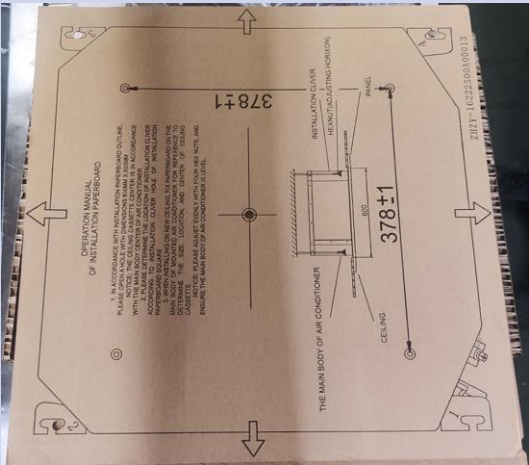

Standard part



Customized part

Key optimization :
The installation paperboard must be customized with installation hook.

Structure difference

+ New cassette panel

40CAS-L6



- ◆ Independent Vane Control
- ◆ Corner display
- ◆ KJR-12B connection

Note, KJR-12B can not control independent vane and Breezeless.

Structure difference

New cassette panel

T-MBQ4-04BD

RG67G1



Vane function

Press Vane button when the unit is turned on.

4 Louvers

Press this button to activate the louver setting feature. Each time you press the Vane button, the display panel will display the selected louver in an order as ("0" indicates that four louvers are all selected):

→ -1 → -2 → -3 → -4 → -0 →

Press Swing button to start/stop the auto swing feature of the selected louvers.

The system will exit the louver setting mode if there is no operation during a 10 seconds period.

- ◆ Independent Vane Control
- ◆ Corner display
- ◆ KJR-12B connection

Note ,

1. KJR-12B can not control independent vane control ;
2. If you want to realize independent vane control , you must choose a special RC(RG67G1)) or 485WRC(KJR-120G/X, KJR-120G2/X2) .

 Structure difference

 New cassette panel

Note ,

New cassette panel and old cassette panel are not compatible

New cassette panel just match new cassette type

Old cassette panel just match super slim cassette type

Features difference

New features

- 1%~100%Grades Indoor Fan Speed
- Active clean
- Twins
- GA compressor frequency control
- X-ECO
- Gear

Below are old features, new LC also have below features



Feature difference

-New Features

1% ~ 100% Grades Indoor Fan Speed

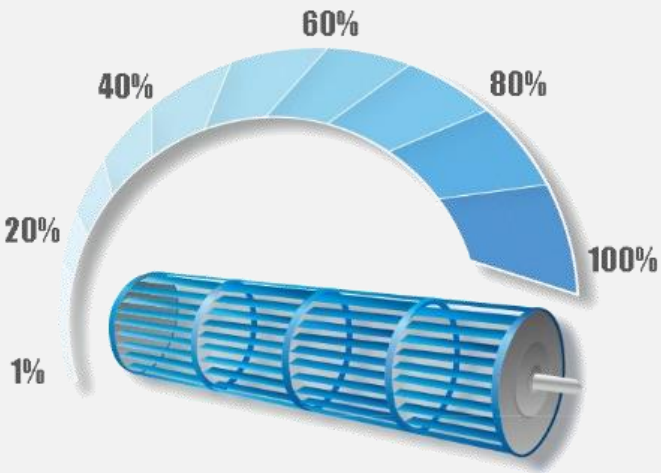

Displays selected fan speed:

✿ >	1%-10%
✿ >>	11%-20%
✿ >>>	21%-30%
.....	
✿ >>>>>>>>>>>>	91%-100%
✿ >>>>>>>>>>>>	AUTO

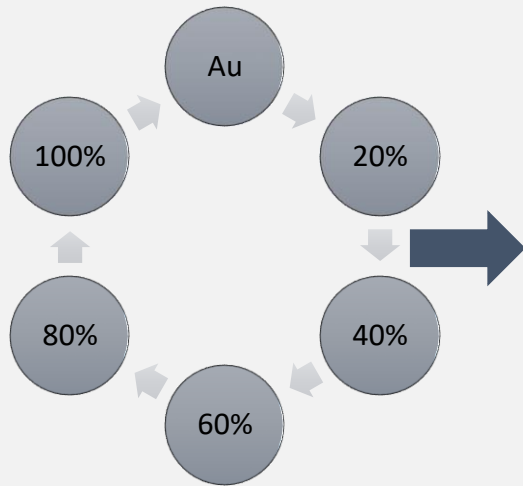

Due to the DC fan motor, indoor fan speeds are 100 grades, more comfortable and energy saving.

Via remote controller to select fan speed first, then the controller will display fan speed percentage, you can use the "UP and Down" button to increase or decrease fan speed in 1% increments, to change into any percentage.

Feature difference

-New Features

Active clean

The active Clean Technology washes away dust, mold, and grease that may cause odors when it adheres to the heat exchanger by automatically freezing and then rapidly thawing the frost.

The internal wind wheel then keeps operating to blow-dry the evaporator, thus preventing the growth of mold and keeping the inside clean.



Step1 :
Cool evap

Step2 :
Evap frost

Step3 :
Evap defrost
and heat

Step4 :
Fan

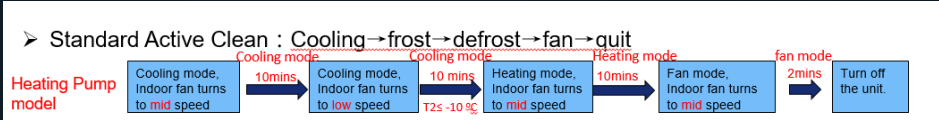

Feature difference

-New Features

Twins

Twins combination(Standard for some model)

The units can be installed as Twin systems: one outdoor unit can be connected with two indoor units. The indoor units can be combined in any of the different available ratings.

	IDU Type	Indoor Units	Outdoor Unit
Twins System	Duct	12K + 12K	24k
	Duct U&C	18K + 18K	36k
	Duct Cassette U&C	24K + 24K	48K
	Duct Cassette	30K + 30K	60K

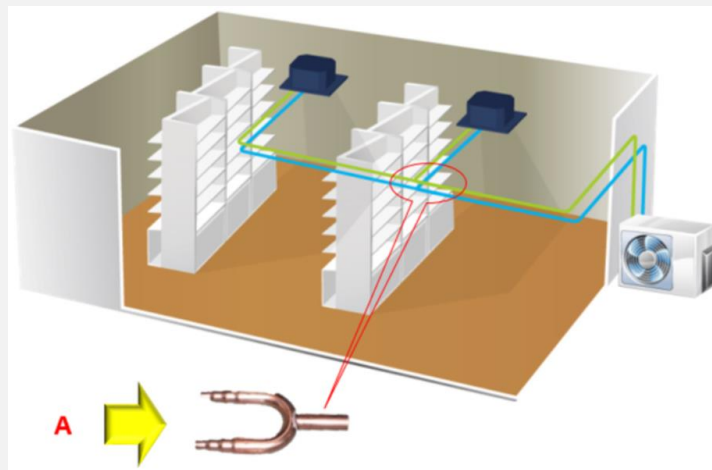
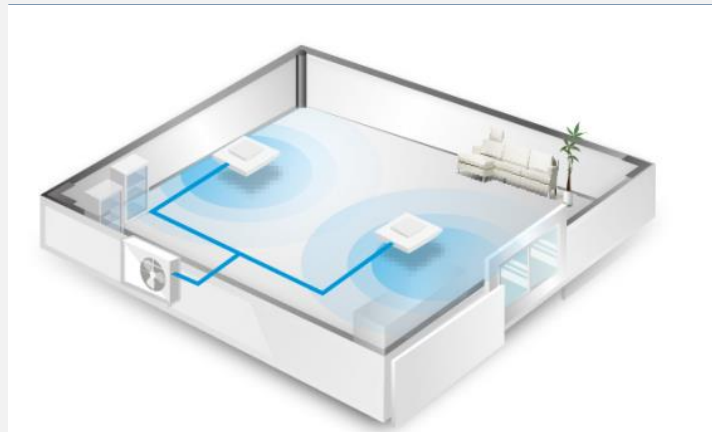

Feature difference

-New Features

Twins

Twins combination(Standard for some model)

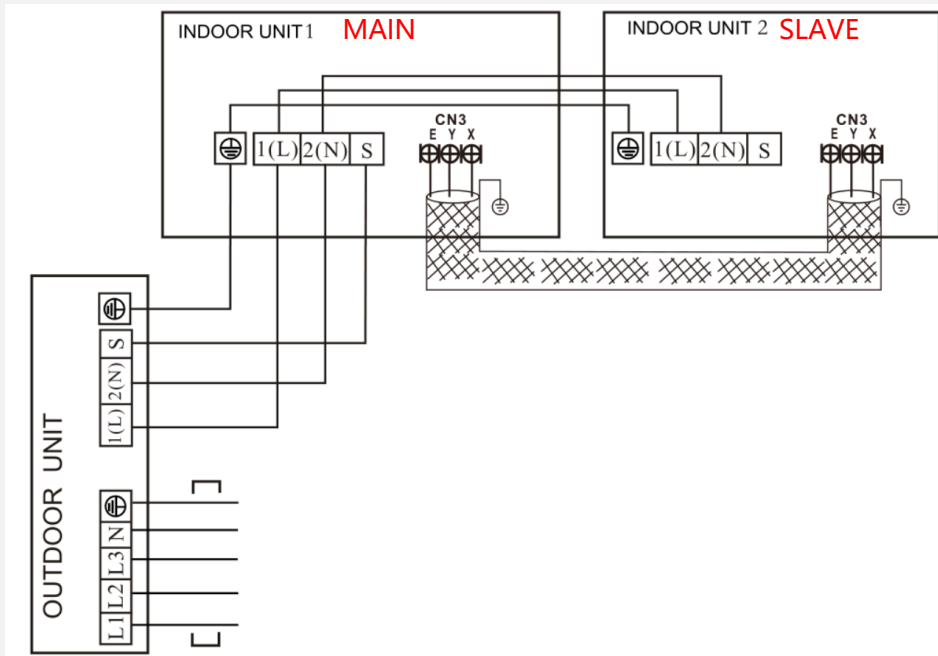

with two indoor units. The indoor units can be combined in any of the different available ratings

Note, TWINS and Central controller use same terminal X/Y/E, so these two functions you can just choose one .

Feature difference

-New Features

+ Twins Function combination table(include Twins)

New cassette	2 WIRES WC	4 WIRES WC	Central controller	WIFI	TWINS	ONOFF	ALARM
Standard 1	Y	N	Y	Y	N	Y	Y
Standard 2	Y	N	N	Y	Y	Y	Y
Customized	N	Y	Y	Y	N	Y	Y
Customized	N	Y	N	Y	Y	Y	Y

DUCT/C&F	2 WIRES WC	4 WIRES WC	Central controller	Wifi	TWINS	ONOFF	ALARM
Standard 1	Y	N	Y	N	N	Y	Y
Standard 2	Y	N	N	N	Y	Y	Y
Customized	Y	N	N	Y	N	Y	Y
Customized	N	Y	Y	N	N	Y	Y
Customized	N	N	Y	Y	N	Y	Y
Customized	N	Y	N	N	Y	Y	Y
Customized	N	N	N	Y	Y	Y	Y
Customized	N	Y	Y	Y	N	Y	Y
Customized	N	Y	N	Y	Y	Y	Y

Feature difference -New Features

GA compressor frequency control

The frequency of traditional air conditioner has dramatic fluctuation during operation, leading to the instability of room temperature. However, air conditioners break away from this pattern with our unique GA Stepless Comfort Technology (0.6Hz for every step) . Its inverter frequency variation is so smooth that you wouldn't notice the room temperature fluctuation ($\pm 0.5^{\circ}\text{C}$) at all.

Ordinary Inverter Mode

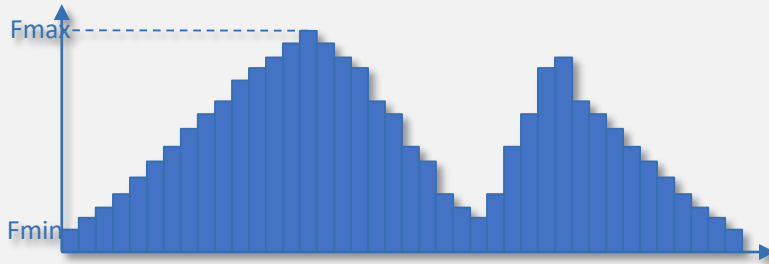

GA Stepless Inverter Mode

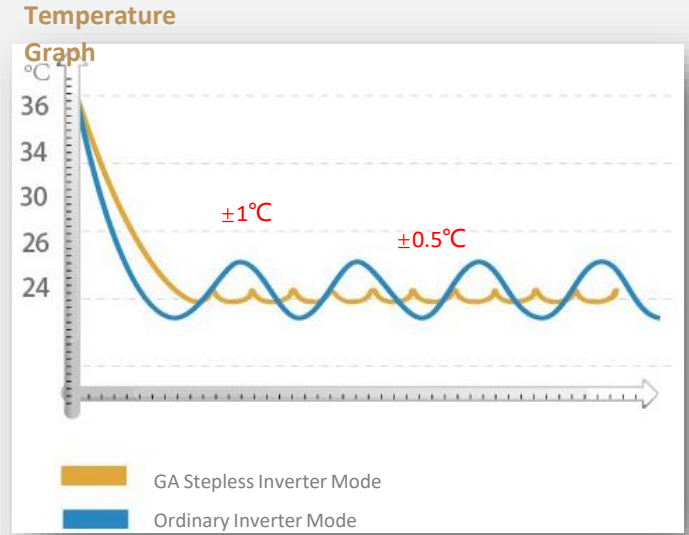
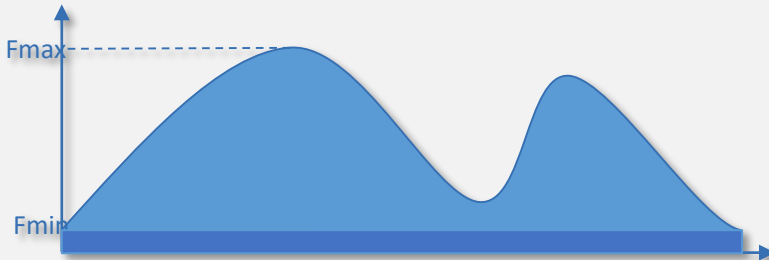

Feature difference

-New Features

X-ECO

X-ECO mode applies to inverter model, smart control on compressor frequency as low as 12HZ(depend on model). As a smart running mode, it limits the highest compressor frequency and fan speed of each stage by intelligent control system.

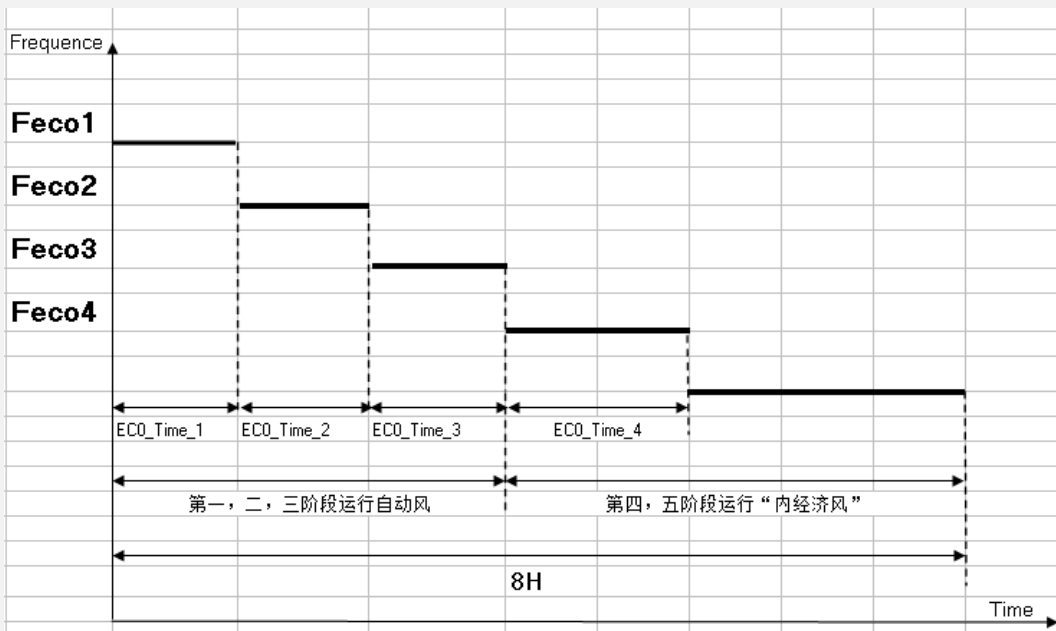

X-ECO mode could energy save.

Feature difference

-New Features

Gear



Press this button under COOL Mode to enter the energy efficient mode.



Press X-ECO button to enter the energy efficient mode in a sequence of following:
ECO → GEAR(75%) → GEAR(50%) → Previous setting mode → ECO.....
Note: This function is only available under COOL mode.

Carrier inverter air conditioners offer three operating power options: 50%, 75%, and 100%. You can choose a lower power level to conserve energy.

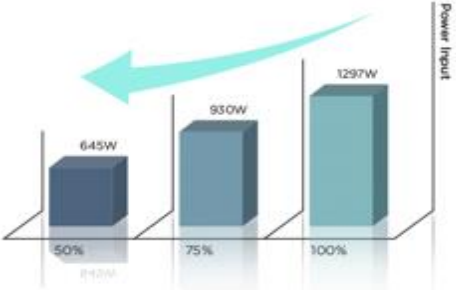

The end