

GAME CHANGER

BIXOLON

BIXOLON®

Carrier-Leave If No Response
USPS DELIVER TO:
BASIC REMOTE BAG 207
POSTOFFICEBOX 33312Y MAX ADDRESS 1X
126 N HANSELMAN LANE MAX ADDRESS 2X
SAINT MARY OF THE WOODSXX, UT 84102
ZIP:USPS DELIVERY CONFIRMATION eVS

BIXOLON®

QLD 4000
BRISBANE
VIRGINIA STREET
VIRGINIA TEST
kg

XM7-30

3-inch Mobile Label Printer

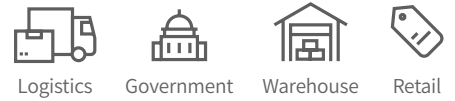

Ultimate Printing Capability

- Fast Liner & Linerless label printing speed of up to 5 ips
- Enabling power delivery charging and data communication with USB Type-C® cable
- Direct printing from the SAP® Smart Forms
- Compatible with diverse MDM solutions (SOTI Connect and BIXOLON Profile Manager XPM™, XCM™)
- Fully compatible with SLCS, BPL-Z™, BPL-C™ and BXL / POS : Interchanged without setting the mode

Exceptional Mobility

- Standard smart battery providing visibility over status and large capacity of 3400 mAh
- Simultaneously connects both Bluetooth® and Dual-band Wireless Lan (2.4GHz and 5GHz)
- Supporting all major operating systems
- Easy Bluetooth Pairing™
- SoftAP : Simple Wi-Fi set up to a mobile device

Compact and Rugged Design

- Built with a large colour display for easy set-up and battery status management
- Embedded Peeler and media holder
- Up to 2.1 m / 7 ft. drop rate
- IP54 water and dust proof



SRP-330III

3-inch Thermal POS Printer

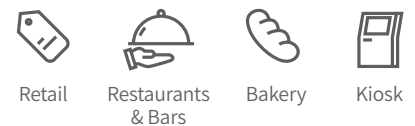

Multiple Interface Choice

- Triple Interface: USB V2.0 FS + Ethernet + Serial
- Dual Interface: USB V2.0 FS + Serial
USB V2.0 FS + Parallel
USB V2.0 FS + Dual Serial

User-Friendly Design

- Auto media width switch with 2-inch (58 mm) partiion
- Paper saving mode, reducing the length of a receipt up to 25%
- 180 or 203 dpi options

Reliable Printing Performance

- Fast printing speeds up to 250 mm/sec
- Energy Star certified



SRP-350V

3-inch Thermal POS Printer



Retail



Restaurants & Bars



Quick Service Restaurant



Coffee

Powerful Printing Performance

- Fast printing speeds up to 300 mm/sec
- Paper saving mode, reducing the length of a receipt up to 25%
- Part of the world-class SRP-350 line
- Energy Star certified

User Convenience

- Anti-jam guide
- 180 or 203 dpi options
- Optional B-melodist

Multiple Interface Choice

- Built-in USB
- Optional Serial, Parallel or Ethernet



SRP-350plusV

3-inch Thermal POS Printer



Retail



Restaurants & Bar



Lottery



Hypermarket

High-Quality Printing Performance

- Fast printing up to 400 mm/sec
- 16-shade grey scale printing of graphics
- Part of the world-class SRP-350 line
- Paper save mode supported

World-Class Flexibility

- Built-in USB and Ethernet
- Optional Serial, Parallel, WLAN, Bluetooth®, and Powered USB
- Compatible with major operating systems including iOS™, Android™, and Windows®
- SoftAP (Captive Portal), Simple Wi-Fi set up to a mobile device

User-Friendly Design

- Special designed for anti-jam guide
- Optional diverse printer accessories and B-melodist
- 180 dpi, 203 dpi options



MOBILE PRINTERS

Providing printing accessibility and stability

Packed with value added features at numerous product levels, BIXOLON's mobile receipt and label printers provide class-leading durability and performance. Comprising of 2, 3 and 4 inch mobile printing solutions for a range of requirements, the lineup's specialised products include a rugged UHF RFID mobile printer, alongside a printer-sled which can be attached with a third-party PIN Entry Device (PED). Their ergonomic designs, user-friendly functions and seamless wireless connectivity options are reinforced throughout mobile portfolio.



LABEL PRINTERS

Delivering performance and efficiency

Consisting of Direct Thermal to Thermal Transfer printer options, BIXOLON's 2 and 4 inch label printing solutions are classified as Industrial, Desktop, RFID and Speciality labelling which also include powerful linerless and tablet embedded label printers. Designed to support a wide variety of applications from low volume standard printing on a limited budget, to demanding mission-critical operations. These user-oriented and environmentally conscious label printers offer outstanding reliability, while taking productivity to the next level.



POS PRINTERS

Enabling environmental and high-quality printing

BIXOLON's 2 to 3 inch Thermal and Impact printers offer outstanding receipt / ticket printing solutions. Among those include a range of market-leading thermal linerless printers which provide numerous eco-friendly benefits, while ensuring business continuity with proven reliability. Alongside, the compact, easy-to-use B-gate mPOS Hub solutions support various USB peripherals and speedy integration for Web & Cloud based printing. Their paper saving modes and back feeding functions enable a reduction in total operational costs.



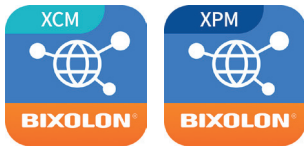

XPM™, XCM™

BIXOLON's web-based printer profile management software XPM™ offers the ability to remotely control an unlimited number of registered printers. It supports access to XPM.Bixelon.com directly from any major browser through a range of wired/wireless connectivity options.

XCM™ is an agent App allowing legacy, non-network interface models and locally wired printers to connect to the XPM™ server.



Label Artist™ Mobile

Label Artist™ Mobile allows users to easily edit and print labels from their chosen iOS™ or Android™ device to a BIXOLON printer using Bluetooth or Wi-Fi. A USB connection is also supported for Android™ devices.



Web Print SDK

Web Print SDK provides a set of Javascript APIs businesses can utilize to build a browser-based, multi-platform solutions which enables direct printing from Windows and Apple iOS platformed web browsers to BIXOLON printers.

Web Print SDK for Windows

- OS: Windows XP, Windows VISTA, Windows 7, Windows 8, Windows 10
- Interface: Serial, USB, Ethernet, Bluetooth and WLAN
- Browser: All major browsers

Web Print SDK for iOS

- OS: iOS 10.0 or later
- Interface: Ethernet, Bluetooth and WLAN
- Browser: Web Print SDK



SOTI Connect

A dedicated range of BIXOLON label printers are certified with SOTI Connect, an IoT solution providing complete lifecycle management to IoT devices within an organization. BIXOLON printers paired with SOTI Connect can be quickly deployed and managed, reducing the time-to-market for IoT initiatives.



SAP® Member Silver
Printer Vendor Program

Driver for SAP®

BIXOLON supports fast and simple direct label printing capabilities from the SAP® Smart Form without the need for additional software or middleware.



Network Auto Installer

Network Auto Installer supports a one-click-installation of printer drivers (Seagull) by automatically detecting and retrieving the IP information of active printers currently connected to the same network as the host device. Designed for printers in Windows based environments.



XI

XI(BIXOLON Interpreter) is an optional programming language that enables users to develop an application using BASIC which customizes printers to fit their unique labelling requirements. The printers can be programmed to produce labels using input data from peripherals directly connected to the printer, such as Electronic Scales, Barcode Scanners or Keyboards. XI also stores received log data as text format.

9x

Nº1

MOBILE
RECEIPT
PRINTER
MANUFACTURER





9x **N^o1** MOBILE RECEIPT PRINTER MANUFACTURER

BIXOLON's success, especially in mobile printing has been recognised through many industry research reports.

According to latest printer market research report by Chunichisha, the Japanese Research Company, BIXOLON secures its ninth consecutive year as the global leader in the mobile receipt printer market.



Chunichisha, Japan (2014-2022), Whole Picture of the Printer Market

Mobile Printers Accessories



MOBILE LABEL PRINTERS



XM7 Series

SPP-L3000

Print Characteristics			
Print Method	Direct Thermal	Direct Thermal	
Print Speed	XM7-40, XM7-30: Up to 5 ips (127 mm/sec - Liner, Linerless) XM7-20: Up to 6 ips (152 mm/sec - Liner, Linerless)	Up to 5 ips (127 mm/sec - Liner, Linerless)	
Print Resolution	203 dpi	203 dpi	
Print Width	XM7-40: Up to 104 mm, XM7-30: Up to 72 mm, XM7-20: Up to 48 mm	Up to 72 mm	
Sensing	Paper End, Gap, Black Mark, Paper Cover Open, Peel-off	Paper End, Gap, Black Mark, Paper Cover Open, Peel-off	
Media Characteristics			
Media Type	Liner, Notch, Receipt Optional: Linerless, RFID Tag (XM7-40R only)	Liner, Linerless (Optional)	
Media Width	XM7-40: 50 ~ 112 mm, XM7-30: 25 ~ 80 mm, XM7-20: 25 ~ 58 mm	25 ~ 80 mm	
Media Roll Diameter	XM7-40, XM7-30: Up to 66 mm, XM7-20: Up to 57 mm	Up to 66 mm	
Media Thickness	0.07 ~ 0.19 mm	0.07 ~ 0.19 mm	
Media Inner Core	19 mm, 12 mm	19 mm, 12 mm	
Supply Method	Easy Paper Loading	Easy Paper Loading	
Physical Characteristics			
Dimensions (W x L x H)	XM7-40: 158 x 186 x 82 mm (6.23 x 7.33 x 3.23 inch) XM7-30: 119 x 180 x 79 mm (4.69 x 7.09 x 3.12 inch) XM7-20: 93 x 168 x 69 mm (3.66 x 6.61 x 2.72 inch)	119 x 159 x 79 mm (4.67 x 6.26 x 3.12 inch)	
Weight	XM7-40: Including battery: approx. 1,090 g (2.41 lbs), Paper: approx. 360 g (0.79 lbs.) XM7-30: Including battery: 795 g (1.76 lbs.), Paper: 260 g (0.58 lbs.) XM7-20: Including battery: 600 g (1.32 lbs.), Paper: 120g (0.26 lbs.)	Including battery: 694 g (1.53 lbs.) Paper: 257 g (0.57 lbs.)	
Electrical	EnergyStar Certified, USB Type-C Power delivery charging support XM7-40: 7.2 V Li-ion, 6800 mAh (Nominal) Smart Battery, Rechargeable XM7-30: Standard: 7.2 V Li-ion, 3400 mAh (Nominal) Smart Battery, Rechargeable Optional: 7.3 V Li-ion, 2850 mAh (Nominal), Rechargeable XM7-20: Standard: 7.3 V Li-ion, 2850 mAh (Nominal), Rechargeable, Optional: 7.2 V Li-ion, 3400 mAh (Nominal) Smart Battery, Rechargeable	Standard: 7.3 V Li-ion, 2850 mAh (Nominal), Rechargeable (Charging time: Up to 2.5 hrs) Optional: 7.2 V Li-ion, 3400 mAh (Nominal) Smart Battery, Rechargeable (Charging time: Up to 3 hrs) EnergyStar Certified, USB Type-C Power delivery charging support	
Peeler	Supported	Supported	
Media Holder	Yes (Inner core: 19 mm)	Yes (Inner core: 19 mm)	
Display	TFT LCD (IPS, 240 x 320 pixels)	FSTN LCD (200 x 100 pixels)	
Performance Characteristics			
Memory	128 MB SDRAM, 256 MB Flash 256 MB SDRAM, 512 MB Flash (Optional)	128 MB SDRAM, 256 MB Flash 256 MB SDRAM, 512 MB Flash (Optional)	
Interface	Standard: USB V2.0 HS + Serial Optional: USB V2.0 HS + Serial + Bluetooth / WLAN / Dual (Bluetooth + WLAN) WLAN: 802.11a/b/g/n (Infrastructure, Ad-hoc, Wi-Fi Direct, SoftAP) - WEP40/104, WPA1/2 (PSK, EAP) Easy Bluetooth Pairing™ via NFC	Standard: USB V2.0 HS + Serial Optional: USB V2.0 HS + Serial + Bluetooth / WLAN / Dual (Bluetooth + WLAN) WLAN: 802.11a/b/g/n (Infrastructure, Ad-hoc, Wi-Fi Direct, SoftAP) - WEP40/104, WPA1/2 (PSK, EAP) Easy Bluetooth Pairing™ via NFC	
Environment Characteristics			
Temperature	Operating: -15 ~ 50°C (5 ~ 122°F), Storage: -30 ~ 70°C (-22 ~ 158°F)	Operating: -15 ~ 50°C (5 ~ 122°F), Storage: -30 ~ 70°C (-22 ~ 158°F)	
Humidity	Operating: 10 ~ 80% RH	Operating: 10 ~ 80% RH	
Sealing	IP54	IP54	
Drop Rate	XM7-40: 1.8 m (6 ft.), XM7-30, XM7-20: 2.1 m (7 ft.)	2.1 m (7 ft.)	
Software			
Emulation	SLCS, BPL-Z™, BPL-C™, BXL / POS, XM7-40R (RFID); SLCS, BPL-Z™	SLCS, BPL-Z™, BPL-C™	
Driver / Utility	Windows Driver (Europlus/Seagull), Linux/Mac CUPS Driver, Virtual COM USB Driver, Utility Program, Label Artist-IT™, Bartender UL, OPOS/JPOS Driver, SAP® Device Driver, Network Auto Installer	Windows Driver (Europlus/Seagull), Linux/Mac CUPS Driver, Virtual COM USB Driver, Utility Program, Label Artist-IT™, Bartender UL, OPOS/JPOS Driver, SAP® Device Driver, Network Auto Installer	
SDK / Plugin	Android/iOS/Windows SDK, Linux SDK, Chrome SDK, Xamarin SDK, Web Print SDK, Cordova Plugin	Android/iOS/Windows SDK, Linux SDK, Chrome SDK, Xamarin SDK, Web Print SDK, Cordova Plugin	
Application	Label Artist™ Mobile (Android, iOS), mPrint App (Android, iOS)	Label Artist™ Mobile (Android, iOS), mPrint App (Android, iOS)	
MDM (Optional)	BIXOLON Profile Manager - XPM™, XCM™ (Windows, Android), SOTI Connect supported	BIXOLON Profile Manager - XPM™, XCM™ (Windows, Android), SOTI Connect supported	
Fonts / Graphics / Symbolologies			
Fonts	Bitmap Fonts (10 SLCS™, 16 BPL-Z™, 7 BPL-C™), Scalable Fonts (1 SLCS™, 1 BPL-Z™), 23 Code page, Unicode supported (UTF-8, UTF-16LE, UTF-16BE)	Bitmap Fonts (10 SLCS™, 16 BPL-Z™, 7 BPL-C™), Scalable Fonts (1 SLCS™, 1 BPL-Z™), 23 Code page, Unicode supported (UTF-8, UTF-16LE, UTF-16BE)	
Graphics	Supporting user-defined fonts, graphics, formats, layouts and logos	Supporting user-defined fonts, graphics, formats, layouts and logos	
Barcode Symbolologies	1D: Codabar, Code 11, Code 39, Code 93, Code 128, EAN-13, EAN-8, Industrial 2-of-5, Interleaved 2-of-5, Logmars, MSI, Plessey, Postnet, GS1 DataBar (RSS-14), Standard 2-of-5, UPC/EAN extensions, UPC-A, UPC-E, IMB 2D: Aztec, Codablock, Code 49, Data Matrix, MaxiCode, MicroPDF417, PDF417, QR code, TLC 39	1D: Codabar, Code 11, Code 39, Code 93, Code 128, EAN-13, EAN-8, Industrial 2-of-5, Interleaved 2-of-5, Logmars, MSI, Plessey, Postnet, GS1 DataBar (RSS-14), Standard 2-of-5, UPC/EAN extensions, UPC-A, UPC-E, IMB 2D: Aztec, Codablock, Code 49, Data Matrix, MaxiCode, MicroPDF417, PDF417, QR code, TLC 39	
Accessories / Supplies			
Standard Accessories	XM7-40, XM7-30: Belt Strap, Smart Battery, AC/DC Adapter, Power Cord, Media Disk (Inner core: 12 mm) XM7-20: Belt Strap, Battery Pack, SMPS, Power Cord, Media Disk (Inner core: 12mm)	Belt Strap, Battery, AC/DC Adapter, Power Cord, Media Disk (Inner core: 12 mm)	
Optional Accessories	Shoulder Strap, Single Battery Charger, Quad Battery Charger, Single Docking Cradle (XM7-20 only), Serial/USB Cable, Fixed Serial/USB Cable, Vehicle Holder, Vehicle Adapter, Smart Battery (XM7-20 only), Battery	Smart Battery, Shoulder Strap, Single Battery Charger, Quad Battery Charger, Serial/USB Cable, Fixed Serial/USB Cable, RAM mount Vehicle-Holder, Vehicle Charger	
Supplies	Compatible with B-linerless™ BIXOLON's flexible and ecological linerless label consumables	Compatible with B-linerless™ BIXOLON's flexible and ecological linerless label consumables	
RFID (XM7-40R only)			
Frequency	UHF, 865 ~ 868 MHz (EU), 902 ~ 928 MHz (KR, USA)	-	
Transmit Power	1W	-	
Modulation	ASK	-	
Protocol	ISO 18000-6C (EPC Class1 Gen2)	-	
Tag Pitch	Min 16 mm	-	



SPP-L410



SPP-L310

Print Characteristics

Print Method	Direct Thermal	Direct Thermal
Print Speed	Up to 4 ips (102 mm/sec - Liner) Up to 3 ips (76 mm/sec - Linerless)	Up to 5 ips (127 mm/sec - Liner) Up to 4 ips (102 mm/sec - Linerless)
Print Resolution	203 dpi	203 dpi
Print Width	Up to 104 mm	Up to 72 mm
Sensing	Paper End, Gap, Black Mark, Paper Cover Open	Paper End, Gap, Black Mark, Paper Cover Open

Media Characteristics

Media Type	Liner, Linerless (Optional)	Liner, Linerless (Optional)
Media Width	112 mm / 105 mm (Optional)	80 mm Optional 58 / 62 / 66 / 70 / 74 mm
Media Roll Diameter	Up to 56 mm	Up to 49 mm
Media Thickness	0.07 ~ 0.19 mm	0.07 ~ 0.19 mm
Media Inner Core	-	-
Supply Method	Easy Paper Loading	Easy Paper Loading

Physical Characteristics

Dimensions (W x L x H)	143 x 138 x 66 mm (5.63 x 5.44 x 2.60 inch)	105 x 126 x 58 mm (4.14 x 4.97 x 2.29 inch)
Weight	Including battery: 530 g (1.17 lbs.) Paper: 242 g (0.53 lbs.)	Including battery: 385 g (0.85 lbs.) Paper: 133 g (0.29 lbs.)
Electrical	7.3 V Li-ion, 2850 mAh (Nominal), Rechargeable Charging time: Up to 4 hrs EnergyStar Certified	7.3 V Li-ion, 2850 mAh (Nominal), Rechargeable Charging time: Up to 4 hrs EnergyStar Certified
Peeler	-	-
Media Holder	-	-
Display	-	-

Performance Characteristics

Memory	128 MB SDRAM, 256 MB Flash 256 MB SDRAM, 512 MB Flash (Optional)	128 MB SDRAM, 256 MB Flash 256 MB SDRAM, 512 MB Flash (Optional)
Interface	Standard: USB V2.0 HS + Serial Optional: USB V2.0 HS + Serial + Bluetooth / WLAN WLAN: 802.11a/b/g/n (Infrastructure, Ad-hoc, Wi-Fi Direct, SoftAP) - WEP40/104, WPA1/2 (PSK, EAP) Easy Bluetooth Pairing™ via NFC	Standard: USB V2.0 HS + Serial Optional: USB V2.0 HS + Serial + Bluetooth / WLAN WLAN: 802.11a/b/g/n (Infrastructure, Ad-hoc, Wi-Fi Direct, SoftAP) - WEP40/104, WPA1/2 (PSK, EAP) Easy Bluetooth Pairing™ via NFC

Environment Characteristics

Temperature	Operating: -15 ~ 50°C (5 ~ 122°F), Storage: -30 ~ 70°C (-22 ~ 158°F)	Operating: -15 ~ 50°C (5 ~ 122°F), Storage: -30 ~ 70°C (-22 ~ 158°F)
Humidity	Operating: 10 ~ 80% RH	Operating: 10 ~ 80% RH
Sealing	IP54	IP54
Drop Rate	1.8 m (6 ft.)	1.8 m (6 ft.)

Software

Emulation	SLCS, BPL-Z™, BPL-C™	SLCS, BPL-Z™, BPL-C™
Driver / Utility	Windows Driver (Europlus/Seagull), Linux/Mac CUPS Driver, Virtual COM USB Driver, Utility Program, Label Artist-II™, Bartender UL, OPOS/JPOS Driver, SAP® Device Driver, Network Auto Installer	Windows Driver (Europlus/Seagull), Linux/Mac CUPS Driver, Virtual COM USB Driver, Utility Program, Label Artist-II™, Bartender UL, OPOS/JPOS Driver, SAP® Device Driver, Network Auto Installer
SDK / Plugin	Android/iOS/Windows SDK, Linux SDK, Chrome SDK, Xamarin SDK, Cordova Plugin	Android/iOS/Windows SDK, Linux SDK, Chrome SDK, Xamarin SDK, Cordova Plugin
Application	Label Artist™ Mobile (Android, iOS), mPrint App (Android, iOS)	Label Artist™ Mobile (Android, iOS), mPrint App (Android, iOS)
MDM (Optional)	-	-

Fonts / Graphics / Symbologies

Fonts	Bitmap Fonts (10 SLCS™, 16 BPL-Z™, 7 BPL-C™), Scalable Fonts (1 SLCS™, 1 BPL-Z™), 23 Code page, Unicode supported (UTF-8, UTF-16LE, UTF-16BE)	Bitmap Fonts (10 SLCS™, 16 BPL-Z™, 7 BPL-C™), Scalable Fonts (1 SLCS™, 1 BPL-Z™), 23 Code page, Unicode supported (UTF-8, UTF-16LE, UTF-16BE)
Graphics	Supporting user-defined fonts, graphics, formats, layouts and logos	Supporting user-defined fonts, graphics, formats, layouts and logos
Barcode Symbologies	1D: Codabar, Code 11, Code 39, Code 93, Code 128, EAN-13, EAN-8, Industrial 2-of-5, Interleaved 2-of-5, Logmars, MSI, Plessey, Postnet, GS1 DataBar (RSS-14), Standard 2-of-5, UPC/EAN extensions, UPC-A, UPC-E, IMB 2D: Aztec, Codablock, Code 49, Data Matrix, MaxiCode, MicroPDF417, PDF417, QR code, TLC 39	1D: Codabar, Code 11, Code 39, Code 93, Code 128, EAN-13, EAN-8, Industrial 2-of-5, Interleaved 2-of-5, Logmars, MSI, Plessey, Postnet, GS1 DataBar (RSS-14), Standard 2-of-5, UPC/EAN extensions, UPC-A, UPC-E, IMB 2D: Aztec, Codablock, Code 49, Data Matrix, MaxiCode, MicroPDF417, PDF417, QR code, TLC 39

Accessories / Supplies

Standard Accessories	Belt Clip, Battery, Battery Charger, Power Cord	Belt Clip, Battery, Battery Charger, Power Cord
Optional Accessories	Belt Strap, Shoulder Strap, Single Battery Cradle, Quad Battery Charger, Vehicle Charger, Serial/USB Cable, RAM Mount Vehicle Holder, Case	Belt Strap, Shoulder Strap, Single Battery Cradle, Quad Battery Charger, Vehicle Charger, Serial/USB Cable, Vehicle-Holder, RAM mount Vehicle-Holder, Case, Protective Case, Detachable Media Holder
Supplies	Compatible with B-linerless™ BIXOLON's flexible and ecological linerless label consumables	Compatible with B-linerless™ BIXOLON's flexible and ecological linerless label consumables

MOBILE PRINTERS



SPP-R410

SPP-R310

SPP-R200III

Print Characteristics			
Print Method	Direct Thermal	Direct Thermal	Direct Thermal
Print Speed	Up to 90 mm/sec (Receipt) Up to 60 mm/sec (Linerless)	Up to 100 mm/sec (Receipt) Up to 80 mm/sec (Linerless)	Up to 100 mm/sec (Receipt) Up to 80 mm/sec (Linerless)
Print Resolution	203 dpi	203 dpi	203 dpi
Print Width	Up to 104 mm	Up to 72 mm	Up to 48 mm
Sensing	Paper End Paper Cover Open Black Mark (Optional positioning) Gap (Optional)	Paper End Paper Cover Open Black Mark (Optional positioning) Gap (Optional)	Paper End Paper Cover Open
Media Characteristics			
Media Type	Receipt, Liner, Linerless (Optional)	Receipt, Liner, Linerless (Optional)	Receipt, Liner, Linerless (Optional)
Media Width	112 mm / 105 mm (Optional)	80 mm	58 mm / 50 mm (Optional)
Media Roll Diameter	Up to 57 mm	Up to 50 mm	Up to 40 mm
Media Thickness	0.07 ± 0.005 mm	0.07 ± 0.005 mm	0.07 ± 0.005 mm
Supply Method	Easy Paper Loading	Easy Paper Loading	Easy Paper Loading
Physical Characteristics			
Dimensions (W x L x H)	143 x 138 x 66 mm (5.63 x 5.44 x 2.60 inch)	105 x 126 x 58 mm (4.14 x 4.97 x 2.29 inch)	79.5 x 124.5 x 44.1 mm (3.13 x 4.9 x 1.74 inch)
Weight	Including battery: 530 g (1.17 lbs.) Paper: 242 g (0.53 lbs.)	Including battery: 385 g (0.85 lbs.) Including MSR: 405 g (0.9 lbs.) Paper: 133 g (0.29 lbs.)	Including battery: 228 g (0.50 lbs.) Including MSR: 238 g (0.52 lbs.)
Electrical	7.3 V Li-ion, 2850 mAh (Nominal), Rechargeable Charging time: Up to 4 hrs EnergyStar Certified	7.3 V Li-ion, 2850 mAh (Nominal), Rechargeable Charging time: Up to 4 hrs EnergyStar Certified	7.4 V Li-ion, 1200 mAh, Rechargeable Charging time: Up to 2.5 hrs EnergyStar Certified
Performance Characteristics			
Memory	8 MB SDRAM, 4 MB Flash	8 MB SDRAM, 4 MB Flash	8 MB SDRAM, 4 MB Flash
Interface	Standard: USB V2.0 FS + Serial Optional: USB V2.0 FS + Serial + Bluetooth / WLAN WLAN: 802.11a/b/g/n (Infrastructure, Ad-hoc, Wi-Fi Direct, SoftAP) - WEP40/104, WPA1/2 (PSK, EAP) Easy Bluetooth Pairing™ via NFC	Standard: USB V2.0 FS + Serial SPP-R310plus: USB V2.0 FS + Serial + Bluetooth / WLAN WLAN: 802.11a/b/g/n (Infrastructure, Ad-hoc, Wi-Fi Direct, SoftAP) - WEP40/104, WPA1/2 (PSK, EAP) Easy Bluetooth Pairing™ via NFC	Standard: USB V2.0 FS + Serial SPP-R200IIIplus: USB V2.0 FS + Serial + Bluetooth / WLAN WLAN: 802.11a/b/g/n (Infrastructure, Ad-hoc, Wi-Fi Direct, SoftAP) - WEP40/104, WPA1/2 (PSK, EAP) Easy Bluetooth Pairing™ via NFC
Environment Characteristics			
Temperature	Operating: -15 ~ 50°C (5 ~ 122°F), Storage: -30 ~ 70°C (-22 ~ 158°F)	Operating: -15 ~ 50°C (5 ~ 122°F), Storage: -30 ~ 70°C (-22 ~ 158°F)	Operating: -15 ~ 50°C (5 ~ 122°F), Storage: -30 ~ 70°C (-22 ~ 158°F)
Humidity	Operating: 10 ~ 80% RH	Operating: 10 ~ 80% RH	Operating: 10 ~ 80% RH
Sealing	IP54	IP54	IP43 (IP54 with protective case)
Drop Rate	1.8 m (6 ft.)	1.8 m (6 ft.)	2.1 m (7 ft.) / 1.5 m (5 ft.) for MSR model
Software			
Emulation	BXL / POS	BXL / POS	BXL / POS
Driver / Utility	Windows Driver, OPOS/JPOS Driver, Linux/Mac CUPS Driver, Utility Program, Network Auto Installer	Windows Driver, OPOS/JPOS Driver, Linux/Mac CUPS Driver, Utility Program, Network Auto Installer	Windows Driver, OPOS/JPOS Driver, Linux/Mac CUPS Driver, Utility Program, Network Auto Installer
SDK / Plugin	Android/iOS/Windows SDK, Linux SDK, Xamarin SDK, Chrome SDK, Web Print SDK, Cordova Plugin	Android/iOS/Windows SDK, Linux SDK, Xamarin SDK, Chrome SDK, Web Print SDK, Cordova Plugin	Android/iOS/Windows SDK, Linux SDK, Xamarin SDK, Chrome SDK, Web Print SDK, Cordova Plugin
Browser / App	mPrint App (Android, iOS)	mPrint App (Android, iOS)	mPrint App (Android, iOS)
Fonts / Graphics / Symbolologies			
Character Size	Font A: 12 x 24, Font B: 9 x 17, Font C: 9 x 24, KOR, CHN, JPN: 24 x 24	Font A: 12 x 24, Font B: 9 x 17, Font C: 9 x 24, KOR, CHN, JPN: 24 x 24	Font A: 12 x 24, Font B: 9 x 17, Font C: 9 x 24, KOR, CHN, JPN: 24 x 24
Characters Per Line	Font A: 69, Font B, C: 92, KOR, CHN, JPN: 34	Font A: 48, Font B, C: 64, KOR, CHN, JPN: 24	Font A: 32, Font B, C: 42, KOR, CHN, JPN: 16
Character Sets	Alphanumeric: 95 Expanded Graphics: 128 x 33 page International: 32 Optional Unicode supported (UTF-8, UTF-16LE, UTF-16BE)	Alphanumeric: 95 Expanded Graphics: 128 x 33 page International: 32 Optional Unicode supported (UTF-8, UTF-16LE, UTF-16BE)	Alphanumeric: 95 Expanded Graphics: 128 x 33 page International: 32 Optional Unicode supported (UTF-8, UTF-16LE, UTF-16BE)
Graphics	Supporting user-defined fonts, graphics, formats, layouts, and logos	Supporting user-defined fonts, graphics, formats, layouts, and logos	Supporting user-defined fonts, graphics, formats, layouts, and logos
Barcode Symbolologies	1D: Codabar, Code 39, Code 93, Code 128, EAN-8, EAN-13, ITF, UPC-A, UPC-E 2D: Aztec, Data Matrix, GS1 Databar, MaxiCode, PDF417, QR code	1D: Codabar, Code 39, Code 93, Code 128, EAN-8, EAN-13, ITF, UPC-A, UPC-E 2D: Aztec, Data Matrix, GS1 Databar, MaxiCode, PDF417, QR code	1D: Codabar, Code 39, Code 93, Code 128, EAN-8, EAN-13, ITF, UPC-A, UPC-E 2D: Aztec, Data Matrix, GS1 Databar, MaxiCode, PDF417, QR code
Accessories / Supplies			
Standard Accessories	Belt Clip, Battery, Battery Charger, Power Cord, Paper	Belt Clip, Battery, Battery Charger, Power Cord, Paper	Belt Clip, Battery, Battery Charger, Power Cord
Optional Accessories	Belt Strap, Shoulder Strap, Single Battery Cradle, Quad Battery Charger, Vehicle Charger, Serial/USB Cable, RAM Mount Vehicle Holder, Case	Belt Strap, Case, Protective Case, Shoulder Strap, Single Battery Cradle, Quad Battery Charger, Vehicle Charger, Vehicle Holder, RAM Mount Vehicle Holder, Serial/USB Cable	Belt Strap, Case, Protective Case, Shoulder Strap, Battery Pack_V2 (with outer contacts), Single Battery Cradle, Single Docking Cradle, Quad Battery Charger, Quad Docking Cradle, Vehicle Charger, Vehicle Holder, Serial/USB Cable
Supplies	Compatible with B-linerless™ BIXOLON's flexible and ecological linerless label consumables	Compatible with B-linerless™ BIXOLON's flexible and ecological linerless label consumables	Compatible with B-linerless™ BIXOLON's flexible and ecological linerless label consumables
Integrated Card Reader (Optional)			
MSR	-	3 Track (T-DES/DUKPT (Optional))	3 Track (T-DES/DUKPT (Optional))



SPP-R210

SPP-C300

SPP-C200

SPP-A200

Print Characteristics

Print Method	Direct Thermal	Direct Thermal	Direct Thermal	Direct Thermal
Print Speed	Up to 90 mm/sec (Receipt) Up to 60 mm/sec (Linerless)	Up to 50 mm/sec	Up to 80 mm/sec	Up to 80 mm/sec
Print Resolution	203 dpi	203 dpi	203 dpi	203 dpi
Print Width	Up to 48 mm	Up to 72 mm	Up to 48 mm	Up to 48 mm
Sensing	Paper End, Paper Cover Open	Paper End	Paper End	Paper End

Media Characteristics

Media Type	Receipt, Linerless (Optional)	Receipt	Receipt	Receipt
Media Width	58 mm	80 mm	58 mm	58 mm
Media Roll Diameter	Up to 30 mm	Up to 50 mm	Up to 40 mm	Up to 30 mm
Media Thickness	0.07 ± 0.005 mm	0.07 ± 0.005 mm	0.07 ± 0.005 mm	0.07 ± 0.005 mm
Supply Method	Easy Paper Loading	Easy Paper Loading	Easy Paper Loading	Easy Paper Loading

Physical Characteristics

Dimensions (W x L x H)	79 x 116 x 36.5 mm (3.11 x 4.57 x 1.44 inch)	104.4 x 126 x 55.5 mm (4.11 x 4.96 x 2.19 inch)	79.5 x 115.5 x 45 mm (3.13 x 4.55 x 1.77 inch)	82.8 x 149 x 41 mm (3.26 x 5.87 x 1.61 inch)
Weight	Including MSR + battery: 232 g (0.51 lbs.)	Including battery: 290.5 g (0.64 lbs.) Paper: 133 g (0.29 lbs.)	Including battery: 224 g (0.49 lbs.) Paper: 57 g (0.13 lbs.)	Including battery: 240 g (0.53 lbs.)
Electrical	7.4 V Li-ion, 1200 mAh, Rechargeable Charging time: Up to 2.5 hrs	3.6 V Li-ion, 3000 mAh, Rechargeable Charging time: Up to 3.5 hrs, EnergyStar Certified, USB Type-C charging support	3.6 V Li-ion, 3000 mAh, Rechargeable Charging time: Up to 3.5 hrs, EnergyStar Certified, USB Type-C charging support	7.4 V Li-ion, 1200 mAh, Rechargeable Charging time: Up to 2.5 hrs

Performance Characteristics

Memory	8 MB SDRAM, 4 MB Flash	8 MB SDRAM, 4 MB Flash	8 MB SDRAM, 4 MB Flash	8 MB SDRAM, 4 MB Flash
Interface	Standard: USB V2.0 FS Optional: USB V2.0 FS + Bluetooth	USB + Bluetooth (Classic + LE)	USB + Bluetooth	Standard: USB V2.0 FS

Environment Characteristics

Temperature	Operating: -15 ~ 50°C (5 ~ 122°F) Storage: -30 ~ 70°C (-22 ~ 158°F)	Operating: -15 ~ 50°C (5 ~ 122°F) Storage: -30 ~ 70°C (-22 ~ 158°F)	Operating: -15 ~ 50°C (5 ~ 122°F) Storage: -30 ~ 70°C (-22 ~ 158°F)	Operating: -15 ~ 50°C (5 ~ 122°F) Storage: -30 ~ 70°C (-22 ~ 158°F)
Humidity	Operating: 10 ~ 80% RH	Operating: 10 ~ 80% RH	Operating: 10 ~ 80% RH	Operating: 10 ~ 80% RH
Sealing	IP54 (with protective case)	IP42	IP42	-
Drop Rate	1.2 m (4 ft.)	1.2 m (4 ft.)	1.5 m (5 ft.)	1 m (3.3 ft.)

Software

Emulation	BXL / POS	BXL / POS	BXL / POS	BXL / POS
Driver / Utility	Windows Driver, OPOS/JPOS Driver, Linux/Mac CUPS Driver, Utility Program, Network Auto Installer	Windows Driver, OPOS/JPOS Driver, Linux/Mac CUPS Driver, Utility Program	Windows Driver, OPOS/JPOS Driver, Linux/Mac CUPS Driver, Utility Program	-
SDK / Plugin	Android/iOS/Windows SDK, Linux SDK, Xamarin SDK, Chrome SDK, Cordova Plugin	Android/iOS/Windows SDK, Linux SDK, Xamarin SDK, Cordova Plugin, Web Print SDK	Android/iOS/Windows SDK, Linux SDK, Xamarin SDK, Cordova Plugin, Web Print SDK	-
Application	mPrint App (Android, iOS)	mPrint App (Android, iOS)	mPrint App (Android, iOS)	-

Fonts / Graphics / Symbologies

Character Size	Font A: 12 x 24, Font B: 9 x 17, Font C: 9 x 24, KOR, CHN, JPN: 24 x 24	Font A: 12 x 24, Font B: 9 x 17, Font C: 9 x 24, KOR, CHN, JPN: 24 x 24	Font A: 12 x 24, Font B: 9 x 17, Font C: 9 x 24, KOR, CHN, JPN: 24 x 24	Font A: 12 x 24, Font B: 9 x 17, Font C: 9 x 24, KOR, CHN, JPN: 24 x 24
Characters Per Line	Font A: 32, Font B, C: 42, KOR, CHN, JPN: 16	Font A: 48, Font B, C: 64, KOR, CHN, JPN: 24	Font A: 32, Font B, C: 42, KOR, CHN, JPN: 16	Font A: 32, Font B, C: 42, KOR, CHN, JPN: 16
Character Sets	Alphanumeric: 95 Expanded Graphics: 128 x 33 page International: 32 Optional Unicode supported (UTF-8, UTF-16LE, UTF-16BE)	Alphanumeric: 95 Expanded Graphics: 128 x 33 page International: 32	Alphanumeric: 95 Expanded Graphics: 128 x 33 page International: 32	Alphanumeric: 95 Expanded Graphics: 128 x 33 page International: 32
Graphics	Supporting user-defined fonts, graphics, formats, layouts, and logos	Supporting user-defined fonts, graphics, formats, layouts, and logos	Supporting user-defined fonts, graphics, formats, layouts, and logos	Supporting user-defined fonts, graphics, formats, layouts, and logos
Barcode Symbologies	1D: Codabar, Code 39, Code 93, Code 128, EAN-8, EAN-13, ITF, UPC-A, UPC-E 2D: Aztec, Data Matrix, MaxiCode, PDF417, QR code	1D: Codabar, Code 39, Code 93, Code 128, EAN-8, EAN-13, ITF, UPC-A, UPC-E 2D: Aztec, Data Matrix, GS1 Databar, MaxiCode, PDF417, QR code	1D: Codabar, Code 39, Code 93, Code 128, EAN-8, EAN-13, ITF, UPC-A, UPC-E 2D: Aztec, Data Matrix, GS1 Databar, MaxiCode, PDF417, QR code	1D: Codabar, Code 39, Code 93, Code 128, EAN-8, EAN-13, ITF, UPC-A, UPC-E 2D: Aztec, Data Matrix, MaxiCode, PDF417, QR code

Accessories / Supplies

Standard Accessories	Belt Clip, Battery, Battery Charger, Power Cord	Belt Clip, USB Type-C Cable, Battery	Belt Clip, USB Type-C Cable, Battery	Belt Clip, Battery, Battery Charger, Power Cord, Paper
Optional Accessories	Belt Strap, Case, Protective Case, Battery Pack_V2 (with outer contacts), Single Battery Cradle, Single Docking Cradle, Quad Battery Charger, Quad Docking Cradle, Wall Mount (for Quad Battery Charger), Vehicle Charger, Vehicle Holder, USB Cable	-	-	Single Battery Cradle, Quad Battery Charger, Wall Mount (for Quad Battery Charger), Belt Clip
Supplies	-	-	-	-

Integrated Card Reader (Optional)

MSR	3 Track (T-DES/DUKPT (Optional))	-	-	-
-----	----------------------------------	---	---	---

LABEL PRINTERS



XT5-40



XT5-40NR



XT3-40

XT5-40 Series

Print Characteristics		XT3-40	
Print Method	Thermal Transfer, Direct Thermal	Thermal Transfer, Direct Thermal	
Print Speed	XT5-40: Up to 14 ips (356 mm/sec), XT5-43: Up to 10 ips (254 mm/sec)	XT3-40: Up to 8 ips (203 mm/sec), XT3-43: Up to 6 ips (152 mm/sec)	
Print Resolution	XT5-40: 203 dpi, XT5-43: 300 dpi	XT3-40: 203 dpi, XT3-43: 300 dpi	
Print Width	XT5-40: 104 mm, XT5-43: 105.7 mm	XT3-40 : 108 mm, XT3-43 : 105.7 mm	
Print Length	XT5-40: Up to 4,000 mm, XT5-43: Up to 2,500 mm	XT3-40: Up to 4,000 mm, XT3-43: Up to 2,000 mm	
Sensor	Transmissive (Adjustable), Reflective (Adjustable), Ribbon-End, Head Open	Transmissive (Adjustable), Reflective (Adjustable), Ribbon-End, Head Open	
Media Characteristics			
Media Type	Gap, Black Mark, Notch, Continuous, Fan-Fold	Gap, Black Mark, Notch, Continuous, Fan-Fold	
Media Width	25 ~ 114 mm	20 ~ 114 mm	
Media Roll Diameter	Up to 203 mm	Up to 203 mm	
Media Thickness	0.06 ~ 0.30 mm	0.06 ~ 0.25 mm	
Supply Method	Easy Paper Loading	Easy Paper Loading	
Inner Core	38.1 ~ 76.2 mm, 25.4 mm (Optional)	25.4 ~ 76.2 mm	
Ribbon Characteristics			
Ribbon Type	Wax, Wax/Resin, Resin, Outside, Inside	Wax, Wax/Resin, Resin, Outside, Inside	
Ribbon Width	50 ~ 110 mm	40 ~ 110 mm	
Ribbon Length	Up to 450 m	Up to 450 m	
Core Inner Diameter	25.4 mm	25.4 mm	
Physical Characteristics			
Dimensions (W x L x H)	STD: 269 x 490 x 324 mm (10.59 x 19.29 x 12.76 inch) Rewinder: 269 x 490 x 407 mm (10.59 x 19.29 x 16.02 inch)	STD: 240 x 430.5 x 276.7 mm (9.44 x 16.94 x 10.89 inch) Rewinder: 240 x 430.5 x 326.7 mm (9.44 x 16.94 x 12.86 inch)	
Weight	STD: 13.98 kg (30.82 lbs.), Rewinder: 17.98 kg (39.64 lbs.)	STD: 9.3 kg (20.5 lbs.), Rewinder: 11.88 kg (26.19 lbs.)	
Electrical	Internal Power Adaptor 100-120 V/200-240V AC, 50/60 Hz	EnergyStar Certified, Internal Power Adaptor 100-240 V AC, 50-60 Hz	
Display	XT5-40: 3.5-inch HVGA (262K Colors) TFT LCD XT5-40NR: 4.3-inch CTP TFT LCD	2.4-inch Color TFT LCD	
Performance Characteristics			
Memory	512 MB SDRAM, 512 MB Flash	128 MB SDRAM, 128 MB Flash	
Interface	① USB + Serial + Ethernet + 2 USB Host ports ② USB + Serial + Parallel or GPIO + Ethernet + 2 USB Host ports ③ USB + WLAN + Ethernet + 2 USB Host ports ④ USB + WLAN + Parallel or GPIO + Ethernet + 2 USB Host ports ⑤ USB + Bluetooth + Ethernet + 2 USB Host ports ⑥ USB + Bluetooth + Parallel or GPIO + Ethernet + 2 USB Host ports Ethernet: 10/100/1000 Mbps (1 Gbps) WLAN: 802.11a/b/g/n (Infrastructure, Ad-hoc, Wi-Fi Direct, SoftAP) - WEP40/104, WPA1/2 (PSK, EAP) GPIO: DB15 (Female), 5/24 V, 4 GPI, 8 GPO	Standard: USB + USB Host + Serial + Ethernet Optional: ① USB + USB Host + Serial+Ethernet + Parallel ② USB + USB Host + Serial+Ethernet + Parallel + Bluetooth ③ USB + USB Host + Serial+Ethernet + Parallel + WLAN ④ USB + USB Host + Serial+Ethernet + Bluetooth ⑤ USB + USB Host + Serial+Ethernet + WLAN Ethernet: 10/100 Mbps WLAN: 802.11a/b/g/n (Infrastructure, Ad-hoc, Wi-Fi Direct, SoftAP) - WEP40/104, WPA1/2 (PSK, EAP) * WLAN & Bluetooth: Dongle type not supported	
Real Time Clock	Supported	Supported	
Environment Characteristics			
Temperature	Operating: 5 ~ 40°C (41 ~ 104°F), Storage: -20 ~ 60°C (-4 ~ 140°F)	Operating: 5 ~ 40°C (41 ~ 104°F), Storage: -20 ~ 60°C (-4 ~ 140°F)	
Humidity	Operating: 10 ~ 80% RH, Storage: 10 ~ 90% RH	Operating: 10 ~ 80% RH, Storage: 10 ~ 90% RH	
Software			
Emulation	SLCS™, BPL-Z™, BPL-E™, BPL-D™	SLCS™, BPL-Z™, BPL-E™	
Driver / Utility	Windows Driver (Europlus/Seagull), Linux/Mac CUPS Driver, Virtual COM USB/Ethernet Driver, Utility Program, OPOS/JPOS Driver, Bartender Ultralite for BIXOLON, Label Artist-II™, SAP® Device Driver, Network Auto Installer	Windows Driver (Europlus/Seagull), Linux/Mac CUPS Driver, Virtual COM USB/Ethernet Driver, Utility Program, OPOS/JPOS Driver, Bartender Ultralite for BIXOLON, Label Artist-II™, Network Auto Installer, SAP® Device Driver	
SDK / Plugin	Android/iOS/Windows SDK, Linux SDK, Chrome SDK, Xamarin SDK, Web Print SDK	Android/iOS/Windows SDK, Linux SDK, Xamarin SDK, Web Print SDK	
Application	Label Artist™ Mobile (Android, iOS), mPrint App (Android, iOS)	Label Artist™ Mobile (Android, iOS), mPrint App (Android, iOS)	
MDM (Optional)	BIXOLON Profile Manager - XPM™, XCM™ (Windows, Android), SOTI Connect supported	BIXOLON Profile Manager - XPM™, XCM™ (Windows, Android)	
XI (Optional)	Supported	Supported	
Fonts / Graphics / Symbolologies			
Fonts	Bitmap Fonts (10 SLCS™, 16 BPL-Z™, 5 BPL-E™, 9 BPL-D™), Scalable Fonts (1 SLCS™, 1 BPL-Z™, 1 BPL-E™), 23 Code page, Unicode supported (UTF-8, UTF-16LE, UTF-16BE)	Bitmap Fonts (10 SLCS™, 16 BPL-Z™, 5 BPL-E™), Scalable Fonts (1 SLCS™, 1 BPL-Z™), 23 Code page, Unicode supported (UTF-8, UTF-16LE, UTF-16BE)	
Graphics	Supporting user-defined fonts, graphics, formats and logos	Supporting user-defined fonts, graphics, formats and logos	
Barcode Symbolologies	1D: Codabar, Code 11, Code 39, Code 93, Code 128, EAN-13, EAN-8, Industrial 2-of-5, Interleaved 2-of-5, Logmars, MSI, Plessey, Postnet, GS1 DataBar (RSS-14), Standard 2-of-5, UPC/EAN extensions, UPC-A, UPC-E, IMB 2D: Aztec, Codablock, Code 49, Data Matrix, MaxiCode, MicroPDF417, PDF417, QR code, TLC 39	1D: Codabar, Code 11, Code 39, Code 93, Code 128, EAN-13, EAN-8, Industrial 2-of-5, Interleaved 2-of-5, Logmars, MSI, Plessey, Postnet, GS1 DataBar (RSS-14), Standard 2-of-5, UPC/EAN extensions, UPC-A, UPC-E, IMB 2D: Aztec, Codablock, Code 49, Data Matrix, MaxiCode, MicroPDF417, PDF417, QR code, TLC 39	
Accessories / Supplies			
Standard Accessories	-	USB cable	
Optional Accessories	Peeler, Auto Cutter, Rewinder, 1" I.D. Core media supply hanger, Serial cable, Parallel cable, USB cable	Peeler, Auto Cutter, Rewind (Liner Take-up only, Internal, Max.OD 130 mm), Serial cable, Parallel cable	
Supplies	Compatible with B-ribbon™	Compatible with B-ribbon™	
RFID			
Frequency	UHF, 865 ~ 868 MHz (EU), 902 ~ 928 MHz (KR, USA)	-	
Transmit Power	1W	-	
Modulation	ASK	-	
Protocol	ISO 18000-6C (EPC Class1 Gen2)	-	
Auto Cutter	Optional	-	
Tag Pitch	Min 16 mm	-	



XQ-840



XL5-40

Print Characteristics		
Print Method	Direct Thermal	Direct Thermal
Print Speed	XQ-840: Up to 6 ips (152 mm/sec), XQ-843: Up to 4 ips (100 mm/sec)	XL5-40: Up to 6 ips (152 mm/sec), XL5-43: Up to 5 ips (127 mm/sec)
Print Resolution	XQ-840: 203 dpi, XQ-843: 300 dpi	XL5-40: 203 dpi, XL5-43: 300 dpi
Print Width	XQ-840: Up to 108 mm, XQ-843: Up to 105.7 mm	XL5-40: Up to 108 mm, XL5-43: Up to 105.7 mm
Print Length	Up to 1,000 mm	30 ~ 1,000 mm
Sensor	Transmissive, Reflective (Adjustable), Head Open	Gap (Fixed) / Black mark (Adjustable), Head Open, Paper Taken Sensor
Media Characteristics		
Media Type	Gap, Black Mark, Notch, Continuous, Fan-Fold	Linerless : Continuous, Black Mark Liner: Gap, Black Mark, Fan-Fold
Media Width	15 ~ 118 mm	20 ~ 114 mm
Media Roll Diameter	Up to 130 mm	Up to 127 mm
Media Thickness	0.06 ~ 0.20 mm	0.09 ~ 0.20 mm
Supply Method	Easy Paper Loading	-
Inner Core	25.4 ~ 38.1 mm	38.1 mm (1.5 inch) - Recommended, 25.4 mm (1 inch)
Ribbon Characteristics		
Ribbon Type	-	-
Ribbon Width	-	-
Ribbon Length	-	-
Core Inner Diameter	-	-
Physical Characteristics		
Dimensions (W x L x H)	194 x 273 x 212 mm (7.63 x 10.74 x 8.34 inch)	186 x 287.7 x 173 mm (7.32 x 11.33 x 6.81)
Weight	2.2 kg (4.85 lbs.)	2.8 kg (6.17 lbs.)
Electrical	EnergyStar Certified, External Power Adaptor 100-24 0V AC, 50/60 Hz	EnergyStar Certified, External Power Adaptor 100-24 0V AC, 50/60 Hz
Display	8-inch IPS TFT LCD (800 x 1280 pixels) Android 7.0	Standard: None Optional: FSTN LCD (200 x 100 pixels)
Camera	5MP Auto focus	-
Performance Characteristics		
Memory	Printer: 64 MB SDRAM, 128 MB Flash Tablet: 1 GB RAM, 8GB Flash	Standard: 64 MB SDRAM, 128 MB Flash Optional: ① 64 MB SDRAM, 128 MB Flash ② 256 MB SDRAM, 256 MB Flash
Interface	Tablet: 2 USB Host ports + Ethernet + WLAN + Bluetooth 2 USB Host ports: For scanner or keyboard or mouse WLAN: 802.11a/b/g/n (Infrastructure, Ad-hoc, Wi-Fi Direct, SoftAP) - WEP40/104, WPA1/2 (PSK, EAP)	Standard: USB + USB Host Optional: ① USB + USB Host + WLAN ② USB + USB Host + Bluetooth ③ USB + USB Host + Serial + Ethernet ④ USB + USB Host + Serial + Ethernet + WLAN ⑤ USB + USB Host + Serial + Ethernet + Bluetooth WLAN: 802.11a/b/g/n (Infrastructure, Ad-hoc, Wi-Fi Direct, SoftAP) - WEP40/104, WPA1/2 (PSK, EAP) Ethernet: 10/100Mbps
Real Time Clock	Supported (Optional)	Supported (Optional)
Environment Characteristics		
Temperature	Operating: 0 ~ 40°C (32 ~ 104°F), Storage: -20 ~ 60°C (-4 ~ 140°F)	Operating: 0 ~ 40°C (32 ~ 104°F), Storage: -20 ~ 60°C (-4 ~ 140°F)
Humidity	Operating: 10 ~ 80% RH, Storage: 10 ~ 90% RH	Operating: 10 ~ 80% RH, Storage: 10 ~ 90% RH
Software		
Emulation	SLCS™, BPL-Z™, BPL-E™, BXL/POS	SLCS™, BPL-Z™, BPL-E™
Driver / Utility	-	Windows Driver (Europlus/Seagull), Linux/Mac CUPS Driver, Virtual COM USB/Ethernet Driver, Utility Program, OPOS/JPOS Driver, Bartender Ultralite for BIXOLON, Label Artist-II™, SAP® Device Driver, Network Auto Installer
SDK / Plugin	Android SDK, Xamarin SDK (Android), Web Print SDK (Android)	Android/iOS/Windows SDK, Linux SDK, Chrome SDK, Xamarin SDK, Web Print SDK
Application	Label Artist™ Mobile, Food Safety Label App, BIXOLON Utility, BIXOLON Pass Through, mPrint App, BIXOLON Downloader, Amazon Appstore	Label Artist™ Mobile (Android, iOS), mPrint App (Android, iOS)
MDM (Optional)	BIXOLON Profile Manager - XCM™ (Android)	BIXOLON Profile Manager - XPM™, XCM™ (Windows, Android), SOTI Connect supported
XI (Optional)	-	-
Fonts / Graphics / Symbologies		
Fonts	Bitmap Fonts (10 SLCS™, 16 BPL-Z™, 5 BPL-E™), Scalable Fonts (1 SLCS™, 1 BPL-Z™), 23 Code page, Unicode supported (UTF-8, UTF-16LE, UTF-16BE)	Bitmap Fonts (10 SLCS™, 16 BPL-Z™, 5 BPL-E™), Scalable Fonts (1 SLCS™, 1 BPL-Z™), 23 Code page, Unicode supported (UTF-8, UTF-16LE, UTF-16BE)
Graphics	Supporting user-defined fonts, graphics, formats and logos	Supporting user-defined fonts, graphics, formats and logos
Barcode Symbologies	1D: Codabar, Code 11, Code 39, Code 93, Code 128, EAN-13, EAN-8, Industrial 2-of-5, Interleaved 2-of-5, Logmars, MSI, Plessey, Postnet, GS1 DataBar (RSS-14), Standard 2-of-5, UPC/EAN extensions, UPC-A, UPC-E, IMB 2D: Aztec, Codablock, Code 49, Data Matrix, MaxiCode, MicroPDF417, PDF417, QR code, TLC 39	1D: Codabar, Code 11, Code 39, Code 93, Code 128, EAN-13, EAN-8, Industrial 2-of-5, Interleaved 2-of-5, Logmars, MSI, Plessey, Postnet, GS1 DataBar (RSS-14), Standard 2-of-5, UPC/EAN extensions, UPC-A, UPC-E, IMB 2D: Aztec, Codablock, Code 49, Data Matrix, MaxiCode, MicroPDF417, PDF417, QR code, TLC 39
Accessories / Supplies		
Standard Accessories	-	USB cable
Optional Accessories	Peeler, Auto Cutter	Serial cable
Supplies	-	Compatible with B-linerless™ BIXOLON's flexible and ecological linerless label consumables

LABEL PRINTERS



XD5-40d



XD5-40t



XD5-40tR



XD3-40d



XD3-40t

XD5-40 Series

XD3-40 Series

Print Characteristics	
Print Method	XD5-40d: Direct Thermal, XD5-40t: Thermal Transfer or Direct Thermal
Print Speed	XD5-40d: Up to 7 ips (178 mm/sec), XD5-43d: Up to 5 ips (127 mm/sec) XD5-40t: Up to 6 ips (152 mm/sec), XD5-43t: Up to 4 ips (102 mm/sec)
Print Resolution	XD5-40d, 40t: 203 dpi, XD5-43d, 43t: 300 dpi
Print Width	XD5-40t: Up to 108 mm, XD5-43t: Up to 105.7 mm
Print Length	Up to 1,000 mm
Sensor	Transmissive (Fixed), Reflective (Adjustable), Head Open
Media Characteristics	
Media Type	Gap, Black Mark, Notch, Continuous, Fan-Fold
Media Width	15 ~ 118 mm
Media Roll Diameter	Up to 127 mm
Media Thickness	0.06 ~ 0.20 mm
Supply Method	Easy Paper Loading
Inner Core	25.4 ~ 38.1 mm
Ribbon Characteristics	
Ribbon Type	Wax, Wax/Resin, Resin, Outside
Ribbon Width	33 ~ 110 mm
Ribbon Length	Up to 300 m
Core Inner Diameter	25.4 mm, 12.7 mm
Physical Characteristics	
Dimensions (W x L x H)	XD5-40d: 194 x 248 x 169 mm (7.64 x 9.76 x 6.65 inch) XD5-40t: 210 x 284 x 188 mm (8.3 x 11.2 x 7.4 inch)
Weight	XD5-40d: 1.89 kg (4.17 lbs.), XD5-40t: 2.48 kg (5.46 lbs.)
Electrical	EnergyStar Certified, External Power Adaptor 100-240 V AC, 50/60 Hz
Display	XD5-40d & XD5-40t: Standard: None Optional: FSTN LCD (200 x 100 pixels) XD5-40tR: Standard: FSTN LCD (200 x 100 pixels)
Performance Characteristics	
Memory	STD: 64 MB SDRAM, 128 MB Flash Optional: ① 64 MB SDRAM, 128 MB Flash ② 256 MB SDRAM, 256 MB Flash
Interface	XD5-40tR (RFID): STD: 256 MB SDRAM, 256 MB Flash Standard: USB + USB Host Optional: ① USB + USB Host + Serial+Ethernet ② USB + USB Host + Serial + Ethernet + WLAN ③ USB + USB Host + Serial + Ethernet + Bluetooth XD5-40tR (RFID) Standard: USB + USB Host + Serial + Ethernet Optional: ① USB + USB Host + Serial + Ethernet + WLAN ② USB + USB Host + Serial + Ethernet + Bluetooth WLAN: 802.11a/b/g/n (Infrastructure, Ad-hoc, Wi-Fi Direct, SoftAP) - WEP40/104, WPA1/2 (PSK, EAP) Ethernet: 10/100Mbps
Real Time Clock	Supported (Optional)
Environment Characteristics	
Temperature	Operating: XD5-40d: 0 ~ 40°C (32 ~ 104°F), XD5-40t: 5 ~ 40°C (41 ~ 104°F) Storage: -20 ~ 60°C (-4 ~ 140°F)
Humidity	Operating: 10 ~ 80% RH, Storage: 10 ~ 90% RH
Software	
Emulation	SLCS™, BPL-Z™, BPL-E™, BPL-D™ (Optional)
Driver / Utility	Windows Driver (Europlus/Seagull), Linux/Mac CUPS Driver, Virtual COM USB/Ethernet Driver, Utility Program, OPOS/JPOS Driver, Bartender Ultralite for BIXOLON, Label Artist™-II, SAP® Device Driver, Network Auto Installer
SDK / Plugin	Android/iOS/Windows SDK, Linux SDK, Chrome SDK, Xamarin SDK, Web Print SDK
Application	Label Artist™ Mobile (Android, iOS), mPrint App (Android, iOS)
MDM (Optional)	BIXOLON Profile Manager - XPM™, XCM™ (Windows, Android), SOTI Connect supported
Xi (Optional)	Supported
Fonts / Graphics / Symbolologies	
Fonts	Bitmap Fonts (10 SLCS™, 16 BPL-Z™, 5 BPL-E™, 9 BPL-D™), Scalable Fonts (1 SLCS™, 1 BPL-Z™, 1 BPL-D™), 23 Code page, Unicode supported (UTF-8, UTF-16LE, UTF-16BE)
Graphics	Supporting user-defined fonts, graphics, formats and logos
Barcode Symbolologies	1D: Codabar, Code 11, Code 39, Code 93, Code 128, EAN-13, EAN-8, Industrial 2-of-5, Interleaved 2-of-5, Logmars, MSI, Plessey, Postnet, GS1 DataBar (RSS-14), Standard 2-of-5, UPC/EAN extensions, UPC-A, UPC-E, IMB 2D: Aztec, Codablock, Code 49, Data Matrix, MaxiCode, MicroPDF417, PDF417, QR code, TLC 39
Accessories / Supplies	
Standard Accessories	USB cable
Optional Accessories	Peeler, Auto Cutter, External Paper Supply, Serial cable
Supplies	B-ribbon™, B-band™
RFID	
Frequency	UHF, 865 ~ 868 MHz (EU), 902 ~ 928 MHz (KR, USA)
Transmit Power	1W
Modulation	ASK
Protocol	ISO 18000-6C (EPC Class1 Gen2)
Auto Cutter	Optional
Tag Pitch	Min 16 mm



SLP-TX400



SLP-TX400R



SLP-TX420

SLP-TX400 Series

Print Characteristics		SLP-TX420	
Print Method	Thermal Transfer, Direct Thermal	Thermal Transfer, Direct Thermal	
Print Speed	SLP-TX400: Up to 7 ips (178 mm/sec), SLP-TX403: Up to 5 ips (127 mm/sec)	SLP-TX420: Up to 7 ips (178 mm/sec), SLP-TX423: Up to 5 ips (127 mm/sec)	
Print Resolution	SLP-TX400: 203 dpi, SLP-TX403: 300 dpi	SLP-TX420: 203 dpi, SLP-TX423: 300 dpi	
Print Width	SLP-TX400: Up to 108 mm, SLP-TX403: Up to 105.7 mm	SLP-TX420: Up to 108 mm, SLP-TX423: Up to 105.7 mm	
Print Length	Up to 1,000 mm	Up to 2,000 mm	
Sensor	Transmissive, Reflective (Adjustable), Ribbon-End, Head Open	Transmissive, Reflective (Adjustable), Ribbon-End, Head Open	
Media Characteristics			
Media Type	Gap, Black Mark, Notch, Continuous, Fan-Fold	Gap, Black Mark, Notch, Continuous, Fan-Fold	
Media Width	25 ~ 112 mm	20 ~ 110 mm	
Media Roll Diameter	Up to 130 mm	Up to 130 mm	
Media Thickness	0.06 ~ 0.20 mm	0.06 ~ 0.20 mm	
Supply Method	Easy Paper Loading	Easy Paper Loading	
Inner Core	25.4 ~ 38.1 mm	25.4 ~ 38.1 mm	
Ribbon Characteristics			
Ribbon Type	Wax, Wax/Resin, Resin, Outside	Wax, Wax/Resin, Resin, Outside	
Ribbon Width	33 ~ 110 mm	110 mm	
Ribbon Length	Up to 300 m	Up to 74 m	
Core Inner Diameter	25.4 mm, 12.7 mm	12.7 mm	
Physical Characteristics			
Dimensions (W x L x H)	214 x 310 x 195 mm (8.42 x 12.20 x 7.67 inch)	200 x 252 x 173 mm (7.87 x 9.92 x 6.81 inch)	
Weight	2.85 kg (6.28 lbs.)	2.35 kg (5.18 lbs.)	
Electrical	EnergyStar Certified, External Power Adaptor 100-240 V AC, 50/60 Hz	EnergyStar Certified, External Power Adaptor 100-240 V AC, 50/60 Hz	
Display	-	-	
Performance Characteristics			
Memory	64 MB SDRAM, 128 MB Flash	64 MB SDRAM, 128 MB Flash	
Interface	Standard: USB + Serial + Parallel Optional: ① USB + Serial + Ethernet + WLAN ② USB + Serial + Ethernet + Bluetooth SLP-TX400R (RFID): USB + Serial + Ethernet + Bluetooth / WLAN + RFID WLAN: 802.11a/b/g/n/ac Dongle type - requires a USB Host port (Optional) Bluetooth: USB dongle type (Optional)	Standard: USB + Serial + Parallel Optional: ① USB + Serial + Ethernet + WLAN ② USB + WLAN + Bluetooth WLAN: 802.11a/b/g/n/ac Dongle type - requires a USB Host port (Optional)	
Real Time Clock	Supported (Optional)	Supported (Optional)	
Environment Characteristics			
Temperature	Operating: 5 ~ 40°C (41 ~ 104°F), Storage: -20 ~ 60°C (-4 ~ 140°F)	Operating: 5 ~ 40°C (41 ~ 104°F), Storage: -20 ~ 60°C (-4 ~ 140°F)	
Humidity	Operating: 10 ~ 80% RH, Storage: 10 ~ 90% RH	Operating: 10 ~ 80% RH, Storage: 10 ~ 90% RH	
Software			
Emulation	SLCS™, BPL-Z™, BPL-E™	SLCS™, BPL-Z™, BPL-E™	
Driver / Utility	Windows Driver (Europlus/Seagull), Linux/Mac CUPS Driver, Virtual COM USB/Ethernet Driver, Utility Program, OPOS/JPOS Driver, Bartender Ultralite for BIXOLON, Label Artist-II™, SAP® Device Driver, Network Auto Installer	Windows Driver (Europlus/Seagull), Linux/Mac CUPS Driver, Virtual COM USB/Ethernet Driver, Utility Program, OPOS/JPOS Driver, Bartender Ultralite for BIXOLON, Label Artist-II™, SAP® Device Driver, Network Auto Installer	
SDK / Plugin	Android/iOS/Windows SDK, Linux SDK, Chrome SDK, Xamarin SDK, Web Print SDK	Android/iOS/Windows SDK, Linux SDK, Chrome SDK, Xamarin SDK, Web Print SDK	
Application	Label Artist™ Mobile (Android, iOS), mPrint App (Android, iOS)	Label Artist™ Mobile (Android, iOS), mPrint App (Android, iOS)	
MDM (Optional)	SOTI Connect supported	SOTI Connect supported	
XI (Optional)	-	-	
Fonts / Graphics / Symbologies			
Fonts	Bitmap Fonts (10 SLCS™, 16 BPL-Z™, 5 BPL-E™), Scalable Fonts (1 SLCS™, 1 BPL-Z™), 23 Code page, Unicode supported (UTF-8, UTF-16LE, UTF-16BE)	Bitmap Fonts (10 SLCS™, 16 BPL-Z™, 5 BPL-E™), Scalable Fonts (1 SLCS™, 1 BPL-Z™), 23 Code page, Unicode supported (UTF-8, UTF-16LE, UTF-16BE)	
Graphics	Supporting user-defined fonts, graphics, formats and logos	Supporting user-defined fonts, graphics, formats and logos	
Barcode Symbologies	1D: Codabar, Code 11, Code 39, Code 93, Code 128, EAN-13, EAN-8, Industrial 2-of-5, Interleaved 2-of-5, Logmars, MSI, Plessey, Postnet, GS1 DataBar (RSS-14), Standard 2-of-5, UPC/EAN extensions, UPC-A, UPC-E, IMB 2D: Aztec, Codablock, Code 49, Data Matrix, MaxiCode, MicroPDF417, PDF417, QR code, TLC 39	1D: Codabar, Code 11, Code 39, Code 93, Code 128, EAN-13, EAN-8, Industrial 2-of-5, Interleaved 2-of-5, Logmars, MSI, Plessey, Postnet, GS1 DataBar (RSS-14), Standard 2-of-5, UPC/EAN extensions, UPC-A, UPC-E, IMB 2D: Aztec, Codablock, Code 49, Data Matrix, MaxiCode, MicroPDF417, PDF417, QR code, TLC 39	
Accessories / Supplies			
Optional Accessories	RFID, Peeler, Auto Cutter, External Paper Supply, WLAN Dongle (Consensus required), Serial cable, Parallel cable, USB cable	Peeler, Auto Cutter, External Paper Supply, WLAN Dongle (Consensus required), Serial cable, Parallel cable, USB cable	
Supplies	B-ribbon™, B-band™	B-ribbon™, B-band™	
RFID			
Frequency	UHF, 865 ~ 868 MHz (EU), 902 ~ 928 MHz (KR, USA, CHN)	-	
Transmit Power	1W	-	
Modulation	ASK	-	
Protocol	ISO 18000-6C (EPC Class1 Gen2)	-	
Auto Cutter	Optional	-	
Tag Pitch	Min 25 mm	-	

LABEL PRINTERS



SRP-E770III



SLP-DL410



SLP-DL410KV

Print Characteristics		SLP-DL410 Series	
Print Method	Direct Thermal	Direct Thermal	
Print Speed	Up to 5 ips (127 mm/sec)	SLP-DL410: Up to 5 ips (127 mm/sec) SLP-DL413: Up to 5 ips (127 mm/sec)	
Print Resolution	203 dpi	SLP-DL410: 203 dpi SLP-DL413: 300 dpi	
Print Width	Up to 104 mm	SLP-DL410: Up to 108 mm SLP-DL413: Up to 105.7 mm	
Print Length	Up to 1,000 mm	Up to 2,000 mm	
Sensor	Transmissive, Reflective, Head Open	Transmissive, Reflective (Adjustable), Head Open	
Media Characteristics			
Media Type	Gap, Black Mark, Notch, Continuous, Fan-Fold	Gap, Black Mark, Notch, Continuous, Fan-Fold	
Media Width	42 ~ 106 mm	25 ~ 116 mm	
Media Roll Diameter	Up to 130 mm	External roll media options up to 150 mm to 205 mm	
Media Thickness	0.06 ~ 0.20 mm	0.06 ~ 0.20 mm	
Supply Method	Easy Paper Loading	-	
Inner Core	25.4 ~ 38.1 mm	-	
Ribbon Characteristics			
Ribbon Type	-	-	
Ribbon Width	-	-	
Ribbon Length	-	-	
Core Inner Diameter	-	-	
Physical Characteristics			
Dimensions (W x L x H)	189 x 221 x 171 mm (7.44 x 8.70 x 6.73 inch)	177 x 150 x 148.5 mm (6.97 x 5.91 x 5.85 inch)	
Weight	1.47 kg (3.24 lbs.)	1.6 kg (3.53 lbs.) SLP-DL410KV: 1.73 kg (3.81 lbs.)	
Electrical	EnergyStar Certified, External Power Adaptor 100-240 V AC, 50/60 Hz	EnergyStar Certified, Internal Power Adaptor 100-240 V AC, 50/60 Hz SLP-DL410KV: Internal Power Converter, Input DC12 V 6.0 A, Output DC24 V 2.5 A, LPC-4000)	
Performance Characteristics			
Memory	64 MB SDRAM, 128 MB Flash	64 MB SDRAM, 128 MB Flash	
Interface	Standard: USB Optional: ① USB + Serial ② USB + Ethernet	Standard: USB + USB Host (WLAN) Optional: ① USB + USB Host (WLAN) + Ethernet ② USB + USB Host (WLAN) + Ethernet + Bluetooth ③ USB + USB Host (WLAN) + Bluetooth WLAN: 802.11a/b/g/n/ac USB Dongle type Supported (Optional)	
Real Time Clock	Not Supported	Supported (Optional)	
Environment Characteristics			
Temperature	Operating: 0 ~ 40°C (32 ~ 104°F), Storage: -20 ~ 60°C (-4 ~ 140°F)	Operating: 0 ~ 40°C (32 ~ 104°F), Storage: -20 ~ 60°C (-4 ~ 140°F)	
Humidity	Operating: 10 ~ 80% RH, Storage: 10 ~ 90% RH	Operating: 10 ~ 80% RH, Storage: 10 ~ 90% RH	
Software			
Emulation	SLCS™, BPL-Z™, BPL-E™	SLCS™, BPL-Z™, BPL-E™	
Driver / Utility	Windows Driver (Europlus/Seagull), Linux/Mac CUPS Driver, Virtual COM USB/Ethernet Driver, Utility Program, OPOS Driver, Bartender Ultralite for BIXOLON, Label Artist-II™, Network Auto Installer	Windows Driver (Europlus/Seagull), Linux/Mac CUPS Driver, Virtual COM USB/Ethernet Driver, Utility Program, OPOS/JPOS Driver, Bartender Ultralite for BIXOLON, Label Artist-II™, SAP® Device Driver, Network Auto Installer	
SDK / Plugin	Android/iOS/Windows SDK, Linux SDK, Chrome SDK, Xamarin SDK	Android/iOS/Windows SDK, Linux SDK, Chrome SDK, Xamarin SDK, Web Print SDK	
Application	Label Artist™ Mobile (Android, iOS), mPrint App (Android, iOS)	Label Artist™ Mobile (Android, iOS), mPrint App (Android, iOS)	
MDM (Optional)		SOTI Connect supported	
XI (Optional)	-	-	
Fonts / Graphics / Symbolologies			
Fonts	Bitmap Fonts (10 SLCS™, 16 BPL-Z™, 5 BPL-E™), Scalable Fonts (1 SLCS™, 1 BPL-Z™), 23 Code page, Unicode supported (UTF-8, UTF-16LE, UTF-16BE)	Bitmap Fonts (10 SLCS™, 16 BPL-Z™, 5 BPL-E™), Scalable Fonts (1 SLCS™, 1 BPL-Z™), 23 Code page, Unicode supported (UTF-8, UTF-16LE, UTF-16BE)	
Graphics	Supporting user-defined fonts, graphics, formats and logos	Supporting user-defined fonts, graphics, formats and logos	
Barcode Symbolologies	1D: Codabar, Code 11, Code 39, Code 93, Code 128, EAN-13, EAN-8, Industrial 2-of-5, Interleaved 2-of-5, Logmars, MSI, Plessey, Postnet, GS1 DataBar (RSS-14), Standard 2-of-5, UPC/EAN extensions, UPC-A, UPC-E, IMB 2D: Aztec, Codablock, Code49, Data Matrix, MaxiCode, MicroPDF417, PDF417, QR Code, TLC39	1D: Codabar, Code 11, Code 39, Code 93, Code 128, EAN-13, EAN-8, Industrial 2-of-5, Interleaved 2-of-5, Logmars, MSI, Plessey, Postnet, GS1 DataBar (RSS-14), Standard 2-of-5, UPC/EAN extensions, UPC-A, UPC-E, IMB 2D: Aztec, Codablock, Code 49, Data Matrix, MaxiCode, MicroPDF417, PDF417, QR code, TLC 39	
Accessories / Supplies			
Standard Accessories	USB cable	SLP-DL410KV: Cigar Jack Cable	
Optional Accessories	Peeler, Serial cable	Peeler, Auto Cutter, External Paper Supply, External Power Adaptor (Not for SLP-DL410KV), WLAN Dongle (Consensus required), USB cable	



SLP-TX220

SLP-DX220

Print Characteristics		
Print Method	Thermal Transfer, Direct Thermal	Direct Thermal
Print Speed	SLP-TX220: Up to 6 ips (152 mm/sec) SLP-TX223: Up to 4 ips (100 mm/sec)	SLP-DX220: Up to 6 ips (152 mm/sec) SLP-DX223: Up to 4 ips (100 mm/sec)
Print Resolution	SLP-TX220: 203 dpi SLP-TX223: 300 dpi	SLP-DX220: 203 dpi SLP-DX223: 300 dpi
Print Width	SLP-TX220: Up to 54 mm SLP-TX223: Up to 56.9 mm	SLP-DX220: Up to 54 mm SLP-DX223: Up to 56.9 mm
Print Length	Up to 2,000 mm	XT2-40 : 108 mm XT2-43 : 105.7 mm
Sensor	Transmissive, Reflective (Adjustable), Head Open	Transmissive, Reflective (Adjustable), Head Open
Media Characteristics		
Media Type	Gap, Black Mark, Notch, Continuous, Fan-Fold	Gap, Black Mark, Notch, Continuous, Fan-Fold
Media Width	15 ~ 60 mm	STD: 15 ~ 60 mm Peeler: 15 ~ 58 mm
Media Roll Diameter	Up to 130 mm	Up to 130 mm
Media Thickness	0.06 ~ 0.20 mm	0.06 ~ 0.20 mm
Supply Method	Easy Paper Loading	Easy Paper Loading
Inner Core	12.5 ~ 38.1 mm	12.5 ~ 38.1 mm
Ribbon Characteristics		
Ribbon Type	Wax, Wax/Resin, Resin, Outside	-
Ribbon Width	58 mm	-
Ribbon Length	Up to 74 m	-
Core Inner Diameter	12.7 mm	-
Physical Characteristics		
Dimensions (W x L x H)	144 x 252 x 173 mm (5.67 x 9.92 x 6.81 inch)	120 x 230 x 170 mm (4.72 x 9.05 x 6.69 inch)
Weight	1.71 kg (3.77 lbs.)	1.36 kg (2.99 lbs.)
Electrical	EnergyStar Certified, External Power Adaptor 100-240 V AC, 50/60 Hz	EnergyStar Certified, External Power Adaptor 100-240 V AC, 50/60 Hz
Performance Characteristics		
Memory	64 MB SDRAM, 128 MB Flash	64 MB SDRAM, 128 MB Flash
Interface	Standard: USB + Serial Optional: ① USB + Ethernet + WLAN ② USB + WLAN + Bluetooth WLAN: 802.11a/b/g/n/ac Dongle type - requires a USB Host port (Optional)	Standard: USB + Serial Optional: ① USB + Ethernet + WLAN ② USB + WLAN + Bluetooth WLAN: 802.11a/b/g/n/ac Dongle type - requires a USB Host port (Optional)
Real Time Clock	Supported (Optional)	Supported (Optional)
Environment Characteristics		
Temperature	Operating: 5 ~ 40°C (41 ~ 104°F), Storage: -20 ~ 60°C (-4 ~ 140°F)	Operating: 0 ~ 40°C (32 ~ 104°F), Storage: -20 ~ 60°C (-4 ~ 140°F)
Humidity	Operating: 10 ~ 80% RH, Storage: 10 ~ 90% RH	Operating: 10 ~ 80% RH, Storage: 10 ~ 90% RH
Software		
Emulation	SLCS™, BPL-Z™, BPL-E™	SLCS™, BPL-Z™, BPL-E™
Driver / Utility	Windows Driver (Europlus/Seagull), Linux/Mac CUPS Driver, Virtual COM USB/Ethernet Driver, Utility Program, OPOS/JPOS Driver, Bartender Ultralite for BIXOLON, Label Artist-III™, SAP® Device Driver, Network Auto Installer	Windows Driver (Europlus/Seagull), Linux/Mac CUPS Driver, Virtual COM USB/Ethernet Driver, Utility Program, OPOS/JPOS Driver, Bartender Ultralite for BIXOLON, Label Artist-III™, SAP® Device Driver, Network Auto Installer
SDK / Plugin	Android/iOS/Windows SDK, Linux SDK, Chrome SDK, Xamarin SDK, Web Print SDK	Android/iOS/Windows SDK, Linux SDK, Chrome SDK, Xamarin SDK, Web Print SDK
Application	Label Artist™ Mobile (Android, iOS), mPrint App (Android, iOS)	Label Artist™ Mobile (Android, iOS), mPrint App (iOS)
MDM (Optional)	SOTI Connect supported	SOTI Connect supported
XI (Optional)	-	-
Fonts / Graphics / Symbologies		
Fonts	Bitmap Fonts (10 SLCS™, 16 BPL-Z™, 5 BPL-E™), Scalable Fonts (1 SLCS™, 1 BPL-Z™), 23 Code page, Unicode supported (UTF-8, UTF-16LE, UTF-16BE)	Bitmap Fonts (10 SLCS™, 16 BPL-Z™, 5 BPL-E™), Scalable Fonts (1 SLCS™, 1 BPL-Z™), 23 Code page, Unicode supported (UTF-8, UTF-16LE, UTF-16BE)
Graphics	Supporting user-defined fonts, graphics, formats and logos	Supporting user-defined fonts, graphics, formats and logos
Barcode Symbologies	1D: Codabar, Code 11, Code 39, Code 93, Code 128, EAN-13, EAN-8, Industrial 2-of-5, Interleaved 2-of-5, Logmars, MSI, Plessey, Postnet, GS1 DataBar (RSS-14), Standard 2-of-5, UPC/EAN extensions, UPC-A, UPC-E, IMB 2D: Aztec, Codablock, Code49, Data Matrix, MaxiCode, MicroPDF417, PDF417, QR Code, TLC39	1D: Codabar, Code 11, Code 39, Code 93, Code 128, EAN-13, EAN-8, Industrial 2-of-5, Interleaved 2-of-5, Logmars, MSI, Plessey, Postnet, GS1 DataBar (RSS-14), Standard 2-of-5, UPC/EAN extensions, UPC-A, UPC-E, IMB 2D: Aztec, Codablock, Code49, Data Matrix, MaxiCode, MicroPDF417, PDF417, QR Code, TLC39
Accessories / Supplies		
Optional Accessories	Peeler, Auto Cutter, External Paper Supply, WLAN Dongle (Consensus required), Serial cable, USB cable	Peeler, Auto Cutter, WLAN Dongle (Consensus required), Serial cable, USB cable
Supplies	B-ribbon™, B-band™	-

B-GATE & POS PRINTERS

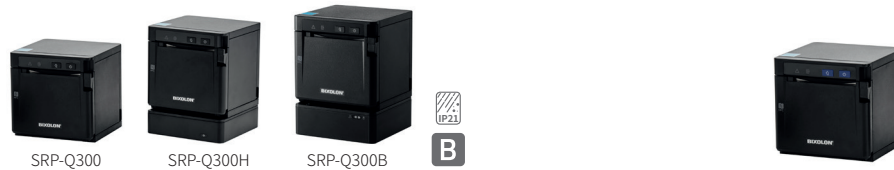

SRP-Q300 Series

SRP-QE300

Print Characteristics		
Print Method	Direct Thermal	Direct Thermal
Print Speed	SRP-Q300, Q300H, Q300B: Up to 220 mm/sec	SRP-QE300: Up to 200 mm/sec
Print Resolution	SRP-Q300, Q300H, Q300B: 180 dpi SRP-Q302, Q302H, Q302B: 203 dpi	SRP-QE300: 180 dpi SRP-QE302: 203 dpi
Print Width	Up to 72 mm	Up to 72 mm
Sensor	Paper End, Cover Open	Paper End, Cover Open
Media Characteristics		
Media Type	Receipt	Receipt
Media Width	80 mm Optional 58 mm	80 mm Optional 58 mm
Media Roll Diameter	Up to 80 mm	Up to 80 mm
Media Thickness	0.05 - 0.08 mm	0.05 - 0.08 mm
Supply Method	Easy Paper Loading	Easy Paper Loading
Physical Characteristics		
Dimensions (W x L x H)	SRP-Q300: 128 x 125 x 125 mm (5.03 x 4.92 x 4.92 inch) SRP-Q300H: 128 x 125 x 160.2 mm (5.03 x 4.92 x 6.30 inch) SRP-Q300B: 128 x 125 x 169.2 mm (5.03 x 4.92 x 6.66 inch)	128 x 125 x 125 mm (5.03 x 4.92 x 4.92 inch)
Weight	SRP-Q300: 1.23 kg (2.71 lbs.) SRP-Q300H: 1.38 kg (3.04 lbs.) SRP-Q300B: 1.72 kg (3.79 lbs.)	1.13 kg (2.49 lbs.)
Electrical	EnergyStar Certified, External Power Adaptor 100-240 V AV, 50/60 Hz, 24 V Li-ion, 2850 mAh (Nominal), Rechargeable Charging time: Up to 4.0 hrs (SRP-Q300B Only)	EnergyStar Certified, External Power Adaptor 100-240 V AV, 50/60 Hz
Drawer Port	2 ports (Via y-type adaptor)	2 ports (Via y-type adaptor)
Performance Characteristics		
Memory	-	-
NV Image Memory	768 Kbytes (Mono)	768 Kbytes (Mono)
Receive Buffer	4 Kbytes	4 Kbytes
User Define Buffer	12 Kbytes	12 Kbytes
Interface	SRP-Q300 / Q300B: Standard: USB V2.0 FS + Ethernet + 1 USB only Charging port Optional: ① Standard + WLAN ¹ ② Standard + Bluetooth SRP-Q300H: 4 USB Host ports (V2.0 HS) + 1 Device port (V2.0 HS) + 1 USB only Charging port + Ethernet + Bluetooth / WLAN ² WLAN ¹ : 802.11a/b/g/n (Infrastructure, Ad-hoc, Wi-Fi Direct, SoftAP) - WEP40/104, WPA1/2 (PSK, EAP) WLAN ² : 802.11a/ac/b/g/n USB dongle type (Optional)	USB V2.0 FS + Ethernet
Environment Characteristics		
Temperature	Operating: 0 ~ 40°C (32 ~ 104°F), Storage: -20 ~ 60°C (-4 ~ 140°F)	Operating: 0 ~ 40°C (32 ~ 104°F), Storage: -20 ~ 60°C (-4 ~ 140°F)
Humidity	Operating: 10 ~ 80% RH, Storage: 10 ~ 90% RH	Operating: 10 ~ 80% RH, Storage: 10 ~ 90% RH
Software		
Emulation	BXL / POS	BXL / POS
Driver / Utility	Windows Driver, OPOS/JPOS Driver, Linux/Mac CUPS Driver, Virtual COM USB/Ethernet Driver, Utility Program, Network Auto Installer SRP-Q300H: Utility Program	Windows Driver, OPOS/JPOS Driver, Linux/Mac CUPS Driver, Virtual COM USB/Ethernet Driver, Utility Program
SDK / Plugin	Android/iOS/Windows SDK, Linux SDK, Xamarin SDK, Chrome SDK, Web Print SDK, Cordova Plugin SRP-Q300H: B-gate iOS/Android/Windows SDK, Chrome SDK, B-gate SDK_Cloud Server Print, B-gate SDK_Web App Print	Android/iOS/Windows SDK, Linux SDK, Xamarin SDK, Chrome SDK, Web Print SDK (Android, iOS), Cordova Plugin
Application	mPrint App (Android, iOS)	mPrint App (Android, iOS)
MDM (Optional)	BIXOLON Profile Manager - XPM™, XCM™ (Windows, Android)	-
Fonts/Graphics/Symbologies		
Character Size	Font A: 12 x 24, Font B: 9 x 17, Font C: 9 x 24, KOR, CHN, JPN: 24 x 24	Font A: 12 x 24, Font B: 9 x 17, Font C: 9 x 24, KOR, CHN, JPN: 24 x 24
Characters Per Line	SRP-Q300, Q300H, Q300B: Font A: 42, Font B, C: 56, KOR, CHN, JPN: 21 SRP-Q302, Q302H, Q302B: Font A: 48, Font B, C: 64, KOR, CHN, JPN: 24	SRP-QE300: Font A: 42, Font B, C: 56, KOR, CHN, JPN: 21 SRP-QE302: Font A: 48, Font B, C: 64, KOR, CHN, JPN: 24
Character Sets	Alphanumeric: 95 Extended Graphics: 128 x 35 page International: 32 Unicode: UTF-8, UTF-16, UTF-32	Alphanumeric: 95 Extended Graphics: 128 x 35 page International: 32
Graphics	Supporting user-defined fonts, graphics, formats and logos	Supporting user-defined fonts, graphics, formats and logos
Barcode Symbologies	1D: Coda Bar, Code 39, Code 93, Code 128, EAN-8, EAN-13, ITF, UPC-A, UPC-E 2D: Data Matrix, GS1-128, GS1 DataBar Stacked / Omnidirectional / Truncated / Limited / Expanded, PDF417, QR code	1D: Coda Bar, Code 39, Code 93, Code 128, EAN-8, EAN-13, ITF, UPC-A, UPC-E 2D: Data Matrix, GS1-128, GS1 DataBar Stacked / Omnidirectional / Truncated / Limited / Expanded, PDF417, QR code
Accessories / Supplies		
Standard Accessories	USB A-B Cable 1.8 m	USB A-B Cable 1.8 m
Optional Accessories	Tablet stand (RTS-Q300), Mini LCD Display (BCD-3000), External buzzer, B-Melodist, Powered A-B USB Y Cable (1.2/4.8 m), USB to Serial cable, WLAN Dongle	Tablet stand (RTS-Q300), External buzzer, B-Melodist



SRP-Q200



BGT-100P

Print Characteristics		
Print Method	Direct Thermal	Direct Thermal
Print Speed	Up to 250 mm/sec	BGT-100P: Up to 300 mm/sec BGT-102P: Up to 270 mm/sec
Print Resolution	203 dpi	BGT-100P: 180 dpi BGT-102P: 203 dpi
Print Width	Up to 54 mm	Up to 72 mm
Sensor	Paper End, Cover Open	Paper End, Paper Near End, Cover Open
Media Characteristics		
Media Type	Receipt	Receipt
Media Width	58.0 mm	80 mm Optional 58 mm
Media Roll Diameter	Up to 60 mm	Up to 83 mm
Media Thickness	0.05 ~ 0.08 mm	0.05 ~ 0.08 mm
Supply Method	Easy Paper Loading	Easy Paper Loading
Physical Characteristics		
Dimensions (W x L x H)	103 x 104 x 109 mm (4.03 x 4.10 x 4.24 inch)	145 x 200 x 146 mm (5.70 x 7.87 x 5.74 inch)
Weight	0.61 kg (1.34 lbs.)	1.56 kg (3.43 lbs.)
Electrical	EnergyStar Certified, External Power Adaptor 100-240 V AV, 50/60 Hz	EnergyStar Certified, External Power Adaptor 100-240 V AV, 50/60 Hz
Drawer Port	2 ports (Via y-type adaptor)	2 ports (Via y-type adaptor)
Performance Characteristics		
Memory	-	64 MB SDRAM, 256 MB Flash
NV Image Memory	768 Kbytes (Mono)	768 Kbytes (Mono)
Receive Buffer	4 Kbytes	4 Kbytes
User Define Buffer	12 Kbytes	12 Kbytes
Interface	Standard: ① USB V2.0 FS + Serial ② USB V2.0 FS + Ethernet Optional: ① USB V2.0 FS + Ethernet + WLAN ② USB V2.0 FS + Ethernet + Bluetooth WLAN: 802.11a/b/g/n (Infrastructure, Ad-hoc, Wi-Fi Direct, SoftAP) - WEP40/104, WPA1/2 (PSK, EAP)	3 USB Host ports (V2.0 HS) + 1 device port (V2.0 HS) + 1 USB Host with charging + Ethernet + Bluetooth + WLAN WLAN: 802.11a/ac/b/g/n USB dongle type (Optional)
Environment Characteristics		
Temperature	Operating: 0 ~ 40°C (32 ~ 104°F) Storage: -20 ~ 60°C (-4 ~ 140°F)	Operating: 0 ~ 40°C (32 ~ 104°F) Storage: -20 ~ 60°C (-4 ~ 140°F)
Humidity	Operating: 10 ~ 80% RH Storage: 10 ~ 90% RH	Operating: 10 ~ 80% RH Storage: 10 ~ 90% RH
Software		
Emulation	BXL / POS	BXL / POS
Driver / Utility	Windows Driver, OPOS/JPOS Driver, Linux/Mac CUPS Driver, Virtual COM USB/Ethernet Driver, Utility Program	BGT-100P/102P: Windows Driver, Utility Program
SDK / Plugin	Android/iOS/Windows SDK, Linux SDK, Xamarin SDK, Chrome SDK, Web Print SDK (Android, iOS), Cordova Plugin	BGT-100P/102P: B-gate iOS/Android/Windows SDK, Chrome SDK, B-gate SDK_Cloud Server Print, B-gate SDK_Web, App Print, Web Print SDK
Application	mPrint App (Android, iOS)	-
MDM (Optional)	-	BIXOLON Profile Manager - XPM™, XCM™ (Windows, Android)
Fonts/Graphics/Symbologies		
Character Size	Font A: 12 x 24, Font B: 9 x 17, Font C: 9 x 24, KOR, CHN, JPN: 24 x 24	Font A: 12 x 24, Font B: 9 x 17, Font C: 9 x 24, KOR, CHN, JPN: 24 x 24
Characters Per Line	Font A: 36, Font B, C: 48, KOR, CHN, JPN: 18	BGT-100P: Font A: 42, Font B, C: 56, KOR, CHN, JPN: 21 BGT-102P: Font A: 48, Font B, C: 64, KOR, CHN, JPN: 24
Character Sets	Alphanumeric: 95 Extended Graphics: 128 x 35 page International: 32	Alphanumeric: 95 Extended Graphics: 128 x 33 page International: 32
Graphics	Supporting user-defined fonts, graphics, formats and logos	Supporting user-defined fonts, graphics, formats and logos
Barcode Symbologies	1D: Coda Bar, Code39, Code93, Code128, EAN-8, EAN-13, ITF, UPC-A, UPC-E 2D: Data Matrix, PDF417, QR Code	1D: Coda Bar, Code 39, Code 93, Code 128, EAN-8, EAN-13, ITF, UPC-A, UPC-E 2D: Data Matrix, PDF417, QR code
Accessories / Supplies		
Standard Accessories	USB A-B Cable 1.8 m	USB A-B Cable 1.8 m
Optional Accessories	External buzzer, B-Melodist, Serial Cable (9-9 pin)	Built-in SMPS, Vertical stand, Wall mount, Splash Proof Cover, External buzzer, B-Melodist, USB to Serial cable, WLAN Dongle



SRP-S300



SRP-S300



SRP-S320

SRP-S300 Series

Print Characteristics		SRP-S300 Series	
Print Method	Direct Thermal (Front Exit)	Direct Thermal	
Print Speed	Up to 200 mm/sec	SRP-S300L/LX: Up to 170 mm/sec, SRP-S300R: Up to 300 mm/sec, SRP-S320: Up to 150 mm/sec	
Print Resolution	203 dpi	203 dpi	
Print Width	Up to 32 / 48 / 72 mm	SRP-S300: Up to 80 / 72 / 60 / 48 / 32 mm, SRP-S320: Up to 72 / 60 / 48 / 32 mm	
Sensor	Paper End, Black Mark, Cover Open, Paper Taken, Gap	SRP-S300: Paper End, Black Mark, Cover Open, Paper Taken (Option), Paper Near End (Receipt Only) SRP-S320: Paper End, Black Mark, Cover Open, Paper Taken	
Media Characteristics		SRP-S300 Series	
Media Type	Linerless Extreme, Restick, Liner Label (Gap, Black Mark, Notch, Continuous)	SRP-S300L/T: Re-stick, SRP-S300LX/TX, SRP-S320: Linerless Extreme, SRP-S300R: Receipt	
Media Width	40 / 58 / 80 mm	Standard: 80 mm SRP-S300 Optional: 40 / 58 / 62 / 83 mm, SRP-S320 Optional: 40 / 58 / 62 mm	
Media Roll Diameter	Up to 103 mm	SRP-S300: Up to 103 mm, SRP-S320: Up to 120 mm	
Media Thickness	BXL / POS - 0.06 ~ 0.09 mm, SLCS / BPL-Z™ / BPL-C™ - 0.06 ~ 0.15 mm	0.06 ~ 0.09 mm	
Supply Method	Easy Paper Loading	Easy Paper Loading	
Physical Characteristics		SRP-S300 Series	
Dimensions (W x L x H)	144 x 158 x 210 mm (5.67 x 6.22 x 8.27 inch)	SRP-S300: 156 x 210 x 160 mm (6.14 x 8.27 x 6.30 inch) SRP-S320: 156 x 227 x 161 mm (6.14 x 8.94 x 6.34 inch)	
Weight	2.00 kg (4.40 lbs.)	SRP-S300: 2.00 kg (4.40 lbs.), SRP-S320: 2.20 kg (4.85 lbs.)	
Electrical	Energy Star Certified, External Power Supply Housed Internally (Adaptor 24 V/2.5 A)	Energy Star Certified, External Power Supply Housed Internally (Adaptor 24 V/2.5 A)	
Display	2 inch Colour TFT LCD	-	
Drawer Port	2 ports (Via y-type adaptor)	SRP-S300: 2 Ports (Via y-type adaptor), SRP-S320: N/A	
Performance Characteristics		SRP-S300 Series	
Memory	128 MB SDRAM, 256 MB Flash / 256 MB SDRAM, 512 MB Flash (Optional)	-	
NV Image Memory	768 Kbytes (Mono)	SRP-S300: 256 Kbytes (Mono), SRP-S320: 768 Kbytes (Mono)	
Receive Buffer	4 Kbytes	4 Kbytes	
User Define Buffer	12 Kbytes	12 Kbytes	
Interface	Standard: USB V2.0 HS + 1 USB Host port + Ethernet + Serial Optional: ① USB V2.0 HS + 1 USB Host port + Ethernet + Serial + WLAN ② USB V2.0 HS + 1 USB Host port + Ethernet + Serial + Bluetooth WLAN: 802.11a/b/g/n (Infrastructure, Ad-hoc, Wi-Fi Direct, SoftAP) - WEP40/104, WPA1/2 (PSK, EAP)	SRP-S300: Standard: USB V2.0 FS Optional: ① USB V2.0 FS + Serial ② USB V2.0 FS + Parallel ③ USB V2.0 FS + Ethernet ④ USB V2.0 FS + WLAN ¹ ⑤ USB V2.0 FS + Bluetooth ⑥ USB V2.0 FS + Powered USB SRP-S320: Standard: USB V2.0 FS + Ethernet Optional: ① USB V2.0 FS + Ethernet + Serial ② USB V2.0 FS + Ethernet + WLAN ¹ ③ USB V2.0 FS + Ethernet + Bluetooth SRP-S300Hi, 320Hi (B-gate Hub Interface): 3 USB Host ports (V2.0 HS) + 1 USB charging port + 1 Device port (V2.0 HS) + Ethernet + WLAN ² WLAN ¹ : 802.11a/b/g/n (Infrastructure, Ad-hoc, Wi-Fi Direct, SoftAP) - WEP40/104, WPA1/2 (PSK, EAP) WLAN ² : 802.11a/ac/b/g/n USB dongle type (Optional)	
Environment Characteristics		SRP-S300 Series	
Temperature	Operating: 0 ~ 40°C (32 ~ 104°F), Storage: -20 ~ 60°C (-4 ~ 140°F)	Operating: 0 ~ 40°C (32 ~ 104°F), Storage: -20 ~ 60°C (-4 ~ 140°F)	
Humidity	Operating: 10 ~ 80% RH, Storage: 10 ~ 90% RH	Operating: 10 ~ 80% RH, Storage: 10 ~ 90% RH	
Sealing	IP23	IP21	
Software		SRP-S300 Series	
Emulation	BXL / POS, SLCS, BPL-Z™, BPL-C™	BXL / POS	
Driver / Utility	BXL / POS: Windows Driver, OPOS/JPOS Driver, Linux/Mac CUPS Driver, Virtual COM USB/Ethernet Driver, Utility Program, Network Auto Installer SLCS, BPL-Z™, BPL-C™: Windows Driver (Europlus/Seagull), OPOS/JPOS Driver, Linux/Mac CUPS Driver, Virtual COM USB/Ethernet Driver, Utility Program, Bartender Ultralite for BIXOLON, Label Artist-III™, SAP® Device Driver	Windows Driver, OPOS/JPOS Driver, Linux/Mac CUPS Driver, Virtual COM USB/Ethernet Driver, Utility Program, Network Auto Installer SRP-S300/320Hi: Utility Program	
SDK / Plugin	Android/iOS/Windows SDK, Linux SDK, Xamarin SDK, Chrome SDK, Web Print SDK, Cordova Plugin	Android/iOS/Windows SDK, Linux SDK, Xamarin SDK, Chrome SDK, Web Print SDK, Cordova Plugin SRP-S300 / 320Hi: B-gate iOS/Android/Windows SDK, Chrome SDK, B-gate SDK_Cloud Server Print, B-gate SDK_Web App Print	
Application	BXL / POS: mPrint App (Android, iOS), SLCS, BPL-Z™, BPL-C™: mPrint App (Android, iOS), Label Artist™ Mobile (Android, iOS)	mPrint App (Android, iOS): B-gate Not Supported	
MDM (Optional)	BIXOLON Profile Manager - XPM™, XCM™ (Windows, Android)	BIXOLON Profile Manager - XPM™, XCM™ (Windows, Android)	
Fonts/Graphics/Symbologies		SRP-S300 Series	
Character Size	BXL / POS: Font A: 12 x 24, Font B: 9 x 17, Font C: 9 x 24, KOR, CHN, JPN: 24 x 24 SLCS, BPL-Z™, BPL-C™: Bitmap Fonts (10 SLCS™, 16 BPL-Z™), Scalable Fonts (1 SLCS™, 1 BPL-Z™, 7 BPL-C™), 23 Code page, Unicode supported (UTF-8, UTF-16LE, UTF-16BE)	Font A: 12 x 24, Font B: 9 x 17, Font C: 9 x 24, KOR, CHN, JPN: 24 x 24	
Characters Per Line	Font A: 42, Font B, C: 56, KOR, CHN, JPN: 21	SRP-S300: Font A: 48, Font B, C: 64, SRP-S320: Font A: 42, Font B, C: 56, KOR, CHN, JPN: 21	
Character Sets	Alphanumeric: 95 Extended Graphics: 128 x 35 page International: 32	Alphanumeric: 95 Extended Graphics: 128 x 33 page International: 32	
Graphics	Supporting user-defined fonts, graphics, formats, and logos BXL / POS: 1D: Code Bar, Code 39, Code 93, Code 128, EAN-8, EAN-13, ITF, UPC-A, UPC-E 2D: Data Matrix, PDF417, QR code	Supporting User-Defined Fonts, Graphics, Formats and Logos 1D: Code Bar, Code 39, Code 93, Code 128, EAN-8, EAN-13, ITF, UPC-A, UPC-E 2D: Data Matrix, PDF417, QR code	
Barcode Symbologies	SLCS, BPL-Z™, BPL-C™: 1D: Codabar, Code 11, Code 39, Code 93, Code 128, EAN-13, EAN-8, Industrial 2-of-5, Interleaved 2-of-5, Logmars, MSI, Plessey, Postnet, GS1 DataBar (RSS-14), Standard 2-of-5, UPC/EAN extensions, UPC-A, UPC-E, IMB 2D: Aztec, Codablock, Code 49, Data Matrix, MaxiCode, MicroPDF417, PDF417, QR code, TLC 39		
Accessories / Supplies		SRP-S300 Series	
Standard Accessories	2-inch Partition (58/40 mm), USB A-B Cable 1.8 m	SRP-S300: 2-inch Partition (62/58/40 mm), 3 inch Partition (83 mm) SRP-S320: 2-inch Partition (62/58/40 mm), USB A-B Cable 1.8 m	
Optional Accessories	Serial Cable (9-9 pin)	External buzzer, B-Melodist (SRP-S300 only), USB to Serial cable, WLAN Dongle, Powered USB (0.5/1.2 m - SRP-S300 only), Serial Cable (9-9/25-9 pin)	
Supplies	B-linerless™ BIXOLON's flexible and ecological linerless label consumables	B-linerless™ BIXOLON's flexible and ecological linerless label consumables	



SRP-S200



SRP-F310II

Print Characteristics		
Print Method	Direct Thermal (Front Exit)	Direct Thermal (Front Exit)
Print Speed	Up to 150 mm/sec	Up to 350 mm/sec
Print Resolution	203 dpi	SRP-F310II: 180 dpi (512 dots), SRP-F312II: 203 dpi (576 dots) SRP-F313II: 203 dpi (640 dots)
Print Width	Up to 54 / 32 mm	SRP-F310II: Up to 72 mm, SRP-F312II: Up to 72 mm, SRP-F313II: Up to 80 mm
Sensor	Paper End, Black Mark, Cover Open, Paper Taken	Paper End, Paper Near End, Cover Open
Media Characteristics		
Media Type	Re-stick	Receipt
Media Width	58 mm, Optional 40 mm	80 mm, Optional 83 mm
Media Roll Diameter	Up to 103 mm	Up to 105 mm
Media Thickness	0.06 ~ 0.09 mm	0.05 ~ 0.08 mm
Supply Method	Easy Paper Loading	Easy Paper Loading
Physical Characteristics		
Dimensions (W x L x H)	128 x 156 x 196 mm (5.03 x 6.14 x 7.71 inch)	154 x 203 x 148 mm (6.06 x 7.99 x 5.82 inch)
Weight	1.80 kg (3.96 lbs.)	2.00 kg (4.40 lbs.)
Electrical	Energy Star Certified, External Power Supply Housed Internally (Adaptor 24 V/2.5 A)	EnergyStar Certified, External Power Supply Housed Internally (Adaptor 24 V/2.5 A, 50/60 Hz)
Drawer Port	-	2 ports (Via y-type adaptor)
Performance Characteristics		
NV Image Memory	-	-
NV Image Memory	768 Kbytes (Mono)	768 Kbytes (Mono)
Receive Buffer	4 Kbytes	4 Kbytes
User Define Buffer	12 Kbytes	12 Kbytes
Interface	USB V2.0 FS + Ethernet + Serial	Standard: USB V2.0 FS + Ethernet Optional: ① USB V2.0 FS + Ethernet + Serial ② USB V2.0 FS + Ethernet + Dual Serial ③ USB V2.0 FS + Ethernet + Parallel ④ USB V2.0 FS + Ethernet + WLAN ¹ ⑤ USB V2.0 FS + Ethernet + Bluetooth ⑥ USB V2.0 FS + Ethernet + Powered USB SRP-F310IIHi (B-gate Hub Interface): 3 USB Host ports (V2.0 HS) + 1 Device port (V2.0 HS) + 1 USB Host with charging + Ethernet + WLAN ² WLAN ¹ : 802.11a/b/g/n (Infrastructure, Ad-hoc, Wi-Fi Direct, SoftAP) - WEP40/104, WPA1/2 (PSK, EAP) WLAN ² : 802.11a/ac/b/g/n USB dongle type (Optional)
Environment Characteristics		
Temperature	Operating: 0 ~ 40°C (32 ~ 104°F), Storage: -20 ~ 60°C (-4 ~ 140°F)	Operating: 0 ~ 40°C (32 ~ 104°F), Storage: -20 ~ 60°C (-4 ~ 140°F)
Humidity	Operating: 10 ~ 80% RH, Storage: 10 ~ 90% RH	Operating: 10 ~ 80% RH, Storage: 10 ~ 90% RH
Sealing	IP23	IP12
Software		
Emulation	BXL / POS	BXL / POS
Driver / Utility	Windows Driver, OPOS/JPOS Driver, Linux/Mac CUPS Driver, Virtual COM USB/Ethernet Driver, Utility Program, Network Auto Installer	Windows Driver, OPOS/JPOS Driver, Linux/Mac CUPS Driver, Virtual COM USB/Ethernet Driver, Utility Program, Network Auto Installer SRP-F310IIHi: Utility Program
SDK / Plugin	Android/iOS/Windows SDK, Linux SDK, Xamarin SDK, Chrome SDK, Web Print SDK, Cordova Plugin	Android/iOS/Windows SDK, Linux SDK, Xamarin SDK, Chrome SDK, Web Print SDK, Cordova Plugin SRP-F310IIHi: B-gate iOS/Android/Windows SDK, Chrome SDK, B-gate SDK_Cloud Server Print, B-gate SDK_Web App Print
Application	mPrint App (Android, iOS): B-gate Not Supported	mPrint App (Android, iOS)
MDM (Optional)	-	BIXOLON Profile Manager - XPM™, XCM™ (Windows, Android)
Fonts / Graphics / Symbolgies		
Character Size	Font A: 12 x 24, Font B: 9 x 17, Font C: 9 x 24, KOR, CHN, JPN: 24 x 24	Font A: 12 x 24, Font B: 9 x 17, Font C: 9 x 24, KOR, CHN, JPN: 24 x 24
Characters Per Line	Font A: 36, Font B, C: 48, KOR, CHN, JPN: 18	SRP-F310II: Font A: 42, Font B, C: 56, KOR, CHN, JPN: 21 SRP-F312II: Font A: 48, Font B, C: 64, KOR, CHN, JPN: 24 SRP-F313II: Font A: 53, Font B, C: 71, KOR, CHN, JPN: 26
Character Sets	Alphanumeric: 95 Extended Graphics: 128 x 35 page International: 32	Alphanumeric: 95 Extended Graphics: 128 x 35 page International: 32
Graphics	Supporting user-defined fonts, graphics, formats, and logos	Supporting user-defined fonts, graphics, formats and logos
Barcode Symbolgies	1D: Coda Bar, Code 39, Code 93, Code 128, EAN-8, EAN-13, ITF, UPC-A, UPC-E 2D: Data Matrix, PDF417, QR code	1D: Coda Bar, Code39, Code93, Code128, EAN-8, EAN-13, ITF, UPC-A, UPC-E 2D: Data Matrix, PDF417, QR Code
Accessories / Supplies		
Standard Accessories	40 mm Partition, USB A-B Cable 1.8 m	3-inch Partition (83 mm), USB A-A Cable 1.8 m
Optional Accessories	External buzzer, USB to Serial cable, Serial Cable (9-9 pin)	External buzzer, B-Melodist, USB to Serial cable, WLAN Dongle, Powered USB (0.5/1.2 m), Serial Cable (9-9/25-9 pin), Parallel Cable
Supplies	B-linerless™ BIXOLON's flexible and ecological linerless label consumables	-

*** Specified Paper: TF50KS-E (Paper thickness: 65µm) - Nippon Paper industries / PD 150R (Paper thickness: 75µm) - New Oji Paper / PD 160R (Paper thickness: 75µm) - New Oji Paper / P350 (Paper thickness: 62µm) - Kansaki Specialty Paper (USA)



SRP-380



SRP-350plusV

Print Characteristics		Media Characteristics	
Print Method	Direct Thermal	Receipt	Receipt
Print Speed	SRP-380, 382: Up to 350 mm/sec	80 mm	80 mm
Print Resolution	SRP-380: 180 dpi SRP-382: 203 dpi	Optional 58 mm	Optional 58 mm
Print Width	SRP-380, 382: Up to 72 mm	Up to 83 mm	Up to 83 mm
Sensor	Paper End, Paper Near End, Cover Open, Variable Optic Sensor	Media Thickness	0.05 - 0.08 mm
Physical Characteristics		Supply Method	Easy Paper Loading
Dimensions (W x L x H)	147 x 200 x 148 mm (5.79 x 7.87 x 5.82 inch)	Standard: USB V2.0 FS	Standard: USB V2.0 FS + Ethernet
Weight	SRP-380, 382: 1.56 kg (3.43 lbs.)	Optional: ① USB V2.0 FS + Ethernet ② USB V2.0 FS + Serial ③ USB V2.0 FS + Dual Serial ④ USB V2.0 FS + Parallel ⑤ USB V2.0 FS + WLAN ⑥ USB V2.0 FS + Bluetooth ⑦ USB V2.0 FS + Powered USB	Optional: ① USB V2.0 FS + Ethernet + Serial ② USB V2.0 FS + Ethernet + Dual Serial ③ USB V2.0 FS + Ethernet + Parallel ④ USB V2.0 FS + Ethernet + WLAN ¹ ⑤ USB V2.0 FS + Ethernet + Bluetooth ⑥ USB V2.0 FS + Ethernet + Powered USB
Electrical	EnergyStar Certified, External Power Adaptor 100-240 V AV, 50/60 Hz	WLAN: 802.11a/b/g/n (Infrastructure, Ad-hoc, Wi-Fi Direct, SoftAP) - WEP40/104, WPA1/2 (PSK, EAP)	WLAN: 802.11a/b/g/n (Infrastructure, Ad-hoc, Wi-Fi Direct, SoftAP) - WEP40/104, WPA1/2 (PSK, EAP)
Drawer Port	2 ports (Via y-type adaptor)	Environment Characteristics	
Performance Characteristics		Temperature	Operating: 0 ~ 40°C (32 ~ 104°F) Storage: -20 ~ 60°C (-4 ~ 140°F)
Memory	-	Humidity	Operating: 10 ~ 80% RH Storage: 10 ~ 90% RH
NV Image Memory	SRP-380, 382: 768 Kbytes (Mono)	Software	
Receive Buffer	4 Kbytes	Emulation	BXL / POS
User Define Buffer	12 Kbytes	Driver / Utility	Windows Driver, OPOS/JPOS Driver, Linux/Mac CUPS Driver, Virtual COM USB/Ethernet Driver, Utility Program, Network Auto Installer
Interface		SDK / Plugin	Android/iOS/Windows SDK, Linux SDK, Windows Runtime SDK, Xamarin SDK, Chrome SDK, Web Print SDK, Cordova Plugin
Environment Characteristics		Application	mPrint App (Android, iOS)
Temperature	Operating: 0 ~ 40°C (32 ~ 104°F) Storage: -20 ~ 60°C (-4 ~ 140°F)	MDM (Optional)	BIXOLON Profile Manager - XPM™, XCM™ (Windows, Android)
Humidity	Operating: 10 ~ 80% RH Storage: 10 ~ 90% RH	Fonts/Graphics/Symbologies	
Software		Character Size	Font A: 12 x 24, Font B: 9 x 17, Font C: 9 x 24, KOR, CHN, JPN: 24 x 24
Emulation	BXL / POS	Characters Per Line	SRP-380: Font A: 42, Font B, C: 56, KOR, CHN, JPN: 21 SRP-382: Font A: 48, Font B, C: 64, KOR, CHN, JPN: 24
Driver / Utility	Windows Driver, OPOS/JPOS Driver, Linux/Mac CUPS Driver, Virtual COM USB/Ethernet Driver, Utility Program, Network Auto Installer	Character Sets	Alphanumeric: 95 Extended Graphics: 128 x 35 page International: 32 Unicode: UTF-8, UTF-16, UTF-32
SDK / Plugin	Android/iOS/Windows SDK, Linux SDK, Windows Runtime SDK, Xamarin SDK, Chrome SDK, Web Print SDK, Cordova Plugin	Graphics	Supporting user-defined fonts, graphics, formats and logos
Application	mPrint App (Android, iOS)	Barcode Symbologies	1D: Coda Bar, Code 39, Code 93, Code 128, EAN-8, EAN-13, ITF, UPC-A, UPC-E 2D: Data Matrix, GS1-128, GS1 DataBar Stacked / Omnidirectional / Truncated / Limited / Expanded, PDF417, QR code
MDM (Optional)	BIXOLON Profile Manager - XPM™, XCM™ (Windows, Android)	Accessories / Warranty	
Fonts/Graphics/Symbologies		Standard Accessories	2-inch Partition (58 mm), USB A-B Cable 1.8 m
Character Size	Font A: 12 x 24, Font B: 9 x 17, Font C: 9 x 24, KOR, CHN, JPN: 24 x 24	Optional Accessories	Splash cover, External buzzer, B-Melodist, Powered USB (0.5/1.2 m), Serial Cable (9-9/25-9 pin), Powered A-B USB Y Cable (1.2/4.8 m)
Characters Per Line	SRP-380: Font A: 42, Font B, C: 56, KOR, CHN, JPN: 21 SRP-382: Font A: 48, Font B, C: 64, KOR, CHN, JPN: 24	Warranty	Extended warranty (Optional)
Character Sets	Alphanumeric: 95 Extended Graphics: 128 x 35 page International: 32 Unicode: UTF-8, UTF-16, UTF-32	Accessories / Warranty	
Graphics	Supporting user-defined fonts, graphics, formats, and logos	Standard Accessories	RJ12 6pin cable Adapter (Male to Female), USB A-B Cable 1.8 m
Barcode Symbologies	1D: Coda Bar, Code 39, Code 93, Code 128, EAN-8, EAN-13, ITF, UPC-A, UPC-E 2D: Data Matrix, PDF417, QR code	Optional Accessories	Built-in SMPS, Vertical stand, Wall mount, Splash Proof Cover, External buzzer, B-Melodist, Powered USB (0.5/1.2 m), Serial Cable (9-9/25-9 pin), Parallel Cable
Accessories / Warranty		Warranty	-
Standard Accessories	2-inch Partition (58 mm), USB A-B Cable 1.8 m		
Optional Accessories	Splash cover, External buzzer, B-Melodist, Powered USB (0.5/1.2 m), Serial Cable (9-9/25-9 pin), Powered A-B USB Y Cable (1.2/4.8 m)		
Warranty	Extended warranty (Optional)		



SRP-350plusIII



SRP-350V

Print Characteristics		
Print Method	Direct Thermal	Direct Thermal
Print Speed	SRP-350plusIII: Up to 300 mm/sec SRP-352plusIII: Up to 270 mm/sec	SRP-350V: Up to 300 mm/sec SRP-352V: Up to 270 mm/sec
Print Resolution	SRP-350plusIII: 180 dpi SRP-352plusIII: 203 dpi	SRP-350V: 180 dpi SRP-352V: 203 dpi
Print Width	Up to 72 mm	Up to 72 mm
Sensor	Paper End, Paper Near End, Cover Open	Paper End, Paper Near End, Cover Open
Media Characteristics		
Media Type	Receipt	Receipt
Media Width	80 mm Optional 58 mm	80 mm Optional 58 mm
Media Roll Diameter	Up to 83 mm	Up to 83 mm
Media Thickness	0.05 ~ 0.08 mm	0.05 ~ 0.08 mm
Supply Method	Easy Paper Loading	Easy Paper Loading
Physical Characteristics		
Dimensions (W x L x H)	145 x 200 x 146 mm (5.70 x 7.87 x 5.74 inch)	145 x 200 x 146 mm (5.70 x 7.87 x 5.74 inch)
Weight	1.56 kg (3.43 lbs.)	1.6 kg (3.52 lbs.)
Electrical	EnergyStar Certified, External Power Adaptor 100-240 V AV, 50/60 Hz	EnergyStar Certified, External Power Adaptor 100-240 V AV, 50/60 Hz
Drawer Port	2 ports (Via y-type adaptor)	2 ports (Via y-type adaptor)
Performance Characteristics		
Memory	-	64 Mb SDRAM, 64 Mb Flash
NV Image Memory	768 Kbytes (Mono)	256 Kbytes (Mono)
Receive Buffer	4 Kbytes	4 Kbytes
User Define Buffer	12 Kbytes	12 Kbytes
Interface	Standard: USB V2.0 FS + Ethernet Optional: ① USB V2.0 FS + Ethernet + Serial ② USB V2.0 FS + Ethernet + Parallel ③ USB V2.0 FS + Ethernet + WLAN ¹ ④ USB V2.0 FS + Ethernet + Bluetooth ⑤ USB V2.0 FS + Ethernet + Powered USB WLAN: 802.11a/b/g/n (Infrastructure, Ad-hoc, Wi-Fi Direct, SoftAP) - WEP40/104, WPA1/2 (PSK, EAP)	Standard: USB V2.0 FS Optional: ① USB V2.0 FS + Serial ② USB V2.0 FS + Parallel ③ USB V2.0 FS + Ethernet ④ USB V2.0 FS + Dual Serial
Environment Characteristics		
Temperature	Operating: 0 ~ 40°C (32 ~ 104°F) Storage: -20 ~ 60°C (-4 ~ 140°F)	Operating: 0 ~ 40°C (32 ~ 104°F) Storage: -20 ~ 60°C (-4 ~ 140°F)
Humidity	Operating: 10 ~ 80% RH Storage: 10 ~ 90% RH	Operating: 10 ~ 80% RH Storage: 10 ~ 90% RH
Software		
Emulation	BXL / POS	BXL / POS
Driver / Utility	Windows Driver, OPOS/JPOS Driver, Linux/Mac CUPS Driver, Virtual COM USB/Ethernet Driver, Utility Program, Network Auto Installer	Windows Driver, OPOS/JPOS Driver, Linux/Mac CUPS Driver, Virtual COM USB/Ethernet Driver, Utility Program, Network Auto Installer
SDK / Plugin	Android/iOS/Windows SDK, Linux SDK, Windows Runtime SDK, Xamarin SDK, Chrome SDK, Web Print SDK, Cordova Plugin	Android/iOS/Windows SDK, Linux SDK, Xamarin SDK, Web Print SDK, Cordova Plugin
Application	mPrint App (Android, iOS)	mPrint App (Android, iOS)
MDM (Optional)	BIXOLON Profile Manager - XPM™, XCM™ (Windows, Android)	-
Fonts/Graphics/Symbologies		
Character Size	Font A: 12 x 24 Font B: 9 x 17 Font C: 9 x 24, KOR, CHN, JPN: 24 x 24	Font A: 12 x 24, Font B: 9 x 17, Font C: 9 x 24, KOR, CHN, JPN: 24 x 24
Characters Per Line	SRP-350plusIII: Font A: 42 Font B, C: 56, KOR, CHN, JPN: 21 SRP-352plusIII: Font A: 48 Font B, C: 64, KOR, CHN, JPN: 24	SRP-350V: Font A: 42, Font B, C: 56, KOR, CHN, JPN: 21 SRP-352V: Font A: 48, Font B, C: 64, KOR, CHN, JPN: 24
Character Sets	Alphanumeric: 95 Extended Graphics: 128 x 35 page International: 32	Alphanumeric: 95 Extended Graphics: 128 x 35 page International: 32
Graphics	Supporting user-defined fonts, graphics, formats, and logos	Supporting user-defined fonts, graphics, formats, and logos
Barcode Symbologies	1D: Coda Bar, Code 39, Code 93, Code 128, EAN-8, EAN-13, ITF, UPC-A, UPC-E 2D: Data Matrix, PDF417, QR code	1D: Coda Bar, Code39, Code93, Code128, EAN-8, EAN-13, ITF, UPC-A, UPC-E 2D: Data Matrix, PDF417, QR Code
Accessories		
Standard Accessories	RJ12 6pin cable Adapter (Male to Female), USB A-B Cable 1.8 m	USB A-B Cable 1.8 m
Optional Accessories	Built-in SMPS, Vertical stand, Wall mount, Splash Proof Cover, External buzzer, B-Melodist, Powered USB (0.5/1.2 m), Serial Cable (9-9/25-9 pin), Parallel Cable	Built-in SMPS, Vertical stand, Wall mount, Splash Proof Cover, External buzzer, B-Melodist, Serial Cable (9-9/25-9 pin), Parallel Cable



SRP-350III



SRP-330III

Print Characteristics		
Print Method	Direct Thermal	Direct Thermal
Print Speed	SRP-350III: Up to 250 mm/sec SRP-352III: Up to 230 mm/sec	SRP-330III: Up to 250 mm/sec SRP-332III: Up to 250 mm/sec
Print Resolution	SRP-350III: 180 dpi SRP-352III: 203 dpi	SRP-330III: 180 dpi SRP-332III: 203 dpi
Print Width	Up to 72 mm	Up to 72 mm
Sensor	Paper End, Paper Near End, Cover Open	Paper End, Cover Open
Media Characteristics		
Media Type	Receipt	Receipt
Media Width	80 mm Optional 58 mm	80 mm Optional 58 mm
Media Roll Diameter	Up to 83 mm	Up to 80 mm
Media Thickness	0.05 - 0.08 mm	0.05 - 0.08 mm
Supply Method	Easy Paper Loading	Easy Paper Loading
Physical Characteristics		
Dimensions (W x L x H)	145 x 204 x 146 mm (5.70 x 8.03 x 5.74 inch)	145 x 195 x 146 mm (5.72 x 7.79 x 5.74 inch)
Weight	1.55 kg (3.41 lbs.)	1.6 kg (3.52 lbs.)
Electrical	EnergyStar Certified, External Power Adaptor 100-240 V AV, 50/60 Hz	EnergyStar Certified, External Power Adaptor 100-240 V AV, 50/60 Hz
Drawer Port	2 ports (Via y-type adaptor)	2 ports (Via y-type adaptor)
Performance Characteristics		
Memory	-	128 Mb SDRAM, 64 Mb Flash
NV Image Memory	256 Kbytes (Mono)	768 Kbytes (Mono)
Receive Buffer	4 Kbytes	4 Kbytes
User Define Buffer	12 Kbytes	12 Kbytes
Interface	Standard: USB V2.0 FS Optional: ① USB V2.0 FS + Serial ② USB V2.0 FS + Parallel ③ USB V2.0 FS + Ethernet ④ USB V2.0 FS + Dual Serial	① USB V2.0 FS + Ethernet + Serial ② USB V2.0 FS + Serial ③ USB V2.0 FS + Parallel ④ USB V2.0 FS + Dual Serial
Environment Characteristics		
Temperature	Operating: 0 ~ 40°C (32 ~ 104°F) Storage: -20 ~ 60°C (-4 ~ 140°F)	Operating: 0 ~ 40°C (32 ~ 104°F) Storage: -20 ~ 60°C (-4 ~ 140°F)
Humidity	Operating: 10 ~ 80% RH Storage: 10 ~ 90% RH	Operating: 10 ~ 80% RH Storage: 10 ~ 90% RH
Software		
Emulation	BXL / POS	BXL / POS
Driver / Utility	Windows Driver, OPOS/JPOS Driver, Linux/Mac CUPS Driver, Virtual COM USB/Ethernet Driver, Utility Program	Windows Driver, OPOS/JPOS Driver, Linux/Mac CUPS Driver, Virtual COM USB/Ethernet Driver, Utility Program, Network Auto Installer
SDK / Plugin	Android/iOS/Windows SDK, Linux SDK, Xamarin SDK, Chrome SDK, Web Print SDK, Cordova Plugin	Android/iOS/Windows SDK, Linux SDK, Xamarin SDK, Web Print SDK, Cordova Plugin
Application	mPrint App (Android, iOS)	mPrint App (Android, iOS)
MDM (Optional)	-	-
Fonts / Graphics / Symbologies		
Character Size	Font A: 12 x 24, Font B: 9 x 17, Font C: 9 x 24, KOR, CHN, JPN: 24 x 24	Font A: 12 x 24, Font B: 9 x 17, Font C: 9 x 24, KOR, CHN, JPN: 24 x 24
Characters Per Line	SRP-350III: Font A: 42, Font B, C: 56, KOR, CHN, JPN: 21 SRP-352III: Font A: 48, Font B, C: 64, KOR, CHN, JPN: 24	SRP-330III: Font A: 42, Font B, C: 56, KOR, CHN, JPN: 21 SRP-332III: Font A: 48, Font B, C: 64, KOR, CHN, JPN: 24
Character Sets	Alphanumeric: 95 Extended Graphics: 128 x 33 page International: 32	Alphanumeric: 95 Extended Graphics: 128 x 35 page International: 32
Graphics	Supporting user-defined fonts, graphics, formats and logos	Supporting user-defined fonts, graphics, formats, and logos
Barcode Symbologies	1D: Coda Bar, Code39, Code93, Code128, EAN-8, EAN-13, ITF, UPC-A, UPC-E 2D: Data Matrix, PDF417, QR Code	1D: Coda Bar, Code39, Code93, Code128, EAN-8, EAN-13, ITF, UPC-A, UPC-E 2D: Data Matrix, PDF417, QR Code
Accessories		
Standard Accessories	USB A-B Cable 1.8 m	2-inch Partition (58 mm), USB A-B Cable 1.8 m
Optional Accessories	Built-in SMPS, Vertical stand, Wall mount, Splash Proof Cover, External buzzer, B-Melodist, Serial Cable (9-9/25-9 pin), Parallel Cable	External buzzer, B-Melodist, Serial Cable (9-9/25-9 pin), Parallel Cable



SRP-330II

SRP-275III

STP-103III

Print Characteristics			
Print Method	Direct Thermal	9 Pin Serial Dot Matrix	Direct Thermal
Print Speed	Up to 220 mm/sec	Up to 5.1 lps (at 40 columns)	Up to 80 mm/sec
Print Resolution	SRP-330II: 180 dpi SRP-332II: 203 dpi	80 dpi (Horizontal) 144 dpi (Vertical)	203 dpi
Print Width	Up to 72 mm	Up to 63.5 mm	Up to 48 mm
Sensor	Paper End, Cover Open	Paper End, Paper Near End, Wall Mounting Paper Near End, Rear Cover Open, Black Mark	Paper End, Paper Near End, Cover Open
Media Characteristics			
Media Type	Receipt	Receipt	Receipt
Media Width	80 mm Optional 58 mm	76.5 mm	57.5 mm
Media Roll Diameter	Up to 80 mm	Up to 83 mm	Up to 60 mm
Media Thickness	0.05 ~ 0.08 mm	0.06 ~ 0.085 mm	0.05 ~ 0.08 mm
Supply Method	Easy Paper Loading	Easy Paper Loading	Easy Paper Loading
Physical Characteristics			
Dimensions (W x L x H)	145 x 198 x 146 mm (5.72 x 7.79 x 5.74 inch)	160 x 239 x 157 mm (6.29 x 9.40 x 6.18 inch)	116 x 180 x 90 mm (4.56 x 7.08 x 3.54 inch)
Weight	1.37 kg (3.02 lbs.)	A: 2.4 kg (5.29 lbs.) C: 2.5 kg (5.51 lbs.)	450 g (0.99 lbs.)
Electrical	EnergyStar Certified, External Power Adaptor 100-240 V AV, 50/60 Hz	EnergyStar Certified, External Power Supply Housed Internally (Adaptor 24V/2.5A), 50/60Hz	External Power Adaptor 100-240V AV, 50/60Hz
Drawer Port	2 ports (Via y-type adaptor)	2 ports (Via y-type adaptor)	2 ports (Via y-type adaptor)
Performance Characteristics			
NV Image Memory	768 Kbytes (Mono)	256 Kbytes (Mono)	256 Kbytes (Mono)
Receive Buffer	4 Kbytes	64 Kbytes	64 Kbytes
User Define Buffer	12 Kbytes	64 Kbytes	12 Kbytes
Interface	① USB V2.0 FS + Ethernet + Serial ② USB V2.0 FS + Serial ③ USB V2.0 FS + Parallel ④ USB V2.0 FS + Dual Serial	① USB V2.0 FS + Serial + Ethernet* ② USB V2.0 FS + Parallel ③ USB V2.0 FS + Serial * DHCP enabled	① USB V2.0 FS + Serial ② USB V2.0 FS + Parallel
Environment Characteristics			
Temperature	Operating: 0 ~ 40°C (32 ~ 104°F) Storage: -20 ~ 60°C (-4 ~ 140°F)	Operating: 0 ~ 40°C (32 ~ 104°F) Storage: -20 ~ 60°C (-4 ~ 140°F)	Operating: 0 ~ 40°C (32 ~ 104°F) Storage: -20 ~ 60°C (-4 ~ 140°F)
Humidity	Operating: 10 ~ 80% RH Storage: 10 ~ 90% RH	Operating: 10 ~ 80% RH Storage: 10 ~ 90% RH	Operating: 10 ~ 80% RH Storage: 10 ~ 90% RH
Software			
Emulation	BXL / POS	BXL / POS	BXL / POS
Driver / Utility	Windows Driver OPOS/JPOS Driver Linux/Mac CUPS Driver Virtual COM USB/Ethernet Driver Utility Program	Windows Driver OPOS/JPOS Driver Linux/Mac CUPS Driver Virtual COM USB/Ethernet Driver Utility Program	Windows Driver OPOS/JPOS Driver Linux/Mac CUPS Driver Virtual COM USB Driver Utility Program
SDK / Plugin	Android/iOS/Windows SDK Linux SDK Xamarin SDK Chrome SDK Web Print SDK Cordova Plugin	Android/iOS/Windows SDK Linux SDK Chrome SDK Web Print SDK	Android SDK Linux SDK Web Print SDK (Android)
Application	mPrint App (Android, iOS)	-	-
MDM (Optional)	-	BIXOLON Profile Manager - XPM™, XCM™ (Windows, Android)	-
Fonts / Graphics / Symbologies			
Character Size	Font A: 12 x 24, Font B: 9 x 17, Font C: 9 x 24, KOR, CHN, JPN: 24 x 24	Font A: 9 x 9, Font B: 7 x 9, KOR: 17 x 9, CHN: 16 x 16	Font A: 12 x 24, Font B: 9 x 17, Font C: 9 x 24, KOR, CHN, JPN: 24 x 24
Characters Per Line	SRP-330II: Font A: 42, Font B, C: 56, KOR, CHN, JPN: 21 SRP-332II: Font A: 48, Font B, C: 64, KOR, CHN, JPN: 24	Font A: 35 Font B: 40 KOR: 20 CHN: 22	Font A: 32, Font C: 42, KOR, CHN, JPN: 16
Character Sets	Alphanumeric: 95 Extended Graphics: 128 x 33 page International: 32	-	Alphanumeric: 95 Extended Graphics: 128 x 33 page International: 32
Graphics	Supporting user-defined fonts, graphics, formats and logos	Supporting user-defined fonts, graphics, formats and logos	Supporting user-defined fonts, graphics, formats and logos
Barcode Symbologies	1D: Coda Bar, Code39, Code93, Code128, EAN-8, EAN-13, ITF, UPC-A, UPC-E 2D: Data Matrix, PDF417, QR Code	-	-
Accessories			
Standard Accessories	2-inch Partition (58 mm), USB A-B Cable 1.8 m	-	USB A-B Cable 1.8 m, Serial Cable (25-9 pin), Parallel Cable
Optional Accessories	External buzzer, B-Melodist, Serial Cable (9-9/25-9 pin), Parallel Cable	Wall Mount, Splash Proof Cover, Ribbon Cartridge, B-Melodist, External Buzzer, USB A-B Cable 1.8m	External buzzer, B-Melodist,

KIOSK PRINTERS & PERIPHERALS



BK3-31 Series BK3-21

Print Characteristics		
Print Method	Direct Thermal	Direct Thermal
Print Speed	Up to 250 mm/s	Up to 250 mm/s
Print Resolution	203dpi	203dpi
Print Width	12 / 48 / 54 / 72 mm	12 / 48 / 54 mm
Sensor	Paper End, Cover Open, Near End, Black Mark	Paper End, Cover Open, Near End, Black Mark

Media Characteristics		
Media Type	Receipt, Ticket	Receipt
Media Width	20 / 58 / 60 / 80 / 83 mm	20 / 58 / 60 mm
Media Roll Diameter	BK3-31: 80 / 102 / 120 / 150 mm, BK3-32: Up to 250 mm	80 / 102 / 120 mm
Media Thickness	0.05 ~ 0.12 mm	0.05 ~ 0.12 mm
Supply Method	Easy Paper Loading	Easy Paper Loading

Physical Characteristics		
Dimensions (W x L x H)	BK3-31: Media Roll Diameter Φ80: 130 x 130 x 91 mm Media Roll Diameter Φ102: 130 x 137 x 99 mm Media Roll Diameter Φ120: 130 x 144 x 105 mm Media Roll Diameter Φ150: 130 x 160 x 105 mm	BK3-21: Media Roll Diameter Φ80: 109 x 130 x 91 mm Media Roll Diameter Φ102: 109 x 137 x 99 mm Media Roll Diameter Φ120: 109 x 144 x 105 mm
	BK3-31: Media Roll Diameter Φ80: 130 x 159 x 91 mm (Vertical) Media Roll Diameter Φ102: 130 x 167 x 99 mm Media Roll Diameter Φ120: 130 x 173 x 105 mm Media Roll Diameter Φ150: 130 x 189 x 105 mm BK3-32: Media Roll Diameter Φ250: 130 x 339 x 145 mm	BK3-21: Media Roll Diameter Φ80: 109 x 160 x 91 mm (Vertical) Media Roll Diameter Φ102: 109 x 167 x 99 mm Media Roll Diameter Φ120: 109 x 173 x 105 mm
Weight	BK3-31: 700 g, BK3-32: 1,470 g	600 g
Electrical	100-240 V AV, 50/60 Hz	100-240 V AV, 50/60 Hz
Lever Direction	Left, Right	Right
Mount Direction	BK3-31: Horizontal / Vertical, BK3-32: Horizontal	Horizontal / Vertical

Performance Characteristics		
NV Image Memory	256 Kbytes (Mono)	256 Kbytes (Mono)
Receive Buffer	64 Kbytes	64 Kbytes
User Define Buffer	12 Kbytes	12 Kbytes
Interface	Standard: USB (V2.0 Full Speed) + Serial Optional: USB (V2.0 Full Speed) + Serial + Ethernet	USB (V2.0 Full Speed) + Serial
Connector Type	Power	DC-Jack or 2P Connector
	USB	USB B or 4P Connector
	Serial	9P Male or 5P Connector

Environment Characteristics		
Temperature	Operating: -20 ~ 60°C (-4 ~ 140°F) ※ Optimal printing performances and maximum reliability will be obtained between 0 and 40°C Storage: -20 ~ 60°C (-4 ~ 140°F)	Operating: -20 ~ 60°C (-4 ~ 140°F) ※ Optimal printing performances and maximum reliability will be obtained between 0 and 40°C Storage: -20 ~ 60°C (-4 ~ 140°F)
Humidity	Operating: 10 ~ 95% (non-condensing), Storage: 10 ~ 95% (non-condensing) excluding paper	Operating: 10 ~ 95% (non-condensing), Storage: 10 ~ 95% (non-condensing) excluding paper

Software		
Emulation	BXL / POS	BXL / POS
Driver / Utility	Windows Driver, OPOS Driver, Linux / Mac CUPS Driver, Utility Program, Network Auto Installer	Windows Driver, OPOS Driver, Linux / Mac CUPS Driver, Utility Program, Network Auto Installer
SDK / Plugin	Android SDK, Windows SDK, Linux SDK	Android SDK, Windows SDK, Linux SDK

Fonts / Graphics / Symbolologies		
Character Size	Font A: 12 x 24, Font B: 9 x 17, Font C: 9 x 24, KOR, CHN, JPN: 24 x 24 Print width 12 mm: Font A: 8, Font B, C: 10, KOR, CHN, JPN: 4 Print width 48 mm: Font A: 32, Font B, C: 42, KOR, CHN, JPN: 16 Print width 54 mm: Font A: 36, Font B, C: 48, KOR, CHN, JPN: 18 Print width 72 mm: Font A: 48, Font B, C: 64, KOR, CHN, JPN: 24	Font A: 12 x 24, Font B: 9 x 17, Font C: 9 x 24, KOR, CHN, JPN: 24 x 24 Print width 12 mm: Font A: 8, Font B, C: 10, KOR, CHN, JPN: 4 Print width 48 mm: Font A: 32, Font B, C: 42, KOR, CHN, JPN: 16 Print width 54 mm: Font A: 36, Font B, C: 48, KOR, CHN, JPN: 18
Character Sets	Alphanumeric: 95 Extended Graphics: 128 x 35 page International: 32	Alphanumeric: 95 Extended Graphics: 128 x 35 page International: 32
Graphics	Supporting user-defined fonts, graphics, formats and logos	Supporting user-defined fonts, graphics, formats and logos
Barcode Symbolologies	1D: Coda Bar, Code 39, Code 93, Code 128, EAN-8, EAN-13, ITF, UPC-A, UPC-E 2D: Data Matrix, GS1-128, GS1 DataBar Stacked / Omnidirectional / Truncated / Limited / Expanded, PDF417, QR code	1D: Coda Bar, Code 39, Code 93, Code 128, EAN-8, EAN-13, ITF, UPC-A, UPC-E 2D: Data Matrix, GS1-128, GS1 DataBar Stacked / Omnidirectional / Truncated / Limited / Expanded, PDF417, QR code

Accessories		
Optional Accessories	SMPS (DC Jack), SMPS (2P Connector), Male to Male type Serial Cable, 5P to Male type Serial Cable, USB A-B Cable 1.8 m, Power Cord	SMPS (DC Jack), SMPS (2P Connector), Male to Male type Serial Cable, 5P to Male type Serial Cable, USB A-B Cable 1.8 m, Power Cord

Option		
Bezel	Type	Non-Bezel / Standard-Bezel (4 types) / LED-Bezel (Green) Non-Bezel / Standard-Bezel (4 types)
Presenter (BK3-31 Series only, LED-Bezel default)	Paper Stock Direction	Upper
	Media Width	80 mm
	Media Thickness	0.05 ~ 0.10 mm
	Media Length	50 ~ 250 mm
	Ejection Speed	250 mm/s (Max)
Ticket (BK3-31 Series only)	Media Width	60 mm
	Media Thickness	0.05 ~ 0.15 mm
	Print Speed	Up to 130 mm/s
	Thermal Print Head (TPH) Reliability	50 km
	Auto Cutter Reliability	0.3 Million Cuts

BCD-2000 BCD-3000

Display		
Display Method	STN LCD	STN LCD
Display Color	Blue / White	Blue / White
Background / Text (Image)		
Active Area (W) x (H) mm	118.5 x 45.5	96 x 19.2
Visual Area (W) x (H) mm	127.2 x 33.9	99 x 24
Brightness (cd/m ²)	100	100
Character Number (Letters) x (Lines)	30 x 4	20 x 2
Character Type(Set)	95 Alphanumeric, 6 International	95 Alphanumeric, 6 International
Character Pattern (W) x (H) dot	8 x 16, 9 x 17	8 x 16
Character Size (W) x (H) mm	4.24 x 8.48	4.8 x 9.6
Character Space (mm)	0.03	0.05
Receive Buffer (byte)	1K	1K

Emulation		
	ESC/POS, CD5220, UTC Enhance, UTC Standard, PD6000	ESC/POS, CD5220, UTC Enhance, UTC Standard, PD6000

Electrical		
Electrical	Voltage	USB: 5VDC ± 5% (USB Bus Power) RS232: 5VDC ~ 24VDC
	Current	500mA
Interface	RS232/USB	RS232 (for SRP-Q300 only) / USB

Software		
Driver	Windows Driver, OPOS Driver	Windows Driver, OPOS Driver
SDK	Android SDK, iOS SDK	Windows SDK, Android SDK, iOS SDK

Exterior		
Body Color	Ivory / Dark-Gray	Ivory / Black
Rotation Angle	Horizontal: +/-180° Vertical: 52° (5 positions)	Vertical: 35°
Overall Dimension (W x L x H) mm	BCD-2000A/AU: 162.5 x 97.6 x 167-521 BCD-2000N/NU: 161 x 75.8 x 153-507 BCD-2000DS: 220.4 x 105.4 x 174-528 BCD-2000WA/WAU: 162.5 x 166 x 189 BCD-2000WN/WNU: 161 x 152 x 178 BCD-2000WS: 220.4 x 173 x 193	130 x 110.3 x 68.5

Product weight (g)	850	250
--------------------	-----	-----

Environment & Reliability		
Operating Temperature	0 ~ 40°C (32 ~ 104°F)	0 ~ 40°C (32 ~ 104°F)
Operating Humidity	10 ~ 80%	10 ~ 80%
Storage Temperature	-20 ~ 55°C (-4 ~ 131°F)	-20 ~ 55°C (-4 ~ 131°F)
Storage Humidity	10 ~ 90%	10 ~ 90%
Reliability (Display) (hours)	50,000 (Backlight)	50,000 (Backlight)



Comparison Table of Linerless Printers

	SRP-S3000	SRP-S300 Series				SRP-S200
		SRP-S300TX, SRP-S320TX	SRP-S300T	SRP-S300LX	SRP-S300L	
Taken Sensor	•	•		×		•
Linerless Re-stick	•	•	•	•	•	•
Linerless Extreme	•	•		•		
Liner Label	•					

Comparison Table of SRP-Q300 Series

	SRP-QE300	SRP-Q300	SRP-Q300B	SRP-Q300H
Description	Economy Ver.	mPOS Printer	Q300 Built in Battery	B-gate mPOS Hub with Q300
Speed	Up to 200 mm/sec	Up to 220 mm/sec		
Sealing	IP21	IP21	None	
Dimension	128 x 125 x 125 mm (5.03 x 4.92 x 4.92 inch)		128 x 125 x 169.2 mm (5.03 x 4.92 x 6.66 inch)	128 x 125 x 160.2 mm (5.03 x 4.92 x 6.30 inch)
Weight	1.13 kg (2.49 lbs.)	1.23 kg (2.71 lbs.)	1.72 kg (3.79 lbs.)	1.38 kg (3.04 lbs)
Interface	USB V2.0 FS + Ethernet	Standard: USB V2.0 FS + Ethernet + 1 USB only Charging port Optional: ① Standard + WLAN ¹ ② Standard + Bluetooth WLAN ¹ : 802.11a/b/g/n (Infrastructure, Ad-hoc, Wi-Fi Direct, SoftAP) - WEP40/104, WPA1/2 (PSK, EAP)		4 USB Host ports (V2.0 HS) + 1 Device port (V2.0 HS) + 1 USB only Charging port + Ethernet + Bluetooth / WLAN ² WLAN ² : 802.11a/ac/b/g/n USB dongle type (Optional)
NFC				
Unicode	Not supported		Supported	
BCD-3000				

On board Type

Model	On board
SRP-103III	① USB V2.0 FS + Serial ② USB V2.0 FS + Parallel
SRP-330II	① USB V2.0 FS + Ethernet + Serial ② USB V2.0 FS + Serial ③ USB V2.0 FS + Parallel ④ USB V2.0 FS + Dual Serial
BGT-100P	3 USB Host ports (V2.0 HS) + 1 device port (V2.0 HS) + 1 USB Host with charging + Ethernet + Bluetooth + WLAN
SRP-Q300 Series	Standard: USB V2.0 FS + Ethernet + 1 USB only Charging port Optional: ① Standard + WLAN ¹ ② Standard + Bluetooth
SRP-QE300	USB V2.0 FS + Ethernet
SRP-Q300H	4 USB Host ports (V2.0 HS) + 1 Device port (V2.0 HS) + 1 USB only Charging port + Ethernet + Bluetooth / WLAN
SRP-275III	① USB V2.0 FS + Serial + Ethernet ② USB V2.0 FS + Parallel ③ USB V2.0 FS + Serial
SRP-S3000	Standard: USB V2.0 HS + 1 USB Host port + Ethernet + Serial Optional: ① USB V2.0 HS + 1 USB Host port + Ethernet + Serial + WLAN ② USB V2.0 HS + 1 USB Host port + Ethernet + Serial + Bluetooth
SRP-330III	① USB + Ethernet + Serial ② USB + Serial ③ USB + Parallel ④ USB + Dual Serial

Interface Card Reference

Model	On board	Serial			Parallel		S + USB	USB		Ethernet	Bluetooth	WLAN	B-gate
		IFA-S V2	IFJ-SD	IFJ-S	IFA-P	IFJ-P	IFA-SU	IFA-U	IFJ-PW (Powered USB)	IFJ-E	IFJ-Ba	IFJ-Wda	IFJ-BGT
SRP-270	-	•			•		•	•		•			
SRP-350III	USB		•	•	•	•				•			
SRP-350plusIII	USB, Ethernet		•	•	•	•		•			•	•	
SRP-F310II	USB, Ethernet		•	•	•	•		•			•	•	•
SRP-380	USB		•	•	•	•		•		•	•	•	
SRP-S300	USB		•	•	•	•		•		•	•	•	•
SRP-350V	USB		•	•	•	•				•			
SRP-350plusV	USB, Ethernet		•	•	•	•		•			•	•	

B-linerless™

The B-linerless™ label is an environmental friendly labelling solution eliminating the requirement of silicon liner backing waste on its labels. Available in two different adhesive strengths - B-linerless™ Permanent and B-linerless™ Re-stick.



Product Line		B-linerless™ Permanent						
Model Name		BL-PM058-01	BL-PM080-01	BL-PM112-01	BL-PP080-01	BL-PP058-01	BL-PP080-02	BL-PL100-02
Applicable models		SPP-R200III, XM7-20, SRP-S3000	SPP-R310, SPP-L310, SPP-L3000, SRP-S3000	SPP-R410, SPP-L410, XM7-40	SRP-S300 Series, SRP-S3000	XL5-40, SRP-S300 Series, SRP-S3000	XL5-40, SRP-S300 Series, SRP-S3000	XL5-40
Dimensions of the product	width (mm)	58	80	112	80	58	80	100
	length (m)	10	17	24	80	70	70	100
Number of rolls in carton		200	30	30	5	40	24	18

Product Line		B-linerless™ Restick			
Model Name		BL-RP040-01	BL-RP040-02	BL-RP058-01	BL-RP080-01
Applicable models		SRP-S200, SRP-S300 Series, SRP-S3000			SRP-S300 Series, SRP-S3000
Dimensions of the product	width (mm)	40	40	58	80
	length (m)	82	82	82	82
Number of rolls in carton		30	30	12	30

B-band™

B-band™ are hardwearing printable wristbanding solutions available in Lux and Flex versions. Ideal for patient identification in hospitals, ticketing in amusement park, parties/events, as well as crop management.



B-band™ Lux		B-band™ Flex	
	Nylon material		Polypropylene material
	Luxurious Touch		Flexible Touch
	Anti allergic reaction for infants use - MSDS Certified		MSDS certified
	Runproof from humidity, temperature or alcohol		Waterproof

	Length	Color
Adult	20 x 270 mm (0.8 x 10.6 inch)	White, Blue, Green, Pink
Child	20 x 178 mm (0.8 x 7 inch)	
Infant	20 x 153 mm (0.8 x 6 inch)	

B-post Label™

B-post Label™ is a label solution featuring an adhesive-free black mark on the reverse of the label, making it ideal for printing labels of various sizes for the Postal Industry.



Cost-Efficiency

- Reduces the amount of printing hardware required to print various labels on different types of media
- Using only one printer enables space utilization
- Enhances productivity enabling easy media changes for different applications
- Maintains the high performance of the Auto Cutter by cutting on a non-glued position on a label of continuous length

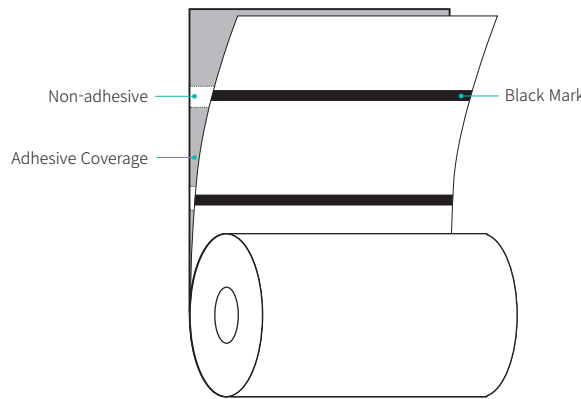

B-ribbon™

The B-ribbon™ can be used with BIXOLON Thermal Transfer Label Printers consisting of Wax, Wax/Resin and Resin types.

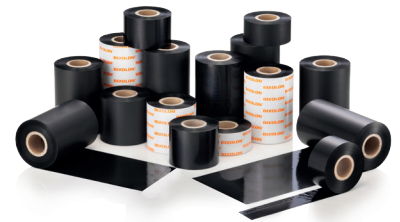
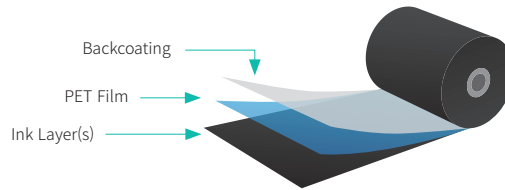

	B-Ribbon™ WAX		B-Ribbon™ WAX-RESIN		B-Ribbon™ RESIN	
	Premium	Standard	Premium	Standard	Premium	Standard
Model Name	BR-WX12	BR-WX11	BR-WR12	BR-WR11	BR-RS12	BR-RS11
Inner Core	0.5 or 1 inch	0.5 or 1 inch	0.5 or 1 inch	0.5 or 1 inch	0.5 or 1 inch	0.5 or 1 inch
Width	30 ~ 110 mm	30 ~ 110 mm	30 ~ 110 mm	30 ~ 110 mm	30 ~ 110 mm	30 ~ 110 mm
Length	300, 450, 600 m	300, 450, 600 m	300, 450, 600 m	300, 450, 600 m	300, 450, 600 m	300, 450, 600 m
Print Resistance	38	30	58	50	85	80
PET Film	4.5 µm	4.5 µm	4.5 µm	4.5 µm	4.5 µm	4.5 µm
INK	Wax	Wax	Wax-Resin	Wax-Resin	Resin	Resin
Melting Point	65°C / 149°F	65°C / 149°F	85°C / 185°F	75°C / 167°F	80°C / 176°F	80°C / 176°F
Back Coating	Silicon based	Silicon based	Silicon based	Silicon based	Silicon based	Silicon based
Coefficient of Friction	Kd < 0.2	Kd < 0.2	Kd < 0.2	Kd < 0.2	Kd < 0.2	Kd < 0.2
Ribbon Thickness	< 9 µm	< 9 µm	< 9 µm	< 9 µm	< 9 µm	< 9 µm
Storage	12 months recommended	12 months recommended	12 months recommended	12 months recommended	12 months recommended	12 months recommended
Humidity	20 ~ 80%	20 ~ 80%	20 ~ 80%	20 ~ 80%	20 ~ 80%	20 ~ 80%
Temperature	5 ~ 35°C (40 ~ 95°F)	5 ~ 35°C (40 ~ 95°F)	5 ~ 35°C (40 ~ 95°F)	5 ~ 35°C (40 ~ 95°F)	5 ~ 35°C (40 ~ 95°F)	5 ~ 35°C (40 ~ 95°F)
Printing Quality and Speed						
Sharpness	85	80.00	95.00	90.00	95.00	95.00
Blackness	2.00	2.10	2.10	2.10	1.70	2.00
Printing Speed	Up to 12 ips	Up to 12 ips	Up to 12 ips	Up to 12 ips	Up to 10 ips	Up to 10 ips
Vertical Barcode	75.00	60.00	90.00	85.00	95.00	95.00
Horizontal Barcode	100.00	100.00	100.00	100.00	100.00	100.00
Resistance						
Mechanical	55.00	40.00	70.00	60.00	95.00	95.00
Solvents	0.00	0.00	0.00	0.00	60.00	50.00
Heat	100°C (212°F)	60°C (140°F)	150°C (302°F)	100°C (212°F)	180°C (356°F)	180°C (356°F)
Light	7.5	7.5	7.5	7.5	7.5	7.5
Water	100	100	100	100	100	100

To give the convenience with the best printer solution on the market, BIXOLON provides full support for industry standard development platforms.



		Mobile Printers										Label Printers											
		XM7 Series	SPP-L3000	SPP-L410	SPP-L310	SPP-R410	SPP-R310	SPP-R200III	SPP-R210	SPP-C300	SPP-C200	XT5-40 Series	XT3-40	XQ-840	XL5-40	XD5-40 Series	XD3-40 Series	SLP-TX400 Series	SLP-TX420	SRP-E770III	SLP-DL410 Series	SLP-TX220	SLP-DX220
Windows Driver	Windows Server 2008 32 bit / 64 bit	●	●	●	●	●	●	●	●	●	●	●	●		●	●	●	●	●	●	●	●	●
	Windows Server 2008 R2 64 bit	●	●	●	●	●	●	●	●	●	●	●	●		●	●	●	●	●	●	●	●	●
	Windows 7 32 bit / 64 bit	●	●	●	●	●	●	●	●	●	●	●	●		●	●	●	●	●	●	●	●	●
	Windows 8 32 bit / 64 bit	●	●	●	●	●	●	●	●	●	●	●	●		●	●	●	●	●	●	●	●	●
	Windows Server 2012 64 bit	●	●	●	●	●	●	●	●	●	●	●	●		●	●	●	●	●	●	●	●	●
	Windows 10 32bit / 64 bit	●	●	●	●	●	●	●	●	●	●	●	●		●	●	●	●	●	●	●	●	●
OPOS Driver	Windows 11 64 bit	●	●	●	●	●	●	●	●	●	●	●		●	●	●	●	●	●	●	●	●	●
	Windows Server 2008 32 bit / 64 bit	●	●	●	●	●	●	●	●	●	●	●		●	●	●	●	●	●	●	●	●	●
	Windows Server 2008 R2 64 bit	●	●	●	●	●	●	●	●	●	●	●		●	●	●	●	●	●	●	●	●	●
	Windows 7 32 bit / 64 bit	●	●	●	●	●	●	●	●	●	●	●		●	●	●	●	●	●	●	●	●	●
	Windows 8 32 bit / 64 bit	●	●	●	●	●	●	●	●	●	●	●		●	●	●	●	●	●	●	●	●	●
	Windows Server 2012 64 bit	●	●	●	●	●	●	●	●	●	●	●		●	●	●	●	●	●	●	●	●	●
JPOS Driver	Windows 10 32bit / 64 bit	●	●	●	●	●	●	●	●	●	●	●		●	●	●	●	●	●	●	●	●	●
	Windows 11 64 bit	●	●	●	●	●	●	●	●	●	●	●		●	●	●	●	●	●	●	●	●	●
	Windows 7 32 bit / 64 bit	●	●	●	●	●	●	●	●	●	●	●		●	●	●	●	●	●	●	●	●	●
	Windows 8 32 bit / 64 bit	●	●	●	●	●	●	●	●	●	●	●		●	●	●	●	●	●	●	●	●	●
Linux CUPS Driver	Linux Kernel 2.6.32 and later	●	●	●	●	●	●	●	●	●	●	●		●	●	●	●	●	●	●	●	●	●
	Linux Kernel 2.6.32 and later	●	●	●	●	●	●	●	●	●	●	●		●	●	●	●	●	●	●	●	●	●
Linux SDK	Linux Kernel 2.6.32 and later	●	●	●	●	●	●	●	●	●	●	●		●	●	●	●	●	●	●	●	●	●
	Mac OS X 10.7, 10.8	●	●	●	●	●	●	●	●	●	●	●		●	●	●	●	●	●	●	●	●	●
Mac Driver	Mac OS X 10.9	●	●	●	●	●	●	●	●	●	●	●		●	●	●	●	●	●	●	●	●	●
	Mac OS X 10.10 and later	●	●	●	●	●	●	●	●	●	●	●		●	●	●	●	●	●	●	●	●	●
Virtual COM Driver	Virtual COM USB Driver	●	●	●	●					●	●	●		●	●	●	●	●	●	●	●	●	●
	Virtual COM Ethernet Driver	●	●	●	●					●	●	●		●	●	●	●	●	●	●	●	●	●
Web Print SDK	Windows 7 32 bit / 64 bit	●	●			●	●	●	●	●	●	●		●	●	●	●	●	●	●	●	●	●
	Windows 8 32 bit / 64 bit	●	●			●	●	●	●	●	●	●		●	●	●	●	●	●	●	●	●	●
	Windows 10 32bit / 64 bit	●	●			●	●	●	●	●	●	●		●	●	●	●	●	●	●	●	●	●
	Windows 11 64 bit	●	●			●	●	●	●	●	●	●		●	●	●	●	●	●	●	●	●	●
	Android 6.0 and later	●	●			●	●	●	●	●	●	●		●	●	●	●	●	●	●	●	●	●
iOS SDK	iOS 12.0 and later	●	●			●	●	●	●	●	●		●	●	●	●	●	●	●	●	●	●	●
Android SDK	iOS 9.0 and later	●	●	●	●					●	●	●		●	●	●	●	●	●	●	●	●	●
	Android 2.3 and later																						
	Android 3.1 and later	●	●	●	●																		
	Android 3.2 and later																						
Windows SDK	Android 4.0 and later					●	●	●	●	●	●												
	Windows XP 32 bit / 64 bit	●	●	●	●	●	●	●	●	●	●	●		●	●	●	●	●	●	●	●	●	●
	Windows Server 2003 32 bit / 64 bit	●	●	●	●	●	●	●	●	●	●	●		●	●	●	●	●	●	●	●	●	●
	Windows VISTA 32 bit / 64 bit	●	●	●	●	●	●	●	●	●	●	●		●	●	●	●	●	●	●	●	●	●
	Windows Server 2008 32 bit / 64 bit	●	●	●	●	●	●	●	●	●	●	●		●	●	●	●	●	●	●	●	●	●
	Windows Server 2008 R2 64 bit	●	●	●	●	●	●	●	●	●	●	●		●	●	●	●	●	●	●	●	●	●
	Windows 7 32 bit / 64 bit	●	●	●	●	●	●	●	●	●	●	●		●	●	●	●	●	●	●	●	●	●
	Windows 8 32 bit / 64 bit	●	●	●	●	●	●	●	●	●	●	●		●	●	●	●	●	●	●	●	●	●
	Windows Server 2012 64 bit	●	●	●	●	●	●	●	●	●	●	●		●	●	●	●	●	●	●	●	●	●
	Windows 10 32bit / 64bit	●	●	●	●	●	●	●	●	●	●	●		●	●	●	●	●	●	●	●	●	●
Windows SDK (CE/Mobile)	Windows 11 64bit	●	●	●	●	●	●	●	●	●	●		●	●	●	●	●	●	●	●	●	●	●
	Windows CE 5.0 and later	●	●	●	●	●	●	●	●	●	●	●		●	●	●	●	●	●	●	●	●	●
Xamarin SDK	Windows Mobile 5.0 and later	●	●	●	●	●	●	●	●	●	●		●	●	●	●	●	●	●	●	●	●	●
	Windows 10 32 bit / 64 bit	●	●	●	●	●	●	●	●	●	●		●	●	●	●	●	●	●	●	●	●	●
	Windows 11 64 bit	●	●	●	●	●	●	●	●	●	●		●	●	●	●	●	●	●	●	●	●	●
Cordova Plugin	Android 4.0 and later.	●	●	●	●	●	●	●	●	●	●		●	●	●	●	●	●	●	●	●	●	●
	iOS 12.0 and later	●	●	●	●	●	●	●	●	●	●		●	●	●	●	●	●	●	●	●	●	●
	Windows 10 32 bit / 64 bit	●	●	●	●	●	●	●	●	●	●		●	●	●	●	●	●	●	●	●	●	●
Chrome SDK	Android 4.0 and later	●	●	●	●	●	●	●	●	●	●		●	●	●	●	●	●	●	●	●	●	●
	iOS 9.0 and later	●	●	●	●	●	●	●	●	●	●		●	●	●	●	●	●	●	●	●	●	●
XPM™ (Optional)	Chrome Browser V49 and later	●	●	●	●	●	●	●	●	●	●		●	●	●	●	●	●	●	●	●	●	●
	Windows 10 64 bit	●	●											●	●	●	●	●	●	●	●	●	●
	Windows 11 64 bit	●	●											●	●	●	●	●	●	●	●	●	●
	Windows Server 2012 64 bit	●	●											●	●	●	●	●	●	●	●	●	●
XCM™ (Optional)	Windows Server 2016 64 bit	●	●											●	●	●	●	●	●	●	●	●	●
	Windows VISTA 32 bit / 64 bit	●	●											●	●	●	●	●	●	●	●	●	●
	Windows 7 32 bit / 64 bit	●	●											●	●	●	●	●	●	●	●	●	●
	Windows 8 32 bit / 64 bit	●	●											●	●	●	●	●	●	●	●	●	●
	Windows 10 32bit / 64bit	●	●											●	●	●	●	●	●	●	●	●	●
SOTI Connect	Windows 11 64bit	●	●											●	●	●	●	●	●	●	●	●	●
	Android 6.0 and later	●	●											●	●	●	●	●	●	●	●	●	●
SAP® Device Driver		●	●	●	●								●	●	●	●	●	●	●	●	●	●	●

* SDK: Software Development Kit



		B-GATE & POS Printers																Kiosk Printers & Peripherals		
		SRP-Q300 Series	SRP-QE300	SRP-Q200	BGT-100P	SRP-S3000	SRP-S300 Series	SRP-S200	SRP-F310II	SRP-380	SRP-350 plusV	SRP-350 plusIII	SRP-350V	SRP-350III	SRP-330III	SRP-330II	SRP-275III	STP-103III	BK3 Series	BCD-2000/3000
Windows Driver	Windows Server 2008 32 bit / 64 bit	•	•	•	•	•	•	•	•	•	•	•	•	•	•	•	•	•	•	•
	Windows Server 2008 R2 64 bit	•	•	•	•	•	•	•	•	•	•	•	•	•	•	•	•	•	•	•
	Windows 7 32 bit / 64 bit	•	•	•	•	•	•	•	•	•	•	•	•	•	•	•	•	•	•	•
	Windows 8 32 bit / 64 bit	•	•	•	•	•	•	•	•	•	•	•	•	•	•	•	•	•	•	•
	Windows Server 2012 64 bit	•	•	•	•	•	•	•	•	•	•	•	•	•	•	•	•	•	•	•
	Windows 10 32bit / 64 bit	•	•	•	•	•	•	•	•	•	•	•	•	•	•	•	•	•	•	•
OPOS Driver	Windows 11 64 bit	•	•	•	•	•	•	•	•	•	•	•	•	•	•	•	•	•	•	•
	Windows Server 2008 32 bit / 64 bit	•	•	•	•	•	•	•	•	•	•	•	•	•	•	•	•	•	•	•
	Windows Server 2008 R2 64 bit	•	•	•	•	•	•	•	•	•	•	•	•	•	•	•	•	•	•	•
	Windows 7 32 bit / 64 bit	•	•	•	•	•	•	•	•	•	•	•	•	•	•	•	•	•	•	•
	Windows 8 32 bit / 64 bit	•	•	•	•	•	•	•	•	•	•	•	•	•	•	•	•	•	•	•
	Windows Server 2012 64 bit	•	•	•	•	•	•	•	•	•	•	•	•	•	•	•	•	•	•	•
JPOS Driver	Windows 10 32bit / 64 bit	•	•	•	•	•	•	•	•	•	•	•	•	•	•	•	•	•	•	•
	Windows 11 64 bit	•	•	•	•	•	•	•	•	•	•	•	•	•	•	•	•	•	•	•
	Linux Kernel 2.6.32 and later	•	•	•	•	•	•	•	•	•	•	•	•	•	•	•	•	•	•	•
Linux CUPS Driver	Linux Kernel 2.6.32 and later	•	•	•	•	•	•	•	•	•	•	•	•	•	•	•	•	•	•	•
Linux SDK	Linux Kernel 2.6.32 and later	•	•	•	•	•	•	•	•	•	•	•	•	•	•	•	•	•	•	•
Mac Driver	Mac OS X 10.7, 10.8	•	•	•	•	•	•	•	•	•	•	•	•	•	•	•	•	•	•	•
	Mac OS X 10.9	•	•	•	•	•	•	•	•	•	•	•	•	•	•	•	•	•	•	•
	Mac OS X 10.10 and later	•	•	•	•	•	•	•	•	•	•	•	•	•	•	•	•	•	•	•
Virtual COM Driver	Virtual COM USB Driver	•	•	•	•	•	•	•	•	•	•	•	•	•	•	•	•	•	•	•
	Virtual COM Ethernet Driver	•	•	•	•	•	•	•	•	•	•	•	•	•	•	•	•	•	•	•
Web Print SDK	Windows 7 32 bit / 64 bit	•	•	•	•	•	•	•	•	•	•	•	•	•	•	•	•	•	•	•
	Windows 8 32 bit / 64 bit	•	•	•	•	•	•	•	•	•	•	•	•	•	•	•	•	•	•	•
	Windows 10 32bit / 64 bit	•	•	•	•	•	•	•	•	•	•	•	•	•	•	•	•	•	•	•
	Windows 11 64 bit	•	•	•	•	•	•	•	•	•	•	•	•	•	•	•	•	•	•	•
	Android 6.0 and later	•	•	•	•	•	•	•	•	•	•	•	•	•	•	•	•	•	•	•
iOS SDK	iOS 12.0 and later	•	•	•	•	•	•	•	•	•	•	•	•	•	•	•	•	•	•	•
Android SDK	iOS 9.0 and later	•	•	•	•	•	•	•	•	•	•	•	•	•	•	•	•	•	•	•
	Android 2.3 and later	•	•	•	•	•	•	•	•	•	•	•	•	•	•	•	•	•	•	•
	Android 3.1 and later	•	•	•	•	•	•	•	•	•	•	•	•	•	•	•	•	•	•	•
	Android 3.2 and later	•	•	•	•	•	•	•	•	•	•	•	•	•	•	•	•	•	•	•
Windows SDK	Android 4.0 and later	•	•	•	•	•	•	•	•	•	•	•	•	•	•	•	•	•	•	•
	Windows XP 32 bit / 64 bit	•	•	•	•	•	•	•	•	•	•	•	•	•	•	•	•	•	•	•
	Windows Server 2003 32 bit / 64 bit	•	•	•	•	•	•	•	•	•	•	•	•	•	•	•	•	•	•	•
	Windows VISTA 32 bit / 64 bit	•	•	•	•	•	•	•	•	•	•	•	•	•	•	•	•	•	•	•
	Windows Server 2008 32 bit / 64 bit	•	•	•	•	•	•	•	•	•	•	•	•	•	•	•	•	•	•	•
	Windows Server 2008 R2 64 bit	•	•	•	•	•	•	•	•	•	•	•	•	•	•	•	•	•	•	•
	Windows 7 32 bit / 64 bit	•	•	•	•	•	•	•	•	•	•	•	•	•	•	•	•	•	•	•
	Windows 8 32 bit / 64 bit	•	•	•	•	•	•	•	•	•	•	•	•	•	•	•	•	•	•	•
	Windows Server 2012 64 bit	•	•	•	•	•	•	•	•	•	•	•	•	•	•	•	•	•	•	•
Windows SDK (CE/Mobile)	Windows 10 32bit / 64bit	•	•	•	•	•	•	•	•	•	•	•	•	•	•	•	•	•	•	•
	Windows 11 64bit	•	•	•	•	•	•	•	•	•	•	•	•	•	•	•	•	•	•	•
Xamarin SDK	Windows CE 5.0 and later	•	•	•	•	•	•	•	•	•	•	•	•	•	•	•	•	•	•	•
	Windows Mobile 5.0 and later	•	•	•	•	•	•	•	•	•	•	•	•	•	•	•	•	•	•	•
	Windows 10 32 bit / 64 bit	•	•	•	•	•	•	•	•	•	•	•	•	•	•	•	•	•	•	•
Cordova Plugin	Windows 11 64 bit	•	•	•	•	•	•	•	•	•	•	•	•	•	•	•	•	•	•	•
	Android 4.0 and later.	•	•	•	•	•	•	•	•	•	•	•	•	•	•	•	•	•	•	•
	iOS 12.0 and later	•	•	•	•	•	•	•	•	•	•	•	•	•	•	•	•	•	•	•
Chrome SDK	Windows 10 32 bit / 64 bit	•	•	•	•	•	•	•	•	•	•	•	•	•	•	•	•	•	•	•
	Chrome Browser V49 and later	•	•	•	•	•	•	•	•	•	•	•	•	•	•	•	•	•	•	•
	Windows 10 64 bit	•	•	•	•	•	•	•	•	•	•	•	•	•	•	•	•	•	•	•
XPM™ (Optional)	Windows 11 64 bit	•	•	•	•	•	•	•	•	•	•	•	•	•	•	•	•	•	•	•
	Windows Server 2012 64 bit	•	•	•	•	•	•	•	•	•	•	•	•	•	•	•	•	•	•	•
	Windows Server 2016 64 bit	•	•	•	•	•	•	•	•	•	•	•	•	•	•	•	•	•	•	•
XCM™ (Optional)	Windows VISTA 32 bit / 64 bit	•	•	•	•	•	•	•	•	•	•	•	•	•	•	•	•	•	•	•
	Windows 7 32 bit / 64 bit	•	•	•	•	•	•	•	•	•	•	•	•	•	•	•	•	•	•	•
	Windows 8 32 bit / 64 bit	•	•	•	•	•	•	•	•	•	•	•	•	•	•	•	•	•	•	•
	Windows 10 32bit / 64bit	•	•	•	•	•	•	•	•	•	•	•	•	•	•	•	•	•	•	•
SOTI Connect	Windows 11 64bit	•	•	•	•	•	•	•	•	•	•	•	•	•	•	•	•	•	•	•
	Android 6.0 and later	•	•	•	•	•	•	•	•	•	•	•	•	•	•	•	•	•	•	•
SAP® Device Driver					•															

* SDK: Software Development Kit

GAME CHANGER

