

Bodo's Power Systems®

Electronics in Motion and Conversion

June 2013

POLAR3™ POWER MOSFETS

NEXT GENERATION OF ENERGY-EFFICIENT AND RELIABLE POWER-SWITCHING SOLUTIONS

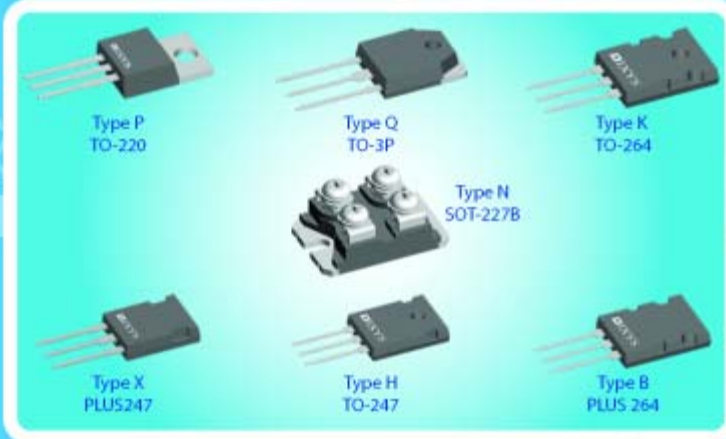

High voltage? **RELAX!**

Medium voltage components for power electronics

Does this sound familiar? Voltage increases, whenever it is least expected. Good for thrillers. Not so good for power electronic installations. That is why we developed our "ready-to-use switch components" based on IGBT and Thyristor technology, specifically for use in MV applications. They are even available with or without control or current loop feed power supply. So sit back, relax and look forward to an exciting conversation with your House of Competence. It's worth it.



- **MV IGBT DC switches**
- **MV Thyristor AC switches**
- **MV IGBT / Thyristor control**
- **MV current loop feed power supply**

engineered by

GVA
Power Electronics

Welcome to the House of Competence.

Read online and search for key subjects from all articles in Bodo's Power Systems by going to Powerguru:



Viewpoint 4
Being a Beach Boy for the Summer

Events 4

News 6-10

Blue Product of the Month 12
Achieve Improved Motion and Efficiency for Advanced Motor Control Designs in Minutes
Texas Instruments

Guest Editorial 14
Semiconductor Materials for the Future
By Ranbir Singh, GeneSiC

Market 16
Electronics Industry Digest
By Aubrey Dunford, Europartners

Market 18-19
Darnell Report
By Jeff Shepard, President, Darnell Group

Cover Story 20-24
Switching Performance Comparison between HiPerFET and Super Junction MOSFETs
By Abdus Sattar, IXYS Corporation

Power Quality 26-27
EMC for Renewable Energy, Eliminating Interference
By Ronald Seeger, TDK

Driver ICs 28-29
Driver and LED Companies must Work Together to Achieve High-Efficiency, Practical LED Lighting
By Andrew Smith, Product Marketing Manager, Power Integrations

Power Management 30-31
Synchronization of SMPS Power Modules
By Quentin Bichon and Seán Walsh, Texas Instruments, Freising, Germany

Thermal Management 32-33
The Good Gap-Filling Guide
By Mark Carter, Chomerics Division Europe - Parker Hannifin Ltd

IGBT Driver 34-36
Thermal Evaluation of High Voltage Half Bridge EiceDRIVER™ ICs with Integrated Bootstrap Diode
By Wolfgang Frank, Infineon Technologies AG, Neubiberg, Germany

Packaging 38-41
SMD Power GaN & SiC Devices on Power Boards Replace High Power 600V & 1200V IGBT Modules
By Courtney R. Furnival, CRFurnival@SPSPower.com

Capacitors 42-43
Capacitors Built to Customer Specifications
By Peter Fischer, Fischer & Tausche

Power Supply 44-46
Advanced Regulator Modules Bring Flexibility to High-Density Power Subsystems
By Ian Mazsa, Manager, VI Chip Product Line, Vicor

Power Supply 48-49
Improving Efficiency on AC-DC Supply Efficiency
By Don Knowles, VP Engineering, N2Power

New Products 50-64



Excellent Products Provide Perfect Solutions

- Discrete Thyristors / Chips
- Discrete Diodes / Chips
- Thyristor / Diode Modules
- Bridge Rectifiers
- Solid State Relays
- Power Stacks
- Custom Devices



Visit us at
PCIM Asia 2013
18-20 June, Shanghai
Booth 516

Zhejiang Guidu Power Electronic Co., Ltd

T 86-578-3185606
F 86-578-3185550
E sales@zjguidu.com
W www.zjguidu.com



The Gallery

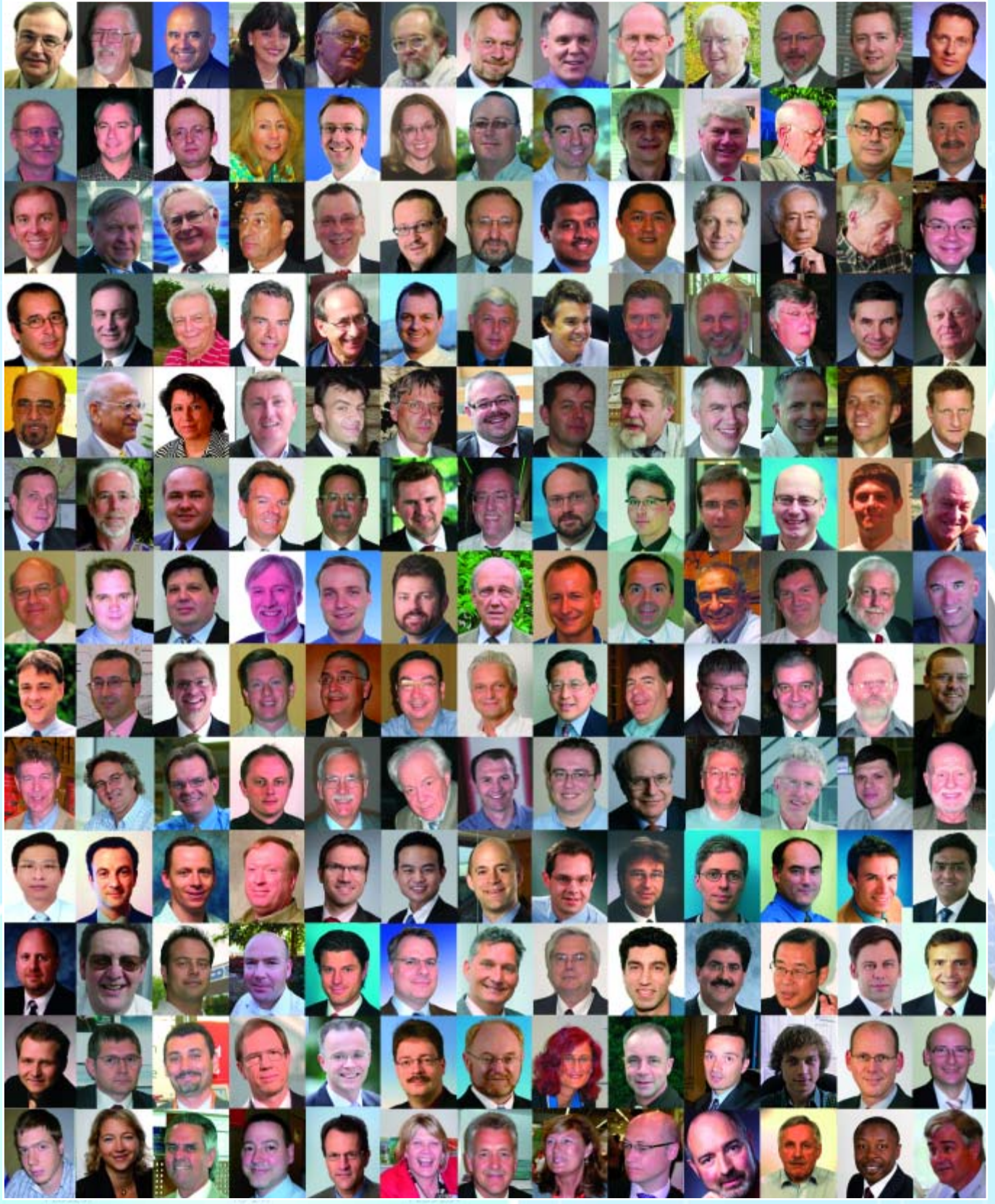

Renesas power solutions – a breakthrough in efficiency

If you are tired of wasting energy from power semiconductors in your power supply, inverters and motor control circuits, we've got a treat for you.



Come and take the efficiency challenge

Our best-in-class solutions are smart and efficient. We can help you:

- Minimise costs while increasing efficiency
- Increase light load efficiency to up to 95% for long battery life
- Achieve up to 96% efficiency in power distribution applications



www.full-of-power.com

Bodo's Power Systems®

A Media

Katzbek 17a
D-24235 Laboe, Germany
Phone: +49 4343 42 17 90
Fax: +49 4343 42 17 89
editor@bodospower.com
www.bodospower.com

Publishing Editor

Bodo Artl, *Dipl.-Ing.*
editor@bodospower.com

Senior Editor

Donald E. Burke, *BSEE, Dr. Sc(hc)*
don@bodospower.com

Corresponding Editor

Marisa Robles Consée,
Marisa@bodospower.com

Creative Direction & Production

Repro Studio Peschke
Repro.Peschke@t-online.de

Free Subscription to qualified readers

Bodo's Power Systems

is available for the following
subscription charges:

Annual charge (12 issues) is 150 €
world wide

Single issue is 18 €

subscription@bodospower.com

circulation  print run 20000

Printing by:

Druckhaus Main-Echo GmbH & Co KG
63741 Aschaffenburg, Germany

A Media and Bodos Power Systems assume and hereby disclaim any liability to any person for any loss or damage by errors or omissions in the material contained herein regardless of whether such errors result from negligence accident or any other cause whatsoever.

Events

CWIEME 2013,

Berlin, Germany, June 4th-6th
<http://coilwindingexpo.com>

Thermal Management 2013,

Denver, CO, June 6-7,
www.thermalnews.com/conferences/

ISiCPEAW 2013, Stockholm, Sweden,

June 9th -11th, www.acreo.se

Distributed Energy Storage,

London, UK, Jun-17th -18th
[www.smi-online.co.uk/
distributed-energy-storage32.asp](http://www.smi-online.co.uk/distributed-energy-storage32.asp)

PCIM Asia 2013,

Shanghai, China, June 18th -20th
www.mesago.de/de/AsiaPCIM/home.htm

COWEC Wind Energy,

Berlin, Germany, June 18th -19th
[www.vdi-wissensforum.de/en/cowec-
landingpage/event/02KO181013/](http://www.vdi-wissensforum.de/en/cowec-landingpage/event/02KO181013/)

Being a Beach Boy for the Summer

Summertime, up here in the northern areas, is something special. Now is the time that the Baltic Sea and North Sea provide for comfortable swimming. My neighbors started in May in the chilly water – like the Vikings ! For myself, I will wait until the water temperature is about 20 C (I may miss out this year). Definitely it is time to relax and recharge batteries for the exciting events yet to come this summer and autumn.

PCIM Europe in Nuremberg was a success for all - exhibitors, visitors, and the attendees of the conference. I remember the early days of PCIM Europe, and the years of growth since then. Celebrating 30 Years is a highlight for a Conference and Exhibition – now it is an institution that brings the Power Community together. Nuremberg has been an innovations hub since Peter Henlein made, and possibly even invented, watches back in 1505. Today it is semiconductors and drive applications that play the important role in Nuremberg, and the pace of change would make Henlein gasp. ECPE is an organization that recently celebrated its own milestone - ten successful years in Power Electronics, bringing companies and academia together in fast-paced R&D projects. It is obvious that time is moving by for us veterans, so it is important for young people to be motivated early to choose a technical profession. Time moves faster as we get older, true for young and old.

We are now approaching the annual Asian highlight – PCIM Asia, in Shanghai, in late June – keeping the successful year rolling, after APEC in Long Beach and PCIM in Nuremberg. It is a pleasure to see the contributions made by power electronic technology to a growing list of modern functions of ever higher efficiencies. The new semiconductor materials are becoming standard products to be used off the shelf from many manufactures. SiC and GaN are setting new standards for efficiency.

Energy harvesting has a very wide range of potential sources. The discussions at my PCIM podium generated some insight as to the current state-of-the-art, and an outlook to what is ahead of us. Interesting stuff !



Storage of electrical energy is critical in many applications. Electro-mobility will not become successful until we have an energy storage approach that makes driving longer distances not a gamble. We recognize that wind power and solar now contribute significant energy to the power grid. Excess generation from these renewable sources, that is, generation above the current demand level, should make us think of new alternatives to use the excess, such as to heat and store water for home heating. Modern grids and smart demand-side controls can communicate to make this happen. Large scale or highly diversified energy storage schemes await innovation.

Communication is the way to progress. We delivered twelve issues last year and will continue this year, each month, on time, every time. This year, with my June issue, we have 66 technical articles amongst 390 pages. As a media partner, Bodo's Power Systems is internationally positioned. If you speak the language, or just want to take a look, don't miss our Chinese version: www.bodospowerchina.com

My Green Power Tip for June:

The time for strawberries is coming. Go and pick them yourself in the fields. Eat as much as you can, you never can have them fresher. Take them home as well and have your family and friends enjoy them. Eating them in season saves a lot of refrigeration – and from the field they taste superb.

Best Regards,

Solar energy committed to a lifetime of safety and performance



CTSR

LEM commits to renewable energy sources of the future by enabling control and ensuring safety of today's solar power solutions. CTSR transducers combine safety and performance, accurately measuring small AC and DC leakage currents. Easy installation for single or three phase residual current measurement: CTSR is today's choice for the energy of tomorrow.

- Two nominal current ranges: 0.3 and 0.6 A_{RMS}
- Printed circuit mounting
- Large 20.1 mm diameter aperture
- Available with primary inserted conductor
- +5 V single supply
- Up to 11 mm creepage and clearance distances
+ CTI 600 for high insulation
- Low offset drift
- -40 to +105° C operation
- Reference Voltage access and control
- Self-test and degauss
- High overload capability: 3300 A

www.lem.com

At the heart of power electronics.



 LEM®

Infiniteon Technologies AG joins PowerGuru.org

The power electronics portal PowerGuru (www.powerguru.org) adds Infiniteon Technologies AG to its list of supporting companies. As a supporting company, Infiniteon will contribute content to the website including technical articles and information about products, jobs, and company activities.

As the one year anniversary of the website's launch in May, 2012 approaches, PowerGuru continues to build on its first-year successes with the addition of Infiniteon Technologies AG as a supporting company. With this addition, PowerGuru's roster of affiliates now includes Bodo's Power Systems, Infiniteon, LEM, Mersen, PCIM, Proton-Electrotex, SEMIKRON, Sindopower, TDK Epcos, and Weidmüller. PowerGuru will be working specifically with Infiniteon's Industrial Power Control (IPC) Division, which focuses primarily on components for drives in industrial applications, such as machines or locomotives, and energy generation components in solar or wind power plants. Infiniteon will make regular contributions to PowerGuru's content and be given a company category in the website's "Power Electronics Jobs" and "Industry News" sections.

"We attribute the success of our website over the past year to the support we've had from major players in the power electronics sector", explains Donald Dahl, PowerGuru Project Manager. "Infiniteon is a global leader in this field, and we are very excited to welcome them aboard."



*Another recent addition to PowerGuru is the PowerGuru Smart-Phone App.

Download the PowerGuru SmartPhone App for your Android or iPhone to easily access PowerGuru features such as Bodo's Power articles and Power Electronics News from your smart device.

www.powerguru.org

LED professional Symposium + Expo (LpS)



The leading European LED technology event in the lighting industry presents an extended program for 2013.

LED/OLED leading convention-trade show with 45 expert lectures, 5 workshops, 2 tech panels, 1 light art project, 80 exhibitors, 2,000 m² of exhibition space and over 1,000 expected visitors.

The LpS light convention-trade show opens its doors for the third year in a row in Bregenz, Austria, together with internationally renowned exhibitors and speakers and leading light industry organizations from around the world (LightingEurope, Zhaga, Assodel, EPIC, ISA, PIDA and LED Light for you). The president of LightingEurope and CEO of TRILUX, Mr. Dietmar Zembrot, will open the course of lectures with his keynote speech on the subject of "Challenges and Opportunities of the European Lighting Industry." Mr. Menno Treffers, the general secretary of the Zhaga Consortium will follow with "Zhaga – Lowering the Risk and Cost of Getting LED Technology Innovation to Market". Rounding the keynote speeches off, Dr. Alfred Felder, CEO of Tridonic will give some insights on the

topic of "Lighting Module and Component Industry – Market and Technology Opportunities".

Lectures, Workshops and Tech-Panels

This year, a total of 45 expert lectures were chosen from a large number of submissions by the advisory board from international experts to be presented during the three day symposium.

Exhibition and Networking

Over 80 well-known international companies from the areas of component and modules will be presenting their products on 2,000 m² of exhibition space. The LpS organizers are expecting over 1,000 visitors this year.

Light Art Project

This year a "Light Art Project" will be staged as an evening event. Zumtobel, a global player in the lighting industry, will present the criteria, design and practical effects of a modern light installation in the newly renovated "Vorarlberg Museum".

www.LpS2013.com/Registration

Largest Research Project to Strengthen Europe's Role as Semiconductor Production Site

Infiniteon Technologies AG has been hosting a two-day meeting at its Villach site to kick-off one of the largest European research projects focused on advancing industrial production capability. The research project, "Enhanced Power Pilot Line" (EPPL), is aimed at further strengthening Europe as a high-technology industrial production site. A total of 32 European partners from industry and research are collaborating to advance production technology for power semiconductors, an industry segment where Europe already has the leading position. Europe is home to the first power semiconductor production sites manufacturing devices using 300-millimeter thin-wafer technology, i.e. on silicon wafers with a 300mm diameter which in addition are

extremely thin: hardly thicker than a sheet of paper. With EPPL, Europe intends to further expand this production advantage.

The partner organizations cover the entire industry and research value chain of 300 millimeter power semiconductor production, comprising material research with a focus on silicon, semiconductor development that includes 3D integration and packaging, and related developments in logistics and automation technologies. The project will run until mid 2016, with Infiniteon as the project lead.

www.infineon.com

THANK YOU FOR
30 AMAZING YEARS

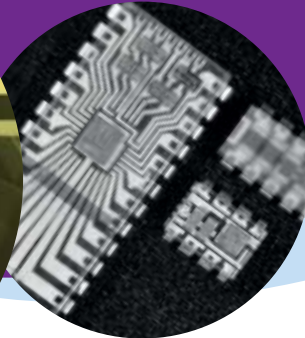

Our world changes by the nanosecond. New connections are formed. Old problems are solved. And what once seemed impossible is suddenly possible. You're doing amazing things with technology, and we're excited to be a part of it.

www.maximintegrated.com



© 2013 Maxim Integrated Products, Inc. All rights reserved. Maxim Integrated and the Maxim Integrated logo are trademarks of Maxim Integrated Products, Inc., in the United States and other jurisdictions throughout the world.

EPIC Publishes European Photonics Database, Report, and Map

EPIC, the European Photonics Industry Consortium, has published a public database of more than 5000 company entries, an interactive map, and a report on the photonics ecosystem in Europe. With the support and contribution of numerous associations, clusters, event organizers, media organizations, and all the individuals who contributed to the survey, EPIC compiled a database of companies active in the field of Photonics. The database lists companies that manufacture photonic related equipment/materials/components/systems or extensively use photonics components, or provide services to the European photonics ecosystem. The European photonics companies are segmented by the type of systems they provide, with respectively Sensing 27%, Imaging 17%, Transmitting information 11%, Information storage and Display 5% Light providing 19%, Energy providing 6%, and Processing 15%.

The survey breaks down the total market of 65,8 Billion EUR into Sensing & Imaging Systems 28.9B EUR, Communication Systems 7.2B EUR, Display/Imaging/Projectors 3.5B EUR, Lighting 12.5B EUR, Photovoltaic 4.4B EUR, and Lasers 9.4B EUR.

"One of the nice surprises of the study is the breakdown of final markets with a fairly uniform distribution, the photonics industry in Europe clearly tends to diversify" says Carlos Lee, Director General at EPIC. The final markets are Manufacturing 13%, Lab equipment 10%, Healthcare and biomedical 9%, Life science 7%, Automotive 6%, Defense 6%, Energy 5%, Consumer electronics 5%, Communications 5% and a large variety of other sectors. In addition to serving a variety of end-markets, European photonics companies are less exposed to the European crisis due to their strong exposure to for-

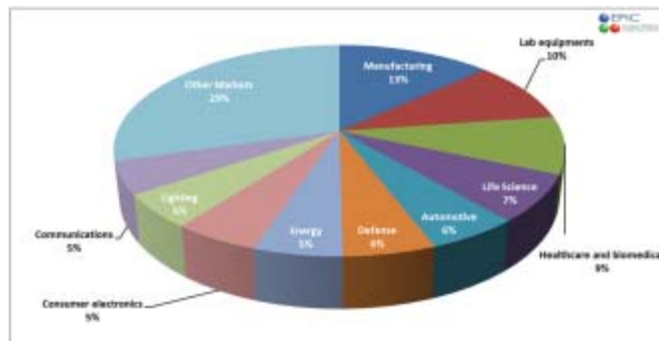

European Photonics companies by final markets

eign markets, more than 50% of sales are done outside Europe. "The photonics market is terrific for Europe! The photonics companies purchase and manufacture mainly in Europe, and sell mainly outside Europe." says Lee.

The survey also quantified Europe's photonics employment at 377.000 people. Most companies are small, 86% have less than a hundred employees, but those are the ones that forecast highest growth in employment. "The ratio turnover/staff between 150 and 250k€/employee reflects a generally high skilled workforce" says Lee. The database, report, and map are freely available from:

www.epic-assoc.com/database

Innovation Cluster for Renewable Energy



Itzehoe, Schleswig-Holstein, Germany, is located in the North border region to Denmark and has become a center for Power Electronics; one internationally respected. This Cluster structure is provided by the Fraunhofer ISIT and local industrial partners. At a ceremony at the Fraunhofer ISIT on May 2nd, the Governor of Schleswig Holstein, Mr. Torsten Albig, presented government funding for the Innovation Cluster for Renewable Energy. There will be a total of 4 million Euros involved in the program. The Fraunhofer organization and the state of Schleswig-Holstein are contributing 1 million Euros each, while the remaining will be invested by the several industry partners involved. The most prolific renewable energy resources in Schleswig-Holstein are generated by the Baltic Sea and the North Sea, and the sun. With wind and sun continuously available, the industrial partners will naturally focus on wind power and solar power.

www.isit.fraunhofer.de

Distribution Agreements in Europe

Advanced Power Electronics Corp. has signed a UK distribution deal with Neutron Ltd, covering the UK and Ireland and in addition Advanced Power Electronics Corp. has signed a distribution agreement with Compomill covering the Nordic and Baltic countries. Neutron LLP is an ISO9001 approved specialist distributor supplying a range of power components including diodes, mosfets, IGBTs, passives and wound components.

Compomill is one of the largest independent distributors in the region with sales offices in Sweden (Gothenburg, Stockholm and Malmo),

Finland (Espoo) and Denmark (Copenhagen) and bases its approach on thorough experience and technical competence.

Ralph Waggitt, President/CEO, Advanced Power Electronics Corp. (USA) stated: "We need specialist distributors in our key European territories to ensure that designers understand the performance and cost benefits offered by our wide portfolio of products."

www.a-powerusa.com

SILICA'S

BORN POWER

THE FUTURE OF
POWER DESIGN SUPPORT
STARTS NOW



Power 'n More is SILICA's solution to fulfil the escalating demand for professional development support in power electronics and power supply design – both at system and product level.

With a new, highly customized training concept, close collaboration with leading suppliers, and a comprehensive range of additional services, SILICA provides a revolutionary approach to technical support for every aspect of your power design, including:

- Qualified support team of 15 dedicated Power FAEs who have successfully completed over 1700 hours of intensive power training

- Fully-equipped power labs for project design and simulation (available soon!)
- Industry- leading portfolio of power products
- Support network of SILICA-certified independent consultants for power system design

Power 'n More offers the highest level of technical support available, covering everything from system specification advise, assistance with topology and layout - right through to product selection.

Power 'n More – the Future of Power Design Support starts now.

www.born-power.com

PRODUCED BY  **SILICA**[™]
An Avnet Company

WRITTEN AND DIRECTED BY



Power 'n More
SILICA Power Design Support

Education Solution Offers Comprehensive Advantage for Students

Zilog, an IXYS Company introduces its Educational Platform, which includes all of the necessary components and software to allow

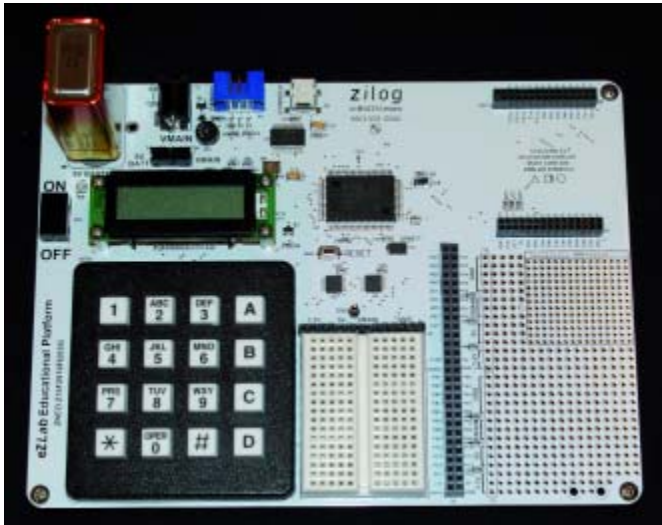

instructors and students to design with freedom. The Zilog Educational Platform is an electronics development system for learning and teaching at the university level, yet can also serve the needs of students at the high school level.

The core of the Zilog Educational Platform is Zilog's Z16F2810 MCU, a 16-bit Flash chip based on Zilog's ZNEO CPU. The Platform's robust educational capabilities allow students to learn about micro-controller architecture, language programming, wireless communication, analog-to-digital conversion, sensing technologies and security encryption methods; students can also experiment with creating industrial lighting and motor control applications. The Platform can also be configured as a data acquisition and remote control system. It ships with a command shell that allows control of the Platform without the need for additional programming.

The Zilog Educational Platform is supported by a wide assortment of application shields. These shields are application-specific modules that form part of the larger Zilog Education Solutions system.

www.zilog.com

Successful Market Launch of Heat Conducting Paste TIM

The Thermal Interface Material (TIM) developed by Infineon Technologies AG for the reduction of contact resistance between the metal surface of power semiconductors and the heat sink has been launched successfully. Using the EconoPACK™ + of the new D Series, customers were able to see for themselves that conductivity was substantially improved with the heat conducting paste. As a result of strong customer demand, Infineon is now planning to



expand the range. In the first quarter of 2014 the product groups 62mm, EconoDUAL™ 3 and PrimePACK™ 2 are going to be available with TIM pre-applied. Toward the end of the first half of 2014 the modules EconoPACK™ 4 and PrimePACK™ 3 as well as the modules Econo 2 and 3 are to be available with the material. The launch

of the TIM-applied production series Easy 1B and 2B, Smart 2 and 3, and IHM / IHV is planned for 2015.

In order to be able to meet the greatly increasing demand, Infineon has set up a production line for applying TIM to the modules at the Hungarian Backend site for power electronics in Cegléd. The thermally conductive paste is applied to the modules using a stencil-printing process. An elaborate quality assurance procedure integrated into the fabrication process guarantees that no air is trapped when joining the module and the heat sink. Special technical processes and machines were developed just for the fabrication process.

"TIM and the process developed by us for applying the paste makes it possible for the first time to assure a maximum value instead of typical values," says Dr. Martin Schulz, the manager responsible for qualification in Application Engineering at Infineon Technologies AG. "Against the background of increasingly higher power densities, the thermal budget can now be planned more precisely in the design stage of applications."

www.infineon.com/TIM

ABB to Acquire Power-One to Become a Global Leader in Solar Photovoltaic Inverters

The boards of ABB and Power-One have agreed to a transaction in which ABB will acquire Power-One at \$6.35 per share or approximately \$1 billion equity value, which includes Power-One's net cash of \$266 million. Combination creates global leader in the most attractive and "intelligent" part of the PV value chain. Deal gives Power-One access to ABB's substantial R&D, global service and sales capabilities and complements ABB's growing inverter business and leadership in power electronics.

Right time: Solar PV industry is set for 10 percent-plus annual growth as PV-generated power rapidly approaches grid parity in many countries and will change the energy mix in the long term.

Management continuity ensured Integration with proven approach into the Discrete Automation and Motion division. Transaction expected to close in 2H 2013, subject to shareholder and regulatory approvals

ABB and Power-One, Inc. announced that their boards of directors have agreed to a transaction in which ABB will acquire Power-One for \$6.35 per share in cash or \$1,028 million equity value..

www.abb.com

TI Power Design Tools

Getting you to market faster: free, quick and easy to use



PowerLab™ Power Reference Design Library

Find 900+ tested power management reference designs on the web.

ti.com/powerlab-eu



WEBENCH® Design Center

Solve your power supply design needs with a mouse click.

ti.com/webench-eu



Power Stage Designer™

Calculate and visualize the power stage of your power supply.

ti.com/powerstagedesigner

 **TEXAS INSTRUMENTS**

Learn more, find answers and stay up to date
www.ti.com/power-eu



Achieve Improved Motion and Efficiency for Advanced Motor Control Designs in Minutes

Optimize motor performance across speeds and simplify commissioning, tuning and motion sequencing using C2000™ Piccolo™ microcontrollers.

At long last, system designers have been liberated from limited operating ranges and time-consuming tuning processes with the new InstaSPIN™-MOTION motor control solution from Texas Instruments Incorporated (TI) (NASDAQ: TXN). InstaSPIN-MOTION is a comprehensive torque-, speed- and motion- control software solution that delivers robust system performance at the highest efficiency for motor applications that operate in various motion state transitions. Built upon TI's InstaSPIN™-FOC motor control solution, InstaSPIN-MOTION is uniquely designed to optimize complex motion sequences, reduce tuning to a single parameter and tracking desired trajectories with unmatched accuracy across operating ranges. It constitutes the easiest and most effective method for achieving optimized sensorless motor control.

TI's InstaSPIN-FOC solution, which was announced earlier this year, takes advantage of the FAST™ premium software sensor for rotor flux measurement and provides motor identification, automatic current control tuning and sensorless feedback in a field-oriented control (FOC) torque controller and speeds deployment of efficient, sensorless, variable load three-phase motor solutions.

InstaSPIN-MOTION further improves motor performance and development time

Adding additional motor control functionality, InstaSPIN-MOTION enables more expertise on chip. With the core algorithms embedded in the read-only-memory (ROM) on TI's 32-bit C2000™ Piccolo™ microcontrollers (MCUs), InstaSPIN-MOTION integrates SpinTAC™ components from LineStream Technologies, featuring optimized motion profiling, single-parameter tuning and a disturbance-rejecting controller, which speeds development and increases performance across changing speeds and loads.



InstaSPIN-MOTION can be used with sensorless feedback or with the included sensorless InstaSPIN-FOC solution.

InstaSPIN™-MOTION features and benefits:

Eliminate motion control challenges in traditional motor systems. InstaSPIN-MOTION removes the need for inefficient, older design techniques. For example, defining the motor's desired motion in other methods requires simplistic, inflexible trajectories, resulting in mechanical stress. Hand-coded, calculation-heavy trajectories consume valuable memory. Likewise, achieving desired motor performance across varying conditions requires multiple sets of multi-parameter, proportional-integral (PI) controllers needing time-intensive tuning.

InstaSPIN-MOTION's SpinTAC™ components include:

- **IDENTIFY:** Ensure optimum tracking and disturbance rejection, working with the real inertia of the system.
- **CONTROL:** Minimize effort and reduce complexity with single coefficient tuning. Rapidly test and tune velocity control from soft to stiff response, defining a controller gain that typically works across the entire variable speed and load range of an application. Actively estimate and cancel system disturbances in real time, providing maximum performance.

- **MOVE:** Produce an automatically optimized motion profile based on start velocity, target velocity and system limitations for acceleration, jerk and motion trajectory type.
- **PLAN:** Quickly build various states of motion (speed A to speed B) and tie them together with state-based logic.

Develop and evaluate quickly using the new motor control software infrastructure, MotorWare. Take advantage of modules, drivers, system examples and documentation representing the latest in C object-oriented and API-based coding techniques.

Pricing and availability

InstaSPIN-MOTION is available on the production-ready, 90 MHz, 32-bit floating point Piccolo F2806xM microcontrollers starting at \$10.22 USD per 10 Ku. Designers can begin their latest InstaSPIN-MOTION motor designs with a low-voltage, low-current motor control kit for \$299 (DRV8312-69M-KIT), low-voltage, high-current motor control kit for \$299 (DRV8301-69M-KIT) or high-voltage motor control kit for \$699 (TMD-SHVMTRINSPIN). If designers have a previously purchased TI motor control development kit, they can order the modular InstaSPIN-MOTION-enabled Piccolo control-CARD for \$99 (TMDSCNCD28069MISO). If designers purchased any of the above kits with last month's InstaSPIN-FOC announcement, they are already InstaSPIN-MOTION ready, just download the latest kit contents and MotorWare software.

Find out more about InstaSPIN™-MOTION and TI motor control solutions:

TI motor control solutions:

<http://www.ti.com/c2x-ismot-pr-lp3-eu>

Motor control training: <http://www.ti.com/c2x-ismot-pr-tr-eu>

www.ti.com

Introducing Allegro's Smallest Integrated Current Sensor IC For Low Side or < 100 V Sensing Applications



A 30-Amp current sensor IC in a 3-millimetre square package!



Allegro's new ACS711 is quite possibly the world's smallest integrated current sensor IC.

Designed for low-side or <100 V sensing applications, the new device can sense up to 30 Amps continuous current, yet is housed in a 0.75 mm low-profile QFN package measuring only 3 mm x 3 mm.

The internal conductor resistance is only 0.6 milliohms: much lower than the sense resistors used in most current sensing configurations.

The Allegro sensor IC employs the Hall-effect to measure the current flowing into and out of the package, making it immune to variations in conductor resistance due to temperature. The fully integrated sensor allows Allegro to program the amplifier gain and offset to produce a solution that is more accurate than a sense resistor op-amp combination.

The advances integrated into this micro-packaged ACS711 means that it can deliver the smallest current sensor footprint available for user applications while at the same time reducing resistive power loss by an order of magnitude, all without compromising sensing accuracy over temperature.

Current Transformer	Sense Resistor Op-Amp	Allegro Solution
		



Representatives

ALLREM
94616 Rungis Cedex, FRANCE
Tel: +33 (0) 1 56 70 03 80
E-mail: info@allrem.com

SSG Semiconductor Systems GmbH
D79856 Hinterzarten, GERMANY
Tel: +49 (0) 7652-91060
Website: www.ssg-de.com
E-mail: mail@ssg-de.com

Consystem S.r.l.
I-20144 Milano, ITALY
Tel: +39 02 4241471
Website: www.consystem.it
E-mail: support@consystem.it

MSM Ltd.
Weybridge Surrey, KT13 0RZ
United Kingdom
Tel: +44 (0) 1932 341106
E-mail: msm@intonet.co.uk



MicroSystems Europe Ltd

www.allegromicro.com/camp1166

Driving and Using Emerging SiC Switches

By Ranbir Singh, GeneSiC



Power switches made with Silicon Carbide (SiC) are expected to show great performance advantages as compared to those made with other semiconductors. This is because SiC has an order of magnitude higher breakdown electric field than conventional materials. A high breakdown electric field allows the design of SiC

power devices with an order of magnitude thinner and higher doped blocking layers. The large bandgap of SiC also results in a much higher operating temperature and a higher radiation hardness. The requirement that a power device must be able to dissipate a significant amount of heat indicates that the thermal characteristics of the semiconductor are also of fundamental importance. The thermal conductivity of SiC is 4.9 W/oC-cm at room temperature which is greater than most metals. The high value of thermal conductivity for SiC allows dissipated heat to be readily extracted from the device. This, in turn, allows a corresponding increase in power to be applied to the device for a given junction temperature.

The power electronics industry is looking for a SiC switch solution to replace the ubiquitous Silicon (Si) IGBT in many high frequency applications. After many years of research and development, SiC-based switches are rapidly becoming commercially available. These include: SiC Junction Transistors (SJTs); Power MOSFETs – including planar DMOSFET as well as trench-MOSFETs; JFETs – including normally-ON, and normally OFF, and other Transistors/Thyristors. Unlike Silicon, where IGBTs offered much superior drive and switching performance and drive as compared to BJTs, and much higher current carrying capability than MOSFETs, it may not be obvious which of the devices may offer the best performance and circuit efficiency in SiC. This is because SiC material properties offer a different set of advantages and disadvantages as compared to Silicon devices. For example, unlike Si BJTs and IGBTs, SiC Junction Transistors are completely free of any minority carriers in the Drain region, making them operate with the high frequencies like majority carrier devices, and are completely free of dynamic breakdown (reverse bias safe operating area, RBSOA) issues. Also, contemporary SiC MOSFETs suffer from much poorer channel mobilities (10-20X) as compared to Silicon MOS-devices. Further, realizing normally-OFF SiC JFETs is extremely difficult from a manufacturing standpoint because of the high dopings typically in their Drain regions.

Most motor control and power supply applications presently use voltage controlled drivers due to the dominance of Si IGBTs in these applications. Modern Gate drivers generally switch at +15V levels, and their current sourcing/sinking capabilities have recently increased to many amperes to accommodate the high operating switching frequencies and large gate capacitances in these IGBTs as well as high current MOSFETs. Contemporary SiC MOSFETs require +20 V gate drive voltage to achieve a sufficiently low on-resistance. Junction-based devices like Junction Transistors and Normally-OFF JFETs require a +4 V drive, but can require continuous Gate currents that

are non-zero. Normally-ON JFETs can require a high negative bias (up to -30 V) to turn them completely OFF. From an initial assessment, it may appear that each of these devices require a non-standard gate drivers, and indeed, many SiC device manufacturers are actively working on optimum gate drivers for their switch offerings. A few Si IGBT/MOSFET gate drivers may offer up to +20 V, making them compatible with SiC MOSFETs. In addition, SiC Junction Transistors offer current gains in excess of 100, enabling the use of off-the-shelf IGBT drivers because their continuous gate current requirement can be supplied by them. A series Gate Resistance, similar to that used in IGBT drive can easily control the amount of gate current, as well as provide the requisite Gate-Source voltage (3-4V) required for operating SJTs.

While these gate drive considerations take into account only steady state on-state operation, it is much more important to consider dynamic losses at high operating frequencies. This is because SiC switches make commercial sense only when operating frequencies exceed many 10s or 100s of kHz. At these operating conditions, the charging/discharging of Gate-Source and Miller capacitances may play a dominant role in determining the driver, as well as overall losses. The driver switching losses are directly proportional to the Gate-Source (CGS) capacitance, and the SQUARE of the voltage swing. For SJTs, and normally-OFF JFETs, the voltage swing is only 4-5V; while for MOSFETs and Normally-ON JFETs, it may be 20-30 V, with correspondingly higher driver losses. Device switching loss is a product of Gate-Drain (CGD, Miller) capacitance and square of the device voltage swing (for example 800 V). Presently, SJTs and normally-OFF JFETs can offer 2-3X smaller CGD as compared to a MOSFET of a similar current rating.

In applications where switch-rectifier anti-parallel configurations are used (for example motor drive H-Bridge, and front end rectification), having a fast switching SiC switch along with a similarly fast SiC rectifier are essential to achieve an overall high operating frequency. Many Si IGBTs are preferred over MOSFETs because MOSFETs suffer from a slow switching reverse PiN body diode in its structure, which competes with an external fast diode in the flyback configuration of a switch-rectifier pair. Similarly SiC MOSFETs have a slower SiC PiN body diode which can compete with an external SiC Schottky diode at higher operating temperatures. However, SJTs do not have a body diode, and like Si IGBTs, are quite compatible for use with a fast SiC Schottky diode. SiC JFETs also do not have a body diode.

As various families, and ratings of SiC switches become available in the marketplace, it is up to power circuits engineering community to analyze all the choices before deciding which SiC switch technology works best for their application. The decision to replace Si IGBTs with SiC switches may not be as easy as most may have anticipated.

www.genesicsemi.com



Capacitors for Power Electronics



- IGBT Snubbers**
- RF Mica Capacitors**
- DC Link Capacitors**
 - High Current, High Voltage Film
 - High Capacitance Aluminum Electrolytic
- AC Output Harmonic Filter Capacitors**

CDE **CORNELL DUBILIER**
www.cde.com/bodo

ELECTRONICS INDUSTRY DIGEST

By Aubrey Dunford, Europartners



SEMICONDUCTORS

2012 was still a miserable year for the semiconductor market and suppliers with a 2.2 percent decline from 2011, with only eight out of the Top 25 chip-makers managing to

eke out revenue growth—but nine suffering double-digit declines, so IHS. The modest improvement in the final results came from year-over-year growth in the fourth quarter, topping out at a 2.8 percent increase. The stronger performance in the fourth quarter represents a positive signal for the semiconductor market, marking the beginning of a new growth cycle in the industry that will be sustained through 2013.

Avago Technologies, a supplier of analog interface components for communications, industrial and consumer applications, announced the acquisition of CyOptics, involved in Indium Phosphide (InP) optical chip and component technologies for the data communications and telecommunications markets, for approximately \$ 400 M in cash. In 2012, CyOptics net sales were \$ 210 M, up 21 percent from 2011.

Toshiba has started volume production in Japan of silicon carbide (SiC) power devices, in anticipation of growing demand for industrial and automotive applications. Toshiba will manufacture Schottky Barrier Diodes (SBDs) as the first of its new line-up of SiC products. SiC power devices offer more stable operation than current silicon devices -even at high voltages and currents - as they significantly reduce heat dissipation during operation. Analysts estimate that the SiC power device market will grow to about 10 times the current scale by 2020. Toshiba aims to secure 30 percent market share in 2020.

Plessey announced that samples of its Gallium Nitride (GaN) on silicon LED products are available. These entry level products are the first LEDs manufactured on 6-inch GaN on silicon substrates to be commercially available anywhere in the world, says the British company. Plessey is using its propri-

etary GaN on silicon process technology to manufacture the LEDs on its 6-inch MAGIC (Manufactured on GaN I/C) line at its Plymouth, England facility. Using standard semiconductor manufacturing processing provides yield entitlements of greater than 95 percent and fast processing times providing a significant cost advantage over sapphire and silicon carbide based solutions for LEDs of similar quality.

The global semiconductor materials market decreased 2 percent in 2012 compared to 2011, so SEMI. Revenues of \$ 47.11 mark the first decline in the semiconductor materials market in three years. Total wafer fabrication materials and packaging materials were \$ 23.38 billion and \$ 23.74 billion, respectively.

Electro Scientific Industries, a supplier of laser-based manufacturing solutions for smart consumer electronics and other microtechnology industries, has signed a definitive agreement to acquire the semiconductor systems business of GSI Group, a supplier of precision photonics, laser-based solutions and precision motion devices to the medical, industrial, scientific, and electronics markets. Based in Massachusetts, the business unit provides products in laser marking and trimming of semiconductor wafers and hybrid circuits. This acquisition will add approximately \$ 20-30 M of annual revenue to ESI.

PASSIVE COMPONENTS

The PCB industry in Germany posted a better-than expected result for the first two months of the year, so the ZVEI. Total February sales were just 4 percent lower compared to January. In terms of new orders, February saw just a slight, 2 percent drop compared to the same period last year. Book-to-bill ratio, meanwhile, reached 0.97. The number of employees increased slightly compared to January, but employment figures were 3 percent lower than those reported in February 2012.

OTHER COMPONENTS

The Electronic Design Automation finished 2012 with a record quarter: the EDA industry revenue increased 4.6 percent for Q4 2012

to \$ 1779.1 M, compared to \$ 1700.1 M in Q4 2011, so the EDA Consortium. Sequential EDA revenue for Q4 2012 increased 9.8 percent compared to Q3 2012. Geographically, all of the regions reported positive growth, with the Europe/Middle East/Africa region leading the way. Revenue in EMEA was up 8.1 percent in Q4 2012 compared to Q4 2011 on revenues of \$ 331 M. The EMEA four-quarters moving average increased 6.8 percent.

EMS PROVIDERS

Manufacturing Market Insider has released its annual MMI Top 50 list of the world's largest EMS providers. In 2012, Top 50 sales reached a new high of \$ 223.9 billion. Top 50 sales grew by 4.8 percent last year, despite end market weakness. However, without the contribution of industry giant Hon Hai Precision Industry, sales would have fallen by 5.0 percent.

DISTRIBUTION

Richardson RFPD, an Arrow Electronics company, has committed to the Myriad open source RF initiative. The US-based distributor will begin stocking and selling the Myriad-RF-1 board to customers around the world via its website. Myriad was launched in March 2013 as an open source, non-profit initiative to increase access for easy-touse, low-cost RF hardware and to drive innovation in the sector. Pre-built boards will initially retail for \$299 or less.

Greenview Communications, a RF mixed-signal and digital signal processing semiconductor company focused on developing Powerline Communications (PLC) and Zig-Bee wireless products, appoints Broadband Technology 2000 as UK & Ireland representative and distributor.

This is the comprehensive power related extract from the « Electronics Industry Digest », the successor of The Lennox Report. For a full subscription of the report contact:

eid@europartners.eu.com
or by fax 44/1494 563503.

www.europartners.eu.com

3-LEVEL POWER MODULES

Up to 1500 V DC link



SEMİTOP®
20 A - 150 A



MiniSKiiP®
75 A - 200 A

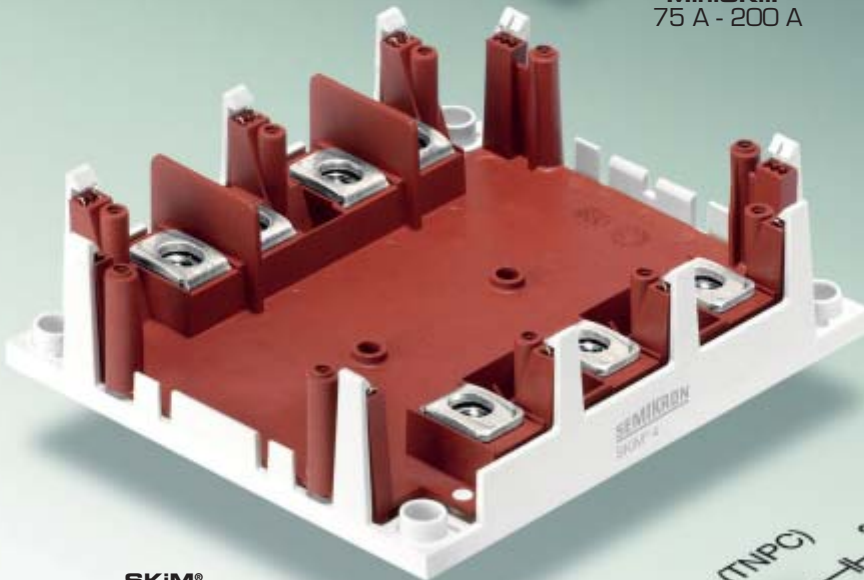

SKiM®
200 A - 600 A



20 A up to 600 A

NPC and TNPC topologies

600 V, 650 V and 1200 V

Higher efficiency for solar and UPS

Less filtering via better harmonics

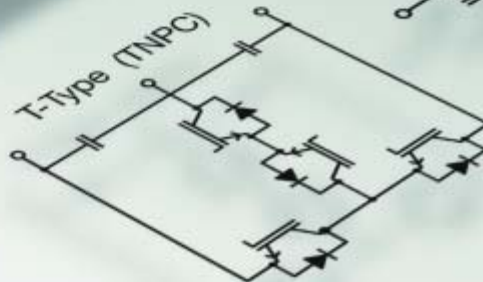
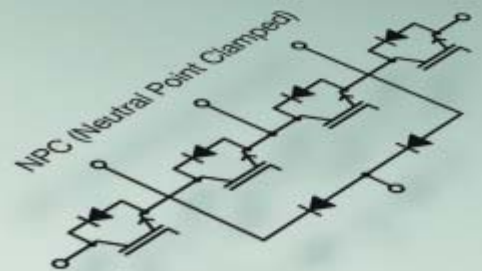

Advanced Materials Support Leading-Edge Applications

Jeff Shepard, President, Darnell Group, Inc.

Materials such as gallium-nitride (GaN) and silicon-carbide (SiC) will be key drivers of next-generation power converters. Understanding the capabilities and limitations of these materials and the devices produced using these materials will be vitally-important for power electronics engineers and the companies they work for. GaN and SiC were again a major focus at last month's PCIM Europe event in Nuremberg, Germany. And they will be some of key topics of discussion at Darnell's Energy Summit (DES) in Dallas in September.

In many ways, PCIM presented a high-level preview of topics that will be delved deeply into at DES. In addition to numerous conference papers, DES will include half-day design seminars to help designers understand and use the latest GaN and SiC devices. Among the companies making recent announcements in SiC and GaN semiconductor devices have been Toshiba Electronics Europe, ROHM, Cree, Transphorm and Avago Technologies. Announcements included a hybrid N-channel injection-enhanced gate transistor (IEGT), high-voltage N-channel SiC MOSFETs, GaN HEMT devices, SiC modules and even high-speed gate drive optocouplers designed specifically to work with the latest SiC MOSFETs

Toshiba Electronics Europe announced a hybrid N-channel IEGT module that features an embedded SiC fast-recovery diode (FRD). The high-efficiency PMI (Plastic case Module IEGT) will help designers to save energy, space and weight in high-power switching, inverter and motor control applications. Rated at 1700V and 1200A, the half-bridge MG1200V2YS71 is ideal for switching in industrial, rail traction, renewable energy and electricity transmission and distribution systems. The module incorporates two switches (IEGTs), each with its own embedded SiC diode.

Use of a SiC diode leads to a significant decrease in reverse recovery current and a corresponding decrease in turn-on loss. As a result the new PMI offers a reverse recovery loss up to 97% lower than a module with a conventional silicon diode. This improvement in efficiency has allowed Toshiba to realize a cooling system that is much smaller than its silicon-based predecessor. In addition, thanks to the size reduction of some motor control parts, overall equipment size could be reduced by as much as 40%.

The new module has an isolation rating of 6000Vac (rms for one minute) and will operate with junction temperatures from -40°C to 150°C. As well as size, weight and efficiency improvements, use of the PMI module in applications such as rail traction can also lead to improved ride quality and lower acoustic noise.

Adding to its broad range of SiC products, ROHM presented its new line-up expansion of high-voltage N-channel SiC (Silicon Carbide) Power MOSFETs. The SCT2xx series without Schottky diode features different ON-resistance types and max. currents in a TO247 package without an integrated SiC SBD. They provide significantly lower power loss and handle a maximum junction temperature of 175°C which is unmatched in the market. The SCH2080KEC variant comes co-packed with a SiC SBD in a single package.

With low on-resistance, high breakdown voltage, high speed switching and reverse recovery these new MOSFETs (SCT2080KEC, SCH2080KEC, SCT2160KEC, SCT22280KEC and SCT2450KEC) are easy to parallel and to drive which makes them suited for deployment in solar inverters, dc-dc converters, switch mode power supplies, induction heating or motor drives. Overall, these devices not only enable power saving and high speed operation but also the reduction of space and components, and can be configured based on customer requirements.

Current Si IGBTs commonly used in 1200V-class inverters and converters cause power switching loss due to tail current or recovery of the external FRD, bringing a need for SiC power MOSFETs capable of operating with low switching loss at high frequencies. However, conventional SiC power MOSFETs experienced numerous reliability problems, including characteristic degradation due to body diode conduction (e.g. increased ON resistance, forward voltage, and resistance degradation) as well as failures of the gate oxide film, making full-scale integration impossible. ROHM has succeeded in overcoming these problems by improving processes related to crystal defects and device structure and reducing ON resistance per unit area by approximately 30% compared to conventional products, also leading to increased miniaturization.

Transphorm announced the implementation of a high efficiency off-line 1 kW 48 Vdc power supply that has demonstrated peak efficiency of 97.5 percent. The power supply design utilizes Transphorm's JEDEC-qualified GaN on silicon 600V high electron mobility transistors (HEMTs) to implement a 99-percent-efficiency totem pole power factor correction (PFC) front end, combined with a 98.6% efficiency LLC converter. A prototype circuit was on display during the event.

Based on Transphorm's patented, high-performance EZ-GaNTM technology, the TPH3006PS HEMT combines low switching and conduction losses to reduce energy loss by 50 percent compared to conventional silicon-based power conversion designs. The TO-220-packaged GaN transistor features low on-state resistance (RDS(on)) of 150 milliohms (m?), low reverse-recovery charge (Qrr) of 54 nanocoulombs (nC) and high-frequency switching capability — all of which result in lower loss, more compact, lower cost systems.

"Transphorm's GaN-based power supply design exceeds the best efficiency results possible with silicon by at least one percent," said Umesh Mishra, CEO of Transphorm, Inc. "And while recent advances in super junction silicon devices have reduced the output capacitance by 20 percent and the Qrr of the intrinsic body diode by 25 percent, these improvements lag far behind the effective Qrr of the new GaN transistors which reduce Qrr by 95 percent."

For approved customers, the TPH3006PS and TPH3006PD HEMT devices are available for sale at a price of \$5.89 each in 1,000 quantities. The TPS3410PK and TPS3411PK diodes are priced at \$2.06 and \$1.38, respectively, also in 1,000-piece quantities.

When compared to state-of-the-art silicon modules, Cree's new SiC 1.2 kV, 50A modules deliver performance equivalent to silicon modules rated at 150A. "The efficient switching of the SiC module allows us to use them with significantly less derating than silicon IGBTs," stated Dr. Jun Kang, research and applications manager, Yaskawa America, Inc. "This feature enables significantly higher frequency operation, which both increases fundamental output frequency and reduces passive component size in the motor drive."

"Cree's SiC power module family can also provide significant benefits to applications such as solar inverters, uninterruptible power supplies (UPS) and industrial power supplies," explained Mrinal Das, product marketing manager, Cree Power and RF. "Even when designers simply substitute Si modules with SiC in motor drive applications, the improved performance of SiC reduces power losses, leading to reduced cooling requirements and, in turn, to a reduction in size, weight, complexity and the overall cost of the power electronics system."

Avago Technologies unveiled two new sets of high speed gate drive optocoupler devices, the ACPL-P/W345 and ACPL-P/W346. These devices are 1A and 2.5A gate drive optocouplers designed to protect and drive power MOSFETs and silicon-carbide (SiC) MOSFETs for high-switching frequency applications such as inverter, motor control, and switching power supply. Compared to Avago's previous generation devices, the ACPL-P/W345 and ACPL-P/W346 are twice as fast in terms of propagation delay.

Technical highlights include; 120ns maximum propagation delay; 2.5A maximum peak output current (ACPL-P/W346); 1.0A maximum peak output current (ACPL-P/W345); rail-to-rail output voltage; under

voltage lock-out (ULVO) with hysteresis; 50kV/us minimum high common mode rejection (CMR); small stretched SO6 package minimizing PCB board space and cost.

"Avago continues to bring value to customers by setting new standards for optocoupler performance," said Kheng-Jam Lee, marketing director of Avago's Isolation Products Division. "With the introduction of the ACPL-P/W345 and ACPL-P/W346, Avago is in the forefront of development of new high speed gate drive optocouplers capable of supporting SiC MOSFET for next-generation energy-efficient motor control and power conversion applications."

"We have evaluated Avago's ACPL-W346 driving our first and second generation SiC MOSFETs. The fast switching performance of this new gate driving solution achieves very high power conversion efficiency," said Paul Kierstead, Director of Power Marketing with Cree, Inc.. "More importantly, this solution provides customers with a cost effective and easily available gate driving solution for Cree's SiC MOSFETs."

These and other advanced power conversion materials, devices and technologies will be discussed at the first-annual Darnell Energy Summit (DES '13) to be hosted September 9-13 in Dallas, Texas. DES '13 will be a combined event featuring the Tenth Darnell Power Forum (DPF '13) plus the Fifth Green Building Power Forum (GBPF '13) plus the Fourth Smart Grid Electronics Forum (SGEF '13). With a single registration, delegates can attend any sessions of interest during these simultaneous leading-edge events. You can find details at:

<http://energysummit.darnell.com>

100% of our sensors could be customised?

Absolutely.



In our changing and complex world, ABB is fully committed to support permanent improvements. Because applications are more compact and sensitive to perturbations, we have enhanced the ES and ESM ranges in term of magnetic immunity and dynamic performances. You have a dedicated application, we have a dedicated range. www.abb.com

ABB France
Current & Voltage Sensors Department
e-mail: sensors.sales@fr.abb.com

Power and productivity
for a better world™ **ABB**

Comparison between HiPerFET™ MOSFETs and Super Junction MOSFETs

With the introduction of P3-series HiPerFET™ power MOSFETs, IXYS sets a milestone in HiPerFET™ technology, provides one of the best solutions in power MOSFETs for medium to high frequency designs. These devices have an optimum combination of low on-resistance ($R_{DS(on)}$), low gate charge (Q_G), a fast intrinsic diode for low reverse-recovery (Q_{rr}) and improved turn-off dV/dt immunity. The enhanced dV/dt ratings offer significant safety margins for the stresses encountered in high-voltage switching applications.

By Abdus Sattar, IXYS Corporation

Additional features include low thermal resistances (R_{thJC}), high power dissipation (P_D), and high avalanche energy capabilities (E_{AS}). These outstanding electrical and thermal characteristics are essential for implementing improved power efficiency and reliability in today's demanding high-voltage conversion systems. Innovative designs and process technologies yield switching characteristics that can challenge the total switching performance (conduction + switching) of a comparable super junction (SJ) power MOSFET available in the market [1].

The objective of this article is to explore the switching characteristics and to present a comparison between P3-series HiPerFET™ power MOSFETs and super junction (SJ) power MOSFETs under the same operating conditions. We have selected three SJ-MOSFETs: IPW60R041C6, FCH76N60NF and STW88N65M5 and one P3-series MOSFET: IXFX80N60P3 with similar characteristics in order to have a correct comparison. Table 1 shows the principal characteristics of these devices.

Symbol	Super Junction (SJ) power MOSFETs			P3-series MOSFET	Unit
	IPW60R041C6	STW88N65M5	FCH76N60NF	IXFX80N60P3	
V_{DS}	600	650	600	600	V
I_D	77	84	73	80	A
I_{DM}	272	336	218	200	A
$R_{DS(on)}$ (max)	0.041	0.029	0.038	0.070	Ω
P_D	481	450	543	1300	W
Q_G	290	204	230	190	nC
T_{JM}	150	150	150	150	$^{\circ}C$
I_A	13	15	24	40	A
E_{AS}	1954	2000	7381	2000	mJ
t_{rr}	950	660	200	250	nS

Table 1: Principal characteristics of SJ power MOSFETs and One P3-series MOSFET ($T_J = 25^{\circ}C$ unless otherwise specified)

Based on Table 1, IXFX80N60P3 has better values on Q_G , P_D , I_A and t_{rr} than that of SJ devices.

Gate Charge Evaluation

Figure 1 shows gate voltage vs. gate charge plots for IXFX80N60P3 (red), IPW60R041C6 (blue), STW88N65M5 (light blue) and FCH76N60F (green) under the same operating conditions.

IXFX80N60P (Red line) shows much better gate charge characteristics than that of SJ devices. The advantages of using IXFX80N60P3 can be easily understood from its gate charge curve.

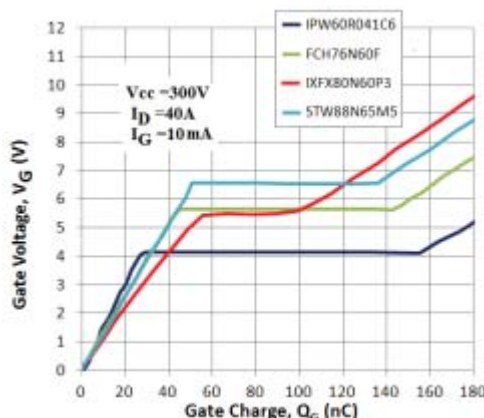

Figure 1: Gate voltage vs. Gate charge plots for IXFX80N60P3 (red), IPW60R041C6 (blue), STW88N65M5 (light blue) and FCH76N60F (green).

High frequency switching applications such as switch mode power supplies (SMPS) and uninterruptible power supplies (UPS) will greatly benefit from the low total gate charge (Q_G) and gate-to-drain charge (Q_{GD}) observed for IXFX80N60P. Low Q_G and Q_{GD} characteristic allows designers the ability to boost power conversion efficiency through the use of high-speed switching and to promote the use of smaller passive components, thus freeing up additional PCB real-estate and reducing the cost of bulky passive components. In addition, the low total gate charge (Q_G) reduces the amount of gate drive power requirement (Gate Drive Power = $Q_G \times V_{GS} \times f_{SW}$) needed for the Power MOSFET to fully conduct. Since these devices require less gate drive power, simple economical gate drive solutions can be implemented, further reducing cost and complexity [2].

Body Diode Reverse Recovery Evaluation

Figure 2 shows an inductive switching circuit that IXYS uses for MOSFET's body diode reverse recovery evaluation. The gate and source of the D.U.T. (Q1) are shorted to test the body diode.



New 650V Rapid 1 and Rapid 2 Diode Families

Infineon Enters the Hyperfast Silicon Diode Market



As a perfect partner to CoolMOS™ and discrete IGBTs such as TRENCHSTOP™ 5, the Rapid diode families provide outstanding cost/performance ratio in AC/DC stages, such as PFC stages and free-wheeling diodes in DC/DC stages. Split into two families, the Rapid 1 is V_F optimized for applications switching between 18kHz and 40kHz, whilst the Rapid 2 is Q_{rr} optimized to offer outstanding performance between 40kHz and 100kHz.

Key features and benefits of the new 650V Rapid 1 and Rapid 2 Diode families

- 650V repetitive peak reverse voltage as standard for higher reliability
- Temperature stability of major electrical parameters
- Lowest I_{rrm} for improved E_{on} losses of the boost switch
- S-factor $\gg 1$ for outstanding EMI behaviour
- Rapid 1 Diode – V_F of 1.35V, $t_{rr} < 100ns$
- Rapid 2 Diode – lowest $Q_{rr} \cdot V_F$, $t_{rr} < 50ns$



For further information please visit our website:
www.infineon.com/rapiddiodes



Q2 acts as a control device which is subjected to a double pulse. The current ramps in Q2 and freewheels through the D.U.T. body diode when Q2 turns off. When Q2 is turned on again by the second pulse, the D.U.T. body diode must recover before Q2 voltage can drop. During diode reverse recovery, its reverse current goes to Q2 along with the load current. The reverse recovery di/dt can cause large voltage overshoots ($L di/dt$) due to circuit and package lead's stray inductance. Figure 3 demonstrates the test waveforms at 75oC operation. The larger the reverse current and the longer recovery time translate into more reverse recovery losses.

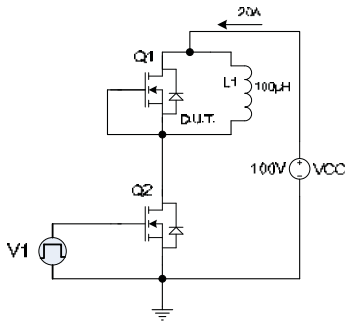

Figure 2: Body diode reverse recovery test setup for MOSFET. The test conditions are $V_{CC}=100V$, $I_D=20A$, $V_{GS}=10V$ and $L=100\mu H$ and $di/dt=200A/ns$.

Table 2 summarizes the reverse recovery test parameters for each device at 75oC operation. IXFX80N60P has the second fastest recovery time and the lowest peak reverse current. Severe voltage spikes are generated by FCH76N60NF (>320V), STW88N65M5 (>350V), FCH76N60NF (>140V) and comparatively very small by IXFX80N60P. In comparing with IPW60R041C6, we can see that the reverse recovery time of IXFX80N60P is 37% of IPW60R041C6. The peak reverse current is cut down to 30% and the reverse recovery energy is reduced by 80% of IPW60R041C6. Lower Err leads to lower switching loss. This is often the largest single component of switching loss in a switching converter [4].

Part Number	t_{rr} (ns)	I_{rrm} (A)	Reverse-recovery energy, Err (Joules)
IXFX80N60P	200	24	2.18e-04
IPW60R041C6	540	80	8.72e-04
FCH76N60NF	165	30	1.65e-04
STW88N65M5	330	52	2.74e-04

Table 2: Diode Reverse Recovery parameters at 75oC operation.

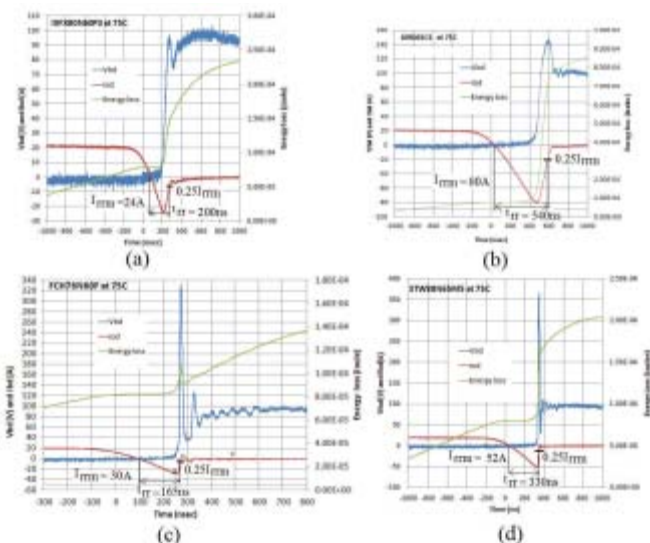

Figure 3: Body diode reverse recovery waveforms at 75°C operation: (a) IXFX80N60P, (b) IPW60R041C6, (c) FCH76N60NF and (d) STW88N65M5.

Because of superior intrinsic diode characteristics, P3-series MOSFETs can eliminate the need for discrete anti-parallel high voltage diodes used in conventional designs, thereby reducing part count, simplifying PCB layouts, reducing overall losses and improving power density

Turn-off and Turn-on Switching

Turn-on and turn-off switching comparisons with SJ power MOSFETs have been carried out in order to give evidence to the performance of P3-series power MOSFET. Figure 4 shows a half-bridge inductive load switching circuit for this test. The gate and source of the top transistor (Q1) are shorted. The bottom transistor (Q2) with a gate resistor (R_{G1}) is used as the D.U.T. for evaluating turn-on and turn-off performance under the same operating conditions: $V_{CC}=300V$, $I_D=20A$, $V_{GS}=15V$, $L=100\mu H$ and $R_{G1}=20\text{ ohm}$.

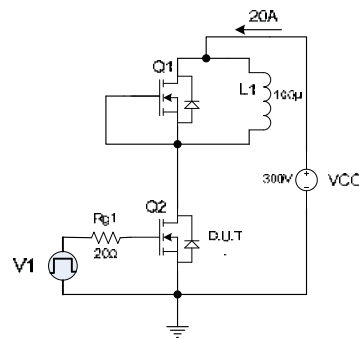

Figure 4: Test circuit for turn-on and turn-off characteristics of power MOSFET.

Turn off Characteristics

The turn-off waveforms are shown in Figure 5 for 75 oC operation. The quantities measured are the energy losses (E_{off}), the fall time of the drain current (t_{fi}), the rise time of the drain voltage (t_{rv}) and the current slope (di/dt), which are presented in Table 3.

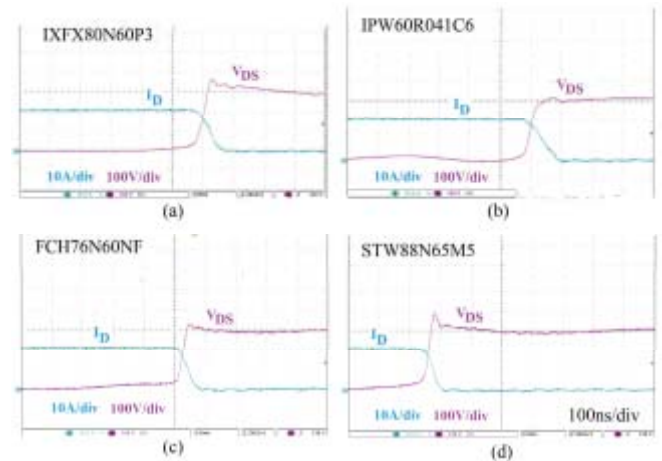

Figure 5: Turn-off waveforms at 75 oC operation: (a) IXFX80N60P3 (b) IPW60R041C6, (c) FCH76N60NF and (d) STW88N65M5.

Devices	E_{off} (μJ)	t_{fi} (ns)	t_{rv} (ns)	di/dt [A/ns]
IXFX80N60P3	322	51	24	0.260
IPW60R041C6	449	87	46	0.284
FCH76N60NF	350	68	28	0.210
STW88N65M5	420	58	27	0.177

Table 3: Extracted turn-off switching parameters at 75 oC operation

According to parameters in table 3, under the same operating conditions, E_{off} of IXFX80N60P is better than that of all SJ devices. Fall and rise times (t_{fi} and t_{rv}) of IXFX80N60P are better than all SJ devices. Therefore, IXYS P3-series MOSFET IXFX80N60P behaves

Fuji's Chip Technology

The Independent Way V-Series IGBTs



- Trench-FS IGBT
- High thermal cycling capability
- Low spike voltage & oscillation free
- Excellent turn-on di/dt control by R_c

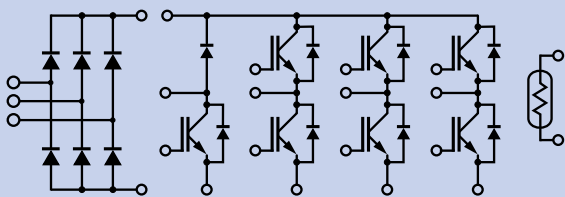

Think Easy...

Mini PIMs
for
low power applications



*6-Pack configuration is under development

With solder pins

Package	I_c	600V	1200V
	10A	●	●
	15A	●	●
	20A	●	
	30A	●	
	15A		●
	25A		●
	35A		●
	50A	●	

With PressFit contacts

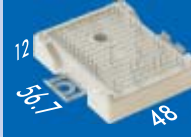
Package	I_c	600V	1200V
	10A	●	●
	15A	●	●
	20A	●	
	30A	●	
	15A		●
	25A		●
	35A		●
	50A	●	

better than most of SJ devices in terms of turn-off energy losses, fall and rise times. These results are reflected in the computation of di/dt as well [4].

Turn on Characteristics

The turn-on waveforms are shown in Figure 6 for 75 °C operation. The quantities measured are the turn-on energy losses (E_{on}), the rise time of the drain current (t_{ri}), the fall time of the drain voltage (t_{fv}) and the current slope (di/dt), which are presented in Table 4.

Devices	Peak Current (A)	E_{on} (mJ)	t_{ri} (ns)	t_{fv} (ns)	di/dt [A/ns]	t_{rr} (ns)	I_{RRM} (A)
IXFX80N60P3	80	1.14	30	146	0.260	174	60
IPW60R041C6	89	1.39	32	149	0.284	212	68
FCH76N60NF	79	1.43	32	158	0.210	155	59
STW88N65M5	108	2.45	43	215	0.177	228	87

Table 4: Extracted turn-on switching parameters

According to parameters in table 4, under the same operating conditions, E_{on} of IXFX80N60P is better than that of all SJ devices. Rise and fall times (t_{ri} and t_{fv}) of IXFX80N60P are much better than all SJ devices. Therefore, IXYS P3-series MOSFET IXFX80N60P behaves better than most of SJ devices in terms of turn-off energy losses and the switching speed. These results are reflected in the computation of di/dt as well [4].

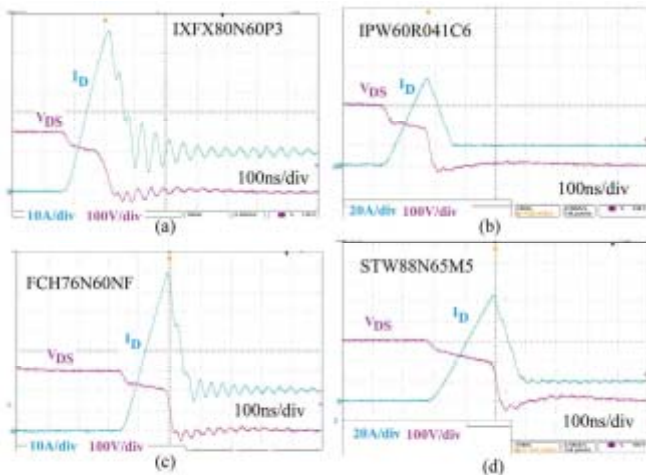

Figure 6: Turn-on waveforms at 75 °C operation: (a) IXFX80N60P3 (b) IPW60R041C6, (c) FCH76N60NF and (d) STW88N65M5.

Intrinsic body diode plays an important role in the turn-on behavior of the device. The peak current during turn-on is strongly dependent on both the di/dt of the drain current and the intrinsic characteristics of the diode. The peak current values are 80A for IXFX80N60P, 89A for IPW60R041C6, 79A for FCH76N60NF and 108A for STW88N65M5.

A Case Study

100 kHz switching with 50% duty cycle

Table 5 summarizes the reverse-recovery energy, inductive turn-on and turn-off energy and the conduction energy losses for both MOSFET and body diode under 75 °C operation. All energies are in

Part number	Diode reverse-recovery energy loss		Inductive switch energy loss		Conduction energy loss at 50% duty cycle		Total Energy Loss/Cycle (J)
	E_r (J)	E_{off} (J)	E_{on} (J)		MOSFET (J)		
IPW60R041C6	8.72E-04	4.49E-04	1.39E-03	2.90E-03	1.10E-04	2.90E-03	
FCH76N60NF	1.65E-04	3.50E-04	1.43E-03	2.11E-03	8.60E-05	2.11E-03	
IXFX80N60P3	2.18E-04	3.22E-04	1.14E-03	1.91E-03	1.60E-04	1.91E-03	
STW88N65M5	2.74E-04	4.20E-04	2.45E-03	3.29E-03	6.00E-05	3.29E-03	

Table 5: Reverse-recovery energy, switching and conduction switching losses in joules at 75 °C operation.

joules. The conduction energy are computed using datasheet parameters (V_f and $R_{DS(on)}$) at specific temperature, assumed device current $I_D=20A$ and duty cycle-50%.

The efficiency of a power converter mainly depends on the power losses on the switching devices. The total power losses can be divided into the following two major items: switching power losses and conduction power losses:

$$P_{total} = P_{sw} + P_{con} = (P_{off} + P_{on}) + P_{con}$$

Table 6 presents the total power losses (P_{total}), total switching power losses (P_{sw}) and total conduction power losses (P_{con}) for 75 °C operation. IXFX80N60P rows are marked with dark blue in table 6. IXFX80N60P3 has total power losses of 191 watts whereas IPW60R041C6 has 289 watts, FCH76N60NF has 210 watts and STW88N65M5 has 329 watts.

Part Number	Switching Power Loss, P_{sw} (W)			Conduction Power Loss, P_{con} (W)			Total Power Loss, P_{total} (W)
	Diode Loss (W)	MOSFET Loss (W)	Total Switching Loss (W)	Diode loss (W)	MOSFET Loss (W)	Total Cond. Loss (W)	
IPW60R041C6	87.2	183.9	271.1	7.5	11.0	18.5	289.6
FCH76N60NF	16.5	178.0	194.5	7.5	8.6	16.1	210.6
IXFX80N60P3	21.8	146.2	168.0	7.0	16.0	23.0	191.0
STW88N65M5	27.4	287.0	314.4	9.0	6.0	15.0	329.4

Table 6: Total energy loss (in joules), total switching power loss (P_{sw}), total conduction power loss (P_{con}) and total power loss (P_{total}) for different MOSFETs at 75 °C operation.

In this article a full analysis of advantages and disadvantages of a P3-series MOSFET relative to comparable SJ power MOSFETs has been presented. The switching characterization shows the better performances of the P3-series MOSFETs in comparison with SJ MOSFETs available in the market now.

Applications such as motor drives, lamp ballasts, laser drivers, DC-DC converters, battery chargers, solar inverters and robotic control will greatly benefit from the superior performance, energy savings, rugged design, and cost effectiveness of these P3-Series Power MOSFETs.

Power MOSFET's principal limitation in high voltage devices is the on-state resistance ($R_{DS(on)}$) which reduces the current carrying capability. Because of high on-resistance, power MOSFETs experience high power losses, which increase at increasing temperatures. In order to overcome the on-resistance power loss, P3-series power MOSFETs can deliver the better overall (conduction + switching) performance than the existing MOSFETs available in the market [3].

References:

- [1] B. Jayant Baliga, "Fundamental of Power Semi. Devices", Springer Science + Business Media LLC, NY, 2008.
- [2] Abdus Sattar, "Power MOSFET Basics", IXAN0061, IXYS Corporation, 2007.
- [3] Vinod Kumar Khanna, "IGBT Theory and Design", John Wiley & Sons, 2003.
- [4] A. Galluzzo, M. Melito, S. Musumeci and M. Saggio, STMicroelectronics, "A New High-Voltage Power MOSFET for Power Conversion Applications" Stradale Primosole, 50 - 95 121-Catania, Italy, IEEE, 2000.



Be certain you have the coolest solution in power electronics

It cannot be stressed enough: efficient cooling is the most important feature in power modules. Danfoss Silicon Power's cutting-edge ShowerPower® solution is designed to secure an even cooling across base plates, offering extended lifetime at no increase in costs. All our modules are customized to meet the exact requirements of the application. In short,

when you choose Danfoss Silicon Power as your supplier you choose a thoroughly tested solution with unsurpassed power density.

Please go to <http://siliconpower.danfoss.com> for more information.



EMC for Renewable Energy

Eliminating interference

The use of renewable energy is growing worldwide. Higher numbers of ever more complex systems and installations are leading to a growing need for EMC solutions – especially for new high-power converters. EPCOS components ensure that wind power plants do not introduce interference into the grid.

By Ronald Seeger, TDK

The rotors, generators, gearing and converters of wind turbines are undergoing a rapid rate of development to significantly boost the system performance. Thus, power outputs of 2.5 MW and more have already been attained. The use of frequency converters operating with pulse width modulation (PWM) for the transmission of the total output of the generator now enables a greater efficiency of the wind turbine. This is achieved by more flexible matching of its speed to the wind strength. A further advantage is that frequency converters can also adjust the phase shift as needed. However, the switching operations of the converters produce interference in the range of the switching frequencies, which is between 1 kHz and 5 kHz, depending on the design. They will become even higher in future as a result of the further development of power semiconductors.

Every deviation from the ideal sinusoidal shape leads to losses in power grids, and ultimately also in the loads. The requirements on the power utilities in terms of preventing distortion and harmonics are correspondingly high.

The use of power chokes at the converter output is common practice and already allows a good approximation to the ideal sinusoidal shape. However, residual switching frequencies and their harmonics remain.

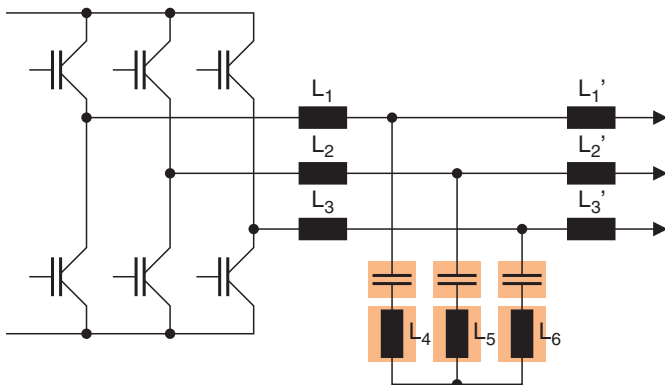

Figure 1: Output filtering of power converters. The combined EPCOS chokes L4 to L6 form a series resonant circuit which suppresses the interference from the switching

Chokes L1 to L3 and L1' to L3' (Figure 1) carry the total load current of the converter. Their inductance and core material determine the filter effect of these chokes on the switching frequency. However, high inductance values necessitate a large choke volume, corresponding cooling measures and considerable costs. All these are limiting factors, especially for the design of converters of wind turbines.

This situation can be remedied by a series resonant circuit with the combined EPCOS chokes L4 to L6 connected in series with EPCOS power capacitors of the B3236* or B2536* series (Figure 1). This circuit ensures sufficient attenuation of the switching frequencies but is not exposed to the actual load current. To ensure that the circuit is not detuned and thus becomes ineffective, its chokes must not go to saturation up to the maximum load.

Benefits of ferrite cores

Ferrites are used as the core materials especially in transformers and chokes operating at frequencies of more than 50 kHz. This option is countered by efforts to replace ferrites by new materials with high saturation capacities. However, these improved materials require rare earth metals, which are expensive. This is especially disadvantageous when the materials are to be used in large cores of the type required for resonant circuit chokes for high powers.

Even in comparison with less expensive materials, ferrite cores have proved to be more cost-effective when used in resonant circuits at switching frequencies of between 2.5 kHz and 25 kHz. Grain-oriented silicon sheets or iron powder cause much higher losses due to the significant proportion of switching frequency current, resulting in overheating. Ferrite materials are also corrosion-resistant, as they are oxides.

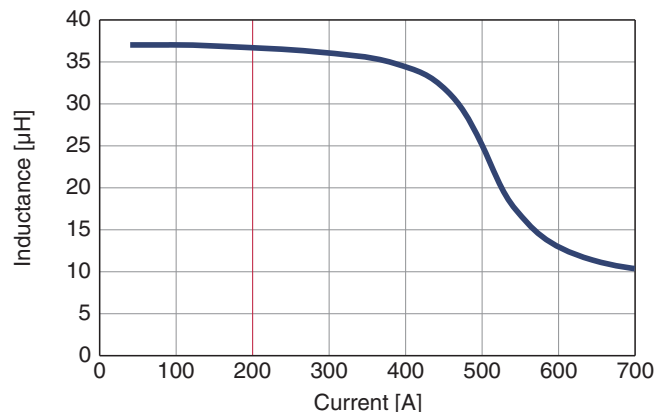

Figure 2: Saturation curve of a new EPCOS resonant circuit choke for 200 A. Thanks to the EPCOS choke's ferrite core, its inductance decreases by only about 2 µH, even at double the rated current.

By designing the chokes accordingly, the low saturation strength of the ferrites can be compensated so that it extends to double the rated current. Figure 2 shows the saturation curve of a new EPCOS resonant circuit choke for 200 A.

Lightweight aluminum windings save costs

The aluminum winding of these EPCOS chokes is not only more cost-effective than copper solutions but also saves weight. Thanks to the combination of an aluminum strip and copper connection angles, the critical contact between aluminum and copper is moved into the protected inner zone of the coil. Vacuum impregnation of the choke with high-grade epoxy resins ensures that the contact zone between copper and aluminum is completely protected from moisture and oxygen. Figure 3 shows an EPCOS three-phase ferrite choke.



Figure 3: EPCOS three-phase ferrite choke for 130 A

A solvent-free impregnation resin prevents the occurrence of cracks during the entire operating life of the choke. Such cracks would allow moisture and oxygen to penetrate through to the contact point, leading to electrolytic corrosion of the terminals. Copper terminal rails prevent any electrolytic corrosion of the contacts even if the choke is exposed to salt water during operation. A frame made of a stainless steel sheet, which surrounds the entire core, secures the choke during transport and assembly. This minimizes any risk of damage before it is put into operation. As the frame is non-magnetic, no losses due to leakage fields occur either.

Current handling capacity [A]	130
Inductance [μ H]	12
Test voltage [V AC]	3000
Dimensions [mm]	200x150x220
Weight [kg]	9
Max. temperature [$^{\circ}$ C]	180

Table 1: Key data of the EPCOS three-phase ferrite choke. The stainless steel frame prevents damage during transport and assembly.

Many years of experience in the development and manufacture of EPCOS three-phase chokes with ferrite cores and aluminum strip windings have gone into the production of these new chokes. Compared with other solutions, they are able to withstand the extremely harsh operating conditions of wind power plants and also offer cost advantages.

www.epcos.com/inquiry

www.epcos.com/film_mkp

Superior Solutions for Green Energy.



 Aluminum electrolytic capacitors for high ripple currents

 PFC products for energy saving and power quality

 EMC and sine-wave filters for currents up to 8 kA

 EMC output filters for solar and wind power inverters

 Common-mode chokes with high voltage capability

 Large ferrite cores for solar and wind power inverters

 NTC thermistors for temperature measurement

 Varistors and surge arresters for over-voltage protection



 Various types of MLCCs for highest reliability

 Rare earth and ferrite magnets

 SMT power inductors with high reliability

 Large ferrite cores

Driver and LED Companies must Work Together to Achieve High-Efficiency, Practical LED Lighting

The story of a PAR 38 LED spotlight design

Delivering real-world LED lighting systems that live up to their billing – reduced power consumption, increased life, improved efficiency – has not proved to be a simple task. Of course, LED lighting is being increasingly used in many applications, but there have been horror stories too.

By Andrew Smith, Product Marketing Manager, Power Integrations

Partly, the challenge is to cope with legacy bulb formats that are far from optimal for LED technology. Another issue is that control systems which were developed for incandescent lighting, and which are installed in countless houses, offices, work spaces and public spaces are not ideal for simple LED driver power supplies.

In an ideal world, we would all – for domestic, commercial, public and industrial applications – take the decision to move to LED lighting systems and install brand new products developed specifically and optimised for solid state technology. However, this would mean a complete rethink and more than likely a rewiring of the building. To change one blown bulb would mean a total new system installation – and this is clearly not going to happen.

Gradually though, the teething problems which first affected LED lighting systems are being addressed. Design engineers have become very adept in fitting quite complex power systems into traditional light bulb fittings. Dimming, however, can still pose problems, so manufacturers of LEDs and power systems have come together to deliver reference designs that provide efficient, workable and reliable

demonstrations that illustrate exactly what can be achieved.

One such design details a PAR 38 spotlight based on Cree's Easy-White LEDs and powered by a circuit based on a device within Power Integrations' LYTSwitch™ LED-driver IC family. Explains Mark Youmans, an Applications Engineer based at Cree's Santa Barbara Technology Center: "The key challenge with this design is really thermal management because the application is a spotlight and as smooth dimming is also a requirement, the power supply needs to be quite complex with very high efficiency.

Cree's application note CLDA P117 REV0 details a 150-watt equivalent, narrow beam PAR38 replacement lamp using the company's 36 volt XLamp MT-G2 EasyWhite LED array. It is the first LED array of this type to be built on Cree's SC³ Technology™, a next-generation silicon carbide LED platform. The MT-G2 array delivers up to 25% more lumens than previous-generation devices, while occupying the same footprint and operating with the same drive conditions, so the new design is a drop-in retrofit replacement for existing products.

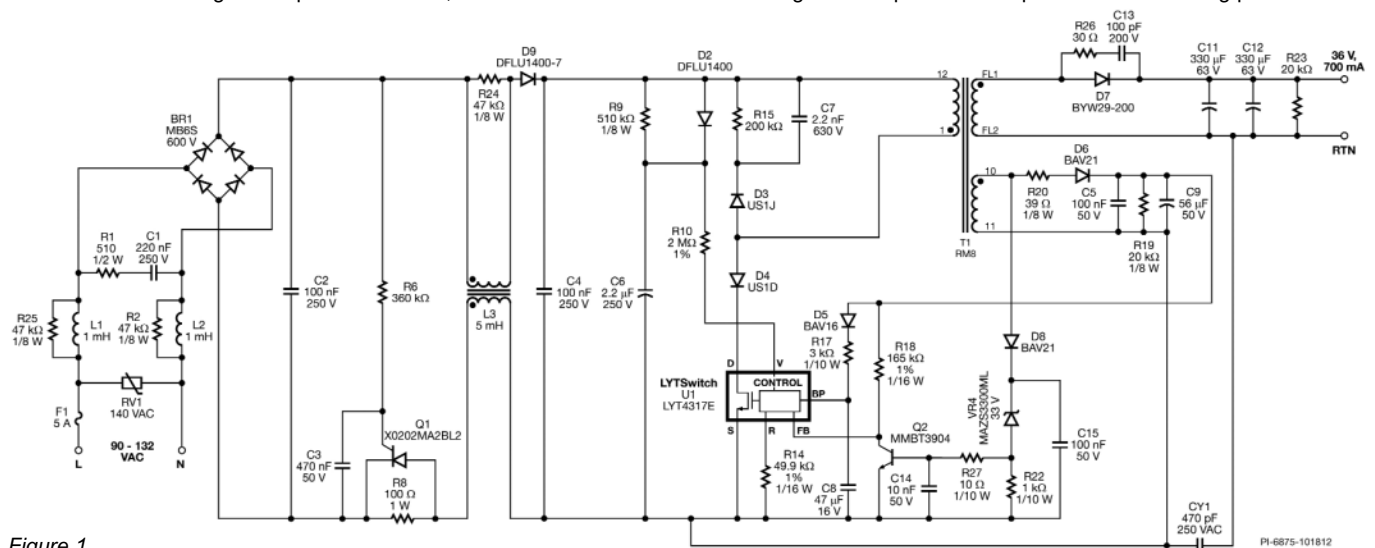
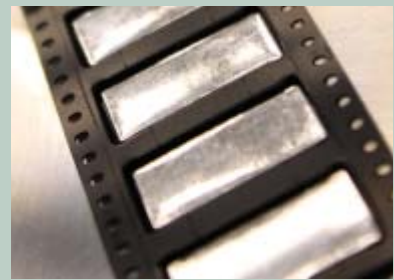

Figure 1

Solder



Continues Youmans: "Our team set out to create a lamp with a 50,000 hour L70 life-time (after 50,000 hours of operation, the LED will still deliver at least 70% of its initial luminous flux) which conforms to the latest ENERGY STAR requirements. We used an elegant, commercially-available, lightweight parabolic aluminized reflector (PAR) form factor heat sink design, and worked closely with industry-leading driver and optic partners to create an integrated, optimized system."

Heat is a killer in such space-restricted, high-luminance applications, and efficiency is the key to reducing heat. Although Cree evaluated several LED driver systems, the PAR 38 spotlight design is based on the LYT4317E IC, a member of Power Integrations' recently announced LYTSwitch™ IC family which delivers tight-regulation and high-efficiency for tube replacements and high-bay lighting, while providing exceptional performance in TRIAC-dimmable bulb applications. Power Integrations' DER 350 describes a 20 watt, isolated flyback, LED Driver with a power factor of above 0.98.

LYTSwitch ICs combine the controller with an integrated 650 V power MOSFET for use in LED driver applications. They are configured for use in a single-stage flyback topology which provides a primary side regulated constant current output while maintaining high power factor from the AC input. As well as high-efficiency, the topology also delivers low THD, and low component count, and LYTSwitch ICs also provide a sophisticated range of protection features including auto-restart for open control loop and output short-circuit conditions. Line overvoltage provides extended line fault and surge withstand, and accurate hysteretic thermal shut-down that ensures safe average PCB temperatures under all conditions.

The circuit shown in figure 1 (figure 4 in DER 350) shows the schematic diagram for an isolated, high power factor (PF) TRIAC-dimmable LED driver intended to power a nominal LED string voltage of 36 V at 550 mA typical from an input voltage range of 90 VAC to 132 VAC. The requirement to provide output dimming with low cost, TRIAC based, leading edge phase dimmers introduced a number of trade-offs in the design.

Because LED lighting systems consume so much less power than traditional technology solutions, the current drawn by the lamp can fall below the holding current of the TRIAC within the dimmer. This causes undesirable behaviour, such as the lamp turning off

before the end of the dimmer control range and/or flickering as the TRIAC fires inconsistently. The relatively large impedance that the LED lamp presents to the line allows significant ringing to occur due to the inrush current charging the input capacitance when the TRIAC turns on. This too can cause similar undesirable behaviour as ringing may cause the TRIAC current to fall to zero.

To overcome these issues, active damper and passive bleeder circuits were added. The drawback of these circuits is increased dissipation and therefore reduced efficiency of the supply. For non-dimming applications these components can simply be omitted.

The active damper consists of components R6, R28, R29, D10, Q1, Q3, C3, VR5, in conjunction with R8. This circuit limits the inrush current that flows to charge input capacitors C2 and C4 when the TRIAC turns on by placing resistor R8 in series for the first ~0.5 ms of the conduction period. After approximately 0.5 ms, transistor Q1 turns on and shorts resistor R8. This keeps the power dissipation on R8 low and allows a larger value during current limiting. Resistors R6, R29, and capacitor C3 provide the 0.5 ms delay after the TRIAC conducts. Transistor Q3 discharges capacitor C3 when the TRIAC is not conducting; VR5 clamps the gate voltage of Q1 to 15 V while R28 prevents MOSFET oscillation.

The passive bleeder circuit is comprised of C1 and R1. This keeps the input current above the TRIAC holding current while the driver input current increases during each AC half-cycle preventing the TRIAC switch from oscillating at the start (and end) of each conduction angle period.

Cree Services provide a comprehensive suite of Thermal, Electrical, Mechanical, Photometric and Optical tests (TEMPO) for LED luminaires (<http://www.cree.com/tempo>). The company takes the implementation of its LED arrays very seriously, running a driver compatibility program' (<http://www.cree.com/led-components-and-modules/tools-and-support/dcp>). This is specifically tailored to compatibility at the company's range of modules, but also shows some of the testing it performs in conjunction with reference design drivers including the PI PAR38.

www.powerint.com



Solder Ribbon



Solder Preforms

Over 200 alloys available

- Pb-free
- Pb-containing
- Tape & reel packaging
- Bulk or custom packaging



Learn more:
<http://indium.us/F614>

INDIUM
CORPORATION®
From One Engineer
To Another®

www.indium.com
askus@indium.com

ASIA • CHINA • EUROPE • USA

Synchronization of SMPS Power Modules

A Practical Application for Cyclone V FPGA Power Requirements

The integration of multiple power modules on a single power board allows for specific load requirements to be achieved. This arrangement, commonly known as Distributed Power Architecture (DPA), matches each individual DC/DC converter to a specific load, resulting in an improved dynamic response while eliminating problems associated while distributing low voltages around a system.[1]

By Quentin Bichon and Seán Walsh, Texas Instruments, Freising, Germany

By integrating a number of power modules on a single power board, multiple switching frequencies co-exist. This results in undesirable sub-harmonic beat frequencies and EMI effects, causing elusive noise problems which can affect controller performance. Therefore switching frequency synchronization between the multiple power converters becomes necessary for stable operation.[2]

This article describes a method for synchronizing multiple DC/DC buck modules on a single power board to address specific FPGA load requirements. A detailed description of the simple and effective 'Synchronization Circuit' is included while relevant results and outcomes are discussed. The specific modules used in the example are the TPS84320 and TPS84621 from Texas Instruments.

Circuit Description

A simplified block diagram of the power board is shown in Figure 1. The board integrates four DC-DC power modules to address four specific load requirements for the Cyclone V FPGA. In this particular example a switching frequency of 480 kHz is selected. (The permissible ranges are 330-780 kHz and 250-780 kHz for the TPS84320 and TPS84621 respectively.) As can be seen, the switch node from one of the modules acts as the 'master', providing the clock frequency to which the remaining three modules are synchronized.

According to the device datasheets, the RT/CLK pin of each module requires a square wave clock signal with a duty cycle between 20% and 80%. The TPS84320 module providing 3.3V output was therefore selected to provide the synchronization clock signal as it contains the most suitable duty cycle (27.5%), ensuring maximum precision.

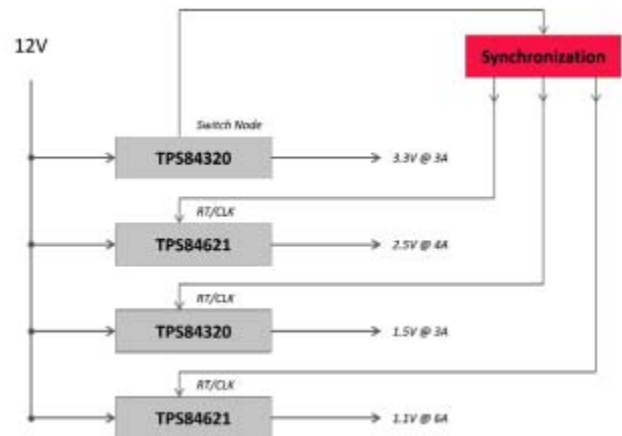

Figure 1: Power Board Block Diagram

This square wave clock signal is applied to the 'Synchronization Circuit' which in turn, provides three synchronized clock signals to each RT/CLK pin of each of the remaining modules. Figure 2 below shows a detailed schematic of this circuit.

The input voltage, provided by the master clock signal, is likely to exceed the maximum voltage tolerance of each RT/CLK pin, which in this case is 6V. Therefore this input signal is clamped to 3.3V, using two Schottky diodes (D1, D2) as shown. An RC filter is also applied (R2, C3) to prevent erroneous switching action caused by ringing in the master switching node.

A buffer stage (U1) is implemented to provide the necessary power to drive the output signals. Since the TPS84k series of power modules are synchronized to the falling edge of the clock signal, an inverting buffer was used to ensure that the synchronization always occurs on the rising edge. This results in more precise switching, preventing jitter that would be caused by duty cycle changes in the main clock signal.

During start-up, a zero value signal might exist on the input of the 'Synchronization Circuit'.

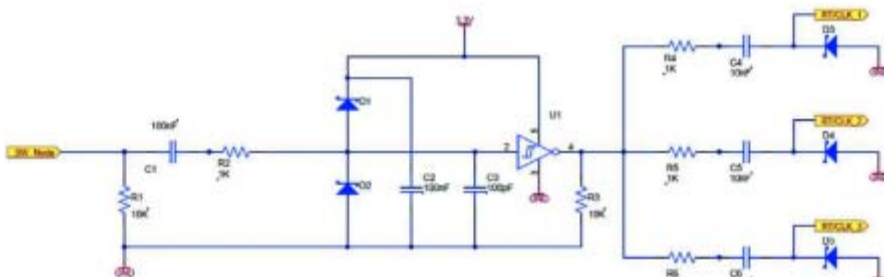

Figure 2: Synchronization Circuit

cuit'. This would result in a constant high output signal on each of the three outputs, confusing the power modules and impeding their function. To avoid this, capacitors C4, C5, and C6 are inserted to isolate the outputs during this short start-up time. While this occurs, each power module operates at their individual default switching frequencies. These default switching frequencies are pre-programmed using an external resistor and are overtaken as soon as the synchronization signal is present. These 'back-up' frequencies also come into play in the event of failure in the master signal.

As a result of the inclusion of these capacitors, the DC portion of the signal is suppressed resulting in a square wave oscillating between positive and negative. However, the minimum voltage accepted by the RT/CLK pin is -0.3V. Therefore, a Schottky diode is added to clamp the negative portion.

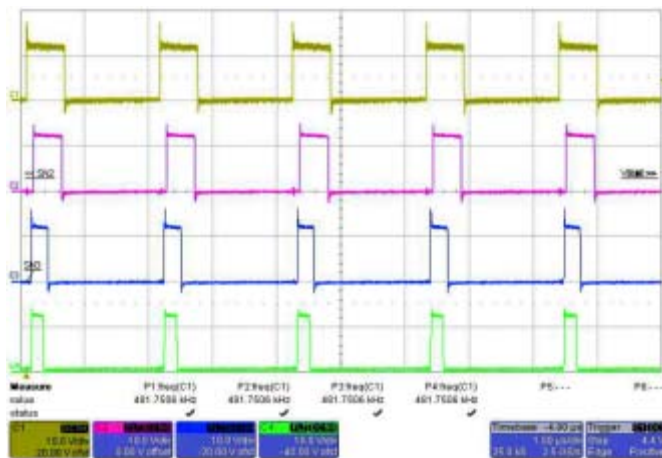

Figure 3: Switching Frequency Waveforms

Results

Figure 3 displays the switching frequency waveforms of each of the four on-board power modules. As can be seen, the power modules are each synchronized to an identical switching frequency of 482 kHz.

Conclusion

This article has presented a simple and effective method for accurately synchronizing multiple power modules. The solution discussed eliminates difficult-to-filter sub-harmonic beat frequencies while improving overall EMI performance.

References

- (1) NetPower Technologies, Inc. (April 2007). Synchronisation of Power Converters. 1-5.
- (2) Ozkaynak, I. (n.d.). A Universal Synchronisation System for Multiple Switch Mode Power Supplis. 186-193.

www.ti.com

www.electr...

Scan me!

PK16™ High Density DC Filter Capacitors

The PK16™ capacitor can be universally used for the assembly of low inductance DC buffer circuits and DC filters; with its high energy density it can replace banks of series-connected electrolytic capacitors as well as large film capacitors in rectangular cases. Create your own superior technical solution within existing or reduced space parameters:

- superior voltage and current strength
- dramatic increase in operational life
- drastic reduction in failure rates
- minimization of power dissipation losses
- substantial reduction of self-inductance and series resistance
- more exact manufacturing tolerances
- elimination of sharing resistors

ELECTRONICON
CONDENSATOREN GMBH
KEPLERSTRASSE 2
D-07549 GERA
TELEFON: +49 365 7346 100
FAX: +49 365 7346 101
E-MAIL: SALES@ELECTRONICON.COM
WWW.ELECTRONICON.COM

THE IDEAL CHOICE FOR YOUR DC LINK

ELECTRONICON
always in charge

ELECTRONICON Kondensatoren GmbH · Keplerstrasse 2 · Germany - 07549 Gera
Fon: +49 365 7346 100 · email: sales@electronicon.com · web: www.electronicon.com

The Good Gap-Filling Guide

Proper thermal management in equipment such as consumer electronics, handhelds, automotive modules and power supplies requires engineers to eliminate air gaps between hot components and nearby heat-dissipating surfaces. Understanding how to select and use the wide range of gap fillers now on the market is a valuable skill.

By Riaz Ahmed, Chomerics Division Europe - Parker Hannifin Ltd

The wide variety of thermal material types now available to designers reflects a shift in best design practice; moving away from air cooling of electronic components to more pervasive use of heatsinks and diligent connection of hot components to dissipating surfaces such as a metal chassis or enclosure lid. These changes reflect general demands to miniaturise assemblies. Increasing component density effectively reduces the volume of air for cooling and prevents air from circulating. In systems where a fan has traditionally been used for forced-air cooling, a fanless design is frequently now preferred to reduce cost, power consumption, bulk and audible noise. Also, the fan is often the least reliable component in the system.

Air as Enemy

Air, when still, is a known enemy of thermal management. With its low thermal conductivity of 0.024W/m-K, compared to 250W/m-K for aluminium, the air held in microscopic pockets at the interface where a heatsink is attached to a component can significantly impair heat transfer. Traditionally, a thermal grease or phase-change material has been applied to the surfaces to eliminate these air gaps.

To satisfy modern thermal-management practice, more diverse products and materials are now available, offering a wider range of properties to help engineers eliminate air gaps effectively in many locations throughout the assembly. A major challenge facing today's designers is the need to fill relatively large air gaps within the enclosure. These can be in the range of 1mm to 5mm. In addition, where multiple components are attached to a common heatsink, the size of the air gap can be inconsistent from one component to the next. This may be compounded further by mechanical assembly tolerance 'stack-up' issues. In such cases, the chosen gap filler must be able to accommodate such variations to remain in full contact with each surface, without exerting high forces on component casings.

Two of the most important solutions in common use today are gap filler pads and thermal gels. Pads are shaped, compressible items comprising a silicone elastomer binder loaded with thermally conductive particles. A gel is a vulcanising silicone material that can be applied using a pump or dispensing equipment. Gel is ideal in situations where the distance between the component surface and the adjacent cold surface may vary, such as when connecting multiple components to a common heatsink. It can also be used as an alternative to traditional thermal grease or a phase-change material as it places only a low and consistent force on the board and its components.

Gap Filling Pads

Advances in polymer-based binder materials capable of operating across a wide temperature range have been critical to the development of gap filler pads addressing many of the thermal management challenges now facing engineers. The silicone elastomers typically

used have a low compressive modulus, and so are able to conform to the contours of the mating surfaces when lightly compressed. This avoids placing high stresses on components and solder joints. Hence ideal qualities for a gap-filler pad are low compressive modulus as well as high thermal conductivity. Newer materials such as Chomerics' HCS10 show a continuing trend for increasingly softer compounds that prove valuable to designers of small form factor, delicate electronics.

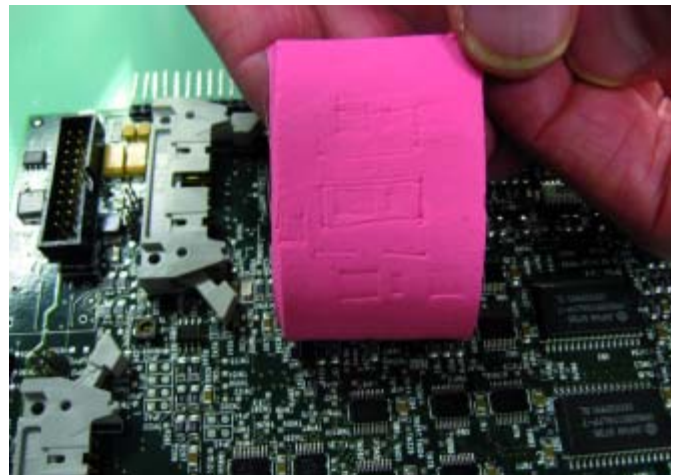

Figure 1: Chomerics HCS10 material

Many different levels of thermal performance are available; thermal conductivity ranges from below 1 W/m-K to over 6 W/m-K. Since conductivity is usually determined by the quantity and type of conductive filler – which may be particles of a ceramic material or a metallic compound such as Aluminium Oxide, Zinc Oxide or Boron Nitride – higher conductivity is traditionally achieved alongside an increase in compressive modulus.



Figure 2: Gap filling pads

Designers can also choose from several values of compressive modulus. Among the most compliant formulations, THERM-A-GAP™ HCS10 pad material is deflected by 73% under pressure of 50psi, while THERM-A-GAP 580 deflects by just 30% under the same conditions. Hence some types of gap fillers can be used to provide vibration damping as well as conformability for thermal management.

Gap filler pads are usually offered in a variety of thicknesses. However, designers must bear in mind that the thermal conductivity of the pad is much lower than that of a metal. The pad is not a cure for poor thermal design. Hence engineers should ensure that any gaps to be filled are as small as possible, therefore requiring the thinnest possible gap pad.

Thermally conductive pads can be ordered as complete sheets, to be cut to size as required, or custom die-cut pads on a sheet or as individual components. A carrier such as aluminium foil or woven glass is also applied. The pad surfaces usually have a degree of tack to keep the pad in position and to minimise contact resistance. A pressure-sensitive adhesive may be pre-applied to one surface for permanent attachment to the cold material. Low-outgassing and silicone-free formulations are available for silicone-sensitive applications such as aerospace equipment, optical electronics and hard-disk drives.

Thermal Gels

A gel, in contrast, can be supplied as a bulk material or in a cartridge or syringe. It can be stored under standard conditions, with no refrigeration required, and there is no tendency for the gel to settle.



Figure 3: Form in place thermal gel gap fillers can be dispensed automatically for high volumes or by syringe for low volumes

A thermal gel has several key advantages. These include the fact that there is no need to maintain supply and inventory of gap filler pads in multiple shapes and sizes, and there is no possibility of incorrect pad selection or positioning. Gels are fully cured and form stable, and hence are easy to use in a production environment. They can be applied inline, with high repeatability in terms of deposit shape and volume, using automated dispensing equipment. In some situations a round-shaped deposit produces optimum coverage of the mating surfaces, while a serpentine, box or spiral shape is often used to reach the extremities of square IC packages such as QFN, LGA or BGA. A single line of gel is known to work best for attaching a heatsink to a traditional DIL package.

A variety of thermal gels are available, such as the Parker Chomerics' GEL30 which is suitable for gap-filling applications as well as direct replacement of thermal greases. Compared to thermal grease,

High Voltage Specialists
 Opto-couplers, Multipliers, Power Supplies, Diodes
SMD Voltage Multipliers
 6 to 14 stages

2kV to 7kV singly, or up to 12kV in series

VMI VOLTAGE MULTIPLIERS INC.
www.VoltageMultipliers.com

a gel's cross-linked structure ensures a low modulus while eliminating disadvantages such as pump-out and drying.

GEL30 provides thermal conductivity performance of 3.5 W/m-K. Compared to some gap filler pads, gels can impose much lower mechanical stresses on components. This is often important as there is a trend for the latest product designs to use quick-and-easy click together fixings that can only achieve low closure forces rather than more time consuming traditional fixings such as screws that exert more force to compress the interface material.

Gels capable of maintaining electrical isolation between the component and heatsink are also available. These incorporate 0.25mm diameter glass beads that act as a compression or dielectric stop. These ensure a minimum separation distance between the component surface and the heatsink, enabling engineers to take advantage of gel properties when using power packages in which the thermal connection also provides an electrical termination to the die.

Summary

As part of a well-conceived thermal-management strategy, thermally conductive pads and gels are able to fill most of the air gaps that cannot otherwise be designed out of an electronic assembly. Both types of fillers incorporate advanced material technologies, and provide a number of benefits in terms of performance and ease of use. Each is a valuable tool for the engineer seeking to maximise the thermal performance of a new design. The table summarises the strengths of popular gels and pads for gap filling applications.

www.parker.com/chomerics

Thermal Evaluation of High Voltage Half Bridge EiceDRIVER™ ICs with Integrated Bootstrap Diode

Consumer electronic applications and home appliances strive continuously for higher efficiency of applications and smaller form factors. The new 2EDL EiceDRIVER(TM) Compact family supports this requirement by integrating many helpful functions such as the bootstrap function.

By Wolfgang Frank, Infineon Technologies AG, Neubiberg, Germany

This article discusses various parameters such as switching frequency and DC link voltage, which influence the power dissipation. Furthermore, it gives a simplified model for the IC surface temperature, which is dependent on the switching frequency and the DC bus voltage.

Only a few half bridge driver ICs now available offer an integrated bootstrap function for the high side supply. More typically the integrated bootstrap functions are realized by high voltage FET structures, such as in [2] and [3], which are very area consumptive. This technique is shown on the left in Figure 1. The resulting on-state resistance of the FET is above 120 Ohms and therefore quite high. On the other hand the high on-state resistance causes a high voltage drop at low duty cycles [1] and additionally high power dissipation in the IC.

However, the advantages of a powerful integrated bootstrap function are striking. Firstly, the layout gets simpler, because of fewer components on the board. Secondly, fewer components need of course less PCB space. The bootstrapping components and tracks are high voltage ones and a related creeping distance must be considered, when routing these connections. Finally, a better placement of the driver IC is possible in respect of distance to the gate terminal of the power transistor. This keeps also the switching EMI low and optimizes the switching performance, hence the switching losses of the power transistor. In consideration of these advantages, Infineon developed its new half bridge EiceDRIVER™ IC family, which contains two output

current classes of 0.5A and 2.3A. It uses integrated diode structures to overcome the disadvantage of high on-state resistance bootstrap FET. The general functionality of the bootstrap diode as well as the EiceDRIVER™ IC family is given in [4]. This article proposes evaluation results of the 0.5A class as well as a thermal model, which is derived out of the measurements.

Thermal behavior in application

Test setup

The self heating behavior combines the static and dynamic losses of the driver IC. These are:

- Gate charge Q_g of the driven power transistor including external gate-emitter capacitance C_G according to Figure 1.
- Junction capacitance between high side and low side (C_{HL})
- Reverse recovery losses of the bootstrap diode (E_{rec})
- Resistive losses of the current limiting resistor (P_{RLim})
- Quiescent losses of the IC caused by the supply

The test setup is defined in the right side of Figure 1. An infrared camera continuously measures the surface temperature of the DUT and communicates with a PC. The evaluation of the thermal performance of the 2EDL EiceDRIVER™ Compact family was performed using a 2EDL05106PF device. The values of the test circuit are given in Table 1.

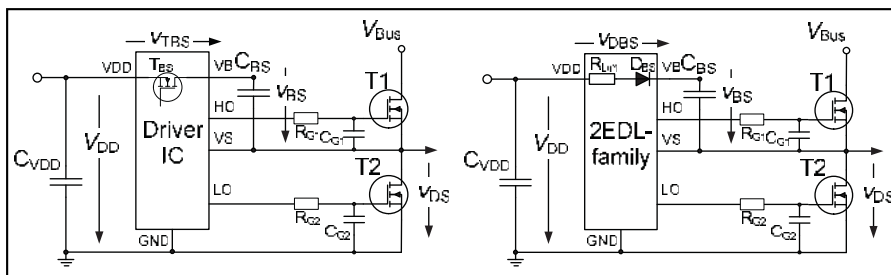

Figure 1: Bootstrap circuit of a half bridge configuration: Left: bootstrapping of competitor parts by FET; Right: bootstrapping of 2EDL family by bootstrap diode

Component / parameter	Value
C_{BS}	4.7 μ F
T1, T2	SPD03N50C3
R_{G1}, R_{G2}	22 Ω
C_{G1}, C_{G2}	560 pF, 560 pF - 22nF
VDD	15 V
VBus	50V ... 450 V

Table 1: Test circuit values

Two measurements with 10 kHz and 200 kHz were performed in order to evaluate the self heating effect as a function of the dc link voltage V_{Bus} . Additionally, it is proven by measurement that the device temperature scales linearly with the switching frequency. A third measurement shows the IC temperature depending on the external gate-source capacitance.

Influence of switching frequency f_p

The blue curve in Fig. 2 shows the absolute temperature T_{IC} of the device surface, while the red curve shows the relative temperature increase ΔT_{IC} above ambient temperature. The lines are strictly linear, which proves the linear dependency of the power dissipation to the switching frequency. It gives a simplification for the thermal modeling further below.

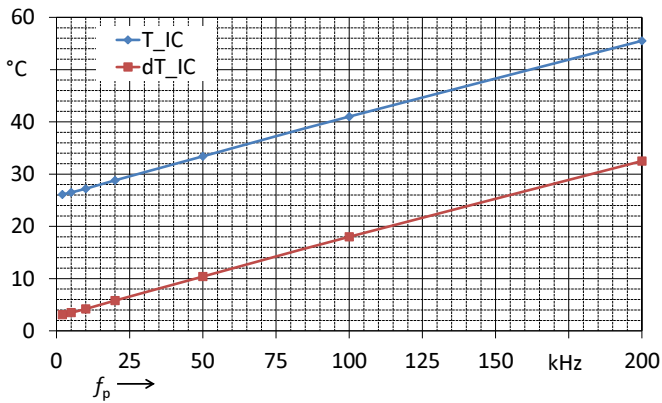

Figure 2: IC surface temperature of EiceDRIVER™ Compact 2EDL05I06PF as a function of switching frequency ($V_{Bus} = 300V$)

The temperature increase of the EiceDRIVER™ IC operating at 200 kHz is around $\Delta T_{IC} = 31^\circ C$. This is an excellent value. This measurement shows that the IC is capable of supporting modern switch mode power supply technologies.

Influence of DC bus voltage V_{DC}

Figure 3 shows the relative temperature increase of over dc link voltage variation of the IC at two different switching frequencies. The linear approximations are given by these equations:

$$\Delta T_{IC,100kHz} = 0.0563 \frac{K}{V} \cdot V_{Bus} + 8.247 K = m_1 \cdot V_{Bus} + t_1 \quad (2)$$

$$\Delta T_{IC,10kHz} = 0.0119 \frac{K}{V} \cdot V_{Bus} + 0.1288 K = m_2 \cdot V_{Bus} + t_2 \quad (3)$$

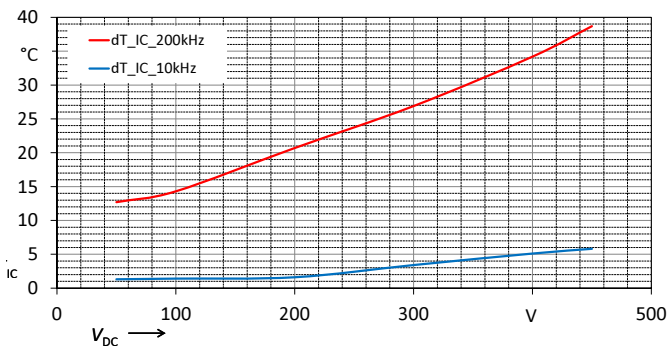

Figure 3: IC surface temperature of 2EDL05I06PF as a function of the dc link voltage: Blue: switching frequency $V_{Bus} = 10$ kHz; Red: switching frequency $V_{Bus} = 200$ kHz

power. precision. excellence.

Highly-integrated SCALE-2® ASIC chipset
IGBT driver with plug-and-play functionality
Advanced Active Clamping (A²C)

driven by prime
performance

 engineered
in Switzerland



The total influence of switching frequency and the bus voltage can be extracted by deriving a linear function for $m = m(f_p)$ and $t = t(f_p)$ by using m_1 , t_1 , m_2 and t_2 :

$$m(f_p) = 0.281 \frac{\text{K}}{\text{V kHz}} \cdot f_p + 9.095 \frac{\text{K}}{\text{V}} \quad (4)$$

$$t(f_p) = 42.73 \frac{\text{K}}{\text{V Hz}} \cdot f_p + 2.985 \frac{\text{K}}{\text{V}} \quad (5)$$

Combining equations (2) – (5) results then in the final thermal model depending on the bus voltage V_{Bus} and the switching frequency f_p :

$$\Delta T_{\text{IC, tot}}(f_p, V_{\text{Bus}}) = m(f_p) \cdot V_{\text{Bus}} + t_1(f_p) \\ = \left(0.000281 \frac{\text{K}}{\text{V kHz}} \cdot f_p + 0.0091 \frac{\text{K}}{\text{V}} \right) \cdot V_{\text{DC}} + 0.0427 \frac{\text{K}}{\text{kHz}} f_p + 0.2985 \text{ K} \quad (6)$$

where the switching frequency f_p is given in kHz.

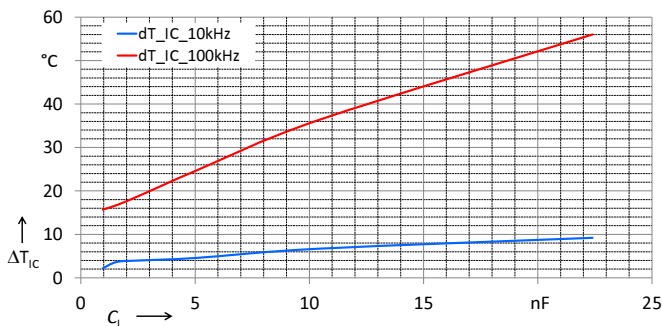

Figure :4 IC surface temperature of 2EDL05I06PF as a function of the gate load ($V_{\text{Bus}} = 300\text{V}$, $f_p = 100\text{ kHz}$)

Influence of gate capacitance C_{gs}

A third measurement evaluates the dependency of the IC temperature over the gate load. This was achieved by adding higher values for the external gate-source capacitance C_{gs} . The switching frequency was set to 100 kHz and the bus voltage is 300 V.

The IC temperature can be approximated as a linear function of the gate load.

Conclusion

The integration of dissipative bootstrap diodes increases the IC temperature. However, the temperature increase is limited. It is shown that the influences of DC bus voltage V_{DC} , switching frequency f_p and gate-source capacitance C_{g1} and C_{g2} are linear. The measured values can be therefore used to predict the IC temperature precisely by calculation. Additionally, a calculation method is presented. It is shown that the newly developed 2EDL EiceDRIVER™ Compact family can be operated up to 200 kHz or even above under application relevant conditions. This includes the full use of the integrated bootstrap diode. It is proven that the device can easily manage the gate control of modern power electronic topologies such as LLC converters or other half bridge based topologies, which are widely used in consumer electronics and home appliances.

Literature:

- (1) International Rectifier: AN-1123 Bootstrap Network Analysis: Focusing on the Integrated Bootstrap Functionality, application note, USA
- (2) STMicro: L6398 High voltage high and low side driver; datasheet, 2011, STMicro, Italy
- (3) International Rectifier: IRS2607DSPbF High voltage high and low side driver; datasheet, 2008, USA
- (4) W. Frank, et al.: A new high voltage half bridge driver IC concept for consumer electronics and home appliances; accepted paper on PCIM Europe, Nuremberg, 2013

www.infineon.com

Power Your Recognition Instantly

Based in Munich, Germany, ITPR Information-Travels Public Relations is a full-service consultancy with over a decade of experience in the electronics sector.

As a small exclusive agency, we offer extremely high ROI, no-nonsense flexibility and highest priority to only a handful of companies.

Strategical Support

Corporate/Product Positioning, Market/Competitive Analysis, PR Programs, Roadmaps, Media Training, Business Development, Partnerships, Channel Marketing, Online Marketing

Tactical PR

Writing: Press Releases, Feature Articles, Commentaries, Case Studies, White Papers
Organizing: Media Briefings, Road Shows, Product Placements in Reviews and Market Overviews, Exhibitions, Press Conferences

Monitoring and Research: Speaking Opportunities, Editorial Calendars, Feature Placement, Media Coverage, Competitive Analysis

Translations: Releases, By-Lined Articles, Websites, etc.

Call or contact us today for a free consultation on how PR can dramatically affect your company's bottom line.

ITPR Information-Travels Public Relations
Stefanusstrasse 6a, 82166 Gräfelfing-Munich, Germany
Tel ++49 (89) 898687-20, Fax ++49 (89) 898687-21,
electronics@information-travels.com

www.information-travels.com



SHORTER time-to-market!



HIL400 and HIL600 – the real time machines!

- Your power lab in a box
- Fast, programmable, safe and accurate controller testing
- Shorter development time and reduced cost
- Real-time desktop emulation
- Maximum development security and minimized risk of damage to expensive power inverter hardware



distributed by

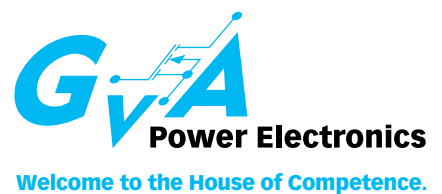

SMD Power GaN & SiC Devices on Power Boards Replace High Power 600V & 1200V IGBT Modules

Power GaN and SiC Transistors with higher power densities and efficiencies enable corresponding improvements to system architecture. New technology enables optimum performance of compound semiconductors, accommodates system customization, and uses low cost commercial manufacturing techniques

By Courtney R. Furnival, CRFurnival@SPSPower.com

Modules versus SMD Boards

Surface mount package (SMD) high-power 600 V and 1200 V GaN and SiC devices offer extremely high efficiencies in high-performance packages. New SMD package architectures enable high-frequency operation with exceptionally low inductance, low DC/AC resistance and low thermal resistance. Last month's article, "Power GaN and SiC Demands High Performance Modules" (1), focused on using the μ MaxPak as building-blocks for smaller and more efficient conventional screw-terminal modules. This module solution allows high-speed compound semiconductors to operate more efficiently, while minimizing conduction and switching losses. However, conventional module packages, although readily accepted in the marketplace, still severely limit the realizable power density and possible cost savings.

In this article, the next step is taken to further increase power density using SMD assembly on open power boards similar to the familiar printed circuit boards, enabling more system integration and most of all reducing overall system costs. The foundation elements in this approach are the SMD power device. As explained in the previous article, the μ MaxPak unique SMD package is built using a modified QFN package platform, which offers proven low cost commercial packages that can be assembled at most QFN assemblers. The μ MaxPak accommodates co-packaged switches, paralleled die, cascode MOSFET and 3-D configured bump-chip gate drivers, all of which contribute to optimum compound semiconductor device performance when tightly integrated. The packaging technique is ideally

suited for half bridges (HB), full bridges, and three phasebridges (3-Ph), while accommodating the full system with functions like protection, current sense, input rectifiers, gate drivers, and control circuitry. The Power Bridges are only one converter example.

The μ MaxPak packages are well suited for other power converters that contain both switches and diodes such as the boost, the power factor correction, and bi-level switch circuits. The high-density μ MaxPak architecture is ideal for paralleling high-speed power GaN and SiC die. This SMD construction is much simpler than the conventional screw-terminal module enabling assembly at typical printed circuit board (PCB) assembly houses. As a supply-chain streamliner, the μ MaxPak SMD can be assembled, tested, and controlled by semiconductor device manufacturers. Since the power board is similar to the printed circuit board, the end-users or system manufactures can tailor board design to their products and applications, with common PCB assembly techniques including coating or potting the power board to accommodate voltage and environmental requirements. The proper selection of board type is dependent on specific board properties and power level.

High-Performance Power SMD Boards

The μ MaxPak SMD enables high speed and efficient power GaN and SiC performance at very high power density. It is important to select a power board to maintain that optimum performance and power density, and to maintain the low commercial manufacturing costs at the system level. Key factors at the system or board level are low thermal resistance, low inductance, system power density,

simple SMD assembly, and easy user customization.

Low Thermal Resistance: The μ MaxPak package can provide extremely low R_{jc} below 0.1C/W, with the mounting board or substrate providing the required heat transfer to the heatsink while maintaining the required high-voltage isolation. Insulated metal substrates (IMS) with excellent heat transfer from the μ MaxPak case to system heatsink, have been used extensively for decades in Japan for high voltage IGBT six-paks and power modules. IMS is much lower cost and simpler to assemble than DBC modules, and has become more available in the U.S. and Europe. As an example, Laird Technology's premium Tlam² HTD has an insulation layer that is more than 10 times more thermally conductive than FR4. At 0.004 inches thick the thermal resistance can be 100 times lower than a 0.040 inch FR4 PCB., This unique premium HTD thermal prepreg Tpreg and thermal via can provide Power PCBs (PPCB) with similarly low thermal resistance (R_{cs}), without a metal baseplate. That said, the metal baseplate can be important because it not only provides a heat transfer and heat capacity, but also acts as package body, mechanical structure and mounting surface for SMD components, connectors and the complete system. The IMS and PPCB can accommodate power dissipation (PD) for HB μ MaxPak's with 5x5mm die switches for output power up to 25 kVA at 600 V, and 18 kVA at 1200 V. See Table 1 for details on power dissipation, efficiency, output power and associated conditions.

Higher power levels can be achieved with high-temperature non-isolated PCBs with attached/soldered Al₂O₃ or AlN direct bond copper (DBC) substrate. The DBC provides excellent heat transfer and isolation. It can provide power dissipation (PD) for μ MaxPak HB with 5x5mm die switch output of up to 50 kVA on Al₂O₃, DBC and 148 kVA on AlN DBC. See Table 1 for details on power dissipation, efficiency and output power. The Power PCB with attached DBC is more complex and expensive, but still accommodates SMD reflow assembly with all of the advantages of a single board system performance costs, relative to conventional modules.

Low Inductance (L) and Resistance (R): Short traces and 4 oz copper layers on IMS. Provide very trace low L and R. SMD components and connectors can be easily placed and solder reflowed without additional jumpers or connections. The traces can be wide and thin to minimize DC and AC resistance, and the very thin dielectric layer to the baseplate or ground plane provides natural field cancelling, minimizing parasitic inductance.

Maximum Power Density: The simple SMD board accommodates simple small SMD component without additional electrical, mechanical and thermal structures. The boards enable 3-D structures with heatsink below the power board and control board/components above. Ideally, gate drivers and associated components are co-packaged in the μ MaxPak. The following output examples are for 5x5 mm die switches, in 15 mm x 8 mm x 1 mm HB μ MaxPak, with 99.0-99.5% efficiency. The maximum HB output based on the thermal limitations are; 1) insulated metal substrates in Figure 1b accommodate outputs of 25-50 kVA, 2) insulated PPCBs in Figure 1c also accommodate outputs of 25-50 kVA and 3) PPCBs with external DBC isolator in Figure 1d accommodate outputs of 75-150 kVA. The substrate thermal capabilities sometimes surpass the output capabilities of 5x5 mm GaN and SiC devices, but even higher device outputs are achievable with paralleled 5x5 mm die switches. Figure 1a shows the simplicity of a SMD inverter with three HB μ MaxPaks containing one 5x5mm die per switch. The external connectors are nominal and will change with current levels. Connectors can

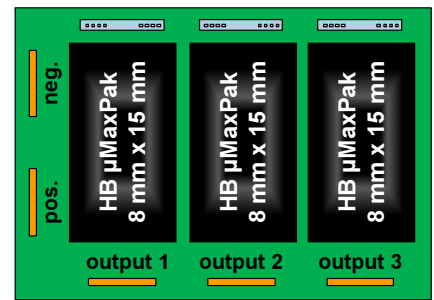

Figure 1a: Top-View of 31mm x 22mm Inverter with three μ MaxPak HB w or w/o Bump-chip Gate Drivers



Figure 1b: Side-View of IMS Inverter with Three μ MaxPak HB



Figure 1c: Side-View of Isolated PPCB with Three μ maxPakHB



Figure 1d: Side-View of Non - Isolated PPCB Inverter with Three μ MaxPak HB and DBC Isolator of Bottom-Side

Strip Wound Cores
Tape Wound Cores
Bobbin Cores

Powder Cores
Kool M μ [®] Cores
Molypermalloy Cores
High Flux Cores
XFlux[®] Cores

Ferrite Cores
Power Materials
High Permeability Materials
Special Materials

New! AmoFlux[®] Cores

1 800 245 3984 • +1 412 696 1333 • +852 3102 9337 • www.mag-inc.com



Darnell's Energy Summit

September 9-13, 2013 Dallas, Texas
Three Shows Under One roof



Darnell's
Power Forum



Smart Grid
Electronics Forum

Sponsorships
and Exhibits
Available



greenbuilding
power forum

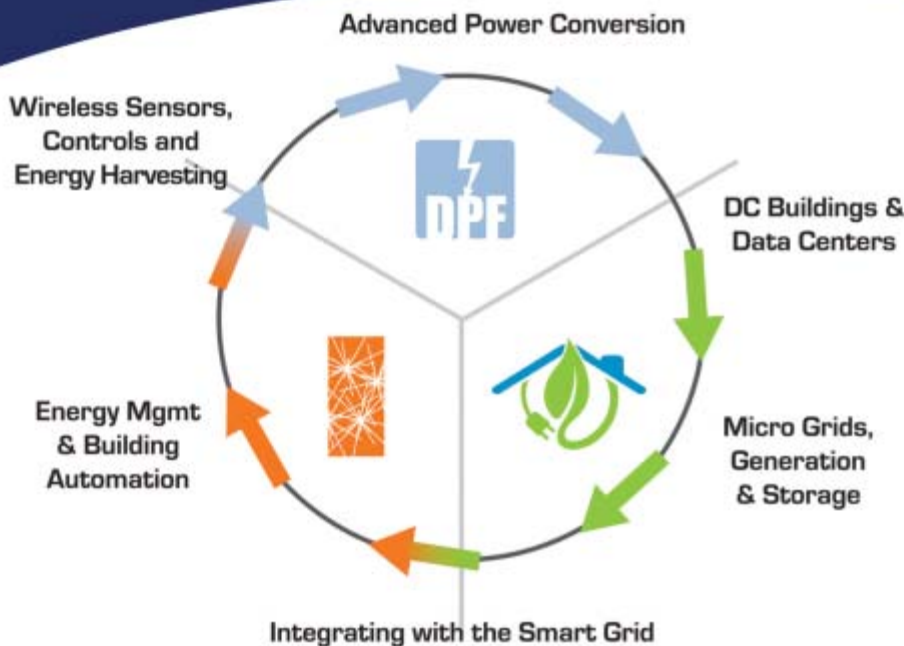

Diamond Sponsor:



Platinum Sponsors:



energysummit.darnell.com

be FASTON type at the lower current ranges, and solder at mid-range currents. This type of lead can carry 3-5 times the typical rated current on FR4 PCBs, because the IMS and PPCB can keep them cooler, and temperature is a major factor in their current ratings. At hundreds of amperes, screw terminals may still be required, but ideally only once per function exiting the full system. The inverter was used as a common example, but again it is most advantageous to maximize integration with power components on the IMS/PPCB, and other components above.

Simple SMD Assembly: The IMS or Power PCB accommodate easy SMD pick & place and solder reflow assembly, which is low cost and compatible with most PCB assembly houses. It minimizes mechanical and thermal hardware, and accommodates easy post potting or coating.

Devices Type	600V GaN			1200V SiC			Units
V(operation)	240	240	240	480	480	480	Vac
V(Isolation)	>3.5	>3.5	>3.5	>5.0	>5.0	>5.0	kV
Isolation Board/Substrate	T-lam/HTD	Al ₂ O ₃ /DBC	AlN/DBC	T-lam/HTD	Al ₂ O ₃ /DBC	AlN/DBC	
Isolator Thickness	0.004	0.02	0.025	0.006	0.02	0.025	inch
Thermal Conductivity	2.2	24	220	2.2	24	220	W/mK
Tj(max)	175	185	185	175	185	185	C
Ts(max)	75	75	75	75	75	75	C
PD(max)	62	124	369	45	124	369	W
Assumed Efficiency	99-99.5	99-99.5	99-99.5	99-99.5	99-99.5	99-99.5	%
SS Output 100% Swt Duty	6.2-12	12-25	37-74	4.5-9.0	12-25	37-74	kVA
HB Output 50% Swt.Duty	12-25	25-50	74-148	9-18	25-50	74-148	kVA

Table 1: 5x5 mm GaN & SiC Die in μ MaxPak on Thermal Boards

User Customization: These boards can be designed and modified with PCB type artwork, making it easy for the user to optimize their products and systems, and do not require the user to build around a large and awkward standard module. Likewise, the GaN and SiC supplier creates the μ MaxPak with conventional QFN/DFN platform, and does not need to create multiple module configurations with associated mechanical structures, special materials, and costly equipment and tooling NRE.

Integration, Integration, Integration: The final key to Power GaN and SiC performance and high power density is integration. Smaller die, smaller SMD packages, high-speed and higher efficiencies enable more integration in smaller systems. The close proximity of all components in the system further reduces parasitics, interconnects, complexity and manufacturing costs.

Parallel Worlds

The first world being high-speed high-density digital devices like microprocessors, memory and interface, and the second world being power compound semiconductor services. The point being that today's digital devices were not possible in plastic dual in-line (P-DIP) and small outline integrated circuit (SOIC) packages. Further, emerging power GaN & SiC devices cannot advance when limited by TO-220, TO247 and standard screw-terminal bridge modules. The reason is that power converters using high-speed high-density GaN and SiC devices must include leadless, wire bondless, 3-D stacked, integrated, and co-packaged structures. These packages do not just help power GaN and SiC performance, but are IMPERATIVE to the full performance of these devices. Further, most technologies and techniques developed for the high-speed high-density digital world are applica-

ble to the high-speed high-density power compound semiconductor world.

(¹) "Power GaN and SiC Demands High Performance Modules", by Courtney R. Furnival, Semiconductor Packaging Solutions, published in Bodo's Power Systems Magazine, May 2013, pp 56-58

(²) Laird Technology's trademarked "Tlam" is a "Tpreg" with metal on both side (DSL), and that metal can be copper foil or can be an aluminum or copper plate on one side. The "Tlam ML" is a multilayer insulated metal substrate with DSL laminated to a metal base plate with Tpreg

For additional information please contact Courtney R. Furnival: CRFurnival@SPSPower.com

www.SPSPower.com



IGBT driver power supply

DC/DC converters for IGBT drivers

- RxxPxx, RxxP2xx, RV, RP and RH series with asymmetric outputs +15V/-9V
- Efficiency up to 86%
- High grade isolation up to 6.4kVDC
- Operating temperature range up to +90°C
- EN/UL, CSA & CB certified
- 5 year warranty

www.recom-electronic.com

RECOM

Capacitors Built to Customer Specifications

Historically, capacitor designs have been primarily defined by the final cost of the capacitor itself. Fischer & Tausche Capacitors (FTCap) suggests a more comprehensive approach because cost is not just limited to the purchasing price of the capacitor.

By Peter Fischer, Fischer & Tausche

Customers cannot ignore installation, test, and maintenance costs. This is now more true than ever. Today's sophisticated developments in the field of power electronics require a new range of capacitors that can be built to customer specifications, delivered within a reasonable time-frame and at an affordable overall price.

Although progress is certainly possible, the dielectric strength of capacitor films has been nearly optimized. This means that capacitor manufacturers cannot reduce volume by simply changing to a thinner film.



Figure 1: FischerLink capacitor

Fischer & Tausche Capacitors (FTCap) has taken these elements into account and the result is the FischerLink, a new capacitor design which is compact, robust, including an integrated bus-bar and manufactured to customer specifications. Although mainly for the power conversion industry (inverters, rectifiers, converters), engineers throughout the power electronics industry will quickly understand the advantages of the FischerLink.

Installation costs: Rather than installing several capacitors in a parallel/series configuration to achieve the necessary C/U and I values, the FischerLink gets the job done with one single capacitor. Less expensive to install, and with additional savings during testing and maintenance.

Quality: One capacitor built to customer specifications, fulfilling all the requirements.

Very low inductance: Please refer to Figure 2 for more details.

The patented FischerLink design is simple and ingenious. The different winding elements are welded directly to the copper bus-bar. By eliminating the conventional housing, the FischerLink allows increased capacitance of +10% within the same volume when compared to traditional solutions.

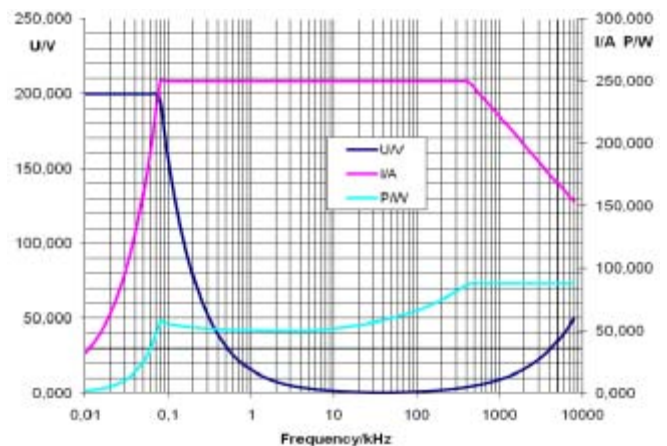

Figure 2: Capacitors with an inductance of the FischerLink. The inductance and parasitic resistances are minimized.

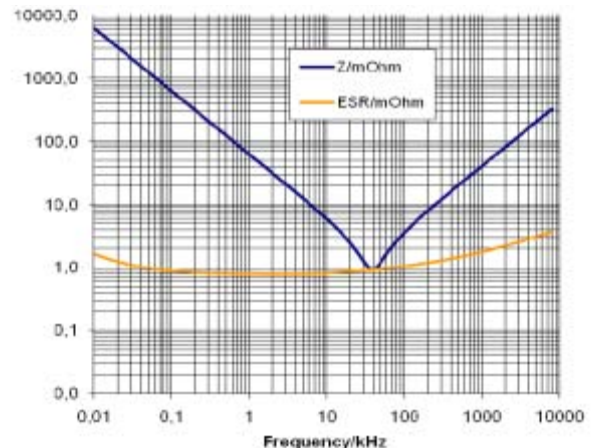

Figure 3: Frequency range of the FischerLink capacitor FL2600i1100d: The bus-bar is built from pure copper to withstand high levels of current across all frequency ranges. The very low inductance gives high resonant frequency while keeping ESR values as low as 1 mOhm!

When exposed to air, contacts runs the risk of corrosion. The FischerLink seals the contacts onto the bus-bar with a water-tight UL94-VO resin-epoxy. This innovative process eliminates the risk of corrosion.

Conventional capacitor solutions are completely enveloped in resin-epoxy. This allows for poor heat dissipation. The FischerLink uses the resin-epoxy exactly and only where it is needed. The winding elements are free to optimize cooling.

As mentioned already, the FischerLink is built to customer specifications, with a single bus-bar designed to withstand high current therefore optimizing all electrical values.

Upon request, the FischerLink can be delivered with an integrated safety discharge resistor.

An additional option is to combine the FischerLink design with electrolytic capacitor technology to offer other advantages.



Figure 4: Switch cabinet with FischerLink

The FischerLink can also be designed to sit directly on a heat-sink for optimal heat dissipation thereby withstanding even higher currents with increased lifetime.

Reduced maintenance and repair costs are still another advantage of the FischerLink. Along with a well-known manufacturer of windmills, Fischer and Tausche Capacitors (FTCap) has helped to reduce overall costs in a significant way.

In the past, due to failures or simply planned maintenance, windmill technicians removed the old capacitors and replaced with new ones. This operation is time-consuming and expensive. Typically the technicians go on-site to evaluate a series of capacitors within a bank. It happens quite frequently that a new replacement capacitor is installed into an old capacitor bank. As it is a new capacitor, the leakage current is quite low.

Because the balancing resistor cannot equalize the levels of leakage current of each capacitor within the bank, there is an advanced risk of failure.

Replacing each capacitor within the bank is the only quality solution, but that is very time-consuming and costly. Along with Fischer and Tausche Capacitors (FTCap), the windmill manufacturer has created a solution where the old bank is removed and a new FischerLink is installed at just a fraction of the time and cost. Windmill downtime is also kept to a minimum further decreasing the total cost of the operation.

Prototypes were tested successfully and this windmill FischerLink is now going into series production.

In another project, a customer chose to create a FischerLink by using affordable Snap-in capacitors in a series/parallel configuration across a printed circuit board.

In spite of all efforts made, the capacitors in this particular device could only offer a 2 year lifetime because of the extremely harsh environment. The replacement costs in terms of technicians time and labor were enormous. So the customer decided to reduce his overall maintenance and repair costs by removing the old capacitors (de-soldering them one-by-one) and then replacing them with one simple, easy-to-install FischerLink. In this particular example, the FischerLink was delivered with heat-transfer pads to optimize even more the dissipation of the heat. In the end, the customer is also benefitting from longer lifetimes, further reducing his maintenance costs!

In the customer's original design, the current had to be limited because of the thickness of the copper plates. The FischerLink solution was designed with bus-bar that withstands significantly higher levels of current.

www.ftcap.de

Our Power Inductor family from small and filigree to **LARGE** and **POWERFUL**



No "next generation" issues!

- Available from stock
- Free samples within 24 hrs
- Design kits with free refills
- Software tools for product selection
- On-site Design-In consultations
- IC reference designs



www.we-online.com

Advanced Regulator Modules Bring Flexibility to High-Density Power Subsystems

The long-standing trend of increasing efficiency in power-conversion, from the upper 80s of percent to the mid and upper 90s, has come thanks to innovations spanning power-switching device designs, converter-control techniques, and component-packaging technologies. Beyond the obvious operational cost benefits that high-efficiency power subsystems bring to the products they inhabit, one consequence of this trend has been a significant increase in achievable power densities.

By Ian Mazsa, Manager, VI Chip Product Line, Vicor

Converters capable of delivering several hundred watts have commonly occupied brick packages that cover as much as 65 cm² of board space and consume 83 cm³ of package volume. These have been joined by converters of comparable power capability available now that occupy barely over 7 cm² of board space and deliver roughly 100 W/cm³.

The effect of such small board areas and high power densities extends well beyond the power subsystem. Reducing the power subsystem size and weight can bring numerous follow-on effects beneficial to the overall system design. Indeed, in highly space-constrained applications, such as on-board systems for aircraft, such high power densities facilitate electronic functions that would otherwise not fit in the already confined room available for instrumentation. The same high power density converters are also relieving space constraints while satisfying power demands in computing, communications, and industrial process control applications, among others.

More recently, configurable versions of these high power density converter modules have become available. These flexible modules allow you to optimize their parametric performance to your application's requirements while at the same time reducing external circuitry.

For example, Vicor's VI Chip® PRM™ non-isolated regulator modules are available in full-sized packages measuring 32.5 x 22 x 6.73 mm and can deliver up to 500 W of

power (figure 1). The buck-boost regulator is also available in half-sized packages measuring a mere 22 x 16.5 x 6.73 mm capable of delivering up to 250 W of power.



Figure 1: Vicor VI Chip PRM Modules can provide up to 500 W from a 7-cm² package.

The high power density of PRM modules is due to Vicor's proprietary ZVS (zero-voltage switching) topology and custom magnetics. The ZVS topology enables high-frequency switching operation—on the order of 1 MHz—with higher conversion efficiency than conventional regulators using hard switching topologies. High switching frequency reduces the size of reactive components, minimizing the required space needed for the circuitry. High switching frequency also reduces the size of the external filter components, increasing power density while enabling fast dynamic response to line and load transients. For supply-noise sensitive systems, the high switching frequency also puts the converter's spectral artifacts beyond the band of interest for many applications.

Thanks to their versatile feedback and control capabilities, PRM modules can achieve higher power outputs by operating in arrays

well into the kW range (figure 2). In addition to operating as freestanding non-isolated regulators, PRM modules can also pair with VTM™ modules—isolated current-multiplier modules—to supply high-current low-voltage loads. These arrangements can form high-efficiency PoL converter topologies that drive even the lowest voltage processor or memory-subsystem supply rails from, say, a 48 V distribution bus with a single conversion stage.

New versions of the PRM module allow you to specify operating parameters through the VI Chip PRM Module Configurator, part of Vicor's PowerBench™ online tool suite. Vicor builds unconfigured modules to stock and configures them to order. This arrangement provides modules that you've optimized to your system design's requirements.

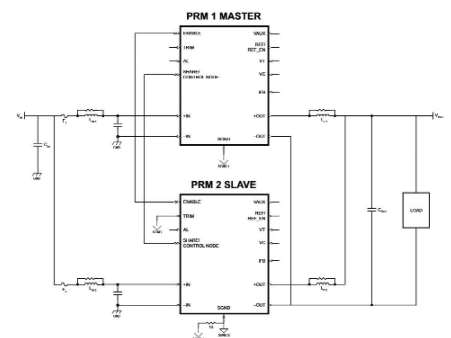

Figure 2: PRM Modules can provide power levels into the kW range using simple arraying connections.

The configurator tool gives access to a substantial range of settings, providing you a great deal of flexibility to tune and optimize a

power converter module to the specific needs of your application. For example, you can specify the module's low-line, nominal, and high-line input voltages and set under- and over-voltage lockout thresholds and hysteresis bands (figure 3). You can also set the output voltage, of course, but also the turn-on delay and output rise time—important variables when coordinating multiple converters that serve multi-rail loads. You can also set the maximum load current. The output current-limit set point tracks this value with a 20% margin.

Input Voltage		
Voltage Range Platform		
<input checked="" type="checkbox"/> Wide (35-75 V) <input type="checkbox"/> Narrow (30-55V)		
		Selection Range
Vin Low Line	35.0 V	35.0 - 54.9 V
Vin Nominal	48.0 V	39.0 - 71.9 V
Vin High Line	75.0 V	51.0 - 75.0 V
Undervoltage Lockout	94.0 % 33.84 V	88.3 - 94.0 %
Undervoltage Lockout Hysteresis	6.0 % 2.0 V	6.0 - 11.0 %
Overvoltage Lockout	107.0 % 80.25 V	107.0 - 110.1 %
Overvoltage Lockout Hysteresis	2.0 % 1.5 V	2.0 - 3.7 %

Output Voltage		
		Selection Range
Vout Set Point	48.0 V	25.0 - 52.0 V
Maximum Trim	55 V	52.8 - 55 V
Overvoltage Limit	%	
Overvoltage Limit Hysteresis	N/A	
Turn On Delay	1 ms	1 - 4 ms
Output Rise Time	1 ms	1 - 4 ms

Output Power, Package, and Product Grade		
Package Size <input type="checkbox"/> Half (0.65 x 0.57 in) <input checked="" type="checkbox"/> Full (1.28 x 0.87 in)		
		Selection Range
Load Current	8.3 A	4.2 - 8.3 A
Current Limit Setpoint	10.0 A	
Pin Style <input checked="" type="checkbox"/> Surface Mount <input type="checkbox"/> Through Hole		
Product Grade <input checked="" type="checkbox"/> T-Grade <input type="checkbox"/> M-Grade		

Requests / Results	
Calculate	Get Part Number, Price, and Delivery

Figure 3: The VI Chip PRM Module Configurator—part of Vicor's PowerBench™ online tool suite—allows you to optimize regulator modules to your application.

Another advantage of configurable modules is that they simplify the converter's electrical interface, eliminating the external circuits that commonly establish various parametric settings. This further reduces board area and assembly costs. It also, in effect, binds the parametric settings such as output voltage, turn-on delay, ramp rate, and protection thresholds to the module instead of to external components. Keeping user-configurable parameters internal to the module reduces post assembly inspection and eliminates potentially destructive events due to, for example, WPMP (wrong part / missing part) assembly faults.

Control over the startup delay and ramp rate, coupled with a hardware enable allow modules to coordinate multiple rails natively without the added cost and development time associated with a logic block to manage the rails. Here again, you can implement even sophisticated power subsystems for processors, memory systems, and other multi-rail loads in a small area and simpler layout than with modules that control such behaviors with external components.

The configurator can generate a unique part number and data sheet that conforms to your specifications. It also immediately provides sample pricing and delivery information to help reduce scheduling and budgetary uncertainties.

Lastly, the configurator can load the device model into the PowerBench simulator, allowing you to start testing the configured PRM module's performance within the context of



One less hat to wear.

Let us be your power expert. We understand that you don't have the time to master every aspect of electronic design. As a leading manufacturer of power supplies we are here to collaborate with you to ensure your next project is a success.



Novum®
Advanced Power



Ac-Dc
Power Supplies



Dc-Dc
Converters



www.cui.com/PowerExpert

its application circuit in advance of sampling (figure 4). Spend just a few minutes with the simulator and you'll come to appreciate how much of the risk associated with a power subsystem design you can front load ahead of final component selection and sampling. The ability to simulate the power train's performance in seconds speeds your design decisions while resolving risk factors.

Using the PRM module's built-in features and your ability to configure devices to specific applications, you can, for example, determine the sequence and timing for rails to start and stop under both normal and fault conditions. Should you, during your product's life cycle, need to make modifications that alter the sequence, ramp timing, output voltage or any other configurable parameter, you needn't recalculate component values or reprogram a sequence controller. Simply modify your configuration data through the online tool and generate a new part in seconds.



Figure 4: The versatile PowerBench Simulator allows you to test modular power components over seven simulation types: VIN start-up, EN start-up, steady state, EN shutdown, VIN step, load step, and thermal.

Many applications in computing, communications, and industrial spaces are increasingly demanding scalability to satisfy varying power capacity requirements with like structures. While scaling structures benefit equipment provider and customer alike, they are incompatible with discrete power designs and fast design cycles. For example, with many discrete designs, you don't have to change the power capacity requirements more than several tens of watts before you need to re-optimize your power train component selections including power MOSFETs, inductors, and capacitors or settle for suboptimal power efficiency. By contrast, scaling power subsystems with modular components and readily accessible design-support tools allows you to experiment, simulate, and test design options with far less engineering time and provide you with an efficient, high-density, and fully specified design.

Another advantage these modular converters bring, compared to a discrete design, is that the circuit board layout—typically a time-consuming exercise to properly manage critical parasitic impedances in a high-speed, high-current application—is already solved within the module. Various application notes and reference designs are available to help ensure that a design realizes the module's full performance.

The PRM modules and PowerBench toolset embody substantial power engineering intellectual property and application expertise, saving you design-cycle time, cost, complexity, and risk that so often accompany discrete designs. The combination of the power components and online design support results in devices uniquely optimized to your system design goals.

www.vicorpower.com

E|DPC

Electric Drives Production
Conference and Exhibition
Nuremberg, 29–30 October 2013

Scientific Partner:



Official Association Partner:



Antriebstechnik



Produce optimized electric drives; meet the requirements of industrial motors and electromobility.

Join at E|DPC and experience the combined technical knowledge about products, ideas, and concepts all in one place.

Get your free entry ticket:
edpc-expo.com/tickets

More information at
+49 711 61946-65 or edpc-expo@mesago.com



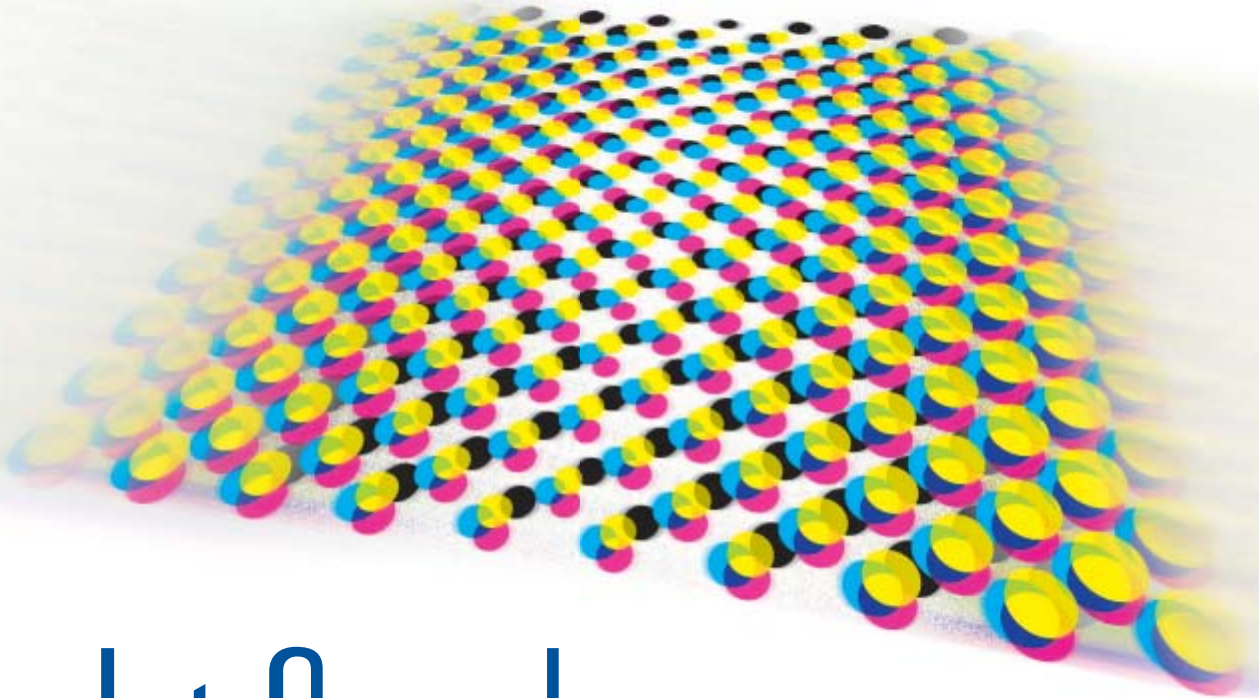

Jet Speed

PB63 Power Booster: Hit Speeds of 700 V/ μ s With Multi-Channel Drivers

DUAL-AMPLIFIER TEAMS UP WITH SMALL SIGNAL OP AMPS TO DELIVER VOLTAGE AND CURRENT GAINS.

Apex Microtechnology is driving high voltage instrumentation with its next generation power booster. The PB63 is a high density, dual channel booster designed for evolving technologies such as high-speed industrial printers and pattern generators in flat panel display inspection (AUO) systems. The PB63 uses an exceptional 700 V/ μ s slew rate to deliver voltage and current gains when used in a composite amplifier configuration with a small signal op amp driver. Accuracy, offset, input noise and settling time are also optimized. The 1 MHz power bandwidth of the PB63 benefits these additional applications:

- Deflection circuitry in semiconductor wafer and mask inspection and lithography systems
- Programmable power supplies for semiconductor automated test equipment (ATE)
- Print head electronic drivers for industrial ink jet printers



Power up at www.apexanalog.com/bodospb63

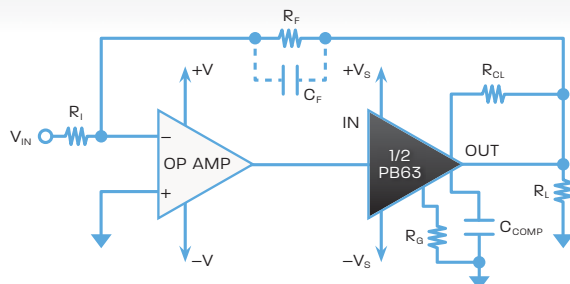

apexanalog.com/bodospb63



Improving Efficiency on AC-DC Supply Efficiency

Can further gains continue to be made?

It's tough to get improve efficiency when supplies are already at 90%, but it can be done by focusing on passive and active components, digital control, supply topologies and packaging

By Don Knowles, VP Engineering, N2Power

For AC-DC power supply users, the good news is that efficiency is now over 90 percent, which represents a significant improvement over the past 20 years when it hovered in the 60 to 80% zone. The not-so-good news is that there are still market pressures to increase the overall efficiency. As all designers know, achieving those last few points of improvement can be more challenging than getting the first 10 or 20 points.

While there is still room for improvement in both efficiency and thermal performance, why try for a few more points of gain if it is so difficult? The reason is that what looks like 'merely' two percentage points still represents considerable dissipation, especially at higher power levels. An improvement from 90% to 92% efficiency is really a decrease of 20% in inefficiency (10% down to 8%), which is a significant energy cost saving. It can be done: at 230 VAC input, AC-DC supplies from N2Power have achieved 93% efficiency for 48V output, for example.

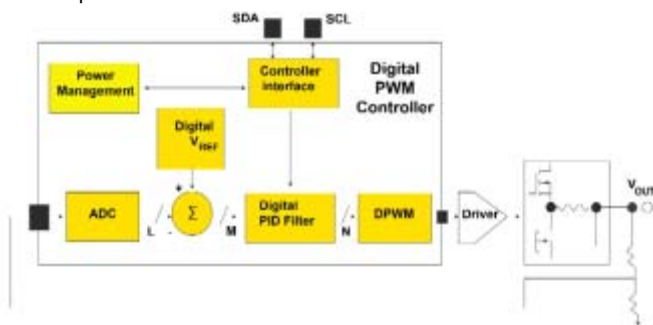

Figure 1: The 375W AC/DC unit from N2Power achieves 93% efficiency for 48V output

There are potential gains in four areas: power-circuit topologies, intelligent digital control, better power components and packaging. Factors which are being explored to improve efficiency include:

- More options to select the best overall converter topology for a desired power level. Digital control of the inner loop will not only improve efficiency, it will also allow for dynamic changes in control strategy to meet varying line and load conditions.
- Reduction of parasitic resistance and inductance in interconnections, as well as copper and energy losses in the inductor.
- Better magnetic components, including lower-loss core material, where applicable. Magnetics have shown much progress over the years, but not as much as semiconductors or topologies, so there is room for improvement.

- New technologies for discrete power semiconductors. For example, Efficient Power Conversion Corporation plans to introduce a line of enhancement-mode gallium-nitride-on-silicon FETs which may provide a better performance than conventional MOSFETs, due to their lower gate to source charge and lower RDS(ON). Note that it is not just the FETs, as low-loss silicon carbide (SiC) diodes from Infineon, ST Micro and Cree offer some intriguing design opportunities.
- Packaging improvements are offering new options for getting the heat away from the supply itself. It's not enough to have an efficient supply if you can't dissipate the heat and therefore prevent temperature build-up.

Change will come, quickly and slowly

We might see an increase of one to two percentage points in efficiency in 2013, and two to three points over the next five years. This means we can perhaps reach 93% at 115 VAC, and 95% at 230 VAC. However, achieving another four to five point improvement is less likely because that would mean 98% to 99% efficiency at 230VAC for +12V output, for example, which would be very tough.

We'll also see improvements in power factor correction (PFC) performance over a broader range of AC-line input range, as well as tolerance of various load faults and characteristics.

Perhaps most dramatically, the increased use of digital control loops (not just digital supervision of analog loops) will change performance levels, improve PFC, add flexibility and enable the supply to adapt to varying and complex line and load situations.

This will open new ways to optimize the supply's operation for non-static situations, hot-swap requirements and N+1 operation. Increased real-time reporting on the supply's operation and internal parameters will become more common and detailed, allowing for earlier assessment of the supply's 'health' and system situation. The challenge is that the power-supply user community is very cautious—and rightly so—transitioning to this new technology will take time.

Efficiency challenges still remain

Current levels are increasing, so factors such as contact and lead resistance, internal IR drop, and related electrical basics are becoming more critical. Operating the supply at higher internal voltage is part of the answer for increased efficiency, but this brings new creepage, spacing and safety issues.



Figure 2: The increased use of digital control loops enhances performance and enables the supply to adapt to varying and complex line and load situations

Increasing the frequency of operation represents a trade-off in size versus efficiency. This is due to increased core losses in magnetics and increased switching losses in the semiconductors. In the AC input range from 90VAC to 264VAC, we have 380-400VDC at the output of PFC stage, but it is difficult to employ a 450VDC capacitor because of size. In this universal range right now, it is not advisable to go to higher internal voltages. But if 48VDC becomes the standard voltage for the output, very high efficiencies could result.

Many other challenges exist. These include the lack of very low-loss core materials, the lack of smaller-size high-voltage capacitors, and slow development of lower RDS(on) and gate-charge MOSFETs. That is before you consider the absence of low-cost, low-drop, high-voltage Schottky diodes.

There are also broader design issues. Many engineers are unfamiliar with how to use digital control to implement switching a single con-

verter on/off in a PFC interleaved stage, or switching off one converter at low loads in paralleled converters. ICs with low quiescent current are required to minimize the no-load input power. Replacing a lot of internal circuitry with a microcontroller could provide more space for other components.

Users must play their part, too

Of course, the entire system-level efficiency burden can't be placed on the supply OEMs. For supply users, a few basic rules will help. First, don't oversize the supply as insurance to be used in case the unit can't actually provide its full output under all specified conditions. It's actually counterproductive, since most supplies have a 'sweet spot' of efficiency somewhere in the range of 80-90% of their maximum load rating. If you run the supply at much lower loads than this, you'll actually be operating in a very inefficient region. Instead, rely on engineers at top-tier supply OEMs to provide the necessary design margin for corner-case performance.

Second, try to avoid active (forced air) cooling using fans, since they waste power, increase noise and reduce reliability. Instead, use an efficient supply, properly sized, and mount it so unforced convection and conduction cooling will keep it within its rated temperature. That way, you will have a more efficient design and one which is also more reliable, if done right. At N2Power, for example, we have characterized and fully specified our XL375 Series of 375W supplies for operation with passive convection cooling in response to user requests.

www.n2power.com

New High Voltage Modules for Traction, UPS, Rectifiers

FROM
IDEA
TO
REALIZATION



High Blocking Voltage
High Isolated Voltage of the Base
Plate Pressure Contact Construction



Thyristor Modules

Type device	V _{max} V _{nom}	I _{TRM} (T _C °C)	T _{TRM}	R _{TRM}	Package	Baseplate width/length mm	V _{max}	
	V	A	°C	°CW			Sine wave, 50 Hz;	RMS; t=1 sec
MTx-280-44-A2	3800-4400	290 (85)	125	0,0690	MA2	60*124	6,0	8,0
MTx-340-65-A2	4600-6500	240 (85)	125	0,0690	MA2	60*124	6,0	8,0

Diode Modules

Type device	V _{max} V _{nom}	I _{TRM} (T _C °C)	T _{TRM}	R _{TRM}	Package	Baseplate width/length mm	V _{max}	
	V	A	°C	°CW			Sine wave, 50 Hz;	RMS; t=1 sec
MDx-470-44-A2	3800-4400	470 (100)	150	0,0690	MA2	60*124	6,0	8,0
MDx-380-52-A2	4600-5200	380 (100)	140	0,0690	MA2	60*124	6,0	8,0
MDx-320-65-A2	5200-6500	320 (100)	140	0,0690	MA2	60*124	6,0	8,0



PROTON-ELECTROTEX
Power semiconductor devices

Proton-Electrotex, JSC
19, Leskova st., Orel, 302027, Russia
Tel: +7 (4862) 44 06 42
Fax: +7 (4862) 44 04 45
e-mail: sales@proton-electrotex.com
www.proton-electrotex.com



FROM
IDEA
TO
REALIZATION

CREE Power Devices now available from MEV

With CREE, the leading manufacturer of SiC and GaN wafers as well as SiC products, MEV presents a new partner for highly reliable solutions on SiC basis.

The experienced FAE team of MEV and an already existing sample stock support you in finding the optimum solution for your high power project.

Torben Niermeyer, CREE line manager and high power expert at MEV, says: "CREE is a very important new partner for us. In the promising markets such as renewable energies with their main focus on efficiency, we can offer our customers attractive solutions. The combination of the CREE products having already proven themselves



on the market and of the technical support by MEV offers our customers a complete package for the support of their high power applications."

www.mev-elektronik.com

SMI

SOLUTIONS IN TELECOM AND SYSTEMS INTEGRATION

SMi present their 2nd annual conference...

Distributed Energy Storage 2013

Supporting the developments of energy storage

17TH-18TH JUNE 2013 | COPTHORNE TARA HOTEL | LONDON, UK

SPEAKER PANEL INCLUDES

- **Alistair Steels**, R&D Project Manager, **Scottish and Southern Energy Power Distribution**
- **Karima Boukir**, Energy Management & Future Grids, **EDF Energy**
- **Dr Stewart Norman**, Storage Programme Manager, **E.ON New Build and Technology**
- **Chris Thompson**, Project Delivery Manager for the Customer-Led Network Revolution Project, **Northern Power Grid**
- **Sally Fenton**, Project Leader, Innovation Delivery, **Department of Energy and Climate Change (DECC)**
- **Denis O'Leary**, Head of Smart Energy Technology, **ESB**
- **Keith Maclean**, Future Networks and Policy Manager, **Scottish and Southern Energy**
- **Graham Taylor**, Senior Commercial Analyst, **National Grid**
- **Nick Heyward**, Commercial Manager, Future Networks, **UK Power Networks**
- **Mo Cloonan**, Head of Development, **Community Energy Scotland**

PLUS AN INTERACTIVE HALF-DAY POST-CONFERENCE WORKSHOP

8.30 - 12.30 | 19TH JUNE 2013

Developing the potential of microgeneration and domestic energy storage for the smart grid

Hosted by: **David Sowden**, Chief Executive, **Micropower**

Sponsored by

Supported by

www.distributed-energy-storage.com

Aaron Jackson on +44 (0)20 7827 6064

ajackson@smi-online.co.uk

350V Solid State Relay in a Miniature 8-Pin SOIC Package

IXYS Integrated Circuits Division announced the availability of the miniature 350V, 8-pin narrow SOIC, Dual 1-Form-A (2 Single-Pole, Normally Open switches in a single package) Solid State Relay (SSR). The CPC2030 is 40% smaller compared to the popular standard 8-lead SOIC, thus enabling significant board space savings. The CPC2030N uses IXYS Integrated Circuits Division's state of the art, double-molded vertical construction packaging to produce one of the world's smallest relays, and is a drop-in replacement for the Panasonic AQW210SX.

The CPC2030 features 120mA maximum load current and 30 Ohms of maximum on-resistance with 2mA of input trigger control current. The reduction of input current allows for the direct drive of these SSRs directly from our Zilog MCUs. Input to output isolation voltage is 1500Vrms. The 350V blocking voltage of the relay is ideal for use in telecom switching systems and instrumentation. Approvals include UL Certified Component: File E76270, CSA Certified Component: Certificate 1172007, EN/IEC 60950-1 Certified Component, and TUV Certificate B 10 05 49410 006.

www.ixysic.com

50

Bodo's Power Systems®

June 2013

www.bodospower.com



CONFERENCE OF THE WINDPOWER ENGINEERING COMMUNITY

WITH EXHIBITION

JUNE 18–19, 2013 / BERLIN, GERMANY

An event organized by VDI Wissensforum GmbH



www.cowec.de

With keynotes by:

- Dr. Andrew Garrad, President, GL Garrad Hassan, United Kingdom
- Tuomo Hatakka, CEO, Vattenfall Europe, Germany
- Dirk Simons, CFO, RWE Innogy, Germany

Expect the following topics:

- Innovative developments for the sustainable increase of the wind turbine output
- Measurement of decisive vibrations and effective damping solutions
- Reliability and failure analysis of wind turbines
- News about weather forecasting models
- Most informative legal and technical aspects from countries with fast-growing wind markets
- ... and many more

With over 80 experts from more than 20 countries

OFFICIAL PARTNERS

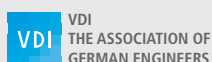

FEANI
EUROPEAN FEDERATION OF NATIONAL
ENGINEERING ASSOCIATIONS



WFEO
WORLD FEDERATION OF ENGINEERING
ORGANIZATIONS

Breakthrough Battery Monitoring Technology for Lead-Acid Batteries

Texas Instruments introduced the first lead-acid battery management gas gauge integrated circuit with TI's proprietary Impedance Track™ capacity measurement technology for lead acid batteries. The bq34z110 gas gauge IC, which comes in a small 14-pin package, is the industry's only scalable power management device to support multi-cell lead-acid battery packs with battery voltages of 4 V, 12 V, 24 V, 48 V and higher. The highly accurate, simple-to-use gauge supports batteries used in mobile and stationary applications like medical instruments, wireless base stations and telecom shelters, e-bikes, inverters and uninterruptible power supplies (UPS).

For samples visit: <http://www.ti.com/bq34z110-pr-eu>.

Lead-acid batteries typically behave better than lithium chemistries in environments with wide temperature ranges. However, today's lead-acid battery designs do not accurately measure and report current battery capacity, which often frustrates the end user, and could mean adding more batteries to keep the system adequately charged. The new bq34z110 gauge with Impedance Track technology constantly informs a user about the battery's state-of-health and state-of-charge and maintains up to a 95-percent accurate capacity measurement for the entire life of the battery. This information also prevents premature shutdown, increasing the longevity of the battery and end-equipment.



www.ti.com

Step-Down Switching Regulators with Built-in Power MOSFET

ROHM Semiconductor has announced step-down switching regulators with a built-in 800mV Power MOSFET. The BD9G101G series provides 0.5A DC output with excellent line and load regulation for smart power management in a small SOT23 (SSOP6) package. The operating frequency is fixed at 1.5MHz, allowing the use of a small inductor and a ceramic capacitor in order to reduce space requirements. All phase compensation components are integrated as well. The input voltage can vary from 6 to 42V, the internal reference voltage is set to 0.75V with an accuracy of typical $\pm 1.5\%$. Ideally suited to facilitate step-down switching designs, the new device offers first-rate thermal resistance and multiple protection features such as internal over current protection, under voltage locked out and thermal shutdown. The operating temperature spans from -40°C to $+105^{\circ}\text{C}$ while the maximum junction temperature lays at 150° . Areas of deployment are industrial distributed power and automotive applications, battery powered equipment and medical OA instruments.



www.rohm.com/eu

Silica rolls out Power 'n More design support strategy

Silica aims to establish itself as a power expert in European semiconductor distribution. The new strategy called Power 'n More builds on an ability to support end-to-end designs both at system and device level. "With the continuing trend for energy saving in electronic systems, designers need more and more support to align with the relentless wave of new regulations and directives. To date, engineers have been hampered by a lack of in-depth expertise and know-how across the distribution channel", states Karlheinz Weigl, Silica's regional Vice President of Sales for Central Europe and Executive Sponsor for Power 'n More.

The distributor intends to develop the facilities to support designers from system specification, architecture definition and topology to assistance on best-fit device selection, PCB layout or EMC analysis. In doing so, the company puts extensive resources at design engineers' disposal, providing its 14 dedicated power field application



Support at every stage of the Power Supply Design

engineers with simulation technology backed by five fully equipped power labs across Europe which will be launched in 2013. The power labs will be located in Munich (Germany), Maidenhead (United Kingdom), Paris (France), Milan (Italy) and Stockholm (Sweden).

www.born-power.com

www.silica.com

THE ENERGY OF YOUR DEVELOPMENT

**POWER
ELECTRONICS** 

26 – 28 NOVEMBER 2013

VENUE | **CROCUS EXPO, MOSCOW, RUSSIA**

www.powerelectronics.ru

10th International Exhibition and Conference **POWER ELECTRONICS**

Power Semiconductors • Integrated Circuits and Opto • Passive Components • Magnetics & Core Materials • Thermal Management • Sensors • Assemblies and Subsystems • Servo-Technology / Actuators • Intelligence in Motion • Power Quality • Test & Measurement • Development Software • Cables • Energy efficiency and energy saving • Electric power industry • Hybrid technologies

SPECIAL EXPOSITION: POWER SUPPLIES AND BATTERIES

ORGANISERS:



Tel.: +7 (812) 380 6003/ 07

Fax: +7 (812) 380 6001

E-mail: power@primexpo.ru

inter solar

connecting solar business

| EUROPE



**JUNE
19-21
2013**

www.intersolar.de

The World's Largest
Exhibition for the Solar Industry
Messe München, Germany

Intersolar Europe gives you an insider advantage on cutting-edge information about the dynamic markets of the solar industry

- Connect with 1,500 international exhibitors
- Learn everything about the latest innovations
- Keep up with future trends for continued business success
- Get inspired!



Top information for your
visit in Munich, Germany

High Efficiency Stepping Motor Control Drivers

Toshiba Electronics Europe (TEE) has announced five next-generation stepping motor control drivers. The new drivers are designed using the Toshiba BiCD 130nm mixed-signal process technology, providing excellent Ron per unit area. The result is highly integrated, low-power devices with the industry's highest voltage and current combinations, (Part TB67H302HG)1 and compact footprints (Parts TB67S213FTAG, TB67S215FTAG, TB62261FTAG and TB62262FTAG). These devices are well suited for a variety of applications such as printers, ATM, robotics, process control machines, and medical equipment.

Today's printers, ATMs, and process control machines require high speed, high torque, and high precision for efficient long-term operation. The new Toshiba stepping motor control drivers satisfy these requirements through exceptional design, superior performance, and optimum packaging. For high-power applications, the TB67H302HG combines the highest voltage and current combination in class and is rated 50V/5.0A*. The device is supplied in a heatsink-mountable HZIP25 package.

The TB67S213FTAG and TB67S215FTAG devices are rated 40V/2.5A* and are housed in a compact QFN-36 6mm x 6mm package for medium-power applications. They also reduce power consumption by 50% compared to previous generation devices. The TB62261FTAG and TB62262FTAG devices are rated 40V/1.5A* and also come in a QFN-36 6mm x 6mm package for low-power applications.



All of the motor control drivers have a mixed-decay mode, which improves the response characteristics of the motor drive current by changing the current path, for optimum motor driving. The QFN36 6mm x 6mm packaged devices are also around 30% smaller than surface mount devices of similar performance. As such, these motor control drivers can be integrated in motor control boards to reduce customer design costs.

www.toshiba-components.com

Dual Half-Bridge Motor Driver IC

The A3910 from Allegro MicroSystems Europe is a dual half-bridge motor driver IC designed for the unidirectional drive of two DC motors in low-cost, low-voltage battery-operated applications.



The A3910 offers features such as thermal shutdown and "sleep" functionality in a small package that is competitive in size and price with equivalent discrete-component solutions. The new device is targeted at the consumer market for applications such as game controllers and home entertainment systems featuring haptic feedback. The outputs of the A3910 are rated for operation at up to 500 mA. Direct control of high-side and low-side drivers is implemented to allow either high-side or low-side pulse-width modulation. The motor can be connected to either supply or ground. The use of an MOS switch results in improved braking action for the motor, compared to implementation with a simple clamp diode. The A3910 can also be used to drive a single bidirectional DC motor.

The Allegro A3910EEETR-T is supplied in a 2 mm x 2 mm 8-lead DFN package with exposed thermal pad (suffix EE). It is lead (Pb) free, with 100% matt tin leadframe plating.

www.allegromicro.com

TOSHIBA

Leading Innovation >>>

> POWER UP!

Power up your designs with our improved and extended range of power products.

- SiC Diodes
- DT MOS IV-low loss performance and lowest R_{on} in 600V class
- UMOS VIII: 30-250V MOSFETs Best in class C_{iss} * R_{on} performance
- Smallest packaging (SMOS line-up)
- Automotive MOSFETs

Turn the power on now at:

◆ WWW.TOSHIBA-COMPONENTS.COM/POWER



▶ WWW.TOSHIBA-COMPONENTS.COM/VIDEO

EPE '13 – ECCE Europe

LILLE, France

15th European Conference on Power Electronics and Applications

3–5 September 2013

<http://www.epe2013.com>

Conference in a carbon care philosophy



Main themes:

*Power electronics
for sustainable
transportation systems
and
for the grids of the future*

*Keynotes and industrial
special sessions*

*Early bird
registration fee
till 13 June*

Photo: OT Lille



How stable is your power supply?



Easily determine the stability using the **Vector Network Analyzer Bode 100** in combination with the Wideband Injection Transformer B-WIT 100.

Measure in the frequency range from 1 Hz to 40 MHz:

- Loop gain
- Plant transfer function
- Phase and gain margin

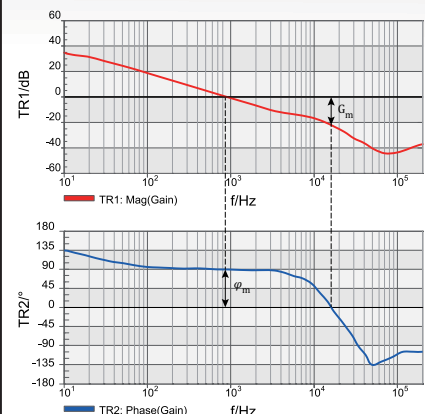

More information at www.omicron-lab.com/bps

Smart Measurement Solutions

Hall Sensors of High Precision and High Energy Efficiency



Infineon Technologies AG has launched Hall Sensors aimed at automotive and industrial applications demanding the highest precision, the lowest energy consumption and the smallest space requirements. The new TLE496x sensors are available in the world's smallest package (SOT23) for Hall Sensors. They are based on a new 0,35µm process technology developed by Infineon. Based on this new technology Infineon can now offer Hall Sensors with various magnetic switching thresholds in an ultra small package. These not only provide an extremely low current consumption of less than 1.6mA, they can also withstand a high operating voltage up to 32V. Additional features provided by the TLE496x product family are enhanced turn-on,

reset, and turn-off characteristics compared with the previous generation as well as extensive protective functions for improved system quality, reliability, and control.

Typical applications for the TLE496x family are position measurements, brushless motor commutation, and index counting. The unipolar and bipolar switches or latches of the TLE496x family are used e.g. in window lifts, sunroofs, boot locks, windscreen wipers, safety belts, camshafts, gearshift levers, and a wide range of industrial BLDC motors.

The Hall Sensor TLE496x family is currently made up of three series: TLE4961, TLE4964, and TLE4968. All derivatives operate at the extended temperature range from -40 °C to 170 °C. With their switching thresholds of +/-1mT (bipolar switches), +/-2mT to +/-15mT (latches) and 2.5/3.5mT to 22.5/28mT (unipolar switches) they cover a very wide switching threshold range for latches as well as for unipolar switches.

www.infineon.com/hall-switches

Two PFC Controllers with Expanded Functionality

TDK Corporation presents two types of the BR7000 series of EPCOS power factor controllers (PFC). The BR7000-T power factor controller offers 15 transistor outputs instead of 15 relay outputs. It is designed for applications that require fast switching operations and enables delay-free switching of thyristor modules, such as the EPCOS TSM series.



The second innovation is the EPCOS BR7000-I with an RS485 interface, which can be used for embedding into networks, for controller coupling and for visualization via PC.

The BR7000-T offers various control modes, for example, switching of 15 steps with three-phase capacitors, switching of 15 single-phase steps in L-N or L-L operation, or mixed operation. The switch on and off times of capacitor steps can be selected between 50 and 1000 milliseconds. The BR7000-T has an illuminated graphic display; the BR7000-T/HD has an OLED display to ensure better visibility in poor lighted surroundings.

The BR7000-I/S485 is delivered with Windows-based BR7000-SOFT software and allows the evaluation and further processing of measured grid data via PC. The additional external input of the BR7000-I/S485 can be individually programmed, for example, for a second set of parameters. Also, the controller features a freely programmable message-relay, for instance, to trigger a fan or for status messages. An internal clock marks all recorded values and messages with a time stamp, allowing a better evaluation of all values.

The operating voltage covers 110 V AC to 230 V AC with a very low consumption of < 3 VA when all outputs are activated.

www.epcos.com/pfc_controllers

PCIM

ASIA



International Exhibition and Conference
for Power Electronics, Intelligent Motion,
Renewable Energy and Energy Management

Shanghai, 18 - 20 June 2013

Gateway to your Asian market!

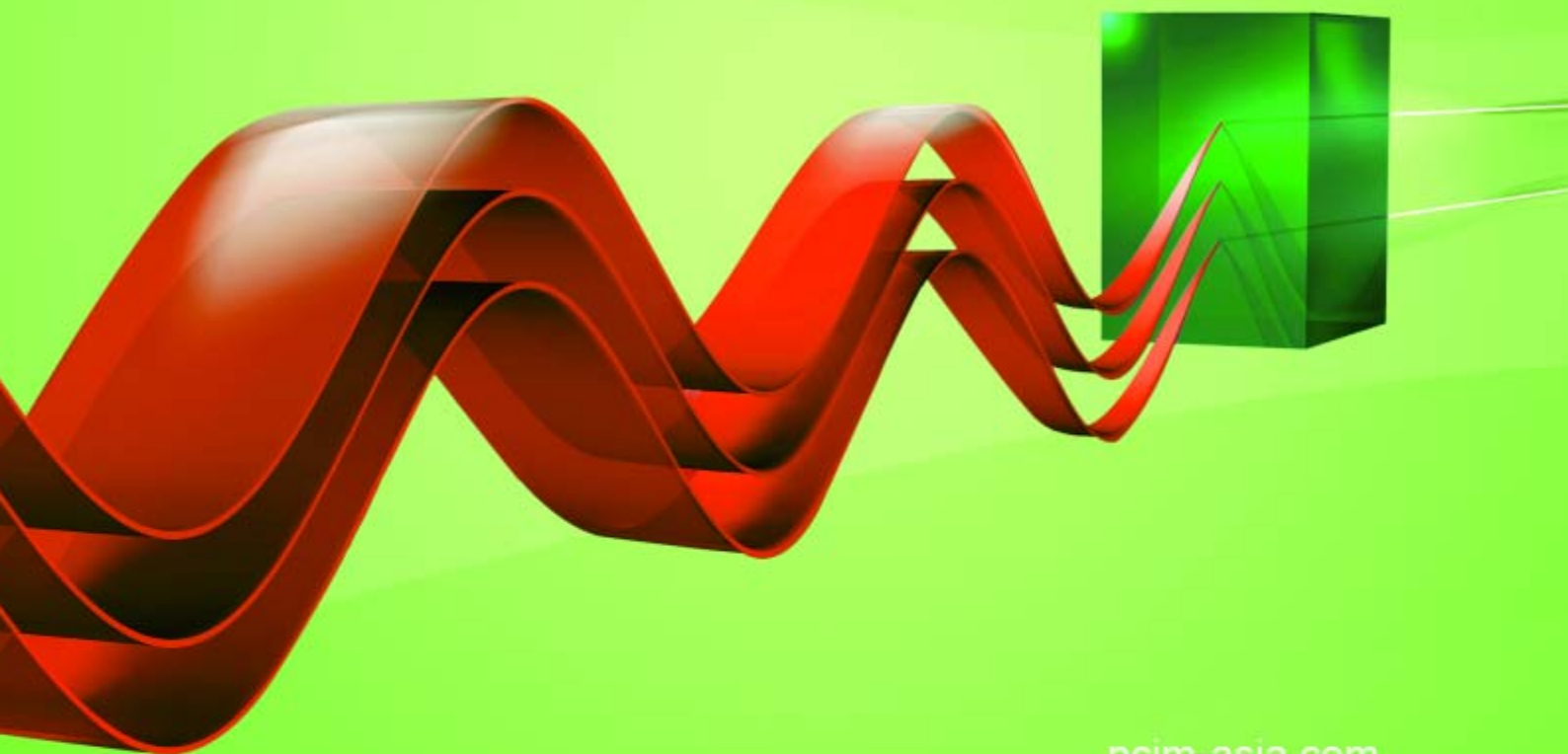

pcim-asia.com

Check out the latest technology and meet up
with industry developers & innovators



Tektronix Enters Power Analyzer Market

"The move to the power analyzer instrument market enables Tektronix to offer a broader set of test & measurement tools to help engineers debug and optimize their power-electronics designs", Peter Bachmayr is convinced. That's why the measurement company now offers its Precision Multi-Phase Power Analyzer PA4000. Featuring a Spiral Shunt design, the PA4000 gives power electronics engineers stable, precise current measurements even on highly distorted power waveforms common in many applications. The PA4000 uses two Spiral Shunts on each channel – one for low-current measurements up to 1 A, and one for higher-current measurements up to 30 A. This shunt design is combined with high-speed digital signal processing algorithms, allowing the PA4000 to track power cycles even in the presence of transients and noise. To save setup time and reduce errors, the PA4000 offers various application-specific measurement modes such as standby current, motor drive and ballast. Among the standard features are LAN, USB, and RS-232 interfaces as well as measurement up to the 100th harmonic. In addition, software for controlling the analyzer, downloading measurements, and logging on a PC is included in the package.

What's the Spiral Shunt?

The Spiral Shunt used in the PA4000 is a novel design with several features that are supposed to improve linearity and stability of current readings. The material used is Manganin, an alloy of manganese, copper and nickel. Manganin has attractive properties for this application, including a temperature-stable resistance. The alloy is formed into a wide, flat "ribbon" shape increasing surface area. This "ribbon" is then insulated and formed into a loop with the material folded back upon itself, so that the input and output connections to the shunt are on the same end. An ideal shunt is purely resistive at all frequencies,



but any real-world shunt material will have some inductance, however low. The spiral shunt design minimizes inductance by virtue of the loop construction, where inductance is effectively cancelled out by equal currents flowing in both directions, outbound and returning. Low inductance contributes to higher bandwidth capability. Higher levels of current through a shunt will raise its temperature, causing non-linearity. To reduce heat-induced non-linearity, the Manganin loop is formed into a spiral shape with a cooling fan at one end which moves air across the entire surface of the shunt. The Spiral Shunt's cooling fan has variable speed, controlled according to the measured current. The fan's cooling effect can be precisely controlled to maintain constant shunt temperature and thus maximize linearity. The remaining small errors are measured and stored as calibration constants within the analyzer in order to compensate for amplitude and phase over the specified 1 MHz bandwidth.

www.tektronix.com

Scaling New Heights with 1200V IGBTs



- 25A to 600A IGBT
- Up to 100 KHz
- Discretes and Modules
- UIS and SCOA Rated
- With or Without Anti-Parallel Diode

- Improved System Efficiency
- Lower Temperature
- Cooler Operation
- Higher Reliability
- Easy to Parallel

E_{on2} Losses Reduced
45% with SiC Diode

sales.support@microsemi.com
www.microsemi.com



The Power of

[SEMICON West]

Wafer Processing
Packaging
Test

Photovoltaic
Silicon Photonics
MEMS—LEDs

REGISTER NOW and get ready to be a part of the biggest event in microelectronics manufacturing—SEMICON® West 2013!

- Access more than 50 hours of technical programs focused on the critical issues in microelectronics manufacturing
- 450 mm, 3D IC, next-generation lithography, test, contemporary packaging, advanced materials, and more
- Discover technologies, materials, and manufacturing solutions for LEDs, MEMS, plastic electronics, and other emerging and adjacent markets
- Connect with technical experts and find solutions that move your ideas from the lab to the fab

Connect to the Power of [X]—
Connect to the Power of SEMICON West

SEMICON®
West2013

July 9–11

Moscone Center
San Francisco, California
www.semiconwest.org

New Programs for 2013

- Silicon Innovation Forum—Top strategic investors review an exciting line-up of new and emerging companies
- A conversation on semiconductor R&D with leaders from imec, SEMATECH and CEA-Leti
- 450 mm Wafer Processing: Opportunities and Prospects
- The latest requirements on nonplanar architectures, stacked 3D ICs, the two paths for lithography, nano defect detection, silicon photonics, printed/flexible electronics, MEMS, LEDs
- Keynote address: Ajit Manocha, CEO, GLOBALFOUNDRIES

SEMICON West is brought to you by:

ADVANTEST

APPLIED MATERIALS

KLA Tencor
Accelerating Yield

semi

Expanded Power Management Portfolio with Radiation-Hardened Isolated DC-DC Converters

Microsemi Corporation announced the release of a new family of radiation-hardened isolated DC-to-DC converters for aerospace applications. The SB30-100 family is designed for the rigors of space, providing single event effect (SEE) rated protection against "total dose" ionized radiation that can change the operating state of a device and cause it to malfunction. With the addition of

the new SB30-100 family to its product line-up, Microsemi now offers complete power train solutions for FPGAs, processors, microcontrollers and other digital control systems. The SB30-100 family is designed and constructed using proven surface mount technology thus enabling customization significantly faster than lead times typically needed to build hybrid solutions. The converters also

virtually eliminate an entire stage of power conversion, while decreasing the weight, cost and size of the total power supply. Key features include the ability to directly convert power from a satellite solar panel to end voltages required by FPGAs, DSPs, CPUs, MCUs and other digital devices.

www.microsemi.com

Power Meters are Key to LUX-TSI EcoDesign Test Programmes

Yokogawa power meters and analysers are the key elements in tests being carried out by LUX-TSI: an independent UK test house specialising in the testing of energy efficient lighting and electronic products, including LEDs, to ensure compatibility with international standards governing energy efficiency. The two companies have entered into a relationship to test products using Yokogawa's WT210 and WT3000 instruments to evaluate compliance with European Ecodesign (ErP) Directives, and this capability will be demonstrated at the euroLED Conference at the International Convention Centre, Birmingham, on 24th and 25th June 2013. At this event, LUX-TSI will also be exhibiting with its partner, UL, who are global players in the provision of energy performance and safety testing and certification.



The Yokogawa WT3000 precision power analyser provides "best in class" precision and stability. With a basic power accuracy of $\pm 0.02\%$ of reading, DC and 0.1 Hz-1 MHz measurement bandwidth, and up to four input elements, the WT3000 provides a high-accuracy measurement solution for testing all types of power electronics products. Current estimates suggest that LEDs will achieve more than 70% market penetration by 2020, displacing traditional technologies that have existed for 100 years within a very short timescale.

www.tmi.yokogawa.com

www.bodospower.com

SUBSTITUTE FOR TRANSFORMERS – 5 LETTERS



LOW OHMIC PRECISION AND POWER RESISTORS



SMD SHUNT RESISTORS SAVE SPACE AND OFFER A NUMBER OF ADVANTAGES:

- _ High pulse loadability (10 J)
- _ High total capacity (7 W)
- _ Very low temperature dependency over a large temperature range
- _ Low thermoelectric voltage
- _ Customer-specific solutions (electrical/mechanical)

Areas of use:

Power train technology (automotive and non-automotive applications), digital electricity meters, AC/DC as well as DC/DC converters, power supplies, IGBT modules, etc.



ISABELLENHÜTTE

Innovation by Tradition

Isabellenhütte Heusler GmbH & Co. KG

Eibacher Weg 3-5 · 35683 Dillenburg · Phone +49 (0) 2771 934-0 · Fax +49 (0) 2771 23030
sales.components@isabellenhuette.de · www.isabellenhuette.de

All in a single box

Rohde & Schwarz satisfies the growing demand for mobile high-speed data communications with its R&S SMW200A – a high-end vector signal generator which creates complex multichannel scenarios. "The device combines flexibility, performance and intuitive operation to outperform all comparable solutions available on the market", states Wolfgang Kernchen, Director Subdivision Signal Generators, Audio Analyzers and Power Meters of Rohde & Schwarz. It includes a baseband generator, RF generator and MIMO fading simulator in a single instrument. The vector signal generator covers the frequency range from 100 kHz to 3 GHz or 6 GHz and features an I/Q modulation bandwidth of 160 MHz with internal baseband. Its modulation and RF characteristics propose to make it suitable for the development of high-end components, modules and complete products for wideband communications systems such as LTE-Advanced and WLAN IEEE 802.11ac. According to the manufacturer, the generator is suitable for the verification of 3G and 4G base stations as well as aerospace and defence applications. The R&S SMW200A can be equipped with an optional second RF path for frequencies up to 6 GHz and with a maximum of two baseband and four fading simulator



modules, giving users two full-featured vector signal generators in a single unit. Fading scenarios such as 2x2 MIMO, 8x2 MIMO for TD-LTE and 2x2 MIMO for LTE-Advanced carrier aggregation can be simulated. Generally, this requires complex setups consisting of multiple instruments.

www.rohde-schwarz.com

Non-Contact Current Probes Target Advanced Power Designs

Power Electronic Measurements (PEM) has launched its latest generation of Rogowski coils for non-contact current measurement, designed specifically for monitoring today's most advanced power systems and semiconductors. The CWT Ultra-mini probe offers higher maximum frequency and increased stability over a wider operating temperature range.

The CWT Ultra-mini current transducer is a powerful development or diagnostic instrument for examining switching waveforms, ripple currents, transients or harmonics. The extended temperature range of -40°C to +125°C and improved temperature coefficient of 50ppm/°C allow accurate measurement of semiconductors operating at increased temperatures. In addition, the wider 3dB bandwidth of 30MHz enables engineers to analyse high-order harmonics in systems operating at high switching frequencies, or accurately monitor switching waveforms with rapid rise-times.

The coil has a cross section of 1.6mm, allowing users to take measurements at locations that are difficult to access. It can be positioned between the pins of MOSFETs or IGBTs in packages such as TO-220 or TO-247.

The complete CWT Ultra-mini range comprises several variants suitable for measurements from as low as 1A to a maximum full-scale current of 6000A. The new family also has enhanced transient response, and can measure fast-changing currents up to 80kA/μs and has a typical measurement accuracy: ±2%.



PEM has special expertise in wide-band Rogowski current probes, which allow alternating current to be measured accurately by integrating voltages induced in the coil when looped around a current-carrying conductor. Since no electrical contact is required, this provides a convenient means of measuring current without effecting circuit performance. PEM's clip-around coil design allows fast and easy positioning, and provides accurate results without needing to be centred around the conductor.

www.pemuk.com

Power Management Solutions at PCIM Europe 2013

IR engineering and sales staff have demonstrate IR's latest energy-saving and high power density enabling technologies and products at the IR booth at PCIM. The IR booth has featured the company's latest power management solutions including a demonstration of its COOLiR™ technology for automotive, μIPM™ integrated modules and Gen8 IGBTs for motor control applications, and IR's GaN-based power device platform, GaNpowIR®. IR's latest SupIRBuck® integrated voltage regulators for DC-DC applications, as well as benchmark MOSFETs for a wide range of applications have been also be featured.

www.irf.com

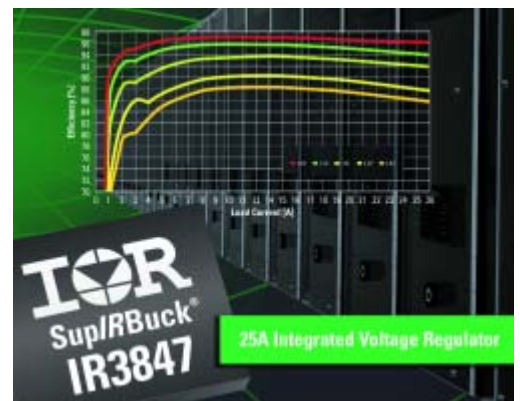



Messe München
International

more information

www.productronica.com/en/2013



for electronic manufacturing



productronica 2013

innovation all along the line



20th international trade fair for
innovative electronics production

messe münchen
november 12-15, 2013
www.productronica.com

Dual n- and p-Channel MOSFETs for Battery Management

Advanced Power Electronics Corp. (USA), a leading Taiwanese manufacturer of MOS power semiconductors for DC-DC power conversion applications, has announced two new power MOSFETs well-suited for battery management and protection applications, the



AP9922GEO-HF-3 and AP9923GEO-HF-3, dual n- and dual p-channel enhancement-mode products respectively.

Both products feature low on-resistance, 16mΩ for the AP9922GEO-HF-3 and 25mΩ for the AP9923GEO-HF-3, and both devices are capable of operating with gate drive down to 1.8V. RoHS-compliant and halogen-free, the devices are available in the small, thin TSSOP-8 package.

Comments Ralph Waggitt, President/CEO, Advanced Power Electronics Corp. (USA): "We specialise in providing the designer with the best combination of fast switching, ruggedness, ultra low on-resistance and cost-effectiveness. As designers of battery-powered applications continue to focus on battery life, it becomes increasingly more important to address the need to manage the battery efficiently, and provide appropriate components for efficient protection."

www.a-powerusa.com/docs/AP9922GEO-3.pdf

www.a-powerusa.com/docs/AP9923GEO-3.pdf

Full-Bridge 3-Level Modules for Photo-Voltaic Multi-String Inverters

Infineon extends its family of tailor-made modules for photo-voltaic (PV) string and multi-string inverters by two full-bridge 3-level modules. The fully-integrated modules feature three 3-level NPC1 inverter legs. The solutions offer superb power density and high reliability at the same time. The 30 A module covers the power range through 7 kVA and the 50 A module through 9 kVA. Optimized inverter efficiency and performance is achieved by using the best suited semiconductor devices. HighSpeed 3 IGBTs and SiC diodes help to optimize switching losses whereas low loss IGBTs and diodes reduce conduction losses. Hence, the new modules can be easily used for switching frequencies of 15 kHz and above. Fast and solder-less assembly is possible using the proven PressFIT technology. The inverter modules can be combined with existing Infineon photo-voltaic booster modules.

The entire product family for 3-phase PV inverters features now 3-level inverter and booster modules – 8 types in total. These modules are applicable for photo-voltaic inverters with maximum DC Input Voltage of 1000 V, maximum efficiency beyond 98% and an output power up to 25 kVA. Inverter modules can be combined with as many booster modules as desired. Advantages are: excellent efficiency and performance due to state of the art chips like Infineon's HighSpeed 3



IGBTs, module types with SiC diodes are available and up to four MPP-trackers possible using only one booster module.

For single phase applications Infineon offers an all-in-one module solution with booster and H-bridge for maximum efficiency beyond 97 % and an output power between 1 kVA and 8 kVA. An optimized combination of newest IGBT, CoolMOS™ and diode technologies are providing highest performance.

www.infineon.com/string

ADVERTISING INDEX

ABB	C3	EPE ECCE	Omicron	57
ABB france	19	Fuji Electric Europe	23	PCIM Asia
Allegro	13	Guidu	1	PE Moscow
Apex	47	GVA	C2+37	Productronica
CDE	15	Indium	29	Proton
COWEC	51	Infineon	21	Recom
CT Concept	35	International Rectifier	C4	Renesas
CUI	45	Intersolar	54	Semicon West
Danfoss	25	Isabellenhütte	61	Semikron
Darnell	40	ITPR	36	Silica
Distributed Energy Storage	50	Lem	5	Texas instruments
e dpc	46	Magnetics	39	Toshiba
Electronicon	31	Maxim	7	VMI
Epcos	27	Microsemi	59	Würth



IGCTs making grid code issues a thing of the past?

Naturally.



ABB's integrated gate-commutated thyristors (IGCTs) powered converters support turbine manufacturers to achieve grid code compliance. IGCT is the semiconductor of choice for demanding high power applications such as medium voltage drives, marine drives, co-generation, wind power converters, interties and STATCOMs. ABB's portfolio offers a complete range of IGCTs and diodes for all your high power switching needs. For more information please visit our website:

www.abb.com/semiconductors

ABB Switzerland Ltd. / ABB s.r.o.
www.abb.com/semiconductors
m.abb.com
abbsem@ch.abb.com

Power and productivity
for a better world™



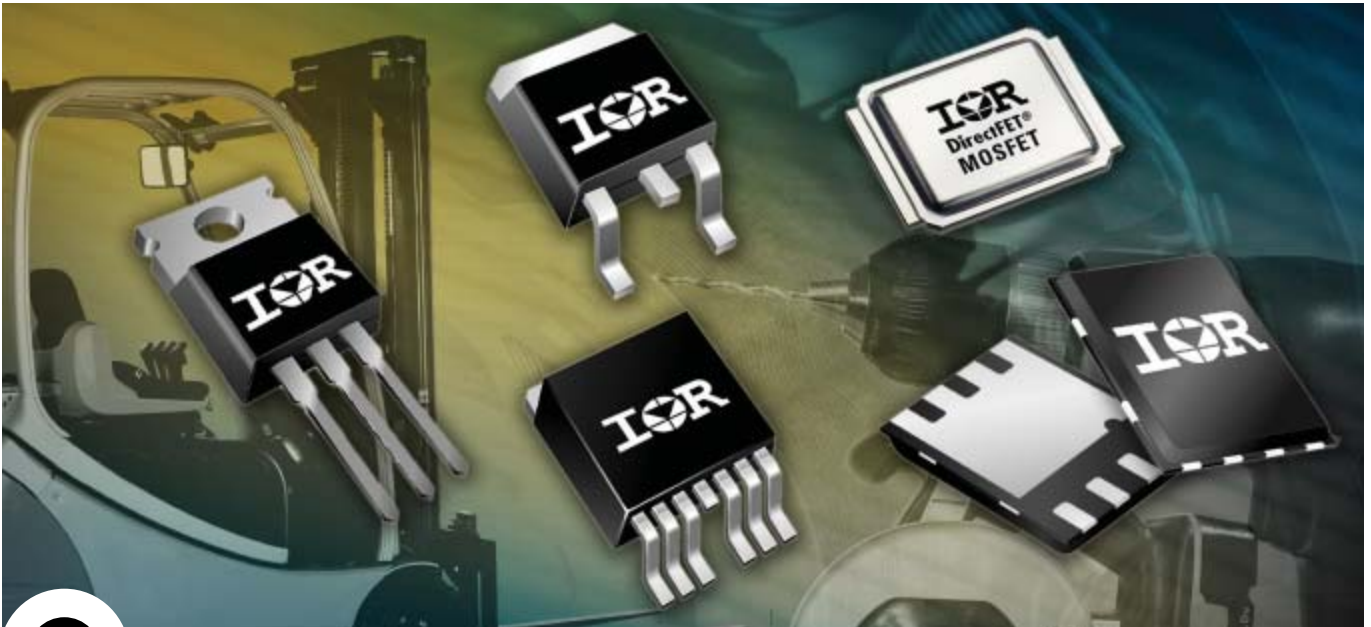

StrongIRFET™ Rugged, Reliable MOSFETs

Specifications

Part Number	$B_{V_{DS}}$	ID@ 25°C	$R_{DS(on) \max@}$ Vgs = 10V	Qg@ Vgs = 10V	Package
IRFH7004TRPbF	40 V	100 A	1.4 mΩ	134 nC	PQFN 5x6
IRFH7440TRPbF	40 V	85 A	2.4 mΩ	92 nC	PQFN 5x6
IRFH7446TRPbF	40 V	85 A	3.3 mΩ	65 nC	PQFN 5x6
IRF7946TRPbF	40 V	90 A	1.4 mΩ	141 nC	DirectFET Medium Can
IRFS7437TRLPbF	40 V	195 A	1.8 mΩ	150 nC	D²-Pak
IRFS7440TRLPbF	40 V	120 A	2.8 mΩ	90 nC	D²-Pak
IRFS7437TRL7PP	40 V	195 A	1.5 mΩ	150 nC	D²-Pak 7pin
IRFR7440TRPbF	40 V	90 A	2.5 mΩ	89 nC	D-Pak
IRFB7430PbF	40 V	195 A	1.3 mΩ	300 nC	TO-220AB
IRFB7434PbF	40 V	195 A	1.6 mΩ	216 nC	TO-220AB
IRFB7437PbF	40 V	195 A	2 mΩ	150 nC	TO-220AB
IRFB7440PbF	40 V	120 A	2.5 mΩ	90 nC	TO-220AB
IRFB7446PbF	40 V	118 A	3.3 mΩ	62 nC	TO-220AB
IRFP7430PbF	40 V	195 A	1.3 mΩ	300 nC	TO-247

Features:

- Ultra low $R_{DS(on)}$
- High current capability
- Industrial qualified
- Broad portfolio offering

Applications:

- Battery Packs
- Inverters
- UPS
- Solar Inverter
- DC Motors
- ORing or Hotswap

For more information call +49 (0) 6102 884 311

or visit us at www.irf.com

International
IOR Rectifier
THE POWER MANAGEMENT LEADER