

REBSTOCK®

Precision made in Germany

Mikro - Neuro - Wirbelsäule
Micro - Neuro - Spine

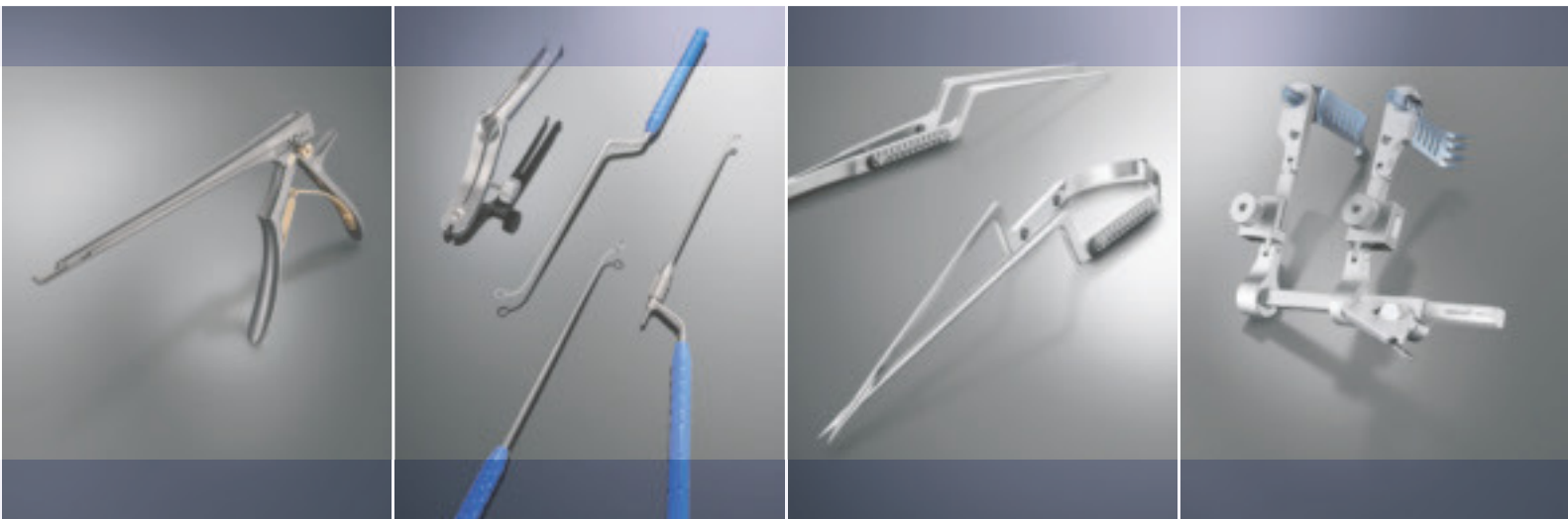

/// WILLKOMMEN BEI REBSTOCK
WELCOME TO REBSTOCK



NEUBAU 2017
NEW BUILDING 2017



Qualität Made in Germany. Hochpräzise Instrumente für mehr Sicherheit von Patienten und Operateure.

Quality Made in Germany. Highly precise instruments for more safety of patients and surgeons.

PRECISION + INNOVATION



/// **DIE KUNDEN STEHEN AN OBERSTER STELLE**
THE CUSTOMERS ARE OUR TOP PRIORITY

SERVICE + SUPPORT



Zuverlässiger Lieferservice, garantierter After Sales Service sowie kompetente und fachkundige Beratung. Ihre Zufriedenheit ist unser oberstes Ziel.

Reliable delivery service, guaranteed After Sales Service and competent expert advice. Your satisfaction is our utmost goal.



/// QUALITÄT IN DER PRODUKTION *PRODUCTION QUALITY*

Beste Rohmaterialien, modernste Technologie und qualifiziertes Fachpersonal sind unsere Gewähr für langlebige Instrumente und Implantate mit höchster Funktionalität.

Best raw materials, modern technology and qualified staff are our guarantee for durable instruments and implants with high functionality.





RESEARCH +
DEVELOPMENT

/// **DIE ZUKUNFT WIRD REALITÄT**
THE FUTURE BECOMES REALITY

Ständige Neu- und Weiterentwicklung angepasst an den medizinischen Fortschritt tragen zu einer permanenten Programmweiterung bei.

Permanent new developments and enhancements due to the medical progress are crucial for a continuously growing product portfolio.





/// **HOCHWERTIGE MEDIZINTECHNIK**
TOP-QUALITY MEDICAL TECHNOLOGY

Präzision bis ins Detail garantiert Langlebigkeit,
Sicherheit, Zuverlässigkeit und Funktionalität.

*Precision down to the last detail guarantees
durability, safety, reliability and functionality.*



COMPETENCE IN PERFECTION

/// MEHR SICHERHEIT UND TRANSPARENZ BEI DER STERILGUTVERSORGUNG

Identifikation von Instrumenten mit DATA Matrix Kennzeichnung

Auf Wunsch können alle REBSTOCK Instrumente mit DATA Matrix gekennzeichnet werden.

Diese Kennzeichnung ist für jedes Instrument individuell und beinhaltet alle notwendigen Angaben wie Hersteller- nummer, Artikelnummer und Seriennummer.

VORTEILE

- Ermöglicht die Rückverfolgung und Dokumentation bei Aufbereitungs- und Sterilisationsprozessen
- Bessere Patientensicherheit
- Überwachung des Produktlebenszyklus
- Zeitersparnis durch Maschinenlesbarkeit

/// MORE SECURITY AND TRANSPARENCY FOR YOUR ENTIRE STERILIZATION PROCESS

Identification of instruments – DATA-Matrix

On request all REBSTOCK instruments can be marked with a DATA Matrix code.

This coding is individual for every instrument and includes all necessary information like manufacturer number, article number and lot number.

ADVANTAGES

- *Assures the traceability and documentation during cleaning and sterilization processes*
- *Enhanced patient safety*
- *Control of the product life cycle*
- *Machine readability saves time*



DATA MATRIX

02

HF-Instrumente und Zubehör
HF Instruments and Accessoires

03

Kopf-Schädelinstrumente und Haltesysteme
Head-Cranio Instruments and Holding Systems

04

Aneurysmen-Clip System
Aneurysm Clip System

05

Schädel-Verplattung
Cranial Plate System

06

Hypophysektomie-Instrumente
Pituitary Instruments

07

Instrumente für die Wirbelsäule, Wundspreizer
Spine Instruments, Self-retaining Retractors

08

Laminektomie-Stanzen, Rongeurs, Hohlmeißelzangen
Laminectomy Punches, Rongeurs

09

Gefäß- und Bulldogklemmen, Gefäß-Clips
Vessel- and Bulldog-Clamps, Vessel Clips

10

Allgemeinchirurgische Instrumente
General Surgical Instruments

11

Alphabetischer Index, Numerischer Index
Alphabetical Index, Numerical Index

// 01



SURGICAL
INSTRUMENTS
MICRO-NEURO-SPINE

REBSTOCK®
Precision made in Germany

Mikro-Neurochirurgische Instrumente
Micro-Neurosurgical Instruments

 1/1
06-13-120
 190 mm
 7½"

	Artikel-Nr. Cat. No.	Gesamtlänge Total length
	1/1 06-13-120	190 mm / 7½"
	06-13-122	210 mm / 8¼"
	06-13-124	240 mm / 9½"
	06-13-159	255 mm / 10"
	gerade straight	
	1/1 06-13-130	190 mm / 7½"
	06-13-132	210 mm / 8¼"
	06-13-134	240 mm / 9½"
	06-63-136	255 mm / 10"
	gerade straight	
	1/1 06-13-140	190 mm / 7½"
	06-13-142	210 mm / 8¼"
	06-13-144	240 mm / 9½"
	06-13-160	255 mm / 10"
	gerade straight	
	1/1 06-13-121	190 mm / 7½"
	06-13-123	210 mm / 8¼"
	06-13-125	240 mm / 9½"
	06-13-161	255 mm / 10"
	aufwärts gebogen curved up	
	1/1 06-13-131	190 mm / 7½"
	06-13-133	210 mm / 8¼"
	06-13-135	240 mm / 9½"
	06-63-137	255 mm / 10"
	aufwärts gebogen curved up	
	1/1 06-13-141	190 mm / 7½"
	06-13-143	210 mm / 8¼"
	06-13-145	240 mm / 9½"
	06-13-162	255 mm / 10"
	aufwärts gebogen curved up	

Standard Line

 Oberfläche matt gebürstet
 Surface polished





 Beispiel-Artikel-Nr.
 Example Cat. No.

06-13-120
Black Line

 Oberfläche schwarz, titanbeschichtet
 Surface black, titanium-coated

 Beispiel-Artikel-Nr.
 Example Cat. No.

06-13-120B

Artikel-Nr. Cat. No.	Gesamtlänge Total length	
06-13-163 abwärts gebogen <i>curved up curved down</i>	210 mm / 8¼"	1/1 
06-13-164 abwärts gebogen <i>curved down</i>	210 mm / 8¼"	1/1 
06-13-167 mit Knopf, seitwärts gewinkelt <i>with probe, angled to the side</i>	210 mm / 8¼"	1/1 45° 
06-13-168 seitwärts gewinkelt <i>angled to the side</i>	210 mm / 8¼"	1/1 45° 
06-13-169 seitwärts gewinkelt <i>angled to the side</i>	210 mm / 8¼"	1/1 125° 



Standard Line	Black Line
Oberfläche matt gebürstet <i>Surface polished</i>	Oberfläche schwarz, titanbeschichtet <i>Surface black, titanium-coated</i>
Beispiel-Artikel-Nr. Example Cat. No. 06-13-168	Beispiel-Artikel-Nr. Example Cat. No. 06-13-168B

1/1
06-13-168
 210 mm
 8¼"

 1/1
YASARGIL
06-04-035
 200 mm
 8"

TITAN

		Artikel-Nr. Cat. No.	Artikel-Nr. Cat. No.	Gesamtlänge Total length
1/1	YASARGIL	06-04-118	06-04-118T	145 mm / 5¾"
		06-04-030	06-04-030T	165 mm / 6½"
		06-04-034	06-04-034T	200 mm / 8"
				gerade straight
1/1	YASARGIL	06-04-031	06-04-031T	165 mm / 6½"
		06-04-035	06-04-035T	200 mm / 8"
				aufwärts gebogen curved up
1/1	YASARGIL	06-04-119	06-04-119T	145 mm / 5¾"
		06-04-036	06-04-036T	200 mm / 8"
				abwärts gebogen curved down
1/1	YASARGIL	06-04-073	06-04-073T	165 mm / 6½"
		06-04-075	06-04-075T	185 mm / 7½"
		06-04-032	06-04-032T	200 mm / 8"
				Präparierschere, gerade dissecting scissors, straight
1/1	YASARGIL	06-04-033	06-04-033T	200 mm / 8"
				Präparierschere, aufwärts gebogen dissecting scissors, curved up

Standard Line

 Oberfläche matt gebürstet
 Surface polished

 Beispiel-Artikel-Nr.
 Example Cat. No.















06-04-035
Black Line

 Oberfläche schwarz, titanbeschichtet
 Surface black, titanium-coated

 Beispiel-Artikel-Nr.
 Example Cat. No.

06-04-035B

TITAN

Artikel-Nr. Cat. No.	Artikel-Nr. Cat. No.	Gesamtlänge Total length		
06-04-038	06-04-038T	225 mm / 9"	YASARGIL	1/1
06-04-060	06-04-060T	225 mm / 9" Schneiden gezahnt, gerade <i>serrated blades, straight</i>		
06-54-062		245 mm / 9¾"		
06-04-039	06-04-039T	225 mm / 9"	YASARGIL	1/1
06-04-061		245 mm / 9¾" aufwärts gebogen <i>curved up</i>		
				
06-04-047	06-04-047T	225 mm / 9" abwärts gebogen <i>curved down</i>	YASARGIL	1/1
				
				
06-04-037	06-04-037T	225 mm / 9" gerade <i>straight</i>	VANNAS	1/1
				
				
06-04-040	06-04-040T	225 mm / 9" aufwärts gebogen <i>curved up</i>	VANNAS	1/1
				
				
06-04-044	06-04-044T	225 mm / 9" Präparierschere, gerade <i>dissecting scissors, straight</i>	YASARGIL	1/1
				
				
06-04-043	06-04-043T	225 mm / 9" Präparierschere, aufwärts gebogen <i>dissecting scissors, curved up</i>	YASARGIL	1/1
				
				



Standard Line	Black Line
Oberfläche matt gebürstet <i>Surface polished</i> Beispiel-Artikel-Nr. <i>Example Cat. No.</i>	Oberfläche schwarz, titanbeschichtet <i>Surface black, titanium-coated</i> Beispiel-Artikel-Nr. <i>Example Cat. No.</i>
06-04-039	06-04-039B

1/1
YASARGIL
06-04-039
 225 mm
 9"

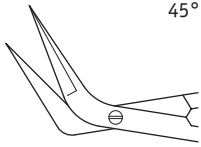
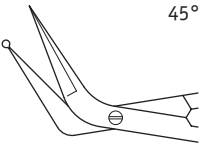
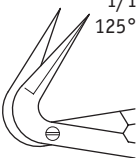

		Artikel-Nr. Cat. No.	Gesamtlänge Total length
 1/1 45°	NAGEL	06-04-056	200 mm / 8" seitwärts gewinkelt angled to the side
 1/1 45°		06-04-057	200 mm / 8" mit Knopf, seitwärts gewinkelt with probe, angled to the side
 1/1 125°		06-04-059	190 mm / 7½" seitwärts gewinkelt angled to the side

1/1
NAGEL
06-04-056
 200 mm
 8"

Standard Line

Oberfläche matt gebürstet
 Surface polished

Beispiel-Artikel-Nr.
 Example Cat. No.





06-04-056

Black Line

Oberfläche schwarz, titanbeschichtet
 Surface black, titanium-coated

Beispiel-Artikel-Nr.
 Example Cat. No.

06-04-056B

Artikel-Nr. Cat. No.	Gesamtlänge Total length		
06-04-105	190 mm / 7½"		1/1 
06-04-106	190 mm / 7½"		1/1 
06-04-107	190 mm / 7½"	VANNAS	1/1 
06-04-108	190 mm / 7½"	VANNAS	1/1 
06-04-120	195 mm / 7¾"		1/1 



Standard Line	Black Line
Oberfläche matt gebürstet <i>Surface polished</i> Beispiel-Artikel-Nr. <i>Example Cat. No.</i> 06-04-108	Oberfläche schwarz, titanbeschichtet <i>Surface black, titanium-coated</i> Beispiel-Artikel-Nr. <i>Example Cat. No.</i> 06-04-108B

1/1
06-04-108
 190 mm
 7½"



		Artikel-Nr. Cat. No.	Gesamtlänge Total length
1/1		06-13-010 06-63-010	120 mm / 4¾" 145 mm / 5¾" gerade straight
1/1		06-13-011 06-63-011	120 mm / 4¾" 145 mm / 5¾" gebogen curved
1/1		06-13-012 06-63-012	120 mm / 4¾" 145 mm / 5¾" gebogen curved
1/1		06-13-013 06-63-013	120 mm / 4¾" 145 mm / 5¾" gebogen curved
1/1		06-13-014 06-63-014	120 mm / 4¾" 145 mm / 5¾" mit Knopf, gebogen with probe, curved

1/1
06-13-010
 120 mm
 4¾"

Standard Line



Oberfläche matt gebürstet
 Surface polished

Beispiel-Artikel-Nr.
 Example Cat. No. **06-13-010**

Black Line

Oberfläche schwarz, titanbeschichtet
 Surface black, titanium-coated

Beispiel-Artikel-Nr.
 Example Cat. No. **06-13-010B**

Artikel-Nr. Cat. No.		Gesamtlänge Total length	
06-13-040	gerade straight	170 mm / 6¾"	1/1 
06-13-041	gebogen curved	170 mm / 6¾"	1/1 



1/1
 06-13-040
 170 mm
 6¾"

Standard Line	Black Line
Oberfläche matt gebürstet Surface polished Beispiel-Artikel-Nr. Example Cat. No. 06-13-040	Oberfläche schwarz, titanbeschichtet Surface black, titanium-coated Beispiel-Artikel-Nr. Example Cat. No. 06-13-040B

 1/1
 06-04-019
 160 mm
 6¼"

		Artikel-Nr. Cat. No.	Gesamtlänge Total length
1/1		06-04-012	120 mm / 4¾"
		06-04-016	160 mm / 6¼"
		06-04-020	160 mm / 6¼" Schneiden gezahnt <i>serrated blades</i>
		06-04-022	185 mm / 7¼"
		gerade <i>straight</i>	
1/1		06-04-013	120 mm / 4¾"
		06-04-017	160 mm / 6¼"
		06-04-021	160 mm / 6¼" Schneiden gezahnt <i>serrated blades</i>
		06-04-023	185 mm / 7¼"
		gebogen <i>curved</i>	
1/1		06-04-014	120 mm / 4¾"
		06-04-018	160 mm / 6¼"
		gerade <i>straight</i>	
1/1		06-04-015	120 mm / 4¾"
		06-04-019	160 mm / 6¼"
		gebogen <i>curved</i>	
1/1		06-04-025	185 mm / 7¼" Präparierschere, gerade <i>dissecting scissors, straight</i>
1/1		06-04-028	130 mm / 5⅛" Venenschere <i>vein scissors</i>
1/1		06-04-011	120 mm / 4¾" gewinkelt <i>angled</i>
1/1 45°		06-04-024	185 mm / 7¼" seitwärts gebogen <i>curved to the side</i>











Standard Line

 Oberfläche matt gebürstet
Surface polished

 Beispiel-Artikel-Nr.
Example Cat. No.
06-04-019
Black Line

 Oberfläche schwarz, titanbeschichtet
Surface black, titanium-coated

 Beispiel-Artikel-Nr.
Example Cat. No.
06-04-019B

Artikel-Nr. Cat. No.	Gesamtlänge Total length		
06-54-012	120 mm / 4¾"		1/1
06-54-016	160 mm / 6¼"		
06-54-020	160 mm / 6¼" Schneiden gezahnt <i>serrated blades</i>	MILLESI	
06-54-022	185 mm / 7¼"	YASARGIL	
	gerade <i>straight</i>		
06-54-013	120 mm / 4¾"		1/1
06-54-017	160 mm / 6¼"		
06-54-021	160 mm / 6¼" Schneiden gezahnt <i>serrated blades</i>	MILLESI	
06-54-023	185 mm / 7¼"	JACOBSON	
	gebogen <i>curved</i>		
06-54-014	120 mm / 4¾"	VANNAS	1/1
06-54-018	160 mm / 6¼"		
	gerade <i>straight</i>		
06-54-015	120 mm / 4¾"	VANNAS	1/1
06-54-019	160 mm / 6¼"		
	gebogen <i>curved</i>		
06-54-025	185 mm / 7¼"		1/1
	Präparierschere, gerade <i>dissecting scissors, straight</i>		
06-54-028	130 mm / 5½"	BIEMER	1/1
	Venenschere <i>vein scissors</i>		
06-54-011	120 mm / 4¾"	VANNAS	1/1
	gewinkelt <i>angled</i>		
06-54-024	185 mm / 7¼"	POTTS-YASARGIL	1/1 45°
	seitwärts gebogen <i>curved to the side</i>		



1/1
06-54-016
160 mm
6¼"

Standard Line	Black Line
Oberfläche matt gebürstet <i>Surface polished</i>	Oberfläche schwarz, titanbeschichtet <i>Surface black, titanium-coated</i>
Beispiel-Artikel-Nr. Example Cat. No. 06-54-016	Beispiel-Artikel-Nr. Example Cat. No. 06-54-016B

 1/1
06-13-433
 170 mm
 6¾"

kurzes Blatt short blade	Artikel-Nr. Cat. No.	Gesamtlänge Total length
1/1 25° 	06-13-431	170 mm / 6¾" seitwärts gewinkelt angled to the side
1/1 45° 	06-13-432	170 mm / 6¾" seitwärts gewinkelt angled to the side
1/1 60° 	06-13-433	170 mm / 6¾" seitwärts gewinkelt angled to the side
1/1 90° 	06-13-434	165 mm / 6½" seitwärts gewinkelt angled to the side
1/1 125° 	06-13-435	165 mm / 6½" seitwärts gewinkelt angled to the side
1/1 	06-13-444	165 mm / 6½" gerade straight
1/1 	06-13-430	165 mm / 6½" gebogen curved

Standard Line

 Oberfläche matt gebürstet
 Surface polished

 Beispiel-Artikel-Nr.
 Example Cat. No. **06-13-433**
Black Line

 Oberfläche schwarz, titanbeschichtet
 Surface black, titanium-coated

 Beispiel-Artikel-Nr.
 Example Cat. No. **06-13-433B**

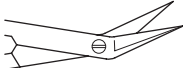
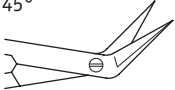
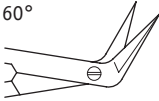
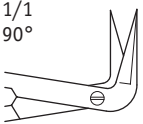
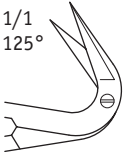
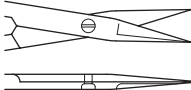
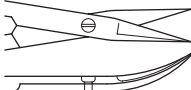
Artikel-Nr. Cat. No.	Gesamtlänge Total length	mittellanges Blatt medium blade
06-13-437	170 mm / 6¾"	1/1 25° 
06-13-438	170 mm / 6¾"	1/1 45° 
06-13-439	170 mm / 6¾"	1/1 60° 
06-13-440	165 mm / 6½"	1/1 90° 
06-13-441	165 mm / 6½"	1/1 125° 
06-13-442	165 mm / 6½"	1/1 
06-13-436	165 mm / 6½"	1/1 

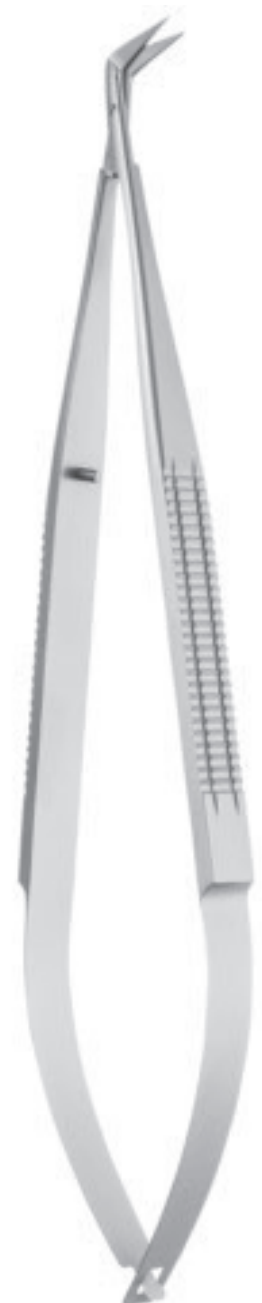

1/1
06-13-439
170 mm
6¾"

Standard Line	Black Line
<p>Oberfläche matt gebürstet Surface polished</p> <p>Beispiel-Artikel-Nr. Example Cat. No. 06-13-439</p>	<p>Oberfläche schwarz, titanbeschichtet Surface black, titanium-coated</p> <p>Beispiel-Artikel-Nr. Example Cat. No. 06-13-439B</p>

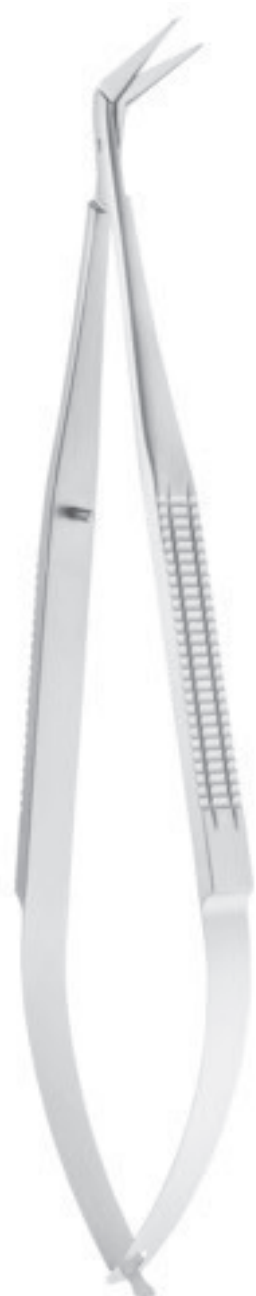
 1/1
06-13-472
 170 mm
 6¾"

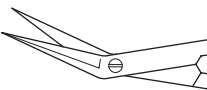
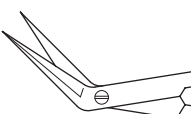
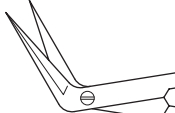
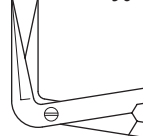
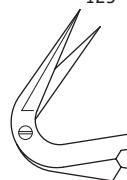
langes Blatt long blade	Artikel-Nr. Cat. No.	Gesamtlänge Total length
1/1 25° 	06-13-470	170 mm / 6¾" seitwärts gewinkelt angled to the side
1/1 45° 	06-13-471	170 mm / 6¾" seitwärts gewinkelt angled to the side
1/1 60° 	06-13-472	170 mm / 6¾" seitwärts gewinkelt angled to the side
1/1 90° 	06-13-473	165 mm / 6½" seitwärts gewinkelt angled to the side
1/1 125° 	06-13-474	165 mm / 6½" seitwärts gewinkelt angled to the side

Standard Line

 Oberfläche matt gebürstet
 Surface polished

 Beispiel-Artikel-Nr.
 Example Cat. No. **06-13-472**
Black Line

 Oberfläche schwarz, titanbeschichtet
 Surface black, titanium-coated

 Beispiel-Artikel-Nr.
 Example Cat. No. **06-13-472B**

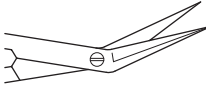
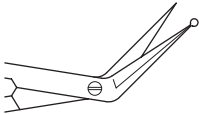
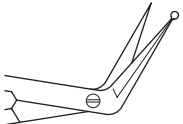
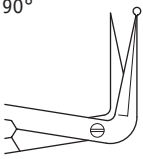
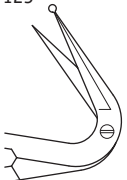



Artikel-Nr. Cat. No.	Gesamtlänge Total length	langes Blatt long blade
06-13-451 mit Knopf, seitwärts gewinkelt with probe, angled to the side	170 mm / 6¾"	1/1 25° 
06-13-452 mit Knopf, seitwärts gewinkelt with probe, angled to the side	170 mm / 6¾"	1/1 45° 
06-13-453 mit Knopf, seitwärts gewinkelt with probe, angled to the side	170 mm / 6¾"	1/1 60° 
06-13-454 mit Knopf, seitwärts gewinkelt with probe, angled to the side	165 mm / 6½"	1/1 90° 
06-13-455 mit Knopf, seitwärts gewinkelt with probe, angled to the side	165 mm / 6½"	1/1 125° 

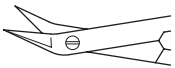

1/1
06-13-451
170 mm
6¾"

Standard Line	Black Line
Oberfläche matt gebürstet <i>Surface polished</i>	Oberfläche schwarz, titanbeschichtet <i>Surface black, titanium-coated</i>
Beispiel-Artikel-Nr. Example Cat. No. 06-13-451	Beispiel-Artikel-Nr. Example Cat. No. 06-13-451B

 1/1
06-13-506
 170 mm
 6¾"

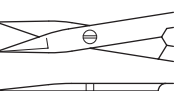
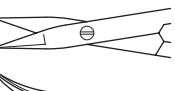
kurzes Blatt short blade	Artikel-Nr. Cat. No.	Gesamtlänge Total length
1/1 25° 	06-13-504	170 mm / 6¾" seitwärts gewinkelt angled to the side
1/1 45° 	06-13-505	170 mm / 6¾" seitwärts gewinkelt angled to the side
1/1 60° 	06-13-506	170 mm / 6¾" seitwärts gewinkelt angled to the side
1/1 90° 	06-13-507	170 mm / 6¾" seitwärts gewinkelt angled to the side
1/1 125° 	06-13-508	170 mm / 6¾" seitwärts gewinkelt angled to the side
1/1 	06-63-502	175 mm / 7" gerade straight
1/1 	06-13-503	175 mm / 7" gebogen curved

Standard Line

 Oberfläche matt gebürstet
 Surface polished



 Beispiel-Artikel-Nr.
 Example Cat. No.

06-13-506
Black Line

 Oberfläche schwarz, titanbeschichtet
 Surface black, titanium-coated

 Beispiel-Artikel-Nr.
 Example Cat. No.

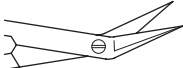
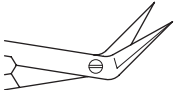
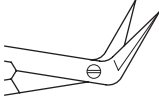
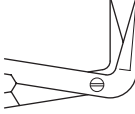
06-13-506B

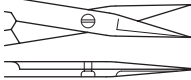
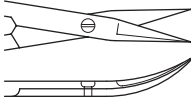
Artikel-Nr. Cat. No.	Gesamtlänge Total length	mittellanges Blatt medium blade
06-13-482	170 mm / 6¾"	1/1 25° 
06-13-483	170 mm / 6¾"	1/1 45° 
06-13-484	170 mm / 6¾"	1/1 60° 
06-13-485	170 mm / 6¾"	1/1 90° 
06-13-486	170 mm / 6¾"	1/1 125° 
06-13-488	175 mm / 7"	1/1 
06-13-481	175 mm / 7"	1/1 







1/1
06-13-484
170 mm
6¾"

Standard Line	Black Line
<p>Oberfläche matt gebürstet Surface polished</p> <p>Beispiel-Artikel-Nr. Example Cat. No. 06-13-484</p>	<p>Oberfläche schwarz, titanbeschichtet Surface black, titanium-coated</p> <p>Beispiel-Artikel-Nr. Example Cat. No. 06-13-484B</p>

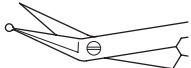
 1/1
06-13-491
 170 mm
 6¾"

mittellanges Blatt
medium blade
Artikel-Nr.
Cat. No.
Gesamtlänge
Total length

 1/1 25°	06-13-489	170 mm / 6¾" mit Knopf, seitwärts gewinkelt <i>with probe, angled to the side</i>
 1/1 45°	06-13-490	170 mm / 6¾" mit Knopf, seitwärts gewinkelt <i>with probe, angled to the side</i>
 1/1 60°	06-13-491	170 mm / 6¾" mit Knopf, seitwärts gewinkelt <i>with probe, angled to the side</i>
 1/1 90°	06-13-492	165 mm / 6½" mit Knopf, seitwärts gewinkelt <i>with probe, angled to the side</i>
 1/1 125°	06-13-493	165 mm / 6½" mit Knopf, seitwärts gewinkelt <i>with probe, angled to the side</i>



Standard Line

 Oberfläche matt gebürstet
Surface polished

 Beispiel-Artikel-Nr. **06-13-491**
Example Cat. No.
Black Line

 Oberfläche schwarz, titanbeschichtet
Surface black, titanium-coated

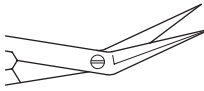
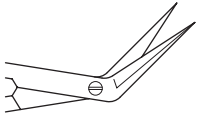
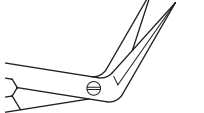
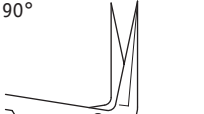
 Beispiel-Artikel-Nr. **06-13-491B**
Example Cat. No.





Artikel-Nr. Cat. No.	Gesamtlänge Total length	langes Blatt long blade
06-13-476	170 mm / 6¾"	1/1 25° 
06-13-477	170 mm / 6¾"	1/1 45° 
06-13-478	170 mm / 6¾"	1/1 60° 
06-13-479	170 mm / 6¾"	1/1 90° 
06-13-480	170 mm / 6¾"	1/1 125° 

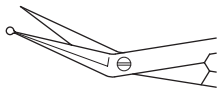
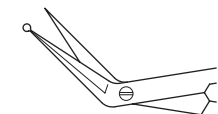

1/1
06-13-478
170 mm
6¾"

Standard Line	Black Line
Oberfläche matt gebürstet <i>Surface polished</i>	Oberfläche schwarz, titanbeschichtet <i>Surface black, titanium-coated</i>
Beispiel-Artikel-Nr. Example Cat. No. 06-13-478	Beispiel-Artikel-Nr. Example Cat. No. 06-13-478B

 1/1
06-54-127
 175 mm
 7"

langes Blatt long blade	Artikel-Nr. Cat. No.	Gesamtlänge Total length
1/1 25° 	06-54-125	180 mm / 7" mit Knopf, seitwärts gewinkelt <i>with probe, angled to the side</i>
1/1 45° 	06-54-126	180 mm / 7" mit Knopf, seitwärts gewinkelt <i>with probe, angled to the side</i>
1/1 60° 	06-54-127	175 mm / 7" mit Knopf, seitwärts gewinkelt <i>with probe, angled to the side</i>
1/1 90° 	06-54-128	165 mm / 6½" mit Knopf, seitwärts gewinkelt <i>with probe, angled to the side</i>
1/1 125° 	06-54-129	165 mm / 6½" mit Knopf, seitwärts gewinkelt <i>with probe, angled to the side</i>

Standard Line

 Oberfläche matt gebürstet
Surface polished

 Beispiel-Artikel-Nr.
Example Cat. No. **06-54-127**
Black Line

 Oberfläche schwarz, titanbeschichtet
Surface black, titanium-coated

 Beispiel-Artikel-Nr.
Example Cat. No. **06-54-127B**

TITAN

Artikel-Nr. Cat. No.	Artikel-Nr. Cat. No.	Gesamtlänge Total length		
06-04-100	06-04-100T	145 mm / 5¾"		1/1
06-04-600	06-04-600T	180 mm / 7"	gerade straight	
06-04-101	06-04-101T	145 mm / 5¾"		1/1
06-04-601	06-04-601T	180 mm / 7"	gebogen curved	
06-54-115	06-54-115T	145 mm / 5¾"	VANNAS	1/1
06-54-116	06-54-116T	180 mm / 7"		
06-04-117	06-04-117T	230 mm / 9"		gerade straight
06-04-103	06-04-103T	145 mm / 5¾"		1/1
06-04-603	06-04-603T	180 mm / 7"	Präparierschere, gebogen dissecting scissors, curved	



1/1
06-04-100
145 mm
5¾"

Standard Line	Black Line
Oberfläche matt gebürstet Surface polished	Oberfläche schwarz, titanbeschichtet Surface black, titanium-coated
Beispiel-Artikel-Nr. Example Cat. No. 06-04-100	Beispiel-Artikel-Nr. Example Cat. No. 06-04-100B



	Artikel-Nr. Cat. No.	Gesamtlänge Total length
1/1	06-13-170	200 mm / 7¾"
	06-13-173	220 mm / 8½"
	06-13-175	240 mm / 9¾"
		aufwärts gebogen curved up

Standard Line

 Oberfläche matt gebürstet
Surface polished

 Beispiel-Artikel-Nr.
 Example Cat. No.

06-13-170
Black Line

 Oberfläche schwarz, titanbeschichtet
Surface black, titanium-coated

 Beispiel-Artikel-Nr.
 Example Cat. No.

06-13-170B
 **Diamond Line**

 Maul diamantbeschichtet
Jaw diamond dust coated

 Beispiel-Artikel-Nr.
 Example Cat. No.

06-13-170D

 1/1
06-13-170
 200 mm
 7¾"

TITAN

Artikel-Nr. Cat. No.	Artikel-Nr. Cat. No.	Gesamtlänge Total length		
06-54-089	06-54-089T	165 mm / 6½"	YASARGIL	1/1
06-04-092	06-04-092T	200 mm / 8"		
06-04-096	06-04-096T	225 mm / 9"		
06-54-099		245 mm / 9¾"		
		gerade straight		
06-04-089	06-04-089T	165 mm / 6½"	YASARGIL	1/1
06-04-093	06-04-093T	200 mm / 8"		
06-04-097	06-04-097T	225 mm / 9"		
06-04-099		245 mm / 9¾"		
		aufwärts gebogen curved up		



Standard Line	Black Line	Diamond Line
Oberfläche matt gebürstet Surface polished Beispiel-Artikel-Nr. Example Cat. No. 06-04-092	Oberfläche schwarz, titanbeschichtet Surface black, titanium-coated Beispiel-Artikel-Nr. Example Cat. No. 06-04-092B	Maul diamantbeschichtet Jaw diamond dust coated Beispiel-Artikel-Nr. Example Cat. No. 06-04-092D



1/1
YASARGIL
06-04-092
 200 mm
 8"



		Artikel-Nr. Cat. No.	Gesamtlänge Total length
1/1		06-63-021	145 mm / 5¾" ohne Sperre, gebogen without ratchet, curved
1/1		06-13-021	145 mm / 5¾" mit Sperre, gebogen with ratchet, curved

1/1
06-13-021
145 mm
5¾"

Standard Line	Black Line	Diamond Line
Oberfläche matt gebürstet <i>Surface polished</i>	Oberfläche schwarz, titanbeschichtet <i>Surface black, titanium-coated</i>	Maul diamantbeschichtet <i>Jaw diamond dust coated</i>
Beispiel-Artikel-Nr. Example Cat. No. 06-13-021	Beispiel-Artikel-Nr. Example Cat. No. 06-13-021B	Beispiel-Artikel-Nr. Example Cat. No. 06-13-021D



Artikel-Nr. Cat. No.	Gesamtlänge Total length		
06-63-061	180 mm / 7" ohne Sperre, gebogen <i>without ratchet, curved</i>		1/1 
06-13-061	180 mm / 7" mit Sperre, gebogen <i>with ratchet, curved</i>		1/1 



1/1
06-13-061
 180 mm
 7"



Standard Line	Black Line	 Diamond Line
Oberfläche matt gebürstet <i>Surface polished</i>	Oberfläche schwarz, titanbeschichtet <i>Surface black, titanium-coated</i>	Maul diamantbeschichtet <i>Jaw diamond dust coated</i>
Beispiel-Artikel-Nr. <i>Example Cat. No.</i> 06-13-061	Beispiel-Artikel-Nr. <i>Example Cat. No.</i> 06-13-061B	Beispiel-Artikel-Nr. <i>Example Cat. No.</i> 06-13-061D



	Artikel-Nr. Cat. No.	Gesamtlänge Total length
1/1	06-04-076	160 mm / 6¼"
	06-04-080	185 mm / 7¼"
		ohne Sperre, gerade without ratchet, straight
1/1	06-04-079	160 mm / 6¼"
	06-04-081	185 mm / 7¼"
		ohne Sperre, gebogen without ratchet, curved

1/1
06-04-076
 160 mm
 6¼"

Standard Line	Black Line	 Diamond Line
Oberfläche matt gebürstet Surface polished Beispiel-Artikel-Nr. <i>Example Cat. No.</i> 06-04-076	Oberfläche schwarz, titanbeschichtet Surface black, titanium-coated Beispiel-Artikel-Nr. <i>Example Cat. No.</i> 06-04-076B	Maul diamantbeschichtet Jaw diamond dust coated Beispiel-Artikel-Nr. <i>Example Cat. No.</i> 06-04-076D





Artikel-Nr. Cat. No.	Gesamtlänge Total length	
06-54-076	160 mm / 6¼"	1/1
06-54-080	185 mm / 7¼"	
	ohne Sperre, gerade without ratchet, straight	
06-54-079	160 mm / 6¼"	1/1
06-54-081	185 mm / 7¼"	
	ohne Sperre, gebogen without ratchet, curved	







1/1
06-54-079
160 mm
6¼"

Standard Line	Black Line	 Diamond Line
Oberfläche matt gebürstet <i>Surface polished</i>	Oberfläche schwarz, titanbeschichtet <i>Surface black, titanium-coated</i>	Maul diamantbeschichtet <i>Jaw diamond dust coated</i>
Beispiel-Artikel-Nr. Example Cat. No. 06-54-079	Beispiel-Artikel-Nr. Example Cat. No. 06-54-079B	Beispiel-Artikel-Nr. Example Cat. No. 06-54-079D

 1/1
JACOBSON
06-54-117
 180 mm
 7"



		TC		
		Artikel-Nr. Cat. No.	Artikel-Nr. Cat. No.	Gesamtlänge Total length
1/1	CASTROVIEJO JACOBSON 	06-54-200	06-54-210	145 mm / 5¾"
		06-04-045	06-54-212	180 mm / 7"
		06-54-202	06-54-214	210 mm / 8¼"
		06-54-204	06-54-216	230 mm / 9"
		mit glatten TC-Einlagen with smooth TC inserts		ohne Sperre, gerade without ratchet, straight
1/1	CASTROVIEJO JACOBSON 	06-54-201	06-54-211	145 mm / 5¾"
		06-54-045	06-54-213	180 mm / 7"
		06-54-203	06-54-215	210 mm / 8¼"
		06-54-205	06-54-217	230 mm / 9"
		mit glatten TC-Einlagen with smooth TC inserts		ohne Sperre, gebogen without ratchet, curved
1/1	CASTROVIEJO JACOBSON 		06-54-218	145 mm / 5¾"
			06-54-117	180 mm / 7"
			06-54-220	210 mm / 8¼"
			06-54-222	230 mm / 9"
		mit gerieften TC-Einlagen with serrated TC inserts		ohne Sperre, gerade without ratchet, straight
1/1	CASTROVIEJO JACOBSON 		06-54-219	145 mm / 5¾"
			06-54-118	180 mm / 7"
			06-54-221	210 mm / 8¼"
			06-54-223	230 mm / 9"
		mit gerieften TC-Einlagen with serrated TC inserts		ohne Sperre, gebogen without ratchet, curved

		TC			
Artikel-Nr. Cat. No.	Artikel-Nr. Cat. No.	Gesamtlänge Total length			
02-13-563	02-13-001	145 mm / 5¾"	CASTROVIEJO	1/1	
06-04-046	06-54-224	180 mm / 7"	JACOBSON		
06-54-206	06-54-226	210 mm / 8¼"			
06-54-208	06-54-228	230 mm / 9"			
	mit glatten TC-Einlagen with smooth TC inserts	mit Sperre, gerade with ratchet, straight			
02-13-564	02-63-001	145 mm / 5¾"	CASTROVIEJO	1/1	
06-54-046	06-54-225	180 mm / 7"	JACOBSON		
06-54-207	06-54-227	210 mm / 8¼"			
06-54-209	06-54-229	230 mm / 9"			
	mit glatten TC-Einlagen with smooth TC inserts	mit Sperre, gebogen with ratchet, curved			
	02-13-002	145 mm / 5¾"	CASTROVIEJO	1/1	
	02-13-004	180 mm / 7"	JACOBSON		
	02-13-005	210 mm / 8¼"			
	02-63-230	230 mm / 9"			
	mit gerieften TC-Einlagen with serrated TC inserts	mit Sperre, gerade with ratchet, straight			
	02-63-002	145 mm / 5¾"	CASTROVIEJO	1/1	
	02-63-004	180 mm / 7"	JACOBSON		
	02-63-005	210 mm / 8¼"			
	02-63-231	230 mm / 9"			
	mit gerieften TC-Einlagen with serrated TC inserts	mit Sperre, gebogen with ratchet, curved			



1/1
JACOBSON
02-13-004
180 mm
7"

TITAN

		Artikel-Nr. Cat. No.	Artikel-Nr. Cat. No.	Gesamtlänge Total length
1/1	BARRAQUER REILL 	06-04-230		120 mm / 4¾"
		06-04-240	06-04-240T	150 mm / 6"
		06-04-244	06-04-244T	180 mm / 7"
		06-54-248	06-54-248T	210 mm / 8¼"
		06-54-252		230 mm / 9"
				ohne Sperre, gerade without ratchet, straight
1/1	BARRAQUER 	06-04-231		120 mm / 4¾"
				ohne Sperre, gebogen without ratchet, curved
1/1	REILL 	06-04-241	06-04-241T	150 mm / 6"
		06-04-245	06-04-245T	180 mm / 7"
		06-54-251	06-54-251T	210 mm / 8¼"
		06-54-255		230 mm / 9"
				ohne Sperre, gebogen without ratchet, curved

1/1
REILL
06-04-241
 150 mm
 6"

Standard Line

Oberfläche matt gebürstet
Surface polished

Beispiel-Artikel-Nr.
 Example Cat. No.

06-04-241

Black Line

Oberfläche schwarz, titanbeschichtet
Surface black, titanium-coated

Beispiel-Artikel-Nr.
 Example Cat. No.

06-04-241B



 **Diamond Line**

Maul diamantbeschichtet
Jaw diamond dust coated

Beispiel-Artikel-Nr.
 Example Cat. No.

06-04-241D

TITAN

Artikel-Nr. Cat. No.	Artikel-Nr. Cat. No.	Gesamtlänge Total length		
06-04-232		120 mm / 4¾"	BARRAQUER	1/1
06-04-242	06-04-242T	150 mm / 6"		
06-04-246	06-04-246T	180 mm / 7"		
06-54-250	06-54-250T	210 mm / 8¾"		
06-54-254		230 mm / 9"		
		mit Sperre, gerade with ratchet, straight		
06-04-233		120 mm / 4¾"	BARRAQUER	1/1
		mit Sperre, gebogen with ratchet, curved		
06-04-243	06-04-243T	150 mm / 6"		
06-04-247	06-04-247T	180 mm / 7"		
06-54-253	06-54-253T	210 mm / 8¾"		
06-04-249		230 mm / 9"		
		mit Sperre, gebogen with ratchet, curved		





1/1
06-04-243
150 mm
6"

Standard Line	Black Line	Diamond Line
<p>Oberfläche matt gebürstet <i>Surface polished</i></p> <p>Beispiel-Artikel-Nr. Example Cat. No. 06-04-243</p>	<p>Oberfläche schwarz, titanbeschichtet <i>Surface black, titanium-coated</i></p> <p>Beispiel-Artikel-Nr. Example Cat. No. 06-04-243B</p>	<p>Maul diamantbeschichtet <i>Jaw diamond dust coated</i></p> <p>Beispiel-Artikel-Nr. Example Cat. No. 06-04-243D</p>



1/1
06-13-524
 120 mm
 4¾"



	Artikel-Nr. Cat. No.	Gesamtlänge Total length
1/1	06-13-524	120 mm / 4¾"
	06-13-525	160 mm / 6¼"
	06-13-526	185 mm / 7¼"
	06-13-527	210 mm / 8¼"
	06-13-532	230 mm / 9"
für Nahtmaterial 7/0-10/0 for suture size 7/0-10/0		ohne Sperre, gerade without ratchet, straight diamantbeschichtet diamond dust coated
1/1	06-13-528	145 mm / 5¾"
	06-13-529	160 mm / 6¼"
	06-13-530	185 mm / 7¼"
	06-13-531	210 mm / 8¼"
	06-13-533	230 mm / 9"
für Nahtmaterial 5/0-8/0 for suture size 5/0-8/0		ohne Sperre, gerade without ratchet, straight diamantbeschichtet diamond dust coated





Artikel-Nr. Cat. No.	Gesamtlänge Total length	
06-13-520	120 mm / 4¾"	1/1
06-13-521	160 mm / 6¼"	
06-13-563	185 mm / 7¼"	
06-13-565	210 mm / 8¼"	
06-13-567	230 mm / 9"	
	mit Sperre, gerade with ratchet, straight diamantbeschichtet diamond dust coated	
06-13-522	145 mm / 5¾"	1/1
06-13-523	160 mm / 6¼"	
06-13-564	185 mm / 7¼"	
06-13-566	210 mm / 8¼"	
06-13-568	230 mm / 9"	
	mit Sperre, gerade with ratchet, straight diamantbeschichtet diamond dust coated	
06-13-218	185 mm / 7¼"	1/1
06-13-228	210 mm / 8¼"	
06-13-230	230 mm / 9"	
	mit Sperre, gerade with ratchet, straight diamantbeschichtet diamond dust coated	
06-13-221	210 mm / 8¼"	1/1
06-13-223	230 mm / 9"	
	mit Sperre, gebogen with ratchet, curved diamantbeschichtet diamond dust coated	





1/1
06-13-520
120 mm
4¾"



1/1
06-54-262
 180 mm
 7"

	TC	
	Artikel-Nr. Cat. No.	Gesamtlänge Total length
	1/1 06-54-260	150 mm / 6"
	06-54-262	180 mm / 7"
	06-54-264	210 mm / 8¼"
	06-54-266	230 mm / 9"
	mit gerieften TC-Einlagen with serrated TC inserts	ohne Sperre, gerade without ratchet, straight
	1/1 06-54-261	150 mm / 6"
	06-54-263	180 mm / 7"
	06-54-265	210 mm / 8¼"
	06-54-267	230 mm / 9"
	mit gerieften TC-Einlagen with serrated TC inserts	ohne Sperre, gebogen without ratchet, curved





TC

Artikel-Nr. Cat. No.	Gesamtlänge Total length	
06-54-270	150 mm / 6"	1/1
06-54-272	180 mm / 7"	
06-54-274	210 mm / 8¼"	
06-54-276	230 mm / 9"	
mit gerieften TC-Einlagen with serrated TC inserts	mit Sperre, gerade with ratchet, straight	
06-54-271	150 mm / 6"	1/1
06-54-273	180 mm / 7"	
06-54-275	210 mm / 8¼"	
06-54-277	230 mm / 9"	
mit gerieften TC-Einlagen with serrated TC inserts	mit Sperre, gebogen with ratchet, curved	



1/1
06-54-272
180 mm
7"

 1/1
06-13-392
 230 mm
 9"

		TC	
	Artikel-Nr. Cat. No.	Artikel-Nr. Cat. No.	Gesamtlänge Total length
1/1 		06-13-388 mit gerieften TC-Einlagen with serrated TC inserts	180 mm / 7" mit Sperre, gerade with ratchet, straight
1/1 		06-13-390 mit gerieften TC-Einlagen with serrated TC inserts	200 mm / 8" mit Sperre, gerade with ratchet, straight
1/1 	06-13-392		230 mm / 9" mit Sperre, gerade with ratchet, straight
1/1 	06-13-398		200 mm / 8" ohne Sperre, gerade without ratchet, straight



Artikel-Nr. Cat. No.	Gesamtlänge Total length		
06-13-560	125 mm / 5"		1/1
06-13-561	180 mm / 7"		
	mit Sperre, gerade with ratchet, straight		A
	diamantbeschichtet diamond dust coated		



1/1
06-13-560
125 mm
5"



		Artikel-Nr. Cat. No.	Gesamtlänge Total length
1/1		06-13-150	190 mm / 7¾"
		06-13-153	210 mm / 8¼"
		06-13-156	240 mm / 9½"
Spitzen 0,5 mm, gerade tips 0.5 mm, straight			
1/1		06-13-151	190 mm / 7¾"
		06-13-154	210 mm / 8¼"
		06-13-157	240 mm / 9½"
Spitzen 0,9 mm, gerade tips 0.9 mm, straight			
1/1		06-13-174	210 mm / 8¼"
1 x 2 Zähne, gerade 1 x 2 teeth, straight			

1/1
06-13-150
 190 mm
 7¾"

Standard Line

Oberfläche matt gebürstet
Surface polished

Beispiel-Artikel-Nr.
 Example Cat. No.

06-13-150

Black Line

Oberfläche schwarz, titanbeschichtet
Surface black, titanium-coated

Beispiel-Artikel-Nr.
 Example Cat. No.

06-13-150B

Diamond Line

Maul diamantbeschichtet
Jaw diamond dust coated

Beispiel-Artikel-Nr.
 Example Cat. No.

06-13-150D

TITAN

Artikel-Nr. Cat. No.	Artikel-Nr. Cat. No.	Gesamtlänge Total length		
02-04-830	02-04-830T	160 mm / 6¼"	YASARGIL	1/1
02-04-835	02-04-835T	180 mm / 7"		
02-04-840	02-04-840T	200 mm / 8"		
02-04-845	02-04-845T	220 mm / 8¾"		
02-04-850		240 mm / 9½"		
		Spitzen 0,6 mm, gerade tips 0.6 mm, straight		
02-04-831	02-04-831T	160 mm / 6¼"	YASARGIL	1/1
02-04-836	02-04-836T	180 mm / 7"		
02-04-841	02-04-841T	200 mm / 8"		
02-04-846	02-04-846T	220 mm / 8¾"		
02-04-851		240 mm / 9½"		
		Spitzen 0,9 mm, gerade tips 0.9 mm, straight		
02-04-837		180 mm / 7"	YASARGIL	1/1
02-54-838		200 mm / 8"		
02-54-839		220 mm / 8¾"		
02-54-840		240 mm / 9½"		
		1x2 Zähne, gerade 1x2 teeth, straight		



Standard Line	Black Line	Diamond Line
Oberfläche matt gebürstet <i>Surface polished</i> Beispiel-Artikel-Nr. <i>Example Cat. No.</i> 02-04-840	Oberfläche schwarz, titanbeschichtet <i>Surface black, titanium-coated</i> Beispiel-Artikel-Nr. <i>Example Cat. No.</i> 02-04-840B	Maul diamantbeschichtet <i>Jaw diamond dust coated</i> Beispiel-Artikel-Nr. <i>Example Cat. No.</i> 02-04-840D

1/1
YASARGIL
02-04-840
 200 mm
 8"

 1/2
06-04-110
 185 mm
 7¼"

	Artikel-Nr. Cat. No.	Gesamtlänge Total length
	1/1 06-04-110	185 mm / 7¼" Spitzen 0,3 mm, gerade tips 0.3 mm, straight
	1/1 06-04-111	185 mm / 7¼" Spitzen 0,6 mm, gerade tips 0.6 mm, straight
	1/1 06-04-112	185 mm / 7¼" Spitzen 0,6 mm, aufwärts gebogen tips 0.6 mm, angled up

 1/2
02-04-887
 160 mm
 6¼"

	Artikel-Nr. Cat. No.	Gesamtlänge Total length
	1/1 02-04-887	160 mm / 6¼" spitz, gerade pointed, straight
	1/1 02-04-888	160 mm / 6¼" 1 x 2 Zähne, gerade 1 x 2 teeth, straight

Standard Line

 Oberfläche matt gebürstet
 Surface polished

 Beispiel-Artikel-Nr.
 Example Cat. No. **06-04-110**
Black Line

 Oberfläche schwarz, titanbeschichtet
 Surface black, titanium-coated

 Beispiel-Artikel-Nr.
 Example Cat. No. **06-04-110B**
Diamond Line

 Maul diamantbeschichtet
 Jaw diamond dust coated

 Beispiel-Artikel-Nr.
 Example Cat. No. **06-04-110D**

Artikel-Nr. Cat. No.	Gesamtlänge Total length		
02-04-878	140 mm / 5½"	gerade straight	LUCAE 1/1
02-04-880	160 mm / 6¼"	gerade straight	JANSEN 1/1
02-04-870	175 mm / 7"	gerade straight	ADSON 1/1

1/2
JANSEN
02-04-880
160 mm
6¼"



TC	Artikel-Nr. Cat. No.	Gesamtlänge Total length		
	02-04-168	185 mm / 7¼"	gerade straight	GRUENWALD 1/1
	02-04-883	200 mm / 8"	gerade straight	GRUENWALD 1/1

1/2
GRUENWALD
02-04-168
185 mm
7¼"





Artikel-Nr. Cat. No.	Gesamtlänge Total length		
02-04-885	185 mm / 7¼"	spitz, gerade pointed, straight	1/1
02-04-879	140 mm / 5½"	1 x 2 Zähne, gerade 1 x 2 teeth, straight	LUCAE 1/1
02-04-886	200 mm / 8"	1 x 2 Zähne, gerade 1 x 2 teeth, straight	1/1

1/2
02-04-885
185 mm
7¼"





1/1
06-13-176
 210 mm
 8¼"

		Artikel-Nr. Cat. No.	Gesamtlänge Total length
2,5 mm		06-13-176	210 mm / 8¼"
		06-13-178	245 mm / 9¾"
			Maul flach gezahnt, gerade jaw flat toothed, straight
3,5 mm		06-13-177	210 mm / 8¼"
		06-13-179	245 mm / 9¾"
			Maul flach gezahnt, gerade jaw flat toothed, straight

Standard Line

Oberfläche matt gebürstet
 Surface polished

Beispiel-Artikel-Nr.
 Example Cat. No. **06-13-176**

Black Line

Oberfläche schwarz, titanbeschichtet
 Surface black, titanium-coated

Beispiel-Artikel-Nr.
 Example Cat. No. **06-13-176B**

Artikel-Nr. Cat. No.	Gesamtlänge Total length		
06-04-210	220 mm / 8¾"	YASARGIL	1/1 ø 3 mm
06-04-200	240 mm / 9½"	YASARGIL- SAMII	⊙
Maul löffelförmig, gerade <i>jaw spoon-shaped, straight</i>			
06-04-212	220 mm / 8¾"	YASARGIL	1/1 ø 5 mm
06-04-202	240 mm / 9½"	YASARGIL- SAMII	⊙
Maul löffelförmig, gerade <i>jaw spoon-shaped, straight</i>			
06-04-204	240 mm / 9½"	YASARGIL- SAMII	1/1 ø 7 mm
Maul löffelförmig, gerade <i>jaw spoon-shaped, straight</i>			
06-04-221	165 mm / 6½"	YASARGIL	1/1 ø 3 mm
06-04-223	200 mm / 8"		
06-04-214	220 mm / 8¾"		⊙
Maul flach gezahnt, gerade <i>jaw flat toothed, straight</i>			
06-04-225	165 mm / 6½"	YASARGIL	1/1 ø 5 mm
06-04-229	200 mm / 8"		
06-04-216	220 mm / 8¾"		⊙
Maul flach gezahnt, gerade <i>jaw flat toothed, straight</i>			
06-04-215	220 mm / 8¾"	HEIFETZ	1/1 ø 3 mm
Maul kürettenförmig gezahnt, gerade <i>urette jaw toothed, straight</i>			
06-04-217	220 mm / 8¾"	HEIFETZ	1/1 ø 5 mm
Maul kürettenförmig gezahnt, gerade <i>urette jaw toothed, straight</i>			











Standard Line	Black Line
Oberfläche matt gebürstet <i>Surface polished</i>	Oberfläche schwarz, titanbeschichtet <i>Surface black, titanium-coated</i>
Beispiel-Artikel-Nr. Example Cat. No. 06-04-216	Beispiel-Artikel-Nr. Example Cat. No. 06-04-216B

1/1
YASARGIL
06-04-216
220 mm
8¾"



1/1
SAMII
06-04-190
 230 mm
 9"

		Artikel-Nr. Cat. No.	Gesamtlänge Total length
	1/1 ø 3 mm SAMII	06-04-190	230 mm / 9" Maul löffelförmig, aufwärts gebogen <i>jaw spoon-shaped, angled up</i>
	1/1 ø 4 mm SAMII	06-04-191	230 mm / 9" Maul löffelförmig, aufwärts gebogen <i>jaw spoon-shaped, angled up</i>
	1/1 ø 5 mm SAMII	06-04-192	230 mm / 9" Maul löffelförmig, aufwärts gebogen <i>jaw spoon-shaped, angled up</i>
	1/1 ø 3 mm SAMII	06-04-195	230 mm / 9" Maul löffelförmig, abwärts gebogen <i>jaw spoon-shaped, angled down</i>
	1/1 ø 4 mm SAMII	06-04-196	230 mm / 9" Maul löffelförmig, abwärts gebogen <i>jaw spoon-shaped, angled down</i>
	1/1 ø 5 mm SAMII	06-04-197	230 mm / 9" Maul löffelförmig, abwärts gebogen <i>jaw spoon-shaped, angled down</i>
	1/1 ø 3 mm SAMII	06-04-218	220 mm / 8¾" Maul flach gezahnt, aufwärts gebogen <i>jaw flat serrated, angled up</i>
	1/1 ø 3 mm SAMII	06-04-219	220 mm / 8¾" Maul flach gezahnt, aufwärts gebogen <i>jaw flat serrated, angled up</i>

Standard Line

Oberfläche matt gebürstet
Surface polished

Beispiel-Artikel-Nr.
Example Cat. No.

06-04-190
Black Line

Oberfläche schwarz, titanbeschichtet
Surface black, titanium-coated

Beispiel-Artikel-Nr.
Example Cat. No.

06-04-190B



Artikel-Nr. Cat. No.	Gesamtlänge Total length		
06-04-234	220 mm / 8¾"	YASARGIL	1/1
	Maulbreite 3 mm jaw width 3 mm		
06-04-236	220 mm / 8¾"	YASARGIL	1/1
	Maulbreite 5 mm jaw width 5 mm		

Standard Line	Black Line
Oberfläche matt gebürstet <i>Surface polished</i>	Oberfläche schwarz, titanbeschichtet <i>Surface black, titanium-coated</i>
Beispiel-Artikel-Nr. Example Cat. No. 06-04-234	Beispiel-Artikel-Nr. Example Cat. No. 06-04-234B

1/1
YASARGIL
06-04-234
 220 mm
 8¾"



1/1
HUNT
02-04-766
 200 mm
 8"

		Artikel-Nr. Cat. No.	Gesamtlänge Total length
 1/1 ø 3 mm	YASARGIL	02-04-768	200 mm / 8" Maul flach gezahnt, gerade <i>jaw flat toothed, straight</i>
 1/1 ø 5 mm	HUNT	02-04-766	200 mm / 8" Maul flach gezahnt, gerade <i>jaw flat toothed, straight</i>

Standard Line

Oberfläche matt gebürstet
Surface polished

Beispiel-Artikel-Nr.
Example Cat. No. **02-04-766**

Black Line

Oberfläche schwarz, titanbeschichtet
Surface black, titanium-coated

Beispiel-Artikel-Nr.
Example Cat. No. **02-04-766B**

Artikel-Nr. Cat. No.	Gesamtlänge Total length	HUNT	1/1 ø 5 mm
02-04-765	200 mm / 8" Maul flach gezahnt, gewinkelt <i>jaw flat toothed, angled</i>		



Standard Line	Black Line
Oberfläche matt gebürstet <i>Surface polished</i> Beispiel-Artikel-Nr. <i>Example Cat. No.</i> 02-04-765	Oberfläche schwarz, titanbeschichtet <i>Surface black, titanium-coated</i> Beispiel-Artikel-Nr. <i>Example Cat. No.</i> 02-04-765B

1/1
HUNT
02-04-765
200 mm
8"



1/1
06-13-001
 110 mm
 4³/₈"

	Artikel-Nr. Cat. No.	Gesamtlänge Total length
	1/1 06-13-001	110 mm / 4 ³ / ₈ " Spitzen 0,15 mm, gerade <i>tips 0.15 mm, straight</i>
	1/1 06-13-002	110 mm / 4 ³ / ₈ " Spitzen 0,2 mm, gerade <i>tips 0.2 mm, straight</i>
	1/1 06-13-003	110 mm / 4 ³ / ₈ " Spitzen 0,3 mm, gerade <i>tips 0.3 mm, straight</i>
	1/1 06-13-004	110 mm / 4 ³ / ₈ " Spitzen 0,5 mm, gerade <i>tips 0.5 mm, straight</i> 1 x 2 Zähne <i>1 x 2 teeth</i>
	1/1 06-13-005	110 mm / 4 ³ / ₈ " Ring ø 1,2 mm, gerade <i>ø of ring 1.2 mm, straight</i>
	1/1 06-13-006	110 mm / 4 ³ / ₈ " Dreikant 1,2 mm breit, gerade <i>triangular 1.2 mm wide, straight</i>

Standard Line





Oberfläche matt gebürstet
Surface polished

Beispiel-Artikel-Nr.
Example Cat. No. **06-13-001**

Black Line

Oberfläche schwarz, titanbeschichtet
Surface black, titanium-coated

Beispiel-Artikel-Nr.
Example Cat. No. **06-13-001B**

Artikel-Nr. Cat. No.	Gesamtlänge Total length		
06-13-033	160 mm / 6¼"	Spitzen 0,3 mm, gerade tips 0.3 mm, straight	1/1 
06-13-036	160 mm / 6¼"	Spitzen 0,4 mm, gerade tips, 0.4 mm, straight	1/1 
06-13-034	160 mm / 6¼"	Spitzen 0,5 mm, gerade tips 0.5 mm, straight 1 x 2 Zähne 1 x 2 teeth	1/1 
06-13-035	160 mm / 6¼"	Ring ø 1,2 mm, gerade ø of ring 1.2 mm, straight	1/1 



1/1
06-13-033
160 mm
6¼"

Standard Line	Black Line
Oberfläche matt gebürstet Surface polished	Oberfläche schwarz, titanbeschichtet Surface black, titanium-coated
Beispiel-Artikel-Nr. Example Cat. No. 06-13-033	Beispiel-Artikel-Nr. Example Cat. No. 06-13-033B



	Artikel-Nr. Cat. No.	Gesamtlänge Total length
	1/1 06-54-950	150 mm / 6"
	06-54-951	180 mm / 7"
	06-54-952	210 mm / 8¼"
Spitzen 0,6 mm, gerade tips 0.6 mm, straight		
	1/1 06-54-953	150 mm / 6"
	06-54-954	180 mm / 7"
	06-54-955	210 mm / 8¼"
Spitzen 0,6 mm, gebogen tips 0.6 mm, curved		
	1/1 06-54-960	150 mm / 6"
	06-54-961	180 mm / 7"
	06-54-962	210 mm / 8¼"
Spitzen 0,6 mm, gerade tips 0.6 mm, straight		
1 x 2 Zähne 1 x 2 teeth		
	1/1 06-54-963	150 mm / 6"
	06-54-964	180 mm / 7"
	06-54-965	210 mm / 8¼"
Spitzen 0,6 mm, gebogen tips 0.6 mm, curved		
1 x 2 Zähne 1 x 2 teeth		

1/1
06-54-953
 150 mm
 6"

Standard Line

Oberfläche matt gebürstet
 Surface polished

Beispiel-Artikel-Nr.
 Example Cat. No. **06-54-953**

Black Line

Oberfläche schwarz, titanbeschichtet
 Surface black, titanium-coated

Beispiel-Artikel-Nr.
 Example Cat. No. **06-54-953B**

Diamond Line

Maul diamantbeschichtet
 Jaw diamond dust coated

Beispiel-Artikel-Nr.
 Example Cat. No. **06-54-953D**







Artikel-Nr. Cat. No.	Artikel-Nr. Cat. No.	Gesamtlänge Total length		
06-54-980		150 mm / 6"	DE BAKEY	1/1
06-54-981		180 mm / 7"		
06-54-982		210 mm / 8¼"		
		Spitzen 1,2 mm, atraumatisch, gerade <i>tips 1.2 mm, atraumatic, straight</i>		
06-54-983		150 mm / 6"	DE BAKEY	1/1
06-54-984		180 mm / 7"		
06-54-985		210 mm / 8¼"		
		Spitzen 1,2 mm, atraumatisch, gewinkelt <i>tips 1.2 mm, atraumatic, angled</i>		
06-54-970		150 mm / 6"		1/1 ø 1 mm
06-54-971		180 mm / 7"		
06-54-972		210 mm / 8¼"		
		Ringe gerieft, gerade <i>rings serrated, straight</i>		
	06-13-570	150 mm / 6"		1/1 ø 1 mm
	06-13-572	180 mm / 7"		
	06-13-574	210 mm / 8¼"		
		Ringe diamantbeschichtet, gerade <i>rings diamond dust coated, straight</i>		
06-54-973		150 mm / 6"		1/1 ø 2 mm
06-54-974		180 mm / 7"		
06-54-975		210 mm / 8¼"		
		Ringe gerieft, gerade <i>rings serrated, straight</i>		
	06-54-976	150 mm / 6"		1/1 ø 2 mm
	06-13-579	180 mm / 7"		
	06-54-977	210 mm / 8¼"		
		Ringe diamantbeschichtet, gerade <i>rings diamond dust coated, straight</i>		



1/1
 06-54-970
 150 mm
 6"

Standard Line	Black Line
Oberfläche matt gebürstet <i>Surface polished</i>	Oberfläche schwarz, titanbeschichtet <i>Surface black, titanium-coated</i>
Beispiel-Artikel-Nr. Example Cat. No. 06-54-970	Beispiel-Artikel-Nr. Example Cat. No. 06-54-970B

 1/1
 DE BAKEY
 06-54-926
 180 mm
 7"

		TITAN		
		Artikel-Nr. Cat. No.	Artikel-Nr. Cat. No.	Gesamtlänge Total length
	1/1 DE BAKEY	06-54-925	06-54-925T	150 mm / 6"
		06-54-926	06-54-926T	180 mm / 7"
		06-54-927	06-54-927T	210 mm / 8¼"
Spitzen 1,2 mm, gerade tips 1.2 mm, straight				
	1/1 DE BAKEY	06-54-928	06-54-928T	150 mm / 6"
		06-54-929	06-54-929T	180 mm / 7"
		06-54-930	06-54-930T	210 mm / 8¼"
Spitzen 1,2 mm, gewinkelt tips 1.2 mm, angled				
	1/1 DE BAKEY	06-54-931	06-54-931T	150 mm / 6"
		06-54-932	06-54-932T	180 mm / 7"
		06-54-933	06-54-933T	210 mm / 8¼"
Spitzen 1,8 mm, gerade tips 1.8 mm, straight				
	1/1 DE BAKEY	06-54-934	06-54-934T	150 mm / 6"
		06-54-935	06-54-935T	180 mm / 7"
		06-54-936	06-54-936T	210 mm / 8¼"
Spitzen 1,8 mm, gewinkelt tips 1.8 mm, angled				

Standard Line





 Oberfläche matt gebürstet
 Surface polished

 Beispiel-Artikel-Nr.
 Example Cat. No. **06-54-926**
Black Line

 Oberfläche schwarz, titanbeschichtet
 Surface black, titanium-coated

 Beispiel-Artikel-Nr.
 Example Cat. No. **06-54-926B**

TITAN

Artikel-Nr. Cat. No.	Artikel-Nr. Cat. No.	Gesamtlänge Total length	
06-54-937	06-54-937T	150 mm / 6"	1/1 ø 1 mm
06-54-938	06-54-938T	180 mm / 7"	
06-54-939	06-54-939T	210 mm / 8¼"	
		Ringe gerieft, gerade rings serrated, straight	
06-54-940	06-54-940T	150 mm / 6"	1/1 ø 1 mm
06-54-941	06-54-941T	180 mm / 7"	
06-54-942	06-54-942T	210 mm / 8¼"	
		Ringe diamantbeschichtet, gerade rings diamond dust coated, straight	
06-54-943	06-54-943T	150 mm / 6"	1/1 ø 2 mm
06-54-944	06-54-944T	180 mm / 7"	
06-54-945	06-54-945T	210 mm / 8¼"	
		Ringe gerieft, gerade rings serrated, straight	
06-54-946	06-54-946T	150 mm / 6"	1/1 ø 2 mm
06-54-947	06-54-947T	180 mm / 7"	
06-54-948	06-54-948T	210 mm / 8¼"	
		Ringe diamantbeschichtet, gerade rings diamond dust coated, straight	



1/1
06-54-938
180 mm
7"

Standard Line	Black Line
<p>Oberfläche matt gebürstet Surface polished</p> <p>Beispiel-Artikel-Nr. Example Cat. No. 06-54-938</p>	<p>Oberfläche schwarz, titanbeschichtet Surface black, titanium-coated</p> <p>Beispiel-Artikel-Nr. Example Cat. No. 06-54-938B</p>

TITAN

	Artikel-Nr. Cat. No.	Artikel-Nr. Cat. No.	Gesamtlänge Total length
1/1	06-04-280		120 mm / 4¾"
	06-04-284	06-04-284T	150 mm / 6"
	06-54-286	06-54-286T	180 mm / 7"
	06-54-288	06-54-288T	210 mm / 8¼"
Spitzen 0,3 mm, gerade tips 0.3 mm, straight			
1/1	06-54-280		120 mm / 4¾"
	06-54-284	06-54-284T	150 mm / 6"
	06-04-286	06-04-286T	180 mm / 7"
	06-54-290	06-54-290T	210 mm / 8¼"
	06-04-288		230 mm / 9"
Spitzen 0,6 mm, gerade tips 0.6 mm, straight			
1/1	06-04-281		120 mm / 4¾"
	06-04-285	06-04-285T	150 mm / 6"
	06-54-287	06-54-287T	180 mm / 7"
	06-54-289	06-54-289T	210 mm / 8¼"
Spitzen 0,3 mm, gebogen tips 0.3 mm, curved			
1/1	06-54-281		120 mm / 4¾"
	06-54-285	06-54-285T	150 mm / 6"
	06-04-287	06-04-287T	180 mm / 7"
	06-54-291	06-54-291T	210 mm / 8¼"
	06-54-293		230 mm / 9"
Spitzen 0,6 mm, gebogen tips 0.6 mm, curved			

1/1
06-04-284
 150 mm
 6"

Standard Line

Oberfläche matt gebürstet
 Surface polished

Beispiel-Artikel-Nr.
 Example Cat. No. **06-04-284**

Black Line



Oberfläche schwarz, titanbeschichtet
 Surface black, titanium-coated

Beispiel-Artikel-Nr.
 Example Cat. No. **06-04-284B**

Diamond Line

Maul diamantbeschichtet
 Jaw diamond dust coated

Beispiel-Artikel-Nr.
 Example Cat. No. **06-04-284D**

Artikel-Nr. Cat. No.	Gesamtlänge Total length		
02-04-260	155 mm / 6"	LAZAR	1/1 
02-04-261	155 mm / 6"	LAZAR	1/1 
02-04-264	185 mm / 7¼"		1/1 



1/1
LAZAR
02-04-261
155 mm
6"





 **Diamond Line**

Maul diamantbeschichtet
Jaw diamond dust coated

Beispiel-Artikel-Nr. **02-04-261D**
Example Cat. No.







1/1
WISE
02-04-336
 135 mm
 5¼"

		Artikel-Nr. Cat. No.	Gesamtlänge Total length
1/1		02-04-338	120 mm / 4¾" Spitzen 0,3 mm, gerade <i>tips 0.3 mm, straight</i>
1/1	WISE 	02-04-336	135 mm / 5¼" Spitzen 0,3 mm, gerade <i>tips 0.3 mm, straight</i>
1/1	WISE 	02-04-337	135 mm / 5¼" Spitzen 0,3 mm, gebogen <i>tips 0.3 mm, curved</i>
1/1	WISE 	02-04-345	135 mm / 5¼" 1 x 2 Zähne, gerade <i>1 x 2 teeth, straight</i>

 **Diamond Line**

Maul diamantbeschichtet
Jaw diamond dust coated

Beispiel-Artikel-Nr. **02-04-336D**
 Example Cat. No.

Artikel-Nr. Cat. No.	Gesamtlänge Total length	
02-04-331	110 mm / 4 ³ / ₈ " Spitzen 0,15 mm, gerade <i>tips 0.15 mm, straight</i>	1/1 
02-04-330	110 mm / 4 ³ / ₈ " Spitzen 0,2 mm, gerade <i>tips 0.2 mm, straight</i>	1/1 
02-04-329	110 mm / 4 ³ / ₈ " Spitzen 0,3 mm, gewinkelt <i>tips 0.3 mm, angled</i>	1/1 
02-04-333	115 mm / 4 ¹ / ₂ " Spitzen 0,2 mm, gebogen <i>tips 0.2 mm, curved</i>	1/1 







1/1
02-04-331
 110 mm
 4³/₈"

Diamond Line
 Maul diamantbeschichtet
Jaw diamond dust coated
 Beispiel-Artikel-Nr. **02-04-331D**
 Example Cat. No.

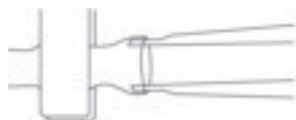

2/3
06-54-315
 135 mm
 5¼"







	Artikel-Nr. Cat. No.	Gesamtlänge Total length
1/1 	06-54-313	110 mm / 4¾" Spitzen 0,2 mm, 10° gewinkelt tips 0.2 mm, 10° angled
1/1 	06-54-314	110 mm / 4¾" Spitzen 0,3 mm, 10° gewinkelt tips 0.3 mm, 10° angled
1/1 	06-54-315	135 mm / 5¼" Spitzen 0,2 mm, gerade tips 0.2 mm, straight
1/1 	06-54-316	135 mm / 5¼" Spitzen 0,3 mm, gerade tips 0.3 mm, straight



2/3
06-54-317
 135 mm
 5¼"

	Artikel-Nr. Cat. No.	Gesamtlänge Total length
1/1 	06-54-317	135 mm / 5¼" Spitzen 0,3 mm, gewinkelt tips 0.3 mm, angled

Artikel-Nr. Cat. No.	Gesamtlänge Total length		
02-02-046	135 mm / 5¼"		1/1 
02-02-048	155 mm / 6"		1/1 
02-02-052	180 mm / 7"	CASPAR	1/1 
02-02-054	200 mm / 8"		1/1 



1/1
02-02-054
200 mm
8"



	Artikel-Nr. Cat. No.	Gesamtlänge Total length
LANDOLT	02-02-053	210 mm / 8¼" für mikrochirurgische Klagen for microsurgery blades

1/1
LANDOLT
02-02-053
210 mm
8¼"

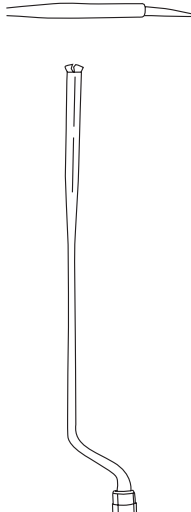
Artikel-Nr. Cat. No.	Gesamtlänge Total length	LANDOLT	1/2
02-02-057	250 mm / 10"	für mikrochirurgische Klengen for microsurgery blades	



2/3
LANDOLT
02-02-057
250 mm
10"

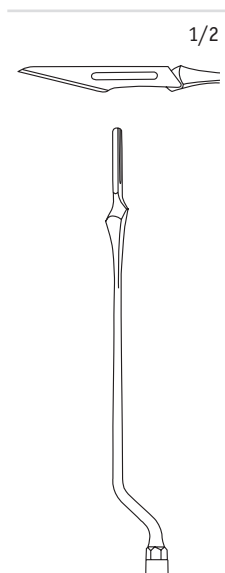

Artikel-Nr.
Cat. No.

Gesamtlänge
Total length

02-02-071

210 mm / 8¼"

02-52-070

240 mm / 9½"

horizontal
horizontal

02-52-071

210 mm / 8¼"

02-52-072

240 mm / 9½"

vertikal
vertical

1/1
LANDOLT
02-02-071
210 mm
8"

Artikel-Nr. Cat. No.	Gesamtlänge Total length		
06-04-361	105 mm / 4 1/8"		
	Metallgriff für auswechselbare Mikroschäfte, 360° drehbar <i>metal handle for micro-shaft instruments, 360° turnable</i>		

Artikel-Nr. Cat. No.	Gesamtlänge Total length		
06-54-361	155 mm / 6 1/4"		
	Kunststoffgriff für auswechselbare Mikroschäfte, 360° drehbar, mit Gegengewicht <i>plastic handle for micro-shaft instruments, 360° turnable, with counter balance</i>		



2/3
06-04-361
 105 mm
 4 1/8"

2/3
06-54-361
 155 mm
 6 1/4"



2/3
13-56-100
 160 mm
 6¼"

Artikel-Nr.
Cat. No.

13-56-100

Gesamtlänge
Total length

160 mm / 6¼"

Metallgriff für auswechselbare Mikroschäfte, bajonettförmig, in der Länge variabel einstellbar, 360° drehbar

metal handle, bayonet-shaped, for micro-shaft instruments, shaft length adjustable, 360° turnable

Artikel-Nr.
Cat. No.

13-56-000





Gesamtlänge
Total length

170 mm / 6¼"

Kunststoffgriff für auswechselbare Mikroschäfte, bajonettförmig, in der Länge variabel einstellbar, 360° drehbar, mit Gegengewicht

plastic handle, bayonet-shaped, for micro-shaft instruments, shaft length adjustable, 360° turnable, with counter balance

2/3
13-56-000
 170 mm
 6¾"

Artikel-Nr. Cat. No.	Schaftlänge Length of shaft		
13-56-001	150 mm / 6" 90° klein 90° small	CASPAR modif.	1/1 
13-56-002	150 mm / 6" 90° mittel 90° medium	CASPAR modif.	1/1 
13-56-003	150 mm / 6" 90° groß 90° large	CASPAR modif.	1/1 
13-56-004	150 mm / 6" 45° mittel 45° medium	CASPAR modif.	1/1 

Zur Verwendung mit den Griffen
for use with handles

13-56-000
 13-56-100
 06-04-361
 06-54-361









1/1
CASPAR modif.
13-56-001
 150 mm
 6"

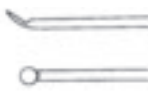
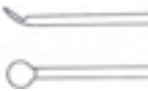

1/1
 RHOTON modif.
 13-56-008
 150 mm
 6"

TITAN

		Artikel-Nr. Cat. No.	Artikel-Nr. Cat. No.	Schaftlänge Length of shaft
	1/1 1 mm RHOTON modif.	13-56-005	13-56-005T	150 mm / 6" Dissektor, rund, Nr. 1 dissector, round, no. 1
	1/1 2 mm RHOTON modif.	13-56-006	13-56-006T	150 mm / 6" Dissektor, rund, Nr. 2 dissector, round, no. 2
	1/1 3 mm RHOTON modif.	13-56-007	13-56-007T	150 mm / 6" Dissektor, rund, Nr. 3 dissector, round, no. 3
	1/1 1,2 mm RHOTON modif.	13-56-008	13-56-008T	150 mm / 6" Elevatorium, gewinkelt, Nr. 4 elevator, angled, no. 4
	1/1 2,8 mm RHOTON modif.	13-56-009	13-56-009T	150 mm / 6" Elevatorium, gebogen, Nr. 5 elevator, curved, no. 5
	1/1 1 mm RHOTON modif.	13-56-010	13-56-010T	150 mm / 6" Dissektor, klein, Nr. 6 dissector, small, no. 6
	1/1 1,5 mm RHOTON modif.	13-56-011	13-56-011T	150 mm / 6" Dissektor, mittel, Nr. 7 dissector, medium, no. 7
	1/1 2 mm RHOTON modif.	13-56-012	13-56-012T	150 mm / 6" Dissektor, groß, Nr. 8 dissector, large, no. 8

Zur Verwendung mit den Griffen
 for use with handles
 13-56-000
 13-56-100
 06-04-361
 06-54-361

TITAN







Artikel-Nr. Cat. No.	Artikel-Nr. Cat. No.	Schaftlänge Length of shaft		
13-56-013	13-56-013T	150 mm / 6" Häkchen, halbscharf, gewinkelt 90°, Nr. 9 <i>hook, semi-sharp, angled 90°, no. 9</i>	RHOTON modif.	1/1 
13-56-014	13-56-014T	150 mm / 6" Häkchen, stumpf, gewinkelt 90°, Nr. 10 <i>hook, blunt, angled 90°, no. 10</i>	RHOTON modif.	1/1 
13-56-015	13-56-015T	150 mm / 6" Häkchen, halbscharf, gewinkelt 45°, Nr. 11 <i>hook, semi-sharp, angled 45°, no. 11</i>	RHOTON modif.	1/1 
13-56-016	13-56-016T	150 mm / 6" Nadel, gerade, Nr. 12 <i>needle, straight, no. 12</i>	RHOTON modif.	1/1 
13-56-017	13-56-017T	150 mm / 6" Kürette, klein, Nr. 13 <i>curette, small, no. 13</i>	RHOTON modif.	1/1 
13-56-018	13-56-018T	150 mm / 6" Kürette, groß, Nr. 14 <i>curette, large, no. 14</i>	RHOTON modif.	1/1 
13-56-019	13-56-019T	150 mm / 6" Kugeldissektor, gerade, Nr. 15 <i>teardrop dissector, straight, no. 15</i>	RHOTON modif.	1/1 
13-56-020	13-56-020T	150 mm / 6" Kugeldissektor, 90° gewinkelt, Nr. 16 <i>teardrop dissector, 90° angled, no. 16</i>	RHOTON modif.	1/1 
13-56-021	13-56-021T	150 mm / 6" Kugeldissektor, 90° gewinkelt, Nr. 17 <i>teardrop dissector, 90° angled, no. 17</i>	RHOTON modif.	1/1 
13-56-022	13-56-022T	150 mm / 6" Kugeldissektor, 40° gewinkelt, Nr. 18 <i>teardrop dissector, 40° angled, no. 18</i>	RHOTON modif.	1/1 
13-56-023	13-56-023T	150 mm / 6" Kugeldissektor, 40° gewinkelt, Nr. 19 <i>teardrop dissector, 40° angled, no. 19</i>	RHOTON modif.	1/1 



1/1
RHOTON modif.
13-56-013
 150 mm
 6"

Zur Verwendung mit den Griffen
 for use with handles
13-56-000
13-56-100
06-04-361
06-54-361

TITAN







		Artikel-Nr. Cat. No.	Artikel-Nr. Cat. No.	Schaftlänge Length of shaft
	1/1 YASARGIL modif.	13-56-043	13-56-043T	150 mm / 6" Raspatorium, gewinkelt <i>raspatory, angled</i>
	1/1 YASARGIL modif.	13-56-044	13-56-044T	150 mm / 6" Raspatorium, gewinkelt <i>raspatory, angled</i>
	1/1 YASARGIL modif.	13-56-045	13-56-045T	150 mm / 6" Raspatorium, gebogen <i>raspatory, curved</i>
	1/1 YASARGIL modif.	13-56-046	13-56-046T	150 mm / 6" Raspatorium, gebogen <i>raspatory, curved</i>
	1/1	13-56-047	13-56-047T	150 mm / 6" Raspatorium, plattenförmig <i>raspatory, round blade</i>
	1/1	13-56-048	13-56-048T	150 mm / 6" Raspatorium, plattenförmig <i>raspatory, round blade</i>
	1/1 CASPAR modif.	13-56-049	13-56-049T	150 mm / 6" Dissektor, gebogen <i>dissector, curved</i>

 Zur Verwendung mit den Griffen
 for use with handles

 13-56-000
 13-56-100
 06-04-361
 06-54-361

 1/2
 Griff
 handle

 1/1
YASARGIL modif.
13-56-043
 150 mm
 6"

Artikel-Nr. Cat. No.	Schaftlänge Length of shaft		
13-56-039	150 mm / 6"	KOOS modif.	1/1 
13-56-040	150 mm / 6"	KOOS modif.	1/1 
13-56-041	150 mm / 6"	KOOS modif.	1/1 
13-56-042	150 mm / 6"	KOOS modif.	1/1 
13-56-056	150 mm / 6"	JACOBSON	1/1 
13-56-057	150 mm / 6"		1/1 

Zur Verwendung mit den Griffen
 for use with handles
 13-56-000
 13-56-100
 06-04-361
 06-54-361







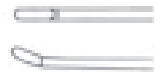

1/1
KOOS modif.
13-56-039
 150 mm
 6"

 1/2
 Griff
 handle







 1/1
SAMII modif.
13-56-029
 150 mm
 6"

TITAN

		Artikel-Nr. Cat. No.	Artikel-Nr. Cat. No.	Schaftlänge Length of shaft
	1/1 1,0 mm SAMII modif.	13-56-024	13-56-024T	150 mm / 6" Tumormesser tumor knife
	1/1 1,5 mm SAMII modif.	13-56-025	13-56-025T	150 mm / 6" Tumormesser tumor knife
	1/1 2,0 mm SAMII modif.	13-56-026	13-56-026T	150 mm / 6" Tumormesser tumor knife
	1/1 2,5 mm SAMII modif.	13-56-027	13-56-027T	150 mm / 6" Tumormesser tumor knife
	1/1 3,0 mm SAMII modif.	13-56-028	13-56-028T	150 mm / 6" Tumormesser tumor knife
	1/1 3,5 mm SAMII modif.	13-56-029	13-56-029T	150 mm / 6" Tumormesser tumor knife
	1/1 4,0 mm SAMII modif.	13-56-030	13-56-030T	150 mm / 6" Tumormesser tumor knife
	1/1 5,0 mm SAMII modif.	13-56-031	13-56-031T	150 mm / 6" Tumormesser tumor knife

 Zur Verwendung mit den Griffen
 for use with handles
13-56-000
13-56-100
06-04-361
06-54-361

TITAN

Artikel-Nr. Cat. No.	Artikel-Nr. Cat. No.	Schaftlänge Length of shaft		
13-56-032	13-56-032T	150 mm / 6"	Tumormesser tumor knife	SAMII modif. 1/1 ø 1,5 mm 
13-56-033	13-56-033T	150 mm / 6"	Tumormesser tumor knife	SAMII modif. 1/1 ø 3 mm 
13-56-034	13-56-034T	150 mm / 6"	Tumormesser tumor knife	SAMII modif. 1/1 ø 4,5 mm 
13-56-035	13-56-035T	150 mm / 6"	Tumormesser tumor knife	SAMII modif. 1/1 ø 6 mm 
13-56-036	13-56-036T	150 mm / 6"	Lanzettenmesser lancet knife	SAMII modif. 1/1 1,8 mm 
13-56-037	13-56-037T	150 mm / 6"	Lanzettenmesser lancet knife	SAMII modif. 1/1 2,5 mm 
13-56-038	13-56-038T	150 mm / 6"	Mikro-Lanzettenmesser, biegsam, für Akustikusneurinom micro lancet knife, malleable, for acoustic neurinoma	OPPEL modif. 1/1 ø 2 mm 







1/2
Griff
handle

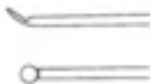
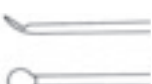

1/1
SAMII modif.
13-56-033
150 mm
6"

Zur Verwendung mit den Griffen
 for use with handles
 13-56-000
 13-56-100
 06-04-361
 06-54-361

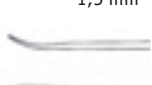

		TITAN		
		Artikel-Nr. Cat. No.	Artikel-Nr. Cat. No.	Gesamtlänge Total length
1/1 1 mm	RHOTON	06-54-320	06-54-320T	190 mm / 7½"
				Dissektor, rund Nr. 1 <i>dissector, round no. 1</i>
1/1 2 mm	RHOTON	06-54-321	06-54-321T	190 mm / 7½"
				Dissektor, rund Nr. 2 <i>dissector, round no. 2</i>
1/1 3 mm	RHOTON	06-54-322	06-54-322T	190 mm / 7½"
				Dissektor, rund Nr. 3 <i>dissector, round no. 3</i>
1/1 1,2 mm	RHOTON	06-54-323	06-54-323T	190 mm / 7½"
				Elevatorium, gewinkelt, Nr. 4 <i>elevator, angled no. 4</i>
1/1 2,8 mm	RHOTON	06-54-324	06-54-324T	190 mm / 7½"
				Elevatorium, gebogen, Nr. 5 <i>elevator, curved, no. 5</i>
1/1 1 mm	RHOTON	06-54-325	06-54-325T	190 mm / 7½"
				Dissektor, klein, Nr. 6 <i>dissector, small, no. 6</i>
1/1 1,5 mm	RHOTON	06-54-326	06-54-326T	190 mm / 7½"
				Dissektor, mittel, Nr. 7 <i>dissector, medium, no. 7</i>
1/1 2 mm	RHOTON	06-54-327	06-54-327T	190 mm / 7½"
				Dissektor, groß, Nr. 8 <i>dissector, large, no. 8</i>

1/1
RHOTON
06-54-323
 190 mm
 7½"

Lagerungstray siehe Seite 119-121
storage tray see page 119-121

TITAN

Artikel-Nr. Cat. No.	Artikel-Nr. Cat. No.	Gesamtlänge Total length		
06-54-328	06-54-328T	190 mm / 7½"	RHOTON	1/1 
		Häkchen, halbscharf, gewinkelt 90°, Nr. 9 <i>hook, semi-sharp, angled 90°, no. 9</i>		
06-54-329	06-54-329T	190 mm / 7½"	RHOTON	1/1 
		Häkchen, stumpf, gewinkelt 90°, Nr. 10 <i>hook, blunt, angled 90°, no. 10</i>		
06-54-330	06-54-330T	190 mm / 7½"	RHOTON	1/1 
		Häkchen, halbscharf, gewinkelt 45°, Nr. 11 <i>hook, semi-sharp, angled 45°, no. 11</i>		
06-54-331	06-54-331T	190 mm / 7½"	RHOTON	1/1 
		Nadel, gerade, Nr. 12 <i>needle, straight, no. 12</i>		
06-54-332	06-54-332T	190 mm / 7½"	RHOTON	1/1 
		Kürette, klein, Nr. 13 <i>curette, small, no. 13</i>		
06-54-333	06-54-333T	190 mm / 7½"	RHOTON	1/1 
		Kürette, groß, Nr. 14 <i>curette, large, no. 14</i>		
06-54-334	06-54-334T	190 mm / 7½"	RHOTON	1/1 
		Kugeldissektor, gerade, Nr. 15 <i>teardrop dissector, straight, no. 15</i>		
06-54-335	06-54-335T	190 mm / 7½"	RHOTON	1/1 
		Kugeldissektor, 90° gewinkelt, Nr. 16 <i>teardrop dissector, 90° angled, no. 16</i>		
06-54-336	06-54-336T	190 mm / 7½"	RHOTON	1/1 
		Kugeldissektor, 90° gewinkelt, Nr. 17 <i>teardrop dissector, 90° angled, no. 17</i>		
06-54-337	06-54-337T	190 mm / 7½"	RHOTON	1/1 
		Kugeldissektor, 40° gewinkelt, Nr. 18 <i>teardrop dissector, 40° angled, no. 18</i>		
06-54-338	06-54-338T	190 mm / 7½"	RHOTON	1/1 
		Kugeldissektor, 40° gewinkelt, Nr. 19 <i>teardrop dissector, 40° angled, no. 19</i>		









1/1
RHOTON
06-54-328
190 mm
7½"

Lagerungstray siehe Seite 119-121
storage tray see page 119-121

 1/1
CASPAR
02-20-088
 245 mm
 9¾"

		TITAN		
		Artikel-Nr. Cat. No.	Artikel-Nr. Cat. No.	Gesamtlänge Total length
1/1	CASPAR	02-20-088	02-20-088T	245 mm / 9¾"
		02-70-088	02-70-088T	245 mm / 9¾"
<i>90° klein, isoliert 90° small, isolated</i>				
1/1	CASPAR	02-20-089	02-20-089T	245 mm / 9¾"
		02-70-089	02-70-089T	245 mm / 9¾"
<i>90° mittel, isoliert 90° medium, isolated</i>				
1/1	CASPAR	02-20-090	02-20-090T	245 mm / 9¾"
		02-70-090	02-70-090T	245 mm / 9¾"
<i>90° groß, isoliert 90° large, isolated</i>				
1/1	CASPAR	02-20-091	02-20-091T	245 mm / 9¾"
		02-70-091	02-70-091T	245 mm / 9¾"
<i>45° mittel, isoliert 45° medium, isolated</i>				
<i>45° mittel, nicht isoliert 45° medium, not isolated</i>				



TITAN

Artikel-Nr. Cat. No.	Artikel-Nr. Cat. No.	Gesamtlänge Total length		
06-04-330	06-04-330T	230 mm / 9" halbscharf semi sharp		1/1 
06-04-331	06-04-331T	230 mm / 9" stumpf blunt		1/1 
06-04-375	06-04-375T	185 mm / 7¼" scharf, gebogen sharp, curved		1/1 
06-04-376	06-04-376T	185 mm / 7¼" scharf, abgewinkelt sharp, angled	FISCH	1/1 
06-04-430	06-04-430T	230 mm / 9" Knopfhäkchen 90°, biegsam, für Akustikusneurinom <i>hook 90°, malleable, for acoustic neurinoma</i>	OPPEL	1/1 
06-04-432	06-04-432T	230 mm / 9" Knopfhäkchen 45°, biegsam, für Akustikusneurinom <i>hook 45°, malleable, for acoustic neurinoma</i>	OPPEL	1/1 



1/1
06-04-331
230 mm
9"

 1/1
SPETZLER
06-54-311
 240 mm
 9½"

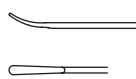
		TITAN		
		Artikel-Nr. Cat. No.	Artikel-Nr. Cat. No.	Gesamtlänge Total length
1/1	SPETZLER	06-54-310	06-54-310T	240 mm / 9½"
				Kugelhäkchen, 30° aufwärts gebogen <i>teardrop, 30° curved up</i>
1/1	SPETZLER	06-54-311	06-54-311T	240 mm / 9½"
				Kugelhäkchen, 90° aufwärts gebogen <i>teardrop, 90° curved up</i>
1/1	SPETZLER	06-54-312	06-54-312T	240 mm / 9½"
				Dissektor, aufwärts gebogen <i>dissector, curved up</i>







Artikel-Nr. Cat. No.	Gesamtlänge Total length			
06-04-270	185 mm / 7¼"	Fadenführer, geknöpft <i>ligature guide, probe pointed</i>	YASARGIL	1/1
06-04-271	185 mm / 7¼"	Fadenführer, geknöpft <i>ligature guide, probe pointed</i>	YASARGIL	1/1
06-04-272	185 mm / 7¼"	Fadenführer, geknöpft <i>ligature guide, probe pointed</i>	YASARGIL	1/1
06-04-273	185 mm / 7¼"	Fadenführer, geknöpft <i>ligature guide, probe pointed</i>	YASARGIL	1/1
06-04-396	185 mm / 7¼"	Nerv- und Gefäßhäkchen <i>nerve and vessel hook</i>	KRAYEN- BÜHL	1/1
06-04-397	185 mm / 7¼"	Nerv- und Gefäßhäkchen <i>nerve and vessel hook</i>	KRAYEN- BÜHL	1/1
06-04-398	185 mm / 7¼"	Nerv- und Gefäßhäkchen <i>nerve and vessel hook</i>	KRAYEN- BÜHL	1/1
06-04-399	185 mm / 7¼"	Nerv- und Gefäßhäkchen <i>nerve and vessel hook</i>	KRAYEN- BÜHL	1/1



1/1
KRAYENBÜHL
06-04-396
185 mm
7¼"







1/2
FRAZIER
 06-06-321
 130 mm
 5 1/8"

		Artikel-Nr. Cat. No.	Gesamtlänge Total length
1/1	 CAIRNS	06-06-313	130 mm / 5 1/8"
1/1	 FRAZIER	06-06-321	130 mm / 5 1/8"
1/1	 TOENNIS	06-06-322	150 mm / 6"
1/1	 GRAEFE	15-01-332	125 mm / 5"
1/1	 GRAEFE	15-01-333	125 mm / 5"
1/1	 JÄGER	15-01-351	135 mm / 5 3/4"



1/2
GILLIES
 15-12-611
 180 mm
 7"

		Artikel-Nr. Cat. No.	Gesamtlänge Total length
1/1	 GILLIES	15-12-611	180 mm / 7"
1/1	 GILLIES	15-12-612	180 mm / 7"
1/1	 COTTLE	15-12-619	160 mm / 6 3/4"
	 COTTLE	15-12-617	160 mm / 6 3/4"
	 FREER	15-12-621	150 mm / 6"

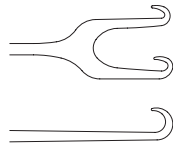
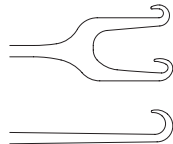
Artikel-Nr. Cat. No.	Gesamtlänge Total length		
15-12-615	150 mm / 6"	MC INDOE	9 mm 
15-12-616	150 mm / 6"	MC INDOE	10 mm 



2/3
MC INDOE
15-12-615
150 mm
6"

Artikel-Nr. Cat. No.	Gesamtlänge Total length		
15-12-610	160 mm / 6¼"	KILNER	





2/3
KILNER
15-12-610
160 mm
6¼"



		Artikel-Nr. Cat. No.	Gesamtlänge Total length
	JOSEPH	15-12-620	165 mm / 6½"
2 mm 	JOSEPH	15-12-622	165 mm / 6½"
5 mm 	JOSEPH	15-12-623	165 mm / 6½"
7 mm 	JOSEPH	15-12-624	165 mm / 6½"
10 mm 	JOSEPH	13-04-581	165 mm / 6½"

1/1
JOSEPH
15-12-620
165 mm
6½"

Artikel-Nr. Cat. No.	Gesamtlänge Total length		
15-12-601	160 mm / 6¼"	KLEINERT-KUTZ	3 mm 
15-12-602	160 mm / 6¼"	KLEINERT-KUTZ	5 mm 
15-12-603	160 mm / 6¼"	KLEINERT-KUTZ	7 mm 









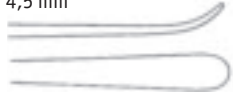

1/1
KLEINERT-KUTZ
15-12-603
160 mm
6¼"

 1/1
CASPAR
06-06-305
 230 mm
 9"

		TITAN		
		Artikel-Nr. Cat. No.	Artikel-Nr. Cat. No.	Gesamtlänge Total length
1/1 4,5 mm	CASPAR	06-06-305	06-06-305T	230 mm / 9" abwärts gebogen <i>curved down</i>
1/1 2 mm	CASPAR	06-06-307	06-06-307T	230 mm / 9" abwärts gebogen <i>curved down</i>
1/1 2 mm	HARDY	06-56-307	06-56-307T	230 mm / 9" aufwärts gebogen <i>curved up</i>
1/1 1,8 mm		06-04-343	06-04-343T	230 mm / 9" aufwärts gebogen <i>curved up</i>
1/1 1,8 mm		06-04-344	06-04-344T	230 mm / 9" abwärts gebogen <i>curved down</i>
1/1 1 mm	CASPAR	06-06-312	06-06-312T	210 mm / 8¼" abwärts gebogen <i>curved down</i>
1/1 1 mm	CASPAR	06-06-311	06-06-311T	210 mm / 8¼" aufwärts gebogen <i>curved up</i>

TITAN

Artikel-Nr. Cat. No.	Artikel-Nr. Cat. No.	Gesamtlänge Total length		
06-06-303	06-06-303T	230 mm / 9"	CASPAR	1/1 4,5 mm 
06-04-333	06-04-333T	230 mm / 9"		1/1 2 mm 
06-04-334	06-04-334T	230 mm / 9"		1/1 1,8 mm 
06-04-332	06-04-332T	230 mm / 9"		1/1 1,4 mm 
06-04-429	06-04-429T	230 mm / 9"	OPPEL	1/1 1 mm 
06-06-310	06-06-310T	200 mm / 8"	CASPAR	1/1 1 mm 
06-02-150	06-02-150T	185 mm / 7¼"		1/1 3 mm 
06-02-151	06-02-151T	215 mm / 8½"		1/1 3 mm 



1/1
06-06-303
230 mm
9"

1/2
PENFIELD
06-06-293
 195 mm
 7¾"

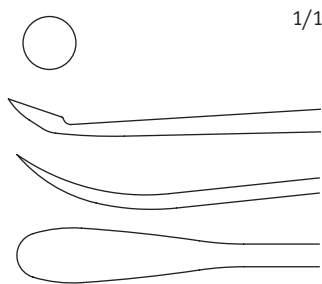

1/1

PENFIELD
Artikel-Nr.
Cat. No.
06-06-291
Gesamtlänge
Total length

175 mm / 7"

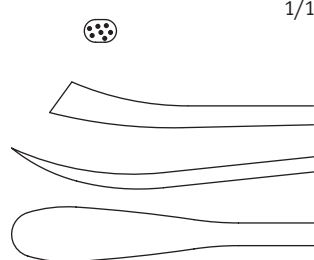
 #1
 doppelendig
 double ended

1/1

PENFIELD**06-06-292**

195 mm / 7¾"

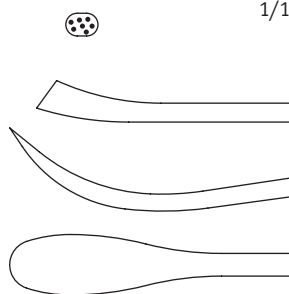
 #2
 doppelendig
 double ended

1/1

PENFIELD**06-06-293**

195 mm / 7¾"

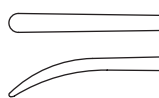
 #3
 doppelendig
 double ended

1/1

PENFIELD**06-06-294**

205 mm / 8"

 #4
 einendig
 single ended



1/1

PENFIELD**06-06-295**

290 mm / 11½"

 #5
 doppelendig
 double ended

1/2
PENFIELD
06-06-295
 290 mm
 11½"

Artikel-Nr. Cat. No.	Gesamtlänge Total length		
06-06-301	240 mm / 9½"	TOENNIS	1/1
	stumpf – stumpf blunt – blunt		
06-06-302	240 mm / 9½"	TOENNIS	1/1
	stumpf – stumpf blunt – blunt		

1/2
TOENNIS
06-06-302
240 mm
9½"

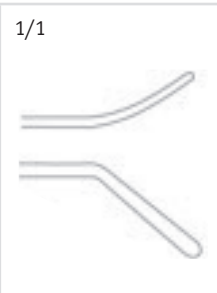

Artikel-Nr. Cat. No.	Gesamtlänge Total length		
06-06-349	230 mm / 9"	PENNY-BACKER	1/1
	Sonde und Dissektor probe and dissector		

1/2
PENNYBACKER
06-06-349
230 mm
9"

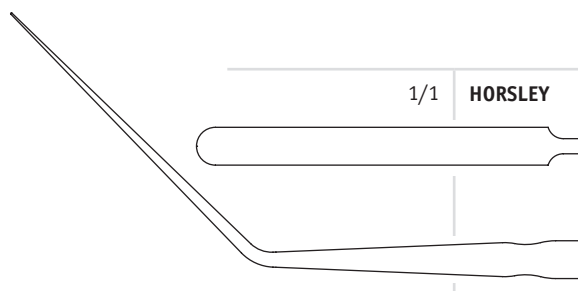

 Artikel-Nr.
 Cat. No.

 Gesamtlänge
 Total length

1/1 HORSLEY

06-56-305

200 mm / 8"

 1/2
HORSLEY
06-56-305
 200 mm
 8"

 Artikel-Nr.
 Cat. No.

 Gesamtlänge
 Total length

 1/1
 4 mm YASARGIL

06-06-326

195 mm / 7¾"



 für Kinder, mit flexiblem Schaft
 for children, with flexible shaft

 1/1
 7 mm YASARGIL

06-06-327

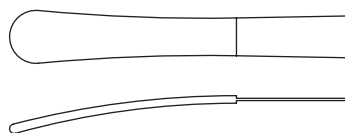
195 mm / 7¾"

 für Erwachsene, mit flexiblem Schaft
 for adults, with flexible shaft

 1/2
YASARGIL
06-06-326
 195 mm
 7¾"

Artikel-Nr. Cat. No.	Gesamtlänge Total length		
06-56-302	150 mm / 6"	FRAZIER	1/1 4 mm 
06-56-303	150 mm / 6"	HOEN	1/1 3 mm 
06-56-304	150 mm / 6"	HOEN	1/1 3 mm 



1/1
HOEN
06-56-303
150 mm
6"

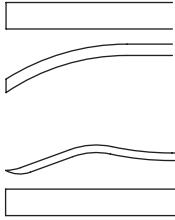



		Artikel-Nr. Cat. No.	Gesamtlänge Total length
1/1	ALLEN	06-06-346	230 mm / 9"
			Osteophytenmeißel und Schaber <i>osteophyte chisel and scraper</i>

1/1
ALLEN
06-06-346
230 mm
9"

Artikel-Nr. Cat. No.	Gesamtlänge Total length		
15-12-160	180 mm / 7"	HALLE	1/1 3,3 mm
	Raspatorium, stumpf <i>raspatory, blunt</i>		



1/2
HALLE
15-12-160
180 mm
7"

Artikel-Nr. Cat. No.	Gesamtlänge Total length		
04-15-611	150 mm / 6"	PARTSCH	1/1 3,2 mm
	Raspatorium <i>raspatory</i>		
04-15-612	150 mm / 6"	PARTSCH	1/1 4,6 mm
	Raspatorium <i>raspatory</i>		
04-15-642	145 mm / 5 3/4"	PARTSCH	1/1 4 mm
	Raspatorium <i>raspatory</i>		



1/2
PARTSCH
04-15-612
150 mm
6"







 1/2
KILIAN
15-12-170
 185 mm
 7 3/4"

 1/2
FREER
15-12-162
 190 mm
 7 1/2"

		Artikel-Nr. Cat. No.	Gesamtlänge Total length
1/1	FREER-YASARGIL	15-12-166	185 mm / 7 3/4" Elevatorium <i>elevator</i> scharf – scharf <i>sharp – sharp</i>
1/1	FREER	15-12-165	185 mm / 7 3/4" Elevatorium <i>elevator</i> scharf – stumpf <i>sharp – blunt</i>
1/1	KILLIAN	15-12-170	185 mm / 7 3/4" Elevatorium <i>elevator</i> scharf – stumpf <i>sharp – blunt</i>
1/1	DAVIS	06-06-300	245 mm / 9 3/4" Dissektor <i>dissector</i> scharf – stumpf <i>sharp – blunt</i>

		Artikel-Nr. Cat. No.	Gesamtlänge Total length
1/1	FREER	15-12-162	190 mm / 7 1/2" Raspatorium <i>raspatory</i> scharf <i>sharp</i>
		15-12-163	190 mm / 7 1/2" Raspatorium <i>raspatory</i> stumpf <i>blunt</i>





TITAN

Artikel-Nr. Cat. No.	Artikel-Nr. Cat. No.	Gesamtlänge Total length		
06-04-301	06-04-301T	185 mm / 7¼"	YASARGIL	1/1 
06-04-302	06-04-302T	185 mm / 7¼"	YASARGIL	1/1 
06-04-303	06-04-303T	185 mm / 7¼"	YASARGIL	1/1 
06-04-304	06-04-304T	185 mm / 7¼"	YASARGIL	1/1 
06-04-305	06-04-305T	185 mm / 7¼"	YASARGIL	1/1 



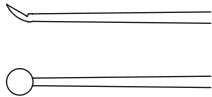



1/1
YASARGIL
06-04-301
 185 mm
 7¼"

 1/1
YASARGIL
06-04-321
 185 mm
 7¼"

		TITAN		
		Artikel-Nr. Cat. No.	Artikel-Nr. Cat. No.	Gesamtlänge Total length
1/1		06-04-346	06-04-346T	230 mm / 9" Raspatorium, aufwärts gebogen <i>raspatory, curved up</i>
1/1		YASARGIL 06-04-320	06-04-320T	185 mm / 7¼" Raspatorium, abwärts gebogen <i>raspatory, curved down</i>
1/1		YASARGIL 06-04-321	06-04-321T	185 mm / 7¼" Raspatorium, abwärts gebogen <i>raspatory, curved down</i>
1/1		YASARGIL 06-04-322	06-04-322T	185 mm / 7¼" Raspatorium, aufwärts gebogen <i>raspatory, curved up</i>
1/1		YASARGIL 06-04-325		185 mm / 7¼" Löffel, scharf, bajonettförmig <i>scoop, sharp, bayonet-shaped</i>
1/2				







TITAN

Artikel-Nr. Cat. No.	Artikel-Nr. Cat. No.	Gesamtlänge Total length		
06-04-335	06-04-335T	230 mm / 9" Löffel, scharf, gerade <i>scoop, sharp, straight</i>		1/1 
06-04-336	06-04-336T	230 mm / 9" Löffel, scharf, gebogen <i>scoop, sharp, curved</i>		1/1 
06-04-337	06-04-337T	230 mm / 9" Raspatorium, plattenförmig <i>raspatory, round blade</i>		1/1 
06-04-338	06-04-338T	230 mm / 9" Raspatorium, plattenförmig <i>raspatory, round blade</i>		1/1 

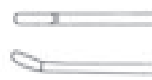



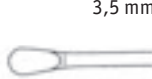



1/1
YASARGIL
06-04-336
 230 mm
 9"

TITAN

		Artikel-Nr. Cat. No.	Artikel-Nr. Cat. No.	Gesamtlänge Total length
	1/1 1 mm	SAMII 06-04-400	06-04-400T	200 mm / 8"
		06-04-410	06-04-410T	230 mm / 9"
	1/1 1,5 mm	SAMII 06-04-401	06-04-401T	200 mm / 8"
		06-04-411	06-04-411T	230 mm / 9"
	1/1 2 mm	SAMII 06-04-402	06-04-402T	200 mm / 8"
		06-04-412	06-04-412T	230 mm / 9"
	1/1 2,5 mm	SAMII 06-04-403	06-04-403T	200 mm / 8"
		06-04-413	06-04-413T	230 mm / 9"
	1/1 3 mm	SAMII 06-04-404	06-04-404T	200 mm / 8"
		06-04-414	06-04-414T	230 mm / 9"
	1/1 3,5 mm	SAMII 06-04-405	06-04-405T	200 mm / 8"
		06-04-415	06-04-415T	230 mm / 9"
	1/1 4 mm	SAMII 06-04-406	06-04-406T	200 mm / 8"
		06-04-416	06-04-416T	230 mm / 9"
	1/1 5 mm	SAMII 06-04-408	06-04-418T	200 mm / 8"
		06-04-418	06-04-418T	230 mm / 9"

1/1
SAMII
06-04-405
 200 mm
 8"

TITAN

Artikel-Nr. Cat. No.	Artikel-Nr. Cat. No.	Gesamtlänge Total length		
06-04-851	06-04-851T	200 mm / 8"	SAMII	1/1 ø 1,5 mm 
06-04-861	06-04-861T	230 mm / 9"		
06-04-854	06-04-854T	200 mm / 8"	SAMII	1/1 ø 3 mm 
06-04-864	06-04-864T	230 mm / 9"		
06-04-856	06-04-856T	200 mm / 8"	SAMII	1/1 ø 4,5 mm 
06-04-866	06-04-866T	230 mm / 9"		
06-04-858	06-04-858T	200 mm / 8"	SAMII	1/1 ø 6 mm 
06-04-868	06-04-868T	230 mm / 9"		
06-04-298	06-04-298T	230 mm / 9" Lanzettenmesser lancet knife	SAMII	1/1 1,8 mm 
06-04-299	06-04-299T	230 mm / 9" Lanzettenmesser lancet knife	SAMII	1/1 2,5 mm 
06-04-427	06-04-427T	230 mm / 9" Mikro-Lanzettenmesser, biegsam, für Akustikus- neurinom micro lancet knife, mallea- ble for acoustic neurinoma	OPPEL	1/1 2 mm 



1/1
SAMII
06-04-864
230 mm
9"



		Artikel-Nr. Cat. No.	Gesamtlänge Total length
1/1	KOOS	06-04-351	185 mm / 7¼" spitz, aufwärts gebogen <i>pointed, curved up</i>
1/1	KOOS	06-04-352	185 mm / 7¼" spitz, abwärts gebogen <i>pointed, curved down</i>
1/1	KOOS	06-04-353	185 mm / 7¼" spitz, aufwärts gebogen <i>pointed, curved up</i>
1/1	KOOS	06-04-354	185 mm / 7¼" spitz, abwärts gebogen <i>pointed, curved down</i>
1/1	KOOS	06-04-357	185 mm / 7¼" stumpf, aufwärts gebogen <i>blunt, curved up</i>
1/1	KOOS	06-04-356	185 mm / 7¼" stumpf, abwärts gebogen <i>blunt, curved down</i>
1/1	YASARGIL	06-04-366	185 mm / 7¼" stumpf, aufwärts gebogen <i>blunt, curved up</i>
1/1	YASARGIL	06-04-365	185 mm / 7¼" stumpf, abwärts gebogen <i>blunt, curved down</i>
1/1	JACOBSON	06-04-350	185 mm / 7¼" Mikro-Gefäßmesser <i>micro vessel knife</i>

1/1
KOOS
06-04-352
 185 mm
 7¼"

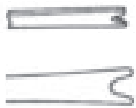
Artikel-Nr. Cat. No.	Gesamtlänge Total length		
06-04-315	185 mm / 7¼"	JACOBSON	1/1 
06-06-309	230 mm / 9"	CASPAR	1/1 



1/1
CASPAR
06-06-309
230 mm
9"



1/1
OKONEK-YASARGIL
06-04-380
 230 mm
 9"





		Artikel-Nr. Cat. No.	Gesamtlänge Total length
	1/1 3 mm	06-04-380	230 mm / 9"
	1/1 4 mm	06-04-381	230 mm / 9"
	1/1 5 mm	06-04-382	230 mm / 9"
	1/1 8 mm	06-04-384	230 mm / 9"
	1/1 5 mm	YASARGIL 06-04-385	220 mm / 8¾"
	1/1 8 mm	YASARGIL 06-04-388	200 mm / 8"

Artikel-Nr. Cat. No.	Gesamtlänge Total length	
06-04-392	185 mm / 7¼"	1/1 1,8 mm
	mit Schutzkappe with guard	

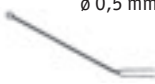

1/1
06-04-392
185 mm
7¼"

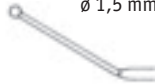

			Artikel-Nr. Cat. No.	Gesamtlänge Total length
	2/1	BIEMER	06-04-310	160 mm / 6¼"
				Gefäßspreizer <i>vessel spreader</i>
	1/1 ø 0,5 mm		06-04-306	125 mm / 5"
				Gefäßdilator <i>vessel dilator</i>
	1/1 ø 1 mm		06-04-307	125 mm / 5"
				Gefäßdilator <i>vessel dilator</i>
	1/1 ø 1,5 mm		06-04-308	125 mm / 5"
				Gefäßdilator <i>vessel dilator</i>
	1/1	JACOBSON	06-04-311	185 mm / 7¼"
				Knopfsonde <i>probe with ball tip</i>
	1/1	JACOBSON	06-04-312	185 mm / 7¼"
				Doppelsonde <i>vessel probe</i>

1/1
BIEMER
06-04-310
160 mm
6¼"

Artikel-Nr. Cat. No.	Gesamtlänge Total length		
06-06-701	220 mm / 8¾"	gerade straight	LOVE

1/2
LOVE
06-06-701
220 mm
8¾"



Artikel-Nr. Cat. No.	Gesamtlänge Total length		
06-06-702	220 mm / 8¾"	45° gewinkelt 45° angled	LOVE

1/2
LOVE
06-06-702
220 mm
8¾"

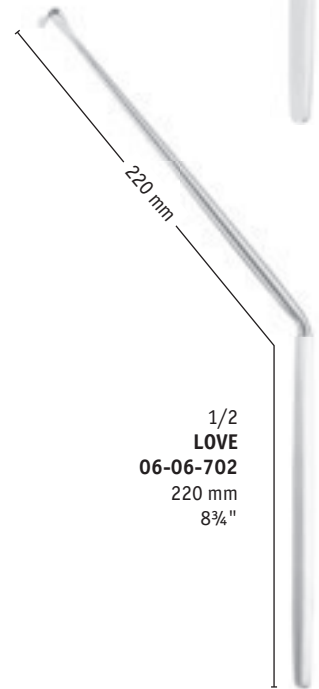

Artikel-Nr. Cat. No.	Gesamtlänge Total length		
06-06-703	220 mm / 8¾"	90° gewinkelt 90° angled	LOVE

1/2
LOVE
06-06-703
220 mm
8¾"

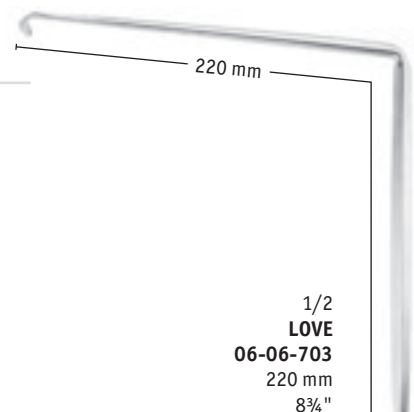



1/2
LOVE
06-06-700
210 mm
8¼"

		Artikel-Nr. Cat. No.	Gesamtlänge Total length
	LOVE	06-06-700	210 mm / 8¼"



1/2
CASPAR
06-06-710
240 mm
9½"

		Artikel-Nr. Cat. No.	Gesamtlänge Total length
	CASPAR	06-06-697	240 mm / 9½"
		06-06-699	Breite 4 mm width 4 mm 240 mm / 9½"
		06-06-710	Breite 6 mm width 6 mm 240 mm / 9½"
		06-06-698	Breite 8 mm width 8 mm 240 mm / 9½"
			Breite 10 mm width 10 mm 240 mm / 9½"

Artikel-Nr. Cat. No.	Gesamtlänge Total length		
02-20-082	190 mm / 7½"	CUSHING	1/1
02-70-084	280 mm / 11"		
02-20-083	190 mm / 7½"	CUSHING	1/1
02-20-084	280 mm / 11"		



1/2
CUSHING
02-20-083
190 mm
7½"

Artikel-Nr. Cat. No.	Gesamtlänge Total length		
06-04-394	200 mm / 8"	ADSON	1/1
stumpf blunt			
06-04-395	200 mm / 8"	ADSON	1/1
scharf sharp			



1/2
ADSON
06-04-394
200 mm
8"



1/3
HOLSHER
06-56-680
 250 mm
 10"

		Artikel-Nr. Cat. No.	Gesamtlänge Total length
1/1 7 mm	HOLSHER	06-56-680	250 mm / 10"

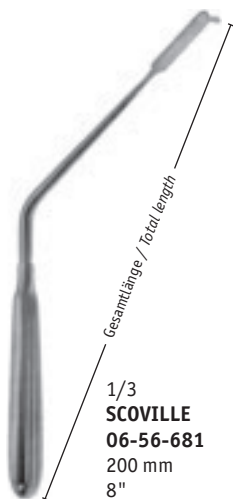



1/3
SCOVILLE
06-56-681
 200 mm
 8"

		Artikel-Nr. Cat. No.	Gesamtlänge Total length
1/1	SCOVILLE	06-56-681	200 mm / 8"



1/3
SCOVILLE
06-56-682
 230 mm
 9"

		Artikel-Nr. Cat. No.	Gesamtlänge Total length
1/1	SCOVILLE	06-56-682	230 mm / 9"

Artikel-Nr. Cat. No.	Gesamtlänge Total length		
06-06-707	175 mm / 7"	HESS	1/1 3 mm 
06-06-708	175 mm / 7"	HESS	1/1 5 mm 
06-06-709	175 mm / 7"	HESS	1/1 7 mm 









1/2
HESS
06-06-707
175 mm
7"

Artikel-Nr. Cat. No.	Gesamtlänge Total length		
06-06-730	220 mm / 8 3/4" doppellendig double-ended	O'CONNELL	1/1 



1/2
O'CONNELL
06-06-730
220 mm
8 3/4"

 1/1
06-54-510
 180 mm
 7"









	Artikel-Nr. Cat. No.	Gesamtlänge Total length
1/1 	06-54-510	180 mm / 7" gerade, vertikal <i>straight, vertical</i>
1/1 	06-54-511	180 mm / 7" gerade, horizontal <i>straight, horizontal</i>
1/1 	06-54-512	180 mm / 7" aufgebogen, vertikal <i>angled up, vertical</i>
1/1 	06-54-513	180 mm / 7" aufgebogen, horizontal <i>angled up, horizontal</i>
1/1 	06-54-514	180 mm / 7" rechts gebogen <i>curved right</i>
1/1 	06-54-515	180 mm / 7" links gebogen <i>curved left</i>

Artikel-Nr. Cat. No.	Gesamtlänge Total length	
06-54-500	180 mm / 7"	1/1 
06-54-501	180 mm / 7"	1/1 
06-54-502	180 mm / 7"	1/1 
06-54-503	180 mm / 7"	1/1 
06-54-504	180 mm / 7"	1/1 
06-54-505	180 mm / 7"	1/1 
06-54-506	180 mm / 7"	1/1 



1/1
06-54-500
 180 mm
 7"

 1/1
06-54-530
 180 mm
 7"





	Artikel-Nr. Cat. No.	Gesamtlänge Total length
1/1 	06-54-530	180 mm / 7" gerieft, gerade <i>serrated, straight</i>
1/1 	06-54-531	180 mm / 7" gerieft, aufgebogen <i>serrated, angled up</i>
1/1 	06-54-532	180 mm / 7" gerieft, rechts gebogen <i>serrated, curved right</i>
1/1 	06-54-533	180 mm / 7" gerieft, links gebogen <i>serrated, curved left</i>
1/1 	06-54-534	180 mm / 7" Alligator, gerade <i>alligator, straight</i>
1/1 	06-54-536	180 mm / 7" Alligator, rechts gebogen <i>alligator, curved right</i>
1/1 	06-54-537	180 mm / 7" Alligator, links gebogen <i>alligator, curved left</i>
1/1 	06-54-538	180 mm / 7" 1 x 2 Zähne, gerade <i>1 x 2 teeth, straight</i>

Artikel-Nr. Cat. No.	Gesamtlänge Total length	
06-54-520	180 mm / 7"	1/1 
06-54-521	180 mm / 7"	1/1 
06-54-522	180 mm / 7"	1/1 
06-54-523	180 mm / 7"	1/1 
06-54-524	180 mm / 7"	1/1 
06-54-525	180 mm / 7"	1/1 
06-54-526	180 mm / 7"	1/1 
06-54-527	180 mm / 7"	1/1 
06-54-528	180 mm / 7"	1/1 



1/1
 06-54-520
 180 mm
 7"



	ø 1 mm rund round ◦	oval oval ○	Gesamtlänge Total length
1/1 	06-54-560	06-54-564	180 mm / 7" gerade <i>straight</i>
1/1 	06-54-561	06-54-565	180 mm / 7" aufgebogen <i>angled up</i>
1/1 	06-54-562	06-54-566	180 mm / 7" rechts gebogen <i>curved right</i>
1/1 	06-54-563	06-54-567	180 mm / 7" links gebogen <i>curved left</i>

1/1
06-54-560
180 mm
7"

ø 1 mm rund round ○	ø 1,5 mm rund round ○	ø 2 mm rund round ○	ø 2,5 mm rund round ○	oval oval ○	Gesamtlänge Total length	
06-54-540	06-54-544	06-54-548	06-54-552	06-54-556	180 mm / 7"	1/1 gerade <i>straight</i>
06-54-541	06-54-545	06-54-549	06-54-553	06-54-557	180 mm / 7"	1/1 aufgebogen <i>angled up</i>
06-54-542	06-54-546	06-54-550	06-54-554	06-54-558	180 mm / 7"	1/1 rechts gebogen <i>curved right</i>
06-54-543	06-54-547	06-54-551	06-54-555	06-54-559	180 mm / 7"	1/1 links gebogen <i>curved left</i>



1/1
06-54-540
 180 mm
 7"

 1/2
06-54-600
 230 mm
 9"

		Artikel-Nr. Cat. No.	Schaftlänge Length of shaft
1/1		06-54-600	230 mm / 9" gerade, vertikal straight, vertical
1/1		06-54-601	230 mm / 9" gerade, horizontal straight, horizontal
1/1		06-54-602	230 mm / 9" aufgebogen, vertikal angled up, vertical
1/1		06-54-603	230 mm / 9" aufgebogen, horizontal angled up, horizontal
1/1		06-54-604	230 mm / 9" rechts gebogen curved right
1/1		06-54-605	230 mm / 9" links gebogen curved left
1/1	OPPEL 	06-04-420	150 mm / 6" gerade, vertikal, für Akustikusneurinom straight, vertical, for acoustic neurinoma

Artikel-Nr. Cat. No.	Schaftlänge Length of shaft	
06-54-630	230 mm / 9"	1/1 
06-54-631	230 mm / 9"	1/1 
06-54-632	230 mm / 9"	1/1 
06-54-633	230 mm / 9"	1/1 
06-54-634	230 mm / 9"	1/1 
06-54-635	230 mm / 9"	1/1 
06-54-636	230 mm / 9"	1/1 



1/2
06-54-630
 230 mm
 9"



		Artikel-Nr. Cat. No.	Schaftlänge Length of shaft
1/1		06-54-606	230 mm / 9" gerieft, gerade serrated, straight
1/1		06-54-607	230 mm / 9" gerieft, aufgebogen serrated, angled up
1/1		06-54-608	230 mm / 9" gerieft, rechts gebogen serrated, curved right
1/1		06-54-609	230 mm / 9" gerieft, links gebogen serrated, curved left
1/1		06-54-610	230 mm / 9" Alligator, gerade alligator, straight
1/1		06-54-611	230 mm / 9" Alligator, aufgebogen alligator, angled up
1/1		06-54-612	230 mm / 9" Alligator, rechts aufgebogen alligator, curved right
1/1		06-54-613	230 mm / 9" Alligator, links aufgebogen alligator, curved left
1/1		06-54-614	230 mm / 9" Herzform, aufgebogen, 45° rechts heart shaped, angled up, 45° right
1/1		06-54-615	230 mm / 9" Herzform, aufgebogen, 45° links heart shaped, angled up, 45° left
1/1		OPPEL 06-04-423	150 mm / 6" gerieft, gerade, für Akustikneurinom serrated, straight, for acoustic neurinoma

1/2
 06-54-606
 230 mm
 9"

Artikel-Nr. Cat. No.	Schaftlänge Length of shaft	
06-54-637	230 mm / 9"	1/1 
06-54-638	230 mm / 9"	1/1 
06-54-639	230 mm / 9"	1/1 
06-54-640	230 mm / 9"	1/1 
06-54-641	230 mm / 9"	1/1 
06-54-642	230 mm / 9"	1/1 
06-54-643	230 mm / 9"	1/1 
06-54-644	230 mm / 9"	1/1 
06-54-645	230 mm / 9"	1/1 
06-54-646	230 mm / 9"	1/1 
06-54-647	230 mm / 9"	1/1 
06-54-648	230 mm / 9"	1/1 



\emptyset 2 mm

\emptyset 3 mm

1/2
06-54-637
 230 mm
 9"

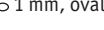
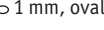

		Artikel-Nr. Cat. No.	Schaftlänge Length of shaft
1/1 ø 1 mm 		06-54-616	230 mm / 9" gerade straight
1/1 ø 1 mm 		06-54-617	230 mm / 9" aufgebogen angled up
1/1 ø 1 mm 		06-54-618	230 mm / 9" rechts gebogen curved right
1/1 ø 1 mm 		06-54-619	230 mm / 9" links gebogen curved left
1/1 ø 1 mm 		06-54-620	230 mm / 9" aufgebogen, 45° rechts angled up, 45° right
1/1 ø 1 mm 		06-54-621	230 mm / 9" aufgebogen, 45° links angled up, 45° left
1/1 ø 1 mm, oval 		06-54-622	230 mm / 9" gerade straight
1/1 ø 1 mm, oval 		06-54-623	230 mm / 9" aufgebogen angled up
1/1 ø 1 mm, oval 		06-54-624	230 mm / 9" rechts gebogen curved right
1/1 ø 1 mm, oval 		06-54-625	230 mm / 9" links gebogen curved left
1/1 ø 1 mm, oval 	OPPEL	06-04-426	150 mm / 6" gerade, für Akustikusneurinom straight, for acoustic neurinoma

1/2
06-54-617
230 mm
9"

Artikel-Nr. Cat. No.	Schaftlänge Length of shaft	
06-54-649	230 mm / 9"	1/1 2,5 mm 
06-54-650	230 mm / 9"	1/1 2,5 mm 
06-54-651	230 mm / 9"	1/1 2,5 mm 
06-54-652	230 mm / 9"	1/1 2,5 mm 
06-54-653	230 mm / 9"	1/1 2,5 mm 
06-54-654	230 mm / 9"	1/1 2,5 mm 
06-54-655	230 mm / 9"	1/1 2,5 mm 



1/2
06-54-650
 230 mm
 9"



1/2
 06-54-657
 230 mm
 9"

	Artikel-Nr. Cat. No.	Schaftlänge Length of shaft
1/1 \varnothing 2,5 x 4 mm 	06-54-656	230 mm / 9" gerade straight
1/1 \varnothing 2,5 x 4 mm 	06-54-657	230 mm / 9" aufgebogen 45° angled up 45°
1/1 \varnothing 2,5 x 4 mm 	06-54-658	230 mm / 9" rechts gebogen curved right
1/1 \varnothing 2,5 x 4 mm 	06-54-659	230 mm / 9" links gebogen curved left
1/1 \varnothing 2,5 x 4 mm 	06-54-660	230 mm / 9" spitz, aufgebogen 45° pointed, angled up 45°
1/1 \varnothing 2,5 x 4 mm 	06-54-661	230 mm / 9" spitz, aufgebogen rechts öffnend pointed, angled, open to right
1/1 \varnothing 2,5 x 4 mm 	06-54-662	230 mm / 9" spitz, aufgebogen links öffnend pointed, angled, open to left
1/1 \varnothing 2,5 x 5 mm 	06-54-663	230 mm / 9" gefenstert, aufgebogen fenestrated, curved up

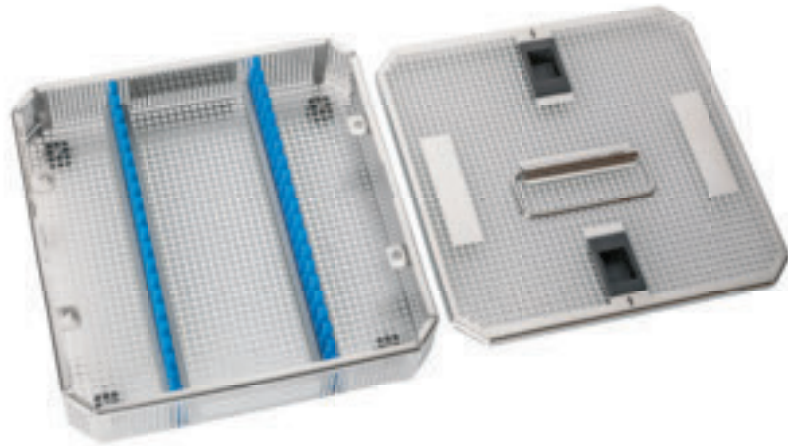

Artikel-Nr.
Cat. No.

Gesamtlänge
Total length

10-56-024

243 x 253 x 50 mm

Siebkorb aus Edelstahlblech mit Deckel und
Silikonhalterungen für Rhoton-Instrumente
und feine Mikro-Instrumente

*stainless steel basket with lid and silicone
fixation system for Rhoton instruments and
fine micro instruments*

Artikel-Nr.
Cat. No.

Sterilisier-Container aus Edelstahl mit Deckel- und Bodenlochung, Langzeittextilfilter für Dampfsterilisation, Silikon-Andruckleiste im Deckel, mit 1 Siebeinsatz mit Silikon-Fixationssystem zur Lagerung von Mikro-Instrumenten

Sterilization Container, stainless steel, lid and bottom perforated, long-life textile filter for steam sterilisation, silicone stripes in the lid, with 1 tray insert with silicone fixation system for micro instruments

Maße
Measurements

10-56-010	200 x 140 x 50 mm
10-56-011	280 x 200 x 50 mm
10-56-012	270 x 260 x 50 mm
10-56-013	380 x 260 x 50 mm



Artikel-Nr.
Cat. No.

	<p>Sterilisier-Container aus Edelstahl mit Deckel- und Bodenlochung, Langzeittextilfilter für Dampfsterilisation, Silikon-Andruckleiste im Deckel, mit 2 Siebeinsätzen mit Silikon-Fixationssystem zur Lagerung von Mikro-Instrumenten</p> <p><i>Sterilization Container, stainless steel, lid and bottom perforated, long-life textile filter for steam sterilisation, silicone stripes in the lid, with 2 trays insert with silicone fixation system for micro instruments</i></p> <p style="text-align: center;">Maße Measurements</p>
10-56-020	200 x 140 x 60 mm
10-56-021	280 x 200 x 60 mm
10-56-022	270 x 260 x 60 mm
10-56-023	380 x 260 x 60 mm

01

Mikro-Neurochirurgische Instrumente
Micro-Neurosurgical Instruments

HF-Instrumente und Zubehör
HF Instruments and Accessoires

03

Kopf-Schädelinstrumente und Haltesysteme
Head-Cranio Instruments and Holding Systems

04

Aneurysmen-Clip System
Aneurysm Clip System

05

Schädel-Verplattung
Cranial Plate System

06

Hypophysektomie-Instrumente
Pituitary Instruments

07

Instrumente für die Wirbelsäule, Wundspreizer
Spine Instruments, Self-retaining Retractors

08

Laminektomie-Stanzen, Rongeure, Hohlmeißelzangen
Laminectomy Punches, Rongeurs

09

Gefäß- und Bulldogklemmen, Gefäß-Clips
Vessel- and Bulldog-Clamps, Vessel Clips

10

Allgemeinchirurgische Instrumente
General Surgical Instruments

11

Alphabetischer Index, Numerischer Index
Alphabetical Index, Numerical Index

/// 02



SURGICAL
INSTRUMENTS
MICRO-NEURO-SPINE

REBSTOCK®
Precision made in Germany

/// HF-Instrumente und Zubehör
HF Instruments and Accessoires

/// www.rebstock.de



Bipolare Pinzette Standard
Bipolare Forceps Standard

Beispiel-Artikel-Nr. **07-11-920**
Example Cat. No.



Spezialbeschichtete Edelmetallspitzen verhindern das Verkleben mit koagulierte[m] Gewebe

Special coated noble metal tips prevent from sticking with coagulated tissue



Bipolare Pinzette NON-STICK
Bipolare Forceps NON-STICK

Beispiel-Artikel-Nr. **07-11-920N**
Example Cat. No.

NON-STICK



NON-STICK

Artikel-Nr. Cat. No.	Artikel-Nr. Cat. No.	Gesamtlänge Total length		
07-61-904	07-61-904N	110 mm / 4 $\frac{3}{4}$ "	JEWELER	1/1 0,25 mm 
07-61-905	07-61-905N	110 mm / 4 $\frac{3}{4}$ "	JEWELER	1/1 0,5 mm 

1/1
JEWELER
07-61-904
110 mm
4 $\frac{3}{4}$ "



NON-STICK





Artikel-Nr. Cat. No.	Artikel-Nr. Cat. No.	Gesamtlänge Total length		
07-61-906	07-61-906N	110 mm / 4 $\frac{3}{4}$ "	JEWELER	1/1 0,25 mm 
07-61-907	07-61-907N	110 mm / 4 $\frac{3}{4}$ "	JEWELER	1/1 0,5 mm 

1/1
JEWELER
07-61-907
110 mm
4 $\frac{3}{4}$ "









1/1
07-61-916
 180 mm
 7"

		NON-STICK		
	Artikel-Nr. Cat. No.	Artikel-Nr. Cat. No.		Gesamtlänge Total length
1/1 0,3 mm 	07-61-910	07-61-910N		160 mm / 6 $\frac{1}{8}$ "
	07-61-911	07-61-911N		180 mm / 7"
	07-61-912	07-61-912N		195 mm / 7 $\frac{3}{4}$ "
	07-61-913	07-61-913N		220 mm / 8 $\frac{3}{4}$ "
	07-61-914	07-61-914N		240 mm / 9 $\frac{1}{2}$ "
1/1 0,5 mm 	07-61-801	07-61-801N		160 mm / 6 $\frac{1}{8}$ "
	07-61-802	07-61-802N		180 mm / 7"
	07-61-803	07-61-803N		195 mm / 7 $\frac{3}{4}$ "
	07-61-804	07-61-804N		220 mm / 8 $\frac{3}{4}$ "
	07-61-805	07-61-805N		240 mm / 9 $\frac{1}{2}$ "
1/1 1 mm 	07-61-915	07-61-915N		160 mm / 6 $\frac{1}{8}$ "
	07-61-916	07-61-916N		180 mm / 7"
	07-61-917	07-61-917N		195 mm / 7 $\frac{3}{4}$ "
	07-61-918	07-61-918N		220 mm / 8 $\frac{3}{4}$ "
	07-61-919	07-61-919N		240 mm / 9 $\frac{1}{2}$ "
1/1 2 mm 	07-61-920	07-61-920N		160 mm / 6 $\frac{1}{8}$ "
	07-61-921	07-61-921N		180 mm / 7"
	07-61-922	07-61-922N		195 mm / 7 $\frac{3}{4}$ "
	07-61-923	07-61-923N		220 mm / 8 $\frac{3}{4}$ "
	07-61-924	07-61-924N		240 mm / 9 $\frac{1}{2}$ "

NON-STICK





Artikel-Nr. Cat. No.	Artikel-Nr. Cat. No.	Gesamtlänge Total length	
07-61-925	07-61-925N	160 mm / 6 $\frac{1}{8}$ "	1/1 0,3 mm
07-61-926	07-61-926N	180 mm / 7"	
07-61-927	07-61-927N	195 mm / 7 $\frac{3}{4}$ "	
07-61-928	07-61-928N	220 mm / 8 $\frac{3}{4}$ "	
07-61-929	07-61-929N	240 mm / 9 $\frac{1}{2}$ "	
07-61-811	07-61-811N	160 mm / 6 $\frac{1}{8}$ "	1/1 0,5 mm
07-61-812	07-61-812N	180 mm / 7"	
07-61-813	07-61-813N	195 mm / 7 $\frac{3}{4}$ "	
07-61-814	07-61-814N	220 mm / 8 $\frac{3}{4}$ "	
07-61-815	07-61-815N	240 mm / 9 $\frac{1}{2}$ "	
07-61-930	07-61-930N	160 mm / 6 $\frac{1}{8}$ "	1/1 1 mm
07-61-931	07-61-931N	180 mm / 7"	
07-61-932	07-61-932N	195 mm / 7 $\frac{3}{4}$ "	
07-61-933	07-61-933N	220 mm / 8 $\frac{3}{4}$ "	
07-61-934	07-61-934N	240 mm / 9 $\frac{1}{2}$ "	
07-61-935	07-61-935N	160 mm / 6 $\frac{1}{8}$ "	1/1 2 mm
07-61-936	07-61-936N	180 mm / 7"	
07-61-937	07-61-937N	195 mm / 7 $\frac{3}{4}$ "	
07-61-938	07-61-938N	220 mm / 8 $\frac{3}{4}$ "	
07-61-939	07-61-939N	240 mm / 9 $\frac{1}{2}$ "	







1/1
07-61-931
180 mm
7"



1/1
07-61-940
 165 mm
 6½"

	Artikel-Nr. Cat. No.	NON-STICK Artikel-Nr. Cat. No.	Gesamtlänge Total length
1/1 0,3 mm 	07-61-940	07-61-940N	165 mm / 6½"
1/1 0,5 mm 	07-61-816	07-61-816N	165 mm / 6½"
1/1 1 mm 	07-61-941	07-61-941N	165 mm / 6½"
1/1 2 mm 	07-61-942	07-61-942N	165 mm / 6½"

NON-STICK

Artikel-Nr. Cat. No.	Artikel-Nr. Cat. No.	Gesamtlänge Total length	
07-11-899	07-11-899N	160 mm / 6 $\frac{1}{6}$ "	1/1 0,3 mm
07-61-943	07-61-943N	180 mm / 7"	
07-11-929	07-11-929N	195 mm / 7 $\frac{3}{4}$ "	
07-11-959	07-11-959N	220 mm / 8 $\frac{3}{4}$ "	
07-61-944	07-61-944N	240 mm / 9 $\frac{1}{2}$ "	
07-11-900	07-11-900N	160 mm / 6 $\frac{1}{6}$ "	1/1 0,5 mm
07-61-817	07-61-817N	180 mm / 7"	
07-11-930	07-11-930N	195 mm / 7 $\frac{3}{4}$ "	
07-11-960	07-11-960N	220 mm / 8 $\frac{3}{4}$ "	
07-61-818	07-61-818N	240 mm / 9 $\frac{1}{2}$ "	
07-11-910	07-11-910N	160 mm / 6 $\frac{1}{6}$ "	1/1 1 mm
07-61-945	07-61-945N	180 mm / 7"	
07-11-940	07-11-940N	195 mm / 7 $\frac{3}{4}$ "	
07-11-970	07-11-970N	220 mm / 8 $\frac{3}{4}$ "	
07-61-946	07-61-946N	240 mm / 9 $\frac{1}{2}$ "	
07-11-920	07-11-920N	160 mm / 6 $\frac{1}{6}$ "	1/1 2 mm
07-61-947	07-61-947N	180 mm / 7"	
07-11-950	07-11-950N	195 mm / 7 $\frac{3}{4}$ "	
07-11-980	07-11-980N	220 mm / 8 $\frac{3}{4}$ "	
07-61-948	07-61-948N	240 mm / 9 $\frac{1}{2}$ "	







1/1
07-11-940
195 mm
7 $\frac{3}{4}$ "

NON-STICK

	Artikel-Nr. Cat. No.	Artikel-Nr. Cat. No.	Gesamtlänge Total length
1/1 0,3 mm 	07-61-840	07-61-840N	160 mm / 6 $\frac{1}{8}$ "
	07-61-960	07-61-960N	180 mm / 7"
	07-61-961	07-61-961N	195 mm / 7 $\frac{3}{4}$ "
	07-61-962	07-61-962N	220 mm / 8 $\frac{3}{4}$ "
	07-61-963	07-61-963N	240 mm / 9 $\frac{1}{2}$ "
			abwärts gewinkelt angled down
1/1 0,5 mm 	07-61-841	07-61-841N	160 mm / 6 $\frac{1}{8}$ "
	07-61-842	07-61-842N	180 mm / 7"
	07-61-843	07-61-843N	195 mm / 7 $\frac{3}{4}$ "
	07-61-844	07-61-844N	220 mm / 8 $\frac{3}{4}$ "
	07-61-845	07-61-845N	240 mm / 9 $\frac{1}{2}$ "
			abwärts gewinkelt angled down
1/1 1 mm 	07-61-846	07-61-846N	160 mm / 6 $\frac{1}{8}$ "
	07-61-964	07-61-964N	180 mm / 7"
	07-61-965	07-61-965N	195 mm / 7 $\frac{3}{4}$ "
	07-11-972	07-11-972N	220 mm / 8 $\frac{3}{4}$ "
	07-61-966	07-61-966N	240 mm / 9 $\frac{1}{2}$ "
			abwärts gewinkelt angled down
1/1 2 mm 	07-61-847	07-61-847N	160 mm / 6 $\frac{1}{8}$ "
	07-61-967	07-61-967N	180 mm / 7"
	07-61-968	07-61-968N	195 mm / 7 $\frac{3}{4}$ "
	07-61-969	07-61-969N	220 mm / 8 $\frac{3}{4}$ "
	07-61-970	07-61-970N	240 mm / 9 $\frac{1}{2}$ "
			abwärts gewinkelt angled down

 1/1
07-61-965
 195 mm
 7 $\frac{3}{4}$ "





NON-STICK

Artikel-Nr. Cat. No.	Artikel-Nr. Cat. No.	Gesamtlänge Total length	
07-61-830	07-61-830N	160 mm / 6 $\frac{1}{6}$ "	1/1 0,3 mm
07-61-949	07-61-949N	180 mm / 7"	
07-61-950	07-61-950N	195 mm / 7 $\frac{3}{4}$ "	
07-61-951	07-61-951N	220 mm / 8 $\frac{3}{4}$ "	
07-61-952	07-61-952N	240 mm / 9 $\frac{1}{2}$ "	
		aufwärts gewinkelt angled up	
07-61-831	07-61-831N	160 mm / 6 $\frac{1}{6}$ "	1/1 0,5 mm
07-61-832	07-61-832N	180 mm / 7"	
07-61-833	07-61-833N	195 mm / 7 $\frac{3}{4}$ "	
07-61-834	07-61-834N	220 mm / 8 $\frac{3}{4}$ "	
07-61-835	07-61-835N	240 mm / 9 $\frac{1}{2}$ "	
		aufwärts gewinkelt angled up	
07-61-836	07-61-836N	160 mm / 6 $\frac{1}{6}$ "	1/1 1 mm
07-61-953	07-61-953N	180 mm / 7"	
07-61-954	07-61-954N	195 mm / 7 $\frac{3}{4}$ "	
07-11-974	07-11-974N	220 mm / 8 $\frac{3}{4}$ "	
07-61-955	07-61-955N	240 mm / 9 $\frac{1}{2}$ "	
		aufwärts gewinkelt angled up	
07-61-837	07-61-837N	160 mm / 6 $\frac{1}{6}$ "	1/1 2 mm
07-61-956	07-61-956N	180 mm / 7"	
07-61-957	07-61-957N	195 mm / 7 $\frac{3}{4}$ "	
07-61-958	07-61-958N	220 mm / 8 $\frac{3}{4}$ "	
07-61-959	07-61-959N	240 mm / 9 $\frac{1}{2}$ "	
		aufwärts gewinkelt angled up	







1/1
07-61-954
195 mm
7 $\frac{3}{4}$ "

NON-STICK

	Artikel-Nr. Cat. No.	Artikel-Nr. Cat. No.	Gesamtlänge Total length
1/1 0,3 mm 	07-61-806	07-61-806N	160 mm / 6 1/8"
	07-61-807	07-61-807N	180 mm / 7"
	07-61-808	07-61-808N	195 mm / 7 3/4"
	07-61-809	07-61-809N	220 mm / 8 3/4"
	07-61-810	07-61-810N	240 mm / 9 1/2"
			breiter Griff wide handle
1/1 0,5 mm 	07-61-850	07-61-850N	160 mm / 6 1/8"
	07-61-860	07-61-860N	180 mm / 7"
	07-61-861	07-61-861N	195 mm / 7 3/4"
	07-61-862	07-61-862N	220 mm / 8 3/4"
	07-61-851	07-61-851N	240 mm / 9 1/2"
			breiter Griff wide handle
1/1 1 mm 	07-61-852	07-61-852N	160 mm / 6 1/8"
	07-61-863	07-61-863N	180 mm / 7"
	07-61-864	07-61-864N	195 mm / 7 3/4"
	07-61-865	07-61-865N	220 mm / 8 3/4"
	07-61-853	07-61-853N	240 mm / 9 1/2"
			breiter Griff wide handle
1/1 2 mm 	07-61-854	07-61-854N	160 mm / 6 1/8"
	07-61-866	07-61-866N	180 mm / 7"
	07-61-867	07-61-867N	195 mm / 7 3/4"
	07-61-868	07-61-868N	220 mm / 8 3/4"
	07-61-855	07-61-855N	240 mm / 9 1/2"
			breiter Griff wide handle

 1/1
07-61-864
 195 mm
 7 3/4"

NON-STICK

Artikel-Nr. Cat. No.	Artikel-Nr. Cat. No.	Gesamtlänge Total length	
07-61-819	07-61-819N	170 mm / 6¾"	1/1 0,3 mm
07-61-820	07-61-820N	200 mm / 8"	
07-61-821	07-61-821N	220 mm / 8¾"	
07-61-822	07-61-822N	230 mm / 9"	
07-61-823	07-61-823N	250 mm / 10"	
		breiter Griff wide handle	
07-61-824	07-61-824N	170 mm / 6¾"	1/1 0,5 mm
07-61-870	07-61-870N	200 mm / 8"	
07-61-871	07-61-871N	220 mm / 8¾"	
07-61-872	07-61-872N	230 mm / 9"	
07-61-873	07-61-873N	250 mm / 10"	
		breiter Griff wide handle	
07-61-825	07-61-825N	170 mm / 6¾"	1/1 1 mm
07-61-874	07-61-874N	200 mm / 8"	
07-61-875	07-61-875N	220 mm / 8¾"	
07-61-876	07-61-876N	230 mm / 9"	
07-61-877	07-61-877N	250 mm / 10"	
		breiter Griff wide handle	
07-61-826	07-61-826N	170 mm / 6¾"	1/1 2 mm
07-61-878	07-61-878N	200 mm / 8"	
07-61-879	07-61-879N	220 mm / 8¾"	
07-61-880	07-61-880N	230 mm / 9"	
07-61-881	07-61-881N	250 mm / 10"	
		breiter Griff wide handle	



1/1
07-61-878
 200 mm
 8"

Alle REBSTOCK monopolaren Pinzetten sind mit den folgenden Buchsen erhältlich:
 All REBSTOCK monopolar forceps are available with the following plugs:



	Artikel-Nr. Cat. No.	Durchmesser Diameter
	07-61-705	ø 4,0 mm Buchse mit männlichem Anschluss, geschützt <i>plug with male connector, protected</i>
	07-61-706	ø 4,0 mm Buchse mit männlichem Anschluss <i>plug with male connector</i>
	07-61-707	ø 4,0 mm Buchse mit weiblichem Anschluss, geschützt <i>plug with female connector, protected</i>

Abbildungsbeispiel / Example:
 Monopolare Pinzette mit integrierter Buchse
monopolar forceps with integrated plug
07-61-704 + 07-61-706

Artikel-Nr. Cat. No.	Gesamtlänge Total length	
07-61-700	140 mm / 5½"	1/1
07-61-701	180 mm / 7"	
07-61-702	210 mm / 8¼"	
07-61-703	250 mm / 10"	
07-61-704	300 mm / 12"	

Alle monopolaren Pinzetten werden serienmäßig ohne Buchse geliefert. Die Buchse ist jeweils separat zu bestellen. Hierbei bitte die Artikel-Nummer der gewünschten Ausführung von Seite 134 angeben.

All monopolar forceps are serially supplied without plug. The plug needs to be ordered separately by adding the article number of the requested model as shown on page 134.



1/1
07-61-700
140 mm
5½"



		Artikel-Nr. Cat. No.	Gesamtlänge Total length
1/1	LUCAE	07-61-720	145 mm / 5½"
1/1	JANSEN	07-61-721	160 mm / 6⅝"
1/1	GRUENWALD	07-61-722	190 mm / 7¾"

Alle monopolaren Pinzetten werden serienmäßig ohne Buchse geliefert. Die Buchse ist jeweils separat zu bestellen. Hierbei bitte die Artikel-Nummer der gewünschten Ausführung von Seite 134 angeben.

All monopolar forceps are serially supplied without plug. The plug needs to be ordered separately by adding the article number of the requested model as shown on page 134.

1/1
JANSEN
07-61-721
 160 mm
 6⅝"

Artikel-Nr. Cat. No.	Gesamtlänge Total length	
07-61-710	140 mm / 5½"	1/1
07-61-711	180 mm / 7"	
07-61-712	210 mm / 8¼"	
07-61-713	250 mm / 10"	
07-61-714	300 mm / 12"	



Alle monopolaren Pinzetten werden serienmäßig ohne Buchse geliefert. Die Buchse ist jeweils separat zu bestellen. Hierbei bitte die Artikel-Nummer der gewünschten Ausführung von Seite 134 angeben.

All monopolar forceps are serially supplied without plug. The plug needs to be ordered separately by adding the article number of the requested model as shown on page 134.





1/1
07-61-710
 140 mm
 5½"



		Stecker, geräteseitig passend für Geräte: plug, generator side for units:	Artikel-Nr. Cat. No.	Gesamtlänge Total length
Geräteseite equipment side		ERBE	07-61-980	3 m
			07-61-981	5 m
	Instrumentenseite instrument side			



		Stecker, geräteseitig passend für Geräte: plug, generator side for units:	Artikel-Nr. Cat. No.	Gesamtlänge Total length
Geräteseite equipment side		AESCULAP GK 4	07-61-982	3 m
			07-61-983	5 m
	Instrumentenseite instrument side			



		Stecker, geräteseitig passend für Geräte: plug, generator side for units:	Artikel-Nr. Cat. No.	Gesamtlänge Total length
Geräteseite equipment side		USA MOD. 2-Banannen- stecker	07-61-984	3 m
			07-61-985	5 m
	Instrumentenseite instrument side			

		Stecker, geräteseitig passend für Geräte: plug, generator side for units:	Artikel-Nr. Cat. No.	Gesamtlänge Total length
Geräteseite equipment side		MARTIN BERCHTOLD AESCULAP GK55 GK60	07-61-986	3 m
			07-61-987	5 m
	Instrumentenseite instrument side			

Artikel-Nr. Cat. No.	Gesamtlänge Total length	Stecker, geräteseitig passend für Geräte: plug, generator side for units:	
07-61-730	3 m	ERBE ACC/ICC	 <p>5 mm I</p> <p>Geräteseite equipment side</p>  <p>Instrumentenseite instrument side</p>
07-61-731	5 m		

Artikel-Nr. Cat. No.	Gesamtlänge Total length	Stecker, geräteseitig passend für Geräte: plug, generator side for units:	
07-61-732	3 m	ERBE T-MODELL	 <p>Geräteseite equipment side</p>  <p>Instrumentenseite instrument side</p>
07-61-733	5 m		

Artikel-Nr. Cat. No.	Gesamtlänge Total length	Stecker, geräteseitig passend für Geräte: plug, generator side for units:	
07-61-734	5 m	MARTIN BERCHTOLD AESCULAP	 <p>Geräteseite equipment side</p>  <p>Instrumentenseite instrument side</p>

Artikel-Nr. Cat. No.	Gesamtlänge Total length	Stecker, geräteseitig passend für Geräte: plug, generator side for units:	
07-61-735	3 m	VALLEYLAB	 <p>Geräteseite equipment side</p>  <p>Instrumentenseite instrument side</p>
07-61-736	5 m		

01

Mikro-Neurochirurgische Instrumente
Micro-Neurosurgical Instruments

02

HF-Instrumente und Zubehör
HF Instruments and Accessoires

Kopf-Schädelinstrumente und Haltesysteme
Head-Cranio Instruments and Holding Systems

04

Aneurysmen-Clip System
Aneurysm Clip System

05

Schädel-Verplattung
Cranial Plate System

06

Hypophysektomie-Instrumente
Pituitary Instruments

07

Instrumente für die Wirbelsäule, Wundspreizer
Spine Instruments, Self-retaining Retractors

08

Laminektomie-Stanzen, Rongeure, Hohlmeißelzangen
Laminectomy Punches, Rongeurs

09

Gefäß- und Bulldogklemmen, Gefäß-Clips
Vessel- and Bulldog-Clamps, Vessel Clips

10

Allgemeinchirurgische Instrumente
General Surgical Instruments

11

Alphabetischer Index, Numerischer Index
Alphabetical Index, Numerical Index

/// 03



SURGICAL
INSTRUMENTS
MICRO-NEURO-SPINE

REBSTOCK®
Precision made in Germany



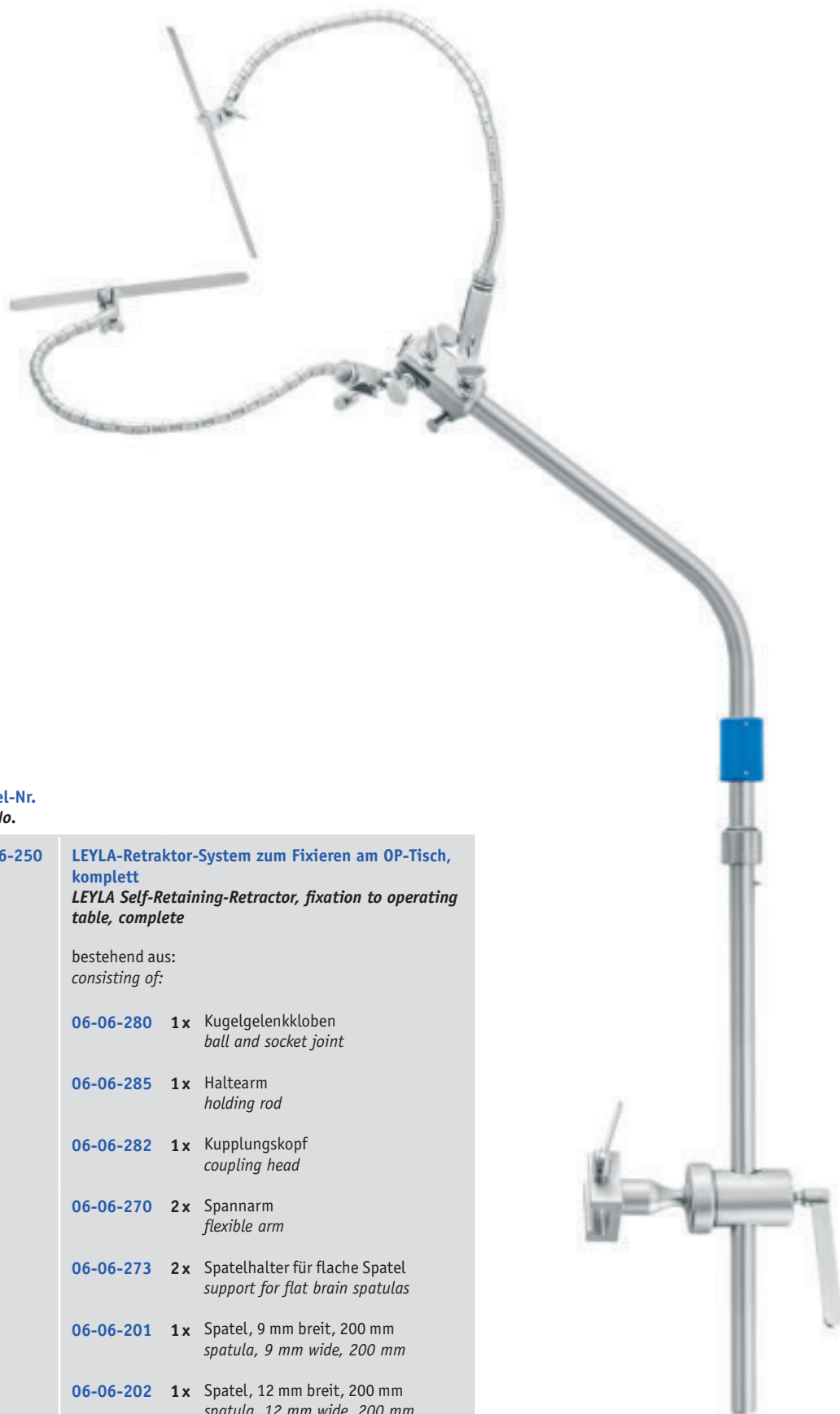

/// Kopf-Schädelinstrumente und Haltesysteme
Head-Cranio Instruments and Holding Systems

/// www.rebstock.de



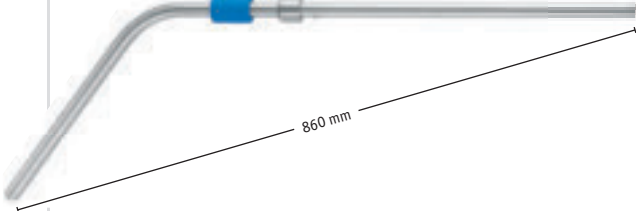

Artikel-Nr.
Cat. No.

LEYLA	06-56-250	LEYLA-Retraktor-System zum Fixieren am OP-Tisch, komplett LEYLA Self-Retaining-Retractor, fixation to operating table, complete bestehend aus: <i>consisting of:</i> 06-06-280 1x Kugelgelenkkloben <i>ball and socket joint</i> 06-06-285 1x Haltearm <i>holding rod</i> 06-06-282 1x Kupplungskopf <i>coupling head</i> 06-06-270 2x Spannarm <i>flexible arm</i> 06-06-273 2x Spatelhalter für flache Spatel <i>support for flat brain spatulas</i> 06-06-201 1x Spatel, 9 mm breit, 200 mm <i>spatula, 9 mm wide, 200 mm</i> 06-06-202 1x Spatel, 12 mm breit, 200 mm <i>spatula, 12 mm wide, 200 mm</i>
--------------	------------------	--



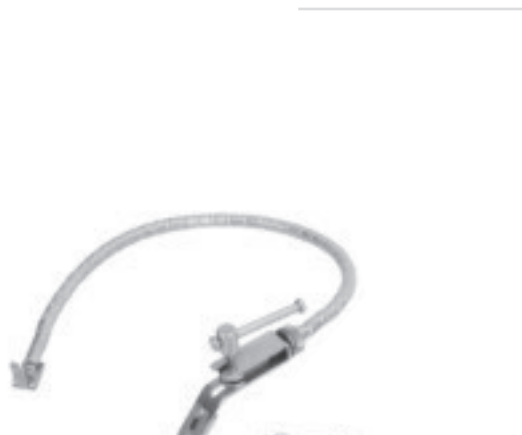

Artikel-Nr.
Cat. No.

<p>06-06-280</p>	<p>Kugelgelenkkloben zum Befestigen an der OP-Tischschiene und zur Aufnahme des Haltearms 06-06-285</p> <p><i>ball and socket joint for fixing holding rod 06-06-285 to the operating table</i></p>	<p>LEYLA</p>	
<p>06-06-285</p>	<p>Haltearm, starr, 860 mm, auseinandernehmbar, zur Fixation im Kugelgelenkkloben 06-06-280 und zur wahlweisen Aufnahme der Kupplungsköpfe 06-06-282, 06-06-283 und 06-06-284</p> <p><i>holding rod, rigid, 860 mm, detachable, for fixation in ball and socket joint 06-06-280 and to hold coupling head 06-06-282, 06-06-283 and 06-06-284</i></p>	<p>LEYLA</p>	
<p>06-06-282</p>	<p>Kupplungskopf zur Aufnahme von max. 5 Spannarmen 06-06-270</p> <p><i>coupling head to hold up to 5 flexible arms 06-06-270</i></p>	<p>LEYLA</p>	
<p>06-06-283</p>	<p>Kupplungskopf, drehbar auf Haltearm, zur Aufnahme von 1 Spannarm 06-06-270</p> <p><i>coupling head, rotatable on holding rod, to hold 1 flexible arm 06-06-270</i></p>	<p>LEYLA</p>	
<p>06-06-284</p>	<p>Kupplungskopf, seitlich offen, zum Aufstecken auf Haltearm, zur Aufnahme von 1 Spannarm 06-06-270</p> <p><i>coupling head, lateral open, for mounting on holding rod, to hold 1 flexible arm 06-06-270</i></p>	<p>LEYLA</p>	

Artikel-Nr.
Cat. No.

	YASARGIL	06-06-260	LEYLA Retraktor mit flexiblem Spannarm, zur Aufnahme von 1 flachen Spatel, komplett LEYLA Retractor with flexible arm, to adapt 1 flat spatula, complete bestehend aus: <i>consisting of:</i> 06-06-267 1x Fixiervorrichtung für 1 Spannarm <i>fixation base for 1 flexible arm</i> 06-06-270 1x Spannarm <i>flexible arm</i> 06-06-273 1x Halter für flache Spatel <i>support for flat brain spatulas</i>
	YASARGIL	06-06-262	LEYLA Retraktor mit 2 flexiblen Spannarmen, zur Aufnahme von 2 flachen Spateln, komplett LEYLA Retractor with 2 flexible arms, to adapt 2 flat spatulas, complete bestehend aus: <i>consisting of:</i> 06-06-268 1x Fixiervorrichtung für 2 Spannarme <i>fixation base for 2 flexible arms</i> 06-06-270 2x Spannarm <i>flexible arm</i> 06-06-273 2x Halter für flache Spatel <i>support for flat brain spatulas</i>
		15-06-099	LEYLA Retraktor mit flexiblem Spannarm, für Ohrtrichterhalter, komplett LEYLA Retractor with flexible arm, for ear spatula holder, complete bestehend aus: <i>consisting of:</i> 06-06-266 1x Fixiervorrichtung zum Befestigen an Rohrteilen bis ø 16 mm <i>fixation base for mounting to bars up to ø 16 mm</i> 06-06-270 1x Spannarm <i>flexible arm</i> 06-06-275 1x Ohrtrichterhalter <i>ear specula holder</i>

Artikel-Nr.
 Cat. No.

<p>06-06-270</p>	<p>Flexibler Spannarm, 520 mm <i>flexible arm, 520 mm</i></p>	<p>YASARGIL</p>	
<p>06-06-273</p>	<p>Halter für flache Spatel <i>support for flat spatulas</i></p>		
<p>06-06-274</p>	<p>Halter für Spatel mit rundem Schaft <i>support for spatulas with round shaft</i></p>		
<p>06-06-268</p>	<p>Fixiervorrichtung am Schädel für 2 flexible Spannarme 06-06-270 <i>fixation base for skull mounting, holding 2 flexible arms 06-06-270</i></p>		

Artikel-Nr.
Cat. No.
**06-06-267**
 Fixiervorrichtung am Schädel, für
 1 flexiblen Spannarm 06-06-270



*fixation base for skull mounting,
 holding 1 flexible arm 06-06-270*
**06-06-266**
 Fixiervorrichtung zum Befestigen an
 Rohrteilen bis \varnothing 16 mm, für 1 flexiblen
 Spannarm 06-06-270

*fixation base for mounting to bars
 up to \varnothing 16 mm, for 1 flexible arm
 06-06-270*
**06-56-281**
 Universal Halterung zur Fixierung von
 3 flexiblen Spannarmen 06-06-270

*universal clamp for fixation of
 3 flexible arms 06-06-270*

TITAN

Artikel-Nr.
 Cat. No.

<p>06-06-270T</p>	<p>Flexibler Spannarm, 470 mm, TITAN <i>flexible arm, 470 mm, TITANIUM</i></p>	<p>YASARGIL</p>	
<p>06-06-268T</p>	<p>Fixiervorrichtung am Schädel für 2 flexible Spannarme 06-06-270T, TITAN <i>fixation base for skull mounting, holding 2 flexible arms 06-06-270T, TITANIUM</i></p>		
<p>06-06-273T</p>	<p>Halter für flache Spatel, TITAN <i>support for flat brain spatulas, TITANIUM</i></p>		

 MEMORY

 1/2
MEMORY
06-56-457B
 200 mm
 8"

Artikel-Nr.
Cat. No.
Gesamtlänge
Total length

MEMORY

06-56-456

200 mm / 8"

4 + 8 mm breit
4 + 8 mm wide

06-56-457

200 mm / 8"

6 + 13 mm breit
6 + 13 mm wide

06-56-458

200 mm / 8"

7 + 17 mm breit
7 + 17 mm wide

06-56-459

200 mm / 8"

11 + 21 mm breit
11 + 21 mm wide

biegsam, aus spezieller MEMORY Legierung,
 biegt sich bei der Sterilisation automatisch
 in den ursprünglich geraden Zustand zurück
*malleable, made out of special MEMORY
 alloy, straightens automatically during the
 sterilisation process*

Artikel-Nr.
Cat. No.
Gesamtlänge
Total length

MEMORY

06-56-224

200 mm / 8"

9 mm breit
9 mm wide

06-56-226

200 mm / 8"

12 mm breit
12 mm wide

06-56-228

200 mm / 8"

14 mm breit
14 mm wide

06-56-230

200 mm / 8"

18 mm breit
18 mm wide

06-56-232

200 mm / 8"

20 mm breit
20 mm wide

06-56-234

200 mm / 8"

25 mm breit
25 mm wide

biegsam, aus spezieller MEMORY-Legierung,
 biegt sich bei der Sterilisation automatisch
 in den ursprünglich geraden Zustand zurück
*malleable, made out of special MEMORY
 alloy, straightens automatically during the
 sterilisation process*

 MEMORY

 1/2
MEMORY
06-56-224
 200 mm
 8"

Standard Line
Oberfläche matt gebürstet
Surface polished

 Beispiel-Artikel-Nr.
Example Cat. No.

06-56-224

Black Line
Oberfläche schwarz, titanbeschichtet
Surface black, titanium-coated

 Beispiel-Artikel-Nr.
Example Cat. No.

06-56-224B

TITAN

Artikel-Nr. Cat. No.	Artikel-Nr. Cat. No.	Gesamtlänge Total length
06-06-456	06-06-456T	200 mm / 8" 4 + 8 mm breit 4 + 8 mm wide
06-06-457	06-06-457T	200 mm / 8" 6 + 13 mm breit 6 + 13 mm wide
06-06-458	06-06-458T	200 mm / 8" 7 + 17 mm breit 7 + 17 mm wide
06-06-459	06-06-459T	200 mm / 8" 11 + 21 mm breit 11 + 21 mm wide biegsam malleable

1/2
06-06-457
200 mm
8"



3

Artikel-Nr. Cat. No.	Gesamtlänge Total length
06-06-201	200 mm / 8" 9 mm breit 9 mm wide
06-06-202	200 mm / 8" 12 mm breit 12 mm wide
06-06-222	250 mm / 10" 12 mm breit 12 mm wide gerieft, biegsam serrated, malleable

Standard Line	Black Line
Oberfläche matt gebürstet <i>Surface polished</i>	Oberfläche schwarz, titanbeschichtet <i>Surface black, titanium-coated</i>
Beispiel-Artikel-Nr. Example Cat. No. 06-06-201	Beispiel-Artikel-Nr. Example Cat. No. 06-06-201B

1/2
06-06-201
200 mm
8"





1/2
AACHEN
06-06-444
 200 mm
 8"

	Artikel-Nr. Cat. No.	Gesamtlänge Total length
AACHEN	06-06-441	200 mm / 8" 7 + 8 mm breit 7 + 8 mm wide
	06-06-442	200 mm / 8" 10 + 11 mm breit 10 + 11 mm wide
	06-06-443	200 mm / 8" 13 + 14 mm breit 13 + 14 mm wide
	06-06-444	200 mm / 8" 16 + 17 mm breit 16 + 17 mm wide
	06-06-445	200 mm / 8" 19 + 20 mm breit 19 + 20 mm wide
	06-06-446	200 mm / 8" 22 + 25 mm breit 22 + 25 mm wide

Standard Line

 Oberfläche matt gebürstet
Surface polished

 Beispiel-Artikel-Nr. **06-06-444**
 Example Cat. No.

Black Line

 Oberfläche schwarz, titanbeschichtet
Surface black, titanium-coated

 Beispiel-Artikel-Nr. **06-06-444B**
 Example Cat. No.

Artikel-Nr. Cat. No.	Gesamtlänge Total length		
02-20-751	200 mm / 8" 12 mm breit 12 mm wide		
02-20-752	200 mm / 8" 17 mm breit 17 mm wide		
02-20-755	250 mm / 10" 25 mm breit 25 mm wide biegsam malleable		

Artikel-Nr. Cat. No.	Gesamtlänge Total length	DAVIS	
06-56-200	180 mm / 7" 6 mm breit 6 mm wide		
06-56-201	180 mm / 7" 10 mm breit 10 mm wide		
06-56-202	180 mm / 7" 14 mm breit 14 mm wide		
06-56-203	180 mm / 7" 16 mm breit 16 mm wide		
06-56-204	180 mm / 7" 19 mm breit 19 mm wide		
06-56-205	180 mm / 7" 25 mm breit 25 mm wide		
06-56-206	180 mm / 7" 32 mm breit 32 mm wide		
06-56-207	180 mm / 7" 38 mm breit 38 mm wide biegsam malleable		



1/2
02-20-752
200 mm
8"



1/2
DAVIS
06-56-203
180 mm
7"

Standard Line	Black Line
Oberfläche matt gebürstet <i>Surface polished</i>	Oberfläche schwarz, titanbeschichtet <i>Surface black, titanium-coated</i>
Beispiel-Artikel-Nr. Example Cat. No. 06-56-203	Beispiel-Artikel-Nr. Example Cat. No. 06-56-203B



3

 1/2
CUSHING
06-06-212
 180 mm
 7"

		Artikel-Nr. Cat. No.	Gesamtlänge Total length
	CUSHING	06-06-211	180 mm / 7" 7 + 9 mm breit 7 + 9 mm wide
		06-06-212	180 mm / 7" 11 + 13 mm breit 11 + 13 mm wide
		06-06-213	180 mm / 7" 15 + 18 mm breit 15 + 18 mm wide
		06-06-214	180 mm / 7" 18 + 22 mm breit 18 + 22 mm wide
			biegsam malleable

 1/2
OLIVECRONA
06-06-217
 180 mm
 7"

		Artikel-Nr. Cat. No.	Gesamtlänge Total length
	OLIVECRONA	06-06-216	180 mm / 7" 7 + 9 mm breit 7 + 9 mm wide
		06-06-217	180 mm / 7" 11 + 13 mm breit 11 + 13 mm wide
		06-06-218	180 mm / 7" 15 + 18 mm breit 15 + 18 mm wide
		06-06-219	180 mm / 7" 18 + 22 mm breit 18 + 22 mm wide
			biegsam malleable

Standard Line

 Oberfläche matt gebürstet
 Surface polished

 Beispiel-Artikel-Nr.
 Example Cat. No.

06-06-212
Black Line

 Oberfläche schwarz, titanbeschichtet
 Surface black, titanium-coated

 Beispiel-Artikel-Nr.
 Example Cat. No.

06-06-212B

Artikel-Nr. Cat. No.	Gesamtlänge Total length		
06-06-231	200 mm / 8" 14 mm breit 14 mm wide		
06-06-232	200 mm / 8" 17 mm breit 17 mm wide		
06-06-233	200 mm / 8" 20 mm breit 20 mm wide biegsam malleable		



Artikel-Nr. Cat. No.	Gesamtlänge Total length	HEIFETZ	
06-56-254	155 mm / 6" 3 mm breit 3 mm wide		
06-56-255	155 mm / 6" 6 mm breit 6 mm wide		
06-06-256	155 mm / 6" 8 mm breit 8 mm wide		
06-06-257	155 mm / 6" 11 mm breit 11 mm wide		
06-06-258	155 mm / 6" 14 mm breit 14 mm wide		
06-06-259	155 mm / 6" 17 mm breit 17 mm wide biegsam malleable		

1/2
06-06-233
200 mm
8"



1/2
HEIFETZ
06-06-257
155 mm
6"

Standard Line	Black Line
Oberfläche matt gebürstet <i>Surface polished</i>	Oberfläche schwarz, titanbeschichtet <i>Surface black, titanium-coated</i>
Beispiel-Artikel-Nr. Example Cat. No. 06-06-233	Beispiel-Artikel-Nr. Example Cat. No. 06-06-233B

Modulares Haltesystem für die Neurochirurgie
Modular Retractor System for the Neurosurgery

Flexibel einsetzbar zur selbsthaltenden Fixierung von Spateln oder Instrumenten und als Handauflage für kontrolliertes und ermüdungsfreies Arbeiten. Zur Montage an allen gängigen Kopfhaltungen. Individueller Aufbau und Anpassung an die operativen Erfordernisse.

The retractor and handrest is a versatile system for the self-retaining fixation of instruments and spatulas that allows performance with more control and less fatigue. It attaches to all common skull clamps and can be individually assembled and adjusted to surgeons need.

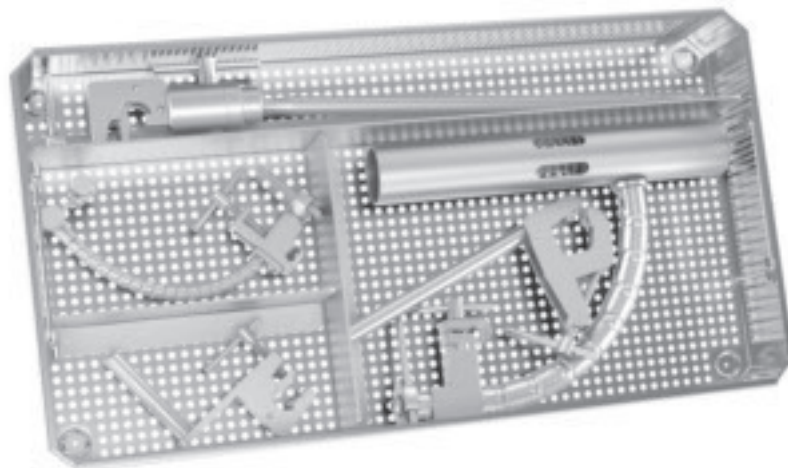
Artikel-Nr.
Cat. No.

06-45-000

Universal Haltesystem
universal retractor system

 bestehend aus:
consisting of:

- 06-56-002** 2x Primärstange
primary bar
- 06-56-003** 4x Sekundärstange
secondary bar
- 06-56-006** 4x Haltearm lang, flexibel, 240 mm
long retractor arm, flexibel, 240 mm
- 06-56-001** 1x Handauflage mit flexiblem Arm, 245 mm
handrest with flexible arm, 245 mm
- 06-56-013** 1x Tupperablage
pattie tray
- 06-56-015** 1x Spatel, konisch 6 x 19 mm
spatula, conical 6 x 19 mm
- 06-56-016** 1x Spatel, konisch 4 x 16 mm
spatula, conical 4 x 16 mm
- 06-56-017** 1x Spatel, konisch 3,2 x 12,7 mm
spatula, conical 3.2 x 12.7 mm
- 06-56-018** 1x Spatel, konisch 2,4 x 9,5 mm
spatula, conical 2.4 x 9.5 mm
- 06-56-019** 1x Spatel, konisch 1,6 x 6 mm
spatula, conical 1.6 x 6 mm
- 06-56-014** 1x Siebkorb mit 4 Fächern und Deckel, 480 x 253 x 70 mm
tray with 4 compartments and lid, 480 x 253 x 70 mm

Artikel-Nr.
Cat. No.

06-56-002 Primärstange zur Aufnahme der Sekundärstange 06-56-003 und Anschlussstange 06-56-004. Montage an Kopfhalterung

primary bar for fixation of secondary bar 06-56-003 and floating secondary bar 06-56-004. For mounting to skull clamp



Artikel-Nr.
Cat. No.

06-56-003 Sekundärstange zur Montage an Primärstange 06-56-002 oder Anschlussstange 06-56-004

secondary bar for mounting to primary bar 06-56-002 and floating secondary bar 06-56-004



Artikel-Nr.
Cat. No.

06-56-004 Anschlussstange zur Montage an Primärstange 06-56-002 und Sekundärstange 06-56-003

floating secondary bar for mounting to primary bar 06-56-002 and secondary bar 06-56-003



Artikel-Nr.
Cat. No.

06-56-011 Kurzer Anschluss zur Aufnahme der Handauflage 06-56-001. Montage an Sekundärstange 06-56-003 oder Anschlussstange 06-56-004

short coupler to adapt handrest 06-56-001. Mounting to secondary bar 06-56-003 and floating secondary bar 06-56-004

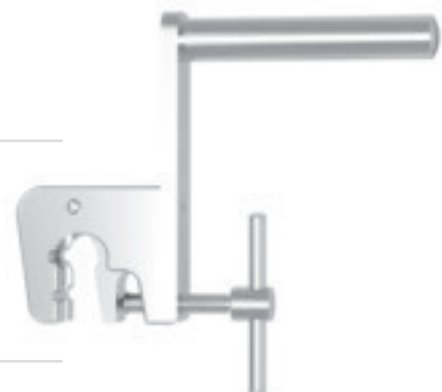

Artikel-Nr.
Cat. No.
Gesamtlänge
Total length

06-56-005

165 mm / 6½"

Haltearm kurz, flexibel, zur Aufnahme der Spatel. Montage an Sekundärstange 06-56-003 und Anschlussstange 06-56-004

flexible holding arm, short, to adapt the spatulas, for mounting to secondary bar 06-56-003 and floating secondary bar 06-56-004

06-56-006

240 mm / 9¾"

Haltearm lang, flexibel, zur Aufnahme der Spatel. Zur Montage an Sekundärstange 06-56-003 und Anschlussstange 06-56-004

flexible holding arm, long, to adapt the spatulas, for mounting to secondary bar 06-56-003 and floating secondary bar 06-56-004

Artikel-Nr.
Cat. No.
Haltearm flexibel, zur Aufnahme von:
Holding Arm, flexible, used to hold:

06-56-007

 Mikro Instrumente bis
 ø 3 mm / 1/8"

*micro instruments up to
 ø 3 mm / 1/8"*

06-56-008

 kleine Instrumente bis
 ø 8 mm / 5/16"

*small instruments up to
 ø 8 mm / 5/16"*

06-56-009

 mittlere Instrumente bis
 ø 25 mm / 1"

*medium instruments up to
 ø 25 mm / 1"*

06-56-010

 große Instrumente bis
 ø 51 mm / 2"

*large instruments up to
 ø 51 mm / 2"*

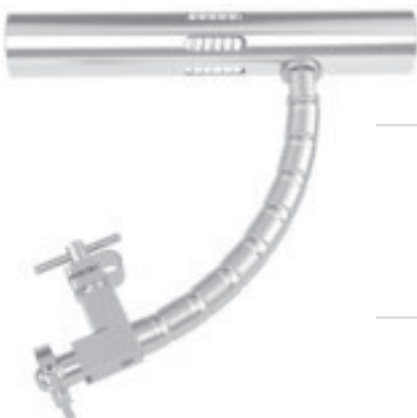

Montage an Sekundärstange 06-56-003 und Anschlussstange 06-56-004
 for mounting to secondary bar 06-56-003 and floating secondary bar 06-56-004

Artikel-Nr.
Cat. No.
Gesamtlänge
Total length

06-56-001

245 mm / 9⅔"

Handauflage mit flexiblen Arm zur Montage an Anschluss 06-56-011

handrest with flexible arm for mounting to short coupler 06-56-011

Artikel-Nr.
Cat. No.

06-56-012	Maxi Vise Adapter zur Aufnahme von Instrumenten bis \varnothing 8 mm. Montage an die flexiblen Haltearme 06-56-005 und 06-56-006 <i>maxi vise adapter holds instruments up to \varnothing 8 mm, to be mounted to flexible holding arms 06-56-005 and 06-56-006</i>		
------------------	--	--	--

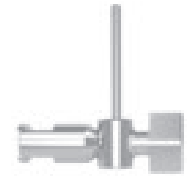

Artikel-Nr.
Cat. No.

Maße
Measurements

06-56-013	171 x 76 mm Tupperablage zur Montage an die flexiblen Haltearme 06-56-005 und 06-56-006 <i>tupper tray for mounting to flexible holding arms 06-56-005 and 06-56-006</i>		
------------------	--	--	--



Artikel-Nr.
Cat. No.

Maße
Measurements

	230 mm / 9" Spatel konisch, schwarz, titanbeschichtet Montage an flexiblen Haltearmen 06-56-005 und 06-56-006 <i>spatula conical, black, titanium-coated, for mounting to flexible holding arms 06-56-005 and 06-56-006</i>		
06-56-015	6 x 19 mm		
06-56-016	4 x 16 mm		
06-56-017	3,2 x 12,7 mm		
06-56-018	2,4 x 9,5 mm		
06-56-019	1,6 x 6 mm		



Artikel-Nr.
Cat. No.

Maße
Measurements

06-56-014	480 x 253 x 70 mm Siebkorb mit 4 Fächern und Deckel zur Lagerung der Komponenten <i>tray with 4 compartments and lid for storage of the components</i>		
------------------	--	--	--

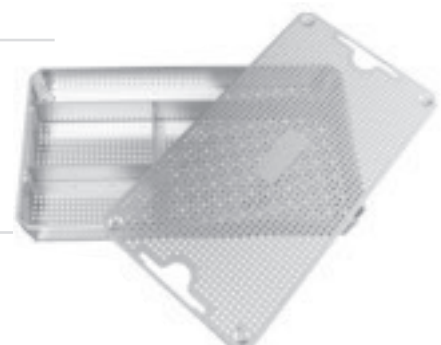

		Artikel-Nr. Cat. No.	
	1/3	HUDSON 06-06-058	Bogen allein <i>brace only</i>
		HUDSON 06-06-059	Verlängerungsstück allein <i>extension piece only</i>
		HUDSON 06-06-061	Bohrer <i>burr</i> ø 9 mm
		HUDSON 06-06-062	Bohrer <i>burr</i> ø 14 mm
		HUDSON 06-06-063	Bohrer <i>burr</i> ø 16 mm
		HUDSON 06-06-064	Bohrer <i>burr</i> ø 22 mm
		ADSON 06-06-065	Bohrer <i>burr</i> ø 15 mm
		MC KENZIE 06-06-066	Bohrer <i>burr</i> ø 13 mm

Artikel-Nr.
Cat. No.

06-56-064	Bohrer <i>burr</i>	ø 10 mm	CUSHING	
06-56-065	Bohrer <i>burr</i>	ø 15 mm	CUSHING	
06-56-066	Bohrer <i>burr</i>	ø 20 mm	CUSHING	
06-56-060	Flachbohrer <i>perforator drill</i>	ø 10 mm	CUSHING	
06-56-061	Flachbohrer <i>perforator drill</i>	ø 13 mm	CUSHING	
06-06-067	Flachbohrer <i>perforator drill</i>	ø 14 mm	CUSHING	
06-56-062	Flachbohrer <i>perforator drill</i>	ø 16 mm	CUSHING	
06-06-068	Spiralbohrer <i>twist drill</i>	ø 2 mm		
06-56-063	Bohrer <i>burr</i>	ø 16 mm	D'ERRICO	

Artikel-Nr.
 Cat. No.

	HUDSON DOWNS	06-06-052	Bogen allein <i>brace only</i>
	HUDSON DOWNS	06-06-053	Verlängerungsstück allein <i>extension piece only</i>
	HUDSON DOWNS	06-06-031	ø 10 mm Flachbohrer <i>perforator drill</i>
	HUDSON DOWNS	06-06-032	ø 12 mm Flachbohrer <i>perforator drill</i>
	HUDSON DOWNS	06-06-033	ø 15 mm Flachbohrer <i>perforator drill</i>
	HUDSON DOWNS (LEWIS)	06-06-034	ø 10 mm Flachbohrer <i>perforator drill</i>
	HUDSON DOWNS (LEWIS)	06-06-035	ø 12 mm Flachbohrer <i>perforator drill</i>
	HUDSON DOWNS (LEWIS)	06-06-036	ø 15 mm Flachbohrer <i>perforator drill</i>
	HUDSON DOWNS	06-06-037	ø 11 mm Bohrer <i>burr</i>

Artikel-Nr.
Cat. No.

06-06-038	Bohrer <i>burr</i>	ø 13 mm	HUDSON DOWNS	
06-06-039	Bohrer <i>burr</i>	ø 16 mm	HUDSON DOWNS	
06-06-040	Bohrer <i>burr</i>	ø 11 mm	HUDSON DOWNS	
06-06-041	Bohrer <i>burr</i>	ø 13 mm	HUDSON DOWNS	
06-06-042	Bohrer <i>burr</i>	ø 16 mm	HUDSON DOWNS	
06-06-043	Bohrer <i>burr</i>	ø 19 mm	HUDSON DOWNS	
06-06-044	Bohrer <i>burr</i>	ø 22 mm	HUDSON DOWNS	
06-06-048	Bohrer <i>burr</i>	ø 16 mm	MC KENZIE	
06-06-047	Bohrer <i>burr</i>		MC KENZIE	

Artikel-Nr.
Cat. No.
06-56-112
Gesamtlänge
Total length

210 mm / 8¼"

 Schädelstanze mit je
 1 großen Blatt (06-56-110) und
 1 kleinen Blatt (06-56-111)

*cranial rongeur with
 1 large blade (06-56-110) and
 1 small blade (06-56-111)*

Artikel-Nr.
Cat. No.
06-06-113
Gesamtlänge
Total length

210 mm / 8¼"

 Schädelstanze mit
 2 Reserveblättern (06-56-113)

*cranial rongeur with
 2 spare blades (06-56-113)*

Artikel-Nr.
Cat. No.

Gesamtlänge
Total length

06-06-050

205 mm / 8"

Bohrloch Schutzzange
burr hole protection forceps



1/2
06-06-050
205 mm
8"



1/2
06-08-403
 300 mm
 12"

	Artikel-Nr. Cat. No.	Gesamtlänge Total length
GIGLI	06-58-409	250 mm / 10"
	06-08-413	300 mm / 12"
	06-08-414	400 mm / 16"
	06-08-415	500 mm / 20"
	06-58-410	600 mm / 24"
	06-58-411	700 mm / 28"
		Dreifach gedreht Verkaufseinheit = 1 Stück 3 wires twisted sales unit = 1 pc.
OLIVE-CRONA	06-58-402	230 mm / 9"
	06-08-403	300 mm / 12"
	06-08-404	400 mm / 16"
	06-08-405	500 mm / 20"
	06-58-406	600 mm / 24"
	06-08-407	700 mm / 28"
	06-58-408	750 mm / 30"
		Zweifach gedreht Verkaufseinheit = 1 Stück 2 wires twisted sales unit = 1 pc.
OLIVE-CRONA-GIGLI	06-58-412	300 mm / 12"
	06-58-413	400 mm / 16"
	06-58-414	500 mm / 20"
	06-58-415	600 mm / 24"
	06-58-416	700 mm / 28"
		Vierfach gedreht Verkaufseinheit = 1 Stück 4 wires twisted sales unit = 1 pc.

Artikel-Nr. Cat. No.	Gesamtlänge Total length	GIGLI	1/2
06-08-480	Handgriffe für Drahtsägen, Packung á 2 Stück <i>handles for wire saws, package of 2 pieces</i>	GIGLI	1/2
06-58-480	Handgriffe für Drahtsägen, Packung á 2 Stück <i>handles for wire saws, package of 2 pieces</i>	GIGLI	
06-06-130	350 mm / 14" Umföhrungsinstrument für Drahtsägen, flexibel <i>conductor for wire saws, flexible</i>	DE MARTEL	
06-06-133	250 mm / 10" Umföhrungsinstrument für Drahtsägen <i>conductor for wire saws</i>	LEBSCHÉ	



1/3
DE MARTEL
06-06-130
 350 mm
 14"

1/2
LEBSCHÉ
06-06-133
 250 mm
 10"

3

 1/1
FRAZIER
06-06-330
 100 mm
 4"

		Artikel-Nr. Cat. No.	Arbeitslänge Working length
	FRAZIER	06-06-330	100 mm / 4" ø 3 mm

 1/1
FRAZIER
06-06-331
 70 mm
 2¾"

		Artikel-Nr. Cat. No.	Arbeitslänge Working length
	FRAZIER	06-06-331	70 mm / 2¾" ø 2 mm
		06-06-332	70 mm / 2¾" ø 2,5 mm

Artikel-Nr. Cat. No.	Gesamtlänge Total length		
06-56-330	0,7 x 80 mm / 3"	QUINKE	
06-56-331	0,7 x 90 mm / 3½"		
06-56-332	1,0 x 80 mm / 3"		
06-56-333	1,0 x 90 mm / 3½"		
06-56-334	1,2 x 90 mm / 3½"		
06-56-335	1,2 x 100 mm / 4"		
06-56-336	1,2 x 150 mm / 6"		



1/1
QUINKE
06-56-330
80 mm
3"

Artikel-Nr. Cat. No.	Gesamtlänge Total length		
06-56-337	1,3 x 80 mm / 3"	TUOHY	1/1
06-56-338	1,5 x 80 mm / 3"		
06-56-339	1,7 x 80 mm / 3"		



1/1
TUOHY
06-56-337
80 mm
3"

 Artikel-Nr.
 Cat. No.

 CRUTCH-
 FIELD

06-06-860

 Schädelhalter für Kinder
skull traction tongs for children

 1/3
 CRUTCHFIELD
 06-06-860

 Artikel-Nr.
 Cat. No.

 CRUTCH-
 FIELD

06-06-865

 Schädelhalter, mittlere Größe
skull traction tongs, medium size

 1/3
 CRUTCHFIELD
 06-06-865

 Artikel-Nr.
 Cat. No.

 Größe
 Size

06-06-861

ø 3,5 mm

 Vorbohrer für CRUTCHFIELD Schädelhalter
 06-06-860 und 06-06-865

*drill for CRUTCHFIELD skull traction tongs
 06-06-860 and 06-06-865*

06-06-862

ø 5,0 mm

 Vorbohrer für CRUTCHFIELD Schädelhalter
 06-06-860 und 06-06-865

*drill for CRUTCHFIELD skull traction tongs
 06-06-860 and 06-06-865*

Artikel-Nr.
Cat. No.

<p>06-06-870</p>	<p>Schädelhalter, großes Modell, mit verstellbaren Dornen</p> <p><i>skull traction tongs, large type, with adjustable pins</i></p>		
<p>06-56-871</p>	<p>Ersatzdorn für Schädelhalter 06-06-870</p> <p><i>spare pin for skull traction tongs 06-06-870</i></p>		



1/3
06-06-870

Artikel-Nr.
Cat. No.

<p>06-56-030</p>	<p>Schädelhalter komplett, bestehend aus: Rahmen, 2 Muttern, Testrohr, S-Haken mit Schild, 2 Gewindebolzen</p> <p><i>skull tongs complete, consisting of: frame, 2 lock nuts, test bar, s-hook, 2 fixation screws</i></p>	<p>GARNER- WELLS</p>	
-------------------------	---	---------------------------------	--



1/3
GARDNER-WELLS
06-56-030

Artikel-Nr.
 Cat. No.

	MC KENZIE	06-06-421	Klammerblock, allein clip rack, empty
	MC KENZIE	06-06-426	Silberklammern, Packung à 100 Stück silver clips, package of 100 pieces

 Artikel-Nr.
 Cat. No.

 Gesamtlänge
 Total length

1/1	MC KENZIE	06-56-422	150 mm / 6"
		06-56-423	190 mm / 7½"
1/1	MC KENZIE	06-56-424	150 mm / 6"
		06-56-425	190 mm / 7½"

1/2
 MC KENZIE
 06-56-424
 150 mm
 6"



 Artikel-Nr.
 Cat. No.

 Schaftlänge
 Length of shaft

1/1	OLIVE- CRONA- TOENNIS	06-56-427	140 mm / 5½"
		06-56-428	200 mm / 8"

1/2
 OLIVECRONA-
 TOENNIS
 06-56-427
 140 mm
 5½"

Artikel-Nr.
 Cat. No.

06-06-001	Kopfhautklammer, Packung à 12 Stück <i>scalp clips, package of 12 pieces</i>	RANEY	
06-06-005	Kopfhautklammer, Packung à 50 Stück <i>scalp clips, package of 50 pieces</i>	KÖLN	

Artikel-Nr.
 Cat. No.

Gesamtlänge
 Total length

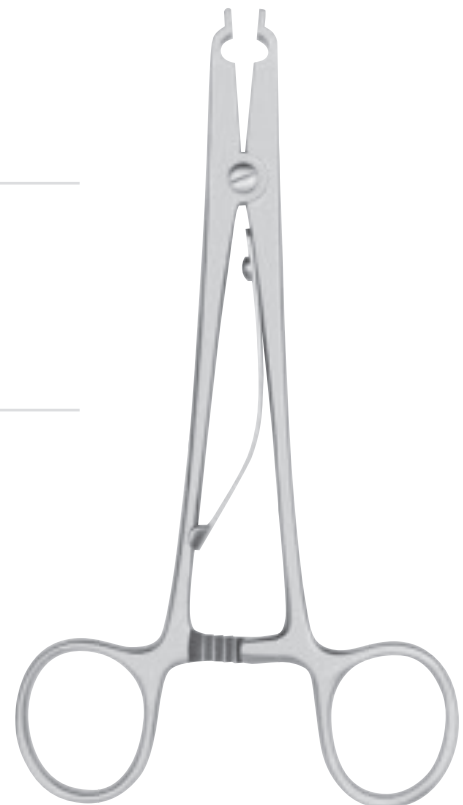

06-06-003	160 mm / 6¼" Anlege- und Abnehmezange, für Kopfhautklammern 06-06-001 <i>applying and removing forceps for scalp clips 06-06-001</i>	RANEY	
-----------	--	-------	--



2/3
RANEY
06-06-003
 160 mm
 6¼"

3



		Artikel-Nr. Cat. No.	Gesamtlänge Total length
 	1/1	YASARGIL	
		06-06-020	310 mm / 12¼"
		06-06-022	410 mm / 16"

1/2
YASARGIL
06-06-022
 410 mm
 16"

Area with horizontal lines for taking notes.

01

Mikro-Neurochirurgische Instrumente
Micro-Neurosurgical Instruments

02

HF-Instrumente und Zubehör
HF Instruments and Accessoires

03

Kopf-Schädelinstrumente und Haltesysteme
Head-Cranio Instruments and Holding Systems

Aneurysmen-Clip System
Aneurysm Clip System

05

Schädel-Verplattung
Cranial Plate System

06

Hypophysektomie-Instrumente
Pituitary Instruments

07

Instrumente für die Wirbelsäule, Wundspreizer
Spine Instruments, Self-retaining Retractors

08

Laminektomie-Stanzen, Rongeurs, Hohlmeißelzangen
Laminectomy Punches, Rongeurs

09

Gefäß- und Bulldogklemmen, Gefäß-Clips
Vessel- and Bulldog Clamps, Vessel Clips

10

Allgemeinchirurgische Instrumente
General Surgical Instruments

11

Alphabetischer Index, Numerischer Index
Alphabetical Index, Numerical Index

/// 04



SURGICAL
INSTRUMENTS
MICRO-NEURO-SPINE

REBSTOCK®
Precision made in Germany

/// Aneurysmen-Clip System
Aneurysm Clip System





VERPACKUNG – UNSTERIL
 Membrandose und Umkarton

PACKING – NON STERILE
 Membrane box and outer carton



VERPACKUNG – STERIL
 Blister und Umkarton

PACKING – STERILE
 Blister box and outer carton

Material / MR-Kompatibilität

Aneurysmen Clips werden aus TITAN gemäß ISO 5832-3 oder PHYNIX gemäß ISO 5832-7 hergestellt. Beide Implantat-Werkstoffe entsprechen höchsten Qualitätsansprüchen. Alle Aneurysmen Clips sind MRT-kompatibel bis zu einer Feldstärke von 3 Tesla.

Rückverfolgbarkeit

aufgrund individueller Seriennummer auf jedem Clip.

Garantierte Schließkraft

Computergesteuerte Druckmessung bei einem Drittel der Maullänge und 1,0 mm Öffnung.

Optimaler Verschluss

durch pyramidenförmiges atraumatisches Maulprofil.

Material / MRI-Compatibility

The aneurysm clips are made of TITANIUM according to ISO 5832-3 or PHYNIX according to ISO 5832-7. Both materials for implants meet high quality requirements. Every aneurysm clip is MRI-compatible up to a field strength of 3 Tesla.

Traceability

because of an individual serial number marked on each clip.

Guaranteed Closing Force

Computer controlled measuring of the closing force at one third of the jaw length and an opening of 1.0 mm.

Optimal Closure

because of atraumatic and pyramid formed profile of the jaw.

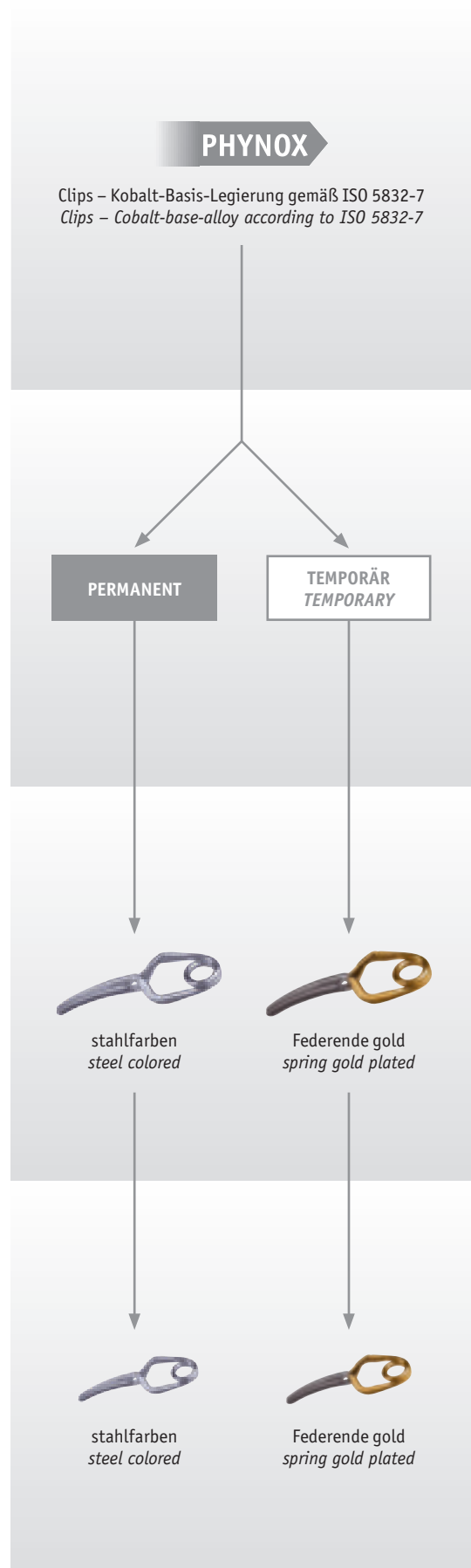
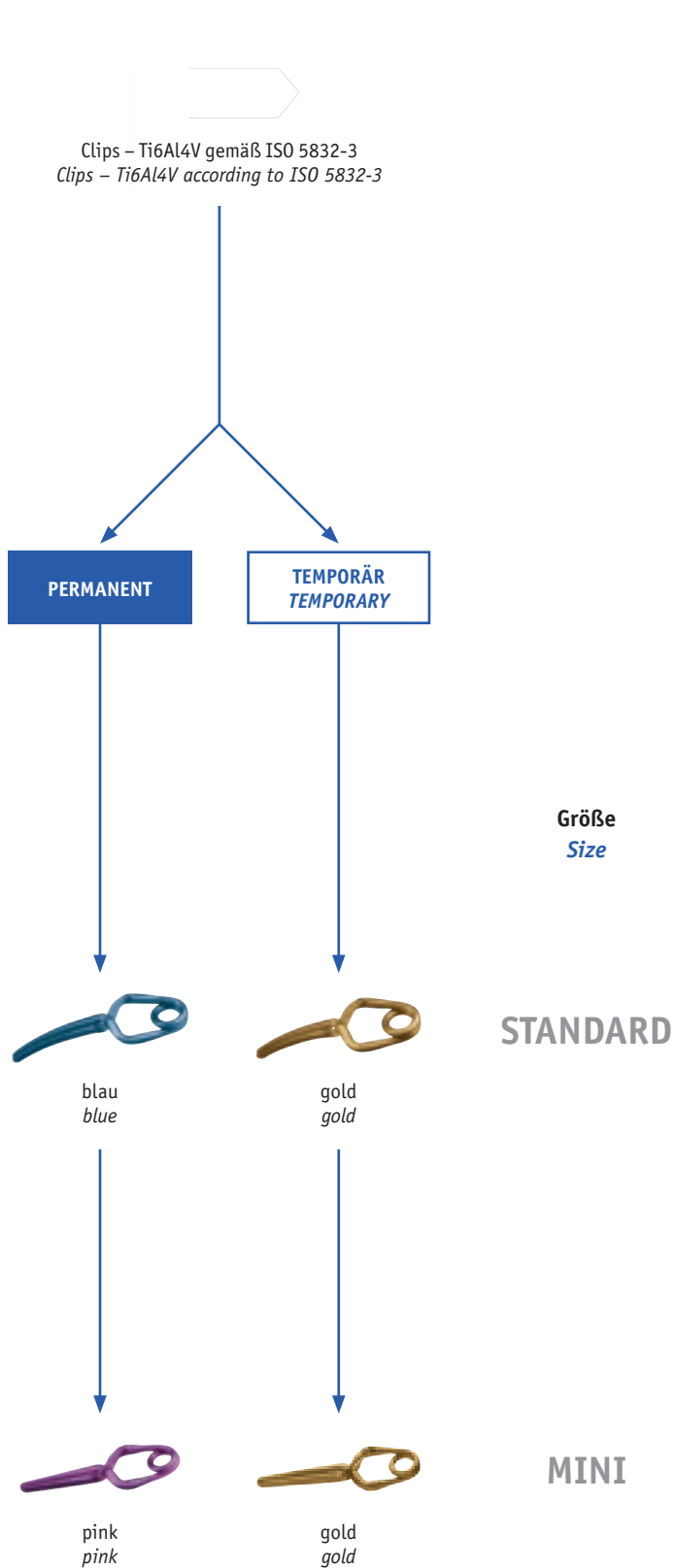

4

PERMANENT

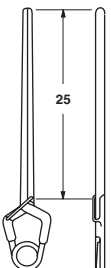
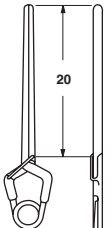
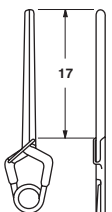
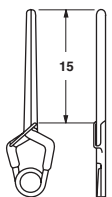
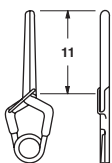
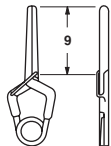
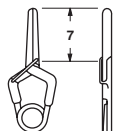

Öffnung Opening	6,2 mm	7,0 mm	7,8 mm	9,2 mm	10,6 mm	11,4 mm	13,3 mm
Druck Force	150 gms	180 gms	180 gms	200 gms	200 gms	200 gms	200 gms
	65 740T	65 750T	65 760T	65 780T	65 792T	65 790T	65 840T
STERILE	06-05-740T	06-05-750T	06-05-760T	06-05-780T	06-05-792T	06-05-790T	06-05-840T
	65 740	65 750	65 760	65 780	65 792	65 790	65 840
STERILE	06-05-740	06-05-750	06-05-760	06-05-780	06-05-792	06-05-790	06-05-840

TITAN

PHYNOX

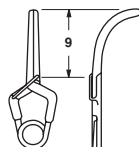
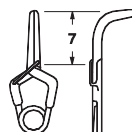
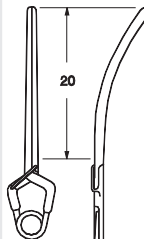
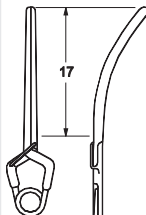
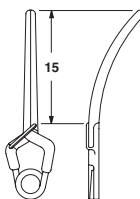
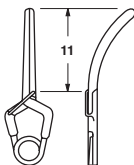
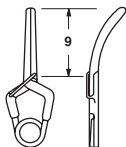
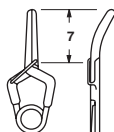

Öffnung Opening	6,0 mm	6,8 mm	7,5 mm	8,7 mm	10,0 mm	11,0 mm	5,5 mm	6,1 mm
Druck Force	150 gms	180 gms	180 gms	200 gms	180 gms	200 gms	150 gms	180 gms
	65 742T	65 752T	65 762T	65 782T	65 786T	65 895T	65 744T	65 754T
STERILE	06-05-742T	06-05-752T	06-05-762T	06-05-782T	06-05-786T	06-05-895T	06-05-744T	06-05-754T
	65 742	65 752	65 762	65 782	65 786	65 895	65 744	65 754
STERILE	06-05-742	06-05-752	06-05-762	06-05-782	06-05-786	06-05-895	06-05-744	06-05-754

TITAN

PHYNOX

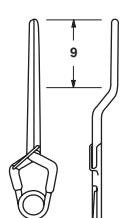
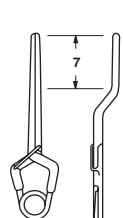
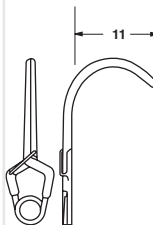
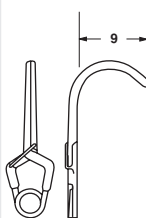
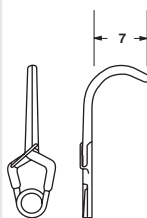
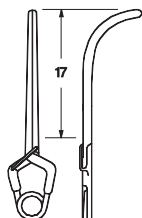
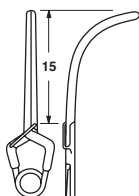
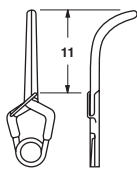

Öffnung Opening	6,5 mm	7,4 mm	9,9 mm	5,4 mm	5,8 mm	6,2 mm	7,9 mm	8,7 mm
Druck Force	180 gms	200 gms	200 gms	180 gms	180 gms	180 gms	200 gms	200 gms
	65 764T	65 784T	65 896T	65 823T	65 824T	65 825T	65 748T	65 758T
STERILE	06-05-764T	06-05-784T	06-05-896T	06-05-823T	06-05-824T	06-05-825T	06-05-748T	06-05-758T
	65 764	65 784	65 896	65 823	65 824	65 825	65 748	65 758
STERILE	06-05-764	06-05-784	06-05-896	06-05-823	06-05-824	06-05-825	06-05-748	06-05-758

TITAN

PHYNOX

TEMPORÄR
TEMPORARY

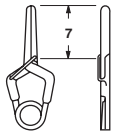

6,2 mm

110 gms

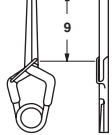

7,0 mm

90 gms

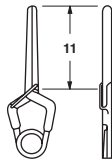

7,8 mm

90 gms

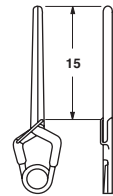

9,2 mm

90 gms

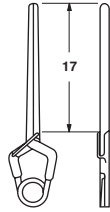

10,6 mm

90 gms

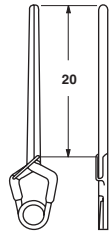

11,4 mm

110 gms

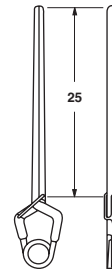

13,3 mm

110 gms

Öffnung
Opening
Druck
Force

TITAN

65 240T

65 250T

65 260T

65 280T

65 292T

65 290T

65 340 T

06-05-240T

06-05-250T

06-05-260T

06-05-280T

06-05-292T

06-05-290T

06-05-340T

STERILE

PHYNOX

65 240

65 250

65 260

65 280

65 292

65 290

65 340

06-05-240

06-05-250

06-05-260

06-05-280

06-05-292

06-05-290

06-05-340

STERILE

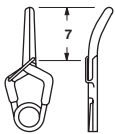

6,0 mm

110 gms

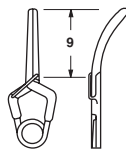

6,8 mm

90 gms

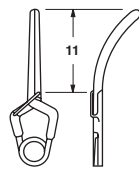

7,5 mm

90 gms

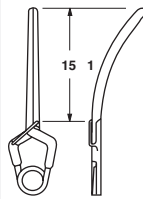

8,7 mm

110 gms

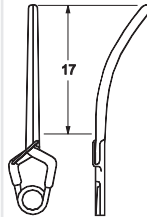

10,0 mm

110 gms

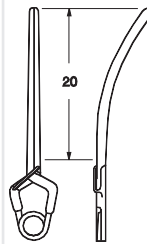

11,0 mm

90 gms

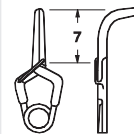

5,5 mm

110 gms

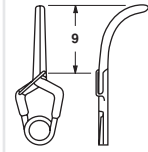

6,1 mm

110 gms

Öffnung
Opening
Druck
Force

TITAN

65 242T

65 252T

65 262T

65 282T

65 286T

65 395T

65 244T

65 254T

06-05-242T

06-05-252T

06-05-262T

06-05-282T

06-05-286T

06-05-395T

06-05-244T

06-05-254T

STERILE

PHYNOX

65 242

65 252

65 262

65 282

65 286

65 395

65 244

65 254

06-05-242

06-05-252

06-05-262

06-05-282

06-05-286

06-05-395

06-05-244

06-05-254

STERILE

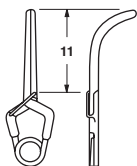

6,5 mm

110 gms

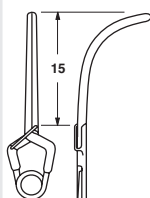

7,4 mm

110 gms

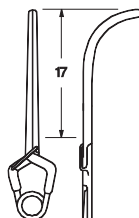

9,9 mm

90 gms

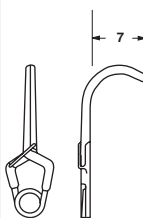

5,4 mm

110 gms

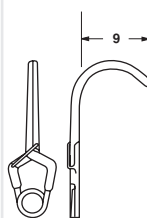

5,8 mm

110 gms

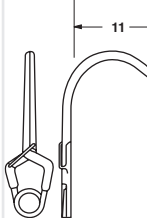

6,2 mm

110 gms

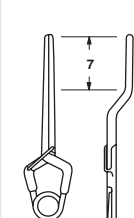

7,9 mm

90 gms

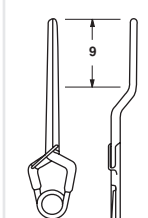

8,7 mm

90 gms

Öffnung
Opening
Druck
Force

TITAN

65 264T

65 284T

65 396T

65 323T

65 324T

65 325T

65 248T

65 258T

06-05-264T

06-05-284T

06-05-396T

06-05-323T

06-05-324T

06-05-325T

06-05-248T

06-05-258T

STERILE

PHYNOX

65 264

65 284

65 396

65 323

65 324

65 325

65 248

65 258

06-05-264

06-05-284

06-05-396

06-05-323

06-05-324

06-05-325

06-05-248

06-05-258

STERILE



PERMANENT

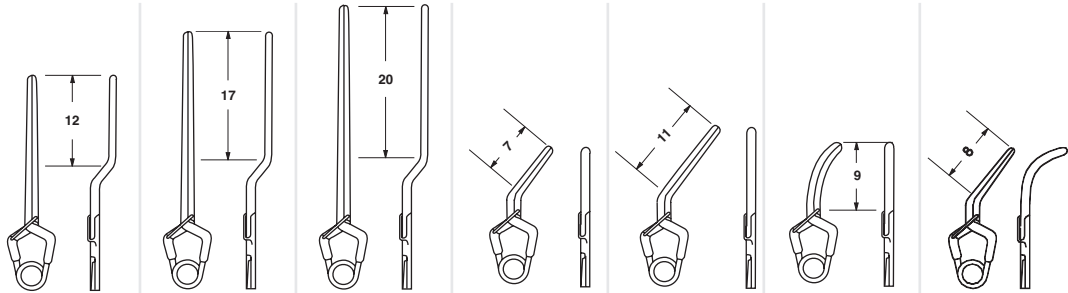

Öffnung Opening	10,2 mm	11,9 mm	13,0 mm	5,7 mm	8,0 mm	6,2 mm	6,5 mm
Druck Force	200 gms	180 gms	180 gms	200 gms	200 gms	200 gms	180 gms
	65 759T	65 797T	65 798T	65 746T	65 761T	65 747T	65 773T

STERILE	06-05-759T	06-05-797T	06-05-798T	06-05-746T	06-05-761T	06-05-747T	06-05-773T
----------------	-------------------	-------------------	-------------------	-------------------	-------------------	-------------------	-------------------

	65 759	65 797	65 798	65 746	65 761	65 747	65 773
STERILE	06-05-759	06-05-797	06-05-798	06-05-746	06-05-761	06-05-747	06-05-773

TITAN

PHYNOX

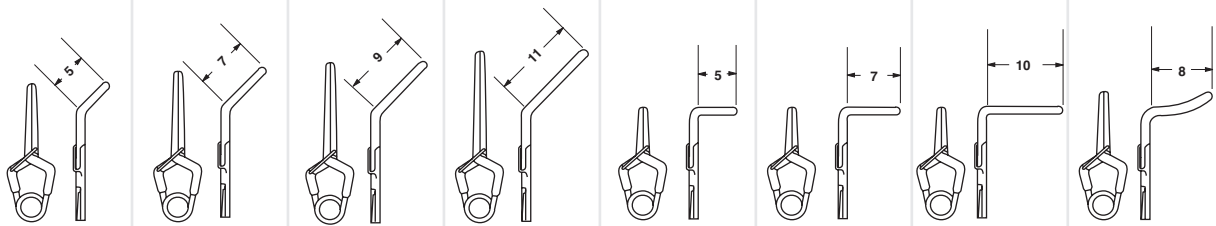

Öffnung Opening	6,2 mm	6,5 mm	7,8 mm	8,4 mm	5,6 mm	5,6 mm	5,6 mm	5,4 mm
Druck Force	200 gms	200 gms	200 gms	200 gms	200 gms	200 gms	200 gms	200 gms
	65 603T	65 613T	65 623T	65 763T	65 819T	65 820T	65 822T	65 850T

STERILE	06-05-603T	06-05-613T	06-05-623T	06-05-763T	06-05-819T	06-05-820T	06-05-822T	06-05-850T
----------------	-------------------	-------------------	-------------------	-------------------	-------------------	-------------------	-------------------	-------------------

	65 603	65 613	65 623	65 763	65 819	65 820	65 822	65 850
--	---------------	---------------	---------------	---------------	---------------	---------------	---------------	---------------

STERILE	06-05-603	06-05-613	06-05-623	06-05-763	06-05-819	06-05-820	06-05-822	06-05-850
----------------	------------------	------------------	------------------	------------------	------------------	------------------	------------------	------------------

TITAN

PHYNOX

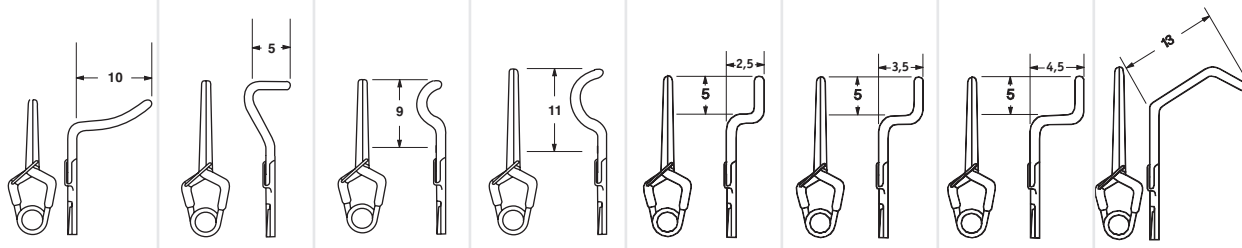

Öffnung Opening	5,6 mm	7,2 mm	7,2 mm	8,2 mm	8,0 mm	8,0 mm	8,0 mm	7,5 mm
Druck Force	200 gms	200 gms	200 gms	200 gms	200 gms	200 gms	200 gms	200 gms
	65 851T	65 830T	65 832T	65 833T	65 770T	65 771T	65 772T	65 897T

STERILE	06-05-851T	06-05-830T	06-05-832T	06-05-833T	06-05-770T	06-05-771	06-05-772T	06-05-897T
----------------	-------------------	-------------------	-------------------	-------------------	-------------------	------------------	-------------------	-------------------

	65 851	65 830	65 832	65 833	65 770	65 771	65 772	65 897
--	---------------	---------------	---------------	---------------	---------------	---------------	---------------	---------------

STERILE	06-05-851	06-05-830	06-05-832	06-05-833	06-05-770	06-05-771	06-05-772	06-05-897
----------------	------------------	------------------	------------------	------------------	------------------	------------------	------------------	------------------

TITAN

PHYNOX

TEMPORÄR
TEMPORARY

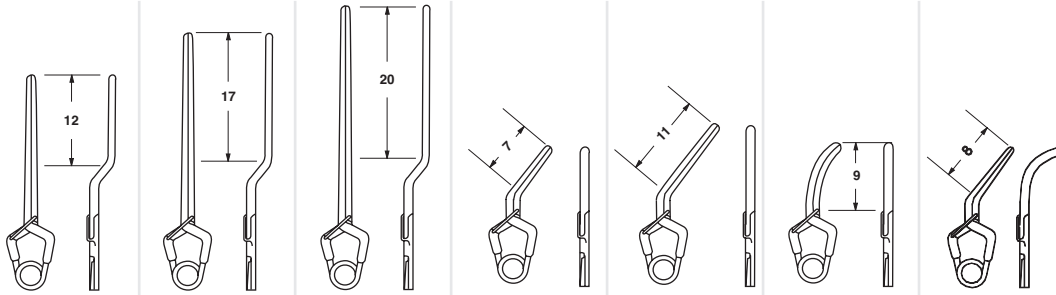

10,2 mm	11,9 mm	13,0 mm	5,7 mm	8,0 mm	6,2 mm	6,5 mm	Öffnung Opening
90 gms	90 gms	90 gms	90 gms	90 gms	90 gms	90 gms	Druck Force

TITAN

65 259T	65 297T	65 298T	65 246T	65 261T	65 247T	65 273 T	
06-05-259T	06-05-297T	06-05-298T	06-05-246T	06-05-261T	06-05-247T	06-05-273T	STERILE

PHYNOX

65 259	65 297	65 298	65 246	65 261	65 247	65 273	
06-05-259	06-05-297	06-05-298	06-05-246	06-05-261	06-05-247	06-05-273	STERILE

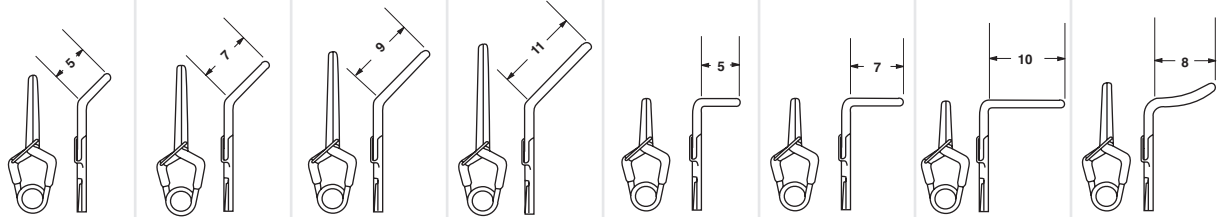

6,2 mm	6,5 mm	7,8 mm	8,4 mm	5,6 mm	5,6 mm	5,6 mm	5,4 mm	Öffnung Opening
110 gms	110 gms	110 gms	110 gms	130 gms	130 gms	110 gms	130 gms	Druck Force

TITAN

65 103T	65 113T	65 123T	65 263T	65 319T	65 320T	65 322T	65 350T	
06-05-103T	06-05-113T	06-05-123T	06-05-263T	06-05-319T	06-05-320T	06-05-322T	06-05-350T	STERILE

PHYNOX

65 103	65 113	65 123	65 263	65 319	65 320	65 322	65 350	
06-05-103	06-05-113	06-05-123	06-05-263	06-05-319	06-05-320	06-05-322	06-05-350	STERILE

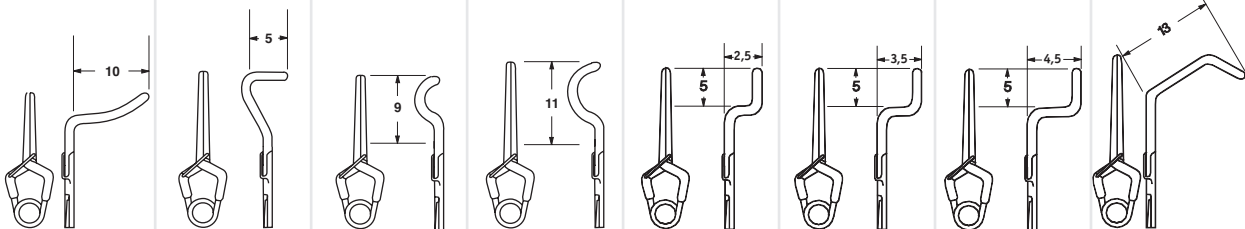

5,6 mm	7,2 mm	7,2 mm	8,2 mm	8,0 mm	8,0 mm	8,0 mm	7,5 mm	Öffnung Opening
130 gms	90 gms	90 gms	90 gms	90 gms	90 gms	90 gms	90 gms	Druck Force

TITAN

65 351T	65 330T	65 332T	65 333T	65 270T	65 271T	65 272T	65 397T	
06-05-351T	06-05-330T	06-05-332T	06-05-333T	06-05-270T	06-05-271T	06-05-272T	06-05-397T	STERILE

PHYNOX

65 351	65 330	65 332	65 333	65 270	65 271	65 272	65 397	
06-05-351	06-05-330	06-05-332	06-05-333	06-05-270	06-05-271	06-05-272	06-05-397	STERILE



PERMANENT

Öffnung Opening	7,4 mm	7,4 mm	7,4 mm	7,4 mm	8,4 mm	9,6 mm
Druck Force	150 gms	150 gms	150 gms	150 gms	150 gms	180 gms
	65 597T	65 598T	65 599T	65 600T	65 610T	65 620T
STERILE	06-05-597T	06-05-598T	06-05-599T	06-05-600T	06-05-610T	06-05-620T
	65 597	65 598	65 599	65 600	65 610	65 620
STERILE	06-05-597	06-05-598	06-05-599	06-05-600	06-05-610	06-05-620

TITAN

PHYNOX

Öffnung Opening	5,8 mm	6,5 mm	7,2 mm	4,9 mm	4,9 mm	4,9 mm
Druck Force	150 gms	150 gms	180 gms	150 gms	150 gms	180 gms
	65 602T	65 612T	65 622T	65 604T	65 614T	65 624T
STERILE	06-05-602T	06-05-612T	06-05-622T	06-05-604T	06-05-614T	06-05-624T
	65 602	65 612	65 622	65 604	65 614	65 624
STERILE	06-05-602	06-05-612	06-05-622	06-05-604	06-05-614	06-05-624

TITAN

PHYNOX

TEMPORÄR
 TEMPORARY

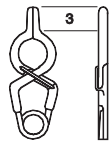

7,4 mm

110 gms

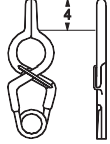

7,4 mm

110 gms

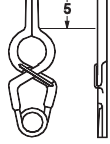

7,4 mm

110 gms

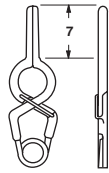

7,4 mm

110 gms

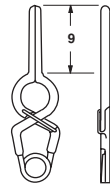

8,4 mm

110 gms

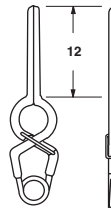

9,0 mm

90 gms

Öffnung
 Opening
 Druck
 Force

TITAN

65 097T

65 098T

65 099T

65 100T

65 110T

65 120T

STERILE

06-05-097T

06-05-098T

06-05-099T

06-05-100T

06-05-110T

06-05-120T

PHYNOX

65 097

65 098

65 099

65 100

65 110

65 120

STERILE

06-05-097

06-05-098

06-05-099

06-05-100

06-05-110

06-05-120

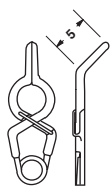

5,8 mm

110 gms

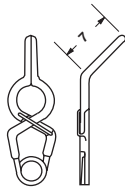

6,5 mm

110 gms

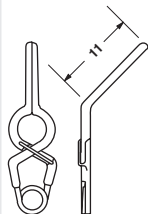

7,2 mm

110 gms

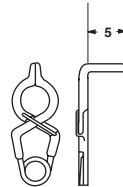

4,9 mm

110 gms

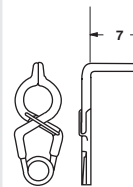

4,9 mm

110 gms

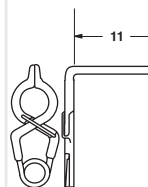

4,9 mm

110 gms

Öffnung
 Opening
 Druck
 Force

TITAN

65 102T

65 112T

65 122T

65 104T

65 114T

65 124T

STERILE

06-05-102T

06-05-112T

06-05-122T

06-05-104T

06-05-114T

06-05-124T

PHYNOX

65 102

65 112

65 122

65 104

65 114

65 124

STERILE

06-05-102

06-05-112

06-05-122

06-05-104

06-05-114

06-05-124



PERMANENT

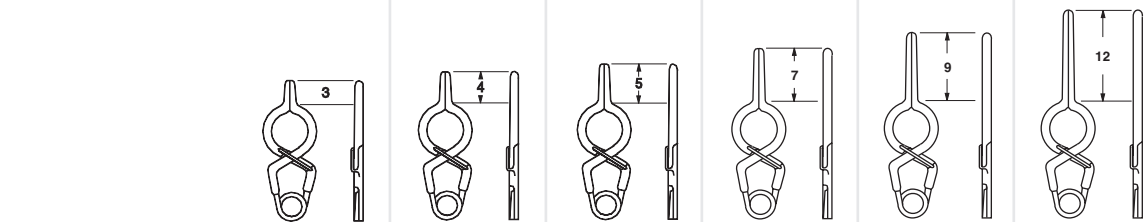

Öffnung Opening	7,4 mm	7,4 mm	7,4 mm	7,9 mm	9,1 mm	10,3 mm
Druck Force	150 gms	150 gms	150 gms	150 gms	150 gms	180 gms

	65 637T	65 638T	65 639T	65 640T	65 650T	65 660T
STERILE	06-05-637T	06-05-638T	06-05-639T	06-05-640T	06-05-650T	06-05-660T
	65 637	65 638	65 639	65 640	65 650	65 660
STERILE	06-05-637	06-05-638	06-05-639	06-05-640	06-05-650	06-05-660

TITAN

PHYNOX

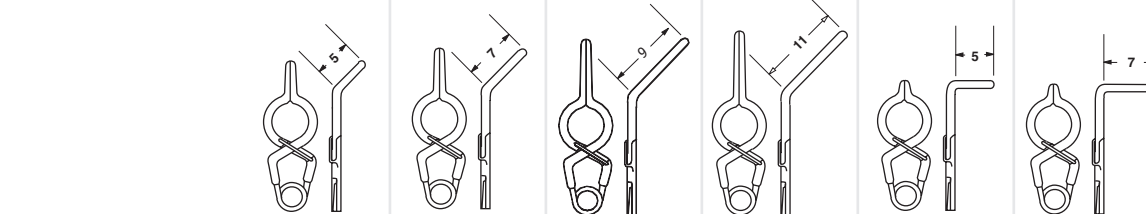

Öffnung Opening	6,5 mm	7,2 mm	7,5 mm	7,8 mm	5,5 mm	5,5 mm
Druck Force	150 gms	150 gms	150 gms	180 gms	150 gms	150 gms

	65 642T	65 652T	65 853T	65 662T	65 644T	65 654T
STERILE	06-05-642T	06-05-652T	06-05-853T	06-05-662T	06-05-644T	06-05-654T
	65 642	65 652	65 853	65 662	65 644	65 654
STERILE	06-05-642	06-05-652	06-05-853	06-05-662	06-05-644	06-05-654

TITAN

PHYNOX

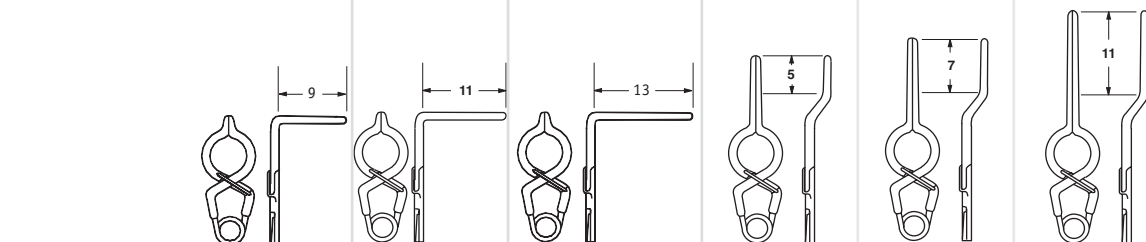

Öffnung Opening	5,5 mm	5,5 mm	5,5 mm	7,9 mm	8,8 mm	10,0 mm
Druck Force	150 gms	180 gms	150 gms	150 gms	150 gms	180 gms

	65 855T	65 664T	65 856T	65 648T	65 658T	65 668T
STERILE	06-05-855T	06-05-664T	06-05-856T	06-05-648T	06-05-658T	06-05-668T
	65 855	65 664	65 856	65 648	65 658	65 668
STERILE	06-05-855	06-05-664	06-05-856	06-05-648	06-05-658	06-05-668

TITAN

PHYNOX

TEMPORÄR
 TEMPORARY

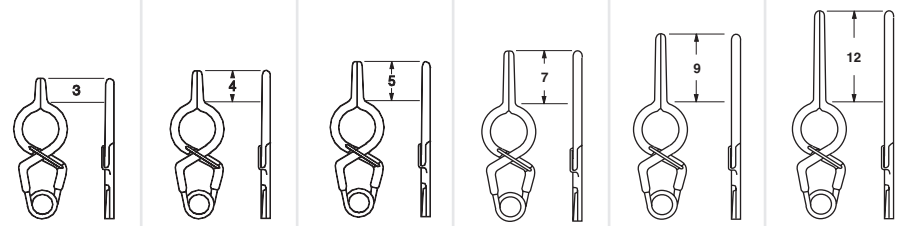

7,4 mm	7,4 mm	7,4 mm	7,9 mm	9,1 mm	10,3 mm
110 gms	110 gms	110 gms	110 gms	100 gms	90 gms

Öffnung
 Opening
 Druck
 Force

TITAN	65 137T	65 138T	65 139T	65 140T	65 150T	65 160T	STERILE
	06-05-137T	06-05-138T	06-05-139T	06-05-140T	06-05-150T	06-05-160T	
PHYNOX	65 137	65 138	65 139	65 140	65 150	65 160	STERILE
	06-05-137	06-05-138	06-05-139	06-05-140	06-05-150	06-05-160	

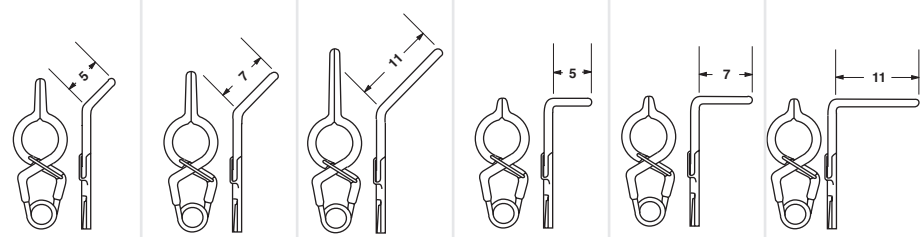

6,5 mm	7,2 mm	7,8 mm	5,5 mm	5,5 mm	5,5 mm
110 gms	110 gms	110 gms	110 gms	110 gms	90 gms

Öffnung
 Opening
 Druck
 Force

TITAN	65 142T	65 152T	65 162T	65 144T	65 154T	65 164T	STERILE
	06-05-142T	06-05-152T	06-05-162T	06-05-144T	06-05-154T	06-05-164T	
PHYNOX	65 142	65 152	65 162	65 144	65 154	65 164	STERILE
	06-05-142	06-05-152	06-05-162	06-05-144	06-05-154	06-05-164	

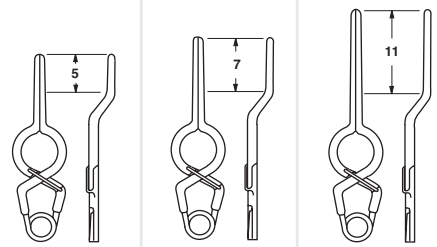

7,9 mm	8,8 mm	10,0 mm
90 gms	90 gms	90 gms

Öffnung
 Opening
 Druck
 Force

TITAN	65 148T	65 158T	65 168T	STERILE
	06-05-148T	06-05-158T	06-05-168T	
PHYNOX	65 148	65 158	65 168	STERILE
	06-05-148	06-05-158	06-05-168	



PERMANENT

Öffnung Opening	5,8 mm	5,8 mm	5,8 mm	5,8 mm	5,8 mm	5,8 mm
Druck Force	150 gms	150 gms	150 gms	150 gms	150 gms	150 gms
	65 774T	65 775T	65 776T	65 777T	65 778T	65 779T
STERILE	06-05-774T	06-05-775T	06-05-776T	06-05-777T	06-05-778T	06-05-779T
	65 774	65 775	65 776	65 777	65 778	65 779
STERILE	06-05-774	06-05-775	06-05-776	06-05-777	06-05-778	06-05-779

TITAN

PHYNOX

Öffnung Opening	7,0 mm	7,8 mm	8,8 mm	5,8 mm	6,2 mm	5,8 mm	6,2 mm
Druck Force	150 gms	150 gms	150 gms	150 gms	150 gms	150 gms	150 gms
	65 881T	65 882T	65 883T	65 886T	65 887T	65 888T	65 889T
STERILE	06-05-881T	06-05-882T	06-05-883T	06-05-886T	06-05-887T	06-05-888T	06-05-889T
	65 881	65 882	65 883	65 886	65 887	65 888	65 889
STERILE	06-05-881	06-05-882	06-05-883	06-05-886	06-05-887	06-05-888	06-05-889

TITAN

PHYNOX

Öffnung Opening	5,6 mm	5,6 mm	5,6 mm	5,6 mm
Druck Force	150 gms	150 gms	150 gms	150 gms
	65 891T	65 892T	65 893T	65 894T
STERILE	06-05-891T	06-05-892T	06-05-893T	06-05-894T
	65 891	65 892	65 893	65 894
STERILE	06-05-891	06-05-892	06-05-893	06-05-894

TITAN

PHYNOX

4

TEMPORÄR
 TEMPORARY

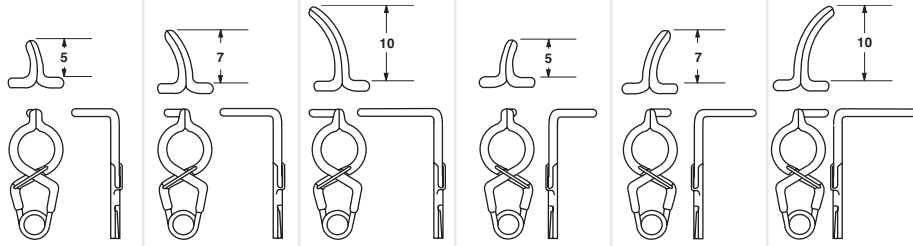

5,8 mm 5,8 mm 5,8 mm 5,8 mm 5,8 mm 5,8 mm
 110 gms 110 gms 110 gms 110 gms 110 gms 110 gms

Öffnung
 Opening
 Druck
 Force

TITAN

65 274T 65 275T 65 276T 65 277T 65 278T 65 279T

06-05-274T 06-05-275T 06-05-276T 06-05-277T 06-05-278T 06-05-279T

STERILE

PHYNOX

65 274 65 275 65 276 65 277 65 278 65 279

06-05-274 06-05-275 06-05-276 06-05-277 06-05-278 06-05-279

STERILE

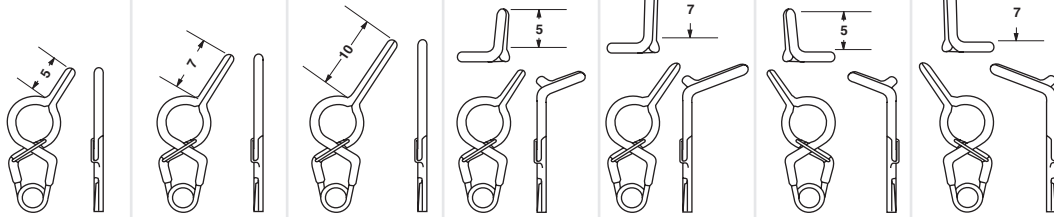

7,0 mm 7,8 mm 8,8 mm 5,8 mm 6,2 mm 5,8 mm 6,2 mm
 110 gms 110 gms 110 gms 110 gms 110 gms 110 gms 110 gms

Öffnung
 Opening
 Druck
 Force

TITAN

65 381T 65 382T 65 383T 65 386T 65 387T 65 388T 65 389T

06-05-381T 06-05-382T 06-05-383T 06-05-386T 06-05-387T 06-05-388T 06-05-389T

STERILE

PHYNOX

65 381 65 382 65 383 65 386 65 387 65 388 65 389

06-05-381 06-05-382 06-05-383 06-05-386 06-05-387 06-05-388 06-05-389

STERILE

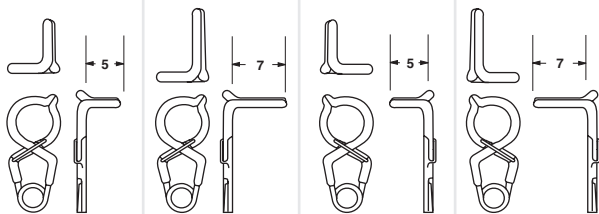

5,6 mm 5,6 mm 5,6 mm 5,6 mm
 110 gms 110 gms 110 gms 110 gms

Öffnung
 Opening
 Druck
 Force

TITAN

65 391T 65 392T 65 393T 65 394T

06-05-391T 06-05-392T 06-05-393T 06-05-394T

STERILE

PHYNOX

65 391 65 392 65 393 65 394

06-05-391 06-05-392 06-05-393 06-05-394

STERILE



PERMANENT

Öffnung Opening	3,3 mm	4,0 mm	3,3 mm	4,0 mm	4,6 mm	3,2 mm	3,8 mm
Druck Force	110 gms	110 gms	110 gms	110 gms	110 gms	110 gms	110 gms
	65 680T	65 690T	65 700T	65 710T	65 720T	65 682T	65 692T
STERILE	06-05-680T	06-05-690T	06-05-700T	06-05-710T	06-05-720T	06-05-682T	06-05-692T
	65 680	65 690	65 700	65 710	65 720	65 682	65 692
STERILE	06-05-680	06-05-690	06-05-700	06-05-710	06-05-720	06-05-682	06-05-692

TITAN

PHYNOX

Öffnung Opening	3,6 mm	3,8 mm	3,6 mm	4,0 mm	4,4 mm	3,6 mm	3,5 mm
Druck Force	110 gms	110 gms	110 gms	110 gms	110 gms	110 gms	110 gms
	65 711T	65 712T	65 713T	65 726T	65 722T	65 694T	65 714T
STERILE	06-05-711T	06-05-712T	06-05-713T	06-05-726T	06-05-722T	06-05-694T	06-05-714T
	65 711	65 712	65 713	65 726	65 722	65 694	65 714
STERILE	06-05-711	06-05-712	06-05-713	06-05-726	06-05-722	06-05-694	06-05-714

TITAN

PHYNOX

Öffnung Opening	4,0 mm	3,5 mm	6,0 mm	7,0 mm	5,7 mm	4,5 mm	4,0 mm
Druck Force	110 gms	130 gms	130 gms	130 gms	130 gms	130 gms	130 gms
	65 724T	65 716T	65 717T	65 727T	65 728T	65 806T	65 807T
STERILE	06-05-724T	06-05-716T	06-05-717T	06-05-727T	06-05-728T	06-05-806T	06-05-807T
	65 724	65 716	65 717	65 727	65 728	65 806	65 807
STERILE	06-06-724	06-05-716	06-05-717	06-05-727	06-05-728	06-05-806	06-05-807

TITAN

PHYNOX

TEMPORÄR
TEMPORARY

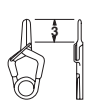

3,3 mm
90 gms

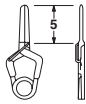

4,0 mm
70 gms

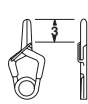

3,3 mm
90 gms

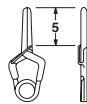

4,0 mm
70 gms

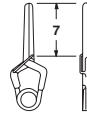

4,6 mm
70 gms

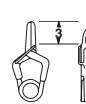

3,2 mm
90 gms

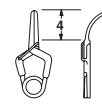

3,8 mm
70 gms

Öffnung
Opening
Druck
Force

TITAN

65 180T

65 190T

65 200T

65 210T

65 220T

65 182T

65 192T

06-05-180T

06-05-190T

06-05-200T

06-05-210T

06-05-220T

06-05-182T

06-05-192T

STERILE

PHYNOX

65 180

65 190

65 200

65 210

65 220

65 182

65 192

06-05-180

06-05-190

06-05-200

06-05-210

06-05-220

06-05-182

06-05-192

STERILE

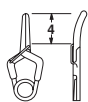

3,6 mm
80 gms

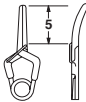

3,8 mm
70 gms

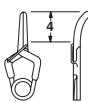

3,6 mm
80 gms

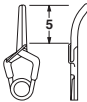

4,0 mm
70 gms

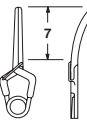

4,4 mm
70 gms

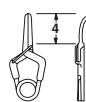

3,6 mm
80 gms

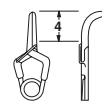

3,5 mm
80 gms

Öffnung
Opening
Druck
Force

TITAN

65 211T

65 212T

65 213T

65 226T

65 222T

65 194T

65 214T

06-05-211T

06-05-212T

06-05-213T

06-05-226T

06-05-222T

06-05-194T

06-05-214T

STERILE

PHYNOX

65 211

65 212

65 213

65 226

65 222

65 194

65 214

06-05-211

06-05-212

06-05-213

06-05-226

06-05-222

06-05-194

06-05-214

STERILE

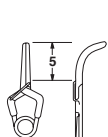

4,0 mm
70 gms

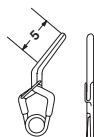

3,5 mm
70 gms

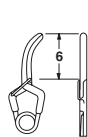

6,0 mm
70 gms

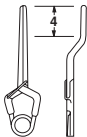

7,0 mm
70 gms

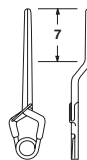

5,7 mm
70 gms

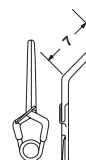

4,5 mm
70 gms

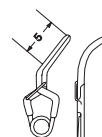

4,0 mm
70 gms

Öffnung
Opening
Druck
Force

TITAN

65 224T

65 216T

65 217T

65 227T

65 228T

65 306T

65 307T

06-05-224T

06-05-216T

06-05-217T

06-05-227T

06-05-228T

06-05-306T

06-05-307T

STERILE

PHYNOX

65 224

65 216

65 217

65 227

65 228

65 306

65 307

06-05-224

06-05-216

06-05-217

06-05-227

06-05-228

06-05-306

06-05-307

STERILE



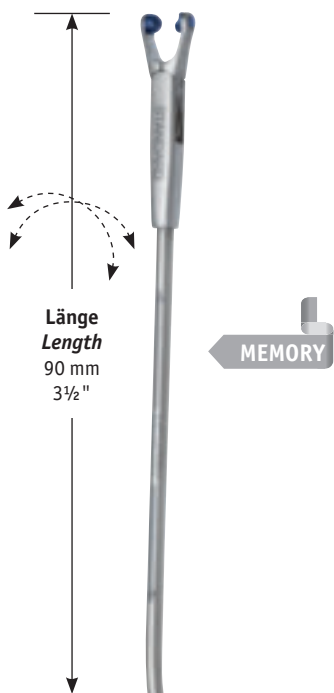

Memory Anlegezangen für STANDARD Clips

Der Memory Schaft kann flexibel gebogen werden.
Bei der Sterilisation nimmt er seine ursprüngliche Form ein.

Memory Applying Forceps for STANDARD Clips

The memory shaft is flexible and can be bent.
The memory shaft turns back to its initial shape during sterilisation.

4

Länge
Length
90 mm
3 1/2"

MEMORY

für/for
PHYNOX-Clips

für/for
TITAN-Clips

Artikel-Nr.
Cat. No.

Artikel-Nr.
Cat. No.

Arbeitslänge
Working length

	MEMORY STANDARD	06-55-552	06-55-555T	70 mm / 2 3/4"
		06-55-553	06-55-556T	90 mm / 3 1/2"
		06-55-554	06-55-557T	110 mm / 4 1/3"
				Maul drehbar, MEMORY Schaft flexibel biegsam, mit Spülanschluss <i>jaw rotatable, MEMORY shaft flexible, with irrigation adapter</i>

für/for
PHYNOX-Clips

für/for
TITAN-Clips

Artikel-Nr.
Cat. No.

Artikel-Nr.
Cat. No.

Arbeitslänge
Working length

		06-20-402	06-20-402T	Einstellschlüssel zum Positionieren der drehbaren Maulbacken <i>adjusting key for positioning of the rotatable jaws</i>
Anwendungsbeispiel example for use		06-20-900	06-20-900T	Clip zur Verstärkung des Schließdrucks bei STANDARD Aneurysmen Clips <i>The booster clip increases the closing force of STANDARD aneurysm clips</i>

1/1
06-55-556T
90 mm
3 1/2"

Memory Anlegezangen für MINI Clips

Der Memory Schaft kann flexibel gebogen werden.
 Bei der Sterilisation nimmt er seine ursprüngliche Form ein.

Memory Applying Forceps for MINI Clips

The memory shaft is flexible and can be bent.
The memory shaft turns back to it's initial shape during sterilisation.

für/for
PHYNOX-Clips

für/for
TITAN-Clips

Artikel-Nr. Cat. No.	Artikel-Nr. Cat. No.	Arbeitslänge Working length
06-55-558	06-55-561T	70 mm / 2¾"
06-55-559	06-55-562T	90 mm / 3½"
06-55-560	06-55-563T	110 mm / 4⅓"

Maul drehbar,
 MEMORY Schaft
 flexibel biegsam,
 mit Spülanschluss

*jaw rotatable,
 MEMORY shaft flexible,
 with irrigation adapter*

MEMORY
 MINI



1/1
06-55-562T
 90 mm
 3½"

Anlegezangen für STANDARD Clips
 Applying Forceps for STANDARD Clips

 für/for
 TITAN-Clips

 Artikel-Nr.
 Cat. No.

 Gesamtlänge
 Total length

	STANDARD	Artikel-Nr. Cat. No.	Gesamtlänge Total length
		06-05-412T	210 mm / 8¼"
		06-55-514T	230 mm / 9"
			Maul drehbar und abwinkelbar <i>jaw rotatable and adjustable</i>

 1/1
 06-05-412T
 210 mm
 8¼"

Anlegezangen für MINI Clips
Applying Forceps for MINI Clips

für/for
TITAN-Clips



Artikel-Nr. Cat. No.	Gesamtlänge Total length		
06-05-402T	210 mm / 8¼"	MINI	
06-55-504T	230 mm / 9"		

Maul drehbar
und abwinkelbar
*jaw rotatable
and adjustable*



4

1/1
06-05-402T
210 mm
8¼"

Anlegezangen für STANDARD Clips
 Applying Forceps for STANDARD Clips

 für/for
 TITAN-Clips

		Artikel-Nr. Cat. No.	Gesamtlänge Total length
	STANDARD	06-20-480T	190 mm / 7½"
		06-20-482T	210 mm / 8¼"
		06-20-484T	230 mm / 9"
Maul starr, gerade <i>jaw fixed, straight</i>			
	STANDARD	06-20-485T	210 mm / 8¼"
		06-20-487T	230 mm / 9"
Maul starr, 15° aufwärts gewinkelt <i>jaw fixed, 15° upward angled</i>			
	STANDARD	06-55-528T	210 mm / 8¼"
		06-55-529T	230 mm / 9"
Maul drehbar <i>jaw rotatable</i>			

 1/1
 06-55-528T
 210 mm
 8¼"

Anlegezangen für MINI Clips
Applying Forceps for MINI Clips

für/for
TITAN-Clips



Artikel-Nr. Cat. No.	Gesamtlänge Total length	MINI	
06-20-470T	190 mm / 7½"	MINI	
06-20-472T	210 mm / 8¼"		
06-20-474T	230 mm / 9"		
	Maul starr, gerade <i>jaw fixed, straight</i>		
06-20-475T	210 mm / 8¼"	MINI	
06-20-477T	230 mm / 9"		
	Maul starr, 15° aufwärts gewinkelt <i>jaw fixed, 15° upward angled</i>		
06-55-522T	210 mm / 8¼"	MINI	
06-55-524T	230 mm / 9"		
	Maul drehbar <i>jaw rotatable</i>		



4

1/1
06-55-522T
 210 mm
 8¼"

Anlegezangen für STANDARD Clips
Applying Forceps for STANDARD Clips

 für/for
 PHYNOX-Clips

		Artikel-Nr. Cat. No.	Gesamtlänge Total length
	STANDARD	06-05-580	170 mm / 6¾"
		06-05-582	210 mm / 8¼"
		06-05-584	230 mm / 9"
Maul starr, gerade <i>jaw fixed, straight</i>			
	STANDARD	06-05-585	210 mm / 8¼"
		06-05-587	230 mm / 9"
Maul starr, 15° aufwärts gewinkelt <i>jaw fixed, 15° upward angled</i>			
	STANDARD	06-05-512	210 mm / 8¼"
		06-55-513	230 mm / 9"
Maul drehbar und abwinkelbar <i>jaw rotatable and adjustable</i>			

 1/1
06-05-582
 210 mm
 8¼"

Anlegezangen für MINI Clips
 Applying Forceps for MINI Clips

für/for
 PHYNOX-Clips



Artikel-Nr. Cat. No.	Gesamtlänge Total length	MINI	
06-05-570	170 mm / 6¾"	MINI	
06-05-572	210 mm / 8¼"		
06-05-574	230 mm / 9"		
	Maul starr, gerade jaw fixed, straight		
06-05-575	210 mm / 8¼"	MINI	
06-05-577	230 mm / 9"		
	Maul starr, 15° aufwärts gewinkelt jaw fixed, 15° upward angled		
06-05-502	210 mm / 8¼"	MINI	
06-55-503	230 mm / 9"		
	Maul drehbar und abwinkelbar jaw rotatable and adjustable		



4

1/1
 06-05-572
 210 mm
 8¼"

Ringgriff Anlegezangen für STANDARD Clips
 Ring Handle Applying Forceps for STANDARD Clips
für/for
PHYNOX-Clipsfür/for
TITAN-ClipsArtikel-Nr.
Cat. No.Artikel-Nr.
Cat. No.Schaftlänge
Length of shaft

	STANDARD	06-55-590	06-55-590T	160 mm / 6 1/4"
		06-05-530	06-05-530T	180 mm / 7"
Maul starr, Schaft 360° drehbar, mit Spülanschluss <i>jaw fixed, shaft 360° rotatable with irrigation adapter</i>				
	STANDARD	06-55-591	06-55-591T	160 mm / 6 1/4"
		06-55-592	06-55-592T	180 mm / 7"
Maul drehbar, Schaft 360° drehbar, mit Spülanschluss <i>jaw rotatable, shaft 360° rotatable with irrigation adapter</i>				

Ringgriff Anlegezangen für MINI Clips
Ring Handle Applying Forceps for MINI Clips

für/for
PHYNOX-Clips

für/for
TITAN-Clips

Artikel-Nr. Cat. No.	Artikel-Nr. Cat. No.	Schaftlänge Length of shaft		
06-55-594	06-55-594T	160 mm / 6¼"	MINI	
06-05-520	06-05-520T	180 mm / 7"		
		Maul starr, Schaft 360° drehbar, mit Spülanschluss <i>jaw fixed, shaft 360° rotatable with irrigation adapter</i>		
06-55-595	06-55-595T	160 mm / 6¼"	MINI	
06-55-596	06-55-596T	180 mm / 7"		
		Maul drehbar, Schaft 360° drehbar, mit Spülanschluss <i>jaw rotatable, shaft 360° rotatable with irrigation adapter</i>		



1/1
06-55-595T
 160 mm
 6¼"

Anlegezange für STANDARD Clips, gerade
Applying Forceps for STANDARD Clips, straight

 für/for
 PHYNOX-Clips

Artikel-Nr.
Cat. No.
Gesamtlänge
Total length

	STANDARD	06-05-558	180 mm / 7"
			Maul starr jaw fixed

 1/1
06-05-558
 180 mm
 7"

Anlegezange für MINI Clips, gerade
Applying Forceps for MINI Clips, straight

für/for
PHYNOX-Clips



Artikel-Nr. Cat. No.	Gesamtlänge Total length		
06-05-548	180 mm / 7" Maul starr jaw fixed	MINI	



4

1/1
06-05-548
180 mm
7"

Entnahmezangen für STANDARD Clips
 Removers for STANDARD Clips

4

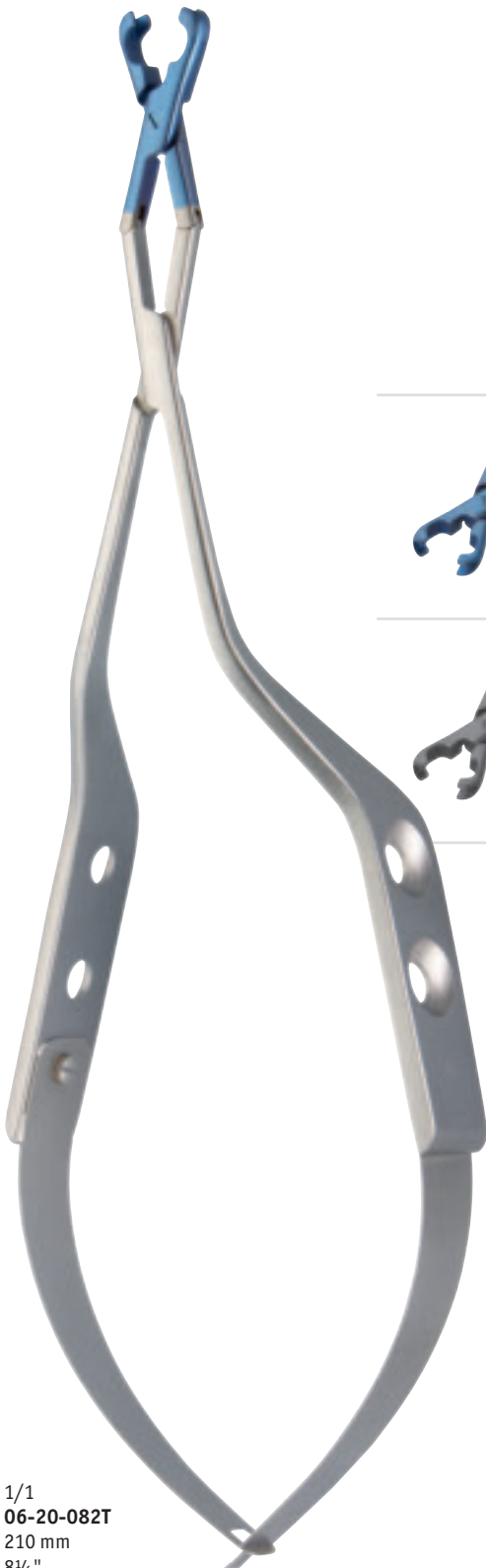
für/for
PHYNOX-Clipsfür/for
TITAN-ClipsArtikel-Nr.
Cat. No.Artikel-Nr.
Cat. No.Gesamtlänge
Total length

	STANDARD		06-20-082T	210 mm / 8¼"
				Maul starr, gerade jaw fixed, straight
	STANDARD	06-20-082		210 mm / 8¼"
				Maul starr, gerade jaw fixed, straight

 1/1
 06-20-082T
 210 mm
 8¼"



Entnahmezangen für MINI Clips
Removers for MINI Clips

für/for
 PHYNOX-Clips



für/for
 TITAN-Clips



Artikel-Nr. Cat. No.	Artikel-Nr. Cat. No.	Gesamtlänge Total length		
	06-20-072T	210 mm / 8¼"	MINI	
06-20-072		210 mm / 8¼"	MINI	



4

1/1
06-20-072T
 210 mm
 8¼"

Artikel-Nr.
Cat. No.

06-20-002

Maße
Measurements

528 x 254 x 40 mm

Clip Lagerungstray aus PPSU mit 58 Fächern zur Aufnahme von Aneurysmen-Clips, sterilisierbar

storage tray for 58 aneurysm clips, made of PPSU, for sterilisation

Artikel-Nr.
Cat. No.

06-20-022

Maße
Measurements

528 x 254 x 40 mm

Clip Lagerungstray aus PPSU mit 23 Fächern zur Aufnahme von Aneurysmen-Clips und Anlegezangen, sterilisierbar

storage tray for 23 aneurysm clips and applying forceps, made of PPSU, for sterilisation

Kennzeichnung
Identification

Die Kennzeichnungsschilder für die Clip Lagerungstrays 06-20-002 und 06-20-022 ermöglichen eine einfache Identifikation und erleichtern das Einsortieren der Aneurysmen Clips.

Die Schilder für permanente STANDARD Clips sind **blau**, für permanente MINI Clips **pink** codiert. Für temporäre Clips sind die Schilder **gelb** codiert.

Identification tags for clip storage trays 06-20-002 and 06-20-022 allow a simple identification and help by sorting the aneurysm clips into the tray.

*The tags for permanent STANDARD clips are **blue** and for permanent MINI clips **pink** coded. The tags for temporary clips are **yellow** coded.*

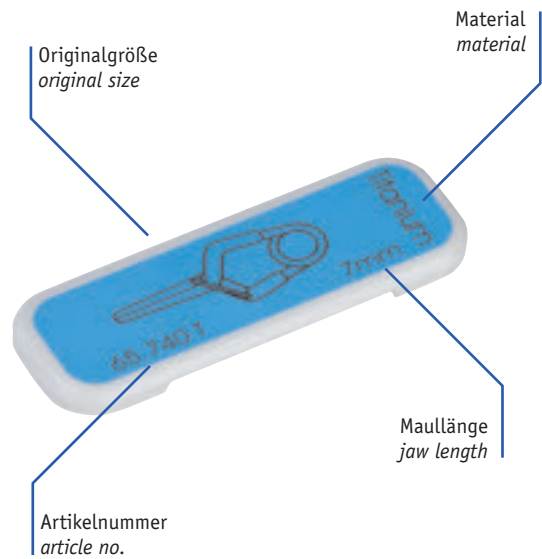

Artikel-Nr.
Cat. No.

65 000	Kennzeichnungsschild für Clip Lagerungstray 06-20-002 und 06-20-022 <i>identification tag for clips storage trays 06-20-002 and 06-20-022</i>
---------------	--

Bei Bestellung von Kennzeichnungsschildern bitte zusätzlich die Artikelnummer des Clips angeben.

When placing the order for identification tag, please add the article number of the clip.

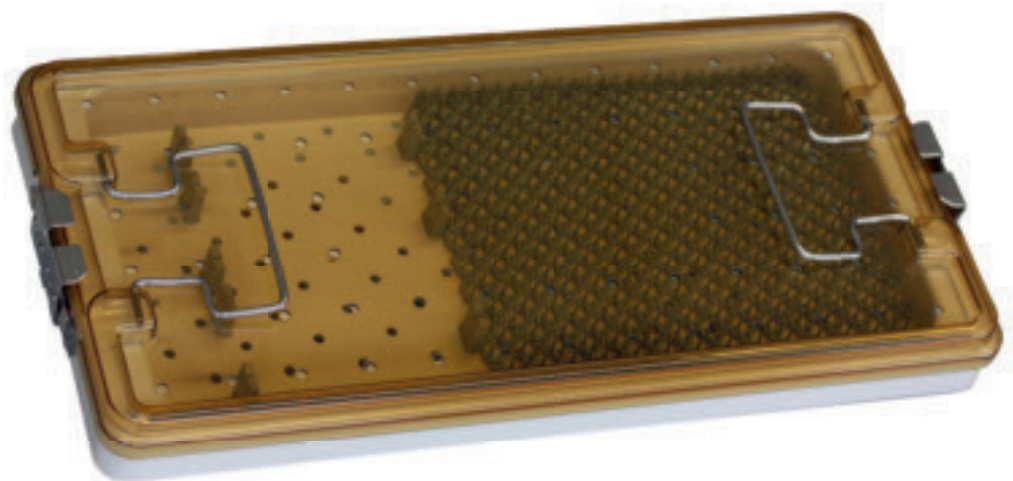

Artikel-Nr.
Cat. No.

Maße
Measurements

06-20-007	528 x 254 x 40 mm Lagerungstray aus PPSU für Clipanlagezangen und Instrumente, sterilisierbar <i>storage tray for clip applicators and instruments, made of PPSU, for sterilisation</i>
------------------	---

Artikel-Nr.
Cat. No.

06-55-010

Maße
Measurements

150 x 95 x 13 mm

Lagerungstray aus Edelstahl mit 18 Unterteilungen zur Aufnahme von Aneurysmen-Clips

storage tray made of stainless steel, with space for 18 aneurysm clips

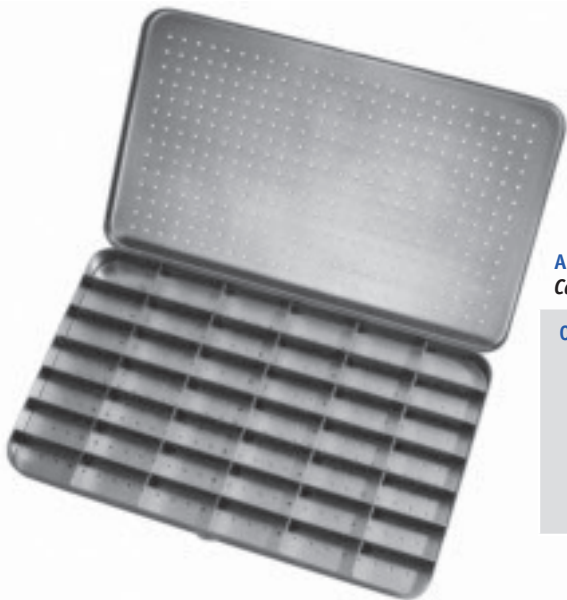
Artikel-Nr.
Cat. No.

06-55-011

Maße
Measurements

210 x 125 x 17 mm

Lagerungstray aus Edelstahl mit 42 Unterteilungen zur Aufnahme von Aneurysmen-Clips

storage tray made of stainless steel, with space for 42 aneurysm clips

Area with horizontal lines for notes.





Mikro-Neurochirurgische Instrumente
Micro-Neurosurgical Instruments

HF-Instrumente und Zubehör
HF Instruments and Accessoires

Kopf-Schädelinstrumente und Haltesysteme
Head-Cranio Instruments and Holding Systems

Aneurysmen-Clip System
Aneurysm Clip System

Schädel-Verplattung
Cranial Plate System



Hypophysektomie-Instrumente
Pituitary Instruments

Instrumente für die Wirbelsäule, Wundspreizer
Spine Instruments, Self-retaining Retractors

Laminektomie-Stanzen, Rongeuere, Hohlmeißelzangen
Laminectomy Punches, Rongeurs

Gefäß- und Bulldogklemmen, Gefäß-Clips
Vessel- and Bulldog-Clamps, Vessel Clips

Allgemeinchirurgische Instrumente
General Surgical Instruments

Alphabetischer Index, Numerischer Index
Alphabetical Index, Numerical Index

/// 05

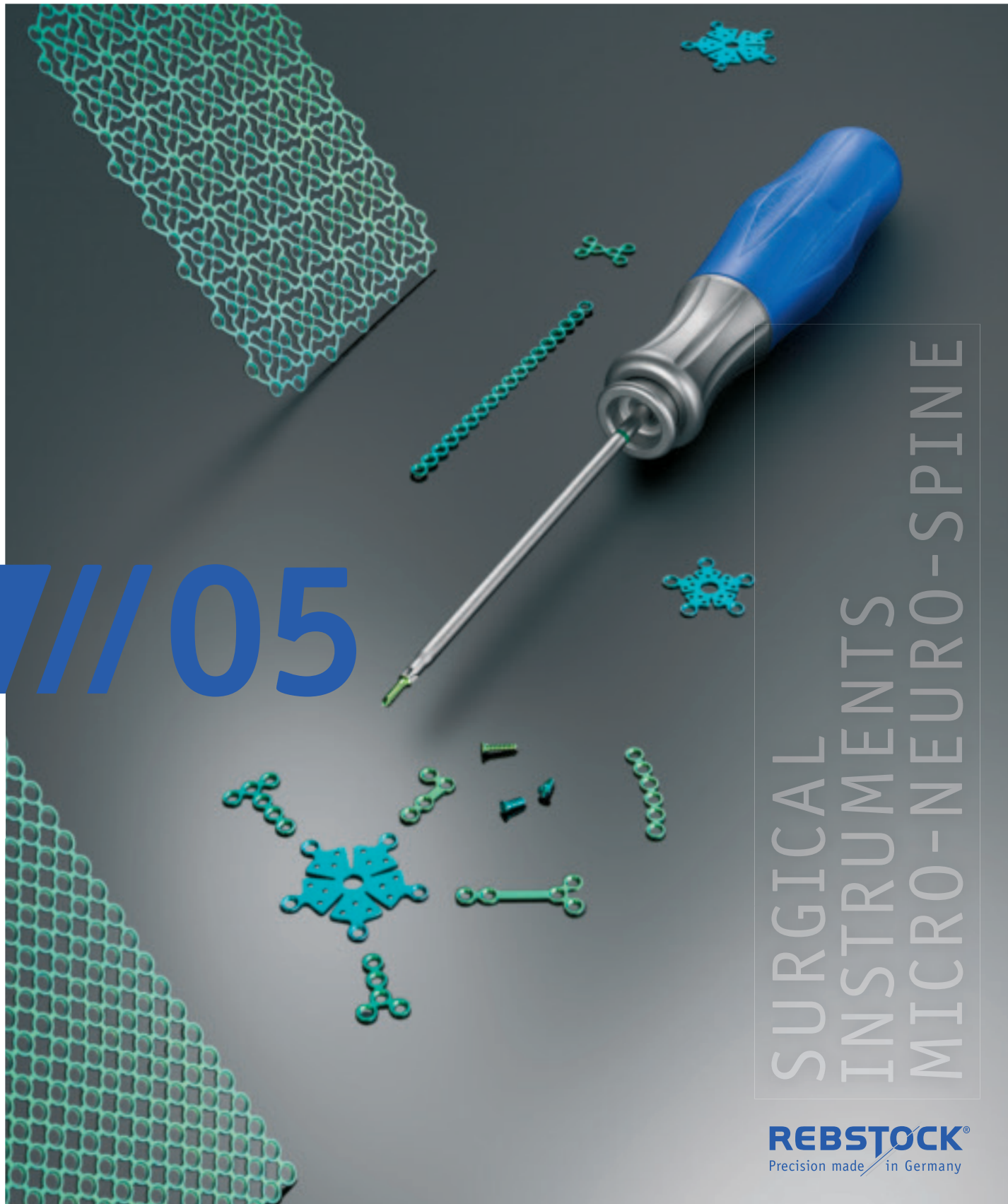

SURGICAL
INSTRUMENTS
MICRO-NEURO-SPINE

REBSTOCK®
Precision made in Germany

/// Schädel-Verplattung
Cranial Plate System

/// 05

SURGICAL
INSTRUMENTS
MICRO-NEURO-SPINE

REBSTOCK®
Precision made in Germany



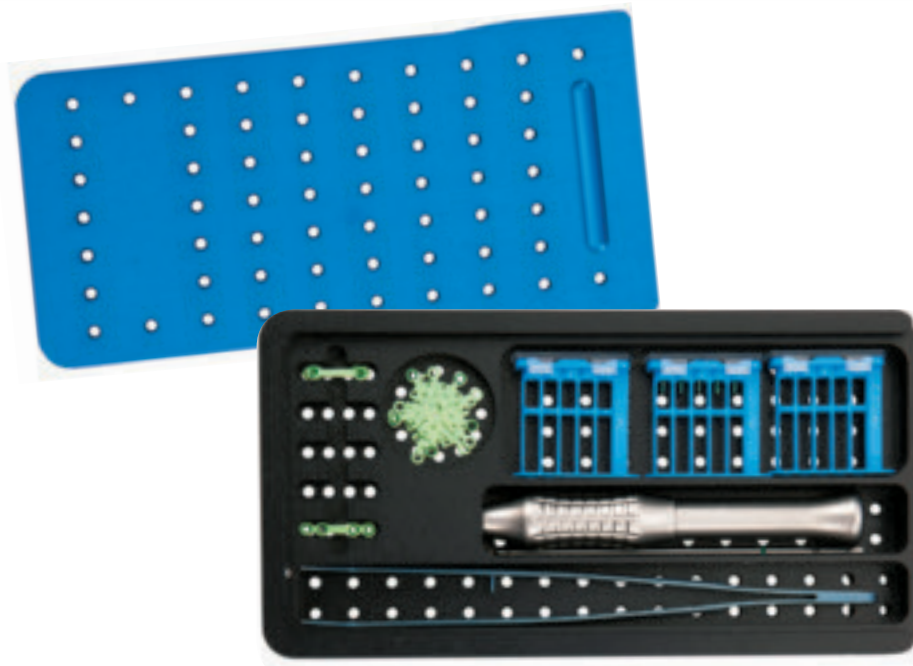



/// Schädel-Verplattung
Cranial Plate System

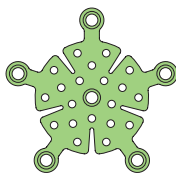

Artikel-Nr.
 Cat. No.

50-31-011	Schädel-Verplattungs-Set zur Fixierung der Knochendeckel, komplett, bestehend aus: <i>Cranio Plate Set for fixation of cranio lids, complete, consisting of:</i>
50-31-015	1 x Rack mit Deckel, 170 x 90 x 25 mm, für Instrumente und Implantate <i>rack with lid, 170 x 90 x 25 mm, for instruments and implants</i>
50-31-505	1 x Platten-/Schrauben-Haltepinzette, 150 mm, abgewinkelt, TITAN <i>plate and screw holding forceps, 150 mm, angled, TITANIUM</i>
50-31-510	1 x Schraubendreher, selbsthaltend, 180 mm, für Kreuzschlitzschrauben <i>screwdriver, self-holding, 180 mm, for cross head screws</i>
50-31-101	1 x Medium Platte, mit Steg, TITAN 1,6 mm x 0,6 mm, 2-Loch, VE = 5 Stück <i>medium plate, TITANIUM 1.6 mm x 0.6 mm, 2 holes, pack. of 5 pcs.</i>
50-31-102	1 x Medium Platte, mit Steg, TITAN 1,6 mm x 0,6 mm, 2-Loch, VE = 5 Stück <i>medium plate, TITANIUM 1.6 mm x 0.6 mm, 2 holes, pack. of 5 pcs.</i>
50-31-139	3 x Medium Bohrlochplatte, TITAN 1,6 mm x 0,6 mm, ø 15 mm <i>medium burr hole plate, TITANIUM 1.6 mm x 0.6 mm, ø 15 mm</i>
50-31-352	3 x Medium Schraube, TITAN, Kreuzschlitz, 1,6 mm x 4 mm, selbstbohrend, VE = 5 Stück <i>medium screw, TITANIUM, cross head, 1.6 mm x 4 mm, self drilling, pack. of 5 pcs.</i>

Medium-Platten 1,6 mm, Profil 0,6 mm, TITAN
Medium Plates 1.6 mm, Profile 0.6 mm, TITANIUM
Artikel-Nr.
Cat. No.

1/1		50-31-101	Medium Platte, mit Steg, TITAN 2-Loch, VE = 5 Stück <i>medium plate, TITANIUM 2 holes, pack. of 5 pcs.</i>
1/1		50-31-102	Medium Platte, mit Steg, TITAN 2-Loch, VE = 5 Stück <i>medium plate, TITANIUM 2 holes, pack. of 5 pcs.</i>
1/1		50-31-139	Medium Bohlochplatte, TITAN ø 15 mm <i>medium burr hole plate, TITANIUM ø 15 mm</i>
2/1	  	50-31-352	Medium Schraube, Kreuzschlitz, TITAN 1,6 mm x 4 mm, selbstbohrend, VE = 5 Stück <i>medium screw, cross head, TITANIUM 1.6 mm x 4 mm, self drilling, pack. of 5 pcs.</i>

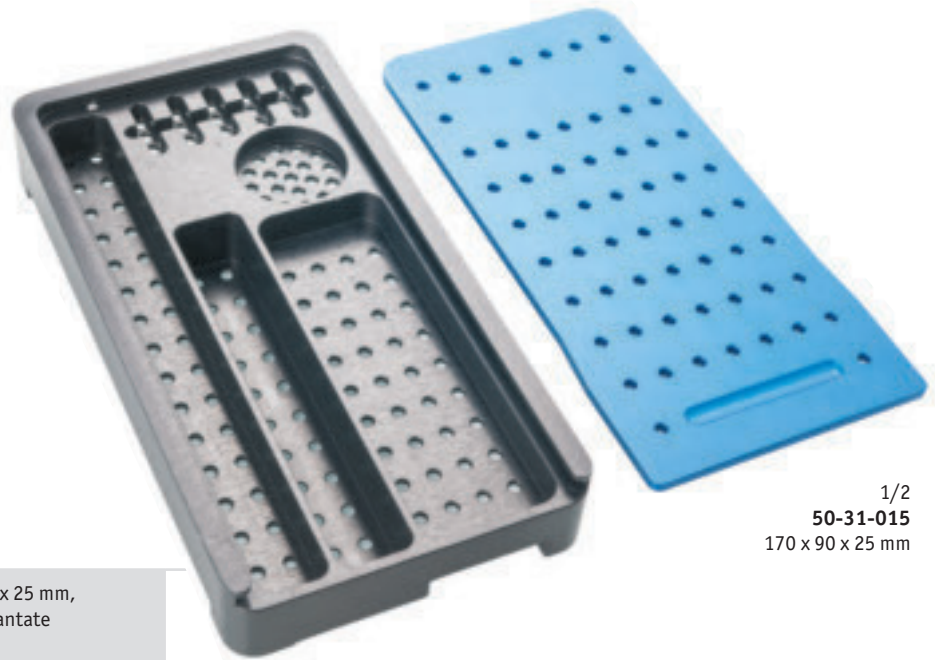

Artikel-Nr.
Cat. No.

1/2
50-31-015
 170 x 90 x 25 mm

50-31-015

Rack mit Deckel, 170 x 90 x 25 mm,
 für Instrumente und Implantate

*rack with lid, 170 x 90 x 25 mm,
 for instruments and implants*



5

Artikel-Nr.
Cat. No.

Gesamtlänge
Total length

50-31-505

150 mm / 6"

Platten-/Schrauben-Haltepinzette,
 abgewinkelt, TITAN

*plate and screw holding forceps,
 angled, TITANIUM*



1/2
50-31-505
 150 mm
 6"

Artikel-Nr.
Cat. No.

Gesamtlänge
Total length

50-31-510

180 mm / 7"

Schraubendreher, selbsthaltend,
 für Kreuzschlitzschrauben

*screwdriver, self-holding,
 for cross head screws*



1/2
50-31-510
 180 mm
 7"



Artikel-Nr.
Cat. No.

50-31-000

Medium-Platten Standard Set für die Neurochirurgie
Standard Set Medium Plate for Neurosurgery

Inhalt Set siehe Seite 215.
Content of the set see page 215.

Artikel-Nr.
 Cat. No.

50-31-000	Medium-Platten Standard Set für die Neurochirurgie, bestehend aus: <i>Standard Set Medium Plate for Neurosurgery, consisting of:</i>	
50-31-001	1x	Sterilisier-Container 300 x 200 x 70 mm <i>sterilisation container 300 x 200 x 70 mm</i>
50-31-002	1x	Rack für Instrument <i>rack for instruments</i>
50-31-003	1x	Rack für Platten und Schrauben <i>rack for plates and screws</i>
50-31-501	1x	Plattenschneidezange, 120 mm, TC <i>plate cutting forceps, 120 mm, TC</i>
50-31-502	1x	Flachzange, 135 mm <i>flat pliers, 135 mm</i>
50-31-503	1x	ADERER Plattenbiegezange, 130 mm <i>ADERER plate bending pliers, 130 mm</i>
50-31-505	1x	Platten-/Schrauben-Haltepinzette, 150 mm, abgewinkelt, TITAN <i>plate and screw holding forceps, 150 mm, angled, TITANIUM</i>
50-31-510	1x	Schraubendreher, selbsthaltend, 180 mm für Kreuzschlitzschrauben <i>screwdriver, self-holding, 180 mm for cross head screws</i>
50-31-525	1x	Spiralbohrer ø 1,3 mm x 47 mm, mit Stryker Ansatz <i>twist drill ø 1.3 mm x 47 mm, with Stryker coupling</i>
50-31-526	1x	Spiralbohrer ø 1,3 mm x 50 mm, mit Stryker Ansatz <i>twist drill ø 1.3 mm x 50 mm, with Stryker coupling</i>
50-31-101	1x	Medium Platte, mit Steg, TITAN 2-Loch / VE = 5 Stück <i>plate, straight with bar, 2-holes / pack. of 5 pcs.</i>
50-31-102	1x	Medium Platte, mit Steg, TITAN 2-Loch / VE = 5 Stück <i>plate, straight with bar, 2-holes / pack. of 5 pcs.</i>
50-31-104	1x	Medium Platte, mit Steg, TITAN 4-Loch / VE = 5 Stück <i>plate, straight with bar, 4-holes / pack. of 5 pcs.</i>
50-31-105	1x	Medium Platte, mit Steg, TITAN 4-Loch / VE = 5 Stück <i>plate, straight with bar, 4-holes / pack. of 5 pcs.</i>
50-31-106	1x	Medium Platte, mit Steg, TITAN 4-Loch / VE = 5 Stück <i>plate, straight with bar, 4-holes / pack. of 5 pcs.</i>
50-31-129	1x	Y-Platte mit Steg, 5-Loch / VE = 5 Stück <i>Y-plate with bar, 5-holes / pack. of 5 pcs.</i>
50-31-132	1x	Doppel-Y-Platte mit Steg, 6-Loch / VE = 5 Stück <i>double-Y-plate with bar, 6-holes / pack. of 5 pcs.</i>
50-31-141	1x	Rechteckplatte, 4-Loch / VE = 5 Stück <i>square-plate, 4-holes / pack. of 5 pcs.</i>
50-31-143	1x	Rechteckplatte, 3 x 2-Loch / VE = 5 Stück <i>square-plate, 3 x 2 holes / pack. of 5 pcs.</i>
50-31-145	1x	Rechteckplatte, 4 x 2-Loch / VE = 5 Stück <i>square-plate, 4 x 2 holes / pack. of 5 pcs.</i>
50-31-138	5x	Bohrlochplatte, ø 11,5 mm <i>burr hole plate, ø 11.5 mm</i>
50-31-139	5x	Bohrlochplatte, ø 15 mm <i>burr hole plate, ø 15 mm</i>
50-31-140	5x	Bohrlochplatte, ø 18 mm <i>burr hole plate, ø 18 mm</i>
50-31-158	5x	Bohrlochplatte, mit Drainage, ø 11,5 mm <i>burr hole plate, with drainage, ø 11.5 mm</i>
50-31-159	5x	Bohrlochplatte, mit Drainage, ø 15 mm <i>burr hole plate, with drainage, ø 15 mm</i>
50-31-160	5x	Bohrlochplatte, mit Drainage, ø 18 mm <i>burr hole plate, with drainage, ø 18 mm</i>
50-31-351	2x	Medium Schraube, Kreuzschlitz, 1,6 mm x 3 mm, selbstbohrend, VE = 5 Stück <i>medium screw, cross head, 1.6 mm x 3 mm, self drilling, pack. of 5 pcs.</i>
50-31-352	2x	Medium Schraube, Kreuzschlitz, 1,6 mm x 4 mm, selbstbohrend, VE = 5 Stück <i>medium screw, cross head, 1.6 mm x 4 mm, self drilling, pack. of 5 pcs.</i>
50-31-353	2x	Medium Schraube, Kreuzschlitz, 1,6 mm x 5 mm, selbstbohrend, VE = 5 Stück <i>medium screw, cross head, 1.6 mm x 5 mm, self drilling, pack. of 5 pcs.</i>
50-31-304	2x	Medium Schraube, Kreuzschlitz, 1,6 mm x 6 mm, selbstschneidend, VE = 5 Stück <i>medium screw, cross head, 1.6 mm x 6 mm, self tapping, pack. of 5 pcs.</i>















Medium-Platten 1,6 mm, Profil 0,6 mm, TITAN
 Medium Plates 1.6 mm, Profile 0.6 mm, TITANIUM

TITAN

5

Verpackungseinheit/VE = 5 Stück / packing unit 5 pcs.

 Artikel-Nr.
 Cat. No.

1/1		50-31-101	Platte, gerade mit Steg, 2-Loch plate, straight with bar, 2-holes
1/1		50-31-102	Platte, gerade mit Steg, 2-Loch plate, straight with bar, 2-holes
1/1		50-31-103	Platte, gerade, 4-Loch plate, straight, 4-holes
1/1		50-31-104	Platte, gerade mit Steg, 4-Loch plate, straight with bar, 4-holes
1/1		50-31-105	Platte, gerade mit Steg, 4-Loch plate, straight with bar, 4-holes
1/1		50-31-106	Platte, gerade mit Steg, 4-Loch plate, straight with bar, 4-holes
1/1		50-31-107	Platte, gerade, 6-Loch plate, straight, 6-holes
1/1		50-31-108	Platte, gerade mit Steg, 6-Loch plate, straight with bar, 6-holes
1/1		50-31-109	Platte, gerade, 8-Loch plate, straight, 8-holes
1/1		50-31-161	Platte, gerade, 12-Loch plate, straight, 12-holes
1/1		50-31-110	Platte, gerade, 16-Loch plate, straight, 16-holes
1/1		50-31-111	Platte, gerade, 18-Loch plate, straight, 18-holes
1/1		50-31-112	Platte, gerade, 30-Loch plate, straight, 30-holes











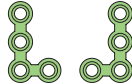

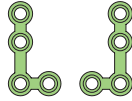
Medium-Platten 1,6 mm, Profil 0,6 mm, TITAN
Medium Plates 1.6 mm, Profile 0.6 mm, TITANIUM

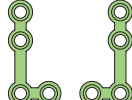
TITAN

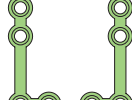
5

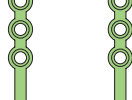
Verpackungseinheit/VE = 5 Stück / packing unit 5 pcs.

Artikel-Nr.
Cat. No.

50-31-113	L-Platte, 4-Loch, rechts <i>L-plate, 4-holes, right</i>	1/1 
50-31-114	L-Platte, 4-Loch, links <i>L-plate, 4-holes, left</i>	
50-31-115	L-Platte mit Steg, 4-Loch, rechts <i>L-plate with bar, 4-holes, right</i>	1/1 
50-31-116	L-Platte mit Steg, 4-Loch, links <i>L-plate with bar, 4-holes, left</i>	
50-31-117	L-Platte mit Steg, 4-Loch, rechts <i>L-plate with bar, 4-holes, right</i>	1/1 
50-31-118	L-Platte mit Steg, 4-Loch, links <i>L-plate with bar, 4-holes, left</i>	
50-31-119	L-Platte mit Steg, 4-Loch, rechts <i>L-plate with bar, 4-holes, right</i>	1/1 
50-31-120	L-Platte mit Steg, 4-Loch, links <i>L-plate with bar, 4-holes, left</i>	
50-31-121	L-Platte mit Steg, 5-Loch, rechts <i>L-plate with bar, 5-holes, right</i>	1/1 
50-31-122	L-Platte mit Steg, 5-Loch, links <i>L-plate with bar, 5-holes, left</i>	
50-31-123	T-Platte mit Steg, 4-Loch <i>T-plate with bar, 4-holes</i>	1/1 
50-31-124	T-Platte mit Steg, 4-Loch <i>T-plate with bar, 4-holes</i>	1/1 







Medium-Platten 1,6 mm, Profil 0,6 mm, TITAN
 Medium Plates 1.6 mm, Profile 0.6 mm, TITANIUM

TITAN
5

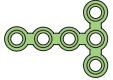
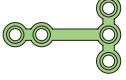
Verpackungseinheit/VE = 5 Stück / packing unit 5 pcs.

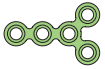
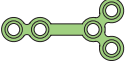
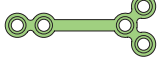
 Artikel-Nr.
 Cat. No.

1/1		50-31-125	T-Platte, 6-Loch <i>T-plate, 6-holes</i>
1/1		50-31-126	T-Platte mit Steg, 5-Loch <i>T-plate with bar, 5-holes</i>
1/1		50-31-127	Doppel-T-Platte, 6-Loch <i>double T-plate, 6-holes</i>
1/1		50-31-128	Y-Platte, 5-Loch <i>Y-plate, 5-holes</i>
1/1		50-31-162	Y-Platte mit Steg, 5-Loch <i>Y-plate with bar, 5-holes</i>
1/1		50-31-129	Y-Platte mit Steg, 5-Loch <i>Y-plate with bar, 5-holes</i>
1/1		50-31-130	Y-Platte mit Steg, 5-Loch <i>Y-plate with bar, 5-holes</i>







Medium-Platten 1,6 mm, Profil 0,6 mm, TITAN
Medium Plates 1.6 mm, Profile 0.6 mm, TITANIUM

TITAN

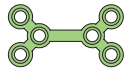
5

Verpackungseinheit/VE = 5 Stück / packing unit 5 pcs.

Artikel-Nr.
Cat. No.

50-31-131	Doppel-Y-Platte, 6-Loch <i>double Y-plate, 6-holes</i>	1/1 
50-31-132	Doppel-Y-Platte mit Steg, 6-Loch <i>double Y-plate with bar, 6-holes</i>	1/1 
50-31-133	Doppel-Y-Platte, 7-Loch <i>double Y-plate, 7-holes</i>	1/1 
50-31-134	Orbita Platte, 4-Loch <i>orbita plate, 4-holes</i>	1/1 
50-31-135	Orbita Platte, 6-Loch <i>orbita plate, 6-holes</i>	1/1 
50-31-136	Orbita Platte, 8-Loch <i>orbita plate, 8-holes</i>	1/1 
50-31-137	Orbita Platte, 10-Loch <i>orbita plate, 10-holes</i>	1/1 



5

Bohrlochplatten für Trepanation
Burr hole plates for Trepanation
TITAN
1 Verpackungseinheit/VE = 1 Stück / packing unit 1 pcs.

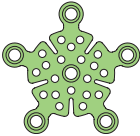
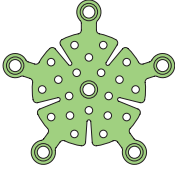
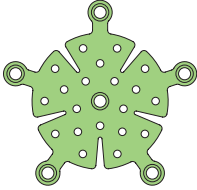
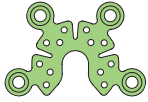
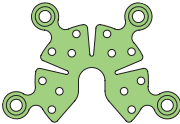
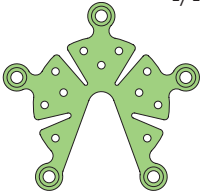
	Artikel-Nr. Cat. No.	
1/1 	50-31-138	Bohrlochplatte, ø 11,5 mm <i>burr hole plate, ø 11.5 mm</i>
1/1 	50-31-139	Bohrlochplatte, ø 15 mm <i>burr hole plate, ø 15 mm</i>
1/1 	50-31-140	Bohrlochplatte, ø 18 mm <i>burr hole plate, ø 18 mm</i>
1/1 	50-31-158	Bohrlochplatte, mit Drainage, ø 11,5 mm <i>burr hole plate, with drainage, ø 11.5 mm</i>
1/1 	50-31-159	Bohrlochplatte, mit Drainage, ø 15 mm <i>burr hole plate, with drainage, ø 15 mm</i>
1/1 	50-31-160	Bohrlochplatte, mit Drainage, ø 18 mm <i>burr hole plate, with drainage, ø 18 mm</i>



Medium-Platten 1,6 mm, Profil 0,6 mm, TITAN
Medium Plates 1.6 mm, Profile 0.6 mm, TITANIUM

TITAN

5

Verpackungseinheit/VE = 5 Stück / packing unit 5 pcs.

Artikel-Nr.
Cat. No.

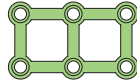
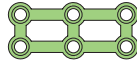
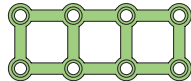
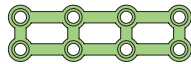
50-31-141	Rechteckplatte, 4-Loch <i>square plate, 4-holes</i>	1/1 
50-31-142	Rechteckplatte, 4-Loch <i>square plate, 4-holes</i>	1/1 
50-31-143	Rechteckplatte, 3 x 2-Loch <i>square plate, 3 x 2-holes</i>	1/1 
50-31-144	Rechteckplatte, 3 x 2-Loch <i>square plate, 3 x 2-holes</i>	1/1 
50-31-145	Rechteckplatte, 4 x 2-Loch <i>square plate, 4 x 2-holes</i>	1/1 
50-31-146	Rechteckplatte, 4 x 2-Loch <i>square plate, 4 x 2-holes</i>	1/1 



5

Medium-Platten 1,6 mm, Profil 0,6 mm, TITAN
 Medium Plates 1.6 mm, Profile 0.6 mm, TITANIUM

TITAN

1 Verpackungseinheit/VE = 1 Stück / packing unit 1 pcs.

Artikel-Nr.
 Cat. No.

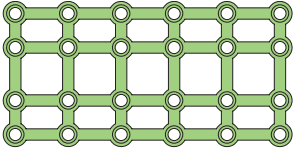
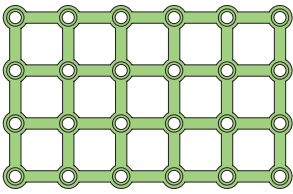
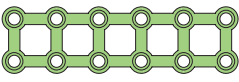
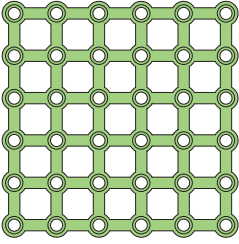
1/1	50-31-147	Rechteckplatte, 6 x 4-Loch square plate, 6 x 4-holes
		
1/1	50-31-148	Rechteckplatte, 6 x 4-Loch square plate, 6 x 4-holes
		
1/1	50-31-163	Rechteckplatte, 6 x 2-Loch square plate, 6 x 2-holes
		
1/1	50-31-164	Rechteckplatte, 6 x 6-Loch square plate, 6 x 6-holes
		

Medium-Platten 1,6 mm, Profil 0,6 mm, TITAN
 Medium Plates 1.6 mm, Profile 0.6 mm, TITANIUM

TITAN

1 Verpackungseinheit/VE = 1 Stück / packing unit 1 pcs.

Artikel-Nr.
 Cat. No.

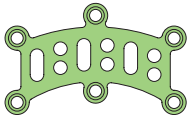
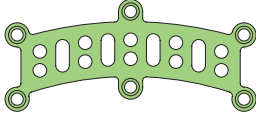
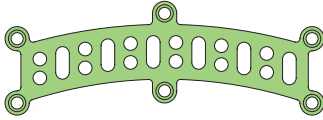
50-31-149	Neuro-Spaltenplatte <i>neuro gap plate</i>	1/1 
50-31-150	Neuro-Spaltenplatte <i>neuro gap plate</i>	1/1 
50-31-151	Neuro-Spaltenplatte <i>neuro gap plate</i>	1/1 

Artikel-Nr.
 Cat. No.

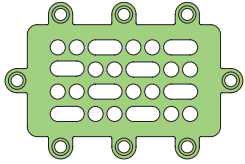
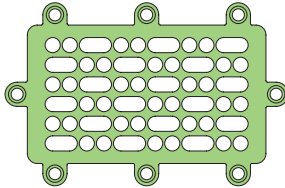
50-31-152	Neuro-Sub-temporale Platte <i>neuro sub temporal plate</i>	1/1 
50-31-153	Neuro-Sub-temporale Platte <i>neuro sub temporal plate</i>	1/1 

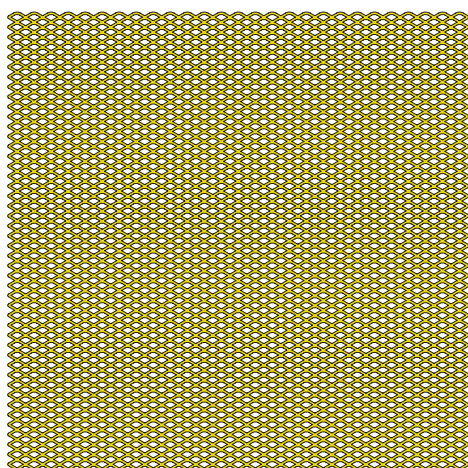

Gitter-Platten, TITAN
Mesh Plates, TITANIUM
TITAN
1 Verpackungseinheit/VE = 1 Stück / packing unit 1 pcs.

Artikel-Nr.
Cat. No.
Maße
Measurement

50-31-251

60 x 60 x 0,1 mm

50-31-252

120 x 60 x 0,1 mm

50-31-253

120 x 120 x 0,1 mm

50-31-254

60 x 60 x 0,2 mm

50-31-255

120 x 60 x 0,2 mm

50-31-256

120 x 120 x 0,2 mm

Artikel-Nr.
Cat. No.
Maße
Measurement

50-31-257

80 x 50 x 0,3 mm

50-31-258

80 x 50 x 0,6 mm

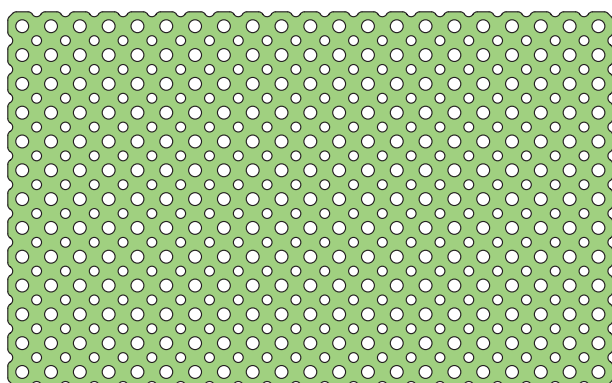

Gitter-Platten, TITAN
Mesh Plates, TITANIUM

TITAN

1 Verpackungseinheit/VE = 1 Stück / packing unit 1 pcs.

Artikel-Nr. Cat. No.	Maße Measurement
50-36-200	40 x 60 x 0,3 mm
50-36-201	50 x 70 x 0,3 mm
50-36-202	60 x 80 x 0,3 mm
50-36-203	70 x 90 x 0,3 mm
50-36-204	90 x 90 x 0,3 mm
50-36-100	40 x 60 x 0,6 mm
50-36-101	50 x 70 x 0,6 mm
50-36-102	60 x 80 x 0,6 mm
50-36-103	70 x 90 x 0,6 mm
50-36-104	90 x 90 x 0,6 mm
50-36-105	80 x 120 x 0,6 mm
50-36-106	90 x 120 x 0,6 mm
50-36-107	100 x 120 x 0,6 mm
50-36-108	120 x 120 x 0,6 mm
50-36-109	100 x 150 x 0,6 mm
50-36-110	120 x 150 x 0,6 mm
50-36-111	150 x 150 x 0,6 mm
50-36-112	150 x 200 x 0,6 mm

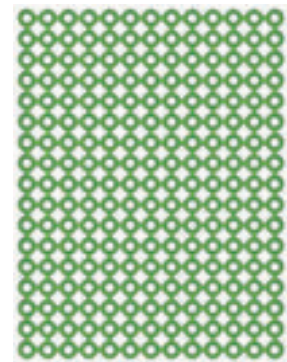

Artikel-Nr. Cat. No.	Maße Measurement
50-36-240	40 x 60 x 0,3 mm
50-36-244	90 x 90 x 0,3 mm
50-36-140	40 x 60 x 0,6 mm
50-36-144	90 x 90 x 0,6 mm
50-36-148	120 x 120 x 0,6 mm
50-36-152	150 x 200 x 0,6 mm

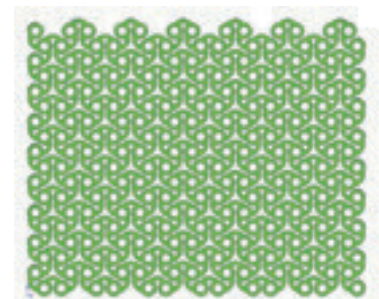

Medium-Knochenschrauben 1,6 mm, TITAN
Medium Bone Screws, 1.6 mm, TITANIUM

TITAN

5

Verpackungseinheit/VE = 5 Stück / packing unit 5 pcs.



Schrauben im handlichen Spendermagazin zur Direktentnahme. Sterilisierbar im Autoklav bei 134° C.
 In convenient dispenser unit for direct extraction. Sterilizable in the vacuum autoclave with 134 °C.

Kreuzschlitz-Schrauben
Cross Head Screws

2/1

Selbstschneidend Self cutting	Selbstbohrend Self drilling	∅	Länge Length
50-31-301	50-31-351	1,6 mm	3 mm
50-31-302	50-31-352	1,6 mm	4 mm
50-31-303	50-31-353	1,6 mm	5 mm
50-31-304		1,6 mm	6 mm
50-31-305		1,6 mm	7 mm
50-31-306		1,6 mm	8 mm

Notfallschrauben, Kreuzschlitz
Emergency Screws, Cross Head

2/1

	∅	Länge Length
50-31-307	1,9 mm	5 mm

Instrumente für Medium-Platten System 1,6 mm
 Instruments for Medium Plate System 1.6 mm

TC

Artikel-Nr. Cat. No.	Gesamtlänge Total length
50-31-501	120 mm / 4¾"
	Plattenschneidezange, TC plate cutting pliers, TC



2/3
 50-31-501
 120 mm
 4¾"

Artikel-Nr. Cat. No.	Gesamtlänge Total length
50-31-502	135 mm / 5¼"
	Flachzange flat pliers



2/3
 50-31-502
 135 mm
 5¼"

Artikel-Nr. Cat. No.	Gesamtlänge Total length	ADERER
50-31-503	130 mm / 5⅛"	
	Plattenbiegezange plate bending pliers	



2/3
 ADERER
 50-31-503
 130 mm
 5⅛"



Instrumente für Medium-Platten System 1,6 mm
Instruments for Medium Plate System 1.6 mm

 2/3
50-31-505
 150 mm
 6"

TITAN
Artikel-Nr.
Cat. No.
Gesamtlänge
Total length
50-31-505

150 mm / 6"

 Platten-/Schrauben-Haltepinzette,
 abgewinkelt, TITAN

plate and screw holding forceps,
angled, TITANIUM

Artikel-Nr. Cat. No.	Gesamtlänge Total length
50-31-505	150 mm / 6"

 2/3
04-16-551
 120 mm
 4¾"

TC
Artikel-Nr.
Cat. No.
Gesamtlänge
Total length

1/1

04-16-552

120 mm / 4¾"

 Draht-/Blechscherer, TC
wire cutting scissors, TC

Artikel-Nr. Cat. No.	Gesamtlänge Total length
04-16-552	120 mm / 4¾"

Instrumente für Medium-Platten System 1,6 mm
 Instruments for Medium Plate System 1.6 mm

Artikel-Nr. Cat. No.	Gesamtlänge Total length	
50-31-507	180 mm / 7"	1/1
	Schraubendreher komplett, selbsthaltend für Kreuzschlitzschrauben <i>screwdriver complete, self-holding for cross drive screws</i>	

1/2
 50-31-507
 180 mm
 7"



5

Artikel-Nr. Cat. No.		
50-31-509	Schraubendrehergriff allein, für alle Schraubendreherklingen <i>screwdriver handle alone for screwdriver blades</i>	

1/2
 50-31-509



Artikel-Nr. Cat. No.	Gesamtlänge Total length	
50-31-510	180 mm / 7"	1/1
	Schraubendreher komplett, selbsthaltend für Kreuzschlitzschrauben <i>screwdriver complete, self-holding for cross head screws</i>	

1/2
 50-31-510
 180 mm
 7"



Instrumente für Medium-Platten System 1,6 mm
Instruments for Medium Plate System 1.6 mm

 1/2
 50-31-513

Artikel-Nr.
Cat. No.
50-31-513

 Schraubendrehergriff allein,
 für alle Schraubendreherklingen

*screwdriver handle alone,
 for screwdriver blades*

 1/2
 50-31-514

Artikel-Nr.
Cat. No.

1/1

50-31-514

 Schraubendreherklinge allein,
 selbsthaltend,
 für Kreuzschlitzschrauben

*screwdriver blade alone, self-holding,
 for cross head screws*

 1/2
 50-31-518

Artikel-Nr.
Cat. No.
50-31-518

 Tiefenmesser, Messtiefe 50 mm
depth gauge, measuring depth 50 mm

Instrumente für Medium-Platten System 1,6 mm
Instruments for Medium Plate System 1.6 mm

Artikel-Nr.
Cat. No.

	Spiralbohrer mit Stryker-Anschluss <i>Twist Drill with Stryker Coupling</i>
50-31-525	Spiralbohrer ø 1,3 x 47 mm für Schrauben bis 4 mm Länge <i>twist drill ø 1.3 x 47 mm for screws up to 4 mm length</i>
50-31-526	Spiralbohrer ø 1,3 x 50 mm für Schrauben bis 8 mm Länge <i>twist drill ø 1.3 x 50 mm for screws up to 8 mm length</i>

Artikel-Nr.
Cat. No.

	Spiralbohrer mit Dental-Anschluss <i>Twist Drill with Dental Coupling</i>
50-31-527	Spiralbohrer ø 1,3 x 31 mm für Schrauben bis 4 mm Länge <i>twist drill ø 1.3 x 31 mm for screws up to 4 mm length</i>
50-31-528	Spiralbohrer ø 1,3 x 34 mm für Schrauben bis 8 mm Länge <i>twist drill ø 1.3 x 34 mm for screws up to 8 mm length</i>





Mikro-Neurochirurgische Instrumente
Micro-Neurosurgical Instruments

HF-Instrumente und Zubehör
HF Instruments and Accessoires

Kopf-Schädelinstrumente und Haltesysteme
Head-Cranio Instruments and Holding Systems

Aneurysmen-Clip System
Aneurysm Clip System

Schädel-Verplattung
Cranial Plate System

Hypophysektomie-Instrumente *Pituitary Instruments*



Instrumente für die Wirbelsäule, Wundspreizer
Spine Instruments, Self-retaining Retractors

Laminektomie-Stanzen, Rongeure, Hohlmeißelzangen
Laminectomy Punches, Rongeurs

Gefäß- und Bulldogklemmen, Gefäß-Clips
Vessel- and Bulldog-Clamps, Vessel Clips

Allgemeinchirurgische Instrumente
General Surgical Instruments

Alphabetischer Index, Numerischer Index
Alphabetical Index, Numerical Index

/// 06

SURGICAL
INSTRUMENTS
MICRO-NEURO-SPINE

REBSTOCK®
Precision made in Germany

/// Hypophysektomie-Instrumente
Pituitary Instruments

/// www.rebstock.de



SURGICAL
INSTRUMENTS
MICRO-NEURO-SPINE

REBSTOCK
Precision made in Germany

/// Hypophysektomie-Instrumente
Pituitary Instruments

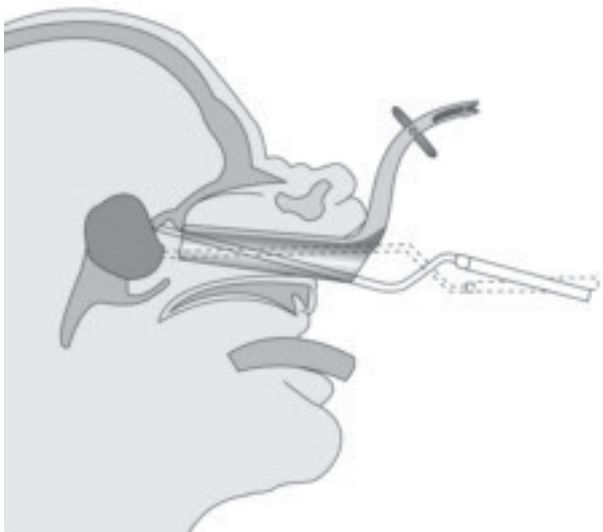

Artikel-Nr. Cat. No.	Größe Size		
15-11-100	70 x 15 mm	CUSHING- LANDOLT	
15-11-101	90 x 15 mm		
15-11-102	110 x 15 mm		
Spekula für transphenoidale Hypophysektomie			
<i>specula for transphenoidal hypophysectomy</i>			

1/2
CUSHING-LANDOLT
15-11-101
90 x 15 mm

Artikel-Nr. Cat. No.	Gesamtlänge Total length		
15-11-103	210 mm / 8¼"	LANDOLT	
Spreizzange zum Spreizen der Spekula 15-11-100 bis 15-11-102			
<i>spreader for specula 15-11-100 to 15-11-102</i>			



1/2
LANDOLT
15-11-103
210 mm
8¼"

Standard Line	Black Line
Oberfläche matt gebürstet <i>Surface polished</i>	Oberfläche schwarz, titanbeschichtet <i>Surface black, titanium-coated</i>
Beispiel-Artikel-Nr. Example Cat. No. 15-11-103	Beispiel-Artikel-Nr. Example Cat. No. 15-11-103B

PAPAVERO-CASPAR
Artikel-Nr.
Cat. No.
Größe
Size
06-06-589
06-06-590
06-06-591

 80 x 11 mm
 90 x 13 mm
 100 x 13 mm

 Spekula für transphenoidale
 Hypophysektomie

specula for transphenoidal hypophysectomy
20-05-749

 Spanschlüssel für Spekula
 06-06-589 bis 06-06-591

key for specula
06-06-589 to 06-06-591

 1/2
PAPAVERO-CASPAR
06-06-590
 90 x 13 mm

1/2

PAPAVERO-HARTMANN
Artikel-Nr.
Cat. No.
06-06-595

 Spreizer für Spekula
 06-06-589 bis 06-06-591

spreader for specula
06-06-589 to 06-06-591

 1/2
PAPAVERO-HARTMANN
06-06-595

1/2

COTTLE
Artikel-Nr.
Cat. No.
Größe
Size
15-11-089
15-11-090

 80 x 7 mm
 90 x 7 mm

 Selbsthaltende Nasenspekula,
 als Einführungshilfe für Spekula
 06-06-589 bis 06-06-591

self-retaining nasal specula,
as introducer for 06-06-589 to 06-06-591

 1/2
COTTLE
15-11-090
 90 x 7 mm

Standard Line

 Oberfläche matt gebürstet
Surface polished

 Beispiel-Artikel-Nr.
Example Cat. No.
15-11-090
Black Line

 Oberfläche schwarz, titanbeschichtet
Surface black, titanium-coated

 Beispiel-Artikel-Nr.
Example Cat. No.
15-11-090B

Artikel-Nr. Cat. No.	Gesamtlänge Total length		
15-12-301	180 mm / 7" 4 mm		COTTLE
15-12-302	180 mm / 7" 6 mm		
15-12-303	180 mm / 7" 8 mm		
15-62-300	180 mm / 7" 10 mm		
15-12-304	180 mm / 7" 12 mm		
Osteotome, graduiert osteotomes, graduated			

1/2
COTTLE
15-12-301
180 mm
7"



Artikel-Nr. Cat. No.	Gesamtlänge Total length		
06-06-610	220 mm / 8¾" 4 mm breit 4 mm wide Meißel chisel		PAPAVERO

1/2
PAPAVERO
06-06-610
220 mm
8¾"



Artikel-Nr. Cat. No.	Gesamtlänge Total length		
06-12-038	180 mm / 7" ø 30 mm, 240 g 1 Seite flach, 1 Seite convex 1 side flat, 1 side convex		COTTLE

1/2
COTTLE
06-12-038
180 mm
7"





		Artikel-Nr. Cat. No.	Schaftlänge Length of shaft
1/1	FAHLBUSCH	06-04-220	165 mm / 6½" Mikro-Schere, gebogen, horizontal schneidend <i>micro scissors, curved, horizontal cutting</i>
1/1	NICOLA	06-04-226	165 mm / 6½" Mikro-Schere, gerade <i>micro scissors, straight</i>
1/1	CASPAR	06-04-228	165 mm / 6½" Mikro-Schere, gebogen <i>micro scissors, curved</i>
1/1	YASARGIL- NICOLA	06-04-222	165 mm / 6½" Löffelzange, gerade <i>spoon forceps, straight</i>
1/1	CASPAR	06-04-224	165 mm / 6½" Faßzange, gerade <i>grasping forceps, straight</i>

 1/2
CASPAR
06-04-226
 165 mm
 6½"



Artikel-Nr. Cat. No.	Gesamtlänge Total length		
06-04-083	215 mm / 8½"	LANDOLT	
	Schaftlänge 140 mm / 5½" length of shaft 140 mm / 5½"		

1/2
LANDOLT
06-04-083
215 mm
8½"

Artikel-Nr. Cat. No.	Gesamtlänge Total length		
06-74-645	135 mm / 5¼"	1/1 6 mm	
06-74-646	135 mm / 5¼"	1/1 8 mm	
06-74-647	135 mm / 5¼"	1/1 10 mm	
06-74-648	135 mm / 5¼"	1/1 12 mm	
	Alle Spiegel passend für Spiegelgriffe all mirrors for mirror handles 13-56-000, 13-56-100, 06-04-361, 06-54-361		



1/2
06-74-648
135 mm
5¼"

Griffe siehe Seite 240, 241
Handle see page 240, 241



2/3
06-04-361
 105 mm
 4 1/8"

Artikel-Nr.
Cat. No.

Gesamtlänge
Total length

06-04-361

105 mm / 4 1/8"

Metallgriff für auswechselbare
 Mikroschäfte, 360° drehbar

*metal handle for micro-shaft instruments,
 360° turnable*

Artikel-Nr.
Cat. No.

Gesamtlänge
Total length

06-54-361

155 mm / 6 1/4"

Kunststoffgriff für auswechselbare Mikro-
 schäfte, 360° drehbar, mit Gegengewicht

*plastic handle for micro-shaft instruments,
 360° turnable, with counter balance*

2/3
06-54-361
 155 mm
 6 1/4"

Artikel-Nr. Cat. No.	Gesamtlänge Total length
13-56-100	160 mm / 6¼"
Metallgriff für auswechselbare Mikroschäfte, bajonettförmig, in der Länge variabel einstellbar, 360° drehbar <i>metal handle, bayonet-shaped, for micro-shaft instruments, shaft length adjustable, 360° turnable</i>	

Artikel-Nr. Cat. No.	Gesamtlänge Total length
13-56-000	170 mm / 6¾"
Kunststoffgriff für auswechselbare Mikroschäfte, bajonettförmig, in der Länge variabel einstellbar, 360° drehbar, mit Gegengewicht <i>plastic handle, bayonet-shaped, for micro-shaft instruments, shaft length adjustable, 360° turnable, with counter balance</i>	



2/3
13-56-100
 160 mm
 6¼"

2/3
13-56-000
 170 mm
 6¾"

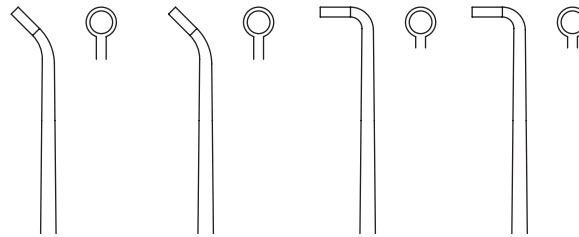
 1/1
13-06-117
 150 mm
 6"

**Mikroschaft
Küretten**
*Micro shaft
Currettes*

	45° gebogen, scharf 45° curved, sharp	45° gebogen, stumpf 45° curved, blunt	90° gebogen, scharf 90° curved, sharp	90° gebogen, stumpf 90° curved, blunt	Gesamtlänge Total length
ø 2 mm	13-06-121	13-06-112	13-06-125	13-06-116	150 mm / 6"
ø 3 mm	13-06-122	13-06-113	13-06-126	13-06-117	150 mm / 6"
ø 4 mm	13-06-123	13-06-114	13-06-127	13-06-118	150 mm / 6"
ø 5 mm	13-06-124	13-06-115	13-06-128	13-06-119	150 mm / 6"
ø 6 mm	13-56-124	13-56-115	16-56-128	13-06-120	150 mm / 6"

TITAN
**Mikroschaft
Küretten, TITAN**
*Micro shaft
Currettes, TITANIUM*

	45° gebogen, scharf 45° curved, sharp	45° gebogen, stumpf 45° curved, blunt	90° gebogen, scharf 90° curved, sharp	90° gebogen, stumpf 90° curved, blunt	Gesamtlänge Total length
ø 2 mm	13-06-121T	13-06-112T	13-06-125T	13-06-116T	150 mm / 6"
ø 3 mm	13-06-122T	13-06-113T	13-06-126T	13-06-117T	150 mm / 6"
ø 4 mm	13-06-123T	13-06-114T	13-06-127T	13-06-118T	150 mm / 6"
ø 5 mm	13-06-124T	13-06-115T	13-06-128T	13-06-119T	150 mm / 6"
ø 6 mm	13-56-124T	13-56-115T	13-56-128T	13-06-120T	150 mm / 6"

 Zur Verwendung mit den Griffen **13-56-000, 13-56-100, 06-04-361, 06-54-361**
 to use with handles **13-56-000, 13-56-100, 06-04-361, 06-54-361**



45° horizontal
45° horizontal



45° vertikal
45° vertical

Gesamtlänge
Total length

Küretten
Curettes

06-56-600	06-56-610	265 mm / 10½"	RAY	ø 3 mm
06-06-611	06-06-614	265 mm / 10½"	RAY	ø 4 mm
06-56-609	06-56-611	265 mm / 10½"	RAY	ø 5 mm



45° horizontal
45° horizontal



45° vertikal
45° vertical

Gesamtlänge
Total length

TITAN

Küretten, TITAN
Curettes, TITANIUM

06-56-600T	06-56-610T	265 mm / 10½"	RAY	ø 3 mm
06-06-611T	06-06-614T	265 mm / 10½"	RAY	ø 4 mm
06-56-609T	06-56-611T	265 mm / 10½"	RAY	ø 5 mm



6

1/1
RAY
06-06-611
180 mm
7½"



Küretten, halbscharf Curettes, semi-sharp		45° gewinkelt, langer Hals 45° angled, long neck	45° gewinkelt, kurzer Hals 45° angled, short neck	90° gewinkelt, langer Hals 90° angled, long neck	90° gewinkelt, kurzer Hals 90° angled, short neck	Gesamtlänge Total length
ø 2 mm	HARDY	06-51-001	06-51-006	06-51-010	06-51-013	265 mm / 10½"
ø 3 mm	HARDY	06-51-002	06-51-007	06-51-011	06-51-014	265 mm / 10½"
ø 4 mm	HARDY	06-51-003	06-01-036	06-01-034	06-01-035	265 mm / 10½"
ø 5 mm	HARDY	06-51-004	06-51-008	06-51-012	06-51-015	265 mm / 10½"
ø 6 mm	HARDY	06-51-005	06-51-009	06-01-037	06-01-038	265 mm / 10½"

Küretten, halbscharf Curettes, semi-sharp		45°vertikal gewinkelt, beidseitig arbeitend 45°vertical angled, working on both sides	45°horizontal gewinkelt 45°horizontal angled	Gesamtlänge Total length
ø 6,5 mm	NICOLA	06-01-030	06-01-031	265 mm / 10½"

		Enukleator links schneidend Enucleator left cutting	Enukleator rechts schneidend Enucleator right cutting	Mikro- Häkchen 1,7 mm Micro Hook 1.7 mm	Dissektor stumpf 2,0 mm Dissector blunt 2.0 mm	Gesamtlänge Total length
	HARDY	06-01-032	06-01-033			265 mm / 10½"
	LANDOLT- REULEN			06-01-039	06-01-040	265 mm / 10½"

2/3
HARDY
06-01-034
265 mm
10½"

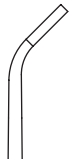

45°
gewinkelt,
langer Hals
45° angled,
long neck



45°
gewinkelt,
kurzer Hals
45° angled,
short neck

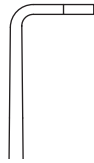

90°
gewinkelt,
langer Hals
90° angled,
long neck

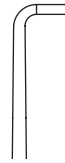

90°
gewinkelt,
kurzer Hals
90° angled,
short neck

Gesamtlänge
Total length

TITAN

Küretten, halbscharf, TITAN
Curettes, semi-sharp, TITANIUM

06-51-001T	06-51-006T	06-51-010T	06-51-013T	265 mm / 10½"	HARDY	ø 2 mm
06-51-002T	06-51-007T	06-51-011T	06-51-014T	265 mm / 10½"	HARDY	ø 3 mm
06-51-003T	06-01-036T	06-01-034T	06-01-035T	265 mm / 10½"	HARDY	ø 4 mm
06-51-004T	06-51-008T	06-51-012T	06-51-015T	265 mm / 10½"	HARDY	ø 5 mm
06-51-005T	06-51-009T	06-01-037T	06-01-038T	265 mm / 10½"	HARDY	ø 6 mm

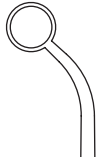

45°vertikal gewinkelt,
beidseitig arbeitend
45°vertical angled,
working on both sides



45°horizontal gewinkelt
45°horizontal angled

Gesamtlänge
Total length

TITAN

Küretten, halbscharf, TITAN
Curettes, semi-sharp, TITANIUM

06-01-030T	06-01-031T	265 mm / 10½"	NICOLA	ø 6,5 mm
------------	------------	---------------	--------	----------

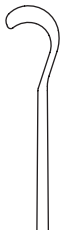

Enukleator
links
schneidend
Enucleator
left cutting



Enukleator
rechts
schneidend
Enucleator
right cutting



Mikro-
Häkchen
1,7 mm
Micro Hook
1.7 mm



Dissektor
stumpf
2,0 mm
Dissector
blunt
2.0 mm

Gesamtlänge
Total length

TITAN

06-01-032T	06-01-033T			265 mm / 10½"	HARDY	
		06-01-039T	06-01-040T	265 mm / 10½"	LANDOLT- REULEN	



2/3
HARDY
06-01-034T
265 mm
10½"

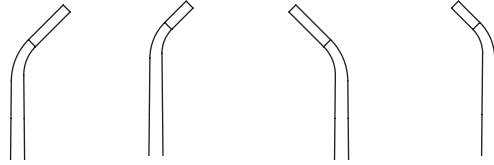

Küretten, halbscharf Curettes, semi-sharp		45° rechts, langer Hals 45° right, long neck	45° rechts, kurzer Hals 45° right, short neck	45° links, langer Hals 45° left, long neck	45° links, kurzer Hals 45° left, short neck	Gesamtlänge Total length
ø 2 mm	HARDY	06-51-016	06-51-021	06-51-025	06-51-030	280 mm / 11"
ø 3 mm	HARDY	06-51-017	06-51-022	06-51-026	06-51-031	280 mm / 11"
ø 4 mm	HARDY	06-51-018	06-01-062	06-51-027	06-01-061	280 mm / 11"
ø 5 mm	HARDY	06-51-019	06-51-023	06-51-028	06-51-032	280 mm / 11"
ø 6 mm	HARDY	06-51-020	06-51-024	06-51-029	06-51-033	280 mm / 11"

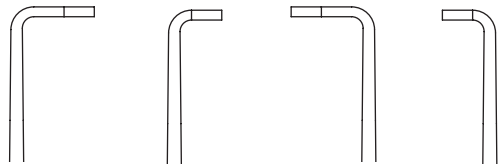

Küretten, halbscharf Curettes, semi-sharp		90° rechts, langer Hals 90° right, long neck	90° rechts, kurzer Hals 90° right, short neck	90° links, langer Hals 90° left, long neck	90° links, kurzer Hals 90° left, short neck	Gesamtlänge Total length
ø 2 mm	HARDY	06-51-034	06-51-037	06-51-040	06-51-043	280 mm / 11"
ø 3 mm	HARDY	06-51-035	06-51-038	06-51-041	06-51-044	280 mm / 11"
ø 4 mm	HARDY	06-01-047	06-01-060	06-01-045	06-01-046	280 mm / 11"
ø 5 mm	HARDY	06-51-036	06-51-039	06-51-042	06-51-045	280 mm / 11"
ø 6 mm	HARDY	06-01-065	06-01-066	06-01-063	06-01-064	280 mm / 11"



Küretten, halbscharf Curettes, semi-sharp		45° vertikal aufwärts ge- winkelt, beidseitig arbeitend 45° vertical angled up, working on both sides	45° horizontal aufwärts gewinkelt 45° horizontal angled up	Gesamtlänge Total length
ø 2 mm	HARDY	06-51-046	06-51-051	280 mm / 11"
ø 3 mm	HARDY	06-51-047	06-51-052	280 mm / 11"
ø 4 mm	HARDY	06-51-048	06-51-053	280 mm / 11"
ø 5 mm	HARDY	06-51-049	06-51-054	280 mm / 11"
ø 6 mm	HARDY	06-51-050	06-51-055	280 mm / 11"
ø 6,5 mm	NICOLA	06-01-041	06-01-042	280 mm / 11"

2/3
 HARDY
 06-01-045
 280 mm
 11"

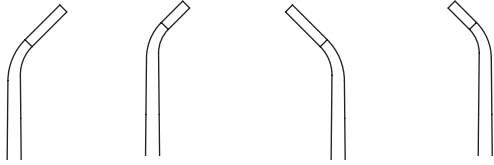

45° rechts, langer Hals
45° right, long neck

45° rechts, kurzer Hals
45° right, short neck

45° links, langer Hals
45° left, long neck

45° links, kurzer Hals
45° left, short neck

Gesamtlänge
Total length

TITAN
Küretten, halbscharf, TITAN
Curettes, semi-sharp, TITANIUM

06-51-016T	06-51-021T	06-51-025T	06-51-030T	280 mm / 11"	HARDY	ø 2 mm
06-51-017T	06-51-022T	06-51-026T	06-51-031T	280 mm / 11"	HARDY	ø 3 mm
06-51-018T	06-01-062T	06-51-027T	06-01-061T	280 mm / 11"	HARDY	ø 4 mm
06-51-019T	06-51-023T	06-51-028T	06-51-032T	280 mm / 11"	HARDY	ø 5 mm
06-51-020T	06-51-024T	06-51-029T	06-51-033T	280 mm / 11"	HARDY	ø 6 mm

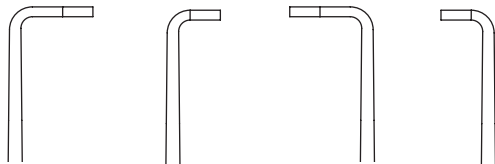

90° rechts, langer Hals
90° right, long neck

90° rechts, kurzer Hals
90° right, short neck

90° links, langer Hals
90° left, long neck

90° links, kurzer Hals
90° left, short neck

Gesamtlänge
Total length

TITAN
Küretten, halbscharf, TITAN
Curettes, semi-sharp, TITANIUM

06-51-034T	06-51-037T	06-51-040T	06-51-043T	280 mm / 11"	HARDY	ø 2 mm
06-51-035T	06-51-038T	06-51-041T	06-51-044T	280 mm / 11"	HARDY	ø 3 mm
06-01-047T	06-01-060T	06-01-045T	06-01-046T	280 mm / 11"	HARDY	ø 4 mm
06-51-036T	06-51-039T	06-51-042T	06-51-045T	280 mm / 11"	HARDY	ø 5 mm
06-01-065T	06-01-066T	06-01-063T	06-01-064T	280 mm / 11"	HARDY	ø 6 mm



45° vertikal aufwärts ge-
winkelt, beidseitig arbeitend
45° vertical angled up,
working on both sides

45° horizontal aufwärts
gewinkelt
45° horizontal angled up

Gesamtlänge
Total length

TITAN
Küretten, halbscharf, TITAN
Curettes, semi-sharp, TITANIUM

06-51-046T	06-51-051T	280 mm / 11"	HARDY	ø 2 mm
06-51-047T	06-51-052T	280 mm / 11"	HARDY	ø 3 mm
06-51-048T	06-51-053T	280 mm / 11"	HARDY	ø 4 mm
06-51-049T	06-51-054T	280 mm / 11"	HARDY	ø 5 mm
06-51-050T	06-51-055T	280 mm / 11"	HARDY	ø 6 mm
06-01-041T	06-01-042T	280 mm / 11"	NICOLA	ø 6,5 mm



2/3
HARDY
06-01-045T
280 mm
11"

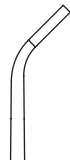

 45° rechts,
 langer Hals
 45° right,
 long neck

 45° rechts,
 kurzer Hals
 45° right,
 short neck

 45° links,
 langer Hals
 45° left,
 long neck

 45° links,
 kurzer Hals
 45° left,
 short neck

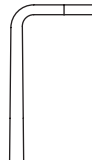
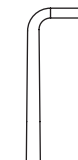
Küretten, scharf Curettes, sharp						Gesamtlänge Total length
ø 2 mm	HARDY	06-56-620	06-56-623	06-56-626	06-56-629	240 mm / 9½"
ø 3 mm	HARDY	06-56-612	06-56-618	06-56-614	06-56-607	240 mm / 9½"
ø 4 mm	HARDY	06-56-621	06-56-624	06-56-627	06-56-630	240 mm / 9½"
ø 5 mm	HARDY	06-56-613	06-56-619	06-56-615	06-56-608	240 mm / 9½"
ø 6 mm	HARDY	06-56-622	06-56-625	06-56-628	06-56-631	240 mm / 9½"

 90° rechts,
 langer Hals
 90° right,
 long neck

 90° rechts,
 kurzer Hals
 90° right,
 short neck

 90° links,
 langer Hals
 90° left,
 long neck

 90° links,
 kurzer Hals
 90° left,
 short neck

Küretten, scharf Curettes, sharp						Gesamtlänge Total length
ø 2 mm	HARDY	06-56-632	06-56-637	06-56-640	06-56-645	240 mm / 9½"
ø 3 mm	HARDY	06-56-633	06-56-605	06-56-641	06-56-616	240 mm / 9½"
ø 4 mm	HARDY	06-56-634	06-56-638	06-56-642	06-56-646	240 mm / 9½"
ø 5 mm	HARDY	06-56-635	06-56-606	06-56-643	06-56-617	240 mm / 9½"
ø 6 mm	HARDY	06-56-636	06-56-639	06-56-644	06-56-647	240 mm / 9½"

 45° vertikal aufwärts ge-
 winkelt, beidseitig arbeitend
 45° vertical angled up,
 working on both sides

 45° horizontal aufwärts
 gewinkelt
 45° horizontal angled up

Küretten, scharf Curettes, sharp				Gesamtlänge Total length
ø 2 mm	HARDY	06-56-648	06-56-653	240 mm / 9½"
ø 3 mm	HARDY	06-56-649	06-56-601	240 mm / 9½"
ø 4 mm	HARDY	06-56-650	06-56-654	240 mm / 9½"
ø 5 mm	HARDY	06-56-651	06-56-602	240 mm / 9½"
ø 6 mm	HARDY	06-56-652	06-56-655	240 mm / 9½"

 2/3
 HARDY
 06-56-619
 240 mm
 9½"

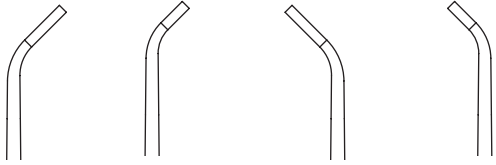

45° rechts, langer Hals
45° right, long neck

45° rechts, kurzer Hals
45° right, short neck

45° links, langer Hals
45° left, long neck

45° links, kurzer Hals
45° left, short neck

Gesamtlänge
Total length

TITAN

Küretten, scharf, TITAN
Curettes, sharp, TITANIUM

06-56-620T	06-56-623T	06-56-626T	06-56-629T	240 mm / 9½"	HARDY	ø 2 mm
06-56-612T	06-56-618T	06-56-614T	06-56-607T	240 mm / 9½"	HARDY	ø 3 mm
06-56-621T	06-56-624T	06-56-627T	06-56-630T	240 mm / 9½"	HARDY	ø 4 mm
06-56-613T	06-56-619T	06-56-615T	06-56-608T	240 mm / 9½"	HARDY	ø 5 mm
06-56-622T	06-56-625T	06-56-628T	06-56-631T	240 mm / 9½"	HARDY	ø 6 mm

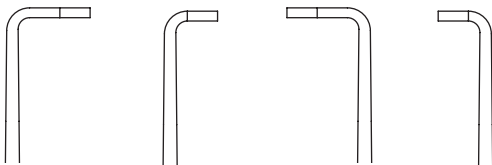

90° rechts, langer Hals
90° right, long neck

90° rechts, kurzer Hals
90° right, short neck

90° links, langer Hals
90° left, long neck

90° links, kurzer Hals
90° left, short neck

Gesamtlänge
Total length

TITAN

Küretten, scharf, TITAN
Curettes, sharp, TITANIUM

06-56-632T	06-56-637T	06-56-640T	06-56-645T	240 mm / 9½"	HARDY	ø 2 mm
06-56-633T	06-56-605T	06-56-641T	06-56-616T	240 mm / 9½"	HARDY	ø 3 mm
06-56-634T	06-56-638T	06-56-642T	06-56-646T	240 mm / 9½"	HARDY	ø 4 mm
06-56-635T	06-56-606T	06-56-643T	06-56-617T	240 mm / 9½"	HARDY	ø 5 mm
06-56-636T	06-56-639T	06-56-644T	06-56-647T	240 mm / 9½"	HARDY	ø 6 mm



45° vertikal aufwärts ge-
winkelt, beidseitig arbeitend
45° vertical angled up,
working on both sides

45° horizontal aufwärts
gewinkelt
45° horizontal angled up

Gesamtlänge
Total length

TITAN

Küretten, scharf, TITAN
Curettes, sharp, TITANIUM

06-56-648T	06-56-653T	240 mm / 9½"	HARDY	ø 2 mm
06-56-649T	06-56-601T	240 mm / 9½"	HARDY	ø 3 mm
06-56-650T	06-56-654T	240 mm / 9½"	HARDY	ø 4 mm
06-56-651T	06-56-602T	240 mm / 9½"	HARDY	ø 5 mm
06-56-652T	06-56-655T	240 mm / 9½"	HARDY	ø 6 mm



6

2/3
HARDY
06-56-619T
240 mm
9½"



vertikal
aufwärts
gebogen,
rechts
schneidend,
biegsam
vertical
curved up,
right cutting,
malleable

vertikal
aufwärts ge-
bogen, links
schneidend,
biegsam
vertical
curved up,
left cutting,
malleable

horizontal
aufwärts
gewinkelt,
biegsam
horizontal
angled up,
malleable

Küretten
Curettes
Gesamtlänge
Total length

ø 6,5 mm	NICOLA	06-06-616			260 mm / 10¼"
ø 6,5 mm	NICOLA		06-06-617		260 mm / 10¼"
ø 6,5 mm	NICOLA			06-06-618	260 mm / 10¼"

TITAN
Küretten, TITAN
Curettes, TITANIUM
Gesamtlänge
Total length

ø 6,5 mm	NICOLA	06-06-616T			260 mm / 10¼"
ø 6,5 mm	NICOLA		06-06-617T		260 mm / 10¼"
ø 6,5 mm	NICOLA			06-06-618T	260 mm / 10¼"



vertikal
aufwärts
gebogen,
rechts
schneidend,
biegsam
vertical
curved up,
right cutting,
malleable

vertikal
aufwärts ge-
bogen, links
schneidend,
biegsam
vertical
curved up,
left cutting,
malleable

horizontal
aufwärts
gewinkelt,
biegsam
horizontal
angled up,
malleable

 2/3
NICOLA
06-06-616
 260 mm
 10¼"



90° horizontal aufwärts
gewinkelt, biegsam
90° horizontal angled up,
malleable



90° horizontal aufwärts
gewinkelt, biegsam
90° horizontal angled up,
malleable

Gesamtlänge
Total length

Küretten
Curettes

		Gesamtlänge Total length		Küretten Curettes
06-06-631		260 mm / 10¼"	HARDY	ø 4 mm
	06-06-632	260 mm / 10¼"	HARDY	ø 6 mm



90° horizontal aufwärts
gewinkelt, biegsam
90° horizontal angled up,
malleable



90° horizontal aufwärts
gewinkelt, biegsam
90° horizontal angled up,
malleable

Gesamtlänge
Total length

TITAN
Küretten, TITAN
Curettes, TITANIUM

		Gesamtlänge Total length		Küretten, TITAN Curettes, TITANIUM
06-06-631T		260 mm / 10¼"	HARDY	ø 4 mm
	06-06-632T	260 mm / 10¼"	HARDY	ø 6 mm



6

2/3
HARDY
06-06-631
260 mm
10¼"



**Enukleator
abwärts
gebogen,
Klinge rechts**
*Enucleator
curved down,
blade right*



**Enukleator
abwärts
gebogen,
Klinge links**
*Enucleator
curved down,
blade left*



**Enukleator
aufwärts
gebogen,
Klinge rechts**
*Enucleator
curved up,
blade right*



**Enukleator
aufwärts
gebogen,
Klinge links,**
*Enucleator
curved up,
blade left*

Gesamtlänge
Total length

stumpf / blunt	HARDY	06-06-620	06-06-650	06-06-621	06-06-651	245 mm / 9¾"
scharf / sharp	HARDY	06-06-622	06-06-652	06-06-623	06-06-653	245 mm / 9¾"



**Dissektor
abwärts
gebogen,
Klinge links**
*Dissector
curved down,
blade left*



**Dissektor
aufwärts
gebogen,
Klinge rechts**
*Dissector
curved up,
blade right*



**Implanta-
tionsgabel**
Implant Fork



**Raspatorium
abwärts
gebogen**
*Raspatory
curved down*

Gesamtlänge
Total length

	HARDY- FAHLBUSCH	06-06-608	06-06-609			245 mm / 9¾"
	HARDY			06-06-624		245 mm / 9¾"
	NICOLA				06-06-619	215 mm / 8¼"



Mikro-Häkchen
 1,7 mm
Micro Hook
 1.7 mm



Dissektor stumpf
 2,0 mm
Dissector blunt
 2.0 mm

Gesamtlänge
Total length

	LANDOLT- REULEN	06-56-656	06-56-657			245 mm / 9¾"
--	----------------------------	-----------	-----------	--	--	--------------

2/3
HARDY
06-06-650
 245 mm
 9¾"

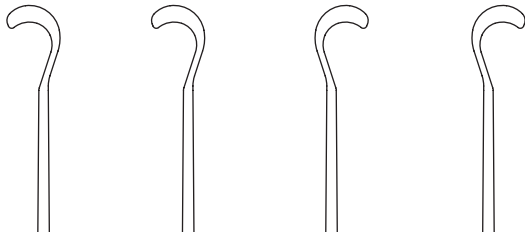

E nukleator abwärts gebogen, Klinge rechts
E nucleator curved down, blade right

E nukleator abwärts gebogen, Klinge links
E nucleator curved down, blade left

E nukleator aufwärts gebogen, Klinge rechts
E nucleator curved up, blade right

E nukleator aufwärts gebogen, Klinge links
E nucleator curved up, blade left

Gesamtlänge
Total length

TITAN

06-06-620T	06-06-650T	06-06-621T	06-06-651T	245 mm / 9¾"	HARDY	stumpf / <i>blunt</i>
06-06-622T	06-06-652T	06-06-623T	06-06-653T	245 mm / 9¾"	HARDY	scharf / <i>sharp</i>



Dissektor abwärts gebogen, Klinge links
Dissector curved down, blade left

Dissektor aufwärts gebogen, Klinge rechts
Dissector curved up, blade right

Raspatorium, abwärts gebogen
Raspatory, curved down

Gesamtlänge
Total length

TITAN

06-06-608T	06-06-609T			245 mm / 9¾"	HARDY-FAHLBUSCH	
		06-06-619T		215 mm / 8¼"		



Mikro-Häkchen 1,7 mm
Micro Hook 1.7 mm

Dissektor stumpf 2,0 mm
Dissector blunt 2.0 mm

Gesamtlänge
Total length

TITAN

06-56-656T	06-56-657T	245 mm / 9¾"	LANDOLT-REULEN	
------------	------------	--------------	-----------------------	--



6

2/3
HARDY
06-06-650
245 mm
9¾"



**Enukleator
abwärts
gebogen,
Klinge rechts,
biegsam**
*Enucleator
curved down,
blade right,
malleable*



**Enukleator
abwärts
gebogen,
Klinge links,
biegsam**
*Enucleator
curved down,
blade left,
malleable*



**Enukleator
aufwärts
gebogen,
Klinge rechts,
biegsam**
*Enucleator
curved up,
blade right
malleable*



**Enukleator
aufwärts
gebogen,
Klinge links,
biegsam**
*Enucleator
curved up,
blade left
malleable*

Gesamtlänge
Total length

stumpf / blunt	LANDOLT	06-06-625	06-06-655	06-06-626	06-06-656	260 mm / 10¼"
----------------	----------------	------------------	------------------	------------------	------------------	---------------

**Enukleator
abwärts
gebogen,
Klinge rechts,
biegsam**
*Enucleator
curved down,
blade right,
malleable*

**Enukleator
abwärts
gebogen,
Klinge links,
biegsam**
*Enucleator
curved down,
blade left,
malleable*

**Enukleator
aufwärts
gebogen,
Klinge rechts,
biegsam**
*Enucleator
curved up,
blade right
malleable*

**Enukleator
aufwärts
gebogen,
Klinge links,
biegsam**
*Enucleator
curved up,
blade left
malleable*

Gesamtlänge
Total length

stumpf / blunt	LANDOLT	06-06-625T	06-06-655T	06-06-626T	06-06-656T	260 mm / 10¼"
----------------	----------------	-------------------	-------------------	-------------------	-------------------	---------------

TITAN



**Löffel,
biegsam**
*Spoon,
malleble*



**Häkchen,
stumpf,
biegsam**
*Hook, blunt,
malleable*



**Gabelspatel,
fest**
*Fork spatula,
rigid*



**Kürette,
biegsam**
*Curette,
malleble*

Gesamtlänge
Total length

	LANDOLT	06-06-628				260 mm / 10¼"
	LANDOLT		06-06-629			260 mm / 10¼"
	HOSOBUCHI			06-06-630		260 mm / 10¼"
	LANDOLT				06-06-627	260 mm / 10¼"

TITAN

	LANDOLT		06-06-629T			260 mm / 10¼"
--	----------------	--	-------------------	--	--	---------------



2/3
LANDOLT
06-06-625
260 mm
10¼"



Löffel,
biegsam
Spoon,
malleable

Kürette,
biegsam
Curette,
malleable

Kürette, fest
Curette, rigid

Gesamtlänge
Total length

06-06-635				260 mm / 10¼"	FAHLBUSCH	ø 2,0 mm
	06-06-637			260 mm / 10¼"	FAHLBUSCH	ø 2,5 mm
		06-06-642		260 mm / 10¼"	LANDOLT-REULEN	ø 2,5 mm

Löffel,
biegsam
Spoon,
malleable

Kürette,
biegsam
Curette,
malleable

Kürette, fest
Curette, rigid

Gesamtlänge
Total length

TITAN

06-06-635T				260 mm / 10¼"	FAHLBUSCH	ø 2,0 mm
	06-06-637T			260 mm / 10¼"	FAHLBUSCH	ø 2,5 mm
		06-06-642T		260 mm / 10¼"	LANDOLT-REULEN	ø 2,5 mm



Raspatorium,
fest
Raspatory,
rigid

Raspatorium,
fest
Raspatory,
rigid

Häkchen,
stumpf, fest
Hook, blunt,
rigid

Dissektor,
fest
Dissector,
rigid

Gesamtlänge
Total length

06-06-640				260 mm / 10¼"	LANDOLT-REULEN	ø 2,2 mm
	06-06-641			260 mm / 10¼"	LANDOLT-REULEN	ø 3,2 mm
		06-06-643		260 mm / 10¼"	LANDOLT-REULEN	
			06-06-644	260 mm / 10¼"	LANDOLT-REULEN	

Raspatorium,
fest
Raspatory,
rigid

Raspatorium,
fest
Raspatory,
rigid

Häkchen,
stumpf, fest
Hook, blunt,
rigid

Dissektor,
fest
Dissector,
rigid

Gesamtlänge
Total length

TITAN

06-06-640T				260 mm / 10¼"	LANDOLT-REULEN	ø 2,2 mm
	06-06-641T			260 mm / 10¼"	LANDOLT-REULEN	ø 3,2 mm
		06-06-643T		260 mm / 10¼"	LANDOLT-REULEN	
			06-06-644T	260 mm / 10¼"	LANDOLT-REULEN	



2/3
FAHLBUSCH
06-06-635
260 mm
10¼"



Mikro-Neurochirurgische Instrumente
Micro-Neurosurgical Instruments

HF-Instrumente und Zubehör
HF Instruments and Accessoires

Kopf-Schädelinstrumente und Haltesysteme
Head-Cranio Instruments and Holding Systems

Aneurysmen-Clip System
Aneurysm Clip System

Schädel-Verplattung
Cranial Plate System

Hypophysektomie-Instrumente
Pituitary Instruments

Instrumente für die Wirbelsäule, Wundspreizer
Spine Instruments, Self-retaining Retractors



Laminektomie-Stanzen, Rongeure, Hohlmeißelzangen
Laminectomy Punches, Rongeurs

Gefäß- und Bulldogklemmen, Gefäß-Clips
Vessel- and Bulldog-Clamps, Vessel Clips

Allgemeinchirurgische Instrumente
General Surgical Instruments

Alphabetischer Index, Numerischer Index
Alphabetical Index, Numerical Index

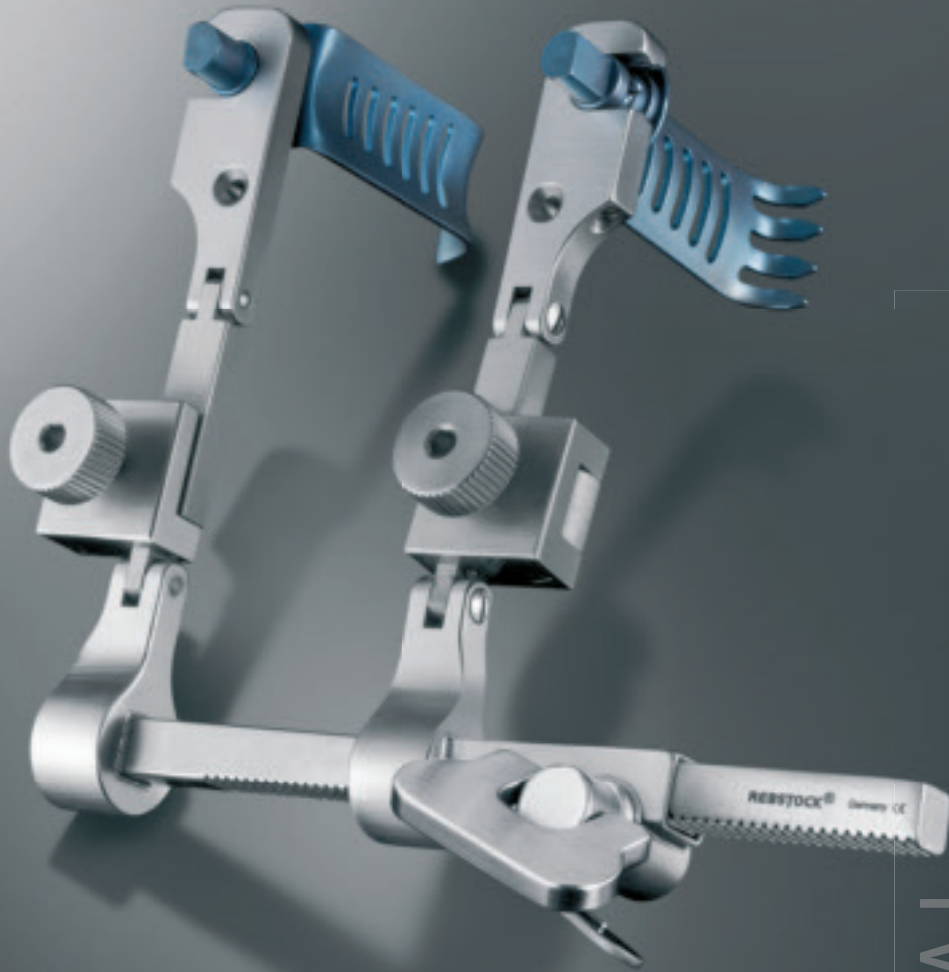

SURGICAL
INSTRUMENTS
MICRO-NEURO-SPINE

/// 07

REBSTOCK®
Precision made in Germany

/// Instrumente für die Wirbelsäule, Wundspreizer
Spine Instruments, Self-retaining Retractors

 Artikel-Nr.
 Cat. No.

	CASPAR	06-06-890	Wirbelkörper-Distraktor zur anterioren, zervikalen Verplattung, für rechtsseitigen Zugang zu C5-T1/2 und linksseitigem Zugang zur oberen HWS, komplett, bestehend aus: <i>Vertebral Body Distractor for anterior, cervical plating, for use in surgical procedures from the right approach for C5 through T1/2 and from the left approach for the upper cervical spine, complete, consisting of:</i>
			06-06-891 1x Distraktor, allein <i>distractor, only</i>
			06-06-897 1x Bohrlehre, rechts <i>drill guide, right</i>
			06-06-908 1x Bohrer <i>twist drill</i>
			06-06-905 1x Distraktionsschrauben, 16 mm <i>distraction screw, 16 mm</i> VE = 2 Stück <i>pack. à 2 pcs.</i>
			06-06-906 1x Schraubendreher <i>screwdriver</i>



Artikel-Nr.
Cat. No.

06-06-900	<p>Wirbelkörper-Distraktor zur anterioren, zervikalen Verplattung, für linksseitigen Zugang zu C5-T1/2 und rechtsseitigem Zugang zur oberen HWS, komplett, bestehend aus: <i>Vertebral Body Distractor for anterior, cervical plating, for use in surgical procedures from the left approach for C5 through T1/2 and from the right approach for the upper cervical spine, complete, consisting of:</i></p>	CASPAR	
06-06-901	1x Distraktor, allein <i>distractor, only</i>		
06-06-907	1x Bohrlehre, links <i>drill guide, left</i>		
06-06-908	1x Bohrer <i>twist drill</i>		
06-06-905	1x Distraktionsschrauben, 16 mm VE = 2 Stück <i>distraction screw, 16 mm pack. à 2 pcs.</i>		
06-06-906	1x Schraubendreher <i>screwdriver</i>		



Artikel-Nr.
Cat. No.

CASPAR

06-06-891

Wirbelkörper-Distraktor, alleine, für rechtsseitigen Zugang zu C5-T1/2 und linksseitigen Zugang zur oberen HWS, max. Spreizweite 70 mm

vertebral body distractor, only, for use in surgical procedures from the right approach for C5 through T1/2 and from the left approach for the upper cervical spine, max. spread 70 mm

CASPAR

06-06-893

Wirbelkörper-Distraktor, alleine, mit verlängerter Führungsstange für eine multisegmentale Distraction für rechtsseitigen Zugang zu C5-T1/2 und linksseitigen Zugang zur oberen HWS, max. Spreizweite 90 mm

vertebral body distractor, only, with elongated toothed bar, for multilevel distraction for use in surgical procedures from the right approach for C5 through T1/2 and from the left approach for the upper cervical spine, max. spread 90 mm

2/3
 CASPAR
 06-06-891



2/3
 CASPAR
 06-06-897

Artikel-Nr.
Cat. No.

CASPAR

06-06-897

Bohrlehre, rechts für Distraktor 06-06-891 und 06-06-893

drill guide, right for distractor 06-06-891 and 06-06-893

Artikel-Nr.
Cat. No.

<p>06-06-901</p>	<p>Wirbelkörper-Distraktor, alleine, für linksseitigen Zugang zu C5-T1/2 und rechtsseitigen Zugang zur oberen HWS, max. Spreizweite 70 mm</p> <p><i>vertebral body distractor, only, for use in surgical procedures from the left approach for C5 through T1/2 and from the right approach for the upper cervical spine, max. spread 70 mm</i></p>	<p>CASPAR</p>	
<p>06-06-903</p>	<p>Wirbelkörper-Distraktor, alleine, mit verlängerter Führungsstange für eine multisegmentale Distraction für linksseitigen Zugang zu C5-T1/2 und rechtsseitigen Zugang zur oberen HWS, max. Spreizweite 90 mm</p> <p><i>vertebral body distractor, only, with elongated toothed bar, for multilevel distraction for use in surgical procedures from the left approach for C5 through T1/2 and from the right approach for the upper cervical spine, max. spread 90 mm</i></p>	<p>CASPAR</p>	

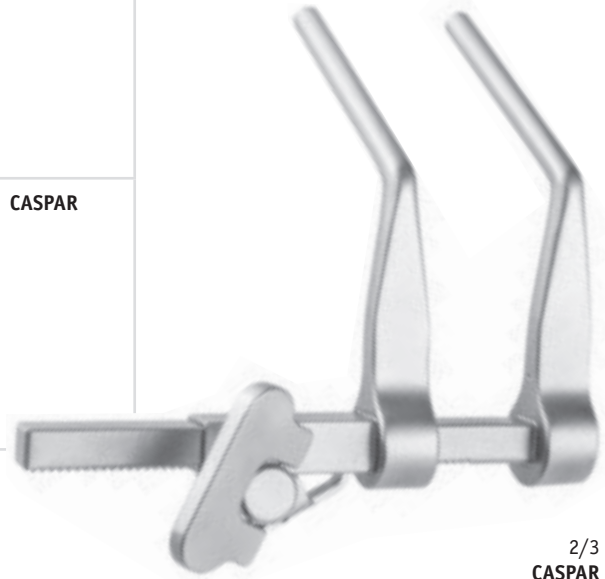

2/3
CASPAR
06-06-901



2/3
CASPAR
06-06-907

Artikel-Nr.
Cat. No.

<p>06-06-907</p>	<p>Bohrlehre, links für Distraktor 06-06-901 und 06-06-903</p> <p><i>drill guide, left for distractor 06-06-901 and 06-06-903</i></p>	<p>CASPAR</p>	
-------------------------	---	----------------------	--



1/2
CASPAR
06-06-905
 16 mm

Artikel-Nr.
Cat. No.

Gewindelänge
length of thread

	CASPAR	Artikel-Nr. Cat. No.	Gewindelänge length of thread
		06-06-912	12 mm
		06-06-904	14 mm
		06-06-905	16 mm
		06-06-909	18 mm
Distraktionsschrauben, zur Verwendung mit den Distraktoren 06-06-891, 06-06-893, 06-06-901 und 06-06-903 (VE = 2 Stück) <i>distraction screws, to be used with distractors 06-06-891, 06-06-893, 06-06-901 and 06-06-903 (pack. à 2 pcs.)</i>			



1/2
CASPAR
06-06-908
 145 mm
 5 3/4"

Artikel-Nr.
Cat. No.

Gesamtlänge
Total length

	CASPAR	Artikel-Nr. Cat. No.	Gesamtlänge Total length
		06-06-908	145 mm / 5 3/4"
Bohrer ø 1,7 mm für Distraktionsschrauben, Bohrtiefe 8 mm <i>twist drill ø 1,7 mm for distractions screws, drilling depth 8 mm</i>			





1/2
CASPAR
06-06-906
 200 mm
 8"

Artikel-Nr.
Cat. No.

Gesamtlänge
Total length

	CASPAR	Artikel-Nr. Cat. No.	Gesamtlänge Total length
		06-06-906	200 mm / 8"
Schraubendreher für Distraktionsschrauben <i>screwdriver for distraction screws</i>			

Artikel-Nr. Cat. No.	Gesamtlänge Total length		
06-06-917	205 mm / 8"	CASPAR	1/1 
06-06-918	205 mm / 8"	CASPAR	1/1 



1/2
CASPAR
06-06-917
205 mm
8"

Artikel-Nr. Cat. No.			
01-01-845	Messschieber zum Vermessen des Knochenspans und des Span-Situs Messbereich 0-125 mm <i>caliper, for measurement of the bone graft and graft site measuring range 0-125 mm</i>	CASPAR	



CASPAR
01-01-845

Artikel-Nr. Cat. No.	Gesamtlänge Total length		
06-06-911	220 mm / 8 1/4"	CASPAR	

Knochenspanhalter und
-einsetzinstrument
bone graft holder and impactor



1/2
CASPAR
06-06-911
220 mm
8 1/4"





1/2
CASPAR
06-11-775
 220 mm
 8¾"

		Artikel-Nr. Cat. No.	Gesamtlänge Total length
1/1 3,6 mm		CASPAR 06-11-773	220 mm / 8¾" gerade straight
1/1 4,4 mm		CASPAR 06-11-774	220 mm / 8¾" gerade straight
1/1 5,2 mm		CASPAR 06-11-775	220 mm / 8¾" gerade straight
1/1 3,6 mm		CASPAR 06-11-783	220 mm / 8¾" gebogen curved
1/1 4,4 mm		CASPAR 06-11-784	220 mm / 8¾" gebogen curved
1/1 5,2 mm		CASPAR 06-11-785	220 mm / 8¾" gebogen curved



1/2
CASPAR
06-11-835
 220 mm
 8¾"

		Artikel-Nr. Cat. No.	Gesamtlänge Total length
1/1 4 mm		CASPAR 06-11-834	220 mm / 8¾" gezahnt toothed
1/1 5 mm		CASPAR 06-11-835	220 mm / 8¾" gezahnt toothed
1/1 6 mm		CASPAR 06-11-836	220 mm / 8¾" gezahnt toothed

Artikel-Nr. Cat. No.	Gesamtlänge Total length	CASPAR	
06-11-854	250 mm / 10"		1/1 4 mm
	gezahnt toothed		
06-11-855	250 mm / 10"		1/1 5 mm
	gezahnt toothed		



1/2
CASPAR
06-11-854
250 mm
10"

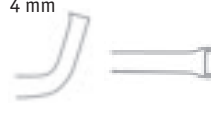





Artikel-Nr. Cat. No.	Gesamtlänge Total length	CASPAR	
06-11-863	270 mm / 10 ³ / ₄ "		1/1 3 mm
	gezahnt toothed		
06-11-864	270 mm / 10 ³ / ₄ "		1/1 4 mm
	gezahnt toothed		



1/2
CASPAR
06-11-863
270 mm
10³/₄"







1/2
CASPAR
06-06-913
 200 mm
 8"

			Artikel-Nr. Cat. No.	Gesamtlänge Total length
	1/1 3 mm	CASPAR	06-06-913	200 mm / 8"
	1/1 5 mm	CASPAR	06-06-914	200 mm / 8"
	1/1 8 mm	CASPAR	06-06-915	200 mm / 8"
	1/1 12 mm		06-12-090	200 mm / 8"
	1/1 14 mm		06-12-091	200 mm / 8"
	1/1 16 mm		06-12-092	200 mm / 8"



1/3
SYPERT
06-07-093
 290 mm
 11½"

			Artikel-Nr. Cat. No.	Gesamtlänge Total length
	1/1 3x8 mm	SYPERT	06-07-093	290 mm / 11½"
	1/1 4x10 mm	SYPERT	06-07-094	290 mm / 11½"
	1/1 5x15 mm	SYPERT	06-07-095	290 mm / 11½"
	1/1 6x20 mm	SYPERT	06-07-096	290 mm / 11½"

Die K-Line Küretten sind speziell für den Einsatz in der Mikrodiskektomie geeignet. Sie sind in drei Ausführungen erhältlich und entsprechen den speziellen klinischen Anforderungen der Wirbelsäulenchirurgie.

Zervikale Küretten

Kleine Löffelgrößen, für die kleine Anatomie im zervikalen Bereich.

Zervikale lange Küretten

Gleiche Spitzenkonfiguration wie die zervikalen Küretten, jedoch länger, für eine größere Reichweite.

Lumbale Küretten

Größere Löffel, optimal für lumbale Eingriffe.

- Bajonett-Ausführung für verbesserte Visualisierung
- Ergonomischer Handgriff für optimale Kontrolle
- Große Anzahl an Konfigurationen und Größen

K-Line curettes are specifically suitable for the use in microdiscectomy procedures. They are available in three designs to meet the unique clinical needs of spinal surgery.

Cervical Curettes

Smaller cup sizes for the smaller anatomy in the cervical area.

Cervical Long Curettes

Same tip configurations as the cervical curettes, but longer to improve reach.

Lumbar Curettes

Larger cup sizes optimally suited for lumbar procedures.

- bayonet design for improved visualization
- ergonomic handle for enhanced control
- multiple tip configurations and sizes



Ausführungen
Tip configurations

BS abwärts gerade <i>backward straight</i>	
BA abwärts gewinkelt <i>backward angle</i>	
BD abwärts schneidend / aufwärts gewinkelt <i>backward down</i>	
FS aufwärts gerade <i>forward straight</i>	
FA aufwärts gewinkelt <i>forward angle</i>	
FD aufwärts schneidend / abwärts gewinkelt <i>forward down</i>	



	Größe <i>Size</i>	Figur <i>Figure</i>
	4.0 mm	2
	3.5 mm	1
	3.0 mm	0
	2.7 mm	00
	2.4 mm	000
	1.6 mm	0000







Artikel-Nr.
Cat. No.

13-56-200

K-LINE Zervikal Mikrodiskektomie Instrumenten Set, bestehend aus:
K-LINE Cervical Microdiscectomy Instrument Set, consisting of:

13-06-251	1 x Kürette, 3,0 mm, FS <i>curette, 3.0 mm, FS</i>	13-06-264	1 x Kürette, 1,6 mm, BS <i>curette, 1.6 mm, BS</i>
13-06-252	1 x Kürette, 2,7 mm, FS <i>curette, 2.7 mm, FS</i>	13-06-265	1 x Kortikal Kürette, 3,0 mm, BS <i>cortical bone cutter, 3.0 mm, BS</i>
13-06-253	1 x Kürette, 2,4 mm, FS <i>curette, 2.4 mm, FS</i>	13-06-266	1 x Kürette, 3,0 mm, BA <i>curette, 3.0 mm, BA</i>
13-06-254	1 x Kürette, 1,6 mm, FS <i>curette, 1.6 mm, FS</i>	13-06-267	1 x Kürette, 2,7 mm, BA <i>curette, 2.7 mm, BA</i>
13-06-255	1 x Kortikal Kürette, 3,0 mm, FS <i>cortical bone cutter, 3.0 mm, FS</i>	13-06-268	1 x Kürette, 2,4 mm, BA <i>curette, 2.4 mm, BA</i>
13-06-256	1 x Kürette, 3,0 mm, FA <i>curette, 3.0 mm, FA</i>	13-06-269	1 x Kürette, 1,6 mm, BA <i>curette, 1.6 mm, BA</i>
13-06-257	1 x Kürette, 2,7 mm, FA <i>curette, 2.7 mm, FA</i>	13-06-270	1 x Kortikal Kürette, 3,0 mm, BA <i>cortical bone cutter, 3.0 mm, BA</i>
13-06-258	1 x Kürette, 2,4 mm, FA <i>curette, 2.4 mm, FA</i>	13-06-321	1 x Zervikal Mikro Nerv Haken <i>cervical micro nerve hook</i>
13-06-259	1 x Kürette, 1,6 mm, FA <i>curette, 1.6 mm, FA</i>	13-06-322	1 x Zervikal Mikro Nerv Haken, extra fein <i>cervical ultra micro nerve hook</i>
13-06-260	1 x Kortikal Kürette, 3,0 mm, FA <i>cortical bone cutter, 3.0 mm, FA</i>	13-06-323	1 x Zervikal Knochenwaxser <i>cervical bone waxer</i>
13-06-261	1 x Kürette, 3,0 mm, BS <i>curette, 3.0 mm, BS</i>	10-56-032	2 x Sterilisationscontainer mit Siebeinsatz für 12 Küretten, 380 x 260 x 65 mm <i>sterilisation case with tray insert for 12 currettes, 380 x 260 x 65 mm</i>
13-06-262	1 x Kürette, 2,7 mm, BS <i>curette, 2.7 mm, BS</i>		
13-06-263	1 x Kürette, 2,4 mm, BS <i>curette, 2.4 mm, BS</i>		

Zervikale Kürette mit Bajonettgriff
Cervical Curette with bayonet handle

Artikel-Nr. Cat. No.	Gesamtlänge Total length	Konfiguration Configuration	Figur Figure	Größe Size
13-06-254	215 mm / 8½"	FS	0000	1,6 mm
13-06-253	215 mm / 8½"	FS	000	2,4 mm
13-06-252	215 mm / 8½"	FS	00	2,7 mm 
13-06-251	215 mm / 8½"	FS	0	3,0 mm
13-06-255	215 mm / 8½"	FS		3,0 mm Kortal Kürette <i>cortical bone cutter</i>
13-06-259	215 mm / 8½"	FA	0000	1,6 mm
13-06-258	215 mm / 8½"	FA	000	2,4 mm
13-06-257	215 mm / 8½"	FA	00	2,7 mm 
13-06-256	215 mm / 8½"	FA	0	3,0 mm
13-06-260	215 mm / 8½"	FA		3,0 mm Kortal Kürette <i>cortical bone cutter</i>
13-06-264	215 mm / 8½"	BS	0000	1,6 mm
13-06-263	215 mm / 8½"	BS	000	2,4 mm
13-06-262	215 mm / 8½"	BS	00	2,7 mm 
13-06-261	215 mm / 8½"	BS	0	3,0 mm
13-06-265	215 mm / 8½"	BS		3,0 mm Kortal Kürette <i>cortical bone cutter</i>
13-06-269	215 mm / 8½"	BA	0000	1,6 mm
13-06-268	215 mm / 8½"	BA	000	2,4 mm
13-06-267	215 mm / 8½"	BA	00	2,7 mm 
13-06-266	215 mm / 8½"	BA	0	3,0 mm
13-06-270	215 mm / 8½"	BA		3,0 mm Kortal Kürette <i>cortical bone cutter</i>



2/3
13-06-253
215 mm
8½"

Artikel-Nr. Cat. No.	Gesamtlänge Total length		
13-06-321	215 mm / 8½"	Zervikal Mikro Nerv Haken <i>cervical micro nerve hook</i>	
13-06-322	215 mm / 8½"	Zervikal Mikro Nerv Haken, extra fein <i>cervical ultra micro nerve hook</i>	
13-06-323	215 mm / 8½"	Zervikal Knochenwachser <i>cervical bone waxer</i>	





Artikel-Nr.
Cat. No.

13-56-201

K-LINE Zervikal Mikrodiskektomie Instrumenten Set, lang, bestehend aus:
K-LINE Cervical Microdiscectomy Instrument Set, long, consisting of:

13-06-272	1 x Kürette, 3,0 mm, FS <i>curette, 3.0 mm, FS</i>	13-06-285	1 x Kürette, 1,6 mm, BS <i>curette, 1.6 mm, BS</i>
13-06-273	1 x Kürette, 2,7 mm, FS <i>curette, 2.7 mm, FS</i>	13-06-286	1 x Kortikal Kürette, 3,0 mm, BS <i>cortical bone cutter, 3.0 mm, BS</i>
13-06-274	1 x Kürette, 2,4 mm, FS <i>curette, 2.4 mm, FS</i>	13-06-287	1 x Kürette, 3,0 mm, BA <i>curette, 3.0 mm, BA</i>
13-06-275	1 x Kürette, 1,6 mm, FS <i>curette, 1.6 mm, FS</i>	13-06-288	1 x Kürette, 2,7 mm, BA <i>curette, 2.7 mm, BA</i>
13-06-276	1 x Kortikal Kürette, 3,0 mm, FS <i>cortical bone cutter, 3.0 mm, FS</i>	13-06-289	1 x Kürette, 2,4 mm, BA <i>curette, 2.4 mm, BA</i>
13-06-277	1 x Kürette, 3,0 mm, FA <i>curette, 3.0 mm, FA</i>	13-06-290	1 x Kürette, 1,6 mm, BA <i>curette, 1.6 mm, BA</i>
13-06-278	1 x Kürette, 2,7 mm, FA <i>curette, 2.7 mm, FA</i>	13-06-291	1 x Kortikal Kürette, 3,0 mm, BA <i>cortical bone cutter, 3.0 mm, BA</i>
13-06-279	1 x Kürette, 2,4 mm, FA <i>curette, 2.4 mm, FA</i>	13-06-292	1 x Zervikal Mikro Nerv Haken <i>cervical micro nerve hook</i>
13-06-280	1 x Kürette, 1,6 mm, FA <i>curette, 1.6 mm, FA</i>	13-06-293	1 x Zervikal Mikro Nerv Haken, extra fein <i>cervical ultra micro nerve hook</i>
13-06-281	1 x Kortikal Kürette, 3,0 mm, FA <i>cortical bone cutter, 3.0 mm, FA</i>	13-06-294	1 x Zervikal Knochenwaxser <i>cervical bone waxer</i>
13-06-282	1 x Kürette, 3,0 mm, BS <i>curette, 3.0 mm, BS</i>	10-56-032	2 x Sterilisationscontainer mit Siebeinsatz für 12 Küretten, 380 x 260 x 65 mm <i>sterilisation case with tray insert for 12 currettes, 380 x 260 x 65 mm</i>
13-06-283	1 x Kürette, 2,7 mm, BS <i>curette, 2.7 mm, BS</i>		
13-06-284	1 x Kürette, 2,4 mm, BS <i>curette, 2.4 mm, BS</i>		

Lange zervikale Kürette mit Bajonettgriff
Long Cervical Curette with bayonet handle

Artikel-Nr. Cat. No.	Gesamtlänge Total length	Konfiguration Configuration	Figur Figure	Größe Size	
13-06-275	240 mm / 9½"	FS	0000	1,6 mm	
13-06-274	240 mm / 9½"	FS	000	2,4 mm	
13-06-273	240 mm / 9½"	FS	00	2,7 mm	
13-06-272	240 mm / 9½"	FS	0	3,0 mm	
13-06-276	240 mm / 9½"	FS		3,0 mm	Kortical Kürette <i>cortical bone cutter</i>
13-06-280	240 mm / 9½"	FA	0000	1,6 mm	
13-06-279	240 mm / 9½"	FA	000	2,4 mm	
13-06-278	240 mm / 9½"	FA	00	2,7 mm	
13-06-277	240 mm / 9½"	FA	0	3,0 mm	
13-06-281	240 mm / 9½"	FA		3,0 mm	Kortical Kürette <i>cortical bone cutter</i>
13-06-285	240 mm / 9½"	BS	0000	1,6 mm	
13-06-284	240 mm / 9½"	BS	000	2,4 mm	
13-06-283	240 mm / 9½"	BS	00	2,7 mm	
13-06-282	240 mm / 9½"	BS	0	3,0 mm	
13-06-286	240 mm / 9½"	BS		3,0 mm	Kortical Kürette <i>cortical bone cutter</i>
13-06-290	240 mm / 9½"	BA	0000	1,6 mm	
13-06-289	240 mm / 9½"	BA	000	2,4 mm	
13-06-288	240 mm / 9½"	BA	00	2,7 mm	
13-06-287	240 mm / 9½"	BA	0	3,0 mm	
13-06-291	240 mm / 9½"	BA		3,0 mm	Kortical Kürette <i>cortical bone cutter</i>



2/3
13-06-273
240 mm
9½"



Artikel-Nr. Cat. No.	Gesamtlänge Total length		
13-06-292	240 mm / 9½"	Zervikal Mikro Nerv Haken <i>cervical micro nerve hook</i>	
13-06-293	240 mm / 9½"	Zervikal Mikro Nerv Haken, extra fein <i>cervical ultra micro nerve hook</i>	
13-06-294	240 mm / 9½"	Zervikal Knochenwachser <i>cervical bone waxer</i>	

Artikel-Nr.
Cat. No.

13-56-202	K-LINE Lumbal Mikrodiskektomie Instrumenten Set, lang, bestehend aus: <i>K-LINE Lumbar Microdiscectomy Instrument Set, long, consisting of:</i>	
13-06-296	1 x Kürette, 3,0 mm, FS <i>curette, 3.0 mm, FS</i>	13-06-309 1 x Kürette, 3,5 mm, BA <i>curette, 3.5 mm, BA</i>
13-06-297	1 x Kürette, 3,5 mm, FS <i>curette, 3.5 mm, FS</i>	13-06-310 1 x Kürette, 4,0 mm, BA <i>curette, 4.0 mm, BA</i>
13-06-298	1 x Kürette, 4,0 mm, FS <i>curette, 4.0 mm, FS</i>	13-06-311 1 x Kürette, 3,0 mm, BD <i>curette, 3.0 mm, BD</i>
13-06-299	1 x Kürette, 3,0 mm, FA <i>curette, 3.0 mm, FA</i>	13-06-312 1 x Kürette, 2,7 mm, BD <i>curette, 2.7 mm, BD</i>
13-06-300	1 x Kürette, 3,5 mm, FA <i>curette, 3.5 mm, FA</i>	13-06-313 1 x Kürette, 2,4 mm, BD <i>curette, 2.4 mm, BD</i>
13-06-301	1 x Kürette, 4,0 mm, FA <i>curette, 4.0 mm, FA</i>	13-06-314 1 x Lumbal PENFIELD Dissektor #1 <i>lumbar PENFIELD dissector #1</i>
13-06-302	1 x Kürette, 3,0 mm, FD <i>curette, 3.0 mm, FD</i>	13-06-315 1 x Lumbal PENFIELD Dissektor #2 <i>lumbar PENFIELD dissector #2</i>
13-06-303	1 x Kürette, 3,5 mm, FD <i>curette, 3.5 mm, FD</i>	13-06-316 1 x Lumbal Nerv Haken <i>lumbar nerve hook</i>
13-06-304	1 x Kürette, 4,0 mm, FD <i>curette, 4.0 mm, FD</i>	13-06-317 1 x Lumbal PENFIELD Dissektor #4 <i>lumbar PENFIELD dissector #4</i>
13-06-305	1 x Kürette, 3,0 mm, BS <i>curette, 3.0 mm, BS</i>	13-06-318 1 x Lumbal Knochenwaxer <i>lumbar bone waxer</i>
13-06-306	1 x Kürette, 3,5 mm, BS <i>curette, 3.5 mm, BS</i>	13-06-319 1 x Lumbal Wirbelsäulensonde <i>lumbar spine probe</i>
13-06-307	1 x Kürette, 4,0 mm, BS <i>curette, 4.0 mm, BS</i>	10-56-032 2 x Sterilisationscontainer mit Siebeinsatz für 12 Küretten, 380 x 260 x 65 mm <i>sterilisation case with tray insert for 12 curettes, 380 x 260 x 65 mm</i>
13-06-308	1 x Kürette, 3,0 mm, BA <i>curette, 3.0 mm, BA</i>	

Lumbale Kürette mit Bajonettgriff
Lumbar Curette with bayonet handle

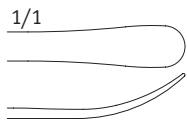
Artikel-Nr. Cat. No.	Gesamtlänge Total length	Konfiguration Configuration	Figur Figure	Größe Size
13-06-296	240 mm / 9½"	FS	0	3,0 mm
13-06-297	240 mm / 9½"	FS	1	3,5 mm
13-06-298	240 mm / 9½"	FS	2	4,0 mm
13-06-299	240 mm / 9½"	FA	0	3,0 mm
13-06-300	240 mm / 9½"	FA	1	3,5 mm
13-06-301	240 mm / 9½"	FA	2	4,0 mm
13-06-302	240 mm / 9½"	FD	0	3,0 mm
13-06-303	240 mm / 9½"	FD	1	3,5 mm
13-06-304	240 mm / 9½"	FD	2	4,0 mm
13-06-305	240 mm / 9½"	BS	0	3,0 mm
13-06-306	240 mm / 9½"	BS	1	3,5 mm
13-06-307	240 mm / 9½"	BS	2	4,0 mm
13-06-308	240 mm / 9½"	BA	0	3,0 mm
13-06-309	240 mm / 9½"	BA	1	3,5 mm
13-06-310	240 mm / 9½"	BA	2	4,0 mm
13-06-311	240 mm / 9½"	BD	0	3,0 mm
13-06-312	240 mm / 9½"	BD	1	3,5 mm
13-06-313	240 mm / 9½"	BD	2	4,0 mm

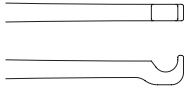
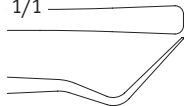
Artikel-Nr. Cat. No.	Gesamtlänge Total length		
13-06-314	240 mm / 9½"	PENFIELD	1/1 
13-06-315	240 mm / 9½"	PENFIELD	1/1 
13-06-317	240 mm / 9½"	PENFIELD	1/1 
13-06-316	240 mm / 9½"		1/1 
13-06-318	240 mm / 9½"		1/1 
13-06-319	240 mm / 9½"		1/1 



2/3
13-06-296
240 mm
9½"



Artikel-Nr.
Cat. No.

13-56-203	K-LINE Mikrodissektomie Instrumenten Set, bestehend aus: <i>K-LINE Microdissectomy Instrument Set, consisting of:</i>	
13-56-500	1x	Mikro-Kürette #1, vorwärts gebogen <i>micro curette #1, forward angled</i>
13-56-501	1x	Mikro-Kürette #1, rückwärts gebogen <i>micro curette #1, backward angled</i>
13-56-502	1x	Mikro-Kürette #2, vorwärts gebogen <i>micro curette #2, forward angled</i>
13-56-503	1x	Mikro-Kürette #2, rückwärts gebogen <i>micro curette #2, backward angled</i>
13-56-504	1x	Mikro-Kürette #3, vorwärts gebogen <i>micro curette #3, forward angled</i>
13-56-505	1x	Mikro-Kürette #3, rückwärts gebogen <i>micro curette #3, backward angled</i>
13-56-506	1x	Mikro-Kürette #4, vorwärts gebogen <i>micro curette #4, forward angled</i>
13-56-507	1x	Mikro-Kürette #4, rückwärts gebogen <i>micro curette #4, backward angled</i>
13-56-508	1x	Mikro-Kürette #5, vorwärts gebogen <i>micro curette #5, forward angled</i>
13-56-509	1x	Mikro-Kürette #5, rückwärts gebogen <i>micro curette #5, backward angled</i>
13-56-510	1x	Mikro-Dissektor, gerade, 3 mm <i>micro dissector, straight, 3 mm</i>
13-56-511	1x	Mikro-Dissektor, gerade, 5 mm <i>micro dissector, straight, 5 mm</i>
10-56-032	1x	Sterilisationscontainer mit Siebeinsatz für 12 Küretten, 380 x 260 x 65 mm <i>sterilisation case with tray insert for 12 curettes, 380 x 260 x 65 mm</i>



Mikro-Küretten und -Dissektoren mit rundem Bajonettgriff
Micro Curette and Dissector with round bayonet handle

Artikel-Nr. Cat. No.	Gesamtlänge Total length	Konfiguration Configuration	Figur Figure	Größe Size
13-56-500	259 mm / 10"	F	1	1,0 mm
13-56-501	259 mm / 10"	B	1	1,0 mm
13-56-502	259 mm / 10"	F	2	1,5 mm
13-56-503	259 mm / 10"	B	2	1,5 mm
13-56-504	259 mm / 10"	F	3	2,0 mm
13-56-505	259 mm / 10"	B	3	2,0 mm
13-56-506	259 mm / 10"	F	4	2,5 mm
13-56-507	259 mm / 10"	B	4	2,5 mm
13-56-508	259 mm / 10"	F	5	3,0 mm
13-56-509	259 mm / 10"	B	5	3,0 mm
13-56-510	259 mm / 10" Mikro-Dissektor <i>micro dissector</i>	gerade <i>straight</i>		3 mm
13-56-511	259 mm / 10" Mikro-Dissektor <i>micro dissector</i>	gerade <i>straight</i>		5 mm



2/3
13-56-500
259 mm
10"



13-56-325

Artikel-Nr.
Cat. No.

	13-56-325	Griff für Mikro-Messer <i>handle for micro knife</i>
--	------------------	---

Artikel-Nr.
Cat. No.

	13-56-327	Mikro-Messer, 2 mm <i>micro knife blade, 2 mm</i>
	13-56-328	Mikro-Messer, 1,5 mm <i>micro knife blade, 1.5 mm</i>



CCR-Doppelgelenk-Retraktor mit erweiterter Tiefenspreizung

- Doppelgelenke für flexible operative Anpassung
- Erweiterte Tiefenspreizung durch distal verstellbare Valven
- Side-load Aufnahme für einfachen und schnellen intra-operativen Valvenwechsel
- Umlegbare Flügelschraube
- Umfangreiche Auswahl an Valvengrößen und -ausführungen für individuelle und flexible Anwendung
- Gefensterte Titanvalven, semi-transparent, zum rutschsicheren und schonenden Sitz

CCR-Double Hinge Retractor with extended deep spreading

- double articulation for a flexible operative adjustment
- extended deep spreading by means of distally adjustable blades
- side-load attachment for an easy and quick intra-operative exchange of blades
- reversible wing screw
- a large selection of blade sizes and -designs for an individual and flexible application
- fenestrated titanium blades, semi-transparent, for a slip-resistant and gentle fit



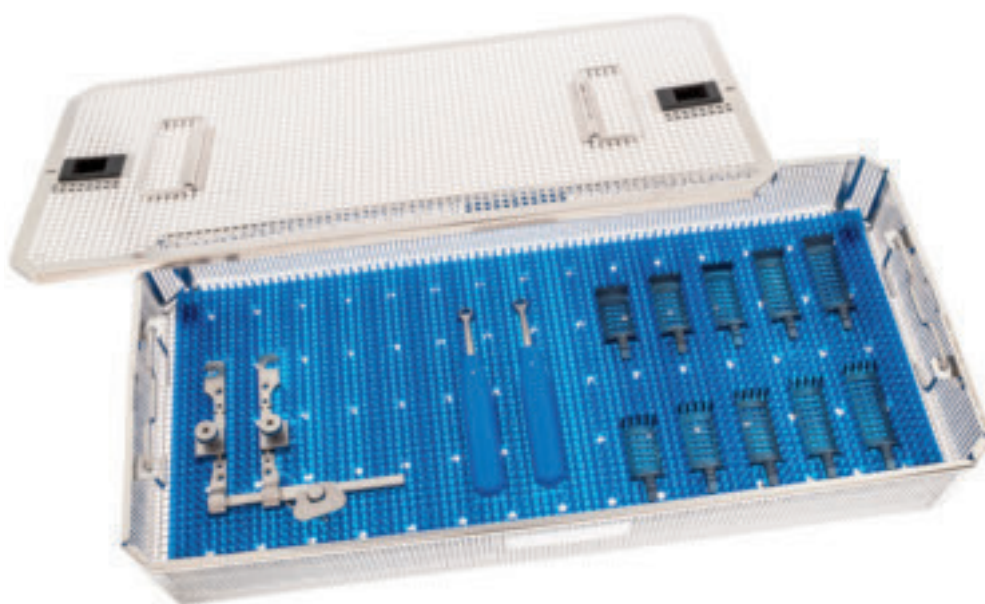

Artikel-Nr.
Cat. No.

02-73-122	CCR Zervikales Retraktor Set mit erweiterter Tiefenspreizung, bestehend aus: CCR Cervical Retractor Set with extended deep spreading, consisting of:	
10-07-224	1x	Siebkorb 545 x 255 x 100 mm aus Edelstahl <i>basket 545 x 255 x 100 mm, stainless steel screen</i>
10-06-227	1x	Deckel zu Siebkorb 545 x 255 mm aus Edelstahl, mit Verschluss <i>lid for basket 545 x 255 mm, with closure, stainless steel screen</i>
10-56-933	1x	Silikon-Matte 500 x 230 mm, blau <i>silicon mat 500 x 230 mm, blue</i>
02-73-049	1x	CCR Basis Retraktor, Doppelgelenk, mit erweiterter Tiefenspreizung <i>CCR basic retractor, double hinge, with extended deep spreading</i>
02-23-010	2x	Handgriff zum Einsetzen der Valven <i>handle for the insertion of blades</i>
02-23-143T	1x	CCR Valve, lateral 24 x 40 mm <i>CCR blade, lateral 24 x 40 mm</i>
02-23-144T	1x	CCR Valve, lateral 24 x 45 mm <i>CCR blade, lateral 24 x 45 mm</i>
02-23-145T	1x	CCR Valve, lateral 24 x 50 mm <i>CCR blade, lateral 24 x 50 mm</i>
02-23-146T	1x	CCR Valve, lateral 24 x 55 mm <i>CCR blade, lateral 24 x 55 mm</i>
02-23-147T	1x	CCR Valve, lateral 24 x 60 mm <i>CCR blade, lateral 24 x 60 mm</i>
02-23-153T	1x	CCR Valve, medial 24 x 40 mm <i>CCR blade, medial 24 x 40 mm</i>
02-23-154T	1x	CCR Valve, medial 24 x 45 mm <i>CCR blade, medial 24 x 45 mm</i>
02-23-155T	1x	CCR Valve, medial 24 x 50 mm <i>CCR blade, medial 24 x 50 mm</i>
02-23-156T	1x	CCR Valve, medial 24 x 55 mm <i>CCR blade, medial 24 x 55 mm</i>
02-23-157T	1x	CCR Valve, medial 24 x 60 mm <i>CCR blade, medial 24 x 60 mm</i>



Artikel-Nr.
Cat. No.

02-73-049	CCR Basisretraktor, Doppelgelenk, mit erweiterter Tiefenspreizung <i>CCR basic retractor, double hinge, with extended deep spreading</i> (ohne Valven / <i>without blades</i>)	CASPAR modif.	
------------------	--	--------------------------	--

Passende Valven siehe Seite 286-289
suitable blades please see page 286-289



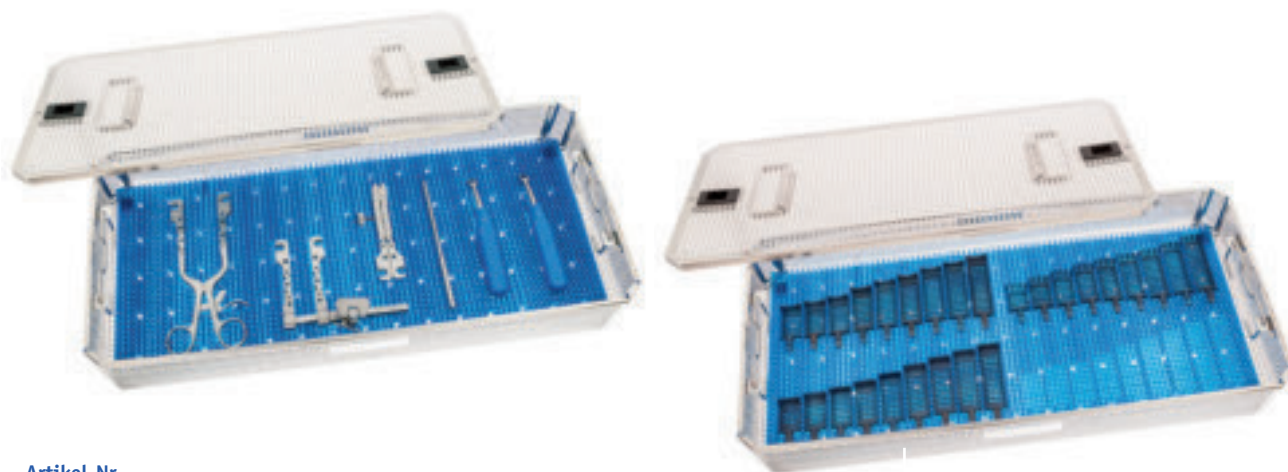

Artikel-Nr.
Cat. No.

02-23-124	CCR Zervikales Retraktor Set, bestehend aus: CCR Cervical Retractor Set, consisting of:	
10-07-224	2x	Siebkorb 545 x 255 x 100 mm aus Edelstahl <i>basket 545 x 255 x 100 mm, stainless steel screen</i>
10-06-227	2x	Deckel zu Siebkorb 545 x 255 mm aus Edelstahl, mit Verschluss <i>lid for basket 545 x 255 mm with closure, stainless steel screen</i>
10-56-933	2x	Silikon-Matte 500 x 230 mm, blau <i>silicon mat 500 x 230 mm, blue</i>
02-23-049	1x	CCR Basis Retraktor, Doppelgelenk <i>CCR basic retractor, double hinge</i>
02-23-047	1x	CCR Basis Gegensperrer <i>CCR basic counter retractor</i>
02-23-048	1x	CCR Gegensperrer <i>CCR counter retractor</i>
02-23-010	2x	Handgriff zum Einsetzen der Valven <i>handle for the insertion of blades</i>
02-23-011	1x	Tiefenmesser <i>depth gauge</i>
02-23-141T	1x	CCR Valve, lateral 24 x 30 mm <i>CCR blade, lateral 24 x 30 mm</i>
02-23-142T	1x	CCR Valve, lateral 24 x 35 mm <i>CCR blade, lateral 24 x 35 mm</i>
02-23-143T	1x	CCR Valve, lateral 24 x 40 mm <i>CCR blade, lateral 24 x 40 mm</i>
02-23-144T	1x	CCR Valve, lateral 24 x 45 mm <i>CCR blade, lateral 24 x 45 mm</i>
02-23-145T	1x	CCR Valve, lateral 24 x 50 mm <i>CCR blade, lateral 24 x 50 mm</i>
02-23-146T	1x	CCR Valve, lateral 24 x 55 mm <i>CCR blade, lateral 24 x 55 mm</i>
02-23-147T	1x	CCR Valve, lateral 24 x 60 mm <i>CCR blade, lateral 24 x 60 mm</i>
02-23-148T	1x	CCR Valve, lateral 24 x 65 mm <i>CCR blade, lateral 24 x 65 mm</i>
02-23-149T	1x	CCR Valve, lateral 24 x 70 mm <i>CCR blade, lateral 24 x 70 mm</i>
02-23-151T	1x	CCR Valve, medial 24 x 30 mm <i>CCR blade, medial 24 x 30 mm</i>
02-23-152T	1x	CCR Valve, medial 24 x 35 mm <i>CCR blade, medial 24 x 35 mm</i>
02-23-153T	1x	CCR Valve, medial 24 x 40 mm <i>CCR blade, medial 24 x 40 mm</i>
02-23-154T	1x	CCR Valve, medial 24 x 45 mm <i>CCR blade, medial 24 x 45 mm</i>
02-23-155T	1x	CCR Valve, medial 24 x 50 mm <i>CCR blade, medial 24 x 50 mm</i>
02-23-156T	1x	CCR Valve, medial 24 x 55 mm <i>CCR blade, medial 24 x 55 mm</i>
02-23-157T	1x	CCR Valve, medial 24 x 60 mm <i>CCR blade, medial 24 x 60 mm</i>
02-23-158T	1x	CCR Valve, medial 24 x 65 mm <i>CCR blade, medial 24 x 65 mm</i>
02-23-159T	1x	CCR Valve, medial 24 x 70 mm <i>CCR blade, medial 24 x 70 mm</i>
02-23-162T	1x	CCR Valve, stumpf 24 x 35 mm <i>CCR blade, blunt 24 x 35 mm</i>
02-23-163T	1x	CCR Valve, stumpf 24 x 40 mm <i>CCR blade, blunt 24 x 40 mm</i>
02-23-164T	1x	CCR Valve, stumpf 24 x 45 mm <i>CCR blade, blunt 24 x 45 mm</i>
02-23-165T	1x	CCR Valve, stumpf 24 x 50 mm <i>CCR blade, blunt 24 x 50 mm</i>
02-23-166T	1x	CCR Valve, stumpf 24 x 55 mm <i>CCR blade, blunt 24 x 55 mm</i>
02-23-167T	1x	CCR Valve, stumpf 24 x 60 mm <i>CCR blade, blunt 24 x 60 mm</i>
02-23-168T	1x	CCR Valve, stumpf 24 x 65 mm <i>CCR blade, blunt 24 x 65 mm</i>
02-23-169T	1x	CCR Valve, stumpf 24 x 70 mm <i>CCR blade, blunt 24 x 70 mm</i>
02-23-170T	1x	CCR Valve, stumpf 24 x 75 mm <i>CCR blade, blunt 24 x 75 mm</i>

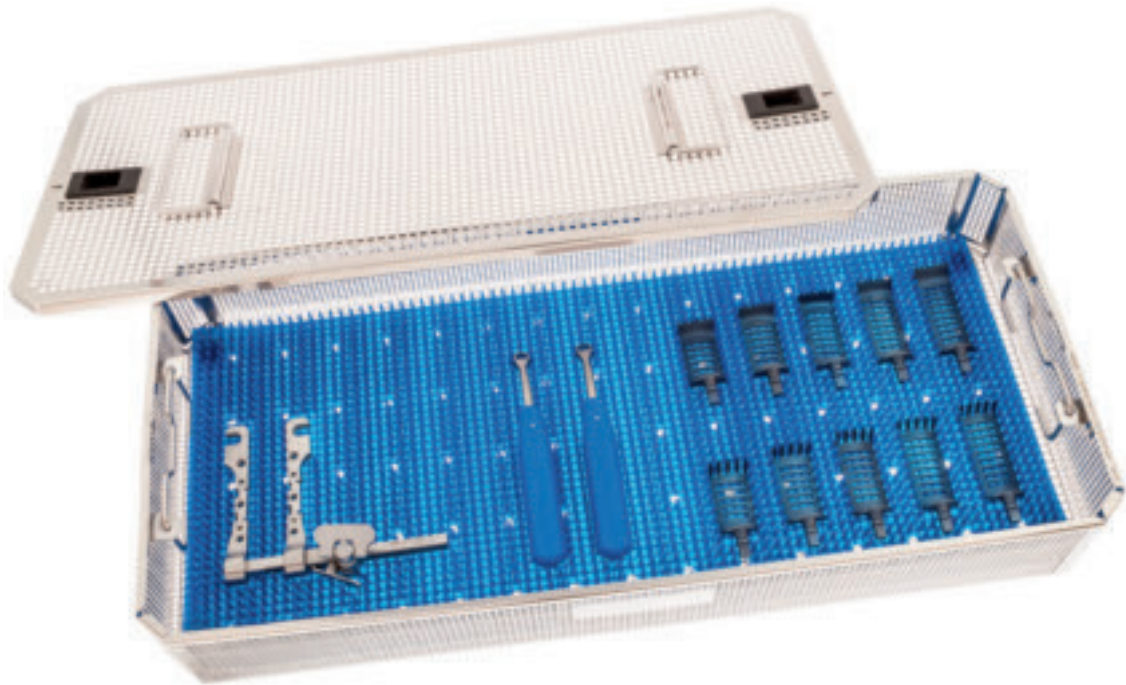

Artikel-Nr.
Cat. No.

02-23-122

CCR Basis Retraktor Set, bestehend aus:
CCR Basic Retractor Set, consisting of:

10-07-224 1x Siebkorb 545 x 255 x 100 mm aus Edelstahl
basket 545 x 255 x 100 mm,
stainless steel screen

10-06-227 1x Deckel zu Siebkorb 545 x 255 mm
aus Edelstahl, mit Verschluss
lid for basket 545 x 255 mm with closure,
stainless steel screen

10-56-933 1x Silikon-Matte 500 x 230 mm, blau
silicon mat 500 x 230 mm, blue

02-23-049 1x CCR Basis Retraktor, Doppelgelenk
CCR basic retractor, double hinge

02-23-010 2x Handgriff zum Einsetzen der Valven
handle for the insertion of blades

02-23-143T 1x CCR Valve, lateral 24 x 40 mm
CCR blade, lateral 24 x 40 mm

02-23-144T 1x CCR Valve, lateral 24 x 45 mm
CCR blade, lateral 24 x 45 mm

02-23-145T 1x CCR Valve, lateral 24 x 50 mm
CCR blade, lateral 24 x 50 mm

02-23-146T 1x CCR Valve, lateral 24 x 55 mm
CCR blade, lateral 24 x 55 mm

02-23-147T 1x CCR Valve, lateral 24 x 60 mm
CCR blade, lateral 24 x 60 mm

02-23-153T 1x CCR Valve, medial 24 x 40 mm
CCR blade, medial 24 x 40 mm

02-23-154T 1x CCR Valve, medial 24 x 45 mm
CCR blade, medial 24 x 45 mm

02-23-155T 1x CCR Valve, medial 24 x 50 mm
CCR blade, medial 24 x 50 mm

02-23-156T 1x CCR Valve, medial 24 x 55 mm
CCR blade, medial 24 x 55 mm

02-23-157T 1x CCR Valve, medial 24 x 60 mm
CCR blade, medial 24 x 60 mm



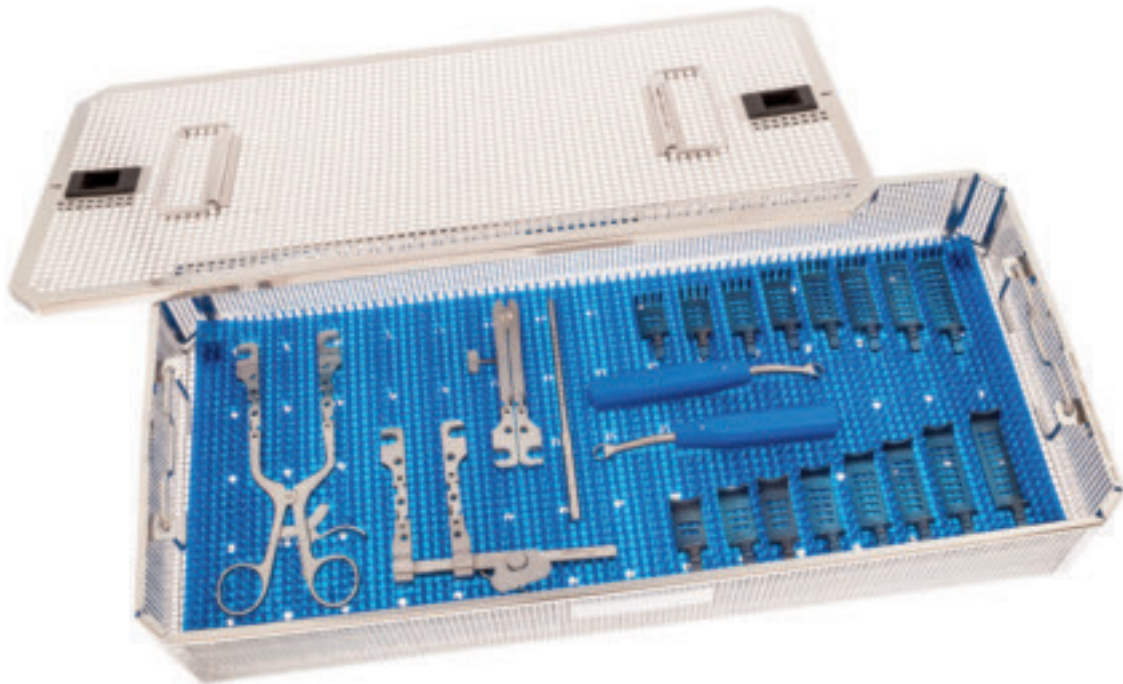

Artikel-Nr.
Cat. No.

Artikel-Nr.	Beschreibung
02-23-119	CCR Retraktor Set für mikrochirurgische Eingriffe, bestehend aus: CCR Retractor Set for micro surgical intervention, consisting of:
10-07-224	2 x Siebkorb 545 x 255 x 100 mm aus Edelstahl <i>basket 545 x 255 x 100 mm, stainless steel screen</i>
10-06-227	2 x Deckel zu Siebkorb 545 x 255 mm aus Edelstahl, mit Verschluss <i>lid for basket 545 x 255 mm, with closure, stainless steel screen</i>
10-56-933	2 x Silikon-Matte 500 x 230 mm, blau <i>silicon mat 500 x 230 mm, blue</i>
02-23-049	1 x CCR Basis Retraktor, Doppelgelenk <i>CCR basic retractor, double hinge</i>
02-23-047	1 x CCR Basis Gegensperrer <i>CCR basic counter retractor</i>
02-23-048	1 x Gegensperrer <i>counter retractor</i>
02-23-010	2 x Handgriff zum Einsetzen der Valven <i>handle for the insertion of blades</i>
02-23-011	1 x Tiefenmesser <i>depth gauge</i>
02-23-050T	2 x CCR Valve, gezahnt 19 x 25 mm <i>CCR blade, toothed 19 x 25 mm</i>
02-23-051T	2 x CCR Valve, gezahnt 19 x 30 mm <i>CCR blade, toothed 19 x 30 mm</i>
02-23-052T	2 x CCR Valve, gezahnt 19 x 35 mm <i>CCR blade, toothed 19 x 35 mm</i>
02-23-053T	2 x CCR Valve, gezahnt 19 x 40 mm <i>CCR blade, toothed 19 x 40 mm</i>
02-23-054T	2 x CCR Valve, gezahnt 19 x 45 mm <i>CCR blade, toothed 19 x 45 mm</i>
02-23-055T	2 x CCR Valve, gezahnt 19 x 50 mm <i>CCR blade, toothed 19 x 50 mm</i>
02-23-056T	2 x CCR Valve, gezahnt 19 x 55 mm <i>CCR blade, toothed 19 x 55 mm</i>
02-23-057T	2 x CCR Valve, gezahnt 19 x 60 mm <i>CCR blade, toothed 19 x 60 mm</i>
02-23-060T	1 x CCR Valve, stumpf 19 x 25 mm <i>CCR blade, blunt 19 x 25 mm</i>
02-23-061T	1 x CCR Valve, stumpf 19 x 30 mm <i>CCR blade, blunt 19 x 30 mm</i>
02-23-062T	1 x CCR Valve, stumpf 19 x 35 mm <i>CCR blade, blunt 19 x 35 mm</i>
02-23-063T	1 x CCR Valve, stumpf 19 x 40 mm <i>CCR blade, blunt 19 x 40 mm</i>
02-23-064T	1 x CCR Valve, stumpf 19 x 45 mm <i>CCR blade, blunt 19 x 45 mm</i>
02-23-065T	1 x CCR Valve, stumpf 19 x 50 mm <i>CCR blade, blunt 19 x 50 mm</i>
02-23-066T	1 x CCR Valve, stumpf 19 x 55 mm <i>CCR blade, blunt 19 x 55 mm</i>
02-23-067T	1 x CCR Valve, stumpf 19 x 60 mm <i>CCR blade, blunt 19 x 60 mm</i>

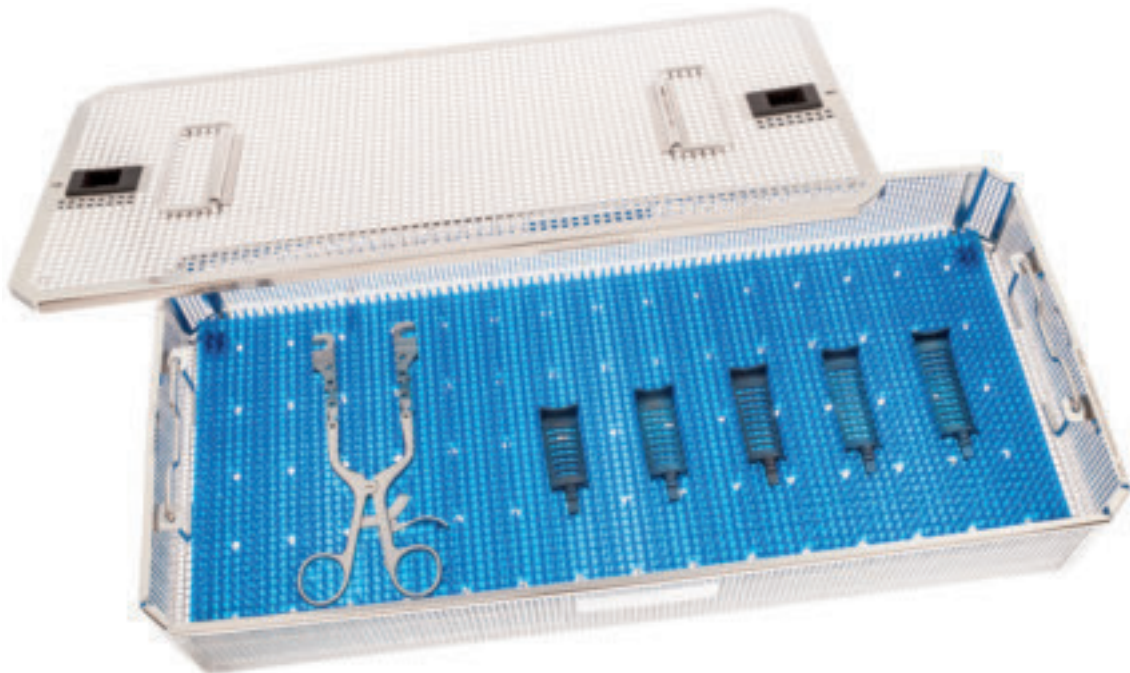

Artikel-Nr.
Cat. No.

02-23-123	CCR Basis-Gegensperrer Set, bestehend aus: CCR Basic Counter Retractor, set consisting of:		
10-07-224	1x Siebkorb 545 x 255 x 100 mm aus Edelstahl <i>basket 545 x 255 x 100 mm, stainless steel screen</i>		
10-06-227	1x Deckel zu Siebkorb 545 x 255 mm, aus Edelstahl, mit Verschluss <i>lid for basket 545 x 255 mm, with closure, stainless steel screen</i>		
10-56-933	1x Silikon-Matte 500 x 230 mm, blau <i>silicon mat 500 x 230 mm, blue</i>		
02-23-047	1x CCR Basis Gegensperrer <i>CCR basic counter retractor</i>		
		02-23-164T	1x CCR Valve, stumpf 24 x 45 mm <i>CCR blade, blunt 24 x 45 mm</i>
		02-23-165T	1x CCR Valve, stumpf 24 x 50 mm <i>CCR blade, blunt 24 x 50 mm</i>
		02-23-166T	1x CCR Valve, stumpf 24 x 55 mm <i>CCR blade, blunt 24 x 55 mm</i>
		02-23-167T	1x CCR Valve, stumpf 24 x 60 mm <i>CCR blade, blunt 24 x 60 mm</i>
		02-23-168T	1x CCR Valve, stumpf 24 x 65 mm <i>CCR blade, blunt 24 x 65 mm</i>



Artikel-Nr.
Cat. No.

	CASPAR	02-23-049	CCR Basis Retraktor mit Doppelgelenk, Spreizweite 90 mm <i>CCR basic retractor, double hinge, spread 90 mm</i> (ohne Valven / without blades)
--	---------------	------------------	---

CASPAR
02-23-049

Artikel-Nr.
Cat. No.

	CASPAR	02-23-047	CCR Basis Gegensperrer mit Doppelgelenk, Spreizweite 90 mm <i>CCR basic counter retractor, double hinge, spread 90 mm</i> (ohne Valven / without blades)
--	---------------	------------------	--

CASPAR
02-23-047

7

Artikel-Nr.
Cat. No.

02-23-048	CCR Gegensperrer, Spreizweite 90 mm <i>CCR counter retractor, spread 90 mm</i> (ohne Valven / <i>without blades</i>)	CASPAR	
-----------	---	--------	--



CASPAR
 02-23-048

Artikel-Nr.
Cat. No.

02-23-010	Handgriff zum Einsetzen der Valven auch verwendbar als Wundhaken in Verbindung mit CCR-Valven <i>handle for the insertion of blades</i> <i>also for use as retractor with CCR blades</i>		
-----------	--	--	--



02-23-010

Artikel-Nr.
Cat. No.

02-23-011	Tiefenmesser zur Bestimmung der Valvenlänge <i>depth gauge for determining the</i> <i>length of the blades</i>		
-----------	---	--	--



02-23-011

 1/1
02-23-055T
 19 x 50 mm

Valven gezahnt, medial-lateral, semi-röntgentransparent, TITAN
 Blades toothed, medial-lateral, semi x-ray transparent, TITANIUM

TITAN

Artikel-Nr. Cat. No.	Maße B x L Measurements W x L
02-23-050T	19 x 25 mm
02-23-051T	19 x 30 mm
02-23-052T	19 x 35 mm
02-23-053T	19 x 40 mm
02-23-054T	19 x 45 mm
02-23-055T	19 x 50 mm
02-23-056T	19 x 55 mm
02-23-057T	19 x 60 mm



7

Valven stumpf, longitudinal, semi-röntgentransparent, TITAN
 Blades blunt, longitudinal, semi x-ray transparent, TITANIUM

TITAN

Artikel-Nr. Cat. No.	Maße B x L Measurements W x L
02-23-060T	19 x 25 mm
02-23-061T	19 x 30 mm
02-23-062T	19 x 35 mm
02-23-063T	19 x 40 mm
02-23-064T	19 x 45 mm
02-23-065T	19 x 50 mm
02-23-066T	19 x 55 mm
02-23-067T	19 x 60 mm

 1/1
02-23-065T
 19 x 50 mm

Valven lateral, semi röntgentransparent, TITAN
Blades lateral, semi x-ray transparent, TITANIUM

TITAN

Artikel-Nr. Cat. No.	Maße B x L Measurements W x L
02-23-141T	24 x 30 mm
02-23-142T	24 x 35 mm
02-23-143T	24 x 40 mm
02-23-144T	24 x 45 mm
02-23-145T	24 x 50 mm
02-23-146T	24 x 55 mm
02-23-147T	24 x 60 mm
02-23-148T	24 x 65 mm
02-23-149T	24 x 70 mm



1/1
02-23-145T
24 x 50 mm

Valven medial, semi-röntgentransparent, TITAN
Blades medial, semi x-ray transparent, TITANIUM

TITAN

Artikel-Nr. Cat. No.	Maße B x L Measurements W x L
02-23-151T	24 x 30 mm
02-23-152T	24 x 35 mm
02-23-153T	24 x 40 mm
02-23-154T	24 x 45 mm
02-23-155T	24 x 50 mm
02-23-156T	24 x 55 mm
02-23-157T	24 x 60 mm
02-23-158T	24 x 65 mm
02-23-159T	24 x 70 mm



1/1
02-23-155T
24 x 50 mm

Valven stumpf, longitudinal, semi-röntgentransparent, TITAN
Blades blunt, longitudinal, semi x-ray transparent, TITANIUM

TITAN

Artikel-Nr. Cat. No.	Maße B x L Measurements W x L
02-23-162T	24 x 35 mm
02-23-163T	24 x 40 mm
02-23-164T	24 x 45 mm
02-23-165T	24 x 50 mm
02-23-166T	24 x 55 mm
02-23-167T	24 x 60 mm
02-23-168T	24 x 65 mm
02-23-169T	24 x 70 mm
02-23-170T	24 x 75 mm



1/1
02-23-165T
24 x 50 mm

Solid TITAN Valven
Solid TITANIUM blades

 1/1
02-23-255T
 19 x 50 mm

Valven gezahnt, medial-lateral, semi-röntgentransparent, TITAN-
 Blades toothed, medial-lateral, semi x-ray transparent, TITANIUM

TITAN

Artikel-Nr. Cat. No.	Maße B x L Measurements W x L
02-23-250T	19 x 25 mm
02-23-251T	19 x 30 mm
02-23-252T	19 x 35 mm
02-23-253T	19 x 40 mm
02-23-254T	19 x 45 mm
02-23-255T	19 x 50 mm
02-23-256T	19 x 55 mm
02-23-257T	19 x 60 mm

Valven stumpf, longitudinal, semi-röntgentransparent, TITAN
 Blades blunt, longitudinal, semi x-ray transparent, TITANIUM

TITAN

Artikel-Nr. Cat. No.	Maße B x L Measurements W x L
02-23-260T	19 x 25 mm
02-23-261T	19 x 30 mm
02-23-262T	19 x 35 mm
02-23-263T	19 x 40 mm
02-23-264T	19 x 45 mm
02-23-265T	19 x 50 mm
02-23-266T	19 x 55 mm
02-23-267T	19 x 60 mm

 1/1
02-23-265T
 19 x 50 mm

Valven lateral, semi röntgentransparent, TITAN
Blades lateral, semi x-ray transparent, TITANIUM

TITAN

Artikel-Nr. Cat. No.	Maße B x L Measurements W x L
02-23-341T	24 x 30 mm
02-23-342T	24 x 35 mm
02-23-343T	24 x 40 mm
02-23-344T	24 x 45 mm
02-23-345T	24 x 50 mm
02-23-346T	24 x 55 mm
02-23-347T	24 x 60 mm
02-23-348T	24 x 65 mm
02-23-349T	24 x 70 mm

Solid TITAN Valven
Solid TITANIUM blades



1/1
02-23-345T
24 x 50 mm

Valven medial, semi-röntgentransparent, TITAN
Blades medial, semi x-ray transparent, TITANIUM

TITAN

Artikel-Nr. Cat. No.	Maße B x L Measurements W x L
02-23-351T	24 x 30 mm
02-23-352T	24 x 35 mm
02-23-353T	24 x 40 mm
02-23-354T	24 x 45 mm
02-23-355T	24 x 50 mm
02-23-356T	24 x 55 mm
02-23-357T	24 x 60 mm
02-23-358T	24 x 65 mm
02-23-359T	24 x 70 mm



1/1
02-23-355T
24 x 50 mm

Valven stumpf, longitudinal, semi-röntgentransparent, TITAN
Blades blunt, longitudinal, semi x-ray transparent, TITANIUM

TITAN

Artikel-Nr. Cat. No.	Maße B x L Measurements W x L
02-23-362T	24 x 35 mm
02-23-363T	24 x 40 mm
02-23-364T	24 x 45 mm
02-23-365T	24 x 50 mm
02-23-366T	24 x 55 mm
02-23-367T	24 x 60 mm
02-23-368T	24 x 65 mm
02-23-369T	24 x 70 mm
02-23-370T	24 x 75 mm



1/1
02-23-365T
24 x 50 mm

Artikel-Nr.
 Cat. No.

 1/2
 CASPAR
 02-22-460

CASPAR

02-22-460

Zervikal-Sperrer, Spreizweite 90 mm, komplett, bestehend aus:
Cervical Retractor, spread 90 mm, complete, consisting of:

- | | | |
|------------------|------------|--|
| 02-22-439 | 1 x | Zervikal Sperrer, allein
cervical retractor, only |
| 02-22-772 | 1 x | Valve medial, 23 x 40 mm
blade medial, 23 x 40 mm |
| 02-22-773 | 1 x | Valve medial, 23 x 45 mm
blade medial, 23 x 45 mm |
| 02-22-774 | 1 x | Valve medial, 23 x 50 mm
blade medial, 23 x 50 mm |
| 02-22-775 | 1 x | Valve medial, 23 x 55 mm
blade medial, 23 x 55 mm |
| 02-22-776 | 1 x | Valve medial, 23 x 60 mm
blade medial, 23 x 60 mm |
| 02-22-792 | 1 x | Valve lateral, 23 x 40 mm
blade lateral, 23 x 40 mm |
| 02-22-793 | 1 x | Valve lateral, 23 x 45 mm
blade lateral, 23 x 45 mm |
| 02-22-794 | 1 x | Valve lateral, 23 x 50 mm
blade lateral, 23 x 50 mm |
| 02-22-795 | 1 x | Valve lateral, 23 x 55 mm
blade lateral, 23 x 55 mm |
| 02-22-796 | 1 x | Valve lateral, 23 x 60 mm
blade lateral, 23 x 60 mm |

 1/2
 CASPAR
 02-22-490

CASPAR

 Artikel-Nr.
 Cat. No.

02-22-490

Zervikal Gegensperrer, Spreizweite 90 mm, komplett, bestehend aus:
Cervical Counter Retractor, spread 90 mm, complete, consisting of:

- | | | |
|------------------|------------|---|
| 02-22-491 | 1 x | Zervikal Gegensperrer, allein
cervical counter retractor, only |
| 02-22-783 | 1 x | Valve stumpf, 23 x 45 mm
blade blunt, 23 x 45 mm |
| 02-22-784 | 1 x | Valve stumpf, 23 x 50 mm
blade blunt, 23 x 50 mm |
| 02-22-785 | 1 x | Valve stumpf, 23 x 55 mm
blade blunt, 23 x 55 mm |
| 02-22-786 | 1 x | Valve stumpf, 23 x 60 mm
blade blunt, 23 x 60 mm |
| 02-22-787 | 1 x | Valve stumpf, 23 x 65 mm
blade blunt, 23 x 65 mm |

Artikel-Nr.
 Cat. No.

02-22-780	Zervikal Gegensperrer, Spreizweite 90 mm, komplett, bestehend aus: <i>Cervical Counter Retractor, spread 90 mm, complete, consisting of:</i>	CASPAR	
02-22-771	1 x Zervikal Gegensperrer, allein <i>cervical counter retractor, only</i>		
02-22-783	1 x Valve stumpf, 23 x 45 mm, <i>blade blunt, 23 x 45 mm</i>		
02-22-784	1 x Valve stumpf, 23 x 50 mm <i>blade blunt, 23 x 50 mm</i>		
02-22-785	1 x Valve stumpf, 23 x 55 mm <i>blade blunt, 23 x 55 mm</i>		
02-22-786	1 x Valve stumpf, 23 x 60 mm <i>blade blunt, 23 x 60 mm</i>		
02-22-787	1 x Valve stumpf, 23 x 65 mm <i>blade blunt, 23 x 65 mm</i>		

1/2
 CASPAR
 02-22-789

Artikel-Nr.
 Cat. No.

02-22-399	Blätter-Wechselpinzette <i>blade ejector</i>		
-----------	---	--	---

1/2
 02-22-399

TITAN

 Artikel-Nr.
 Cat. No.

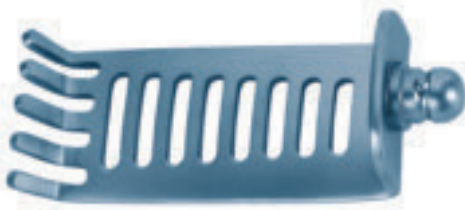
 Maße B x L
 Measurements W x L

 1/1
02-22-884T
 24 x 50 mm

02-22-879T
02-22-880T
02-22-881T
02-22-882T
02-22-883T
02-22-884T
02-22-885T
02-22-886T
02-22-887T
02-22-888T

 24 x 25 mm
 24 x 30 mm
 24 x 35 mm
 24 x 40 mm
 24 x 45 mm
 24 x 50 mm
 24 x 55 mm
 24 x 60 mm
 24 x 65 mm
 24 x 70 mm

 Valven, medial, gefenstert, TITAN
 für Sperrer 02-22-439, 02-22-491, 02-22-771

*blades, medial, fenestrated, TITANIUM
 for retractors 02-22-439, 02-22-491,
 02-22-771*

 1/1
02-22-892T
 24 x 40 mm

02-22-889T
02-22-890T
02-22-891T
02-22-892T
02-22-893T
02-22-894T
02-22-895T
02-22-896T
02-22-897T
02-22-898T

 24 x 25 mm
 24 x 30 mm
 24 x 35 mm
 24 x 40 mm
 24 x 45 mm
 24 x 50 mm
 24 x 55 mm
 24 x 60 mm
 24 x 65 mm
 24 x 70 mm

 Valven, lateral, gefenstert, TITAN
 für Sperrer 02-22-439, 02-22-491, 02-22-771

*blades, lateral, fenestrated, TITANIUM
 for retractors 02-22-439, 02-22-491,
 02-22-771*





 1/1
02-22-783T
 24 x 45 mm

02-22-779T
02-22-781T
02-22-782T
02-22-783T
02-22-784T
02-22-785T
02-22-786T
02-22-787T
02-22-788T
02-22-789T

 24 x 30 mm
 24 x 35 mm
 24 x 40 mm
 24 x 45 mm
 24 x 50 mm
 24 x 55 mm
 24 x 60 mm
 24 x 65 mm
 24 x 70 mm
 24 x 75 mm

 Valven, stumpf, TITAN
 für Sperrer 02-22-439, 02-22-491, 02-22-771

*blades, blunt, TITANIUM
 for retractors 02-22-439, 02-22-491,
 02-22-771*

Artikel-Nr. Cat. No.	Maße B x L Measurements W x L	
02-22-772	23 x 40 mm	 <p>1/1 02-22-775 23 x 55 mm</p>
02-22-773	23 x 45 mm	
02-22-774	23 x 50 mm	
02-22-775	23 x 55 mm	
02-22-776	23 x 60 mm	
	Valven, medial, für Sperrer 02-22-439, 02-22-491, 02-22-771 <i>blades, medial, for retractors 02-22-439, 02-22-491, 02-22-771</i>	
02-22-792	23 x 40 mm	 <p>1/1 02-22-794 23 x 50 mm</p>
02-22-793	23 x 45 mm	
02-22-794	23 x 50 mm	
02-22-795	23 x 55 mm	
02-22-796	23 x 60 mm	
	Valven, lateral, für Sperrer 02-22-439, 02-22-491, 02-22-771 <i>blades, lateral, for retractors 02-22-439, 02-22-491, 02-22-771</i>	
02-22-783	23 x 45 mm	 <p>1/1 02-22-783 23 x 45 mm</p>
02-22-784	23 x 50 mm	
02-22-785	23 x 55 mm	
02-22-786	23 x 60 mm	
02-22-787	23 x 65 mm	
	Valven, stumpf, für Sperrer 02-22-439, 02-22-491, 02-22-771 <i>blades, blunt, for retractors 02-22-439, 02-22-491, 02-22-771</i>	
02-22-764	25 x 50 mm	 <p>1/1 02-22-764 25 x 50 mm</p>
02-22-766	25 x 60 mm	
	Valven, stumpf, für Sperrer 02-22-439, 02-22-491, 02-22-771 <i>blades, blunt, for retractors 02-22-439, 02-22-491, 02-22-771</i>	

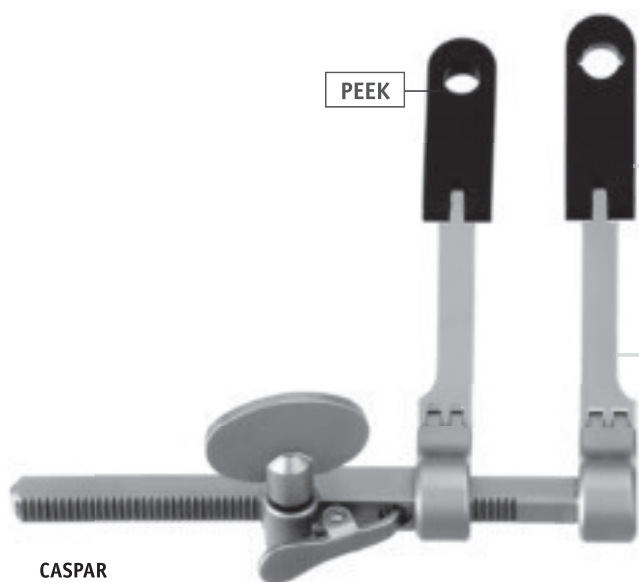
 CASPAR
 02-23-049P

 Artikel-Nr.
 Cat. No.

CASPAR

02-23-049P

 CCR Zervikal Sperrer mit Doppelgelenk und
 röntgentransparenten PEEK Armen

*CCR cervical retractor with double hinge and
 x-ray transparent PEEK arms*

 CASPAR
 02-23-047P

 Artikel-Nr.
 Cat. No.

CASPAR

02-23-047P

 CCR Basis Gegensperrer mit Doppelgelenk
 und röntgentransparenten PEEK Armen

*CCR cervical counter retractor with double
 hinge and x-ray transparent PEEK arms*

Artikel-Nr.
 Cat. No.

02-22-439P	CCR Zervikal Sperrer mit röntgentransparenten PEEK Armen <i>CCR cervical retractor with x-ray transparent PEEK arms</i>
------------	--

CASPAR

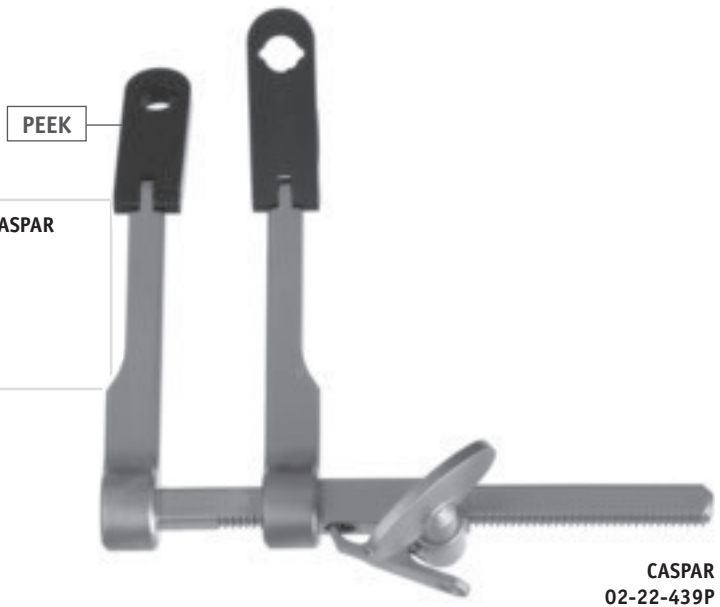

Artikel-Nr.
 Cat. No.

02-22-491P	CCR Basis Gegensperrer mit röntgentransparenten PEEK Armen <i>CCR cervical counter retractor with x-ray transparent PEEK arms</i>
------------	--

CASPAR



 CASPAR
 02-22-771P

**Artikel-Nr.
 Cat. No.**

CASPAR

02-22-771P

CCR Gegensperrer mit röntgen-
transparenten PEEK Armen
*CCR counter retractor with x-ray transparent
 PEEK arms*

7

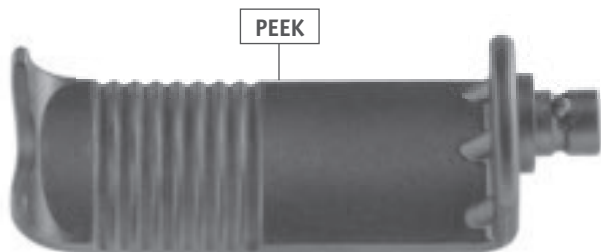
**PEEK Valve stumpf, röntgentransparent
 PEEK blade blunt, x-ray transparent**

 1/1
 02-22-786P
 23 x 60 mm

**Artikel-Nr.
 Cat. No.**
**Maße B x L
 Measurements W x L**

02-72-782P

23 x 40 mm

02-22-783P

23 x 45 mm

02-22-784P

23 x 50 mm

02-22-785P

23 x 55 mm

02-22-786P

23 x 60 mm

02-22-787P

23 x 65 mm

02-72-788P

23 x 75 mm

PEEK Valve lateral, röntgentransparent
PEEK blade lateral, x-ray transparent

Artikel-Nr. Cat. No.	Maße B x L Measurements W x L
02-22-792P	23 x 40 mm
02-22-793P	23 x 45 mm
02-22-794P	23 x 50 mm
02-22-795P	23 x 55 mm
02-22-796P	23 x 60 mm
02-72-797P	23 x 65 mm
02-72-798P	23 x 75 mm

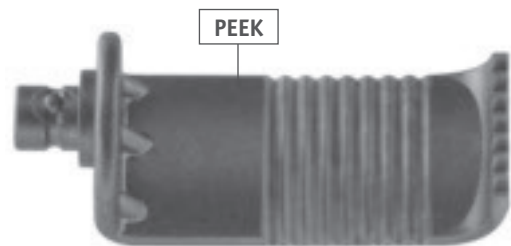

1/1
02-22-794P
 23 x 50 mm

PEEK Valve medial, röntgentransparent
PEEK blade medial, x-ray transparent

Artikel-Nr. Cat. No.	Maße B x L Measurements W x L
02-22-772P	23 x 40 mm
02-22-773P	23 x 45 mm
02-22-774P	23 x 50 mm
02-22-775P	23 x 55 mm
02-22-776P	23 x 60 mm
02-72-777P	23 x 65 mm
02-72-778P	23 x 75 mm

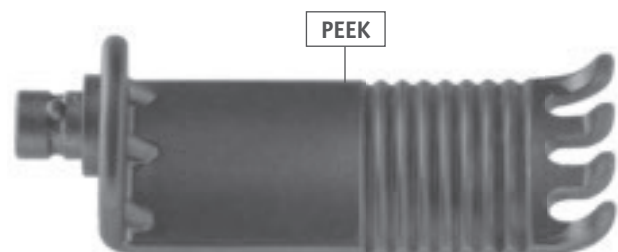

1/1
02-22-776P
 23 x 60 mm

Vorteile:

- Retraktor System für Mikro Lumbale Eingriffe
- Kleiner Zugang
- Spekula mit vergrößerter distaler Spreizweite
- Gegensperrer mit Doppelgelenk für flexiblen Einsatz
- Laterale und mediale Valven in der Tiefe zusätzlich spreizbar
- Umlegbare Flügelschraube

Advantages:

- retractor system for micro lumbar discectomy
- small access
- specula with enlarged distal spreading
- double hinged counter retractor for flexible handling
- lateral and medial blades can be additionally spreaded in the depth
- reversible wing screw



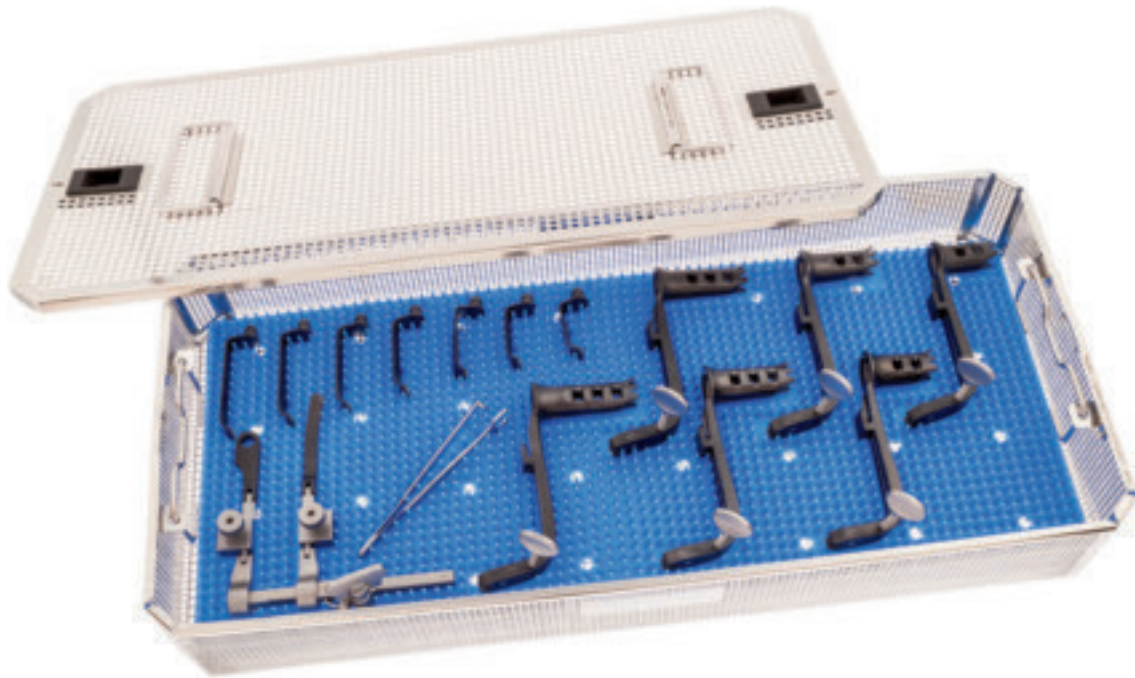

Artikel-Nr.
 Cat. No.

06-57-170

Mikrodiskektomie Retraktor Set mit erweiterter Tiefenspreizung, komplett, bestehend aus:
Micro Discectomy Retractor Set with extended deep spreading, complete, consisting of:

10-07-223 1x Siebkorb 545 x 255 x 70 mm,
 aus Edelstahl
*wire basket 545 x 255 x 70 mm,
 stainless steel*

10-06-227 1x Deckel zu Siebkorb 545 x 255 mm,
 aus Edelstahl, mit Verschluss
*lid for basket 545 x 255 mm,
 with closure, stainless steel*

10-56-933 1x Silikon-Matte 500 x 230 mm, blau
silicon mat 500 x 230 mm, blue

02-72-799 1x Spekula 40 mm
specula 40 mm

02-72-800 1x Spekula 45 mm
specula 45 mm

02-72-801 1x Spekula 50 mm
specula 50 mm

02-72-802 1x Spekula 55 mm
specula 55 mm

02-72-803 1x Spekula 60 mm
specula 60 mm

02-72-804 1x Spekula 65 mm
specula 65 mm

02-72-812 1x Gegensperrer, allein
counter retractor, only

02-22-870 1x Valve 35 mm
blade 35 mm

02-22-871 1x Valve 40 mm
blade 40 mm

02-22-872 1x Valve 45 mm
blade 45 mm

02-22-873 1x Valve 50 mm
blade 50 mm

02-22-874 1x Valve 55 mm
blade 55 mm

02-22-875 1x Valve 60 mm
blade 60 mm

02-22-876 1x Valve 65 mm
blade 65 mm

02-22-399 1x Blätter-Wechselpinzette
blade ejector



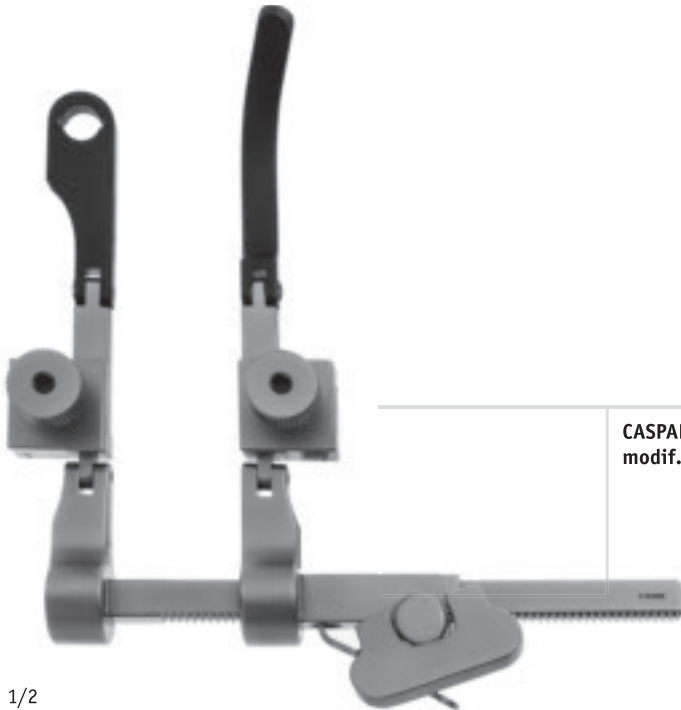

Artikel-Nr.
Cat. No.
CASPAR
modif.
02-72-812

 Gegensperrer mit Doppelgelenk und
 tiefenverstellbaren Armen, schwarz,
 titanbeschichtet

*double hinge counter retractor with
 deep spreading arm, black, titanium-coated*

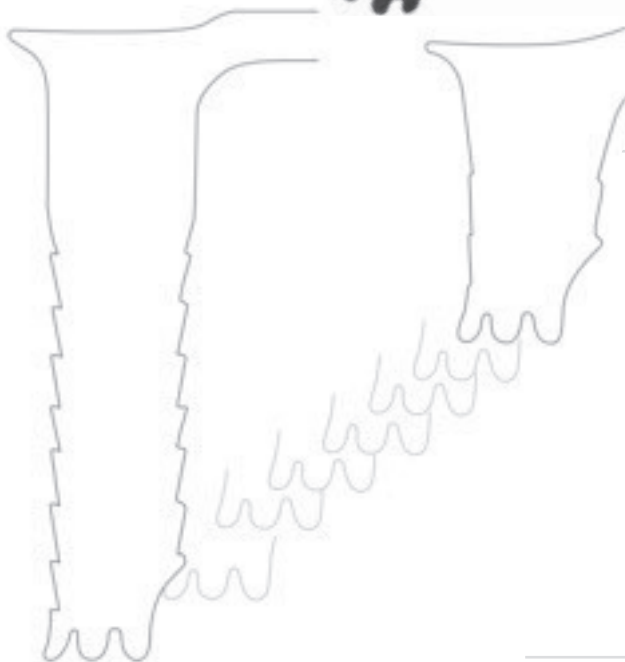
 1/2
CASPAR modif.
02-72-812

 1/1
02-72-804
 65 mm
 2½"

Artikel-Nr.
Cat. No.
Blattlänge
Length of blades
02-72-799

40 mm / 1½"

02-72-800

45 mm / 1¾"

02-72-801

50 mm / 2"

02-72-802

55 mm / 2⅛"

02-72-803

60 mm / 2¼"

02-72-804

65 mm / 2½"

02-72-806

75 mm / 3"

02-72-808

85 mm / 3¼"

 Spekula, schwarz, titanbeschichtet
 mit erweiterter Tiefenspreizung
*specula, black, titanium-coated
 with extended deep spreading*

Artikel-Nr. Cat. No.	Blattlänge Length of blades
02-22-870	35 mm / 1¼"
02-22-871	40 mm / 1½"
02-22-872	45 mm / 1¾"
02-22-873	50 mm / 2"
02-22-874	55 mm / 2⅛"
02-22-875	60 mm / 2¼"
02-22-876	65 mm / 2½"
02-22-877	75 mm / 3"
02-22-878	85 mm / 3¼"
	Valve lateral, schwarz, titanbeschichtet, für Gegensperrer 02-72-812 und 02-22-812 <i>blade lateral, black, titanium-coated for counter retractor 02-72-812 and 02-22-812</i>
02-72-851	40 mm / 1½"
02-72-852	45 mm / 1¾"
02-72-853	50 mm / 2"
02-72-854	55 mm / 2⅛"
02-72-855	60 mm / 2¼"
02-72-856	65 mm / 2½"
02-72-857	70 mm / 2¾"
	Valve medial, schwarz, titanbeschichtet, für Gegensperrer 02-72-812 <i>blade medial, black, titanium-coated, for counter retractor 02-72-812</i>



1/1
02-22-873
 50 mm
 2"



1/1
02-72-851
 40 mm
 1½"

Artikel-Nr. Cat. No.	
02-22-399	Blätter-Wechselpinzette <i>blade ejector</i>

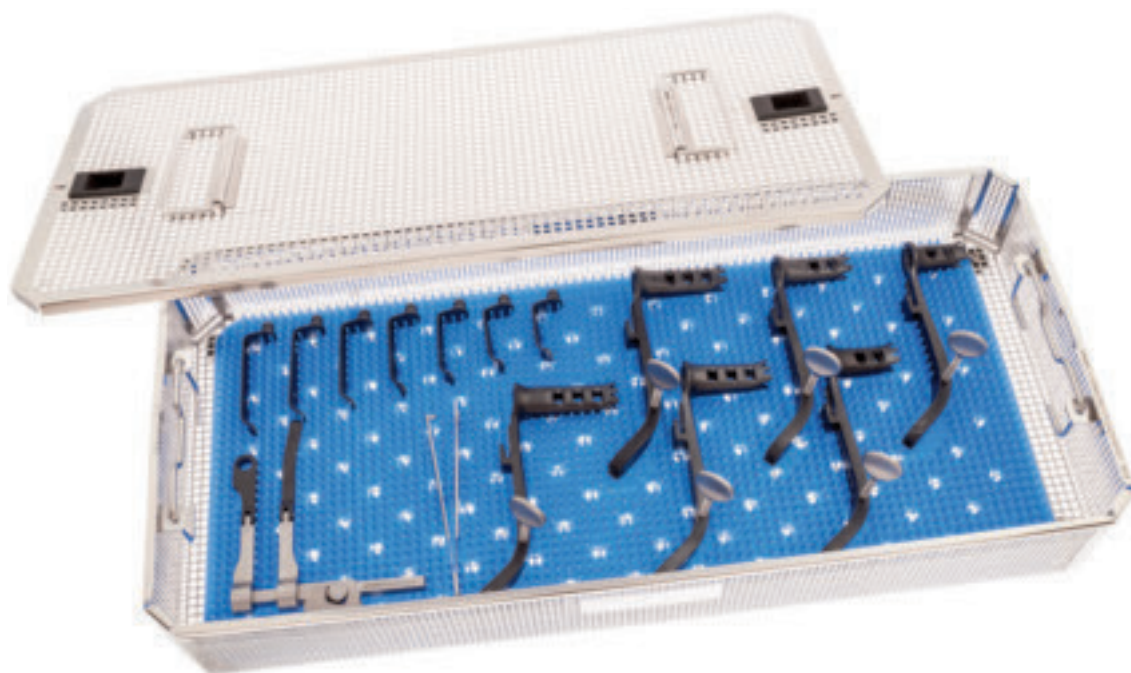

1/2
02-22-399

Artikel-Nr.
Cat. No.

CASPAR	06-07-170	Mikrodiskektomie Retraktor Set, komplett, bestehend aus: Micro Lumbar Discectomy Retractor Set, complete, consisting of:	
	10-07-223	1x Siebkorb 545 x 255 x 70 mm, aus Edelstahl <i>wire basket 545 x 255 x 70 mm, stainless steel</i>	02-22-812 1x Gegensperrer, allein <i>counter retractor, only</i>
	10-06-227	1x Deckel zu Siebkorb 545 x 255 mm, aus Edelstahl, mit Verschluss <i>lid for basket 545 x 255 mm, with closure, stainless steel</i>	02-22-870 1x Valve 35 mm <i>blade 35 mm</i>
	10-56-933	1x Silikon-Matte 500 x 230 mm, blau <i>silicon mat 500 x 230 mm, blue</i>	02-22-871 1x Valve 40 mm <i>blade 40 mm</i>
	02-22-799	1x Spekula 40 mm <i>specula 40 mm</i>	02-22-872 1x Valve 45 mm <i>blade 45 mm</i>
	02-22-800	1x Spekula 45 mm <i>specula 45 mm</i>	02-22-873 1x Valve 50 mm <i>blade 50 mm</i>
	02-22-801	1x Spekula 50 mm <i>specula 50 mm</i>	02-22-874 1x Valve 55 mm <i>blade 55 mm</i>
	02-22-802	1x Spekula 55 mm <i>specula 55 mm</i>	02-22-875 1x Valve 60 mm <i>blade 60 mm</i>
	02-22-803	1x Spekula 60 mm <i>specula 60 mm</i>	02-22-876 1x Valve 65 mm <i>blade 65 mm</i>
	02-22-804	1x Spekula 70 mm <i>specula 70 mm</i>	02-22-399 1x Blätter-Wechselpinzette <i>blade ejector</i>

Artikel-Nr.
 Cat. No.

<p>02-22-810</p>	<p>Gegensperrer, komplett mit 6 Valven 02-22-870 - 02-22-875 <i>counter retractor, complete with 6 blades</i> 02-22-870 - 02-22-875</p>	<p>CASPAR</p>
<p>02-22-812</p>	<p>Gegensperrer, allein, schwarz, titanbeschichtet <i>counter retractor, only,</i> <i>black, titanium-coated</i></p>	<p>CASPAR</p>



2/3
CASPAR
 02-22-812

Artikel-Nr.
 Cat. No.

Blattlänge
 Length of blades

<p>02-22-870</p>	<p>35 mm / 1¼"</p>	
<p>02-22-871</p>	<p>40 mm / 1½"</p>	
<p>02-22-872</p>	<p>45 mm / 1¾"</p>	
<p>02-22-873</p>	<p>50 mm / 2"</p>	
<p>02-22-874</p>	<p>55 mm / 2⅛"</p>	
<p>02-22-875</p>	<p>60 mm / 2¼"</p>	
<p>02-22-876</p>	<p>65 mm / 2½"</p>	
<p>02-22-877</p>	<p>75 mm / 3"</p>	
<p>02-22-878</p>	<p>85 mm / 3¼"</p>	
<p>Valven, lateral, schwarz, titanbeschichtet, für Gegensperrer 02-22-812 und 02-72-812 <i>blades, lateral, black, titanium-coated,</i> <i>for counter retractor 02-22-812 and</i> <i>02-72-812</i></p>		
<p>02-22-851</p>	<p>40 mm / 1½"</p>	
<p>02-22-852</p>	<p>45 mm / 1¾"</p>	
<p>02-22-853</p>	<p>50 mm / 2"</p>	
<p>02-22-854</p>	<p>55 mm / 2⅛"</p>	
<p>02-22-855</p>	<p>60 mm / 2¼"</p>	
<p>02-22-856</p>	<p>65 mm / 2½"</p>	
<p>02-22-857</p>	<p>70 mm / 2¾"</p>	
<p>Valven, medial, schwarz, titanbeschichtet, für Gegensperrer 02-22-812 <i>blades, medial, black, titanium-coated,</i> <i>for counter retractor 02-22-812</i></p>		



2/3
02-22-873
 50 mm
 2"



2/3
02-22-853
 50 mm
 2"





2/3
CASPAR
02-22-801
 50 mm
 2"

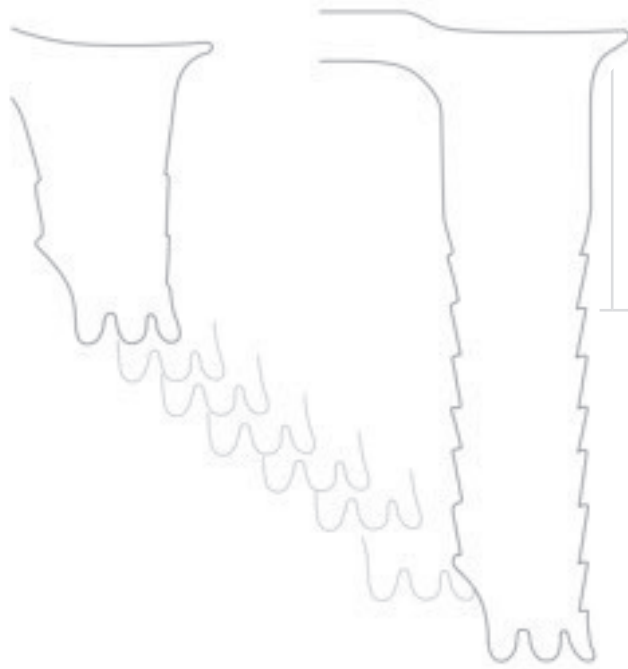

Artikel-Nr.
Cat. No.

Blattlänge
Length of blades

CASPAR

02-22-799

40 mm / 1½"

02-22-800

45 mm / 1¾"

02-22-801

50 mm / 2"

02-22-802

55 mm / 2⅛"

02-22-803

60 mm / 2¼"

02-22-804

65 mm / 2½"

02-22-806

75 mm / 3"

02-22-808



85 mm / 3¼"

Spekula, schwarz, titanbeschichtet
 specula, black, titanium-coated





Artikel-Nr.
Cat. No.

13-52-499	Ring Retraktor System komplett, bestehend aus: Ring Retractor System complete, consisting out of:
13-52-669	1 x Ring Retraktor Tischarretierung 300 mm, 12" <i>ring retractor table post 300 mm, 12"</i>
13-02-487	1 x Ring Retraktor, horizontale Stange <i>ring retractor, horizontal bar</i>
13-02-504	1 x Arretierkupplung \varnothing 25 mm, 1" <i>post coupling \varnothing 25 mm, 1"</i>
13-02-516	1 x Rahmen oval, mittel <i>ring oval, medium</i>
13-02-946	2 x Valve biegsam, flach, 51 x 152 mm <i>blade malleable, flat, 51 x 152 mm</i>
13-02-524	2 x KELLY Valve 51 x 76 mm <i>KELLY blade 51 x 76 mm</i>
13-02-525	1 x KELLY Valve 51 x 101 mm <i>KELLY blade 51 x 101 mm</i>
13-02-534	1 x BALFOUR Valve, schmal <i>BALFOUR blade, narrow</i>
13-02-503	2 x Rastmechanismus, standard <i>ratchet mechanism, standard</i>
13-02-510	6 x Rastmechanismus, kippbar <i>tilt ratchet mechanism</i>
13-02-497	1 x Zerlegbarer Rahmen, mittel <i>segmented ring, medium</i>
13-02-944	1 x Valve biegsam, flach, 38 x 152 mm <i>blade malleable, flat, 38 x 152 mm</i>
13-02-947	1 x Valve biegsam, flach, 76 x 152 mm <i>blade malleable, flat, 76 x 152 mm</i>
13-02-526	1 x KELLY Valve 51 x 127 mm <i>KELLY blade 51 x 127 mm</i>
13-02-527	1 x KELLY Valve 51 x 152 mm <i>KELLY blade 51 x 152 mm</i>
13-02-488	1 x Horizontale Wendestange, 360° drehbar <i>horizontal flex bar, 360° rotation</i>
13-02-831	1 x HARRINGTON Valve 63 x 143 mm <i>HARRINGTON blade 63 x 143 mm</i>
13-02-546	1 x GELPI Valve mit Spitze <i>GELPI point blade</i>



	Artikel-Nr. Cat. No.	
	13-52-669	Ring Retraktor Tischarretierung 300 mm, 12" <i>ring retractor table post</i> 300 mm, 12"
	13-02-487	Ring Retraktor, horizontale Stange <i>ring retractor, horizontal bar</i>
	13-02-488	Horizontale Wendestange, 360° drehbar <i>horizontal flex bar, 360° rotation</i>
	13-02-504	Arretierkupplung ø 25 mm, 1" <i>post coupling ø 25 mm, 1"</i>
	13-02-503	Rastmechanismus, standard <i>ratchet mechanism, standard</i>
	13-02-510	Rastmechanismus, kippbar <i>tilt ratchet mechanism</i>
	13-02-516	Rahmen oval, mittel <i>ring oval, medium</i>
	13-02-497	Zerlegbarer Rahmen, mittel <i>segmented ring, medium</i>

Artikel-Nr.
Cat. No.

13-02-944	Valve biegsam, flach, 38 x 152 mm <i>blade malleable, flat, 38 x 152 mm</i>		
13-02-946	Valve biegsam, flach, 51 x 152 mm <i>blade malleable, flat, 51 x 152 mm</i>		
13-02-947	Valve biegsam, flach, 76 x 152 mm <i>blade malleable, flat, 76 x 152 mm</i>		
13-02-524	Valve 51 x 76 mm <i>blade 51 x 76 mm</i>	KELLY	
13-02-525	Valve 51 x 101 mm <i>blade 51 x 101 mm</i>		
13-02-526	Valve 51 x 127 mm <i>blade 51 x 127 mm</i>		
13-02-527	Valve 51 x 152 mm <i>blade 51 x 152 mm</i>		
13-02-546	Valve mit Spitze <i>point blade</i>	GELPI	
13-02-534	Valve schmal <i>blade narrow</i>	BALFOUR	
13-02-831	Valve 63 x 143 mm <i>blade 63 x 143 mm</i>	HARRINGTON	

Artikel-Nr.
Cat. No.

 1/2
CASPAR
02-22-450

CASPAR

02-22-450

Laminektomie-Sperrer, lumbal, thorakal, zervikal, Spreizweite 150 mm, komplett, bestehend aus: Laminectomy Retractor, lumbal, thoracal, cervical, spread 150 mm, complete, consisting of:

- 02-22-449** 1x Sperrer allein, mit Drehschlüssel 20-55-749
retractor only, with key 20-55-749
- 02-22-435** 1x Haken 38 mm
hook 38 mm
- 02-22-442** 1x Valve 22 x 37 mm
blade 22 x 37 mm
- 02-22-443** 1x Valve 22 x 43 mm
blade 22 x 43 mm
- 02-22-444** 1x Valve 22 x 47 mm
blade 22 x 47 mm
- 02-22-445** 1x Valve 22 x 52 mm
blade 22 x 52 mm
- 02-22-446** 1x Valve 22 x 57 mm
blade 22 x 57 mm

 1/2
20-55-749
Artikel-Nr.
Cat. No.

- 20-55-749** Schlüssel für Sperrer 02-22-449
key for retractor 02-22-449

 1/2
CASPAR
02-22-435
 38 mm

CASPAR

02-22-435

Haken 38 mm
hook 38 mm

02-22-437



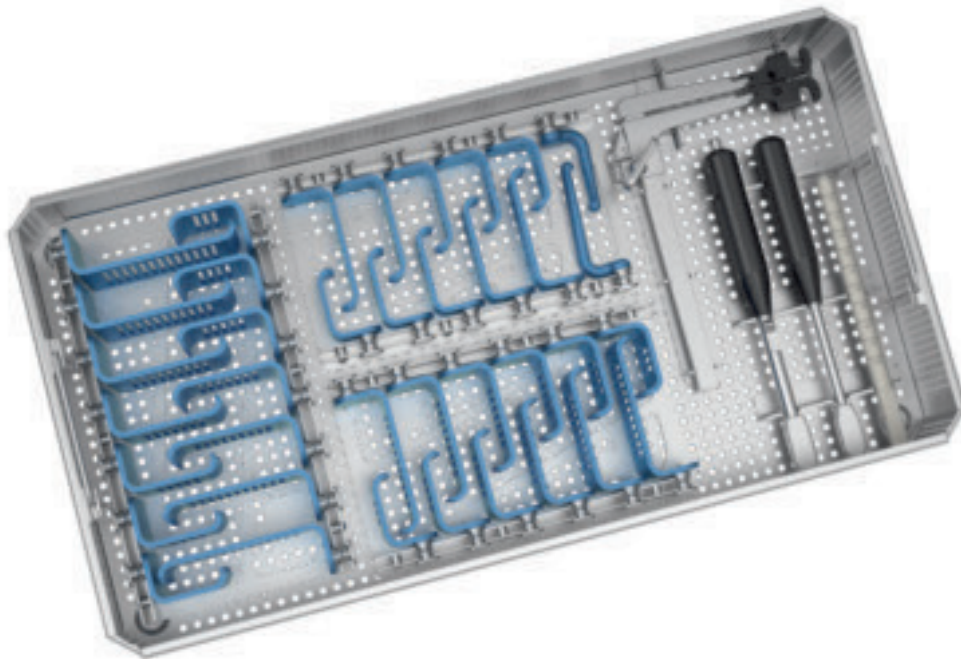

Haken 58 mm
hook 58 mm

Artikel-Nr. Cat. No.	Maße B x L Measurements W x L		
02-22-441	Valve 22 x 32 mm blade 22 x 32 mm	CASPAR	 <p>1/2 CASPAR 02-22-445 22 x 52 mm</p>
02-22-442	Valve 22 x 37 mm blade 22 x 37 mm		
02-22-443	Valve 22 x 42 mm blade 22 x 42 mm		
02-22-444	Valve 22 x 47 mm blade 22 x 47 mm		
02-22-445	Valve 22 x 52 mm blade 22 x 52 mm		
02-22-446	Valve 22 x 57 mm blade 22 x 57 mm		
02-22-447	Valve 22 x 62 mm blade 22 x 62 mm		
02-22-448	Valve 22 x 67 mm blade 22 x 67 mm		
02-22-451	Valve 37 x 32 mm blade 37 x 32 mm	CASPAR	 <p>1/2 CASPAR 02-22-456 37 x 57 mm</p>
02-22-452	Valve 37 x 37 mm blade 37 x 37 mm		
02-22-453	Valve 37 x 42 mm blade 37 x 42 mm		
02-22-454	Valve 37 x 47 mm blade 37 x 47 mm		
02-22-455	Valve 37 x 52 mm blade 37 x 52 mm		
02-22-456	Valve 37 x 57 mm blade 37 x 57 mm		
02-22-457	Valve 37 x 62 mm blade 37 x 62 mm		
02-22-458	Valve 37 x 67 mm blade 37 x 67 mm		
02-22-461	Valve 52 x 32 mm blade 52 x 32 mm	CASPAR	 <p>1/2 CASPAR 02-22-467 52 x 62 mm</p>
02-22-462	Valve 52 x 37 mm blade 52 x 37 mm		
02-22-463	Valve 52 x 42 mm blade 52 x 42 mm		
02-22-464	Valve 52 x 47 mm blade 52 x 47 mm		
02-22-465	Valve 52 x 52 mm blade 52 x 52 mm		
02-22-466	Valve 52 x 57 mm blade 52 x 57 mm		
02-22-467	Valve 52 x 62 mm blade 52 x 62 mm		
02-22-468	Valve 52 x 67 mm blade 52 x 67 mm		



Artikel-Nr.
Cat. No.

02-23-120	CLR Set Side-load, bestehend aus: <i>CLR Set Side load, consisting of:</i>	
02-23-121	1 x	CLR Siebkorb, Edelstahl mit Deckel, 485 x 253 x 70 mm <i>CLR Tray, stainless steel with cover, 485 x 253 x 70 mm</i>
02-23-001	1 x	CLR Retraktor Side-load <i>CLR retractor side-load</i>
02-73-050	1 x	CLR Handgriff Side-load <i>CCR handle side-load for blades</i>
02-73-051	1 x	CLR Handgriff Side-load, kanuliert mit Luer-Lock <i>CCR handle side-load for blades, cannulated with Luer-Lock</i>
02-23-011	1 x	CLR Tiefenmeßstab <i>CLR depth gauge</i>
02-23-020T	2 x	CLR Valve 20 x 35 mm <i>CLR blade 20 x 35 mm</i>
02-23-021T	2 x	CLR Valve 20 x 40 mm <i>CLR blade 20 x 40 mm</i>
02-23-022T	2 x	CLR Valve 20 x 45 mm <i>CLR blade 20 x 45 mm</i>
02-23-023T	2 x	CLR Valve 20 x 55 mm <i>CLR blade 20 x 55 mm</i>
02-23-024T	2 x	CLR Valve 20 x 65 mm <i>CLR blade 20 x 65 mm</i>
02-23-030T	2 x	CLR Valve 40 x 35 mm <i>CLR blade 40 x 35 mm</i>
02-23-031T	2 x	CLR Valve 40 x 40 mm <i>CLR blade 40 x 40 mm</i>
02-23-032T	2 x	CLR Valve 40 x 45 mm <i>CLR blade 40 x 45 mm</i>
02-23-033T	2 x	CLR Valve 40 x 55 mm <i>CLR blade 40 x 55 mm</i>
02-23-034T	2 x	CLR Valve 40 x 65 mm <i>CLR blade 40 x 65 mm</i>
02-23-035T	2 x	CLR Valve 40 x 75 mm <i>CLR blade 40 x 75 mm</i>
02-23-040T	2 x	CLR Valve 60 x 35 mm <i>CLR blade 60 x 35 mm</i>
02-23-041T	2 x	CLR Valve 60 x 40 mm <i>CLR blade 60 x 40 mm</i>
02-23-042T	2 x	CLR Valve 60 x 45 mm <i>CLR blade 60 x 45 mm</i>
02-23-043T	2 x	CLR Valve 60 x 55 mm <i>CLR blade 60 x 55 mm</i>
02-23-044T	2 x	CLR Valve 60 x 65 mm <i>CLR blade 60 x 65 mm</i>
02-23-045T	2 x	CLR Valve 60 x 75 mm <i>CLR blade 60 x 75 mm</i>
02-23-046T	2 x	CLR Valve 60 x 85 mm <i>CLR blade 60 x 85 mm</i>
02-23-028T	1 x	Hemi-Laminektomie Haken, klein, 50 mm <i>hemilaminectomy hook, small, 50 mm</i>
02-23-038T	1 x	Hemi-Laminektomie Haken, groß, 70 mm <i>hemi-laminectomy hook, large, 70 mm</i>

Artikel-Nr. Cat. No.			 <p data-bbox="1340 761 1444 817">CASPAR 02-23-001</p>
02-23-001	CLR Retraktor Side-load <i>CLR retractor side-load</i>	CASPAR	
02-73-050	CLR Handgriff Side-load <i>CCR handle side-load for blades</i>		 <p data-bbox="1340 1064 1444 1097">02-23-050</p>
02-73-051	CLR Handgriff Side-loaded, kanuliert mit Luer-Lock <i>CCR handle side-load for blades, cannulated with Luer-Lock</i>		 <p data-bbox="1340 1332 1444 1355">02-23-051</p>
02-23-011	CLR Tiefenmessstab <i>CLR depth gauge</i>		 <p data-bbox="1340 1590 1444 1624">02-23-011</p>

 1/2
02-23-024T
 20 x 55 mm

 1/2
02-23-034T
 40 x 55 mm

 1/2
02-23-046T
 60 x 85 mm

 1/2
02-23-028T
 50 mm

TITAN Valve für mono-segmentalen Zugang, semi-röntgentransparent
TITANIUM Blade for mono-segmental access, semi x-ray transparent
TITAN

Artikel-Nr. Cat. No.	Maße B x L Measurements W x L
02-23-020T	20 x 35 mm
02-23-021T	20 x 40 mm
02-23-022T	20 x 45 mm
02-23-023T	20 x 50 mm
02-23-024T	20 x 55 mm

TITAN Valve für bi-segmentalen Zugang, semi-röntgentransparent
TITANIUM Blade for bi-segmental access, semi x-ray transparent
TITAN

Artikel-Nr. Cat. No.	Maße B x L Measurements W x L
02-23-030T	40 x 35 mm
02-23-031T	40 x 40 mm
02-23-032T	40 x 45 mm
02-23-033T	40 x 55 mm
02-23-034T	40 x 65 mm
02-23-035T	40 x 75 mm

TITAN Valve für multi-segmentalen Zugang, semi-röntgentransparent
TITANIUM Blade for multi-segmental access, semi x-ray transparent
TITAN

Artikel-Nr. Cat. No.	Maße B x L Measurements W x L
02-23-040T	60 x 35 mm
02-23-041T	60 x 40 mm
02-23-042T	60 x 45 mm
02-23-043T	60 x 55 mm
02-23-044T	60 x 65 mm
02-23-045T	60 x 75 mm
02-23-046T	60 x 85 mm

TITAN

Artikel-Nr. Cat. No.	Länge Length
02-23-028T	50 mm CLR Hemi-Laminektomiehooken, klein, semi-röntgentransparent, TITAN CLR hemi-laminectomy hook, small, semi x-ray transparent, TITANIUM
02-23-038T	70 mm CLR Hemi-Laminektomiehooken, groß, semi-röntgentransparent, TITAN CLR hemi-laminectomy hook, large, semi x-ray transparent, TITANIUM

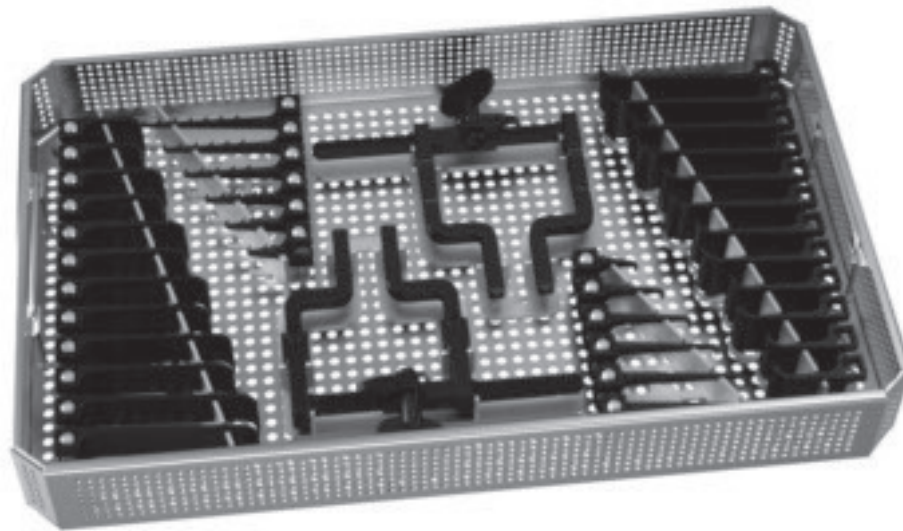

Artikel-Nr.
Cat. No.

02-72-667

MC CULLOCH Retraktor Set groß, bestehend aus:
MC CULLOCH Retractor Set large, consisting of:

- | | | | |
|------------------|---|------------------|---|
| 02-72-668 | 1 x Siebkorb für MC CULLOCH Set groß, 405 x 253 x 50 mm
<i>basket for MC CULLOCH set large, 405 x 253 x 50 mm</i> | 02-72-684 | 2 x Breite Muskelvalve 27 x 80 mm
<i>wide muscle blade 27 x 80 mm</i> |
| 02-72-670 | 2 x MC CULLOCH Retraktor mit Gelenken
<i>MC CULLOCH retractor with hinge</i> | 02-72-686 | 1 x Haken 1,8 x 20 mm
<i>hook 1.8 x 20 mm</i> |
| 02-72-672 | 2 x Schmale Muskelvalve 20 x 30 mm
<i>narrow muscle blade 20 x 30 mm</i> | 02-72-687 | 1 x Haken 1,8 x 30 mm
<i>hook 1.8 x 30 mm</i> |
| 02-72-673 | 2 x Schmale Muskelvalve 20 x 40 mm
<i>narrow muscle blade 20 x 40 mm</i> | 02-72-688 | 1 x Haken 1,8 x 40 mm
<i>hook 1.8 x 40 mm</i> |
| 02-72-674 | 2 x Schmale Muskelvalve 20 x 50 mm
<i>narrow muscle blade 20 x 50 mm</i> | 02-72-689 | 1 x Haken 1,8 x 50 mm
<i>hook 1.8 x 50 mm</i> |
| 02-72-675 | 2 x Schmale Muskelvalve 20 x 60 mm
<i>narrow muscle blade 20 x 60 mm</i> | 02-72-690 | 1 x Haken 1,8 x 60 mm
<i>hook 1.8 x 60 mm</i> |
| 02-72-676 | 2 x Schmale Muskelvalve 20 x 70 mm
<i>narrow muscle blade 20 x 70 mm</i> | 02-72-691 | 1 x Haken 1,8 x 70 mm
<i>hook 1.8 x 70 mm</i> |
| 02-72-677 | 2 x Schmale Muskelvalve 20 x 80 mm
<i>narrow muscle blade 20 x 80 mm</i> | 02-72-693 | 1 x Mehrzahn-Haken 2 x 20 mm
<i>multiple toothed hook 2 x 20 mm</i> |
| 02-72-679 | 2 x Breite Muskelvalve 27 x 30 mm
<i>wide muscle blade 27 x 30 mm</i> | 02-72-694 | 1 x Mehrzahn-Haken 2 x 30 mm
<i>multiple toothed hook 2 x 30 mm</i> |
| 02-72-680 | 2 x Breite Muskelvalve 27 x 40 mm
<i>wide muscle blade 27 x 40 mm</i> | 02-72-695 | 1 x Mehrzahn-Haken 2 x 40 mm
<i>multiple toothed hook 2 x 40 mm</i> |
| 02-72-681 | 2 x Breite Muskelvalve 27 x 50 mm
<i>wide muscle blade 27 x 50 mm</i> | 02-72-696 | 1 x Mehrzahn-Haken 2 x 50 mm
<i>multiple toothed hook 2 x 50 mm</i> |
| 02-72-682 | 2 x Breite Muskelvalve 27 x 60 mm
<i>wide muscle blade 27 x 60 mm</i> | 02-72-697 | 1 x Mehrzahn-Haken 2 x 60 mm
<i>multiple toothed hook 2 x 60 mm</i> |
| 02-72-683 | 2 x Breite Muskelvalve 27 x 70 mm
<i>wide muscle blade 27 x 70 mm</i> | 02-72-698 | 1 x Mehrzahn-Haken 2 x 70 mm
<i>multiple toothed hook 2 x 70 mm</i> |



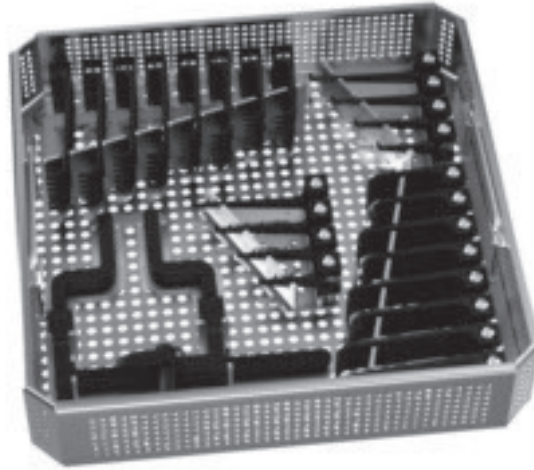

Artikel-Nr.
Cat. No.

02-72-665	MC CULLOCH Retraktor Set klein, bestehend aus: <i>MC CULLOCH Retractor Set small ,consisting of:</i>		
02-72-666	1 x Siebkorb für MC CULLOCH Set klein, 243 x 253 x 50 mm <i>basket for MC CULLOCH set small, 243 x 253 x 50 mm</i>		02-72-687 1 x Haken 1,8 x 30 mm <i>hook 1.8 x 30 mm</i>
02-72-670	1 x MC CULLOCH Retraktor mit Gelenken <i>MC CULLOCH retractor with hinge</i>		02-72-688 1 x Haken 1,8 x 40 mm <i>hook 1.8 x 40 mm</i>
02-72-673	2 x Schmale Muskelvalve 20 x 40 mm <i>narrow muscle blade 20 x 40 mm</i>		02-72-689 1 x Haken 1,8 x 50 mm <i>hook 1.8 x 50 mm</i>
02-72-674	2 x Schmale Muskelvalve 20 x 50 mm <i>narrow muscle blade 20 x 50 mm</i>		02-72-690 1 x Haken 1,8 x 60 mm <i>hook 1.8 x 60 mm</i>
02-72-675	2 x Schmale Muskelvalve 20 x 60 mm <i>narrow muscle blade 20 x 60 mm</i>		02-72-694 1 x Mehrzahn-Haken 2 x 30 mm <i>multiple toothed hook 2 x 30 mm</i>
02-72-676	2 x Schmale Muskelvalve 20 x 70 mm <i>narrow muscle blade 20 x 70 mm</i>		02-72-695 1 x Mehrzahn-Haken 2 x 40 mm <i>multiple toothed hook 2 x 40 mm</i>
02-72-680	2 x Breite Muskelvalve 27 x 40 mm <i>wide muscle blade 27 x 40 mm</i>		02-72-696 1 x Mehrzahn-Haken 2 x 50 mm <i>multiple toothed hook 2 x 50 mm</i>
02-72-681	2 x Breite Muskelvalve 27 x 50 mm <i>wide muscle blade 27 x 50 mm</i>		02-72-697 1 x Mehrzahn-Haken 2 x 60 mm <i>multiple toothed hook 2 x 60 mm</i>
02-72-682	2 x Breite Muskelvalve 27 x 60 mm <i>wide muscle blade 27 x 60 mm</i>		
02-72-683	2 x Breite Muskelvalve 27 x 70 mm <i>wide muscle blade 27 x 70 mm</i>		

Artikel-Nr.
Cat. No.

02-72-670

Retraktor mit Gelenk,
max. Spreizweite 85 mm,
schwarz, titanbeschichtet

*retractor with hinge,
max. spread 85 mm,
black, titanium-coated*

MC CULLOCH

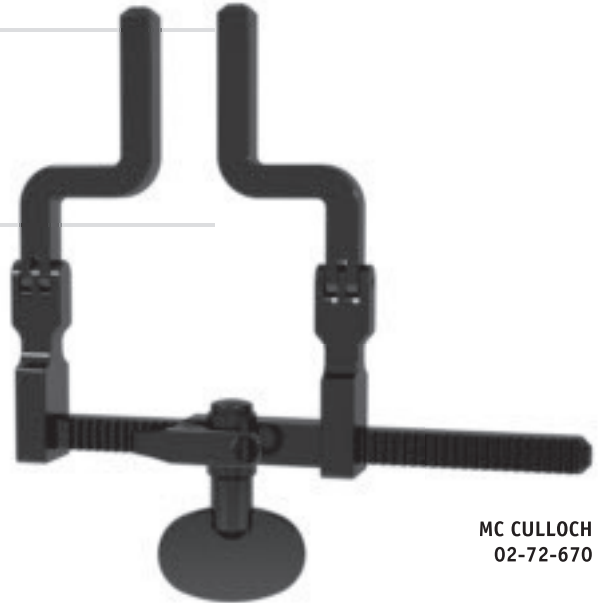

MC CULLOCH
02-72-670

Artikel-Nr.
Cat. No.

02-72-671

Retraktor mit starren Armen,
max. Spreizweite 85 mm,
schwarz, titanbeschichtet

*retractor with rigid arms,
max. spread 85 mm,
black, titanium-coated*

MC CULLOCH



MC CULLOCH
02-72-671



	Artikel-Nr. Cat. No.	Maße B x L Measurements W x L
MC CULLOCH	02-72-672	20 x 30 mm
	02-72-673	20 x 40 mm
	02-72-674	20 x 50 mm
	02-72-675	20 x 60 mm
	02-72-676	20 x 70 mm
	02-72-677	20 x 80 mm
	02-72-678	20 x 90 mm
Schmale Muskelvalve, schwarz, titanbeschichtet <i>narrow muscle blade, black, titanium-coated</i>		



MC CULLOCH	02-72-679	27 x 30 mm
	02-72-680	27 x 40 mm
	02-72-681	27 x 50 mm
	02-72-682	27 x 60 mm
	02-72-683	27 x 70 mm
	02-72-684	27 x 80 mm
	02-72-685	27 x 90 mm
Breite Muskelvalve, schwarz, titanbeschichtet <i>wide muscle blade, black, titanium-coated</i>		



MC CULLOCH	02-72-686	1,8 x 20 mm
	02-72-687	1,8 x 30 mm
	02-72-688	1,8 x 40 mm
	02-72-689	1,8 x 50 mm
	02-72-690	1,8 x 60 mm
	02-72-691	1,8 x 70 mm
	02-72-692	1,8 x 80 mm
Haken, schwarz, titanbeschichtet <i>hook, black, titanium-coated</i>		



MC CULLOCH	02-72-693	2 x 20 mm
	02-72-694	2 x 30 mm
	02-72-695	2 x 40 mm
	02-72-696	2 x 50 mm
	02-72-697	2 x 60 mm
	02-72-698	2 x 70 mm
	02-72-699	2 x 80 mm
Mehrzahn-Haken, schwarz, titanbeschichtet <i>multiple toothed hook, black, titanium-coated</i>		

Artikel-Nr. Cat. No.	Maße B x L Measurements W x L		
02-72-710	40 x 27 mm Konische Muskelvalve, schwarz, titanbeschichtet <i>tapered muscle blade, black, titanium-coated</i>	MC CULLOCH	
02-72-700	17 x 30 mm	MC CULLOCH	
02-72-701	17 x 40 mm		
02-72-702	17 x 50 mm		
02-72-703	17 x 60 mm		
02-72-704	17 x 70 mm		
02-72-705	17 x 80 mm		
02-72-706	17 x 90 mm Kleine Muskelvalve, 2 Zähne, schwarz, titanbeschichtet <i>small muscle blade, 2 teeth, black, titanium-coated</i>		
02-72-707	20 x 50 mm	MC CULLOCH	
02-72-708	20 x 60 mm		
02-72-709	20 x 70 mm Kleine Muskelvalve, 2 Zähne, schwarz, titanbeschichtet <i>small muscle blade, 2 teeth, black, titanium-coated</i>		





 1/1
ALM
02-22-010
 70 mm
 2¾"

		Artikel-Nr. Cat. No.	Gesamtlänge Total length
1/1	ALM	02-22-010	70 mm / 2¾"
		02-72-010	100 mm / 4"
			spitz sharp
1/1	ALM	02-72-011	70 mm / 2¾"
		02-22-011	100 mm / 4"
			stumpf blunt

 1/1
JANSEN
02-22-030
 100 mm
 4"

		Artikel-Nr. Cat. No.	Gesamtlänge Total length
1/1	JANSEN	02-22-030	100 mm / 4"
		02-72-032	110 mm / 4¾"
			scharf sharp
1/1	JANSEN	02-22-032	100 mm / 4"
		02-72-032	110 mm / 4¾"
			stumpf blunt

Artikel-Nr. Cat. No.	Gesamtlänge Total length		
02-72-996	130 mm / 5 $\frac{1}{8}$ "	GELPI	1/1
02-22-997	175 mm / 7"		
Hautspreizer, scharf skin retractor, sharp			



1/2
GELPI
02-22-997
175 mm
7"

Artikel-Nr. Cat. No.	Gesamtlänge Total length		
02-22-993	185 mm / 7 $\frac{1}{4}$ "	JACKSON-BURROWS	
	Hautspreizer, stumpf skin retractor, blunt		



1/2
JACKSON-BURROWS
02-22-993
185 mm
7 $\frac{1}{4}$ "



1/2
PLESTER
02-22-090
 110 mm
 4³/₈"

		Artikel-Nr. Cat. No.	Gesamtlänge Total length
	PLESTER	02-22-090	110 mm / 4 ³ / ₈ " stumpf, volles Blatt links <i>blunt, solid blade left</i>
	PLESTER	02-22-091	110 mm / 4 ³ / ₈ " stumpf, volles Blatt rechts <i>blunt, solid blade right</i>



7



1/2
PLESTER
02-22-078
 130 mm
 5¹/₈"

		Artikel-Nr. Cat. No.	Gesamtlänge Total length
	PLESTER	02-22-078	130 mm / 5 ¹ / ₈ " scharf <i>sharp</i>
	PLESTER	02-22-079	130 mm / 5 ¹ / ₈ " stumpf <i>blunt</i>

Artikel-Nr. Cat. No.	Gesamtlänge Total length		
15-11-794	130 mm / 5 1/8" scharf, volles Blatt rechts <i>sharp, solid blade right</i>	PERKINS	
15-11-795	130 mm / 5 1/8" scharf, volles Blatt links <i>sharp, solid blade left</i>	PERKINS	



1/2
PERKINS
15-11-795
130 mm
5 1/8"

Artikel-Nr. Cat. No.	Gesamtlänge Total length		
02-22-076	130 mm / 5 1/8" scharf <i>sharp</i>	WULLSTEIN	
02-22-077	130 mm / 5 1/8" stumpf <i>blunt</i>	WULLSTEIN	



1/2
WULLSTEIN
02-22-077
130 mm
5 1/8"

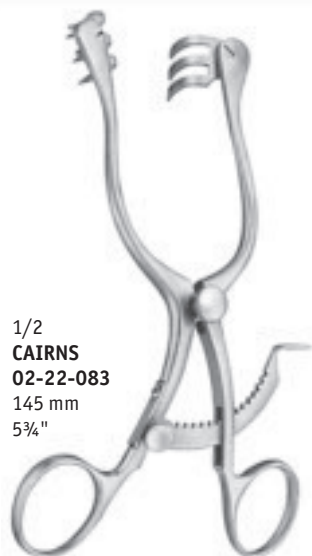

1/2
CAIRNS
 02-22-083
 145 mm
 5¾"

		Artikel-Nr. Cat. No.	Gesamtlänge Total length
1/1	CAIRNS	02-22-083	145 mm / 5¾"
			scharf sharp
1/1	CAIRNS	02-72-081	145 mm / 5¾"
			stumpf blunt





1/2
ADSON-BABY
 02-72-085
 160 mm
 6¾"

		Artikel-Nr. Cat. No.	Gesamtlänge Total length
1/1	ADSON-BABY	02-22-085	145 mm / 5¾"
		02-72-085	160 mm / 6¾"
1/1	ADSON-BABY	02-72-086	145 mm / 5¾"
		02-72-087	160 mm / 6¾"





1/2
JEFFERSON
 02-22-092
 140 mm
 5½"

		Artikel-Nr. Cat. No.	Gesamtlänge Total length
1/1	JEFFERSON	02-22-092	140 mm / 5½"
			stumpf, gebogen blunt, curved

Artikel-Nr. Cat. No.	Gesamtlänge Total length		
02-22-093	130 mm / 5½"	MOLLISON	1/1
	2 x 2 Zähne, scharf 2 x 2 teeth, sharp		
02-22-088	155 mm / 6"	MOLLISON	1/1
	4 x 4 Zähne, scharf 4 x 4 teeth, sharp		



1/2
MOLLISON
02-22-088
155 mm
6"

Artikel-Nr. Cat. No.	Gesamtlänge Total length		
02-72-090	140 mm / 5½"	CONTOUR	1/1
	Kopfhautspreizer, scharf scalp retractor, sharp		
02-72-091	140 mm / 5½"	CONTOUR	1/1
	Kopfhautspreizer, stumpf scalp retractor, blunt		



1/2
CONTOUR
02-72-090
140 mm
5½"

 1/2
WEITLANER
02-22-068
 165 mm
 6½"

		Artikel-Nr. Cat. No.	Gesamtlänge Total length
1/1		WEITLANER 02-22-101	130 mm / 5¼"
		02-22-072	165 mm / 6½"
			scharf <i>sharp</i>
		WEITLANER 02-22-068	165 mm / 6½"
			halbscharf <i>semi sharp</i>
1/1		WEITLANER 02-22-104	130 mm / 5¼"
		02-22-075	165 mm / 6½"
			stumpf <i>blunt</i>

 1/2
WEITLANER
02-22-206
 240 mm
 9½"

		Artikel-Nr. Cat. No.	Gesamtlänge Total length
1/1		WEITLANER 02-22-200	195 mm / 7¾"
		02-22-206	240 mm / 9½"
			3 x 4 Zähne, scharf <i>3 x 4 teeth, sharp</i>
		WEITLANER 02-22-208	255 mm / 10"
			5 x 6 Zähne, scharf <i>5 x 6 teeth, sharp</i>
1/1		WEITLANER 02-22-201	195 mm / 7¾"
		02-22-207	240 mm / 9½"
		02-22-209	255 mm / 10"
			3 x 4 Zähne, stumpf <i>3 x 4 teeth, blunt</i>
			3 x 4 Zähne, stumpf <i>3 x 4 teeth, blunt</i>
			5 x 6 Zähne, stumpf <i>5 x 6 teeth, blunt</i>

Artikel-Nr. Cat. No.	Gesamtlänge Total length		
02-72-220	140 mm / 5½"	scharf sharp	WEITLANER- BECKMANN
02-72-221	170 mm / 6¾"		
02-72-222	220 mm / 8¾"		
02-72-223	140 mm / 5½"	stumpf blunt	WEITLANER- BECKMANN
02-72-224	170 mm / 6¾"		
02-72-225	220 mm / 8¾"		



1/2
WEITLANER-
BECKMANN
02-72-221
170 mm
6¾"

Artikel-Nr. Cat. No.	Gesamtlänge Total length		
02-72-226	310 mm / 12"	scharf sharp	BECKMANN



1/3
BECKMANN
02-72-226
310 mm
12"



1/2
MAYO-ADAMS
02-22-112
 165 mm
 6½"

		Artikel-Nr. Cat. No.	Gesamtlänge Total length
	MAYO-ADAMS	02-22-112	165 mm / 6½"



1/2
HENDERSON
02-22-113
 180 mm
 7"

		Artikel-Nr. Cat. No.	Gesamtlänge Total length
	HENDERSON	02-22-113	180 mm / 7" scharf sharp

Artikel-Nr. Cat. No.		Gesamtlänge Total length		
02-72-210	scharf <i>sharp</i>	220 mm / 8¾"	MISKIMON	1/1
02-72-211	stumpf <i>blunt</i>	220 mm / 8¾"	MISKIMON	1/1



1/2
MISKIMON
02-72-210
220 mm
8¾"

Artikel-Nr. Cat. No.		Gesamtlänge Total length		
02-22-250	scharf <i>sharp</i>	190 mm / 7¼"	ANDERSON- ADSON	1/1
02-72-249	stumpf <i>blunt</i>	190 mm / 7¼"	ANDERSON- ADSON	1/1



1/2
ANDERSON-ADSON
02-22-250
190 mm
7¼"

 Artikel-Nr.
 Cat. No.

CLOWARD

02-22-380

Wundspreizer, komplett, bestehend aus:
Self-Retaining Retractor, complete, consisting of:

- | | |
|------------------|--|
| 02-22-379 | 1x Sperrer, allein, 250 mm, 10"
<i>spreader only, 250 mm, 10"</i> |
| 02-22-381 | 1x Valve, 40 mm
<i>blade, 40 mm</i> |
| 02-22-382 | 1x Valve, 45 mm
<i>blade, 45 mm</i> |
| 02-22-383 | 1x Valve, 50 mm
<i>blade, 50 mm</i> |
| 02-22-384 | 1x Valve, 55 mm
<i>blade, 55 mm</i> |
| 02-22-385 | 1x Valve, 60 mm
<i>blade, 60 mm</i> |

 1/2
CLOWARD
02-22-380
 250 mm
 10"

 Artikel-Nr.
 Cat. No.

CLOWARD

02-72-390

Wundspreizer, komplett, bestehend aus:
Self-Retaining Retractor, complete, consisting of:

- | | |
|------------------|--|
| 02-72-389 | 1x Sperrer, allein, 150 mm, 6"
<i>spreader only, 150 mm, 6"</i> |
| 02-22-391 | 1x Valve, 40 mm
<i>blade, 40 mm</i> |
| 02-22-392 | 1x Valve, 45 mm
<i>blade, 45 mm</i> |
| 02-22-393 | 1x Valve, 50 mm
<i>blade, 50 mm</i> |
| 02-22-394 | 1x Valve, 55 mm
<i>blade, 55 mm</i> |
| 02-22-395 | 1x Valve, 60 mm
<i>blade, 60 mm</i> |

 1/2
CLOWARD
02-72-390
 130 mm
 5 1/8"

Artikel-Nr. Cat. No.	Blattlänge Length of blades		
02-22-381	40 mm / 1½"	CLOWARD	
02-22-382	45 mm / 1¾"		
02-22-383	50 mm / 2"		
02-22-384	55 mm / 2⅛"		
02-22-385	60 mm / 2¼"		
Valven gezahnt, für CLOWARD-Spreizer 02-22-379 und 02-72-389 <i>blades, teathed, for CLOWARD retractor 02-22-397 and 02-72-389</i>			



2/3
02-22-383
50 mm
2"

Artikel-Nr. Cat. No.	Blattlänge Length of blades		
02-22-391	40 mm / 1½"	CLOWARD	
02-22-392	45 mm / 1¾"		
02-22-393	50 mm / 2"		
02-22-394	55 mm / 2⅛"		
02-22-395	60 mm / 2¼"		
Valven stumpf, für CLOWARD-Spreizer 02-22-379 und 02-72-389 <i>blades, blunt, for CLOWARD retractor 02-22-397 and 02-72-389</i>			



2/3
02-22-394
55 mm
2⅛"





	Artikel-Nr. Cat. No.	Gesamtlänge Total length
1/1 	02-22-254	280 mm / 11" scharf, langes Blatt rechts <i>sharp, long blade right</i>
1/1 	02-22-255	280 mm / 11" scharf, langes Blatt links <i>sharp, long blade left</i>

1/3
02-22-254
 280 mm
 11"





	Artikel-Nr. Cat. No.	Gesamtlänge Total length
1/1 	HARVEY JACKSON 02-22-258	280 mm / 11" scharf <i>sharp</i>

1/3
HARVEY JACKSON
02-22-258
 280 mm
 11"

Artikel-Nr. Cat. No.	Gesamtlänge Total length		
02-22-248	220 mm / 8¾"	NORFOLK AND NORWICH	1/2
	stumpf blunt		



1/2
NORFOLK
AND
NORWICH
02-22-248
220 mm
8¾"

Artikel-Nr. Cat. No.	Gesamtlänge Total length		
02-72-250	200 mm / 8"	ADSON	1/1
02-72-251	265 mm / 10½"		
	stumpf blunt		
02-72-252	200 mm / 8"	ADSON	1/1
02-22-252	265 mm / 10½"		
	scharf sharp		



1/2
ADSON
02-22-252
265 mm
10½"





		Artikel-Nr. Cat. No.	Gesamtlänge Total length
1/1	CONE	02-72-260	200 mm / 8"
		02-22-260	265 mm / 10½"
			scharf sharp
1/1	CONE	02-72-262	200 mm / 8"
		02-72-263	265 mm / 10½"
			stumpf blunt

1/3
CONE
02-22-260
 265 mm
 10½"



		Artikel-Nr. Cat. No.	Gesamtlänge Total length
1/1	ADSON	02-22-273	320 mm / 12½"
			halbscharf semi sharp

1/3
ADSON
02-22-273
 320 mm
 12½"

Artikel-Nr. Cat. No.	Gesamtlänge Total length		
02-22-271	310 mm / 12"	BECKMANN-ADSON	1/1
	halbscharf semi sharp		
02-22-272	310 mm / 12"	BECKMANN-ADSON	1/1
	scharf sharp		



1/3
BECKMANN-ADSON
02-22-272
310 mm
12"

Artikel-Nr. Cat. No.	Gesamtlänge Total length		
02-22-276	320 mm / 12 ³ / ₄ "	BECKMANN-EATON	1/2
	scharf sharp		



1/3
BECKMANN-EATON
02-22-276
320 mm
12³/₄"



7



1/2
WILLIAMS
02-72-310
 170 mm
 6¾"

	Artikel-Nr. Cat. No.	Gesamtlänge Total length
WILLIAMS	02-72-300	170 mm / 6¾"
		50 x 10 mm, gezahntes Blatt rechts 50 x 10 mm, serrated blade right
	02-72-310	170 mm / 6¾"
		50 x 10 mm, gezahntes Blatt links 50 x 10 mm, serrated blade left
	02-72-301	170 mm / 6¾"
		60 x 10 mm, gezahntes Blatt rechts 60 x 10 mm, serrated blade right
	02-72-311	170 mm / 6¾"
		60 x 10 mm, gezahntes Blatt links 60 x 10 mm, serrated blade left
	02-72-302	170 mm / 6¾"
		70 x 10 mm, gezahntes Blatt rechts 70 x 10 mm, serrated blade right
	02-72-312	170 mm / 6¾"
		70 x 10 mm, gezahntes Blatt links 70 x 10 mm, serrated blade left
	02-72-303	170 mm / 6¾"
		50 x 20 mm, gezahntes Blatt rechts 50 x 20 mm, serrated blade right
	02-72-313	170 mm / 6¾"
	50 x 20 mm, gezahntes Blatt links 50 x 20 mm, serrated blade left	
02-72-304	170 mm / 6¾"	
	60 x 20 mm, gezahntes Blatt rechts 60 x 20 mm, serrated blade right	
02-72-314	170 mm / 6¾"	
	60 x 20 mm, gezahntes Blatt links 60 x 20 mm, serrated blade left	
02-72-305	170 mm / 6¾"	
	70 x 20 mm, gezahntes Blatt rechts 70 x 20 mm, serrated blade right	
02-72-315	170 mm / 6¾"	
	70 x 20 mm, gezahntes Blatt links 70 x 20 mm, serrated blade left	

Artikel-Nr. Cat. No.	Gesamtlänge Total length	
02-72-283	190 mm / 7½"	MEYERDING
	Blätter gezahnt 32 x 25 mm <i>blades serrated 32 x 25 mm</i>	
02-72-280	190 mm / 7½"	
	Blätter gezahnt 45 x 25 mm <i>blades serrated 45 x 25 mm</i>	
02-72-281	190 mm / 7½"	
	Blätter gezahnt 55 x 25 mm <i>blades serrated 55 x 25 mm</i>	
02-72-284	190 mm / 7½"	
	Blätter gezahnt 60 x 19 mm <i>blades serrated 60 x 19 mm</i>	
02-72-282	190 mm / 7½"	
	Blätter gezahnt 60 x 25 mm <i>blades serrated 60 x 25 mm</i>	



1/2
MEYERDING
02-72-281
190 mm
7¾"

Artikel-Nr. Cat. No.	Gesamtlänge Total length	
02-72-285	180 mm / 7"	MARKHAM-MEYERDING
	45 x 25 mm, gezahntes Blatt rechts <i>45 x 25 mm, serrated blade right</i>	
02-72-299	180 mm / 7"	
	45 x 25 mm, gezahntes Blatt links <i>45 x 25 mm, serrated blade left</i>	
02-72-295	180 mm / 7"	
	55 x 25 mm, gezahntes Blatt rechts <i>55 x 25 mm, serrated blade right</i>	
02-72-296	180 mm / 7"	
	55 x 25 mm, gezahntes Blatt links <i>55 x 25 mm, serrated blade left</i>	



1/2
MARKHAM-MEYERDING
02-72-285
180 mm
7"

 1/2
SCOVILLE
 02-72-520

**Artikel-Nr.
 Cat. No.**
SCOVILLE
02-72-520
**Laminektomie-Sperrer, komplett, bestehend aus:
 Laminectomy Retractor, complete consisting of:**
02-72-521 1x Spreizer, allein, Spreizweite 140 mm
retractor, only, spread 140 mm
02-72-525 1x Haken 50 mm
hook 50 mm
02-72-537 1x Valve 25 x 50 mm
blade 25 x 50 mm

 1/2
**SCOVILLE-
 HAVERFIELD**
 02-22-400

**Artikel-Nr.
 Cat. No.**
**SCOVILLE-
 HAVER-
 FIELD**
02-22-400
**Laminektomie-Sperrer mit Gelenk-
 armen, komplett, bestehend aus:
 Laminectomy Retractor, Arms with
 hinge, complete, consisting of:**
02-22-401 1x Spreizer, allein
 Spreizweite 140 mm
retractor, only, spread 140 mm
02-72-525 1x Haken 50 mm
hook 50 mm
02-72-537 1x Valve 25 x 50 mm
blade 25 x 50 mm

Artikel-Nr. Cat. No.	Maße Measurements
02-72-525	50 mm
02-72-526	70 mm
02-72-527	75 mm
	Haken, scharf, für Spreizer 02-22-401 und 02-72-521 <i>hook, sharp, for retractors 02-22-401 and 02-72-521</i>
02-22-403	50 mm
02-72-529	70 mm
02-72-530	75 mm
	Haken, stumpf, für Spreizer 02-22-401 und 02-72-521 <i>hook, blunt for retractors 02-22-401 and 02-72-521</i>
02-72-531	40 x 25 mm
02-72-532	40 x 40 mm
02-22-409	40 x 50 mm
	Valve, 3 Zähne, für Spreizer 02-22-401 und 02-72-521 <i>blade, 3 teeth, for retractors 02-22-401 and 02-72-521</i>
02-72-534	50 x 50 mm
02-22-411	50 x 60 mm
02-72-536	50 x 75 mm
	Valve, 4 Zähne, für Spreizer 02-22-401 und 02-72-521 <i>blade, 4 teeth, for retractors 02-22-401 and 02-72-521</i>
02-72-537	25 x 50 mm
02-22-405	25 x 60 mm
02-72-539	25 x 75 mm
	Valve für Spreizer 02-22-401 und 02-72-521 <i>blade for retractors 02-22-401 and 02-72-521</i>
02-72-540	50 x 50 mm
02-22-406	50 x 60 mm
02-72-542	50 x 75 mm
	Valve für Spreizer 02-22-401 und 02-72-521 <i>blade for retractors 02-22-401 and 02-72-521</i>



1/2
02-72-525
50 mm



1/2
02-72-534
50 x 50 mm

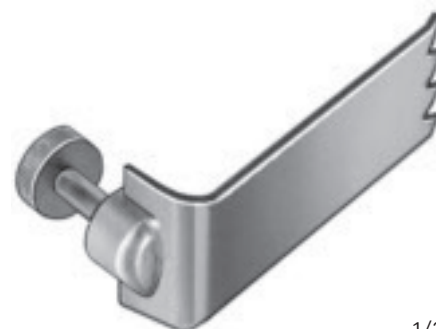

1/2
02-72-539
25 x 75 mm



7

 1/3
 SCOVILLE-RICHTER
 02-22-510

 Artikel-Nr.
 Cat. No.

 SCOVILLE-
 RICHTER

02-22-510

**Laminektomie-Sperrer, Spreizweite 160 mm,
 komplett, bestehend aus:**
*Laminectomy Retractor, spread 160 mm,
 complete, consisting of:*

 02-22-509 1x Sperrer, allein
spreader only

 02-22-516 1x Set Valven
set of blades

02-22-516

 Valven Set, bestehend aus:
set of blades, consisting of:

 1 Blatt 62 x 52 mm, 4 Zähne
1 blade 62 x 52 mm, 4 teeth

 1 Blatt 62 x 37 mm, 3 Zähne
1 blade 62 x 37 mm, 3 teeth

02-22-517

 Blatt 47 x 51 mm
blade 47 x 51 mm

02-22-518

 Blatt 30 x 40 mm
blade 30 x 40 mm

02-22-519

 Blatt 37 x 62 mm
blade 37 x 62 mm

Artikel-Nr. Cat. No.	Gesamtlänge Total length		
02-22-296	155 mm / 6" Blatt 5 mm, ohne Zähne blade 5 mm, without teeth	CLOWARD	
02-72-320	155 mm / 6" Blatt 5 mm, mit Zähnen blade 5 mm, with teeth	CLOWARD	



1/2
CLOWARD
02-22-320
 155 mm
 6"

Artikel-Nr. Cat. No.	Gesamtlänge Total length		
02-22-299	135 mm / 5¼" Blatt 4,5 mm, ohne Zähne blade 4.5 mm, without teeth	CLOWARD	
02-72-321	135 mm / 5¼" Blatt 4,5 mm, mit Zähnen blade 4.5 mm, with teeth	CLOWARD	



1/2
CLOWARD
02-22-299
 135 mm
 5¼"



1/2
INGE
02-72-297
 170 mm
 6¾"

	Artikel-Nr. Cat. No.	Gesamtlänge Total length
INGE	02-22-297	170 mm / 6¾" Blatt 6 mm, mit Zähnen <i>blade 6 mm, with teeth</i>
INGE	02-72-297	170 mm / 6¾" Blatt 6 mm, ohne Zähne <i>blade 6 mm, without teeth</i>



7



1/3
02-22-298
 250 mm
 10"

	Artikel-Nr. Cat. No.	Gesamtlänge Total length
INGE	02-72-298	250 mm / 10" Blatt 8 mm <i>blade 8 mm</i>
	02-22-298	250 mm / 10" Blatt 12 mm <i>blade 12 mm</i>

Area with horizontal lines for notes.



01

Mikro-Neurochirurgische Instrumente
Micro-Neurosurgical Instruments

02

HF-Instrumente und Zubehör
HF Instruments and Accessoires

03

Kopf-Schädelinstrumente und Haltesysteme
Head-Cranio Instruments and Holding Systems

04

Aneurysmen-Clip System
Aneurysm Clip System

05

Schädel-Verplattung
Cranial Plate System

06

Hypophysektomie-Instrumente
Pituitary Instruments

07

Instrumente für die Wirbelsäule, Wundspreizer
Spine Instruments, Self retaining Retractors

Laminektomie-Stanzen, Rongeure
Laminectomy Punches, Rongeurs

09

Gefäß- und Bulldogklemmen, Gefäß-Clips
Vessel- and Bulldog-Clamps, Vessel Clips

10

Allgemeinchirurgische Instrumente
General Surgical Instruments

11

Alphabetischer Index, Numerischer Index
Alphabetical Index, Numerical Index



SURGICAL
INSTRUMENTS
MICRO-NEURO-SPINE

/// 08

REBSTOCK®
Precision made in Germany

/// Laminektomie-Stanzen, Rongeurs
Laminectomy Punches, Rongeurs

/// www.rebstock.de

Die dünne Fußplatte für den Einsatz im zervikalen Bereich.

Thin footplate for the use in cervical surgeries.

Einfaches zerlegen per Knopf.

Quick and easy disassembling by pull button.

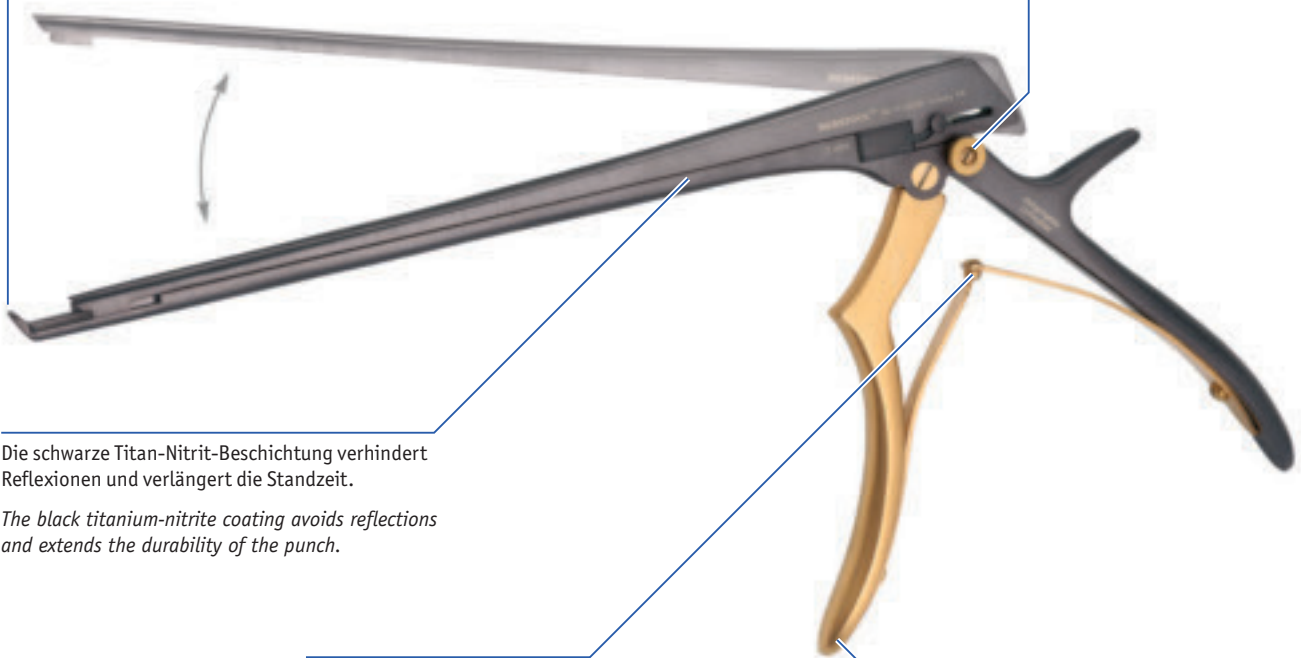

Die schwarze Titan-Nitrit-Beschichtung verhindert Reflexionen und verlängert die Standzeit.

The black titanium-nitrite coating avoids reflections and extends the durability of the punch.

Die goldene Feder definiert die Zerlegbarkeit der Stanze.

The golden spring stands for the detachability of the punch.

Der goldene Griff weist auf die dünne Fußplatte hin.

The golden handle refers to the thin footplate.

Der Auswerfer ist in die Führung integriert.



The ejector is integrated in the guiding.

Die präzise Führung reicht bis zum Schnitt.



The precise guiding extends to the cut.

Glatte Innenflächen an Haupt- und Schieberteilen.



Smooth inner surfaces on main and sliding part.

Doppelte Markierung der Schnittbreite.



The cutting size is marked on the punch twice.

Die zerlegte Stanze bleibt als ein Teil zusammen.



The detached punch remains one part.

Die Stanze kann bei Bedarf auch in zwei Teile zerlegt werden.



The punch can also be disassembled in two parts.

Demontage
Disassembly

Stanze schließen und Auslöseknopf ziehen.

Close the punch and pull the release button.



Stanze öffnen und Schieber nach oben klappen. Die Stanze ist zerlegt. Alle Teile bleiben miteinander verbunden.

Open the punch and lift the sliding part up. The punch is disassembled. All parts remain connected with each other.

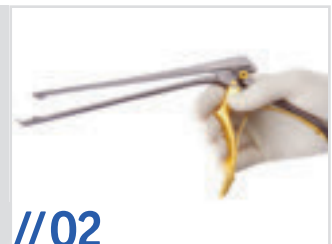

Montage
Assembly

Schieber in Führung am Hauptteil einsetzen.

Insert the sliding part in the guiding of the main part.



Stanze schließen und gleichzeitig Schieber nach vorne bewegen. Die Stanze ist montiert und einsatzbereit.

Close the punch and push the sliding part to the front. The punch is assembled and ready for use.









D E T A C H A B L E

 Alle Stanzen mit integriertem Auswerfer
 All punches with integrated ejector







 1/2
KERRISON
06-11-908
 180 mm
 7"

Schaftlänge
Length of shaft

		180 mm 7"	200 mm 8"	230 mm 9"	250 mm 10"	280 mm 11"	300 mm 12"
 1 mm, 130° (40°)	KERRISON	06-11-900	06-11-960	06-11-918	06-81-100	06-11-981	06-81-112
 2 mm, 130° (40°)		06-11-901	06-11-913	06-11-919	06-81-101	06-11-986	06-81-113
 3 mm, 130° (40°)		06-11-902	06-11-914	06-11-920	06-81-102	06-11-987	06-81-114
 4 mm, 130° (40°)		06-11-903	06-11-915	06-11-921	06-81-103	06-11-988	06-81-115
 5 mm, 130° (40°)		06-11-904	06-11-916	06-11-922	06-81-104	06-11-989	06-81-116
 6 mm, 130° (40°)		06-11-905	06-11-917	06-61-962	06-81-105	06-81-111	06-81-117

 mit dünner Fußplatte
 with thin footplate

Schaftlänge
Length of shaft

		180 mm 7"	200 mm 8"	230 mm 9"	250 mm 10"	280 mm 11"	300 mm 12"
 1 mm, 130° (40°)	KERRISON	06-11-906	06-11-961	06-11-929	06-81-121	06-11-980	06-81-129
 2 mm, 130° (40°)		06-11-907	06-11-962	06-11-925	06-81-122	06-11-976	06-81-130
 3 mm, 130° (40°)		06-11-908	06-11-963	06-11-926	06-81-123	06-11-977	06-81-131
 4 mm, 130° (40°)		06-11-909	06-11-964	06-11-927	06-81-124	06-11-978	06-81-132
 5 mm, 130° (40°)		06-11-910	06-11-965	06-11-928	06-81-125	06-11-979	06-81-133
 6 mm, 130° (40°)		06-61-947	06-61-948	06-61-949	06-81-126	06-81-128	06-81-134

Standard Line

 Oberfläche matt gebürstet
 Surface polished

 Beispiel-Artikel-Nr.
 Example Cat. No.

06-11-908
Black Line

 Oberfläche schwarz, titanbeschichtet
 Surface black, titanium-coated

 Beispiel-Artikel-Nr.
 Example Cat. No.

06-11-908B

D E T A C H A B L E



Alle Stanzen mit integriertem Auswerfer
All punches with integrated ejector

1/2
KERRISON
06-61-930B
200 mm
8"

Schaftlänge
Length of shaft

180 mm 7"	200 mm 8"	230 mm 9"	250 mm 10"	280 mm 11"	300 mm 12"		
06-11-948	06-61-921	06-61-933	06-81-135	06-81-141	06-81-147	KERRISON	1 mm, 90°
06-11-949	06-61-922	06-61-934	06-81-136	06-81-142	06-81-148		2 mm, 90°
06-11-950	06-61-923	06-61-935	06-81-137	06-81-143	06-81-149		3 mm, 90°
06-11-951	06-61-924	06-61-936	06-81-138	06-81-144	06-81-150		4 mm, 90°
06-11-952	06-61-925	06-61-937	06-81-139	06-81-145	06-81-151		5 mm, 90°
06-11-953	06-61-926	06-61-938	06-81-140	06-81-146	06-81-152		6 mm, 90°



Schaftlänge
Length of shaft

180 mm 7"	200 mm 8"	230 mm 9"	250 mm 10"	280 mm 11"	300 mm 12"		
06-61-915	06-61-927	06-61-939	06-81-153	06-81-159	06-81-165	KERRISON	1 mm, 90°
06-61-916	06-61-928	06-61-940	06-81-154	06-81-160	06-81-166		2 mm, 90°
06-61-917	06-61-929	06-61-941	06-81-155	06-81-161	06-81-167		3 mm, 90°
06-61-918	06-61-930	06-61-942	06-81-156	06-81-162	06-81-168		4 mm, 90°
06-61-919	06-61-931	06-61-943	06-81-157	06-81-163	06-81-169		5 mm, 90°
06-61-920	06-61-932	06-61-944	06-81-158	06-81-164	06-81-170		6 mm, 90°

mit dünner Fußplatte
with thin footplate



Standard Line	Black Line
Oberfläche matt gebürstet Surface polished	Oberfläche schwarz, titanbeschichtet Surface black, titanium-coated
Beispiel-Artikel-Nr. Example Cat. No. 06-61-930	Beispiel-Artikel-Nr. Example Cat. No. 06-61-930B

D E T A C H A B L E

 Alle Stanzen mit integriertem Auswerfer
 All punches with integrated ejector

 1/2
KERRISON
06-61-910
 200 mm
 8"

 Schaftlänge
 Length of shaft

		180 mm 7"	200 mm 8"	230 mm 9"	250 mm 10"	280 mm 11"	300 mm 12"
1 mm, 130° (40°)	KERRISON	06-11-930	06-61-900	06-61-902	06-81-171	06-81-177	06-81-183
2 mm, 130° (40°)		06-11-931	06-61-990	06-11-943	06-81-172	06-81-178	06-81-184
3 mm, 130° (40°)		06-11-932	06-61-991	06-11-944	06-81-173	06-81-179	06-81-185
4 mm, 130° (40°)		06-11-933	06-61-992	06-11-945	06-81-174	06-81-180	06-81-186
5 mm, 130° (40°)		06-11-934	06-61-993	06-11-946	06-81-175	06-81-181	06-81-187
6 mm, 130° (40°)		06-61-908	06-61-910	06-61-912	06-81-176	06-81-182	06-81-188

 mit dünner Fußplatte
 with thin footplate

 Schaftlänge
 Length of shaft

		180 mm 7"	200 mm 8"	230 mm 9"	250 mm 10"	280 mm 11"	300 mm 12"
1 mm, 130° (40°)	KERRISON	06-11-936	06-61-901	06-61-903	06-81-189	06-81-195	06-81-201
2 mm, 130° (40°)		06-11-937	06-61-994	06-61-904	06-81-190	06-81-196	06-81-202
3 mm, 130° (40°)		06-11-938	06-61-995	06-61-905	06-81-191	06-81-197	06-81-203
4 mm, 130° (40°)		06-11-939	06-61-996	06-61-906	06-81-192	06-81-198	06-81-204
5 mm, 130° (40°)		06-11-940	06-61-997	06-61-907	06-81-193	06-81-199	06-81-205
6 mm, 130° (40°)		06-61-909	06-61-911	06-61-913	06-81-194	06-81-200	06-81-206

Standard Line

 Oberfläche matt gebürstet
 Surface polished

 Beispiel-Artikel-Nr.
 Example Cat. No.

06-61-910
Black Line

 Oberfläche schwarz, titanbeschichtet
 Surface black, titanium-coated

 Beispiel-Artikel-Nr.
 Example Cat. No.

06-61-910B







D E T A C H A B L E









Alle Stanzen mit integriertem Auswerfer
All punches with integrated ejector

1/2
KERRISON
06-11-954
180 mm
6"

Schaftlänge
Length of shaft

180 mm 7"	200 mm 8"	230 mm 9"	250 mm 10"	280 mm 11"	300 mm 12"		
06-11-954	06-61-964	06-61-966	06-81-207	06-81-213	06-81-219	KERRISON	1 mm, 90° 
06-11-955	06-61-974	06-61-982	06-81-208	06-81-214	06-81-220		2 mm, 90° 
06-11-956	06-61-975	06-61-983	06-81-209	06-81-215	06-81-221		3 mm, 90° 
06-11-957	06-61-976	06-61-984	06-81-210	06-81-216	06-81-222		4 mm, 90° 
06-11-958	06-61-977	06-61-985	06-81-211	06-81-217	06-81-223		5 mm, 90° 
06-11-959	06-61-965	06-61-967	06-81-212	06-81-218	06-81-224		6 mm, 90° 

Schaftlänge
Length of shaft

180 mm 7"	200 mm 8"	230 mm 9"	250 mm 10"	280 mm 11"	300 mm 12"		
06-61-968	06-61-969	06-61-998	06-81-225	06-81-231	06-81-237	KERRISON	1 mm, 90° 
06-61-970	06-61-978	06-61-986	06-81-226	06-81-232	06-81-238		2 mm, 90° 
06-61-971	06-61-979	06-61-987	06-81-227	06-81-233	06-81-239		3 mm, 90° 
06-61-972	06-61-980	06-61-988	06-81-228	06-81-234	06-81-240		4 mm, 90° 
06-61-973	06-61-981	06-61-989	06-81-229	06-81-235	06-81-241		5 mm, 90° 
06-61-950	06-61-951	06-61-952	06-81-230	06-81-236	06-81-242		6 mm, 90° 







mit dünner Fußplatte
with thin footplate

Standard Line	Black Line
Oberfläche matt gebürstet Surface polished	Oberfläche schwarz, titanbeschichtet Surface black, titanium-coated
Beispiel-Artikel-Nr. Example Cat. No. 06-11-954	Beispiel-Artikel-Nr. Example Cat. No. 06-11-954B

Alle Stanzen mit integriertem Auswerfer
All punches with integrated ejector







 1/2
KERRISON
06-06-663B
 200 mm
 8"

Schaftlänge
Length of shaft

		180 mm 7"	200 mm 8"	230 mm 9"	250 mm 10"	280 mm 11"	300 mm 12"
 1 mm, 130° (40°)	KERRISON	06-06-715	06-06-691	06-06-674	06-76-125	06-06-696	06-76-131
 2 mm, 130° (40°)		06-06-717	06-06-737	06-06-682	06-76-126	06-06-686	06-76-132
 3 mm, 130° (40°)		06-06-720	06-06-738	06-06-683	06-76-127	06-06-687	06-76-133
 4 mm, 130° (40°)		06-06-724	06-06-727	06-06-684	06-76-128	06-06-688	06-76-134
 5 mm, 130° (40°)		06-06-722	06-06-728	06-06-685	06-76-129	06-06-689	06-76-135
 6 mm, 130° (40°)		06-06-726	06-06-729	06-56-735	06-76-130	06-06-690	06-76-136

 mit dünner Fußplatte
with thin footplate

Schaftlänge
Length of shaft

		180 mm 7"	200 mm 8"	230 mm 9"	250 mm 10"	280 mm 11"	300 mm 12"
 1 mm, 130° (40°)	KERRISON	06-06-771	06-06-661	06-06-734	06-76-501	06-06-673	06-76-509
 2 mm, 130° (40°)		06-06-772	06-06-662	06-06-746	06-76-502	06-06-666	06-76-510
 3 mm, 130° (40°)		06-06-773	06-06-663	06-06-747	06-76-503	06-06-667	06-76-511
 4 mm, 130° (40°)		06-06-769	06-06-664	06-06-748	06-76-504	06-06-668	06-76-512
 5 mm, 130° (40°)		06-06-770	06-06-665	06-06-749	06-76-505	06-06-669	06-76-513
 6 mm, 130° (40°)		06-56-736	06-56-742	06-56-744	06-76-506	06-76-508	06-76-514

Standard Line

 Oberfläche matt gebürstet
Surface polished

 Beispiel-Artikel-Nr.
Example Cat. No.
06-06-663
Black Line

 Oberfläche schwarz, titanbeschichtet
Surface black, titanium-coated

 Beispiel-Artikel-Nr.
Example Cat. No.
06-06-663B



Alle Stanzen mit integriertem Auswerfer
All punches with integrated ejector

1/2
KERRISON
06-06-718
180 mm
7"

Schaftlänge
Length of shaft

180 mm 7"	200 mm 8"	230 mm 9"	250 mm 10"	280 mm 11"	300 mm 12"		
06-06-716	06-06-025	06-56-707	06-76-101	06-76-515	06-76-107	KERRISON	1 mm, 90°
06-06-718	06-06-026	06-56-708	06-76-102	06-76-516	06-76-108		2 mm, 90°
06-06-750	06-06-027	06-56-709	06-76-103	06-76-517	06-76-109		3 mm, 90°
06-06-752	06-06-028	06-56-710	06-76-104	06-76-518	06-76-110		4 mm, 90°
06-06-754	06-06-029	06-56-711	06-76-105	06-76-519	06-76-111		5 mm, 90°
06-06-755	06-06-076	06-56-712	06-76-106	06-76-520	06-76-112		6 mm, 90°



Schaftlänge
Length of shaft

180 mm 7"	200 mm 8"	230 mm 9"	250 mm 10"	280 mm 11"	300 mm 12"		
06-06-115	06-06-077	06-56-727	06-76-521	06-76-527	06-76-533	KERRISON	1 mm, 90°
06-06-116	06-06-078	06-56-728	06-76-522	06-76-528	06-76-534		2 mm, 90°
06-06-117	06-06-079	06-56-729	06-76-523	06-76-529	06-76-535		3 mm, 90°
06-06-118	06-06-080	06-56-730	06-76-524	06-76-530	06-76-536		4 mm, 90°
06-06-119	06-06-085	06-56-731	06-76-525	06-76-531	06-76-537		5 mm, 90°
06-56-720	06-56-726	06-56-732	06-76-526	06-76-532	06-76-538		6 mm, 90°

mit dünner Fußplatte
with thin footplate









Standard Line	Black Line
Oberfläche matt gebürstet Surface polished	Oberfläche schwarz, titanbeschichtet Surface black, titanium-coated
Beispiel-Artikel-Nr. Example Cat. No. 06-06-718	Beispiel-Artikel-Nr. Example Cat. No. 06-06-718B

Alle Stanzen mit integriertem Auswerfer
 All punches with integrated ejector







 1/2
KERRISON
06-06-712
 180 mm
 7"

 Schaftlänge
 Length of shaft

		180 mm 7"	200 mm 8"	230 mm 9"	250 mm 10"	280 mm 11"	300 mm 12"
	KERRISON	06-06-711	06-56-779	06-56-785	06-76-137	06-76-539	06-76-143
		06-06-712	06-56-780	06-06-692	06-76-138	06-76-540	06-76-144
		06-06-713	06-56-781	06-06-693	06-76-139	06-76-541	06-76-145
		06-06-714	06-56-782	06-06-694	06-76-140	06-76-542	06-76-146
		06-06-725	06-56-783	06-06-695	06-76-141	06-76-543	06-76-147
		06-56-778	06-56-784	06-56-786	06-76-142	06-76-544	06-76-148

 mit dünner Fußplatte
 with thin footplate

 Schaftlänge
 Length of shaft

		180 mm 7"	200 mm 8"	230 mm 9"	250 mm 10"	280 mm 11"	300 mm 12"
	KERRISON	06-06-781	06-56-788	06-56-794	06-76-545	06-76-551	06-76-557
		06-06-782	06-56-789	06-56-795	06-76-546	06-76-552	06-76-558
		06-06-783	06-56-790	06-56-796	06-76-547	06-76-553	06-76-559
		06-06-784	06-56-791	06-56-797	06-76-548	06-76-554	06-76-560
		06-06-785	06-56-792	06-56-798	06-76-549	06-76-555	06-76-561
		06-56-787	06-56-793	06-56-799	06-76-550	06-76-556	06-76-562

Standard Line

 Oberfläche matt gebürstet
 Surface polished

 Beispiel-Artikel-Nr.
 Example Cat. No.

06-06-712
Black Line

 Oberfläche schwarz, titanbeschichtet
 Surface black, titanium-coated

 Beispiel-Artikel-Nr.
 Example Cat. No.







06-06-712B









Alle Stanzen mit integriertem Auswerfer
All punches with integrated ejector

1/2
KERRISON
06-06-721
180 mm
7"

Schaftlänge
Length of shaft

180 mm 7"	200 mm 8"	230 mm 9"	250 mm 10"	280 mm 11"	300 mm 12"		
06-06-741	06-56-745	06-56-895	06-76-113	06-76-563	06-76-119	KERRISON	1 mm, 90° 
06-06-719	06-06-828	06-56-896	06-76-114	06-76-564	06-76-120		2 mm, 90° 
06-06-721	06-06-829	06-56-897	06-76-115	06-76-565	06-76-121		3 mm, 90° 
06-06-742	06-06-830	06-56-898	06-76-116	06-76-566	06-76-122		4 mm, 90° 
06-06-723	06-06-831	06-56-899	06-76-117	06-76-567	06-76-123		5 mm, 90° 
06-06-743	06-06-841	06-56-900	06-76-118	06-76-568	06-76-124		6 mm, 90° 

Schaftlänge
Length of shaft

180 mm 7"	200 mm 8"	230 mm 9"	250 mm 10"	280 mm 11"	300 mm 12"		
06-56-960	06-56-966	06-56-901	06-76-569	06-76-575	06-76-581	KERRISON	1 mm, 90° 
06-06-816	06-06-809	06-56-902	06-76-570	06-76-576	06-76-582		2 mm, 90° 
06-06-817	06-06-812	06-56-903	06-76-571	06-76-577	06-76-583		3 mm, 90° 
06-06-819	06-06-813	06-56-904	06-76-572	06-76-578	06-76-584		4 mm, 90° 
06-06-821	06-06-815	06-56-905	06-76-573	06-76-579	06-76-585		5 mm, 90° 
06-56-965	06-56-971	06-56-906	06-76-574	06-76-580	06-76-586		6 mm, 90° 

mit dünner Fußplatte
with thin footplate

Standard Line	Black Line
Oberfläche matt gebürstet Surface polished	Oberfläche schwarz, titanbeschichtet Surface black, titanium-coated
Beispiel-Artikel-Nr. Example Cat. No. 06-06-721	Beispiel-Artikel-Nr. Example Cat. No. 06-06-721B







Alle Stanzen mit integriertem Auswerfer
 All punches with integrated ejector

 1/2
KERRISON
06-06-739B
 200 mm
 8"

 mit Langhub
 with large jaw opening

 Schaftlänge
 Length of shaft

180 mm 7"	200 mm 8"	230 mm 9"	250 mm 10"	280 mm 11"	300 mm 12"
--------------	--------------	--------------	---------------	---------------	---------------

		180 mm 7"	200 mm 8"	230 mm 9"	250 mm 10"	280 mm 11"	300 mm 12"
 1 mm, 130° (40°)	KERRISON	06-76-900	06-76-901	06-76-902	06-76-908	06-76-914	06-76-920
 2 mm, 130° (40°)		06-06-677	06-06-660	06-76-903	06-76-909	06-76-915	06-76-921
 3 mm, 130° (40°)		06-06-678	06-06-739	06-76-904	06-76-910	06-76-916	06-76-922
 4 mm, 130° (40°)		06-06-679	06-06-745	06-76-905	06-76-911	06-76-917	06-76-923
 5 mm, 130° (40°)		06-06-680	06-06-751	06-76-906	06-76-912	06-76-918	06-76-924
 6 mm, 130° (40°)		06-06-681	06-06-753	06-76-907	06-76-913	06-76-919	06-76-925

Standard Line

 Oberfläche matt gebürstet
 Surface polished

 Beispiel-Artikel-Nr. **06-06-739**
 Example Cat. No.

Black Line

 Oberfläche schwarz, titanbeschichtet
 Surface black, titanium-coated

 Beispiel-Artikel-Nr. **06-06-739B**
 Example Cat. No.









Alle Stanzen mit integriertem Auswerfer
 All punches with integrated ejector

1/2
KERRISON
06-06-136
 180 mm
 7"

mit Langhub
 with large jaw opening

Schaftlänge
 Length of shaft

180 mm 200 mm 230 mm 250 mm 280 mm 300 mm
 7" 8" 9" 10" 11" 12"

06-76-926	06-76-928	06-76-930	06-76-936	06-76-942	06-76-948	KERRISON	1 mm, 90°	
06-76-927	06-76-929	06-76-931	06-76-937	06-76-943	06-76-949		2 mm, 90°	
06-06-136	06-06-086	06-76-932	06-76-938	06-76-944	06-76-950		3 mm, 90°	
06-06-137	06-06-087	06-76-933	06-76-939	06-76-945	06-76-951		4 mm, 90°	
06-06-138	06-06-088	06-76-934	06-76-940	06-76-946	06-76-952		5 mm, 90°	
06-06-139	06-06-089	06-76-935	06-76-941	06-76-947	06-76-953		6 mm, 90°	

Standard Line	Black Line
Oberfläche matt gebürstet Surface polished Beispiel-Artikel-Nr. Example Cat. No. 06-06-136	Oberfläche schwarz, titanbeschichtet Surface black, titanium-coated Beispiel-Artikel-Nr. Example Cat. No. 06-06-136B

D E T A C H A B L E

 Alle Stanzen mit integriertem Auswerfer
 All punches with integrated ejector

 1/2
KERRISON
06-76-426
 230 mm
 9"

Schaftlänge
Length of shaft

 180 mm 200 mm 230 mm
 7" 8" 9"

Ø	KERRISON	06-76-400	06-76-412	06-76-424			
1 mm, 130° (40°)	aufwärts gebogen <i>curved up</i>	06-76-400	06-76-412	06-76-424			
2 mm, 130° (40°)		06-76-401	06-76-413	06-76-425			
3 mm, 130° (40°)		06-76-402	06-76-414	06-76-426			
4 mm, 130° (40°)		06-76-403	06-76-415	06-76-427			
5 mm, 130° (40°)		06-76-404	06-76-416	06-76-428			
6 mm, 130° (40°)		06-76-405	06-76-417	06-76-429			

 Foraminotomie-Stanzen
 Foraminotomy Punches

Schaftlänge
Length of shaft

 180 mm 200 mm 230 mm
 7" 8" 9"

Ø	KERRISON	06-76-406	06-76-418	06-76-430			
1 mm, 130° (40°)	abwärts gebogen <i>curved down</i>	06-76-406	06-76-418	06-76-430			
2 mm, 130° (40°)		06-76-407	06-76-419	06-76-431			
3 mm, 130° (40°)		06-76-408	06-76-420	06-76-432			
4 mm, 130° (40°)		06-76-409	06-76-421	06-76-433			
5 mm, 130° (40°)		06-76-410	06-76-422	06-76-434			
6 mm, 130° (40°)		06-76-411	06-76-423	06-76-435			

 Foraminotomie-Stanzen
 Foraminotomy Punches

Standard Line

 Oberfläche matt gebürstet
 Surface polished

 Beispiel-Artikel-Nr. **06-76-426**
 Example Cat. No.

Black Line

 Oberfläche schwarz, titanbeschichtet
 Surface black, titanium-coated

 Beispiel-Artikel-Nr. **06-76-426B**
 Example Cat. No.

Alle Stanzen mit integriertem Auswerfer
 All punches with integrated ejector



1/2
KERRISON
06-76-052
 200 mm
 8"

Schaftlänge
 Length of shaft

180 mm 200 mm 230 mm
 7" 8" 9"

06-76-050	06-76-052	06-56-054				KERRISON	1 mm, 130° (40°)
06-76-150	06-06-466	06-56-055					2 mm, 130° (40°)
06-76-151	06-06-467	06-56-056					3 mm, 130° (40°)
06-76-152	06-06-468	06-56-057					4 mm, 130° (40°)
06-76-153	06-06-469	06-56-058					5 mm, 130° (40°)
06-76-051	06-76-053	06-56-059					6 mm, 130° (40°)

Foraminotomie-Stanzen
 Foraminotomy Punches

Schaftlänge
 Length of shaft

180 mm 200 mm 230 mm
 7" 8" 9"

06-76-060	06-76-063	06-76-066				KERRISON	1 mm, 130° (40°)
06-76-158	06-76-161	06-76-067					2 mm, 130° (40°)
06-76-159	06-76-162	06-76-068					3 mm, 130° (40°)
06-76-160	06-76-163	06-76-069					4 mm, 130° (40°)
06-76-061	06-76-064	06-76-070					5 mm, 130° (40°)
06-76-062	06-76-065	06-76-071					6 mm, 130° (40°)

Foraminotomie-Stanzen
 Foraminotomy Punches

Standard Line	Black Line
Oberfläche matt gebürstet <i>Surface polished</i>	Oberfläche schwarz, titanbeschichtet <i>Surface black, titanium-coated</i>
Beispiel-Artikel-Nr. <i>Example Cat. No.</i> 06-76-052	Beispiel-Artikel-Nr. <i>Example Cat. No.</i> 06-76-052B

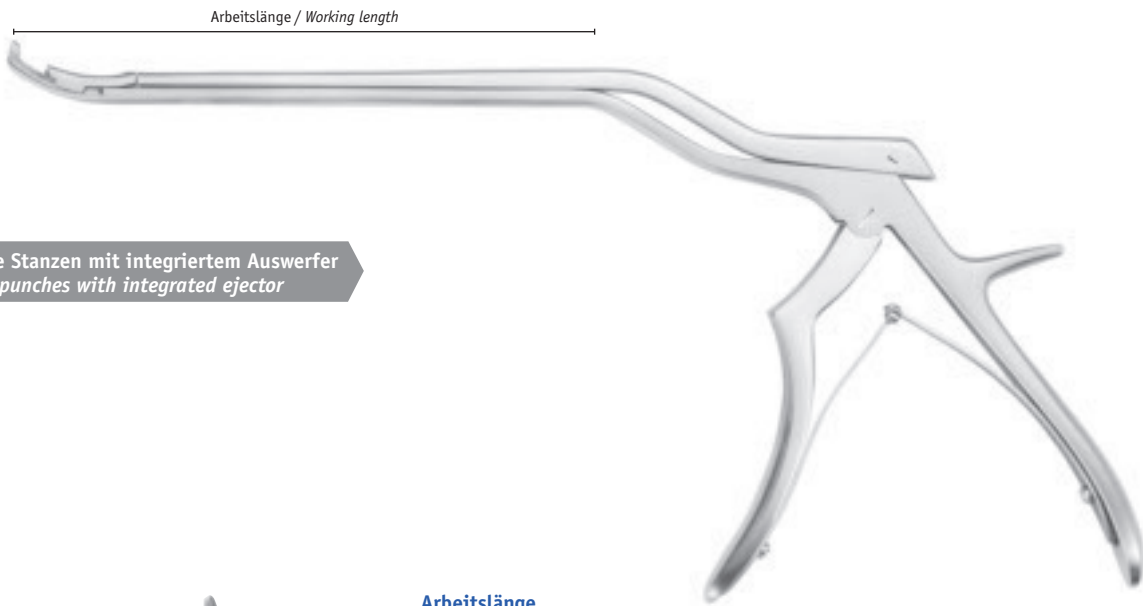

Alle Stanzen mit integriertem Auswerfer
 All punches with integrated ejector

1/2
KERRISON
06-76-308
 150 mm
 6"



Arbeitslänge
Working length

110 mm 150 mm 180 mm
 4 1/8" 6" 7"

Ø	Winkel	KERRISON	110 mm	150 mm	180 mm			
1 mm	130° (40°)	aufwärts gebogen curved up	06-76-300	06-76-306	06-76-312			
2 mm	130° (40°)		06-76-301	06-76-307	06-76-313			
3 mm	130° (40°)		06-76-302	06-76-308	06-76-314			
4 mm	130° (40°)		06-76-303	06-76-309	06-76-315			
5 mm	130° (40°)		06-76-304	06-76-310	06-76-316			
6 mm	130° (40°)		06-76-305	06-76-311	06-76-317			

Foraminotomie-Stanzen
 Foraminotomy Punches



Arbeitslänge
Working length

110 mm 150 mm 180 mm
 4 1/8" 6" 7"

Ø	Winkel	KERRISON	110 mm	150 mm	180 mm			
1 mm	130° (40°)	abwärts gebogen curved down	06-76-318	06-76-324	06-76-330			
2 mm	130° (40°)		06-76-319	06-76-325	06-76-331			
3 mm	130° (40°)		06-76-320	06-76-326	06-76-332			
4 mm	130° (40°)		06-76-321	06-76-327	06-76-333			
5 mm	130° (40°)		06-76-322	06-76-328	06-76-334			
6 mm	130° (40°)		06-76-323	06-76-329	06-76-335			

Foraminotomie-Stanzen
 Foraminotomy Punches

Standard Line

Oberfläche matt gebürstet
 Surface polished

Beispiel-Artikel-Nr. **06-76-308**
 Example Cat. No.

Black Line

Oberfläche schwarz, titanbeschichtet
 Surface black, titanium-coated

Beispiel-Artikel-Nr. **06-76-308B**
 Example Cat. No.

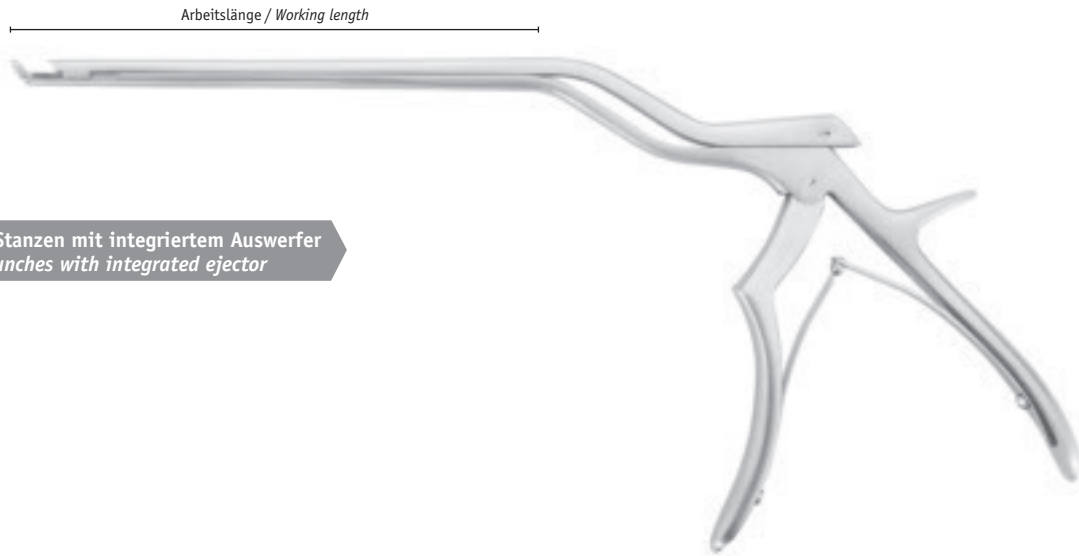

Alle Stanzen mit integriertem Auswerfer
 All punches with integrated ejector

1/2
KERRISON
06-76-199
 150 mm
 6"

Arbeitslänge
Working length

110 mm 150 mm 180 mm
 4 1/8" 6" 7"



06-76-190	06-76-196	06-76-202				KERRISON	1 mm, 130° (40°)
06-76-191	06-76-197	06-76-203					2 mm, 130° (40°)
06-76-192	06-76-198	06-76-204					3 mm, 130° (40°)
06-76-193	06-76-199	06-76-205					4 mm, 130° (40°)
06-76-194	06-76-200	06-76-206					5 mm, 130° (40°)
06-76-195	06-76-201	06-76-207					6 mm, 130° (40°)

Arbeitslänge
Working length

110 mm 150 mm 180 mm
 4 1/8" 6" 7"



06-76-170	06-76-176	06-76-182				KERRISON	1 mm, 90°
06-76-171	06-76-177	06-06-496					2 mm, 90°
06-76-172	06-76-178	06-06-497					3 mm, 90°
06-76-173	06-76-179	06-06-498					4 mm, 90°
06-76-174	06-76-180	06-06-499					5 mm, 90°
06-76-175	06-76-181	06-76-187					6 mm, 90°

Standard Line	Black Line
Oberfläche matt gebürstet <i>Surface polished</i>	Oberfläche schwarz, titanbeschichtet <i>Surface black, titanium-coated</i>
Beispiel-Artikel-Nr. <i>Example Cat. No.</i> 06-76-199	Beispiel-Artikel-Nr. <i>Example Cat. No.</i> 06-76-199B

Arbeitslänge / Working length

 Alle Stanzen mit integriertem Auswerfer
 All punches with integrated ejector

 1/2
KERRISON
06-76-258
 150 mm
 6"

Arbeitslänge
Working length

 Bajonett links
 bayonet left

 110 mm 150 mm 180 mm
 4 1/3" 6" 7"

Ø	KERRISON	06-76-250	06-76-256	06-76-262			
1 mm, 130° (40°)		06-76-251	06-76-257	06-76-263			
2 mm, 130° (40°)		06-76-252	06-76-258	06-76-264			
3 mm, 130° (40°)		06-76-253	06-76-259	06-76-265			
4 mm, 130° (40°)		06-76-254	06-76-260	06-76-266			
5 mm, 130° (40°)		06-76-255	06-76-261	06-76-267			
6 mm, 130° (40°)							

Arbeitslänge
Working length

 Bajonett rechts
 bayonet right

 110 mm 150 mm 180 mm
 4 1/3" 6" 7"

Ø	KERRISON	06-76-268	06-76-274	06-76-280			
1 mm, 130° (40°)		06-76-269	06-76-275	06-76-281			
2 mm, 130° (40°)		06-76-270	06-76-276	06-76-282			
3 mm, 130° (40°)		06-76-271	06-76-277	06-76-283			
4 mm, 130° (40°)		06-76-272	06-76-278	06-76-284			
5 mm, 130° (40°)		06-76-273	06-76-279	06-76-285			
6 mm, 130° (40°)							

Standard Line

 Oberfläche matt gebürstet
 Surface polished

 Beispiel-Artikel-Nr.
 Example Cat. No.

06-76-258
Black Line

 Oberfläche schwarz, titanbeschichtet
 Surface black, titanium-coated

 Beispiel-Artikel-Nr.
 Example Cat. No.

06-76-258B

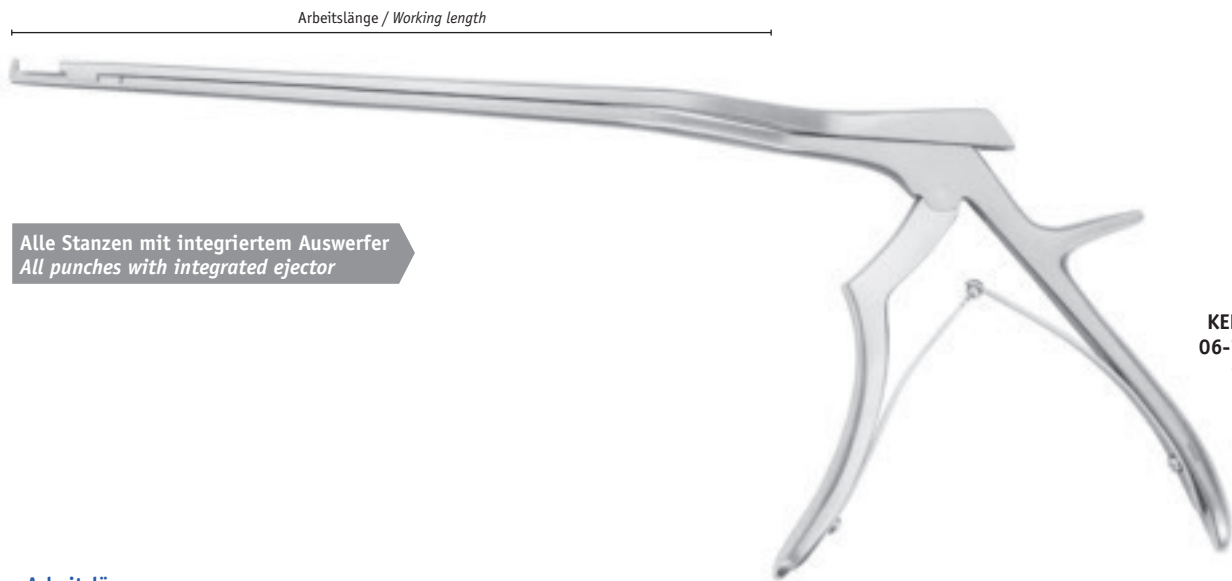

Alle Stanzen mit integriertem Auswerfer
 All punches with integrated ejector







1/2
KERRISON
06-76-217
 150 mm
 6"

Arbeitslänge
 Working length

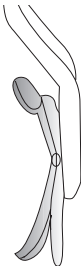
110 mm 150 mm 180 mm
 4 1/3" 6" 7"

Bajonett links
 bayonet left









06-76-210	06-76-216	06-76-222					KERRISON 1 mm, 90°  2 mm, 90°  3 mm, 90°  4 mm, 90°  5 mm, 90°  6 mm, 90° 
06-76-211	06-76-217	06-76-223					
06-76-212	06-76-218	06-76-224					
06-76-213	06-76-219	06-76-225					
06-76-214	06-76-220	06-76-226					
06-76-215	06-76-221	06-76-227					

Arbeitslänge
 Working length

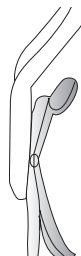
110 mm 150 mm 180 mm
 4 1/3" 6" 7"

Bajonett rechts
 bayonet right



06-76-230	06-76-236	06-76-242					KERRISON 1 mm, 90°  2 mm, 90°  3 mm, 90°  4 mm, 90°  5 mm, 90°  6 mm, 90° 
06-76-231	06-76-237	06-76-243					
06-76-232	06-76-238	06-76-244					
06-76-233	06-76-239	06-76-245					
06-76-234	06-76-240	06-76-246					
06-76-235	06-76-241	06-76-247					

Standard Line

Oberfläche matt gebürstet
 Surface polished



Beispiel-Artikel-Nr.
 Example Cat. No. **06-76-217**

Black Line



Oberfläche schwarz, titanbeschichtet
 Surface black, titanium-coated

Beispiel-Artikel-Nr.
 Example Cat. No. **06-76-217B**

 1/2
HAJEK-KOFLER
 15-11-740
 140 mm
 5½"

		Artikel-Nr. Cat. No.	Schaftlänge Length of shaft
	3,5 mm, 90°	HAJEK-KOFLER 15-11-740	140 mm / 5½"
	4 mm, 90°	15-11-742	140 mm / 5½"



		Artikel-Nr. Cat. No.	Schaftlänge Length of shaft
	3,5 mm, 90°	HAJEK-KOFLER 15-11-741	140 mm / 5½"
	4 mm, 90°	15-11-743	140 mm / 5½"

Standard Line

 Oberfläche matt gebürstet
 Surface polished

 Beispiel-Artikel-Nr.
 Example Cat. No. **15-11-740**
Black Line





 Oberfläche schwarz, titanbeschichtet
 Surface black, titanium-coated

 Beispiel-Artikel-Nr.
 Example Cat. No. **15-11-740B**



1/2
RANEY
06-56-690
150 mm
6"

Artikel-Nr. Cat. No.	Schaftlänge Length of shaft		
06-56-690	150 mm / 6"	RANEY	6 mm, 90° 
06-56-691	180 mm / 7"		

Artikel-Nr. Cat. No.	Schaftlänge Length of shaft		
15-61-711	85 mm / 3 3/4"	KERRISON	3 mm, 90° 
15-11-711	85 mm / 3 3/4"		4 mm, 90° 
15-11-712	85 mm / 3 3/4"		5 mm, 90° 
15-61-712	85 mm / 3 3/4"		6 mm, 90° 









1/2
KERRISON
15-61-711
85 mm
3 3/4"

Standard Line	Black Line
Oberfläche matt gebürstet <i>Surface polished</i>	Oberfläche schwarz, titanbeschichtet <i>Surface black, titanium-coated</i>
Beispiel-Artikel-Nr. Example Cat. No. 15-61-711	Beispiel-Artikel-Nr. Example Cat. No. 15-61-711B

 1/2
**FERRIS-SMITH-
KERRISON**
13-03-322
 180 mm
 7"

Schaftlänge
Length of shaft

180 mm 7"	200 mm 8"	280 mm 11"
--------------	--------------	---------------

		180 mm 7"	200 mm 8"	280 mm 11"			
 1 mm, 130° (40°)	FERRIS-SMITH-KERRISON	13-03-300	13-03-306	13-03-312			
 2 mm, 130° (40°)		13-03-301	13-03-307	13-03-313			
 3 mm, 130° (40°)		13-03-302	13-03-308	13-03-314			
 4 mm, 130° (40°)		13-03-303	13-03-309	13-03-315			
 5 mm, 130° (40°)		13-03-304	13-03-310	13-03-316			
 6 mm, 130° (40°)		13-03-305	13-03-311	13-03-317			

Standard Line

 Oberfläche matt gebürstet
Surface polished

 Beispiel-Artikel-Nr. **13-03-322**
 Example Cat. No.

Black Line

 Oberfläche schwarz, titanbeschichtet
Surface black, titanium-coated

 Beispiel-Artikel-Nr. **13-03-322B**
 Example Cat. No.



1/2
**FERRIS-SMITH-
KERRISON**
13-03-322
180 mm
7"

Schaftlänge
Length of shaft

180 mm 200 mm 280 mm
7" 8" 11"



13-03-318	13-03-324	13-03-330				FERRIS-SMITH-KERRISON	1 mm, 90°	
13-03-319	13-03-325	13-03-331					2 mm, 90°	
13-03-320	13-03-326	13-03-332					3 mm, 90°	
13-03-321	13-03-327	13-03-333					4 mm, 90°	
13-03-322	13-03-328	13-03-334					5 mm, 90°	
13-03-323	13-03-329	13-03-335					6 mm, 90°	

Schaftlänge
Length of shaft

180 mm 200 mm 280 mm
7" 8" 11"



13-53-300	13-53-306	13-53-312				FERRIS-SMITH-KERRISON	1 mm, 90°	
13-53-301	13-53-307	13-53-313					2 mm, 90°	
13-53-302	13-53-308	13-53-314					3 mm, 90°	
13-53-303	13-53-309	13-53-315					4 mm, 90°	
13-53-304	13-53-310	13-53-316					5 mm, 90°	
13-53-305	13-53-311	13-53-317					6 mm, 90°	

Standard Line	Black Line
Oberfläche matt gebürstet <i>Surface polished</i>	Oberfläche schwarz, titanbeschichtet <i>Surface black, titanium-coated</i>
Beispiel-Artikel-Nr. <i>Example Cat. No.</i> 13-03-322	Beispiel-Artikel-Nr. <i>Example Cat. No.</i> 13-03-322B

Besonders stabile Maulkonstruktion.

Firm construction of jaw.

Der zerlegte Rongeur bleibt als ein Teil zusammen.

The detached rongeur remains one part.

Die schwarze Titan-Nitrit-Beschichtung verhindert Reflexionen.

The black titanium-nitrite coating avoids reflections.

Der goldene Griff weist auf die Zerlegbarkeit hin.

The golden handle refers to the detachability.

Die Maulbreite wird zweifach angezeigt.

Jaw size is marked on the rongeur twice.

Einfaches Zerlegen per Knopf.

Quick and easy disassembling by pull button.

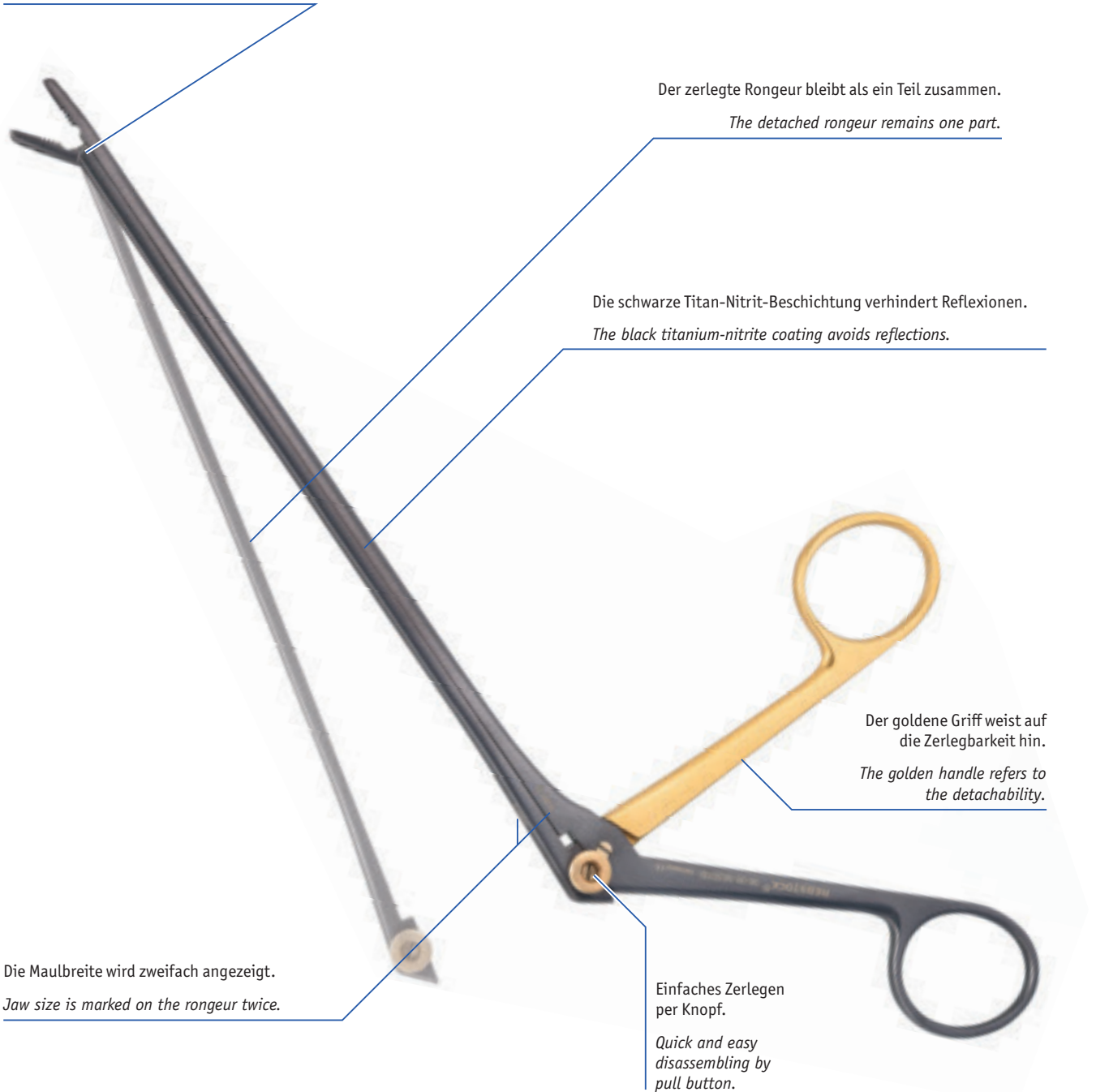

Standard Line	D E T A C H A B L E
Oberfläche matt gebürstet Surface polished Beispiel-Artikel-Nr. 06-06-543 <i>Example Cat. No.</i>	zerlegbar detachable Beispiel-Artikel-Nr. 06-06-543DT <i>Example Cat. No.</i>
Black Line	D E T A C H A B L E
Oberfläche schwarz, titanbeschichtet Surface black, titanium-coated Beispiel-Artikel-Nr. 06-06-543B <i>Example Cat. No.</i>	zerlegbar detachable Beispiel-Artikel-Nr. 06-06-543DTB <i>Example Cat. No.</i>

Demontage
Disassembly

Auslöseknopf ziehen und
Schieber nach oben klappen.
*Pull the release button and lift
the sliding part up.*



Der Rongeur ist zerlegt. Alle
Teile bleiben miteinander
verbunden.
*The rongeur is disassembled.
All parts remain connected with
each other.*

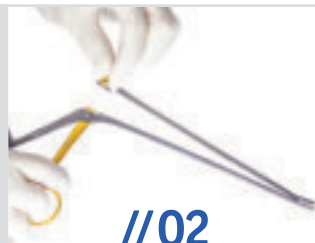

Montage
Assembly



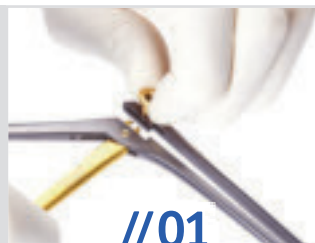

Schieber bei gezogenem Auslöseknopf in Hauptteil einsetzen.
*When the release button is
pulled, insert the sliding part in
the main part.*

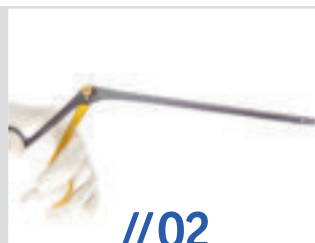

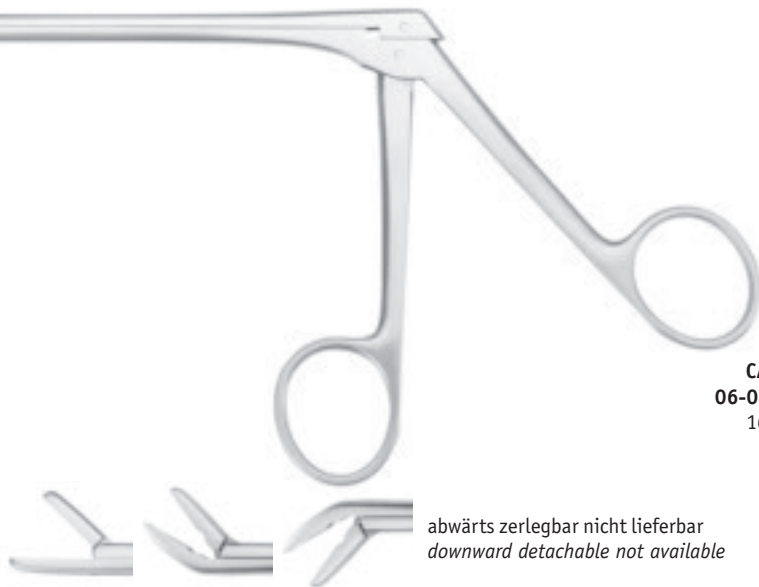
Der Rongeur ist montiert und
einsatzbereit.
*The rongeur is assembled and
ready for use.*





		Artikel-Nr. Cat. No.	Artikel-Nr. Cat. No.	Artikel-Nr. Cat. No.	Schaftlänge Length of shaft
1/1 2 x 12 mm 	CASPAR	06-06-502	06-56-512	06-56-522	140 mm / 5 1/2"
		06-06-532	06-56-542	06-56-552	160 mm / 6 3/4"
		06-06-562	06-56-572	06-56-582	185 mm / 7 3/4"
1/1 3 x 12 mm 	CASPAR	06-06-503	06-06-513	06-06-523	140 mm / 5 1/2"
		06-06-533	06-06-543	06-06-553	160 mm / 6 3/4"
		06-06-563	06-06-573	06-06-583	185 mm / 7 3/4"
1/1 4 x 14 mm 	CASPAR	06-06-504	06-06-514	06-06-524	140 mm / 5 1/2"
		06-06-534	06-06-544	06-06-554	160 mm / 6 3/4"
		06-06-564	06-06-574	06-06-584	185 mm / 7 3/4"
1/1 5 x 14 mm 	CASPAR	06-06-505	06-06-515	06-56-525	140 mm / 5 1/2"
		06-06-535	06-06-545	06-56-555	160 mm / 6 3/4"
		06-06-565	06-06-575	06-56-585	185 mm / 7 3/4"
1/1 6 x 16 mm 	CASPAR	06-06-506			140 mm / 5 1/2"
		06-06-536			160 mm / 6 3/4"
		06-06-566			185 mm / 7 3/4"

Standard Line

 Oberfläche matt gebürstet
 Surface polished

 Beispiel-Artikel-Nr.
 Example Cat. No. **06-06-543**
D E T A C H A B L E

 zerlegbar
 detachable

 Beispiel-Artikel-Nr.
 Example Cat. No. **06-06-543DT**
Black Line

 Oberfläche schwarz, titanbeschichtet
 Surface black, titanium-coated

 Beispiel-Artikel-Nr.
 Example Cat. No. **06-06-543B**
D E T A C H A B L E

 zerlegbar
 detachable

 Beispiel-Artikel-Nr.
 Example Cat. No. **06-06-543DTB**



zerlegbare Rongeurs siehe
Fußnote und Seite 366
Rongeurs detachable please refer
to footnote and page 366



1/2
CASPAR
06-56-837
180 mm
7"

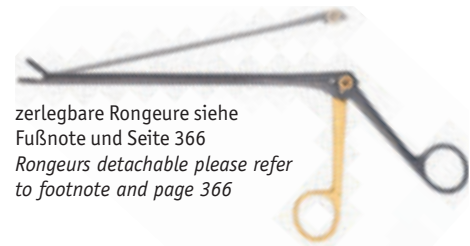

Artikel-Nr. Cat. No.	Artikel-Nr. Cat. No.	Artikel-Nr. Cat. No.	Schaftlänge Length of shaft		
06-56-830	06-56-840	06-56-850	120 mm / 4¾"	CASPAR	1/1 2 mm
06-06-832	06-06-842	06-06-852	155 mm / 6"		
06-56-832	06-56-842	06-56-852	180 mm / 7"		
06-56-833	06-56-843	06-56-853	120 mm / 4¾"	CASPAR	1/1 3 mm
06-06-833	06-06-843	06-06-853	155 mm / 6"		
06-56-837	06-56-847	06-56-857	180 mm / 7"		
06-56-834	06-56-844	06-56-854	120 mm / 4¾"	CASPAR	1/1 4 mm
06-06-834	06-06-844	06-06-854	155 mm / 6"		
06-56-836	06-56-846	06-56-856	180 mm / 7"		
06-56-838	06-56-848	06-56-858	120 mm / 4¾"	CASPAR	1/1 5 mm
06-06-835	06-56-849	06-56-859	155 mm / 6"		
06-56-841	06-56-851	06-56-861	180 mm / 7"		

Standard Line	D E T A C H A B L E
Oberfläche matt gebürstet <i>Surface polished</i> Beispiel-Artikel-Nr. Example Cat. No. 06-56-837	zerlegbar <i>detachable</i> Beispiel-Artikel-Nr. Example Cat. No. 06-56-837DT
Black Line	D E T A C H A B L E
Oberfläche schwarz, titanbeschichtet <i>Surface black, titanium-coated</i> Beispiel-Artikel-Nr. Example Cat. No. 06-56-837B	zerlegbar <i>detachable</i> Beispiel-Artikel-Nr. Example Cat. No. 06-56-837DTB

 1/2
LOVE-GRUENWALD
06-06-806DT
 180 mm
 7"

 zerlegbare Rongeurs siehe
 Fußnote und Seite 366
*Rongeurs detachable please refer
 to footnote and page 366*

			Artikel-Nr. Cat. No.	Artikel-Nr. Cat. No.	Artikel-Nr. Cat. No.	Schaftlänge Length of shaft
1/1 1,5 x 10 mm 	CUSHING	06-76-800	06-76-805	06-76-810	130 mm / 5 1/8"	
		06-76-801	06-76-806	06-76-811	150 mm / 6"	
		06-76-802	06-76-807	06-76-812	180 mm / 7"	
		06-76-803	06-76-808	06-76-813	230 mm / 9"	
		06-76-804	06-76-809	06-76-814	280 mm / 11"	
1/1 2 x 10 mm 	CUSHING	06-06-799	06-56-769	06-56-760	130 mm / 5 1/8"	
		06-56-802	06-56-770	06-56-761	150 mm / 6"	
		06-06-803	06-56-771	06-56-762	180 mm / 7"	
		06-56-803	06-56-772	06-56-763	230 mm / 9"	
		06-56-804	06-56-773	06-56-764	280 mm / 11"	
1/1 3 x 10 mm 	LOVE-GRUENWALD	06-06-800	06-06-774	06-06-777	130 mm / 5 1/8"	
		06-56-800	06-56-774	06-56-777	150 mm / 6"	
		06-06-805	06-06-806	06-06-810	180 mm / 7"	
		06-56-805	06-56-811	06-56-810	230 mm / 9"	
		06-56-806	06-56-812	06-56-816	280 mm / 11"	

Standard Line	D E T A C H A B L E
Oberfläche matt gebürstet <i>Surface polished</i> Beispiel-Artikel-Nr. <i>Example Cat. No.</i> 06-06-806	zerlegbar <i>detachable</i> Beispiel-Artikel-Nr. <i>Example Cat. No.</i> 06-06-806DT
Black Line	D E T A C H A B L E
Oberfläche schwarz, titanbeschichtet <i>Surface black, titanium-coated</i> Beispiel-Artikel-Nr. <i>Example Cat. No.</i> 06-06-806B	zerlegbar <i>detachable</i> Beispiel-Artikel-Nr. <i>Example Cat. No.</i> 06-06-806DTB



1/2
CUSHING
06-56-771DT
180 mm
7"



zerlegbare Rongeurs siehe
Fußnote und Seite 366
*Rongeurs detachable please refer
to footnote and page 366*



Artikel-Nr. Cat. No.	Artikel-Nr. Cat. No.	Artikel-Nr. Cat. No.	Schaftlänge Length of shaft		
06-06-801	06-06-775	06-06-778	130 mm / 5 1/8"	SPURLING	1/1 4 x 10 mm
06-56-801	06-56-775	06-56-807	150 mm / 6"		
06-06-807	06-06-814	06-06-811	180 mm / 7"		
06-56-808	06-56-814	06-56-817	230 mm / 9"		
06-56-809	06-56-815	06-56-818	280 mm / 11"		
06-06-767	06-06-776	06-76-823	130 mm / 5 1/8"	CUSHING	1/1 5 x 10 mm
06-76-815	06-76-819	06-76-824	150 mm / 6"		
06-76-816	06-76-820	06-76-825	180 mm / 7"		
06-76-817	06-76-821	06-76-826	230 mm / 9"		
06-76-818	06-76-822	06-76-827	280 mm / 11"		
06-06-768	06-76-832	06-76-837	130 mm / 5 1/8"	CUSHING	1/1 6 x 10 mm
06-76-828	06-76-833	06-76-838	150 mm / 6"		
06-76-829	06-76-834	06-76-839	180 mm / 7"		
06-76-830	06-76-835	06-76-840	230 mm / 9"		
06-76-831	06-76-836	06-76-841	280 mm / 11"		

Standard Line	D E T A C H A B L E
Oberfläche matt gebürstet <i>Surface polished</i> Beispiel-Artikel-Nr. <i>Example Cat. No.</i> 06-56-771	zerlegbar <i>detachable</i> Beispiel-Artikel-Nr. <i>Example Cat. No.</i> 06-56-771DT
Black Line	D E T A C H A B L E
Oberfläche schwarz, titanbeschichtet <i>Surface black, titanium-coated</i> Beispiel-Artikel-Nr. <i>Example Cat. No.</i> 06-56-771B	zerlegbar <i>detachable</i> Beispiel-Artikel-Nr. <i>Example Cat. No.</i> 06-56-771DTB

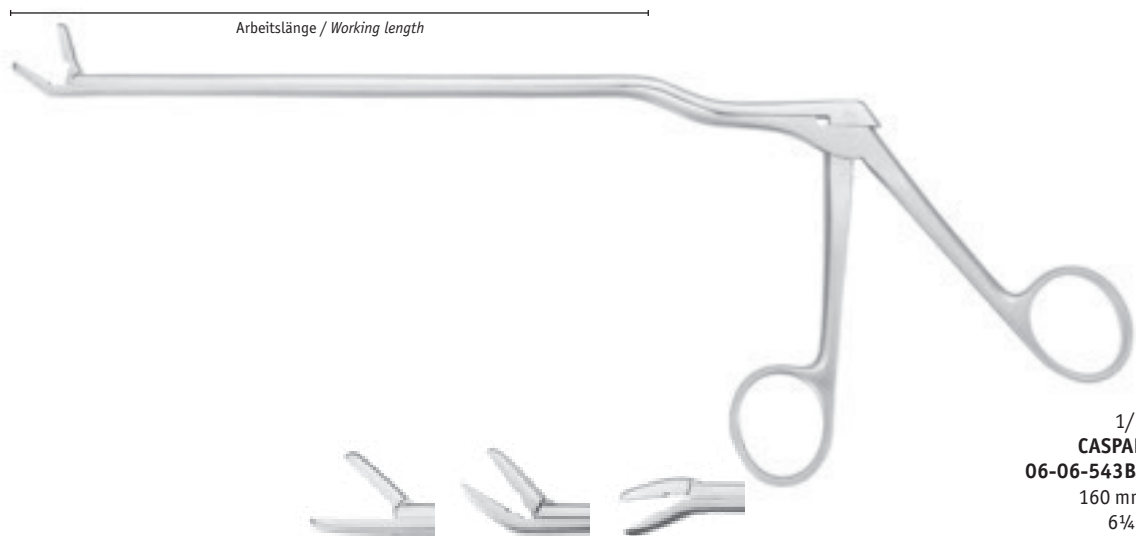
 Maulteil gefenestert und gezahnt
 Mouth fenestrated and serrated

 1/2
CASPAR
06-06-543BJ
 160 mm
 6 1/4"

		Artikel-Nr. Cat. No.	Artikel-Nr. Cat. No.	Artikel-Nr. Cat. No.	Arbeitslänge Working length
1/1 2 x 12 mm 	CASPAR	06-06-502BJ	06-56-512BJ	06-56-522BJ	140 mm / 5 1/2"
		06-06-532BJ	06-56-542BJ	06-56-552BJ	160 mm / 6 1/4"
		06-06-562BJ	06-56-572BJ	06-56-582BJ	185 mm / 7 1/4"
1/1 3 x 12 mm 	CASPAR	06-06-503BJ	06-06-513BJ	06-06-523BJ	140 mm / 5 1/2"
		06-06-533BJ	06-06-543BJ	06-06-553BJ	160 mm / 6 1/4"
		06-06-563BJ	06-06-573B	06-06-583BJ	185 mm / 7 1/4"
1/1 4 x 14 mm 	CASPAR	06-06-504BJ	06-06-514BJ	06-06-524BJ	140 mm / 5 1/2"
		06-06-534BJ	06-06-544BJ	06-06-554BJ	160 mm / 6 1/4"
		06-06-564BJ	06-06-574BJ	06-06-584BJ	185 mm / 7 1/4"
1/1 5 x 14 mm 	CASPAR	06-06-505BJ	06-06-515BJ	06-56-525BJ	140 mm / 5 1/2"
		06-06-535BJ	06-06-545BJ	06-56-555BJ	160 mm / 6 1/4"
		06-06-565BJ	06-06-575BJ	06-56-585BJ	185 mm / 7 1/4"
1/1 6 x 16 mm 	CASPAR	06-06-506BJ			140 mm / 5 1/2"
		06-06-536BJ			160 mm / 6 1/4"
		06-06-566BJ			185 mm / 7 1/4"

Standard Line





 Oberfläche matt gebürstet
 Surface polished

 Beispiel-Artikel-Nr.
 Example Cat. No. **06-06-543BJ**
Black Line

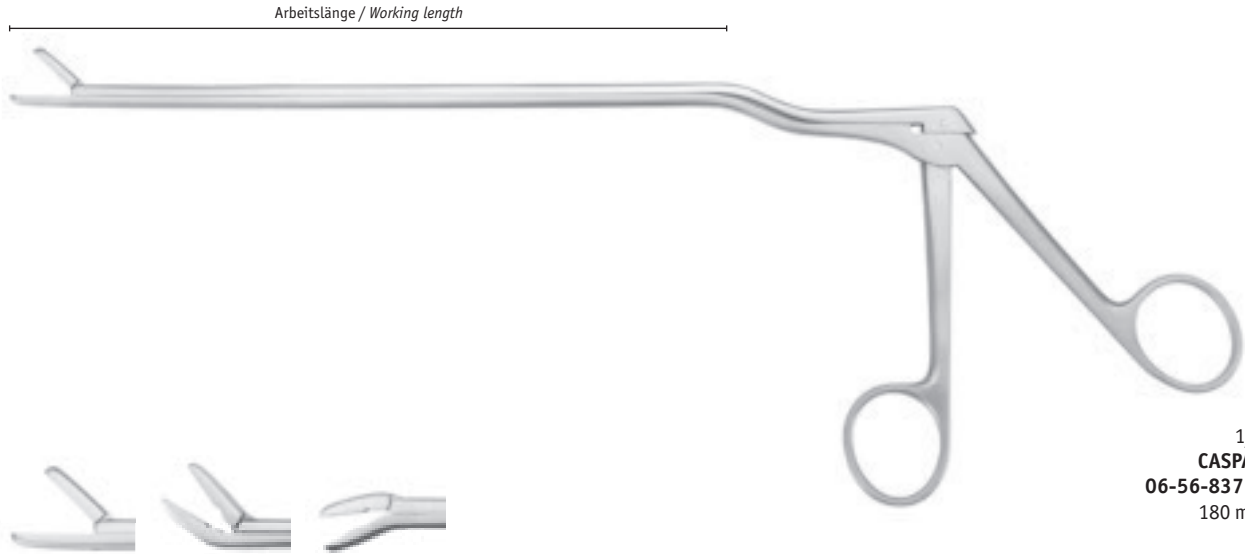
 Oberfläche schwarz, titanbeschichtet
 Surface black, titanium-coated

 Beispiel-Artikel-Nr.
 Example Cat. No. **06-06-543BJB**



Artikel-Nr. Cat. No.	Artikel-Nr. Cat. No.	Artikel-Nr. Cat. No.	Arbeitslänge Working length		
06-56-830BJ	06-56-840BJ	06-56-850BJ	120 mm / 4 ³ / ₄ "	CASPAR	1/1 2 mm
06-06-832BJ	06-06-842BJ	06-06-852BJ	155 mm / 6"		
06-56-832BJ	06-56-842BJ	06-56-852BJ	180 mm / 7"		
06-56-833BJ	06-56-843BJ	06-56-853BJ	120 mm / 4 ³ / ₄ "	CASPAR	1/1 3 mm
06-06-833BJ	06-06-843BJ	06-06-853BJ	155 mm / 6"		
06-56-837BJ	06-56-847BJ	06-56-857BJ	180 mm / 7"		
06-56-834BJ	06-56-844BJ	06-56-854BJ	120 mm / 4 ³ / ₄ "	CASPAR	1/1 4 mm
06-06-834BJ	06-06-844BJ	06-06-854BJ	155 mm / 6"		
06-56-836BJ	06-56-846BJ	06-56-856BJ	180 mm / 7"		
06-56-838BJ	06-56-848BJ	06-56-858BJ	120 mm / 4 ³ / ₄ "	CASPAR	1/1 5 mm
06-06-835BJ	06-56-849BJ	06-56-859BJ	155 mm / 6"		
06-56-841BJ	06-56-851BJ	06-56-861BJ	180 mm / 7"		

Standard Line	Black Line
<p>Oberfläche matt gebürstet Surface polished</p> <p>Beispiel-Artikel-Nr. Example Cat. No. 06-56-837BJ</p>	<p>Oberfläche schwarz, titanbeschichtet Surface black, titanium-coated</p> <p>Beispiel-Artikel-Nr. Example Cat. No. 06-56-837BJB</p>

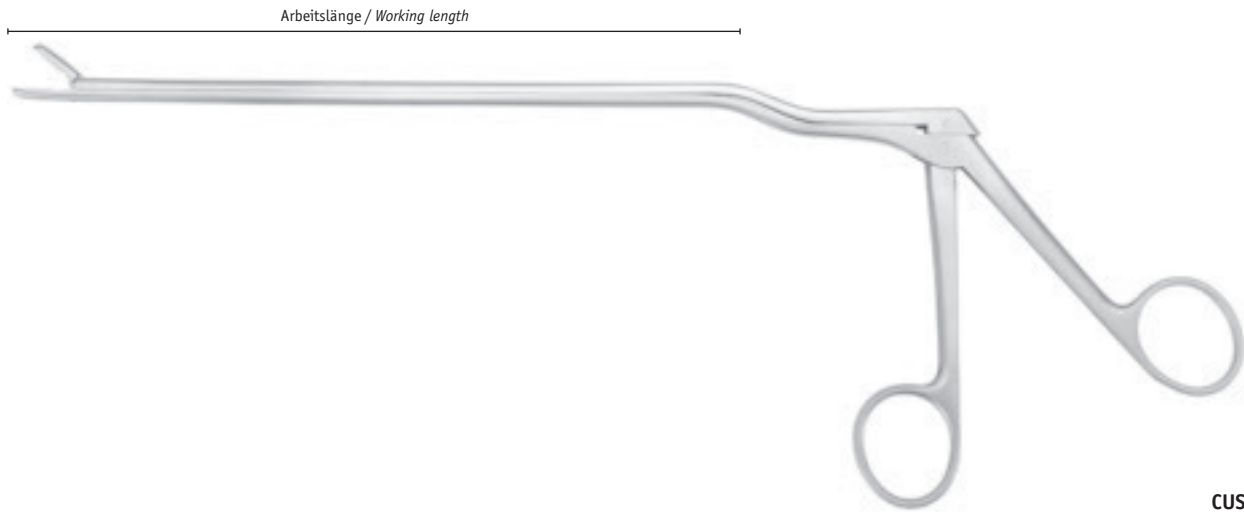
 1/2
CUSHING
06-06-807BJ
 180 mm
 7"

		Artikel-Nr. Cat. No.	Artikel-Nr. Cat. No.	Artikel-Nr. Cat. No.	Arbeitslänge Working length
1/1 1,5 x 10 mm	CUSHING	06-76-800BJ	06-76-805BJ	06-76-810BJ	130 mm / 5 1/8"
		06-76-801BJ	06-76-806BJ	06-76-811BJ	150 mm / 6"
		06-76-802BJ	06-76-807BJ	06-76-812BJ	180 mm / 7"
		06-76-803BJ	06-76-808BJ	06-76-813BJ	230 mm / 9"
		06-76-804BJ	06-76-809BJ	06-76-814BJ	280 mm / 11"
1/1 2 x 10 mm	CUSHING	06-06-799BJ	06-56-769BJ	06-56-760BJ	130 mm / 5 1/8"
		06-56-802BJ	06-56-770BJ	06-56-761BJ	150 mm / 6"
		06-06-803BJ	06-56-771BJ	06-56-762BJ	180 mm / 7"
		06-56-803BJ	06-56-772BJ	06-56-763BJ	230 mm / 9"
		06-56-804BJ	06-56-773BJ	06-56-764BJ	280 mm / 11"
1/1 3 x 10 mm	LOVE-GRUEN-WALD	06-06-800BJ	06-06-774BJ	06-06-777BJ	130 mm / 5 1/8"
		06-56-800BJ	06-56-774BJ	06-56-777BJ	150 mm / 6"
		06-06-805BJ	06-06-806BJ	06-06-810BJ	180 mm / 7"
		06-56-805BJ	06-56-811BJ	06-56-810BJ	230 mm / 9"
		06-56-806BJ	06-56-812BJ	06-56-816BJ	280 mm / 11"

Standard Line

 Oberfläche matt gebürstet
 Surface polished

 Beispiel-Artikel-Nr. **06-06-807BJ**
 Example Cat. No.

Black Line

 Oberfläche schwarz, titanbeschichtet
 Surface black, titanium-coated

 Beispiel-Artikel-Nr. **06-06-807BJB**
 Example Cat. No.

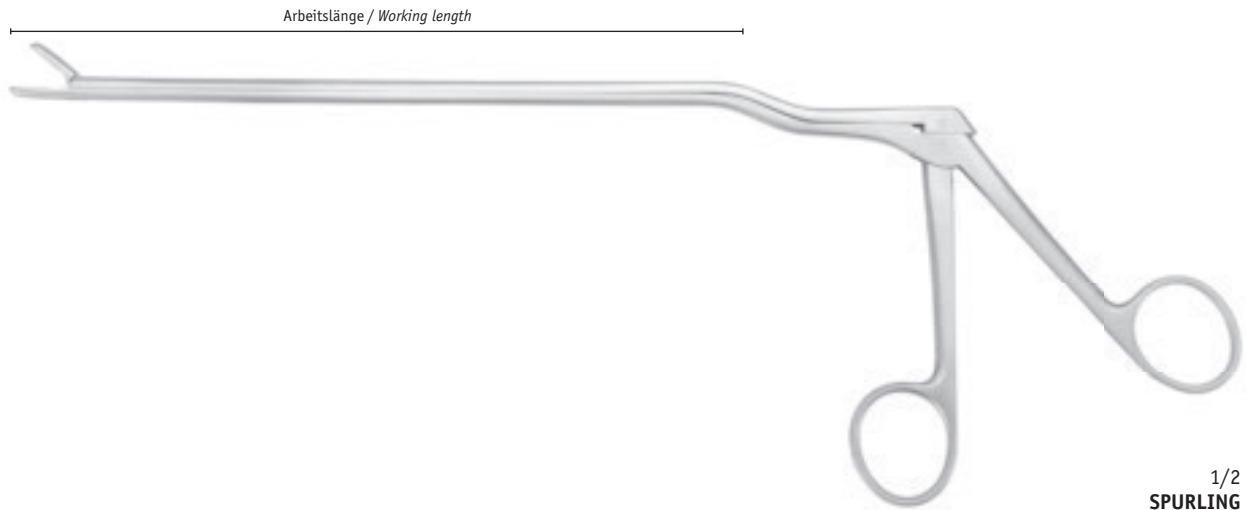

1/2
SPURLING
06-06-807BJ
180 mm
7"



Artikel-Nr. Cat. No.	Artikel-Nr. Cat. No.	Artikel-Nr. Cat. No.	Arbeitslänge Working length		
06-06-801BJ	06-06-775BJ	06-06-778BJ	130 mm / 5 1/8"	SPURLING	1/1 4 x 10 mm
06-56-801BJ	06-56-775BJ	06-56-807BJ	150 mm / 6"		
06-06-807BJ	06-06-814BJ	06-06-811BJ	180 mm / 7"		
06-56-808BJ	06-56-814BJ	06-56-817BJ	230 mm / 9"		
06-56-809BJ	06-56-815BJ	06-56-818BJ	280 mm / 11"		
06-06-767BJ	06-06-776BJ	06-76-823BJ	130 mm / 5 1/8"	CUSHING	1/1 5 x 10 mm
06-76-815BJ	06-76-819BJ	06-76-824BJ	150 mm / 6"		
06-76-816BJ	06-76-820BJ	06-76-825BJ	180 mm / 7"		
06-76-817BJ	06-76-821BJ	06-76-826BJ	230 mm / 9"		
06-76-818BJ	06-76-822BJ	06-76-827BJ	280 mm / 11"		
06-06-768BJ	06-76-832BJ	06-76-837BJ	130 mm / 5 1/8"	CUSHING	1/1 6 x 10 mm
06-76-828BJ	06-76-833BJ	06-76-838BJ	150 mm / 6"		
06-76-829BJ	06-76-834BJ	06-76-839BJ	180 mm / 7"		
06-76-830BJ	06-76-835BJ	06-76-840BJ	230 mm / 9"		
06-76-831BJ	06-76-836BJ	06-76-841BJ	280 mm / 11"		

Standard Line	Black Line
Oberfläche matt gebürstet <i>Surface polished</i> Beispiel-Artikel-Nr. Example Cat. No. 06-06-807BJ	Oberfläche schwarz, titanbeschichtet <i>Surface black, titanium-coated</i> Beispiel-Artikel-Nr. Example Cat. No. 06-06-807BJB

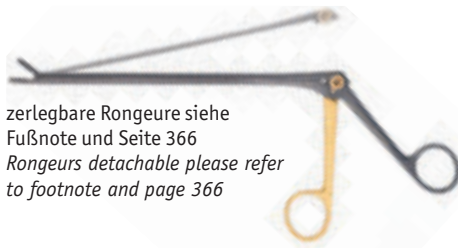





zerlegbare Rongeurs siehe
Fußnote und Seite 366
Rongeurs detachable please refer
to footnote and page 366



1/2
TAKAHASHI
15-11-525
120 mm
4¾"



			Artikel-Nr. Cat. No.	Artikel-Nr. Cat. No.	Artikel-Nr. Cat. No.	Schaftlänge Length of shaft
1/1 2 mm 	BECK	06-06-765				130 mm / 5½"
1/1 3 mm 	ST. BARTS	15-11-536	15-11-537	15-11-538		115 mm / 4½"
1/1 3 mm 	TAKAHASHI	15-11-525	15-11-526			120 mm / 4¾"
1/1 3 mm 	PENNY- BACKER	06-06-779				120 mm / 4¾"



Standard Line	D E T A C H A B L E
Oberfläche matt gebürstet <i>Surface polished</i> Beispiel-Artikel-Nr. Example Cat. No. 15-11-525	zerlegbar <i>detachable</i> Beispiel-Artikel-Nr. Example Cat. No. 15-11-525DT
Black Line	D E T A C H A B L E
Oberfläche schwarz, titanbeschichtet <i>Surface black, titanium-coated</i> Beispiel-Artikel-Nr. Example Cat. No. 15-11-525B	zerlegbar <i>detachable</i> Beispiel-Artikel-Nr. Example Cat. No. 15-11-525DTB



1/2
WAGNER
06-06-808
210 mm
8¼"

zerlegbare Rongeurs siehe
Fußnote und Seite 366
*Rongeurs detachable please refer
to footnote and page 366*

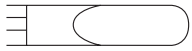
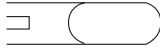

Artikel-Nr. Cat. No.	Artikel-Nr. Cat. No.	Schaftlänge Length of shaft		
14-04-087	14-54-087	255 mm / 10"		1/1 5,3 mm 
06-06-808	06-56-828	210 mm / 8¼"	WAGNER	1/1 5,5 mm 
06-57-057	06-07-057	255 mm / 10"		1/1 5,8 mm 

Standard Line	D E T A C H A B L E
Oberfläche matt gebürstet <i>Surface polished</i> Beispiel-Artikel-Nr. <i>Example Cat. No.</i> 06-06-808	zerlegbar <i>detachable</i> Beispiel-Artikel-Nr. <i>Example Cat. No.</i> 06-06-808DT
Black Line	D E T A C H A B L E
Oberfläche schwarz, titanbeschichtet <i>Surface black, titanium-coated</i> Beispiel-Artikel-Nr. <i>Example Cat. No.</i> 06-06-808B	zerlegbar <i>detachable</i> Beispiel-Artikel-Nr. <i>Example Cat. No.</i> 06-06-808DTB

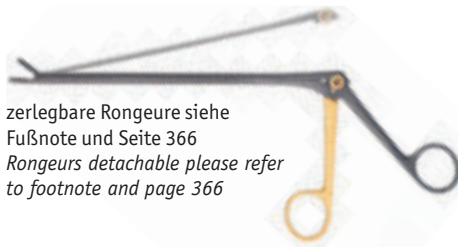

zerlegbare Rongeurs siehe
Fußnote und Seite 366
Rongeurs detachable please refer
to footnote and page 366



1/2
WEIL-BLAKESLEY
15-11-505
120 mm
4¾"



			Artikel-Nr. Cat. No.	Artikel-Nr. Cat. No.	Schaftlänge Length of shaft
	1/1 2 mm	WEIL-BLAKESLEY	15-61-501	15-61-517	120 mm / 4¾"
	1/1 2,5 mm	WEIL-BLAKESLEY	15-61-502	15-61-518	120 mm / 4¾"
	1/1 3 mm	WEIL-BLAKESLEY	15-11-505	15-61-519	120 mm / 4¾"
	1/1 3,5 mm	WEIL-BLAKESLEY	15-11-506	15-11-520	120 mm / 4¾"
	1/1 4,2 mm	WEIL-BLAKESLEY	15-11-507	15-11-521	120 mm / 4¾"
	1/1 4,8 mm	WEIL-BLAKESLEY	15-11-508	15-11-522	120 mm / 4¾"
	1/1 6 mm	WEIL-BLAKESLEY	15-11-509	15-61-523	120 mm / 4¾"

Standard Line	D E T A C H A B L E
Oberfläche matt gebürstet <i>Surface polished</i> Beispiel-Artikel-Nr. Example Cat. No. 15-11-505	zerlegbar <i>detachable</i> Beispiel-Artikel-Nr. Example Cat. No. 15-11-505DT
Black Line	D E T A C H A B L E
Oberfläche schwarz, titanbeschichtet <i>Surface black, titanium-coated</i> Beispiel-Artikel-Nr. Example Cat. No. 15-11-505B	zerlegbar <i>detachable</i> Beispiel-Artikel-Nr. Example Cat. No. 15-11-505DTB

zerlegbare Rongeurs siehe
Fußnote und Seite 366
Rongeurs detachable please refer
to footnote and page 366



1/2
SCHLESINGER
15-61-601
130 mm
5 1/8"

Artikel-Nr.
Cat. No.

Schaftlänge
Length of shaft

15-61-601			130 mm / 5 1/8"	SCHLESINGER	1/1 2 x 10 mm	
15-61-598			150 mm / 6"			
15-61-602			130 mm / 5 1/8"	SCHLESINGER	1/1 3 x 10 mm	
15-61-599			150 mm / 6"			
15-61-603			130 mm / 5 1/8"	SCHLESINGER	1/1 4 x 10 mm	
15-61-600			150 mm / 6"			

zerlegbare Rongeurs siehe
Fußnote und Seite 366
Rongeurs detachable please refer
to footnote and page 366



1/2
CLOWARD
15-61-606
150 mm
6"

Artikel-Nr.
Cat. No.

Artikel-Nr.
Cat. No.





Artikel-Nr.
Cat. No.

Schaftlänge
Length of shaft

15-61-605	15-61-608	15-61-611	120 mm / 4 3/4"	CLOWARD	1/1 6 x 10 mm	
15-61-606	15-61-609	15-61-612	150 mm / 6"			
15-61-607	15-61-610	15-61-613	180 mm / 7"			

Standard Line	D E T A C H A B L E					
Oberfläche matt gebürstet <i>Surface polished</i> Beispiel-Artikel-Nr. Example Cat. No. 15-61-601	zerlegbar <i>detachable</i> Beispiel-Artikel-Nr. Example Cat. No. 15-61-601DT					
Black Line	D E T A C H A B L E					
Oberfläche schwarz, titanbeschichtet <i>Surface black, titanium-coated</i> Beispiel-Artikel-Nr. Example Cat. No. 15-61-601B	zerlegbar <i>detachable</i> Beispiel-Artikel-Nr. Example Cat. No. 15-61-601DTB					

 1/2
WILDE
15-61-615
 130 mm
 5 1/8"

		Artikel-Nr. Cat. No.	Artikel-Nr. Cat. No.	Schaftlänge Length of shaft
1/1 3 x 8 mm 	WILDE	15-61-615	15-61-621	130 mm / 5 1/8"
		15-61-616	15-61-622	170 mm / 6 3/4"
1/1 4 x 10 mm 	WILDE	15-61-617	15-61-623	130 mm / 5 1/8"
		15-61-618	15-61-624	170 mm / 6 3/4"
1/1 5 x 12 mm 	WILDE	15-61-619	15-61-625	130 mm / 5 1/8"
		15-61-620	15-61-626	170 mm / 6 3/4"
1/1 6,5 x 12 mm 	HENCKEL-TILLEY	15-11-503		110 mm / 4 3/8"

Standard Line

 Oberfläche matt gebürstet
Surface polished

 Beispiel-Artikel-Nr. **15-61-615**
 Example Cat. No.

Black Line





 Oberfläche schwarz, titanbeschichtet
Surface black, titanium-coated

 Beispiel-Artikel-Nr. **15-61-615B**
 Example Cat. No.



1/2
OLDBERG
06-06-605
180 mm
7"

zerlegbare Rongeure siehe
Fußnote und Seite 366
*Rongeurs detachable please refer
to footnote and page 366*

Artikel-Nr. Cat. No.	Schaftlänge Length of shaft			
06-06-605	180 mm / 7"	OLDBERG	1/1 Ø 7 mm	
06-06-599	190 mm / 7½"	LANDOLT	1/1 Ø 2,2 mm	
06-06-600	190 mm / 7½"	YASARGIL	1/1 Ø 3,5 mm	
06-06-345	200 mm / 8"	LANDOLT	1/1 Ø 9 mm	

Standard Line	D E T A C H A B L E
Oberfläche matt gebürstet <i>Surface polished</i> Beispiel-Artikel-Nr. <i>Example Cat. No.</i> 06-06-605	zerlegbar <i>detachable</i> Beispiel-Artikel-Nr. <i>Example Cat. No.</i> 06-06-605DT
Black Line	D E T A C H A B L E
Oberfläche schwarz, titanbeschichtet <i>Surface black, titanium-coated</i> Beispiel-Artikel-Nr. <i>Example Cat. No.</i> 06-06-605B	zerlegbar <i>detachable</i> Beispiel-Artikel-Nr. <i>Example Cat. No.</i> 06-06-605DTB

 1/2
CASPAR
06-06-856
 180 mm
 7"

 Artikel-Nr.
 Cat. No.

 Schaftlänge
 Length of shaft

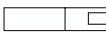
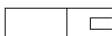
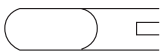
1/1 3 mm 	CASPAR	06-06-856	180 mm / 7"
1/1 4 mm 	CASPAR	06-06-857 06-06-858	180 mm / 7" 220 mm / 8¾"
1/1 5,5 mm 	WAGNER	06-06-818	200 mm / 8"

Standard Line

 Oberfläche matt gebürstet
 Surface polished

 Beispiel-Artikel-Nr. **06-06-856**
 Example Cat. No.

Black Line



 Oberfläche schwarz, titanbeschichtet
 Surface black, titanium-coated

 Beispiel-Artikel-Nr. **06-06-856B**
 Example Cat. No.



1/2
**FERRIS-
SMITH**
06-56-880
180 mm
7"



Artikel-Nr. Cat. No.	Artikel-Nr. Cat. No.	Artikel-Nr. Cat. No.	Schaftlänge Length of shaft		
06-56-880	06-56-885	06-56-890	180 mm / 7"	FERRIS- SMITH	1/1 2 x 10 mm 
06-56-881	06-56-886	06-56-891	180 mm / 7"	FERRIS- SMITH	1/1 3 x 10 mm 
06-56-882	06-56-887	06-56-892	180 mm / 7"	FERRIS- SMITH	1/1 4 x 10 mm 
06-56-883	06-56-888	06-56-893	180 mm / 7"	FERRIS- SMITH	1/1 5 x 10 mm 
06-56-884	06-56-889	06-56-894	180 mm / 7"	FERRIS- SMITH	1/1 6 x 10 mm 

Standard Line	Black Line
<p>Oberfläche matt gebürstet <i>Surface polished</i></p> <p>Beispiel-Artikel-Nr. Example Cat. No. 06-56-880</p>	<p>Oberfläche schwarz, titanbeschichtet <i>Surface black, titanium-coated</i></p> <p>Beispiel-Artikel-Nr. Example Cat. No. 06-56-880B</p>



Mikro-Neurochirurgische Instrumente
Micro-Neurosurgical Instruments



HF-Instrumente und Zubehör
HF Instruments and Accessoires



Kopf-Schädelinstrumente und Haltesysteme
Head-Cranio Instruments and Holding Systems



Aneurysmen-Clip System
Aneurysm Clip System



Schädel-Verplattung
Cranial Plate System



Hypophysektomie-Instrumente
Pituitary Instruments



Instrumente für die Wirbelsäule, Wundspreizer
Spine Instruments, Self-retaining Retractors



Laminektomie-Stanzen, Rongeure, Hohlmeißelzangen
Laminectomy Punches, Rongeurs

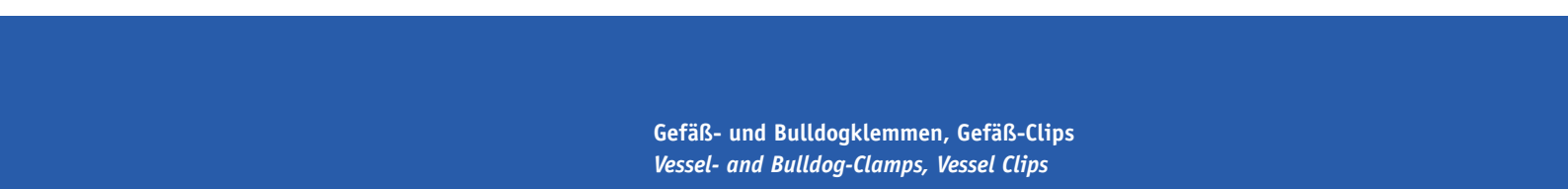

Gefäß- und Bulldogklemmen, Gefäß-Clips
Vessel- and Bulldog-Clamps, Vessel Clips



Allgemeinchirurgische Instrumente
General Surgical Instruments



Alphabetischer Index, Numerischer Index
Alphabetical Index, Numerical Index

/// Gefäß- und Bulldogklemmen, Gefäß-Clips
Vessel- and Bulldog-Clamps, Vessel Clips



REBSTOCK®
Precision made in Germany







SURGICAL
INSTRUMENTS
MICRO-NEURO-SPINE

/// 09

	Einzelklemme <i>Single Clamp</i>	Einzelklemme <i>Single Clamp</i>	Doppelklemme <i>Double Clamp</i>	Approximator <i>Approximator</i>	Approximator <i>Approximator</i>	ACLAND
						
8 mm 0,4 - 1 mm ø Gefäß / vessel	90-80-244 90-80-196	90-80-396 90-80-397	90-80-402 90-80-403	90-80-408 90-80-409	90-80-414 90-80-415	Vene / vein Arterie / artery

	Einzelklemme <i>Single Clamp</i>	Einzelklemme <i>Single Clamp</i>	Doppelklemme <i>Double Clamp</i>	Approximator <i>Approximator</i>	Approximator <i>Approximator</i>	ACLAND
						
11 mm 0,6 - 1,5 mm ø Gefäß / vessel	90-80-245 90-80-197	90-80-398 90-80-399	90-80-404 90-80-405	90-80-410 90-80-411	90-80-416 90-80-417	Vene / vein Arterie / artery

	Einzelklemme <i>Single Clamp</i>	Einzelklemme <i>Single Clamp</i>	Doppelklemme <i>Double Clamp</i>	Approximator <i>Approximator</i>	Approximator <i>Approximator</i>	ACLAND
						
14 mm 1 - 2 mm ø Gefäß / vessel	90-80-500 90-80-501	90-80-502 90-80-503	90-80-504 90-80-505	90-80-506 90-80-507	90-80-508 90-80-509	Vene / vein Arterie / artery

	Einzelklemme <i>Single Clamp</i>	Einzelklemme <i>Single Clamp</i>	Doppelklemme <i>Double Clamp</i>	Approximator <i>Approximator</i>	Approximator <i>Approximator</i>	ACLAND
						
17 mm 1 - 2,25 mm ø Gefäß / vessel	90-80-246 90-80-198	90-80-400 90-80-401	90-80-406 90-80-407	90-80-412 90-80-413	90-80-418 90-80-419	Vene / vein Arterie / artery

Standard Line

 Oberfläche matt gebürstet
Surface polished

 Beispiel-Artikel-Nr. **90-80-412**
 Example Cat. No.

Black Line

 Oberfläche schwarz, titanbeschichtet
Surface black, titanium-coated

 Beispiel-Artikel-Nr. **90-80-412B**
 Example Cat. No.

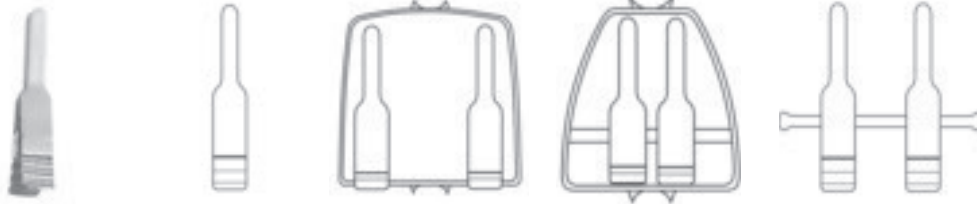

ACLAND

25 mm 1,5 - 3,5 mm Ø Gefäß / vessel	90-80-325	90-80-329	90-80-323	90-80-326	Vene / vein Arterie / artery
	90-80-327	90-80-330	90-80-324	90-80-328	

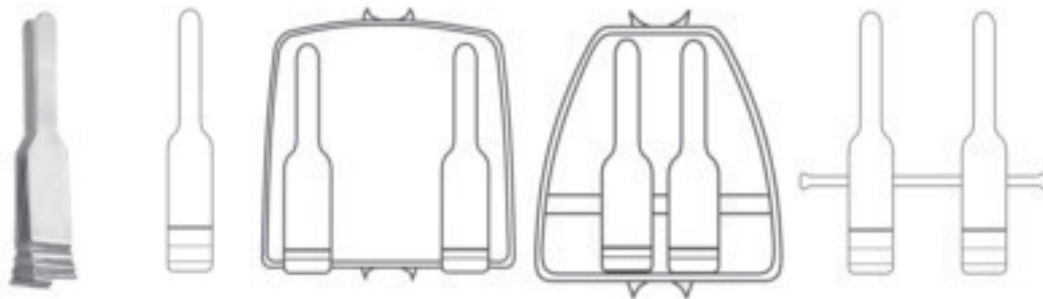

ACLAND

36 mm 2 - 5 mm Ø Gefäß / vessel	90-80-286	90-80-390	90-80-292	90-80-287	Vene / vein Arterie / artery
	90-80-288	90-80-391	90-80-293	90-80-289	

Artikel-Nr.
Cat. No.

Gesamtlänge
Total length

90-80-075	50 x 25 x 4,5 mm		
90-80-076	70 x 45 x 8 mm		
90-80-077	75 x 25 x 4,5 mm		
Lagerungstray für Gefäßklemmen utility tray for storage of vessel clamps			



90-80-075





2/3
ACLAND
90-80-072
 140 mm
 5½"

		Artikel-Nr. Cat. No.	Gesamtlänge Total length
	ACLAND	90-80-071	140 mm / 5½" mit Sperre with ratchet
	ACLAND	90-80-072	140 mm / 5½" ohne Sperre without ratchet



2/3
90-80-073
 140 mm
 5½"

		Artikel-Nr. Cat. No.	Gesamtlänge Total length
		90-80-073	140 mm / 5½" Anlegepinzette zum gleichzeitigen Öffnen beider Klemmen bei Approximatoren und Doppelklemmen applying forceps for opening approximators and double clamps simultaneously

Artikel-Nr. Cat. No.	Gesamtlänge Total length		
06-04-568	145 mm / 5¾"	BIEMER	1/1
	ohne Sperre <i>without ratchet</i>		
06-04-569	145 mm / 5¾"	BIEMER	
	mit Sperre <i>with ratchet</i>		
	für Gefäßclips <i>for vessel clips</i> 06-04-560 - 06-04-562		
	für Approximatoren <i>for approximators</i> 06-04-611 - 06-04-615, 06-04-671 - 06-04-674		

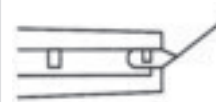
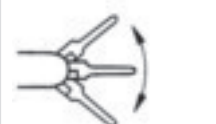

Artikel-Nr. Cat. No.	Gesamtlänge Total length		
06-04-578	145 mm / 5¾"	MEHDORN	1/1
	ohne Sperre <i>without ratchet</i>		
	für Gefäßclips <i>for vessel clips</i> 06-04-552 - 06-04-558		
			



1/1
BIEMER
06-04-569
 145 mm
 5¾"

 1/1
 BIEMER-MÜLLER
 06-04-612

		Artikel-Nr. Cat. No.	Schließkraft Closing Force
1/1	BIEMER-MÜLLER	06-04-611	25 - 30 g Maullänge: 9 mm length of jaw: 9 mm
1/1	BIEMER-MÜLLER	06-04-612	25 - 30 g Maullänge: 9 mm length of jaw: 9 mm
1/1	BIEMER-MÜLLER	06-04-613	25 - 30 g Maullänge: 9 mm length of jaw: 9 mm
1/1	BIEMER-MÜLLER	06-04-614	25 - 30 g Maullänge: 9 mm length of jaw: 9 mm
1/1	BIEMER-MÜLLER	06-04-615	25 - 30 g Maullänge: 4,5 mm length of jaw: 4.5 mm





 1/1
 MÜLLER
 06-04-674

		Artikel-Nr. Cat. No.	Schließkraft Closing Force
1/1	MÜLLER	06-04-671	25 - 30 g Maullänge: 9 mm, \varnothing 1 mm length of jaw: 9 mm, \varnothing 1 mm
1/1	MÜLLER	06-04-672	25 - 30 g Maullänge: 9 mm, \varnothing 2 mm length of jaw: 9 mm, \varnothing 2 mm
1/1	MÜLLER	06-04-673	25 - 30 g Maullänge: 9 mm, \varnothing 3 mm length of jaw: 9 mm, \varnothing 3 mm
1/1	MÜLLER	06-04-674	25 - 30 g Maullänge: 9 mm, \varnothing 4 mm length of jaw: 9 mm, \varnothing 4 mm

Artikel-Nr. Cat. No.	Schließkraft Closing Force		
06-04-560	30 - 40 g Maullänge: 6 mm <i>length of jaw: 6 mm</i>	BIEMER	1/1 
06-04-561	30 - 40 g Maullänge: 9 mm <i>length of jaw: 9 mm</i>	BIEMER	1/1 
06-04-562	20 - 25 g Maullänge: 9 mm <i>length of jaw: 9 mm</i>	BIEMER	1/1 



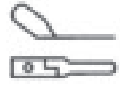





1/1
BIEMER
06-04-561

Artikel-Nr. Cat. No.	Schließkraft Closing Force		
06-04-552	10 - 15 g Maul: 4 x 1 mm <i>jaw: 4 x 1 mm</i>	MEHDORN	1/1 
06-04-554	15 - 20 g Maul: 4 x 1,4 mm <i>jaw: 4 x 1.4 mm</i>	MEHDORN	1/1 
06-04-556	10 - 15 g Maul: 6 x 1 mm <i>jaw: 6 x 1 mm</i>	MEHDORN	1/1 
06-04-558	15 - 20 g Maul: 6 x 1.4 mm <i>jaw: 6 x 1.4 mm</i>	MEHDORN	1/1 

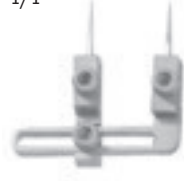

1/1
MEHDORN
06-04-558

Artikel-Nr. Cat. No.			
06-04-570	Approximator <i>approximator</i>	BIEMER	1/1 
06-04-575	Approximator mit Schlüssel 06-04-576 zur individuellen Druckeinstellung <i>approximator with key 06-04-576 for individual pressure adjustment</i>		1/1 
06-04-574	Approximator allein <i>approximator only</i>		
06-04-635	Approximator mit Schlüssel 06-04-576 <i>approximator with key</i>	BIEMER	1/1 
06-04-634	Approximator allein <i>approximator only</i>		
06-04-636	1 Paar Ersatznadeln <i>1 pair of spare needles</i>		
06-04-576	Schlüssel für Approximatoren <i>key for approximators</i> 06-04-574, 06-04-634		1/1 



TITAN
Artikel-Nr.
Cat. No.
Packungsgröße
Packing unit

	1/1 06-52-241	30 à 6 Clips TITAN Clips klein, rot <i>TITANIUM clips</i> <i>small, red</i>
	1/1 06-52-244	30 à 6 Clips TITAN Clips mittel, blau <i>TITANIUM clips</i> <i>medium, blue</i>
	1/1 06-52-245	20 à 6 Clips TITAN Clips mittel-groß, grün <i>TITANIUM clips</i> <i>medium-large, green</i>
	1/1 06-52-247	20 à 6 Clips TITAN Clips groß, orange <i>TITANIUM clips</i> <i>large, orange</i>

Anlegezangen für REBSTOCK TITAN Ligaturclips
Applying Forceps for REBSTOCK TITANIUM Ligating Clips
Artikel-Nr.
Cat. No.
Gesamtlänge
Total length

06-52-200	150 mm / 6"	gebogen / curved
06-52-201	200 mm / 7¾"	gebogen / curved
06-52-202	200 mm / 7¾"	gewinkelt / angled
06-52-203	280 mm / 11"	gebogen / curved
für Clips 06-52-241 (klein, rot) for clips 06-52-241 (small, red)		

06-52-206	150 mm / 6"	gebogen / curved
06-52-207	200 mm / 7¾"	gebogen / curved
06-52-208	200 mm / 7¾"	gewinkelt / angled
06-52-209	280 mm / 11"	gebogen / curved
06-52-216	280 mm / 11"	gewinkelt / angled
für Clips 06-52-244 (mittel, blau) for clips 06-52-244 (medium, blue)		

06-52-220	150 mm / 6"	gebogen / curved
06-52-221	200 mm / 7¾"	gebogen / curved
06-52-226	200 mm / 7¾"	gewinkelt / angled
06-52-227	280 mm / 11"	gebogen / curved
06-52-228	280 mm / 11"	gewinkelt / angled
für Clips 06-52-245 (mittel-groß, grün) for clips 06-52-245 (middle-large, green)		

06-52-230	150 mm / 6"	gebogen / curved
06-52-231	200 mm / 7¾"	gebogen / curved
06-52-232	200 mm / 7¾"	gewinkelt / angled
06-52-233	280 mm / 11"	gebogen / curved
06-52-238	280 mm / 11"	gewinkelt / angled
für Clips 06-52-247 (groß, orange) for clips 06-52-247 (large, orange)		

Anlegezangen für SLS TITAN Ligaturclips
 Applying Forceps for SLS TITANIUM Ligating Clips

Artikel-Nr. Cat. No.	Gesamtlänge Total length	
06-52-210	150 mm / 6"	mikro, weiß micro, white
06-52-211	200 mm / 7¾"	
06-52-212	280 mm / 11"	

06-02-222	150 mm / 6"	klein, gelb small, yellow
06-02-223	200 mm / 7¾"	
06-02-224	280 mm / 11"	

06-52-213	150 mm / 6"	klein-mittel, lila small-medium, purple
06-52-214	200 mm / 7¾"	
06-52-215	280 mm / 11"	

06-02-234	150 mm / 6"	mittel, blau medium, blue
06-02-235	200 mm / 7¾"	
06-02-236	280 mm / 11"	

06-02-240	200 mm / 7¾"	mittel-groß, grün medium-large, green
06-02-242	280 mm / 11"	

06-02-246	200 mm / 7¾"	groß, orange large, orange
06-02-248	280 mm / 11"	



Anlegezangen für ETHICON TITAN Ligaturclips
 Applying Forceps for ETHICON TITANIUM Ligating Clips

Artikel-Nr. Cat. No.	Gesamtlänge Total length		
06-52-222	150 mm / 6"		klein, blau small, blue
06-52-223	200 mm / 7¾"		

06-52-234	150 mm / 6"		mittel, weiß medium, white
06-52-235	200 mm / 7¾"		
06-52-236	280 mm / 11"		

06-52-240	200 mm / 7¾"		mittel-groß, grün middle-large, green
06-52-242	280 mm / 11"		

06-52-246	200 mm / 7¾"	gewinkelt angled	groß, gelb large, yellow
06-52-248	280 mm / 11"	gebogen curved	

 1/1
06-54-681
 6 mm

	Artikel-Nr. Cat. No.	Maullänge Length of jaws
1/1 	06-54-680	4 mm
1/1 	06-54-681	6 mm
1/1 	06-54-682	8 mm
1/1 	06-54-683	10 mm

 1/1
06-54-684
 6 mm

	Artikel-Nr. Cat. No.	Maullänge Length of jaws
1/1 	06-54-684	6 mm leicht gebogen <i>slightly curved</i>
1/1 	06-54-685	6 mm gebogen <i>curved</i>
1/1 	06-54-686	6 mm abgewinkelt 45° <i>angled 45°</i>
1/1 	06-54-687	8 mm seitwärts abgewinkelt 45° <i>angled to side 45°</i>

Artikel-Nr. Cat. No.	Gesamtlänge Total length
06-54-688	140 mm / 5½"
06-54-689	180 mm / 7"
mit Sperre with ratchet	
für Gefäßclips for vessel clips	
06-54-680 - 06-54-687	









1/2
06-54-689
180 mm
7"

Artikel-Nr. Cat. No.	Gesamtlänge Total length
06-54-690	180 mm / 7"
06-54-691	220 mm / 8¾"
mit Sperre with ratchet	
für Gefäßclips for vessel clips	
06-54-680 - 06-54-687	



2/3
06-54-691
180 mm
7"

 1/1
 MÜLLER
 06-05-010

			Artikel-Nr. Cat. No.	Schließkraft Closing Force
	1/1	MÜLLER	06-05-010	50 g
			06-05-020	80 g
	1/1	MÜLLER	06-05-011	50 g
			06-05-021	80 g
	1/1	MÜLLER	06-05-012	50 g
			06-05-022	80 g
	1/1	MÜLLER	06-05-013	50 g
			06-05-023	80 g
	1/1	MÜLLER	06-05-014	50 g
			06-05-024	80 g
	1/1	MÜLLER	06-05-005	Fadenklemme <i>ligature forceps</i>

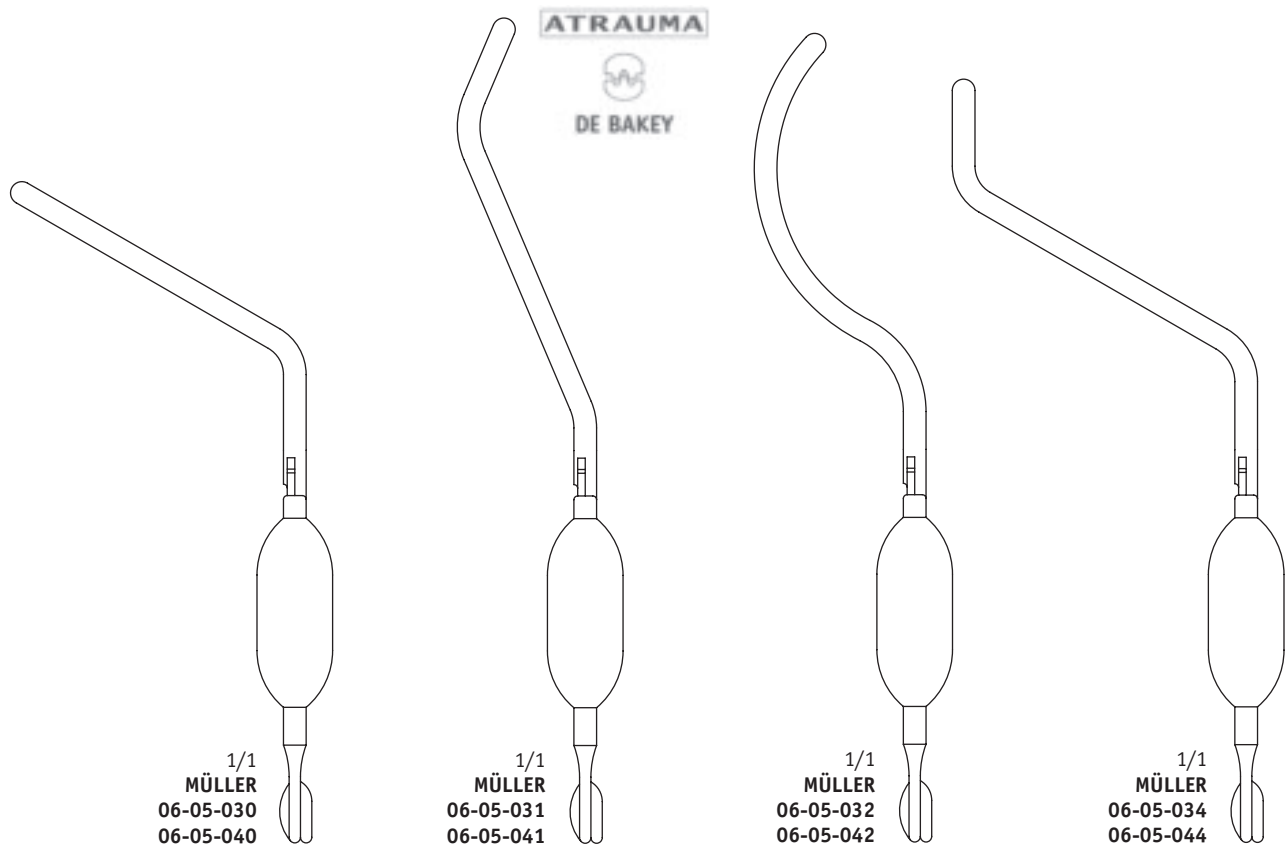



Artikel-Nr. Cat. No.	Schließkraft Closing Force		
06-05-030	250 g	MÜLLER	
06-05-040	350 g		
06-05-031	250 g	MÜLLER	
06-05-041	350 g		
06-05-032	250 g	MÜLLER	
06-05-042	350 g		
06-05-034	250 g	MÜLLER	
06-05-044	350 g		



1/1
MÜLLER
06-05-031





1/1
06-52-351
 35 mm
 1 1/4"

		Artikel-Nr. Cat. No.	Gesamtlänge Total length
1/1 10 mm 		06-52-350	31 mm / 1 1/8" Schließdruck 30 g closing pressure 30 g
1/1 14 mm 		06-52-351	35 mm / 1 1/4" Schließdruck 30 g closing pressure 30 g
1/1 18 mm 		06-52-352	39 mm / 1 1/2" Schließdruck 30 g closing pressure 30 g



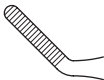
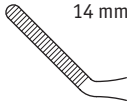
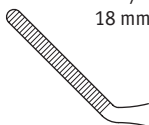

1/1
06-52-354
 35 mm
 1 1/4"

		Artikel-Nr. Cat. No.	Gesamtlänge Total length
1/1 10 mm 		06-52-353	31 mm / 1 1/8" Schließdruck 30 g closing pressure 30 g
1/1 14 mm 		06-52-354	35 mm / 1 1/4" Schließdruck 30 g closing pressure 30 g
1/1 18 mm 		06-52-355	39 mm / 1 1/2" Schließdruck 30 g closing pressure 30 g

Artikel-Nr. Cat. No.	Gesamtlänge Total length		
02-08-020	35 mm / 1½"	DIEFFEN- BACH	1/1
02-08-022	50 mm / 2"		
02-08-021	35 mm / 1½"	DIEFFEN- BACH	1/1
02-08-023	50 mm / 2"		



1/1
DIEFFENBACH
02-08-022
50 mm
2"

Artikel-Nr. Cat. No.	Gesamtlänge Total length		
02-08-026	58 mm / 2¼"	DIEFFEN- BACH	1/1
			
02-08-027	58 mm / 2¼"	DIEFFEN- BACH	1/1
			



1/1
DIEFFENBACH
02-08-026
58 mm
2¼"

ATRAUMA

DE BAKEY

1/1
DE BAKEY-DIETRICH
02-52-202
 60 mm
 2 1/4"

		Artikel-Nr. Cat. No.	Gesamtlänge Total length
1/1	DE BAKEY-DIETRICH	02-52-200	50 mm / 2"
1/1	DE BAKEY-DIETRICH	02-52-201	55 mm / 2 1/8"
1/1	DE BAKEY-DIETRICH	02-52-202	60 mm / 2 1/4"

		Artikel-Nr. Cat. No.	Gesamtlänge Total length
1/1	DE BAKEY-DIETRICH	02-52-203	50 mm / 2"
1/1	DE BAKEY-DIETRICH	02-52-204	55 mm / 2 1/8"
1/1	DE BAKEY-DIETRICH	02-52-205	60 mm / 2 1/4"

		Artikel-Nr. Cat. No.	Gesamtlänge Total length
1/1	DIETRICH	02-52-210	50 mm / 2"
1/1	DIETRICH	02-52-211	55 mm / 2 1/8"
1/1	DIETRICH	02-52-212	60 mm / 2 1/4"

		Artikel-Nr. Cat. No.	Gesamtlänge Total length
1/1	DIETRICH	02-52-213	50 mm / 2"
1/1	DIETRICH	02-52-214	55 mm / 2 1/8"
1/1	DIETRICH	02-52-215	60 mm / 2 1/4"

1/1
DIETRICH
02-52-214
 55 mm
 2 1/8"

Artikel-Nr. Cat. No.	Gesamtlänge Total length		
02-58-012	50 mm / 2"	JOHN-HOPKINS	1/1
02-58-013	55 mm / 2 1/8"		
02-58-014	65 mm / 2 1/2"		
02-58-015	70 mm / 2 3/4"		
02-58-016	75 mm / 3"		
02-58-017	90 mm / 3 1/2"		
02-08-012	50 mm / 2"	JOHN-HOPKINS	1/1
02-08-013	55 mm / 2 1/8"		
02-08-014	65 mm / 2 1/2"		
02-08-015	70 mm / 2 3/4"		
02-08-016	75 mm / 3"		
02-08-017	90 mm / 3 1/2"		



1/1
JOHN-HOPKINS
02-08-013
55 mm
2 1/8"

Artikel-Nr. Cat. No.	Gesamtlänge Total length		
02-08-018	230 mm / 9"		
	Anlege- und Entnahmezange für JOHN HOPKINS Bulldogklemmen		
	<i>applying and removing forceps for JOHN HOPKINS bulldog clamps</i>		



1/3
02-08-018
230 mm
9"



Schließkraft (110 g),
für Venen
closing pressure (110 g),
for veins



Schließkraft (220 g),
für Arterien
closing pressure (220 g),
for arteries



1/1
06-52-304T
40 mm
1½"





1/1
06-52-314T
40 mm
1½"



1/1
06-52-324T
40 mm
1½"

TITAN

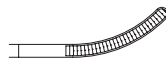
	Artikel-Nr. Cat. No.		Gesamtlänge Total length
1/1	06-52-300T	Vene vein	30 mm / 1½"
	06-52-301T	Arterie artery	
1/1	06-52-302T	Vene vein	35 mm / 1¾"
	06-52-303T	Arterie artery	
1/1	06-52-304T	Vene vein	40 mm / 1½"
	06-52-305T	Arterie artery	
1/1	06-52-306T	Vene vein	50 mm / 2"
	06-52-307T	Arterie artery	
1/1	06-52-310T	Vene vein	30 mm / 1½"
	06-52-311T	Arterie artery	
1/1	06-52-312T	Vene vein	35 mm / 1¾"
	06-52-313T	Arterie artery	
1/1	06-52-314T	Vene vein	40 mm / 1½"
	06-52-315T	Arterie artery	
1/1	06-52-316T	Vene vein	50 mm / 2"
	06-52-317T	Arterie artery	
1/1	06-52-320T	Vene vein	30 mm / 1½"
	06-52-321T	Arterie artery	
1/1	06-52-322T	Vene vein	35 mm / 1¾"
	06-52-323T	Arterie artery	
1/1	06-52-324T	Vene vein	40 mm / 1½"
	06-52-325T	Arterie artery	
1/1	06-52-326T	Vene vein	50 mm / 2"
	06-52-327T	Arterie artery	

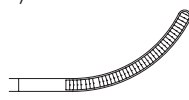
Artikel-Nr. Cat. No.	Gesamtlänge Total length		
06-02-328	45 mm / 1¾"		1/1 
06-02-329	45 mm / 1¾"		1/1 
06-02-330	50 mm / 2"		1/1 
06-02-331	50 mm / 2"		1/1 



1/1
06-02-328
45 mm
1¾"

mit Rändelschraube zur individuellen Druckeinstellung
with knurled screw for individual pressure adjustment



Artikel-Nr. Cat. No.	Gesamtlänge Total length		
06-02-352	50 mm / 2"	DE BAKEY	1/1 
06-02-353	50 mm / 2"	DE BAKEY	1/1 



1/1
06-02-353
50 mm
2"

mit Rändelschraube zur individuellen Druckeinstellung
with knurled screw for individual pressure adjustment



ATRAUMA



DE BAKEY

 1/1
 06-02-422
 90 mm
 3½"

20 mm

DE BAKEY

 Artikel-Nr.
 Cat. No.

06-02-420

 Gesamtlänge
 Total length

80 mm / 3¼"



30 mm

DE BAKEY

06-02-422

90 mm / 3½"



45 mm

DE BAKEY

06-02-424

105 mm / 4¼"



68 mm

DE BAKEY

06-02-426

125 mm / 5"



ATRAUMA



DE BAKEY

 1/1
 06-02-423
 85 mm
 3½"

20 mm

DE BAKEY

 Artikel-Nr.
 Cat. No.

06-02-421

 Gesamtlänge
 Total length

75 mm / 3"



30 mm

DE BAKEY

06-02-423

85 mm / 3½"



45 mm

DE BAKEY

06-02-425

95 mm / 3¾"







68 mm

DE BAKEY

06-02-427

115 mm / 4½"





Artikel-Nr. Cat. No.	Gesamtlänge Total length		
06-52-358	90 mm / 3½"	GREGORY- „SOFT“	27 mm 
06-52-359	110 mm / 4¼"	GREGORY- „SOFT“	44 mm 
06-52-360	90 mm / 3½"	GREGORY- „SOFT“	41 mm 
06-52-361	110 mm / 4¼"	GREGORY- „SOFT“	60 mm 

ATRAUMA



DE BAKEY



Artikel-Nr. Cat. No.	Gesamtlänge Total length		
06-52-363	110 mm / 4¼" links left	GREGORY- „SOFT“	60 mm 
06-52-362	110 mm / 4¼" rechts right	GREGORY- „SOFT“	60 mm 

1/2
GREGORY „SOFT“
06-52-361
110 mm
4¼"

ATRAUMA



DE BAKEY



Artikel-Nr. Cat. No.	Gesamtlänge Total length		
06-52-364	70 mm / 2¾"	SANTULLI	30 mm 

1/2
SANTULLI
06-52-364
70 mm
2¾"

ATRAUMA



COOLEY



1/1
COOLEY
06-52-368
90 mm
3½"

			Artikel-Nr. Cat. No.	Gesamtlänge Total length
	20 mm	COOLEY	06-52-366	80 mm / 3⅛"
	30 mm	COOLEY	06-52-368	90 mm / 3½"
	45 mm	COOLEY	06-52-370	105 mm / 4¼"
	68 mm	COOLEY	06-52-372	125 mm / 5"

			Artikel-Nr. Cat. No.	Gesamtlänge Total length
	20 mm	COOLEY	06-52-367	75 mm / 3"
	30 mm	COOLEY	06-52-369	85 mm / 3⅓"
	45 mm	COOLEY	06-52-371	95 mm / 3¾"
	68 mm	COOLEY	06-52-373	115 mm / 4½"

Artikel-Nr. Cat. No.	Gesamtlänge Total length	SHUNT	
06-52-380	75 mm / 3" ø 10 Fr.	SHUNT	1/1 10° 
06-52-381	ø 12 Fr.		
06-52-382	ø 14 Fr.		



Artikel-Nr. Cat. No.	Gesamtlänge Total length	SHUNT	
06-52-383	75 mm / 3" ø 10 Fr.	SHUNT	1/1 25° 
06-52-384	ø 12 Fr.		
06-52-385	ø 14 Fr.		



1/1
SHUNT
06-52-381
75 mm
3"

Artikel-Nr. Cat. No.	Gesamtlänge Total length	SHUNT	
06-52-386	75 mm / 3" ø 10 Fr.	SHUNT	1/1 45° 
06-52-387	ø 12 Fr.		
06-52-388	ø 14 Fr.		



1/1
SHUNT
06-52-384
75 mm
3"

Artikel-Nr. Cat. No.	Gesamtlänge Total length	SHUNT	
06-52-389	75 mm / 3" ø 10 Fr.	SHUNT	1/1 60° 
06-52-390	ø 12 Fr.		
06-52-391	ø 14 Fr.		



1/1
SHUNT
06-52-387
75 mm
3"

1/1
SHUNT
06-52-390
75 mm
3"

ATRAUMA

DE BAKEY

 1/1
GLOVER
06-02-432
 80 mm
 3 1/8"

			Artikel-Nr. Cat. No.	Gesamtlänge Total length
	20 mm	GLOVER	06-52-430	70 mm / 2 3/4"
	30 mm	GLOVER	06-02-432	80 mm / 3 1/8"
	43 mm	GLOVER	06-02-434	95 mm / 3 3/4"
	56 mm	GLOVER	06-02-436	115 mm / 4 1/2"

 mit Rändelschraube zur individuellen Druckeinstellung
 with knurled screw for individual pressure adjustment

ATRAUMA

DE BAKEY

 1/1
GLOVER
06-02-433
 75 mm
 2 3/4"

			Artikel-Nr. Cat. No.	Gesamtlänge Total length
	20 mm	GLOVER	06-52-431	65 mm / 2 1/2"
	30 mm	GLOVER	06-02-433	75 mm / 3"
	43 mm	GLOVER	06-02-435	85 mm / 3 1/2"
	56 mm	GLOVER	06-02-437	105 mm / 4 1/4"

 mit Rändelschraube zur individuellen Druckeinstellung
 with knurled screw for individual pressure adjustment

Artikel-Nr. Cat. No.	Gesamtlänge Total length		
06-02-357	70 mm / 2¾"	DE BAKEY	1/1
06-02-359	95 mm / 3¾"	DE BAKEY	1/1
06-02-358	100 mm / 4"	DE BAKEY	1/1

mit Rändelschraube zur individuellen Druckeinstellung
 with knurled screw for individual pressure adjustment

ATRAUMA



DE BAKEY

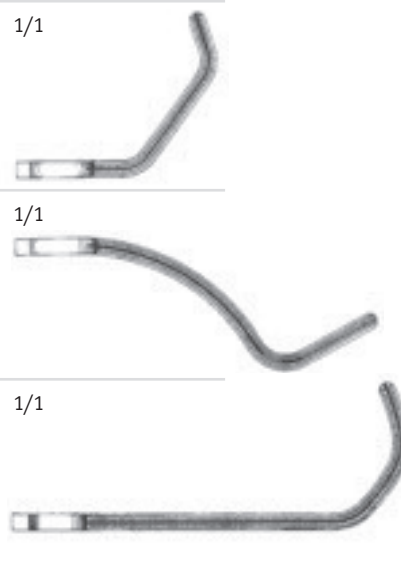

1/1
DE BAKEY
06-02-357
 70 mm
 2¾"

Artikel-Nr. Cat. No.	Gesamtlänge Total length		
06-02-431	55 mm / 2¼"	GLOVER	27 mm

mit Rändelschraube zur individuellen Druckeinstellung
 with knurled screw for individual pressure adjustment

ATRAUMA



DE BAKEY



1/1
GLOVER
06-02-431
 55 mm
 2¼"



Mikro-Neurochirurgische Instrumente
Micro-Neurosurgical Instruments

HF-Instrumente und Zubehör
HF Instruments and Accessoires

Kopf-Schädelinstrumente und Haltesysteme
Head-Cranio Instruments and Holding Systems

Aneurysmen-Clip System
Aneurysm Clip System

Schädel-Verplattung
Cranial Plate System

Hypophysektomie-Instrumente
Pituitary Instruments

Instrumente für die Wirbelsäule, Wundspreizer
Spine Instruments, Self-retaining Retractors

Laminektomie-Stanzen, Rongeure, Hohlmeißelzangen
Laminectomy Punches, Rongeurs

Gefäß- und Bulldogklemmen, Gefäß-Clips
Vessel- and Bulldog-Clamps, Vessel Clips

Allgemeinchirurgische Instrumente
General Surgical Instruments



Alphabetischer Index, Numerischer Index
Alphabetical Index, Numerical Index

/// Allgemeinchirurgische Instrumente
General Surgical Instruments

REBSTOCK®
Precision made in Germany

SURGICAL
INSTRUMENTS
MICRO-NEURO-SPINE



/// 10



**Gr.
3**

 Skalpellgriffe, passend für auswechselbare Skalpellklingen Fig. 10, 11, 12, 13, 15
scalpel handles for scalpel blades fig. 10, 11, 12, 13, 15

 1/2
02-02-073
 125 mm
 4¾"

	Artikel-Nr. Cat. No.	Gesamtlänge Total length
	02-02-073	125 mm / 4¾"
	02-02-074	125 mm / 4¾" No. 3 mit Zentimeter-Graduierung <i>cm graduation</i>

 1/2
02-02-075
 210 mm
 8½"

	Artikel-Nr. Cat. No.	Gesamtlänge Total length
	02-02-075	210 mm / 8½" No. 3L

 1/2
02-52-075
 210 mm
 8½"

	Artikel-Nr. Cat. No.	Gesamtlänge Total length
1/1 	02-52-075	210 mm / 8½" No. 3L abgewinkelt <i>angled</i>



Skalpelli, passend für auswechselbare Skalpellklingen Fig. 10, 11, 12, 13, 15
scalpel handles for scalpel blades fig. 10, 11, 12, 13, 15

**Gr.
3**

Artikel-Nr. Cat. No.	Gesamtlänge Total length		
02-52-078	160 mm / 6¼"		
No. 5			

1/2
02-52-078
160 mm
6¼"



Artikel-Nr. Cat. No.	Gesamtlänge Total length		
02-02-078	215 mm / 8½"		
No. 5			

1/2
02-02-078
215 mm
8½"



Artikel-Nr. Cat. No.	Gesamtlänge Total length		
02-02-079	210 mm / 8¼"		1/1
No. 5 abgewinkelt angled			

1/2
02-02-079
210 mm
8¼"



**Gr.
3**

 Skalpelli, passend für auswechselbare Skalpelli-
 Scalpel handles for scalpel blades fig. 10, 11, 12, 13, 15

 1/2
02-02-077
 160 mm
 6¼"

		Artikel-Nr. Cat. No.	Gesamtlänge Total length
		02-02-077	160 mm / 6¼"
			No. 7

 1/2
02-52-077
 125 mm
 5"

		Artikel-Nr. Cat. No.	Gesamtlänge Total length
		02-52-077	125 mm / 5"
			No. 7K

 1/2
02-52-079
 220 mm
 8¾"

		Artikel-Nr. Cat. No.	Gesamtlänge Total length
		02-52-079	220 mm / 8¾"
			No. 7L



10

Skalpellgriffe, passend für auswechselbare Skalpellklingen Fig. 10, 11, 12, 13, 15
scalpel handles for scalpel blades fig. 10, 11, 12, 13, 15

Artikel-Nr. Cat. No.	Gesamtlänge Total length		
02-02-063	145 mm / 5¾"	No. 3R	



Gr.
3

1/2
02-02-063
145 mm
5¾"

Artikel-Nr. Cat. No.	Gesamtlänge Total length		
02-52-063	140 mm / 5⅔"	No. 3R	1/1 



1/2
02-52-063
140 mm
5⅔"

Artikel-Nr. Cat. No.			
02-52-060	Skalpellklingen-Entferner scalpel blade remover		



1/1
02-52-060

Gr.
4

 Skalpellgriffe, passend für auswechselbare Skalpellklingen Fig. 18, 19, 20, 21, 22, 23, 24, 25, 34, 36
scalpel handles for scalpel blades fig. 18, 19, 20, 21, 22, 23, 24, 25, 34, 36

 1/2
02-02-084
 135 mm
 5¼"

Artikel-Nr.
Cat. No.
Gesamtlänge
Total length

Artikel-Nr. Cat. No.	Gesamtlänge Total length
02-02-084	135 mm / 5¼"
	No. 4
02-52-084	135 mm / 5¼"
	No. 4 mit Zentimeter-Graduierung <i>cm graduation</i>

 1/2
02-02-085
 210 mm
 8¼"

Artikel-Nr.
Cat. No.
Gesamtlänge
Total length

Artikel-Nr. Cat. No.	Gesamtlänge Total length
02-02-085	210 mm / 8¼"
	No. 4L

10

Skalpellgriffe, passend für auswechselbare Skalpellklingen Fig. 18, 19, 20, 21, 22, 23, 24, 25, 34, 36
scalpel handles for scalpel blades fig. 18, 19, 20, 21, 22, 23, 24, 25, 34, 36

**Gr.
4**

Artikel-Nr. Cat. No.	Gesamtlänge Total length		
02-52-085	210 mm / 8¼"		1/1
	No. 4L abgewinkelt angled		



1/2
02-52-085
210 mm
8¼"



TC



1/2
02-03-110
110 mm
4 3/8"

Artikel-Nr. Cat. No.	Artikel-Nr. Cat. No.	Gesamtlänge Total length
1/1	IRIS	
02-03-100	02-03-210	90 mm / 3 1/2"
02-03-056		95 mm / 3 3/4"
02-03-060		105 mm / 4 1/4"
02-03-110		110 mm / 4 3/8"
02-03-106		115 mm / 4 1/2"
02-03-064		120 mm / 4 3/4"
		spitz / spitz sharp / sharp
1/1	IRIS	
02-03-101	02-03-211	90 mm / 3 1/2"
02-03-057		95 mm / 3 3/4"
02-03-061		105 mm / 4 1/4"
02-03-111		110 mm / 4 3/8"
02-03-107		115 mm / 4 1/2"
02-03-065		120 mm / 4 3/4"
		spitz / spitz sharp / sharp
1/1		
02-03-112		110 mm / 4 3/8"
02-03-113		110 mm / 4 3/8"
		spitz / stumpf sharp / blunt
1/1		
02-03-117		110 mm / 4 3/8"
		seitwärts gebogen curved to side



1/2
IRIS SUPERCUT
02-03-900
110 mm
4 3/8"

Artikel-Nr. Cat. No.	Gesamtlänge Total length
1/1	IRIS Supercut
02-03-900	110 mm / 4 3/8"
1/1	IRIS Supercut
02-03-901	110 mm / 4 3/8"

Artikel-Nr. Cat. No.	Gesamtlänge Total length		
02-03-117	110 mm / 4 ³ / ₈ "	IRIS	

2/3
IRIS
02-03-117
110 mm
4³/₈"



Artikel-Nr. Cat. No.	Gesamtlänge Total length		
02-53-032	115 mm / 4 ¹ / ₂ "	IRIS	

2/3
IRIS
02-53-032
115 mm
4¹/₂"



Artikel-Nr. Cat. No.	Gesamtlänge Total length		
02-03-033	115 mm / 4 ¹ / ₂ "	IRIS	

2/3
IRIS
02-03-033
115 mm
4¹/₂"





2/3
PERWITZCHKY
02-03-030
115 mm
4½"

		Artikel-Nr. Cat. No.	Gesamtlänge Total length
	PER- WITZCHKY	02-03-030	115 mm / 4½" mit Knopf with probe





2/3
PERWITZCHKY
15-13-489
100 mm
4"

		Artikel-Nr. Cat. No.	Gesamtlänge Total length
	PER- WITZCHKY	15-13-489	100 mm / 4" mit Knopf with probe



1/2
SANVENERO
02-53-126
140 mm
5½"

		Artikel-Nr. Cat. No.	Gesamtlänge Total length
1/1	 SANVENERO	02-53-126	140 mm / 5½"
1/1	 SANVENERO	02-53-127	140 mm / 5½"

Artikel-Nr. Cat. No.	Gesamtlänge Total length		
02-03-156	140 mm / 5½"	JOSEPH	1/1
02-03-157	140 mm / 5½"	JOSEPH	1/1

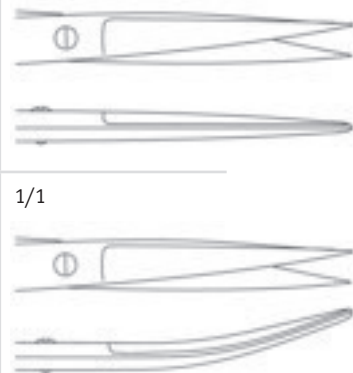

1/2
JOSEPH
02-03-156
140 mm
5½"

Artikel-Nr. Cat. No.	Gesamtlänge Total length		
02-03-916	140 mm / 5½"	JOSEPH Supercut	1/1
02-03-917	140 mm / 5½"	JOSEPH Supercut	1/1

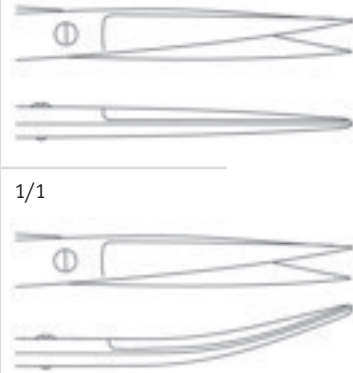

1/2
JOSEPH
Supercut
02-03-916
140 mm
5½"





1/2
02-53-670
 150 mm
 6"

		Artikel-Nr. Cat. No.	Gesamtlänge Total length
1/1		02-53-670	150 mm / 6"
1/1		02-03-628	150 mm / 6"



1/2
KELLY
02-03-160
 175 mm
 7"

		Artikel-Nr. Cat. No.	Gesamtlänge Total length
1/1		02-03-160	175 mm / 7"
1/1		02-03-161	175 mm / 7"

TC

Artikel-Nr. Cat. No.	Artikel-Nr. Cat. No.	Gesamtlänge Total length		
02-53-340		105 mm / 4¼"	STANDARD	1/1
02-03-341		115 mm / 4½"		
02-03-343		130 mm / 5"		
02-03-344		145 mm / 5¾"		
02-03-345	02-03-228	150 mm / 6"		
02-03-346	02-53-200	165 mm / 6½"		
02-53-347		175 mm / 7"		
02-53-348	02-53-202	185 mm / 7¼"		
02-53-349		200 mm / 8"		
02-53-440		105 mm / 4¼"		
02-03-441		115 mm / 4½"		
02-03-443		130 mm / 5"		
02-03-444		145 mm / 5¾"		
02-03-445	02-53-199	150 mm / 6"		
02-03-446	02-53-201	165 mm / 6½"		
02-53-447		175 mm / 7"		
02-53-448	02-53-203	185 mm / 7¼"		
02-53-449		200 mm / 8"		



1/2
02-03-346
165 mm
6½"

TC

Artikel-Nr. Cat. No.	Artikel-Nr. Cat. No.	Gesamtlänge Total length		
02-53-080		105 mm / 4¼"	STANDARD Supercut	1/1
02-53-081		115 mm / 4½"		
02-53-082		130 mm / 5"		
02-53-083	02-53-096	145 mm / 5¾"		
02-53-084		150 mm / 6"		
02-53-085	02-53-097	165 mm / 6½"		
02-53-086		185 mm / 7¼"		
02-53-087		200 mm / 8"		
02-53-088		105 mm / 4¼"	STANDARD Supercut	1/1
02-53-089		115 mm / 4½"		
02-53-090		130 mm / 5"		
02-53-091	02-53-098	145 mm / 5¾"		
02-53-092		150 mm / 6"		
02-53-093	02-53-099	165 mm / 6½"		
02-53-094		185 mm / 7¼"		
02-53-095		200 mm / 8"		



1/2
Supercut
02-03-346
165 mm
6½"

TC

 1/2
02-03-326
 165 mm
 6½"

		Artikel-Nr. Cat. No.	Artikel-Nr. Cat. No.	Gesamtlänge Total length
1/1	STANDARD	02-03-320		105 mm / 4¼"
		02-03-321		115 mm / 4½"
		02-03-323		130 mm / 5"
		02-03-324		145 mm / 5¾"
		02-03-325	02-03-224	150 mm / 6"
		02-03-326	02-53-206	165 mm / 6½"
		02-03-327		175 mm / 7"
		02-03-328	02-53-208	185 mm / 7¼"
02-03-330		200 mm / 8"		
1/1	STANDARD	02-53-420		105 mm / 4¼"
		02-03-421		115 mm / 4½"
		02-03-423		130 mm / 5"
		02-03-424		145 mm / 5¾"
		02-03-425	02-03-234	150 mm / 6"
		02-03-426	02-53-207	165 mm / 6½"
		02-03-427		175 mm / 7"
		02-53-428	02-53-209	185 mm / 7¼"
		02-53-429		200 mm / 8"

TC

 1/2
Supercut
02-53-064
 165 mm
 6½"

		Artikel-Nr. Cat. No.	Artikel-Nr. Cat. No.	Gesamtlänge Total length
1/1	STANDARD Supercut	02-53-060		115 mm / 4½"
		02-53-061		130 mm / 5"
		02-53-062	02-53-074	145 mm / 5¾"
		02-53-063		150 mm / 6"
		02-53-064	02-53-075	165 mm / 6½"
		02-53-065		185 mm / 7¼"
		02-53-066		200 mm / 8"
1/1	STANDARD Supercut	02-53-067		115 mm / 4½"
		02-53-068		130 mm / 5"
		02-53-069	02-53-076	145 mm / 5¾"
		02-53-070		150 mm / 6"
		02-53-071	02-53-077	165 mm / 6½"
		02-53-072		185 mm / 7¼"
		02-53-073		200 mm / 8"

TC

Artikel-Nr. Cat. No.	Artikel-Nr. Cat. No.	Gesamtlänge Total length		
02-53-311		105 mm / 4¼"	STANDARD	1/1
02-53-312		115 mm / 4½"		
02-03-313		130 mm / 5"		
02-03-314		145 mm / 5¾"		
02-03-315	02-53-230	150 mm / 6"		
02-03-316	02-53-232	165 mm / 6½"		
02-03-317		175 mm / 7"		
02-53-318	02-53-234	185 mm / 7¼"		
02-53-319		200 mm / 8"		
02-53-410		105 mm / 4¼"		
02-03-411		115 mm / 4½"		
02-03-413		130 mm / 5"		
02-03-414		145 mm / 5¾"		
02-03-415	02-03-231	150 mm / 6"		
02-03-416	02-53-233	165 mm / 6½"		
02-03-417		175 mm / 7"		
02-53-418	02-53-235	185 mm / 7¼"		
02-53-419		200 mm / 8"		



1/2
02-03-316
165 mm
6½"

TC

Artikel-Nr. Cat. No.	Artikel-Nr. Cat. No.	Gesamtlänge Total length				
02-53-040		105 mm / 4¼"	STANDARD Supercut	1/1		
02-53-041		115 mm / 4½"				
02-53-042		130 mm / 5"				
02-53-043	02-53-056	145 mm / 5¾"				
02-53-044		150 mm / 6"				
02-53-045	02-53-057	165 mm / 6½"				
02-53-046		185 mm / 7¼"				
02-53-047		200 mm / 8"				
02-53-048		105 mm / 4¼"			STANDARD Supercut	1/1
02-53-049		115 mm / 4½"				
02-53-050		130 mm / 5"				
02-53-051	02-53-058	145 mm / 5¾"				
02-53-052		150 mm / 6"				
02-53-053	02-53-059	165 mm / 6½"				
02-53-054		185 mm / 7¼"				
02-53-055		200 mm / 8"				





1/2
Supercut
02-53-045
165 mm
6½"







1/2
DEAVER
02-03-374
145 mm
5¾"

		TC		
		Artikel-Nr. Cat. No.	Artikel-Nr. Cat. No.	Gesamtlänge Total length
1/1	DEAVER	02-03-374	02-53-374	145 mm / 5¾"
				
1/1	DEAVER	02-03-474	02-53-474	145 mm / 5¾"
				



1/2
DEAVER
02-53-568
145 mm
5¾"

		TC		
		Artikel-Nr. Cat. No.	Artikel-Nr. Cat. No.	Gesamtlänge Total length
1/1	DEAVER	02-53-568	02-53-472	145 mm / 5¾"
				
1/1	DEAVER	02-03-464	02-53-473	145 mm / 5¾"
				

Artikel-Nr. Cat. No.	Gesamtlänge Total length		
02-03-503	130 mm / 5 1/8"		
	Inzisions-Scheren <i>incision scissors</i>		
02-03-504	145 mm / 5 3/4"		
	Inzisions-Scheren <i>incision scissors</i>		



1/2
02-03-503
130 mm
5 1/8"

Artikel-Nr. Cat. No.	Gesamtlänge Total length		
02-53-470	150 mm / 6"	KAYE FACE LIFT Supercut	1/1
02-53-471	190 mm / 7 1/2"		



1/2
KAYE FACE LIFT
Supercut
02-53-471
190 mm
7 1/2"











1/2
STEVENS
02-03-186
 100 mm
 4"

		Artikel-Nr. Cat. No.	Gesamtlänge Total length
1/1	STEVENS	02-03-186	100 mm / 4" Gefäß- und Sehnenschere <i>vessel and tendon scissors</i>
1/1	STEVENS	02-03-187	100 mm / 4" Gefäß- und Sehnenschere <i>vessel and tendon scissors</i>
1/1	STEVENS	15-11-366	100 mm / 4" Gefäß- und Sehnenschere, fein <i>vessel and tendon scissors, delicate</i>





1/2
COTTLE-MASING
15-11-365
 105 mm
 4 1/8"

		Artikel-Nr. Cat. No.	Gesamtlänge Total length
1/1	COTTLE-MASING	15-11-365	105 mm / 4 1/8" scharf <i>sharp</i>
1/1	COTTLE-MASING	15-11-367	105 mm / 4 1/8" stumpf <i>blunt</i>

Artikel-Nr. Cat. No.	Gesamtlänge Total length		
02-03-170	110 mm / 4 ³ / ₈ "	STEVENS	1/1 
02-03-171	110 mm / 4 ³ / ₈ "	STEVENS	1/1 
02-03-172	110 mm / 4 ³ / ₈ "	STEVENS	1/1 
02-03-173	110 mm / 4 ³ / ₈ "	STEVENS	1/1 
02-03-194	125 mm / 5"	STEVENS	1/1 
02-03-195	125 mm / 5"	STEVENS	1/1 



1/2
STEVENS
02-03-170
110 mm
4³/₈"

Artikel-Nr. Cat. No.	Gesamtlänge Total length		
02-53-452	110 mm / 4 ³ / ₈ "	STEVENS Supercut	1/1 
02-53-453	110 mm / 4 ³ / ₈ "	STEVENS Supercut	1/1 



1/2
STEVENS
Supercut
02-53-452
110 mm
4³/₈"









1/2
COTTLE
15-11-374
 115 mm
 4½"



		Artikel-Nr. Cat. No.	Gesamtlänge Total length
1/1	COTTLE	15-11-374	115 mm / 4½"
			



1/2
02-03-164
 115 mm
 4½"

		Artikel-Nr. Cat. No.	Gesamtlänge Total length
1/1	KILNER	02-03-162	115 mm / 4½"
			spitz sharp
1/1	LITTLER	02-03-163	115 mm / 4½"
			mit Fadenbohrung in der Spitze tips with eye for suture
1/1		02-03-164	115 mm / 4½"
			stumpf blunt
1/1		02-03-165	115 mm / 4½"
			stumpf blunt



Artikel-Nr. Cat. No.	Gesamtlänge Total length		
15-11-368	105 mm / 4 1/8"	COTTLE-KNAPP	1/1
			
15-11-369	105 mm / 4 1/8"	COTTLE-KNAPP	1/1
			

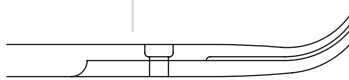
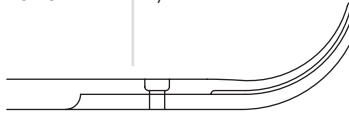

1/2
COTTLE-KNAPP
15-11-368
105 mm
4 1/8"

Artikel-Nr. Cat. No.	Gesamtlänge Total length		
15-11-373	115 mm / 4 1/2"	FOMON	1/1
			
15-11-372	135 mm / 5 1/4"	FOMON	1/1
			



1/2
FOMON
15-11-373
115 mm
4 1/2"



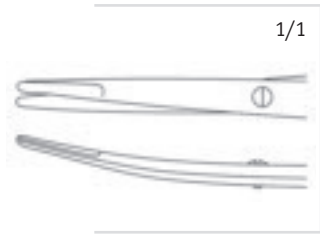

1/1 KILNER

		TC		
Artikel-Nr. Cat. No.	Artikel-Nr. Cat. No.	Gesamtlänge Total length		
02-03-166	02-53-266	125 mm / 5"		
02-03-168	02-53-268	150 mm / 6"		

1/2
KILNER
02-03-168
150 mm
6"

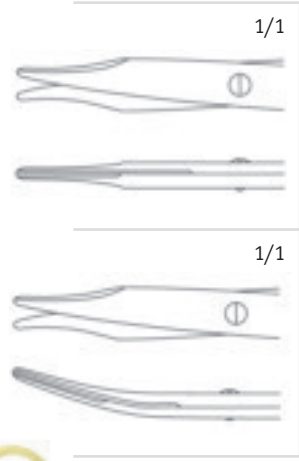



1/1 REYNOLDS

1/1 REYNOLDS



		TC		
Artikel-Nr. Cat. No.	Artikel-Nr. Cat. No.	Gesamtlänge Total length		
02-53-178	02-53-179	145 mm / 5¾"		
02-03-180	02-53-180	145 mm / 5¾"		
02-03-181		175 mm / 7"		

1/2
REYNOLDS
02-53-178
145 mm
5¾"

Artikel-Nr. Cat. No.	Gesamtlänge Total length		
02-03-184	125 mm / 5"	GORNEY	1/1
	gezahnt toothed		
02-03-188	195 mm / 7¾"	GORNEY	1/1
	gezahnt toothed		
02-03-189	195 mm / 7¾"	GORNEY	1/1
	gezahnt toothed		



1/2
GORNEY
02-03-188
195 mm
7¾"

Artikel-Nr. Cat. No.	Gesamtlänge Total length		
02-03-920	195 mm / 7¾"	GORNEY Supercut	1/1
			
02-03-921	195 mm / 7¾"	GORNEY Supercut	1/1
			



1/2
GORNEY
Supercut
02-03-920
195 mm
7¾"







1/2
LANDOLT
15-03-430
 120 mm
 4¾"

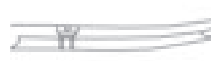

		Artikel-Nr. Cat. No.	Gesamtlänge Total length
1/1	LANDOLT	15-03-430	120 mm / 4¾"
1/1	LANDOLT	15-03-431	120 mm / 4¾"



Artikel-Nr. Cat. No.	Gesamtlänge Total length		
02-03-175	130 mm / 5 1/8"	JAMESON- WERBER	1/1 
02-03-177	150 mm / 6"	JAMESON	1/1 



1/2
JAMESON
02-03-177
150 mm
6"

Artikel-Nr. Cat. No.	Gesamtlänge Total length		
02-03-911	130 mm / 5 1/8"	JAMESON Supercut	1/1 
02-03-915	150 mm / 6"	JAMESON Supercut	1/1 



1/2
JAMESON
Supercut
02-03-915
150 mm
6"





1/2
TOENNIS
02-03-633
 180 mm
 7"



1/1

TOENNIS
Artikel-Nr.
Cat. No.
02-03-633
Gesamtlänge
Total length

180 mm / 7"

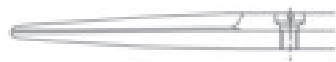
 sehr fein
very delicate

1/1

TOENNIS**02-03-634**

180 mm / 7"

 fein
delicate

1/1

TOENNIS**02-03-635**

180 mm / 7"

 fein
delicate

TC

Artikel-Nr. Cat. No.	Artikel-Nr. Cat. No.	Gesamtlänge Total length		
02-03-629		175 mm / 7" spitz sharp	DE BAKEY	1/1
02-03-630		175 mm / 7" sehr fein very delicate	TOENNIS-ADSON	1/1
02-03-631	02-03-273	175 mm / 7" fein delicate	TOENNIS-ADSON	1/1



1/2
TOENNIS-ADSON
02-03-630
175mm
7"

Artikel-Nr. Cat. No.	Gesamtlänge Total length		
02-53-465	170 mm / 6¾"	TOENNIS-ADSON Supercut	1/1



1/2
TOENNIS-ADSON
Supercut
02-53-465
170 mm
6¾"



 1/2
METZENBAUM
02-03-601
 145 mm
 5¾"



		TC				
		Artikel-Nr. Cat. No.	Artikel-Nr. Cat. No.	Gesamtlänge Total length		
1/1	METZEN- BAUM	02-03-601	02-03-260	145 mm / 5¾"		
		02-03-680		160 mm / 6¼"		
		02-03-602	02-03-262	180 mm / 7"		
		02-03-604	02-53-274	200 mm / 8"		
		02-03-611	02-03-266	230 mm / 9"		
		02-03-612	02-53-276	250 mm / 10"		
		02-03-613	02-53-286	280 mm / 11"		
		02-03-614	02-53-288	300 mm / 12"		
		1/1	METZEN- BAUM	02-03-605	02-03-261	145 mm / 5¾"
				02-03-683		160 mm / 6¼"
02-03-606	02-03-263			180 mm / 7"		
02-03-607	02-03-265			200 mm / 8"		
02-03-615	02-53-637			230 mm / 9"		
	02-03-287			230 mm / 9"		
				breite Blätter broad blade ends		
02-03-616	02-53-639			250 mm / 10"		
02-03-618	02-53-613			280 mm / 11"		
02-03-619	02-03-289			300 mm / 12"		
02-03-625		350 mm / 14"				

Black Line

 Oberfläche schwarz, titanbeschichtet
 Surface black, titanium-coated

 Beispiel-Artikel-Nr. **02-03-601B**
 Example Cat. No.

TC

Artikel-Nr. Cat. No.	Artikel-Nr. Cat. No.	Gesamtlänge Total length		
02-03-930	02-53-143	115 mm / 4½"		METZEN-BAUM Supercut 1/1
02-03-934	02-53-144	145 mm / 5¾"		
02-03-936	02-53-145	180 mm / 7"		
02-53-133	02-53-146	200 mm / 8"		
02-53-134	02-53-147	230 mm / 9"		
02-53-135	02-53-148	250 mm / 10"		
02-53-136	02-53-149	280 mm / 11"		
02-53-137	02-53-150	300 mm / 12"		
02-03-931	02-53-151	115 mm / 4½"		METZEN-BAUM Supercut 1/1
02-03-935	02-53-152	145 mm / 5¾"		
02-03-937	02-53-153	180 mm / 7"		
02-53-432	02-53-154	200 mm / 8"		
02-53-139	02-53-155	230 mm / 9"		
02-53-140	02-53-156	250 mm / 10"		
02-53-141	02-53-157	280 mm / 11"		
02-53-142	02-53-158	300 mm / 12"		



1/2
METZENBAUM Supercut
02-03-934
145 mm
5¾"

Black Line

Oberfläche schwarz, titanbeschichtet
Surface black, titanium-coated

Beispiel-Artikel-Nr. **02-03-934B**
Example Cat. No.



 1/2
METZENBAUM fino
02-03-600
 145 mm
 5¾"

 1/2
METZENBAUM fino
Supercut
02-53-490
 145 mm
 5¾"

TC

		Artikel-Nr. Cat. No.	Artikel-Nr. Cat. No.	Gesamtlänge Total length
1/1	METZEN- BAUM fino	02-53-599	02-03-256	115 mm / 4½"
		02-03-600	02-03-258	145 mm / 5¾"
		02-53-622	02-03-270	180 mm / 7"
		02-53-624	02-03-274	200 mm / 8"
		02-53-626	02-03-276	230 mm / 9"
		02-53-628	02-53-638	250 mm / 10"
1/1	METZEN- BAUM fino	02-53-610	02-53-612	280 mm / 11"
		02-53-601	02-03-257	115 mm / 4½"
		02-03-603	02-03-259	145 mm / 5¾"
		02-53-623	02-03-271	180 mm / 7"
		02-53-625	02-03-275	200 mm / 8"
		02-53-627	02-03-277	230 mm / 9"
1/1	METZEN- BAUM fino	02-53-629	02-03-279	250 mm / 10"
		02-53-611	02-03-281	280 mm / 11"

TC

		Artikel-Nr. Cat. No.	Artikel-Nr. Cat. No.	Gesamtlänge Total length
1/1	METZEN- BAUM fino Supercut	02-53-490	02-53-500	145 mm / 5¾"
		02-53-491	02-53-501	180 mm / 7"
		02-53-492	02-53-502	200 mm / 8"
		02-53-493	02-53-503	230 mm / 9"
		02-53-494	02-53-504	250 mm / 10"
		02-53-495	02-53-505	280 mm / 11"
1/1	METZEN- BAUM fino Supercut	02-53-462	02-53-506	145 mm / 5¾"
		02-53-463	02-53-507	180 mm / 7"
		02-53-464	02-53-508	200 mm / 8"
		02-53-496	02-53-509	230 mm / 9"
		02-53-497	02-53-510	250 mm / 10"
		02-53-498	02-53-511	280 mm / 11"

Black Line

 Oberfläche schwarz, titanbeschichtet
 Surface black, titanium-coated

 Beispiel-Artikel-Nr.
 Example Cat. No. **02-03-600B**

TC

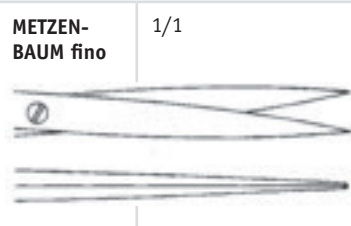
Artikel-Nr. Cat. No.	Artikel-Nr. Cat. No.	Gesamtlänge Total length		
02-53-520	02-53-528	140 mm / 5½"		1/1
02-53-521	02-53-529	180 mm / 7"		
02-53-522	02-53-530	200 mm / 8"		
02-53-523	02-53-531	230 mm / 9"		



1/2
METZENBAUM fino
02-53-520
140 mm
5½"

TC

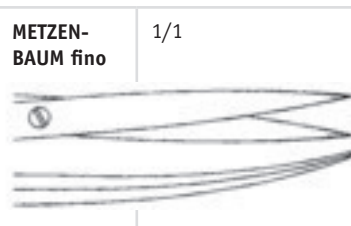
Artikel-Nr. Cat. No.	Artikel-Nr. Cat. No.	Gesamtlänge Total length		
02-53-524	02-53-532	140 mm / 5½"		1/1
02-53-525	02-53-533	180 mm / 7"		
02-53-526	02-53-534	200 mm / 8"		
02-53-527	02-53-535	230 mm / 9"		



1/2
METZENBAUM fino
02-53-524
140 mm
5½"



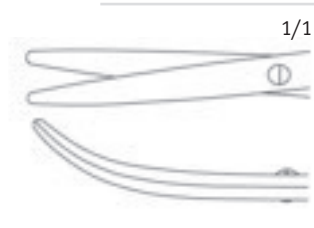

1/1

**METZEN-
BAUM fino
„S“**

Artikel-Nr.
Cat. No.

02-53-514

TC

Artikel-Nr.
Cat. No.

02-53-515

Gesamtlänge
Total length

180 mm / 7"

1/2
METZENBAUM fino „S“
02-53-514
180 mm
7"



1/1

**METZEN-
BAUM
NELSON**

Artikel-Nr.
Cat. No.

02-53-516

02-53-517

Gesamtlänge
Total length



180 mm / 7"

200 mm / 8"

1/2
**METZENBAUM
NELSON**
02-53-516
180 mm
7"





TC

Artikel-Nr. Cat. No.	Artikel-Nr. Cat. No.	Gesamtlänge Total length		
02-03-544	02-03-250	140 mm / 5½"		MAYO 1/1
02-03-545		155 mm / 6"		
02-03-547	02-03-252	170 mm / 6¾"		
02-53-548		190 mm / 7½"		
02-53-549	02-53-254	230 mm / 9"		
02-53-550		280 mm / 11"		
02-03-554	02-03-251	140 mm / 5½"		MAYO 1/1
02-03-555		155 mm / 6"		
02-03-557	02-03-253	170 mm / 6¾"		
02-53-558		190 mm / 7½"		
02-53-559	02-53-255	230 mm / 9"		
02-53-560		280 mm / 11"		

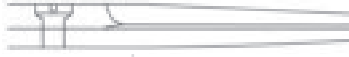

1/2
MAYO
02-03-547
170 mm
6¾"

TC

Artikel-Nr. Cat. No.	Artikel-Nr. Cat. No.	Gesamtlänge Total length		
02-53-466	02-53-477	140 mm / 5½"		MAYO Supercut 1/1
02-53-467	02-53-478	170 mm / 6¾"		
02-53-475	02-53-479	230 mm / 9"		
02-53-468	02-53-480	140 mm / 5½"		MAYO Supercut 1/1
02-53-469		170 mm / 6¾"		
02-53-476	02-53-481	230 mm / 9"		



1/2
MAYO
Supercut
02-53-467
170 mm
6¾"





TC

		Artikel-Nr. Cat. No.	Artikel-Nr. Cat. No.	Gesamtlänge Total length
1/1	MAYO-STILLE	02-03-580	02-53-278	150 mm / 6"
		02-03-584	02-03-242	170 mm / 6¾"
		02-03-585		200 mm / 8"
		02-53-576		210 mm / 8¼"
1/1	MAYO-STILLE	02-03-581	02-53-279	150 mm / 6"
		02-03-587	02-03-243	170 mm / 6¾"
		02-03-588		200 mm / 8"
		02-03-589		210 mm / 8¼"

1/2
MAYO STILLE
02-03-584
170 mm
6¾"





		Artikel-Nr. Cat. No.	Gesamtlänge Total length
1/1	LEXER fino	02-53-590	160 mm / 6¼"
1/1	LEXER fino	02-53-591	160 mm / 6¼"

1/2
LEXER fino
02-53-590
160 mm
6¼"





TC

Artikel-Nr. Cat. No.	Artikel-Nr. Cat. No.	Gesamtlänge Total length		
02-03-590	02-53-282	165 mm / 6½"		LEXER 1/1
02-53-592	02-53-284	210 mm / 8¼"		
02-03-591	02-03-283	165 mm / 6½"		LEXER 1/1
02-53-593	02-53-285	210 mm / 8¼"		



1/2
LEXER
02-03-590
165 mm
6½"

TC

Artikel-Nr. Cat. No.	Artikel-Nr. Cat. No.	Gesamtlänge Total length		
02-03-924	02-53-584	165 mm / 6½"		LEXER Supercut 1/1
02-53-581	02-53-585	210 mm / 8¼"		
02-03-925	02-53-586	165 mm / 6½"		LEXER Supercut 1/1
02-53-583	02-53-587	210 mm / 8¼"		



1/2
LEXER
Supercut
02-03-924
165 mm
6½"





		Artikel-Nr. Cat. No.	Gesamtlänge Total length
1/1	BARRÈ	02-03-715	280 mm / 11"



2/3
BARRÈ
 02-03-715
 280 mm
 11"



		Artikel-Nr. Cat. No.	Gesamtlänge Total length
1/1	WELLER	02-03-620	280 mm / 11"



2/3
WELLER
 02-03-620
 280 mm
 11"



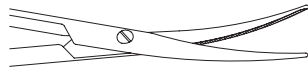

TC

Artikel-Nr.
Cat. No.

Gesamtlänge
Total length

02-03-257W

115 mm / 4½"

1/1



1/2
02-03-257W
115 mm
4½"

TC

Artikel-Nr.
Cat. No.

Gesamtlänge
Total length

02-03-259W

145 mm / 5¾"

BABY-
METZEN-
BAUM

1/1



1/2
BABY-
METZENBAUM
02-03-259W
145 mm
5¾"

Black Line

Oberfläche schwarz, titanbeschichtet
Surface black, titanium-coated

Beispiel-Artikel-Nr. **02-03-257WB**
Example Cat. No.



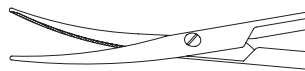

1/2
TOENNIS-ADSON
02-03-273W
 175 mm
 7"

		TC	
		Artikel-Nr. Cat. No.	Gesamtlänge Total length
1/1	TOENNIS-ADSON	02-03-273W	175 mm / 7"



1/2
MAYO
02-03-253W
 170 mm
 6¾"

		TC	
		Artikel-Nr. Cat. No.	Gesamtlänge Total length
1/1	MAYO	02-03-253W	170 mm / 6¾"

Black Line

Oberfläche schwarz, titanbeschichtet
 Surface black, titanium-coated

Beispiel-Artikel-Nr.
 Example Cat. No. **02-03-253WB**

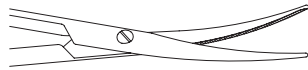

TC

Artikel-Nr.
Cat. No.

Gesamtlänge
Total length

02-03-283W	165 mm / 6½"	LEXER	1/1
------------	--------------	-------	-----



1/2
LEXER
02-03-283W
165 mm
6½"

TC

Artikel-Nr.
Cat. No.

Gesamtlänge
Total length

02-03-261W	145 mm / 5¾"	METZEN- BAUM	1/1
02-03-263W	180 mm / 7"		
02-03-265W	200 mm / 8"		



1/2
METZENBAUM
02-03-261W
145 mm
5¾"

Black Line

Oberfläche schwarz, titanbeschichtet
Surface black, titanium-coated

Beispiel-Artikel-Nr. **02-03-261WB**
Example Cat. No.



 1/3
**NELSON-
 METZENBAUM**
 02-03-267W
 230 mm
 9"

		TC	
		Artikel-Nr. Cat. No.	Gesamtlänge Total length
1/1	NELSON- METZEN- BAUM	02-03-267W	230 mm / 9"



 1/3
METZENBAUM
 02-03-287W
 230 mm
 9"

		TC	
		Artikel-Nr. Cat. No.	Gesamtlänge Total length
1/1	METZEN- BAUM	02-03-287W	230 mm / 9"

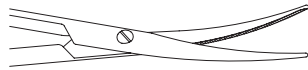

Black Line

 Oberfläche schwarz, titanbeschichtet
 Surface black, titanium-coated

 Beispiel-Artikel-Nr.
 Example Cat. No. **02-03-267WB**



TC

Artikel-Nr. Cat. No.	Gesamtlänge Total length		
02-03-271W	180 mm / 7"	METZEN- BAUM fino	1/1
02-03-275W	200 mm / 8"		
02-03-277W	230 mm / 9"		



1/2
METZENBAUM fino
02-03-271W
180 mm
7"

TC

Artikel-Nr. Cat. No.	Gesamtlänge Total length		
02-03-279W	260 mm / 10 ³ / ₄ "	NELSON- METZEN- BAUM	1/1
02-03-281W	280 mm / 11"		



1/3
NELSON-
METZENBAUM
02-03-279W
260 mm
10³/₄"

Black Line

Oberfläche schwarz, titanbeschichtet
Surface black, titanium-coated

Beispiel-Artikel-Nr. **02-03-271WB**
Example Cat. No.



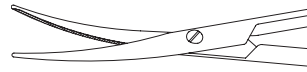

1/2
02-03-211W
110 mm
4 3/8"

		TC	
		Artikel-Nr. Cat. No.	Gesamtlänge Total length
1/1		02-03-211W	110 mm / 4 3/8"







1/2
02-03-294W
145 mm
5 3/4"

		TC	
		Artikel-Nr. Cat. No.	Gesamtlänge Total length
1/1		02-03-294W	145 mm / 5 3/4"
1/1		02-03-295W	180 mm / 7"
1/1		02-03-296W	230 mm / 9"
1/1		02-03-297W	260 mm / 1 1/4"

Black Line
Oberfläche schwarz, titanbeschichtet
Surface black, titanium-coated
Beispiel-Artikel-Nr. **02-03-211WB**
Example Cat. No.







TC

Artikel-Nr. Cat. No.	Artikel-Nr. Cat. No.	Gesamtlänge Total length		
02-53-640	02-53-650	135 mm / 5¼"	DIETHRICH-HEGEMANN	1/1 25° 
02-53-641		160 mm / 6¼"		
02-03-662		180 mm / 7"		
02-53-642	02-53-651	135 mm / 5¼"	DIETHRICH-HEGEMANN	1/1 45° 
02-53-643		160 mm / 6¼"		
02-03-663		180 mm / 7"		
02-53-644	02-53-652	135 mm / 5¼"	DIETHRICH-HEGEMANN	1/1 60° 
02-53-645		160 mm / 6¼"		
02-03-664		180 mm / 7"		
02-53-646	02-53-653	135 mm / 5¼"	DIETHRICH-HEGEMANN	1/1 90° 
02-53-647		160 mm / 6¼"		
02-03-653		180 mm / 7"		
02-53-648	02-53-654	135 mm / 5¼"	DIETHRICH-HEGEMANN	1/1 125° 
02-53-649		160 mm / 6¼"		
02-03-654		180 mm / 7"		







1/2
DIETHRICH-HEGEMANN
02-03-663
180 mm
7"



		TC				
		Artikel-Nr. Cat. No.	Artikel-Nr. Cat. No.	Gesamtlänge Total length		
		1/1 25°	POTTS-DE MARTELL	02-03-647	02-53-658	185 mm / 7¼"
		1/1 45°	POTTS-DE MARTELL	02-03-648	02-53-659	185 mm / 7¼"
		1/1 60°	POTTS-DE MARTELL	02-03-649	02-53-660	185 mm / 7¼"
		1/1 60°	POTTS-DE MARTELL	02-03-650		210 mm / 8¼"
		1/1 60°	POTTS-DE MARTELL	02-03-651		220 mm / 8¾"
		1/1 60°	MILLS	02-03-651		220 mm / 8¾"

1/3
POTTS-DE MARTELL
02-03-649
 185 mm
 7¼"

		TC				
		Artikel-Nr. Cat. No.	Artikel-Nr. Cat. No.	Gesamtlänge Total length		
		1/1 25°	POTTS-DE MARTELL Supercut	02-53-680	02-53-683	185 mm / 7¼"
		1/1 45°	POTTS-DE MARTELL Supercut	02-53-681	02-53-684	185 mm / 7¼"
		1/1 60°	POTTS-DE MARTELL Supercut	02-53-682	02-53-685	185 mm / 7¼"

1/3
POTTS-DE MARTELL
Supercut
02-53-681
 185 mm
 7¼"

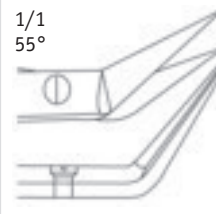
Artikel-Nr. Cat. No.	Gesamtlänge Total length		
02-03-646	180 mm / 7"	POTTS-SMITH	1/1 55° 

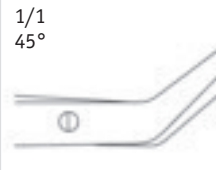
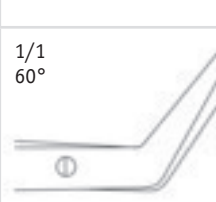

1/3
POTTS-SMITH
02-03-646
180 mm
7"

TC		Artikel-Nr. Cat. No.	Artikel-Nr. Cat. No.	Gesamtlänge Total length	
02-53-661	02-53-655	160 mm / 6¼"	DE BAKEY	1/1 25° 	
02-53-690	02-53-693	180 mm / 7"			
02-53-662	02-53-694	230 mm / 9"			
02-53-663		280 mm / 11"			
02-53-664	02-53-656	160 mm / 6¼"	DE BAKEY	1/1 45° 	
02-53-691	02-53-695	180 mm / 7"			
02-53-665	02-53-696	230 mm / 9"			
02-53-666	02-53-697	280 mm / 11"			
02-53-667	02-53-657	160 mm / 6¼"	DE BAKEY	1/1 60° 	
02-53-692	02-53-698	180 mm / 7"			
02-53-668	02-03-245	230 mm / 9"			
02-53-669		280 mm / 11"			



1/2
DE BAKEY
02-53-664
160 mm
6¼"





1/2
DIETHRICH
 02-53-673
 180 mm
 7"

		Artikel-Nr. Cat. No.	Gesamtlänge Total length
1/1 125° 	DIETHRICH	02-53-673	180 mm / 7"





1/2
**POTTS-
 DE MARTELL**
 02-53-674
 240 mm
 9½"

		Artikel-Nr. Cat. No.	Gesamtlänge Total length
1/1 	POTTS- DE MARTELL	02-03-650 02-53-674	210 mm / 8¼" 240 mm / 9½"



1/2
POTTS-SMITH
 02-03-652
 180 mm
 7"

		Artikel-Nr. Cat. No.	Gesamtlänge Total length
1/1 60° 	POTTS- SMITH	02-03-652	180 mm / 7"

Artikel-Nr. Cat. No.	Gesamtlänge Total length		
02-53-679	155 mm / 6"	DE BAKEY	1/1
	Offsetschere <i>offset scissors</i>		
02-03-669	155 mm / 6"	DE BAKEY	1/1 45°
	Offsetschere <i>offset scissors</i>		

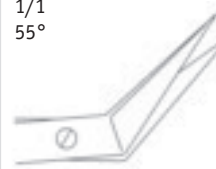

1/2
DE BAKEY
02-53-679
155 mm
6"

Artikel-Nr. Cat. No.	Gesamtlänge Total length		
02-03-670	140 mm / 5½"	FAVALORO	1/1 55°
	Coronararterien-Schere <i>coronary artery scissors</i>		





1/2
FAVALORO
02-03-670
140 mm
5½"



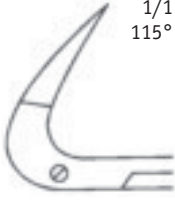

1/2
BEAL
02-53-035
 150 mm
 6"

		Artikel-Nr. Cat. No.	Gesamtlänge Total length
 1/1 115° BEAL Circumflex	02-53-035	spitz pointed	150 mm / 6"
 1/1 115° BEAL Circumflex	02-53-036	stumpf blunt	150 mm / 6"



1/2
POTTS-SMITH
02-53-037
 190 mm
 7½"

		Artikel-Nr. Cat. No.	Gesamtlänge Total length
 1/1 POTTS-SMITH	02-53-037		190 mm / 7½"



Artikel-Nr. Cat. No.	Gesamtlänge Total length		
02-03-660	170 mm / 6¾"	SCHMIEDEN-TAYLOR	1/1
	Duraschere <i>dura scissors</i>		

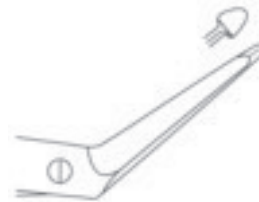

1/2
SCHMIEDEN-TAYLOR
02-03-660
 170 mm
 6¾"

Artikel-Nr. Cat. No.	Schaftlänge Length of the shaft		
02-03-665	180 mm / 7"	OLIVECRONA	1/1
	Duraschere <i>dura scissors</i>		



1/2
OLIVECRONA
02-03-665
 180 mm
 7"









1/2
MC INDOE
02-03-672
 190 mm
 7½"

		Artikel-Nr. Cat. No.	Gesamtlänge Total length
1/1	MC INDOE	02-03-672	190 mm / 7½"
			Knorpelschere, gezahnt <i>cartilage scissors, toothed</i>



1/2
DANDY
02-53-671
 170 mm
 6¾"

		Artikel-Nr. Cat. No.	Gesamtlänge Total length
1/1	DANDY	02-53-671	170 mm / 6¾"
		02-53-672	190 mm / 7½"
			Trigeminusschere <i>trigeminal scissors</i>

Artikel-Nr. Cat. No.	Gesamtlänge Total length		
02-53-038	190 mm / 7½"		1/1
			
02-53-039	190 mm / 7½"		1/1
			



1/2
02-53-038
 190 mm
 7½"

Artikel-Nr. Cat. No.	Gesamtlänge Total length		
02-03-642	225 mm / 9" spitz / spitz sharp / sharp		1/1



1/2
02-03-642
 225 mm
 9"





1/2
THOREK
02-03-636
190 mm
7½"

		Artikel-Nr. Cat. No.	Gesamtlänge Total length
1/1	THOREK	02-03-636	190 mm / 7½"
		02-53-712	250 mm / 10"



1/2
STRULLY
02-03-645
220 mm
8¾"

		Artikel-Nr. Cat. No.	Gesamtlänge Total length
1/1	STRULLY	02-03-644	220 mm / 8¾"
			spitz pointed
1/1	STRULLY	02-03-645	220 mm / 8¾"
			geknöpft probe pointed



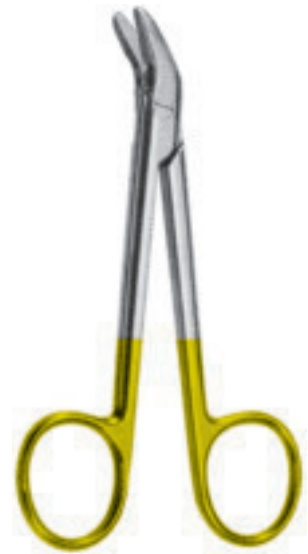

TC

Artikel-Nr. Cat. No.	Gesamtlänge Total length		
04-16-552	120 mm / 4¾"		1/1
	Draht- und Blehschere, 1 Schneide gezahnt wire cutting scissors, 1 blade toothed		

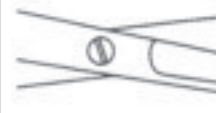

1/2
04-16-552
120 mm
4¾"

Artikel-Nr. Cat. No.	Gesamtlänge Total length		
02-03-801	90 mm / 3½"	SPENCER	1/1
			
02-03-802	110 mm / 4¼"	SPENCER	1/1
			
02-53-800	120 mm / 4¾"	SPENCER	1/1
			



1/2
SPENCER
02-03-802
110 mm
4¼"

Artikel-Nr. Cat. No.	Gesamtlänge Total length		
02-03-803	140 mm / 5½"	LITTAUER	1/1
			



1/2
LITTAUER
02-03-803
140 mm
5½"



1/2
FOMON
 15-11-370
 145 mm
 5¾"

		Artikel-Nr. Cat. No.	Gesamtlänge Total length
1/1	FOMON	15-11-370	145 mm / 5¾"
			Schneiden gezahnt blades toothed



1/2
COTTLE
 15-11-371
 165 mm
 6½"

		Artikel-Nr. Cat. No.	Gesamtlänge Total length
1/1	COTTLE	15-11-371	165 mm / 6½"

Artikel-Nr. Cat. No.	Gesamtlänge Total length		
15-11-350	175 mm / 7"	HEYMANN- KNIGHT	1/1
15-11-351	190 mm / 7½"		



Artikel-Nr. Cat. No.	Gesamtlänge Total length		
15-11-352	175 mm / 7" Schneiden gezahnt blades toothed	KIRSTEIN	1/1



1/2
HEYMANN-
KNIGHT
15-11-351
190 mm
7½"





2/3
15-03-021
100 mm
4"





		Artikel-Nr. Cat. No.	Gesamtlänge Total length
1/1		15-03-020	100 mm / 4"
1/1		15-03-021	100 mm / 4"
1/1		15-03-022	100 mm / 4"







2/3
02-04-215
125 mm
5"

TITAN

		Artikel-Nr. Cat. No.	Artikel-Nr. Cat. No.	Gesamtlänge Total length
1/1		02-04-210		115 mm / 4½"
1/1	SEMKEN 	02-04-215	02-04-215T	125 mm / 5"
1/1		02-04-500		100 mm / 4"
1/1		02-04-501		110 mm / 4¾"
1/1		02-04-502		110 mm / 4¾"
1/1	SEMKEN 	02-04-668		125 mm 5¾"
		02-04-669		145 mm / 5¾"
1/1	SEMKEN 	02-04-665		125 mm / 5"
		02-04-667		150 mm / 6"
1/1	SEMKEN 	02-04-666		125 mm / 5"

Artikel-Nr. Cat. No.	Gesamtlänge Total length		
02-04-301	90 mm / 3½"		1/1 
02-04-302	105 mm / 4¼"		1/1 
02-04-303	115 mm / 4½"		1/1 
02-04-304	125 mm / 5"		1/1 
02-04-305	145 mm / 5¾"		1/1 

Artikel-Nr. Cat. No.	Gesamtlänge Total length		
02-04-311	90 mm / 3½"		1/1 
02-04-312	105 mm / 4¼"		1/1 
02-04-313	115 mm / 4½"		1/1 
02-04-314	125 mm / 5"		1/1 
02-04-315	145 mm / 5¾"		1/1 



1/1
02-04-304
125 mm
5"





1/2
MICRO-ADSON
02-04-223
150 mm
6"

		Artikel-Nr. Cat. No.	Gesamtlänge Total length
1/1		02-04-220	120 mm / 4¾"
1/1		02-04-223	150 mm / 6"



1/2
MICRO-ADSON
02-04-520
150 mm
6"



		Artikel-Nr. Cat. No.	Gesamtlänge Total length
1/1		02-04-509	120 mm / 4¾"
1/1		02-04-510	120 mm / 4¾"
1/1		02-04-520	150 mm / 6"
1/1		02-54-521	180 mm / 7"



1/2
MICRO-ADSON
02-54-523
150 mm
6"

		TC Artikel-Nr. Cat. No.	Gesamtlänge Total length
1/1		02-54-522	120 mm / 4¾"
1/1		02-54-523	150 mm / 6"



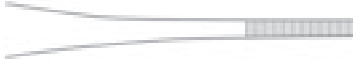

TITAN

Artikel-Nr. Cat. No.	Artikel-Nr. Cat. No.	Gesamtlänge Total length		
02-04-222	02-04-222T	120 mm / 4¾"	ADSON	1/1 
02-54-223		150 mm / 6"	ADSON	1/1 
02-04-224		180 mm / 7"	ADSON	1/1 
02-04-226		180 mm / 7"	ADSON	1/1 



2/3
ADSON
02-04-222
120 mm
4¾"

TC

Artikel-Nr. Cat. No.	Gesamtlänge Total length		
02-04-151	120 mm / 4¾"	ADSON	1/1 
02-54-152	150 mm / 6"	ADSON	1/1 
02-54-153	120 mm / 4¾"	ADSON	1/1 
02-54-154	150 mm / 6"	ADSON	1/1 



2/3
ADSON
02-04-153
120 mm
4¾"





2/3
02-04-511
120 mm
4¾"





		Artikel-Nr. Cat. No.	Gesamtlänge Total length
	1/1	ADSON 02-04-511	120 mm / 4¾"
	1/1	ADSON 13-02-454	120 mm / 4¾"
	1/1	ADSON 02-04-512 02-54-513	120 mm / 4¾" 150 mm / 6"
	1/1	ADSON 02-04-522	180 mm / 7"
	1/1	JEFFERSON 02-04-523	180 mm / 7"
	1/1	ADSON-BROWN 02-04-700	120 mm / 4¾"



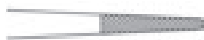

1/1
ADSON
02-04-521
150 mm
6"

		Artikel-Nr. Cat. No.	Gesamtlänge Total length
	1/1	ADSON 02-04-506	120 mm / 4¾"
	1/1	ADSON 02-04-508	120 mm / 4¾"
	1/1	ADSON 02-04-507	120 mm / 4¾"
	1/1	ADSON 02-04-513	120 mm / 4¾"
	1/1	ADSON 02-04-521	150 mm / 6"

TC

Artikel-Nr. Cat. No.	Gesamtlänge Total length		
02-04-154	145 mm / 5¾"		1/1 
02-04-155	160 mm / 6¼"		1/1 
02-04-156	180 mm / 7"		1/1 
02-04-157	200 mm / 8"		1/1 
02-04-158	230 mm / 9"		1/1 
02-04-159	250 mm / 10"		1/1 

TC

Artikel-Nr. Cat. No.	Gesamtlänge Total length		
02-04-164	145 mm / 5¾"	STANDARD	1/1 
02-04-165	200 mm / 8"	STANDARD	1/1 
02-04-166	250 mm / 10"	STANDARD	1/1 



1/1
02-04-154
145 mm
5¾"





1/1
02-04-047
 145 mm
 5¾"



		Artikel-Nr. Cat. No.	Gesamtlänge Total length
1/1	STANDARD	02-04-043	115 mm / 4½"
1/1	STANDARD	02-04-045	130 mm / 5⅛"
1/1	STANDARD	02-04-047	145 mm / 5¾"
1/1	STANDARD	02-04-049	160 mm / 6¼"
1/1	STANDARD	02-04-050	180 mm / 7"
1/1	STANDARD	02-04-051	200 mm / 8"
1/1	STANDARD	02-04-052	250 mm / 10"
1/1	STANDARD	02-04-053	300 mm / 12"



Artikel-Nr. Cat. No.	Gesamtlänge Total length		
02-04-023	115 mm / 4½"		1/1 
02-04-025	130 mm / 5⅛"		1/1 
02-04-027	145 mm / 5¾"		1/1 
02-04-029	160 mm / 6¼"		1/1 
02-04-030	180 mm / 7"		1/1 
02-04-031	200 mm / 8"		1/1 
02-04-032	250 mm / 10"		1/1 
02-04-033	300 mm / 12"		1/1 

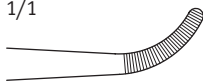

1/1
02-04-027
145 mm
5¾"

Artikel-Nr. Cat. No.	Gesamtlänge Total length		
02-04-035	130 mm / 5⅛"		1/1 
02-04-037	145 mm / 5¾"		1/1 





1/1
02-04-557
 145 mm
 5¾"

		Artikel-Nr. Cat. No.	Gesamtlänge Total length
1/1	STANDARD	02-04-553	115 mm / 4½"
1/1	STANDARD	02-04-555	130 mm / 5⅛"
1/1	STANDARD	02-04-557	145 mm / 5¾"
1/1	STANDARD	02-04-559	160 mm / 6¼"
1/1	STANDARD	02-04-560	180 mm / 7"
1/1	STANDARD	02-04-561	200 mm / 8"
1/1	STANDARD	02-04-562	250 mm / 10"
1/1	STANDARD	02-04-563	300 mm / 12"



Artikel-Nr. Cat. No.		Gesamtlänge Total length		
02-04-533	schmal narrow	115 mm / 4½"		1/1 
02-04-535	schmal narrow	130 mm / 5⅛"		1/1 
02-04-537	schmal narrow	145 mm / 5¾"		1/1 
02-04-539	schmal narrow	160 mm / 6¼"		1/1 
02-04-540	schmal narrow	180 mm / 7"		1/1 
02-04-541	schmal narrow	200 mm / 8"		1/1 
02-04-542	schmal narrow	250 mm / 10"		1/1 
02-04-543	schmal narrow	300 mm / 12"		1/1 



1/1
02-04-537
145 mm
5¾"





1/2
CUSHING
02-04-238
180 mm
7"







		Artikel-Nr. Cat. No.	Gesamtlänge Total length
1/1	CUSHING	02-04-238	180 mm / 7"
1/1	CUSHING	02-04-239	200 mm / 8"
1/1	CUSHING	02-04-243	200 mm / 8"
1/1	CUSHING	02-04-240	250 mm / 10"



1/2
02-04-231
185 mm
7 1/4"

		Artikel-Nr. Cat. No.	Gesamtlänge Total length
1/1	BROPHY	02-04-246	200 mm / 8"
1/1	BROPHY	02-04-247	200 mm / 8"
1/1	BROPHY	02-54-248	300 mm / 8"
1/1	BROPHY	02-04-678	200 mm / 8"

		Artikel-Nr. Cat. No.	Gesamtlänge Total length
1/1		02-04-231	185 mm / 7 1/4"
1/1		02-04-232	200 mm / 8"
1/1		02-04-257	200 mm / 8"

Artikel-Nr. Cat. No.	Gesamtlänge Total length		
02-54-574	115 mm / 4½"		1/1 
02-54-575	130 mm / 5"		1/1 
02-54-577	145 mm / 5¾"		1/1 
02-54-579	160 mm / 6¼"		1/1 
02-54-580	180 mm / 7"		1/1 
02-54-581	200 mm / 8"		1/1 
02-54-582	250 mm / 10"		1/1 



1/1
02-04-579
160 mm
6¼"





1/2
BROWN
02-04-701
150 mm
6"

		Artikel-Nr. Cat. No.	Gesamtlänge Total length
1/1	BROWN	02-04-701	150 mm / 6"
1/1	BROWN	02-04-702	200 mm / 8"





1/2
02-04-587
145 mm
5 3/4"

		Artikel-Nr. Cat. No.	Gesamtlänge Total length
1/1		02-04-587	145 mm / 5 3/4"
1/1		02-04-589	160 mm / 6 1/4"
1/1		02-04-591	200 mm / 8"





1/2
LANE
02-04-602
125 mm
5"

		Artikel-Nr. Cat. No.	Gesamtlänge Total length
1/1	LANE	02-04-602	125 mm / 5"
1/1	LANE	02-04-603	145 mm / 5 3/4"
1/1	LANE	02-04-604	145 mm / 5 3/4"
1/1	LANE	02-04-606	175 mm / 7"
1/1	LANE	02-04-607	175 mm / 7"

		TITAN	TC		
Artikel-Nr. Cat. No.	Artikel-Nr. Cat. No.	Artikel-Nr. Cat. No.	Gesamtlänge Total length		
02-04-236	02-04-236T		150 mm / 6"	MC INDOE	1/1 
		02-54-237	150 mm / 6"	MC INDOE	1/1 
02-04-661			150 mm / 6"	MC INDOE	1/1 





2/3
MC INDOE
02-54-237
150 mm
6"

		TC		
Artikel-Nr. Cat. No.	Artikel-Nr. Cat. No.	Gesamtlänge Total length		
02-04-213		150 mm / 6"	GILLIES	1/1 
02-04-660		150 mm / 6"	GILLIES	1/1 
	02-54-661	150 mm / 6"	GILLIES	1/1 





2/3
GILLIES
02-54-661
150 mm
6"

 1/2
CUSHING
13-04-463
 170 mm
 6¾"

		Artikel-Nr. Cat. No.	Gesamtlänge Total length
1/1	 CAIRNS-DOTT	02-04-268	175 mm / 7"
1/1	 CUSHING	13-04-463	170 mm / 6¾"

 1/2
CUSHING
02-04-160
 180 mm
 7"

		TC Artikel-Nr. Cat. No.	Gesamtlänge Total length
1/1	 CUSHING	02-04-160	180 mm / 7"
1/1	 CUSHING	02-54-161	170 mm / 6¾"
1/1	 CUSHING	02-54-162	170 mm / 6¾"

TITAN

Artikel-Nr. Cat. No.	Artikel-Nr. Cat. No.	Gesamtlänge Total length	GERALD	1/1
02-04-228	02-04-228T	175 mm / 7"	GERALD	1/1
02-04-229		175 mm / 7"	GERALD	1/1
02-04-230		230 mm / 9"	GERALD	1/1



1/2
GERALD
02-04-228
175 mm
7"

Artikel-Nr. Cat. No.	Gesamtlänge Total length	GERALD	1/1
02-04-662	175 mm / 7"	GERALD	1/1
02-04-663	175 mm / 7"	GERALD	1/1
02-04-664	230 mm / 9"	GERALD	1/1



1/2
GERALD
02-04-662
175 mm
7"





 1/2
WAUGH
02-04-671
 200 mm
 8"

		Artikel-Nr. Cat. No.	Gesamtlänge Total length
	1/1	WAUGH 02-04-670	180 mm / 7"
	1/1	WAUGH 02-04-671	200 mm / 8"
	1/1	WAUGH 02-04-672	250 mm / 10"
	1/1	WAUGH 02-04-679	305 mm / 12"



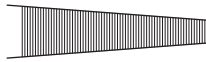
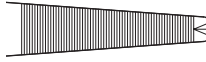

 1/2
TREVES
02-04-609
 150 mm
 6"

		Artikel-Nr. Cat. No.	Gesamtlänge Total length
	1/1	TREVES 02-04-608	125 mm / 5"
	1/1	TREVES 02-04-609	150 mm / 6"

Artikel-Nr. Cat. No.	Gesamtlänge Total length		
02-04-078	175 mm / 7"	BONNEY	1/1 
02-04-693	175 mm / 7"	BONNEY	1/1 

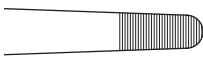

1/2
BONNEY
02-04-693
175 mm
7"

Artikel-Nr. Cat. No.	Gesamtlänge Total length		
02-04-083	180 mm / 7"	RAMSEY	1/1 
02-04-610	180 mm / 7"	RAMSEY	1/1 
02-04-611	180 mm / 7"	RAMSEY	1/1 







1/2
RAMSEY
02-04-610
180 mm
7"

ATRAUMA

DE BAKEY

TITAN

		Artikel-Nr. Cat. No.	Artikel-Nr. Cat. No.	Gesamtlänge Total length
1/1 1,5 mm 	DE BAKEY	06-02-411	06-02-411T	160 mm / 6¼"
		06-02-412	06-02-412T	200 mm / 8"
		06-52-100	06-52-100T	240 mm / 9½"
		06-52-101	06-52-101T	300 mm / 12"
1/1 1,5 mm 	DE BAKEY	06-52-102		160 mm / 6¼"
		06-52-103		200 mm / 8"
		06-52-104		240 mm / 9½"
		06-52-105		300 mm / 12"
1/1 2,0 mm 	DE BAKEY	06-02-400	06-02-400T	160 mm / 6¼"
		06-02-402	06-02-402T	200 mm / 8"
		06-02-404	06-02-404T	240 mm / 9½"
		06-02-405	06-02-405T	300 mm / 12"
1/1 2,0 mm 	DE BAKEY	06-02-401	06-02-401T	160 mm / 6¼"
		06-02-403	06-02-403T	200 mm / 8"
		06-52-119	06-52-119T	240 mm / 9½"
		06-52-120	06-52-120T	300 mm / 12"
1/1 2,4 mm 	DE BAKEY	06-52-106	06-52-106T	160 mm / 6¼"
		06-52-107	06-52-107T	200 mm / 8"
		06-52-108	06-52-108T	240 mm / 9½"
		06-52-109	06-52-109T	300 mm / 12"

 1/1
DE BAKEY
06-02-412
 200 mm
 8"

TITAN

Artikel-Nr. Cat. No.	Artikel-Nr. Cat. No.	Gesamtlänge Total length		
06-02-414	06-02-414T	160 mm / 6¼"	DE BAKEY	1/1 2,8 mm
06-02-415	06-02-415T	200 mm / 8"		
06-02-416	06-02-416T	240 mm / 9½"		
06-02-417	06-02-417T	300 mm / 12"		
06-52-110		160 mm / 6¼"	DE BAKEY	1/1 2,8 mm
06-52-111		200 mm / 8"		
06-52-112		240 mm / 9½"		
06-52-113		300 mm / 12"		
06-52-114	06-52-114T	160 mm / 6¼"	DE BAKEY	1/1 3,5 mm
06-52-115	06-52-115T	200 mm / 8"		
06-52-116	06-52-116T	240 mm / 9½"		
06-52-117	06-52-117T	300 mm / 12"		
06-52-118		160 mm / 6¼"	DE BAKEY	1/1 3,5 mm
06-02-406		200 mm / 8"		
06-02-407		240 mm / 9½"		
06-02-408		300 mm / 12"		
06-02-409		350 mm / 14"		

ATRAUMA



1/1
DE BAKEY
06-02-414
160 mm
6¼"



ATRAUMA

DE BAKEY

 1/1
 1,0 mm

DE BAKEY
Artikel-Nr.
Cat. No.
06-02-394
06-02-395
06-02-396
Gesamtlänge
Total length

150 mm / 6"

195 mm / 7¾"





240 mm / 9½"

 1/1
DE BAKEY
06-02-395
 195 mm
 7¾"

ATRAUMA



DE BAKEY

Artikel-Nr. Cat. No.	Gesamtlänge Total length		
06-03-411	150 mm / 6"	DE BAKEY	1/1 1,2 mm 
06-03-412	200 mm / 8"	DE BAKEY	1/1 1,5 mm 
06-03-413	240 mm / 9½"	DE BAKEY	1/1 1,5 mm 
06-03-418	300 mm / 12"	DE BAKEY	1/1 1,5 mm 



1/2
DE BAKEY
06-03-412
200 mm
8"



ATRAUMA

COOLEY

 1/1
 2,0 mm

COOLEY
Artikel-Nr.
Cat. No.
Gesamtlänge
Total length
06-02-784

160 mm / 6¼"

06-02-785

200 mm / 8"

06-52-786

240 mm / 9½"

10

 1/1
COOLEY
06-02-785
 200 mm
 8"

Area with horizontal lines for notes.





2/3
BABY-MOSQUITO
02-08-104
100 mm
4"



		Artikel-Nr. Cat. No.	Gesamtlänge Total length
1/1	BABY-MOSQUITO	02-08-104	100 mm / 4"
1/1	BABY-MOSQUITO	02-08-105	100 mm / 4"
1/1	BABY-MOSQUITO	02-08-114	100 mm / 4"
1/1	BABY-MOSQUITO	02-08-115	100 mm / 4"
1/1	MICRO-HALSTED	02-08-108	125 mm / 5"
1/1	MICRO-HALSTED	02-08-109	125 mm / 5"
1/1	MICRO-HALSTED	02-08-118	125 mm / 5"
1/1	MICRO-HALSTED	02-08-119	125 mm / 5"



2/3
HALSTED-MOSQUITO
02-08-110
125 mm
5"



		Artikel-Nr. Cat. No.	TITAN Artikel-Nr. Cat. No.	Gesamtlänge Total length
1/1	HALSTED-MOSQUITO	02-08-110	02-08-110T	125 mm / 5"
1/1	HALSTED-MOSQUITO	02-08-111	02-08-111T	125 mm / 5"
1/1	HALSTED-MOSQUITO	02-08-120	02-08-120T	125 mm / 5"
1/1	HALSTED-MOSQUITO	02-08-121	02-08-121T	125 mm / 5"

Artikel-Nr. Cat. No.	Gesamtlänge Total length		
02-08-123	125 mm / 5"	DUNHILL	1/1 



Artikel-Nr. Cat. No.	Gesamtlänge Total length		
02-08-124	140 mm / 5½"	CAIRNS	1/1 
02-08-125	140 mm / 5½"	CAIRNS	1/1 



1/2
CAIRNS
02-08-124
140 mm
5½"

Artikel-Nr. Cat. No.	Gesamtlänge Total length		
02-08-130	140 mm / 5½"	PROVIDENCE-HOSPITAL	1/1 
02-08-131	140 mm / 5½"	PROVIDENCE-HOSPITAL	1/1 

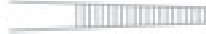
TITAN

Artikel-Nr. Cat. No.	Artikel-Nr. Cat. No.	Gesamtlänge Total length		
02-08-134	02-08-134T	140 mm / 5½"	KELLY	1/1 
02-08-135	02-08-135T	140 mm / 5½"	KELLY	1/1 



1/2
KELLY
02-08-134
140 mm
5½"









1/2
BABY-CRILE
02-08-140
140 mm
5½"

		Artikel-Nr. Cat. No.	Gesamtlänge Total length
	1/1 BABY-CRILE	02-08-140	140 mm / 5½"
	1/1 BABY-CRILE	02-08-141	140 mm / 5½"
	1/1 BABY-CRILE	02-08-150	140 mm / 5½"
	1/1 BABY-CRILE	02-08-151	140 mm / 5½"



1/2
CRILE
02-08-144
140 mm
5½"

		Artikel-Nr. Cat. No.	TITAN Artikel-Nr. Cat. No.	Gesamtlänge Total length
	1/1 CRILE	02-08-144	02-08-144T	140 mm / 5½"
	1/1 CRILE	02-08-145	02-08-145T	140 mm / 5½"
	1/1 CRILE	02-08-154		140 mm / 5½"
	1/1 CRILE	02-08-155		140 mm / 5½"

Artikel-Nr. Cat. No.	Gesamtlänge Total length		
02-08-166	160 mm / 6¼"	CRILE	1/1 
02-08-167	160 mm / 6¼"	CRILE	1/1 
02-08-176	160 mm / 6¼"	CRILE	1/1 
02-08-177	160 mm / 6¼"	CRILE	1/1 

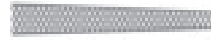

1/2
CRILE
02-08-166
160 mm
6¼"

Artikel-Nr. Cat. No.	Gesamtlänge Total length		
02-08-168	160 mm / 6¼"	DIXON- LOVELACE	1/1 
02-08-178	160 mm / 6¼"	DIXON- LOVELACE	1/1 







1/2
DIXON-LOVELACE
02-08-178
160 mm
6¼"





1/2
LERICHE
02-08-160
150 mm
6"







		Artikel-Nr. Cat. No.	Gesamtlänge Total length
1/1		LERICHE 02-08-160	150 mm / 6"
1/1		LERICHE 02-08-161	150 mm / 6"
1/1		LERICHE 02-08-170	150 mm / 6"
1/1		LERICHE 02-08-171	150 mm / 6"









1/2
RANKIN
02-08-164
160 mm
6 1/4"

		Artikel-Nr. Cat. No.	Gesamtlänge Total length
1/1		RANKIN 02-08-164	160 mm / 6 1/4"
1/1		RANKIN 02-08-165	160 mm / 6 1/4"



Artikel-Nr. Cat. No.	Gesamtlänge Total length			
02-08-412	130 mm / 5 1/8"	PEAN	1/1	
	fein delicate			
02-08-413	130 mm / 5 1/8"	PEAN	1/1	
	fein delicate			
02-08-414	140 mm / 5 1/2"	PEAN	1/1	
	fein delicate			
02-08-415	140 mm / 5 1/2"	PEAN	1/1	
	fein delicate			
02-58-416	160 mm / 6 1/4"	PEAN	1/1	
	fein delicate			
02-58-417	160 mm / 6 1/4"	PEAN	1/1	
	fein delicate			

1/2
PEAN
02-08-414
140 mm
5 1/2"

Artikel-Nr. Cat. No.	Gesamtlänge Total length			
02-08-612	130 mm / 5 1/8"	KOCHER	1/1	
	fein delicate			
02-08-613	130 mm / 5 1/8"	KOCHER	1/1	
	fein delicate			
02-08-614	140 mm / 5 1/2"	KOCHER	1/1	
	fein delicate			
02-08-615	140 mm / 5 1/2"	KOCHER	1/1	
	fein delicate			
02-58-616	160 mm / 6 1/4"	KOCHER	1/1	
	fein delicate			
02-58-617	160 mm / 6 1/4"	KOCHER	1/1	
	fein delicate			

1/2
KOCHER
02-08-614
140 mm
5 1/2"



1/2
ROCHESTER-PEAN
02-08-444
 180 mm
 7"

		Artikel-Nr. Cat. No.	Gesamtlänge Total length
1/1	ROCHESTER-PEAN	02-08-424	140 mm / 5½"
1/1	ROCHESTER-PEAN	02-08-442	160 mm / 6¼"
1/1	ROCHESTER-PEAN	02-08-444	180 mm / 7"
1/1	ROCHESTER-PEAN	02-08-446	200 mm / 8"
1/1	ROCHESTER-PEAN	02-08-448	220 mm / 8¾"
1/1	ROCHESTER-PEAN	02-08-450	240 mm / 9½"
1/1	ROCHESTER-PEAN	02-08-472	260 mm / 10¼"
1/1	ROCHESTER-PEAN	02-08-474	300 mm / 12"



Artikel-Nr. Cat. No.	Gesamtlänge Total length		
02-08-425	140 mm / 5½"	ROCHESTER-PEAN	1/1
02-08-443	160 mm / 6¼"	ROCHESTER-PEAN	1/1
02-08-445	180 mm / 7"	ROCHESTER-PEAN	1/1
02-08-447	200 mm / 8"	ROCHESTER-PEAN	1/1
02-08-449	220 mm / 8¾"	ROCHESTER-PEAN	1/1
02-08-451	240 mm / 9½"	ROCHESTER-PEAN	1/1
02-08-473	260 mm / 10¼"	ROCHESTER-PEAN	1/1
02-08-475	300 mm / 12"	ROCHESTER-PEAN	1/1

1/2
ROCHESTER-PEAN
02-08-445
180 mm
7"



1/2
ROCHESTER-OCHSNER
02-08-644
180 mm
7"



		Artikel-Nr. Cat. No.	Gesamtlänge Total length
1/1	ROCHESTER-OCHSNER	02-08-618	140 mm / 5½"
1/1	ROCHESTER-OCHSNER	02-08-642	160 mm / 6¼"
1/1	ROCHESTER-OCHSNER	02-08-644	180 mm / 7"
1/1	ROCHESTER-OCHSNER	02-08-646	200 mm / 8"
1/1	ROCHESTER-OCHSNER	02-08-648	220 mm / 8¾"
1/1	ROCHESTER-OCHSNER	02-08-650	240 mm / 9½"
1/1	ROCHESTER-OCHSNER	02-08-652	260 mm / 10¼"
1/1	ROCHESTER-OCHSNER	02-08-654	300 mm / 12"

Artikel-Nr. Cat. No.	Gesamtlänge Total length		
02-08-619	140 mm / 5½"	ROCHESTER-OCHSNER	1/1
02-08-643	160 mm / 6¼"	ROCHESTER-OCHSNER	1/1
02-08-645	180 mm / 7"	ROCHESTER-OCHSNER	1/1
02-08-647	200 mm / 8"	ROCHESTER-OCHSNER	1/1
02-08-649	220 mm / 8¾"	ROCHESTER-OCHSNER	1/1
02-08-651	240 mm / 9½"	ROCHESTER-OCHSNER	1/1
02-08-653	260 mm / 10¼"	ROCHESTER-OCHSNER	1/1
02-08-655	300 mm / 12"	ROCHESTER-OCHSNER	1/1



1/2
ROCHESTER-OCHSNER
02-08-645
180 mm
7"







1/2
MICRO-ADSON
02-10-008
 140 mm
 5½"

		Artikel-Nr. Cat. No.	Gesamtlänge Total length
	1/1 MICRO-ADSON	02-10-008	140 mm / 5½"



1/2
BABY-MIXTER
02-10-011
 140 mm
 5½"

		Artikel-Nr. Cat. No.	Gesamtlänge Total length
	1/1 BABY-MIXTER	02-10-011	140 mm / 5½"
	1/1 BABY-MIXTER	02-10-012	180 mm / 7"

Artikel-Nr. Cat. No.	Gesamtlänge Total length		
02-10-100	130 mm / 5 1/8"	GEMINI	1/1
02-10-102	180 mm / 7"	GEMINI	1/1
02-10-103	200 mm / 8"	GEMINI	1/1
02-10-104	230 mm / 9"	GEMINI	1/1
02-10-106	280 mm / 11"	GEMINI	1/1

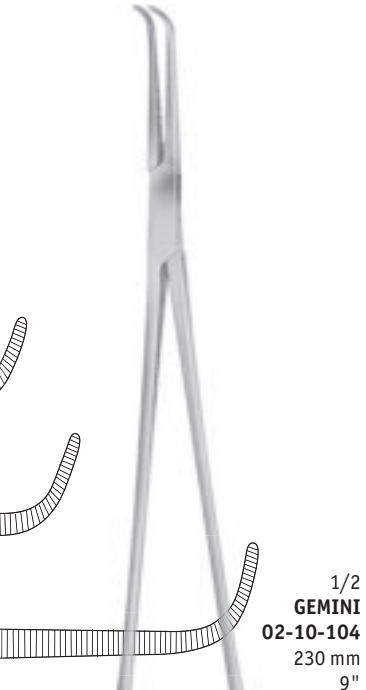

1/2
GEMINI
02-10-104
230 mm
9"

Artikel-Nr. Cat. No.	Gesamtlänge Total length		
02-10-020	195 mm / 7 3/4"	OVERHOLT- GEISSEN- DOERFER	1/1
02-10-021	210 mm / 8 1/4"	OVERHOLT- GEISSEN- DOERFER	1/1
02-10-022	220 mm / 8 3/4"	OVERHOLT- GEISSEN- DOERFER	1/1
02-10-023	225 mm / 9"	OVERHOLT- GEISSEN- DOERFER	1/1
02-10-024	210 mm / 8 1/4"	OVERHOLT- GEISSEN- DOERFER	1/1
02-10-025	230 mm / 9"	OVERHOLT- GEISSEN- DOERFER	1/1
02-10-026	225 mm / 9"	OVERHOLT- GEISSEN- DOERFER	1/1



1/2
OVERHOLT-
GEISSEN-
DOERFER
02-10-020
195 mm
7 3/4"



1/2
02-56-467
 160 mm
 6¼"

	Artikel-Nr. Cat. No.	Gesamtlänge Total length
1/1	02-56-463	90 mm / 3½"
	02-56-464	100 mm / 4"
	02-06-465	110 mm / 4¼"
	02-06-464	130 mm / 5"
	02-56-466	140 mm / 5½"
	02-56-467	160 mm / 6¼"

für Papierabdeckung
for paper clothes



1/2
02-06-466
 130 mm
 5"





	Artikel-Nr. Cat. No.	Gesamtlänge Total length
1/1	02-56-465	100 mm / 4" stumpf blunt
1/1	02-06-466	130 mm / 5" stumpf blunt



Artikel-Nr. Cat. No.	Gesamtlänge Total length		
02-06-431	90 mm / 3½"	BACKHAUS	1/1
02-06-432	110 mm / 4¾"		
02-06-433	135 mm / 5¼"		
02-56-434	150 mm / 6"		

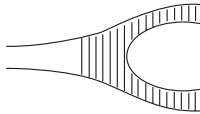

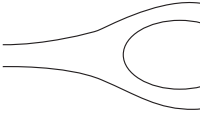
1/2
BACKHAUS
02-06-432
110 mm
4¾"

Artikel-Nr. Cat. No.	Gesamtlänge Total length		
02-06-112	180 mm / 7"	FOERSTER	1/1
02-56-114	200 mm / 8"		
02-06-122	240 mm / 9½"		
	gerade straight		
02-06-113	180 mm / 7"	FOERSTER	1/1
02-56-115	200 mm / 8"		
02-06-123	240 mm / 9½"		
	gebogen curved		
02-56-116	180 mm / 7"	FOERSTER	1/1
02-56-117	200 mm / 8"		
02-06-120	240 mm / 9½"		
	gerade straight		
02-56-118	180 mm / 7"	FOERSTER	1/1
02-56-119	200 mm / 8"		
02-06-121	240 mm / 9½"		
	gebogen curved		



1/2
FOERSTER
02-06-112
180 mm
7"





1/1

DE MARTEL
Artikel-Nr.
Cat. No.
06-06-010**06-06-011**
Gesamtlänge
Total length

135 mm / 5¼"

185 mm / 7¼"

 Kopfhautklemme, leicht gebogen
scalp flap forceps, slightly curved

 1/2
DE MARTEL
06-06-010
 135 mm
 5¼"

Artikel-Nr.
Cat. No.
02-08-139**02-08-143****02-08-126**
Gesamtlänge
Total length

140 mm / 5½"

140 mm / 5½"

145 mm / 5¾"

 seitwärts gebogen
curved to side

 seitwärts gebogen
curved to side

 seitwärts gebogen
curved to side

1/1

DANDY

1/1

DANDY





1/1

MOYNIHAN
 1/2
DANDY
02-08-139
 140 mm
 5½"

Area with horizontal lines for notes.





Folgende Hartmetalleinlagen werden für REBSTOCK TC Nadelhalter verwendet:
 The REBSTOCK TC needle holders are equipped with the following tungsten carbide inserts

		TC	
		Teilung Structure	empfohlen für Nahtmaterial recommended for suture material
	normal regular	0,5 mm	>3/0
	mini mini	0,4 mm	4/0 - 6/0
	mikro micro	0,3 mm	5/0 - 8/0
	glatt smooth	-	7/0 - 10/0





TC

Artikel-Nr. Cat. No.	Artikel-Nr. Cat. No.	Gesamtlänge Total length		
02-13-200		125 mm / 5"	CONVERSE	1/1 
02-13-204		125 mm / 5"	DERF	1/1 
	02-13-008	125 mm / 5"	DERF	1/1 0,4 mm 





1/2
DERF
02-13-204
125 mm
5"

Artikel-Nr. Cat. No.		Gesamtlänge Total length		
02-13-201	glattes Maul smooth jaw	130 mm / 5 1/8"	HALSEY	1/1 
02-13-205		130 mm / 5 1/8"	HALSEY	1/1 



1/2
HALSEY
02-13-205
130 mm
5 1/8"

TC

Artikel-Nr. Cat. No.		Gesamtlänge Total length		
02-13-010	glattes Maul smooth jaw	120 mm / 4 3/4"	HALSEY	1/1 
02-13-012		130 mm / 5 1/8"	HALSEY	1/1 0,4 mm 
02-13-011		130 mm / 5 1/8"	CONVERSE	1/1 0,4 mm 





1/2
HALSEY
02-13-010
120 mm
4 3/4"





1/2
WEBSTER
02-13-202
 130 mm
 5 1/8"

		TC		
	Artikel-Nr. Cat. No.	Artikel-Nr. Cat. No.	Gesamtlänge Total length	
1/1	WEBSTER	02-63-202	115 mm / 4 1/2"	
		02-13-202	130 mm / 5 1/8"	
			glattes Maul smooth jaw	
1/1	WEBSTER	02-63-014	120 mm / 4 3/4"	
		02-13-014	130 mm / 5 1/8"	
			glattes Maul smooth jaw	
1/1 0,4 mm	WEBSTER	02-13-024	125 mm / 5"	
				



1/2
BAUMGARTNER
02-13-015
 140 mm
 5 1/2"

		TC		
	Artikel-Nr. Cat. No.	Artikel-Nr. Cat. No.	Gesamtlänge Total length	
1/1 0,5 mm	BAUM- GARTNER	02-63-016	125 mm / 5"	
		02-13-015	140 mm / 5 1/2"	









		TC		
	Artikel-Nr. Cat. No.	Artikel-Nr. Cat. No.	Gesamtlänge Total length	
1/1 0,5	KILNER	02-13-018	135 mm / 5 1/4"	
				

1/2
KILNER
02-13-018
 135 mm
 5 1/4"

Artikel-Nr. Cat. No.	Gesamtlänge Total length		
02-13-218	150 mm / 6"	CRILE- WOOD	1/1
02-63-220	180 mm / 7"		
02-63-221	200 mm / 8"		



1/2
CRILE-WOOD
02-13-218
150 mm
6"

TC				
Artikel-Nr. Cat. No.	Gesamtlänge Total length			
02-13-013	150 mm / 6"	BABY CRILE- WOOD	1/1 0,4 mm	
02-13-016	145 mm / 5 3/4"	CRILE- WOOD	1/1 0,4 mm	
02-63-013	150 mm / 6" für Linkshänder for left-handed	CRILE- WOOD	1/1 0,4 mm	
02-13-017	180 mm / 7"	CRILE- WOOD	1/1 0,4 mm	
02-13-019	200 mm / 8"	CRILE- WOOD	1/1 0,4 mm	
02-13-021	305 mm / 12 1/2"	CRILE- WOOD	1/1 0,4 mm	



1/2
CRILE-WOOD
02-13-019
200 mm
8"





1/2
DE BAKEY
02-13-033
 165 mm
 6½"







1/2
DE BAKEY
02-13-025
 180 mm
 7"







TC

		Artikel-Nr. Cat. No.	Gesamtlänge Total length
1/1 0,4 mm	DE BAKEY	02-13-033	165 mm / 6½"
		02-13-034	210 mm / 8¼"
			<i>schlankes Modell delicate pattern</i>

TC









		Artikel-Nr. Cat. No.	Gesamtlänge Total length
1/1 0,3 mm	DE BAKEY	02-63-024	160 mm / 6¼"
			<i>schlankes Modell delicate pattern</i>
1/1 0,3 mm	DE BAKEY	02-13-025	180 mm / 7"
			<i>schlankes Modell delicate pattern</i>
1/1 0,3 mm	DE BAKEY	02-13-026	210 mm / 8¼"
			<i>schlankes Modell delicate pattern</i>
1/1 0,3 mm	DE BAKEY	02-13-027	230 mm / 9"
			<i>schlankes Modell delicate pattern</i>
1/1 0,4 mm	DE BAKEY	02-13-040	310 mm / 12½"
			<i>schlankes Modell delicate pattern</i>

TC

Artikel-Nr. Cat. No.	Gesamtlänge Total length		
02-13-032	150 mm / 6"	DE BAKEY	1/1 0,4 mm 
02-13-035	180 mm / 7"	DE BAKEY	1/1 0,4 mm 
02-63-035	200 mm / 8"	DE BAKEY	1/1 0,4 mm 
02-13-036	230 mm / 9"	DE BAKEY	1/1 0,4 mm 
02-13-037	250 mm / 10"	DE BAKEY	1/1 0,4 mm 
02-13-038	300 mm / 12"	DE BAKEY	1/1 0,4 mm 
02-63-039	370 mm / 14¾"	DE BAKEY	1/1 0,4 mm 



1/2
DE BAKEY
02-13-035
180 mm
7"

Artikel-Nr. Cat. No.	Gesamtlänge Total length		
02-63-064	140 mm / 5½"	MAYO-HEGAR	1/1 0,5 mm 
02-13-065	150 mm / 6"	MAYO-HEGAR	1/1 0,5 mm 
02-13-066	180 mm / 7"	MAYO-HEGAR	1/1 0,5 mm 
02-13-067	200 mm / 8"	MAYO-HEGAR	1/1 0,5 mm 
02-13-068	240 mm / 9½"	MAYO-HEGAR	1/1 0,5 mm 
02-13-070	260 mm / 10¼"	MAYO-HEGAR	1/1 0,5 mm 
02-13-069	300 mm / 12"	MAYO-HEGAR	1/1 0,5 mm 
02-63-069	160 mm / 6¼"	MAYO-HEGAR	1/1 
02-63-070	180 mm / 7"	MAYO-HEGAR	1/1 
	glattes Maul smooth jaw		



1/2
MAYO-HEGAR
02-13-067
200 mm
8"



 1/2
RYDER
02-63-046
 230 mm
 9"

		TC	
		Artikel-Nr. Cat. No.	Gesamtlänge Total length
	1/1 0,4 mm 	RYDER 02-13-044 02-63-044	135 mm / 5¼" 150 mm / 6"
	1/1 0,4 mm 	RYDER 02-13-045	180 mm / 7"
	1/1 0,4 mm 	RYDER 02-13-046 02-63-046	200 mm / 8" 230 mm / 9"
	1/1 0,4 mm 	RYDER 02-13-047	265 mm / 10½"
	1/1 	RYDER 02-63-047	135 mm / 5¼" glattes Maul <i>smooth jaw</i>
	1/1 	RYDER 02-13-074	150 mm / 6" glattes Maul <i>smooth jaw</i>
	1/1 	RYDER 02-13-075	180 mm / 7" glattes Maul <i>smooth jaw</i>
	1/1 	RYDER 02-63-075	200 mm / 8" glattes Maul <i>smooth jaw</i>
	1/1 	RYDER 02-13-076	230 mm / 9" glattes Maul <i>smooth jaw</i>



TC

Artikel-Nr.
Cat. No.

Gesamtlänge
Total length

02-13-020	175 mm / 7"	SAROT	1/1 0,5 mm
02-13-023	260 mm / 10¼"	SAROT	1/1 0,5 mm



1/2
SAROT
02-13-020
175 mm
7"





1/2
02-20-123
 160 mm
 6¼"

		Artikel-Nr. Cat. No.	Gesamtlänge Total length
1/1		02-20-121	160 mm / 6¼" scharf sharp
1/1		02-20-122	160 mm / 6¼" scharf sharp
1/1		02-20-123	160 mm / 6¼" scharf sharp
1/1		02-20-124	160 mm / 6¼" scharf sharp



1/2
02-20-128
 160 mm
 6¼"

		Artikel-Nr. Cat. No.	Gesamtlänge Total length
1/1		02-20-126	160 mm / 6¼" stumpf blunt
1/1		02-20-127	160 mm / 6¼" stumpf blunt
1/1		02-20-128	160 mm / 6¼" stumpf blunt
1/1		02-20-129	160 mm / 6¼" stumpf blunt

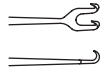
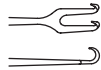

Artikel-Nr. Cat. No.	Gesamtlänge Total length		
15-01-334	160 mm / 6¼"	GUTHRIE	1/1 
15-01-335	160 mm / 6¼"	GUTHRIE	1/1 

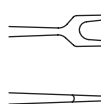
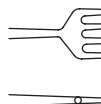
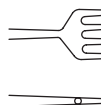

1/2
GUTHRIE
15-01-334
160 mm
6¼"

Artikel-Nr. Cat. No.	Gesamtlänge Total length		
15-01-336	130 mm / 5½"	ROLLET	1/1 
15-01-337	130 mm / 5½"	ROLLET	1/1 
15-01-338	130 mm / 5½"	ROLLET	1/1 







1/2
ROLLET
15-01-336
130 mm
5½"









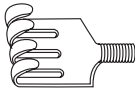

2/3
02-20-133
 160 mm
 6¼"

		Artikel-Nr. Cat. No.	Gesamtlänge Total length
1/1		02-20-132	160 mm / 6¼" flexibel, scharf <i>flexible, sharp</i>
1/1		02-20-133	160 mm / 6¼" flexibel, scharf <i>flexible, sharp</i>
1/1		02-20-134	160 mm / 6¼" flexibel, scharf <i>flexible, sharp</i>

		Artikel-Nr. Cat. No.	Gesamtlänge Total length
1/1		02-20-136	160 mm / 6¼" flexibel, stumpf <i>flexible, blunt</i>
1/1		02-20-137	160 mm / 6¼" flexibel, stumpf <i>flexible, blunt</i>
1/1		02-20-138	160 mm / 6¼" flexibel, stumpf <i>flexible, blunt</i>

Artikel-Nr. Cat. No.	Gesamtlänge Total length	MEYERDING	
02-20-193	180 mm / 7"	MEYERDING	1/1 18 x 7 mm 
02-20-194	180 mm / 7"	MEYERDING	1/1 16 x 5 mm 
02-20-195	180 mm / 7"	MEYERDING	1/1 7 x 4 mm 

Artikel-Nr. Cat. No.	Gesamtlänge Total length	MEYERDING	
02-20-196	180 mm / 7"	MEYERDING	1/1 5 x 10 mm 
02-20-197	180 mm / 7"	MEYERDING	1/1 11 x 4 mm 
02-20-198	180 mm / 7"	MEYERDING	1/1 6 x 4 mm 



2/3
MEYERDING
02-20-193
180 mm
7"











1/2
RAGNELL
02-20-004
 150 mm
 6"

		Artikel-Nr. Cat. No.	Gesamtlänge Total length
	RAGNELL	02-20-004	150 mm / 6"



1/2
SENN-MILLER
02-20-008
 160 mm
 6 1/4"

		Artikel-Nr. Cat. No.	Gesamtlänge Total length
1/1	SENN-MILLER	02-70-002	160 mm / 6 1/4" stumpf blunt
1/1	SENN-MILLER	02-20-008	160 mm / 6 1/4" scharf sharp

Artikel-Nr. Cat. No.	Gesamtlänge Total length		
02-70-180	205 mm / 8"	CUSHING	1/1 8 mm
02-70-181	240 mm / 9½"		
02-20-184	205 mm / 8"	CUSHING	1/1 10 mm
02-70-182	240 mm / 9½"		
02-70-184	205 mm / 8"	CUSHING	1/1 12 mm
02-70-183	240 mm / 9½"		
02-20-185	205 mm / 8"	CUSHING	1/1 14 mm
02-70-187	240 mm / 9½"		
02-70-185	205 mm / 8"	CUSHING	1/1 16 mm
02-70-188	240 mm / 9½"		
02-70-186	205 mm / 8"	CUSHING	1/1 18 mm
02-70-189	240 mm / 9½"		



2/3
CUSHING
02-20-184
205 mm
8"









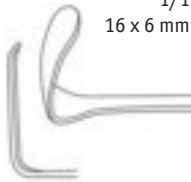
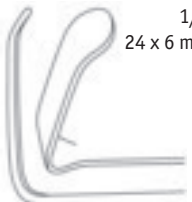

2/3
LANGENBECK-GREEN
02-20-177
 160 mm
 6¼"



2/3
DESMARRES
15-01-310
 140 mm
 5½"

		Artikel-Nr. Cat. No.	Gesamtlänge Total length	
	1/1 16 x 6 mm	LANGEN- BECK- GREEN	02-20-177	160 mm / 6¼"
	1/1 24 x 6 mm	LANGEN- BECK- GREEN	02-20-178	160 mm / 6¼"

		Artikel-Nr. Cat. No.	Gesamtlänge Total length	
	1/1 9 x 9 mm	DESMARRES	15-01-310	140 mm / 5½"
	1/1 9 x 12 mm	DESMARRES	15-01-311	140 mm / 5½"
	1/1 11 x 14 mm	DESMARRES	15-01-312	140 mm / 5½"
	1/1 12 x 16 mm	DESMARRES	15-01-313	140 mm / 5½"
	1/1 13 x 18 mm	DESMARRES	15-01-314	140 mm / 5½"



Artikel-Nr. Cat. No.	Gesamtlänge Total length		
02-70-770	240 mm / 9½"	Sattelhäkchen, biegsamer Schaft <i>saddle hook, malleable shaft</i>	GIL VERNET 1/1 4 mm 
02-70-778	240 mm / 9½"	Sattelhäkchen, biegsamer Schaft <i>saddle hook, malleable shaft</i>	GIL VERNET 1/1 6 mm 
02-70-771	240 mm / 9½"	Sattelhäkchen, biegsamer Schaft <i>saddle hook, malleable shaft</i>	GIL VERNET 1/1 8 mm 
02-70-772	240 mm / 9½"	Sattelhäkchen, biegsamer Schaft <i>saddle hook, malleable shaft</i>	GIL VERNET 1/1 11 mm 
02-70-773	240 mm / 9½"	Sattelhäkchen, biegsamer Schaft <i>saddle hook, malleable shaft</i>	GIL VERNET 1/1 13 mm 
02-70-774	240 mm / 9½"	Sattelhäkchen, biegsamer Schaft <i>saddle hook, malleable shaft</i>	GIL VERNET 1/1 15 mm 
02-70-775	240 mm / 9½"	Sattelhäkchen, biegsamer Schaft <i>saddle hook, malleable shaft</i>	GIL VERNET 1/1 17 mm 
02-70-776	240 mm / 9½"	Sattelhäkchen, biegsamer Schaft <i>saddle hook, malleable shaft</i>	GIL VERNET 1/1 20 mm 
02-70-777	240 mm / 9½"	Sattelhäkchen, biegsamer Schaft <i>saddle hook, malleable shaft</i>	GIL VERNET 1/1 23 mm 





1/2
GIL VERNET
02-70-776
240 mm
9½"











2/3
MANNERFELT mod.
02-20-918
 155 mm
 6"





			Artikel-Nr. Cat. No.	Gesamtlänge Total length
1/1	MANNER-FELT mod.		02-20-911	155 mm / 6" enge Biegung, scharf <i>small curve, sharp</i>
1/1	MANNER-FELT mod.		02-20-912	155 mm / 6" enge Biegung, scharf <i>small curve, sharp</i>
1/1	MANNER-FELT mod.		02-20-913	155 mm / 6" enge Biegung, scharf <i>small curve, sharp</i>



			Artikel-Nr. Cat. No.	Gesamtlänge Total length
1/1	MANNER-FELT mod.		02-20-916	155 mm / 6" enge Biegung, stumpf <i>small curve, blunt</i>
1/1	MANNER-FELT mod.		02-20-917	155 mm / 6" enge Biegung, stumpf <i>small curve, blunt</i>
1/1	MANNER-FELT mod.		02-20-918	155 mm / 6" enge Biegung, stumpf <i>small curve, blunt</i>

Artikel-Nr. Cat. No.	Gesamtlänge Total length		
02-20-921	155 mm / 6" weite Biegung, scharf large curve, sharp	MANNER- FELT mod.	1/1 
02-20-922	155 mm / 6" weite Biegung, scharf large curve, sharp	MANNER- FELT mod.	1/1 
02-20-923	155 mm / 6" weite Biegung, scharf large curve, sharp	MANNER- FELT mod.	1/1 



Artikel-Nr. Cat. No.	Gesamtlänge Total length		
02-20-926	155 mm / 6" weite Biegung, stumpf large curve, blunt	MANNER- FELT mod.	1/1 
02-20-927	155 mm / 6" weite Biegung, stumpf large curve, blunt	MANNER- FELT mod.	1/1 
02-20-928	155 mm / 6" weite Biegung, stumpf large curve, blunt	MANNER- FELT mod.	1/1 



2/3
MANNERFELT mod.
02-20-928
155 mm
6"







1/1
LANGENBECK
MANNERFELT mod.
02-20-945
 155 mm
 6"

		Artikel-Nr. Cat. No.	Gesamtlänge Total length
	1/1 16 x 6 mm	02-20-940	155 mm / 6" hohlgekehrt hollow grooved
	1/1 15 x 6 mm	02-20-943	155 mm / 6"
	1/1 20 x 6 mm	02-20-944	155 mm / 6"
	1/1 25 x 6 mm	02-20-945	155 mm / 6"
	1/1 30 x 8 mm	02-20-946	155 mm / 6"



1/2
MANNERFELT mod.
02-20-949
 155 mm
 6"

		Artikel-Nr. Cat. No.	Gesamtlänge Total length
	1/1 12 x 12 mm	02-20-948	155 mm / 6" Sattelhaken saddle hook
	1/1 12 x 14 mm	02-20-949	155 mm / 6" Sattelhaken saddle hook
	1/1 14 x 16 mm	02-20-951	155 mm / 6" Sattelhaken saddle hook

Artikel-Nr. Cat. No.	Gesamtlänge Total length		
02-20-200	250 mm / 10"	CUSHING	1/1 11 x 14 mm 
02-20-201	250 mm / 10"	CUSHING	1/1 13 x 18 mm 
02-20-202	250 mm / 10"	CUSHING	1/1 15 x 22 mm 



Artikel-Nr. Cat. No.	Gesamtlänge Total length		
02-20-192	210 mm / 8¼" 6 x 13 mm	SCHOEN- BORN	



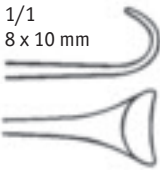





Artikel-Nr. Cat. No.	Gesamtlänge Total length		
02-70-190	215 mm / 8½"	CUSHING	1/1 8 x 10 mm 











1/2
VOLKMANN
02-20-244
 220 mm
 8 3/4"

		Artikel-Nr. Cat. No.	Gesamtlänge Total length
1/2	VOLKMANN	02-70-241	220 mm / 8 3/4"
			scharf sharp
1/2 9 x 8 mm	VOLKMANN	02-20-242	220 mm / 8 3/4"
			scharf sharp
1/2 9 x 13 mm	VOLKMANN	02-20-243	220 mm / 8 3/4"
			scharf sharp
1/2 9 x 19 mm	VOLKMANN	02-20-244	220 mm / 8 3/4"
			scharf sharp
1/2 9 x 29 mm	VOLKMANN	02-20-246	220 mm / 8 3/4"
			scharf sharp
1/2 9 x 40 mm	VOLKMANN	02-20-248	220 mm / 8 3/4"
			scharf sharp



Artikel-Nr. Cat. No.	Gesamtlänge Total length		
02-70-250	220 mm / 8¾"	VOLKMANN	1/2 
02-20-252	220 mm / 8¾"	VOLKMANN	1/2 9 x 8 mm 
02-20-253	220 mm / 8¾"	VOLKMANN	1/2 9 x 13 mm 
02-20-254	220 mm / 8¾"	VOLKMANN	1/2 9 x 19 mm 
02-20-256	220 mm / 8¾"	VOLKMANN	1/2 9 x 29 mm 
02-20-258	220 mm / 8¾"	VOLKMANN	1/2 9 x 40 mm 



1/2
VOLKMANN
02-20-254
220 mm
8¾"



1/2
VOLKMANN
02-20-260
 220 mm
 8¾"

		Artikel-Nr. Cat. No.	Gesamtlänge Total length
1/2	VOLKMANN	02-70-255	220 mm / 8¾" halbscharf semi-sharp
1/2 9 x 8 mm	VOLKMANN	02-20-257	220 mm / 8¾" halbscharf semi-sharp
1/2 9 x 13 mm	VOLKMANN	02-20-259	220 mm / 8¾" halbscharf semi-sharp
1/2 9 x 19 mm	VOLKMANN	02-20-260	220 mm / 8¾" halbscharf semi-sharp
1/2 9 x 29 mm	VOLKMANN	02-20-261	220 mm / 8¾" halbscharf semi-sharp
1/2 9 x 40 mm	VOLKMANN	02-20-265	220 mm / 8¾" halbscharf semi-sharp

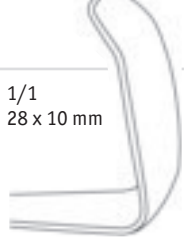

Artikel-Nr. Cat. No.	Gesamtlänge Total length	LANGEN- BECK	1/1 28 x 10 mm
02-20-320	210 mm / 8¼"		

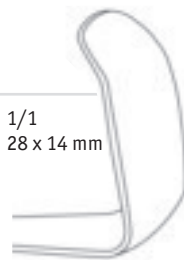
Artikel-Nr. Cat. No.	Gesamtlänge Total length	LANGEN- BECK	1/1 28 x 14 mm
02-20-321	210 mm / 8¼"		

Artikel-Nr. Cat. No.	Gesamtlänge Total length	LANGEN- BECK	1/1 28 x 16 mm
02-20-323	210 mm / 8¼"		

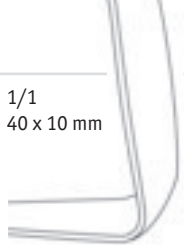
Artikel-Nr. Cat. No.	Gesamtlänge Total length	LANGEN- BECK	1/1 40 x 10 mm
02-20-325	210 mm / 8¼"		

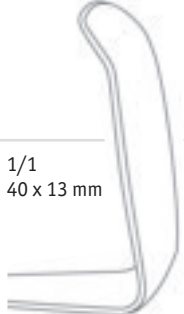
Artikel-Nr. Cat. No.	Gesamtlänge Total length	LANGEN- BECK	1/1 40 x 13 mm
02-20-326	210 mm / 8¼"		



1/2
LANGENBECK
02-20-321
210 mm
8¼"



1/1

MEYERDING
Artikel-Nr.
Cat. No.
02-20-485
Gesamtlänge
Total length

230 mm / 9"

 50 x 16 mm
 Laminektomie-Retraktor
laminectomy retractor

1/1

MEYERDING
Artikel-Nr.
Cat. No.
02-20-486
Gesamtlänge
Total length

240 mm / 9"

 80 x 25 mm
 Laminektomie-Retraktor
laminectomy retractor

1/1

MEYERDING
Artikel-Nr.
Cat. No.
02-20-487
Gesamtlänge
Total length

250 mm / 10"

 90 x 50 mm
 Laminektomie-Retraktor
laminectomy retractor

 1/2
MEYERDING
02-20-485
 230 mm
 9"

Artikel-Nr. Cat. No.	Gesamtlänge Total length		
02-70-480	200 mm / 8" Blattbreite 18 mm width of blade 18 mm		
02-70-481	200 mm / 8" Blattbreite 20 mm width of blade 20 mm		
02-70-482	200 mm / 8" Blattbreite 23 mm width of blade 23 mm		



1/2
02-70-481
200 mm
8"

Artikel-Nr. Cat. No.	Gesamtlänge Total length		
02-70-270	185 mm / 7¼" 30 x 80 mm Spinal Retraktor spinal retractor	TAYLOR	
02-70-271	185 mm / 7¼" 30 x 100 mm Spinal Retraktor spinal retractor	TAYLOR	



1/2
TAYLOR
02-70-270
185 mm
7¼"





1/3
HIBBS
02-70-272
 240 mm
 9½"

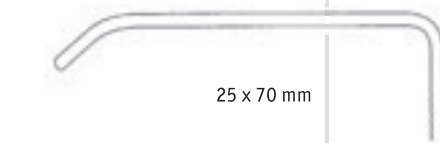
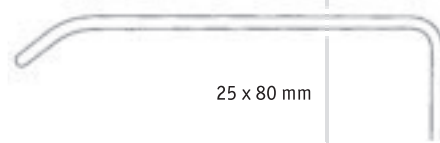

	Artikel-Nr. Cat. No.	Gesamtlänge Total length
HIBBS	02-70-273	240 mm / 9½"
HIBBS	02-70-274	240 mm / 9½"
HIBBS	02-70-272	Paar bestehend aus: pair consisting of: 02-70-273 - 02-70-274

Area with horizontal lines for notes.





1/3
YANKAUER-BABY
07-56-943
 220 mm
 8¾"

		Artikel-Nr. Cat. No.	Gesamtlänge Total length
	YANKAUER-BABY	07-56-943	220 mm / 8¾"



1/3
YANKAUER
07-06-944
 285 mm
 11¼"

		Artikel-Nr. Cat. No.	Gesamtlänge Total length
	YANKAUER	07-06-944	285 mm / 11¼" mit zentraler Bohrung ø 2 mm with central nub ø 2 mm
	YANKAUER	15-13-671	285 mm / 11¼" mit zentraler Bohrung ø 4,8 mm with central nub ø 4.8 mm



Artikel-Nr. Cat. No.	Gesamtlänge Total length		
07-56-945	270 mm / 10 $\frac{1}{4}$ "	YANKAUER	
	komplett mit Saugspitze und Schlaucholive <i>complete with suction tip and olive</i>		
07-56-946	Saugspitze <i>suction tip</i>		
07-56-947	Schlaucholive <i>olive</i>		



1/3
YANKAUER
07-56-945
270 mm
10 $\frac{1}{4}$ "

Artikel-Nr. Cat. No.	Gesamtlänge Total length		
07-56-948	320 mm / 12 $\frac{1}{2}$ " ø 10 mm (30 Charr.)	WALTON YANKAUER	
	mit Absperrventil und abschraubbarem Rohr <i>with stopcock and tube to be screwed off</i>		



1/3
WALTON
YANKAUER
07-56-948
320 mm
12 $\frac{1}{2}$ "



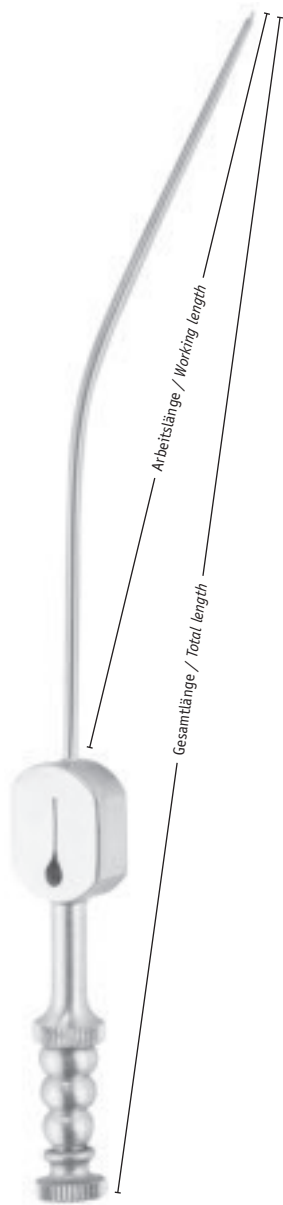

Arbeitslänge Working Length	100 mm 4"	115 mm 4½"	140 mm 5½"	165 mm 6½"
Gesamtlänge Total Length	165 mm 6½"	180 mm 7"	205 mm 8"	230 mm 9"

∅

○	3 Fr / 1,0 mm	07-06-401	07-06-391	07-06-411	07-06-421
○	4 Fr / 1,4 mm	07-06-402	07-06-392	07-06-412	07-06-422
○	5 Fr / 1,7 mm	07-06-403	07-06-393	07-06-413	07-06-423
○	6 Fr / 2,0 mm	07-06-404	07-06-394	07-06-414	07-06-424
○	7 Fr / 2,3 mm	07-06-405	07-06-395	07-06-415	07-06-425
○	8 Fr / 2,7 mm	07-06-406	07-06-396	07-06-416	07-06-426
○	9 Fr / 3,0 mm	07-06-407	07-06-397	07-06-417	07-06-427
○	12 Fr / 4,0 mm	07-06-409	07-06-399	07-06-419	07-06-429

 1/1
07-06-401
 100 mm
 4"

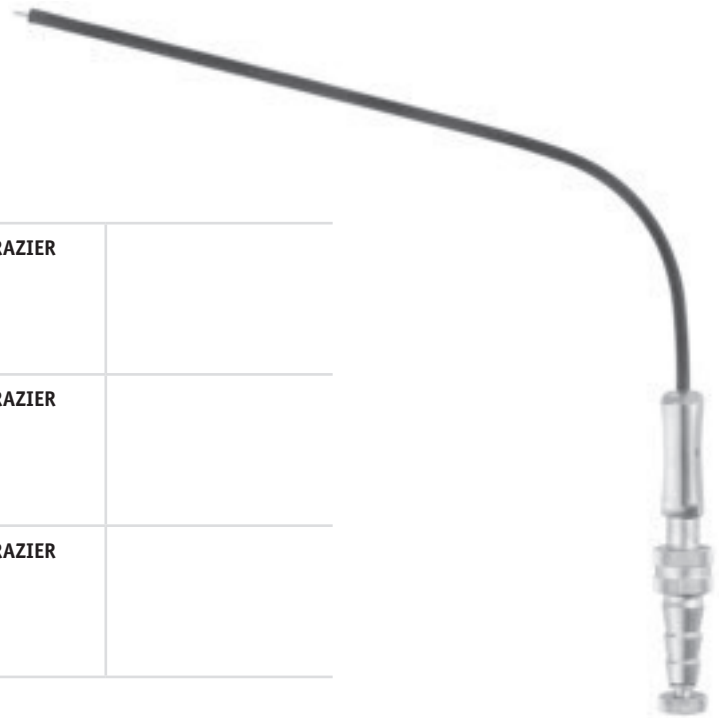

Artikel-Nr. Cat. No.	Gesamtlänge Total length		
07-56-909	190 mm / 7½" 7 Charr., Ø 2,3 mm isoliert <i>insulated</i>	FRAZIER	
07-56-910	190 mm / 7½" 9 Charr., Ø 3,0 mm isoliert <i>insulated</i>	FRAZIER	
07-56-911	190 mm / 7½" 11 Charr., Ø 3,7 mm isoliert <i>insulated</i>	FRAZIER	

1/2
FRAZIER
07-56-909
190 mm
7½"

Artikel-Nr. Cat. No.	Gesamtlänge Total length		
07-06-933	180 mm / 7" Ø 4 mm Schlaucholive Ø 6-9 mm, isoliert <i>olive Ø 6-9 mm, insulated</i>	FERGUSSON	



1/2
FERGUSSON
07-06-933
180 mm
7¼"





1/2
FRAZIER
07-06-930
 180 mm
 7¼"

Artikel-Nr.
Cat. No.
Gesamtlänge
Total length

	FRAZIER	
		180 mm / 7¼"
	07-06-927	F.G. Charr. 6, ø 2,0 mm, 30°
	07-56-927	F.G. Charr. 7, ø 2,3 mm, 30°
	07-06-928	F.G. Charr. 8, ø 2,7 mm, 30°
	07-06-923	F.G. Charr. 9, ø 3,0 mm, 30°
	07-56-930	F.G. Charr. 10, ø 3,3 mm, 30°
	07-56-931	F.G. Charr. 11, ø 3,7 mm, 30°
	07-06-930	F.G. Charr. 12, ø 4,0 mm, 30°
	07-06-931	F.G. Charr. 15, ø 5,0 mm, 30°
		Saugkanülen mit Unterbrecher und Mandrin
		<i>suction cannulae with finger cut-off and stylet</i>

Artikel-Nr.
Cat. No.
Gesamtlänge
Total length

	FRAZIER	
		180 mm / 7¼"
	07-56-933	F.G. Charr. 6, ø 2,0 mm, 75°
	07-56-934	F.G. Charr. 7, ø 2,3 mm, 75°
	07-56-935	F.G. Charr. 8, ø 2,7 mm, 75°
	07-56-936	F.G. Charr. 9, ø 3,0 mm, 75°
	07-56-937	F.G. Charr. 10, ø 3,3 mm, 75°
	07-56-938	F.G. Charr. 11, ø 3,7 mm, 75°
	07-56-939	F.G. Charr. 12, ø 4,0 mm, 75°
	07-56-940	F.G. Charr. 15, ø 5,0 mm, 75°
		Saugkanülen mit Unterbrecher und Mandrin
		<i>suction cannulae with finger cut-off and stylet</i>



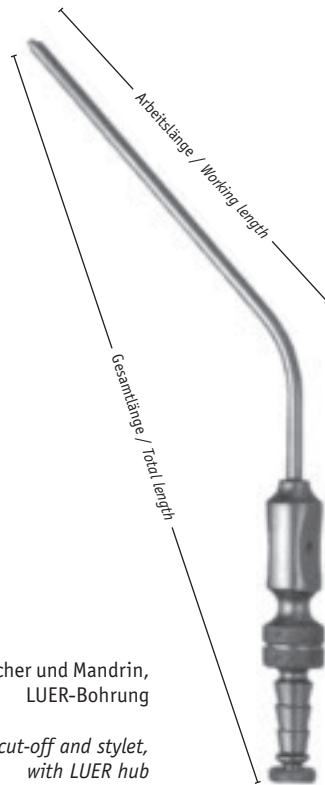

Mit Saugunterbrecher und Mandrin,
LUER-Bohrung

with finger cut-off and stylet,
with LUER hub

1/2
FRAZIER
(FERGUSSON)
07-06-354
110 mm
4 3/8"

Arbeitslänge <i>Working Length</i>	110 mm 4 3/8"	130 mm 5 1/8"	160 mm 6 3/8"	200 mm 8"
Gesamtlänge <i>Total Length</i>	195 mm 7 3/4"	215 mm 8 1/2"	245 mm 9 3/4"	280 mm 11"

∅

1,5 mm	07-06-350	07-06-360	07-06-370	07-06-380
2,0 mm	07-06-351	07-06-361	07-06-371	07-06-381
2,5 mm	07-06-352	07-06-362	07-06-372	07-06-382
3,0 mm	07-06-353	07-06-363	07-06-373	07-06-383
4,0 mm	07-06-354	07-06-364	07-06-374	07-06-384
5,0 mm	07-06-355	07-06-365	07-06-375	07-06-385





1/3
ADSON
07-06-917
 210 mm
 8 3/4"

		Artikel-Nr. Cat. No.	Gesamtlänge Total length
	ADSON	07-06-917	210 mm / 8 3/4" ø 4 mm mit Saugunterbrecher und Mandrin with finger cut-off and stylet



1/2
FRAZIER
07-56-908
 200 mm
 8"

		Artikel-Nr. Cat. No.	Gesamtlänge Total length
	FRAZIER	07-56-904	200 mm / 8" ø 2 mm
		07-56-905	200 mm / 8" ø 2,3 mm
		07-56-906	200 mm / 8" ø 2,7 mm
		07-56-907	200 mm / 8" ø 3,3 mm
		07-56-908	200 mm / 8" ø 3,7 mm
			mit Saugunterbrecher und Mandrin with finger cut-off and stylet

Artikel-Nr. Cat. No.	Gesamtlänge Total length		
07-06-939	195 mm / 7¾" ø 1,5 mm	PLESTER	
07-06-940	195 mm / 7¾" ø 2,0 mm		
07-06-941	195 mm / 7¾" ø 2,5 mm		
07-06-942	195 mm / 7¾" ø 3,0 mm		
mit Saugunterbrecher und Mandrin, LUER-Bohrung with finger cut-off and stylet, LUER hub			



1/2
PLESTER
07-06-941
195 mm
7¾"

Artikel-Nr. Cat. No.	Gesamtlänge Total length		
07-56-915	130 mm / 5" ø 1,6 mm	POPPEN	
07-56-916	130 mm / 5" ø 2,0 mm		
07-56-917	130 mm / 5" ø 2,3 mm		
07-56-918	130 mm / 5" ø 2,7 mm		
07-56-919	130 mm / 5" ø 3,0 mm		
07-56-920	130 mm / 5" ø 3,3 mm		
07-56-921	130 mm / 5" ø 4,0 mm		
07-56-922	130 mm / 5" ø 5,0 mm		
mit Saugunterbrecher und Mandrin, LUER-Bohrung with finger cut-off and stylet, LUER hub			



2/3
POPPEN
07-56-921
130 mm
5"





1/2
LUER
15-12-183
 180 mm
 7"

		Artikel-Nr. Cat. No.	Gesamtlänge Total length
	LUER	15-12-183	180 mm / 7" \varnothing 4,5 mm Schlaucholive \varnothing 6-9 mm olive \varnothing 6-9 mm
	LUER	15-12-185	180 mm / 7" \varnothing 5,5 mm Schlaucholive \varnothing 6-9 mm olive \varnothing 6-9 mm



1/2
MAGILL
07-06-908
 245 mm
 9 3/4"

		Artikel-Nr. Cat. No.	Gesamtlänge Total length
	MAGILL	07-06-906	245 mm / 9 3/4" \varnothing 3 mm / Fig. 1
	MAGILL	07-06-907	245 mm / 9 3/4" \varnothing 3,5 mm / Fig. 2
	MAGILL	07-06-908	245 mm / 9 3/4" \varnothing 4 mm / Fig. 3
	MAGILL	07-06-909	Mandrin stylet

Artikel-Nr. Cat. No.	Gesamtlänge Total length		
07-06-937	200 mm / 8" ø 2 mm	LEMPERT	
07-06-938	200 mm / 8" ø 3 mm		
mit Saugunterbrecher und Mandrin with finger cut-off and stylet			



1/2
LEMPERT
07-06-937
200 mm
8"

Artikel-Nr. Cat. No.	Gesamtlänge Total length		
07-06-980	200 mm / 8" ø 3,2 mm	LANDOLT	
Präpariersauger, bajonettförmig, scharf dissecting suction tube, bayonet-shaped, sharp			



1/2
LANDOLT
07-06-980
200 mm
8"

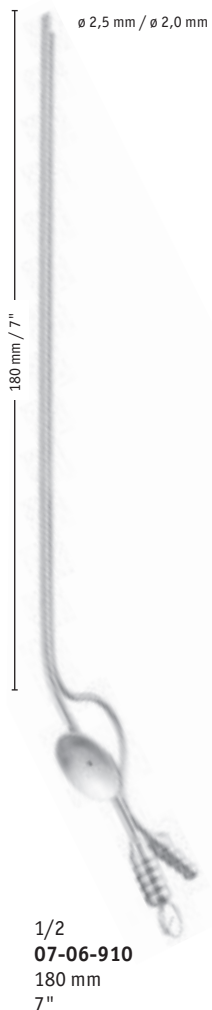

 A long, thin suction tube with a curved tip and a control handle. A vertical dimension line on the left indicates a length of 180 mm / 7". At the top, the diameters are listed as ø 2,5 mm / ø 2,0 mm.

ø 2,5 mm / ø 2,0 mm

180 mm / 7"

Artikel-Nr.
Cat. No.

Arbeitslänge
working length

07-06-910

180 mm / 7"

Schlaucholive ø 4,5 mm
mit Saugunterbrecher und Mandrin
*olive ø 4.5 mm
with finger cut-off and stylet*

1/2
07-06-910
180 mm
7"

Artikel-Nr.
Cat. No.

Gesamtlänge
Total length

YASARGIL

07-06-905

200 mm / 8"
ø 2,0 mm / 4,5 mm

Saug- und Spülkanüle
suction and irrigation cannula

 A shorter, thicker suction and irrigation cannula with a side port. A vertical dimension line on the left indicates a length of 200 mm / 8".

1/2
YASARGIL
07-06-905
200 mm
8"

Artikel-Nr. Cat. No.	Arbeitslänge working length		
07-06-911	90 mm / 3½" ø 0,9 mm / ø 0,7 mm	HOUSE	
07-06-912	90 mm / 3½" ø 1,2 mm / ø 0,9 mm		
07-06-913	90 mm / 3½" ø 1,5 mm / ø 1,2 mm		
07-56-890	90 mm / 3½" ø 1,8 mm / ø 1,8 mm		
07-56-891	90 mm / 3½" ø 2,0 mm / ø 2,0 mm		
07-56-892	90 mm / 3½" ø 3,0 mm / ø 2,0 mm		
07-56-893	90 mm / 3½" ø 4,5 mm / ø 2,0 mm		
mit Saugunterbrecher und Mandrin, LUER-Bohrung with finger cut-off and stylet, LUER hub			



1/2
HOUSE
07-06-913
90 mm
3½"

Artikel-Nr. Cat. No.	Gesamtlänge Total length		
07-06-768	55 mm / 2¼" Saugadapter mit Saugunterbrecher Schlaucholive ø 7,0 mm suction adapter with finger cut-off olive ø 7,0 mm	HOUSE	



1/1
HOUSE
07-06-768
55 mm
2¼"



 1/2
VERHOEVEN
07-06-763
 100 mm
 4"

		Artikel-Nr. Cat. No.	Gesamtlänge Total length
	VERHOEVEN	07-06-763	100 mm / 4" ø 1,6 mm / 16 swg
		07-06-764	100 mm / 4" ø 1,2 mm / 18 swg
		07-06-765	100 mm / 4" ø 0,9 mm / 20 swg
		07-06-766	100 mm / 4" ø 0,7 mm / 22 swg
		07-06-767	100 mm / 4" ø 0,6 mm / 24 swg

 1/2
WULLSTEIN
15-07-960

		Artikel-Nr. Cat. No.	
	WULLSTEIN	15-07-960	Mikro-Absaugrohr, komplett, bestehend aus: Micro Suction Tube, complete, consisting of:
		15-07-961	1x Absaugrohr mit LUER-Bohrung suction tube with LUER hub
		15-07-962	1x Mikro-Saugkanüle ø 0,4 mm micro suction cannula ø 0.4 mm
		15-07-963	1x Mikro-Saugkanüle ø 0,6 mm micro suction cannula ø 0.6 mm
		15-07-964	1x Mikro-Saugkanüle ø 0,8 mm micro suction cannula ø 0.8 mm

Artikel-Nr.
Cat. No.

15-07-970	Absaugrohr, komplett, bestehend aus: Suction Tube, complete, consisting of:		
15-07-971	1 x Saughandgriff suction handle		
15-07-972	2 x Aufsatz ø 0,5 mm tip ø 0.5 mm		
15-07-973	2 x Aufsatz ø 0,7 mm tip ø 0.7 mm		
15-07-974	2 x Aufsatz ø 1,0 mm tip ø 1.0 mm		
15-07-975	2 x Aufsatz ø 1,3 mm tip ø 1.3 mm		

Artikel-Nr.
Cat. No.

15-07-971	Saughandgriff suction handle		
------------------	---------------------------------	--	--

Artikel-Nr.
Cat. No.

15-07-972	Aufsatz ø 0,5 mm tip ø 0.5 mm		
15-07-973	Aufsatz ø 0,7 mm tip ø 0.7 mm		
15-07-974	Aufsatz ø 1,0 mm tip ø 1.0 mm		
15-07-975	Aufsatz ø 1,3 mm tip ø 1.3 mm		



1/1
15-07-971



1/1
15-07-972





1/2
ADSON
07-06-918
 165 mm
 6½"

		Artikel-Nr. Cat. No.	Gesamtlänge Total length
	ADSON	07-06-918	165 mm / 6½" ø 3 mm mit Saugunterbrecher und Mandrin <i>with finger cut-off and stylet</i>



1/2
BARRON
07-06-935
 160 mm
 6¼"

		Artikel-Nr. Cat. No.	Gesamtlänge Total length
	BARRON	07-06-935	160 mm / 6¼" ø 1,3 mm
		07-06-936	160 mm / 6¼" ø 2 mm mit Saugunterbrecher und Mandrin <i>with finger cut-off and stylet</i>



1/2
SCHUHKNECHT
07-06-756
 130 mm
 5⅛"

		Artikel-Nr. Cat. No.	Gesamtlänge Total length
	SCHUHKNECHT	07-06-756	130 mm / 5⅛" ø 0,9 mm
		07-06-757	130 mm / 5⅛" ø 0,5 mm

Artikel-Nr.
Cat. No.

15-07-950	Sauger, komplett, bestehend aus: suction set, complete, consisting of:	BELLUCCI	
15-07-951	1 x Saugkanüle suction tube		
07-56-772	1 x Saugspitze ø 0,9 mm suction tip ø 0.9 mm		
07-56-773	1 x Saugspitze ø 0,7 mm suction tip ø 0.7 mm		
07-56-774	1 x Saugspitze ø 0,5 mm suction tip ø 0.5 mm		



Artikel-Nr.
Cat. No.

Gesamtlänge
Total length

15-07-951	155 mm / 6"	BELLUCCI	
	Saugkanüle allein, mit Saugunterbrecher und Mandrin suction tube only, with finger cut-off and stylet		

Artikel-Nr.
Cat. No.

07-56-772	ø 0,9 mm	BELLUCCI	
	Saugspitze, auswechselbar suction tip, detachable		
07-56-773	ø 0,7 mm		
	Saugspitze, auswechselbar suction tip, detachable		
07-56-774	ø 0,5 mm		
	Saugspitze, auswechselbar suction tip, detachable		



Artikel-Nr.
Cat. No.

Gesamtlänge
Total length

07-06-770	180 mm / 7" ø 2,5 mm	ZOELLNER	
	Saugkanüle allein, mit Mandrin, passend zu den Saugspitzen 07-06-771 bis 07-06-775 suction cannula only, with stylet, fitting to the suction tips 07-06-771 to 7-06-775		

Artikel-Nr.
Cat. No.

07-06-771	ø 1,2 mm	ZOELLNER	
07-06-772	ø 0,9 mm		
07-06-773	ø 0,7 mm		
07-06-774	ø 0,5 mm		
07-06-775	ø 0,4 mm		
	Saugspitzen, auswechselbar zu 07-06-770 und 15-07-951, Packung á 10 Stück suction tips, detachable, fitting to 07-06-770 and 15-07-951, package of 10 pcs.		





1/2
HARVEY
12-74-156
 160 mm
 6 1/4"



1/1

HARVEY**TC**
Artikel-Nr.
Cat. No.
12-74-156
Gesamtlänge
Total length

160 mm / 6 1/4"

 für weiche Drähte bis \varnothing 1,2 mm
 for soft wires up to \varnothing 1.2 mm

 für harte Drähte bis \varnothing 1,6 mm
 for hard wires up to \varnothing 1.6 mm

1/2
HARVEY
12-24-157
 235 mm
 9 1/4"



TC
Artikel-Nr.
Cat. No.
12-24-157
Gesamtlänge
Total length

235 mm / 9 1/4"

 für weiche Drähte bis \varnothing 3,0 mm
 for soft wires up to \varnothing 3.0 mm

 für harte Drähte bis \varnothing 2,2 mm
 for hard wires up to \varnothing 2.2 mm



TC

Artikel-Nr. Cat. No.	Gesamtlänge Total length	REIL	
12-24-159	180 mm / 7" für weiche Drähte bis \varnothing 2,0 mm for soft wires up to \varnothing 2.0 mm für harte Drähte bis \varnothing 1,7 mm for hard wires up to \varnothing 1.7 mm		1/1 
12-74-160	220 mm / 8¾" für weiche Drähte bis \varnothing 3,0 mm for soft wires up to \varnothing 3.0 mm für harte Drähte bis \varnothing 2,5 mm for hard wires up to \varnothing 2.5 mm		1/1 



1/2
12-74-160
220 mm
8¾"

TC

Artikel-Nr. Cat. No.	Gesamtlänge Total length		
12-24-158	180 mm / 7" Kopf- und Seitenschneider, für weichen Draht bis \varnothing 2,0 mm und harten Draht bis \varnothing 1,7 mm front and lateral cutting action, for soft wire up to \varnothing 2.0 mm and for hard wire up to \varnothing 1.7 mm		1/1 



1/2
12-24-158
180 mm
7"





1/2
HARVEY
02-03-815
 125 mm
 5"

		Artikel-Nr. Cat. No.	Gesamtlänge Total length
1/1	HARVEY	02-03-815	125 mm / 5"



1/2
04-16-551
 120 mm
 4¾"

		TC	Artikel-Nr. Cat. No.	Artikel-Nr. Cat. No.	Gesamtlänge Total length
1/1			04-16-551	04-16-552	120 mm / 4¾" Eine Schneide gezahnt <i>one toothed cutting edge</i> für weiche Drähte bis ø 0,8 mm <i>for soft wires up to ø 0.8 mm</i> für harte Drähte bis ø 0,3 mm <i>for hard wires up to ø 0.3 mm</i>



1/2
04-16-530
 140 mm
 5½"

		TC	Artikel-Nr. Cat. No.	Gesamtlänge Total length
			04-16-530	140 mm / 5½" für weiche Drähte bis ø 1,4 mm <i>for soft wires up to ø 1.4 mm</i> für harte Drähte bis ø 1,0 mm <i>for hard wires up to ø 1.0 mm</i>

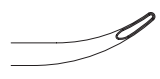
Artikel-Nr. Cat. No.	Gesamtlänge Total length		
06-15-599	130 mm / 5 1/8"		1/1 

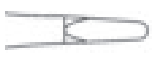

1/2
06-15-599
130 mm
5 1/8"

Artikel-Nr. Cat. No.	Gesamtlänge Total length		
13-04-617	155 mm / 6"	LEMPERT	1/1 



1/2
LEMPERT
13-04-617
155 mm
6"





1/2
FRIEDMANN
06-15-406
 140 mm
 5½"



		Artikel-Nr. Cat. No.	Gesamtlänge Total length
1/1	FRIEDMANN	06-15-406	140 mm / 5½"
			



1/2
FRIEDMANN
06-15-407
 140 mm
 5½"



		Artikel-Nr. Cat. No.	Gesamtlänge Total length
1/1	FRIEDMANN	06-15-407	140 mm / 5½"
			



Artikel-Nr. Cat. No.	Gesamtlänge Total length		
06-65-397	140 mm / 5½"	KLEINERT-KUTZ	1/1 
06-65-398	140 mm / 5½"	KLEINERT-KUTZ	1/1 



1/2
KLEINERT-KUTZ
06-65-397
140 mm
5½"

Artikel-Nr. Cat. No.	Gesamtlänge Total length		
06-15-409	145 mm / 5¾"	LUER-FRIEDMANN	1/1 
06-15-408	145 mm / 5¾"		1/1 



1/2
LUER-FRIEDMANN
06-15-409
145 mm
5¾"







1/2
LUER
06-15-412
150 mm
6"

		Artikel-Nr. Cat. No.	Gesamtlänge Total length
1/1		06-15-410	140 mm / 5½"
1/1	LUER	06-15-411	150 mm / 6"
1/1	LUER	06-15-412	150 mm / 6"
1/1	BLUMEN- THAL	06-15-415	150 mm / 6"
1/1	BLUMEN- THAL	06-15-416	150 mm / 6"





1/2
06-15-413
150 mm
6"

		Artikel-Nr. Cat. No.	Gesamtlänge Total length
1/1		06-15-413	150 mm / 6"
1/1		06-15-414	145 mm / 5¾"

Artikel-Nr. Cat. No.	Gesamtlänge Total length		
06-15-399	175 mm / 7"	STELLBRINK	1/1 
06-15-400	170 mm / 6¾"	STELLBRINK	1/1 

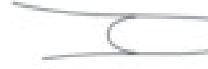

1/2
STELLBRINK
06-15-399
175 mm
7"

Artikel-Nr. Cat. No.	Gesamtlänge Total length		
06-15-457	175 mm / 7"	BANE- HARTMANN	1/1 
06-15-430	175 mm / 7"	JANSEN	1/1 
06-15-432	175 mm / 7"	JANSEN	1/1 



1/2
JANSEN
06-15-430
175 mm
7"



1/2
BEYER
06-15-453
 180 mm
 7"

		Artikel-Nr. Cat. No.	Gesamtlänge Total length
1/1	BEYER	06-15-453	180 mm / 7"
1/1	BEYER	06-65-453	180 mm / 7"



1/2
MEAD
06-15-455
 165 mm
 6½"

		Artikel-Nr. Cat. No.	Gesamtlänge Total length
1/1	MEAD	06-15-455	165 mm / 6½"
1/1	MEAD	06-15-459	165 mm / 6½"



Artikel-Nr. Cat. No.	Gesamtlänge Total length		
06-15-442	190 mm / 7½"	JANSEN	1/1



1/2
JANSEN
06-15-442
190 mm
7½"

Artikel-Nr. Cat. No.	Gesamtlänge Total length		
06-15-450	200 mm / 8"	LEMPERT	1/1
06-15-451	200 mm / 8"	LEMPERT	1/1



1/2
LEMPERT
06-15-450
200 mm
8"

 1/2
LUER
06-15-460
 170 mm
 6¾"

		Artikel-Nr. Cat. No.	Gesamtlänge Total length
1/1	LUER	06-15-460	170 mm / 6¾"
1/1	LUER	06-15-461	170 mm / 6¾"
1/1	LUER	06-15-462	180 mm / 7"
1/1	LUER	06-15-463	180 mm / 7"



 1/2
GULEKE
06-15-472
 205 mm
 8"

		Artikel-Nr. Cat. No.	Gesamtlänge Total length
1/1	OLIVE-CRONA	06-15-470	200 mm / 8"
1/1	GULEKE	06-15-472	205 mm / 8"
1/1	PENNY-BACKER	06-15-475	200 mm / 8"

Artikel-Nr. Cat. No.	Gesamtlänge Total length		
06-15-474	210 mm / 8¼"	NORTH-FIELD	1/1 



1/2
NORTHFIELD
06-15-474
210 mm
8¼"



Artikel-Nr. Cat. No.	Gesamtlänge Total length		
13-04-615	200 mm / 8"	ADSON	1/1 





1/2
ADSON
13-04-615
200 mm
8"







		Artikel-Nr. Cat. No.	Gesamtlänge Total length
1/1		HAKANSSON 06-15-428	170 mm / 6¾" seitwärts gebogen curved to side
1/1		TROTTER 06-15-467	205 mm / 8" seitwärts gebogen curved to side





		Artikel-Nr. Cat. No.	Gesamtlänge Total length
1/1 3 mm		LEKSELL 06-65-560	360 mm / 14½"
1/1 5 mm		LEKSELL 06-65-561	360 mm / 14½"
1/1 8 mm		LEKSELL 06-65-562	360 mm / 14½"

Artikel-Nr. Cat. No.	Gesamtlänge Total length		
06-15-500	155 mm / 6"	BÖHLER	1/1 2 mm 
06-15-502	155 mm / 6"	BÖHLER	1/1 3 mm 



1/2
BÖHLER
06-15-500
155 mm
6"

Artikel-Nr. Cat. No.	Gesamtlänge Total length		
06-15-511	175 mm / 7"	MAYFIELD	1/1 3 mm 
06-15-520	200 mm / 8"	MAR- QUARDT	1/1 3 mm 





1/2
MAYFIELD
06-15-511
175 mm
7"







1/2
BEYER
06-15-514
 180 mm
 7"



		Artikel-Nr. Cat. No.	Gesamtlänge Total length
	1/1 3 mm BEYER	06-15-514	180 mm / 7"
	1/1 5 mm ZAUFAL- JANSEN	06-15-515	180 mm / 7"



1/2
RUSKIN
06-15-518
 190 mm
 7½"

		Artikel-Nr. Cat. No.	Gesamtlänge Total length
	1/1 5 mm RÖTTGEN- RUSKIN	06-65-516 06-65-517	190 mm / 7½" 240 mm / 9½"
	1/1 5 mm RUSKIN	06-15-518 06-15-521	190 mm / 7½" 240 mm / 9½"



Artikel-Nr. Cat. No.	Gesamtlänge Total length		
06-15-522	230 mm / 9"	ECHLIN	1/1 2 mm 
06-15-523	230 mm / 9"	ECHLIN	1/1 3 mm 
06-65-524	230 mm / 9"	ECHLIN	1/1 4 mm 





Artikel-Nr. Cat. No.	Gesamtlänge Total length		
06-15-525	240 mm / 9½"	FRYKHOLM	1/1 5 mm 





		Artikel-Nr. Cat. No.	Gesamtlänge Total length
	1/1 6 mm STILLE	06-15-530	235 mm / 9¼"

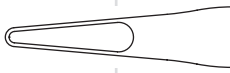



		Artikel-Nr. Cat. No.	Gesamtlänge Total length
	1/1 3 mm LEKSELL	06-15-527	240 mm / 9½"
	1/1 5 mm LEKSELL	06-15-526	240 mm / 9½"
	1/1 8 mm LEKSELL-STILLE	06-15-532	240 mm / 9½"

Artikel-Nr. Cat. No.	Gesamtlänge Total length		
06-15-534	240 mm / 9½"	STILLE- RUSKIN	1/1 8 mm 



1/3
STILLE-RUSKIN
06-15-534
240 mm
9½"

Artikel-Nr. Cat. No.	Gesamtlänge Total length		
06-65-535	230 mm / 9"	LEKSELL	1/1 3 mm 
06-65-536	230 mm / 9"	LEKSELL	1/1 6 mm 
06-65-537	230 mm / 9"	LEKSELL	1/1 8 mm 



1/3
LEKSELL
06-65-536
230 mm
9"







1/3
LUER-STILLE
06-15-551
 225 mm
 9"

		Artikel-Nr. Cat. No.	Gesamtlänge Total length
1/1 10 mm		06-15-550	225 mm / 9"
		06-65-551	270 mm / 10 ³ / ₄ "
1/1 10 mm		06-15-551	225 mm / 9"
		06-65-552	270 mm / 10 ³ / ₄ "





1/3
LUER-STILLE
06-15-566
 270 mm
 10³/₄"

		Artikel-Nr. Cat. No.	Gesamtlänge Total length
1/1 17 mm		06-65-553	230 mm / 9"
		06-65-554	270 mm / 10 ³ / ₄ "
1/1 17 mm		06-65-556	230 mm / 9"
		06-15-566	270 mm / 10 ³ / ₄ "
1/1		SEMB 06-15-555	230 mm / 9"
		06-65-557	270 mm / 10 ³ / ₄ "

Artikel-Nr. Cat. No.	Gesamtlänge Total length		
06-15-601	130 mm / 5 $\frac{1}{8}$ "		1/1 
06-15-602	170 mm / 6 $\frac{3}{4}$ "		1/1 



1/2
06-15-602
170 mm
6 $\frac{3}{4}$ "

Artikel-Nr. Cat. No.	Gesamtlänge Total length		
06-15-610	145 mm / 5 $\frac{3}{4}$ "	BÖHLER	1/1 
06-15-611	145 mm / 5 $\frac{3}{4}$ "	BÖHLER	1/1 



1/2
BÖHLER
06-15-610
145 mm
5 $\frac{3}{4}$ "





 1/2
LISTON
06-15-622
 170 mm
 6¾"

		Artikel-Nr. Cat. No.	Gesamtlänge Total length
1/1	LISTON	06-15-620	140 mm / 5½"
1/1	LISTON	06-15-622	170 mm / 6¾"
1/1	LISTON	06-15-624	200 mm / 8"
1/1	LISTON	06-15-626	220 mm / 8¾"



 1/2
LISTON
06-15-632
 170 mm
 6¾"

		Artikel-Nr. Cat. No.	Gesamtlänge Total length
1/1	LISTON	06-65-531	140 mm / 5½"
1/1	LISTON	06-15-632	170 mm / 6¾"
1/1	LISTON	06-15-634	200 mm / 8"
1/1	LISTON	06-15-636	220 mm / 8¾"

Artikel-Nr. Cat. No.	Gesamtlänge Total length		
06-15-614	175 mm / 7"	MC INDOE	1/1 



1/2
MC INDOE
06-15-614
175 mm
7"

Artikel-Nr. Cat. No.	Gesamtlänge Total length		
06-15-640	190 mm / 7½"	RUSKIN-LISTON	1/1 
06-15-641	190 mm / 7½"	RUSKIN-LISTON	1/1 



1/2
RUSKIN-LISTON
06-15-640
190 mm
7½"







		Artikel-Nr. Cat. No.	Gesamtlänge Total length
1/1	LISTON	06-15-645	240 mm / 9½"
		06-65-645	270 mm / 10¾"

		Artikel-Nr. Cat. No.	Gesamtlänge Total length
1/1	LISTON	06-15-646	280 mm / 11"



1/2
LISTON
06-15-646
 280 mm
 11"



Artikel-Nr. Cat. No.	Gesamtlänge Total length		
06-11-120	165 mm / 6½"	WILLIGER	1/1 5 mm
	Elevatorium elevator		
06-11-121	170 mm / 6¾"	WILLIGER	1/1 5,5 mm
	Elevatorium elevator		

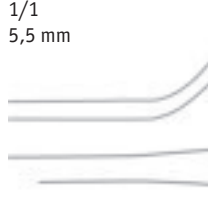

1/2
WILLIGER
06-11-121
170 mm
6¾"

Artikel-Nr. Cat. No.	Gesamtlänge Total length		
15-13-307	155 mm / 6"	KÖNIG	1/1 4,5 mm
	Elevatorium elevator		
15-13-308	155 mm / 6"	KÖNIG	1/1 4,5 mm
	Elevatorium elevator		
06-11-110	155 mm / 6"		1/1 5,5 mm
	Knochenheber bone lever		



1/2
KÖNIG
15-13-308
155 mm
6"





1/2
MC DONALD
06-11-291
190 mm
7½"

		Artikel-Nr. Cat. No.	Gesamtlänge Total length
1/1	MC DONALD	06-11-291	190 mm / 7½"



1/2
WATSON-CHEYNE
06-11-292
125 mm
5"

		Artikel-Nr. Cat. No.	Gesamtlänge Total length
1/1	WATSON-CHEYNE	06-11-292	125 mm / 5"
1/1	WATSON-CHEYNE	06-11-293	190 mm / 7½"



1/2
FREER
15-12-164
180 mm
7"

		Artikel-Nr. Cat. No.	Gesamtlänge Total length
1/1	FREER	15-12-164	180 mm / 7"

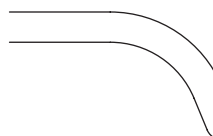
Artikel-Nr. Cat. No.	Gesamtlänge Total length		
15-13-314	140 mm / 5½"		1/1 4 mm
	links gebogen <i>curved left</i>		
15-13-315	140 mm / 5½"		1/1 4 mm
	rechts gebogen <i>curved right</i>		



1/2
15-13-314
140 mm
5½"

Artikel-Nr. Cat. No.	Gesamtlänge Total length		
04-15-543	180 mm / 7"	MOLT	1/1
			



1/2
MOLT
04-15-543
180 mm
7"





		Artikel-Nr. Cat. No.	Gesamtlänge Total length
1/1 6,3 mm	LEMPERT	15-07-164	185 mm / 7¼"
			halbscharf semi-sharp

 1/2
LEMPERT
15-07-164
 185 mm
 7¼"

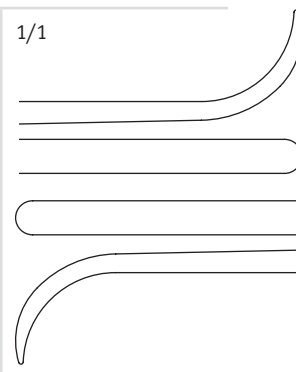

		Artikel-Nr. Cat. No.	Gesamtlänge Total length
1/1 3,2 mm	LEMPERT	15-07-165	165 mm / 6½"
			stumpf blunt

 1/2
LEMPERT
15-07-165
 165 mm
 6½"

Artikel-Nr. Cat. No.	Gesamtlänge Total length		
15-12-155	230 mm / 9"	COTTLE	1/1
	scharf / scharf sharp / sharp		

1/2
COTTLE
15-12-155
230 mm
9"

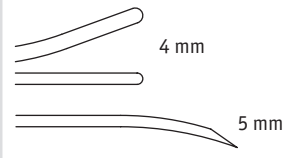

Artikel-Nr. Cat. No.	Gesamtlänge Total length		
15-12-179	220 mm / 8¾"	HILL	1/1
	stumpf / halbscharf blunt / semi-sharp		

1/2
HILL
15-12-179
220 mm
8¾"





1/2
LANGENBECK
06-11-130
195 mm
7 3/4"

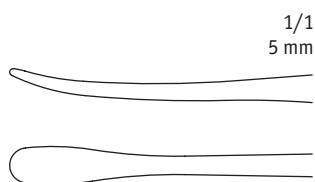

1/1
5 mm

SEBILEAU

Artikel-Nr.
Cat. No.

06-11-124

Gesamtlänge
Total length

175 mm / 7"

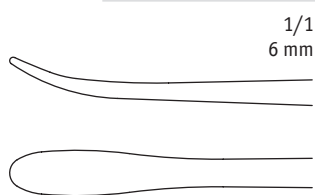

1/1
6 mm

QUERVAIN

06-11-133

195 mm / 7 3/4"

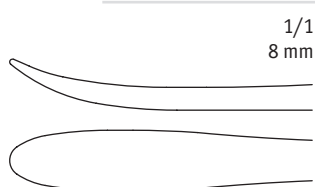

1/1
8 mm

**LANGEN-
BECK**

06-11-130

195 mm / 7 3/4"



1/1
10 mm

**LANGEN-
BECK**

06-11-131

195 mm / 7 3/4"



1/2
LANGENBECK
06-11-139
230 mm
9"

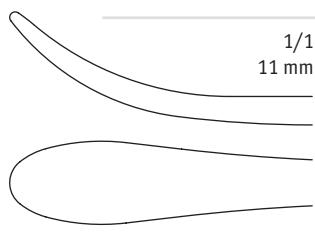

1/1
11 mm

**LANGEN-
BECK**

Artikel-Nr.
Cat. No.

06-11-139

Gesamtlänge
Total length

230 mm / 9"

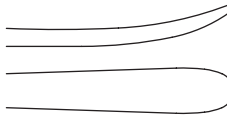
Artikel-Nr. Cat. No.	Gesamtlänge Total length		
04-15-510	140 mm / 5½"	WILLIGER	1/1 4,2 mm 
06-11-300	160 mm / 6¼"	WILLIGER	1/1 6 mm 
06-11-303	160 mm / 6¼"	WILLIGER	1/1 8 mm 

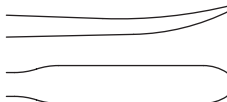

1/2
WILLIGER
04-15-510
140 mm
5½"

Artikel-Nr. Cat. No.	Gesamtlänge Total length		
15-13-309	155 mm / 6"	KÖNIG	1/1 5 mm 



1/2
KÖNIG
15-13-309
155 mm
6"





1/2
SEDILLOT
06-11-350
 185 mm
 7¼"

	Artikel-Nr. Cat. No.	Gesamtlänge Total length
<p>1/1 18 mm</p> <p>SEDILLOT</p>	06-11-350	185 mm / 7¼"



1/2
MITCHELL
06-11-336
 210 mm
 8¼"

	Artikel-Nr. Cat. No.	Gesamtlänge Total length
<p>1/1 17 mm</p> <p>MITCHELL</p>	06-11-336	210 mm / 8¼"



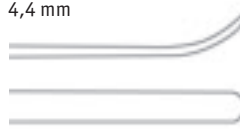

1/2
MC KENTY
15-12-192
155 mm
6"

Artikel-Nr. Cat. No.	Gesamtlänge Total length		
15-12-192	155 mm / 6"	MC KENTY	1/1 4,4 mm 



1/2
SEWALL
15-12-198
200 mm
8"

Artikel-Nr. Cat. No.	Gesamtlänge Total length		
15-12-198	200 mm / 8" stumpf blunt	SEWALL	1/1 6 mm 





		Artikel-Nr. Cat. No.	Gesamtlänge Total length
1/1	HOWARTH	15-12-171	215 mm / 8½"
			scharf / stumpf sharp / blunt

1/2
HOWARTH
15-12-171
215 mm
8½"





		Artikel-Nr. Cat. No.	Gesamtlänge Total length
1/1	KILLIAN	15-12-170	185 mm / 7¼"
			scharf / stumpf sharp / blunt



		Artikel-Nr. Cat. No.	Gesamtlänge Total length
1/1	KILLIAN	15-12-172	185 mm / 7¼"
			scharf / stumpf sharp / blunt

1/2
KILLIAN
15-12-172
185 mm
7¼"



Artikel-Nr. Cat. No.	Gesamtlänge Total length	KEY	
06-61-410	180 mm / 7"	KEY	1/1 3 mm 
06-11-410	180 mm / 7"	KEY	1/1 6 mm 
06-11-411	190 mm / 7½"	KEY	1/1 10 mm 
06-11-412	190 mm / 7½"	KEY	1/1 13 mm 
06-61-412	190 mm / 7½"	KEY	1/1 16 mm 
06-11-413	200 mm / 8"	KEY	1/1 19 mm 
06-11-414	210 mm / 8¼"	KEY	1/1 25 mm 



1/1
KEY
06-11-410
180 mm
7"





1/1
MANNERFELT
06-11-532
155 mm
6"

		Artikel-Nr. Cat. No.	Gesamtlänge Total length
1/1 4 mm	MANNER- FELT	06-11-530	155 mm / 6"
1/1 7 mm	MANNER- FELT	06-11-532	155 mm / 6"
1/1 9 mm	MANNER- FELT	06-11-534	155 mm / 6"

		Artikel-Nr. Cat. No.	Gesamtlänge Total length
1/1 3 mm	MANNER- FELT	06-11-541	155 mm / 6"
1/1 6 mm	MANNER- FELT	06-11-542	155 mm / 6"
1/1 6 mm	MANNER- FELT	06-11-543	155 mm / 6"

		Artikel-Nr. Cat. No.	Gesamtlänge Total length
1/1 6 mm	MANNER- FELT	06-11-551	155 mm / 6"
1/1 8 mm	MANNER- FELT	06-11-552	155 mm / 6"



Artikel-Nr. Cat. No.	Gesamtlänge Total length	MANNER- FELT	1/1 4 mm
06-11-556	155 mm / 6"	MANNER- FELT	1/1 4 mm
06-11-554	155 mm / 6"	MANNER- FELT	1/1 5 mm
06-11-553	155 mm / 6"	MANNER- FELT	1/1 6 mm

Artikel-Nr. Cat. No.	Gesamtlänge Total length	MANNER- FELT	1/1 4 mm
06-11-560	155 mm / 6"	MANNER- FELT	1/1 4 mm
06-11-562	155 mm / 6"	MANNER- FELT	1/1 6 mm
06-11-565	155 mm / 6"	MANNER- FELT	1/1 3,5 mm



1/1
MANNERFELT
06-11-554
155 mm
6"





		Artikel-Nr. Cat. No.	Gesamtlänge Total length
1/1 6 mm		06-11-301	165 mm / 6½"
1/1 8 mm		06-11-302	165 mm / 6½"

1/2
06-11-301
165 mm
6½"



		Artikel-Nr. Cat. No.	Gesamtlänge Total length
1/1 8 mm		ADSON 06-11-306	170 mm / 6¾"
1/1 7 mm		ADSON 06-11-307	170 mm / 6¾"
1/1 7 mm		ADSON 06-11-308	170 mm / 6¾"
1/1 7 mm		ADSON 06-11-309	170 mm / 6¾"

1/2
ADSON
06-11-306
170 mm
6¾"

Artikel-Nr. Cat. No.	Gesamtlänge Total length		
06-11-310	180 mm / 7"	JOSEPH	1/1 4 mm 

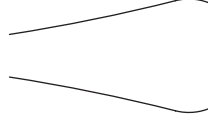
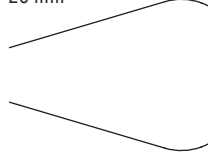

1/2
JOSEPH
06-11-310
180 mm
7"

Artikel-Nr. Cat. No.	Gesamtlänge Total length		
06-61-311	160 mm / 7½"	HOEN	1/1 7 mm 
06-61-312	190 mm / 7½"	HOEN	1/1 15 mm 
06-61-313	190 mm / 7½"	HOEN	1/1 20 mm 



1/2
HOEN
06-61-312
190 mm
7½"





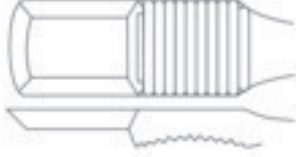
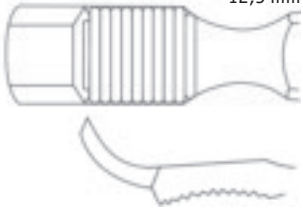



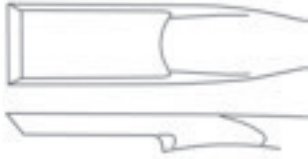
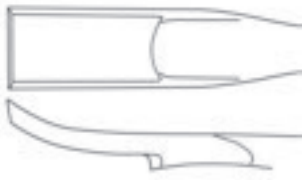

		Artikel-Nr. Cat. No.	Gesamtlänge Total length
1/1 12,5 mm		FARABEUF 06-11-340	140 mm / 5½"
1/1 12,5 mm		FARABEUF 06-11-341	140 mm / 5½"

1/2
FARABEUF
06-11-340
 140 mm
 5½"



		Artikel-Nr. Cat. No.	Gesamtlänge Total length
1/1 11 mm		FARABEUF-COLLIN 06-11-344	160 mm / 6¼"
1/1 11 mm		FARABEUF-COLLIN 06-11-345	160 mm / 6¼"

1/2
FARABEUF-COLLIN
06-11-344
 160 mm
 6¼"

Artikel-Nr. Cat. No.	Gesamtlänge Total length		
06-11-355	215 mm / 8½"	LAMBOTTE	1/1 5 mm 
06-11-356	215 mm / 8½"	LAMBOTTE	1/1 10 mm 
06-11-357	215 mm / 8½"	LAMBOTTE	1/1 15 mm 
06-11-358	215 mm / 8½"	LAMBOTTE	1/1 20 mm 
06-11-359	215 mm / 8½"	LAMBOTTE	1/1 25 mm 



1/2
LAMBOTTE
06-11-357
215 mm
8½"



1/2
JANSSEN
06-11-362
165 mm
6½"

Artikel-Nr. Cat. No.	Gesamtlänge Total length		
06-11-362	165 mm / 6½"	JANSEN	1/1 15 mm 





1/2
SCHNEIDER
06-11-365
 175 mm
 7"

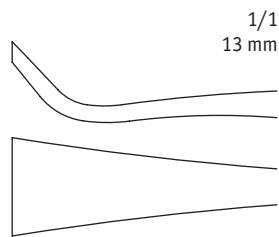

1/1
 13 mm

SCHNEIDER

Artikel-Nr.
Cat. No.

06-11-365

Gesamtlänge
Total length

175 mm / 7"

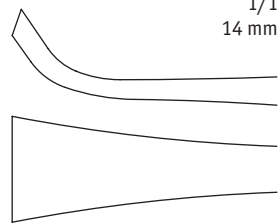

1/1
 14 mm

**SCHNEIDER-
 SAUER-
 BRUCH**

06-11-366

190 mm / 7½"



1/2
SEDILLOT
06-11-351
 215 mm
 8½"

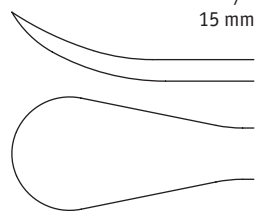

1/1
 15 mm

SEDILLOT

Artikel-Nr.
Cat. No.

06-11-351

Gesamtlänge
Total length



215 mm / 8½"

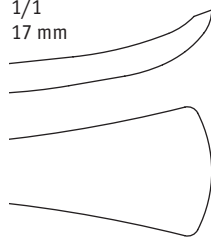
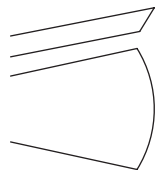
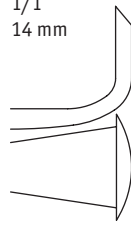
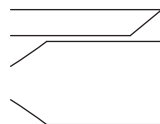

Artikel-Nr. Cat. No.	Gesamtlänge Total length		
13-02-279	190 mm / 7½"	LANGEN- BECK	1/1 17 mm 
06-11-360	190 mm / 7½"	LANGEN- BECK	1/1 16 mm 
06-11-361	180 mm / 7"	LANGEN- BECK	1/1 14 mm 
06-11-379	195 mm / 7¾"	MC KISSOCK	1/1 11 mm 

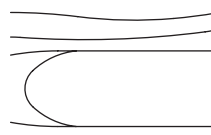

1/2
LANGENBECK
06-11-360
190 mm
7½"

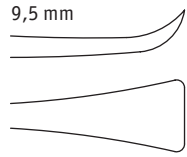
Artikel-Nr. Cat. No.	Gesamtlänge Total length		
06-11-390	185 mm / 7¼"	KRÄMER	1/1 10 mm 
06-11-391	190 mm / 7½"	KRÄMER	1/1 10 mm 
04-15-518	190 mm / 7½"	BÜCHS	1/1 9,5 mm 





1/2
KRÄMER
06-11-390
185 mm
7¼"





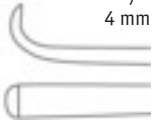

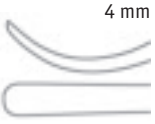
1/2
MÜHLING
06-11-394
 170 mm
 6¾"





		Artikel-Nr. Cat. No.	Gesamtlänge Total length
	1/1 4 mm	MÜHLING 06-11-394	170 mm / 6¾"
	1/1 4 mm	MÜHLING 06-11-395	170 mm / 6¾"
	1/1 4 mm	MÜHLING 06-11-396	170 mm / 6¾"
	1/1 4 mm	MÜHLING 06-11-397	170 mm / 6¾"

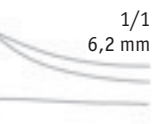
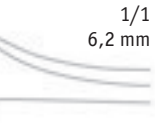
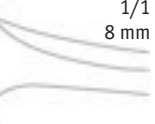

1/2
LANDOLT
06-11-314
 175 mm
 7"

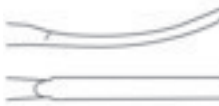
		Artikel-Nr. Cat. No.	Gesamtlänge Total length
	1/1 3 mm	04-15-521	170 mm / 6¾"
	1/1 6 mm	04-15-523	170 mm / 6¾"
	1/1 4,7 mm	LANDOLT 06-11-314	175 mm / 7"
	1/1 6,2 mm	CASPAR 06-11-328	180 mm / 7"
	1/1 6,2 mm	CASPAR 06-11-329	180 mm / 7"
	1/1 8 mm	COTTLE 15-12-157	195 mm / 7¾"



Artikel-Nr. Cat. No.	Gesamtlänge Total length		
06-11-317	185 mm / 7¼"	mit Ferrozell-Griff with handle from artificial wood	1/1 3 mm 
06-11-318	190 mm / 7½"	mit Ferrozell-Griff with handle from artificial wood	1/1 6 mm 
06-11-319	190 mm / 7½"	mit Ferrozell-Griff with handle from artificial wood	1/1 6 mm 
06-11-321	190 mm / 7½"	mit Ferrozell-Griff with handle from artificial wood	1/1 6 mm 



1/2
06-11-318
190 mm
7½"





 1/2
06-11-324
 195 mm
 7¾"

	Artikel-Nr. Cat. No.	Gesamtlänge Total length
<p>1/1 13 mm</p>	06-11-323	185 mm / 7¼" mit Ferrozell-Griff <i>with handle from artificial wood</i>
<p>1/1 14 mm</p>	06-11-324	195 mm / 7¾" mit Ferrozell-Griff <i>with handle from artificial wood</i>
<p>1/1 14 mm</p>	06-11-325	190 mm / 7½" mit Ferrozell-Griff <i>with handle from artificial wood</i>



 1/2
06-61-327
 205 mm
 8"

	Artikel-Nr. Cat. No.	Gesamtlänge Total length
<p>1/1 20 mm</p>	06-61-327	205 mm / 8" mit Ferrozell-Griff <i>with handle from artificial wood</i>

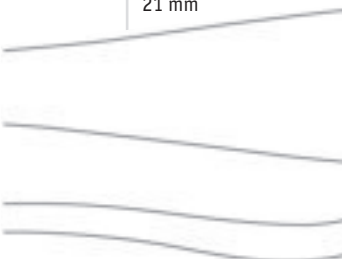

Artikel-Nr. Cat. No.	Gesamtlänge Total length		
06-61-328	330 mm / 13"	WAGNER	1/1 8 mm
mit Ferrozell-Griff with handle from artificial wood			

Artikel-Nr. Cat. No.	Gesamtlänge Total length		
06-61-329	330 mm / 13"	WAGNER	1/1 17 mm
mit Ferrozell-Griff with handle from artificial wood			

Artikel-Nr. Cat. No.	Gesamtlänge Total length		
06-61-330	275 mm / 10¾"	WAGNER	1/1 21 mm
mit Ferrozell-Griff with handle from artificial wood			



1/2
WAGNER
06-61-328
330 mm
13"











1/2
COBB
06-11-146
280 mm
11"

		Artikel-Nr. Cat. No.	Gesamtlänge Total length
1/1 10 mm		06-11-146	280 mm / 11"
1/1 13 mm		06-11-147	280 mm / 11"
1/1 19 mm		06-11-148	280 mm / 11"
1/1 25 mm		06-11-149	280 mm / 11"
1/1 32 mm		06-11-157	280 mm / 11"



		Artikel-Nr. Cat. No.	Gesamtlänge Total length
1/1 4 mm		06-61-331	280 mm / 11"
1/1 6 mm		06-61-332	280 mm / 11"
1/1 8 mm		06-61-333	280 mm / 11"



Artikel-Nr. Cat. No.	Gesamtlänge Total length		
06-11-801	140 mm / 5½"	MARTINI	1/1 
06-11-814	145 mm / 5¾"	WILLIGER	1/1 
06-11-850	210 mm / 8¼"		1/1 
06-11-840	130 mm / 5½"	VOLKMANN	1/1 
06-11-841	145 mm / 5¾"	VOLKMANN	1/1 
06-11-842	170 mm / 6¾"	VOLKMANN	1/1 

1/2
WILLIGER
06-11-814
145 mm
5¾"

















Artikel-Nr. Cat. No.	Gesamtlänge Total length		
06-11-845	130 mm / 5½"		1/1 
06-11-846	160 mm / 6¼"		1/1 
06-11-848	200 mm / 8"		1/1 

1/2
06-11-846
160 mm
6¼"









 1/1
VOLKMANN
06-11-632
 170 mm
 6¾"

		Artikel-Nr. Cat. No.	Gesamtlänge Total length
1/1 2,8 mm 	VOLKMANN	06-11-630	170 mm / 6¾" Fig. 0000
1/1 3,6 mm 	VOLKMANN	06-11-631	170 mm / 6¾" Fig. 000
1/1 4,4 mm 	VOLKMANN	06-11-632	170 mm / 6¾" Fig. 00
1/1 5,2 mm 	VOLKMANN	06-11-633	170 mm / 6¾" Fig. 0
1/1 6,8 mm 	VOLKMANN	06-11-634	170 mm / 6¾" Fig. 1
1/1 8,5 mm 	VOLKMANN	06-11-635	170 mm / 6¾" Fig. 2
1/1 10 mm 	VOLKMANN	06-11-636	170 mm / 6¾" Fig. 3
1/1 11,5 mm 	VOLKMANN	06-11-637	170 mm / 6¾" Fig. 4
1/1 13 mm 	VOLKMANN	06-11-638	170 mm / 6¾" Fig. 5
1/1 14,5 mm 	VOLKMANN	06-11-639	170 mm / 6¾" Fig. 6

Artikel-Nr. Cat. No.	Gesamtlänge Total length		
06-11-662	200 mm / 8" Fig. 0000	DAUBEN-SPECK	1/1 2,8 mm 
06-11-663	200 mm / 8" Fig. 000	DAUBEN-SPECK	1/1 3,6 mm 
06-11-664	200 mm / 8" Fig. 00	DAUBEN-SPECK	1/1 4,4 mm 
06-11-665	200 mm / 8" Fig. 0	DAUBEN-SPECK	1/1 5,2 mm 



1/2
DAUBENSPECK
06-11-665
200 mm
8"

Artikel-Nr. Cat. No.	Gesamtlänge Total length		
06-11-675 06-61-675	215 mm / 8½" gerade / straight gewinkelt / angled	LEMPERT	1/1 1,8 mm 
06-11-676 06-61-676	215 mm / 8½" gerade / straight gewinkelt / angled	LEMPERT	1/1 2 mm 
06-11-677 06-61-677	215 mm / 8½" gerade / straight gewinkelt / angled	LEMPERT	1/1 2,4 mm 
06-11-678 06-61-678	215 mm / 8½" gerade / straight gewinkelt / angled	LEMPERT	1/1 2,6 mm 
06-11-679 06-61-679	215 mm / 8½" gerade / straight gewinkelt / angled	LEMPERT	1/1 2,8 mm 



1/1
LEMPERT
06-11-677
215 mm
8½"













 1/2
HALLE
06-11-686
 215 mm
 8½"

		Artikel-Nr. Cat. No.	Gesamtlänge Total length
1/1 4,4 mm	HALLE	06-11-684	215 mm / 8½" Fig. 00 biegsam malleable
1/1 5,2 mm	HALLE	06-11-685	215 mm / 8½" Fig. 0 biegsam malleable
1/1 6,8 mm	HALLE	06-11-686	215 mm / 8½" Fig. 1 biegsam malleable

 1/2
SIMON
06-11-689
 235 mm
 9¼"

		Artikel-Nr. Cat. No.	Gesamtlänge Total length
1/1 3,6 mm	SIMON	06-11-688	235 mm / 9¼" Fig. 000
1/1 4,4 mm	SIMON	06-11-689	235 mm / 9¼" Fig. 00
1/1 5,2 mm	SIMON	06-11-690	235 mm / 9¼" Fig. 0





Artikel-Nr. Cat. No.	Gesamtlänge Total length	BRUNS	
13-02-872	230 mm / 9" Fig. 000	BRUNS	1/1 2 mm 
13-02-873	230 mm / 9" Fig. 00	BRUNS	1/1 2,5 mm 
13-02-874	230 mm / 9" Fig. 0	BRUNS	1/1 3,3 mm 
13-02-875	230 mm / 9" Fig. 1	BRUNS	1/1 3,8 mm 
13-02-876	230 mm / 9" Fig. 2	BRUNS	1/1 4,8 mm 
13-02-877	230 mm / 9" Fig. 3	BRUNS	1/1 5,3 mm 
13-02-878	230 mm / 9" Fig. 4	BRUNS	1/1 6,0 mm 
13-02-879	230 mm / 9" Fig. 5	BRUNS	1/1 6,7 mm 
13-02-880	230 mm / 9" Fig. 6	BRUNS	1/1 7,3 mm 





1/2
BRUNS
13-02-876
230 mm
9"







 1/3
06-11-704
 250 mm
 10"

		Artikel-Nr. Cat. No.	Gesamtlänge Total length
1/1 3,6 mm 		06-11-702	250 mm / 10" Fig. 000
		06-11-712	gerade / straight gewinkelt / angled
1/1 4,4 mm 		06-11-703	250 mm / 10" Fig. 00
		06-11-713	gerade / straight gewinkelt / angled
1/1 5,2 mm 		06-11-704	250 mm / 10" Fig. 0
		06-11-714	gerade / straight gewinkelt / angled
1/1 6,8 mm 		06-11-705	250 mm / 10" Fig. 1
		06-11-715	gerade / straight gewinkelt / angled

 1/3
BUSHE
06-11-724
 250 mm
 10"



		Artikel-Nr. Cat. No.	Gesamtlänge Total length
1/1 3 mm 	BUSHE	06-11-723	250 mm / 10"
1/1 4 mm 	BUSHE	06-11-724	250 mm / 10"
1/1 5 mm 	BUSHE	06-11-725	250 mm / 10"



Artikel-Nr. Cat. No.	Gesamtlänge Total length		
06-11-773	220 mm / 8¾" Fig. 000	CASPAR	1/1 3,6 mm 
	gerade / straight		
06-11-783			
06-11-774	220 mm / 8¾" Fig. 00	CASPAR	1/1 4,4 mm 
	gerade / straight		
06-11-784			
06-11-775	220 mm / 8¾" Fig. 0	CASPAR	1/1 5,2 mm 
	gerade / straight		
06-11-785			



1/2
CASPAR
06-11-775
220 mm
8¾"

Artikel-Nr. Cat. No.	Gesamtlänge Total length		
06-11-834	220 mm / 8¾"	CASPAR	1/1 4 mm 
	gezahnt toothed		
06-11-835	220 mm / 8¾"	CASPAR	1/1 5 mm 
	gezahnt toothed		
06-11-836	220 mm / 8¾"	CASPAR	1/1 6 mm 
	gezahnt toothed		





1/2
CASPAR
06-11-835
220 mm
8¾"









1/2
CASPAR
06-11-854
 250 mm
 10"

		Artikel-Nr. Cat. No.	Gesamtlänge Total length
	1/1 4 mm	CASPAR 06-11-854	250 mm / 10" gezahnt toothed
	1/1 5 mm	CASPAR 06-11-855	250 mm / 10" gezahnt toothed





1/2
CASPAR
06-11-863
 270 mm
 10¾"

		Artikel-Nr. Cat. No.	Gesamtlänge Total length
	1/1 3 mm	CASPAR 06-11-863	270 mm / 10¾" gezahnt toothed
	1/1 4 mm	CASPAR 06-11-864	270 mm / 10¾" gezahnt toothed

Artikel-Nr. Cat. No.	Gesamtlänge Total length		
06-61-870	230 mm / 9"	CONE	1/1 Ø 4 mm 
06-61-871	230 mm / 9"	CONE	1/1 Ø 7 mm 
06-61-872	230 mm / 9"	CONE	1/1 Ø 9 mm 



1/3
CONE
06-61-872
230 mm
9"

Artikel-Nr. Cat. No.	Gesamtlänge Total length		
06-61-873	230 mm / 9"	CONE	1/1 Ø 4 mm 
06-61-874	230 mm / 9"	CONE	1/1 Ø 7 mm 
06-61-875	230 mm / 9"	CONE	1/1 Ø 9 mm 











1/3
CONE
06-61-875
230 mm
9"





2/3
COBB
06-11-582
 280 mm
 10¾"

		Artikel-Nr. Cat. No.	Gesamtlänge Total length
1/1 3,25 mm	COBB		280 mm / 10¾" Fig. 000
		06-11-581	gerade / straight
		06-11-591	gewinkelt / angled
1/1 4 mm	COBB		280 mm / 10¾" Fig. 00
		06-11-582	gerade / straight
		06-11-592	gewinkelt / angled
1/1 5 mm	COBB		280 mm / 10¾" Fig. 0
		06-11-583	gerade / straight
		06-11-593	gewinkelt / angled
1/1 6 mm	COBB		280 mm / 10¾" Fig. 1
		06-11-584	gerade / straight
		06-11-594	gewinkelt / angled
1/1 7,5 mm	COBB		280 mm / 10¾" Fig. 2
		06-11-585	gerade / straight
		06-11-595	gewinkelt / angled
1/1 9 mm	COBB		280 mm / 10¾" Fig. 3
		06-11-586	gerade / straight
		06-11-596	gewinkelt / angled
1/1 11,5 mm	COBB		280 mm / 10¾" Fig. 4
		06-11-587	gerade / straight
		06-11-597	gewinkelt / angled
1/1 13 mm	COBB		280 mm / 10¾" Fig. 5
		06-11-588	gerade / straight
		06-11-598	gewinkelt / angled
1/1 15,5 mm	COBB		280 mm / 10¾" Fig. 6
		06-11-589	gerade / straight
		06-11-599	gewinkelt / angled



Artikel-Nr. Cat. No.	Gesamtlänge Total length		
15-12-294	180 mm / 7" 4 mm	COTTLE	1/1
15-12-296	180 mm / 7" 6 mm		
15-12-298	180 mm / 7" 8 mm		
15-12-299	180 mm / 7" 10 mm		
15-12-300	180 mm / 7" 12 mm		
	graduiert graduated		
15-12-301	180 mm / 7" 4 mm	COTTLE	1/1
15-12-302	180 mm / 7" 6 mm		
15-12-303	180 mm / 7" 8 mm		
15-62-300	180 mm / 7" 10 mm		
15-12-304	180 mm / 7" 12 mm		
	graduiert graduated		
15-62-301	180 mm / 7" 4 mm	COTTLE	1/1
15-62-302	180 mm / 7" 6 mm		
15-62-303	180 mm / 7" 8 mm		
15-62-304	180 mm / 7" 10 mm		
15-62-305	180 mm / 7" 12 mm		
	graduiert graduated		



1/2
COTTLE
15-12-301
180 mm
7"

Artikel-Nr. Cat. No.	Gesamtlänge Total length		
15-12-307	180 mm / 7" 8 mm	COTTLE	1/1
	Fischschwanzosteotom, graduiert fishtail chisel, graduated		



1/2
COTTLE
15-12-307
180 mm
7"





1/2
SMITH-PETERSEN
13-02-659
 200 mm
 8"

		Artikel-Nr. Cat. No.	Gesamtlänge Total length
1/1		SMITH-PETERSEN 13-02-657	200 mm / 8" 6 mm
		13-02-658	200 mm / 8" 9 mm
		13-02-659	200 mm / 8" 13 mm
		13-02-660	200 mm / 8" 16 mm
		13-02-661	200 mm / 8" 19 mm
		13-02-662	200 mm / 8" 25 mm
		13-52-663	200 mm / 8" 32 mm



1/2
SMITH-PETERSEN
13-02-665
 200 mm
 8"

		Artikel-Nr. Cat. No.	Gesamtlänge Total length
1/1		SMITH-PETERSEN 13-02-663	200 mm / 8" 6 mm
		13-02-664	200 mm / 8" 9 mm
		13-02-665	200 mm / 8" 13 mm
		13-02-666	200 mm / 8" 16 mm
		13-02-667	200 mm / 8" 19 mm
		13-02-668	200 mm / 8" 25 mm
		13-02-669	200 mm / 8" 32 mm

Artikel-Nr. Cat. No.	Gesamtlänge Total length		
13-02-675	240 mm / 9½" 6 mm	HIBBS	1/1
13-02-676	240 mm / 9½" 10 mm		
13-02-677	240 mm / 9½" 13 mm		
13-02-678	240 mm / 9½" 16 mm		
13-02-679	240 mm / 9½" 19 mm		
13-02-680	240 mm / 9½" 22 mm		
13-02-681	240 mm / 9½" 25 mm		
13-02-682	240 mm / 9½" 28 mm		
13-02-683	240 mm / 9½" 32 mm		
13-02-684	240 mm / 9½" 38 mm		



1/2
HIBBS
13-02-677
240 mm
9½"



Artikel-Nr. Cat. No.	Gesamtlänge Total length		
13-02-685	240 mm / 9½" 6 mm	HIBBS	1/1
13-02-686	240 mm / 9½" 10 mm		
13-02-687	240 mm / 9½" 13 mm		
13-02-688	240 mm / 9½" 16 mm		
13-02-689	240 mm / 9½" 19 mm		
13-02-690	240 mm / 9½" 22 mm		
13-02-691	240 mm / 9½" 25 mm		
13-02-692	240 mm / 9½" 28 mm		
13-02-693	240 mm / 9½" 32 mm		
13-02-694	240 mm / 9½" 38 mm		



1/2
HIBBS
13-02-687
240 mm
9½"



 1/3
06-12-653
 245 mm
 9 3/4"

		Artikel-Nr. Cat. No.	Gesamtlänge Total length
1/1	LAMBOTTE	06-12-650	245 mm / 9 3/4" 4 mm
		06-12-651	245 mm / 9 3/4" 8 mm
		06-12-652	245 mm / 9 3/4" 10 mm
		06-12-653	245 mm / 9 3/4" 13 mm
		06-12-654	245 mm / 9 3/4" 15 mm
		06-12-655	245 mm / 9 3/4" 18 mm
		06-12-656	245 mm / 9 3/4" 20 mm
		06-12-658	245 mm / 9 3/4" 25 mm
		06-12-659	245 mm / 9 3/4" 30 mm
		06-12-660	245 mm / 9 3/4" 38 mm
		06-12-661	245 mm / 9 3/4" 44 mm
		06-12-662	245 mm / 9 3/4" 50 mm

 1/3
LAMBOTTE
06-12-785
 245 mm
 9 3/4"

		Artikel-Nr. Cat. No.	Gesamtlänge Total length
1/1	LAMBOTTE	06-12-781	245 mm / 9 3/4" 8 mm
		06-12-783	245 mm / 9 3/4" 13 mm
		06-12-785	245 mm / 9 3/4" 18 mm
		06-12-788	245 mm / 9 3/4" 25 mm
		06-12-789	245 mm / 9 3/4" 30 mm
		06-12-790	245 mm / 9 3/4" 38 mm

 1/3
OBWEGESER
04-15-720
 235 mm
 9 3/4"

		Artikel-Nr. Cat. No.	Gesamtlänge Total length
1/1	OBWEGESER	04-15-720	235 mm / 9 3/4" 11 mm

Artikel-Nr. Cat. No.	Gesamtlänge Total length		
06-12-512	205 mm / 8" 8 mm	STILLE	1/1
06-12-513	205 mm / 8" 10 mm		
06-12-514	205 mm / 8" 12 mm		
06-12-515	205 mm / 8" 15 mm		
06-12-516	205 mm / 8" 20 mm		
06-12-517	205 mm / 8" 25 mm		
Osteotome osteotomes			
06-12-523	205 mm / 8" 10 mm	STILLE	1/1
06-12-524	205 mm / 8" 12 mm		
06-12-525	205 mm / 8" 15 mm		
06-12-526	205 mm / 8" 20 mm		
06-12-527	205 mm / 8" 25 mm		
Osteotome osteotomes			



1/2
STILLE
06-12-516
 205 mm
 8"

Artikel-Nr. Cat. No.	Gesamtlänge Total length		
06-12-553	205 mm / 8" 10 mm	STILLE	1/1
06-12-554	205 mm / 8" 12 mm		
06-12-555	205 mm / 8" 15 mm		
06-12-556	205 mm / 8" 20 mm		
06-12-557	205 mm / 8" 25 mm		
Osteotome osteotomes			



1/2
STILLE
06-12-553
 205 mm
 8"



 1/2
STILLE
06-12-506
 205 mm
 8"

		Artikel-Nr. Cat. No.	Gesamtlänge Total length
	1/1	STILLE	06-12-503 205 mm / 8" 10 mm
			06-12-504 205 mm / 8" 12 mm
			06-12-505 205 mm / 8" 15 mm
			06-12-506 205 mm / 8" 20 mm
			06-12-507 205 mm / 8" 25 mm
			Flachmeißel chisels



 1/2
STILLE
06-12-576
 205 mm
 8"

		Artikel-Nr. Cat. No.	Gesamtlänge Total length
	1/1	STILLE	06-12-573 205 mm / 8" 10 mm
			06-12-574 205 mm / 8" 12 mm
			06-12-575 205 mm / 8" 15 mm
			06-12-576 205 mm / 8" 20 mm
			06-12-577 205 mm / 8" 25 mm
			Hohlmeißel gouges

Artikel-Nr. Cat. No.	Gesamtlänge Total length		
06-12-401	220 mm / 8¾" 5 mm		LEXER 1/1
06-12-402	220 mm / 8¾" 7 mm		
06-12-403	220 mm / 8¾" 10 mm		
06-12-405	220 mm / 8¾" 15 mm		
06-12-406	220 mm / 8¾" 20 mm		
06-12-407	220 mm / 8¾" 25 mm		
06-12-408	220 mm / 8¾" 30 mm		
Osteotome, mit Ferrozell-Griff <i>osteotomes, with handle from artificial wood</i>			

1/2
LEXER
06-12-405
 220 mm
 8¾"



Artikel-Nr. Cat. No.	Gesamtlänge Total length		
06-12-411	220 mm / 8¾" 5 mm		LEXER 1/1
06-12-412	220 mm / 8¾" 7 mm		
06-12-413	220 mm / 8¾" 10 mm		
06-12-415	220 mm / 8¾" 15 mm		
06-12-416	220 mm / 8¾" 20 mm		
06-12-417	220 mm / 8¾" 25 mm		
06-12-418	220 mm / 8¾" 30 mm		
Hohlmeißel, mit Ferrozell-Griff <i>gouges, with handle from artificial wood</i>			

1/2
LEXER
06-12-415
 220 mm
 8¾"







 1/2
06-12-438
 235 mm
 9¼"

		Artikel-Nr. Cat. No.	Gesamtlänge Total length
1/1 8 mm 		06-12-437	235 mm / 9¼" 6 mm
		06-12-438	235 mm / 9¼" 8 mm
		06-12-439	235 mm / 9¼" 11 mm
		06-12-440	235 mm / 9¼" 16 mm
		Wirbelsäulenmeißel, bajonettförmig, mit Ferrozell-Griff <i>lamina gouge, bajonet-shaped, with handle from artificial wood</i>	

 1/2
ZIELKE
06-12-702
 230 mm
 9"

		Artikel-Nr. Cat. No.	Gesamtlänge Total length
1/1 ZIELKE 		06-12-701	230 mm / 9" 5,5 mm
		06-12-702	230 mm / 9" 9 mm
		Hohlmeißel, gebogen, mit Ferrozell-Griff <i>gouges, curved with handle from artificial wood</i>	



Artikel-Nr. Cat. No.	Gesamtlänge Total length		
06-62-705	280 mm / 11"	gerade <i>straight</i>	COBB 1/1 
06-62-706	280 mm / 11"	leicht gebogen <i>slightly curved</i>	COBB 1/1 
06-62-707	280 mm / 11"	stark gebogen <i>full curved</i>	COBB 1/1 
06-62-708	280 mm / 11"	rückwärts gebogen <i>reverse curved</i>	COBB 1/1 



1/2
COBB
06-62-705
 280 mm
 11"



Artikel-Nr.
Cat. No.

06-62-000

K-LINE MAGNUM Flachmeißel Set, bestehend aus:
K-LINE MAGNUM Chisel Set, consisting of:

K-LINE MAGNUM Flachmeißel, 273 mm / 10¾",
 Griff ø 32 mm
 K-LINE MAGNUM chisel, 273 mm / 10¾", handle ø 32 mm

06-62-001	6 mm
06-62-002	10 mm
06-62-003	15 mm
06-62-004	20 mm
06-62-005	25 mm
06-62-006	30 mm

gerade
 straight

06-62-007 Sterilisiergestell für 6 K-LINE MAGNUM
 Instrumente mit Griff ø 32 mm

*sterilizing rack for 6 K-LINE MAGNUM
 instruments with handle ø 32 mm*



1/4
06-62-000

Artikel-Nr.
Cat. No.

06-62-008

K-LINE MAGNUM Flachmeißel Set, bestehend aus:
K-LINE MAGNUM Chisel Set, consisting of:

K-LINE MAGNUM Flachmeißel, 273 mm / 10¾",
 Griff ø 32 mm
 K-LINE MAGNUM chisel, 273 mm / 10¾", handle ø 32 mm

06-62-009	6 mm
06-62-010	10 mm
06-62-011	15 mm
06-62-012	20 mm
06-62-013	25 mm
06-62-014	30 mm

gebogen
 curved

06-62-007 Sterilisiergestell für 6 K-LINE MAGNUM
 Instrumente mit Griff ø 32 mm

*sterilizing rack for 6 K-LINE MAGNUM
 instruments with handle ø 32 mm*

Artikel-Nr. Cat. No.	Gesamtlänge Total length	
06-62-001	273 mm / 10¾"	6 mm
	gerade straight	
06-62-002	273 mm / 10¾"	10 mm
	gerade straight	
06-62-003	273 mm / 10¾"	15 mm
	gerade straight	
06-62-004	273 mm / 10¾"	20 mm
	gerade straight	
06-62-005	273 mm / 10¾"	25 mm
	gerade straight	
06-62-006	273 mm / 10¾"	30 mm
	gerade straight	



Artikel-Nr. Cat. No.	Gesamtlänge Total length	
06-62-009	273 mm / 10¾"	6 mm
	gebogen curved	
06-62-010	273 mm / 10¾"	10 mm
	gebogen curved	
06-62-011	273 mm / 10¾"	15 mm
	gebogen curved	
06-62-012	273 mm / 10¾"	20 mm
	gebogen curved	
06-62-013	273 mm / 10¾"	25 mm
	gebogen curved	
06-62-014	273 mm / 10¾"	30 mm
	gebogen curved	



Artikel-Nr. Cat. No.	
06-62-007	Sterilisiergestell für 6 K-LINE MAGNUM Instrumente mit Griff ø 32 mm sterilizing rack for 6 K-LINE MAGNUM instruments with handle ø 32 mm

1/2
06-62-002
273 mm
10¾"



10



1/4

06-61-630

Artikel-Nr.
Cat. No.

06-61-630



K-LINE MAGNUM XL Küretten Set, bestehend aus:
K-LINE MAGNUM XL Curettes Set, consisting of:

 K-LINE MAGNUM Kürette, extra lang (XL),
 337 mm / 13¼", Griff ø 32 mm

 K-LINE MAGNUM curette, extra long (XL),
 337 mm / 13¼", handle ø 32 mm

06-61-631	7 mm	gerade / straight
06-61-632	9 mm	gerade / straight
06-61-633	11 mm	gerade / straight
06-61-634	13 mm	gerade / straight
06-61-635	15 mm	gerade / straight
06-61-636	17 mm	gerade / straight
06-61-637	19 mm	gerade / straight
06-61-638	7 mm	vorwärts gewinkelt / forward angled
06-61-639	9 mm	vorwärts gewinkelt / forward angled
06-61-640	11 mm	vorwärts gewinkelt / forward angled
06-61-641	7 mm	rückwärts gewinkelt / reverse angled
06-61-642	9 mm	rückwärts gebogen / reverse angled
06-61-643	Sterilisiergestell für 12 K-LINE MAGNUM Instrumente mit Griff ø 32 mm sterilizing case for 12 K-LINE MAGNUM instruments with handle ø 32 mm	



Artikel-Nr. Cat. No.	Gesamtlänge Total length		
06-61-631	337 mm / 13¼"	7 mm	
	gerade / straight		
06-61-632	337 mm / 13¼"	9 mm	
	gerade / straight		
06-61-633	337 mm / 13¼"	11 mm	
	gerade / straight		
06-61-634	337 mm / 13¼"	13 mm	
	gerade / straight		
06-61-635	337 mm / 13¼"	15 mm	
	gerade / straight		
06-61-636	337 mm / 13¼"	17 mm	
	gerade / straight		
06-61-637	337 mm / 13¼"	19 mm	
	gerade / straight		
06-61-638	337 mm / 13¼"	7 mm	
	vorwärts gebogen / forward angled		
06-61-639	337 mm / 13¼"	9 mm	
	vorwärts gebogen / forward angled		
06-61-640	337 mm / 13¼"	11 mm	
	vorwärts gebogen / forward angled		
06-61-641	337 mm / 13¼"	7 mm	
	rückwärts gebogen / reverse angled		
06-61-642	337 mm / 13¼"	9 mm	
	rückwärts gebogen / reverse angled		



Artikel-Nr.
Cat. No.

06-61-643	Sterilisiergestell für 12 K-LINE MAGNUM Instrumente mit Griff ø 32 mm sterilizing case for 12 K-LINE MAGNUM instruments with handle ø 32 mm		
-----------	--	--	--

1/2
06-61-634
337 mm
13¼"



 1/4
06-61-660
Artikel-Nr.
Cat. No.
06-61-660
K-LINE MAGNUM Küretten Set, bestehend aus:
K-LINE MAGNUM Curettes Set, consisting of:

 K-LINE MAGNUM Kürette, 320 mm / 12²/₃" , Griff ø 28 mm
 K-LINE MAGNUM curette, 320 mm / 12²/₃" , handle ø 28 mm

06-61-661	7 mm
	gerade / straight
06-61-662	9 mm
	gerade / straight
06-61-663	11 mm
	gerade / straight
06-61-664	13 mm
	gerade / straight
06-61-665	15 mm
	gerade / straight
06-61-666	17 mm
	gerade / straight
06-61-667	19 mm
	gerade / straight
06-61-668	7 mm
	vorwärts gebogen / forward angled
06-61-669	9 mm
	vorwärts gebogen / forward angled
06-61-670	11 mm
	vorwärts gebogen / forward angled
06-61-671	7 mm
	rückwärts gebogen / reverse angled
06-61-672	9 mm
	rückwärts gebogen / reverse angled
06-61-657	Sterilisiergestell für 12 K-LINE MAGNUM Instrumente mit Griff ø 28 mm
	sterilizing case for 12 K-LINE MAGNUM instruments with handle ø 28 mm



Artikel-Nr. Cat. No.	Gesamtlänge Total length		
06-61-661	320 mm / 12 ² / ₃ "	7 mm	
	gerade / <i>straight</i>		
06-61-662	320 mm / 12 ² / ₃ "	9 mm	
	gerade / <i>straight</i>		
06-61-663	320 mm / 12 ² / ₃ "	11 mm	
	gerade / <i>straight</i>		
06-61-664	320 mm / 12 ² / ₃ "	13 mm	
06-61-665	320 mm / 12 ² / ₃ "	15 mm	
	gerade / <i>straight</i>		
06-61-666	320 mm / 12 ² / ₃ "	17 mm	
	gerade / <i>straight</i>		
06-61-667	320 mm / 12 ² / ₃ "	19 mm	
	gerade / <i>straight</i>		
06-61-668	320 mm / 12 ² / ₃ "	7 mm	
	vorwärts gebogen / <i>forward angled</i>		
06-61-669	320 mm / 12 ² / ₃ "	9 mm	
	vorwärts gebogen / <i>forward angled</i>		
06-61-670	320 mm / 12 ² / ₃ "	11 mm	
	vorwärts gebogen / <i>forward angled</i>		
06-61-671	320 mm / 12 ² / ₃ "	7 mm	
	rückwärts gebogen / <i>reverse angled</i>		
06-61-672	320 mm / 12 ² / ₃ "	9 mm	
	rückwärts gebogen / <i>reverse angled</i>		



Artikel-Nr. Cat. No.		
06-61-657	Sterilisiergestell für 12 K-LINE MAGNUM Instrumente mit Griff ø 28 mm <i>sterilizing case for 12 K-LINE MAGNUM instruments with handle ø 28 mm</i>	

1/2
06-61-669
320 mm
12²/₃"



1/4
06-61-680

Artikel-Nr.
Cat. No.

06-61-680 K-LINE MAGNUM Ring-Küretten Set, bestehend aus:
K-LINE MAGNUM Ring Curettes Set, consisting of:

K-LINE MAGNUM Ring-Kürette, extra lang (XL),
 337 mm / 13¼", Griff ø 32 mm

*K-LINE MAGNUM ring curette, extra long (XL),
 337 mm / 13¼", handle ø 32 mm*

06-61-681 6 mm

gerade / straight

06-61-682 8 mm

gerade / straight

06-61-683 10 mm

gerade / straight

06-61-684 6 mm

gebogen / curved

06-61-685 8 mm

gebogen / curved

06-61-686 10 mm

gebogen / curved

06-61-643 Sterilisiergestell für 12 K-LINE MAGNUM
 Instrumente mit Griff ø 32 mm

*sterilizing case for 12 K-LINE MAGNUM
 instruments with handle ø 32 mm*



Artikel-Nr. Cat. No.	Gesamtlänge Total length		
06-61-681	337 mm / 13¼"	6 mm	
	gerade / straight		
06-61-682	337 mm / 13¼"	8 mm	
	gerade / straight		
06-61-683	337 mm / 13¼"	10 mm	
	gerade / straight		
06-61-684	337 mm / 13¼"	6 mm	
	gebogen / curved		
06-61-685	337 mm / 13¼"	8 mm	
	gebogen / curved		
06-61-686	337 mm / 13¼"	10 mm	
	gebogen / curved		

Artikel-Nr. Cat. No.		
06-61-643	Sterilisiergestell für 12 K-LINE MAGNUM Instrumente mit Griff ø 32 mm sterilizing case for 12 K-LINE MAGNUM instruments with handle ø 32 mm	



1/2
06-61-685
337 mm
13¼"





1/4
 06-61-650

Artikel-Nr.
Cat. No.

06-61-650	K-LINE MAGNUM Ring-Küretten Set, bestehend aus: K-LINE MAGNUM Ring Curettes Set, consisting of: K-LINE MAGNUM Ring-Kürette, 320 mm / 12 ² / ₅ " , Griff ø 28 mm K-LINE MAGNUM ring curette, 320 mm / 12 ² / ₅ " , handle ø 28 mm
06-61-651	6 mm gerade / straight
06-61-652	8 mm gerade / straight
06-61-653	10 mm gerade / straight
06-61-654	6 mm gebogen / curved
06-61-655	8 mm gebogen / curved
06-61-656	10 mm gebogen / curved
06-61-657	Sterilisiergestell für 12 K-LINE MAGNUM Instrumente mit Griff ø 28 mm <i>sterilizing case for 12 K-LINE MAGNUM instruments with handle ø 28 mm</i>



Artikel-Nr. Cat. No.	Gesamtlänge Total length		
06-61-651	320 mm / 12 ² / ₃ "	6 mm	
	gerade / straight		
06-61-652	320 mm / 12 ² / ₃ "	8 mm	
	gerade / straight		
06-61-653	320 mm / 12 ² / ₃ "	10 mm	
	gerade / straight		
06-61-654	320 mm / 12 ² / ₃ "	6 mm	
	gebogen / curved		
06-61-655	320 mm / 12 ² / ₃ "	8 mm	
	gebogen / curved		
06-61-656	320 mm / 12 ² / ₃ "	10 mm	
	gebogen / curved		

Artikel-Nr. Cat. No.		
06-61-657	Sterilisiergestell für 12 K-LINE MAGNUM Instrumente mit Griff ø 28 mm sterilizing case for 12 K-LINE MAGNUM instruments with handle ø 28 mm	



1/2
06-61-652
320 mm
12²/₃"





1/4
06-62-015

Artikel-Nr.
Cat. No.

06-62-015 K-LINE MAGNUM COBB Elevatoren Set, bestehend aus:
K-LINE MAGNUM COBB Elevators Set, consisting of:

K-LINE MAGNUM COBB Elevatorium, extra lang (XL),
 337 mm / 13¼", Griff ø 32 mm

*K-LINE MAGNUM COBB elevators, extra long (XL),
 337 mm / 13¼", handle ø 32 mm*

06-62-016 10 mm

06-62-017 15 mm

06-62-018 20 mm

06-62-019 25 mm

06-62-020 30 mm

06-62-021 35 mm

06-61-643 Sterilisiergestell für 12 K-LINE MAGNUM
 Instrumente mit Griff ø 32 mm

*sterilizing case for 12 K-LINE MAGNUM
 instruments with handle ø 32 mm*

Artikel-Nr. Cat. No.	Gesamtlänge Total length			
06-62-016	337 mm / 13¼"	COBB	10 mm	
06-62-017	337 mm / 13¼"	COBB	15 mm	
06-62-018	337 mm / 13¼"	COBB	20 mm	
06-62-019	337 mm / 13¼"	COBB	25 mm	
06-62-020	337 mm / 13¼"	COBB	30 mm	
06-62-021	337 mm / 13¼"	COBB	35 mm	

Artikel-Nr. Cat. No.			
06-61-643	Sterilisiergestell für 12 K-LINE MAGNUM Instrumente mit Griff ø 32 mm <i>sterilizing case for 12 K-LINE MAGNUM instruments with handle ø 32 mm</i>		



1/2
06-62-017
337 mm
13¼"





1/4

06-62-022

Artikel-Nr.
Cat. No.
06-62-022 **K-LINE MAGNUM COBB Elevatoren Set, bestehend aus:**
K-LINE MAGNUM COBB Elevators Set, consisting of:

 K-LINE MAGNUM COBB Elevatorium, 320 mm / 12 $\frac{2}{3}$ " ,
 Griff ø 28 mm

K-LINE MAGNUM COBB elevators, 320 mm / 12 $\frac{2}{3}$ " ,
handle ø 28 mm
06-62-023 10 mm

06-62-024 15 mm

06-62-025 20 mm

06-62-026 25 mm

06-62-027 30 mm

06-62-028 35 mm

06-61-657 Sterilisiergestell für 12 K-LINE MAGNUM
 Instrumente mit Griff ø 28 mm

sterilizing case for 12 K-LINE MAGNUM
instruments with handle ø 28 mm

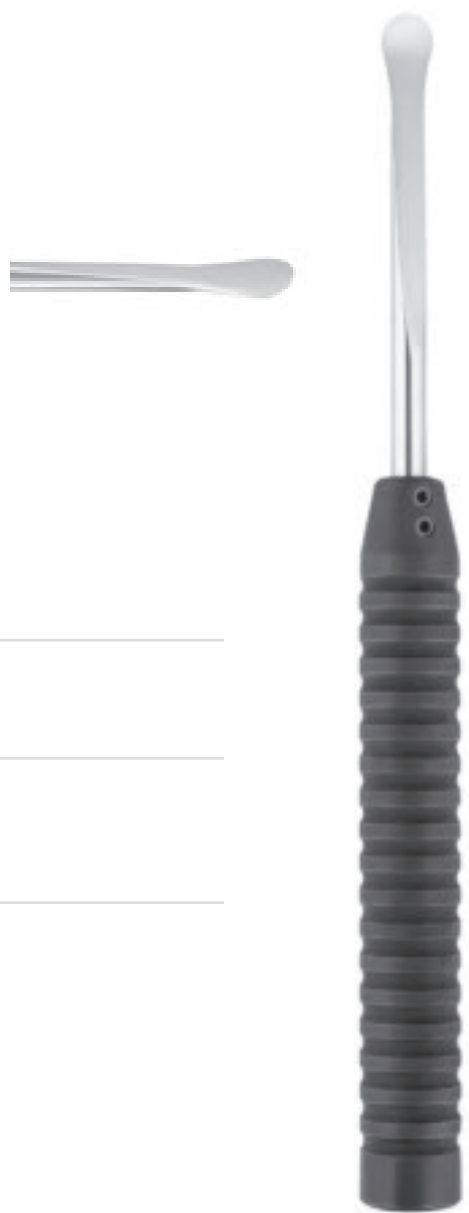
Artikel-Nr. Cat. No.	Gesamtlänge Total length			
06-62-023	320 mm / 12 ² / ₃ "	COBB	10 mm	
06-62-024	320 mm / 12 ² / ₃ "	COBB	15 mm	
06-62-025	320 mm / 12 ² / ₃ "	COBB	20 mm	
06-62-026	320 mm / 12 ² / ₃ "	COBB	25 mm	
06-62-027	320 mm / 12 ² / ₃ "	COBB	30 mm	
06-62-028	320 mm / 12 ² / ₃ "	COBB	35 mm	

Artikel-Nr. Cat. No.			
06-61-657	Sterilisiergestell für 12 K-LINE MAGNUM Instrumente mit Griff ø 28 mm <i>sterilizing case for 12 K-LINE MAGNUM instruments with handle ø 28 mm</i>		

1/2
06-62-025
320 mm
12²/₃"





1/2
06-62-030
 240 mm
 9½"

		Artikel-Nr. Cat. No.	Gesamtlänge Total length
		06-62-030	240 mm / 9½" ø 25 mm, 193 g
		06-62-031	245 mm / 9½" ø 32 mm, 340 g



Artikel-Nr. Cat. No.	Gesamtlänge Total length		
06-12-036	185 mm / 7¼"		
	ø 25 mm, 130 g mit auswechselbaren Kunststoffbacken with interchangeable plastic discs		
06-12-037	Paar Ersatzbacken pair of spare discs		



1/2
06-12-036
185 mm
7¼"



1/2
COTTLE
06-12-038
180 mm
7"

Artikel-Nr. Cat. No.	Gesamtlänge Total length		
06-12-038	180 mm / 7"	COTTLE	
	ø 30 mm, 240 g 1 Seite flach, 1 Seite convex 1 side flat, 1 side convex		

Artikel-Nr. Cat. No.	Gesamtlänge Total length		
06-12-044	220 mm / 8¾"	HAJEK	
	ø 27 mm, 130 g		



1/2
HAJEK
06-12-044
220 mm
8¾"



1/2
04-06-112
 165 mm
 6½"

Artikel-Nr.
Cat. No.

Gesamtlänge
Total length

		04-06-112	165 mm / 6½"
			ø 22 mm, 80 g
			mit Bleifüllung lead filled head



1/2
04-06-114
 190 mm
 7½"

Artikel-Nr.
Cat. No.

Gesamtlänge
Total length

		04-06-114	190 mm / 7½"
			ø 22 mm, 155 g
			mit Bleifüllung lead filled head



1/2
 MEAD
06-12-035
 190 mm
 7½"

Artikel-Nr.
Cat. No.

Gesamtlänge
Total length

	MEAD	06-12-035	190 mm / 7½"
			ø 20 mm, 180 g
			mit auswechselbaren Kunststoffbacken with interchangeable plastic discs
		06-12-034	Paar Ersatzbacken pair of spare discs



Artikel-Nr. Cat. No.	Gesamtlänge Total length		
06-12-045	250 mm / 10"		
	ø 30 mm, 200 g mit auswechselbaren Kunststoffbacken <i>with interchangeable plastic discs</i>		
06-12-047	Paar Ersatzbacken <i>pair of spare discs</i>		



1/2
06-12-045
250 mm
10"

Artikel-Nr. Cat. No.	Gesamtlänge Total length		
06-62-700	180 mm / 7"	GERZOG	
	ø 25 mm, 250 g mit Bleifüllung <i>lead filled head</i>		



1/2
GERZOG
06-62-700
180 mm
7"



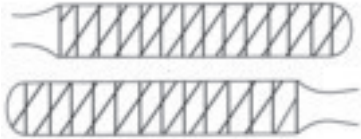
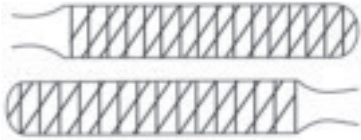
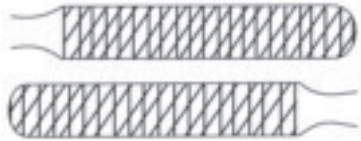
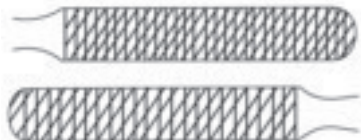
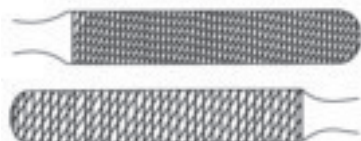

TC

		Artikel-Nr. Cat. No.	Gesamtlänge Total length
1/1		15-12-421	205 mm / 8" Hartmetall-Zähne, Fig. 1/2 carbide inserts teeth, fig. 1/2
1/1		15-12-423	205 mm / 8" Hartmetall-Zähne, Fig. 3/4 carbide inserts teeth, fig. 3/4
1/1		15-12-425	205 mm / 8" Hartmetall-Zähne, Fig. 5/6 carbide inserts teeth, fig. 5/6
1/1		15-12-427	205 mm / 8" Hartmetall-Zähne, Fig. 7/8 carbide inserts teeth, fig. 7/8
1/1		15-12-429	205 mm / 8" Hartmetall-Zähne, Fig. 9/10 carbide inserts teeth, fig. 9/10

 1/1
15-12-421
 205 mm
 8"

Area with horizontal lines for notes.





Mikro-Neurochirurgische Instrumente
Micro-Neurosurgical Instruments

HF-Instrumente und Zubehör
HF Instruments and Accessoires

Kopf-Schädelinstrumente und Haltesysteme
Head-Cranio Instruments and Holding Systems

Aneurysmen-Clip System
Aneurysm Clip System

Schädel-Verplattung
Cranial Plate System

Hypophysektomie-Instrumente
Pituitary Instruments

Instrumente für die Wirbelsäule, Wundspreizer
Spine Instruments, Self-retaining Retractors

Laminektomie-Stanzen, Rongeure, Hohlmeißelzangen
Laminectomy Punches, Rongeurs

Gefäß- und Bulldogklemmen, Gefäß-Clips
Vessel- and Bulldog-Clamps, Vessel Clips

Allgemeinchirurgische Instrumente
General Surgical Instruments

Siehe separate Anlage
Please see the separate enclosure

/// Alphabetischer Index, Numerischer Index
Alphabetical Index, Numerical Index



REBSTOCK®
Precision made in Germany

**SURGICAL
INSTRUMENTS
MICRO-NEURO-SPINE**

	Seite
A	
AACHEN	
- Spatel.....	150
ACLAND	
- Anlegepinzetten.....	388
- Approximatoren.....	386,387
- Doppelklemmen.....	386,387
- Einzelklemmen.....	386,387
- Gefäßclips.....	386,387
Adapter Maxi Vise.....	157
ADERER	
Plattenbiegezeuge.....	215,227
ADSON	
- Bohrer.....	158
- Hohlmeißelzange.....	561
- Laminektomie-Wundspreizer.....	331,332
- Nervwurzelhaken.....	103
- Pinzetten.....	41,469,470
- Raspatorien.....	586
- Saugrohre.....	540,548
ADSON-BABY	
- Wundspreizer.....	322
ADSON-BROWN	
- Pinzetten.....	470
Akustikusneurinom	
- Knopfhäkchen.....	75
- Mikro-Dissektoren.....	83
ALLEN	
- Osteophytenmeißel und Schaber.....	88
Allgemeine Instrumente.....	412-634
ALM	
- Wundspreizer.....	318
ANDERSON-ADSON	
- Wundspreizer.....	327
Aneurysmen-Clip-System.....	176-189
- Anlegezangen.....	190-201
- Einstellschlüssel.....	190
- Kennzeichnungsschild für Clip Lagerungstray.....	205
- Mini-Clips.....	188,189
- PHYNOX-Clips.....	178-189
- Standard-Clips.....	178-187
- Sterilisier- und Lagerungstrays.....	204-206
- TITAN-Clips.....	178-189
- Verstärkungs-Clip.....	190
Anlegepinzetten für	
- ACLAND Approximatoren.....	388
- ACLAND Doppelklemmen.....	388
- ACLAND Einzelklemmen.....	388
- Approximatoren.....	388,389
- BIEMER Approximatoren.....	389
- BIEMER Gefäßclips.....	389
- MEHDORN Gefäßclips.....	389
- Gefäßclips.....	389,395
Anlege- und Entnahmезangen für	
- Bulldogklemmen.....	401
Anlegezangen für	
- Aneurysmen-Clips.....	190-201
- Gefäßclips.....	395
- Kopfhautklammern.....	170,171
- TITAN Ligaturclips.....	392,393
Anschluss kurz.....	155
Anschlussstange.....	155
Approximatoren	
- ACLAND.....	386,387
- Gefäß.....	390,391
Arretierungskupplung.....	305,306
Arterienklemmen.....	490-499
- fein.....	490,491
Atraumatisch	
- Bulldogklemmen.....	400,403-406,408,409
- Gefäß-Clips.....	397
- Gefäßklemmen.....	403
- Mikro-Pinzetten.....	51,52
- Pinzetten.....	484-488

	Seite
B	
BABY-CRILE	
- Arterienklemmen.....	492
BABY-CRILE-WOOD	
- Nadelhalter.....	509
BABY-METZENBAUM	
- Präparierscheren, gezahnt.....	447
BABY-MIXTER	
- Präparier- und Ligaturklemmen.....	500
BABY-MOSQUITO	
- Arterienklemmen.....	490
BACKHAUS	
- Tuckklemmen.....	503
BALFOUR	
- Valve.....	305,307
BANE-HARTMANN	
- Hohlmeißelzange.....	557
BARRAQUER	
- Mikro-Nadelhalter.....	30,31
BARRÉ	
- Präparierschere.....	440
BARRON	
- Saugrohre.....	548
BAUMGARTNER	
- Nadelhalter.....	508
BEAL	
- Circumflex Gefäßscheren.....	458
BECK	
- Rongeur.....	376
BECKMANN	
- Wundspreizer.....	325
BECKMANN-ADSON	
- Laminektomie-Wundspreizer.....	333
BECKMANN-EATON	
- Laminektomie-Wundspreizer.....	333
BELLUCCI	
- Saugkanüle.....	549
- Saugspitzen.....	549
BEYER	
- Hohlmeißelzange.....	558,564
BIEMER	
- Anlegepinzetten.....	389
- Approximatoren.....	391
- Gefäßclips.....	391
- Mikro-Gefäßspreizer.....	100
- Mikro-Venenscheren.....	10,11
BIEMER-MÜLLER	
- Approximatoren.....	390
Bipolare Koagulationskabel.....	138
Bipolare Koagulationspinzetten.....	125-133
- mit Spülung.....	132-133
- NON-STICK.....	125-133
Blätter-Wechselpinzette.....	291,299,301,302
BLUMENTHAL	
- Hohlmeißelzange.....	556
BÖHLER	
- Hohlmeißelzange.....	563
- Knochensplitterzangen.....	569
Bohrer	
- für Wirbelkörper Distraktions- System.....	258,259,262
- für Handbohrapparat.....	158-1611
Bohrlehren für Wirbelkörper Distraktions-System.....	258-261
Bohrlochplatten für	
- Schädel-Verplattung.....	211,212,215,220
Bohrloch Schutzzange.....	163
BONNEY	
- Pinzetten.....	483
BROPHY	
- Pinzetten.....	476
BROWN	
- Pinzetten.....	478
BRUNS	
- scharfe Löffel.....	601
BÜCHS	
- Raspatorium.....	591
Bulldogklemmen.....	398-401,404-409
- atraumatisch.....	400,403-406,408,409
- federleicht.....	398

	Seite
BUSHE	
- scharfe Löffel.....	602
C	
CAIRNS	
- Arterienklemmen.....	491
- Häkchen, Durahäkchen.....	78
- Wundspreizer.....	322
CAIRNS-DOTT	
- Pinzette.....	480
CASPAR	
- Bohrer für Wirbelkörper Distraktions-System.....	258,259,262
- Bohrlehren für Wirbelkörper Distraktions-System.....	258-261
- Distraktor.....	258,261
- Distraktionsschrauben.....	258,259,262
- Explorationshäkchen.....	74
- Fadengabel.....	97
- Faßzange.....	238
- Gegensperrer.....	296
- Gegensperrer, zervikal.....	290,291,294,295
- Gegensperrer zur lumbalen Mikrodissektomie.....	303
- Haken.....	308
- Knochenspanhalter und -einsetzinstrument.....	263
- Koagulationshäkchen.....	74
- Küretten.....	264,265,603,604
- Laminektomie Wundsperrer.....	308
- Messschieber.....	263
- Mikro-Dissektoren.....	82,83
- Mikro-Schere.....	238
- Mikro-Skalpellgriff.....	59
- Mikroschäfte.....	65
- Nervwurzelhaken.....	102
- Raspatorien.....	592
- Retraktor-Set zur lumbalen Mikrodissektomie.....	302
- Rongeurs.....	368,369,372,373,382
- Rongeurs, bajonett.....	372,373
- scharfe Löffel.....	603
- Schraubendreher für Wirbelkörper Distraktions-System.....	258,259,262
- Spekula zur lumbalen Mikrodissektomie.....	304
- Sperrer, zervikal.....	290,291,294,296
- Stössel.....	266
- Valven.....	308,309
- Wirbelkörperdissektoren.....	263
- Wirbelkörper Distraktions-System.....	258-263
- Wirbelkörperdistraktoren.....	258-261
CASPAR modif.	
- Basisretraktor.....	278,279
- Dissektor modif.....	68
- Explorationshäkchen modif.....	65
- Gegensperrer.....	300
CASTROVIEJO	
- Mikro-Nadelhalter.....	28,29
CCR Zervikales Retraktor System.....	280-293
- mit erweiterter Tiefenspreizung.....	277-279
- PEEK.....	294-297
Chirurgische Scheren.....	423-427
Circumflex Gefäßscheren.....	458
Clips	
- Aneurysmen-Clip-System.....	178-189
- Gefäß.....	391,394,396
CLOWARD	
- Rongeurs.....	379
- Valven / Blätter.....	329
- Wirbelkörper-Spreizer.....	339
- Wundspreizer.....	328
CLR Retraktor Set	
- Handgriff.....	310,311
- Hemi-Laminektomie Haken.....	310,312
- Retraktor.....	310,311
- Siebkorb.....	310
- Tiefenmessstab.....	310,311
- Valven TITAN.....	310,312
COBB	
- Hohlmeißel.....	615

	Seite
- Küretten	606
- Raspatorien	596
CONE	
- Küretten	605,606
- Laminektomie-Wundspreizer	332
CONTOUR	
- Kopfhautspreizer	323
CONVERSE	
- Nadelhalter	507
COOLEY	
- Bulldogklemmen, atraumatisch	406
- Pinzetten, atraumatisch	488
Coronararterien-Schere	457
COTTLE	
- Elevatorium	577
- Fischschwanzosteotom	607
- Häkchen, Durahäkchen	78
- Hammer	237,631
- Meißel für Hypophysektomie	237
- Nasenschere	464
- Nasenspekula für Hypophysektomie	236
- Osteotome	237,607
- Präparierschere, fein	430
- Raspatorium	592
COTTLE-KNAPP	
- Präparierschere, fein	431
COTTLE-MASING	
- Präparierschere, fein	428
CRILE	
- Arterienklemmen	492,493
CRILE-WOOD	
- Nadelhalter	509
CRUTCHFIELD	
- Schädelhalter	168
CUSHING	
- Bohrer	159
- Nervwurzelhaken	103
- Pinzetten	48,476
- Rongeuere	370,371,374,375
- Rongeuere, bajonett	374,375
- Spatel	152
- Wundhaken	519,525
CUSHING-LANDOLT	
- Hypophysen-Spekula	235
D	
DAHLGREN	
- Schädelstanze	162
DANDY	
- Kopfhautklemmen	504
- Trigeminnusscheren	460
DAUBENSPECK	
- scharfe Löffel	599
DAVIS	
- Dissektor	90
- Spatel	151
D'ERRICO	
- Bohrer	159
DEAVER	
- Scheren, chirurgisch	426
DE BAKEY	
- Bulldogklemmen, atraumatisch	404,409
- Gefäßklemmen	403
- Gefäßscheren	455,457
- Mikro-Pinzetten, atraumatisch	51,52
- Nadelhalter	510,511
- Offsetscheren	457
- Pinzetten, atraumatisch	52,484-487
- Präparierscheren, fein	437
DE BAKEY-DIETHRICH	
- Bulldogklemmen, atraumatisch	400
Deckel zu Siebkorb	278,280-283,299,302
DE MARTEL	
- Kopfhautklemmen	504
- Umführungsinstrument	165
DERF	
- Nadelhalter	507
DESMARRES	
- Wundhaken	520

	Seite
DE VILBISS	
- Schädelstanze	162
DIEFFENBACH	
- Bulldogklemmen	399
DIETHRICH	
- Bulldogklemmen	400
- Gefäßklemmen	456
- Gefäßscheren	456
DIETHRICH-HEGEMANN	
- Gefäßscheren	453
Dissektoren	84-86,90
- für Hypophysektomie	244,245,252,253,255
- für die Mikrodisektomie	272-275
- Kugel	67,73
- lumbal	272,273
- Mikro	82,83,91
- modif.	66,68
Distraktionsschrauben für Wirbelkörper Distractions-System	258,259,262
DIXON-LOVELACE	
- Arterienklemmen	493
Doppelsonde	100
Drahtsägen	164
Drahtschneideschere	228,552
Drahtschneidezangen	550-552
DUNHILL	
- Arterienklemmen	491
Durahäkchen	78
Durascheren	459
E	
ECHLIN	
- Hohlmeißelzangen	565
Einstellschlüssel für Clip-Anlegezangen	190
Elevatoren	87,90,573-578
- modif.	66
Entnahmezangen für Aneurysmen-Clip System	202,203
Eukleatoren für Hypophysektomie	244,245,252-255
Ersatzdorn für Schädelhalter	169
Ersatznadeln für Approximator	391
Explorationshäkchen	74
- modif.	65
F	
FADENFÜHRER	
Fadenführer	77
FADENGABEL	
Fadengabel	97
FADENKLEMMEN	
Fadenklemme	396
FADENSCHERE	
Fadenschere	463
FAHLBUSCH	
- Küretten	255
- Löffel	255
- Mikro-Schere	238
FARABEUF	
- Raspatorien	588
FARABEUF-COLLIN	
- Raspatorien	588
FAßZANGEN	
- für Hypophysektomie	238,381
- Tumor	381
FAVALORO	
- Coronararterien-Schere	457
- Gefäßschere	457
FERGUSSON	
- Saugrohre, isoliert	537
FERRIS-SMITH	
- Rongeuere	383
FERRIS-SMITH-KERRISON	
- Laminektomie-Stanzen	364,365
FISCH	
- Mikrohäkchen	75
Fischschwanzosteotom	607
Fixiervorrichtung für LEYLA-Retractor-System	144,145,146
- TITAN	147
Flachmeißel	612
Flachzange	215,227
FOERSTER	
- Tupferzangen	503

	Seite
FOMON	
- Nasenscheren	464
- Präparierschere, fein	431
Foraminotomie-Stanzen	356-358
FRAZIER	
- Durahäkchen	78
- Elevatorium	87
- Häkchen	78
- Punktionskanülen	166
- Saugrohre	538,540
- Saugrohre, isoliert	537
FRAZIER (FERGUSSON)	
- Saugrohre	539
FREER	
- Durahäkchen	78
- Elevatoren	90,574
- Häkchen	78
- Raspatorien	90
FREER-YASARGIL	
- Elevatorium	90
FRIEDMANN	
- Hohlmeißelzange	554
FRYKHOLM	
- Hohlmeißelzange	565
G	
GABEL	
- Faden	97
- Tumor	98
Gabelspatel für Hypophysektomie	254
Galeahaken	172
GARDNER-WELLS	
- Schädelhalter	169
GEFÄß	
- Approximatoren	386,387,390,391
- Clips	391,394,396
- Clips, atraumatisch	397
- Dilatatoren	58,100
- Doppelklemmen	386,387
- Einzelklemmen	386,387
- Klemmen	403
- Klemmen atraumatisch	403
- Klemmen, TITAN	402
- Messer, Mikro	96
- Scheren	428,429,453-458
- Spreizer	100
GEGENSPERRER	
- zervikal	284,285,290,291,294-296
- zur lumbalen Mikrodisektomie	299,300,302,303
GELPI	
- Hautspreizer, Wundspreizer	319
- Valve	305,307
GEMINI	
- Präparier- und Ligaturklemmen	501
GERALD	
- Pinzetten	481
GERZOG	
- Hammer	633
Gewebekrallen	99
GIGLI	
- Drahtsägen	164
- Drahtsägen-Handgriffe	165
GILLIES	
- Häkchen, Durahäkchen	78
- Pinzetten	479
GIL VERNET	
- Sattelhäkchen	521
Gitterplatten für Schädelverplattung	224,225
GLOVER	
- Bulldogklemmen, atraumatisch	408,409
GORNEY	
- Präparierscheren, fein	433
- Präparierscheren, fein, Supercut	433
GRAEFE	
- Häkchen, Durahäkchen	78
GREGORY SOFT	
- Bulldogklemmen, atraumatisch	405
GRIFFE	
- für auswechselbare Mikroschäfte	63,64,240,241

	Seite
GRUENWALD	
- Pinzetten, Hartmetall	41
- Pinzetten, monopolar	136
GULEKE	
-Hohlmeißelzange	560
GUTRHE	
- Wundhaken	515
H	
HAJEK	
- Hammer	631
HAJEK-KOFLER	
- Laminketomie-Stanzen	362
HAKANNSON	
- Hohlmeißelzange	562
Häkchen	78-81
- Dura	78
- für Hypophysektomie	244,245,252-255
- Knopf für Akustikusneurinom	75
- Kugel	76
- Mikro	67,69,73,75,76
- Nerv-Gefäß	77
Haken	308,337
- Galea	172
- Nervwurzelhaken	101-105
HALLE	
- Raspatorium	89
- scharfe Löffel	600
HALSEY	
- Nadelhalter	507
HALSTED-MOSQUITO	
- Arterienklemme	490
Haltearme	
- für LEYLA-Reetraktor-System	142,143
- für selbsthaltendes Retraktor-System ..	154,156
Hammer für Hypophysektomie	237
Hämmer	237,630-633
Handauflage	154,156
Handbohrapparat	158-161
Handgriffe	
- für Drahtsägen	165
- zum Einsetzen der Valven	280,281,282,285
HARDY	
- Enukleatoren	244,245,252,253
- Implantationsgabel	252
- Küretten	244-249,251,254
- Mikro-Dissektoren	82,83
HARDY-FAHLBUSCH	
- Dissektoren	252,253
HARRINGTON	
- Valve	305,307
Hartmetall-Instrumente	
- Chirurgische Scheren	423-426
- Drahtschneideschere	463,552
- Drahtschneidezangen	550-552
- Gefäßschere	453-455
- Mikro-Nadelhalter	28,29,34,35,36
- Nadelhalter	507-513
- Pinzetten	468,469,471,479,480
- Pinzetten, bajonettförmig	41
- Plattenschneidezange	227
- Präparierschere	438-445
- Präparierschere, fein	432,437
- Präparierschere, gezahnt	447-452
- Raspeln	634
- Schere, fein	418
HARVEY	
- Drahtschneideschere	552
- Drahtschneidezangen	550
HARVEY- JACKSON	
- Laminketomie-Wundspreizer	330
Hautspreizer	319
HEIFETZ	
- Spatel	153
- Tumorfasspinzetten	43
Hemi-Laminketomie Haken	310,312
HENCKEL-TILLEY	
- Rongeur	380
HENDERSON	
- Wundspreizer	326

	Seite
HESS	
- Nervwurzelhaken	105
HEYMANN-KNIGHT	
- Nasenschere	465
HIBBS	
- Osteotome	609
- Wundhaken	532
HILL	
- Elevatorium	577
HOEN	
- Elevatoren	87
- Raspatorien	587
Hohlmeißel	612-614
Hohlmeißelzangen	553-568
HOLSHER	
- Nervwurzelhaken	104
HORSLEY	
- Dissektor	86
HOSOBUCHI	
- Gabelspatel	254
HOUSE	
- Saugadapter	545
- Saugrohre	545
HOWARTH	
- Raspatorium	582
HUDSON	
- Bohrer	158
- Handbohrapparat	158
- Verlängerungsstück	158
HUDSON DOWNS	
- Bohrer	160,161
- Handbohrapparat	160
HUDSON DOWNS (LEWIS)	
- Bohrer	160
HUNT	
- Tumorfasspinzetten	46,47
Hypophysektomie-Instrumente	235-255
- Dissektoren	244,245,252,253,255
- Enukleatoren	244,245,252-254
- Faßzangen	238
- Gabelspatel	254
- Griffe für auswechselbare Mikroschäfte ..	240,241
- Häkchen	254,255
- Hammer	237
- Implantationsgabel	252
- Küretten	242,243,251,254,255
- Löffel	254,255
- Löffelzange	238
- Meißel	237
- Mikro-Häkchen	244,245,252,253
- Mikroschaft Küretten	242
- Mikro-Schere	238
- Nasenspekula	236
- Osteotome	237
- Pinzette	239
- Raspatorien	252,253,255
- Spannschlüssel für Spekula	236
- Spekula	235,236
- Spiegel	239
- Spreizer für Spekula	236
- Spreizzange für Spekula	235
I	
Implantationsgabel für Hypophysektomie ..	252
INGE	
- Wirbelkörper-Spreizer	340
Inzisions Scheren	427
IRIS	
- Schere	418,419
- Schere, Supercut	418
J	
JACKSON-BURROWS	
- Hautspreizer, Wundspreizer	319
JACOBSON	
- Mikro-Doppelsonde	100
- Mikro-Fadengabel	97
- Mikro-Gefäßmesser	69,96
- Mikro-Knopfsonde	100
- Mikro-Nadelhalter	28,29

	Seite
- Mikro-Schere	10,11
JÄGER	
- Häkchen, Durahäkchen	78
JAMESON	
- Präparierschere, fein	435
JAMESON-WERBER	
- Präparierschere, fein	435
- Präparierschere, fein, Supercut	435
JANSEN	
- Hohlmeißelzange	557,559
- Pinzette, bajonettförmig	41
- Pinzetten, monopolar	136
- Raspatorium	589
- Wundspreizer	318
JEFFERSON	
- Pinzette	470
- Wundspreizer	322
JEWELER	
- Bipolare Koagulationspinzetten	125
- Bipolare Koagulationspinzetten, NON STICK	125
JOSEPH	
- Häkchen	80
- Raspatorium	587
- Schere	421
- Schere, Supercut	421
K	
Kabel für	
- bipolare Pinzetten	138
- monopolare Pinzetten	139
KAYE FACE LIFT	
- Präparierschere Supercut	427
KELLY	
- Arterienklemmen	491
- Arterienklemmen, TITAN	491
- Schere	422
- Valven	305,307
Kennzeichnungsschild für Clip Lagerungstray	205
KERRISON	
- Bajonettenschaft-Stanzen	358-361
- Foraminotomie-Stanzen	356-358
- gebogene Stanzen	356,357
- Laminketomie-Stanzen	346-365
- Laminketomie-Stanzen mit Langhub	354,355
- Stanzen zerlegbar	346-349
KEY	
- Raspatorien	583
KILLIAN	
- Elevatorium	90
- Raspatorien	582
KILNER	
- Häkchen	79
- Nadelhalter	508
- Präparierschere, fein	430,432
KIRSTEIN	
- Nasenschere	465
Klammerblock für Kopfhautklammern	170
KLEINERT-KUTZ	
- Häkchen	81
- Hohlmeißelzange	555
Klemmen	
- Arterien	490-499
- Bulldog	398-401,404-409
- Gefäß	402,403
- Gefäß, TITAN	402
- Kopfhaut	504
- Präparier- und Ligatur	500,501
- Tuch	502,503
K-LINE Instrumente für die Mikrodisektomie	267-276
- Dissektor	272,273
- Griff für Mikro-Messer	276
- Küretten, kortikal	268-271
- Küretten, lumbal	272-273
- Küretten, zervikal	268-271
- Knochenwachser, lumbal	272,273
- Knochenwachser, zervikal	268-271
- Mikro-Dissektoren	274,275
- Mikro-Küretten	274,275
- Mikro-Messer	276
- Mikro Nerv Haken, zervikal	268-271
- Mikro Nerv Haken zervikal, extra fein ..	268-271

	Seite
MC KISSOCK	
- Raspatorium	591
MEAD	
- Hammer	632
- Hohlmeißelzangen	558
MEHDORN	
- Anlegepinzette	389
- Gefäß-Clips	391
Meißel	
- Flachmeißel	612
- für Hypophysektomie	237
- Hohlmeißel	612-615
- Wirbelsäulenmeißel	614
MEMORY	
- Anlegezangen für Aneurysmen-Clips	190,191
- Spatel	148
Messer	
- Gefäß	96
- Gefäß modif.	69
- Lanzetten	95
- Lanzetten modif.	71
- Mikro modif.	69
- Mikro-Gefäß	96
- Mikro-Gefäß modif.	69
- Mikro-Lanzetten für Akustikusneurinom	95
- Mikro-Lanzetten für Akustikusneurinom modif.	71
- Tumor	94,95
- Tumor modif.	70,71
Messschieber	263
METZENBAUM	
- Präparierscheren	438
- Präparierscheren, gezahnt	449,450
- Präparierscheren, Supercut	439
METZENBAUM fino	
- Präparierscheren	440,441
- Präparierscheren, gezahnt	451
- Präparierscheren, Supercut	440
METZENBAUM-NELSON	
- Präparierscheren	442
MEYERDING	
- Laminektomie-Wundspreizer	335
- Wundhaken	517,530
MICRO-ADSON	
- Pinzetten	468
- Präparier- und Ligaturklemme	500
MICRO-ADSON-BIEMER	
- Pinzetten	468
MICRO-HALSTED	
- Arterienklemmen	490
Mikro	
- Dissektoren	72,76,82,83,91,244,245,252,253,255
- Dissektoren für Akustikusneurinom	83
- Doppelsonde	100
- Elevatorien	72
- Enukleatoren	244,245,252-254
- Explorationshäkchen	74
- Fadenführer	77
- Fadengabel	97
- Gabelspatel	254
- Gefäßdilatoren	100
- Gefäßhäkchen	77
- Gefäßmesser	96
- Gefäßmesser modif.	69
- Gefäßspreizer	100
- Gewebekralen	99
- Häkchen	73,75,76,78-81,244,245,252-255
- Häkchen modif.	69
- Implantationsgabel	252
- Knopfhäkchen für Akustikusneurinom	75
- Knopfsonde	100
- Koagulationshäkchen	74
- Kugeldissektoren	73
- Kugelhäkchen	76
- Küretten	73,243-251,254,255
- Lanzettenmesser	95
- Lanzettenmesser für Akustikusneurinom	95
- Löffel	92,93,254,255
- Messer modif.	69
- Mikroschaft Küretten	242
- Nadelhalter	7,22-37
- Nadelhalter SMARTLINE	22,24,25

	Seite
- Nadeln	73
- Nervhäkchen	77
- Pinzetten	38-40,50,54-57
- Pinzetten, atraumatisch	51,52
- Pinzetten, bajonettförmig	38-41
- Pinzetten, bajonettförmig, SMARTLINE	38
- Pinzetten, diamantiert	51,53
- Pinzetten mit Gegengewicht	50,51
- Pinzetten SMARTLINE	38,48,49
- Präparierscheren	4,5,10,11,21
- Raspatorien	91-93,252,253,255
- Ring-Pinzetten	51,53
- Ring-Pinzetten, diamantiert	51,53
- Rohrschaft-Löffelzängchen	111,116-118
- Rohrschaft-Löffelzängchen, fein	110
- Rohrschaft-Scheren	107,112,113
- Rohrschaft-Scheren, fein	106
- Rohrschaft-Zängchen	109,114,115
- Rohrschaft-Zängchen, fein	108
- Saugkanülen	546
- Saugrohr	546
- Scheren	2-21
- Scheren für Hypophysektomie	238
- Scheren SMARTLINE	2,3,8,9
- Skalpellgriffe	59,61
- Tumorgabeln	98
- Tumormesser	94,95
- Uhrmacherpinzetten	57
- Venenscheren	10,11
Mikrodiskektomie Retraktor Set	299-304
Mikrodiskektomie	
- Griff für Mikro-Messer	276
- Knochenwachser, lumbal	272,273
- Knochenwachser, zervikal	268-271
- Küretten, kortikal	268-271
- Küretten, lumbal	272,273
- Küretten, zervikal	268-271
- Mikro-Dissektoren	274,275
- Mikro-Küretten	274,275
- Mikro-Messer	276
- Mikro Nerv Haken, zervikal	268-271
- Mikro Nerv Haken, extra fein, zervikal	268-271
- Nerv Haken, lumbal	272,273
- Dissektor, lumbal	272,273
- Sterilisiercontainer	268,270,272,274
- Wirbelsäulensonde, lumbal	272,273
Mikroschäfte	65-71
- CASPAR modif.	68
- Dissektor modif.	66,68
- Elevatoren modif.	66
- Explorationshäkchen modif.	65
- Häkchen modif.	67
- KOOS modif.	69
- Kugeldissektor modif.	67
- Kürette modif.	67
- Lanzettenmesser modif.	71
- Mikro-Gefäßmesser modif.	69
- Mikro-Häkchen modif.	69
- Mikro-Messer modif.	69
- Mikro-Lanzettenmesser modif. für Akustikusneurinom	71
- Mikro-Raspatorien modif.	68
- Nadeln modif.	67
- OPPEL modif.	71
- RHOTON modif.	66,67
- SAMII modif.	70,71
- Tumormesser modif.	70,71
- YASARGIL modif.	68
MILLESI	
- Mikro-Scheren	10,11
MILLS	
- Gefäßschere	454
MISKIMON	
- Wundspreizer	327
MITCHELL	
- Raspatorium	580
MOLLISON	
- Wundspreizer	323
MOLT	
- Elevatorium	575
MOYNIHAN	
- Kopfhautklemme	504

	Seite
MÜHLING	
- Raspatorien	592
MÜLLER	
- Approximatoren	390
- Fadenklemme	396
- Gefäßapproximatoren	390
- Gefäß-Clips	396
- Gefäß-Clips, atraumatisch	397
N	
Nadeln	73
- modif.	67
Nadelhalter	506-513
- Mikro	7,22-37
- SMARTLINE	22,24,25
NAGEL	
- Mikro-Schere	6
Nasenscheren	464,465
Nasenspekula für Hypophysektomie	236
NELSON-METZENBAUM	
- Präparierschere, gezahnt	450,451
Nerv-/Gefäßhäkchen	77
Nervhaken	
- lumbal	272,273
- zervikal	268-271
Nervwurzelhaken	101,105
Neuro-Spaltenplatten	223
Neuro Sub-temporale Platten	223
NICOLA	
- Mikro-Schere	238
- Küretten	244-247,250
- Raspatorien	252,253
NON-STICK	
- Bipolare Koagulationspinzetten	124-133
NORFOLK and NORWICH	
- Laminektomie-Wundspreizer	331
NORTHFIELD	
- Hohlmeißelzange	561
O	
OBWEGESER	
- Osteotom	610
O'CONNELL	
- Nervwurzelhaken	105
Offsetscheren	457
Ohrtrichterhalter für LEYLA-Retraktor-System	144
OKONEK-YASARGIL	
- Tumorgabeln	98
OLDBERG	
- Hypophysenzange	381
OLIVECRONA	
- Drahtsägen	164
- Duraschere	459
- Hohlmeißelzange	560
- Spatel	152
OLIVECRONA-GIGLI	
- Drahtsägen	164
OLIVECRONA-TOENNIS	
- Kopfhautklemmer-Anlegezange	170
OPPEL	
- Knopfhäkchen für Akustikusneurinom	75
- Mikro-Dissektor für Akustikusneurinom	83
- Mikro-Lanzettenmesser für Akustikusneurinom	71
- Rohrschaft-Löffelzängchen für Akustikusneurinom	116
- Rohrschaft-Scheren für Akustikusneurinom	112
- Rohrschaft-Zängchen für Akustikusneurinom	114
OPPEL	
- Mikro-Lanzettenmesser modif. für Akustikusneurinom	95
Osteophytenmeißel und Schaber	88
Osteotome	607-615
OVERHOLT-GEISSENDOERFER	
- Präparier- und Ligaturklemmen	501

	Seite
- Inzisions	427
- Knorpel	460
- Mikro	2-21
- Mikro-Präparier	4,5,11,21
- Mikro-Rohrschaft	106,107,112,113
- Mikro-Venen	10,11
- Nasen	464-465
- Offset	457
- Präparier	438-446
- Präparier, fein	428-437
- Präparier, gezahnt	447-452
- Sehnen	428,429
- SMARTLINE	2,3,8,9
- Supercut	418,421,423-427,429, 433,435,437,439,440,443,445
- Trigeminus	460
Schlaucholive	535
SCHLESINGER	
- Rongeurs	379
Schlüssel für Approximatoren	391
SCHMIEDEN-TAYLOR	
- Dura-Schere	459
SCHNEIDER	
- Raspatorium	590
SCHNEIDER-SAUERBRUCH	
- Raspatorium	590
SCHOENBORN	
- Wundhaken	525
Schrauben für Schädel-Verplattung ..	211,212,215,226
Schraubendreher	
- für Schädel-Verplattung	211,213,215,229
- für Wirbelkörper Distractions System	258,259,262
Schraubendreher-Griffe für Schädel-Verplattung	229,230
Schraubendreher-Klingen für Schädel-Verplattung ..	230
SCHUHKNECHT	
- Saugrohre	548
SCOVILLE	
- Laminektomie-Wundspreizer	336
- Nervwurzelhaken	104
- Valven	337
SCOVILLE-HAVERFIELD	
- Laminektomie-Wundspreizer	336
- Valven/Blätter	337
SCOVILLE-RICHTER	
- Laminektomie-Wundspreizer	338
- Haken	338
- Valven	338
SEBILEAU	
- Elevatorium	578
SEDILOTT	
- Raspatorien	580,590
Sehnscheren	428,429
Seitenschneider	551
Sekundärstange	154,155
Selbsthaltendes Retraktor System	155-157
- Anschluss kurz zur Aufnahme der Haltearme ..	155
- Anschlussstange	155
- Haltearme	154,155
- Handauflage	154,155
- Maxi Vise Adapter	157
- Primärstange	154,155
- Sekundärstange	154,155
- Siebkorb	154,157
- Spatel	154,157
- Tupperablage	154,157
SEMB	
- Hohlmeißelzange	568
SEMKEN	
- Pinzetten	466
SENN-MILLER	
- Wundhaken	518
SEWALL	
- Raspatorium	581
Siebkorb 154,157,278,280-283,299,302,310,313,314	
Silberklammern	170
Silikonmatten	278,280-283,299,302
SIMON	
- scharfe Löffel	600
SHUNT	
- Bulldogklemme	407

	Seite
Skalpellgriffe	62,412-417
- Mikro	59-61
Skalpellklingenentferner	415
SMARTLINE	
- Mikro-Scheren	2,3,8,9
- Mikro-Nadelhalter	22,24,25
- Mikro-Pinzetten	48,49
- Mikro-Pinzetten, bajonettförmig	38
- Tumorfasspinzetten, bajonettförmig	42
SMITH-PETERSON	
- Osteotome	608
Sonde	
- Doppel	100
- Knopf	100
Spannarm, flexibel für LEYLA-Retraktor ..	142,144,145
- TITAN	147
Spannschlüssel für Hypophysen-Spekula	236
Spatel	142,148-153,154,157
Spatelhalter für LEYLA-Retraktor	142,144,145
- TITAN	147
Spekula	
- für Hypophysektomie	235,236
- zur lumbalen Mikrodisektomie ..	299,300,302,304
SPENCER	
- Fadenscheren	463
SPETZLER	
- Mikro-Dissektoren	76
- Mikro-Kugel-Häkchen	76
Spiegel	
- für Hypophysektomie	239
Spinalretractoren	531
Spiralbohrer für Schädel-Verplattung	215,231
Spreizer für Hypophysen-Spekula	236
Spreizer/Sperrer	
- Haut	319
- für lumbale Mikrodisektomie ..	299,300,302,303
- Kopfhaut	323
- Laminektomie	308,330,338
- lumbal	310,311,313,315
- Wirbelkörper	339,340
- Wund	318-327
- zervikal	278-285,290,291,294-296,328
Spreizzange für Hypophysen-Spekula	235
SPURLING	
- Rongeurs	371,374,375
- Rongeurs, bajonettförmig	374,375
Stange horizontal	305,306
Stanzen	
- Foraminotomie	356-358
- Laminektomie	346-365
ST. BARTS	
- Rongeurs	376
STELLBRINK	
- Hohlmeißelzange	557
Sterilisier-Container ..	120,121,215,268,270,272,274
STEVENS	
- Gefäß- und Sehnscheren	428,429
- Gefäß- und Sehnscheren, Supercut	429
- Präparierscheren, fein	428,429
STILLE	
- Flachmeißel	612
- Hohlmeißel	612
- Hohlmeißelzange	566
- Osteotome	611
STILLE-RUSKIN	
- Hohlmeißelzange	567
Stössel	
- für Wirbelkörper Distractions-System	266
STRULLY	
- Scheren für Gefäß- und Neurochirurgie	462
Supercut Scheren	418,421,423-425,427
T	
TAKAHASHI	
- Rongeurs	376
TAYLOR	
- Spinal Retraktor	531
THOREK	
- Schere für Gefäß- und Neurochirurgie	462
Tiefenmesser für Schädel-Verplattung	230
Tischarretierung	305,306

	Seite
TITAN Instrumente und Implantate	
- Aneurysmen-Clips	178-189
- Anlegezangen für Aneurysmen-Clips	190-195,198,199
- Arterienklammern	490,492
- Bohrlochplatten	211,212,215,220
- Dissektoren	72,76,82,83,91
- Dissektoren für Akustikusneurinom	83
- Doppel-T-Platten	218
- Doppel-Y-Platten	215,219
- Einstellschlüssel für Clips-Anlegezangen ..	190
- Elevatoren	72
- Entnahmezangen für Aneurysmen-Clip System	202,203
- Eukleatoren	244,245,252-254
- Explorationshäkchen	74
- Fixiervorrichtung für LEYLA-Retraktor-System	147
- Gefäßklammern	402
- Gitterplatten	224,225
- Häkchen	73
- Knopfhäkchen für Akustikusneurinom	75
- Koagulationshäkchen	74
- Küretten	73
- Kugeldissektoren	73
- Kugelhäkchen	76
- L-Platten	217
- Lanzettenmesser	95
- Lanzettenmesser für Akustikusneurinom ..	95
- LEYLA-Retraktor-System	147
- Ligaturclips	392
- Löffel	92,93
- Medium-Platten	211,212,215-223
- Medium-Schrauben	211,212,215,226
- Mikro-Häkchen	75
- Mikro-Nadelhalter	30,31
- Mikro-Scheren	4,5,21,23
- Mikro-Pinzetten	39,52,53,54
- Nadeln	73
- Neuro-Spaltenplatten	223
- Neuro-Sub-temporale Platten	223
- Orbita Platten	219
- Pinzetten	466,469,479,481
- Pinzetten, atraumatisch	484,485
- Platten-/Schrauben- Haltepinzette	211,213,215,228
- Raspatorien	91-93
- Rechteckplatten	215,221,222
- Rhoton-Instrumente	66,67,72,73
- Schädel-Verplattungs-System	211-231
- Spannarm, flexibel	147
- Spatel	149
- Spatelhalter	147
- T-Platten	217
- Tumormesser	94,95
- Valven für Wundsperrer	278,280-283, 286-289,292,310,312
- Verstärkungs-Clip	190
- Y-Platten	215,218
TOENNIS	
- Dissektoren	85
- Häkchen, Durahäkchen	78
- Präparierscheren, fein	436
TOENNIS-ADSON	
- Präparierscheren, fein	437
- Präparierscheren, fein, Supercut	437
- Präparierscheren, gezahnt	448
TREVES	
- Pinzetten	482
Trigeminusscheren	460
TROTTER	
- Hohlmeißelzangen	562
Tuchklammern	502,503
Tumor	
- Fasspinzetten	42-47
- Fasspinzetten SMARTLINE	42
- Faßzangen	381
- Gabeln	98
- Messer	94,95
- Messer modif.	70,71
TUOHY	
- Punktionskanülen	167
Tupperablage	154,157
Tupperzangen	503

	Seite
U	
Uhrmacherpinzetten	57
Umführungsinstrument	165
Universalhalterung für LEYLA-Retraktor-System ..	146
V	
Valven/Haken	
- für Gegensperrler	
Mikrodissektomie	299,301-303
für Laminektomie-Sperrler	308,309,336-338
für Lumbal Retraktor System	308,310,
.....	312-314,316,317
für Ring Retraktor System	305,307
für Sperrler/Spreizer	286-290,292,293,296,
.....	297,299,301-303,308-310,312-314,
.....	316,317,328,329,336-338
für Wundpreizer, zervikal	278,280-283,
.....	286-289,290-293,328,329
PEEK für Wundpreizer, zervikal	296,297
TITAN	278,280-283,286-289,292,310,312
Wechselpinzette	291,299,301,302
VANNAS	
- Mikro-Scheren	5,10,11,21
Venenscheren	10,11
VERHOEVEN	
- Saugrohre	546
Verlängerungsstück für Handbohrapparat	158
Verplattungs-System für Schädel, TITAN	211-231
Verstärkungs-Clip	190
WISE	
- Mikro-Pinzetten	56
VOLKMANN	
- scharfe Löffel	597,598
- Wundhaken	526-528
Vorböhrer für Schädelhalter	168
W	
WAGNER	
- Raspatorien	595
- Rongeure	377,382
WALTON YANKAUER	
- Saugrohr	55
WATSON-CHEYNE	
- Elevatoren	574
WAUGH	
- Pinzetten	582
WEBSTER	
- Nadelhalter	508
WEIL-BLAKESLEY	
- Rongeure	378
WEITLANER	
- Wundspreizer	324
WEITLANER-BECKMANN	
- Wundspreizer	325
WELLER	
- Präparierschere	446
Wendestange horizontal	305,306
WILDE	
- Rongeure	380
WILLIAMS	
- Laminektomie-Wundspreizer	334
WILLIGER	
- Elevatoren	573
- Raspatorien	579
- scharfer Löffel	597
Wirbelkörperdissektoren	263
Wirbelkörper-Distraktions-System	258-263
- Bohrer	258,259,262
- Bohrlehren	258-261
- Dissektoren	263
- Distraktionsschrauben	258,259,262
- Distraktoren	258-261
- Knochenspanhalter und -einsetzinstrument	263
- Küretten	264,265
- Messschieber	263
- Schraubendreher	258,259,262
- Stössel	266
Wirbelkörper-Distraktoren	258-261
Wirbelkörper-Spreizer	339,340

	Seite
Wirbelsäulen-	614
- Meißel	614
- Sonde, lumbal	273
WULLSTEIN	
- Mikro-Absaugrohr	546
- Mikro-Saugkanülen	546
- Wundspreizer	321
Wundhaken	514-552
Wundspreizer/-sperrler	318-327
- Blätter-Wechselpinzette	291,299,301,302
- Gegensperrler für	
Mikrodissektomie	299,300,302,303
- Gegensperrler, zervikal	284,285,290,291,294-296
- Haut	319
- Kopfhaut	323
- Laminektomie	330
- lumbal	310,311,313-315
- Valven/Haken	278,280-283,286-293,296,
.....	297,299,303,308,309,310,312-314,316,318,
.....	328,329,336-338
- Wirbelkörper	339,340
- zervikal	278-285,290,291,294-296
Y	
YANKAUER	
- Saugrohre	534,535
YANKAUER-BABY	
- Saugrohr	534
YASARGIL	
- Aneurysmen-Clip-System	176-189
- Anlegezangen für Aneurysm-Clips	190-201
- Dissektoren	86
- Fadenführer	77
- Galeahaken	172
- Hypophysenzange	381
- Mikro-Dissektoren	91
- Mikro-Fadenführer	77
- Mikro-Gefäßmesser	96
- Mikro-Löffel	92,93
- Mikro-Nadelhalter	23
- Mikro-Pinzetten	39
- Mikro-Präparierscheren	4,5,10,11,21
- Mikro-Raspatorien	91-93
- Mikro-Scheren	4,5,10,11
- Saugrohr	504
- Spannarm, flexibel	142,144,145
- Spannarm, flexibel, TITAN	147
- Spatelhalter	142,144,145
- Tumorfasspinzetten	43,45,46
- Tumorgabeln	98
YASARGIL modif.	
- Mikro-Raspatorien modif.	68
YASARGIL-NICOLA	
- Löffelzange	238
YASARGIL-SAMII	
- Tumorfasspinzetten	43
Z	
Zängchen	
- Faß	108,109,114,115
- für Hypophysektomie	238,381
- Löffel	110,111,116-118
- Rohrschaft	108-111,114-118
Zangen	
- Drahtschneide	550-552
- Hohlmeißel	553-568
- für Hypophysektomie	238
- Knochensplitter	569-572
- Kopf- und Seitenschneider	551
- Tupfer	503
ZAUFAL-JANSEN	
- Hohlmeißelzange	564
Zervikal	
- Basis Retraktor	279,280-282,284
- Gegensperrler	280,282,283-285,290,291,
.....	294-296
- Handgriff	278,280-282,285
- Knochenwächser	268-271

	Seite
- Küretten	268-271
- Küretten, kortikal	268-271
- Mikrodissektomie Instrumenten Set	268,270
- Mikro Nerv Haken	268-271
- Retraktor System	278-297
- Sperrler	290
- Sperrler, PEEK	294-297
- Tiefenmesser	280,282,285
- Valven	290,291,293
- Valven, PEEK	296,297
- Valven, TITAN	278,280-283,286-289,292
ZIELKE	
- Hohlmeißel	614
ZOELLNER	
- Saugkanüle	549
- Saugspitzen	549s

	page
A	
AACHEN	
- Spatulas.....	150
ACLAND	
- Applying Forceps	388
- Approximators.....	386,387
- Double Clamp	386,387
- Single Clamp	386,387
- Vessel Clips.....	386,387
Acoustic Neurinoma	
- Hook	75
- Mikro Dissectors	83
Adapter Maxi Vise	157
ADERER	
- Plate Bending Pliers	215,227
Adjusting Key for Clip Applying Forceps	190
ADSON	
- Burr	158
- Bone Rongeur	561
- Forceps	41,469,470
- Nerve Root Retractors	103
- Raspatories	586
- Self-Retaining Laminectomy Retractor	331,332
- Suction Tubes	540,548
ADSON-BABY	
- Self-Retaining Retractor	322
ADSON-BROWN	
- Forceps	470
ALLEN	
- Osteophyte Chisel and Scraper.....	88
ALM	
- Self-Retaining Retractor	318
ANDERSON-ADSON	
- Self-Retaining Retractor	327
Aneurysm Clip System	176-189
- Adjusting Key.....	190
- Applying Forceps	190-201
- Booster Clips.....	190
- Identification Tag for Clip Storage	205
- Mini Clips	188,189
- PHYNOX Clips.....	178-189
- Standard Clips	178-187
- Sterilisation and Storage Tray	204-206
- TITAN Clips	178-189
Applying Forceps for	
- ACLAND Approximators	388
- ACLAND Double Clamps	388
- ACLAND Single Clamps	388
- Aneurysm Clip	190-201
- Approximators.....	388,389
- BIEMER Approximators.....	389
- BIEMER Vessel Clips	389
- MEHDORN Vessel Clips.....	389
- Scalp Clips	170,171
- TITAN Ligating Clips.....	392,393
- Vessel Clips	389,395
Applying and Removing Forceps for	
- Bulldog Clamps	401
Approximators	
- ACLAND.....	386,387
- Vessel	390,391
Atraumatic	
- Bulldog Clamps	400,403-406,408,409
- Forceps	484-488
- Micro Forceps	51,52
- Vessel Clips	397
- Vessel Clamps.....	403
B	
BABY-CRILE	
- Haemostatic Forceps, delicate	492
BABY-CRILE-WOOD	
- Needle Holder	509
BABY-METZENBAUM	
- Dissecting Scissors, toothed.....	447
BABY-MIXTER	
- Dissecting and Ligature Forceps	500

BABY-MOSQUITO	
- Haemostatic Forceps	490
BACKHAUS	
- Towel Clamps	503
BALFOUR	
- Blade	305,307
Ball and Socket Joint for	
LEYLA Retractor System.....	142,143
BANE-HARTMANN	
- Bone Rongeur	557
Bar Horizontal Flex.....	305,306
BARRAQUER	
- Micro Needle Holder	30,31
BARRÈ	
- Dissecting Scissors	440
BARRON	
- Suction Tubes	548
Basket/Tray.....	119,154,157,278,280-283,299,302,310,313,314
BAUMGARTNER	
- Needle Holder	508
BEAL	
- Circumflex Vessel Scissors.....	458
BECK	
- Rongeur	376
BECKMANN	
- Self-Retaining Retractor.....	325
BECKMANN-ADSON	
- Self-Retaining Laminectomy Retractor	333
BECKMANN-EATON	
- Self-Retaining Laminectomy Retractor	333
BELLUCCI	
- Suction Tip	549
- Suction Tubes.....	549
BEYER	
- Bone Rongeur	558,564
BIEMER	
- Applying Forceps	389
- Approximators.....	391
- Micro Vein Scissors	10,11
- Micro Vessel Spreader	100
- Vessel Clips	391
BIEMER-MÜLLER	
- Approximators.....	390
Bipolar Coagulation Forceps	125-133
- NON-STICK.....	125-133
- with Irrigation	132,133
Blade Ejector.....	291,299,301,302
Blades/Hooks	
- for Counter Retractor for	
Micro Lumbar Microdiscectomy	299,301-303
- for Laminectomy Retractors ..	308,309,336-338
- for Lumbar Retractor System	308,310,312-314,316,317
- for Retractor/Spreader ..	286-290,292,293,296,297,299,301-303,308-310,312-314,316,317,328,329,336-338
- for Ring Retractor System	305,307
- for Self-Retaining Retractor, cervical	278,280-283,286-289,290-293,328,329
- PEEK, for Self-Retaining Retractor, cervical.....	296,297
- TITANIUM ..	278,280-283,286-289,292,310,312
BLUMENTHAL	
- Bone Rongeur	556
BÖHLER	
- Bone Cutting Forceps.....	569
- Bone Rongeur	563
Bone Curettes.....	597-603
Bone Cutting Forceps	569-572
Bone Graft Holder and Impactor	263
Bone Rongeurs	553-568
Bone Waxer	
- lumbar	272,273
- cervical.....	268-271
BONNEY	
- Forceps	483
Booster Clip	190
BROPHY	
- Forceps	476

	page
BROWN	
- Forceps	478
BRUNS	
- Bone Curettes.....	601
BÜCHS	
- Raspatories	591
Bulldog Clamps.....	398-401,404-409
- Atraumatic	400,403-406,408,409
- Featherweight.....	398
Burr for Handdrill.....	158-161
Burr Hole Plate for	
Cranio Plate System.....	211,212,215,220
Burr Hole Protection Forceps	163
BUSHE	
- Bone Curettes.....	602
C	
Cable for	
- Bipolar Forceps	138
- Monopolar Forceps.....	139
CAIRNS	
- Haemostatic Forceps	491
- Hook, Dura Hooks	78
- Self-Retaining Retractor.....	322
CAIRNS-DOTT	
- Forceps.....	480
Caliper	263
Cartilage Scissors.....	460
CASPAR	
- Blades	308,309
- Bone Curettes.....	603
- Bone Graft Holder and Impactor.....	263
- Caliper	263
- Cervical Retractor	290,291,294,296
- Coagulation Hook	74
- Counter Retractor	296
- Counter Retractor, cervical....	290,291,294,295
- Counter Retractor for	
Micro Lumbar Discectomy	303
- Curettes	264,265,603,604
- Distractions Screws	258,259,262
- Distractor.....	258,261
- Drill Guide for Vertebral Body	
Distraction System	258-261
- Exploration Hook	74
- Grasping Forceps	238
- Hooks	308
- Laminectomy Retractor	308
- Micro Dissectors.....	82,83
- Micro Scalpel Handle	59
- Micro Scissors	238
- Micro Shaft Instruments	65
- Nerve Root Retractors	102
- Raspatories	592
- Retractor Set for Micro Lumbar Discectomy.....	302
- Rongeurs.....	368,369,372,373,382
- Rongeurs, bayonet-shaped	372,373
- Screwdriver for Distraction System ..	258,259,262
- Specula for Micro Lumbar Discectomy.....	304
- Suture Pusher.....	97
- Tamps	266
- Twist Drill for Vertebral Body	
Distraction System	258,259,262
- Vertebral Body Dissector	263
- Vertebral Body Distraction System.....	258-263
- Vertebral Body Distractor	258-261
CASPAR modif.	
- Basic Retractor	278,279
- Counter Retractor	300
- Dissectors modif.	68
- Exploration Hooks modif.	65
CASTROVIEJO	
- Micro Needle Holder	28,29
CCR Cervical Retractor System	280-293
- PEEK	294-297
- with extended deep spreading	277-279
Cervical	
- Basic Retractor	279,280-282,284

	page
FAVALORO	
- Coronary Artery Scissors.....	457
- Vessel Scissors.....	457
FERGUSSON	
- Suction Tubes, insulated.....	537
FERRIS-SMITH	
- Rongeurs.....	383
FERRIS-SMITH-KERRISON	
- Laminectomy Punches.....	364,365
FISCH	
- Micro Hooks.....	75
Fishtail Chisel.....	607
Fixation Base for LEYLA Retractor System..	144,145,146
- TITANIUM.....	147
Flat Pliers.....	215,227
Flexible Arm for LEYLA Retractor.....	142,144-145
Flexible Arm for LEYLA Retractor, TITANIUM.....	147
Floating Secondary Bar.....	155
FOERSTER	
- Sponge Holding Forceps.....	503
FOMON	
- Dissecting Scissors, delicate.....	431
- Nasal Scissors.....	464
Foraminotomy Punches.....	356-358
Forceps.....	466-488
- atraumatic.....	51,484-488
- atraumatic, Micro.....	52
- bayonet-shaped.....	38-46
- Bone Cutting.....	569-572
- Coagulation.....	124-137
- Coagulation NON-STICK.....	124-133
- Cup Shaped.....	110,111,116-118
- Diamond dust coated.....	51,53
- Dissecting and Ligature.....	500,501
- for Hypophysectomy.....	238,239,381
- for Plates and Screws.....	211,213,215,228
- Front- and Lateral Cutting.....	551
- Grasping.....	108,109,114,115
- Haemostatic.....	490-499
- Jeweler.....	57
- Micro.....	38-40,48-57
- Ring Micro.....	51,53
- Scalp Flap Forceps.....	504
- SMARTLINE.....	38,42,48,49
- Towel.....	503
- Tube Shaft.....	108-111,114-118
- Tumor Grasping Forceps.....	42-47
- Wire Cutting.....	550-552
- with Counter Weight.....	50,51
Forks	
- Spatula for Hypophysectomy.....	254
- Tumor.....	98
FRAZIER	
- Dura Hooks.....	78
- Elevators.....	87
- Hooks.....	78
- Puncture Cannulas.....	166
- Suction Tubes.....	538,540
- Suction Tubes, insulated.....	537
FRAZIER FERGUSSON	
- Suction Tubes.....	539
FREER	
- Dura Hooks.....	78
- Elevators.....	90,574
- Hooks.....	78
- Raspatories.....	90
FREER-YASARGIL	
- Elevators.....	90
FRIEDMANN	
- Bone Rongeur.....	554
FRYKHOLM	
- Bone Rongeur.....	565
G	
Galea Hooks.....	172
GARDNER-WELLS	
- Skull Traction Tongs.....	169

GELPI	
- Blade.....	305,307
- Skin Retractor, Self-Retaining Retractor.....	319
GEMINI	
- Dissecting and Ligature Forceps.....	501
General Surgical Instruments.....	412-634
GERALD	
- Forceps.....	481
GERZOG	
- Mallet.....	633
GIGLI	
- Handles for Wire Saws.....	165
- Wire Saws.....	164
GIL VERNET	
- Saddle hooks.....	521
GILLIES	
- Forceps.....	479
- Hook, Dura Hooks.....	78
GLOVER	
- Bulldog clamps, atraumatic.....	408,409
GORNEY	
- Dissecting Scissors, delicate.....	433
- Dissecting Scissors, delicate, Supercut.....	433
Gouges.....	612-614
GRAEFE	
- Hook, Dura Hooks.....	78
Grasping Forceps	
- for Hypophysectomy.....	238,381
- Tumor.....	381
GREGORY SOFT	
- Bulldog clamps, atraumatic.....	405
GRUENWALD	
- Forceps, TC.....	41
- Monopolar Forceps.....	136
GULEKE	
- Bone Rongeur.....	560
GUTHRIE	
- Retractors.....	515
H	
Haemostatic Forceps.....	490-499
- delicate.....	490,491
HAJEK	
- Mallets.....	631
HAJEK-KOFLER	
- Laminectomy Punches.....	362
HAKANNSON	
- Bone Rongeur.....	562
HALLE	
- Bone Curettes.....	600
- Raspatories.....	89
HALSEY	
- Needle Holder.....	507
HALSTED-MOSQUITO	
- Haemostatic Forceps.....	490
Handdrill.....	158-161
Handles	
- for interchangeable Micro Shaft Instruments.....	63,64,240,241
- for the Inserting of Blades.....	280,281,282,285
- for Wire Saws.....	165
Handrest.....	154,156
HARDY	
- Curettes.....	244-249,251,254
- Enucleators.....	244,245,252,253
- Implant Fork.....	252
- Micro Dissectors.....	82,83
HARDY-FAHLBUSCH	
- Dissectors.....	252,253
HARRINGTON	
- Blade.....	305,307
HARVEY	
- Wire Cutting Pliers.....	550
- Wire Cutting Scissors.....	552
HARVEY- JACKSON	
- Self-Retaining Laminectomy Retractors.....	330

	page
HEIFETZ	
- Spatulas.....	153
- Tumor Grasping Forceps.....	43
Hemi-Laminectomy Hooks.....	310,312
HENCKEL-TILLEY	
- Rongeur.....	380
HENDERSON	
- Self-Retaining Retractor.....	326
HESS	
- Nerve Root Retractors.....	105
HEYMANN-KNIGHT	
- Nasal Scissors.....	465
HIBBS	
- Osteotomes.....	609
- Retractors.....	532
HILL	
- Elevators.....	577
HOEN	
- Elevators.....	87
- Raspatories.....	587
Holding Rods	
- for LEYLA-Self-Retaining Retractor System.....	142,143
- for Self-Retaining Retractor System.....	154,156
HOLSHER	
- Nerve Root Retractors.....	104
Hooks.....	78-81,308,337
- Dura.....	78
- for Hypophysectomy.....	244,245,252-255
- Galea.....	172
- Hook for Acoustic Neurinoma.....	75
- Micro.....	67,69,73,75,76
- Nerve and Vessel.....	77
- Teardrop.....	76
Horizontal Flex Bar.....	305,306
HORSLEY	
- Dissectors.....	86
HOSOBUCHI	
- Fork Spatula.....	254
HOUSE	
- Suction Adapter.....	545
- Suction Tubes.....	545
HOWARTH	
- Raspatory.....	582
HUDSON	
- Burr.....	158
- Extension Piece.....	158
- Handdrill.....	158
HUDSON DOWNS	
- Burr.....	160,161
- Handdrill.....	160
HUDSON DOWNS (LEWIS)	
- Burr.....	160
HUNT	
- Tumor Grasping Forceps.....	46,47
I	
Identification Tag for Clips Storage Trays.....	205
Incision Scissors.....	427
INGE	
- Lamina Spreader.....	340
IRIS	
- Scissors.....	418,419
- Scissors, Supercut.....	418
J	
JACKSON-BURROWS	
- Skin Retractor, Self-Retaining Retractor.....	319
JACOBSON	
- Micro Needle Holder.....	28,29
- Micro Scissors.....	10,11
- Micro Vessel Knives.....	69,96
- Micro Vessel Probe.....	100
- Suture Pusher.....	97
JÄGER	
- Hook, Dura Hooks.....	78

	page		page
JAMESON		Knives	
- Dissecting Scissors, delicate.....	435	- Lancet	95
JAMESON-WERBER		- Lancet modif.	71
- Dissecting Scissors, delicate.....	435	- Micro modif.	69
- Dissecting Scissors, delicate, Supercut	435	- Micro Vessel	96
JANSEN		- Micro Vessel modif.	69
- Bone Rongeur	557,559	- Micro Lancet for Acoustic Neurinoma	95
- Forceps, bayonet- shaped	41	- Micro Lancet for Acoustic Neurinoma modif. .	71
- Monopolar Forceps	136	- Tumor	94,95
- Raspatories	589	- Tumor modif.	70,71
- Self-Retaining Retractor.....	318	- Vessel	96
JEFFERSON		- Vessel modif.	69
- Forceps	470	KOCHER	
- Self-Retaining Retractor.....	322	- Haemostatic Forceps, delicate	495
JEWELER		KÖLN	
- Bipolar Coagulation Forceps.....	125	- Scalp Clips	171
- Bipolar Coagulation Forceps, NON-STICK	125	KÖNIG	
- Forceps	57	- Elevators	573
JOSEPH		- Raspatories	579
- Hooks	80	KOOS	
- Raspatories	587	- Micro Vessel Knives.....	96
- Scissors.....	421	KOOS modif.	
- Scissors, Supercut	421	- Hook modif.	69
K		- Micro Knives modif.	69
KAYE FACE LIFT		KRÄMER	
- Dissecting Scissors, Supercut.....	427	- Raspatories	591
KELLY		KRAYENBÜHL	
- Blades	305,307	- Nerve and Vessel Hooks.....	77
- Haemostatic Forceps	491	L	
- Haemostatic Forceps, TITANIUM.....	491	LAMBOTTE	
- Scissors.....	422	- Osteotomes	610
KERRISON		- Raspatories	589
- Foraminotomy Punches	356-358	Lamina	614
- Laminectomy Punches.....	346-365	- Gouge.....	614
- Laminectomy Punches, bayonet-shaped .	358-361	- Spine Probe	273
- Laminectomy Punches, detachable	346-349	- Spreader	339,340
- Laminectomy Punches, shaft curved.....	356,357	Laminectomy Punches	345-365
- Laminectomy Punches with large		- bayonet-shaped.....	358-361
jaw opening.....	354,355	- curved	356,357
KEY		- detachable	344-349,356
- Raspatories	583	- Foraminotomy.....	356-358
Key	391	- with large jaw opening.....	354,355
- for Approximators	391	Laminectomy Retractors	336,358,530
- for Specula	236	- Blades	336,337
KILLIAN		- Self-Retaining.....	330-335
- Elevator	90	LANDOLT	
- Raspatories	582	- Curettes	254
KILNER		- Dissecting Scissors, delicate.....	434
- Dissecting Scissors, delicate.....	430,432	- Dissection Suction Tube.....	543
- Hooks	79	- Enucleators.....	254
- Needle Holder	508	- Forceps for Hypophysectomy	239
KIRSTEIN		- Hooks.....	254
- Nasal Scissors.....	465	- Micro Scalpel Handle	60,61
KLEINERT-KUTZ		- Pituitary Rongeurs	381
- Bone Rongeur	555	- Raspatory.....	592
- Hooks.....	81	- Spoon	254
K-LINE Instruments for Microdissectomy ..	267-276	- Spreader for Specula	235
- Bone Waxer, cervical.....	268-271	- Tumor Grasping Forceps	381
- Bone Waxer, lumbar.....	272,273	LANDOLT-REULEN	
- Cortical Bone Cutter	268-271	- Pituitary Curettes.....	255
- Curettes, cervical	268-271	- Pituitary Dissectors	244,245,252,253,255
- Curettes, lumbar	272,273	- Pituitary Hooks	255
- Dissector	272,273	- Pituitary Micro Hooks	244,245
- Handle for Micro Knife.....	276	- Pituitary Raspatories	255
- Micro Curettes	274,275	LANE	
- Micro Dissectors.....	274,275	- Forceps, bayonet-shaped	478
- Micro Knives	276	LANGENBECK	
- Micro Nerve Hooks, cervical	268-271	- Elevators.....	578
- Nerve Hook, lumbar.....	272,273	- Raspatories	591
- Sterilisation Case.....	268,270,272,274	- Retractors	529
- Spine Probe, lumbar	272,273	LANGENBECK-GREEN	
- Ultra Micro Nerve Hooks, cervical.....	268-271	- Retractors	520
K-LINE MAGNUM		LANGENBECK-MANNERFELT modif.	
- Chisels	616,617	- Retractors	524
- Curettes	618-621	Lancet Knife	95
- Elevators	626-629	- Micro for Acoustic Neurinoma	95
- Ring Curettes	622-625	- Micro for Acoustic Neurinoma modif.....	71
- Sterilizing Case.....	616-629	- modif.....	71
		LAZAR	
		- Micro Forceps	55
		LEBSCHÉ	
		- Conductor for Wire Saws	165
		LEKSELL	
		- Bone Rongeurs	562,566,567
		LEKSELL-STILLE	
		- Bone Rongeurs	566
		LEMPERT	
		- Bone Curettes.....	599
		- Bone Rongeurs	553,559
		- Elevators.....	576
		- Suction Tubes	543
		LERICHE	
		- Haemostatic Forceps	494
		LEXER	
		- Gouges	613
		- Dissecting Scissors	445
		- Dissecting Scissors, Supercut.....	445
		- Dissecting Scissors, toothed	449
		- Osteotomes	613
		LEXER fino	
		- Dissecting Scissors	444
		LEYLA Retractor System	142-146
		- Ball and Socket Joint.....	142,143
		- Coupling Head.....	144
		- Ear Specula Holder	144
		- Fixation Base	144-146
		- Flexible Arm.....	142,144,145
		- Holding Rod.....	142,143
		- Spatulas	142,148-153
		- Support	142,144,145
		- Universal Clamp.....	146
		LEYLA Retractor System, TITANIUM	147
		Lid for Basket	278,280-283,299,302
		Ligature	
		- Forceps	396
		- Guide.....	77
		LISTON	
		- Bone Cutting Foreeps	570,572
		LITTAUER	
		- Stitch Scissors	463
		LITTLER	
		- Dissecting Scissors, delicate.....	430
		LOVE	
		- Nerve Root Retractors	101,102
		LOVE-GRUENWALD	
		- Rongeurs.....	370,374,375
		- Rongeurs, bayonet-shaped	374,375
		LUCAE	
		- Forceps, bayonet-shaped.....	41
		- Forceps, monopolar.....	136
		LUER	
		- Bone Rongeurs	556,560
		- Suction Tubes	542
		LUER-FRIEDMANN	
		- Bone Rongeurs	555
		LUER-STILLE	
		- Bone Rongeurs	568
		Lumbar	
		- Blades	299,301,303,308,309
		- Bone Waxer.....	272,273
		- Counter Retractor	299,303
		- Curettes	272,273
		- Dissectors.....	272-275
		- Hooks.....	308
		- Micro Dissectomy	298-304
		- Micro Dissectomy Instrument Set	272
		- Nerve Hook	272,273
		- Retractors	308
		- Specula	299,300,302,304
		- Spine Probe	272,273
		Lumbar Retractor System	308-317
		- Blades	308,309
		- Blades TITANIUM	310,312
		- CLR Handle	310,311
		- CLR Hemi-Laminectomy Hooks.....	310,312
		- CLR Retractor Set	310
		- CLR Retractor	310,311
		- CLR Tray	310

	page
- CLR Depth Gauge.....	310,311
- Hooks.....	308
- Key for Retractor.....	308
- MC CULLOCH Basket.....	313,314
- MC CULLOCH Hooks.....	313,314,316
- MC CULLOCH Hooks multiple toothes.....	313,314,316
- MC CULLOCH Muscle Blade	313,314,316,317
- MC CULLOCH Retractor.....	313-315
- MC CULLOCH Retractor Set	313,314
- Retractor.....	308
M	
MAGILL	
- Suction Tubes.....	542
Mallets.....	237,630-633
Mallet for Hypophysectomy.....	237
MANNERFELT modif.	
- Raspatories.....	584,585
- Retractors.....	522-524
- Saddle Hooks.....	524
MARKHAM-MEYERDING	
- Self-Retaining Laminectomy Retractor	335
MARQUARDT	
- Bone Rongeur.....	563
MARTINI	
- Bone Curettes.....	597
MAYFIELD	
- Bone Rongeur.....	563
MAYO	
- Dissecting Scissors.....	443
- Dissecting Scissors, Supercut.....	443
- Dissecting Scissors, toothed.....	448
MAYO-ADAMS	
- Self-Retaining Retractor.....	326
MAYO-HEGAR	
- Needle Holder.....	511
MAYO-STILLE	
- Dissecting Scissors.....	444
MC CULLOCH	
- Basket.....	313,314
- Hooks.....	313,314,316
- Hooks multiple toothed.....	313,314,316
- Muscle Blades.....	313,314,316,317
- Retractor.....	313-315
- Retractor Set.....	313,314
MC DONALD	
- Elevators.....	574
MC INDOE	
- Bone Cutting Forceps.....	571
- Cartilage Scissors.....	460
- Forceps.....	479
- Hooks.....	79
MC KENTHY	
- Raspatory.....	581
MC KENZIE	
- Burr.....	158,161
- Clip Applying Forceps.....	170
- Clip Block.....	170
- Silver Clips.....	170
MC KISSOCK	
- Raspatory.....	591
MEAD	
- Bone Rongeurs.....	558
- Mallet.....	632
MEHDORN	
- Applying Forceps.....	389
- Vessel Clips.....	391
MEMORY	
- Applying Forceps for Aneurysm-Clips ...	190,191
- Spatulas.....	148
Mesh Plates for Cranio Plate System	224,225
METZENBAUM	
- Dissecting Scissors.....	438
- Dissecting Scissors, Supercut.....	439
- Dissecting Scissors, toothed.....	449,450

	page
METZENBAUM fino	
- Dissecting Scissors.....	440,441
- Dissecting Scissors, Supercut.....	440
- Dissecting Scissors, toothed.....	451
METZENBAUM-NELSON	
- Dissecting Scissors.....	442
MEYERDING	
- Retractors.....	517,530
- Self-Retaining Laminectomy Retractor	335
MICRO-ADSON	
- Dissecting and Ligature Forceps.....	500
- Forceps.....	468
MICRO-ADSON-BIEMER	
- Forceps.....	468
MICRO-HALSTED	
- Haemostatic Forceps.....	490
Micro	
- Coagulation Hook.....	74
- Curettes.....	73,243-251,254,255
- Dissecting Scissors.....	4,5,10,11,21
- Dissectors.....	72,76,82,83,91,244,245,252,253,255
- Dissectors for Acoustic Neurinoma.....	83
- Elevators.....	72
- Enucleators.....	244,245,252-254
- Exploration Hooks.....	74
- Forceps.....	38-40,50,54-57
- Forceps, atraumatic.....	51,52
- Forceps, bayonet-shaped.....	38-41
- Forceps, bayonet-shaped, SMARTLINE	38
- Forceps, diamond dust coated.....	51,53
- Forceps SMARTLINE.....	38,48,49
- Forceps with Counter Weight	50,51
- Fork Spatula.....	254
- Hooks.....	73,75,76,78-81,244,245,252-255
- Hooks for Acoustic Neurinoma.....	75
- Hooks modif.....	69
- Implant Fork.....	252
- Jeweler Forceps.....	57
- Knife modif.....	69
- Lancet Knife.....	95
- Lancet Knife for Acoustic Neurinoma	95
- Ligature Guides.....	77
- Microshaft Curettes.....	242
- Needle Holder.....	7,22-37
- Needle Holder SMARTLINE.....	22,24,25
- Needles modif.....	73
- Nerve Hook.....	77
- Probe with Ball Tip.....	100
- Raspatories.....	91-93,252,253,255
- Ring Forceps.....	51,53
- Ring Forceps, diamond dust coted.....	51,53
- Scalpel Handles.....	59,61
- Scissors.....	2-21
- Scissors for Hypophysectomy.....	238
- Scissors SMARTLINE.....	2,3,8,9
- Scoop.....	92-93,254,255
- Suction Cannulas.....	546
- Suction Tubes.....	546
- Suture Pusher.....	97
- Teardrop.....	76
- Teardrop Dissectors.....	73
- Tissue Picks.....	99
- Tube Shaft Micro cup-shaped Forceps.....	111,116-118
- Tube Shaft Micro cup-shaped Forceps, delicate.....	110
- Tube Shaft Micro Grasping Forceps	109,114,115
- Tube Shaft Micro Grasping Forceps, delicate	108
- Tube Shaft Micro Scissors.....	107,112,113
- Tube Shaft Micro Scissors.....	106
- Tumor Forks.....	98
- Tumor Knife.....	94,95
- Vein Scissors.....	10,11
- Vessel Dilators.....	100
- Vessel Hooks.....	77
- Vessel Knives.....	96
- Vessel Knives modif.....	69
- Vessel Probe.....	100
- Vessel Spreader.....	100

	page
Micro Discectomy Retractor Set.....	299-304
Microdiscectomy	
- Bone Waxer, cervical.....	268-271
- Bone Waxer, lumbar.....	272,273
- Curettes, cervical.....	268-271
- Curettes, cortical.....	268-271
- Curettes, lumbar.....	272,273
- Dissector, lumbar.....	272,273
- Handle for Micro- Knife.....	276
- Micro Curettes.....	274,275
- Micro Dissectors.....	274,275
- Micro Knives.....	276
- Micro Nerve Hook, cervical.....	268-271
- Micro Nerve Hook, cervical, delicate ...	268-271
- Nerve Hook, lumbar.....	272,273
- Spine Probe, lumbar.....	272,273
- Sterilisation Case.....	268,270,272,274
Micro Shaft Instruments.....	65-71
- CASPAR modif.....	68
- Curettes modif.....	67
- Dissectors modif.....	66,68
- Elevators modif.....	66
- Exploration Hooks modif.....	65
- Hooks modif.....	67
- KOOS modif.....	69
- Lancet Knife modif.....	71
- Micro Hooks modif.....	69
- Micro Knives modif.....	69
- Micro Lancet Knife modif.....	71
- Micro Raspatories modif.....	68
- Micro Vessel Knife modif.....	69
- Needles modif.....	67
- OPPEL modif.....	71
- RHOTON modif.....	66,67
- SAMII modif.....	70,71
- Teardrop Dissectors modif.....	67
- Tumor Knivess modif.....	70,71
- YASARGIL modif.....	68
MILLESI	
- Micro Scissors.....	10,11
MILLS	
- Vessel Scissors.....	454
Mirrors	
- for Hypophysectomy.....	239
MISKIMON	
- Self Retaining Retractor	327
MITCHELL	
- Raspatory.....	580
MOLLISON	
- Self Retaining Retractor	323
MOLT	
- Elevator.....	575
MOYNIHAN	
- Scalp Flap Forceps.....	504
MÜHLING	
- Raspatories.....	592
MÜLLER	
- Approximators.....	390
- Ligature Forceps.....	396
- Vessel Approximator.....	390
- Vessel Clips.....	396
- Vessel Clips, atraumatic.....	397
N	
NAGEL	
- Micro Scissors.....	6
Nasal Scissors.....	464,465
Nasal Specula for Hypophysectomy.....	236
Needle Holder.....	506-513
- Micro.....	7,22-37
Needles.....	73
- modif.....	67
NELSON-METZENBAUM	
- Dissecting Scissors, toothed.....	450,451
Nerve Hook	
- and Vessel.....	77
- cervical.....	268-271
- lumbar.....	272,273

	page
Nerve Root Retractors	101,105
Neuro Gap Plate	223
Neuro Sub Temporal Plate	223
NICOLA	
- Currettes	244-247,250
- Micro Scissors.....	238
- Raspatories	252,253
NON-STICK Bipolar Coagulation Forceps.....	124-133
NORFOLK and NORWICH	
- Self-Retaining Laminectomy Retractor	331
NORTHFIELD	
- Bone Rongeur	561
O	
OBWEGESER	
- Osteotome.....	610
O'CONNELL	
- Nerve Root Retractor	105
Offset Scissors	457
OKONEK-YASARGIL	
- Tumor Forks	98
OLDBERG	
- Pituitary Rongeur.....	381
Olive.....	535
OLIVECRONA	
- Bone Rongeur	560
- Dura Scissors.....	459
- Spatulas.....	152
- Wire Saws	164
OLIVECRONA-GIGLI	
- Wire Saws	164
OLIVECRONA-TOENNIS	
- Clip Applying Forceps.....	170
OPPEL	
- Hook for Acoustic Neurinoma	75
- Micro Dissector for Acoustic Neurinoma	83
- Micro Lancet Knife for Acoustic Neurinoma ..	71
- Tube Shaft Micro cup-shaped Forceps for Acoustic Neurinoma.....	116
- Tube Shaft Micro Grasping Forceps for Acoustic Neurinoma	114
- Tube Shaft Micro Scissors for Acoustic Neurinoma	112
OPPEL modif.	
- Micro Lancet Knife modif. for Acoustic Neurinoma	95
Osteophyte Chisel and Scraper	88
Osteotomes	607-615
OVERHOLT-GEISSENDOERFER	
- Dissecting and Ligature Forceps	501
P	
PAPAVERO	
- Chisel	237
PAPAVERO-CASPAR	
- Hypophysectomy Specula	236
PAPAVERO-HARTMANN	
- Spreader for Specula.....	236
PARTSCH	
- Raspatories	89
Pattie Tray.....	154,157
PEAN	
- Haemostatic Forceps, delicate	495
PEEK	
- Blades	296,297
- Retractors, cervical	294-296
PENFIELD	
- Dissectors.....	84,272,273
PENNYBACKER	
- Probe and Dissector.....	85
- Bone Rongeur	560
- Rongeur	376
PERWITZCHKY	
- Scissors.....	420
Pituitary Instruments.....	235-255
- Chisel	237

	page
- Currettes	242,243,251,254,255
- Dissectors.....	244,245,252,253,255
- Enucleators.....	244,245,252-254
- Forceps	239
- Fork Spatula	254
- Grasping Forceps	238
- Handles for interchangeable Micro Shaft Instruments.....	240,241
- Hooks.....	254,255
- Implant Fork	252
- Key for Specula.....	236
- Mallet.....	237
- Micro Hooks.....	244,245,252,253
- Micro Scissors.....	238
- Micro shaft Currettes.....	242
- Mirror.....	239
- Nasal Specula.....	236
- Osteotome.....	237
- Raspatories	252,253,255
- Specula.....	235,236
- Spoon.....	254,255
- Spoon Forceps.....	238
- Spreader for Specula.....	235,236
Plate and Screw Holding Forceps ...	211,213,215,228
Plate Bending Forceps for Cranio Plate System.....	215,227
Plate Cutting Forceps for Cranio Plate System..	215,227
Plates for Cranio Plate System.....	211,212,215-225
PLESTER	
- Self-Retaining Retractor.....	320
- Suction Tubes	541
POPPEL	
- Suction Tubes	541
Post Coupling	305,306
POTTS-DE MARTELL	
- Vessel Scissors.....	454,456
- Vessel Scissors, Supercut	454
POTTS-SMITH	
- Vessel Scissors.....	455,456,458
POTTS-YASARGIL	
- Micro Scissors.....	10,11
Primary bar.....	154,155
Probe	
- Vessel Probe.....	100
- with Ball Tip.....	100
PROVIDENCE-HOSPITAL	
- Haemostatic Forceps	491
Punches	
- Foraminotomie.....	356-358
- Laminectomy	346-365
Puncture Cannulas.....	166,167
Pusher	
- Suture	97
Q	
QUERVAIN	
- Elevators.....	578
QUINKE	
- Puncture Cannulas	167
R	
RAGNELL	
- Retractors	518
RAMSEY	
- Forceps	483
RANEY	
- Applying and Removing Forceps.....	171
- Laminectomy Punches.....	363
- Scalp Clips.....	171
RANKIN	
- Haemostatic Forceps	494
Raspatories	89,90,579-596
- for Hypophysectomy	
- Micro	91-93
- modif.	68
Rasps.....	634

	page
Ratchet Mechanism	
- Standard	305,306
- Tilt.....	305,306
RAY	
- Currettes for Hypophysectomy	243
REIL	
- Micro Needle Holder	30
- Wire Cutting Pliers.....	551
Removers for Aneurysm Clips	202,203
Retractors.....	318-327,514-552
- Blades/Hooks	278,280-283,286-293,296, 297,299,303,308,309,310,312-314,316, 318,328,329,336-338
- Blade Ejector	291,299,301,302
- Cervical.....	278-285,290,291,294-296,328
- Counter Retractor, cervical.....	284,285,290,291,294-296
- Counter Retractor for Microdissectomy	299,300,302,303
- for Micro Lumbar Dissectomy..	299,300,302,303
- Laminectomy	308,330,338
- Lumbar	310,311,313-315
- Nerve Root	101-105
- Scalp	323
- Skin	319
Retractor System	
- Self-Retaining	154-157
Retractor System LEYLA	142-146
- Ball and Socket Joint.....	142,143
- Coupling Head.....	144
- Ear Specula Holder	144
- Fixation Base	144-146
- Flexible Arm.....	142,144,145
- Holding Rod.....	142,143
- Spatulas.....	142,148-153
- Support for Spatulas.....	142,144,145
- TITAN.....	147
- Universal clamp	146
Retractor System for Micro Lumbar Dissectomy .	302-304
- with extended deep spreading	298-301
REYNOLDS	
- Dissecting Scissors, delicate.....	432
RHOTON	
- Micro Currettes	73
- Micro Dissectors.....	72
- Micro Elevators.....	72
- Micro Hooks.....	73
- Micro Needle	73
- Micro Teardrop Dissector.....	73
RHOTON modif.	
- Micro Currettes modif.	67
- Micro Dissectors modif.	66
- Micro Elevators modif.	66
- Micro Hooks modif.	67
- Micro Needles modif.	67
- Micro Shaft Instruments	66,67
- Micro Teardrop Dissector modif.	67
Ring	
- oval.....	305,307
- segmented	305,306
Ring Forceps.....	51,53
Ring Retractor System	305-307
- Blades	305,307
- Horizontal Flex bar.....	305,306
- Post Coupling.....	305,306
- Ratched Mechanism, Standard	305,306
- Ring oval, medium	305,306
- Segmented Ring, medium	305,306
- Table Post.....	305,306
- Tilt Ratched Mechanism.....	305,306
ROCHESTER-PEAN	
- Haemostatic Forceps	496,497
ROCHESTER-OCHSNER	
- Haemostatic Forceps	498,499
RÖTTGEN-RUSKIN	
- Bone Rongeurs	564
ROLLET	
- Retractors	515
RUSKIN	
- Bone Rongeurs	564

	page
RUSKIN-LISTON	
- Bone Cutting Forceps	571
RYDER	
- Needle Holder	512
S	
SAMII	
- Lancet Knife	95
- Tumor Grasping Forceps.....	44
- Tumor Knife	94,95
SAMII modif.	
- Lancet Knife modif.	71
- Tumor Knife modif.	70,71
SANTULLI	
- Bulldog Clamps, atraumatic	405
SANVENERO	
- Scissors.....	420
SAROT	
- Needle Holder	513
Saddle Hook.....	521,524
Scalp Clips	170,171
Scalp Flap Forceps	504
Scalp Retractor	323
Scalpel Blade Remover	415
Scalpel Handles	62,412-417
- Micro.....	59-61
SCHLESINGER	
- Rongeurs.....	379
SCHMIEDEN-TAYLOR	
- Dura Scissors.....	459
SCHNEIDER	
- Raspatory.....	590
SCHNEIDER-SAUERBRUCH	
- Raspatory.....	590
SCHOENBORN	
- Retractors	525
SCHUHKNECHT	
- Suction Tubes	548
Scissors	
- Cartilage	460
- Coronary Artery Scissors.....	457
- delicate	418-422
- Dissecting	438-446
- Dissecting, delicate	428-437
- Dissecting, toothed	447-452
- Dura	459
- for Hypophysectomy	238
- for Vascular and Neuro Surgery	459-462
- Incision	427
- Micro	2-21
- Micro Dissecting	4,5,11,21
- Micro Vein	10,11
- Nasal	464,465
- Offset	457
- Stitch	463
- Supercut	418,421,423-427, 429, 433,435, 437,439,440,443,445
- Surgical	423-427
- Tendon.....	428,429
- Trigeminal	460
- Tube Shaft	106,107,112,113
- Vessel	428,429,453-458
- Wire	463
- Wire Cutting	228,552
Scoops	
- for Hypophysectomy	254,255
- Micro	92,93
SCOVILLE	
- Blades	337
- Nerve Root Retractor	104
- Self-Retaining Laminectomy Retractor	336
SCOVILLE-HAVERFIELD	
- Blades	337
- Self-Retaining Laminectomy Retractor	336

	page
SCOVILLE-RICHTER	
- Blades	338
- Hooks	338
- Self-Retaining Laminectomy Retractor	338
Screws for Cranio Plate System	211,212,215,226
Screwdriver	
- for Cranio Plate System	211,213,215,229
- for Vertebral Body Distraction-System	258,259,262
Screwdriver Blade for Cranio Plate System.....	230
Screwdriver Handle for Cranio Plate System	229,230
SEBILEAU	
- Elevators.....	578
Secondary Bar	154,155
SEDILLOT	
- Raspatories	580,590
Self-Retaining Retractor System	155-157
- Floating Secondary Bar	155
- Handrest	154,155
- Maxi Vise Adapter.....	157
- Pattie Tray	154,157
- Primary Bar	154,155
- Retractor Arms	154,155
- Secondary Bar	154,155
- Short Coupler	155
- Spatulas.....	154,157
- Tray.....	154,157
SEMB	
- Bone Rongeur	568
SEMKEN	
- Forceps	466
SENN-MILLER	
- Retractors	518
SEWALL	
- Raspatory.....	581
SHUNT	
- Bulldog Clamps	407
Side Cutter.....	551
Silicon Mat.....	278,280-283,299,302
Silver Clips	170
SIMON	
- Bone Curettes.....	600
Skin Retractor.....	319
Skull Traction Tongs	168,169
SMARTLINE	
- Mikro Forceps	48,49
- Mikro Forceps, bayonet-shaped.....	38
- Micro Needle Holders	22,24,25
- Micro Scissors.....	2,3,8,9
- Tumor Grasping Forceps, bayonet-shaped	42
SMITH-PETERSON	
- Osteotomes	608
Spare Discs for Mallets.....	631-633
Spare Needles for Approximators	391
Spare Pin for Skull Traction Tongs	169
Spatulas	142,148-153,154,157
Specula	
- for Hypophysectomy	235,236
- for Micro Lumbar Discectomy.	299,300,302,304
SPENCER	
- Stitch Scissors	463
SPETZLER	
- Micro Dissectors.....	76
- Micro Teardrop.....	76
Spinal Retractors.....	531
Sponge Holding Forceps	503
Spreader for Hypophysectomy Specula	236
Spreader	
- for Specula	235
- Lamina	339,340
SPURLING	
- Rongeurs.....	371,374,375
- Rongeurs, bayonet-shaped	374,375
Stainless Steel Basket for RHOTON Instruments and fine micro instruments	119
ST. BARTS	
- Rongeurs.....	376
STELLBRINK	
- Bone Rongeur	557

	page
Sterilisation Container/Tray	120,121,215,268, 270,272,274
STEVENS	
- Dissecting Scissors, delicate.....	428,429
- Vessel and Tendon Scissors.....	428,429
- Vessel and Tendon Scissors, Supercut	429
STILLE	
- Bone Rongeur	566
- Chissel	612
- Gouge	612
- Osteotomes	611
STILLE-RUSKIN	
- Bone Rongeur	567
Stitch Scissors	463
Storage Tray for Aneurysm Clips	204-206
STRULLY	
- Scissors for Vascular and Neuro Surgery.....	462
Suction Adapter	545
Suction Cannulas	546,549
Suction Handle	547
Suction Tip.....	535,549
Suction Tubes	534-549
Suction and Irrigation Cannula	544
Supercut Scissors	418,421,423-425,427
Surgical Scissors	423-427
Support for Spatulas for LEYLA Retractor... ..	142,144,145
- TITANIUM	147
Suture Pusher	97
T	
Table Post	305,306
TAKAHASHI	
- Rongeurs.....	376
Tamps	
- for Vertebral Distraction System	266
TAYLOR	
- Spinal Retractor.....	531
TC Instruments	
- Dissecting Scissors	438-445
- Dissecting Scissors, delicate.....	432,437
- Dissecting Scissors, toothed	447-452
- Forceps	468,469,471,479,480
- Forceps, bayonet-shaped.....	41
- Micro Needle Holder	28,29,34,35,36
- Needle Holder	507-513
- Plate Cutting Pliers.....	227
- Rasps.....	634
- Scissors, delicate	418
- Surgical Scissors	423-426
- Wire Cutting Pliers.....	550-552
- Wire Cutting Scissors	463,552
- Vessel Scissors.....	453-455
Teardrop Dissector	73
- modif.	67
Tendon Scissors.....	428,429
THOREK	
- Scissors for Vascular and Neuro Surgery.....	462
Tissue Picks	99
TITAN	
- Adjusting Key for Clip Applying Forceps	190
- Aneurysm Clips.....	178-189
- Applying Forceps for Aneurysm Clips.....	190-195,198,199
- Blades for Retractors	278,280-283, 286-289,292,310,312
- Booster.....	190
- Burr Hole Plates.....	211,212,215,220
- Coagulation Hooks	74
- Cranio Plate System.....	211-231
- Curettes	73
- Dissectors.....	72,76,82,83,91
- Dissectors for Acoustic Neurinoma.....	83
- Double T-Plates	218
- Double Y-Plates	215,219
- Elevators	72
- Enucleators.....	245,253,254

	page		page
- Exploration Hook	74	U	
- Fixation Base for LEYLA Retractor System	147	Universal Clamp for LEYLA Retractor System	146
- Flexible Arm	147	Utility Tray for Storage of Vessel Clamps	387
- Forceps	466,469,479,481		
- Forceps, atraumatic	484,485	V	
- Haemostatic Forceps	490,492	VANNAS	
- Hooks	73	- Micro Scissors	5,10,11,21
- Hooks for Acoustic Neurinoma	75	Vein Scissors	10,11
- L-Plates	217	VERHOEVEN	
- Lancet Knife for Acoustic Neurinoma	95	- Suction Tubes	546
- Lancet Knife	95	Vertebral Body Dissector	263
- LEYLA Retractor System	147	Vertebral Body Distraction System	258-263
- Ligating Clips	392	- Bone Graft Holder and Impactor	263
- Mesh Plates	224,225	- Caliper	263
- Medium Plates	211,212,215-223	- Curettes	264-265
- Medium Screws	211,212,215,226	- Dissectors	263
- Micro Forceps	39,52,53,54	- Distraction Screws	258,259,262
- Micro Hooks	75	- Distractors	258-261
- Micro Needle Holder	30,31	- Drill Guide	258-261
- Micro Scissors	4,5,21,23	- Screwdriver	258,259,262
- Needle	73	- Tamps	266
- Neuro Gap Plate	223	- Twist Drill	258,259,262
- Neuro Sub Temporal Plate	223	Vertebral Body Distractor	258-261
- Orbita Plate	219	Vessel	
- Plate and Screw Holding Forceps	211,213,215,228	- Approximators	386,387,390,391
- Raspatories	91-93	- Clamps	403
- Removers for Aneurym Clip System	202,203	- Clamps, atraumatic	403
- Rhoton-Instruments	66,67,72,73	- Clamps, TITANIUM	402
- Scoops	92,93	- Clips	391,394,396
- Spatulas	149	- Clips, atraumatic	397
- Square Plates	215,221,222	- Dilator	58,100
- Support for spatula	147	- Double Clamps	386,387
- Teardrop	76	- Knives, Mikro	96
- Teardrop Dissector	73	- Probe	100
- T-Plattes	217	- Scissors	428,429,453-458
- Tumor Knife	94,95	- Single Clamps	386,387
- Vessel Clamps	402	- Spreader	100
- Y-Plates	215,218	WISE	
TOENNIS		- Micro Forceps	56
- Dissecting Scissors, delicate	436	VOLKMANN	
- Dissectors	85	- Bone Curettes	597,598
- Hooks, Dura Hooks	78	- Retractors	526-528
TOENNIS-ADSON		W	
- Dissecting Scissors, delicate	437	WAGNER	
- Dissecting Scissors, delicate, Supercut	437	- Raspatories	595
- Dissecting Scissors, toothed	448	- Rongeurs	377,382
TREVES		WALTON YANKAUER	
- Forceps	482	- Suction Tubes	55
Trigeminal Scissors	460	WATSON-CHEYNE	
TROTTER		- Elevators	574
- Bone Rongeur	562	WAUGH	
Towel Clamps	502,503	- Forceps	582
Tube Shaft Instruments		WEBSTER	
- for Hypophysectomy	238	- Needle Holder	508
- Micro cup-shaped Forceps	111,116-118	WEIL-BLAKESLEY	
- Micro cup-shaped Forceps, delicate	110	- Rongeurs	378
- Micro Scissors	107,112,113	WEITLANER	
- Micro Scissors, delicate	106	- Self-Retaining Retractor	324
- Micro Grasping Forceps	109,114,115	WEITLANER-BECKMANN	
- Micro Grasping Forceps, delicate	108	- Self-Retaining Retractor	325
- Rongeurs	368-383	WELLER	
- Rongeurs, bayonet-shaped	372-375	- Dissecting Scissors	446
- Rongeurs, detachable	368-383	WILDE	
Tumor		- Rongeurs	380
- Forks	98	WILLIAMS	
- Grasping Forceps	42-47,381	- Self-Retaining Laminectomy Retractor	334
- Grasping Forceps SMARTLINE	42	WILLIGER	
- Knives	94,95	- Bone Curette	597
- Knives modif.	70,71	- Elevators	573
TUOHY		- Raspatories	579
- Puncture Cannulas	167	Wire Cutter, Front- and Lateral Cutting	551
Twist Drill		Wire Cutting Pliers	550-552
- for Cranio Plate System	215,231	Wire Cutting Scissors	228,552
- for Vertebral Body Distraction System	258,259,262	Wire Saws	164
		Y	
		YANKAUER	
		- Suction Tubes	534,535
		YANKAUER-BABY	
		- Suction Tubes	534
		YASARGIL	
		- Aneurysm Clip System	176-189
		- Applying Forceps for Aneurysm Clips	190-201
		- Dissectors	86
		- Flexible Arm	142,144,145
		- Flexible Arm, TITANIUM	147
		- Galea Hooks	172
		- Ligature Guide	77
		- Micro Dissecting Scissors	4,5,10,11,21
		- Micro Dissectors	91
		- Micro Forceps	39
		- Micro Ligature Guide	77
		- Micro Needle Holder	23
		- Micro Raspatories	91-93
		- Micro Scoop	92,93
		- Micro Scissors	4,5,10,11
		- Micro Vessel Knife	96
		- Pituitary Rongeur	381
		- Suction Tubes	504
		- Support for Spatula	142,144,145
		- Tumor Forks	98
		- Tumor Grasping Forceps	43,45,46
		YASARGIL modif.	
		- Micro Raspatories modif.	68
		YASARGIL-NICOLA	
		- Grasping Forceps	238
		YASARGIL-SAMII	
		- Tumor Grasping Forceps	43
		Z	
		ZAUFAL-JANSEN	
		- Bone Rongeur	564
		ZIELKE	
		- Gouges	614
		ZOELLNER	
		- Suction Cannula	549
		- Suction Tip	549

<i>Seite/page</i>	<i>Seite/page</i>	<i>Seite/page</i>			
01-01-845	263	02-03-263	438	02-03-590	445
02-02-046	59	02-03-263W	449	02-03-591	445
02-02-048	59	02-03-265	438	02-03-600	440
02-02-052	59	02-03-265W	449	02-03-601	438
02-02-053	60	02-03-266	438	02-03-602	438
02-02-054	59	02-03-267W	450	02-03-603	440
02-02-057	61	02-03-270	440	02-03-604	438
02-02-063	415	02-03-271	440	02-03-605	438
02-02-071	62	02-03-271W	451	02-03-606	438
02-02-073	412	02-03-273	437	02-03-607	438
02-02-074	412	02-03-273W	448	02-03-611	438
02-02-075	412	02-03-274	440	02-03-612	438
02-02-077	414	02-03-275	440	02-03-613	438
02-02-078	413	02-03-275W	451	02-03-614	438
02-02-079	413	02-03-276	440	02-03-615	438
02-02-084	416	02-03-277	440	02-03-616	438
02-02-085	416	02-03-277W	451	02-03-618	438
02-03-030	420	02-03-279	440	02-03-619	438
02-03-033	419	02-03-279W	451	02-03-625	438
02-03-056	418	02-03-281	440	02-03-628	422
02-03-057	418	02-03-281W	451	02-03-629	437
02-03-060	418	02-03-283	445	02-03-629	437
02-03-061	418	02-03-283W	449	02-03-630	437
02-03-064	418	02-03-287	438	02-03-631	437
02-03-065	418	02-03-287W	450	02-03-633	436
02-03-100	418	02-03-289	438	02-03-634	436
02-03-101	418	02-03-294W	452	02-03-635	436
02-03-106	418	02-03-295W	452	02-03-636	462
02-03-107	418	02-03-296W	452	02-03-642	461
02-03-110	418	02-03-297W	452	02-03-644	462
02-03-111	418	02-03-313	425	02-03-645	462
02-03-112	418	02-03-314	425	02-03-646	455
02-03-113	418	02-03-315	425	02-03-647	454
02-03-117	418,419	02-03-316	425	02-03-648	454
02-03-156	421	02-03-317	425	02-03-649	454
02-03-157	421	02-03-320	424	02-03-650	454,456
02-03-160	422	02-03-321	424	02-03-651	454
02-03-161	422	02-03-323	424	02-03-652	456
02-03-162	430	02-03-324	424	02-03-653	453
02-03-163	430	02-03-325	424	02-03-654	453
02-03-164	430	02-03-326	424	02-03-660	459
02-03-165	430	02-03-327	424	02-03-662	453
02-03-166	432	02-03-328	424	02-03-663	453
02-03-168	432	02-03-330	424	02-03-664	453
02-03-170	429	02-03-341	423	02-03-665	459
02-03-171	429	02-03-343	423	02-03-669	457
02-03-172	429	02-03-344	423	02-03-670	457
02-03-173	429	02-03-345	423	02-03-672	460
02-03-175	435	02-03-346	423	02-03-680	438
02-03-177	435	02-03-374	426	02-03-683	438
02-03-180	432	02-03-411	425	02-03-715	446
02-03-181	432	02-03-413	425	02-03-801	463
02-03-184	433	02-03-414	425	02-03-802	463
02-03-186	428	02-03-415	425	02-03-803	463
02-03-187	428	02-03-416	425	02-03-815	552
02-03-188	433	02-03-417	425	02-03-900	418
02-03-189	433	02-03-421	424	02-03-901	418
02-03-194	429	02-03-423	424	02-03-911	435
02-03-195	429	02-03-424	424	02-03-915	435
02-03-210	418	02-03-425	424	02-03-916	421
02-03-211	418	02-03-426	424	02-03-917	421
02-03-211W	452	02-03-427	424	02-03-920	433
02-03-224	424	02-03-441	423	02-03-921	433
02-03-228	423	02-03-443	423	02-03-924	445
02-03-231	425	02-03-444	423	02-03-925	445
02-03-234	424	02-03-445	423	02-03-930	439
02-03-242	444	02-03-446	423	02-03-931	439
02-03-243	444	02-03-464	426	02-03-934	439
02-03-245	455	02-03-474	426	02-03-935	439
02-03-250	443	02-03-503	427	02-03-936	439
02-03-251	443	02-03-504	427	02-03-937	439
02-03-252	443	02-03-544	443	02-04-023	473
02-03-253	443	02-03-545	443	02-04-025	473
02-03-253W	448	02-03-547	443	02-04-027	473
02-03-256	440	02-03-554	443	02-04-029	473
02-03-257	440	02-03-555	443	02-04-030	473
02-03-257W	447	02-03-557	443	02-04-031	473
02-03-258	440	02-03-580	444	02-04-032	473
02-03-259	440	02-03-581	444	02-04-033	473
02-03-259W	447	02-03-584	444	02-04-035	473
02-03-260	438	02-03-585	444	02-04-037	473
02-03-261	438	02-03-587	444	02-04-043	472
02-03-261W	449	02-03-588	444	02-04-045	472
02-03-262	438	02-03-589	444	02-04-047	472

<i>Seite/page</i>	<i>Seite/page</i>	<i>Seite/page</i>	
02-04-049	472	02-06-464	502
02-04-050	472	02-06-465	502
02-04-051	472	02-06-466	502
02-04-052	472	02-08-012	401
02-04-053	472	02-08-013	401
02-04-078	483	02-08-014	401
02-04-083	483	02-08-015	401
02-04-151	469	02-08-016	401
02-04-154	471	02-08-017	401
02-04-155	471	02-08-018	401
02-04-156	471	02-08-020	399
02-04-157	471	02-08-021	399
02-04-158	471	02-08-022	399
02-04-159	471	02-08-023	399
02-04-160	480	02-08-026	399
02-04-164	471	02-08-027	399
02-04-165	471	02-08-104	490
02-04-166	471	02-08-105	490
02-04-168	41	02-08-108	490
02-04-210	466	02-08-109	490
02-04-213	479	02-08-110	490
02-04-215	466	02-08-110T	490
02-04-215T	466	02-08-111	490
02-04-220	468	02-08-111T	490
02-04-222	469	02-08-114	490
02-04-222T	469	02-08-115	490
02-04-223	468	02-08-118	490
02-04-224	469	02-08-119	490
02-04-226	469	02-08-120	490
02-04-228	481	02-08-120T	490
02-04-228T	481	02-08-121	490
02-04-229	481	02-08-121T	490
02-04-230	481	02-08-123	491
02-04-231	476	02-08-124	491
02-04-232	476	02-08-125	491
02-04-236	479	02-08-126	504
02-04-236T	479	02-08-130	491
02-04-238	476	02-08-131	491
02-04-239	476	02-08-134	491
02-04-240	476	02-08-134T	491
02-04-243	476	02-08-135	491
02-04-246	476	02-08-135T	491
02-04-247	476	02-08-139	504
02-04-257	476	02-08-140	492
02-04-260	55	02-08-141	492
02-04-261	55	02-08-143	504
02-04-264	55	02-08-144	492
02-04-268	480	02-08-144T	492
02-04-301	467	02-08-145	492
02-04-302	467	02-08-145T	492
02-04-303	467	02-08-150	492
02-04-304	467	02-08-151	492
02-04-305	467	02-08-154	492
02-04-311	467	02-08-155	492
02-04-312	467	02-08-160	494
02-04-313	467	02-08-161	494
02-04-314	467	02-08-164	494
02-04-315	467	02-08-165	494
02-04-329	57	02-08-166	493
02-04-330	57	02-08-167	493
02-04-331	57	02-08-168	493
02-04-333	57	02-08-170	494
02-04-336	56	02-08-171	494
02-04-337	56	02-08-176	493
02-04-338	56	02-08-177	493
02-04-345	56	02-08-178	493
02-04-500	466	02-08-412	495
02-04-501	466	02-08-413	495
02-04-502	466	02-08-414	495
02-04-506	470	02-08-415	495
02-04-507	470	02-08-424	496
02-04-508	470	02-08-425	497
02-04-509	468	02-08-442	496
02-04-510	468	02-08-443	497
02-04-511	470	02-08-444	496
02-04-512	470	02-08-445	497
02-04-513	470	02-08-446	496
02-04-520	468	02-08-447	497
02-04-521	470	02-08-448	496
02-04-522	470	02-08-449	497
02-04-523	470	02-08-450	496
02-04-533	475	02-08-451	497
02-04-535	475	02-08-472	496
02-04-537	475	02-08-473	497
02-04-539	475		
02-04-540	475		
02-04-541	475		
02-04-542	475		
02-04-543	475		
02-04-553	474		
02-04-555	474		
02-04-557	474		
02-04-559	474		
02-04-560	474		
02-04-561	474		
02-04-562	474		
02-04-563	474		
02-04-587	478		
02-04-589	478		
02-04-591	478		
02-04-602	478		
02-04-603	478		
02-04-604	478		
02-04-606	478		
02-04-607	478		
02-04-608	482		
02-04-609	482		
02-04-610	483		
02-04-611	483		
02-04-660	479		
02-04-661	479		
02-04-662	481		
02-04-663	481		
02-04-664	481		
02-04-665	466		
02-04-666	466		
02-04-667	466		
02-04-668	466		
02-04-669	466		
02-04-670	482		
02-04-671	482		
02-04-672	482		
02-04-678	476		
02-04-679	482		
02-04-693	483		
02-04-700	470		
02-04-701	478		
02-04-702	478		
02-04-765	47		
02-04-766	46		
02-04-768	46		
02-04-830	39		
02-04-830T	39		
02-04-831	39		
02-04-831T	39		
02-04-835	39		
02-04-835T	39		
02-04-836	39		
02-04-836T	39		
02-04-837	39		
02-04-840	39		
02-04-840T	39		
02-04-841	39		
02-04-841T	39		
02-04-845	39		
02-04-845T	39		
02-04-846	39		
02-04-846T	39		
02-04-850	39		
02-04-851	39		
02-04-870	41		
02-04-878	41		
02-04-879	41		
02-04-880	41		
02-04-883	41		
02-04-885	41		
02-04-886	41		
02-04-887	40		
02-04-888	40		
02-06-112	503		
02-06-113	503		
02-06-120	503		
02-06-121	503		
02-06-122	503		
02-06-123	503		
02-06-431	503		
02-06-432	503		
02-06-433	503		

<i>Seite/page</i>	<i>Seite/page</i>	<i>Seite/page</i>
02-08-474496	02-13-204507	02-20-940524
02-08-475497	02-13-205507	02-20-943524
02-08-612495	02-13-218509	02-20-944524
02-08-613495	02-13-56329	02-20-945524
02-08-614495	02-13-56429	02-20-946524
02-08-615495	02-20-004518	02-20-948524
02-08-618498	02-20-008518	02-20-949524
02-08-619499	02-20-082103	02-20-951524
02-08-642498	02-20-083103	02-22-010318
02-08-643499	02-20-084103	02-22-011318
02-08-644498	02-20-08874	02-22-030318
02-08-645499	02-20-088T74	02-22-032318
02-08-646498	02-20-08974	02-22-068324
02-08-647499	02-20-089T74	02-22-072324
02-08-648498	02-20-09074	02-22-075324
02-08-649499	02-20-090T74	02-22-076321
02-08-650498	02-20-09174	02-22-077321
02-08-651499	02-20-091T74	02-22-078320
02-08-652498	02-20-121514	02-22-079320
02-08-653499	02-20-122514	02-22-083322
02-08-654498	02-20-123514	02-22-085322
02-08-655499	02-20-124514	02-22-088323
02-10-008500	02-20-126514	02-22-090320
02-10-011500	02-20-127514	02-22-091320
02-10-012500	02-20-128514	02-22-092322
02-10-020501	02-20-129514	02-22-093323
02-10-021501	02-20-132516	02-22-101324
02-10-022501	02-20-133516	02-22-104324
02-10-023501	02-20-134516	02-22-112326
02-10-024501	02-20-136516	02-22-113326
02-10-025501	02-20-137516	02-22-200324
02-10-026501	02-20-138516	02-22-201324
02-10-100501	02-20-177520	02-22-206324
02-10-102501	02-20-178520	02-22-207324
02-10-103501	02-20-184519	02-22-208324
02-10-104501	02-20-185519	02-22-209324
02-10-106501	02-20-192525	02-22-248331
02-13-00129	02-20-193517	02-22-250327
02-13-00229	02-20-194517	02-22-252331
02-13-00429	02-20-195517	02-22-254330
02-13-00529	02-20-196517	02-22-255330
02-13-008507	02-20-197517	02-22-258330
02-13-010507	02-20-198517	02-22-260332
02-13-011507	02-20-200525	02-22-271333
02-13-012507	02-20-201525	02-22-272333
02-13-013509	02-20-202525	02-22-273332
02-13-014508	02-20-242526	02-22-276333
02-13-015508	02-20-243526	02-22-296339
02-13-016509	02-20-244526	02-22-297340
02-13-017509	02-20-246526	02-22-298340
02-13-018508	02-20-248526	02-22-299339
02-13-019509	02-20-252527	02-22-379328
02-13-020513	02-20-253527	02-22-380328
02-13-021509	02-20-254527	02-22-381328,329
02-13-023513	02-20-256527	02-22-382328,329
02-13-024508	02-20-257528	02-22-383328,329
02-13-025510	02-20-258527	02-22-384328,329
02-13-026510	02-20-259528	02-22-385328,329
02-13-027510	02-20-260528	02-22-391328,329
02-13-032511	02-20-261528	02-22-392328,329
02-13-033510	02-20-265528	02-22-393328,329
02-13-034510	02-20-320529	02-22-394328,329
02-13-035511	02-20-321529	02-22-395328,329
02-13-036511	02-20-323529	02-22-399291,299,301,302
02-13-037511	02-20-325529	02-22-400336
02-13-038511	02-20-326529	02-22-401336
02-13-040510	02-20-485530	02-22-403337
02-13-044512	02-20-486530	02-22-405337
02-13-045512	02-20-487530	02-22-406337
02-13-046512	02-20-751151	02-22-409337
02-13-047512	02-20-752151	02-22-411337
02-13-065511	02-20-755151	02-22-435308
02-13-066511	02-20-911522	02-22-437308
02-13-067511	02-20-912522	02-22-439290
02-13-068511	02-20-913522	02-22-439P295
02-13-069511	02-20-916522	02-22-441309
02-13-070511	02-20-917522	02-22-442308,309
02-13-074512	02-20-918522	02-22-443308,309
02-13-075512	02-20-921523	02-22-444308,309
02-13-076512	02-20-922523	02-22-445308,309
02-13-120310	02-20-923523	02-22-446308,309
02-13-200507	02-20-926523	02-22-447309
02-13-201507	02-20-927523	02-22-448309
02-13-202508	02-20-928523	02-22-449308

<i>Seite/page</i>	<i>Seite/page</i>	<i>Seite/page</i>	
02-22-450	308	02-23-123	283
02-22-451	309	02-23-124	280
02-22-452	309	02-23-141T	280,287
02-22-453	309	02-23-142T	280,287
02-22-454	309	02-23-143T	278,280,281,287
02-22-455	309	02-23-144T	278,280,281,287
02-22-456	309	02-23-145T	278,280,281,287
02-22-457	309	02-23-146T	278,280,281,287
02-22-458	309	02-23-147T	278,280,281,287
02-22-460	290	02-23-148T	280,287
02-22-461	309	02-23-149T	280,287
02-22-462	309	02-23-151T	280,287
02-22-463	309	02-23-152T	280,287
02-22-464	309	02-23-153T	278,280,281,287
02-22-465	309	02-23-154T	278,280,281,287
02-22-466	309	02-23-155T	278,280,281,287
02-22-467	309	02-23-156T	278,280,281,287
02-22-468	309	02-23-157T	278,280,281,287
02-22-490	290	02-23-158T	280,287
02-22-491	290	02-23-159T	280,287
02-22-491P	295	02-23-162T	280,287
02-22-509	338	02-23-163T	280,287
02-22-510	338	02-23-164T	280,283,287
02-22-516	338	02-23-165T	280,283,287
02-22-517	338	02-23-166T	280,283,287
02-22-518	338	02-23-167T	280,283,287
02-22-519	338	02-23-168T	280,283,287
02-22-764	293	02-23-169T	280,287
02-22-766	293	02-23-170T	280,287
02-22-771	291	02-23-250T	288
02-22-771P	296	02-23-251T	288
02-22-772	290,293	02-23-252T	288
02-22-772P	297	02-23-253T	288
02-22-773	290,293	02-23-254T	288
02-22-773P	297	02-23-255T	288
02-22-774	290,293	02-23-256T	288
02-22-774P	297	02-23-257T	288
02-22-775	290,293	02-23-260T	288
02-22-775P	297	02-23-261T	288
02-22-776	290,293	02-23-262T	288
02-22-776P	297	02-23-263T	288
02-22-779T	292	02-23-264T	288
02-22-780	291	02-23-265T	288
02-22-781T	292	02-23-266T	288
02-22-782T	292	02-23-267T	288
02-22-783	290,291,293	02-23-341T	289
02-22-783P	296	02-23-342T	289
02-22-783T	292	02-23-343T	289
02-22-784	290,291,293	02-23-344T	289
02-22-784P	296	02-23-345T	289
02-22-784T	292	02-23-346T	289
02-22-785	290,291,293	02-23-347T	289
02-22-785P	296	02-23-348T	289
02-22-785T	292	02-23-349T	289
02-22-786	290,291,293	02-23-351T	289
02-22-786P	296	02-23-352T	289
02-22-786T	292	02-23-353T	289
02-22-787	290,291,293	02-23-354T	289
02-22-787P	296	02-23-355T	289
02-22-787T	292	02-23-356T	289
02-22-788T	292	02-23-357T	289
02-22-789T	292	02-23-358T	289
02-22-792	290,293	02-23-359T	289
02-22-792P	297	02-23-362T	289
02-22-793	290,293	02-23-363T	289
02-22-793P	297	02-23-364T	289
02-22-794	290,293	02-23-365T	289
02-22-794P	297	02-23-366T	289
02-22-795	290,293	02-23-367T	289
02-22-795P	297	02-23-368T	289
02-22-796	290,293	02-23-369T	289
02-22-796P	297	02-23-370T	289
02-22-799	302,304	02-52-060	415
02-22-800	302,304	02-52-063	415
02-22-801	302,304	02-52-070	62
02-22-802	302,304	02-52-071	62
02-22-803	302,304	02-52-072	62
02-22-804	304	02-52-075	412
02-22-806	304	02-52-077	414
02-22-808	304	02-52-078	413
02-22-810	303	02-52-079	414
02-22-812	302,303	02-52-084	416
02-22-851	303	02-52-085	417
02-22-852	303	02-52-200	400
02-22-853	303		
02-22-854	303		
02-22-855	303		
02-22-856	303		
02-22-857	303		
02-22-870	299,301,303		
02-22-871	299,301,303		
02-22-872	299,301,303		
02-22-873	299,301,303		
02-22-874	299,301,303		
02-22-875	299,301,303		
02-22-876	299,301,303		
02-22-877	301,303		
02-22-878	301,303		
02-22-879T	292		
02-22-880T	292		
02-22-881T	292		
02-22-882T	292		
02-22-883T	292		
02-22-884T	292		
02-22-885T	292		
02-22-886T	292		
02-22-887T	292		
02-22-888T	292		
02-22-889T	292		
02-22-890T	292		
02-22-891T	292		
02-22-892T	292		
02-22-893T	292		
02-22-894T	292		
02-22-895T	292		
02-22-896T	292		
02-22-897T	292		
02-22-898T	292		
02-22-993	319		
02-22-997	319		
02-23-001	310,311		
02-23-010	278,280,281,282,285		
02-23-011	280,282,285,310,311		
02-23-020T	310,312		
02-23-021T	310,312		
02-23-022T	310,312		
02-23-023T	310,312		
02-23-024T	310,312		
02-23-028T	310,312		
02-23-030T	310,312		
02-23-031T	310,312		
02-23-032T	310,312		
02-23-033T	310,312		
02-23-034T	310,312		
02-23-035T	310,312		
02-23-038T	310,312		
02-23-040T	310,312		
02-23-041T	310,312		
02-23-042T	310,312		
02-23-043T	310,312		
02-23-044T	310,312		
02-23-045T	310,312		
02-23-046T	310,312		
02-23-047	280,282,283,284		
02-23-047P	294		
02-23-048	280,282,285		
02-23-049	280,281,282,284		
02-23-049P	294		
02-23-050T	282,286		
02-23-051T	282,286		
02-23-052T	282,286		
02-23-053T	282,286		
02-23-054T	282,286		
02-23-055T	282,286		
02-23-056T	282,286		
02-23-057T	282,286		
02-23-060T	282,286		
02-23-061T	282,286		
02-23-062T	282,286		
02-23-063T	282,286		
02-23-064T	282,286		
02-23-065T	282,286		
02-23-066T	282,286		
02-23-067T	282,286		
02-23-119	282		
02-23-120	310		
02-23-121	310		
02-23-122	281		

<i>Seite/page</i>	<i>Seite/page</i>	<i>Seite/page</i>
02-52-201 400	02-53-141 439	02-53-476 443
02-52-202 400	02-53-142 439	02-53-477 443
02-52-203 400	02-53-143 439	02-53-478 443
02-52-204 400	02-53-144 439	02-53-479 443
02-52-205 400	02-53-145 439	02-53-480 443
02-52-210 400	02-53-146 439	02-53-481 443
02-52-211 400	02-53-147 439	02-53-490 440
02-52-212 400	02-53-148 439	02-53-491 440
02-52-213 400	02-53-149 439	02-53-492 440
02-52-214 400	02-53-150 439	02-53-493 440
02-52-215 400	02-53-151 439	02-53-494 440
02-53-032 419	02-53-152 439	02-53-495 440
02-53-035 458	02-53-153 439	02-53-496 440
02-53-036 458	02-53-154 439	02-53-497 440
02-53-037 458	02-53-155 439	02-53-498 440
02-53-038 461	02-53-156 439	02-53-500 440
02-53-039 461	02-53-157 439	02-53-501 440
02-53-040 425	02-53-158 439	02-53-502 440
02-53-041 425	02-53-178 432	02-53-503 440
02-53-042 425	02-53-179 432	02-53-504 440
02-53-043 425	02-53-180 432	02-53-505 440
02-53-044 425	02-53-199 423	02-53-506 440
02-53-045 425	02-53-200 423	02-53-507 440
02-53-046 425	02-53-201 423	02-53-508 440
02-53-047 425	02-53-202 423	02-53-509 440
02-53-048 425	02-53-203 423	02-53-510 440
02-53-049 425	02-53-206 424	02-53-511 440
02-53-050 425	02-53-207 424	02-53-514 442
02-53-051 425	02-53-208 424	02-53-515 442
02-53-052 425	02-53-209 424	02-53-516 442
02-53-053 425	02-53-230 425	02-53-517 442
02-53-054 425	02-53-232 425	02-53-520 441
02-53-055 425	02-53-233 425	02-53-521 441
02-53-056 425	02-53-234 425	02-53-522 441
02-53-057 425	02-53-235 425	02-53-523 441
02-53-058 425	02-53-254 443	02-53-524 441
02-53-059 425	02-53-255 443	02-53-525 441
02-53-060 424	02-53-266 432	02-53-526 441
02-53-061 424	02-53-268 432	02-53-527 441
02-53-062 424	02-53-274 438	02-53-528 441
02-53-063 424	02-53-276 438	02-53-529 441
02-53-064 424	02-53-278 444	02-53-530 441
02-53-065 424	02-53-279 444	02-53-531 441
02-53-066 424	02-53-282 445	02-53-532 441
02-53-067 424	02-53-284 445	02-53-533 441
02-53-068 424	02-53-285 445	02-53-534 441
02-53-069 424	02-53-286 438	02-53-535 441
02-53-070 424	02-53-288 438	02-53-548 443
02-53-071 424	02-53-311 425	02-53-549 443
02-53-072 424	02-53-312 425	02-53-550 443
02-53-073 424	02-53-318 425	02-53-558 443
02-53-074 424	02-53-319 425	02-53-559 443
02-53-075 424	02-53-340 423	02-53-560 443
02-53-076 424	02-53-347 423	02-53-568 426
02-53-077 424	02-53-348 423	02-53-576 444
02-53-080 423	02-53-349 423	02-53-581 445
02-53-081 423	02-53-374 426	02-53-583 445
02-53-082 423	02-53-410 425	02-53-584 445
02-53-083 423	02-53-418 425	02-53-585 445
02-53-084 423	02-53-419 425	02-53-586 445
02-53-085 423	02-53-420 424	02-53-587 445
02-53-086 423	02-53-428 424	02-53-590 444
02-53-087 423	02-53-429 424	02-53-591 444
02-53-088 423	02-53-432 439	02-53-592 445
02-53-089 423	02-53-440 423	02-53-593 445
02-53-090 423	02-53-447 423	02-53-599 440
02-53-091 423	02-53-448 423	02-53-601 440
02-53-092 423	02-53-449 423	02-53-610 440
02-53-093 423	02-53-452 429	02-53-611 440
02-53-094 423	02-53-453 429	02-53-612 440
02-53-095 423	02-53-462 440	02-53-613 438
02-53-096 423	02-53-463 440	02-53-622 440
02-53-097 423	02-53-464 440	02-53-623 440
02-53-098 423	02-53-465 437	02-53-624 440
02-53-099 423	02-53-466 443	02-53-625 440
02-53-126 420	02-53-467 443	02-53-626 440
02-53-127 420	02-53-468 443	02-53-627 440
02-53-133 439	02-53-469 443	02-53-628 440
02-53-134 439	02-53-470 427	02-53-629 440
02-53-135 439	02-53-471 427	02-53-637 438
02-53-136 439	02-53-472 426	02-53-638 440
02-53-137 439	02-53-473 426	02-53-639 438
02-53-139 439	02-53-474 426	02-53-640 453
02-53-140 439	02-53-475 443	02-53-641 453

<i>Seite/page</i>	<i>Seite/page</i>	<i>Seite/page</i>	
02-53-642	453	02-72-210	327
02-53-643	453	02-72-211	327
02-53-644	453	02-72-220	325
02-53-645	453	02-72-221	325
02-53-646	453	02-72-222	325
02-53-647	453	02-72-223	325
02-53-648	453	02-72-224	325
02-53-649	453	02-72-225	325
02-53-650	453	02-72-226	325
02-53-651	453	02-72-249	327
02-53-652	453	02-72-250	331
02-53-653	453	02-72-251	331
02-53-654	453	02-72-252	331
02-53-655	455	02-72-260	332
02-53-656	455	02-72-262	332
02-53-657	455	02-72-263	332
02-53-658	454	02-72-280	335
02-53-659	454	02-72-281	335
02-53-660	454	02-72-282	335
02-53-661	455	02-72-283	335
02-53-662	455	02-72-284	335
02-53-663	455	02-72-285	335
02-53-664	455	02-72-295	335
02-53-665	455	02-72-296	335
02-53-666	455	02-72-297	340
02-53-667	455	02-72-298	340
02-53-668	455	02-72-299	335
02-53-669	455	02-72-300	334
02-53-670	422	02-72-301	334
02-53-671	460	02-72-302	334
02-53-672	460	02-72-303	334
02-53-673	456	02-72-304	334
02-53-674	456	02-72-305	334
02-53-679	457	02-72-310	334
02-53-680	454	02-72-311	334
02-53-681	454	02-72-312	334
02-53-682	454	02-72-313	334
02-53-683	454	02-72-314	334
02-53-684	454	02-72-315	334
02-53-685	454	02-72-320	339
02-53-690	455	02-72-321	339
02-53-691	455	02-72-389	328
02-53-692	455	02-72-390	328
02-53-693	455	02-72-520	336
02-53-694	455	02-72-521	336
02-53-695	455	02-72-525	336,337
02-53-696	455	02-72-526	337
02-53-697	455	02-72-527	337
02-53-698	455	02-72-529	337
02-53-712	462	02-72-530	337
02-53-800	463	02-72-531	337
02-54-152	469	02-72-532	337
02-54-153	469	02-72-534	337
02-54-154	469	02-72-536	337
02-54-161	480	02-72-537	336,337
02-54-162	480	02-72-539	337
02-54-223	469	02-72-540	337
02-54-237	479	02-72-542	337
02-54-248	476	02-72-665	314
02-54-513	470	02-72-666	314
02-54-521	468	02-72-667	313
02-54-522	468	02-72-668	313
02-54-523	468	02-72-670	313,314,315
02-54-574	477	02-72-671	315
02-54-575	477	02-72-672	313,316
02-54-577	477	02-72-673	313,314,316
02-54-579	477	02-72-674	313,314,316
02-54-580	477	02-72-675	313,314,316
02-54-581	477	02-72-676	313,314,316
02-54-582	477	02-72-677	313,316
02-54-661	479	02-72-678	316
02-54-838	39	02-72-679	313,316
02-54-839	39	02-72-680	313,314,316
02-54-840	39	02-72-681	313,314,316
02-56-114	503	02-72-682	313,314,316
02-56-115	503	02-72-683	313,314,316
02-56-116	503	02-72-684	313,316
02-56-117	503	02-72-685	316
02-56-118	503	02-72-686	313,316
02-56-119	503	02-72-687	313,314,316
02-56-434	503	02-72-688	313,314,316
02-56-463	502	02-72-689	313,314,316
02-56-464	502	02-72-690	313,314,316
02-56-465	502	02-72-691	313,316
02-56-466	502		
02-56-467	502		
02-58-012	401		
02-58-013	401		
02-58-014	401		
02-58-015	401		
02-58-016	401		
02-58-017	401		
02-58-416	495		
02-58-417	495		
02-58-616	495		
02-58-617	495		
02-63-001	29		
02-63-002	29		
02-63-004	29		
02-63-005	29		
02-63-013	509		
02-63-014	508		
02-63-016	508		
02-63-024	510		
02-63-035	511		
02-63-039	511		
02-63-044	512		
02-63-046	512		
02-63-047	512		
02-63-064	511		
02-63-069	511		
02-63-070	511		
02-63-075	512		
02-63-202	508		
02-63-220	509		
02-63-221	509		
02-63-230	29		
02-63-231	29		
02-70-002	518		
02-70-084	103		
02-70-088	74		
02-70-088T	74		
02-70-089	74		
02-70-089T	74		
02-70-090	74		
02-70-090T	74		
02-70-091	74		
02-70-091T	74		
02-70-180	519		
02-70-181	519		
02-70-182	519		
02-70-183	519		
02-70-184	519		
02-70-185	519		
02-70-186	519		
02-70-187	519		
02-70-188	519		
02-70-189	519		
02-70-190	525		
02-70-241	526		
02-70-250	527		
02-70-255	528		
02-70-270	531		
02-70-271	531		
02-70-272	532		
02-70-273	532		
02-70-274	532		
02-70-480	531		
02-70-481	531		
02-70-482	531		
02-70-770	521		
02-70-771	521		
02-70-772	521		
02-70-773	521		
02-70-774	521		
02-70-775	521		
02-70-776	521		
02-70-777	521		
02-70-778	521		
02-72-010	318		
02-72-011	318		
02-72-032	318		
02-72-081	322		
02-72-085	322		
02-72-086	322		
02-72-087	322		
02-72-090	323		
02-72-091	323		

	<i>Seite/page</i>
02-72-692	316
02-72-693	313,316
02-72-694	313,314,316
02-72-695	313,314,316
02-72-696	313,314,316
02-72-697	313,314,316
02-72-698	313,316
02-72-699	316
02-72-700	317
02-72-701	317
02-72-702	317
02-72-703	317
02-72-704	317
02-72-705	317
02-72-706	317
02-72-707	317
02-72-708	317
02-72-709	317
02-72-710	317
02-72-777P	297
02-72-778P	297
02-72-782P	296
02-72-788P	296
02-72-797P	297
02-72-798P	297
02-72-799	299,300
02-72-800	299,300
02-72-801	299,300
02-72-802	299,300
02-72-803	299,300
02-72-804	299,300
02-72-806	300
02-72-808	300
02-72-812	299,300
02-72-851	301
02-72-852	301
02-72-853	301
02-72-854	301
02-72-855	301
02-72-856	301
02-72-857	301
02-72-996	319
02-72-997	319
02-73-049	278,279
02-73-050	310,311
02-73-051	310,311
02-73-122	278
04-06-112	632
04-06-114	632
04-15-510	579
04-15-518	591
04-15-521	592
04-15-523	592
04-15-543	575
04-15-611	89
04-15-612	89
04-15-642	89
04-15-720	610
04-16-530	552
04-16-551	552
04-16-552	228,463,552
06-01-030	244
06-01-030T	245
06-01-031	244
06-01-031T	245
06-01-032	244
06-01-032T	245
06-01-033	244
06-01-033T	245
06-01-034	244
06-01-034T	245
06-01-035	244
06-01-035T	245
06-01-036	244
06-01-036T	245
06-01-037	244
06-01-037T	245
06-01-038	244
06-01-038T	245
06-01-039	244
06-01-039T	245
06-01-040	244
06-01-040T	245
06-01-041	246

	<i>Seite/page</i>
06-01-041T	247
06-01-042	246
06-01-042T	247
06-01-045	246
06-01-045T	247
06-01-046	246
06-01-046T	247
06-01-047	246
06-01-047T	247
06-01-060	246
06-01-060T	247
06-01-061	246
06-01-061T	247
06-01-062	246
06-01-062T	247
06-01-063	246
06-01-063T	247
06-01-064	246
06-01-064T	247
06-01-065	246
06-01-065T	247
06-01-066	246
06-01-066T	247
06-02-150	83
06-02-150T	83
06-02-151	83
06-02-151T	83
06-02-222	393
06-02-223	393
06-02-224	393
06-02-234	393
06-02-235	393
06-02-236	393
06-02-240	393
06-02-242	393
06-02-246	393
06-02-248	393
06-02-328	403
06-02-329	403
06-02-330	403
06-02-331	403
06-02-352	403
06-02-353	403
06-02-357	409
06-02-358	409
06-02-359	409
06-02-394	486
06-02-395	486
06-02-396	486
06-02-400	484
06-02-400T	484
06-02-401	484
06-02-401T	484
06-02-402	484
06-02-402T	484
06-02-403	484
06-02-403T	484
06-02-404	484
06-02-404T	484
06-02-405	484
06-02-405T	484
06-02-406	485
06-02-407	485
06-02-408	485
06-02-409	485
06-02-411	484
06-02-411T	484
06-02-412	484
06-02-412T	484
06-02-414	485
06-02-414T	485
06-02-415	485
06-02-415T	485
06-02-416	485
06-02-416T	485
06-02-417	485
06-02-417T	485
06-02-420	404
06-02-421	404
06-02-422	404
06-02-423	404
06-02-424	404
06-02-425	404
06-02-426	404

	<i>Seite/page</i>
06-02-427	404
06-02-431	409
06-02-432	408
06-02-433	408
06-02-434	408
06-02-435	408
06-02-436	408
06-02-437	408
06-02-784	488
06-02-785	488
06-03-411	487
06-03-412	487
06-03-413	487
06-03-418	487
06-04-011	10
06-04-012	10
06-04-013	10
06-04-014	10
06-04-015	10
06-04-016	10
06-04-017	10
06-04-018	10
06-04-019	10
06-04-020	10
06-04-021	10
06-04-022	10
06-04-023	10
06-04-024	10
06-04-025	10
06-04-028	10
06-04-030	4
06-04-030T	4
06-04-031	4
06-04-031T	4
06-04-032	4
06-04-032T	4
06-04-033	4
06-04-033T	4
06-04-034	4
06-04-034T	4
06-04-035	4
06-04-035T	4
06-04-036	4
06-04-036T	4
06-04-037	5
06-04-037T	5
06-04-038	5
06-04-038T	5
06-04-039	5
06-04-039T	5
06-04-040	5
06-04-040T	5
06-04-043	5
06-04-043T	5
06-04-044	5
06-04-044T	5
06-04-045	28
06-04-046	29
06-04-047	5
06-04-047T	5
06-04-056	6
06-04-057	6
06-04-059	6
06-04-060	5
06-04-060T	5
06-04-061	5
06-04-073	4
06-04-073T	4
06-04-075	4
06-04-075T	4
06-04-076	26
06-04-079	26
06-04-080	26
06-04-081	26
06-04-083	239
06-04-089	23
06-04-089T	23
06-04-092	23
06-04-092T	23
06-04-093	23
06-04-093T	23
06-04-096	23
06-04-096T	23
06-04-097	23

<i>Seite/page</i>	<i>Seite/page</i>	<i>Seite/page</i>			
06-04-097T.....	23	06-04-287T.....	54	06-04-401T.....	94
06-04-099.....	23	06-04-288.....	54	06-04-402.....	94
06-04-100.....	21	06-04-298.....	95	06-04-402T.....	94
06-04-100T.....	21	06-04-298T.....	95	06-04-403.....	94
06-04-101.....	21	06-04-299.....	95	06-04-403T.....	94
06-04-101T.....	21	06-04-299T.....	95	06-04-404.....	94
06-04-103.....	21	06-04-301.....	91	06-04-404T.....	94
06-04-103T.....	21	06-04-301T.....	91	06-04-405.....	94
06-04-105.....	7	06-04-302.....	91	06-04-405T.....	94
06-04-106.....	7	06-04-302T.....	91	06-04-406.....	94
06-04-107.....	7	06-04-303.....	91	06-04-406T.....	94
06-04-108.....	7	06-04-303T.....	91	06-04-408.....	94
06-04-110.....	40	06-04-304.....	91	06-04-408T.....	94
06-04-111.....	40	06-04-304T.....	91	06-04-410.....	94
06-04-112.....	40	06-04-305.....	91	06-04-410T.....	94
06-04-117.....	21	06-04-305T.....	91	06-04-411.....	94
06-04-117T.....	21	06-04-306.....	100	06-04-411T.....	94
06-04-118.....	4	06-04-307.....	100	06-04-412.....	94
06-04-118T.....	4	06-04-308.....	100	06-04-412T.....	94
06-04-119.....	4	06-04-310.....	100	06-04-413.....	94
06-04-119T.....	4	06-04-311.....	100	06-04-413T.....	94
06-04-120.....	7	06-04-312.....	100	06-04-414.....	94
06-04-190.....	44	06-04-315.....	97	06-04-414T.....	94
06-04-191.....	44	06-04-320.....	92	06-04-415.....	94
06-04-192.....	44	06-04-320T.....	92	06-04-415T.....	94
06-04-195.....	44	06-04-321.....	92	06-04-416.....	94
06-04-196.....	44	06-04-321T.....	92	06-04-416T.....	94
06-04-197.....	44	06-04-322.....	92	06-04-418.....	94
06-04-200.....	43	06-04-322T.....	92	06-04-418T.....	94
06-04-202.....	43	06-04-325.....	92	06-04-420.....	112
06-04-204.....	43	06-04-330.....	75	06-04-423.....	114
06-04-210.....	43	06-04-330T.....	75	06-04-426.....	116
06-04-212.....	43	06-04-331.....	75	06-04-427.....	95
06-04-214.....	43	06-04-331T.....	75	06-04-427T.....	95
06-04-215.....	43	06-04-332.....	83	06-04-429.....	83
06-04-216.....	43	06-04-332T.....	83	06-04-429T.....	83
06-04-217.....	43	06-04-333.....	83	06-04-430.....	75
06-04-218.....	44	06-04-333T.....	83	06-04-430T.....	75
06-04-219.....	44	06-04-334.....	83	06-04-432.....	75
06-04-220.....	238	06-04-334T.....	83	06-04-432T.....	75
06-04-221.....	43	06-04-335.....	93	06-04-552.....	391
06-04-222.....	238	06-04-335T.....	93	06-04-554.....	391
06-04-223.....	43	06-04-336.....	93	06-04-556.....	391
06-04-224.....	238	06-04-336T.....	93	06-04-558.....	391
06-04-225.....	43	06-04-337.....	93	06-04-560.....	391
06-04-226.....	238	06-04-337T.....	93	06-04-561.....	391
06-04-228.....	238	06-04-338.....	93	06-04-562.....	391
06-04-229.....	43	06-04-338T.....	93	06-04-568.....	389
06-04-230.....	30	06-04-343.....	82	06-04-569.....	389
06-04-231.....	30	06-04-343T.....	82	06-04-570.....	391
06-04-232.....	31	06-04-344.....	82	06-04-574.....	391
06-04-233.....	31	06-04-344T.....	82	06-04-575.....	391
06-04-234.....	45	06-04-346.....	92	06-04-576.....	391
06-04-236.....	45	06-04-346T.....	92	06-04-578.....	389
06-04-240.....	30	06-04-350.....	96	06-04-600.....	21
06-04-240T.....	30	06-04-351.....	96	06-04-600T.....	21
06-04-241.....	30	06-04-352.....	96	06-04-601.....	21
06-04-241T.....	30	06-04-353.....	96	06-04-601T.....	21
06-04-242.....	31	06-04-354.....	96	06-04-603.....	21
06-04-242T.....	31	06-04-356.....	96	06-04-603T.....	21
06-04-243.....	31	06-04-357.....	96	06-04-604T.....	182
06-04-243T.....	31	06-04-361.....	63,240	06-04-611.....	390
06-04-244.....	30	06-04-365.....	96	06-04-612.....	390
06-04-244T.....	30	06-04-366.....	96	06-04-613.....	390
06-04-245.....	30	06-04-375.....	75	06-04-614.....	390
06-04-245T.....	30	06-04-375T.....	75	06-04-615.....	390
06-04-246.....	31	06-04-376.....	75	06-04-634.....	391
06-04-246T.....	31	06-04-376T.....	75	06-04-635.....	391
06-04-247.....	31	06-04-380.....	98	06-04-636.....	391
06-04-247T.....	31	06-04-381.....	98	06-04-671.....	390
06-04-249.....	31	06-04-382.....	98	06-04-672.....	390
06-04-270.....	77	06-04-384.....	98	06-04-673.....	390
06-04-271.....	77	06-04-385.....	98	06-04-674.....	390
06-04-272.....	77	06-04-388.....	98	06-04-851.....	95
06-04-273.....	77	06-04-392.....	99	06-04-851T.....	95
06-04-280.....	54	06-04-394.....	103	06-04-854.....	95
06-04-281.....	54	06-04-395.....	103	06-04-854T.....	95
06-04-284.....	54	06-04-396.....	77	06-04-856.....	95
06-04-284T.....	54	06-04-397.....	77	06-04-856T.....	95
06-04-285.....	54	06-04-398.....	77	06-04-858.....	95
06-04-285T.....	54	06-04-399.....	77	06-04-858T.....	95
06-04-286.....	54	06-04-400.....	94	06-04-861.....	95
06-04-286T.....	54	06-04-400T.....	94	06-04-861T.....	95
06-04-287.....	54	06-04-401.....	94	06-04-864.....	95

Seite/page	Seite/page	Seite/page			
06-04-864T.....	95	06-05-180.....	189	06-05-277.....	187
06-04-866.....	95	06-05-180T.....	189	06-05-277T.....	187
06-04-866T.....	95	06-05-182.....	189	06-05-278.....	187
06-04-868.....	95	06-05-182T.....	189	06-05-278T.....	187
06-04-868T.....	95	06-05-190.....	189	06-05-279.....	187
06-05-005.....	396	06-05-190T.....	189	06-05-279T.....	187
06-05-010.....	396	06-05-192.....	189	06-05-280.....	179
06-05-011.....	396	06-05-192T.....	189	06-05-280T.....	179
06-05-012.....	396	06-05-194.....	189	06-05-282.....	179
06-05-013.....	396	06-05-194T.....	189	06-05-282T.....	179
06-05-014.....	396	06-05-200.....	189	06-05-284.....	179
06-05-020.....	396	06-05-200T.....	189	06-05-284T.....	179
06-05-021.....	396	06-05-210.....	189	06-05-286.....	179
06-05-022.....	396	06-05-210T.....	189	06-05-286T.....	179
06-05-023.....	396	06-05-211.....	189	06-05-290.....	179
06-05-024.....	396	06-05-211T.....	189	06-05-290T.....	179
06-05-030.....	397	06-05-212.....	189	06-05-292.....	179
06-05-031.....	397	06-05-212T.....	189	06-05-292T.....	179
06-05-032.....	397	06-05-213.....	189	06-05-297.....	181
06-05-034.....	397	06-05-213T.....	189	06-05-297T.....	181
06-05-040.....	397	06-05-214.....	189	06-05-298.....	181
06-05-041.....	397	06-05-214T.....	189	06-05-298T.....	181
06-05-042.....	397	06-05-216.....	189	06-05-306.....	189
06-05-044.....	397	06-05-216T.....	189	06-05-306T.....	189
06-05-097.....	183	06-05-217.....	189	06-05-307.....	189
06-05-097T.....	183	06-05-217T.....	189	06-05-307T.....	189
06-05-098.....	183	06-05-220.....	189	06-05-319.....	181
06-05-098T.....	183	06-05-220T.....	189	06-05-319T.....	181
06-05-099.....	183	06-05-222.....	189	06-05-320.....	181
06-05-099T.....	183	06-05-222T.....	189	06-05-320T.....	181
06-05-100.....	183	06-05-224.....	189	06-05-322.....	181
06-05-100T.....	183	06-05-224T.....	189	06-05-322T.....	181
06-05-102.....	183	06-05-226.....	189	06-05-323.....	179
06-05-102T.....	183	06-05-226T.....	189	06-05-323T.....	179
06-05-103.....	181	06-05-227.....	189	06-05-324.....	179
06-05-103T.....	181	06-05-227T.....	189	06-05-324T.....	179
06-05-104.....	183	06-05-228.....	189	06-05-325.....	179
06-05-104T.....	183	06-05-228T.....	189	06-05-325T.....	179
06-05-110.....	183	06-05-240.....	179	06-05-330.....	181
06-05-110T.....	183	06-05-240T.....	179	06-05-330T.....	181
06-05-112.....	183	06-05-242.....	179	06-05-332.....	181
06-05-112T.....	183	06-05-242T.....	179	06-05-332T.....	181
06-05-113.....	181	06-05-244.....	179	06-05-333.....	181
06-05-113T.....	181	06-05-244T.....	179	06-05-333T.....	181
06-05-114.....	183	06-05-246.....	181	06-05-334.....	179
06-05-114T.....	183	06-05-246T.....	181	06-05-340.....	179
06-05-120.....	183	06-05-247.....	181	06-05-350.....	181
06-05-120T.....	183	06-05-247T.....	181	06-05-350T.....	181
06-05-122.....	183	06-05-248.....	179	06-05-351.....	181
06-05-122T.....	183	06-05-248T.....	179	06-05-351T.....	181
06-05-123.....	181	06-05-250.....	179	06-05-381.....	187
06-05-123T.....	181	06-05-250T.....	179	06-05-381T.....	187
06-05-124.....	183	06-05-252.....	179	06-05-382.....	187
06-05-124T.....	183	06-05-252T.....	179	06-05-382T.....	187
06-05-137.....	185	06-05-254.....	179	06-05-383.....	187
06-05-137T.....	185	06-05-254T.....	179	06-05-383T.....	187
06-05-138.....	185	06-05-258.....	179	06-05-386.....	187
06-05-138T.....	185	06-05-258T.....	179	06-05-386T.....	187
06-05-139.....	185	06-05-259.....	181	06-05-387.....	187
06-05-139T.....	185	06-05-259T.....	181	06-05-387T.....	187
06-05-140.....	185	06-05-260.....	179	06-05-388.....	187
06-05-140T.....	185	06-05-260T.....	179	06-05-388T.....	187
06-05-142.....	185	06-05-261.....	181	06-05-389.....	187
06-05-142T.....	185	06-05-261T.....	181	06-05-389T.....	187
06-05-144.....	185	06-05-262.....	179	06-05-391.....	187
06-05-144T.....	185	06-05-262T.....	179	06-05-391T.....	187
06-05-148.....	185	06-05-263.....	181	06-05-392.....	187
06-05-148T.....	185	06-05-263T.....	181	06-05-392T.....	187
06-05-150.....	185	06-05-264.....	179	06-05-393.....	187
06-05-150T.....	185	06-05-264T.....	179	06-05-393T.....	187
06-05-152.....	185	06-05-270.....	181	06-05-394.....	187
06-05-152T.....	185	06-05-270T.....	181	06-05-394T.....	187
06-05-154.....	185	06-05-271.....	181	06-05-395.....	179
06-05-154T.....	185	06-05-271T.....	181	06-05-395T.....	179
06-05-158.....	185	06-05-272.....	181	06-05-396.....	179
06-05-158T.....	185	06-05-272T.....	181	06-05-396T.....	179
06-05-160.....	185	06-05-273.....	181	06-05-397.....	181
06-05-160T.....	185	06-05-273T.....	181	06-05-397T.....	181
06-05-162.....	185	06-05-274.....	187	06-05-402T.....	193
06-05-162T.....	185	06-05-274T.....	187	06-05-412T.....	192
06-05-164.....	185	06-05-275.....	187	06-05-502.....	197
06-05-164T.....	185	06-05-275T.....	187	06-05-512.....	196
06-05-168.....	185	06-05-276.....	187	06-05-520.....	199
06-05-168T.....	185	06-05-276T.....	187	06-05-520T.....	199

<i>Seite/page</i>	<i>Seite/page</i>	<i>Seite/page</i>			
06-05-530	198	06-05-700	188	06-05-784	178
06-05-530T	198	06-05-700T	188	06-05-784T	178
06-05-548	201	06-05-710	188	06-05-786	178
06-05-558	200	06-05-710T	188	06-05-786T	178
06-05-570	197	06-05-711	188	06-05-790	178
06-05-572	197	06-05-711T	188	06-05-790T	178
06-05-574	197	06-05-712	188	06-05-792	178
06-05-575	197	06-05-712T	188	06-05-792T	178
06-05-577	197	06-05-713	188	06-05-797	180
06-05-580	196	06-05-713T	188	06-05-797T	180
06-05-582	196	06-05-714	188	06-05-798	180
06-05-584	196	06-05-714T	188	06-05-798T	180
06-05-585	196	06-05-716	188	06-05-806	188
06-05-587	196	06-05-716T	188	06-05-806T	188
06-05-597	182	06-05-717	188	06-05-807	188
06-05-597T	182	06-05-717T	188	06-05-807T	188
06-05-598	182	06-05-720	188	06-05-819	180
06-05-598T	182	06-05-720T	188	06-05-819T	180
06-05-599	182	06-05-722	188	06-05-820	180
06-05-599T	182	06-05-722T	188	06-05-820T	180
06-05-600	182	06-05-724	188	06-05-822	180
06-05-600T	182	06-05-724T	188	06-05-822T	180
06-05-602	182	06-05-726	188	06-05-823	178
06-05-602T	182	06-05-726T	188	06-05-823T	178
06-05-603	180	06-05-727	188	06-05-824	178
06-05-603T	180	06-05-727T	188	06-05-824T	178
06-05-604	182	06-05-728	188	06-05-825	178
06-05-604T	182	06-05-728T	188	06-05-825T	178
06-05-610	182	06-05-740	178	06-05-830	180
06-05-610T	182	06-05-740T	178	06-05-830T	180
06-05-612	182	06-05-742	178	06-05-832	180
06-05-612T	182	06-05-742T	178	06-05-832T	180
06-05-613	180	06-05-744	178	06-05-833	180
06-05-613T	180	06-05-744T	178	06-05-833T	180
06-05-614	182	06-05-746	180	06-05-840	178
06-05-614T	182	06-05-746T	180	06-05-840T	178
06-05-620	182	06-05-747	180	06-05-850	180
06-05-620T	182	06-05-747T	180	06-05-850T	180
06-05-622	182	06-05-748	178	06-05-851	180
06-05-622T	182	06-05-748T	178	06-05-851T	180
06-05-623	180	06-05-750	178	06-05-853	184
06-05-623T	180	06-05-750T	178	06-05-853T	184
06-05-624	182	06-05-752	178	06-05-855	184
06-05-624T	182	06-05-752T	178	06-05-855T	184
06-05-637	184	06-05-754	178	06-05-856	184
06-05-637T	184	06-05-754T	178	06-05-856T	184
06-05-638	184	06-05-758	178	06-05-881	186
06-05-638T	184	06-05-758T	178	06-05-881T	186
06-05-639	184	06-05-759	180	06-05-882	186
06-05-639T	184	06-05-759T	180	06-05-882T	186
06-05-640	184	06-05-760	178	06-05-883	186
06-05-640T	184	06-05-760T	178	06-05-883T	186
06-05-642	184	06-05-761	180	06-05-886	186
06-05-642T	184	06-05-761T	180	06-05-886T	186
06-05-644	184	06-05-762	178	06-05-887	186
06-05-644T	184	06-05-762T	178	06-05-887T	186
06-05-648	184	06-05-763	180	06-05-888	186
06-05-648T	184	06-05-763T	180	06-05-888T	186
06-05-650	184	06-05-764	178	06-05-889	186
06-05-650T	184	06-05-764T	178	06-05-889T	186
06-05-652	184	06-05-770	180	06-05-891	186
06-05-652T	184	06-05-770T	180	06-05-891T	186
06-05-654	184	06-05-771	180	06-05-892	186
06-05-654T	184	06-05-771T	180	06-05-892T	186
06-05-658	184	06-05-772	180	06-05-893	186
06-05-658T	184	06-05-772T	180	06-05-893T	186
06-05-660	184	06-05-773	180	06-05-894	186
06-05-660T	184	06-05-773T	180	06-05-894T	186
06-05-662	184	06-05-774	186	06-05-895	178
06-05-662T	184	06-05-774T	186	06-05-895T	178
06-05-664	184	06-05-775	186	06-05-896	178
06-05-664T	184	06-05-775T	186	06-05-896T	178
06-05-668	184	06-05-776	186	06-05-897	180
06-05-668T	184	06-05-776T	186	06-05-897T	180
06-05-680	188	06-05-777	186	06-06-001	171
06-05-680T	188	06-05-777T	186	06-06-003	171
06-05-682	188	06-05-778	186	06-06-005	171
06-05-682T	188	06-05-778T	186	06-06-010	504
06-05-690	188	06-05-779	186	06-06-011	504
06-05-690T	188	06-05-779T	186	06-06-020	172
06-05-692	188	06-05-780	178	06-06-022	172
06-05-692T	188	06-05-780T	178	06-06-025	351
06-05-694	188	06-05-782	178	06-06-026	351
06-05-694T	188	06-05-782T	178	06-06-027	351

Seite/page	Seite/page	Seite/page	
06-06-028	351	06-06-534	368
06-06-029	351	06-06-534BJ	372
06-06-031	160	06-06-535	368
06-06-032	160	06-06-535BJ	372
06-06-033	160	06-06-536	368
06-06-034	160	06-06-536BJ	372
06-06-035	160	06-06-543	368
06-06-036	160	06-06-543BJ	372
06-06-037	160	06-06-544	368
06-06-038	161	06-06-544BJ	372
06-06-039	161	06-06-545	368
06-06-040	161	06-06-545BJ	372
06-06-041	161	06-06-553	368
06-06-042	161	06-06-553BJ	372
06-06-043	161	06-06-554	368
06-06-044	161	06-06-554BJ	372
06-06-047	161	06-06-562	368
06-06-048	161	06-06-562BJ	372
06-06-050	163	06-06-563	368
06-06-052	160	06-06-563BJ	372
06-06-053	160	06-06-564	368
06-06-058	158	06-06-564BJ	372
06-06-059	158	06-06-565	368
06-06-061	158	06-06-565BJ	372
06-06-062	158	06-06-566	368
06-06-063	158	06-06-566BJ	372
06-06-064	158	06-06-573	368
06-06-065	158	06-06-573BJ	372
06-06-066	158	06-06-574	368
06-06-067	159	06-06-574BJ	372
06-06-068	159	06-06-575	368
06-06-076	351	06-06-575BJ	372
06-06-077	351	06-06-583	368
06-06-078	351	06-06-583BJ	372
06-06-079	351	06-06-584	368
06-06-080	351	06-06-584BJ	372
06-06-085	351	06-06-589	236
06-06-086	355	06-06-590	236
06-06-087	355	06-06-591	236
06-06-088	355	06-06-595	236
06-06-089	355	06-06-599	381
06-06-113	162	06-06-600	381
06-06-115	351	06-06-605	381
06-06-116	351	06-06-608	252
06-06-117	351	06-06-608T	253
06-06-118	351	06-06-609	252
06-06-119	351	06-06-609T	253
06-06-130	165	06-06-610	237
06-06-133	165	06-06-611	243
06-06-136	355	06-06-611T	243
06-06-137	355	06-06-614	243
06-06-138	355	06-06-614T	243
06-06-139	355	06-06-616	250
06-06-201	142,149	06-06-616T	250
06-06-202	142,149	06-06-617	250
06-06-211	152	06-06-617T	250
06-06-212	152	06-06-618	250
06-06-213	152	06-06-618T	250
06-06-214	152	06-06-619	252
06-06-216	152	06-06-619T	253
06-06-217	152	06-06-620	252
06-06-218	152	06-06-620T	253
06-06-219	152	06-06-621	252
06-06-222	149	06-06-621T	253
06-06-231	153	06-06-622	252
06-06-232	153	06-06-622T	253
06-06-233	153	06-06-623	252
06-06-256	153	06-06-623T	253
06-06-257	153	06-06-624	252
06-06-258	153	06-06-625	254
06-06-259	153	06-06-625T	254
06-06-260	144	06-06-626	254
06-06-262	144	06-06-626T	254
06-06-266	144,146	06-06-627	254
06-06-267	144,146	06-06-628	254
06-06-268	144,145	06-06-629	254
06-06-268T	147	06-06-629T	254
06-06-270	142,144,145	06-06-630	254
06-06-270T	147	06-06-631	251
06-06-273	142,144,145	06-06-631T	251
06-06-273T	147	06-06-632	251
06-06-274	145	06-06-632T	251
06-06-275	144	06-06-635	255
06-06-280	142,143	06-06-635T	255
06-06-282	142,143		
06-06-283	143		
06-06-284	143		
06-06-285	142,143		
06-06-291	84		
06-06-292	84		
06-06-293	84		
06-06-294	84		
06-06-295	84		
06-06-300	90		
06-06-301	85		
06-06-302	85		
06-06-303	83		
06-06-303T	83		
06-06-305	82		
06-06-305T	82		
06-06-307	82		
06-06-307T	82		
06-06-309	97		
06-06-310	83		
06-06-310T	83		
06-06-311	82		
06-06-311T	82		
06-06-312	82		
06-06-312T	82		
06-06-313	78		
06-06-321	78		
06-06-322	78		
06-06-326	86		
06-06-327	86		
06-06-330	166		
06-06-331	166		
06-06-332	166		
06-06-345	381		
06-06-346	88		
06-06-349	85		
06-06-421	170		
06-06-426	170		
06-06-441	150		
06-06-442	150		
06-06-443	150		
06-06-444	150		
06-06-445	150		
06-06-446	150		
06-06-456	149		
06-06-456T	149		
06-06-457	149		
06-06-457T	149		
06-06-458	149		
06-06-458T	149		
06-06-459	149		
06-06-459T	149		
06-06-466	357		
06-06-467	357		
06-06-468	357		
06-06-469	357		
06-06-496	359		
06-06-497	359		
06-06-498	359		
06-06-499	359		
06-06-502	368		
06-06-502BJ	372		
06-06-503	368		
06-06-503BJ	372		
06-06-504	368		
06-06-504BJ	372		
06-06-505	368		
06-06-505BJ	372		
06-06-506	368		
06-06-506BJ	372		
06-06-513	368		
06-06-513BJ	372		
06-06-514	368		
06-06-514BJ	372		
06-06-515	368		
06-06-515BJ	372		
06-06-523	368		
06-06-523BJ	372		
06-06-524	368		
06-06-524BJ	372		
06-06-532	368		
06-06-532BJ	372		
06-06-533	368		
06-06-533BJ	372		

<i>Seite/page</i>	<i>Seite/page</i>	<i>Seite/page</i>			
06-06-637	255	06-06-728	350	06-06-833BJ	373
06-06-637T	255	06-06-729	350	06-06-834	369
06-06-640	255	06-06-730	105	06-06-834BJ	373
06-06-640T	255	06-06-734	350	06-06-835	369
06-06-641	255	06-06-737	350	06-06-835BJ	373
06-06-641T	255	06-06-738	350	06-06-841	353
06-06-642	255	06-06-739	354	06-06-842	369
06-06-642T	255	06-06-741	353	06-06-842BJ	373
06-06-643	255	06-06-742	353	06-06-843	369
06-06-643T	255	06-06-743	353	06-06-843BJ	373
06-06-644	255	06-06-745	354	06-06-844	369
06-06-644T	255	06-06-746	350	06-06-844BJ	373
06-06-650	252	06-06-747	350	06-06-852	369
06-06-650T	253	06-06-748	350	06-06-852BJ	373
06-06-651	252	06-06-749	350	06-06-853	369
06-06-651T	253	06-06-750	351	06-06-853BJ	373
06-06-652	252	06-06-751	354	06-06-854	369
06-06-652T	253	06-06-752	351	06-06-854BJ	373
06-06-653	252	06-06-753	354	06-06-856	382
06-06-653T	253	06-06-754	351	06-06-857	382
06-06-655	254	06-06-755	351	06-06-858	382
06-06-655T	254	06-06-765	376	06-06-860	168
06-06-656	254	06-06-767	371	06-06-861	168
06-06-656T	254	06-06-767BJ	375	06-06-862	168
06-06-660	354	06-06-768	371	06-06-865	168
06-06-661	350	06-06-768BJ	375	06-06-870	169
06-06-662	350	06-06-769	350	06-06-890	258
06-06-663	350	06-06-770	350	06-06-891	258,260
06-06-664	350	06-06-771	350	06-06-893	260
06-06-665	350	06-06-772	350	06-06-897	258,260
06-06-666	350	06-06-773	350	06-06-900	259
06-06-667	350	06-06-774	370	06-06-901	259,261
06-06-668	350	06-06-774BJ	374	06-06-903	261
06-06-669	350	06-06-775	371	06-06-904	262
06-06-673	350	06-06-775BJ	375	06-06-905	258,259,262
06-06-674	350	06-06-776	371	06-06-906	258,259,262
06-06-677	354	06-06-776BJ	375	06-06-907	259,261
06-06-678	354	06-06-777	370	06-06-908	259,259,262
06-06-679	354	06-06-777BJ	374	06-06-909	262
06-06-680	354	06-06-778	371	06-06-911	263
06-06-681	354	06-06-778BJ	375	06-06-912	262
06-06-682	350	06-06-779	376	06-06-913	266
06-06-683	350	06-06-781	352	06-06-914	266
06-06-684	350	06-06-782	352	06-06-915	266
06-06-685	350	06-06-783	352	06-06-917	263
06-06-686	350	06-06-784	352	06-06-918	263
06-06-687	350	06-06-785	352	06-07-057	377
06-06-688	350	06-06-799	370	06-07-093	266
06-06-689	350	06-06-799BJ	374	06-07-094	266
06-06-690	350	06-06-800	370	06-07-095	266
06-06-691	350	06-06-800BJ	374	06-07-096	266
06-06-692	352	06-06-801	371	06-07-170	302
06-06-693	352	06-06-801BJ	375	06-08-403	164
06-06-694	352	06-06-803	370	06-08-404	164
06-06-695	352	06-06-803BJ	374	06-08-405	164
06-06-696	350	06-06-805	370	06-08-407	164
06-06-697	102	06-06-805BJ	374	06-08-413	164
06-06-698	102	06-06-806	370	06-08-414	164
06-06-699	102	06-06-806BJ	374	06-08-415	164
06-06-700	102	06-06-807	371	06-08-480	165
06-06-701	101	06-06-807BJ	375	06-11-110	573
06-06-702	101	06-06-808	377	06-11-120	573
06-06-703	101	06-06-809	353	06-11-121	573
06-06-707	105	06-06-810	370	06-11-124	578
06-06-708	105	06-06-810BJ	374	06-11-130	578
06-06-709	105	06-06-811	371	06-11-131	578
06-06-710	102	06-06-811BJ	375	06-11-133	578
06-06-711	352	06-06-812	353	06-11-139	578
06-06-712	352	06-06-813	353	06-11-146	596
06-06-713	352	06-06-814	371	06-11-147	596
06-06-714	352	06-06-814BJ	375	06-11-148	596
06-06-715	350	06-06-815	353	06-11-149	596
06-06-716	351	06-06-816	353	06-11-157	596
06-06-717	350	06-06-817	353	06-11-291	574
06-06-718	351	06-06-818	382	06-11-292	574
06-06-719	353	06-06-819	353	06-11-293	574
06-06-720	350	06-06-821	353	06-11-300	579
06-06-721	353	06-06-828	353	06-11-301	586
06-06-722	350	06-06-829	353	06-11-302	586
06-06-723	353	06-06-830	353	06-11-303	579
06-06-724	350	06-06-831	353	06-11-306	586
06-06-725	352	06-06-832	369	06-11-307	586
06-06-726	350	06-06-832BJ	373	06-11-308	586
06-06-727	350	06-06-833	369	06-11-309	586

Seite/page	Seite/page	Seite/page			
06-11-310	587	06-11-664	599	06-11-944	348
06-11-314	592	06-11-665	599	06-11-945	348
06-11-317	593	06-11-675	599	06-11-946	348
06-11-318	593	06-11-676	599	06-11-948	347
06-11-319	593	06-11-677	599	06-11-949	347
06-11-321	593	06-11-678	599	06-11-950	347
06-11-323	594	06-11-679	599	06-11-951	347
06-11-324	594	06-11-679	599	06-11-952	347
06-11-325	594	06-11-684	600	06-11-953	347
06-11-328	592	06-11-685	600	06-11-954	349
06-11-329	592	06-11-686	600	06-11-955	349
06-11-336	580	06-11-688	600	06-11-956	349
06-11-340	588	06-11-689	600	06-11-957	349
06-11-341	588	06-11-690	600	06-11-958	349
06-11-344	588	06-11-702	602	06-11-959	349
06-11-345	588	06-11-703	602	06-11-960	346
06-11-350	580	06-11-704	602	06-11-961	346
06-11-351	590	06-11-705	602	06-11-962	346
06-11-355	589	06-11-712	602	06-11-963	346
06-11-356	589	06-11-713	602	06-11-964	346
06-11-357	589	06-11-714	602	06-11-965	346
06-11-358	589	06-11-715	602	06-11-976	346
06-11-359	589	06-11-723	602	06-11-977	346
06-11-360	591	06-11-724	602	06-11-978	346
06-11-361	591	06-11-725	602	06-11-979	346
06-11-362	589	06-11-773	264,603	06-11-980	346
06-11-365	590	06-11-774	264,603	06-11-981	346
06-11-366	590	06-11-775	264,603	06-11-986	346
06-11-379	591	06-11-783	264,603	06-11-987	346
06-11-390	591	06-11-784	264,603	06-11-988	346
06-11-391	591	06-11-785	264,603	06-11-989	346
06-11-394	592	06-11-801	597	06-12-034	632
06-11-395	592	06-11-814	597	06-12-035	632
06-11-396	592	06-11-834	264,603	06-12-036	631
06-11-397	592	06-11-835	264,603	06-12-037	631
06-11-410	583	06-11-836	264,603	06-12-038	237,631
06-11-411	583	06-11-840	597	06-12-044	631
06-11-412	583	06-11-841	597	06-12-045	633
06-11-413	583	06-11-842	597	06-12-047	633
06-11-414	583	06-11-845	597	06-12-090	266
06-11-530	584	06-11-846	597	06-12-091	266
06-11-532	584	06-11-848	597	06-12-092	266
06-11-534	584	06-11-850	597	06-12-401	613
06-11-541	584	06-11-854	265,604	06-12-402	613
06-11-542	584	06-11-855	265,604	06-12-403	613
06-11-543	584	06-11-863	265,604	06-12-405	613
06-11-551	584	06-11-864	265,604	06-12-406	613
06-11-552	584	06-11-900	346	06-12-407	613
06-11-553	585	06-11-901	346	06-12-408	613
06-11-554	585	06-11-902	346	06-12-411	613
06-11-556	585	06-11-903	346	06-12-412	613
06-11-560	585	06-11-904	346	06-12-413	613
06-11-562	585	06-11-905	346	06-12-415	613
06-11-565	585	06-11-906	346	06-12-416	613
06-11-581	606	06-11-907	346	06-12-417	613
06-11-582	606	06-11-908	346	06-12-418	613
06-11-583	606	06-11-909	346	06-12-437	614
06-11-584	606	06-11-910	346	06-12-438	614
06-11-585	606	06-11-913	346	06-12-439	614
06-11-586	606	06-11-914	346	06-12-440	614
06-11-587	606	06-11-915	346	06-12-503	612
06-11-588	606	06-11-916	346	06-12-504	612
06-11-589	606	06-11-917	346	06-12-505	612
06-11-591	606	06-11-918	346	06-12-506	612
06-11-592	606	06-11-919	346	06-12-507	612
06-11-593	606	06-11-920	346	06-12-512	611
06-11-594	606	06-11-921	346	06-12-513	611
06-11-595	606	06-11-922	346	06-12-514	611
06-11-596	606	06-11-925	346	06-12-515	611
06-11-597	606	06-11-926	346	06-12-516	611
06-11-598	606	06-11-927	346	06-12-517	611
06-11-599	606	06-11-928	346	06-12-523	611
06-11-630	598	06-11-929	346	06-12-524	611
06-11-631	598	06-11-930	348	06-12-525	611
06-11-632	598	06-11-931	348	06-12-526	611
06-11-633	598	06-11-932	348	06-12-527	611
06-11-634	598	06-11-933	348	06-12-553	611
06-11-635	598	06-11-934	348	06-12-554	611
06-11-636	598	06-11-936	348	06-12-555	611
06-11-637	598	06-11-937	348	06-12-556	611
06-11-638	598	06-11-938	348	06-12-557	611
06-11-639	598	06-11-939	348	06-12-573	612
06-11-662	599	06-11-940	348	06-12-574	612
06-11-663	599	06-11-943	348	06-12-575	612

<i>Seite/page</i>	<i>Seite/page</i>	<i>Seite/page</i>	
06-12-576	612	06-15-408	555
06-12-577	612	06-15-409	555
06-12-650	610	06-15-410	556
06-12-651	610	06-15-411	556
06-12-652	610	06-15-412	556
06-12-653	610	06-15-413	556
06-12-654	610	06-15-414	556
06-12-655	610	06-15-415	556
06-12-656	610	06-15-416	556
06-12-658	610	06-15-428	562
06-12-659	610	06-15-430	557
06-12-660	610	06-15-432	557
06-12-661	610	06-15-442	559
06-12-662	610	06-15-450	559
06-12-701	614	06-15-451	559
06-12-702	614	06-15-453	558
06-12-781	610	06-15-455	558
06-12-783	610	06-15-457	557
06-12-785	610	06-15-459	558
06-12-788	610	06-15-460	560
06-12-789	610	06-15-461	560
06-12-790	610	06-15-462	560
06-13-001	48	06-15-463	560
06-13-002	48	06-15-467	562
06-13-003	48	06-15-470	560
06-13-004	48	06-15-472	560
06-13-005	48	06-15-474	561
06-13-006	48	06-15-475	560
06-13-010	8	06-15-500	563
06-13-011	8	06-15-502	563
06-13-012	8	06-15-511	563
06-13-013	8	06-15-514	564
06-13-014	8	06-15-515	564
06-13-021	24	06-15-518	564
06-13-033	49	06-15-520	563
06-13-034	49	06-15-521	564
06-13-035	49	06-15-522	565
06-13-036	49	06-15-523	565
06-13-040	9	06-15-525	565
06-13-041	9	06-15-526	566
06-13-061	25	06-15-527	566
06-13-120	2	06-15-530	566
06-13-121	2	06-15-532	566
06-13-122	2	06-15-534	567
06-13-123	2	06-15-550	568
06-13-124	2	06-15-551	568
06-13-125	2	06-15-555	568
06-13-130	2	06-15-566	568
06-13-131	2	06-15-599	553
06-13-132	2	06-15-601	569
06-13-133	2	06-15-602	569
06-13-134	2	06-15-610	569
06-13-135	2	06-15-611	569
06-13-140	2	06-15-614	571
06-13-141	2	06-15-620	570
06-13-142	2	06-15-622	570
06-13-143	2	06-15-624	570
06-13-144	2	06-15-626	570
06-13-145	2	06-15-632	570
06-13-150	38	06-15-634	570
06-13-151	38	06-15-636	570
06-13-153	38	06-15-640	571
06-13-154	38	06-15-641	571
06-13-156	38	06-15-645	572
06-13-157	38	06-15-646	572
06-13-159	2	06-20-002	204
06-13-160	2	06-20-007	205
06-13-161	2	06-20-022	204
06-13-162	2	06-20-072	203
06-13-163	3	06-20-072T	203
06-13-164	3	06-20-082	202
06-13-167	3	06-20-082T	202
06-13-168	3	06-20-402	190
06-13-169	3	06-20-402T	190
06-13-170	22	06-20-470T	195
06-13-173	22	06-20-472T	195
06-13-174	38	06-20-474T	195
06-13-175	22	06-20-475T	195
06-13-176	42	06-20-477T	195
06-13-177	42	06-20-480T	194
06-13-178	42	06-20-482T	194
06-13-179	42	06-20-484T	194
06-13-218	33	06-20-485T	194
06-13-221	33	06-20-487T	194
06-13-223	33		
06-13-228	33		
06-13-230	33		
06-13-388	36		
06-13-390	36		
06-13-392	36		
06-13-398	36		
06-13-430	12		
06-13-431	12		
06-13-432	12		
06-13-433	12		
06-13-434	12		
06-13-435	12		
06-13-436	13		
06-13-437	13		
06-13-438	13		
06-13-439	13		
06-13-440	13		
06-13-441	13		
06-13-442	13		
06-13-444	12		
06-13-451	15		
06-13-452	15		
06-13-453	15		
06-13-454	15		
06-13-455	15		
06-13-470	14		
06-13-471	14		
06-13-472	14		
06-13-473	14		
06-13-474	14		
06-13-476	19		
06-13-477	19		
06-13-478	19		
06-13-479	19		
06-13-480	19		
06-13-481	17		
06-13-482	17		
06-13-483	17		
06-13-484	17		
06-13-485	17		
06-13-486	17		
06-13-488	17		
06-13-489	18		
06-13-490	18		
06-13-491	18		
06-13-492	18		
06-13-493	18		
06-13-503	16		
06-13-504	16		
06-13-505	16		
06-13-506	16		
06-13-507	16		
06-13-508	16		
06-13-520	33		
06-13-521	33		
06-13-522	33		
06-13-523	33		
06-13-524	32		
06-13-525	32		
06-13-526	32		
06-13-527	32		
06-13-528	32		
06-13-529	32		
06-13-530	32		
06-13-531	32		
06-13-532	32		
06-13-533	32		
06-13-560	37		
06-13-561	37		
06-13-563	33		
06-13-564	33		
06-13-565	33		
06-13-566	33		
06-13-567	33		
06-13-568	33		
06-13-570	51		
06-13-572	51		
06-13-574	51		
06-13-579	51		
06-15-399	557		
06-15-400	557		
06-15-406	554		
06-15-407	554		

Seite/page	Seite/page	Seite/page			
06-20-900	190	06-51-041T	247	06-52-230	392
06-20-900T	190	06-51-042	246	06-52-231	392
06-45-000	154	06-51-042T	247	06-52-232	392
06-51-001	244	06-51-043	246	06-52-233	392
06-51-001T	245	06-51-043T	247	06-52-234	393
06-51-002	244	06-51-044	246	06-52-235	393
06-51-002T	245	06-51-044T	247	06-52-236	393
06-51-003	244	06-51-045	246	06-52-238	392
06-51-003T	245	06-51-045T	247	06-52-240	393
06-51-004	244	06-51-046	246	06-52-241	392
06-51-004T	245	06-51-046T	247	06-52-242	393
06-51-005	244	06-51-047	246	06-52-244	392
06-51-005T	245	06-51-047T	247	06-52-245	392
06-51-006	244	06-51-048	246	06-52-246	393
06-51-006T	245	06-51-048T	247	06-52-247	392
06-51-007	244	06-51-049	246	06-52-248	393
06-51-007T	245	06-51-049T	247	06-52-300T	402
06-51-008	244	06-51-050	246	06-52-301T	402
06-51-008T	245	06-51-050T	247	06-52-302T	402
06-51-009	244	06-51-051	246	06-52-303T	402
06-51-009T	245	06-51-051T	247	06-52-304T	402
06-51-010	244	06-51-052	246	06-52-305T	402
06-51-010T	245	06-51-052T	247	06-52-306T	402
06-51-011	244	06-51-053	246	06-52-307T	402
06-51-011T	245	06-51-053T	247	06-52-310T	402
06-51-012	244	06-51-054	246	06-52-311T	402
06-51-012T	245	06-51-054T	247	06-52-312T	402
06-51-013	244	06-51-055	246	06-52-313T	402
06-51-013T	245	06-51-055T	247	06-52-314T	402
06-51-014	244	06-52-100	484	06-52-315T	402
06-51-014T	245	06-52-100T	484	06-52-316T	402
06-51-015	244	06-52-101	484	06-52-317T	402
06-51-015T	245	06-52-101T	484	06-52-320T	402
06-51-016	246	06-52-102	484	06-52-321T	402
06-51-016T	247	06-52-102T	484	06-52-322T	402
06-51-017	246	06-52-103	484	06-52-323T	402
06-51-017T	247	06-52-104	484	06-52-324T	402
06-51-018	246	06-52-105	484	06-52-325T	402
06-51-018T	247	06-52-106	484	06-52-326T	402
06-51-019	246	06-52-106T	484	06-52-327T	402
06-51-019T	247	06-52-107	484	06-52-350	398
06-51-019T	247	06-52-107T	484	06-52-351	398
06-51-020	246	06-52-108	484	06-52-352	398
06-51-020T	247	06-52-108T	484	06-52-353	398
06-51-021	246	06-52-109	484	06-52-354	398
06-51-021T	247	06-52-109T	484	06-52-355	398
06-51-022	246	06-52-110	485	06-52-358	405
06-51-022T	247	06-52-111	485	06-52-359	405
06-51-023	246	06-52-112	485	06-52-360	405
06-51-023T	247	06-52-113	485	06-52-361	405
06-51-024	246	06-52-114	485	06-52-362	405
06-51-024T	247	06-52-114T	485	06-52-363	405
06-51-025	246	06-52-115	485	06-52-364	405
06-51-025T	247	06-52-115T	485	06-52-366	406
06-51-026	246	06-52-116	485	06-52-367	406
06-51-026T	247	06-52-116T	485	06-52-368	406
06-51-027	246	06-52-117	485	06-52-369	406
06-51-027T	247	06-52-117T	485	06-52-370	406
06-51-028	246	06-52-118	485	06-52-371	406
06-51-028T	247	06-52-119	484	06-52-372	406
06-51-029	246	06-52-119T	484	06-52-373	406
06-51-029T	247	06-52-120	484	06-52-380	407
06-51-030	246	06-52-120T	484	06-52-381	407
06-51-030T	247	06-52-200	392	06-52-382	407
06-51-031	246	06-52-201	392	06-52-383	407
06-51-031T	247	06-52-202	392	06-52-384	407
06-51-032	246	06-52-203	392	06-52-385	407
06-51-032T	247	06-52-206	392	06-52-386	407
06-51-033	246	06-52-207	392	06-52-387	407
06-51-033T	247	06-52-208	392	06-52-388	407
06-51-034	246	06-52-209	392	06-52-389	407
06-51-034T	247	06-52-210	393	06-52-390	407
06-51-035	246	06-52-211	393	06-52-391	407
06-51-035T	247	06-52-212	393	06-52-430	408
06-51-036	246	06-52-213	393	06-52-431	408
06-51-036T	247	06-52-214	393	06-52-786	488
06-51-037	246	06-52-215	393	06-54-011	11
06-51-037T	247	06-52-216	392	06-54-012	11
06-51-038	246	06-52-220	392	06-54-013	11
06-51-038T	247	06-52-221	392	06-54-014	11
06-51-039	246	06-52-222	393	06-54-015	11
06-51-039T	247	06-52-223	393	06-54-016	11
06-51-040	246	06-52-226	392	06-54-017	11
06-51-040T	247	06-52-227	392	06-54-018	11
06-51-041	246	06-52-228	392		

<i>Seite/page</i>	<i>Seite/page</i>	<i>Seite/page</i>	
06-54-019	11	06-54-520	109
06-54-020	11	06-54-521	109
06-54-021	11	06-54-522	109
06-54-022	11	06-54-523	109
06-54-023	11	06-54-524	109
06-54-024	11	06-54-525	109
06-54-025	11	06-54-526	109
06-54-028	11	06-54-527	109
06-54-045	28	06-54-528	109
06-54-046	29	06-54-530	108
06-54-062	5	06-54-531	108
06-54-076	27	06-54-532	108
06-54-079	27	06-54-533	108
06-54-080	27	06-54-534	108
06-54-081	27	06-54-536	108
06-54-089	23	06-54-537	108
06-54-089T	23	06-54-538	108
06-54-099	23	06-54-540	111
06-54-115	21	06-54-541	111
06-54-115T	21	06-54-542	111
06-54-116	21	06-54-543	111
06-54-116T	21	06-54-544	111
06-54-117	28	06-54-545	111
06-54-118	28	06-54-546	111
06-54-125	20	06-54-547	111
06-54-126	20	06-54-548	111
06-54-127	20	06-54-549	111
06-54-128	20	06-54-550	111
06-54-129	20	06-54-551	111
06-54-200	28	06-54-552	111
06-54-201	28	06-54-553	111
06-54-202	28	06-54-554	111
06-54-203	28	06-54-555	111
06-54-204	28	06-54-556	111
06-54-205	28	06-54-557	111
06-54-206	29	06-54-558	111
06-54-207	29	06-54-559	111
06-54-208	29	06-54-560	110
06-54-209	29	06-54-561	110
06-54-210	28	06-54-562	110
06-54-211	28	06-54-563	110
06-54-212	28	06-54-564	110
06-54-213	28	06-54-565	110
06-54-214	28	06-54-566	110
06-54-215	28	06-54-567	110
06-54-216	28	06-54-600	112
06-54-217	28	06-54-601	112
06-54-218	28	06-54-602	112
06-54-219	28	06-54-603	112
06-54-220	28	06-54-604	112
06-54-221	28	06-54-605	112
06-54-222	28	06-54-606	114
06-54-223	28	06-54-607	114
06-54-224	29	06-54-608	114
06-54-225	29	06-54-609	114
06-54-226	29	06-54-610	114
06-54-227	29	06-54-611	114
06-54-228	29	06-54-612	114
06-54-229	29	06-54-613	114
06-54-248	30	06-54-614	114
06-54-248T	30	06-54-615	114
06-54-250	31	06-54-616	116
06-54-250T	31	06-54-617	116
06-54-251	30	06-54-618	116
06-54-251T	30	06-54-619	116
06-54-252	30	06-54-620	116
06-54-253	31	06-54-621	116
06-54-253T	31	06-54-622	116
06-54-254	31	06-54-623	116
06-54-255	30	06-54-624	116
06-54-260	34	06-54-625	116
06-54-261	34	06-54-630	113
06-54-262	34	06-54-631	113
06-54-263	34	06-54-632	113
06-54-264	34	06-54-633	113
06-54-265	34	06-54-634	113
06-54-266	34	06-54-635	113
06-54-267	34	06-54-636	113
06-54-270	35	06-54-637	115
06-54-271	35	06-54-638	115
06-54-272	35	06-54-639	115
06-54-273	35	06-54-640	115
06-54-274	35	06-54-641	115
06-54-275	35	06-54-642	115
06-54-276	35		
06-54-277	35		
06-54-280	54		
06-54-281	54		
06-54-284	54		
06-54-284T	54		
06-54-285	54		
06-54-285T	54		
06-54-286	54		
06-54-286T	54		
06-54-287	54		
06-54-287T	54		
06-54-288	54		
06-54-288T	54		
06-54-289	54		
06-54-289T	54		
06-54-290	54		
06-54-290T	54		
06-54-291	54		
06-54-291T	54		
06-54-293	54		
06-54-310	76		
06-54-310T	76		
06-54-311	76		
06-54-311T	76		
06-54-312	76		
06-54-312T	76		
06-54-313	58		
06-54-314	58		
06-54-315	58		
06-54-316	58		
06-54-317	58		
06-54-320	72		
06-54-320T	72		
06-54-321	72		
06-54-321T	72		
06-54-322	72		
06-54-322T	72		
06-54-323	72		
06-54-323T	72		
06-54-324	72		
06-54-324T	72		
06-54-325	72		
06-54-325T	72		
06-54-326	72		
06-54-326T	72		
06-54-327	72		
06-54-327T	72		
06-54-328	73		
06-54-328T	73		
06-54-329	73		
06-54-329T	73		
06-54-330	73		
06-54-330T	73		
06-54-331	73		
06-54-331T	73		
06-54-332	73		
06-54-332T	73		
06-54-333	73		
06-54-333T	73		
06-54-334	73		
06-54-334T	73		
06-54-335	73		
06-54-335T	73		
06-54-336	73		
06-54-336T	73		
06-54-337	73		
06-54-337T	73		
06-54-338	73		
06-54-338T	73		
06-54-361	63,240		
06-54-500	107		
06-54-501	107		
06-54-502	107		
06-54-503	107		
06-54-504	107		
06-54-505	107		
06-54-506	107		
06-54-510	106		
06-54-511	106		
06-54-512	106		
06-54-513	106		
06-54-514	106		
06-54-515	106		

Seite/page	Seite/page	Seite/page	
06-54-643	115	06-56-061	159
06-54-644	115	06-56-062	159
06-54-645	115	06-56-063	159
06-54-646	115	06-56-064	159
06-54-647	115	06-56-065	159
06-54-648	115	06-56-066	159
06-54-649	117	06-56-110	162
06-54-650	117	06-56-111	162
06-54-651	117	06-56-112	162
06-54-652	117	06-56-113	162
06-54-653	117	06-56-200	151
06-54-654	117	06-56-201	151
06-54-655	117	06-56-202	151
06-54-656	118	06-56-203	151
06-54-657	118	06-56-204	151
06-54-658	118	06-56-205	151
06-54-659	118	06-56-206	151
06-54-660	118	06-56-207	151
06-54-661	118	06-56-224	148
06-54-662	118	06-56-226	148
06-54-663	118	06-56-228	148
06-54-680	394	06-56-230	148
06-54-681	394	06-56-232	148
06-54-682	394	06-56-224	148
06-54-683	394	06-56-226	148
06-54-684	394	06-56-250	142
06-54-685	394	06-56-255	153
06-54-686	394	06-56-281	147
06-54-687	394	06-56-302	87
06-54-688	395	06-56-303	87
06-54-689	395	06-56-304	87
06-54-690	395	06-56-305	86
06-54-691	395	06-56-307	82
06-54-925	52	06-56-307T	82
06-54-925T	52	06-56-330	167
06-54-926	52	06-56-331	167
06-54-926T	52	06-56-332	167
06-54-927	52	06-56-333	167
06-54-927T	52	06-56-334	167
06-54-928	52	06-56-335	167
06-54-928T	52	06-56-336	167
06-54-929	52	06-56-337	167
06-54-929T	52	06-56-338	167
06-54-930	52	06-56-339	167
06-54-930T	52	06-56-422	170
06-54-931	52	06-56-423	170
06-54-931T	52	06-56-424	170
06-54-932	52	06-56-425	170
06-54-932T	52	06-56-427	170
06-54-933	52	06-56-428	170
06-54-933T	52	06-56-456	148
06-54-934	52	06-56-457	148
06-54-934T	52	06-56-458	148
06-54-935	52	06-56-459	148
06-54-935T	52	06-56-512	368
06-54-936	52	06-56-512BJ	372
06-54-936T	52	06-56-522	368
06-54-937	53	06-56-522BJ	372
06-54-937T	53	06-56-525	368
06-54-938	53	06-56-525BJ	372
06-54-938T	53	06-56-542	368
06-54-939	53	06-56-542BJ	372
06-54-939T	53	06-56-552	368
06-54-940	53	06-56-552BJ	372
06-54-940T	53	06-56-555	368
06-54-941	53	06-56-555BJ	372
06-54-941T	53	06-56-572	368
06-54-942	53	06-56-572BJ	372
06-54-942T	53	06-56-582	368
06-54-943	53	06-56-582BJ	372
06-54-943T	53	06-56-585	368
06-54-944	53	06-56-585BJ	372
06-54-944T	53	06-56-600	243
06-54-945	53	06-56-600T	243
06-54-945T	53	06-56-601	248
06-54-946	53	06-56-601T	249
06-54-946T	53	06-56-602	248
06-54-947	53	06-56-602T	249
06-54-947T	53	06-56-605	248
06-54-948	53	06-56-605T	249
06-54-948T	53	06-56-606	248
06-54-950	50	06-56-606T	249
06-54-951	50	06-56-607	248
06-54-952	50	06-56-607T	249
06-54-953	50	06-56-061	159
06-54-954	50	06-56-062	159
06-54-955	50	06-56-063	159
06-54-960	50	06-56-064	159
06-54-961	50	06-56-065	159
06-54-962	50	06-56-066	159
06-54-963	50	06-56-110	162
06-54-964	50	06-56-111	162
06-54-965	50	06-56-112	162
06-54-970	51	06-56-113	162
06-54-971	51	06-56-200	151
06-54-972	51	06-56-201	151
06-54-973	51	06-56-202	151
06-54-974	51	06-56-203	151
06-54-975	51	06-56-204	151
06-54-976	51	06-56-205	151
06-54-977	51	06-56-206	151
06-54-980	51	06-56-207	151
06-54-981	51	06-56-224	148
06-54-982	51	06-56-226	148
06-54-983	51	06-56-228	148
06-54-984	51	06-56-230	148
06-54-985	51	06-56-232	148
06-55-010	206	06-56-224	148
06-55-011	206	06-56-226	148
06-55-503	197	06-56-250	142
06-55-504T	193	06-56-255	153
06-55-513	196	06-56-281	147
06-55-514T	192	06-56-302	87
06-55-522T	195	06-56-303	87
06-55-524T	195	06-56-304	87
06-55-528T	194	06-56-305	86
06-55-529T	194	06-56-307	82
06-55-552	190	06-56-307T	82
06-55-553	190	06-56-330	167
06-55-554	190	06-56-331	167
06-55-555T	190	06-56-332	167
06-55-556T	190	06-56-333	167
06-55-557T	190	06-56-334	167
06-55-558	191	06-56-335	167
06-55-559	191	06-56-336	167
06-55-560	191	06-56-337	167
06-55-561T	191	06-56-338	167
06-55-562T	191	06-56-339	167
06-55-563T	191	06-56-422	170
06-55-590	198	06-56-423	170
06-55-590T	198	06-56-424	170
06-55-591	198	06-56-425	170
06-55-591T	198	06-56-427	170
06-55-592	198	06-56-428	170
06-55-592T	198	06-56-456	148
06-55-594	199	06-56-457	148
06-55-594T	199	06-56-458	148
06-55-595	199	06-56-459	148
06-55-595T	199	06-56-512	368
06-55-596	199	06-56-512BJ	372
06-56-001	154,156	06-56-522	368
06-56-002	154,155	06-56-522BJ	372
06-56-003	154,155	06-56-525	368
06-56-004	155	06-56-525BJ	372
06-56-005	156	06-56-542	368
06-56-006	154,156	06-56-542BJ	372
06-56-007	156	06-56-552	368
06-56-008	156	06-56-552BJ	372
06-56-009	156	06-56-555	368
06-56-010	156	06-56-555BJ	372
06-56-011	155	06-56-572	368
06-56-012	157	06-56-572BJ	372
06-56-013	154,157	06-56-582	368
06-56-014	154,157	06-56-582BJ	372
06-56-015	154,157	06-56-585	368
06-56-016	154,157	06-56-585BJ	372
06-56-017	154,157	06-56-600	243
06-56-018	154,157	06-56-600T	243
06-56-019	154,157	06-56-601	248
06-56-030	169	06-56-601T	249
06-56-054	357	06-56-602	248
06-56-055	357	06-56-602T	249
06-56-056	357	06-56-605	248
06-56-057	357	06-56-605T	249
06-56-058	357	06-56-606	248
06-56-059	357	06-56-606T	249
06-56-060	159	06-56-607	248
		06-56-607T	249

<i>Seite/page</i>		<i>Seite/page</i>		<i>Seite/page</i>	
06-56-608	248	06-56-650	248	06-56-796	352
06-56-608T	249	06-56-650T	249	06-56-797	352
06-56-609	243	06-56-651	248	06-56-798	352
06-56-609T	243	06-56-651T	249	06-56-799	352
06-56-610	243	06-56-652	248	06-56-800	370
06-56-610T	243	06-56-652T	249	06-56-800BJ	374
06-56-611	243	06-56-653	248	06-56-801	371
06-56-611T	243	06-56-653T	249	06-56-801BJ	375
06-56-612	248	06-56-654	248	06-56-802	370
06-56-612T	249	06-56-654T	249	06-56-802BJ	374
06-56-613	248	06-56-655	248	06-56-803	370
06-56-613T	249	06-56-655T	249	06-56-803BJ	374
06-56-614	248	06-56-656	252	06-56-804	370
06-56-614T	249	06-56-656T	253	06-56-804BJ	374
06-56-615	248	06-56-657	252	06-56-805	370
06-56-615T	249	06-56-657T	253	06-56-805BJ	374
06-56-616	248	06-56-680	104	06-56-806	370
06-56-616T	249	06-56-681	104	06-56-806BJ	374
06-56-617	248	06-56-682	104	06-56-807	371
06-56-617T	249	06-56-690	363	06-56-807BJ	375
06-56-618	248	06-56-691	363	06-56-808	371
06-56-618T	249	06-56-707	351	06-56-808BJ	375
06-56-619	248	06-56-708	351	06-56-809	371
06-56-619T	249	06-56-709	351	06-56-809BJ	375
06-56-620	248	06-56-710	351	06-56-810	370
06-56-620T	249	06-56-711	351	06-56-810BJ	374
06-56-621	248	06-56-712	351	06-56-811	370
06-56-621T	249	06-56-720	351	06-56-811BJ	374
06-56-622	248	06-56-726	351	06-56-812	370
06-56-622T	249	06-56-727	351	06-56-812BJ	374
06-56-623	248	06-56-728	351	06-56-814	371
06-56-623T	249	06-56-729	351	06-56-814BJ	375
06-56-624	248	06-56-730	351	06-56-815	371
06-56-624T	249	06-56-731	351	06-56-815BJ	375
06-56-625	248	06-56-732	351	06-56-816	370
06-56-625T	249	06-56-735	350	06-56-816BJ	374
06-56-626	248	06-56-736	350	06-56-817	371
06-56-626T	249	06-56-742	350	06-56-817BJ	375
06-56-627	248	06-56-744	350	06-56-818	371
06-56-627T	249	06-56-745	353	06-56-818BJ	375
06-56-628	248	06-56-760	370	06-56-828	377
06-56-628T	249	06-56-760BJ	374	06-56-830	369
06-56-629	248	06-56-761	370	06-56-830BJ	373
06-56-629T	249	06-56-761BJ	374	06-56-832	369
06-56-630	248	06-56-762	370	06-56-832BJ	373
06-56-630T	249	06-56-762BJ	374	06-56-833	369
06-56-631	248	06-56-763	370	06-56-833BJ	373
06-56-631T	249	06-56-763BJ	374	06-56-834	369
06-56-632	248	06-56-764	370	06-56-834BJ	373
06-56-632T	249	06-56-764BJ	374	06-56-836	369
06-56-633	248	06-56-769	370	06-56-836BJ	373
06-56-633T	249	06-56-769BJ	374	06-56-837	369
06-56-634	248	06-56-770	370	06-56-837BJ	373
06-56-634T	249	06-56-770BJ	374	06-56-838	369
06-56-635	248	06-56-771	370	06-56-838BJ	373
06-56-635T	249	06-56-771BJ	374	06-56-840	369
06-56-636	248	06-56-772	370	06-56-840BJ	373
06-56-636T	249	06-56-772BJ	374	06-56-841	369
06-56-637	248	06-56-773	370	06-56-841BJ	373
06-56-637T	249	06-56-773BJ	374	06-56-842	369
06-56-638	248	06-56-774	370	06-56-842BJ	373
06-56-638T	249	06-56-774BJ	374	06-56-843	369
06-56-639	248	06-56-775	371	06-56-843BJ	373
06-56-639T	249	06-56-775BJ	375	06-56-844	369
06-56-640	248	06-56-777	370	06-56-844BJ	373
06-56-640T	249	06-56-777BJ	374	06-56-846	369
06-56-641	248	06-56-778	352	06-56-846BJ	373
06-56-641T	249	06-56-779	352	06-56-847	369
06-56-642	248	06-56-780	352	06-56-847BJ	373
06-56-642T	249	06-56-781	352	06-56-848	369
06-56-643	248	06-56-782	352	06-56-848BJ	373
06-56-643T	249	06-56-783	352	06-56-849	369
06-56-644	248	06-56-784	352	06-56-849BJ	373
06-56-644T	249	06-56-785	352	06-56-850	369
06-56-645	248	06-56-786	352	06-56-850BJ	373
06-56-645T	249	06-56-787	352	06-56-851	369
06-56-646	248	06-56-788	352	06-56-851BJ	373
06-56-646T	249	06-56-789	352	06-56-852	369
06-56-647	248	06-56-790	352	06-56-852BJ	373
06-56-647T	249	06-56-791	352	06-56-853	369
06-56-648	248	06-56-792	352	06-56-853BJ	373
06-56-648T	249	06-56-793	352	06-56-854	369
06-56-649	248	06-56-794	352	06-56-854BJ	373
06-56-649T	249	06-56-795	352	06-56-856	369

Seite/page	Seite/page	Seite/page			
06-56-856BJ	373	06-61-653	624,625	06-61-951	349
06-56-857	369	06-61-654	624,625	06-61-952	349
06-56-857BJ	373	06-61-655	624,625	06-61-962	346
06-56-858	369	06-61-656	624,625	06-61-964	349
06-56-858BJ	373	06-61-657	620,621,624,625,628,629	06-61-965	349
06-56-859	369	06-61-660	620	06-61-966	349
06-56-859BJ	373	06-61-661	620,621	06-61-967	349
06-56-861	369	06-61-662	620,621	06-61-968	349
06-56-861BJ	373	06-61-663	620,621	06-61-969	349
06-56-871	169	06-61-664	620,621	06-61-970	349
06-56-880	383	06-61-665	620,621	06-61-971	349
06-56-881	383	06-61-666	620,621	06-61-972	349
06-56-882	383	06-61-667	620,621	06-61-973	349
06-56-883	383	06-61-668	620,621	06-61-974	349
06-56-884	383	06-61-669	620,621	06-61-975	349
06-56-885	383	06-61-670	620,621	06-61-976	349
06-56-886	383	06-61-671	620,621	06-61-977	349
06-56-887	383	06-61-672	620,621	06-61-978	349
06-56-888	383	06-61-675	599	06-61-979	349
06-56-889	383	06-61-676	599	06-61-980	349
06-56-890	383	06-61-677	599	06-61-981	349
06-56-891	383	06-61-678	599	06-61-982	349
06-56-892	383	06-61-679	599	06-61-983	349
06-56-893	383	06-61-680	622	06-61-984	349
06-56-894	383	06-61-681	622,623	06-61-985	349
06-56-895	353	06-61-682	622,623	06-61-986	349
06-56-896	353	06-61-683	622,623	06-61-987	349
06-56-897	353	06-61-684	622,623	06-61-988	349
06-56-898	353	06-61-685	622,623	06-61-989	349
06-56-899	353	06-61-686	622,623	06-61-990	348
06-56-900	353	06-61-870	605	06-61-991	348
06-56-901	353	06-61-871	605	06-61-992	348
06-56-902	353	06-61-872	605	06-61-993	348
06-56-903	353	06-61-873	605	06-61-994	348
06-56-904	353	06-61-874	605	06-61-995	348
06-56-905	353	06-61-875	605	06-61-996	348
06-56-906	353	06-61-900	348	06-61-997	348
06-56-960	353	06-61-901	348	06-61-998	349
06-56-965	353	06-61-902	348	06-62-000	616
06-56-966	353	06-61-903	348	06-62-001	616,617
06-56-971	353	06-61-904	348	06-62-002	616,617
06-57-057	377	06-61-905	348	06-62-003	616,617
06-57-170	299	06-61-906	348	06-62-004	616,617
06-58-402	164	06-61-907	348	06-62-005	616,617
06-58-406	164	06-61-908	348	06-62-006	616,617
06-58-408	164	06-61-909	348	06-62-007	616,617
06-58-409	164	06-61-910	348	06-62-008	616
06-58-410	164	06-61-911	348	06-62-009	616,617
06-58-411	164	06-61-912	348	06-62-010	616,617
06-58-412	164	06-61-913	348	06-62-011	616,617
06-58-413	164	06-61-915	347	06-62-012	616,617
06-58-414	164	06-61-916	347	06-62-013	616,617
06-58-415	164	06-61-917	347	06-62-014	616,617
06-58-416	164	06-61-918	347	06-62-015	626
06-58-480	165	06-61-919	347	06-62-016	626,627
06-61-311	587	06-61-920	347	06-62-017	626,627
06-61-312	587	06-61-921	347	06-62-018	626,627
06-61-313	587	06-61-922	347	06-62-019	626,627
06-61-327	594	06-61-923	347	06-62-020	626,627
06-61-328	595	06-61-924	347	06-62-021	626,627
06-61-329	595	06-61-925	347	06-62-022	628
06-61-330	595	06-61-926	347	06-62-023	628,629
06-61-331	596	06-61-927	347	06-62-024	628,629
06-61-332	596	06-61-928	347	06-62-025	628,629
06-61-333	596	06-61-929	347	06-62-026	628,629
06-61-410	583	06-61-930	347	06-62-027	628,629
06-61-412	583	06-61-931	347	06-62-028	628,629
06-61-630	618	06-61-932	347	06-62-030	630
06-61-631	618,619	06-61-933	347	06-62-031	630
06-61-632	618,619	06-61-934	347	06-62-700	633
06-61-633	618,619	06-61-935	347	06-62-705	615
06-61-634	618,619	06-61-936	347	06-62-706	615
06-61-635	618,619	06-61-937	347	06-62-707	615
06-61-636	618,619	06-61-938	347	06-62-708	615
06-61-637	618,619	06-61-939	347	06-63-010	8
06-61-638	618,619	06-61-940	347	06-63-011	8
06-61-639	618,619	06-61-941	347	06-63-012	8
06-61-640	618,619	06-61-942	347	06-63-013	8
06-61-641	618,619	06-61-943	347	06-63-014	8
06-61-642	618,619	06-61-944	347	06-63-021	24
06-61-643	618,619,622,623,626,627	06-61-947	346	06-63-061	25
06-61-650	624	06-61-948	346	06-63-136	2
06-61-651	624,625	06-61-949	346	06-63-137	2
06-61-652	624,625	06-61-950	349	06-63-502	16

Seite/page	Seite/page	Seite/page	
06-76-414	356	06-76-829BJ	375
06-76-415	356	06-76-830	371
06-76-416	356	06-76-830BJ	375
06-76-417	356	06-76-831	371
06-76-418	356	06-76-831BJ	375
06-76-419	356	06-76-832	371
06-76-420	356	06-76-832BJ	375
06-76-421	356	06-76-833	371
06-76-422	356	06-76-833BJ	375
06-76-423	356	06-76-834	371
06-76-424	356	06-76-834BJ	375
06-76-425	356	06-76-835	371
06-76-426	356	06-76-835BJ	375
06-76-427	356	06-76-836	371
06-76-428	356	06-76-836BJ	375
06-76-429	356	06-76-837	371
06-76-430	356	06-76-837BJ	375
06-76-431	356	06-76-838	371
06-76-432	356	06-76-838BJ	375
06-76-433	356	06-76-839	371
06-76-434	356	06-76-839BJ	375
06-76-435	356	06-76-840	371
06-76-501	350	06-76-840BJ	375
06-76-502	350	06-76-841	371
06-76-503	350	06-76-841BJ	375
06-76-504	350	06-76-900	354
06-76-505	350	06-76-901	354
06-76-506	350	06-76-902	354
06-76-508	350	06-76-903	354
06-76-509	350	06-76-904	354
06-76-510	350	06-76-905	354
06-76-511	350	06-76-906	354
06-76-512	350	06-76-907	354
06-76-513	350	06-76-908	354
06-76-514	350	06-76-909	354
06-76-515	351	06-76-910	354
06-76-516	351	06-76-911	354
06-76-517	351	06-76-912	354
06-76-518	351	06-76-913	354
06-76-519	351	06-76-914	354
06-76-520	351	06-76-915	354
06-76-521	351	06-76-916	354
06-76-522	351	06-76-917	354
06-76-523	351	06-76-918	354
06-76-524	351	06-76-919	354
06-76-525	351	06-76-920	354
06-76-526	351	06-76-921	354
06-76-527	351	06-76-922	354
06-76-528	351	06-76-923	354
06-76-529	351	06-76-924	354
06-76-530	351	06-76-925	354
06-76-531	351	06-76-926	355
06-76-532	351	06-76-927	355
06-76-533	351	06-76-928	355
06-76-534	351	06-76-929	355
06-76-535	351	06-76-930	355
06-76-536	351	06-76-931	355
06-76-537	351	06-76-932	355
06-76-538	351	06-76-933	355
06-76-539	352	06-76-934	355
06-76-540	352	06-76-935	355
06-76-541	352	06-76-936	355
06-76-542	352	06-76-937	355
06-76-543	352	06-76-938	355
06-76-544	352	06-76-939	355
06-76-545	352	06-76-940	355
06-76-546	352	06-76-941	355
06-76-547	352	06-76-942	355
06-76-548	352	06-76-943	355
06-76-549	352	06-76-944	355
06-76-550	352	06-76-945	355
06-76-551	352	06-76-946	355
06-76-552	352	06-76-947	355
06-76-553	352	06-76-948	355
06-76-554	352	06-76-949	355
06-76-555	352	06-76-950	355
06-76-556	352	06-76-951	355
06-76-557	352	06-76-952	355
06-76-558	352	06-76-953	355
06-76-559	352	06-81-100	346
06-76-560	352	06-81-101	346
06-76-561	352	06-81-102	346
06-76-562	352	06-81-103	346
06-76-563	353	06-81-104	346
06-76-564	353		
06-76-565	353		
06-76-566	353		
06-76-567	353		
06-76-568	353		
06-76-569	353		
06-76-570	353		
06-76-571	353		
06-76-572	353		
06-76-573	353		
06-76-574	353		
06-76-575	353		
06-76-576	353		
06-76-577	353		
06-76-578	353		
06-76-579	353		
06-76-580	353		
06-76-581	353		
06-76-582	353		
06-76-583	353		
06-76-584	353		
06-76-585	353		
06-76-586	353		
06-76-799	370		
06-76-799BJ	374		
06-76-800	370		
06-76-800BJ	374		
06-76-801	370		
06-76-801BJ	374		
06-76-802	370		
06-76-802BJ	374		
06-76-803	370		
06-76-803BJ	374		
06-76-804	370		
06-76-804BJ	374		
06-76-805	370		
06-76-805BJ	374		
06-76-806	370		
06-76-806BJ	374		
06-76-807	370		
06-76-807BJ	374		
06-76-808	370		
06-76-808BJ	374		
06-76-809	370		
06-76-809BJ	374		
06-76-810	370		
06-76-810BJ	374		
06-76-811	370		
06-76-811BJ	374		
06-76-812	370		
06-76-812BJ	374		
06-76-813	370		
06-76-813BJ	374		
06-76-814	370		
06-76-814BJ	374		
06-76-815	371		
06-76-815BJ	375		
06-76-816	371		
06-76-816BJ	375		
06-76-817	371		
06-76-817BJ	375		
06-76-818	371		
06-76-818BJ	375		
06-76-819	371		
06-76-819BJ	375		
06-76-820	371		
06-76-820BJ	375		
06-76-821	371		
06-76-821BJ	375		
06-76-822	371		
06-76-822BJ	375		
06-76-823	371		
06-76-823BJ	375		
06-76-824	371		
06-76-824BJ	375		
06-76-825	371		
06-76-825BJ	375		
06-76-826	371		
06-76-826BJ	375		
06-76-827	371		
06-76-827BJ	375		
06-76-828	371		
06-76-828BJ	375		
06-76-829	371		

<i>Seite/page</i>	<i>Seite/page</i>	<i>Seite/page</i>
06-81-105 346	06-81-198 348	07-06-409 536
06-81-111 346	06-81-199 348	07-06-411 536
06-81-112 346	06-81-200 348	07-06-412 536
06-81-113 346	06-81-201 348	07-06-413 536
06-81-114 346	06-81-202 348	07-06-414 536
06-81-115 346	06-81-203 348	07-06-415 536
06-81-116 346	06-81-204 348	07-06-416 536
06-81-117 346	06-81-205 348	07-06-417 536
06-81-121 346	06-81-206 348	07-06-419 536
06-81-122 346	06-81-207 349	07-06-421 536
06-81-123 346	06-81-208 349	07-06-422 536
06-81-124 346	06-81-209 349	07-06-423 536
06-81-125 346	06-81-210 349	07-06-424 536
06-81-126 346	06-81-211 349	07-06-425 536
06-81-128 346	06-81-212 349	07-06-426 536
06-81-129 346	06-81-213 349	07-06-427 536
06-81-130 346	06-81-214 349	07-06-429 536
06-81-131 346	06-81-215 349	07-06-756 548
06-81-132 346	06-81-216 349	07-06-757 546
06-81-133 346	06-81-217 349	07-06-763 546
06-81-134 346	06-81-218 349	07-06-764 546
06-81-135 347	06-81-219 349	07-06-765 546
06-81-136 347	06-81-220 349	07-06-766 546
06-81-137 347	06-81-221 349	07-06-767 546
06-81-138 347	06-81-222 349	07-06-768 545
06-81-139 347	06-81-223 349	07-06-770 549
06-81-140 347	06-81-224 349	07-06-771 549
06-81-141 347	06-81-225 349	07-06-772 549
06-81-142 347	06-81-226 349	07-06-773 549
06-81-143 347	06-81-227 349	07-06-774 549
06-81-144 347	06-81-228 349	07-06-775 549
06-81-145 347	06-81-229 349	07-06-905 544
06-81-146 347	06-81-230 349	07-06-906 542
06-81-147 347	06-81-231 349	07-06-907 542
06-81-148 347	06-81-232 349	07-06-908 542
06-81-149 347	06-81-233 349	07-06-909 542
06-81-150 347	06-81-234 349	07-06-910 544
06-81-151 347	06-81-235 349	07-06-911 545
06-81-152 347	06-81-236 349	07-06-912 545
06-81-153 347	06-81-237 349	07-06-913 545
06-81-154 347	06-81-238 349	07-06-917 540
06-81-155 347	06-81-239 349	07-06-918 548
06-81-156 347	06-81-240 349	07-06-923 538
06-81-157 347	06-81-241 349	07-06-927 538
06-81-158 347	06-81-242 349	07-06-928 538
06-81-159 347	07-06-350 539	07-06-930 538
06-81-160 347	07-06-351 539	07-06-931 538
06-81-161 347	07-06-352 539	07-06-933 537
06-81-162 347	07-06-353 539	07-06-935 548
06-81-163 347	07-06-354 539	07-06-936 548
06-81-164 347	07-06-355 539	07-06-937 543
06-81-165 347	07-06-360 539	07-06-938 543
06-81-166 347	07-06-361 539	07-06-939 541
06-81-167 347	07-06-362 539	07-06-940 541
06-81-168 347	07-06-363 539	07-06-941 541
06-81-169 347	07-06-364 539	07-06-942 541
06-81-170 347	07-06-365 539	07-06-944 534
06-81-171 348	07-06-370 539	07-06-980 543
06-81-172 348	07-06-371 539	07-11-899 129
06-81-173 348	07-06-372 539	07-11-899N 129
06-81-174 348	07-06-373 539	07-11-900 129
06-81-175 348	07-06-374 539	07-11-900N 129
06-81-176 348	07-06-375 539	07-11-910 129
06-81-177 348	07-06-380 539	07-11-910N 129
06-81-178 348	07-06-381 539	07-11-920 129
06-81-179 348	07-06-382 539	07-11-920N 129
06-81-180 348	07-06-383 539	07-11-929 129
06-81-181 348	07-06-384 539	07-11-929N 129
06-81-182 348	07-06-385 539	07-11-930 129
06-81-183 348	07-06-391 536	07-11-930N 129
06-81-184 348	07-06-392 536	07-11-940 129
06-81-185 348	07-06-393 536	07-11-940N 129
06-81-186 348	07-06-394 536	07-11-950 129
06-81-187 348	07-06-395 536	07-11-950N 129
06-81-188 348	07-06-396 536	07-11-959 129
06-81-189 348	07-06-397 536	07-11-959N 129
06-81-190 348	07-06-399 536	07-11-960 129
06-81-191 348	07-06-401 536	07-11-960N 129
06-81-192 348	07-06-402 536	07-11-970 129
06-81-193 348	07-06-403 536	07-11-970N 129
06-81-194 348	07-06-404 536	07-11-972 130
06-81-195 348	07-06-405 536	07-11-972N 130
06-81-196 348	07-06-406 536	07-11-974 131
06-81-197 348	07-06-407 536	07-11-974N 131

Seite/page	Seite/page	Seite/page			
07-11-980	129	07-61-811	127	07-61-864	132
07-11-980N	129	07-61-811N	127	07-61-864N	132
07-56-772	549	07-61-812	127	07-61-865	132
07-56-773	549	07-61-812N	127	07-61-865N	132
07-56-774	549	07-61-813	127	07-61-866	132
07-56-890	545	07-61-813N	127	07-61-866N	132
07-56-891	545	07-61-814	127	07-61-867	132
07-56-892	545	07-61-814N	127	07-61-867N	132
07-56-893	545	07-61-815	127	07-61-868	132
07-56-904	540	07-61-815N	127	07-61-868N	132
07-56-905	540	07-61-816	128	07-61-870	133
07-56-906	540	07-61-816N	128	07-61-870N	133
07-56-907	540	07-61-817	129	07-61-871	133
07-56-908	540	07-61-817N	129	07-61-871N	133
07-56-909	537	07-61-818	129	07-61-872	133
07-56-910	537	07-61-818N	129	07-61-872N	133
07-56-911	537	07-61-819	133	07-61-873	133
07-56-915	541	07-61-819N	133	07-61-873N	133
07-56-916	541	07-61-820	133	07-61-874	133
07-56-917	541	07-61-820N	133	07-61-874N	133
07-56-918	541	07-61-821	133	07-61-875	133
07-56-919	541	07-61-821N	133	07-61-875N	133
07-56-920	541	07-61-822	133	07-61-876	133
07-56-921	541	07-61-822N	133	07-61-876N	133
07-56-922	541	07-61-823	133	07-61-877	133
07-56-927	538	07-61-823N	133	07-61-877N	133
07-56-930	538	07-61-824	133	07-61-878	133
07-56-931	538	07-61-824N	133	07-61-878N	133
07-56-933	538	07-61-825	133	07-61-879	133
07-56-934	538	07-61-825N	133	07-61-879N	133
07-56-935	538	07-61-826	133	07-61-880	133
07-56-936	538	07-61-826N	133	07-61-880N	133
07-56-937	538	07-61-830	131	07-61-881	133
07-56-938	538	07-61-830N	131	07-61-881N	133
07-56-939	538	07-61-831	131	07-61-904	125
07-56-940	538	07-61-831N	131	07-61-904N	125
07-56-943	534	07-61-832	131	07-61-905	125
07-56-945	535	07-61-832N	131	07-61-905N	125
07-56-946	535	07-61-833	131	07-61-906	125
07-56-947	535	07-61-833N	131	07-61-906N	125
07-56-948	535	07-61-834	131	07-61-907	125
07-61-700	135	07-61-834N	131	07-61-907N	125
07-61-701	135	07-61-835	131	07-61-910	126
07-61-702	135	07-61-835N	131	07-61-910N	126
07-61-703	135	07-61-836	131	07-61-911	126
07-61-704	135	07-61-836N	131	07-61-911N	126
07-61-705	134	07-61-837	131	07-61-912	126
07-61-706	134	07-61-837N	131	07-61-912N	126
07-61-707	134	07-61-840	130	07-61-913	126
07-61-710	137	07-61-840N	130	07-61-913N	126
07-61-711	137	07-61-841	130	07-61-914	126
07-61-712	137	07-61-841N	130	07-61-914N	126
07-61-713	137	07-61-842	130	07-61-915	126
07-61-714	137	07-61-842N	130	07-61-915N	126
07-61-720	136	07-61-843	130	07-61-916	126
07-61-721	136	07-61-843N	130	07-61-916N	126
07-61-722	136	07-61-844	130	07-61-917	126
07-61-730	139	07-61-844N	130	07-61-917N	126
07-61-731	139	07-61-845	130	07-61-918	126
07-61-732	139	07-61-845N	130	07-61-918N	126
07-61-733	139	07-61-846	130	07-61-919	126
07-61-734	139	07-61-846N	130	07-61-919N	126
07-61-735	139	07-61-847	130	07-61-920	126
07-61-736	139	07-61-847N	130	07-61-920N	126
07-61-801	126	07-61-850	132	07-61-921	126
07-61-801N	126	07-61-850N	132	07-61-921N	126
07-61-802	126	07-61-851	132	07-61-922	126
07-61-802N	126	07-61-851N	132	07-61-922N	126
07-61-803	126	07-61-852	132	07-61-923	126
07-61-803N	126	07-61-852N	132	07-61-923N	126
07-61-804	126	07-61-853	132	07-61-924	126
07-61-804N	126	07-61-853N	132	07-61-924N	126
07-61-805	126	07-61-854	132	07-61-925	127
07-61-805N	126	07-61-854N	132	07-61-925N	127
07-61-806	132	07-61-855	132	07-61-926	127
07-61-806N	132	07-61-855N	132	07-61-926N	127
07-61-807	132	07-61-860	132	07-61-927	127
07-61-807N	132	07-61-860N	132	07-61-927N	127
07-61-808	132	07-61-861	132	07-61-928	127
07-61-808N	132	07-61-861N	132	07-61-928N	127
07-61-809	132	07-61-862	132	07-61-929	127
07-61-809N	132	07-61-862N	132	07-61-929N	127
07-61-810	132	07-61-863	132	07-61-930	127
07-61-810N	132	07-61-863N	132	07-61-930N	127

Seite/page	Seite/page	Seite/page	
07-61-931	127	13-03-300	364
07-61-931N	127	13-03-301	364
07-61-932	127	13-03-302	364
07-61-932N	127	13-03-303	364
07-61-933	127	13-03-304	364
07-61-933N	127	13-03-305	364
07-61-934	127	13-03-306	364
07-61-934N	127	13-03-307	364
07-61-935	127	13-03-308	364
07-61-935N	127	13-03-309	364
07-61-936	127	13-03-310	364
07-61-936N	127	13-03-311	364
07-61-937	127	13-03-312	364
07-61-937N	127	13-03-313	364
07-61-938	127	13-03-314	364
07-61-938N	127	13-03-315	364
07-61-939	127	13-03-316	364
07-61-939N	127	13-03-317	364
07-61-940	128	13-03-318	365
07-61-940N	128	13-03-319	365
07-61-941	128	13-03-320	365
07-61-941N	128	13-03-321	365
07-61-942	128	13-03-322	365
07-61-942N	128	13-03-323	365
07-61-943	129	13-03-324	365
07-61-943N	129	13-03-325	365
07-61-944	129	13-03-326	365
07-61-944N	129	13-03-327	365
07-61-945	129	13-03-328	365
07-61-945N	129	13-03-329	365
07-61-946	129	13-03-330	365
07-61-946N	129	13-03-331	365
07-61-947	129	13-03-332	365
07-61-947N	129	13-03-333	365
07-61-948	129	13-03-334	365
07-61-948N	129	13-03-335	365
07-61-949	131	13-04-463	480
07-61-949N	131	13-04-581	80
07-61-950	131	13-04-615	561
07-61-950N	131	13-04-617	553
07-61-951	131	13-06-112	242
07-61-951N	131	13-06-112T	242
07-61-952	131	13-06-113	242
07-61-952N	131	13-06-113T	242
07-61-953	131	13-06-114	242
07-61-953N	131	13-06-114T	242
07-61-954	131	13-06-115	242
07-61-954N	131	13-06-115T	242
07-61-955	131	13-06-116	242
07-61-955N	131	13-06-116T	242
07-61-956	131	13-06-117	242
07-61-956N	131	13-06-117T	242
07-61-957	131	13-06-118	242
07-61-957N	131	13-06-118T	242
07-61-958	131	13-06-119	242
07-61-958N	131	13-06-119T	242
07-61-959	131	13-06-120	242
07-61-959N	131	13-06-120T	242
07-61-960	130	13-06-121	242
07-61-960N	130	13-06-121T	242
07-61-961	130	13-06-122	242
07-61-961N	130	13-06-122T	242
07-61-962	130	13-06-123	242
07-61-962N	130	13-06-123T	242
07-61-963	130	13-06-124	242
07-61-963N	130	13-06-124T	242
07-61-964	130	13-06-125	242
07-61-964N	130	13-06-125T	242
07-61-965	130	13-06-126	242
07-61-965N	130	13-06-126T	242
07-61-966	130	13-06-127	242
07-61-966N	130	13-06-127T	242
07-61-967	130	13-06-128	242
07-61-967N	130	13-06-128T	242
07-61-968	130	13-06-251	268,269
07-61-968N	130	13-06-252	268,269
07-61-969	130	13-06-253	268,269
07-61-969N	130	13-06-254	268,269
07-61-970	130	13-06-255	268,269
07-61-970N	130	13-06-256	268,269
07-61-980	138	13-06-257	268,269
07-61-981	138	13-06-258	268,269
07-61-982	138	13-06-259	268,269
07-61-983	138	13-06-260	268,269
07-61-984	138		
07-61-985	138		
07-61-986	138		
07-61-987	138		
10-06-227	278,280,281,282,283,299,302		
10-07-223	299,302		
10-07-224	278,280,281,282,283		
10-56-010	120		
10-56-011	120		
10-56-012	120		
10-56-013	120		
10-56-020	121		
10-56-021	121		
10-56-022	121		
10-56-023	121		
10-56-024	119		
10-56-032	268,270,272,274		
10-56-933	278,280,281,282,283,299,302		
12-24-157	550		
12-24-158	551		
12-24-159	551		
12-74-156	550		
12-74-160	551		
13-02-279	591		
13-02-454	470		
13-02-487	305,306		
13-02-488	305,306		
13-02-497	305,306		
13-02-503	305,306		
13-02-504	305,306		
13-02-510	305,306		
13-02-516	305,306		
13-02-524	305,307		
13-02-525	305,307		
13-02-526	305,307		
13-02-527	305,307		
13-02-534	305,307		
13-02-546	305,307		
13-02-657	608		
13-02-658	608		
13-02-659	608		
13-02-660	608		
13-02-661	608		
13-02-662	608		
13-02-663	608		
13-02-664	608		
13-02-665	608		
13-02-666	608		
13-02-667	608		
13-02-668	608		
13-02-669	608		
13-02-675	609		
13-02-676	609		
13-02-677	609		
13-02-678	609		
13-02-679	609		
13-02-680	609		
13-02-681	609		
13-02-682	609		
13-02-683	609		
13-02-684	609		
13-02-685	609		
13-02-686	609		
13-02-687	609		
13-02-688	609		
13-02-689	609		
13-02-690	609		
13-02-691	609		
13-02-692	609		
13-02-693	609		
13-02-694	609		
13-02-831	305,307		
13-02-872	601		
13-02-873	601		
13-02-874	601		
13-02-875	601		
13-02-876	601		
13-02-877	601		
13-02-878	601		
13-02-879	601		
13-02-880	601		
13-02-944	305,307		
13-02-946	305,307		
13-02-947	305,307		

Seite/page	Seite/page	Seite/page			
13-06-261	268,269	13-56-003	65	13-56-048	68
13-06-262	268,269	13-56-004	65	13-56-048T	68
13-06-263	268,269	13-56-005	66	13-56-049	68
13-06-264	268,269	13-56-005T	66	13-56-049T	68
13-06-265	268,269	13-56-006	66	13-56-056	69
13-06-266	268,269	13-56-006T	66	13-56-057	69
13-06-267	268,269	13-56-007	66	13-56-100	64,241
13-06-268	268,269	13-56-007T	66	13-56-115	242
13-06-269	268,269	13-56-008	66	13-56-115T	242
13-06-270	268,269	13-56-008T	66	13-56-124	242
13-06-272	270,271	13-56-009	66	13-56-124T	242
13-06-273	270,271	13-56-009T	66	13-56-128	242
13-06-274	270,271	13-56-010	66	13-56-128T	242
13-06-275	270,271	13-56-010T	66	13-56-200	268
13-06-276	270,271	13-56-011	66	13-56-201	270
13-06-277	270,271	13-56-011T	66	13-56-202	272
13-06-278	270,271	13-56-012	66	13-56-203	274
13-06-279	270,271	13-56-012T	66	13-56-325	276
13-06-280	270,271	13-56-013	67	13-56-327	276
13-06-281	270,271	13-56-013T	67	13-56-328	276
13-06-282	270,271	13-56-014	67	13-56-500	274,275
13-06-283	270,271	13-56-014T	67	13-56-501	274,275
13-06-284	270,271	13-56-015	67	13-56-502	274,275
13-06-285	270,271	13-56-015T	67	13-56-503	274,275
13-06-286	270,271	13-56-016	67	13-56-504	274,275
13-06-287	270,271	13-56-016T	67	13-56-505	274,275
13-06-288	270,271	13-56-017	67	13-56-506	274,275
13-06-289	270,271	13-56-017T	67	13-56-507	274,275
13-06-290	270,271	13-56-018	67	13-56-508	274,275
13-06-291	270,271	13-56-018T	67	13-56-509	274,275
13-06-292	270,271	13-56-019	67	13-56-510	274,275
13-06-293	270,271	13-56-019T	67	13-56-511	274,275
13-06-294	270,271	13-56-020	67	14-04-087	377
13-06-296	272,273	13-56-020T	67	14-54-087	377
13-06-297	272,273	13-56-021	67	15-01-310	520
13-06-298	272,273	13-56-021T	67	15-01-311	520
13-06-299	272,273	13-56-022	67	15-01-312	520
13-06-300	272,273	13-56-022T	67	15-01-313	520
13-06-301	272,273	13-56-023	67	15-01-314	520
13-06-302	272,273	13-56-023T	67	15-01-332	78
13-06-303	272,273	13-56-024	70	15-01-333	78
13-06-304	272,273	13-56-024T	70	15-01-334	515
13-06-305	272,273	13-56-025	70	15-01-335	515
13-06-306	272,273	13-56-025T	70	15-01-336	515
13-06-307	272,273	13-56-026	70	15-01-337	515
13-06-308	272,273	13-56-026T	70	15-01-338	515
13-06-309	272,273	13-56-027	70	15-01-351	78
13-06-310	272,273	13-56-027T	70	15-03-020	466
13-06-311	272,273	13-56-028	70	15-03-021	466
13-06-312	272,273	13-56-028T	70	15-03-022	466
13-06-313	272,273	13-56-029	70	15-03-430	434
13-06-314	272,273	13-56-029T	70	15-03-431	434
13-06-315	272,273	13-56-030	70	15-03-671	534
13-06-316	272,273	13-56-030T	70	15-06-099	144
13-06-317	272,273	13-56-031	70	15-07-164	576
13-06-318	272,273	13-56-031T	70	15-07-165	576
13-06-319	272,273	13-56-032	71	15-07-950	549
13-06-321	268,269	13-56-032T	71	15-07-951	549
13-06-322	268,269	13-56-033	71	15-07-960	546
13-06-323	268,269	13-56-033T	71	15-07-961	546
13-52-499	305	13-56-034	71	15-07-962	546
13-52-663	608	13-56-034T	71	15-07-963	546
13-52-669	305,306	13-56-035	71	15-07-964	546
13-53-300	365	13-56-035T	71	15-07-970	547
13-53-301	365	13-56-036	71	15-07-971	547
13-53-302	365	13-56-036T	71	15-07-972	547
13-53-303	365	13-56-037	71	15-07-973	547
13-53-304	365	13-56-037T	71	15-07-974	547
13-53-305	365	13-56-038	71	15-07-975	547
13-53-306	365	13-56-038T	71	15-11-089	236
13-53-307	365	13-56-039	69	15-11-090	236
13-53-308	365	13-56-040	69	15-11-100	235
13-53-309	365	13-56-041	69	15-11-101	235
13-53-310	365	13-56-042	69	15-11-102	235
13-53-311	365	13-56-043	68	15-11-103	235
13-53-312	365	13-56-043T	68	15-11-350	465
13-53-313	365	13-56-044	68	15-11-351	465
13-53-314	365	13-56-044T	68	15-11-352	465
13-53-315	365	13-56-045	68	15-11-365	428
13-53-316	365	13-56-045T	68	15-11-366	428
13-53-317	365	13-56-046	68	15-11-367	428
13-56-000	64,241	13-56-046T	68	15-11-368	431
13-56-001	65	13-56-047	68	15-11-369	431
13-56-002	65	13-56-047T	68	15-11-370	464

Seite/page	Seite/page	Seite/page	
15-11-371	464	50-31-142	221
15-11-372	431	50-31-143	215,221
15-11-373	431	50-31-144	221
15-11-374	430	50-31-145	215,221
15-11-503	380	50-31-146	221
15-11-505	378	50-31-147	222
15-11-506	378	50-31-148	222
15-11-507	378	50-31-149	223
15-11-508	378	50-31-150	223
15-11-509	378	50-31-151	223
15-11-520	378	50-31-152	223
15-11-521	378	50-31-153	223
15-11-522	378	50-31-158	215,220
15-11-525	376	50-31-159	215,220
15-11-526	376	50-31-160	215,220
15-11-536	376	50-31-161	216
15-11-537	376	50-31-162	218
15-11-538	376	50-31-163	222
15-11-711	363	50-31-164	222
15-11-712	363	50-31-251	224
15-11-740	362	50-31-252	224
15-11-741	362	50-31-253	224
15-11-742	362	50-31-254	224
15-11-743	362	50-31-255	224
15-11-794	321	50-31-256	224
15-11-795	321	50-31-257	224
15-12-155	577	50-31-258	224
15-12-157	592	50-31-301	226
15-12-160	89	50-31-302	226
15-12-162	90	50-31-303	226
15-12-163	90	50-31-304	215,226
15-12-164	574	50-31-305	226
15-12-165	90	50-31-306	226
15-12-166	90	50-31-307	226
15-12-170	90,582	50-31-351	215,226
15-12-171	582	50-31-352	211,212,215,216
15-12-172	582	50-31-353	215,226
15-12-179	577	50-31-501	215,227
15-12-183	542	50-31-502	215,227
15-12-185	542	50-31-503	215,227
15-12-192	581	50-31-505	211,213,215,228
15-12-198	581	50-31-507	229
15-12-294	607	50-31-509	229
15-12-296	607	50-31-510	211,213,215,229
15-12-298	607	50-31-513	230
15-12-299	607	50-31-514	230
15-12-300	607	50-31-518	230
15-12-301	237,607	50-31-525	215,231
15-12-302	237,607	50-31-526	215,231
15-12-303	237,607	50-31-527	231
15-12-304	237,607	50-31-528	231
15-12-307	607	50-36-100	225
15-12-421	634	50-36-101	225
15-12-423	634	50-36-102	225
15-12-425	634	50-36-103	225
15-12-427	634	50-36-104	225
15-12-429	634	50-36-105	225
15-12-601	81	50-36-106	225
15-12-602	81	50-36-107	225
15-12-603	81	50-36-108	225
15-12-610	79	50-36-109	225
15-12-611	78	50-36-110	225
15-12-612	78	50-36-111	225
15-12-615	79	50-36-112	225
15-12-616	79	50-36-140	225
15-12-617	78	50-36-144	225
15-12-619	78	50-36-148	225
15-12-620	80	50-36-152	225
15-12-621	78	50-36-200	225
15-12-622	80	50-36-201	225
15-12-623	80	50-36-202	225
15-12-624	80	50-36-203	225
15-13-307	573	50-36-204	225
15-13-308	573	50-36-240	225
15-13-309	579	50-36-244	225
15-13-314	575	65 000	205
15-13-315	575	65 097	183
15-13-489	420	65 097T	183
15-13-671	534	65 098	183
15-61-501	378	65 098T	183
15-61-502	378	65 099	183
15-61-517	378	65 099T	183
15-61-518	378	65 100	183
15-61-519	378	65 100T	183
15-61-523	378		
15-61-598	379		
15-61-599	379		
15-61-600	379		
15-61-601	379		
15-61-602	379		
15-61-603	379		
15-61-605	379		
15-61-606	379		
15-61-607	379		
15-61-608	379		
15-61-609	379		
15-61-610	379		
15-61-611	379		
15-61-612	379		
15-61-613	379		
15-61-615	380		
15-61-616	380		
15-61-617	380		
15-61-618	380		
15-61-619	380		
15-61-620	380		
15-61-621	380		
15-61-622	380		
15-61-623	380		
15-61-624	380		
15-61-625	380		
15-61-626	380		
15-61-711	363		
15-61-712	363		
15-62-300	237,607		
15-62-301	607		
15-62-302	607		
15-62-303	607		
15-62-304	607		
15-62-305	607		
20-05-749	236		
20-55-749	308		
50-31-000	214		
50-31-001	215		
50-31-002	215		
50-31-003	215		
50-31-011	211		
50-31-015	211,213		
50-31-101	211,212,215,216		
50-31-102	211,212,215,216		
50-31-104	215,216		
50-31-105	215,216		
50-31-106	215,216		
50-31-107	216		
50-31-108	216		
50-31-109	216		
50-31-110	216		
50-31-111	216		
50-31-112	216		
50-31-113	217		
50-31-114	217		
50-31-115	217		
50-31-116	217		
50-31-117	217		
50-31-118	217		
50-31-119	217		
50-31-120	217		
50-31-121	217		
50-31-122	217		
50-31-123	217		
50-31-124	217		
50-31-125	218		
50-31-126	218		
50-31-127	218		
50-31-128	218		
50-31-129	215,218		
50-31-130	218		
50-31-131	219		
50-31-132	215,219		
50-31-133	219		
50-31-134	219		
50-31-135	219		
50-31-136	219		
50-31-137	219		
50-31-138	215,220		
50-31-139	211,212,215,220		
50-31-140	215,220		
50-31-141	215,221		

Seite/page	Seite/page	Seite/page			
65 102	183	65 226	189	65 323	179
65 102T	183	65 226T	189	65 323T	179
65 103	181	65 227	189	65 324	179
65 103T	181	65 227T	189	65 324T	179
65 104	183	65 228	189	65 325	179
65 104T	183	65 228T	189	65 325T	179
65 110	183	65 240	179	65 330	181
65 110T	183	65 240T	179	65 330T	181
65 112	183	65 242	179	65 332	181
65 112T	183	65 242T	179	65 332T	181
65 113	181	65 244	179	65 333	181
65 113T	181	65 244T	179	65 333T	181
65 114	183	65 246	181	65 340	179
65 114T	183	65 246T	181	65 340T	179
65 120	183	65 247	181	65 350	181
65 120T	183	65 247T	181	65 350T	181
65 122	183	65 248	179	65 351	181
65 122T	183	65 248T	179	65 351T	181
65 123	181	65 250	179	65 381	187
65 123T	181	65 250T	179	65 381T	187
65 124	183	65 252	179	65 382	187
65 124T	183	65 252T	179	65 382T	187
65 137	185	65 254	179	65 383	187
65 137T	185	65 254T	179	65 383T	187
65 138	185	65 258	179	65 386	187
65 138T	185	65 258T	179	65 386T	187
65 139	185	65 259	181	65 387	187
65 139T	185	65 259T	181	65 387T	187
65 140	185	65 260	179	65 388	187
65 140T	185	65 260T	179	65 388T	187
65 142	185	65 261	181	65 389	187
65 142T	185	65 261T	181	65 389T	187
65 144	185	65 262	179	65 391	187
65 144T	185	65 262T	179	65 391T	187
65 148	185	65 263	181	65 392	187
65 148T	185	65 263T	181	65 392T	187
65 150	185	65 264	179	65 393	187
65 150T	185	65 264T	179	65 393T	187
65 152	185	65 270	181	65 394	187
65 152T	185	65 270T	181	65 394T	187
65 154	185	65 271	181	65 395	179
65 154T	185	65 271T	181	65 395T	179
65 158	185	65 272	181	65 396	179
65 158T	185	65 272T	181	65 396T	179
65 160	185	65 273	181	65 397	181
65 160T	185	65 273T	181	65 397T	181
65 162	185	65 274	187	65 597	182
65 162T	185	65 274T	187	65 597T	182
65 164	185	65 275	187	65 598	182
65 164T	185	65 275T	187	65 598T	182
65 168	185	65 276	187	65 599	182
65 168T	185	65 276T	187	65 599T	182
65 180	189	65 277	187	65 600	182
65 180T	189	65 277T	187	65 600T	182
65 182	189	65 278	187	65 602	182
65 182T	189	65 278T	187	65 602T	182
65 190	189	65 279	187	65 603	180
65 190T	189	65 279T	187	65 603T	180
65 192	189	65 280	179	65 604	182
65 192T	189	65 280T	179	65 604T	182
65 194	189	65 282	179	65 610	182
65 194T	189	65 282T	179	65 610T	182
65 200	189	65 284	179	65 612	182
65 200T	189	65 284T	179	65 612T	182
65 210	189	65 286	179	65 613	180
65 210T	189	65 286T	179	65 613T	180
65 211	189	65 290	179	65 614	182
65 211T	189	65 290T	179	65 614T	182
65 212	189	65 292	179	65 620	182
65 212T	189	65 292T	179	65 620T	182
65 213	189	65 297	181	65 622	182
65 213T	189	65 297T	181	65 622T	182
65 214	189	65 298	181	65 623	180
65 214T	189	65 298T	181	65 623T	180
65 216	189	65 306	189	65 624	182
65 216T	189	65 306T	189	65 624T	182
65 217	189	65 307	189	65 637	184
65 217T	189	65 307T	189	65 637T	184
65 220	189	65 319	181	65 638	184
65 220T	189	65 319T	181	65 638T	184
65 222	189	65 320	181	65 639	184
65 222T	189	65 320T	181	65 639T	184
65 224	189	65 322	181	65 640	184
65 224T	189	65 322T	181	65 640T	184

<i>Seite/page</i>	<i>Seite/page</i>	<i>Seite/page</i>	
65 642	184	65 886	186
65 642T	184	65 886T	186
65 644	184	65 887	186
65 644T	184	65 887T	186
65 648	184	65 888	186
65 648T	184	65 888T	186
65 650	184	65 889	186
65 650T	184	65 889T	186
65 652	184	65 891	186
65 652T	184	65 891T	186
65 654	184	65 892	186
65 654T	184	65 892T	186
65 658	184	65 893	186
65 658T	184	65 893T	186
65 660	184	65 894	186
65 660T	184	65 894T	186
65 662	184	65 895	178
65 662T	184	65 895T	178
65 664	184	65 896	178
65 664T	184	65 896T	178
65 668	184	65 897	180
65 668T	184	65 897T	180
65 680	188	90-80-071	388
65 680T	188	90-80-072	388
65 682	188	90-80-073	388
65 682T	188	90-80-075	387
65 690	188	90-80-076	387
65 690T	188	90-80-077	387
65 692	188	90-80-196	386
65 692T	188	90-80-197	386
65 694	188	90-80-198	386
65 694T	188	90-80-244	386
65 700	188	90-80-245	386
65 700T	188	90-80-246	386
65 710	188	90-80-286	387
65 710T	188	90-80-287	387
65 711	188	90-80-288	387
65 711T	188	90-80-289	387
65 712	188	90-80-292	387
65 712T	188	90-80-293	387
65 713	188	90-80-323	387
65 713T	188	90-80-324	387
65 714	188	90-80-325	387
65 714T	188	90-80-326	387
65 716	188	90-80-327	387
65 716T	188	90-80-328	387
65 717	188	90-80-329	387
65 717T	188	90-80-330	387
65 720	188	90-80-390	387
65 720T	188	90-80-391	387
65 722	188	90-80-396	386
65 722T	188	90-80-397	386
65 724	188	90-80-398	386
65 724T	188	90-80-399	386
65 726	188	90-80-400	386
65 726T	188	90-80-401	386
65 727	188	90-80-402	386
65 727T	188	90-80-403	386
65 728	188	90-80-404	386
65 728T	188	90-80-405	386
65 740	178	90-80-406	386
65 740T	178	90-80-407	386
65 742	178	90-80-408	386
65 742T	178	90-80-409	386
65 744	178	90-80-410	386
65 744T	178	90-80-411	386
65 746	180	90-80-412	386
65 746T	180	90-80-413	386
65 747	180	90-80-414	386
65 747T	180	90-80-415	386
65 748	178	90-80-416	386
65 748T	178	90-80-417	386
65 750	178	90-80-418	386
65 750T	178	90-80-419	386
65 752	178	90-80-500	386
65 752T	178	90-80-501	386
65 754	178	90-80-502	386
65 754T	178	90-80-503	386
65 758	178	90-80-504	386
65 758T	178	90-80-505	386
65 759	180	90-80-506	386
65 759T	180	90-80-507	386
65 760	178	90-80-508	386
65 760T	178	90-80-509	386
65 761	180		
65 761T	180		
65 762	178		
65 762T	178		
65 763	180		
65 763T	180		
65 764	178		
65 764T	178		
65 770	180		
65 770T	180		
65 771	180		
65 771T	180		
65 772	180		
65 772T	180		
65 773	180		
65 773T	180		
65 774	186		
65 774T	186		
65 775	186		
65 775T	186		
65 776	186		
65 776T	186		
65 777	186		
65 777T	186		
65 778	186		
65 778T	186		
65 779	186		
65 779T	186		
65 780	178		
65 780T	178		
65 782	178		
65 782T	178		
65 784	178		
65 784T	178		
65 786	178		
65 786T	178		
65 790	178		
65 790T	178		
65 792	178		
65 792T	178		
65 797	180		
65 797T	180		
65 798	180		
65 798T	180		
65 806	188		
65 806T	188		
65 807	188		
65 807T	188		
65 819	180		
65 819T	180		
65 820	180		
65 820T	180		
65 822	180		
65 822T	180		
65 823	178		
65 823T	178		
65 824	178		
65 824T	178		
65 825	178		
65 825T	178		
65 830	180		
65 830T	180		
65 832	180		
65 832T	180		
65 833	180		
65 833T	180		
65 840	178		
65 840T	178		
65 850	180		
65 850T	180		
65 851	180		
65 851T	180		
65 853	184		
65 853T	184		
65 855	184		
65 855T	184		
65 856	184		
65 856T	184		
65 881	186		
65 881T	186		
65 882	186		
65 882T	186		
65 883	186		
65 883T	186		

SURGICAL
INSTRUMENTS
MICRO-NEURO-SPINE

© Copyright by Rebstock Instruments GmbH. Alle Rechte vorbehalten. Nachdruck, auch auszugsweise, verboten. Kein Teil dieses Katalogs darf ohne schriftliche Genehmigung der Firma Rebstock Instruments GmbH in irgendeiner Form reproduziert oder unter Verwendung elektronischer Systeme verarbeitet, vervielfältigt oder verbreitet werden.
Modell- und technische Änderungen vorbehalten.

© Copyright by Rebstock Instruments GmbH. All rights reserved. Full or partial reproduction prohibited. No part of this catalogue may be reproduced, processed or transmitted in any form or manner, electronic or mechanical without written permission of Rebstock Instruments GmbH.
Models and technical specifications are subject to change.

REBSTOCK®
Precision made in Germany

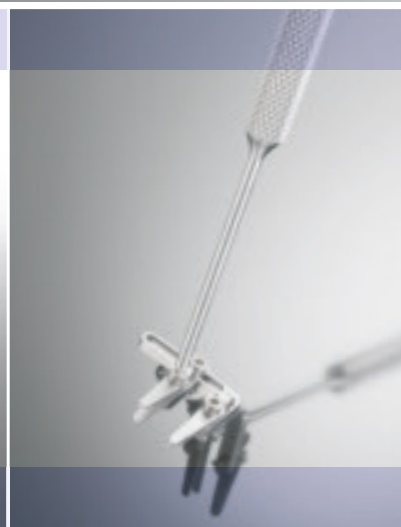
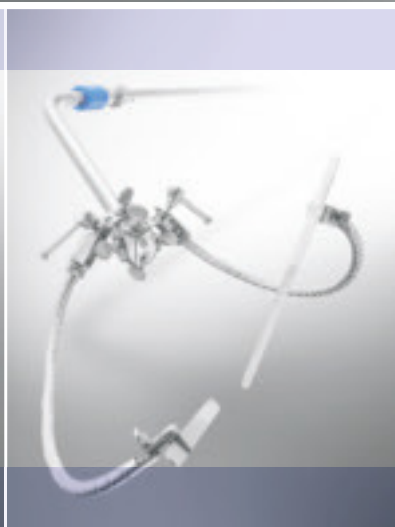
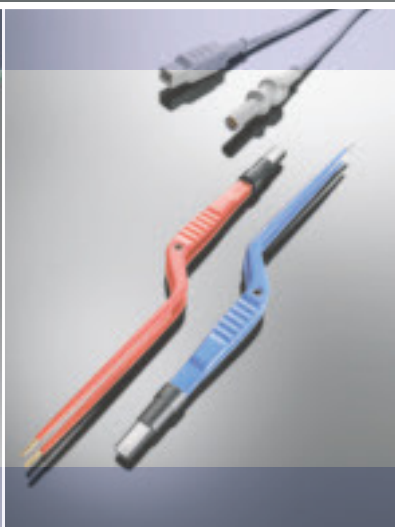
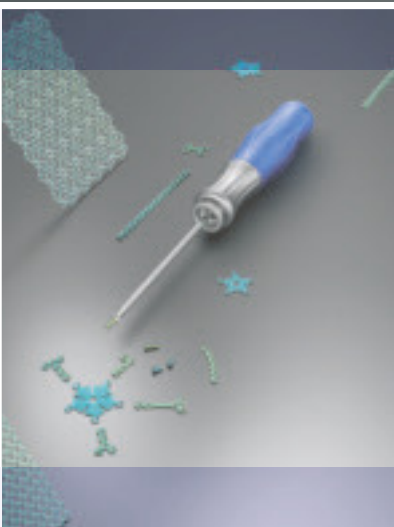

REBSTOCK INSTRUMENTS GMBH
IN WEIHERÄCKER 7
D-78589 DÜRBHEIM / TUTTLINGEN

TEL +49 7424 6734
FAX +49 7424 4334

www.rebstock.de
info@rebstock.de