

# TOP DEAL

**KSTOOLS**

WWW.KSTOOLS.COM

*No Limits!*

UNSERE SCHLÜSSELKOMPETENZ:

QUALITÄT ZUM HAMMER-PREIS!

EVOLUTION  
SERIES



Komplette  
Stückliste

917.0255

1/4" + 3/8" + 1/2" + 5/16"

255 TEILE  
FÜR NUR

**119,90**

**EDELSTAHL**  
ROSTFREI

**i** **397**  
Weitere Informationen

**P<sub>10</sub>**

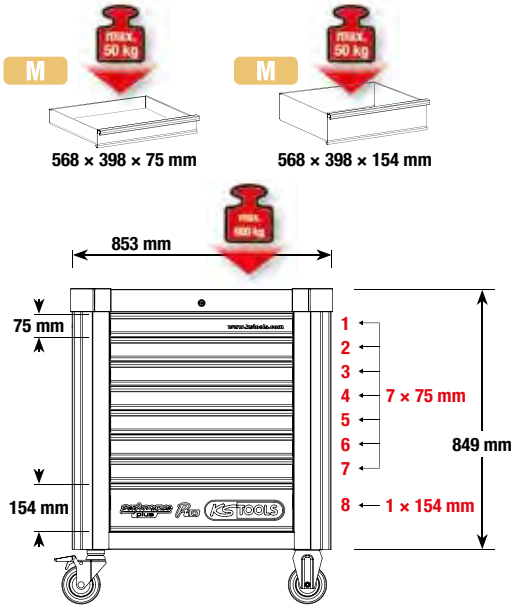

**WÄHLEN SIE IHR POWER-PAKET**

810.7397

**i** **397**  
Weitere Informationen

- inklusive Papierrollenhalter
- inklusive Dosenhalter
- Stabile Kugellager
- Antistatische Rollen mit Bremse

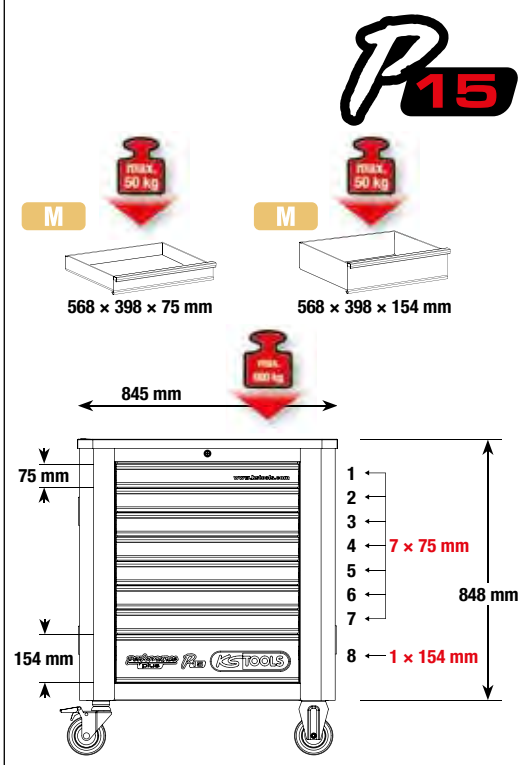

815.7397

**DAS PERFEKTE PAKET MIT 397 TEILEN**

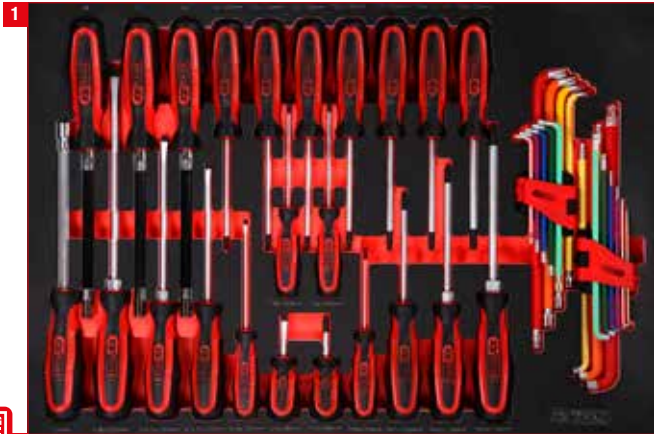

41 Schraubendreher-Satz



41 Schraubenschlüssel-Satz

**2699,00**

810.7397 P10 Werkstattwagen mit 397 Werkzeugen



111 1/4" + 3/8" + 1/2" Steckschlüssel-Satz

**2799,00**

815.7397 P15 Werkstattwagen mit 397 Werkzeugen



28 Zangen- und Feilen-Satz



43 Öl- und Reifendienst-Satz



111 1/2" Bit-Stecknuss-Satz



22 Hammer- und Meißel-Satz

# HERZLICH WILLKOMMEN IN

**i** **564**  
 Weitere Informationen



**MIT 564 WERKZEUGEN**

**3799,00**



Integrierter Kantenschutz



inklusive Dosenhalter



Stabile Kugellager



Antistatische Rollen mit Bremse



Schloss

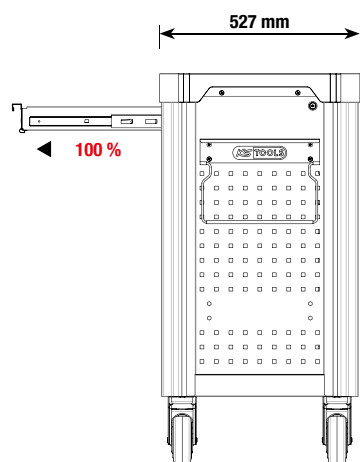
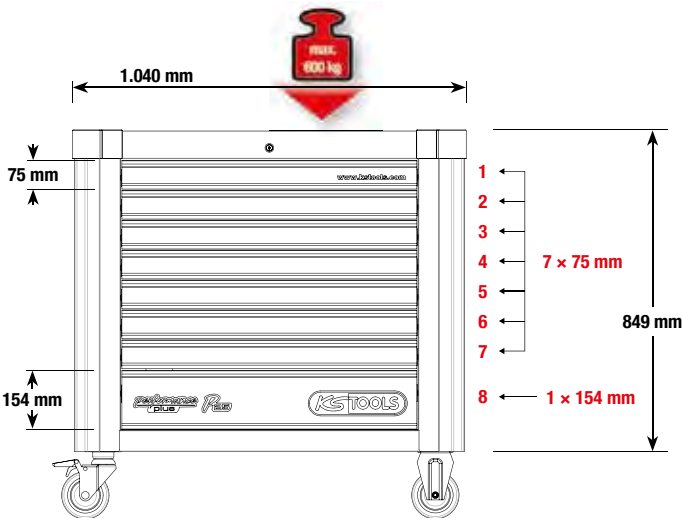

825.8564

# DER KÖNIGSKLASSE!

Performance  
plus

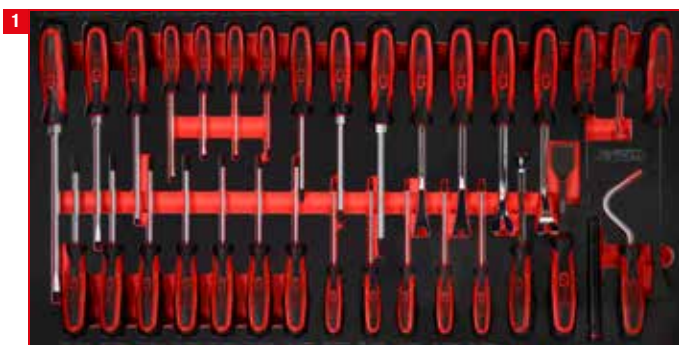

Schraubendreher-Satz

33



1/4" + 3/8" Steckschlüssel-Satz

213



1/2" Steckschlüssel-Satz

86

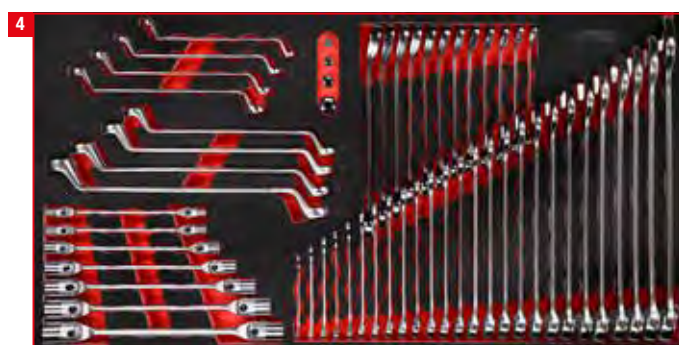

Schraubenschlüssel-Satz

57



Schraubenschlüssel-Satz

54

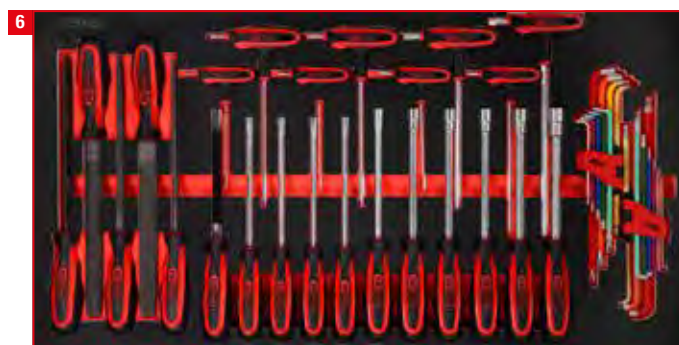

Schraubendreher- und Feilen-Satz

42

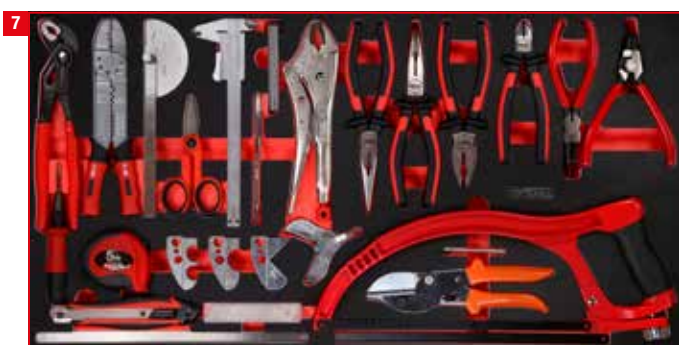

Zangen- und Messwerkzeug-Satz

39



Hammer- Meißel- und Kraft-Stecknuss-Satz

40

# WIE VIEL WAGEN DARF'S SEIN?



Arbeitsplatte mit 10 mm starker Schaumstoffeinlage



verschiebbar durch eingebautes Zylinderschloss



mit Selbsteinzug und SOFT-CLOSE-Funktion



Vierkantlochung für Zubehörteile



2 x Roll- und Drehbremsen Ø Räder: 125 mm

## ECO Line

# 449,90

OHNE WERKZEUGE



**i** **1** 897.0007  
Weitere Informationen

Technische Daten:	Eco Line 897.0007	Racing Line 826.0007
Gesamttragkraft:	300,0 kg	350,0 kg
Belastbarkeit je Schublade:	25,0 kg	30,0 kg
Selbsteinzug und SOFT-CLOSE-Funktion:	✓	✗
Raddurchmesser:	125,0 mm	125,0 mm
Radfeststeller:	✓	✓
Mit Zentralverriegelung:	✓	✓
Einzelverriegelung Schubladen:	✗	✓
Höhe:	1014,0 mm	976,0 mm
Breite:	748 mm	788 mm
Tiefe:	459,0 mm	496,0 mm
Schubladeninnenmaß:	565 x 395 mm	565 x 395 mm
mit Polyurethan Ecken-Kantenschutz:	✗	✓
Vierkantlochung für Zubehörteile:	✓	✓
Anzahl Schubladen:	7	7
Blechstärke:	0,8 mm	0,9 mm
Griffeisten:	✓	✓
Schubladenauszug:	100 %	90 %
Arbeitsplatte mit Kleinteilfächern:	✗	✓
Arbeitsplatte mit Schaumstoffeinlagen:	✓	✗
kugellagerte Schubladenführung:	✓	✓
seitlicher Metallhandgriff:	✓	✓

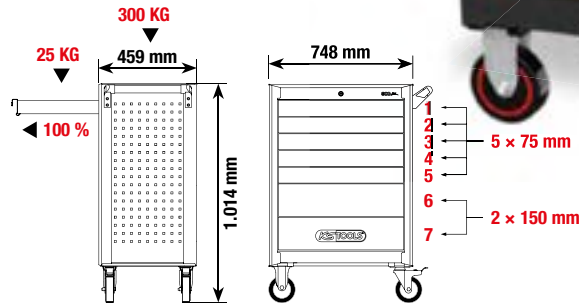

## QUAL DER WAHL? WAHL MIT QUALITÄT!

## RACING Line



Arbeitsplatte aus ABS mit Kleinteilfächern



verschiebbar durch eingebautes Zylinderschloss



Einzelverriegelung verhindert ungewolltes Öffnen



Vierkantlochung für Zubehörteile



2 x Roll- und Drehbremsen Ø Räder: 125 mm

# 499,90

OHNE WERKZEUGE

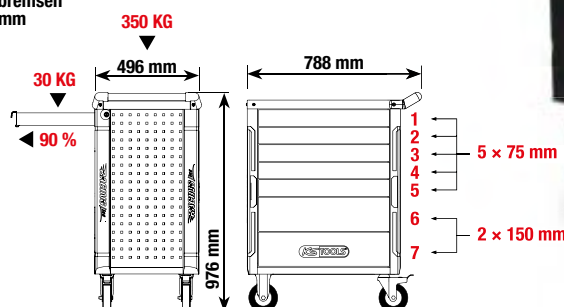

**i** **1** 826.0007  
Weitere Informationen

**ECO** *line*

Mit 7 Schubladen und  
215 Premium-Werkzeugen

**679,90**

897.7215

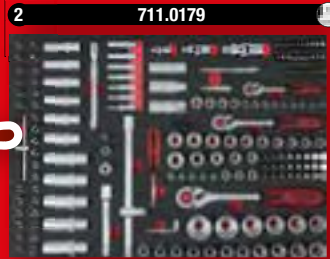

# START PAKET - 215 TLG.

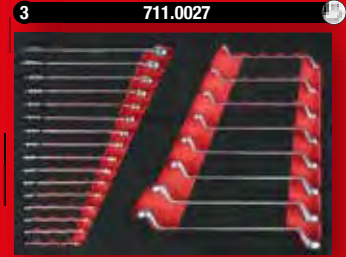

Weitere Informationen

**RACING** *line*

Mit 7 Schubladen und  
215 Premium-Werkzeugen

**699,90**

826.7215



# UNIVERSAL PAKET - 515 TLG.

**ECO** *line*

Mit 7 Schubladen und  
515 Premium-Werkzeugen

**879,90**

897.7515

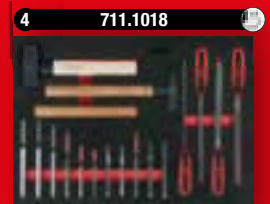

**RACING** *line*

Mit 7 Schubladen und  
515 Premium-Werkzeugen

**899,90**

826.7515

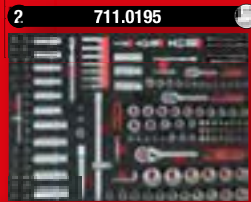

Weitere Informationen

**ECO** *line*

Mit 7 Schubladen und  
598 Premium-Werkzeugen

**1299,00**

897.7598

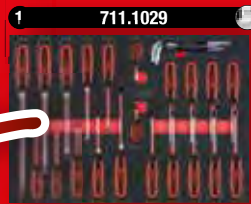

# POWER PAKET - 598 TLG.



**RACING** *line*

Mit 7 Schubladen und  
598 Premium-Werkzeugen

**1349,00**

826.7598

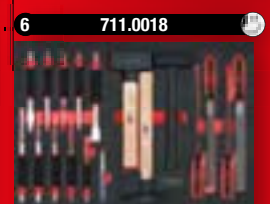
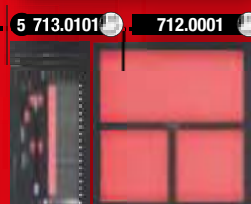
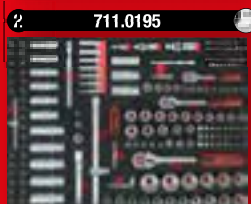

Weitere Informationen

- DIN 3110 / ISO 1085 / ISO 10102 / ISO 3318
- Maulstellung 15° abgewinkelt
- geschliffene Köpfe
- matt satiniert
- Chrom Vanadium

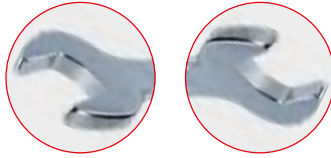

**ab 19,90**

<b>A</b>	517.0148			6x7 · 8x9 · 10x11 · 12x13 14x15 · 16x17 · 18x19 20x22 mm	19,90 €
<b>B</b>	517.0123			6x7 · 8x9 · 10x11 · 12x13 14x15 · 16x17 · 18x19 20x22 · 21x23 · 24x27 30x32 mm	44,90 €
<b>C</b>	517.0125			6x7 · 8x9 · 10x11 · 12x13 14x15 · 16x17 · 18x19 20x22 · 21x23 · 24x27 25x28 · 30x32 mm	49,90 €



- FlankTraction-Profil
- Maulstellung 15° abgewinkelt
- Ring 15° abgewinkelt
- polierte Köpfe
- matt satiniert



**ab 22,90**

<b>A</b>	517.0048			8 · 9 · 10 · 11 · 13 · 14 17 · 19 mm	22,90 €
<b>B</b>	517.0052			8 · 9 · 10 · 11 · 12 · 13 · 14 15 · 16 · 17 · 18 · 19 mm	42,90 €
<b>C</b>	517.0043			6 · 7 · 8 · 9 · 10 · 11 · 12 13 · 14 · 15 · 16 · 17 · 18 19 · 20 · 21 · 22 · 24 · 27 30 · 32 mm	109,50 €



- 12-kant
- DIN 838 / ISO 1085 / ISO 10104 / ISO 3318
- Ringe 75° gekröpft
- dünnwandig
- polierte Köpfe



**ab 24,90**

<b>A</b>	517.0248			6x7 · 8x9 · 10x11 · 12x13 14x15 · 16x17 · 18x19 20x22 mm	24,90 €
<b>B</b>	517.0222			6x7 · 8x9 · 10x11 · 12x13 14x15 · 16x17 · 18x19 20x22 · 21x23 · 24x27 30x32 mm	49,90 €





**i** **1**  
Weitere Informationen

**14,90**

315 mm

22 mm

19 mm

522.1922

**i** **1**  
Weitere Informationen

**DIE 4 IN 1 WENDERATSCHKE**

10 mm

13 mm

17 mm

19 mm

**19,90**

72

5°

503.4565

10 x 13 x 17 x 19 mm

**i** **1**  
Weitere Informationen

**DAS MULTITALENT**

Einhand-Multifunktions-Schlüssel

260 mm

8-17 mm

14-32 mm

114.0055

8 · 9 · 10 · 11 · 12 · 13 · 14 · 15 · 16 · 17 · 18 · 19 · 20 · 21 · 22 · 23 · 24 · 25 · 26 · 27 · 28 · 29 · 30 · 31 · 32 mm

**33,90**

**i** **12**  
Weitere Informationen

72

5°

**119,90**

503.4665

8 · 9 · 10 · 11 · 12 · 13 · 14 · 15 · 16 · 17 · 18 · 19 mm

**i** **30**  
Weitere Informationen

**DER ALLESKÖNNER**

5/16" x 13 mm

1/2"

10 mm x 13 mm

3/8"

1/4" x 10 mm

1/4"

12 x

12 x

**168,90**

503.4960

8 · 9 · 10 · 11 · 12 · 13 · 14 · 15 · 16 · 17 · 18 · 19 mm

**i** **2**  
Weitere Informationen

72 5°

1/2" 305 - 445 mm

173 - 283 mm

1/4"

**VERSTELLBAR:**  
1/4" IN 4 STUFEN  
1/2" IN 6 STUFEN

**NEU** **34,90**

914.1412

**i** **1**  
Weitere Informationen

**NEU** 600 MM!

72 5°

1/2" 460 - 600 mm

Stufe: 1 2 3 4 5 6

**24,90**

**VERSTELLBAR IN 6 STUFEN**

914.1205

**i** **1**  
Weitere Informationen

**49,90**

760 mm

**MAXIMALE FLEXIBILITÄT,  
OPTIMALE KONTROLLE**

1/2"

918.1293

**72 5°**

**BESTÄNDIGE POWER –  
INNOVATIVE FUNKTION**

A B C

1/4" 3/8" 1/2"

**ab 24,90**

**+** 1/4" 102 Nm

1/2" 710 Nm

72 5°

**54,90**

**i** **2**  
Weitere Informationen

920.0002

			Nm	↔	
<b>A</b>	920.1490		102	140 mm	24,90 €
<b>B</b>	920.3890		325	190 mm	29,90 €
<b>C</b>	920.1290		710	245 mm	36,50 €

**-40%**

# DIE BESTEN, DIE WIR JE GEBAUT HABEN!

Wir wissen, was wir können. Und weil wir ganz genau wissen, wie gut unser neues Monster-Ratschen-Sortiment ist, ist es für uns selbstverständlich, Ihnen eine Garantie auf jedes Modell zu gewähren. Nicht 2 oder 3 Jahre. Nein, es sind gleich 10 Jahre! Damit die Garantie genauso Premium ist wie unsere Monster-Ratschen!



**1** **80**  $\angle$  **4,5°**

**1/4"**

**29,90**

**i** **1**

Weitere Informationen

935.1490 **1/4"** **106 g** **125 mm** **>110 Nm**

**2** **80**  $\angle$  **4,5°**

**1/4"**

**29,90**

**i** **1**

Weitere Informationen

935.1495 **1/4"** **106 g** **125 mm** **>100 Nm**

**3** **96**  $\angle$  **3,75°**

**3/8"**

**39,90**

**i** **1**

Weitere Informationen

935.3890 **3/8"** **227 g** **199 mm** **>365 Nm**

**i**

**GARANTIERT:**

**6 MONSTER**

**FÜRS LEBEN!**

**4** **100**  $\angle$  **3,6°**

**1/2"**

**49,90**

**i** **1**

Weitere Informationen

935.1290 **1/2"** **567 g** **275 mm** **>950 Nm**

**5** **100**  $\angle$  **3,6°**

**1/2"**

**69,90**

**i** **1**

Weitere Informationen

935.1295 **1/2"** **757 g** **425 mm** **>950 Nm**

**6** **100**  $\angle$  **3,6°**

**1/2"**

**99,90**

**i** **1**

Weitere Informationen

**TELESKOPIERBAR**

406 431 457 482 508 533 557 582 607 635 mm

935.1285 **1/2"** **1.280 g** **406 - 635 mm** **>950 Nm**

**-15%**

**NEU**

935.0002

**>950 Nm**

**100**  $\angle$  **3,6°**

**1/2"**

**+**

**80**  $\angle$  **4,5°**

**1/4"**

**>110 Nm**

**i** **2**

Weitere Informationen

**69,90**

**i**  **9**  
 Weitere Informationen

**Bit-Stecknuss-Satz  
 für Innensechskant-Schrauben, kurz**

**3/8"** 

4 mm 5 mm 6 mm 7 mm 8 mm 9 mm 10 mm 12 mm 14 mm

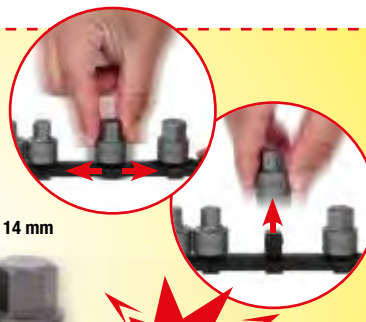

**NEU**

**34,90**

917.4000  4 - 5 - 6 - 7 - 8 - 9 - 10 - 12 - 14 mm

**BITTE EIN BIT. ABER KURZ!**

**i**  **10**  
 Weitere Informationen

**Bit-Stecknuss-Satz  
 für Torx-Schrauben, kurz**

**3/8"** 

T10 T15 T20 T25 T27 T30 T40 T45 T50 T55

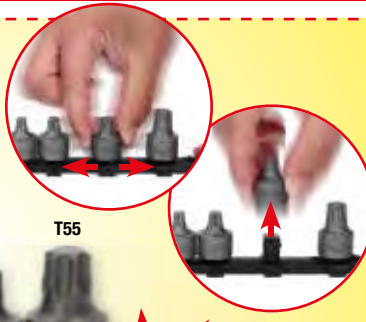



















**NEU**







**39,90**

917.4015  T10 - T15 - T20 - T25 - T27 - T30 - T40 - T45 - T50 - T55

**TORX TOTAL: ALLES IN EINEM KOFFER**

**i**  **77**  
 Weitere Informationen

5 x		1/4": E4 - E5 - E6 - E7 - E8
4 x		3/8": E10 - E12 - E14 - E16
4 x		1/2": E18 - E20 - E22 - E24
5 x		1/4": EPL4 - EPL5 - EPL6 - EPL7 - EPL8
4 x		3/8": EPL10 - EPL12 - EPL14 - EPL16
4 x		1/2": EPL18 - EPL20 - EPL22 - EPL24
8 x		1/4": T6 - T8 - T10 - T15 - T20 - T25 - T27 - T30
5 x		3/8": T40 - T45 - T47 - T50 - T55
2 x		1/2": T60 - T70
7 x		1/4": TB8 - TB10 - TB15 - TB20 - TB25 - TB27 - TB30
4 x		3/8": TB40 - TB45 - T50 - T55
1 x		1/2": TB60
7 x		1/4": IP8 - IP10 - IP15 - IP20 - IP25 - IP27 - IP30
3 x		3/8": IP40 - IP45 - IP50
2 x		1/2": IP55 - IP60
7 x		1/4": IPR8 - IPR10 - IPR15 - IPR20 - IPR25 - IPR27 - IPR30
3 x		3/8": IPR40 - IPR45 - IPR50
2 x		1/2": IPR55 - IPR60

-  E ✓
-  EPL ✓
-  TX ✓
-  TB ✓
-  IP ✓
-  IPR ✓

**99,90**

**NEU**



EVOLUTION  
 SERIES

**1/4" + 3/8" + 1/2"**



911.0077

**i** **30**  
Weitere Informationen

EVOLUTION SERIES

**NEU**

**79,90**

**1/2"**

**911.4510**

55 mm		5 - 6 - 7 - 8 - 10 - 12 - 14 - 17 - 19 mm
100 mm		5 - 6 - 7 - 8 - 10 - 11 - 12 - 13 mm
140 mm		5 - 6 - 7 - 8 - 10 - 12 - 14 mm
200 mm		5 - 6 - 7 - 8 - 10 - 12 mm

**i** **32**  
Weitere Informationen

EVOLUTION SERIES

**NEU**

**79,90**

**1/2"**

**911.4520**

55 mm		M5 - M6 - M7 - M8 - M9 - M10 - M12 - M13 - M14
100 mm		M5 - M6 - M7 - M8 - M9 - M10 - M12 - M13 - M14
140 mm		M7 - M8 - M9 - M10 - M12 - M13 - M14
200 mm		M7 - M8 - M9 - M10 - M12 - M13 - M14

**i** **26**  
Weitere Informationen

EVOLUTION SERIES

**NEU**

**79,90**

**1/2"**

**911.4540**

55 mm		M5 - M6 - M8 - M9 - M10 - M12 - M14 - M16
100 mm		M5 - M6 - M8 - M9 - M10 - M12 - M14
140 mm		M5 - M6 - M8 - M9 - M10 - M12 - M14
200 mm		M8 - M10 - M12 - M14

**i** **32**  
Weitere Informationen

EVOLUTION SERIES

**NEU**

**79,90**

**1/2"**

**911.4550**

55 mm		T20 - T25 - T27 - T30 - T40 - T45 - T50 - T55 - T60 - T70
100 mm		T20 - T25 - T27 - T30 - T40 - T45 - T50 - T55 - T60 - T70
140 mm		T40 - T45 - T50 - T55 - T60 - T70
200 mm		T40 - T45 - T50 - T55 - T60 - T70

**A** matt satiniert **B** hochglanz verchromt

**ab 27,90**

vernickelt

<b>A</b>	917.0648		48	27,90 €	1/4"	
<b>B</b>	918.0648		48	29,90 €	1/4"	

4 - 4,5 - 5 - 5,5 - 6 - 7 - 8 - 9  
10 - 11 - 12 - 13 - 14 mm

**i** **20**  
Weitere Informationen

**59,90**

matt satiniert

1/2"

10 - 11 - 12 - 13 - 14 - 15 - 16  
17 - 18 - 19 - 20 - 21 - 22 - 24  
27 - 30 - 32 mm

911.0620

**A** matt satiniert **B** hochglanz verchromt

**ab 79,90**

vernickelt

<b>A</b>	911.0694		94	79,90 €	1/4" + 1/2"	
<b>B</b>	918.0694		94	89,90 €	1/4" + 1/2"	

4 - 4,5 - 5 - 5,5 - 6 - 7 - 8 - 9  
10 - 11 - 12 - 13 - 14 - 15 - 16  
17 - 18 - 19 - 20 - 21 - 22 - 23  
24 - 27 - 30 - 32 mm

**i** **108**  
Weitere Informationen

**89,90**

matt satiniert

1/4" + 1/2"

4 - 4,5 - 5 - 5,5 - 6 - 7 - 8 - 9  
10 - 11 - 12 - 13 - 14 - 15 - 16  
17 - 18 - 19 - 20 - 21 - 22 - 24  
27 - 30 - 32 mm

911.0708



Weitere Informationen

1/4"	<ul style="list-style-type: none"> <li>4 - 4,5 - 5 - 5,5 - 6 - 7 - 8 - 9 - 10 - 11 - 12 - 13 - 14 mm</li> <li>4 - 5 - 6 - 7 - 8 - 9 - 10 mm</li> <li>E4 - E5 - E6 - E7 - E8</li> </ul>
3/8"	<ul style="list-style-type: none"> <li>10 - 11 - 12 - 13 - 14 - 15 - 16 - 17 - 18 - 19 mm</li> <li>10 - 11 - 12 - 13 - 14 - 15 mm</li> <li>E10 - E11 - E12 - E14 - E16 - E1</li> </ul>
1/2"	<ul style="list-style-type: none"> <li>10 - 11 - 12 - 13 - 14 - 15 - 16 - 17 - 18 - 19 - 20 - 21 - 22 - 24 - 27 - 30 - 32 mm</li> <li>16 - 17 - 18 - 19 - 22 mm</li> <li>E20 - E24</li> </ul>
1/4" 5/16"	<ul style="list-style-type: none"> <li>10 - 11 - 12 - 13 - 14 - 15 - 16 - 17 - 18 - 19 - 20 - 21 - 22 - 24 - 27 - 30 - 32 mm</li> <li>16 - 17 - 18 - 19 - 22 mm</li> <li>E20 - E24</li> </ul>
1/4" - 3/8" 1/2"	<ul style="list-style-type: none"> <li>50 - 100 - 125 - 150 - 250 mm</li> <li>1,3 - 1,5 - 2 - 2,5 - 3 - 4 - 5 mm</li> </ul>
1/4" - 3/8" 1/2"	<ul style="list-style-type: none"> <li>1/4" - 5/16"</li> </ul>
1/4"	

1/4" + 3/8" + 1/2"

vernickelt

matt satiniert



94,90

1/4"	<ul style="list-style-type: none"> <li>4 - 4,5 - 5 - 5,5 - 6 - 7 - 8 - 9 - 10 - 11 - 12 - 13 - 14 mm</li> <li>6 - 7 - 8 - 9 - 10 - 11 - 12 - 13 - 14 - 15 mm</li> </ul>
3/8"	<ul style="list-style-type: none"> <li>10 - 11 - 12 - 13 - 14 - 15 - 16 - 17 - 18 - 19 mm</li> <li>10 - 11 - 12 - 13 - 14 - 15 mm</li> </ul>
1/2"	<ul style="list-style-type: none"> <li>10 - 11 - 12 - 13 - 14 - 15 - 17 - 18 - 19 - 20 - 21 - 22 - 24 - 27 - 30 - 32 mm</li> <li>17 - 19 - 22 mm</li> </ul>
1/4" 5/16"	<ul style="list-style-type: none"> <li>10 - 11 - 12 - 13 - 14 - 15 - 16 - 17 - 18 - 19 - 20 - 21 - 22 - 24 - 27 - 30 - 32 mm</li> <li>17 - 19 - 22 mm</li> </ul>
12 x	<ul style="list-style-type: none"> <li>8 - 9 - 10 - 11 - 12 - 13 - 14 - 15 - 16 - 17 - 18 - 19 mm</li> <li>1,3 - 1,5 - 2 - 2,5 - 3 - 4 - 5 mm</li> </ul>
1/4" - 3/8" 1/2"	
1/4"	

A matt satiniert

B hochglanz verchromt

A 917.0216



216

174,90 €

B 918.0216



216

189,90 €

1/4" + 3/8" + 1/2"

vernickelt

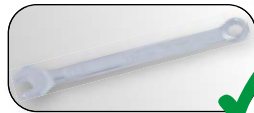

ab 174,90



<b>A</b>	911.0721			21		19 · 21 · 22 · 23 · 24 · 26 · 27 · 29 · 30 32 · 35 · 36 · 38 · 41 · 46 · 50 mm	219, <sup>90</sup> €
<b>B</b>	911.0722			21		19 · 21 · 22 · 23 · 24 · 26 · 27 · 29 · 30 32 · 35 · 36 · 38 · 41 · 46 · 50 mm	248, <sup>50</sup> €
<b>C</b>	911.0751			21		3/4" · 13/16" · 7/8" · 15/16" · 1" 1.1/16" · 1.1/8" · 1.3/16" · 1.1/4" 1.5/16" · 1.3/8" · 1.7/16" · 1.1/2" 1.5/8" · 1.3/4" · 2"	248, <sup>50</sup> €

**ab**  
**219,<sup>90</sup>**

			82
<b>Weitere Informationen</b>			
1/4"			4 - 4,5 - 5 - 5,5 - 6 - 7 - 8 - 9 - 10 - 11 12 - 13 - 14 mm
1/2"			14 - 15 - 16 - 17 - 18 - 19 - 20 - 21 - 22 24 - 27 - 30 - 32 mm
1/4"			16 - 21 mm
1/4"			
5/16"			
1/4"			
1/2"			
1/4"			150 mm
1/4"			50 - 100 - 125 - 250 mm
1/2"			
1/4"			150 mm
12 x			8 - 10 - 11 - 12 - 13 - 14 - 17 - 19 - 22 mm



**129,<sup>90</sup>**

911.0682 **1/4" + 1/2"**



**i**  **47**  
 Weitere Informationen



1/2"		10 - 11 - 12 - 13 - 14 - 15 - 16 - 17 18 - 19 - 20 - 21 - 22 - 24 mm
3 x		16 - 18 - 21 mm
14 x		6 - 7 - 8 - 9 - 10 - 11 - 12 - 13 - 14 15 - 16 - 17 - 18 - 19 mm
1 x		250 mm
2 x		125 - 250 mm
1 x		1/2"
5 x		3 - 5,5 - 8 mm PH1 - PH2
1 x		T8 - T10 - T15 - T20 - T25 - T27 T30 - T40
1 x		2,5 - 3 - 4 - 5 - 6 - 7 - 8 - 10 mm
1 x		3 - 48 V
1 x		240 mm
1 x		180 mm
1 x		300 g















**149,90**

matt  
satinert

1/2"

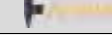
940.0047 

1/4"		4 - 4,5 - 5 - 5,5 - 6 - 7 - 8 - 9 - 10 11 - 12 - 13 mm
1/2"		10 - 11 - 12 - 13 - 14 - 15 - 16 - 17 19 - 20 - 21 - 22 - 24 - 27 - 30 - 32 mm
12 x		8 - 9 - 10 - 11 - 12 - 13 - 14 - 15 - 16 17 - 18 - 19 mm
2 x		1/4": 100 mm / 1/2": 125 mm
1 x		1/4" / 1/2"
7 x		3 - 4 - 5,5 - 6,5 mm PH0 - PH1 - PH2
1 x		T8 - T10 - T15 - T20 - T25 - T27 - T30 T40 - T45 - T50
1 x		1,5 - 2 - 2,5 - 3 - 4 - 5 - 6 - 8 - 10 mm
1 x		
1 x		300 g
1 x		160 mm
1 x		200 mm



1/4" + 1/2"

**A** matt  
satinert

**B** hochglanz  
verchromt

**A**

917.0797



97

174,90 €

**B**

918.0797



97

189,90 €

vernickelt



**ab**  
**174,90**



88













**Weitere Informationen**

1/4"		4 - 4,5 - 5 - 5,5 - 6 - 7 - 8 - 9 - 10 - 11 12 - 13 mm
1/2"		14 - 15 - 16 - 17 - 18 - 19 - 20 - 21 - 22 23 - 24 - 25 - 26 - 27 - 28 30 - 32 mm
12 x		6 - 7 - 8 - 9 - 10 - 11 - 12 - 13 - 14 17 - 19 - 22 mm
3 x		1/4": 50 - 100 mm / 1/2": 125 mm
1 x		1/4"
4 x		6,5 - 8 mm PH1 - PH2
1 x		1/4"
1 x		1/4"
1 x		150 - 250 V
1 x		250 mm
1 x		180 mm
1 x		300 g



# 189,<sup>90</sup>



**matt satiniert**

1/4" + 1/2"

911.0688



127

## DER ALLESKÖNNER



**Weitere Informationen**

**1**



4 x

**2**



8 x 8 - 9 - 10 - 11 - 13  
14 - 17 - 19 mm

**3**



**4**



# 369,<sup>90</sup>



490 mm      400 mm





1/4" + 1/2"

911.0727

1/4"		4 - 4,5 - 5 - 5,5 - 6 - 7 8 - 9 - 10 - 11 - 12 13 - 14 mm
1/4"		
1/2"		10 - 13 - 14 - 16 - 17 18 - 19 - 20 - 22 - 24 27 - 30 - 32 mm



**389,90**

1/4"		4 - 4,5 - 5 - 5,5 - 6 - 7 8 - 9 - 10 - 11 - 12 13 mm
1/2"		10 - 13 - 14 - 15 - 16 17 - 18 - 19 - 21 - 22 24 - 27 - 30 - 32 mm
10 x		8 - 10 - 11 - 12 - 13 14 - 15 - 17 - 19 - 22 mm

911.0649 **1/4" + 1/2"**

**VOLLAUSSTATTUNG?  
DANN HIER ZUGREIFEN!**



**449,90**

9 x		1,5 - 2 - 2,5 - 3 - 4 - 5 - 6 8 - 10 mm
9 x		TS10 - TS15 - TS20 - TS25 TS27 - TS30 - TS40 - TS45 TS50
1/4"		4 - 4,5 - 5 - 5,5 - 6 - 7 8 - 9 - 10 - 11 - 12 13 mm
1/2"		10 - 11 - 12 - 13 - 14 15 - 16 - 17 - 18 - 19 21 - 22 - 24 - 27 - 30 32 mm
11 x		8 - 9 - 10 - 11 - 12 13 - 14 - 16 - 17 - 19 22 mm

911.0630 **1/4" + 1/2"**



Weitere Informationen

# FÜR ELEKTRIKER



4 x

1/4" 4 - 4,5 - 5 - 5,5 - 6 - 7 - 8  
9 - 10 - 11 - 12 - 13 mm

1/2" 10 - 11 - 12 - 13 - 14 - 15  
16 - 17 - 18 - 19 - 21 - 22 mm

10 x 8 - 10 - 11 - 12 - 13 - 14  
15 - 17 - 19 - 22 mm

# 389,90

911.0628

1/4" + 1/2"



Weitere Informationen

# DER ALLROUNDER



1/4" 4 - 5 - 6 - 7 - 8 - 9 - 11  
12 - 13 mm

1/2" 10 - 11 - 12 - 13 - 14 - 15 - 16  
17 - 18 - 19 - 21 - 22 - 24 mm

10 x 8 - 9 - 10 - 11 - 12 - 13  
14 - 16 - 17 - 18 - 19 mm

# 519,90

911.0735



1/4" + 1/2"

**i**  **99**  
Weitere Informationen

# DIE SCHATZTRUHEN!

**i**  **99**  
Weitere Informationen



	4 - 5 - 6 - 7 - 8 - 9 - 10 - 11 - 12 13 - 14 mm
	13 - 15 - 17 - 18 - 19 - 20 - 21 - 22 24 - 27 - 30 - 32 mm



## RATSCHENRINGMAULSCHLÜSSEL

## RINGMAULSCHLÜSSEL

**SIE HABEN DIE WAHL!**

8 - 9 - 10 - 11 - 12 - 13 - 14 - 15 - 16 - 17 - 18 - 19 mm

8 - 9 - 10 - 11 - 12 - 13 - 14 - 15 - 16 - 17 - 18 - 19 mm



**599,90**

**519,90**

1/4" 1/2"

1/4" 1/2"



918.0100 

918.0200 

**i**  **40**  
Weitere Informationen

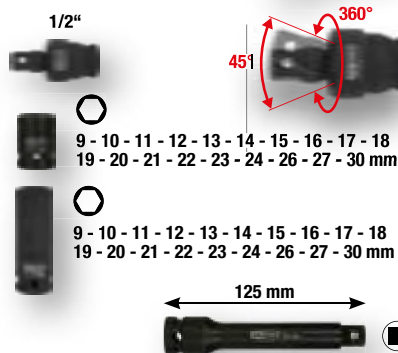

**114,90**

515.0065 **1/2"**



Weitere Informationen





1





ab  
99,90

Skala mit Lupe

Mikrometerskala



mit Kategorie:  
Konformitätsklärung  
DIN EN ISO 6799  
Zertifikat  
Gültigkeit  
auf 20%

		Nm	Teilung Nm	Lbf-ft		
516.1402		1/4"	1-5	0,10	0,8 - 3,6	99,90 €
516.1412		1/4"	5-25	0,10	0,8 - 18	99,90 €
516.1422		3/8"	10-50	0,25	4 - 37	99,90 €
516.1432		1/2"	20-100	0,50	8 - 75	110,90 €
516.1442		1/2"	40-200	1,00	15 - 150	110,90 €
516.1472		1/2"	60-320	1,00	45 - 236	124,90 €
516.1482		1/2"	80-420	1,00	60 - 310	135,90 €
516.1493		3/4"	150-750	10,00	150 - 550	588,90 €
516.1495		1"	200-1000	20,00	220 - 730	673,90 €



3 IN 1



LANG



LANG

9,90

A	151.2100		8		 <p>2 - 2,5 - 3 - 4 - 5 - 6 8 - 10 mm</p>	9,90 €
B	151.2300		8		 <p>T10 - T15 - T20 - T25 T30 - T40 - T45 - T50</p>	9,90 €



Weitere Informationen





22



+ LANG

12,90

DIE WICHTIGSTEN 22  
IN EINEM SATZ

151.4000

**32**  
Weitere Informationen

**vernickelt**

1 x		1/4"
1 x		1/4"
3 x		PH1 - PH2 - PH3
6 x		2 x PZ1 - 2 x PZ2 - 2 x PZ3
3 x		5,5 - 6,5 - 8 mm
3 x		4 - 5 - 6 mm
15 x		2 x TB10 - 3 x TB15 - 2 x TB20 3 x TB25 - 3 x TB30 - 2 x TB40

911.2060

**32**  
Weitere Informationen

**TORION power**

+30%

1 x		1/4"
1 x		1/4"
4 x		3 - 4 - 5 - 6 mm
4 x		PH1 - 2 x PH2 - PH3
4 x		PZ1 - 2 x PZ2 - PZ3
4 x		3 - 4 - 5 - 6 mm
7 x		T10 - T15 - T20 - T25 - T27 - T30 - T40
7 x		TB10 - TB15 - TB20 - TB25 - TB27 - TB30 - TB40

911.3030

**108**  
Weitere Informationen

**TORION power**

25 mm

6x		4 - 5 - 6 mm
6x		4 - 5 - 6 mm
6x		PH1 - PH2 - PH3
6x		PZ1 - PZ2 - PZ3
6x		T10 - T15 - T20 - T25 - T30 - T40

918.3108

**29,90**

**NEU**

**TORION power**

+30%

**108 BITS, DIE DEN UNTERSCHIED MACHEN**

**32**  
Weitere Informationen

68 mm

100 mm

4 x		3 - 4 - 5 - 6 mm
4 x		PH1 - 2 x PH2 - PH3
4 x		PZ1 - 2 x PZ2 - PZ3
4 x		3 - 4 - 5 - 6 mm
7 x		T10 - T15 - T20 - T25 T27 - T30 - T40
7 x		TB10 - TB15 - TB20 - TB25 TB27 - TB30 - TB40

918.3010

**44,90**

**TORION power**

+30%

**44,90**

**31**  
Weitere Informationen

2 x		4 - 5 mm
3 x		PH1 - PH2 - PH3
3 x		PZ1 - PZ2 - PZ3
9 x		1,5 - 2 - 2,5 - 3 - 4 - 5 - 6 7 - 8 mm
11 x		T6 - T7 - T8 - T9 - T10 - T15 T20 - T25 - T27 - T30 - T40

918.3015

**57,90**

**TORION power**

+30%

**57,90**

**i** **24**  
Weitere Informationen

## KLEIN & FEIN

25 mm  
vernickelt

# 19,90

1 x		1/4": 92 mm
1 x		1/4": 50 mm
1 x		1/4"
6 x		6 - 7 - 8 - 10 - 11 - 13 mm
2 x		PH1 - PH2
2 x		PZ1 - PZ2
2 x		4,5 - 5,5 mm
4 x		3 - 4 - 5 - 6 mm
5 x		TB10 - TB15 - TB20 - TB25 - TB30

911.2010 **1/4"**

**i** **208**  
Weitere Informationen

# 39,90

## DER ALLES-SCHRAUBER!

1/4"		1/4": 205 mm
138 x		25 mm
29 x		50 mm
18 x		75 mm
20 x		4 - 5 - 6 - 7 - 8 - 9 - 10 - 11 - 12 - 13 mm 5/32" - 3/16" - 7/32" - 1/4" - 9/32" 5/16" - 11/32" - 3/8" - 7/16" - 1/2"
1 x		1/4": 50 mm
1 x		1/4"

911.2008 **1/4"**

**i** **7**  
Weitere Informationen

## DAS KLEINE TECHNIKWUNDER!

# 9,90

## 6 IN ONE

- 4 - 5 mm
- PH1 - PH2
- PZ1 - PZ2

**NEU**

110 mm

**1/4"**

159.2025 **6 in 1 Mini-Ratschen-Schraubendreher**

**i** **13**  
Weitere Informationen

# 14,90

## 12 IN ONE

- 4 - 5 - 6 mm
- PH1 - PH2 - PH3
- 3 - 4 - 5 mm
- T15 - T20 - T25

240 mm

**1/4"**

159.2035 **12 in 1 Ratschen-Bit-Schraubendreher**



**1**  
Weitere Informationen

**2 IN 1**

**1/4"**

**85 mm**

**8,90**

**ODER**

514.1126

**1**  
Weitere Informationen

**1/4"**

**10,90**

**MIT GELENK**

**90 mm**

**20°**

514.1136

**21**  
Weitere Informationen

**4 mm**

**30 mm** **165 mm**

**Ø 16 mm**

**39,90**

500.7195

1 - 1,3 - 1,5 - 2 - 2,5 - 3 mm

PH00 - PH0 - PH1 - PH2

1,5 - 2 - 2,5 - 3 - 3,5 mm

T3 - T4 - T5 - T6 - T7

**27**  
Weitere Informationen

**LED**

**1/4"**

**eMONSTER**

**EINMAL BERÜHRT, FÜR IMMER VERFÜHRT.**

**34,90**

515.3600

4x		3,0 - 4,0 - 5,0 - 6,0 mm
4x		3,0 - 4,0 - 5,0 - 6,0 mm
5x		PH0 - PH1 - PH2 - PH3
4x		PZ0 - PZ1 - PZ2 - PZ3
4x		T10 - T15 - T20 - T25
4x		#0 - #1 - #2 - #3
1x		PH1
1x		50 mm
1x		Max. 6 Nm

max 6 Nm

max 4 Nm

max 2 Nm

USB-C

3,6 V

1.500 mAh

300 rpm

USB-C

2+ LED



Weitere Informationen

# DER ALLROUNDER



## 1 Bohren



## 2 Reinigen



## 3 Schleifen



## 4 Gravieren

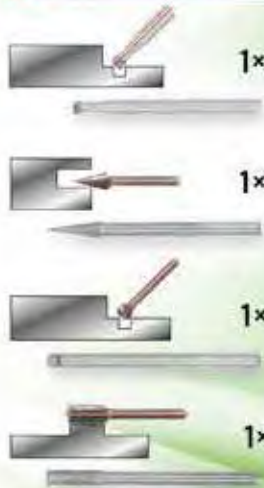

## 5 Trennen



## 6 Polieren



eMONSTER  
Akku-Multifunktions-  
werkzeug-Satz mit  
50 Zubehörteilen



eMONSTER



49,<sup>90</sup>

515.3990



Weitere Informationen

## ZUM NACHKAUFEN



Zubehör-Satz, 50-tlg

9,<sup>90</sup>

515.3992

# DER TRANSFORMER UNTER DEN SCHRAUBERN



e**MONSTER**

**Hohe 210 RPM  
Drehzahl, dadurch  
5 x schneller als  
manueller  
Anziehungsvorgang**

praktische Batterie-  
Ladezustandsanzeige  
mit 3 LEDs

verstärktes  
Getriebe



2 in 1 Gerät mit ausgewogenem Verhältnis zwischen Leistung und Größe, ideal zum Arbeiten über Kopf und an engen Stellen.

magnetische  
Bitaufnahme



Drehmomentvorwahl in  
10 Stufen einstellbar



verbesserter  
Griffkomfort



**1.3 Ah Akku  
mit einer Laufzeit  
für  
1000+  
Schrauben**

Der Li-ION-Hochleistungsakku  
ist dank USB-C Anschluss auch  
schnell wieder aufgeladen und  
einsatzbereit.

integrierte Lampe



Ein Überdrehen der Schrauben wird  
durch automatisches Verriegeln  
des Motors bei Überschreiten des  
Drehmoments verhindert.

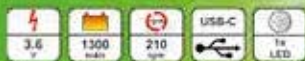

Weitere Informationen

inkl.  
25 Bits



**39,90**

515.6500

**ERGOTORQUE<sup>plus</sup>**

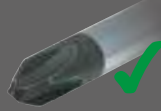

verchromt mit  
brüniertes Spitze



mit Profilkennzeichnung  
am Griff

**i** **5**  
Weitere Informationen

159.0005

**9,90**

PH1 PH2 6,5 mm 5,5 mm 4 mm

**i** **6**  
Weitere Informationen

159.0030

**19,90**

T10 T15 T20 T25 T30 T40

**i** **6**  
Weitere Informationen

159.0040

**19,90**

TB10 TB15 TB20 TB25 TB30 TB40

**i** **39**  
Weitere Informationen

**50,90**

6 x		3 - 4 - 5,5 - 6,5 8 - 10 mm	7 x		2 - 2,5 - 3 - 4 - 5 6 - 8 mm
5 x		PH0 - PH1 - PH2 PH3 - PH4	7 x		TB10 - TB15 - TB20 TB25 - TB27 - TB30 TB40
4 x		PZ0 - PZ1 - PZ2 PZ3	7 x		T10 - T15 - T20 T25 - T27 - T30 T40
1 x		6 mm	1 x		1/4"
1 x		PH2	1 x		205 mm

159.0100 **1/4"**

**i** **13**  
Weitere Informationen

**DER  
VERTRÄGT  
SCHLÄGE!**

**67,90**

durchgehende Klinge

5 x		3,5 - 5,5 - 7 - 8 - 10 mm
5 x		PH0 - PH1 - PH2 - PH3 - PH4
1 x		6 mm
1 x		PH2
1 x		1/4"

151.1150 **1/4"**

**i** **15**  
 Weitere Informationen

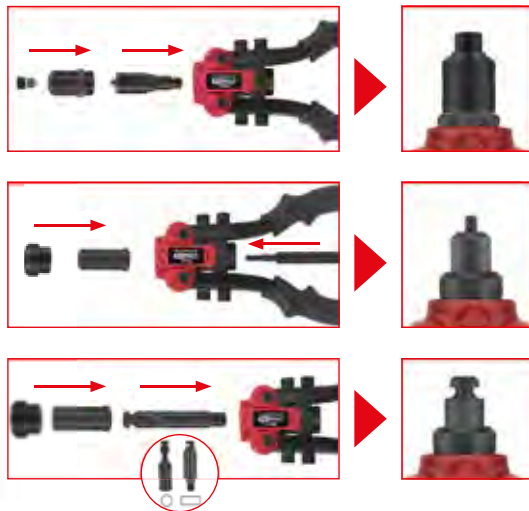

**67,90**

150.9805



		A	B
		150.9805	150.9630
	im Koffer	✓	✓
	Länge mm	260	510
	Blechknabber	✓	✗
	Ein- oder Zweihand- Bedienung		
	M10	✓	✓
	M8	✓	✓
	M6	✓	✓
	M5	✓	✓
	M4	✓	✓
	M3	✓	✓
	Stahl 4,8 mm	✓	✓
	Stahl 4,0 mm	✓	✓
	Stahl 3,2 mm	✓	✓
	Stahl 2,4 mm	✓	✓
	ALU 6,4 mm	✓	✓
	ALU 4,8 mm	✓	✓
	ALU 4,0 mm	✓	✓
	ALU 3,2 mm	✓	✓
	ALU 2,4 mm	✓	✓

**i** **17**  
 Weitere Informationen

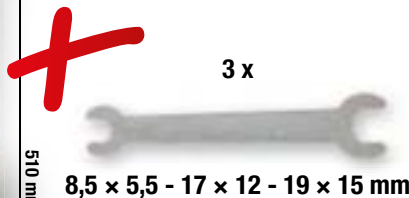

**174,90**

150.9630





1  
Weitere Informationen

















35 - 90 mm

ab 10,90



	↔	↔	
115.2011	175 mm	7"	10,90 €
115.2010	240 mm	10"	12,90 €
115.2012	300 mm	12"	15,90 €
115.2016	415 mm	16"	31,90 €

4  
Weitere Informationen

PREMIUM QUALITÄT!

4  
Weitere Informationen



**A** 19 - 60 mm



**B** 40 - 100 mm

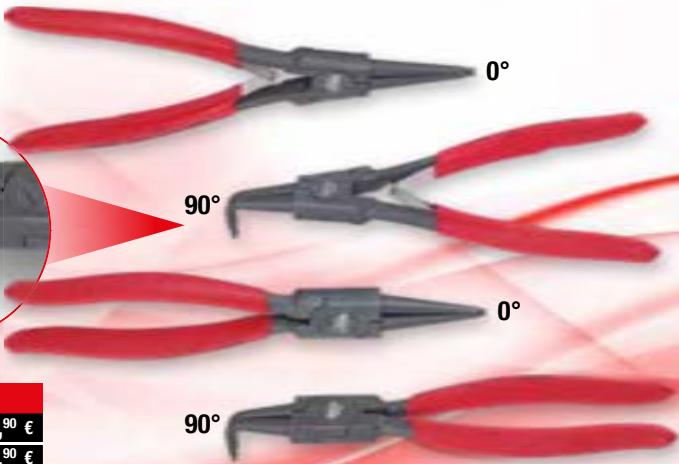

ab 110,90

	↺ ↻	↔	
<b>A</b>	119.2055	19 - 60 mm	160 mm
<b>B</b>	119.2060	40 - 100 mm	230 mm





20  
Weitere Informationen

SAFETY FIRST



60 - 100 mm



40 - 85 mm







49,90

500.1350

**Sicherungszangen-Satz mit Ratschenfunktion**

# SCHAU MIR IN DIE AUGEN, FEINES!

**i** **10**  
Weitere Informationen



1 x		120 mm	1 x		160 mm
1 x		120 mm	3 x		PH00 - PH0 - PH1
1 x		120 mm	3 x		2,0 - 2,4 - 3,0 mm

500.7220



2 x		125 - 130 mm
1 x		100 mm
1 x		100 mm
1 x		125 mm
1 x		150 mm
1 x		145 mm

500.7190

**i** **21**  
Weitere Informationen

**99,90**



3 x		PH00 - PH0 - PH1
4 x		1,4 - 2,0 - 2,4 - 3,0 mm
7 x		T6 - T7 - T8 - T9 - T10 - T15 - T20

**i** **1**  
Weitere Informationen



mit stabiler, reissnadelähnlicher Einstellspitze

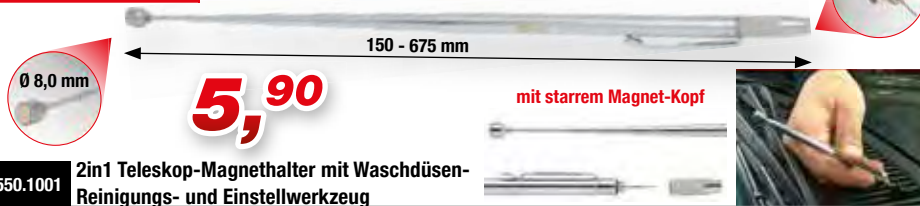

550.1001

2in1 Teleskop-Magnethalter mit Waschdüsen-Reinigungs- und Einstellwerkzeug

**5,90**

**i** **1**  
Weitere Informationen

**9,90**



550.1136

Flexibler Inspektions-Spiegel mit Beleuchtung

**i** **1**  
Weitere Informationen



mit dünnem Reinigungsstab



550.1023

2in1 Teleskop-Magnethalter mit Waschdüsen-Reinigungs- und Einstellwerkzeug

**7,90**

**i** **5**  
Weitere Informationen



3,6 kg



**14,90**

**5 IN 1**

550.1145

172 - 640 mm

**i** **4**  
 Weitere Informationen

**9,90**

45° 135° 0° 90°

550.1045

**i** **9**  
 Weitere Informationen

**19,90**

45° 135° 0° 90° 45° 90° 0°

550.1070

**i** **1**  
 Weitere Informationen

**8,90**

Piezo

115 mm

960.1110

**i** **1**  
 Weitere Informationen

**19,90**

300 mm

550.1060

**i** **8**  
 Weitere Informationen

**19,90**

95 mm

Ø 40 mm

49 mm

5 mm

Ø 1,6 mm

Ø 3,5 mm

Ø 4,5 mm

960.1265

**ISO BUTAN**

**i** **11**  
 Weitere Informationen

**29,90**

Piezo

200 mm

20 mm

33 mm

Ø 1,6 mm

Ø 3,5 mm

Ø 4,5 mm

Ø 5 mm

30 mm

95 mm

95 mm

Ø 40 mm

960.1160 Mikro-Löt-Satz



**i** **283**  
Weitere Informationen

**169,90**

220 mm

Ø 0,5 - 6 mm  
Ø 0,5 - 6 mm  
Ø 0,5 - 10 mm  
Ø 6,50 / 5,41 / 1,72 mm  
Ø 0,5 - 4 mm  
Ø 1,0 - 3,2 mm

115.1400

**i** **1**  
Weitere Informationen

**3,90**

143 mm

118.0013

**i** **1**  
Weitere Informationen

EG II

**ab 2,90**

	Artikelnummer	Länge	Blattbreite	Preis
A	300.0113	3 m	16 mm	2,90 €
B	300.0114	5 m	19 mm	3,90 €
C	300.0115	5 m	25 mm	4,90 €
D	300.0116	8 m	25 mm	5,90 €

A 16 mm B 19 mm C 25 mm D 25 mm

**i** **5**  
Weitere Informationen

Temperaturregulierung:  
1≈50°C / 2≈100°C / 3≈200°C /  
4≈350°C / 5≈550°C / 6≈650°C

260 mm

1 2 3 4 5 6

1 max. 450°C  
2 max. 650°C

**29,90**

960.1190

Anwendungsgebiete: Entfernen von Farbe, Verlöten von Röhren, Schrumpfen von PVC, Verschweißen und Biegen von Kunststoffen, Trocknungen, Auftauen etc.

**i** **1**  
Weitere Informationen

**IP 34**

15+1 m

3x 1,5 mm²

230 V 50 Hz

1000/3000 W

10 A

**134,90**

150.4217

**i** **12**  
Weitere Informationen

**9,90**

145 mm

5,0 x 1,0 mm  
5,0 x 1,0 mm  
3,0 mm  
3,0 mm  
5,0 mm  
5,0 mm  
3,0 mm  
2,0 mm  
2,0 mm  
5,0 mm  
5,0 mm  
5,0 mm

140.3050

**i** **5**  
Weitere Informationen

**29,90**

200 mm

140.3000

**i** **1**  
Weitere Informationen

138 x 69 x 31 mm 342 9 V

**19,90**

69 mm 138 mm

150.1495

**i** **1**  
Weitere Informationen

3 - 48 V

140 mm

**11,90**

550.1503 **Polaritäts- und Spannungsprüfer 3 - 48 V**

**i** **1**  
Weitere Informationen

125 mm

6 - 24 V

**4,90**

550.1504 **Prüflampe 6 - 24 V**

**i** **1**  
Weitere Informationen

**AUTOMATIC DIGITAL MULTIMETER**

143 x 70 x 16 mm 119 AAA

16 mm

143 mm

70 mm

**49,90**

150.1765

**Nr. Beschreibung**

- Ein-/Aus-Taste
- Funktionsschalter
- Kapazitätsschalter
- Beleuchtungsschalter
- LCD-Display
- NCV-Sensor-Bereich
- Messleitungen

**Symbol Beschreibung**

	Gleichspannung
	Wechselspannung
	Anzeige für automatische Abschaltfunktion
	Anzeige für niedrigen Batteriestand
	Dioden-Modus
	Durchgang
	Kapazität
	Leistungsmessverhältnis
<b>HOLD</b>	Data-Hold-Funktion
<b>V, mV</b>	Einheit der Spannung: Volt, Millivolt
<b>mF, µF, nF</b>	Einheit der Kapazität
<b>MΩ, KΩ, Ω</b>	Einheit des Widerstands
<b>NCV</b>	Kontaktlose Spannungsinduktion
<b>Live</b>	Prüfung spannungsführender Leitungen
<b>KHz, Hz</b>	Einheit der Frequenz
<b>°C/°F</b>	Celsius/Fahrenheit

**NCV**

**3 COLOUR ANALOG BAR**

**BUZZER ALARM**

USB-A USB-C

**i** **3**  
Weitere Informationen

210 x 88 x 44 mm  
655  
9 V  
Data Hold

**34,90**

27,0 mm

max. messbarer Leiterdurchmesser 29,0 mm

150.0925

**i** **1**  
Weitere Informationen

für Gleich- und Wechselspannung

AC	6 - 50 - 120 - 230 - 400 V
DC	6 - 50 - 120 - 230 - 400 V

**23,90**

550.1501

# UNIVERSAL-SCHLITTSCHLÜSSEL

**i** **1**  
Weitere Informationen

**MINI**

42 mm

- 6 - 7 - 8 mm
- ▲ 9 mm
- 3 - 5 mm
- ⊕ PH 2
- ⊖ 7 mm

**16,90**

130.1010

**i** **1**  
Weitere Informationen

71 mm

- 6 - 7 - 8 mm
- ▲ 9 mm
- 3 - 5 mm
- ⊕ PH 2
- ⊖ 7 mm

**17,90**

130.1015

**i** **1**  
Weitere Informationen

61 mm

- 5 - 7 - 8 mm
- ▲ 9 - 10 mm
- 4 - 10 mm
- ⊕ PH 2
- ⊖ 7 mm

**17,90**

130.1020

**Kabel-Einziehdraht**

10 Meter    20 Meter

**ab 4,90**

<b>A</b>	150.0960		<b>1</b>	∅ 3,0 mm 10 m	4,90 €
<b>B</b>	150.0970		<b>1</b>	∅ 4,0 mm 20 m	9,90 €

**i** **1**  
Weitere Informationen

**34,90**

∅ 3,0 mm

30 Meter

**115.1113 Kabeleinziehilfe**

**i**  **1**  
Weitere Informationen

**22,90**



- mit Momentfeststellung
- Messschiene in mm und Zoll-Teilung
- mit Gewindetabelle

300.0510

**i**  **1**  
Weitere Informationen

**24,90**



- mit Feststellschraube und Rollenfeineinstellung
- für Außen-, Innen-, Stufen- und Tiefenmessungen

300.0532

**i**  **1**  
Weitere Informationen

**INFRAROT-THERMOMETER, -38° BIS 520°**





**49,90**

150.3040

**i**  **4**  
Weitere Informationen

**56,90**







Refraktometer - optisches Prüfgerät für Batterieflüssigkeit und Frostschutzmittel

550.1290

**i**  **4**  
Weitere Informationen

**67,90**







Refraktometer - optisches Prüfgerät für Batterieflüssigkeit, Frostschutzmittel und AdBlue®-Zusätze

550.1285

**i** **4**  
Weitere Informationen

**19,90**

11 x 115 mm  
15 x 185 mm  
18 x 320 mm  
18 x 470 mm

**911.8100 Hebeleisen-Satz**

**i** **4**  
Weitere Informationen

**XL**

900 mm  
600 mm

01  
45°  
75°  
90°

**179,90**

**911.8410 Hebeleisen-Satz**

**i** **22**  
Weitere Informationen

**Hydraulischer Universal-Abzieher-Satz 2+3-armig**

- geringe Abrutschgefahr durch automatisch schließende Abzieherarme
- 8 Abziehervarianten möglich
- extrem robuste Spindel mit induktiv gehärtetem Gewinde
- geringer Kraftaufwand
- Spezial-Werkzeugstahl

**304,90**

**700.1200**

20 - 35 - 85 mm  
235 mm  
185 mm  
10 t, AG 1.1/2" x 16G  
Ø max. 100 mm  
225 mm  
170 mm  
120 mm

**i** **13**  
Weitere Informationen

**NEU**

**FÜR NOTFÄLLE**

**79,90**

**0% ✓** **85% ✓**

zum Lösen und Herausdrehen von feststehenden Muttern und Schrauben mit beschädigten oder bis zu 85% „rundgedrehten“ Köpfen

**89,90**

Ringe 45° gekröpft

**913.3930** 8 - 9 - 10 - 11 - 12 - 13 - 14 - 15 - 16 - 17 - 18 - 19 mm **3/8"**

**517.1555** 6x7 - 8x9 - 10x11 - 12x13 - 14x15 - 16x17 - 18x19 mm

**3/8"** **1/2"**

ICH BIN EINE SCHRAUBE, HOLT MICH HIER RAUS!



Weitere Informationen

- für Schrauben von M3 - M18
- ermöglicht das Ausdrehen von abgerissenen Schrauben und Bolzen
- konisch zulaufende Spirale
- in stabiler Kunststoffbox

**16,90**

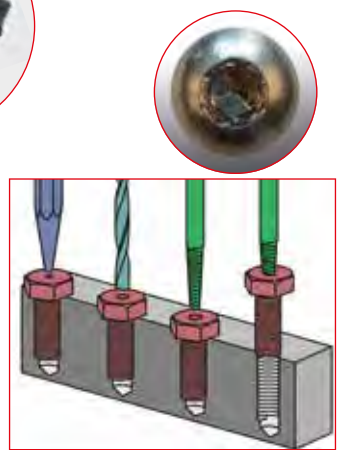

150.1330 Schrauben-Ausdreher-Satz



Weitere Informationen

**TORXION** power

**44,90**

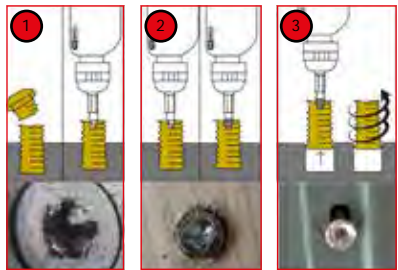

9 x		TE10 - TE15 - TE20 - TE25 - TE27 - TE30 - TE40 - TE50 - TE55
9 x		1,5 - 2 - 2,5 - 3 - 4 - 5 - 6 - 8 - 10 mm
7 x		1,5 - 2 - 2,5 - 3 - 4 - 5 - 6 mm
7 x		T10 - T15 - T20 - T25 - T27 - T30 - T40

150.7060 1/4" + 10 mm Torx- und Innensechskant-Schrauben-Ausdreher-Satz



Weitere Informationen

Gewindeausdreh-Satz

- umfangreiche Satzzusammenstellung
- zum Entfernen von abgebrochenen Gewindebolzen und Schrauben
- keine Beschädigung des Gewindes
- nur geringfügiges Aufweiten der Gewindebolzen durch speziell profilierte Ausdrehstifte

Führungshülse drill guide	Hülse Innen-Ø mm guide	vorböhren Ø mm pre-drilling	aufbohren re-drilling	Stift pin	Art.Nr. Stift No. Pin	Mutter D nut D	Art.Nr. Mutter nut D	Stift + Mutter pin + nut
150.0501	4,0 / 3,2	3,2	-	3,2	150.0521	SW 10	150.0511	150.0511S
150.0502	4,8 / 3,2	3,2	-	3,2	150.0521	SW 10	150.0511	150.0511S
150.0503	4,8 / 3,2	3,2	4,8	4,8	150.0522	SW 11	150.0512	150.0512S
150.0504	4,8 / 3,2	3,2	4,8	4,8	150.0522	SW 11	150.0512	150.0512S
150.0505	6,0 / 4,8	4,8	6,4	6,4	150.0523	SW 13	150.0513	150.0513S
150.0506	7,0 / 4,8	4,8	6,4	6,4	150.0523	SW 13	150.0513	150.0513S
150.0507	7,0 / 4,8	4,8	8,0	8,0	150.0524	SW 14	150.0514	150.0514S
150.0508	7,0 / 4,8	4,8	8,7	8,7	150.0525	SW 17	150.0515	150.0515S
150.0509	9,0 / 6,5	6,4	8,7	8,7	150.0525	SW 17	150.0515	150.0515S
150.0510	9,5 / 6,5	6,4	8,7	8,7	150.0525	SW 17	150.0515	150.0515S



150.1305 M5 - M6 - M8 - M10 - M12 - M14 - M16

**39,90**

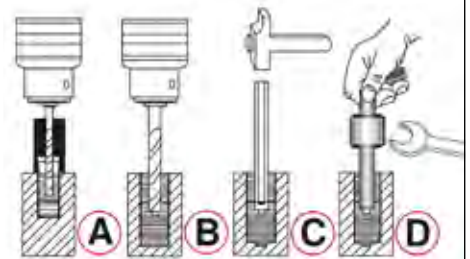

**i** **7**  
Weitere Informationen

## Stehbolzen-Ausdreher-Satz

**49,90**

- Außensechskantantrieb 21,0 mm
- mit Rechts- und Linksspannfunktion
- sicherer Halt durch je 3 Rollwalzen
- Ein- und Ausdrehen ohne umständliches Verkontern zweier Muttern auf dem Bolzen
- auch für überlange Stehbolzen geeignet - da durchgehend gebohrt

**1/2"**  
21 mm

M5 M6 M7 M8 M10 M12 M14

152.1101 M5 - M6 - M7 - M8 - M10 - M12 - M14

**i** **54**  
Weitere Informationen

## HSS Co Gewindeschneidwerkzeug-Satz in Industriekassette

- universaler Satz
- gerade genutete Handgewindebohrer
- mit verstellbarem Windeisen und Schneiseisenhalter
- inklusive Gewindelehre und Schraubendreher
- kobaltierter Hochleistungs-Stahl

**DEM FEHLT ES AN NICHTS**

510 mm 230 mm

33 x		M3 - M4 - M5 - M6 - M8 - M10 - M12 M14 - M15 - M18 - M20
11 x		M3 - M4 - M5 - M6 - M8 - M10 - M12 M14 - M15 - M18 - M20
6 x		M3-M4 - M4,5-M6 - M7-M9 - M10-M11 - M12-M14 - M16-M20
2 x		M1-M10 - M5-M20

**499,90**

331.0754

**i** **12**  
Weitere Informationen

## TRÄGT JEDER GERNE!

**24,90**

EN388  
4131X Mikro-Feinstrick

	Größe	Inhalt
310.0490	7	12 Paar
310.0491	8	12 Paar
310.0470	9	12 Paar
310.0475	10	12 Paar
310.0480	11	12 Paar

**i** **1**  
Weitere Informationen

**3,90**

**CE**  
EN 166

310.0120

**FLAME DESIGN**

Weitere Informationen

**49,90**

310.0155

**STEEL DESIGN**

Weitere Informationen

**49,90**

310.0195

EN 379 1/1/1/2	EN 175
<b>Technische Daten:</b>	
Farbauswahl:	stufenlos regelbar von DIN 9-13 Standard Lichteinstellung: DIN 4
Umschaltreaktionszeit:	1/25.000 s 0,2 - 0,8 s Verzögerung (einstellbar)
UV / IR Schutz:	nach EN169 / bis DIN 16
Betriebstemperatur:	-5°C bis + 55°C
Lagertemperatur:	-20°C bis + 70°C
Stromversorgung:	über Solarzellen
Höhe:	220 mm
Breite:	200 mm
Länge:	295 mm
Gewicht:	480 g
Maße Kassette:	110 x 90 x 9 mm
Sichtfenster:	92 x 42 mm

**Universal-Druck-Zerstäuber**

Weitere Informationen

- aus hochwertigem Polyethylen
- für verschiedene Chemikalien wie z.B. Wasch-, Lösungs- und Reinigungsmittel etc.
- für Bremsenreiniger ungeeignet
- Sprühkopf aus Messing verstellbar und verschleißbar
- Dichtungen aus Viton®
- geeignet für Überkopf-Arbeiten

**für Bremsenreiniger ungeeignet**

**ab 14,90**

150.8251	1 L	14,90 €
150.8252	2 L	19,90 €

**Aluminium**

Weitere Informationen

0,25 L  
max. 8 bar (116 psi)  
60°C / 140°F

**NEU**

**Speziell für Bremsenreiniger**

**49,90**

150.8272



**16**  
 Weitere Informationen  
**EVOLUTION**  
 SERIES

**Schaber-Satz**

- ideal zum Entfernen von Plaketten, Dichtungs- und Klebstoffresten
- einfacher Klingenwechsel durch Lösen der Rändelschraube am Spannfutter
- praktisches Aufbewahrungssystem durch wechselbare Klingensformen
- bestens geeignet für unterschiedlichste Anwendungsbereiche durch verschiedene Klingen
- Schaber mit 2-Komponentengriff

Ersatzklingen: 907.2202, 907.2203, 907.2204, 907.2205, 907.2206

**NEU**

5x 12 mm  
 5x 16 mm  
 5x 20 mm

145 mm

**12,90**

907.2255

**27**  
 Weitere Informationen

**Messer-Schaber-Satz**

5x 19 mm  
 145 mm

5x 12 mm  
 5x 16 mm  
 5x 16 mm  
 5x 20 mm

145 mm

**19,90**

907.2200

**Plaketenschaber**

A 110 mm  
 B 145 mm

**ab 3,90**

A	907.2240		1	110 x 39 mm	3,90 €
B	907.2242		1	145 x 40 mm	4,90 €

**Klappmesser mit Arretierung**

A 190 mm  
 B 220 mm

**ab 10,90**

A	907.2105		1	190 x 25 mm	10,90 €
B	907.2190		1	220 x 28 mm	11,90 €

**2**  
 Weitere Informationen

155 mm  
 97 mm

**14,90**

907.2172 **Klappmesser-Satz**

**3**  
 Weitere Informationen

250 mm

**39,90**

118.0050 **Hebel-Blechdurchgangsscheren-Satz**

**Wi-Fi-Videoskop-Satz mit Ø 5,5 mm 0° HD Frontkamera-Sonde**

**5** Weitere Informationen

**HD**

**WiFi**

Ø 5,5 mm

Ø 5,5 mm

3500 mm

**IP68**

**39,90**

550.7560

**EXTEND YOUR EYE**

**ab 239,90**

Edelstahlhülse  
Schraubanschluss  
für Zubehör

Kronendesign  
(Schutz +  
optimale  
Reinigung)

Kamera  
Linse  
LED  
Edelstahlhülse  
mit Außengewinde  
Saphirglas

Ø 6,0 mm

Ø 4,5 mm

1500 mAh  
Li-polymer

0 / 90°  
PUSH  
0 / 90°

1000 mm

Anschluss Sonde

3,5"

USB 2.0

microSD

**HD**

6 dimmbare  
Mini-LED-  
Lampen

Ø

0° 90°

1000 mm  
50 mm

**A** **Magnet**

**B** **Magnet** **Haken**

<b>A</b>	550.7500		<b>5</b>	<b>6,0 mm</b>	0° + 90°	<b>239,90 €</b>
<b>B</b>	550.7530		<b>7</b>	<b>4,5 mm</b>	0° + 90°	<b>299,90 €</b>

**IP 67**

1280 x 720

JPG

150 mm

-10°/+60°C



    
Weitere Informationen

  
Ø  
3,9 mm

6 dimmbare  
Mini-LED-  
Lampen

1000 mm  
90 mm

0°  
steuerbar  
180° 180°

drehbar  
drehbar  
360°

Anschluss Sonde

  
USB 2.0  
  
microSD

  
3000 mAh  
Li-polymer

IP  
67

AVI  
1280 x 720

JPG

150 mm

-10°/+60°C

**NEU**

**449,<sup>90</sup>**

**+ 32 GB**

550.7550 HD-Videoskop-Satz mit Ø 3,9 mm 180° und 0° HD Frontkamera-Sonde, flexible PVC Hülle





Ø 12 - 35 MM



104.5060

Inox

Steel

Ratschen-Rohrabschneider

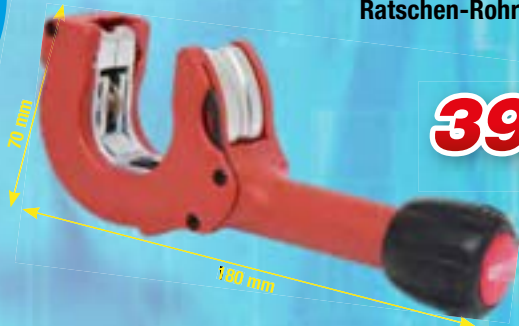

39,90



Ø 28 - 67 MM



104.5050

Inox

Steel

Ratschen-Rohrabschneider



129,90



116.1050



FUGENFIX®

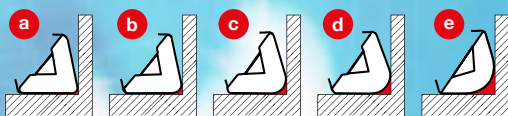

7,90



FUGENFIX Silikonschaber- und Abziehsatz



903.3300

Gewinde-Schneidkluppen-Satz

3/8"  
1/2"  
3/4"  
1"  
1.1/4"

79,90



116.2000

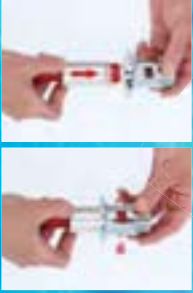

**57,90**

Ventilfix

130.3000 1/2"

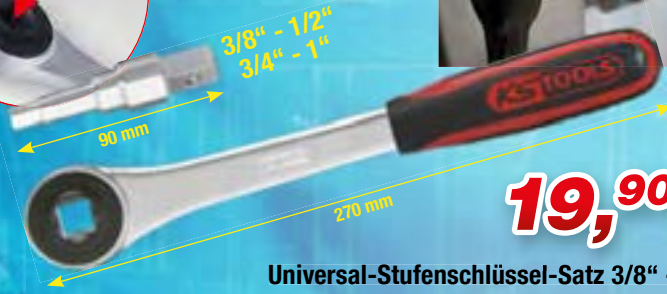

**19,90**

Universal-Stufenschlüssel-Satz 3/8" - 1"

903.5902

- Flammentemperatur ca. 1700°C
- Arbeitstemperatur ca. 650°C
- Weichlöten bis max. Ø 22 mm
- Lieferung erfolgt ohne Gaskartusche
- Verwendung nur mit Standard-Hochleistungsbrenner
- Grundkörper aus Kunststoff



**24,90**

Universal-Kartuschenlötgerät mit Piezo-Zündung

907.2113

Japan-Zugsäge, doppelverzahnt



17x pro 2,5cm

8x pro 2,5cm

325 mm

**17,90**



850.0300

SMARTBAG Universal-Werkzeugtasche

**73,90**

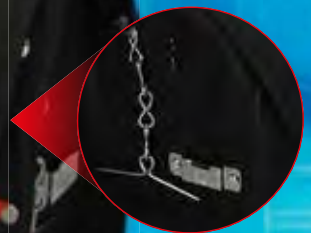

NEU



### Kompakte und robuste Bauweise:

Durch hochwertige Kunststoffe und feste Verschraubungen, bietet der Akku besonders guten Schutz vor mechanischen Einflüssen.



### 18V eMONSTER Akku-System

Das kraftvolle 18V eMONSTER Akku-System vereint eine Reihe von professionellen akkubetriebenen Elektrowerkzeugen. Alle Geräte können mit einem Akku-System betrieben werden. Das Sortiment ist breit aufgestellt und wird stetig erweitert. Jedes neue Gerät kann ebenso mit diesem Akku-System genutzt werden. So können Sie über viele Jahre dieses Akku-System nutzen und mit eMONSTER 18V Geräten erweitern - Sie bleiben in einer Akku-Familie.



### Wärmeableitung:

Durch die Rippenstruktur wird die Wärme wie bei einem Kühler an die Umgebungsluft angeleitet.



### Zusätzlicher Schutz für eine lange Lebensdauer des Akkus:

#### Überspannungsschutz:

- Schutz vor unzulässig hohen Spannungsquellen

#### Niederspannungsschutz:

- Schutz vor Tiefenentladung im Betrieb

#### Temperaturmanagement:

- Zusammenspiel von Gerät und Akku, um eine Überlastung am Akku zu verhindern



### Aktive Luftkühlung:

(nur bei 8.0Ah Schnellladegerät) Der integrierte Lüfter des 8.0Ah Schnellladegeräts liefert während dem Ladevorgang durchgehend kühle Frischluft, um entstehende Wärme im Akku und Ladegerät bestmöglich zu reduzieren. Durch diesen schonenden Ladevorgang wird die Lebensdauer des Akkus deutlich erhöht.



### Optimierte Zellanordnung:

Durch die Röhrenstruktur werden die einzelnen Zellen in den wärmeleitenden Kunststoff geschoben. So entsteht ein fester Kontakt zwischen der Zelle und dem wärmeleitenden Kunststoff. Es ist keine isolierende Luftschicht mehr vorhanden, welche die Wärmeableitung verringert.



STAINLESS STEEL



STAINLESS STEEL





### eMONSTER Brushless-Akku-Bohr-Schrauber-Satz

## MINI



# 159,90

Drehmoment max: 40 Nm  
Antrieb: 10 mm Schnellspann-Bohrfutter

515.6400



### eMONSTER Brushless-Akku-Schlag-Bohr-Schrauber-Satz



# 189,90

Drehmoment max: 60 Nm  
Antrieb: 13 mm Röhren-Metall-Schnellspann-Bohrfutter

515.6300

### INKLUSIVE

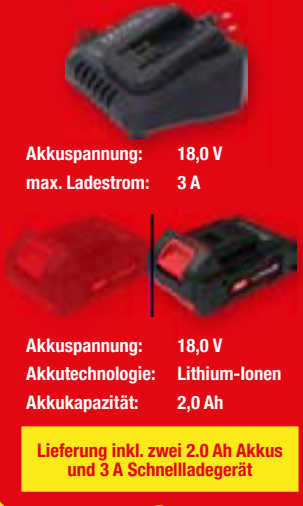

Akkuspannung: 18,0 V  
max. Ladestrom: 3 A

Akkuspannung: 18,0 V  
Akkutechnologie: Lithium-Ionen  
Akkukapazität: 2,0 Ah

Lieferung inkl. zwei 2,0 Ah Akkus und 3 A Schnellladegerät

### INKLUSIVE



Akkuspannung: 18,0 V  
max. Ladestrom: 8 A

Akkuspannung: 18,0 V  
Akkutechnologie: Lithium-Ionen  
Akkukapazität: 4,0 Ah

Lieferung inkl. zwei 4,0 Ah Akkus und 8 A Schnellladegerät



### eMONSTER 1/2" Brushless-Akku-Schlag-Schrauber-Satz



# 269,90

max. Löse-Drehmoment: 690 Nm  
Antrieb: 1/2"

515.6100



### eMONSTER Brushless-Akku-Winkelschleifer-Satz



# 299,90

Drehzahl: 9000 U/min  
Vibrationsbeschleunigung: < 4,831 m/s<sup>2</sup>  
3,371 m/s<sup>2</sup>

515.6200



# NEU

### 1/4" TORSIONpower Bit-Satz im eMONSTER-Akku-Design, 32-tlg

# 9,90

515.6932

1 x		1/4"
1 x		1/4"
4 x		3 - 4 - 5 - 6 mm
4 x		PH1 - 2 x PH2 - PH3
4 x		PZ1 - 2 x PZ2 - PZ3
4 x		3 - 4 - 5 - 6 mm
7 x		T10 - T15 - T20 - T25 - T27 - T30 - T40
7 x		TB10 - TB15 - TB20 - TB25 - TB27 - TB30 - TB40

+30%

lässt sich an die 18V eMONSTER Geräte als Akku-Dummy anstecken und arretieren

# HIER GEHT'S SCHLAG AUF SCHLAG!

**1.390 N·m**

1/2"

90 mm

115 mm



515.1150

1  **199,90**

**1.390 N·m**

1/2"

95 mm

190 mm



515.1270

2  **149,90**

**1.084 N·m**

1/2"

115 mm

180 mm



515.1315

3  **69,90**

**1.600 N·m**

1/2"

170 mm

188 mm



515.1200

4  **69,90**

**2.000 N·m**

3/4"

170 mm

185 mm



515.3400

5  **124,90**

**1.690 N·m**

1/2" 3/4"

175 mm

200 mm



515.1210

6  **149,90**

7  **189,90**

**3.405 N·m**

3/4" 1"

40 mm

350 mm



515.3250

9  **849,90**

11  **849,90**

**3.405 N·m**

3/4" 1"

195 mm











350 mm



515.3260

10  **904,90**

12  **904,90**

													
		Nm	U/min	m/s <sup>2</sup>	dB(A)	dB(A)	U/min	PT				Kg	
1	515.1150	1/2"	1390	10.000	<9,18	102,0	113,0	135	1/4"	-	✓	-	1,08
2	515.1270	1/2"	1390	10.000	<9,18	102,0	113,0	135	1/4"	-	✓	-	1,3
3	515.1315	1/2"	1084	9000	<10,36	106,0	115,0	169	1/4"	-	✓	-	1,2
4	515.1200	1/2"	1600	8500	<17,5	89,9	100,9	169	1/4"	✓	-	-	2,1
5	515.3400	3/4"	2000	8500	<17,25	91,0	100,9	196	1/4"	✓	-	-	2,2
6	515.1210	1/2"	1690	7930	<17,9	87,0	98,0	178	1/4"	✓	-	-	2,1
7	515.3785	3/4"	1690	7930	<13,56	88,0	104,0	178	1/4"	✓	-	-	2,2
8	512.0002	1/2"	2300	8500	<8,69	99,7	110,9	244	1/4"	✓	-	✓	1,6
9	515.3250	3/4"	3405	6200	<12,57	115,5	104,5	283	1/2"	✓	-	-	6,7
10	515.3260	3/4"	3405	6200	<12,88	115,5	104,5	283	1/2"	✓	-	-	7,7
11	515.3270	1"	3405	6200	<12,57	115,5	104,5	283	1/2"	✓	-	-	6,7
12	515.3280	1"	3405	6200	<12,88	115,5	104,5	283	1/2"	✓	-	-	7,8





**i** 1  
Weitere Informationen

**Fettförderung: Je ein Hub pro Abzugsbetätigung**

200 mm

400 g

400 mm

**66,50**

**515.3900** Druckluft-Fettpresse für hubweise Fettförderung

**i** 1  
Weitere Informationen

**ab 24,90**

**PU** ✓

515.3330	6,0 mm	G1/4" AG	8,0 m	24,90 €
515.3335	8,0 mm	G1/4" AG	15,0 m	34,90 €
515.3340	10,0 mm	G3/8" AG	15,0 m	39,90 €

**i** 1  
Weitere Informationen

**9,90**

regulierbar

100 mm

**515.1901** Druckluft-Ausblaspistole mit Durchflussregulierung

**i** 3  
Weitere Informationen

**19,90**

510 mm

330 mm

95 mm

**515.1921** Druckluft-Ausblaspistolen-Satz

**Automatischer Druckluftschlauch-Aufroller**

15 m

1,5 m

180°

**STOP**

**i** 1  
Weitere Informationen

**119,90**

**Ø 10 MM X 15 M**

**A**

Technische Daten:  
Schlauchinnendurchmesser: 10,0 mm  
max. Druck: 20,0 bar  
Anschlussgewinde: 1/4"

**515.3440**

**i** 1  
Weitere Informationen

**179,90**

**Ø 13 MM X 15 M**

**B**

Technische Daten:  
Schlauchinnendurchmesser: 13,0 mm  
max. Druck: 20,0 bar  
Anschlussgewinde: 3/8"

**515.3445**

**i** **1**  
Weitere Informationen

**A** 480 mm 320 mm 36 mm  
**B** 1.150 mm 550 mm 36 mm

**ab 11,90**

	↔	
<b>A</b>	500.8040	480 mm 11,90 €
<b>B</b>	500.8045	1.150 mm 39,90 €

**i** **1**  
Weitere Informationen

**1** 360 mm 365 mm 360 mm

**49,90**

500.8020

**i** **1**  
Weitere Informationen

**2** 360 mm 365 mm 400 - 540 mm

**59,90**

500.8030

**i** **1**  
Weitere Informationen

**HOCHBELASTBAR MIT 135 KG**

**3** 463 - 580 mm 360 mm

**69,90**

500.8004

**i** **1**  
Weitere Informationen

**4** 400 mm 490 mm 1.040 mm 85 mm

**69,90**

500.8011

**i** **1**  
Weitere Informationen

**6** 145 mm 1.200 mm 510 mm 145 mm

**99,90**

500.8000

	<b>1</b>	<b>2</b>	<b>3</b>	<b>4</b>	<b>5</b>	<b>6</b>
<b>Technische Daten:</b>	500.8020	500.8030	500.8004	500.8011	500.8090	500.8000
Farbe	rot	rot	rot	rot	rot	rot
Material	Stahlrohr	Metall	Metall	Metall	Kunststoff	Metall
Anzahl Lenkrollen	4	5	5	6	6	6
rollbar	✓	✓	✓	✓	✓	✓
Art der Bereifung	Kunststoff	Kunststoff	Gummi	Kunststoff	Kunststoff	Kunststoff
gepolstert	✓	✓	✓	✓	✗	✓
höhenverstellbar	✗	✓	✓	✓	✗	✓
Verpackungsinhalt	1	1	1	1	1	1
Gesamtlänge L in mm	365,0 mm	370,0 mm	360,0 mm	1040,0 mm	1030,0 mm	1200,0 mm
Breite B	360,0 mm	370,0 mm	360,0 mm	490,0 mm	480,0 mm	420,0 mm
Höhe H	360,0 mm	420,0 - 540,0 mm	463,0 - 580,0 mm	85,0 - 400,0 mm	115,0 mm	145,0 - 510,0 mm
Gesamttragkraft kg	90 kg	90 kg	135 kg	90 kg	120 kg	90 kg

**i** **1**  
Weitere Informationen

**DIE LEICHTESTE**

**5** 480 mm 1.030 mm 115 mm

**67,90**

500.8090

**i**  **3**  
Weitere Informationen

**Genial flexibel**

**NEU**

**44,90**

500.8077 **Werkzeugablagensatz aus Silikon**

1 53 x 29,5 x 3,2 cm

2 25,5 x 23,3 x 2,4 cm

3 27,5 x 14,5 x 2,4 cm

**i**  **1**  
Weitere Informationen

- mit rutschfestem Profil auf der Laufbühne
- mit großer Plattform für sicheren Stand
- Kunststoffkanten an Füßen schützen Laufbühne und den Boden

**99,90**

800.0960 **Aluminium-Sicherheits-Laufbühne**

300 mm

960 mm

495 mm

**FÜR IHRE SICHERHEIT**

**TÜV SÜD**

**GEPRÜFT!**

**i**  **1**  
Weitere Informationen

- mit Riffelblech-Profil auf der Trittstufe
- kein Kippen durch schräg gestellte Standfüße
- zusammenklappbar und dadurch platzsparend zu verstauen

**54,90**

800.0965 **Aluminium-Stufen-Stehleiter**

600 mm

440 mm

620 mm

**FÜR IHRE SICHERHEIT**

**TÜV SÜD**

**GEPRÜFT!**

**MAXIMALE ARBEITSFLÄCHE**

**1199,<sup>90</sup>**

**XXL**

840 mm

2000 mm

680 mm

865.0201 **XXL-Werkbank mit 3 Schubladen und 1 Tür**

**KLEIN UND GROSS ZUGLEICH!**

**179,<sup>90</sup>**

257 - 1380 mm

845 - 1320 mm

257 - 1380 mm

500.8100 **Universal Teleskop-Mehrzweckwagen mit Rollen**

**NEU**

**49,<sup>90</sup>**

610 mm

570 mm

Ø 440 mm

180°

3 5000 rpm, 57 dB, 4,9 m/s, 56,9 W

2 4500 rpm, 51,5 dB, 4,3 m/s, 53 W

1 4000 rpm, 48 dB, 3,5 m/s, 49 W

**EXTREM LEISE  
ULTRALEICHT  
< 3,5 KG**

999.2000 **Werkstattventilator, 70 Watt**

**Parallel-Schraubstock**

**ab 165,<sup>90</sup>**

360°  
mit Drehteller

360°

Backen und Amboss  
induktiv gehärtet

914.0004	120 mm	4"	165, <sup>90</sup> €
914.0005	140 mm	5"	178, <sup>90</sup> €
914.0006	160 mm	6"	189, <sup>90</sup> €
914.0008	200 mm	8"	229, <sup>90</sup> €

914.0004 120 mm 4" 165,<sup>90</sup> €

914.0005 140 mm 5" 178,<sup>90</sup> €

914.0006 160 mm 6" 189,<sup>90</sup> €

914.0008 200 mm 8" 229,<sup>90</sup> €

**i** **1**  
Weitere Informationen

 max. 8 bar (116 PSI)	 60° C 140° F
-----------------------------	---------------------

**19,90**

**1** Water    **2** Detergent    **4**

Max. 40° C    Max.

**4**    **5**    Switch    Lock

**150.8271 Druck-Pump-Schaum-Sprüher (Schäumer)**

**i** **1**  
Weitere Informationen

**84,90**

350 mm

650 mm

**500.8013 Fahrbarer Hocker**

**i** **1**  
Weitere Informationen

 6,3 bar	 96 Liter/min
 92 dB(A)	 1/4" FT

**39,90**

145 mm    3/8" - Ø 10 mm

saugen    pusten

**515.5090 Druckluft-Saug-Blaspistole**

**i** 1  
Weitere Informationen

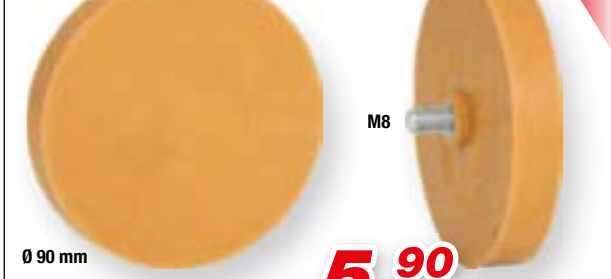

515.1243 **Folienradierer**

**5,90**



**i** 1  
Weitere Informationen

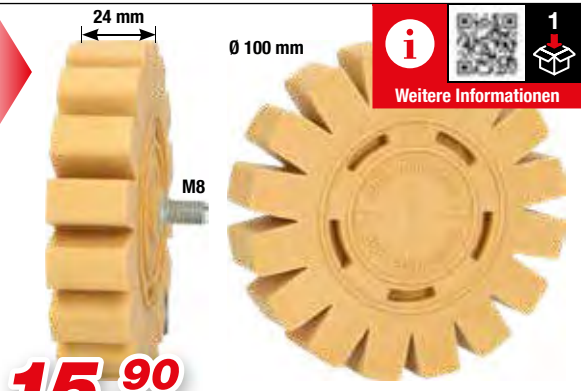

515.1247 **Folienradierer mit Lamellen**

**15,90**

**i** 6  
Weitere Informationen

**SETPREIS = 6x**



515.1285

**29,90**



515.1366

**SETPREIS = 6x**

**i** 6  
Weitere Informationen



515.1366

**89,90**

**i** 1  
Weitere Informationen



**141,90**

515.1980 **Druckluft-Reinigungs-Pistole**

		<3,90 min⁻² icon"/>

**OPTIONAL**

**i** 1  
Weitere Informationen



515.1983

**Bürsten-Aufsatz**

**5,90**

**i** 1  
Weitere Informationen



515.1986

**Bürsten-Pinsel**

**5,90**

**i** **6**  
 Weitere Informationen

**29,90**

510 mm

4 mm  
8 mm  
10 mm

4 mm  
8 mm  
10 mm

245 mm

**140.2370 Clip-Löse-Satz**

**i** **11**  
 Weitere Informationen

**19,90**

180 mm 200 mm 200 mm 200 mm 210 mm

160 mm 200 mm 200 mm 180 mm 200 mm 200 mm

**911.6205 MASTER Kunststoffkeil-Satz**

**i** **1**  
 Weitere Informationen

DC 12V 24V AC 100-240V 50/60 Hz

- beseitigt Gerüche und desinfiziert den Fahrzeuginnenraum
- automatische Abschaltung im Geruchs- beseitigungs-Modus nach 60 Minuten
- arbeitet ohne chemische Zusätze, daher ist eine rückstandslose Reinigung garantiert
- hinterlässt selbst auf empfindlichen Oberflächen keine Spuren
- beseitigt Schimmel, Bakterien, Pilze und Milben

173 mm

49 mm

122 mm

**550.1183 Plasma-Luftreiniger mit Ionisator-Technik**

**79,90**

**i** **1**  
 Weitere Informationen

- ideal geeignet zum Reinigen von engen Röhren, Schläuchen oder Abflüssen
- doppelseitig verwendbar
- flexibler Edelstahlschaft
- Nylonborsten

**3,90 NEU**

Ø 16 mm

Ø 22 mm

**150.1762 Flexible Reinigungsbürste**

**i** **7**  
 Weitere Informationen

Ø 0 - 38 mm

Ø 0 - 48,5 mm

Ø 0 - 65 mm

Ø 0 - 30 mm

Ø 0 - 45 mm

Ø 0 - 45 mm

Ø 0 - 60 mm

**79,90**

**115.1055 KFZ Schlauchschellenzangen-Satz**



**i** **3**  
Weitere Informationen

**9,90**

Ø 15 mm    Ø 30 mm    Ø 60 mm

150 mm    400 mm    250 mm

115.5050

**i** **3**  
Weitere Informationen

Ø 35 mm    Ø 15 mm    Ø 23 mm

155 mm    255 mm    165 mm

115.5055

**12,90**

**i** **1**  
Weitere Informationen

**14,90**

Absaug- und Füllhandpumpe

150.9221

**i** **1**  
Weitere Informationen

**19,90**

100 mm

3/8" Spezial-Steckschlüssel für Saugrohr-Verschraubungen

150.2519

**i** **1**  
Weitere Informationen

**19,90**

12V 5A 60W  
Richtung Direction  
150.2620

PETROL DIESEL OIL

Elektrische Öl-Absaug- und Umfüllpumpe

150.2620

**i** **1**  
Weitere Informationen

Wechselsnuss für 30-45 mm und 60-80 mm Schlauchschellen

**4,90**

**NEU**

30 mm

2 in 1 Spezial-Steckschlüssel für Schlauchschellen mit 3-Punkt-Profil

115.0915

**i** **1**  
Weitere Informationen

**12,90**

**NEU**

1/2"

108 mm

Kühlerdeckel-Lösewerkzeug für VAG

150.1919





**25**

Weitere Informationen











0 - 2,5 bar

max. 76 cm

0 - 200 °C  
0 - 400 °F

1600 mm



R123  
R124



R123  
R125



#1



#2



#3



M50 x 2,5



M42 x 3



M58 x 3



M62 x 3



M48 x 4



M45 x 3



M50 x 2,5



M60 x 4



M52 x 3



M48 x 2,5



M42 x 2,5



M50 x 3



M46 x 3



M34 x 2,5



75 mm

# 179,<sup>90</sup>

**MASTER**  
Kühlsystem-Diagnose-Service-Satz



150.1930





**1**

Weitere Informationen

**Kupplung 7,2 mm auf 4,4 mm**



7,2 mm



4,4 mm

**NEU**



# 19,<sup>90</sup>

150.1936





**1**

Weitere Informationen

**Kupplung 4,4 mm auf 7,2 mm**



4,4 mm



7,2 mm

**NEU**



# 24,<sup>90</sup>

150.1937

**i** **8**  
Weitere Informationen

250 ml

**99,90**

150.1910 C02-Zylinderkopf-Lecktest-Satz

**OPTIONAL ZUM NACHKAUF**

**14,90**

150.1914

**i** **3**  
Weitere Informationen

**GENIAL FLEXIBEL**

53 x 29,5 x 3,2 cm

1

2

25,5 x 23,3 x 2,4 cm

3

27,5 x 14,5 x 2,4 cm

**NEU**

**44,90**

500.8077 **Werkzeugablagensatz aus Silikon**

**i** 2  
Weitere Informationen

**Ford EcoBoost**

**NEU**

14 mm 180 mm 215 mm 16 mm

**24,90**

**FÜR FORD ECOBOOST MOTOREN 1,0 LITER**

**FÜR FORD ECOBOOST MOTOREN 1,5 LITER**

517.1135 **Zündkerzen-Stecknuss-Satz für EcoBoost Motoren**

**i** 2  
Weitere Informationen

M20 x 1.5 M22 x 1.5

27 mm 13 mm

- zum Nachschneiden verrosteter und beschädigter Sondengewinde
- ideal für NOX- und Partikelfiltersensoren an Abgasanlagen
- mit 6 Schneiden für ideale Zentrierung
- besonders kurze Ausführung
- mit Reinigungsnuten im Führungsbolzen

mit 6 Schneiden für ideale Zentrierung

mit Reinigungsnuten im Führungsbolzen

**179,90**

150.2540 **Gewindeschneider-Satz mit Führungsbolzen für Sensoren**

**GENIALE PROBLEMLÖSER**

**NEU**

**i** 1  
Weitere Informationen

**Gewindeschneider mit Führungsbolzen**

- zum Nachschneiden verrosteter und beschädigter Sondengewinde

13 mm

mit 6 Schneiden für ideale Zentrierung

mit Reinigungsnuten im Führungsbolzen

**99,90**

			L1	L2			
<b>A</b>	150.2541	für Temperatursensoren	M12 x 1,25	55 mm	33 mm	13 mm	99,90 €
<b>B</b>	150.2542	für Temperatursensoren	M14 x 1,5	45 mm	30 mm	13 mm	99,90 €
<b>C</b>	150.2543	für Lambdasonden	M18 x 1,5	42 mm	27 mm	13 mm	99,90 €
<b>D</b>	150.2544	für NOX-Sensoren	M20 x 1,5	50 mm	27 mm	13 mm	99,90 €
<b>E</b>	150.2546	für Partikelfiltersensoren	M22 x 1,5	50 mm	27 mm	13 mm	99,90 €

**i**  **1**  
 Weitere Informationen

**19,90**



**1** **2**

**500.7505** Zündspulen-Abzieher für Stab-Zündspulen



**i**  **7**  
 Weitere Informationen

**FÜR VAG UND OPEL MOTOREN**

**69,90**



**1** **2** **3** **4** **5** **6** **7**

**500.7570** T-Griff-Zündspulen-Abzieher-Satz für VAG und Opel Motoren







**i**  **7**  
 Weitere Informationen

120 ml 120 ml



6x10  
6x6  
6x8  
6x4  
600 mm  
Ø 6x9 mm

**169,90**

**150.1900** Druck- und Unterdruck-pumpen-Satz



**i**  **24**  
 Weitere Informationen



**49,90**

**700.1280** Universal Wellendichtring und Simerring Montagewerkzeug-Satz



**i** **1**  
Weitere Informationen

**39,90**

**150.3170 Universal-Rillen-Riemenscheiben-Abzieher Ø 40-165 mm**

**i** **1**  
Weitere Informationen

**NEU**

• zum Spannen und Entspannen der Zahnriemen-Spannrolle  
• verstellbar, universal einsetzbar  
• Innenvierkantantrieb nach DIN 3120 / ISO 1174  
• mit Außensechskantantrieb 13,0 mm  
• phosphatiert

**19,90**

**150.3046 Universal-Zapfenschlüssel für Zahnriemen-Spannrolle, verstellbar**

**i** **1**  
Weitere Informationen

Anwendungsgebiete: Citroën, Peugeot, Opel und Toyota mit 1,0 und 1,2 Benzin-Motoren (Motorcode: ZMZ (EB0F / EB0) / HMO1 (1PP) / HMV, HMZ (EB2) / HMZ (EB2 / EB2F) / HMT (EB2D) / HMU (EB2D) / HNZ (EB2DT) / HNY (EB2DTS) / HMV (EB2M) / HMY (EB2M) / B12XE (EB2F) / D12XE (EB2FA) / B12XHL (EB2DT) / D12XHL, F12XHL (EB2ADT) / B12XHT (EB2DTS) / D12XHT, F12XHT (EB2ADTS))

**9,90**

**400.2118 Zahnriemen-Prüfwerkzeug für PSA**

**i** **1**  
Weitere Informationen

**34,90**

**150.3130 Universal-Riemenscheiben-Abzieher 3-armig**

**i** **22**  
Weitere Informationen

**Petrol Diesel OIL**

• für die Montage und Demontage der schwer zu öffnenden CLIC-Federverschluß-Leitungskuppungen bei Kraftstoff-, Klimaanlage-, Luft- und Hydraulikleitungen  
• keine Beschädigung der Steckkupplungen, Kraftstoffleitungen und Kraftstoffschläuche  
• schnelles und einfaches Trennen der Kraftstoffleitungen  
• für nahezu alle Leitungskuppungen an europäischen, asiatischen und amerikanischen Fahrzeugen

**115.1260 Leitungsverbinder-Entrieglungs-Satz**

**49,90**

5/16" 1/4" 5/16" 3/8" 3/8" 1/2" 5/8" 7/8"  
3/8" 1/2" 5/8" 3/4" 5/16"  
3/8" 1/2" 5/8"  
3/4" 7/8" 5/16" x 3/8"  
5/16"



Weitere Informationen

# MIT 3.873 SCHLÄGEN PRO MINUTE ZIEHT ER JEDEN AUS!

- inklusive 7 Adaptern für nahezu alle Injektoren
- enorm hohe Schlagwirkung (3365 (6,3 bar) / 3873 (8 bar) Schläge pro Minute)
- zum Ausbau der festgebrannten Injektoren im Zylinderkopf
- mit einem entsprechenden Adapter wird der Auszieher an der feststehenden Einspritzdüse verschraubt
- geringer Platzbedarf durch kompakte Bauweise



223 L/min	3/4"-19 mm	108,4 dbA
6,3 bar (90 psi)	71,9 m/s²	6 mm
12 bar	119,4 dbA	M18 x 1,5



<b>A</b>	M25 x 1,0	Siemens
<b>B</b>	M20 x 1,0	Denso
<b>C</b>	M27 x 1,0	Siemens
<b>D</b>	M27/M17/10 mm	Bosch/Fiat/BMW/PSA/ Mercedes/ Renault
<b>E</b>	M18 x 1,5	Adapter
<b>F</b>	M17 x 1,0	Bosch/ Mercedes
<b>G</b>	M16 x 1,0	Toyota
<b>H</b>	M14 x 1,5	Bosch/Delphi/BMW

**BOSCH** ✓  
**DENSO** ✓  
**DELPHI** ✓  
**SIEMENS** ✓  
 ... ✓

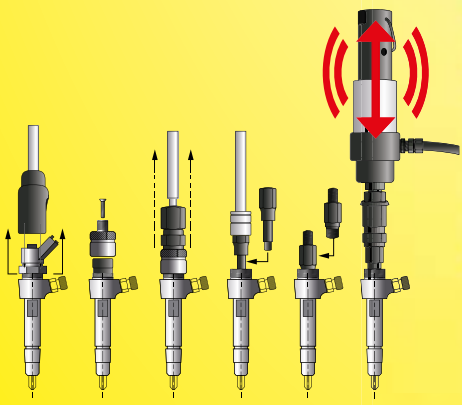

# 269,90

152.1130 Druckluft Injektoren-Auszieher-Satz

Alle Preise in EUR zzgl. MwSt. gelten bis 30.09.2024

**6**  
Weitere Informationen

285 - 875 mm  
**TELESKOPIERBAR**  
150 - 675 mm

500g  
200g  
1000g  
2000g  
3000g

Ø 4 mm  
Ø 13 mm  
Ø 16 mm  
Ø 19 mm

400 mm  
510 mm

**NEU**

**26,90**

550.1090 **Flexibler und teleskopierbarer Magnethalter und Inspektionsspiegel-Satz**

**1**  
Weitere Informationen

125 mm

6 - 24 V  
**4,90**

550.1504 **Prüflampe 6 - 24 V**

**1**  
Weitere Informationen

**11,90**

3 - 48 V

550.1503 **Polaritäts- und Spannungsprüfer 3 - 48 V**

**2**  
Weitere Informationen

**129,90**

25 m

6 - 24 V

150.1655 **Funktionsprüflampe**

**2**  
Weitere Informationen

**1** Empfänger  
**2** Sender mit Krokodilklemmen

**59,90**

150.3075 **Gleichstrom-Kurzschlussdetektor**







1  
Weitere Informationen





# 369,<sup>90</sup>



-  Batterie laden
-  Erhaltungsladen
-  Reparatur der Batterie
-  Gleichstromversorgung
-  umschaltbar zwischen 12 und 24 Volt

**Technische Daten:**

Batteriekapazität:	12V: 75-500Ah - 24V: 45-250Ah
Spannungsbereich:	220-240V AC, 50/60HZ
Ladespannung:	14,4V - 25A (12V), 28,8V - 12,5A (24V)
Frequenzbereich:	50 Hz
Leitung:	H05RN-F 2x1,0 mm <sup>2</sup>

**550.1745 12V + 24V SMARTcharger Hochfrequenz-Batterieladegerät 25A/12,5A**







1  
Weitere Informationen

# 367,<sup>90</sup>





**12V / 24V Digital-Batterie- und Ladesystemtester mit integriertem Drucker**

**550.1649**

**Technische Daten:**

Anzeige:	digital
Arbeitsbereich CA / MCA:	40-2.000 CCA
Arbeitsbereich CCA:	40-2.000 CCA
Arbeitsbereich DIN:	40-2.000 CCA
Arbeitsbereich EN:	40-2.000 CCA
Arbeitsbereich IEC:	40-2.000 CCA
Arbeitsbereich JIS#:	40-2.000 CCA
Arbeitsbereich SAE:	40-2.000 CCA
Arbeitstemperatur:	0°C bis +55°C
Frequenzbereich:	100 Hz
Messbereich:	9-36 V
Messgenauigkeit:	+/- 0,5 Megaohm
Spannungsbereich:	9-36 V

**Für fast alle Batterien**

**Mit Drucker und 3 Rollen Papier**

**MF WET AGM VRLA GEL** ✓

**START STOP**





1  
Weitere Informationen

# 599,<sup>90</sup>





**12 V + 24 V Batterie-Booster - mobiles Starthilfegerät 1400 A**

**550.1720**

**1.400 A**

**Intelligentes Sicherheitskonzept vermeidet Anwender-Fehler:**

Sicherheits-schaltung gibt erst Strom auf die Klemmen wenn:

- korrekt angeschlossen wurde (Polung)
- die Verbindung kurzschluss-sicher ist
- die richtige Spannung anliegt
- die Fahrzeugbatterie in Ordnung ist

**i** **26**  
Weitere Informationen

**DVE** **GS**  
1000 V

**3/8"**

**329,90**

Werkzeugsatz mit isolierten Werkzeugen für Hybrid- und Elektrofahrzeuge

117.1895

2 x		4 mm - 5,5 mm
2 x		PH1 - PH2
6 x		6 - 8 - 10 - 12 - 13 - 17 mm
1 x		185 mm
1 x		165 mm
1 x		3/8"
1 x		3/8": 200 mm
1 x		3/8": 125 mm
10 x		3/8": 8 - 10 - 11 - 12 - 13 - 14 - 16 - 17 - 19 - 22 mm
1 x		200 mm

**i** **43**  
Weitere Informationen

**DVE** **GS**  
1000 V

**3/8"**

**564,90**

Isolierter Werkzeug-Satz für Hybrid- und Elektrofahrzeuge

117.1890

4 x		2,5 - 3 - 3,5 - 4 mm
3 x		PH1 - PH2 - PH3
3 x		T20 - T25 - T30
1 x		210 mm
1 x		185 mm
1 x		165 mm
1 x		215 mm
1 x		165 mm
1 x		240 mm
2 x		10 - 25 mm
1 x		180 mm
1 x		3/8"
15 x		3/8": 6 - 7 - 8 - 9 - 10 - 11 - 12 - 13 - 14 - 16 - 17 - 18 - 19 - 20 - 22 mm
2 x		3/8": 150 - 250 mm
3 x		3/8": M8 - M10 - M12
1 x		Ø 200 mm
1 x		200 mm
1 x		500 m

**i** **18**  
Weitere Informationen

**DVE** **GS**  
1000 V

**329,90**

Maulschlüssel-Satz mit Schutzisolierung

118.1500

18 x		7 - 8 - 9 - 10 - 11 - 12 - 13 - 14 - 15 - 16 - 17 - 18 - 19 - 20 - 21 - 22 - 23 - 24 mm
------	--	---

**i** **1**  
Weitere Informationen

**<44.500 V**

**179,90**

Isolierte Rettungsstange

150.0913

1.680 mm

# DER EINSTEIGER-SATZ IN DIE ELEKTROMOBILITÄT

**eco**line



1

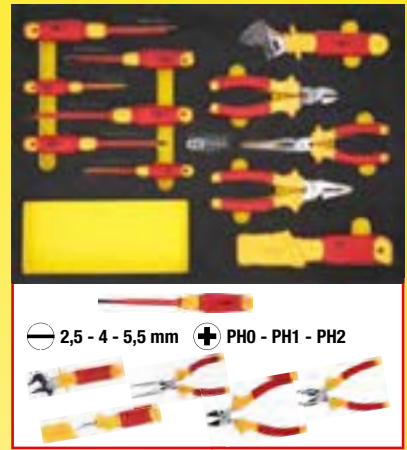

2

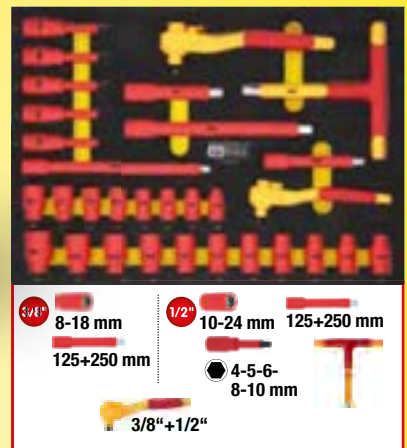

Vierkantlochung für  
 Zubehörteile



verschießbar  
 durch eingebautes  
 Zylinderschloss



Arbeitsplatte mit  
 10 mm starker  
 Schaumstoffeinlage



mit Selbsteinzug und  
 SOFT-CLOSE-Funktion



2 x Roll- und Drehbremsen  
 Ø Räder: 125 mm

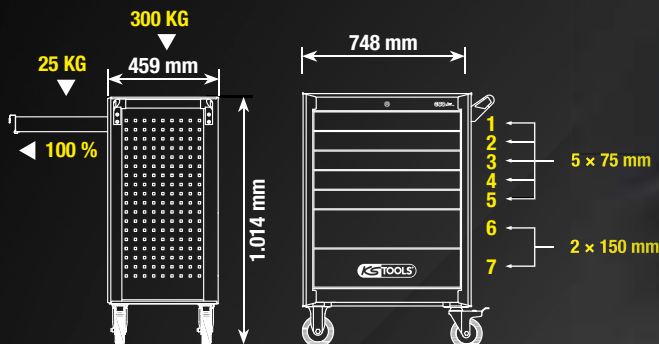

**ECOline Werkstattwagen mit 42 isolierten Werkzeugen  
 für Hybrid- und Elektrofahrzeuge**

**1299,00**   
**INKLUSIVE 42 WERKZEUGE**

117.6144

**4299,00**



**117.6172** 3/8"+1/2" Isolierter Steckschlüssel-Satz mit Drehmomentschlüssel in Schaumstoffeinlage, 72-tlg



**117.6133** Isolierte Schlüssel-Satz in Schaumstoffeinlage, 33-tlg

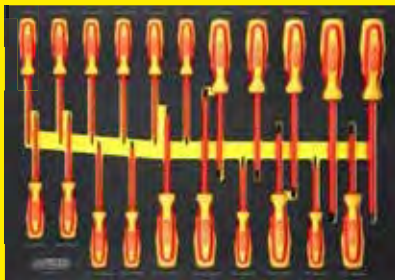

**117.6121** ERGOTORQUE VDE Schraubendreher-Satz in Schaumstoffeinlage, 21-tlg



**117.6117** ERGOTORQUE VDE Zangen-Satz in Schaumstoffeinlage, 17-tlg



**917.3898**



**917.3897**



**117.3819**



**117.1660**



**117.1664**



**117.1796**

**117.6155**

**PERFORMANCEplus Werkstattwagen e10 mit 164 isolierten Werkzeugen für Hybrid- und Elektrofahrzeuge**

**9,90**



**117.0223**

Dachaufsteller mit Blitzsymbol und Magnet



**DER UMFANGREICHSTE SEINER KLASSE**

**9,90**

117.0222

Dachaufsteller mit Blitzsymbol  
und Saugnapf



Den Elektromobilitäts-Katalog  
mit 188 Seiten finden Sie unter  
[www.kstools.com](http://www.kstools.com)

**14,90**

117.0226

Aufsteller mit Blitzsymbol

**69,90**

117.1550

Absperrpfosten-Satz  
mit Kette



**2x**

**139,90**

117.1545  
2 x Scherensperre aus  
Kunststoff



**i**  **4**  
**Weitere Informationen**

Ø 22,0 - 28,0 mm

Ø 15,0 - 21,0 mm

Ø 17,0 - 25,0 mm

**Kupplungs-Zentrier-Werkzeug-Satz**

**8,90**

150.2180 Ø 15,0 - 28,0 mm



**i**  **11**  
**Weitere Informationen**

150 kg

310 mm

450 mm

**394,90**

300 mm



160.0910 **Universal-Getriebehalter-Satz**



**i**  **3**  
**Weitere Informationen**

- 1 Füllwerkzeug A montieren und demontieren
- 2 Öl ablassen, geringer Durchfluss
- 3 Füllstand überprüfen
- 4 Öl ablassen, voller Durchfluss

**24,90**

**9G-TRONIC**

56 mm

74,5 mm

20 mm

9 mm

28,5 mm

39,5 mm

9 mm

152 mm

48 mm



**i**  **24**  
**Weitere Informationen**

# DER UMFANGREICHSTE!

**199,90**

**INKLUSIVE 23-TLG ADAPTERSATZ**

**NEU!**

150.9261		1/8-27 NPT Ford
150.9262		BMW, Honda, Nissan etc.
150.9263		VAG
150.9264		VAG, Porsche
150.9265		M10 x 1.0 VAG, Mini Cooper
150.9267		M12 x 1.5 Mercedes
150.9268		M24 x 1.5 VAG DSG
150.9269		M22 x 1.5 VAG CVT
150.9271		M18 x 1.5 Skoda
150.9272		M30 x 1.5 VAG, Skoda
150.9273		Universal Flexible 300 mm, Honda, Hyundai, Kia, etc.
150.9274		5/16-24 (UNF) Volvo
150.9276		M18 x 1,5 Toyota / Lexus
150.9277		M8 x 1,0 Nissan / Infinity
150.9278		ATF-Adapter V.W, Passat
150.9562		Nissan Juke M12 x 1,25
150.9563		Mini Cooper M14 x 1,5
150.9564		issan M10 x 1,5
150.9566		GM M12 x 1,75
150.9567		Mercedes 725-9G
150.9102		VAG 7 DSG
150.9103		VAG 7 DSG
150.9104		VAG 7 DSG

150.9105 **Universal Getriebeöl-Füllsystem-Satz inkl. 23-tlg Adaptersatz**



**i**  **4**  
Weitere Informationen



**111,90**

**Ø 30 mm**

**McPherson Federbeinstütze für Getriebeheber**

160.0195

**i**  **7**  
Weitere Informationen



6 mm

**99,90**

**Spezial Stoßdämpfer-Montagehilfe-Satz für Stoßdämpfer mit Zuganschlagfeder**

150.9545





**FÜR IHRE SICHERHEIT**  **GEPRÜFT!**

**i**  **6**  
Weitere Informationen

universal für 90% aller gängigen Fahrzeugfedern im PKW und Transporterbereich



Ø 80 - 160 mm

Ø 140 - 195 mm

**BELASTUNG max 26000 N**

**451,90**

**Universal Federspanner-Satz**

500.8400

**Technische Daten:**

Federdruck max.:	2600 kg
Spannweite max.:	355,0
Federkapazität:	80,0 - 195,0 mm

- ideal geeignet zur sicheren Montage und Demontage von Mc Pherson Federbeinen
- erforderlich beim Stoßdämpfer- oder Schraubenfederwechsel
- universal für 90% aller gängigen Fahrzeugfedern im PKW und Transporterbereich
- kostengünstige und solide Alternative zu gängigen Federspanner
- auch für konische - und Kugelfedern geeignet
- mit TÜV-Zulassung

# FÜR IHRE SICHERHEIT



# GEPRÜFT!

**i** **11**  
Weitere Informationen

**TUV SUD**

1/2" x 1/2", 100 Nm

Ø 30 mm

**372,90**

Ø 90 - 140 mm

**500.8765 Audi und Seat Teleskop-Centerspanner-Satz für innenliegende Federn**

ZUR ERWEITERUNG

**i** **2**  
Weitere Informationen

**FÜR FEDERSPANNER**  
**500.8755 + 500.8765**

Ø 95-110 mm

**99,90**

**500.8770 Paar-Federhalter Ø 95-110 mm**

Anwendungsgebiete:  
Mercedes E-Klasse (W211 / W212), C-Klasse (W204), GLA (X156), GLK (X204),  
Ford Focus II (MK2), BMW 1er (E81), Volkswagen Passat (B8 / 3G)

ZUR ERWEITERUNG

**i** **9**  
Weitere Informationen

**TUV SUD**

Ø 30 mm

Ø 90 - 140 mm

Ø 75 - 115 mm

**338,90**

**500.8755 Universal Teleskop-Centerspanner-Satz für innenliegende Federn**

WARNING - ACHTUNG - ADVARSEL  
ADVERTENCIA - AVERTISSEMENT



# FÜR 95% ALLER FAHRZEUGE



Weitere Informationen

1

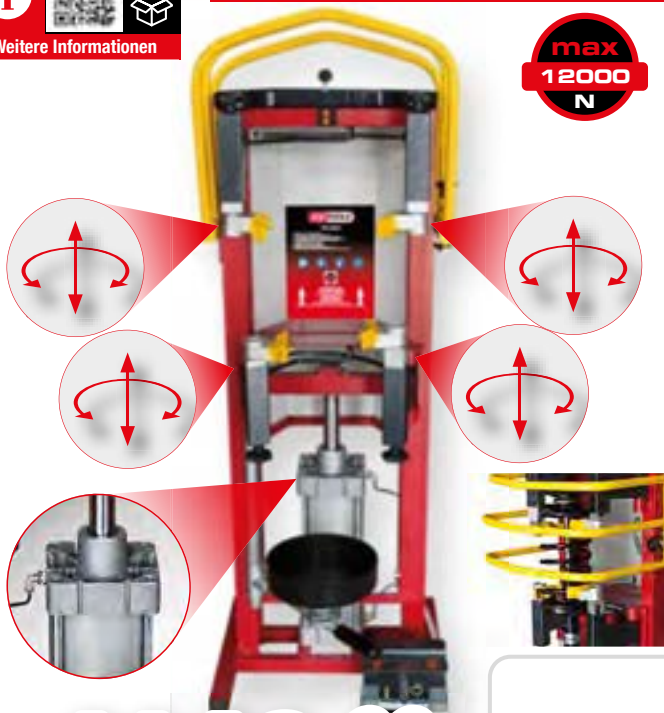

max  
12000  
N

**1149,00**

Druckluft-Stand-Federspanner,  
max. 10 bar

500.8800



Weitere Informationen

1



max  
24000  
N

**1599,00**

Druckluft-Stand-Federspanner  
mit Doppel-Zylinder

500.8810



Weitere Informationen

1

- einfache Handhabung
- Spezial-Werkzeugstahl
- ideal zur Aufnahme von Federbeinen
- optimal für sicheren Stand bei der Montage und Demontage
- mit 4 Fixierbolzen und 4 Gewindebolzen
- Lieferung erfolgt mit 2 Sprengringen zur Montage



**281,90**



500.8801

Adapterplatte für Druckluft-Stand-Federspanner

## FEDERSPANNER-SATZ INKLUSIVE ADAPTERPLATTE



Weitere Informationen

2

Druckluft-Stand-Federspanner  
inkl. Adapterplatte

**1349,00**

500.8805



Weitere Informationen

2

Druckluft-Stand-Federspanner  
mit Doppel-Zylinder  
inkl. Adapterplatte

**1799,00**

500.8815

## KONFIGURIEREN SIE NACH IHREN WÜNSCHEN



440.9051



1199,<sup>90</sup>



GRÖßER  
ALS  
MAN  
DENKT

**BREMSE**



440.9087



2499,<sup>90</sup>

**SILENTLAGER**



440.9025

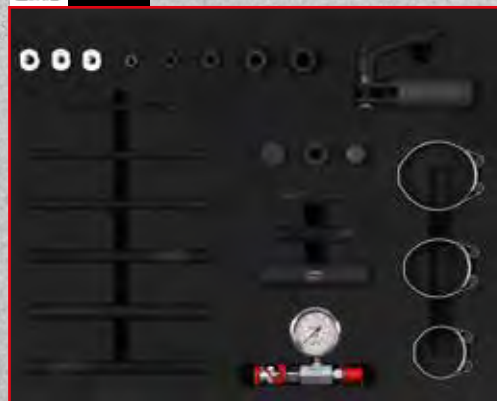

**HYDRAULIKZYLINDER OHNE  
BETÄTIGUNGSWERKZEUGE**



440.9161



3399,<sup>90</sup>

**KOMPAKT-RADLAGER**



440.9026



**ACHSE**



# HALBE LEBEN

# MODULO 2



873.6008

**PERFORMANCEplus P40 SCHWARZ/ROT**  
Werkstattwagen mit 4 Schubladen

**2760,50**

**OHNE WERKZEUGE**



Weitere Informationen





4



**899,90**

Hydraulik-Pumpen-Satz  
mit Ablage für P40

440.9004



**999,90**



440.9076



**1999,90**



**RADLAGER**



**799,90**



440.9061



**1899,90**



**STOSSDÄMPFER**



**i** **1**  
Weitere Informationen

**99,90**

max. 8 bar

450 mm

1/4" PT

für Universal Achsmanschetten

**515.3100 Druckluftmontagegerät für Achsmanschetten**

**i** **1**  
Weitere Informationen

100 mm

255 mm

Ø 30 mm

**49,90**

**150.1850 Universal Gelenkwellen-Abzieher**

**i** **1**  
Weitere Informationen

0 - 45 mm

270 mm

**39,90**

**115.1056 Schlauchklemmzange für Drehmomentanzug**

**i** **1**  
Weitere Informationen

max. 12 mm

**49,90**

**115.1590 Spannzange für Edelstahl-Kabelbinder mit Kugerverschluss**

**ab 25,90**

Edelstahl-Kabelbinder mit Kugerverschluss

200 - 350 mm

115.1591		<b>100</b>	4,6 × 200 mm	25,90 €
115.1592		<b>100</b>	4,6 × 250 mm	25,90 €
115.1593		<b>100</b>	4,6 × 350 mm	28,90 €
115.1594		<b>100</b>	4,6 × 500 mm	37,90 €

**i** **1**  
Weitere Informationen

**UNIVERSAL**

10 mm

**39,90**

**700.5662 Klemmbohrungs-Spreizwerkzeug**

**1**  
Weitere Informationen

**24,90**

**Spezial Tragelenkstecknuss für Mercedes**

150.1721 Mercedes W167, W205, W213, W238, W253, W25

**6**  
Weitere Informationen

**369,90**

**Vibro-Impact Druckluft-Meißelhammer-Satz**

515.3880

- 110 mm
- 110 mm
- 130 mm
- 100 x 25 x 12 mm

10 mm

10 mm

10 mm

10 mm

31 x 1 sec.

VIPRO

**3**  
Weitere Informationen

**31,90**

**Klemmschrauben-  
Austreiber-Satz**

700.5635

**1**  
Weitere Informationen

**159,90**

**Vibro-Impact Lösewerkzeug für Spurstangen**

150.1608

- vibrationsunterstütztes Lösen von Spurstangen, Konterverschraubungen oder Verschraubungen im Achsenbereich etc.
- durch den speziellen Vibrationsdorn wird ein Schlagimpuls auf die zu lösende Verschraubung gegeben, dabei werden Anrostungen gelöst und der Lösevorgang unterstützt
- Druckluft-Meißeladapter (10 mm) für den Einsatz mit marktüblichen Druckluft-Meißel-Schlaghammer

27 mm

290 mm

10 mm

65 mm



Weitere Informationen



168,90

700.1495 Universal-Achshebel mit Kette



- durch flexible Kette lassen sich Querlenker unterschiedlichster Bauformen ohne großen Kraftaufwand sicher niederdrücken



Weitere Informationen

121,90

- stabile Trapez-Gewindespindel
- Fußpedal zur Feinjustierung (20mm)
- der ideale Werkstatthelfer in vielen Situationen



160.0342 Teleskop-Unterstellstütze



Weitere Informationen



89,90

911.6187 Teleskop Gelenk-Rollkopf-Hebeleisen



Weitere Informationen

99,90



700.1465 Achsspielprüfer

**i**  **6**  
 Weitere Informationen

**MIT SCHNELLVERRIEGELUNG**



**451,90**

**1000 W**

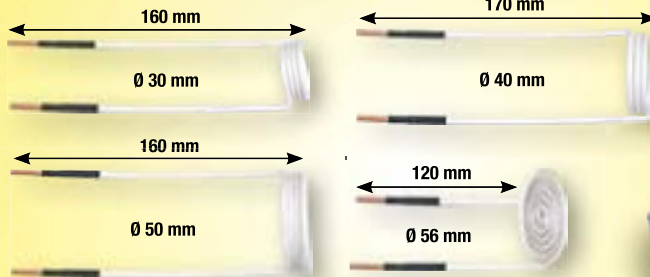

500.8605 Induktions-Heizpistolen-Satz



**OPTIONAL ZUM NACHKAUF**



**129,90**

500.8440

**2. GENERATION - 2. GENERATION - 2. GENERATION**

**i**  **1**  
 Weitere Informationen

**HAKEN DRAN!**

**NEU 14,90**

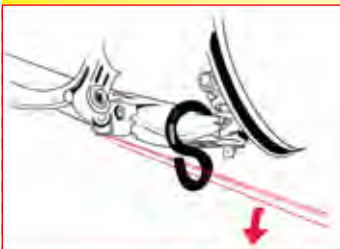

**Universal-Achshebel-Haken**

700.1499

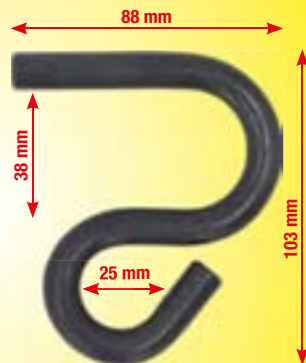

spezielle Form ermöglicht diesen sehr nah am Tragelenk anzusetzen

spezieller Hebel für die fachgerechte und schonende Montage und Demontage von Achsenteilen

**i**  **37**  
 Weitere Informationen

- 1 x 
- 2 x 
- 9 x  Ø 38 - 40 - 42 - 50 - 52  
54 - 62 - 64 - 66 mm
- 13 x  Ø 34 - 36 - 44 - 46  
48 - 56 - 58 - 60 - 68  
70 - 72 - 75 - 80 mm
- 4 x  M10x1,5  
M12x2,0  
M14x2,0  
M16x2,5



**299,90**

700.1550 Druck- und Zughülsen-Satz



**i** **22**  
Weitere Informationen

42 40 38 36 34  
32 30 28 26 24  
#1  
#2  
#3  
#4  
M12  
M10  
M12 M10  
TR20

**700.2355 Stufen-Druckhülsen-Satz**

**499,90**



**i** **4**  
Weitere Informationen

**79,90**

30-35 mm 35-40 mm 40-45 mm  
360 mm  
1/2" / 32 mm

**150.1125 Axialgelenk-Spezialschlüssel-Satz**



**i** **2**  
Weitere Informationen

**M12**

**NEU**

115 mm  
72 mm

**19,90**

**Spezial-Kraft-Bit-Stecknuss-Satz für Vielzahn(XZN®)-Schrauben**

**515.0595**

**i** **30**  
Weitere Informationen

1 x  $\emptyset$  90 - 130 mm  
1 x  
4 x M 14  
4 x M12 x 1,25  
M12 x 1,5  
M12 x 1,25  
M12 x 1,5  
M14 x 1,5  
1 x M18 x 2,5 x 230 mm  
M57 x 2

**4,3 Kg**

**224,90**

**700.1530 Universal-Radnaben- und Gelenkwellen-Abzieher-Satz**



# WENIGER PERSONALEINSATZ, MEHR GEWINN.

## SCHEIBE AUSTRENNEN OHNE HELFER!

140.2630

### Universal Ein-Mann-Betrieb-Scheiben-Austrenngerät

- ideal für den fachgerechten und schonenden Ausbau von geklebten Windschutzscheiben sowie den meisten Heck- und Seitenscheiben
- mit großer Umlenkrolle, dadurch geringerer Kraftaufwand und Minimierung der Gefahr von Drahriss
- Drahtführung unmittelbar vor der Scheibe, dadurch entfällt in den meisten Fällen die aufwendige Demontage von Verkleidungsteilen
- leichte Bedienung durch Einmannbetrieb
- besonders hochwertige Pumpsauger für sicheren Halt auf der Scheibe



Profi-Schutztafel-Satz, 4-tlg  
2x 270x200 mm + 2x 450x300 mm

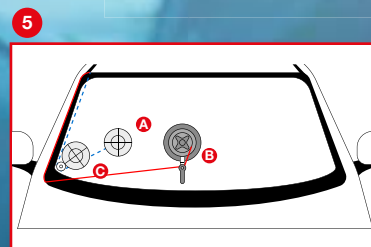
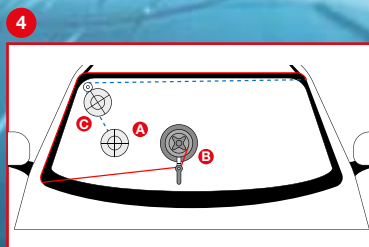
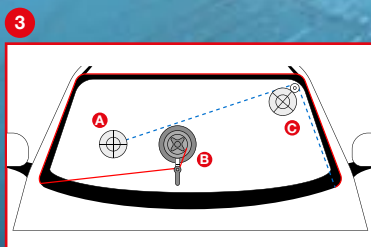
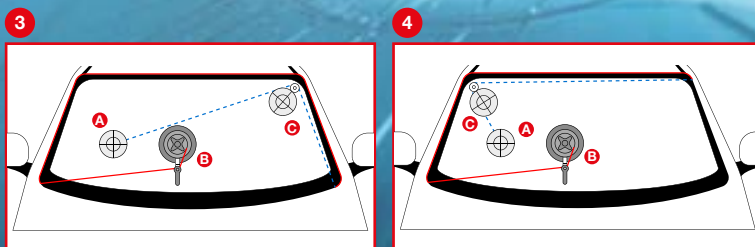
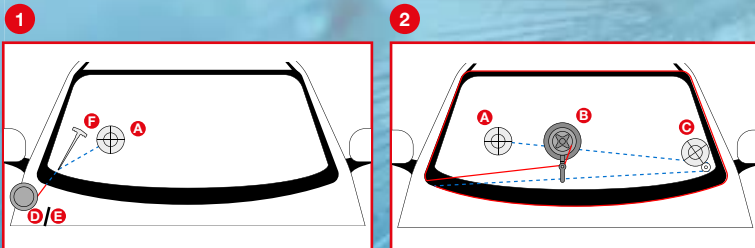

# 599,90

Inklusive



**NEU**

**1**  
Weitere Informationen

**AUCH FÜR DOT5.1, ENV4 UND ENV6**

- Dot3 ✓
- Dot4 ✓

0 20 mm

155 mm

**14,90**

**150.1969 Bremsflüssigkeitstester**

**1**  
Weitere Informationen

**VITON® EKM**

**27,90**

**150.8258 Pumpsprühflasche**

**Speziell für Bremsenreiniger**

**2**  
Weitere Informationen

**10,90**

**150.1935 Universal-Haken-Satz, formbar**

**2**  
Weitere Informationen

**14,90**

**150.2235 Universal-Haken-Satz, starr**

**12**  
Weitere Informationen

1/2" 11,5 mm 14 mm 15 mm 20 mm AS 22 mm

1/4" 9 x 20 mm

3/8" 7 x 72 mm  
7 x 92 mm  
9 x 50 mm  
11 x 100 mm

3/8" 7 x 25 - 8 x 25 mm

**49,90**

**Bremssattelverschraubung-Spezialstecknuss-Satz**

**150.2400** 1/4" 3/8" 1/2"

**41**  
Weitere Informationen

**99,90**

**150.1970 Bremskolben-Rückstell-Werkzeug-Satz**



Weitere Informationen

# DAS UNIVERSAL-GENIE



**UNIVERSAL**  
Für 95% aller Fahrzeuge



**129,90**

150.2440 Universal Bremskolben-Rückstell-Werkzeug-Satz



Weitere Informationen

**699,90**



5L

160.0700 Bremsenwartungsgerät KS5

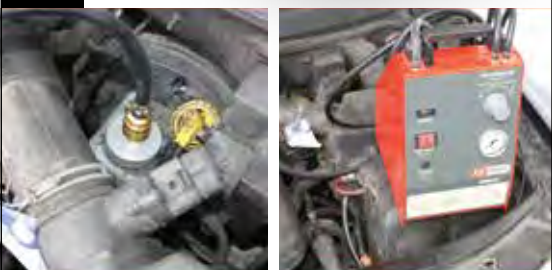

Weitere Informationen

**49,90**



360°

min. 18 mm

universal verstellbar



Max. 70 mm

Min. 28 mm

160.0718 Universal-Entlüfterstutzen-Adapter, verstellbar



Weitere Informationen

**TOYOTA & LEXUS**

**NEU**

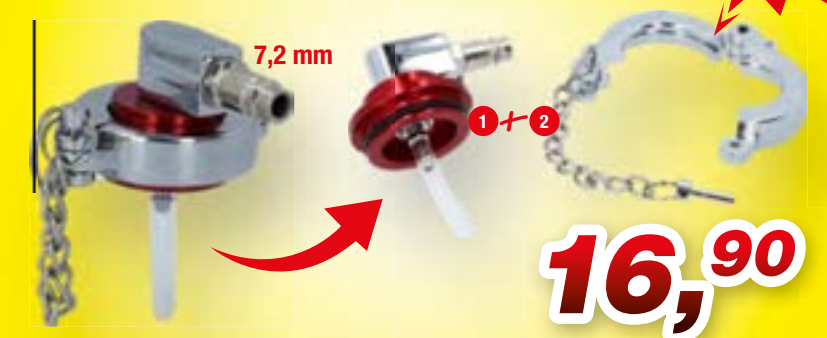

7,2 mm

1+2

**16,90**

160.0719 Universal-Entlüfterstutzen-Adapter für Toyota und Lexus

**i** **6**  
Weitere Informationen

1.200 mm

**69,90**

**Bremsen-Entlüftungsschlüssel-Satz**

11 mm  
10 mm  
9 mm  
8 mm  
7 mm

**i** **11**  
Weitere Informationen

**DER KOMPLETTE**

1.200 mm

9x12 mm

180 mm

**NEU**

11 mm  
10 mm  
11 mm  
7 mm  
11 mm  
60 mm  
70 mm  
75 mm  
85 mm

**74,90**

**Bremsen-Entlüftungs-Werkzeug-Satz für VAG**

**i** **1**  
Weitere Informationen

4,75 mm (3/16")

21 mm  
31 mm  
41 mm  
61 mm  
76 mm

**39,90**

**Bremsleitungs-Biegewerkzeug**

120.1006

**i** **1**  
Weitere Informationen

4,75 mm (3/16")  
6,35 mm (1/4")

**29,90**

**Bremsleitungs-Richtwerkzeug / -Biegewerkzeug**

1 Biegen  
2 Duplizieren  
3 Richten

OUT IN

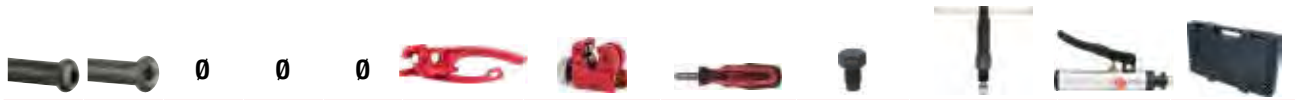

		DIN	SAE	4,75 mm	5,0 mm	6,0 mm	mit Rohrbieger	mit Rohrschneider	mit Rohrentgrater	mechanisch	mit Hydraulikspindel	Handpumpe	im Koffer
1	122.1215	✓	✗	✓	✗	✗	✗	✗	✗	✓	✗	✗	✗
2	122.1290	✓	✓	✓	✓	✓	✓	✓	✓	✗	✓	✗	✓
3	122.1260	✓	✓	✓	✓	✓	✗	✗	✗	✗	✗	✓	✓

**i** **4**

Weitere Informationen

**STOP**

**49,90**

4,75 mm

**1**

**FLAREFIXeco 4,75 mm Universal-Brandsleitungs-Bördelgerät-Satz**

122.1215

**i** **16**

Weitere Informationen

## FLAREFIX

**DIN**  
**SAE**

**169,90**

**2**

**FLAREFIX 1 Universal-Brandsleitungs-Bördelgerät-Satz mit Hydraulik-Spindel**

122.1290

4,75-5,0 mm, SAE

6,0 mm, SAE

4,75-5,0-6,0 mm, SAE-90°

4,75-5,0 mm, DIN

6,0 mm, DIN

M12x1,25

3,0-12,0 mm

3,0-6,0 mm

3,0-16,0 mm

4,75 mm, 3/16"

5,0 mm

6,0 mm

**HYDRAULISCH, PRAKTISCH, GUT!**

**i** **11**

Weitere Informationen

## FLAREFIX II

### Hydraulic

**DIN**  
**SAE**

**299,90**

**3**

**FLAREFIX 2 Universal-Brandsleitungs-Bördelgerät-Satz mit Hydraulik-Zylinder**

122.1260

M12 x 1,25 mm

4,75-5,0 mm, SAE

6,0 mm, SAE

4,75-5,0-6,0 mm, SAE-90°

4,75-5,0 mm, DIN

6,0 mm, DIN

M12x1,25

4,75 mm, 3/16"

5,0 mm

6,0 mm

**i**  **9**  
 Weitere Informationen



<b>1</b> Ford/PSA	<b>2</b> BMW	<b>3</b> VAG	<b>4</b> Mercedes	<b>5</b> DAF/MAN
<b>6</b> GM	<b>7</b> Ford	<b>8</b> Ford	<b>9</b> Ford	

**24,90**







**150.1040** 3/8" Öldienst-Spezialprofil-Satz für Kunststoff-Ölablassschrauben, 9-tlg

**i**  **6**  
 Weitere Informationen

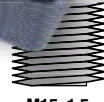

**69,90**

- Werkzeug zum Planen des Dichtses von Ölablassschrauben
- Planen des Dichtses sichert einwandfreie Abdichtung im Bereich der Ölablassschraube
- exakte Zentrierung und Ausrichtung zur Dichtfläche
- Satz inklusive Adaption für Original-Ölablassschraube und Übermaß-Reparaturgewindeschraube
- in stabilem Kunststoffkoffer

 0° / Ø 22	 M14x1,5	 M15x1,5
		

**150.1485** Ölablassschrauben-Dichtses-Planfräser-Satz

**i**  **1**  
 Weitere Informationen



**7,5 Liter**

**Ø 385 mm**

**12,90**

**150.9359** Auffangwanne 7,5 Liter



**i**  **30**  
 Weitere Informationen

1/2" 21 mm  
 Ø 63 - 102 mm

**99,90**

**3/8"**

65-14, 65/67-14, 66-6, 68-14, 73-14, 74-15, 74/76-15, 75/77-15, 76-8, 76-12, 76-14, 76-30, 78-15, 80-15, 80/82-15, 86-18, 86-16, 90-15, 92-10, 93-15, 93-36, 93-45, 95-15, 96-18, 100-15, 106-15, 108-15, 108-18

**150.9350 3/8" Ölfilterschlüssel-Satz**



**i**  **24**  
 Weitere Informationen

2,0 L

**99,90**

VW Lexus Lotus Ford Nissan  
 Subaru Mitsubishi Land Rover Hyundai Audi  
 Chrysler Toyota Citroën Volvo Cadillac  
 Citroën Buick Volvo Buick universal

**150.9130 MASTER Öl-Einfülltrichter-Satz mit drehbarem Winkelarm**



**i**  **4**  
 Weitere Informationen

**FÜR VAG**

mit drehbarem Winkelarm für schwer zugängliche Stellen

**14,90**

2,0 L

**150.9155 Öl-Einfülltrichter-Satz mit drehbarem Winkelarm für VAG**



# AUF DIE BÜHNE - FERTIG - LOS!

aus Voll-Gummi



**NEU**

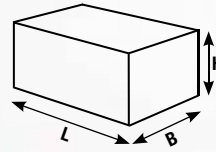

**i**  **1**  
Weitere Informationen

Teile	L mm	B mm	H mm		
160.0476	1	160	120	20	4, <sup>90</sup> €
160.0477	1	160	120	30	6, <sup>90</sup> €
160.0478	1	160	120	40	8, <sup>90</sup> €
160.0479	1	160	120	60	12, <sup>90</sup> €
160.0480	1	160	120	80	16, <sup>90</sup> €
160.0481	1	160	120	100	20, <sup>90</sup> €
160.0482	1	160	120	115	23, <sup>90</sup> €
160.0483	1	116,5	116,5	36,5	5, <sup>90</sup> €
160.0499	1	160	120	85	17, <sup>90</sup> €

PE (Polyethylen)

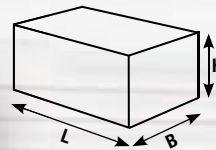

**NEU**

**i**  **1**  
Weitere Informationen

Teile	L mm	B mm	H mm		
160.0437	1	250	150	55	14, <sup>90</sup> €
160.0438	1	250	150	100	26, <sup>90</sup> €
160.0486	1	340	150	55	19, <sup>90</sup> €
160.0489	1	340	130	100	31, <sup>90</sup> €

**i**  **1**  
Weitere Informationen

aus Voll-Gummi mit verstärktem Kern



**NEU**

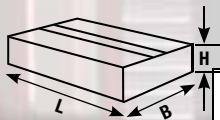

Teile	L mm	B mm	H mm		
160.0484	1	373	100	35	39, <sup>90</sup> €

**i**  **4**  
Weitere Informationen

aus hochfestem Kunststoff



**NEU**

- Model 3 ✓
- Model S ✓
- Model X ✓
- Model Y ✓



160.0460 Tesla Model 3, S, X, Y

**23,<sup>90</sup>**

**i**  **4**  
Weitere Informationen

aus Voll-Gummi

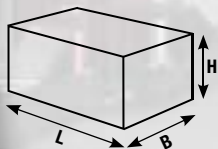

Teile	L mm	B mm	H mm		
160.0391-TD	4	155	125	35	34, <sup>90</sup> €

**i**  **1**  
Weitere Informationen

aus Voll-Gummi



**NEU**

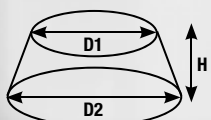

Teile	D1 mm	D2 mm	H mm		
160.0485	1	78	105	60	9, <sup>90</sup> €



**i**  **1**  
 Weitere Informationen

aus Gummi und Stahlplatte

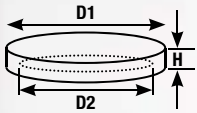

	D1 mm	D2 mm	H mm	Ravaglioli	Grazia	OMCN	Intertech	MAHA	Werther	Nussbaum	AMI	Twin Bush	Sirio	Space	Launch	RP Tools	J.A. Becker	ATH	HOFMANN	Hermann		
<b>A</b>	160.0463	120	113	22				✓														8,90 €
<b>B</b>	160.0465	123	108	25	✓				✓													8,90 €
<b>C</b>	160.0475	120	110	19													✓	✓	✓	✓		8,90 €

**i**  **1**  
 Weitere Informationen

aus Gummi

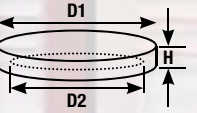

	D1 mm	D2 mm	H mm	Ravaglioli	Grazia	OMCN	Intertech	MAHA	Werther	Nussbaum	AMI	Twin Bush	Sirio	Space	Launch	RP Tools	J.A. Becker	ATH	HOFMANN	Hermann		
<b>A</b>	160.0466	125	120	24						✓	✓											11,90 €
<b>B</b>	160.0467	140	130	25								✓										5,90 €
<b>C</b>	160.0468	100	85	14	✓								✓	✓								4,90 €
<b>D</b>	160.0464	120	113	23				✓														4,90 €
<b>E</b>	160.0469	120	108	32								✓			✓	✓						7,90 €
<b>F</b>	160.0470	130	125	14	✓								✓	✓								4,90 €
<b>G</b>	160.0471	140	125	30								✓										7,90 €
<b>H</b>	160.0472	150	130	23	✓																	6,90 €
<b>I</b>	160.0473	120	105	30								✓										6,90 €
<b>J</b>	160.0474	120	110	19													✓	✓	✓	✓		4,90 €
<b>K</b>	160.0490	100	80	21	✓																	3,90 €
<b>L</b>	160.0491	120	108	26	✓	✓																4,90 €
<b>M</b>	160.0492	120	110	26	✓	✓																4,90 €
<b>N</b>	160.0493	145	108	24	✓		✓															7,90 €
<b>O</b>	160.0494	145	135	26	✓																	6,90 €
<b>P</b>	160.0495	160	135	28			✓															6,90 €
<b>Q</b>	160.0496	140	103	25						✓												7,90 €
<b>R</b>	160.0497	150	127	25	✓																	5,90 €
<b>S</b>	160.0498	140	132	28																		8,90 €

**i** **1**  
Weitere Informationen

**7,90**

**800.0156** Kunststoff-Magnet-Schale, Ø 150 mm

**i** **1**  
Weitere Informationen

**9,90**

**150.2032** Metall-Reifen-Ventilhebel, 330 mm

**i** **1**  
Weitere Informationen

**27,90**

**911.8135** Runflat Reifen- und Montagehebel

**i** **1**  
Weitere Informationen

**49,90**

**800.0190** Metall-Magnethalter, 390 mm

**i** **1**  
Weitere Informationen

**19,90**

**515.1950** Druckluft-Reifenfüllmesser

600 mm

0 - 12 bar

1/4" PT

**i** **1**  
Weitere Informationen

**GEEICHT**

**61,90**

**515.1960** Geeichter Druckluft-Reifenfüllmesser

400 mm

0 - 10 bar

1/4" PT

**i** **5**  
Weitere Informationen

**56,90**

**150.1070** Reifenvulkanisier-Satz für KFZ, inklusive 100 mm Fäden

60 x 100 mm

70 g

9 mm

**OPTIONAL ZUM NACHKAUF**

60 Stück

**17,90**

**150.1072**

**i** **1**  
Weitere Informationen

**89,90**

Aluminium-Radnabenschleifer-Satz Ø 150 mm, Innen-Ø 90 mm

100.5080

**OPTIONAL ZUM NACHKAUF**

**34,90**

100.5077

90 mm

150 mm

**VORHER:**

**NACHHER:**

**i** **4**  
Weitere Informationen

8 mm

10 mm

8 mm

8 mm

**NEU**

OZ Spezial-Alu-Felgen-Stecknuss-Satz für mehrteilige OZ-Felgen

515.0795

**14,90**

**i** **3**  
Weitere Informationen

**39,90**

1/2" Spiral-Profil-Kraft-Stecknuss-Satz, 3-tlg, 17-21 mm

913.1270 17 - 19 - 21 mm

**i** **2**  
Weitere Informationen

19,5 mm

18,5 mm

21,5 mm

20,5 mm

**+**

Spezial-Alu-Felgen-Kraft-Stecknuss-Satz für Ford, 18,5 / 19,5 / 20,5 / 21,5 mm

515.0895 18,5 - 19,5 - 20,5 - 21,5 mm

**27,90**

**i** **1**  
Weitere Informationen

**FÜR MERCEDES**

max. 75 Nm

**17,90**

1/2" Kraft-Torsions-Verlängerung, 75 Nm

515.1491



Weitere Informationen



### Radsicherungs-Demontageset



# 59,90

913.1480 18 - 19 - 20 - 21 - 22 - 23 - 24 - 25 mm



Weitere Informationen

### Felgenschloss-Demontage-Satz



mit Handschutz



# 139,90



beidseitig verwendbar

913.1430

UNIVERSAL GENIAL - DIE PASSEN SICH AN JEDES PROFIL AN!

# ROBUSTE 1/2" ALU-FELGEN KRAFT-STECKNUSS-SÄTZE

**1**

Weitere Informationen

21 mm 19 mm 17 mm

**17,90**

515.1070 1/2" 17 - 19 - 21 mm

**2**

Weitere Informationen

15 mm 17 mm 19 mm 21 mm 22 mm

**24,90**

515.0870 1/2" 15 - 17 - 19 - 21 - 22 mm

**3**

Weitere Informationen

17 mm 15 mm 19 mm 22 mm 23 mm

21 mm 17 mm 21 mm 24 mm

**69,90**

515.0890 1/2" 15 - 17 - 19 - 21 - 22 - 23 - 24 mm  
7/8" 17 mm MS21

**4**

Weitere Informationen

15 mm 17 mm 19 mm 21 mm 22 mm 23 mm 24 mm

17 mm 21 mm

**139,90**

**DER KOMPLETTE ALLESKÖNNER**

515.0885 1/2" 15 - 17 - 19 - 21 - 22 - 23 - 24 mm 7/8" 17 mm MS21 17 - 19 - 21 mm 18,5 / 19,5 - 20,5 / 21,5 - 17,5 / 22,5 mm

	515.1072 15 mm	515.1073 17 mm	515.1075 19 mm	515.1076 21 mm	515.1077 22 mm	515.1078 23 mm	515.1079 24 mm	515.1089 Tesla 7/8"	515.2055 Mercedes 17 mm	515.2060 Hyundai KIA MS21	913.1271 Spiralstecknuss 17 mm	913.1272 Spiralstecknuss 19 mm	913.1273 Spiralstecknuss 21 mm	515.0896 Ford 18,5 / 19,5 mm	515.0897 Ford 20,5 / 21,5 mm	515.0899 Ford 17,5 / 22,5 mm	515.1134 Kraft-Verlängerung, 75mm
<b>1</b>	X	✓	✓	✓	X	X	X	X	X	X	X	X	X	X	X	X	X
<b>2</b>	✓	✓	✓	✓	✓	X	X	X	X	X	X	X	X	X	X	X	X
<b>3</b>	✓	✓	✓	✓	✓	✓	✓	✓	✓	✓	X	X	X	X	X	X	X
<b>4</b>	✓	✓	✓	✓	✓	✓	✓	✓	✓	✓	✓	✓	✓	✓	✓	✓	✓

**i** 1  
Weitere Informationen

aufladbar mit USB-C-Kabel (inklusive)

**16,90**

**350 Lumen**

**UV LED**

**Li-Ion**  
POWER-AREA  
800mAh

mit Laserpointer

**LED COB Stripe Inspektionslampe**  
350 Lumen mit UV-Spot LED und Laserpointer

150.4400

max. 3 h  
 3 h  
 IP20

**i** 1  
Weitere Informationen

**14,90**

**85 Lumen**

**perfectLight**  
Taschenlampe 85 Lumen

25 m

**2 x AA** ✓

150.4370

max. 10 h  
 IPX3

**i** 1  
Weitere Informationen

**DAS MUST HAVE!**  
**FÜR WERKSTATT ODER OUTDOOR**

**14,90**

**MAX. 350 Lumen**

**MAX. 100 Lumen**

**270°**

USB-C  
On/Off

Sensorschalter

Li-Ion 3,7 V 1200 mAh

Power Display

Bewegungssensor

XPE LED 2 Leuchtstufen

Größeneinstellung

COB LED 3 Leuchtstufen

**95 g**

max. 8 h  
 4,5 h

On/Off

Modi	COB 100%	COB 40%	COB rot	XPE 100%	XPE 40%
LED	270° 3 Watt COB LED			1 Watt High Power XPE LED	
40%  100%	350 LM	150 LM	-	100 LM	40 LM
	3 h	6 h	8 h	4 h	8 h

**17,90**

Weitere Informationen

360°

250 Lumen

500 Lumen

USB

1200 mAh Lithium-Ionen Akku (inklusive)

ON OFF

180°

oder

3x AAA Batterien (nicht im Lieferumfang enthalten)

inklusive USB Power Bank Funktion

20 %	●
40 %	●●
60 %	●●●
80 %	●●●●
100 %	●●●●●

150.4510

max. 3 h

3 h

+

IP65

**19,90**

Weitere Informationen

130 Lumen

300 Lumen

ON OFF

USB-A OUT

USB-C IN

integrierter Lithium-Ionen Akku 1.200 mAh

20 %	●
40 %	●●
60 %	●●●
80 %	●●●●
100 %	●●●●●

150.4505

max. 3 h

3 h

+

IP65

**16,50**

Weitere Informationen

60 Lumen

150 Lumen

Micro USB

ON OFF

360°

180°

20 %	●
40 %	●●
60 %	●●●
80 %	●●●●
100 %	●●●●●

150.4495

max. 3,5 h

2,5 h

IP20

**37,50**

Weitere Informationen

250 Lumen

550 Lumen

ON OFF

USB-A OUT

USB-C IN

20 %	●
40 %	●●
60 %	●●●
80 %	●●●●
100 %	●●●●●

150.4490

max. 3,5 h

3 h

+

IP65

**i**  **11**  
 Weitere Informationen



**20-200 Nm**

mit Kunden-Kontrollbescheinigung  
**DIN EN ISO 6789**  
**Zertifikat**  
 Genauigkeit ±1,2%

125 mm

10 mm 13 mm 17 mm 19 mm 21 mm 24 mm

17 mm 19 mm 21 mm

500 mm

**119,90**

516.2400 1/2" 10 - 13 - 17 - 19 - 21 - 24 mm

**i**  **8**  
 Weitere Informationen

**FÜR REIFENWECHSEL IN REKORDZEIT**

**THE DEVIL**

**1600 Nm**

2 x Ø 150 mm

10 m

0 - 12 bar

21 mm 19 mm 17 mm

1/2"

**NEU**

**119,90**

Ihr Partner:

 LL23-06D\_EUR

**KS Tools Werkzeuge - Maschinen GmbH**  
 Seligenstädter Grund 10 - 12  
 D-63150 Heusenstamm  
 DEUTSCHLAND

Mail: [aftersales@kstools.com](mailto:aftersales@kstools.com)  
 Web: [www.kstools.com](http://www.kstools.com)

515.2100

Mit Erscheinen dieses Prospektes verlieren alle vorangegangenen Preise hiermit ihre Gültigkeit. Verkauf nur an den Fachhandel. Druckfehler, Irrtümer und technische Änderungen vorbehalten. Alle Preise in EUR zzgl. MwSt. gelten bis 30.09.2024.