

DEWALT®

ANCHORS & FASTENERS

BUYERS GUIDE



DEWALT

Powers
FASTENING INNOVATIONS

ELCO

DESIGN SOFTWARE OPTIONS • ADHESIVE ANCHORS • MECHANICAL ANCHORS • DIRECT FASTENING • ELCO FASTENERS

DEWALT®

DDA™

DEWALT DESIGN ASSIST™



DESIGN



COMPARE



DOCUMENT



ANCHOR

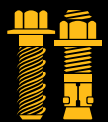

Mechanical



Adhesives



Cast-in-Place

STATE-OF-THE-ART STRUCTURAL DESIGN SOFTWARE

FOR MORE INFORMATION OR TO DOWNLOAD NOW

log on to <http://anchors.DEWALT.com/dda>

www.DEWALT.com (800) 524-3244 | anchors@DEWALT.com



MECHANICAL ANCHORS	4
EXPANSION ANCHORS	4
UNDERCUT ANCHORS	12
BOLT/SHIELD ANCHORS	14
SCREW ANCHORS	15
CAST-IN ANCHORS INSERTS	20
ROD HANGER ANCHORS	24
PIN/NAIL ANCHORS	34
LIGHT DUTY ANCHORS	38
CHEMICAL ANCHORS	43
ACRYLIC ADHESIVES	45
CAPSULE ADHESIVES	46
EPOXY ADHESIVES	47
FOAM / SEALANTS	48
INSTALLATION TOOLS	51
INSTALLATION ACCESSORIES	52
SILICA DUST SOLUTIONS	53
CORDLESS DRILL DRIVERS	54
DRILLING ACCESSORIES	55
DIRECT FASTENING	61
POWER ACTUATED	64
POWERS FASTENERS	
GAS FASTENING	73
ELCO CONSTRUCTION PRODUCTS	
DRILIT® DRILL SCREWS	76
TAPFAST®	81
ARCHITECTURAL ROOF CLIPS	81
DRIL-FLEX®	82
ALUMI-FLEX®	83
BI-FLEX®	84
TAP-FLEX®	86
FAB-LOK®	86
RAPIDSET® TOOLS	87

SELECTION GUIDE

ADHESIVE ANCHORING SYSTEMS

			Concrete	Lightweight Concrete	Hollow Core Pre-Cast	Grout-filled Concrete Masonry	Hollow Masonry	Solid Brick	Hollow Brick	Unreinforced Masonry	Drywall	Plywood	Wood (Lumber)	Anchor Diameter	Threaded Rod and Hex Nut	Round / Acorn Nut Head	Hex Head	Flat Head	Under 500 lbs.	Over 500 lbs.	Over 5000 lbs.	Zinc Plated Carbon Steel	Galvanized Steel	Stainless Steel	Approvals/ Listings	Similar Anchoring Products
Pure110+[®] High Strength Epoxy Anchoring System				■	■	■	■	■	■	■	■	■	■	3/8" - 1-1/4" #3 - #11 Rebar	■	■	■	■	■	■	■	■	■	■	1 4 6 7,	Hilti RE 500 V3 Simpson SET-XP Simpson SET 3G
Pure50+[™] Epoxy Anchoring System				■	■	■	■	■	■	■	■	■	■	3/8" - 1-1/4" #3 - #10 Rebar	■	■	■	■	■	■	■	■	■	■	1 4 6 7	Hilti RE 500 SD Hilti RE 100 Simpson SET
AC200+[™] High Strength Acrylic Anchoring System				■	■	■	■	■	■	■	■	■	■	3/8" - 1-1/4" #3 - #10 Rebar	■	■	■	■	■	■	■	■	■	■	1 4 6 7	Hilti HY 200
AC100+ Gold[®] Vinylester Adhesive Anchoring System				■	■	■	■	■	■	■	■	■	■	3/8" - 1-1/4" #3 - #10 Rebar	■	■	■	■	■	■	■	■	■	■	1 4 6 7	Hilti HY 100 Hilti HY 270 Simpson AT-XP

EXPANSION ANCHORS

			Concrete	Lightweight Concrete	Hollow Core Pre-Cast	Grout-filled Concrete Masonry	Hollow Masonry	Solid Brick	Hollow Brick	Unreinforced Masonry	Drywall	Plywood	Wood (Lumber)	Anchor Diameter	Threaded Rod and Hex Nut	Round / Acorn Nut Head	Hex Head	Flat Head	Under 500 lbs.	Over 500 lbs.	Over 5000 lbs.	Zinc Plated Carbon Steel	Galvanized Steel	Stainless Steel	Approvals/ Listings	Similar Anchoring Products
Power-Stud[®] + SD1 Carbon Steel Wedge-Anchor				■	■	■	■	■	■	■	■	■	■	1/4" - 1-1/4"	■	■	■	■	■	■	■	■	■	■	1 2 3 4	Hilti Kwik Bolt 3 (KB3) Hilti KBV-TZ Simpson Strong Bolt 2
Power-Stud[®] + SD2 High Performance Carbon Steel Wedge-Anchor				■	■	■	■	■	■	■	■	■	■	3/8" - 3/4"	■	■	■	■	■	■	■	■	■	■	1 2 3 4	Hilti Kwik Bolt TZ Simpson Strong Bolt 2
Power-Stud[®] + SD4 304 Stainless Steel Wedge-Anchor				■	■	■	■	■	■	■	■	■	■	1/4" - 3/4"	■	■	■	■	■	■	■	■	■	■	1 4	Hilti Kwik Bolt 3 (KB3) / KB TZ SS Simpson Strong Bolt 2
Power-Stud[®] + SD6 316 Stainless Steel Wedge-Anchor				■	■	■	■	■	■	■	■	■	■	1/4" - 3/4"	■	■	■	■	■	■	■	■	■	■	1 4	Hilti Kwik Bolt 3 (KB3) / KB TZ SS Simpson Strong Bolt 2
Power-Stud[®] HD5 Hot-Dip Galvanized Wedge Expansion Anchor				■	■	■	■	■	■	■	■	■	■	3/8" - 3/4"	■	■	■	■	■	■	■	■	■	■	1 4	Hilti Kwik Bolt 3 (KB3) / KB TZ SS Simpson Strong Bolt 2

SCREW ANCHORS

			Concrete	Lightweight Concrete	Hollow Core Pre-Cast	Grout-filled Concrete Masonry	Hollow Masonry	Solid Brick	Hollow Brick	Unreinforced Masonry	Drywall	Plywood	Wood (Lumber)	Anchor Diameter	Threaded Rod and Hex Nut	Round / Acorn Nut Head	Hex Head	Flat Head	Under 500 lbs.	Over 500 lbs.	Over 5000 lbs.	Zinc Plated Carbon Steel	Galvanized Steel	Stainless Steel	Approvals/ Listings	Similar Anchoring Products
Screw-Bolt+[™] High Performance Screw Anchor				■	■	■	■	■	■	■	■	■	■	1/4" - 3/4" (Zinc Plated & Mech Galv)	■	■	■	■	■	■	■	■	■	■	1 4	Hilti KH-EZ / KWIK Simpson Titen HD
Screw-Bolt+[™] Flat Head High Performance Screw Anchor				■	■	■	■	■	■	■	■	■	■	1/4" - 3/4" (Zinc Plated)	■	■	■	■	■	■	■	■	■	■	1 4	Hilti KH-EZ / KWIK Simpson Titen HD
316 Stainless Steel Wedge-Bolt[™] Screw Anchor				■	■	■	■	■	■	■	■	■	■	1/4" - 1/2"	■	■	■	■	■	■	■	■	■	■	1 4	Simpson Titen HD
UltraCon+[®] Concrete Screw Anchor				■	■	■	■	■	■	■	■	■	■	3/16" - 1/4"	■	■	■	■	■	■	■	■	■	■	1 4 5	Simpson Titen Turbo ITW Tapcon

SPECIALTY ANCHORS

			Concrete	Lightweight Concrete	Hollow Core Pre-Cast	Grout-filled Concrete Masonry	Hollow Masonry	Solid Brick	Hollow Brick	Unreinforced Masonry	Drywall	Plywood	Wood (Lumber)	Anchor Diameter	Threaded Rod and Hex Nut	Round / Acorn Nut Head	Hex Head	Flat Head	Under 500 lbs.	Over 500 lbs.	Over 5000 lbs.	Zinc Plated Carbon Steel	Galvanized Steel	Stainless Steel	Approvals/ Listings	Similar Anchoring Products
CCU+[™] Heavy Duty Undercut Anchor				■	■	■	■	■	■	■	■	■	■	3/8" - 3/4" anchor rod Zinc plated A36 & B7 316 Stainless Steel	■	■	■	■	■	■	■	■	■	■	1 4	Hilti HDA Undercut
Power-Bolt+[®] Heavy Duty Sleeve Anchor				■	■	■	■	■	■	■	■	■	■	1/4" - 3/4"	■	■	■	■	■	■	■	■	■	■	1 4	Hilti HSL-3

MEP THREADED ROD HANGING ANCHORS

			Concrete	Lightweight Concrete	Hollow Core Pre-Cast	Grout-filled Concrete Masonry	Hollow Masonry	Solid Brick	Hollow Brick	Unreinforced Masonry	Drywall	Plywood	Wood (Lumber)	Anchor Diameter	Threaded Rod and Hex Nut	Round / Acorn Nut Head	Hex Head	Flat Head	Under 500 lbs.	Over 500 lbs.	Over 5000 lbs.	Zinc Plated Carbon Steel	Galvanized Steel	Stainless Steel	Approvals/ Listings	Similar Anchoring Products
Snake+[®] Rod Hanger / Screw Anchor				■	■	■	■	■	■	■	■	■	■	1/4" - 1/2"	■	■	■	■	■	■	■	■	■	■	1 2 4	No Similar Product
Smart DI[™] Internally Threaded Expansion Anchor				■	■	■	■	■	■	■	■	■	■	1/4" - 1/2"	■	■	■	■	■	■	■	■	■	■	2 3	Hilti HDI
Hangermate+[®] (Concrete) Rod Hanging Anchor				■	■	■	■	■	■	■	■	■	■	1/4" - 1/2"	■	■	■	■	■	■	■	■	■	■	1 2 4	ITW Sammys Hilti KH-EZ Simpson Titen Rod Hanger
Hangermate[®] (Steel Wood) Rod Hanging Anchor				■	■	■	■	■	■	■	■	■	■	1/4" - 3/8"	■	■	■	■	■	■	■	■	■	■	2 3	ITW Sammys
Mini-Undercut+[™] Rod Hanger for PT Slabs and Hollow Core Plank				■	■	■	■	■	■	■	■	■	■	3/8"	■	■	■	■	■	■	■	■	■	■	1 4	Hilti HDI-TZ
Bang-It+[®] Metal deck cast in place anchor				■	■	■	■	■	■	■	■	■	■	1/4" - 3/4"	■	■	■	■	■	■	■	■	■	■	1 2 3 4	Hilti HCI-MD KCS-MD
Wood-Knocker[®] II+ Cast-in-Place Anchor for Forms				■	■	■	■	■	■	■	■	■	■	1/4" - 3/4"	■	■	■	■	■	■	■	■	■	■	1 2 3 4	Hilti HCI-WF Hilti KCS-WF
DDI+[™] (Deck Insert) Metal Deck Cast In Place Anchor				■	■	■	■	■	■	■	■	■	■	3/8" - 7/8"	■	■	■	■	■	■	■	■	■	■	1 2 3 4	No Similar Product

*Hilti is registered trademark of Hilti Corporation

*Simpson is registered trademark of Simpson Strong-Tie Company Inc.

*ITW Red Head is registered trademark of Illinois Tool Works Inc.

SELECTION GUIDE

LIGHT/MEDIUM DUTY ANCHORS

	Concrete	Lightweight Concrete	Hollow Core Pre-Cast	Grout-filled Concrete Masonry	Hollow Masonry	Solid Brick	Hollow Brick	Unreinforced Masonry	Drywall	Plywood	Wood (Lumber)	Anchor Diameter	Threaded Rod and Hex Nut	Round / Acorn Nut Head	Hex Head	Flat Head	Under 500 lbs.	Over 500 lbs.	Over 5000 lbs.	Zinc Plated Carbon Steel	Galvanized Steel	Stainless Steel	Approvals/ Listings	Similar Anchoring Products
Polly™ Hollow Wall Anchor												Wall Thickness 1/8" - 1-1/8"												ITW Red Head Poly-Set® Anchor
Toggle Bolt Hollow Wall Anchor			□	■	■	□	■	■	■	□		1/8" x 2" - 1/2" x 4"	■	■	■				■					
Sharkie™ Wall Anchor	■	■		■	■	■	■	■	■	■		#4-#10 #6-#12 #8-#14 Screw												
Strap-Toggle™ Hollow Wall Anchor			□				□					3/16" - 1/2"	■							■				Hilti HTB Toggle Bolt
Zip-Toggle® Hollow Wall Anchor												#6 x 2												
Wall-Dog™ Universal Light Duty Anchor	■	■		■	■	■	■	■	■	■		1/4" Diameter with #8 Head	■	■										Simpson Sure Wall
Bantam Plug Plastic Wall Anchor	■	■		■	■	■	■	■				#6-8 x 3/4" - #14-16 x 1-1/2"												Hilti HUD-1 Wall Plug
Zip-It® Zinc or Nylon Wallboard Anchor										■		#6 to #8 Screws												ITW Red Head EZ
Lok-Bolt AS® Sleeve Anchor	■	□	□	■	■	■	□					1/4" - 3/4"	■	■	■									Hilti HLC Sleeve
Hollow-Set Dropin™ Internally Threaded Expansion Anchor	■	□		■	■	■	□					1/4" - 5/8"										3		Simpson HDIA
Zamac Hammer-Screw® Nail Anchor	■	□		■								1/4" x 3/4" - 1/4" x 3"			■									Hilti HPS-1
Zamac Nailin® Nail Anchor	■	□		■		■						3/16" x 7/8" - 1/4" x 3"			■									Hilti HMH Nail In
Spike® Pin Anchor	■	■		■								3/16" - 1/2"	■							■	■			Simpson Crimp Drive®
Calk-In™ Mechanical Bolt Anchor	■			■								#8 Screw to 1/2"												
Double™ Shield Expansion Anchor	■	□		■	■	■						1/4" - 3/4"												
Single™ Shield Expansion Anchor	■			■								1/4" - 5/8"												

For technical support please contact a DeWALT Product & Code Expert at 800-524-3244 or visit our website at www.DeWALT.com
 Verify scope of approval relative to intended application. The information and data contained within this document is current as of July 1 2021 and is subject to change after such date. DEWALT reserves the right to change the designs materials and specifications of the products in this document without notice and shall have no liability with respect to such changes. Please contact DEWALT for the most current and up to date information and data or refer to our website at www.DeWALT.com

DeWALT®

ANCHORS & FASTENERS

WWW.ANCHORS.DEWALT.COM



EXPANSION ANCHORS

Power-Stud® + SD1

Type	Wedge Expansion Anchor
Approvals	ICC-ES ESR-2818 (Concrete) ESR-2966 (Masonry) IBC & IRC 2021, 2018, 2015, 2012 Recognition in cracked & uncracked concrete including seismic and wind loading (Category 1 Anchors) Full FM & UL listings in product brochure or at www.DeWALT.com
Description	Fully threaded Torque controlled
Base Materials	Normal and sand-light-weight concrete over metal deck grouted concrete masonry (CMU)
Anchor Material	Zinc plated carbon steel body with expansion clip, nut and washer



POWER-STUD+ SD1 CARBON STEEL BODY & EXPANSION CLIP

CAT #	SIZE	THREAD LENGTH	PACK	CTN
7400SD1-PWR*	1/4" x 1-3/4"	3/4"	100	600
7402SD1-PWR	1/4" x 2-1/4"	1-1/4"	100	600
7404SD1-PWR	1/4" x 3-1/4"	2-1/4"	100	600
7410SD1-PWR*	3/8" x 2-1/4"	7/8"	50	300
7412SD1-PWR*	3/8" x 2-3/4"	1-3/8"	50	300
7413SD1-PWR	3/8" x 3"	1-5/8"	50	300
7414SD1-PWR	3/8" x 3-1/2"	2-1/8"	50	300
7415SD1-PWR	3/8" x 3-3/4"	2-3/8"	50	300
7416SD1-PWR	3/8" x 5"	3-5/8"	50	300
7417SD1-PWR	3/8" x 7"	5-5/8"	50	200
7420SD1-PWR*	1/2" x 2-3/4"	1"	50	200
7422SD1-PWR	1/2" x 3-3/4"	2"	50	200
7423SD1-PWR	1/2" x 4-1/2"	2-3/4"	50	200
7424SD1-PWR	1/2" x 5-1/2"	3-3/4"	50	150
7426SD1-PWR	1/2" x 7"	5-1/4"	25	100
7427SD1-PWR	1/2" x 8-1/2"	6-3/4"	25	100
7428SD1-PWR	1/2" x 10"	8-1/4"	25	100
7430SD1-PWR*	5/8" x 3-1/2"	1-1/2"	25	100
7432SD1-PWR	5/8" x 4-1/2"	2-1/2"	25	100
7433SD1-PWR	5/8" x 5"	3"	25	100
7434SD1-PWR	5/8" x 6"	4"	25	75
7436SD1-PWR	5/8" x 7"	5"	25	75
7438SD1-PWR	5/8" x 8-1/2"	6-1/2"	25	50
7439SD1-PWR	5/8" x 10"	8"	25	50
7440SD1-PWR*	3/4" x 4-1/4"	1-3/4"	20	60
7441SD1-PWR*	3/4" x 4-3/4"	2-1/4"	20	60
7442SD1-PWR	3/4" x 5-1/2"	3"	20	60
7444SD1-PWR	3/4" x 6-1/4"	3-3/4"	20	60
7446SD1-PWR	3/4" x 7"	4-1/2"	20	60
7448SD1-PWR	3/4" x 8-1/2"	6"	10	40
7449SD1-PWR	3/4" x 10"	7-1/2"	10	40
7451SD1-PWR	3/4" x 12"	9-1/2"	10	20
7450SD1-PWR*	7/8" x 6"	2-3/4"	10	40
7452SD1-PWR	7/8" x 8"	4-3/4"	10	40
7454SD1-PWR	7/8" x 10"	6-3/4"	10	20
7461SD1-PWR*	1" x 6"	2-3/8"	10	30
7463SD1-PWR	1" x 9"	5-3/8"	10	20
7465SD1-PWR	1" x 12"	8-3/8"	5	10
7473SD1-PWR	1-1/4" x 9"	4-3/4"	5	10
7475SD1-PWR	1-1/4" x 12"	7-3/4" ^{na}	5	10



TIE-WIRE POWER-STUD







CAT #	SIZE	WIRE HOLE	MIN EMBED	PACK	CTN
7409SD1-PWR*	1/4" x 2"	9/32"	1-1/8"	100	600

*For Power-Stud+ SD1
Less than the minimum standard anchor length for strength design. Published length is the overall length of the anchor. Allow for fixture thickness plus one anchor diameter for the nut and washer thickness when selecting a length. Packaged with nuts and washers.

1/4" diameter Power-Stud+ SD1 and Tie-Wire Power-Stud for uncracked concrete only

EXPANSION ANCHORS

Power-Stud®+ SD2







Type	Wedge Expansion Anchor
Approvals	ICC-ES ESR-2502 (Concrete); IBC & IRC 2018 2015 2012 2009       
Description	Fully threaded Torque controlled
Base Materials	Normal and sand-lightweight concrete concrete over metal deck grouted concrete masonry (CMU)
Anchor Material	Zinc Plated Carbon Steel Body hex nut and washer with 316 SS Expansion Clip



POWER-STUD+ SD2 CARBON STEEL BODY & SS EXPANSION CLIP

CAT #	SIZE	THREAD LENGTH	PACK	CTN
7413SD2-PWR	3/8" x 3"	1-5/8"	50	300
7414SD2-PWR	3/8" x 3-1/2"	2-1/4"	50	300
7415SD2-PWR	3/8" x 3-3/4"	2-1/2"	50	300
7416SD2-PWR	3/8" x 5"	3-3/4"	50	300
7422SD2-PWR	1/2" x 3-3/4"	2-1/8"	50	200
7423SD2-PWR	1/2" x 4-1/2"	2-7/8"	50	200
7424SD2-PWR	1/2" x 5-1/2"	3-7/8"	50	150
7426SD2-PWR	1/2" x 7"	5-3/8"	25	100
7427SD2-PWR	1/2" x 8-1/2"	6-7/8"	25	100
7435SD2-PWR	5/8" x 4-3/4"	2-7/8"	25	100
7433SD2-PWR	5/8" x 5"	3-1/8"	25	100
7434SD2-PWR	5/8" x 6"	4-1/8"	25	75
7436SD2-PWR	5/8" x 7"	5-1/8"	25	75
7438SD2-PWR	5/8" x 8-1/2"	6-5/8"	25	50
7442SD2-PWR	3/4" x 5-1/2"	3-1/4"	20	60
7444SD2-PWR	3/4" x 6-1/4"	4"	20	60
7446SD2-PWR	3/4" x 7"	4-3/4"	20	60
7448SD2-PWR	3/4" x 8-1/2"	6-1/4"	10	40

Power-Stud®+ SD4/SD6

Type	Wedge Expansion Anchor
Approvals	ICC-ES ESR-2502 (Concrete) IBC & IRC 2021 2018 2015 2012       
Description	Fully threaded Torque controlled
Base Materials	Normal and sand-lightweight concrete grouted concrete masonry (CMU)
Anchor Material	SD4: Type 304 stainless steel body with 300 series washer and Type 316 stainless steel expansion clip and nut. SD6: Type 316 stainless steel anchor body expansion clip washer and nut

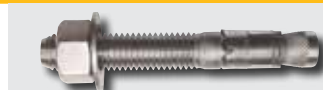

POWER-STUD+ SD4 (304 SS)

CAT #	SIZE	THREAD LENGTH	PACK	CTN
7300SD4-PWR*	1/4" x 1-3/4"	3/4"	100	600
7302SD4-PWR	1/4" x 2-1/4"	1-1/4"	100	600
7304SD4-PWR	1/4" x 3-1/4"	2-1/4"	100	600
7313SD4-PWR	3/8" x 3"	1-5/8"	50	300
7315SD4-PWR	3/8" x 3-3/4"	2-3/8"	50	300
7316SD4-PWR	3/8" x 5"	3-5/8"	50	300
7322SD4-PWR	1/2" x 3-3/4"	2"	50	200
7323SD4-PWR	1/2" x 4-1/2"	2-3/4"	50	200
7324SD4-PWR	1/2" x 5-1/2"	3-3/4"	50	150
7326SD4-PWR	1/2" x 7"	5-1/4"	25	100
7333SD4-PWR	5/8" x 5"	3"	25	100
7334SD4-PWR	5/8" x 6"	4"	25	75
7338SD4-PWR	5/8" x 8-1/2"	6-1/2"	25	50
7342SD4-PWR	3/4" x 5-1/2"	3-1/8"	20	60
7348SD4-PWR	3/4" x 8-1/2"	6-1/8"	10	40

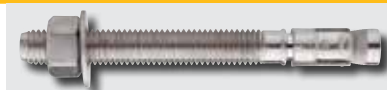

POWER-STUD+ SD6 (316SS)

CAT #	SIZE	THREAD LENGTH	PACK	CTN
7600SD6-PWR*	1/4" x 1-3/4"	3/4"	100	600
7602SD6-PWR	1/4" x 2-1/4"	1-1/4"	100	600
7604SD6-PWR	1/4" x 3-1/4"	2-1/4"	100	600
7610SD6-PWR*	3/8" x 2-1/4"	7/8"	50	300
7612SD6-PWR	3/8" x 2-3/4"	1-3/8"	50	300
7613SD6-PWR	3/8" x 3"	1-5/8"	50	300
7614SD6-PWR	3/8" x 3-1/2"	2-1/8"	50	300
7615SD6-PWR	3/8" x 3-3/4"	2-3/8"	50	300
7316SD6-PWR	3/8" x 5"	3-5/8"	50	300
7617SD6-PWR	3/8" x 7"	5-5/8"	50	200
7620SD6-PWR*	1/2" x 2-3/4"	1"	50	200
7622SD6-PWR	1/2" x 3-3/4"	2"	50	200
7623SD6-PWR	1/2" x 4-1/2"	2-3/4"	50	200
7624SD6-PWR	1/2" x 5-1/2"	3-3/4"	50	150
7626SD6-PWR	1/2" x 7"	5-1/4"	25	100
7630SD6-PWR*	5/8" x 3-1/2"	1-1/2"	25	100
7632SD6-PWR	5/8" x 4-1/2"	2-1/2"	25	100
7633SD6-PWR	5/8" x 5"	3"	25	100
7634SD6-PWR	5/8" x 6"	4"	25	75
7636SD6-PWR	5/8" x 7"	5"	25	75
7638SD6-PWR	5/8" x 8-1/2"	6-1/2"	25	50
7640SD6-PWR*	3/4" x 4-1/4"	1-7/8"	20	60
7641SD6-PWR*	3/4" x 4-3/4"	2-3/8"	20	60
7642SD6-PWR	3/4" x 5-1/2"	3-1/8"	20	60
7644SD6-PWR	3/4" x 6-1/4"	3-7/8"	20	60
7646SD6-PWR	3/4" x 7"	4-5/8"	20	60
7648SD6-PWR	3/4" x 8-1/2"	6-1/8"	10	40
7649SD6-PWR	3/4" x 10"	7-5/8"	10	40

* For Power-Stud+ SD4 and SD6: Less than the minimum standard anchor length for strength design. Published length is the overall length of the anchor. Allow for fixture thickness plus one anchor diameter for the nut and washer thickness when selecting a length. Packaged with nuts and washers.

1/4" diameter Power-Stud+ SD4 and SD6 for uncracked concrete only

EXPANSION ANCHORS

Power-Stud® + SD4/SD6

Type	Wedge Expansion Anchor
Approvals	ICC-ES ESR-2502 (Concrete) IBC & IRC 2021 2018 2015 2012 Recognition in cracked & uncracked concrete including seismic and wind loading (Category 1 Anchors)
Description	Fully threaded Torque controlled
Base Materials	Normal and sand-lightweight concrete grouted concrete masonry (CMU)
Anchor Material	SD4: Type 304 stainless steel body with 300 series washer and Type 316 stainless steel expansion clip and nut. SD6: Type 316 stainless steel anchor body expansion clip washer and nut



POWER-STUD+ SD4 (304 SS)

CAT #	SIZE	THREAD LENGTH	PACK	CTN
7315SD4USA-PWR	3/8" x 3-3/4"	2-3/8"	50	300
7316SD4USA-PWR	3/8" x 5"	3-5/8"	50	300
7317SD4USA-PWR	3/8" x 7"	5-5/8"	50	200
7320SD4USA-PWR	1/2" x 2-3/4"	1"	50	200
7322SD4USA-PWR	1/2" x 3-3/4"	2"	50	200
7323SD4USA-PWR	1/2" x 4-1/2"	2-3/4"	50	200
7324SD4USA-PWR	1/2" x 5-1/2"	3-3/4"	50	150
7326SD4USA-PWR	1/2" x 7"	5-1/4"	25	100
7330SD4USA-PWR	5/8" x 3-1/2"	1-1/2"	25	100
7332SD4USA-PWR	5/8" x 4-1/2"	2-1/2"	25	100
7333SD4USA-PWR	5/8" x 5"	3"	25	100
7334SD4USA-PWR	5/8" x 6"	4"	25	75
7336SD4USA-PWR	5/8" x 6"	4"	25	75
7338SD4USA-PWR	5/8" x 8-1/2"	6-1/2"	25	50
7342SD4USA-PWR	3/4" x 5-1/2"	3-1/8"	20	60
7344SD4USA-PWR	3/4" x 6-1/4"	3-7/8"	20	60
7346SD4USA-PWR	3/4" x 7"	4-5/8"	20	60
7348SD4USA-PWR	3/4" x 8-1/2"	6-1/8"	10	40
7349SD4USA-PWR	3/4" x 10"	7-5/8"	10	40



POWER-STUD+ SD6 (316SS)

CAT #	SIZE	THREAD LENGTH	PACK	CTN
7615SD6USA-PWR	3/8" x 3-3/4"	2-3/8"	50	300
7616SD6USA-PWR	3/8" x 5"	3-5/8"	50	300
7617SD6USA-PWR	3/8" x 7"	5-5/8"	50	200
7620SD6USA-PWR*	1/2" x 2-3/4"	1"	50	200
7622SD6USA-PWR	1/2" x 3-3/4"	2"	50	200
7623SD6USA-PWR	1/2" x 4-1/2"	2-3/4"	50	200
7624SD6USA-PWR	1/2" x 5-1/2"	3-3/4"	50	150
7626SD6USA-PWR	1/2" x 7"	5-1/4"	25	100
7630SD6USA-PWR*	5/8" x 3-1/2"	1-1/2"	25	100
7632SD6USA-PWR	5/8" x 4-1/2"	2-1/2"	25	100
7633SD6USA-PWR	5/8" x 5"	3"	25	100
7634SD6USA-PWR	5/8" x 6"	4"	25	75
7636SD6USA-PWR	5/8" x 7"	5"	25	75
7638SD6USA-PWR	5/8" x 8-1/2"	6-1/2"	25	50
7640SD6USA-PWR*	3/4" x 4-1/4"	1-7/8"	20	60
7641SD6USA-PWR*	3/4" x 4-3/4"	2-3/8"	20	60
7642SD6USA-PWR	3/4" x 5-1/2"	3-1/8"	20	60
7644SD6USA-PWR	3/4" x 6-1/4"	3-7/8"	20	60
7646SD6USA-PWR	3/4" x 7"	4-5/8"	20	60
7648SD6USA-PWR	3/4" x 8-1/2"	6-1/8"	10	40

* For Power-Stud+ SD4 and SD6: Less than the minimum standard anchor length for strength design. Published length is the overall length of the anchor. Allow for fixture thickness plus one anchor diameter for the nut and washer thickness when selecting a length. Packaged with nuts and washers.

1/4" diameter Power-Stud+ SD4 and SD6 for uncracked concrete only

Power-Stud® HD5

Type	Wedge Expansion Anchor
Approvals	
Description	Torque controlled Fully threaded Hot-Dip (zinc) galvanized coating
Base Materials	Concrete grouted concrete masonry (CMU)
Anchor Material	Hot-dip galvanized carbon steel body nut and washer Type 304 stainless steel expansion clip. Zinc galvanized according to ASTM A 153 Class C or D



HOT-DIP GALVANIZED POWER-STUD

CAT #	SIZE	THREAD LENGTH	PACK	CTN
7713HD5-PWR	3/8" x 3"	1-1/2"	50	300
7715HD5-PWR	3/8" x 3-3/4"	2-3/8"	50	300
7716HD5-PWR	3/8" x 5"	3-1/2"	50	300
7717HD5-PWR	3/8" x 7"	5-1/2"	50	200
7720HD5-PWR	1/2" x 2-3/4"	1"	50	200
7722HD5-PWR	1/2" x 3-3/4"	2"	50	200
7723HD5-PWR	1/2" x 4-1/2"	2-3/4"	50	200
7724HD5-PWR	1/2" x 5-1/2"	3-3/4"	50	150
7726HD5-PWR	1/2" x 7"	5-1/4"	25	100
7730HD5-PWR	5/8" x 3-1/2"	1-1/2"	25	100
7733HD5-PWR	5/8" x 5"	3"	25	100
7734HD5-PWR	5/8" x 6"	4"	25	75
7738HD5-PWR	5/8" x 8-1/2"	6-1/2"	25	50
7741HD5-PWR	3/4" x 4-3/4"	2-1/4"	20	60
7742HD5-PWR	3/4" x 5-1/2"	3"	20	60
7746HD5-PWR	3/4" x 7"	4-1/2"	20	60
7748HD5-PWR	3/4" x 8-1/2"	6"	10	40

EXPANSION ANCHORS

Power-Stud®

Type	Wedge Expansion Anchor
Approvals	Federal GSA Specification – Meets the descriptive and proof load requirements of CID A-A-1923A Type 4 Full UL listings in product brochure or at www.DEWALT.com
	
	If your jobsite requires ICC-ESR compliance reference page 9 for Power-Stud+ SD4/SD6 anchor options.
Description	Torque controlled Fully threaded
Base Materials	Normal weight concrete Lightweight concrete gouted concrete masonry (CMU)
Anchor Material	Type 304: 304 stainless steel body with 300 series expansion clip hex nut and washer Type 316: 316 stainless steel body expansion clip hex nut and washer



TYPE 304 STAINLESS STEEL POWER-STUD

CAT #	SIZE	THREAD LENGTH	PACK	CTN
07300-PWR	1/4" x 1-3/4"	3/4"	100	500
07302-PWR	1/4" x 2-1/4"	1-1/4"	100	500
07304-PWR	1/4" x 3-1/4"	2-1/4"	100	500
07310-PWR	3/8" x 2-1/4"	1-1/4"	50	250
07312-PWR	3/8" x 2-3/4"	1-5/8"	50	250
07313-PWR	3/8" x 3"	1-7/8"	50	250
07314-PWR	3/8" x 3-1/2"	2-3/8"	50	250
07315-PWR	3/8" x 3-3/4"	2-5/8"	50	250
07316-PWR	3/8" x 5"	3-1/8"	50	250
07320-PWR	1/2" x 2-3/4"	1-3/8"	50	200
07322-PWR	1/2" x 3-3/4"	2-3/8"	50	200
07323-PWR	1/2" x 4-1/2"	3-1/8"	50	200
07324-PWR	1/2" x 5-1/2"	4-1/8"	50	150
07326-PWR	1/2" x 7"	5-5/8"	25	100
07330-PWR	5/8" x 3-1/2"	2"	25	100
07332-PWR	5/8" x 4-1/2"	3"	25	100
07333-PWR	5/8" x 5"	3-1/2"	25	100
07334-PWR	5/8" x 6"	4-1/2"	25	75
07336-PWR	5/8" x 7"	5-1/2"	25	75
07338-PWR	5/8" x 8-1/2"	7"	25	75
07340-PWR	3/4" x 4-1/4"	2-3/8"	20	60
07341-PWR	3/4" x 4-3/4"	2-7/8"	20	60
07342-PWR	3/4" x 5-1/2"	3-5/8"	20	60
07344-PWR	3/4" x 6-1/4"	4-3/8"	20	60
07346-PWR	3/4" x 7"	5-1/8"	20	60
07348-PWR	3/4" x 8-1/2"	6-5/8"	10	40
07349-PWR	3/4" x 10"	8-1/8"	10	30
07352-PWR	7/8" x 8"	4-3/4"	10	40
07361-PWR	1" x 6"	2-3/8"	10	30
07363-PWR	1" x 9"	5-3/8"	10	30
07365-PWR	1" x 12"	8-3/8"	5	15

The published length is the overall length of the anchor. Allow for fixture thickness plus one anchor diameter for the nut and washer thickness when selecting a length

TYPE 316 STAINLESS STEEL POWER-STUD

CAT #	SIZE	THREAD LENGTH	PACK	CTN
07600-PWR	1/4" x 1-3/4"	3/4"	100	500
07602-PWR	1/4" x 2-1/4"	1-1/4"	100	500
07604-PWR	1/4" x 3-1/4"	2-1/4"	100	500
07610-PWR	3/8" x 2-1/4"	1-1/4"	50	250
07612-PWR	3/8" x 2-3/4"	1-5/8"	50	250
07613-PWR	3/8" x 3"	1-7/8"	50	250
07614-PWR	3/8" x 3-1/2"	2-3/8"	50	250
07615-PWR	3/8" x 3-3/4"	2-5/8"	50	250
07616-PWR	3/8" x 5"	3-1/8"	50	250
07620-PWR	1/2" x 2-3/4"	1-3/8"	50	200
07622-PWR	1/2" x 3-3/4"	2-3/8"	50	200
07623-PWR	1/2" x 4-1/2"	3-1/8"	50	200
07624-PWR	1/2" x 5-1/2"	4-1/8"	50	150
07626-PWR	1/2" x 7"	5-5/8"	25	100
07630-PWR	5/8" x 3-1/2"	2"	25	100
07332-PWR	5/8" x 4-1/2"	3"	25	100
07633-PWR	5/8" x 5"	3-1/2"	25	100
07634-PWR	5/8" x 6"	4-1/2"	25	75
07636-PWR	5/8" x 7"	5-1/2"	25	75
07638-PWR	5/8" x 8-1/2"	7"	25	75
07640-PWR	3/4" x 4-1/4"	2-3/8"	20	60
07641-PWR	3/4" x 4-3/4"	2-7/8"	20	60
07642-PWR	3/4" x 5-1/2"	3-5/8"	20	60
07644-PWR	3/4" x 6-1/4"	4-3/8"	20	60
07646-PWR	3/4" x 7"	5-1/8"	20	60
07648-PWR	3/4" x 8-1/2"	6-5/8"	10	40

Power-Bolt®+

Type	Heavy Duty Sleeve Anchor
Approvals	ICC-ES ESR-3260 (Concrete); 1/2" 5/8" & 3/4" IBC & IRC 2021 2018 2015 2012 Recognition in cracked & uncracked concrete including seismic and wind loading (Category 1 Anchors)
	
Description	Torque controlled Low profile finished hex head
Base Materials	Normal and lightweight concrete
Anchor Material	Carbon steel Grade 8 bolt (equivalent)



CARBON STEEL HEX HEAD POWER-BOLT+

CAT #	SIZE	DRILL DIAMETER	PACK	CTN
6902SD-PWR	1/4" x 1-3/4"	1/4"	100	600
6906SD-PWR	1/4" x 3"	1/4"	100	600
6911SD-PWR	3/8" x 1-7/8"	3/8"	50	300
6910SD-PWR	3/8" x 2-1/4"	3/8"	50	300
6913SD-PWR	3/8" x 3"	3/8"	50	300
6914SD-PWR	3/8" x 3-1/2"	3/8"	50	300
6916SD-PWR	3/8" x 4"	3/8"	50	300
6930SD-PWR*	1/2" x 2-3/4"	1/2"	50	200
6932SD-PWR	1/2" x 3-1/2"	1/2"	50	200
6934SD-PWR	1/2" x 4-3/4"	1/2"	25	150
6936SD-PWR	1/2" x 5-3/4"	1/2"	25	150
6940SD-PWR*	5/8" x 3"	5/8"	20	120
6942SD-PWR	5/8" x 4"	5/8"	15	90
6944SD-PWR	5/8" x 5"	5/8"	15	90
6945SD-PWR	5/8" x 6"	5/8"	15	60
6947SD-PWR	5/8" x 8-1/2"	5/8"	10	40

*Less than the minimum standard anchor length for strength design or not included in ESR-3260. The published size includes the diameter and the length which is measured from below the washer to the end of the anchor. Allow for fixture thickness when selecting a length.

CARBON STEEL HEX HEAD POWER-BOLT+

CAT #	SIZE	DRILL DIAMETER	PACK	CTN
6950SD-PWR	3/4" x 3-1/4"	1/4"	15	90
6952SD-PWR	3/4" x 4-1/2"	3/4"	10	60
6954SD-PWR	3/4" x 5-1/4"	3/4"	10	50
6956SD-PWR	3/4" x 7-1/4"	3/4"	10	40
6957SD-PWR	3/4" x 8-1/4"	3/4"	10	40

EXPANSION ANCHORS

Power-Bolt®

Type	Heavy Duty Sleeve Anchor
Approvals	Full UL listings in product brochure or at www.DeWALT.com
	
Description	Finished hex head or flat head
Base Materials	Concrete block brick and stone
Anchor Material	Type 304 stainless steel & carbon steel (flat head)

Published length is measured from under the washer to the end of the anchor.



304 STAINLESS STEEL HEX HEAD POWER-BOLT

CAT #	SIZE	DRILL DIAMETER	PACK	CTN
05902-PWR	1/4" x 1-3/4"	1/4"	100	600
05906-PWR	1/4" x 3"	1/4"	100	600
05910-PWR	3/8" x 2-1/4"	3/8"	50	300
05914-PWR	3/8" x 3-1/2"	3/8"	50	300
05916-PWR	3/8" x 4"	3/8"	50	300
05930-PWR	1/2" x 2-3/4"	1/2"	50	200
05934-PWR	1/2" x 4-3/4"	1/2"	25	150



CARBON STEEL FLAT HEAD POWER-BOLT

CAT #	SIZE	DRILL DIAMETER	PACK	CTN
06981-PWR	3/8" x 3-3/4"	3/8"	50	300
06982-PWR	3/8" x 5"	3/8"	50	250

CARBON STEEL FLAT HEAD POWER-BOLT

CAT #	SIZE	DRILL DIAMETER	PACK	CTN
06983-PWR	3/8" x 6"	3/8"	50	250
06984-PWR	1/2" x 5"	1/2"	25	125
06987-PWR	5/8" x 5-1/2"	5/8"	15	90

Published length is the overall length of the anchor.

Lok-Bolt AS®

Type	Sleeve Expansion Anchor
Approvals	
Description	Pre-assembled single unit sleeve anchor Extension sleeves create longer lengths AS refers to all-steel sleeve
Base Materials	Concrete block brick
Anchor Material	Carbon steel & stainless steel

Hex Nut Lok-Bolt: Published length measured from below the washer to the end of the anchor.

Acorn Nut Lok-Bolt: The published length is measured from below the washer to the end of the anchor.

Combo and Threshold Flat Head Lok-Bolt: These parts do not have a compression ring.



HEX NUT LOK-BOLT AS CARBON STEEL

CAT #	SIZE	DRILL DIAMETER	PACK	CTN
05005S-PWR	5/16" x 1-1/2"	5/16"	100	600
05010S-PWR	5/16" x 2-3/8"	5/16"	100	500
05015S-PWR	3/8" x 1-7/8"	3/8"	50	300
05020S-PWR	3/8" x 3"	3/8"	50	250
05022S-PWR	3/8" x 4"	3/8"	50	250
05025S-PWR	1/2" x 2-1/2"	1/2"	25	150
05030S-PWR	1/2" x 3"	1/2"	25	150
05034S-PWR	1/2" x 3-3/4"	1/2"	25	150
05033S-PWR	1/2" x 5-1/4"	1/2"	25	125
05032S-PWR	1/2" x 6"	1/2"	10	50
05035S-PWR	5/8" x 2-1/2"	5/8"	25	125
05038S-PWR	5/8" x 3"	5/8"	25	100
05040S-PWR	5/8" x 4-1/4"	5/8"	10	60
05045S-PWR	5/8" x 5-3/4"	5/8"	10	50
05050S-PWR	3/4" x 2-3/4"	3/4"	10	60
05055S-PWR	3/4" x 4-1/4"	3/4"	10	40
05060S-PWR	3/4" x 6-1/4"	3/4"	10	30
05065S-PWR	3/4" x 8-1/4"	3/4"	10	20

HEX NUT LOK-BOLT AS 304 STAINLESS STEEL

CAT #	SIZE	DRILL DIAMETER	PACK	CTN
06152S-PWR	3/8" x 1-7/8"	3/8"	50	300
06153S-PWR	3/8" x 3"	3/8"	50	250
06156S-PWR	1/2" x 2-1/2"	1/2"	25	150
06157S-PWR	1/2" x 3"	1/2"	25	150
06160S-PWR	1/2" x 3-3/4"	1/2"	25	150
06164S-PWR	5/8" x 4-1/4"	5/8"	10	60
06168S-PWR	3/4" x 4-1/4"	3/4"	10	40



ACORN NUT LOK-BOLT AS CARBON STEEL

CAT #	SIZE	DRILL DIAMETER	PACK	CTN
05125S-PWR	1/4" x 5/8"	1/4"	100	1000
05150S-PWR	1/4" x 1-3/8"	1/4"	100	600
05175S-PWR	1/4" x 2-1/4"	1/4"	100	600

ACORN NUT LOK-BOLT AS 304 STAINLESS STEEL

#	SIZE	DRILL DIAMETER	PACK	CTN
06150S-PWR	1/4" x 1-3/8"	1/4"	100	600

The published length is measured from below the washer to the end of the anchor.



ROUND HEAD LOK-BOLT AS CARBON STEEL

CAT #	SIZE	DRILL DIAMETER	PACK	CTN
05205S-PWR	1/4" x 1-3/8"	1/4"	100	1000
05210S-PWR	1/4" x 2-1/4"	1/4"	100	600
05215S-PWR	1/4" x 3"	1/4"	100	600
05240S-PWR	3/8" x 3-3/4"	3/8"	50	250

ROUND HEAD LOK-BOLT AS 304 STAINLESS STEEL

CAT #	SIZE	DRILL DIAMETER	PACK	CTN
06180S-PWR	1/4" x 2-1/4"	1/4"	100	600



COMBO FLAT HEAD LOK-BOLT AS CARBON STEEL

CAT #	SIZE	DRILL DIAMETER	PACK	CTN
05305S-PWR	1/4" x 1-1/2"	1/4"	100	1000
05310S-PWR	1/4" x 2-1/4"	1/4"	100	600
05315S-PWR	1/4" x 3"	1/4"	100	600
05320S-PWR	1/4" x 4"	1/4"	100	600
05325S-PWR	1/4" x 5-1/4"	1/4"	100	600
05330S-PWR	5/16" x 2-1/4"	5/16"	100	600
05340S-PWR	3/8" x 2-3/4"	3/8"	50	300
05345S-PWR	3/8" x 4"	3/8"	50	250
05350S-PWR	3/8" x 5"	3/8"	50	250
05360S-PWR	3/8" x 6"	3/8"	50	250

COMBO FLAT HEAD LOK-BOLT AS 304 STAINLESS STEEL

CAT #	SIZE	DRILL DIAMETER	PACK	CTN
06170S-PWR	1/4" x 2-1/4"	1/4"	100	600
06172S-PWR	1/4" x 3"	1/4"	100	600
06174S-PWR	3/8" x 4"	3/8"	50	250
06175S-PWR	3/8" x 5"	3/8"	50	250
06176S-PWR	3/8" x 6"	3/8"	50	250



THRESHOLD FLAT HEAD LOK-BOLT AS

CAT #	SIZE	DRILL DIAMETER	PACK	CTN
05500S-PWR	1/4" x 2"	1/4"	100	600

EXPANSION ANCHORS

Lok-Bolt AS®

Type	Sleeve Expansion Anchor
Approvals	
Description	Pre-assembled single unit sleeve anchor Extension sleeves create longer lengths AS refers to all-steel sleeve
Base Materials	Concrete block brick
Anchor Material	Carbon steel & stainless steel



ROD HANGER LOK-BOLT AS CARBON STEEL

CAT #	SIZE	DRILL DIAMETER	PACK	CTN
05810S-PWR	1/4" x 1-1/2"	5/16"	50	300
05815S-PWR	3/8" x 1-7/8"	3/8"	50	300
05825S-PWR	1/2" x 2-1/4"	1/2"	25	150



TIE-WIRE LOK-BOLT AS

CAT #	SIZE	DRILL DIAMETER	PACK	CTN
05700S-PWR	5/16" x 1-1/2"	5/16"	100	600



LOK-BOLT AS EXTENDERS CARBON STEEL

CAT #	SIZE	PACK	CTN
05684-PWR	3/8" x 1-1/4"	50	500



DEWALT'S PERFORM & PROTECT™ line of tools is designed to provide a high level of one or more of the following: control dust containment or low vibration without sacrificing performance.

YOUR FIRST LINE OF DEFENSE.



DEWALT.com/PERFORMANDPROTECT



DUST X+™

ANCHOR INSTALLATION SYSTEM



DESIGNED TO FAST-TRACK ANCHOR INSTALLATION AND REDUCE DUST EXPOSURE.

Using the DeWALT Hollow Bit™ and dust extractor with SDS rotary hammers creates an OSHA-compliant (1926.1153) solution for dust control. The Hollow Bit™ simultaneously extracts dust to clean holes while drilling. For agility on the jobsite go cordless with DeWALT's offering of battery-powered hammer drills dust extractors and Portable Power Station™s.



DUST EXTRACTORS



DWV010 8 Gallon HEPA/RRP Dust Extractor DWV012 10 Gallon Wet/Dry HEPA/RRP Dust Extractor DCV585 60V MAX* Dust Extractor

SDS MAX ROTARY HAMMERS



DCH416 60V MAX* Brushless 1-1/4" SDS PLUS Rotary Hammer DCH614 60V MAX* Brushless 1-3/4" SDS MAX Combination Rotary Hammer

With respect to 60V MAX Maximum initial battery voltage (measured without a workload) is 60 volts. Nominal voltage is 54.

DEWALT®

ANCHORS & FASTENERS

HEAVY DUTY UNDERCUT ANCHORS



CCU+™ CRITICAL CONNECTION UNDERCUT

When critical mechanical anchor connections are required consider the DEWALT® Critical Connection Undercut Anchor (CCU+™). The 3/8" 1/2" 5/8" or 3/4" CCU+™ anchor range combine with Hollow Stop and Undercutting Bits 60V MAX* rotary hammers and dust extractors for an OSHA Table 1 compliant cordless system. Available in 3 steel grades and Made in the USA** for Buy America Act construction projects.

* System is compliant to the Exposure Control Methods described in Table 1 of 29 CFR 1926.1153 when outlined components are operating and maintained in accordance to manufacturer's instructions.

**CCU+ Anchors are 100% domestically produced and qualify under FHWA as Made In the USA.



UNDERCUT ANCHORS

CCU+™

Type	Heavy Duty Undercut Anchor
Approvals	ICC-ES ESR-4810 (Concrete) IBC & IRC 2021 2018 2015 2012 Recognition in cracked & uncracked concrete including seismic and wind loading (Category 1 Anchors)
Description	Standard and through-bolt applications Transfers load mainly through bearing not dependent upon friction between the expansion sleeve and the concrete
Base Materials	Normal-weight concrete Lightweight concrete
Anchor Material	Zinc plated A36 carbon steel zinc plated high strength A 193 grade B7 steel type 316 stainless steel



A36 CARBON STEEL, EXTERNALLY THREADED

CAT #	ANCHOR TYPE	SIZE	DRILL HOLE DIAMETER	PRIMARY BIT		UNDERCUT BIT		SETTING SLEEVES		PACK.
				HSB	HB	HUCB	UCB	POWERED	MANUAL	
DFM1311050	PS	3/8" x 6"	11/16"	DFX11380	DWA54116	DFX21380	DFX21381	DFX313825	DFX313805	20
DFM1311550	TB	3/8" x 6"	11/16"		DWA54116	DFX21380	DFX21381	DFX313825	DFX313805	20
DFM1311100	PS	1/2" x 7-1/2"	13/16"	DFX11120	DWA54316	DFX21120	DFX21121	DFX311230	DFX311210	12
DFM1311600	TB	1/2" x 7-1/2"	13/16"		DWA54316	DFX21120	DFX21121	DFX311230	DFX311210	12
DFM1311150	PS	1/2" x 8-1/4"	13/16"	DFX11120	DWA54316	DFX21120	DFX21121	DFX311230	DFX311210	12
DFM1311650	TB	1/2" x 8-1/4"	13/16"		DWA54316	DFX21120	DFX21121	DFX311230	DFX311210	12
DFM1311200	PS	5/8" x 10-3/4"	1"	DFX11580	DWA58001	DFX21580*	DFX21581*	DFX315835	DFX315815	10
DFM1311700	TB	5/8" x 10-3/4"	1"		DWA58001	DFX21580*	DFX21581*	DFX315835	DFX315815	10
DFM1311250	PS	5/8" x 11-1/2"	1"	DFX11580	DWA58001	DFX21580*	DFX21581*	DFX315835	DFX315815	10
DFM1311750	TB	5/8" x 11-1/2"	1"		DWA58001	DFX21580*	DFX21581*	DFX315835	DFX315815	10
DFM1311300	PS	3/4" x 14"	1-1/4"	DFX11340	DWA58115	DFX21340	DFX21341	DFX313440	DFX313420	6
DFM1311800	TB	3/4" x 14"	1-1/4"		DWA58115	DFX21340	DFX21341	DFX313440	DFX313420	6
DFM1311350	PS	3/4" x 16"	1-1/4"	DFX11340	DWA58115	DFX21340	DFX21341	DFX313440	DFX313420	6
DFM1311850	TB	3/4" x 16"	1-1/4"		DWA58115	DFX21340	DFX21341	DFX313440	DFX313420	6

PS = Preset Version
TB = Thru-bolt Version

CCU+™

Type	Heavy Duty Undercut Anchor
Approvals	ICC-ES ESR-4810 (Concrete) IBC & IRC 2021 2018 2015 2012 Recognition in cracked & uncracked concrete including seismic and wind loading (Category 1 Anchors)
Description	Standard and through-bolt applications Transfers load mainly through bearing not dependent upon friction between the expansion sleeve and the concrete
Base Materials	Normal-weight concrete Lightweight concrete
Anchor Material	Zinc plated A36 carbon steel zinc plated high strength A 193 grade B7 steel type 316 stainless steel



B7 CARBON STEEL EXTERNALLY THREADED

CAT #	ANCHOR TYPE	SIZE	DRILL HOLE DIAMETER	PRIMARY BIT		UNDERCUT BIT		SETTING SLEEVES		PACK.
				HSB	HB	HUCB	UCB	POWERED	MANUAL	
DFM1371050	PS	3/8" x 6"	11/16"	DFX11380	DWA54116	DFX21380	DFX21381	DFX313825	DFX313805	20
DFM1371550	TB	3/8" x 6"	11/16"		DWA54116	DFX21380	DFX21381	DFX313825	DFX313805	20
DFM1371100	PS	1/2" x 7-1/2"	13/16"	DFX11120	DWA54316	DFX21120	DFX21121	DFX311230	DFX311210	12
DFM1371600	TB	1/2" x 7-1/2"	13/16"		DWA54316	DFX21120	DFX21121	DFX311230	DFX311210	12
DFM1371150	PS	1/2" x 8-1/4"	13/16"	DFX11120	DWA54316	DFX21120	DFX21121	DFX311230	DFX311210	12
DFM1371650	TB	1/2" x 8-1/4"	13/16"		DWA54316	DFX21120	DFX21121	DFX311230	DFX311210	12
DFM1371200	PS	5/8" x 10-3/4"	1"	DFX11580	DWA58001	DFX21580*	DFX21581*	DFX315835	DFX315815	10
DFM1371700	TB	5/8" x 10-3/4"	1"		DWA58001	DFX21580*	DFX21581*	DFX315835	DFX315815	10
DFM1371250	PS	5/8" x 11-1/2"	1"	DFX11580	DWA58001	DFX21580*	DFX21581*	DFX315835	DFX315815	10
DFM1371750	TB	5/8" x 11-1/2"	1"		DWA58001	DFX21580*	DFX21581*	DFX315835	DFX315815	10
DFM1371300	PS	3/4" x 14"	1-1/4"	DFX11340	DWA58115	DFX21340	DFX21341	DFX313440	DFX313420	6
DFM1371800	TB	3/4" x 14"	1-1/4"		DWA58115	DFX21340	DFX21341	DFX313440	DFX313420	6
DFM1371350	PS	3/4" x 16"	1-1/4"	DFX11340	DWA58115	DFX21340	DFX21341	DFX313440	DFX313420	6
DFM1371850	TB	3/4" x 16"	1-1/4"		DWA58115	DFX21340	DFX21341	DFX313440	DFX313420	6

PS - Preset
TB - Thru-bolt

*For rotary hammer drill connector options designated drill bits can be considered for use with a DW5891 SDS-Max to SDS-Plus adapter (e.g. HUCB and UCB for 5/8-inch nominal anchor size).

PS = Preset Version
TB = Thru-bolt Version

UNDERCUT ANCHORS

CCU+™

Type	Heavy Duty Undercut Anchor
Approvals	ICC-ES ESR-4810 (Concrete) IBC & IRC 2021 2018 2015 2012 Recognition in cracked & uncracked concrete including seismic and wind loading (Category 1 Anchors)
Description	Standard and through-bolt applications Transfers load mainly through bearing not dependent upon friction between the expansion sleeve and the concrete
Base Materials	Normal and sand-lightweight concrete over metal deck
Anchor Material	Zinc plated A36 carbon steel zinc plated high strength A 193 grade B7 steel type 316 stainless steel



PS = Preset Version
TB = Thru-bolt Version type
*For rotary hammer drill connector options designated drill bits can be considered for use with a DW5891 SDS-Max to SDS-Plus adapter.



316 STAINLESS STEEL EXTERNALLY THREADED CLASS 2

CAT #	ANCHOR TYPE	SIZE	DRILL HOLE DIAMETER	PRIMARY BIT		UNDERCUT BIT		SETTING SLEEVES		PACK.
				HSB	HB	HUCB	UCB	POWERED	MANUAL	
DFM1361050	PS	3/8" x 6"	11/16"	DFX21380	DWA54116	DFX21380	DFX21381	DFX313825	DFX313805	20
DFM1361550	TB	3/8" x 6"	11/16"		DWA54116	DFX21380	DFX21381	DFX313825	DFX313805	20
DFM1361100	PS	1/2" x 7-1/2"	13/16"	DFX11120	DWA54316	DFX21120	DFX21121	DFX311230	DFX311210	12
DFM1361600	TB	1/2" x 7-1/2"	13/16"		DWA54316	DFX21120	DFX21121	DFX311230	DFX311210	12
DFM1361150	PS	1/2" x 8-1/4"	13/16"	DFX11120	DWA54316	DFX21120	DFX21121	DFX311230	DFX311210	12
DFM1361650	TB	1/2" x 8-1/4"	13/16"		DWA54316	DFX21120	DFX21121	DFX311230	DFX311210	12
DFM1361200	PS	5/8" x 10-3/4"	1"	DFX11580	DWA58001	DFX21580*	DFX21581*	DFX315835	DFX315815	10
DFM1361700	TB	5/8" x 10-3/4"	1"		DWA58001	DFX21580*	DFX21581*	DFX315835	DFX315815	10
DFM1361250	PS	5/8" x 11-1/2"	1"	DFX11580	DWA58001	DFX21580*	DFX21581*	DFX315835	DFX315815	10
DFM1361750	TB	5/8" x 11-1/2"	1"		DWA58001	DFX21580*	DFX21581*	DFX315835	DFX315815	10
DFM1361300	PS	3/4" x 14"	1-1/4"	DFX11340	DWA58115	DFX21340	DFX21341	DFX313440	DFX313420	6
DFM1361800	TB	3/4" x 14"	1-1/4"		DWA58115	DFX21340	DFX21341	DFX313440	DFX313420	6
DFM1361350	PS	3/4" x 16"	1-1/4"	DFX11340	DWA58115	DFX21340	DFX21341	DFX313440	DFX313420	6
DFM1361850	TB	3/4" x 16"	1-1/4"		DWA58115	DFX21340	DFX21341	DFX313440	DFX313420	6

PS - Preset, TB - Thru-bolt
*For rotary hammer drill connector options designated drill bits can be considered for use with a DW5891 SDS-Max to SDS-Plus adapter (e.g. HUCB and UCB for 5/8-inch nominal anchor size).



SETTING SLEEVES (MANUAL)

CAT #	FITS ANCHOR SIZE	USABLE LENGTH	PACK
DFX313805	3/8"	5"	1
DFX311210	1/2"	5"	1
DFX315815	5/8"	5-1/4"	1
DFX313420	3/4"	7"	1



SETTING SLEEVES (POWERED)

CAT #	FITS ANCHOR SIZE	USABLE LENGTH	SHANK TYPE	PACK
DFX313825	3/8"	2-3/4"	SDS-Plus	1
DFX311230	1/2"	3-3/4"	SDS-Plus	1
DFX315835	5/8"	4-3/4"	SDS-Max	1
DFX313440	3/4"	6-1/2"	SDS-Max	1



HOLLOW STOP BITS (HSB)

CAT #	FITS ANCHOR SIZE	DRILL DEPTH	SHANK TYPE	PACK
DFX11380	11/16"	4-1/4"	SDS-Plus	1
DFX11120	13/16"	5-3/8"	SDS-Plus	1
DFX11580	1"	8"	SDS-Max	1
DFX11340	1-1/4"	10-5/8"	SDS-Max	1



HOLLOW UNDERCUT BITS (HUCB)

CAT #	NOMINAL DRILL BIT DIAMETER	MAX HOLE DEPTH	SHANK TYPE	PACK
DFX21380	11/16"	6"	SDS-Plus	1
DFX21120	13/16"	8"	SDS-Plus	1
DFX21580*	1"	11"	SDS-Plus	1
DFX21340	1-1/4"	15-1/4"	SDS-Max	1



UNDERCUT BITS (UCB)

CAT #	NOMINAL DRILL BIT DIAMETER	MAX HOLE DEPTH	SHANK TYPE	PACK
DFX21381	11/16"	6"	SDS-Plus	1
DFX21121	13/16"	8"	SDS-Plus	1
DFX21581*	1"	11"	SDS-Plus	1
DFX21341	1-1/4"	15-1/4"	SDS-Max	1



REPLACEMENT CUTTER BLADES FOR UNDERCUT BITS

CAT #	NOMINAL DRILL BIT DIAMETER	COMPATIBLE WITH		PACK	CAR
		HUCB	UCB		
DFX213825	11/16"	DFX21380	DFX21381	1	1
DFX211230	13/16"	DFX21120	DFX21121	1	1
DFX215835	1"	DFX21580	DFX21581	1	1
DFX213440	1-1/4"	DFX21340	DFX21341	1	1



REPLACEMENT BOW JAWS FOR UNDERCUT BITS

CAT #	NOMINAL STOP BIT DIAMETER	COMPATIBLE WITH		PACK
		HUCB	UCB	
DFX213807	11/16"	DFX21380	-	1
DFX213805	11/16"	-	DFX21381	1
DFX211212	13/16"	DFX21120	-	1
DFX211210	13/16"	-	DFX21121	1
DFX215817	1"	DFX21580	-	1
DFX215815	1"	-	DFX21581	1
DFX213422	1-1/4"	DFX21340	-	1
DFX213420	1-1/4"	-	DFX21341	1

BOLT/SHIELD ANCHORS

Double™ Expansion Anchor

Type	Shell Expansion Anchor
Approvals	Federal GSA Specification – Meets the requirements CID A-A 1923A Type 3
Description	Dual expansion machine bolt anchor
Base Materials	Concrete
Anchor Material	Zamac alloy



ZAMAC ALLOY THREADED INTERNALLY

CAT #	SIZE	DRILL DIAMETER	LENGTH	PACK	CAR.
09510-PWR	1/4"	1/2"	1-3/8"	50	500
09515-PWR	5/16"	5/8"	1-5/8"	50	500
09520-PWR	3/8"	3/4"	2"	50	250
09525-PWR	1/2"	7/8"	2-1/2"	25	250
09530-PWR	5/8"	1"	2-3/4"	25	100
09535-PWR	3/4"	1-1/4"	3-15/16"	10	50

Single™ Expansion Anchor

Type	Shell Expansion Anchor
Approvals	Federal GSA Specification – Meets the requirements CID A-A 1923A Type 2
Description	Machine bolt anchor
Base Materials	Concrete
Anchor Material	Zamac alloy



ZAMAC ALLOY THREADED INTERNALLY

CAT #	SIZE	DRILL DIAMETER	PACK.	CAR.
09650-PWR	1/4"	1/2"	50	250
09655-PWR	5/16"	5/8"	50	250
09665-PWR	3/8"	5/8"	50	250
09675-PWR	1/2"	7/8"	25	125
09685-PWR	5/8"	1"	25	125

Lag Shield™

Type	Shell Expansion Anchor
Approvals	Federal GSA Specification – Meets the requirements CID A-A 1923A Type 1 Tested in accordance with ASTM E 488
Description	For Lag Bolts Short style for harder base materials long for softer materials
Base Materials	Concrete and mortar joints of block and brick
Anchor Material	Zamac alloy



ZAMAC ALLOY LONG

CAT #	SIZE	DRILL DIAMETER	LENGTH	PACK.	CAR.
01055-PWR	1/4"	1/2"	1-1/2"	50	500
01105-PWR	5/16"	1/2"	1-3/4"	50	500
01155-PWR	3/8"	5/8"	2-1/2"	50	250
01205-PWR	1/2"	3/4"	3"	50	200
01255-PWR	5/8"	7/8"	3-1/2"	25	125
01305-PWR	3/4"	1"	3-1/2"	25	100



ZAMAC ALLOY SHORT

CAT #	SIZE	DRILL DIAMETER	LENGTH	PACK.	CAR.
01051-PWR	1/4"	1/2"	1"	50	500
01101-PWR	5/16"	1/2"	1-1/4"	50	500
01151-PWR	3/8"	5/8"	1-3/4"	50	500
01201-PWR	1/2"	3/4"	2"	50	500
01251-PWR	5/8"	7/8"	2"	25	125
01301-PWR	3/4"	1"	2"	25	125

Calk-In™

Type	Machine Bolt Anchor
Approvals	Federal GSA Specification – Meets the requirements CID A-A 1923A Type 3
Description	Calking type machine bolt anchor (Requires setting tool for installation - ordered separately)
Base Materials	Concrete block and brick
Anchor Material	Zamac alloy and lead



LEAD ANTIMONY ALLOY THREADED INTERNALLY

CAT #	SIZE	DRILL DIAMETER	PACK.	CAR.
09205-PWR	#8-32	5/16"	100	1000
09210-PWR	#10-24	3/8"	100	1000
09220-PWR	1/4"-20	1/2"	100	600
09222-PWR	1/4"-20	3/8"	1000	-
09225-PWR	5/16"-18	5/8"	50	300
09230-PWR	3/8"-16	3/4"	50	300
09240-PWR	1/2"-13	7/8"	50	250



CALK-IN SETTING TOOLS PURCHASED SEPARATELY

CAT #	SIZE	DRILL DIAMETER	MIN. HOLE DEPTH	PACK	CAR
09201-PWR	#8-32	5/16"	1/2"	100	1000
09211-PWR	#10-24	3/8"	5/8"	100	1000
09221-PWR	1/4"-20	1/2"	7/8"	100	600
09221-PWR	1/4"-20	1/2"	7/8"	1000	-
09226-PWR	5/16"-18	5/8"	1"	50	300
09231-PWR	3/8"-16	3/4"	1-1/4"	50	300
09241-PWR	1/2"-13	7/8"	1-1/2"	50	250

SCREW ANCHORS

Screw-Bolt™+

Type	High Performance Screw Anchor
Approvals	ICC-ES ESR-3889 (Concrete) ESR-4042 (Masonry) IBC & IRC 2021 2018 2015 2012 Recognition in cracked & uncracked concrete including seismic and wind loading (Category 1 Anchors)
Description	Uses standard ANSI tolerance drill bits One-piece finished head Tough threads tap high strength concrete Head ratchet teeth lock against fixture
Base Materials	Normal and sand-lightweight concrete over metal deck grouted concrete masonry (CMU) clay brick masonry
Anchor Material	Carbon steel



CARBON STEEL HEX HEAD

CAT #	SIZE	PACK	CTN
PFM1411000	1/4" x 1-1/4"	100	600
PFM1411020	1/4" x 1-3/4"	100	600
PFM1411060	1/4" x 2-1/4"	100	600
PFM1411080	1/4" x 2-5/8"	100	500
PFM1411100	1/4" x 3"	100	500
PFM1411160	3/8" x 1-3/4"	50	300
PFM1411220	3/8" x 2-1/2"	50	300
PFM1411240	3/8" x 3"	50	250
PFM1411280	3/8" x 4"	50	250
PFM1411300	3/8" x 5"	50	250
PFM1411320	3/8" x 6"	50	150
PFM1411340	1/2" x 2"	50	200
PFM1411360	1/2" x 2-1/2"	50	200
PFM1411380	1/2" x 3"	50	150
PFM1411420	1/2" x 4"	50	150
PFM1411460	1/2" x 5"	25	100
PFM1411480	1/2" x 6"	25	75
PFM1411520	1/2" x 8"	25	100
PFM1411540	5/8" x 3"	25	100
PFM1411580	5/8" x 4"	25	100
PFM1411600	5/8" x 5"	25	75
PFM1411640	5/8" x 6"	25	75
PFM1411680	5/8" x 8"	25	50
PFM1411700	3/4" x 3"	20	60
PFM1411720	3/4" x 4"	20	60
PFM1411760	3/4" x 5"	20	60
PFM1411800	3/4" x 6"	20	60
PFM1411840	3/4" x 8"	10	40
PFM1411880	3/4" x 10"	10	20



CARBON STEEL FLAT HEAD

CAT #	SIZE	PACK	CTN.
PFM1411105	1/4" x 3"	100	500
PFM1411225	3/8" x 2-1/2"	50	300
PFM1411245	3/8" x 3"	50	250
PFM1411285	3/8" x 4"	50	250
PFM1411385	1/2" x 3"	50	150
PFM1411425	1/2" x 4"	50	150
PFM1411465	1/2" x 5"	25	100

CARBON STEEL FLAT HEAD

CAT #	SIZE	PACK	CTN	DRIVER BIT	BIT SIZE
PFM1411105	1/4" x 3"	100	500	DWATX30IR2-Z	T30
PFM1411225	3/8" x 2 1/2"	50	300	PFM1411SKT50	T50
PFM1411245	3/8" x 3"	50	250	PFM1411SKT50	T50
PFM1411285	3/8" x 4"	50	250	PFM1411SKT50	T50
PFM1411385	1/2" x 3"	50	150	PFM1411SKT55	T55
PFM1411425	1/2" x 4"	50	150	PFM1411SKT55	T55
PFM1411465	1/2" x 5"	25	100	PFM1411SKT55	T55



CARBON STEEL GALVANIZED MECHANICALLY HEX HEAD

CAT #	SIZE	PACK	CTN.
PFM1461240	3/8" x 3"	50	250
PFM1461280	3/8" x 4"	50	250
PFM1461300	3/8" x 5"	50	250
PFM1461320	3/8" x 6"	50	150
PFM1461420	1/2" x 4"	50	150
PFM1461460	1/2" x 5"	25	100
PFM1461480	1/2" x 6"	25	75
PFM1461520	1/2" x 8"	25	100
PFM1461600	5/8" x 5"	25	75
PFM1461640	5/8" x 6"	25	75
PFM1461680	5/8" x 8"	25	50
PFM1461800	3/4" x 6"	20	60
PFM1461850	3/4" x 8"	10	40



SCREW ANCHORS

316 Stainless Steel Wedge-Bolt

Type	Screw Anchor
Approvals	Tested in accordance with ASTM E488 AC106 criteria and AC193 criteria
Description	Uses special matched tolerance Wedge-Bit™ One-piece finished head Additional corrosion resistance Head ratchet teeth lock against fixture
Base Materials	Concrete grouted concrete masonry (CMU)
Anchor Material	316 Stainless steel



316 STAINLESS STEEL FINISHED HEX WASHER HEAD

CAT #	ANCHOR SIZE	PACK	CTN	SUGGESTED WEDGE-BIT			
				SDS-PLUS	SDS-MAX	SPLINE	STRAIGHT SHANK
07870-PWR	1/4" x 2"	100	600	01312-PWR			01370-PWR
07872-PWR	1/4" x 3"	100	500	01314-PWR			01372-PWR
07876-PWR	1/4" x 4"	100	500	01314-PWR			01372-PWR
07878-PWR	1/4" x 5"	100	500	01315-PWR			
07880-PWR	3/8" x 2-1/2"	50	300	01316-PWR			01380-PWR
07882-PWR	3/8" x 3"	50	250	01316-PWR			01380-PWR
07884-PWR	3/8" x 4"	50	250	01316-PWR			01380-PWR
07886-PWR	3/8" x 5"	50	250	01318-PWR	01354-PWR	01342-PWR	01384-PWR
07888-PWR	1/2" x 3"	50	150	01320-PWR	01354-PWR	01342-PWR	01390-PWR
07890-PWR	1/2" x 4"	50	150	01320-PWR	01354-PWR	01342-PWR	01390-PWR
07892-PWR	1/2" x 5"	25	100	01322-PWR	01354-PWR	01342-PWR	01394-PWR
07894-PWR	1/2" x 6"	25	75	01322-PWR	01354-PWR	01342-PWR	01394-PWR

UltraCon® +

Type	Concrete Screw
Approvals	ICC-ES ESR-3068 (Concrete) ICC-ES ESR-3196 (Masonry-CMU) ICC-ES ESR-3042 (Wood-to-Wood) ICC-ES ESR-3213 (Chemically Treated Lumber) Miami-Dade NOA Florida Building Code
Description	Stalgard® Coating Blue White Silver or Bronze
Base Materials	Concrete Block Brick Wood Pressure Treated Lumber
Anchor Material	Carbon Steel



CARBON STEEL FINISHED BLUE HEX WASHER HEAD

CAT #	SIZE	PACK
DFM12700*	3/16" x 1-1/4"	100
DFM12700B	3/16" x 1-1/4"	5000
DFM12702*	3/16" x 1-3/4"	100
DFM12702B*	3/16" x 1-3/4"	3000
DFM12704	3/16" x 2-1/4"	100
DFM12704B	3/16" x 2-1/4"	2000
DFM12706	3/16" x 2-3/4"	100
DFM12706B	3/16" x 2-3/4"	1500
DFM12708	3/16" x 3-1/4"	100
DFM12708B	3/16" x 3-1/4"	1000
DFM12710	3/16" x 3-3/4"	100
DFM12710B	3/16" x 3-3/4"	1000
DFM12712	3/16" x 4"	100
DFM12712B	3/16" x 4"	1000
DFM12715*	1/4" x 1"	100
DFM12720*	1/4" x 1-1/4"	100
DFM12720B*	1/4" x 1-1/4"	2000
DFM12722*	1/4" x 1-3/4"	100
DFM12722B*	1/4" x 1-3/4"	2000
DFM12724	1/4" x 2-1/4"	100
DFM12724B	1/4" x 2-1/4"	1500
DFM12726	1/4" x 2-3/4"	100
DFM12726B	1/4" x 2-3/4"	1000
DFM12728	1/4" x 3-1/4"	100
DFM12728B	1/4" x 3-1/4"	1000
DFM12730	1/4" x 3-3/4"	100
DFM12730B	1/4" x 3-3/4"	500
DFM12732	1/4" x 4"	100
DFM12732B	1/4" x 4"	500
DFM12734	1/4" x 5"	100
DFM12734B	1/4" x 5"	500

*Sizes which are less than the minimum standard anchor length for strength design.



CARBON STEEL FINISHED BLUE PHILLIPS FLAT HEAD

CAT #	SIZE	PACK
DFM12740*	3/16" x 1-1/4"	100
DFM12740B*	3/16" x 1-1/4"	5000
DFM12742*	3/16" x 1-3/4"	100
DFM12742B*	3/16" x 1-3/4"	3000
DFM12744	3/16" x 2-1/4"	100
DFM12744B	3/16" x 2-1/4"	2500
DFM12746	3/16" x 2-3/4"	100
DFM12746B	3/16" x 2-3/4"	1500
DFM12748	3/16" x 3-1/4"	100
DFM12748B	3/16" x 3-1/4"	1000
DFM12750	3/16" x 3-3/4"	100
DFM12750B	3/16" x 3-3/4"	1000
DFM12752	3/16" x 4"	100
DFM12752B	3/16" x 4"	1000
DFM12760*	1/4" x 1-1/4"	100
DFM12760B*	1/4" x 1-1/4"	2500
DFM12762*	1/4" x 1-3/4"	100
DFM12762B*	1/4" x 1-3/4"	2500
DFM12764	1/4" x 2-1/4"	100
DFM12764B	1/4" x 2-1/4"	1500
DFM12766	1/4" x 2-3/4"	100
DFM12766B	1/4" x 2-3/4"	1000
DFM12768	1/4" x 3-1/4"	100
DFM12768B	1/4" x 3-1/4"	1000
DFM12770	1/4" x 3-3/4"	100
DFM12770B	1/4" x 3-3/4"	500
DFM12772	1/4" x 4"	100
DFM12772B	1/4" x 4"	500
DFM12774	1/4" x 5"	100
DFM12776	1/4" x 6"	100

SCREW ANCHORS

UltraCon® + Continued

Type	Concrete Screw
Approvals	ICC-ES ESR-3068 (Concrete) ICC-ES ESR-3196 (Masonry-CMU) ICC-ES ESR-3042 (Wood-to-Wood) ICC-ES ESR-3213 (Chemically Treated Lumber) Miami-Dade NOA Florida Buiding Code
Description	Stalgard® Coating Blue White Silver or Bronze
Base Materials	Concrete Block Brick Wood Pressure Treated Lumber
Anchor Material	Carbon Steel



*Sizes which are less than the minimum standard anchor length for strength design.



CARBON STEEL FINISHED WHITE HEX WASHER HEAD

CAT #	SIZE	PACK
DFM2ELD200*	3/16" x 1-1/4"	5000
DFM2ELD210*	3/16" x 1-3/4"	3000
DFM2ELD220	3/16" x 2-1/4"	2500
DFM2ELD230	3/16" x 2-3/4"	1500
DFM2ELD240	3/16" x 3-1/4"	1000
DFM2ELD250*	1/4" x 1-1/4"	2500
DFM2ELD195*	1/4" x 1-3/4"	2000
DFM2ELD205	1/4" x 2-1/4"	1500
DFM2ELD215	1/4" x 2-3/4"	1000
DFM2ELD225	1/4" x 3-1/4"	1000
DFM2ELD235	1/4" x 3-3/4"	500
DFM2ELD245	1/4" x 4"	500
DFM2ELD255	1/4" x 5"	500
DFM2ELD265	1/4" x 6"	500



CARBON STEEL FINISHED WHITE PHILLIPS FLAT HEAD

CAT #	SIZE	PACK
DFM2ELD320*	3/16" x 1-1/4"	5000
DFM2ELD330*	3/16" x 1-3/4"	3000
DFM2ELD340	3/16" x 2-1/4"	2500
DFM2ELD350	3/16" x 2-3/4"	1500
DFM2ELD360	3/16" x 3-1/4"	1000
DFM2ELD370	3/16" x 3-3/4"	1000
DFM2ELD385*	1/4" x 1-1/4"	2500
DFM2ELD386*	1/4" x 1-3/4"	2000
DFM2ELD387	1/4" x 2-1/4"	1500
DFM2ELD388	1/4" x 2-3/4"	1000
DFM2ELD389	1/4" x 3-1/4"	1000



CARBON STEEL FINISHED WHITE HEX WASHER FLANGE HEAD

CAT #	SIZE	PACK
DFM2ELD270*	1/4" x 1-3/4"	2000
DFM2ELD275*	1/4" x 1-3/4"	1500
DFM2ELD285	1/4" x 2-1/4"	1000
DFM2ELD295	1/4" x 2-3/4"	1000
DFM2ELD305	1/4" x 3-1/4"	500



CARBON STEEL FINISHED WHITE PHILLIPS FLAT TRIM HEAD

CAT #	SIZE	PACK
DFM2ELD400*	1/4" x 1-3/4"	2000
DFM2ELD410	1/4" x 2-1/4"	1500
DFM2ELD420	1/4" x 2-3/4"	1000
DFM2ELD430	1/4" x 3-1/4"	1000
DFM2ELD440	1/4" x 3-3/4"	500
DFM2ELD450	1/4" x 4"	500



CARBON STEEL FINISHED SILVER HEX WASHER HEAD

CAT #	SIZE	PACK
DFM2ELG340*	1/4" x 1-1/4"	2500
DFM2ELG341*	1/4" x 1-3/4"	2000
DFM2ELG371	1/4" x 2-1/4"	1500
DFM2ELG401	1/4" x 2-3/4"	1000
DFM2ELG431	1/4" x 3-1/4"	1000



CARBON STEEL FINISHED SILVER PHILLIPS FLAT HEAD

CAT #	SIZE	PACK
DFM2ELG521*	3/16" x 1-1/4"	5000
DFM2ELG551*	3/16" x 1-3/4"	3000
DFM2ELG581	3/16" x 2-1/4"	2500
DFM2ELG611	3/16" x 2-3/4"	1500
DFM2ELG641	3/16" x 3-1/4"	1000
DFM2ELG671	3/16" x 3-3/4"	1000



CARBON STEEL FINISHED SILVER PHILLIPS FLAT TRIM HEAD

CAT #	SIZE	PACK
DFM2ELG770*	1/4" x 1-1/4"	2500
DFM2ELG771*	1/4" x 1-3/4"	2000
DFM2ELG801	1/4" x 2-1/4"	1500
DFM2ELG831	1/4" x 2-3/4"	1000
DFM2ELG861	1/4" x 3-1/4"	1000
DFM2ELG891	1/4" x 3-3/4"	500
DFM2ELG921	1/4" x 4"	500



CARBON STEEL FINISHED SILVER HEX WASHER FLANGE HEAD

CAT #	SIZE	PACK
DFM2ELC145*	1/4" x 1-3/4"	1500
DFM2ELG510*	1/4" x 1-3/4"	1500
DFM2ELC151	1/4" x 2-1/4"	1000
DFM2ELG512	1/4" x 2-1/4"	1000
DFM2ELC160	1/4" x 2-3/4"	1000
DFM2ELC170	1/4" x 3-1/4"	1000



CARBON STEEL FINISHED BRONZE HEX WASHER HEAD

CAT #	SIZE	PACK
DFM2ELE465	1/4" x 4"	500



CARBON STEEL FINISHED BRONZE PHILLIPS FLAT TRIM HEAD

CAT #	SIZE	PACK
DFM2ELG832	1/4" x 2-3/4"	1000
DFM2ELG862	1/4" x 3-1/4"	1000
DFM2ELG892	1/4" x 3-3/4"	500



CARBON STEEL FINISHED BRONZE PHILLIPS FLAT HEAD

CAT #	SIZE	PACK
DFM2ELG612	3/16" x 2-3/4"	1500

ULTRACON+ SDS+ DRILL BITS

CAT #	SIZE
DW5381	5/32" x 7"
DW5382	3/16" x 7"

INSTALLATION KIT

CAT #	DESCRIPTION
DW5366	5/32" and 3/16" SDS+ Drill Bits, 1/4" And 5/16" Nutsetters, #2 and #3 Phillips Bits, Phillips Flathead Adapter, Percussion Adapter, Drive Sleeve, and 1/8" Allen Wrench



SCREW ANCHORS

UltraCon®

Type	Concrete Screw
Approvals	Miami-Dade NOA Florida Building Code
Description	Silver Stalgard® Coating
Base Materials	Concrete brick block
Anchor Material	Carbon steel



CARBON STEEL STALGARD® SILVER FINISHED HEX WASHER HEAD

CAT #	SIZE	PACK
DFM5ELG481	5/16" x 1-3/4"	1000
DFM5ELG486	5/16" x 2-1/4"	1000
DFM5ELG491	5/16" x 2-3/4"	500
DFM5ELG496	5/16" x 3-1/4"	500
DFM5ELG501	5/16" x 3-3/4"	500
DFM5ELG506	5/16" x 4"	500
DFM5ELG511	5/16" x 5"	250
DFM5ELG516	5/16" x 6"	250



CARBON STEEL STALGARD® SILVER FINISHED HEX WASHER TRIM HEAD

CAT #	SIZE	PACK
DFM5ELG482	5/16" x 1-3/4"	1500
DFM5ELG487	5/16" x 2-1/4"	1000
DFM5ELG492	5/16" x 2-3/4"	1000
DFM5ELG497	5/16" x 3-1/4"	500
DFM5ELG502	5/16" x 3-3/4"	500



CARBON STEEL STALGARD® SILVER FINISHED PHILLIPS FLAT HEAD

CAT #	SIZE	PACK
DFM5ELG941	5/16" x 2-1/4"	1000
DFM5ELG948	5/16" x 2-3/4"	500
DFM5ELG960	5/16" x 3-1/4"	500
DFM5ELG976	5/16" x 4"	500
DFM5ELG979	5/16" x 4"	500
DFM5ELG992	5/16" x 5"	500
DFM5ELG998	5/16" x 6"	250



CARBON STEEL STALGARD® SILVER FINISHED PHILLIPS FLAT TRIM HEAD

CAT #	SIZE	PACK
DFM5ELG941	5/16" x 2-1/4"	1000
DFM5ELG948	5/16" x 2-3/4"	500
DFM5ELG960	5/16" x 3-1/4"	500
DFM5ELG976	5/16" x 4"	500
DFM5ELG979	5/16" x 4"	500
DFM5ELG992	5/16" x 5"	500
DFM5ELG998	5/16" x 6"	250



CARBON STEEL STALGARD® SILVER FINISHED PHILLIPS FLAT OVERSIZED HEAD

CAT #	SIZE	PACK
DFM5ELG945	5/16" x 2-1/4"	1500
DFM5ELG955	5/16" x 2-3/4"	1000
DFM5ELG965	5/16" x 3-1/4"	500
DFM5ELG972	5/16" x 3-3/4"	500
DFM5ELG991	5/16" x 5"	250



SDS+ DRILL BITS

CAT #	SIZE
DW5417	1/4" x 6"
DW5418	1/4" x 8 1/2"
DW5420	1/4" x 12"
DW5421	1/4" x 14"

UltraCon® SS4

Type	Concrete Screw
Approvals	Miami-Dade NOA Florida Building Code
Description	Silver Stalgard® Coating 410 Stainless Steel provides enhanced corrosion resistance and ductility over carbon steel fasteners
Base Materials	Concrete brick block
Anchor Material	410 Stainless Steel



410 STAINLESS STEEL STALGARD® SILVER FINISHED HEX WASHER HEAD

CAT #	SIZE	PACK
DFM4EUH310	1/4" x 1-1/4"	100
DFM4EUH311	1/4" x 1-3/4"	100
DFM4EUH312	1/4" x 2-1/4"	100
DFM4EUH313	1/4" x 2-3/4"	100
DFM4EUH314	1/4" x 3-1/4"	100
DFM4EUH315	1/4" x 3-3/4"	100
DFM4EUH316	1/4" x 4"	100
DFM4EUH317	1/4" x 5"	100
DFM4EUH318	1/4" x 6"	100



410 STAINLESS STEEL STALGARD® SILVER FINISHED PHILLIPS FLAT HEAD

CAT #	SIZE	PACK
DFM4EUF310	1/4" x 1-1/4"	100
DFM4EUF315	1/4" x 1-3/4"	100
DFM4EUF325	1/4" x 2-1/4"	100
DFM4EUF335	1/4" x 2-3/4"	100
DFM4EUF345	1/4" x 3-1/4"	100
DFM4EUF355	1/4" x 3-3/4"	100
DFM4EUF365	1/4" x 4"	100

SDS+ DRILL BITS

CAT #	SIZE
DFM4EUF310	1/4" x 1-1/4"

INSTALLATION KIT

CAT #	DESCRIPTION
DW5366	5/32" and 3/16" SDS+ Drill Bits, 1/4" and 5/16" Nutsetters, #2 and #3 Phillips Bits, Phillips Flathead Adapter, Percussion Adapter, Drive Sleeve, and 1/8" Allen Wrench

SCREW ANCHORS

Crete-Flex®

Type	Concrete Screw
Approvals	Miami-Dade NOA Florida Building Code
Description	Silver Stalgard® Coating 410 Stainless Steel provides enhanced corrosion resistance and ductility for outstanding performance
	Larger .201 root diameter provides exceptionally high shear values
Base Materials	Concrete brick block
Anchor Material	410 Stainless Steel



410 STAINLESS STEEL STALGARD® SILVER FINISHED HEX WASHER HEAD

CAT #	SIZE	PACK	CTN
DFM4EMH500	3/16" x 1-1/4"	100	500
DFM4EMH510	3/16" x 1-3/4"	100	500
DFM4EMH530	3/16" x 2-1/4"	100	500
DFM4EMH550	3/16" x 2-3/4"	100	500
DFM4EMF310	#14 x 1-1/4"	100	500
DFM4EMF330	#14 x 1-3/4"	100	500
DFM4EMF350	#14 x 2-1/4"	100	500
DFM4EMF370	#14 x 2-3/4"	100	500
DFM4EMF390	#14 x 3-1/4"	100	500
DFM4EMF410	#14 x 3-3/4"	100	500
DFM4EMF430	#14 x 4"	100	500
DFM4EMF450	#14 x 5"	100	500
DFM4EMF470	#14 x 6"	100	500



410 STAINLESS STEEL STALGARD® SILVER FINISHED HEX WASHER FLANGE HEAD

CAT #	SIZE	PACK	CTN
DFM4EMF340	#14 x 1-3/4"	100	500
DFM4EMF360	#14 x 2-1/4"	100	500



410 STAINLESS STEEL STALGARD® SILVER FINISHED PHILLIPS FLAT TRIM HEAD

CAT #	SIZE	PACK	CTN
DFM4EMF510	#14 x 1-3/4"	100	500
DFM4EMF530	#14 x 2-1/4"	100	500
DFM4EMF550	#14 x 2-3/4"	100	500



410 STAINLESS STEEL STALGARD® SILVER FINISHED PHILLIPS FLAT HEAD

CAT #	SIZE	PACK	CTN
DFM4EMF610	3/16" x 1-1/4"	100	500
DFM4EMF620	3/16" x 1-3/4"	100	500
DFM4EMF630	3/16" x 2-1/4"	100	500
DFM4EMF640	3/16" x 2-3/4"	100	500
DFM4EMF650	3/16" x 3-1/4"	100	500
DFM4EMF690	#14 x 1-1/4"	100	500
DFM4EMF710	#14 x 1-3/4"	100	500
DFM4EMF730	#14 x 2-1/4"	100	500
DFM4EMF750	#14 x 2-3/4"	100	500
DFM4EMF770	#14 x 3-1/4"	100	500
DFM4EMF790	#14 x 3-3/4"	100	500
DFM4EMF810	#14 x 4"	100	500
DFM4EMF830	#14 x 5"	100	500
DFM4EMF850	#14 x 6"	100	500

SDS+ DRILL BITS

CAT #	SIZE
DW5381	5/32" x 7"
DW5410	7/32" x 6"
DW5411	7/32" x 10"

INSTALLATION KIT

CAT #	DESCRIPTION
DW5366	5/32" and 3/16" SDS+ Drill Bits, 1/4" and 5/16" Nutsetters, #2 and #3 Phillips Bits, Phillips Flathead Adapter, Percussion Adapter, Drive Sleeve, and 1/8" Allen Wrench



Aggre-Gator®

Type	Concrete Screw
Approvals	Miami-Dade NOA High Velocity Hurricane Zone Florida Building Code
Description	Corrosion resistant
	High strength and ductility Galvanic compatibility in dissimilar metal applications involving aluminum Silver Stalgard® GB (Galvanic Barrier) Coating
Base Materials	Concrete brick block ACQ- treated lumber
Anchor Material	Bi-Metal 300 Series Stainless Steel

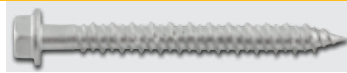

300 STAINLESS STEEL STALGARD® GB SILVER FINISHED HEX WASHER HEAD

CAT #	SIZE	PACK	CTN
DFM3EML300	1/4" x 1-1/4"	50	300
DFM3EML315	1/4" x 1-3/4"	50	300
DFM3EML325	1/4" x 2-1/4"	50	300
DFM3EML335	1/4" x 2-3/4"	50	300
DFM3EML345	1/4" x 3-1/4"	50	300
DFM3EML365	1/4" x 4"	50	300

SDS+ DRILL BITS

CAT #	SIZE
DW5382	3/16" x 7"

INSTALLATION KIT

CAT #	DESCRIPTION
DW5366	5/32" and 3/16" SDS+ Drill Bits, 1/4" and 5/16" Nutsetters, #2 and #3 Phillips Bits, Phillips Flathead Adapter, Percussion Adapter, Drive Sleeve, and 1/8" Allen Wrench



CAST-IN ANCHOR INSERTS

DDI+™ (DEWALT Deck Insert)

Type	Rod Hanging Anchor
Approvals	ICC-ES ESR-3958 (Concrete) Recognition in cracked & uncracked concrete including seismic and wind loading (Category 1 Anchors) Full FM & UL listings in product brochure or at www.DEWALT.com
Description	Installs through predrilled pan deck used to support MEP attachments in poured concrete slabs
Base Materials	Normal and lightweight concrete over steel deck
Anchor Material	Plain and zinc plated carbon steel



#	ANCHOR/ROD SIZE	DRILL DIAMETER	INSERT PACK
PFM2511100	3/8"	7/16"	20
PFM2511110	1/2"	9/16"	20
PFM2511120	5/8"	11/16"	20
PFM2511130*	3/4"	13/16"	12
PFM2511140*	7/8"	15/16"	12

* Parts not included in ESR-3958

RECOMMENDED INSTALLATION POWER TOOLS

CAT #	TYPE
DCD996P2	20V MAX* XR LITHIUM ION BRUSHLESS 3-SPEED DRILL
PFM3611000	DECK DRILLER EXTENSION
30912VB12	LENOX VARI-BIT STEP DRILL BITS
1779804	LENOX STANDARD HOLE SAW ARBOR - 5L 3/8" SOLID HEX SHANK
1779801	LENOX STANDARD HOLE SAW ARBORS 2L ARBOR 1/2" SOLID HEX SHANK
2009314CHC	7/8" LENOX CARBIDE HOLE CUTTER (USE 5L ARBOR NOT INCLUDED)
2009820CHC	1-1/4" LENOX CARBIDE HOLE CUTTER (USE 2L ARBOR NOT INCLUDED)

Wood-Knocker® II+

Type	Cast-In-Place Concrete Insert
Approvals	ICC-ES ESR-3657 (Concrete) IBC & IRC 2021 2018 2015 2012 Recognition in cracked & uncracked concrete including seismic and wind loading (Category 1 Anchors) Full FM & UL listings in product brochure or at www.DEWALT.com
Description	Installs onto forms used to support MEP attachments in poured concrete slabs
Base Materials	Normal and lightweight concrete
Anchor Material	Carbon steel and engineered plastic



WOOD-KNOCKER II+ LOW PROFILE				
CAT #	ROD SIZE	COLOR	PACK	
PFM2500014	1/4"	Brown	100	
PFM2500038	3/8"	Green	100	
PFM2501438	1/4" & 3/8"	Yellow	100	

WOOD-KNOCKER II+ SINGLE THREAD				
CAT #	ROD SIZE	COLOR	PACK	
PFM2521100	1/4"	Brown	100	
PFM2521150	3/8"	Green	100	
PFM2521200	1/2"	Yellow	100	
PFM2521250	5/8"	Red	100	
PFM2521300	3/4"	Purple	100	

WOOD-KNOCKER II+ DOUBLE THREAD				
CAT #	ROD SIZE	COLOR	PACK	
PFM2521438	1/4" & 3/8"	White	100	
PFM2521350	3/8" & 1/2"	Grey	100	
PFM2525834	5/8" & 3/4"	Black	50	

WOOD-KNOCKER II+ TRIPLE THREAD				
CAT #	ROD SIZE	COLOR	PACK	
PFM253143812	1/4" & 3/8" & 1/2"	Aqua	100	
PFM253381258	3/8" & 1/2" & 5/8"	Orange	50	

WOOD-KNOCKER II+ PUSH-IN THREAD				
CAT #	ROD SIZE	COLOR	PACK	
PFM2610038	3/8"	GREEN	50	
PFM2610012	1/2"	YELLOW	50	

ACCESSORIES	
CAT #	DESCRIPTION
PFM3612000	WOOD-KNOCKER II+ INSTALLATION TOOL



Push-In Coupler

Type	Single Push-In Thread Coupler
Description	Push-In Couplers have one end that does not require turning threaded rod elements during installation which can be ideal for applications such as mounting pre-fabricated hardware and hanger assemblies.
Base Materials	Steel Connections
Anchor Material	Zinc Plated Carbon Steel



PUSH-IN THREAD COUPLERS				
CAT #	INTERNAL THREAD DIAMETER	THREADS PER INCH	PACK	CTN
PFM3613012	1/2"	16	20	120
PFM3613038	3/8"	13	20	120

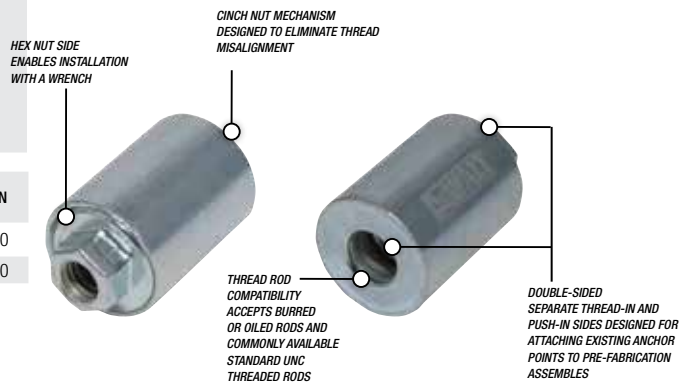

**GUARANTEED
TOUGH.®**

DEWALT

ANCHORS & FASTENERS

**UP TO 70%
TIME SAVINGS
ON INITIAL
HANGER
PLACEMENT***

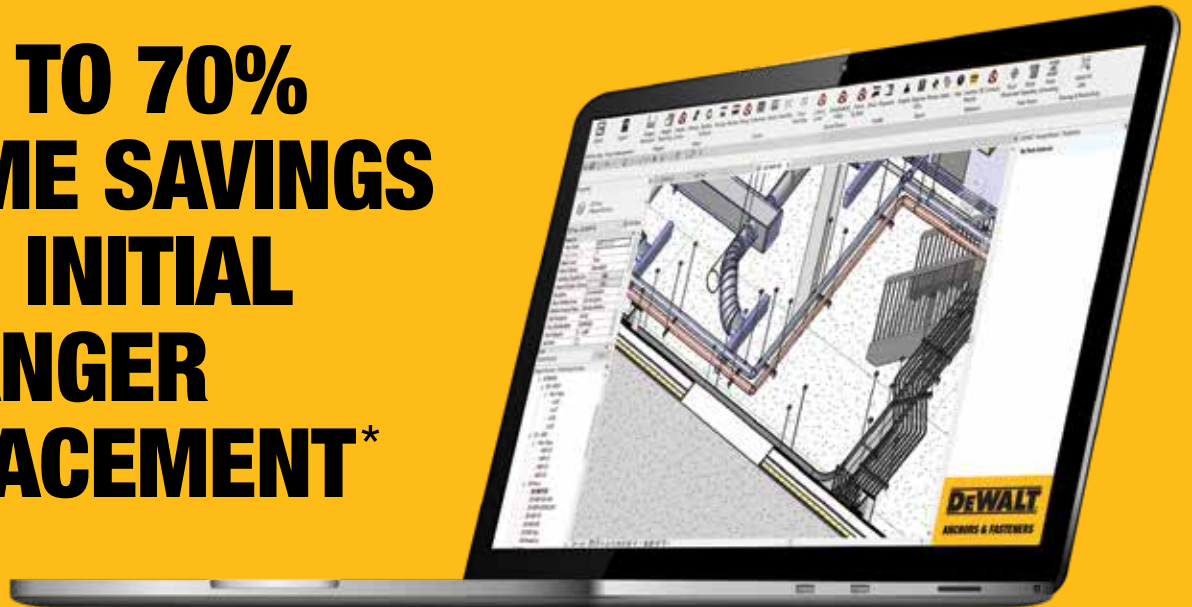

*vs. HangerWorks™ 2.0 Hanger Placement in Revit® Design Software

HangerWorks™ PRO

**AUTOMATE HANGER PLACEMENT
AND DESIGN FOR MEP SYSTEMS
SUCH AS PIPE DUCT
CONDUIT AND CABLE TRAYS.**

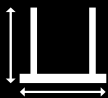

**PREFABRICATION
SPOOLS**



**AUTOMATED POINT LOADS
& SEISMIC BRACING**



**BILL OF
MATERIALS**



**FIELD LAYOUT
POINTS**



**CUSTOMIZABLE
DESIGNS**



**CLASH
DETECTION**



**ENGINEERING
QUICK STAMPS**

GUARANTEED TOUGH.®

PLUG-IN FOR
 **AUTODESK
REVIT**

CAST-IN ANCHOR INSERTS

Bang-It®+

Type	Cast-In-Place Concrete Insert
Approvals	ICC-ES ESR-3657 (Concrete) IBC & IRC 2021 2018 2015 2012 Recognition in cracked & uncracked concrete including seismic and wind loading (Category 1 Anchors) Full FM & UL listings in product brochure or at www.DEWALT.com
Description	Installs through predrilled pan deck used to support MEP attachments in poured concrete slabs
Base Materials	Normal and lightweight concrete
Anchor Material	Carbon steel and engineered plastic



BANG-IT+ SINGLE THREAD			
CAT #	ROD SIZE	COLOR	PACK
07540-PWR	1/4"	Brown	100
07542-PWR	3/8"	Green	100
07544-PWR	1/2"	Yellow	100
07546-PWR	5/8"	Red	50
07548-PWR	3/4"	Purple	50
BANG-IT+ DOUBLE THREAD			
CAT #	ROD SIZE	COLOR	PACK
PFM3521438	1/4" & 3/8"	White	100
07543-PWR	3/8" & 1/2"	Grey	100
PFM3525834	5/8" & 3/4"	Black	50
BANG-IT+ TRIPLE THREAD			
CAT #	ROD SIZE	COLOR	PACK
PFM353143812	1/4" & 3/8" & 1/2"	Aqua	50
PFM353381258	3/8" & 1/2" & 5/8"	Orange	50
BANG-IT+ PUSH-IN THREAD			
CAT #	ROD SIZE	COLOR	PACK
PFM3610038	3/8"	Green	50
PFM3610012	1/2"	Yellow	50

RECOMMENDED INSTALLATION POWER TOOLS		
CAT #	TYPE	PACK
DCD996P2	20V Max Xr Lithium Ion Cordless Drill Driver Kit (5.0Ah)	1
ACCESSORIES		
CAT #	TYPE	PACK
PFM3611000	Bang-It+ Deck Driller Extension 28" (Use with 1/2" Drill Driver)	1
1779804	5L Arbor, 3/8" Solid Hex Shank	1
1779801	2L Arbor, 1/2" Solid Hex Shank	1
2009314CHC	Carbide Hole Cutter Bit 7/8" (use 5L Arbor, not included)	1
2009820CHC	Carbide Hole Cutter Bit 1-1/4" (use 2L Arbor, not included)	1
30912VB12	Vari-Bit Step Drill Bit 7/8", 1-1/8", 1-7/32", 1-1/4", 1-3/8"	1
PFM3613000	Bang-It+ Bridge Bar	20



Pan-Knocker II+

Type	Cast-In-Place Concrete Insert
Approvals	ICC-ES ESR-3657 (Concrete) IBC & IRC 2021 2018 2015 2012 Recognition in cracked & uncracked concrete including seismic and wind loading (Category 1 Anchors) Full FM & UL listings in product brochure or at www.DEWALT.com
Description	Installs onto forms used to support MEP attachments in poured concrete slabs
Base Materials	Normal and lightweight concrete
Anchor Material	Carbon steel and engineered plastic



PAN-KNOCKER II+ LOW PROFILE			
CAT #	ROD SIZE	COLOR	PACK
PFM2501438NN	1/4" & 3/8"	WHITE	100
PAN-KNOCKER II+ DOUBLE THREAD			
CAT #	ROD SIZE	COLOR	PACK
PFM2525834NN	5/8" & 3/4"	BLACK	100
PAN-KNOCKER II+ TRIPLE THREAD			
CAT #	ROD SIZE	COLOR	PACK
PFM253143812NN	1/4" & 3/8" & 1/2"	AQUA	100
PFM253381258NN	3/8" & 1/2" & 5/8"	ORANGE	100
PAN-KNOCKER II+ PUSH-IN THREAD			
CAT #	ROD SIZE	COLOR	PACK
PFM2610038NN	3/8"	GREEN	50
PFM2610012NN	1/2"	YELLOW	50



CAST-IN ANCHOR INSERTS

Bridge Bar with Bang-It® + Inserts

Type	Cast-In-Place Concrete Insert
Approvals	ICC-ES ESR-3657 (Concrete) IBC & IRC 2021 2018 2015 2012 Recognition in cracked & uncracked concrete including seismic and wind loading (Category 1 Anchors) Full FM & UL listings in product brochure or at www.DEWALT.com
Description	Installs through predrilled pan deck used to support MEP attachments in poured concrete slabs
Base Materials	Normal and lightweight concrete
Anchor Material	Carbon steel and engineered plastic



BANG-IT BRIDGE BAR		
CAT #	HOLE SIZES	PACK
PFM3613000	7/8" & 1-1/4"	20

THREAD-IN SINGLE & MULTI-THREAD		
CAT #	ROD DIAMETER (UNC)	NOMINAL HOLE SIZE
07540-PWR	1/4"	7/8"
07542-PWR	3/8"	7/8"
07543-PWR	3/8"-1/2"	7/8"
07544-PWR	1/2"	7/8"
07546-PWR	5/8"	1-1/4"
07548-PWR	3/4"	1-1/4"
PFM3521438	1/4"-3/8"	7/8"
PFM3525834	5/8"-3/4"	1-1/4"
PFM353143812	1/4"-3/8"-1/2"	7/8"
PFM353381258	3/8"-1/2"-5/8"	1-1/4"

PUSH-IN THREAD		
CAT #	ROD DIAMETER (UNC)	NOMINAL HOLE SIZE
PFM3610038	3/8"	1-1/4"
PFM3810012	1/2"	1-1/4"

WOOD-KNOCKER II INSTALLATION TOOL

PFM3612000

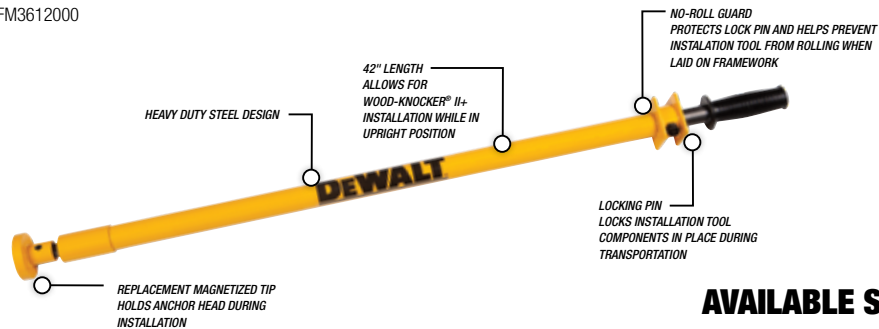

AVAILABLE SERVICE PARTS

PFM3612001

PFM3612002



DECK DRILLER EXTENSION

PFM3611000

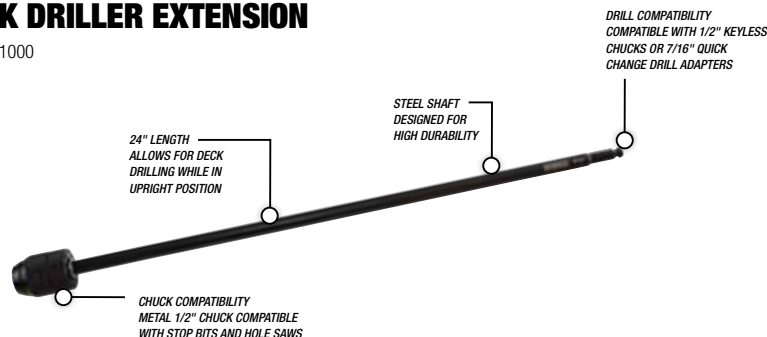

ROD HANGER ANCHORS

Mini-Undercut+™

Type	Internally Threaded Undercut Anchor
Approvals	ICC-ES ESR-3912 (Concrete); IBC & IRC 2021 2018 2015 2012 Recognition in cracked & uncracked concrete including seismic and wind loading (Category 1 Anchors)
Description	Transfers load mainly through bearing not dependent upon friction between the expansion sleeve and the concrete.
Base Materials	Post-tension concrete (PT slabs) hollow-core precast concrete normal-weight concrete sand-lightweight concrete and concrete over steel deck
Anchor Material	Carbon steel



MINI UNDERCUT ANCHOR

CAT #	ANCHOR SIZE	ROD DIAMETER	DRILL DIAMETER	PACK	CTN
PFM2111820	3/8" x 3/4"	3/8"	5/8"	100	600



ACCU-BIT

CAT #	STOP BIT SIZE	ROD DIAMETER	DRILL DIAMETER	DRILL DEPTH	PACK
PPA2431720	5/8" x 3/4"	3/8"	5/8"	3/4"	1



SDS SETTING TOOL

CAT #	SETTING TOOL SIZE	ROD DIAMETER	PACK
PFM2101720	5/8" x 3/4"	3/8"	10

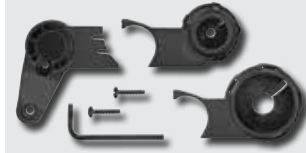

ACCESSORIES FOR INSTALLATION

SEE PAGE 49 FOR ON BOARD DUST COLLECTION ROTARY HAMMERS

CAT #	TYPE
DWH003SBH	Stop Bit Head Nozzle Kit
DWH002SBH	Stop Bit Head Replacement 3-Pack

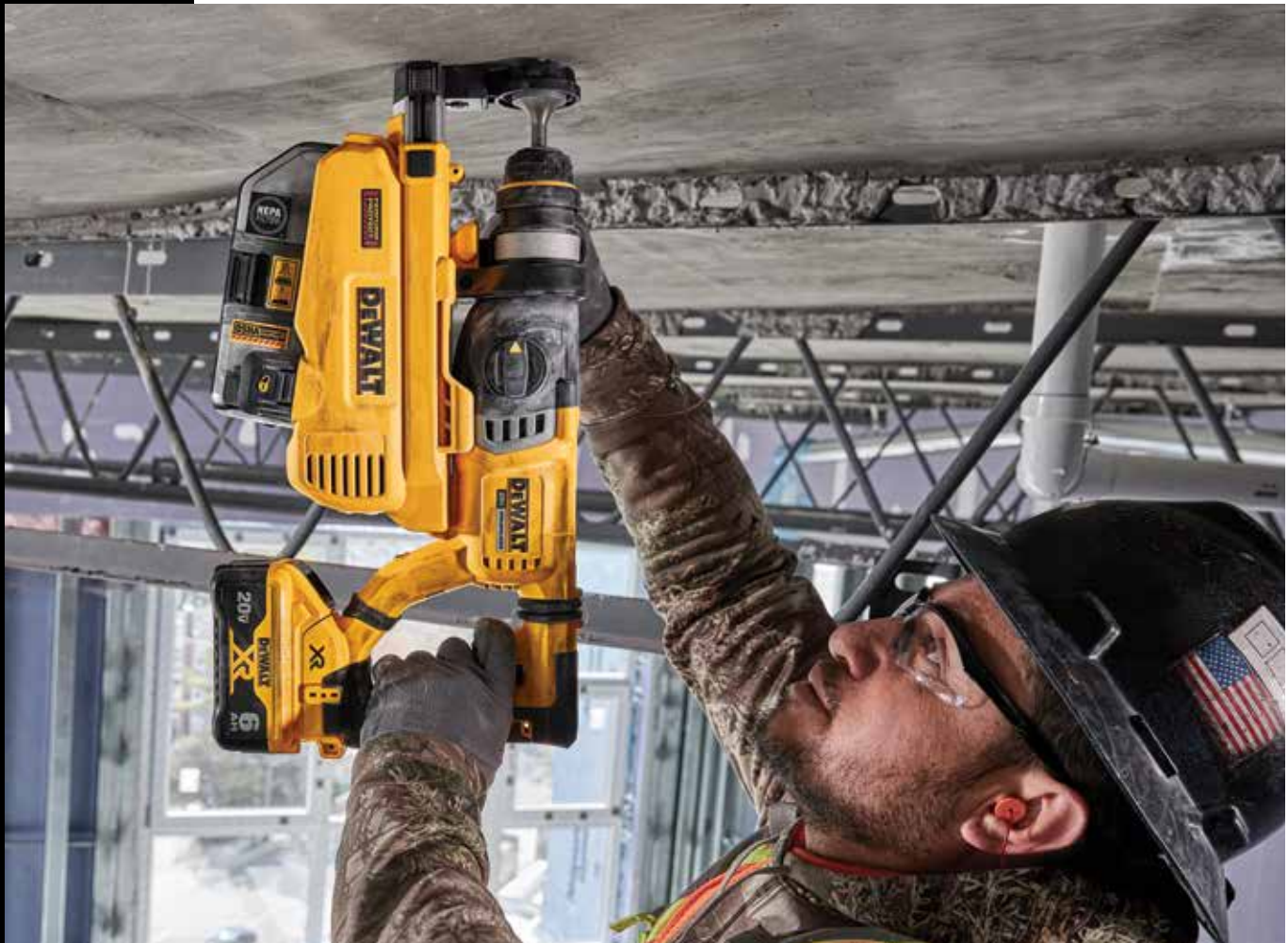

ROD HANGER ANCHORS

Snake+®

Type	Internally Threaded Screw Anchor
Approvals	ICC-ES ESR-2272 (Concrete) IBC & IRC 2021 2018 2015 2012 Recognition in cracked & uncracked concrete including seismic and wind loading (Category 1 Anchors) Full FM listings in product brochure or at www.DeWALT.com
Description	Self-tapping
Base Materials	Normal and sand-light-weight concrete concrete over metal deck
Anchor Material	Carbon steel



Snake+

CAT #	SIZE	MIN HOLE DEPTH	INTERNAL THREAD DEPTH	PACK	CTN
6400SD-PWR	1/4"	1-5/8"	22/32"	100	1000
6401SD-PWR	3/8"	1-5/8"	11/16"	50	500
6403SD-PWR	1/2"	2-1/2"	29/32"	50	300

One setting tool included per pack

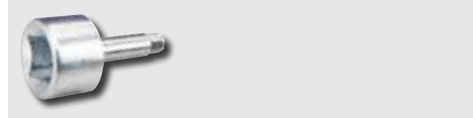

EXTRA SNAKE & SNAKE+ SETTING TOOLS

CAT #	SIZE	PACK	CTN
6402SD-PWR	1/4"	1	100
6407SD-PWR	3/8"	1	250
6404SD-PWR	1/2"	1	250

Smart DI Anchor (Drop-In)

Type	Internally Threaded Expansion Anchor
Approvals	Full FM & UL listings in product brochure or at www.DeWALT.com
Description	Patented plug design yields more expansion at anchor bottom Smart Drill and DI tool reduce drilling/setting effort
Base Materials	Concrete
Anchor Material	Carbon steel



SMART DI

CAT #	SIZE	PACK	CTN
6304SD-PWR	1/4"	100	1000
6306SD-PWR	3/8"	50	500
6308SD-PWR	1/2"	50	300

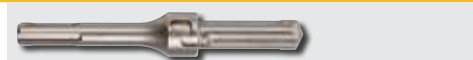

DRILL

CAT #	SIZE	PACK	CTN
00391SD-PWR	3/8" (for 1/4" Smart DI)	1	12
00397SD-PWR	1/2" (for 3/8" Smart DI)	1	12
00410SD-PWR	5/8" (for 1/2" Smart DI)	1	12



DI TOOL

CAT #	SIZE	PACK	CTN
00425SD-PWR	1/4"	1	6
00427SD-PWR	3/8"	1	6
00429SD-PWR	1/2"	1	6

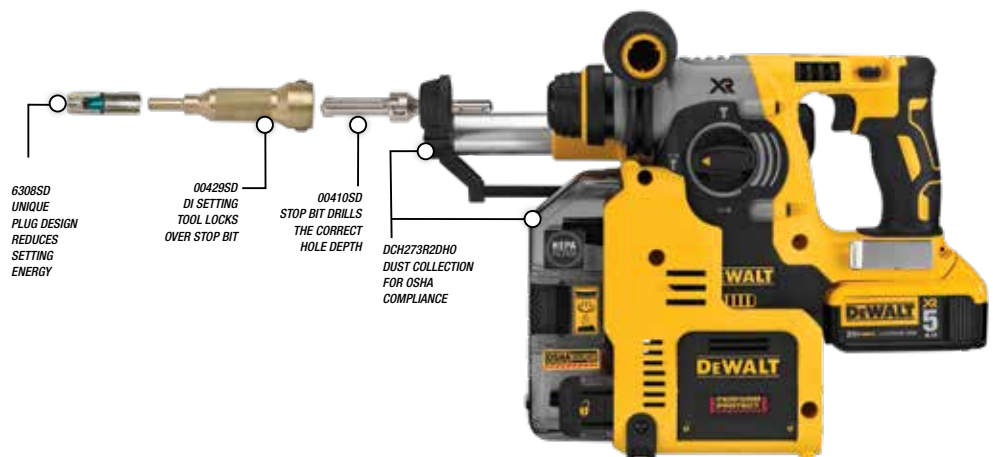

ROD HANGER ANCHORS

Hollow-Set® Drop-In

Type	Internally Threaded Expansion Anchor
Approvals 	Full UL listings in product brochure or at www.DEWALT.com
Description	For anchoring in hollow base materials Overcomes spalling issues
Base Materials	Concrete block brick pre-cast hollow core plank and stone
Anchor Material	Zamac alloy with carbon or stainless steel cones



ZAMAC BODY WITH CARBON STEEL CONE

CAT #	SIZE	DRILL DIAMETER	OVERALL LENGTH	SLEEVE LENGTH	PACK	CTN
09320-PWR	1/4"	3/8"	7/8"	5/8"	100	1000
09330-PWR	5/16"	5/8"	1-5/16"	15/16"	50	300
09340-PWR	3/8"	5/8"	1-5/16"	15/16"	50	300
09350-PWR	1/2"	3/4"	1-3/4"	1-1/4"	50	250
09360-PWR	5/8"	1"	2"	1-1/2"	25	125

ZAMAC BODY WITH STAINLESS STEEL CONE

CAT #	SIZE	DRILL DIAMETER	OVERALL LENGTH	SLEEVE LENGTH	PACK	CTN
09420-PWR	1/4"	3/8"	7/8"	5/8"	100	1000
09440-PWR	3/8"	5/8"	1-5/16"	15/16"	100	500



SOLID BASE MATERIAL SETTING TOOLS

CAT #	SIZE	PACK	CTN
09322-PWR	1/4"	1	200
09342-PWR	5/16" & 3/8"	1	50
09352-PWR	1/2"	1	25
09362-PWR	5/8"	1	-



HOLLOW BASE MATERIAL SETTING TOOLS

CAT #	SIZE	PACK	CTN
09323-PWR	1/4"	1	50
09333-PWR	5/16"	1	50
09343-PWR	3/8"	1	50
09353-PWR	1/2"	1	50
09363-PWR	5/8"	1	-

Mini Dropin™

Type	Internally Threaded Expansion Anchor
Approvals 	Full FM listings in product brochure or at www.DEWALT.com
Description	Machine bolt anchor for shallow embedment applications
Base Materials	Pre-cast hollow core plank concrete
Anchor Material	Carbon steel



MINI DROP-IN

CAT #	SIZE	DRILL DIAMETER	MIN DEPTH	THREAD DEPTH	PACK	CTN
06335-PWR	1/4"	3/8"	5/8"	3/8"	100	1000
06322-PWR	3/8"	1/2"	3/4"	13/32"	100	1000
06337-PWR	1/2"	5/8"	1"	5/8"	50	250



SETTING TOOLS FOR MINI DROP-IN ANCHORS

CAT #	SIZE	PACK	CTN
06336-PWR	1/4"	1	50
06323-PWR	3/8"	1	50
06338-PWR	1/2"	1	50



SDS-PLUS ACCU-BIT FOR MINI DROP-IN

CAT #	SIZE		PACK
DWA5491	SDS-Plus 3/8"	for 1/4" Mini Drop-In	1
DWA5492	SDS-Plus 1/2"	for 3/8" Mini Drop-In	1
DWA5494	SDS-Plus 5/8"	for 1/2" Mini Drop-In	1

ROD HANGER ANCHORS

Steel-Dropin™

Type	Internally Threaded Expansion Anchor
Approvals	Full UL listings in product brochure or at www.DeWALT.com
Description	Machine bolt anchor
Base Materials	Solid concrete solid block hard stone
Anchor Material	Carbon Steel Type 303 Stainless Steel and Type 316 Stainless Steel Coil thread version available for forming applications



Carbon Steel Coil Thread Drop-In: Use Setting Tool # 6309 for 1/2" size # 6313 for 3/4" size.



CARBON STEEL SMOOTH WALL DROPIN

CAT#	SIZE	LENGTH	DIAMETER	PACK	CTN
06304-PWR	1/4"	1"	3/8"	100	1000
06306-PWR	3/8"	1-9/16"	1/2"	50	500
06308-PWR	1/2"	2"	5/8"	50	300
06320-PWR	5/8"	2-1/2"	7/8"	25	125
06312-PWR	3/4"	3-13/16"	1"	10	50



CARBON STEEL SMOOTH WALL DROPIN

CAT#	SIZE	LENGTH	DIAMETER	PACK	CTN
6304USA-PWR	1/4"	1"	3/8"	100	1000
6306USA-PWR	3/8"	1-9/16"	1/2"	50	500
6308USA-PWR	1/2"	2"	5/8"	50	300
6320USA-PWR	5/8"	2-1/2"	7/8"	25	125
6312USA-PWR	3/4"	3-13/16"	1"	10	50



CARBON STEEL FLANGED DROPIN (LIPPED)

CAT#	SIZE	LENGTH	DIAMETER	PACK	CTN
06324-PWR	1/4"	1"	3/8"	100	1000
06326-PWR	3/8"	1-9/16"	1/2"	50	500
06328-PWR	1/2"	2"	5/8"	50	300



CARBON STEEL KNURLED WALL DROPIN

CAT#	SIZE	LENGTH	DIAMETER	PACK	CTN
06340-PWR	1/4"	1"	3/8"	100	1000
06342-PWR	3/8"	1-9/16"	1/2"	50	500
06344-PWR	1/2"	2"	5/8"	50	300



TYPE 300 SERIES STAINLESS STEEL DROPIN

CAT#	SIZE	LENGTH	DIAMETER	PACK	CTN
06304-PWR	1/4"	1"	3/8"	100	1000
06306-PWR	3/8"	1-9/16"	1/2"	50	500
06308-PWR	1/2"	2"	5/8"	50	300
06320-PWR	5/8"	2-1/2"	7/8"	25	125
06312-PWR	3/4"	3-13/16"	1"	10	50



TYPE 300 SERIES STAINLESS STEEL DROPIN

CAT#	SIZE	LENGTH	DIAMETER	PACK	CTN
6304USA-PWR	1/4"	1"	3/8"	100	1000
6306USA-PWR	3/8"	1-9/16"	1/2"	50	500
6308USA-PWR	1/2"	2"	5/8"	50	300
6320USA-PWR	5/8"	2-1/2"	7/8"	25	125
6312USA-PWR	3/4"	3-13/16"	1"	10	50



TYPE 316 STAINLESS STEEL DROPIN

CAT#	SIZE	LENGTH	DIAMETER	PACK	CTN
06224-PWR	1/4"	1"	3/8"	100	1000
06226-PWR	3/8"	1-9/16"	1/2"	50	500
06228-PWR	1/2"	2"	5/8"	50	300
06230-PWR	5/8"	2-1/2"	7/8"	25	125
06232-PWR	3/4"	3-13/16"	1"	10	50



TYPE 316 STAINLESS STEEL DROPIN

CAT#	SIZE	LENGTH	DIAMETER	PACK	CTN
6224USA-PWR	1/4"	1"	3/8"	100	1000
6226USA-PWR	3/8"	1-9/16"	1/2"	50	500
6228USA-PWR	1/2"	2"	5/8"	50	300
6230USA-PWR	5/8"	2-1/2"	7/8"	25	125
6232USA-PWR	3/4"	3-13/16"	1"	10	50



CARBON STEEL COIL THREAD DROPIN

CAT#	SIZE	LENGTH	DIAMETER	PACK	CTN
06330-PWR	1/2"	2"	5/8"	50	300
06332-PWR	3/4"	3-3/16"	1"	10	50



SETTING TOOLS FOR STEEL DROPIN

CAT#	ROD/ANCHOR SIZE	PIN LENGTH	PACK.
06305-PWR	1/4"	39/64"	1
06307-PWR	3/8"	61/64"	1
06309-PWR	1/2"	1-3/16"	1
06311-PWR	5/8"	1-5/16"	1
06313-PWR	3/4"	1-61/64"	1



ACCU-BIT™ DRILL STOP FOR STEEL DROPIN

CAT. NO.	ROD/ANCHOR SIZE	DRILL STOP	PACK.
DWA5493	1/2" Accu-Bit for 3/8" Steel Dropin	1-13/16"	1
DWA5495	5/8" Accu-Bit for 1/2" Steel Dropin	2-3/8"	1

ROD HANGER ANCHORS

Hangermate®+ for Concrete

Type	Rod Hanging Anchor
Approvals	ICC-ES ESR-3889 (Concrete); IBC & IRC 2021 2018 2015 2012
	 <p>Recognition in cracked & uncracked concrete including seismic and wind loading (Category 1 Anchors) Full FM listings in product brochure or at www.DEWALT.com</p>
Description	Rod hanging anchors
Base Materials	Concrete
Anchor Material	Carbon steel



HANGERMATE+ FOR CONCRETE - INTERNALLY THREADED - VERTICAL

CAT #	ROD DIAMETER	DESCRIPTION	PACK	CTN
PFM2211100	1/4"	1/4" x 1-5/8"	25	125
PFM2211200	3/8"	1/4" x 1-5/8"	25	125
PFM2211250	3/8"	1/4" x 2-1/2"	25	125
PFM2211260	3/8"	3/8" x 1-5/8"	25	125
PFM2211270	3/8"	3/8" x 2"	25	125
PFM2211280	1/2"	3/8" x 2"	25	125



HANGERMATE+ FOR CONCRETE - EXTERNALLY THREADED - VERTICAL

CAT #	ROD DIAMETER	DESCRIPTION	PACK	CTN
PFM1421000	3/8"	1/4" x 1-5/8"	25	125
PFM1421050	3/8"	1/4" x 2-1/2"	25	125

**INSTALLATION DRIVERS AND ACCESSORIES:
HANGERMATE+ FOR CONCRETE - INTERNALLY THREADED - VERTICAL**

CAT #	SOCKET SIZE	DRIVE	ANCHOR	PACK	CTN
PFM1491050	3/8"	1/4" Hex	1/4" HangerMate®+ 5	5	25
PFM1491100	1/2"	1/4" Hex	3/8" HangerMate®+ 5	5	25

**INSTALLATION DRIVERS AND ACCESSORIES:
HANGERMATE+ FOR CONCRETE - EXTERNALLY THREADED - VERTICAL**

CAT #	SOCKET SIZE	DRIVE	PACK	CTN
DWMT19052B	1/2" (Deep)	3/8" Square	1	50
CAT #	DESCRIPTION	PACK	CTN	
PFM2201050	3/8" to 1/2" Adaptor ¹	25	125	

1. The 3/8" to 1/2" adaptor has a 3/8-16 external thread and a 1/2-13 internal thread.

Hangermate® for Concrete

Type	Rod Hanging Anchor
Approvals	Full FM listings in product brochure or at www.DEWALT.com
	
Description	Rod hanging anchors
Base Materials	Concrete
Anchor Material	Carbon steel



HANGERMATE BASIC FOR CONCRETE - INTERNALLY THREADED - VERT.

CAT #	ROD DIAMETER	DESCRIPTION	PACK	CTN
PFM2217171	1/4"	1/4" x 1-1/4"	100	600
PFM2217173	3/8"	1/4" x 1-1/2"	100	600



HANGERMATE FOR CONCRETE - INTERNALLY THREADED - PIVOT

CAT #	ROD DIAMETER	DESCRIPTION	PACK	CTN
PFM2281300	3/8"	1/4" x 2"	25	125

RECOMMENDED INSTALLATION POWER TOOLS

CAT #	TYPE
DCH273P2DHO	1" SDS PLUS 20V ROTARY HAMMER
DCF887D2	20V MAX 1/4" HEX IMPACT DRIVER
DCF913	20V MAX 3/8" DRIVE IMPACT WRENCH

**INSTALLATION DRIVERS AND ACCESSORIES:
HANGERMATE BASIC FOR CONCRETE - INTERNALLY THREADED - VERT.**

CAT #	SOCKET SIZE	DRIVE	PACK	CTN
PFM1491050	3/8"	1/4" Hex	5	25
PFM1491100	1/2"	1/4" Hex	5	25
By Diameter	3/8" - 1/2"	3/8" Square		

**INSTALLATION DRIVERS AND ACCESSORIES:
HANGERMATE FOR CONCRETE - INTERNALLY THREADED - PIVOT**

CAT #	DRIVE	PACK	CTN
PFM2201250	1/4" Hex	5	25

**OTHER ACCESSORIES:
HANGERMATE FOR CONCRETE**

CAT #	DESCRIPTION	PACK	CTN
PFM2201050	3/8" to 1/2" Adaptor ¹	25	125

1. The 3/8" to 1/2" adaptor has a 3/8-16 external thread and a 1/2-13 internal thread.

Suspender® for Concrete

Type	Rod Hanging Anchor
Approvals	Full FM listings in product brochure or at www.DEWALT.com
	
Description	Rod hanging anchors
Base Materials	Concrete
Anchor Material	Carbon steel

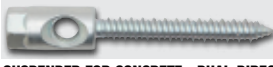

SUSPENDER FOR CONCRETE - DUAL-DIRECTIONAL

CAT #	DESCRIPTION	DRIVER	PACK	CTN
PFM2271050	5/16" x 2-1/4"	PFM2201300	25	125

**INSTALLATION DRIVERS AND ACCESSORIES:
SUSPENDER FOR CONCRETE - DUAL-DIRECTION**

CAT #	SOCKET SIZE	PACK	CTN
PFM2201300	1/4" Hex	25	25

**OTHER ACCESSORIES:
SUSPENDER FOR CONCRETE**

CAT #	DESCRIPTION	PACK	CTN
PFM2201050	3/8" to 1/2" Adaptor ¹	25	125



1. The 3/8" to 1/2" adaptor has a 3/8-16 external thread and a 1/2-13 internal thread.

**RECOMMENDED INSTALLATION POWER TOOLS
HANGERMATE+ FOR CONCRETE**

CAT #	TYPE
DCH273P2DHO	1" SDS PLUS 20V ROTARY HAMMER
DCF887D2	20V MAX 1/4" HEX IMPACT DRIVER
DCF913	20V MAX 3/8" DRIVE IMPACT WRENCH

ROD HANGER ANCHORS



Hangermate®+ and Hangermate® for Concrete Systems

								 APPROVED	 ICC ES
HANGERMATE+ FOR CONCRETE - INTERNALLY-THREADED - VERTICAL									
CAT #	HANG	ROD DIAMETER	DESCRIPTION	SOCKET SIZE	DRIVER	PIPE SIZE	LOAD	ICC-ES	
PFM2211100	Vertical	1/4"	1/4" x 1-5/8"	3/8"	PFM1491050	4"	1,475	ESR-3889	
PFM2211200	Vertical	3/8"	1/4" x 1-5/8"	1/2"	PFM1491100	4"	1,475	ESR-3889	
PFM2211250	Vertical	3/8"	1/4" x 2-1/2"	1/2"	PFM1491100	4"	1,475	ESR-3889	
PFM2211260	Vertical	3/8"	3/8" x 1-5/8"	1/2"	PFM1491100				
PFM2211270	Vertical	3/8"	3/8" x 2"	1/2"	PFM1491100				
PFM2211280	Vertical	1/2"	3/8" x 2"	11/16"					
HANGERMATE FOR CONCRETE - EXTERNALLY THREADED VERTICAL									
CAT #	HANG	ROD DIAMETER	DESCRIPTION	SOCKET SIZE	DRIVER	PIPE SIZE	LOAD	ICC-ES	
PFM1421000	Vertical	3/8"	1/4" x 1-5/8"	1/2"	DWMT19052B	4"	1,475	ESR-3889	
PFM1421050	Vertical	3/8"	1/4" x 2-1/2"	1/2"	DWMT19052B	4"	1,475	ESR-3889	
HANGERMATE BASIC FOR CONCRETE - INTERNALLY THREADED - VERTICAL									
CAT #	HANG	ROD DIAMETER	DESCRIPTION	SOCKET SIZE	DRIVER	PIPE SIZE	LOAD	ICC-ES	
PFM2217171	Vertical	1/4"	1/4" x 1-1/4"	3/8"	PFM1491050			-	
PFM2217173	Vertical	3/8"	1/4" x 1-1/2"	1/2"	PFM1491100	4"	1,475	-	
HANGERMATE FOR CONCRETE - INTERNALLY THREADED - PIVOT									
CAT #	HANG	ROD DIAMETER	DESCRIPTION	DRIVER	PIPE SIZE	LOAD	ICC-ES		
PFM2281300	Variable	3/8"	1/4" x 2"	PFM2201250	-	-	-		
SUSPENDER FOR CONCRETE - DUAL-DIRECTIONAL									
CAT #	HANG	ROD DIAMETER	DESCRIPTION	DRIVER	PIPE SIZE	LOAD	ICC-ES		
PFM2271050	Vertical & Horizontal	3/8"	5/16" x 2-1/4"	PFM2201300	4"	1,475	-		



ROD HANGER ANCHORS

Hangermate® for Wood

Type	Rod Hanging Anchor
Approvals	 
Description	Rod hanging anchors in a wide range of styles
Base Materials	Wood
Anchor Material	Carbon steel



HANGERMATE FOR WOOD - INTERNALLY THREADED - VERTICAL

CAT #	ROD DIAMETER	DESCRIPTION	PACK	CTN
PFM2251000	1/4"	1/4" x 2"	25	125
PFM2251050	3/8"	1/4" x 1"	25	125
PFM2251100	3/8"	1/4" x 2"	25	125
PFM2251150	3/8"	5/16" x 2-1/2"	25	125
PFM2251200	3/8"	1/4" x 3"	25	125
PFM2251250	3/8"	1/4" x 4"	25	125
PFM2251300	1/2"	15/16" x 2-1/2"	25	125



HANGERMATE FOR WOOD - INTERNALLY THREADED - HORIZONTAL

CAT #	ROD DIAMETER	DESCRIPTION	PACK	CTN
PFM2261000	1/4"	1/4" x 1"	25	125
PFM2261050	3/8"	1/4" x 1"	25	125
PFM2261100	3/8"	1/4" x 2"	25	125
PFM2261150	3/8"	5/16" x 2-1/2"	25	125



HANGERMATE FOR WOOD - INTERNALLY THREADED - PIVOT

CAT #	ROD DIAMETER	DESCRIPTION	PACK	CTN
PFM2281100	3/8"	1/4" x 2"	25	125



HANGERMATE - WOOD - ACOUSTICAL CEILING SCREW EYELET

CAT #	HOLE DIAMETER	DESCRIPTION	PACK	CTN
PFM2251500	3/16"	1/4" x 3-1/4"	25	125

INSTALLATION DRIVERS AND ACCESSORIES:

HANGERMATE FOR WOOD - INTERNALLY THREADED - VERTICAL

CAT #	SOCKET SIZE	DRIVE	PACK	CTN
PFM2201150	5/8"	1/4" Hex	5	25

INSTALLATION DRIVERS AND ACCESSORIES:

HANGERMATE FOR WOOD - INTERNALLY THREADED - HORIZONTAL

CAT #	SOCKET SIZE	DRIVE	PACK	CTN
PFM2201150	5/8"	1/4" Hex	5	25

INSTALLATION DRIVERS AND ACCESSORIES:

HANGERMATE FOR WOOD - INTERNALLY THREADED - PIVOT

CAT #	DRIVE	PACK	CTN
DW22862	1/4" Hex	5	25

INSTALLATION DRIVERS AND ACCESSORIES:

HANGERMATE FOR WOOD - CEILING SCREW EYELET

CAT #	DRIVE	PACK	CTN
DW22862	1/4" Hex	5	25

OTHER ACCESSORIES:



HANGERMATE FOR WOOD

CAT #	DESCRIPTION	PACK	CTN
PFM2201050	3/8" to 1/2" Adaptor ¹	25	125
PFM2201100	Hangermate Pole Tool Kit ²	25	125

1. The 3/8" to 1/2" adaptor has a 3/8-16 external thread and a 1/2-13 internal thread.

2. The Hangermate pole tool kit is designed for use with standard 1/2" steel conduit tubing (conduit not included) and can be customized to various lengths and ceiling heights. Compatible with standard steel and wood Hangermate.

Suspender® for Wood

Type	Rod Hanging Anchor
Approvals	 
Description	Rod hanging anchors in a wide range of styles
Base Materials	Wood
Anchor Material	Carbon steel



SUSPENDER FOR WOOD - DUAL-DIRECTIONAL

CAT #	ROD DIAMETER	DESCRIPTION	PACK	CTN
PFM2271000	3/8"	5/16" x 2-1/4"	25	125

INSTALLATION DRIVERS AND ACCESSORIES:

SUSPENDER FOR WOOD - IDUAL DIRECTION

CAT #	DRIVE	PACK	CTN
DW22862	1/4" Hex	5	25

OTHER ACCESSORIES:

SUSPENDER FOR WOOD

CAT #	DESCRIPTION	PACK	CTN
PFM2201050	3/8" to 1/2" Adaptor ¹	25	125
PFM2201100	Hangermate Pole Tool Kit ²	25	125

1. The 3/8" to 1/2" adaptor has a 3/8-16 external thread and a 1/2-13 internal thread.

2. The Hangermate pole tool kit is designed for use with standard 1/2" steel conduit tubing (conduit not included) and can be customized to various lengths and ceiling heights. Compatible with standard steel and wood Hangermate.

ROD HANGER ANCHORS

Hangermate® for Wood

						APPROVALS			
						UL		FM APPROVED	
						PIPE SIZE	LOAD	PIPE SIZE	LOAD
HANGERMATE FOR WOOD - INTERNALLY THREADED - VERTICAL									
CAT #	HANG	ROD DIAMETER	DESCRIPTION	SOCKET SIZE	DRIVER	PIPE SIZE	LOAD	PIPE SIZE	LOAD
PFM2251000	Vertical	1/4"	1/4" x 2"	5/8"	PFM2201150	-	-	-	-
PFM2251050	Vertical	3/8"	1/4" x 1"	5/8"	PFM2201150	-	-	-	-
PFM2251100	Vertical	3/8"	1/4" x 2"	5/8"	PFM2201150	3"	1,050	-	-
PFM2251150	Vertical	3/8"	5/16" x 2-1/2"	5/8"	PFM2201150	4"	1,500	4"	1,475
PFM2251200	Vertical	3/8"	1/4" x 3"	5/8"	PFM2201150	3"	1,050	-	-
PFM2251250	Vertical	3/8"	1/4" x 4"	5/8"	PFM2201150	3"	1,050	-	-
PFM2251300	Vertical	1/2"	15/16" x 2-1/2"	5/8"	PFM2201150	-	-	-	-
HANGERMATE FOR WOOD - INTERNALLY THREADED - HORIZONTAL									
CAT #	HANG	ROD DIAMETER	DESCRIPTION	SOCKET SIZE	DRIVER	PIPE SIZE	LOAD	PIPE SIZE	LOAD
PFM2261000	Horizontal	1/4"	1/4" x 1"	5/8"	PFM2201150	-	-	-	-
PFM2261050	Horizontal	3/8"	1/4" x 1"	5/8"	PFM2201150	-	-	-	-
PFM2261100	Horizontal	3/8"	1/4" x 2"	5/8"	PFM2201150	3"	1,050	-	-
PFM2261150	Horizontal	3/8"	5/16" x 2-1/2"	5/8"	PFM2201150	3"	1,050	-	-
HANGERMATE PIVOT FOR WOOD - INTERNALLY THREADED - PIVOT									
CAT #	HANG	ROD DIAMETER	DESCRIPTION	DRIVER	PIPE SIZE	LOAD	PIPE SIZE	LOAD	
PFM2281100	Variable	3/8"	1/4" x 2"	PFM2201250	-	-	-	-	
HANGERMATE SUSPENDER FOR WOOD - CEILING SCREW EYELET									
CAT #	HANG	HOLE DIAMETER	DESCRIPTION	DRIVER	PIPE SIZE	LOAD	PIPE SIZE	LOAD	
PFM2251500	-	3/16"	1/4" x 3-1/4"	PFM2201350	4"	1,500	4"	1,475	
SUSPENDER FOR WOOD - DUAL-DIRECTION									
CAT #	HANG	ROD DIAMETER	DESCRIPTION	DRIVER	PIPE SIZE	LOAD	PIPE SIZE	LOAD	
PFM2271000	Vertical and Horizontal	3/8"	5/16" x 2-1/4"	PFM2201300	-	-	4"	1,475	



ROD HANGER ANCHORS

Hangermate® for Steel

Type	Rod Hanging Anchor
Approvals	Full FM & UL listings in product brochure or at www.DeWALT.com
Description	Rod hanging anchors in a wide range of styles
Base Materials	Steel
Anchor Material	Carbon steel



HANGERMATE FOR STEEL - INTERNALLY THREADED - VERTICAL

CAT #	ROD DIAMETER	DESCRIPTION	PACK	CTN
PFM2231000	1/4"	1/4"-20 x 1" #3	25	125
PFM2231100	3/8"	1/4"-20 x 1" #3	25	125
PFM223110N	3/8"	1/4"-20 x 1" #3 w/ Nut	25	125
PFM2231150	3/8"	1/4"-20 x 1-1/2" #5	25	125
PFM223115N	3/8"	1/4"-20 x 1-1/2" #5 w/ Nut	25	125
PFM2231200	3/8"	1/4"-20 x 1-1/2" #3	25	125
PFM223120N	3/8"	1/4"-20 x 1-1/2" #3 w/ Nut	25	125
PFM2231250	3/8"	1/4"-20 x 2" #3	25	125



HANGERMATE FOR STEEL - INTERNALLY THREADED - HORIZONTAL

CAT #	ROD DIAMETER	DESCRIPTION	PACK	CTN
PFM2241100	3/8"	1/4"-20 x 1" #3	25	125
PFM224110N	3/8"	1/4"-20 x 1" #3 w/ Nut	25	125
PFM2241150	3/8"	1/4"-20 x 1-1/2" #3	25	125
PFM224115N	3/8"	1/4"-20 x 1-1/2" #3 w/ Nut	25	125
PFM2241200	3/8"	1/4"-20 x 1-1/2" #5	25	125
PFM224120N	3/8"	1/4"-20 x 1-1/2" #5 w/ Nut	25	125

HANGERMATE FOR STEEL - INTERNALLY THREADED - PIVOT

CAT #	ROD DIAMETER	DESCRIPTION	PACK	CTN
PFM2281150	3/8"	1/4"-20 x 1" #3	25	125
PFM2281200	3/8"	1/2"-20 x 1-3/4" #5	25	125
PFM2281250	3/8"	1/4"-14 x 1" #3	25	125



HANGERMATE FOR STEEL - CEILING SCREW EYELET

CAT #	HOLE DIAMETER	DESCRIPTION	PACK	CTN
PFM2231500	3/8"	1/4" x 2"	25	125
PFM2231550	3/8"	1/4" x 3-1/4"	25	125

INSTALLATION DRIVERS AND ACCESSORIES:

HANGERMATE FOR STEEL - INTERNALLY THREADED - VERTICAL

CAT #	SOCKET SIZE	DRIVE	PACK	CTN
PFM2201200	1/2"	1/4" Hex	5	25

INSTALLATION DRIVERS AND ACCESSORIES:

HANGERMATE FOR STEEL - HORIZONTALLY THREADED - HORIZONTAL

CAT #	SOCKET SIZE	DRIVE	PACK	CTN
PFM2201200	1/2"	1/4" Hex	5	25

INSTALLATION DRIVERS AND ACCESSORIES:

HANGERMATE FOR STEEL - INTERNALLY THREADED - PIVOT

CAT #	DRIVE	PACK	CTN
PFM2201250	1/4" Hex	5	25

INSTALLATION DRIVERS AND ACCESSORIES:

HANGERMATE FOR STEEL - CEILING SCREW EYELET

CAT #	DRIVE	PACK	CTN
PFM2201350	1/4" Hex	5	25

OTHER ACCESSORIES:

HANGERMATE FOR STEEL

CAT #	DESCRIPTION	PACK	CTN
PFM2201050	3/8" to 1/2" Adaptor ¹	25	125
PFM2201100	Hangermate Pole Tool Kit ²	25	125

1. The 3/8" to 1/2" adaptor has a 3/8-16 external thread and a 1/2-13 internal thread.
2. The Hangermate pole tool kit is designed for use with standard 1/2" steel conduit tubing (conduit not included) and can be customized to various lengths and ceiling heights. Compatible with standard steel and wood Hangermate.

Suspender® for Steel

Type	Rod Hanging Anchor
Approvals	Full FM & UL listings in product brochure or at www.DeWALT.com
Description	Rod hanging anchors in a wide range of styles
Base Materials	Steel
Anchor Material	Carbon steel



SUSPENDER FOR STEEL - DUAL-DIRECTIONAL

CAT #	ROD DIAMETER	DESCRIPTION	PACK	CTN
PFM227110N	3/8"	1/4"-20 x 1" #3 w/ Nut	25	125
PFM227120N	3/8"	1/4"-29 x 1-1/2" #3 w/ Nut	25	125
PFM227130N	3/8"	1/4"-20 x 1-1/2" #5 w/ Nut	25	125

INSTALLATION DRIVERS AND ACCESSORIES:

SUSPENDER FOR STEEL - CEILING SCREW EYELET

CAT #	DRIVE	PACK	CTN
DW22862	1/4" Hex	5	25

OTHER ACCESSORIES:

SUSPENDER FOR STEEL

CAT #	DESCRIPTION	PACK	CTN
PFM2201050	3/8" to 1/2" Adaptor ¹	25	125
PFM2201100	Hangermate Pole Tool Kit ²	25	125

1. The 3/8" to 1/2" adaptor has a 3/8-16 external thread and a 1/2-13 internal thread.
2. The Hangermate pole tool kit is designed for use with standard 1/2" steel conduit tubing (conduit not included) and can be customized to various lengths and ceiling heights. Compatible with standard steel and wood Hangermate.

ROD HANGER ANCHORS

Hangermate® for Steel System

APPROVALS



HANGERMATE FOR STEEL - INTERNALLY THREADED - VERTICAL

CAT #	HANG	ROD DIAMETER	DESCRIPTION	SOCKET SIZE	DRIVER	MIN THICKNESS	MAX THICKNESS	LOAD DIRECTION	PIPE SIZE	UL THICK.	PIPE SIZE	FM THICK.
PFM2231000	Vertical	1/4"	1/4"-20 x 1" #3	1/2"	PFM2201200	0.060"	0.210"	Vertical	-	-	-	-
PFM2231100	Vertical	3/8"	1/4"-20 x 1" #3	1/2"	PFM2201200	0.060"	0.210"	Vertical	4"	0.060"	-	-
PFM223110N	Vertical	3/8"	1/4"-20 x 1" #3 w/ Nut	1/2"	PFM2201200	0.060"	0.210"	Vertical	4"	0.125"	4"	0.105"
PFM2231150	Vertical	3/8"	1/4"-20 x 1-1/2" #5	1/2"	PFM2201200	0.125"	0.500"	Vertical	4"	0.060"	4"	0.060"
PFM223115N	Vertical	3/8"	1/4"-20 x 1-1/2" #5 w/ Nut	1/2"	PFM2201200	0.125"	0.500"	Vertical	4"	0.125"	4"	0.105"
PFM2231200	Vertical	3/8"	1/4"-20 x 1-1/2" #3	1/2"	PFM2201200	0.060"	0.210"	Vertical	4"	0.060"	-	-
PFM223120N	Vertical	3/8"	1/4"-20 x 1-1/2" #3 w/ Nut	1/2"	PFM2201200	0.060"	0.210"	Vertical	4"	0.060"	-	-
PFM2231250	Vertical	3/8"	1/4"-20 x 2" #3	1/2"	PFM2201200	0.060"	0.210"	Vertical	4"	0.125"	-	-

HANGERMATE FOR STEEL - INTERNALLY THREADED - HORIZONTAL

CAT #	HANG	ROD DIAMETER	DESCRIPTION	SOCKET SIZE	DRIVER	MIN THICKNESS	MAX THICKNESS	LOAD DIRECTION	PIPE SIZE	UL THICK.	PIPE SIZE	FM THICK.
PFM2241100	Horizontal	3/8"	1/4"-20 x 1" #3	1/2"	PFM2201200	0.060"	0.210"	Horizontal	-	-	-	-
PFM224110N	Horizontal	3/8"	1/4"-20 x 1" #3 w/ Nut	1/2"	PFM2201200	0.060"	0.210"	Horizontal	4"	0.060"	4"	0.060"
PFM2241150	Horizontal	3/8"	1/4"-20 x 1-1/2" #3	1/2"	PFM2201200	0.060"	0.210"	Horizontal	-	-	-	-
PFM224115N	Horizontal	3/8"	1/4"-20 x 1-1/2" #3 w/ Nut	1/2"	PFM2201200	0.060"	0.210"	Horizontal	4"	0.060"	4"	0.060"
PFM2241200	Horizontal	3/8"	1/4"-20 x 1-1/2" #5	1/2"	PFM2201200	0.125"	0.500"	Horizontal	-	-	-	-
PFM224120N	Horizontal	3/8"	1/4"-20 x 1-1/2" #5 w/ Nut	1/2"	PFM2201200	0.125"	0.500"	Horizontal	4"	0.060"	4"	0.060"

HANGERMATE FOR STEEL - INTERNALLY THREADED - PIVOT

CAT #	HANG	ROD DIAMETER	DESCRIPTION	DRIVER	MIN THICKNESS	MAX THICKNESS	LOAD DIRECTION	PIPE SIZE	UL THICK.	PIPE SIZE	FM THICK.
PFM2281150	Variable	3/8"	1/4"-20 x 1" #3	PFM2201250	0.060	0.188	Vertical 45°	-	-	-	-
PFM2281200	Variable	3/8"	1/2"-20 x 1-3/4" #5	PFM2201250	0.125	0.500	Vertical 45°	-	-	-	-
PFM2281250	Variable	3/8"	1/4"-14 x 1" #3	PFM2201250	0.060	0.188	Vertical 45°	-	-	-	-

HANGERMATE FOR STEEL - CEILING SCREW EYELET

CAT #	HANG	HOLE DIAMETER	DESCRIPTION	DRIVER	MIN THICKNESS	MAX THICKNESS	LOAD DIRECTION	PIPE SIZE	UL THICK.	PIPE SIZE	FM THICK.
PFM2231500	-	3/8"	1/4" x 2"	PFM2201350	0.060"	0.105"	-	-	-	-	-
PFM2231550	-	3/8"	1/4" x 3-1/4"	PFM2201350	0.060"	0.105"	-	-	-	-	-

SUSPENDER FOR STEEL - DUAL-DIRECTION

CAT #	HANG	ROD DIAMETER	DESCRIPTION	DRIVER	MIN THICKNESS	MAX THICKNESS	LOAD DIRECTION	PIPE SIZE	UL THICK.	PIPE SIZE	FM THICK.
PFM227110N	Vertical and Horizontal	3/8"	1/4"-20 x 1" #3 w/ Nut	PFM2201300	0.060"	0.188"	Vertical Horizontal	4"	0.060"	4"	0.060"
PFM227120N	Vertical and Horizontal	3/8"	1/4"-29 x 1-1/2" #3 w/ Nut	PFM2201300	0.125"	0.500"	Vertical Horizontal	4"	0.060"	4"	0.060"
PFM227130N	Vertical and Horizontal	3/8"	1/4"-20 x 1-1/2" #5 w/ Nut	PFM2201300	0.060"	0.188"	Vertical	4"	0.060"	4"	0.060"

Loads vary depending on steel thickness. Contact DeWALT for more information.



PIN/NAIL ANCHORS

Heli-Pin™

Type	Façade anchor
Approvals	Tested in accordance with CSA70
Description	Helical wall tie system Anchors existing brick veneers to back-up structural members without exposed hardware
Base Materials	Concrete block brick stone clay tile and wood
Anchor Material	304 stainless steel



HELI-PIN ANCHOR

CAT #	SIZE	PACK	CTN
08341-PWR	8mm (5/16") x 6"	100	600
08342-PWR	8mm (5/16") x 8"	100	300
08343-PWR	8mm (5/16") x 10"	100	400
08344-PWR	8mm (5/16") x 12"	50	100

HELI-PIN SETTING TOOL

CAT #	DESCRIPTION	PACK	CTN
08345-PWR	SDS Setting Tool	1	2

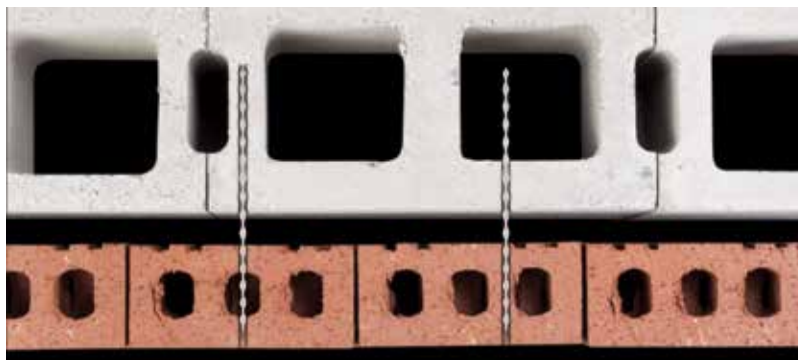

Safe-T+® Pin

Type	Nail Anchor
Approvals	Tested in accordance with ASTM E 488 Tested in accordance with ICC-ES AC193 for use in structural concrete
Description	Improved alternative to Zamac Nailin anchors where overhead use is not recommended
Base Materials	Normal and structural sand-lightweight concrete grout-filled concrete and brick masonry
Anchor Material	Zinc plated carbon steel



SAFE-T PIN ANCHOR

CAT #	SIZE	DRILL DIAMETER	PACK	CTN
2800SD-PWR	6mm (1/4") x 1-3/8"	6mm	100	600



ADDITIONAL SAFE-T PIN DRILL BIT ALSO AVAILABLE SEPARATELY

CAT #	SIZE	USABLE LENGTH	PACK	CTN
02800-PWR	6mm	3-1/4"	250	-

Hammer Drive®

Type	Fasteners for Hammer Drive Tools
Approvals	Tested in accordance with E488
Description	One piece, Hammer driven, No powder loads
Base Materials	Concrete and Block
Anchor Material	Hardened carbon steel 0.250" diameter head 0.140" diameter shank 3/8" diameter washer



1/4" HEAD HAMMER DRIVE PINS

CAT #	DESCRIPTION	PACK	CTN
50294-PWR	HAMMER DRIVE PIN 3/4"	100	5000
50296-PWR	HAMMER DRIVE PIN 1"	100	5000
50298-PWR	HAMMER DRIVE PIN 1 1/4"	100	1000

HAMMER DRIVE SETTING TOOL

CAT #	DESCRIPTION	PACK	CTN
50310-PWR	HAMMER DRIVE TOOL STANDARD	1	6

PIN/NAIL ANCHORS

Spike®

Type	Pin Anchor
Approvals	Tested in accordance with ASTM E488 and AC01 criteria
Description	One Piece Tamper-proof Pre-Expanded; no secondary tightening operation
Base Materials	Concrete and block
Anchor Material	Carbon steel and Type 316 stainless steel



MUSHROOM HEAD GRADE 8.2 CARBON STEEL SPIKE

CAT #	SIZE	DRILL DIAMETER	PACK	CTN
05502-PWR	3/16" x 1"	3/16"	100	1000
05503-PWR	3/16" x 1-1/4"	3/16"	100	1000
05504-PWR	3/16" x 1-1/2"	3/16"	100	1000
05506-PWR	3/16" x 2"	3/16"	100	1000
05508-PWR	3/16" x 2-1/2"	3/16"	100	600
05510-PWR	3/16" x 3"	3/16"	100	600
05511-PWR	3/16" x 3-1/2"	3/16"	100	600
05512-PWR	3/16" x 4"	3/16"	100	600
05522-PWR	1/4" x 1"	1/4"	100	1000
05523-PWR	1/4" x 1-1/4"	1/4"	100	1000
05524-PWR	1/4" x 1-1/2"	1/4"	100	1000
05526-PWR	1/4" x 2"	1/4"	100	600
05528-PWR	1/4" x 2-1/2"	1/4"	100	600
05530-PWR	1/4" x 3"	1/4"	100	600
05531-PWR	1/4" x 3-1/2"	1/4"	100	600
05532-PWR	1/4" x 4"	1/4"	100	600
05546-PWR	3/8" x 2"	3/8"	25	250
05548-PWR	3/8" x 2-1/2"	3/8"	25	150
05550-PWR	3/8" x 3"	3/8"	25	150
05551-PWR	3/8" x 3-1/2"	3/8"	25	150
05552-PWR	3/8" x 4"	3/8"	25	150
05554-PWR	3/8" x 5"	3/8"	25	150
05556-PWR	3/8" x 6"	3/8"	25	125
05569-PWR	1/2" x 2-3/4"	1/2"	50	200
05571-PWR	1/2" x 3-1/2"	1/2"	50	150
05572-PWR	1/2" x 4"	1/2"	25	125
05574-PWR	1/2" x 5"	1/2"	25	125
05577-PWR	1/2" x 6-1/2"	1/2"	25	100

The published length is measured from below the head to the end of the anchor



MUSHROOM HEAD 316 STAINLESS STEEL SPIKE

CAT #	SIZE	DRILL DIAMETER	PACK	CTN
06602-PWR	3/16" x 1"	3/16"	100	600
06603-PWR	3/16" x 1-1/4"	3/16"	100	600
06604-PWR	3/16" x 1-1/2"	3/16"	100	600
06606-PWR	3/16" x 2"	3/16"	100	1000
06623-PWR	1/4" x 1-1/4"	1/4"	100	1000
06624-PWR	1/4" x 1-1/2"	1/4"	100	600
06626-PWR	1/4" x 2"	1/4"	100	600
06628-PWR	1/4" x 2-1/2"	1/4"	100	600
06630-PWR	1/4" x 3"	1/4"	100	600
06646-PWR	3/8" x 2"	3/8"	25	250
06648-PWR	3/8" x 2-1/2"	3/8"	25	250
06650-PWR	3/8" x 3"	3/8"	25	250

The published length is the overall length of the anchor



SPECIAL APPLICATION ROD HANGING PIPE SPIKE GRADE 8.2 CARBON STEEL

CAT #	SIZE	DRILL DIAMETER	PACK	CTN
03755-PWR	1/4"	3/16"	100	600
03758-PWR	3/8"	1/4"	50	300



FLAT HEAD GRADE 8.2 CARBON STEEL SPIKE

CAT #	SIZE	DRILL DIAMETER	PACK	CTN
05608-PWR	3/16" x 2-1/2"	3/16"	100	600
05610-PWR	3/16" x 3"	3/16"	100	600
05612-PWR	3/16" x 4"	3/16"	100	600
05624-PWR	1/4" x 1-1/2"	1/4"	100	1000
05626-PWR	1/4" x 2"	1/4"	100	600
05628-PWR	1/4" x 2-1/2"	1/4"	100	600
05630-PWR	1/4" x 3"	1/4"	100	600
05631-PWR	1/4" x 3-1/2"	1/4"	100	600
05632-PWR	1/4" x 4"	1/4"	100	500



SPECIAL APPLICATION- SUSPENDED CEILING TIE-WIRE SPIKE GRADE 8.2 CARBON STEEL

CAT #	SIZE	DRILL DIAMETER	PACK	CTN
03756-PWR	3/16"	3/16"	100	600
03758-PWR	1/4"	1/4"	50	600



SPECIAL APPLICATION CONCRETE FORMING FORMING SPIKE GRADE 8.2 CARBON STEEL

CAT #	SIZE	DRILL DIAMETER	PACK	CTN
03795-PWR	3/16" x 1-1/2"	3/16"	100	600
03796-PWR	3/16" x 2"	3/16"	100	600
03797-PWR	3/16" x 2-3/4"	3/16"	100	600
03794-PWR	1/4" x 2-3/4"	1/4"	100	500

SPIKE INSTALLATION TOOLS

CAT #	DESCRIPTION	TIP O.D.	PACK	CTN
03790-PWR	Spike Driver 1000	1/2"	1	10

ROOFING SPIKE

CAT #	DRILL DIAMETER	MIN EMBED	PACK	PACK
3811-PWR	1/4" x 1-1/4"	1/4"	7/8"	500
3723-PWR	1/4" x 1-1/2"	1/4"	7/8"	500
3725-PWR	1/4" x 2"	1/4"	1-1/4"	500
3727-PWR	1/4" x 2-1/2"	1/4"	1-1/4"	500
3729-PWR	1/4" x 3"	1/4"	1-1/4"	500
3731-PWR	1/4" x 3-1/2"	1/4"	1-1/4"	500
3733-PWR	1/4" x 4"	1/4"	1-1/4"	500
3735-PWR	1/4" x 4-1/2"	1/4"	1-1/4"	500
3737-PWR	1/4" x 5"	1/4"	1-1/4"	500
3739-PWR	1/4" x 5-1/2"	1/4"	1-1/4"	500
3741-PWR	1/4" x 6"	1/4"	1-1/4"	250
3743-PWR	1/4" x 6-1/2"	1/4"	1-1/4"	250
3745-PWR	1/4" x 7"	1/4"	1-1/4"	250
3747-PWR	1/4" x 7-1/2"	1/4"	1-1/4"	250
3749-PWR	1/4" x 8"	1/4"	1-1/4"	250
3753-PWR	1/4" x 9"	1/4"	1-1/4"	250
3757-PWR	1/4" x 10"	1/4"	1-1/4"	250
3765-PWR	1/4" x 11"	1/4"	1-1/4"	100
3769-PWR	1/4" x 12"	1/4"	1-1/4"	100
3773-PWR	1/4" x 13"	1/4"	1-1/4"	100
3777-PWR	1/4" x 14"	1/4"	1-1/4"	100

PIN/NAIL ANCHORS

Drive®

Type Split Pin Pre-Expanded Anchor

Approvals Full FM & UL listings at www.DEWALT.com



Description One Piece
Tamper-proof
Pre-Expanded; no secondary tightening operation

Base Materials Concrete

Anchor Material Carbon steel



ROUND HEAD DRIVE

CAT #	SIZE	DRILL DIAMETER	PACK	CTN
03211-PWR	1/4" x 1-1/4"	1/4"	100	1000
03241-PWR	1/4" x 1-1/2"	1/4"	100	1000
03271-PWR	1/4" x 2"	1/4"	100	600
03301-PWR	1/4" x 2-1/2"	1/4"	100	600
03601-PWR	3/8" x 2"	3/8"	25	250
03631-PWR	3/8" x 2-1/2"	3/8"	25	150
03691-PWR	3/8" x 3-1/2"	3/8"	25	150
03781-PWR	1/2" x 3"	1/2"	25	150



FLAT HEAD DRIVE

CAT #	SIZE	DRILL DIAMETER	PACK	CTN
03092-PWR	3/16" x 1-1/2"	3/16"	100	1000
03122-PWR	3/16" x 2"	3/16"	100	1000
03152-PWR	3/16" x 2-1/2"	3/16"	100	600
03162-PWR	3/16" x 3"	3/16"	100	600
03242-PWR	1/4" x 1-1/2"	1/4"	100	1000
03272-PWR	1/4" x 2"	1/4"	100	600
03302-PWR	1/4" x 2-1/2"	1/4"	100	600
03332-PWR	1/4" x 3"	1/4"	100	600
03362-PWR	1/4" x 3-1/2"	1/4"	100	600
03392-PWR	1/4" x 4"	1/4"	100	600



TIE-WIRE DRIVE (13/64" TIE-WIRE HOLE)

CAT #	SIZE	DRILL HOLE DIAMETER	EYELET HOLE DIAMETER	PACK	CTN
03244-PWR	1/4" x 1-3/4"	1/4"	13/64"	500	
03245-PWR	1/4" x 1-3/4"	1/4"	13/64"	100	1000

Zamac Hammer-Screw® Anchor

Type Nail Anchor

Approvals Federal GSA Specification— Meets the proof load requirements of CID A-A 1925A Type 1



Description One-step anchor
Phillips head with internal screw
Removable

Base Materials Concrete block brick and stone

Anchor Material Zamac alloy with carbon steel or Perma-Seal drive screw

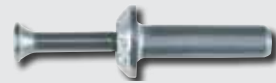

ZAMAC HAMMER-SCREW - MUSHROOM HEAD / NO. 2 PHILLIPS TYPE SCREW CARBON STEEL

CAT #	SIZE	DRILL DIAMETER	PACK	CTN
02839-PWR	1/4" x 3/4"	1/4"	100	500
02939-PWR	1/4" x 3/4"	1/4"	1000	
02840-PWR	1/4" x 1"	1/4"	100	500
02940-PWR	1/4" x 1"	1/4"	1000	
02842-PWR	1/4" x 1-1/4"	1/4"	100	500
02942-PWR	1/4" x 1-1/4"	1/4"	1000	
02844-PWR	1/4" x 1-1/2"	1/4"	100	500
02944-PWR	1/4" x 1-1/2"	1/4"	1000	
02846-PWR	1/4" x 2"	1/4"	100	500
02946-PWR	1/4" x 2"	1/4"	1000	
02848-PWR	1/4" x 2-1/4"	1/4"	100	500
02948-PWR	1/4" x 2-1/4"	1/4"	1000	
02850-PWR	1/4" x 3"	1/4"	100	500
02949-PWR	1/4" x 3"	1/4"	1000	

The published size includes the diameter and length of the anchor measured from under the shoulder of the anchor body.

PIN/NAIL ANCHORS

Zamac Nailin® Anchor

Type	Drive Pin Anchor
Approvals	Federal GSA Specification Meets the requirements of CID A-A 1925A Type 1 (mushroom head) & Type 2 (flat head) ¹
	
Description	Tamper-proof Nail drive anchor
Base Materials	Concrete block brick and stone
Anchor Material	Zamac alloy with carbon or stainless steel screw



ZAMAC Nailin® MUSHROOM HEAD WITH CARBON STEEL NAIL

CAT #	SIZE	DRILL DIAMETER	PACK	CTN
02802-PWR	3/16" x 7/8"	3/16"	100	500
02803-PWR	3/16" x 7/8"	3/16"	1000	
02806-PWR	1/4" x 3/4"	1/4"	100	500
02807-PWR	1/4" x 3/4"	1/4"	1000	
02808-PWR	1/4" x 1"	1/4"	100	500
02809-PWR	1/4" x 1"	1/4"	1000	
02814-PWR	1/4" x 1-1/4"	1/4"	100	500
02815-PWR	1/4" x 1-1/4"	1/4"	1000	
02820-PWR	1/4" x 1-1/2"	1/4"	100	500
02821-PWR	1/4" x 1-1/2"	1/4"	1000	
02826-PWR	1/4" x 2"	1/4"	100	500
02827-PWR	1/4" x 2"	1/4"	1000	
02804-PWR	1/4" x 3"	1/4"	100	500
02805-PWR	1/4" x 3"	1/4"	1000	

The published size includes the diameter and length of the anchor measured from under the shoulder of the anchor body.



ZAMAC Nailin® MUSHROOM HEAD WITH STAINLESS STEEL NAIL

CAT #	SIZE	DRILL DIAMETER	PACK	CTN
02858-PWR	1/4" x 1"	1/4"	100	500
02864-PWR	1/4" x 1-1/4"	1/4"	100	500
02870-PWR	1/4" x 1-1/2"	1/4"	100	500
02876-PWR	1/4" x 2"	1/4"	100	500

The published size includes the diameter and length of the anchor measured from under the shoulder of the anchor body.



ZAMAC Nailin® FLAT HEAD WITH CARBON STEEL NAIL

CAT #	SIZE	DRILL DIAMETER	PACK	CTN
02836-PWR	1/4" x 1-1/2"	1/4"	100	500
02838-PWR	1/4" x 2"	1/4"	100	500

The published size includes the diameter and length of the anchor measured from under the shoulder of the anchor body.

Nylon Nailin® Anchor

Type	Plastic Drive Pin Anchor
Approvals	Federal GSA Specification Meets load requirements of CID A-A 1925A Type 1 (mushroom head) & Type 2 (flat head) ¹
	
Description	Tamper-proof Nail drive anchor
Base Materials	Concrete block brick and stone
Anchor Material	Engineered nylon with carbon or stainless steel drive pin



ROUND HEAD NYLON NAILIN - CARBON STEEL NAIL

CAT #	SIZE	DRILL DIAMETER	PACK	CTN
02431-PWR	3/16" x 1"	3/16"	100	1000
02451-PWR	3/16" x 1-1/2"	3/16"	100	1000
02521-PWR	1/4" x 1"	1/4"	100	1000
02541-PWR	1/4" x 1-1/2"	1/4"	100	1000



FLAT HEAD NYLON NAILIN- CARBON STEEL NAIL

CAT #	SIZE	DRILL DIAMETER	PACK	CTN
02542-PWR	1/4" x 1-1/2"	1/4"	100	1000
02562-PWR	1/4" x 2"	1/4"	100	1000



MUSHROOM HEAD NYLON NAILIN CARBON STEEL NAIL

CAT #	SIZE	DRILL DIAMETER	PACK	CTN
02433-PWR	3/16" x 1"	3/16"	100	1000
02513-PWR	1/4" x 3/4"	1/4"	100	1000
02523-PWR	1/4" x 1"	1/4"	100	1000
02543-PWR	1/4" x 1-1/2"	1/4"	100	1000
02563-PWR	1/4" x 2"	1/4"	100	1000
02573-PWR	1/4" x 3"	1/4"	100	1000
02583-PWR	1/4" x 4"	1/4"	100	1000



MUSHROOM HEAD NYLON NAILIN STAINLESS STEEL NAIL

CAT #	SIZE	DRILL DIAMETER	PACK	CTN
02528-PWR	1/4" x 1"	1/4"	100	1000
02548-PWR	1/4" x 1-1/2"	1/4"	100	1000



MUSHROOM HEAD BODIES ONLY

CAT #	SIZE	DRILL DIAMETER	PACK	CTN
02574-PWR	1/4" x 3"	1/4"	2500	-

LIGHT DUTY ANCHORS

Wall Dog®

Type	Universal Light-Duty Anchor
Approvals	
Description	Smooth entry clean cutting; strong hold Self-drills in wallboard and in plywood Install with Phillips® Screwdriver
Base Materials	Concrete grout-filled concrete masonry hollow concrete masonry brick masonry wallboard plywood plaster
Anchor Material	Carbon steel

*Screws with a white finish have a white head and a zinc body
Phillips® is a registered trademark of Phillips Consumer Electronics Corporation.



WALL-DOG™ COMBO HEX WASHER HEAD

CAT #	SCREW LENGTH	COLOR	PACK	CTN
02265-PWR	1-1/4"	Zinc	5000	
02271-PWR	1-1/4"	Zinc	100	500



WALL-DOG™ PHILLIPS WAFER HEAD

CAT #	SCREW LENGTH	COLOR	PACK	CTN
02277-PWR	1-1/2"	White*	100	500
02278-PWR	2"	White*	100	500
02279-PWR	2-1/4"	White*	100	500
02280-PWR	2-1/2"	White*	100	500



WALL-DOG™ ROBERTSON HEAD

CAT #	SCREW LENGTH	COLOR	PACK	CTN
02266-PWR	1-1/4"	Zinc	100	500
02281-PWR	1-1/4"	Zinc	5000	



WALL-DOG™ PHILLIPS OVAL HEAD

CAT #	SCREW LENGTH	COLOR	PACK	CTN
02288-PWR	1-1/4"	Black	100	500
02314-PWR	1-1/4"	Zinc	100	1000
02317-PWR	1-1/4"	Zinc	5000	
02328-PWR	1-1/4"	White*	100	1000



WALL-DOG™ PHILLIPS PAN HEAD

CAT #	SCREW LENGTH	COLOR	PACK	CTN
02273-PWR	1-1/2"	White*	100	600
02274-PWR	1-1/2"	Bronze	100	600
02275-PWR	1-1/2"	Zinc	100	600
02276-PWR	1-1/2"	Black	100	600
02286-PWR	1-1/4"	Black	100	500
02294-PWR	1-1/4"	Brass	100	500
02315-PWR	1-1/4"	Zinc	5000	
02316-PWR	1-1/4"	Zinc	100	1000
02330-PWR	1-1/4"	White*	100	1000
02398-PWR	1-1/4"	White*	5000	



LIGHT DUTY ANCHORS

Polly™

Type	Hollow Wall Anchor
Approvals	Federal GSA Specification – Meets the descriptive requirements of FF-B-588D Type III Class A (Standard Polly) and Class B (Drive Polly)
	
Description	Sleeve type hollow wall anchor Allows fixture and screw removal and re-anchoring
Base Materials	Wallboard plywood
Anchor Material	Carbon steel



COMBINATION SLOTTED PHILLIPS HEAD POLLY

CAT #	SIZE	SCREW LENGTH	DRILL DIAMETER	WALL THICKNESS	PACK	CTN
02100-PWR	1/8" Ex Short	1-1/16"	5/16"	1/8" to 1/4"	100	500
02101-PWR	1/8" Short	1-3/4"	5/16"	3/8" to 1/2"	100	500
02102-PWR	1/8" Long	2-1/4"	5/16"	5/8" to 1"	100	500
02111-PWR	3/16" Short	2"	3/8"	3/8" to 5/8"	50	250
02112-PWR	3/16" Long	2-1/2"	3/8"	3/4" to 1-1/8"	50	250
02121-PWR	1/4" Short	2-1/4"	7/16"	3/8" to 1/2"	50	250
02122-PWR	1/4" Long	2-3/4"	7/16"	5/8" to 1-1/8"	50	250

XS - Extra Short S - Short L - Long XL - Extra Long



SLOTTED HEX HEAD POLLY

CAT #	SIZE	SCREW LENGTH	DRILL DIAMETER	WALL THICKNESS	PACK	CTN
02105-PWR	1/8" Short	1-3/4"	5/16"	3/8" to 1/2"	100	500



DRIVE POLLY

CAT #	SIZE	SCREW LENGTH	WALL THICKNESS	PACK	CTN
02182-PWR	1/8" Short	2"	3/8" to 1/2"	100	500
02184-PWR	1/8" Long	2-3/8"	1/2" to 3/4"	100	500



POLLY SETTING TOOL (FITS ALL SIZES)

CAT #	DESCRIPTION	PACK	CTN
02150-PWR	Polly Setting Tool	1	-

Toggle Bolt

Type	Hollow Wall Anchor
Approvals	
Description	Two-part assembly consisting of a machine screw and a spring wing toggle Variety of head styles and lengths
Base Materials	Wallboard plaster hollow concrete masonry pre-cast hollow core concrete plank
Anchor Material	Carbon Steel



COMBO MUSHROOM HEAD

CAT #	SIZE	DRILL DIAMETER	PACK	CTN
04023-PWR	1/8" x 2"	3/8"	50	500
04033-PWR	1/8" x 3"	3/8"	50	500
04043-PWR	1/8" x 4"	3/8"	50	500
04133-PWR	3/16" x 3"	1/2"	50	500
04143-PWR	3/16" x 4"	1/2"	50	500
04233-PWR	1/4" x 3"	5/8"	50	500
04243-PWR	1/4" x 4"	5/8"	50	500



COMBO ROUND HEAD

CAT #	SIZE	DRILL DIAMETER	PACK	CTN
04021-PWR	1/8" x 2"	3/8"	50	500
04031-PWR	1/8" x 3"	3/8"	50	500
04041-PWR	1/8" x 4"	3/8"	50	500
04121-PWR	3/16" x 2"	1/2"	50	500
04131-PWR	3/16" x 3"	1/2"	50	500
04141-PWR	3/16" x 4"	1/2"	50	500
04151-PWR	3/16" x 5"	1/2"	50	500
04161-PWR	3/16" x 6"	1/2"	50	500
04231-PWR	1/4" x 3"	5/8"	50	500
04241-PWR	1/4" x 4"	5/8"	50	500
04251-PWR	1/4" x 5"	5/8"	50	500
04261-PWR	1/4" x 6"	5/8"	50	500
04341-PWR	5/16" x 4"	7/8"	25	250
04431-PWR	3/8" x 3"	7/8"	25	250
04441-PWR	3/8" x 4"	7/8"	25	250
04451-PWR	3/8" x 5"	7/8"	25	125
04461-PWR	3/8" x 6"	7/8"	25	125
04541-PWR	1/2" x 4"	1-1/4"	25	125



SLOTTED HEX HEAD

CAT #	SIZE	DRILL DIAMETER	PACK	CTN
04038-PWR	1/8" x 3"	3/8"	50	500



FLAT HEAD

CAT #	SIZE	DRILL DIAMETER	PACK	CTN
04132-PWR	3/16" x 3"	1/2"	50	500
04142-PWR	3/16" x 4"	1/2"	50	500
04232-PWR	1/4" x 3"	5/8"	50	500

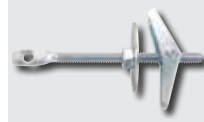

TIE WIRE ACOUSTICAL TOGGLE

CAT #	SIZE	DRILL DIAMETER	WIRE HOLE SIZE	PACK
04247-PWR	1/4" x 4"	5/8"	7/32"	100
04257-PWR	1/4" x 5"	5/8"	7/32"	100



TOGGLE WINGS ONLY

CAT #	SIZE	DRILL DIAMETER	PACK	CTN
04000-PWR	1/8"	3/8"	100	500
04020-PWR	3/16"	1/2"	100	1000
04220-PWR	1/4"	5/8"	100	1000
04330-PWR	5/16"	7/8"	50	500
04430-PWR	3/8"	7/8"	50	500
04540-PWR	1/2"	1 1/4"	25	125

LIGHT DUTY ANCHORS

Legs®

Type	Wallboard Anchor
Approvals	
Description	Expansion anchor Pierce point; no pre-drilling
Base Materials	Wallboard
Anchor Material	Zinc plated carbon steel



LEGS WALLBOARD ANCHOR

CAT.NO.	DESCRIPTION	PACK	CTN
02336-PWR	Leggs Wallboard Anchor	100	1000
02335-PWR	Leggs Anchor w/ No.8 x 1" Screw	100	1000

MASTER PACK

CAT #	DESCRIPTION	MASTER CTN
02338-PWR	Leggs Wallboard Anchor	5000

Zip-All®

Type	Wallboard Anchor
Approvals	
Description	Self drilling Use No. 6 or No. 8 screws
Base Materials	Wallboard
Anchor Material	Zamac alloy



ZIP-ALL

CAT #	WALL THICKNESS	DESCRIPTION	PACK	CTN
02297-PWR	3/8" to 1"	Zinc - with screws	100	1000

Sharkie™

Type	Plastic Wall Anchor
Approvals	
Description	Light duty Suitable for screws with various thread sizes and styles
Base Materials	Concrete brick cinder block wood masonry ceramic tile plaster stone stucco aerated concrete flakeboard wallboard/drywall
Anchor Material	Engineered plastic



SHARKIE ANCHOR

CAT #	DESCRIPTION	PACK	CTN
07580-PWR	Sharkie Anchor Flange #4-#10	100	1000
07582-PWR	Sharkie Anchor Flange #6-#12	100	1000
07584-PWR	Sharkie Anchor Flange #8-#14	100	500

Strap-Toggle™

Type	Hollow Wall Anchor
Approvals	Federal GSA Specification – Meets the descriptive requirements of FF-B-588D Type V for a captive toggle (superseded)
Description	Heavy duty Small installation hole; removable Accommodates range of wall thicknesses
Base Materials	Wallboard hollow concrete masonry
Anchor Material	Engineered plastic and carbon steel wings

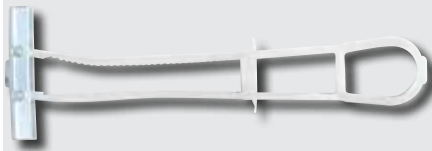

STRAP-TOGGLE

(not packed with screws)

CAT #	SIZE	DRILL DIAMETER	WALL THICKNESS	PACK	CTN
04052-PWR	3/16" x 4	1/2"	3/8" - 2-1/2"	50	300
04054-PWR	1/4" x 4-1/2"	1/2"	3/8" - 2-1/2"	50	300
04056-PWR	3/8" x 4"	3/4"	3/8" - 2-1/2"	25	150



STRAP-TOGGLE INSTALLATION

LIGHT DUTY ANCHORS

Zip-It® and Zip-It® Jr.

Type	Wallboard Anchor
Approvals	
Description	Light duty
Base Materials	Wallboard
Anchor Material	Engineered Plastic or Zamac Alloy



NYLON ZIP-IT®

CAT #	DESCRIPTION	WALL THICKNESS	PACK	CTN
02345-PWR	Nylon Zip-It no screws	3/8" to 1"	100	1000
02348-PWR	Nylon Zip-It with #8 x 1" screws	3/8" to 1"	100	1000
02355-PWR	Nylon Zip-It No Screws (Bulk)	3/8" to 1"	5000	
09630-PWR	Nylon Zip-It no screws (Bulk)	3/8" to 1"	5000	



NYLON ZIP-IT®

CAT #	DESCRIPTION	WALL THICKNESS	PACK	CTN
02350-PWR	Nylon Zip-It Jr. no screws	3/8" to 5/8"	100	1000
02351-PWR	Nylon Zip-It Jr. with #6 x 1" screws	3/8" to 5/8"	100	1000
02365-PWR	Nylon Zip-It Jr. no screws (Bulk)	3/8" to 5/8"	5000	



ZINC ZIP-IT®

CAT #	DESCRIPTION	WALL THICKNESS	PACK	CTN
02346Z-PWR	Zinc Zip-It no screws	3/8" to 1"	100	1000
02349Z-PWR	Zinc Zip-It with #8 x 1" screws	3/8" to 1"	100	1000
02356Z-PWR	Zinc Zip-It no screws (Bulk)	3/8" to 1"	5000	



ZINC ZIP-IT JR.

CAT #	DESCRIPTION	WALL THICKNESS	PACK	CTN
02362Z-PWR	Zinc Zip-It Jr. no screws	3/8" to 5/8"	100	1000
02363Z-PWR	Zinc Zip-It Jr. no screws (Bulk)	3/8" to 5/8"	5000	
02364Z-PWR	Zinc Zip-It Jr. with #6 x 1" screws	3/8" to 5/8"	100	1000

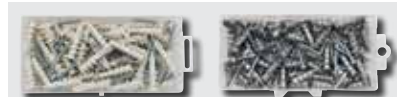

ZIP-IT® KITS

CAT #	DESCRIPTION	WALL THICKNESS	PACK	CTN
02368-PWR	50 Nylon Zip-It Anchors with #8 x 1" screws	3/8" to 1"	1	
02369Z-PWR	50 Zinc Zip-It Anchors with #8 x 1" screws	3/8" to 1"	1	



ZIP-IT® JR. KITS

CAT #	DESCRIPTION	WALL THICKNESS	PACK	CTN
02367-PWR	50 Nylon Zip-It Jr. with #6 x 1" Screws (includes #2 Phillips driver bit)	3/8" to 5/8"	1	

Zip-Toggle®

Type	Hollow Wall Anchor
Approvals	
Description	Heavy duty Fastens fixtures up to 3/4"
Base Materials	Wallboard
Anchor Material	Zinc



CAT #	SIZE	SCREWS	PACK	CTN
02295-PWR	Metal Zip-Toggle with screws	No. 6 x 2"	50	250

Poly-Toggle®

Type	Plastic Hollow Wall Anchor
Approvals	Federal GSA Specification – Meets the descriptive requirements of FF-B-588D Type IV (superseded)
Description	Light duty
Base Materials	Solid base materials wallboard hollow concrete masonry
Anchor Material	Engineered plastic



CAT #	SIZE	WALL THICKNESS	DRILL DIAMETER	PACK	CTN
02302-PWR	Mini	1/8"	5/16"	100	1000
02303-PWR	Short	3/8"	5/16"	100	1000
02304-PWR	Medium	1/2"	5/16"	100	1000
02305-PWR	Long	5/8"	5/16"	100	1000

LIGHT DUTY ANCHORS

Pop-Toggle

Type	Hollow Wall Anchor
Approvals	
Description	Light to medium duty Pre-installs without a screw; easy placement and removal
Base Materials	Wallboard plaster plywood
Anchor Material	Engineered plastic

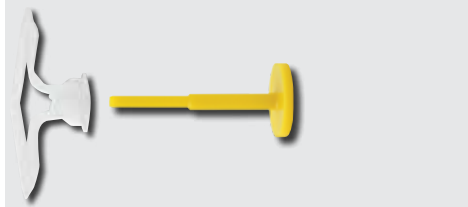

POP-TOGGLE

CAT #	DESCRIPTION	PACK	CTN
04060-PWR	Pop-Toggle Small	100	1000
04062-PWR	Pop-Toggle Medium	100	1000
04064-PWR	Pop-Toggle Large	100	1000

Fluted Plastic Anchor

Type	Plastic Wall Anchor
Approvals	
Description	Light duty Use with sheet metal or wood screw
Base Materials	Normal-weight concrete
Anchor Material	Engineered plastic

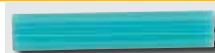

FLUTED PLASTIC ANCHOR

CAT #	SIZE	COLOR	DRILL DIAMETER	PACK	CTN
07500-PWR	#4-#6 x 1"	White	3/16"	100	5,000
07510-PWR	#10-#12 x 1"	Green	1/4"	100	5,000
07515-PWR	#10-#12 x 1-1/4"	Green	1/4"	100	1,000
07520-PWR	#10-#12 x 1-1/2"	Green	1/4"	100	1,000
07530-PWR	#14 x 1-1/2"	Blue	5/16"	100	1,000

Bantam Plug

Type	Plastic Wall Anchor
Approvals	
Description	Light duty Use with sheet metal or wood screw
Base Materials	Normal-weight concrete solid or hollow concrete masonry solid or hollow brick masonry gypsum wallboard
Anchor Material	Engineered plastic



BANTAM PLUG

(not packed with screws)

CAT #	SIZE	DRILL DIAMETER	PACK	CTN
07559-PWR	#6 -#8 x 3/4"	3/16"	100	5000
07569-PWR	#8 -#10 x 7/8"	3/16"	100	5000
07579-PWR	#10 -#12 x 1"	1/4"	100	5000
07589-PWR	#14 -#16 x 1-1/2"	5/16"	50	2500

MASTER PACK

CAT #	KIT #	ANCHOR SIZE	SCREW SIZE	ANCHORS & SCREWS	PACK	CTN
08934-PWR	B-8	#8 -#10	#8 x 1"	100	1	10
08936-PWR	B-10	#10 - #12	#10 x 1"	100	1	10
08938-PWR	B-12	#10 - #12	#12 x 1"	100	1	10



BANTAM KITS

CAT #	DESCRIPTION	PACK	CTN
008937-PWR	#10 x 1-1/4" Pan Head Anchor Kit: 10 -12 Bantam Anchors (100 qty.) 10 x 1-1/4" Tapping Pan Combo Screws (100 qty.) 1/4 C/T Drill Bit (1 qty.)	1	10
008941-PWR	#10 x 1" Hex Head Anchor Kit: 10 x 1" Bantam Anchors (100 qty.) 10 x 1" Hex Washer Head Screws (100 qty.) 1/4 C/T Drill Bit (1 qty.) 5/16 Hex Driver (1 qty.)	1	10
008948-PWR	#10 Super Yellow Anchor Kit: #10-12 Yellow Ribbed Anchors (100 qty.) #10 x 1" Pan Hd Screws (100 qty.) 1/4 x 4 Masonry Bit (1 qty.)	1	10

ADHESIVES



ACRYLIC ADHESIVES

AC200+®

Type High Performance Two-Component Acrylic

Bonds threaded rod and reinforcing bar hardware elements
Wide installation temperature range with small edge distances and spacings
Optimized curing adhesive; reliable installation yet easy to dispense
High bond strength values. Embedment depths from 4d to 20d and up to 60d for post-installed rebars (PIR)

Approvals ICC-ES ESR-4027 (Concrete & PIR)
Conforms to AC308 / ACI 355.4
Compliant with NSF/ANSI Standard 61 for drinking water system components
Department of Transportation listings

Base Materials Normal-weight concrete grouted concrete masonry brick
Installation conditions: Dry concrete water-saturated concrete water-filled holes

Size Range 3/8" to 1-1/4" diameter threaded rod No.3 to No.10 rebar

*One mixing nozzle packaged with each cartridge. AC200+ nozzles must be used to ensure complete and proper mixing of the adhesive



AC200+ CARTRIDGES

CAT #	DESCRIPTION	PACK	CTN	PALLET
PFC1271050	9.5 fl. oz. Quik-Shot*	12	36	648
PFC1271150	28 fl. oz. Dual Cartridge*	8	-	240

AC200+ EXTRA MIXING NOZZLES

CAT #	FITS CARTRIDGE	PACK	CTN
PFC1641600	PFC1271050 and PFC1271150	2	24

DISPENSERS

CAT #	TYPE
08437-PWR	Standard Quik-Shot Manual - 9oz / 9.5oz
08479-PWR	High Performance Quik-Shot Manual - 9oz / 9.5oz
DCE560B	20V Quik-Shot Adhesive Dispenser Bare
DCE560D1	20V Quik-Shot Adhesive Dispenser Kit
08494-PWR	Standard Manual 10:1 - 28oz
DCE595B	20V Acrylic Dispenser 10:1 28oz Bare
DCE595D1	20V Acrylic Dispenser 10:1 28oz Kit
08496SD	Pneumatic 10:1 Dispenser - 28oz

AC100+ Gold®

Type Two-Component Acrylic

Bonds threaded rod and reinforcing bar hardware elements
Consistent performance in low and high strength concrete
Evaluated and recognized for freeze/thaw performance and for a range of embedments in interior and exterior applications
Evaluated and recognized for long term and short term loading
Versatile low odor formula with quick cure time

Approvals ICC-ES ESR-2582 (Concrete); ICC-ES ESR-3200 (Masonry); ESR-4105 (Unreinforced Masonry (URM))
Compliant with NSF/ANSI Standard 61 for drinking water system components
Conforms to ASTM C 881 and AASHTO M235 Types I II IV and V Grade 3 Classes A & B
Department of Transportation listings

Base Materials Normal-weight concrete grouted and hollow concrete masonry (CMU unreinforced masonry brick
Installation conditions: Dry concrete water-saturated concrete water-filled holes

Size Range 3/8" to 1-1/4" diameter threaded rod No.3 to No.10 rebar

* One mixing nozzle packaged with each cartridge. AC100+Gold nozzles must be used to ensure complete and proper mixing of the adhesive.



AC100+GOLD CARTRIDGES

CAT #	DESCRIPTION	PACK	CTN	PALLET
8478SD-PWR	9.5 fl. oz. Quik-Shot*	12	36	684
8486SD-PWR	11.5 fl. oz. Dual Cartridge*	12	-	540
8490SD-PWR	28 fl. oz. Dual Cartridge*	8	-	240

AC100+GOLD EXTRA MIXING NOZZLES

CAT #	FITS CARTRIDGE	QY	CTN
08293-PWR	8478S-PWR and 8486SD-PWR	2	24
08294-PWR	8490SD-PWR	2	24

DISPENSERS

CAT #	TYPE
08437-PWR	Standard Manual - 9oz / 9.5oz
08479-PWR	High Performance Manual - 9oz / 9.5oz
DCE560B	20V Quik-Shot Adhesive Dispenser Bare
DCE560D1	20V Quik-Shot Adhesive Dispenser Kit
08485-PWR	Standard Manual - 11.5oz
08494-PWR	Standard 10:1 Manual - 28oz
DCE595B	20V Acrylic Dispenser 10:1 28oz Bare
DCE595D1	20V Acrylic Dispenser 10:1 28oz Kit
08496SD-PWR	Pneumatic 10:1 Dispenser - 28oz

ACRYLIC ADHESIVES

AC50™

Type Two-Component Acrylic

Bonds threaded rod and reinforcing bar into hardened concrete
Evaluated for installation and use in dry holes
Can be installed in a range of base material temperatures (as low as 5°F)

Approvals
 Conforms to ASTM C 881 and AASHTO M235 Types I II IV and V Grade 3 Classes A & B
Department of Transportation listings



Base Materials Normal and lightweight concrete
Installation conditions: Dry concrete

AC50 CARTRIDGES

CAT #	DESCRIPTION	PACK	CTN	PALLET
08497-PWR	28 fl. oz. Dual Cartridge*	8	-	240

AC50+ MIXING NOZZLES

CAT #	FITS CARTRIDGE	PACK	CTN
08294-PWR	8497-PWR	2	24

DISPENSERS

CAT #	TYPE
08494-PWR	Standard 10:1 Manual - 28oz
DCE595B	20V Acrylic Dispenser 10:1 28oz Bare
DCE595D1	20V Acrylic Dispenser 10:1 28oz Kit
08496SD-PWR	Pneumatic 10:1 Dispenser - 28oz

Size Range 3/8" to 1" diameter threaded rod
No.3 to No.8 rebar

*One mixing nozzle packaged with each cartridge. AC50+ nozzles must be used to ensure complete and proper mixing of the adhesive.



CAPSULE ADHESIVES

Hammer-Capsule

Type Drive-In Capsule Adhesive

Fast easy installation - no special adapters required for setting
Excellent chemical resistance
Components are mixed during installation of rod or rebar
Pre-measured chemical component volumes – no waste and simplified placement

Approvals
 Department of Transportation listings



Base Materials Normal weight concrete and grouted concrete masonry

HAMMER-CAPSULE

CAT #	DESCRIPTION	PACK	CTN
06702-PWR	3/8" Hammer-Capsule	10	500
06703-PWR	1/2" Hammer-Capsule	10	200
06704-PWR	5/8" Hammer-Capsule	10	100
06705-PWR	3/4" Hammer-Capsule	6	60
06706-PWR	7/8" Hammer-Capsule	6	60
06707-PWR	1" Hammer-Capsule	6	60

Size Range 3/8" to 1" diameter threaded rod No.3 to No.8 rebar

EPOXY ADHESIVES

Pure110+®

Type	Two-Component High Strength Epoxy Adhesive
Approvals	<p>ICC-ES ESR-3298 (Concrete & PIR)</p> <p>Conforms to ASTM C 881 and AASHTO M235 Types I II IV and V Grade 3 Classes B & C</p> <p>Compliant with NSF/ANSI 61 for drinking water system components</p> <p>Department of Transportation listings</p>
Base Materials	<p>Normal and lightweight concrete grouted concrete masonry and hollow concrete masonry</p> <p>Installation conditions: Dry concrete water-saturated concrete water-filled holes submerged concrete</p>
Size Range	3/8" to 1-1/4" diameter threaded rod No.3 to No.11 rebar



Bonds threaded rod and reinforcing bar into hardened concrete | Evaluated for installation and use in dry and wet holes including water filled and underwater | Can be installed in a wide range of base material temperatures | Embedments up to 60 bar diameters for post-installed rebars (PIR) | Same bond strength at room temperature and at 110°F.



PURE110+ 1:1 MIX RATIO CARTRIDGES

CAT #	DESCRIPTION	PACK	CTN	PALLET
08310SD-PWR	9 fl. oz. Quik-Shot*	12	36	648
08321SD-PWR	20.5 fl. oz. dual cartridge*	12	-	360
08351SD-PWR	50.5 fl. oz. dual cartridge*	5	-	150

PURE110+ MIXING NOZZLES

CAT #	FITS CARTRIDGE	PACK	CTN
PFC1641600	08310SD-PWR	2	24
08609-PWR	08321SD-PWR,08351SD-PWR	2	24

*One mixing nozzle packaged with each cartridge. Pure110+ nozzles must be used to ensure complete and proper mixing of the adhesive.

Pure50+™

Type	Two-Component Epoxy Adhesive
Approvals	<p>ICC-ES ESR-3576 (Concrete)</p> <p>Conforms to ASTM C 881 and AASHTO M235 Types I II IV and V Grade 3 Classes B & C (also meets Type III except for elongation)</p> <p>Compliant with NSF/ANSI Standard G1 for Drinking Water System Components</p> <p>Department of Transportation listings</p>
Base Materials	<p>Normal and lightweight concrete</p> <p>Installation conditions: Dry concrete water-saturated concrete water-filled holes</p>
Size Range	3/8" to 1-1/4" diameter threaded rod No.3 to No.10 rebar



Bonds threaded rod and reinforcing bar into hardened concrete | Evaluated for installation and use in dry and wet holes including water filled | Can be installed in a wide range of base material temperatures



PURE50+ CARTRIDGES

CAT #	DESCRIPTION	PACK	CTN	PALLET
08600-PWR	9 fl. oz. Quik-Shot*	12	36	648
08605-PWR	20.5 fl. oz. dual cartridge*	12	-	360
08651-PWR	50.5 fl. oz. dual cartridge*	5	-	150

PURE50+ MIXING NOZZLES

CAT #	FITS CARTRIDGE	PACK	CTN
PFC1641600	08600-PWR	2	24
08294-PWR	08605-PWR	2	24
08609-PWR	08651-PWR	2	24

*One mixing nozzle packaged with each cartridge. Pure50+ nozzles must be used to ensure complete and proper mixing of the adhesive



FOAM ADHESIVES

TriggerFoam™ Pro

Type	Expanding Polyurethane Foam
Approvals	ICC-ES ESR-3263 Thermal and Moisture Protection and annular space protection for wood fire blocking: FireBlock Formula Window & Door Formula All Season Formula Full UL listings in product brochure or at www.DEWALT.com
Base Materials	Concrete masonry wood and metal

Professional gun applied normal expansion polyurethane foam sealant with an extended temperature range which allows for use at temperatures as low as 23°F. It is designed to seal gaps insulate and deaden sound. Recommended for use in heating and air conditioning electrical and plumbing applications.



TRIGGERFOAM PRO DISPENSERS

CAT #	TYPE	PACK	CTN
08126-PWR	20" Dispensing tool	1	-
08128-PWR	Deluxe metal gun	1	10
08139-PWR	Deluxe plastic gun	1	10

DISPENSING ACCESSORIES

CAT #	TYPE	PACK	CTN
08147-PWR	TriggerFoam Pro Cleaner 17 fl. oz.	1	6

TRIGGERFOAM PRO

CAT #	DESCRIPTION	PACK	PALLET
08133P-PWR	Fire Block Formula 29 oz.	12	612
08134P-PWR	Window & Door Formula 29 oz.	12	612
08135P-PWR	All Season Formula 29 oz.	12	612
08136N-PWR	Standard Formula 29 oz.	12	612



PowerFoam™

Type	Expanding Polyurethane Foam
Approvals	Full UL listings in product brochure or at www.DEWALT.com
Base Materials	Concrete masonry wood and metal

One-part polyurethane expanding foam that sets and cures into its final form by reacting to moisture and humidity present in the air. PowerFoam's exceptional ability to bond allows it to be applied to various building elements including the surfaces of concrete brick block wood steel aluminum and other miscellaneous metals. As it is being dispensed PowerFoam has a neutral odor. Cured foam is standard yellow.



POWERFOAM

CAT #	DESCRIPTION	PACK	PALLET
08130N-PWR	PowerFoam 12 oz.	12	1020
08132N-PWR	PowerFoam 29 oz.	12	612

ADHESIVE SEALANT

PowerStick™

Type	Adhesive Sealant
Base Materials	Concrete masonry metals wood plastics

One component universal adhesive/sealant based on proprietary MS Polymer chemistry. PowerStick is the first professional grade product on the market that delivers high bond strength and superior flexibility.



POWERSTICK

CAT #	DESCRIPTION	COLOR	PACK	PALLET
08166N-PWR	PowerStick 10 oz.	White	12	1200
08168N-PWR	PowerStick 10 oz.	Gray	12	1200

THE FIRST CORDLESS ADHESIVE ANCHOR INSTALLATION SYSTEM



DUST X+™
ANCHOR INSTALLATION SYSTEM

DRILL + EXTRACT + ANCHOR

ICC
ES
APPROVED



PFC1271050



08310SD-PWR



08600-PWR



DUST X+™

ANCHOR INSTALLATION SYSTEM

**PERFORM
PROTECT**

USE WITH DWV012
for OSHA silica dust
Table 1 Compliance

* System is compliant to the Exposure Control Methods described in Table 1 of 29 CFR 1926.1153 when outlined components are operating and maintained in accordance to manufacturer's instructions.

OSHA COMPLIANT
1926.1153

**SDS MAX
Y-CUTTER
CARBIDE**
for positioning
and hole starting

**HOLLOW
DRILL BIT**
bit extracts
while drilling
for less dust
fast holes



**AIR
LOCK™**

AirLock™ Adapter allows for quick, easy and durable connection between 1-1/4" vacuum hose and various DeWALT tools and shrouds

AIRLOCK™ ADAPTER
connects directly to DeWALT's AirLock™ Adapter System forming a secure locking connection between bit and dust extractor

**SDS MAX AND
SDS PLUS**
sizes available

	DIAMETER	OVERALL LENGTH	USABLE LENGTH
DWA54038	3/8"	9-3/4"	14-1/2"
SDS plus DWA54012	1/2"	14-1/2"	9-3/4"
DWA54916	9/16"	14-1/2"	9-3/4"
DWA54058	5/8"	14-1/2"	9-3/4"
DWA54034	3/4"	14-1/2"	9-3/4"
DWA58058	5/8"	23-5/8"	15-3/4"
DWA54034	3/4"	14-1/2"	9-3/4"
DWA58078	3/4"	23-5/8"	15-3/4"
DWA58001	1"	23-5/8"	15-3/4"
SDS max DWA58116	11/16"	23-5/8"	15-3/4"
DWA58118	1-1/8"	23-5/8"	15-3/4"
DWA58958	5/8"	39-3/8"	47-1/4"
DWA58934	3/4"	39-3/8"	47-1/4"
DWA58978	7/8"	39-3/8"	47-1/4"
DWA58901	1"	39-3/8"	47-1/4"
DWA58918	1-1/8"	39-3/8"	47-1/4"
DWA58918	1-1/4"	39-3/8"	47-1/4"
DWA58138	1-3/8"	39-3/8"	47-1/4"
DWA58112	1-1/2"	39-3/8"	47-1/4"



SDS+ ROTARY HAMMERS

<1" SDS PLUS CORDLESS L-SHAPE



DCH072D2



DCH172D2

Catalog #	DCH072D2	DCH172D2
Motor Type	12V	N/A
Impact Energy (Joules) [™]	1.1	1.4
RPM	910	1,060
BPM	4,280	4,980
Optimal Drilling Range	5/32" – 3/8"	5/32" – 3/8"
Battery Voltage/Amps	12V	20V
Kit Battery Ah	(2) 3.0 Ah	(2) 2.0 Ah
Weight (lbs.)	3.69	4.72
Vibration Control	NO	N/A
Vibration m/s ²	9.7	8.8
Service Contract	1 Year Free Service	2 Year Free Service

1" SDS PLUS CORDLESS L-SHAPE



DCH273P2

Catalog #	DCH273P2
Impact Energy (Joules) [™]	2.1
RPM	1,100
BPM	4,600
Optimal Drilling Range	3/16" - 1/2"
Rotation Control	✓
Battery Voltage/Amps	20V
Kit Battery Ah	(2) 20V 5.0 Ah
Weight (lbs.)	6.8
Vibration Control	✓
Vibration m/s ²	6.6
Chipping	✓
Cordless Dust Extractor	DWH303
Service Contract	2 Years

1" SDS PLUS CORDLESS/CORDED D-HANDLE



DCH133M2



D25262K

Catalog #	DCH133M2	D25262K
Impact Energy (Joules) [™]	2.6	2.8
RPM	1,500	1,500
BPM	5,500	5,540
Optimal Drilling Range	5/32" – 5/8"	5/32" – 5/8"
Rotation Control	Integral Clutch	Integral Clutch
Battery Voltage/Amps	20V MAX*	8 Amps
Battery Ah	4.0 Ah	N/A
Weight (lbs.)	5.5	6.6
Vibration Control	NO	✓
Vibration m/s ²	N/A	9.6
Chipping	✓	✓
Service Contract	1 Year Free Service	2 Year Free Service

1-1/8" SDS PLUS CORDED L-SHAPE



D25333K

Catalog #	D25333K
Impact Energy (Joules) [™]	3.5
RPM	1,150
BPM	5,200
Optimal Drilling Range	3/16" - 7/8"
Rotation Control	Integral Clutch
Battery Voltage/Amps	8.5 Amps
Battery AH	N/A
Weight (lbs.)	8.2
Vibration Control	✓
Vibration m/s ²	10
Chipping	✓
Service Contract	2 Year Free Service

1-1/8" SDS PLUS CORDLESS/CORDED D-HANDLE



DCH263R2



D25263K

Catalog #	DCH263R2	D25263K
Impact Energy (Joules) [™]	3	3
RPM	1,165	1,450
BPM	4,300	5,350
Optimal Drilling Range	1/4" – 3/4"	1/4" – 3/4"
Rotation Control	✓	Integral Clutch
Battery Voltage/Amps	20V	8.5 Amps
Battery Ah	(2) 6.0 Ah	N/A
Weight (lb s.)	5.95	6.8
Cordless Dust Extractor	DWH205DH	NO
Vibration Control	✓	NO
Vibration m/s ²	9.1	9.8
Chipping	✓	✓
Service Contract	2 Year Free Service	2 Year Free Service

1-1/8" SDS PLUS CORDLESS L-SHAPE



DCH293R2

Catalog #	DCH293R2
Impact Energy (Joules) [™]	3.5
RPM	1,000
BPM	4,480
Optimal Drilling Range	1/4" x 7/8"
Rotation Control	E-CLUTCH®
Battery Voltage/Amps	20V
Battery Ah	(2) 20V 6.0 Ah
Weight (lbs.)	6.8
Cordless Dust Extractor	✓
Vibration Control	✓
Vibration m/s ²	8.2
Chipping	✓
Service Contract	2 Year Free Service

1 1/4" SDS PLUS CORDLESS/CORDED L-SHAPE



DCH416X2



D25416K

Catalog #	DCH416X2	D25416k
Impact Energy (Joules) ^{**}	4.5	4.2
RPM	725	1,150
BPM	4,200	4700
Optimal Drilling Range	5/8" - 1-1/8"	3/16" - 7/8"
Rotation Control	E-CLUTCH®	Integral Clutch
Battery Voltage/Amps	60V	9 Amps
Battery AH	(2) 9 Ahr	N/A
Weight (lbs.)	9	14.35
Vibration Control	SHOCKS®	SHOCKS®
Vibration m/s ²	6.3 m/s ²	8.5
Chipping	YES	YES
Wireless Tool Control	YES	NO
Tag Ready	YES	NO
Service Contract	2 Year Free Service	2 Year Free Service

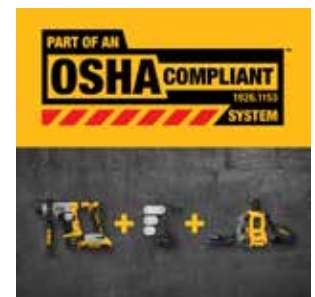

DUST EXTRACTION

ONBOARD DUST EXTRACTOR FOR 1-1/8 IN. SDS PLUS D-HANDLE HAMMERS

 DWH205DH	Catalog #	DWH205DH
	Compatibility	DCH263B DCH263R2
	Interchangeable Drilling Nozzles	3
	Optimal Bit Type (Nozzle 1)	Stop Bit
	Optimal Bit Length (Nozzle 2)	Up to 1/2"
	Optimal Bit Length (Nozzle 3)	Up to 1"
	Max Drilling Length	10"
	Adjustable Depth Gauge	Yes
Tool Weight	3.42 lbs	

ONBOARD DUST EXTRACTOR FOR 1-1/8 IN. SDS PLUS HAMMERS

 DWH304DH	Catalog #	DWH304DH
	Compatibility	DCH293B DCH293R2 DCH293X2 D25333K
	Optimal Drilling Range	Up to 1"
	Optimal Bit Length	Up to 8"
	Max Bit Length	10"
	Tool Weight	3.5 lbs

20V MAX* BRUSHLESS UNIVERSAL DUST EXTRACTOR

 DWH161D1	Catalog #	DWH161D1
	Compatibility	D25301D DWH200D
	Voltage	20V MAX*
	Airflow	19 CFM
	Nozzle Inside Diameter	1"
	WIRELESS TOOL CONTROL™	Yes
	Airlock Connector Ready	Yes
	Wet or Dry	Dry Only
	Tool Weight	3.62 lbs

LARGE HAMMER DUST EXTRACTION - HOLE CLEANING

 DWH050	Catalog #	DWH050
	Compatibility	SDS PLUS SDS MAX Spline
	Interchangeable Drilling Heads	2
	Optimal Drilling Range (Head 1)	Up to 1-1/2"
	Optimal Drilling Range (Head 2)	Up to 2"
	Airlock Connector Ready	Yes
	Tool Weight	1.32 lbs

1-1/8" HEX DEMOLITION DUST COLLECTION ATTACHMENT

 DWH052	Catalog #	DWH052
	Compatibility	1-1/8" Hex
	Max Chisel Width	1-1/4"
	Airlock Connector Ready	Yes
	Tool Weight	1.32 lbs

FLEXVOLT® 60V MAX* DUST EXTRACTOR

 DCV585T2	Catalog #	DCV585T2
	Compatibility	DWH050 DWH052 DWH053
	Voltage	60V MAX*
	Tank Size	2 gal
	Airflow	125 CFM
	Hose Length	8 ft
	WIRELESS TOOL CONTROL™	Yes
	Airlock Connector Ready	Yes
	Wet or Dry	Both
	Tool Weight	17.6 lbs

ONBOARD DUST EXTRACTOR FOR 1 IN. SDS PLUS HAMMERS

 DWH303DH	Catalog #	DWH303DH
	Compatibility	DCH273B DCH273P2
	Optimal Drilling Range	Up to 5/8"
	Optimal Bit Length	Up to 4"
	Max Bit Length	6"
	Adjustable Depth Gauge	Yes
	Tool Weight	3.08 lbs

SDS ROTARY HAMMER DUST BOX EVACUATOR

 DWH079D	Catalog #	DWH079D
	On-Board Extractor Compatibility	DWH205DH DWH302DH DWH304DH DWH303DH D25303DH
	Extractor Compatibility	DCV585T2 DCV010 DCV012
	Airlock Connector Ready	Yes
	Tool Weight	0.78 lbs

DUST EXTRACTOR TELESCOPE WITH HOSE FOR SDS ROTARY HAMMERS

 D25301D	Catalog #	D25301D
	Compatibility	SDS PLUS excluding D25416K
	Optimal Drilling Range	5/32" to 5/8"
	Max Drilling Depth	4"
	Tool Weight	2.6 lbs

DUST EXTRACTION TUBE KIT WITH HOSE

 DWH200D	Catalog #	DWH200D
	Compatibility	SDS PLUS excluding D25416K
	Clear Dust Tubes	3
	Optimal Bit Type (Tube 1)	Stop Bit
	Optimal Bit Length (Tube 2)	Up to 6"
	Optimal Bit Length (Tube 3)	Up to 10"
	Hose Length	4 ft
	Airlock Connector Ready	Yes
	Tool Weight	0.89 lbs

SDS MAX CHISELING DUST COLLECTION ATTACHMENT

 DWH053	Catalog #	DWH053
	Compatibility	SDS MAX 1-1/8" Hex
	Optimal Chisel Length	10" to 18"
	Dust Boots	3
	Airlock Connector Ready	Yes
	Tool Weight	1.32 lbs

































8 GALLON WET/DRY HEPA/RRP DUST EXTRACTOR

 DWV010	Catalog #	DWV010
	Compatibility	DWH050 DWH052 DWH053
	Amps	15
	Tank Size	8 gal
	Airflow	150 CFM
	Hose Length	15 ft
	Wet or Dry	Both
	Tool Weight	21.0 lbs

10 GALLON WET/DRY HEPA/RRP DUST EXTRACTOR

 DWV012	Catalog #	DWV012
	Compatibility	DWH050 DWH052 DWH053
	Amps	15
	Tank Size	10 gal
	Airflow	155 CFM
	Hose Length	15 ft
	Wet or Dry	Both
	Variable-Speed Dial	Yes
	Tool Weight	33.5 lbs

SILICA DUST SOLUTIONS

SDS PLUS DRILLING	 <p>DCH273P2 DCH273B</p>	 <p>DWH303DH</p>	 <p>SDS PLUS Hollow Bit</p>	 <p>DWH050 Large Hammer Drilling Dust Extraction</p>	
	 <p>DCH293R2 DCH293B D25333K</p>	 <p>DWH304DH</p>			OR
	 <p>DCH263R2 DCH263B</p>	 <p>DWH205DH</p>	 <p>DWH050 Large Hammer Drilling Dust Extraction</p>	 <p>DWH050 Large Hammer Drilling Dust Extraction</p>	
	 <p>DCH133M2</p> <p>DCH133B D25133K D25262K 25263K D25416K, DCH416X2 DCH416B</p>	 <p>DWH200D Dust Extractor Telescope with Hose</p>			OR
	 <p>DCH273P2</p> <p>DCH273B D25133K DCH133B DCH133M2 D25262K D25263K DCH263B DCH263R2 D25333K DCH072G2 DCH072B DCH172D2 DCH172B DCH172E2</p>	 <p>DWH050 Large Hammer Drilling Dust Extraction</p>	 <p>DWH053 Large Hammer Chipping Dust Extraction</p>	 <p>D25301D Dust Extractor Telescope with Hose</p>	
 <p>DCH775X2</p> <p>DCH481B D25481K D25614K DCH614B DCH614X2 DCH832X1 D25733K DCH733B DCH733X2 D25773K DCH773Y2 DCH735X2 DCH775X2</p>	 <p>DWH012 Dust Extractor</p>	 <p>DWH010 Dust Extractor</p>	 <p>DWH161 Dust Extractor</p>		
CHIPPING & DEMOLITION	 <p>D25832K</p> <p>D25810K D25872K D25892K DCH832X1 DCH892X1</p>	 <p>DWH053 SDS MAX Chiseling Dust Collection Attachment</p>	 <p>DCV585 Dust Extractor</p>	 <p>PERFORM PROTECT</p>	
	 <p>D25901K</p> <p>D25899K D25951K</p>	 <p>DWH052 Breaker Dust Extraction</p>	 <p>DWH012 Dust Extractor</p>		 <p>DCV585 Dust Extractor</p>
	 <p>D25980K D25960K</p>	 <p>DWH010 Dust Extractor</p>	 <p>DCV585 Dust Extractor</p>		 <p>220+ SOLUTIONS FOR OSHA TABLE 1 COMPLIANCE OSHA COMPLIANT 1926.1153</p>

CORDLESS DRILL DRIVERS



	DCF901	DCF903	DCF911	DCF913
Battery Platform	12V MAX*	12V MAX*	20V MAX*	20V MAX*
Anvil Size	1/2"	3/8"	1/2"	3/8"
Anvil Type	Hog Rung	Hog Ring	Hog Ring	Hog Ring
Max FWD Torque	250 ft-lbs	250 ft-lbs	250 ft-lbs	250 ft-lbs
Max Breakaway Torque	400 ft-lbs	400 ft-lbs	400 ft-lbs	400 ft-lbs



	DCF921	DCF922	DCF923	DCF891
Battery Platform	20V MAX*	20V MAX*	20V MAX*	20V MAX*
Anvil Size	1/2"	1/2"	3/8"	1/2"
Anvil Type	Hog Ring	Detent	Hog Ring	Hog Ring
Max FWD Torque	300 ft-lbs	300 ft-lbs	300 ft-lbs	600 ft-lbs
Max Breakaway Torque	450 ft-lbs	500 ft-lbs	450 ft-lbs	800 ft-lbs



	DCF899	DCF898	DCF900
Battery Platform	20V MAX*	20V MAX*	20V
Anvil Size	1/2"	7/16"	1/2"
Anvil Type	Detent	QC	Hog Ring
Max FWD Torque	700 ft-lbs	700 ft-lbs	10000 ft-lbs
Max Breakaway Torque	1200 ft-lbs	1200 ft-lbs	1400 ft-lbs



*Maximum initial battery voltage (measured without a workload) is 20 volts.
Nominal voltage is 18.

SDS+ DRILL BITS



SDS+ Full Head Carbide

Shank / Tip		CAT #	DIAMETER	USABLE LENGTH	OVERALL LENGTH	CAT #	DIAMETER	USABLE LENGTH	OVERALL LENGTH
Tool	Rotary hammer with SDS + (slotted drive shaft) type chuck	DW5503	3/16"	4"	6-1/2"	DW5527	3/8"	4"	6-1/2"
		DW5504	3/16"	5"	8-1/2"	DW5529	3/8"	8"	10"
Base Materials	Concrete block brick and soft stone	DW5506	3/16"	10"	12"	DW55300	3/8"	10"	12"
		DW5512	7/32"	8"	10"	DW5531	3/8"	16"	18"
Size Range	5/32" x 6-1/2" to 1-1/8" x 18"	DW5517	1/4"	4"	6"	DW5537	1/2"	4"	6"
		DW5518	1/4"	6"	8-1/2"	DW5538	1/2"	8"	10-1/2"
Description	High Impact Tip Open Head Elongated 4 Flute Design	DW55200	1/4"	10"	12"	DW5539	1/2"	10"	12"
		DW5521	1/4"	12"	14"	DW5540	1/2"	16"	18"
		DW5524	5/16"	4"	6"				
		DW5526	5/16"	10"	12"				



SDS+ 4-Cutter Carbide

Shank / Tip		CAT #	DIAMETER	USABLE LENGTH	OVERALL LENGTH	CAT #	DIAMETER	USABLE LENGTH	OVERALL LENGTH
Tool	Rotary hammer with SDS + (slotted drive shaft) type chuck	DW5471	5/8"	8"	10"	DW5479	1"	8"	10"
		DW5472	5/8"	16"	18"	DW5480	1"	16"	18"
Base Materials	Concrete block brick and soft stone	DW5474	3/4"	8"	10"	DW5481	1-1/8"	8"	10"
		DW5475	3/4"	16"	18"	DW5482	1-1/8"	6"	18"
Size Range	5/8" x 10" to 1-1/8" x 18"	DW5477	7/8"	8"	10"				
		DW5478	7/8"	16"	18"				
Description	High Impact Tip Open Head Elongated 4 Flute Design								



SDS+ 2-Cutter Carbide

Shank / Tip		CAT #	DIAMETER	USABLE LENGTH	OVERALL LENGTH	CAT #	DIAMETER	USABLE LENGTH	OVERALL LENGTH
Tool	Rotary hammer with SDS + (slotted drive shaft) type chuck	DW5438_1	5/32"	4-1/2"	6-1/2"	DW5437	1/2"	4"	6"
		DW5400	5/32"	2"	4"	DW5438	1/2"	8"	10"
Base Materials	Concrete block brick and soft stone	DW5403	3/16"	4-1/2"	6-1/2"	DW5439	1/2"	10"	12"
		DW5404	3/16"	6-1/2"	8-1/2"	DW5440	1/2"	16"	18"
Size Range	5/32" x 6-1/2" to 1-1/8" x 16"	DW5407	3/16"	12"	14"	DW5441	1/2"	22"	24"
		DW5408	3/16"	14"	16"	DW5442	9/16"	4"	6"
Description	Carbide Tip Four Flute Helix Increased Steel	DW5406	3/16"	10"	12"	DW5443	9/16"	10"	12"
		DW5405	3/16"	8"	10"	DW5444	9/16"	16"	18"
		DW5402	3/16"	2"	4"	DW5446	5/8"	6"	8"
		DW5410	7/32"	4"	6"	DW5448	5/8"	16"	18"
		DW5412	7/32"	4"	6"	DW5447	5/8"	10"	12"
		DW5416	1/4"	2"	4"	DW5449	5/8"	22"	24"
		DW5417	1/4"	4"	6"	DW5450	11/16"	6"	8"
		DW5418	1/4"	6-1/2"	8-1/2"	DW5455	3/4"	10"	12"
		DW5420	1/4"	10"	12"	DW5453	3/4"	6"	8"
		DW5421	1/4"	12"	14"	DW5456	3/4"	16"	18"
		DW5424	5/16"	4"	6"	DW5457	3/4"	22"	24"
		DW5426	5/16"	10"	12"	DW5460	7/8"	6"	8"
		DW5432	3/8"	22"	24"	DW5462	7/8"	16"	18"
		DW5430	3/8"	10"	12"	DW5464	1"	8"	10"
		DW5427	3/8"	4"	6"	DW5466	1"	16"	18"
		DW5429	3/8"	8"	10"	DW5468	1-1/8"	8"	10"
		DW5431	3/8"	16"	18"	DW5469	1-1/8"	16"	18"
		DW5435	7/16"	10"	12"	DW5468	1 1/8	8	10
		DW5437	1/2"	4"	6"	DW5469	1 1/8	16	18
		DW5436	7/16"	16"	18"				

SDS-MAX DRILL BITS



SDS-Max 4-Cutter Carbide

Shank / Tip		CAT #	DIAMETER	USABLE LENGTH	OVERALL LENGTH	CAT #	DIAMETER	USABLE LENGTH	OVERALL LENGTH
Tool	Rotary hammer with SDS Max (slotted drive shaft) type chuck	DW5806	5/8"	8"	13-1/2"	DW5818	1"	8"	13-1/2"
		DW5809	5/8"	16"	21-1/2"	DW5819	1"	16"	21-1/2"
		DW5807	5/8"	31"	36"	DW5852	1"	24"	29"
Base Materials	Concrete block brick and soft stone	DW5808	11/16"	16"	21-1/2"	DW5820	1"	31"	36"
		DW5810	3/4"	8"	13-1/2"	DW5821	1-1/8"	10"	15"
		DW5812	3/4"	16"	21-1/2"	DW5822	1-1/8"	18"	22-1/2"
Size Range	5/8" x 13-1/2" to 1-1/4" x 22-1/2"	DW5813	3/4"	31"	36"	DW5853	1-1/8"	24"	29"
		DW5814	13/16"	16"	21-1/2"	DW5854	1-1/8"	31"	36"
		DW5815	7/8"	8"	13-1/2"	DW5824	1-1/4"	10"	15"
Description	Open Head U-Flute Design	DW5816	7/8"	16"	21-1/2"	DW5825	1-1/4"	18"	22-1/2"
		DW5851	7/8"	31"	36"	DW5825	1-1/4"	18"	22-1/2"



SDS Max 2 Cutter Carbide

Shank / Tip		CAT #	DIAMETER	USABLE LENGTH	OVERALL LENGTH	CAT #	DIAMETER	USABLE LENGTH	OVERALL LENGTH
Tool	Rotary hammer with SDS Max (slotted drive shaft) type chuck	DW5801	9/16"	8"	13-1/2"	DW5818	1"	8"	13-1/2"
		DW5803	1/2"	8"	13-1/2"	DW5819	1"	16"	21-1/2"
		DW5804	1/2"	16"	21-1/2"	DW5821	1-1/8"	10"	15"
Base Materials	Concrete block brick and soft stone	DW5806	5/8"	8"	13-1/2"	DW5822	1-1/8"	18"	22-1/2"
		DW5809	5/8"	16"	21-1/2"	DW5824	1-1/4"	10"	15"
		DW5810	3/4"	8"	13-1/2"	DW5825	1-1/4"	18"	22-1/2"
Size Range	9/16" x 13-1/2" to 1-1/4" x 22-1/2"	DW5812	3/4"	16"	21-1/2"	DW5881	1-1/4"	18"	22-1/2"
		DW5815	7/8"	8"	13-1/2"				
		DW5816	7/8"	16"	21-1/2"				
Description	Open Head U-Flute Design								

**NO BREAK
GUARANTEE™**



HOLLOW DRILL BITS

SDS-Plus Carbide Hollow Drill Bit

Approvals



Shank / Tip

SDS+



Tool

Rotary hammer with SDS + or SDS Max type chuck

Base Materials

Concrete Block Brick and Soft Stone

Size Range

1/2" x 14-1/2" to 1-1/2" x 47-1/4"

Description

Hollow Bit conducts dust away from drill hole via DEWALT DustX+ System



SDS+

CAT #	DIA	OVERALL LENGTH	USABLE LENGTH
DWA54038	3/8"	9 3/4"	14-1/2"
DWA54012	1/2"	14-1/2"	9-3/4"
DWA54916	9/16"	14-1/2"	9-3/4"
DWA54058	5/8"	14-1/2"	9-3/4"
DWA54034	3/4"	14-1/2"	9-3/4"

SDS-Max Carbide Hollow Drill Bit

Approvals



Shank / Tip

SDS Max



Tool

Rotary hammer with SDS + or SDS Max type chuck

Base Materials

Concrete Block Brick and Soft Stone

Size Range

1/2" x 14-1/2" to 1-1/2" x 47-1/4"

Description

Hollow Bit conducts dust away from drill hole via DEWALT DustX+ System

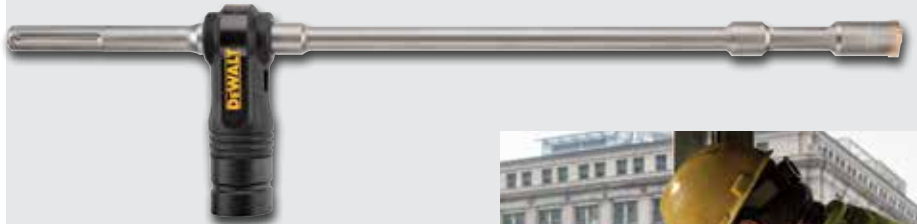

SDS MAX

CAT #	DIAMETER	OVERALL LENGTH	USABLE LENGTH
DWA58058	5/8"	23-5/8"	15-3/4"
DWA58034	3/4"	23-5/8"	15-3/4"
DWA58078	7/8"	23-5/8"	15-3/4"
DWA58001	1"	23-5/8"	15-3/4"
DWA58116	1 1/16"	23-5/8"	15-3/4"
DWA58118	1-1/8"	23-5/8"	15-3/4"
DWA58958	5/8"	39- 3/8"	47-1/4"
DWA58934	3/4"	39- 3/8"	47-1/4"
DWA58978	7/8"	39- 3/8"	47-1/4"
DWA58901	1"	39- 3/8"	47-1/4"
DWA58918	1-1/8"	39- 3/8"	47-1/4"
DWA58114	1-1/4"	39- 3/8"	47-1/4"
DWA58138	1-3/8"	39- 3/8"	47-1/4"
DWA58112	1-1/2"	39- 3/8"	47-1/4"



ANCHOR ACCESSORIES

Installation Hand Tools and Accessories



HAMMER/SLEDGE

CAT #	DESCRIPTION	PACK
DWHT51064	22Oz. One-Piece Steel Hammer Head Length 5-1/2"; Head Weight 22Oz. Overall Length 16" Overall Weight 2 Lbs.	1
J1433G	Proto 2.5lb Sledge Hammer	1



MICROMETER TORQUE WRENCHES

CAT #	DRIVE SIZE	TORQUE RANGE	HEAD WIDTH	HEAD DEPTH	OVERALL LENGTH	PACK
DWMT75463	3/8	20-100 ft-lbs	1-9/16"	78	17-5/16"	1
DWMT75462	1/2	50-250 ft-lbs	-	1	27-1/2"	1



DRIVE IMPACT RATED UNIVERSAL SOCKETS SET

CAT #	DESCRIPTION	PACK
DWMT19228	3/8 in Drive Impact Universal Socket Set (12pc): SAE 5/16 3/8 7/16 1/2 9/16 5/8 11/16 3/4 13/16 7/8 15/16 1	1
DWMT19240	1/2" Drive 6pt Impact Socket Set (19pc): SAE 3/8 7/16 1/2 9/16 5/8 11/16 3/4 13/16 7/8 15/16 1 1-1/16 1-1/8 1-3/16 1-1/4 1-5/16 1-3/8 1-7/16 1-1/2.	1



MANUAL SOCKETS FOR ATOMIC UNDERCUT+ AND POWER-STUDS

CAT #	ANCHOR DIAMETER	SOCKET SIZE	SOCKET DRIVE	PACK
DWMT88977	1/4"	7/16"	3/8" Drive	1
DWMT86443	1/4"	7/16"	1/2" Drive	1
DWMT88979	3/8"	9/16"	3/8" Drive	1
DWMT86445	3/8"	9/16"	1/2" Drive	1
DWMT88982	1/2"	3/4"	3/8" Drive	1
DWMT86449	1/2"	3/4"	1/2" Drive	1
DWMT19573	5/8"	15/16"	3/8" Drive	1
DWMT86453	5/8"	15/16"	1/2" Drive	1
DWMT86457	3/4"	1-1/8"	1/2" Drive	1
DWMT17211	7/8"	1-15/16"	1/2" Drive	1
DWMT17227	1"	1-1/2"	1/2" Drive	1
DWMT74658	1-1/4"	1-7/8"	1/2" Drive	1

MANUAL SOCKETS FOR POWER BOLTS

DWMT88980	1/2"	5/8"	3/8" Drive	1
DWMT88766	1/2"	5/8"	1/2" Drive	1
DWMT88982	5/8"	3/4"	3/8" Drive	1
DWMT86449	5/8"	3/4"	1/2" Drive	1
DWMT19573	3/4"	15/16"	3/8" Drive	1
DWMT86453	3/4"	15/16"	1/2" Drive	1

MANUAL SOCKETS FOR LOK BOLT ACORN NUT & HEX HEAD

DWMT88976	1/4"	3/8"	3/8" Drive	1
DWMT88977	5/16"	7/16"	3/8" Drive	1
DWMT88978	3/8"	1/2"	3/8" Drive	1
DWMT88979	1/2"	9/16"	3/8" Drive	1
DWMT88982	5/8"	3/4"	3/8" Drive	1
DWMT19573	3/4"	15/16"	3/8" Drive	1



IMPACT RATED SOCKETS FOR SCREW-BOLT+ AND WEDGE-BOLT 316 SS

CAT #	ANCHOR DIAMETER	SOCKET SIZE	SOCKET DRIVE	PACK
DWMT74479	1/4"	7/16"	3/8" Drive	1
DWMT75122	3/8"	9/16"	1/2" Drive	1
DWMT75113	1/2"	3/4"	1/2" Drive	1
DWMT75104	5/8"	15/16"	1/2" Drive	1
DWMT75125	3/4"	1-1/8"	1/2" Drive	1



IMPACT RATED DEEP SOCKET FOR HANGERMATE+ EXTERNALLY THREADED CONCRETE ANCHOR

CAT #	NOM ANCHOR SIZE	SOCKET SIZE	PACK
DWMT73934	3/8"	1/2"	1



IMPACT RATED SOCKET FOR HANGERMATE+ EXTERNALLY THREADED CONCRETE ANCHOR

CAT #	NOM ANCHOR SIZE	SOCKET SIZE	PACK
DW2286	3/8"	3/8"	1



20V MAX* THREADED ROD CUTTER KIT

CAT #	DESCRIPTION	PACK
DCS350D1	Kit Includes: DCS371B Threaded Rod Cutter DCB203 2 Ah Lithium Ion Battery DCB112 Charger(2) DCS3501B3 4 Sided Cutting Dies Cutting Die Adjustment Wrench 1 Cuts 1/4" 3/8" 1/2" Mild Steel Coarse Threaded Rod and 1/4" 3/8" Stainless Steel Coarse Threaded Rod	1



*Maximum initial battery voltage (measured without a workload) is 20 volts. Nominal voltage is 18.

ADHESIVE ACCESSORIES

Hole Cleaning Tools and Accessories



STEEL PREMIUM BRUSHES (REQUIRED FOR AC200+)

CAT #	DESCRIPTION	PACK
PFC1671050	Steel Premium Brush For 7/16" Hole	1
PFC1671100	Steel Premium Brush For 1/2" Hole	1
PFC1671150	Steel Premium Brush For 9/16" Hole	1
PFC1671200	Steel Premium Brush For 5/8" Hole	1
PFC1671225	Steel Premium Brush For 11/16" Hole	1
PFC1671250	Steel Premium Brush For 3/4" Hole	1
PFC1671300	Steel Premium Brush For 7/8" Hole	1
PFC1671350	Steel Premium Brush For 1" Hole	1
PFC1671400	Steel Premium Brush For 1-1/8" Hole	1
PFC1671450	Steel Premium Brush For 1-3/8" Hole	1
PFC1671500	Steel Premium Brush For 1-1/2" Hole	1
PFC1671000	Premium Manual Brush Wood Handle	1
PFC1671010	Premium Brush Extension	1
PFC1671820	Premium Steel Brush Extension 12"	1
PFC1671830	Premium Steel Brush SDS Adapter	1
PFC1671960	Premium Steel Brush Drill Chuck Adapter	1



WIRE BRUSHES

CAT #	DESCRIPTION	PACK
08271-PWR	Wire Brush For 2" Hole	
08272-PWR	Wire Brush For 2-3/16" Hole	
08275-PWR	Wire Brush For 5/8" ANSI Hole	1
08284-PWR	Wire Brush For 7/16" ANSI Hole	1
08287-PWR	Wire Brush For 7/8" ANSI Hole	1
08285-PWR	Wire Brush For 9/16" ANSI Hole	1
08278-PWR	Wire Brush For 3/4" ANSI Hole	1
08286-PWR	Wire Brush For 11/16 In ANSI Hole	1
08288-PWR	Wire Brush For 1" ANSI Hole	1
08289-PWR	Wire Brush For 1-1/8" ANSI Hole	1

WIRE BRUSHES CONTINUED

CAT #	DESCRIPTION	PACK
08290-PWR	Wire Brush For 1-3/8" ANSI Hole	1
08291-PWR	Wire Brush For 1-1/2" ANSI Hole	1
08299-PWR	Wire Brush For 1-3/4" Hole	1
08282-PWR	Brush Extension 12"	1
08283-PWR	SDS Plus Adapter For Wire Brush	1
08296-PWR	Jacobs Chuck Adapter	1

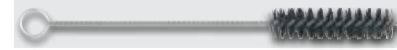

NYLON BRUSHES

CAT #	DESCRIPTION	PACK
07931-PWR	Nylon Brush For 7/16" ANSI Hole	1
07932-PWR	Nylon Brush For 9/16" ANSI Hole	1
07933-PWR	Nylon Brush For 3/4" ANSI Hole	1
07934-PWR	Nylon Brush For 1" to 1-1/8" ANSI Hole	1
07935-PWR	Nylon Brush For 1-1/4" ANSI Hole	1
52073-PWR	Adhesive Cleaning Kit	1



AIR NOZZLE

CAT #	DESCRIPTION	PACK
08292-PWR	Air Nozzle W/Extension	1



HAND PUMP

CAT #	DESCRIPTION	PACK
08280-PWR	Hand Pump / Dust Blower 25oz.	1

Dispensing Tools



STANDARD MANUAL DISPENSERS

CAT #	DESCRIPTION	PACK	CTN
08437-PWR	Standard Quik-Shot Manual Dispenser 9/9.5oz	1	432
08485-PWR	Standard 10:1 Manual Dispenser 11.5 oz	1	144
08298-PWR	Standard 3:1 Manual Dispenser 13oz & 19.5oz	1	80
08409-PWR	Standard 1:1 Manual Dispenser 20.5oz	1	96
08494-PWR	Standard 10:1 Manual Dispenser 28oz	1	60



PNEUMATIC DISPENSERS

CAT #	DESCRIPTION	PACK
8497SD-PWR	Pneumatic 3:1 Dispenser 13oz & 19.5oz	1
08459-PWR	Pneumatic 1:1 Dispenser 20.5oz	1
8496SD-PWR	Pneumatic 10:1 Dispenser 28oz	1
08438-PWR	Pneumatic 1:1 Dispenser 50.5	1



CORDESS 20V DISPENSERS

CAT #	DESCRIPTION	PACK
DCE560B	20V Quik-Shot Dispenser Bare	1
DCE560D1	20V Quik-Shot Dispenser Kitte	1
DCE593B	20V Epoxy Dispenser 3:1 13/19.5oz Bare	1
DCE593D1	20V Epoxy Dispenser 3:1 13/19.5oz Kit	1
DCE591B	20V Epoxy Dispenser 1:1 20.5oz Bare	1
DCE591D1	20V Epoxy Dispenser 1:1 20.5oz Kit	1
DCE595B	20V Acrylic Dispenser 10:1 28oz Bare	1
DCE595D1	20V Acrylic Dispenser 10:1 28oz Kit	1

ADHESIVE ACCESSORIES

Mixing Nozzles and Nozzle Extensions



MIXING NOZZLES

CAT #	DESCRIPTION	PACK	CTN
PFC1641600	AC200+/PURE110+/PURE50+ QUIKSHOT NOZZLE	2	21
08609-PWR	PURE110+ 20.5/50.5 OZ HIGH FLOW NOZZLE	2	24
08293-PWR	AC100+GOLD 9.5/11.5 OZ NOZZLE	2	24
08294-PWR	PE1000/AC50/PURE GP NOZZLE	2	24
08281-PWR	MIXER EXTENSION 8"	1	12



FLEXIBLE EXTENSIONS

CAT #	DESCRIPTION	PACK	CTN
08297-PWR	Extension Tubing	1	12
PFC1640600	Flexible Extension Hose 25 Ft	1	12

Adhesive Piston Plugs



STANDARD PISTON PLUGS

CAT #	DESCRIPTION	ANSI BIT DIA	ROD DIA	REBAR SIZE	PACK
08302-PWR	9/16" Plug	9/16"	1/2"	#4	10
08304-PWR	5/8" Plug	5/8"	-	#4	10
08258-PWR	11/16" Plug	11/16"	5/8"	#5	10
08259-PWR	3/4" Plug	3/4"	5/8"	#5	10
08300-PWR	7/8" Plug	7/8"	3/4"	#6	10
08301-PWR	1" Plug	1"	7/8"	#7	10
08303-PWR	1-1/8" Plug	1-1/8"	1"	#8	10
08305-PWR	1-3/8" Plug	1-3/8"	1-1/4"	#9	10
08309-PWR	1-1/2" Plug	1-1/2"	-	#10	10



NEW!

PREMIUM PISTON PLUGS

CAT #	DESCRIPTION	ANSI BIT DIA	ROD DIA	REBAR SIZE	PACK
PFC1691510	Premium Plug	5/8" Hole	-	#4	1
PFC1691515	Premium Plug	11/16" Hole	5/8"	-	1
PFC1691520	Premium Plug	3/4" Hole	5/8"	#5	1
PFC1691530	Premium Plug	7/8" Hole	3/4"	#6	1
PFC1691540	Premium Plug	1" Hole	7/8"	#7	1
PFC1691550	Premium Plug	1-1/8" Hole	1"	#8	1
PFC1691560	Premium Plug	1-3/8" Hole	1-1/4"	#9	1
PFC1691570	Premium Plug	1-1/2" Hole	-	#10	1
PFC1691580	Premium Plug	1-3/4" Hole	1-1/2"	#11	1
PFC1691590	Premium Plug	2" Hole	2"	#14	1
PFC1691600	Premium Plug	12-3/16" Hole	2-3/16"	-	1

Screen Tubes



PLASTIC SCREEN TUBES

CAT #	DESCRIPTION	DRILL DIAMETER	PACK
08470-PWR	1/4" x 1-3/4"	1/2"	25
08310-PWR	3/8" x 3-1/2"	9/16"	25
08311-PWR	3/8" x 6"	9/16"	25
08313-PWR	3/8" x 8"	9/16"	25
08315-PWR	1/2" x 3-1/2"	3/4"	25
08317-PWR	1/2" x 6"	3/4"	25
08321-PWR	5/8" x 6"	7/8"	25
08323-PWR	3/4" x 6"	1"	10



STAINLESS STEEL SCREEN TUBES

CAT #	DESCRIPTION	DRILL DIAMETER	PACK
07960-PWR	1/4" x 2"	3/8"	25
07862-PWR†	1/4" x 6"	3/8"	25
07864-PWR†	1/4" x 8"	3/8"	25
07866-PWR	1/4" x 10"	3/8"	25
07856-PWR	3/8" x 2"	1/2"	25
07961-PWR	3/8" x 3-1/2"	1/2"	25
07962-PWR†	3/8" x 6"	1/2"	25
07963-PWR†	3/8" x 8"	1/2"	25
07964-PWR†	3/8" x 10"	1/2"	25
07959-PWR†	3/8" x 12"	1/2"	25
07857-PWR	1/2" x 2"	5/8"	25
07965-PWR	1/2" x 3-1/2"	5/8"	25
07966-PWR†	1/2" x 6"	5/8"	25
07967-PWR†	1/2" x 8"	5/8"	25
07968-PWR†	1/2" x 10"	5/8"	25

CAT #	DESCRIPTION	DRILL DIAMETER	PACK
07858-PWR	5/8" x 2"	3/4"	25
07969-PWR	5/8" x 4-1/2"	3/4"	20
07970-PWR	5/8" x 6"	3/4"	20
07971-PWR†	5/8" x 8"	3/4"	20
07972-PWR†	5/8" x 10"	3/4"	20
07859-PWR	3/4" x 2"	7/8"	25
07973-PWR	3/4" x 6"	7/8"	10
07977-PWR	3/4" x 8"	7/8"	10
07974-PWR	3/4" x 10"	7/8"	10
07975-PWR	3/4" x 13"	7/8"	10
07978-PWR	3/4" x 17"	7/8"	10
07855-PWR	15/16" x 2"	1"	25
07865-PWR	15/16" x 8"	1"	10
07867-PWR	15/16" x 13"	1"	25
07869-PWR†	15/16" x 18"	1"	10

† Includes extension tubes

DIRECT FASTENING

Cordless Concrete Nailing System

Type	Cordless Direct Fastening System
Approvals	ICC-ES ESR-4076
Base Materials	Hollow block concrete and steel
Anchor Size Range	1/2" - 2-1/4" length .102 to .145 diameter
Tool Platform	DeWALT 20V MAX*

*Maximum initial battery voltage (measured without a workload) is 20 volts. Nominal voltage is 18.



20V MAX* 1" MAGAZINE CORDLESS CONCRETE NAILER (TOOL ONLY)

- CAT # DESCRIPTION**
- DCN891B Includes:
- DCN891 20V MAX* Cordless Concrete Nailer
 - (1) DCN8904 Standard / Drywall Nose Piece
 - Kit box



20V MAX* 1" MAGAZINE CORDLESS CONCRETE NAILER KIT

- CAT # DESCRIPTION**
- DCN891P2 Includes:
- DCN891 20V MAX* Cordless Concrete Nailer
 - (2) DCB205 20V MAX* XR Lithium Ion Batteries (5 Ah)
 - (1) DCB115 Charger
 - (1) DCN8904 Standard / Drywall Nose Piece
 - Kit box



20V MAX* XR® CORDLESS CONCRETE NAILER KIT

- CAT # DESCRIPTION**
- DCN890P2 Includes:
- DCN891 20V MAX* Cordless Concrete Nailer
 - (2) DCB205 5.0Ah Batteries
 - DCB115 Charger
 - DCN8904 Standard/Drywall Contact Trip
 - Kit box



CONCRETE FASTENERS

CAT #	SHANK DIAMETER	SHANK LENGTH	PACK	CTN
DCN890075	0.102"	3/4"	1000	6000
DCN890100	0.102"	1"	1000	6000
DCN890125	0.102"	1-1/4"	1000	6000
DCN890150	0.102"	1-1/2"	1000	6000
DCN8912075	0.120"	3/4"	1000	6000
DCN890225	0.137"	2-1/4"	500	3000
DCN891075	0.145"	3/4"	1000	6000

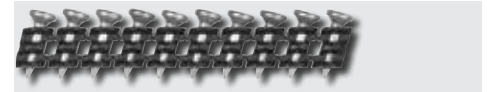

STEEL FASTENERS

CAT #	SHANK DIAMETER	SHANK LENGTH	PACK	CTN
DCN8910500	0.120"	1/2"	1000	6000



SPECIALTY FASTENERS

CAT #	SHANK DIAMETER	SHANK LENGTH	STEP DIAMETER	PACK	CTN
DCN8907804	0.102"	0.78"	0.088"	1000	6000
DCN8941380	0.108"	1-3/8"	-	1000	6000
DCN8910680	0.120"	0.68"	0.102"	1000	6000
DCN8917300	0.120"	0.73"	0.102"	1000	6000

K: Knurled S: Step T: Tapered Z: Zinc YZ: Yellow Zinc

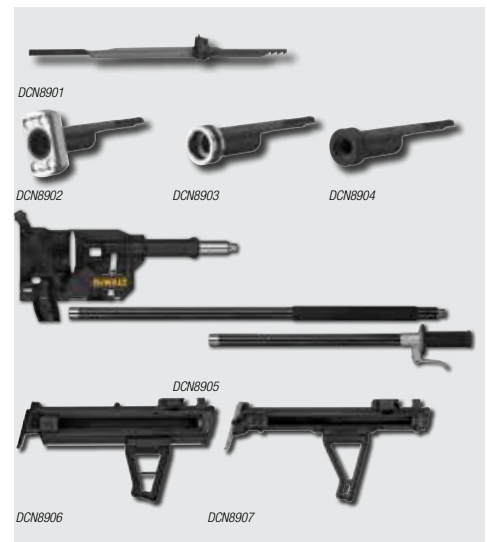

ACCESSORIES

CAT #	SIZE	PACK	CTN
DCN8905	6' Pole Tool (for Cordless Concrete Nailer only). Pole tool can be used as 3' or 6' extension	1	-
DCN8902	Magnetic Stick-E Contact Trip (nosepiece)	1	40
DCN8901	Replacement Driver Blade	1	40
DCN8904	Standard / Drywall Contact Trip (nosepiece)	1	40
DCN8903	Stick-E Contact Trip (nosepiece)	1	40
DCN8907	1" Deep Tool Magazine	1	-
DCN8906	2-1/4" Deep Tool Magazine	1	-

DIRECT FASTENING

STICK-E™ Direct Fastening Assemblies



STICK-E WASHERS



CAT #	DESCRIPTION	PACK	CTN
DFD405112	Stick-E Strap Metal Washer 1/2"	100	1000
DFD405102	Stick-E Stainless Steel Sealing Washer 3/4"	100	1000
DFD405101	Stick-E Lathing Washer 1"	100	1000
DFD405610	Stick-E Square Washer 1"	100	1000
DFD405100	Lathing Washer (No Stick-E) 1"	100	1000
DFD405901	Stick-E Denz Glass Washer 1-1/4"	250	2500
DFD405716	Stick-E Insulation Washer 1-7/16"	100	1000

STICK-E CEILING CLIP ASSEMBLIES



CAT #	DESCRIPTION	PACK	CTN
DFD405530	Stick-E Right Angle Clip 90°	100	1000
DFD405550	Stick-E Angle Clip 60°	100	1000

STICK-E™ DIRECT FASTENING ASSEMBLIES



CAT #	DESCRIPTION	PACK	CTN
DFD405338	Stick-E BX Clip 3/8"	100	1000
DFD405312R	Stick-E Mini Conduit Clip 1/2"	100	1000
DFD405334R	Stick-E Mini Conduit Clip 3/4"	100	1000
DFD405310R	Stick-E Mini Conduit Clip 1"	100	1000

STICK-E™ CONDUIT CLIP ASSEMBLIES



CAT #	DESCRIPTION	PACK	CTN
DFD405412	Stick-E Conduit Clamp 1/2"	50	200
DFD405434	Stick-E Conduit Clamp 3/4"	50	200
DFD405410	Stick-E Conduit Clamp 1"	50	100

STICK-E CONDUIT STRAP ASSEMBLIES

STICK-E ROD HANGING ASSEMBLIES



STICK-E™ ROD HANGER AND NUT

CAT #	ROD DIAMETER	PACK	CTN
DFD405214	Stick-E Rod Hanger 1/4"-20	100	1000
DFD405238	Stick-E Rod Hanger 3/8"-16	100	1000

STICK-E™ POST NUT ROD HANGER

CAT #	ROD DIAMETER	PACK	CTN
DFD405215	Stick-E Post Nut Rod Hanger 1/4"-20	100	1000
DFD405239	Stick-E Post Nut Rod Hanger 3/8"-16	100	1000

STICK-E™ MISC. ASSEMBLIES



CAT #	REBAR SIZE	PACK	CTN
DFD405902	Stick-E Cable Tie Donut 1-1/4"	100	1000
DFD405300	Stick-E Rebar/Dowel Basket Clip	100	1000

SELECTION GUIDE

		Dimensions		Base				DEWALT Tools							Other Tools							ICC-ES Approvals			
		Shank Length	Shank Diameter	Concrete	Lightweight Concrete	Grout-filled CMU	Steel	DFD270	P1000	T1000	P2201	P35s	P3500/PA3500	P3600	Sniper	SA270	Cobra	Viper / Viper 4	XT540	DX35	DX351		DX2	DX460 / DX5	
Pins	Spiral CSI Drive Pins	1/2" to 1-1/2"	0.157"	●	●	●	●	●			○	●	●	●	●	●	●	●	●	●	●	●	●	●	ESR-2024
	Spiral CSI Drive Pins	2" to 2-7/8"	0.157"	●	●	●	●	●			○	●	●	●	●	●	●	●	●	●	●	●	●	●	ESR-2024
	Spiral CSI Drive Pins Collated	5/8" to 2"	0.157"					●								●			●		○		●	●	ESR-2024
	Spiral CSI Drive Pins with Washer	3/4" to 2-7/8"	0.157"	●	●	○	○	●			○	●	●	●	●	●	●	●	○	●	●	●	●	●	ESR-2024
0.300" Head Drive Pins	0.300" Head Drive Pins	1/2" to 1-1/2"	0.145"	●	●	●	●	●	●	●	●	●	●	●	●	●	●	●	●	●	●	●	●	●	ESR-2024
	0.300" Head Drive Pins	1-3/4" to 3"	0.145"	●	●	○	○	●	●	●	●	●	●	●	●	●	●	●	●	●	●	●	●	●	ESR-2024
	0.300" Head Drive Pins with Top Hat	1/2" to 1"	0.145"	●	●	○	○	●	●	●	●	●	●	●	●	●	●	●	●	●	○	●	●	●	ESR-2024
	0.300" Head Drive Pins with Washer	3/4" to 1-1/2"	0.145"	●	●	●	●	●	●	●	●	●	●	●	●	●	●	●	●	●	●	●	●	●	ESR-2024
	0.300" Head Drive Pins with Washer	2" to 3"	0.145"	●	●	○		●	●	●	●	●	●	●	●	●	●	●	●	●	●	●	●	●	ESR-2024
8mm Head Drive Pins	8mm Head Drive Pins with Top Hat	5/8" to 1"	0.145"	●	●	●	●	●	●	●	●	●	●	●	●	●	●	●	●	●	●	●	●	●	ESR-2024
	8mm Head Drive Pins with Washer	1" to 1-1/2"	0.145"	●	●	●	●	●	●	●	●	●	●	●	●	●	●	●	●	●	●	●	●	●	ESR-2024
	8mm Head Drive Pins with Washer	2" to 2-7/8"	0.145"	●	●	●	○	●	●	●	●	●	●	●	●	●	●	●	●	●	●	●	●	●	ESR-2024
Threaded Studs	1/4"-20 Threaded Studs	1/2" to 1-1/4"	0.145"	●	●	●	●	●	○	○	●	●	●	●	●	●	●	●	●	●	●	●	●	●	ESR-2024
	3/8"-16 Threaded Studs	3/4" to 1-1/4"	0.205"	●	●	○	●						●												ESR-2024
Rod Hangers	Rod Hangers and Post Nut Hangers (0.300" 8mm)	1-1/8" to 1-1/4"	0.145"	●	●	○	●	●			○	●	●	●	●	●	●	●	●	●	●	●	●	●	ESR-2024
Clips & Assemblies	Drive Pins with Ceiling Clip (0.300" 8mm)	1" to 1-1/4"	0.145" / 0.157"	●	●		●	●			○	●	●	●	●	●	●	●	●	●	●	●	●	●	ESR-2024
	Drive Pins with BX-EMT Conduit Clip (0.300" 8mm)	1" to 1-1/4"	0.145"	●	●	●	●	●	●	●	●	●	●	●	●	●	●	●	●	●	●	●	●	●	
	Drive Pins with Rebar Basket Clip (8mm)	2-7/16" 2-7/8"	0.145"	●	●	○	○	●	●	●	●	●	●	●	●	●	●	●	●	●	●	●	●	●	

● Suitable ○ May Be Suitable

	Load Power					DEWALT Tools							Examples of Other Tools*											
	Gray—Level 1	Brown—Level 2	Green—Level 3	Yellow—Level 4	Red—Level 5	P1000 / T1000	P2201	P35s	P3500/PA3500	P3600	Sniper	DFD270	SA270	Cobra / Cobra+	Viper / Viper4	DX E37	DX600N	DX35	DX351	DX460 / DX5	DX2			
Loads	22 Caliber Single (Short) Loads	●	●	●	●	●	●									●								
	27 Caliber Single (Long) Loads					●											●							
	25 Caliber 10-Load Strip			●	●	●		●										●						
	27 Caliber 10-Load Safety Strip		●	●	●	●			●	●	●	●	●	●	●	●					●	●	●	●

* The indicated powder loads are generally compatible for form and fit in the examples given.

POWDER ACTUATED

P3600 Tool

Description	Trigger-Actuated Semi-Automatic Powder-Actuated Tool Tool Length: 13-5/8" Tool Weight: 5.0 lbs.
Load Type	.27 Caliber (Short) Load Safety Strips Brown (2) Green (3) Yellow (4) Red (5)
Pin Type	0.300" and 10mm Head Drive Pins 3/8" Head Drive Pins 3/8" Threaded Studs
Pin Length	1/2" - 3"



P3600			
CAT #	DESCRIPTION	PACK	CTN
52010-PWR	P3600 Tool (Deluxe Kit)	1	-



Sniper™ Tool

Description	Bump-Fire Powder-Actuated Tool for Over-head Applications Tool Length: 17" Tool Weight: 4.0 lbs.
Load Type	.27 Caliber (Short) Load Safety Strips Brown (2) Green (3) Yellow (4) Red (5)
Pin Type	0.300" and 8mm Head Drive Pins
Pin Length	1/2" - 1-1/2"



SNIPER TOOL			
CAT #	DESCRIPTION	PACK	CTN
52051-PWR	Sniper Tool (Kit)	1	-

DFD270 Tool

Description	Trigger-Actuated Fully-Automatic Powder-Actuated Tool Tool Length: 18" Tool Weight: 7.1 lbs.
Load Type	.27 Caliber (Short) Load Safety Strips Brown (2) Green (3) Yellow (4) Red (5)
Pin Type	0.300" and 8mm Head Drive Pins 1/4"-20 Threaded Studs
Pin Length	1/2" to 2-7/8"



P35s			
CAT #	DESCRIPTION	PACK	
DFD270SK	DFD270 Tool Single Shot (Deluxe Kit)	1	
DFD270MK	DFD270 Tool Single Shot and Magazine (Deluxe Kit)	1	

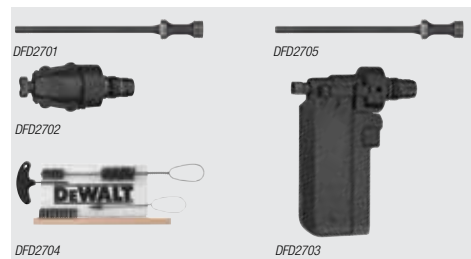

ACCESSORIES			
CAT #	DESCRIPTION	PACK	CTN
DFD2704	Cleaning Kit for DFD270 Tool	1	
DFD2705	Replacement Driver Piston for DFD270 Tool (Flat for CSI and 8mm Head Drive Pins)	1	40
DFD2701	Replacement Driver Piston for DFD270 Tool (Flat for .300" Head Drive Pins)	1	40
DFD2703	Magazine Nose Piece for DFD270	1	
DFD2702	Replacement Single Shot Nose Piece for DFD270 Tool	1	

POWDER ACTUATED

P1000 Tool

Description	Hammer-Actuated Semi-Automatic Powder-Actuated Tool Tool Length: 13" Tool Weight: 3.0 lbs.
Load Type	.22 Caliber (Short) Brown (2) Green (3) Yellow (4)
Pin Type	0.300" and 8mm Head Drive Pins 1/4"-20 Threaded Studs
Pin Length	1/2" – 3"



P1000

CAT #	DESCRIPTION	PACK	CTN
DDF211000P	P1000 Tool (Blister Pack)	1	5

T1000 Tool

Description	Trigger-Actuated Semi-Automatic Powder-Actuated Tool Tool Length: 13" Tool Weight: 3.0 lbs.
Load Type	.22 Caliber (Short) Brown (2) Green (3) Yellow (4)
Pin Type	0.300" and 8mm Head Drive Pins 1/4"-20 Threaded Studs
Pin Length	1/2" – 3"



P1000

CAT #	DESCRIPTION	PACK	CTN
DDF211010P	T1000 Tool (Blister Pack)	1	5

P2201 Tool

Description	Trigger-Actuated Semi-Automatic Powder-Actuated Tool Tool Length: 12-1/2" Tool Weight: 4.3 lbs.
Load Type	.22 Caliber (Short) Brown (2) Green (3) Yellow (4)
Pin Type	0.300" and 8mm Head Drive Pins 1/4"-20 Threaded Studs
Pin Length	1/2" – 3"



P35s

CAT #	DESCRIPTION	PACK	CTN
DDF211022P	P2201 Tool (Blister Pack)	1	4

Powder Actuated Tool Operation: Powder actuated tools may be used only by properly trained and licensed operators as described in ANSI Standard A 10.3. For complete tool operation details completely review the tool manual and contact your local DEWALT branch office or distributor for training.

POWDER ACTUATED

P35s Tool

Description	Trigger-Actuated Semi-Automatic Powder-Actuated Tool Tool Length: 11-1/4" Tool Weight: 4.3 lbs.
Load Type	.25 Caliber Load Strips Green (3) Yellow (4) Red (5)
Pin Type	0.300" and 8mm Head Drive Pins 1/4"-20 Threaded Studs
Pin Length	1/2" – 1-1/2"



P35s			
CAT #	DESCRIPTION	PACK	CTN
52002-PWR	P35s Tool (Deluxe Kit)	1	-



P3500 Tool

Description	Trigger-Actuated Semi-Automatic Powder-Actuated Tool Tool Length: 13-5/8" Tool Weight: 5.0 lbs.
Load Type	.27 Caliber (Short) Load Safety Strips Brown (2) Green (3) Yellow (4) Red (5)
Pin Type	0.300" and 8mm Head Drive Pins 1/4"-20 Threaded Studs
Pin Length	1/2" – 3"



P3500			
CAT #	DESCRIPTION	PACK	CTN
DDF212035P	P3500 Tool (Blister)	1	-
52000-PWR	P3500 Tool (Deluxe Kit)	1	-



PA3500 Tool

Description	Trigger-Actuated Semi-Automatic Powder-Actuated Tool with Adjustable Power Tool Length: 13-5/8" Tool Weight: 5.0 lbs.
Load Type	.27 Caliber (Short) Load Safety Strips Brown (2) Green (3) Yellow (4) Red (5)
Pin Type	0.300" and 8mm Head Drive Pins 1/4"-20 Threaded Studs
Pin Length	1/2" – 3"



PA3500			
CAT #	DESCRIPTION	PACK	CTN
52019-PWR	PA3500 Tool (Deluxe Kit)	1	-



Powder Actuated Tool Operation: Powder actuated tools may be used only by properly trained and licensed operators as described in ANSI Standard A 10.3. For complete tool operation details completely review the tool manual and contact your local DEWALT branch office or distributor for training.

POWDER ACTUATED

Accessories

ACCESSORIES

CAT #	DESCRIPTION	PACK
50065-PWR	6' Pole Tool	1
50066-PWR	8' Pole Tool	1
52053-PWR	6' Pole Tool for Sniper Tool	1
52061-PWR	8' Pole Tool for Sniper Tool	1
52070-PWR	Tool Cleaning Kit for P3500 / P35s Tools	1



PAT POWDER LOADS

Powder Loads

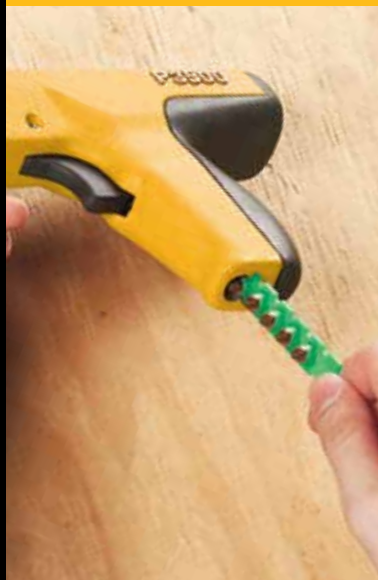

.22 CALIBER (SHORT) LOADS

CAT #	SIZE	LOAD POWER	PACK	CTN
50502-PWR	.22 Short	Brown (2)	100	10000
50504-PWR	.22 Short	Green (3)	100	10000
50506-PWR	.22 Short	Yellow (4)	100	10000



.27 CALIBER (LONG) LOADS

CAT #	SIZE	LOAD POWER	PACK	CTN
50612-PWR	.27 Long	Red (5)	100	10000



.25 CALIBER (SHORT) LOAD STRIPS

CAT #	SIZE	LOAD POWER	PACK	CTN
50570-PWR	.25 Strip	Green (3)	100	10000
50572-PWR	.25 Strip (Master Pack)	Green (3)	1000	10000
50574-PWR	.25 Strip	Yellow (4)	100	10000
50576-PWR	.25 Strip (Master Pack)	Yellow (4)	1000	10000
50578-PWR	.25 Strip	Red (5)	100	10000
50580-PWR	.25 Strip (Master Pack)	Red (5)	1000	20000

.25 CALIBER DISK LOADS

50536-PWR	.25 DISK YELLOW	Yellow (4)	100	10000
-----------	-----------------	------------	-----	-------

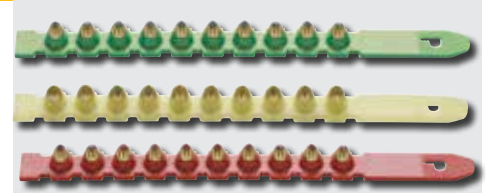

.27 CALIBER (SHORT) SAFETY STRIP LOAD

CAT #	SIZE	LOAD POWER	PACK	CTN
50620-PWR	.27 Safety Strip	Brown (2)	100	10000
50622-PWR	.27 Safety Strip	Green (3)	100	10000
50624-PWR	.27 Safety Strip (Master Pack)	Green (3)	1000	10000
50626-PWR	.27 Safety Strip	Yellow (4)	100	10000
50628-PWR	.27 Safety Strip (Master Pack)	Yellow (4)	1000	10000
50630-PWR	.27 Safety Strip	Red (5)	100	10000

POWDER ACTUATED

0.300" Head Drive Pins

Type Fasteners for Powder Actuated Tools

Approvals ICC-ES ESR-2024



Description For permanent fastening
 Knurled shank for increased performance in steel base materials
 Top hat pins for fastening drywall track to concrete or steel. Top hat provides extra bearing surface against the drywall track.
 Washered pins provide resistance to pullover. Pre-assembled with 14 gauge metal washers.
 Mechanically galvanized pins for fastening through pressure treated lumber. Available with washer for increased pullover resistance

Base Materials Concrete some types of masonry and A36 structural steel

K = Knurled
 BO = Black Oxide



0.300" DIAMETER HEAD DRIVE PINS

CAT #	SHANK DIAMETER	SHANK LENGTH	PACK	CTN
50012-PWR	0.145"	1/2" (K)	100	5000
50016-PWR	0.145"	5/8" (K)	100	5000
50022-PWR	0.145"	3/4"	100	5000
50023-PWR	0.145"	3/4" (black)	100	5000
50026-PWR	0.145"	1"	100	5000
50032-PWR	0.145"	1-1/4"	100	1000
50034-PWR	0.145"	1-1/2"	100	1000
50038-PWR	0.145"	2"	100	1000
50040-PWR	0.145"	2-1/4"	100	1000
50044-PWR	0.145"	2-1/2"	100	1000
50048-PWR	0.145"	3"	100	1000



0.300" DIAMETER HEAD DRIVE PINS (MECHANICALLY GALVANIZED)

CAT #	SHANK DIAMETER	SHANK LENGTH	PACK	CTN
50038MG-PWR	0.145"	2"	100	1000
50045MG-PWR	0.145"	2-1/2"	100	1000
50047MG-PWR	0.145"	3"	100	1000



0.300" DIAMETER HEAD DRIVE PINS WITH TOP HAT

CAT #	SHANK DIAMETER	SHANK LENGTH	PACK	CTN
50136-PWR	0.145"	1/2" (K)	100	5000
50140-PWR	0.145"	3/4"	100	5000
50144-PWR	0.145"	1"	100	5000



0.300" DIAMETER HEAD BALLISTIC POINT DRIVE PINS

CAT #	SHANK DIAMETER	SHANK LENGTH	PACK	CTN
50057-PWR	0.181/0.150"	1-7/8"	100	1000

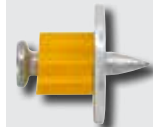

0.300" DIAMETER HEAD DRIVE PINS WITH 3/4" WASHER

CAT #	SHANK DIAMETER	SHANK LENGTH	PACK	CTN
50070-PWR	0.145"	3/4"	100	1000



0.300" DIAMETER HEAD DRIVE PINS WITH 7/8" WASHER

CAT #	SHANK DIAMETER	SHANK LENGTH	PACK	CTN
50090-PWR	0.145"	1"	100	1000
50092-PWR	0.145"	1-1/4"	100	1000
50094-PWR	0.145"	1-1/2"	100	1000
50096-PWR	0.145"	2"	100	1000
50098-PWR	0.145"	2-1/2"	100	1000
50100-PWR	0.145"	3"	100	1000

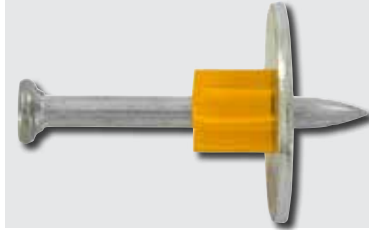

0.300" DIAMETER HEAD DRIVE PINS WITH 1" WASHER

CAT #	SHANK DIAMETER	SHANK LENGTH	PACK	CTN
50108-PWR	0.145"	1-1/4"	100	1000
50110-PWR	0.145"	1-1/2"	100	1000
50112-PWR	0.145"	2"	100	1000
50114-PWR	0.145"	2-1/2"	100	1000
50116-PWR	0.145"	3"	100	1000
50120-PWR*	0.145"	3"	100	1000

*Square Washer

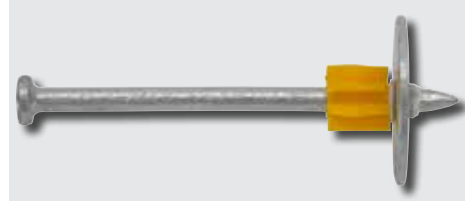

0.300" DIAMETER HEAD DRIVE PINS WITH 1" WASHER (MECHANICALLY GALVANIZED)

CAT #	SHANK DIAMETER	SHANK LENGTH	PACK	CTN
50110MG-PWR	0.145"	1-1/2"	100	1000
50112MG-PWR	0.145"	2"	100	1000
50113MG-PWR	0.145"	2-1/2"	100	1000
50115MG-PWR	0.145"	3"	100	1000



0.300" DIAMETER HEAD DRIVE PINS WITH 1-7/8" INSULATION WASHER

CAT #	SHANK DIAMETER	SHANK LENGTH	PACK	CTN
50122-PWR	0.145"	1-1/2"	100	1000
50126-PWR	0.145"	2-1/2"	50	500

POWDER ACTUATED

CSI Spiral and 8mm Head Drive Pins

Type Fasteners for Powder Actuated Tools

Approvals ICC-ES ESR-2024



Description For permanent fastening
 Knurled shank for increased performance in steel base materials
 Top hat pins for fastening drywall track to concrete or steel. Top hat provides extra bearing surface against the drywall track.
 Washered pins provide resistance to pullover. Pre-assembled with 14 gauge metal washers.
 CSI Spiral (Concrete Steel and I-Beam) pins have a knurled shank for consistent optimized performance in steel base materials

Base Materials Concrete some types of masonry and A36 or A572 structural steel

K = Knurled
 MG = Mechanically Galvanized



CSI SPIRAL DRIVE PINS (8MM HEAD DIAMETER)

CAT #	SHANK DIAMETER	SHANK LENGTH	PACK	CTN
50178-PWR	0.145"	1/2" (13mm) (K)	100	5000
50179-PWR	0.157"	1/2" (13mm)(K)	100	1000
51201-PWR	0.157"	5/8" (16mm) (K)	100	1000
50203-PWR	0.157"	3/4" (19mm) (K)	100	1000
50204-PWR	0.157"	7/8" (22mm) (K)	100	1000
50205-PWR	0.157"	1" (27mm) (K)	100	1000
50208-PWR	0.157"	1-1/4" (32mm) (K)	100	1000
50207-PWR	0.157"	1-1/2" (37mm) (K)	100	1000
50209-PWR	0.157"	2" (52mm) (K)	100	1000
50241-PWR	0.157"	2-1/2" (62mm) (K)	100	1000
50211-PWR	0.157"	2-7/8" (72mm) (K)	100	1000



CSI SPIRAL DRIVE PINS WITH WASHER (8MM HEAD DIAMETER)

CAT #	SHANK DIAMETER	SHANK LENGTH	PACK	CTN
50245-PWR	0.157"	3/4" (19mm) (K)	100	1000
50247-PWR	0.157"	1" (27mm) (K)	100	1000
50261-PWR	0.157"	1-1/4" (32mm) (K)	100	1000
50263-PWR	0.157"	2-1/2" (62mm) (K)	100	1000
50265-PWR	0.157"	2-7/8" (72mm) (K)	100	1000



CSI SPIRAL DRIVE PINS COLLATED (8MM HEAD DIAMETER)

CAT #	SHANK DIAMETER	SHANK LENGTH	PACK	CTN
51440-PWR	0.157"	1/2"(13mm) (K)	100	1000
51450-PWR	0.157"	5/8" (16mm) (K)	100	1000
50452-PWR	0.157"	3/4" (19mm) (K)	100	1000
50454-PWR	0.157"	7/8" (22mm) (K)	100	1000
50456-PWR	0.157"	1" (27mm) (K)	100	1000
50458-PWR	0.157"	1-1/4" (32mm) (K)	100	1000
50460-PWR	0.157"	1-1/2" (37mm) (K)	100	1000
50461-PWR	0.157"	1-5/8" (42mm) (K)	100	1000
50462-PWR	0.157"	2" (52mm) (K)	100	1000
50463-PWR	0.157"	2-1/2" (62mm) (K)	100	1000



8MM DIAMETER HEAD DRIVE PINS WITH TOP HAT

CAT #	SHANK DIAMETER	SHANK LENGTH	PACK	CTN
50210-PWR	0.145"	16mm (5/8") (K)	100	5000
50214-PWR	0.145"	22mm (7/8")	100	5000
50216-PWR	0.145"	27mm (1")	100	5000



8MM DIAMETER HEAD DRIVE PINS WITH 1" WASHER

CAT #	SHANK DIAMETER	SHANK LENGTH	PACK	CTN
50224-PWR	0.145"	37mm (1-1/2")	100	1000



POWDER ACTUATED

Threaded Studs

Type	Fasteners for Powder Actuated Tools
Approvals	ICC-ES ESR-2024
Description	Removeable Accommodates shimming Knurled shank for increased performance in steel base materials
Base Materials	Concrete and A36 structural steel



1/4"-20 THREADED STUDS (UNC THREAD)

CAT #	SHANK DIAMETER	SHANK LENGTH	THREAD DIAMETER	PACK	CTN
50322-PWR	0.145"	1/2" (K)	3/4"	100	1000
50326-PWR	0.145"	3/4"	3/4"	100	1000
50328-PWR	0.145"	1"	1/2"	100	1000
50330-PWR	0.145"	1"	3/4"	100	1000
50336-PWR	0.145"	1-1/4"	3/4"	100	1000
50338-PWR	0.145"	1-1/4"	1-1/4"	100	1000



3/8"-16 THREADED STUDS (UNC THREAD)

CAT #	SHANK DIAMETER	SHANK LENGTH	THREAD DIAMETER	PACK	CTN
50340-PWR	0.205"	3/4" (K)	1-1/4"	100	1000
50342-PWR	0.205"	1"	1-1/4"	100	1000
50344-PWR	0.205"	1-1/4"	1-1/4"	100	1000

K = Knurled

PAT ASSEMBLIES

Ceiling Clip Assemblies

Type	Drive Pins Pre-assembled with Stamped Steel Clips
Approvals	ICC-ES ESR-2024
Description	For suspending acoustical ceiling systems or light fixtures A dome mechanism or top hat holds the pin in the clip
Base Materials	Concrete and some types of masonry



CSI SPIRAL DRIVE PIN WITH CEILING CLIP (90 DEGREE)

CAT #	SHANK DIAMETER	SHANK LENGTH	PACK	CTN
50212-PWR	0.157"	22mm (7/8") (TH)	100	1000
50213-PWR	0.157"	27mm (1") (TH)	100	1000
50218-PWR	0.157"	32mm (1-1/4") (TH)	100	1000

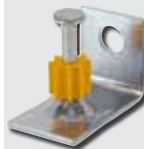

0.300" HEAD DRIVE PINS WITH CEILING CLIPS (90 DEGREE)

CAT #	HOLE SIZE	SHANK DIAMETER	SHANK LENGTH	PACK
DFD3373**	0.278"	0.145"	1"	100
DFD3374**	0.278"	0.145"	1-1/4"	100
50364-PWR*	0.278"	0.145"	1"	100
50370-PWR*	0.278"	0.145"	1-1/4"	100

TH = Top Hat
† 60° Angle Economy Clip



CEILING CLIP WITHOUT PIN (90 DEGREE)

CAT #	DESCRIPTION	PACK	CTN
50400-PWR	Ceiling Clip (no pin) 3/4-inch wide and 14 gauge thick. Long leg is 1-1/4" long with 7/32" hole; short leg is 5/8" long with 5/16" hole.	100	1000

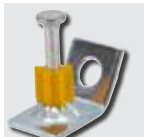

0.300" HEAD DRIVE PINS WITH ECONOMY CEILING CLIPS (60 DEGREE)

CAT #	HOLE SIZE	SHANK DIAMETER	SHANK LENGTH	PACK
50368-PWR	0.278"	0.145"	1-1/8"	100

BALLISTIC POINT DRIVE PIN WITH CEILING CLIP

CAT #	HOLE SIZE	SHANK DIAMETER	SHANK LENGTH	PACK	CTN
50366-PWR	7/8" (TH)	0.300"	0.150"	0.313"	100
50058-PWR	1-1/4"	0.300"	0.181/0.150"	0.278"	100



8MM HEAD PIN WITH CEILING CLIP (90 DEGREE)

CAT #	HOLE SIZE	SHANK DIAMETER	SHANK LENGTH	PACK
50206-PWR	0.313"	0.177"	27MM (1")(TH)	100
50272-PWR	0.279"	0.145"	27MM (1")(TH)	100

POWDER ACTUATED

BX & EMT Conduit Clip Assemblies

Type Drive pins pre-assembled with stamped steel Clips

Description For the electrical trade BX and EMT conduit clips are provided in various sizes for attaching conduit to base materials.

Base Materials Concrete and some types of masonry

TH = Top Hat
EMT = Electrical Metallic Tube



0.300" HEAD DRIVE PINS WITH BX CABLE STRAPS

CAT #	SHANK DIAMETER	SHANK LENGTH	PACK	CTN
50150-PWR	0.145"	1"	100	1000



0.300" HEAD DRIVE PINS WITH CONDUIT CLIPS

CAT #	SHANK DIAMETER	SHANK LENGTH	PACK	CTN
50382-PWR	0.145"	1"	50	500
50385-PWR	0.145"	1"	50	500
50388-PWR	0.145"	1"	25	250
50386-PWR	0.145"	1-1/8"	50	500
50384-PWR	0.145"	1-1/4"	50	500



8MM HEAD DRIVE PINS WITH EMT CONDUIT CLIPS

CAT #	SHANK DIAMETER	HEAD DIAMETER	SHANK LENGTH	PACK	CTN
50278-PWR	0.145"	27mm (1")	50	500	1000
50280-PWR	0.145"	27mm (1")	25	250	500

Rod Hanging Clip Assemblies

Type Drive pins pre-assembled with stamped steel clips

Description For the mechanical electrical and plumbing trades rod hanging clips are provided in various sizes for attaching threaded rod to base materials.

Base Materials Concrete and some types of masonry

TH = Top Hat
EMT = Electrical Metallic Tube
XL = Extended Length



CSI SPIRAL AND 8MM HEAD DRIVE PINS WITH ROD HANGER (UNC THREAD)

CAT #	SHANK DIAMETER	SHANK LENGTH	HANGER SIZE	PACK	CTN
50219-PWR	0.145"	32mm (1-1/4")	1/4"-20	100	1000
50221-PWR	0.145"	32mm (1-1/4")	3/8"-16	100	1000
50215-PWR	0.157"	32mm (1-1/4")	1/4"-20 CSI Spiral	100	1000



0.300" HEAD DRIVE PINS WITH POST NUT ROD HANGER (UNC THREAD)

CAT #	SHANK DIAMETER	SHANK LENGTH	HANGER SIZE	PACK	CTN
50376-PWR	0.145"	1-1/8"	1/4"-20 (domed right angle clip)	100	1000
DFD3388	0.145"	1-1/8"	1/4"-20 (XL right angle clip)	50	500
50378-PWR	0.145"	1-1/4"	1/4"-20 (domed right angle clip)	100	1000
DFD3389	0.145"	1-1/4"	1/4"-20 (XL right angle clip)	50	500

Rebar/Dowel Basket Assemblies

Type Drive Pins Pre-assembled with Stamped Steel Clips

Description Holds support baskets for reinforcing bars in place while the concrete is being poured. For #3 rebar and wire baskets.

Base Materials Concrete and some types of masonry

TH = Top Hat



8MM HEAD DRIVE PINS WITH REBAR/DOWEL BASKET CLIPS

CAT #	SHANK DIA	SHANK LEN	HANGER SIZE	PACK	CTN
50704-PWR	0.145"	37mm (1-1/2")	Std. basket clip	100	500
50712-PWR	0.145"	52mm (2")	Std. basket clip	100	500
50716-PWR	0.145"	62mm (2-1/2")	Std. basket clip	50	500
50718-PWR	0.145"	72mm (2-7/8")	Std. basket clip	50	500



Trak-It® C5

Gas Fastening System

BASE MATERIAL

Concrete, Lightweight Concrete, Hollow and Grouted CMU, Masonry & Steel

The fuel injected Trak-It C5 cordless concrete pin nailer is the lightest and smallest tool in its class, resulting in less operator fatigue and a better overall ergonomic feel. C5 has a high power output at 105 Joules, which allows for shooting into even the hardest concrete. It is able to shoot pins .102, .108, .120 and .145 diameter pins up to 1-1/2" in length. Safety training and licencing not required to use this system.



TRAK-IT C5 TOOL

CAT #	DESCRIPTION	BOX
55142-PWR	Trak-It C5 Tool w/ Deep Track	1
55144-PWR	Trak-It C5 Tool w/ Short Track	1
55148-PWR	Trak-It C5 Tool w/ Long Track	1

Trak-It® C5 Pins



TRAK-IT C5 CONCRETE AND CONCRETE MASONRY (CMU)

CAT #	SHANK DIA.	LENGTH	STEP DIA.	SHANK TYPE	BOX	CTN
55310-PWR	0.102"	3/4"	-	Straight, smooth	800	4000
55312-PWR	0.102"	1"	-	Straight, smooth	800	4000
55314-PWR	0.102"	1-1/4"	-	Straight, smooth	800	4000
55316-PWR	0.102"	1-1/2"	-	Straight, smooth	800	4000
55318-PWR	0.145"	3/4"	-	Straight, smooth	800	4000
55320-PWR	0.145"	1"	-	Straight, smooth	800	4000
55322-PWR	0.145"	1-1/4"	0.102"	Step, smooth	800	4000
55324-PWR	0.145"	1-1/2"	0.102"	Step, smooth	800	4000



TRAK-IT C5 STEEL PINS

CAT #	SHANK DIA.	LENGTH	STEP DIA.	SHANK TYPE	BOX	CTN
55325-PWR	0.120"	1/2"	-	Straight, smooth	800	4000
55343-PWR	0.120"	3/4"	-	Straight	800	4000
55336-PWR	0.145"	1"	0.120"	Step, knurled	800	4000
55338-PWR	0.145"	1-1/4"	0.120"	Step, knurled	800	4000



TRAK-IT C5 SPECIALTY PINS

CAT #	SHANK DIA.	LENGTH	STEP DIA.	BOX	CTN
55328-PWR	0.120"	0.680"	0.102"	800	4,000
55330-PWR	0.120"	0.730"	0.102"	800	4,000
55340-PWR	0.108"	1-3/8"	-	800	4,000
55342-PWR	0.102"	0.780"	0.088"	800	4,000

	Dimensions		Base Material											ICC-ES Code Recognition	
	Diameter	Length	Concrete	High Strength / Concrete Precast Concrete	Lightweight Concrete	Lightweight Concrete On Metal Deck	Wood Sill Plate to Concrete	Grouted Concrete Masonry	Hollow Concrete Masonry	Brick Masonry	Plywood to Light Gauge Steel	A36/A572 Steel	Wood to Steel		Stick-E Accessories
Trak-It C5 Pins	Straight Pins (Smooth Shank)	0.102"	3/4" – 1-1/2"	●		●	●		○	○	○			●	ESR-3275
	Straight Pins (Smooth Shank)	0.120"	3/4"	●	●	●	●		●	●	●				ESR-3275
	Straight Pins (Smooth Shank)	0.145"	3/4" – 1"	●	○	●	●		○	○		○			ESR-3275
	Step Shank Pins	0.102" – 0.120"	1/2" – 0.730"										●		ESR-3275
	Step Shank Pins	0.145"	7/8" – 1-1/2"	●	●				○	○					ESR-3275
	Stick-E Pins (Step Shank)	0.120" – 0.088"	0.780"	●	○	●	●		●	●	○			●	
	Plywood to Steel Pins (Special Knurl Shank Rolled Point)	0.102"	1-3/8"									●		Denz-Glass Washer	

● Suitable ○ May be Suitable



56347-PWR



55619-PWR



55583-PWR



55618-PWR



Trak-It® C5 Fuel Cell

FUEL CELL			
CAT #	SIZE	PK QTY	CTN
55302-PWR	Trak-It C5 Fuel Cell	20	80



56342-PWR



56344-PWR



56346-PWR

Trak-It® C5 Accessories

ACCESSORIES		
CAT #	SIZE	PK QTY
55619-PWR	Trak-It C5 110V Adapter Cord	1
55583-PWR	Trak-It C5 Battery	1
55618-PWR	Trak-It C5 Charger Base	1
56342-PWR	Accessory Deep Track for Trak-It C5 (Up to 1-1/4" Pins - 42 Pin Capacity)	1
56344-PWR	Accessory Long Track for Trak-It C5 (Up to 1-1/2" Pins - 42 Pin Capacity)	1
56348-PWR	Trak-It C5 Pole Tool 3' Extension	1
56347-PWR	Trak-It C5 Pole Tool Full System	1
56346-PWR	Accessory Short Track for Trak-It C5 (Up to 1-1/2" Pins - 22 Pin Capacity)	1

DRILIT® DRILL SCREWS	76
TAPFAST®	81
ARCHITECTURAL ROOF CLIPS	81
DRILL-FLEX®	82
ALUMI-FLEX®	83
BI-FLEX®	84
TAP-FLEX®	86
FAB-LOCK®	86
RAPIDSET® TOOLS	87



FASTENER DESCRIPTION/TYPE	Connection Type								Fastener Diameter								Head Style				Material		Plating/Coating		Available Features		ICC-ES Code Recognition												
	Steel-to-Steel	Miscellaneous Building Material to Steel	Aluminum-to-Steel (dissimilar metals)	Aluminum-to-Aluminum	Miscellaneous Building Materials to Aluminum	Wood-to-Steel	Wood-to-Aluminum	Steel Panel-to-Wood	Aluminum Panel-to-Wood	Standing Seam Roof Clips to Steel	Standing Seam Roof Clips to Wood	#6	#8	#10	#12	1/4"	5/16"	3/8"	1/2"	5/8"	Hex Washer Head	Phillips Pan Head	Phillips Pancake Head	Phillips Undercut Flat Head	Phillips Water head	Phillips Flat Head		Carbon Steel (Case Hardened)	Carbon Steel (Grade 5 Equivalent Heat Treatment)	Type 302/304 Stainless Steel	Aluminum Alloy	Zinc Plated	Stalgard	Stalgard SUB	Stalgard GB	Pre-Assembled EPDM Bonded Sealing Washer	Wings for Wood-to-Metal Applications	Pilot Point® for Wood-to-Metal Applications	
SELF-DRILLING TAPPING SCREWS	Drilit	●	●			●				○	●	●	●	●	●	●					●	●		●	●													ESR-3294 ESR-4367	
	Architectural Roof Clip Fasteners (For Steel)	●	●						●					●	●								●				●												ESR-3294
	Dril-Flex	●	●	●	●	●	●						●	●	●	●						●	●	●	●		●											ESR-3332 ESR-4367 ESR-4374	
	Alumi-Flex				●	●		○					●	●	●							●		●				●											ESR-4374
	Bi-Flex	●	●	●	●	●	●			●			●	●	●	●						●	●	●	●	●		●											ESR-4367 ESR-4374
TAPPING SCREWS	Architectural Roof Clip Fasteners (For Wood)								●					●	●								●				●												
	Tap-Fast							●	○												●						●												
	Tap-Flex	●	●	●	●	●	○	○									●	●	●	●							●												
FASTENERS	Fab-Lok	○	○	○	○	○	○	○				●									●							●											

● Suitable ○ May be Suitable

Screw Point Style	Uses	Product Line
Self-Drilling (#1, #2, #3, #4, #4.5, #5)	Metal connections	Drilit® / Architectural Roof Clip Fasteners Drilit® Flo-Seal® Drill Screws / Dril-Flex® / Bi-Flex® / Alumi-Flex®
Self-Drilling with Wings	Attaching wood or composite materials to metal	Drilit® Wood-to-Metal Bi-Flex® Wood-to-Metal
Self-Drilling with Pilot	Attaching wood or composite materials to light gauge metal	Drilit® Wood-to-Metal
Pierce Point	Wood/ light gauge metal applications	Architectural Roof Clip Fasteners
Type 17	Attaching light gauge metal to wood	TapFast®

Stalgard® High-Performance Protective Coatings

Provide consistent, high corrosion resistance



Stalgard® durable, multi-layer, corrosion-resistant coatings are engineered to provide optimal performance in demanding construction applications. These environmentally-friendly finishes are free of chromates and silicates and any process, like electroplating, that might induce hydrogen embrittlement, preventing structural failures.

- Maximizes fastener performance
- Salt spray at 1000+ hours with no red rust per ASTM B117
- Uniform thickness
- Low coefficient of friction – eliminates the need for post-coating lubricants to ease installation
- Does not use processes that introduce hydrogen – will not cause brittle failures like those caused by electroplating
- Durable tough finish – doesn't come off during handling
- Clean and dry – no oily residue
- Eliminates the plating process, resulting in a more environmentally-friendly product than those with plated zinc or other finishes
- Grey Stalgard is ACQ-compatible
- Maintains drilling and tapping performance

STALGARD® Stalgard Coating for Induction Heat-Treated Fasteners

Outstanding Corrosion Protection
Proven, outstanding corrosion resistance for most construction applications, including metal and wood. Salt spray resistance: 1000 hours per ASTM B117. Available colors: silver and gray.

STALGARD® GB Stalgard GB (Galvanic Barrier) Coating

Galvanic Barrier Corrosion Protection
Standard on all Elco stainless steel fasteners
Prevents a galvanic reaction between the stainless steel and dissimilar application materials, which could lead to fastener and/or joint failure. Available color: Silver

STALGARD® SUB Stalgard SUB Ultimate Barrier Coating

Ultimate Barrier Corrosion Protection
For more severely-corrosive environments. Salt spray 2,000 hours per ASTM B117. Available color: Silver



Drilit® Standard Drill Screws

Self-drilling fasteners in the most popular sizes

Self-drilling fasteners eliminate separate drilling and tapping operations for faster, more economical installations.

Specifications

- Diameters: #6 to 5/16"
- Lengths: 1/2" to 4"
- Drill Points: Drilit® forged
- Drive Systems: Hex and Phillips
- Material: Carbon steel
- Finishes: Stalgard® coating or zinc

Features & Benefits

- Eliminates separate drilling and tapping operations
- Fasteners coated with Stalgard finish typically show no red rust or other base metal corrosion on significant surfaces even after 1000 hours of 5% neutral salt spray exposure (per ASTM B117)

Approvals & Listings

- ICC-ES ESR-3294 available on some SKUs

Drill Screw Head Styles	Product Line
Hex Washer Head	Drilit® / Drilit® Flo-Seal® Drill Screws / Dril-Flex® / Bi-Flex® Alumi-Flex® / TapFast® / Tap-Flex®
Phillips Pan Head	Drilit® / Dril-Flex® / Bi-Flex®
Phillips Wafer Head	Drilit® Wood-to-Metal / Dril-Flex®
Phillips Flat Head	Drilit® Wood-to-Metal / Bi-Flex® Wood-to-Metal
Phillips Pancake Head	Architectural Roof Clip Fasteners / Bi-Flex®
Phillips Under-cut Flat Head	Dril-Flex® / Bi-Flex® / Alumi-Flex®

Cat #	Description	Point	Finish	Ctn Qty
-------	-------------	-------	--------	---------



#6 DIAMETER, 1/4" HEX WASHER HEAD

EDA135-I-100	6-20 x 3/8	#2	Zinc	100
EDA140-I-100	6-20 x 1/2	#2	Zinc	100
EDA146-I-100	6-20 x 5/8	#2	Zinc	100
EDA160-I-100	6-20 x 3/4	#2	Zinc	100
EDA190-I-100	6-20 x 1	#2	Zinc	100



#8 DIAMETER, 1/4" HEX WASHER HEAD

EDA235-I-100	8-18 x 1/2	#2	Zinc	100
EDA236-I	8-18 x 1/2	#2	Stalgard®	10000
EDA236-I-100	8-18 x 1/2	#2	Stalgard®	100
EDA250-I-100	8-18 x 5/8	#2	Zinc	100
EDA260-I-100	8-18 x 3/4	#2	Zinc	100
EDA261-I	8-18 x 3/4	#2	Stalgard®	8000
EDA261-I-100	8-18 x 3/4	#2	Stalgard®	100
EDA285-I-100	8-18 x 1	#2	Zinc	100
EDA286-I	8-18 x 1	#2	Stalgard®	5000
EDA290-I-100	8-18 x 1-1/4	#2	Zinc	100
EDA295-I-100	8-18 x 1-1/2	#2	Zinc	100



#8 DIAMETER, #2 PHILLIPS PAN HEAD

EDD251-I	8-18 x 1/2	#2	Stalgard®	10000
EDD251-I-100	8-18 x 1/2	#2	Stalgard®	100
EDD266-I	8-18 x 3/4	#2	Stalgard®	10000



#10 DIAMETER, 5/16" HEX WASHER HEAD

EDA431-I-100	10-16 x 1/2	#2	Stalgard®	100
EDB600-I-100	10-24 x 1/2	#2	Zinc	100
EDB401-I	10-16 x 1/2	#2	Stalgard®	5000
EDB401-I-100	10-16 x 1/2	#2	Stalgard®	100
EDB426-I	10-16 x 5/8	#3	Stalgard®	6000
EDB426-I-100	10-16 x 5/8	#3	Stalgard®	100
EDC450-I	10-16 x 3/4	#1	Stalgard®	5000
EDC450-I-500	10-16 x 3/4	#1	Stalgard®	500
EDB445-I-100	10-16 x 3/4	#3	Zinc	100
EDB446-I	10-16 X 3/4	#3	Stalgard®	6000
EDB446-I-500	10-16 X 3/4	#3	Stalgard®	500
EDB485-I	10-16 x 1	#3	Zinc	5000

Cat #	Description	Point	Finish	Ctn Qty
-------	-------------	-------	--------	---------

EDB485-I-100	10-16 x 1	#3	Zinc	100
EDB486-I	10-16 x 1	#3	Stalgard®	5000
EDB486-I-100	10-16 x 1	#3	Stalgard®	100
EDB490-I-100	10-16 x 1-1/4	#3	Zinc	100
EDB540-I	10-16 x 1-1/2	#3	Zinc	3000
EDB540-I-100	10-16 x 1-1/2	#3	Zinc	100
EDB541-I	10-16 x 1-1/2	#3	Stalgard®	3000
EDB541-I-100	10-16 x 1-1/2	#3	Stalgard®	100
EDB550-I-100	10-16 x 1-3/4	#3	Zinc	100
EDB570-I-100	10-16 x 2	#3	Zinc	100
EDB571-I	10-16 x 2	#3	Stalgard®	2000
EDB580-I-025	10-16 x 3	#3	Zinc	25



#10 DIAMETER, 5/16" HEX WASHER HEAD WITH SERRATIONS

EDC576-I-100	10-16 x 3/4	#3	Stalgard®	100
EFC460-I	10-16 x 3/4	#3	Zinc	6000



#10 DIAMETER, #2 PHILLIPS PAN HEAD

EDD501-I	10-16 x 1	#2	Zinc	5000
----------	-----------	----	------	------



#12 DIAMETER, 5/16" HEX WASHER HEAD

EDC745-I	12-14 x 3/4	#1	Stalgard®	5000
EDC745-I-500	12-14 x 3/4	#1	Stalgard®	500
EDB740-I	12-14 x 3/4	#3	Zinc	5000
EDB740-I-100	12-14 x 3/4	#3	Zinc	100
EDB741-I	12-14 x 3/4	#3	Stalgard®	5000
EDB741-I-100	12-14 x 3/4	#3	Stalgard®	100
EDB760-I	12-14 x 1	#3	Zinc	4000
EDB760-I-100	12-14 x 1	#3	Zinc	100
EDB761-I	12-14 x 1	#3	Stalgard®	4000
EDB761-I-100	12-14 x 1	#3	Stalgard®	100
EDB780-I-100	12-14 x 1-1/4	#3	Zinc	100
EDB782-I	12-14 x 1-1/4	#3	Stalgard®	3000
EDB782-I-050	12-14 x 1-1/4	#3	Stalgard®	50
EDB800-I	12-14 x 1-1/2	#3	Zinc	2500
EDB800-I-050	12-14 x 1-1/2	#3	Zinc	50
EDB801-I	12-14 x 1-1/2	#3	Stalgard®	2500
EDB820-I-050	12-14 x 2	#3	Zinc	50
EDB821-I	12-14 x 2	#3	Stalgard®	2000
EDB821-I-100	12-14 x 2	#3	Stalgard®	100
EDB829-I-050	12-14 x 2-1/2	#3	Zinc	50
EDB830-I	12-14 x 2-1/2	#3	Stalgard®	1500
EDB839-I-025	12-14 x 3	#3	Zinc	25
EDB840-I	12-14 x 3	#3	Stalgard®	1000
EDB845-I	#12-14 X 4"	#3	#3	500

Cat #	Description	Point	Finish	Washer Diameter	Ctn Qty
-------	-------------	-------	--------	-----------------	---------



1/4" DIAMETER, 5/16" HEX WASHER HEAD

EDC930-I	1/4-14 x 7/8	#1	Stalgard®	4000	
----------	--------------	----	-----------	------	--



1/4" DIAMETER, 3/8" HEX OVERSIZED (11/16") WASHER HEAD

EDB947-I	1/4-14 x 1	#3	Zinc	2000	
----------	------------	----	------	------	--



1/4" DIAMETER, 3/8" HEX WASHER HEAD

EDB935-I	1/4"-14 X 3/4"	#3	Zinc	3500	50
EDB935-I-100	1/4"-14 X 3/4"	#3	Zinc	100	2500
EDB936-I	1/4"-14 X 3/4"	#3	Stalgard®	3500	50
EDB945-I	1/4"-14 X 1"	#3	Zinc	3000	2000
EDB945-I-050	1/4"-14 X 1"	#3	Zinc	50	50
EDB946-I	1/4"-14 X 1"	#3	Stalgard®	3000	1500
EDB955-I-050	1/4"-14 X 1-1/4"	#3	Zinc	50	50
EDB956-I	1/4"-14 X 1-1/4"	#3	Stalgard®	2000	1500
EDB960-I-050	1/4"-14 X 1-1/2"	#3	Zinc	50	50
EDB961-I	1/4"-14 X 1-1/2"	#3	Stalgard®	2000	1000
EDB976-I	1/4"-14 X 2-1/2"	#3	Stalgard®	1000	800
EDB965-I-050	1/4"-14 X 1-3/4"	#3	Zinc	50	500
EDB970-I-050	1/4"-14 X 2"	#3	Zinc	50	
EDB971-I	1/4"-14 X 2"	#3	Stalgard®	1500	
EDB975-I-025	1/4"-14 X 2-1/2"	#3	Zinc	25	
EDB980-I-025	1/4"-14 X 3"	#3	Stalgard®	25	
EDB981-I	1/4"-14 X 3"	#3	Zinc	800	
EDB983-I	1/4"-14 X 4"	#3	Stalgard®	500	
EDB970-I	1/4"-14 X 2"	#3	Zinc		



5/16" DIAMETER, 3/8" HEX WASHER HEAD

EDB990-I-010	5/16-18 x 1	#3	Zinc	10	
EDB991-I	5/16-18 x 1	#3	Stalgard®	1000	
EDB993-I-010	5/16-18 x 1-1/4	#3	Zinc	10	
EDB994-I	5/16-18 x 1-1/4	#3	Stalgard®	1000	
EDB997-I-010	5/16-18 x 1-1/2	#3	Zinc	10	
EDB998-I	5/16-18 x 1-1/2	#3	Stalgard®	1000	

Drilit® Drill Screws with Bonded Sealing Washers



Economical fasteners for applications requiring a weather-tight seal

This economical line of drill screws provides a weather-tight seal for protection against the elements.

Specifications

- Diameters: #8 to 1/4", Lengths: 3/4" to 4"
- Head Styles: Hex washer
- Drive System: Hex
- Point Types: #1 to #5
- Material: Carbon steel
- Finish: Stalgard® coating

Features & Benefits

- EPDM washer material is UV- and heat-resistant for long-term protection against leakage
- Stalgard coating provides 1000 hours of salt spray resistance (per ASTM B117)

Approvals

- ICC-ES ESR-3294 available on some SKUs

Cat #	Description	Point	Finish	Washer Diam	Ctn Qty
-------	-------------	-------	--------	-------------	---------

#8 DIAMETER, 1/4" HEX WASHER HEAD

EHL100-I-050	#8-18 X 3/4"	#2	Zinc	1/2"	50
--------------	--------------	----	------	------	----



#10 DIAMETER, 5/16" HEX WASHER HEAD

EHL111-I	#10-16 X 3/4"	#3	Stalgard®	1/2"	3000
EHL112-I-100	#10-16 X 3/4"	#3	Zinc	1/2"	100
EHL115-I-100	#10-16 X 1"	#3	Zinc	1/2"	100
EHL146-I	#10-16 X 1-1/2"	#3	Stalgard®	1/2"	2000



#12 DIAMETER, 5/16" HEX WASHER HEAD

EHL160-I-100	#12-14 X 3/4"	#3	Zinc	9/16"	100
EHL165-I	#12-14 X 3/4"	#3	Stalgard®	9/16"	3000
EHL351-I	#12-24 X 7/8"	#4	Stalgard®	9/16"	2500
EHL180-I-100	#12-14 X 1"	#3	Zinc	9/16"	100
EHL181-I	#12-14 X 1"	#3	Stalgard®	9/16"	2500
EHL235-I	#12-14 X 1-1/4"	#3	Stalgard®	9/16"	2000
EHL371-I	#12-24 X 1-1/4"	#4.5	Stalgard®	9/16"	2500
ECW725-I	#12-24 X 1-1/4"	#5	Stalgard®	9/16"	2500
ECW725-I-050	#12-24 X 1-1/4"	#5	Stalgard®	9/16"	50
EHL276-I	#12-14 X 1-1/2"	#3	Stalgard®	9/16"	2000
ECW745-I	#12-24 X 1-1/2"	#5	Stalgard®	9/16"	2000
EHL280-I	#12-14 X 2"	#3	Stalgard®	9/16"	1500
ECW755-I	#12-24 X 2"	#5	Stalgard®	9/16"	1000
EHL285-I	#12-14 X 2-1/2"	#3	Stalgard®	9/16"	1000
EHL295-I	#12-14 X 3"	#3	Stalgard®	9/16"	1000
EHL310-I	#12-14 X 4"	#3	Stalgard®	9/16"	500

1/4" DIAMETER, 5/16" HEX WASHER HEAD

EHK315-I	1/4"-14 X 7/8"	#1	Stalgard®	9/16"	2500
----------	----------------	----	-----------	-------	------

Cat #	Description	Point Type	Finish	Washer Diameter	Pack Qty
-------	-------------	------------	--------	-----------------	----------



1/4" DIAMETER, 3/8" HEX WASHER HEAD

EHL514-I-050	1/4"-14 X 3/4"	#3	Zinc	5/8"	50
EHL515-I	1/4"-14 X 3/4"	#3	Stalgard®	5/8"	2500
EHL525-I-050	1/4"-14 X 1"	#3	Zinc	5/8"	50
EHL530-I	1/4"-14 X 1"	#3	Stalgard®	5/8"	2000
EHL555-I-050	1/4"-14 X 1-1/4"	#3	Zinc	5/8"	50
EHL556-I	1/4"-14 X 1-1/4"	#3	Stalgard®	5/8"	1500
EHL575-I-050	1/4"-14 X 1-1/2"	#3	Zinc	5/8"	50
EHL577-I	1/4"-14 X 1-1/2"	#3	Stalgard®	5/8"	1500
EHL584-I-050	1/4"-14 X 2"	#3	Zinc	5/8"	50
EHL585-I	1/4"-14 X 2"	#3	Stalgard®	5/8"	1000
EHL600-I	1/4"-14 X 3"	#3	Stalgard®	5/8"	800
EHL610-I	1/4"-14 X 4"	#3	Stalgard®	5/8"	500

To assure a weather-tight seal, fasteners must be properly installed.

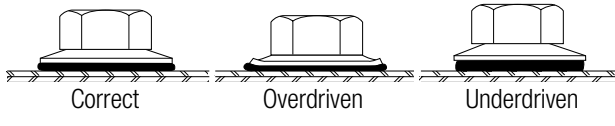

Drilit® Flo-Seal® Drill Screws with Integral Sealing System

For self-drilling applications requiring a weather-tight seal

Special underhead design and EPDM sealing washer combine to provide a custom, weather-tight seal

Specifications

- Diameters: #12"
- Lengths: 3/4" to 2"
- Head Styles: Hex washer (5/16" across flats)
- Drive System: Hex
- Material: Carbon steel
- Finish: Stalgard® coating

Features & Benefits

- EPDM washer material is UV- and heat-resistant for long-term protection against leakage
- Reliable and consistent sealing even in under-tightened, overtightened or angle driven installations
- Stalgard coating provides 1000 hours of salt spray resistance (per ASTM B117)

Cat #	Description	Point	Finish	Ctn Qty
-------	-------------	-------	--------	---------



#12 DIAMETER, 5/16" HEX WASHER HEAD

EHB150-I-050	#12-14 X 3/4"	#3	Stalgard®	50
EHB180-I	#12-14 X 1"	#3	Stalgard®	2500
EHB235-I	#12-14 X 1-1/4"	#3	Stalgard®	2000
EHB295-I	#12-14 X 1-1/2"	#3	Stalgard®	2000
EHB310-I	#12-14 X 2"	#3	Stalgard®	1500

1-800-435-7213

Features and Benefits of the Flo-Seal Fasteners Sealing System

- Fastener head engineered to control the flow of the special sealing washer, ensuring sealing in critical areas
- Provides reliable and consistent sealing even in under-tightened, overtightened or angle-driven installations
- Ensures long-term protection against leakage
- Compensates for different installation situations and techniques

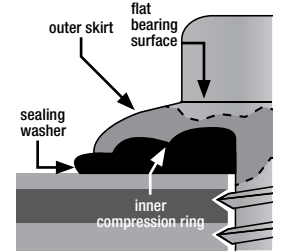

Drill Screw with Flo-Seal System

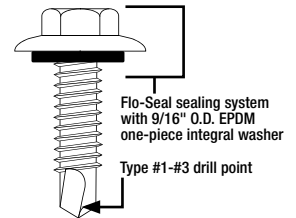

Maximum Material Attachment

Size	Material Attachment Max.
12-14 x 1	0.490"
12-14 x 1-1/4	0.560"
12-14 x 1-1/4	0.790"

Drilit® Drill Screws for Wood-to-Metal Applications

For efficient fastening of wood or composite materials to steel

These self-drilling fasteners eliminate separate drilling and tapping operations for faster installation in wood-to-metal applications.

Specifications

- Diameters: #10 to 1/4"
- Lengths: 3/4" to 4"
- Head Styles: Flat and wafer
- Drive System: Phillips
- Point Types: #2 to #4
- Material: Carbon steel
- Finishes: Gray Stalgard® coating

Features & Benefits

- Eliminates pre-drilling of wood
- Broad selection of sizes
- Can be used with steel up to 5/16" thick

Approvals & Listings

- ICC-ES ESR-4367 available on some SKUs



Cat #	Description	Point	Finish	Wood Thickness	Drilling Capacity	CTN Qty
-------	-------------	-------	--------	----------------	-------------------	---------



#10 DIAMETER, #2 PHILLIPS WAFFER HEAD

EDM582-I	#10-24 X 3/4"	#3	Stalgard®	1/4"	.036" - .187"	8000
EDM592-I	#10-24 X 1"	#3	Stalgard®	1/2"	.036" - .187"	6000
EDM607-I	#10-24 X 1-1/4"	#3	Stalgard®	5/8"	.036" - .187"	5000
EDM607-I-100	#10-24 X 1-1/4"	#3	Stalgard®	5/8"	.036" - .187"	100
EDT602-I	#10-24 X 1-7/16"	#3 w/wings	Stalgard®	3/4"	.036" - .187"	4000
EDM622-I	#10-16 X 1-1/2"	#3	Stalgard®	3/4"	.036" - .187"	3500
EDM622-I-100	#10-16 X 1-1/2"	#3	Stalgard®	3/4"	.036" - .187"	100
EDM635-I	#10-16 X 1-13/16"	#3 w/pilot	Stalgard®	3/4"	.036" - .150"	2500



#12 DIAMETER, #3 PHILLIPS WAFFER HEAD

EDT720-I	#12-24 X 1-3/4"	#4 w/ wings	Stalgard®	3/4"	.060" - .312"	2000
----------	-----------------	-------------	-----------	------	---------------	------



#12 DIAMETER, #3 PHILLIPS FLAT HEAD

EDT267-I	#12-24 X 2-1/4"	#4 w/ wings	Stalgard®	1-1/4"	.060" - .312"	2000
EDT282-I	#12-24 X 2-3/4"	#4 w/ wings	Stalgard®	1-5/8"	.060" - .312"	1500
EDJ867-I	#12-14 X 3-5/8"	#2 w/ pilot	Stalgard®	1-5/8"	.036" - .150"	1000



1/4" DIAMETER, #3 PHILLIPS FLAT HEAD

EDT442-I	1/4"-20 X 3"	#4 w/ wings	Stalgard®	2"	.060" - .312"	1000
EDT470-I	1/4"-20 X 4"	#4 w/ wings	Stalgard®	3"	.060" - .312"	1000

Drill Screws with Extended Drilling Capacity

Specially-designed drill points handle the toughest applications

This line of heavy-duty drill screws is designed for fast installation in steel applications up to 1/2" thick.

Approvals & Listings

- ICC-ES ESR-3294 available on some SKUs

Cat #	Description	Point	Finish	CTN Qty
-------	-------------	-------	--------	---------



#12 DIAMETER 5/16" HEX WASHER HEAD FOR STEEL .175" to .500" THICK

EDC801-I	#12-24 X 7/8"	#4	Stalgard®	4500
EDC816-I	#12-24 X 1-1/4"	#4.5	Stalgard®	3500
ECC720-I	#12-24 X 1-1/4"	#5	Stalgard®	4000
ECC720-I-100	#12-24 X 1-1/4"	#5	Stalgard®	100
EDC846-I	#12-24 X 1-1/2"	#4.5	Stalgard®	2500
ECC740-I	#12-24 X 1-1/2"	#5	Stalgard®	2500
ECC750-I	#12-24 X 2"	#5	Stalgard®	2000



1/4" DIAMETER, 5/16" HEX WASHER HEAD FOR STEEL .175" to .500" THICK

ECC940-I	1/4"-20 X 3"	#5	Stalgard®	1000
ECC950-I	1/4"-20 X 4"	#5	Stalgard®	500



1/4" DIAMETER, 3/8" HEX WASHER HEAD FOR STEEL .175" to .500" THICK

ECC960-I	1/4"-20 X 5"	#5	Stalgard®	500
ECC970-I	1/4"-20 X 6"	#5	Stalgard®	500
ECC980-I	1/4 - 20 x 8	#5	Stalgard®	150

Average Drill Time Comparison Elco vs. Buildex

#12-24 x 1/14" Ty-5 Point
3/8" Carbon Steel
1800 rpm
50 lb End Load

* Buildex is a Registered Trademark of ITW Buildex and Illinois Tool Works, Inc.

**40%
FASTER
DRILLING**

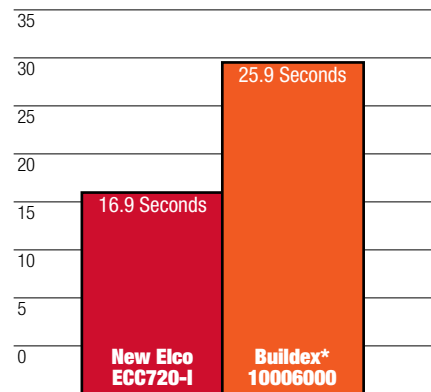

TapFast® Fasteners

For use in metal-to-wood application

High-performance fastener designed specifically for attaching light-gauge metal panels (18 GA max.) to wood frame structures.

Specifications

- Size: #10, Lengths: 1" to 3"
- Head/Drive: 1/4" HWH
- Thread: Hi-lo, Point: Type 17
- Material: Carbon steel
- Finish: Stalgard® coating

Features & Benefits

- Aluminum bonded sealing washer
- High-low thread increases performance
- Easily penetrates multiple panel thicknesses
- Stalgard coating provides 1000 hours of salt spray resistance (per ASTM B117)

Cat #	Description	Point Type	Finish	Ctn Qty
-------	-------------	------------	--------	---------



#10 DIAMETER, 1/4" HEX WASHER HEAD / ALUMINIUM BONDED SEALING WASHER

Cat #	Description	Point Type	Finish	Ctn Qty
EHH210-I	#10-16 X 1"	#17	Stalgard®	3000
EHH210-I-100	#10-16 X 1"	#17	Stalgard®	100
EHH230-I	#10-16 X 1-1/2"	#17	Stalgard®	2500
EHH230-I-100	#10-16 X 1-1/2"	#17	Stalgard®	100
EHH250-I	#10-16 X 2"	#17	Stalgard®	1500
EHH250-I-050	#10-16 X 2"	#17	Stalgard®	50
EHH265-I	#10-16 X 2-1/2"	#17	Stalgard®	1000
EHH265-I-050	#10-16 X 2-1/2"	#17	Stalgard®	50
EHH280-I	#10-16 X 3"	#17	Stalgard®	800
EHH280-I-050	#10-16 X 3"	#17	Stalgard®	50

Architectural Roof Clip Fasteners

Low-profile head design for wood and steel applications

The efficiency of self-drilling fasteners and the aesthetics of an unobtrusive head are ideal for attaching metal roof clips to metal and wood.

Specifications

- Diameters: #10 to #12", Lengths: 1" to 2"
- Head/Drive Styles: Pancake, phillips
- Material: Carbon steel; Finishes: Silver or gray Stalgard® coating

Features & Benefits

- Eliminates separate drilling and tapping operations
- Pancake head improves aesthetics, prevents panel dimpling
- Stalgard coating provides 1000 hours of salt spray resistance (per ASTM B117), Gray Stalgard is ACQ-compatible*

Approvals & Listings

- ICC-ES ESR-4374 available on some SKUs

Cat #	Description	Point	Finish	Ctn Qty
-------	-------------	-------	--------	---------



#10 DIAMETER, #2 PHILLIPS PANCAKE HEAD

Cat #	Description	Point	Finish	Ctn Qty
ED0450-I	#10-16 X 1"	#3	Stalgard®	4000
ED0460-I	#10-16 X 1-1/2"	#3	Stalgard®	3000
ED0470-I	#10-16 X 2"	#3	Stalgard®	2000
ETA850-I	#10-12 X 1"	Pierce Point	Stalgard®	4000
ETA855-I	#10-12 X 1-1/2"	Pierce Point	Stalgard®	3000
ETA860-I	#10-12 X 2"	Pierce Point	Stalgard®	2000



#12 DIAMETER, #2 PHILLIPS PANCAKE HEAD

Cat #	Description	Point	Finish	Ctn Qty
ED0735-I	#12-14 X 1"	#3	Stalgard®	4000
ETA870-I	#12-11 X 1"	Pierce Point	Stalgard®	4000



Dril-Flex® Structural Drill Screws

Virtually immune to delayed embrittlement failures

Dual heat treated drill screws provide the strength, ductility and resistance to embrittlement required for critical applications.

Specifications

- Diameters: #10 to 5/16"
- Lengths: 3/4" to 4"
- Head/Drive Styles: Hex washer, phillips pan, wafer and undercut flat
- Point Types: #2, #3, #4 and #5
- Material: Alloy steel
- Heat Treat: Grade 5
- Finish: Silver Stalgard® or Stalgard SUB coating

Features & Benefits

- Stalgard SUB coating (Hex washer product only) provides 2000 hours of salt spray resistance (per ASTM B117)
- High-hardness EAF points and lead threads for drilling and tapping
- Lower hardness in load-bearing threads for ductility
- Virtually immune to delayed embrittlement failures

Approvals & Listings

- ICC-ES ESR-3332
- ICC-ES ESR-4367
- ICC-ES ESR-4374
- COLA (City of Los Angeles) Report #25095

Cat #	Description	Point	Max Load	Finish	Ctn Qty
-------	-------------	-------	----------	--------	---------



#10 Diameter, 5/16" Hex Washer Head

EAF430	#10-16 X 3/4"	#3	0.250"	Stalgard® SUB	6,000
EAF460	#10-16 X 1-1/2"	#3	1.000"	Stalgard® SUB	2,500
EAF470	#10-16 X 2"	#3	1.500"	Stalgard® SUB	2,000
EAF480	#10-16 X 2-1/2"	#3	2.000"	Stalgard® SUB	1,500

Cat #	Description	Point	Max Load	Finish	Ctn Qty
-------	-------------	-------	----------	--------	---------



#10 Diameter, #2 Phillips Pan Head

EDX445	#10-16 X 3/4"	#2	0.344"	Stalgard®	6000
--------	---------------	----	--------	-----------	------



#10 Diameter, #2 Phillips Wafer Head

EBL530	#10-24 X 1-1/4"	#3	0.781"	Stalgard®	Y	5,000
--------	-----------------	----	--------	-----------	---	-------



#12 Diameter, 5/16" Hex Washer Head

EAF621*	#12-14 X 7/8"	#3	0.375"	Stalgard® SUB	5,000
EAF641	#12-14 X 1"	#3	0.500"	Stalgard® SUB	4,000
EAF661	#12-14 X 1-1/4"	#3	0.750"	Stalgard® SUB	2,500
EAF681	#12-14 X 1-1/2"	#3	1.000"	Stalgard® SUB	2,500
EAF755	#12-24 X 1-3/4"	#5	0.813"	Stalgard® SUB	2,500
EAF690	#12-14 X 2"	#3	1.500"	Stalgard® SUB	2,000
EAF715	#12-14 X 3"	#2	2.375"	Stalgard® SUB	1,000

*for aluminum applications only



#12 Diameter, #3 Phillips Undercut Flat Head

EBL215	#12-14 X 1"	#3	0.500"	Stalgard®	4,000
EBL220	#12-14 X 1-1/4"	#3	0.750"	Stalgard®	3000
EBL223	#12-14 X 1-1/2"	#3	1.000"	Stalgard®	2,500



1/4" Diameter, 3/8" Hex Washer Head

EAF816	1/4"-14 X 1"	#3	0.438"	Stalgard® SUB	3,000
EAF865	1/4"-20 X 1-1/8"	#4	0.438"	Stalgard® SUB	2,500
EAF841	1/4"-14 X 1-1/2"	#3	0.938"	Stalgard® SUB	2,000
EAF876	1/4"-20 X 1-1/2"	#4	0.813"	Stalgard® SUB	2,000
EAF888	1/4"-20 X 1-3/4"	#5	0.813"	Stalgard® SUB	1,000
EAF846	1/4"-14 X 2"	#3	1.4375"	Stalgard® SUB	1,500
EAF886	1/4"-20 X 2"	#4	1.313"	Stalgard® SUB	1,500
EAF890	1/4"-20 X 2-1/2"	#4	1.813"	Stalgard® SUB	1,000
EAF900	1/4"-20 X 3-3/8"	#4	2.625"	Stalgard® SUB	500
EAF910	1/4"-20 X 4"	#4	3.250"	Stalgard® SUB	500



1/4" Diameter, #3 Phillips Undercut Flat Head

EBL330	1/4"-20 X 3"	#4	2.250"	Stalgard®	500
EBL340	1/4"-20 X 4"	#4	3.250"	Stalgard®	500



5/16" Diameter, 3/8" Hex Washer Head

EAF940	5/16"-18 X 1-1/2"	#3	0.813"	Stalgard® SUB	1,000
EAF960	5/16"-24 X 1-1/2"	#4	0.750"	Stalgard® SUB	1,000
EAF970	5/16"-24 X 2"	#4	1.250"	Stalgard® SUB	1,000



Alumi-Flex™ 302 (18-8) Stainless Steel Drill Screws

For fastening to aluminum when corrosion and galvanic reaction are a primary concern

Stainless steel drill screws provide strength and corrosion resistance in a variety of aluminum applications.

Specifications

- Diameters: #10 to 1/4"
- Lengths: 1/2" to 1-1/2"
- Head Style: Hex washer
- Drive System: Hex
- Point Types: #3 and #4
- Material: 302 stainless steel
- Finish: Stalgard® GB (Galvanic Barrier) coating

Features & Benefits

- Provides a very high level of corrosion resistance
- Coating allows greater galvanic compatibility in dissimilar metal applications involving aluminum
- Head marked with a "3" for easy identification

Approvals & Listings

- ICC-ES ESR-4374

Cat #	Description	Point	Finish	CTN QTY
-------	-------------	-------	--------	---------



#10 Diameter, 5/16" Hex Washer Head

EAH430-I*	10-16 x 1/2"	#3	Stalgard GB	8000
EAH445-I*	#10-16 X 3/4"	#3	Stalgard® GB	6,000
EAH460-I*	#10-16 X 1"	#3	Stalgard® GB	5,000



#10 Diameter, #2 Phillips Undercut Flat Head

EBM160-I*	#10-16 X 3/4"	#3	Stalgard® GB	10,000
-----------	---------------	----	--------------	--------

Cat #	Description	Point	Finish	CTN QTY
-------	-------------	-------	--------	---------



#12 Diameter, 5/16" Hex Washer Head

EAH630-I*	#12-14 X 3/4"	#3	Stalgard® GB	5,000
EAH650-I*	#12-14 X 1"	#3	Stalgard® GB	5,000
EAH680-I*	#12-14 X 1-1/2"	#3	Stalgard® GB	3,000



1/4" Diameter, 3/8" Hex Washer Head

EAH800-I*	1/4"-14 X 3/4"	#3	Stalgard® GB	3,500
EAH820-I*	1/4"-14 X 1"	#3	Stalgard® GB	3,000
EAH835-I*	1/4"-14 X 1-1/2"	#3	Stalgard® GB	2,000
EAH870-I*	1/4"-20 X 1"	#4	Stalgard® GB	2,000
EAH880-I*	1/4"-20 X 1-1/2"	#4	Stalgard® GB	2,000



1/4" Diameter, #3 Phillips Undercut Flat Head

EBM260-I*	1/4"-14 X 1"	#3	Stalgard® GB	4,500
-----------	--------------	----	--------------	-------

*for aluminum applications only

Identification

The head marking consists of the number "3" below the Elco® logo.



Hex Washer Head

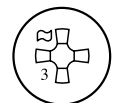

Flat Head



Bi-Flex® 300 Series Stainless Steel Bi-Metal Self-Drilling Screws

Bi-metal technology provides outstanding corrosion resistance and long service life

Bi-Flex® fasteners provide the corrosion resistance of 300 series stainless steel and the efficiency of drill screws.

Specifications

- Diameters: #10 to 1/4"
- Lengths: 3/4" to 8"
- Drive Systems: Hex and Phillips
- Material: Hardened steel tapping threads and point fused onto an 18-8 stainless steel shank and head
- Finish: Stalgard® GB (Galvanic Barrier) coating

Features & Benefits

- High strength, ductility and reliability
- Virtually immune to delayed embrittlement failures
- Greater galvanic compatibility in dissimilar metal applications involving aluminum
- High in-place value over the life of application

Approvals & Listings

- ICC-ES ESR-4374 available on some SKUs

Cat #	Description	Point	Finish	Max Load	Pack Qty
-------	-------------	-------	--------	----------	----------



#8 Diameter, 1/4" Hex Washer Head

EAJ100	#8-18 X 3/4"	#2	Stalgard® GB	0.156"	5000
EAJ102	#8-18 X 1"	#2	Stalgard® GB	0.406"	5000



#8 Diameter, #2 Phillips Pan Head

EAX100	#8-18 X 3/4"	#2	Stalgard® GB	0.156"	5000
EAX102	#8-18 X 1"	#2	Stalgard® GB	0.406"	5000

Cat #	Description	Point	Finish	Max Load	Pack Qty
-------	-------------	-------	--------	----------	----------



#10 Diameter, 5/16" Hex Washer Head

EAJ110	#10-16 X 3/4"	#2	Stalgard® GB	0.25"	5000
EAJ120	#10-16 X 1"	#2	Stalgard® GB	0.5"	5000
EAJ140	#10-16 X 1-1/2"	#2	Stalgard® GB	1"	2500



#10 Diameter, #2 Phillips Pan Head

EAX110	#10-16 X 3/4"	#2	Stalgard® GB	0.25"	5000
EAX120	#10-16 X 1"	#2	Stalgard® GB	0.5"	5000



#10 Diameter, #2 Phillips Pancake Head

EBN300	#10-16 X 1"	#2	Stalgard® GB	0.5"	4000
--------	-------------	----	--------------	------	------

Identification

The head marking consists of the number "3" above the ELCO® logo as shown below.



Hex Washer Head



Flat, Pan and Pancake Head

Cat #	Description	Point	Finish	Max Load	Pack Qty
-------	-------------	-------	--------	----------	----------



#12 Diameter, 5/16" Hex Washer Head

EAJ185	#12-14 X 1"	#2	Stalgard® GB	0.406"	3000
EAJ190	#12-14 X 1"	#3	Stalgard® GB	0.406"	4000
EAJ200	#12-14 X 1-1/4"	#3	Stalgard® GB	0.656"	2500
EAJ215	#12-14 X 1-1/2"	#2	Stalgard® GB	0.906"	2500
EAJ220	#12-14 X 1-1/2"	#3	Stalgard® GB	0.906"	2500
EAJ320	#12-24 X 1-1/2"	#5	Stalgard® GB	0.5"	2500
EAJ240	#12-14 X 2"	#2	Stalgard® GB	1.406"	1500
EAJ340	#12-24 X 2"	#5	Stalgard® GB	1"	2000
EAJ260	#12-14 X 2-1/2"	#3	Stalgard® GB	1.906"	1000



#2 Diameter, #3 Phillips Undercut Flat Head

EBN200	#12-14 X 1"	#2	Stalgard® GB	0.406"	4000
EBN220	#12-14 X 1-1/4"	#2	Stalgard® GB	0.656"	2500
EBN240	#12-14 X 1-1/2"	#2	Stalgard® GB	0.906"	2500



#12 Diameter, #2 Phillips Pancake Head

EBN320	#12-14 X 1"	#3	Stalgard® GB	0.406"	4000
--------	-------------	----	--------------	--------	------



1/4" Diameter, 3/8" Hex Washer Head

EAJ415	1/4"-14 X 1"	#2	Stalgard® GB	0.406"	2500
EAJ540	1/4"-20 X 1"	#3	Stalgard® GB	0.406"	2500
EAJ430	1/4"-14 X 1-1/2"	#2	Stalgard® GB	0.906"	1000
EAJ580	1/4"-20 X 1-1/2"	#3	Stalgard® GB	0.906"	1000
EAJ600	1/4"-20 X 1-1/2"	#5	Stalgard® GB	0.5"	1000
EAJ445	1/4"-14 X 2"	#2	Stalgard® GB	1.406"	1500
EAJ610	1/4"-20 X 2"	#3	Stalgard® GB	1.406"	1500
EAJ615	1/4"-20 X 2"	#5	Stalgard® GB	1"	1500
EAJ640	1/4"-20 X 2-1/2"	#3	Stalgard® GB	1.906"	1000
EAJ650	1/4"-20 X 3"	#3	Stalgard® GB	2.406"	500
EAJ630	1/4"-20 X 3"	#5	Stalgard® GB	2"	500
EAJ660	1/4"-20 X 4"	#3	Stalgard® GB	3.406"	500
EAJ670	1/4"-20 X 4"	#5	Stalgard® GB	3"	500
EAJ675	1/4"-20 X 5"	#5	Stalgard® GB	4"	250
EAJ680	1/4"-20 X 6"	#5	Stalgard® GB	5"	250
EAJ690C	1/4"-20 X 8"	#5	Stalgard® GB	7"	150

Cat #	Description	Point	Finish	Max Load	Pack Qty
-------	-------------	-------	--------	----------	----------



1/4" Diameter, #3 Phillips Undercut Flat Heads

EBN630	1/4"-20 X 3"	#3	Stalgard® GB	2.406"	500
EBN640	1/4"-20 X 4"	#3	Stalgard® GB	3.406"	500

The load-bearing length is the length of 300 series stainless under the hex, pan or pancake head or including the flat head. Hardened steel length (lead threads and point) should be through the connection and not in the load bearing section of the connection.



#10 Diameter, #2 Phillips Flat Head with Wings

EBN140	#10-16 X 1-1/2"	#3	Stalgard® GB	0.813"	3500
--------	-----------------	----	--------------	--------	------



#12 Diameter, #3 Phillips Flat Head with Wings

EBN345	#12-24 X 2-13/16"	#5	Stalgard® GB	1.563"	1000
--------	-------------------	----	--------------	--------	------



1/4" Diameter, #3 Phillips Flat Head with Wings

EBN645	1/4"-20 X 2-13/16"	#5	Stalgard® GB	1.563"	1000
--------	--------------------	----	--------------	--------	------



Tap-Flex™ Thread-Forming Structural Screws

Increased thread engagement with strength and ductility

Feature a unique thread profile to ease installation and increase performance.

Specifications

- Diameters: 3/8", 1/2", and 5/8"
- Head Style: Hex washer
- Threads: E-Form® five-lobe thread forming
- Material: Alloy steel, Finish: Silver Stalgard® SUB coating
- Heat Treat: Grade 5; meets ASTM A449 specifications (120 KSI strength)

Features and Benefits

- E-Form thread overcomes friction build-up and reduces drive torque
- Roll forms own work-hardened thread to resist loosening and provide enhanced pull-out values
- Virtually immune to delayed embrittlement failures
- Stalgard SUB coating provides 2000 hours of salt spray resistance (per ASTM B117)

Identification

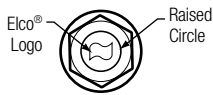

E-Form® Profile



Cat #	Description	Drill Bit	Finish	Pack Qty
-------	-------------	-----------	--------	----------



3/8" Diameter, 9/16" Hex Washer Head with Serrations

ESU310	3/8"-16 X 1-1/2"	8.5 mm	Stalgard® SUB	500
ESU320	3/8"-16 X 2"	8.5 mm	Stalgard® SUB	500
ESU330	3/8"-16 X 2-1/2"	8.5 mm	Stalgard® SUB	500
ESU340	3/8"-16 X 3"	8.5 mm	Stalgard® SUB	250
ESU350	3/8"-16 X 4"	8.5 mm	Stalgard® SUB	250
ESU360	3/8"-16 X 5"	8.5 mm	Stalgard® SUB	150

Cat #	Description	Drill Bit	Finish	Pack Qty
-------	-------------	-----------	--------	----------



1/2" Diameter, 3/4" Hex Washer Head with Serrations

ESU410	1/2"-13 X 1-1/2"	29/64"	Stalgard® SUB	250
ESU420	1/2"-13 X 2"	29/64"	Stalgard® SUB	250
ESU430	1/2"-13 X 2-1/2"	29/64"	Stalgard® SUB	250
ESU440	1/2"-13 X 3"	29/64"	Stalgard® SUB	150
ESU450	1/2"-13 X 4"	29/64"	Stalgard® SUB	150
ESU460	1/2"-13 X 5"	29/64"	Stalgard® SUB	100



5/8" Diameter, 15/16" Hex Washer Head with Serrations

ESU510	5/8"-11 X 1-1/2"	37/64"	Stalgard® SUB	250
ESU520	5/8"-11 X 2"	37/64"	Stalgard® SUB	150
ESU530	5/8"-11 X 2-1/2"	37/64"	Stalgard® SUB	150
ESU540	5/8"-11 X 3"	37/64"	Stalgard® SUB	100
ESU550	5/8"-11 X 4"	37/64"	Stalgard® SUB	100
ESU560	5/8"-11 X 5"	37/64"	Stalgard® SUB	50



Fab-Lok® Fasteners

To maintain panel integrity in high-stress and high-vibration environments

Vibration, either from inside or outside a building, can make ordinary fasteners loosen and back out. Fab-Lok fasteners combine a slotted aluminum sleeve and fastener to provide high resistance to vibration loosening. Excellent for use with insulated panels.

Specifications

- Drive System: Hex
- Materials: Low carbon steel or 300 series stainless steel screw with aluminum sleeve
- Finish: Zinc

Features & Benefits

- Hex washer head machine screw assembled to a slotted aluminum sleeve and EPDM sealing washer
- After tightening, clamping times remain in place even if screw is removed
- Greater joint integrity with clamping force

Cat #	Grip Range	Max. Penetrating Length	Head Height	Head Diam	Ctn Qty
-------	------------	-------------------------	-------------	-----------	---------



Carbon Steel

EZJ100	.062" - .250"	1.300"	0.385"	0.710"	1000
EZJ120	.250" - .500"	1.600"	0.385"	0.710"	1000
EZJ140	.500" - .750"	1.800"	0.385"	0.710"	1000



H3 (300 Series) Stainless Steel

EZJ210	.062" - .250"	1.300"	0.385"	0.710"	1000
EZJ230	.250" - .500"	1.600"	0.385"	0.710"	1000
EZJ250	.500" - .750"	1.800"	0.385"	0.710"	1000

Fab-Lok Drive Tools*

EZJ900	Holding Sleeve with Socket				1
--------	----------------------------	--	--	--	---

*Fab-Lok fastener is inserted into a 5/16" hole (hole size is not critical) then installed with a power driver equipped with a Fab-Lok holding sleeve, with a socket designed to fit DeWALT® tools DCF622, DW267, DW268 and DW269. Max. 1000 rpm during installation.

Identification



Carbon Steel Screw:
Elco Flag



Stainless Steel Screw:
"F" Above "2"

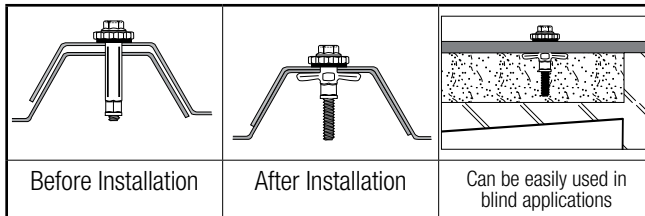

RapidSet® Tools

The fastest, easiest and most reliable way to install machine screw anchors

Efficient RapidSet® tools eliminate clumsy hammer and -setting processes or expensive, slow expander tools.*

Specifications









- For machine screw anchor sizes #10, 1/4" and 3/8"
- Designed for use with power tools, including battery impact drivers
- MAXX model allows placement of 1/4" anchors at various depths (up to 2") below the surface

Features & Benefits

- Power tool does all the work – no pounding with setting tools
- Automatically sets anchor just below the surface
- Maximizes expansion of bottom portion of lead sleeve, which results in consistently high pull-out values

Cat #	For Insert-Anchor Size
Standard RapidSet tool	
EZB790	#10-24
EZB800	1/4-20
EZB820	3/8-16
RapidSet MAXX tool	
EZB810	1/4-20
Repair Kits	
EZB811	Repair Kit for EZB810 (Rapidset MAXX Tool)
EZB801	Repair Kit for EZB800 (Rapidset Tool for 1/4-20 Inserts)

* Note: RapidSet tools draw the anchor's internal insert up into the anchor's outer sleeve; this installation process eliminates the need to maintain a back bearing surface (required by hammer setting tools).

Fastener Type	Self-Drilling Tapping Screws						Self-Piercing Tapping Screws		Thread Forming Tapping Screws			Panel Rivets
Fastener Family	Drilit · Dril-Flex · Bi-Flex · Alumi-Flex Architectural Roof- Clip Fasteners (For Steel)						TapFast Architectural Roof Clip Fas- teners (For Wood)		Tap-Flex			Fab- Lok
Diameter	#6	#8	#10	#12	1/4"	5/16"	#10	#12	3/8"	1/2"	5/8"	—
 <p>DeWALT 20V MAX* XR® Versa-Clutch™ ADJUSTABLE TORQUE SCREWGUN DCF622</p>	●	●	●	●	●		●	●				●
 <p>DeWALT 2,500 rpm VSR™ Versa-Clutch™ SCREWGUN DCF622</p>	●	●	●	○			●	●				●
 <p>DeWALT 2,000 rpm VSR™ Versa-Clutch™ SCREWGUN DW267</p>	●	●	●	●	●		●	●				●
 <p>DeWALT 1,000 rpm VSR™ Versa-Clutch™ SCREWGUN DW269</p>				○	○	●						●
 <p>20V MAX* 3/8" CORDLESS IMPACT WRENCH WITH HOG RING ANVIL DCF913</p>									●	○	○	
 <p>20V MAX* 1/2" IMPACT WRENCH WITH HOG RING ANVIL DCF911</p>									●	○	○	
 <p>20V MAX* XR® 1/2" MID-RANGE IMPACT WRENCH (DCF896 WITH Tool Connect™ System) DCF894 or DCF896</p>									●	●	●	
 <p>20V MAX* XR® HIGH TORQUE 1/2" IMPACT WRENCH DCF889</p>										○	●	

For 20V MAX Maximum initial battery voltage measured without a workload is 20 volts. Nominal voltage is 18.

Impact tools are not recommended for the installation of self drilling screws. A max 2500 rpm screw gun with torque sensing nose pieces should be used.

DEWALT

ANCHORS & FASTENERS

- **GAS-FREE OPERATION:**
Runs on DEWALT 20V MAX* battery.
- **1" MAGAZINE:** Reduces weight vs. DCN890 and allows for improved access into deep track. Interchangeable with 2-1/4" magazine.
- **BRUSHLESS MOTOR:** Comparable application speed to gas concrete nailers.
- **FIELD SERVICEABLE PISTON:** Can be replaced by user in the field in under 2 minutes



DCN891P2

* Maximum initial battery voltage (measured without a workload) is 20 volts. Nominal voltage is 18.
** 2-1/4" magazine and pins also available



DEWALT®

GUARANTEED TOUGH.®

VISIT [ANCHORS.DEWALT.COM](https://anchors.dewalt.com) FOR:

DOWNLOADS

TRAINING

SUPPORT

SOFTWARE

CUSTOMER SERVICE

Call: 1-800-524-3244

Email: DEWALTanchors@sbdinc.com

ENGINEERING & PRODUCT SUPPORT

Call: 1-800-524-3244

Email: anchors@DEWALT.com

1-800-4 DEWALT®

[www.DEWALT.com](https://www.dewalt.com)

*Maximum initial battery voltage (measured without a workload) is 20 volts. Nominal voltage is 18.

¹ With 5.0Ah battery pack, driving 3/4" .102 fasteners into concrete.

Copyright ©2022 DEWALT. The following are trademarks for one or more DEWALT power tools, accessories, anchors and concrete adhesives: The yellow and black color scheme; the "D"-shaped air intake grill; the array of pyramids on the handgrip; the kit box configuration; and the array of lozenge-shaped humps on the surface of the tool.

ICDWPWRELCORG22 01/22