



Dust extraction

Overview of products and applications 298

CLEANTEC mobile dust extractors, compact CT 17, CTL SYS, CTL MINI, CTL MIDI 302

CLEANTEC mobile dust extractors CT 26/36/48 306

CLEANTEC AUTOCLEAN mobile dust extractors CT 26/36/48 AC, CT 36 AC PLANEX, CT 26/36 AC HD 308

CLEANTEC special extractors CT 48 EC, CT 48 EC/B22, CTH 26/48 311

Accessories and consumable materials 314

The Festool system

Dust extraction

Overview of products and applications

Compact yet effective. Lightweight yet powerful. Whether on the construction site or in the workshop – Festool mobile dust extractors are prepared for every challenge.

Page 302 — 303 — 304 — 305 — 306 — 306

CT 17

CTL SYS

CTL MINI

CTL MIDI

CTL 26/36

CTM 26/36



Applications

CLEANTEC
mobile dust extractors, compact

CLEANTEC
mobile dust extractors

Application area

Assembly (low quantities of coarse dust)

Workshop, industry

Building site, drywall construction (large quantities of fine dust)

Zone 22

Application

Extraction of dust from power tools

Dust extraction from air tools (LE variants)

Cleaning work

Continuous industrial use

Special features

Modular flexibility with 2 sockets/compressed air module

AUTOCLEAN fully automatic main filter cleaning system

Combination with ASA/EAA

Type of dust

wood dust

Mineral, quartziferous dust

Aluminium, powder coating and polyurethane dust

Carcinogenic dust and asbestos

Technical data

	CT 17	CTL SYS	CTL MINI	CTL MIDI	CTL 26/36	CTM 26/36
Power consumption (W)	400 – 1.200	1.000	400 – 1.200	400 – 1.200	350 – 1.200	350 – 1.200
Max. flow rate (l/min)	3.700	3.000	3.700	3.700	3.900	3.900
Max. vacuum (Pa)	24.000	20.000	24.000	24.000	24.000	24.000
Max. container/filter bag capacity (l)	17/17	4,5/3,5	10/7,5	15/12,5	26/24 / 36/34	26/24 / 36/34
Dimensions (L x W x H) (mm)	445 x 380 x 485	396 x 296 x 270	430 x 330 x 422	430 x 330 x 470	630 x 365 x 540 630 x 365 x 596	630 x 365 x 540 630 x 365 x 596
Weight (kg)	9,4	6,9	8,7	9,0	13,9 / 14,4	13,9 / 14,4



CLEANTEC mobile dust extractors

CLEANTEC AUTOCLEAN mobile dust extractors

CLEANTEC special extractors

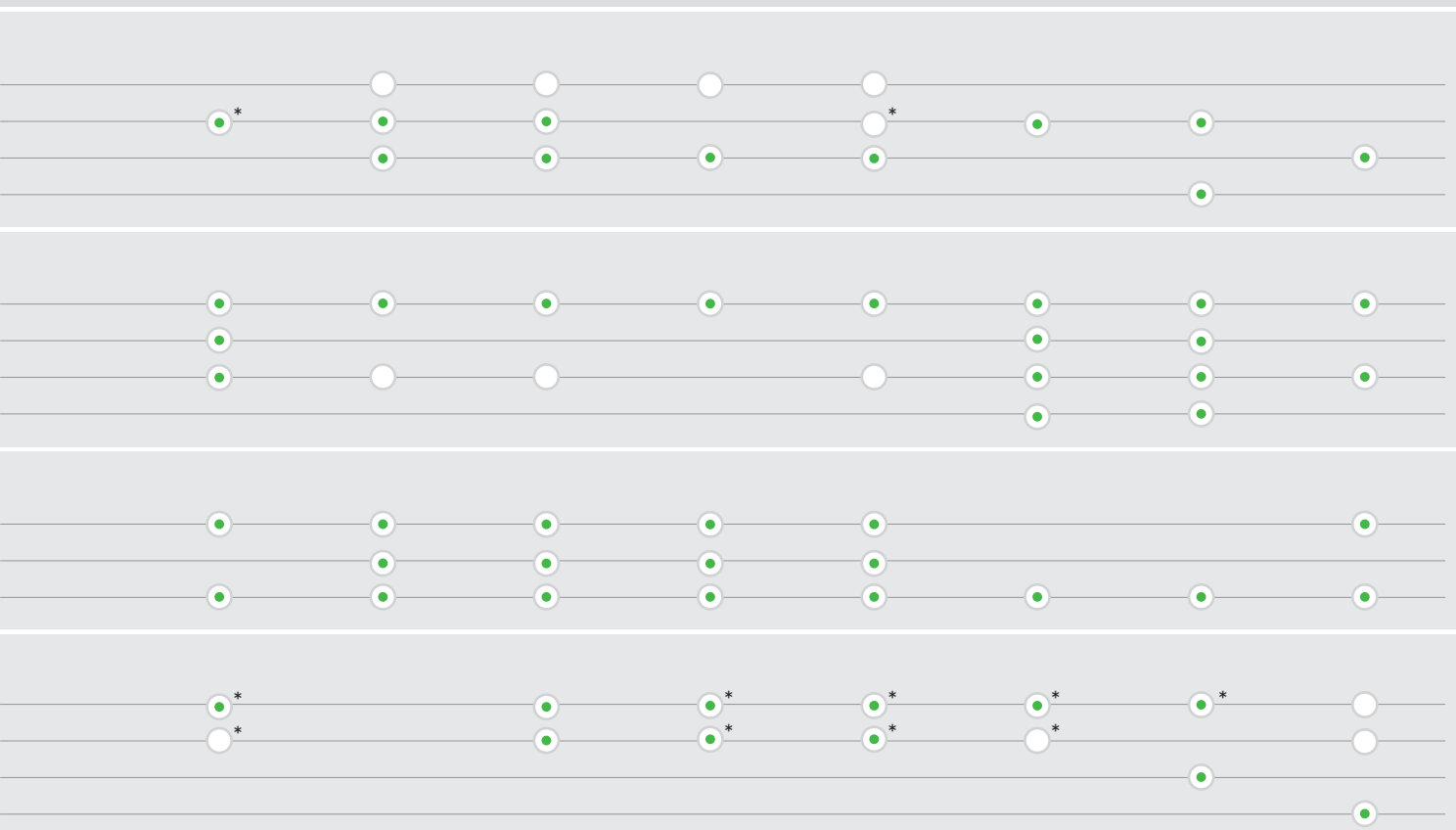

* CTM only

● Ideal

○ Suitable

	307	308	308	309	310	311	312	313
Weight	350 – 1.200	350 – 1.200	350 – 1.200	350 – 1.200	350 – 1.200	150 – 1.100	150 – 1.100	350 – 1.000
Power	3.900	3.900	3.900	3.900	3.900	3.400	3.400	3.900
Flow rate	24.000	24.000	24.000	24.000	24.000	23.000	23.000	24.000
Filter area	48/46	26/24 / 36/34 / 48/46	26/24 / 36/34 / 48/46	36/34	26/24 / 36/34	48/46	48/46	26/24 / 48/46
Dimensions (mm)	740 x 406 x 1.005	630 x 365 x 540 630 x 365 x 596 740 x 406 x 1.005	630 x 365 x 540 630 x 365 x 596 740 x 406 x 1.005	630 x 365 x 596	673 x 365 x 455 673 x 365 x 522	630 x 406 x 640	630 x 406 x 640	630 x 365 x 540 740 x 406 x 1.005
Height (mm)	18,8	14,7 / 15,2 / 19,6	14,7 / 15,2 / 19,6	15,2	14,5 / 15,2	17,9	18,6	13,9 / 18,8

Dust extraction

We recommend using a dust extraction system.

We strongly recommend choosing the right extractor when selecting a dust extraction system.

When working in a dusty environment and especially when handling materials that generate large quantities of dust, your main priority should be protecting your health! How harmful the dust is to your health depends on the size of the dust particles as well as the quantity and time that the materials remain inside your lungs. The smaller the dust particles are, the deeper they can penetrate into the lung tissue and this is why finer dust particles are much more harmful to the airways. Many dust particles are even categorised as extremely hazardous to health.

For example, crystalline silicon dioxide is closely associated with the development of lung cancer. In the interests of your own health, it is imperative that you keep the air clean when handling mineral dust that invariably contains quartziferous substances and always work with a certified and approved dust extractor or safety extractor.

Your Industrial Employers' Liability Insurance Association will provide you with detailed information and specially prepared lists of substances that exceed specified OEL (occupational exposure limits).



CTL MINI/MIDI
CTL 26/36/48/
48 EC

Specialists for dust with OEL
> 1 mg/m³.



CTM 26/36/48/
48 EC

Specialists for dust with OEL
≥ 0.1 mg/m³.
For quartziferous, mineral dust
and wood dust.



CTH 26/48

Specialists for dust with OEL
> 0.1 mg/m³.
For carcinogenic and pathogenic
dust, e.g. asbestos and mould.



CTL 48 LE EC/B 22
CTM 48 LE EC/B 22

Specialised in the extraction of
flammable and explosive dust.

Dust categories in accordance with EN 60335-2-69, Appendix AA

	Appropriate	Max. permeability (test)	Disposal	Contamination risk
L (Low)	- dust with OEL > 1 mg/m ³	1% (filter material)		
M (Medium)	- dust with OEL ≥ 0.1 mg/m ³ - mineral dust - wood dust	0.1% (complete machine incl. upholstery nail test)	Dust-free	Cap for transportation
H (High)	- dust with OEL > 0.1 mg/m ³ - carcinogenic dust - dust containing pathogens	0.005% (complete machine incl. upholstery nail test)	dust-free	Cap for transportation

As important as the air you breathe. 3 good reasons why you should work with a dust extractor.

1. Let us begin with the most important thing first: your health. Mobile dust extractors can collect up to 99.995% of dust generated during classic sanding, sawing and routing applications. In other words, any particles that would have otherwise passed down your airways and into your lungs find their way directly into a large collection container.
2. A pleasant side-effect: mobile dust extractors also make your customers happy. They keep your work environment as clean as your working results. Not only do you leave a lasting impression but also significantly increase the likelihood of your customers recommending you.
3. And finally, they extend the life of your electric power tools considerably. Any particles that are safely extracted into the container cannot adhere to the motor or contacts.

Full utilisation of the container volume

The sophisticated container geometry, compatible SELFCLEAN filter bag and space-saving flat filter combine to produce a net volume that corresponds almost exactly to the gross volume of the container.



SYS-Dock

Simple transportation, better organisation and endless flexibility. The SYS-Dock for the safe connection of SYSTAINER, SORTAINER and SYS-ToolBox units.



Hose garage

The integral hose holder eliminates the need for annoying external hooks and protects the suction hose and mains cable from damage. The suction hose winds around the holder for clean, compact transportation.



AUTOCLEAN technology

Less cleaning work and constant suction power. The AUTOCLEAN automatic cleaning system eliminates the need to clean the main filter manually. Individual cleaning intervals can be defined to guarantee powerful, constant suction.



Better in a system

Festool mobile dust extractors are an integral part of the system concept and perfectly adapted to Festool electric power and air tools. They switch on automatically when the tool is activated. Any mobile dust extractor can be fitted with an optional handle or tool holder or combined with a Workcenter or Toolcenter to create a mobile work station.



Dust extraction

Mobile dust extractor CLEANTEC CT 17



CLEANTEC CT 17



Matter of cleanliness.

Ideal for cleaning offices, garages, vehicles and construction sites. Also suitable for extracting water.

The specialists for cleaning work.

- ▶ Maximum utilisation of filter bag capacity due to innovative design principle
- ▶ High suction performance and flow rate due to powerful single-stage turbine
- ▶ Blow function with end cap on the rear of the housing
- ▶ Electronic level control for vacuum extraction of liquids

Technical data

Power consumption (W)	400 – 1.200
Airflow max. (l/min)	3.700
Max. vacuum (Pa)	24.000
Filter surface area (cm ²)	4.600
Power cord (m)	5,5
Container/Filter bag capacity (l)	17/17
dimension (L x W x H) (mm)	445 x 380 x 485
Maximum wattage of connected tool (W)	2.400
weight (kg)	9,4



■ = Electronic

Scope of delivery

double-wall filter bag

CT 17 E AUS

suction hose dia. 27 mm x 3.5 m with rotary connection hubs, in carton

CT 17 WDS AUS

suction hose D 36, cleaning attachment set

Order no.

769809

574869

System accessories from page 316





CTL SYS

The dust extractor in Systainer size.

- ▶ 99.95 separation efficiency at .03 microns
- ▶ Extremely small, light and compact in a Systainer size for maximum mobility
- ▶ Comfortable transport whether by hand or strap
- ▶ With integrated hose, cable and nozzle garage, you always have everything you need

Technical data

Power consumption (W)	1.000
Airflow max. (l/min)	3.000
Max. vacuum (Pa)	20.000
Filter surface area (cm ²)	5.357
Rubber-insulated mains cable (m)	5
Container/Filter bag capacity (l)	4,5/3,5
dimension (L x W x H) (mm)	396 x 296 x 270
Maximum wattage of connected tool (W)	1.200
weight (kg)	6,9



■ = Electronic

Scope of delivery

Order no.

CTL SYS AUS

584177

fitted filter bag, suction hose Ø 27 x 3 m-AS, with angled rotating adapter on extractor end, integrated hose garage, SYS-Dock with T-LOC function, upholstery nozzle D 36 PD, crevice nozzle D 36 FD-150, SYS-CT carrying strap, in carton



09

Cleanliness has never been so compact.

Ideal dust extractor for quick, mobile use for small on-site jobs and maintenance work: very compact, light, quiet, and designed to connect to the Systainer system. The Systainer dust extractor is perfect for cleaning tasks with small volumes of dust and dirt. For dust in dust class L.

System accessories from page 316

SYSTAINER from page 406

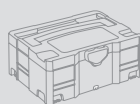

Dust extraction

Mobile dust extractor CLEANTEC CTL MINI



CLEANTEC CTL MINI



Ideal for carrying en route.

With a low weight and compact dimensions, the CTL MINI is easy to transport and therefore the first choice for assembly tasks.

The compact wet/dry extractor is ideal for extracting small to medium volumes of dust and dirt. For class L dust.

The little on-site extractor with 10 l container capacity.

- ▶ 99.95 separation efficiency at .03 microns
- ▶ Extremely lightweight and compact, for easy transport
- ▶ Tidier due to hose garage for secure storage of hose and cables
- ▶ High suction power due to compact high-power turbine and tapered suction hose

Technical data

Power consumption (W)	400 – 1.200
Airflow max. (l/min)	3.700
Max. vacuum (Pa)	24.000
Filter surface area (cm ²)	5.000
Rubber-insulated mains cable (m)	7,5
Container/Filter bag capacity (l)	10/7,5
dimension (L x W x H) (mm)	430 x 330 x 422
Maximum wattage of connected tool (W)	2.400
weight (kg)	8,7



= Electronic

Scope of delivery

fitted filter bag, suction hose, Ø 27/32 x 3.5 m AS with rotating angle adapter at extractor side, integrated hose garage, SYS-Dock with T-LOC function, in carton

Order no.

CT MINI AUS

584155

CT MINI-Set AUS

cleaning attachment set

574870

System accessories from page 316





CLEANTEC CTL MIDI

The compact on-site extractor with 15 l container capacity.

- ▶ 99.95 separation efficiency at .03 microns
- ▶ Extremely lightweight and compact, for easy transport
- ▶ Tidier due to hose garage for secure storage of hose and cables
- ▶ High suction power due to compact high-power turbine and tapered suction hose

Technical data

Power consumption [W]	400 – 1.200
Airflow max. [l/min]	3.700
Max. vacuum [Pa]	24.000
Filter surface area [cm ²]	5.000
Rubber-insulated mains cable (m)	7,5
Container/Filter bag capacity [l]	15/12,5
dimension [L x W x H] [mm]	430 x 330 x 470
Maximum wattage of connected tool [W]	2.400
weight [kg]	9



■ = Electronic

Scope of delivery

fitted filter bag, suction hose, Ø 27/32 x 3.5 m AS with rotating angle adapter at extractor side, integrated hose garage, SYS-Dock with T-LOC function, in carton

Order no.

CT MIDI AUS 584164

CT MIDI-Set AUS 574871
cleaning attachment set



09

Small on the outside, large on the inside.

The CTL MIDI is the ideal companion for assembly, installation and renovation work. The compact wet/dry extractor with 15 l container volume is perfect for extracting small to medium volumes of dust and dirt. For class L dust.

System accessories from page 316



Dust extraction

CLEANTEC CT 26 / CT 36 mobile dust extractors



CLEANTEC CT 26 / CT 36



All-rounder in the perfect size.

Compact yet effective. Lightweight yet powerful. Whether on the construction site or in the bodyshop – the perfected container geometry of the CLEANTEC CT 26/36 offers a significantly larger capacity with minimal external dimensions.

Small on the outside, big on the inside.

- ▶ Antistatic function prevents static build-up during use
- ▶ 99.95 separation efficiency at .03 microns
- ▶ Attachment of Systainers via Sys-Dock
- ▶ Constantly high suction because of the compact high performance turbine

Technical data	CT 26	CT 36
Power consumption (W)	350 – 1.200	350 – 1.200
Airflow max. (l/min)	3.900	3.900
Max. vacuum (Pa)	24.000	24.000
Filter surface area (cm ²)	6.318	6.318
Rubber-insulated mains cable (m)	7,5	7,5
Container/Filter bag capacity (l)	26/24	36/34
dimension (L x W x H) (mm)	630 x 365 x 540	630 x 365 x 596
Maximum wattage of connected tool (W)	2.400	2.400
weight (kg)	13,9	14,4



■ = Electronic

Scope of delivery	Order no.
self-cleaning filter bag, integrated hose garage, cable wrap, suction hose Ø 27 mm x 3.5 m long, anti-static, in carton	
CT 26 E AUS HEPA SYS-Dock with T-LOC function	583494
CT 26 E-LLF AUS with Longlife filter sack, SYS-Dock with T-LOC function	574867
CT 36 E AUS HEPA SYS-Dock with T-LOC function	583495
CTL 36 LE AUS compressed air module, SYS-Dock with T-LOC function	201623
CT 36 E-LLF AUS with Longlife filter sack, SYS-Dock with T-LOC function	574868
CTM 26 E AUS end cap for intake adapter, Sys dock	201475
CTM 36 E AUS end cap for intake adapter, Sys dock	201476

System accessories
from page 316



Workcenter WCR 1000
from page 389

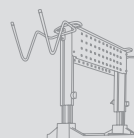

Dust extraction

Mobile dust extractor CLEANTEC CT 48



CLEANTEC CT 48



There's more to it than meets the eye.

- ▶ 99.95 separation efficiency at .03 microns
- ▶ Approval for dust class L or M
- ▶ Antistatic function prevents static build-up during use
- ▶ Constantly high suction because of the compact high performance turbine

Technical data

Power consumption (W)	350 – 1.200
Airflow max. (l/min)	3.900
Max. vacuum (Pa)	24.000
Filter surface area (cm ²)	6.318
Rubber-insulated mains cable (m)	7,5
Container/Filter bag capacity (l)	48/46
dimension (L x W x H) (mm)	740 x 406 x 1.005
Maximum wattage of connected tool (W)	2.400
weight (kg)	18,8



■ = Electronic

Scope of delivery

self-cleaning filter bag, suction hose Ø 27 mm x 3.5 m long, anti-static, integrated hose garage, Sys dock, cable wrap, handle, in carton

Order no.

CTL 48 E AUS HEPA	201477
CTM 48 E AUS	201479
end cap for intake adapter	

For use in the workshop.

The CT 48 has a container volume of 48 litres, which is ideal for extracting large quantities of dust in the bodyshop. As CTL and CTM it is suitable for dust classes L and M.

System accessories from page 316



Workcenter WCR 1000 from page 389

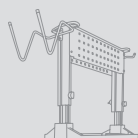

CT boom arm from page 324



Dust extraction

Mobile dust extractors CLEANTEC
CT 26 AC / CT 36 AC / CT 48 AC



CLEANTEC CT 26 AC / 36 AC / 48 AC



Fully automatic filter cleaning.

- ▶ AUTOCLEAN automatic main filter cleaning system with infinitely adjustable cleaning intervals
- ▶ ComfortClean closing slide (accessory) for even more powerful cleaning
- ▶ Constantly high suction because of the compact high performance turbine
- ▶ Antistatic function prevents static build-up during use

Technical data	CT 26 AC	CT 36 AC	CT 48 AC
Power consumption (W)	350 – 1.200	350 – 1.200	350 – 1.200
Airflow max. (l/min)	3.900	3.900	3.900
Max. vacuum (Pa)	24.000	24.000	24.000
Filter surface area (cm ²)	6.318	6.318	6.318
Rubber-insulated mains cable (m)	7,5	7,5	7,5
Container/Filter bag capacity (l)	26/24	36/34	48/46
dimension (L x W x H) (mm)	630 x 365 x 540	630 x 365 x 596	740 x 406 x 1.005
Maximum wattage of connected tool (W)	2.400	2.400	2.400
weight (kg)	14,7	15,2	19,6



☐ = Electronic

This product is not available in Australia.

The weapon against clogged filters.

We have got something against clogged filters: the CLEANTEC AC. An automatic filter cleaning system keeps the filter clean and maintains a constant suction power. One-touch cleaning can be initiated at any time.

System accessories
from page 316



Workcenter WCR 1000
from page 389

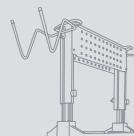

Dust extraction

Mobile dust extractor CLEANTEC CT 36 AC PLANEX



CLEANTEC CT 36 AC PLANEX

Ideal for use on plasterboard.

- ▶ Antistatic function prevents static build-up during use
- ▶ 99.95 separation efficiency at .03 microns
- ▶ Attachment of Systainers via Sys-Dock
- ▶ Constantly high suction because of the compact high performance turbine

Technical data

Power consumption (W)	350 – 1.200
Airflow max. (l/min)	3.900
Max. vacuum (Pa)	24.000
Filter surface area (cm ²)	6.318
Rubber-insulated mains cable (m)	7,5
Container/Filter bag capacity (l)	36/34
dimension (L x W x H) (mm)	630 x 365 x 596
Maximum wattage of connected tool (W)	2.400
weight (kg)	15,2



■ = Electronic

Scope of delivery

CT 36 E AC-PLANEX AUS

comfort clean closing slide, High-performance main filter, self-cleaning filter bag, disposal bag, kink-resistant suction hose D36x3.5-AS/LHS 225, integrated hose garage, tool holder PLANEX, cable wrap, in carton

Order no.

584063



Our contribution to shorter working hours.

The quicker a sander removes material, the more powerful the connected mobile dust extractor needs to be. The powerful CT 36 AC PLANEX was designed specifically for the extreme material removal rate of the PLANEX long-reach sander. Includes a tool holder, kink-proof hose and series standard ComfortClean closing slide for even more efficient filter cleaning. Perfect results every time at maximum speed.

System accessories from page 316



PLANEX LHS 225 from page 92



Dust extraction

Mobile dust extractors CLEANTEC CT 26 AC HD / CT 36 AC HD

CLEANTEC CT 26 AC HD / 36 AC HD



Heavy-duty tool.

The CT 26/36 AC HD is in its element when there is an abundance of dust, which occurs, for example, when working with masonry renovators and diamond grinders. The automatic main filter cleaning flushes the main filter regularly, thus ensuring a constantly high suction power.

The construction site dust extractor with automatic filter cleaning.

- ▶ Automatic cleaning for constantly high suction flow
- ▶ Extremely sturdy design with large wheels and steel axle for use on construction sites.
- ▶ Specifically designed for use with electric power tools, with electrical outlet, automatic switch-on with start-up and shut-off delay and fully variable suction power adjustment.
- ▶ Large storage and set-down area for power tools and Systainer.

Technical data

CT 36 AC HD

Power consumption (W)	350 – 1.200
Airflow max. (l/min)	3.900
Max. vacuum (Pa)	24.000
Filter surface area (cm ²)	6.318
Rubber-insulated mains cable (m)	7,5
Container/Filter bag capacity (l)	36/34
dimension (L x W x H) (mm)	673 x 365 x 522
Maximum wattage of connected tool (W)	2.400
weight (kg)	15,2



■ = Electronic

Scope of delivery

Order no.

High-performance main filter, self-cleaning filter bag, disposal bag, anti-static suction hose Ø 36/32 mm x 3.5 m AS with rotary connection sleeves, comfort clean closing slide, Accessory case, in carton

CT 36 E AC HD AUS

584169

System accessories from page 316



Concrete grinders from page 346

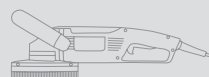

Dust extraction

Mobile dust extractor CLEANTEC CT 48 EC



Brushless EC-TEC motor
for a long service life and
high efficiency



CLEANTEC CT 48 EC

Made for long-term industrial use.

- ▶ constant power from the EC-TEC drive with a service life several times longer than a universal motor
- ▶ with suction power adjustment, flexible adaptation to any working situation
- ▶ Antistatic function prevents static build-up during use
- ▶ With integrated connection for EAA and compressed air tools

Technical data

Power consumption (W)	150 – 1.100
Airflow max. (l/min)	3.400
Max. vacuum (Pa)	23.000
Filter surface area (cm ²)	6.318
Rubber-insulated mains cable (m)	7,5
Container/Filter bag capacity (l)	48/46
dimension (L x W x H) (mm)	630 x 406 x 640
Maximum wattage of connected tool (W)	2.400
weight (kg)	17,9



■ = Electronic

Scope of delivery

CTL 48 E LE EC AUS

self-cleaning filter bag, suction hose Ø 27 mm x 3.5 m long, anti-static, cable wrap, compressed air module, in carton

Order no.

201481

Reliable. Durable. Powerful.

Tough continuous operation is its speciality and the EC-TEC drive concept guarantees greater reliability and a longer life. For relentless suction power when processing plastic, ceramic, wooden or painted surfaces.

System accessories from page 316



Workcenter WCR 1000 from page 389

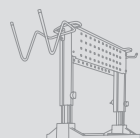

EAA energy box from page 401

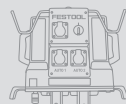

Dust extraction

Mobile dust extractor CLEANTEC CT 48 EC/B22



Brushless EC-TEC motor
for a long service life and
high efficiency



CLEANTEC CT 48 EC/B22



For the greatest possible safety.

- ▶ conforms with ATEX Directive 94/9/EC for Zone 22 – dust from explosion classes St1, St2 and St3 is reliably extracted
- ▶ constant power from the EC-TEC drive with a service life several times longer than a universal motor
- ▶ Antistatic function prevents static build-up during use
- ▶ With integrated connection for EAA and compressed air tools

Technical data

Power consumption (W)	150 – 1.100
Airflow max. (l/min)	3.400
Max. vacuum (Pa)	23.000
Filter surface area (cm ²)	6.318
Rubber-insulated mains cable (m)	7,5
Container/Filter bag capacity (l)	48/46
dimension (L x W x H) (mm)	630 x 406 x 640
Maximum wattage of connected tool (W)	2.400
weight (kg)	18,6



■ = Electronic

For dry and combustible dusts.

The CT 48 EC/B22 special extractor with EC-TEC drive is designed for continuous use. The robust ABS plastic container is fitted with additional flame protection and is therefore suitable for the safe extraction of everything from aluminium, paper, soot and powder coating dust to glass-fibre and carbon-fibre reinforced plastics.

Scope of delivery

CTL 48 E LE EC/B22 R1 AUS
self-cleaning filter bag, suction hose Ø 27 mm x 3.5 m long, anti-static, cable wrap, compressed air module, in carton

Order no.

201480

System accessories from page 316



Workcenter WCR 1000 from page 389

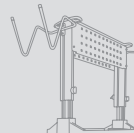

EAA energy box from page 401

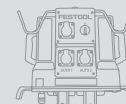

Dust extraction

Mobile dust extractor
CLEANTEC CTH 26 / CTH 48



2013

CLEANTEC CTH 26 / CTH 48



Hazardous dust doesn't stand a chance.

- ▶ Approved for dust class H and asbestos dust
- ▶ sealed tight – with dual-layer safety filter bag
- ▶ Constantly high suction because of the compact high performance turbine
- ▶ with infinitely variable suction power adjustment and antistatic function

Technical data	CTH 26	CTH 48
Power consumption [W]	350 – 1.000	350 – 1.000
Airflow max. [l/min]	3.900	3.900
Max. vacuum [Pa]	24.000	24.000
Filter surface area [cm ²]	6.318	6.318
Rubber-insulated mains cable (m)	7,5	7,5
Container/Filter bag capacity [l]	26/24	48/46
dimension [L x W x H] [mm]	630 x 365 x 540	740 x 406 x 1.005
Maximum wattage of connected tool [W]	2.400	2.400
weight [kg]	13,9	18,8



■ = Electronic

Scope of delivery Order no.

safety filter bag, suction hose Ø 27 mm x 3.5 m long, anti-static, integrated hose garage, Sys dock, cable wrap, in carton

CTH 26 E / a AUS **201636**

CTH 48 E / a AUS **201482**
handle

The specialist for the toughest demands.

Asbestos, mould, fibrous mineral dust, lead, cadmium, nickel, zinc chromate. Many hazards – one answer: Festool's CTH special application dust extractor. Carcinogenic and pathogenic dusts don't stand a chance against it. With a 99.995% degree of filtration there is no danger to health, even during mould and asbestos removal or when working on wood treated with hazardous protective agents.

09

System accessories
from page 316



The Festool system.

Because things work better when everything fits together: Which is why all Festool mobile dust extractors are equipped with an integrated hose garage and SYS-Dock for holding the SYSTAINER. Many models are also fitted with modular plug-in slots. A handle or removable tool holder can be added as an option. Furthermore, they are not only compatible with all Festool power and compressed air tools, but the various accessories are also interchangeable.



Dust extraction

Accessories and consumable materials

Cleaning sets	316
Suction hoses and hose sleeves	317
Tubes and nozzles	322
Modules and boom arms	324
Filters and filter bags	325
CT and compressed air accessories	330













Dust extraction

System accessories

CLEANTEC cleaning sets		Type	Order no.
	Cleaning set crevice nozzle D 36 FD-210, upholstery nozzle D 36 PD, suction brush D 36 SP, in self-service display pack	D 27 / D 36 D-RS	492392
	Standard cleaning set curved hand tube D 36 HR-K, 4-piece floor nozzle D 36 BD270, extension pipes D 36 VR-K, crevice nozzle D 36 FD-210, upholstery nozzle D 36 PD, in carton	D 27 / D 36 S-RS	492389
	Professional cleaning set curved hand tube, D 36 HR-M, extension tube, special steel 3-piece D 36 VR-M3x, carpet nozzle, D 36 TD, crevice nozzle D 36 FD-210, in carton	D 27 / D 36 P-RS	492390
	Compact cleaning set curved hand tube D 36 HR-K, 4-piece floor nozzle D 36 BD270, extension pipes D 36 VR-K, crevice nozzle D 36 FD-210, upholstery nozzle D 36 PD, in SYSTAINER SYS 1 T-LOC	D 27/D 36 K-RS-Plus	497697
	Cleaning set for tradesmen Suction hose D 36 antistatic, curved hand tube, D 36 HR-M, extension tube, special steel 3-piece D 36 VR-M3x, carpet nozzle, D 36 TD, crevice nozzle D 36 FD-210, upholstery nozzle D 36 PD, suction brush D 36 SP, in SYSTAINER SYS 5 T-LOC	D 36 HW-RS-Plus	497700
	Cleaning set for the workshop Suction hose D 36 antistatic, curved hand tube, D 36 HR-M, extension tube, special steel 3-piece D 36 VR-M3x, floor nozzle, D 36 BD 370, in SYSTAINER SYS 5 T-LOC	D 36 WB-RS-Plus	497701
	Universal cleaning set suction hose D 36, floor nozzle, D 36 BD 300, curved hand tube D 36 HR-K, extension pipes D 36 VR-K, crevice nozzle D 36 FD-210, suction brush D 36 SP, upholstery nozzle D 36 PD, in SYSTAINER SYS 5 T-LOC	D 36 UNI-RS-Plus	497702
	Cleaning set for industrial use suction hose Ø 50 x 2,5m, extension tubes D50VR-K, floor nozzle D 50 BD370, square nozzle D 50 QD, suction brush D 50 SP, crevice nozzle D 50 FD, in carton	D 50 GS-RS	454770
	Masonry renovation cleaning set curved hand tube, D 36 HR-M, carpet nozzle, D 36 TD, extension tube, special steel 3-piece D 36 VR-M3x, crevice nozzle D 36 FD-210, upholstery nozzle D 36 PD, in SYSTAINER SYS 2 T-LOC	D 36 RS-M-Plus	497698
	Floor cleaning set curved hand tube, D 36 HR-M, extension tube, special steel 3-piece D 36 VR-M3x, floor nozzle, D 36 BD 370, in SYSTAINER SYS 2 T-LOC	D 36 BD 370 RS-Plus	497699
	Construction cleaning set for all CT and VCP (except VCP 30 E), construction set, Suction hose D 36/32 x 3 m, curved hand tube D 36 HR-K, stainless steel extension tubes, 2-piece, 4-piece floor nozzle D 36 BD270, crevice nozzle D 36 FD-210, suction brush D 36 SP, in carton	D36 BA-RS	767985
	Office cleaning set for all CT and VCP (except VCP 30 E), office set, Suction hose D 36/32 x 3 m, curved hand tube D 36 HR-K, stainless steel extension tubes, 2-piece, carpet nozzle, D 36 TD, upholstery nozzle D 36 PD, crevice nozzle D 36 FD-210, in carton	D36 BU-RS	767987

Accessories for mobile dust extractors CT and dust extractors SR

CLEANTEC suction hose anti-static version





		Type	Order no.
	Suction hose D 32/27, antistatic for CT MINI/MIDI, temperature-resistant to +70°C, with rotating angle adapter at extractor side, date of manuf. 09/2013 onwards, bleeder resistor (DIN IEC 312) <1 mΩ/m, diameter 27/32 mm, length 3,5 m, in carton	D 32/27x3,5m-AS	499742
	Suction hose D 27 antistatic temperature-resistant to +70°C, bleeder resistor (DIN IEC 312) <1 mΩ/m, diameter 27 mm, in carton with rotating adapter and tool end connector, length 3,5 m	D 27x3,5m-AS	452878
	with rotating adapter and tool end connector, length 5 m	D 27x5m-AS	452880
	for CTL-SYS, with rotating adapter and tool end connector, length 3 m	D 27x3m-AS	500559
	ordered by metre (without rotating adapter or end connector)	D 27 MW-AS	452384
	Suction hose D 36 antistatic temperature-resistant to +70°C, bleeder resistor (DIN IEC 312) <1 mΩ/m, in carton with rotating adapter and tool end connector, diameter 36 mm, length 3,5 m	D 36x3,5m-AS	452882
	with rotating adapter and tool end connector, diameter 36 mm, length 5 m	D 36x5m-AS	452884
	with rotating adapter and tool end connector, diameter 36 mm, length 7 m	D 36x7m-AS	452886
	for long-reach sander PLANEX, extremely flexible, kink-resistant suction hose, diameter 36 mm, length 3,5 m	D 36x3,5-AS/KS/LHS 225	496972
	ordered by metre (without rotating adapter or end connector), diameter 36 mm	D 36 MW-AS	452385
	for CT AC and VCP, for work with masonry renovator and cleaning tasks, conical, diameter 36/32 mm, length 3,5 m	D 36/32x3,5m-AS	497925

Dust extraction









System accessories

Accessories for mobile dust extractors CT and dust extractors SR

CLEANTEC suction hose anti-static version

	Type	Order no.
 <p>Suction hose D 50 antistatic temperature-resistant to +70°C, bleeder resistor (DIN IEC 312) <1 mΩ/m, diameter 50 mm, in carton with 2x rotating adapters, length 2,5 m</p>	D 50x2,5m-AS	452888
<p>with 2x rotating adapters, length 4 m</p>	D 50x4m-AS	452890
 <p>ordered by metre (without rotating adapter or end connector)</p>	D 50 MW-AS	452386
 <p>Suction hose plug it D 27/22, antistatic smooth for all electric tools with D27 and D36 flange (all Festool electric tools) and cleaning accessories, specially designed for sanding applications, with rotating adapter and reducing sleeve with bayonet fitting, temperature-resistant to +70°C, bleeder resistor (DIN IEC 312) <1 mΩ/m, diameter 27/22 mm, in carton length 3,5 m</p>	D 27/22x3,5m-AS-GQ/CT	200041
<p>length 5 m</p>	D27/22x5m-AS-GQ/CT	201758
 <p>Suction hose plug it D 32/22, antistatic smooth for all electric tools with D27 and D36 flange (all Festool electric tools) and cleaning accessories, specially designed for sanding applications, with rotating adapter and reducing sleeve with bayonet fitting, temperature-resistant to +70°C, length 10 m, bleeder resistor (DIN IEC 312) <1 mΩ/m, diameter 32/22 mm, in carton</p>	D 32/22x10m-AS-GQ/CT	200051

CLEANTEC suction hose









		Type	Order no.
	Suction hose D 21.5 for direct connection (without coupling sleeve) to the hand sanding block with dust extraction, diameter 21,5 mm, length 5 m, in a bag	D21,5 x 5m HSK	495019
	Suction hose D 27 temperature-resistant to +70°C, diameter 27 mm, in carton with rotating adapter and tool end connector, length 3,5 m	D 27x3,5m	452877
	with rotating adapter and tool end connector, length 5 m	D 27x5m	452879
	ordered by metre (without rotating adapter or end connector)	D 27 MW	452383
	Suction hose D 36 temperature-resistant to +70°C, diameter 36 mm, in carton with rotating adapter and tool end connector, length 3,5 m	D 36x3,5m	452881
	with rotating adapter and tool end connector, length 5 m	D 36x5m	452883
	with rotating adapter and tool end connector, length 7 m	D 36x7m	452885
	ordered by metre (without rotating adapter or end connector)	D 36 MW	454157
	Suction hose D 36/32 for all CT and VCP (except VCP 30 E), temperature-resistant to +70°C, with dust extraction coupling, rotary, diameter 36/32 mm, length 3 m, in carton	D 36/32x3m	768114
	Suction hose D 50 ordered by metre (without rotating adapter or end connector), temperature-resistant to +70°C, diameter 50 mm, in carton	D 50 MW	454158
	Adapter hose for CS 50, CS 70, CMS, 0.5 m hose D36 with two rotating adapters and antistatic connector sleeve D50/D50 VM-AS, for Y-connector together with CTL MINI/MIDI, length 0,5 m, diameter 36 mm, in carton	AD-D36/CS50/CS70/CMS	499196

Dust extraction







System accessories

Accessories for mobile dust extractors CT and dust extractors SR

CLEANTEC hose sleeves

		Type	Order no.
	Antistatic rotating adapter hose connector to fit inlet nozzle of dust extractor, external Ø 58 mm, in self-service display pack		
	for antistatic suction hose D 27	D 27 DAG-AS	452892
			
	for antistatic suction hose D 36	D 36 DAG-AS	452894
			
	for antistatic suction hose D 50	D 50 DAG-AS	452896
	Antistatic rotating angle adapter		
	for antistatic suction hoses D 22 and D 27 on CT MINI and CT MIDI up to date of manuf. 08/2013 and CTL SYS, in a bag	D 27 DAG/90°-AS	456806
	for antistatic suction hose D 32/27 on CTL MINI and CTL MIDI, date of manuf. 09/2013 onwards, in self-service display pack	D 32/27 DAG/90°-AS	499907
	Reducing sleeve, antistatic in self-service display pack		
	for all electric tools with D27 and D36 flange (all Festool electric tools) and cleaning accessories, for all D27 and D27/32 suction hoses; not suitable for the GQ models with integrated plug it cable, for connection on the tool end (electric tool or suction nozzle), secure connection between the mobile dust extractor and power tool, thanks to the bayonet fitting	D 27 DM-AS/CT	500669
			
	for all electric tools with D27 and D36 flange (all Festool electric tools) and cleaning accessories, especially for the smooth suction hoses with integrated plug-it cable, for connection on the tool end (electric tool or suction nozzle), secure connection between the mobile dust extractor and power tool, thanks to the bayonet fitting	D 27/22 DM-AS/CT	500668
			
	for suction hose D 36, hose connector for electric tool or suction nozzle	D 36 DM-AS	487721
			
	for suction hose D 36/32, for suction-side connections (electric tool or suction nozzle)	D 36/32 DM-AS	499723

Dust extraction System accessories



		Type	Order no.
	<p>Reducing sleeve in self-service display pack</p> <p>for suction hose D 36, for reducing to D 27 (on the power tool side)</p>	RM D36/27-AS	498528
	<p>for all VCP/CT models, for attachment on power tool, reduction from Ø 36 to 27 mm, diameter 36 mm</p>	DC-D 36/27-AS	768135
	<p>Reducing sleeve, antistatic for suction hose D 36, for long-reach sander PLANEX, hose connector for electric tool or suction nozzle, in self-service display pack</p>	D 36 DM-AS-LHS 225	495013
	<p>Extraction adapter for connecting a D 50 suction hose with D 36 accessories, in self-service display pack</p>	D 50/D 36 AS	452897
	<p>Y-piece, antistatic for D 50/D 36/D 27, for connection of two dust extraction hoses, with plug, simultaneous operation is not permissible with extractors approved for hazardous dusts, in self-service display pack</p>	D 50 SV-AS/D 50 V	452898
	<p>Plug for closing off the inlet connection, for retrofit on all CT/CTL mobile dust extractors, in self-service display pack</p>	D 50/V	452899
	<p>Antistatic connector sleeve to connect suction hoses D 50 / D 36 / D 27, with D 27/D 36 hoses the reducing sleeve on one hose must be replaced by rotating adapter D 27/D 36, in self-service display pack</p>	D 50/D 50 VM-AS	493047

Dust extraction





System accessories

Accessories for mobile dust extractors CT and dust extractors SR



Tubes

		Type	Order no.
	Hand tube for D 27/D 36, in self-service display pack stainless steel, curved	D 36 HR-M	452900
	with sliding air regulator for suction power adjustment, polypropylene (PP), curved	D 36 HR-K	452901
Extension pipe			
	for D 27/D 36, of stainless steel, 3-piece, length 950 mm, in self-service display pack	D 36 VR-M 3x	452902
	for D 27/D 36, polypropylene (PP), 3-piece, length 950 mm, in self-service display pack	D 36 VR-K 3x	452903
	for D 50, anodised aluminium, 1 piece, length 1.100 mm, in carton	D 50 VR-M	447599
	for D 50, plastic, 2 pieces, length 970 mm, in carton	D 50 VR-K 2x	440412

Floor nozzles







		Type	Order no.
	Floor nozzle for D 27/D 36, high-quality industrial design, aluminium, with 2 castors and 2 brush inserts, width 370 mm, in carton	D 36 BD 370	452908
	for D 50, high-quality industrial design, aluminium, with 2 castors and 2 brush inserts, width 450 mm, in carton	D 50 BD 450	452910
	for D 27/D 36, plastic, with 2 castors and 2 brush inserts, width 300 mm, in self-service display pack	D 36 BD 300	452907
	for D 27/D 36, 4 pieces, plastic, with 3 replaceable inserts (brush insert, tile cleaning insert, carpet cleaning insert), width 270 mm, in self-service display pack	D 36 BD 270	452906

Carpet and combination suction hose

		Type	Order no.
	Carpet nozzle for D 27/D 36, with sliding base, changeover from carpet to smooth floor, width 292 mm, in carton	D 36 TD	452911
	Turbo combination suction brush for D 27/D 36, for textile and linoleum floors, with 4 castors, brush rollers driven by intake air, width 270 mm, in carton	D 36 TKB	450644

Accessories for CT dust extractors

Special nozzles/brushes





		Type	Order no.
	Crevice nozzle Plastic, in self-service display pack		
	for D 27/D 36, length 300 mm	D 36 FD-300	452904
	for D 27/D 36, length 210 mm	D 36 FD-210	492391
	for D 27/D 36, for CTL-SYS, fits in the accessory holder on the CTL SYS, length 150 mm	D 36 FD-150	500593
	for D 50, length 200 mm	D 50 FD	452912
	Suction brush Plastic, in self-service display pack		
	for D 27/D 36, diameter 70 mm	D 36 SP	440404
	for D 50, diameter 85 mm	D 50 SP	440419
	Upholstery nozzle for D 27/D 36, for CTL-SYS, plastic, with brush insert, fits in the accessory holder on the CTL SYS, width 120 mm, in self-service display pack	D 36 PD	500592
	Universal brush nozzle for D 27/D 36, plastic, with brush ring and rotary hinge, in self-service display pack	D 36 UBD	498527
	Flat nozzle for D 27, special rubber, oil resistant, width 100 mm, in self-service display pack	D 27 FDG	440408

Dust extraction





System accessories

Accessories for CT dust extractors

Modules for attachment system CTL/CTM 26/36/48

		Type	Order no.
	Energy box module for CT 26/36/48, to connect a CT mobile dust extractor with the energy box / boom arm, dust extractor must not be LE model, in carton	EAA CT 26/36/48	496143
	for CT 26/36/48, in carton Socket electrical outlet with continuous power	Modul-SD CT 26/36/48	496142
	Electrical outlet module electrical outlet with automatic On and Off switch	Modul-SD E/A CT 26/36/48	496405
	Compressed air module for CT 26/36/48, for upgrading LE model mobile dust extractors, with additional compressed air automatic On and Off switching mechanism, in carton	DL CT 26/36/48	496141

CT boom arm

		Type	Order no.
	CT boom arm pipe set with connections, length 2.119 mm, width 1.136 mm, in carton		
	for CT 44, CT 48, without handle	CT-ASA	492452
	for CT 22, CT 33, with handle SB-CT, handle	CT-ASA/SB	492767
	for CT 26/36, with the SB-CT 26/36 handle, boom arm for mounting on all CT 26/36 models (except CT 36 AC HD), handle	CT-ASA CT 26/36/SB	496372
	Tool holder for CT-ASA, CT-ASA/SB, for safe, ergonomic storage of two electric power or pneumatic tools, in carton	WHR/CT-ASA	493558

CLEANTEC filter







		Type	Order no.
	Filter cartridge for CT 17 E, VCP 170 E, VCP 320 E, for dry extraction, qty. in pack 1 piece(s), in carton	HF-CT 17	769134
	Main filter for CT MINI/MIDI, qty. in pack 1 piece(s), in self-service display pack	HF-CT-MINI/MIDI	456790
	for CT 26/36/48 and TURBO II, not suitable for dust extractors with AUTOCLEAN, qty. in pack 1 piece(s), in carton	HF-CT 26/36/48	496170
	for CT AC and VCP, for CT 26/36/48, main filter optimised for self-cleaning, qty. in pack 1 piece(s), in carton	High Performance HF CT 26/36/48	496172
	for CTH 26, CTH 48, specialised filter meeting the requirements of dust class H, qty. in pack 1 piece(s), in self-service display pack	HF CTH 26/48	498995
	for CT 26/36/48, specially designed Hepa filter, not suitable for dust extractors with AUTOCLEAN, qty. in pack 1 piece(s), in self-service display pack	HEPA-HF-CT 26/36/48	498994
	for CT 11, 22, 33, 44, 55, qty. in pack 2 piece(s), in carton	HF-CT/2	452923
	for CTL-SYS, qty. in pack 1 piece(s), in self-service display pack	HF-CT SYS	500558
	Long-life main filter for CT 11, 22, 33, 44, 55, used only for extraction of dust types which are not hazardous to health, qty. in pack 2 piece(s), in carton	Longlife-HF-CT/2	454869
	Wet filter for CT MINI/MIDI, qty. in pack 1 piece(s), in self-service display pack	NF-CT MINI/MIDI	456805
	for CT 26/36/48, qty. in pack 1 piece(s), in self-service display pack	NF-CT 26/36/48	496169
	for CT 11, 22, 33, 44, 55, qty. in pack 2 piece(s), in carton	NF-CT/2	452924
	for CT 17 E, VCP 170 E, VCP 320 E, VCP 171 E-L, VCP 321 E-L, for liquid suction, in carton	NF-CT 17	769135







Dust extraction

System accessories

Accessories for CT dust extractors

CLEANTEC filter bags

		Type	Order no.
	Filter bag for CT 17 E, VCP 170 E, VCP 171 E-L, double-wall, qty. in pack 5 piece(s), in carton	FIS-CT 17/5	769136
	Selfclean filter bag qty. in pack 5 piece(s), in carton		
	for CTL-SYS, optimum utilisation of filter bag capacity and non-woven filter for high tear resistance, non-woven Selfclean filter bag	SC FIS-CT SYS/5	500438
	for CT MINI, optimum usage of filter bag volume and constant suction power thanks to SELFCLEAN filter bag	SC FIS-CT MINI/5	498410
	for CT MIDI, optimum usage of filter bag volume and constant suction power thanks to SELFCLEAN filter bag	SC FIS-CT MIDI/5	498411
	for CT 26, optimum usage of filter bag volume and constant suction power thanks to SELFCLEAN filter bag	SC FIS-CT 26/5	496187
	for CT 36, optimum usage of filter bag volume and constant suction power thanks to SELFCLEAN filter bag	SC FIS-CT 36/5	496186
	for CT 48, optimum usage of filter bag volume and constant suction power thanks to SELFCLEAN filter bag	SC FIS-CT 48/5	497539
	Waste bag not suitable for the standard CT model (without AC), qty. in pack 5 piece(s), in carton		
	for CT 26 AC	ENS-CT 26 AC/5	496216
	for CT 36 AC/CTL 36 E AC HD	ENS-CT 36 AC/5	496215
	for CT/CTL/CTM 48 AC	ENS-CT 48 AC/5	497540
	Safety filter bag two-layer, qty. in pack 3 piece(s), in carton		
	for CTH 26	FIS-CTH 26/3	497541
	for CTH 48	FIS-CTH 48/3	497542

		Type	Order no.
	Longlife filter bag used only for extraction of dust types which are not hazardous to health, from high strength, 3-layer polyester fleece with a long service life		
	for CTL-SYS, multi-ply filter bag for dust disposal, in self-service display pack	Longlife-FIS-CT SYS	500642
	for CT MINI, in carton	Longlife-FIS-CTL MINI	499703
	for CT MIDI, in carton	Longlife-FIS-CTL MIDI	499704
	for CT 26, in carton	Longlife-FIS-CT 26	496120
	for CT 36, in carton	Longlife-FIS-CT 36	496121
	for CT 48, in carton	Longlife-FIS-CT 48	498506
	for CT 22, in carton	Longlife-FIS-CT 22	456737
	for CT 33, in carton	Longlife-FIS-CT 33	456738
	Filter bag in carton		
	for CT 22, qty. in pack 5 piece(s)	FIS-CT 22/5	452970
	for CT 22, qty. in pack 20 piece(s)	FIS-CT 22/20	494631
	for CT 33, qty. in pack 5 piece(s)	FIS-CT 33/5	452971
	for CT 33, qty. in pack 20 piece(s)	FIS-CT 33/20	494632
	for CT 44, qty. in pack 5 piece(s)	FIS-CT 44/5	452972
	for CT 55, qty. in pack 5 piece(s)	FIS-CT 55/5	452973
	for CT 22, with spunbond outer layer, extremely durable and tear-resistant, for extracting fine dust particles, qty. in pack 5 piece(s)	FIS-CT 22 SP VLIES/5	456870
	for CT 33, with spunbond outer layer, extremely durable and tear-resistant, for extracting fine dust particles, qty. in pack 5 piece(s)	FIS-CT 33 SP VLIES/5	456871
	for CT 44, with spunbond outer layer, extremely durable and tear-resistant, for extracting fine dust particles, qty. in pack 5 piece(s)	FIS-CT 44 SP VLIES/5	456874

Dust extraction

System accessories

Accessories for SR dust extractors

SR filters



		Type	Order no.
	Absolute filter in carton		
	for SRM 45 LE-EC, SRM 70 LE-EC	AB-FI SRM 45/70	493826
	for SRH 45	AB-FI SRH 45	493825
			
	Main filter for SRM 45 E-PLANEX, nano, in carton	NANO HF-SRM 45-LHS 225	496406

SR filter bags

		Type	Order no.
	Filter bag qty. in pack 5 piece(s), in carton		
	for SRM 45 LE-EC	FIS-SRM 45 /5	493775
	for SRM 45 E-PLANEX	FIS-SRM 45-LHS 225 /5	495014
			
	for SRM 70 LE-EC	FIS-SRM 70 /5	493777
	for SRH 45 E	FIS-SRH 45 /5	493776

		Type	Order no.
	Waste bag for SRM 45 E-PLANEX, qty. in pack 5 piece(s), in carton	ENS-SRM 45-LHS 225/5	495015

SR filters and filter bags for discontinued models









		Type	Order no.
	Absolute filter in carton		
	for SR 5, SR 200, SR 201	AB-FI/U	485808
	for SR151	AB-FI	488461
	for SR 6, SR 12, SR 14, SR 202, SR 203, SR 212, SR 301, SR 302, SR 303, application category C/M	AB-FI/C	486241
	Two-ply filter bag qty. in pack 5 piece(s), in carton		
	for SR 5, SR 6, double-layered	FIS-SR 5/6 /5	483143
	for SR 12, SR 14	FIS-SR 12/14 /5	483142
	for SR 151, SRM 152	FIS-SR 150 /5	488460
	for SR 200, SR 201, SR 203	FIS-SR 200 /5	487070
	for SR 301, SR 303, SRM 312	FIS-SR 300 /5	487790
	for SR15, SR12, SR14, for substances with dust exposure limits and carcinogens as defined by GefStoffV35, BIA-approved	FIS-SR 15 /5	483889
for SR 202, SR 212, SRH 204, SR 200, SR 201, SR 203	FIS-SR 202 /5	487482	

Dust extraction

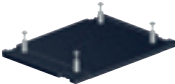

System accessories

Accessories for mobile dust extractors CT and dust extractors SR

CT accessories

		Type	Order no.
	Hose garage for CT 11, 22, 33, 44, 55, for storing the suction hose and mains cable, suitable hose sizes: plug it hose D 22 x 3.5 m / D 27 x 3.5 m / D 27 x 5 m / D 36 x 3.5 m / D 50 x 2.5 m / IAS 2-3500 AS, dimension (L x W x H) 530 x 360 x 110 mm, in carton	CT-SG	494388
	Tool holder in carton		
	for CT 26/36, tool holder for sanders, made of galvanised steel, for stable and ergonomic placement of an electrical or compressed air power tool	WHR-CT	496122
	for CT 36 PLANEX, with practical carry handle, for temporary storage of PLANEX	WHR-CT 36-LHS 225	495964
	Handle for pushing the dust extractors along easily, in carton		
	for CT 11, 22, 33, 44, 55	SB-CT	452921
	for CT 26/36, with nozzle holder	SB-CT 26/36	495802
	for CT 48, with nozzle holder	SB-CT 48	497295
	Sealing slide for CT AC / CT 36 AC PLANEX, provides extreme vacuum in the container, the filter is cleaned even more effectively, in carton	VS-CT AC/SRM45 PLANEX	497926
	Adapter adapter for attaching the WCR and/or service unit VE CT 26/36/48 for CT 48 EC and CT 48 EC B22, in carton	AD-WCR	498805
	Sys-Adapter for CT 36 E HD-AC, VCP 260 E-L AC, VCP 260 E-M AC, VCP 260 E-H, year 2011 onwards; VCP 480 E-L AC, VCP 480 E-M AC, for connecting Systainer to dust extractor, qty. in pack 1 piece(s), in self-service display pack	SYS-AP-CT 36 HD	768115
	Vacuum clamping nozzle for CT dust extractors and D 27 suction hose, flexible aid for temporary clamping and securing of workpieces on horizontal and vertical surfaces, max. clamping height 50 mm, max. load 3 kg, dimension (L x W x H) 130 x 80 x 50 mm, weight 0,35 kg, in self-service display pack	CT-W	500312
	Shoulder strap for CT-SYS and all SYSTAINERS T-LOC, easy transport of the CTL SYS and SYSTAINERS T-LOC, max. load 20 kg, qty. in pack 1 piece(s), in self-service display pack	SYS-TG	500532
	Dirt trap to collect wet coarse dirt (e.g. cuttings + cooling lubricant), in carton		
	for CT 22	SBH-CT 22	452925
	for CT 33	SBH-CT 33	452926

CT compressed air accessories

		Type	Order no.
	<p>Compressed air module to convert the CT mobile extractor, model E to LE design with additional automatic on/off switch for air tools, compatible only with CT 22/33/44, in carton</p>	DLM-CT	452829
	<p>Versorgungseinheit im Karton</p> <p>Service unit for the LE version of the CT 26/36/48, pressure controller, condensate quick discharge, oiler and oil-free compressed air outlet with quick coupling in carton</p>	VE-CT 26/36/48	495886
	<p>Assembly set for assembly of supply unit VE-CT 26/36 in conjunction with CT-ASA CT 26/36 SB, in carton</p>	MS DH VE-CT-ASA-CT26/36	496862



Stirring and mixing

Overview of products and applications 334

Stirrers MX 1000, MX 1000/2, MX 1200, MX 1200/2, MX 1600/2 337

Duo stirrers MX 1600/2 DUO 339

Accessories and consumable materials 340

The Festool system

Stirring and mixing

Overview of products and applications

Page 337 ——— 337 ——— 337

Our stirrers revolve around the most important requirements in your daily stirring and mixing applications: sturdiness, durability, constant power under load and outstanding ergonomics.

MX 1000

MX 1000/2

MX 1200



Applications

Stirrers

Mixing and stirring

Liquid materials: paints, clear coats, wallpaper paste



Viscous materials: filling mixtures and smoothing cement



Stiff, compact materials: plaster, tile cement, mortar



Mixing volume

up to 40 l



up to 70 l



up to 90 l

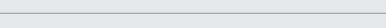

Technical data

Power consumption (W)	1.020	1.020	1.200
No-load speed, 1st gear (rpm)	360 – 630	360 – 630	360 – 630
No-load speed, 2nd gear (rpm)		580 – 1.010	
Bit holder	M14/ErgoFix	M14/ErgoFix	M14/ErgoFix
Clamping collar diameter (mm)	57	57	57
Max. stirrer basket diameter (mm)	120	120	140
Weight (kg)	4,5	4,9	4,5

Stirring and mixing

Overview of products and applications

338 ——— 338 ——— 339

MX 1200/2

MX 1600/2

MX 1600/2 DUO



Stirrers

Duo stirrers



Ideal

Suitable

	1.200	1.500	1.500
	150 - 360	150 - 300	100 - 250
	320 - 780	320 - 650	130 - 350
	M14/ErgoFix	M14/ErgoFix	FastFix
	57	57	57
	140	160	140
	6,2	6,4	7,9

Stirring and mixing

Maintains its position.

Stooped over mixing is now a thing of the past: The size of the MX stirrers can be adapted with the ErgoFix height adjustment. You work upright, protect your back and can completely rely on the powerful engines, which ensure intensive and quick mixing. For in between usage the stirrers have anti-slip rubber corners for positioning against the wall. And after the work is completed, they are easy to clean and transport – the machine and stirrer can be disconnected without the need for any tools.



Ergonomic – mix while standing upright.

Simply adjust the stirrer to match your height with the patented ErgoFix height adjustment system. Mix in a natural upright position for relaxed and effortless working.



One for all.

The ErgoFix adapter has a classic M14 tool holder so that all current stirrer baskets can be used. In addition, it is designed for the entire service life of the stirrer thanks to its special coating.



Lightning quick changes without using tools.

The FastFix quick-change system allows the detachment of the stirrer basket from the machine and rapid basket changes without the need for tools, easy cleaning and space-saving transportation.



Stirring and mixing

Stirrers MX 1000, MX 1000/2, MX 1200



MX 1000 / MX 1000/2 / MX 1200

Tough. Ergonomic. Powerful.

- ▶ ErgoFix height adjustment with integrated quick-change function
- ▶ Variable speed trigger for soft start to eliminate splashing of material at start-up
- ▶ High-power 1020 W motor
- ▶ Little force needed to guide the stirrer due to ergonomic handle arrangement with large lever arm



Technical data	MX 1000	MX 1000/2
Power consumption [W]	1.020	1.020
No-load speed, 1st gear/2nd gear [min ⁻¹]	360 – 630/-	360 – 630/580 – 1.010
Bit holder	M14/ErgoFix	M14/ErgoFix
Collar Ø [mm]	57	57
Max. paddle diameter [mm]	120	120
Mixing volume [l]	40	40
weight [kg]	4,5	4,9



■ = MMC digital electronics

Scope of delivery	Order no.
ErgoFix adapter, double open-ended wrench, in carton	
MX 1000 E EF HS3R AUS double open-ended wrench, with 767887 Helical stirring rod, HS 3 120x600 R M14, for heavy mixtures with high viscosity: mortar, concrete, cement and lime plaster, bonding compounds, screed, quartz-filled epoxy resins, thick bitumen coatings	574791
MX 1000 E EF HS3L AUS stirring rod HS 3 120x600 L M14	574790

Powerful.

Powerful motors combined with a perfectly adapted gear unit ensure a constant performance under load, can tackle even the most demanding mixing applications and withstand long periods of continuous use.

10

System accessories
from page 342



Stirring and mixing

Stirrers MX 1200/2, MX 1600/2



MX 1200/2 / MX 1600/2



Extremely sturdy design.

Whether it is stubborn dirt, hard impacts or collisions – the new stirrers can withstand the toughest of conditions thanks to the long-life drive, solid tubular steel frame, switch protector and rubber edges.

Extremely strong for heavy-duty use on construction sites.

- ▶ ErgoFix height adjustment with integrated quick-change function
- ▶ Little force needed to guide the stirrer due to ergonomic handle arrangement with large lever arm
- ▶ Hard-wearing rubber edges provide effective protection against damage and prevent the tool from slipping when set down or leaned against a wall.
- ▶ Variable speed trigger and electronic speed control

Technical data	MX 1200/2	MX 1600/2
Power consumption (W)	1.200	1.500
No-load speed, 1st gear/2nd gear (min ⁻¹)	150 – 360/320 – 780	150 – 300/320 – 650
Bit holder	M14/ErgoFix	M14/ErgoFix
Collar Ø (mm)	57	57
Max. paddle diameter (mm)	140	160
Mixing volume (l)	70	90
weight (kg)	6,2	6,4



☐ = MMC digital electronics

Scope of delivery	Order no.
ErgoFix adapter, double open-ended wrench, in carton	
MX 1200/2 E EF HS3R AUS double open-ended wrench, with 768708 Helical stirring rod, HS 3 140 x 600 R M14, for heavy mixtures with high viscosity: mortar, concrete, cement and lime plaster, bonding compounds, screed, quartz-filled epoxy resins, thick bitumen coatings	574793
MX 1200/2 E EF HS3L AUS stirring rod HS 3 140x600 L M14	574792
MX 1600/2 E EF HS3R AUS double open-ended wrench, with 768710 Helical stirring rod, HS 3 160 x 600 R M14, for heavy mixtures with high viscosity: mortar, concrete, cement and lime plaster, bonding compounds, screed, quartz-filled epoxy resins, thick bitumen coatings	574795
MX 1600/2 E EF HS3L AUS double open-ended wrench, with 768710 Helical stirring rod, HS 3 160 x 600 R M14, for heavy mixtures with high viscosity: mortar, concrete, cement and lime plaster, bonding compounds, screed, quartz-filled epoxy resins, thick bitumen coatings	574794

System accessories from page 342



Stirring and mixing

Stirrer MX 1600/2 DUO



MX 1600/2 DUO



DUO stirrer: faster, lighter, more intensive

- ▶ Faster with less power thanks to opposing mixing tools
- ▶ Intensive and thorough mixing process with combing action
- ▶ FastFix system for rapid stirring rod changes
- ▶ Electronic control and 2-speed manual transmission: the right speed for any material

Technical data

Power consumption (W)	1.500
No-load speed, 1st gear/2nd gear (min ⁻¹)	100 – 250/130 – 350
Bit holder	FastFix
Collar Ø (mm)	57
Max. paddle diameter (mm)	140
Spindle pitch (mm)	110
Mixing volume (l)	90
weight (kg)	7,9



■ = MMC digital electronics

Scope of delivery

MX 1600/2 EQ DUO DOUBLE AUS

1 pair of stirring rods, HS 3 Double 140x600, in carton

Order no.

201676

Stationary application.

The DUO stirrer becomes the complete mixing station in the MS 57 stirrer stand. While you process the already mixed material, the next quantity is already being prepared in the stirrer stand.

10

System accessories
from page 345



The Festool system.

Because it's simply better when everything fits together: The right stirrer for every application. With the FastFix quick-change system, the stirrer basket can be changed easily and quickly for different materials.



Stirring and mixing

Accessories and consumable materials

System accessories

Stirring rods	342
Adapter	345
Stirrer stand	345



Stirring and mixing

Stirring rods

The ultimate solution for every mixing task.



RS
Round stirrer

WS
Disc stirrer

HS3L
Helical stirrer
with 3 anticlock-
wise spirals

CS
Whisk

HS2
Helical stirrer
with 2 spirals

HS3R
Helical stirrer
with 3 clockwise
spirals

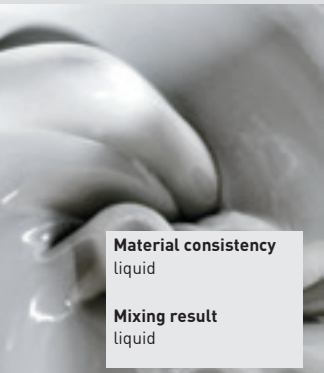

Material consistency
liquid

Mixing result
liquid

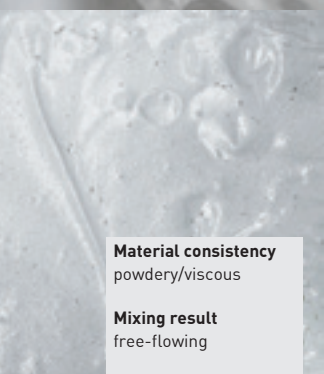

Material consistency
powdery/viscous

Mixing result
free-flowing



Material consistency
powdery/viscous

Mixing result
compact

	RS	WS	HS3L	CS	HS2	HS3R
Paints	●	●	●			
Emulsion paint	○	●	●			
Wallpaper paste	●	●	○			
Clear coat, varnish	●	●	○			
Epoxy resin	○	○	○	●		
Filler				●	●	○
Bonding mortar				○	●	○
Levelling compound				●	○	
Waterproofing filler				●	●	○
Bitumen				○		○
Ready-mix plaster					○	○
Plaster			○		●	●
Tile cement					●	○
Joint mortar					●	●
Mortar					●	●
Quartz-filled epoxy resin					○	●
Concrete, screed					○	●

● Ideal

○ Very suitable

Stirring rods

Disc stirrer



Round stirrer

for stirring low-viscosity substances: latex and emulsion paints, wallpaper paste, grouting compounds, clear coats, lacquers, bitumen, slurry, in self-service display pack

for chuck with clamping range ≥ 10 mm, material quantity -15 kg, diameter 85 mm, length 400 mm

RS 2 85x400 SW 8

769023

for chuck with clamping range ≥ 13 mm, material quantity 15-25 kg, diameter 100 mm, length 600 mm

RS 2 100x600 SW 10

769024

for MX 1000, MX 1000/2, MXP 800, MXP 1000, MXP 1002, material quantity 15-25 kg, diameter 100 mm, length 600 mm

RS 2 100x600 M14

769020

for MX 1000, MX 1000/2, MXP 800, MXP 1000, MXP 1002, material quantity 20-40 kg, diameter 120 mm, length 600 mm

RS 2 120x600 M14

769021

Disk stirrer WS



Disk stirrer

for very low-viscosity substances: paints, clear coats, lacquers, latex and emulsion paints, wallpaper paste, whitewash, tile adhesives, in self-service display pack

for chuck with clamping range ≥ 10 mm, material quantity -5 kg, diameter 60 mm, length 350 mm

WS 2 60x350 SW 8

769033

for chuck with clamping range ≥ 10 mm, material quantity 5-10 kg, diameter 80 mm, length 350 mm

WS 2 80x350 SW 8

769034

for chuck with clamping range ≥ 13 mm, material quantity 10-15 kg, diameter 100 mm, length 600 mm

WS 2 100x600 SW 10

769035

Disk stirrer



Disk stirrer

for very low-viscosity substances: paints, clear coats, lacquers, latex and emulsion paints, wallpaper paste, whitewash, tile adhesives, length 600 mm, in self-service display pack

for MX 1000, MX 1000/2, MXP 800, MXP 1000, MXP 1002, material quantity 15-20 kg, diameter 120 mm

WS 2 120x600 M14

768122

for MX 1200, MX 1200/2, MXP 1200, MXP 1202, material quantity 20-30 kg, diameter 140 mm

WS 2 140x600 M 14

769022

for MX 1600/2, MXP 1602, material quantity 30-60 kg, diameter 160 mm

WS 2 160x600 M 14

769036

Helical stirrer



Helical stirrer

3 anticlockwise spirals, for stirring low-viscosity substances: gypsum plaster, latex and emulsion paints, clear coats, lacquers, grouting compounds, length 600 mm, in self-service display pack

for MX 1000, MX 1000/2, MXP 800, MXP 1000, MXP 1002, material quantity 15-25 kg, diameter 120 mm

HS 3 120x600 L M14

767921

for MX 1200, MX 1200/2, MXP 1200, MXP 1202, material quantity 25-40 kg, diameter 140 mm

HS 3 140x600 L M14

768138

for MX 1600/2, MXP 1602, material quantity 30-60 kg, diameter 160 mm

HS 3 160x600 L M14

768709

Stirring and mixing

System accessories

Stirring rods

Stirring rods CS



Stirring rods

for levelling compounds, filler, sealants, adhesives; for stirring without trapped air (no bubbles), length 600 mm, in self-service display pack

	Type	Order no.
for chuck with clamping range >13mm, material quantity 10-25 kg, diameter 120 mm	CS 120x600 SW10	769119
for MX 1000, MX 1000/2, MXP 800, MXP 1000, MXP 1002, material quantity 10-15 kg, diameter 120 mm	CS 120x600 M14	769118
for MX 1200, MX 1200/2, MXP 1200, MXP 1202, material quantity 20-40 kg, diameter 140 mm	CS 140x600 M14	769117
for MX 1600/2, MXP 1602, material quantity 40-60 kg, diameter 160 mm	CS 160x600 M14	769116

Helical stirrer HS 2



Helical stirrer

for chuck with clamping range >10mm, 2 spirals, for stirring viscous substances: tile adhesives, joint compound, adhesive mortar, ready-mix plaster, screed, filler, levelling compound, length 400 mm, in self-service display pack

	Type	Order no.
material quantity -8 kg, diameter 70 mm	HS 2 70x400 SW 8	769025
material quantity 8-10 kg, diameter 85 mm	HS 2 85x400 SW 8	769026

Helical stirrer



Helical stirrer

2 spirals, for stirring viscous substances: tile adhesives, joint compound, adhesive mortar, ready-mix plaster, screed, filler, levelling compound, in self-service display pack

	Type	Order no.
for chuck with clamping range >10mm, material quantity 10-15 kg, diameter 100 mm, length 400 mm	HS 2 100x400 SW 8	769027
for chuck with clamping range >13mm, material quantity 15-20 kg, diameter 120 mm, length 600 mm	HS 2 120x600 SW 10	769028
for chuck with clamping range >13mm, material quantity 20-40 kg, diameter 140 mm, length 600 mm	HS 2 140x600 SW 12	769029
for MX 1000, MX 1000/2, MXP 800, MXP 1000, MXP 1002, material quantity 15-20 kg, diameter 120 mm, length 600 mm	HS 2 120x600 M14	769030
for MX 1200, MX 1200/2, MXP 1200, MXP 1202, material quantity 20-40 kg, diameter 140 mm, length 600 mm	HS 2 140x600 M14	769031
for MX 1600/2, MXP 1602, material quantity 30-60 kg, diameter 160 mm, length 600 mm	HS 2 160x600 M14	769032

Helical stirrer





Helical stirrer

3 clockwise spirals, for heavy mixtures with high viscosity: mortar, concrete, cement and lime plaster, bonding compounds, screed, quartz-filled epoxy resins, thick bitumen coatings, length 600 mm, in self-service display pack

	Type	Order no.
for MX 1000, MX 1000/2, MXP 800, MXP 1000, MXP 1002, material quantity 15-25 kg, diameter 120 mm	HS 3 120x600 R M14	767887
for MX 1200, MX 1200/2, MXP 1200, MXP 1202, material quantity 25-40 kg, diameter 140 mm	HS 3 140x600 R M14	768708
for MX 1600/2, MXP 1602, material quantity 30-60 kg, diameter 160 mm	HS 3 160x600 R M14	768710



Stirring rods for MX 1600/2 EQ DUO

		Type	Order no.
	Stirring rod for MX 1600/2 DUO, MXP 1602 DUO, for low and high viscosity mixtures, the lower part of the stirrer rod basket draws the material upwards from the base of the material container. The upper section of the stirrer rod basket forces the material downwards, diameter 140 mm, length 600 mm, in carton	HS 3 COMBI 140x600 FF	768092
	Stirring rod for MX 1600/2 DUO, MXP 1602 DUO, for heavy mixtures with high viscosity, dual stirring rods with triple spirals mix efficiently by moving in opposite directions. The material is thoroughly kneaded with a combining effect, diameter 140 mm, length 600 mm, in carton	HS 3 DOUBLE 140x600 FF	768800



ErgoFix adapter

		Type	Order no.
	Adapter with M14 thread, to hold Festool stirring rods M14 on ErgoFix stirrers, stroke length 80 mm, in self-service display pack	AD-EF-M14/80 ErgoFix	769091

Adapters and extensions

		Type	Order no.
	in self-service display pack Adapter attaching stirring rod with internal thread	MA M14-M14	769148
	Adapter For clamping chuck 5/8" to stirrer	MA M14-5/8" x 16	769149
	Adapter clamping drill chuck 1/2" to stirrer	MA M14-1/2" x 20	769150
	Adapter for attaching Festool stirring rod with M 14 male thread to stirrer (RW 1000) with male thread	MAI M14-M14	769151
	Adapter for power drills with bit holder 5/8" - 16 UNF, attaching Festool stirring rod to drill	MAI M14-5/8" x 16	769153
	Adapter for power drills with bit holder 1/2" - 20 UNF, attaching Festool stirring rod to drill	MAI M14-1/2" x 20	769152
	Guide extension for extending stirring rods by 400 mm, thread, both ends M14	PL 400 M14/M14	769037

Stirrer stand

		Type	Order no.
	Stirrer stand excellent stability and reliability due to the robust zinc-coated steel construction, folding column for easy transport to the working location, mixing centre with electrical switch, 4-metre power cord, clamp for attachment collar 57 mm, length x Width 950 x 550 mm, height adjustable 1.000-1.520 mm, max. Ø mixture container 400 mm, weight 30 kg, in carton	MS 57	769039
	Fixed rod to clamp the stirring container to the MS 57 stirrer stand, can be used for containers of heights 300-500 mm, in carton	CL-MS	769048
	Adapter ring to hold stirrers with collar Ø 43 mm in the MS 57, in self-service display pack	A-GD 57/43	768712



Substrate preparation

Overview of products and applications 348

RENOFIX concrete grinders RG 80, RG 150 353

Diamond grinders RENOFIX RG 130 355

Diamond grinding system DSG-AG 125 356

Diamond cutting systems DSC-AG 125, DSC-AG 125 FH, DSC-AG 230 357

Carpet remover TPE 360

Wallpaper perforator TP 220 361

Accessories and consumable materials 362

The Festool system

Substrate preparation

Overview of products and applications

Concrete, stone, plaster, adhesive, paint and other old coatings can often only be removed with great effort. That's why there is the RENOFIX renovation millers, with which you can easily master all challenges in material removal capacity.

Page

353

354

RG 80



RG 150



RENOFIX concrete grinder



Applications

Plaster

Milling off mineral/soft plaster on walls and façades

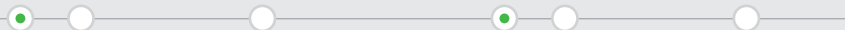

Milling off hard (cement) plaster on walls and façades

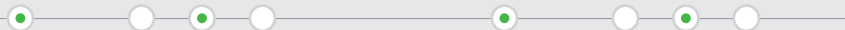

Milling off synthetic resin plaster



Adhesive

Removing tile adhesive/adhesive residue

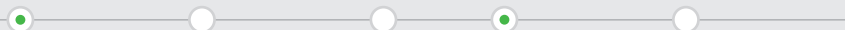

Removing elasticised adhesive for PVC or wooden flooring



Concrete

Grinding unset concrete area/parts

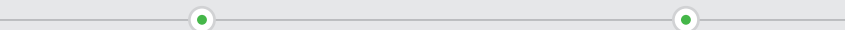

Light grinding of weathered and cured concrete areas

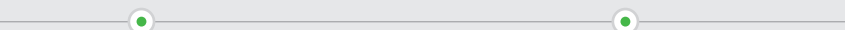

Roughing up smooth surfaces on concrete

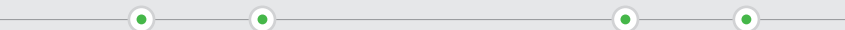

Grinding very hard concrete (C30/37 and harder)

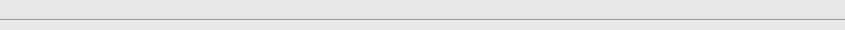

Sanding off for levelling unevenness on cured concrete

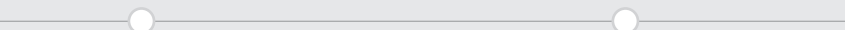

Paint

Removing latex paints, oil-based paints and paint coatings on plaster



Removing concrete paint on concrete surfaces

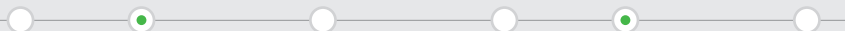

Removing elasticised protective coating



Coatings

Removing bitumen

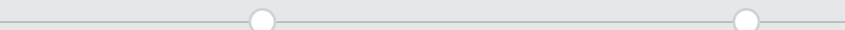

Removing PU coatings

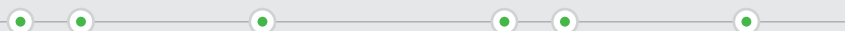

Levelling unevenness on screed flooring



Removing epoxy resin coatings

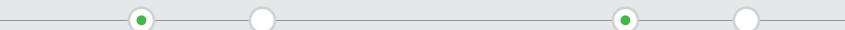

Removing impaired fillers

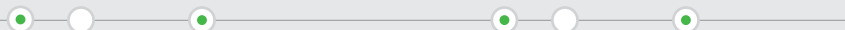

Others

Light sanding/Roughing of Terazzo/tiles

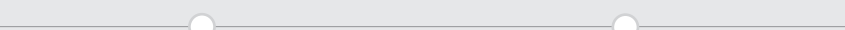

Technical data

Power consumption (W)	1.100	1.600
Idle engine speed (rpm)	2.000 – 5.900	1.000 – 2.200
Disc Ø (mm)		
Tool diameter (mm)	80	150
Connection Ø d/e (mm)	36	36
Bit holder	2 x M5	D14/M8
Weight (kg)	3,2	5,5

Substrate preparation

Overview of products and applications

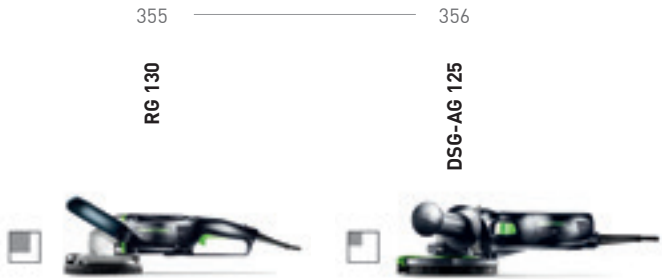

Diamond grinders RENOFIX

Diamond grinding system

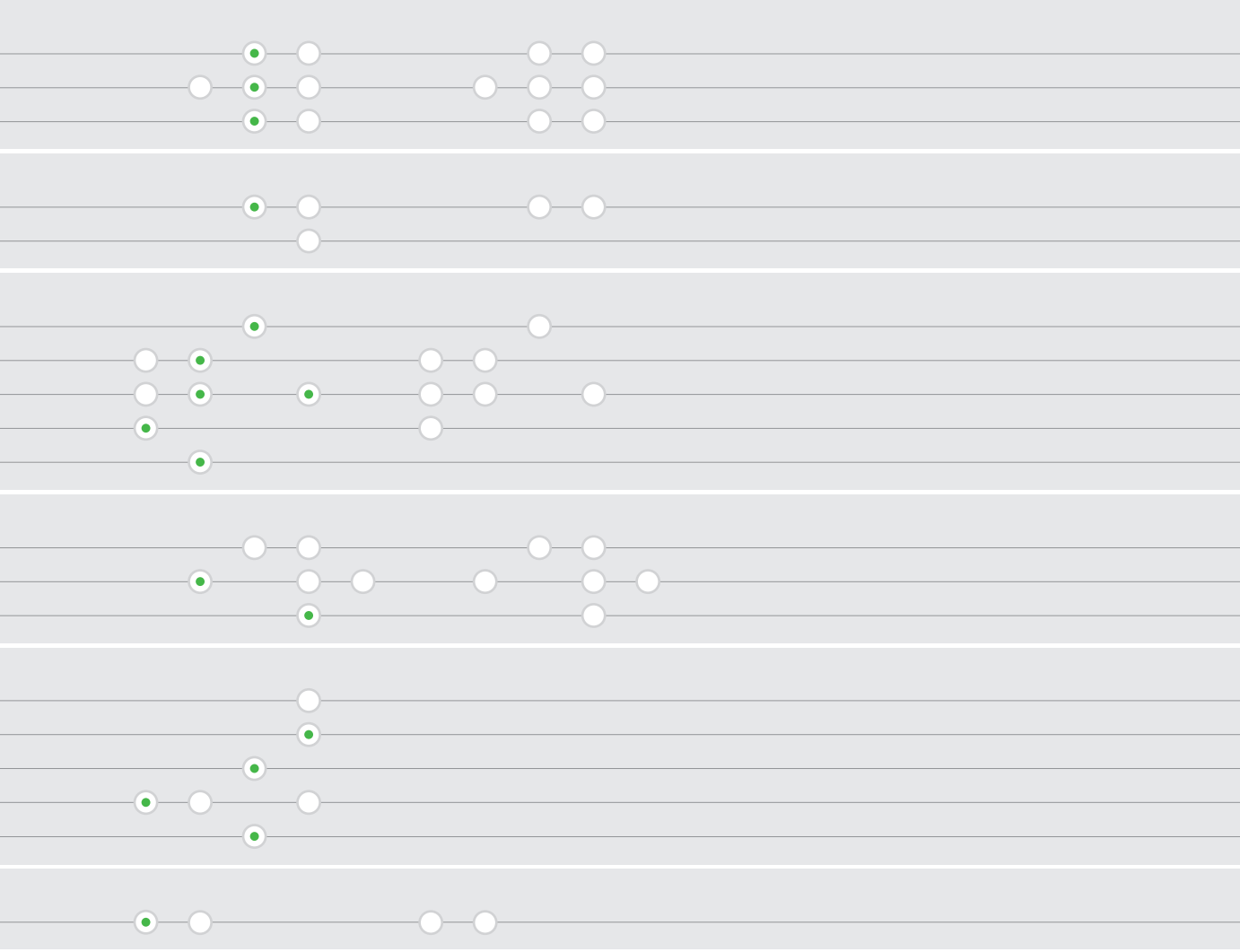

Suitable for areas in size shown, by comparison

Ideal

Suitable

1.600	1.400
3.000 - 7.700	3.500 - 11.000
	125/130
130	
36	36/27
D25/M14	
3,8	2,7

Substrate preparation

Overview of products and applications

Page 357 ————— 358 ————— 359

Whether in indoor or outdoor areas, the Festool diamond cutting system always works virtually dust-free. With the Festool dust extraction system, you can avoid time-consuming cleaning on the construction site.

DSC-AG 125

DSC-AG 125 FH

DSC-AG 230



Applications

Diamond cutting systems

Cutting boards to size

Cutting tiles	<input checked="" type="radio"/>	<input checked="" type="radio"/>	<input type="radio"/>
Cutting plasterboard/fibre cement board	<input type="radio"/>	<input type="radio"/>	<input type="radio"/>
Cutting HPL boards	<input type="radio"/>	<input type="radio"/>	<input type="radio"/>
Cutting natural stone	<input type="radio"/>	<input type="radio"/>	<input checked="" type="radio"/>

Cutting roofing tiles

Cutting expansion joints	<input checked="" type="radio"/>	<input checked="" type="radio"/>	<input checked="" type="radio"/>
Cutting open cracks in screed	<input checked="" type="radio"/>	<input checked="" type="radio"/>	<input checked="" type="radio"/>
Cutting screed / concrete	<input checked="" type="radio"/>	<input type="radio"/>	<input checked="" type="radio"/>
Cutting precast concrete elements	<input type="radio"/>	<input type="radio"/>	<input checked="" type="radio"/>

Cutting grooves

Grooves for electrical installations	<input type="radio"/>	<input type="radio"/>	<input type="radio"/>
--------------------------------------	-----------------------	-----------------------	-----------------------

Ideal

Suitable

Technical data

	DSC-AG 125	DSC-AG 125 FH	DSC-AG 230
Power consumption (W)	1.400	1.400	2.600
Idle engine speed (rpm)	3.500 – 11.000	3.500 – 11.000	6.500
Disc Ø (mm)	125	125	230
Connection Ø d/e (mm)	36/27	36/27	36/27
Weight (kg)	4,1	2,9	8,9

Removing carpet or wallpaper, sanding plasterboard – materials and requirements in the area of refurbishment, drywalling and renovation are diverse. Festool offers a wide range of solutions, incorporated in a complete system of accessories and consumables.

TPE

TP 220



Applications

Carpet remover

Wallpaper perforator

Renovation and refurbishment

Removing wallpaper

Removing carpet

Removing backing and adhesive layers

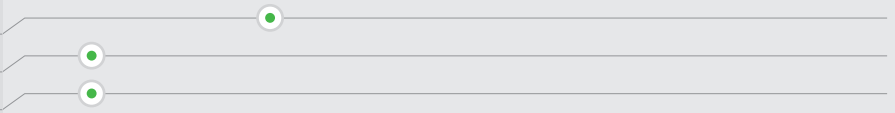

Ideal

Suitable

Technical data

Power consumption (W)	620	
Idle engine speed (rpm)	6.000	
No. of strokes (rpm)	12.000	
Stroke (mm)	5	
Weight (kg)	3,6	1,5

Substrate preparation

You're up against some tough opponents when renovating.

Concrete, stone, plaster, adhesive, paint and other residual layers are often very difficult to remove. Hard manual work or conventional tools such as rotary hammers, chisels and angle grinders have no chance. That's why Festool invented RENOFIX. The RENOFIX diamond grinders and concrete grinders remove all kinds of old coatings from walls, exteriors, floors and ceilings quickly and thoroughly.



Comfortable handling.

The additional handle with vibration damping significantly reduces vibrations, protecting the hands of the user. So the work won't tire you out. The position of the additional handle can be quickly adjusted without keys or tools to suit a range of working conditions. The handle can even be folded back completely, allowing you to reach under central heating pipes, for example.

The guide base ensures smooth guidance of the diamond grinder along the surfaces being worked on, and also allows you to set a specific amount of material removal.



Right up to the wall.

The folding segment (requiring no tools to fold) allows you to work right up to edges. Thanks to the wall stop and the diamond disc set back 0.5 mm, there is no risk of damage to walls and edges.



Substrate preparation

RENOFIX concrete grinder RG 80



RENOFIX RG 80



The all-rounder for walls, ceilings and floors.

- ▶ All-purpose concrete grinder with ideal rpm for work on soft materials and the option of using DIA tools
- ▶ Compact, easy to handle and powerful owing to the 1100 watt motor
- ▶ Constant speed under load due to power electronics
- ▶ Coil temperature monitor protects against motor damage in the event of overload

Technical data

Power consumption (W)	1.100
No-load speed (min ⁻¹)	2.000 – 5.900
Tool Ø (mm)	80
Bit holder	2 x M5
Connection Ø for dust extraction (mm)	36
weight (kg)	3,2

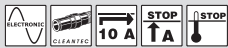

■ = Electronic

Scope of delivery

RG 80 E-Plus AUS
dust extraction hood, auxiliary handle VIBRASTOP, hexagon socket wrench,
in SYSTAINER SYS 3 T-LOC

Order no.

768973

One for all.

The RG 80 renovation miller is a multitalent-ed tool for medium-sized and larger areas. Thanks to the wide range of accessories, you can effortlessly remove hard and soft materials. Adhesives, paint and coatings, synthetic resin plaster, porous concrete and sand-lime brick on flooring, walls and ceilings can be removed easily and quickly.

11

System accessories
from page 364



Mobile dust extractors
from page 310



Substrate preparation

RENOFIX concrete grinder RG 150

RENOFIX RG 150



The all-rounder for large areas.

The RG 150 renovation miller is your perfect partner for large areas thanks to the 150 mm tool diameter and a wide range of accessories. In conjunction with the laminate, screed, coatings and adhesive residue can be removed effectively. The ergonomic double grip in a D shape sits perfectly in the hands in every work position.

The large space ace.

- ▶ Constant speed under load due to power electronics
- ▶ Coil temperature monitor protects against motor damage in the event of overload
- ▶ Adjustable speed to match the working material
- ▶ Safe guidance due to supporting base with stepless depth adjustment

Technical data

Power consumption (W)	1.600
No-load speed (min ⁻¹)	1.000 – 2.200
Tool Ø (mm)	150
Bit holder	D14/M8
Connection Ø for dust extraction (mm)	36
weight (kg)	5,5



= Electronic

Scope of delivery

RG 150 E-Plus AUS
Puller/removal tool, Open end wrench, in SYSTAINER SYS 5 T-LOC

Order no.

768991

System accessories
from page 365



Mobile dust extractors
from page 310



Substrate preparation

RENOFIX diamond grinder RG 130



RENOFIX RG 130



The ace of diamonds.

- ▶ Diamond grinder with the ideal rpm for diamond tools
- ▶ High rate of material removal and fast work with the 1600 watt motor
- ▶ Work right up to the edge thanks to the folding segment
- ▶ reliable guidance and adjustable, defined material removal with guide table

Technical data

Power consumption (W)	1.600
No-load speed (min ⁻¹)	3.000 – 7.700
Tool Ø (mm)	130
Bit holder	D25/M14
Connection Ø for dust extraction (mm)	36
weight (kg)	3,8



■ = Electronic

Scope of delivery

RG 130 E-Plus AUS
guide base, clamping flange fittings, Spanner, in SYSTAINER SYS 5 T-LOC

Order no.

768976

The ace of diamonds.

The RG 130 diamond grinder is the ace in material removal on larger areas. The optimised speed for diamond tools enables quick removal of concrete, screed and coatings on hard substrate. The folding cover segment which can be removed without any tools allows working right into edges and corners. Thanks to the patented extraction spiral excellent dust extraction results are guaranteed.

11

System accessories
from page 366



Mobile dust extractors
from page 310



Substrate preparation

Diamond grinding system DSG-AG 125



DSG-AG 125



The compact angle grinding system.

With the grinding system Festool provides a compact system for virtually dust-free grinding. Unevenness can be levelled, paints, concrete, adhesive and plaster can be removed and surfaces prepared for new coatings. The folding front segment enables working right into edges and corners.

Diamond grinding system – virtually dust-free work with the DSG-AG.

- ▶ FastFix system allows the hood to be attached and detached quickly
- ▶ Sliding segment for working close to edges.
- ▶ Brush ring for efficient dust extraction.

Technical data

Power consumption (W)	1.400
No-load speed (min ⁻¹)	3.500 – 11.000
Disc Ø (mm)	125/130
Connection Ø for dust extraction (mm)	36/27
Weight of hood/system (kg)	0,4/2,7



= MMC Multi Material Control electronics

Scope of delivery

DSG-AG 125 Plus AUS
dust extraction hood, diamond disc ALL-D125 Premium,
in SYSTAINER SYS 3 T-LOC

Order no.

768998

System accessories from page 367



Mobile dust extractors from page 310



Substrate preparation

Diamond cutting system DSC-AG 125



DSC-AG 125

Accurate cuts without dust.

- ▶ Cutting system with efficient dust extraction, to protect your health.
- ▶ Guide base with smooth-running rollers for secure guidance on the workpiece.
- ▶ Viewing window gives a clear view of the cut line.
- ▶ Plunge cut function: allows you to start cutting at any point on the workpiece



Technical data	
Power consumption (W)	1.400
No-load speed (min ⁻¹)	3.500 – 11.000
Disc Ø (mm)	125
Side clearance (mm)	32
Front clearance (mm)	78
Cutting depth without/with guide rail (mm)	27/23
Connection Ø for dust extraction (mm)	36/27
Weight of hood/system (kg)	2,2/4,1



■ = MMC Multi Material Control electronics

Scope of delivery	Order no.
dust extraction attachment DCC-AG 125, diamond disc ALL-D125 Premium, in SYSTAINER SYS 4 T-LOC	
DSC-AG 125 Plus AUS	768923
DSC-AG 125 Plus-FS AUS guide rail FS 800/2	201650

Virtually dust-free work.

The DSC-AG 125 diamond cutting system with its efficient dust extraction protects your health when working. In combination with the Festool guide rail, it allows precise cuts on doors, windows, grooves and for expansion joints on floors.

System accessories
from page 368

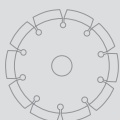

Mobile dust extractors
from page 310



Substrate preparation

Diamond cutting system DSC-AG 125 FH



DSC-AG 125 FH



Easy cutting without dust.

The freehand cutting system with cutting depth to 27 mm. For dust-free, precise cutting of mineral plate material such as tiles and natural stone. Ideal for tiling work, wall and floor repairs, crack repair or cutting expansion joints.

The versatility of an angle grinder, without the dust.

- ▶ Highly effective suction for virtually dust-free cutting work
- ▶ Excellent view of the cut location for precise, clean cuts
- ▶ The dust extraction attachment can be opened for forward work right up to edges
- ▶ Speed control for adjusting to the working material

Technical data

Power consumption (W)	1.400
No-load speed (min ⁻¹)	3.500 – 11.000
Disc Ø (mm)	125
Side clearance (mm)	23
Front clearance (mm)	16
Cutting depth without/with guide rail (mm)	27/-
Connection Ø for dust extraction (mm)	36/27
Weight of hood/system (kg)	0,6/2,9



■ = MMC Multi Material Control electronics

Scope of delivery

DSC-AG 125 FH-Plus AUS
dust extraction attachment DCC-AG 125 FH, diamond disc ALL-D125 Standard, plate TP-DSC-AG 125 FH, auxiliary handle VIBRASTOP, in SYSTAINER SYS 3 T-LOC

Order no.

769956

System accessories
from page 368

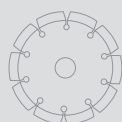

Mobile dust extractors
from page 310



Substrate preparation

Diamond cutting system DSC-AG 230



DSC-AG 230



Accurate cuts without dust for materials up to 63 mm.

- ▶ Cutting system with efficient dust extraction, to protect your health.
- ▶ Guide base with smooth-running rollers for secure guidance on the workpiece.
- ▶ Viewing window gives a clear view of the cut line.
- ▶ Rotary handle for optimum switch position and easier working.

Technical data

Power consumption (W)	2.600
No-load speed (min ⁻¹)	6.500
Disc Ø (mm)	230
Side clearance (mm)	35
Front clearance (mm)	85
Cutting depth without/with guide rail (mm)	63/59
Connection Ø for dust extraction (mm)	36/27
Weight of hood/system (kg)	3,2/8,9



Precise and efficient cutting – without dust.

Gone are the days when cutting and grinding concrete, brick and stone was a dusty affair. Hazardous dust is extracted reliably, your health is protected and a clear view of the cut line is guaranteed. A combination of compatible tools, accessories and consumables provides the perfect solution for efficient, tidy and precise work.

Scope of delivery

dust extraction attachment DCC-AG 230, diamond disc ALL-D230 Premium, in a case

Order no.

DSC-AG 230 AUS

769002

DSC-AG 230 FS AUS

guide rail FS 800/2

201651

System accessories
from page 368

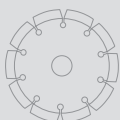

Mobile dust extractors
from page 310



Substrate preparation

Carpet remover TPE-RS 100

TPE



Wear-resistant blade.

The carpet blade moves back and forth, doing all the hard work for you. Always reliable, easy to sharpen. It quickly works its way in between the sublayer and the adhesive layer. All you have to do is push forwards slightly. Saving time has never been easier.



Quick and easy.

- ▶ Hand-held use for awkward spots and stairs
- ▶ Extension handle for fatigue-free work over large areas
- ▶ Powerful stirring action and reduction gearing for maximum economic efficiency
- ▶ High area capacity: 25 m² per hour on compact foam-backed carpets

Technical data

Power consumption (W)	620
No-load speed (min ⁻¹)	6.000
No. of strokes (min ⁻¹)	12.000
Sanding stroke (mm)	5
blade width (mm)	195
weight (kg)	3,6



Scope of delivery

TPE-RS 100 Q-Plus
in SYSTEMAINER SYS 3 T-LOC

Order no.

567873

System accessories
from page 369

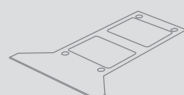

Substrate preparation

Wallpaper perforator TP 220



TP 220

A real breakthrough.

- ▶ Little effort required because of the completely new working principle
- ▶ The adjustable penetration depth of the rollers protects the subsurface from being damaged
- ▶ The adjustable telescoping handle is perfect for work in rooms with high walls, and on ceilings
- ▶ Protective cover for safe and clean transport

Technical data

Telescoping handle length (m)	0,9 – 1,3
Depth adjuster (mm)	3,5
Cutting diameter (mm)	45
dimension (L x W x H) (mm)	168 x 224 x 52
weight (kg)	1,5

Scope of delivery

TP 220
protective cover, telescoping handle, in carton

Order no.

495747



Completely new working principle.

The TP 220 is our expert when it comes to removing wallpaper. Rollers rotating at different speeds create funnel-shaped openings so that water can flow in behind and then seep into the wallpaper – without damaging the what's underneath.

System accessories
from page 369



The Festool system.

Because things work better when everything fits together: our comprehensive system of accessories for refurbishment and renovation provide appropriate and dust-free solutions for removing concrete, stone, plaster, adhesive, paint, carpet and wallpaper. Festool always has the right solution available, from the best tool heads for working on various materials with RENOFIX tools, through to our standard-setting mobile dust extractors for concrete grinders.



Substrate preparation

Accessories and consumable materials

System accessories

364



Substrate preparation

System accessories

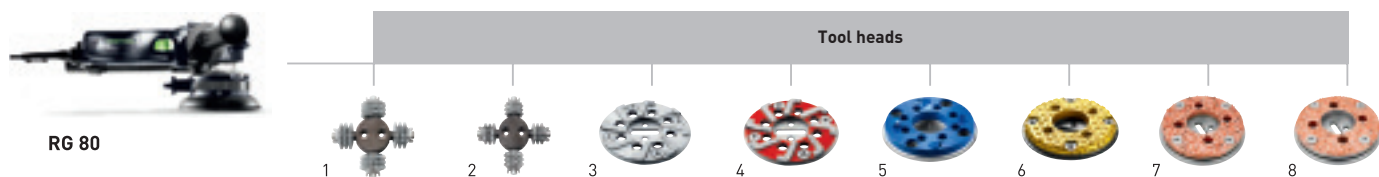

Accessories for concrete grinder RG 80 E

Denomination	Explanation	Order no.
1 Machine/tool head SZ-RG 80	for RG 80, RGP 80, for hard plaster, adhesive residue and synthetic resin plaster, 12 carbide grinding wheels, "pointed" shape, diameter 80 mm, in self-service display pack	767982
Grinding wheel HW-SZ 12	12 carbide grinding wheels, "pointed" shape, replacement wheels for SZ-RG 80, complete set with spacers and clamping elements, in self-service display pack	769132
2 Machine/tool head FZ-RG 80	for RG 80, RGP 80, for soft plaster and fresh concrete, for adhesive residue and protective coatings, 12 carbide grinding wheels, "flat" shape, diameter 80 mm, in self-service display pack	769131
Grinding wheel HW-FZ 12	complete set with spacers and clamping elements, 12 carbide grinding wheels, "flat" shape, replacement wheels for FZ-RG 80, in self-service display pack	769133
3 Machine/tool head DIA HARD-RG 80	for RG 80, RGP 80, for hard old concrete, epoxy resin on a hard substrate, coatings and paint on concrete, grinding head with diamond segments HARD, diameter 80 mm, in self-service display pack	767983
Diamond disc DIA HARD-D80	replacement disc for grinding head DIA HARD-RG 80, diameter 80 mm, in self-service display pack	769054
4 Machine/tool head DIA ABRASIVE-RG 80	for RG 80, RGP 80, for materials with high sand content, screed, fresh concrete, adhesive on screed, sand-lime brick and aerated concrete, grinding head with diamond segments ABRASIV, diameter 80 mm, in self-service display pack	767984
Diamond disc DIA ABRASIVE-D80	replacement disc for grinding head DIA ABRASIVE-RG 80, diameter 80 mm, in self-service display pack	769055
5 Machine/tool head DIA THERMO-RG 80	for RG 80, RGP 80, For thermoelastic materials on concrete, screed, etc., grinding head with diamond disc THERMO, diameter 80 mm, in self-service display pack	769082
Diamond disc DIA-THERMO 80	replacement disc for grinding head DIA THERMO-RG 80, diameter 80 mm, in self-service display pack	769084
6 Machine/tool head DIA UNI-RG 80	for RG 80, RGP 80, for paint, adhesive on wood floors, grinding head with diamond disc UNI, diameter 80 mm, in self-service display pack	769169
Diamond disc DIA UNI-D80	replacement disc for grinding head DIA UNI-RG 80, diameter 80 mm, in self-service display pack	769170
7 Machine/tool head HW COARSE-RG 80	for RG 80, RGP 80, for elastic coatings, adhesive on soft plaster, plaster and lime on beams, thick and old layers of paint and for roughening GRP, grinding head with carbide disc, coarse GROB, diameter 80 mm, in self-service display pack	769056
8 Machine/tool head HW FINE-RG 80	for RG 80, RGP 80, for elastic coatings, adhesive on soft plaster, plaster and lime on beams, thick and old layers of paint and for roughening GRP, grinding head with carbide disc, fine, diameter 80 mm, in self-service display pack	769057

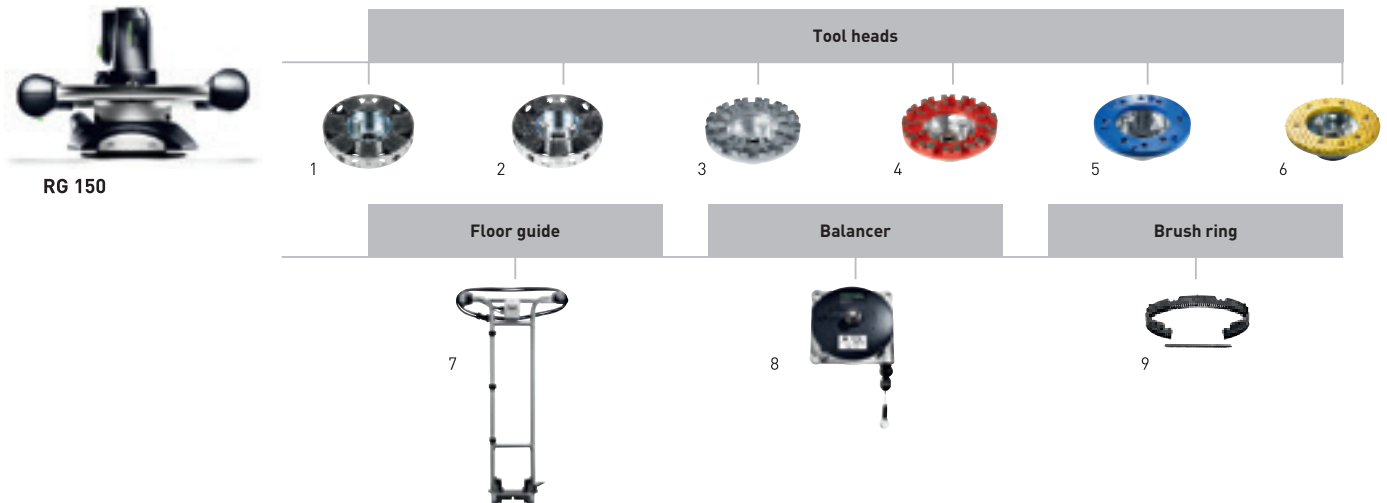

Accessories for concrete grinder RG 150 E

Denomination	Explanation	Order no.
1 Machine/tool head SZ-RG 150	for RG 150, RGP 150, for hard plaster, adhesive residue and synthetic resin plaster, Grinding head with 35 carbide grinding wheels, "pointed" shape, diameter 150 mm, in self-service display pack	768020
Grinding wheel HW-SZ 35	35 carbide grinding wheels, "pointed" shape, replacement wheels for SZ-RG 150, complete set with sleeves, in self-service display pack	769050
2 Machine/tool head FZ-RG 150	for RG 150, RGP 150, for soft plaster and fresh concrete, for adhesive residue and protective coatings, grinding head with 35 carbide grinding wheels, "flat" shape, diameter 150 mm, in self-service display pack	769105
Grinding wheel HW-FZ 35	35 carbide grinding wheels, "flat" shape, replacement wheels for FZ-RG 150, complete set with sleeves, in self-service display pack	769051
3 Machine/tool head DIA HARD-RG 150	for RG 150, RGP 150, for hard old concrete, epoxy resin on a hard substrate, coatings and paint on concrete, grinding head with diamond segments HARD, diameter 150 mm, in self-service display pack	768021
Diamond disc DIA HARD-D150	replacement disc for grinding head DIA HARD-D150, diameter 150 mm, in self-service display pack	769069
4 Machine/tool head DIA ABRASIVE-RG 150	for RG 150, RGP 150, for materials with high sand content, screed, fresh concrete, adhesive on screed, sand-lime brick and aerated concrete, grinding head with diamond segments ABRASIV, diameter 150 mm, in self-service display pack	768022
Diamond disc DIA ABRASIVE-D150	replacement disc for grinding head DIA ABRASIVE-D150, diameter 150 mm, in self-service display pack	769070
5 Machine/tool head DIA THERMO-RG 150	for RG 150, RGP 150, For thermoelastic materials on concrete, screed, etc., grinding head with diamond disc THERMO, diameter 150 mm, in self-service display pack	769083
Diamond disc DIA THERMO-D150	replacement disc for grinding head DIA THERMO-D150, diameter 150 mm, in self-service display pack	769085
6 Machine/tool head DIA UNI-RG 150	for RG 150, RGP 150, for paint, adhesive on wood floors, grinding head with diamond disc UNI, diameter 150 mm, in self-service display pack	769120
Diamond disc DIA UNI-D150	replacement disc for grinding head DIA UNI-D150, diameter 150 mm, in self-service display pack	769122
7 Floor guide BG-RG 150	for RG 150, RGP 150, for easy guidance of the RENOFIX RG 150 E on large areas of flooring, in carton	769109
8 Balancer BR-RG 150	for RG 150, RGP 150, for secure and easy guidance of the RENOFIX RG 150 E on walls, max. load 8 kg, length 2,5 m, in carton	769121
9 Brush ring BC-RG 150	for RG 150, RGP 150, replaceable brush ring, in self-service display pack	769123

Substrate preparation

System accessories

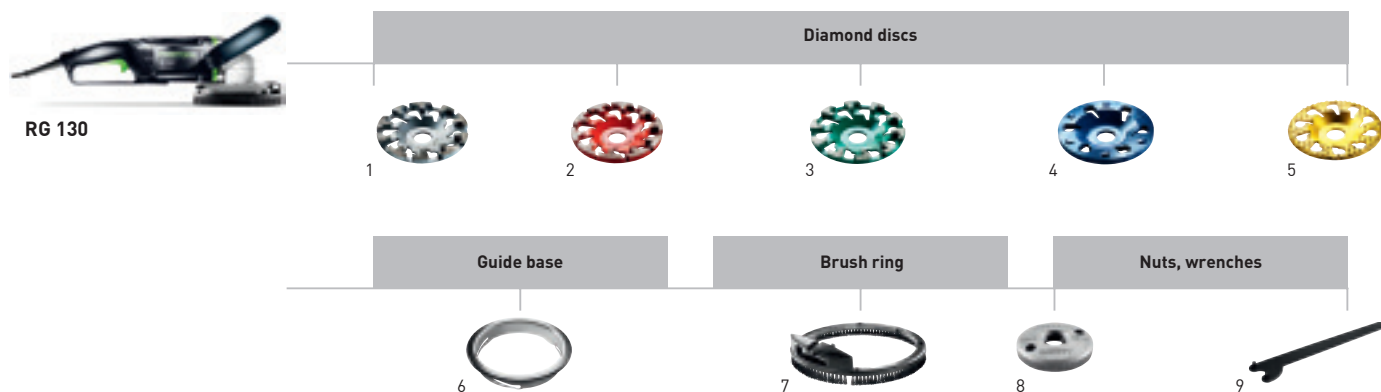

Accessories for diamond grinder RENOFIX RG 130

Denomination	Explanation	Order no.
1 Diamond disc DIA HARD-D130 PREMIUM	for RG 130, AG 125, RGP 130, AGP 125, for hard old concrete, epoxy resin on a hard substrate, coatings and paint on concrete, diameter 130 mm, interior Ø 25/22,2 mm, in self-service display pack	768017
Diamond disc DIA HARD-D130-ST	for RG 130, AG 125, RGP 130, AGP 125, for hard old concrete, epoxy resin on a hard substrate, coatings and paint on concrete, diameter 130 mm, interior Ø 25/22,2 mm, in carton	499972
2 Diamond disc DIA ABRASIVE-D130 PREMIUM	for RG 130, AG 125, RGP 130, AGP 125, for materials with high sand content, screed, fresh concrete, adhesive on screed, sand-lime brick and aerated concrete, diameter 130 mm, interior Ø 25/22,2 mm, in self-service display pack	768018
Diamond disc DIA ABRASIVE-D130-ST	for RG 130, AG 125, RGP 130, AGP 125, for materials with high sand content, screed, fresh concrete, adhesive on screed, sand-lime brick and aerated concrete, diameter 130 mm, interior Ø 25/22,2 mm, in carton	499973
3 Diamond disc DIA STONE-D130 PREMIUM	for RG 130, AG 125, RGP 130, AGP 125, For very hard materials and hard concrete (harder than B 35), diameter 130 mm, interior Ø 25/22,2 mm, in self-service display pack	769166
4 Diamond disc DIA THERMO-D130 PREMIUM	for RG 130, AG 125, RGP 130, AGP 125, For removing thermoelastic materials, diameter 130 mm, interior Ø 25/22,2 mm, in self-service display pack	768023
5 Diamond disc DIA UNI-D130 PREMIUM	for RG 130, AG 125, RGP 130, AGP 125, for paint, adhesive on wood floors, diameter 130 mm, interior Ø 25/22,2 mm, in self-service display pack	769167
6 Guide base GT-RG 130	for RG 130, RGP 130, Allows you to adjust the material removal capacity, allowing removal in defined layers, in self-service display pack	769080
7 Brush ring BC-RG 130	for RG 130, RGP 130, replaceable brush ring, in self-service display pack	769110
8 Clamping nut UF-DSC/DSG-AG M14	for disc-Ø 115-230 mm, for DSC-AG 125/230 and DSG-AG 125, Front mounting flange, to hold the cut-off wheel, date of manuf. 03/2015 onwards, bit holder M14, in self-service display pack	200241
9 Key KF-AG	for DSC-AG 125/230, for clamping flange, in a bag	769040

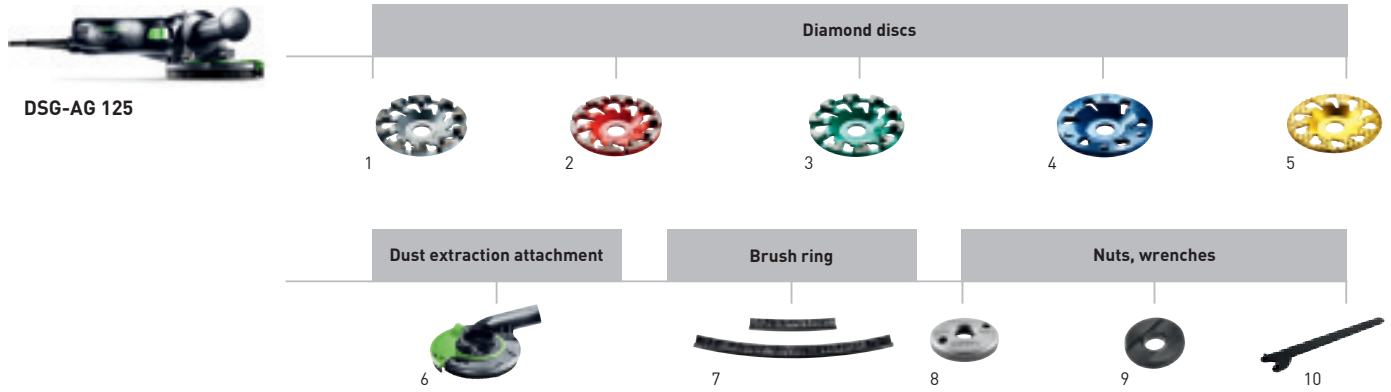

Accessories for Diamant grinding system DSG-AG 125

Denomination	Explanation	Order no.
1 Diamond disc DIA HARD-D130 PREMIUM	for RG 130, AG 125, RGP 130, AGP 125, for hard old concrete, epoxy resin on a hard substrate, coatings and paint on concrete, diameter 130 mm, interior Ø 25/22,2 mm, in self-service display pack	768017
2 Diamond disc DIA ABRASIVE-D130 PREMIUM	for RG 130, AG 125, RGP 130, AGP 125, for materials with high sand content, screed, fresh concrete, adhesive on screed, sand-lime brick and aerated concrete, diameter 130 mm, interior Ø 25/22,2 mm, in self-service display pack	768018
3 Diamond disc DIA STONE-D130 PREMIUM	for RG 130, AG 125, RGP 130, AGP 125, For very hard materials and hard concrete (harder than B 35), diameter 130 mm, interior Ø 25/22,2 mm, in self-service display pack	769166
4 Diamond disc DIA THERMO-D130 PREMIUM	for RG 130, AG 125, RGP 130, AGP 125, For removing thermoelastic materials, diameter 130 mm, interior Ø 25/22,2 mm, in self-service display pack	768023
5 Diamond disc DIA UNI-D130 PREMIUM	for RG 130, AG 125, RGP 130, AGP 125, for paint, adhesive on wood floors, diameter 130 mm, interior Ø 25/22,2 mm, in self-service display pack	769167
6 Dust extraction attachment DCG-AG 125	for AG 125, AGP 125-12/14, Clamping flange, disc Ø 125/130 mm, weight 0,4 kg, connection Ø for dust extraction 36/27 mm, in self-service display pack	769076
7 Brush ring BC-DCG AG 125	for DCG-AGP 125, in self-service display pack	769081
8 Clamping nut UF-AG M14	for disc-Ø 115-230 mm, for DSC-AG 125/230 and DSG-AG 125, Front mounting flange, to hold the cut-off wheel, up to date of manuf. 02/2015, bit holder M14, in self-service display pack	769018
Clamping nut UF-DSC/DSG-AG M14	for disc-Ø 115-230 mm, for DSC-AG 125/230 and DSG-AG 125, Front mounting flange, to hold the cut-off wheel, date of manuf. 03/2015 onwards, bit holder M14, in self-service display pack	200241
9 Flange BF-AG 22,2	for disc-Ø 115-230 mm, for DSC-AG 125/230, Rear mounting flange, to hold the cut-off wheel, bit holder 22,2 mm, in self-service display pack	767973
10 Key KF-AG	for DSC-AG 125/230, for clamping flange, in a bag	769040

Substrate preparation

System accessories

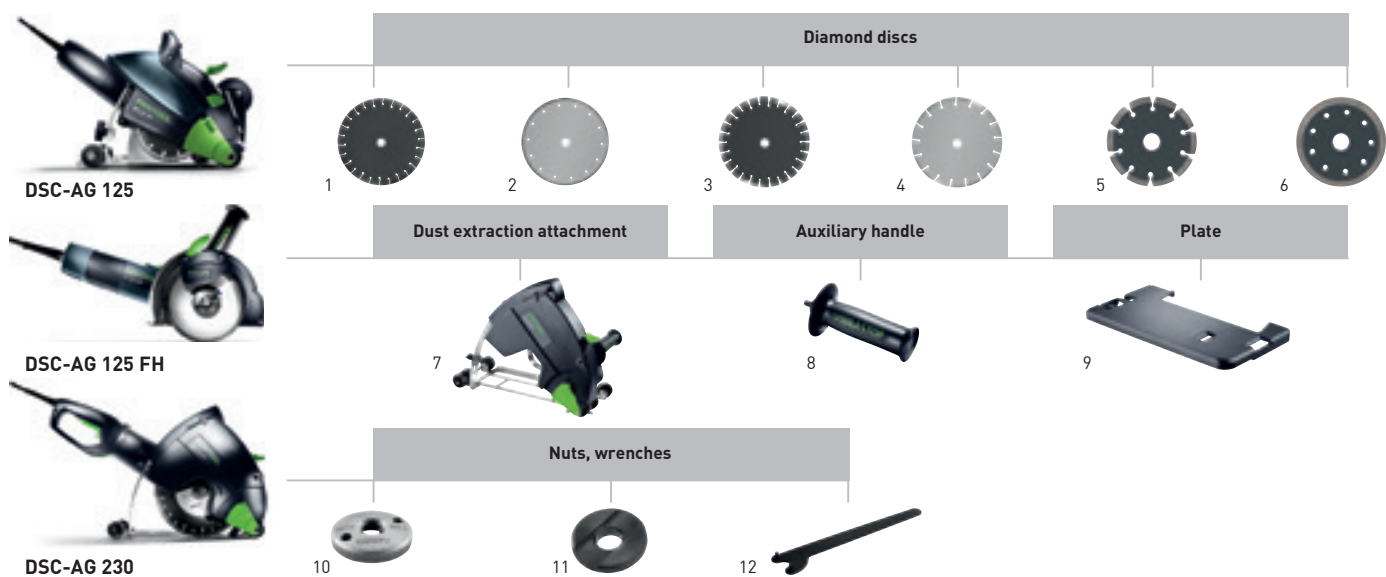

Accessories for diamond cutting system DSC-AG 125, DSC-AG 125 FH, DSC-AG 230

Denomination	Explanation	Order no.
1 Diamond disc ALL-D 125 PREMIUM	for DSC-AG 125, DSC-AG 125 FH, AGP 125, WCP 32, for all applications, mounting Ø 22,2 mm, Ø 125 mm, in self-service display pack	769154
2 Diamond disc ALL-D 230 PREMIUM	for DSC-AG 230, AGP 230, for all applications, Ø 230 mm, mounting Ø 22,2 mm, in self-service display pack	769155
Diamond disc ALL-D 125 STANDARD	for DSC-AG 125, DSC-AG 125 FH, AGP 125, WCP 32, for all applications, mounting Ø 22,2 mm, Ø 125 mm, in self-service display pack	769156
Diamond disc ALL-D 230 STANDARD	for DSC-AG 230, AGP 230, for all applications, Ø 230 mm, mounting Ø 22,2 mm, in self-service display pack	769157
3 Diamond disc C-D 125 PREMIUM	for DSC-AG 125, DSC-AG 125 FH, AGP 125, WCP 32, for concrete, mounting Ø 22,2 mm, Ø 125 mm, in self-service display pack	769158
Diamond disc C-D 230 PREMIUM	for DSC-AG 230, AGP 230, for concrete, Ø 230 mm, mounting Ø 22,2 mm, in self-service display pack	769159
4 Diamond disc C-D 125 STANDARD	for DSC-AG 125, DSC-AG 125 FH, AGP 125, WCP 32, for concrete, mounting Ø 22,2 mm, Ø 125 mm, in self-service display pack	769160
Diamond disc C-D 230 STANDARD	for DSC-AG 230, AGP 230, for concrete, Ø 230 mm, mounting Ø 22,2 mm, in self-service display pack	769161
5 Diamond disc MJ-D125 PREMIUM	for DSC-AG 125, DSC-AG 125 FH, AGP 125, for cleaning grout lines, width 6,5 mm, mounting Ø 22,2 mm, Ø 125 mm, in carton	769087
6 Diamond disc TL-D125 PREMIUM	for DSC AG 125, DSC-AG 125 FH, AGP 125, for cutting tiles, mounting Ø 22,2 mm, Ø 125 mm, in self-service display pack	769162
7 Dust extraction attachment DCC-AG 125	for AG 125, AGP 125-12/14, to reduce dust levels, hexagon socket wrench, Clamping flange, Spanner, weight 2,2 kg, Ø 125 mm, connection Ø for dust extraction 36/27 mm, in carton	769075
Dust extraction attachment DCC-AG 125 FH	for AG 125; AGP 125-14, for virtually dust-free work with the angle grinder, hexagon socket wrench, weight 0,6 kg, Ø 125 mm, connection Ø for dust extraction 36/27 mm, in carton	769953
Dust extraction attachment DCC-AG 230	for AG 230, AGP 230-22/26, to reduce dust levels, hexagon socket wrench, Clamping flange, Spanner, Ø 230 mm, weight 3,2 kg, connection Ø for dust extraction 36/27 mm, in carton	769077
Rubber seal DR-DCC-AG 230	for DCC-AG 230, DCC-AGP 230, increase in effectiveness of dust extraction, in self-service display pack	769092
8 Auxiliary handle AH-M8 VIBRASTOP	for AG 125, AGP 115, AGP 125, AGP 150, VIBRASTOP, bit holder M8, in self-service display pack	769620
Auxiliary handle AH-M14 VIBRASTOP	for AG 230, AGP 180, AGP 230, VIBRASTOP, bit holder M14, in self-service display pack	769621
9 Plate TP-DSC-AG 125 FH	for DSC-AG 125 FH Plus, DCC-AG 125 FH, protects the surface from abrasion marks during cutting work, for mounting on the guide base of the dust extraction attachment DCC-AG 125 FH, dimension [L x W x H] 195 x 103 x 14 mm, in self-service display pack	200002
10 Clamping nut UF-AG M14	for disc-Ø 115-230 mm, for DSC-AG 125/230 and DSG-AG 125, Front mounting flange, to hold the cut-off wheel, up to date of manuf. 02/2015, bit holder M14, in self-service display pack	769018
Clamping nut UF-DSC/DSG-AG M14	for disc-Ø 115-230 mm, for DSC-AG 125/230 and DSG-AG 125, Front mounting flange, to hold the cut-off wheel, date of manuf. 03/2015 onwards, bit holder M14, in self-service display pack	200241
11 Flange BF-AG 22,2	for disc-Ø 115-230 mm, for DSC-AG 125/230, Rear mounting flange, to hold the cut-off wheel, bit holder 22,2 mm, in self-service display pack	767973
12 Key KF-AG	for DSC-AG 125/230, for clamping flange, in a bag	769040



TP 220

Replacement rollers



1



TPE

Extension handle



2

Carpet remover blade

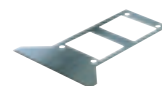

3

Accessories for FAKIR TP 220 wallpaper perforator, TPE carpet remover

Denomination	Explanation	Order no.
1 Replacement roller EW-TP 220	for TP 220, 2 rollers, in self-service display pack	496111
2 Extension-handle SG-TPE/RS 1	with 2 additional hand grips and shoulder cushion, two-part handle for use of carpet remover when standing, length 1.700 mm, in carton	486375
3 Carpet remover-blade TM 195	for TPE-RS 100, blade width 195 mm, in carton	486374



Lighting

Overview of products and applications 372

Rechargeable torch SYSLITE UNI 373

Work light SYSLITE KAL II 374

Site light SYSLITE DUO 375

Lighting

Overview of products and applications

Page 373 — 374 — 375

SYSLITE UNI

SYSLITE KAL II

SYSLITE DUO



Applications

For illuminating smaller surfaces

For illuminating larger surfaces

For illuminating large rooms

Work independent of the mains power supply



Ideal

Suitable



SYSLITE UNI

Lighting your way.

- ▶ Three powerful, energy-saving high-performance LEDs
- ▶ Torch head can be adjusted vertically in nine increments up to 135°
- ▶ Stable and secure against overturning and can be flexibly secured with belt clip and scaffold hook

Technical data	
Battery voltage (V)	10,8/18
Lamp	3 SMD LEDs
Lumens (lm)	43
Weight (without battery pack) (kg)	0,34

Scope of delivery	Order no.
SYSLITE UNI scaffold hook, without charger, battery pack not included, in self-service display pack	769079



Small, but wow!

The handy SYSLITE UNI is always at the ready when you need to bring light into dark corners. With its low weight and compact form, it's always a welcome sight. Takes all common Festool batteries.

Lighting

SYSLITE KAL II



product
design award

2012



SYSLITE KAL II



Total flexibility.

5 available installation and mounting positions: The SYSLITE KAL II lights up the darkest of corners for up to 6 hours non-stop. The housing is made from shatter-proof, shock-proof and impact-resistant cast aluminium – durable enough for any construction site. The light dispersion angle of 170° ensures extensive, homogeneous illumination of the work space.

Lighting your way.

- ▶ Outstanding light output with 12 high-power LEDs
- ▶ Long-life and hard-wearing due to impact-resistant enclosure
- ▶ maximum operational readiness – any Festool battery pack can be attached to supplement the internal battery. The 230 V mains power pack and vehicle charging cable offer additional charging and power supply options
- ▶ Different charging options for the internal 7.2V battery to ensure maximum readiness for use

Technical data

Lamp (W)	12 x 1,5
Lumens, 1st/2nd level (lm)	310/769
Burn time (internal battery), level 1/level 2 (min)	90/240
Lithium-ion battery capacity (Ah)	2,9
Charging time Li Ion battery pack (min)	200
Rated temperature range for operation (°C)	-5/+ 55
Operation with external Festool battery packs (V)	10,8 – 18
Hook opening (mm)	40
Thread size, stand (")	1/4
dimension (L x W x H) (mm)	80 x 100 x 150
Weight (without battery pack) (kg)	0,7

Scope of delivery

integrated lithium-ion battery 7.2 V, car battery charger, battery charger 230 V, carry bag, in self-service display pack

KAL II AUS

Order no.

500724

KAL II-Set AUS

magnetic spherical head with stand plate

500733

System accessories from page 376





SYSLITE DUO

Because good light is essential to good work.

- ▶ Unique arrangement of LEDs for 180° beam angle and even illumination
- ▶ High luminous power (8000 lm) for outstanding illumination over a wide area
- ▶ Colour temperature similar to daylight (5000 K)
- ▶ Sturdy and long-lasting with burn time of 10,000 hours (L70) and impact-resistant corners



Technical data	
Colour (K)	5.000
Lamp (W)	80 x 1,4
Lumens (lm)	8.000
LED service life (L70) (H)	10.000
Colour rendering index, Ra	80
Housing safety class	IP 55
IEC Class	1
Cable length (m)	4,9
weight (kg)	3,4

Scope of delivery	Order no.
in SYSTAINER SYS 3 T-LOC	
DUO-Plus AUS	201648
DUO-Set AUS stand ST DUO 200	201649

A new generation of light.

Illuminates large areas instead of just lighting up particular spots. With sturdy stand which extends up to a height of 2.00 m, and securely packed in a SYSTAINER. And with the kind of practical features you expect from Festool, like a one-hand handle, hook catch for hanging, and a cord holder.

System accessories
from page 376



Lighting

System accessories



SYSLITE KAL II

Magnetic spherical head

1



SYSLITE DUO

Stand

2



Accessories for work light SYSLITE KAL II, site light SYSLITE DUO

Denomination	Explanation	Order no.
1 Magnetic spherical head MA KAL	for Festool FS clamps, spherical head can be rotated 360°, for flexible positioning of the work light SYSLITE KAL and KAL II, pad for external stand, magnetic holding 16 kg, in self-service display pack	499814
2 Stand ST DUO 200	for SYSLITE DUO, two extensions for stepless height adjustment from 150 to 200 cm, collapsible into compact size and easy to transport with weight of just 5,6 kg, in carton	200038

See everything, work more accurately: light your way.

Whether the SYSLITE DUO site light, the SYSLITE KAL work light or the handy SYSLITE UNI – we develop all our lighting solutions with the same aim as our tools: to make your work easier and your results better. In this case through outstanding illumination in any situation, from small surfaces to entire rooms. Because high-quality lighting is a necessary precondition for good work.



SYSLITE UNI

The small, compact light for maximum mobility. Can be used with all Festool battery packs.

SYSLITE KAL II

Makes dark areas into working surfaces, in a very versatile way: can be set up or hung up in 5 positions and can be operated with a wide range of energy sources (internal rechargeable battery, battery pack, power cord, car charger cable).

SYSLITE DUO

Wide-area illumination (on mains power, not battery) of entire rooms with light quality similar to daylight. And the greatest possible flexibility in use: standing on the ground or on surfaces, on the Festool stand, or use the hook catch on the back to hang it up.

The newest member of the Festool lighting family: the new SYSLITE DUO.

Because good light is essential to good work. Experience the difference:



Classic halogen light

Yellowish tone and optical deterioration around the edges.



Conventional LED lamp

Small beam angle, smaller luminous power.



Festool SYSLITE DUO

180° beam angle, even lighting over a wide area, colour temperature similar to daylight.



By the way: thanks to **SERVICE all-inclusive**, you can try out the SYSLITE DUO for up to 30 days! For all the information about this and other services, go to www.festool.com.au/SAI



Workplace organisation

Compact Module System CMS	380
Multifunction table MFT 3	382
Vacuum clamping system VAC-SYS	383
Guide systems FS/2, GECKO	384
Vacuum clamping nozzle CT WINGS	386
Boom arms ASA	387
Energy box EAA	388
Work centre WCR	389
Multi-function stool MFH 1000, UCR 1000	390
Toolcenter TC 3000/2	391
Building site radio SYSROCK BR 10	392
Power distributor SYS-PowerHub	393
Storage systems SYSTAINER, SORTAINER, Sys-ToolBox	394
Transportation systems SYS-Port, SYS-Roll, SYS-Cart	395
Accessories and consumable materials	396

The Festool system

Workplace organisation

The CMS Compact Module System

CMS Compact Module System. Open to change.

Five machines in one. Stationary or handheld. Covers 0.5 m². Only possible with a system. The CMS Compact Module System consists of a basic unit and compatible modules that transform the unit into a stationary bench-mounted saw, jigsaw, bench-mounted router or belt sander.

Safe and convenient.

The machines can be switched on and off from the basic unit.

Mobile and stable.

At only 10.8 kg, the basic unit is extremely lightweight yet robust.

Adjustable height.

Foldaway legs on the basic unit allow you to work on the floor or standing up.

Easy to extend.

A comprehensive selection of accessories such as the sliding table, angle stop and extension table are available so the CMS can be adapted for a wide range of applications.

CMS modules



TS 55 R Plunge-cut saw
Page 20



Module mounting CMS-TS 55 R
Page 23



Module CMS-MOD-TS 55-R
Page 23



TS 75 Plunge-cut saw
Page 22



Module mounting CMS-TS 75
Page 23



Module CMS-MOD-TS 75
Page 23



Router OF
Page 156



Module mounting CMS-OF
Page 160



Pendulum jigsaws PS
Page 16



Module mounting CMS-PS
Page 19
ADT-PS 400 adapter table
Page 42



(PS 420/400)



All modules in the established Basis-Plus System can be combined with the basic unit of the CMS, except for the Basis 1 A module.



Module CMS-MOD BS 120
Page 95

Workplace organisation

The CMS Compact Module System

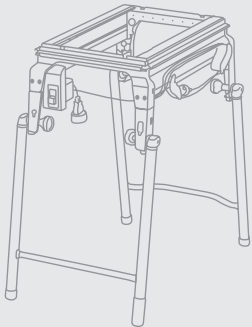

Basic unit

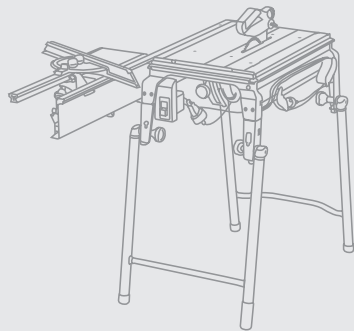
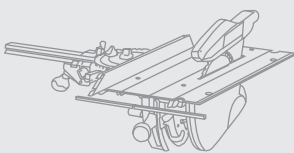

Bench-mounted machine

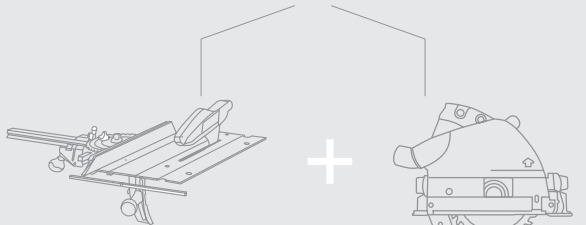

CMS module or hand-guided machine plus
CMS module mounting

Basic unit

Bench-mounted machine



Technical data

Table height, legs unfolded	900 mm
Table height, legs folded away	316 mm
Table dimensions	585 x 400 mm
Weight	10.8 kg

Scope of delivery

Basic unit for fitting CMS modules, foldaway legs, main safety switch, cable holder/workpiece holder, cable and socket

Order no.

561228



Bench saw CMS-TS 55 R Set
Page 23



Bench saw with TS 75



Bench-mounted router TF 2200 Set
Page 161
TF 1400 set
Page 161
Bench-mounted router with OF 1010



Bench-mounted jigsaw with PS



Bench-mounted belt sander with BS 120

Workplace organisation

Multifunction table MFT 3

MFT 3



Always the right accessories.

Everything is secured safely in place, from guide rails to combination bevvels. The MFT/3 extension allows the insertion of all CMS modules, while the sliding table enables cross cuts with a maximum width of 830 mm.



1 table. 1000 possibilities.

- ▶ maximum precision – with aluminium profile for retaining a guide rail and the angle stop
- ▶ Angle stop, stop slide and additional clamping device ensure exact results
- ▶ Ergonomic work positioning thanks to the table height of 90 cm
- ▶ Mobile use of the MFT 3 through space-saving foldaway legs

Technical data

table dimensions (mm)	1.157 x 773
Table height, legs folded away (mm)	180
Table height, legs unfolded (mm)	900
Maximum workpiece thickness (mm)	78
max. workpiece width (mm)	700
load capacity (kg)	120
weight (kg)	28

Scope of delivery

table with perforated top and fold-away legs, in carton

MFT/3

table with perforated top and fold-away legs, hinged rail adapter, rail support adapter, mitre guide, adjustable stop, FS 1080/2 guide rail, FS-AW deflector, fence support clamp, in carton

MFT/3 Basic

table with perforated top and fold-away legs, in carton

MFT/3 CMS Table Ext AUS

Order no.

495315

500608

574879

System accessories from page 399

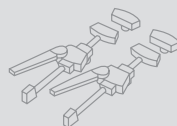



VAC SYS

The future of clamping.

- ▶ Workpieces can be turned up to 360° and swivelled up to 90°
- ▶ Sensitive surfaces can be clamped without damaging them
- ▶ powerful control – each clamping unit can secure workpieces up to 30 kg and 1 x 1 m
- ▶ for mobile use – pump and clamping units are stored in a SYSTAINER for easy transportation

Technical data

Power consumption at 50 Hz min. (W)	160
Power consumption at 50 Hz max. (W)	200
power consumption at 50 Hz (W)	160 – 200
power consumption at 60 Hz (W)	200 – 230
pump capacity at 50 Hz (m³/h)	2,7
pump capacity at 60 Hz (m³/h)	3,5
minimum vacuum	≥ 81% / ≥ 810
weight (kg)	8



Scope of delivery	Order no.
vacuum hose	
VAC SYS SE 2 vacuum pad VAC SYS VT 275 x 100 mm, connector, in SYSTAINER SYS 4	580062
VAC SYS Set SE1 AUS vacuum pump VAC SYS VP, vacuum clamping unit VAC SYS SE1, foot release valve	201658



Pads replaced without using tools.

There are four pad sizes for different workpieces to choose from and they can be replaced quickly with FastFix.

System accessories
from page 400



Workplace organisation

Guide rail FS/2

The guide rail is available in 8 different lengths, from 800 mm to 5000 mm.

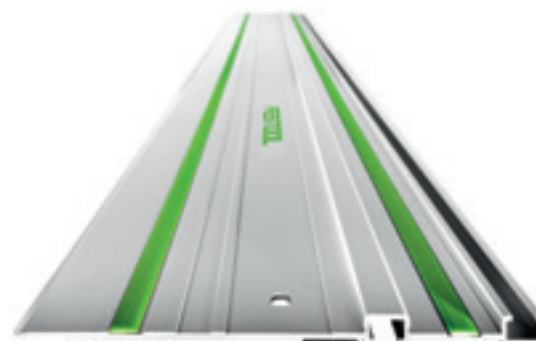

FS/2



Suitable for furniture construction.

A router and guide rail with rows of holes simplify the installation of shelves or fittings.

Flawless guidance.

- ▶ zero-play guidance – you can adjust the guidance jaws on the circular saw to fit the guide rail without using tools
- ▶ splinter-free cuts – the splinter guards positioned directly on the scribe line prevent the edges from splintering, even on angled cuts.
- ▶ precision results – the router guide stop was designed for precision grooves
- ▶ quick for diagonal cuts – with guide rail and combination bevel, angles are easy to transfer from the workpiece or wall

Scope of delivery	Order no.
in carton	
FS 800/2	491499
FS 1080/2	491504
FS 1400/2	491498
FS 1900/2	491503
FS 2400/2	491502
FS 2700/2	491937
FS 3000/2	491501
FS 5000/2	491500
FS 1400/2-LR 32	496939
FS 2424/2-LR 32	491622

FS 800/2 = length 800 mm, FS 1080/2 = length 1080 mm, FS 1400/2 = length 1400 mm etc.
FS 1400/2-LR 32 and FS 2424/2-LR 32 = guide rails with rows of holes 32 mm apart.

System accessories from page 402

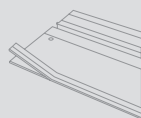



GECKO



Solid hold, easy release.

- ▶ ergonomic – the torsionally rigid handle makes it much easier to lift heavy loads
- ▶ retains the position, preserves the material – special sliding rings mounted on both suction cups allow you to position the GECKO precisely and release it just as easily
- ▶ secure hold – the green clamping levers provide quick and reliable suction. For a loading capacity of 50 kg
- ▶ designed for a system – the GECKO can be mounted directly to a guide rail using the guide rail adapter

Technical data

load capacity (kg) 50

Scope of delivery

in self-service display pack

Order no.

GECKO DOSH

492617

GECKO DOSH-Set

adapter DOSH-FSAD, dual suction pad GECKO DOSH

493507

Designed for a system.

The GECKO can be mounted directly to a guide rail using the guide rail adapter.

System accessories
from page 402

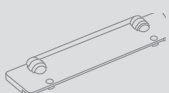

Workplace organisation

Vacuum clamping nozzle CT WINGS



CT WINGS



Assembly aid through suction force.

The practical assembly aid for clamping and fixing workpieces on horizontal and vertical areas. Simply position CT WINGS at a 27 mm suction hose with machine sleeve, switch on the mobile dust extractor and then the workpiece is held in place with the suction power.

The third hand. Precisely when you need it.

- ▶ in many cases replaces the assistant when it comes to having a free hand for marking, clamping, gripping, etc.
- ▶ for effortless, precise and safe work
- ▶ small, compact and always at hand
- ▶ perfect in the system – in combination with a Festool mobile dust extractor and suction hose with 27 mm diameter

Technical data

max. clamping height (mm)	50
max. load (kg)	3
dimension (L x W x H) (mm)	130 x 80 x 50
weight (kg)	0,35

Scope of delivery

CT-W
in self-service display pack

Order no.

500312

CT dust extractors
from page 296





For large working areas.

- ▶ Expands the working range to up to 84 m²
- ▶ Maximum flexibility, extra safety, no dangerous obstacles
- ▶ For use with Festool CT/SRM mobile dust extractors
- ▶ Integrated compressed air and electrical lines for connection to EAA and CT

Technical data	ASA 6000
Connecting line length (m)	3
Boom extension (m)	2 x 3
Range of use (m ²)	56 – 84
weight (kg)	105
Cutting angle adjustment (°)	56 – 84



Scope of delivery	Order no.
ASA 6000 CT/SR-AUS dual-articulated arm system with wall mounting bracket, cable duct, hardware for securing mounting bracket to wall is not included, in carton	583877



Workplace changes made easy.

Boom arms are primarily used in locations where workplaces need to be flexible or where a large operating radius is required. Power and dust extraction is supplied where it is needed, while avoiding tripping hazards. This saves you time moving equipment and creates more space in the workshop.

System accessories
from page 401

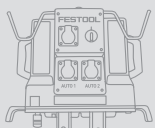

Workplace organisation

EAA energy box CT/SR



EAA



For more freedom of movement.

- ▶ manual or automatic adjustment of the slide valve provides suction power wherever an electric and/or air tool is currently in operation
- ▶ flexible – the EAA can be mounted on a ceiling, wall or boom arm
- ▶ Always ready for use by up to 2 electric and/or compressed air tools (depending on version EW/DW)
- ▶ better organisation – two hoses can be stored and kept clean in the hose holders on the rear of the EAA

Technical data

	EAA EW CT/SRM/M-AUS	EAA EW/DW TURBO/A-AUS
dimension (L x W x H) (mm)	506 x 580 x 367	516 x 580 x 367
Pressure range (bar)	4 – 8	4 – 8
weight (kg)	10,2	13,8



Thought out in every detail.

The EAA with manually or automatically operated valves for use with the CT mobile dust extractors or the TURBO II central dust extractor saves the user annoying fiddling and running around, and ensures optimal dust extraction. Electric and air tools are ready for use and ready to hand at all times.

Scope of delivery

power supply box fitted with 3 x 240 V connections, in carton

Order no.

EAA EW CT/SRM/M-AUS

Sandpaper holder

201637

EAA EW/DW TURBO/A-AUS

2 x Sandpaper holder, compressed air supply unit with 3 compressed air ports (2 x lubr. and 1 x non-lubr.)

583836

System accessories from page 401

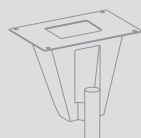



WCR 1000



Mobility in the tightest of spaces.

- ▶ compact and mobile – the WCR can be coupled with any Festool mobile dust extractor with integral Sys-Doc (except CTL MINI/MIDI)
- ▶ flexible equipment – hooks for hanging two machines with extractor hoses, a universal holder, storage compartment and rotating storage tray for sundries
- ▶ individual extension – additional storage trays, hooks or holders can be mounted on the perforated plate and profiled groove
- ▶ work without straining your back – the height of the Workcenter, hooks and storage trays is easy to adjust

Technical data

length (mm)	1.050
width (mm)	362
height adjustable (mm)	545 – 785
Large square hole pattern (mm)	9,2 x 9,2
Hole inner spacing square hole pattern (mm)	38
weight (kg)	10,2

Scope of delivery

WCR 1000
 2 x pegboards with square holes, 6 x standard hooks (125 mm long),
 Storage Shelf, Deposit tray, Deposit base for pegboard, Double tool hook,
 Double universal hook, SYSTAINER retainer, in carton

Order no.

497471

Customised configuration.

SYSTAINER sizes 1 to 4 or SORTAINERs can be integrated into the Workcenter.

System accessories
 from page 404



Workplace organisation

Multifunction stool MFH 1000
and Universalcenter UCR 1000

MFH 1000 /
UCR 1000



Clever, mobile organisation module.

Pull-out drawer that can be locked – for storing accessories, work equipment and personal effects.

Movable seat for efficient work.

- ▶ multifunction stool MFH 1000 + Workcenter WCR 1000 = Universalcenter UCR 1000
- ▶ use the Universalcenter UCR 1000 in mobile applications and benefit from the advantages of the Workcenter WCR 1000
- ▶ pleasant working environment – without the Workcenter WCR, the multifunction stool MFH 1000 is a stable, comfortable seat
- ▶ efficient organisation – hooks and storage trays ensure quick access to machines, accessories and work equipment

Technical data	MFH 1000	UCR 1000
length (mm)		695
dimension [L x W x H] (mm)	695 x 436 x 524	
width (mm)		436
Width of roller (mm)	32	32
height adjustable (mm)		1.031 – 1.271
Roller Ø (mm)	100	100
Large square hole pattern (mm)	9,2 x 9,2	9,2 x 9,2
Hole inner spacing square hole pattern (mm)	38,1	38,1
weight (kg)	27	37

Scope of delivery	Order no.
in carton	
MFH 1000 seat cushion MFH 1000 SK, Assembly set	498967
UCR 1000 Workcenter WCR 1000, multi-function stool MFH 1000 (without seat cushion)	498966

System accessories from page 404





TC 3000/2

Flexibility plus a surface to work on.

- ▶ beneficial organisation – tools, materials and mobile dust extractor are always stored away tidily and close at hand
- ▶ mobile equipment – simple transportation between different locations in the workshop
- ▶ secure attachment – the mobile dust extractor is secured safely in the extractor dock
- ▶ more space – machine and hose holders keep storage areas free for working equipment



Technical data	
dimension (L x W x H) (mm)	470 x 1.070 x 960
Storage area (mm)	460 x 990
Storage area working height (mm)	925
weight (kg)	43

Scope of delivery	Order no.
TC 3000/2	583881
hose holder, non-slip mat, in carton	

Safety included.

Locking cabinet compartment for size 3 SYSTAINERS or smaller provides safe storage for machines and accessories.

System accessories from page 405

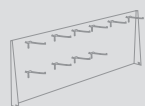

Workplace organisation

Site radio SYSROCK

SYSROCK BR 10



Light, compact, powerful.

The SYSROCK site radio fits on any windowsill and combines compact dimensions and low weight with a perfect sound. And thanks to the Bluetooth interface and integrated hands-free function, you can listen to not only your favourite radio stations, but also the great songs on your smartphone in SYSROCK-quality sound.

Always sounds good – both for working and for making calls.

- ▶ Versatile reception and playback options via Bluetooth and AUX-IN jack – available as analog or digital radio
- ▶ Integrated USB port for charging external devices such as phones and other mobile devices (BR 10 DAB+)
- ▶ Outstanding sound in a compact, modern and rugged design
- ▶ Intuitive operation with large buttons and colour LCD display

Technical data	BR 10 DAB+ AUS	BR 10 AUS
Radio reception	DAB+	FM
FM frequency band (VHF) (MHz)	87,5 – 108	87,5 – 108
Speaker (W)	10	10
Operation with Festool push-in battery packs (V)	10,8 – 18	10,8 – 18
Number of stored stations (piece(s))	4	4
Aux-in socket (mm)	3,5	3,5
Bluetooth standard	4,1	4,1
USB output	5V/1A	
dimension (L x W x H) (mm)	95 x 102 x 149	94 x 102 x 149
weight (kg)	0,7	0,7



Scope of delivery	Order no.
in self-service display pack	
BR 10 DAB+ AUS DAB+ digital radio	202113
BR 10 AUS FM radio	200186



SYS-PowerHub



The first cable reel with corners and edges, and integrated into a system.

- ▶ The Systainer-design cable reel: the hardwired, 10 m long power cable conveniently stows inside for transport. The SYS-PowerHub also provides space for any battery packs or small parts required.
- ▶ Supplies power to up to four electric tools at the same time. If required, a mobile phone or tablet can also be charged on the inside, where it is safely protected.
- ▶ With two cable outlets, the SYS-PowerHub can be coupled to other Systainers even when closed
- ▶ When connected to the power supply, the red light on the front indicates that the device is ready for operation

Technical data

Cable length (m)	10
dimension (L x W x H) (mm)	396 x 296 x 157,5
weight (kg)	4,2
IEC Class	IP44
Power consumption (W)	2.500
Number of electrical sockets	5

Scope of delivery

SYS-PH AUS

Order no.

200232

A whole new generation of power distribution.

The new SYS-PowerHub combines all the benefits of conventional cable reels with the advantages of the Festool Systainer system. With its 10 m long cable and four 230 V electrical sockets fitted on the outside, it gives you the independence you need when connecting your electric tools.

Workplace organisation

SYSTAINER T-LOC, SORTAINER, SYS-ToolBox

Simply tidier, more clearly arranged and better organised.

SYSTAINERS and SORTAINERS from Festool.

SYSTAINER/SORTAINER – can be stacked/connected, extremely robust and virtually indestructible.

Machines, accessories and consumable materials are protected from dust, splash water, extreme fluctuations in temperature and impacts. All your sundries and consumables are stored tidily and are easier to transport – size 1 and 2 SYS T-LOC units can even be carried upright with the attachable additional handle (accessory).

SYS-ToolBox – the open SYSTAINER for instant access.

A robust design made from high-quality plastic provides a maximum load capacity of 7 kg. Two spacious compartments keep your workplace tidy and an open top gives quick access to hand tools, consumable materials and accessories.



Combines three functions.

The central control element of the SYSTAINER: Lock, open, connect with a single turn.



Secure connection.

In combination with a SYSTAINER or a mobile dust extractor, Systainer-Port and Workcenter WCR.



Easy to open.

The new SYSTAINER T-LOC can be opened at any time without having to be disconnected.



Everything at a glance – the drawers of the SORTAINER offer lots of space for sundries.

1. Individual compartments and additional labelling options provide a better overview.
2. From the left or right. The drawers can be opened from both sides to allow quick access to the contents.
3. The pull-out catch and individual safety lock prevent accidental removal of the drawers.
4. A range of different sizes and a modular drawer system offer a SORTAINER to suit every requirement.



Workplace organisation

SYS-Port, SYS-Roll, SYS-Cart



Good for quick transportation.

Everything in its place, stored close at hand at all times. The Systainer-Port, roll board and SYS-Roll SYSTAINER transporter provide greater mobility at the workplace and on assembly sites.



How many SYSTAINERS fit in a SYS-PORT?

Combination options

SYSTAINER size	SYS-PORT 500/2						SYS-PORT 1000/2																																		
	Number of SYSTAINERS						Number of SYSTAINERS																																		
Version	1	2	3	4	5	6	1	2	3	4	5	6	7	8	9	10	11	12	13	14	15	16	17	18	19	20	21	22	23	24	25	26	27	28	29	30	31	32	33		
SYS 1 T-LOC/DF*	3	2	1				8	6	6	5	5	4	4	3	3	3	3	2	2	2	2	2	1	1	1												2	4	1	1	
SYS 2 T-LOC/DF*		1	2	1				1	2	1	1	2	3		1	2	4					2	3	1	1	2	3	4	5										2		
SYS 3 T-LOC/DF*			1	1					1		1	2	1	1	2			3				2	1	2		3	1	1		4	1	1						2			
SYS 4 T-LOC					1					1		1		1		1					2		1	2		1	1					2				1		1			
SYS 5 T-LOC																																				1	1	2	1	1	
Drawers required**	3	3	2	2	2	1	8	7	7	7	6	6	6	6	5	6	6	5	5	5	5	6	5	4	5	5	4	3	4	4	4	5	5	4	3	4	5	2	3	3	4

* DF = Lid compartment ** The SYS-PORT 500/2 is supplied with 3 drawers, the SYS-PORT 1000/2 with 5 drawers.

From machines to sundries. From the workshop to the assembly site.

	SYSTAINER 1-5 SYS-MFT SYS-Combi	SORTAINER	SYS-ToolBox SYS-Storage- Box	MAXI- SYSTAINER	MIDI- SYSTAINER	MINI- SYSTAINER	SYS-Roll	SYS-Cart	Systainer-Port SYS drawer
Organisation/Storage									
Power tools	1)	2)		1)					3)
Sundries	1)					1)			3)
Abrasives	1)								3)
Cartridges	1)								3)
Hand tool	1)								3)
Combinations									
SYSTAINER 1-5									
SORTAINER									
SYS-ToolBox I/II									
MAXI-SYSTAINER									
MIDI-SYSTAINER									
MINI-SYSTAINER									
SYS-Roll									
SYS-Cart									
Systainer-Port									
Mobile dust extractors									
Use/Transportation									
Workshop									
Construction site									

● Ideal

○ Very suitable

○ Suitable

1) In combination with insert 2) Only with Sys 3-Sort/4

3) In combination with a suitable SYSTAINER or SORTAINER

The Festool system.

Because things work better when everything fits together:
Workplace organisation is at least as important as an accurate
power tool, because ultimately almost inexhaustible potential lies
behind this. The Festool system always creates a tidy environment
and guarantees better organisation.



Workplace organisation

Accessories and consumable materials



Workplace organisation

System accessories

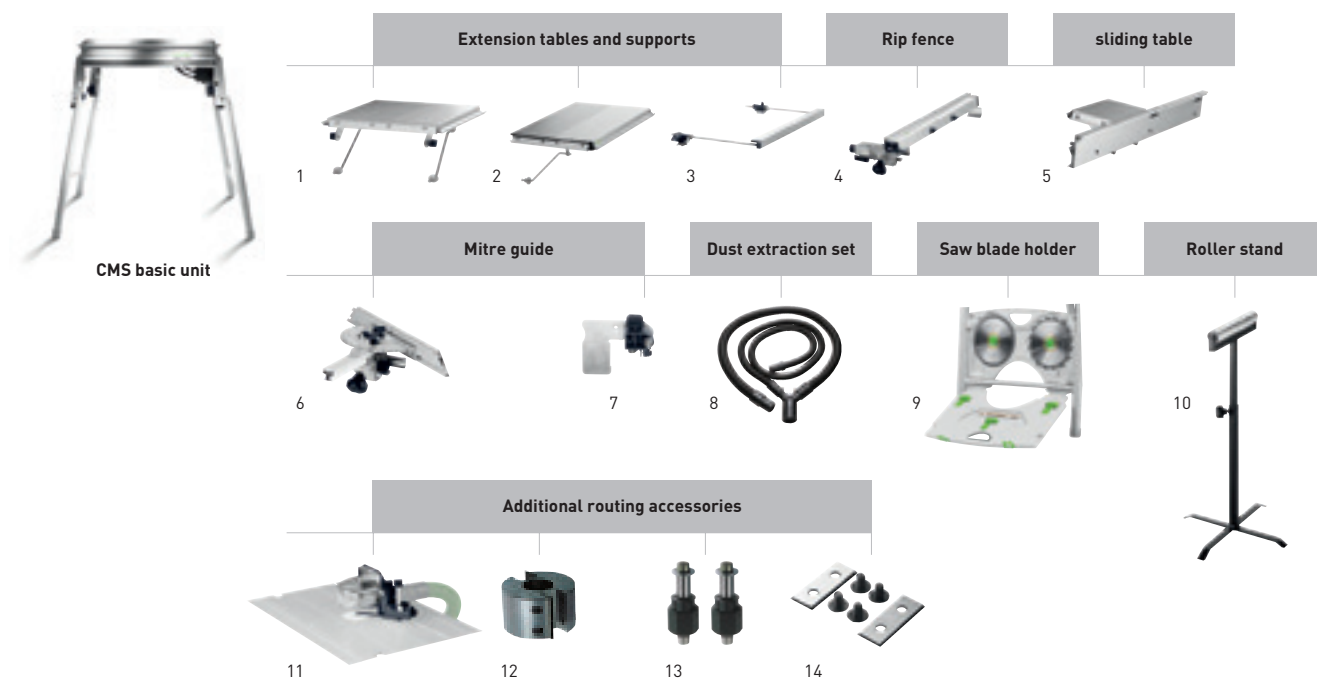

Accessories for Compact Module System CMS

Denomination	Explanation	Order no.
1 Extension table VL	for CS 50, CMS-GE, simple fitting, fold-away, for safe support of long workpieces when sawing to width, extends the support area by 405 mm, dimensions length x width 375 x 454 mm, in carton	492092
2 Extension table VB-CMS	for CMS-GE, with adjustable dimension scale, extends the support area by 410 mm, cutting width 570 mm, dimensions length x width 664 x 438 mm, in carton	493822
3 Support AF	for CS 50, CMS-GE, support for both side use, supports workpieces while cutting, extends the support area by 300 mm, dimensions length x width 662 x 390 mm, in carton	492242
4 Rip fence LA-CS 50/CMS	for CS 50, CMS-GE, with fine depth adjustment and rear clamp, can be operated from front, with moveable stop profile for precise and safe longitudinal cuts, in carton	492095
5 Sliding table ST	for CS 50, CMS-GE, max. working width for trimming cuts 830 mm, in carton	492100
6 Mitre guide WA	for CS 70, CS 50, CMS-GE, for work requiring 2 stops, in carton	488451
7 Adjustable stop WA-AR	for CS 50, CS 70, to stop workpieces on trimming attachment CS 70 WA, CS 50 WA and Basis WRA 500, in self-service display pack	491712
8 Dust extraction set CS 70 AB	for CT/CTM, can be used with Basis, CS 70, CS 50 and CMS, comprising: dust extraction hose D27x2.0 m, dust extraction hose D36x1.0 m, Y terminal, dust extraction with MINI / MIDI only possible with adapter hose 499196, diameter 27/36 mm, in carton	488292
Adapter hose AD-D36/CS50/CS70/CMS	for CS 50, CS 70, CMS, 0.5 m hose D36 with two rotating adapters and antistatic connector sleeve D50/D50 VM-AS, for Y-connector together with CTL MINI/MIDI, length 0.5 m, diameter 36 mm, in carton	499196
9 Saw blade holder SGA	for CS 50, CMS-GE, for safe and space-saving storage of up to 4 saw blades (max. Ø 190 mm) and up to 3 splinterguards (not in scope of delivery), in carton	492228
10 Roller stand RB	for trimming and mitre saws and Compact Module System (CS/KS/CMS), for use with CS 50, CS 70, CB 120, System Basis Plus, CMS-GE, multifunction table, for supporting long workpieces when cutting and sanding, height adjustable 630 - 1.000 mm, in carton	488711
11 Guard BF-OF-CMS	for CMS-OF 1010, for CMS-OF 1400/OF 2000/OF 2200, guard and extractor hood, connection Ø for dust extraction 27/36 mm, in carton	494643
12 Rebating head FK D 50x30	for CMS-OF, for use with cutter spindles, diameter 50 mm, in self-service display pack	489284
13 Cutter spindle ASL20/OF1400-OF2200	for CMS-OF 1400/OF 2000/OF 2200, for use with rebating head Basis FK D 50x30 in the Basis 6 A and CMS-OF, in self-service display pack	490131
Cutter spindle ASL20/OF1010	for CMS-OF, for use with rebating head Basis FK D 50x30 in the Basis 5 A and CMS-OF 1010, in self-service display pack	489285
14 Reversible blade WP 30x12x1,5	for rebating head, qty. in pack 2 piece(s), in self-service display pack	489286



MFT/3

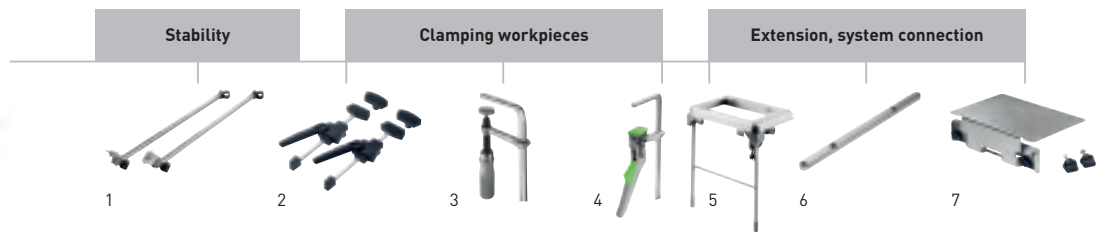

Accessories for multifunction table MFT 3

Denomination	Explanation	Order no.
1 Cross brace MFT 3-QT	for additional MFT 3 stability, qty. in pack 2 piece(s), diameter 20 mm, length 675 mm, in carton	495502
2 Fixed clamps MFT-SP	for MFT, for safe and precise securing of the workpiece (sawing, sanding, routing, drilling, etc.), qty. in pack 2 piece(s), in self-service display pack	488030
3 Fastening clamp FSZ 120	for FS/2, MFT, solid steel version, qty. in pack 2 piece(s), clamping capacity 120 mm, in self-service display pack	489570
Fastening clamp FSZ 300	for FS/2, MFT, solid steel version, qty. in pack 2 piece(s), clamping capacity 300 mm, in self-service display pack	489571
4 Lever clamp FS-HZ 160	for FS/2, MFT, solid steel version, clamping capacity 160 mm, in self-service display pack	491594
5 Guide extension MFT 3-VL	for the MFT 3, foldaway legs, main safety switch, cable and socket, in carton	495510
6 Connector VS	for attachment of FST660/85 or MFT 800 to Basis Plus, for joining MFT/3s together, in self-service display pack	484455
7 Adapter VAC SYS AD MFT 3	for VAC SYS SE 1, VAC SYS SE 2, to connect the VAC SYS clamping unit with the MFT 3, in carton	494977

Workplace organisation

System accessories

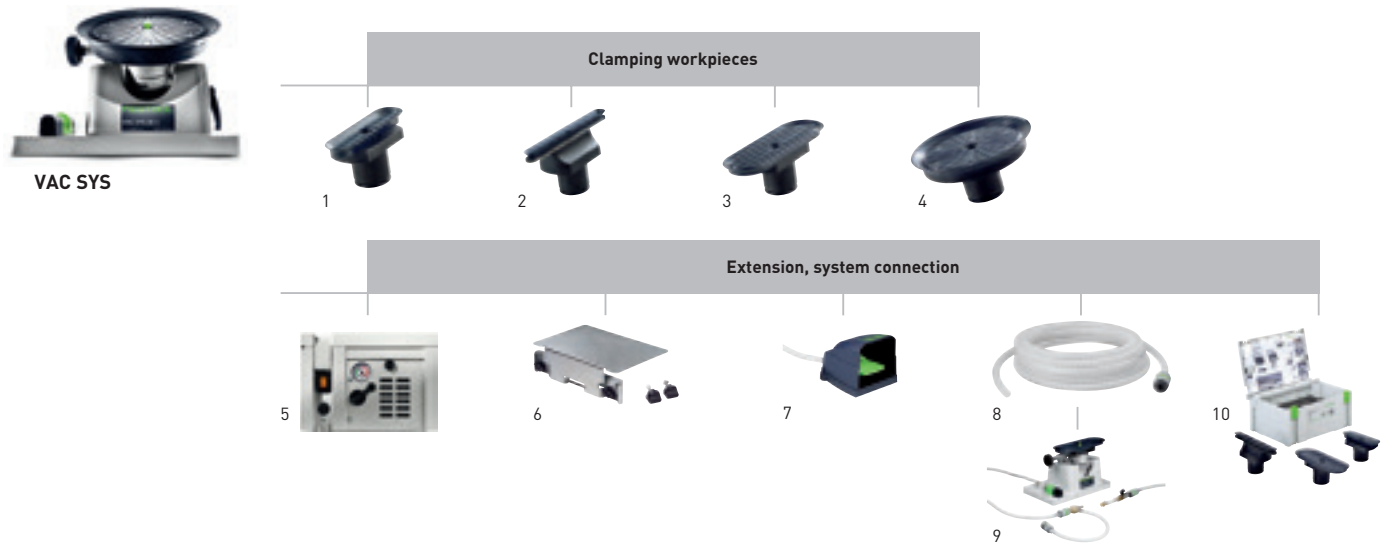

Accessories for vacuum clamping system VAC SYS

Denomination	Explanation	Order no.
1 Vacuum pad VAC SYS VT 200x60	for VAC SYS SE 1, VAC SYS SE 2, pad dimensions 200 x 60 mm, in carton	580064
2 Vacuum pad VAC SYS VT 277x32	for VAC SYS SE 1, VAC SYS SE 2, pad dimensions 277 x 32 mm, in carton	580065
3 Vacuum pad VAC SYS VT 275x100	for VAC SYS SE 1, VAC SYS SE 2, pad dimensions 275 x 100 mm, in carton	580066
4 Vacuum pad VAC SYS VT D 215	for VAC SYS SE 1, VAC SYS SE 2, diameter 215 mm, in carton	580067
6 Adapter VAC SYS AD MFT 3	for VAC SYS SE 1, VAC SYS SE 2, to connect the VAC SYS clamping unit with the MFT 3, in carton	494977
7 Foot release valve VAC SYS FV	for VAC SYS SE 1 or combination of VAC SYS SE 1 with VAC SYS SE 2, for releasing the vacuum pad, in carton	580063
8 Vacuum hose D 16 x 5m VAC SYS	for VAC SYS Set SE 1 and VAC SYS SE2, for extension, length 5 m, in carton	495293
9 Vacuum unit VAC SYS SE 2	vacuum hose, vacuum pad VAC SYS VT 275 x 100 mm, connector, weight 8 kg, power consumption at 50 Hz min. 160 W, power consumption at 50 Hz max. 200 W, pump capacity at 50 Hz 2,7 m ³ /h, pump capacity at 60 Hz 3,5 m ³ /h, minimum vacuum ≥ 81%/ ≥ 810, power consumption at 50 Hz 160 – 200 W, power consumption at 60 Hz 200 – 230 W, in SYSTAINER SYS 4	580062
10 Accessories SYSTAINER VAC SYS VT Sort	for VAC SYS SE 1, VAC SYS SE 2, VAC SYS VT 200x60, VAC SYS VT 277x32, vacuum pad VAC SYS VT 275 x 100 mm, also provides space for the VAC SYS VT D 215, in SYSTAINER SYS 3	495294

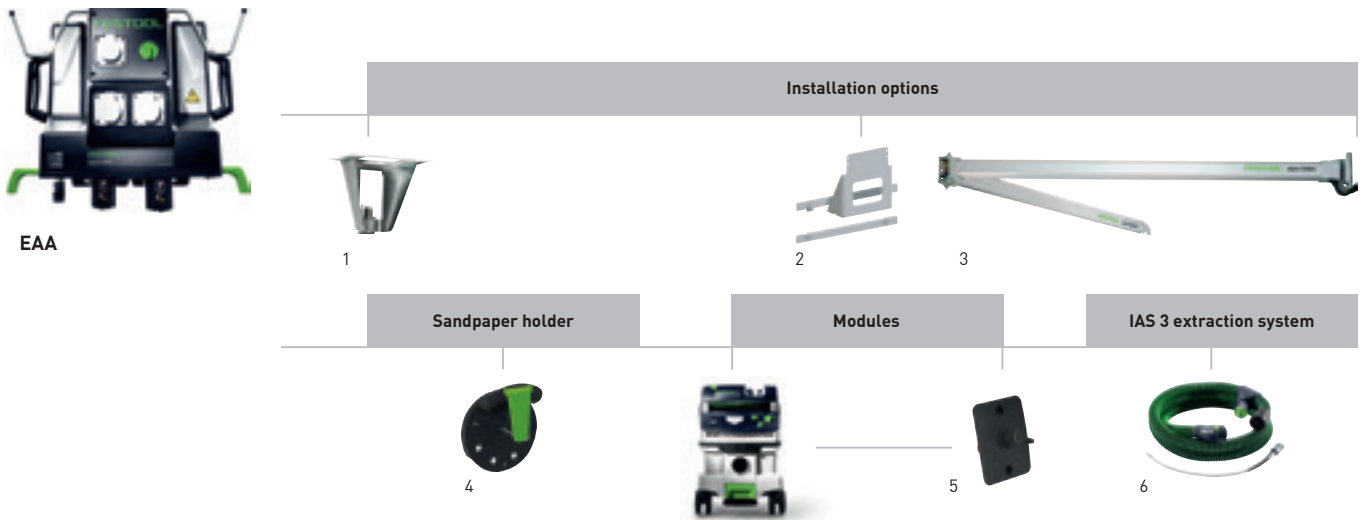

Accessories for ASA boom arms and EAA energy boxes

Denomination	Explanation	Order no.
1 Ceiling installation EAA-D-EU	for energy boxes (from years up to 2008), cable assemblies 2.5 m, compressed air hose 2.5 m, holder, aluminium tube (1310 mm) with reducing sleeve, in carton	495890
2 Wall mounting EAA-W-EU	for energy boxes (from years up to 2008), cable assemblies 4 m, compressed air hose 4 m, aluminium tube (350 mm) with reducing sleeve, installation set for energy boxes, in carton	495889
3 Boom arm ASA 5000 CT/SR-EU	for CT extractors and SRM extractors, dual-articulated arm system with wall mounting bracket, cable duct, hardware for securing mounting bracket to wall is not included, weight 92 kg, Connecting line length 3 m, Boom extension 2 x 2,5 m, Cutting angle adjustment 39 – 58°, Range of use 39 – 58 m ² , in carton	583867
4 Sandpaper holder SH-EAA	without mounting hardware, for abrasives up to Ø 150 mm, in carton	496044
5 Energy box module EAA CT 26/36/48	for CT 26/36/48, to connect a CT mobile dust extractor with the energy box / boom arm, dust extractor must not be LE model, in carton	496143
IAS 2 adapter IAS 2-A-ASA/CT/SRM45/70	for SRM 45, SRM 70, CT dust extractors, antistatic design, to connect IAS 2 hoses, integrated connection for air supply via air connection hose, for EAA in EW/DW-version, not for CT 11/CT MINI/CT MIDI, external conus Ø 58 mm, in carton	454757
IAS 2 adapter IAS 2-A-SR	adapter to connect LE dust extractor from the SR series to IAS 2 hoses, antistatic design, integrated connection for air supply, external conus Ø 58 mm, in carton	488181
6 IAS 3 hose	from page 124	

Workplace organisation

System accessories

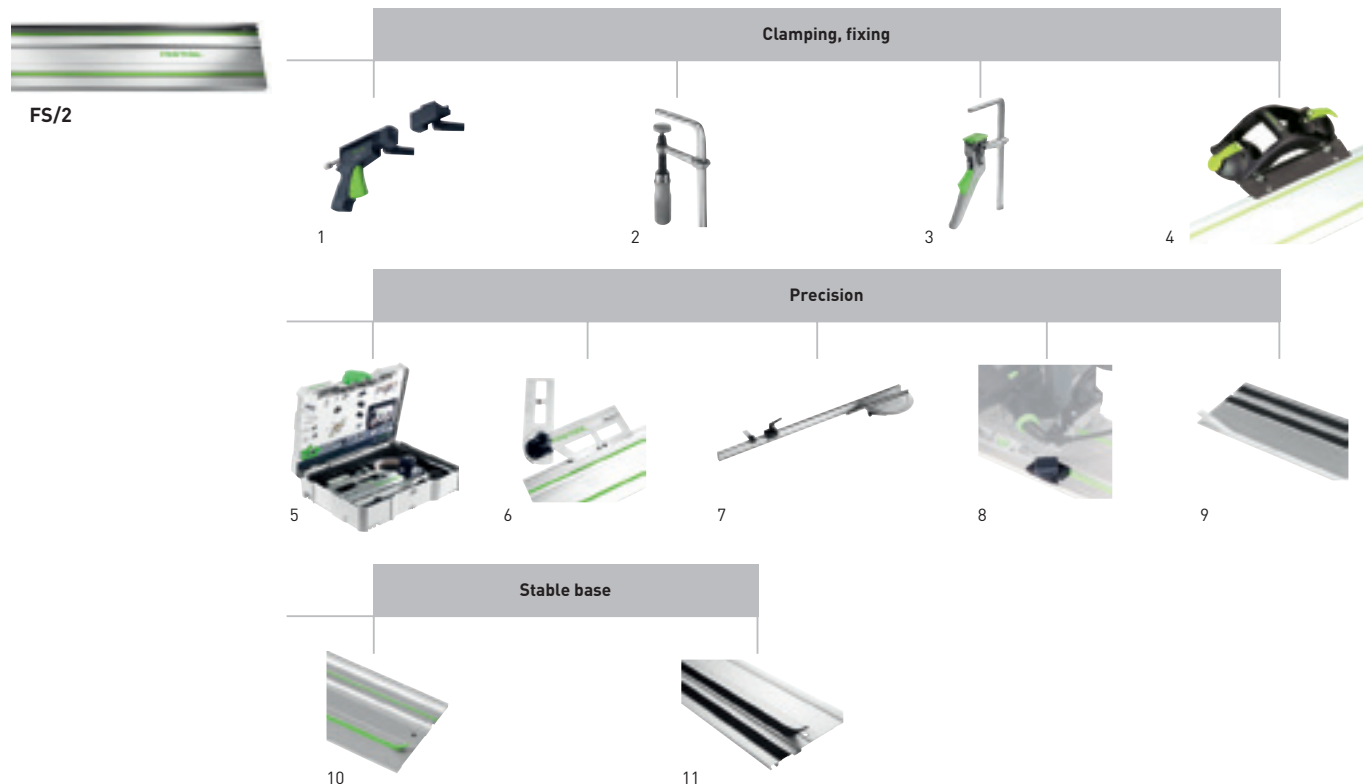

Accessories for the guide rail FS/2

Denomination	Explanation	Order no.
1 Quick-action clamp FS-RAPID/R	for clamping and positioning the Festool guide rails FS and FS/2, Clamping jaws, fixed jaw, in self-service display pack	489790
Quick-action clamp FS-RAPID/L	for the use of SSU 200, IS 330 with guide rail, for clamping and positioning Festool guide rails FS, FS/2 and GRP/2, fixed jaw, clamping jaws, in self-service display pack	768116
2 Fastening clamp FSZ 120	for FS/2, MFT, solid steel version, qty. in pack 2 piece(s), clamping capacity 120 mm, in self-service display pack	489570
Fastening clamp FSZ 300	for FS/2, MFT, solid steel version, qty. in pack 2 piece(s), clamping capacity 300 mm, in self-service display pack	489571
3 Lever clamp FS-HZ 160	for FS/2, MFT, solid steel version, clamping capacity 160 mm, in self-service display pack	491594
4 dual suction pad GECKO DOSH	from page 385	
Adapter DOSH-FSAD	to fix the guide rail at the GECKO, in self-service display pack	492616
5 Accessories set FS-SYS/2	2 x Screw clamp, FSZ 120, FS-AW deflector, combination angle FS-KS, set-back stop FS-RSP, 2 connecting elements FSV, splinter guard FS-SP 1400, in SYSTAINER SYS 1 T-LOC	497657
6 Combination bevel FS-KS	for FS/2, for angle cuts on guide rail between 0 and 180, in self-service display pack	491588
7 Mitre guide FS-AG-2	for FS/2 and GRP/2, for cuts at precise angles when used together with guide rail, in carton	768168
8 Kickback stop FS-RSP	for TS 55, TS 55 R, TSC 55, TS 75, HKC 55, HK 55, ATF 55, AP 55, AT 65, AP 65, AP 85, used as a rear and front stop position on guide rail FS/2, can also be used as guide stop, in self-service display pack	491582
9 Splinter guard FS-SP 1400/T	replacement splinterguard for guide rails, transparent, length 1.400 mm, in self-service display pack	495207
Splinter guard FS-SP 5000/T	replacement splinterguard for guide rails, transparent, length 5.000 mm, in self-service display pack	495209
10 Slideway lining FS-GB 10M	10 m length, replacement slideway lining for guide rail, in self-service display pack	491741
11 Adhesive cushion strip FS-HU 10M	replacement adhesive strips for guide rails, in 10 m rolls, in self-service display pack	485724

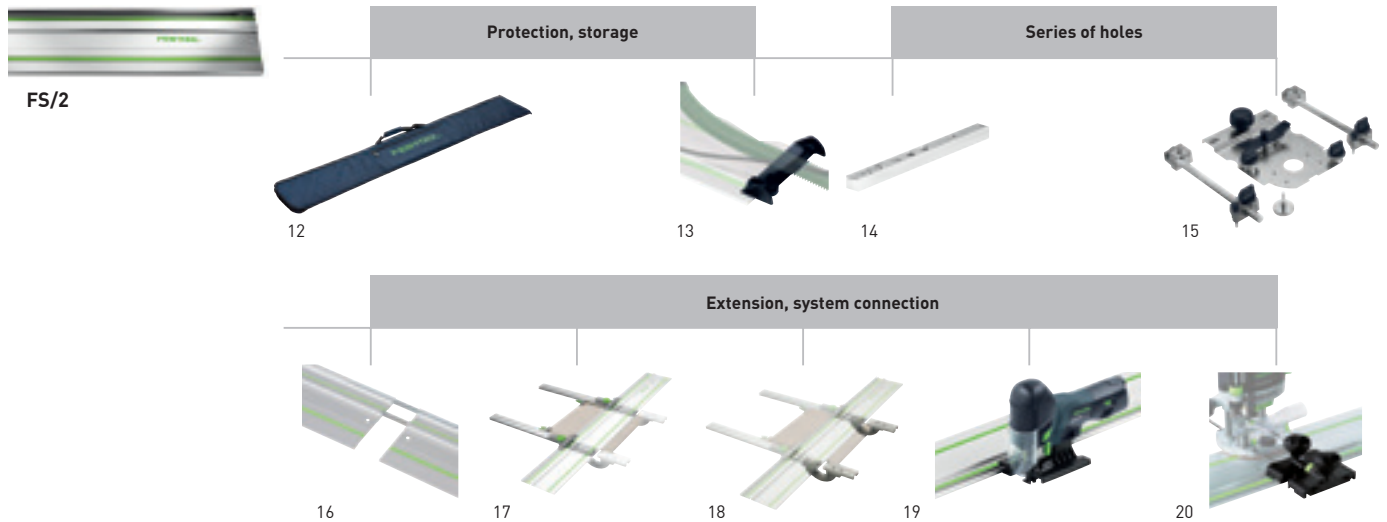

Accessories for the guide rail FS/2

Denomination	Explanation	Order no.
12 Bag FS-BAG	carrying bag with shoulder straps, up to length of FS 1400/2, in carton	466357
13 Deflector FS-AW	prevents suction hoses and cables from catching on the end of the guide rail, in self-service display pack	489022
14 Rip fence LA-LR 32 FS	positions the first hole on the hole series guide rail at a distance of 9.5, 16 or 32 mm from the workpiece edge, qty. in pack 2 piece(s), in self-service display pack	496938
15 Adjustable shelving guide system for FS/2	from page 165	
16 Connector FSV	to connect guide rails for long workpieces, qty. in pack 1 piece(s), in self-service display pack	482107
17 Parallel side fence FS-PA	for FS/2, for sawing along the width, same dimensions may be re-set using the scale and end stop, mounting on the guide rail without the use of tools, stop ruler with additional clamp, adjustable stop, max. workpiece width 650 mm, qty. in pack 2 piece(s), in self-service display pack	495717
18 Guide extension FS-PA-VL	for FS/2, only for use with the FS-PA, bridge, stop ruler, scale, max. workpiece width 195 mm, max. material strength 70 mm, qty. in pack 2 piece(s), in self-service display pack	495718
19 Guide rail adapter FS-PS/PSB 300	for PS 200, PS 300, PSB 300, PS 2, allows use of jigsaws with FS and FS/2 guide systems, in self-service display pack	490031
Adapter table ADT-PS 420	for PS(C) 400/420, PSB(C) 400/420, for using the PS on the guide rail, for installation in the Compact Module System CMS, in conjunction with circle cutting attachment KS-PS 400, in self-service display pack	497303
20 Guide rail adapters for routers	from page 174	

Workplace organisation

System accessories



WCR 1000



UCR 1000



MFH 1000

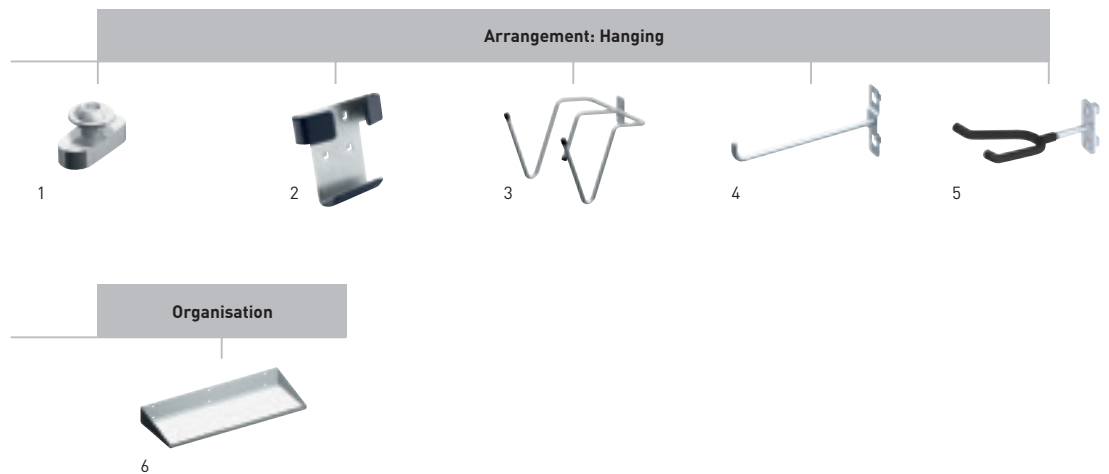

Accessories for Workcenter WCR 1000, Universalcenter UCR 1000, multifunction stool MFH 1000

Denomination	Explanation	Order no.
1 Feather key WCR 1000 PF 2x	for WCR 1000, UCR 1000, The feather keys permit fitting of individual accessories in the profile groove, 2x parallel keys including screws, in self-service display pack	497476
2 Pegboard hooks HSK LWH HSK-A	for WCR 1000, MFH 1000, UCR 1000, to hold hand-sanding blocks HSK-A 80x130, HSK-A 80x200 and HSK-A 115x226, not suitable for hand-sanding block HSK-A 80x400, the protective coating prevents damage, dimensions length x width 38,1 x 38,1 mm, in carton	498968
3 Tool hook WCR 1000 WH	for WCR 1000, UCR 1000, For attaching two tools, For use as a hose holder, in carton	497474
4 Hook WCR 1000 SHQ	for WCR 1000, UCR 1000, Standard hook for fastening to the pegboard, qty. in pack 6 piece(s), in self-service display pack	497475
5 Holder for spray gun WCR 1000 LPH	for Workcenter WCR 1000, holder for a paint gun, for mounting in profiled slot on the Workcenter WCR 1000, 2x screw, 2x square nut, dimension (L x W x H) 148 x 76 x 60 mm, weight 0,5 kg, in carton	498361
6 Deposit base WCR 1000 AB	for WCR 1000, UCR 1000, Large deposit base for storing small parts, abrasive sheets, screw boxes, etc., in carton	497477



TC 3000/2

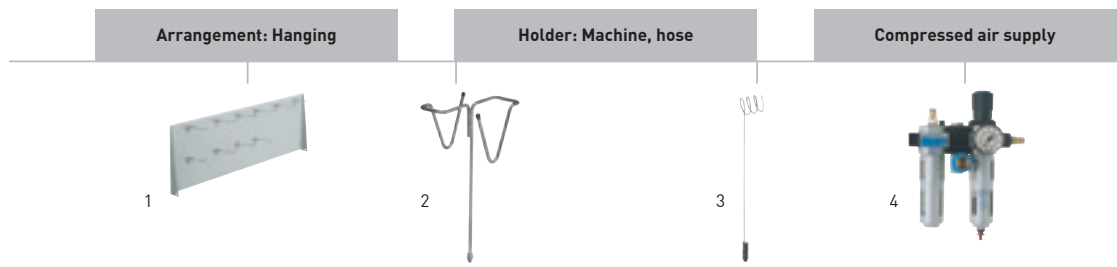









Accessories for Toolcenter TC 3000/2



Denomination	Explanation	Order no.
1 Rear panel TC 3000 RW	for Toolcenter TC 3000, TC 3000/2 including 10 storage hooks, dimensions length x width 990 x 340 mm, in carton	452986
2 Tool holder WHR/D-TC	for TC 2000, TC 3000, TC 3000/2, for safe, ergonomic storage of two electric and air tools at the same time, in carton	493415
3 Hose holder TC-SH	for TC 2000, TC 3000, TC 3000/2, for retrofitting TC 3000, in carton	487304
4 Service unit VE-TC 3000	for Toolcenter TC 2000, TC 3000, for compressed air supply to mobile dust extractors CT 22/33 and SR 151, SR 200-series dust extractors in LE version, in carton	454808

Workplace organisation



System accessories

T-LOC SYSTAINER		Type	Order no.
	SYSTAINER T-LOC 1x cover for label field		
	dimension (L x W x H) 396 x 296 x 105 mm, dimensions with floor stand (L x W x H) 396 x 296 x 112 mm, inner dimensions (L x W x H) 383 x 273 x 75 mm, weight 1,3 kg	SYS 1 TL	497563
	dimension (L x W x H) 396 x 296 x 157,5 mm, dimensions with floor stand (L x W x H) 396 x 296 x 164,5 mm, inner dimensions (L x W x H) 383 x 267 x 127,5 mm, weight 1,5 kg	SYS 2 TL	497564
	dimension (L x W x H) 396 x 296 x 210 mm, dimensions with floor stand (L x W x H) 396 x 296 x 217 mm, inner dimensions (L x W x H) 382 x 266 x 180 mm, weight 1,8 kg	SYS 3 TL	497565
	dimension (L x W x H) 396 x 296 x 315 mm, dimensions with floor stand (L x W x H) 396 x 296 x 322 mm, inner dimensions (L x W x H) 382 x 266 x 285 mm, weight 2,1 kg	SYS 4 TL	497566
	dimension (L x W x H) 396 x 296 x 420 mm, dimensions with floor stand (L x W x H) 396 x 296 x 427 mm, inner dimensions (L x W x H) 381 x 265 x 384 mm, weight 2,7 kg	SYS 5 TL	497567
MAXI-SYSTAINER		Type	Order no.
	MAXI-SYSTAINER to connect with SYS 1, SYS 2, SYS 3, SYS 4, SYS 5, SORTAINER		
	dimension (L x W x H) 596 x 390 x 210 mm, weight 4 kg	SYS MAXI	490701
	dimension (L x W x H) 596 x 390 x 157,5 mm, weight 3 kg	SYS MAXI 2	492582
T-LOC MIDI SYSTAINER		Type	Order no.
	MIDI-SYSTAINER T-LOC can be connected to SYS T-LOC, for clearly organised storage of small parts, power tools, hand tools and accessories, dimension (L x W x H) 496 x 296 x 210 mm, weight 2 kg	SYS-MIDI 3 TL	499621
T-LOC MINI SYSTAINER		Type	Order no.
	T-LOC MINI SYSTAINER for clearly organised storage of small parts and hand tools, cannot be connected to SYS 1, SYS 2, SYS 3, SYS 4, SYS 5, SORTAINER, SYS MINI classic, dimension (L x W x H) 265 x 171 x 71 mm, weight 0,4 kg	SYS-MINI TL	499622





SYSTAINER T-LOC with lid compartment

	Type	Order no.
 <p>SYSTAINER T-LOC DF 1x cover for label field</p> <p>dimension (L x W x H) 396 x 296 x 105 mm, dimensions with floor stand (L x W x H) 396 x 296 x 112 mm, inner dimensions (L x W x H) 383 x 273 x 68 mm, weight 1,5 kg</p>	SYS 1 TL-DF	497851
 <p>dimension (L x W x H) 396 x 296 x 157,5 mm, dimensions with floor stand (L x W x H) 396 x 296 x 164,5 mm, inner dimensions (L x W x H) 383 x 267 x 121 mm, weight 1,7 kg</p>	SYS 2 TL-DF	497852
 <p>dimension (L x W x H) 396 x 296 x 210 mm, dimensions with floor stand (L x W x H) 396 x 296 x 217 mm, inner dimensions (L x W x H) 382 x 266 x 173 mm, weight 2 kg</p>	SYS 3 TL-DF	498390

T-LOC SYSTAINER SYS-Combi









	Type	Order no.
 <p>SYSTAINER T-LOC drawer with flexible partition options for accessories, consumables, small parts etc., inner dimensions of drawer (L x W x H) 350 x 255 x 69 mm</p> <p>combination of classic size 2 SYSTAINER and roomy drawer, dimension (L x W x H) 396 x 296 x 263 mm, dimensions with floor stand (L x W x H) 396 x 296 x 270 mm, inner dimensions of upper compartment (L x W x H) 383 x 267 x 127 mm, weight 3,2 kg</p>	SYS-Combi 2	200117
 <p>combination of classic size 3 SYSTAINER and roomy drawer, dimension (L x W x H) 396 x 296 x 315 mm, dimensions with floor stand (L x W x H) 396 x 296 x 322 mm, inner dimensions of upper compartment (L x W x H) 382 x 266 x 180 mm, weight 3,5 kg</p>	SYS-Combi 3	200118

SORTAINER



	Type	Order no.
 <p>SORTAINER</p> <p>2 x small drawer (L x W x D) 255 x 75 x 30 mm, 6 x label holders, 8 x labels, medium drawer (L x W x D) 255 x 165 x 30 mm, large drawer (L x W x D) 255 x 348 x 85 mm, 2 dividers per drawer, dimension (L x W x H) 395 x 295 x 210 mm, weight 4 kg</p>	SYS 3-SORT/4	491522
 <p>2 dividers per drawer, 6 x medium drawer (L x W x D) 255 x 165 x 30 mm, 6 x label holders, 8 x labels, dimension (L x W x H) 395 x 295 x 210 mm, weight 4,9 kg</p>	SYS 3-SORT/6	491984
 <p>16 x labels, 2 dividers per drawer, 3 x medium drawer (L x W x D) 255 x 165 x 30 mm, 6 x small drawer (L x W x D) 255 x 75 x 30 mm, 9 x label holders, dimension (L x W x H) 395 x 295 x 210 mm, weight 5,1 kg</p>	SYS 3-SORT/9	491985
 <p>12 x small drawer (L x W x D) 255 x 75 x 30 mm, 12 x label holders, 16 x labels, 2 dividers per drawer, dimension (L x W x H) 395 x 295 x 210 mm, weight 5,3 kg</p>	SYS 3-SORT/12	491986
 <p>three drawers each with 6.7 litre capacity can be customised and partitioned with plastic containers and dividers (plastic containers and small dividers not included), can be connected to all T-LOC and classic Systainers, Sortainers, CLEANTEC dust extractors, dimension (L x W x H) 396 x 296 x 322 mm, weight 5,7 kg</p>	SYS 4 TL-SORT/3	200119

Workplace organisation





System accessories

SYS-ToolBox		Type	Order no.
	<p>SYS-ToolBox for practical transport of hand tools, supplies or accessories, usable surface area 396 x 296 mm</p> <p>height 150 mm, carrying power 7 kg, volume 12,5 l</p>	SYS-TB-1	495024
	<p>height 257 mm, carrying power 14 kg, volume 20 l</p>	SYS-TB-2	499550
SYS-StorageBox		Type	Order no.
	<p>SYS Storage Box plastic container, empty, with plastic containers for individual removal, can be connected to the entire Systainer range (except SYS-Mini), 2 x box 60x60x71 SYS-SB, 2 x box 60x120x71 SYS-SB, 1 x box 180x120x71 SYS-SB, dimension (L x W x H) 396 x 296 x 167 mm, height including handle 240 mm, weight 2,5 kg</p>	SYS-SB	499901
Systainer-Port		Type	Order no.
	<p>Systainer-Port no admission for assembly in car, 5 x labels for drawers, stable full metal body, without SYSTAINER, in carton</p> <p>with 3 SYSTAINER telescopic drawers, dimension (L x W x H) 400 x 500 x 500 mm, weight 19 kg</p>	SYS-PORT 500/2	491921
	<p>with 5 SYSTAINER telescopic drawers, 4 castors with ball bearings (of which 2 with locking brake), dimension (L x W x H) 400 x 500 x 1.100 mm, weight 33 kg</p>	SYS-PORT 1000/2	491922
Systainer pull-out		Type	Order no.
	<p>Drawer for all Systainers (Classic and T-LOC), for constructing an individualised shelf system, hole grid with 32 mm between holes, dimension (L x W x H) 425 x 376 x 57 mm, max. load 20 kg, in carton</p>	SYS-AZ	500692
	<p>qty. in pack 5 piece(s)</p>	SYS-AZ-Set	500767
	<p>Lock for SYS-AZ, lock with one master key, for retrofitting in the SYS-AZ drawer, locks the individual drawer to the side of the body (one master key), in carton</p>	S-AZ	500693
Means of transport for SYSTAINER		Type	Order no.
	<p>SYS-Cart for easy transport of Systainers of sizes 1-5 and Sortainers, sturdy handles, 4 swivel castors, 2 of which can be locked, footprint 360 x 520 mm, load capacity 100 kg, roller Ø 100 mm, weight 2,8 kg, in carton</p>	RB-SYS	495020
	<p>SYS-Roll transport of SYS Classic and SYS T-LOC, extra-large wheels (D 200 mm) for ease of movement on stairs, swivelling and lockable front castors – easily steerable in all directions, with safety strap, dimension (L x W x H) 440 x 600 x 1.100 mm, carrying power 100 kg, carrying power 5 kg, castor Ø front 75 mm, castor Ø rear 200 mm, weight 6,5 kg, in carton</p>	SYS-Roll 100	498660

SYSTAINER T-LOC with inlays for abrasives

		Type	Order no.
	SYSTAINER T-LOC		
	with insert for abrasives Ø 125 mm, number of compartments 5, SYSTAINER size SYS 1 T-LOC	SYS-STF D125	497685
	with insert for abrasives 80x133 mm, number of compartments 6, SYSTAINER size SYS 1 T-LOC	SYS-STF 80x133	497684
	with insert for abrasives STF Delta 100x150, number of compartments 5, SYSTAINER size SYS 1 T-LOC	SYS-STF Delta 100x150	497686
	with insert for Ø 90 mm abrasives and 93V abrasives, number of compartments 8, SYSTAINER size SYS 1 T-LOC	SYS-STF-D77/D90/93V	497687
	with insert for abrasives Ø 150 mm, number of compartments 10, SYSTAINER size SYS 3 T-LOC	SYS-STF D150	497690
		with insert for abrasive Ø 225 mm, number of compartments 3, SYSTAINER size SYS 4 T-LOC	SYS-STF D225

SYSTAINER with multi-purpose insert

		Type	Order no.
	SYSTAINER T-LOC		
	with universal insert for bits and pieces, SYSTAINER size SYS 1 T-LOC	SYS 1 UNI	497692
	with single diced foam insert to produce an cut-out of any desired shape, SYSTAINER size SYS 1 T-LOC	SYS 1 VARI	497693
		with diced foam insert to produce a cut-out of any desired shape, SYSTAINER size SYS 2 T-LOC	SYS 2 VARI
		with foam insert, for safe storage of cutters D 8, D 12, SYSTAINER size SYS 1 T-LOC	SYS-OF D8/D12
		with individual removable plastic containers, plastic container, empty, SYSTAINER size SYS 1 T-LOC	SYS 1 BOX

Workplace organisation

System accessories

Plastic containers and inserts for SYS-StorageBox, SYS 1 BOX, SYS-Combi, SYS 4 TL-SORT/

		Type	Order no.
	Plastic containers for SYS Storage Box SYS-SB, dimension (L x W x H) 60 x 60 x 71 mm, qty. in pack 6 piece(s), in a bag	Box 60x60x71/6 SYS-SB	500066
	for SYS Storage Box SYS-SB, dimension (L x W x H) 60 x 120 x 71 mm, qty. in pack 4 piece(s), in a bag	Box 60x120x71/4 SYS-SB	500067
	for SYS Storage Box SYS-SB, dimension (L x W x H) 180 x 120 x 71 mm, qty. in pack 2 piece(s), in a bag	Box 180x120x71/2 SYS-SB	500068
	for SYS-Combi 2, SYS-Combi 3 and SYS 4 TL-SORT/3, plastic containers and compartment dividers for customised drawer partitioning, 2 x cover pads, 3 x compartment dividers, 4 x box of plastic containers 60 x 120 x 71 mm, 8 x box of plastic containers 60 x 60 x 71 mm, in a bag	Set 60x60/120x71 3xFT	201124
	for SYS 1 box, T-LOC, red, containers are empty, for tidy storage and organisation, dimension (L x W x H) 49 x 49 x 71 mm, qty. in pack 12 piece(s), in carton	Box 49x49/12 SYS1 TL	498038
	for SYS 1 box, T-LOC, yellow, containers are empty, for tidy storage and organisation, dimension (L x W x H) 49 x 98 x 71 mm, qty. in pack 6 piece(s), in carton	Box 49x98/6 SYS1 TL	498039
	for SYS 1 box, T-LOC, blue, containers are empty, for tidy storage and organisation, dimension (L x W x H) 98 x 98 x 71 mm, qty. in pack 3 piece(s), in carton	Box 98x98/3 SYS1 TL	498040
	for SYS 1 box, T-LOC, green, containers are empty, for tidy storage and organisation, dimension (L x W x H) 98 x 147 x 71 mm, qty. in pack 2 piece(s), in carton	Box 98x147/2 SYS1 TL	498041
	for SYS 1 box, T-LOC, orange, containers are empty, for tidy storage and organisation, dimension (L x W x H) 49 x 245 x 71 mm, qty. in pack 2 piece(s), in carton	Box 49x245/2 SYS1 TL	498042
	Deep-drawn insert for SYS 1 box, T-LOC, insert for securing and positioning the containers, in carton	Box TZE-SYS 1 TL	498043

T-LOC SYSTAINER with insert for hand tools



SYSTAINER T-LOC

the required tool can be found quickly since all hand tools are clearly displayed for the joiner, scope of delivery without tools, wooden insert, installation recommendations, SYSTAINER size SYS 4 T-LOC

Type

SYS-HWZ

Order no.

497658

SYSTAINER T-LOC SYS-MFT



SYSTAINER T-LOC

1x cover for label field, can be connected to the entire SYSTAINER range (except SYS MINII), simple, compact transport, lid with MDF plate for clamping and attaching workpieces, dimension (L x W x H) 396 x 296 x 105 mm, dimensions with floor stand (L x W x H) 396 x 296 x 112 mm, inner dimensions (L x W x H) 383 x 273 x 75 mm, weight 2 kg

Type

SYS-MFT

Order no.

500076

Adjustable shelving set



Adjustable shelving set

for OF 900, OF 1000, OF 1010, OF 1400, for use with adjustable shelving guide rails, guide plate, centering mandrel, operating tool, hinge location cutter cutter HM Ø 35 mm, dowel drill HW Ø 5 mm (V-shaped tip), dowel drill HM Ø 5 mm (with centring bit and pre-cutter), 2 parallel side fences with adjustable stop, Screw clamp, FSZ 120, 2 longitudinal stops, in SYSTAINER SYS 1 T-LOC

Type

LR 32-SYS

Order no.

584100



Workplace organisation

System accessories

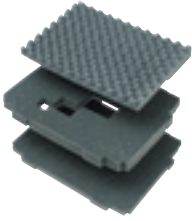
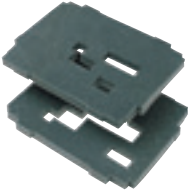

Foam inserts for SYSTAINER

		Type	Order no.
	Foam insert for SYS 1-5 T-LOC, dimpled insert (for lid), base insert and diced insert, qty. in pack 3 piece(s), in a bag	SYS-VARI SE TL	497877
	Diced foam insert set for SYS 1-5 T-LOC, diced sections can be pushed out to produce any desired cut-out, qty. in pack 2 piece(s), in a bag	SYS-VARI RM TL	497878

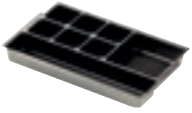

Lids and bottoms for Systainers

		Type	Order no.
	Cover pad in a bag		
	for SYS 1-5 T-LOC, with knobs, dimension (L x W x H) 355 x 245 x 30 mm	SE-DP SYS 1-5 TL	498044
	for SYS MAXI, with knobs, dimension (L x W x H) 560 x 340 x 30 mm	SE-DP SYS-MAXI	491633
	for SYS MIDI 3 TL, dimension (L x W x H) 472 x 247 x 30 mm	SE-DP SYS-MIDI	499617
	for SYS MINI TL, dimension (L x W x H) 247 x 134 x 15 mm	SE-DP SYS-MINI TL	499619
	Base pad in a bag		
	for SYS 1-5 T-LOC, protects the content	SE-BP SYS 1-5 TL	498045
	for SYS MAXI	SE-BP SYS-MAXI	491632
	for SYS MIDI 3 TL, dimension (L x W x H) 480 x 278 x 30 mm	SE-BP SYS-MIDI	499618





Inlays and inserts for SYSTAINER

		Type	Order no.
	Multi-purpose insert for SYS MINI TL, dimension (L x W x H) 258 x 163 x 45 mm, in a bag	TZE-UNI SYS MINI TL	499620
	Cartridge inlay for SYS 5 T-LOC, to store cartridges, height 130 mm, in carton	TZE-KT SYS 5 TL	497876

Other accessories

		Type	Order no.
	Side handle for upright support of SYS 1 T-LOC and SYS 2 T-LOC, in self-service display pack	ZSG -Sys 1/2 TL	497856
	Shoulder strap for CT-SYS and all SYSTAINERS T-LOC, easy transport of the CTL SYS and SYSTAINERS T-LOC, max. load 20 kg, qty. in pack 1 piece(s), in self-service display pack	SYS-TG	500532
	Cover cover for labelling panels SYS T-LOC, protects the labelling panels on the SYSTAINER T-LOC from damage and moisture, qty. in pack 10 piece(s), in self-service display pack	AB-BF SYS TL 55x85mm /10	497855

“plug it” accessories

		Type	Order no.
	plug it-cable in self-service display pack		
	rubber-insulated cable, length 4 m	H05 RN-F/4	489421
	rubber-insulated cable, length 4 m, qty. in pack 3 piece(s)	H05 RN-F/4 3x	499851
	for long-reach sander PLANEX, rubber-insulated cable, extended cable grommet makes it especially suitable for use with the PLANEX LHS 225 e.g. for sanding work on plasterboard, length 4 m	H05 RN-F/4 EU PLANEX	499819
	rubber-insulated cable, length 5,5 m	H 05 RN-F 2X1 5,5M	201884
	rubber-insulated cable, length 7,5 m	H05 RN-F/7,5	489661
	rubber-insulated cable, length 10 m	H05 RN-F 2x1,0/10	500636
	green rubber-insulated cable, length 4 m	H05 BQ-F/4	489662
	green rubber-insulated cable, length 7,5 m	H05 BQ-F/7,5	489663
	plug it conversion-kit in self-service display pack		
	For RS1, RS 1 C, DX 93, RO 150/RO2, RAS 115, BF 1, PS 200/PS/2, KF 4, length 360 mm	UBS-PUR 360 plug it 240 V	491144
	For RS 2, RS 3, RS 400/RS 4, DS 400, ES 125, OF 1000, OF 900, ATF 55, AT 65, AP 55, AP 65, EHL 65, length 420 mm	UBS-PUR 420 plug it 240 V	491145

Like working with Festool electric power tools? Then you will definitely like our select Festool fan products.

LEISURE



Polo shirt

Sporty polo shirt with 3-button strip and green stripes.

Ribbed collar and sleeve seam, side slit on waistband, high-quality 3D Festool logo on the left sleeve, silver decorative print (Festool power tools) at left on waistband. Material: 100% cotton. *Design may vary

Sizes	Reference number
S	498452
M	498453
L	498454
XL	498455
XXL	498456



Beanie

Warm, breathable beanie with Festool look.

Knit cap in blue, Festool logo embroidered in green, breathable and very well insulated. Material: 100% acrylic. *Design may vary

Size	Reference number
One size	202308

Softshell jacket

Breathable, windproof and waterproof softshell jacket with microfleece on the inside and two-way zip for ultimate comfort.

Two hip pockets and one breast pocket, all with zip
Trendy detailing: green decorative stitching and green 3D Festool logo on the left upper arm
Hood is detachable
Outer material: 93% polyester, 7% Spandex
Inner material: 100% polyester microfleece

Sizes	Reference number
S	201321
M	201322
L	201323
XL	201324
XXL	201325
XXXL	201326



More products from our current collection can be found on:

www.festool.com.au



Hoodie

Festool hoodie for real fans.

Hood with drawstring in green, fleecy lining and kangaroo pocket on front, knitted cuffs and waist

Colour: dark blue with Festool Fan print on the left breast and on back

Material: 60% cotton / 40% polyester

Sizes	Reference number
S	201300
M	201301
L	201302
XL	201303
XXL	201304



Baby bodysuit

Baby bodysuit for the littlest Festool fans.

Baby bodysuit in blue, Festool fan logo on the breast, short sleeves, envelope neck, 3 green snap-fasteners in crotch

Material: 100% cotton

Size	Reference number
68	202307



Leisure backpack

Daypack with large-volume main compartment and padded cold-storage compartment at the bottom.

Both compartments easily accessible via 2-way zip; key snap-hook and pocket for small parts in the main compartment; comfortable support system with wide, padded shoulder straps, waist belt and sternum strap; colour: dark blue, green decorative stitching

Outer material: polyester

Inner material: polyester/nylon

Size	Reference number
approx. 50 x 27 x 17 cm	498474



Victorinox pocketknife

Original Victorinox pocketknife with 12 functions.

Large blade, small blade, corkscrew, can opener with small screwdriver, bottle opener with screwdriver and wire stripper, awl/punch/drill, ring, tweezers, toothpick, wood saw

Colour: dark blue with cross relief, Festool logo in green and www.festool.com

Size	Reference number
Height: 17 cm	497898

LEISURE

A - Z

Index

18 V system 256-269

A

Abrasive

Brilliant 2 129-131, 133-138, 140
Granat. 128-129, 131-132, 134-138, 140-141
Overview 126-127
Platin 2 129, 132-133
Rubin 2 128-132, 134-139
Saphir 130, 132-134, 139
Vlies 132-133, 135, 141

Abrasive paper holder 401

Accessories set OF 2200 177

Accessories SYSTAINER

For compressed air eccentric sanders 122

For FS/2 402

For orbital sanders, delta sanders, linear sanders 115-117

For pendulum jigsaws 42

For PLANEX 119

For ROTEX, random orbit sanders 110-114

For VAC SYS 400

AD adapter 247-248

Adapter plate

AP-KA 65 290

For sliding compound mitre saw 47

Adapter table

For pendulum jigsaws 42

Additional hand grip

For BHC 18, QUADRIVE, QUADRILL. 246-248

For DSC-AG 125, DSC-AG 125 FH,

DSC-AG 230 368

For LHS 225 119

For RO 150, RAS 180 112, 118

For rotary polishers 144

For SYSTAINER 413

Additional roller 294

Additional stop 49

Adhesive cushion strip for FS/2 402

Aluminium composite milling machine

PF 1200 155, 170, 183

Aluminium cutter 207

Anchor bolt 283

Angle adapter AU DR 20 248

Angle arm

For routers 181

Angle attachment 244-245, 247

Angle stop

For carpentry portable circular saws 46

For FS/2 402

For planers 226

For trimming saws 50-51, 398

Angle table

For pendulum jigsaws 42

APS 163

ASA 387, 401

B

Bag

For cross cutting guide rails 45

For guide rail 403

Balancer 365

Base runner

For pendulum jigsaws 42

For routers 176-177

Battery pack

BP 18 Li 3.1 Ah Li-Ion C 43-44, 245-247, 249

BP 18 Li 5.2 Ah Li-Ion AS 43-45, 245-247, 249

BP-XS 2.6 Ah Li-Ion 244

Beam planer

PL 205 218, 223, 227

PL 245 218, 223, 227

Belt sander

BS 75 73, 93, 120

BS 105 73, 94, 120

Belt sander module

CMS-BS 73, 95, 120

Bench saw module

CMS-TS 23

Bench-mounted routers

TF 1400 154, 161

TF 2200 154, 161

Bevel

For sliding compound mitre saws 47-48

BHC 18 231, 235, 246, 267

Bit cassette 251

Bit holder 249

Bits

AF-55 249

Bit box 251

Length 25 mm 250

Length 100 mm 250

Blade

For sword saws 52

BMS 180 73, 107, 125

Boom arm

ASA 387, 401

CT 324

BP 18 Li 3.1 Ah Li-Ion C 43-44, 245-247, 249

BP 18 Li 5.2 Ah Li-Ion AS 43-45, 245-247, 249

BP-XS 2.6 Ah Li-Ion 244

BR 10 392

Brush machine

RUSTOFIX BMS 180 73, 107, 125

Brush ring 365-367

Brush segment for LHS 225 119

Brush strip

For LHS 225 119

For RAS 180 118

BS 75 73, 93, 120

BS 105 73, 94, 120

C

C 18 230, 233, 245, 265

Carpentry drill stands 255

Carpentry portable circular saw

HK 132 11, 28, 46

Carpet remover

TPE 351, 360, 369

Carrying harness 119

CARVEX 8-9, 16-18, 262

Ceiling suspension EAA 401

Centring bit 254

Centring mandrel

For routers 174

CENTROTEC 240, 244-245

extra long magnetic bit holder 251

HSS twist drill bit 252

CENTROTEC adapter 251

Chain cutter 184

Chain lubrication oil

For sword saws 52

Chain mortiser

CM 150 155, 171, 184

Chamfer cutter 195

Charger

MXC 244

Chip collection bag 226

For plunge-cut saws 44

For portable circular saws 45

Chip deflector

For routers 175-178

Chip guard 181

Clamp

For sliding compound mitre saws 48

Clamping kit

For sliding compound mitre saws 47-48

Clamping nut 366-368

Cleaning cloth 145, 151

CLEANTEC

CT 17 298, 302

CTL / CTM 48 299, 307

CTL 26 / CTM 26 298, 306

CTL 36 / CTM 36 298, 306

CTL MIDI 298, 305

CTL MINI 298, 304

CTL SYS 298, 303

CLEANTEC AUTOCLEAN

CTL / CTM 26 AC 299, 308

CTL / CTM 26 AC HD 299, 310

CTL / CTM 36 AC 299, 308

CTL / CTM 36 AC HD 299, 310

CTL / CTM 36 AC PLANEX 299, 309

CTL / CTM 48 AC 299, 308

CLEANTEC cleaning sets 316

CLEANTEC special extractor

CTH 26 299, 313

CTH 48 299, 313

CTL / CTM 48 EC 299, 311

CTL / CTM 48 EC/B22 299, 312

CM 150 155, 171, 184

CMS		Corner and surface connector	282-283	Depth stop	
CMS PS 300	9, 19	Counterprofile cutter	204	FastFix for cordless drills	245
CMS TS 55 R	10, 23	Cover		For QUADRIVE	247
CMS TS 75	10, 23	For plunge-cut saws	44	For VECTURO	64
CMS-BS	73, 95, 120	Cross anchor	283	DF 500	272, 274, 278-279
CMS-GE	381, 398	Cross cutting guide rail		DF 700	272, 275, 280-283
CMS-OF	160	FSK	27, 45	Diamant cutting system	
CMS-PS	9, 19	Crown stop		DSC-AG 125	350, 357, 368
Collet		For sliding compound mitre saws	48	DSC-AG 125 FH	350, 358, 368
For routers	174, 176, 178, 182	CS 50	13, 33, 50	DSC-AG 230	350, 359, 368
Combination bevel	402	CS 70	13, 34, 51	Diamant disc	
Compact Module System		CT 17	298, 302	For DSC-AG 125, DSC-AG 125 FH,	
(CMS)	9-10, 19, 73, 95, 380-381, 398	CT WINGS	386	DSC-AG 230	368
Compressed air hose	122-123	CTH 26	299, 313	For DSG-AG 125	367
Compressed air module	331	CTH 48	299, 313	For RG 80	364
Compressed air orbital sander		CTL / CTM 26 AC	299, 308	For RG 130	366
LRS 93	75, 101, 123	CTL / CTM 26 AC HD	299, 310	For RG 150	365
LRS 400	75, 102, 123	CTL / CTM 36 AC	299, 308	Diamant sanding system	
Compressed air random orbital sander		CTL / CTM 36 AC HD	299, 310	DSG-AG 125	349, 356, 367
LEX 2 185	75, 100, 121-122	CTL / CTM 36 AC PLANEX	299, 309	Dirt trap	330
LEX 3 125	74, 98, 121-122	CTL / CTM 48	299, 307	Disc groove cutter	202
LEX 3 150	74-75, 99, 121-122	CTL / CTM 48 AC	299, 308	Disc stirrer	343
LEX 3/77	74, 97, 121-122	CTL / CTM 48 EC	299, 311	DOMINO	
Connecting piece	183, 399, 403	CTL / CTM 48 EC/B22	299, 312	DF 500	272, 274, 278-279
Connecting sleeve		CTL 26 / CTM 26	298, 306	DF 700	272, 275, 280-283
IAS 3	122-123	CTL 36 / CTM 36	298, 306	DOMINO cross stop	279, 281
Construction site radio		CTL MIDI	298, 305	DOMINO cutter	278, 280
SYSROCK BR 10	392	CTL MINI	298, 304	DOMINO dowel	278-281
CONTURO		CTL SYS	298, 303	DOMINO handrail fence	279, 281
KA 65	286, 288, 294-295	Curved saw blade	58-59	DOMINO joining machine	
CONTURO edge bander		Cutter box	190	DF 500	272, 274, 278-279
KA 65	286, 288, 294-295	Cutter chain	184	DF 700	272, 275, 280-283
Conversion kit for TC 3000	405	Cutter spindle for disc groove cutters	202, 398	DOMINO trim stop	279, 281
Copier scanning set		Cutter wheel		Double bolt	283
For routers	181	For RG 80, RG 150	364-365	Dovetail cutter	180, 199
Copying rings		Cutters for OFK 500		Dovetail joint template	180
For routers	174, 176-177	Chamfer cutter	210	Dowel drill	180, 203
Cordless drill		Flush trim cutter	210	DR 20	231, 238, 247
C 18	230, 233, 245, 265	Roundover cutter	210	DRC 18/4	231, 236, 247, 268
CXS	230, 232, 244	Cutters for OFK 700 and MFK 700		Drill	
DRC 18/4	231, 236, 247, 268	Chamfer cutter	208	DR 20	231, 238
T 18+3	230, 234, 244, 266	Flush trim cutter	208	Drill bit with depth stop	254
TXS	230, 232, 244	Plane cutter	209	Drilling and screwdriving	
Cordless drywall screwdriver		Reversible blade chamfer cutter	208	Accessories and consumables	244-255
DWC 18-2500	231, 239, 249, 269	Reversible blade edge trimming cutter	208	Overview of products and	
DWC 18-4500	231, 239, 249, 269	Reversible blade roundover cutter	209	applications	230-231
Cordless hammer drill		Roundover cutter	209	Drilling cutter	198
BHC 18	231, 235, 246, 267	Cutters for putty routers		Drilling dust nozzle	246
Cordless impact drill		Putty router	211	Drywall screws	255
PDC 18/4	231, 236, 247, 268	CXS	230, 232, 244	DSC-AG 125	350, 357
Cordless pendulum jigsaw		D		DSC-AG 125 FH	350, 358
CARVEX PSBC 420	18, 42, 262	Deburring countersink	254	DSC-AG 230	350, 359
CARVEX PSC 420	17, 42, 262	Deflector for FS/2	403	DSG-AG 125	349, 356, 367
Cordless plunge-cut saw		Delta sander		DTS 400 R	71, 89, 116
TSC 55	21, 44, 263	DTS 400 R	71, 89, 116	Dual suction pad	
Cordless portable circular saw		Delta sanding pad	123	GECKO	385
HKC 55	11, 25, 45, 264	deNibber	146	DUPLEX	71, 90, 117
Core maker				DUPLEX profile sanding pad DIY	
KS-PS/PSB 300	42			construction kit	117

A - Z

Index

DURADRIVE	
DWC 18-2500	231, 239, 249, 269
DWC 18-4500	231, 239, 249, 269
Dust bag	
For BS	120
Dust classes	300
Dust extraction	
Accessories and consumables	316-331
Overview of products and applications	294-295
System compatible	301
Dust extraction	
attachment	175-176, 178, 367-368
Dust extraction set	50-51, 398
DWC 18-2500	231, 239, 249, 269
DWC 18-4500	231, 239, 249, 269

E

EAA	388, 401
EAA wall mounting	401
EC-TEC	240
Edge trimming chamfer cutter	198
Edge trimming system	
OF-FH 2200	166, 181
Edging	
Accessories and consumables	294-295
Overview of products and applications	286
Edging holder	294
Edging plate	181
EHL 65	218, 220, 226
Energy box	
EAA	388, 401
ErgoFix	336
ErgoFix adapter	345
ETS 125 R	69, 80, 113
ETS 150	69, 82, 114
ETS EC 125	69, 80, 113
ETS EC 150	69, 83, 114
EVA adhesive	295
Extension profile	
For multi-routing template	179
Extension table	
For routers	175
For trimming saws	50-51, 398
Extraction adapter	
For BS	120

F

Facing cutter	205-206
Fastening clamp	
For MFT, FS/2	183, 399, 402
For sliding compound mitre saws	47
FastFix	240, 245
FastFix eccentric attachment	245
FastFix louvre pad	
For ROTEX	111
FastFix polishing pad	
For ROTEX	110-112

FastFix sanding pad	
For ROTEX	110-112
Feather key	404
Feeler roller for aluminium composite milling machine	183
Filter	
Filter element	325
Long-life main filter	325
Main filter	325
Wet filter	325
Filter bag	
Disposal bag	326
Long-life filter bag	327
Safety filter bag	326
SELFCLEAN	326
Filter for SR dust extractors	328-329
Fine adjuster for guide stop	
For routers	175
Fine cut saw blade	56-57
Fine tooth saw blade	58-59
Finish cleaner	145
Fixed clamps	399
Flange	367-368
Flat sanding pad	117
Flat tooth saw blade	62-63
Floor guide	365
Flush trim cutter	197
Flute cutter	196
Flute profile sanding pad	117
Foam inserts for SYSTAINER	412
Foldaway legs	
For trimming saws	50
Foot valve VAC SYS	400
Forstner drill bit	254
FS/2	384, 402
FSK	
FSK 250	27, 45
FSK 420	27, 45
FSK 670	27, 45
FS-RAPID	402
FS-RAPID quick-action clamp	402

G

GC 2000	46
GC 3000	46
Geared chuck	248
Geared orbital sander	
RS 100	70, 85
GECKO	385
Groove cutter	179, 188-189
Groove unit	
For portable circular saws	45
Guard	398
Guide control black powder	122
Guide extension for FS/2	403
Guide extension for MFT	399
Guide extension for PLANEX	119
Guide frame	184
Guide plate	181, 295

Guide rail	
For carpentry portable circular saws	46
FS/2	384, 402
With row of holes	181
Guide rail adapter	
For routers	175-177
FS-PS/PSB 300	42, 403
Guide table	366

H

Half-round cutter	193
Hammer drill	253
Hand grip cutter	199
Hand rail cutter	199, 207
Handle	330
Hard fibre base runner	175
Helical stirrer	343-344
Hinge location cutter	202
HK 55	11, 24, 45
HK 85	11, 26, 45
HK 132	11, 28, 46
HKC 55	11, 25, 45, 264
HL 850	218, 221, 226
Hole drilling set	411
Hole punch	
For orbital sanders, LRS	115, 123
Hook driver	254
Hook for WCR	404
Hose holder	330, 405
Hose sleeves	
Antistatic rotating adapter	320
Antistatic rotating angle adapter	320
Blanking plug	321
Connecting sleeve for PLANEX	321
Connector sleeve, antistatic	321
Extraction adapter	321
Reducing sleeve	321
Reducing sleeve, antistatic	320
Y-piece, antistatic	321
HSS steel drill	252
HSS twist drill bit	252

I

IAS 3	
System compatible	96
IAS adapter	122-123
IAS double adapter	122-123
IAS hoses	122-124
Increase	
For sliding compound mitre saws	47
Inlays and inserts for SYSTAINER	412
Insulating material saw blade	58-59
Interface pad	
For compressed air eccentric sanders	121
For LHS	119
For linear sanders	117
For random orbital sanders	113-114
For ROTEX	110-112
IS 330	13, 36, 52

J

Jigsaw module
 CMS-PS19
 CMS-PS 300.....19
 Joining – DOMINO joining system
 Accessories and consumables..... 278-283
 Overview of product and applications..... 272
 Joining system
 VS 600..... 164, 180

K

KA 65 286, 288, 294-295
 KAPEX
 KS 60.....12, 29, 47
 KS 88..... 12, 30, 48
 KS 120..... 12, 31, 48
 KAPEX sliding compound mitre saws
 KS 60.....12, 29, 47
 KS 88..... 12, 30, 48
 KS 120..... 12, 31, 48
 Keyless chuck..... 244-245, 247
 Kickback stop
 For plunge-cut saws 44
 For portable circular saws 45, 402
 KS 6012, 29, 47
 KS 88 12, 30, 48
 KS 120..... 12, 31, 48

L

Laminate trimmers
 MFK 700155, 169, 182
 OFK 500155, 167, 182
 OFK 700 155, 168, 182
 Lever clamp..... 183, 399, 402
 LEX 2 18575, 100, 121-122
 LEX 3 12574, 98, 121-122
 LEX 3 15074-75, 99, 121-122
 LEX 3/77.....74, 97, 121-122
 LHS 225 72, 92, 119
 Lids and bottoms for SYSTAINER.....412
 Lighting
 Overview of products and applications..... 372
 Linear sander
 DUPLEX LS 130.....71, 90, 117
 Locking slider..... 330
 Long-life chip collection bag
 For ETS 125 R, RTS 400 R, DTS 400 R ..113, 116
 Long-reach sander
 LHS 225 72, 92, 119
 LR 32..... 165, 181
 LRS 93 75, 101, 123
 LRS 400 75, 102, 123
 LS 130.....71, 90, 117

M

Machining surfaces
 Accessories and consumables..... 110-151
 Overview of product and applications.....68-76
 System compatible..... 84
 Magazine attachment 249
 Magnetic bit holder 251
 Manual abrasive140-141
 Masonry drill..... 253
 MAXI-SYSTAINER..... 406
 Metal saw blade 58-59
 MFH 1000..... 390, 404
 MFK 700.....155, 169, 182
 MFS.....162
 MFT 3 382, 399
 MFT cross brace..... 399
 MFT/3 CONTURO 286, 291
 Microfibre cloth 145
 MIDI-SYSTAINER 406
 Milling set
 RS-HK..... 28, 46
 MINI-SYSTAINER 406
 Mitre cutter..... 200
 Mobile dust extractors
 CT 17..... 298, 302
 CTH 26 299, 313
 CTH 48 299, 313
 CTL / CTM 26 AC 299, 308
 CTL / CTM 26 AC HD 299, 310
 CTL / CTM 36 AC 299, 308
 CTL / CTM 36 AC HD 299, 310
 CTL / CTM 36 AC PLANEX 299, 309
 CTL / CTM 48 299, 307
 CTL / CTM 48 AC 299, 308
 CTL / CTM 48 EC 299, 311
 CTL / CTM 48 EC/B22..... 299, 312
 CTL 26 / CTM 26 298, 306
 CTL 36 / CTM 36 298, 306
 CTL MIDI..... 298, 305
 CTL MINI 298, 304
 CTL SYS 298, 303
 Modular laminate trimmer
 MFK 700155, 169, 182
 Module mounting
 CMS-OF 160
 CMS-PS19
 CMS-TS 23
 Modules for CTL/CTM/CTH attachment
 system 324
 Multifunction stool
 MFH 1000..... 390, 404
 Multifunction table
 For KAPEX.....47-48
 MFT 3 382, 399
 Multifunction template
 MFS 400 162, 179
 MFS 700 162, 179
 Multi-profile cutter 203

MX 1000 334, 337
 MX 1000/2 334, 337
 MX 1200 334, 337
 MX 1200/2 335, 338
 MX 1600/2 335, 338
 MX 1600/2 DUO 335, 339
 MXC..... 244

N

Natural oil151
 Nozzles
 Carpet nozzles 323
 Crevice nozzle..... 323
 Flat nozzle 323
 Floor nozzles..... 322
 Suction brush 323
 Turbo combination suction brush 323
 Universal brush nozzle 323
 Upholstery nozzle..... 323

O

OF 1010..... 154, 156, 174-175, 183
 OF 1400154, 157, 176
 OF 2200 157-158, 177-178
 OF-FH 2200..... 166, 181
 OFK 500155, 167, 182
 OFK 700 155, 168, 182
 Oil application..... 103
 Oil dispenser
 SURFIX OS 106, 151
 Oil sponge151
 One-handed planer
 EHL 65 218, 220, 226
 ORBITAL SANDER
 RS 100..... 70, 85, 115
 RS 200 70, 86, 115
 RS 30070, 87, 115
 RTS 400 R..... 70, 88, 116
 OS 106, 151
 OS 400 14, 37, 64
 Oscillation 38
 Oscillator
 VECTURO OS 400 14, 37, 64
 Ovolo edge cutter 193

P

Paint gun holder 404
 Panther saw blade 58-59
 Parallel side fence
 For carpentry portable circular saws 46
 For guide rails..... 403
 For planers 226
 For plunge-cut saws 44
 For portable circular saws 45
 For routers174, 176, 178, 181-182
 For sword saws..... 52
 PA-PS/PSB 300..... 42

PDC 18/4 231, 237, 247, 268
 Pegboard hook 404
 Pendulum jigsaws
 CARVEX 8-9, 16-18, 42
 TRION 8, 15, 42
 Perforated top 295
 PF 1200 155, 170, 183
 PL 205 218, 223, 227
 PL 245 218, 223, 227
 Accessories and consumables 226-227
 HL 850 218, 221, 226
 PLANEX
 LHS 225 72, 92, 119
 Planing
 Overview of products and applications 218
 Planing head 226
 Planing set
 NS-HK 28, 46
 Plasterboard V-groove cutter 201
 Plastic containers and inlays for SYSTAINER 410
 Plastic saw blade 58-59
 Plate for Diamant cutting system 368
 Plug-it cable 119, 413
 Plug-it conversion kit 413
 Plug-it smooth suction hose, antistatic
 version 318
 Plunge-cut saws
 TS 55 R 10, 20, 44
 TS 75 10, 22, 44
 TSC 55 10, 21, 44
 Pocket StickFix
 For hand-sanding block 140
 Polishing
 Overview of polishes and polishing
 sponges 143
 System overview 142
 Polishing agent 145
 Polishing fleece 151
 Polishing pad
 For RO 150 112
 For rotary polishers 144
 PoliStick
 For 80 mm diameter 147
 For 125 mm diameter 148
 For 150 mm diameter 149
 For 180 mm diameter 150
 POLLUX 180 76, 105
 Portable circular saws
 HK 55 11, 24, 45
 HK 85 11, 26, 45
 HKC 55 11, 25, 45
 Positioning aid
 For VECTURO 64
 Power distributor
 SYS PowerHub 393
 PowerSelect 260-261
 PRECISIO
 CS 50 13, 33, 50
 CS 70 13, 34, 51

PRECISIO trimming saws
 CS 50 13, 33, 50
 CS 70 13, 34, 51
 Precision adjustable square
 For compound mitre saw 49
 Pre-cutter
 For carpentry portable circular saws 46
 Preparing the subsurface
 Accessories and consumables 364-369
 Overview of products and
 applications 348-351
 Profile cutter 204
 Profile groove cutter 205
 Profile tongue cutter 205
 Protective ring 247
 Protector
 For ROTEX, random orbital sanders, orbital
 sanders, delta sanders 110-113, 116
 PS 300 8, 15, 42
 PS 420 8, 16, 42
 PSB 300 8, 15, 42
 PSB 420 8, 16, 42
 PSBC 420 9, 18, 42, 262
 PSC 420 9, 17, 42, 262

Q

QUADRILL
 DR 20 231, 238, 247
 QUADRIVE
 DRC 18/4 231, 236, 247, 268
 PDC 18/4 231, 237, 247, 268
 Quick-change bit holder 251

R

Radius profile sanding pad 117
 Random orbital sander
 ETS 125 R 69, 80, 113
 ETS 150 69, 82, 114
 ETS EC 125 69, 80, 113
 ETS EC 150 69, 83, 114
 RAP 150 76, 104, 144
 Rapid charger
 SCA 8 43-45, 245-247, 249
 TCL 6 43-45, 245-247, 249
 RAS 180 72, 91, 118
 Ratchet set 251
 Rear wall for TC 405
 Rebate depth stop 226
 Rebate sanding pad 117
 Rebating cutter 198
 Rebating head 398
 Rechargeable torch
 SYSLITE UNI 372-373
 RENOFIX
 RG 80 348, 353, 364
 RG 130 349, 355, 366
 RG 150 348, 354, 365

RENOFIX diamant grinder
 RG 130 349, 355, 366
 RENOFIX renovation cutters
 RG 80 348, 353, 364
 RG 150 348, 354, 365
 Reversible blade
 For portable circular saws 45, 398
 Reversible blade chamfer cutter/laminate
 trimmer 194
 Reversible blade edge trimming cutter 197
 Reversible blade groove cutter 179, 191-192
 Reversible blade rebating cutter 198
 Reversible cutter blade
 For beam planers 227
 For carpentry portable circular saws 46
 RG 80 348, 353, 364
 RG 130 349, 355, 366
 RG 150 348, 354, 364
 RO 90 68, 77, 110
 RO 125 68, 78, 111
 RO 150 68, 79, 112
 Rods
 For OF 2200 177
 Roller stand 50-51, 398
 Roman ogee cutter 203
 Rotary polisher
 POLLUX 180 76, 105, 144
 SHINEX RAP 150 76, 104, 144
 Rotary sander
 RAS 180 72, 91, 118
 ROTEX
 RO 90 68, 77, 110
 RO 125 68, 78, 111
 RO 150 68, 79, 112
 ROTEX geared eccentric sander
 RO 90 68, 77, 110
 RO 125 68, 78, 111
 RO 150 68, 79, 112
 Round stirrer 343
 Roundover cutter 194
 Roundover/chamfer cutter 194
 Router carriage 179
 Router table 182
 Routers
 OF 1010 154, 156, 174-175, 183
 OF 1400 154, 157, 176
 OF 2200 157-158, 177-178
 Routing
 Accessories and consumables 174-215
 Overview of cutters 185-187
 Overview of product and applications 154-155
 System compatible 159
 Routing aid 176, 178, 181
 Routing template 179
 Row of holes system
 LR 32 165, 181
 RS 100 70, 85, 115
 RS 200 70, 86, 115

RS 300 70, 87, 115
 RTS 400 R 70, 88, 116
 Rustic planing heads 222
 Rustilon brush 125
 RUSTOFIX
 BMS 180 73, 107, 125

S

Sanding base
 For BS 120
 Sanding block 125
 Sanding frame
 For BS 120
 Sanding pad
 For compressed air eccentric sanders 121
 For LHS 119
 For LRS 123
 For orbital sanders, delta sanders 115-116
 For random orbital sanders 113-114
 For rotary sanders 118
 For ROTEX 110
 Sanding vlies 151
 Saw blade holder
 For trimming saws 50, 398
 Saw blades
 For circular saws 60-63
 For jigsaws 56-59
 For oscillators 65
 Overview 54-55
 Saw chains
 For sword saws 52
 Sawing and oscillating
 Accessories and consumables 42-65
 Overview of products and applications 9-14
 SCA 8 43-45, 245-247, 249
 Scraper 117, 295
 Scratch protector for KA 65 294
 Screwdriver 251
 Scribe cutter 200
 SDS-plus/FastFix adapter 246
 Sealing spray 145
 Self-adhesive sanding disc 140, 146
 SHINEX
 RAP 150 76, 104, 144
 Shoulder strap 330, 413
 Slat sanding pad
 For orbital sanders, linear sanders 115, 117
 Slideway lining 402
 Sliding table 398
 Sliding table
 For trimming saws 50-51
 Slot joint template 180
 Socket wrench 247
 SORTAINER 394, 407
 Spare felt
 For pendulum jigsaws 42
 Spare part drill bit 254

Special saw blade
 For circular saws 62-63
 For pendulum jigsaws 58-59
 Special wood saw blade 56-57
 Specialised cutter for mineral materials
 Basin cutter 213
 Chamfer cutter 213
 Flush trim cutter 215
 Plane cutter 214
 Reversible blade edge trimming cutter 212
 Reversible blade groove cutter 212
 Roundover cutter 214
 Spiral groove cutter 212
 Spiral blade 219, 226
 Spiral groove cutter 180, 190-191
 Splinter guard
 For FS/2 402
 For pendulum jigsaws 42
 For plunge-cut saws 44
 For trimming saws 50-51
 Split anchor 283
 Spot sander 146
 Spotlight
 For KS 60 47
 SSU 200 13, 35, 52
 Staircase drilling system 255
 Standard saw blade 58-59
 Stationary unit
 For belt sanders 120
 Steel drill 252
 Stepped cutter 193
 Stirrer stand 345
 Stirrers
 MX 1000 334, 337
 MX 1000/2 334, 337
 MX 1200 334, 337
 MX 1200/2 335, 338
 MX 1600/2 335, 338
 MX 1600/2 DUO 335, 339
 Stirring
 Accessories and consumables 342-345
 Overview of products and applications 334-335
 Stirring rods
 Disc stirrer 343
 For MX 1600/2 DUO 345
 Helical stirrer 343-344
 Overview of stirring rods 342
 Round stirrer 343
 Whisk 344
 Stop tab
 For routers 181
 For sliding compound mitre saws 48
 For trimming saws 50-51, 398
 Stopper
 For belt sanders 120
 For row of holes system 181, 403
 For trimming saws 50-51, 398
 Suction hose 319

Suction hose, antistatic version 317-318
 Support
 For routers 177
 For trimming saws 50, 398
 SURFIX
 OS 106, 151
 Sword saw
 IS 330 13, 36, 52
 UNIVERS SSU 200 13, 35, 52
 Sword saws
 Applications 53
 SYM 70 12, 32, 49
 SYMMETRIC
 SYM 70 12, 32, 49
 SYMMETRIC compound mitre saw
 SYM 70 12, 32, 49
 SYS adapter 330
 SYS drawer 408
 SYS PowerHub 393
 SYS-Cart 395, 409
 SYSLITE DUO 372, 375
 SYSLITE KAL II 372, 374
 SYSLITE UNI 372-373
 SYS-Port 395, 408
 SYSROCK
 BR 10 392
 SYS-Roll 395, 408
 SYS-StorageBox 408
 SYSTAINER
 SYSTAINER T-LOC 394, 406
 SYSTAINER T-LOC SYS-Combi 407
 SYSTAINER T-LOC SYS-MFT 411
 SYSTAINER T-LOC with inlay for
 abrasives 409
 SYSTAINER T-LOC with inlay for hand
 tools 411
 SYSTAINER T-LOC with lid compartment 407
 SYSTAINER T-LOC with multi-purpose
 inlay 409
 SYS-ToolBox 394, 408

T

T 18+3 230, 234, 244, 266
 Table top insert
 For compound mitre saw 49
 TC 3000/2 391, 405
 TCL 6 43-45, 245-247, 249
 TF 1400 154, 161
 TF 2200 154, 161
 Through-hole drill 203
 Tongue and groove cutter 200
 Tool chuck
 CENTROTEC 244-248
 Tool head
 For RG 80, RG 150 364-365
 Tool holder
 For LHS 225 119, 405, 330
 Tool hook 404

A - Z

Index

Toolcenter
TC 3000/2 391, 404
TP 220 351, 361, 369
TPE 351, 360, 369
Trammel unit
For routers 175
Transport rollers
For CS 70 51
Trimming attachment
For sliding compound mitre saws 47-48
For trimming saws 50-51
Trimming machine KP 65/2 289
TRION 8, 15
TS 55 R 10, 20, 44
TS 75 10, 22, 44
TSC 55 10, 21, 44, 263
T-slot cutter 203
Tubes
Extension pipes 322
Hand tubes 322
Turbo filter bag
For random orbit sanders, orbital
sanders 114-115
Twist drill bit 252
TXS 230, 232, 244

U

UCR 1000 390, 404
Underframe
For sliding compound mitre saws 47-48
UNIVERS
SSU 200 13, 35, 52
Universal saw blade
For circular saws 58-59
For pendulum jigsaws 56-57
Universalcenter
UCR 1000 390, 404

V

VAC SYS 383, 400
VAC SYS adapter 399-400
Vacuum clamping nozzle
CT WINGS 330, 386
Vacuum clamping system
VAC SYS 383, 400
Vacuum hose 400
Vacuum pad 400
Vacuum pump 400
VECTURO
OS 400 14, 37, 64
VECTURO bi-metal saw blade, metal 65
VECTURO bi-metal saw blade, universal 65
VECTURO HSS saw blade, offset 65
VECTURO repair compound 65
VECTURO saw blade for wood 65
VECTURO special blade 65
VECTURO wood saw blade 65
VE-TC 3000 service unit 331, 405

V-groove cutter 183, 201
V-groove profile sanding pad 117
VS 600 164, 180

W

Wallpaper perforator
TP 220 351, 361, 369
Water gutter cutter 196
WCR 1000 389, 404
WCR storage surface 404
Whisk 344
Wood twist drill bit 253
Workcenter
WCR 1000 389, 404
Working light
SYSLITE DUO 372, 375
Workplace organisation
Accessories and consumables 398-413
Worktop template
APS 163, 179

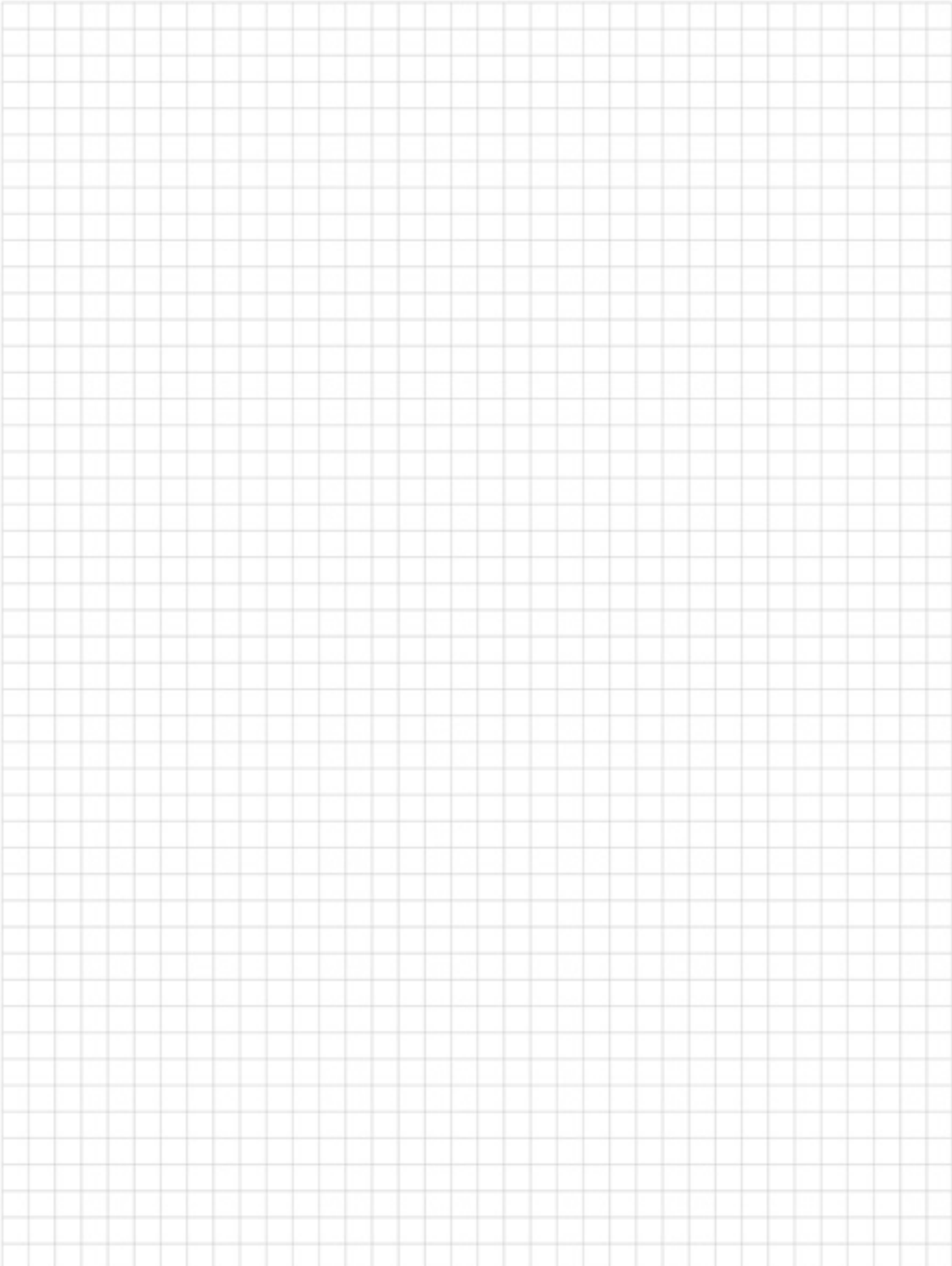

Notes

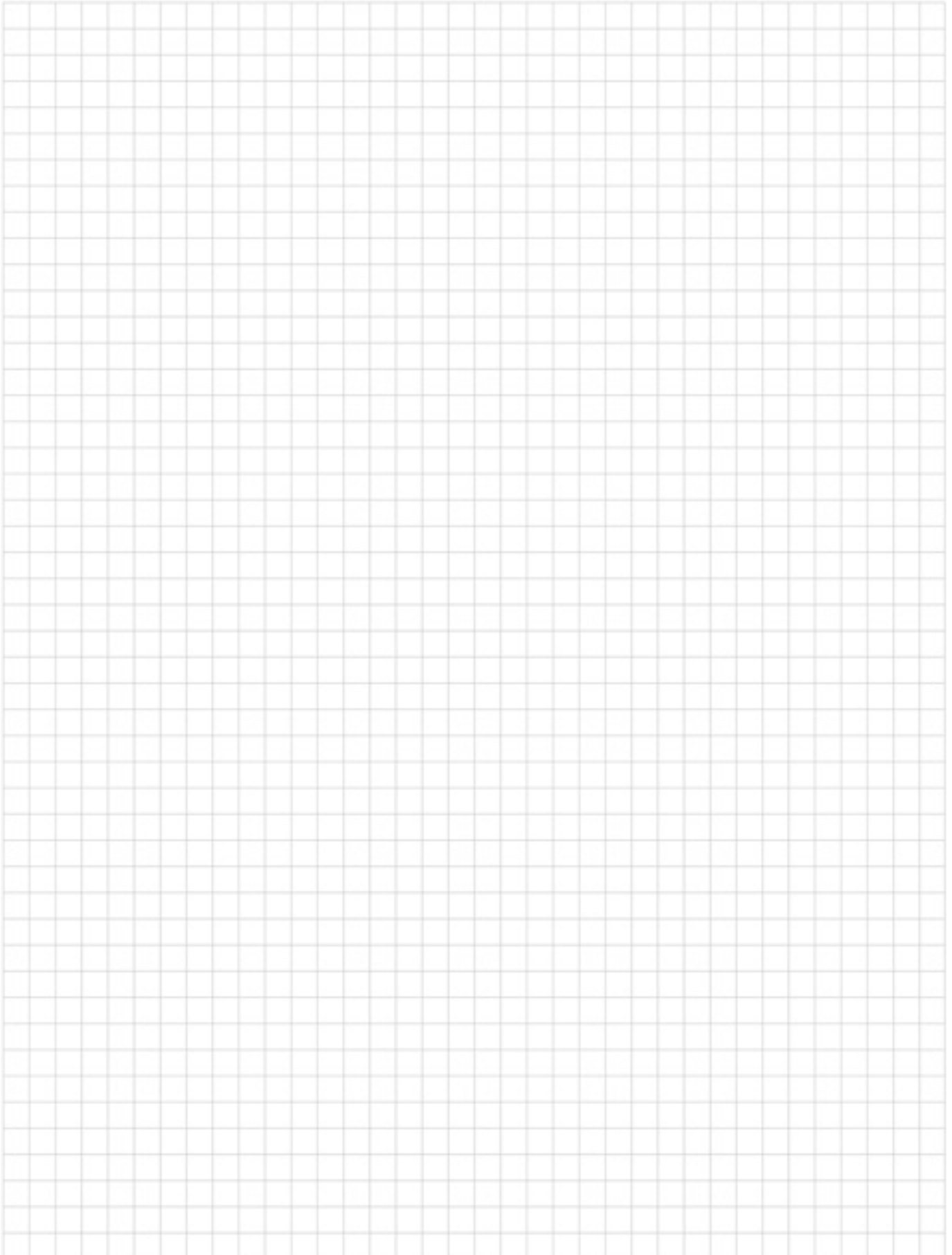

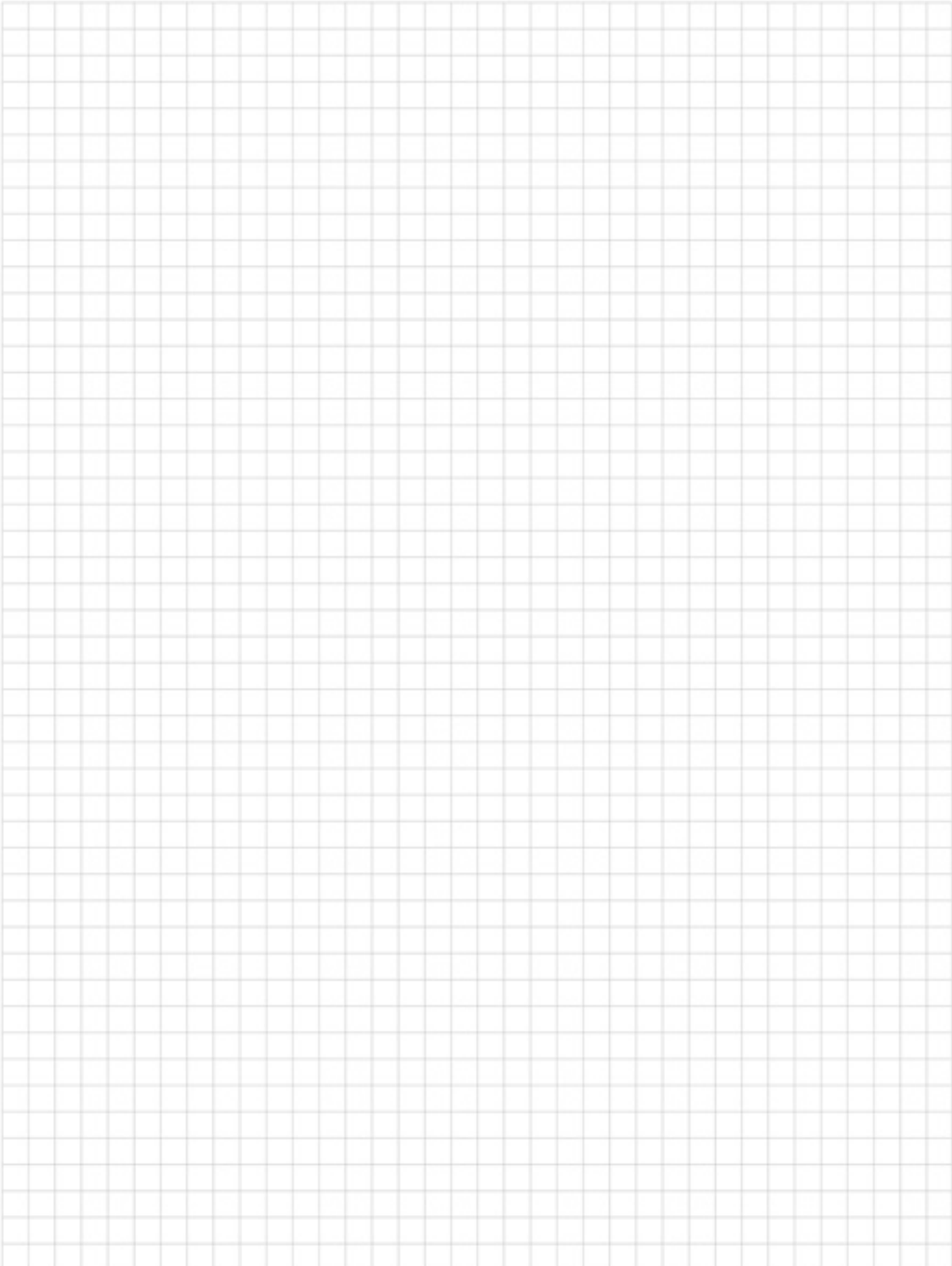

General notes on the catalogue:

1. Please remember to fit appropriate protective devices or wear personal protective equipment when using Festool products such as compressed air and electric power tools with accessories and consumable materials or when machining hazardous materials. For further information, please refer to the relevant safety documentation or consult the relevant regulating authority if you have questions.
2. Machining specifications included in the catalogue, such as quantity specifications, time savings, coverage capacities, etc., are average values and may deviate significantly, depending on the material being processed. The manufacturer does not guarantee that the values will be achieved in each individual case. Your Festool specialist dealer will be glad to answer any queries you may have concerning this matter.
3. All trade mark rights, patent rights and other commercial rights mentioned in this catalogue remain the property of the relevant beneficiary, even in cases where this is not explicitly stated. The use of brand names, trade names, trade marks, etc. in this catalogue (even if not identified as such) does not render these names exempt from trade mark protection and does not therefore authorise anyone to use them.
4. We reserve the right to make modifications, especially to technical data or specifications, without prior notification. Individual features may vary in accordance with country-specific conditions.
5. Products may differ from those pictured and the images may at times present components or parts that are not included with the products. If you have any questions, please contact your Festool dealer.
6. Safety: all electric and compressed air tools listed in this catalogue – depending upon the type of tool – conform to the valid and applicable IEC or EN safety standards (e.g. IEC/EN 61 029, IEC/EN 60 745, IEC/EN 62 841, IEC/EN 60 335, EN ISO 11 148, IEC/CISPR/EN 55 014, IEC/EN 61 000).
7. CE conformity: all electric and compressed air tools listed in this catalogue are in compliance with applicable EU guidelines (e.g. Machinery Directive 2006/42/EC, Low Voltage Directive 2014/35/2014/30/EC, EMC Directive 2004/108/EC, Restriction of Hazardous Substances Directive 2011/65/EU).
8. ISO certification: all the electric power tools and compressed air tools listed in this catalogue are manufactured in production plants that are ISO 9001 certified.
9. Insulation: The electric power tools listed in this catalogue are fully insulated in accordance with regulations.
10. The machine weights specified in the catalogue usually refer to the weight of a machine ready for use and with a standard tool attached, but without a cable, accessories or consumable materials. Please remember that specified weights may deviate from the specifications detailed in the catalogue, depending on the tool, battery pack, accessories or other additional parts.



Egypt

Equipment plus sarl
Mkales street 41
Beirut
Tel. 00961 16 92 136
Fax 00961 99 25 993
info@equipment-plus.com
www.equipment-plus.com



Algeria

PRO' DISTRIBUTEUR sarl
NIF 099909080287849
LOTISSEMENT AIDJA BOUFARIK ALGERIE
Tel. 00213 25 28 39 12/13
Fax 00213 25 28 39 14
info@pro-dist.com
www.pro-dist.com



Azerbaijan

Alman Texnikalari Evi MMC
A. Molla Cuma kuc. 32
1072 Baku, Azerbaijan
Tel. 0099 4 12 565 23 23
Fax 0099 4 12 565 23 30
ate_mmc@yahoo.com
www.atemmc.com



Australia

Festool Australia
21-27 Evolution Drive
Dandenong South Vic 3175
Postal address: PO Box 4401
Dandenong South VIC 3164
Tel. 1300 063 900
Fax (03) 8845 7079
customer@festool.com.au
www.festool.com.au



Belgium

Festool Belgium NV/SA
Rue Colonel Bourgstraat 101
1030 Bruxelles
Tel. 0032 2 893 36 36
Fax 0032 2 726 98 81
info-be@festool.com
www.festool.be



Bolivia

Grupo Ribepar Industria y Comercio SRL.
Av. Cristo Redentor Esq Noel Kempff Mercado
3000 Santa Cruz de la Sierra
Tel. 00591 33 448860
Fax 00591 33 442929
gruporibepar@ribepar.com.bo



Bosnia-Herzegovina

MAJO D.O.O.
Goričica pri Ihanu 2
1230 Domžale (Slovenija)
Tel. 00386 17 24 82 16
Fax 00386 17 24 11 07
majo.doo@siol.net
www.majo.si



Brazil

W&S Saura Ltda.
Av. José Fortunato Santon 580
Distrito Industrial Abdo Najar
13474-750 Americana/ São Paulo
Tel. 0055 19 3469-9889
Fax 0055 19 3469-9888
ws@wsequipamentos.com.br
www.wsequipamentos.com.br



Bulgaria

Tooltechnic Systems E00D
9, Christopher Columbus Blvd.
1592 Sofia
Bulgaria
Tel. 00359 888574208, 00359 888989917
office@festool.bg
www.festool.bg



Chile

SOCIEDAD RHEKO LTDA.
Victoria 984, Villa Llacolen
San Pedro de la Paz
4130000 Concepcion
Tel.: 0056 41 2372 060
Info@reko.cl



China

Festool China
1159 Kangqiao East Rd, No.91-Buildg 1
Kangqiao Industrial Zone
201315 Shanghai (Pudong)
Tel. 0086 21 68 18 28 00
Fax 0086 21 68 18 26 90
info@festool.cn
www.festool.cn



Denmark

Festool Danmark ApS
Postboks 1242
2300 København S
Tel. 0045 44 84 20 24
info-dk@festool.com
www.festool.dk



Germany

Festool Deutschland GmbH
Wertstrasse 20
73240 Wendlingen a.N.
Tel. 0049 (0)7024/ 804-24010
Fax 0049 (0)7024/ 804-29699
vertrieb@festool.com
www.festool.de



Estonia

UAB „TTS Tooltechnic Systems“
Ašigalio g. 6
LT-49142, Kaunas, Lietuva
Tel. 00370 37 308 414
Fax 00370 37 323 848
info@tts-company.lt
www.festool.ee



Finland

Tooltechnic OY
Mäkituvantie 7
01510 Vantaa
Tel. 00358 10 22 95 110
Fax 00358 98 25 47 132
info@festool.fi
www.festool.fi



France

Festool France
47 Grande Allée du 12 Février 1934, Noisiel
77448 Marne la Vallée Cedex 2
Tel. 00 33 (1) 60 06 64 30
Fax 00 33 (1) 60 06 62 26
info-fr@festool.com
www.festool.fr



Georgia

LTD Electron
Agladze str. 7/a
0154 Tbilisi
Tel. 00995 32 2911121
Mobil: 00995 599 291122
contact@rcheuli.com
khaduri@gmail.com
www.rcheuli.com



Greece

Hellenic Tool Center
Driadon 4
141 22 Neo Heraklio (Attica)
Tel. 0030 21 02 81 10 72
Fax 0030 21 02 81 17 64
festool@otenet.gr
www.festool.gr



Great Britain

TTS Tooltechnic Systems GB Ltd.
Saxham Business Park, Saxham
Bury St. Edmunds, Suffolk
IP28 6RX
Tel. 0044 1284 760 791
Fax 0044 1284 702 156
info@festool.co.uk
www.festool.co.uk



India

Caple Industrial Solutions,
WEH, Malad E, Mumbai 97.
Delhi +91 9999394047
Mumbai +91 9930069906
Bengaluru +91 9148788500
Kolkata +91 9599487490
festool.cat@caple.in
www.caple.in



Iran

GEDORE EL ALETLEHERI SAN. ve TIC. LTD. ŞTİ.
Birik Org. San. Bölgesi Tem Yan Yolu
1. Cad. 4. Sok. No:1
34953 Aydınlı-Tuzla / İstanbul
Tel. +90 216 395 32 00
Fax +90 216 395 32 03
info@gedore.com.tr
www.festool.com.tr



Ireland

TTS Tooltechnic Systems Ireland Ltd
C/O McCann Duffy Cleary, E12 Calmount Park
Ballymount
Dublin 12
Tel. 00353 18 64 22 40
Fax 00353 18 64 22 47
sales@festool.ie
www.festool.ie



Iceland

ISOL Ltd.
P.O. Box 8436
Armúli 17
128 Reykjavik
Tel. 00354 53 31 234
Fax 00354 56 80 499
isol@isol.is
www.isol.is



Israel

A. Sherizly & Son Ltd.
Shderot Hamiktsot, 15
Einav Center
Modiin - 7177849
Tel. 00972 89 23 37 77
Fax 00972 89 23 44 77
sherizly@sherizly.com
www.festool.com



Italy

Festool Italia S.r.l.
Agente per l'Italia del marchio Festool
Via Enrico Fermi 36-38
20090 Assago MI
Tel. 0039 02 457851
Fax 0039 02 45785320
marketingit@festool.com
www.festool.it



Japan

Häfele Japan K.K.
14-17, Kami-Shinano, Totsuka-ku
244-0806 Yokohama
Tel. 0081 45 82 83 111
Fax 0081 45 82 83 110
festool@hafele.co.jp
www.festool.jp



Jordan

Equipment plus sarl
Mkales street 41
Beirut
Tel. 00961 16 92 136
Fax 00961 99 25 993
info@equipment-plus.com
www.equipment-plus.com



Canada

Tooltechnic Systems, LLC
400 N. Enterprise Blvd
Lebanon, IN 46052
Tel. 001 88 83 37 86 00
Fax 001 76 54 83 09 03
sales@festoolcanada.com
www.festoolcanada.com

Festool worldwide



Kazakhstan

Voronin I.V.
Mikrorayon Aksay 3 a, dom 80
050031 Almaty
Tel. 007 727 242 94 55
ritm@ritm.asia
www.ritm.ltd.kz



Qatar

Equipment plus sarl
Mkales street 41
Beirut
Tel. 00961 16 92 136
Fax 00961 99 25 993
info@equipment-plus.com
www.equipment-plus.com



Columbia

Ferreteria Al-Diaz
Cra. 50 No. 71C-31
Bogotá, D.C.
Tel. 0057 1 660 0083
Fax 0057 231 4350
gerencia@ferrealdiaz.com
www.ferrealdiaz.com



Croatia

ALAGO d.o.o.
Horvati 112
10436 Rakov Potok
Tel. 00385 1 653 93 92
Fax 00385 1 653 93 93
info@alago.hr
www.alago.hr



Latvia

UAB „TTS Tooltechnic Systems“
Ašigalio g. 6
LT-49142, Kaunas, Lietuva
Tel. 00370 37 308 414
Fax 00370 37 323 848
info@tts-company.lt
www.festool.lv



Lebanon

Equipment plus sarl
Mkales Street 41
Beirut, Lebanon
Tel. 00961 1 692136
Mobile 00961 71 861234
info@equipment-plus.com
www.equipment-plus.com



Lithuania

UAB „TTS Tooltechnic Systems“
Ašigalio g. 6
LT-49142, Kaunas, Lietuva
Tel. 00370 37 308 414
Fax 00370 37 323 848
info@tts-company.lt
www.festool.lt



Luxembourg

Tooltechnic Systems (Belgium) N.V./S.A.
Agent Festool
Rue Colonel Bourgstraat 101
1030 Brussel
Tel. 0032 2 702 32 38
Fax 0032 2 726 98 81
info-be@festool.com
www.festool.be



Malta

PIOVE HOLDINGS Ltd.
Prof. Carmelo Coliero Street
Handaq Industrial Estate
Handaq
QRM4005 Qormi
Tel. 00356 21 44 67 98
Fax 00356 21 44 44 76
piove@usa.net
www.cctechmaltta.com



Macedonia

Rosa Dooel
st. Jadranska Magistrala 90
1000 Skopje
Tel. 00389 022 602 092
Fax 00389 022 602 093
info@rosa.com.mk
contact@rosa.com.mk
www.rosa.com.mk



Moldova

UAB „TTS Tooltechnic Systems“
Ašigalio g. 6
LT-49142, Kaunas, Lietuva
Tel. 00370 37 308 414
Fax 00370 37 323 848
info@tts-company.lt
www.tts-company.lt



Mexico

Etapel, S.A. de C.V.
California No. 167
Col. Parque San Andrés
D.F. 04040 Mexico
Tel. 0052 55 56 89 50 55
Fax 0052 55 56 89 99 11
mbrands@etapel.com.mx
www.etapel.com



New Zealand

Hindin Marquip Ltd.
1012 Great South Road
1061 Penrose - Auckland
Tel. 0064 9 9131661
hamish@hml.co.nz



The Netherlands

Festool Nederland B.V.
Coencoop 2 G
2741 PG Waddinxveen
Tel. 0031 18 26 21 940
Fax 0031 18 26 21 949
info-nl@festool.com
www.festool.nl



Norway

MOTEK AS
Alf Bjerkesvei 22 B
BOX 81 Oekern
0508 Oslo
Tel. 0047 23 05 25 00
Fax 0047 22 64 00 63
odd-arve.rygh@motek.no
www.motek.no



Austria

Festool Österreich GmbH
Schloss Glanegg 2
5082 Grödig
Tel. 0043 (0)810/95 53 14
Fax 0043 (0)810/95 53 12
vertrieb-at@festool.com
www.festool.at



Panama

Formica Distribution Center, S.A.
City of Panama, Panama, street
85, Urb. Ind. Los Angeles
0832-2532 WTC PANAMA
Tel. 00507 260 5503
Fax 00507 260 1440
grettel.amores@bacosa.com



Paraguay

Renpar S.A.
Juan Leopardi N° 1879 c/ Pedro Peña
2160 San Lorenzo
Tel. 00595 21 51 13 29
Fax 00595 21 51 13 29
nlopes@renpar.com.py
www.festool.com



Peru

EURO TOOLS MASCHINEN E.I.R.L.
Costa Rica N° 513
J. Hunter, Arequipa
Tel. 0051 54 65 7454 / 0051 54 65 7455
Mob. 958370884 / 997375706
euroimportacion@hotmail.com
eurotoolsmaschinen@hotmail.com
www.euro-importacion.com



Philippines

HAFELE PHILIPPINES INCORPORATED
Levi Mariano Avenue
Barangay Ususan, Taguig City
1638 Metro Manila
Tel. 0063 (2) 571 3678
Fax 0063 (2) 571 3693
stefan.wolf@hafele.com.ph



Poland

Festool Polska Sp. z o.o.
Sokotów, ul. Sokotowska 47a
05-806 Komorów
Tel. 0048 22 122 74 00
Fax 0048 22 122 74 01
info-pl@festool.com
www.festool.pl



Portugal

Tooltechnic Systems Unipessoal, Lda
Zona Industrial Pau Queimado
E.N. 5, Armazém 25
2870-500 Montijo
Tel. 0034 93 264 30 30
Fax 0034 93 264 30 31
info-pt@tts-company.com
www.festool.pt



Romania

Tooltechnic System Kft.
Lakatos út 40.
1184 Budapest
Tel. 0036 12 97 13 50
Fax 0036 12 97 13 59
info@festool.hu
www.festool.ro



Russia

TTS Tooltechnic Systems 000
Russia, Moscow region
Noginsk district, 142400 Noginsk,
Noginsk-Technopark area, 13
Tel. 007 49 57 75 83 54
Fax 007 49 56 41 23 72
info@festool.ru
www.festool.ru



Saudi Arabia

Equipment plus sarl
Mkales street 41
Beirut
Libanon
Tel. 00961 1 692136
bejjanizad@equipment-plus.com
www.equipment-plus.com



Sweden

Festool Sverige AB
Stenåldersgatan 3
213 76 Malmö
Tel. 0046 40 670 10 00
info-se@festool.com
www.festool.se



Switzerland

Festool Schweiz AG
Moosmattstr. 24
8953 Dietikon
Tel. 0041 44 744 27 27
Fax 0041 44 744 27 28
info-ch@festool.com
www.festool.ch



Serbia

MAKSAL LINE D.O.O.
Pavla Pavlovića 11
11000 BEOGRAD
Mob. 00381 64 127 7581
Tel. 00381 11 407 8421
Fax 00381 11 2412 266
maksal.bg@gmail.com
www.maksal-line.rs



Slovakia

Festool CZ s.r.o.
Chelčického 1932
CZ - 470 37 Česká Lípa
Tel. 00420 48 16 45 162
Fax 00420 48 16 45 163
festool.info@festool.com
www.festool.cz



Slovenia

MAJO D.O.O.
Goričica pri Ihanu 2
1230 Domžale
Tel. 00386-17 248 216
Fax 00386-17 241 107
majo.doo@siol.net
www.majo.si



Spain

Tooltechnic Systems, S.L.U.
Edificio Lisboa
Carretera de L'Hospitalet 147-149
08940 Cornellà de Llobregat
Tel. 0034 93 264 30 30
Fax 0034 93 264 30 31
info-es@festool.com
www.festool.es



South Africa

Vermont Sales [Pty] Ltd
192 Tsesebe Crescent,
Corporate Park South, Old Pretoria Road,
Randjespark, Midrand, South Africa
PO Box 264, Halfway House, 1685
Tel. 0027 (0)11 314 7711
Fax 0027 (0) 866 88 66 33
orders@vermontsales.co.za
www.festool-powertools.co.za



South Korea

URO CORPORATION
51, DongNam-ro 23-gil, Songpa-gu
05726 Seoul
URO Technical Center
24, SanGokDong-ro 14beon-gil, Hanam-si,
13025 Gyeonggi-do
Tel. 0082 24 03 80 11
Fax 0082 24 48 95 11
shin@uro.kr
www.uro.kr



Sri Lanka

Hafele India Pvt. Ltd.
No.52, Nadana Gardens, (Duplication Road)
Colombo 04, Sri Lanka
Tel. 0094 773 895 589
Fax 0094 11 288 9883
sameera.samarakkody@hafeleindia.com



Taiwan

Bestor Trading Corp.
No.12, Chung-Yang Lane
Kuang-Fu Village Shetou
Hsiang Chang-Hua Hsien
Tel. 00886 48 72 66 97
Fax 00886 48 72 52 09
bestor.steven@msa.hinet.net
www.bestor.com.tw



Thailand

Häfele [Thailand] Ltd.
57 Soi Sukhumvit 64
Bangjak Prakhonong
10260 Bangkok
Tel. 0066 27 41 71 71
Fax 0066 27 41 72 72
festool@hafele.co.th
www.hafele.com/th/en



Czech Republic

Festool CZ s.r.o.
Chelčického 1932
CZ - 470 37 Česká Lípa
Tel. 00420 48 16 45 162
Fax 00420 48 16 45 163
festool.info@festool.com
www.festool.cz



Turkey

GEDORE EL ALETLERİ SAN. ve TIC. LTD. ŞTİ.
Birtik Org. San. Bölgesi Tem Yan Yolu
1. Cad. 4. Sok. No:1
34953 Aydinli-Tuzla / Istanbul
Tel. +90 216 395 32 00
Fax +90 216 395 32 03
info@gedore.com.tr
www.festool.com.tr



Ukraine

UAB „TTS Tooltechnic Systems“
Ašigalio g. 6
LT-49142, Kaunas, Lietuva
Tel. 00370 37 308 414
Fax 00370 37 323 848
info@tts-company.lt
www.festool.ua



Hungary

Tooltechnic System Kft.
Lakatos út 40.
1184 Budapest
Tel. 0036 12 97 13 50
Fax 0036 12 97 13 59
info@festool.hu
www.festool.hu



Uruguay

Luganer S.A.
Democracia 2090
Montevideo 11800
Tel. 00598 24 01 76 08
Fax 00598 24 01 76 08
centroventas@luganer.com.uy
www.luganer.com.uy



USA

Tooltechnic Systems, LLC
400 N. Enterprise Blvd
Lebanon, IN 46052
Tel. 001 88 83 37 86 00
Fax 001 76 54 83 09 03
sales@festoolusa.com
www.festoolusa.com



Venezuela

Materiales Manzanillo c. a
Juan Baustista arismendi
001 Portamar. Isla de Margarita
Tel. 0058 295 2744 601
Fax 0058 295 2744 783
Jou37@hotmail.com



United Arab Emirates

POLIMAR
Unit D-8 Sharjah Furniture Complex
Al Wahda Street
P.O. Box 433 Sharjah
Tel. 00971 65 33 41 47
Fax 00971 65 33 00 09
polimar@emirates.net.ae
www.polimar.com



Belarus

UAB „TTS Tooltechnic Systems“
Ašigalio g. 6
LT-49142, Kaunas, Lietuva
Tel. 00370 37 308 414
Fax 00370 37 323 848
info@tts-company.lt
www.festool.by



Cyprus

K and S Industrial Supplies Ltd.
31, Vasilissis Frederikis street
P.O. Box 27147
1642 - Nicosia
Tel. 00357 22 67 46 64
Fax 00357 22 67 22 40
seraphim@cytanet.com.cy
www.festool.com

FESTOOL

Tools for the toughest demands

Festool Australia

Postal address: PO Box 4401

Dandenong South VIC 3164

Australia

Service Hotline: 1300 063 900

Fax: (03) 8845 7079

E-mail: customercare@tooltechnic.com.au

Hindin Marquip Ltd.

1012 Great South Road

Penrose, Auckland 1061

Phone +64 9 9131666

E-mail admin2@hml.co.nz

www.festool.com.au

www.festool.co.nz

Ref. no. 066 051 AUS/aus



4 0 1 4 5 4 9 2 9 4 2 5 3

Festool catalogue 2017

Date: 01/2017, replaces all previous catalogues.

Errors and omissions excepted. Products may differ from those depicted.

Product features

Antistatic function
Dust extractors and tools with antistatic function to prevent static buildup when working.

Jigsaw with precision guidance
Wear-resistant carbide jaws guide the saw blade directly over the cut position. For precise results.

Electronic
Speed control for adjusting to the working material.

IAS 3 system
Hose system incorporates compressed air, dust extraction and exhaust air.

EC-TEC
The EC-TEC drive concept generates an extraordinary amount of power while consuming extremely low amounts of energy.

Jetstream principle.
The 9-hole principle for reduced dust accumulation, less heat and less clogging. Increases service life by up to 30 %.

AIRSTREAM battery
Battery packs ready for use again faster thanks to AIRSTREAM technology (cooling function for quicker availability) and significantly increased charging capacity.

Electronic monitoring
Electronic monitoring of the coil temperature protects against damage to the motor.

Guide system
Patented guide system for safe guidance of saws and routers.

specifically designed for sanding louvre doors and blinds
Makes changing routing, sawing, planing, sanding, drilling and screwdriving tools easier.

CLEANTEC connection system
Integrated bayonet fitting as the connecting element between the extractor and the tool.

Electro-dynamic run-down brake
The saw chain is immobilised the instant the speed regulator is released.

USB port
For charging external devices.

LED spotlight
LED light for easy and precise positioning on the scribe mark.

AUTOCLEAN
AUTOCLEAN automatic main filter cleaning system with infinitely adjustable cleaning intervals.

MMC electronics
Adaptation to different types of material: "Multi Material Control" power electronics with adjustable and constant speed and temperature monitoring.

IAS 3 light
Dust extraction, compressed air with external air exhaust.

StickFix
Quick, economical fastening system for abrasives – no adhesives, no clamping.

MULTI-JETSTREAM principle
Sanding system with integral dust conveying concept. With the patented MULTI-JETSTREAM principle.

High torque
Tool with high torque.

Splinter guard
Patented splinterguard for splinter-free cuts on both sides when sawing.

Cross cut rails
Cross cutting system which joins power tool and cross cut rail firmly together for repeat cuts at precise angles.

Starting current limiter
Simple start for household fuses.

Electronic overload protection
Protects the motor with blocking tool.

Turbo dust extraction
Turbo dust extraction ensures clean, dust-free air and a clear view of the workpiece.

DAB+
Playback in DAB+ standard.

Dual-line laser
Two laser lines for simple, precision positioning along the scribe mark from the left or right.

FlowDetect
Health protection: flow sensor which monitors a minimum air speed of 20 m/sec and issues a warning if the air speed falls below that value.

MMC digital electronics
Processor controlled "Multi Material Control" power electronics provide adjustable and constant speeds as well as temperature monitoring for work on all types of material.

IAS 3-SD
For connecting a Festool compressed air sander directly to a compressed air line (without dust extraction).

MPE sanding pad
Extremely durable sanding pads and sanding discs for long service life.

IAS 2 system
Combines three functions in one hose: compressed air supply, exhaust air extraction and dust extraction.

Protector
Protects the sanding pad and material when working close to edges.

Safety sliding clutch
Mechanical sliding clutch provides protection if the tool suddenly seizes or tilts.

ErgoFix adapter
For holding a M14 stirring rod.

plug it
Removable, replaceable power cable with safety lock for fast switchover.

Vibration Stop
Patented VS balancing so that tools run smoothly during sanding, which makes working less hazardous.

Bluetooth interface
Use of mobile devices via Bluetooth standard.

Forward/Reverse rotation
For screwing and unscrewing screws.

Torque shut-off
Intelligent technology ensures the optimum screwdriving force for every material.

Spir-O-Cut
The one-flute planing head offers decisive advantages: no need to adjust the cutting circle diameter after blade replacement, and drawing cut for high surface quality

PoliStick
Rapid fastening system for attaching felt, foam or sheepskin polishing pads – for greater efficiency.

Standard connection
Built-in connector for dust extraction.

Lithium-ion (Li)
Fitted with high-performance lithium ion battery pack.

SDS-plus
Tool holder for quick tool changes.

Impact stop
Allows manual deactivation of the impact function when drilling into wood or brittle materials.

Start/stop function
AUTO mode, also without having to press the main switch.

Quick-acting brake
For safe work when planing, sawing and routing.

CLEANTEC dust extraction
Standard adapter [27/36/50 mm] for dust extraction to safeguard the operator and the environment.

Groove in saw table.
for fixing and for safeguarding against accidental workpiece slippage, using lever clamps.

Handsfree telephone function
Telephone calls (in full duplex) via feedback.

Product identification key

Product type	Performance class	Equipment variant	Packed in a Systainer	Also included in delivery
RO	150	FEQ	Plus	Set
	Pad Ø, container volume, etc.	F Tool change system E Electronic B Quick-acting brake CE CENTROTEC Q plug it SG Hose garage EW Electric tool DW Air tool LE Compressed air variant	With a Systainer	Extensive range of accessories included

In self-service display pack Accessories are available "off the shelf" in retail outlets