

# BVWS bulletin

Incorporating 405 Alive / vol. 27 no. 2 Summer 2002 [www.bvws.org.uk](http://www.bvws.org.uk)



## The Vintage Wireless Museum

23 Rosendale Road, West Dulwich London SE21 8DS  
Telephone 020 8670 3667

Proprietor: Gerald Wells. Please make appointments beforehand



# The History of the BVWS

available now

Large Format  
176 pages, 250 photos  
Free to BVWS members

(£4 plus postage in the UK)  
(£8 plus postage overseas)

available from Mike Barker, 59 Dunsford Close,  
Swindon, Wilts SN1 4PW

1 copy free per member, additional copies at £5 each + p&p  
available at all BVWS meetings

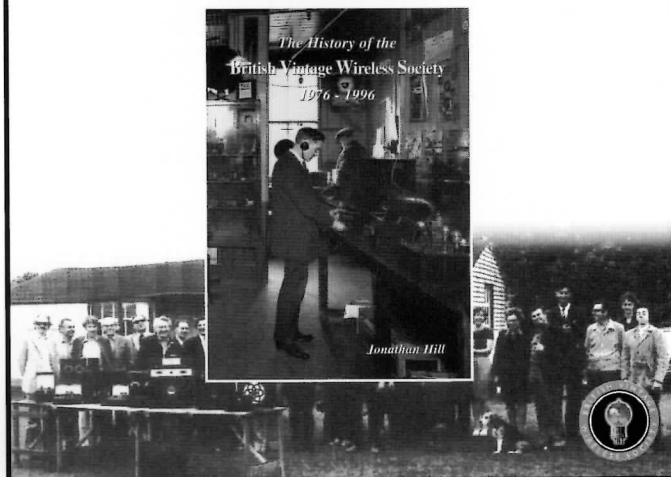

## Radio Bygones

WHETHER your interest is in domestic radio and TV or in amateur radio, in military, aeronautical or marine communications, in radar and radio navigation, in instruments, in broadcasting, in audio and recording, or in professional radio systems fixed or mobile, RADIO BYGONES is the magazine for you.

ARTICLES on restoration and repair, history, circuit techniques, personalities, reminiscences and just plain nostalgia – you'll find them all. Plus features on museums and private collections and a full-colour photo-feature in every issue.

IT'S MOSTLY about valves, of course, but 'solid-state' – whether of the coherer and spark-gap variety or early transistors – also has a place.

FROM THE DAYS of Maxwell, Hertz, Lodge and Marconi to what was the state-of-the-art just a few short years ago . . .

THERE IS ALSO a selection of free readers' For Sale and Wanted advertisements in every issue.

**Radio Bygones covers it all!**

THE MAGAZINE is published six times a year, and is only available by postal subscription. It is not available at newsagents.

TO TAKE OUT a subscription, or to order a sample copy, please contact:

RADIO BYGONES, Wimborne Publishing Ltd.,  
408 Wimborne Road East, Ferndown, Dorset BH22 9ND.  
Tel: 01202 873872. Fax 01202 874562.

Web sites: [www.radiobygones.co.uk](http://www.radiobygones.co.uk)  
[www.radiobygones.com](http://www.radiobygones.com)

## National Vintage Communications Fair

N.E.C. Birmingham  
Sunday 15th Sept 2002

10.30am to 4.00pm

£5 admission

(early entry from c.8.30am @ £15)

Stall Bookings/Details

N.V.C.F., 13 Belmont Road  
Exeter, Devon EX1 2HF

Tel: (01392) 411565

e.mail [sun.press@btinternet.com](mailto:sun.press@btinternet.com)

<http://www.angelfire.com/tx/sunpress/index.html>

## BVWS team

### Chairman:

Mike Barker,  
59 Dunsford Close,  
Swindon, Wilts.  
SN1 4PW  
Tel: 01793 541634  
murphymad@aol.com

### Bulletin Editor/Designer:

Carl Glover, c/o Aleph,  
33 Rangers Square,  
London SE10 8HR  
Tel/fax: 020 8469 2904  
choris.b@virgin.net

### Editor 405 Alive:

Andrew Henderson,  
11/2 Murano Place,  
Edinburgh EH7 5HH  
Tel: 0131-553-6290  
Mfgen.Consultant@  
btopenworld.com

### Treasurer: Jeff Borinsky,

3 Woodberry Grove,  
London N12 0DN  
Tel: 020 8343 8121  
jeffrey@borinsky.demon.co.uk

### Harpden Organiser:

Jeremy Day  
9 Rackham Drive  
Luton, Beds LU3 2AF  
Tel: 01582 576124

### Events Co-ordinator:

Terry Martini,  
122b Cannon Street Rd,  
London E1 2LH  
Tel: 07947 460161  
audiovisual@bmonthonline.net

### Membership Secretary:

Graham Terry  
26 Castleton Road  
Swindon, Wilts SN5 5GD  
Tel: 01793 886062  
g.terry@virgin.net

### Members' Advertisements:

Ian Higginbottom,  
5 Templewood,  
Ealing,  
London W13 8BA  
Tel/Fax: 020 8998 1594

### Bulletin Correspondent:

Robert Chesters,  
Tel: 01244 675826  
bakelite.ekcos@virgin.net

### Technical TV

**Correspondent:**  
David Newman,  
Tel: 01202 730935  
newdave07@aol.com

### Committee Secretary

Guy Peskett,  
13 Warneford Road  
Oxford Oxon  
OX4 1LT  
Tel: 01865 247971  
peskett@atm.ox.ac.uk

Bulletin of the British Vintage Wireless Society  
Incorporating 405 Alive  
Volume 27 No.2 Summer 2002

www.bvws.org.uk

Copyright: No part of this publication may be reproduced, stored in a retrieval system or transmitted in any form or by any means without the prior permission of the publishers, The British Vintage Wireless Society. Copyright may also be the property of contributors. ©2002 British Vintage Wireless Society

Separations and Printing by Clipper Print

### Honorary Members:

Gordon Bussey | Dr A.R. Constable  
Ray Herbert | Jonathan Hill  
David Read | Gerald Wells

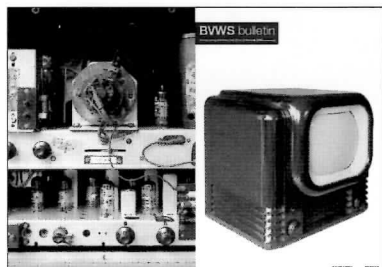

Front cover: Bush TV22A

Rear cover: Rear of Bush TV22A

Front and rear cover photography by Carl Glover  
Graphic design by Carl Glover and Christine Bone

Edited by Carl Glover.

405 Alive edited by Andy Henderson

Proof-reading by Mike Barker, Ian Higginbottom, Andy Henderson and Peter Merriman

### Contents

- 1 Bush TV22A
- 2 From the Chair, Editorials
- 3 Advertisements
- 4 An Emerson midget re-born
- 8 Safety first! and a leaky DAC
- 10 Pictures from the Harpenden auction and AGM
- 11 Communication problems
- 12 British television aerial reconnaissance: the first ten years, part 1
- 14 John Logie Baird: A life
- 15 The Joy of Sets
- 16 The Tomb of the Cybermen on DVD
- 17 Lash-up TV saved wartime Leningrad
- 18 10th Audiojumble
- 20 The Jewel radio
- 25 A substitute for double-ended screen grid valves
- 30 Puppy training
- 33 My friend Harry
- 35 From crystal sets to 405 line televisions
- 40 Loudspeaker Cone repair
- 41 Ferranti, a history
- 42 Letters
- 44 Minutes
- 45 Back issues, Advertisements
- 46 News & Meetings, Advertisements
- 47 Advertisements
- 48 Rear view of Bush TV22

## From the chair

OK so where did April and May of this year go? It's June and hopefully better weather than we had in May. Perhaps I will be able to get started on the foundations for the new workshop some time this month. Well here's hoping. I am in the process of moving my existing workshop from my parents house to a temporary location until I can get the new workshop built. I started on moving the valves a few days ago, but it seems the more that is moved, the more appears. Where did I get them all from? A Victorian house loft full to bursting.

We recently set up the BVWS stall at Godalming for the "Titanic Wireless Commemorative Group" marathon radio link up day, using GB90MGY as their call sign. The 90 for the 90th anniversary and MGY being the call sign of the RMS Titanic. The station operated for 43 hours and 17 minutes and then stopped significantly. Although a small event it certainly attracted many people from far and wide. A replica Titanic radio room was constructed by members of the local Amateur radio group with early equipment and a large display of telegraphy and signalling equipment was put on by our own Ken Tythacott. This brought visible pleasure to those who 'had a go' on the Morse keys. A fitting tribute to Jack Phillips, a Godalming man, and Chief Wireless Telegraphist on the ill-fated Titanic.

I am very happy to tell you that after a spell in Hospital, Steve Pendlebury is more stable and a little better, but he still has a long way to go. The relief of Membership Sec. Duties can only aid his stability and reduce stress until a Kidney donor can be found. This does bring home the real need for everyone who is fortunate to enjoy good health to think about carrying a Donor card. I would like to thank both Steve and Dilys

for the service they have given the Society in doing the Membership Secretary Job over the last two years. Graham Terry has volunteered to take over the duties as Membership Secretary. Many of you will already have seen Graham manning the BVWS stall at meetings for some time. Graham takes over full duties and all future communications from this point onwards which relieves me of the task once again. Thanks Graham, I know your doing a sterling job already. Also we have been fortunate in that Jeremy Day has volunteered to take over the job of Harpenden Organiser. I would like to take this opportunity to welcome both Graham and Jeremy to their respective posts and thank them personally for giving up their time for the Society, we all appreciate it.

At the end of May I was treated to a trip to Dublin. This gave me an ideal chance to hunt down a few 'Irish' Murphy's. Well there were a few made just for the Irish market in their factory in Dublin. A quick call to Noel Vaughen, BVWS member and Chairman of the Irish Vintage Radio and Sound Society soon established the places to look. It was fortuitous that the Society were attending a local Amateur radio event and putting on a display, which meant we'd get a chance to meet up with a number of the members. It turned out to be a very nice event and extremely friendly. Our thanks go to Neill O' Callaghan and his wife who looked after us very well. The trip furnished me with two very nice Murphy radios, versions that I had never seen before.

Now it's time for me to get back to the articles I am currently writing for the Bulletin, in hope that I may actually finish them in time for the September Bulletin. Mike

Below: Neill O'Callaghan, Noel Vaughen, Gerrard mc Kever, Bernard and Caroline Mothersill and Dave Hooper.



## 405 service will be resumed as soon as possible!

Some of you may have noticed that '405' isn't as Alive as usual. Fear not! Computer problems from the digital era have slowed the pace of your quarterly 'fix' of Television. However, all is now in hand. Next issue, be prepared for a Television special, with a quality mix of the technical and also the much missed nostalgia. It will be an issue to treasure. Make sure you don't miss it! Might I also take the opportunity to salute Mike Barker and all the happy crew that make up the B.V.W.S. for supporting '405 Alive' and helping the spirit of Television past continue into the present. Andrew Henderson



# An Emerson midget re-born

Colin Boggis, Radio Renaissance

Shortly before Christmas, I learnt of a midget Emerson radio that was for sale in a shop not far from Blackpool. I was in the process of advising Darren Kitson (another collector) about repairs to his vintage Murphy, when he just happened to mention the Emerson being available. I was interested in American midgets, having never worked on one, and I asked for more details.

Digital photos duly arrived along with a detailed description. Whilst the set looked great, the chassis was in a sorry state, having been somewhat modified in the past. The radio was missing both its back panel and loudspeaker, but seemed otherwise complete, with a good dial and the correct type, if not colour, knobs. As the price was just £25, I decided to purchase the little radio. A big problem was getting the radio to my workshop on the south coast, as I didn't fancy the long trip up North. I was very fortunate as Darren very kindly offered to pick the radio up and ship it to me, in return for my rebuilding a block capacitor for him.

The radio duly arrived, just after the Christmas holiday. It was packed expertly, even a temporary back had been fitted, and there was no transit damage to the case, valves or chassis. Thanks again, Darren. A good hard look at the set revealed many horrors, the set had been well and truly hacked around – a massive dropper was grafted into the hole where the speaker should reside, and a valve base was missing. Further observation showed some very strange wiring modifications, virtually all the pins on one valve base being connected together. The chassis was also very rusty. Rather than being disappointed, I saw this little set as a challenge, and I was determined to resurrect it!

The first problem was not having any circuit information, especially as my set had been got at so badly. Without a back panel I didn't know the model number either, so I had to spend hours scouring the web looking at circuit after circuit in the hope of finding the right one – in the event, I didn't! I tried a few Email requests, to the Yahoo radio group and to several American collectors' sites, but came up with nothing.

Then a breakthrough: I received a mail from another collector, Christopher Ryle, with the same radio. Unfortunately his was also missing the back cover, and he had no circuit diagram either. But he had the set, and one that hadn't been got at! So I asked Chris if he could take some close up photos of his chassis for me, or perhaps sketch out the component layout and wiring. He agreed to make the sketch, and on the strength of this promise, I commenced stripping down my Emerson. By the time I had de-rusted the chassis and located a suitable speaker and output transformer, the sketch arrived by Email. And what a sketch! The detail was as good as any service manual I have seen, showing all the component locations, values and inter-valve wiring. I was delighted – without

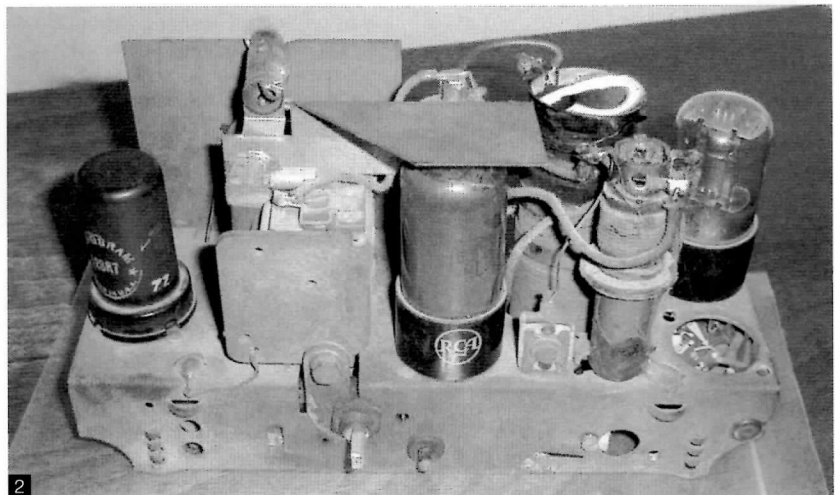

this drawing I could not have got anywhere – thank you Christopher.

The blank chassis was sandblasted clean, and given several coats of galvanising paint. Whilst not the original finish, I felt that it was entirely suitable and much cheaper than having it re-plated. I remounted the valve bases and looked around for an extra base to replace the missing part. I then realised that the original bases were smaller and squarer than the standard UK made parts. I could not get a new paxolin IO base to fit, and in trying to cut it down, I ruined it. The pins were not damaged and so I set about making my own base using fibreglass sheet. After a couple of near successes, I finally made a usable base on the



1: Nice case, shame about the rest!

2: Rust and missing parts

3: The horrible dropper conversion!

4: Rebuilt chassis – underside view

5: Rebuilt chassis – top rear view

6: Simple moulding tool for celluloid dial cover

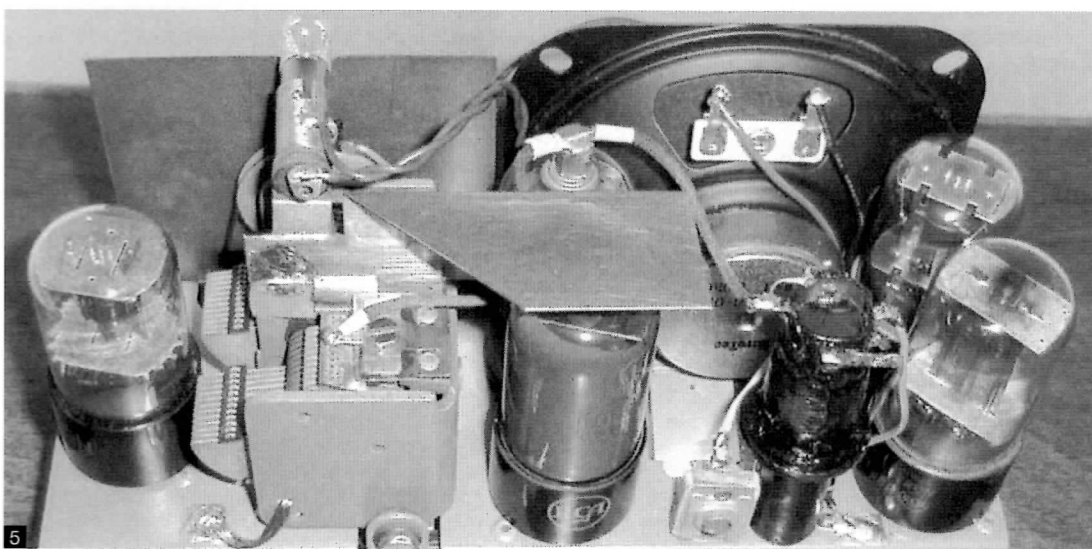

third attempt, and this was fitted into the chassis.

Although the original loudspeaker was a high-impedance moving iron type, I decide to fit a modern moving coil type and an output transformer. I had in stock a 100mm unit that fitted perfectly, even lining up with the mounting holes in the chassis. This was an 8ohm unit, but as I had a supply of multi-ratio transformers this did not present a matching problem. However, the bulk of the transformer was a problem, and after some time trying different locations, I finally mounted the item under chassis and directly beneath the speaker. I used just one fixing bolt; the head being hidden beneath a chassis mounted trimmer. The second fixing was achieved by bending the other transformer foot so that it hooked around part of the speaker frame. The space taken up by the transformer meant that I could not religiously follow the original component layout, and I opted to use two separate electrolytics rather than make up a replacement dual unit.

Before re-wiring commenced, using the layout drawing supplied by my colleague, I drew out the schematic circuit diagram, which I found easier to work from. The chassis was then fully re-built commencing with the heater wiring. The coils were checked and the DC resistance of each winding measured – this easily identified which was for MW and LW. On the second RF coil there was a third winding, connected to the common earth tag. From the layout and circuit diagrams this appeared to be connected via capacitors to the anode of the detector

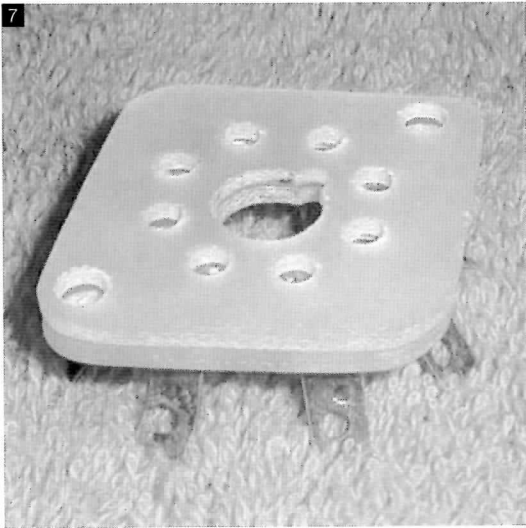

valve and to the output valve HT supply. I could not, and still do not, understand the function of this coil. Its only apparent effect proved to be "top cut" tone correction!

I looked up the 50L6GT output valve characteristics and ascertained that the optimum anode load was 4,000 ohms, and selected the appropriate tap on the output transformer. I purchased 35Z5GT and 12SF5GT valves (the rectifier was missing, and an "alien" 12SR7GT valve was in place of the other), fitted them in place and connected the radio up to my trusty Variac, set to 117 volts. Power was applied, and within a minute all valves and the pilot lamp were glowing nicely, whilst a faint hum could be heard from the speaker. With volume turned up to maximum, the background noise increased, but there were no stations to be heard at all on either MW or LW.

Disappointed, I spent time checking and rechecking my wiring, all of which was correct. Using my signal generator I quickly established that the audio stages were working, and RF came through loud and clear on MW until I transferred the signal to the aerial input

connection. The input mica capacitor was marked just "2" and measured about 20 pF. Thinking about it, this was an unusually low value for an aerial input for MW or LW – it might have been OK for UHF or even VHF, but this was a 1940 radio! I replaced this capacitor with a 0.047 Mfd. and then the signal came through OK. A brief alignment was made of the two trimmers on the tuning gang with the radio set on MW, and then I tried to set up the LW. The gain on LW was very low, and obviously not right. After a little more head scratching, I changed the 0.0033 Mfd. capacitor tuning the 2nd RF anode to a more plausible 300 pF and was immediately rewarded with a great improvement in gain and volume. I then adjusted the 2 LW trimmers for correct frequency and maximum output.

After all this, I was not entirely satisfied with the performance, and even though it meant departing from the original design, I added decoupling to the 1st RF and to the output valve cathodes with consequent improvements in sensitivity and volume. I played around with the values of other components and changed the output cathode bias resistor from 140 to 180 ohms.

7: Home-made Valve Base

8: The finished radio

9: Layout diagram by Chris Ryle of the Emerson midget.

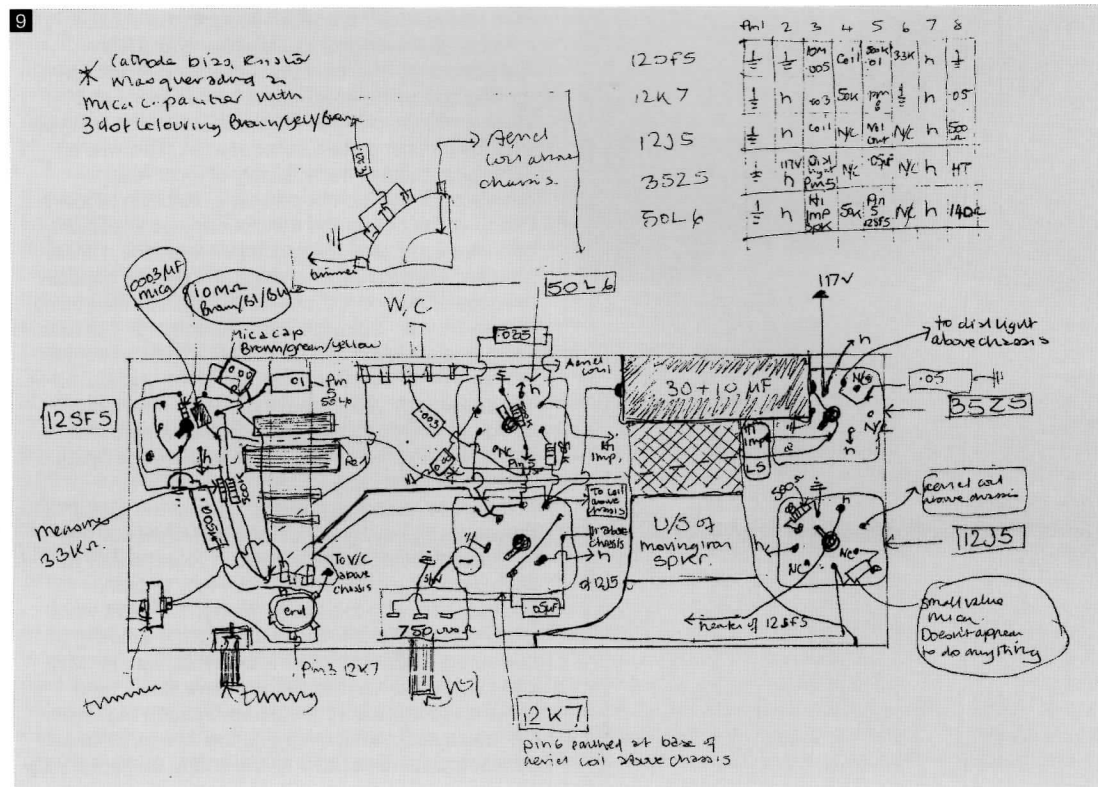

I was then satisfied with the radio's performance, although I still could not understand the function of the coil winding mentioned earlier. Disconnecting it just increased the treble response, and nothing else. Perhaps someone reading this will be able to explain this bit of circuitry – if I had the original manufacturer's schematic maybe I would find it was connected differently and had been changed in my colleague's radio.

All that was left was to make a back cover and a tuning scale window for the case, and I needed to match up the knobs to the same colour. The back panel was relatively easy and cut from ply after first making a paper template. A label was produced on the PC. The tuning scale cover was more difficult – I finally settled for a celluloid window, moulded with a custom made balsa wood former, using a hot air gun. After several failures, I finally got a good result and this was glued into position inside the case, with the "bubble" protruding through.

I believe the original was similar, but clipped into place by 2 small extrusions at either side of the aperture. I admit to the sacrilege of filing these off!

This left me with just the problem of the different coloured knobs. I was fairly sure that the off-white one was correct, whilst the green one had probably once graced another set. To paint this wrong knob to match was considered very difficult, so I took the easy option

and painted them both with Arum White cellulose. Once fitted, they looked fine, and at last the restoration was complete. The completed radio is really quite good for one so small. The case measures just 9 inches wide by 5 high and 4.5 deep! And there are 5 octal valves tucked away inside!

The final decision was how best to convert it for our 240 volt mains. A dropper resistor or even a diode / dropper solution was not even considered as there was so little space and already a lot of heat inside the midget case. Experimenting with a capacitor indicated that a 3.5 Mfd. motor run type would give satisfactory results, but this was rather too large to fit comfortably in the case. I could either fit the cap in a suitable in-line plastic box or use a step down transformer. The transformer was finally chosen as it allowed the set to remain almost authentic and performed the best.

The results using capacitive droppers on 117-volt sets seem never to be quite right – it is difficult to maintain the correct heater power with a correct HT voltage. When replacing a UK dropper there is usually still a heater ballast resistor and current limiters in the HT circuit. By juggling these values it is usually possible to get the conditions perfect.

More on this subject later. I'm going to conduct some more extensive investigations into alternative dropper circuits, including using Zener Diodes, SCR's, Triacs and Switching IC's.



## A Jubilee item



Dicky Howett writes: These two items pictured, preserved in my camera collection, date from 1953. The camera, a Marconi Mk2, with its turret-full of Dallmeyer glassware, is of the type used by the BBC at the 1953 Coronation. The TV set is an upmarket Kolster Brandes consol 15" model (bought especially for the coronation broadcast). My picture shows both ends of the vintage broadcast chain. All wood and hot valves. The 1953 BBC Coronation broadcast was covered using 20 image orthicon monochrome cameras plus one caption camera in a scanner. Five Marconi cameras were in Westminster Abbey, the other fifteen (including Pye Mk 3 cameras) were scattered along the route. It was the biggest outside broadcast anywhere up to that date and attracted 20 million viewers in the UK alone. However, this was the second Coronation covered by BBC Television, the first being on May 12th 1937 for King George VI. On that occasion the broadcast, watched by an estimated 50,000 viewers, was covered using just three cameras (Emitron iconoscopes) positioned at Apsley Gate at Hyde Park Corner. The reception was clear and proved a boost for the fledgling BBC TV service, the only all-electronic service operating anywhere at that time.





## Safety First! and a leaky DAC By Gary Tempest

Colin Boggis's letter, Bulletin Christmas 2001, on safety matters, sparked off a reply and this article. Most AC/DC sets, made in the US, had an isolated chassis. Why this was not done over here for our similar radios, working at an even more lethal voltage, is hard to say. Was it just the extra small cost?



Chas Miller first brought converting such radios to my attention. I had bought some back issues of Radiophile (No. 63 of 1996) and read his short piece with interest. Chas's method of conversion was to disconnect, from chassis negative, only those items passing DC (not forgetting the detector DC component; normally the bottom of the volume control), or 50 Hz. These were connected together to make an HT - ve point. In his example radio there was no bypass capacitor for the output valve; this would be included if present. The new HT - ve was connected back to chassis by a 0.1 micro-F capacitor (600V minimum DC) with a shunt 220 K Ohm discharge resistor. I had tried variants of the method that had worked successfully. By variants, I mean I had connected many more points than the minimum, to the new HT - ve. I had simply done what was easy

to do. If several decoupling capacitors had all been wired to a tag whose connections needed to be moved, I saw no point in separating them; I just moved the wire that went to chassis! I had rebuilt radios, ones that needed to be completely stripped because of a rusty chassis, to be fully isolated. That is, every component previously returning to chassis was connected to a new negative rail. This is how American radios were generally made and only requires a few extra pieces of tag strip. It does have a disadvantage in that the tuning capacitor, insulated from chassis by rubber grommets, could be live. Perhaps, as normally this only presented a hazard to the expendable service man, it was considered to be acceptable. However, if the back of the radio is lost, then a large and prominent topside piece is easily touched by anyone. There are two solutions; just

I had at hand a DAC90A in need of restoration that would make an ideal test bed. This must be one of the easiest radios to fully convert as most components are on a tag board, with just a few connections to chassis.

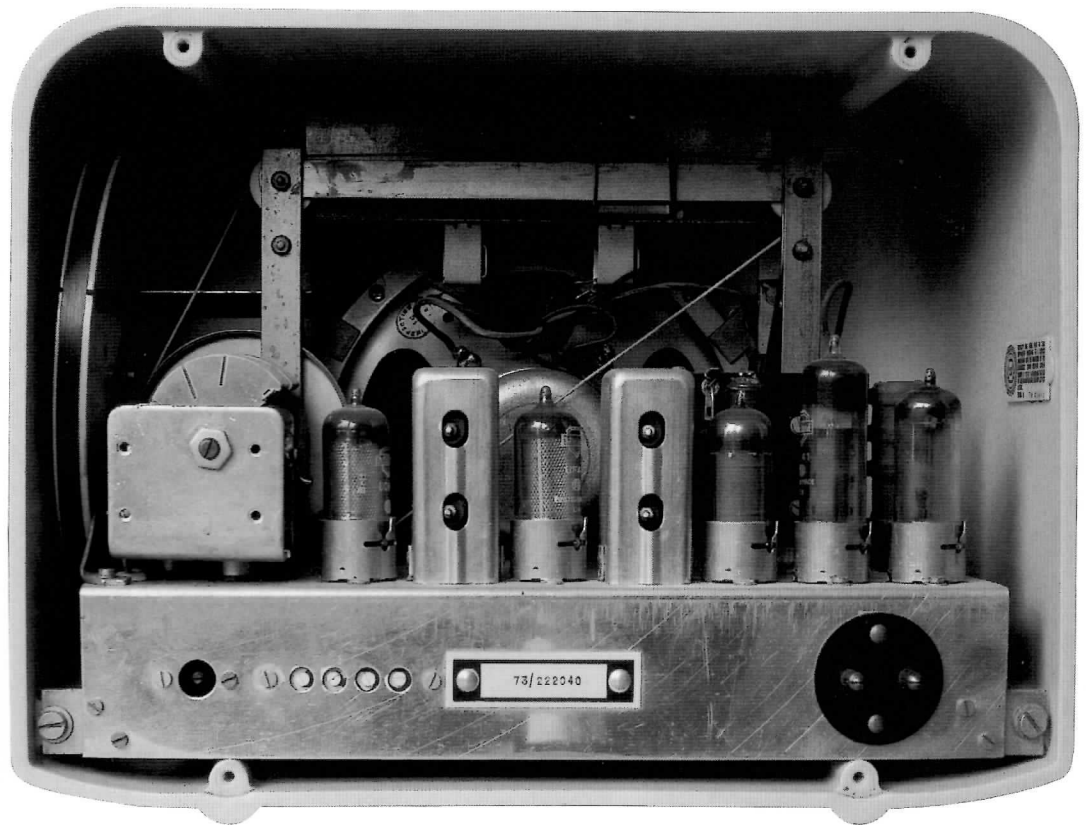

Earth Leakage Trips are so sensitive that they will pop out with just the capacitor surge. My own will drop out, when switching on, with just 0.05 micro-F between a supply leg and earth!

connect it to chassis (instead of HT -ve) or, if you are a purist, then include an isolating capacitor in its return to HT -ve.

What I hadn't done was to fully convert a radio and then reconnect it back to a minimum requirement, for isolation, to see if there were any performance differences.

I had at hand a DAC90A in need of restoration that would make an ideal test bed. This must be one of the easiest radios to convert fully as most components are on a tag board, with just a few connections to chassis. I was going to 're-cap' the electrolytic anyway, so this was easily dealt with. It did in fact have an insulated negative tag. Apart from this item only seven other points had to be re-connected. Having done the work, changed all other wax paper capacitors and found a good set of valves, how did the radio perform? But hang on! Before fitting the chassis capacitor and its shunt resistor, what isolation did I have? I was taken aback to find it only measured 50 K Ohms. Eventually I traced it down to the B8A valve bases. These are the ones with unglazed ceramic inserts, inside a metal skirt, with a spring clip. This snaps over a protrusion on the valve envelope. In the centre of the ceramic base is an 'earthed' metal tube, which acts as a shield, preventing the grid and anode pins from 'seeing each other'. However, just removing this would not afford much of an improvement, as leakage between pins was also surprisingly low. Actual figures were: one pin to chassis around 300 K Ohms, two adjacent pins to chassis 250 K Ohms and adjacent pins, to each other, 300 K Ohms. This was at only 10V as my insulation tester gave off-scale, short circuit readings at higher voltages. Imagine what these values would do to IF coil Q and AVC line performance. I had by the way, during the chassis clean up, cleaned the bases with switch cleaner and cotton buds. For interest I did try the radio like this. It worked, but it was very insensitive on both

wavebands. Also, the audio was garbled and had a Dalek-like quality. What difference would getting rid of all the valve base leakages make!

My first thoughts were that it was possibly metal migration. I had read somewhere that silver was prone to this at the molecular level. I conversed with an Internet friend, Ron Pond, down in Australia. Ron had had this problem and suggested a chemical remedy. Before any etching however, he recommended to do a thorough cleaning, by soaking in acetone, commonly sold under the name Cellulose Thinners. So all the bases were removed and the metal skirts taken off. Then the ceramic parts, along with the pins, were soaked and brushed first in Cellulose Thinners and then methylated spirits. I then fully dried them and, wonderfully, insulation was now into the 1000 M Ohms class. As an added precaution, for the future, and not seeing them as necessary, I pulled out and discarded the centre shield tubes on all bases except that for the frequency changer. It took a while to get the radio re-wired and immediately performance was remarkably good; stations all over both wavebands and clean audio sound. Now I re-measured chassis isolation, without the discharge resistor, and achieved 20 M Ohms at 750v.

From here I could get back to trying the radio with only a minimal conversion for isolation. See Trader Service Sheet 1161 on the BVWS CD. Only R2 (V1 cathode resistor), R6 (V2 and V3 cathode resistor), R14 (V4 cathode resistor), C20 (reservoir capacitor), C21 (smoothing capacitor), V3 heater return to chassis, R18 (dial lamp bypass) and the dial lamps were moved to HT - ve. The radio worked just as before with no signs of instability or other funnies. AVC still worked fine, because the rail is so high-impedance that the 220K provides a reference connection. Oddly, it even works without the 220K, although the valves, chassis and HT -ve are at the same potential so perhaps this is not so surprising.

continued on page 16

# Pictures from the Harpenden Auction and AGM 2002



The auctioneers hold a debate.



Some of the members interested in the AGM.



Gerry's workshop goes to Harpenden.



A fine array of American transistor sets.



A very nice wooden 'tombstone' set.



Mike with the winner of the Pat Leggatt award 2002.



The auction in full swing. Below: two crystal sets.



Mike's AGM report. Below: some fine auction items.

Below: inspecting a McMichael and a Philips TRF.

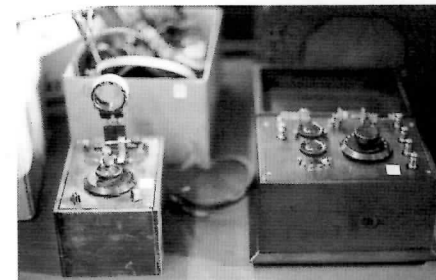
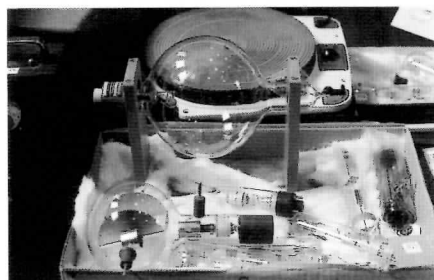





# British Television Aerial Reconnaissance: The first ten years Part 1

by Adrian Hills

In this issue is the first of three articles discussing the first 20 years of British television aerial reconnaissance. This information is based on the research undertaken by Adrian Hills at the University of Strathclyde for his PhD thesis entitled *An Early History of British Military Television with special reference to John Logie Baird*.

The adaptation of television for military aerial reconnaissance started immediately after a true television image had been produced. As television technology used new techniques and increased in quality, so did the related reconnaissance systems. Trials of equipment were undertaken in Britain with various systems as well as for the French government. Perhaps because this technology was not placed into service use it has until now remained largely ignored.

'Experiments in Connection with the Use of Television in Aircraft' is the title of Public Record Office (PRO) File Air 2/269 which records the beginnings of British military interest in television. Perhaps surprisingly, this file dates back to 1924. In this year two articles were published which stimulated the Superintendent of the Royal Aircraft Establishment (RAE) to write to the Air Ministry suggesting that television be investigated for eventual use in aircraft. Television had been subject to Admiralty investigation since 1923, a fact the Air Ministry was aware of, but no practical system had been produced. Hence, when John Logie Baird successfully demonstrated the world's first television images on the 26th of January 1926, the fighting services took immediate interest.

On February the 10th 1926 Dr R.T. Beattie, one of the Admiralty television investigators, visited Mr Baird to see the successful system. On the 2nd of June the Air Ministry sent their own man, Lt. Colonel H. P. Lefroy. It was understood by both services, now co-operating on television research, that the 30-line images produced using rotating scanning discs, were of limited definition.

However, Lt. Col. Lefroy suggested that even in this basic form television could be used to report the fall of shot from guns and requested that J.L. Baird investigate this application. Lefroy proposed a system in which an airborne observer would place a pointer on a map to indicate a shell impact. This indicator would then be received as a point of light by a remote plotter on his corresponding map. The point of light would disappear as the observer's pointer was removed, but the plotter could mark his map to record the position.

By October the 6th both Lefroy and Beattie attended a meeting at Baird's company, Television Ltd, where they discussed a possible future demonstration of 'automatic spotting by radio transmission'. (1) Since the June meeting Baird had made his equipment aircraft

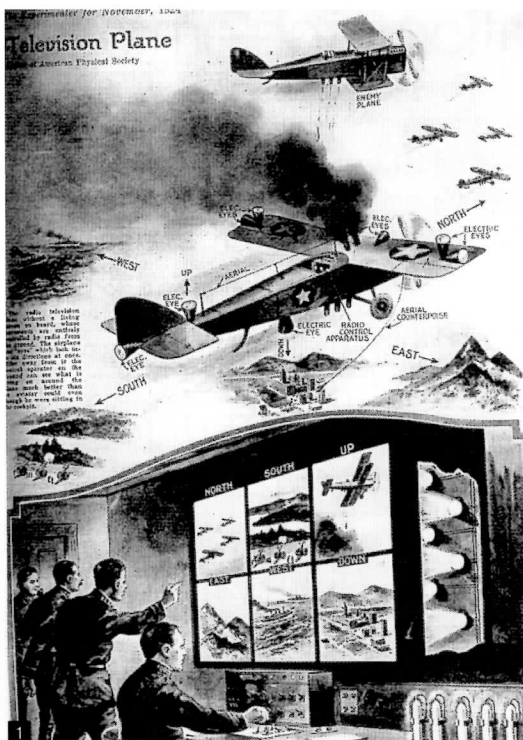

Fig.1: An artist's impression of Television Reconnaissance from 'The Experimenter' November 1924.

Fig.2: A 30-line television image.



Television Ltd offered the fighting services ten sets of equipment at £2000 each, after which they would be prepared to sell full rights of the invention for £20,000. The Air Ministry decided not to commission this equipment.

friendly by miniaturising it from 'a 10 foot cube' (3 metres) to 12 X 12 X 6 inches (30 x 30 x 15 cm) and a proposed weight of just 12 lbs (5.5 kg). Baird must have experimented with some form of system as he realised a cross rather than a point of light would be better to indicate a position on a map. To achieve this cross Baird proposed specially slotted scanning discs as shown in the patent he submitted the following year.

Television Ltd offered the fighting services ten sets of equipment at £2000 each, after which they would be prepared to sell full rights of the invention for £20,000. The Air Ministry decided not to commission this equipment. The Baird organisation was not to be involved in television reconnaissance for the British Government until 1936 when higher definition systems became available.

Television was still too primitive and in 1927 the Admiralty temporarily curtailed investigation. The Air Ministry re-appraised their position regarding television and the Director of Scientific Research, H.E. Wimperis suggested continued research by its 10 Department with a reduced 'C' priority rating. (2) It is interesting to note that a suggestion was made to put television research into the hands of a private company, naming the Marconi Company specifically. But it was noted that '...a firm like Marconi's however is so much internationalised as to call for caution in envisaging such an arrangement' (3) These misgivings were either forgotten about or ignored by 1936 when parallel to the Baird company, Marconi-EMI also investigated television for British aerial reconnaissance.

In America in 1929 the *Detroit Free Press* reported that C.F. Jenkins, an American television researcher, was about to place television equipment in an aircraft for reconnaissance. (4) It is unclear whether this experiment was ever undertaken. Later, the American Government along with the Radio Corporation of America undertook research on television reconnaissance starting in the late 1930s.

British military interest in television after 1927 concentrated on ground based rather than airborne signalling systems. In 1929 Colonel A.C. Fuller of the Royal Corps of Signals and a Royal Engineer investigated a system referred to as the 'area system of telegraphy'. The system was described thus:

*A message written on a tape is passed slowly in front of an aperture at the transmitting end and an*

Fig.3: Remote spotting apparatus defined by J.L.Baird's patent GB 295 210.

Fig. 4: S.E.E. system as recorded in their report of December 1932  
Source: PRO AVIA 23/553

Fig.5: A Fultograph Machine photographed at the Amberley Chalk Pits Museum.

Fig. 6: Diagram from Patent GB 441 235 issued to Baird Television Ltd and Anatole Stoyanowsky

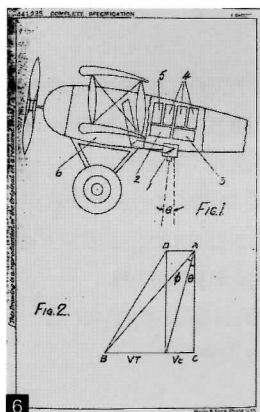
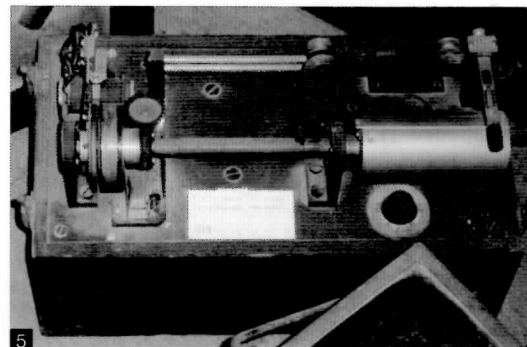
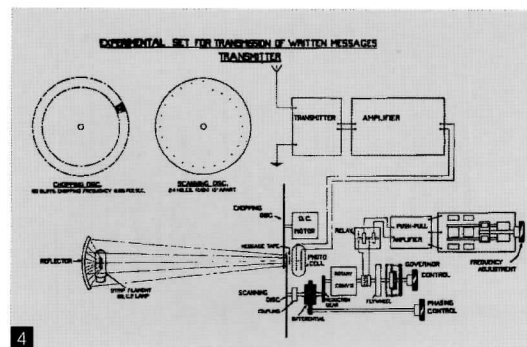
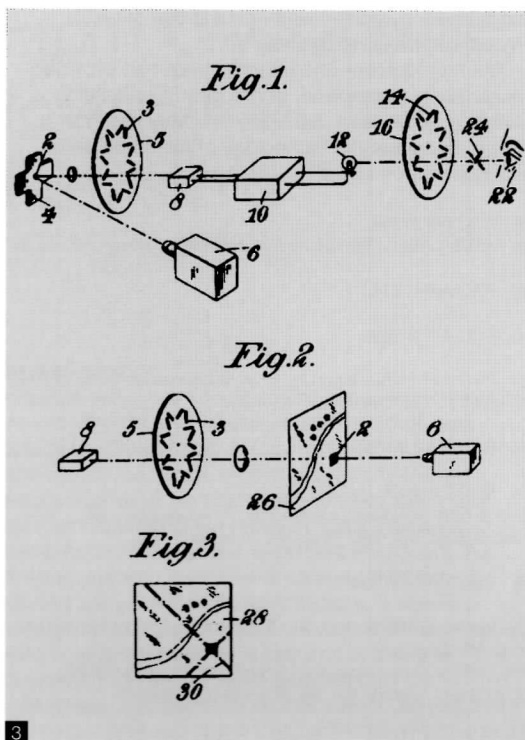

image of this message is seen passing slowly across a similar aperture at the receiving end. The message can be read out by an observer and written down by a second person. The system has advantages in that it will operate through considerable jamming and gives quite a large measure of secrecy. (5)

A similar system was investigated, with good results, by the Signals Experimental Establishment in 1932.(6)

The next British airborne electronic image system involved the use of a Fultograph machine in the airships R100 and R101 beginning in 1929. The Fultograph could scan an image in reasonable half-tone detail and send it over a period of approximately 20 minutes.(7) Because of this ability a modified Fultograph was investigated for sending navigational information, including weather maps, to and from the dirigibles. In September of 1930 the Marconi-EMI Company (M-EMI) also demonstrated facsimile equipment for use with the R100 airship.(8)

From 1926 all successful systems included mechanical scanning. The cathode ray tube, which was eventually to supersede mechanical scanning and display methods, had not yet reached a sufficient degree of development. One method of mechanically increasing image definition was to scan a cinematograph film. Equipment was developed which could rapidly process the film directly from the camera and when electronically scanned, could produce a 'near live' image. This was known as the intermediate film technique, a technology that Baird Television Ltd (BTL) would later use for its public television broadcasts as well as its military aerial reconnaissance trials (This system will be discussed in part 2). However, before rapid film processing was combined with a television scanner the Baird company proposed a purely cine film method for aircraft guidance.

There exists a curious 1936 patent issued to Baird Television Ltd and Anatole Tola Stoyanowsky of the company's French subsidiary, that foreshadowed later developments for aerial reconnaissance. Patent GB 441 235 describes a method of guiding an aircraft at night or in fog using special cinematic film equipment. In this patent a cine camera loaded with infra-red sensitive film is installed in an aircraft. The camera would survey the terrain below and forward of the aircraft and then rapidly process the film for viewing. Direct viewing of the film was inferred, as no electronic

apparatus was included in the patent. The film image would show what was immediately under the aircraft, i.e. the forward motion and height of the aircraft would be balanced with the time taken for development. This system offered an aircraft navigator information he could not obtain simply by looking out of his cockpit. According to the patent, airborne navigators could also use this system to drop either postal packets or bombs at their leisure. Although subject to obvious restrictions, this patent is directly related to later developments and is therefore an important, if obscure, part of the history of British aerial reconnaissance.

In the year that the BTL/ Stoyanowsky patent was issued, television in Britain was to make a great leap forward. 30-line television had been publicly broadcast by the Baird organisation and then the BBC from 1929 to 1935 and in 1936 a new high definition service was to be launched. Both BTL and Marconi-EMI developed equipment for this new service to be started at Alexandra Palace, an activity which was closely watched by military interests. On the 28th and 29th of April 1936 Mr N Hecht of the Air Ministry and Wing Commander Leedham visited BTL and M-EMI to "...obtain knowledge of the state of development of these rival systems, and to form an opinion as to the likelihood of obtaining demonstrations such as would be of special interest to the Air Ministry". (9) Keenly aware of British military interest in television as well as the opportunity for publicity associated with the new television service, Baird Television Ltd fitted an aircraft with television. *Practical and Amateur Wireless* of the 17th of October 1936 reported that a Baird receiver (probably a T5), was installed in a KLM DC-2 aircraft. Sixteen journalists, who flew from Croydon airport, were treated to a film broadcast from Alexandra Palace. This film featured the Queen Mary obtaining the Blue Riband for the fastest crossing of the Atlantic. Gaumont British showed this event in one of their newsreels. Baird Television Ltd had provided the world's first in-flight television entertainment.

Meanwhile, Marconi-EMI demonstrated television apparatus for aircraft installation to the Air Ministry. This system was based on the parameters already specified for public broadcasting. Mr Hecht of the Air Min. was not impressed: he reports, "... a boy carrying two white sheets 2' X 3' at 300yds was visible as two

Keenly aware of British military interest in television as well as the opportunity for publicity associated with the new television service, Baird Television Ltd fitted an aircraft with television.





Fig.7 The last flying DC-2

the technology had to wait until the day the BTL transmissions were switched off.

The first Marconi-EMI airborne trials had provided much useful information, particularly in motivating both the Air Ministry, Admiralty and later the War Office, to pursue the technology of television aerial reconnaissance further.

- (1) PRO AIR 2/269.
- (2) AIR 2/2743.
- (3) PRO AIR 2/2743
- (4) PRO AIR 2/269.
- (5) PRO AIR 2/269 Report by Chief Superintendent Hall of RAE on visit to S.E.E, November 1st 1929.
- (6) PRO AVIA 23/553
- (7) PRO File AVIA 13/294.  
Burns, R.W. "Wireless pictures and the Fultograph", IEE Proceedings, Vol. 128, Pt. A, No.1, January 1981.
- (8) PRO AVIA 13/294
- (9) Hecht, N. (1936, April 30). Television Equipment for Aircraft. PRO AIR 2/1775.  
PRO AIR 9/32 describes the general position of the British government towards the use of television in aircraft.
- (10) Hecht, N. (1936, September 17). Television Transmission from Aircraft; Design Papers. PRO AIR 2/1844.
- (11) Head of 10 Department, RAE. (1936, November 9). Television Demonstrations on Wednesday, 11th November 1936. PRO AVIA 13/1263.
- (12) White, E.L.C. (1999). The Birth of British Television. London: Royal Television Society. pp. 30.
- (13) PRO ADM 1/18581.
- (14) DSR Admiralty (1936, December 12). Use of Television at Sea. PRO ADM 1/18581.
- (15) Minute (1937, February 19). Preliminary Discussion on the use of Television at Sea. PRO ADM 1/18581.

waving white patches with a dark blur in the middle." (10) Despite this lack of definition, in October 1936 the equipment was fitted to the Blackburn CA 15c monoplane, code G-ABKV, serial K4241.

At 11 AM on November the 11th the first demonstration of M-EMI airborne equipment was given.(11) The Emitron camera pointed at the ground showed an image on a cathode ray tube with a four inch (10 cm) screen inside the cabin.(12) From below one thousand feet (300 metres) it was possible to distinguish between a private car and a lorry. The Admiralty were also given a demonstration and their Director of Scientific Research noted, "... the development shows great promise and should be pursued." (13) He then went on to suggest the purchase of television apparatus for use in a Fleet ship. (14) Problems with this form of aerial reconnaissance were also noted, particularly the continually changing view. One Admiralty correspondent noted "A really high speed transmission of a plan view of a battle drawn by the observer would be of considerable value" (15). Another Admiralty staff member suggested that photographs taken every few minutes could be scanned using television and immediately transmitted to the Admiral. Recording images on film and scanning them with television apparatus was a technology already familiar to Baird Television Limited as they were currently using it for television at the Alexandra Palace trial. However, military application of

From below one thousand feet (300 metres) it was possible to distinguish between a private car and a lorry.

Communication problems continued.

about plus 1, and at this point I decided to call a halt. In fact aligning the coils, and there were a lot of them, was quite satisfying, as they had obviously been wrong for quite a long time. The manual contains an excellent drawing for making the proper trimming tool for the job, but as I never expect to meet another CR100 I just flattened a bit of tubing in the vice. The IF response was quite pretty on the wobulator. On the top band Marconi didn't rely on the rather cheap looking mica trimmers and fitted small ceramic caps to align the oscillator. One of these was 2.2pF, and it was rather better without it. There is a warning in the manual that it is easy to align the oscillator to the image on this band, and I took notice of this. No trimmer is fitted on the aerial coils, as there is a manual control.

Now for the moral. If I had only an Avometer I would never have found the leak, and as it is not possible to measure the AVC volts with any accuracy I wouldn't even have known that there was one. I would have just assumed that the CR100 was not a particularly good set, which of course it is. There must be numbers of these sets around which are not giving of their best due to this sort of thing. The worst offenders for leaks

are cable forms of systoflex insulation, as used by EMI.

So cheers for modern technology, in the form of the high impedance digital meter. If you still rely entirely on an Avo, excellent although it is, remember that there are some jobs that it cannot do.

## John Logie Baird: A life

By Antony Kamm & Malcolm Baird

Soon to be published, a new biography on the life and times of John Logie Baird. The authors draw on unpublished and, in some cases, hitherto unknown material to present a comprehensive new account of the life of this enigmatic and controversial Scottish genius.

In January 1926 Baird was the first publicly to demonstrate real television. Other pioneering achievements followed, including the first transatlantic transmission, the first demonstrations of colour television and stereoscopic television, and the first video recordings. In the 1930s he twice televised the Derby, and was the first to demonstrate cinema television, in black-and-white and colour. During WorldWar II he developed

high-definition and stereoscopic television in colour, and invented the first all-electronic colour television tube. He also made significant advances in radio imaging, secret

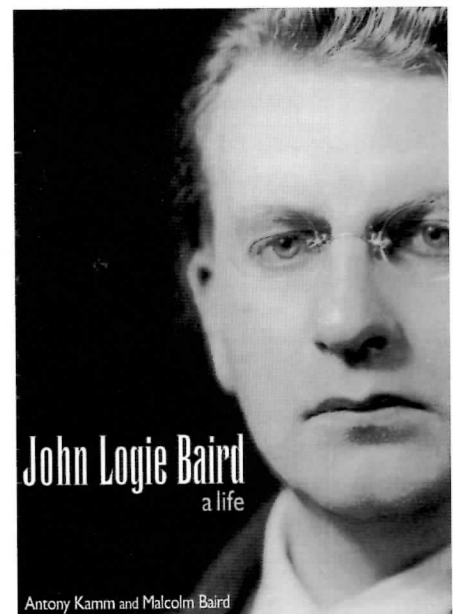

signalling, fibre optics, infra-red scanning, and fast facsimile transmission.

Throughout his life he struggled with ill health and lack of funding, to the extent that he paid for his initial research efforts and his final, heroic, and perhaps most startling, developments out of his own pocket. This balanced, thoroughly documented and splendidly readable account throws new light not only on Baird himself, but on many of those associated with him. Truth is separated from legend, and the facts are uncovered behind Baird's autobiographical memoir, published in 1988 as *Sermons, Soap and Television*, the text of which can now be compared with a recently discovered manuscript containing his own corrections.

Fresh information is revealed about the last years in London and Hastings in the early 1920s, which includes for the first time details of the company Baird established to sell soap, his unconventional romance, and the Falkirk connection.

Special treatment is given to Baird's troubled

relationship with the BBC, and in particular to the role played by the Corporation's Director General, Sir John Reith. There is a full account of Baird's brave efforts to establish a presence in the USA. Also disclosed is the background to the boardroom coup which resulted in Baird being relieved of his duties as Managing Director of the company which he had founded. In the light of their review of existing sources and examination of fresh evidence, the authors reach several conclusions which modify or challenge received opinion.

Much of the documentation from family and other archives, including Baird's wartime letters to his friend Sydney Moseley, extracts from the private diaries of Eustace Robb (the BBC's first television producer), Company memos and reports of the early 1930s, and many of the sixty photographs, have never before been published.

## The joy of Sets

### Ordinary sets - Extraordinary pleasure by Mick Moloney

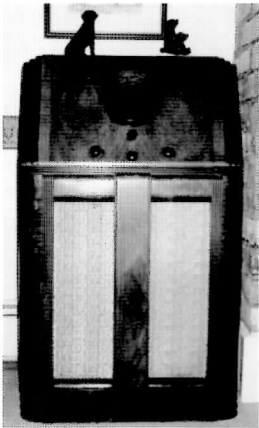

I think it must be the smell, you know, the warming valve dust, the lovely, homely cardboard smell of an operating valve radio or is it the welcoming glow of the dial lights. Or maybe the old station names - Hilversum, Sottens, Kaunas etc.

I don't really know what the magic ingredient is but I have been hooked on wireless for the last 4 years or so - the solid, clunky on/off switches - wonderful stuff!

It started a few years ago one Sunday afternoon. My wife and I were coming home from taking our Labrador for a walk and we saw a sign tied to a lamppost for a vintage wireless exhibition in a village hall at Cowbit, South Lincs (near where we live). In we went and it was love at first sight (for the radios!). I finally purchased a Pye 15A for £15 and I was away. I went a bit mad at first, as you do, buying any old set thinking it was the last one of its type - how wrong I was. I suppose we all do it at first, paying over the odds for any set. Now I am a lot more careful and choosy and I'm beginning to know the true value of what is on offer. I now have a mixed collection of 35 sets, only a small number compared with some collections but not bad! I'm sure that you will agree that space is the problem at home. Most of my collection works and when finances allow I will sort out the others. The problem here is that my technical knowledge is very limited: I do the basics but I tend to leave the tricky work to the experts. I do not have any testing equipment yet.

I tried to fault-find on a Pye type 49 and despite a warning printed on the back by a previous owner I received a bad shock and blew the circuit breaker in the house's fusebox. The chassis was live so these days I tend not to dabble too much - valve changing etc. - yes, circuit testing - not yet. I read manuals and books and am getting to know what does what but I am still in awe of those who can diagnose, remedy and repair.

I do especially enjoy cleaning up sets, especially the bakelite ones using 'Bake-O-Brite' and other products. I find this very relaxing and rewarding to end up with a gleaming set. I have met via Cowbit and Harpenden some helpful people - others I find regard me as a 'nuisance novice' but that's up to them I suppose. I was pleased to find that the majority of collectors and

repairers make sure I don't get ripped off and that I buy sensibly. I have had my let-downs, especially at the NEC when I bought two or three sets which were 'guaranteed to work' but did not.

My wife and I go to auctions and car boot sales and have found a couple of sets, but nothing of real value yet - we are still looking for that elusive round Ekco. I am sure one has my name on it somewhere! All in all I am pleased with my collection and my new skill - dusting! I must say at this point that I am lucky in that I have a very tolerant wife who does not ban me to the shed or garage with the 'You're not having that old junk in here' routine. She likes the wirelesses too.

It is a shame that a lot of stations have left the Medium Wave, Radio 2 in particular, I am told it is possible to get a wave converter to get VHF changed to Medium but I haven't seen one yet.

One set I do have is a Bush AC41 table set which I rescued from my Dad's loft. I have the original receipt. It was purchased in the Tottenham Court Road in 1954 for £20.00 approx. I can remember playing with Lego bricks on the hearth rug in front of a coal fire with the wireless playing in the background - lovely nostalgia - happy days! I suppose the price would be equivalent to about £200 in today's values which of course would have been a major purchase for my dad to make before he got married. Sky TV, Digital etc. etc? You can keep 'em, just give me an old wireless any day.

One unusual transaction I made in my early collecting days was trading a new pair of unused workshoes for a KB Rhapsody miniature valve set, which was a good swap I think. When I tried it at home it worked for about 30 seconds and then expired. It has since been repaired and works well to this day. The chap I dealt with liked bartering rather than selling; he needed shoes he told me and I had a spare pair from work so the deal was done.

I do hope that I have not gone on too much about 'Me and Mine', and that this article has been interesting to at least some of you. We are off to another car boot sale this weekend to find the holy grail - The round Ekco. I was always told the first thing to do was to check the fuse in the plug and change it for a 3 amp.

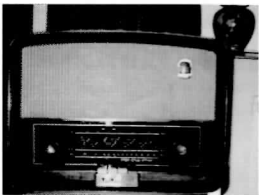

It does show how little needs to be done to isolate the chassis from mains, although I would also move C5 and C16 (V1 and V2 cathode bypass capacitors) if I were converting the radio this way. Note how moving R6 also re-connects the bottom of the volume control.

It is tempting to think that as the chassis is now isolated it can be connected directly to earth. However, there is still the capacitor and its discharge resistor and electricity utilities do not like connections between mains and earth. Also, Earth Leakage Trips are so sensitive that they will pop out with just the capacitor

surge. My own will drop out, when switching on, with just 0.05 micro-F between a supply leg and earth!

In summary then what I found substantiates what Chas said: for most radios conversion to isolated chassis is surprisingly simple and for a DAC90A, even easier to convert to full isolation. The small under-chassis deviation from the original seems to me well worthwhile for the added safety, particularly if it is a repair or a restoration for someone else. I am happy to accept my own risks but not to pass them on to unsuspecting others.

# The Tomb of the Cybermen BBC DVD

Steve Roberts writes about the restoration of a once lost television programme from the 'Golden Age'

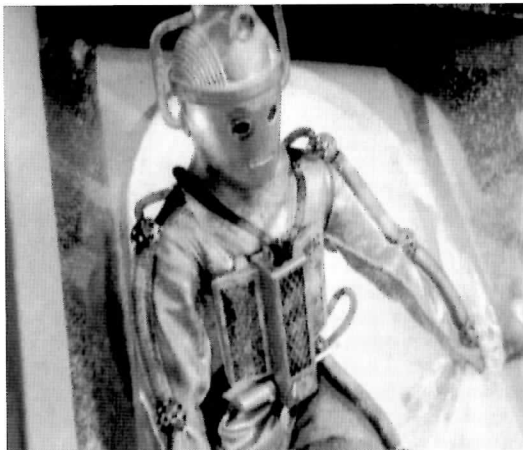

Far left: top half shows unrestored footage, underneath, restored version

The first black and white 'Doctor Who' story chosen for DVD release is the 1967 Patrick Troughton story 'The Tomb of the Cybermen'. This originally opened series five - the classic 'Monster Season'. It was completely missing from the BBC Archives until 1992, when a copy was returned from a Hong Kong TV station. Known to fans as 'Tomb', it is widely regarded as the best complete Troughton story in the BBC archives...

'Tomb' exists as 16mm black and white film recordings, this being the standard format for overseas sales of monochrome Doctor Who stories. Generally, the prints themselves are in fairly good condition, but unfortunately the same cannot be said of the original videotapes used to make the film recordings in the sixties. These show a huge number of flashes, dropouts and film recorder off-locks, all of which needed to be repaired for the DVD release.

The original Hong Kong prints were loaned to us by the BBC Archives, ultrasonically film cleaned and then transferred completely raw by Senior Colourist Jonathan Wood on the Spirit telecine for optimum quality - and also to provide us with a source of pictures for 'before and after' shots which would form part of a featurette on the remastering processing.

Each episode was then dubbed down from the raw Digital Betacam compilation master onto separate Digital Betacam episode tapes. A modest amount of DVNR was applied at this stage to reduce the film grain and to take out the smaller bits of film dirt and sparkle. Most of the scene changes appear to have been done by physical tape edits on the quad studio recordings, which produce one or two-frame off-locks on the film recorder at the cut point. Rather than covering the bad frames by repeating last or first frames of the shot as we had done when remastering the first three stories recently (and which some people

found noticeable), we elected to cut the frames out completely, tightening each affected shot by a frame or two. The audio edit was offset from the vision cut in order to make it fall between words or music so that it would not produce a noticeable audio jump.

Once the episodes were to length, the soundtrack was lifted off onto DAT and sent to Mark Ayres for audio restoration work. Unfortunately, Mark immediately discovered a problem with the optical sound transfer, caused by a fault in the telecine's optical pickup. All four episodes' soundtracks were once again transferred on another telecine and sent to Mark. However, because these soundtracks did not include the edits we had made for picture problems, Mark's job was made somewhat more difficult as he also had to duplicate our edits as well as cleaning up the material. The main tools Mark used were ProTools running on a Macintosh computer, along with Sound Designer II software. Plugins for cleanup included Digidesign Intelligent Noise Reduction, Waves Q10 (audio equaliser), Waves L1+ (Limiter and Noise Shaper), Waves C1 (Dynamics Processor). Clicks and pops were mainly redrawn by hand, or patched using tiny snippets of matching sound from elsewhere. Meanwhile, the major task of video repair and cleanup commenced.

Conveniently, BBC Resources had just taken delivery of an Edifis Sting with Scratchbox. This is an uncompressed hard disc recorder (Sting) with a built-in film retouching tool (Scratchbox). Programmes are recorded into the Sting and can then be retouched in Scratchbox using a pen and graphics tablet interface. The operator selects the frame to be repaired, then by using the pen he can simply rub away the film damage on the foreground layer to reveal the previous frame below on the background layer (this is the default - any frame on the disc can be chosen as the background). In the majority of cases, this is enough

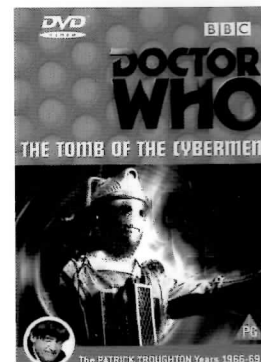

Tomb of the Cybermen: BBC DVD 1032, available from all main retailers / all screen images copyright BBC 1967, renewed BBC Worldwide Ltd 2002





# Lash-up TV saved wartime Leningrad

by Eric Westman

According to Russian historians, Leningrad, the former USSR'S second most prestigious city, had been saved from annihilation during World War II by a hastily contrived, lash-up system of combined radio location and television.



Above: Wartime aerial view of Stalingrad taken by the Luftwaffe.

In 1938, a graduate had built a television set with a screen of nearly two square metres.

In September 1941 the advancing German army was nearing Leningrad and the Nazi leader, Adolf Hitler, had ordered the city to be wiped from the face of the earth. He had assigned an entire Luftwaffe air fleet of nearly 1,000 aircraft to bomb the city, and already the defenders' air defences were overwhelmed and disorganised. All mobile observation, tracking and communication facilities were destroyed, and the enemy bombers could only be detected when they were already overhead. The city appeared doomed.

But, suddenly, the Germans found their aircraft were suffering inexplicably heavy losses. In the early months of the onslaught, almost 750 twin-engined bombers were shot down around Leningrad, and the Nazi leaders were desperate to find out what had gone wrong. But even the Gestapo and Abwehr military intelligence could not explain the failure of the massive German air attack on the city.

It all stemmed from the mid-1930s, when the USSR began experimenting with detecting aircraft by radio. By the time the country was invaded in 1941, the Red Army had already received its first radiolocators, called Redut. These showed the position of an aircraft on an electronic screen and had a range of detection of more than 100 kilometres. The radiolocators were assigned to the Leningrad air defence force and, used

round the clock and in all weathers, effectively detected oncoming enemy aircraft. The co-ordinates were transmitted to the fighter units, which then dealt with the bombers.

But there was one snag: it took too long for the information to reach the airfield. When the radiolocators had been situated outside the city, that did not greatly matter, as the bombers could still be intercepted before they reached their target. But after the radiolocation had been moved back from the advancing front line, every minute was vital. The system was time consuming: when an operator spotted a target on the screen, he encoded the data and sent it to air defence headquarters. There the information was compared with data from other radiolocators, encoded again, and only then was it sent on to the pilots. Meanwhile, the enemy bombers had flown several dozens of kilometres nearer the city. Something much quicker was needed.

On January 11th 1942, at the most desperate time for besieged Leningrad, the Command of the city's Air Defence Corps held an urgent meeting to discuss the problem, during which a service technician suggested building an air-defence television system. He explained his plan clearly and backed it with calculations: the project was given the go-ahead.

The use of television at this time is not surprising, as electronic television had been developing fast in the USSR before the war, and spectacular results had been achieved by the staff of the television laboratory of a Leningrad research institute. In 1938, a graduate had built a television set with a screen of nearly two square metres.

In the besieged city, technicians hurriedly resumed working in the research institute they had occupied before the war, and by January 15th had built the first units of the proposed television centre. They had also installed an army Redut radiolocator in which the electronic beam revolved anticlockwise on the receiver screen as it does in a modern radar. On its screen they drew a transparent map of Leningrad superimposed by a network of graduated lines and circles from which to determine the distance of a target: the centre of the screen represented the location of the Redut radiolocator. When an aircraft appeared in the sky near the city, a bright dot flashed on the screen, and the operator, using the map and scales, instantly determined the bomber's distance.

Above the screen they fixed a downward-pointing television camera which, by means of a radio transmitter and directional aerial on the roof of the building, transmitted an ultra-shortwave signal to the city's air defence headquarters. A receiving antenna was erected on the headquarters' observation tower, and television sets installed at the main centres of air defence, fighter command, and anti-aircraft artillery. The transmission of data about an imminent bombing raid thus became instantaneous. Working day and night, the television system gave adequate warning of enemy air attacks.

The Leningrad tele-radiolocation system soon became a vital part of the city's air defence network. But one summer day it gave operators a surprise

Continued on page 32

# 10th Audiojumble a great success

Many thanks to everyone who came to the Audiojumble on 17th February and helped to make it such a success. With 100 stallholders and approximately 500 visitors, the event was the largest in its 10 year history. 20 rare vintage valve amplifiers were displayed to mark the tenth year anniversary. These included: Lowther A10, Lowther B5F, Lowther LL15S, Leak Type 15, Leak TL12.1, Radford STA100, Sterns Push-pull PX25, Beam Echo DL7/35, Pye HFS20 Mozart, Pye HF25, RCA KT66 monoblock, Rogers "Williamson", Sound Sales Tri-channel, Sound Sales Senior, Sound Sales Junior, and many more. Look out for photographs of this display and of the event in general, which will appear over the coming weeks...

The next Audiojumble is planned for February 16th 2003. Date yet to be confirmed.

The Audiojumble appeals to enthusiasts and collectors alike, because of the range of vintage and modern equipment on display.

To quote Ken Kessler, Hi-fi News May 2001:-  
"It all came flooding back; I was like a kid in a candy store. Despite being in Tonbridge, a tiny burgh in the middle of Kent rather than a major venue in London or Birmingham, the place was bursting with top-flight dealers in vintage audio gear, components, valves, vinyl, open reel tapes - you name it. What staggered me most were the true rarities."

See you next year!

John Howes



1: Intense buying and selling at the Audiojumble.

2 & 3: Setting up the Hi Fi in the 'Demo room' the night before opening.

4: Yes, they sell vintage radio too!

5: A typical stall selling a broad range of audio equipment





6: Tables set up and ready the night before opening.



7: Some of the equipment on display in the 'Demo Room' the night before.

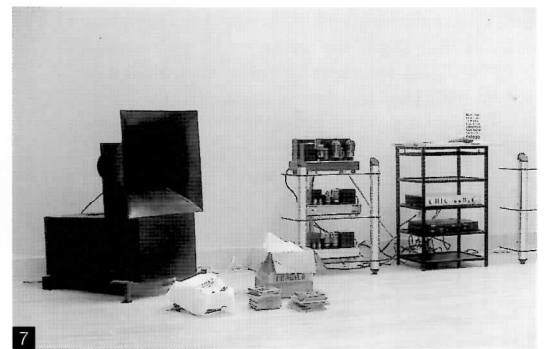

8: Mike Barker manning the BVWS stall.

9: A very nice Nagra Reel-to-Reel.





# The Jewel radio

by Gerald Wells

Very few people will have heard of Tuskite. Very few people in the radio trade will have heard of it either. If you lived in or around Marsh road in Pitsea, Essex and had a Vange 3 number telephone then you would have been aware of the factory that called itself 'Armand Taylor & Co Ltd. You would also be aware of a peculiar smell that emanated from this factory. What you could smell was the process of Bakelizing paper to form what is commonly known as Paxolin.

Everybody in the radio industry had come across this material but didn't know it was also called Tuskite.

It was used for making coil formers, transformer bobbins and tag boards. Half of the factory is still in existence producing Tuskite for what is left of our radio industry. It is but a shadow of its former self, employing a handful of people. The factory is run by a very charming lady called Josephine. I can only assume that she is the daughter of Armand Taylor.

In 1957 this very worthy company decided to produce a radio set. It was to be called the Jewel. I

get the impression that they intended to make about five thousand of them: in actual fact only 1000 were produced. I worked this out from the serial numbers. They were all six figure and started with 111000, I have never found anything beyond 111999.

Up until March 2001 I had only been aware of one: that is in Jonathan Hill's 'Radio Radio' figure 785. It was on the 23rd February that I had a telephone call from Josephine. She informed me that she had a



Top: An original, unrestored 'Jewel' radio.

Left: A view of the exterior of 'Armand Taylor & Co Ltd.'



Top right: A rebuilt 'Jewel' radio.

Above: Views of the factory as it was recently discovered.

Bottom right: A copy of a brochure for the 'Jewel' radio.



factory that had been out of use since 1957. She further stated that she wanted to sell the factory but it was full of radios and unwanted stock.

She said that she had a possible buyer but she would have to get the factory completely emptied. It had to be done in a hurry and I could have it all for nothing; all I had to do was collect it. I told her that I was off on holiday the following Monday, down to Lakeside on Hayling Island.

I telephoned John Thompson who had a very large Citroen hatchback car. He agreed to contact

Josephine and collect the contents of the factory. He cleared everything. He made seven journeys from Pitsea to Dulwich. When I came home a week later, I found my whole dining room two feet deep in clag.

There were about 200 incomplete sets and bits of cases. They were all rejects, in fact about 20% of the first run. I think at this point in 1957 they decided to stop production and padlock the factory.

Although they were very fine little sets they were all valved and the transistor was on its way in. In spite of the fact that I have been continually involved with radio for sixty years, I have not met anything like this sort of design before. The designer was one hell of a genius.

If you examine the accompanying circuit you will wonder what the blazes is going on. If you take a close look at the chassis you will be convinced that the man behind it was no ordinary set designer.

The set is quite usual for the first three valves ie:DK92, DF91 and DAF91. It has a small three-wave-band coil pack that they designed and made themselves and 2 IF transformers that looked odd, two wires came out of each end and their trimmers were on the side of the cases.

You would then spot a weird object that was where the tuning condenser would normally be. This object was their own patent tuning system. It was about the same size as a normal tuning gang.

It consisted of 2 oval pieces of Paxolin or Tuskit, three inches by one and a half inches, three two and a half inch spacers with 4BA thread through the middle. It had a three quarter inch drum running through the middle with a slip ring on each end, the Paxolin drum had two copper strips glued to it which were connected to slip rings which were connected to

**THE JEWEL**

Here at last is a Radio Set which can be taken from the home and used as a Car Radio. It will be found very useful as it can be carried in any part of the car and can be operated by the passenger in the rear seat. An extension in Power Unit Type A.E.P. 163 enables the Set to be taken out of the car to a convenient spot for Picnics.

This is an ideal arrangement for the motorist who wishes to use Car Radio for special occasions as the Radio need not be left in the car permanently and be exposed to inclement atmosphere and theft.

As this Receiver serves a dual purpose, only one Wireless Licence is necessary.

The 'JEWEL' is an extremely attractive Radio Receiver of unconventional design which is fully covered by Patents, and would enhance the most delicately furnished bedroom and make an attractive centre-piece for a dining table.

*Jewel*  
RADIO LIMITED  
PITSEA DARTFORD ESSEX

*Jewel*  
RADIO  
LIMITED



*For My Lady*

**TECHNICAL DATA**

**CASE**  
Completely enclosed case with carrying handle, artistically finished in contemporary style fabrics. A wide variety of colours available to suit all styles of background furnishings. Termite proofed for export. Overall dimensions: 8" x 5 1/2" x 9" high, weight 5 1/2 lb.

**CIRCUIT**  
High performance, patented Super Heterodyne employing 4 valves plus rectifier with low background noise. Automatic volume control. Low current consumption of 16 Watts from the Mains giving an exceptionally high output of 4 to 5 Watts (theoretical) allowing considerable savings of Mains current. This enables the Set to be used from a Car battery or accumulator by the addition of our power unit - A.E.P. 163.

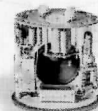

FRONT VIEW

**CONTROLS**

Three controls are provided. The left-hand control is the Waveband Switch indicated 'A' on the illustration. The larger Waveband is obtainable by turning the knob clockwise. The On/Off Switch and volume control is on the right-hand side of the panel indicated 'B', when turned anticlockwise it will switch off the Set. The third knob 'C' rotates the dial and the line upon it indicates the position of the desired station.

**CHANGING VOLTAGES**  
In order to change the Voltage, first remove the cover by releasing the two screw nuts on the top outer rim - indicated on the diagram. Looking at the back of the Speaker the voltage control will be found on the panel situated on the lower right-hand side of the chassis. In order to adjust the voltage it is necessary only to loosen the connecting link and screw it to the top marked with the correct range of voltages - if in doubt, choose the higher range.

BACK VIEW

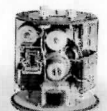





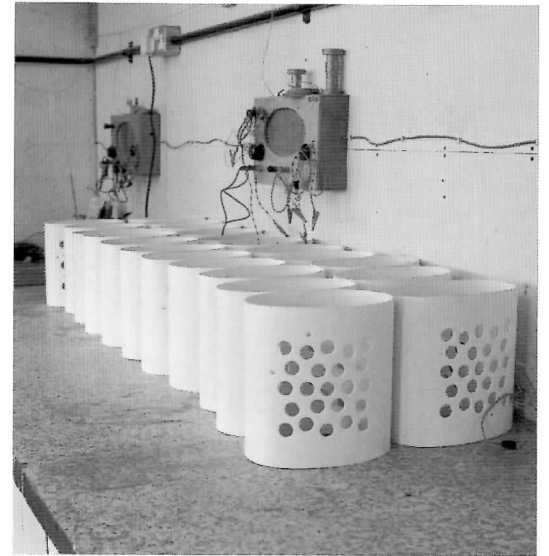

Above and below: Armand Taylor signage with Josephine below.

Above and below: 'Jewel' cases in various stages of production.

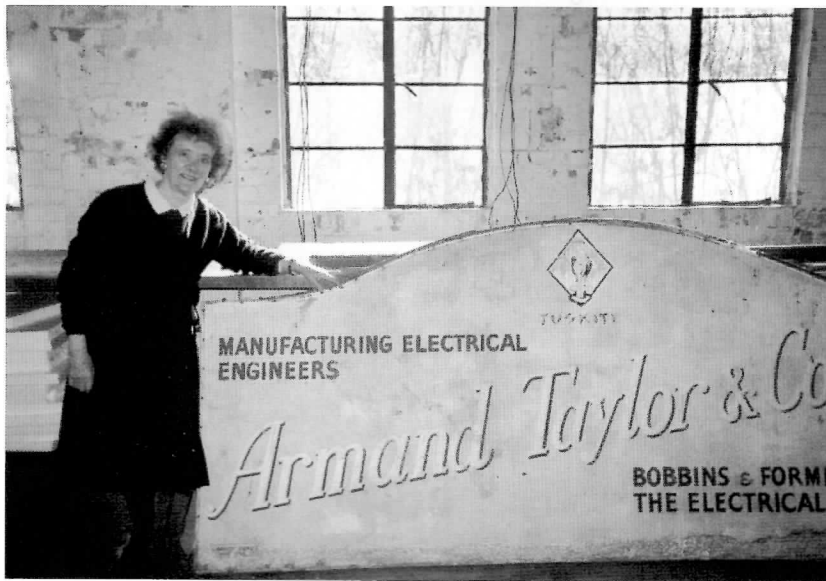

Below: Both sides of the 'Jewel' chassis.

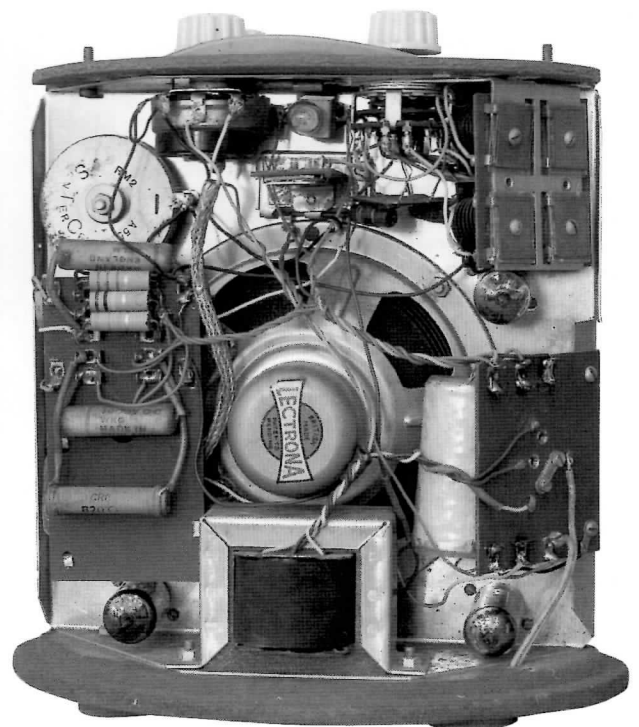
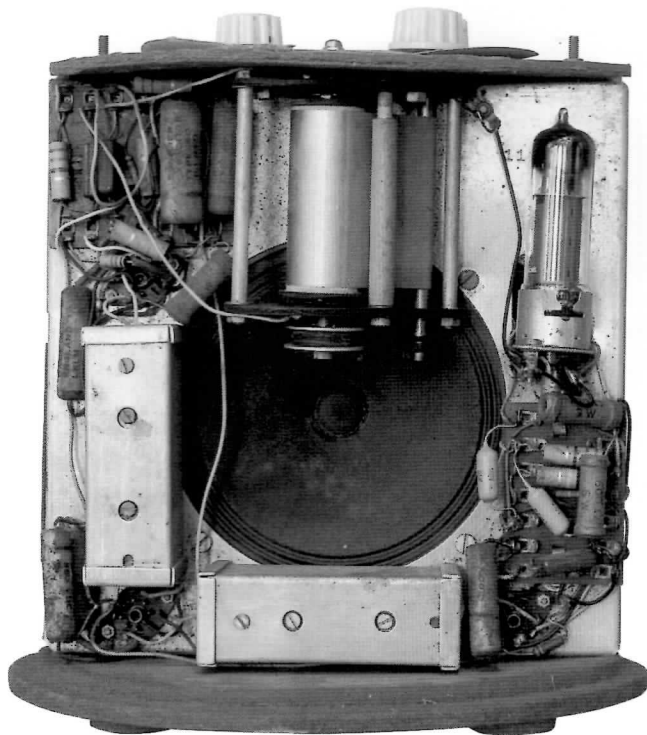



covered with a white fungus. The first thing I had to do was make up the oval top plates. I used 1/4 inch MDF for this and covered them in brightly coloured felts.

The cabinet case tubes were quite easy to form up. I made up a solid wooden mandrel and bought several rolls of the heaviest lining paper that you can get. I cut up the rolls on a fine-bladed circular saw. This meant that I could get eight cases out of each roll. I then coated the paper with wallpaper paste and rolled them over the mandrel, fixed them with string, then took them off the mandrel before they had realised what had happened.

I stood them in rows to dry before putting them on a jig to punch holes in them. I got Eileen to go round to all the local shops to get any suitable material. She did very well and even came back with cloth with teddy bears on.

It now came to the time to make the set work and see how well it performed. I picked a set out at random and gave it to one of our little old men to take home to his prefab in Lewisham.

Ted did a first class job on it. He told me that it performed very well and sounded very fair. He was kind enough to draw me out a first class circuit diagram with all the component values on it. Although Ted has been in the radio repair trade all his life and is seldom beaten, he did state that this set was rather like a City and Guilds test piece with every fault known to man in one chassis.

He had to admit that it was beautifully put together and the soldering was perfect even if the UL41 valve holder was back to front and the electrolytics were in backwards.

Up to date I have completed about fifty of them and sold a few, given a few away as presents and made sure that everyone at the museum has one whether they want one or not.



Top: Gerald Well's impressive array of 'Jewel' chassis ready for the addition of cabinets.

Top left and left: Gerry and helpers hard at work completing the 'Jewels'.

Up to date I have completed about fifty of them and sold a few of them, given a few of them away as presents and made sure that everyone at the museum has one whether they want one or not.

# A substitute for Double-Ended Screened Grid valves

By Peter Kyne

Figure 1 – This familiar, classic shot of a double-ended screened grid valve appears in History of the British Radio Valve to 1940 - author Keith Thrower, OBE and is reproduced here with Keith's kind permission.

Figure 2 – In 1928 the double-ended SG was superseded by the single-ended version. This basic form was maintained until the late 30s, although a metal cap replaced the screw top in 1933 and with the advent of the RF pentode the number of pins in the base increased.



1

I'm currently working on a long-term project for which I needed a double-ended screened grid valve with an uncommon filament voltage. It took me some months to track one down but I did eventually obtain a working sample of the Cossor SG210 required. I am most grateful to those whose kind help enabled me to achieve this. They, along with others, are acknowledged at the end of this article.

This experience started me thinking that there must be vintage receivers around that could be rendered working but for the want of a good double-ended screened grid valve. As I discovered, these valves are not easily obtainable and there are a number of possible reasons why using an original vintage sample may not be seen as the best solution e.g.:

- available samples may be poor or not working at all
- a valve with an uncommon filament voltage may be required and difficult to get.
- the owner of a rare valve may not want to "wear it out", operating a set.

It seemed to me that a suitable substitute for these valves this might be a good thing. So this article is about my quest for such a substitute and the achievement of what I believe is an acceptable outcome.

## A Bit of History

By 1927 half of domestic wireless receivers were crystal sets, the other half were of course valve sets and the situation was developing rapidly. Valve technology had advanced, bringing improvements in filaments and the hardness of the vacuum within the

envelope. Valves were available in different types to suit the various stages within a receiver e.g. Loudspeaker, AF amplifier, Detector and HF amplifier. Not only that but the new dull emitter types with oxide coated filaments were also offered in 2, 4 and 6 volt versions.

Yes, valves abounded - and they were almost all triodes. There were some four-electrode valves: however, these had limited application in specialised circuits e.g. with a low HT supply, using reflexing, or as a mixer in one of the relatively rare superhets of the time.

## The Problem

The problem with triodes is that they are poor HF amplifiers (unless you use them in grounded-grid mode, which just wasn't done then). This, as is well known, is due to the internal capacitance that exists between anode and grid. It causes instability and oscillation when you try to get any useful amount of HF amplification out of the valve. The existing four-electrode valves didn't help either because they had not been designed with this problem in mind.

In 1924, Professor L A Hazeltine had developed his Neutrodyne circuit using "Anode Neutralization", which when correctly balanced, externally neutralised the effects of the grid-anode capacitance. This allowed a reasonable amount of stable HF amplification. It was very popular in America but less so in Britain. One can speculate on the reasons for this but although the circuit often appeared in designs for home construction (most notably the Wireless World Everyman Four) the simple fact is that this technique did not catch on here to the same degree.

Thus the typical receiver of the day was composed of a large aerial and tuned circuit connected to the most sensitive type of detector, which was a Leaky Grid Detector with reaction. If the set was intended for loudspeaker use this was usually followed by two (or more) valves acting as AF amplifiers. These sets gave good results on strong signals but did not perform well if the signal was weak, as was often the case with distant or foreign stations. Even the most sensitive detector needs a reasonable signal (about 100mv) to perform effectively.

## Enter the Screened Grid Valve

Then in late 1927 something happened which was to revolutionise wireless reception. The Marconi - Osram Valve Company released upon a justly grateful world the S625. This valve, designed by Captain H J Round, was the first generally available Screened Grid valve.

If you used this new valve and followed some simple rules on circuit design and layout, you could easily achieve a very useful amount of stable HF gain. Reception was louder and if desired, a smaller aerial could be used. However the greatest benefit was that weaker signals and distant stations could be received.

Of course it was the additional screening grid, forming an electrostatic screen between the anode and control grid, which gave the valve its name. When connected to an "earthy" supply it almost entirely negated the effects of the anode-grid capacitance.

It was said that a receiver fitted with one of these valves would give the same performance as a set having two neutralised triode stages.

Figure 1 shows an S625, the circular screening grid can be clearly seen adjacent to the normal grid and filament assembly. The anode is not visible, being concealed by the screen's flanged edge and the silvery gettering on the inside of the glass bulb. There are two valve "bases" because it is desirable to keep the grid and anode connections widely separated. There is no point in eliminating the internal feedback if you don't also remove the possibility of external coupling.

The new valve was used in a number of



2



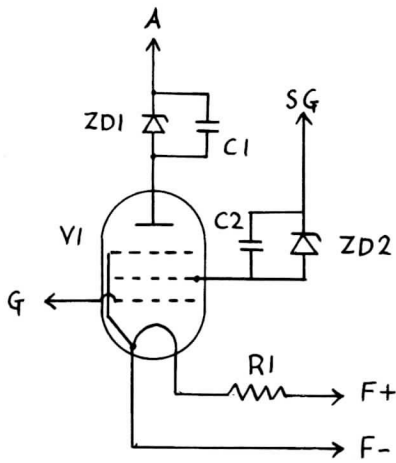

bulbs, variable mu and then on to RF pentodes, the only "improvement" was to replace the 5 BA screw top with a metal cap in 1933.

### The Survivors

As far as I know, most of the surviving double-ended screened grid valves are not in sets, but in valve collections and it could be argued that those which are still working should not have their remaining useful life used up by operating sets. Therefore a suitable substitute might be useful.

### What is a Suitable Substitute?

A good question. For me it would have to meet the following criteria:

- be mechanically and electrically compatible
- produce the same or a similar performance in a receiver.
- have a similar appearance and not look "alien" when in a receiver.

From this it is clear that such a device will have to be designed and made as it does not (so far as I know) already exist.

For the amateur the last of the three criteria, the cosmetic aspect, is the most difficult to achieve. However this is made easier by the fact that both of the valve "bases" required are the same as a standard British 4-pin base but with some of the pins removed. So it's just the bit in the middle that has to be worked at.

The obvious way forward is to use another valve as the basis for this device. I could now list the various candidates and debate their merits but life's too short for that, so I'll cut straight to the chosen solution.

### The Design Solution

The valve chosen was the Mullard DF91, commonly found in post-war personal portables, which run on dry batteries. It has a number of useful features in that it:

- is an HF amplifier
- is small
- is available
- requires no supplies which are greater than those for the original valves
- has suitable values of mutual conductance and anode impedance.

The two obvious differences are that it is a pentode, not a tetrode and it is variable-mu. For the range of conditions under which the valve will be operated these factors have no appreciable impact on its suitability as a substitute. Table 1 below compares the relevant characteristics of the DF91 with those of the MOV S625 and Cossor SG210.

**Table 1 – Comparison of valve characteristics**

Valve Type	Vf	If (amps)	Va	Vsg	ra (KΩ)	gm (mA/v)	Cag (pF)
S625 <sup>(1)</sup>	6	0.25	120	80	170	0.65	0.022
SG210 <sup>(2)</sup>	2	0.1	120	80	250	0.3	-
DF91 <sup>(3)</sup>	1.4	0.05	90	67.5	500	0.9	0.01

#### Notes

- 1 All figures from History of the British Radio Valve to 1940 - author Keith Thrower, OBE.
- 2 All figures from manufacturers' data except ra & gm, which are from the above book.
- 3 All figures from manufacturers' data.

Working through the table, we can see that we need to lose some volts for the filament, anode and screen grid feeds. This we can do.

The filament current requirement is smaller so that's no problem. No problem that is providing you don't want to use an existing filament rheostat to adjust HF

Figure 3 – The circuit diagram shows the additional components used with the DF91 to enable electronic compatibility to be achieved. The component values for various versions are given in table 2.

Figure 4 – Here is shown one of the prototypes, the wires projecting above the top of the DF91 are the screen grid and anode connections.

3

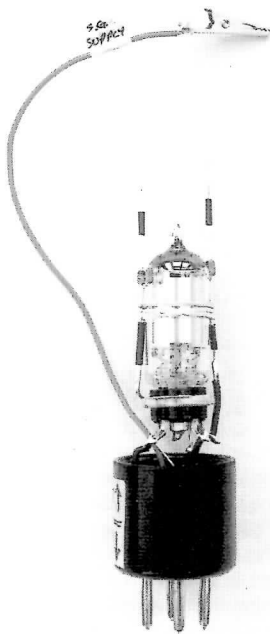

4

commercially produced receivers, examples of which can be seen in Jonathan Hill's Radio! Radio! (pages 90 to 92 in the 3rd edition). It also featured in designs in home construction magazines (e.g. "A Three for the new valve", designer - Percy Harris, The Wireless Constructor November 1927). In addition there must have been a number of successful sets "designed" and built by some of the more able home experimenters. It's not possible to say how many sets were made for this valve but the number could not have been great because the S625 had a short reign.

### A Glorious but Short life

Before the end of the following year (1928) this magnificent valve had been superseded by the slightly more magnificent S215. More magnificent because it had a better and more economical performance, but perhaps it is less charming than this quirky looking valve with its two valve bases? The same fate befell all double-ended SGs with all the major manufacturers producing at least one single-ended version. Figure 2 shows the typical form taken by the double-ended SG's successors.

The new single-ended design was to become the standard form, which was maintained through all the subsequent stages of development, i.e. metallised

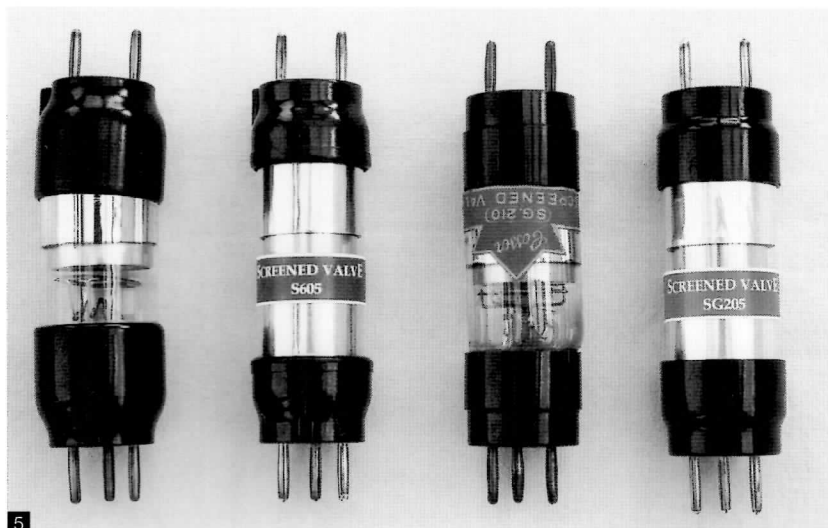

Figure 5 – Shown first and third in the line up are original screen grid valves i.e. Osram S625 and Cosor SG210. Their substitutes, S605 and SG205, are in positions 2 and 4.

Figure 6 – These are the parts used to make the internal assembly for the “new valve”. The only difference between the various versions is in the value of the resistor and one of the zener diodes.

gain by “filament dimming”, as its value will be too low to be very effective with the reduced filament current. Filament dimming is not a good practice and would be slow death to the oxide coated filament of a DF91. Gerry Wells summed it up aptly when he said, “It’s a very effective way of ruining a perfectly good valve”.

The anode impedance is higher but this should make no noticeable difference to the performance of the receiver unless the coils are very low loss, when a slight improvement in selectivity and gain might be noticed.

Mutual conductance is slightly high but of the right order. It can be reduced by running the screening grid at a lower voltage. This was quite a common practice for adjusting HF gain in screened grid valves prior to their being availability in variable- $\mu$  versions.

The anode-to-grid capacitance for the SG210 is not known; but is likely to be similar to that of the S625. The figure for the DF91 is lower and therefore again not a problem.

#### Achieving Electronic Compatibility

Plainly some additional circuitry is necessary to make the DF91 plug-in compatible. The filament will draw a constant current and a series resistor of suitable value in the positive filament lead will meet this requirement.

The current is low (50 mA) so the additional heat generated, even for the 6 volt version, will only be 230 milliwatts. This factor does need to be considered, as all the additional circuitry must be contained with the DF91 in the final package.

A fixed voltage drop of 30 volts is needed for the anode feed. However the anode current could vary for different sets. This is because the original valves, although often operated with 0 volts grid bias, were sometimes used with a bias of up to  $-1.5$  volts. As the anode current is unpredictable a resistor is not the best choice so a miniature 30 volt Zener diode was used here. The same approach was used for the screen grid feed and both Zener diodes were bypassed with sub-miniature  $0.1 \mu\text{F}$  ceramic capacitors. This was not so much for decoupling purposes but rather to suppress any noise which might be generated in the diode junctions.

The circuit diagram is shown in figure 3 and table 2 gives the component values for 3 versions of the “new valve” having 2, 4 and 6 volt filament supplies. For convenience I have given each of these a type number following the normal convention. The value of ZD2 in the “S605” (6 volt version) results in the screen voltage on the DF91 being slightly higher than the other versions. This is to take account of the higher mutual conductance in the S625, for which it can be substituted.

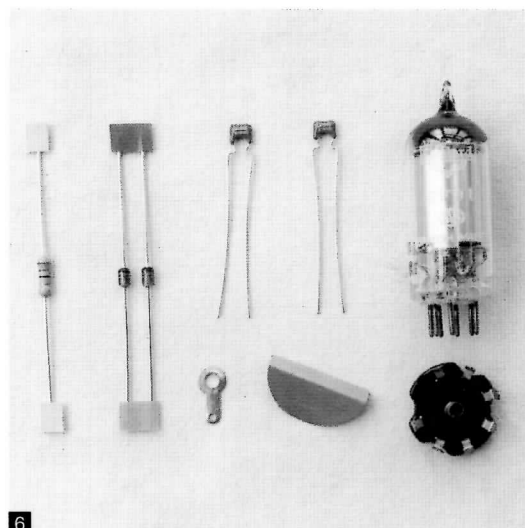

Table 2 – Component values for 3 versions of the “new valve”

Component	SG205	SG405	S605
R1	12 $\Omega$ , 0.5w	52 $\Omega$ , 0.5w	92 $\Omega$ , 0.5w
C1	0.1 $\mu\text{F}$ , 100v	0.1 $\mu\text{F}$ , 100v	0.1 $\mu\text{F}$ , 100v
C2	0.1 $\mu\text{F}$ , 100v	0.1 $\mu\text{F}$ , 100v	0.1 $\mu\text{F}$ , 100v
ZD1	30v, 1.3w	30v, 1.3w	30v, 1.3w
ZD2	39v, 1.3w	39v, 1.3w	30v, 1.3w
V1	DF91	DF91	DF91

Figure 4 shows one of the later prototypes, which is based on the circuit in figure 3. It was used to check characteristics and measure mutual conductance for various values of screen voltage. Despite its crudity this prototype produces stable HF amplification when installed in a receiver in place of the normal screened grid valve.

A certain leap of the imagination is required to bridge the gap from this crude prototype to the finished result illustrated in figure 5. Here two substitutes, S605 and SG205, are shown alongside the original valves, S625 and SG210, which they can be used to replace. The S625 shown is of the long-base type as opposed to the short-base version shown in figure 1.

#### Making the “New Valves”

The parts used to make the internal assembly are shown in figure 6. In addition to the DF91, the components and valve base, there is a small copper screen. This is soldered to the underside of the valve base as an electrostatic shield between the anode pin and any grid circuitry in the receiver.

Figure 7 gives two views of the completed internal assembly. All wires which are not connected to the negative end of the filament, are insulated with heatshrink sleeving.

The main parts needed for the final assembly are laid out in figure 8. The aluminium tube forms both the main body of the finished device and an electrostatic screen for the wire that connects the DF91 anode to the anode pin on the top valve base. It is joined to the copper screen by a pop-rivet and solder tag.

The “glass envelope” shown to the right is in fact a sheet of transparent plastic curled into a cylinder with the assistance of an electric heat gun.

It is necessary to add some cosmetic improvements before completion in order to produce an acceptable result. Two strips of thin card are wound around the aluminium tube followed by a layer of aluminium kitchen foil to simulate the gettering. Then the “glass envelope” is added. These parts are all held in place by backing each of them, at the point of contact, with high tack double-sided tape (this is a very fiddly operation).

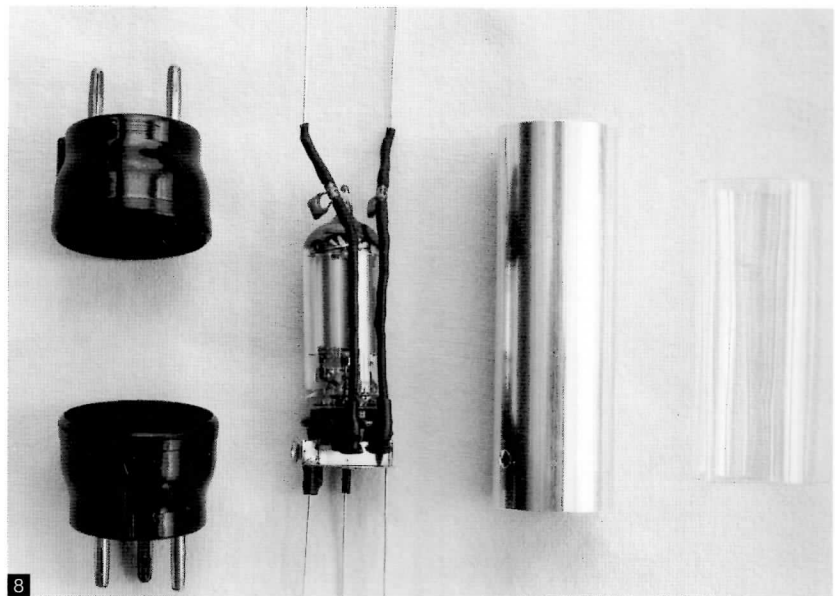
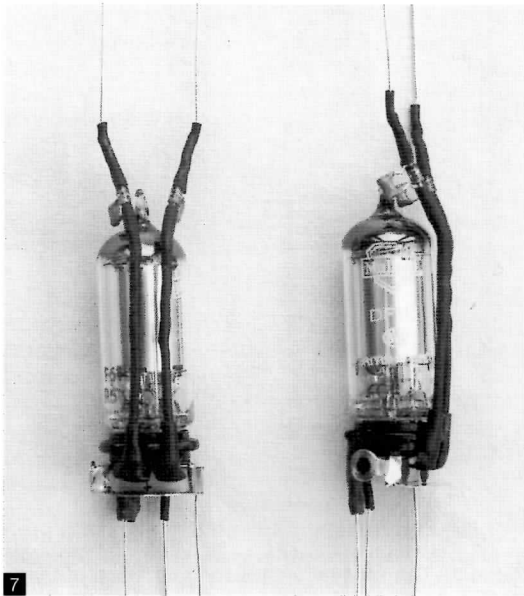

Now the valve bases can be added. The bases were taken from valves which were useless for any other purpose. They were common valve types with open circuit or very low emission filaments and of no value for display purposes.

In the mark 1 version there were additional mechanical parts and the whole was held together by over a dozen 6 BA screws. It was very time consuming, involving lots of drilling and tapping. Clearly some valve engineering techniques needed to be brought to bear and my revised strategy can be summed up as – less screwing, more glueing. The solution was found (no pun intended) in a pack of Araldite Rapid.

The original valves back in 1927 were glued together so this approach seems quite valid. The disadvantage is of course that if there is any kind of internal failure for any reason then the device cannot be repaired. However the same applies to the real thing.

In figure 9, a half assembled S605 can be seen sitting in the glueing jig. Although Araldite is quite viscous it does tend to give in to the force of gravity where it is being used for gap filling, so although it takes longer I glued one end at a time.

The last operation is to put on the labels. The masters for these were produced on an ordinary desktop computer using Word Table. They were printed out with white lettering on a black background and my local stationers copied them on a colour photocopier, substituting an appropriate colour for the black. The labels are attached with high tack double-sided tape.

### Testing

Each of the “new valves” was of course tested before final assembly for the reasons already given. However it was also necessary to demonstrate that these substitutes do give a similar performance to the valves that they can replace.

Readings were taken for the S605 and SG205 substitutes and the results plotted against those for the original valves. The Characteristic curve most often shown for a screen grid valve is that of  $I_a/V_a$  (anode current against anode voltage) with the control grid and screen potentials fixed. I think this is because the curve has an interesting shape due to the negative resistance kink in the middle. However this information is of no practical value if you are going to use the valve for its intended purpose as HF amplifier.

The kink appears when the anode potential drops below that of the screen and although this is relevant in non-standard applications such as a dynatron oscillator, it has no bearing when the valve is used under normal operating conditions.

Nonetheless, far be it for me to flout tradition. So reference to figure 10 shows the  $I_a/V_a$  curve for the new S605 and an original S625. As expected, the S625 shows the characteristic kink and the S605, being a pentode, does not. The point is of course that over the normal range of anode voltage, indicated by the circle on the graph, their characteristics are very similar.

If accurate readings are taken of the anode current with a sensitive meter the figures can be used to calculate anode impedance. This was done and these figures are given (within 10%) in table 3.

The most useful curve when considering a valve as a conventional amplifier is that of  $I_a/V_g$ , as the slope of the curve represents the mutual conductance, in mA/volt. Figure 11a compares an original MOV S625 with its S605 substitute and figure 11b shows a Cossor SG210 in relation to its SG205 substitute.

The Osram S625 that I have has only about 80% emission so the curve for this valve, shown in figure 11a, was plotted using data recorded in 1927 from an early S625. The S605 curve is based on measurements which I made of the device I produced. The anode current is very similar although interestingly the slope for the original shows that its mutual conductance is somewhat lower than that quoted by the manufacturer.

In figure 11b both curves were plotted from measurements made by myself. The anode current and mutual conductance for the SG205 substitute are a little higher than those for the original valve. If the additional gain is not wanted then lowering the screen grid voltage to say 70 volts will reduced both of these figures. I think this is legitimate, as the manufacturer's data sheet suggests adjusting the screen voltage in order to achieve best results.

All of the key characteristics for the two original double-ended screen grid valves and the relevant substitutes are summarised in table 3 below.

**Table 3 – Comparison of characteristics for original and “new” valves**

Valve Type	Vf	If	Va	Vsg	ra	gm	Cag
		(amps)		(KΩ)	(mA/V)	(pF)	
MOV S625 <sup>(1)</sup>	6	0.25	120	80	170	0.65	0.022
S605 Substitute <sup>(2)</sup>	6	0.05	120	80	500	0.66	0.01
Cossor SG210 <sup>(2)</sup>	2	0.1	120	80	250	0.3	-
SG205 Substitute <sup>(2)</sup>	2	0.05	120	80	500	0.57	0.01

### Notes

1 All figures from History of the British Radio Valve to 1940 - author Keith Thrower, OBE.

2 All figures from manufacturers' data except  $r_a$  &  $g_m$ , which are from the above book.

Figure 7 – Here are two views of the internal assembly. The copper screen is in place and the attached solder tag will be pop-riveted to the aluminium tube, which is shown in figure 8.

Figure 8 – These are the main parts used for the final assembly. There are also some cosmetic pieces to be added e.g. to simulate the gettering and a label, they serve the additional function of concealing the innards.

Figure 9 – Here is a part complete S605 sitting in the glueing jig, waiting for time to take its effect on the Araldite.

Figure 10 – The pentode curve of the S605 substitute appears very different from that of the classic tetrode curve exhibited by the original S625. However over the normal range of anode voltage (indicated by the circle) they are extremely similar.

Figures 11a & 11b – The curves demonstrate that original and substitute are very similar although in both cases the “new valve” is slightly better.

Figure 12 – Well they work and they don't look too bad. So that's not bad, is it?



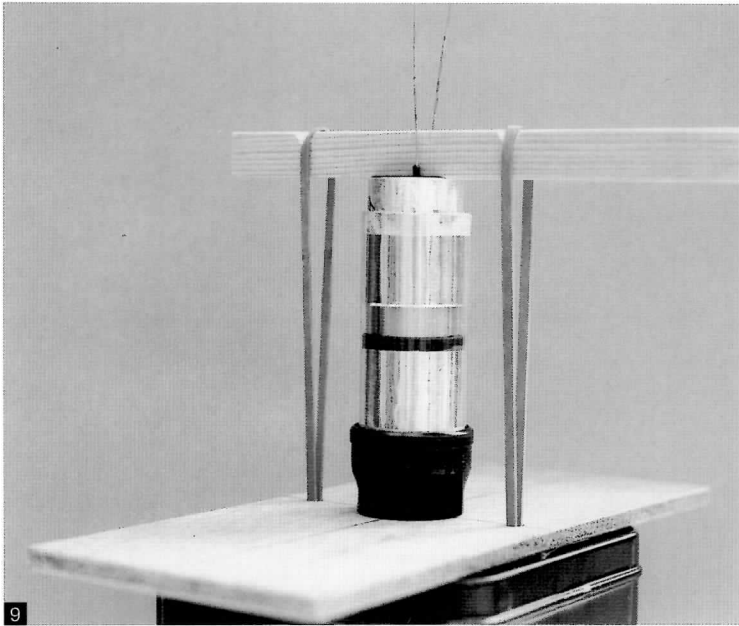

**Acknowledgements**

My grateful thanks go to:

Adrian Cossor (a member of the Cossor family), Richard Trim, OBE (former Technical Director of Cossor Electronics Ltd.) and Rod Burman (Valve expert and BVWS member) who all played a part in helping me to track down a working Cossor SG210 valve.

Dr Graham Winbolt (a major contributor to the Bletchley Park Museum collection) who provided me with the Cossor SG210.

Keith Thrower, OBE (Author, Valve expert and BVWS member) for sharing his experience and knowledge with me and giving permission for the photograph in figure 1 to be reproduced for this article.

Philip Taylor (Valve collector & specialist and BVWS member) for his practical advice and for providing me with a working Osram S625 valve.

Pat Hill (BVWS member) who has provided me with many copies of publications and articles including 3 from The Wireless Constructor on double-ended SGs in late 1927.

And lastly but by no means least

Gerry Wells (Proprietor of The Vintage Wireless Museum at West Dulwich) for his encouragement, guidance and help.

4 All figures measured except Cag, which is from manufacturers data.

The figures in this table would appear to confirm the suitability of these substitutes.

**So Does It Work?**

Well – yes. When you put it in a set and switch on you get stable HF amplification, with about the same amount of gain that you'd expect from a double-ended screened grid valve. The set works normally.

Yes of course it works, the science tells us it must work. However on a personal level I must confess to feeling a slight sense of amazement, because when you lay a DF91 alongside an S625 they are not the same kind of thing at all. They are different types of valve, designed for different purposes and separated by two decades of technological development. However it works.

Well I've said enough, apart from the important task of thanking the people who helped me with this and related projects.

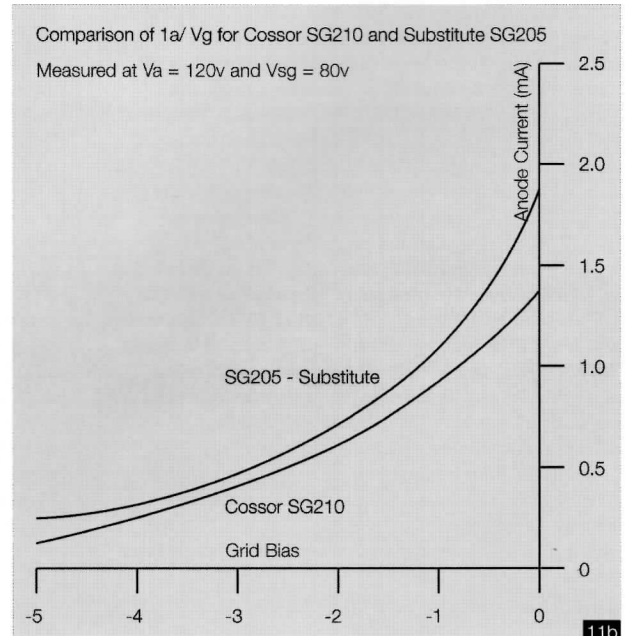
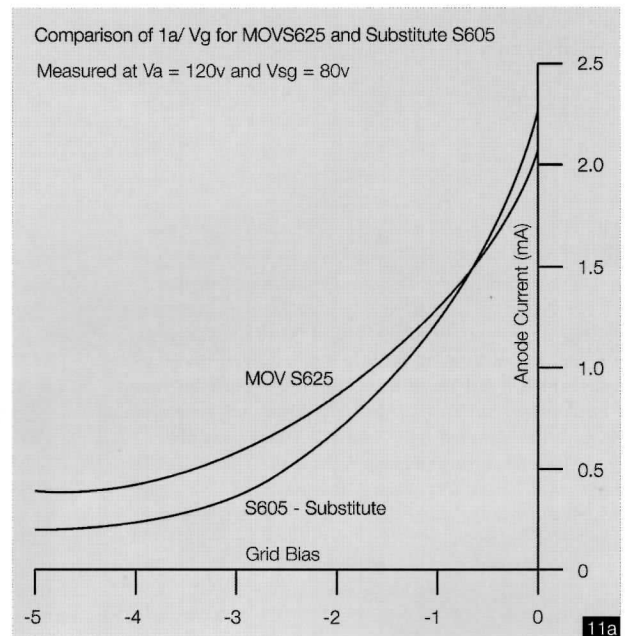
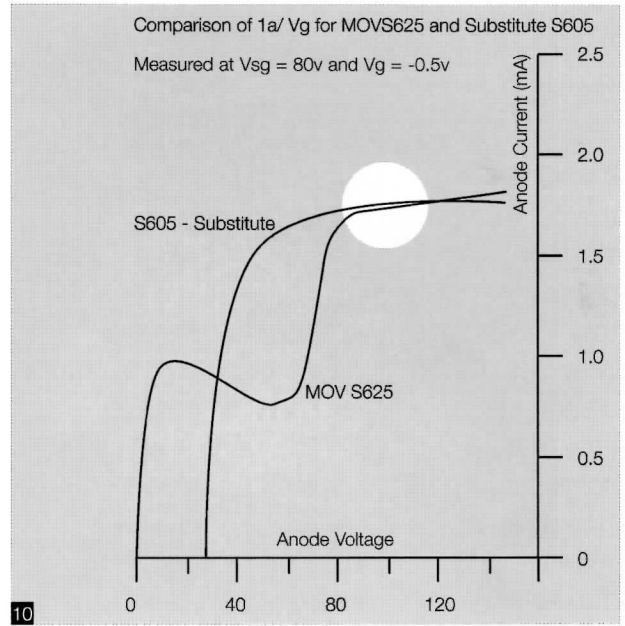

# Puppy Training

John Holloway and Bill Milne

It was late summer and I was sitting in the conservatory of a friend's house sipping a gin and tonic and looking out at his immaculate garden thinking that I wished mine looked as good, when he suddenly said. "Hey I was clearing out one of the sheds" (one of the sheds you note) and I came across something I picked up months ago at an auction."

He went off to bring back this item, during which time his wife glanced at me with a look of relief tinged with guilt when he re-appeared carrying what even a dealer would balk at calling a 'distressed' looking set.

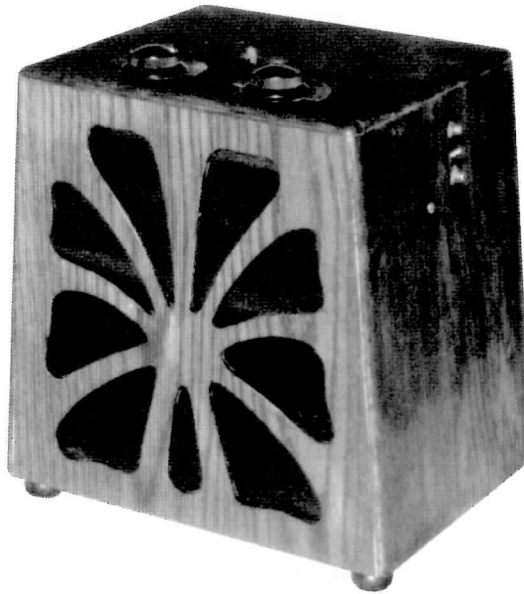

The oak veneer was lifting off the speaker fret, the back was missing and there were various insects alive and dead inhabiting the innards. However, all the knobs were still in place, the celluloid protractor style dials were intact and most of the identifying tags on the fast decomposing battery leads had survived along with some, if not all, of the plugs and spade terminals. I could see a paxolin chassis complete with 2 valves though the speaker was missing. There were the remnants of an original paper label still glued to the base which bore the legend 'Brandes Ltd.' beneath which the words 'supplied by' and 'to be removed' were all that remained.

Now, my own interest is in more modern sets and, due to the ever-pressing problems of space, sets which are practical to use and fit in the overall décor of the room where they are displayed. The KB Pup, for that is what I had been so kindly presented with, fitted none of these categories. It came from an era in which I was not personally interested, design-wise it did little for me, it required a large quantity of batteries and more importantly it relied on reactive tuning, not something to endear one to the neighbours let alone make it easy to operate by the rest of the household. Within reason, my small collection has to earn its keep!

As I drove home the first thought that occurred was why couldn't it have been a Zenith 600 series in immaculate condition, the property of a retired US army Colonel who had retired to the South Coast! But, as I mulled over the prospect I had worked up enough enthusiasm to go and talk to another BVWS member and friend, Bill Milne who runs 'Bill's Vintage Wireless Services' and is a valuable source of expertise, components and vintage sets themselves. He pointed out that, as we had both recently purchased rechargeable 2-volt accumulators for another joint project, we were part-way to providing the motive power. He would make up one of his reproduction Grid Bias Batteries, the HT was plain sailing and having checked out the circuit we'd fire the thing up and see what happened. It was decided that I'd dismantle the set and start work on the cabinet and he'd have a look at the so-called 'chassis' once I'd cleaned it up.

Taking care not to let the set come into contact with other furniture in the house in case of woodworm I started by removing the knob and socket panels and then the chassis itself. There are two engraved, protractor style dials that are pinned directly to the top of the cabinet. Over the years, some 71 years to be exact, dust, polish and the sweat from all those sticky fingers had combined to obscure most of the simple detail on them.

The various aerial sockets and connectors were marked by very faded white lettering on what appeared to be a matt black paint panel adjacent to the two cut outs which exposed the sockets. I suspected that these were transfers which I could see that any restoration or re-polishing would immediately obliterate. Perhaps unwisely, I decided that I would solve that problem later.

Having removed the chassis, I set about cleaning up the chassis prior to giving it to Bill. The debris of the last 70 years was dusted and blown away to reveal the few components, which made up the circuit still in place and, with the exception of the variable condensers, in visually good condition. The chassis wiring was still intact and apparently serviceable, the insulation being cotton based. The valve filaments were ok and there was a reading across the inter-valve transformer. The tuning condensers were somewhat the worse for wear, as the brass rivets and spacers which secured the vanes were long gone. The battery connecting leads had lost well over 80% of their insulation though most of the plugs were still attached. All this was boxed up ready for Bill to look at properly and I turned my attention to the woodwork.

There is no way the Pup could be called anything other than a utility model; the circuitry appears to be identical to the earlier KB Kitten which was given away with cigarette coupons but repackaged in a very simple wood cabinet which I gather came in two models either squared off or in a slightly tapered form (RR fig 341). This latter style was the version I now had on the workbench in front of me. Having carefully removed the rusted fixing pins that held them I removed, and gently cleaned in soapy water, the celluloid dials putting them

As I drove home the first thought that occurred was why couldn't it have been a Zenith 600 series in immaculate condition.....

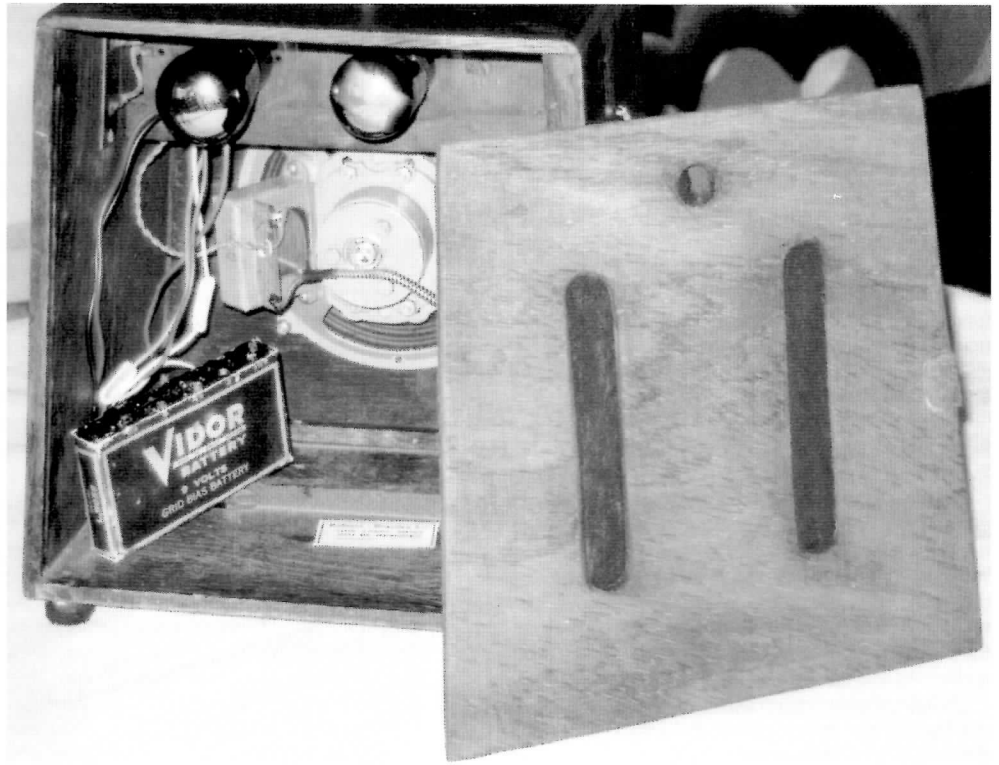

Opposite page: The restored KB Pup.

Above: Side detail of Pup.

Top right: Inside the Pup.

Below: My rough circuit diagram.

to one side for refurbishment at a later date.

The finish of the top, sides and bottom of the cabinet indicated a very low level of polish. The wood was dark oak, not veneered. The fret which as already said was splitting asunder was ply with a facing of oak veneer. It appeared that this panel also acted as a baffle as there was no sign of any other fixings on which to mount the speaker. As one would expect there was a central hole for the speaker adjuster.

Having removed the fretted panel I could now see that apart from the oak veneer the rest of the panel while flimsy could, with the addition of a new veneer, be retained providing a separate baffle was put in behind it. Some oak veneer was found through a friend in the bespoke furniture business and I glued and clamped it over the panel. Once firmly in place, cut out the pattern using the panel as a guide. I did

think of tracing out the pattern on the veneer; however, I felt my skills and my luck might not be up to the task.

I then cleaned the remainder of the cabinet using my own special mixture which removes the dirt but does not touch the polish. I need not have worried about polish as the finish was almost matt and I suspect the housewife of the 1930s used what used to be called elbow grease and polish, a combination which, as far as I can see, is not now available! I started rubbing in a coat of scratch remover each day for a week polishing off the previous day's before applying the new coat.

I then turned to the new veneer which was quite pale. I stained some off-cuts with a couple of coats of various colours of water based wood stain; oak, dark mahogany, and cherry. I then applied a couple of coats

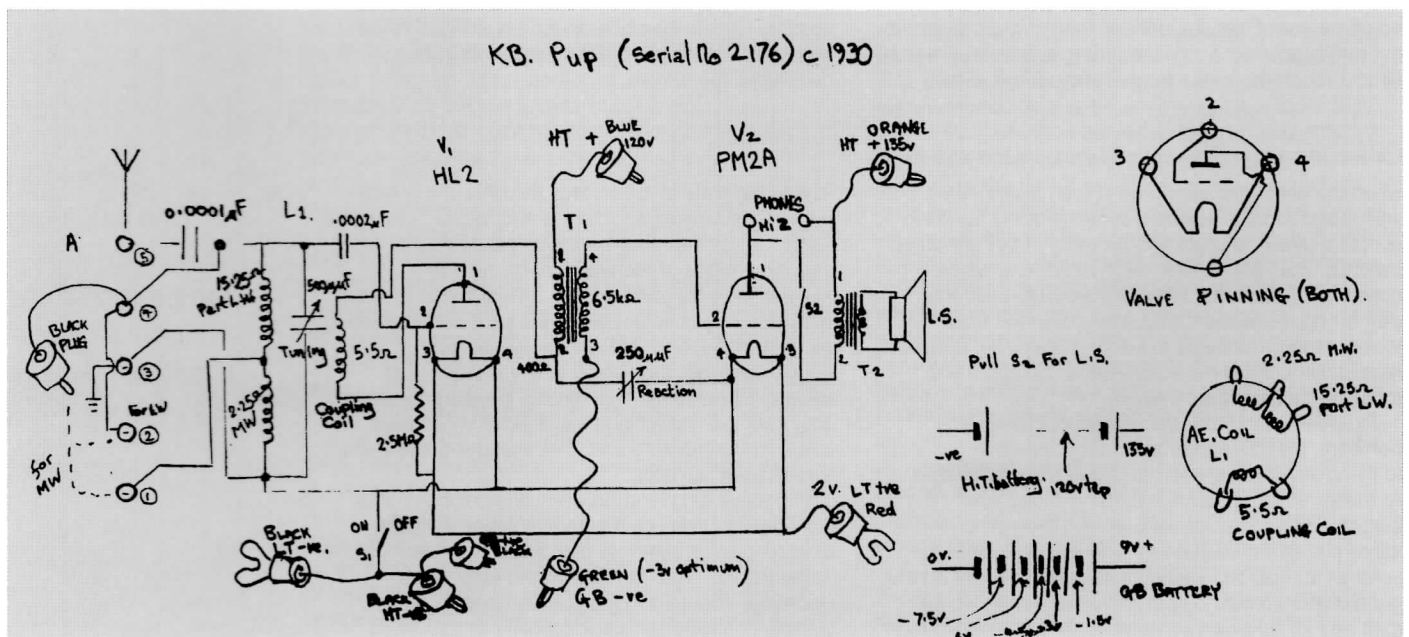



of scratch remover and compared them with the main cabinet and discovered that the best match was that using the mahogany. I then applied more scratch remover until I felt that the match was near perfect. For good measure I asked a friend who had not seen any of this before to compare the two pieces. The next trick was to cut out the fret, stain the panel and re-fix it in the cabinet.

In the meantime Bill had started work on the chassis.

I had already drawn out a rough circuit, inaccurately as it turned out, and replaced the battery lead with some modern plastic-covered cable just to get rid of the fraying and dangerous originals. We had tried to get hold of a circuit diagram but without success and, on a visit to Gerry Wells, discovered his own antipathy towards the Pup!

The valves were identified as RF: HL2 2v 0.1A filament, 120v @ 4.5 mA anode current and AF: PM2A 2volts 0.2A filament, 135volts @ 5mA anode current.

Having redrawn the circuit diagram the battery connections were rewired correctly using a slightly heavier cable and according to a 1930s colour code list. The variable condensers were refurbished and their capacities checked. Tuning was 12 to 500pF and reaction, 12 to 250pF. Though of primitive construction they were in fact working fairly well. They relied on friction for the earthy vanes return.

Measurements were made of coil and winding resistances and these were transferred to the circuit drawing. During this phase a weak tag on the intervalve transformer was strengthened. The initial cleaning had included cleaning up most of the metalwork on the chassis and, based on previous experience, the riveted elbow on the on-off switch was bridged with a short coil of wire, hairspring fashion, on either side of the rivet to ensure reliability in the future.

It was then time to power up. Signals were produced but band changing seemed to indicate the need to change aerial and earth around. Well, pride comes before a fall and a frightening error had been drawn on the diagram, which was being religiously followed. A quick chat with Gerry Wells exposed the problem. Suitably humbled by the fact that the fault was on the diagram, the connections were changed and after selecting best performance valves from stock the set gave good tone and volume from a short aerial and rather inefficient earth, using a spare battery pack that was subsequently discovered to be providing 30volts less than the maximum!

The original moving iron or rocking armature speaker was missing so another speaker was found with a conveniently high resistance primary transformer bolted to it. A baffle was made which could be eased into the cabinet behind the fret with a cut out to accommodate the tuning condensers which almost touch the inside front of the cabinet. Small

pieces of wood were glued to the inside top of the cabinet, effectively acting as clamps for the baffle. The bottom of the baffle was fitted with a rail which was drilled to allow short wood screws to fix in to the bottom of the cabinet. By making the baffle slightly smaller than the inside dimensions it could be shuffled into space. Two strips of card provided a little packing which applied pressure and held the baffle firmly in place. These and the baffle itself were then darkened by the same method used on the exterior of the cabinet. When finally in place, the baffle was what would be termed a 'good fit'. A black grille cloth was stapled to the front of the baffle taking care to hide the staples behind the fret. In fact, even these staples were blacked-out using a felt tipped marker. As the original type of speaker was not replaced the centre hole for the adjuster was left covered by the new veneer. Should a suitable moving iron speaker become available the hole can be exposed.

The set was now more or less complete. All that was needed now was the manufacture of a new back panel and a means of replacing the transfers that had been obliterated by cleaning and polishing the cabinet. The back panel was easy, a piece of thin ply suitably stained to match, and with a couple of slots and a finger hole to make removal easy, was cut out and material glued over the openings.

It will be remembered that there was the remnant of an original manufacturers label stuck to the bottom of the cabinet. Although this had to be carefully removed and placed in an envelope for safe keeping at the start of the restoration, it had crumbled still further. A friend who is a graphic artist scanned the flimsy remains and then using computer software constructed a font to match 'Kolster - Brandes' and the other typeface, and a calculated guess was made on what the missing words were. Various versions were printed adding background colour to aid ageing. A final selection was made and then stained with cold tea and finally fixed in its original position.

We worried long and hard over the transfers. We had noted what was left of the originals before cleaning but how to apply replacements? Letraset would not adhere and any printed label would sit proud of the surface and eventually peel off. Bill remembered some old 1960 dry paint transfers that he'd picked up years ago. We again tried to stick these direct to the wood but again the old problem of adhesion beat us. We then had a brainwave and tried Scotch Magic Tape. Knowing my limitations I took an executive decision and delegated the task to him. My confidence was well placed as the next time we met a few days later the set was standing on the table complete with its transfers looking almost as good as new. The addition of a working reproduction Vidor grid bias battery, one of Bill's many specialities, completed the picture.

We had tried to get hold of a circuit diagram but without success and, on a visit to Gerry Wells, discovered his own antipathy towards the Pup!

---

Lash-up TV saved wartime Leningrad continued from page 17

when the usual picture on the screen disappeared and was replaced by a newsreel showing tanks trundling across a desert and soldiers jumping out of armoured vehicles. This, it was later discovered, was an early case of long-distance television reception. On that day, an experimental transmitter in London was broadcasting newsreels to London hospitals. Quite by hazard, its technical characteristics coincided with those of the Leningrad system.

To speed still further the interception of enemy bombers, a system for transmitting television pictures to flying aircraft was soon built and put into operation. At the air defence centre a plotting-board was installed with a map of the Leningrad region on it and numerous reference points marked on the map. As soon as an operator detected incoming aircraft on the radiolocator screen, he put miniature planes on the map and jotted down commands for the fighter pilot.

Above the plotting-board was installed a television camera to transmit a picture of it to a patrolling Yak-9 fighter aircraft. A small television set had been fitted into the cockpit of the plane, although a few navigation instruments had to be sacrificed to make room for it. On the test flight, the pilot was impressed by the performance of the new system but complained that the screen was too bright and blinded him at night. Technicians covered the screen with coloured cellophane salvaged from a ruined confectionery factory and, they reckoned, the system was virtually perfect.

The siege of Leningrad - nowadays renamed St Petersburg - lasted three horrific years. A million citizens died of cold and starvation, but Hitler's bid to "wipe the city from the face of the earth" was decisively defeated - by a lashed-up emergency system of television radiolocation.

# My friend Harry

by Bill Smith

It must have been in the late fifties or perhaps the early sixties when I first made Harry's acquaintance.

Due in the main to the lack of suitably qualified engineers, work was proving to be rather hectic at this time. It became increasingly obvious to my wife and I that I was getting too involved with my occupation and that most of my waking hours were spent at my place of employment... In fact 'Jack was becoming a very dull boy!' In an effort to rectify matters I decided to take up a hobby and I duly enrolled at the evening classes which were held at the local Academy. As I had always shown an interest in drawing at school, I finally registered for the Art course, and was introduced to my teacher.

Harry and I hit it off right away especially when we discovered that we both had radio interests. He had been a wireless operator on Lancaster bombers during the recent war and still retained a strong attachment to his former calling.

In a moment of nostalgia he had purchased an ex-government surplus R1155 aircraft receiver but had not realised that a power pack and OP stage were required before he could use it on the main supply. Not being very 'Hands on', except in a wireless operator capacity, he was at a loss as to how to resolve his problem. Being ever helpful I rashly offered my assistance and subsequently uplifted the extremely heavy piece of equipment from Harry's abode. As I gazed at the R1155 in my workshop I thought, "What have I let myself in for... will I never learn!"

As luck would have it, there happened to be a series running in Practical Wireless at the time on the R1155 and its conversions, and better still there were firms who supplied kits for the construction of a mains supply and OP stage, so I sent for a set of parts.

On looking back now I realise that 'time' was something that didn't really come into the equation in those early days and that I must have spent countless hours in the construction of Harry's Power supply/amp. Time later took on an entirely different meaning when everyone became obsessed with 'Time and motion studies' and the insidious 'Time sheet' became the norm!

However in this instance it was all in a good cause and I eventually finished the project and delivered it to Harry who lived in a bottom flat of a council house. His wife had died several years before, so as you can well imagine, his flat had become very much 'a bachelor's pad!'

But as Harry did not possess a workshop or shed and the apparatus was not what would be considered suitable for a living room, the problem was ... where to

put the R1155? Well it so happened that there was a shelved cupboard with a door (better known as a 'press' in this part of the world!) situated between the fireplace and the window. This proved to be an ideal situation with the added advantage that when the set was not in use the door could be closed, leaving the room looking reasonably tidy.

I got to know Harry very well over the next few months and considered him to be a good friend. He was tall in stature and quiet by nature and I would guess that he would have been four or five years my senior. The thing that impressed me most about him was his serenity... nothing seemed to upset him. My belief was that having survived all those bombing raids that he had experienced, life as such was a bonus and meant to be enjoyed to the full. Not that Harry would talk much about his experiences (rather the reverse in fact), but occasionally he would let his guard slip and I would be graphically transported on his trips in R for Robert. I would experience the churning in the stomach as we took off on our mission and the great relief on returning safely. And then the euphoria would vanish rapidly when it was realised that the sequence of events was to be repeated over and over again... if one was lucky, that was!

As a friend and being in the trade, I was now naturally expected to repair the television set which sat in the opposite corner of the fireplace. The TV was a Masteradio, one of those insignificant marques... a non-agency product which was normally stocked by lesser-known wholesalers. They could also be obtained quite cheaply and indeed they looked it! They were badly designed and for one reason or another they seemed to require frequent CRT replacement. I finally influenced Harry to invest in a decent TV and he settled on one of our Ekco consolettes with VHF radio. The set also had a spot wobble facility whereby, by elongating the spot, the prominent 405-line structure could be somewhat diminished. The picture did in fact appear less lined but to my mind the resultant image seemed to be very blurred.

Harry's old Dansette record player had long since given up the ghost and had consequently been thrown out. Being desirous of playing his considerable collection of records Harry somehow managed to acquire a BSR record changer (New and Boxed as the salesman put it!), and I was called upon yet again to wave my magic wand!

On looking at Harry's cupboard I realised that by discarding the door, taking out two of the middle shelves and fitting the record changer on the one which was at waist level I need not get involved with complex joinery issues. My joinery skills were of a rather basic nature and in fact I did not have access to the required tools. I did however possess a tool known as a Blosta saw which proved to be very useful indeed and was exactly what I required at this moment. Consequently I got stuck in, fitted the template provided, cut out the aperture, and dropped the changer in. I must admit it looked well and even more so after a diffused tubular light was fitted above to illuminate the area, and Harry had tastefully redecorated the cupboard interior.

The 'Blosta' saw was of German origin and I found it

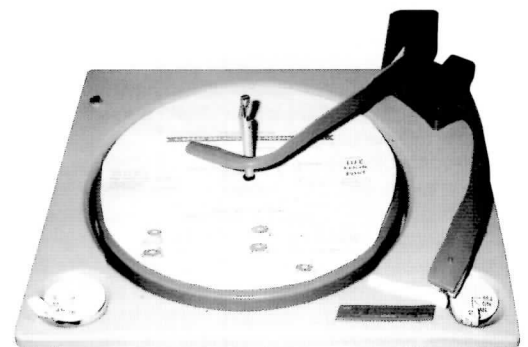
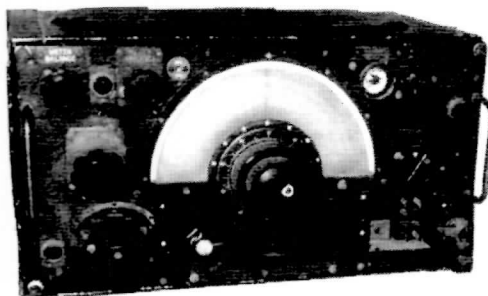
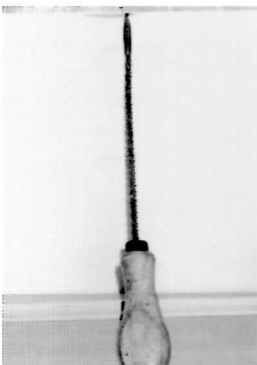

to be an extremely versatile tool. It was particularly useful in the cutting of motor boards to receive record changers. After marking out the template it was just a matter of boring a hole through the wood until the serrated saw part was reached and then one sawed around the mark until the required hole was achieved. I always thought that the tool had potential and I was greatly heartened recently to find that the idea has now been taken up again and drills can be obtained and used on power appliances!

The question of a suitable amplifier had now to be addressed and after toying with the idea of utilising the R1155 I decided to leave well alone and cast around for another solution.

Nowadays the answer would have been to simply pop into the nearest radio store and purchase a cheap little amplifier but in the 60's one had no recourse but to build it oneself. In those days of valve technology the best one could achieve was 10 watts by the use of push-pull circuitry, but there were many single ended designs around, which delivered outputs of up to 5 watts. I had just constructed one such amp. for use in our record department and my thoughts naturally wandered in that direction. The amplifier was of 5 watts output and consisted of a general-purpose triode 6J5 feeding into a pentode 6F6, the rectifier being a 6X5. The OP and quality were of a very high order and I was well pleased with the results. An unusual feature of the amplifier was the application of a controlled negative feedback loop.

Speaking of wattage, the sound achieved from a 10 watt valve amplifier was really something and it beats me as to how these transistor manufacturers can substantiate their claims of 60 watts per channel particularly when some of the loud speakers employed in their products are all of 3" diameter!

While I was debating building and housing an amp and contemplating my limitations as a joiner my reverie was interrupted by Harry who said, "Could you not attach it to the TV?" "Nonsense" I retorted, dismissing his over-simplistic remark out of hand. However it later suddenly dawned on me that given the fact that the Ekco was provided with a VHF radio section and that the CRT and the majority of the valves were shut off while on that mode, Harry's suggestion might well have potential. On further perusal of the circuit diagram, it indeed showed that by the judicious application of a SPDT toggle switch and a PU socket, the modification could be made with minimal disruption. I immediately carried out the task and it worked like a charm; the power from the 30PL1 Triode/ Pentode valve being perfectly adequate and the large speaker in the console cabinet supplying good bass response.

My main problem now was the one of safety as the TV chassis was live. I tried isolating the PU by fitting capacitors in series but this only resulted in introducing hum. In the end I settled for fitting plastic-coated screened leads and made sure that there could be no access to the live chassis.

I was later to carry out several similar such modifications by request but I often wondered what Messrs Ekco's reactions would have been! Actually I believe that they introduced a model with a similar set-up but I can't remember handling one.

The toggle switch was inserted between points SW1B and C59.

As time progressed Harry started complaining about severe bouts of pain he was experiencing and was admitted to hospital where he was found to have gallstones. After an operation and while convalescing, I discovered that the sly old beggar had formed an attachment with his nurse, and soon it developed into a full-blown romance! He and Ruth married after a short courtship, and as they say, lived happily ever after.

Ruth was not a particularly bossy person but like all of her gender she knew just what she wanted and went quietly about ringing the changes. Harry was first to receive 'the treatment', and gone now was the

Bohemian appearance expected of an Art teacher and in its place was substituted a smart dapper persona... in fact a new Harry! Harry, I may say, took it all in good part and I suspect that he rather enjoyed all the mothering.

As you will have expected, our modifications to the cupboard by the fireplace were not very well received and all that lot had to go, to be replaced with an alcove displaying an array of china ornaments. This was very much the era of the radiogram so one was subsequently purchased. The model chosen was a 'Roberne' ... I know because I advised them to buy it! "Roberne!" I hear you expostulate!... "Never heard of them!" Well, you could be forgiven for saying so as I believe that this was, to my knowledge, their one and only venture into the radio trade. The model was well received by the public and we sold loads of them. It was a very attractive radiogram with a well polished wooden cabinet, large speaker, and what was unusual for that period... push-pull output!

It may have been that the company thought that by launching a good quality, competitively priced product on to an eager market they would gain a foothold there. Unfortunately however their efforts seem to have been of no avail, and the name Roberne disappeared. A great pity nevertheless, as although not to be considered top of the range they were very good value and I quite liked them.

Many years have gone by since Ruth and Harry passed away but I'm sure that Harry would have been delighted to be remembered in the pages of the country's favourite radio magazine.

As to my foray into the world of art... my wife proved to be greatly enthusiastic over my minor masterpieces, which are on display on every conceivable space available. Since I retired some ten years or so ago I have taken up writing as a hobby and have rather neglected my painting. I think that I shall take it up again and make a departure from my usual Seascapes and Landscapes. Instead I fancy doing some of the aircraft of my era or perhaps one of an Air Sea Rescue launch on its way to pick up some airman who had to bail out from his plane. By way of interest, I am reliably informed that Messrs Ekco did actually produce a model (The Phonovision?) with record player on top. This is the model which I made mention of earlier which had VHF radio and record player installed.

Question is... did I beat them to it?

My main problem now was the one of safety as the TV chassis was live. I tried isolating the PU by fitting capacitors in series but this only resulted in introducing hum. In the end I settled for fitting plastic-coated screened leads and made sure that there could be no access to the live chassis.

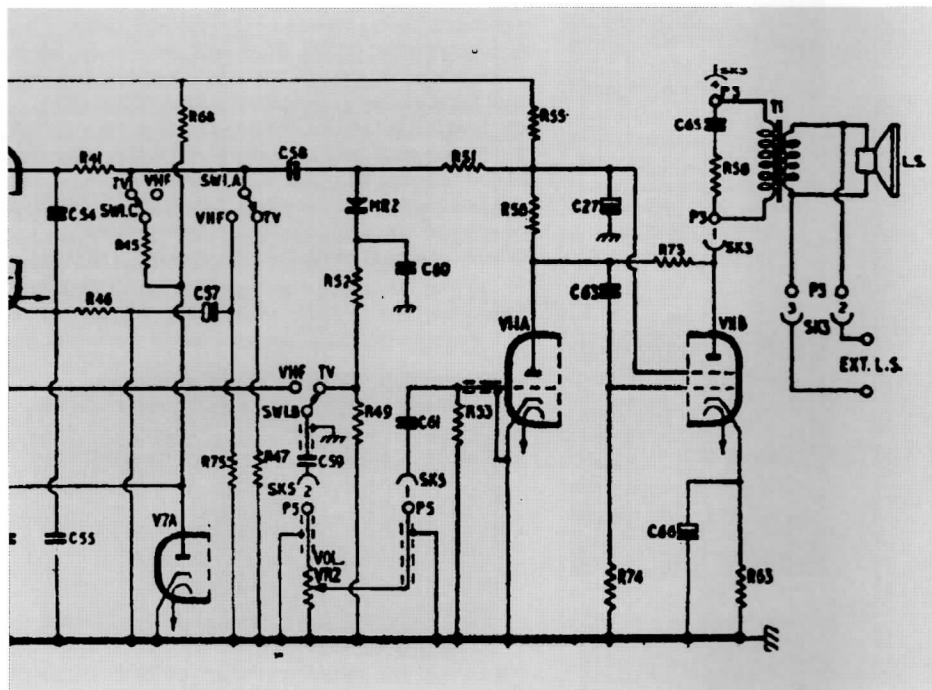



# From Crystal sets to 405 line televisions

Part one in a series of articles by C. S. Garnett

## Introduction

In recent years there has been an increased interest in the old wireless and television receivers that were prevalent in the 1930s, 40s and 50s. Many people now collect such sets. Unfortunately mainstream electronics servicing organisations often seem very reluctant to take on the repair of them. There are specialist companies that undertake such work, but inevitably a fairly heavy fee is charged that may be beyond the pocket of some collectors. It seems a shame that failed radios and televisions should merely remain ornaments. What is required is a way of teaching the collector some basic electronics knowledge. This series of articles tries to do just that. It is aimed primarily at the non-technical collector and hopefully will help them to understand how their sets work and encourage them to "have a go" at mending faulty sets within their collection. The articles assumes no former knowledge of electronics, either of the valve era or of modern micro-electronics. It is necessary to cover a certain amount of basic theory but this has been kept to a minimum and is non-mathematical in nature. If chapter 1 is skipped, the series will also be of interest to the younger electronics technician who has limited knowledge of valves. The text relies heavily on diagrams throughout and wherever possible gives the circuit diagram of a practical application of the topic under discussion.

This series covers the early days of radio up to the introduction of the 405-line television system, broadly up to 1955. I have therefore not included the PAL colour system, F.M radio, or solid-state electronics beyond a reference to germanium diodes, which were beginning to find their way into domestic electronics by the 1950s. I discriminate against the later technology only because I need to limit the scope of the text somehow. Personally I find some of the later technology fascinating, especially the first colour televisions; in particular the "hybrid" sets with their rich mixture of valve and transistor circuitry.

The series is divided into a 3 major sections.

Part A takes the reader through basic electronics theory, and then applies the theory to practical radio circuits. Part B deals with repairing old valve radio receivers, including a section covering safety considerations. Part C deals with 405-line television receivers; first the theory of operation is covered, then practical applications. Part C ends with a section on faultfinding. Repetition between the radio and television faultfinding sections has been kept to a minimum; the television section assumes that the radio faultfinding section has been read first.

The articles do not deal with non-technical topics such as case repairs and how to find sets to restore. Several texts cover such information; I would recommend in particular *Electronic Classics* by Andrew Emmerson.

Although much of this series of articles is applicable to foreign readers, the text is written assuming a British readership. Therefore please take account of the fact that mains voltage is assumed to be nominally 230V

volts as defined for the domestic environment. The following terms differ between British and American

English:- <b>American</b>	<b>British</b>
Plate	Anode
Ground	Earth
B+	HT
Line	Mains
Tube	Valve
Rosin	Resin

Every care has been taken in writing these articles, but with the best will in the world errors and omissions do occur. The author can take no responsibility for damage or injury to persons or property resulting from any information contained in these articles. However, any suggestions on how this series can be improved will be gratefully received by the author. Copyright © 2002 Chris Garnett

## Chapter 1: Passive Components

A domestic valve radio receiver is made up from several types of components linked together. These components are called: -

- i. Capacitors (or condensers)
- ii. Inductors (or chokes)
- iii. Resistors
- iv. Transformers
- v. Valves

Also you may occasionally come across semiconductor diodes, plate rectifiers and crystals. This chapter will deal mainly with the so-called "passive" components, that is resistors, capacitors, transformers and inductors. First I will define a few terms used: -

### Conductor

A conductor is a substance commonly a metal that allows the passage of electricity.

### Current

Current is a stream of negative electrons flowing in a conductor; it is measured in Amperes (Amps).

### AC

AC stands for Alternating Current. It is a current that alternates its direction of flow; however it is not necessarily always in the form of the sine wave as shown in Figure 1a. A.C can be any waveform as long as it flows first in one direction and then another.

### D.C

D.C stands for Direct Current; it is a current that flows in only one direction.

### Ohm

The ohm is the unit of electrical resistance (this is explained more fully later in the text).

### Wavelength

The wavelength of a repetitive signal is the distance between any point on a cycle and that same point on the next cycle; see Figure 1a

### Frequency

The frequency is the number of times a repetitive signal repeats itself in a second. Frequency is

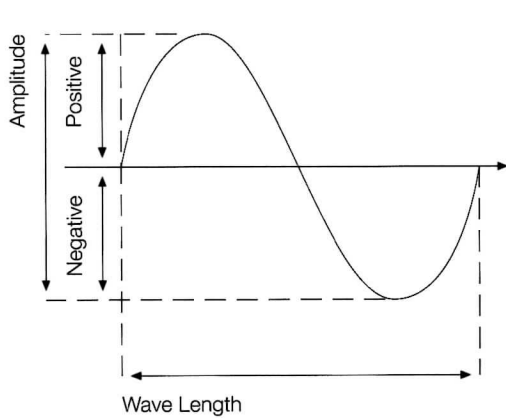

Fig 1a: The Sine Wave

measured in Hertz, although old literature used the (more intuitive) cycles/second.

### Resistors

Note: The suffix "K" relates to one thousand e.g. a 1 K resistor is one of 1000 ohms. Other suffixes used include M, Mega, m, milli. The abbreviations are used to simplify notation. The following section uses some of these suffixes.

A resistor is usually a two terminal device; Figure 1b shows the symbolic representation of a resistor as it is found in old literature. Some modern diagrams use a simple rectangular box to represent resistors. The purpose of a resistor is to resist the flow of current. Resistors are measured in units called ohms; they come in different values ranging from a fraction of an ohm to several million ohms. The sign representing ohms is  $\Omega$ . For simplicity it will be omitted from this text. Other parameters that resistors have are: -

- i. Their ability to dissipate power (measured in Watts).
- ii. Their ability to withstand a voltage placed across them.

### Current, Voltage and Resistance

As mentioned, resistors resist the passage of current; the level of the resistance is dependent upon the value of the resistor. The higher the resistance (in ohms), the more the current is resisted. When a resistor resists a current, it develops a voltage across its terminals. The current through a resistor, voltage across a resistor and the value of the resistor (in ohms) are all linked by a relationship known as Ohms Law, the following equation (assuming a steady current (DC)).

$$\text{Voltage} = \text{Current} \times \text{Resistance}$$

This says that the voltage across a resistor is equal to the value of the resistor multiplied by the current flowing through it (in Amps). Rearranging the formula: -

$$\text{Resistance} = \text{Voltage} / \text{Current}$$

This says that the resistance of an unknown resistor is found by dividing the voltage across it by the current flowing through it.

$$\text{Current} = \text{Voltage} / \text{Resistance}$$

This says that the current flowing through a

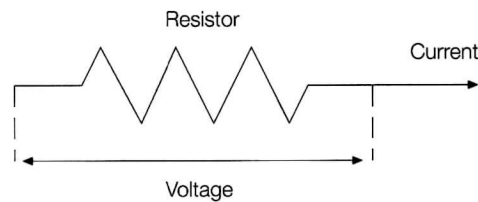

Fig 1b: The Resistor

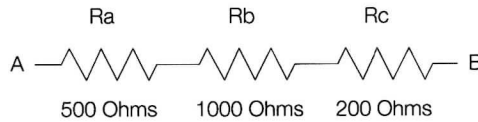

Fig 1c: Series Resistor

resistor is found by dividing the voltage across it by the value of the resistor (in Ohms).

### Power In a Resistive Circuit

As current is resisted, power is "lost" from the circuit; this energy is dissipated as heat by the resistor. The power (measured in Watts) dissipated by a resistor in a DC circuit is given by the equations: -

1.  $W = I^2 \times V$
2.  $W = (I^2) \times R$

Where: W Is Power in Watts  
I Is Current in Amps  
R Is Resistance in Ohms

The "\*" is simply a multiplication sign, it makes equations less ambiguous than the traditional  $\times$

It is important that the resistor is able to withstand the power that it is expected to dissipate in the circuit. A resistor will be destroyed if its temperature is allowed to rise too high. Resistors that are manufactured to deal with higher power dissipation are called "wire wound" types, they consist of resistive wire wound around a heatproof insulator. Resistors not required to dissipate much power were (are) often manufactured from carbon rods.

### Resistors in series and parallel (combining resistor values)

Often it is necessary to know how to combine one or more resistors to give a certain specific value of resistance. When you are measuring resistors "in circuit" the value of resistor combinations needs to be known; this is fully explained in a later article. If resistors are placed in series, the total resistance is simply the sum of the values (in ohms).

In Figure 1c, the resistance between point A and B is given by  $R_a + R_b + R_c$ . For the values given this is  $500 + 1000 + 200 = 1700$  (or 1.7 K Ohms).

For resistors in parallel, one over the sum of one over the values gives the total resistance. In Fig 1d the total resistance for the values given between points A and B is equal to: -

$$\begin{aligned} & 1 / (1/R_a + 1/R_b + 1/R_c) \\ & = 1 / (0.002 + 0.001 + 0.005) \\ & = 1 / 0.008 \\ & = 125 \text{ ohms} \end{aligned}$$

If only two resistors are in parallel then the

shorter formula can be used.

$$R_{\text{total}} = (R_a \times R_b) / (R_a + R_b).$$

Assuming  $R_a = 200$  ohms and  $R_b = 300$  ohms then the combination in parallel is: -

$$\begin{aligned} & = (200 \times 300) / (200 + 300) \\ & = 60,000 / 500 \\ & = 120 \text{ ohms} \end{aligned}$$

### Variable Resistors And Potentiometers

A variable resistor is simply a resistor that is variable! There are two types commonly found. The first type is buried inside receivers and requires adjustment at the time of manufacture or to compensate for components ageing (or when original components fail and are replaced with new ones that have slightly different characteristics to the originals). These "pre-set variables" are generally adjusted with a small screwdriver or special adjusting tool. The second type of potentiometer has a long spindle that protrudes through the side of the set enabling user adjustment; these are typically used as volume and tone controls. The circuit sign for a variable resistor is an ordinary resistor with a line through it, if it represents a preset, the line is terminated with a bar, and if it represents a user control the line is terminated with an arrow. The term "Rheostat" is sometimes used for variable resistors and potentiometers in old literature.

Turning to potentiometers, these are a variety of variable resistor. They have three terminals; two of these maintain a fixed resistance, and the third can be adjusted between the two fixed ones. The nearer this third terminal (or wiper) gets to one of the fixed terminals; the further it gets from the other. The resistance between the wiper and an end terminal is proportional to the distance it is from that terminal. A potentiometer is depicted in Figure 1e.

The resistance between terminals A and B is fixed, but the resistance between C and the fixed terminals (A and B) is variable. The resistance between A and C plus C and B must always equal the resistance between A and B. Figure 1f shows the equivalent circuit diagram of the potentiometer in terms of fixed resistors. Looking at figure 1f, if a voltage is placed across terminals A and B then the voltage at the wiper (C) will be equal to the ratio of the resistances.

Figure 1f shows a 12-ohm potentiometer,

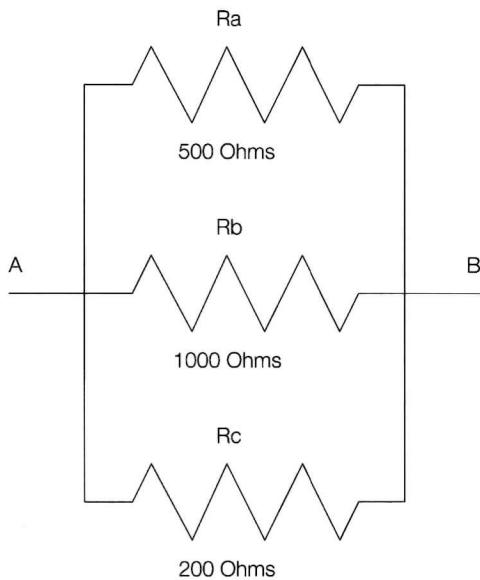

Fig 1d: Series Resistor

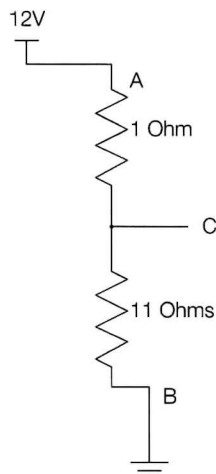

Fig 1f: The Potentiometer represents

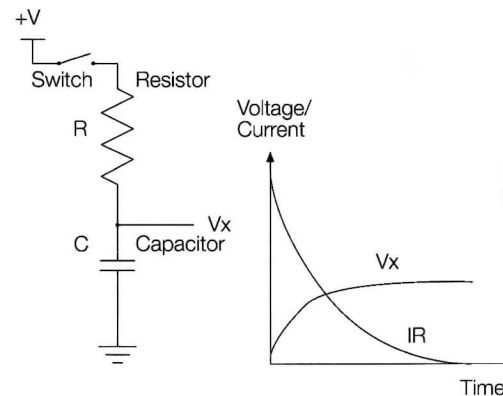

Fig 1g: Charging Capacitor

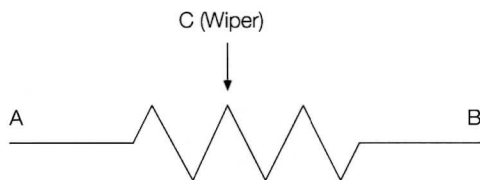

Fig 1e: The Potentiometer

the value of a potentiometer is always given as that of its fixed value measured between A-B. In our example 12 volts is applied across fixed terminals A and B. The symbol attached to the bottom of the 11 ohm resistor denotes "earth". With the values shown, a current of 1 Amp will flow through the potentiometer (current =  $V/R$ ). Assuming Figure 1f represents a linear law potentiometer (more on this later), then if the wiper (terminal C) of the potentiometer is 1/12 of its travel from terminal A, it has to be 11/12 of the way towards terminal B. The resistance between A and C is 1 ohm and between B and C it is 11 ohms ( $11 + 1 = 12$ ). The ratio of the resistances is 1:11, therefore 1 volt will be "dropped" across the terminals A and C, 11 volts will be dropped across terminals B and C. The voltage on the wiper (point C) will be 11 volts (with respect to B which is at earth potential).

Potentiometers are generally either made from a carbon track (which the wiper travels along) or they are constructed of a wirewound on an insulator which the wiper rubs against. Wirewound types tend to be able to handle higher currents and hence dissipate more power. Potentiometers usually come in one of two "laws"; the "law" is the way the resistance (between the wiper and one of the other terminals) varies for a given movement of the spindle. Linear law potentiometers are often used as tone controls in radios, the movement of the wiper gives a linear change in resistance throughout the range of the potentiometer. Logarithmic law potentiometers find use as volume controls in electronic equipment. The human ear perceives sound levels in a logarithmic manner. The increase

(or decrease) in sound for a given movement of the spindle of a logarithmic volume control appears to be "linear" to the human ear throughout the travel of the wiper, even though this is not the case in electronic terms.

### Capacitors

A capacitor consists of an insulator sandwiched two between two conductive plates. The insulator is known as the "dielectric". The electrical "size" of a capacitor is measured in Farads but capacitors are usually only a small fraction of a Farad in size. Different capacitors are designed to withstand different voltages before they "break down" (and become conductors). Capacitors can have the effect of collecting electrical energy (hence the old term for this device was "condenser"). A capacitor is known as an electrostatic device; when it's charged it sets up an electrostatic field. This field is invisible and surrounds the dielectric; it is the form in which the energy in the capacitor, or "charge", is stored. Some types of capacitor that have a very high resistance between their conducting plates are able to "hold" their electrostatic field (and hence their charge) for considerable time (in the order of days, weeks or months).

Different types of capacitor have different uses in a radio receiver. For example, in the power supply, a large electrolytic capacitor is often used to provide high values of capacitance (at high voltage), this is needed to remove unwanted interference from the supply rail. Capacitors used in this way are called "reservoir capacitors"; they act as a reservoir to smooth out peaks and troughs in the supply. Elsewhere in the receiver, capacitors are used for tuning; these are

usually metal vaned types that use the air as the dielectric. In tuning capacitors, the capacitance is varied as the metal plates are moved closer or nearer to each other. A capacitor will measure open circuit with an ordinary ohmmeter, (although the voltage supplied by the meter may charge the capacitor and upset the readings).

### Capacitors with DC

If a capacitor is charged through a fixed resistor from a fixed voltage, it will charge exponentially until it is "full". Looking at Fig 1g, when the switch is closed, the voltage at  $V_x$  will rise quickly at first but the rate of voltage rise will tail off. The current flowing through the resistor will be high at first because the difference in voltage between the "top plate" of the capacitor and the voltage supply +V is large; as the capacitor charges, this voltage difference decreases and less current will flow through the resistor.

### Capacitors with AC

A capacitor will allow the passage of a varying signal (A.C). Depending on the frequency of the signal(s) applied to it and the value of the capacitor, sizeable shifts in phase may occur between the voltage and current flowing through the device. Analysis of these phase shifts is quite mathematical in nature and not covered in detail here. Although a capacitor does not dissipate heat, it does have a kind of "resistance" to varying signals, this is known as "Capacitive Reactance". The capacitive reactance is dependent upon the size of the capacitor (in Farads) and the frequency of the varying signal (in Hertz).



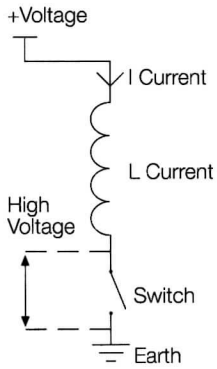

Fig 1h: The Inductor

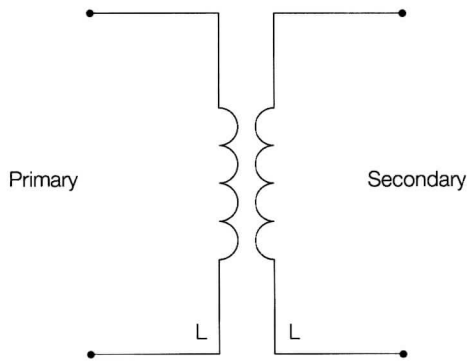

Fig 1i: The Transformer



Fig 1j: The Serially Tuned LC circuit

The following equation shows this link: -

$$XC = 1/(2\pi * F * C)$$

Where XC Is Capacitive Reactance (In Ohms)

$\pi$  Is 3.14 (approx.)

F Is Frequency Of The Signal In Cycles/Second (Hertz)

C Is The Value Of Capacitance In Farads

This equation assumes a "pure" sinusoidal waveform and as such is not totally applicable to "complex" waveforms such as music or speech. However, it can be seen that for a given value of capacitor, as the frequency rises, the "resistance" of the capacitor decreases. This is really all that matters at this stage.

Characteristics of capacitors are:

- Capacitors will effectively "block" a steady voltage.
- Capacitor only allows the passage of varying signals through them.
- Capacitors in parallel are additive, in the same way as resistors in series are.
- Capacitors in series obey the reciprocal law, in the same way as resistors in parallel do.

### Inductors

Inductors (or chokes) consist of a coil of wire wound onto a former of some kind. For high frequencies this former can be a hollow tube containing air; for lower frequencies ferrite and laminated soft iron are often used. The value of an inductor is measured in Henries. Inductors also have a current rating that governs the maximum current that can flow through them. An inductor is surrounded by a magnetic field in much the same way that an electrostatic field surrounds a capacitor. The energy in an inductor is stored in this form.

### Back EMF

If a "step" change is applied to an inductor, it will try to "maintain" the current flowing through its winding, using stored energy. In figure 1h, if the switch is opened, the inductor will try to maintain the current flowing through the switch to earth. The result is that a high voltage builds up on the switch contacts, possibly causing a spark to

jump across them as the switch is opened. This spark means a short switch life and therefore such circuit configurations are usually avoided if possible. However, this "back EMF" property makes the inductor useful in certain power supply designs.

### Inductors with AC

When a varying signal is applied to an inductor, the current through it, and voltage across it, will vary depending on the frequency of the signal applied and the value of the inductor. As with capacitors, I do not intend to cover this aspect in detail because of its mathematical complexity. In the same way that capacitors have a "resistance" to AC, inductors do; it is called "Inductive Reactance" (as opposed to "Capacitive Reactance" for capacitors). Inductive reactance is given by the following equation: -

$$XL = 2\pi * L * F$$

Where: -

XL Is Inductive Reactance in ohms

$\pi$  Is 3.14 (approx.)

L Is Inductance in Henries

F Is Frequency in Hertz

Again, the equation assumes a pure sine wave; however, as with capacitive reactance all that matters is the general result. Inductors allow the passage of D.C but offer a resistance to varying (or A.C) signals. In this respect they are the opposite of capacitors. For a given inductance, the higher the frequency, the greater the inductive reactance.

To summarise:

- Capacitors block DC but progressively let through higher frequency signals.
- Inductors let through DC, but progressively resist the flow of higher frequency signals.

### Transformers

A transformer consists of 2 coils (or inductors) that are coupled together. One of these coils is called the primary and the other the secondary. The common body that the coils are wound on is called the "Former". The circuit diagram representation

of the transformer is shown in fig 1i. The gap between the coils on the circuit diagram representation is sometimes filled with lines; the type of line depends on the former that the coils are wound on. Iron formers are often represented by an unbroken line, ferrite or "dust core" an intermittent line. A transformer will only work with A.C

Transformers are relatively efficient devices; the power (Voltage X Current) of the output (Secondary Coil) is nearly equal to the power of the input winding (Primary Coil). In a conventional transformer (not an auto transformer) the D.C resistance between the two coils is infinite, the two coils are said to be electrically isolated. To improve efficiency, both wires are wound in close proximity to one another to maximise the transfer of energy from primary to secondary coils. The voltage across the secondary coil is dependant upon the voltage applied across the primary and the ratio of turns on the secondary and primary coils. For instance, assume that a 100% efficient transformer is fed with a signal of 5 Volts AC across its primary coil at a current of 5 Amps. If the primary coil consists of 10 turns and the secondary 20 turns, the ratio of the two would be 1:2. A signal of 10 Volts (2 X 5 Volts = 10 Volts) amplitude and 2.5 Amps, current would be available across the secondary.

The transformer illustrated is known as a step-up transformer; it "steps up" the voltage at the secondary with respect to the primary. Step down transformers are also widely used. Transformers are sometimes used in the power supply of valve receivers to generate the correct voltages for the valve filament and anode circuits (after rectification and smoothing). However, as well as changing voltages, transformers can also be used to match impedances. Impedance is resistance to A.C signals. The number of turns on a transformer winding has a bearing on its impedance (for a given frequency). This is why transformers are used to link the audio output valve to the speaker on receivers. The output valve has high impedance (typically several thousand ohms) while the loudspeaker has low impedance (typically 3-50 ohms). The primary side of the transformer is connected to the valve: it has many turns while the secondary side, attached to the

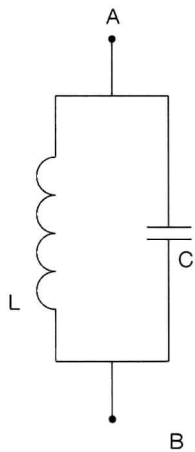

Fig 1jii: The Parallel Tuned LC circuit

speaker, has relatively few; it is a step-down, impedance-matching transformer.

### Tuned Circuits

A tuned circuit is a combination of an inductor and a capacitor. It can either be tuned in series (see fig 1j) or in parallel (see fig 1k).

Ignoring circuit imperfections, the frequency at which resonance takes place in a tuned circuit is given by the equation: -

$$F = 1 / (2\pi \sqrt{LC})$$

Where: -

- F Is Resonant or "Tuned" Frequency in Hertz (or cycles / second)
- $\pi$  Is 3.14 (approx)
- L Is Inductance in Henries
- C Is Capacitance in Farads

For the parallel circuit (figure k) the impedance between A and B is at a maximum at resonance. The opposite is true of the series circuit. Parallel tuned circuits are found on the tuning stage of a receiver. In this application, it is common for the inductor to be the secondary coil of a transformer and the capacitor to be of a variable type to enable the point of resonance to be moved and hence the receiver tuned. This arrangement is shown in Figure 1k

The radio signals enter the aerial and the tuned circuit through the primary of transformer TR1. The impedance of the tuned circuit is at a maximum only at the resonant frequency: away from this frequency the impedance reduces sharply. Because the impedance is at maximum at the resonant frequency, the signal at A will be at a maximum at resonance. This is the frequency to which the radio is tuned; any "station" on this frequency will be allowed into the receiver. Stations on other frequencies are passed through the tuned circuit to earth. In "real" tuned circuits, there are imperfections such as a resistance incorporated within the inductor and stray capacitance, but the general functioning is as described.

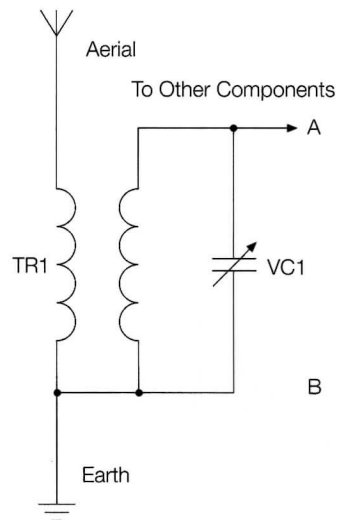

Fig 1k: Application of a parallel tuned circuit

### Crystals

A crystal (not to be confused with a crystal detector) is a piece of quartz that is made to vibrate very accurately at specific frequencies, with a voltage applied; this "vibration" becomes a rapidly changing resistance. The equivalent circuit of a crystal is that of a parallel tuned circuit but with a resistor and capacitor in series with the inductor. Crystals generally have two legs and are housed in a metal case; they find uses in oscillator circuits. These components do not often turn up in domestic receivers, but are included for the sake of completeness.

### Semiconductor Diodes

Semiconductor diodes started to appear in domestic equipment in the 1950s. They have two terminals and let current flow in one direction but not the other. The first diodes used Germanium as the semiconductor material but by the 1960s silicon started to take over. The symbol for a semiconductor diode is shown in Figure 1l. Historically, the symbol was used before the semiconductor diode was invented to represent the "Cats' Whisker" detector. The diode conducts current in the direction in which the symbol points; it resists the flow of current in the other direction.

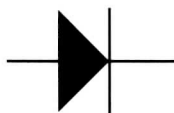

Fig 1l: The Diagrammatic Symbol for the Semiconductor Diode.

### Loudspeakers

Loudspeakers found in old radio receivers can be one of several designs, but electrically they can be seen as inductors. Speakers can be divided into two basic types: Moving Iron or Moving Coil.

### Horn 'Speakers

Early loudspeakers were often a horn shape; the large horn provided a big column of air so that a small movement of the diaphragm could produce a large volume of sound. Horn

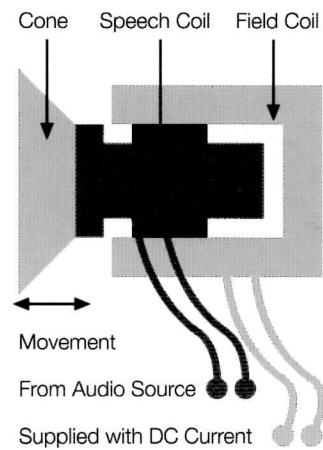

Fig 1m: The Moving Coil Loudspeaker

'speakers have the advantage that they only required small drive currents for a given level of output power (relative to other shapes). The shape of the horn had to follow an "exponential" law to avoid inefficiency and acoustic reflections within the 'speaker.

### The Moving Iron Loudspeaker

Moving iron 'speakers were unequal in their response: they generally had a high impedance. This impedance (resistance to A.C signals) tended to vary greatly with the frequency of the signal applied, therefore, efficient matching of the 'speaker with the driving circuitry was difficult to achieve. Moving iron 'speakers came in two basic types, balanced armature and balanced reed. The principle of operation of both types was the same. A small soft iron armature was attached to the diaphragm of the 'speaker. This armature was surrounded by the magnetic field of a strong permanent magnet. A coil of wire was wound around the magnet. When a signal was applied to the coil, the magnetic flux varied. This varied the force on the soft iron armature, causing it, and the diaphragm attached, to move.

### The Moving Coil Loudspeaker

This kind of 'speaker is still in use today. As the name suggests, in this 'speaker the speech coil moves. Moving coil speakers generally give a far higher quality of reproduction than the moving iron types. Fig 1m shows a moving coil loudspeaker. The field windings are connected to a constant current source (D.C). The speech coils are connected to the audio output valve (usually through an impedance matching transformer). The field windings set up a steady magnetic field but the varying current through the speech coil causes a varying field interaction. The two fields interact, causing the speech coil to move in sympathy with the signal current flowing through them. The speech coil is connected to the cone of the 'speaker, therefore the cone moves in and out in sympathy with the speech coil. Sometimes a permanent magnet is used in place of the field coil.

# Loudspeaker cone repair

by Ian Liston-Smith. Based on an article due to be published in Practical Wireless sometime in 2002. This article is published with permission from the PW Editor.

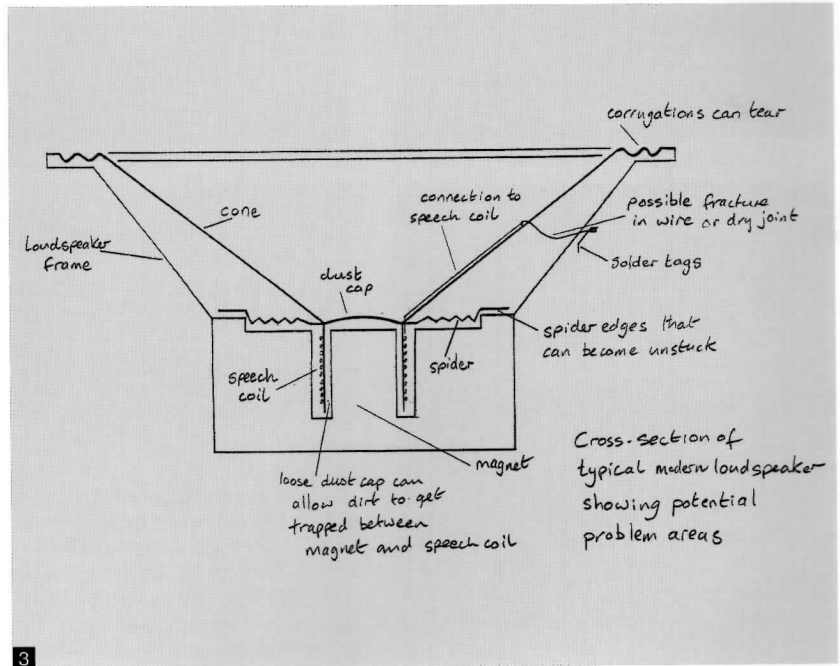
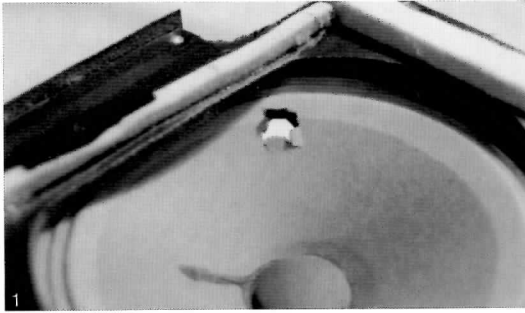

Loudspeakers are very reliable unless grossly misused, but occasionally accidents do happen, and when they do it's usually the cone that gets damaged. A repair is often successful when carried out on inexpensive speakers of domestic equipment, and particularly with vintage radios if a replacement is unavailable.

A surprisingly large amount of harm can occur before the quality becomes noticeably degraded. Don't try to repair a damaged cone with sticky tape or self-adhesive labels. These materials just won't stick well for long. However, the following simple technique will often prove effective.

To do the job properly, both sides of the cone need to be accessible, so if necessary, remove the loudspeaker from the equipment it is mounted in. Place the torn edges so that they align as neatly as possible.

Then mix a little Copydex-style glue 50-50 with water and using a cheap childrens' paintbrush, dab it all over the damaged and adjacent areas from the front of the cone. Without giving the glue chance to dry, place a piece of soft tissue paper (toilet paper for example) over the affected area. Press it down gently on to the glue.

If the other side of the damaged area is accessible, dab the glue mixture over this too, and cover with another piece of tissue, so that the tears are sandwiched between two layers. This will be particularly effective if a small section of the cone is actually missing. Gently dab the area again on both sides with the glue solution to soak all layers and leave to dry.

Although the layers of tissue paper will start to wrinkle, once dried they all shrink back, holding the torn edges together, but still allowing the area to remain flexible.

The photographs show the loudspeaker of an Ekco U122 radio repaired in this way. Unfortunately, on this model, removing the speaker to allow work on the chassis only provides enough slack in the speaker leads for them to pull it back against the control spindles! The hole thus created is shown in diagram 1. The damage is probably not bad enough to cause any noticeable difference in sound quality. Nevertheless, if

left alone, the fragile cone of a set of this age is likely to start tearing further.

Diagram 2 shows the finished repair. Although it looks as if the affected area might be a bit stiff, in reality this is not the case, and the whole area remains supple.

Another difficulty which may also arise on older moving coil loudspeakers is that of a loose 'spider'. The spider is the old name given for the arrangement holding the cone and its moving coil centrally around the magnet. Diagram 3 shows this and other areas where problems may be encountered.

The spider is usually made from circular, corrugated stiffened cloth. This is glued onto the outer metal surface of the magnet structure and can become unstuck. This causes a buzzing noise, although the cone looks and is perfectly intact.

To repair the spider, lift the loose edge up with a thin screwdriver and sparingly smear a good multi-purpose glue under it before pressing it firmly back into place.

Other problems with loudspeakers are more difficult to rectify. An open circuit or uncentred speech coil for example would generally be unrepairable, although an apparent open circuit can sometimes be traced to a bad joint where the flexible braid is soldered to the speaker tags.

Modern loudspeakers have their centring fixed, so there is little that can be done if this needs correcting. Nevertheless, this can often be rectified with old speakers as they have a spider adjustment, allowing the mountings to be slackened for re-centring. Before attempting this, determine if distortion is really due to the speech coil scraping against the magnet. This can often be checked by gently pressing the cone at various points until the distortion disappears. Loosen the centre screw, and with the set playing fairly loudly readjust until the distortion disappears.

Some may consider it hardly worth the effort to carry out any loudspeaker repairs these days. Up to a point this is probably true - replacement speakers are not difficult to come by. But occasionally repair is the only option if the speaker has an odd shape or unusual impedance or another characteristic which is difficult to substitute.

A surprisingly large amount of harm can occur before the quality becomes noticeably degraded. Don't try to repair a damaged cone with sticky tape or self-adhesive labels. These materials just won't stick well for long.



# A state of Flux

by Anode Current

The War being over, on leaving His Majesty's Service, it was decided to build a small amateur-band receiver; transmitting licences were soon to be re-issued.

There were plenty of sophisticated ex. W.D. receivers on offer, Edgware and Tottenham Court roads were a gold mine here. Hallicrafters, Skyriders, R.C.A.'s AR86, the ubiquitous H.R.O. and the Bomber Command 1155 could be bought for a moderate price, but the thought of carrying a Skyrider home on public transport was enough to concentrate the mind quickly. No, a small receiver, just for the amateur frequencies was the best.

Being familiar with the common U.X. and octal based valves it was decided to use the modern B7G miniatures, just being introduced to the public. These were then hard to find, and at full price, expensive, 14/- plus 3/1<sup>st</sup> Purchase Tax was typical. For between half a crown and 7/6 there were plenty of full-sized surplus valves advertised in the magazines.

The valves chosen for use included the 6BE6, as frequency changer, the 6BA6 and the 6AQ5, the latter being the well known 6V6 in disguise.

The aspiring title 'communication' for the receiver might be justified because the circuit had a B.F.O. for morse, and made use of the new Jackson Brothers 70 pF ball-bearing, ganged tuning condenser, just being marketed. Most published circuits for short-wave sets used separate condensers of the traditional type, then available, Eddystone, Raymart, and Wavemaster, to name a few. These were built on a single ceramic plate and had a plain bearing. The earth return through the bearing had minute variations in connection, and this caused indecisive dial markings. Worse, on the higher frequencies this produced a loud rustling sound in the loudspeaker during tuning... 'Onest Guv'nor!

The B7G valves had their pins set directly through the glass envelope bottoms. To relieve any shear stress in the glass here, the pins were made malleable, and this compounded the problem to follow.

In those days, Bath made its own A.C. supply. The nominal voltage was 250 but Austerity conditions which applied during the war and for a while afterwards meant that the actual voltage was much below this. Wherever possible goods, raw materials

and services were reduced to the minimum necessary. Food and clothes etc. were still rationed, plywood from tea-chests was used again, potato sacking and balloon cloth became valuable commodities for the home sewing machines, batteries for torches and wireless receivers were zealously conserved. Stories of good ladies getting up at night to roast their joints ... their meat, I mean, to take advantage of the better off-peak gas pressure, were common.

The electric soldering iron was becoming part of every constructor's equipment, and to go with it cored solder became the norm. The cored solder then available was quite thick by today's standard and had one generous core of flux. The Henley Solon iron in use was no less than 65 watt but had a pencil bit for coping with the finer work; it is on at least its third bit, now.

A start on the receiver was made, but wait ... living in Landsdown at the far end of an A.C. power line, and under the war-time conditions mentioned the iron would not get hot. Repeated attempts to get the solder to 'take' and wet the B7G valveholder tags proved an obstacle. Those of you who solder up old components will know this. In the meantime the flux would run happily all over the valveholder bottom. Bringing the work top-side up revealed the tiny pin holes full solid with flux, and this was the problem. No way could the valve be inserted.

The solution; Bristol also had its own independent electricity, the central part being rated at 210 volt A.C. and further out, I think, 250 volt D.C. You've guessed it: a gallon of Pool petrol for the motor cycle and side-car and a trip to Bristol provided a 210 volt replacement element for the iron. All was then well.

There is a sequel to this, to be quite sure of no further problems all of the miniature valves were gathered up, and taken to London.

A day return ticket (£5 after 9 a.m. I think) took them steam-hauled to Paddington, no more than a minute or two late, on war-time coal. The Proprietor of Messrs. Henry's on Edgware Road showed no signs of hesitation in exchanging B7G valves for the equivalent octal ones. New pots for old, or should it be the other way round? Ex. W.D. Surplus, no doubt, but mansized.

Life was a state of flux.

The Proprietor of Messrs. Henry's on Edgware Road showed no signs of hesitation in exchanging B7G valves for the equivalent octal ones. New pots for old, or should it be the other way round.?



## Book review

**Ferranti A History**, Building a family business, 1882-1975  
by John F. Wilson  
Carnegie Publishing  
ISBN 1-85936-080-7  
£25.00

Bulletin readers with a wider interest in the history of the British electrical industry as well as radio set manufacture will find this book a valuable addition to their library. Ferranti Ltd. were in business from the start of the electric era in Britain, from the 1890s 'Battle of the Currents' (A.C. versus D.C.) onwards, and their diversification into radio components and sets three decades later gave the company a new field for its engineering expertise. Ferranti were also one of the very few companies to establish a radio factory in the industrial North of England.

The radio sections form only a part of the 600-odd pages, but the story of the famous AF3 & AF5 audio transformers, for example, is told in fascinating detail. Subsequent sections cover the company's first radio factory at Stalybridge, Cheshire, the later Radio Works

at Moston, Manchester, valve manufacture and 1930s television research including the link with Scopphony. A good selection of illustrations adds further interest. As with Keith Geddes' 'The Setmakers' economic and personnel factors form a significant part of the story, and John Wilson does not shrink from pointing out mistakes in marketing etc. The author is an economics rather than engineering historian and a few technical details are somewhat garbled - for example, one sentence (deriving from an American source) implies that superhet circuitry of 1924 was the direct successor to the morse coherer. Another (mild) disappointment for me was to find no mention of the superlative ribbon pickup of 1953-6, the company's one attempt to break into the 50s hi-fi market. But elsewhere a convincing picture of a great manufacturing enterprise is painted, with the early computer development particularly interesting. The overall conclusion regarding Ferranti radio is that the company hardly ever made a direct profit from it - but the expertise so gained gave Ferranti its crucial break into computer and defence electronics, and allowed it to stay in business until recent times.

# Letters

Dear Editor,

'Television is born' page 4, Volume 27, No.1. I read this article with interest but I wish to make two comments. First; Mr Newman seems to believe that mechanical imaging is wrong and a blind alley of the past. This is not so as the examples listed below will demonstrate. Second; that Mr Baird was not very practical. I will deal with this later.

The cathode ray tube is now on the wane. It has a number of replacements waiting in the wings. The most interesting of these is the digital light processing chip found in upmarket television receivers and in modern cinema projection apparatus. This is the direct descendant of Dr Fournier D'Albe's television receiver of 1926 [p1986 Harmsworth's wireless encyclopaedia]. Domestic versions of the DLP chip have an array of 1024 x 768 mechanically oscillating mirrors. Each mirror is under 16 microns square. It can oscillate up to 50 kHz. Using pulse width modulation, over 256 shades of grey can be produced in a black and white system. Consumer TV sets make do with one DLP chip modulating a single light source producing 786,432 picture elements. The colour is added after DLP and PWM have taken place. Receivers currently cost the same as some plasma screen models [£14,000]. Unlike plasma screens the DLP chip is not limited to the size of picture produced. Cinema television projectors have three chips, one for each primary colour. Each chip works in the same way having 1280 x 1204 mirrors giving nearly 4 million picture elements. The DLP chip was invented by Mr Larry Hornbeck in 1987 at Texas Instruments. It was first used commercially in 1996.

Here are some other examples of mechanical television practices in use in daily life. My local Sainsbury checkout uses scanners with a four sided mirror for reading barcodes [Mihaly Traub?]. Weather Satellite imaging; since the late 1970s these have used mechanical imaging. Why? 1: Very high resolution pictures can be generated this way. 2: Mechanical cameras can also see infra red as well as visible light. Thermal imaging in military applications; thermal imaging cameras of this type also use a mirror drum, the Pathfinder space craft used an oscillating mirror to form the pictures of the surface of Mars. There are many other examples of mechanical television practice but the list would get too long.

Regarding Mr Baird's practical abilities; I think the 600 line telechrome system demonstrated on 16th August to a group of Journalists and built by Mr Baird plus one assistant demonstrates his practical abilities. There was no large company financing this one at all. This colour television system was all electronic at the receiver end.

Cathode ray bulbs were right for their time but this is now passing. They are fragile, difficult to produce and they require analogue circuitry to power them.

Yours truly  
E.S.C Nowill

Dear Editor,

Andy Emmerson, in his informative article about the resuscitation of electrolytic capacitors, published in volume 26 issue number 2 of our Bulletin gave sound advice which I now have followed: but failure can still occur and so now I insert a 100m/a fuse between rectifier cathode and reservoir capacitor.

This may not be in accordance with the spirit of authenticity but it could avoid the loss of rectifier and possibly transformer in the event of capacitor failure. A timed fuse takes care of any recharging surge should supply be lost for one or two seconds.

Yours sincerely  
Bill Wye

Dear Editors,

It is only recently that I have discovered your excellent magazine and I find it most fascinating.

I have been interested in wireless ever since my dear nanny was electrocuted whilst lifting Tibbles off the family crystal set during a furious thunderstorm. Fortunately she survived this frightful ordeal thanks to long and tender care. Sad to say Nanny was less fortunate; however we did give her a wonderful send off and I still think of her every day as I pass her spot in the rose garden.

From the many articles in your excellent publication I take note that that one of the early popular thermionic devices is known as the 'R' valve. This caught my attention due to the fact that those who know me refer to me as 'R' and also leave the 'Fisch' off the end of my name.

On my own part I am an experienced and accomplished home constructor. I find it easier to order kits, which is done by Roberts my butler. We are so keen when the parts arrive that to speed things up Roberts carries out the more mundane activities such as unpacking, assembling the parts and connecting the wires.

Once attached to the aerial, which Roberts has erected between the stables and the main house, I find the results are very good and I regularly receive transmissions from all over the continent.

However I have a problem with my most recent wireless set. When the kit arrived Roberts was away visiting his sister in Devon

and being very keen to progress things I was forced to carry out the routine assembly tasks which Roberts usually relieves me of. No problem here of course apart from the fact that the dunces had sent me too many parts.

The difficulty is that when I switch on all I get is a loud popping sound and a faint smell of burning. The gardener who seems to know about these things, says I need to 'tune for maximum smoke'. As I am not familiar with this procedure I would be grateful if you would explain how to do this.

Once again many thanks for such an excellent publication.

Yours with most sincerity  
The Rt. Hon. Ronald Soals-Fisch

Dear Editor

Several years ago, I purchased a Hallicrafters prewar diversity receiver, type DD-1 with a Jensen designed cabinet, which included a wooden cap incorporating dual signal strength meters, and the whole veneered in burr walnut, highly polished. There were only a few of these made, and it was reviewed in Ham Radio magazine of April 1980. It was originally presented in June of 1938 with a two page spread in that month's QST. I also enclose a letter written by its previous owner to authenticate the set. There was also an article in the November 1979 Ham radio magazine detailing the Hallicrafters story.

However, here comes the crunch! Sometime during the last few months of last year, a THIEF stole the wooden cap and the dual signal strength meters plus cabling to the main receiver. I have had much of my collection of various other wireless and prewar equipment stolen over the last fifteen years and am getting a bit fed up. I believe the thief to be the same person each time and so I am offering a reward of £1000.00 to any person that can successfully provide me with information that will result in the actual arrest and conviction of this person. I have a very strong belief that he is a rogue trader as well! and that he trades at all the club and other vintage and antique rallies around the country. I almost caught him at one such club rally but he was too clever for me and deserted his stall when he saw me coming! Burglar alarms are useless against him as he is prepared to enter while the householder is still in residence while the alarm is switched

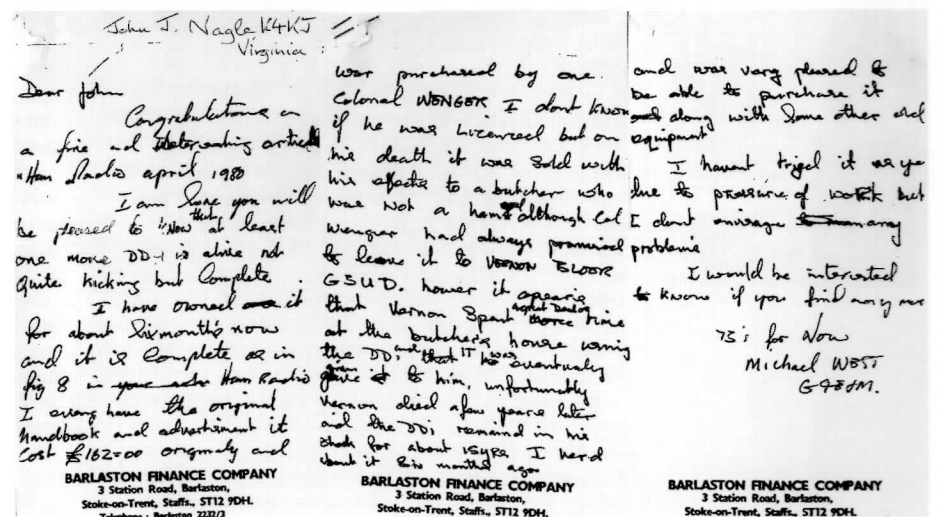

off! I have seen him from a distance and he is about 20's to 30's and scruffy, but that was almost 10 years ago. He broke my mother's heart when he stole all of her valuables a few years ago, she died soon after. So you understand how much I want to catch him! I look forward to hearing from you soon.

I am, yours sincerely,  
Walter S. Williams (GØXEM)

**Dear Editor,**

I was interested by the letter from Gary Tempest on the safety of radios but would like to add a word of caution. Gary mentions fitting an earth lead to chassis. If the radio does not have an isolated chassis and the circuit it is connected to is fitted with an Earth Leakage Circuit Breaker then this will almost certainly trip as soon as the radio is plugged in.

The reason is that an ELCB works by looking for a balance of current between the Line and Neutral. If the Neutral and Earth are connected together somewhere within the circuit then all the return current of the appliances on the circuit will split itself between Neutral and Earth causing an imbalance and a trip of the ELCB. As Gary says, the best answer is to convert to an isolated chassis, and for ELCBs it is the only answer. For those with pens twitching, I have deliberately avoided mention of isolating transformers.

Incidentally, the sale of second hand radios has now effectively ceased under the legislation now applicable to the sale of electrical goods. The local Scout Group and all the Charity Shops in our village have stopped selling second hand electrical goods, including valve radios, because of the liability of the seller should anything untoward happen. I believe this has resulted in far more of our heritage being sent to the tip because there is no one willing to take a risk in getting a few pounds for it. Sad times.

Kind regards  
Neill Ward

**Visit Britain's largest  
Vintage Radio Shop  
Without even leaving your home!**



- ▶ Britain's widest range of Radio, TV and Gramophone collectables for sale in every issue - 6 issues per year.
- ▶ Illustrated with accurate descriptions and prices.
- ▶ Interesting articles on all aspects of vintage technology.
- ▶ Annual subscription fully refundable against purchases.
- ▶ Top prices paid for quality items - collections bought.

**Send S.A.E. for details and sample copy**

**ON THE AIR**

*The Vintage Technology Centre*

The Highway, Hawarden (nr. Chester) CH5 3DN

Tel/Fax (+44) (0) 1244 530300

[www.vintageradio.co.uk](http://www.vintageradio.co.uk)

## **RADIO MAN: The remarkable rise and fall of C.O. Stanley**

**A NEW BOOK FROM IEE PUBLISHING — Available 28 June 2002**

By Mark Frankland

Consultant: Gordon Bussey

RRP: £25.00 (discount available for BVWS members)\*

Format: Hardback with jacket, printed in full colour with 200 superb photos

ISBN: 0 85296 203 7, 368 pages

*Published in association with the Stanley Foundation*

*'A gripping story of commercial and scientific battles in the days of heroes and villains, when victory or defeat could mean life or death. It revolves round a central hero who was larger than life, with huge strengths and weaknesses. Essential reading for anyone interested in the achievements of British scientists and engineers before and during the second world war throwing new light on the origins of commercial TV in Britain.'*

Anthony Sampson—author of 'Anatomy of Britain',  
'The Sovereign State of ITT' and 'The Seven Sisters'.

\*This title is available at the special discounted price of £20 available to BVWS members on orders placed before 31st July 2002. Please quote code BVWS0502 when ordering.

Order from IEE Publishing—tel: 01438 767328, fax: 01438 742792, email: [sales@iee.org.uk](mailto:sales@iee.org.uk),  
web: [www.iee.org/shop](http://www.iee.org/shop)



to conceal the fault totally. In cases where the background is positionally different to the foreground, the background can be panned horizontally and vertically in order to give the best match. Once the operator is happy with the repaired frame, a button push records it back to disc in place of the damaged frame. Once a complete sequence has been repaired, it is dubbed back off to tape.

Several items were put together for inclusion as extras:

Debbie Watling and Frazer Hines recorded a commentary in Dubbing Theatre Y at Television Centre on Monday, 21st May 2001. Both actors found the experience very enjoyable and insisted on doing the first three episodes without a break!

Once again text production notes and a photo gallery is included on the disc.

The introduction by the director, the late Morris Barry, which was specially shot in 1992 for the VHS release, has been included.

A thirty minute featurette has been put together by Paul Vanezis and Peter Finklestone, using material recorded at the BAFTA 'Tombwatch' video launch event in 1992, in which many of the stars and production crew talk about the story after seeing it for the first time in twenty-five years.

A colour 'Late Night Line-Up' feature on the Visual Effects department from 1967 has been edited down to a three minute feature that concentrates on Doctor Who. Joan Bakewell interviews Jack Kine about the department and many Doctor Who props make an appearance, including 'Tomb' Cybermats and a Yeti which shoots a Cybergun at a Cyberman who then discharges foam from his innards! Ironically, this interview was not rediscovered until after the recovery of 'Tomb' in 1992! This feature also includes the two brief extracts from 'The Abominable Snowmen':4, which were inadvertently left out of 'The Missing Years'.

Another three minute featurette has been put together from the various tests and final elements that were used in the creation of the Troughton title sequence, including the unused 'whirlpool' effects and different title graphics. Mark Ayres has supplied an extended version of the Doctor Who theme to accompany it.

It was originally intended that Tony Cornell's 8mm film 'The Last Dalek, shot in Ealing Studios in 1967 during filming of 'The Evil of the Daleks', would be included. However, it has been decided to drop it from this release so that more time can be taken to prepare a fuller and more satisfying presentation of it for a future DVD. Instead, 'The Final End', a revamped version of the short sequence originally put together for 'The Missing Years' will be included. This sequence combines parts of 'The Last Dalek' with extracts from the programme soundtrack of episode 7 of 'The Evil of the Daleks' in order to give a flavour of the climactic Dalek battle from which 'The Tomb of the Cybermen' follows directly on.

A five minute featurette showing examples of shots before and after cleanup is included, with the 'before' shots taken from the master used for the 1992 VHS release in order to include the improvement that scanning on the Spirit has made. This also features a text commentary.

Cleanup work using the Scratchbox commenced on 6 May 2001, with all of episode one being cleaned up. Around 2000 blemishes were corrected in the space of six hours, a rate which would be unheard of using our conventional deblobbing method. Most of the repairs were to film dirt and sparkle, but there were quite a few original VT dropouts as well. It appears that the episodes have at some point been broken down into two rolls and then rejoined, as there is a great deal of visible dirt around the twelve minute point. There was also a burst of dirt over a few frames in the scene where Victoria is rescued from the revitalisation chamber, but this has all now been repaired. The original VHS release from 1992 clearly shows very bad tramline scratching on the first exteriors shots (where the title appears). These scratches were not evident in our new transfers, presumably because the diffuse illumination system employed in the Spirit was able to mask them. Picture stability during this episode is very poor due to either a faulty film recorder or optical printer back in the sixties and unfortunately it is unlikely that this can be repaired, as the movement is non-linear within the frame - ie some parts of the frame are steady, whereas other parts are not. All current image stabilisers work by analysing the entire frame and working out the general motion vector, then cancel it by moving the picture in opposition. This technique works well for linear instability where the entire picture is moving vertically or horizontally. However, the non-linear instability on episode one would cause severe problems for an image stabiliser, probably making some unstable areas even more so.

Episode two exhibited a completely different set of problems, this time consisting mostly of quad videotape dropouts and large horizontal flashes across the screen, along with quite a lot of dirt and sparkle. 2500 frames were repaired in this episode.

Episode three contained mostly Quad tape dropouts and white sparkle, with over 2300 frames being repaired. Some severe film scratches (particularly in the scene where Kaftan finds the gun and threatens the others) were manually painted out. This could never be an invisible mend, but the result is certainly less distracting than the huge white scratch! A bad head tracking error on the opening shot of the Cyberleader's head was disguised by repeating frames from either side of the shot, then adding some motion blur and short mixes to help carry the shot.

Episode four is in the worst state of all of the episodes. It contains a huge number of multiple quad dropouts - the videotapes must have literally been falling to pieces during production of the film recording. Over 4500 frames were repaired. Kaftan's death scene was particularly problematic, as it was covered in multiple dropouts, which had had the knock-on effect of causing the film recorder to off-lock several times. Painstaking retouching was required to repair this shot. Most of the work was done on Scratchbox and then Jonathan Wood worked on it further using a frame store and vision mixer to blend the repairs together into a more coherent shot.

Up to three further Scratchbox passes were made on all episodes, with many more faults being found and repaired on each pass - and

undoubtedly there will be some that even now have been missed. The total number of repairs now stands at over 16,000!

A new transfer of the 35mm title sequence film was made and cleaned up, then laid back in place of the film-recorded sequences for optimum quality. The 35mm print used was actually the one struck for use on 'The Invasion', according to the ident on the film leader.

It was assumed that the poor quality pictures at the beginning of episode two, the reprise of the final scenes of episode one, could be replaced using the better pictures from episode one, with new captions overlaid. However, it was discovered that the reprise is actually a combination of the original takes as used in episode one and some retakes, with subtly different performances and effects. Up until the point where the gun pushes into shot, the pictures are identical to episode one, therefore those shots were reinstated, with new captions cut out of the original episode two opening and overlaid by Dave Chapman in our 3-D Effects department. The shots from the gun pushing in, to the zoom onto the Cyberman's head, were left as original, although the quality is noticeably lower. The programme production file indicates that a 35mm film recorder was booked for the last part of the first day's studio session, so it appears that the last scene and a retake of it were film recorded, edited and then played back in to the episode two studio session from telecine.

Once cleanup was mostly finished, several 'difficult' repairs were compiled off onto a separate tape for the attention of the 3-D Effects department and were mostly fixed by Ian Simpson on an SGI Illusion. These included:-

The shot of the Cyberman re-entering their tomb in episode four, which was badly damaged by three large videotape head clogs and film recorder off-locks. To repair this, Dave Chapman took the version that had been pre-cleaned on Scratchbox, chopped out the three damaged sections and joined the 'good' bits together using short mixes. This underlength shot was then slo-mo'ed to the correct length, with motion blur added on a Charisma DVE and a layer of grain laid back over to mimic the look of the original and help carry the shot.

A number of film recorder bounces were repaired by pinning the shot to steady it and painting back the damaged sections from surrounding frames.

Realviz ReTimer was used in a few shots to invent frames that were irretrievably damaged by off-locks. Good examples are a shot in episode two when the party has entered the Tomb prior to Klieg's attempt to reactivate the Cyberman, and a shot of the hatch opening just before Kaftan's death in episode four.

Two film breaks right across the frame, one at the end of episode one as the dummy Cyberman slides into shot and the other in episode two as the party first enter the tomb, were pinned and repaired. As it turns out, these two film breaks are not visible on the master of the 1992 video release, so the films were broken and badly repaired sometime in the last ten years.

The completed masters were delivered to BBC Video on July 16th and the UK release of the DVD was 14th January 2002 - ten years to the month since the story was returned!

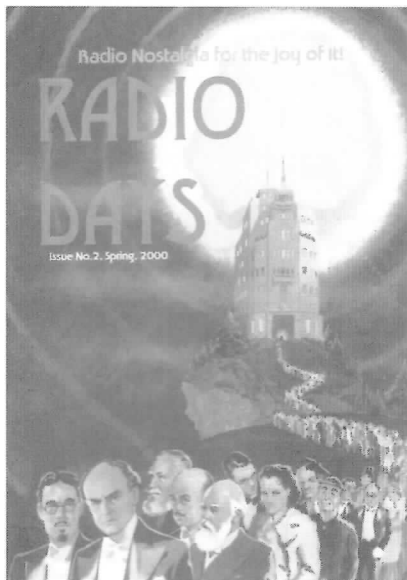

IF YOU LISTENED TO THE RADIO IN THE VINTAGE YEARS... ..OR EVEN IF YOU DIDN'T...

**YOU'LL LOVE RADIO DAYS!**

*Packed full of Nostalgic Radio Articles and Pictures, Many in Colour, Radio Days will Delight Your Eyes!*

Available only by subscription from **The Radiophile**. Sample Copy £4\*. Please send cheque to:

**The Radiophile, "Larkhill", Newport Road, Woodseaves, Stafford, ST20 ONP.**

*\*UK and BFPO; all other territories £5 (Sterling, please)*

**RADIOCRAFT**

**YOUR WIRELESS RESTORED**

FIVE YEAR GUARANTEE

FAIR PRICES  
FREE ESTIMATES  
NATIONAL DELIVERIES

Customers include Harrods, the BBC and leading collectors worldwide

Visit

[www.vintage-wireless.com](http://www.vintage-wireless.com)  
[www.vintage-television.com](http://www.vintage-television.com)

for

- radios for sale
  - radio restorations
  - retrovisors
  - vintage television
  - special projects
- and much more ...

**RADIOCRAFT**

Main Street Sedgeberrow WR11 7UF  
01386 882280 07876 296019  
email: [steve@radiocraft.co.uk](mailto:steve@radiocraft.co.uk)

**Back issues**

**Vol 10** Numbers 2, 3 & 4 Inc. The KB Masterpiece, Extinct Species "A Monster Defiant".

**Vol 11** Numbers 1, 2, 3, 4 Inc. BTH VR3 (1924) receiver, Marconi's 1897 tests, Origin of the term 'Radio', Baird or Jenkins first with TV?

**Vol 12** Numbers 1, 2, 3, 4 Inc. the Emor Globe, The Fultograph, Ekco Coloured Cabinets.

**Vol 13** Numbers 1, 2, 3 Inc. Direct action tuning, The Philips 2514, Noctovision.

**Vol 14** Numbers 1, 2, 3, 4 Inc. Cable broadcasting in the 1930's, The story of the Screen Grid.

**Vol 15** Numbers 2, 3, 4 Inc. The

wartime Civilian Receiver, Coherers in action, Vintage Vision.

**Vol 16** Numbers 1, 2, 3, 4 Inc. The Stenode, The Philips 2511, Inside the Round Ekcos.

**Vol 17** Numbers 1, 3, 4, 5, 6 Inc. Wattless Mains Droppers, The First Philips set, Receiver Techniques.

**Vol 18** Numbers 3, 4, 5 Inc. The First Transistor radio, The AVO Valve tester, The way it was.

**Vol 19** Numbers 1, 2, 3, 4, 5, 6 Inc. The Birth of the Transistor, Super Inductance and all that, reflex circuits, A Murphy Radio display, restoration.

**Vol 20** Numbers 1, 2, 4, 5, 6 Inc. Radio Instruments Ltd., Japanese shirt pocket radios, Philco 'peoples set', notes on piano-keys, the story

of Pilot Radio, the Ever Ready company from the inside, the Cambridge international, the AWA Radiolette, this Murphy tunes itself!

**Vol 21** Numbers 1, 2, 3, 4 Inc. Marconi in postcards, the Defiant M900, GPO registration No.s, Personal portables, the transmission of time signals by wireless, the Ekco A23, historic equipment from the early marine era, the birth pains of radio, inside the BM20, plastics, Ferdinand Braun, pioneer of wireless telegraphy, that was the weekend that was, the first bakelite radios, BVWS - the first five years, the world of cathedrals, Pam 710.

**Vol 22** Numbers 1, 2, 3, 4 Inc. Another AD65 story, the Marconiphone P20B & P17B, listening in, communication with wires, the story of Sudbury radio supply, French collection, Zenith Trans-oceanics, Farnham show, Alba's baby, the first Murphy television receiver, AJS receivers, Fellows magneto Company, Ekco RS3, Black Propaganda.

**Vol 23** Numbers 1, 2, 3, 4 Inc. Sonora Sonorette, Bush SUG3, RNAS Transmitter type 52b, North American 'Woodies', Why collect catalin, Pilot Little Maestro, Theremin or Electronde, The Radio Communication Company, Early FM receivers, an odd Melody Maker, Black propaganda.

**Vol 24** Numbers 1, 2, 3, 4 Inc. The Superhet for beginners, Triode valves in radio receivers, History of GEC and the Marconi - Osram valve, KB FB10,

Great Scotts!, Riders manuals.

**Vol 25** Numbers 1, 2, 3, 4 Inc. Repair of an Aerodyne 302, Henry Jackson, pioneer of Wireless communication at sea, Zenith 500 series, Confessions of a wireless fiend, RGD B2351, John Bailey 1938 Alexandra palace and the BBC, Ekco during the phony war, Repairing a BTH loudspeaker, The portable radio in British life.

**Vol 26** Numbers 1, 2 Inc. How green was your Ekco?, The Amplion Dragon, Crystal gazing, The BVWS at the NEC, Installing aerials and earths, novelty radios, Machine-age Ekco stands of the 1930s, Volksempfänger; myth and reality.

**Supplements:**

- 1 'The story of Burndept'.
- 2 'WW 1927 data sheet'
- 3 'Seeing by wireless' the story of Baird Television
- 4 Reproduction Marconi catalogue

Earlier Bulletins and supplements are priced at £2:00 each + postage. Bulletins from volume 21 onwards are priced at £2.50 each. + postage.

Postage: for individual Bulletins add 50p, for 2-5 bulletins add £1, for 6 or more add an extra 20p each. 23 Rosendale Road, West Dulwich London SE21 8DS

Telephone 0181 670 3667. Cheques to be made payable to 'The Vintage Wireless Museum'.

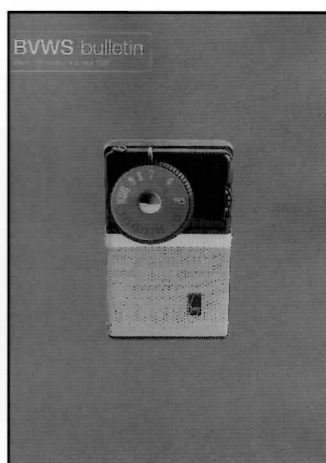

# News and Meetings

## The keeper of the list

Martyn Bennett still has the role of custodian of the BVWS list of G.P.O. Registration Numbers. As many members will know the project of assembling this list was started in the early days of the BVWS and, more recently, has been enthusiastically carried on by Pat Leggatt. Members are strongly urged to help build the list, whenever they get the opportunity, particularly as it is something that will help with the identification of vintage wireless in years to come. The list is by no means complete and the GPO no longer have a record of the numbers granted to wireless manufacturers. The BVWS Handbook contains the current listings - one in numerical order and one ordered by name. Please let Martyn have any additions, or suggestions for corrections, by mail or over the phone.



## Contact address:

Martyn Bennett, 58 Church Road, Fleet, Hampshire GU13 8LB  
telephone: 01252-613660  
e-mail: martyB@globalnet.co.uk

## JUNE:

8th Garden Party at Gerry's  
9th Harpenden  
23rd Workshop at Gerry's

## JULY:

21st Wootton Bassett plus auction of the Norman Richardson Collection.  
21st Sambrook (Radiophile)

## AUGUST:

11th Workshop at Gerry's

## SEPTEMBER:

1st Harpenden  
15th NVCF  
22nd Easton in Gordano, Bristol meeting

## OCTOBER:

6th Shifnal (Radiophile)  
13th Workshop at Gerry's  
20th Cowbit (Radiophile)  
27th October BVWS Southborough Regional Swapmeet. Victoria hall.  
Bookings/enquiries 01892 540022

## NOVEMBER:

24th Harpenden

## DECEMBER:

1st Wootton Bassett

## FEBRUARY 2003

16th Audiojumble Angel Centre, Tonbridge. Enquiries 01892 540022

## New Articles

If you have anything interesting to say concerning Wireless, Television, Broadcasting, Collecting etc. please send it to the Editor for future publication in the BVWS Bulletin. Your article can be just a few paragraphs long if you think it conveys its message to your fellow members. Also if you have any photographic material that would look good in the Bulletin, don't hesitate to post it to the Editor. The chances are that I will definitely use it!

Please send to: Carl Glover, 33 Rangers Square, London SE10 8HR.  
Tel: 020 8469 2904 email: choris.b@virgin.net

## Society Constitution and Bylaws

From time to time the Committee are questioned on the conduct of members either in or outside of Society events where behaviour may not be fitting with the aims of the Society. Over the years, the Committee has reviewed and adjusted the Society Constitution as required.

The purpose of this was to ensure it reflected the needs of the Society and allowed those managing the day to day affairs, and the membership as a whole to enjoy a Society that is open and consults its members, and acts on the requests of the membership to improve the Society if practicable.

Since the 1996 Society Constitution was adopted (the first in the current format), we as a Society have grown considerable and continue to grow. We have been very fortunate in setting up good relations with professional bodies such as the IEE and the Museums communities. This has been achieved in a number of ways, but mainly through the "talking About Wireless" events at Harpenden.

We now find ourselves, as a Society with strong links to other organisations as mentioned and seen as a professional and capable Society by these communities. This however does mean we must have a supporting Constitution and procedures that reflect and uphold this position.

I take for example the IEE, RSGB, BATC (British Amateur Television Society) and SIS (Scientific Instrument Society). These organisations all have Bylaws as part of or in support of their Constitutions and ensure that their governing bodies are able to act where necessary and insure the stability and fairness of the members and Societies activities.

The Committee has therefore decided to create and maintain a set of BVWS bylaws and disciplinary procedures to support our Constitution. We expect to draft these out in the coming months and be in a position to publish them by the end of this year. I believe that this is long overdue for a Society of our size, whilst remaining adamant that any bylaws will not affect the friendly 'club' atmosphere that we are used to and proud of.

Mike...

## FOR SALE

### VINTAGE RADIO GRILLE CLOTHS

Many patterns to choose from

Large and small quantities

New cloths now available

Cabinet fittings • Rexine coverings

Samples available (please send £1.00 stamps for post/packing)

S.W. Chaplin 43 Lime Avenue, Leigh-on-Sea, Essex, SS9 3PA

Tel: 01702 473740

email sidney@tradgrilles.freemove.co.uk

## The Bygone Radio Shop

(Prop. Nicholas Walter)

100s Vintage/Classic radios from the '30's and

'40's from Original Sources

Restoration and Repair Service

Radio Collections Bought Outright

Shop hours: Mon-Sat 9.00 - 12.30 excl. Wed

The Bygone Radio Shop

296 Cheriton Road, Folkestone, Kent CT19 4DP

Tel: (01303) 277716



## Workshops at The Vintage Wireless Museum

25 Pounds per head, to include all minor components, refreshments throughout the day and meals.

**No transistors, Stereo or other modern equipment.**

23rd June, August 11th, 13th October

Please let Gerry know what you are bringing when you book  
23 Rosendale Road, West Dulwich, London SE21 8DS.  
Telephone 020 8670 3667



# Out Now! Tickling the Crystal

Domestic British Crystal Sets of the 1920s by Ian L. Sanders. Photography by Carl Glover

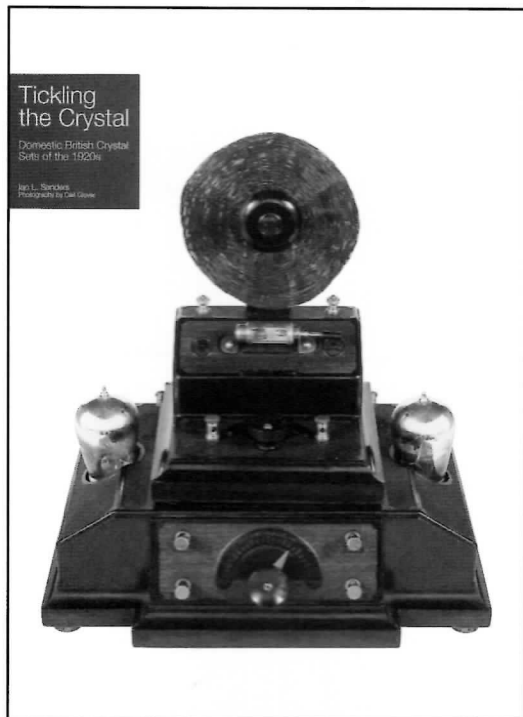

## Reviewer's Comments:

"...a truly exciting, world-class reference book covering just about every aspect of British domestic crystal sets of the 1920s."

Jonathan Hill, Bulletin of the British Vintage Wireless Society.

"...For any collector with an interest in the earliest broadcast receivers used in Great Britain, this book will provide an invaluable reference, full of useful information and with many photographs to drool over."

Geoff Arnold, Radio Bygones.

"...readers and viewers will not be disappointed. Ten years of research went into this book, and that work is evident on every page. ... From cover to cover, this book is first class."

David W. Krauter, The Old Timer's Bulletin, ( Journal of the Antique Wireless Association).

"...it fills a much-needed gap in the literature of early wireless in the UK. ...if you have any interest in the subject, buy this book. You will find it a joy to look at and an invaluable aid in the identification of many British crystal sets."

Howard Stone, Antique Radio Classified.

"...a superb book ...containing a wealth of previously unpublished material, it is undoubtedly the most comprehensive book ever on the subject. ...an invaluable reference work."

Len Kelly, Kelly Publications.

"...the definitive work in this field....should be on the bookshelf of every serious collector with an interest in British crystal sets."

Steve Harris, Airwaves.

256 pages of GPO No. era British crystal sets. Over 200 full-page photographs.

£29.95 plus £7 p&p for UK/EEC (rest of world £14). Bentomel Books, Finchcroft, Tunbridge Wells, Kent TN2 5PE

Telephone 01892 543505 email: bentomelbooks@aol.com website: www.wireless-publications.com

# We want your articles!

Share your interests with your fellow BVWS and 405 Alive members.

We accept: Type, handwriting, fax, email, floppy disc, CD

Send your articles to:  
Carl Glover, 33 Rangers Square, London SE10 8HR  
Tel/Fax: 020 8469 2904  
choris.b@virgin.net

# Ecko, Pye & BBC Receivers, and a Haines Amplifier

To be sold at Lawrence's Fine Art Sale on Thursday 11th July 2002

Telephone: 01460 73041 www.lawrences.co.uk

# BVWS POSTERS

3 designs depicting wireless sets from the 1920's, 1930's and 1940's onwards

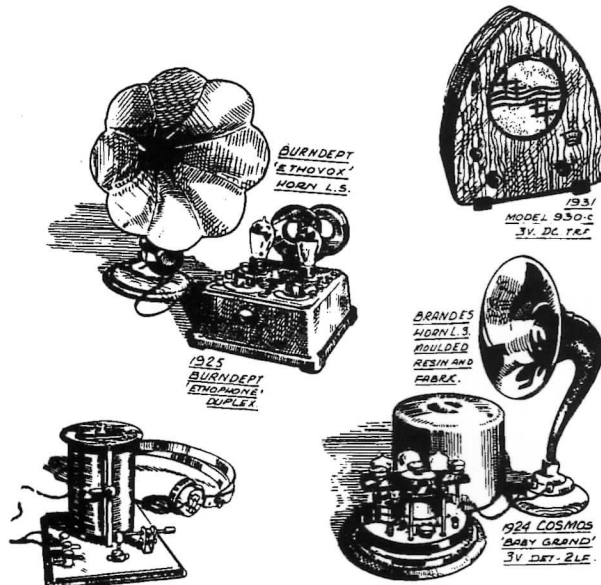

£6 per set at BVWS meetings  
£10 per set mail order including postage

Mike Barker: 59 Dunsford Close, Swindon. Wilts SN1 4PW.  
Telephone 01793 541634



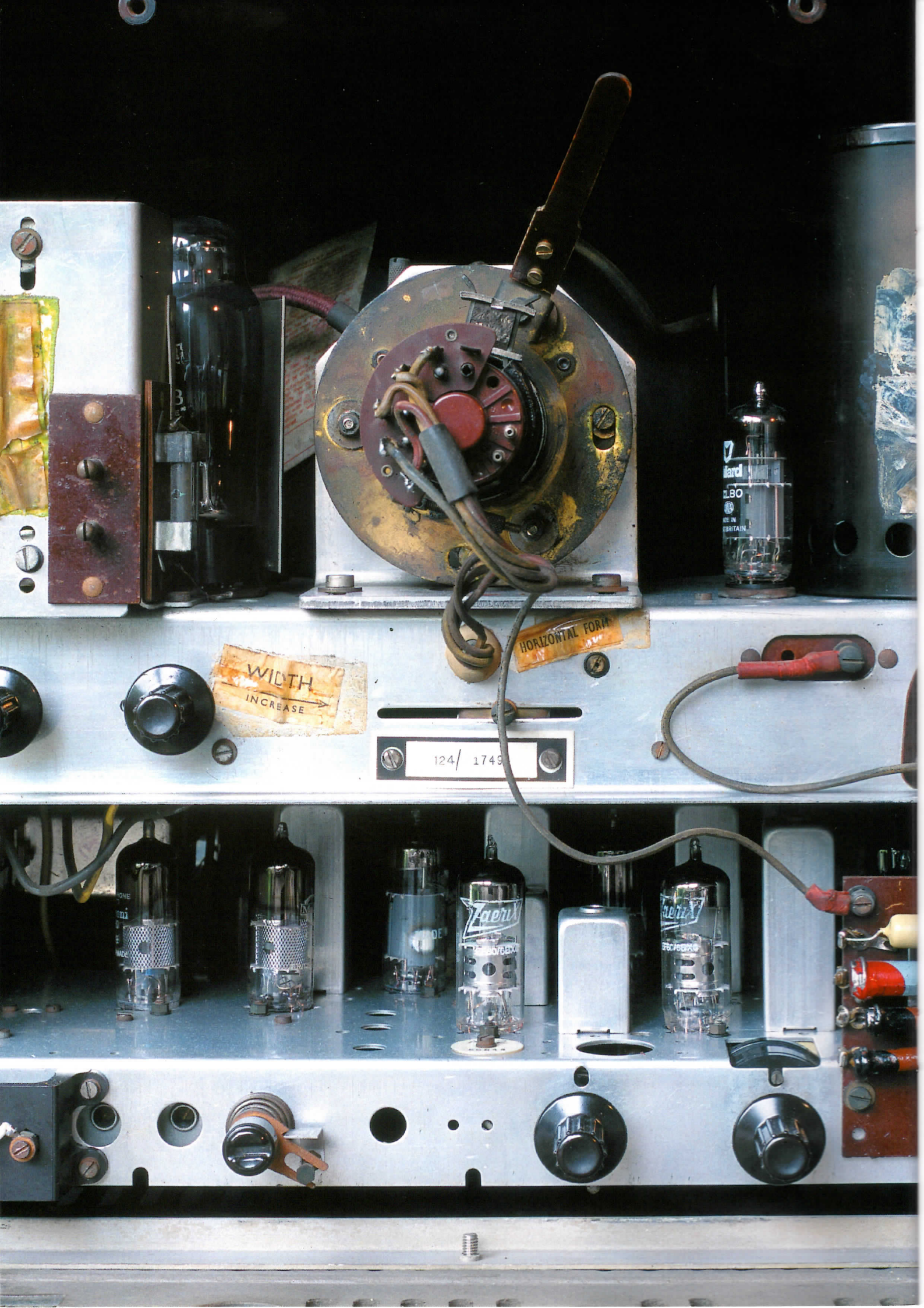

WIDTH  
INCREASE →

HORIZONTAL FORM

124/ 1749

6AR5

6AR5

6AR5

Laerux

6AR5