



Software Zebra CardStudio

O Software Zebra CardStudio 2.0 para impressora de cartão traz um novo nível de simplicidade para o design e impressão de cartões de fidelidade, cartões de presente e cartões de identificação.





CARD DESIGN & PRINT SOFTWARE

CardStudio™ 2.0

USER GUIDE

May 2018 | Version 1 | CardStudio™ V2.0



ZEBRA

Copyright

© 2018 ZIH Corp. and/or its affiliates. All rights reserved. ZEBRA and the stylized Zebra head are trademarks of ZIH Corp., registered in many jurisdictions worldwide. All other trademarks are the property of their respective owners.

COPYRIGHTS & TRADEMARKS: For complete copyright and trademark information, go to www.zebra.com/copyright

WARRANTY: For complete warranty information, go to www.zebra.com/warranty

END USER LICENSE AGREEMENT: For complete EULA information, go to www.zebra.com/eula

This document contains information proprietary to Zebra Technologies Corporation. This document and the information contained within is Copyrighted by Zebra Technologies Corporation and may not be duplicated in full or in part by any person without written approval from Zebra Technologies Corporation. While every effort has been made to keep the information contained within current and accurate as of the date of publication, no guarantee is given that the document is error-free or that it is accurate with regard to any specification. Zebra Technologies Corporation reserves the right to make changes, for product improvement, at any time.

Terms of Use

Proprietary Statement This manual contains proprietary information of Zebra Technologies Corporation and its subsidiaries (“Zebra Technologies”). It is intended solely for the information and use of parties operating and maintaining the equipment described herein. Such proprietary information may not be used, reproduced, or disclosed to any other parties for any other purpose without the express, written permission of Zebra Technologies.

Product Improvements Continuous improvement of products is a policy of Zebra Technologies. All specifications and designs are subject to change without notice.

Liability Disclaimer Zebra Technologies takes steps to ensure that its published Engineering specifications and manuals are correct; however, errors do occur. Zebra Technologies reserves the right to correct any such errors and disclaims liability resulting therefrom.

Limitation of Liability In no event shall Zebra Technologies or anyone else involved in the creation, production, or delivery of the accompanying product (including hardware and software) be liable for any damages whatsoever (including, without limitation, consequential damages including loss of business profits, business interruption, or loss of business information) arising out of the use of, the results of use of, or inability to use such product, even if Zebra Technologies has been advised of the possibility of such damages. Some jurisdictions do not allow the exclusion or limitation of incidental or consequential damages, so the above limitation or exclusion may not apply to you.

Table of Contents

CardStudio™ 2.0 User Guide Introduction	8
CardStudio™ 2.0 User Guide General Information	10
Specifications	10
Minimum Hardware specifications	10
Software	10
Supported Printers	11
CardStudio™ 2.0 User Guide Download and Install	13
Download the CardStudio™ 2.0 Software	13
Install CardStudio™ 2.0	14
Registration of the Software Edition	18
Registration of the Software	18
Online Registration	18
Successful Registration	18
CARDSTUDIO™ 2.0 USER GUIDE DESIGNSTUDIO	19
DesignStudio Interface	19
DesignStudio Navigation	21
Main Menu	21
File	21
Edit	22
View	22
Help	22
Quick Menu	23
DesignStudio Start a Card Design	26
New Card Design	26
Open existing Card Design	27
DesignStudio Card Design Menu	29
Preview	29
Card Settings	29
Dynamic Fields	30
DesignStudio Elements	32
Element Properties	37
Text element properties	37
Image element properties	37
Passport Photo element properties	37
Signature element properties	38
Barcode element properties	38
Dynamic logo element properties	38

Element Position	39
Resize and rotate elements on the canvas	39
Element Style	40
Border & Background	40
Color & Transparency	40
DesignStudio Print a Card Design	42
CARDSTUDIO™ 2.0 USER GUIDE PRINTSTUDIO	43
PrintStudio Interface	44
PrintStudio Navigation	45
Main Menu	45
File	45
Edit	45
Record	45
Options	46
Views	46
Help	46
Quick Menu	47
PrintStudio Create a Project	50
New Project	50
Create a New Project	51
1. Project Structure	51
2. Biometric settings	52
3. View configuration	53
4. Triggers	54
5. Create project	55
Create a New CardStudio Project with database connection	56
1. Data sources	56
2. Image sources	57
3. View configuration	58
4. Triggers	59
5. Create project	60
Create copy of an existing Project	61
1. Select Project	61
2. Copy project	62
Import Project from Excel	63
1. Data source	63
2. Project structure	64
3. Biometric settings	65
4. View configuration	66
5. Triggers	67
6. Import Project	68

New Project from BadgeMaker 7 Project	69
1. Select BadgeMaker 7 Project	69
2. Project structure	70
3. Biometric settings	71
4. View configuration	72
5. Triggers	73
6. Import Project	74
New Project from IDPro 7 Project	75
1. Select IDPro 7 Project	75
2. Project structure	76
3. Biometric settings	77
4. View configuration	78
5. Triggers	79
6. Import Project	80
PrintStudio Open Project	82
PrintStudio Import Data	84
Import an Excel file or CSV data file	85
1. Data source	85
2. Configuration	86
3. Import data	87
Import BadgeMaker 7 project data	88
1. Data source	88
2. Configuration	89
3. Import data	90
Import IDPro 7 data	91
1. Data source	91
2. Configuration	92
3. Import data	93
PrintStudio Import Photos	94
PrintStudio Export Data	96
PrintStudio Export Photos	97
PrintStudio Project Settings	99
Detail View	99
Biometric settings	101
Card Designs	102
Card designs assignment	103
Project Structure	104
Triggers	105
Manage Project	106
PrintStudio Link Card Design to record	108

PrintStudio Records	110
Add Records	110
1. Add a new record	110
2. Photo	111
3. Signature	112
Print records	113
PrintStudio Database Connection	115
Setting up a PrintStudio Database Connection	116
How to set up a PrintStudio Project with Database connection	116
Connect with database	117
Changes when working with PrintStudio with external database connection	120
PrintStudio Encode	122
Contactless Encoding	122
SmartCard Editor	122
Creating a MIFARE Classic Template using the CCI Editor	122
Information about Sector Data	124
Creating a MIFARE DESfire template using the CCI Editor	125
Encoding with PrintStudio	127
Supported standards	128

CardStudio™ 2.0 User Guide

Introduction

CardStudio™ 2.0 User Guide

Introduction

CardStudio™ 2.0 is a full-feature card design and printing software application with complete capabilities for card design, data management and card production. CardStudio is provided in four **editions**: Classic, Standard, Enterprise and Professional. All four editions integrate the required features for ID card design and production.

Classic:

CardStudio 2.0 Classic edition lets you create and print professional-looking photo IDs and other type of card designs with a new easy-to-use interface and design and print features.

Standard:

CardStudio 2.0 Standard Edition lets you create, manage and print professional-looking card designs with a new easy-to-use interface and design and print features. Including internal database, Excel and .csv file integration for ID records, 2D bar codes, and advanced print functionality.

Enterprise:

Designed for enterprise applications, the CardStudio 2.0 Enterprise edition lets you create and print professional-looking photo IDs and other type of card designs with a new easy-to-use interface and design and print features. Including internal database, Excel and .csv file integration for ID records, 2D bar codes, and advanced print functionality. Enterprise edition includes advanced features to connect to multiple Database, ODBC data sources and multiple Projects, for advanced card design, issuance and data management capabilities.ard Design, issuance and Data Management capabilities.

Professional:

Created for advanced enterprise applications that require smart card encoding support, CardStudio 2.0 Professional edition lets you create, print and encode professional-looking card designs with a new easy-to-use interface and design and print features. Including internal database, Excel and .csv file integration for ID records, 2D bar codes, and advanced print functionality. Advanced features to connect to multiple databases and ODBC data sources, and multiple projects for advanced card design, issuance and data management capabilities.

CardStudio™ 2.0 is desktop-based card production software developed to design card layouts, manage, add or import card data, capture photos and signatures and printing a card with one click of a button making the card production process quick and easy.

CardStudio is a combination of two specific modules that each have their own strengths. **DesignStudio** focuses on creating perfect card layouts and **PrintStudio** can handle your data with the ease of known spreadsheet software.

DesignStudio gives you the all the needed tools to create a front and back design, with images, logo's, shapes and dynamic data. You will be able to create a template with placeholders that help determine the layout of dynamic data. For example: where a passport photo should be placed, a signature or the first and last name of person.

As a user you can manage data and layouts for different types of ID cards using different kind of printers. **PrintStudio** gives you the basic tools to import, add and manage data like card holder information, passport photos and signatures. This data can then be connected to a card design or multiple card layouts and selected for printing. CardStudio imports and prints large amounts of data and cards and makes your card production process faster and efficient.

Any Windows PC with a network connection can be used to install CardStudio. This PC needs to have an internet connection to download the installation file, register the software and keep the software up to date with automatic updates.

This manual does not describe the installation of printers or other peripherals like a camera or signature pad.

Please refer to the manufacturers manuals for further information on these devices. Before working with the software, first install the Zebra Windows printer driver so the Zebra Printer is ready to print cards.

CardStudio™ 2.0 User Guide

General Information

CardStudio™ 2.0 User Guide

General Information

When you or your organization choose CardStudio for your card design, data management and card production make sure to have the correct hardware to install on. Choose a Windows PC for installation, that creates an optimal work environment for the CardStudio 2.0 software and supports the correct hardware like a card printer.

Specifications

Minimum Hardware specifications

Processor Intel Pentium Dual core

G640 2,8 Ghz or equal

Memory 2GB

Free Disk space 4GB

Graphics 1024 x 768

Monitor/Mouse/keyboard

3 available USB ports

(printer/webcam/signature pad)

Software

Supported Operating Systems:

Windows Vista (32 bit & 64 bit)

Windows 7 (32 bit & 64 bit)

Windows 8 & 8.1 (32 bit & 64 bit)

Windows 10 (32 bit & 64 bit)

Supported Printers

Updates for support of new printers are added regularly, by means of automatic software updates.

Manufacturer	Type	Single sided	Double sided	Batch Printing	True Black	Print job Preferences	Contactless Encoding	MAGstripe Encoding	Remark
Zebra	ZXP Series 3	✓	✓	✓	✓	✓	✓	✓	
Zebra	ZXP Series 7	✓	✓	✓	✓	✓	✓	✓	
Zebra	ZXP Series 8	✓	✓	✓	✓	✓	✓	✓	
Zebra	ZXP Series 9	✓	✓	✓	✓	✓	-	-	
Zebra	ZCL10	✓	✓	✓	✓	✓	-	-	
Zebra	ZC100	✓	-	✓	✓	✓	-	-	
Zebra	ZC300/350	✓	✓	✓	✓	✓	✓	✓	

CardStudio™ 2.0 User Guide Installation

CardStudio™ 2.0 User Guide

Download and Install

Download the CardStudio™ 2.0 Software

Download the latest version of the CardStudio 2.0 Beta at:

<https://cardstudio.zebra.com>

or use the optional “[USB Card-Drive](#)” if provided.

The link will download the installer file that will look like this:

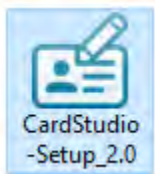

Double clicking on this installer will open a popup window. This popup will ask if you are sure you would like to run the installer. Clicking on the run button will start the CardStudio installation wizard.

Install CardStudio™ 2.0

A. If you would like to run the installer and setup CardStudio on your system, click the “Run” button. If you do not want to install CardStudio, click on the “Cancel” button.

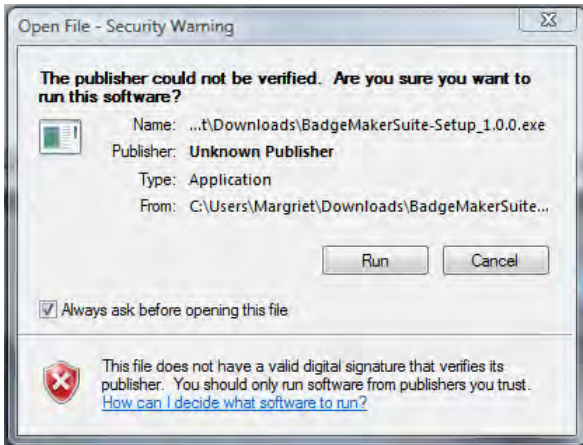

B. Click on the “Next” button to continue the installation of CardStudio.



C. The “Features” tab: This step in the installation process is to select how you would like to install CardStudio. You can select the features you would like to install. DesignStudio, PrintStudio, Demo projects and the SmartCard Editor are selected by default. If you would like to only install PrintStudio or DesignStudio, just un-check the boxes of the features you do not want to install.

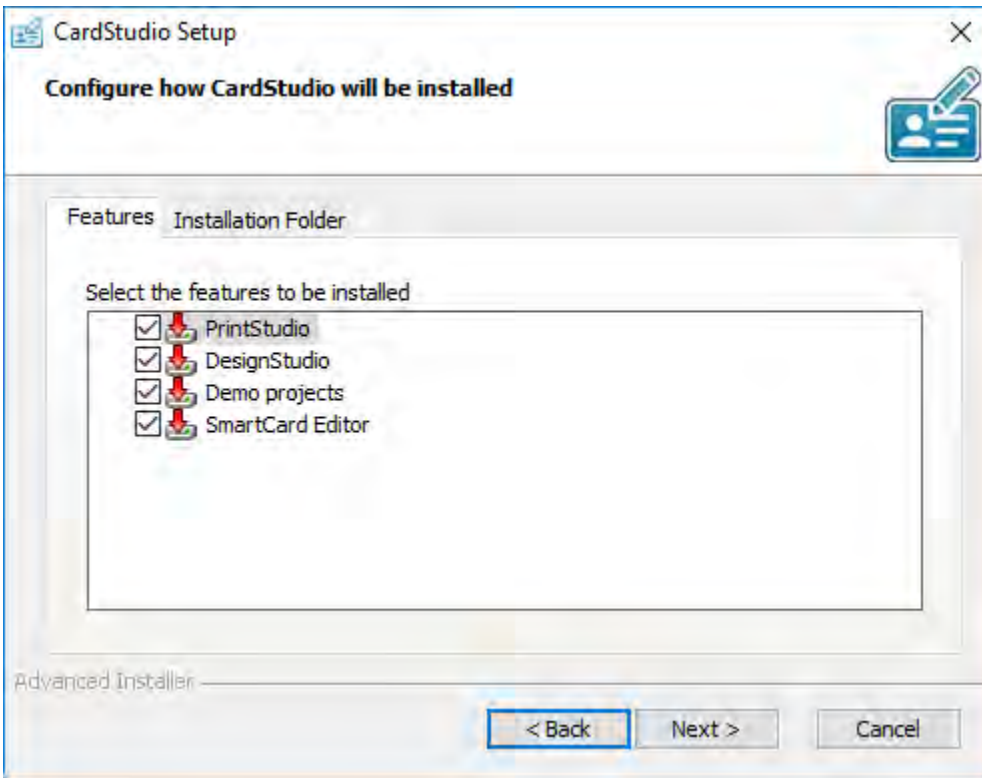

C. The “Installation Folder” tab: The third step in the installation process is selecting the location where you would like to install CardStudio. You can select this by clicking on the browse button and browse to the desired location. If you do not have a specific location for CardStudio you can go with the default location.

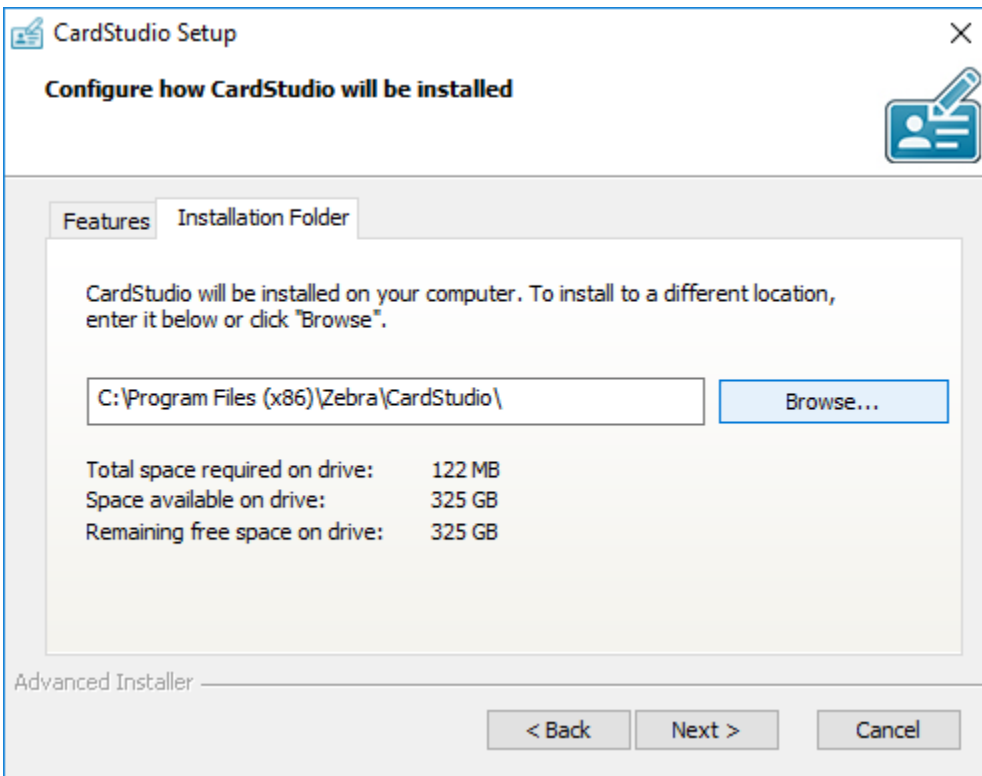

D. The installer is now ready to begin the CardStudio installation. Click the “Install” button to begin the installation. If you want to review or change any of your installation settings, click on the “Back” button. Click “Cancel” to exit the installer.

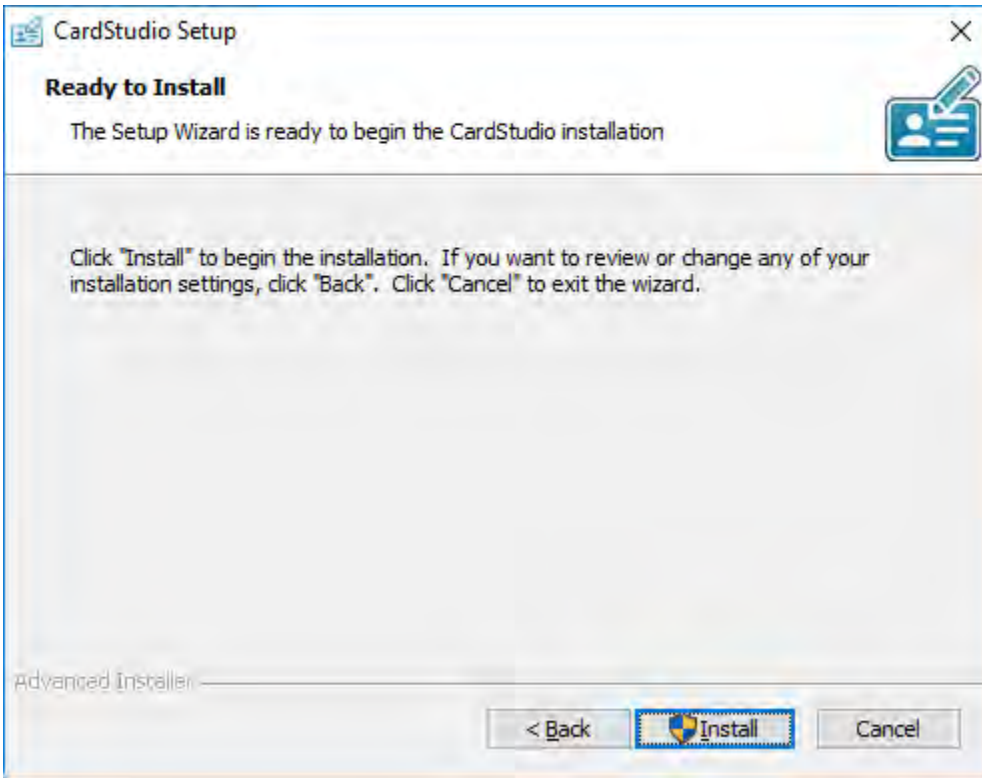

E. The installation is now in process. This can take a couple of minutes. A popup window will appear to make sure that you want to run the installation. Click “Yes” to continue.

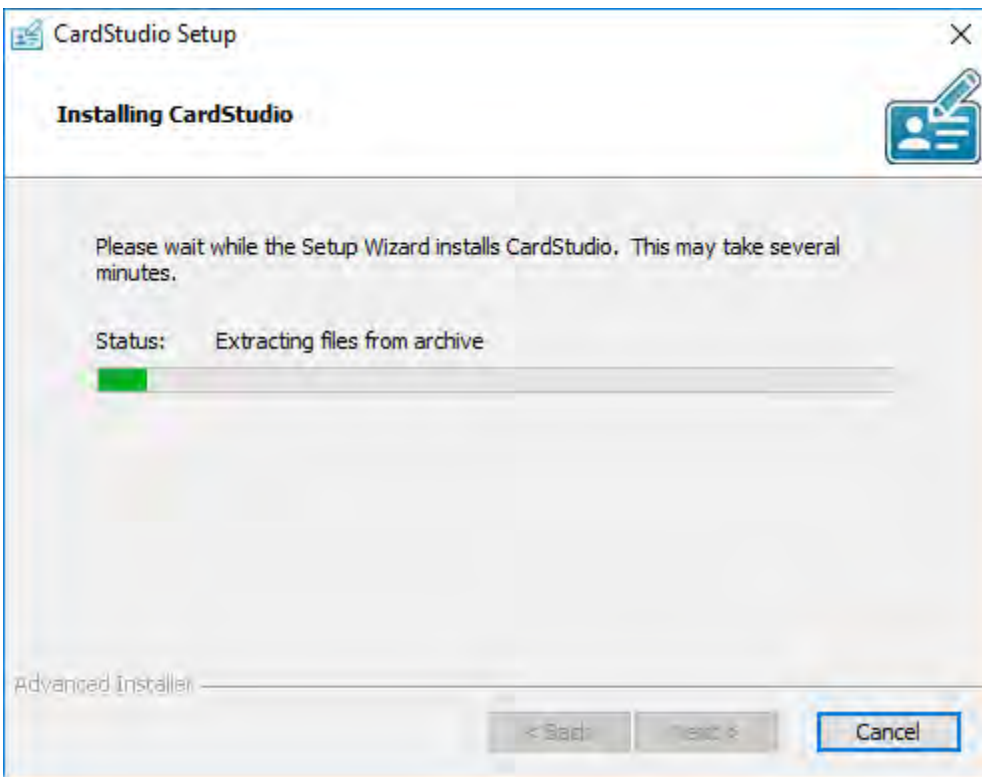

F. The installation is complete click the “Finish” button to exit the installer.

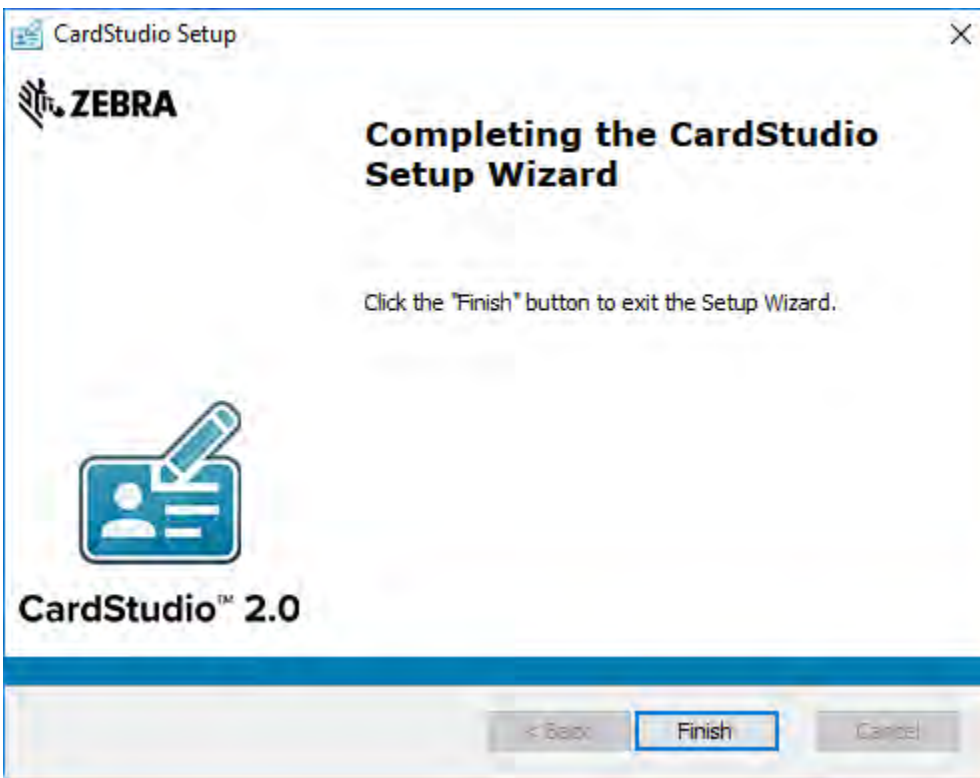

G. After completing the installation, 3 shortcuts will appear on your desktop. For CardStudio, only DesignStudio and PrintStudio are needed. In the case of CardStudio Classic only one desktop Icon will appear. If you have CardStudio Standard or above, you will have 2 or 3 desktop Icons.

If you would like to start creating a new card layout, double click on the “DesignStudio” icon:



If you would like to start a project and add card data, double click on the “PrintStudio” icon:



If you would like to start the SmartCard Editor to create an encoding file, double click on the “SmartCard Editor” icon:

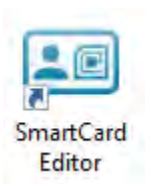

Before you start CardStudio™ 2.0, a license key is needed for the registration of an edition.

Registration of the Software Edition

When [DesignStudio](#) or [PrintStudio](#) starts for the first time, a registration window will pop-up, this is where the license key can be entered, and the CardStudio Software activated.

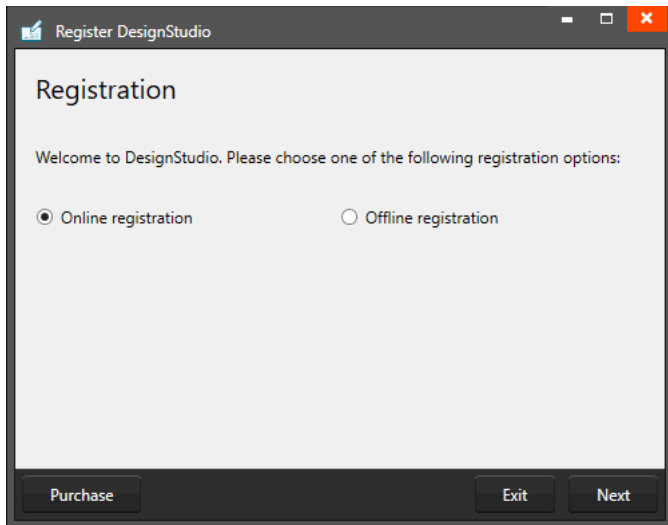

Example of the CardStudio registration window.

Registration of the Software

The first question will be about online or offline registration. Select the online registration.

The license keys will be for online registration. No access to the internet to activate your license keys? Contact your local reseller for more information on offline license keys.

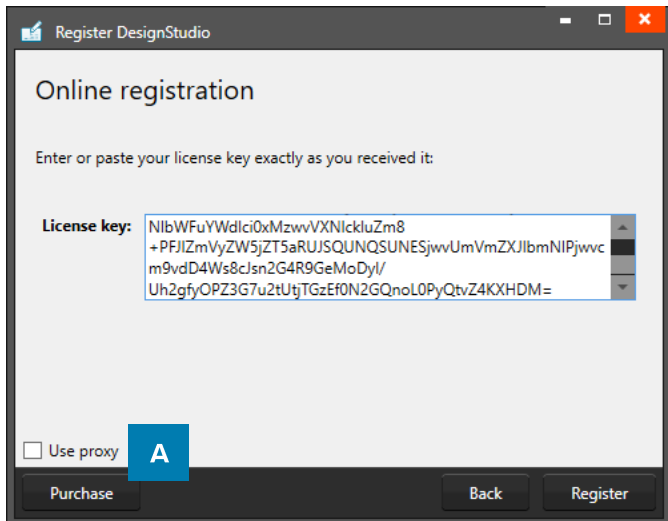

Example of the CardStudio online registration license key window with License Key entered.

Online Registration

You will be requested to enter a license key. The license key will be provided by our License Manager. The license key must be entered (copy-paste), when the key is valid, the software will start. The next time the software will not require the license key to be entered.

Test keys can have a time restriction and may expire on a given date. (View the License Manager User Guide for more information on License Keys).

A. Check the "Use Proxy" box and enter the information needed to connect through a Proxy server in your network.

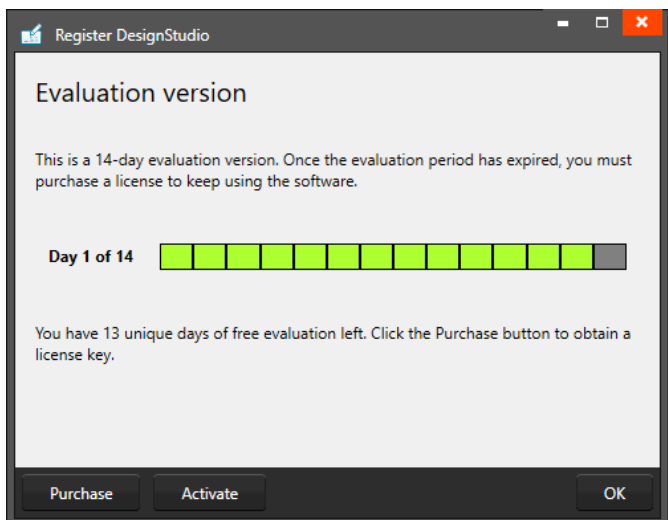
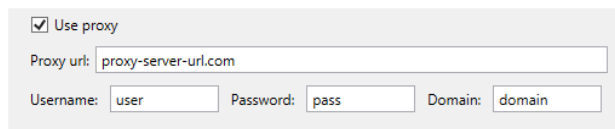

Example of a successful online registration of a CardStudio demo key.

Successful Registration

When you copy-paste the correct key you will see that the registration is successful. In this case it is a demo key that shows the evaluation time. Click the "OK" button to start working with CardStudio.

CardStudio™ 2.0 User Guide

DesignStudio



DesignStudio Interface

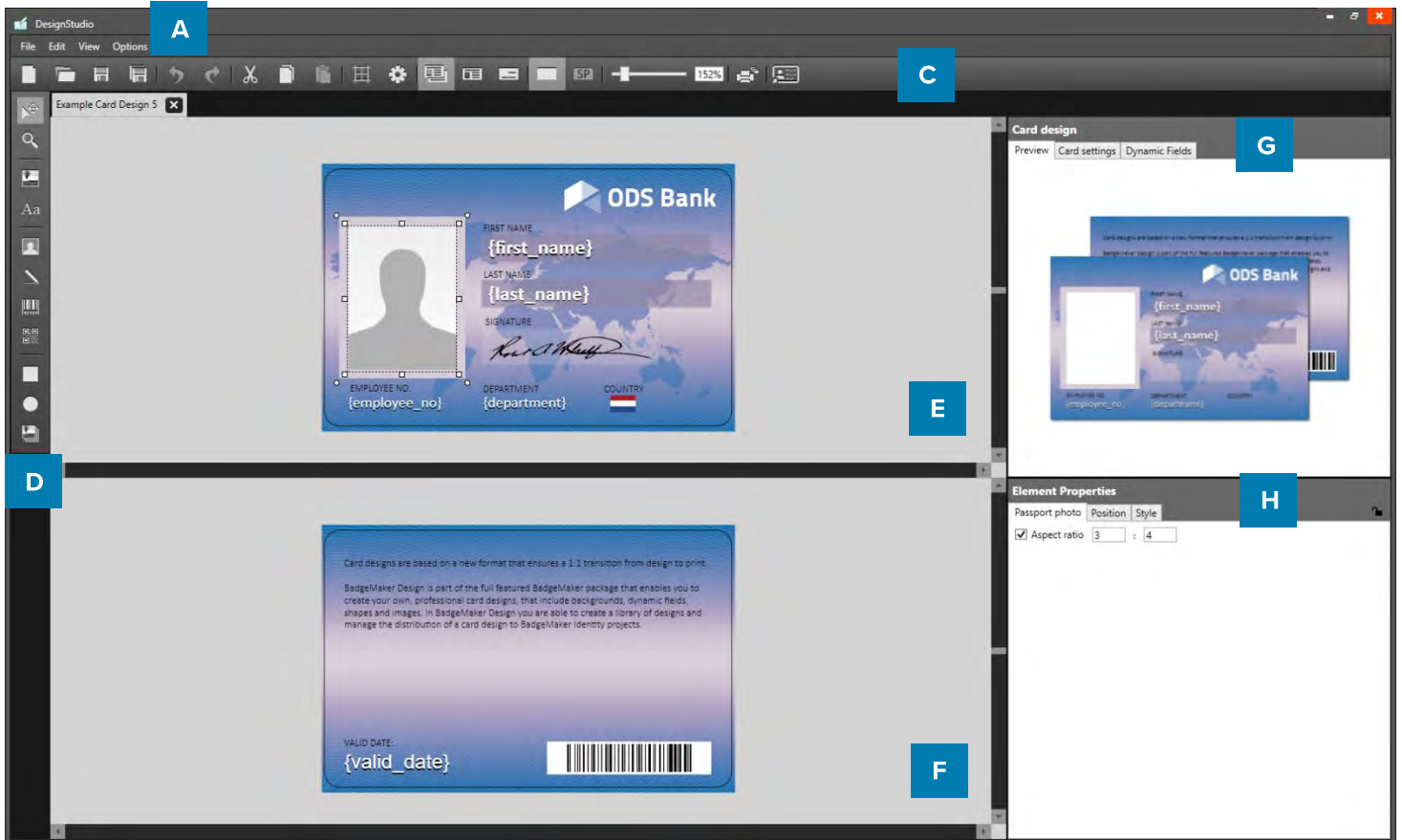

- A. Main menu
- B. Window menu
- C. Quick menu
- D. Toolbar
- E. Workspace/Canvas Front
- F. Workspace/Canvas Back
- G. Card Design:
Preview / Card Settings / Dynamic Data Fields
- H. Element Properties

DesignStudio

Navigation

DesignStudio makes the card design process as easy, fast and intuitive as possible. Accommodating the users in your organization, set with the task of designing the ID-cards. Using a user-friendly overview that shows all the tools needed and is easy to navigate.

Window navigation

The window navigation gives the option to **A.** minimize, **B.** maximize or **C.** close.



Main Menu

The main menu offers the options: “File”, “Edit”, “View” and “Help”

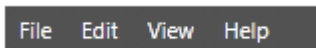

The main menu offers 4 sub-menus.

File

The first button offers the main functions needed to start, use, save and end CardStudio Design:

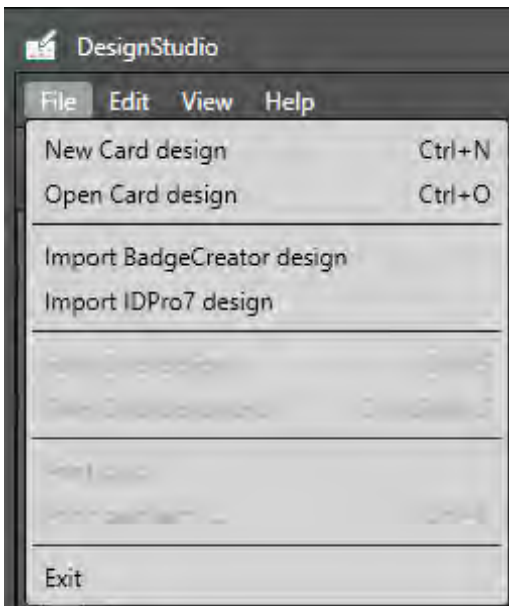

- *New Card design*: Create a blank new layout for your ID-card.
- *Open Card design*: Open an existing card design to adjust.
- *Import BadgeCreator design*: Import designs created in BadgeMaker Classic.
- *Import IDPro7 design*: Import old designs created in IDPro7.
- *Save Card design*: To save a Card Design click here or use CTRL + S.
- *Save Card design as*: To save a Card Design under another name click here. It is also a simple way to create a duplicate of your design.
- *Print card*: The Classic Edition lets you print your design from DesignStudio. Click to select a printer, set preferences and print
- *Print card with*: When a default printer is setup you can skip the printer preferences and print here.
- *Exit*: This button will let you exit CardStudio Design.

Edit

The second button will offer all the edit functions that you use during the design process:



- **Undo**: Undo previous design steps. You can use the short cut **CTRL+Z**.

- **Redo**: Redo design steps you undid.

- **Cut**: To relocate an object (image, text, placeholder) on the canvas use the cut button. You can use the short cut **CTRL + X**.

- **Copy**: To copy an object (image, text, placeholder) on the canvas use the copy button. You can use the short cut **CTRL + C**.

- **Paste**: To paste a copied or cut object (image, text, placeholder) on the canvas use the cut button. You can use the short cut **CTRL + V**.

View

The third button controls the CardStudio dashboard view, make specific views visible or invisible:

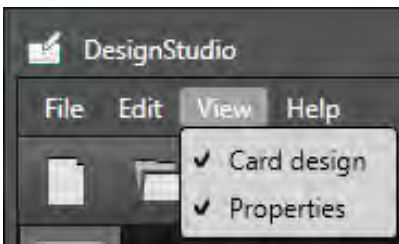

- **Card Design**: See the design preview, card settings and the Dynamic Fields

- **Element Properties**: Adjust the different type of elements by clicking on an element and using the Element Properties to make changes.

Help

The Help button offers information about DesignStudio and offers an online user guide:

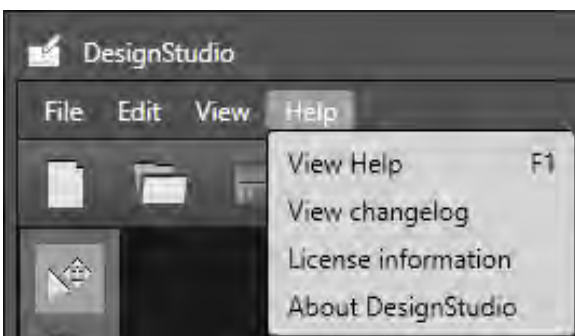

- **View Help**: Opens the online user guide

- **View changelog**: Shows the changes and updates made in the software

- **License Information**: Shows the specific license information, the edition, the reference, versions and activation date

- **About DesignStudio**: Pop-up with version and developer information.

Quick Menu

The Quick Menu offers a selection of large visual buttons often used in the card design process making navigation quick and easy.



A. Create new Card design

Starts a new Card design.

B. Open existing Card design

Open an existing Card design.

C. Save

It is important to save your layout while designing. Quickly saves the card design.

D. Save as

Saves your design under another name.

E. Undo

Undo design steps you made.

F. Redo

Redo design steps you made.

G. Cut

To place an element somewhere else, use this button to cut and replace the image. Just select the element you want to replace, click on the cut button and then click on the paste button to place it somewhere else.

H. Copy

To copy elements, select the element, then click on the copy button. The element is ready to be paste anywhere on the front or back of the design canvas.

I. Paste

If you cut or copy an element, click on the paste button to place the element on the front or the back of the canvas.

J. Show/hide grid

Make a grid visible or invisible. A grid can help you be more precise with your design. Having the grid to align elements.



K. Settings

Settings gives a couple of options:

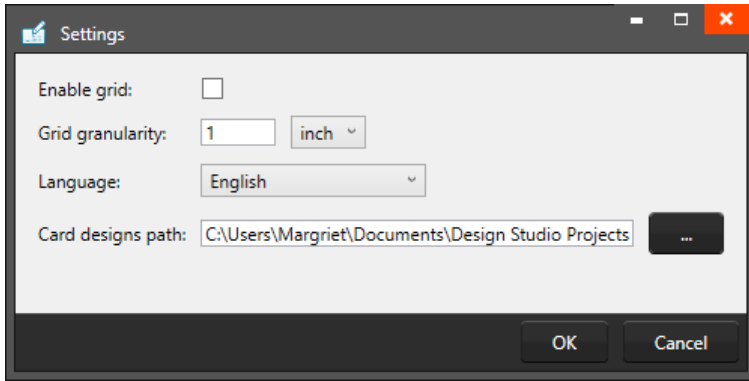

- Check or uncheck the enable grid checkbox to enable or disable the grid.
- Determine the scale of the grid.
- Set the language used in the designer. Languages supported: *English*
The rest of the languages will be supported soon.
- Determine your own project path, where you would like to open and save your designs.
- To confirm settings, click “OK”, to cancel settings, click “Cancel”
- To exit settings, click “X”

L. Show front and back designers

View the canvas for the front and back side of the layout.

M. Show front designer only

View the canvas for the front side of the layout.

N. Show back designer only

View the canvas for back side of the layout.

O. Design layer

This is the base layer to work in to design your (YMCK or monochrome) card layout.

P. Specialty panel

This is a specialty panel to work in if you want your specialty panel (like an pearl panel) to have a certain design or pattern. (Be aware that a specific printer and ribbon are needed to add specific layers with a design or pattern.)

Q. Scale slider

Use this slider to zoom the canvas view in or out.

R. Print Card Design

This Quick button lets you add one record of data and print your card design from Design Studio. You can only use Zebra printers to print your card designs.

S. PrintStudio

This Quick button lets you open PrintStudio and continue with your card production process.

DesignStudio

Start a Card Design

DesignStudio

Start a Card Design

To start and work on a card design, start a new design or open an existing design.

New Card Design

A. Go to “File” in the main menu and click on “New Card Design”.

Or click on the icon below in the quick menu:

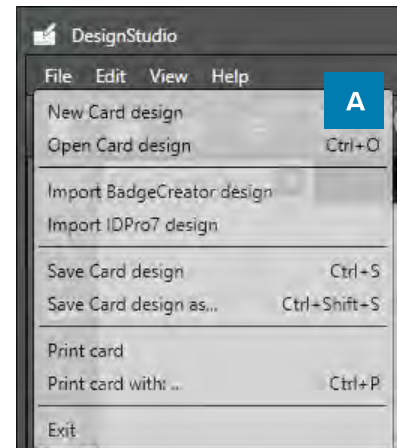

When clicking on the new card design link or button a setup window will pop-up.

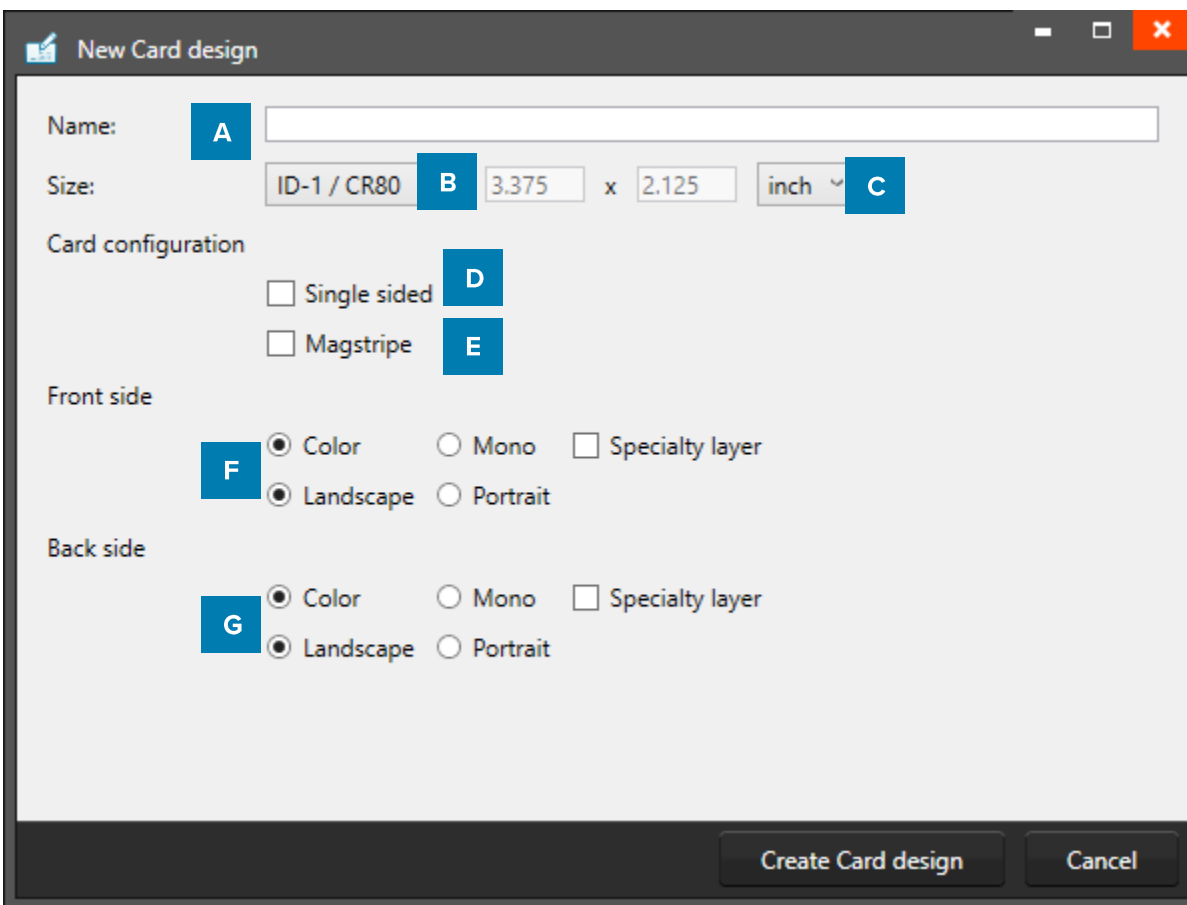

Fig. Example of new card design setup window.

- A. Enter the name for the layout. The exclamation mark at the end appears when the field is not filled, or the name already exists. The ‘OK’ button is not accessible until a unique name is given.
- B. The size of the card can be chosen from a drop down.
- C. Define a custom size for your layout.
- D. Check this box if the design is single sided.
- E. Check this box if the design is for a card with MAGstripe.
- F. Check the ribbon type (color or mono), the orientation of the design for the front and the type of layers.
- G. Check the ribbon type (color or mono), the orientation of the design for the front and the type of layers.

Open existing Card Design

B. To open an existing Card Design go to “File” in the main menu and click on “Open Card design”.

Or click on the icon below in the quick menu:

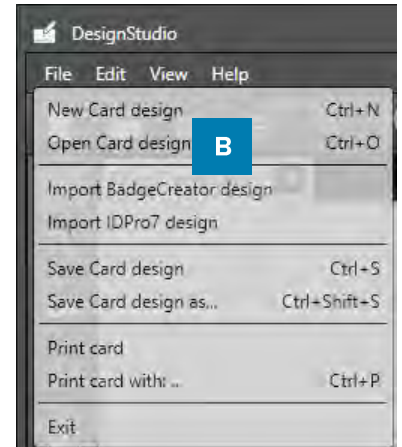

When clicking on the new card design link or button a select window will pop-up.

All available existing designs are displayed, select a layout for editing.

You can open multiple layouts at the same time.

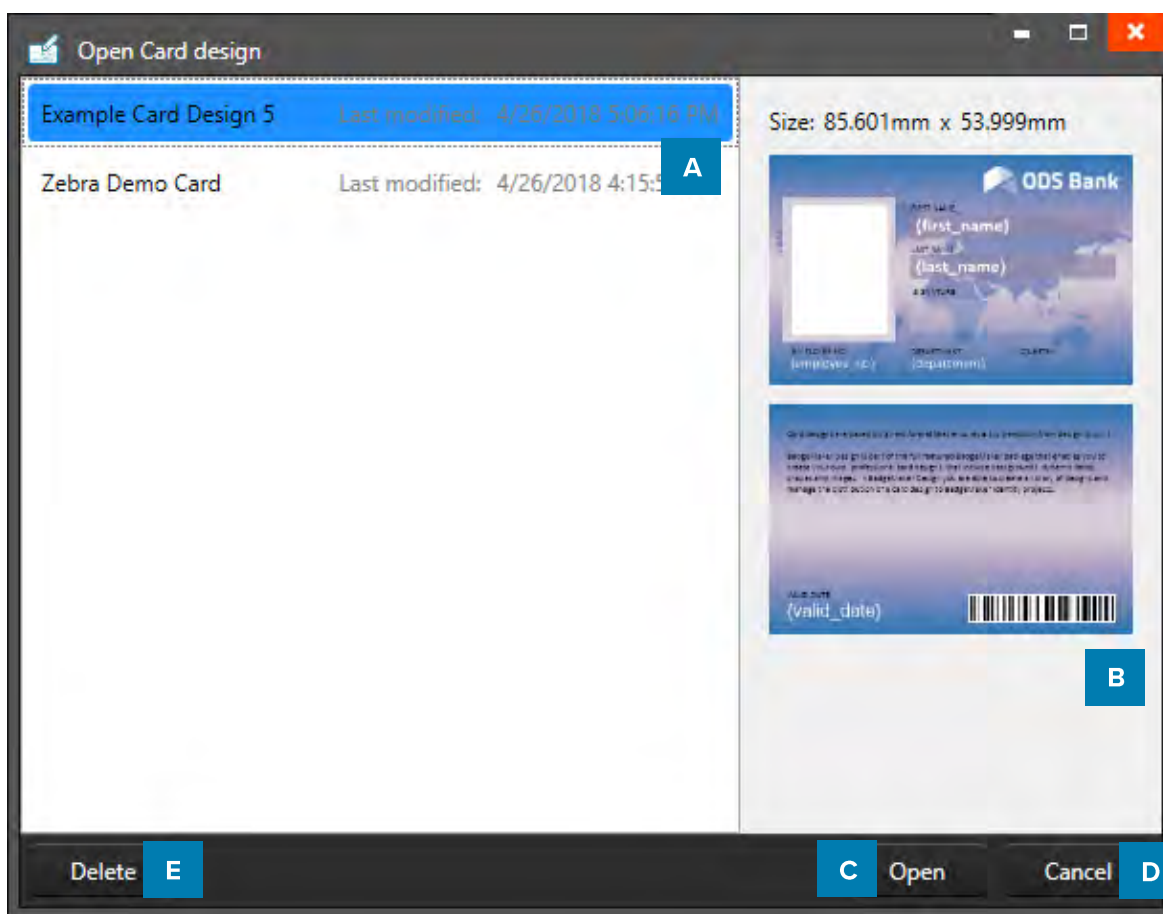

Example of the Open Card design popup window.

- A. Select one of the existing designs
- B. View the layout of the design selected
- C. Open the selected design
- D. Cancel opening a design.
- E. Delete a selected design.

DesignStudio Card Design View

Preview, Card Settings and Dynamic Field

DesignStudio

Card Design Menu

The Card Design window presents three tabs: [Preview](#), [Card Settings](#) and [Dynamic Fields](#).

Preview

The Preview shows a preview of the card; when clicking on the preview it will toggle from front to back.



Example of the Preview in the Card Design view.

Card Settings

The Card Settings tab offers information on the card design settings. Change or edit the settings of the card design. The elements already placed will not be affected, when for example changing a layout from landscape to portrait.

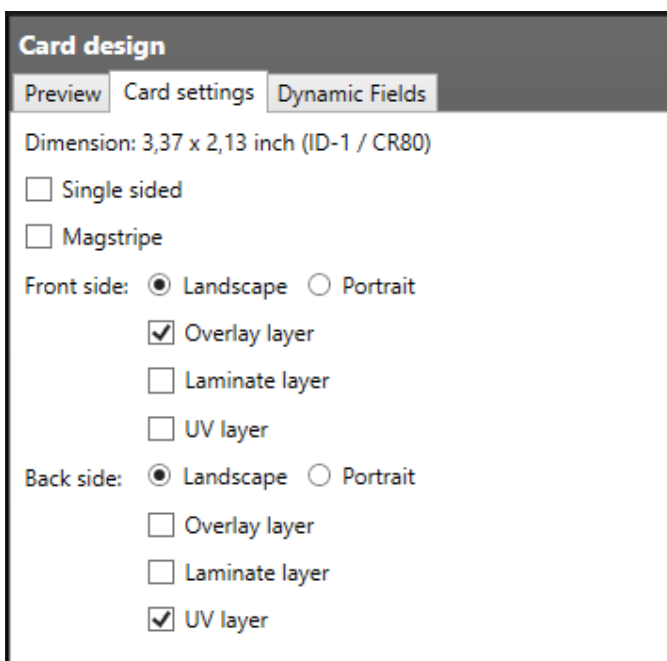

Example of the Card Settings tab in the Card Design Menu.

Dynamic Fields

With the start of a new card design it is important to create the needed dynamic fields for a card design. Dynamic data represents data that need to be on a card design for different card holders. For example: First name, Last name or Department. When dynamic data is linked to project data, the dynamic data placeholder will be replaced with the card holder data.

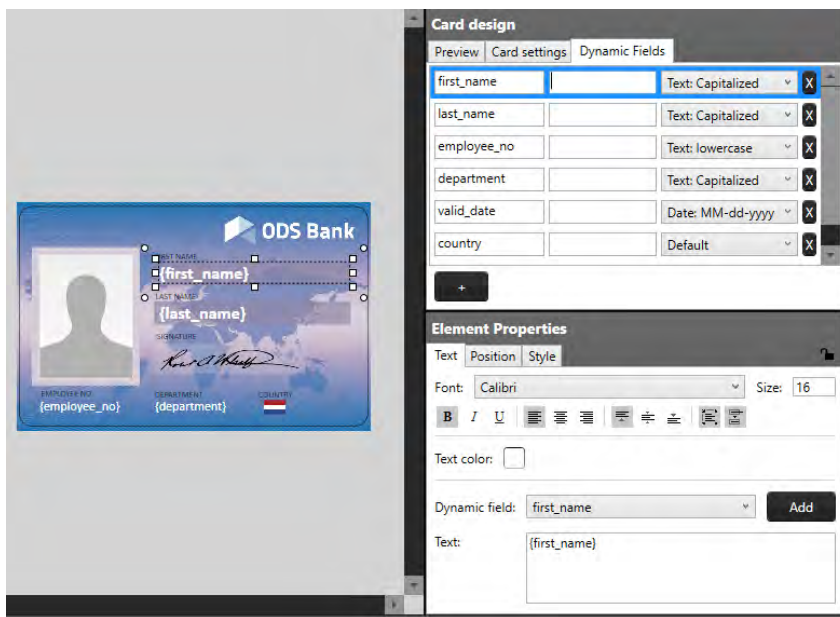

The tab “Dynamic Fields” in the card design view will give a list of the dynamic fields in the layout. When a text element is added to the card design, and the text in the text element has a name in **{between curly brackets}**, DesignStudio will detect this as a dynamic field name and will be added to the list of Dynamic fields.

The user can delete, change and edit the field names and enter default values to be used as preview.

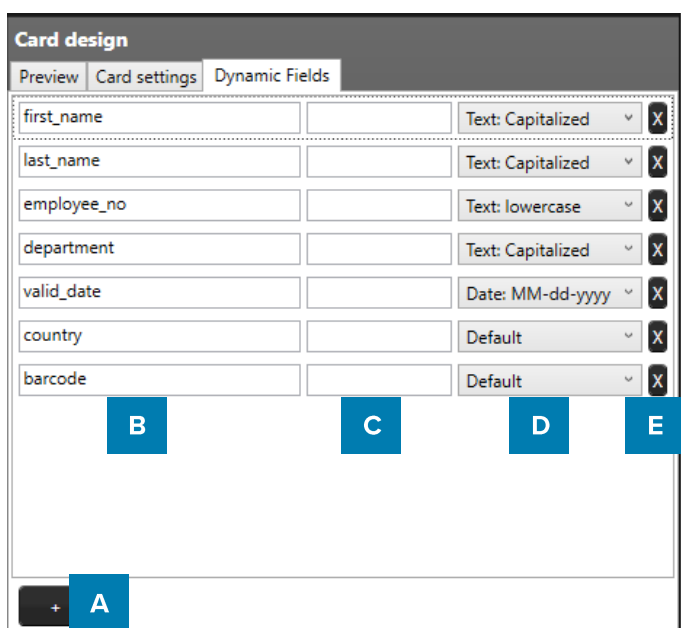

- Add a new dynamic field to the list by clicking on the “+” button.
- Enter a dynamic field name by clicking on it and rename it from, for example, “Dynamic Field 1” to “first_name”.
- It is possible to enter a default value for the fields. For example, the default value for “department” can for example be “Sales”.
- A dynamic field can have a certain format, the dropdown menu offers a couple of options. For example, the value of a certain dynamic text field needs to be “CAPITALIZED”.
- Click on the “X” button to delete a dynamic field.

DesignStudio Elements

DesignStudio

Elements

Element Tool Menu

To create and edit a design you need to work with the toolbar setup on the left side. The tool bar offers the following functions:



A. Select/move tool

The arrow tool is used to select an element. This tool also allows you to move an element in the layout. When an element is selected the move, icon appears and can be used to move or resize an element.

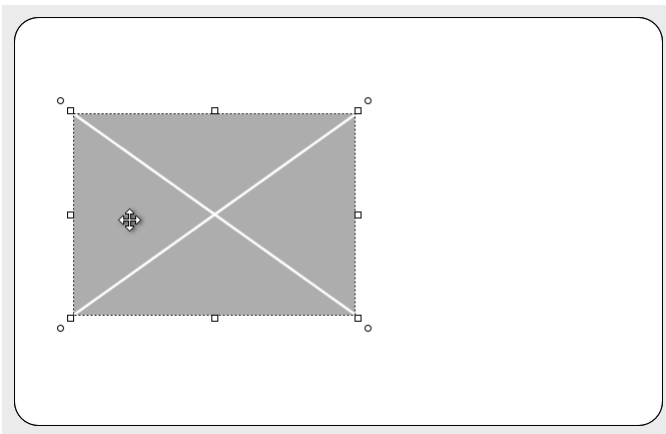



B. Zoom tool

The zoom function is enabled and will zoom in on the layout.

At a click of the mouse the zoom is increased one step, when using CTRL and a click of the mouse the zoom is decreased by one step.

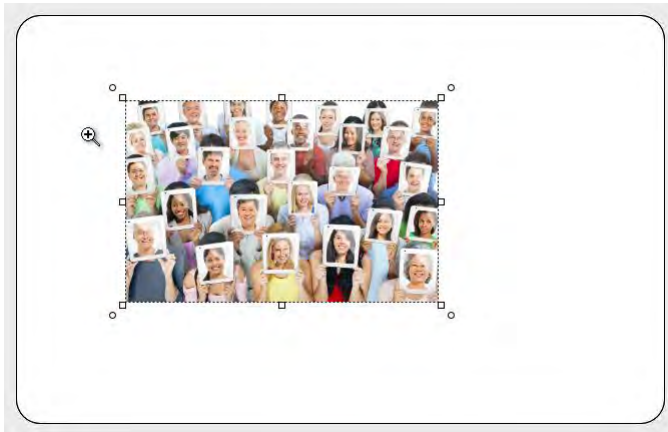

C. Image tool

The image tool is used to place an image element in the layout.

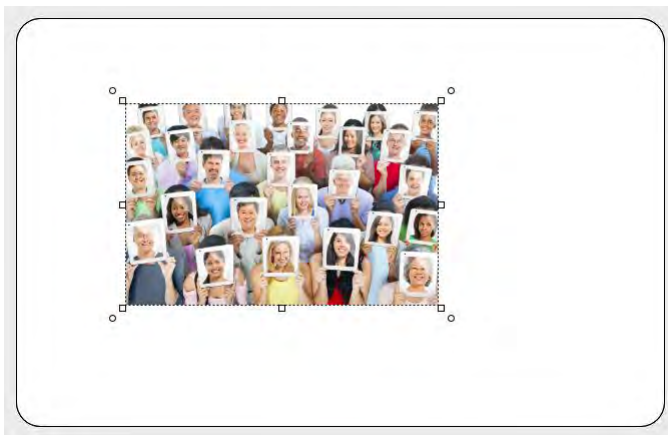

D. Text tool

The text tool can be used to add static and dynamic text to the design. Use the Text Element properties to edit and add text and or dynamic text to the box. Click on the element and go to Element properties to edit the text in the text editor.

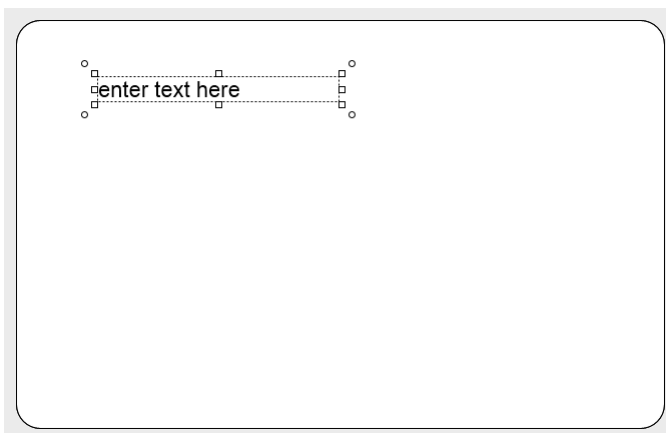



E. Passport Photo tool

The Photo element is used to place a placeholder for the Passport Photo on the layout. The photo element can scale within proportions. When the design is linked to data in for example a PrintStudio Project, the placeholder will replace the dummy image with a real Passport Photo from the project data.

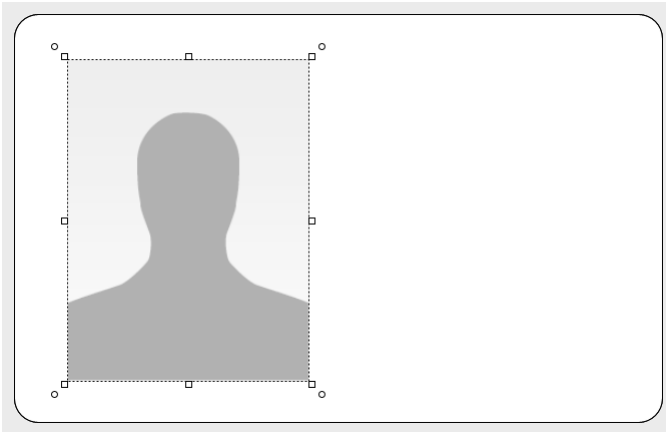

F. Signature tool

The Signature element is used to place a placeholder for the signature on the layout. The signature element can scale within proportions. When the design is used and connected to data in for example a PrintStudio Project, the placeholder will replace the dummy image with a real Signature from the project data.

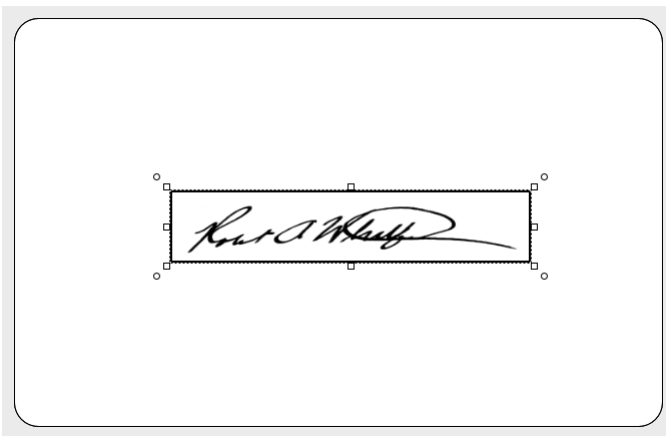



G. [Barcode tool](#)

The Barcode element is used to place a placeholder for a barcode on the layout. The element can scale within proportions. Different types of barcodes are available to select in the element properties. Barcodes that are scaled to small might not work. Test barcodes in your design with the data before continuing.

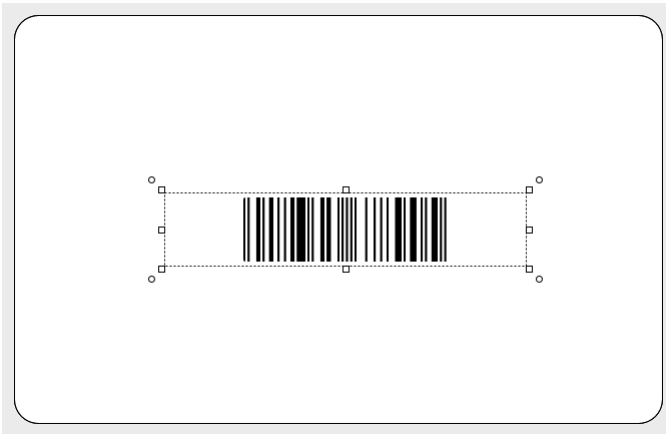

H. [2D Barcode tool](#)

The 2D Barcode element is used to place a placeholder for a 2D barcode on the layout. The element can scale within proportions. When the design is linked to data in a PrintStudio, the placeholder will replace the dummy image with the real 2D Barcode. There are different types of 2D barcodes available to select in the element properties.

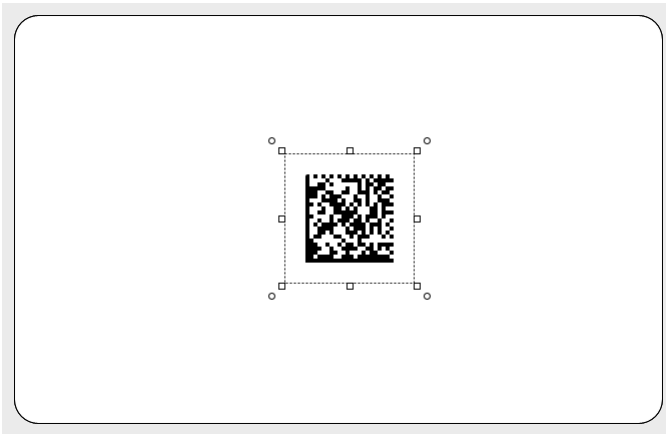



I. Square tool

The rectangular element can be used for frames and boxes in the layout.

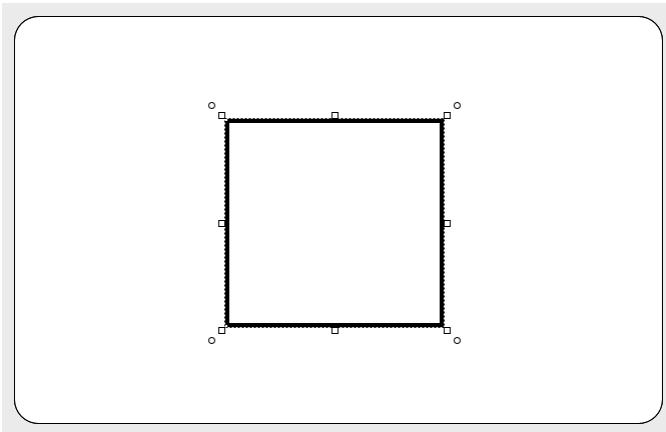

J. Circle tool

The circle element is used for elements like circles and ellipsoids.

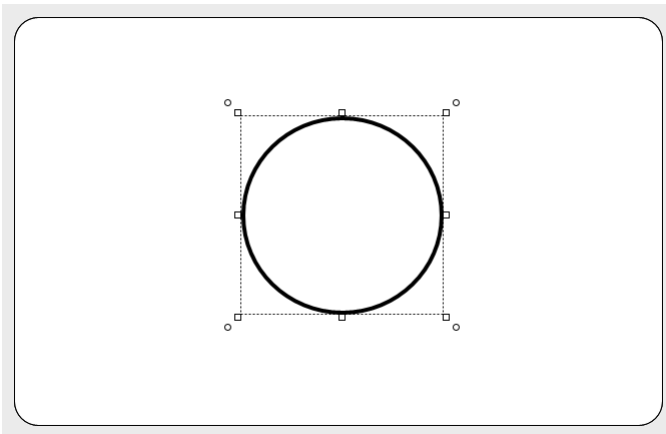

K. Dynamic logo tool

The Dynamic logo element is used to place a placeholder for a dynamic logo on the layout. The element can scale within proportions. When the design is linked to data in for example a PrintStudio project the placeholder will replace the dummy image with one of the Dynamic logos. For more explanation on the dynamic logo read [Dynamic Logo Elements](#).

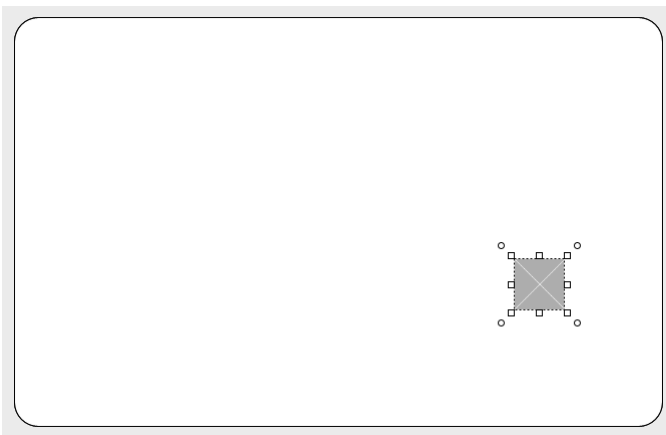

Element Properties

The element properties window has three tabs:
[Element edit](#), [Element position](#) and [Element style](#) tab.

Depending on the type of element, this tab will allow the user to view and/or edit the information of the element. When the values are changed they are reflected immediately in the design; there is no need to hit an enter button. The user can make changes in one window and observe the result in the other window at the same time and vice versa. It depends on the preference of the user to create the layout in a graphical environment or a data element environment.

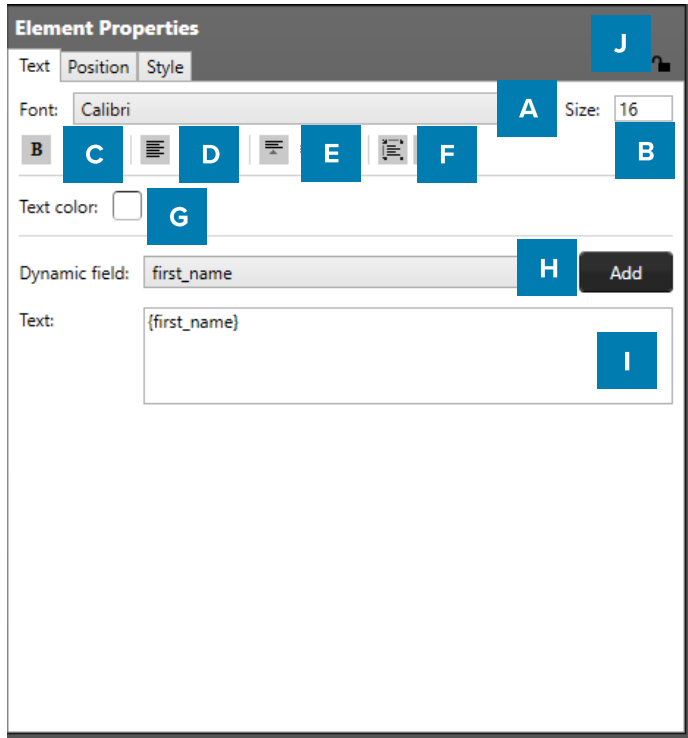

Example of the Text element properties

Text element properties

- A. Change Font
- B. Change Size
- C. Edit style into **bold**, *italic* and underlined.
- D. Outline the text left, center or right
- E. Align the text to top, center or bottom of the box.
- F. Wrap text automatically or let text be cut off when being too long.
- G. Give the text color by clicking on the color box.
- H. Choose to add a dynamic field to the text box below by selecting one out of the drop-down menu and clicking on the “Add” button.
- I. Enter all your text here.
- J. Click the lock icon to lock an element, so it cannot move during the design of the card.



: element is not locked.



: element is locked.

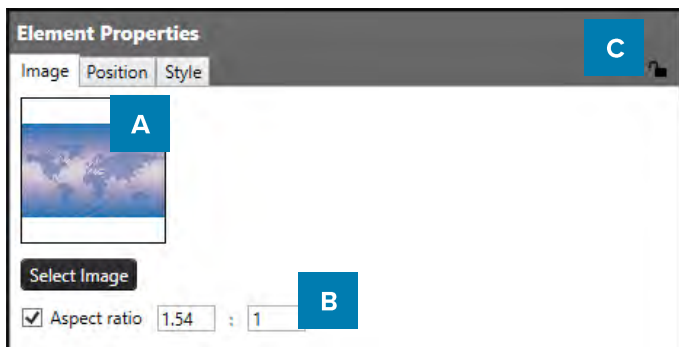

Example of the Image element properties

Image element properties

- A. Select an image from your computer by clicking on the “Select Image” button.
- B. Choose to bind the aspect ratio or adjust the ratio
- C. Click the lock icon to lock an element, so it cannot move during the design of the card.



: element is not locked.



: element is locked.

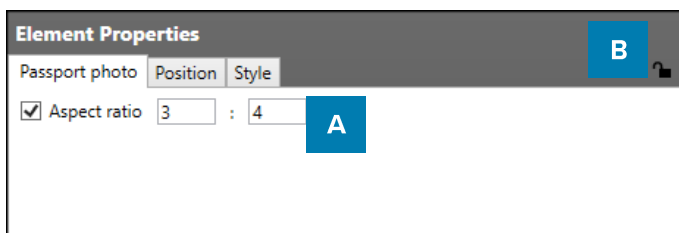

Example of the Passport Photo element properties

Passport Photo element properties

- A. Check box to bind the element to a certain ratio or adjust the ratio.
- B. Click the lock icon to lock an element, so it cannot move during the design of the card.



: element is not locked.



: element is locked.



Example of the Signature element properties

Signature element properties

- A. Check box to bind the element to a certain ratio or adjust the ratio.
- B. Click the lock icon to lock an element, so it cannot move during the design of the card.



: element is not locked.



: element is locked.

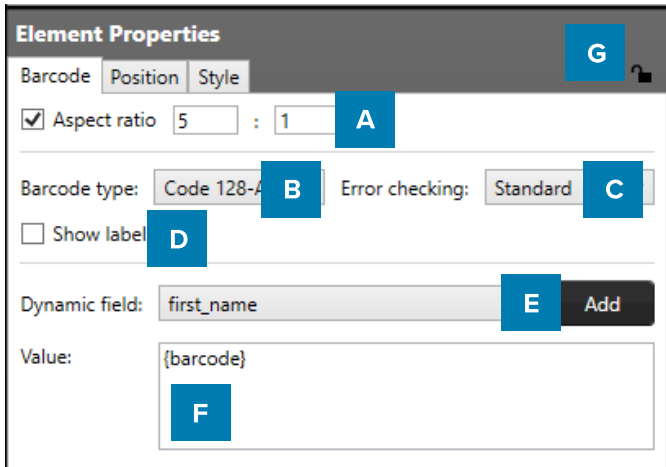

Example of the barcode element properties.

Barcode element properties

- A. Check this box to bind the element to a certain ratio
- B. Choose a barcode type by clicking on the drop-down menu and select the barcode type.
- C. Select a form of error checking from this list to ensure a correct working barcode.
- D. If you want the barcode to show a label with the actual data, check the show label check box.
- E. Select the dynamic field that you want the barcode to reflect, click the “Add” button to add the dynamic field to the value. Barcodes cannot represent all data, make sure the data can be translated to the selected barcode type.
- F. Enter a default value or combine it with a dynamic field.
- G. Click the lock icon to lock an element, so it cannot move during the design of the card.



: element is not locked.



: element is locked.

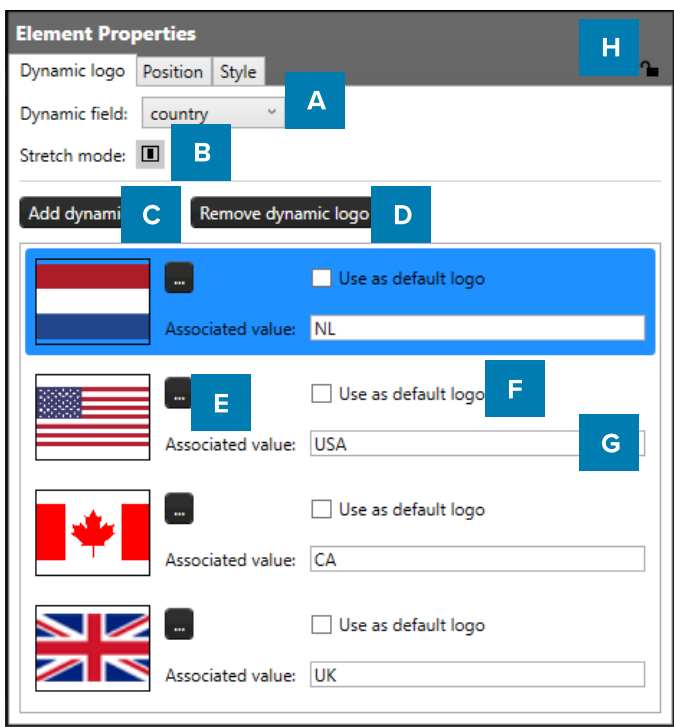

Example of the dynamic logo element properties.

Dynamic logo element properties

- A. Select the dynamic field that needs to reflect the dynamic logo.
- B. Select if you want the logo to be the correct ratio or if you want it to fill the whole field.
- C. Click on this button to add another dynamic logo.
- D. When you want to delete a dynamic logo select the logo you want to delete first and then click on the “Remove dynamic logo” button.
- E. Select an image for your dynamic logo by clicking on this button.
- F. Check the default box if you want this image to show up as the default dynamic logo image.
- G. Add the associated value of your dynamic logo into this field.
- H. Click the lock icon to lock an element, so it cannot move during the design of the card.



: element is not locked.



: element is locked.

Element Position

To change the position of an element, use the arrow tool or select the element and click on to the second tab “Position” in the Element properties. Here the position, dimension and margin of an element can be adjusted, rotated or arranged to the back or front.

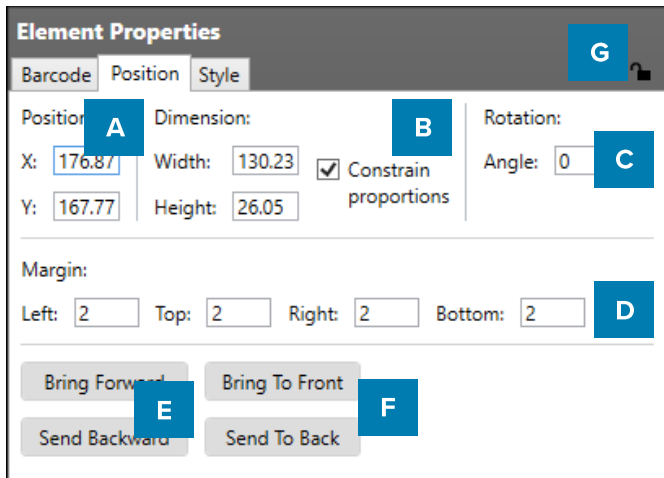

Example of the position of an element.

- A. Determine the position of the used element.
- B. Scale your element giving a width or a height. Check the check-box to constrain proportions.
- C. Rotate the element by entering an angle number, 0 to 360.
- D. Give elements margin space, enter space for the left side, top, right and bottom of the element.
- E. To arrange an element one step forward or backward against the other elements, click on these buttons.
- F. To bring an element completely on top or to the background, click on these buttons.
- G. Click the lock icon to lock an element, so it cannot move during the design of the card.



: element is not locked.



: element is locked.

Resize and rotate elements on the canvas

The canvas represents the front and or back of the card layouts and can be used to place, edit, move elements. When an element is selected the size of the element can be changed using the arrows/squares at the corners of the elements. The element can also be rotated using the circles at the corner of the elements.

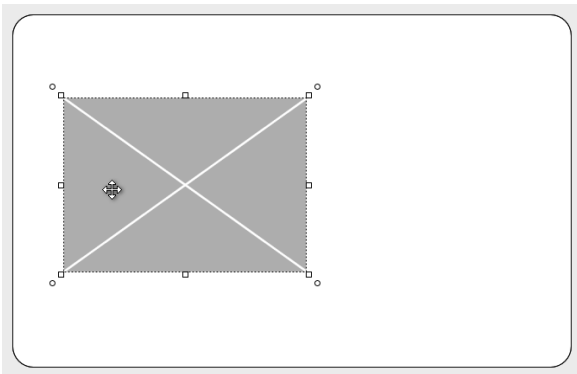

Example of an image element placed on the front of a card.

Increase / decrease the width or height of an element. The arrow appears when the mouse is hovered to the edge of the element.

The height and width of the element can be changed at the same time. The arrow appears when the mouse is hovered to one of the corners of the element.

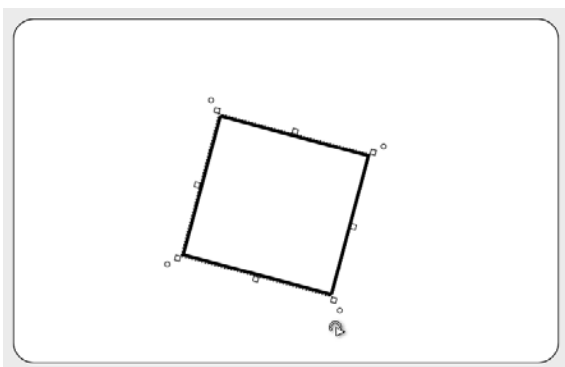

Example of a rotated shape element placed on the back of a card.

The orientation of the element can be rotated when the arrow appears. The arrow appears when the mouse is hovered just outside one of the corners of the element.

Element Style

Border & Background

To change the style of an element, click on the element and go to the third tab “Style” of the Element Properties view.

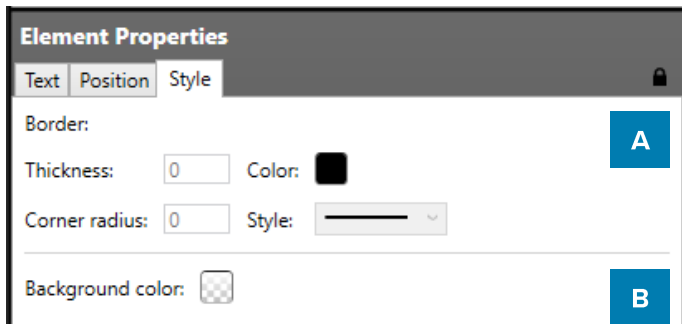

Example of the style tab

- A. Give the element a border, change the thickness of the of the border, its color or style.
- B. Give the element a background color.

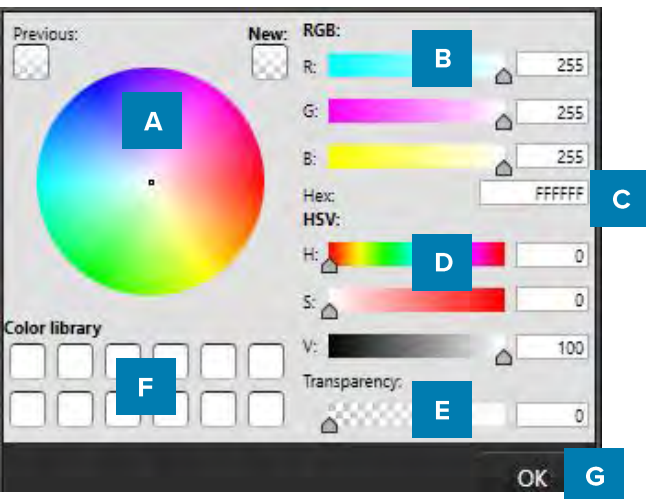

Example of the Color popup menu

Color & Transparency

Choose a color for the border or the background using the color pop-up window. We have a selection of color options to choose from. Use the RGB, Hex or HSV code to select a specific color. You can use:

- A. The color picker
- B. Use the RGB sliders or type in the percentage
- C. Fill in the Hex code for the color
- D. HSV sliders or type in the percentage
- E. Add Transparency or type in the percentage
- F. Color library using saved colors that you can drag into the library.
- G. Click on “Ok” when you selected the correct color and transparency of the border or background.

DesignStudio

Print Card Design

DesignStudio

Print a Card Design

With the **CardStudio Classic Edition** it is possible to design and print your card design from DesignStudio using the Zebra Card Printers. After the design process click on the “Print” button in the Quick Menu:



When a printer is not set yet, a printer setup window appears the first time:

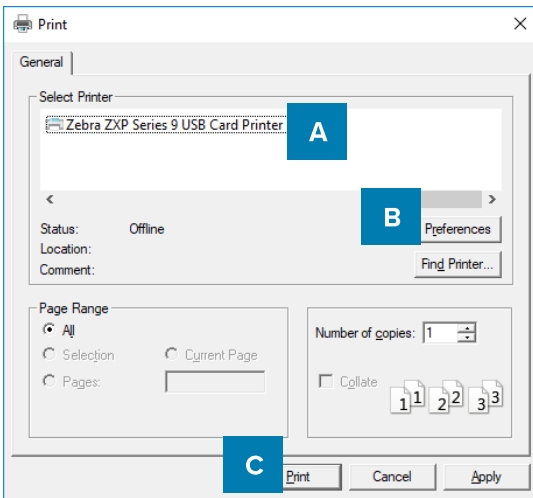

- A. Select the Zebra Card Printer you would like to print your card design with.
- B. Set your printer preferences, make sure the correct default settings of the printer driver have already been set.
- C. Click on the “Print” button to proceed.

Before printing the Card Design it is possible to personalize the Card Design with card holders’ data. For Example, capturing a passport photo. If the card design does not have personalized data, proceed to the print button.

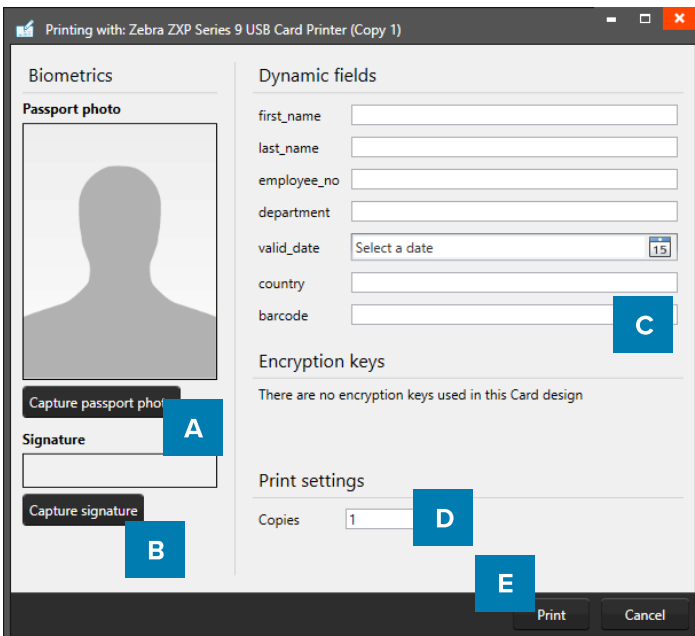

- A. Passport photo: Capture or add a photo to the card design.
- B. Signature: Capture or add a signature to the card design.
- C. Enter data for the dynamic fields in your card design. It is only possible to enter data for 1 card holder, if personalized.
- D. Enter how many copies to print.
- E. Click on the “Print” button to print your card design.

CardStudio™ 2.0 User Guide

PrintStudio



PrintStudio Interface

The dashboard of PrintStudio offers the following sections:

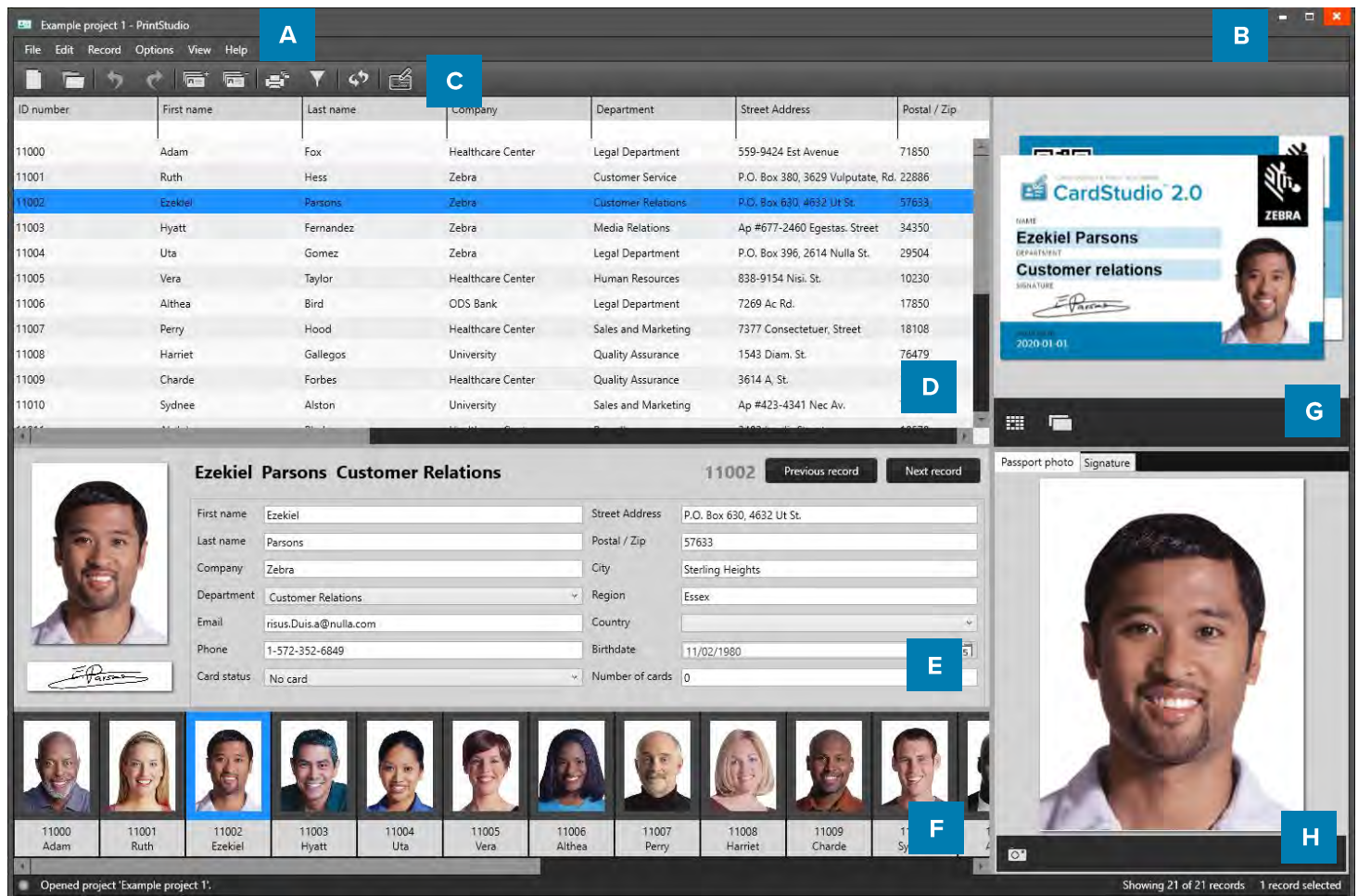

Example of the PrintStudio dashboard overview

- A. Main menu
- B. Window menu
- C. Quick menu
- D. Grid view
- E. Detail view
- F. Photo slider view
- G. Layout gallery and layout preview
- H. Add and Preview Photo and/or Signature

PrintStudio

Navigation

PrintStudio makes the elaborate card design process as easy, fast and intuitive as possible. Accommodating the users in your organization that are set with the task of managing data and printing cards. Using a user-friendly overview that shows all the tools and is easy to navigate.

Window navigation

The window navigation gives the option to **A**. minimize, **B**. maximize or **C**. close.



Main Menu

The main menu offers the options: **File**, **Edit**, **Record**, **Options**, **View** and **Help**

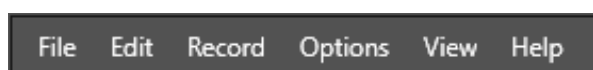

The Main Menu has 6 submenus:

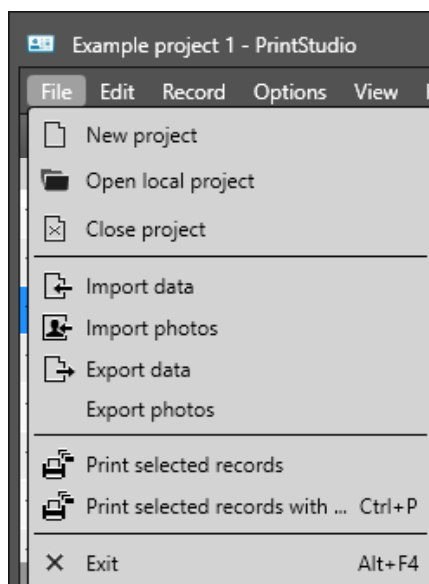

File

The first button offers the main functions needed to start, use, manage and exit a PrintStudio Project:

- *New project*: To start a new project in PrintStudio.
- *Open project*: To open an existing project made in PrintStudio.
- *Close Project*: To close the Print Studio project.
- *Import Data*: Import data from an Excel file, BadgeMaker 7 or IDPro7 project
- *Import Photos*: Batch import photos or signatures.
- *Export project data*: Export the record data to an CSV file.
- *Print selected records*: To print the records selected in the Grid view.
- *Print selected records with...*: To print quickly with an already set printer.
- *Exit*: Exit PrintStudio

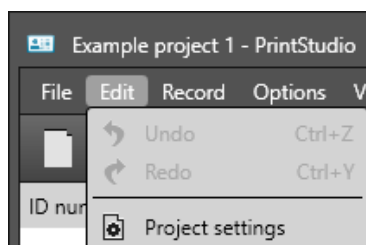

Edit

The second button offers the edit functions and project settings that you use during the data managing process:

- *Undo*: Undo resent actions made in your project
- *Redo*: Redo actions you undid in your project
- *Project Settings*: Change project settings and link card designs to your project.

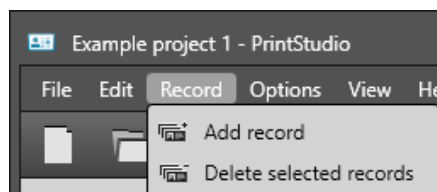

Record

The third button give you control over the records being able to add new records or delete existing records.

- *Add new record*: Add new card holder data, photo and or signature.
- *Delete selected record*

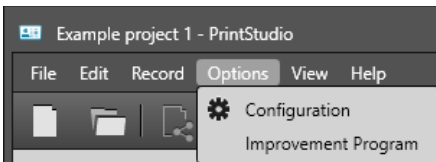

Options

The Options menu brings you to the configurations of the application like date and language settings.

- [Configuration](#)
- [Improvement Program](#)

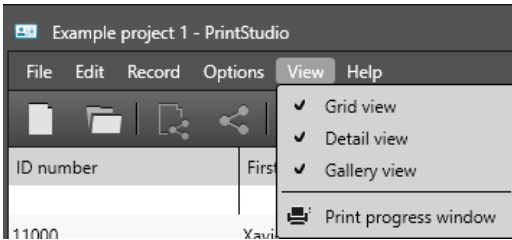

Views

The Views menu makes it possible to make certain views in the main window visible or invisible.

- [Grid View](#)
- [Detail View](#)
- [Photo Slider View](#)
- [Print Status Window](#)



Help

For more information on the application or a user guide click on the Help button.

- [View manual](#)
- [View changelog](#)
- [ScreenCheck on the web](#)
- [License information](#)
- [About](#)

Quick Menu

When opening PrintStudio two Quick buttons appear in the middle of the interface, the buttons give two options, continue working with an existing project or creating a new project.

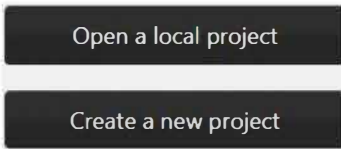

The Quick Menu offers a selection of large visual button often used in the card production process making navigation quick and easy.

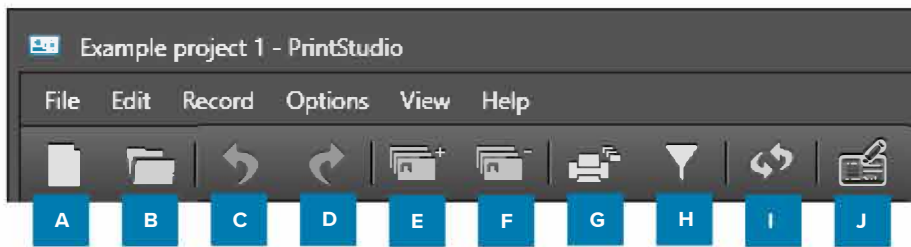

Quick menu view with large visual buttons

A. New

Click to start a new Project.

B. Open existing Project

Click to open an existing project.

C. Undo

Undo actions done working in the project.

D. Redo

Redo an action that was undone working in the project.

E. Add a new record

Records are single data rows that contain all the information of one person. Click to add a new record to the project. This means putting in new information for a new card holder, adding a photo and if needed adding a signature.

F. Delete a selected record

Records are single data rows that contain all the information of one person. Click to delete the selected record(s) from the project.

G. Print all selected records

Print all selected records

1. To print one or more records, select them and click the print button to print the records, using the most recent printer setup. On first-time use, the printer dialogue will be displayed.

A print window pops up, so you can select the printer you installed for the card printing process. This manual does not describe the installation of printers. Please refer to the manufacturers manuals for further information on these devices. After selecting the printer, click on the “Print” button.

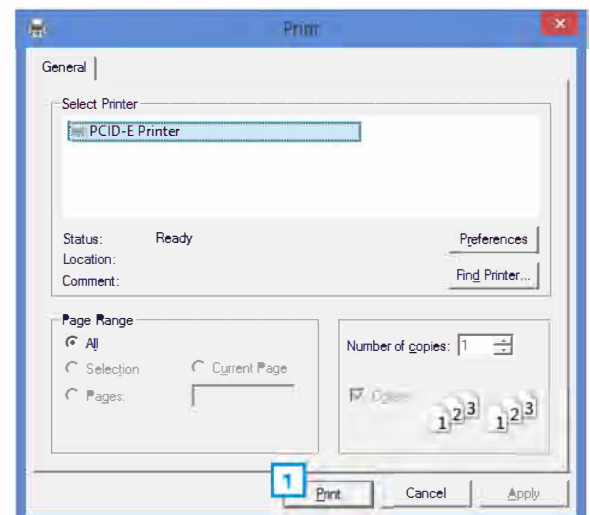

Example printer setup window.

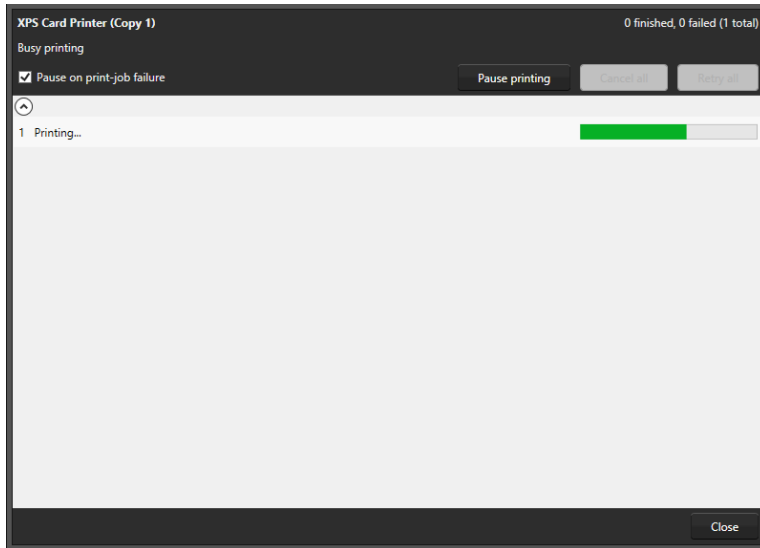

2. A print progress window will pop-up that will show you the progress of the cards that are being printed.

Example of the Card printing progress window.

J. Filter records

Have a lot of data in your data grid? This button will be helpful giving you all kinds of different filter options to search for specific groups or a certain person. You can add multiple filter sets. Every filter set can have one or more filter rules. You can combine one or more filter sets to make your search more specific.

Example of the filter options window that pop-up after clicking the filter button in the Quick menu.

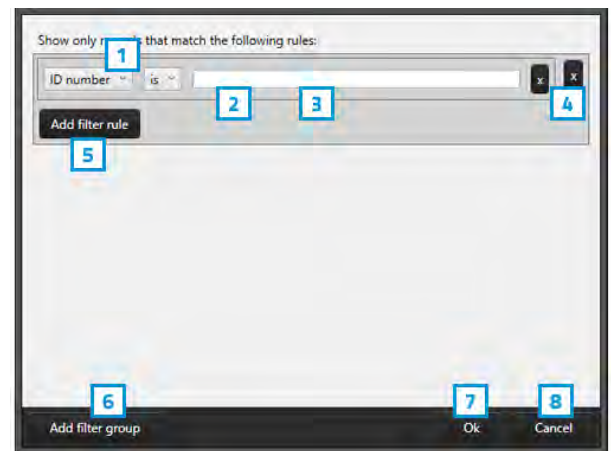

1. To setup a filter rule start with selecting one of the fields that you want to search in. This will narrow a search and make it faster.
2. After selecting the field, you need to select how specific you want to match the field with the input that you will put into field 3. If the value is very specific choose “is”, if you do not want it to be to specific you can choose “Starts with”
3. Put in the information you are looking for depending on if a search is specific or needs to be a group. For example, you could put in a complete index number to find a certain person or just the start of a number.
4. The “X” buttons are to delete a filter rule or a filter set.
5. Click on this button to add a new filter rule to this filter set to narrow your search.
6. Click on this button when you want to add a new filter set. Example: You use a filter set when searching for two different type of records and need to add a separate search.
7. Cancel filter option.
8. To start the search/filter process click on the “Ok” button.

K. Refresh Data

This button allows you to refresh data when working with CardStudio Connect projects making sure all data is up to date with the connected data bases.

L. CardStudio Design

This quick menu button lets you open CardStudio Design and continue with creating or adjusting your card design.

PrintStudio

Create a Project

PrintStudio

Create a Project

To setup a PrintStudio project, start with the setup of a new project or open an existing one.

New Project

A. Go to File in the main menu and click on “New”.

Or click on the icon below in the quick menu:

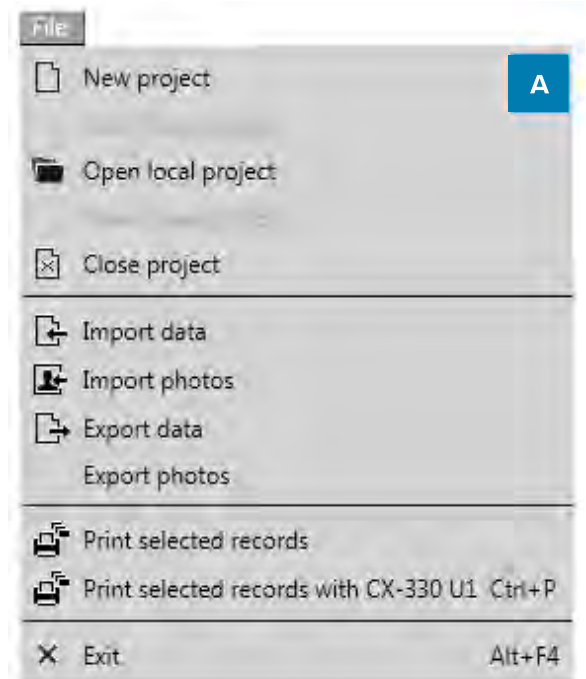

Click on the “New project” link or button a “Create New Project”, a selection window will pop-up. You can select one of the six options to start a new project.

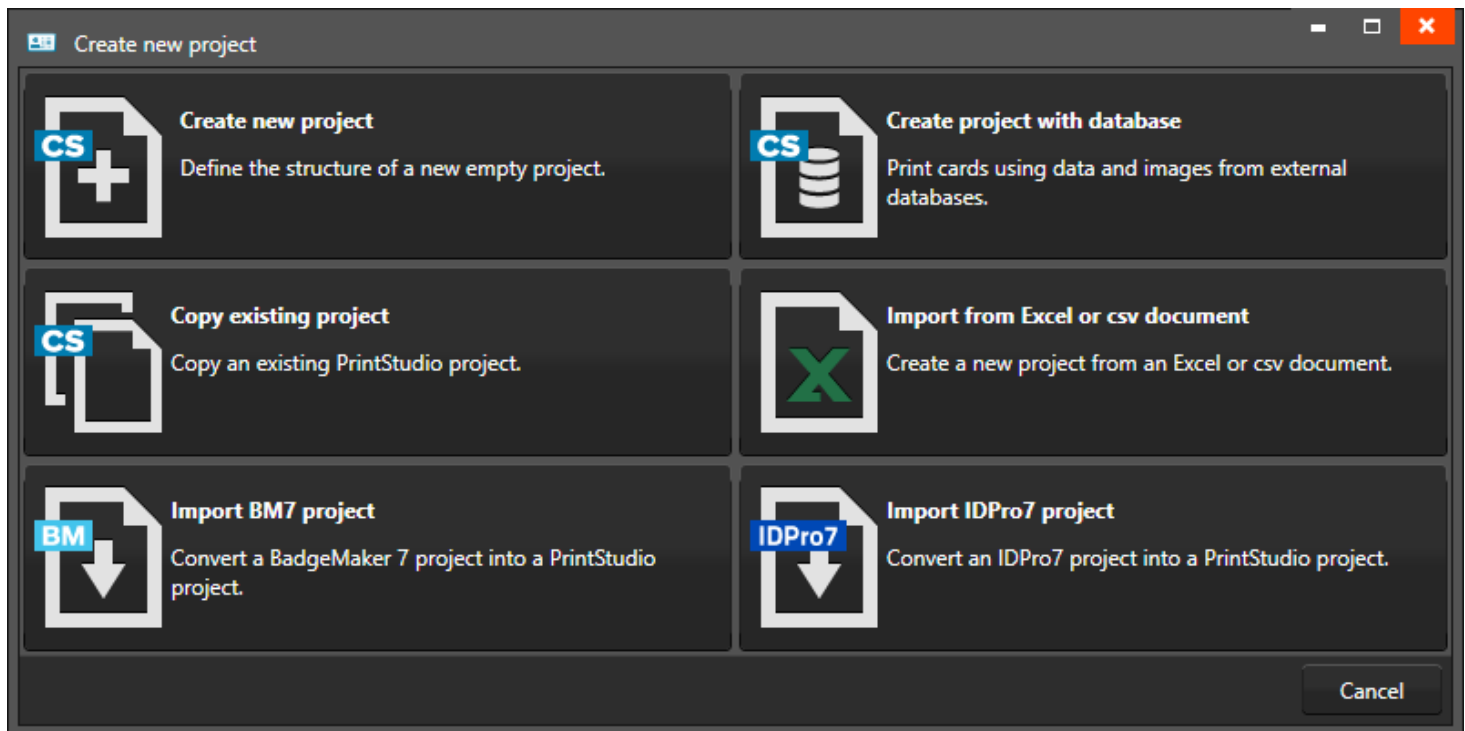

Example of the selection window to create a new project.

Create a New Project

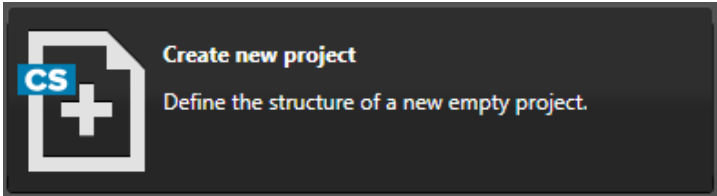

Click on “Create a New Project” to start with a blank data grid and setup your own database field names. A couple of default fields are setup to make the setup process a bit faster. Change the default fields or add the extra fields needed.

1. Project Structure

The screenshot shows the "Project structure" configuration window in PrintStudio. At the top, there's a breadcrumb trail: "Project structure" (active), "Biometric settings", "View configuration", "Triggers", and "Create project". The main title is "Project structure". Below it, the "Project name" is set to "Zebra Demo Project". A table lists several data fields with columns for "Name", "Type", "Required", "Unique", and "Default value". Fields include "ID", "First name", "Last name", "Birthday", "Number of cards", and "Card status". Each field has a corresponding "X" button to delete it. At the bottom, there is an "Add new property" button and "Previous step", "Next step", and "Cancel" buttons.

Example of step 1. New project: add Project Data columns

Step 1. Setup the project structure by adding the project data fields.

- A. Type in the name for your new project.
- B. Put in the database field name
- C. Set the data type. Select if the data are number or text for example.
- D. Check these boxes if the field needs to be “Required” and or “Unique”.
- E. With the default input field, you can add a standard value to your data field, existing empty fields and new records will automatically get the default value you add to this data field.
- F. Click on the “X” button to delete a data field from the project structure setup.
- G. Enable auto-increment
- H. Click on the “Add new property” button and add and describe the data field names you want to use in your new project.
- I. Click on the “Next step” button to go to step 2. And configure the detailed and gallery view

2. Biometric settings

During step 2, you are enable the biometric images you need in your project and determine how they will be stored.

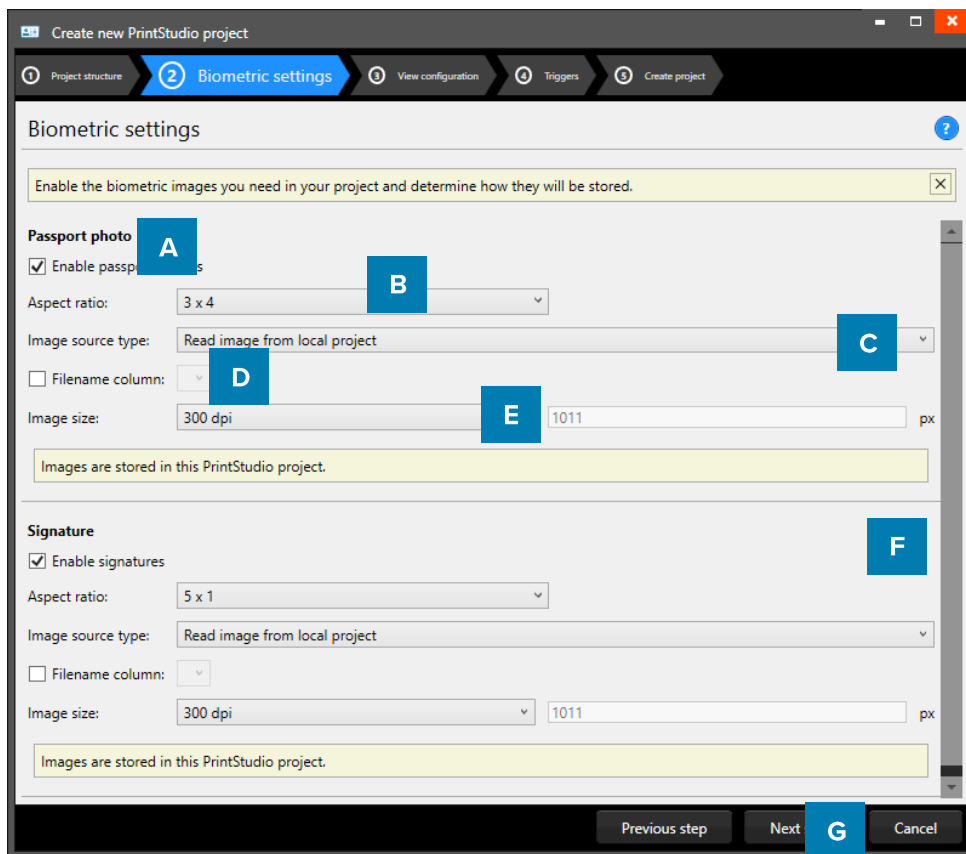
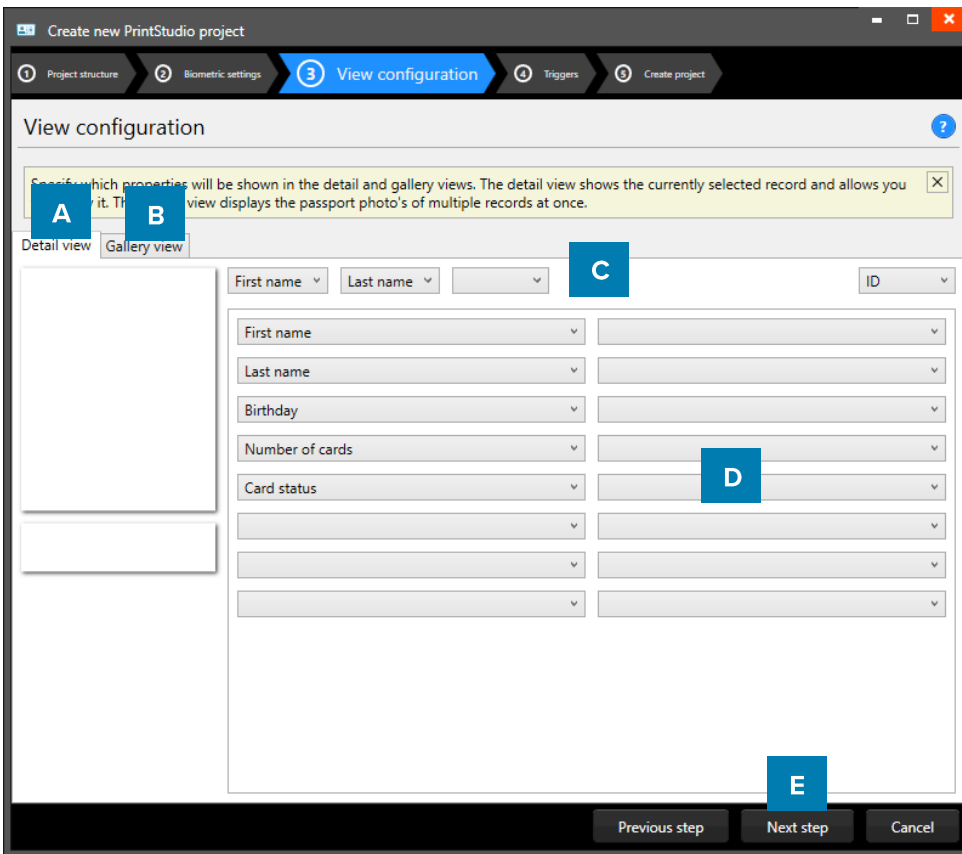

Fig. Example of step 2. New project: Biometric settings

- A. The box for passport photos make photos visible in the project and enables you to add photos.
- B. Determine the ratio of the photo with the drop-down menu.
- C. Select how and where photos will be saved within your project.
- D. Check this box if you want to use data columns to represent the filename.
- E. Select with what dpi and size the photos need to be saved within your project.
- F. The box for the signature makes signatures visible in the project and enables you to add signatures. The signature section works the same as the Passport photo section above.
- G. Click on the “Next step” button to go to step 3. And configure the detailed and gallery view

3. View configuration

During step 3, choose for the default configuration or adjust the setup for Detailed and Gallery view.



Example of step 3. New project: view configuration

- A. Tab to configure Detailed view showing specific card holders information.
- B. Tab to configure Gallery view showing card holders photos.
- C. Setup the title for the detailed view.
- D. Setup the information that will be shown in the detailed view.
- E. Click on the “Next step” button to go to step 3. And add triggers to the project.

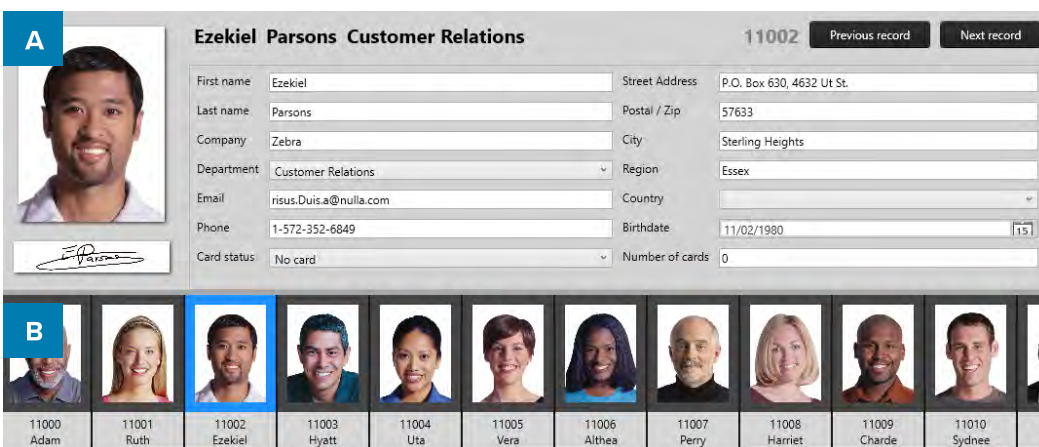

Example of the A. Detailed view and the B. Gallery view

4. Triggers

Step 4. Allows you to setup trigger for your project. Triggers can be used to automatically change data in your project on a certain condition or event.

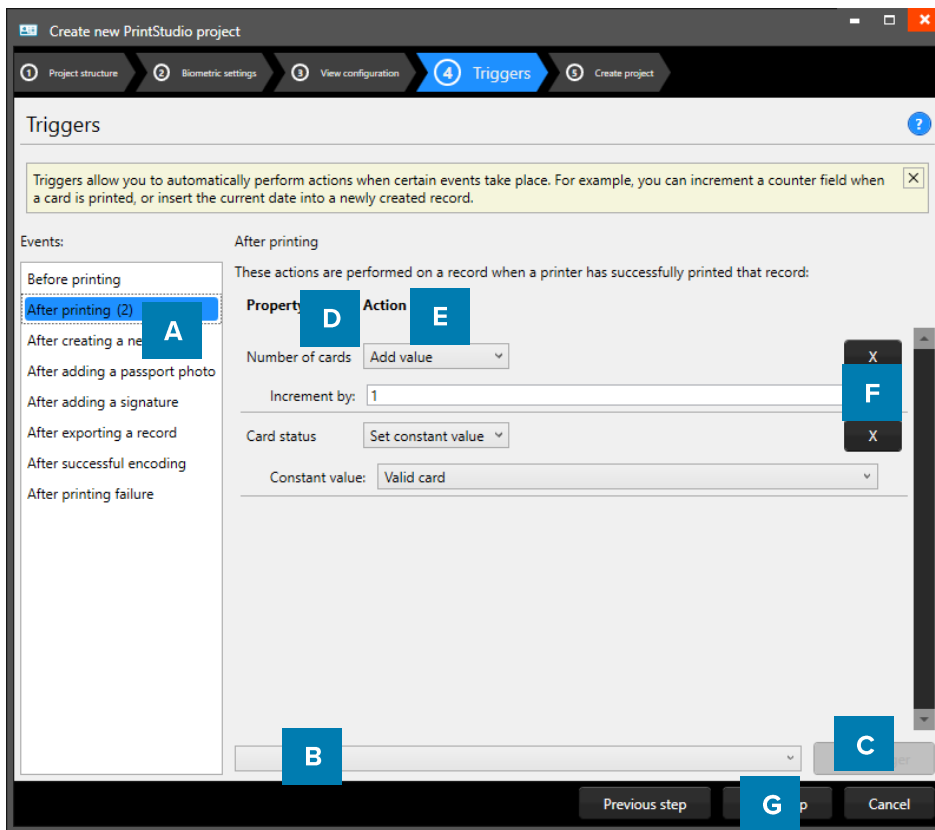

Example of step 4. New project: Triggers

- A. Select one of the events from this list and add specific triggers. CardStudio Identity will automatically wait for the event to occur before performing the action that is linked to the trigger.
- B. All data columns of the new project are listed. Select one of the columns to link a trigger action to it.
- C. Click on the “Add trigger” button to add the trigger to the data column and specify the Trigger with events and actions.
- D. The property shows you the selected data column.
- E. Select the action you want to connect to the data column from the drop-down menu and define the action.
- F. Click on the “X” button to delete a trigger from an event.
- G. Click on the “Next step” button to go to step 4. And create the project.

Define the action that is performed once the event has been met. Some actions are only available for specific columns (for example, incrementing number values can only be done on Number type columns). All changes need to be saved before they become active. Understand that Triggers might cause your original data to change, so make sure no vital data is lost when working with Triggers.

5. Create project

During step 5. The application will start creating your new project after you click on the **A**. “Create project” button. If there are problems read the feedback provided and click on the **B**. “Previous” button to go back and make the needed adjustments.

You are now ready to start adding records to your data grid.

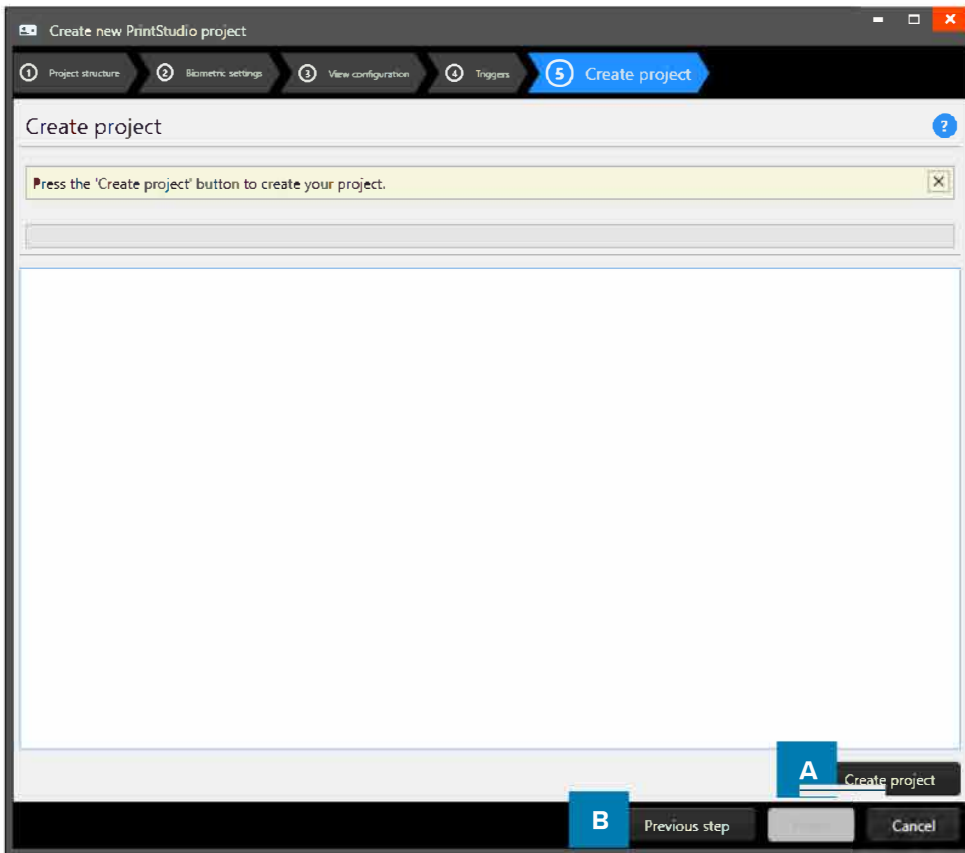

Example of step 5. New project: Create project.

Create a New CardStudio Project with database connection

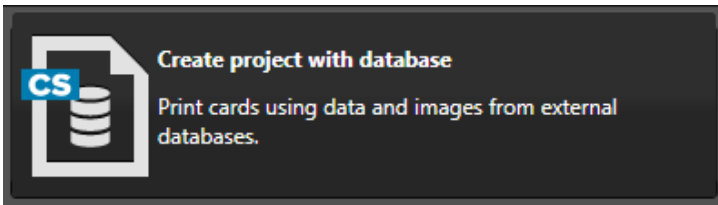

To create a new CardStudio project with database you need the CardStudio 2.0 Enterprise or Professional Edition. Go to the CardStudio Database Connection Chapter for more information.

1. Data sources

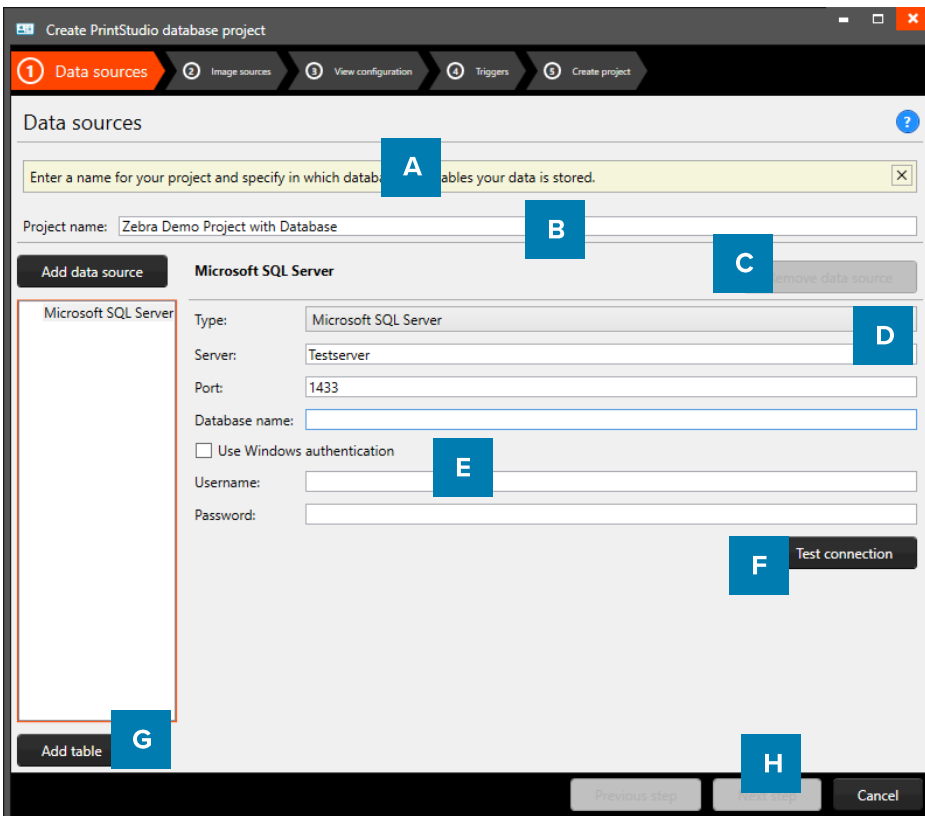

Example of a New PrintStudio Database project with Microsoft SQL database connection step 1: data sources

- A. Give your PrintStudio Database project a unique name.
- B. Click on “Add data source” to add a database connection to your new project.
- C. Select an added database connection and click on “Remove data source” to remove a connection.
- D. Select the type of Database you want to connect with, give the Server name, Port number and database name. Several database types are supported:
 - Microsoft SQL Server
 - Microsoft Access files
 - MySQL Server
 - Oracle Server
 - ODBC
- E. When an external database is secured with credentials you can add those credentials here.
- F. Click on “Test connection” to test the connection with the external database.
- G. Select the added database connection and click on “Add table” to add a table from your database to the project.
- H. Click on “Next” to continue to the next step.

2. Image sources

Step 2. Let you specify where your biometric images are located.

Example of a new project with database connection to a Microsoft SQL database step 2. Image sources.

- A. Check the box when you want to add signatures and or passport photos to your project.
- B. After checking the box, you can determine the ratio of the photo.
- C. Select the image source, from where the images need to be imported into your project.
- D. Select what size the photos need to be saved as, within your project.
- E. Click on the “Next step” button to go to step 3. And configure the detailed and gallery view

3. View configuration

Step 3. Choose for the default configuration or adjust the setup for Detailed and Gallery view.

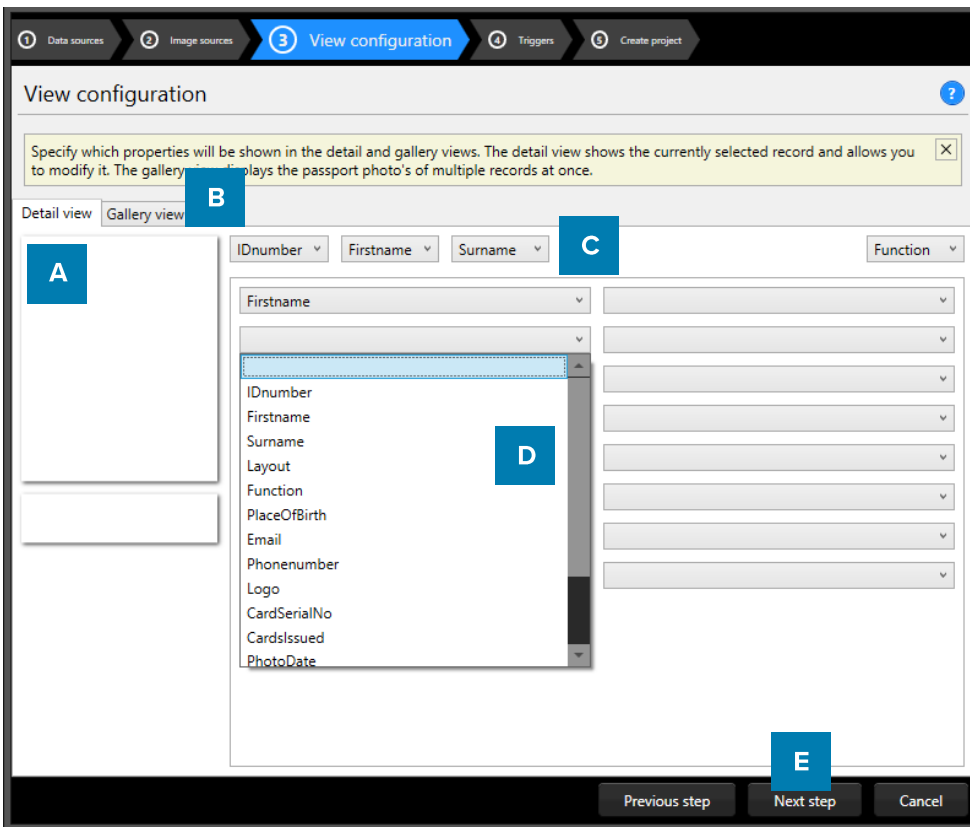

Example of step 3. New project with database: View configuration

- A. Tab to configure Detailed view, showing specific card holders information.
- B. Tab to configure Gallery view, showing card holders photos.
- C. Setup the title for the detailed view.
- D. Setup the information that will be shown in the detailed view.
- E. Click on the “Next step” button to go to step 3. And add triggers to the project.

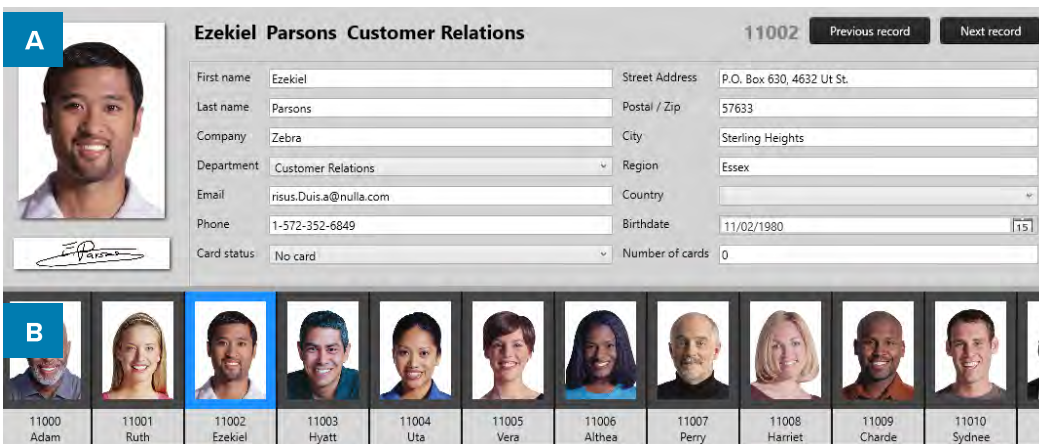

Example of the A. Detailed view and the B. Gallery view

4. Triggers

Step 4. Allows you to setup trigger for your project. Triggers can be used to automatically change data in your project on a certain condition or event.

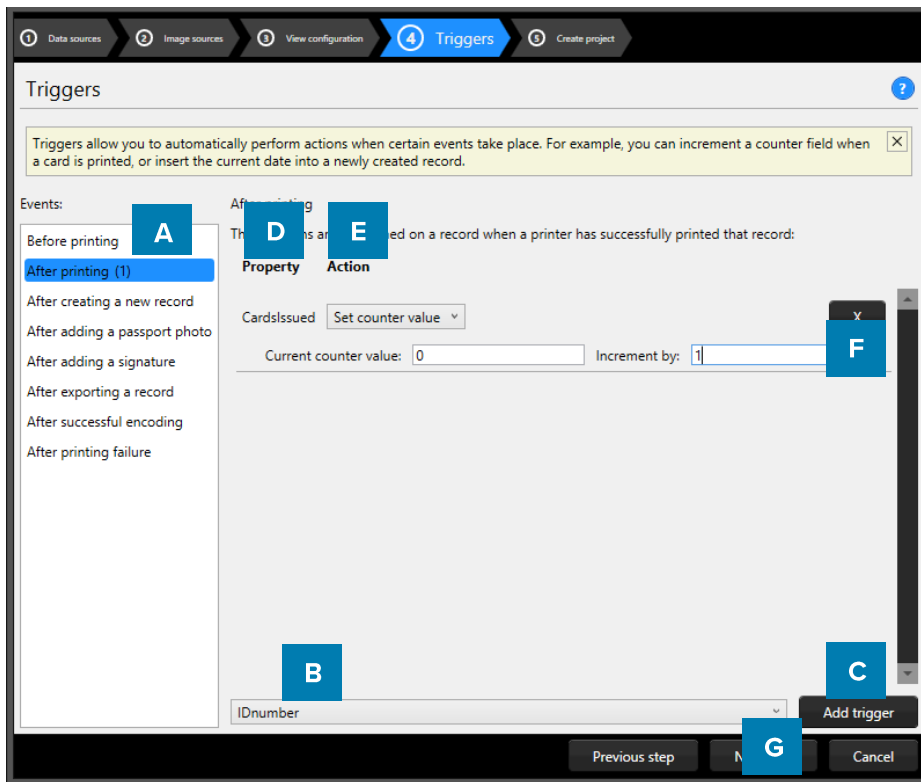

Example of step 4. New project with database: Triggers

- A. Select one of the events from this list and add specific triggers. PrintStudio will automatically wait for the event to occur before performing the action that is linked to the trigger.
- B. All data columns of the new project are listed. Select one of the columns to link a trigger action to it.
- C. Click on the “Add trigger” button to add the trigger to the data column and specify the Trigger with events and actions.
- D. The property shows you the selected data column.
- E. Select the action you want to connect to the data column from the drop-down menu and define the action.
- F. Click on the “X” button to delete a trigger from an event.
- G. Click on the “Next step” button to go to step 4. And create the project.

Define the action that is performed once the event has been met. Some actions are only available for specific columns (for example, incrementing number values can only be done on Number type columns). All changes need to be saved before they become active. Understand that Triggers might cause your original data to change, so make sure no vital data is lost when working with Triggers.

5. Create project

Step 5. Will create your new project after you click on the A. “Create project” button. If there are problems read the feedback provided and click on the B. “Previous” button to go back and make the needed adjustments.

You are now ready to start adding records to your data grid.

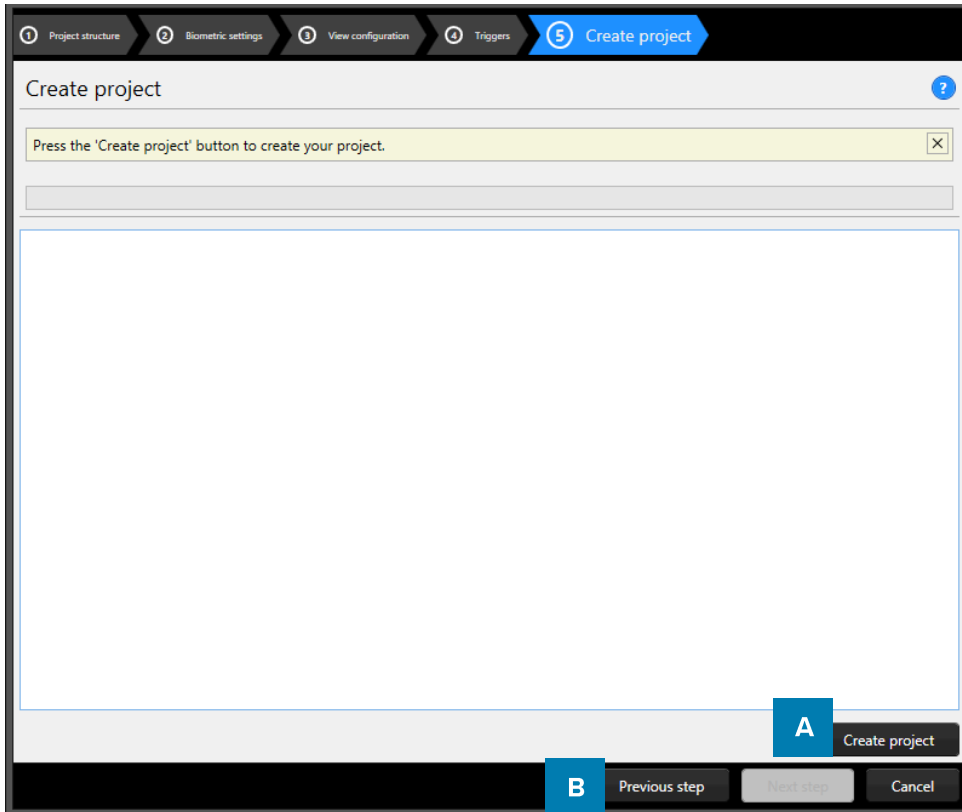

Example of step 5. New project with database: Create project.

Create copy of an existing Project

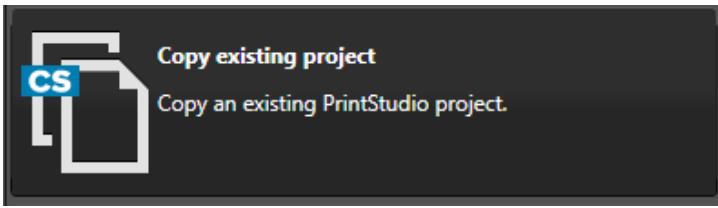

With PrintStudio a new project can be created based on an existing project. Click on the “Copy existing project” to create a new project as a copy of another project.

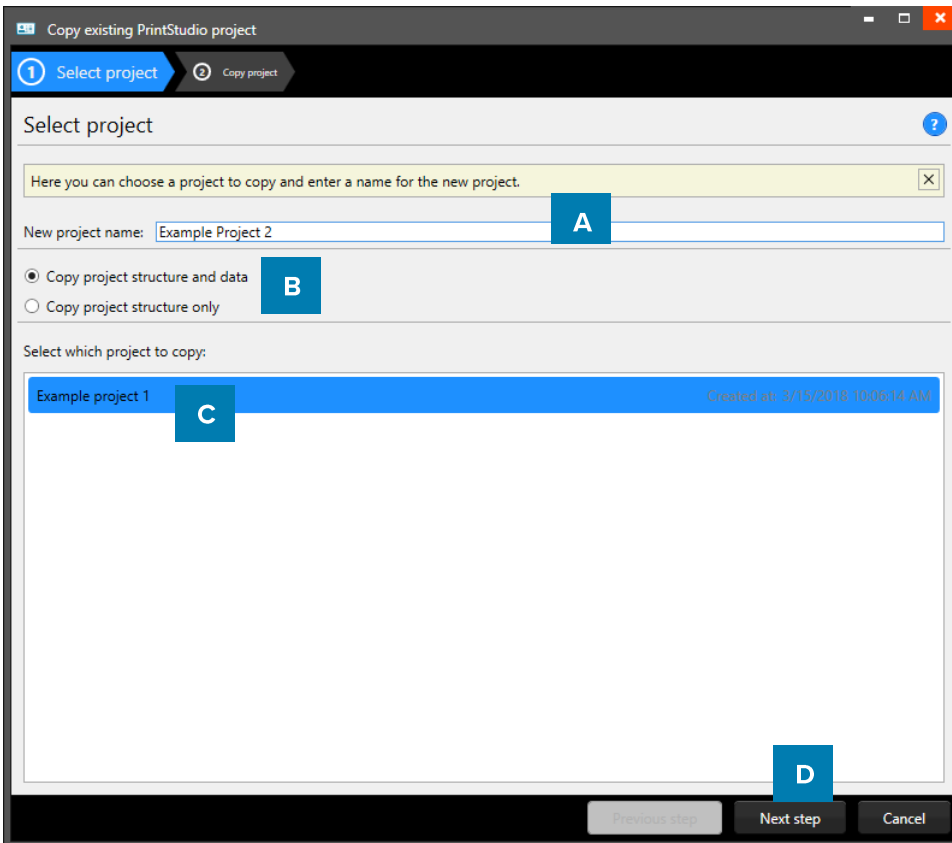

Example of step 1. New project: Copy existing project.

1. Select Project

- A. Give the project a new name.
- B. Select a copy with data or structure only. Select structure if you only want the data field setup and not the content of the previous project.
- C. Select an existing project from the list presented.
- D. Click on the “Next step” button to create the copy project.

2. Copy project

Step 2. creates a copy of the project after you click on the A. “Create project” button. Select B. to make changes in the previous step. You are now ready to start adding records to your data grid.

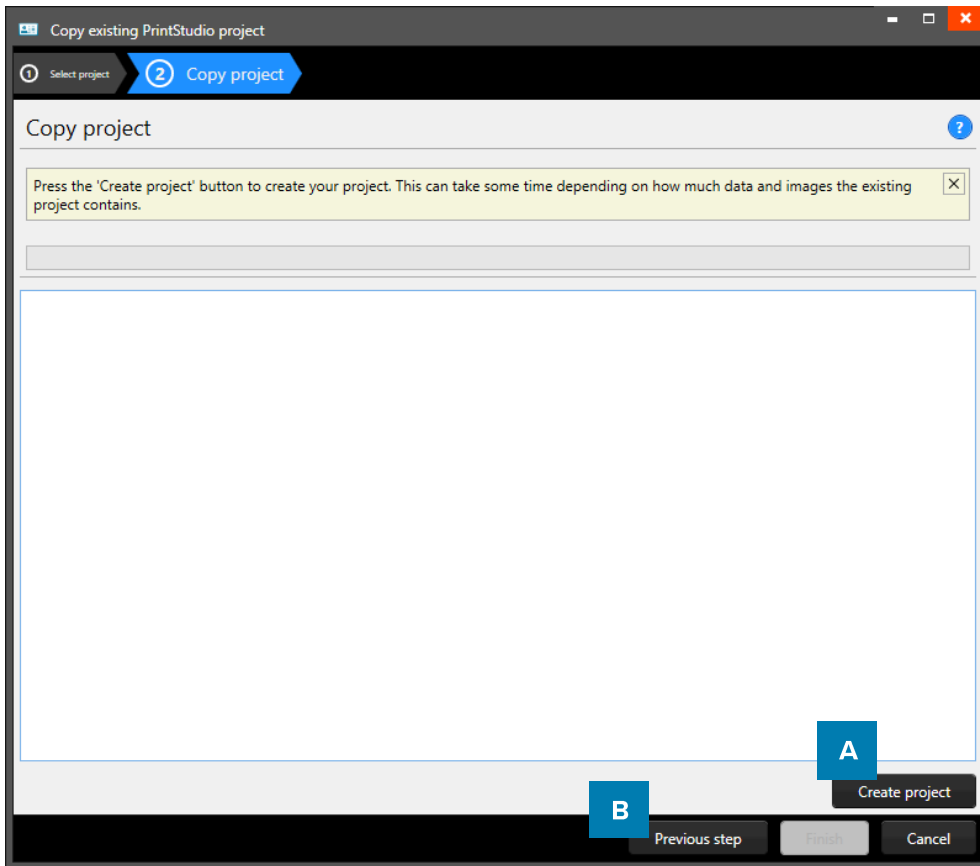

Example of step 2. New project: Copy project.

Import Project from Excel

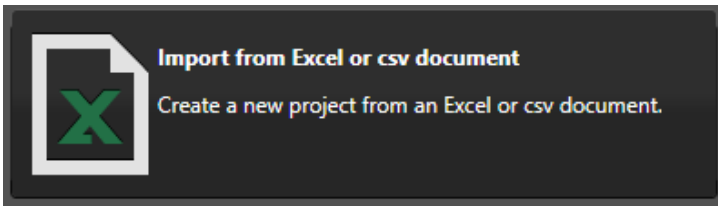

PrintStudio also offers to create new projects based on Excel files. PrintStudio will base the project structure on the Excel structure and will import all the data from the Excel file into the new project.

1. Data source

Step 1. Select the Excel file and Worksheet needed for the setup of the new project. You can also add a Photo source and or Signature Source if needed.

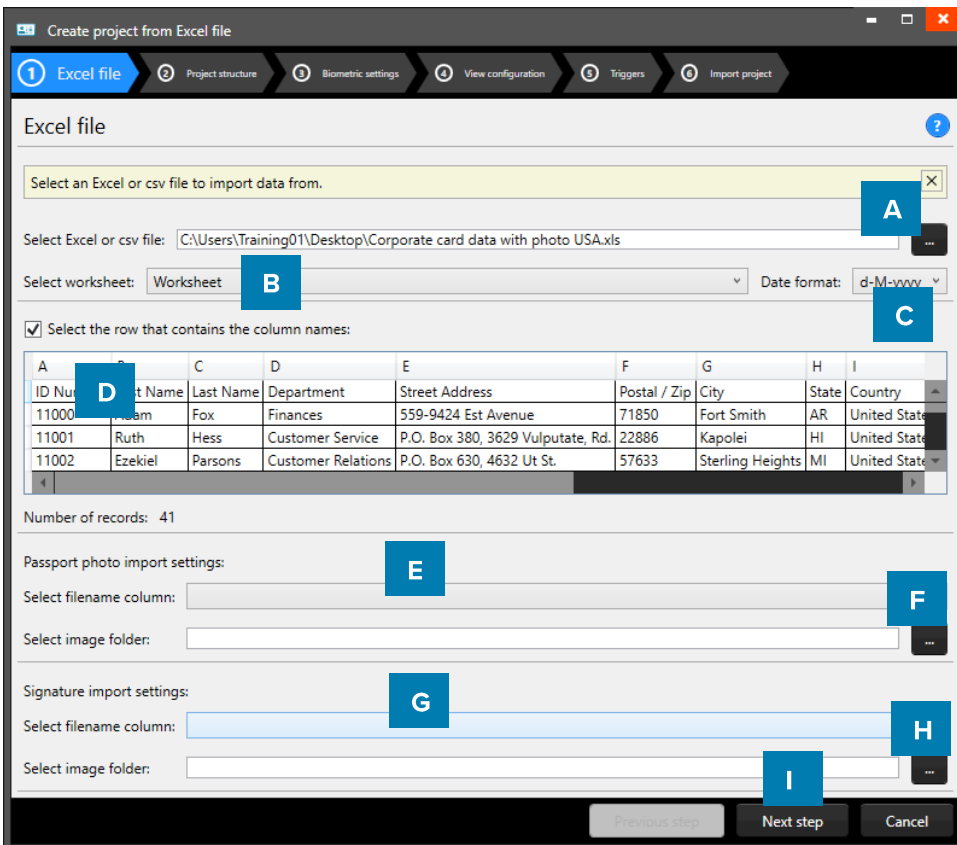

Example of step 1. New project imported from excel file: Data source.

- A. Click on this button and select the Excel/CSV file you want to import and create a new project with.
- B. Select the worksheet you want to use from the drop-down menu.
- C. Select the date format you are using in the Excel file
- D. Select the row that contains the column names.
- E. Select the column that connects with the unique photo names (for example: ID number or index)
- F. Select the folder that contains the card holders' photos
- G. Select the column that connects with the unique signature names (for example: ID number or index)
- H. Select the folder that contains the signatures
- I. Click on the "Next step" button to continue to second step.

2. Project structure

Step 2. Name the new project and check the imported Excel data structure. Change, delete or add data columns here in the new Project structure.

Source column	Name	Type	Required	Unique	Default value	
ID Number	ID Number	Whole number	<input type="checkbox"/>	<input type="checkbox"/>		<input type="checkbox"/>
			<input type="checkbox"/>	<input type="checkbox"/>		<input type="checkbox"/>
First Name	First Name	Text	<input type="checkbox"/>	<input type="checkbox"/>		<input type="checkbox"/>
Last Name	Last Name	Text	<input type="checkbox"/>	<input type="checkbox"/>		<input type="checkbox"/>
Department	Department	Text	<input type="checkbox"/>	<input type="checkbox"/>		<input type="checkbox"/>
Street Address	Street Address	Text	<input type="checkbox"/>	<input type="checkbox"/>		<input type="checkbox"/>
Postal / Zip	Postal / Zip	Whole number	<input type="checkbox"/>	<input type="checkbox"/>		<input type="checkbox"/>
			<input type="checkbox"/>	<input type="checkbox"/>		<input type="checkbox"/>
City	City	Text	<input type="checkbox"/>	<input type="checkbox"/>		<input type="checkbox"/>
State	State	Text	<input type="checkbox"/>	<input type="checkbox"/>		<input type="checkbox"/>

Example of step 2. New project from Excel file: Project data columns

- A. Type in the name for your new project.
- B. Put in the project data column name.
- C. Set the data type. Select if the data are number or text for example. The following types of database fields are supported:
 - o Whole Number, when selecting this type, you can select 'auto-increment'. When a new record is created the number will be the highest number in the Project increased by 1.
 - o Text
 - o Decimal number
 - o Option List, when this list type is selected, you can add and delete the list values from the list that is presented for this database field. When you change a datatype from text to option list, PrintStudio automatically generates a list based on the data already in that data field.
- D. Check these boxes if the field needs to be "Required" and or "Unique".
- E. With the default input field, you can add a standard value to your data field, existing empty fields and new records will automatically get the default value you add to this data field.
- F. Click on the "X" button to delete a data field from the project structure setup.
- G. Click on the "Add new property" button and add and describe the data field names you want to use in your new project.
- H. Click on the "Next step" button to go to step 2. And configure the detailed and gallery view

3. Biometric settings

Step 3. Enable the biometric images needed in the new project and determine how they will be stored.

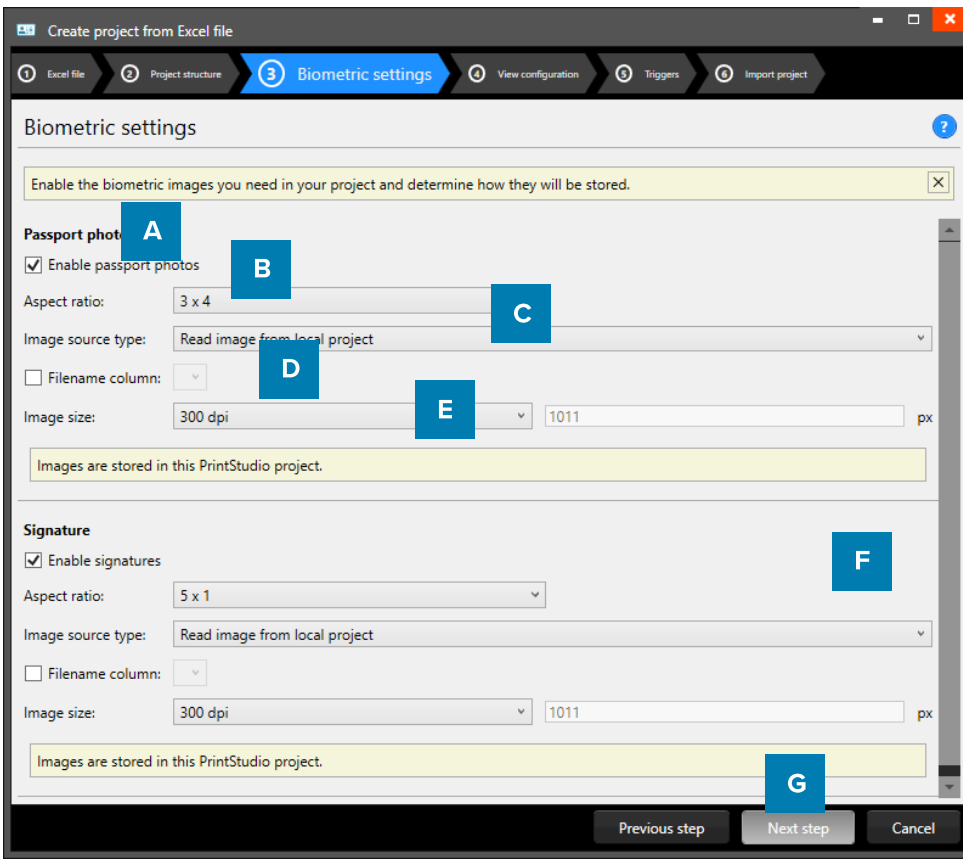

Example of step 3. New project from Excel file: Biometric settings

- A. The box for passport photos makes photos visible in the project and enables you to add photos.
- B. Determine the ratio of the photo with the drop-down menu.
- C. Select how and where photos will be saved within your project.
- D. Check this box if you want to use data columns to represent the filename.
- E. Select with what dpi and size the photos need to be saved within your project.
- F. The box for the signature makes signatures visible in the project and enables you to add signatures. The signature section works the same as the Passport photo section above.
- G. Click on the “Next step” button to go to step 3. And configure the detailed and gallery view

4. View configuration

Step 4. Choose for the default configuration or adjust the setup for Detailed and Gallery view.

View configuration

which properties will be shown in the detail and gallery views. The detail view shows the currently selected record and allows you to edit it. The gallery view displays the passport photo's of multiple records at once.

Detail view Gallery view

Detail view configuration

ID Number First Name Last Name Department

ID Number Country

First Name Email

Last Name Phone Birthdate

Department Birthdate

Street Address

Postal / Zip

City

State

Previous step Next Cancel

Example of step 4. New project from Excel file: View configuration

- A. Tab to configure Detailed view, showing specific card holders information.
- B. Tab to configure Gallery view, showing card holders photos.
- C. Setup the title for the detailed view.
- D. Setup the information that will be shown in the detailed view.
- E. Click on the “Next step” button to go to step 5. And add triggers to the project.

Ezekiel Parsons Customer Relations 11002 Previous record Next record

First name Ezekiel Street Address P.O. Box 630, 4632 Ut St.

Last name Parsons Postal / Zip 57633

Company Zebra City Sterling Heights

Department Customer Relations Region Essex

Email risus.Duis.a@nulla.com Country

Phone 1-572-352-6849 Birthdate 11/02/1980

Card status No card Number of cards 0

11000 Adam 11001 Ruth 11002 Ezekiel 11003 Hyatt 11004 Uta 11005 Vera 11006 Althea 11007 Perry 11008 Harriet 11009 Charde 11010 Sydney

Example of the A. Detailed view and the B. Gallery view

5. Triggers

Step 5. Allows you to setup trigger for your project. Triggers can be used to automatically change data in your project on a certain condition or event.

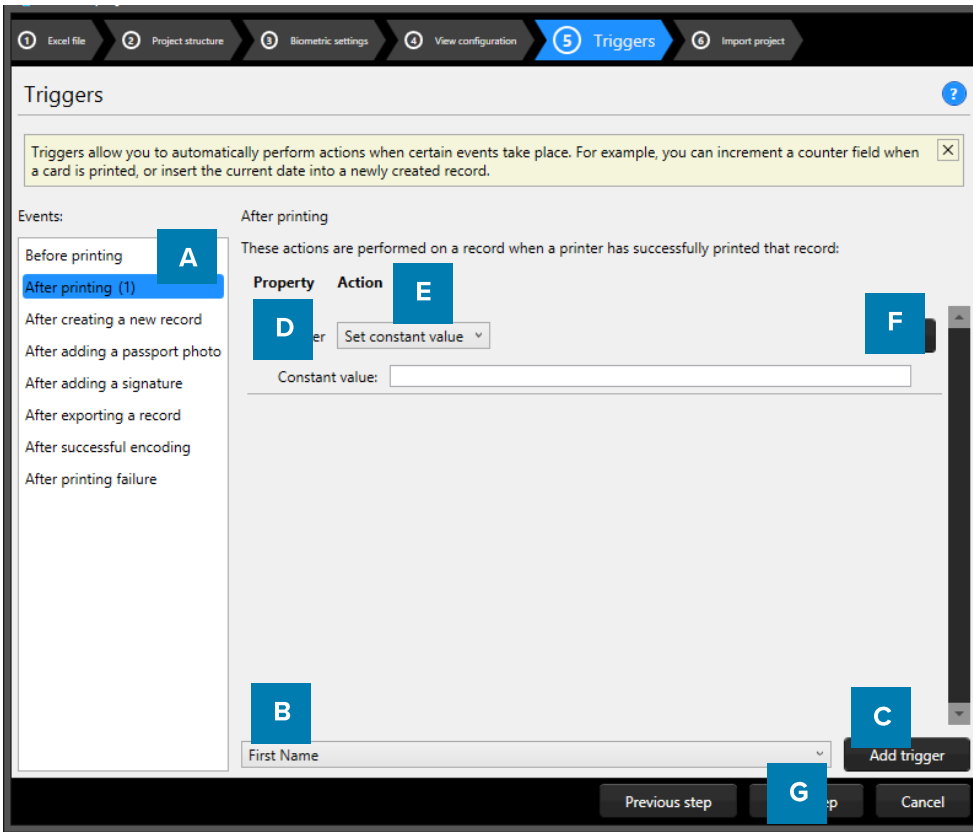

Example of step 5. New project from Excel file: Triggers

- A. Select one of the events from this list and add specific triggers. PrintStudio will automatically wait for the event to occur before performing the action that is linked to the trigger.
- B. All data columns of the new project are listed. Select one of the columns in order to link a trigger action to it.
- C. Click on the “Add trigger” button to add the trigger to the data column and specify the Trigger with events and actions.
- D. The property shows you the selected data column.
- E. Select the action you want to connect to the data column from the drop down menu and define the action.
- F. Click on the “X” button to delete a trigger from an event.
- G. Click on the “Next step” button to go to step 6. And create the project.

Define the action that is performed once the event has been met. Some actions are only available for specific columns (for example, incrementing number values can only be done on Number type columns). All changes need to be saved before they become active. Understand that Triggers might cause your original data to change, so make sure no vital data is lost when working with Triggers.

6. Import Project

Step 6. Creates the new project imported from an Excel file as soon as you click on the **A**. “Create project” button. **B**. Click on the “Previous step” button to make any changes before creating the project.

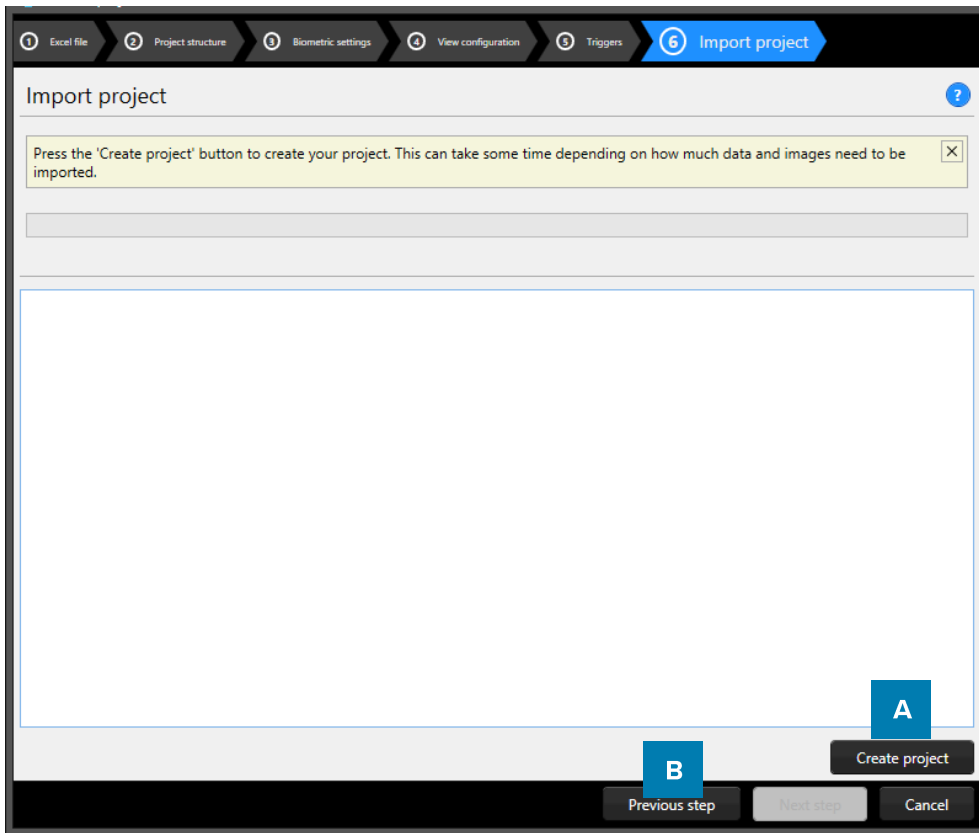

Example of step 6. New project: import new Excel project.

New Project from BadgeMaker 7 Project

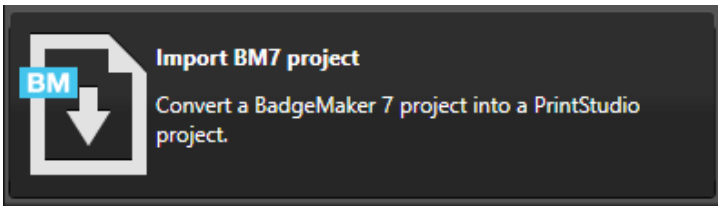

1. Select BadgeMaker 7 Project

PrintStudio supports creating new projects based on a former BadgeMaker 7 (Classic) project.

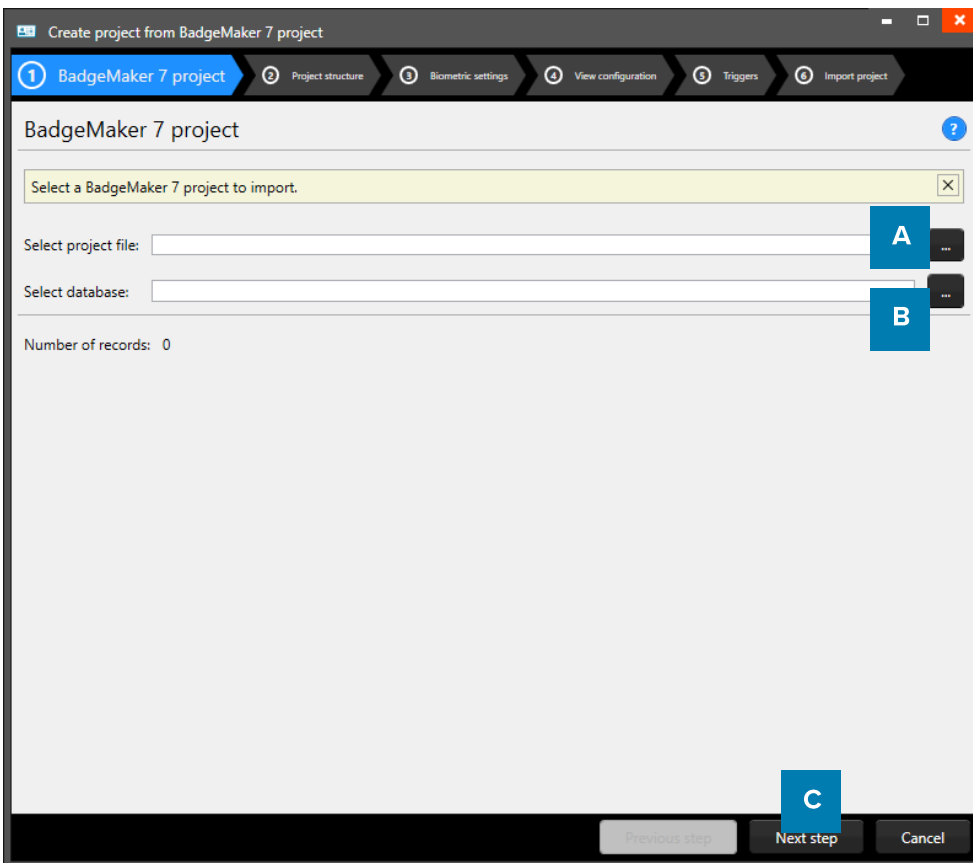

Example of step 1. New project from a BadgeMaker 7 project: Select BadgeMaker 7 Project

- A. Click on this button to select the BadgeMaker 7 project.
- B. Click on this button to select the BadgeMaker 7 database.
- C. Click on the “Next step” button to go to step 2. and check the project structure.

2. Project structure

Step 2. Name the new project and check the imported BadgeMaker 7 structure. Change, delete or add data columns here in the new Project structure.

Source column	Name	Type	Required	Unique	Default value	
IDnumber	IDnumber	Whole number	<input checked="" type="checkbox"/>	<input checked="" type="checkbox"/>		<input checked="" type="checkbox"/>
	<input checked="" type="checkbox"/> Is auto-incrementing					
Firstname	Firstname	Text	<input type="checkbox"/>	<input type="checkbox"/>		<input checked="" type="checkbox"/>
Surname	Surname	Text	<input type="checkbox"/>	<input type="checkbox"/>		<input checked="" type="checkbox"/>
Layout	Layout	Text	<input type="checkbox"/>	<input type="checkbox"/>	STUDENTCARD	<input checked="" type="checkbox"/>
Function	Function	Text	<input type="checkbox"/>	<input type="checkbox"/>		<input checked="" type="checkbox"/>
PlaceOfBirth	PlaceOfBirth	Text	<input type="checkbox"/>	<input type="checkbox"/>		<input checked="" type="checkbox"/>
Email	Email	Text	<input type="checkbox"/>	<input type="checkbox"/>		<input checked="" type="checkbox"/>
Phonenumber	Phonenumber	Text	<input type="checkbox"/>	<input type="checkbox"/>		<input checked="" type="checkbox"/>
Logo	Logo	Text	<input type="checkbox"/>	<input type="checkbox"/>		<input checked="" type="checkbox"/>

Example of step 2. New project from a BadgeMaker 7 project: Project data columns.

- A. Type in the name for your new project.
- B. Put in the column name
- C. Set the data type. Select if the data are number or text for example. The following types of database fields are supported:
 - o *Whole Number, when selecting this type, you can select 'auto-increment'. When a new record is created the number will be the highest number in the Project increased by 1.*
 - o *Text*
 - o *Decimal number*
 - o *Option List, when this list type is selected, you can add and delete the list values from the list that is presented for this database field. When you change a datatype from text to option list, PrintStudio automatically generates a list based on the data already in that data field.*
- D. Check these boxes if the field needs to be “Required” and or “Unique”.
- E. With the default input field, you can add a standard value to your data field, existing empty fields and new records will automatically get the default value you add to this data field.
- F. Click on the “X” button to delete a data field from the project structure setup.
- G. Click on the “Add new property” button and add and describe the data field names you want to use in your new project.
- H. Click on the “Next step” button to go to step 3.

3. Biometric settings

Step 3. Enable biometric images (Passport photos and/or Signatures) for the new project and setup how these images will be stored.

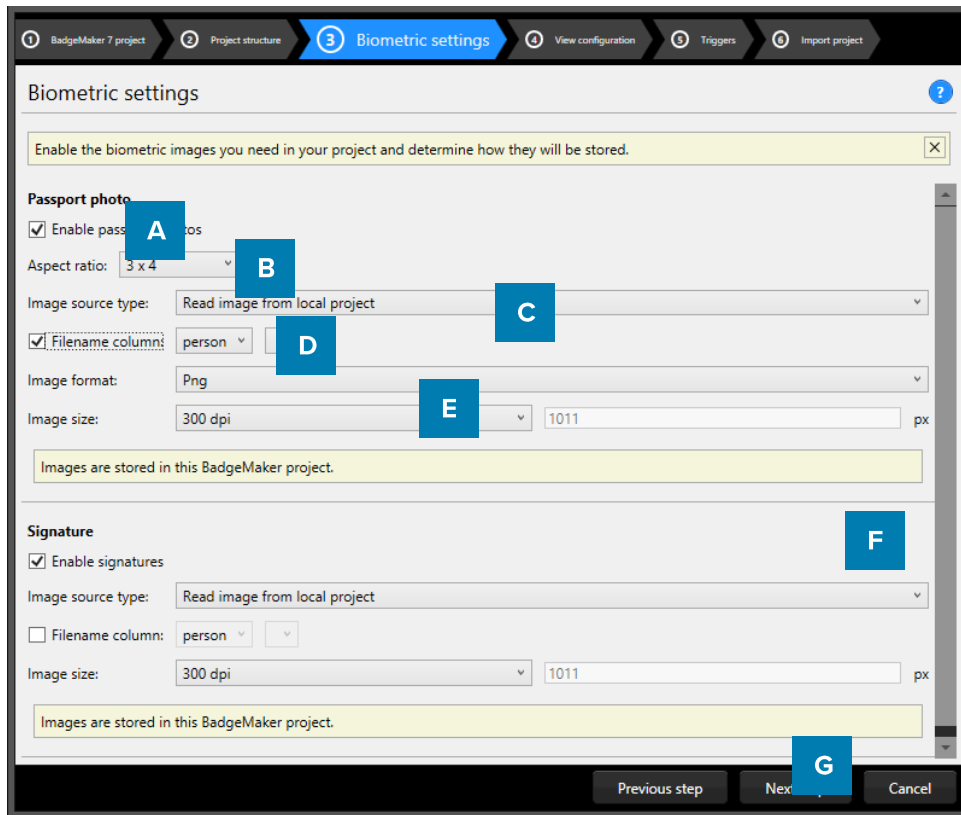

Example of step 3. New project from BadgeMaker 7: Biometric settings

- A. The box for passport photos make photos visible in the project and enables you to add photos.
- B. Determine the ratio of the photo with the drop-down menu.
- C. Select how and where photos will be saved within your project.
- D. Check this box if you want to use data columns to represent the filename.



Example of photo's that have filenames corresponding with their ID number.

- E. Select with what dpi and size the photos need to be saved within your project.
- F. The box for the signature makes signatures visible in the project and enables you to add signatures. The signature section works the same as the Passport photo section above.
- G. Click on the “Next step” button to go to step 3. And configure the detailed and gallery view

4. View configuration

Step 4. Choose for the default configuration or adjust the setup for the Detailed and Gallery view in the new project.

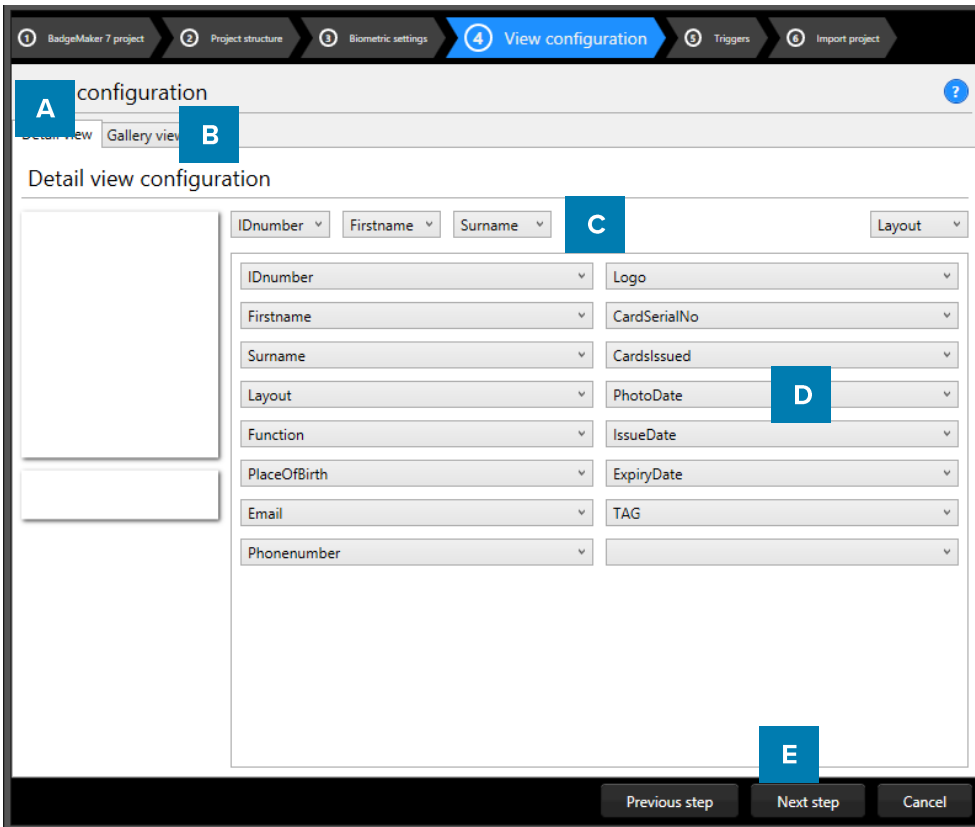

Example of step 4. New project from BadgeMaker 7: View configuration

- A. Tab to configure Detailed view showing specific card holders information.
- B. Tab to configure Gallery view showing card holders photos.
- C. Setup the title for the detailed view.
- D. Setup the information that will be available in the detailed view. Use the detailed view to have a clear overview of the card holders' data and make quick adjustments to the data.
- E. Click on the “Next step” button to go to step 5. And add triggers to the project.

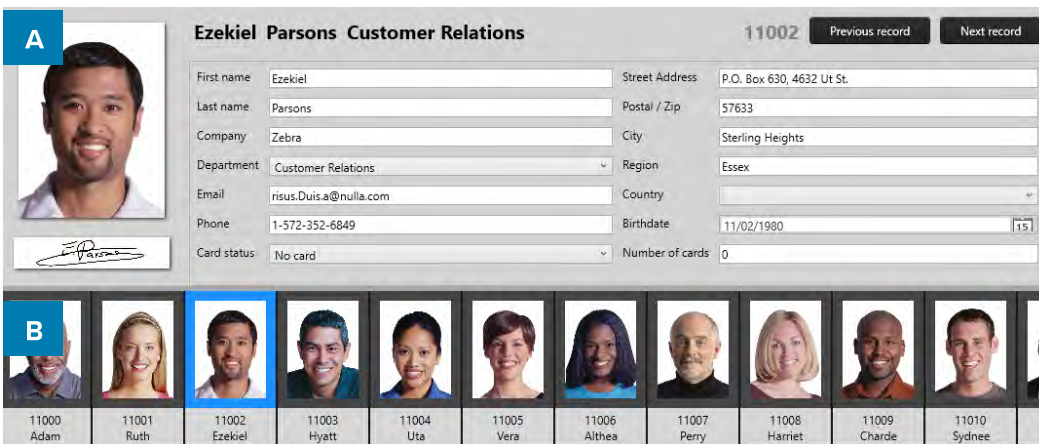

Example of the A. Detailed view and the B. Gallery view

5. Triggers

Step 5. Allows you to setup triggers for your project. Triggers can be used to automatically change data in your project on a certain condition or event.

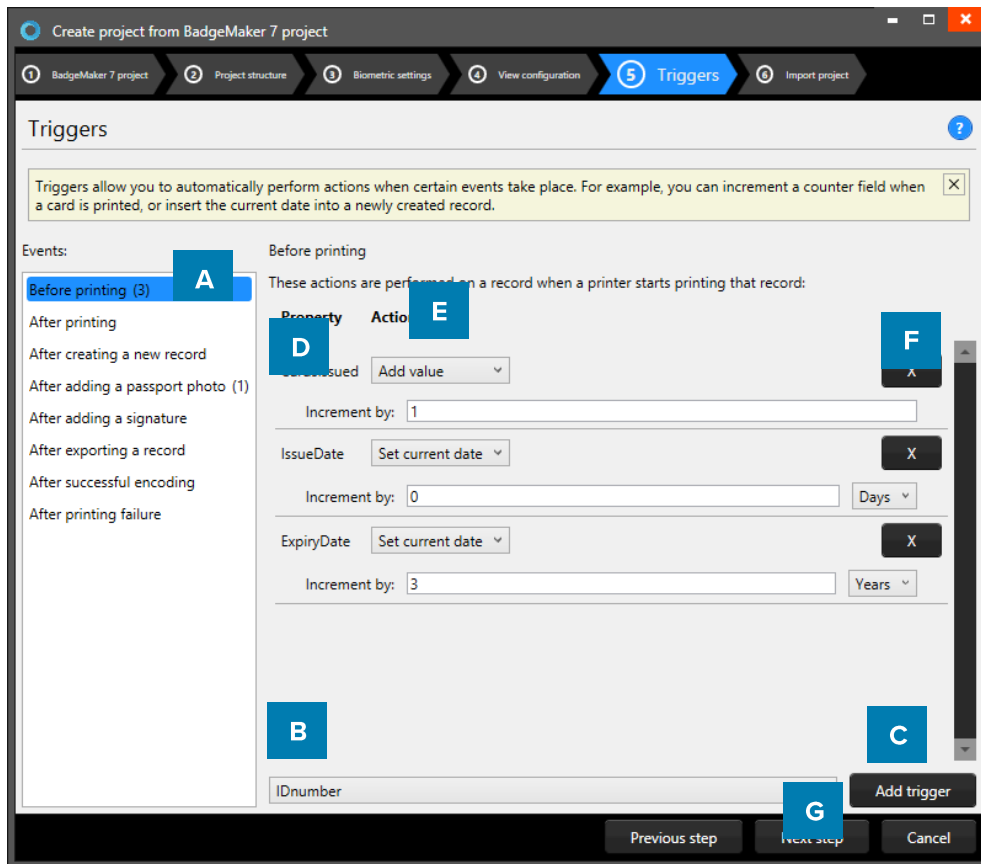

Example of step 5. New project from BadgeMaker 7: Triggers

- A. Select one of the events from this list and add specific triggers. PrintStudio will automatically wait for the event to occur before performing the action that is linked to the trigger.
- B. All data columns of the new project are listed. Select one of the columns in order to link a trigger action to it.
- C. Click on the “Add trigger” button to add the trigger to the data column and specify the Trigger with events and actions.
- D. The property shows you the selected data column.
- E. Select the action you want to connect to the data column from the drop down menu and define the action.
- F. Click on the “X” button to delete a trigger from an event.
- G. Click on the “Next step” button to go to step 6. And create the project.

Define the action that is performed once the event has been met. Some actions are only available for specific columns (for example, incrementing number values can only be done on Number type columns). All changes need to be saved before they become active. Understand that Triggers might cause your original data to change, so make sure no vital data is lost when working with Triggers.

6. Import Project

Step 6. Creates the new project based on the BadgeMaker 7 project as soon as you click on the A. “Create project” button.

B. Click on the “Previous step” button to make any changes before creating the project.

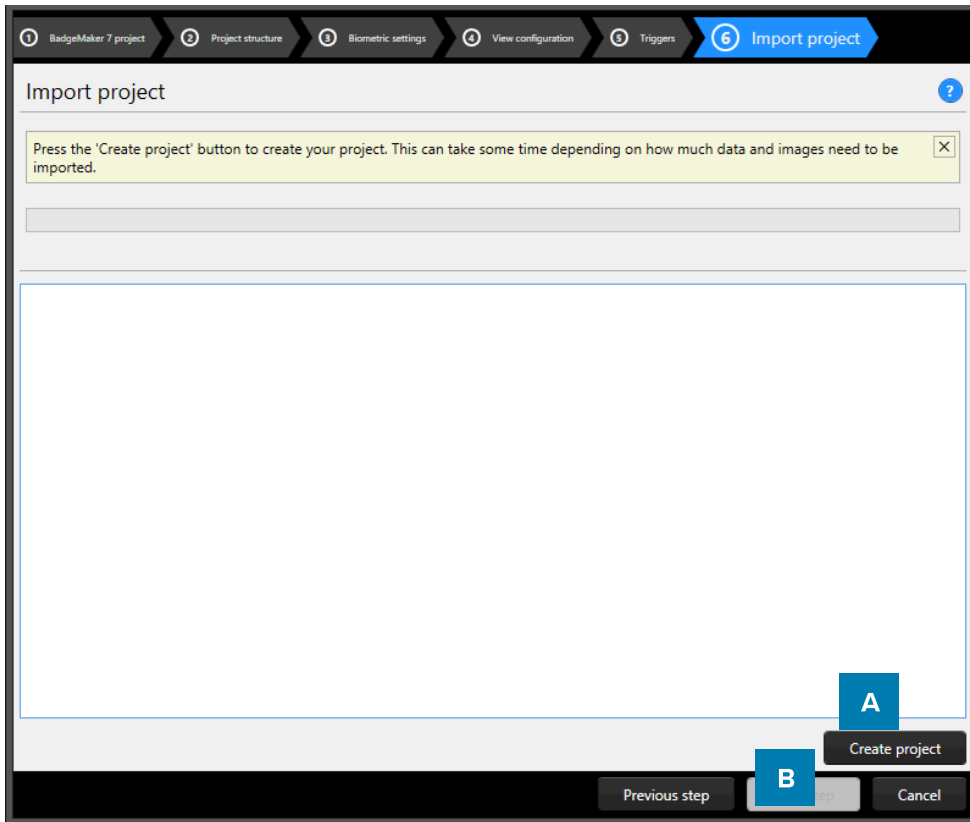

Example of step 6. New project from a BadgeMaker 7 project.

New Project from IDPro 7 Project

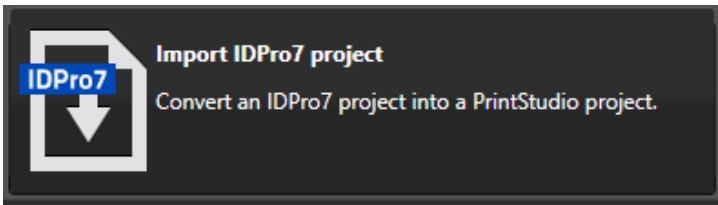

1. Select IDPro 7 Project

PrintStudio supports creating new projects based on a former IDPro 7 project.

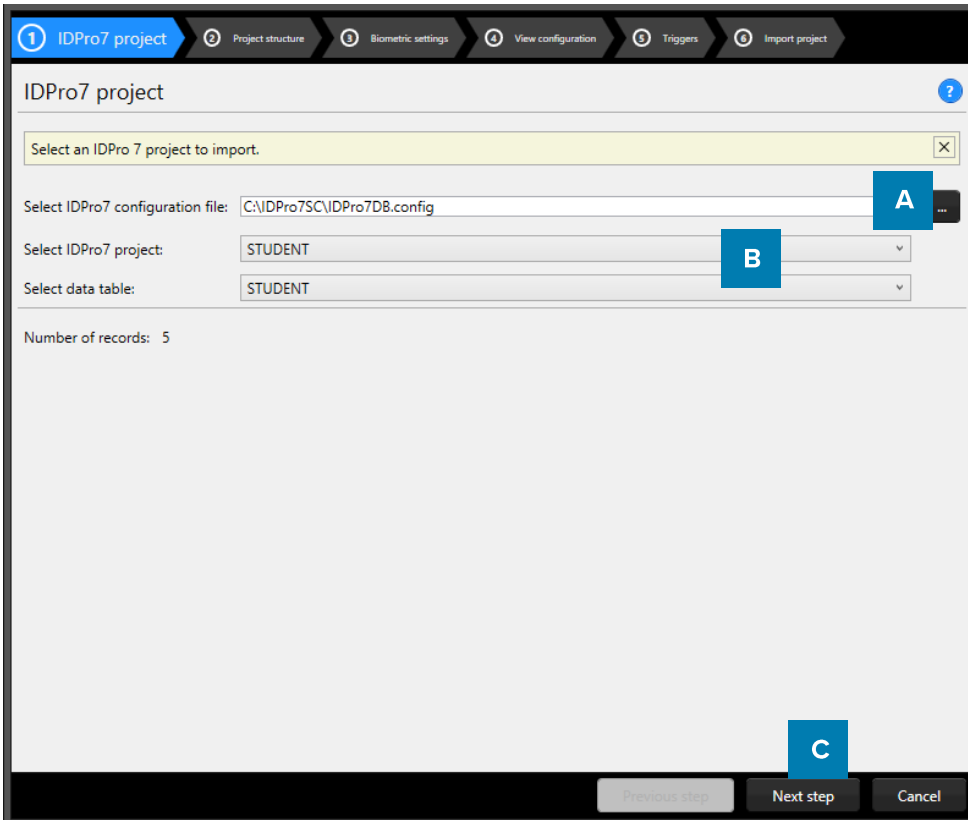

Example of step 1. New project: Select IDPro 7 Project

- A. Click on this button to select the IDPro 7 configuration file from your computer.
- B. Click on the dropdown menu to select the IDPro 7 project and the table you would like to use to setup the new project.
- C. Click on the “Next step” button to go to step 2. And check or adjust the project structure.

2. Project structure

Step 2. Name the new project and check the imported IDPro 7 structure. Change, delete or add data columns here in the new Project structure.

Source column	Name	Type	Required	Unique	Default value	
Student Number	Student N	Whole	<input checked="" type="checkbox"/>	<input checked="" type="checkbox"/>	0	X
	<input type="checkbox"/> Is auto-incrementing					
Student Type	Student Type	Options list	<input type="checkbox"/>	<input type="checkbox"/>	Full Time	X
	Expand to view and modify available values					
Firstname	Firstname	Text	<input type="checkbox"/>	<input type="checkbox"/>		X
Lastname	Lastname	Text	<input type="checkbox"/>	<input type="checkbox"/>		X
Date Of Birth	Date Of Birth	Date	<input type="checkbox"/>	<input type="checkbox"/>	Select a date [15]	X
Card No.	Card No.	Whole number	<input checked="" type="checkbox"/>	<input checked="" type="checkbox"/>	0	X
	<input type="checkbox"/> Is auto-incrementing					
Expiry Date	Expiry Date	Date	<input type="checkbox"/>	<input type="checkbox"/>	Select a date [15]	X

Example of step 2. New project from an IDPro 7 project: Project data columns.

- A. Type in the name for your new project.
- B. Put in the column name
- C. Set the data type. Select if the data are number or text for example. The following types of database fields are supported:
 - o Whole Number, when selecting this type, you can select 'auto-increment'. When a new record is created the number will be the highest number in the Project increased by 1.
 - o Text
 - o Decimal number
 - o Option List, when this list type is selected, you can add and delete the list values from the list that is presented for this database field. When you change a datatype from text to option list, PrintStudio automatically generates a list based on the data already in that data field.
- D. Check these boxes if the field needs to be "Required" and or "Unique".
- E. With the default input field, you can add a standard value to your data field, existing empty fields and new records will automatically get the default value you add to this data field.
- F. Click on the "X" button to delete a data field from the project structure setup.
- G. Click on the "Add new property" button and add and describe the data field names you want to use in your new project.
- H. Click on the "Next step" button to go to step 3.

3. Biometric settings

Step 3. Enable biometric images (Passport photos and/or Signatures) for the new project and setup how these images will be stored.

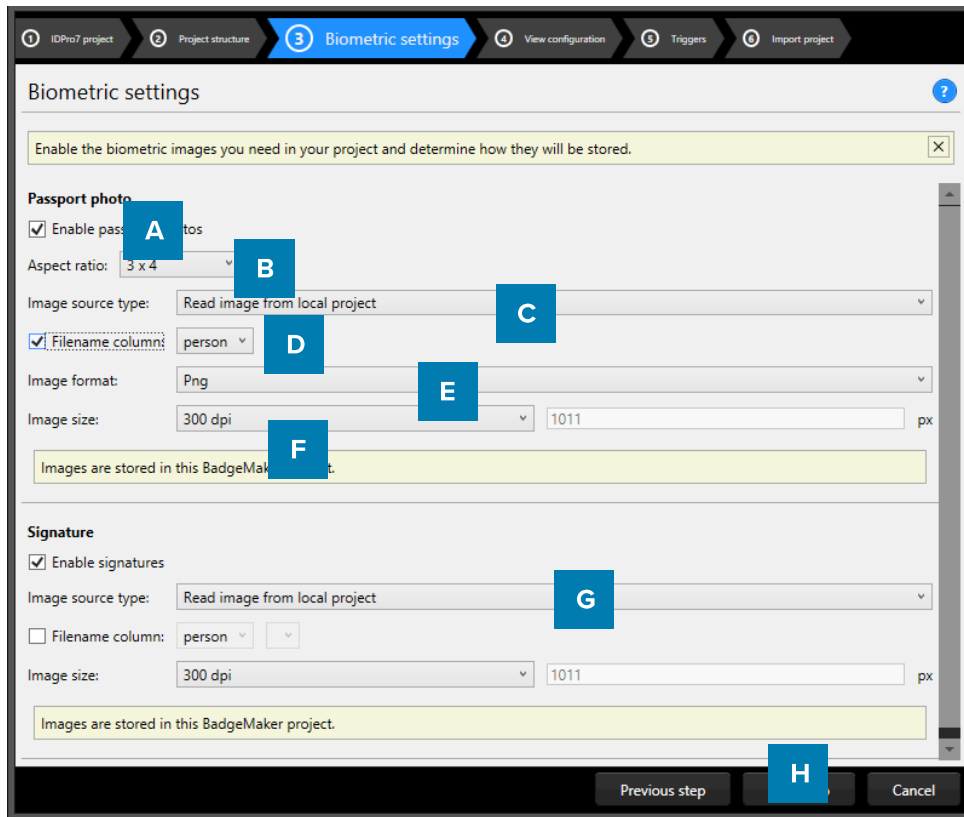

Example of step 3. New project from IDPro 7: Biometric settings

- A. The checkbox for passport photos make photos visible in the project and enable to add photos.
- B. After checking the box, determine the ratio of the photo in the drop-down menu.
- C. Select how and where photos will be saved that are used in the project.
- D. Check this box to use data columns to represent the filename of the photo (for example a person's ID number).



Example of photo's that have filenames corresponding with their ID number.

- E. Select the image format (png, jpg or bmp) that the image needs to be saved as.
- F. Here you can select what size the photos need to be saved as within your project.
- G. The box for the signature makes signatures visible in the project and enable to add signatures. The signature section works the same as the Passport photo section above.
- H. Click on the "Next step" button to go to step 4. And configure the detailed and gallery view

4. View configuration

Step 4. Choose for the default configuration or adjust the setup for the Detailed and Gallery view in the new project.

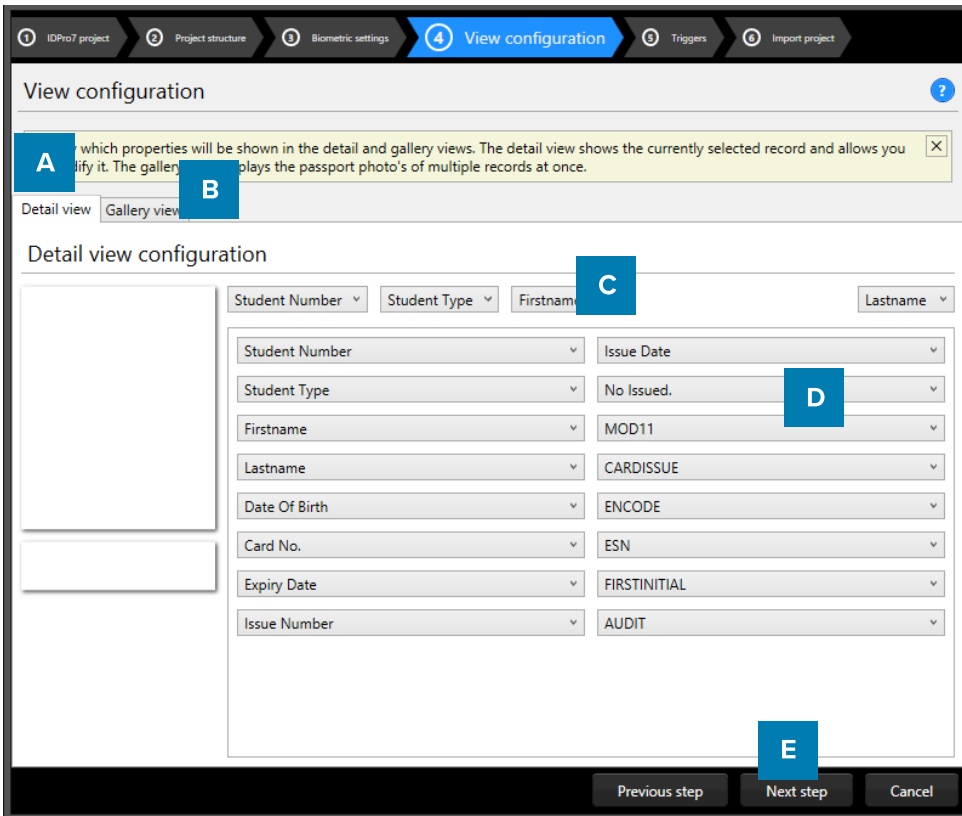

Example of step 4. New project from IDPro 7: View configuration

- A. Tab to configure Detailed view showing specific card holders information.
- B. Tab to configure Gallery view showing card holders photos.
- C. Setup the title for the detailed view.
- D. Setup the information that will be available in the detailed view. Use the detailed view to have a clear overview of the card holders' data and make quick adjustments to the data.
- E. Click on the "Next step" button to go to step 5. And add triggers to the project.

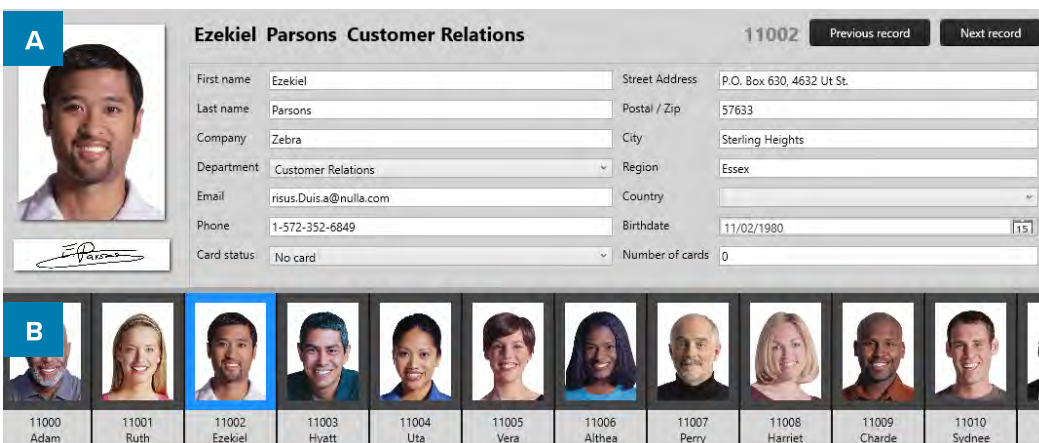

Example of the A. Detailed view and the B. Gallery view

5. Triggers

Step 5. Allows you to setup trigger for your project. Triggers can be used to automatically change data in your project on a certain condition or event.

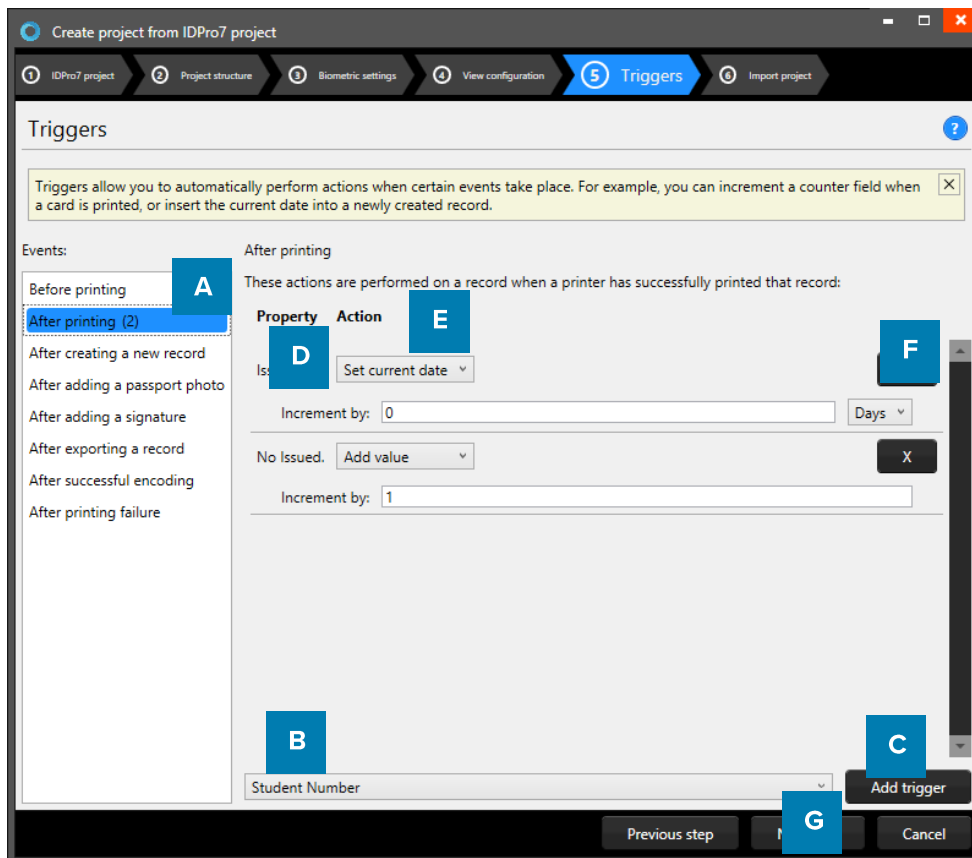

Example of step 5. New project from IDPro 7: Triggers

- A. Select one of the events from this list and add specific triggers. PrintStudio will automatically wait for the event to occur before performing the action that is linked to the trigger.
- B. All data columns of the new project are listed. Select one of the columns to link a trigger action to it.
- C. Click on the “Add trigger” button to add the trigger to the data column and specify the Trigger with events and actions.
- D. The property shows you the selected data column.
- E. Select the action you want to connect to the data column from the drop-down menu and define the action.
- F. Click on the “X” button to delete a trigger from an event.
- G. Click on the “Next step” button to go to step 6. And create the project.

Define the action that is performed once the event has been met. Some actions are only available for specific columns (for example, incrementing number values can only be done on Number type columns). All changes need to be saved before they become active. Understand that Triggers might cause your original data to change, so make sure no vital data is lost when working with Triggers.

6. Import Project

Step 6. Creates the new project based on the IDPro 7 project as soon as you click on the A. “Create project” button. B. Click on the “Previous step” button to make any changes before creating the project.

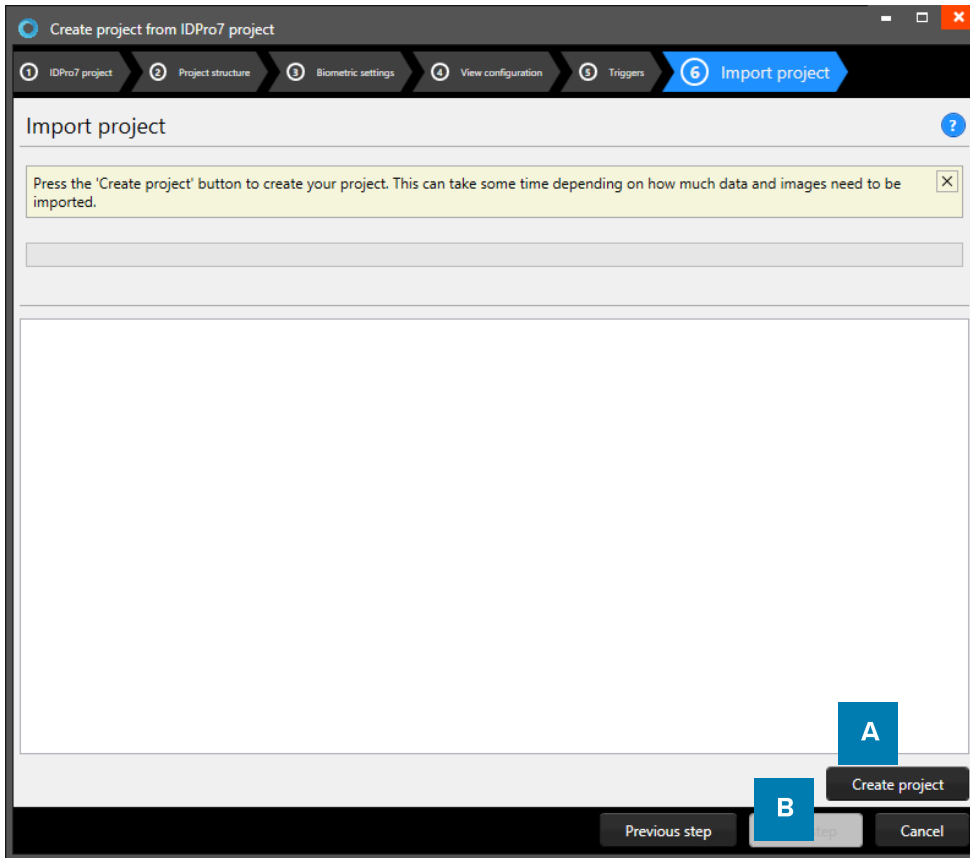

Example of step 6. New project: import IDPro 7 project.

PrintStudio Open Project

PrintStudio

Open Project

To open an existing Project select the “Open” link or button. All available existing projects are displayed, select the project that needs to be opened.

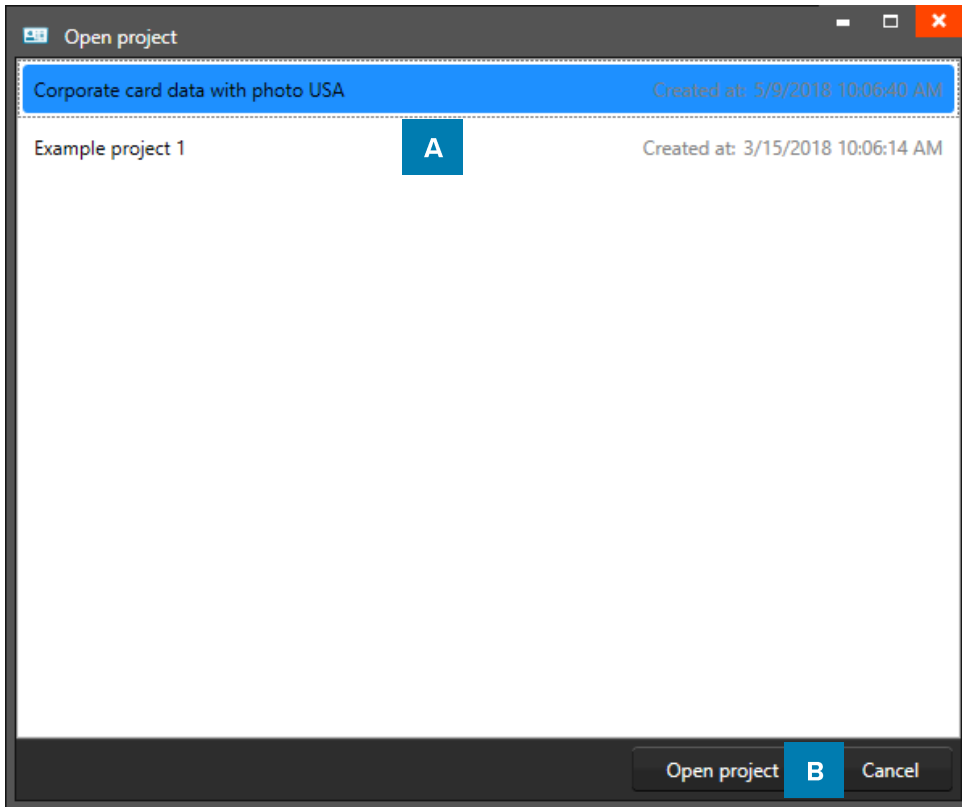

Example of the Open existing project popup window.

- A. Select one of the existing projects
- B. Click on the “Open project” button.

PrintStudio Import Data

PrintStudio

Import Data

Import data into a PrintStudio project if more data from for example, a former project or an output from an HR-system is needed. PrintStudio offers the import of data from an Excel/CSV file, BadgeMaker 7 project or an IDPro 7 project.

Go to the Main Menu and click on “File”, select “Import data”:

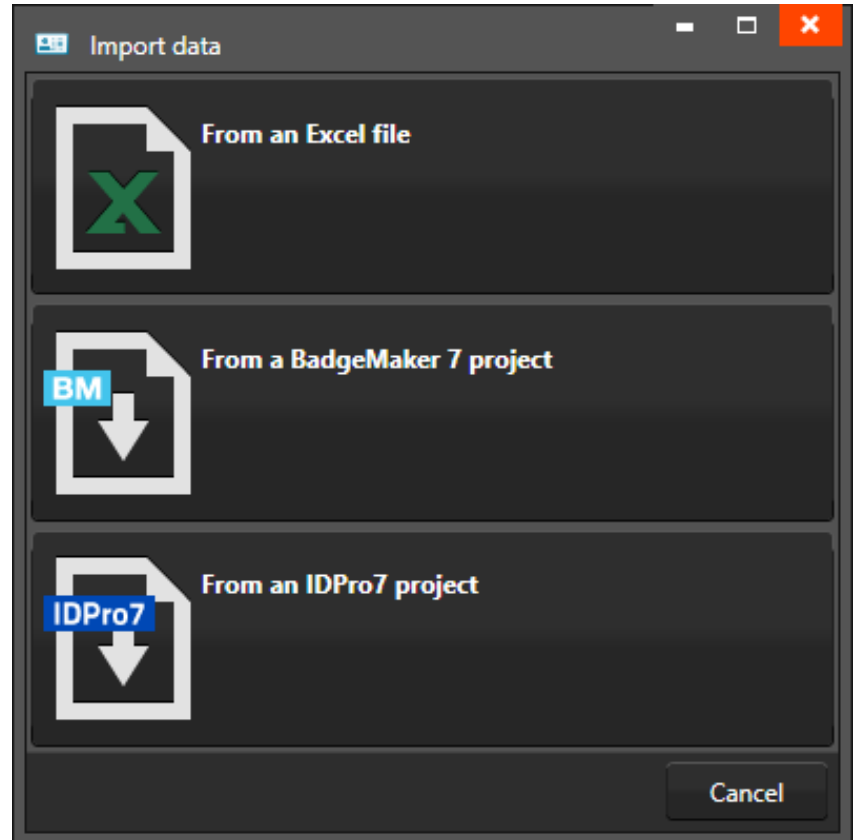
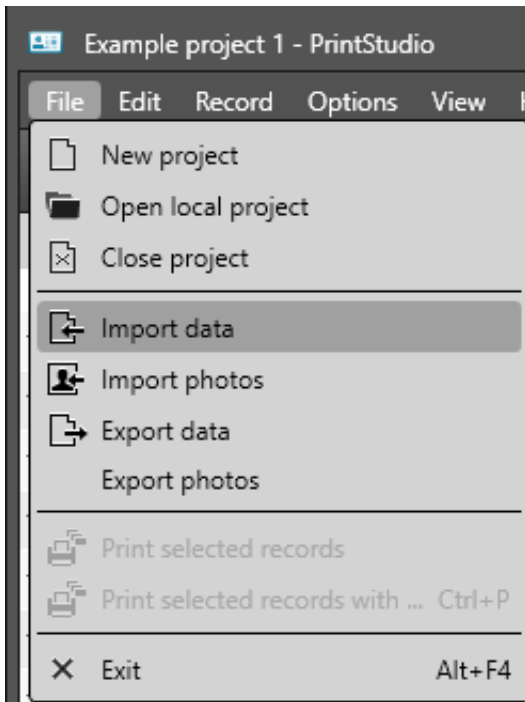

Example of the import data popup window.

Import an Excel file or CSV data file

To import data into the PrintStudio Project from an Excel file click on the first button “From an Excel file”.

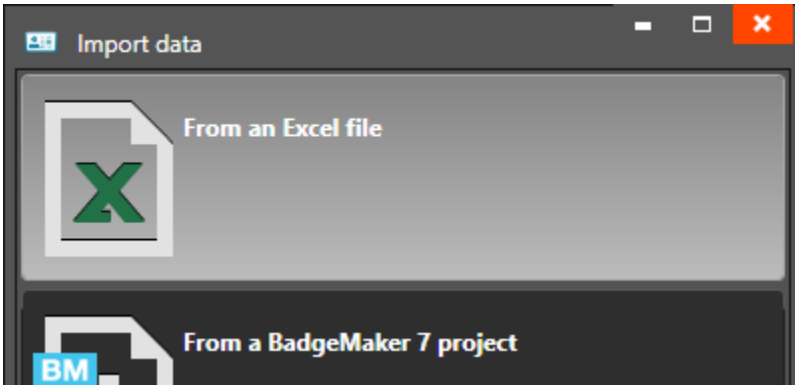

1. Data source

Step 1. Select the Excel file and Worksheet needed for the import of the data. A Photo source and/or Signature Source can be added if needed.

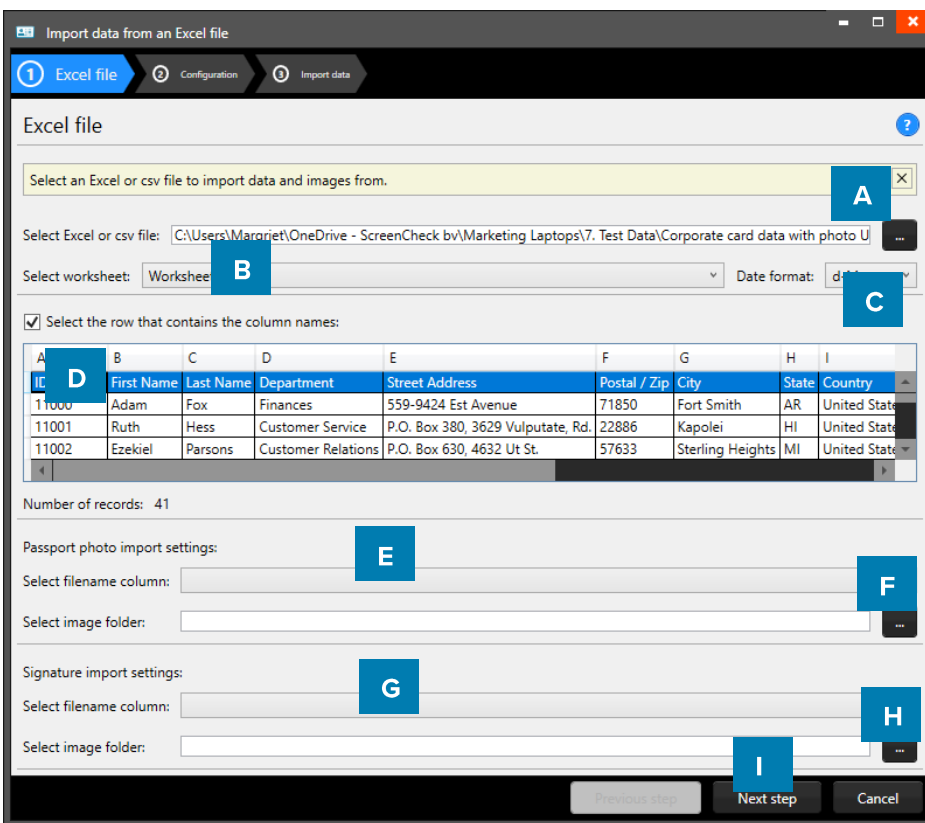

Example of the import data popup window.

- A. Click on this button and select the Excel/CSV file you want to import and select the worksheet you want to use from the drop-down menu below.
- B. Select the row that contains the column names.
- C. Select the column that connects with the unique photo names (for example: ID number or index)
- D. Select the folder that contains the card holders' photos
- E. Select the column that connects with the unique signature names (for example: ID number or index)
- F. Select the folder that contains the signature images
- G. Click on the “Next step” button to continue to second step.

2. Configuration

Step 2. Configure how the data will be imported into the project and handles the existing data.

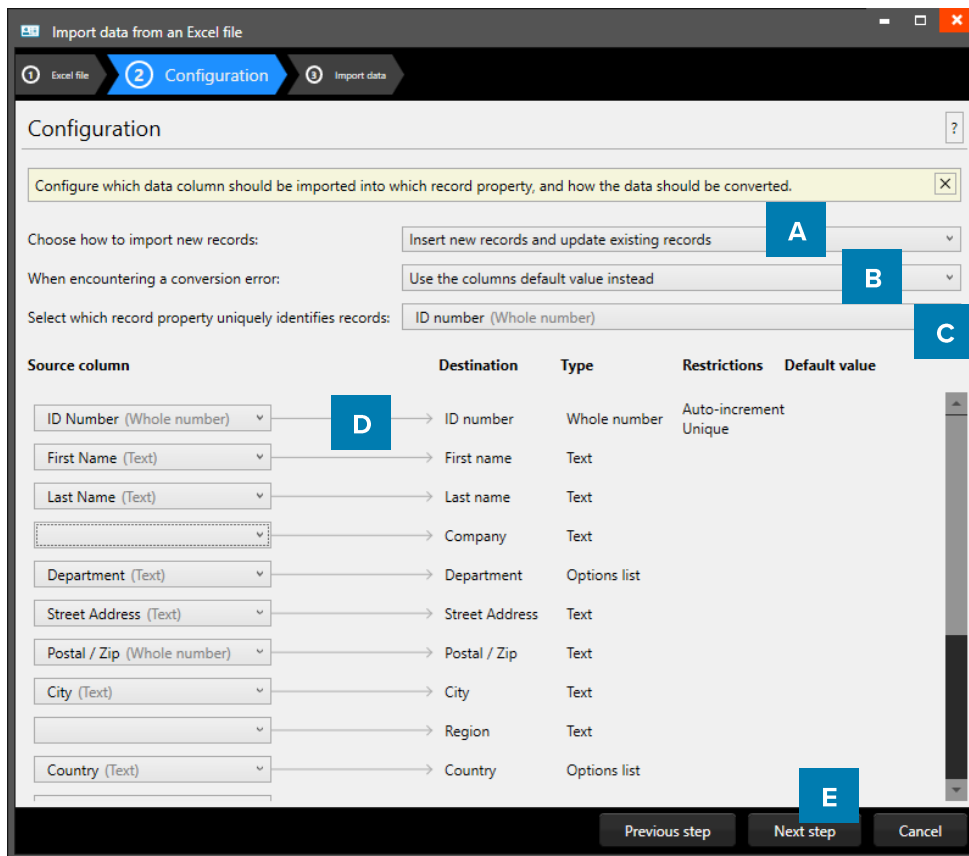

Example of the import Excel/CSV data popup window.

- A. Choose how imported data/new records will be handled. The drop-down menu gives you three options
- B. Select what happens when encountering a conversion error.
- C. Select one of the fields of the excel data which uniquely identifies data in the data source.
- D. Connect the source columns with the destination columns, PrintStudio will connect the columns with similar names automatically.
- E. Click on the “Next step” button to continue to import the data.

3. Import data

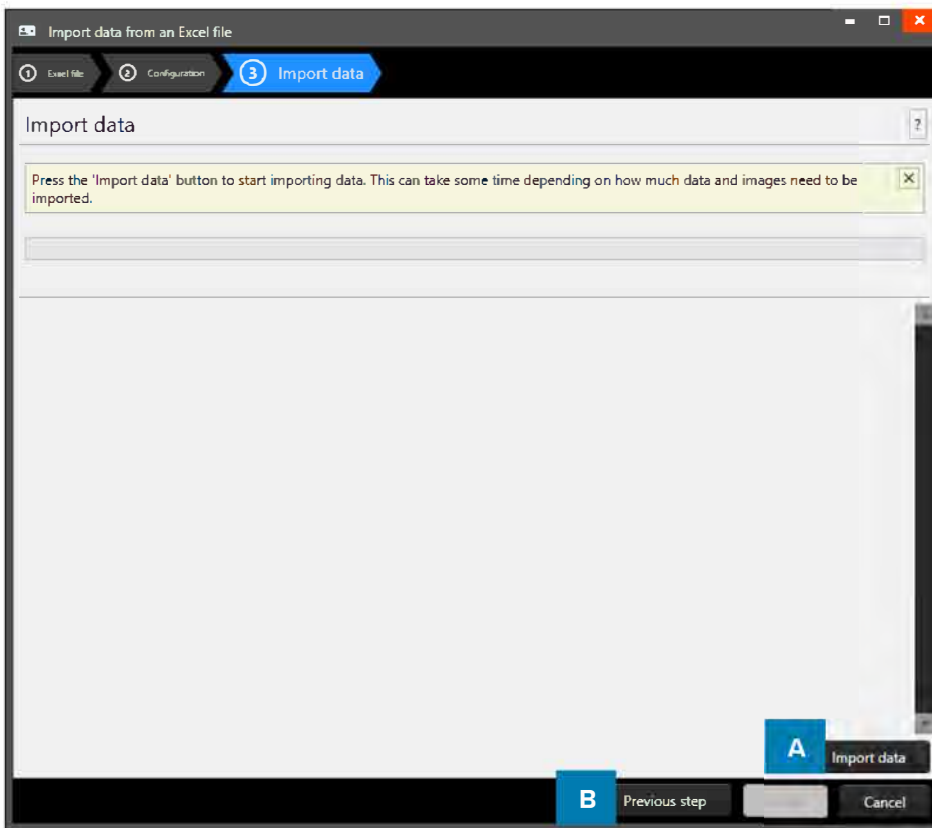

Example of step 3. Import data

Step 3. is processing the import of the Data. A. Click on the “[Import data](#)” button to start importing the data from your Excel file. B. Click on the “[Previous step](#)” button to make any changes before creating the project.

Import BadgeMaker 7 project data

To import data into the project from a BadgeMaker 7 project click on the first button “From a BadgeMaker 7 project”.

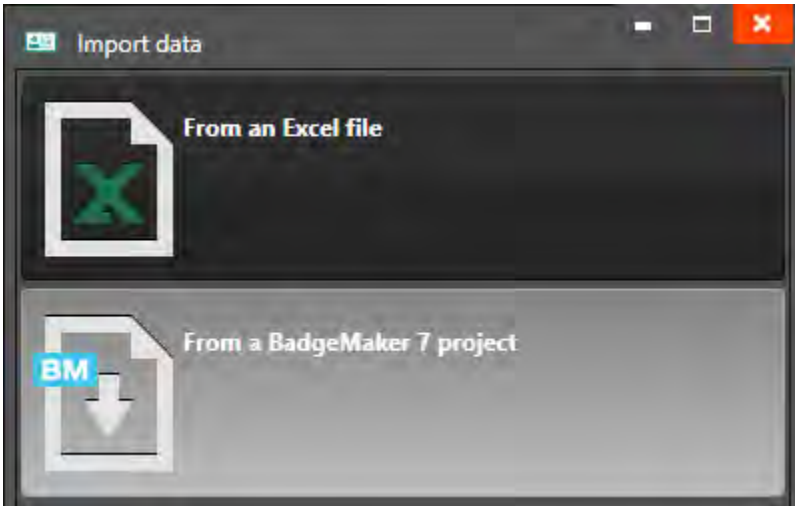

1. Data source

Step 1. Select the BadgeMaker 7 project file and database needed for the import of the data.

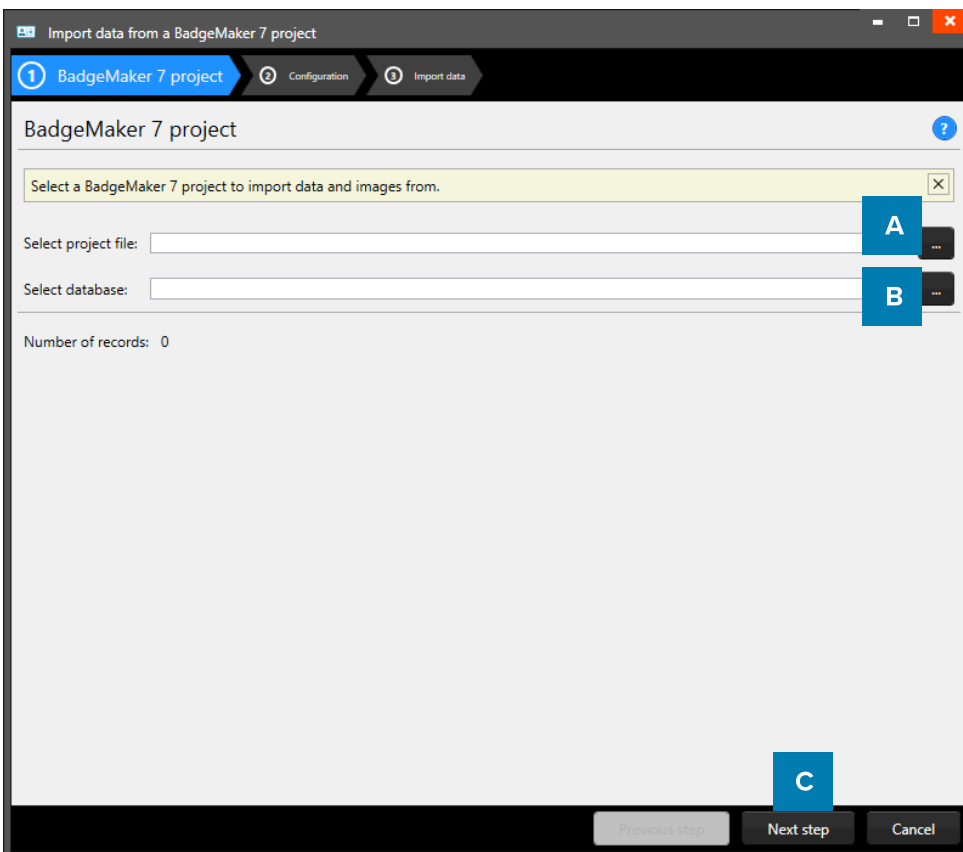

Example of the import data popup window.

- A. Click on this button to select the BadgeMaker 7 project from your computer.
- B. Click on this button to select the BadgeMaker 7 database from your computer.
- C. Click on the “Next step” button to go to step 2.

2. Configuration

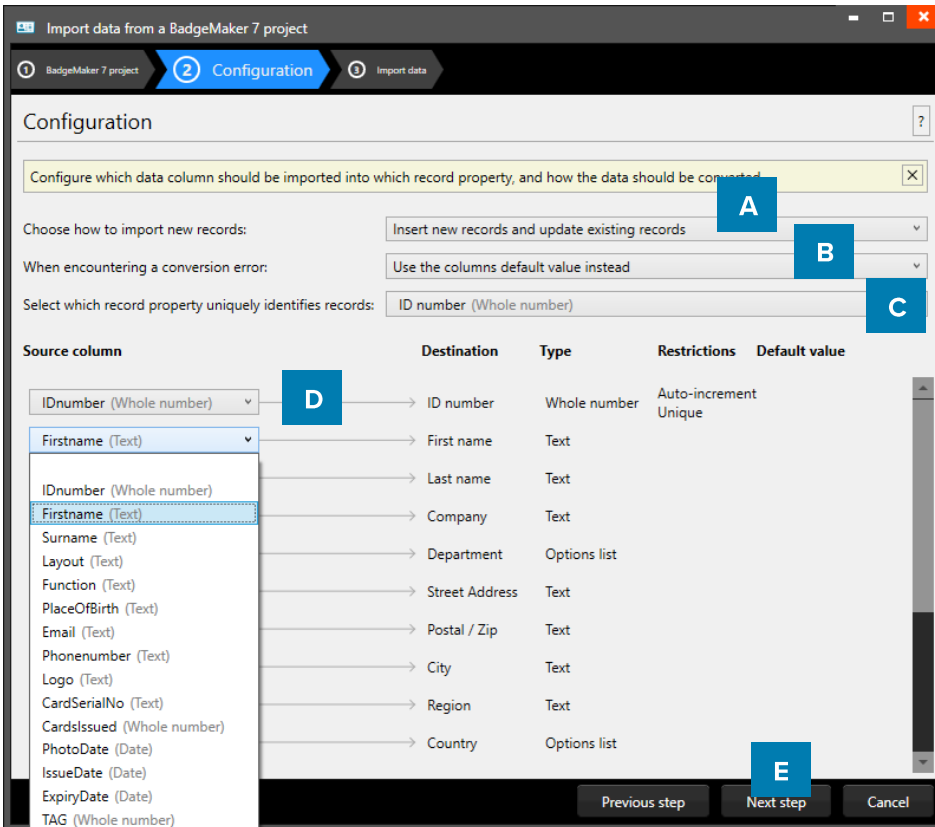

Example of the import of BadgeMaker 7 data popup window.

- A. Choose how imported data/new records will be handled. The drop-down menu gives you three options
- B. Select what happens when encountering a conversion error.
- C. Select one of the fields of the excel data which uniquely identifies data in the data source.
- D. Connect the source columns with the destination columns, PrintStudio will connect the columns with similar names automatically.
- E. Click on the “Next step” button to continue to import the data.

3. Import data

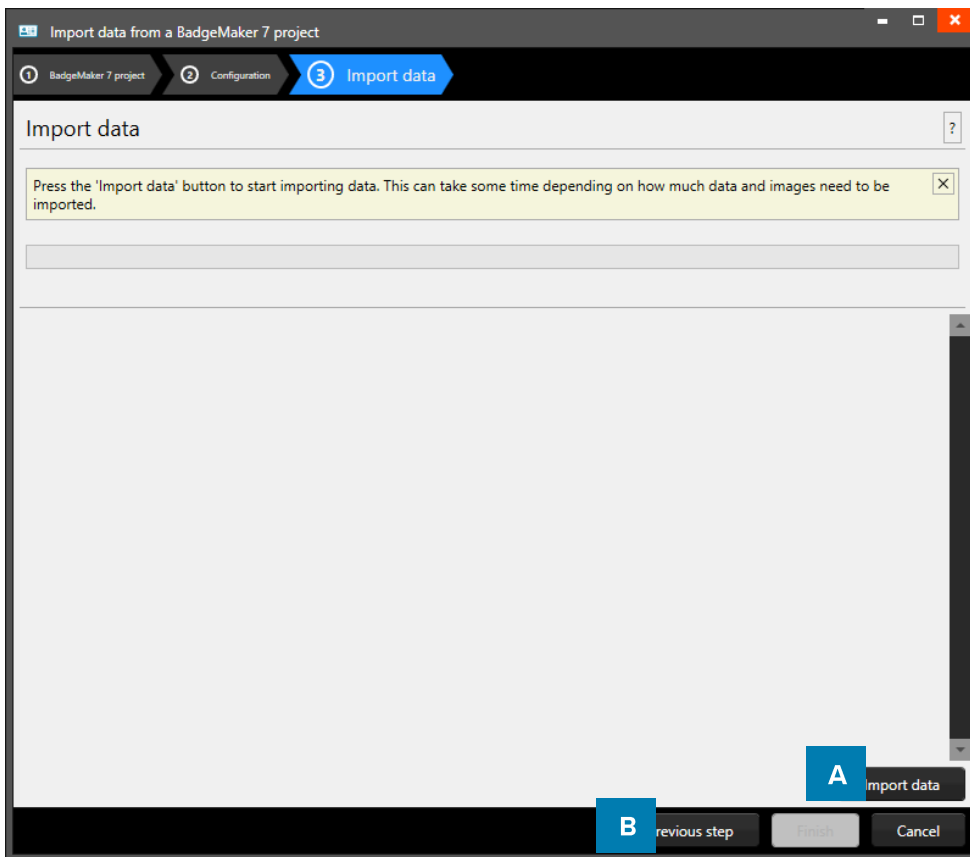

Example of step 3. Import data

Step 3. is processing the import of the Data. **A.** Click on the “**Import data**” button to start importing the data from your Excel file. **B.** Click on the “**Previous step**” button to make any changes before creating the project.

Import IDPro 7 data

To import data into the PrintStudio Project from an IDPro 7 project click on the first button “From an IDPro 7 project”.

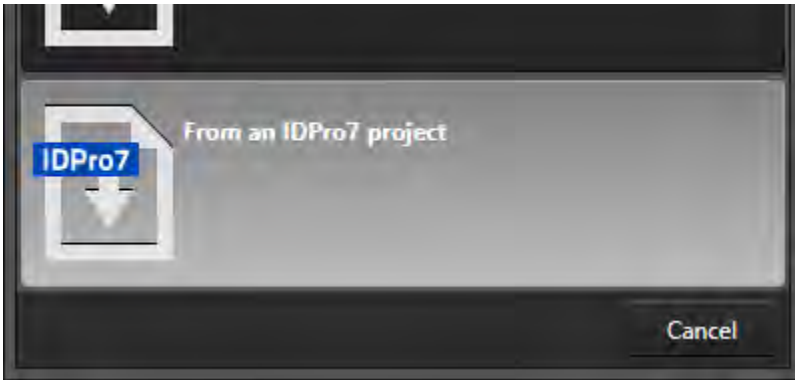

1. Data source

Step 1. Select the IDPro 7 configuration file and the project needed for the import of the data.

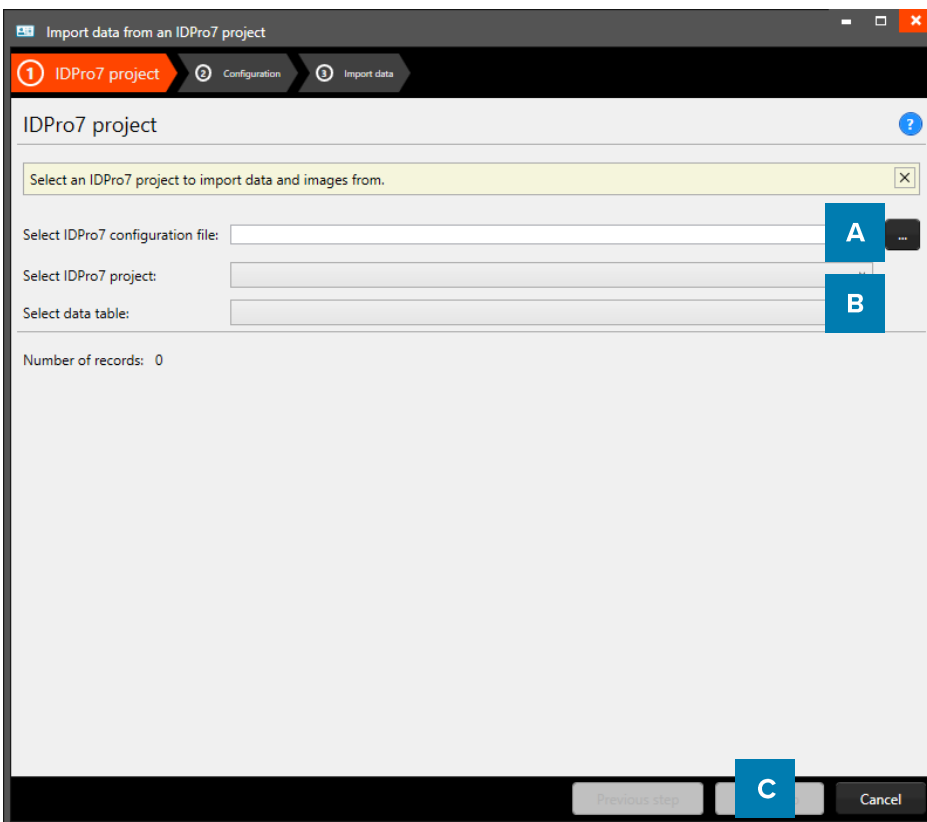

Example of the import data popup window.

- A. Click on this button to select the IDPro 7 configuration file from your computer.
- B. Click on the dropdown menu to select the IDPro 7 project and table.
- C. Click on the “Next step” button to go to step 2.

2. Configuration

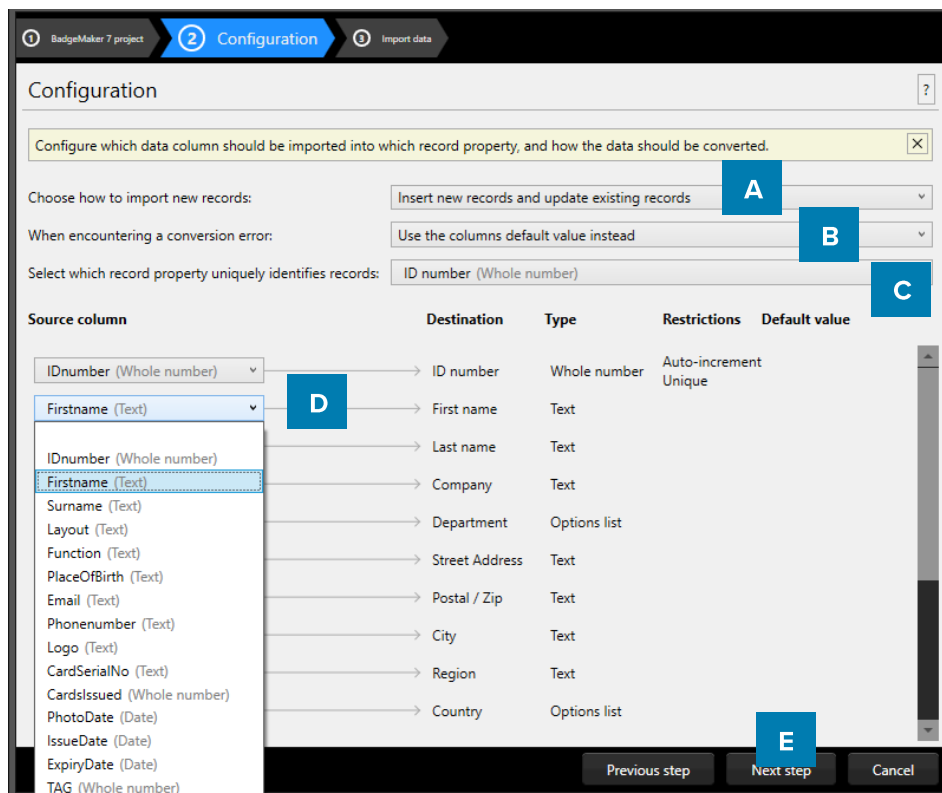

Example of the import of IDPro 7 data popup window.

- A. Choose how imported data/new records will be handled. The drop-down menu gives you three options
- B. Select what happens when encountering a conversion error.
- C. Select one of the fields of the excel data which uniquely identifies data in the data source.
- D. Connect the source columns with the destination columns, PrintStudio will connect the columns with similar names automatically.
- E. Click on the “Next step” button to continue to import the data.

3. Import data

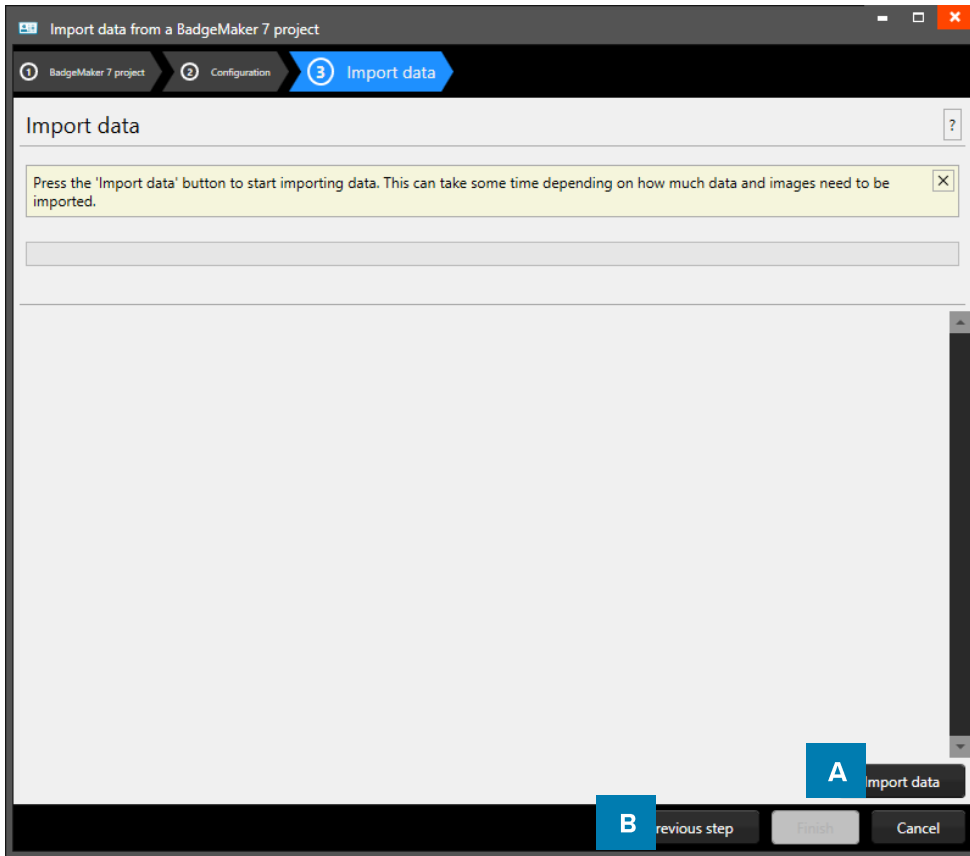

Example of step 3. Import data

Step 3. is processing the import of the Data. **A.** Click on the “**Import data**” button to start importing the data from your Excel file. **B.** Click on the “**Previous step**” button to make any changes before creating the project.

PrintStudio

Import Photos

At step 1. Biometric data you have the option to select the folders you would like to import from for your passport photos and or signature images.

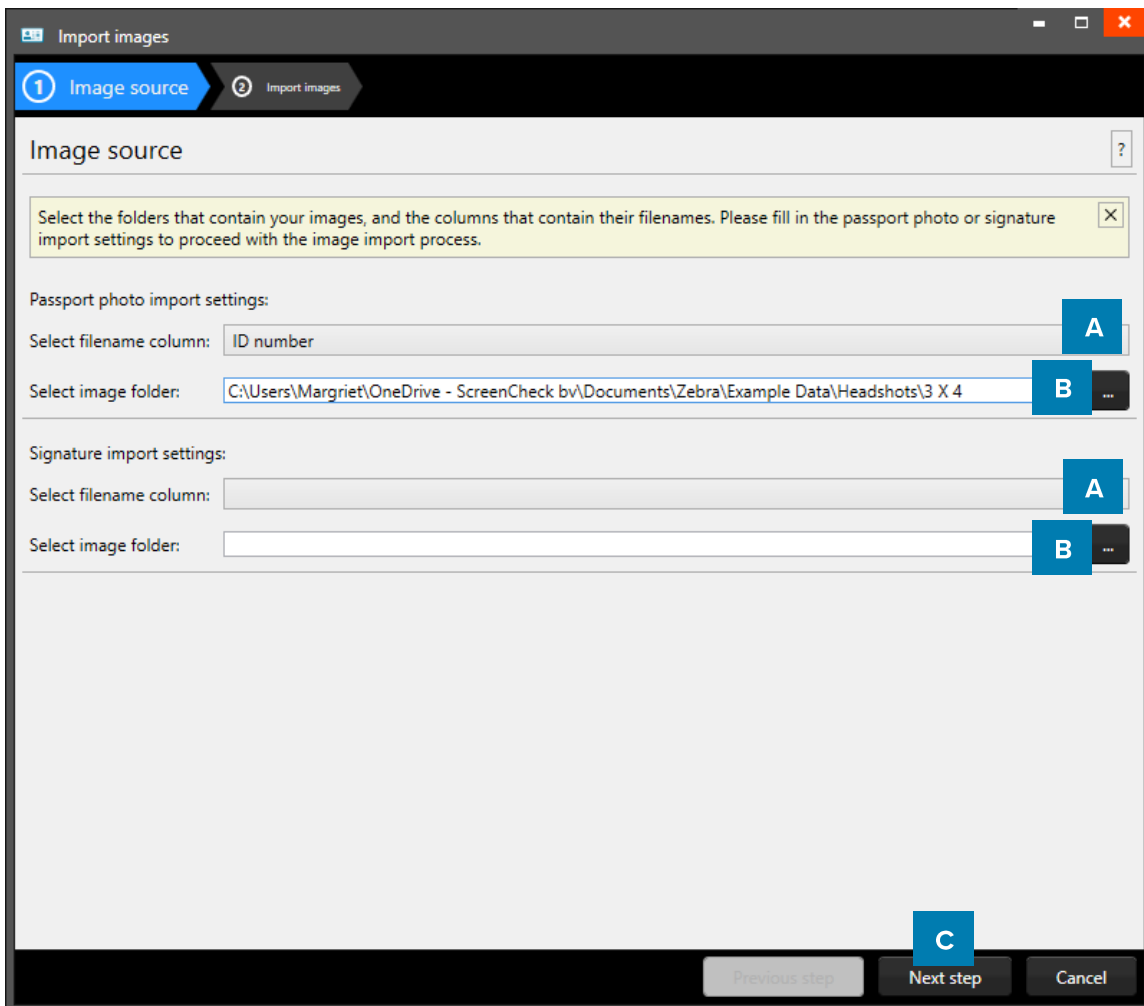

Example of importing biometric data.

- A. Select the data field that contains the unique data like the photos and or signature names.
- B. Click on this button and select the photos and or signatures folder you want to import from. The images need to have a unique name that can be connected to one of the unique fields.
- C. Click on the “Next step” button to continue to import the photos and or signatures.

PrintStudio Export Data

PrintStudio

Export Data

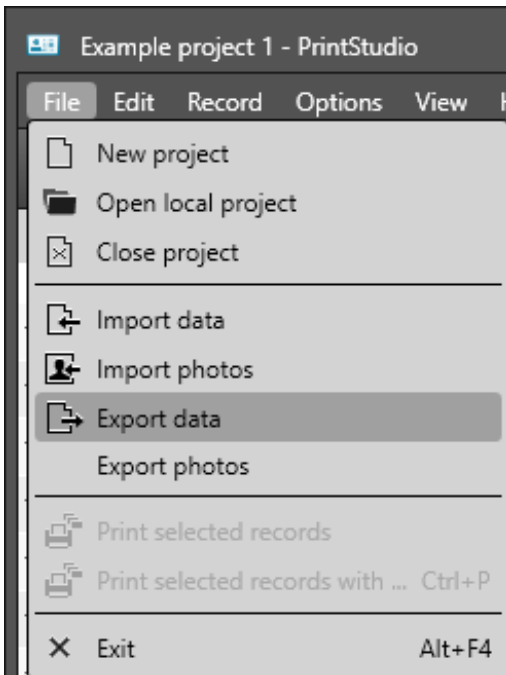

To export data first select the records you would like to export. Select all records or make a selection of records. Go to the Main menu, click on “File” and select “Export data” in the submenu:

- A. Select to export all records or a selection of records.
- B. Now click on the “Export” button and a CSV file will be generated.

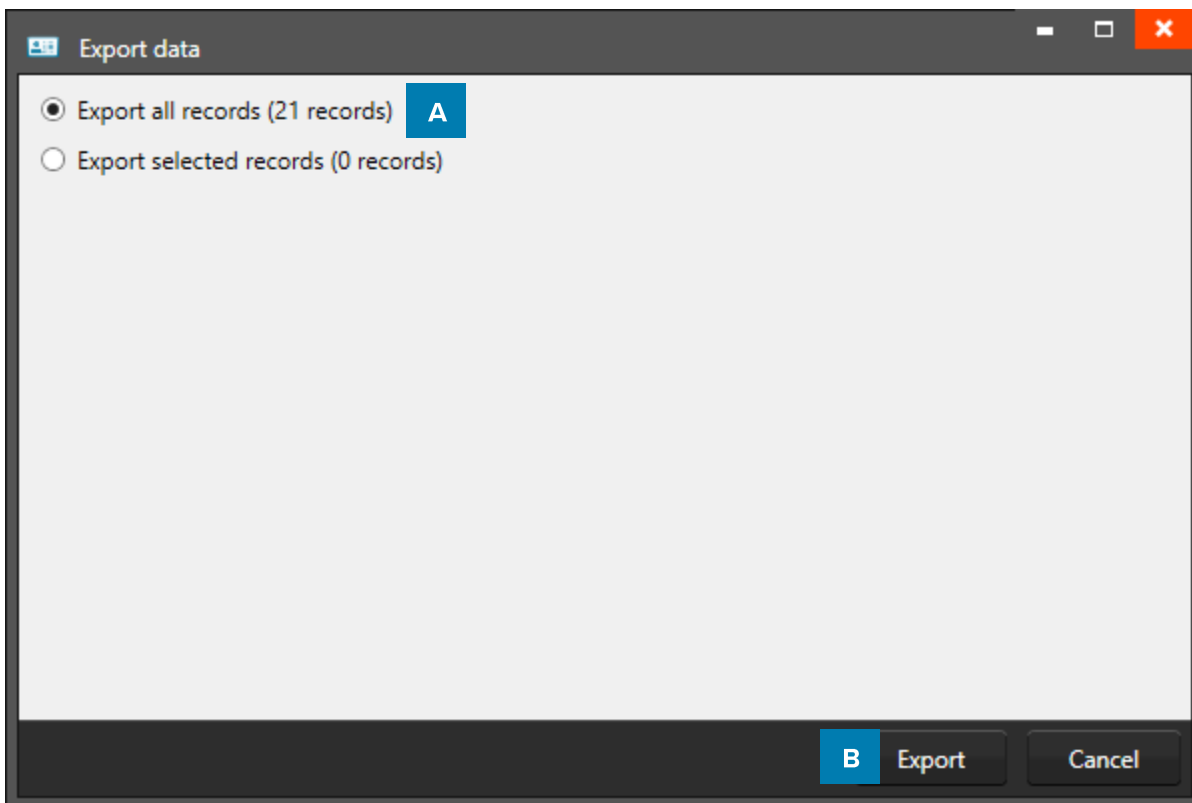

Example of exporting PrintStudio project data.

PrintStudio

Export Photos

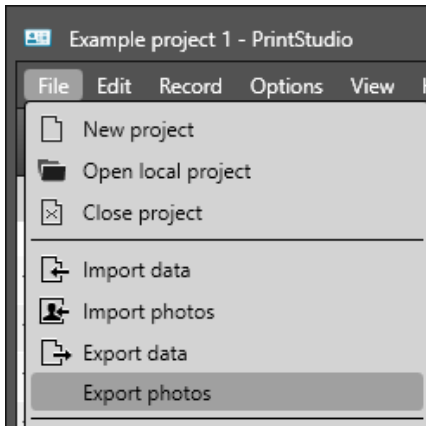

The Export photos function gives the option to export passport photos and or signature images.

To export data first select the records you would like to export. Select all records or make a selection of records. Go to the Main menu, click on “File” and select “Export photos” in the submenu.

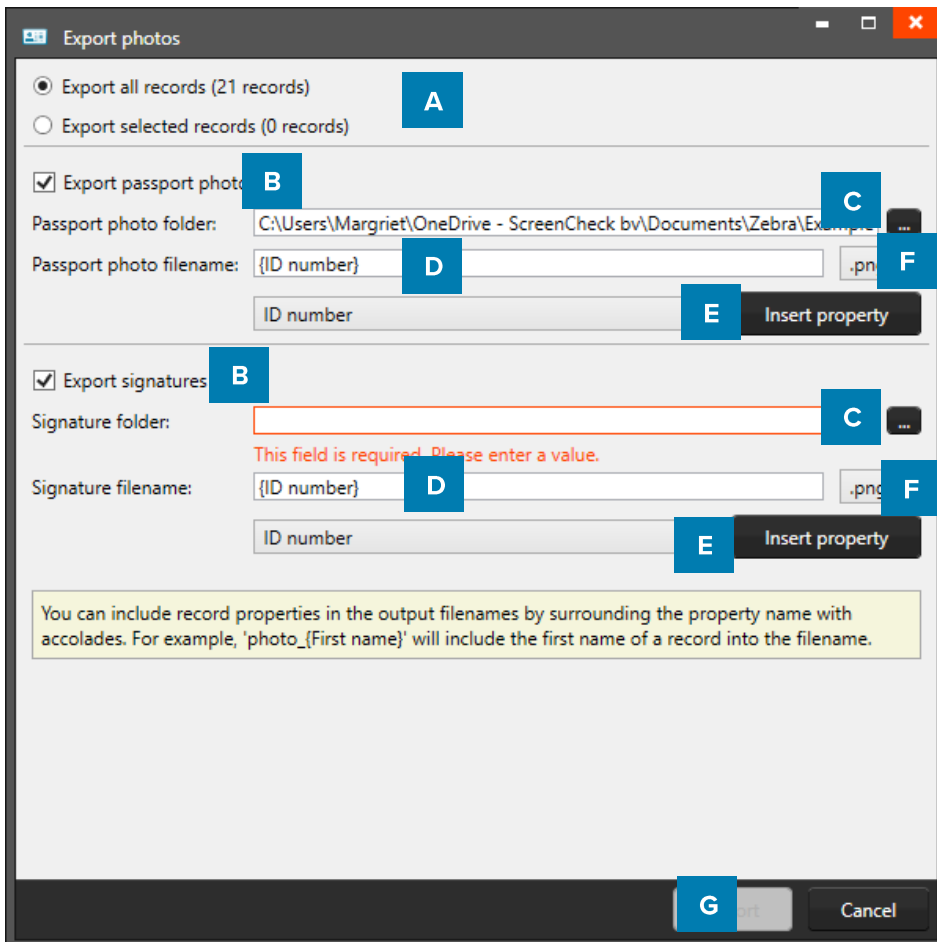

Example of exporting CardStudio project images.

- A. To export data first select if you would like to export all records or a selection you made.
- B. Check the boxes to choose to export photos and/or signatures.
- C. Click on this button and select the photos and or signatures folder to export to.
- D. Give the exported images a name.
- E. You can include column properties in the output filenames by selecting a column and clicking on “insert property”. For example: “{ID number}”.
- F. Select the file type: jpg, png or bmp
- G. Click on the “Next step” button to continue to export the photos and or signatures.

PrintStudio Project Settings

PrintStudio

Project Settings

To change the Project Settings go to the Main Menu, click on “Edit” and select “Project Settings” in the sub menu. Go to Project Settings to change the setup, project structure or to add and manage Card Designs in your project. Make sure you click on the “Save” button when making changes.

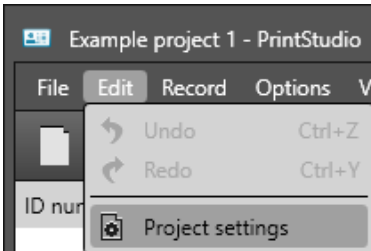

Detail View

Configure the layout of the detail view. The detail view is the view shown in the middle of the dashboard, giving you detailed information of a record. Use the detailed view to quickly adjust record data.

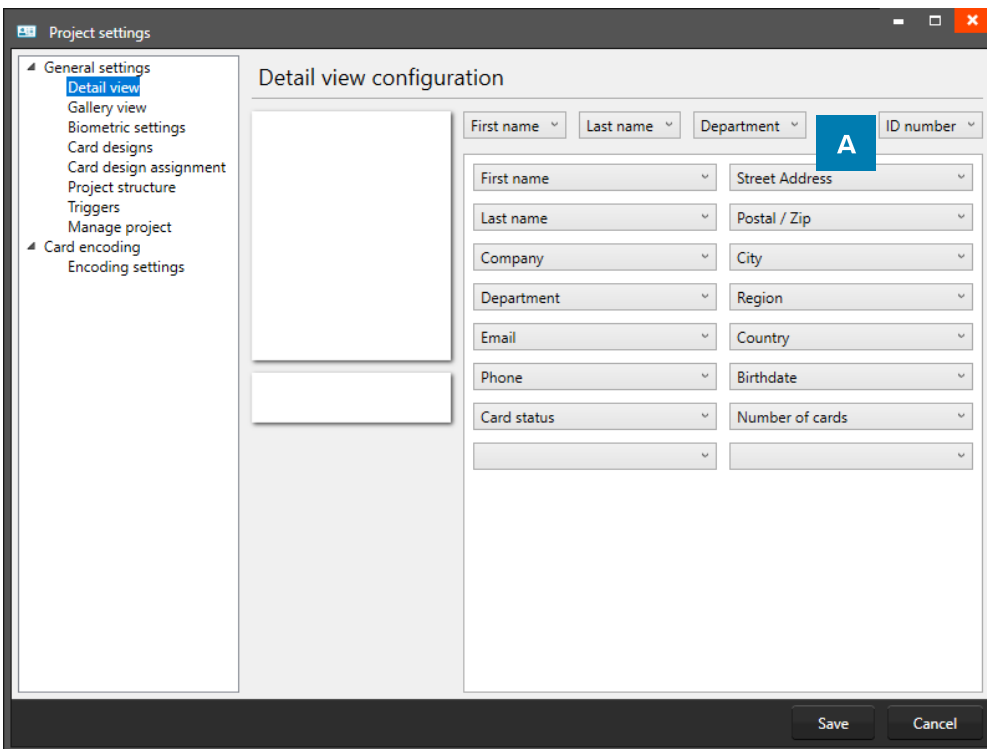

Example of the Project settings: Detailed view configuration

- A. Use the drop-down menus to select where you want to see certain data fields. At the top are usually the most important fields selected like the first name, last name and ID number.



Example of the A. Detailed view in the PrintStudio Dashboard.

Gallery view

The Gallery View is the Photo slide presentation. Gallery view lets you find a persons record very easy when people are showing up at the front desk to change or replace a card. In the Gallery setting you can select 2 (two) database fields that are presented with the Photo. You can select First name and Last name or chose for the record ID or any other database field.

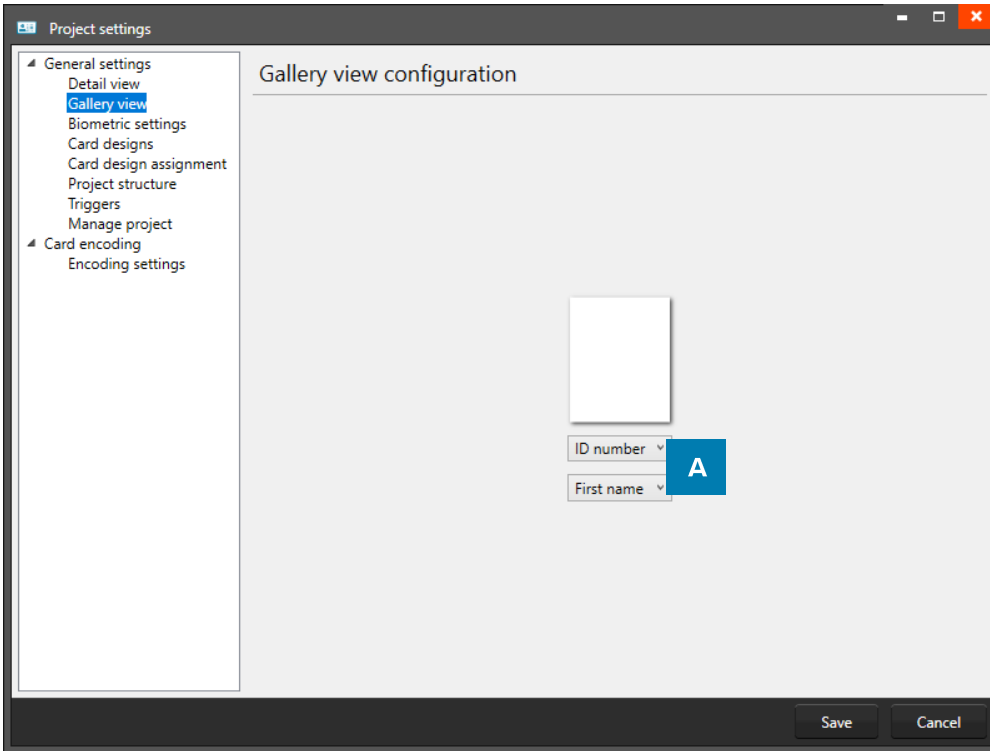

Example of the Preview Project settings: Gallery view

- A. In the Gallery setting you can select 2 (two) database fields that are presented with the Photo. You can select First name and Last name or chose for the record ID or any other database field.



Example of the A. Gallery view in the PrintStudio Dashboard.

Biometric settings

The Biometric settings is for managing the Passport Photos and/or Signatures in the project. Add Photo's and Signatures or adjust the settings for the photos or signatures.

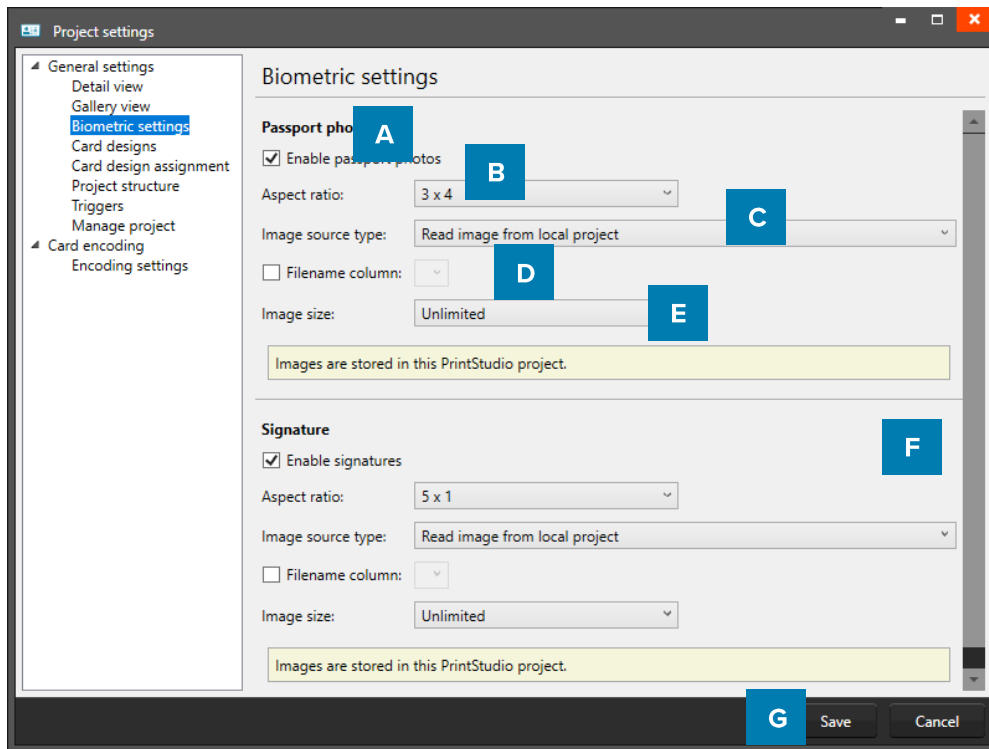

Example of the Project settings: Biometric settings

- A. The box for passport photos make photos visible in the project and enables you to add photos.
- B. Determine the ratio of the photo with the drop-down menu.
- C. Select how and where photos will be saved within your project.
- D. Check this box if you want to use data columns to represent the filename.



Example of photo's that have filenames corresponding with their ID number.

- E. Select with what dpi and size the photos need to be saved within your project.
- F. The box for the signature makes signatures visible in the project and enables you to add signatures. The signature section works the same as the Passport photo section above.
- G. Click on the “Next step” button to go to step 3. And configure the detailed and gallery view

Card Designs

Add and manage Card Designs in your project.

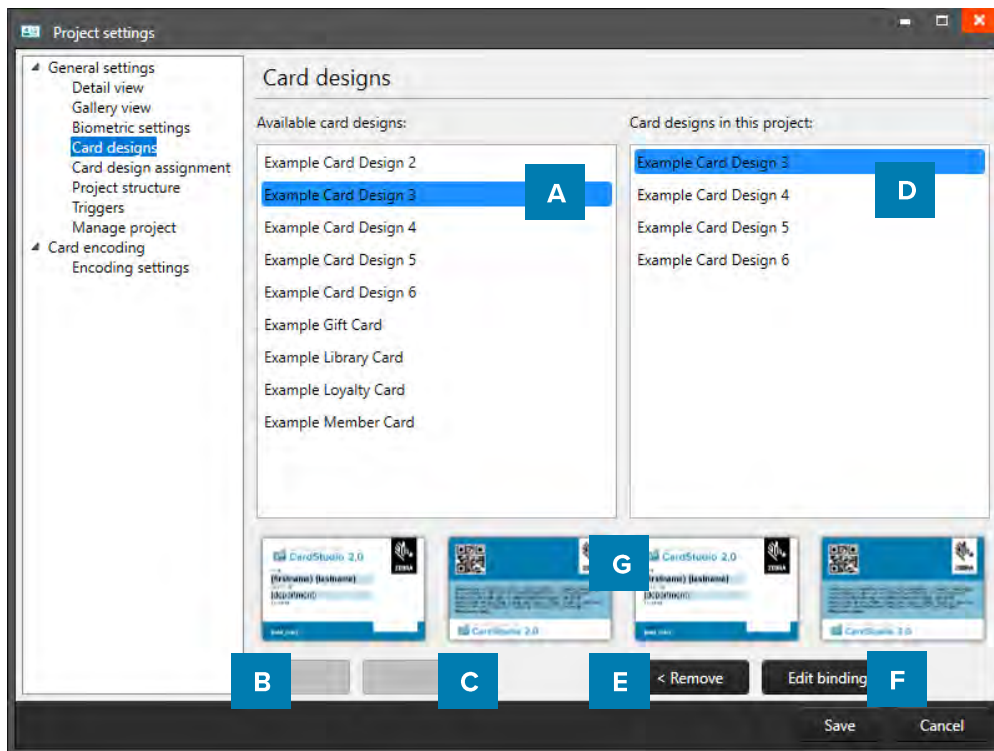

Example of the Project settings: Card Designs

- A. Select one of the available designs
- B. Click on the “Add” button to add the design to your project. If the Design has Dynamic data, bind this data to the correct data fields in your project.
- C. If you already have a card design in the project, but changed the design, choose to update it by clicking on the “Update” button. Any change made to an existing design in the project will be updated after clicking on this button.
- D. If you want to remove a design from your project, select one of the designs in this list. Then click on E.
- E. Click on the remove button if you want to delete one of the selected designs from your project.
- F. Select a design and click on “Edit bindings”, if you want to edit the bindings for the dynamic data of the card design.

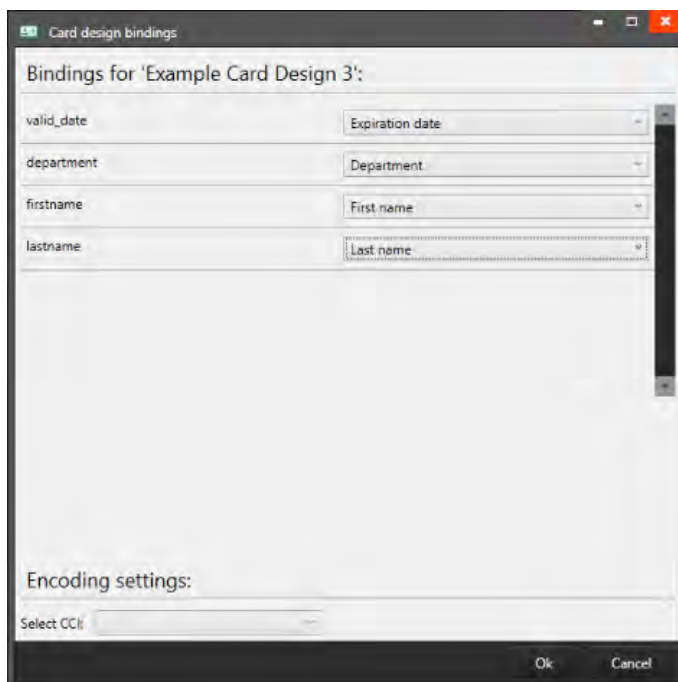

The data binding tool is a powerful option in PrintStudio.

When you add a new layout or update a layout you will be prompted to create the data bindings. Dynamic fields used and created in your layout may differ from the naming or spelling of a name that exists in your Project database. Therefore, you will be allowed to create the data bindings.

The dynamic fields that are created in the layout are presented to the left and you can bind these dynamic fields to the database fields. The tool will create the bindings for you that are obvious: if they are the same or as they were bonded at the previous update; of course, you will be able to modify the bindings and confirm these settings. The new or modified layout will be available in the dashboard of CardStudio Identity.

- G. Preview of a selected Card Design.

Card designs assignment

It is possible to assign the card designs using a specific project column.

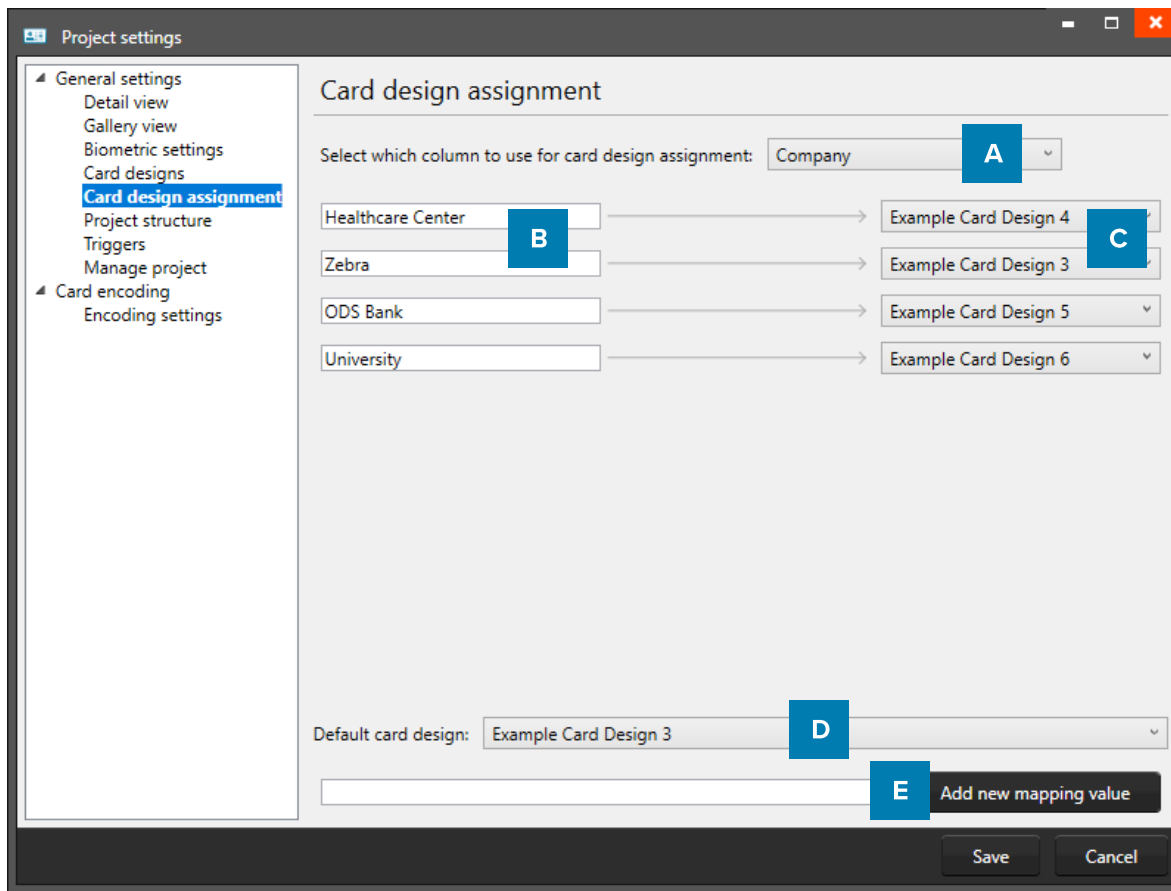

Example of the Project settings: Card design assignment

- A. Click on the drop-down menu to select the column. In the example we select the Company column. There is a different card design for every Company in the project.
- B. Enter the value that needs to be linked to a specific card design. In the example company names are entered.
- C. Select one of the available card designs from the drop-down menu and link the design to the value entered in the input field (B).
- D. Select one of the card designs from the drop-down menu as the default design for all the data not corresponding with the values entered above.
- E. Enter another value to add to the mapping and click the “Add new mapping value”. For example if you would like to add another company with a new company design.

Project Structure

The Project Structure settings is for managing your structure. You can create, edit or delete data columns in your Project.

Name	Type	Required	Unique	Default value	
ID number	Whole number	<input checked="" type="checkbox"/>	<input checked="" type="checkbox"/>		X
<input checked="" type="checkbox"/> Is auto-incrementing					
First name	Text	<input type="checkbox"/>	<input type="checkbox"/>		X
Last name	Text	<input type="checkbox"/>	<input type="checkbox"/>		X
Company	Text	<input type="checkbox"/>	<input type="checkbox"/>		X
Department	Options list	<input type="checkbox"/>	<input type="checkbox"/>		X
<input type="checkbox"/> Expand to view and modify available values					
Street Address	Text	<input type="checkbox"/>	<input type="checkbox"/>		X
Postal / Zip	Text	<input type="checkbox"/>	<input type="checkbox"/>		X
City	Text	<input type="checkbox"/>	<input type="checkbox"/>		X
Region	Text	<input type="checkbox"/>	<input type="checkbox"/>		X

Example of the Project settings: Project Structure

- A. Put in the column name
- B. Set the data type. Select if the data are number or text for example. The following types of database fields are supported:
 - o Whole Number, when selecting this type, you can select 'auto-increment'. When a new record is created the number will be the highest number in the Project increased by 1.
 - o Text
 - o Decimal number
 - o Option List, when this list type is selected, you can add and delete the list values from the list that is presented for this database field. When you change a datatype from text to option list, PrintStudio automatically generates a list based on the data already in that data field.
- C. Check these boxes if the field needs to be "Required" and or "Unique".
- D. With the default input field, you can add a standard value to your data field, existing empty fields and new records will automatically get the default value you add to this data field.
- E. Click on the "X" button to delete a data field from the project structure setup.
- F. Click on the "Add new property" button and add and describe the data field names you want to use in your new project.

Triggers

Setup trigger for your project. Triggers can be used to automatically change data in your project on a certain condition or event.

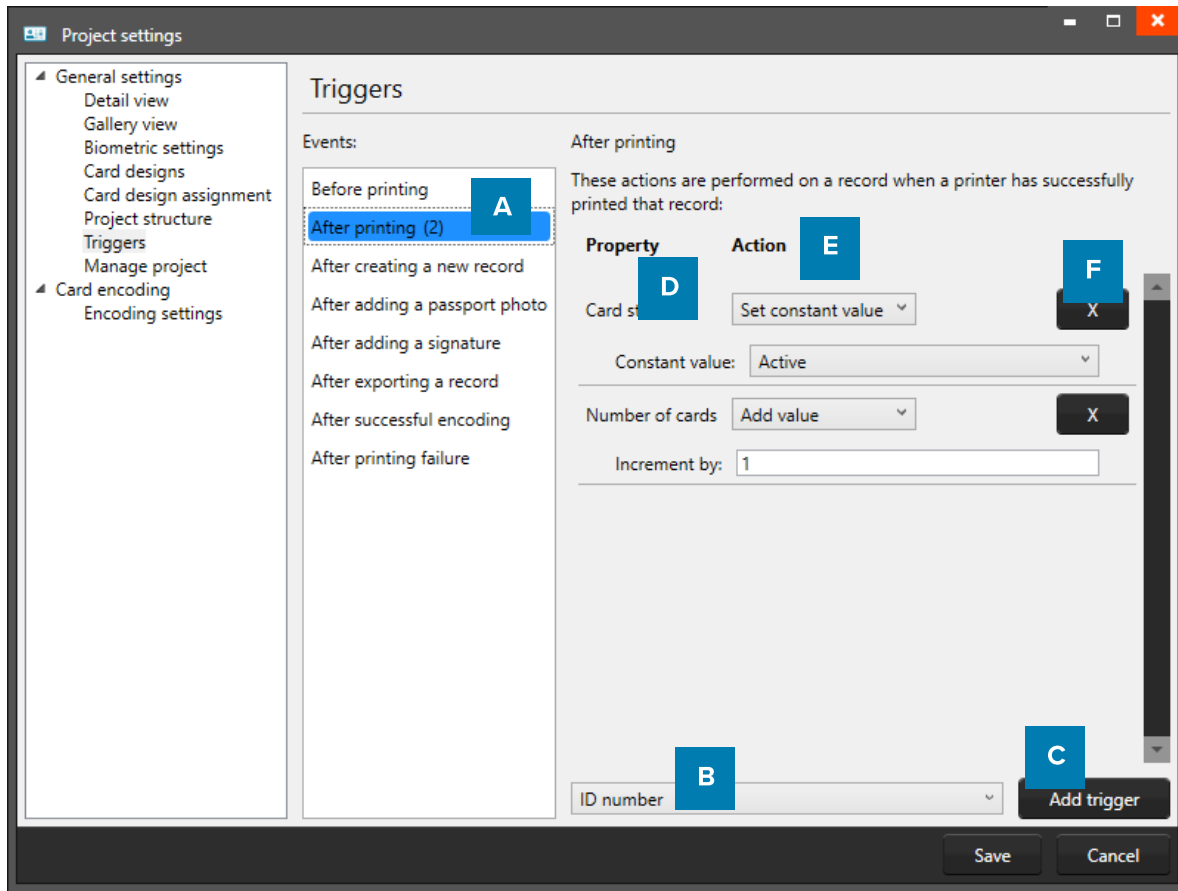

Example of Project Settings: Triggers

- A. Select one of the events from this list and add specific triggers. PrintStudio will automatically wait for the event to occur before performing the action that is linked to the trigger.
- B. All data columns of the new project are listed. Select one of the columns to link a trigger action to it.
- C. Click on the “Add trigger” button to add the trigger to the data column and specify the Trigger with events and actions.
- D. The property shows you the selected data column.
- E. Select the action you want to connect to the data column from the drop-down menu and define the action.
- F. Click on the “X” button to delete a trigger from an event.

Define the action that is performed once the event has been met. Some actions are only available for specific columns (for example, incrementing number values can only be done on Number type columns). All changes need to be saved before they become active. Understand that Triggers might cause your original data to change, so make sure no vital data is lost when working with Triggers.

Manage Project

Delete your project. You are able to completely delete the current project you are working on.

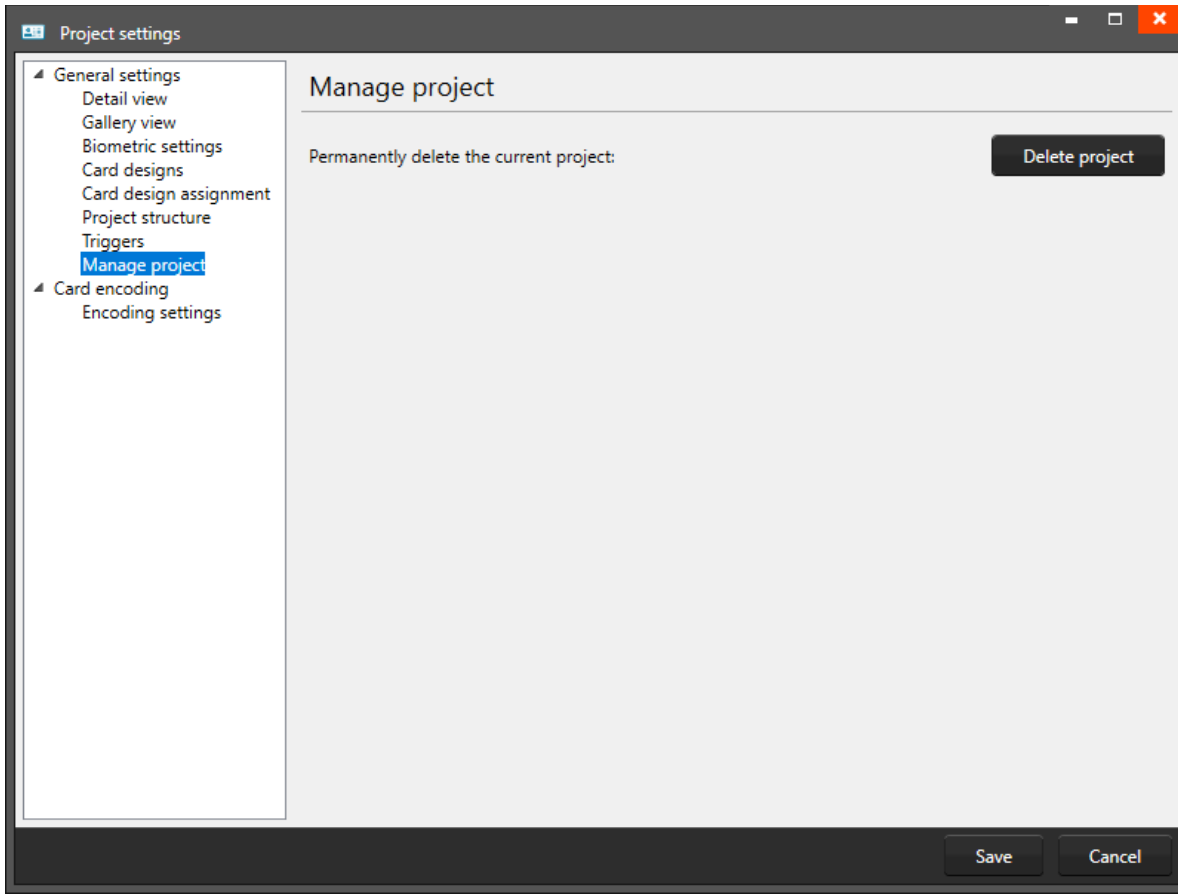

Example of the Project settings: Project management

PrintStudio

Link Card Design to record

PrintStudio

Link Card Design to record

Link your records to your Card Design, so you can print a card.

When a data record is selected click on the “Link” button of one of the card designs in the Card Designs Gallery view to connect the design to the record. To change the connection to a different lay-out the user can click on the “Unlink” button and link another design. It is possible to select more data records at the same time and connect the selected records to a lay-out. Use CTRL+A, + CTRL or +SHIFT, Use CTRL+A to select all records.



PrintStudio Records

PrintStudio Records

Records are single data rows that contain all the information of one person. There is a button for adding and deleting a record.

Add Records

Records are single data rows that contain all the information of one person. There is a button for adding and deleting a record manually. (To add multiple records, choose to import an excel file for example.)



1. Add a new record

If you add a record, a new pop-up window will appear to enter the new record data. The entry form allows the user to enter the data and Capture Photo and/or Signature.

1. Information

- A. Enter the needed information for each field and click on the
- B. “Next Step” button.

A screenshot of a software window titled 'Data' with tabs for 'Data', 'Passport photo', and 'Signature'. The 'Data' tab is active. It contains a form with the following fields: 'ID number' (highlighted in orange with a warning triangle and the text 'This field is required. Please enter a value.'), 'First name', 'Last name', 'Company', 'Department', 'Street Address', 'Postal / Zip', 'City', 'Region', 'Country', 'Email', 'Phone', 'Birthdate', 'List Name', and 'Expiry Date' (with the value '01-01-2019' and a checkmark). A blue square with the letter 'A' is positioned over the 'First name' field. At the bottom, there is a blue square with the letter 'B' over a 'Next step' button, and a 'Cancel' button to its right.

Example of the information tab when adding a new record.

2. Photo

- A. Select the source of camera you want to use from the drop-down menu. You can choose to use your web cam or a TWAIN camera that you installed and connected to your computer.
- B. Click on the “Start automatic capture” button. The application will detect your face automatically and take three pictures. You can select one of the three pictures to add to the new record.
- C. The Photo functionality will show you the camera view.
- D. Click on the “Capture photo” button. The Photo functionality will show you the camera view. You are also able to upload an image from your computer. Click on the “Open file...” button to select an image from a file.
- E. To change the camera setting click on the drop-down to select the capture resolution and click the settings icon to adjust more settings. These settings can be different depending on the camera.
- F. “Next Step” button.

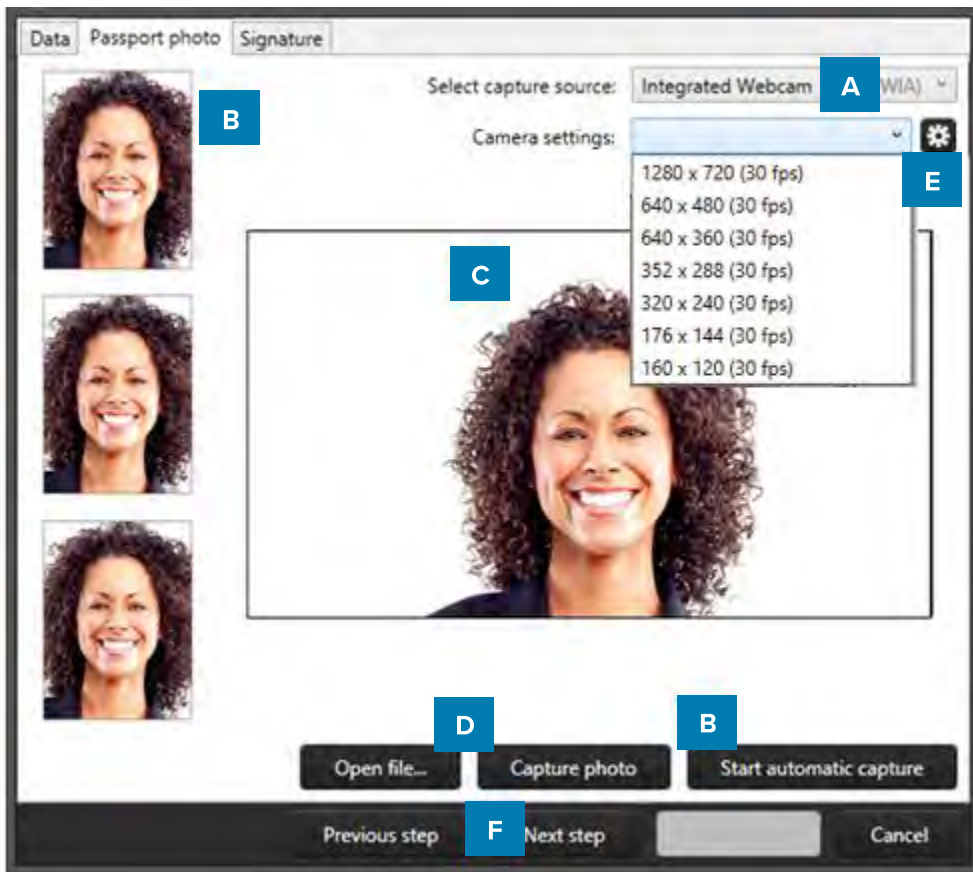
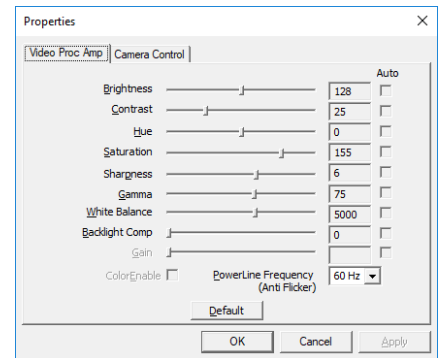

Example of the photo tab when adding a new record.

3. Signature

- A. Connect the signature pad to the PC. Use a signature pad to write a signature into this field.
- B. Scale the signature using the slider.
- C. Select a signature from file.

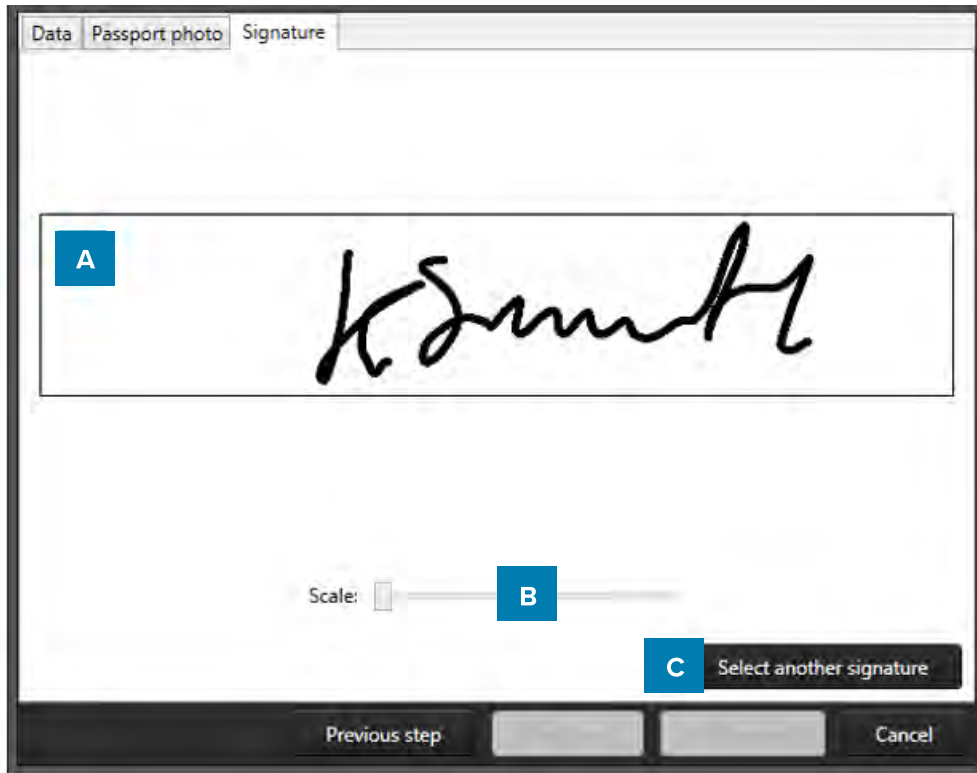

Example of the signature tab when adding a new record.

Print records

To print a certain record, select it and then click on the print button in the quick menu or go to File and click on the print link.

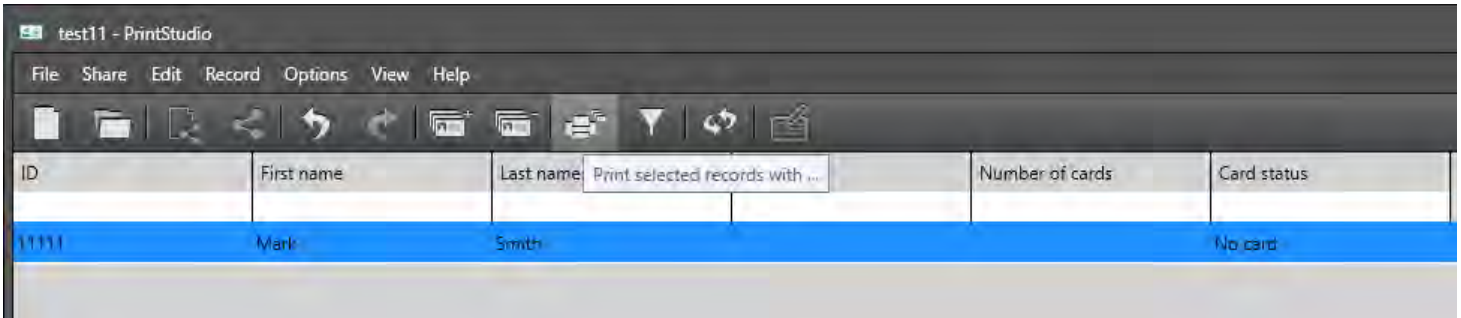

- A. A print window appears, and you can select the printer you installed for the card printing process. This manual does not describe the installation of printers. Please refer to the Zebra Card Printer manuals for further information on these devices. After you select the printer you click on the “Print” button.

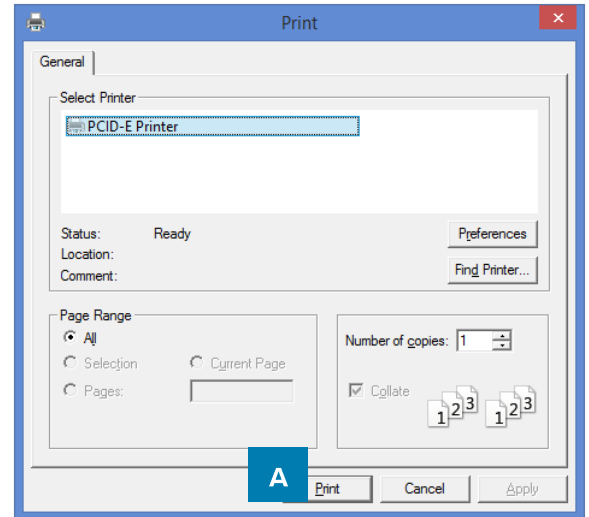

Example printer setup window.

- B. A print progress window will pop up that will show you the progress of the cards that are being printed.

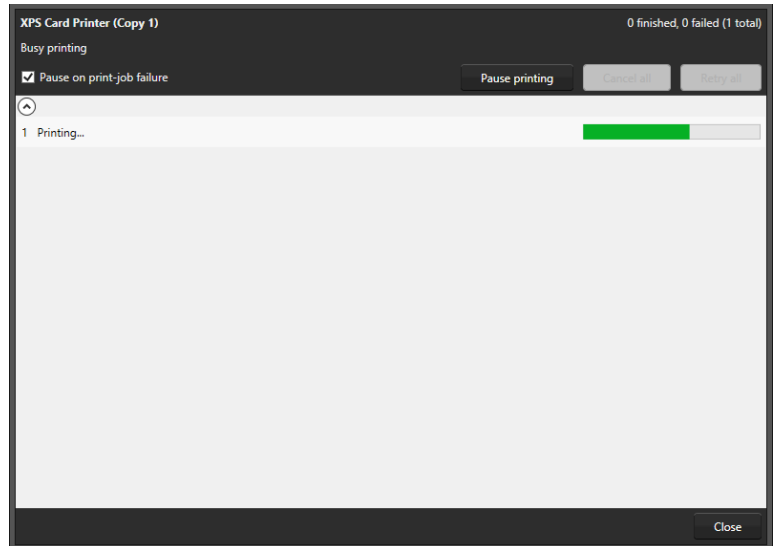

PrintStudio Database Connection

PrintStudio

Database Connection

PrintStudio Project with database connection allows users to connect with external databases, and use the data to complement their local project, or even base the entire project upon. There are four types of databases supported:

- Microsoft SQL Server
- Microsoft Access files
- MySQL Server
- Oracle Server

Choosing from one of these four settings is highly recommended, however it is also possible to connect to a database through an ODBC driver. Connecting with one of the supported databases allows you to make full use of the database's functionality. For example: PrintStudio will automatically lock tables when adding or updating records, it will automatically detect user rights and allows you to work with views.

Connecting with a data source through an ODBC driver provides you with more basic functionality, but it will suffice for most single-user environments. PrintStudio projects with database connection will automatically detect any available ODBC drivers on the system, if the required ODBC driver is not listed, it can be installed using the Microsoft update website or tool in your operating system.

Note: CardStudio does not create an external database for you, it only creates a connection to an existing external database.

The screenshot below shows the Project Settings dialog, where the option for PrintStudio projects with an external database connection will be present depending on the CardStudio Edition you purchased.

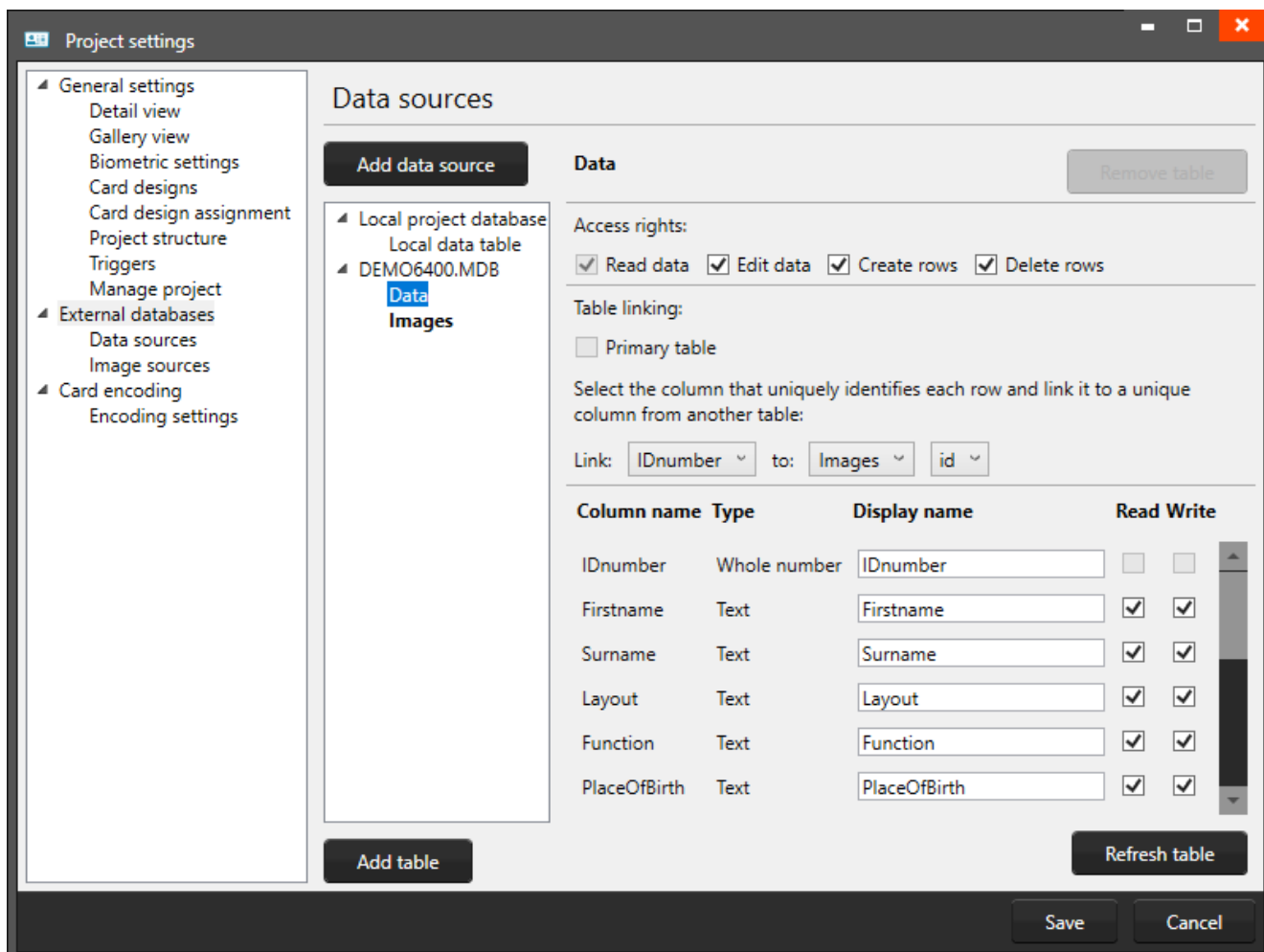

Setting up a PrintStudio Database Connection

How to set up a PrintStudio Project with Database connection

Follow these steps if you want to create a project using an external data source as your primary source of information. Start by creating a new project.

A. Click the New Project icon and select “[Create project with database](#)” from the dialog.

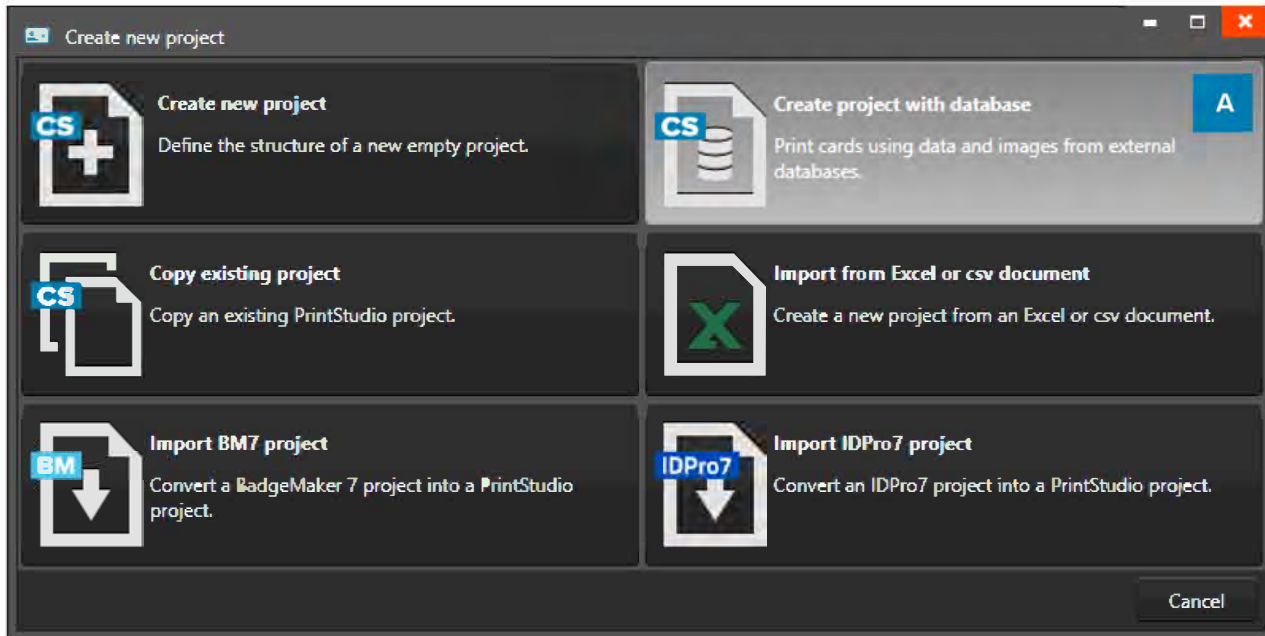

Example of a New Project pop-up window: Create project with database.

Connect with database

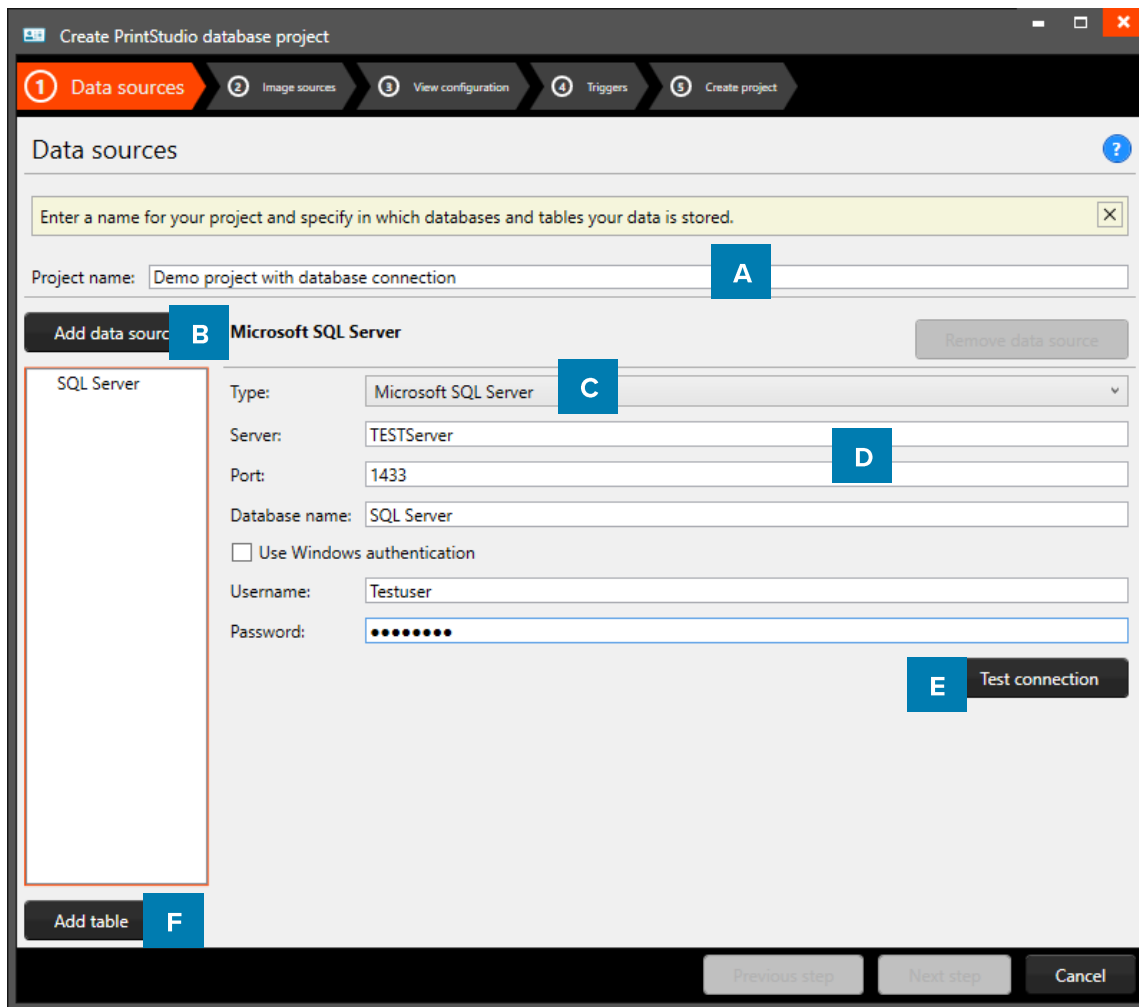

Example of a new PrintStudio Project with external database connection step 1: data sources.

- A. Enter the name of your New PrintStudio project with database connection.
- B. Click on the “Add data source” to connect the database with your external database.
- C. Select the type of database you would like to connect with. Different types of databases are supported:

Configuring a Microsoft SQL Server data source

After selecting Microsoft SQL Server as the type of data source, you can fill in all information required to connect to the server.

- D. **Server:** Path or IP address to the server. If the server is hosted on another system in the network, it can be either addressed as \\servername or the IP address of the server. Information such as the database name, username and password, in most cases are provided by your database administrator.

Note: to be able to work with a Microsoft SQL Server, an active network connection must be available.

Configuring a Microsoft Access data source

To define a Microsoft Access data source, select the option from the drop-down list, and find the path to your database by choosing the Browse (“...”) button behind the Filename field.

Please note that a username and password may not be required for your Microsoft Access file, in which case these fields can be left empty.

Configuring a MySQL or Oracle data source

Configuring a MySQL or Oracle server as a data source is done the same way as defining a Microsoft SQL Server data source.

Server: Path or IP address to the server. If the server is hosted on another system in the network, it can be either addressed as \\servername or the IP address of the server.

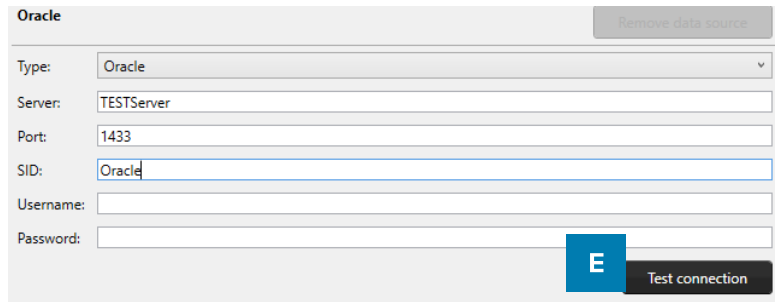

Port: Databases have a standard or adjusted port number. PrintStudio uses the standard port number when the input field is left empty. Information such as the port number, database name, username and password, in most cases are provided by your database administrator.

Note: to be able to work with a MySQL or Oracle Server, an active network connection must be available.

Configuring a data source through an ODBC driver

After selecting ODBC as the type of data source, select one of the ODBC drivers installed on your system. Please note that Windows may have more than one driver installed per file extension.

After selecting the driver, you can provide a direct path to your database file. This can be a local path (C:\Example\Example.mdb) or a remote path (\\Server\Example\Example.mdb).

Note: To be able to open your project using a remote directory, an active network connection must be available.

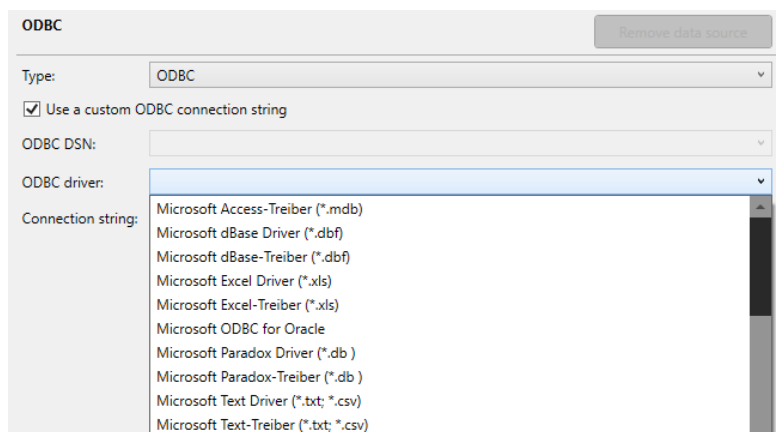

E. After configuring the data source, click the button “**Test connection**”. Once the pop-up reports “**Database connection successful**” you can proceed. If the connection cannot be established, the dialogue will report a detailed overview of the problem. Check all information and make sure a connection with the external server is available before trying again.

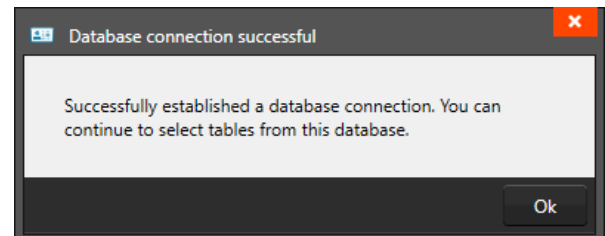

F. Once the connection is established, click “**Add table**” to continue configuring your data source. A pop-up dialogue will list all tables available for you.

Microsoft SQL Server will likely only list database tables, where other files (such as MS Access databases) might also list tables otherwise invisible to the user.

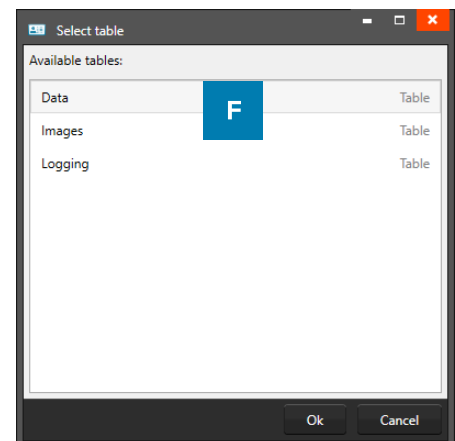

Configure the database tables for the project

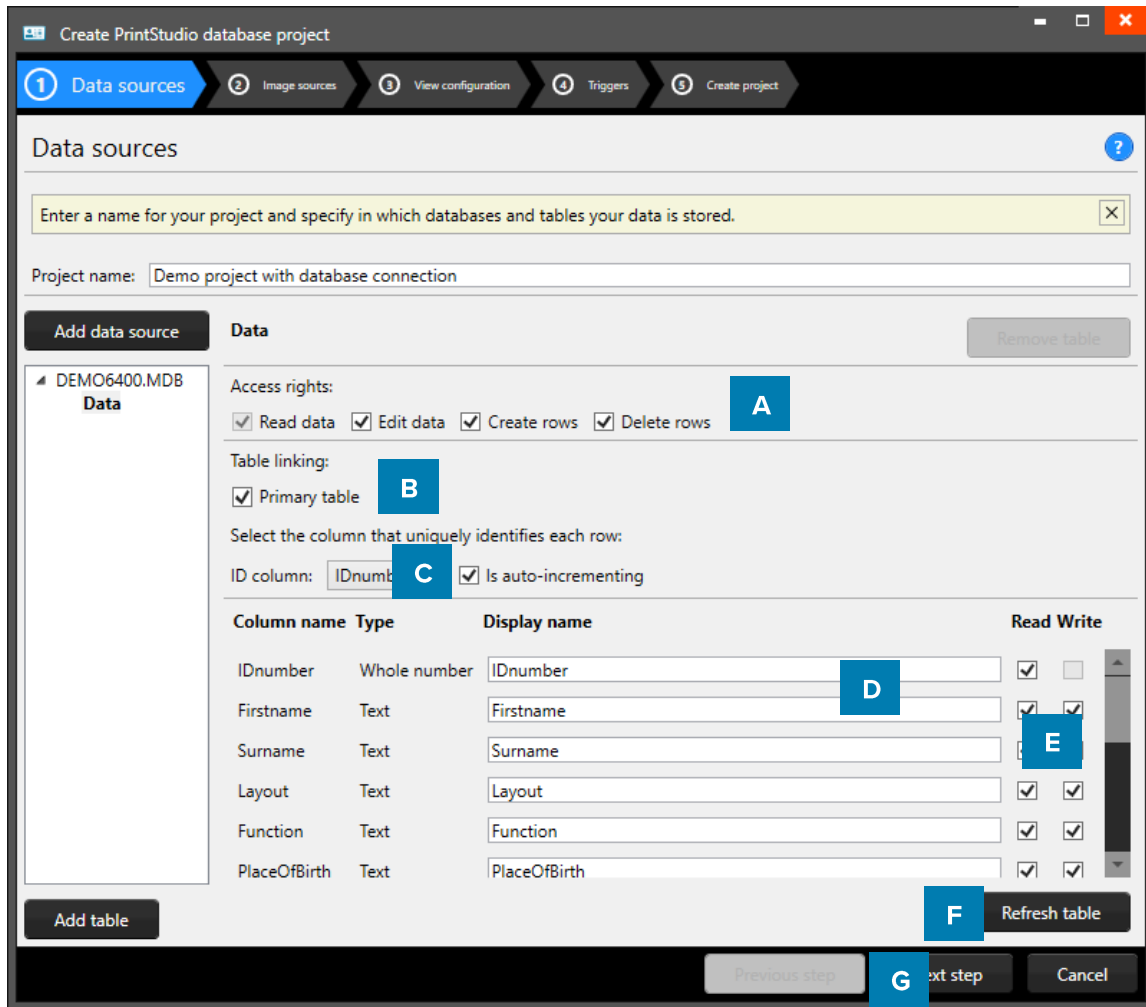

- A. After selecting a table, you can configure the rights to the table, and to each of the listed columns in the table. Users connecting with a Microsoft SQL Server can create and remove rows, whereas users connecting through an ODBC database will only be able to select the “**Edit data**” checkbox for existing rows.
- B. The newly created data source will have the “**Primary table**” checkbox checked. This setting can only be altered during the process of defining the data sources, so make sure that the primary table is correctly configured.
- C. For a primary table, you can define the “**Id column**” this is a column containing unique, numeric data. For secondary tables, you must define its relation to the primary table or to one of the tables linked to the primary table. This means that each table will have to contain a column containing a corresponding type and kind of data. It is advised to keep the column marked as “**Id column**” as read-only or even hidden if the data in the column is not crucial to users working with the data grid.
- D. Edit the display names of the column as you see fit for your PrintStudio Project.
- E. The list of columns can be used to define certain restrictions to each column such as “**Read**” or “**Write**”. By default, columns will be marked as “**Read**”. Think carefully about what data to manage through PrintStudio, and what data should be managed by other external systems.
- F. Click on the “**Refresh table**” to make sure that all the data loaded from the database table is up to date.

- G. Click on the “Next step” and finish the next steps and create the project. With the second step you can define the image sources for Passport Photos and Signatures in your project. You can choose from three different options:
- **Read image from local project**
Selecting this option stores captured images along with the CardStudio Identity project files. This option can be used to capture new image data.
 - **Read or download image from path or URL**
This option allows you to read images from a remote directory either on a server or on a network drive. This can only be used to *read* image data. New data cannot be captured.
 - **Read image from database (blob)**
This allows you to read an image from a specific column in the databased marked as BLOB (**B**inary **L**arge **O**bject)
This option can be used to both read existing data and capture new image data to the database.

Changes when working with PrintStudio with external database connection

There are a couple of changes that may be noticeable when working with PrintStudio connecting to an external database in comparison to regular PrintStudio projects.

Loading times

The time it takes to load your project, or to process changes to your database may increase. This is due to the time it takes to transfer data over the network, login to the database or retrieve data from the external data sources.

Grayed-out columns

Columns that have been marked as “read only” will have a grey background color when selected. It simply means that you will not be able to alter data for that specific column.

Data from local or external database

When working with multiple data sources, it can become confusing to remember what information belongs to what data source. In order to clarify, PrintStudio labels sources with <table_name>.<column_name>. This means that a column “Firstname” coming from a table called “Students” will be displayed as “Students.Firstname”. In the project this will display when hovering over a column name.

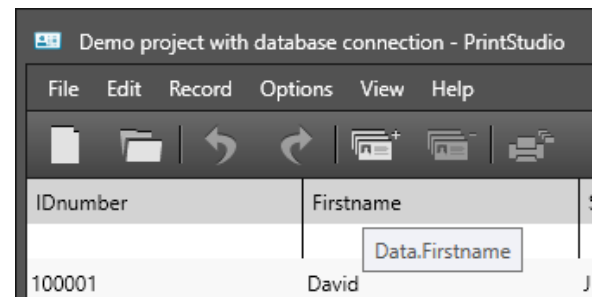

Updating or adding pictures

Depending on the read or write access restrictions and the configuration of image sources in your project, you may or may not be able to add new images.

Project has stopped working

PrintStudio cannot prevent external data sources from changing. If a file gets removed, or a database gets changed, it might cause your PrintStudio project to stop working. Always consult with your database administrator to ensure that data you need in your PrintStudio Project is made redundantly available to you.

Default values

When creating a new project, or when altering a project structure, you can define certain default values for your column types. However, when using PrintStudio with an external database connection, these default values will be only filled for new records or when manually entering the information into the field. The reason for this is because the local project data does not contain the same amount of records as the external sources, and new records are never created automatically.

PrintStudio Encode

PrintStudio

Encode

CardStudio Encode allows you to encode data from your PrintStudio project onto a smart card. With CardStudio Encode, CardStudio introduces a new file format that is used to contain all information related to the encoding of the card, which can easily and securely be shared with other parties who collaborate on the same project.

Contactless Encoding

CardStudio Encode currently supports the encoding of MIFARE Classic, Plus and DESfire cards. Encoding is done using card printers that are fitted with a “reader” such as the HID Omnikey or the Springcard Crazy Writer.

SmartCard Editor

The SmartCard Editor is a tool that is made available to all users of the CardStudio software package. This tool allows you to create an encoding template for MIFARE Classic, Plus and DESfire cards using all the major features for each of the standards.



Creating a MIFARE Classic Template using the CCI Editor

Launch the SmartCard Editor, which will open to a blank window. Choose “File” → “New” → “Mifare Classic (1k)” or “Mifare Classic (4k)” depending on your project requirements.

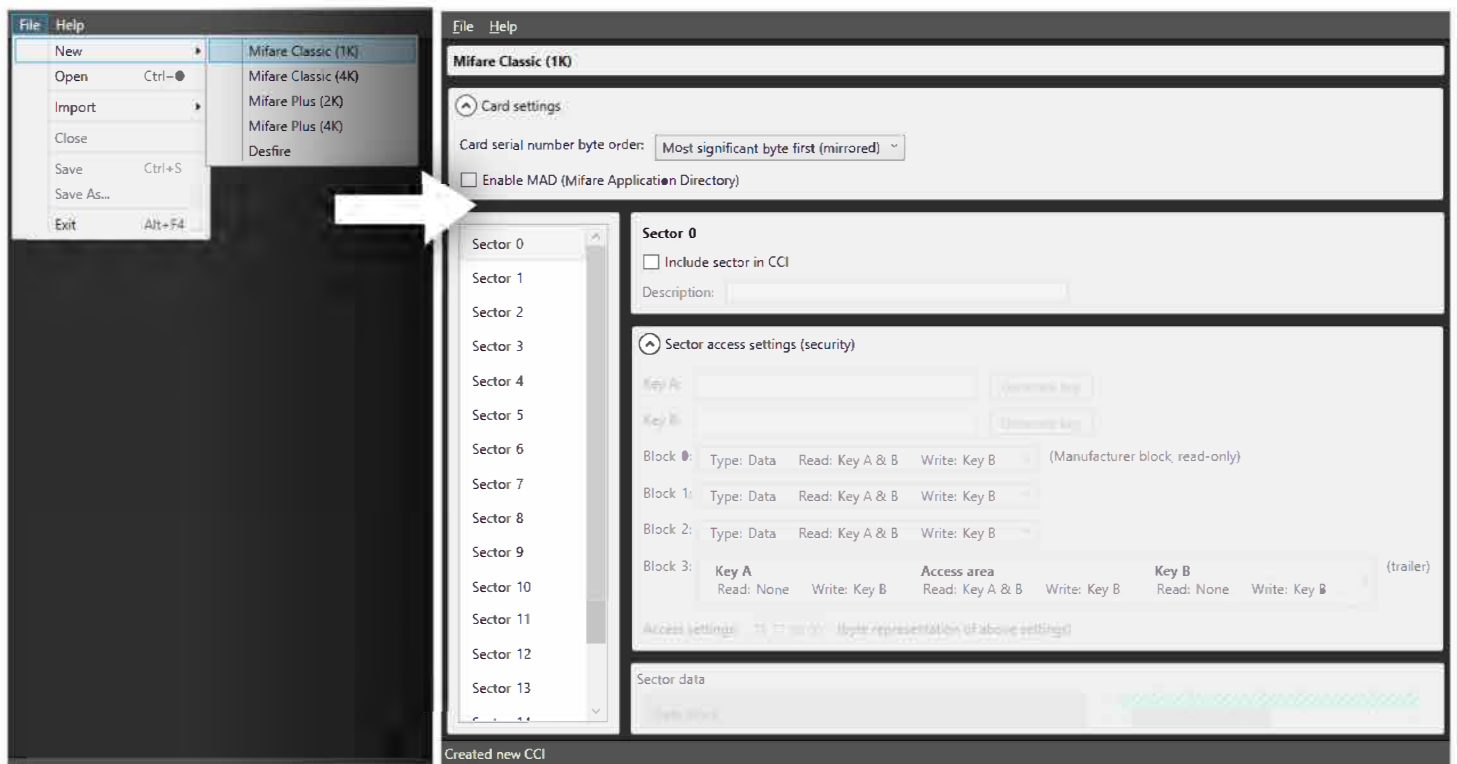

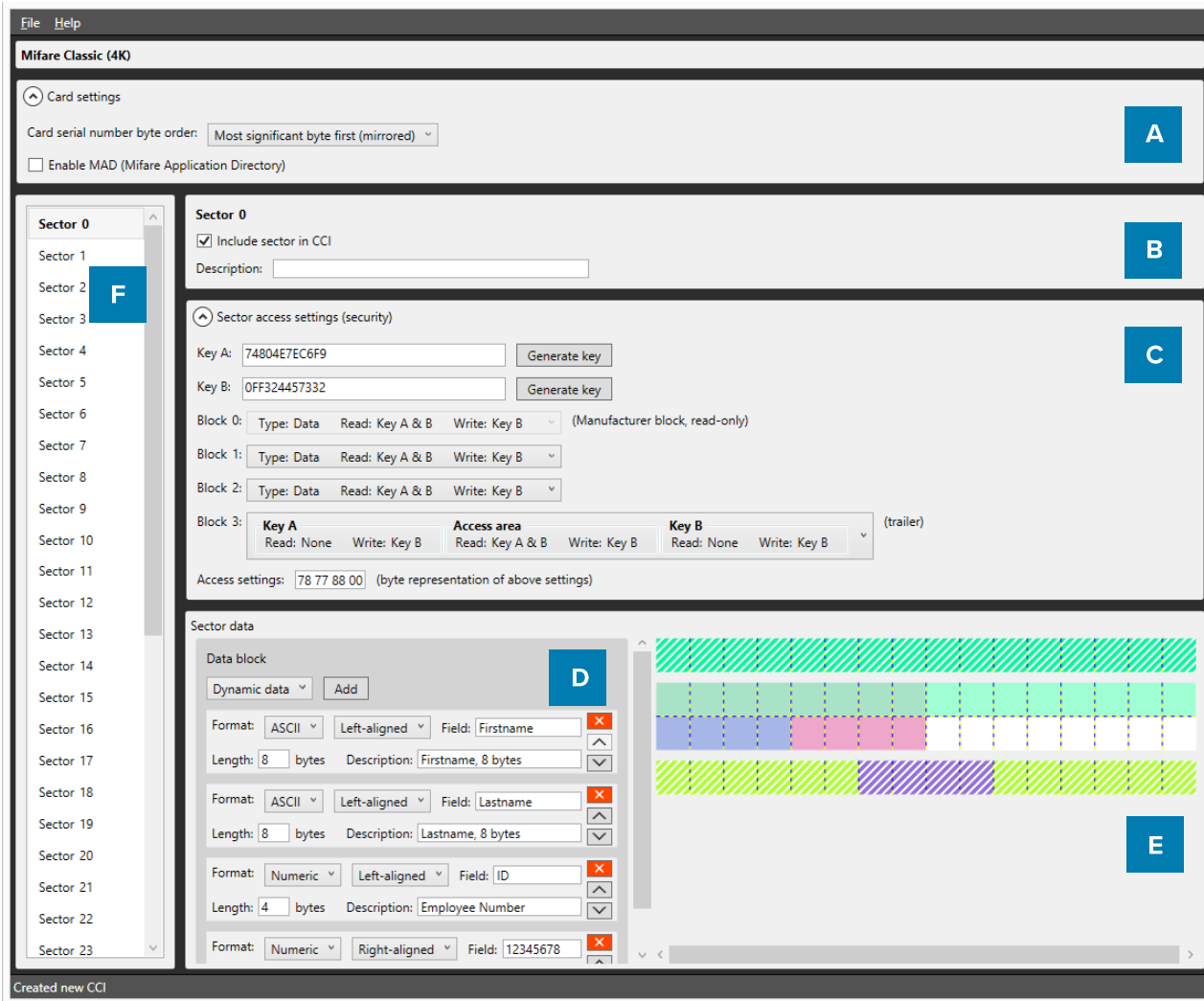

- A. The Card Settings are displayed on top of the screen. You can define whether the card should use MAD Sectors (Mifare Application Directory documents directory-like structure that describes how sectors on card are used) or not. Enabling this setting will have an impact on specific sectors and their contents. It will also automatically generate Key A for sector 0 (and sector 16 for 4K cards).
 - B. Description of the Sector.
 - C. Define keys, determine read and write settings for each of the four data blocks.
 - D. Create data segments to fill the available space.
 - E. The CCI Editor visualizes any data that will be encoded onto the Smart Card to give the user a better view of the amount of used and available space in each sector. Certain blocks (such as Block 0 on Sector 0, and the Trailer Block on all sectors) are reserved for manufacturer information and storing keys. These are not available to the user and are displayed as hatched.
- Each square represents one byte of information. When adding sector data, the length of the data is visualized on the right. Each item in the list is given a slightly different color to make it easier to understand how the data is transferred to the card.
- F. List of sectors is displayed, 16 for 1K cards, 40 for 4K cards. Depending on the settings, each of the sectors can contain information that will be encoded onto the card using PrintStudio.

Information about Sector Data

Dynamic Data

This is information that will be added to the card by your CardStudio project. Like adding card designs, when you add a CCI file to your project, a pop-up will allow you to bind columns in your project to each of these items. You must always ensure that the data in your project corresponds with the settings you have chosen in terms of length and data type. The following data types are available.

- | | |
|-----------------------------|--|
| • ASCII | All standard ASCII characters are allowed. |
| • Numeric | 0 ... 9 |
| • Alphabetic | A ... Z and a ... z |
| • Alpha-numeric | A ... Z, a ... z and 0 ... 9 |
| • Alphabetic and special | A ... Z, a ... z and Punctuation marks |
| • Alpha-numeric and special | A ... Z, a ... z, 0 ... 9 and Punctuation marks |
| • Binary-coded decimal (5) | 0 ... 9, two digits in one byte, maximum 5 bytes |
| • Binary-coded decimal | 0 ... 9, two digits in one byte |
| • Binary-coded decimal date | YYYYMMDD each two digits in one byte |
| • Decimal | 0.00 (Fixed point) |
| • Wiegand-26 | Facility and card codes with parity |
| • Hexadecimal | 0123456789ABCDEF |
| • Octal | 012345678 |
| • Binary | 01 |

In addition, you can add a description of the sector data to remind you of certain agreements.

Constant Data

Constant or Static data is data that is manually entered in the CCI file and will never change. The format of this piece of information can be of any of the types mentioned in the Dynamic Data section.

Empty Space

This item can be used to indicate a specific part of a sector that will never be used.

Card serial number

This is a 10, 7 or 4-byte, data section which will automatically contain the card serial number when the card is being encoded.

Using these options, you can create any type of CCI file. Once completed, you can save your work in either an unencrypted file (XML) or an encrypted CCI file. If you choose the latter option, you will be required to enter a password that will also be required when adding the CCI file to your CardStudio Identity project.

Creating a MIFARE DESfire template using the CCI Editor

DESfire cards take an entirely different approach to encoding compared to MIFARE Classic or Plus cards. With DESfire, you can define Applications and Files that contain information, each with specific access settings. Similar to MIFARE Classic, launch the SmartCard Editor, which will open to a blank window. Choose “File” → “New” → “DESFire”.

- A. The Card settings panel will allow you to define general rules for your encoding template. A DESFire card features a Card master key that can be used to re-encode or erase the card at any time. All keys for DESFire cards can be encoded using 3DES, 3K3DES or AES encrypted keys. A key can be either generated or entered manually.

The other options for the Card settings dialog are self-explanatory but must be decided with caution as they will impact how flexible the card can be used after being encoded. In addition to the default DESFire features, reset keys are implemented that allow for cards to be repurposed, by users even though the Card master key might not be available. Distributing the Card master key might not be desirable because of possible security liabilities. Multiple Reset keys can be created to supply to different vendors.

- B. Once Card settings have been defined, an Application can be created by choosing “Add application” on the bottom left of the screen. Doing so will automatically create an application titled “000001”.

- C. On the right side of the screen, information can be entered to define the Application such as a Description, an ID (Hexadecimal value) and the Encryption type. For each application, settings are available that define future use of the application such as allowing the Master key to be changed or Authentication settings for accessing the data in the Application.

- D. Each Application can have up to 10 keys that can be distributed to vendors for use of the Application.

The screenshot displays the SmartCard Editor interface with the following sections:

- Card settings:** Includes a dropdown for "Card serial number byte order" (Most significant byte first (mirrored)), a text field for "Card master key" (AES, 82A88655011B697DB9314799B68169B2), a "Generate key" button, and checkboxes for "Master key can be changed later", "Authentication required for directory access", "Authentication required for creating / deleting applications", and "Card configuration can be changed later".
- Reset keys:** A section with a note: "Reset keys are not a Desfire feature, but they allow our encoding software to repurpose existing cards." and an "Add key" button.
- Application Settings:** A panel for "Application 000001" with fields for "Description" (A sample DESfire application), "Application ID" (000001), and "Encryption type" (AES). It includes checkboxes for "Master key can be changed", "Authentication required for directory access", "Authentication required for file creating / deleting", and "Key settings can be changed". It also has a "Change key settings" dropdown (Authenticate with application master key), "Enable ISO file ID support" checkbox, and fields for "Iso file ID" and "DF name".
- Application keys:** A section with an "Add key" button, a text field for a key (0 C9F762F37206E0F07C701975F44BCFD0), a "Generate key" button, and a close button (X).

Navigation buttons at the bottom include "Add application", "Remove application", "Add file", and "Remove file".

- E. Once finished, choose “Add file” to create a file named “File 0” for the currently selected Application.
- F. Each file will contain a Description and a File number. Communication mode determines the way in which the File can exchange data. It is highly recommended to use the Encrypted setting, as the Plain (unencrypted) mode should only be used for data that does not contain sensitive information. All DESFire File types are supported to accommodate integration with access control or payment systems that support the DESFire standard. For general purposes, select the “Standard data file” from the dropdown list. Each file has individual settings for Read, Write and Read/Write access, as well as an access rule for changing these settings after encoding the card.
- G. Standard file types require you to set the total file size. Keep in mind that this must be equal to or greater than the total amount of bytes that are used by your File data. In our example, the total amount of data used is 42 bytes, but the file is given 64 bytes instead.

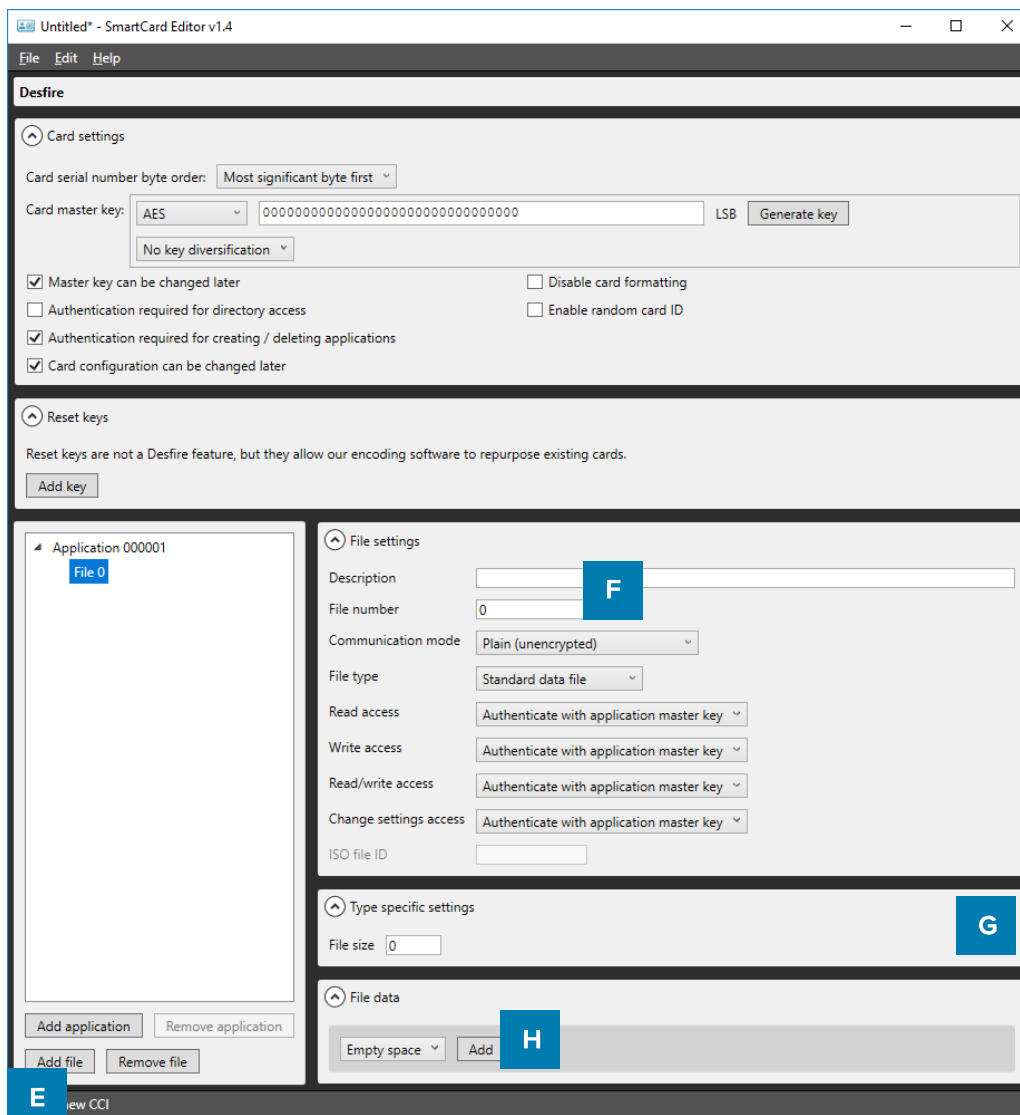

- H. File data is added to the File in a similar fashion to defining MIFARE Classic or Plus templates. Select a data type from the dropdown box and choose “Add” to create a new data block. Define the data format and alignment, as well as the Field as this will be the identifier once the CCI file is linked to your PrintStudio project.

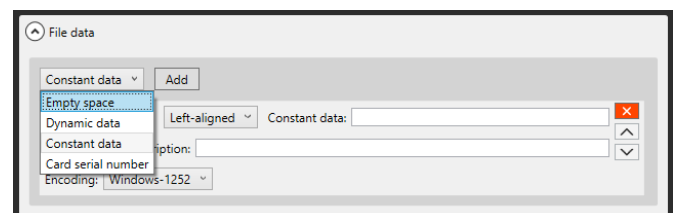

Each DESFire template can contain a maximum of 32 Applications, and each Application can contain a maximum of 32 files.

Once completed, the template can be either saved to a human-readable XML format, or a password-encrypted CCI format. Both can be used to encode cards in your CardStudio Identity project.

Encoding with PrintStudio

Encoding with CardStudio Identity has been fully integrated into the printing process. The most important step to enable encoding for your project is to add your CCI file to your project. Go to the Project Settings panel, and select Encoding Settings from the Card encoding tab.

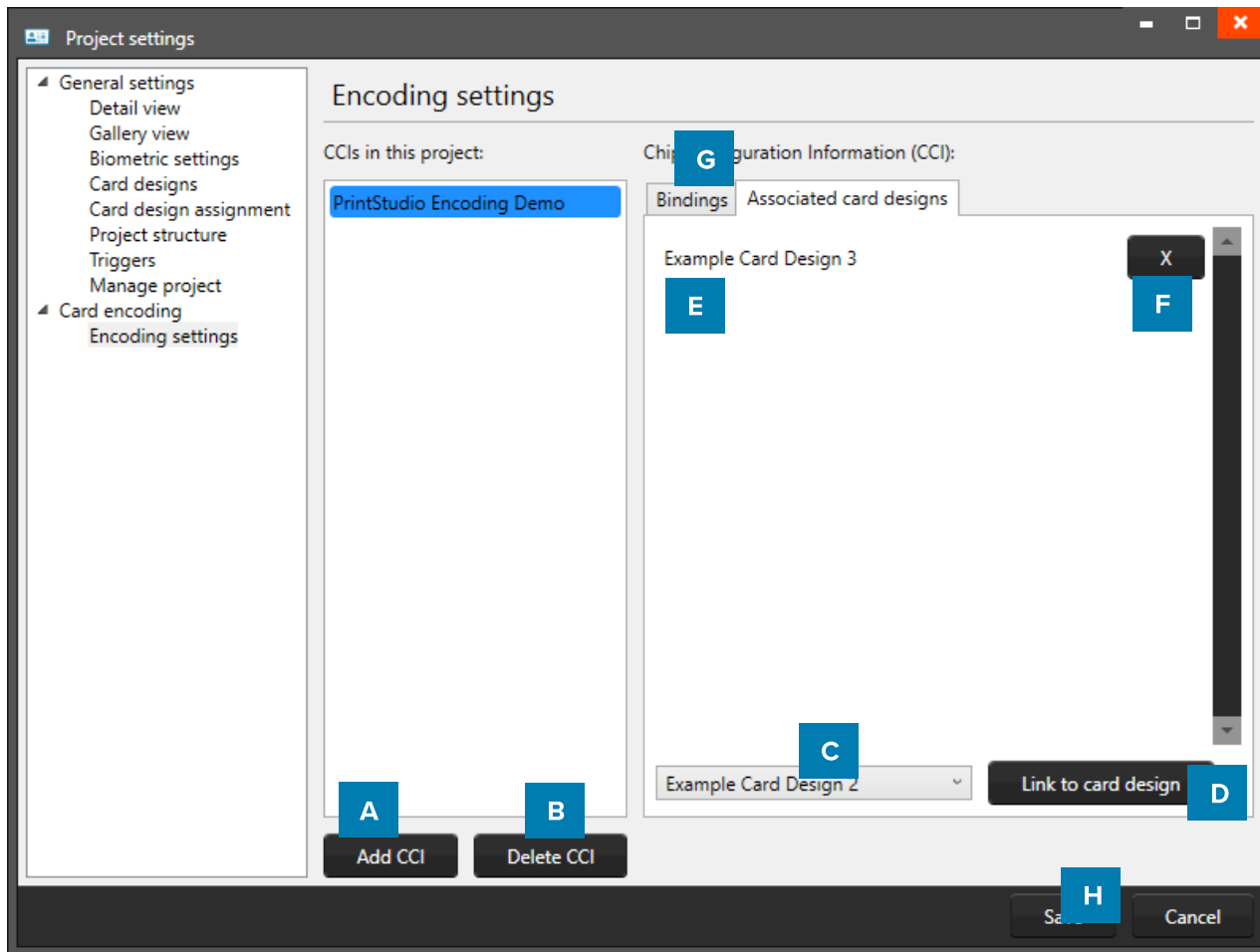

- A. Click on the “Add CCI” button and select the CCI-file you created with the CCI-editor and want to add to your CardStudio project to connect to the card designs. When your CCI-file has been secured with a password you first have to fill in the correct password before the file is added to your project.

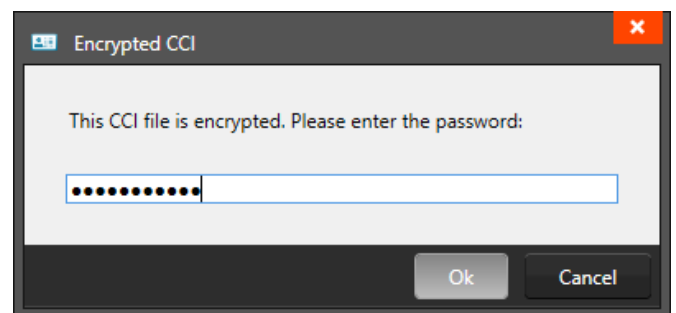

- B. When you added the wrong CCI-file or want to delete an old file you can select the file from the list and click on the “Delete CCI” button to delete the CCI-file from your project.
- C. Select the CCI-file from the list and like to connect to a card design, then select the card design from the drop-down list.
- D. Click on the “Link to card design” to link the card design to the CCI-file. Card holder Records with this card design will be encoded with CCI-file linked to the card design.
- E. Overview of all the card designs connected to the CCI-file.
- F. Click on the “X” button to unlink a card design from the CCI-file.

- G. You can bind dynamic data fields from your CCI-file to the data columns of your project card just by clicking on the “Bindings” tab and selecting one of the data columns from the drop-down menu.

- H. Click on the “Save” button to save the bindings and CCI files connected to your project card designs. You are now ready to encode your cards. Encoding is easy, you select the records connected to the correct card design/CCI-file and click on the print button.

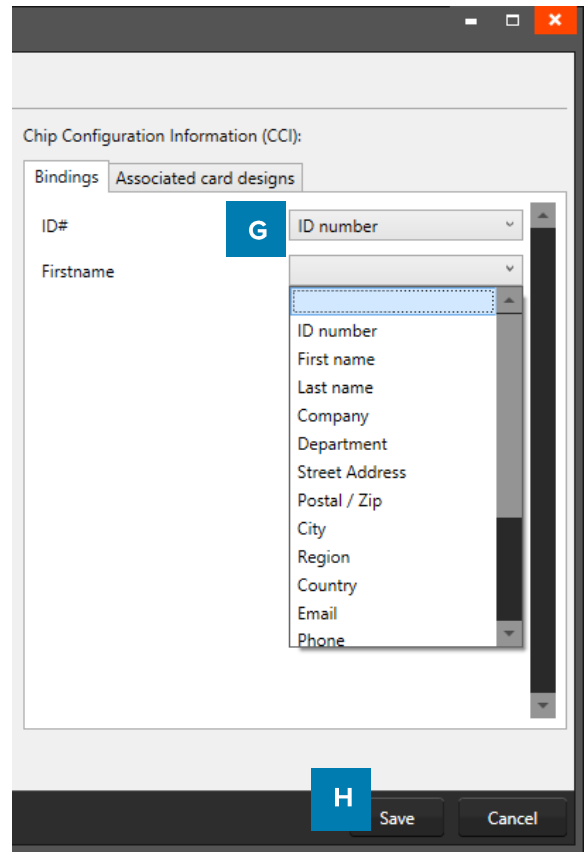

Note: You might need to configure your printer to perform both Encoding and Printing tasks at the same time, otherwise PrintStudio might list your print action as failed, even though encoding did take place.

Supported standards

CardStudio Encode currently supports MIFARE Classic, MIFARE Plus and MIFARE DESFire standards.

Versões:

- **Software Zebra CardStudio 2.0 Classic**
- **Software Zebra CardStudio 2.0 Standard**
- **Software Zebra CardStudio 2.0 Enterprise**
- **Software Zebra CardStudio 2.0 Professional**

O Software Zebra CardStudio 2.0 para impressora de cartão traz um novo nível de simplicidade para o design e impressão de cartões de fidelidade, cartões de presente e cartões de identificação. Quer você esteja imprimindo alguns cartões monocromáticos de um lado ou milhares de cartões codificados de dois lados, coloridos e com criptografia de segurança. Com interface bem projetada e altamente intuitiva, elimina a necessidade de conhecimento técnico complexo e com o CardStudio é possível gerenciar os cartões.