



## Leitor Zebra DS7708

O Leitor Fixo Zebra DS7708 oferece um conjunto de recursos que o colocam no topo de sua categoria: desempenho, facilidade de instalação e custo total de propriedade. Independentemente dos códigos de barras que aparecerem em seu PDV, o mesmo pode realizar a leitura de todos eles; 1D, 2D, impressos e eletrônicos.



# DS7708 2D VERTICAL SLOT SCANNER PRODUCT REFERENCE GUIDE

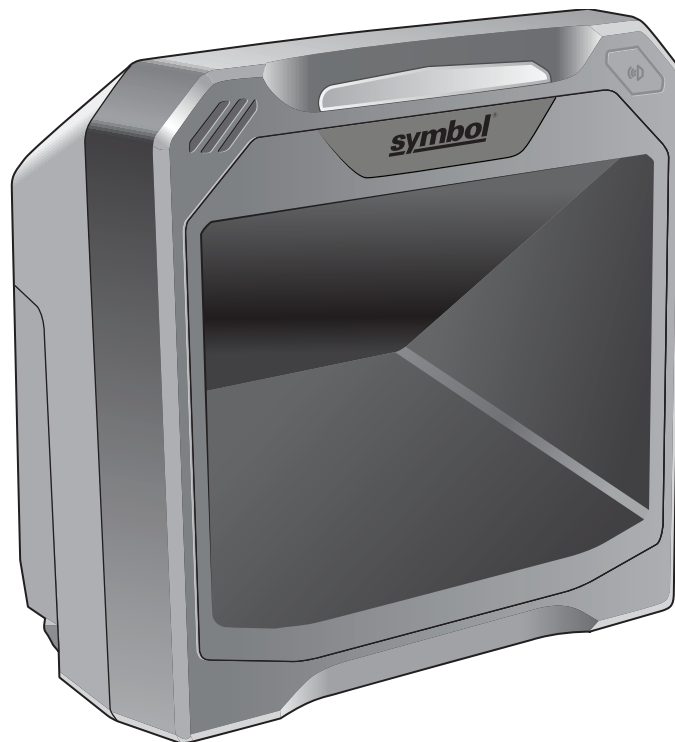



# **DS7708 2D VERTICAL SLOT SCANNER PRODUCT REFERENCE GUIDE**

MN001062A04

Revision A

December 2015

No part of this publication may be reproduced or used in any form, or by any electrical or mechanical means, without permission in writing from Zebra. This includes electronic or mechanical means, such as photocopying, recording, or information storage and retrieval systems. The material in this manual is subject to change without notice.

The software is provided strictly on an “as is” basis. All software, including firmware, furnished to the user is on a licensed basis. Zebra grants to the user a non-transferable and non-exclusive license to use each software or firmware program delivered hereunder (licensed program). Except as noted below, such license may not be assigned, sub-licensed, or otherwise transferred by the user without prior written consent of Zebra. No right to copy a licensed program in whole or in part is granted, except as permitted under copyright law. The user shall not modify, merge, or incorporate any form or portion of a licensed program with other program material, create a derivative work from a licensed program, or use a licensed program in a network without written permission from Zebra. The user agrees to maintain Zebra’s copyright notice on the licensed programs delivered hereunder, and to include the same on any authorized copies it makes, in whole or in part. The user agrees not to decompile, disassemble, decode, or reverse engineer any licensed program delivered to the user or any portion thereof.

Zebra reserves the right to make changes to any software or product to improve reliability, function, or design. Zebra does not assume any product liability arising out of, or in connection with, the application or use of any product, circuit, or application described herein.

No license is granted, either expressly or by implication, estoppel, or otherwise under any Zebra Technologies Corporation, intellectual property rights. An implied license only exists for equipment, circuits, and subsystems contained in Zebra products.

---

## Warranty

For the complete Zebra hardware product warranty statement, go to:

<http://www.zebra.com/warranty>.

---

## Revision History

Changes to the original guide are listed below:

Change	Date	Description
-01 Rev A	3/2015	Initial Release
-02 Rev A	4/2015	Updated note on page 11-2 regarding Using a Zebra Scanner as an Auxiliary Scanner.
-03 Rev A	7/2015	Updated PIN #2 usage.
-04 Rev A	12/2015	Updated: <ul style="list-style-type: none"><li>- Beeper Tone default from Medium to High.</li><li>- <a href="#">Table 12-2 on page 12-42</a> to reflect the correct behavior in the new imagekit.</li></ul>



# TABLE OF CONTENTS

Warranty .....	ii
Revision History .....	iii

## About This Guide

Introduction .....	v
Scanner Configurations .....	v
Accessories .....	vi
Chapter Descriptions .....	viii
Notational Conventions .....	ix
Related Publications .....	x
Service Information .....	x

## Chapter 1: GETTING STARTED

Introduction .....	1-1
Unpacking the Scanner .....	1-1
Protective Cover .....	1-1
Features .....	1-2
Setting Up the Scanner .....	1-4
Power Options .....	1-4
Ports .....	1-4
Connecting the Host and/or Auxiliary Scanner Cable .....	1-4
Removing and Replacing the Back Cover .....	1-5
Removing the Back Cover .....	1-5
Installing the Cable(s) .....	1-5
Removing the Back Cover with Cables Installed .....	1-6
Replacing the Back Cover .....	1-6
Configuring the Scanner .....	1-6
Synchronization of Settings .....	1-7
Host Requested Setting Changes .....	1-7
Bar Code Menu Symbols Scanned on the DS7708 .....	1-7
Bar Code Menu Symbols Scanned on the Hand-held Scanner .....	1-7
Mounting the Scanner (Optional Hardware Required) .....	1-8



Mounting the Scanner to the Table Top .....	1-8
Mounting the Scanner to a Table Top with Double-sided Tape .....	1-8
Mounting the Scanner to a Table Top with Screws .....	1-8
Mounting the Scanner to a Wall .....	1-9
Removing the Scanner from the Mounting Bracket .....	1-10
Operating the Scanner .....	1-11
Indicator Lights .....	1-11
Adjusting Speaker Volume .....	1-11
Adjusting Speaker Tone .....	1-11
Wall Mount Template .....	1-12
Table Mount Template .....	1-13

## Chapter 2: DATA CAPTURE

Overview .....	2-1
Scanning Bar Codes on Products .....	2-2
Active Scan Area .....	2-2
Decode Ranges .....	2-3
User Indicators .....	2-4
Beeper Volume/ Beeper Tone .....	2-4
LED and Beeper Indicators .....	2-4
Electronic Article Surveillance (EAS) .....	2-7
Installing .....	2-7
Checkpoint EAS Model Compatibility .....	2-7
Considerations .....	2-7
Checkpoint Contact Information .....	2-7

## Chapter 3: MAINTENANCE, TECHNICAL SPECIFICATIONS, MOUNTING TEMPLATES

Introduction .....	3-1
Maintenance .....	3-1
Troubleshooting .....	3-2
Technical Specifications .....	3-4
Scanner Signal Descriptions .....	3-7

## Chapter 4: USER PREFERENCES & MISCELLANEOUS OPTIONS

Introduction .....	4-1
Scanning Sequence Examples .....	4-2
Errors While Scanning .....	4-2
User Preferences/Miscellaneous Options Parameter Defaults .....	4-2
User Preferences .....	4-4
Set Default Parameter .....	4-4
Parameter Bar Code Scanning .....	4-6
Beep After Good Decode .....	4-7
Beeper Tone .....	4-8
Beeper Volume .....	4-11
Beeper Duration .....	4-13
Volume/Tone Button Control .....	4-15
Suppress Power-up Beeps .....	4-17
Timeout Between Decodes, Same Symbol .....	4-18

Timeout Between Decodes, Different Symbols .....	4-18
Fuzzy 1D Processing .....	4-19
Decode Mirror Images (Data Matrix Only) .....	4-20
PDF Prioritization .....	4-22
PDF Prioritization Timeout .....	4-23
Mobile Phone/Display Mode .....	4-24
Field of View .....	4-25
Miscellaneous Scanner Parameters .....	4-27
Transmit Code ID Character .....	4-27
Prefix/Suffix Values .....	4-29
Scan Data Transmission Format .....	4-32
FN1 Substitution Values .....	4-36
Unsolicited Heartbeat Interval .....	4-37

## Chapter 5: IMAGING PREFERENCES

Introduction .....	5-1
Scanning Sequence Examples .....	5-2
Errors While Scanning .....	5-2
Imaging Preferences Parameter Defaults .....	5-2
Imaging Preferences .....	5-4
Operational Modes .....	5-4
Decode Mode .....	5-4
Snapshot Mode .....	5-4
Snapshot Mode Timeout .....	5-5
Image Size (Number of Pixels) .....	5-6
Image Brightness (Target White) .....	5-8
JPEG Image Options .....	5-9
JPEG Target File Size .....	5-10
JPEG Quality and Size Value .....	5-11
Image Enhancement .....	5-12
Image File Format Selection .....	5-14
Image Rotation .....	5-16
Bits Per Pixel (BPP) .....	5-18
Bits Per Pixel (continued) .....	5-19
Signature Capture .....	5-20
Output File Format .....	5-20
Signature Capture File Format Selection .....	5-21
Signature Capture Bits Per Pixel .....	5-23
Signature Capture Width .....	5-25
Signature Capture Height .....	5-26
Signature Capture JPEG Quality .....	5-27
Video View Finder .....	5-28
Video View Finder Image Size .....	5-29

**Chapter 6: USB INTERFACE**

Introduction .....	6-1
Connecting a USB Interface .....	6-2
USB Default Parameters .....	6-4
USB Host Parameters .....	6-5
USB Device Type .....	6-5
Symbol Native API (SNAPI) Status Handshaking .....	6-9
USB Keystroke Delay .....	6-10
USB CAPS Lock Override .....	6-12
USB Ignore Unknown Characters .....	6-13
USB Convert Unknown to Code 39 .....	6-14
Emulate Keypad .....	6-15
Keypad Emulation with Leading Zero .....	6-16
USB Keyboard FN1 Substitution .....	6-17
Function Key Mapping .....	6-18
Simulated Caps Lock .....	6-19
Convert Case .....	6-20
USB Static CDC .....	6-22
USB Transmission Speed Parameters .....	6-23
USB HID Polling Interval .....	6-23
Fast HID Keyboard .....	6-28
Quick Keypad Emulation .....	6-29
IBM Specification Version .....	6-30
Optional USB Parameters .....	6-31
Beep Directive .....	6-31
Bar Code Configuration Directive .....	6-32
ASCII Character Set for USB .....	6-33

**Chapter 7: RS-232 INTERFACE**

Introduction .....	7-1
RS-232 Host Parameters .....	7-5
RS-232 Host Types .....	7-7
Baud Rate .....	7-11
Parity .....	7-14
Check Receive Errors .....	7-16
Hardware Handshaking .....	7-17
None .....	7-18
Standard RTS/CTS .....	7-18
RTS/CTS Option 1 .....	7-19
RTS/CTS Option 2 .....	7-19
RTS/CTS Option 3 .....	7-20
Software Handshaking .....	7-21
None .....	7-21
ACK/NAK .....	7-21
ENQ .....	7-22
ACK/NAK with ENQ .....	7-22
XON/XOFF .....	7-23
Host Serial Response Time-out .....	7-24
RTS Line State .....	7-27
Stop Bit Select .....	7-28

Data Bits .....	7-29
Beep on <BEL> .....	7-30
Intercharacter Delay .....	7-31
Nixdorf Beep/LED Options .....	7-34
Ignore Unknown Characters .....	7-36
ASCII Character Set for RS-232 .....	7-37

## Chapter 8: IBM 468X/469X INTERFACE

Introduction .....	8-1
Connecting to an IBM 468X/469X Host .....	8-2
IBM Default Parameters .....	8-4
IBM 468X/469X Host Parameters .....	8-5
Port Address .....	8-5
Convert Unknown to Code 39 .....	8-7
Beep Directive .....	8-8
Bar Code Configuration Directive .....	8-9

## Chapter 9: KEYBOARD WEDGE INTERFACE

Introduction .....	9-1
Connecting a Keyboard Wedge Interface .....	9-2
Keyboard Wedge Default Parameters .....	9-4
Keyboard Wedge Host Types .....	9-5
Ignore Unknown Characters .....	9-6
Keystroke Delay .....	9-7
Intra-Keystroke Delay .....	9-9
Alternate Numeric Keypad Emulation .....	9-10
Quick Keypad Emulation .....	9-11
Caps Lock On .....	9-12
Caps Lock Override .....	9-13
Convert Wedge Data .....	9-14
Function Key Mapping .....	9-16
FN1 Substitution .....	9-17
Send Make Break .....	9-18
ASCII Character Set for Keyboard Wedge .....	9-19

## Chapter 10: SSI INTERFACE

Introduction .....	10-1
Communications .....	10-1
SSI Transactions .....	10-3
General Data Transactions .....	10-3
ACK/NAK Handshaking .....	10-3
Transfer of Decode Data .....	10-4
ACK/NAK Enabled and Packeted Data .....	10-4
ACK/NAK Enabled and Unpacketed ASCII Data .....	10-4
ACK/NAK Disabled and Packeted DECODE_DATA .....	10-4
ACK/NAK Disabled and Unpacketed ASCII Data .....	10-5
Communication Summary .....	10-5
RTS/CTS Lines .....	10-5

ACK/NAK Option .....	10-5
Number of Data Bits .....	10-5
Serial Response Time-out .....	10-5
Retries .....	10-5
Baud Rate, Stop Bits, Parity, Response Time-out, ACK/NAK Handshake .....	10-6
Errors .....	10-6
Things to Remember When Using SSI Communication .....	10-6
Encapsulation of RSM Commands/Responses Over SSI .....	10-7
Command Structure .....	10-7
Response Structure .....	10-7
Simple Serial Interface Default Parameters .....	10-8
SSI Parameters .....	10-10
Select SSI Host .....	10-10
Baud Rate .....	10-11
Parity .....	10-15
Check Parity .....	10-17
Stop Bits .....	10-18
Software Handshaking .....	10-19
Host RTS Line State .....	10-20
Decode Data Packet Format .....	10-21
Host Serial Response Timeout .....	10-22
Host Character Timeout .....	10-24
Multipacket Option .....	10-26
Interpacket Delay .....	10-28
Event Reporting .....	10-31
Decode Event .....	10-31
Boot Up Event .....	10-32
Parameter Event .....	10-33

## Chapter 11: AUXILIARY SCANNER

Connecting an Auxiliary Scanner .....	11-1
Programming the Auxiliary Scanner .....	11-1
Downloading Firmware .....	11-1
12VDC Power Requirement .....	11-2
Using Auxiliary Scanners .....	11-2
Using a Zebra Scanner as an Auxiliary Scanner .....	11-2
Using a Zebra Scanner That Does Not Support RSM Commands as an Auxiliary Scanner .....	11-2
Using a Non-Zebra Scanner as an Auxiliary Scanner .....	11-2
Auxiliary RSM Communication Bar Codes .....	11-3

## Chapter 12: SYMBOLOGIES

Introduction .....	12-1
Scanning Sequence Examples .....	12-1
Errors While Scanning .....	12-1
Symbology Parameter Defaults .....	12-2
Enable/Disable All Code Types .....	12-8
UPC/EAN .....	12-9
Enable/Disable UPC-A .....	12-9
Enable/Disable UPC-E .....	12-10

Enable/Disable UPC-E1 .....	12-11
Enable/Disable EAN-8/JAN-8 .....	12-12
Enable/Disable EAN-13/JAN-13 .....	12-13
Enable/Disable Bookland EAN .....	12-14
Bookland ISBN Format .....	12-15
Decode UPC/EAN/JAN Supplementals .....	12-16
User-Programmable Supplementals .....	12-24
UPC/EAN/JAN Supplemental Redundancy .....	12-25
UPC/EAN/JAN Supplemental AIM ID Format .....	12-26
UPC Reduced Quiet Zone .....	12-28
Transmit UPC-A Check Digit .....	12-29
Transmit UPC-E Check Digit .....	12-30
Transmit UPC-E1 Check Digit .....	12-31
UPC-A Preamble .....	12-32
UPC-E Preamble .....	12-34
UPC-E1 Preamble .....	12-36
Convert UPC-E to UPC-A .....	12-38
Convert UPC-E1 to UPC-A .....	12-39
EAN-8/JAN-8 Extend .....	12-40
UCC Coupon Extended Code .....	12-41
Coupon Report .....	12-42
ISSN EAN .....	12-44
Code 128 .....	12-45
Enable/Disable Code 128 .....	12-45
Set Lengths for Code 128 .....	12-46
Enable/Disable GS1-128 (formerly UCC/EAN-128) .....	12-49
Enable/Disable ISBT 128 .....	12-50
ISBT Concatenation .....	12-51
Check ISBT Table .....	12-53
ISBT Concatenation Redundancy .....	12-54
Code 128 Reduced Quiet Zone .....	12-55
Code 128 Security Level .....	12-56
Ignore Code 128 <FNC4> .....	12-58
Enable/Disable Code 39 .....	12-59
Enable/Disable Trioptic Code 39 .....	12-60
Convert Code 39 to Code 32 .....	12-61
Code 32 Prefix .....	12-62
Set Lengths for Code 39 .....	12-63
Code 39 Check Digit Verification .....	12-66
Transmit Code 39 Check Digit .....	12-67
Code 39 Full ASCII Conversion .....	12-68
Code 39 Security Level .....	12-69
Code 39 Reduced Quiet Zone .....	12-71
Code 93 .....	12-72
Enable/Disable Code 93 .....	12-72
Set Lengths for Code 93 .....	12-73
Code 11 .....	12-76
Set Lengths for Code 11 .....	12-77
Code 11 Check Digit Verification .....	12-80
Transmit Code 11 Check Digits .....	12-82
Interleaved 2 of 5 (ITF) .....	12-83

Enable/Disable Interleaved 2 of 5 .....	12-83
I 2 of 5 Check Digit Verification .....	12-87
Transmit I 2 of 5 Check Digit .....	12-89
Convert I 2 of 5 to EAN-13 .....	12-90
I 2 of 5 Security Level .....	12-91
I 2 of 5 Reduced Quiet Zone .....	12-93
Discrete 2 of 5 (D 2 of F) .....	12-94
Set Lengths for Discrete 2 of 5 .....	12-95
Codabar (NW - 7) .....	12-98
Enable/Disable Codabar .....	12-98
Set Lengths for Codabar .....	12-99
CLSI Editing .....	12-102
NOTIS Editing .....	12-103
Codabar Upper or Lower Case Start/Stop Characters Detection .....	12-104
MSI .....	12-105
Enable/Disable MSI .....	12-105
Set Lengths for MSI .....	12-106
MSI Check Digits .....	12-109
Transmit MSI Check Digit(s) .....	12-110
MSI Check Digit Algorithm .....	12-111
Chinese 2 of 5 .....	12-112
Enable/Disable Chinese 2 of 5 .....	12-112
Matrix 2 of 5 .....	12-113
Enable/Disable Matrix 2 of 5 .....	12-113
Set Lengths for Matrix 2 of 5 .....	12-114
Matrix 2 of 5 Check Digit .....	12-116
Transmit Matrix 2 of 5 Check Digit .....	12-117
Korean 3 of 5 .....	12-118
Enable/Disable Korean 3 of 5 .....	12-118
Inverse 1D .....	12-119
Postal Codes .....	12-121
US Postnet .....	12-121
US Planet .....	12-122
Transmit US Postal Check Digit .....	12-123
UK Postal .....	12-124
Transmit UK Postal Check Digit .....	12-125
Japan Post .....	12-126
Australia Post .....	12-127
Australia Post Format .....	12-128
Netherlands KIX Code .....	12-130
USPS 4CB/One Code/Intelligent Mail .....	12-131
UPU FICS Postal .....	12-132
Inverse 1D .....	12-133
GS1 DataBar .....	12-135
GS1 DataBar Limited .....	12-136
GS1 DataBar Expanded .....	12-137
GS1 DataBar Limited Security Level .....	12-138
Convert GS1 DataBar to UPC/EAN .....	12-140
Composite .....	12-141
Composite CC-C .....	12-141
Composite CC-A/B .....	12-142

Composite TLC-39 .....	12-143
UPC Composite Mode .....	12-144
Composite Beep Mode .....	12-146
GS1-128 Emulation Mode for UCC/EAN Composite Codes .....	12-148
2D Symbolologies .....	12-149
Enable/Disable PDF417 .....	12-149
Enable/Disable MicroPDF417 .....	12-150
Code 128 Emulation .....	12-151
Data Matrix .....	12-152
Data Matrix Inverse .....	12-153
GS1 Data Matrix .....	12-155
Decode Mirror Images (Data Matrix Only) .....	12-156
Maxicode .....	12-158
QR Code .....	12-159
QR Inverse .....	12-160
GS1 QR .....	12-162
MicroQR .....	12-163
Aztec .....	12-164
Aztec Inverse .....	12-165
Han Xin .....	12-167
Han Xin Inverse .....	12-168
Redundancy Level .....	12-170
Redundancy Level 1 .....	12-170
Redundancy Level 2 .....	12-170
Redundancy Level 3 .....	12-170
Redundancy Level 4 .....	12-171
Security Level .....	12-173
Intercharacter Gap Size .....	12-175
1D Quiet Zone Level .....	12-176
Macro PDF Features .....	12-178
Flush Macro Buffer .....	12-178
Abort Macro PDF Entry .....	12-179

## Chapter 13: OCR PROGRAMMING

Introduction .....	13-1
OCR Parameter Defaults .....	13-2
OCR Programming Parameters .....	13-3
Enable/Disable OCR-A .....	13-3
OCR-A Variant .....	13-4
Enable/Disable OCR-B .....	13-7
OCR-B Variant .....	13-8
Enable/Disable MICR E13B .....	13-15
Enable/Disable US Currency Serial Number .....	13-16
OCR Orientation .....	13-17
OCR Lines .....	13-20
OCR Minimum Characters .....	13-22
OCR Maximum Characters .....	13-22
OCR Subset .....	13-23
OCR Reduced Quiet Zone .....	13-24
OCR Template .....	13-25



Required Digit (9)	13-26
Required Alpha (A)	13-26
Optional Alphanumeric (1)	13-27
Optional Alpha (2)	13-27
Alpha or Digit (3)	13-28
Any Including Space & Reject (4)	13-28
Any except Space & Reject (5)	13-29
Optional Digit (7)	13-29
Digit or Fill (8)	13-30
Alpha or Fill (F)	13-30
Optional Space ( )	13-31
Optional Small Special (.)	13-31
Other Template Operators	13-32
Literal String (" and +)	13-32
New Line (E)	13-33
String Extract (C)	13-33
Ignore to End of Field (D)	13-34
Skip Until (P1)	13-34
Skip Until Not (P0)	13-35
Repeat Previous (R)	13-36
Scroll Until Match (S)	13-37
Multiple Templates	13-37
Template Examples	13-37
OCR Check Digit Modulus	13-38
OCR Check Digit Multiplier	13-39
OCR Check Digit Validation	13-40
None	13-40
Product Add Left to Right	13-40
Product Add Right to Left	13-41
Digit Add Left to Right	13-41
Digit Add Right to Left	13-42
Product Add Right to Left Simple Remainder	13-42
Digit Add Right To Left Simple Remainder	13-43
Health Industry - HIBCC43	13-43
Inverse OCR	13-44

**Chapter 14: 123SCAN2**

Introduction	14-1
Communication with 123Scan2	14-1
123Scan2 Requirements	14-2
Scanner SDK, Other Software Tools, and Videos	14-2

**Chapter 15: ADVANCED DATA FORMATTING**

Introduction	15-1
--------------	------

**Appendix A: STANDARD DEFAULT PARAMETERS****Appendix B: COUNTRY CODES**

Introduction .....	B-1
USB and Keyboard Wedge Country Keyboard Types (Country Codes) .....	B-2

**Appendix C: COUNTRY CODE PAGES**

Introduction .....	C-1
Country Code Page Defaults .....	C-2
Country Code Page Bar Codes .....	C-6

**Appendix D: CJK DECODE CONTROL**

Introduction .....	D-1
CJK Control Parameters .....	D-2
Unicode Output Control .....	D-2
CJK Output Method to Windows Host .....	D-3
Non-CJK UTF Bar Code Output .....	D-8
Country Keyboard Type Missing Characters .....	D-9
Unicode/CJK Decode Setup with Windows Host .....	D-10
Setting Up the Windows Registry Table for Unicode Universal Output .....	D-10
Adding CJK IME on Windows .....	D-10
Selecting the Simplified Chinese Input Method on the Host .....	D-11
Selecting the Traditional Chinese Input Method on the Host .....	D-12

**Appendix E: PROGRAMMING REFERENCE**

Symbol Code Identifiers .....	E-1
AIM Code Identifiers .....	E-3

**Appendix F: SAMPLE BAR CODES**

Code 39 .....	F-1
UPC/EAN .....	F-1
UPC-A, 100% .....	F-1
EAN-13, 100% .....	F-2
Code 128 .....	F-2
Interleaved 2 of 5 .....	F-2
GS1 DataBar-14 .....	F-3
PDF417 .....	F-3
Data Matrix .....	F-3
Maxicode .....	F-3
QR Code .....	F-4
Han Xin .....	F-4
US Postnet .....	F-4
UK Postal .....	F-4

**Appendix G: NUMERIC BAR CODES**

Numeric Bar Codes .....	G-1
0 .....	G-1
1 .....	G-1
2 .....	G-2
3 .....	G-3
4 .....	G-4
5 .....	G-5
6 .....	G-6
7 .....	G-7
8 .....	G-8
9 .....	G-9
Cancel .....	G-10

**Appendix H: SIGNATURE CAPTURE CODE**

Introduction .....	H-1
Code Structure .....	H-1
Signature Capture Area .....	H-1
CapCode Pattern Structure .....	H-2
Start / Stop Patterns .....	H-2
Dimensions .....	H-3
Data Format .....	H-3
Additional Capabilities .....	H-4
Signature Boxes .....	H-4

**Appendix I: NON-PARAMETER ATTRIBUTES**

Introduction .....	I-1
Attributes .....	I-1
Model Number .....	I-1
Serial Number .....	I-1
Date of Manufacture .....	I-2
Date of First Programming .....	I-2
Configuration Filename .....	I-2
Beep/LED .....	I-3
Parameter Defaults .....	I-4
Beep on Next Bootup .....	I-4
Reboot .....	I-4
Host Trigger Session .....	I-4
Firmware Version .....	I-5
Imagekit Version .....	I-5

**Index**

# ABOUT THIS GUIDE

---

## Introduction

The *DS7708 2D Vertical Slot Scanner Product Reference Guide* provides general instructions for setting up, operating, maintaining, and troubleshooting the scanner.

---

## Scanner Configurations

[Table v-1](#) lists the configurations of the DS7708 2D Vertical Slot Scanner.

**Table v-1** DS7708 2D Vertical Slot Scanner Configurations

Part Number	Description
DS7708-SR00004ZCWW	Vertical Presentation Area Imager, Standard Range, Corded, Midnight Black, Checkpoint EAS

## Accessories

[Table a](#) lists the accessories available for the DS7708 2D Vertical Slot Scanner.

**Table a.** *Mounting Accessories*

Part Number	Description
11-TM0077-04	Table Mount Bracket - DS7708 (Midnight Black). Allows the scanner to be fixed to the table top with a double sided tape or screws.
11-WM0077-04	Wall Mount Bracket Kit - DS7708 (Midnight Black). Allows the scanner to be fixed to the wall using screws.

**Table b.** *Power Supplies*

Part Number	Description
PWRS-14000-253R	Power Supply, 100 - 220VAC, Output 5V - US/CA/MX/JP/TW
PWRS-14000-255R	Power Supply, 100 - 220VAC, Output 5V - Brazil Korea
PWRS-14000-256R	Power Supply, 100 - 220VAC, Output 5V - EU/UK
PWRS-14000-257R	Power Supply, 100 - 220VAC, Output 5V - CH
PWRS-14000-258R	Power Supply, 100 - 220VAC, Output 5V - HK/AU
PWRS-14000-148R	Power Supply, 100 - 220VAC, Output 12V - Worldwide
PWRS-14000-148C	Power Supply, 100 - 240VAC, Output 12V - Worldwide <b>Note:</b> This power supply is required for Keyboard Wedge only.

**Table c.** *USB Cables*

Part Number	Description
CBA-U21-S07ZAR	USB Cable (Shielded Series A Connector, 7ft. Straight)
CBA-U23-S07ZAR	USB Cable (Shielded Power Plus Connector, 7ft. Straight)
CBA-U28-C15ZAR	USB Cable (Shielded Power Plus Connector, 15ft. Coiled)
CBA-U29-C15ZAR	USB Cable (Shielded Series A Connector, 15ft. Coiled)
CBA-U30-S15ZAR	USB Cable (Shielded Series A Connector, 15ft. Straight)
CBA-U32-C09ZAR	USB Cable (Shielded Series A Connector, 9ft. Coiled)
CBA-U34-C09ZAR	USB Cable (Shielded Power Plus Connector, 9ft. Coiled)
CBA-U35-S15ZAR	USB Cable (Shielded Power Plus Connector, 15ft. Straight)
CBA-U42-S07PAR	USB Cable (Shielded Series A Connector, 7ft. Straight), 12V  For the DS7708 with an auxiliary scanner the PWRS-14000-148R power is required.

**Table c. USB Cables (Continued)**

<b>Part Number</b>	<b>Description</b>
CBA-U44-S15PAR	USB Cable (Shielded Series A Connector, 15ft. Straight), 12V For the DS7708 with an auxiliary scanner the PWRS-14000-148R power supply is required.
CBA-U43-S07ZAR	USB Cable (Shielded Power Plus Connector, 7ft. Straight), 12V For the DS7708 with an auxiliary scanner, 12Volts from host.
CBA-U45-S15ZAR	USB Cable (Shielded Power Plus Connector, 15ft. Straight), 12V For the DS7708 with an auxiliary scanner, 12Volts from host.

**Table d. RS-232 Cables**

<b>Part Number</b>	<b>Description</b>
CBA-R01-S07PAR	RS-232 Cable (DB9 Female, TxD on 2, 7 ft. Straight)
CBA-R03-C12PAR	RS-232 Cable (DB9 Female, TxD on 2, 12ft. Coiled)
CBA-R08-S07ZAR	RS-232 (Nixdorf Beetle- 5V Direct Power) Cable (7ft. Straight)
CBA-R10-S07ZAR	RS-232 (Nixdorf Beetle- Direct Power) Cable (7ft. Straight)
CBA-R16-S07ZAR	RS-232 (IBM Sure One) Cable (DB15 TxD on 2, 7ft Straight)
CBA-R20-S07PAR	RS-232 (Olivetti - ORS500) Cable (7ft straight)
CBA-R23-S07ZAR	RS-232 (Fujitsu Team POS 500 ICL) Cable (7ft straight)
CBA-R27-S07ZAR	RS-232 (NCR 7452 DYNAKEY) Cable (7ft. Straight)
CBA-R28-C09ZAR	RS-232 (VeriFone Ruby) Cable (9ft, Coiled)
CBA-R29-C12ZAR	RS-232 (NCR 7452 DYNAKEY) Cable (12ft. Coiled)
CBA-R31-C09ZAR	RS-232 (NCR 7448) Cable (9ft. Coiled)
CBA-R32-S07PAR	RS-232 (True TTL, DB9 Female, TxD on 2, 7ft. Straight)
CBA-R36-C09ZAR	RS-232 (DB9F PWR Pin 9, 9ft coiled)
CBA-R38-C09ZAR	RS-232 (DB25F PWR Pin 12, 9ft coiled)
CBA-R40-C09SAR	RS-232 (Split DB9F & PWR line, 9ft coiled)
CBA-R41-S12ZAR	RS-232 (Nixdorf Beetle- Direct Power) Cable (12ft. Straight)
CBA-R21-S15PAR	RS-232 Cable (DB9 Female, TxD on 2, 15 ft. Straight), 12V For the DS7708 with an auxiliary scanner the PWRS-14000-148R power supply is required.
CBA-R07-S07PAR	RS-232 Cable (DB9 Female, TxD on 2, 7 ft. Straight), 12V For the DS7708 with an auxiliary scanner the PWRS-14000-148R power supply is required.

**Table e.** Keyboard Wedge Cables

Part Number	Description
CBA-K61-S07PAR	Keyboard Wedge PS/2 Auto-Detect (7ft. Power Port, Straight), 5V
CBA-K63-S07PAR	Keyboard Wedge PS/2 Auto-Detect (7ft. Power Port, Straight), 12V For the DS7708 with an auxiliary scanner the PWRS-14000-148R power supply is required.
CBA-K65-S15PAR	Keyboard Wedge PS/2 Auto-Detect (15ft. Power Port, Straight), 5V

**Table f.** IBM Cables

Part Number	Description
CBA-M61-S07ZAR	IBM 468x/9x (Port 9B) Auto-Detect (7ft. Straight)
CBA-M64-S07ZAR	IBM 468x/9x (Port 5) Auto-Detect (7ft. Straight)
CBA-M65-S07ZAR	IBM 468x/9x (Port 9B) Auto-Detect (7 ft. Straight), 12V For the DS7708 with an auxiliary scanner, 12Volts from host.
CBA-M66-S15ZAR	IBM 468x/9x (Port 9B) Auto-Detect (15ft. Straight), 12V For the DS7708 with an auxiliary scanner, 12Volts from host.

## Chapter Descriptions

Following are brief descriptions of each chapter in this guide.

- [Chapter 1, GETTING STARTED](#) provides a product overview and unpacking instructions.
- [Chapter 2, DATA CAPTURE](#) describes parts of the scanner, beeper and LED definitions, and how to use the scanner.
- [Chapter 3, MAINTENANCE, TECHNICAL SPECIFICATIONS, MOUNTING TEMPLATES](#) provides information on how to care for the scanner, troubleshooting, technical specifications and mounting templates to assist in proper placement of the scanner when attaching it to a surface.
- [Chapter 4, USER PREFERENCES & MISCELLANEOUS OPTIONS](#) provides the programming bar codes necessary for selecting user preference features and commonly used bar codes to customize how data is transmitted to the host device.
- [Chapter 5, IMAGING PREFERENCES](#) provides the programming bar codes necessary for selecting user preference features for the scanner.
- [Chapter 6, USB INTERFACE](#) provides information for setting up the scanner for USB operation.
- [Chapter 7, RS-232 INTERFACE](#) provides information for setting up the scanner for RS-232 operation.
- [Chapter 8, IBM 468X/469X INTERFACE](#) provides information for setting up the scanner with IBM 468X/469X POS systems.
- [Chapter 9, KEYBOARD WEDGE INTERFACE](#) provides information for setting up the scanner for Keyboard Wedge operation.

- [Chapter 10, SSI INTERFACE](#) describes the system requirements of the Simple Serial Interface (SSI), which provides a communications link between Zebra decoders.
- [Chapter 11, AUXILIARY SCANNER](#) provides information for setting up the optional auxiliary scanner.
- [Chapter 12, SYMBOLOGIES](#) describes all symbology features and provides the programming bar codes necessary for selecting these features for the scanner.
- [Chapter 13, OCR PROGRAMMING](#) describes how to set up the scanner for OCR programming.
- [Chapter 14, 123SCAN2](#) describes this PC based scanner configuration tool.
- [Chapter 15, ADVANCED DATA FORMATTING](#) is a means of customizing data before transmission to the host device. This chapter provides the name and location of the Advanced Data Formatting Programmer Guide.
- [Appendix A, STANDARD DEFAULT PARAMETERS](#) provides a table of all host devices and miscellaneous scanner defaults.
- [Appendix B, COUNTRY CODES](#) provides instructions for programming the keyboard to interface with a USB, or Keyboard Wedge host.
- [Appendix C, COUNTRY CODE PAGES](#) provides bar codes for selecting code pages for the country keyboard type selected in [Appendix B, COUNTRY CODES](#).
- [Appendix D, CJK DECODE CONTROL](#) describes control parameters for CJK (Chinese, Japanese, Korean) bar code decode through USB HID Keyboard Emulation mode.
- [Appendix E, PROGRAMMING REFERENCE](#) provides a table of AIM code identifiers, ASCII character conversions, and keyboard maps.
- [Appendix F, SAMPLE BAR CODES](#) includes sample bar codes.
- [Appendix G, NUMERIC BAR CODES](#) includes the numeric bar codes to scan for parameters requiring specific numeric values.
- [Appendix H, SIGNATURE CAPTURE CODE](#) includes information about signature capture codes and patterns that enclose a signature area on a document allowing a scanner to capture a signature.
- [Appendix I, NON-PARAMETER ATTRIBUTES](#) includes non parameter attributes.

---

## Notational Conventions

This document uses these conventions:

- “User” refers to anyone operating the device.
- “Device” refers to the scanner.
- *Italics* are used to highlight specific items in the general text, and to identify chapters and sections in this and related documents. It also identifies names of windows, menus, menu items, and fields within windows.
- **Bold** identifies buttons, and switches to be tapped or clicked, and bar code names.
- Bullets (•) indicate:
  - lists of alternatives or action items.
  - lists of required steps that are not necessarily sequential.



- Numbered lists indicate a set of sequential steps, i.e., those that describe step-by-step procedures.



**NOTE** This symbol indicates something of special interest to the reader. Failure to read the note will not result in physical harm to the bar code reader, equipment or data.



**IMPORTANT** This symbol indicates something of importance to the reader. Failure to read the note may impair the equipment or data.



**CAUTION** This symbol indicates that if this information is ignored, the possibility of data or material damage may occur.



**WARNING!** This symbol indicates that if this information is ignored the possibility that serious personal injury may occur.

- Throughout the programming bar code menus, asterisks (\*) are used to denote default parameter settings.



\* Indicates Default — \* Baud Rate 9600 — Feature/Option

---

## Related Publications

Following is a list of documents that provide additional information about configuring the DS7708:

- DS7708 2D Vertical Slot Scanner Quick Reference Guide, p/n MN001063Axx.

For the latest version of this guide and all guides, go to: <http://www.zebra.com/support>.

---

## Service Information

If you have a problem using the equipment, contact your facility's technical or systems support. If there is a problem with the equipment, they will contact the Zebra Technologies Support Center at: <http://www.zebra.com/support>.

When contacting Zebra Technologies support, please have the following information available:

- Serial number of the unit
- Model number or product name
- Software type and version number

Zebra Technologies responds to calls by e-mail, telephone or fax within the time limits set forth in service agreements.

If your problem cannot be solved by Zebra Technologies support, you may need to return your equipment for servicing and will be given specific directions. Zebra Technologies is not responsible for any damages incurred during shipment if the approved shipping container is not used. Shipping the units improperly can possibly void the warranty.

If you purchased your business product from a Zebra Technologies business partner, please contact that business partner for support.



# CHAPTER 1 GETTING STARTED

---

## Introduction

The DS7708 2D Vertical Slot Scanner provides intuitive, hands-free scanning. The scanner reads all retail symbologies and has multi-interface capability to interface to all popular POS devices. The scanner can be mounted to a table top or vertical surface such as a wall using optional mounting accessories.

---

## Unpacking the Scanner

Remove the scanner from its packing and inspect it for damage. The following items are included in the package:

- Scanner
- *DS7708 2D Vertical Slot Scanner Quick Reference Guide* (p/n MN001063Axx).

If any items are missing or damaged, call the Zebra Technologies Support Center. See [page x](#) for contact information. **KEEP THE PACKING.** It is the approved shipping container and should be used if it is ever necessary to return the equipment for servicing.

## Protective Cover

Before using the scanner peel off the protective cover from the scan window.

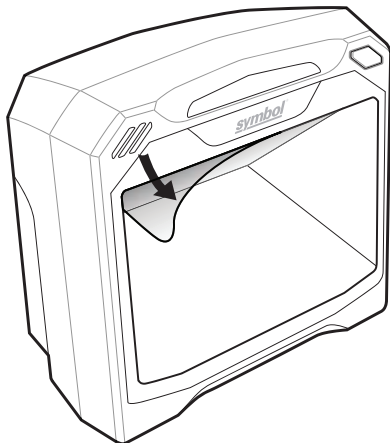

**Figure 1-1** *Peeling Off Protective Covering*

## Features

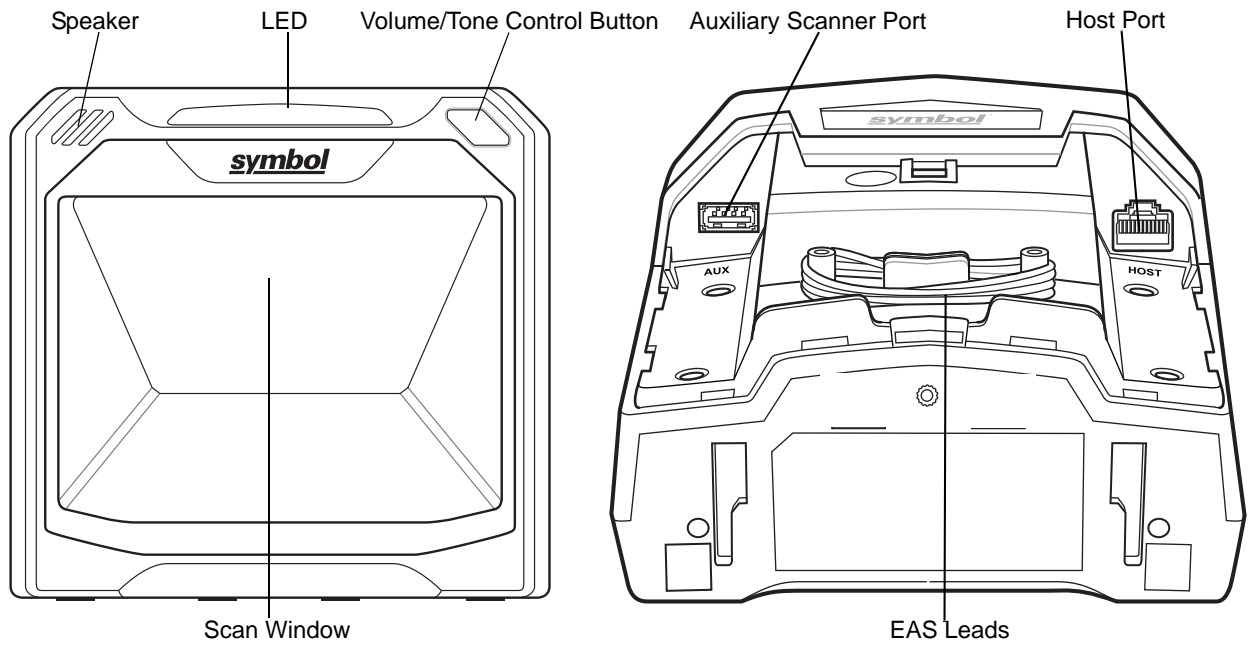

Figure 1-2 DS7708 Views - Front and Back

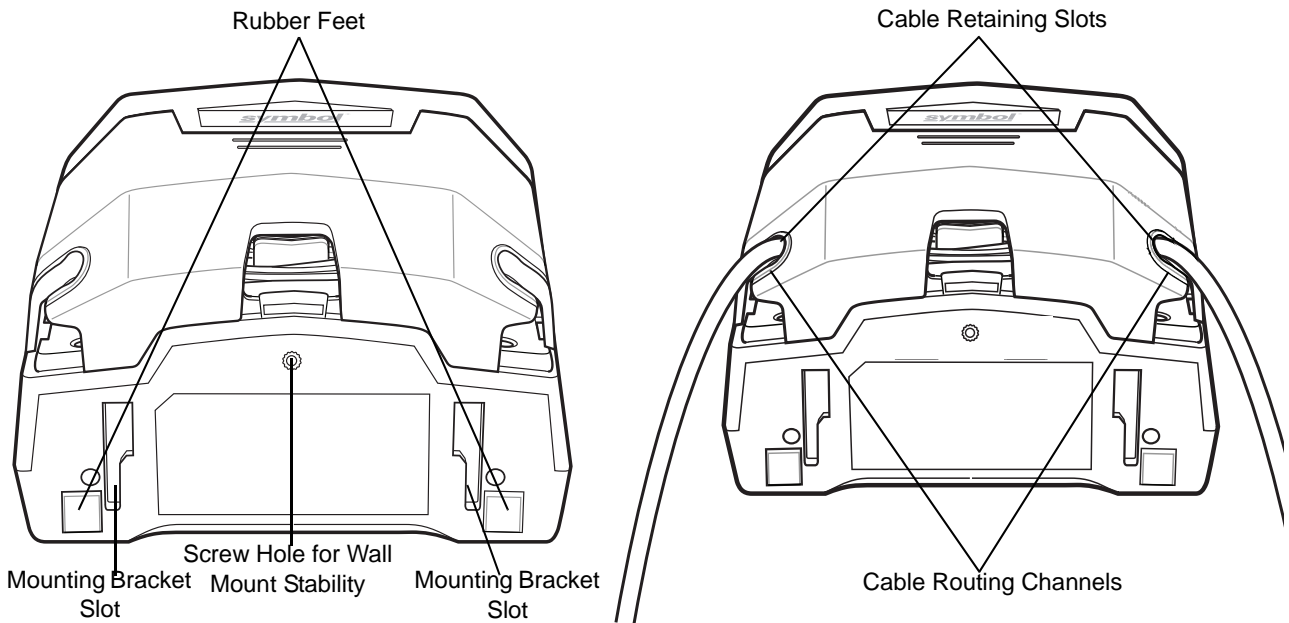
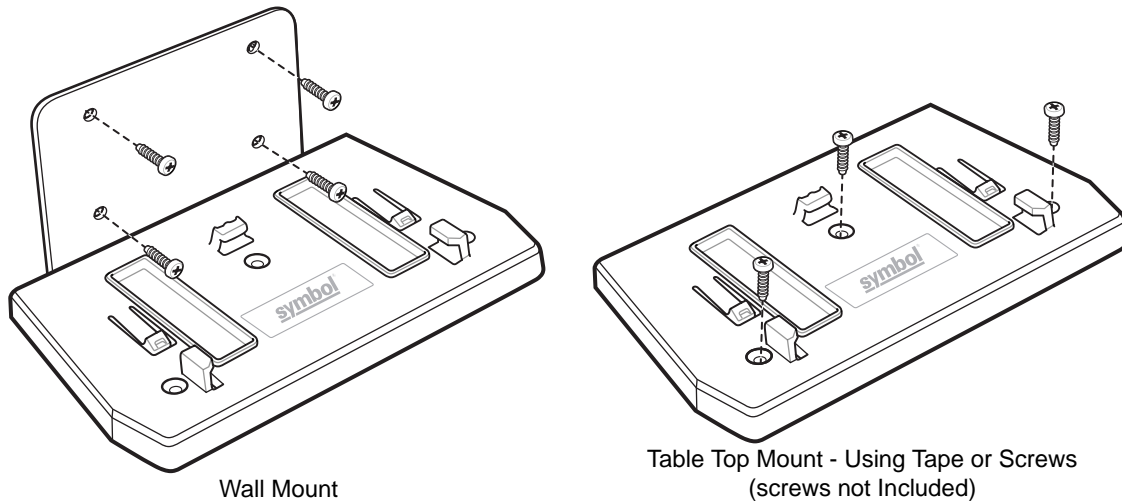

Figure 1-3 DS7708 Views - Bottom and With and Without Cables



**Figure 1-4** DS7708 Mounting Accessories

- ✓ **NOTE** The recommended method of table top installation is attaching the scanner to the table top using the double-sided tape provided. See [Mounting the Scanner \(Optional Hardware Required\)](#) on page 1-8.

The DS7708 Vertical 2D Slot Scanner supports the following interfaces:

- ✓ **NOTE** The DS7708 automatically adapts to the host to which it is connected.
- USB connection to a host. The scanner defaults to the HID keyboard interface type. To select other USB interface types, scan programming bar code menus or use the Windows-based programming tool 123Scan<sup>2</sup>. International keyboards are supported. See [Appendix B, COUNTRY CODES](#) to program the keyboard to interface with a USB host.
  - TTL-level RS-232 connection to a host. The scanner defaults to the standard RS-232 interface type. Modify communication between the scanner and the host either by scanning bar code menus or using the Windows-based programming tool 123Scan<sup>2</sup>.
  - Connection to IBM 468X/469X hosts. User selection is required to configure this interface. Modify communication between the scanner and the IBM terminal either by scanning bar code menus or using the Windows-based programming tool 123Scan<sup>2</sup>.
  - Keyboard Wedge connection to a host. The scanner defaults to the IBM AT Notebook interface type. The host interprets scanned data as keystrokes. International keyboards are supported. See [Appendix B, COUNTRY CODES](#) to program the keyboard to interface with a Keyboard Wedge host.
  - SSI communications link between the scanner and a serial host. It provides the means for the host to control the scanner.

---

## Setting Up the Scanner

### Power Options

The DS7708 does not have an on/off switch. It is powered via the host through the host cable and is ready to scan when connected to a host.

- When an auxiliary scanner is not connected: If an auxiliary scanner is not connected, the DS7708 requires 5VDC from the host. If the host cannot provide 5VDC, or cannot provide sufficient power (for example, RS-232 or Keyboard Wedge hosts) then an external 5VDC power supply is required.
- When an auxiliary scanner is connected: If an auxiliary scanner is connected, the DS7708 requires 12VDC from the host. If the host cannot provide 12VDC, or cannot provide sufficient power (for example, USB Series A type connector, or RS-232) then a cable with a 12VDC power port and external 12VDC power supply is required.

When the scanner receives power, the green LED lights and three short high beeps sound, indicating that the scanner is operational.

### Ports

**Host Port.** A 10-pin RS-45 type connector is provided to connect various host interface cables.

**Auxiliary (Hand-held) Scanner Port.** A Series A type USB connector is provided to connect an auxiliary scanner, such as the DS4308. The auxiliary scanner's host interface is automatically set to match the DS7708 host interface.

✓ **NOTE** For detailed connection information, see the applicable host interface chapter.

### Connecting the Host and/or Auxiliary Scanner Cable

Different hosts require different cables. The connectors illustrated in each host chapter are examples only. Connectors may be different from those illustrated, but the steps to connect the scanner are the same. See each individual host interface chapter for interface specific connections.

The back cover must be removed prior to connecting cables (see [Removing and Replacing the Back Cover on page 1-5](#)).

## Removing and Replacing the Back Cover

- ✓ **NOTE** For instructions on host and auxiliary scanner cable connections, see the applicable host interface chapter.

### Removing the Back Cover

To remove the back cover, lightly press on the indentations at the top of the cover, slide downward until it becomes free, and lift up off the scanner.

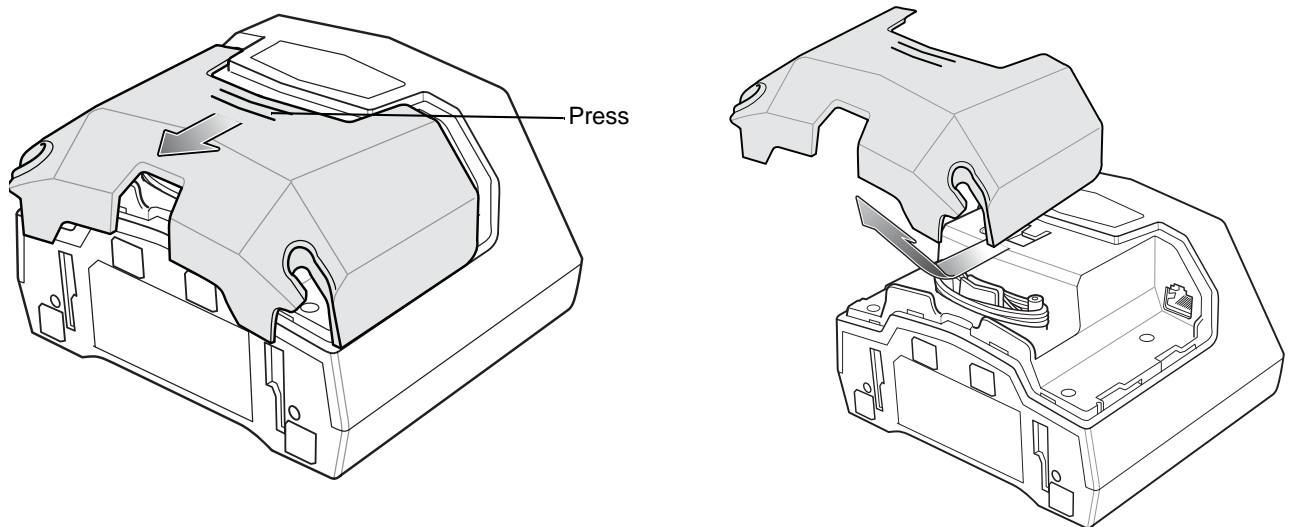

Figure 1-5 Removing the Back Cover

### Installing the Cable(s)

Insert the host cable into the RJ-45 connector on the back right of the scanner. Insert auxiliary scanner cable (optional) into the USB connector on the back left of the scanner. Replace the back cover (see [Replacing the Back Cover on page 1-6](#))

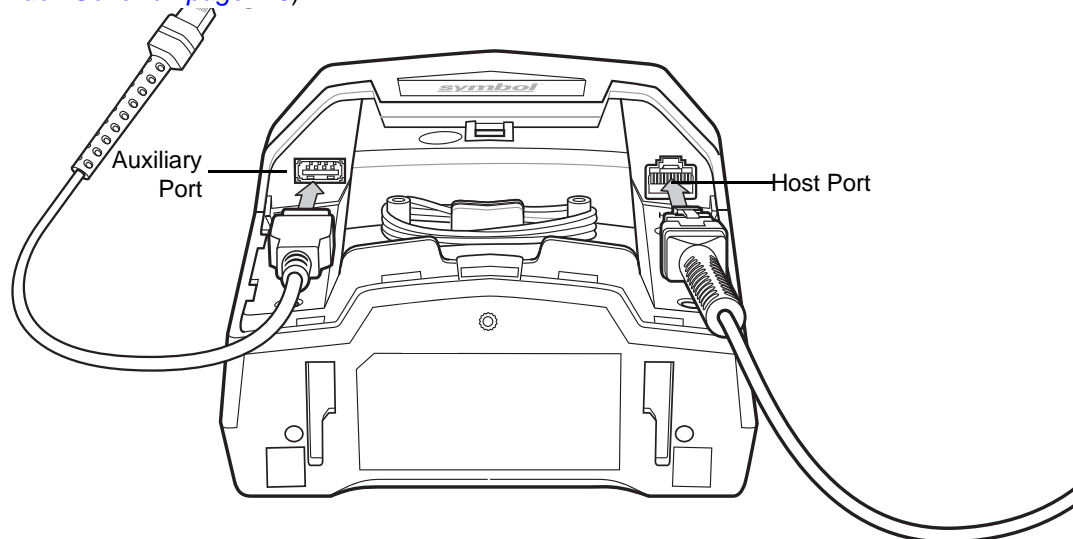
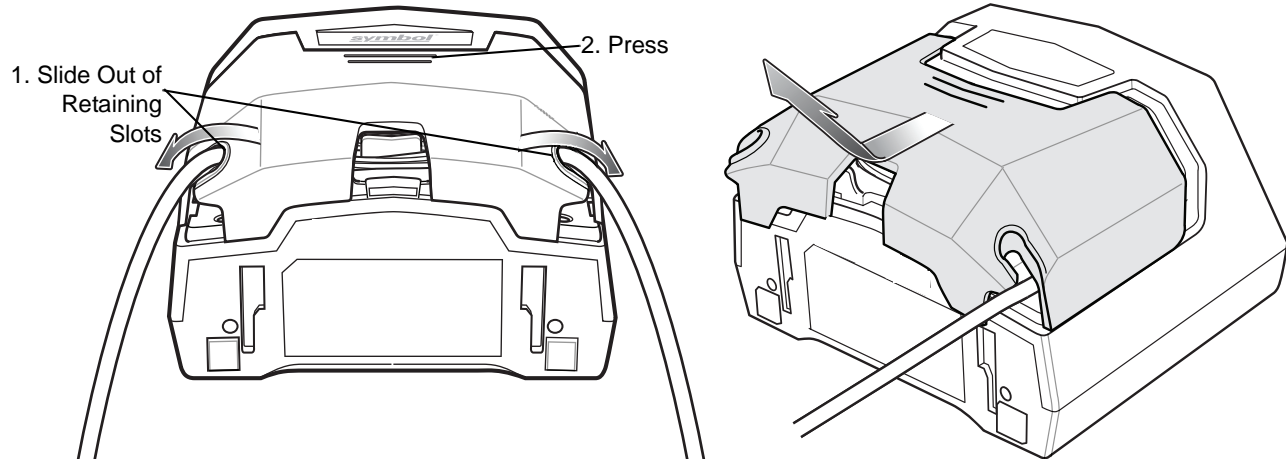

Figure 1-6 Installing Cables



### Removing the Back Cover with Cables Installed

To remove the back cover with cables installed, slide the cable(s) out of the cable retaining slots to ensure they can move freely, lightly press on the indentations at the top of the cover, slide downward until it becomes free, and lift up off the scanner.

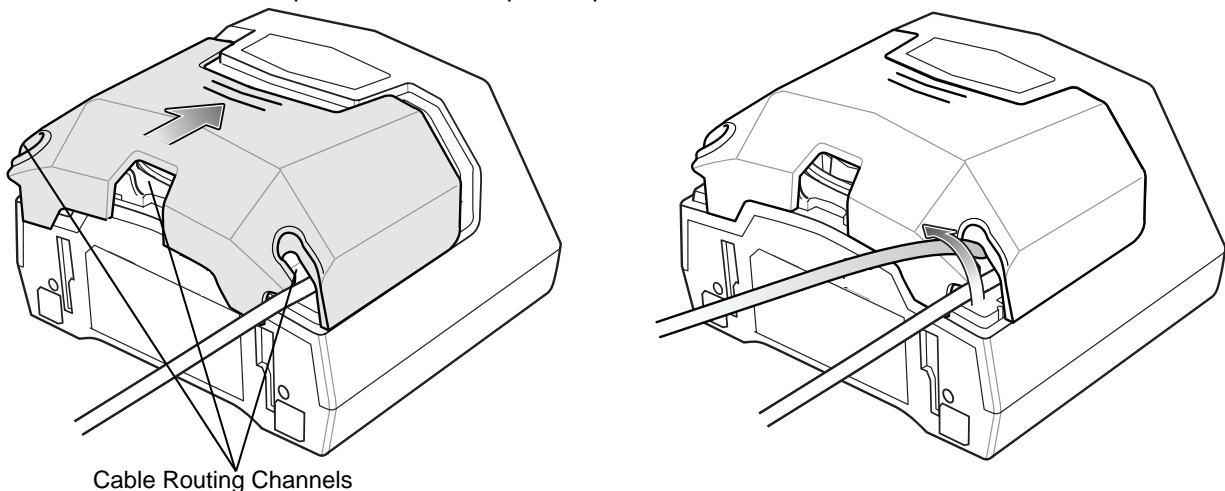

**Figure 1-7** Removing the Back Cover with Cables Installed

### Replacing the Back Cover

The back cover has three channels to route the outgoing cables so that they are organized and do not hinder the scanner's placement. Place the back cover on the back of the scanner and ensure the cables are positioned appropriately to be routed through one or more of the cable routing channels. Route the cables through the nearest channel.

Press the cover and slide upwards until it snaps into place.



**Figure 1-8** Replacing the Back Cover

### Configuring the Scanner

To configure the scanner, use the bar codes in this manual, or use the 123Scan<sup>2</sup> configuration program (see [Chapter 14, 123SCAN2](#)).

The scanner supports RS-232, IBM 468X/469X, Keyboard Wedge, and USB to interface with a host system. Each host-specific chapter describes how to set up each of these connections.

## Synchronization of Settings

### Host Requested Setting Changes

The IBM 4683, IBM Hand-held, and USB hosts can change a limited set of the scanner's settings. The 123Scan<sup>2</sup> host maintains all the scanner settings. When an auxiliary scanner is connected, all setting changes the host requests are processed by both the DS7708 and the auxiliary scanner. Only a limited set of auxiliary scanner settings are updated, including code type enable/disable, code type lengths, beeper settings, redundancy, and security level settings.

For example, if the IBM 4683 host requests to disable the Code 39 symbology, then Code 39 is disabled on both the DS7708 and the auxiliary scanner.

### Bar Code Menu Symbols Scanned on the DS7708

A limited set of bar code menu symbols scanned on the DS7708 are synchronized with the auxiliary scanner (if attached). These settings are code type enable/disable, code type lengths, beeper settings, redundancy, and security level settings.

### Bar Code Menu Symbols Scanned on the Hand-held Scanner

By default, the auxiliary scanner can program the DS7708 settings (primary only mode).

The auxiliary programming mode setting All Scanners Mode allows programming both the auxiliary scanner and the DS7708 simultaneously. In this mode, scanning **Set Defaults** returns the DS7708 to the default mode.

Another setting isolates the auxiliary scanner so that the bar code menu symbols scanned apply only to the auxiliary scanner. To return to the default functionality change the setting on the DS7708 directly.

Regardless of the auxiliary scanner mode, all parameter changes requested by the host and via bar code menu settings on the DS7708 are synchronized on the auxiliary scanner for applicable settings.

## Mounting the Scanner (Optional Hardware Required)

- ✓ **NOTE** The scanner should not be installed behind an additional protective window; this would create blind decode zones in the imaging field of view.

The DS7708 is designed to sit on top of a table, but optional mounting kits are available to mount the DS7708 to a table top or a wall. The mounting bracket slots in the bottom of the scanner accept the various mounting brackets.

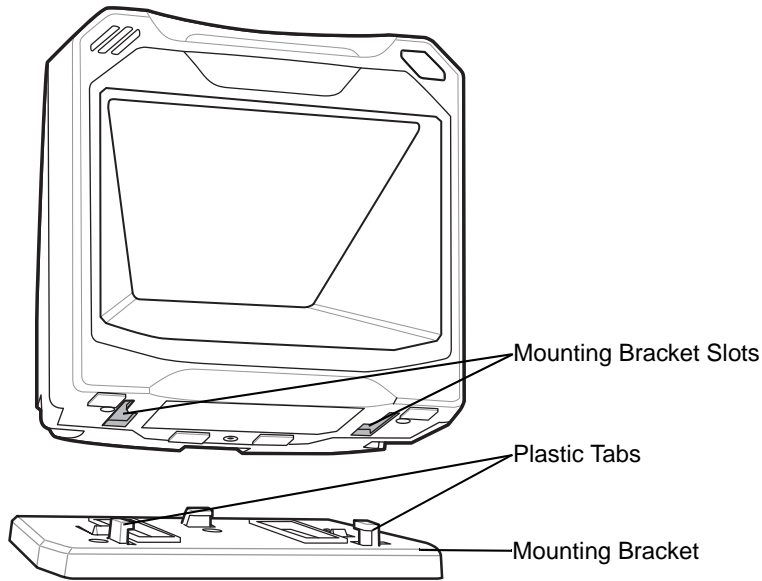

Figure 1-9 Mounting Overview

## Mounting the Scanner to the Table Top

### Mounting the Scanner to a Table Top with Double-sided Tape

The recommended method of installation is attaching the scanner to the table top using the double-sided tape provided. Determine the location for installing the scanner; attach the scanner to the mounting bracket; peel off the paper on the two strips of double-sided tape; position the bracket; and press down onto the table surface.

### Mounting the Scanner to a Table Top with Screws

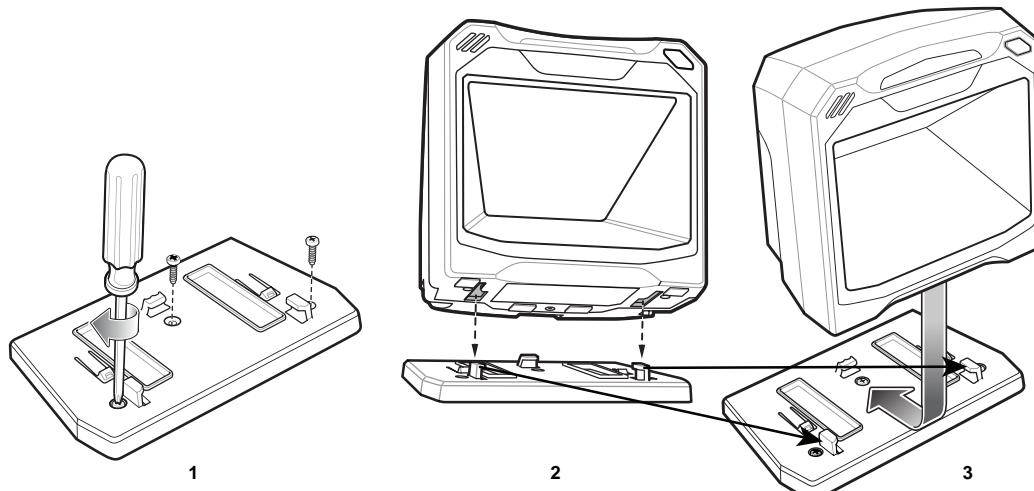
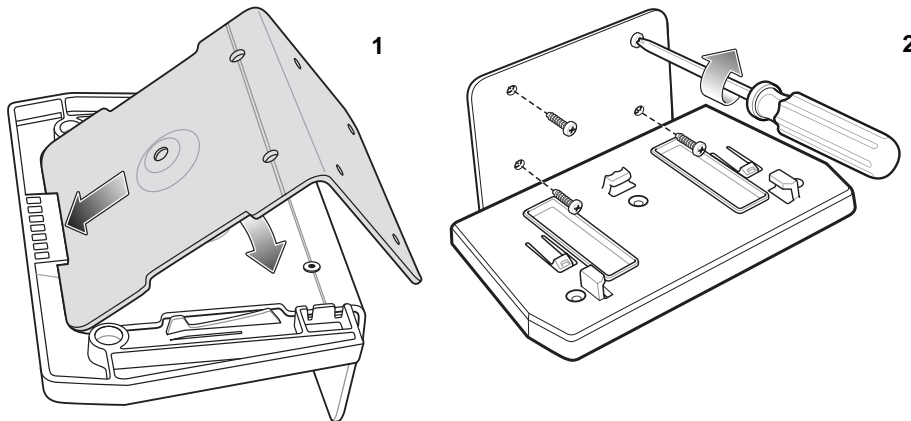

Figure 1-10 Table Top Mounting Diagram

1. See [Removing and Replacing the Back Cover on page 1-5](#) to connect all interface and power cables to the scanner. Ensure the back cover is replaced and the cables are routed appropriately.
2. Determine the location for installing the scanner.
3. [Figure 1-10 - 1](#): Mount the table bracket with three screws (not included).
4. [Figure 1-10 - 2](#): Invert the scanner slightly and align the mounting slots over the plastic tabs on the bracket.
5. [Figure 1-10 - 3](#): Insert the plastic tabs into the mounting slots on the scanner, and slide the scanner back until it clicks into place.

## Mounting the Scanner to a Wall



**Figure 1-11** Wall Mounting Diagram - Mounting the Bracket

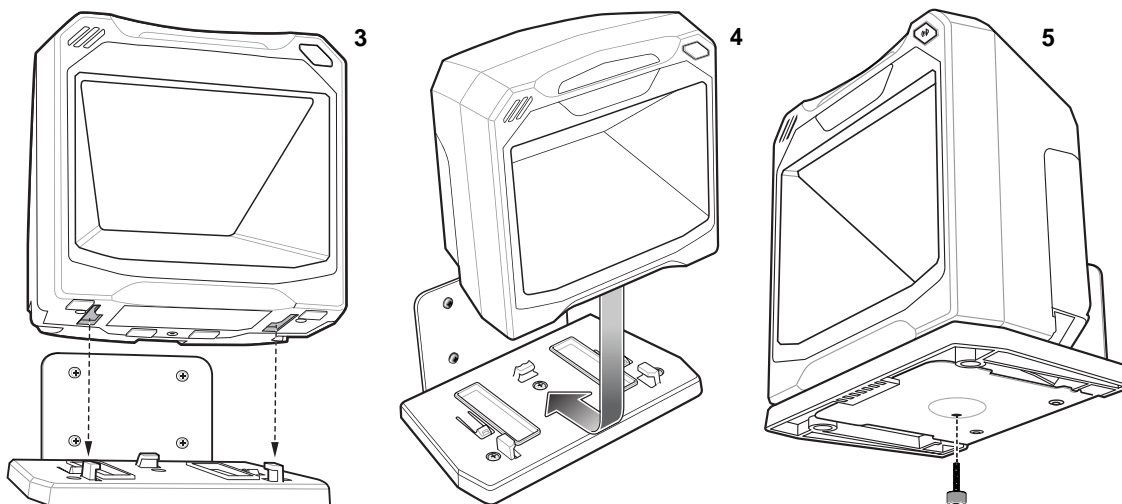

**Figure 1-12** Wall Mounting Diagram - Mounting the Scanner on Bracket

1. Follow the steps in [Removing and Replacing the Back Cover on page 1-5](#) to connect all interface and power cables to the scanner. Ensure the back cover is replaced and the cables are routed appropriately.
2. Determine the location for installing the scanner.
3. Use the [Wall Mount Template on page 1-12](#) as a guide to mark the four mounting holes.
4. [Figure 1-11 - 1](#): Insert the back metal bracket under the plastic hook in the base plate and set in place so that the thumb screw holes align.

5. Place the mounting bracket in position over the drilled holes with its flat surface facing the mounting surface.
6. *Figure 1-11* - 2: Insert four screws (provided) through the holes and fasten to the mounting surface.
7. *Figure 1-12* - 3: Invert the scanner slightly and align the mounting slots over the plastic tabs on the bracket.
8. *Figure 1-12* - 4: Insert the plastic tabs into the mounting slots on the scanner, and slide the scanner back until it clicks into place.
9. *Figure 1-12* - 5: To secure the scanner in the bracket, insert the thumb screw (provided) through the hole in the bottom of the bracket and fasten to the scanner bottom.

## **Removing the Scanner from the Mounting Bracket**

To remove the scanner:

1. Grasp the scanner firmly on both sides.
2. Slide the scanner forward and lift out.

---

## Operating the Scanner

### Indicator Lights

The scanner includes an array of three bi-color (green/red) LEDs to display system status and alerts. Center LED conditions: Off, Dim, Full; Outer LED conditions: Off, Full.

### Adjusting Speaker Volume

To change the volume of the beep, scan the a bar code in the section [Beep Volume on page 4-11](#), or use the two-function **Volume/Tone** button on the front of the scanner (see [Figure 1-2 on page 1-2](#)).

Press and release the **Volume/Tone** button repeatedly until the desired volume level sounds (high, medium or low).

### Adjusting Speaker Tone

To change the tone of the beep, scan the a bar code in the section [Beep Tone on page 4-8](#), or use the two-function **Volume/Tone** button on the front of the scanner (see [Figure 1-2 on page 1-2](#)).

Press and hold the **Volume/Tone** button for three seconds to change to a different tone. Repeat this process until the desired tone sounds (high, medium, low or medium to high tone).

✓ **NOTE** If the decode tone is set to **Off**, the **Volume/Tone** button cannot be used to change the decode tone. To allow the tone change using the **Volume/Tone** button, scan a tone other than **Off**.

If the **Volume/Tone Button Control** parameter is set to **Disable Volume and Tone Change**, the **Volume/Tone** button on the scanner cannot be used to change the volume and tone of the beeps.

## Wall Mount Template

To use this template:

1. **Print the actual size of this page. Do not scale.**
2. Determine the location for installing the scanner.
3. Tape the template to the wall.
4. Drill the four holes using the template.
5. Place the mounting bracket in position over the drilled holes with its flat surface facing the mounting surface.
6. Insert four screws (provided) through the holes and fasten to the mounting surface.

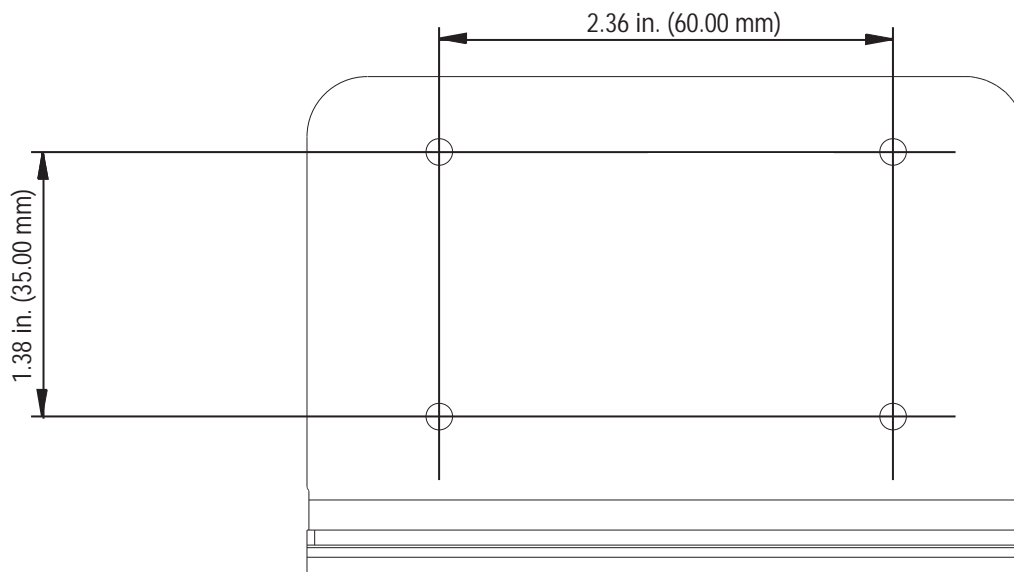

**Figure 1-13** *Wall Mount Template*

## Table Mount Template

The recommended method of installation is attaching the scanner to the table top using the double-sided tape provided on the bottom of the bracket. If you wish to mount the bracket to the table top with screws use the template provided in [Figure 1-14](#).

To use this template:

1. **Print the actual size of this page. Do not scale.**
2. Determine the location for installing the scanner.
3. Tape the template to the table.
4. Drill the three holes using the template.
5. Place the mounting bracket in position over the drilled holes with the Symbol logo facing up.
6. Insert three screws (not provided) through the holes and fasten to the table surface.

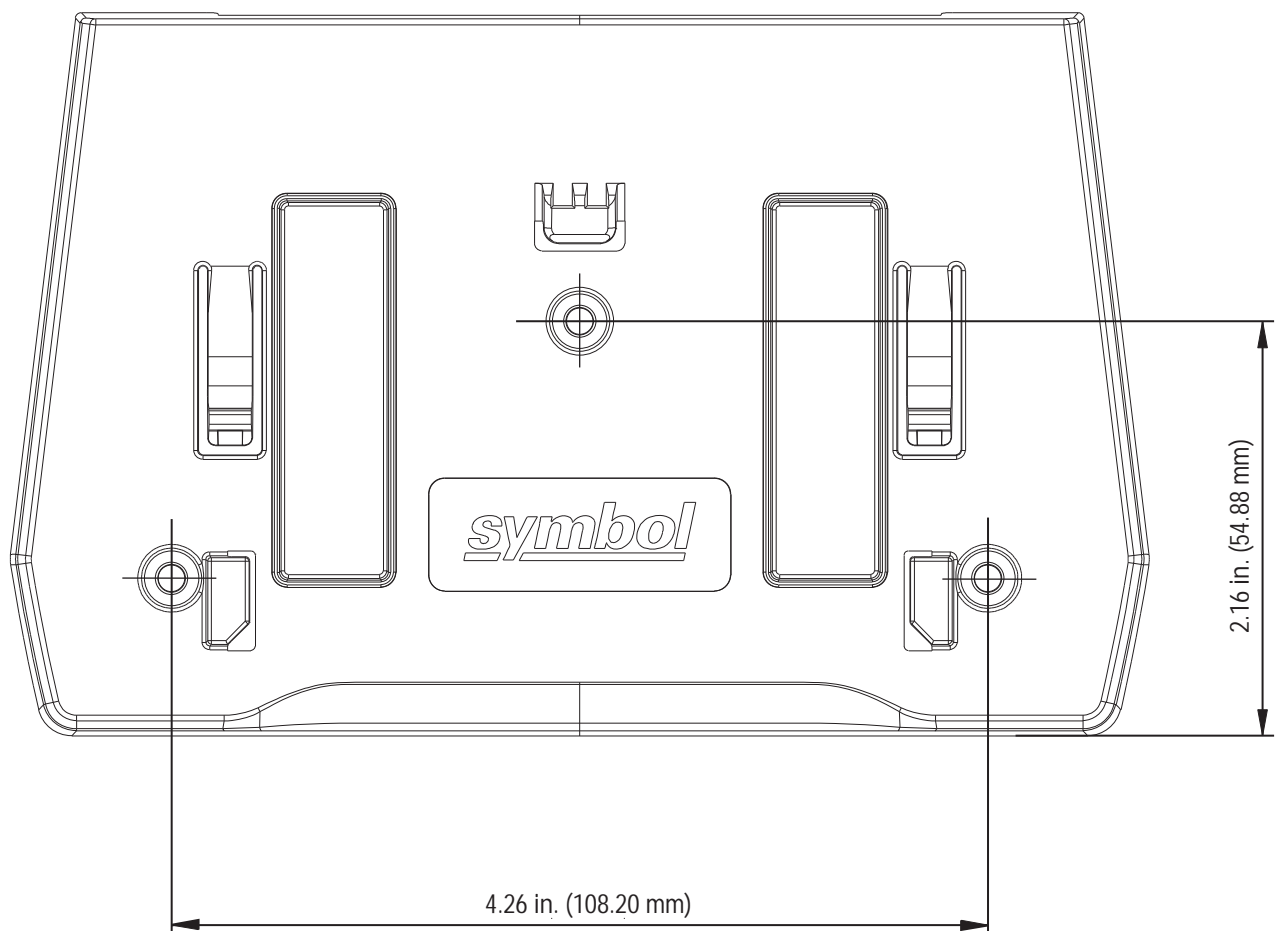

**Figure 1-14** Table Mount Template





# CHAPTER 2 DATA CAPTURE

---

## Overview

This chapter covers the techniques involved in scanning bar codes, beeper and LED definitions, and general instructions and tips about scanning. See [Chapter 1, GETTING STARTED](#) for information on scanner components. See each host chapter for information about connecting host cables and power supplies, when necessary.

## Scanning Bar Codes on Products

Install and program the scanner.

For the best scanning performance, the table top or surface area covered by the active scan area should be free of any designs (for example, stripes or patterns). Ideally, that area should be a light, solid color.

The DS7708 includes an automatic Object Detection wakeup system that provides a high swipe speed and reduces power consumption. The red illumination has two power levels mode: *Idle Mode* for object detection and *Full Illumination* for scanning. When any object is presented in front of the window opening, the red illumination changes from *Idle Mode* to *Full Mode*, but automatically returns to *Idle Mode* when the object is removed. When the object presented in the Field of View (FOV) includes a bar code, the DS7708 scans the bar code, and if the bar code is successfully decoded, the illumination LEDs automatically return to *Idle Mode* when the object is removed.

The DS7708 is able to adjust the FOV by a reading a command bar code and prevent decoding undesired bar codes that are in the FOV.

### Active Scan Area

The active scan area is the area in front of the scanner window opening in which a bar code can be decoded. The dotted area represents the active scan area.

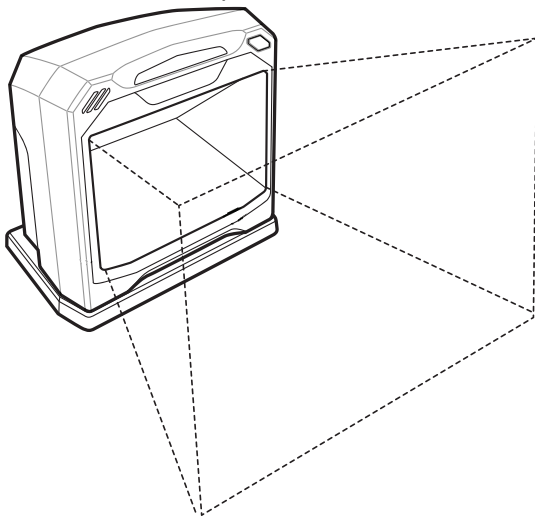

To scan a bar code:

1. Ensure all cable connections are secure.
2. Orient the item with the bar code facing the scanner window.
3. Present the item anywhere within the active scan area.
4. Upon successful decode, the scanner beeps and the green LED flashes momentarily.

**Figure 2-1** Active Scan Area

---

## Decode Ranges

*Table 2-1* includes the paper bar code decode ranges for the scanner.

**Table 2-1** *Decode Ranges*

<b>Symbol Specifications</b>	<b>Typical Ranges (Inches)</b>
Code 39, 5mil	0 - 7.20
UPCA, 10.0mil (80%)	0 - 10.0
UPCA, 13.0mil (100%)	0 - 10.3
PDF417, 4mil	0 - 2.20
PDF417, 5mil	0 - 3.50
PDF417, 6.6mil	0 - 5.20
PDF417, 10 mil	0 - 7.30
PDF417, 15 mil	0 - 9.90
Data Matrix, 10mil	0 - 5.00
Data Matrix, 20mil	0 - 9.50
QR cell phone 23mil	0 - 7.0

## User Indicators

[Table 2-2](#) lists beeper and LED indicators.

### Beeper Volume/ Beeper Tone

If the decode tone is set to **Off**, the **Volume/Tone** button cannot be used to change the decode tone. To allow the tone change using the **Volume/Tone** button, scan a tone other than **Off**.

See [Adjusting Speaker Volume on page 1-11](#) and [Adjusting Speaker Tone on page 1-11](#) to change the volume and/or tone of the beep.

### LED and Beeper Indicators

The scanner includes an array of three bi-color (green/red) LEDs to display system status and alerts.

Center LED conditions: Off, Full; Outer LED conditions: Off, Full.

**Table 2-2** *Beeper and LED Indicators*

Event	Beeper Sequence	LED	Description
<b>Standard Use</b>			
Bootup	Low, medium, high beeps	Green	Power up.
Decode	(as configured)	Center green full on, followed by outer LEDs green full on	A bar code symbol was decoded.
Presentation Mode	None	Center green LED remains ON	Presentation Mode is on.
Transmit Error	4 low beeps	Red	Transmission error
Convert Error	5 low beeps	Red	Conversion or Format error
Parity Error	Low, low, low, extra low beeps	Red	RS-232 Receive error
BELL (RS-232)	High beep	None	A <BEL> character is received over RS-232
<b>Image Capture</b>			
Snapshot Start	Low beep	All green, blinking	Snapshot mode started.
Snapshot Complete	Low beep	Green (default) LED mode based upon Hands-free mode state	Snapshot mode completed.
Snapshot Timeout	High, low beeps	Green (default) LED mode based upon Hand-held/Hands-free mode state	Snapshot mode timed-out.

**Unless otherwise specified, both red and green LEDs display across all three LED indicators (center and outer).**

**Table 2-2** *Beeper and LED Indicators (Continued)*

Event	Beeper Sequence	LED	Description
<b>Parameter Programming</b>			
Entry Error	Low, high beeps	Red	Input error: incorrect bar code, programming sequence, or <b>Cancel</b> scanned.
Number Expected	High, low beeps	Green	Number expected. Enter value using numeric bar codes.
Parameter Entered	High, low, high, low beeps	Green	Successful program exit with change in parameter setting.
<b>ADF Programming</b>			
(Refer to the <i>Advanced Data Formatting Programmer Guide</i> , p/n 72E-69680-xx. for ADF bar codes.)			
Number Expected	High, low beeps	Green	Enter another digit. Add leading zeros to the front if necessary.
Alpha Expected	Low, low beeps	Green	Enter another alphabetic character or scan the <b>End of Message</b> bar code.
Criteria Action Expected	High, high beeps	Green blinking	ADF criteria or action is expected. Enter another criterion or action, or scan the <b>Save Rule</b> bar code.
Rule Saved	High, low, high, low beeps	Green (turns off blinking)	Rule saved. Rule entry mode exited.
Criteria Action Cleared	High, low, low beeps	Green	All criteria or actions cleared for current rule. Continue entering rule.
Last Rule Deleted	Low beep	Green	Delete last saved rule. The current rule is left in tact.
All Rules Deleted	Low, high, high beeps	Green	All rules are deleted.
Out Of Rule Memory	Low, high, low, high beeps	Red	Out of rule memory. Erase some existing rules, then try to save rule again.
Cancel Rule Entry	Low, high, low beeps	Green (turns off blinking)	Cancel rule entry. Rule entry mode exited because of an error, or the user asked to exit rule entry.
Rule Error	Low, high beeps	Red	Entry error, wrong bar code scanned, or criteria/action list is too long for a rule. Re-enter criterion or action.

**Macro PDF**

**Unless otherwise specified, both red and green LEDs display across all three LED indicators (center and outer).**

**Table 2-2** *Beeper and LED Indicators (Continued)*

<b>Event</b>	<b>Beeper Sequence</b>	<b>LED</b>	<b>Description</b>
Macro PDF Buffered	2 Low beeps	None	File ID error. A bar code not in the current Macro PDF sequence was scanned.
Macro PDF File ID Error	2 Long low beeps	None	File ID error. A bar code not in the current Macro PDF sequence was scanned.
Macro PDF Out Of Memory	3 Long low beeps	None	Out of memory. There is not enough buffer space to store the current Macro PDF symbol.
Macro PDF Bad Symbology	4 Long low beeps	None	Bad symbology. Scanned a 1D or 2D bar code in a Macro PDF sequence, a duplicate Macro PDF label, a label in an incorrect order, or trying to transmit an empty or illegal Macro PDF field.
Macro PDF Flush Buffer	5 Long low beeps	None	Flushing Macro PDF buffer.
Macro PDF Abort	Fast warble beep	None	Aborting Macro PDF sequence.
Macro PDF Flush No Data	Low, high beeps	None	Flushing an already empty Macro PDF buffer.

**Unless otherwise specified, both red and green LEDs display across all three LED indicators (center and outer).**

---

## Electronic Article Surveillance (EAS)

The scanner includes an integrated Electronic Article Surveillance (EAS) antenna. The scanner and EAS system can operate independently of each other. The deactivation range is mapped suitable to the scanning range, so both can be accomplished almost simultaneously.

A pair of EAS leads in the back of the DS7708 allow the EAS deactivation antenna to be connected to the Checkpoint EAS system at the other end.

### Installing

#### Checkpoint EAS Model Compatibility

The DS7708 is intended for use with Checkpoint CP-VII, CP-IX, and CP-XI systems. It does not support CP-IV and other low-power receiver-based EAS deactivation systems.

#### Considerations

The Checkpoint CP-VII system generates a periodic burst of electromagnetic energy that deactivates EAS tags brought near the scanner. To avoid interference with the scanner's operation, take the following precautions when installing the EAS system:

- Position the EAS antenna box as far as possible from the scanner (at least 6 in. / 15.24 cm.)
- Position the EAS antenna, EAS antenna box, EAS control cable, and EAS controller box as far as possible from the scanner's host and power cables.

#### Checkpoint Contact Information

Contact your local Checkpoint representative to install the EAS cable to the Checkpoint Deactivation System.





# CHAPTER 3 MAINTENANCE, TECHNICAL SPECIFICATIONS, MOUNTING TEMPLATES

---

## Introduction

This chapter covers suggested scanner maintenance, troubleshooting, technical specifications, and signal descriptions (pinouts).

---

## Maintenance

Cleaning the exit window is the only maintenance required. A dirty window can affect scanning accuracy.

- Do not allow abrasive material to touch the window.
- Remove dirt particles with a damp cloth.
- Wipe the window using a tissue moistened with ammonia/water.
- Do not spray water or other cleaning liquids directly into the window.

## Troubleshooting

- ✓ **NOTE** If after performing the checks in [Table 3-1](#) the problem persists, contact the distributor or call the Zebra Support Center. See [Service Information](#) on [page x](#) for more information.

**Table 3-1** *Troubleshooting*

Problem	Possible Causes	Possible Solutions
The red LED illumination does not come on when the directions for installing the host cable are followed.	No power to the scanner.	Ensure the host has power, and is on. If the scanner uses a separate power supply, ensure it is connected to a working AC outlet. Power-up sequence is incorrect. Refer to the <i>Product Reference Guide</i> for more information.
	Interface cable is not properly connected.	Check for loose cable connections.
The red LED illumination gets brighter when the bar code is presented in the field of view, but bar code cannot be read.	Scanner is not programmed to read the bar code type.	Ensure scanner is programmed to read the bar code type scanned.
	Bar code is damaged.	Try scanning other bar codes of the same bar code type.
	Bar code is not within the scanner's decode range.	Move the bar code to the region within the scanner's decode range.
	The host has disabled scanning or overridden parameter settings.	See the technical person in charge of scanning.
The red LED illumination turns on dim and does not get brighter (the scanner does not change to active decoding mode) when a bar code is presented in the field of view.	Bar code is not within the scanner's detection range.	Move the bar code to the region within the scanner's detection range.

**Table 3-1** *Troubleshooting (Continued)*

<b>Problem</b>	<b>Possible Causes</b>	<b>Possible Solutions</b>
Bar code is decoded, but not transmitted to the host.	Scanner is not programmed for the correct host type.	Scan the appropriate host type bar code.
Scanned data is incorrectly displayed on the host.	Scanner is not programmed to work with the host. Check scanner host type parameters or editing options.	<p>Ensure proper host is selected.</p> <p>For RS-232, ensure the scanner's communication parameters match the host's settings.</p> <p>For Keyboard Wedge, ensure scanner is programmed with the correct country code and that the CAPS LOCK key is off.</p> <p>Ensure editing options (for example., UPCE to UPCA Conversion) are properly programmed.</p>
USB host not functioning properly.	Scanner does not recognize host.	Remove and reinsert the USB cable and the external power supply, if applicable.

## Technical Specifications

**Table 3-2** *Technical Specifications*

Item	Description
<b>Physical Characteristics</b>	
Dimensions	Scanner only 5.63 in. H x 5.86 in. W x 3.81 in. D 14.3 cm H x 14.9 cm W x 9.7 cm D  Scanner with Table Mount Kit 6.06 in. H x 5.93 in. W x 3.85 in. D 15.4 cm H x 15.1 cm W x 9.8 cm D
Weight	17.6 oz. / 500 g
Voltage and Current	Without auxiliary scanner Standby: 5 VDC +/-10% @ 125ma average Operating: 5 VDC +/-10% @ 480ma average  With auxiliary scanner Standby: 12 VDC +/-10% @ 100ma average Operating: 12 VDC +/-10% @ 400ma average
Color	Midnight Black
Host Interfaces	USB, RS-232, Keyboard Wedge, TGCS (IBM) 46XX over RS485
Keyboard Support	Over 90 international keyboards
Auxiliary Scanner Interface	USB
Electronic Article Surveillance	Compatible with Checkpoint EAS deactivation systems
User Feedback	Speaker (Adjustable Tone & Volume), Good Decode LEDs
<b>Performance Characteristics</b>	
Swipe Speed	Up to 100 in/sec (254 cm/sec) for 13 mil UPC in out-of box mode
Light Source	Two deep red LEDs (660nm)
Imager Field of View	48.0°x 36.7° (bar-code reading), 48.0°x 33.7° (image capture)
Image Sensor	Global shutter 1280x 960 (bar-code reading), 1280x 880 (image capture)
Minimum Print Contrast	25% minimum reflective difference
Roll / Pitch / Yaw (Skew)	360°, ±70°, ±70° typical with Code 39 20mil bar code at 3 inches
<b>Imaging Characteristics</b>	
Graphics Format Support	Images can be exported as Bitmap, JPEG or TIFF

**Table 3-2** *Technical Specifications (Continued)*

Item	Description
Image Transfer Speed	USB 2.0: Up to 12 Megabits/second RS-232: Up to 115 kb/second
Image Transfer Time	Typical USB application is ~0.25 seconds with a compressed JPEG of 100kb
Image Quality	210 PPI (Minimum Font Size resolution: 7) on a 4 x 6 in. (10.2 x 15.2 cm) document @ 3.0 in. (7.62 cm)
<b>User Environment</b>	
Operating Temperature	32° to 104° F / 0° to 40° C
Storage Temperature	-40° to 158° F / -40° to 70° C
Humidity	5% to 85% RH, non-condensing
Environmental Sealing:	IP52
Electrostatic Discharge (ESD)	ESD per EN61000-4-2, +/- 25 KV Air Direct, +/- 8 KV Indirect (without auxiliary scanner)
Ambient Light Range	From darkness (0 fcd) to 450 fcd artificial light and 10000 fcd direct sunlight
<b>Utilities and Management</b>	
123Scan2, Scanner Management Services (SMS), Symbol Scanner SDK	
<b>Accessories</b>	
Hands-Free Options	Table Mount Bracket (Midnight Black) Wall Mount Bracket (Midnight Black)
Power Supplies	Power supplies are available for applications that do not supply power over the host cable or utilize an auxiliary scanner.
<b>Symbology Decode Capability</b>	
1D	UPC/EAN (UPCA/UPCE/UPCE1/EAN-8/EAN-13/JAN-8/JAN-13 plus supplementals, ISBN (Bookland), ISSN, Coupon Code), Code 39 (Standard, Full ASCII, Trioptic, Code 32 (Italian Pharmacode)), Code 128 (Standard, Full ASCII, UCC/EAN-128, ISBT-128 Concatenated), Code 93, Codabar/NW7, 2 of 5 (Interleaved 2 of 5, Discrete 2 of 5, IATA, Chinese 2 of 5, Matrix 2 of 5, Code 11), MSI Plessey, GS1 DataBar (Omnidirectional, Truncated, Stacked, Stacked Omnidirectional, Limited, Expanded, Expanded Stacked)

**Table 3-2** *Technical Specifications (Continued)*

Item	Description
2D	PDF417 (Standard, Macro), MicroPDF417 (Standard, Macro), Composite Codes (CC-A, CC-B, CC-C), TLC-39, Aztec (Standard, Inverse), MaxiCode, DataMatrix/ECC 200 (Standard, Inverse, GS1), QR Code (Standard, Inverse, Micro, GS1), Chinese Sensible (Han Xin)
Postal	U.S. Postnet and Planet, U.K. Post, Japan Post, Australian Post, Netherlands KIX Code, Royal Mail 4 State Customer, UPU FICS 4 State Postal, USPS 4CB
Minimum Element Resolution	Code 39 – 3 mil UPC – 7.8 mil (60%), there is no higher density UPC bar code PDF417 – 4 mil Datamatrix – 7.5 mil QR Code – 7.5 mil

## Scanner Signal Descriptions

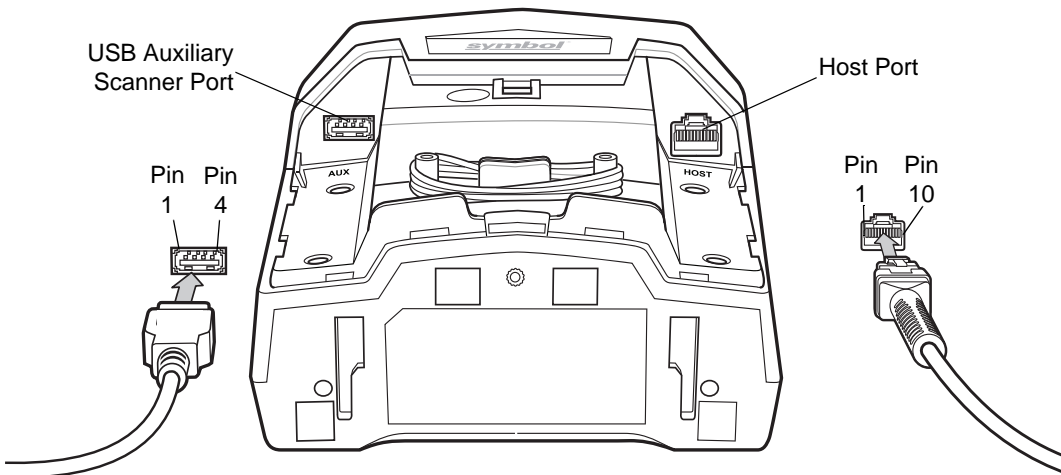

**Figure 3-1** Cable Pinouts

The signal descriptions in [Table 3-3](#) apply to the connectors on the scanner and are for reference only.

**Table 3-3** Scanner/Host Signal Pin-outs

Pin	IBM	RS-232	Keyboard Wedge	USB	Download
1	Reserved	Reserved	Reserved	Jump to Pin 6	Reserved
2	+5v	+5v	+5v	+5v	+5v
3	Ground	Ground	Ground	Ground	Ground
4	IBM_A(+)	TxD	KeyClock	Reserved	TxD
5	Reserved	RxD	TermData	D +	Reserved
6	IBM_B(-)	RTS	KeyData	Jump to Pin 1	RxD
7	Reserved	CTS	TermClock	D -	Reserved
8	Reserved	Reserved	Reserved	Reserved	Reserved
9	Passive Detect	Passive Detect	Passive Detect	Passive Detect	Reserved
10	+12v	+12v	+12v	+12v	Reserved

**Table 3-4** USB Auxiliary Scanner Port Pinouts

Pin 1	Pin 2	Pin 3	Pin 4
VCC	D-	D+	GND





# CHAPTER 4 USER PREFERENCES & MISCELLANEOUS OPTIONS

## Introduction

You can program the scanner to perform various functions, or activate different features. This chapter describes each user preference feature and provides programming bar codes for selecting these features.

The scanner ships with the settings shown in [Table 4-1 on page 4-2](#) (also see [Appendix A, STANDARD DEFAULT PARAMETERS](#) for all host device and miscellaneous defaults). If the default values suit requirements, programming is not necessary.

To set feature values, scan a single bar code or a short bar code sequence. The settings are stored in non-volatile memory and are preserved even when the scanner is powered down.

If not using a USB cable, select a host type (see each host chapter for specific host information) after the power-up beeps sound. This is only necessary upon the first power-up when connected to a new host.

To return all features to default values, scan the [Set Default Parameter on page 4-4](#). Throughout the programming bar code menus, asterisks indicate (\*) default values.



\* Indicates Default — \*High Volume — Feature/Option  
(00h) — Option Hex Value

## Scanning Sequence Examples

In most cases, scanning one bar code sets the parameter value. For example, to set the beeper tone to high, scan the **High Tone** (beeper tone) bar code in the *Beeper Tone* section on [page 4-8](#). Other parameters, such as **Serial Response Timeout** or **Data Transmission Formats**, require scanning several bar codes. See these parameter descriptions for this procedure.

## Errors While Scanning

Unless otherwise specified, to correct an error during a scanning sequence, just re-scan the correct parameter.

## User Preferences/Miscellaneous Options Parameter Defaults

[Table 4-1](#) lists defaults for user preferences parameters. To change the default values, scan the appropriate bar codes in this guide. These new values replace the standard default values in memory. To recall the default parameter values, scan the [Set Default Parameter on page 4-4](#).

✓ **NOTE** See [Appendix A, STANDARD DEFAULT PARAMETERS](#) for all user preferences, hosts, symbologies, and miscellaneous default parameters.

**Table 4-1** User Preferences Parameter Defaults

Parameter	SSI Number <sup>1</sup>	Parameter Number <sup>2</sup>	Default	Page Number
<b>User Preferences</b>				
Set Default Parameter	N/A	N/A	Set Defaults	<a href="#">4-4</a>
Parameter Bar Code Scanning	ECh	236	Enable	<a href="#">4-6</a>
Beep After Good Decode	38h	56	Enable	<a href="#">4-7</a>
Beeper Tone	91h	145	High	<a href="#">4-8</a>
Beeper Volume	8Ch	140	High	<a href="#">4-11</a>
Beeper Duration	F1h 74h	628	Medium	<a href="#">4-13</a>
Volume/Tone Button Control	F8h 05h 07h	1287	Enable (both)	<a href="#">4-15</a>
Suppress Power-up Beeps	F1h D1h	721	Do not suppress	<a href="#">4-17</a>
Timeout Between Decodes, Same Symbol	89h	137	0.5 Sec	<a href="#">4-18</a>
Timeout Between Decodes, Different Symbols	90h	144	0 Sec	<a href="#">4-18</a>
Fuzzy 1D Processing	F1h 02h	514	Enable	<a href="#">4-19</a>
Decode Mirror Images (Data Matrix Only)	F1h 19h	537	Auto	<a href="#">4-20</a>
PDF Prioritization	F1h CFh	719	Disable	<a href="#">4-22</a>

<sup>1</sup> SSI number hex values are used for programming via SSI commands.

<sup>2</sup> Parameter number decimal values are used for programming via RSM commands.

**Table 4-1** *User Preferences Parameter Defaults (Continued)*

Parameter	SSI Number <sup>1</sup>	Parameter Number <sup>2</sup>	Default	Page Number
PDF Prioritization Timeout	F1h D0h	720	200 ms	<a href="#">4-23</a>
Mobile Phone/Display Mode	F1h CCh	716	Enable	<a href="#">4-24</a>
Field of View	F1h 61h	609	Full Field of View	<a href="#">4-25</a>
<b>Miscellaneous Options</b>				
Transmit Code ID Character	2Dh	45	None	<a href="#">4-27</a>
Prefix Value	63h, 69h	99, 105	7013 <CR><LF>	<a href="#">4-29</a>
Suffix 1 Value	62h, 68h	98, 104	7013 <CR><LF>	<a href="#">4-29</a>
Suffix 2 Value	64h, 6Ah	100, 106		
Scan Data Transmission Format	EBh	235	Data as is	<a href="#">4-32</a>
FN1 Substitution Values	67h, 6Dh	103, 109	7013 <CR> <LF>	<a href="#">4-36</a>
Unsolicited Heartbeat Interval	F8h 04h 5Eh	1118	Disable	<a href="#">4-37</a>

<sup>1</sup> SSI number hex values are used for programming via SSI commands.

<sup>2</sup> Parameter number decimal values are used for programming via RSM commands.

---

## User Preferences

### Set Default Parameter

You can reset the scanner to two types of defaults: factory defaults or custom defaults. Scan the appropriate bar code below to reset the scanner to its default settings and/or set its current settings as custom defaults.

Options:

- **\*Set Defaults:** Scan this bar code to reset all default parameters as follows.
  - If you previously set custom defaults by scanning **Write to Custom Defaults**, scan **Set Defaults** to retrieve and restore the scanner custom default settings.
  - If you did not set custom defaults, scan **Set Defaults** to restore the factory default values listed in [Table A-1](#).
- **Set Factory Defaults:** Scan this bar code to restore the factory default values listed in [Table A-1](#). This deletes any custom defaults set.
- **Write to Custom Defaults:** Scan this bar code to set the current scanner settings as custom defaults. Once set, you can recover custom default settings by scanning **Set Defaults**.



**\*Set Defaults**



**Set Factory Defaults**

**Set Default Parameter (continued)**



**Write to Custom Defaults**

## Parameter Bar Code Scanning

### SSI # ECh

#### Parameter # 236

To disable the decoding of parameter bar codes, including the **Set Defaults** parameter bar codes, scan the **Disable Parameter Scanning** bar code below. To enable decoding of parameter bar codes, scan **Enable Parameter Scanning**.

Options:

- \*Enable Parameter Bar Code Scanning
- Disable Parameter Bar Code Scanning.



**\*Enable Parameter Bar Code Scanning  
(01h)**



**Disable Parameter Bar Code Scanning  
(00h)**

## Beep After Good Decode

**SSI # 38h**

**Parameter # 56**

Scan a bar code below to select whether or not the scanner beeps after a good decode. If selecting **Do Not Beep After Good Decode**, the beeper still operates during parameter menu scanning and to indicate error conditions.

Options:

- \*Beep After Good Decode (Enable)
- Do Not Beep After Good Decode (Disable).



**\*Beep After Good Decode  
(Enable)  
(01h)**



**Do Not Beep After Good Decode  
(Disable)  
(00h)**



## Beeper Tone

### SSI # 91h

### Parameter # 145

To select a decode beep frequency (tone), scan one of the bar codes that follow.

If the decode tone is set to **Off**, the **Volume/Tone** button cannot be used to change the decode tone. To allow the tone change using the **Volume/Tone** button, scan a tone other than **Off**.

Options:

- Off
- Low Tone
- Medium Tone
- \*High Tone
- Medium to High Tone (2-tone).



**Off**  
**(03h)**

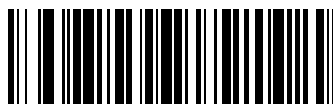

**Low Tone**  
**(02)**

## Beeper Tone (continued)



Medium Tone  
(01h)



\*High Tone  
(00h)

## **Beeper Tone (continued)**



**Medium to High Tone (2-tone)  
(04h)**

## Beeper Volume

**SSI # 8Ch**

**Parameter # 140**

To select a beeper volume, scan the one of the bar codes that follows.

Options:

- Low Volume
- Medium Volume
- \*High Volume



**Low Volume  
(02h)**



**Medium Volume  
(01h)**

## Beeper Volume (continued)



\*High Volume  
(00h)

## Beeper Duration

**SSI # F1h 74h**

**Parameter # 628**

To select the duration for the beeper, scan one of the following bar codes.

Options:

- Short
- \* Medium
- Long.

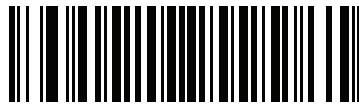

**Short  
(00h)**



**\* Medium  
(01h)**

**Beeper Duration (continued)**



**Long  
(02h)**

## Volume/Tone Button Control

**SSI # F8h 05h 07h**

**Parameter # 1287**

When this parameter is enabled the physical **Volume/Tone** button on the front panel of the scanner can be used to change the speaker volume and tone.

When this parameter is disabled the speaker volume and tone cannot be changed using the physical **Volume/Tone** button on the front panel of the scanner.

Options:

- \*Enable Volume and Tone Change
- Disable Tone Change and Enable Volume Change
- Enable Tone Change and Disable Volume Change
- Disable Volume and Tone Change

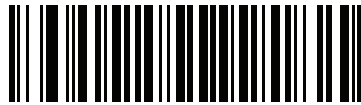

**\*Enable Volume and Tone Change  
(1)**



**Disable Volume and Tone Change  
(0)**



## Volume/Tone Button Control (continued)

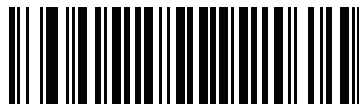

**Disable Tone Change and Enable Volume Change  
(2)**

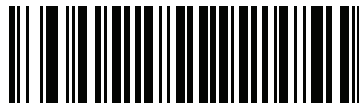

**Enable Tone Change and Disable Volume Change  
(3)**

## Suppress Power-up Beeps

**SSI # F1h D1h**

**Parameter # 721**

Select whether or not to suppress the scanner power-up beeps.

Options:

- \* Do Not Suppress Power-up Beeps
- Suppress Power-up Beeps.



**\* Do Not Suppress Power-up Beeps  
(00h)**



**Suppress Power-up Beeps  
(01h)**

## Timeout Between Decodes, Same Symbol

**SSI # 89h**

**Parameter # 137**

Use this option to prevent the beeper from continuously beeping when a symbol is left in the scanner's field of view. It is programmable in 0.1 second increments from 0.0 to 9.9 seconds. The default interval is 0.5 seconds.

To select the timeout between decodes for the same symbol, scan the bar code below, then scan two numeric bar codes from [Appendix G, NUMERIC BAR CODES](#) that correspond to the desired interval, in 0.1 second increments.



Timeout Between Decodes, Same Symbol

## Timeout Between Decodes, Different Symbols

**SSI # 90h**

**Parameter # 144**

Use this option in to control the time the scanner is inactive between decoding different symbols. It is programmable in 0.1 second increments from 0 to 9.9 seconds. The default is 0 seconds.

To select the timeout between decodes for different symbols, scan the bar code below, then scan two numeric bar codes from [Appendix G, NUMERIC BAR CODES](#) that correspond to the desired interval, in 0.1 second increments.



Timeout Between Decodes, Different Symbols

## Fuzzy 1D Processing

**SSI # F1h 02h**

**Parameter # 514**

This option is enabled by default to optimize decode performance on 1D bar codes, including damaged and poor quality symbols. Disable this only if you experience time delays when decoding 2D bar codes, or in detecting a no decode.

Options:

- \*Enable Fuzzy 1D Processing
- Disable Fuzzy 1D Processing.



**\*Enable Fuzzy 1D Processing  
(01h)**



**Disable Fuzzy 1D Processing  
(00h)**

## Decode Mirror Images (Data Matrix Only)

**SSI # F1h 19h**

**Parameter # 537**

Select an option for decoding mirror image Data Matrix bar codes:

- Always - decode only Data Matrix bar codes that are mirror images
- Never - do not decode Data Matrix bar codes that are mirror images
- Auto - decode both mirrored and unmirrored Data Matrix bar codes.



**Never**  
**(0)**



**Always**  
**(1)**

**Decode Mirror Images (Data Matrix Only - continued)**



\*Auto  
(2)

## PDF Prioritization

### SSI # F1h CFh

#### Parameter # 719

Enable this feature to delay decoding a 1D bar code (Code 128 of 8 to 25 characters length) by the value specified in *PDF Prioritization Timeout*. During that time the scanner attempts to decode a PDF417 symbol (e.g., on a US driver's license), and if successful reports this only. If it does not decode (can not find) a PDF417 symbol, it reports the 1D symbol after the timeout. The 1D symbol must be in the device's field of view for the scanner to report it. This parameter does not affect decoding other symbologies.

Options:

- \*Disable PDF Prioritization
- Enable PDF Prioritization.



\*Disable PDF Prioritization  
(00h)



Enable PDF Prioritization  
(01h)

## PDF Prioritization Timeout

**SSI # F1h D0h**

**Parameter # 720**

When *PDF Prioritization* is enabled, this timeout specifies how long the scanner attempts to decode a PDF417 symbol before reporting the 1D bar code in the field of view.

Scan the following bar code, then scan four digits from *Appendix G, NUMERIC BAR CODES* that specify the timeout in milliseconds. For example, to enter 400 ms, scan the following bar code, then scan 0400. The range is 0 to 5000 ms, and the default is 200 ms.

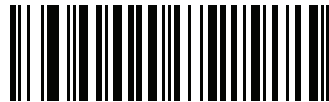

**PDF Prioritization Timeout**



## Mobile Phone/Display Mode

**SSI # F1h CCh**

**Parameter # 716**

When enabled, this mode allows bar code reading from mobile phones and electronic displays.

Options:

- Disable Mobile Phone/Display Mode
- \*Enable Mobile Phone/Display Mode.

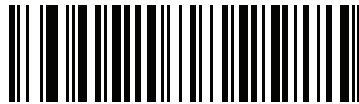

**Disable Mobile Phone/Display Mode  
(00h)**



**\*Enable Mobile Phone/Display Mode  
(02h)**

## Field of View

### SSI # F1h 61h

### Parameter # 609

By default, the scanner searches the full field of view.

To search for a bar code in a smaller region, in order to speed search time and prevent unintended bar code reads, select **Small Field of View** or **Medium Field of View**.

✓ **NOTE** When the scanner is set to **Small Field of View** or **Medium Field of View** and a bar code is only partially presented into the field of view, the scanner automatically opens to **Full Field of View** to scan the bar code. It then returns to the mode set.

Options:

- Small Field of View
- Medium Field of View
- \*Full Field of View.



**Small Field of View  
(00h)**



**Medium Field of View  
(01h)**

## Field of View (continued)



\*Full Field of View  
(02h)

---

## Miscellaneous Scanner Parameters

### Transmit Code ID Character

**SSI # 2Dh**

**Parameter # 45**

A Code ID character identifies the code type of a scanned bar code. This is useful when decoding more than one code type. In addition to any single character prefix already selected, the Code ID character is inserted between the prefix and the decoded symbol.

Select no Code ID character, a Symbol Code ID character, or an AIM Code ID character. For Code ID Characters, see [Symbol Code Identifiers on page E-1](#) and [AIM Code Identifiers on page E-3](#).

Options:

- Symbol Code ID Character
- AIM Code ID Character
- \*None.

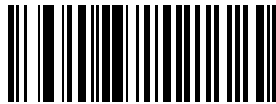

**Symbol Code ID Character  
(02h)**

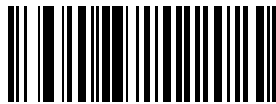

**AIM Code ID Character  
(01h)**

### Transmit Code ID Character (continued)

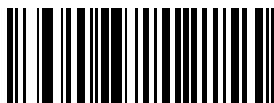

\*None  
(00h)

## Prefix/Suffix Values

**Key Category SSI # P = 63h, S1 = 62h, S2 = 64h**

**Decimal Value SSI # P = 69h, S1 = 68h, S2 = 6Ah**

**Key Category Parameter # P = 99, S1 = 98, S2 = 100**

**Decimal Value Parameter # P = 105, S1 = 104, S2 = 106**

You can append a prefix and/or one or two suffixes to scan data for use in data editing. To set a value for a prefix or suffix, scan a four-digit number (i.e., four bar codes from [Appendix G, NUMERIC BAR CODES](#)) that corresponds to that value. See [ASCII Character Set for USB on page 6-33](#) and [ASCII Character Set for RS-232 on page 7-37](#) for the four-digit codes.

When using host commands to set the prefix or suffix, set the key category parameter to 1, then set the 3-digit decimal value.

To correct an error or change a selection, scan [Cancel on page G-10](#).

✓ **NOTE** To use Prefix/Suffix values, first set the [Scan Data Transmission Format on page 4-32](#).

Options:

- Scan Prefix
- Scan Suffix 1
- Scan Suffix 2
- Data Format Cancel.



**Scan Prefix  
(07h)**

**Prefix/Suffix Values (continued)**

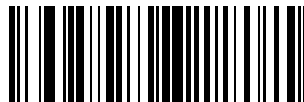

**Scan Suffix 1  
(06h)**

**Prefix/Suffix Values (continued)**



**Scan Suffix 2  
(08h)**



**Data Format Cancel**



## Scan Data Transmission Format

### SSI # EBh

#### Parameter # 235

To set the scan data format, scan one of the following bar codes.

✓ **NOTE** If using this parameter do not use ADF rules to set the prefix/suffix.

To set values for the prefix and/or suffix, see [Prefix/Suffix Values on page 4-29](#).

Options:

- \*Data As Is
- <DATA> <SUFFIX 1>
- <DATA> <SUFFIX 2>
- DATA> <SUFFIX 1> <SUFFIX 2>
- <PREFIX> <DATA >
- <PREFIX> <DATA> <SUFFIX 1>
- <PREFIX> <DATA> <SUFFIX 2>
- <PREFIX> <DATA> <SUFFIX 1> <SUFFIX 2>.



\*Data As Is  
(00h)



<DATA> <SUFFIX 1>  
(01h)

**Scan Data Transmission Format (continued)**

<DATA> <SUFFIX 2>  
(02h)



<DATA> <SUFFIX 1> <SUFFIX 2>  
(03h)

### Scan Data Transmission Format (continued)



<PREFIX> <DATA >  
(04h)



<PREFIX> <DATA> <SUFFIX 1>  
(05h)

**Scan Data Transmission Format (continued)**

<PREFIX> <DATA> <SUFFIX 2>  
(06h)



<PREFIX> <DATA> <SUFFIX 1> <SUFFIX 2>  
(07h)

## FN1 Substitution Values

**Key Category SSI # 67h**

**Decimal Value SSI # 6Dh**

**Key Category Parameter # 103**

**Decimal Value Parameter # 109**

The wedge and USB HID keyboard hosts support a FN1 Substitution feature. Enabling this substitutes any FN1 character (0x1b) in an EAN128 bar code with a value. This value defaults to 7013 (Enter key).

When using host commands to set the FN1 substitution value, set the key category parameter to 1, then set the 3-digit keystroke value. See the ASCII character set table for the current host interface for the desired value.

To select a FN1 substitution value via bar code menus:

1. Scan the **Set FN1 Substitution Value** bar code below.
2. Locate the keystroke desired for FN1 substitution in the ASCII character set table in the appropriate host interface chapter. Enter the 4-digit ASCII value by scanning each digit in [Appendix G, NUMERIC BAR CODES](#).

To correct an error or change the selection, scan [Cancel on page G-10](#).

See [USB Keyboard FN1 Substitution on page 6-17](#) to enable FN1 substitution for the USB HID keyboard.

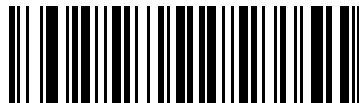

**Set FN1 Substitution Value**

## Unsolicited Heartbeat Interval

**SSI # F8h 04h 5Eh**

**Parameter # 1118**

The scanner supports sending *Unsolicited Heartbeat Messages* to assist in diagnostics. To enable this feature and set the desired unsolicited heartbeat interval, scan one of the time interval bar codes below, or scan **Set Another Interval** followed by four numeric bar codes from [Appendix G, NUMERIC BAR CODES](#) (scan sequential numbers that correspond to the desired number of seconds).

Options:

- 10 seconds
- 1 minute
- Set Another Interval
- \*Disable Unsolicited Heartbeat Interval.

Scan **Disable Unsolicited Heartbeat Interval** to turn off the feature.

The heartbeat event is sent as decode data (with no decode beep) in the form of:

MOTEVTHB:nnn

where nnn is a three digit sequence number starting at 001 and wrapping after 100.



**10 seconds**



**1 minute**

### Unsolicited Heartbeat Interval (continued)



**Set Another Interval**



**\*Disable Unsolicited Heartbeat Interval**

# CHAPTER 5 IMAGING PREFERENCES

---

## Introduction

You can program the scanner to perform various functions, or activate different features. This chapter describes each user preference feature and provides programming bar codes for selecting these features.

The scanner ships with the settings shown in [Table 5-1 on page 5-2](#) (also see [Appendix A, STANDARD DEFAULT PARAMETERS](#) for all host device and miscellaneous defaults). If the default values suit requirements, programming is not necessary.

To set feature values, scan a single bar code or a short bar code sequence. The settings are stored in non-volatile memory and are preserved even when the scanner is powered down.

If not using a USB cable, select a host type (see each host chapter for specific host information) after the power-up beeps sound. This is only necessary upon the first power-up when connected to a new host.

To return all features to default values, scan the [\\*Set Defaults on page 4-4](#). Throughout the programming bar code menus, asterisks indicate (\*) default values.





## Scanning Sequence Examples

In most cases scanning one bar code sets the parameter value. For example, to enable signature capture, scan the **Enable Signature Capture** bar code under [Signature Capture on page 5-20](#). The scanner issues a fast warble beep and the LED turns green, signifying a successful parameter entry.

Other parameters require scanning several bar codes. See these parameter descriptions for this procedure.

## Errors While Scanning

Unless otherwise specified, to correct an error during a scanning sequence, just re-scan the correct parameter.

## Imaging Preferences Parameter Defaults

[Table 5-1](#) lists the defaults for imaging preferences parameters. To change the default values, scan the appropriate bar codes in this guide. These new values replace the standard default values in memory. To recall the default parameter values, scan the [Set Default Parameter on page 4-4](#).

✓ **NOTE** See [Appendix A, STANDARD DEFAULT PARAMETERS](#) for all user preferences, hosts, symbologies, and miscellaneous default parameters.

**Table 5-1** *Imaging Preferences Parameter Defaults*

Parameter	SSI Number <sup>1</sup>	Parameter Number <sup>2</sup>	Default	Page Number
<b>Imaging Preferences</b>				
Operational Modes	N/A	N/A	N/A	<a href="#">5-4</a>
Snapshot Mode Timeout	F0h 43h	323	0 (30 seconds)	<a href="#">5-5</a>
Image Size (Number of Pixels)	F0h 2Eh	302	Full	<a href="#">5-6</a>
Image Brightness (Target White)	F0h 86h	390	180	<a href="#">5-8</a>
JPEG Image Options	F0h 2Bh	299	Quality	<a href="#">5-9</a>
JPEG Target File Size	F1h 31h	561	160 kB	<a href="#">5-10</a>
JPEG Quality and Size Value	F0h 31h	305	65	<a href="#">5-11</a>
Image Enhancement	F1h 34h	564	Low (1)	<a href="#">5-12</a>
Image File Format Selection	F0h 30h	304	JPEG	<a href="#">5-14</a>
Image Rotation	F1h 99h	665	0	<a href="#">5-16</a>
Bits per Pixel (BPP)	F0h 2Fh	303	8 BPP	<a href="#">5-18</a>
Signature Capture	5Dh	93	Disable	<a href="#">5-20</a>

<sup>1</sup> SSI number hex values are used for programming via SSI commands.

<sup>2</sup> Parameter number decimal values are used for programming via RSM commands.

**Table 5-1** *Imaging Preferences Parameter Defaults (Continued)*

Parameter	SSI Number <sup>1</sup>	Parameter Number <sup>2</sup>	Default	Page Number
Signature Capture Image File Format Selection	F0h 39h	313	JPEG	<a href="#">5-21</a>
Signature Capture Bits per Pixel (BPP)	F0h 3Ah	314	8 BPP	<a href="#">5-23</a>
Signature Capture Width	F4h F0h 6Eh	366	400	<a href="#">5-25</a>
Signature Capture Height	F4h F0h 6Fh	367	100	<a href="#">5-26</a>
Signature Capture JPEG Quality	F0h A5h	421	65	<a href="#">5-27</a>
Video View Finder	F0h 44h	324	Disable	<a href="#">5-28</a>
Video View Finder Image Size	F0h 49h	329	1700 bytes	<a href="#">5-29</a>

<sup>1</sup> SSI number hex values are used for programming via SSI commands.

<sup>2</sup> Parameter number decimal values are used for programming via RSM commands.

---

## Imaging Preferences

The parameters in this chapter control image capture characteristics. Image capture occurs in all modes of operation, including decode and snapshot.

### Operational Modes

The scanner has two modes of operation:

- Decode Mode
- Snapshot Mode.

#### Decode Mode

In decode mode, the scanner attempts to locate and decode enabled bar codes within its field of view. The scanner remains in this mode until it decodes a bar code.

#### Snapshot Mode

Use Snapshot Mode to capture a high-quality image and transmit it to the host. To temporarily enter this mode scan the **Snapshot Mode** bar code. While in this mode the scanner blinks the green LED at 1-second intervals to indicate it is not in standard operating (decode) mode.

In Snapshot Mode, the scanner turns on its red LED illumination to highlight the area to capture in the image. The next soft trigger command instructs the scanner to capture a high quality image and transmit it to the host. A short time may pass (less than 2 seconds) between when the soft trigger command is sent and the image is captured as the scanner adjusts to the lighting conditions. Hold the scanner steady until the image is captured, denoted by a single beep.

If you do not send a soft trigger command within the Snapshot Mode Timeout period, the scanner returns to Decode Mode. Use [Snapshot Mode Timeout on page 5-5](#) to adjust this timeout period. The default timeout period is 30 seconds.



**Snapshot Mode**

## Snapshot Mode Timeout

**SSI # F0h, 43h**

**Parameter # 323**

This parameter sets the amount of time the scanner remains in Snapshot Mode. The scanner exits Snapshot Mode when you send a soft trigger command, or when the Snapshot Mode Timeout elapses. To set this timeout value, scan the bar code below followed by a bar code from [Appendix G, NUMERIC BAR CODES](#). The default value is 0 which represents 30 seconds; values increment by 30. For example, 1 = 60 seconds, 2 = 90 seconds, etc.



**Snapshot Mode Timeout**

## Image Size (Number of Pixels)

**SSI # F0h, 2Eh**

**Parameter # 302**

This option alters image resolution before compression. Multiple pixels are combined to one pixel, resulting in a smaller image containing the original content with reduced resolution.

Select one of the following values:

Resolution Value	Image Size
Full	1280 x 880
1/2	640 x 440
1/4	320 x 220



\*Full Resolution  
(00h)



1/2 Resolution  
(01h)

**Image Size (Number of Pixels - continued)**

## Image Brightness (Target White)

SSI # F0h 86h

Parameter # 390

Type: Byte

Range: 1 - 240

Options:

- \*180
- Image Brightness.

This parameter sets the Target White value used in Snapshot and Video Viewfinder mode when using auto exposure. White and black are defined as 240 decimal and 1, respectively. Setting the value to the factory default of 180 sets the white level of the image to ~180.

To set the Image Brightness parameter, scan **Image Brightness** below followed by three numeric bar codes representing the value. Leading zeros are required. For example, to set an Image Brightness value of 99, scan 0, 9, 9. See [Appendix G, NUMERIC BAR CODES](#) for numeric bar codes.



\*180



Image Brightness  
(3 digits)

## JPEG Image Options

**SSI # F0h, 2Bh**

**Parameter # 299**

Select an option to optimize JPEG images for either size or for quality. Scan the **JPEG Quality Selector** bar code to enter a quality value; the scanner then selects the corresponding image size. Scan the **JPEG Size Selector** bar code to enter a size value; the scanner then selects the best image quality.

Options:

- \*JPEG Quality Selector
- JPEG Size Selector.



**\*JPEG Quality Selector  
(01h)**



**JPEG Size Selector  
(00h)**



## JPEG Target File Size

**SSI # F1h, 31h**

**Parameter # 561**

**Type: Word**

**Range: 5-350**

This parameter defines the target JPEG file size in terms 1 Kilobytes (1024 bytes). The default value is 160 kB which represents 160 Kilobytes.



**CAUTION** JPEG compress may take 10 to 15 seconds based on the amount of information in the target image. Scanning **JPEG Quality Selector** (default setting) on [page 5-9](#) produces a compressed image that is consistent in quality and compression time.

To set the JPEG Target File Size parameter, scan **JPEG Target File Size** below followed by three numeric bar codes representing the value. Leading zeros are required. For example, to set an image file size value of 99, scan 0, 9, 9 in [Appendix G, NUMERIC BAR CODES](#).



**JPEG Target File Size**  
**(3 digits)**

## JPEG Quality and Size Value

**SSI # F0h, 31h**

**Parameter # 305**

If you selected **JPEG Quality Selector**, scan the **JPEG Quality Value** bar code followed by 3 bar codes from [Appendix G, NUMERIC BAR CODES](#) corresponding to a value from 5 to 100, where 100 represents the highest quality image.



**JPEG Quality Value**  
(Default: 065)  
(5 - 100 Decimal)

## Image Enhancement

**SSI # F1h, 34h**

**Parameter # 564**

This parameter configures the scanner's Image Enhance feature. This feature uses a combination of edge sharpening and contrast enhancement to produce an image that is visually pleasing.

The levels of image enhancement are:

- Off (0)
- \*Low (1)
- Med (2)
- High (3).



Off  
(0)



\*Low  
(1)

**Image Enhancement (continued)**



**Medium  
(2)**



**High  
(3)**

## Image File Format Selection

**SSI # F0h, 30h**

**Parameter # 304**

Select an image format appropriate for the system (BMP, TIFF, or JPEG). The scanner stores captured images in the selected format.

Options:

- BMP File Format
- \*JPEG File Format
- TIFF File Format.



**BMP File Format  
(03h)**



**\*JPEG File Format  
(01h)**

## Image File Format Selection (continued)



TIFF File Format  
(04h)

## Image Rotation

**SSI # F1h 99h**

**Parameter # 665**

This parameter controls the rotation of the image.

Rotation Options:

- \*0 degrees
- 90 degrees
- 180 degrees
- 270 degrees.



**\*Rotate 0°  
(00h)**



**Rotate 90°  
(01h)**

**Image Rotation (continued)**

Rotate 180°  
(02h)



Rotate 270°  
(03h)



## Bits Per Pixel (BPP)

SSI # F0h, 2Fh

Parameter # 303

Select the number of significant bits per pixel (BPP) to use when capturing an image. Select **1 BPP** for a black and white image, **4 BPP** to assign 1 of 16 levels of grey to each pixel, or **8 BPP** to assign 1 of 256 levels of grey to each pixel.



**NOTE** The scanner ignores these settings for JPEG file formats, which only support **8 BPP**.

The scanner ignores 1 BPP for TIFF file formats, which only support **4 BPP** and **8 BPP**. 1 BPP is coerced to 4 BPP for TIFF file formats.

Options:

- 1 BPP
- 4 BPP
- \*8 BPP.



1 BPP  
(00h)



4 BPP  
(01h)

**Bits Per Pixel (continued)**

\*8 BPP  
(02h)

## Signature Capture

### SSI # 5Dh

#### Parameter # 93

A signature capture bar code is a special-purpose symbology which delineates a signature capture area in a document with a machine-readable format. The recognition pattern is variable so it can optionally provide an index to various signatures. The region inside the bar code pattern is considered the signature capture area. See [Appendix H, SIGNATURE CAPTURE CODE](#) for more information.

#### Output File Format

Decoding a signature capture bar code de-skews the signature image and converts the image to a BMP, JPEG, or TIFF file format. The output data includes the file descriptor followed by the formatted signature image.

File Descriptor			Signature Image
Output Format (1 byte)	Signature Type (1 byte)	Signature Image Size (4 bytes) (BIG Endian)	
JPEG - 1 BMP - 3 TIFF - 4	1-8	0x00000400	0x00010203....

Options:

- Enable Signature Capture
- Disable Signature Capture.



Enable Signature Capture  
(01h)



\*Disable Signature Capture  
(00h)

## Signature Capture File Format Selection

**SSI # F0h, 39h**

**Parameter # 313**

Select a signature file format appropriate for the system (BMP, TIFF, or JPEG). The scanner stores captured signatures in the selected format.

Options:

- BMP Signature Format
- \*JPEG Signature Format
- TIFF Signature Format.



**BMP Signature Format  
(03h)**



**\*JPEG Signature Format  
(01h)**

## Signature Capture File Format Selection (continued)



TIFF Signature Format  
(04h)

## Signature Capture Bits Per Pixel

**SSI # F0h, 3Ah**

**Parameter # 314**

Select the number of significant bits per pixel (BPP) to use when capturing a signature. Select **1 BPP** for a black and white image, **4 BPP** to assign 1 of 16 levels of grey to each pixel, or **8 BPP** to assign 1 of 256 levels of grey to each pixel.

Options:

- 1 BPP
- 4 BPP
- \*8 BPP.

✓ **NOTE** The scanner ignores these settings for JPEG file formats, which only support **8 BPP**.



**1 BPP**  
**(00h)**



**4 BPP**  
**(01h)**

## Signature Capture Bits Per Pixel (continued)



\* 8 BPP  
(02h)

## Signature Capture Width

**SSI # F4h, F0h, 6Eh**

**Parameter # 366**

The aspect ratio of the Signature Capture Width and Signature Capture Height parameters must match that of the signature capture area. For example, a 4 x 1 inch signature capture area would require a 4 to 1 aspect ratio of width to height.

To set the width of the signature capture box, scan the **Signature Capture Width** bar code, followed by 4 bar codes from [Appendix G, NUMERIC BAR CODES](#) corresponding to a value in the range of 0001 to 1280 decimal.



**Signature Capture Width**  
**(Default: 400)**  
**(001 - 1280 Decimal)**



## Signature Capture Height

**SSI # F4h, F0h, 6Fh**

**Parameter # 367**

To set the height of the signature capture box, scan the **Signature Capture Height** bar code, followed by 3 bar codes from [Appendix G, NUMERIC BAR CODES](#) corresponding to a value in the range of 001 to 960 decimal.



**Signature Capture Height (Default: 100)  
(001 - 960 Decimal)**

## Signature Capture JPEG Quality

**SSI # F0h, A5h**

**Parameter # 421**

Scan the **JPEG Quality Value** bar code followed by 3 bar codes from [Appendix G, NUMERIC BAR CODES](#) corresponding to a value from 005 to 100, where 100 represents the highest quality image.



JPEG Quality Value (Default: 065)  
(5 - 100 Decimal)

## Video View Finder

**SSI # F0h 44h**

**Parameter # 324**

Select **Enable Video View Finder** to project the video view finder while in Video Mode, or **Disable Video View Finder** to turn the video view finder off.

Options:

- \*Disable Video View Finder
- Enable Video View Finder.

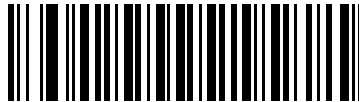

**\*Disable Video View Finder  
(0)**



**Enable Video View Finder  
(1)**

## Video View Finder Image Size

**SSI # F0h 49h**

**Parameter # 329**

Select the number of 100-byte blocks. Values range from 800 to 12,000 bytes. Selecting a smaller value transmits more frames per second; selecting a larger value increases video quality.

To set the Video View Finder Image Size, scan the bar code below followed by three bar codes from [Appendix G, NUMERIC BAR CODES](#) corresponding to the 100-byte value from 800 to 12,000 bytes. For example, to select 1500 bytes, enter 0, 1, 5. To select 900 bytes, enter 0, 0, 9. The default is 1700 bytes.



**Video View Finder Image Size**



# CHAPTER 6 USB INTERFACE

---

## Introduction

This chapter provides information on setting up the scanner with a USB host. The scanner attaches directly to a USB host computer.

If no auxiliary scanner is used, the host can power the scanner through the interface cable. If an auxiliary scanner is used, an external power supply is necessary.

Throughout the programming bar code menus, asterisks (\*) indicate default values.

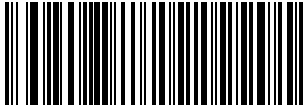

\* Indicates Default      \* No Delay      Feature/Option

## Connecting a USB Interface

The scanner connects with most USB-capable hosts including:

- Desktop PCs and Notebooks
- Apple™
- IBM SurePOS terminals.

The scanner supports a number of Operating Systems including:

- Windows® XP, 7, and 8
- MacOS
- IBM 4690 OS.

The scanner also interfaces with other USB hosts that support USB Human Interface Devices (HID).

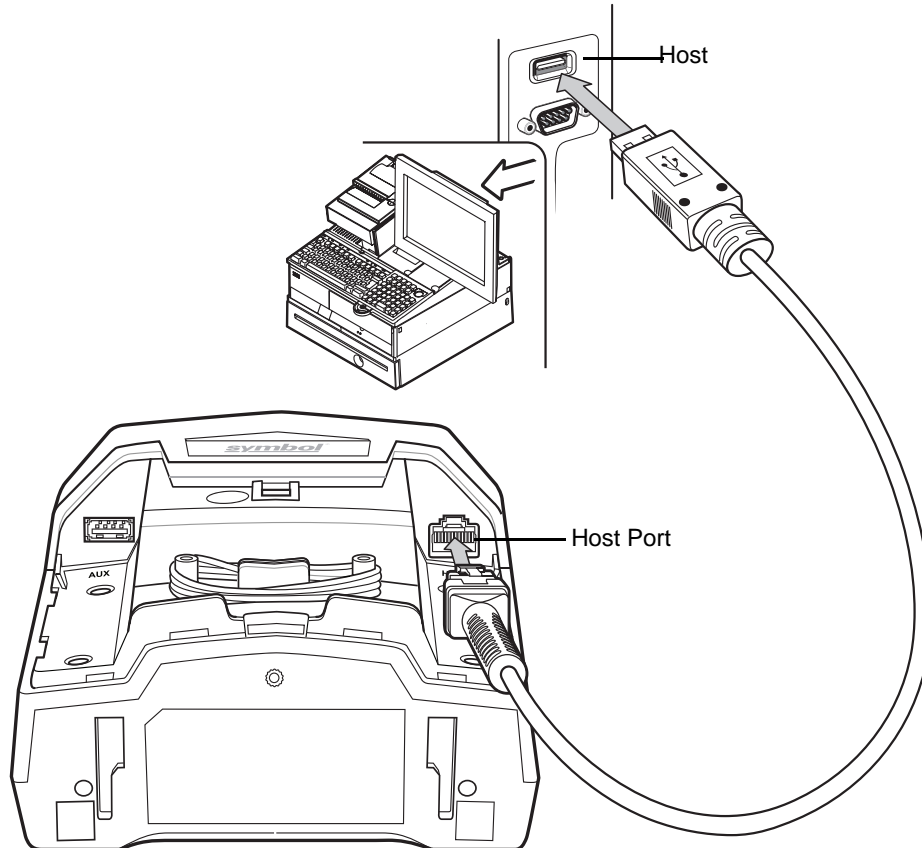

**Figure 6-1** USB Connection - Host Supplies Power

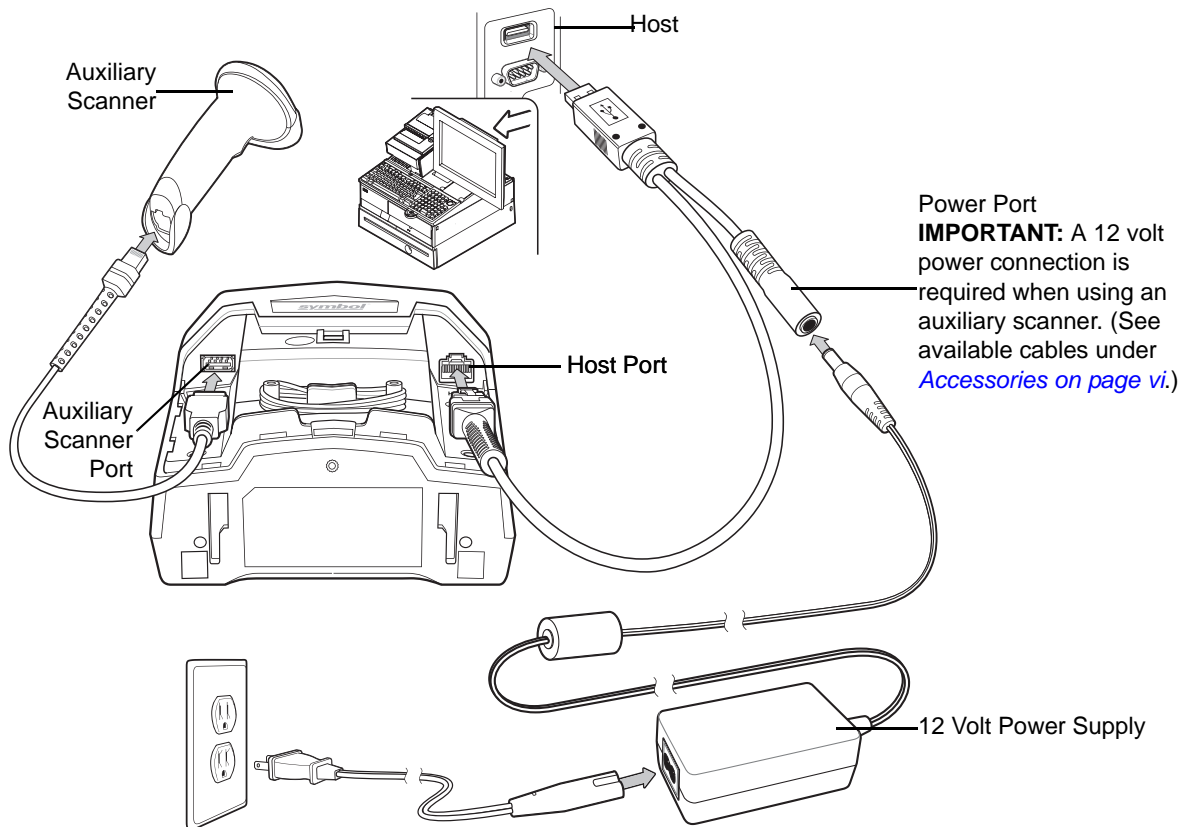

**Figure 6-2** USB Connection With Optional Auxiliary Scanner - 12 Volt Power Supplied Externally

- ✓ **NOTE** Interface cables vary depending on configuration. The connectors may be different from the examples illustrated, but the steps to connect the scanner are the same. See [USB Cables on page vi](#) for cable information and part numbers.

To set up the DS7708 with a USB interface:

1. Remove the back cover from the DS7708. See [Removing the Back Cover on page 1-5](#).
2. Plug the host interface cable modular connector into the scanner's host port.
3. Connect the other end of the interface cable to the host.
4. Select the USB device type. See [USB Device Type on page 6-5](#).
5. If not using a North American keyboard, scan the appropriate country bar code in [Appendix B, COUNTRY CODES](#).
6. If using an auxiliary scanner:
  - a. Connect the auxiliary scanner cable to the auxiliary scanner port on the DS7708.
  - b. Connect a 12 volt external power supply to the host cable as shown in [Figure 6-2](#), or connect a 12 volt Power Plus host connector.
7. Replace the DS7708 back cover (see [Removing and Replacing the Back Cover on page 1-5](#)).



## USB Default Parameters

*Table 6-1* lists the defaults for USB host parameters. To change any option, scan the appropriate bar code(s) beginning in *USB Host Parameters on page 6-5*.



**NOTES** See *Appendix B, COUNTRY CODES* for USB Country Keyboard Types (Country Codes).

See *Appendix A, STANDARD DEFAULT PARAMETERS* for all user preferences, hosts, symbologies, and miscellaneous default parameters.

**Table 6-1** *USB Host Default Table*

Parameter	Default	Page Number
<b>USB Host Parameters</b>		
USB Device Type	USB Keyboard HID (Human Interface Device)	6-5
Symbol Native API (SNAPI) Status Handshaking	Enable	6-9
USB Keystroke Delay	No Delay	6-10
USB CAPS Lock Override	Disable	6-12
USB Ignore Unknown Characters	Send Bar Codes	6-13
USB Convert Unknown to Code 39	Disable	6-14
Emulate Keypad	Enable	6-15
Keypad Emulation with Leading Zero	Enable	6-16
USB Keyboard FN1 Substitution	Disable	6-17
Function Key Mapping	Disable	6-18
Simulated Caps Lock	Disable	6-19
Convert Case	Disable	6-20
USB Static CDC	Enable	6-22
<b>USB Transmission Speed Parameters</b>		
USB HID Polling Interval	3 msec	6-23
Fast HID Keyboard	Enable	6-28
Quick Keypad Emulation	Enable	6-29
IBM Specification Version	2.2	6-30
<b>Optional USB Parameters</b>		
Beep Directive	Ignore	6-31
Bar Code Configuration Directive	Ignore	6-32

---

## USB Host Parameters

### USB Device Type

Select the desired USB device type.



**NOTE** When changing USB Device Types, the scanner automatically restarts and issues the standard startup beep sequences.

Options:

- \* USB Keyboard HID
- IBM Table-Top USB
- IBM Hand-Held USB
- IBM Hand-Held USB with Full Scan Disable (IBM OPOS)
- Simple COM Port Emulation
- USB CDC Host
- Symbol Native API (SNAPI) with Imaging Interface
- Symbol Native API (SNAPI) without Imaging Interface.



\* USB Keyboard HID



IBM Table-Top USB

**USB Device Type (continued)**



**IBM Hand-Held USB**



**IBM Hand-Held USB with Full Scan Disable  
(IBM OPOS)**

**USB Device Type (continued)**



**Simple COM Port Emulation**

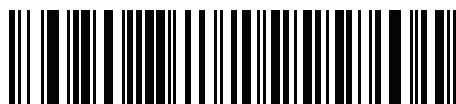

**USB CDC Host**

**USB Device Type (continued)**



**Symbol Native API (SNAPI) with Imaging Interface**



**Symbol Native API (SNAPI) without Imaging Interface**

## Symbol Native API (SNAPI) Status Handshaking

After selecting a SNAPI interface as the USB device type, select whether to enable or disable status handshaking.

Options:

- Enable SNAPI Status Handshaking
- Disable SNAPI Status Handshaking.



**\*Enable SNAPI Status Handshaking**



**Disable SNAPI Status Handshaking**

## USB Keystroke Delay

This parameter sets the delay, in milliseconds, between emulated keystrokes. Scan one of the following bar codes to increase the delay when hosts require a slower transmission of data.

Options:

- No Delay
- Medium Delay (20 msec)
- Long Delay (40 msec).

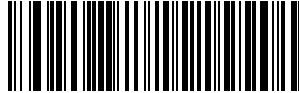

**\* No Delay**



**Medium Delay (20 msec)**

**USB Keystroke Delay (continued)**

**Long Delay (40 msec)**



## USB CAPS Lock Override

This option applies only to the HID Keyboard Emulation device. When enabled, the case of the data is preserved regardless of the state of the caps lock key. This setting is always enabled for the Japanese, Windows (ASCII) keyboard type and can not be disabled.

Options:

- Override Caps Lock Key (Enable)
- \* Do Not Override Caps Lock Key (Disable).

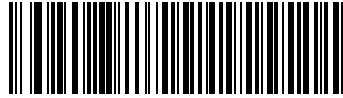

**Override Caps Lock Key  
(Enable)**



**\* Do Not Override Caps Lock Key  
(Disable)**

## USB Ignore Unknown Characters

This option applies only to the HID Keyboard Emulation device and IBM device. Unknown characters are characters the host does not recognize. When **Send Bar Codes With Unknown Characters** is selected, all bar code data is sent except for unknown characters, and no error beeps sound. When **Do Not Send Bar Codes With Unknown Characters** is selected, bar codes containing at least one unknown character are not sent to the host, and an error beep sounds.

Options:

- \*Send Bar Codes With Unknown Characters
- Do Not Send Bar Codes With Unknown Characters.

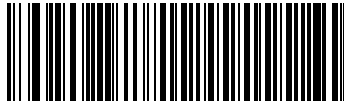

**\*Send Bar Codes With Unknown Characters**

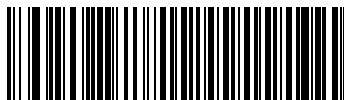

**Do Not Send Bar Codes With Unknown Characters**

## USB Convert Unknown to Code 39

This option applies only to the IBM hand-held, IBM table-top, and OPOS devices. Scan a bar code below to enable or disable converting unknown bar code type data to Code 39.

Options:

- \*Disable Convert Unknown to Code 39
- Enable Convert Unknown to Code 39.



**\*Disable Convert Unknown to Code 39**

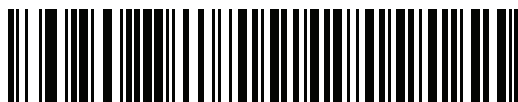

**Enable Convert Unknown to Code 39**

## Emulate Keypad

When enabled, all characters are sent as ASCII sequences over the numeric keypad. For example ASCII A would be sent as "ALT make" 0 6 5 "ALT Break."

Options:

- Disable Emulate Keypad
- \*Enable Emulate Keypad.



**Disable Emulate Keypad**



**\*Enable Emulate Keypad**

## Keypad Emulation with Leading Zero

Enable this to send character sequences sent over the numeric keypad as ISO characters which have a leading zero. For example ASCII A transmits as "ALT MAKE" 0 0 6 5 "ALT BREAK".

Options:

- Disable Keypad Emulation with Leading Zero
- \*Enable Keypad Emulation with Leading Zero.



**Disable Keypad Emulation with Leading Zero**



**\*Enable Keypad Emulation with Leading Zero**

## USB Keyboard FN1 Substitution

This option applies only to the USB HID Keyboard Emulation device. Enable this to replace any FN1 characters in an EAN 128 bar code with a selected Key Category and value (see [FN1 Substitution Values on page 4-36](#) to set the Key Category and Key Value).

Options:

- Enable Keyboard FN1 Substitution
- \*Disable Keyboard FN1 Substitution.

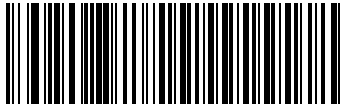

**Enable**



**\*Disable**

## Function Key Mapping

ASCII values under 32 are normally sent as a control-key sequences (see [Table 6-2 on page 6-33](#)). Enable this parameter to send the keys in bold in place of the standard key mapping. Items that do not have a bold entry remain the same whether or not this parameter is enabled.

Options:

- \*Disable Function Key Mapping
- Enable Function Key Mapping.

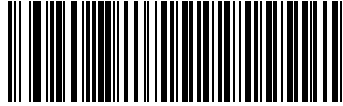

**\*Disable Function Key Mapping**

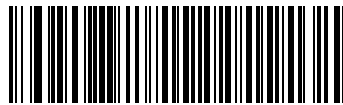

**Enable Function Key Mapping**

## Simulated Caps Lock

Enable this to invert upper and lower case characters on the bar code as if the Caps Lock state is enabled on the keyboard. This inversion occurs regardless of the keyboard's Caps Lock state.

✓ **NOTE** Simulated Caps Lock applies to ASCII characters only.

Options:

- \*Disable Simulated Caps Lock
- Enable Simulated Caps Lock.



**\*Disable Simulated Caps Lock**

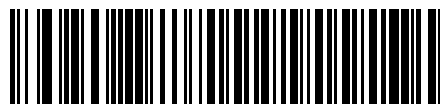

**Enable Simulated Caps Lock**



## Convert Case

When enabled, the scanner converts all bar code data to the selected case.

Options:

- \*No Case Conversion
- Convert All To Upper Case
- Convert All To Lower Case.

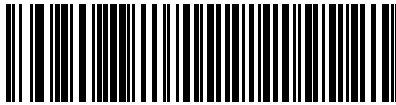

**\*No Case Conversion**

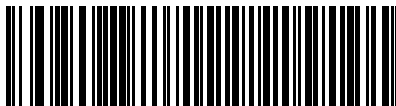

**Convert All to Upper Case**

**Convert Case (continued)**



**Convert All to Lower Case**

## USB Static CDC

When disabled, each device connected consumes another COM port (first device = COM1, second device = COM2, third device = COM3, etc.)

When enabled, each device connects to the same COM port.

Options:

- \*Enable USB Static CDC
- Disable USB Static CDC.



**\*Enable USB Static CDC**



**Disable USB Static CDC**

## USB Transmission Speed Parameters

Use the following parameters to speed USB data transmission:

- *USB HID Polling Interval* - When using more current USB systems, use this parameter to set a lower interval in order to increase data transmission speed.
- *Fast HID Keyboard* - When configured as a USB HID keyboard device, use this parameter to increase the data transmission speed of printable (7-bit) ASCII characters.
- *Quick Keypad Emulation* - When configured as a USB HID keyboard device, use this parameter to increase the data transmission speed of a mix of both printable (7-bit) and full (8-bit) ASCII characters.

✓ **NOTE** Enabling *Emulate Keypad on page 6-15* or *Quick Keypad Emulation on page 6-29* overrides *Fast HID Keyboard*.

### USB HID Polling Interval

This option speeds data transmission for all USB devices except CDC. Scan the appropriate bar code to set the polling interval. The polling interval determines the rate at which data can be sent between the scanner and the host computer. A lower number indicates a faster data rate. The default value is 3 msec.

Options:

- 1 msec
- 2 msec
- \* 3 msec
- 4 msec
- 5 msec
- 6 msec
- 7 msec
- 8 msec.

Changing the polling interval re-initializes the scanner.



**CAUTION** Ensure the host can handle the selected data rate. Selecting a data rate that is too fast for the host can result in lost data.



1 msec

**USB HID Polling Interval (continued)**

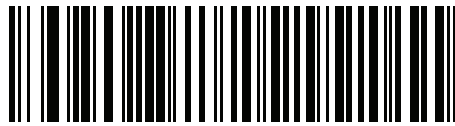

**2 msec**



**\*3 msec**

**USB HID Polling Interval (continued)**



**4 msec**



**5 msec**

**USB HID Polling Interval (continued)**



**6 msec**

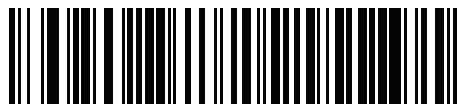

**7 msec**

**USB HID Polling Interval (continued)**



**8 msec**



**9 msec**



### Fast HID Keyboard

This option transmits USB HID keyboard data at a faster rate.

Options:

- \* Enable Fast HID Keyboard
- Disable Fast HID Keyboard.

✓ **NOTE** Enabling [Emulate Keypad on page 6-15](#) or [Quick Keypad Emulation on page 6-29](#) overrides [Fast HID Keyboard](#).

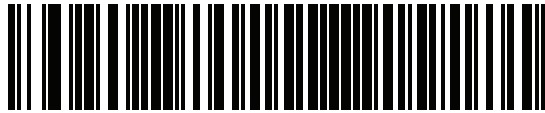

\*Enable



Disable

## Quick Keypad Emulation

This option applies only to the HID keyboard emulation device when [Emulate Keypad on page 6-15](#) is enabled. This parameter enables a quicker method of emulation utilizing the numeric keypad. The default value is **Disable**.

Options:

- \*Enable Quick Keypad Emulation
- Disable Quick Keypad Emulation.

✓ **NOTE** Enabling [Emulate Keypad on page 6-15](#) or [Quick Keypad Emulation on page 6-29](#) overrides [Fast HID Keyboard](#).

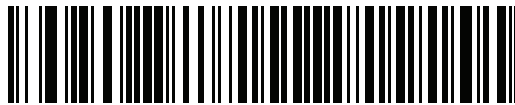

\*Enable

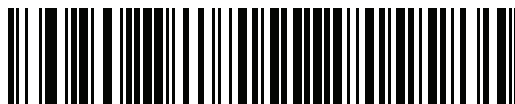

Disable

## IBM Specification Version

The IBM USB interface specification version selected defines how code types are reported over the IBM USB interface.

Options:

- Original Specification
- \*Version 2.2.

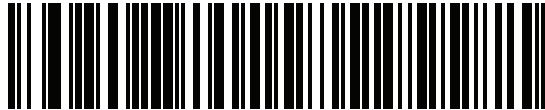

**Original Specification**



**\*Version 2.2**

---

## Optional USB Parameters

If the configured settings are changed or not saved after restarting the system, scan the following bar codes to override USB interface defaults.

### Beep Directive

Scan one of the following bar codes to honor or ignore a beep directive from the USB host. When enabled, the request is **not** sent to the scanner. All directives are still acknowledged to the USB host as if they were processed.

Options:

- \*Ignore Beep Directive
- Honor Beep Directive



**\*Ignore Beep Directive**



**Honor Beep Directive**

## Bar Code Configuration Directive

Scan one of the following bar codes to honor or ignore a bar code configuration (type) directive from the USB host. When this parameter is enabled, this request is **not** sent to the scanner. All directives are still acknowledged to the USB host as if they were processed.

Options:

- Honor Bar Code Configuration Directive
- \*Ignore Bar Code Configuration Directive.



**Honor Bar Code Configuration Directive**



**\*Ignore Bar Code Configuration Directive**

## ASCII Character Set for USB

**Table 6-2** USB Prefix/Suffix Values

Prefix/ Suffix Value	Full ASCII Code 39 Encode Character	Keystroke
1000	%U	CTRL 2
1001	\$A	CTRL A
1002	\$B	CTRL B
1003	\$C	CTRL C
1004	\$D	CTRL D
1005	\$E	CTRL E
1006	\$F	CTRL F
1007	\$G	CTRL G
1008	\$H	CTRL H/ <b>BACKSPACE</b> <sup>1</sup>
1009	\$I	CTRL I/ <b>HORIZONTAL TAB</b> <sup>1</sup>
1010	\$J	CTRL J
1011	\$K	CTRL K
1012	\$L	CTRL L
1013	\$M	CTRL M/ <b>ENTER</b> <sup>1</sup>
1014	\$N	CTRL N
1015	\$O	CTRL O
1016	\$P	CTRL P
1017	\$Q	CTRL Q
1018	\$R	CTRL R
1019	\$S	CTRL S
1020	\$T	CTRL T
1021	\$U	CTRL U
1022	\$V	CTRL V
1023	\$W	CTRL W
1024	\$X	CTRL X
1025	\$Y	CTRL Y

<sup>1</sup>The keystroke in bold transmits only if you enable *Function Key Mapping* on page 6-18. Otherwise, the unbolded keystroke transmits.

**Table 6-2** USB Prefix/Suffix Values (Continued)

Prefix/ Suffix Value	Full ASCII Code 39 Encode Character	Keystroke
1026	\$Z	CTRL Z
1027	%A	CTRL [ <b>/ESC</b> <sup>1</sup>
1028	%B	CTRL \
1029	%C	CTRL ]
1030	%D	CTRL 6
1031	%E	CTRL -
1032	Space	Space
1033	/A	!
1034	/B	"
1035	/C	#
1036	/D	\$
1037	/E	%
1038	/F	&
1039	/G	'
1040	/H	(
1041	/I	)
1042	/J	*
1043	/K	+
1044	/L	,
1045	-	-
1046	.	.
1047	/O	/
1048	0	0
1049	1	1
1050	2	2
1051	3	3
1052	4	4
1053	5	5
1054	6	6

<sup>1</sup>The keystroke in bold transmits only if you enable *Function Key Mapping* on page 6-18. Otherwise, the unbolded keystroke transmits.

**Table 6-2** USB Prefix/Suffix Values (Continued)

Prefix/ Suffix Value	Full ASCII Code 39 Encode Character	Keystroke
1055	7	7
1056	8	8
1057	9	9
1058	/Z	:
1059	%F	;
1060	%G	<
1061	%H	=
1062	%I	>
1063	%J	?
1064	%V	@
1065	A	A
1066	B	B
1067	C	C
1068	D	D
1069	E	E
1070	F	F
1071	G	G
1072	H	H
1073	I	I
1074	J	J
1075	K	K
1076	L	L
1077	M	M
1078	N	N
1079	O	O
1080	P	P
1081	Q	Q
1082	R	R
1083	S	S

<sup>1</sup>The keystroke in bold transmits only if you enable *Function Key Mapping* on page 6-18. Otherwise, the unbolded keystroke transmits.



**Table 6-2** USB Prefix/Suffix Values (Continued)

Prefix/ Suffix Value	Full ASCII Code 39 Encode Character	Keystroke
1084	T	T
1085	U	U
1086	V	V
1087	W	W
1088	X	X
1089	Y	Y
1090	Z	Z
1091	%K	[
1092	%L	\
1093	%M	]
1094	%N	^
1095	%O	_
1096	%W	`
1097	+A	a
1098	+B	b
1099	+C	c
1100	+D	d
1101	+E	e
1102	+F	f
1103	+G	g
1104	+H	h
1105	+I	i
1106	+J	j
1107	+K	k
1108	+L	l
1109	+M	m
1110	+N	n
1111	+O	o
1112	+P	p

<sup>1</sup>The keystroke in bold transmits only if you enable *Function Key Mapping* on page 6-18. Otherwise, the unbolded keystroke transmits.

**Table 6-2** USB Prefix/Suffix Values (Continued)

Prefix/ Suffix Value	Full ASCII Code 39 Encode Character	Keystroke
1113	+Q	q
1114	+R	r
1115	+S	s
1116	+T	t
1117	+U	u
1118	+V	v
1119	+W	w
1120	+X	x
1121	+Y	y
1122	+Z	z
1123	%P	{
1124	%Q	
1125	%R	}
1126	%S	~

<sup>1</sup>The keystroke in bold transmits only if you enable *Function Key Mapping* on page 6-18. Otherwise, the unbolded keystroke transmits.

**Table 6-3** *USB ALT Key Character Set*

<b>ALT Keys</b>	<b>Keystroke</b>
2064	ALT 2
2065	ALT A
2066	ALT B
2067	ALT C
2068	ALT D
2069	ALT E
2070	ALT F
2071	ALT G
2072	ALT H
2073	ALT I
2074	ALT J
2075	ALT K
2076	ALT L
2077	ALT M
2078	ALT N
2079	ALT O
2080	ALT P
2081	ALT Q
2082	ALT R
2083	ALT S
2084	ALT T
2085	ALT U
2086	ALT V
2087	ALT W
2088	ALT X
2089	ALT Y
2090	ALT Z

**Table 6-4** *USB GUI Key Character Set*

<b>GUI Key</b>	<b>Keystroke</b>
3000	Right Control Key
3048	GUI 0
3049	GUI 1
3050	GUI 2
3051	GUI 3
3052	GUI 4
3053	GUI 5
3054	GUI 6
3055	GUI 7
3056	GUI 8
3057	GUI 9
3065	GUI A
3066	GUI B
3067	GUI C
3068	GUI D
3069	GUI E
3070	GUI F
3071	GUI G
3072	GUI H
3073	GUI I
3074	GUI J
3075	GUI K
3076	GUI L
3077	GUI M
3078	GUI N
3079	GUI O
3080	GUI P
3081	GUI Q

**Note: GUI Shift Keys - The Apple™ iMac keyboard has an apple key on either side of the space bar. Windows-based systems have a GUI key to the left of the left ALT key, and to the right of the right ALT key.**

**Table 6-4** *USB GUI Key Character Set (Continued)*

GUI Key	Keystroke
3082	GUI R
3083	GUI S
3084	GUI T
3085	GUI U
3086	GUI V
3087	GUI W
3088	GUI X
3089	GUI Y
3090	GUI Z

**Note: GUI Shift Keys - The Apple™ iMac keyboard has an apple key on either side of the space bar. Windows-based systems have a GUI key to the left of the left ALT key, and to the right of the right ALT key.**

**Table 6-5** *USB F Key Character Set*

<b>F Keys</b>	<b>Keystroke</b>
5001	F1
5002	F2
5003	F3
5004	F4
5005	F5
5006	F6
5007	F7
5008	F8
5009	F9
5010	F10
5011	F11
5012	F12
5013	F13
5014	F14
5015	F15
5016	F16
5017	F17
5018	F18
5019	F19
5020	F20
5021	F21
5022	F22
5023	F23
5024	F24

**Table 6-6** *USB Numeric Keypad Character Set*

<b>Numeric Keypad</b>	<b>Keystroke</b>
6042	*
6043	+
6044	undefined
6045	-
6046	.
6047	/
6048	0
6049	1
6050	2
6051	3
6052	4
6053	5
6054	6
6055	7
6056	8
6057	9
6058	Enter
6059	Num Lock

**Table 6-7** *USB Extended Keypad Character Set*

<b>Extended Keypad</b>	<b>Keystroke</b>
7001	Break
7002	Delete
7003	PgUp
7004	End
7005	Pg Dn
7006	Pause
7007	Scroll Lock
7008	Backspace
7009	Tab
7010	Print Screen
7011	Insert
7012	Home
7013	Enter
7014	Escape
7015	Up Arrow
7016	Down Arrow
7017	Left Arrow
7018	Right Arrow





# CHAPTER 7 RS-232 INTERFACE

---

## Introduction

This chapter provides information for setting up the scanner with an RS-232 host. Use the RS-232 interface to attach the scanner to point-of-sale devices, host computers, or other devices with an available RS-232 port (e.g., com port). This scanner uses TTL RS-232 levels to interface with all PC's without additional hardware.

✓ **NOTE** Particularly noisy electrical environments may require a cable with an RS-232 transceiver. To obtain this cable, contact the Zebra Support Center.

If the particular host is not listed in [Table 7-1](#), set the communication parameters to match the host device. See the documentation for the host device.

Throughout the programming bar code menus, asterisks (\*) indicate default values.

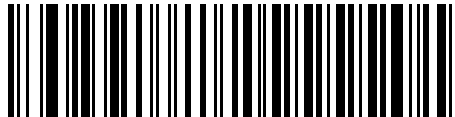

\* Indicates Default — \*Baud Rate 9600 — Feature/Option

## Connecting an RS-232 Interface

There are two possible configurations for connecting to an RS-232 host. The DS7708 connects directly to the host computer; and an auxiliary scanner can connect to the DS7708. Both configurations require a power supply; 5 volt without an auxiliary scanner, and 12 volt with an auxiliary scanner.

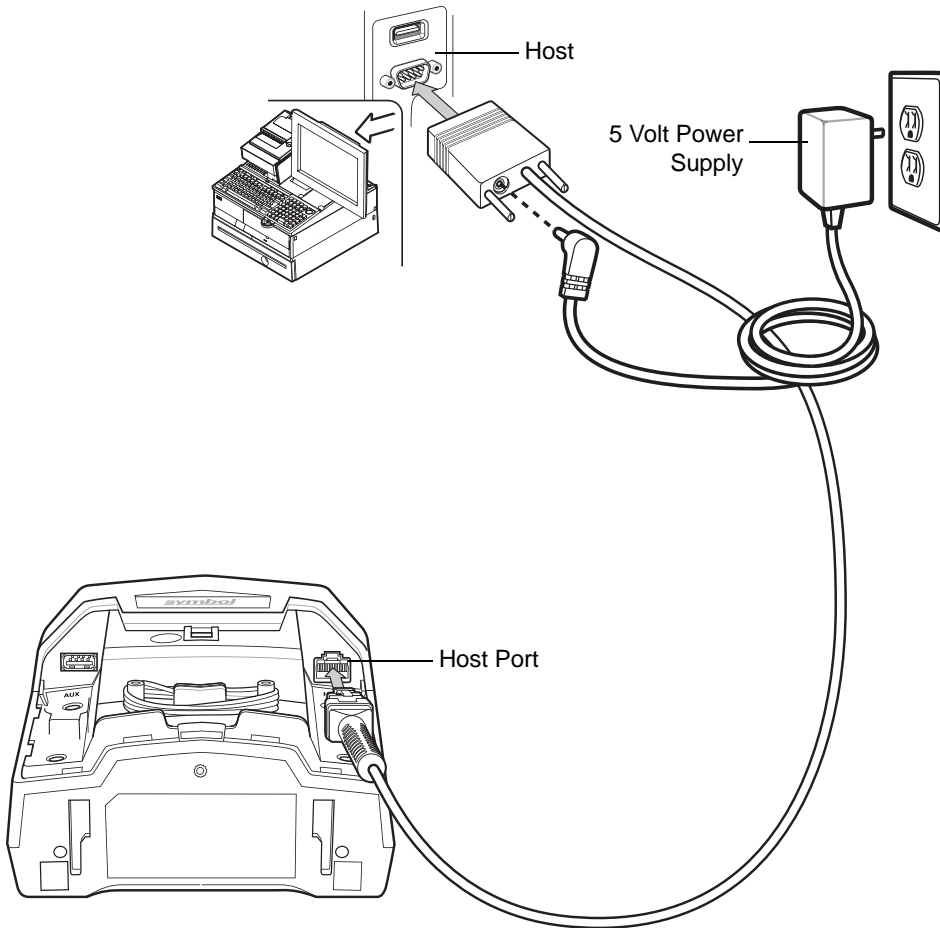

**Figure 7-1** RS-232 Connection - 5 Volt Power Supplied Externally

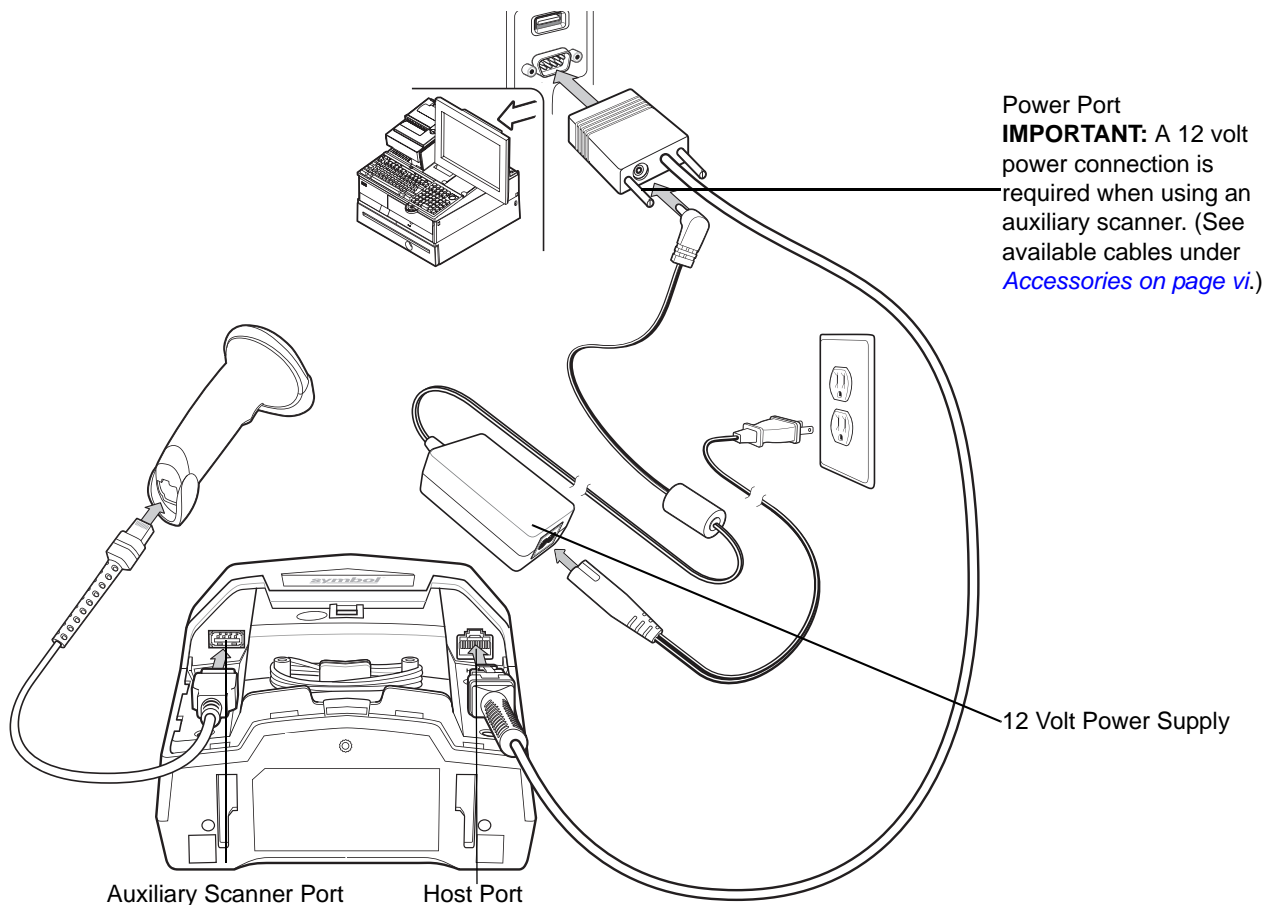

**Figure 7-2** RS-232 Connection with Auxiliary Scanner - 12 Volt Power Supplied Externally

✓ **NOTE** Interface cables vary depending on configuration. The connectors may be different from the examples illustrated, but the steps to connect the scanner are the same. See [RS-232 Cables on page vii](#) for cable information and part numbers.

To set up the DS7708 with an RS-232 interface:

1. Remove the back cover from the DS7708. See [Removing the Back Cover on page 1-5](#).
2. Plug the host interface cable modular connector into the scanner's host port host port.
3. Connect the other end of the interface cable to the serial port on the host.
4. Scan the appropriate bar codes in this chapter, or use 123Scan<sup>2</sup> to match the host settings.
5. If using an auxiliary scanner:
  - a. Connect the auxiliary scanner cable to the auxiliary scanner port on the DS7708.
  - b. Connect a 12 volt external power supply to a 12 volt Power Plus host connector as shown in [Figure 7-2](#).
6. Replace the DS7708 back cover (see [Removing and Replacing the Back Cover on page 1-5](#)).

## RS-232 Default Parameters

*Table 7-1* lists the defaults for RS-232 host parameters. To change any option, scan the appropriate bar code(s) beginning in *RS-232 Host Parameters on page 7-5*.

✓ **NOTES** See *Appendix A, STANDARD DEFAULT PARAMETERS* for all user preferences, hosts, symbologies, and miscellaneous default parameters.

**Table 7-1** *RS-232 Host Default Table*

Parameter	Default	Page Number
<b>RS-232 Host Parameters</b>		
RS-232 Host Types	Standard	<a href="#">7-7</a>
Baud Rate	9600	<a href="#">7-11</a>
Parity	None	<a href="#">7-14</a>
Check Receive Errors	Enable	<a href="#">7-16</a>
Hardware Handshaking	None	<a href="#">7-17</a>
Software Handshaking	None	<a href="#">7-21</a>
Host Serial Response Time-out	2 Sec	<a href="#">7-24</a>
RTS Line State	Low RTS	<a href="#">7-27</a>
Stop Bit Select	1 Stop Bit	<a href="#">7-28</a>
Data Bits	8-Bit	<a href="#">7-29</a>
Beep on <BEL>	Disable	<a href="#">7-30</a>
Intercharacter Delay	0 msec	<a href="#">7-31</a>
Nixdorf Beep/LED Option	Normal Operation	<a href="#">7-34</a>
Ignore Unknown Characters	Send Bar Codes	<a href="#">7-36</a>

## RS-232 Host Parameters

Various RS-232 hosts are set up with their own parameter default settings. Selecting the ICL, Fujitsu, Wincor-Nixdorf Mode A, Wincor-Nixdorf Mode B, Olivetti, Omron, or terminal sets the defaults listed in [Table 7-2](#).

**Table 7-2** Terminal Specific RS-232

Parameter	Standard (Default)	ICL	Fujitsu	Wincor-Nixdorf Mode A	Wincor-Nixdorf Mode B/OPOS	Olivetti	Omron
<b>Transmit Code ID</b>	No	Yes	Yes	Yes	Yes	Yes	Yes
<b>Data Transmission Format</b>	Data as is	Data/Suffix	Data/Suffix	Data/Suffix	Data/Suffix	Prefix/Data/Suffix	Data/Suffix
<b>Suffix</b>	CR/LF (7013)	CR (1013)	CR (1013)	CR (1013)	CR (1013)	ETX (1002)	CR (1013)
<b>Baud Rate</b>	9600	9600	9600	9600	9600	9600	9600
<b>Parity</b>	None	Even	None	Odd	Odd	Even	None
<b>Hardware Handshaking</b>	None	RTS/CTS Option 3	None	RTS/CTS Option 3	RTS/CTS Option 3	None	None
<b>Software Handshaking</b>	None	None	None	None	None	Ack/Nak	None
<b>Serial Response Time-out</b>	2 Sec.	9.9 Sec.	2 Sec.	9.9 Sec.	9.9 Sec.	9.9 Sec.	9.9 Sec.
<b>Stop Bit Select</b>	One	One	One	One	One	One	One
<b>ASCII Format</b>	8-Bit	8-Bit	8-Bit	8-Bit	8-Bit	7-Bit	8-Bit
<b>Beep On &lt;BEL&gt;</b>	Disable	Disable	Disable	Disable	Disable	Disable	Disable
<b>RTS Line State</b>	Low	High	Low	Low	Low = No data to send	Low	High
<b>Prefix</b>	None	None	None	None	None	STX (1003)	None

\*In the Nixdorf Mode B, if CTS is Low, scanning is disabled. When CTS is High, the user can scan bar codes.

\*\*If Nixdorf Mode B is scanned without the scanner connected to the proper host, it may appear unable to scan. If this happens, scan a different RS-232 host type within 5 seconds of cycling power to the scanner.

Selecting the ICL, Fujitsu, Wincor-Nixdorf Mode A, Wincor-Nixdorf Mode B, OPOS, JPOS terminal enables the transmission of code ID characters listed in [Table 7-3](#). These code ID characters are not programmable and are separate from the Transmit Code ID feature. Do not enable the Transmit Code ID feature for these terminals.

**Table 7-3** Terminal Specific Code ID Characters

Code Type	ICL	Fujitsu	Wincor-Nixdorf Mode A	Wincor-Nixdorf Mode B/ OPOS/JPOS	Olivetti	Omron
UPC-A	A	A	A	A	A	A
UPC-E	E	E	C	C	C	E
EAN-8/JAN-8	FF	FF	B	B	B	FF
EAN-13/JAN-13	F	F	A	A	A	F
Code 39	C <len>	None	M	M	M <len>	C <len>
Code 39 Full ASCII	None	None	M	M	None	None
Codabar	N <len>	None	N	N	N <len>	N <len>
Code 128	L <len>	None	K	K	K <len>	L <len>
I 2 of 5	I <len>	None	I	I	I <len>	I <len>
Code 93	None	None	L	L	L <len>	None
D 2 of 5	H <len>	None	H	H	H <len>	H <len>
GS1-128	L <len>	None	P	P	P <len>	L <len>
MSI	None	None	O	O	O <len>	None
Bookland EAN	F	F	A	A	A	F
Trioptic	None	None	None	None	None	None
Code 11	None	None	None	None	None	None
IATA	H<len>	None	H	H	H<len>	H<len>
Code 32	None	None	None	None	None	None
GS1 DataBar Variants	None	None	E	E	None	None
PDF417	None	None	Q	Q	None	None
Data Matrix	None	None	R	R	None	None
QR Codes	None	None	U	U	None	None
Aztec/Aztec Rune	None	None	V	V	None	None
MAXICODE	None	None	T	T	None	None
microPDF	None	None	S	S	None	None
GS1-Datamatrix	None	None	W	W	None	None
GS1-QR	None	None	X	X	None	None

## RS-232 Host Types

To select an RS-232 host interface, scan one of the following bar codes.

Options:

- \*Standard RS-232
- ICL RS-232
- Wincor-Nixdorf RS-232 Mode A
- Wincor-Nixdorf RS-232 Mode B
- Fujitsu RS-232
- Olivetti ORS4500
- Omron
- OPOS/JPOS.



**\*Standard RS-232**



**ICL RS-232**



**RS-232 Host Types (continued)**



**Wincor-Nixdorf RS-232 Mode A**



**Wincor-Nixdorf RS-232 Mode B**

**RS-232 Host Types (continued)**



**Fujitsu RS-232**



**Olivetti ORS4500**

**RS-232 Host Types (continued)**



**Omron**



**OPOS/JPOS**

## Baud Rate

Baud rate is the number of bits of data transmitted per second. Select the baud rate setting to match the baud rate setting of the host device. Otherwise, data may not reach the host device or may reach it in distorted form.

Options:

- \*9600
- 19,200
- 38,400
- 57,600
- 115,200.

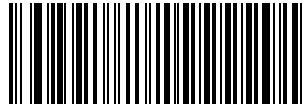

**\*Baud Rate 9600**



**Baud Rate 19,200**

**Baud Rate (continued)**

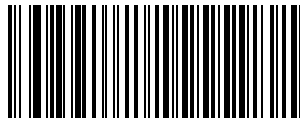

**Baud Rate 38,400**



**Baud Rate 57,600**

**Baud Rate (continued)**



**Baud Rate 115,200**

## Parity

A parity check bit is the most significant bit of each ASCII coded character. Select the parity type according to host device requirements.

Select **Odd** parity and the parity bit value is set to 0 or 1, based on data, to ensure that an odd number of 1 bits are contained in the coded character.

Options:

- Odd
- Even - Select Even parity and the parity bit value is set to 0 or 1, based on data, to ensure that an even number of 1 bits are contained in the coded character.
- \*None - Select **None** when no parity bit is required.

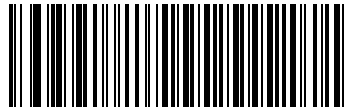

**Odd**



**Even**

**Parity (continued)**



**\*None**



## Check Receive Errors

Select whether or not the parity, framing, and overrun of received characters are checked. The parity value of received characters is verified against the parity parameter selected above.

Options:

- \*Check For Received Errors
- Do Not Check For Received Errors.

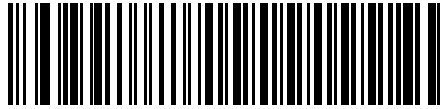

**\*Check For Received Errors**



**Do Not Check For Received Errors**

## Hardware Handshaking

The data interface consists of an RS-232 port designed to operate either with or without the hardware handshaking lines, *Request to Send (RTS)*, and *Clear to Send (CTS)*.

If Standard RTS/CTS handshaking is not selected, scan data is transmitted as it becomes available. If Standard RTS/CTS handshaking is selected, scan data is transmitted according to the following sequence:

- The scanner reads the CTS line for activity. If CTS is asserted, the scanner waits up to 2 seconds for the host to negate the CTS line. If, after 2 seconds (default), the CTS line is still asserted, the scanner sounds a transmit error, and any scanned data is lost.
- When the CTS line is negated, the scanner asserts the RTS line and waits up to 2 seconds for the host to assert CTS. When the host asserts CTS, data is transmitted. If, after 2 seconds (default), the CTS line is not asserted, the scanner sounds a transmit error, and discards the data.
- When data transmission is complete, the scanner negates RTS 10 msec after sending the last character.
- The host should respond by negating CTS. The scanner checks for a negated CTS upon the next transmission of data.

During the transmission of data, the CTS line should be asserted. If CTS is deasserted for more than 50 ms between characters, the transmission is aborted, the scanner sounds a transmission error, and the data is discarded.

If the above communications sequence fails, the scanner issues an error indication. In this case, the data is lost and must be rescanned.

If Hardware Handshaking and Software Handshaking are both enabled, Hardware Handshaking takes precedence.

✓ **NOTE** The DTR signal is jumpered to the active state.

Options:

- \*None
- Standard RTS/CTS
- RTS/CTS Option 1
- RTS/CTS Option 2
- RTS/CTS Option 3.

## Hardware Handshaking (continued)

### None

Scan the bar code below if no Hardware Handshaking is desired.

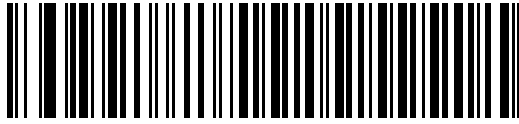

\*None

### Standard RTS/CTS

Scan the bar code below to select Standard RTS/CTS Hardware Handshaking.



Standard RTS/CTS

## Hardware Handshaking (continued)

### RTS/CTS Option 1

When RTS/CTS Option 1 is selected, the scanner asserts RTS before transmitting and ignores the state of CTS. The scanner de-asserts RTS when the transmission is complete.

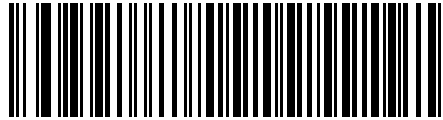

RTS/CTS Option 1

### RTS/CTS Option 2

When Option 2 is selected, RTS is always high or low (user-programmed logic level). However, the scanner waits for CTS to be asserted before transmitting data. If CTS is not asserted within 2 seconds (default), the scanner issues an error indication and discards the data.

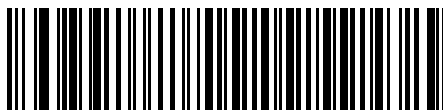

RTS/CTS Option 2

## Hardware Handshaking (continued)

### RTS/CTS Option 3

When Option 3 is selected, the scanner asserts RTS prior to any data transmission, regardless of the state of CTS. The scanner waits up to 2 seconds (default) for CTS to be asserted. If CTS is not asserted during this time, the scanner issues an error indication and discards the data. The scanner de-asserts RTS when transmission is complete.

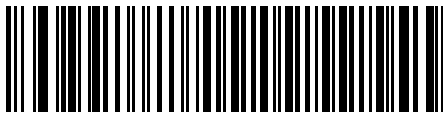

RTS/CTS Option 3

## Software Handshaking

This parameter offers control of the data transmission process in addition to, or instead of, that offered by hardware handshaking. There are five options.

If Software Handshaking and Hardware Handshaking are both enabled, Hardware Handshaking takes precedence.

Options:

- \*None
- ACK/NAK
- ENQ
- ACK/NAK with ENQ
- XON/XOFF.

### None

When this option is selected, data is transmitted immediately.

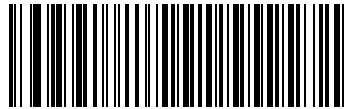

**\*None**

### ACK/NAK

When this option is selected, after transmitting data, the scanner expects either an ACK or NAK response from the host. When a NAK is received, the scanner transmits the same data again and waits for either an ACK or NAK. After three unsuccessful attempts to send data when NAKs are received, the scanner issues an error indication and discards the data.

The scanner waits up to the programmable Host Serial Response Time-out to receive an ACK or NAK. If the scanner does not get a response in this time, it issues an error indication and discards the data. There are no retries when a time-out occurs.



**ACK/NAK**

## Software Handshaking (continued)

### ENQ

When this option is selected, the scanner waits for an ENQ character from the host before transmitting data. If an ENQ is not received within the Host Serial Response Time-out, the scanner issues an error indication and discards the data. The host must transmit an ENQ character at least every Host Serial Response Time-out to prevent transmission errors.

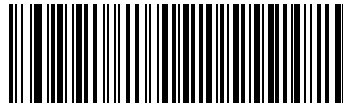

ENQ

### ACK/NAK with ENQ

This combines the two previous options.



ACK/NAK with ENQ

## Software Handshaking (continued)

### XON/XOFF

An XOFF character turns the scanner transmission off until the scanner receives an XON character. There are two situations for XON/XOFF:

- XOFF is received before the scanner has data to send. When the scanner has data to send, it waits up to 2 seconds for an XON character before transmission. If the XON is not received within this time, the scanner issues an error indication and discards the data.
- XOFF is received during a transmission. Data transmission then stops after sending the current byte. When the scanner receives an XON character, it sends the rest of the data message. The scanner waits indefinitely for the XON.

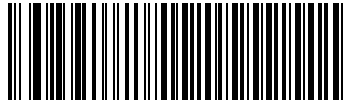

**XON/XOFF**



## Host Serial Response Time-out

This parameter specifies how long the scanner waits for an ACK, NAK, or CTS before determining that a transmission error has occurred. This only applies when in one of the ACK/NAK Software Handshaking modes, or RTS/CTS Hardware Handshaking option.

Options:

- \*Minimum: 2 Sec
- Low: 2.5 Sec.
- Medium: 5 Sec
- High: 7.5 Sec
- Maximum: 9.9 Sec.

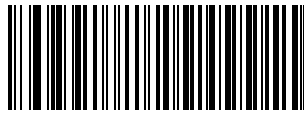

**\*Minimum: 2 Sec**



**Low: 2.5 Sec**

### Host Serial Response Time-out (continued)



**Medium: 5 Sec**



**High: 7.5 Sec**

## Host Serial Response Time-out (continued)



**Maximum: 9.9 Sec**

## RTS Line State

This parameter sets the idle state of the Serial Host RTS line. Scan a bar code below to select **Low RTS** or **High RTS** line state.

Options:

- \*Host: Low RTS
- Host: High RTS.

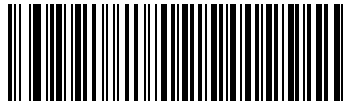

**\*Host: Low RTS**



**Host: High RTS**

## Stop Bit Select

The stop bit(s) at the end of each transmitted character marks the end of transmission of one character and prepares the receiving device for the next character in the serial data stream. The number of stop bits selected (one or two) depends on the number the receiving terminal is programmed to accommodate. Set the number of stop bits to match host device requirements.

Options:

- \*1 Stop Bit
- 2 Stop Bits.

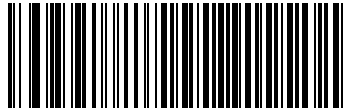

**\*1 Stop Bit**



**2 Stop Bits**

## Data Bits

This parameter allows the scanner to interface with devices requiring a 7-bit or 8-bit ASCII protocol.

Options:

- 7-Bit
- \*6-Bit.

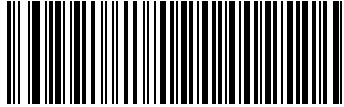

**7-Bit**



**\*8-Bit**

## Beep on <BEL>

When this parameter is enabled, the scanner issues a beep when a <BEL> character is detected on the RS-232 serial line. <BEL> is issued to gain a user's attention to an illegal entry or other important event.

Options:

- Beep On <BEL> Character (Enable)
- \*Do Not Beep On <BEL> Character (Disable).

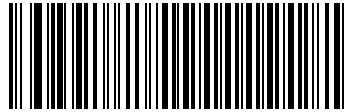

**Beep On <BEL> Character (Enable)**



**\*Do Not Beep On <BEL> Character (Disable)**

## Intercharacter Delay

This parameter specifies the intercharacter delay inserted between character transmissions.

Options:

- \*Minimum: 0 msec
- Low: 25 msec
- Medium: 50 msec
- High: 75 msec
- Maximum: 99 msec.

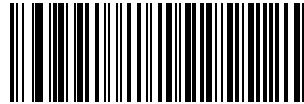

**\*Minimum: 0 msec**



**Low: 25 msec**



## Intercharacter Delay (continued)

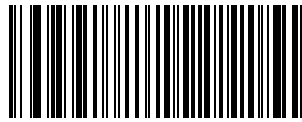

**Medium: 50 msec**

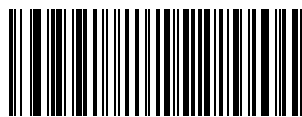

**High: 75 msec**

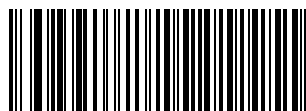
**Intercharacter Delay (continued)****Maximum: 99 msec**

## Nixdorf Beep/LED Options

When Nixdorf Mode B is selected, this indicates when the scanner should beep and turn on its LED after a decode.

Options:

- \*Normal Operation (Beep/LED immediately after decode)
- Beep/LED After Transmission
- Beep/LED After CTS Pulse.

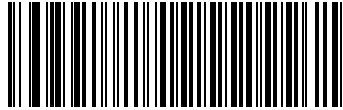

**\*Normal Operation  
(Beep/LED immediately after decode)**



**Beep/LED After Transmission**

## Nixdorf Beep/LED Options (continued)



**Beep/LED After CTS Pulse**

## Ignore Unknown Characters

Unknown characters are characters the host does not recognize. When **Send Bar Codes With Unknown Characters** is selected, all bar code data is sent except for unknown characters, and no error beeps sound on the scanner. When **Do Not Send Bar Codes With Unknown Characters** is selected, bar code data is sent up to the first unknown character and then four (error) beeps sound on the scanner.

Options:

- \*Send Bar Code (With Unknown Characters)
- Do Not Send Bar Codes (With Unknown Characters).

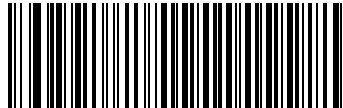

**\*Send Bar Code  
(With Unknown Characters)**



**Do Not Send Bar Codes  
(With Unknown Characters)**

## ASCII Character Set for RS-232

You can assign the values in [Table 7-4](#) as prefixes or suffixes for ASCII character data transmission.

**Table 7-4** *Prefix/Suffix Values*

Prefix/Suffix Value	Full ASCII Code 39 Encode Character	ASCII Character
1000	%U	NUL
1001	\$A	SOH
1002	\$B	STX
1003	\$C	ETX
1004	\$D	EOT
1005	\$E	ENQ
1006	\$F	ACK
1007	\$G	BELL
1008	\$H	BCKSPC
1009	\$I	HORIZ TAB
1010	\$J	LF/NW LN
1011	\$K	VT
1012	\$L	FF
1013	\$M	CR/ENTER
1014	\$N	SO
1015	\$O	SI
1016	\$P	DLE
1017	\$Q	DC1/XON
1018	\$R	DC2
1019	\$S	DC3/XOFF
1020	\$T	DC4
1021	\$U	NAK
1022	\$V	SYN
1023	\$W	ETB
1024	\$X	CAN
1025	\$Y	EM
1026	\$Z	SUB
1027	%A	ESC

Table 7-4 Prefix/Suffix Values (Continued)

Prefix/Suffix Value	Full ASCII Code 39 Encode Character	ASCII Character
1028	%B	FS
1029	%C	GS
1030	%D	RS
1031	%E	US
1032	Space	Space
1033	/A	!
1034	/B	"
1035	/C	#
1036	/D	\$
1037	/E	%
1038	/F	&
1039	/G	'
1040	/H	(
1041	/I	)
1042	/J	*
1043	/K	+
1044	/L	,
1045	-	-
1046	.	.
1047	/O	/
1048	0	0
1049	1	1
1050	2	2
1051	3	3
1052	4	4
1053	5	5
1054	6	6
1055	7	7
1056	8	8
1057	9	9
1058	/Z	:

Table 7-4 Prefix/Suffix Values (Continued)

Prefix/Suffix Value	Full ASCII Code 39 Encode Character	ASCII Character
1059	%F	;
1060	%G	<
1061	%H	=
1062	%I	>
1063	%J	?
1064	%V	@
1065	A	A
1066	B	B
1067	C	C
1068	D	D
1069	E	E
1070	F	F
1071	G	G
1072	H	H
1073	I	I
1074	J	J
1075	K	K
1076	L	L
1077	M	M
1078	N	N
1079	O	O
1080	P	P
1081	Q	Q
1082	R	R
1083	S	S
1084	T	T
1085	U	U
1086	V	V
1087	W	W
1088	X	X
1089	Y	Y



**Table 7-4** *Prefix/Suffix Values (Continued)*

<b>Prefix/Suffix Value</b>	<b>Full ASCII Code 39 Encode Character</b>	<b>ASCII Character</b>
1090	Z	Z
1091	%K	[
1092	%L	\
1093	%M	]
1094	%N	^
1095	%O	_
1096	%W	`
1097	+A	a
1098	+B	b
1099	+C	c
1100	+D	d
1101	+E	e
1102	+F	f
1103	+G	g
1104	+H	h
1105	+I	i
1106	+J	j
1107	+K	k
1108	+L	l
1109	+M	m
1110	+N	n
1111	+O	o
1112	+P	p
1113	+Q	q
1114	+R	r
1115	+S	s
1116	+T	t
1117	+U	u
1118	+V	v
1119	+W	w
1120	+X	x

**Table 7-4** *Prefix/Suffix Values (Continued)*

<b>Prefix/Suffix Value</b>	<b>Full ASCII Code 39 Encode Character</b>	<b>ASCII Character</b>
1121	+Y	y
1122	+Z	z
1123	%P	{
1124	%Q	
1125	%R	}
1126	%S	~
1127		Undefined
7013		ENTER





## Connecting to an IBM 468X/469X Host

The DS7708 connects directly to an IBM host interface. This configuration requires an external power supply regardless of whether peripherals are attached.

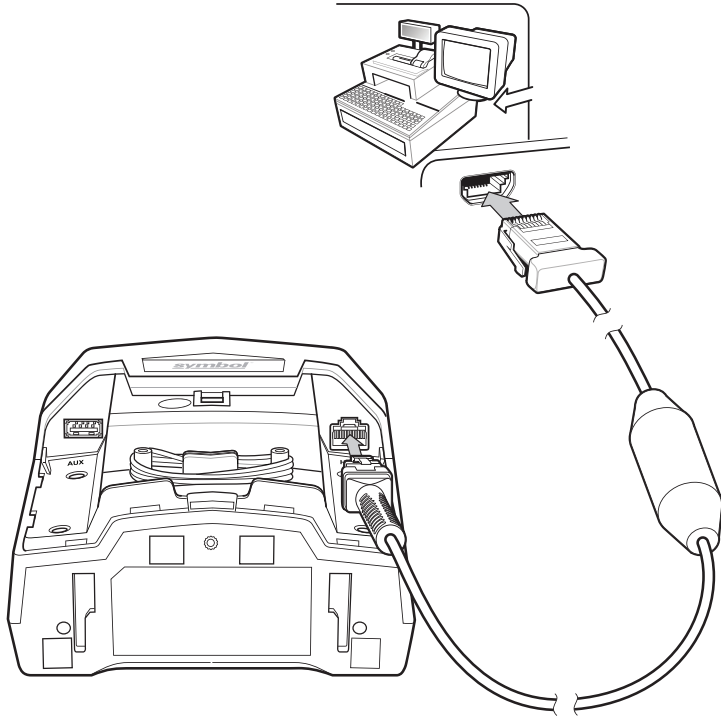

**Figure 8-1** IBM Connection - Host Supplies Power

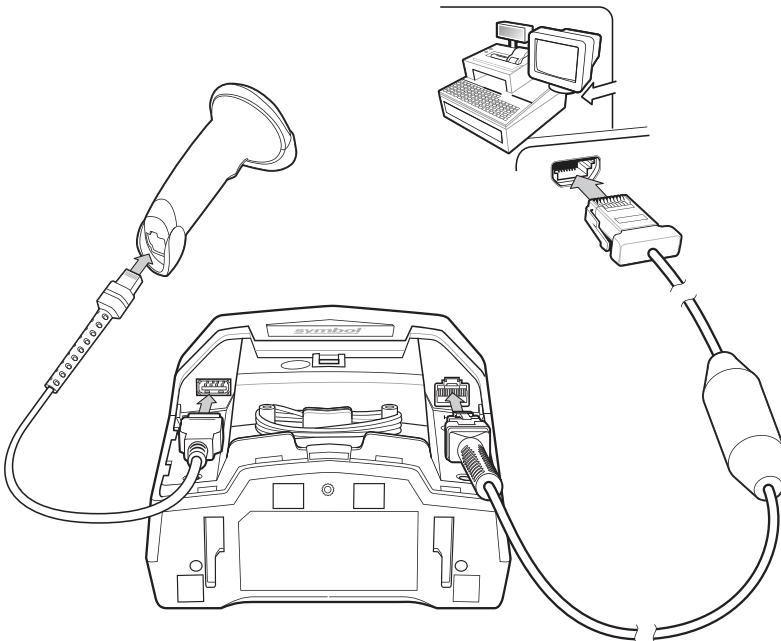

**Figure 8-2** IBM Connection with Optional Auxiliary Scanner



**NOTE** Interface cables vary depending on configuration. The connectors may be different from the examples illustrated, but the steps to connect the scanner are the same. See [IBM Cables on page viii](#) for cable information and part numbers.

To set up the DS7708 with an IBM interface:

1. Remove the back cover from the DS7708. See [Removing the Back Cover on page 1-5](#).
2. Plug the host interface cable into the scanner's host port.
3. Connect the other end of the interface cable to the appropriate port on the host (typically, Port 9).
4. Scan the appropriate bar codes in this chapter, or use 123Scan<sup>2</sup> to match the host settings.
5. If using an auxiliary scanner:
  - a. Connect the auxiliary scanner cable to the auxiliary scanner port on the DS7708.
  - b. Connect either a CBA-M65-S07ZAR or CBA-M66-S15ZAR 12 volt cable to the host as shown in [Figure 8-2](#).
6. Replace the DS7708 back cover (see [Removing and Replacing the Back Cover on page 1-5](#)).

## IBM Default Parameters

Table 8-1 lists the defaults for IBM host parameters. To change any option, scan the appropriate bar code(s) beginning in *IBM 468X/469X Host Parameters on page 8-5*.



**NOTES** See *Appendix A, STANDARD DEFAULT PARAMETERS* for all user preferences, hosts, symbologies, and miscellaneous default parameters.

**Table 8-1** *IBM Host Default Table*

Parameter	Default	Page Number
<b>IBM 468X/469X Host Parameters</b>		
Port Address	None Selected <sup>1</sup>	8-5
Convert Unknown to Code 39	Disable	8-7
Beep Directive	Ignore	8-8
Bar Code Configuration Directive	Ignore	8-9

<sup>1</sup>User selection is required to configure this interface and this is the most common selection.

---

## IBM 468X/469X Host Parameters

### Port Address

This parameter sets the IBM 468X/469X port used.

✓ **NOTE** Scanning one of these bar codes enables the RS-485 interface on the scanner.

Options:

- \*None Selected
- Hand-held Scanner Emulation (Port 9B)
- Hand-Held Scanner Emulation (Port 5B)
- Table-top Scanner Emulation (Port 17).

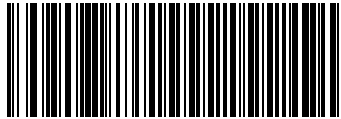

\* None Selected

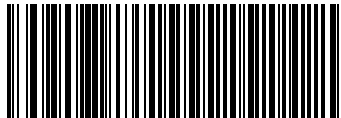

Hand-held Scanner Emulation (Port 9B)



**Port Address (continued)**

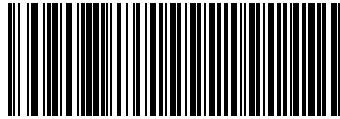

**Hand-Held Scanner Emulation (Port 5B)**



**Table-top Scanner Emulation (Port 17)**

## Convert Unknown to Code 39

Scan a bar code below to enable or disable the conversion of unknown bar code type data to Code 39.

Options:

- Enable Convert Unknown to Code 39
- \*Disable Convert Unknown to Code 39.

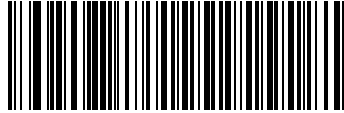

**Enable Convert Unknown to Code 39**



**\* Disable Convert Unknown to Code 39**

## Beep Directive

Scan one of the following bar codes to honor or ignore a beep directive from the IBM RS-485 host. When enabled, the request is **not** sent to the scanner. All directives are still acknowledged to the host as if they were processed.

Options:

- \*Ignore Beep Directive
- Honor Beep Directive.



**\*Ignore Beep Directive**



**Honor Beep Directive**

## Bar Code Configuration Directive

Scan one of the following bar codes to honor or ignore a bar code configuration (type) directive made over the IBM RS-485 bus. When this parameter is enabled, this request is **not** sent to the scanner. All directives are still acknowledged to the IBM RS-485 host as if they were processed.

Options:

- \*Ignore Bar Code Configuration Directive
- Honor Bar Code Configuration Directive.



**\*Ignore Bar Code Configuration Directive**



**Honor Bar Code Configuration Directive**



# CHAPTER 9 KEYBOARD WEDGE INTERFACE

---

## Introduction

This chapter provides information for setting up the scanner with a Keyboard Wedge interface. Use this interface type to attach the scanner between the keyboard and host computer. The scanner translates bar code data into keystrokes which the host computer accepts as if they originate from the keyboard.

This mode of operation allows adding bar code reading functionality to a system designed for manual keyboard input. In this mode the keyboard keystrokes are simply passed through.

Throughout the programming bar code menus, asterisks (\*) indicate default values.

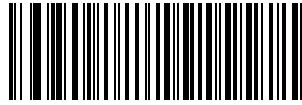

\* Indicates Default      \*No Delay      Feature/Option

## Connecting a Keyboard Wedge Interface

There are two possible configurations for connecting to a Keyboard Wedge host:

- The DS7708 connects directly to the host computer and keyboard using the keyboard wedge Y-cable (see [Figure 9-1](#)).
- The DS7708 connects directly to the host computer and keyboard using the keyboard wedge Y-cable, and an auxiliary scanner connects to the DS7708. A 12 volt power connection is required when using an auxiliary scanner (see [Figure 9-2](#)).

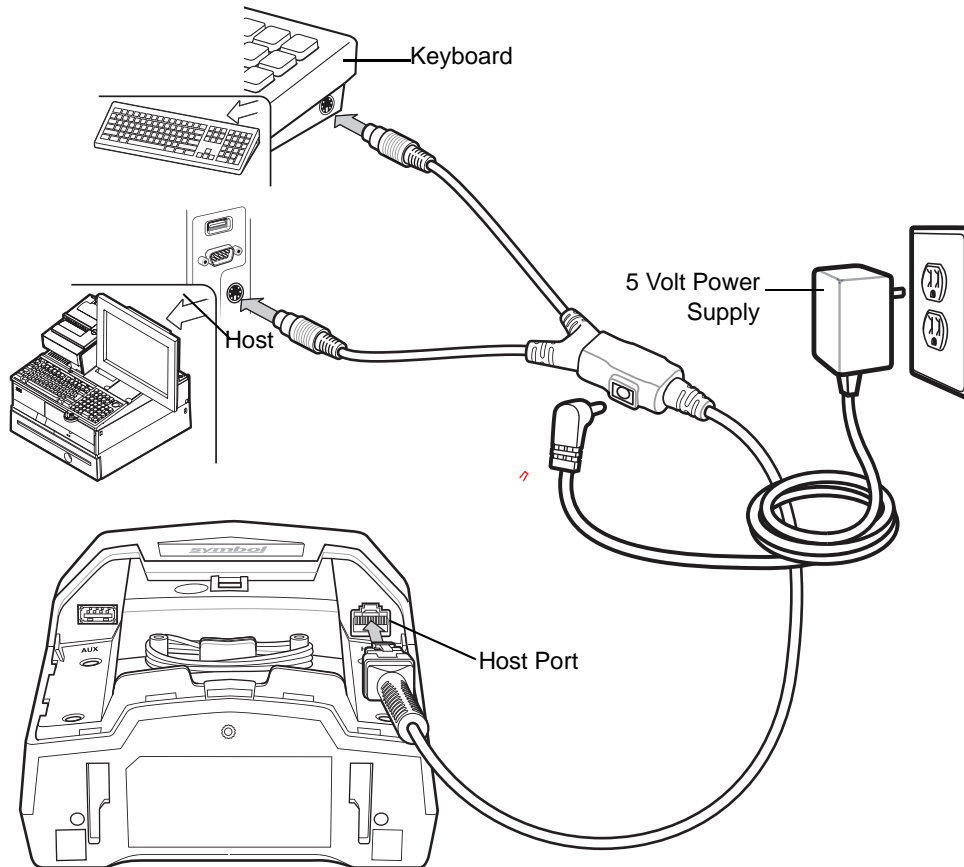

**Figure 9-1** Keyboard Wedge Connection - 5 Volt Power Supplied Externally

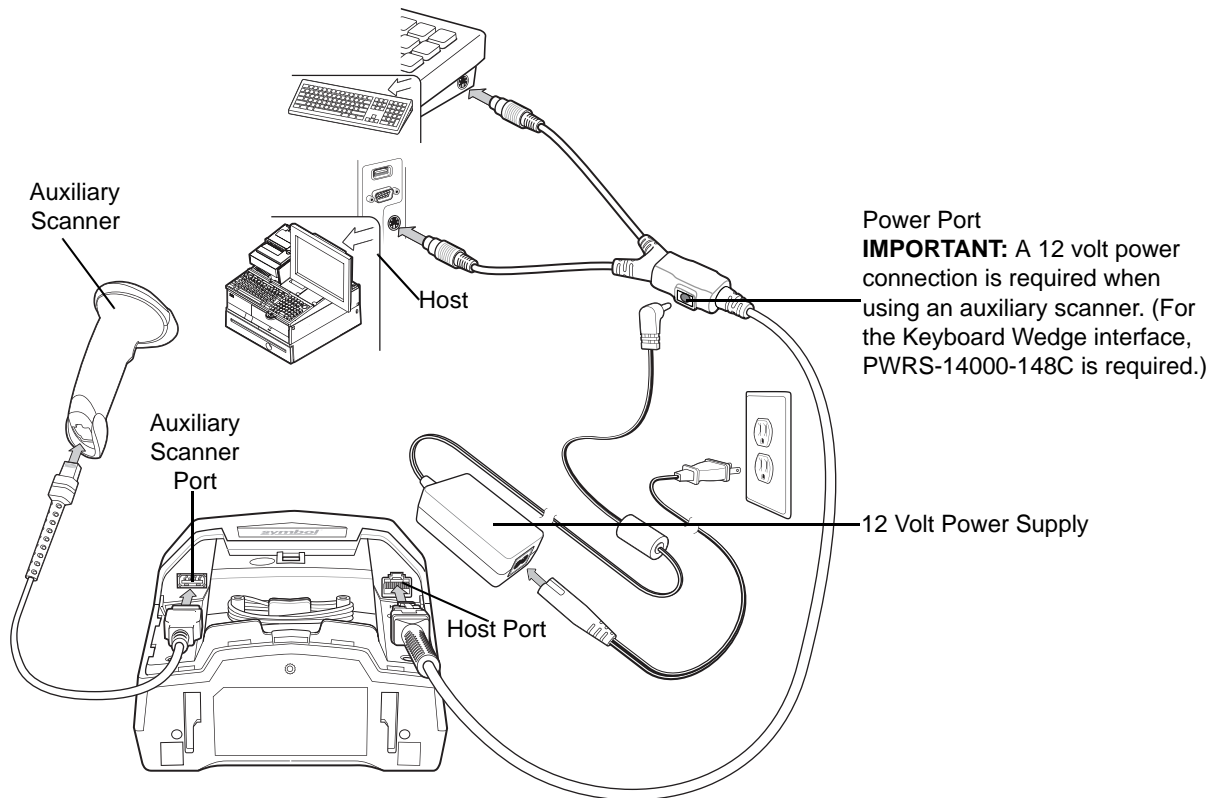

**Figure 9-2** Keyboard Wedge Connection - With Auxiliary Scanner/Power Supplied Externally

- ✓ **NOTE** Interface cables vary depending on configuration. The connectors may be different from the examples illustrated, but the steps to connect the scanner are the same. See [Keyboard Wedge Cables on page viii](#) for cable information and part numbers.

To set up the DS7708 with a Keyboard Wedge interface:

1. Switch off the host and unplug the keyboard connector.
2. Remove the back cover from the DS7708. See [Removing the Back Cover on page 1-5](#).
3. Plug the modular connector of the Y-cable into the scanner's host port.
4. Connect the round male DIN host connector of the Y-cable to the keyboard port on the host.
5. Connect the round female DIN keyboard connector of the Y-cable to the keyboard connector.
6. Connect the power supply to the scanner's power port.

- ✓ **NOTE** When connecting an auxiliary scanner, the required 12 Volt power supply is PWRS-14000-148C.

7. Ensure that all connections are secure.
8. Turn on the host system.
9. If not using a North American keyboard, scan the appropriate country bar code in [Appendix B, COUNTRY CODES](#).
10. If using an auxiliary scanner:
  - a. Connect the auxiliary scanner cable to the auxiliary scanner port on the DS7708.
  - b. Connect a 12 volt external power supply as shown in [Figure 9-2](#).
11. Replace the DS7708 back cover (see [Removing and Replacing the Back Cover on page 1-5](#)).
12. Scan the appropriate bar codes in this chapter or use 123Scan<sup>2</sup> to configure the scanner.



## Keyboard Wedge Default Parameters

*Table 9-1* lists the defaults for Keyboard Wedge host parameters. To change any option, scan the appropriate bar code(s) beginning in *Keyboard Wedge Host Types on page 9-5*.



**NOTES** See *Appendix B, COUNTRY CODES* for USB Country Keyboard Types (Country Codes).

See *Appendix A, STANDARD DEFAULT PARAMETERS* for all user preferences, hosts, symbologies, and miscellaneous default parameters.

**Table 9-1** *Keyboard Wedge Host Default Table*

Parameter	Default	Page Number
<b>Keyboard Wedge Host Parameters</b>		
Keyboard Wedge Host Type	IBM AT Notebook	<a href="#">9-5</a>
Ignore Unknown Characters	Send Bar Codes	<a href="#">9-6</a>
Keystroke Delay	No Delay	<a href="#">9-7</a>
Intra-Keystroke Delay	Disable	<a href="#">9-9</a>
Alternate Numeric Keypad Emulation	Enable	<a href="#">9-10</a>
Quick Keypad Emulation	Enable	<a href="#">9-11</a>
Caps Lock On	Disable	<a href="#">9-12</a>
Caps Lock Override	Disable	<a href="#">9-13</a>
Convert Wedge Data	No Convert	<a href="#">9-14</a>
Function Key Mapping	Disable	<a href="#">9-16</a>
FN1 Substitution	Disable	<a href="#">9-17</a>
Send Make Break	Send	<a href="#">9-18</a>

## Keyboard Wedge Host Types

Select the keyboard wedge host by scanning one of the following bar codes.

Options:

- IBM PC/AT & IBM PC Compatibles
- \*IBM AT NOTEBOOK.

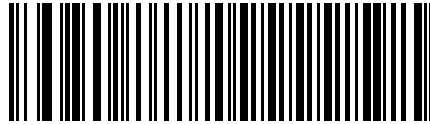

**IBM PC/AT & IBM PC Compatibles**

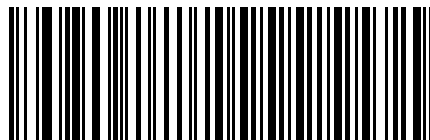

**\*IBM AT NOTEBOOK**

## Ignore Unknown Characters

Unknown characters are characters the host does not recognize. When **Send Bar Codes With Unknown Characters** is selected, all bar code data is sent except for unknown characters, and no error beeps sound on the scanner. When **Do Not Send Bar Codes With Unknown Characters** is selected, bar code data is sent up to the first unknown character and then four (error) beeps sound on the scanner.

Options:

- \*Send Bar Codes With Unknown Characters
- Do Not Send Bar Codes With Unknown Characters.

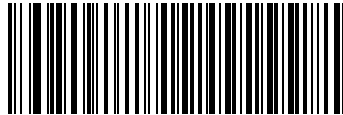

**\*Send Bar Codes With Unknown Characters**



**Do Not Send Bar Codes With Unknown Characters**

## Keystroke Delay

This is the delay in milliseconds between emulated keystrokes. Scan a bar code below to increase the delay when hosts require a slower transmission of data.

Options:

- \*No Delay
- Medium Delay (20 msec)
- Long Delay (40 msec).

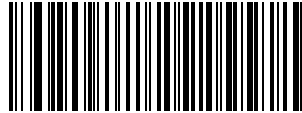

**\*No Delay**



**Medium Delay (20 msec)**

## Keystroke Delay (continued)

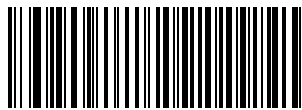

Long Delay (40 msec)

## Intra-Keystroke Delay

Enable this to insert an additional delay between each emulated key depression and release. This sets the Keystroke Delay parameter to a minimum of 5 msec as well.

Options:

- Enable Intra-Keystroke Delay
- \*Disable Intra-Keystroke Delay.

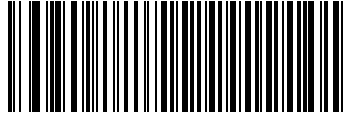

**Enable**



**\*Disable**

## Alternate Numeric Keypad Emulation

This allows emulation of most other country keyboard types not listed in [Appendix B, COUNTRY CODES](#) in a Microsoft operating system environment.

### Options

- \*Enable Alternate Numeric Keypad
- Disable Alternate Numeric Keypad.

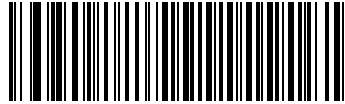

**\*Enable Alternate Numeric Keypad**



**Disable Alternate Numeric Keypad**

## Quick Keypad Emulation

This parameter enables faster keypad emulation where character value sequences are only sent for characters not found on the keyboard.

✓ **NOTE** This option applies only when [Alternate Numeric Keypad Emulation on page 9-10](#) is enabled.

Options:

- \*Enable Quick Keypad Emulation
- Disable Quick Keypad Emulation.



**\*Enable Quick Keypad Emulation**



**Disable Quick Keypad Emulation**



## Caps Lock On

When enabled, the scanner emulates keystrokes as if the Caps Lock key is always pressed.

Options:

- Enable Caps Lock On
- \*Disable Caps Lock On.

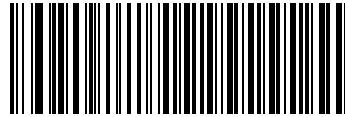

**Enable Caps Lock On**



**\*Disable Caps Lock On**

## Caps Lock Override

When enabled, on AT or AT Notebook hosts, the keyboard ignores the state of the Caps Lock key. Therefore, an 'A' in the bar code is sent as an 'A' regardless of the state of the keyboard's Caps Lock key.

✓ **NOTE** If both Caps Lock On and Caps Lock Override are enabled, Caps Lock Override takes precedence.

Options:

- Enable Caps Lock Override
- \*Disable Caps Lock Override.

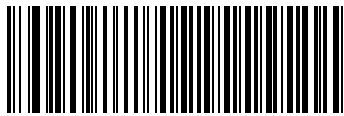

**Enable Caps Lock Override**



**\*Disable Caps Lock Override**

## Convert Wedge Data

When enabled, the scanner converts all bar code data to the selected case.

Options:

- Convert to Upper Case
- Convert to Lower Case
- \*No Convert

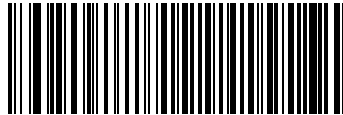

**Convert to Upper Case**



**Convert to Lower Case**

**Convert Wedge Data (continued)**



**\*No Convert**

## Function Key Mapping

ASCII values under 32 are normally sent as a control-key sequences (see [Table 9-2 on page 9-19](#)). Enable this parameter to send the keys in bold in place of the standard key mapping. Items that do not have a bold entry remain the same whether or not this parameter is enabled.

Options:

- Enable Function Key Mapping
- \*Disable Function Key Mapping.

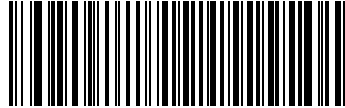

**Enable**

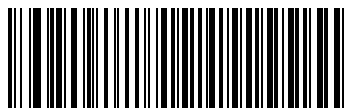

**\*Disable**

## FN1 Substitution

Enable this to replace any FN1 characters in an EAN 128 bar code with a selected Key Category and Key Value (see [FN1 Substitution Values on page 4-36](#)).

Options:

- Enable FN1 Substitution
- \*Disable FN1 Substitution.

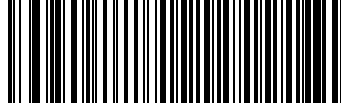

**Enable**

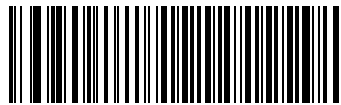

**\*Disable**

## Send Make Break

When enabled, the scan codes for releasing a key are not sent.

Options:

- \*Send Make and Break Scan Codes
- Send Make Scan Code Only.

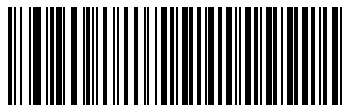

**\*Send Make and Break Scan Codes**

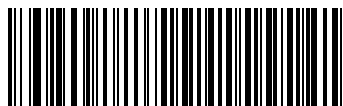

**Send Make Scan Code Only**

## ASCII Character Set for Keyboard Wedge

✓ **NOTE** Code 39 Full ASCII interprets the bar code special character (\$ + % /) preceding a Code 39 character and assigns an ASCII character value to the pair. For example, if you enable Code 39 Full ASCII and scan **+B**, it transmits as **b**, **%J** as **?**, and **%V** as **@**. Scanning **ABC%I** outputs the keystroke equivalent of **ABC >**.

**Table 9-2** Keyboard Wedge ASCII Character Set

ASCII Value	Full ASCII Code 39 Encode Character	Keystroke
1001	\$A	CTRL A
1002	\$B	CTRL B
1003	\$C	CTRL C
1004	\$D	CTRL D
1005	\$E	CTRL E
1006	\$F	CTRL F
1007	\$G	CTRL G
1008	\$H	CTRL H/ <b>BACKSPACE</b> <sup>1</sup>
1009	\$I	CTRL I/ <b>HORIZONTAL TAB</b> <sup>1</sup>
1010	\$J	CTRL J
1011	\$K	CTRL K
1012	\$L	CTRL L
1013	\$M	CTRL M/ <b>ENTER</b> <sup>1</sup>
1014	\$N	CTRL N
1015	\$O	CTRL O
1016	\$P	CTRL P
1017	\$Q	CTRL Q
1018	\$R	CTRL R
1019	\$S	CTRL S
1020	\$T	CTRL T
1021	\$U	CTRL U
1022	\$V	CTRL V
1023	\$W	CTRL W

<sup>1</sup>The keystroke in bold transmits only if you enabled *Function Key Mapping* on page 9-16. Otherwise, the unbolded keystroke transmits.



**Table 9-2** Keyboard Wedge ASCII Character Set (Continued)

ASCII Value	Full ASCII Code 39 Encode Character	Keystroke
1024	\$X	CTRL X
1025	\$Y	CTRL Y
1026	\$Z	CTRL Z
1027	%A	CTRL [ /ESC <sup>1</sup>
1028	%B	CTRL \
1029	%C	CTRL ]
1030	%D	CTRL 6
1031	%E	CTRL -
1032	Space	Space
1033	/A	!
1034	/B	"
1035	/C	#
1036	/D	\$
1037	/E	%
1038	/F	&
1039	/G	'
1040	/H	(
1041	/I	)
1042	/J	*
1043	/K	+
1044	/L	,
1045	-	-
1046	.	.
1047	/O	/
1048	0	0
1049	1	1
1050	2	2
1051	3	3
1052	4	4

<sup>1</sup>The keystroke in bold transmits only if you enabled *Function Key Mapping* on page 9-16. Otherwise, the unbolded keystroke transmits.

**Table 9-2** Keyboard Wedge ASCII Character Set (Continued)

ASCII Value	Full ASCII Code 39 Encode Character	Keystroke
1053	5	5
1054	6	6
1055	7	7
1056	8	8
1057	9	9
1058	/Z	:
1059	%F	;
1060	%G	<
1061	%H	=
1062	%I	>
1063	%J	?
1064	%V	@
1065	A	A
1066	B	B
1067	C	C
1068	D	D
1069	E	E
1070	F	F
1071	G	G
1072	H	H
1073	I	I
1074	J	J
1075	K	K
1076	L	L
1077	M	M
1078	N	N
1079	O	O
1080	P	P
1081	Q	Q

<sup>1</sup>The keystroke in bold transmits only if you enabled *Function Key Mapping* on page 9-16. Otherwise, the unbolded keystroke transmits.

**Table 9-2** Keyboard Wedge ASCII Character Set (Continued)

ASCII Value	Full ASCII Code 39 Encode Character	Keystroke
1082	R	R
1083	S	S
1084	T	T
1085	U	U
1086	V	V
1087	W	W
1088	X	X
1089	Y	Y
1090	Z	Z
1091	%K	[
1092	%L	\
1093	%M	]
1094	%N	^
1095	%O	_
1096	%W	'
1097	+A	<b>a</b>
1098	+B	<b>b</b>
1099	+C	<b>c</b>
1100	+D	<b>d</b>
1101	+E	<b>e</b>
1102	+F	<b>f</b>
1103	+G	<b>g</b>
1104	+H	<b>h</b>
1105	+I	<b>i</b>
1106	+J	<b>j</b>
1107	+K	<b>k</b>
1108	+L	<b>l</b>
1109	+M	<b>m</b>
1110	+N	<b>n</b>

<sup>1</sup>The keystroke in bold transmits only if you enabled *Function Key Mapping* on page 9-16. Otherwise, the unbolded keystroke transmits.

**Table 9-2** Keyboard Wedge ASCII Character Set (Continued)

ASCII Value	Full ASCII Code 39 Encode Character	Keystroke
1111	+O	o
1112	+P	p
1113	+Q	q
1114	+R	r
1115	+S	s
1116	+T	t
1117	+U	u
1118	+V	v
1119	+W	w
1120	+X	x
1121	+Y	y
1122	+Z	z
1123	%P	{
1124	%Q	
1125	%R	}
1126	%S	~

<sup>1</sup>The keystroke in bold transmits only if you enabled *Function Key Mapping* on page 9-16. Otherwise, the unbolded keystroke transmits.

**Table 9-3** *Keyboard Wedge ALT Key Character Set*

<b>ALT Keys</b>	<b>Keystroke</b>
2065	ALT A
2066	ALT B
2067	ALT C
2068	ALT D
2069	ALT E
2070	ALT F
2071	ALT G
2072	ALT H
2073	ALT I
2074	ALT J
2075	ALT K
2076	ALT L
2077	ALT M
2078	ALT N
2079	ALT O
2080	ALT P
2081	ALT Q
2082	ALT R
2083	ALT S
2084	ALT T
2085	ALT U
2086	ALT V
2087	ALT W
2088	ALT X
2089	ALT Y
2090	ALT Z

**Table 9-4** *Keyboard Wedge GUI Key Character Set*

<b>GUI Keys</b>	<b>Keystrokes</b>
3000	Right Control Key
3048	GUI 0
3049	GUI 1
3050	GUI 2
3051	GUI 3
3052	GUI 4
3053	GUI 5
3054	GUI 6
3055	GUI 7
3056	GUI 8
3057	GUI 9
3065	GUI A
3066	GUI B
3067	GUI C
3068	GUI D
3069	GUI E
3070	GUI F
3071	GUI G
3072	GUI H
3073	GUI I
3074	GUI J
3075	GUI K
3076	GUI L
3077	GUI M
3078	GUI N
3079	GUI O
3080	GUI P
3081	GUI Q
3082	GUI R
3083	GUI S

**Table 9-4** Keyboard Wedge GUI Key Character Set (Continued)

<b>GUI Keys</b>	<b>Keystrokes</b>
3084	GUI T
3085	GUI U
3086	GUI V
3087	GUI W
3088	GUI X
3089	GUI Y
3090	GUI Z

**Table 9-5** Keyboard Wedge F Key Character Set

<b>F Keys</b>	<b>Keystroke</b>
5001	F1
5002	F2
5003	F3
5004	F4
5005	F5
5006	F6
5007	F7
5008	F8
5009	F9
5010	F10
5011	F11
5012	F12
5013	F13
5014	F14
5015	F15
5016	F16
5017	F17
5018	F18
5019	F19
5020	F20
5021	F21

**Table 9-5** *Keyboard Wedge F Key Character Set (Continued)*

<b>F Keys</b>	<b>Keystroke</b>
5022	F22
5023	F23
5024	F24

**Table 9-6** *Keyboard Wedge Numeric Keypad Character Set*

<b>Numeric Keypad</b>	<b>Keystroke</b>
6042	*
6043	+
6044	undefined
6045	-
6046	.
6047	/
6048	0
6049	1
6050	2
6051	3
6052	4
6053	5
6054	6
6055	7
6056	8
6057	9
6058	Enter
6059	Num Lock



**Table 9-7** *Keyboard Wedge Extended Keypad Character Set*

<b>Extended Keypad</b>	<b>Keystroke</b>
7001	Break
7002	Delete
7003	Pg Up
7004	End
7005	Pg Dn
7006	Pause
7007	Scroll Lock
7008	Backspace
7009	Tab
7010	Print Screen
7011	Insert
7012	Home
7013	Enter
7014	Escape
7015	Up Arrow
7016	Dn Arrow
7017	Left Arrow
7018	Right Arrow

# CHAPTER 10 SSI INTERFACE

---

## Introduction

This chapter describes the system requirements of the Simple Serial Interface (SSI), which provides a communications link between Zebra decoders (e.g., scan engines, slot scanners, hand-held scanners, two-dimensional scanners, hands-free scanners, and RF base stations) and a serial host. It provides the means for the host to control the decoder or scanner.

---

## Communications

All communication between the decoder and host occurs over the hardware interface lines using the SSI protocol. Refer to the *Simple Serial Interface Programmer's Guide*, p/n 72-40451-xx, for more information on SSI.

The host and the decoder exchange messages in packets. A packet is a collection of bytes framed by the proper SSI protocol formatting bytes. The maximum number of bytes per packet that the SSI protocol allows for any transaction is 257 (255 bytes + 2 byte checksum).

Decode data can be sent as ASCII data (unpacketed), or as part of a larger message (packeted), depending on the decoder configuration.

SSI performs the following functions for the host device:

- Maintains a bi-directional interface with the decoder
- Allows the host to send commands that control the decoder
- Passes data from the decoder to a host device in SSI packet format or straight decode message.

The working environment of the SSI consists of a decoder, a serial cable which attaches to the host device, and in some instances, a power supply.

SSI transmits all decode data including special formatting (e.g., AIM ID). Parameter settings can control the format of the transmitted data.

The decoder can also send parameter information, product identification information, or event codes to the host.

All commands sent between the decoder and host must use the format described in the SSI Message Formats section. *SSI Transactions on page 10-3* describes the required sequence of messages in specific cases.

*Table 10-1* lists all the SSI opcodes the decoder supports. It identifies the SSI partner allowed to send a message of each type. The host transmits opcodes designated type H. The decoder transmits type D opcodes, and either partner can transmit Host/Decoder (H/D) types.

**Table 10-1** SSI Commands

Name	Type	Opcode	Description
BEEP	H	0xE6	Sound the beeper.
CAPABILITIES_REPLY	D	0xD4	Reply to CAPABILITIES_REQUEST; contains a list of the capabilities and commands the decoder supports.
CAPABILITIES_REQUEST	H	0xD3	Request capabilities report from the decoder.
CMD_ACK	H/D	0xD0	Positive acknowledgment of received packet.
CMD_NAK	H/D	0xD1	Negative acknowledgment of received packet.
DECODE_DATA	D	0xF3	Decode data in SSI packet format.
EVENT	D	0xF6	Event indicated by associated event code.
LED_OFF	H	0xE8	De-activate LED output.
LED_ON	H	0xE7	Activate LED output.
PARAM_DEFAULTS	H	0xC8	Set parameter default values.
PARAM_REQUEST	H	0xC7	Request values of certain parameters.
PARAM_SEND	H/D	0xC6	Send parameter values.
REPLY_ID	D	0xA6	Reply to REQUEST_ID; contains decoder's serial number.
REPLY_REVISION	D	0xA4	Reply to REQUEST_REVISION contains decoder's software/hardware configuration.
REQUEST_ID	H	0xA3	Request the decoder's serial number.
REQUEST_REVISION	H	0xA3	Request the decoder's configuration.
SCAN_DISABLE	H	0xEA	Prevent the operator from scanning bar codes.
SCAN_ENABLE	H	0xE9	Permit bar code scanning.
START_DECODE	H	0xE4	Tell decoder to attempt to decode a bar code.
STOP_DECODE	H	0xE5	Tell decoder to abort a decode attempt.

For details of the SSI protocol, refer to the *Simple Serial Interface Programmer's Guide (72-40451-xx)*.

---

## SSI Transactions

### General Data Transactions

#### ACK/NAK Handshaking

If you enable ACK/NAK handshaking, all packeted messages must have a CMD\_ACK or CMD\_NAK response, unless the command description states otherwise. This parameter is enabled by default. Zebra recommends leaving this handshaking enabled to provide feedback to the host. Raw decode data does not use ACK/NAK handshaking since they are not packeted data.

Following is an example of a problem which can occur if you disable ACK/NAK handshaking:

- The host sends a PARAM\_SEND message to the decoder to change the baud rate from 9600 to 19200.
- The decoder cannot interpret the message.
- The decoder does not implement the change the host requested.
- The host assumes that the parameter change occurred and acts accordingly.
- Communication is lost because the change did not occur on both sides.

If you enable ACK/NAK handshaking, the following occurs:

- The host sends a PARAM\_SEND message.
- The decoder cannot interpret the message.
- The decoder CMD\_NAKs the message.
- The host resends the message.
- The decoder receives the message successfully, responds with CMD\_ACK, and implements parameter changes.

## Transfer of Decode Data

The Decode Data Packet Format parameter controls how decode data is sent to the host. Set this parameter to send the data in a DECODE\_DATA packet. Clear this parameter to transmit the data as raw ASCII data.

✓ **NOTE** When transmitting decode data as raw ASCII data, ACK/NAK handshaking does not apply regardless of the state of the ACK/NAK handshaking parameter.

### ACK/NAK Enabled and Packeted Data

The decoder sends a DECODE\_DATA message after a successful decode. The decoder waits for a programmable time-out for a CMD\_ACK response. If it does not receive the response, the decoder tries to send two more times before issuing a host transmission error. If the decoder receives a CMD\_NAK from the host, it may attempt a retry depending on the cause field of the CMD\_NAK message.

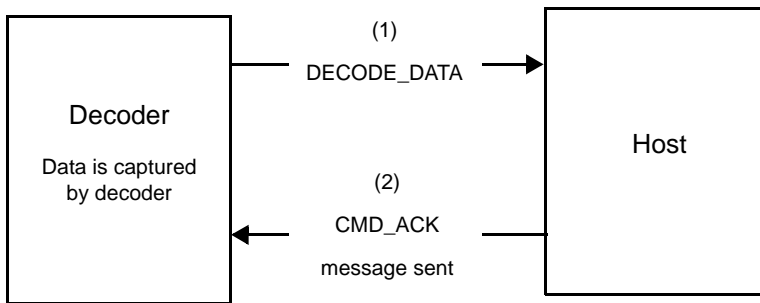

### ACK/NAK Enabled and Unpacketed ASCII Data

Even though the ACK/NAK handshaking is enabled, no handshaking occurs because the handshaking applies only to packeted data. In this example the **packeted\_decode** parameter is disabled.

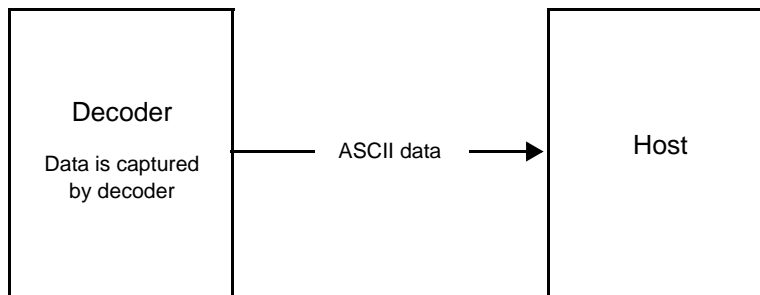

### ACK/NAK Disabled and Packeted DECODE\_DATA

In this example ACK/NAK does not occur even though **packeted\_decode** is enabled because the ACK/NAK handshaking parameter is disabled.

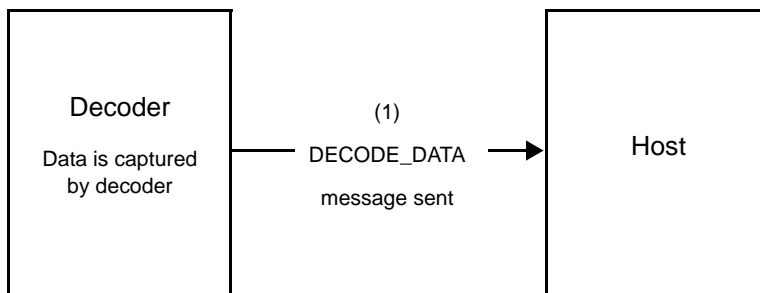

### ACK/NAK Disabled and Unpacketed ASCII Data

Data captured by the decoder is sent to the host.

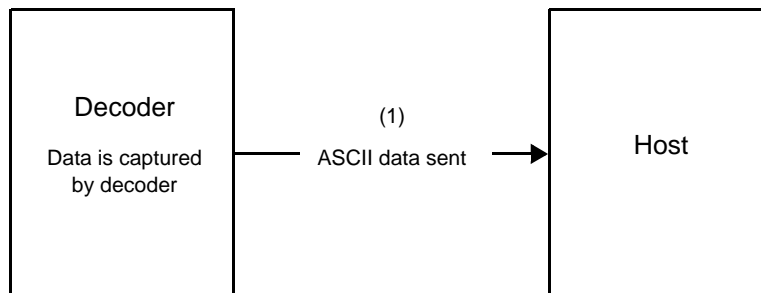

---

## Communication Summary

### RTS/CTS Lines

All communication must use RTS/CTS handshaking as described in the *Simple Serial Interface Programmer's Guide*, p/n 72-40451-xx.

### ACK/NAK Option

Enable or disable ACK/NAK handshaking. This handshaking is enabled by default and Zebra recommends leaving it enabled. Disabling this handshaking can cause communication problems, as handshaking is the only acknowledgment that a message was received, and if it was received correctly. ACK/NAK is not used with unpacketed decode data regardless of whether or not it is enabled.

### Number of Data Bits

All communication with the decoder must use 8-bit data.

### Serial Response Time-out

The Serial Response Time-out parameter determines how long to wait for a handshaking response before trying again, or aborting any further attempts. Set the same value for both the host and decoder.

- ✓ **NOTE** You can temporarily change the Serial Response Time-out when the host takes longer to process an ACK or longer data string. Zebra does not recommend frequent permanent changes due to limited write cycles of non-volatile memory.

### Retries

When sending data, the host should resend twice after the initial send if the decoder does not respond with an ACK or NAK (if ACK/NAK handshaking is enabled), or response data (e.g., PARAM\_SEND, REPLY\_REVISION). If the decoder replies with a NAK RESEND, the host resends the data. All resent messages must have the resend bit set in the Status byte.

The decoder resends data two times after the initial send if the host fails to reply with an ACK or NAK (if ACK/NAK handshaking is enabled).

## **Baud Rate, Stop Bits, Parity, Response Time-out, ACK/NAK Handshake**

If you use PARAM\_SEND to change these serial parameters, the ACK response to the PARAM\_SEND uses the previous values for these parameters. The new values then take effect for the next transaction.

## **Errors**

The decoder issues a communication error when:

- The CTS line is asserted when the decoder tries to transmit, and is still asserted on each of 2 successive retries
- Failure to receive an ACK or NAK after initial transmit and two resends.

---

## **Things to Remember When Using SSI Communication**

When not using hardware handshaking, space messages sufficiently apart. The host must not communicate with the decoder if the decoder is transmitting.

When using hardware handshaking, frame each message properly with the handshaking signals. Do not try to send two commands within the same handshaking frame.

There is a permanent/temporary bit in the PARAM\_SEND message. Removing power from the decoder discards temporary changes. Permanent changes are written to non-volatile memory. Frequent changes shorten the life of the non-volatile memory.

## Encapsulation of RSM Commands/Responses Over SSI

The SSI protocol allows the host to send a command that is variable in length up to 255 bytes. Although there is a provision in the protocol to multi-packet commands from the host, the scan engine does not support this. The host must fragment packets using the provisions in the RSM protocol.

### Command Structure

Byte	7	6	5	4	3	2	1	0
0	Length (not including the checksum)							
1	SSI_MGMT_COMMAND (0x80)							
2	Message Source (4 - Host)							
3	Reserved (0)			Reserved (0)		Reserved (0)	Cont'd packet	Retransmit
4	Payload data (see the following example)							
...								
Length -1								
Length	2's complement checksum (MSB)							
Length +1	2's complement checksum (LSB)							

The expected response in the positive case is SSI\_MGMT\_COMMAND which may be a multi-packet response. For devices that do not support the SSI\_MGMT\_COMMAND, the response is the standard SSI\_NAK.

### Response Structure

Byte	7	6	5	4	3	2	1	0
0	Length (not including the checksum)							
1	SSI_MGMT_COMMAND (0x80)							
2	Message Source (0 - Decoder)							
3	Reserved (0)			Reserved (0)		Reserved (0)	Cont'd packet	Retransmit
4	Payload data (see the following example)							
...								
Length -1								
Length	2's complement checksum (MSB)							
Length +1	2's complement checksum (LSB)							



## Simple Serial Interface Default Parameters

This section describes how to set up the decoder with a SSI host. When using SSI, program the decoder via bar code menu or SSI hosts commands.

Throughout the programming bar code menus, asterisks (\*) indicate default values.



- ✓ **NOTE** Most computer monitors allow scanning the bar codes directly on the screen. When scanning from the screen, be sure to set the document magnification to a level where you can see the bar code clearly, and bars and/or spaces are not merging.

Table 10-2 lists the defaults for the SSI host. There are two ways to change the default values:

- Scan the appropriate bar codes in this guide. These new values replace the standard default values in memory. To recall the default parameter values, scan the bar code *\*Set Defaults on page 4-4*.
- Download data through the device's serial port using SSI. Hexadecimal parameter numbers appear in this chapter below the parameter title, and options appear in parenthesis beneath the accompanying bar codes. Refer to the *Simple Serial Interface (SSI) Programmer's Guide* for detailed instructions for changing parameters using this method.

- ✓ **NOTE** See *Appendix A, STANDARD DEFAULT PARAMETERS* for all user preferences, hosts, symbologies, and miscellaneous default parameters.

**Table 10-2** SSI Default Table

Parameter	SSI Number <sup>1</sup>	Parameter Number <sup>2</sup>	Default	Page Number
Select SSI Host	n/a	n/a	n/a	10-10
Baud Rate	9Ch	156	9600	10-11
Parity	9Eh	158	None	10-15
Check Parity	97h	151	Disable	10-17
Stop Bits	9Dh	157	1	10-18
Software Handshaking	9Fh	159	ACK/NAK	10-19
Host RTS Line State	9Ah	154	Low	10-20
Decode Data Packet Format	EEh	238	Send Raw Decode Data	10-21

<sup>1</sup> SSI number hex values are used for programming via SSI commands.

<sup>2</sup> Parameter number decimal values are used for programming via RSM commands.

**Table 10-2** SSI Default Table (Continued)

Parameter	SSI Number <sup>1</sup>	Parameter Number <sup>2</sup>	Default	Page Number
Host Serial Response Time-out	9Bh	155	2 sec	<a href="#">10-22</a>
Host Character Time-out	EFh	239	200 msec	<a href="#">10-24</a>
Multipacket Option	F0h 4Eh	334	Option 1	<a href="#">10-26</a>
Interpacket Delay	F0h 4Fh	335	0 ms	<a href="#">10-28</a>
<b>Event Reporting</b>				
Decode Event	F0h 00h	256	Disable	<a href="#">10-31</a>
Boot Up Event	F0h 02h	258	Disable	<a href="#">10-32</a>
Parameter Event	F0h 03h	259	Disable	<a href="#">10-33</a>

<sup>1</sup> SSI number hex values are used for programming via SSI commands.

<sup>2</sup> Parameter number decimal values are used for programming via RSM commands.

- ✓ **NOTE** SSI interprets Prefix, Suffix1, and Suffix2 values listed in [ASCII Character Set for USB on page 6-33](#) and [Prefix/Suffix Values on page 7-37](#) differently than other interfaces. SSI does not recognize key categories, only the 3-digit decimal value. The default value of 7013 is interpreted as CR only.

---

## SSI Parameters

### Select SSI Host

To select SSI as the host interface, scan the following bar code.



**SSI Host**

## Baud Rate

### SSI # 9Ch

#### Parameter # 156

Baud rate is the number of bits of data transmitted per second. Set the decoder's baud rate to match the baud rate setting of the host device. Otherwise, data may not reach the host device or may reach it in distorted form.

Options:

- \*9600
- 19,200
- 38,400
- 57,600
- 115,200
- 230,400
- 460,800
- 921,600.



**\*Baud Rate 9600  
(06h)**



**Baud Rate 19,200  
(07h)**

**Baud Rate (continued)**



**Baud Rate 38,400  
(08h)**



**Baud Rate 57,600  
(0Ah)**

**Baud Rate (continued)**



**Baud Rate 115,200  
(0Bh)**



**Baud Rate 230,400  
(0Ch)**

**Baud Rate (continued)**



**Baud Rate 460,800  
(0Dh)**



**Baud Rate 921,600  
(0Eh)**

## Parity

### SSI # 9Eh

#### Parameter # 158

A parity check bit is the most significant bit of each ASCII coded character. Select the parity type according to host device requirements.

- Select **Odd** parity and the parity bit has a value 0 or 1, based on data, to ensure that an odd number of 1 bits is contained in the coded character.
- Select **Even** parity and the parity bit has a value 0 or 1, based on data, to ensure that an even number of 1 bits is contained in the coded character.
- If no parity is required, select **None**.



**Odd**  
**(02h)**



**Even**  
**(01h)**



**Parity (continued)**



**\*None  
(00h)**

## Check Parity

**SSI # 97h**

**Parameter # 151**

Select whether or not to check the parity of received characters. Use the Parity parameter to select the type of parity.

Options:

- \*Do Not Check Parity
- Check Parity.



**\*Do Not Check Parity  
(00h)**



**Check Parity  
(01h)**

## Stop Bits

### SSI # 9Dh

### Parameter # 157

The stop bit(s) at the end of each transmitted character marks the end of transmission of one character and prepares the receiving (host) device for the next character in the serial data stream. Set the number of stop bits (one or two) to match host device requirements.

Options:

- \*1 Stop Bit
- 2 Stop Bits.



**\*1 Stop Bit  
(01h)**



**2 Stop Bits  
(02h)**

## Software Handshaking

### SSI # 9Fh

#### Parameter # 159

This parameter offers control of data transmission in addition to the control hardware handshaking offers. Hardware handshaking is always enabled; you cannot disable it.

- **Disable ACK/NAK Handshaking:** When this option is selected, the decoder neither generates nor expects ACK/NAK handshaking packets.
- **Enable ACK/NAK Handshaking:** When this option is selected, after transmitting data, the decoder expects either an ACK or NAK response from the host. The decoder also ACKs or NAKs messages from the host.

The decoder waits up to the programmable Host Serial Response Time-out to receive an ACK or NAK. If the decoder does not get a response in this time, it resends its data up to two times before discarding the data and declaring a transmit error.



**Disable ACK/NAK  
(00h)**



**\*Enable ACK/NAK  
(01h)**

## Host RTS Line State

### SSI # 9Ah

### Parameter # 154

This parameter sets the expected idle state of the Serial Host RTS line.

The SSI Interface is used with host applications which also implement the SSI protocol. However, you can use the decoder in a "scan-and-transmit" mode to communicate with any standard serial communication software on a host PC (see [Decode Data Packet Format on page 10-21](#)). If transmission errors occur in this mode, the host PC may be asserting hardware handshaking lines which interfere with the SSI protocol. Scan the **Host: RTS High** bar code to address this problem.

Options:

- \*Host: Low RTS
- Host: High RTS.



**\*Host: RTS Low  
(00h)**



**Host: RTS High  
(01h)**

## Decode Data Packet Format

### SSI # EEh

#### Parameter # 238

This parameter selects whether to transmit decoded data in raw format (unpacketed), or with the packet format defined by the serial protocol.

Selecting the raw format disables ACK/NAK handshaking for decode data.

Options:

- \*Send Raw Decode Data
- Send Packeted Decode Data.



**\*Send Raw Decode Data  
(00h)**



**Send Packeted Decode Data  
(01h)**

## Host Serial Response Timeout

### SSI # 9Bh

### Parameter # 155

This parameter specifies how long the decoder waits for an ACK or NAK before resending. Also, if the decoder wants to send, and the host has already been granted permission to send, the decoder waits for the designated time-out before declaring an error.

To set the delay period (options are 2, 5, 7.5, or 9.9 seconds), scan one of the following bar codes.

✓ **NOTE** Other values are available via SSI command.

Options:

- \*Low - 2 Seconds
- Medium - 5 Seconds
- High - 7.5 Seconds
- Maximum - 9.9 Seconds.



**\*Low - 2 Seconds  
(14h)**



**Medium - 5 Seconds  
(32h)**

**Host Serial Response Timeout (continued)**

**High - 7.5 Seconds  
(4Bh)**



**Maximum - 9.9 Seconds  
(63h)**



## Host Character Timeout

### SSI # EFh

### Parameter # 239

This parameter determines the maximum time the decoder waits between characters transmitted by the host before discarding the received data and declaring an error.

To set the delay period (options are 200, 500, 750, or 990 ms), scan one of the following bar codes.

✓ **NOTE** Other values are available via SSI command.

Options:

- \*Low - 200 ms
- Medium - 500 ms
- High - 750 ms
- Maximum - 990 ms.



**\*Low - 200 ms  
(14h)**



**Medium - 500 ms  
(32h)**

**Host Character Timeout (continued)**

High - 750 ms  
(4Bh)



Maximum - 990 ms  
(63h)

## Multipacket Option

SSI # F0h, 4Eh

Parameter # 334

This parameter controls ACK/NAK handshaking for multi-packet transmissions.

- **Multi-Packet Option 1:** The host sends an ACK / NAK for each data packet during a multi-packet transmission.
- **Multi-Packet Option 2:** The decoder sends data packets continuously, with no ACK/NAK handshaking to pace the transmission. The host, if overrun, can use hardware handshaking to temporarily delay decoder transmissions. At the end of transmission, the decoder waits for a CMD\_ACK or CMD\_NAK.
- **Multi-Packet Option 3:** Option 3 is the same as option 2 with the addition of a programmable interpacket delay.



**\*Multipacket Option 1  
(00h)**



**Multipacket Option 2  
(01h)**

**Multipacket Option (continued)**

**Multipacket Option 3  
(02h)**

## Interpacket Delay

**SSI # F0h, 4Fh**

**Parameter # 335**

This parameter specifies the interpacket delay if you selected **Multipacket Option 3**.

To set the delay period (options are 0, 25, 50, 75, or 99 ms), scan one of the following bar codes.

✓ **NOTE** Other values are available via SSI command.

Options:

- \*Minimum - 0 ms
- Low - 25 ms
- Medium - 50 ms
- High - 75 ms
- Maximum - 99 ms.



**\*Minimum - 0 ms  
(00h)**



**Low - 25 ms  
(19h)**

**Interpacket Delay (continued)**

**Medium - 50 ms  
(32h)**



**High - 75 ms  
(4Bh)**

**Interpacket Delay (continued)**



**Maximum - 99 ms  
(63h)**

## Event Reporting

The host can request the decoder to provide certain information (events) relative to the decoder's behavior. Enable or disable the events listed in [Table 10-3](#) and on the following pages by scanning the appropriate bar codes.

**Table 10-3** *Event Codes*

Event Class	Event	Code Reported
Decode Event	Non parameter decode	0x01
Boot Up Event	System power-up	0x03
Parameter Event	Parameter entry error	0x07
	Parameter stored	0x08
	Defaults set (and parameter event is enabled by default)	0x0A
	Number expected	0x0F

### Decode Event

**SSI # F0h, 00h**

**Parameter # 256**

When enabled, the decoder generates a message to the host upon a successful bar code decode. When disabled, no notification is sent.

Options:

- Enable Decode Event
- \*Disable Decode Event.

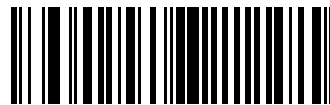

**Enable Decode Event  
(01h)**



**\*Disable Decode Event  
(00h)**



## Boot Up Event

**SSI # F0h, 02h**

**Parameter # 258**

When enabled, the decoder generates a message to the host whenever power is applied. When disabled, no notification is sent.

Options:

- Enable Boot Up Event
- \*Disable Boot Up Event.

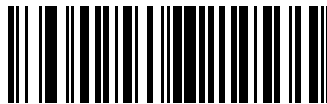

**Enable Boot Up Event  
(01h)**

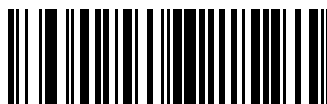

**\*Disable Boot Up Event  
(00h)**

## Parameter Event

**SSI # F0h, 03h**

**Parameter # 259**

When enabled, the decoder generates a message to the host when one of the events specified in [Table 10-3 on page 10-31](#) occurs. When disabled, no notification is sent.

Options:

- Enable Parameter Event
- \*Disable Parameter Event.

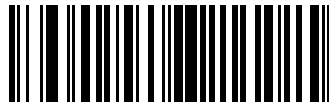

**Enable Parameter Event  
(01h)**



**\*Disable Parameter Event  
(00h)**



# CHAPTER 11 AUXILIARY SCANNER

---

## Connecting an Auxiliary Scanner

The DS7708 provides a USB port to connect an auxiliary hand-held scanner. See the diagrams in each interface chapter for host and auxiliary scanner connection details.

Auxiliary scanners that are supported by the DS7708 include but are not limited to Zebra's LS2208, DS4208, DS4308, DS4308P and DS6878.

---

## Programming the Auxiliary Scanner

The auxiliary scanner can be programmed in the following ways:

- Connect the auxiliary scanner to the DS7708 and connect the DS7708 to a PC running 123Scan<sup>2</sup>. You can program both (independently) via 123Scan<sup>2</sup>.
- Scan a macro programming bar code from this guide, or one created via 123Scan<sup>2</sup> using the auxiliary scanner.
- Scan the programming bar codes in this guide using the auxiliary scanner.

✓ **NOTE** Programming done on the DS7708 is not automatically transferred to the auxiliary scanner.

✓ **NOTE** When the DS7708 powers up it automatically configures the auxiliary scanner host type to be the same as the DS7708 host type. All of the other auxiliary scanner settings and user parameters remain as is.

## Downloading Firmware

Updating firmware on the auxiliary scanner can be done in the following ways:

- Connect the auxiliary scanner to a PC running 123Scan<sup>2</sup>. Update firmware via 23Scan<sup>2</sup>.
- Connect the auxiliary scanner to the DS7708 and connect the DS7708 to a PC running 123Scan<sup>2</sup>. You can update firmware in both (independently) via 123Scan<sup>2</sup>.

---

## 12VDC Power Requirement

The DS7708 requires 12VDC when an auxiliary scanner is connected.

12VDC is provided as follows:

- USB (Series A) - A 12VDC USB (Series A) cable and 12VDC power supply is required.
- USB (PowerPLus) - A 12VDC USB (PowerPlus) cable is required. 12VDC provided by host.
- RS-232 - A 12VDC RS-232 cable and 12VDC power supply is required.
- IBM (RS485) - A 12VDC IBM (RS485) cable is required. 12VDC provided by host.
- Keyboard Wedge - A 12VDC Keyboard Wedge cable and 12VDC power supply is required.

- ✓ **NOTE** Power supply model PWRS-14000-148R is required for USB (Series A) and RS-232.  
Power supply model PWRS-14000-148C is required for USB (Series A) and RS-232.

---

## Using Auxiliary Scanners

### Using a Zebra Scanner as an Auxiliary Scanner

When the DS7708 powers up it automatically configures the auxiliary scanner host type to be the same as the DS7708 host type. This feature is supported by Zebra scanners that support RSM commands. Some Zebra scanners, such as the LS1203 and older LS2208s, do not support this feature. (See [Using a Zebra Scanner That Does Not Support RSM Commands as an Auxiliary Scanner](#) below.) All of the other auxiliary scanner settings and user parameters remain as is.

- ✓ **NOTES** An auxiliary cordless scanner, such as the LI4278, LS4278, or DS6878, can be attached to the DS7708. If a presentation cradle is used with any of these scanners, a separate cradle power supply (12VDC) is required.

If a standard cradle is used with the DS6878, a separate cradle power supply (5VDC) is required.

### Using a Zebra Scanner That Does Not Support RSM Commands as an Auxiliary Scanner

When connecting a Zebra scanner that does not support RSM commands (for example, the LS1203) as an auxiliary scanner you must disable automatic host switching and RSM communication to the auxiliary scanner by setting the parameter **Disable Aux Scanner RSM Communication** ([page 11-3](#)), prior to connecting the auxiliary scanner. Zebra scanners that do not support RSM commands must be programmed separately and pre-configured for the appropriate host type before connecting to the DS7708 as an auxiliary scanner.

### Using a Non-Zebra Scanner as an Auxiliary Scanner

The DS7708 provides a USB port to connect an auxiliary hand-held scanner. Non-Zebra scanners must be programmed separately and pre-configured for the appropriate host type before connecting to DS7708.

- ✓ **NOTE** Zebra does not guarantee that a non-Zebra scanner will operate as an auxiliary scanner on the DS7708.

## Auxiliary RSM Communication Bar Codes

**SSI # F8 05 4E**

**Parameter # 1358**

Prior to connecting the auxiliary scanner, scan **Disable Aux Scanner RSM Communication** when connecting a Zebra auxiliary scanner that does not support RSM commands. This disables automatic host switching and RSM communication to the auxiliary scanner.



**Disable Aux RSM Communication  
(00h)**



**NOTE** This option is not recommended for Zebra scanners that do support RSM, since an auxiliary scanner cannot be configured by 123scan<sup>2</sup> with this option selected.



**\*Enable Aux RSM Communication  
(01h)**



# CHAPTER 12 SYMBOLOGIES

---

## Introduction

This chapter describes symbology features and provides programming bar codes for selecting these features.

To set feature values, scan a single bar code or a short bar code sequence. The settings are stored in non-volatile memory and are preserved even when the scanner powers down.

Select a host type (see each host chapter for specific host information) after the power-up beeps sound. This is only necessary upon the first power-up when connected to a new host.

To return all features to default values, scan the [Set Default Parameter on page 4-4](#). Throughout the programming bar code menus, asterisks (\*) indicate default values.

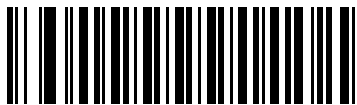

\* Indicates Default — \*Enable UPC-A — Feature/Option  
(01h) — Option Hex Value

---

## Scanning Sequence Examples

In most cases, scanning one bar code sets the parameter value. For example, to transmit bar code data without the UPC-A check digit, simply scan the **Do Not Transmit UPC-A Check Digit** bar code under [Transmit UPC-A Check Digit on page 12-29](#). The scanner issues a fast warble beep and the LED turns green, signifying a successful parameter entry.

Other parameters, such as **Set Length(s) for D 2 of 5** require scanning several bar codes. See the individual parameter, such as **Set Length(s) for D 2 of 5**, for this procedure.

---

## Errors While Scanning

Unless otherwise specified, to correct an error during a scanning sequence, just re-scan the correct parameter.



## Symbology Parameter Defaults

*Table 12-1* lists the defaults for all symbologies parameters. To change the default values, scan the appropriate bar codes in this guide. These new values replace the standard default values in memory. To recall the default parameter values, scan the [Set Default Parameter on page 4-4](#).

✓ **NOTE** See [Appendix A, STANDARD DEFAULT PARAMETERS](#) for all user preferences, hosts, and miscellaneous default parameters.

**Table 12-1** *Parameter Defaults*

Parameter	SSI Number <sup>1</sup>	Parameter Number <sup>2</sup>	Default	Page Number
<b>Enable/Disable All Code Types</b>				<a href="#">12-8</a>
<b>UPC/EAN</b>				
UPC-A	01h	1	Enable	<a href="#">12-9</a>
UPC-E	02h	2	Enable	<a href="#">12-10</a>
UPC-E1	0Ch	12	Disable	<a href="#">12-11</a>
EAN-8/JAN 8	04h	4	Enable	<a href="#">12-12</a>
EAN-13/JAN 13	03h	3	Enable	<a href="#">12-13</a>
Bookland EAN	53h	83	Disable	<a href="#">12-14</a>
Bookland ISBN Format	F1h 40h	576	ISBN-10	<a href="#">12-15</a>
Decode UPC/EAN/JAN Supplementals (2 and 5 digits)	10h	16	Ignore	<a href="#">12-17</a>
User-Programmable Supplementals			N/A	<a href="#">12-24</a>
Supplemental 1:	F1h 43h	579		
Supplemental 2:	F1h 44h	580		
UPC/EAN/JAN Supplemental Redundancy	50h	80	10	<a href="#">12-25</a>
Decode UPC/EAN/JAN Supplemental AIM ID Format	F1h A0h	672	Combined	<a href="#">12-26</a>
UPC Reduced Quiet Zone	F8h 05h 09h	1289	Disable	<a href="#">12-28</a>
Transmit UPC-A Check Digit	28h	40	Enable	<a href="#">12-29</a>
Transmit UPC-E Check Digit	29h	41	Enable	<a href="#">12-30</a>
Transmit UPC-E1 Check Digit	2Ah	42	Enable	<a href="#">12-31</a>
UPC-A Preamble	22h	34	System Character	<a href="#">12-32</a>
UPC-E Preamble	23h	35	System Character	<a href="#">12-34</a>

<sup>1</sup> SSI number hex values are used for programming via SSI commands.

<sup>2</sup> Parameter number decimal values are used for programming via RSM commands.

**Table 12-1** *Parameter Defaults (Continued)*

Parameter	SSI Number <sup>1</sup>	Parameter Number <sup>2</sup>	Default	Page Number
UPC-E1 Preamble	24h	36	System Character	12-36
Convert UPC-E to A	25h	37	Disable	12-38
Convert UPC-E1 to A	26h	38	Disable	12-39
EAN-8/JAN-8 Extend	27h	39	Disable	12-40
UCC Coupon Extended Code	55h	85	Disable	12-41
Coupon Report	F1h DAh	730	New Coupon Symbols	12-42
ISSN EAN	F1h 69h	617	Disable	12-44
<b>Code 128</b>				
Code 128	08h	8	Enable	12-45
Set Length(s) for Code 128	D1h, D2h	209, 210	1 - 55	12-46
GS1-128 (formerly UCC/EAN-128)	0Eh	14	Enable	12-49
ISBT 128	54h	84	Disable	12-50
ISBT Concatenation	F1h 41h	577	Disable	12-51
Check ISBT Table	F1h 42h	578	Enable	12-53
ISBT Concatenation Redundancy	DFh	223	10	12-54
Code 128 Reduced Quiet Zone	F8h 04h B8h	1208	Disable	12-55
Code 128 Security Level	F1h EFh	751	Security Level 1	12-56
Ignore Code 128 <FNC4>	F8h 04h E6h	1254	Disable	12-58
<b>Code 39</b>				
Code 39	00h	0	Enable	12-59
Trioptic Code 39	0Dh	13	Disable	12-60
Convert Code 39 to Code 32 (Italian Pharmacy Code)	56h	86	Disable	12-61
Code 32 Prefix	E7h	231	Disable	12-62
Set Length(s) for Code 39	12h, 13h	18, 19	2 - 55	12-63
Code 39 Check Digit Verification	30h	48	Disable	12-66
Transmit Code 39 Check Digit	2Bh	43	Disable	12-67
Code 39 Full ASCII Conversion	11h	17	Disable	12-68
Code 39 Security Level	F1h EEh	750	Security Level 1	12-69
Code 39 Reduced Quiet Zone	F8h 04h B9h	1209	Disable	12-71

<sup>1</sup> SSI number hex values are used for programming via SSI commands.

<sup>2</sup> Parameter number decimal values are used for programming via RSM commands.

**Table 12-1** Parameter Defaults (Continued)

Parameter	SSI Number <sup>1</sup>	Parameter Number <sup>2</sup>	Default	Page Number
<b>Code 93</b>				
Code 93	09h	9	Disable	<a href="#">12-72</a>
Set Length(s) for Code 93	1Ah, 1Bh	26, 27	1 - 55	<a href="#">12-73</a>
<b>Code 11</b>				
Code 11	0Ah	10	Disable	<a href="#">12-76</a>
Set Lengths for Code 11	1Ch, 1Dh	28, 29	4 - 55	<a href="#">12-77</a>
Code 11 Check Digit Verification	34h	52	Disable	<a href="#">12-80</a>
Transmit Code 11 Check Digit(s)	2Fh	47	Disable	<a href="#">12-82</a>
<b>Interleaved 2 of 5 (I 2 of 5)</b>				
I 2 of 5	06h	6	Enable	<a href="#">12-83</a>
Set Lengths for I 2 of 5	16h, 17h	22, 23	6 - 55	<a href="#">12-84</a>
I 2 of 5 Check Digit Verification	31h	49	Disable	<a href="#">12-87</a>
Transmit I 2 of 5 Check Digit	2Ch	44	Disable	<a href="#">12-89</a>
Convert I 2 of 5 to EAN 13	52h	82	Disable	<a href="#">12-90</a>
I 2 of 5 Security Level	F8h 04h 61h	1121	I 2 of 5 Security Level 1	<a href="#">12-91</a>
I 2 of 5 Reduced Quiet Zone	F8h 04h BAh	1210	Disable	<a href="#">12-93</a>
<b>Discrete 2 of 5 (D 2 of 5)</b>				
Discrete 2 of 5	05h	5	Disable	<a href="#">12-94</a>
Set Length(s) for D 2 of 5	14h, 15h	20, 21	1 - 55	<a href="#">12-95</a>
<b>Codabar (NW - 7)</b>				
Codabar	07h	7	Disable	<a href="#">12-98</a>
Set Lengths for Codabar	18h, 19h	24, 25	4 - 55	<a href="#">12-99</a>
CLSI Editing	36h	54	Disable	<a href="#">12-102</a>
NOTIS Editing	37h	55	Disable	<a href="#">12-103</a>
Codabar Upper or Lower Case Start/Stop Characters Detection	F2h 57h	855	Upper Case	<a href="#">12-104</a>
<b>MSI</b>				
MSI	0Bh	11	Disable	<a href="#">12-105</a>
Set Length(s) for MSI	1Eh, 1Fh	30, 31	4 to 55	<a href="#">12-106</a>
MSI Check Digits	32h	50	One	<a href="#">12-109</a>

<sup>1</sup> SSI number hex values are used for programming via SSI commands.<sup>2</sup> Parameter number decimal values are used for programming via RSM commands.

**Table 12-1** *Parameter Defaults (Continued)*

Parameter	SSI Number <sup>1</sup>	Parameter Number <sup>2</sup>	Default	Page Number
Transmit MSI Check Digit	2Eh	46	Disable	<a href="#">12-110</a>
MSI Check Digit Algorithm	33h	51	Mod 10/Mod 10	<a href="#">12-111</a>
<b>Chinese 2 of 5</b>				
Chinese 2 of 5	F0h 98h	408	Disable	<a href="#">12-112</a>
<b>Matrix 2 of 5</b>				
Matrix 2 of 5	F1h 6Ah	618	Disable	<a href="#">12-113</a>
Matrix 2 of 5 Lengths	F1h 6Bh F1h 6Ch	619, 620	4 - 55	<a href="#">12-114</a>
Matrix 2 of 5 Check Digit	F1h 6Eh	622	Disable	<a href="#">12-116</a>
Transmit Matrix 2 of 5 Check Digit	F1h 6Fh	623	Disable	<a href="#">12-117</a>
<b>Korean 3 of 5</b>				
Korean 3 of 5	F1h 45h	581	Disable	<a href="#">12-118</a>
<b>Postal Codes</b>				
US Postnet	59h	89	Disable	<a href="#">12-121</a>
US Planet	5Ah	90	Disable	<a href="#">12-122</a>
Transmit US Postal Check Digit	5Fh	95	Enable	<a href="#">12-123</a>
UK Postal	5Bh	91	Disable	<a href="#">12-124</a>
Transmit UK Postal Check Digit	60h	96	Enable	<a href="#">12-125</a>
Japan Post	F0h 22h	290	Disable	<a href="#">12-126</a>
Australia Post	F0h 23h	291	Disable	<a href="#">12-127</a>
Australia Post Format	F1h CEh	718	Autodiscriminate	<a href="#">12-128</a>
Netherlands KIX Code	F0h 46h	326	Disable	<a href="#">12-130</a>
USPS 4CB/One Code/Intelligent Mail	F1h 50h	592	Disable	<a href="#">12-131</a>
UPU FICS Postal	F1h 63h	611	Disable	<a href="#">12-132</a>
<b>Inverse 1D</b>	F1h 4Ah	586	Regular	<a href="#">12-133</a>
<b>GS1 DataBar</b>				
GS1 DataBar (GS1 DataBar Omnidirectional, GS1 DataBar Truncated, GS1 DataBar Stacked, GS1 DataBar Stacked Omnidirectional)	F0h 52h	338	Enable	<a href="#">12-135</a>
GS1 DataBar Limited	F0h 53h	339	Enable	<a href="#">12-136</a>

<sup>1</sup> SSI number hex values are used for programming via SSI commands.<sup>2</sup> Parameter number decimal values are used for programming via RSM commands.

**Table 12-1** Parameter Defaults (Continued)

Parameter	SSI Number <sup>1</sup>	Parameter Number <sup>2</sup>	Default	Page Number
GS1 DataBar Limited Security Level	F1h D8h	728	3	<a href="#">12-138</a>
GS1 DataBar Expanded (GS1 DataBar Expanded, GS1 DataBar Expanded Stacked)	F0h 54h	340	Enable	<a href="#">12-137</a>
Convert GS1 DataBar to UPC/EAN	F0h 8Dh	397	Disable	<a href="#">12-140</a>
<b>Composite</b>				
Composite CC-C	F0h 55h	341	Disable	<a href="#">12-141</a>
Composite CC-A/B	F0h 56h	342	Disable	<a href="#">12-142</a>
Composite TLC-39	F0h 73h	371	Disable	<a href="#">12-143</a>
UPC Composite Mode	F0h 58h	344	UPC Never Linked	<a href="#">12-144</a>
Composite Beep Mode	F0h 8Eh	398	Beep As Each Code Type is Decoded	<a href="#">12-146</a>
GS1-128 Emulation Mode for UCC/EAN Composite Codes	F0h ABh	427	Disable	<a href="#">12-148</a>
<b>2D Symbolologies</b>				
PDF417	0Fh	15	Enable	<a href="#">12-149</a>
MicroPDF417	E3h	227	Disable	<a href="#">12-150</a>
Code 128 Emulation	7Bh	123	Disable	<a href="#">12-151</a>
Data Matrix	F0h 24h	292	Disable	<a href="#">12-152</a>
Data Matrix Inverse	F1h 4Ch	588	Inverse Autodetect	<a href="#">12-153</a>
GS1 Data Matrix	F8 05 38	1336	Disable	<a href="#">12-155</a>
Decode Mirror Images (Data Matrix Only)	F1h 19h	537	Auto	<a href="#">12-156</a>
Maxicode	F0h 26h	294	Disable	<a href="#">12-158</a>
QR Code	F0h 25h	293	Enable	<a href="#">12-159</a>
QR Inverse	F1h 4Bh	587	Regular	<a href="#">12-160</a>
GS1 QR	F8 05 3E	1343	Disable	<a href="#">12-162</a>
Micro QR	F1h 3Dh	573	Disable	<a href="#">12-163</a>
Aztec	F1h 3Eh	574	Disable	<a href="#">12-164</a>
Aztec Inverse	F1h 4Dh	589	Inverse Autodetect	<a href="#">12-165</a>
Han Xin	F8h 04h 8Fh	1167	Disable	<a href="#">12-167</a>
Han Xin Inverse	F8h 04h 90h	1168	Regular	<a href="#">12-168</a>

<sup>1</sup> SSI number hex values are used for programming via SSI commands.

<sup>2</sup> Parameter number decimal values are used for programming via RSM commands.

**Table 12-1** *Parameter Defaults (Continued)*

Parameter	SSI Number <sup>1</sup>	Parameter Number <sup>2</sup>	Default	Page Number
<b>Symbology-Specific Security Levels</b>				
Redundancy Level	4Eh	78	1	<a href="#">12-170</a>
Security Level (UPC/EAN and Code 93)	4Dh	77	1	<a href="#">12-173</a>
Intercharacter Gap Size	F0h 7Dh	381	Normal	<a href="#">12-175</a>
1D Quiet Zone Level	F8h 05h 08h	1288	1	<a href="#">12-176</a>
<b>Macro PDF</b>				
Flush Macro PDF Buffer	n/a	n/a	n/a	<a href="#">12-178</a>
Abort Macro PDF Entry	n/a	n/a	n/a	<a href="#">12-179</a>

<sup>1</sup> SSI number hex values are used for programming via SSI commands.

<sup>2</sup> Parameter number decimal values are used for programming via RSM commands.

---

## Enable/Disable All Code Types

To disable all symbologies, scan **Disable All Code Types** below. This is useful when enabling only a few code types.

Scan **Enable All Code Types** to turn on (enable) all code types. This is useful when you want to read all codes, or when you want to disable only a few code types.

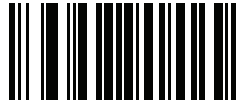

**Enable All Code Types**



**Disable All Code Types**

---

## UPC/EAN

### Enable/Disable UPC-A

**SSI # 01h**

**Parameter # 1**

To enable or disable UPC-A, scan the appropriate bar code below.

Options:

- \*Enable UPC-A
- Disable UPC-A.

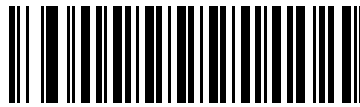

**\*Enable UPC-A  
(01h)**



**Disable UPC-A  
(00h)**



## Enable/Disable UPC-E

**SSI # 02h**

**Parameter # 2**

To enable or disable UPC-E, scan the appropriate bar code below.

Options:

- \*Enable UPC-E
- Disable UPC-E.

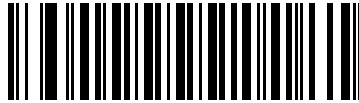

**\*Enable UPC-E  
(01h)**

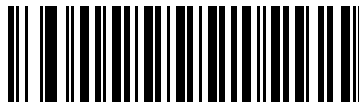

**Disable UPC-E  
(00h)**

## Enable/Disable UPC-E1

**SSI # 0Ch**

**Parameter # 12**

UPC-E1 is disabled by default.

To enable or disable UPC-E1, scan the appropriate bar code below.

✓ **NOTE** UPC-E1 is not a UCC (Uniform Code Council) approved symbology.

Options:

- Enable UPC-E1
- \*Disable UPC-E1.

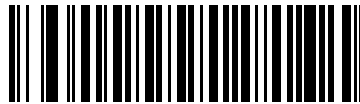

**Enable UPC-E1  
(01h)**



**\*Disable UPC-E1  
(00h)**

## Enable/Disable EAN-8/JAN-8

**SSI # 04h**

**Parameter # 4**

To enable or disable EAN-8/JAN-8, scan the appropriate bar code below.

Options:

- \*Enable EAN-8/JAN-8
- Disable EAN-8/JAN-8.

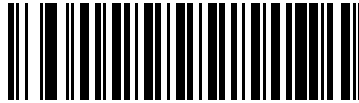

**\*Enable EAN-8/JAN-8  
(01h)**



**Disable EAN-8/JAN-8  
(00h)**

## Enable/Disable EAN-13/JAN-13

**SSI # 03h**

**Parameter # 3**

To enable or disable EAN-13/JAN-13, scan the appropriate bar code below.

Options:

- \*Enable EAN-13/JAN-13
- Disable EAN-13/JAN-13.



**\*Enable EAN-13/JAN-13  
(01h)**

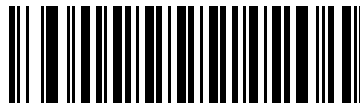

**Disable EAN-13/JAN-13  
(00h)**

## Enable/Disable Bookland EAN

SSI # 53h

Parameter # 83

To enable or disable Bookland EAN, scan the appropriate bar code below.

Options:

- Enable Bookland EAN
- \*Disable Bookland EAN.

✓ **NOTE** If Bookland EAN is enabled, select a [Bookland ISBN Format on page 12-15](#). Also select either Decode UPC/EAN Supplementals, Autodiscriminate UPC/EAN Supplementals, or Enable 978/979 Supplemental Mode in [Decode UPC/EAN/JAN Supplementals on page 12-16](#).

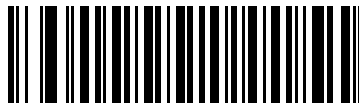

Enable Bookland EAN  
(01h)



\*Disable Bookland EAN  
(00h)

## Bookland ISBN Format

**SSI # F1h 40h**

**Parameter # 576**

If Bookland EAN is enabled, select one of the following formats for Bookland data.

Options:

- \*Bookland ISBN-10 - The scanner reports Bookland data starting with 978 in traditional 10-digit format with the special Bookland check digit for backward-compatibility. Data starting with 979 is not considered Bookland in this mode.
- Bookland ISBN-13 - The scanner reports Bookland data (starting with either 978 or 979) as EAN-13 in 13-digit format to meet the 2007 ISBN-13 protocol.

✓ **NOTE** For Bookland EAN to function properly, ensure Bookland EAN is enabled (see [Enable/Disable Bookland EAN on page 12-14](#)), then select either Decode UPC/EAN Supplementals, Autodiscriminate UPC/EAN Supplementals, or Enable 978/979 Supplemental Mode in [Decode UPC/EAN/JAN Supplementals on page 12-16](#).



**\*Bookland ISBN-10**  
(00h)



**Bookland ISBN-13**  
(01h)

## Decode UPC/EAN/JAN Supplementals

### SSI # 10h

#### Parameter # 16

Supplementals are bar codes appended according to specific format conventions (e.g., UPC A+2, UPC E+2, EAN 13+2).

Options:

- Decode UPC/EAN/JAN with Supplementals - the scanner only decodes UPC/EAN symbols with supplemental characters, and ignores symbols without supplementals.
- \*Ignore UPC/EAN/JAB with Supplementals - if the scanner is presented with a UPC/EAN plus supplemental symbol, the scanner decodes UPC/EAN and ignores the supplemental characters.
- Autodiscriminate UPC/EANJAN Supplementals - the scanner decodes UPC/EAN symbols with supplemental characters immediately. If the symbol does not have a supplemental, the scanner must decode the bar code the number of times set via [UPC/EAN/JAN Supplemental Redundancy on page 12-25](#) before transmitting its data to confirm that there is no supplemental.
- If you select one of the following **Supplemental Mode** options, the scanner immediately transmits EAN-13 bar codes starting with that prefix that have supplemental characters. If the symbol does not have a supplemental, the scanner must decode the bar code the number of times set via [UPC/EAN/JAN Supplemental Redundancy on page 12-25](#) before transmitting its data to confirm that there is no supplemental. The scanner transmits UPC/EAN bar codes that do not have that prefix immediately.
  - Enable 378/379 Supplemental Mode.
  - Enable 978/979 Supplemental Mode.



**NOTE** If you select 978/979 Supplemental Mode and are scanning Bookland EAN bar codes, see [Enable/Disable Bookland EAN on page 12-14](#) to enable Bookland EAN, and select a format using [Bookland ISBN Format on page 12-15](#).

- Enable 977 Supplemental Mode.
- Enable 414/419/434/439 Supplemental Mode.
- Enable 491 Supplemental Mode.
- Enable Smart Supplemental Mode - applies to EAN-13 bar codes starting with any prefix listed previously.
- Supplemental User-Programmable Type 1 - applies to EAN-13 bar codes starting with a 3-digit user-defined prefix. Set this 3-digit prefix using [User-Programmable Supplementals on page 12-24](#).
- Supplemental User-Programmable Type 1 and 2 - applies to EAN-13 bar codes starting with either of two 3-digit user-defined prefixes. Set the 3-digit prefixes using [User-Programmable Supplementals on page 12-24](#).
- Smart Supplemental Plus User-Programmable 1 - applies to EAN-13 bar codes starting with any prefix listed previously or the user-defined prefix set using [User-Programmable Supplementals on page 12-24](#).
- Smart Supplemental Plus User-Programmable 1 and 2 - applies to EAN-13 bar codes starting with any prefix listed previously or one of the two user-defined prefixes set using [User-Programmable Supplementals on page 12-24](#).

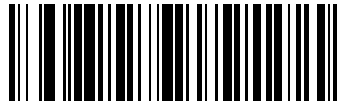

**NOTE** To minimize the risk of invalid data transmission, select either to decode or ignore supplemental characters.

**Decode UPC/EAN/JAN Supplementals (continued)**

**Decode UPC/EAN/JAN Only With Supplementals  
(01h)**



**\*Ignore Supplementals  
(00h)**



## Decode UPC/EAN/JAN Supplementals (continued)



**Autodiscriminate UPC/EAN/JAN Supplementals  
(02h)**



**Enable 378/379 Supplemental Mode  
(04h)**

**Decode UPC/EAN/JAN Supplementals (continued)**

**Enable 978/979 Supplemental Mode  
(05h)**



**Enable 977 Supplemental Mode  
(07h)**

## Decode UPC/EAN/JAN Supplementals (continued)



Enable 414/419/434/439 Supplemental Mode  
(06h)



Enable 491 Supplemental Mode  
(08h)

**Decode UPC/EAN/JAN Supplementals (continued)**

**Enable Smart Supplemental Mode  
(03h)**



**Supplemental User-Programmable Type 1  
(09h)**

## Decode UPC/EAN/JAN Supplementals (continued)



**Supplemental User-Programmable Type 1 and 2  
(0Ah)**



**Smart Supplemental Plus User-Programmable 1  
(0Bh)**

**Decode UPC/EAN/JAN Supplementals (continued)**

**Smart Supplemental Plus User-Programmable 1 and 2  
(0Ch)**

## User-Programmable Supplementals

**Supplemental 1: SSI # F1h 43h**

**Supplemental 2: SSI # F1h 44h**

**Supplemental 1: Parameter # 579**

**Supplemental 2: Parameter # 580**

Options:

- If you selected a Supplemental User-Programmable option from [Decode UPC/EAN/JAN Supplementals on page 12-16](#), select **User-Programmable Supplemental 1** to set the 3-digit prefix. Then select the 3 digits using the numeric bar codes beginning on [page G-1](#).
- Select **User-Programmable Supplemental 2** to set a second 3-digit prefix. Then select the 3 digits using the numeric bar codes beginning on [page G-1](#).



**User-Programmable Supplemental 1**



**User-Programmable Supplemental 2**

## UPC/EAN/JAN Supplemental Redundancy

**SSI # 50h**

**Parameter # 80**

If you selected **Autodiscriminate UPC/EAN/JAN Supplementals**, this option adjusts the number of times to decode a symbol without supplementals before transmission. The range is from 2 to 16 times. Five or above is recommended when decoding a mix of UPC/EAN/JAN symbols with and without supplementals. The default is 10.

Scan **UPC/EAN/JAN Supplemental Redundancy** below to set a decode redundancy value. Next, scan two numeric bar codes in [Appendix G, NUMERIC BAR CODES](#). Enter a leading zero for single digit numbers. To correct an error or change a selection, scan [Cancel on page G-10](#).



**UPC/EAN/JAN Supplemental Redundancy**



## UPC/EAN/JAN Supplemental AIM ID Format

**SSI # F1h A0h**

**Parameter # 672**

Select an output format when reporting UPC/EAN/JAN bar codes with Supplementals with *Transmit Code ID Character on page 4-27* set to **AIM Code ID Character**:

- **Separate** - transmit UPC/EAN with supplementals with separate AIM IDs but one transmission, i.e.:  
]E<0 or 4><data>]E<1 or 2>[supplemental data]
- **Combined** – transmit UPC/EAN with supplementals with one AIM ID and one transmission, i.e.:  
]E3<data+supplemental data>
- **Separate Transmissions** - transmit UPC/EAN with supplementals with separate AIM IDs and separate transmissions, i.e.:  
]E<0 or 4><data>  
]E<1 or 2>[supplemental data]



**Separate  
(00h)**



**\*Combined  
(01h)**

**UPC/EAN/JAN Supplemental AIM ID Format (continued)**



**Separate Transmissions  
(02h)**

## UPC Reduced Quiet Zone

**SSI # F8h 05h 09h**

**Parameter # 1289**

Scan one of the following bar codes to enable or disable decoding UPC bar codes with reduced quiet zones. If you select **Enable**, select a [1D Quiet Zone Level on page 12-176](#).

Options:

- Enable UPC Reduced Quiet Zone
- \*Disable UPC Reduced Quiet Zone.



**Enable UPC Reduced Quiet Zone  
(1)**



**\*Disable UPC Reduced Quiet Zone  
(0)**

## Transmit UPC-A Check Digit

**SSI # 28h**

**Parameter # 40**

The check digit is the last character of the symbol used to verify the integrity of the data. Scan the appropriate bar code below to transmit the bar code data with or without the UPC-A check digit. It is always verified to guarantee the integrity of the data.

Options:

- \*Transmit UPC-A Check Digit
- Do Not Transmit UPC-A Check Digit.

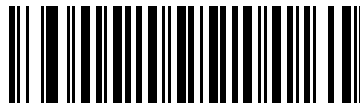

**\*Transmit UPC-A Check Digit  
(01h)**



**Do Not Transmit UPC-A Check Digit  
(00h)**

## Transmit UPC-E Check Digit

**SSI # 29h**

**Parameter # 41**

The check digit is the last character of the symbol used to verify the integrity of the data. Scan the appropriate bar code below to transmit the bar code data with or without the UPC-E check digit. It is always verified to guarantee the integrity of the data.

Options:

- \*Transmit UPC-E Check Digit
- Do Not Transmit UPC-E Check Digit.

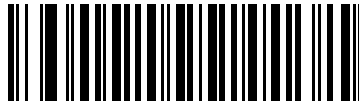

**\*Transmit UPC-E Check Digit  
(01h)**

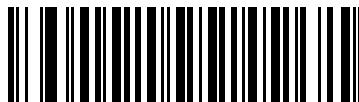

**Do Not Transmit UPC-E Check Digit  
(00h)**

## Transmit UPC-E1 Check Digit

**SSI # 2Ah**

**Parameter # 42**

The check digit is the last character of the symbol used to verify the integrity of the data. Scan the appropriate bar code below to transmit the bar code data with or without the UPC-E1 check digit. It is always verified to guarantee the integrity of the data.

Options:

- \*Transmit UPC-E1 Check Digit
- Do Not Transmit UPC-E1 Check Digit.

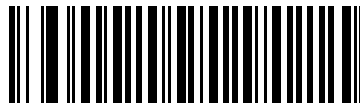

**\*Transmit UPC-E1 Check Digit  
(01h)**



**Do Not Transmit UPC-E1 Check Digit  
(00h)**

## UPC-A Preamble

### SSI # 22h

### Parameter # 34

Preamble characters are part of the UPC symbol, and include Country Code and System Character. There are three options for transmitting a UPC-A preamble to the host device: transmit System Character only, transmit System Character and Country Code ("0" for USA), and transmit no preamble. Select the appropriate option to match the host system.

Options:

- No Preamble (<DATA>)
- \*System Character (<SYSTEM CHARACTER> <DATA>)
- System Character & Country Code (< COUNTRY CODE> <SYSTEM CHARACTER> <DATA>).

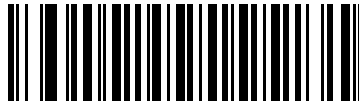

**No Preamble (<DATA>)**  
(00h)

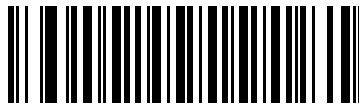

**\*System Character (<SYSTEM CHARACTER> <DATA>)**  
(01h)

**UPC-A Preamble (continued)**

**System Character & Country Code**  
**(< COUNTRY CODE> <SYSTEM CHARACTER> <DATA>**  
**(02h)**



## UPC-E Preamble

### SSI # 23h

### Parameter # 35

Preamble characters are part of the UPC symbol, and include Country Code and System Character. There are three options for transmitting a UPC-E preamble to the host device: transmit System Character only, transmit System Character and Country Code ("0" for USA), and transmit no preamble. Select the appropriate option to match the host system.

Options:

- No Preamble (<DATA>)
- \*System Character (<SYSTEM CHARACTER> <DATA>)
- System Character & Country Code (< COUNTRY CODE> <SYSTEM CHARACTER> <DATA>).

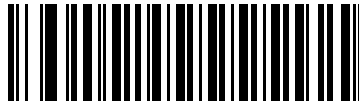

**No Preamble (<DATA>)  
(00h)**

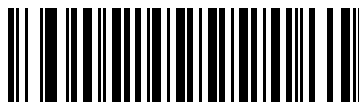

**\*System Character (<SYSTEM CHARACTER> <DATA>)  
(01h)**

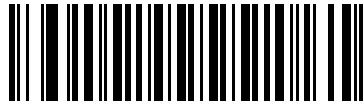
**UPC-E Preamble (continued)**

**System Character & Country Code**  
**(< COUNTRY CODE> <SYSTEM CHARACTER> <DATA>)**  
**(02h)**

## UPC-E1 Preamble

### SSI # 24h

### Parameter # 36

Preamble characters are part of the UPC symbol, and include Country Code and System Character. There are three options for transmitting a UPC-E1 preamble to the host device: transmit System Character only, transmit System Character and Country Code ("0" for USA), and transmit no preamble. Select the appropriate option to match the host system.

Options:

- No Preamble (<DATA>)
- \*System Character (<SYSTEM CHARACTER> <DATA>)
- System Character & Country Code (< COUNTRY CODE> <SYSTEM CHARACTER> <DATA>).

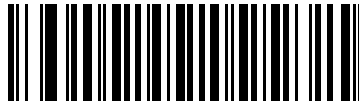

**No Preamble (<DATA>)**  
**(00h)**



**\*System Character (<SYSTEM CHARACTER> <DATA>)**  
**(01h)**

**UPC-E1 Preamble (continued)**

**System Character & Country Code**  
**(< COUNTRY CODE> <SYSTEM CHARACTER> <DATA>**  
**(02h)**

## Convert UPC-E to UPC-A

### SSI # 25h

### Parameter # 37

Enable this to convert UPC-E (zero suppressed) decoded data to UPC-A format before transmission. After conversion, the data follows UPC-A format and is affected by UPC-A programming selections (e.g., Preamble, Check Digit).

Disable this to transmit UPC-E decoded data as UPC-E data, without conversion.

Options:

- Convert UPC-E to UPC-A (Enable)
- \*Do Not Convert UPC-E to UPC-A (Disable).

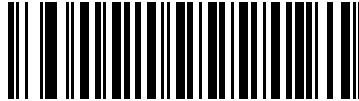

**Convert UPC-E to UPC-A (Enable)**  
(01h)



**\*Do Not Convert UPC-E to UPC-A (Disable)**  
(00h)

## Convert UPC-E1 to UPC-A

**SSI # 26h**

**Parameter # 38**

Enable this to convert UPC-E1 decoded data to UPC-A format before transmission. After conversion, the data follows UPC-A format and is affected by UPC-A programming selections (e.g., Preamble, Check Digit).

Disable this to transmit UPC-E1 decoded data as UPC-E1 data, without conversion.

Options:

- Convert UPC-E1 to UPC-A (Enable)
- \*Do Not Convert UPC-E1 to UPC-A (Disable).

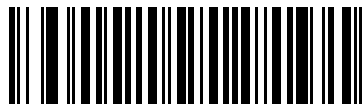

**Convert UPC-E1 to UPC-A (Enable)  
(01h)**



**\*Do Not Convert UPC-E1 to UPC-A (Disable)  
(00h)**

## **EAN-8/JAN-8 Extend**

### **SSI # 27h**

#### **Parameter # 39**

Enable this parameter to add five leading zeros to decoded EAN-8 symbols to make them compatible in format to EAN-13 symbols.

Disable this to transmit EAN-8 symbols as is.

Options:

- Enable EAN/JAN Zero Extend
- \*Disable EAN/JAN Zero Extend.

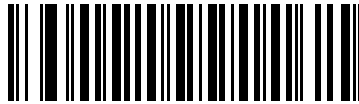

**Enable EAN/JAN Zero Extend  
(01h)**



**\*Disable EAN/JAN Zero Extend  
(00h)**

## UCC Coupon Extended Code

**SSI # 55h**

**Parameter # 85**

Enable this parameter to decode UPC-A bar codes starting with digit '5', EAN-13 bar codes starting with digit '99', and UPC-A/GS1-128 Coupon Codes. UPCA, EAN-13, and GS1-128 must be enabled to scan all types of Coupon Codes.

Options:

- Enable UCC Coupon Extended Code
- \*Disable UCC Coupon Extended Code.



**Enable UCC Coupon Extended Code  
(01h)**

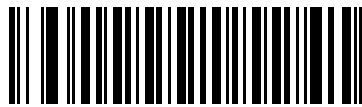

**\*Disable UCC Coupon Extended Code  
(00h)**



**NOTE** See [UPC/EAN/JAN Supplemental Redundancy on page 12-25](#) to control autodiscrimination of the GS1-128 (right half) of a coupon code.



## Coupon Report

### SSI # F1h DAh Parameter # 730

Traditional coupon symbols (old coupon symbols) are composed of two bar codes: UPC/EAN and Code128. A new coupon symbol is composed of a single DataBar Expanded bar code. The new coupon format offers more options for purchase values (up to \$999.99) and supports complex discount offers such as a second purchase requirement.

An interim coupon symbol also exists that contains both types of bar codes: UPC/EAN and DataBar Expanded. This format accommodates both retailers that do not recognize or use the additional information included in the new coupon symbol, as well as those who can process new coupon symbols.

Scan a bar code following [Table 12-2](#) to select one of the scan option modes in [Table 12-2](#) for decoding coupon symbols.

**Table 12-2** Scanning Coupon Symbols

Scan Option Mode	Scan an Old Coupon Symbol	Scanning an Interim Coupon Symbol	Scanning a New Coupon Symbol
<b>*New Coupon Symbols</b>	<ul style="list-style-type: none"> <li>Report UPC or CODE 128 (whichever is seen first).</li> <li>If UPC is covered then report Code 128.</li> <li>If Code 128 is covered then report UPC,</li> </ul>	<ul style="list-style-type: none"> <li>Report UPC or DataBar (whichever is seen first).</li> <li>If UPC is covered then report DataBar .</li> <li>If DataBar is covered then report UPC.</li> </ul>	Reports DataBar.
<b>Both Coupon Formats</b>	<ul style="list-style-type: none"> <li>Report UPC and Code 128.</li> <li>If UPC is covered then report Code 128.</li> <li>If Code 128 is covered then report UPC.</li> </ul>	<ul style="list-style-type: none"> <li>Report UPC or DataBar (whichever is seen first).</li> <li>If UPC is covered then report DataBar.</li> <li>If DataBar is covered then report UPC.</li> </ul>	Reports DataBar.
<b>Old Coupon Symbols</b>	<ul style="list-style-type: none"> <li>Report UPC and Code 128.</li> <li>If UPC is covered then report Code 128.</li> <li>If Code 128 is covered then report UPC.</li> </ul>	<ul style="list-style-type: none"> <li>Report UPC</li> <li>If UPC is covered then report nothing.</li> <li>If DataBar is covered then report UPC.</li> </ul>	Reports nothing.

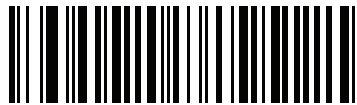

**Old Coupon Symbols  
(00h)**

**Coupon Report (continued)**



**\*New Coupon Symbols  
(01h)**



**Both Coupon Formats  
(02h)**

## ISSN EAN

**SSI # F1h 69h**

**Parameter # 617**

Options:

- Enable ISSN EAN
- \*Disable ISSN EAN.

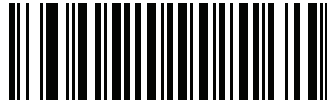

**Enable ISSN EAN  
(01h)**



**\*Disable ISSN EAN  
(00h)**

---

## Code 128

### Enable/Disable Code 128

SSI # 08h

Parameter # 8

Options:

- \*Enable Code 128
- Disable Code 128.

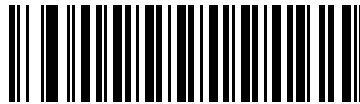

\*Enable Code 128  
(01h)



Disable Code 128  
(00h)

## Set Lengths for Code 128

**SSI # L1 = D1h, L2 = D2h**

**Parameter # L1 = 209, L2 = 210**

The length of a code refers to the number of characters (i.e., human readable characters), including check digit(s) the code contains. Set lengths for Code 128 to any length, one or two discrete lengths, or lengths within a specific range. The range for Code 128 lengths is 1 - 55.



**NOTE** When setting lengths for different bar code types, enter a leading zero for single digit numbers.

Options:

- Code 128 One Discrete Length - Select this option to decode only Code 128 symbols containing a selected length. Select the length using the numeric bar codes in [Appendix G, NUMERIC BAR CODES](#). For example, to decode only Code 128 symbols with 14 characters, scan **Code 128 - One Discrete Length**, then scan **1** followed by **5**. To correct an error or change the selection, scan [Cancel on page G-10](#).
- Code 128 Two Discrete Lengths - Select this option to decode only Code 128 symbols containing either of two selected lengths. Select lengths using the numeric bar codes in [Appendix G, NUMERIC BAR CODES](#). For example, to decode only Code 128 symbols containing either 2 or 14 characters, select **Code 128 - Two Discrete Lengths**, then scan **0, 2, 1**, and then **4**. To correct an error or change the selection, scan [Cancel on page G-10](#).
- \*Code 128 Length Within Range - Select this option to decode a Code 128 symbol with a specific length range. Select lengths using numeric bar codes in [Appendix G, NUMERIC BAR CODES](#). For example, to decode Code 128 symbols containing between 4 and 12 characters, first scan **Code 128 - Length Within Range**. Then scan **0, 4, 1**, and **2** (enter a leading zero for single digit numbers). To correct an error or change the selection, scan [Cancel on page G-10](#).
- Code 128 Any Length - Select this option to decode Code 128 symbols containing any number of characters within the scanner's capability.

**Set Lengths for Code 128 (continued)****Code 128 - One Discrete Length****Code 128 - Two Discrete Lengths**

**Set Lengths for Code 128 (continued)**

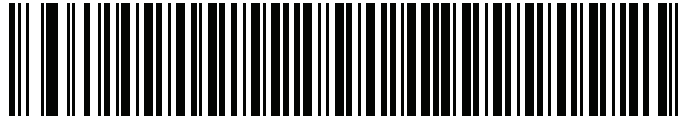

**\*Code 128 - Length Within Range**



**Code 128 - Any Length**

**Enable/Disable GS1-128 (formerly UCC/EAN-128)****SSI # 0Eh****Parameter # 14**

Options:

- \*Enable GS1-128
- Disable GS1-128.

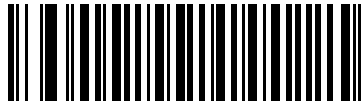

**\*Enable GS1-128  
(01h)**

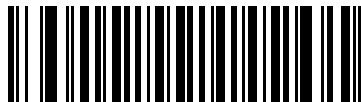

**Disable GS1-128  
(00h)**



## Enable/Disable ISBT 128

**SSI # 54h**

**Parameter # 84**

ISBT 128 is a variant of Code 128 used in the blood bank industry. Scan a bar code below to enable or disable ISBT 128. If necessary, the host must perform concatenation of the ISBT data.

Options:

- Enable ISBT 128
- \*Disable ISBT 128.



**Enable ISBT 128  
(01h)**



**\*Disable ISBT 128  
(00h)**

## ISBT Concatenation

**SSI # F1h 41h**

**Parameter # 577**

Select an option for concatenating pairs of ISBT code types:

- \*Disable ISBT Concatenation - The scanner does not concatenate pairs of ISBT codes it ens.
- Enable ISBT Concatenation - There must be two ISBT codes in order for the scanner to decode and perform concatenation. The scanner does not decode single ISBT symbols.
- Autodiscriminate ISBT Concatenation - The scanner decodes and concatenates pairs of ISBT codes immediately. If only a single ISBT symbol is present, the scanner must decode the symbol the number of times set via *ISBT Concatenation Redundancy on page 12-54* before transmitting its data to confirm that there is no additional ISBT symbol.

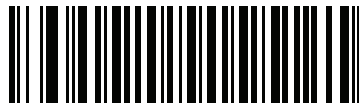

**\*Disable ISBT Concatenation  
(00h)**

## ISBT Concatenation (continued)



**Enable ISBT Concatenation  
(01h)**

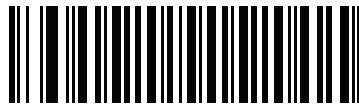

**Autodiscriminate ISBT Concatenation  
(02h)**

## Check ISBT Table

**SSI # F1h 42h**

**Parameter # 578**

The ISBT specification includes a table that lists several types of ISBT bar codes that are commonly used in pairs. If you set **ISBT Concatenation** to **Enable**, enable **Check ISBT Table** to concatenate only those pairs found in this table. Other types of ISBT codes are not concatenated.

Options:

- \*Enable Check ISBT Table
- Disable Check ISBT Table.



**\*Enable Check ISBT Table  
(01h)**

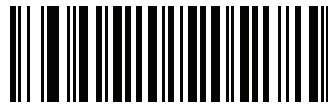

**Disable Check ISBT Table  
(00h)**

## ISBT Concatenation Redundancy

**SSI # DFh**

**Parameter # 223**

If you set **ISBT Concatenation** to **Autodiscriminate**, use this parameter to set the number of times the scanner must decode an ISBT symbol before determining that there is no additional symbol.

Scan the bar code below, then scan two numeric bar codes in [Appendix G, NUMERIC BAR CODES](#) to set a value between 2 and 20. Enter a leading zero for single digit numbers. To correct an error or change a selection, scan [Cancel on page G-10](#). The default is 10.



ISBT Concatenation Redundancy

## Code 128 Reduced Quiet Zone

**SSI # F8h 04h B8h**

**Parameter # 1208**

Scan one of the following bar codes to enable or disable decoding Code 128 bar codes with reduced quiet zones. If you select **Enable**, select a [1D Quiet Zone Level on page 12-176](#).

Options:

- Enable Code 128 Reduced Quiet Zone
- \*Disable Code 128 Reduced Quiet Zone.



**Enable Code 128 Reduced Quiet Zone  
(1)**



**\*Disable Code 128 Reduced Quiet Zone  
(0)**

## Code 128 Security Level

SSI # F1h EFh

Parameter # 751

Code 128 bar codes are vulnerable to misdecodes by the nature of the symbol, especially when **Any Length** is set for Code 128 bar codes. The scanner offers four levels of decode security for Code 128 bar codes. There is an inverse relationship between security and scanner aggressiveness. Increasing the level of security may result in reduced aggressiveness in scanning, so select only the level of security necessary.

Options:

- **Code 128 Security Level 0:** This setting allows the scanner to operate in its most aggressive state, while providing sufficient security in decoding the most in-spec bar codes.
- **Code 128 Security Level 1:** A bar code must be successfully read twice, and satisfy certain safety requirements before being decoded. This default setting eliminates most misdecodes.
- **Code 128 Security Level 2:** Select this option with higher safety requirements to the bar codes if **Security Level 1** fails to eliminate misdecodes.
- **Code 128 Security Level 3:** If you selected **Security Level 2**, and misdecodes still occur, select this security level. The highest safety requirements are applied. A bar code must be successfully read three times before being decoded.

✓ **NOTE** Selecting this option is an extreme measure against mis-decoding severely out-of-spec bar codes. Selecting this level of security significantly impairs the decoding ability of the scanner. If this level of security is required, it is recommended that you try to improve the quality of the bar codes.

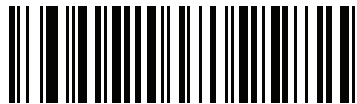

Code 128 Security Level 0  
(00h)



\*Code 128 Security Level 1  
(01h)

**Code 128 Security Level (continued)**

**Code 128 Security Level 2  
(02h)**



**Code 128 Security Level 3  
(03h)**



**Ignore Code 128 <FNC4>****SSI # F8h 04h E6h****Parameter # 1254**

This feature applies to Code 128 bar codes with an embedded <FNC4> character. Enable this to strip the <FNC4> character from the decode data. The remaining characters do not change. When disabled, the <FNC4> character is not transmitted but the following character has 128 added to it.

Options:

- Enable Ignore Code 128 <FNC4>
- \*Disable Ignore Code 128 <FNC4>.



**Enable Ignore Code 128 <FNC4>**  
(1)



**\*Disable Ignore Code 128 <FNC4>**  
(0)

## Enable/Disable Code 39

SSI # 00h

Parameter # 0

To enable or disable Code 39, scan the appropriate bar code below.

Options:

- \*Enable Code 39
- Disable Code 39.

✓ **NOTE** You cannot enable Trioptic Code 39 and Code 39 Full ASCII simultaneously.

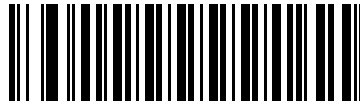

\*Enable Code 39  
(01h)



Disable Code 39  
(00h)

## Enable/Disable Trioptic Code 39

**SSI # 0Dh**

**Parameter # 13**

Trioptic Code 39 is a variant of Code 39 used in the marking of computer tape cartridges. Trioptic Code 39 symbols always contain six characters.

Options:

- Enable Trioptic Code 39
- \*Disable Trioptic Code 39.



**Enable Trioptic Code 39  
(01h)**



**\*Disable Trioptic Code 39  
(00h)**

## Convert Code 39 to Code 32

**SSI # 56h**

**Parameter # 86**

Code 32 is a variant of Code 39 used by the Italian pharmaceutical industry.

✓ **NOTE** Code 39 must be enabled for this parameter to function.

Options:

- Enable Convert Code 39 to Code 32
- \*Disable Convert Code 39 to Code 32.

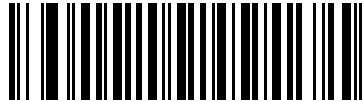

**Enable Convert Code 39 to Code 32  
(01h)**



**\*Disable Convert Code 39 to Code 32  
(00h)**

## Code 32 Prefix

**SSI # E7h**

**Parameter # 231**

Scan the appropriate bar code below to enable or disable adding the prefix character "A" to all Code 32 bar codes.

✓ **NOTE** Convert Code 39 to Code 32 must be enabled for this parameter to function.

Options:

- Enable Code 32 Prefix
- \*Disable Code 32 Prefix.

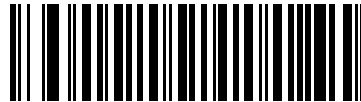

**Enable Code 32 Prefix  
(01h)**



**\*Disable Code 32 Prefix  
(00h)**

## Set Lengths for Code 39

**SSI # L1 = 12h, L2 = 13h**

**Parameter # L1 = 18, L2 = 19**

The length of a code refers to the number of characters (i.e., human readable characters), including check digit(s) the code contains. Set lengths for Code 39 to any length, one or two discrete lengths, or lengths within a specific range. If Code 39 Full ASCII is enabled, **Length Within a Range** or **Any Length** are the preferred options. The supported range for Code 39 lengths is 0 - 99; the default range is 2 - 55.

✓ **NOTE** When setting lengths for different bar code types, enter a leading zero for single digit numbers.

Options:

- Code 39 One Discrete Length - Select this option to decode only Code 39 symbols containing a selected length. Select the length using the numeric bar codes in [Appendix G, NUMERIC BAR CODES](#). For example, to decode only Code 39 symbols with 14 characters, scan **Code 39 - One Discrete Length**, then scan **1** followed by **4**. To correct an error or change the selection, scan [Cancel on page G-10](#).
- Code 39 Two Discrete Lengths - Select this option to decode only Code 39 symbols containing either of two selected lengths. Select lengths using the numeric bar codes in [Appendix G, NUMERIC BAR CODES](#). For example, to decode only Code 39 symbols containing either 2 or 14 characters, select **Code 39 - Two Discrete Lengths**, then scan **0, 2, 1**, and then **4**. To correct an error or change the selection, scan [Cancel on page G-10](#).
- \*Code 39 Length Within Range - Select this option to decode a Code 39 symbol with a specific length range. Select lengths using numeric bar codes in [Appendix G, NUMERIC BAR CODES](#). For example, to decode Code 39 symbols containing between 4 and 12 characters, first scan **Code 39 - Length Within Range**. Then scan **0, 4, 1**, and **2** (enter a leading zero for single digit numbers). To correct an error or change the selection, scan [Cancel on page G-10](#).
- Code 39 Any Length - Select this option to decode Code 39 symbols containing any number of characters within the scanner's capability.

**Set Lengths for Code 39 (continued)**



**Code 39 - One Discrete Length**



**Code 39 - Two Discrete Lengths**

**Set Lengths for Code 39 (continued)**

\*Code 39 - Length Within Range



Code 39 - Any Length



## Code 39 Check Digit Verification

**SSI # 30h**

**Parameter # 48**

Enable this feature to check the integrity of all Code 39 symbols to verify that the data complies with specified check digit algorithm. Only Code 39 symbols which include a modulo 43 check digit are decoded. Enable this feature if the Code 39 symbols contain a Modulo 43 check digit.

Options:

- Enable Code 39 Check Digit
- \*Disable Code 39 Check Digit.

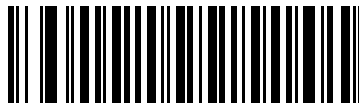

**Enable Code 39 Check Digit  
(01h)**

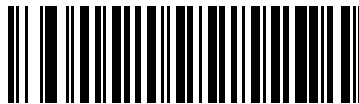

**\*Disable Code 39 Check Digit  
(00h)**

## Transmit Code 39 Check Digit

**SSI # 2Bh**

**Parameter # 43**

Scan a bar code below to transmit Code 39 data with or without the check digit.

Options:

- Transmit Code 39 Check Digit (Enable)
- \*Do Not Transmit Code 39 Check Digit (Disable).

✓ **NOTE** [Code 39 Check Digit Verification on page 12-66](#) must be enabled for this parameter to function.

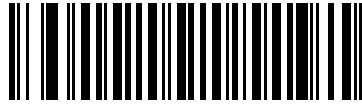

**Transmit Code 39 Check Digit (Enable)**  
**(01h)**



**\*Do Not Transmit Code 39 Check Digit (Disable)**  
**(00h)**

## Code 39 Full ASCII Conversion

### SSI # 11h

#### Parameter # 17

Code 39 Full ASCII is a variant of Code 39 which pairs characters to encode the full ASCII character set. To enable or disable Code 39 Full ASCII, scan the appropriate bar code below.

Options:

- Enable Code 39 Full ASCII
- \*Disable Code 39 Full ASCII.

✓ **NOTE** You cannot enable Trioptic Code 39 and Code 39 Full ASCII simultaneously.

Code 39 Full ASCII to Full ASCII Correlation is host-dependent, and is therefore described in the ASCII Character Set Table for the appropriate interface. See the [ASCII Character Set for USB on page 6-33](#).

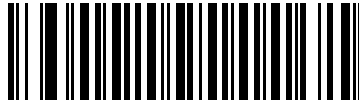

**Enable Code 39 Full ASCII  
(01h)**

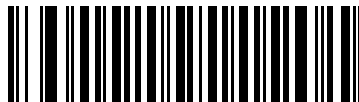

**\*Disable Code 39 Full ASCII  
(00h)**

## Code 39 Security Level

**SSI # F1h EEh**

**Parameter # 750**

The scanner offers four levels of decode security for Code 39. Select increasing levels of security for decreasing levels of bar code quality. There is an inverse relationship between security and scanner aggressiveness, so choose only that level of security necessary for any given application.

Options:

- **Code 39 Security Level 0:** This setting allows the scanner to operate in its most aggressive state, while providing sufficient security in decoding most “in-spec” bar codes.
- **Code 39 Security Level 1:** This default setting eliminates most misdecodes.
- **Code 39 Security Level 2:** Select this option if Security level 1 fails to eliminate misdecodes.
- **Code 39 Security Level 3:** If you selected Security Level 2 and misdecodes still occur, select this security level. Be advised, selecting this option is an extreme measure against mis-decoding severely out of spec bar codes. Selecting this level of security significantly impairs the decoding ability of the scanner. If you need this level of security, try to improve the quality of the bar codes.



**Code 39 Security Level 0  
(00h)**



**\*Code 39 Security Level 1  
(01h)**

## Code 39 Security Level (continued)



**Code 39 Security Level 2  
(02h)**



**Code 39 Security Level 3  
(03h)**

## Code 39 Reduced Quiet Zone

**SSI # F8h 04h B9h**

**Parameter # 1209**

Scan one of the following bar codes to enable or disable decoding Code 39 bar codes with reduced quiet zones. If you select **Enable**, select a [1D Quiet Zone Level on page 12-176](#).

Options:

- Enable Code 39 Reduced Quiet Zone
- \*Disable Code 39 Reduced Quiet Zone.



**Enable Code 39 Reduced Quiet Zone  
(1)**



**\*Disable Code 39 Reduced Quiet Zone  
(0)**

## Code 93

---

### Enable/Disable Code 93

**SSI # 09h**

**Parameter # 9**

To enable or disable Code 93, scan the appropriate bar code below.

Options:

- Enable Code 93
- \*Disable Code 93.



**Enable Code 93  
(01h)**

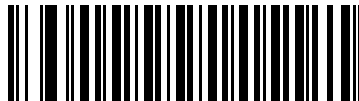

**\*Disable Code 93  
(00h)**

## Set Lengths for Code 93

**SSI # L1 = 1Ah, L2 = 1Bh**

**Parameter # L1 = 26, L2 = 27**

The length of a code refers to the number of characters (i.e., human readable characters), including check digit(s) the code contains. Set lengths for Code 93 to any length, one or two discrete lengths, or lengths within a specific range. The supported range for Code 93 lengths is 0 - 55; the default range is 1 - 55.

Options:

- **Code 93 One Discrete Length** - Select this option to decode only Code 93 symbols containing a selected length. Select the length using the numeric bar codes in [Appendix G, NUMERIC BAR CODES](#). For example, to decode only Code 93 symbols with 14 characters, scan **Code 93 - One Discrete Length**, then scan **1** followed by **4**. To correct an error or to change the selection, scan [Cancel on page G-10](#).
- **Code 93 Two Discrete Lengths** - Select this option to decode only Code 93 symbols containing either of two selected lengths. Select lengths using the numeric bar codes in [Appendix G, NUMERIC BAR CODES](#). For example, to decode only Code 93 symbols containing either 2 or 14 characters, select **Code 93 - Two Discrete Lengths**, then scan **0, 2, 1**, and then **4**. To correct an error or to change the selection, scan [Cancel on page G-10](#).
- **\*Code 93 Length Within Range** - Select this option to decode a Code 93 symbol with a specific length range. Select lengths using the numeric bar codes in [Appendix G, NUMERIC BAR CODES](#). For example, to decode Code 93 symbols containing between 4 and 12 characters, first scan **Code 93 - Length Within Range**. Then scan **0, 4, 1**, and **2** (enter a leading zero for single digit numbers). To correct an error or change the selection, scan [Cancel on page G-10](#).
- **Code 93 Any Length** - Scan this option to decode Code 93 symbols containing any number of characters within the scanner's capability.



**Set Lengths for Code 93 (continued)**



**Code 93 - One Discrete Length**



**Code 93 - Two Discrete Lengths**

**Set Lengths for Code 93 (continued)**

\*Code 93 - Length Within Range



Code 93 - Any Length

## Code 11

**SSI # 0Ah**

**Parameter # 10**

To enable or disable Code 11, scan the appropriate bar code below.

Options:

- Enable Code 11
- \*Disable Code 11.

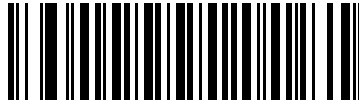

**Enable Code 11  
(01h)**



**\*Disable Code 11  
(00h)**

## Set Lengths for Code 11

**SSI # L1 = 1Ch, L2 = 1Dh**

**Parameter # 28, 29**

The length of a code refers to the number of characters (i.e., human readable characters), including check digit(s) the code contains. Set lengths for Code 11 to any length, one or two discrete lengths, or lengths within a specific range. The default range is 4 - 55.

Options:

- **One Discrete Length** - Select this option to decode only Code 11 symbols containing a selected length. Select the length using the numeric bar codes in [Appendix G, NUMERIC BAR CODES](#). For example, to decode only Code 11 symbols with 14 characters, scan **Code 11 - One Discrete Length**, then scan **1** followed by **4**. To correct an error or to change the selection, scan [Cancel on page G-10](#).
- **Two Discrete Lengths** - Select this option to decode only Code 11 symbols containing either of two selected lengths. Select lengths using the numeric bar codes in [Appendix G, NUMERIC BAR CODES](#). For example, to decode only Code 11 symbols containing either 2 or 14 characters, select **Code 11 - Two Discrete Lengths**, then scan **0, 2, 1**, and then **4**. To correct an error or to change the selection, scan [Cancel on page G-10](#).
- **\*Length Within Range** - Select this option to decode a Code 11 symbol with a specific length range. Select lengths using numeric bar codes in [Appendix G, NUMERIC BAR CODES](#). For example, to decode Code 11 symbols containing between 4 and 12 characters, first scan **Code 11 - Length Within Range**. Then scan **0, 4, 1**, and **2** (enter a leading zero for single digit numbers). To correct an error or change the selection, scan [Cancel on page G-10](#).
- **Any Length** - Scan this option to decode Code 11 symbols containing any number of characters within the decoder's capability.

**Set Lengths for Code 11 (continued)**



**Code 11 - One Discrete Length**



**Code 11 - Two Discrete Lengths**

**Set Lengths for Code 11 (continued)**

\*Code 11 - Length Within Range



Code 11 - Any Length

## Code 11 Check Digit Verification

### SSI # 34h

### Parameter # 52

This feature allows the decoder to check the integrity of all Code 11 symbols to verify that the data complies with the specified check digit algorithm. This selects the check digit mechanism for the decoded Code 11 bar code. The options are to check for one check digit, check for two check digits, or disable the feature.

To enable this feature, scan the bar code below corresponding to the number of check digits encoded in the Code 11 symbols.

Options:

- \*Disable
- One Check Digit
- Two Check Digits.



\*Disable  
(00h)

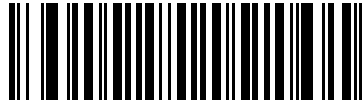

One Check Digit  
(01h)

**Code 11 Check Digit Verification (continued)**

Two Check Digits  
(02h)



## Transmit Code 11 Check Digits

**SSI # 2Fh**

**Parameter # 47**

This feature selects whether or not to transmit the Code 11 check digit(s).

✓ **NOTE** [Code 11 Check Digit Verification on page 12-80](#) must be enabled for this parameter to function.

Options:

- Transmit Code 11 Check Digit(s) (Enable)
- \*Do Not Transmit Code 11 Check Digit(s) (Disable).

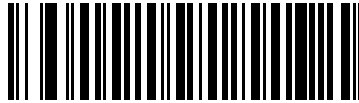

Transmit Code 11 Check Digit(s) (Enable)  
(01h)



\*Do Not Transmit Code 11 Check Digit(s) (Disable)  
(00h)

---

## Interleaved 2 of 5 (ITF)

### Enable/Disable Interleaved 2 of 5

**SSI # 06h**

**Parameter # 6**

To enable or disable Interleaved 2 of 5, scan the appropriate bar code below, and select an Interleaved 2 of 5 length from the following pages.

Options:

- \*Enable Interleaved 2 of 5
- Disable Interleaved 2 of 5.

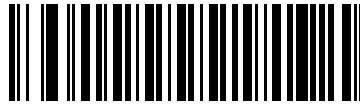

**\*Enable Interleaved 2 of 5  
(01h)**



**Disable Interleaved 2 of 5  
(00h)**

## Set Lengths for Interleaved 2 of 5 (I 2 of 5)

**SSI # L1 = 16h, L2 = 17h**

**Parameter # L1 = 22, L2 = 23**

The length of a code refers to the number of characters (i.e., human readable characters), including check digit(s) the code contains. Set lengths for I 2 of 5 to any length, one or two discrete lengths, or lengths within a specific range. The range for Interleaved 2 of 5 lengths is 6 - 55.

Options:

- I 2 of 5 One Discrete Length - Select this option to decode only I 2 of 5 symbols containing a selected length. Select the length using the numeric bar codes in [Appendix G, NUMERIC BAR CODES](#). For example, to decode only I 2 of 5 symbols with 14 characters, scan **I 2 of 5 - One Discrete Length**, then scan **1** followed by **4**. To correct an error or to change the selection, scan [Cancel on page G-10](#).
- I 2 of 5 Two Discrete Lengths - Select this option to decode only I 2 of 5 symbols containing either of two selected lengths. Select lengths using the numeric bar codes in [Appendix G, NUMERIC BAR CODES](#). For example, to decode only I 2 of 5 symbols containing either 2 or 14 characters, select **I 2 of 5 - Two Discrete Lengths**, then scan **0, 2, 1**, and then **4**. To correct an error or to change the selection, scan [Cancel on page G-10](#).
- \*I 2 of 5 Length Within Range - Select this option to decode an I 2 of 5 symbol with a specific length range. Select lengths using numeric bar codes in [Appendix G, NUMERIC BAR CODES](#). For example, to decode I 2 of 5 symbols containing between 4 and 12 characters, first scan **I 2 of 5 - Length Within Range**. Then scan **0, 4, 1**, and **2** (enter a leading zero for single digit numbers). To correct an error or change the selection, scan [Cancel on page G-10](#).
- I 2 of 5 Any Length - Scan this option to decode I 2 of 5 symbols containing any number of characters within the scanner's capability.

✓ **NOTE** Due to the construction of the I 2 of 5 symbology, it is possible for a scan line covering only a portion of the code to transmit as a complete scan, yielding less data than is encoded in the bar code. To prevent this, select specific lengths (I 2 of 5 - One Discrete Length, Two Discrete Lengths) for I 2 of 5 applications.



I 2 of 5 - One Discrete Length

**Set Lengths for Interleaved 2 of 5 (continued)****I 2 of 5 - Two Discrete Lengths****\*I 2 of 5 - Length Within Range**

**Set Lengths for Interleaved 2 of 5 (continued)**



**I 2 of 5 - Any Length**

## I 2 of 5 Check Digit Verification

**SSI # 31h**

**Parameter # 49**

Enable this feature to check the integrity of all I 2 of 5 symbols to verify the data complies with either the specified Uniform Symbology Specification (USS), or the Optical Product Code Council (OPCC) check digit algorithm.

Options:

- \*Disable I 2 of 5 Check Digit Verification
- USS Check Digit
- OPCC Check Digit.



**\*Disable  
(00h)**



**USS Check Digit  
(01h)**

## I 2 of 5 Check Digit Verification (continued)



OPCC Check Digit  
(02h)

## Transmit I 2 of 5 Check Digit

**SSI # 2Ch**

**Parameter # 44**

Scan the appropriate bar code below to transmit I 2 of 5 data with or without the check digit.

Options:

- Transmit I 2 of 5 Check Digit (Enable)
- \*Do Not Transmit I 2 of 5 Check Digit (Disable).

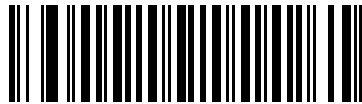

**Transmit I 2 of 5 Check Digit (Enable)**  
**(01h)**



**\*Do Not Transmit I 2 of 5 Check Digit (Disable)**  
**(00h)**



## Convert I 2 of 5 to EAN-13

**SSI # 52h**

**Parameter # 82**

Enable this parameter to convert 14-character I 2 of 5 codes to EAN-13, and transmit to the host as EAN-13. To accomplish this, the I 2 of 5 code must be enabled, and the code must have a leading zero and a valid EAN-13 check digit.

Options:

- Convert I 2 of 5 to EAN-13 (Enable)
- \*Do Not Convert I 2 of 5 to EAN-13 (Disable).

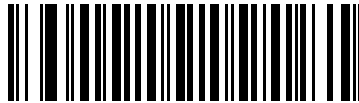

**Convert I 2 of 5 to EAN-13 (Enable)  
(01h)**



**\*Do Not Convert I 2 of 5 to EAN-13 (Disable)  
(00h)**

## I 2 of 5 Security Level

**SSI # F8h 04h 61h**

**Parameter # 1121**

Interleaved 2 of 5 bar codes are vulnerable to misdecodes by the nature of the symbol, especially when **Any Length** is set for Interleaved 2 of 5 bar codes. The scanner offers four levels of decode security for Interleaved 2 of 5 bar codes. There is an inverse relationship between security and scanner aggressiveness. Increasing the level of security may result in reduced aggressiveness in scanning, so select only the level of security necessary.

Options:

- **I 2 of 5 Security Level 0:** This setting allows the scanner to operate in its most aggressive state, while providing sufficient security in decoding the most in-spec bar codes.
- **I 2 of 5 Security Level 1:** A bar code must be successfully read twice, and satisfy certain safety requirements before being decoded. This default setting eliminates most misdecodes.
- **I 2 of 5 Security Level 2:** Select this option with higher safety requirements to the bar codes if **Security Level 1** fails to eliminate misdecodes.
- **I 2 of 5 Security Level 3:** If you selected **Security Level 2**, and misdecodes still occur, select this security level. The highest safety requirements are applied. A bar code must be successfully read three times before being decoded.



**NOTE** Selecting this option is an extreme measure against mis-decoding severely out-of-spec bar codes. Selecting this level of security significantly impairs the decoding ability of the scanner. If this level of security is required, it is recommended that you try to improve the quality of the bar codes.

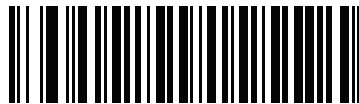

**I 2 of 5 Security Level 0  
(00h)**



**\*I 2 of 5 Security Level 1  
(01h)**

**I 2 of 5 Security Level (continued)**



**I 2 of 5 Security Level 2  
(02h)**



**I 2 of 5 Security Level 3  
(03h)**

## I 2 of 5 Reduced Quiet Zone

**SSI # F8h 04h BAh**

**Parameter # 1210**

Scan one of the following bar codes to enable or disable decoding I 2 of 5 bar codes with reduced quiet zones. If you select **Enable**, select a [1D Quiet Zone Level on page 12-176](#).

Options:

- Enable I 2 of 5 Reduced Quiet Zone
- \*Disable I 2 of 5 Reduced Quiet Zone.

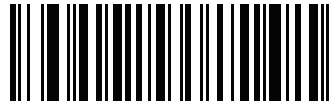

**Enable I 2 of 5 Reduced Quiet Zone  
(1)**



**\*Disable I 2 of 5 Reduced Quiet Zone  
(0)**

## Discrete 2 of 5 (D 2 of F)

**SSI # 05h**

**Parameter # 5**

To enable or disable Discrete 2 of 5, scan the appropriate bar code below.

Options:

- Enable Discrete 2 of 5
- \*Disable Discrete 2 of 5

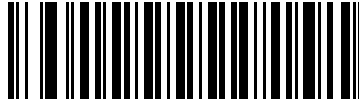

Enable Discrete 2 of 5  
(01h)

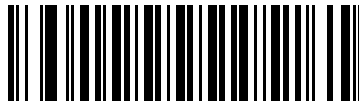

\*Disable Discrete 2 of 5  
(00h)

## Set Lengths for Discrete 2 of 5

**SSI # L1 = 14h, L2 = 15h**

**Parameter # L1 = 20, L2 = 21**

The length of a code refers to the number of characters (i.e., human readable characters), including check digit(s) the code contains. Set lengths for D 2 of 5 to any length, one or two discrete lengths, or lengths within a specific range. The supported range for Discrete 2 of 5 lengths is 0 - 55; the default range is 1 - 55.

Options:

- D 2 of 5 One Discrete Length - Select this option to decode only D 2 of 5 symbols containing a selected length. Select the length using the numeric bar codes in [Appendix G, NUMERIC BAR CODES](#). For example, to decode only D 2 of 5 symbols with 14 characters, scan **D 2 of 5 - One Discrete Length**, then scan **1** followed by **4**. To correct an error or to change the selection, scan [Cancel on page G-10](#).
- D 2 of 5 Two Discrete Lengths - Select this option to decode only D 2 of 5 symbols containing either of two selected lengths. Select lengths using the numeric bar codes in [Appendix G, NUMERIC BAR CODES](#). For example, to decode only D 2 of 5 symbols containing either 2 or 14 characters, select **D 2 of 5 - Two Discrete Lengths**, then scan **0, 2, 1**, and then **4**. To correct an error or to change the selection, scan [Cancel on page G-10](#).
- D 2 of 5 Length Within Range - Select this option to decode a D 2 of 5 symbol with a specific length range. Select lengths using numeric bar codes in [Appendix G, NUMERIC BAR CODES](#). For example, to decode D 2 of 5 symbols containing between 4 and 12 characters, first scan **D 2 of 5 - Length Within Range**. Then scan **0, 4, 1**, and **2** (enter a leading zero for single digit numbers). To correct an error or change the selection, scan [Cancel on page G-10](#).
- \*D 2 of 5 Any Length - Scan this option to decode D 2 of 5 symbols containing any number of characters within the scanner's capability.

✓ **NOTE** Due to the construction of the D 2 of 5 symbology, it is possible for a scan line covering only a portion of the code to transmit as a complete scan, yielding less data than is encoded in the bar code. To prevent this, select specific lengths (**D 2 of 5 - One Discrete Length, Two Discrete Lengths**) for D 2 of 5 applications.



**D 2 of 5 - One Discrete Length**

**Set Lengths for Discrete 2 of 5 (continued)**



**D 2 of 5 - Two Discrete Lengths**



**D 2 of 5 - Length Within Range**

**Set Lengths for Discrete 2 of 5 (continued)**

\*D 2 of 5 - Any Length



---

## Codabar (NW - 7)

### Enable/Disable Codabar

**SSI # 07h**

**Parameter # 7**

Options:

- Enable Codabar
- \*Disable Codabar.

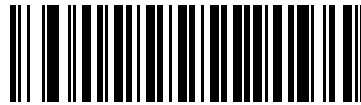

Enable Codabar  
(01h)

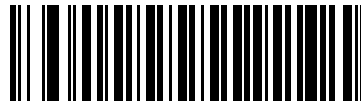

\*Disable Codabar  
(00h)

## Set Lengths for Codabar

**SSI # L1 = 18h, L2 = 19h**

**Parameter # L1 = 24, L2 = 25**

The length of a code refers to the number of characters (i.e., human readable characters), including check digit(s) the code contains. Set lengths for Codabar to any length, one or two discrete lengths, or lengths within a specific range. The supported range for Codabar lengths is 0 - 55; the default range is 4 - 55.

Options:

- **Codabar One Discrete Length** - Select this option to decode only Codabar symbols containing a selected length. Select the length using the numeric bar codes in [Appendix G, NUMERIC BAR CODES](#). For example, to decode only Codabar symbols with 14 characters, scan **Codabar - One Discrete Length**, then scan **1** followed by **4**. To correct an error or to change the selection, scan [Cancel on page G-10](#).
- **Codabar Two Discrete Lengths** - Select this option to decode only Codabar symbols containing either of two selected lengths. Select lengths using the numeric bar codes in [Appendix G, NUMERIC BAR CODES](#). For example, to decode only Codabar symbols containing either 2 or 14 characters, select **Codabar - Two Discrete Lengths**, then scan **0, 2, 1**, and then **4**. To correct an error or to change the selection, scan [Cancel on page G-10](#).
- **\*Codabar Length Within Range** - Select this option to decode a Codabar symbol with a specific length range. Select lengths using numeric bar codes in [Appendix G, NUMERIC BAR CODES](#). For example, to decode Codabar symbols containing between 4 and 12 characters, first scan **Codabar - Length Within Range**. Then scan **0, 4, 1**, and **2** (enter a leading zero for single digit numbers). To correct an error or change the selection, scan [Cancel on page G-10](#).
- **Codabar Any Length** - Scan this option to decode Codabar symbols containing any number of characters within the scanner's capability.



**Codabar - One Discrete Length**

**Set Lengths for Codabar (continued)**



**Codabar - Two Discrete Lengths**



**\*Codabar - Length Within Range**

**Set Lengths for Codabar (continued)****Codabar - Any Length**

## CLSI Editing

### SSI # 36h

### Parameter # 54

Enable this parameter to strip the start and stop characters and insert a space after the first, fifth, and tenth characters of a 14-character Codabar symbol. Enable this feature if the host system requires this data format.

✓ **NOTE** Symbol length does not include start and stop characters.

Options:

- Enable CLSI Editing
- \*Disable CLSI Editing.

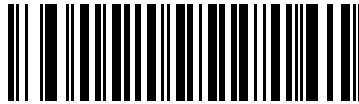

Enable CLSI Editing  
(01h)



\*Disable CLSI Editing  
(00h)

## NOTIS Editing

### SSI # 37h

### Parameter # 55

Enable this parameter to strip the start and stop characters from a decoded Codabar symbol. Enable this feature if the host system requires this data format.

Options:

- Enable NOTIS Editing
- \*Disable NOTIS Editing.

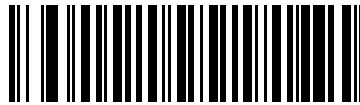

**Enable NOTIS Editing  
(01h)**

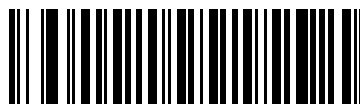

**\*Disable NOTIS Editing  
(00h)**

## Codabar Upper or Lower Case Start/Stop Characters Detection

**SSI # F2h 57h**

**Parameter # 855**

Select whether to detect upper case or lower case Codabar start/stop characters.

Options:

- \*Upper Case
- Lower Case.

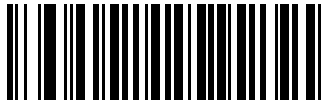

**\*Upper Case  
(00h)**



**Lower Case  
(01h)**

## MSI

---

### Enable/Disable MSI

SSI # 0Bh

Parameter # 11

Options:

- Enable MSI
- \*Disable MSI.

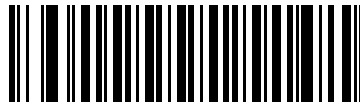

Enable MSI  
(01h)



\*Disable MSI  
(00h)



## Set Lengths for MSI

**SSI # L1 = 1Eh, L2 = 1Fh**

**Parameter # L1 = 30, L2 = 31**

The length of a code refers to the number of characters (i.e., human readable characters), including check digit(s) the code contains. Set lengths for MSI to any length, one or two discrete lengths, or lengths within a specific range. The supported range for MSI lengths is 0 - 55; the default range is 4 - 55.

Options:

- **MSI One Discrete Length** - Select this option to decode only MSI symbols containing a selected length. Select the length using the numeric bar codes in [Appendix G, NUMERIC BAR CODES](#). For example, to decode only MSI symbols with 14 characters, scan **MSI - One Discrete Length**, then scan **1** followed by **4**. To correct an error or to change the selection, scan [Cancel on page G-10](#).
- **MSI Two Discrete Lengths** - Select this option to decode only MSI symbols containing either of two selected lengths. Select lengths using the numeric bar codes in [Appendix G, NUMERIC BAR CODES](#). For example, to decode only MSI symbols containing either 2 or 14 characters, select **MSI - Two Discrete Lengths**, then scan **0**, **2**, **1**, and then **4**. To correct an error or to change the selection, scan [Cancel on page G-10](#).
- **\*MSI Length Within Range** - Select this option to decode a MSI symbol with a specific length range. Select lengths using numeric bar codes in [Appendix G, NUMERIC BAR CODES](#). For example, to decode MSI symbols containing between 4 and 12 characters, first scan **MSI - Length Within Range**. Then scan **0**, **4**, **1**, and **2** (enter a leading zero for single digit numbers). To correct an error or change the selection, scan [Cancel on page G-10](#).
- **MSI Any Length** - Scan this option to decode MSI symbols containing any number of characters within the scanner's capability.

✓ **NOTE** Due to the construction of the MSI symbology, it is possible for a scan line covering only a portion of the code to transmit as a complete scan, yielding less data than is encoded in the bar code. To prevent this, select specific lengths (**MSI - One Discrete Length, Two Discrete Lengths**) for MSI applications.

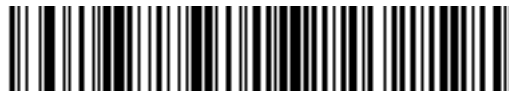

**MSI - One Discrete Length**

**Set Lengths for MSI (continued)****MSI - Two Discrete Lengths****\*MSI - Length Within Range**

**Set Lengths for MSI (continued)**



**MSI - Any Length**

## MSI Check Digits

**SSI # 32h**

**Parameter # 50**

With MSI symbols, one check digit is mandatory and always verified by the reader. The second check digit is optional. If the MSI codes include two check digits, scan the **Two MSI Check Digits** bar code to enable verification of the second check digit.

See [MSI Check Digit Algorithm on page 12-111](#) for the selection of second digit algorithms.

Options:

- \*One MSI Check Digit
- Two MSI Check Digits.

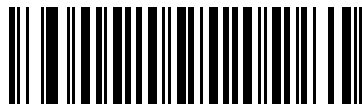

\*One MSI Check Digit  
(00h)



Two MSI Check Digits  
(01h)

## Transmit MSI Check Digit(s)

**SSI # 2Eh**

**Parameter # 46**

Scan a bar code below to transmit MSI data with or without the check digit.

Options:

- Transmit MSI Check Digit(s) (Disable)
- \*Do Not Transmit MSI Check Digit(s) (Disable).

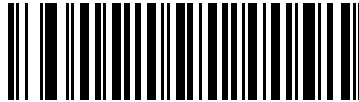

**Transmit MSI Check Digit(s) (Enable)**  
**(01h)**

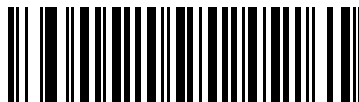

**\*Do Not Transmit MSI Check Digit(s) (Disable)**  
**(00h)**

## MSI Check Digit Algorithm

**SSI # 33h**

**Parameter # 51**

Two algorithms are possible for the verification of the second MSI check digit. Select the bar code below corresponding to the algorithm used to encode the check digit.

Options:

- MOD 10/MOD 11
- \*MOD 10/MOD 10.

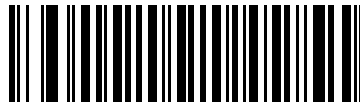

**MOD 10/MOD 11  
(00h)**



**\*MOD 10/MOD 10  
(01h)**

## Chinese 2 of 5

### Enable/Disable Chinese 2 of 5

SSI # F0h 98h

Parameter # 408

Options:

- Enable Chinese 2 of 5
- \*Disable Chinese 2 of 5.

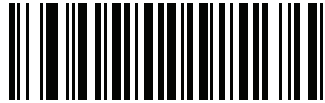

Enable Chinese 2 of 5  
(01h)

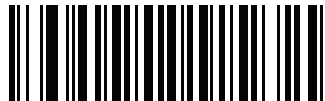

\*Disable Chinese 2 of 5  
(00h)

---

## Matrix 2 of 5

### Enable/Disable Matrix 2 of 5

**SSI # F1h 6Ah**

**Parameter # 618**

To enable or disable Matrix 2 of 5, scan the appropriate bar code below.

Options:

- Enable Matrix 2 of 5
- \*Disable Matrix 2 of 5.



**Enable Matrix 2 of 5  
(01h)**



**\*Disable Matrix 2 of 5  
(00h)**



## Set Lengths for Matrix 2 of 5

**SSI # L1 = F1h 6Bh, L2 = F1h 6Ch**

**Parameter # L1 = 619, L2 = 620**

The length of a code refers to the number of characters (i.e., human readable characters), including check digit(s) the code contains. Set lengths for Matrix 2 of 5 to any length, one or two discrete lengths, or lengths within a specific range. The range for Matrix 2 of 5 lengths is 4 - 55

Options:

- **One Discrete Length** - Select this option to decode only Matrix 2 of 5 symbols containing a selected length. Select the length using the numeric bar codes in [Appendix G, NUMERIC BAR CODES](#). For example, to decode only Matrix 2 of 5 symbols with 14 characters, scan **Matrix 2 of 5 - One Discrete Length**, then scan **1** followed by **4**. To correct an error or to change the selection, scan [Cancel on page G-10](#).
- **Two Discrete Lengths** - Select this option to decode only Matrix 2 of 5 symbols containing either of two selected lengths. Select lengths using the numeric bar codes in [Appendix G, NUMERIC BAR CODES](#). For example, to decode only Matrix 2 of 5 symbols containing either 2 or 14 characters, select **Matrix 2 of 5 - Two Discrete Lengths**, then scan **0**, **2**, **1**, and then **4**. To correct an error or to change the selection, scan [Cancel on page G-10](#).
- **\*Length Within Range** - Select this option to decode a Matrix 2 of 5 symbol with a specific length range. Select lengths using the numeric bar codes in [Appendix G, NUMERIC BAR CODES](#). For example, to decode Matrix 2 of 5 symbols containing between 4 and 12 characters, first scan **Matrix 2 of 5 - Length Within Range**. Then scan **0**, **4**, **1**, and **2** (enter a leading zero for single digit numbers). To correct an error or change the selection, scan [Cancel on page G-10](#).
- **Any Length** - Scan this option to decode Matrix 2 of 5 symbols containing any number of characters within the decoder's capability.



Matrix 2 of 5 - One Discrete Length



Matrix 2 of 5 - Two Discrete Lengths

**Set Lengths for Matrix 2 of 5 (continued)**

\*Matrix 2 of 5 - Length Within Range



Matrix 2 of 5 - Any Length

## Matrix 2 of 5 Check Digit

**SSI # F1h 6Eh**

**Parameter # 622**

The check digit is the last character of the symbol used to verify the integrity of the data. Scan the appropriate bar code below to transmit the bar code data with or without the Matrix 2 of 5 check digit.

Options:

- Enable Matrix 2 of 5 Check Digit
- \*Disable Matrix 2 of 5 Check Digit.

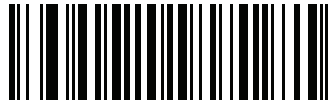

**Enable Matrix 2 of 5 Check Digit  
(01h)**

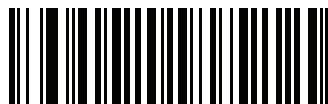

**\*Disable Matrix 2 of 5 Check Digit  
(00h)**

## Transmit Matrix 2 of 5 Check Digit

**SSI # F1h 6Fh**

**Parameter # 623**

Scan a bar code below to transmit Matrix 2 of 5 data with or without the check digit.

Options:

- Transmit Matrix 2 of 5 Check Digit
- \*Do Not Transmit Matrix 2 of 5 Check Digit.



**Transmit Matrix 2 of 5 Check Digit  
(01h)**



**\*Do Not Transmit Matrix 2 of 5 Check Digit  
(00h)**

## Korean 3 of 5

### Enable/Disable Korean 3 of 5

**SSI # F1h 45h**

**Parameter # 581**

To enable or disable Korean 3 of 5, scan the appropriate bar code below.

✓ **NOTE** The length for Korean 3 of 5 is fixed at 6.

Options:

- Enable Korean 3 of 5
- \*Disable Korean 3 of 5.

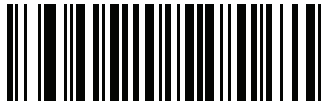

**Enable Korean 3 of 5  
(01h)**



**\*Disable Korean 3 of 5  
(00h)**

---

## Inverse 1D

**SSI # F1h 4Ah**

**Parameter # 586**

This parameter sets the 1D inverse decoder setting.

Options:

- \*Regular Only - the decoder decodes regular 1D bar codes only.
- Inverse Only - the decoder decodes inverse 1D bar codes only.
- Inverse Autodetect - the decoder decodes both regular and inverse 1D bar codes.



**\*Regular  
(00h)**



**Inverse Only  
(01h)**

---

## Inverse 1D (continued)



Inverse Autodetect  
(02h)

---

## Postal Codes

### US Postnet

**SSI # 59h**

**Parameter # 89**

To enable or disable US Postnet, scan the appropriate bar code below.

Options:

- Enable US Postnet
- \*Disable US Postnet.



**Enable US Postnet  
(01h)**



**\*Disable US Postnet  
(00h)**



## US Planet

### SSI # 5Ah

### Parameter # 90

To enable or disable US Planet, scan the appropriate bar code below.

Options:

- Enable US Planet
- \*Disable US Planet.



Enable US Planet  
(01h)



\*Disable US Planet  
(00h)

## Transmit US Postal Check Digit

**SSI # 5Fh**

**Parameter # 95**

Select whether to transmit US Postal data, which includes both US Postnet and US Planet, with or without the check digit.

Options:

- \*Transmit US Postal Check Digit
- Do Not Transmit US Postal Check Digit.

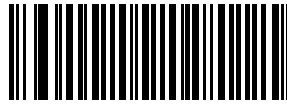

**\*Transmit US Postal Check Digit  
(01h)**



**Do Not Transmit US Postal Check Digit  
(00h)**

## UK Postal

### SSI # 5Bh

### Parameter # 91

To enable or disable UK Postal, scan the appropriate bar code below.

Options:

- Enable UK Postal
- Disable UK Postal.



Enable UK Postal  
(01h)



\*Disable UK Postal  
(00h)

## Transmit UK Postal Check Digit

**SSI # 60h**

**Parameter # 96**

Select whether to transmit UK Postal data with or without the check digit.

Options:

- \*Transmit UK Postal Check Digit
- Do Not Transmit UK Postal Check Digit.



**\*Transmit UK Postal  
Check Digit  
(01h)**



**Do Not Transmit UK Postal Check Digit  
(00h)**

## Japan Post

**SSI # F0h, 22h**

**Parameter # 290**

To enable or disable Japan Post, scan the appropriate bar code below.

Options:

- Enable Japan Post
- \*Disable Japan Post.



**Enable Japan Post  
(01h)**



**\*Disable Japan Post  
(00h)**

## Australia Post

**SSI # F0h, 23h**  
**Parameter # 291**

To enable or disable Australia Post, scan the appropriate bar code below.

Options:

- Enable Australia Post
- \*Disable Australia Post.



**Enable Australia Post**  
**(01h)**



**\*Disable Australia Post**  
**(00h)**

## Australia Post Format

SSI # F1h, CEh

Parameter # 718

To select one of the following formats for Australia Post, scan the appropriate bar code below.

Options:

- **Autodiscriminate** (or Smart mode) - Attempt to decode the Customer Information Field using the N and C Encoding Tables.
- ✓ **NOTE** This option increases the risk of misdecodes because the encoded data format does not specify the Encoding Table used for encoding.
- **Raw Format** - Output raw bar patterns as a series of numbers 0 through 3.
- **Alphanumeric Encoding** - Decode the Customer Information Field using the C Encoding Table.
- **Numeric Encoding** - Decode the Customer Information Field using the N Encoding Table.

For more information on Australia Post Encoding Tables, refer to the *Australia Post Customer Barcoding Technical Specifications* available at <http://www.auspost.com.au>.



\* Autodiscriminate  
(00h)



Raw Format  
(01h)

**Australia Post Format (continued)**

**Alphanumeric Encoding  
(02h)**



**Numeric Encoding  
(03h)**



## Netherlands KIX Code

**SSI # F0h, 46h**

**Parameter # 326**

To enable or disable Netherlands KIX Code, scan the appropriate bar code below.

Options:

- Enable Netherlands KIX Code
- \*Enable Netherlands KIX Code.



**Enable Netherlands KIX Code  
(01h)**



**\*Disable Netherlands KIX Code  
(00h)**

## USPS 4CB/One Code/Intelligent Mail

**SSI # F1h 50h**

**Parameter # 592**

To enable or disable USPS 4CB/One Code/Intelligent Mail, scan the appropriate bar code below.

Options:

- Enable USPS 4CB/One Code/Intelligent Mail
- \*Enable USPS 4CB/One Code/Intelligent Mail.



**Enable USPS 4CB/One Code/Intelligent Mail  
(01h)**



**\*Disable USPS 4CB/One Code/Intelligent Mail  
(00h)**

## UPU FICS Postal

**SSI # F1h 63h**

**Parameter # 611**

To enable or disable UPU FICS Postal, scan the appropriate bar code below.

Options:

- Enable UPU FICS Postal
- \*Disable UPU FICS Postal.

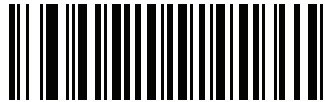

**Enable UPU FICS Postal  
(01h)**



**\*Disable UPU FICS Postal  
(00h)**

---

## Inverse 1D

**SSI # F1h 4Ah**

**Parameter # 586**

This parameter sets the 1D inverse scanner setting.

Options:

- \*Regular Only - the scanner decodes regular 1D bar codes only.
- Inverse Only - the scanner decodes inverse 1D bar codes only.
- Inverse Autodetect - the scanner decodes both regular and inverse 1D bar codes.



**\*Regular  
(00h)**



**Inverse Only  
(01h)**

**Inverse 1D (continued)**



**Inverse Autodetect  
(02h)**

## GS1 DataBar

**SSI # F0h 52h**

**Parameter # 338**

When **Enable GS1 DataBar** is scanned, the following GS1 DataBar types are supported:

- GS1 DataBar Omnidirectional
- GS1 DataBar Truncated
- GS1 DataBar Stacked
- GS1 DataBar Stacked Omnidirectional.

Options:

- \*Enable GS1 DataBar
- Disable GS1 DataBar.

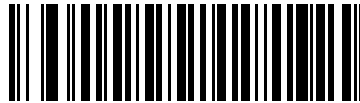

**\*Enable GS1 DataBar  
(01h)**



**Disable GS1 DataBar  
(00h)**

## GS1 DataBar Limited

**SSI # F0h 53h**

**Parameter # 339**

Options:

- \*Enable GS1 DataBar Limited
- Disable GS1 DataBar Limited.

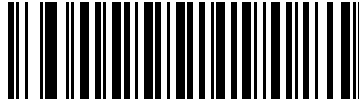

**\*Enable GS1 DataBar Limited  
(01h)**

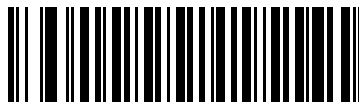

**Disable GS1 DataBar Limited  
(00h)**

## GS1 DataBar Expanded

**SSI # F0h 54h**

**Parameter # 340**

When **Enable GS1 DataBar Expanded** is scanned, the following GS1 DataBar Expanded types are supported:

- GS1 DataBar Expanded
- GS1 DataBar Expanded Stacked.

Options:

- \*Enable GS1 DataBar Expanded
- Disable GS1 DataBar Expanded.

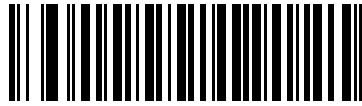

**\*Enable GS1 DataBar Expanded  
(01h)**



**Disable GS1 DataBar Expanded  
(00h)**



## GS1 DataBar Limited Security Level

### SSI # F1h D8h

#### Parameter # 728

The scanner offers four levels of decode security for GS1 DataBar Limited bar codes. There is an inverse relationship between security and scanner aggressiveness. Increasing the level of security may result in reduced aggressiveness in scanning, so only choose the level of security necessary.

Options:

- Level 1 - No clear margin required. This complies with the original GS1 standard, yet might result in erroneous<sup>1</sup> decoding of the DataBar Limited bar code when scanning some UPC symbols that start with the digits "9" and "7".
- Level 2 - Automatic risk detection. This level of security may result in erroneous decoding of DataBar Limited bar codes when scanning some UPC symbols. If a misdecode is detected, the scanner operates in Level 3 or Level 1.
- \*Level 3 - Security level reflects newly proposed GS1 standard that requires a 5X trailing clear margin.
- Level 4 - Security level extends beyond the standard required by GS1. This level of security requires a 5X leading and trailing clear margin.

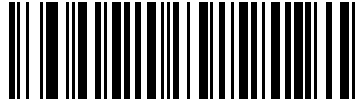

**Security Level 1  
(01h)**

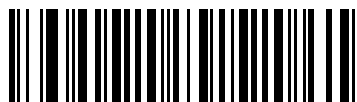

**Security Level 2  
(02h)**

---

1. May result in erroneous decoding due to DataBar Limited and UPC symbologies.

**GS1 DataBar Limited Security Level (continued)**



**\*Security Level 3  
(03h)**



**Security Level 4  
(04h)**

## Convert GS1 DataBar to UPC/EAN

**SSI # F0h 8Dh**

**Parameter # 397**

This parameter only applies to GS1 DataBar and GS1 DataBar Limited symbols not decoded as part of a Composite symbol. Enable this to strip the leading '010' from DataBar and DataBar Limited symbols encoding a single zero as the first digit, and report the bar code as EAN-13.

For bar codes beginning with two or more zeros but not six zeros, this parameter strips the leading '0100' and reports the bar code as UPC-A. The UPC-A Preamble parameter that transmits the system character and country code applies to converted bar codes. Note that neither the system character nor the check digit can be stripped.

Options:

- Enable Convert GS1 DataBar to UPC/EAN
- \*Disable Convert GS1 DataBar to UPC/EAN.

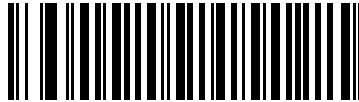

**Enable Convert GS1 DataBar to UPC/EAN  
(01h)**



**\*Disable Convert GS1 DataBar to UPC/EAN  
(00h)**

---

## Composite

### Composite CC-C

SSI # F0h 55h

Parameter # 341

Options:

- Enable CC-C
- \*Disable CC-C.

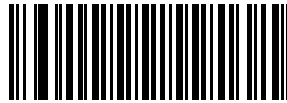

Enable CC-C  
(01h)



\*Disable CC-C  
(00h)

## Composite CC-A/B

**SSI # F0h 56h**

**Parameter # 342**

Scan a bar code below to enable or disable Composite bar codes of type CC-A/B.

✓ **NOTE** If you enable this code type, also see [UPC Composite Mode on page 12-144](#).

Options:

- Enable CC-A/B
- \*Disable CC-A/B.

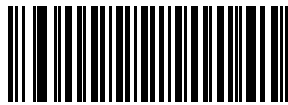

**Enable CC-A/B  
(01h)**

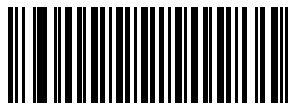

**\*Disable CC-A/B  
(00h)**

## Composite TLC-39

**SSI # F0h 73h**

**Parameter # 371**

Scan a bar code below to enable or disable Composite bar codes of type TLC-39.

Options:

- Enable TLC39
- \*Disable TLC39.

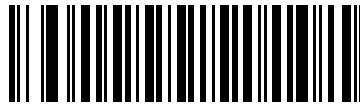

**Enable TLC39  
(01h)**



**\*Disable TLC39  
(00h)**

## UPC Composite Mode

**SSI # F0h 58h**

**Parameter # 344**

If you enable [Composite CC-A/B on page 12-142](#), select an option for linking UPC symbols with a 2D symbol during transmission as if they were one symbol.

Options:

- \*UPC Never Linked - Transmit UPC bar codes regardless of whether a 2D symbol is detected.
- UPC Always Linked - Transmit UPC bar codes and the 2D portion.  
If 2D is not present, the UPC bar code does not transmit.
- Autodiscriminate UPC Composites - The scanner determines if there is a 2D portion, then transmits the UPC, as well as the 2D portion if present.



**\*UPC Never Linked  
(00h)**



**UPC Always Linked  
(01h)**

**UPC Composite Mode (continued)**

**Autodiscriminate UPC Composites  
(02h)**



## Composite Beep Mode

**SSI # F0h 8Eh**

**Parameter # 398**

To select the number of decode beeps when a composite bar code is decoded, scan the appropriate bar code.

Options:

- Single Beep After Both are Decoded
- \*Beep as Each Code Type is Decoded
- Double Beep After Both are Decoded.

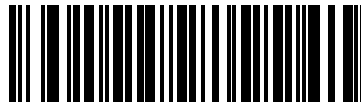

**Single Beep After Both are Decoded  
(00h)**

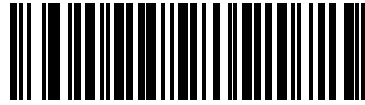

**\*Beep as Each Code Type is Decoded  
(01h)**

**Composite Beep Mode (continued)**

**Double Beep After Both are Decoded  
(02h)**

## **GS1-128 Emulation Mode for UCC/EAN Composite Codes**

**SSI # F0h ABh**

**Parameter # 427**

Options:

- Enable GS1-128 Emulation Mode for UCC/EAN Composite Codes
- \*Disable GS1-128 Emulation Mode for UCC/EAN Composite Codes.



**Enable GS1-128 Emulation Mode for  
UCC/EAN Composite Codes  
(01h)**



**\*Disable GS1-128 Emulation Mode for  
UCC/EAN Composite Codes  
(00h)**

## 2D Symbologies

---

### Enable/Disable PDF417

**SSI # 0Fh**

**Parameter # 15**

Enable or disable PDF417.

Options:

- \*Enable PDF417
- Disable PDF417.



**\*Enable PDF417  
(01h)**



**Disable PDF417  
(00h)**

## Enable/Disable MicroPDF417

**SSI # E3h**

**Parameter # 227**

Enable or disable MicroPDF417.

Options:

- Enable MicroPDF417
- \*Disable MicroPDF417.



**Enable MicroPDF417  
(01h)**



**\*Disable MicroPDF417  
(00h)**

## Code 128 Emulation

### SSI # 7Bh

#### Parameter # 123

Enable this parameter to transmit data from certain MicroPDF417 symbols as Code 128. *AIM Code ID Character (01h) on page 4-27* must be enabled for this parameter to work.

Enable Code 128 Emulation to transmit these MicroPDF417 symbols with one of the following prefixes:

- ]C1        if the first codeword is 903-905
- ]C2        if the first codeword is 908 or 909
- ]C0        if the first codeword is 910 or 911

Disable Code 128 Emulation to transmit these MicroPDF417 symbols with one of the following prefixes:

- ]L3        if the first codeword is 903-905
- ]L4        if the first codeword is 908 or 909
- ]L5        if the first codeword is 910 or 911

Enable or disable Code 128 Emulation.

✓ **NOTE** Linked MicroPDF codewords 906, 907, 912, 914, and 915 are not supported. Use GS1 Composites instead.

Options:

- Enable Code 128 Emulation
- \*Disable Code 128 Emulation.



**Enable Code 128 Emulation  
(01h)**



**\*Disable Code 128 Emulation  
(00h)**

## Data Matrix

**SSI # F0h 24h**  
**Parameter # 292**

Options:

- Enable Data Matrix
- \*Disable Data Matrix.



**Enable Data Matrix**  
**(01h)**



**\*Disable Data Matrix**  
**(00h)**

## Data Matrix Inverse

**SSI # F1h 4Ch**

**Parameter # 588**

This parameter sets the Data Matrix inverse scanner setting.

Options:

- Regular Only - The scanner decodes regular Data Matrix bar codes only.
- Inverse Only - The scanner decodes inverse Data Matrix bar codes only.
- \*Inverse Autodetect - The scanner decodes both regular and inverse Data Matrix bar codes.



**Regular Only  
(00h)**



**Inverse Only  
(01h)**



**Data Matrix Inverse (continued)**



**\*Inverse Autodetect  
(02h)**

## GS1 Data Matrix

**SSI # F8 05 38**

**Parameter # 1336**

Enable or disable GS1 Data Matrix.

Options:

- Enable GS1 Data Matrix
- \*Disable GS1 Data Matrix.

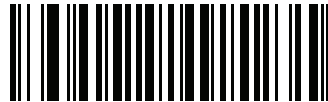

**Enable GS1 Data Matrix  
(01h)**



**\*Disable GS1 Data Matrix  
(00h)**

## Decode Mirror Images (Data Matrix Only)

**SSI # F1h 19h**

**Parameter # 537**

Select an option for decoding mirror image Data Matrix bar codes.

Options:

- Always - decode only Data Matrix bar codes that are mirror images
- Never - do not decode Data Matrix bar codes that are mirror images
- \*Auto - decode both mirrored and unmirrored Data Matrix bar codes.



**Never  
(00h)**



**Always  
(01h)**

**Decode Mirror Images (Data Matrix Only)**

\* Auto  
(02h)

## Maxicode

**SSI # F0h 26h**

**Parameter # 294**

To enable or disable Maxicode, scan the appropriate bar code below.

Options:

- Enable Maxicode
- \*Disable Maxicode.



**Enable Maxicode  
(01h)**



**\*Disable Maxicode  
(00h)**

## QR Code

**SSI # F0h 25h**

**Parameter # 293**

Enable or disable QR Code.

Options:

- \*Enable QR Code
- Disable QR Code.



**\*Enable QR Code  
(01h)**



**Disable QR Code  
(00h)**

## QR Inverse

**SSI # F1h 4Bh**

**Parameter # 587**

This parameter sets the QR inverse scanner setting.

Options:

- \*Regular Only - the scanner decodes regular QR bar codes only.
- Inverse Only - the scanner decodes inverse QR bar codes only.
- Inverse Autodetect - the scanner decodes both regular and inverse QR bar codes.



**\*Regular Only**  
**(00h)**



**Inverse Only**  
**(01h)**

**QR Inverse (continued)**

**Inverse Autodetect  
(02h)**



## GS1 QR

**SSI # F8 05 3E**

**Parameter # 1343**

Enable or disable GS1 QR.

Options:

- Enable GS1 QR
- \*Disable GS1 QR.



**Enable GS1 QR  
(01h)**



**\*Disable GS1 QR  
(00h)**

## MicroQR

### SSI # F1h 3Dh Parameter # 573

Enable or disable MicroQR.

Options:

- Enable MicroQR
- \*Disable MicroQR.



Enable MicroQR  
(01h)



\*Disable MicroQR  
(00h)

## Aztec

### SSI # F1h 3Eh Parameter # 574

Enable or disable Aztec.

Options:

- Enable Aztec
- \*Disable Aztec.



Enable Aztec  
(01h)



\*Disable Aztec  
(00h)

## Aztec Inverse

**SSI # F1h 4Dh**

**Parameter # 589**

This parameter sets the Aztec inverse scanner setting.

Options:

- Regular Only - the scanner decodes regular Aztec bar codes only.
- Inverse Only - the scanner decodes inverse Aztec bar codes only.
- \*Inverse Autodetect - the scanner decodes both regular and inverse Aztec bar codes.



**Regular Only  
(00h)**



**Inverse Only  
(01h)**

**Aztec Inverse (continued)**



**\*Inverse Autodetect  
(02h)**

## Han Xin

**SSI # F3h 8Fh**

**Parameter # 1167**

To enable or disable Han Xin, scan the appropriate bar code below.

Options:

- Enable Han Xin
- \*Disable Han Xin.



**Enable Han Xin  
(01h)**



**\*Disable Han Xin  
(00h)**

## Han Xin Inverse

**SSI # F3h 90h**

**Parameter # 1168**

Select a Han Xin inverse decoder setting.

Options:

- \*Regular Only - the decoder decodes Han Xin bar codes with normal reflectance only.
- Inverse Only - the decoder decodes Han Xin bar codes with inverse reflectance only.
- Inverse Autodetect - the decoder decodes both regular and inverse Han Xin bar codes.



**\*Regular  
(00h)**

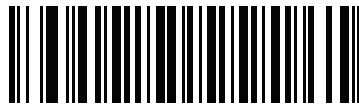

**Inverse Only  
(01h)**

**Han Xin Inverse (continued)**

Inverse Autodetect  
(02h)



## Redundancy Level

### SSI # 4Eh

#### Parameter # 78

The scanner offers four levels of decode redundancy. Select higher redundancy levels for decreasing levels of bar code quality. As redundancy levels increase, the scanner's aggressiveness decreases.

Select the redundancy level appropriate for the bar code quality.

Options:

- \*Redundancy Level 1
- Redundancy Level 2
- Redundancy Level 3
- Redundancy Level 4.

### Redundancy Level 1

The following code types must be successfully read twice before being decoded:

**Table 12-3** *Redundancy Level 1 Codes*

Code Type	Code Length
Codabar	8 characters or less
MSI	4 characters or less
D 2 of 5	8 characters or less
I 2 of 5	8 characters or less

### Redundancy Level 2

The following code types must be successfully read twice before being decoded:

**Table 12-4** *Redundancy Level 2 Codes*

Code Type	Code Length
All	All

### Redundancy Level 3

Code types other than the following must be successfully read twice before being decoded. The following codes must be read three times:

**Table 12-5** *Redundancy Level 3 Codes*

Code Type	Code Length
MSI	4 characters or less
D 2 of 5	8 characters or less
I 2 of 5	8 characters or less
Codabar	8 characters or less

## Redundancy Level (continued)

### Redundancy Level 4

The following code types must be successfully read three times before being decoded:

**Table 12-6** *Redundancy Level 4 Codes*

Code Type	Code Length
All	All

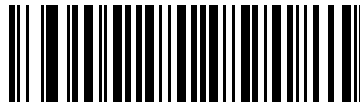

\*Redundancy Level 1  
(01h)



Redundancy Level 2  
(02h)

**Redundancy Level (continued)**



**Redundancy Level 3  
(03h)**



**Redundancy Level 4  
(04h)**

---

## Security Level

**SSI # 4Dh**

**Parameter # 77**

The scanner offers four levels of decode security for delta bar codes, which include UPC/EAN and Code 93. Select increasing levels of security for decreasing levels of bar code quality. There is an inverse relationship between security and scanner aggressiveness, so choose only that level of security necessary for any given application.

Options:

- Security Level 0 - This setting allows the scanner to operate in its most aggressive state, while providing sufficient security in decoding most "in-spec" bar codes.
- \*Security Level 1 - This default setting eliminates most misdecodes.
- Security Level 2 - Select this option if Security level 1 fails to eliminate misdecodes.
- Security Level 3 - If you selected Security Level 2 and misdecodes still occur, select this security level. Be advised, selecting this option is an extreme measure against mis-decoding severely out of spec bar codes. Selecting this level of security significantly impairs the decoding ability of the scanner. If you need this level of security, try to improve the quality of the bar codes.

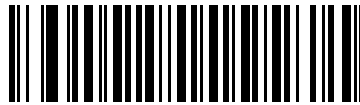

**Security Level 0  
(00h)**

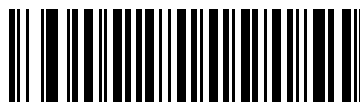

**\*Security Level 1  
(01h)**

**Security Level (continued)**



**Security Level 2  
(02h)**

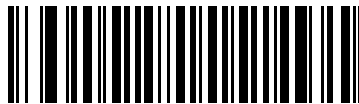

**Security Level 3  
(03h)**

## Intercharacter Gap Size

**SSI # F0h 7Dh**

**Parameter # 381**

The Code 39 and Codabar symbologies have an intercharacter gap that is typically quite small. Due to various bar code-printing technologies, this gap can grow larger than the maximum size allowed, preventing the scanner from decoding the symbol. If this problem occurs, scan the **Large Intercharacter Gaps** parameter to tolerate these out-of-specification bar codes.

Options:

- \*Normal Intercharacter Gaps
- Large Intercharacter Gaps.



**\*Normal Intercharacter Gaps  
(06h)**



**Large Intercharacter Gaps  
(0Ah)**

## 1D Quiet Zone Level

**SSI # F8h 05h 08h**

**Parameter # 1288**

This feature sets the level of aggressiveness in decoding bar codes with a reduced quiet zone (the area in front of and at the end of a bar code), and applies to symbologies enabled by a Reduced Quiet Zone parameter. Because higher levels increase the decoding time and risk of misdecodes, Symbol Technologies strongly recommends enabling only the symbologies which require higher quiet zone levels, and leaving Reduced Quiet Zone disabled for all other symbologies.

Options:

- 0 - The scanner performs normally in terms of quiet zone.
- \*1 - The scanner performs more aggressively in terms of quiet zone.
- 2 - The scanner only requires one side EB (end of bar code) for decoding.
- 3 - The scanner decodes anything in terms of quiet zone or end of bar code.



1D Quiet Zone Level 0  
(0)



\*1D Quiet Zone Level 1  
(1)

**1D Quiet Zone Level (continued)**



**1D Quiet Zone Level 2  
(2)**



**1D Quiet Zone Level 3  
(3)**



---

## Macro PDF Features

Macro PDF is a special feature for concatenating multiple PDF symbols into one file. The scanner can decode symbols that are encoded with this feature, and can store more than 64 Kb of decoded data stored in up to 50 MacroPDF symbols.



**CAUTION** When printing, keep each Macro PDF sequence separate, as each sequence has unique identifiers. Do not mix bar codes from several Macro PDF sequences, even if they encode the same data. When scanning Macro PDF sequences, scan the entire Macro PDF sequence without interruption. If, when scanning a mixed sequence, the scanner emits two long low beeps (Low/Low) this indicates an inconsistent file ID or inconsistent symbology error.

### Flush Macro Buffer

This flushes the buffer of all decoded Macro PDF data stored to that point, transmits it to the host device, and aborts from Macro PDF mode.



**Flush Macro PDF Buffer**

**Abort Macro PDF Entry**

This clears all currently-stored Macro PDF data in the buffer without transmission and aborts from Macro PDF mode.



**Abort Macro PDF Entry**



# CHAPTER 13 OCR PROGRAMMING

---

## Introduction

This chapter describes how to set up the scanner for OCR programming. The scanner can read 6 to 60 point OCR typeface. It supports font types OCR-A and OCR-B.

OCR is not as secure as a bar code. To decrease OCR misdecodes and speed OCR reading, set an accurate OCR template and character subset, and use a check digit.

All OCR fonts are disabled by default. Enabling OCR can slow bar code decoding. Enabling more than one OCR font could also slow OCR decoding and impact OCR decoding accuracy.

Throughout the programming bar code menus, asterisks (\*) indicate default values.

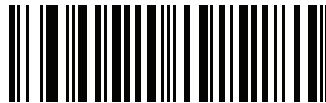

\* Indicates Default — **\*Disable OCR-A** — Feature/Option



**NOTE** Most computer monitors allow scanning the bar codes directly on the screen. When scanning from the screen, be sure to set the document magnification to a level where you can see the bar code clearly, and bars and/or spaces are not merging.

## OCR Parameter Defaults

*Table 13-1* lists the defaults for OCR parameters. To change any option, scan the appropriate bar code(s) provided in the Parameter Descriptions section beginning on [page 13-3](#).

✓ **NOTE** See [Appendix A, STANDARD DEFAULT PARAMETERS](#) for all user preferences, hosts, symbologies, and miscellaneous default parameters.

**Table 13-1** OCR Programming Default Table

Parameter	SSI Number <sup>1</sup>	Parameter Number <sup>2</sup>	Default	Page Number
<b>OCR Programming Parameters</b>				
OCR-A	F1h A8h	680	Disable	<a href="#">13-3</a>
OCR-A Variant	F1h ACh	685	Full ASCII	<a href="#">13-4</a>
OCR-B	F1h A9h	681	Disable	<a href="#">13-7</a>
OCR-B Variant	F1h ADh	685	Full ASCII	<a href="#">13-8</a>
MICR E13B	F1h AAh	682	Disable	<a href="#">13-15</a>
US Currency	F1h ABh	683	Disable	<a href="#">13-16</a>
OCR Orientation	F1h AFh	687	0°	<a href="#">13-17</a>
OCR Lines	F1h B3h	691	1	<a href="#">13-20</a>
OCR Minimum Characters	F1h B1h	689	3	<a href="#">13-22</a>
OCR Maximum Characters	F1h B2h	690	100	<a href="#">13-22</a>
OCR Subset	F1h AEh	686	Selected font variant	<a href="#">13-23</a>
OCR Reduced Quiet Zone	F1h B7h	695	50	<a href="#">13-24</a>
OCR Template	F1h 23h	547	54R	<a href="#">13-25</a>
OCR Check Digit Modulus	F1h B0h	688	1	<a href="#">13-38</a>
OCR Check Digit Multiplier	F1h BCh	700	1212121212	<a href="#">13-39</a>
OCR Check Digit Validation	F1h B6h	694	None	<a href="#">13-40</a>
Inverse OCR	F2h 58h	856	Regular	<a href="#">13-44</a>

<sup>1</sup> SSI number hex values are used for programming via SSI commands.

<sup>2</sup> Parameter number decimal values are used for programming via RSM commands.

---

## OCR Programming Parameters

### Enable/Disable OCR-A

**SSI # F1h A8h**

**Parameter # 680**

To enable or disable OCR-A, scan one of the following bar codes.

- ✓ **NOTES** OCR is not as secure as a bar code. To decrease OCR misdecodes and speed OCR reading, set an accurate OCR template and character subset, and use a check digit. See [OCR Subset on page 13-23](#) and [OCR Template on page 13-25](#).

All OCR fonts are disabled by default. Enabling OCR can slow bar code decoding. Enabling more than one OCR font could also slow OCR decoding and impact OCR decoding accuracy.

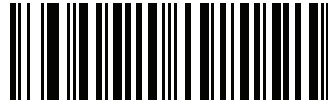

**Enable OCR-A**



**\*Disable OCR-A**

## OCR-A Variant

### SSI # F1 ACh

#### Parameter # 685

Font variant sets a processing algorithm and default character subset for the given font. To choose a variant, scan one of the following bar codes. Selecting the most appropriate font variant optimizes performance and accuracy.

OCR-A supports the following variants:

- **OCR-A Full ASCII**  
!"#\$()\*+,-./0123456789<>ABCDEFGHIJKLMNOPQRSTUVWXYZ^
- **OCR-A Reserved 1**  
\$\*+,-./0123456789ABCDEFGHIJKLMNOPQRSTUVWXYZ
- **OCR-A Reserved 2**  
\$\*+,-./0123456789<>ABCDEFGHIJKLMNOPQRSTUVWXYZ
- **OCR-A Banking**  
-0123456789<> Ψ ϣ ϣ

Special banking characters output as the following representative characters:

- Ψ outputs as f
- ϣ outputs as c
- ϣ outputs as h

✓ **NOTE** Enable OCR-A before setting this parameter. If disabling OCR-A, set the variant to its default (OCR-A Full ASCII).

**OCR-A Variant (continued)**



**\*OCR-A Full ASCII  
(00h)**



**OCR-A Reserved 1  
(01h)**



**OCR-A Variant (continued)**



**OCR-A Reserved 2  
(02h)**



**OCR-A Banking  
(03h)**

## Enable/Disable OCR-B

**SSI # F1h A9h**

**Parameter # 681**

To enable or disable OCR-B, scan one of the following bar codes.

- ✓ **NOTES** OCR is not as secure as a bar code. To decrease OCR misdecodes and speed OCR reading, set an accurate OCR template and character subset, and use a check digit. See [OCR Subset on page 13-23](#) and [OCR Template on page 13-25](#).

All OCR fonts are disabled by default. Enabling OCR can slow bar code decoding. Enabling more than one OCR font could also slow OCR decoding and impact OCR decoding accuracy.



**Enable OCR-B**



**\*Disable OCR-B**

## OCR-B Variant

### SSI # F1h ADh

#### Parameter # 685

OCR-B has the following variants. Selecting the most appropriate font variant affects performance and accuracy.

- **OCR-B Full ASCII**  
!#\$%()\*+,-./0123456789<>ABCDEFGHIJKLMNOPQRSTUVWXYZ^\_`ñ
- **OCR-B Banking**  
#+-0123456789<>JNP|
- **OCR-B Limited**  
+,-./0123456789<>ACENPSTVX
- **OCR-B ISBN 10-Digit Book Numbers**  
-0123456789>BCEINPSXz
- **OCR-B ISBN 10 or 13-Digit Book Numbers**  
-0123456789>BCEINPSXz
- **OCR-B Travel Document Version 1 (TD1) 3-Line ID Cards**  
-0123456789<ABCDEFGHIJKLMNOPQRSTUVWXYZ
- **OCR-B Travel Document Version 2 (TD2) 2-Line ID Cards**  
-0123456789<ABCDEFGHIJKLMNOPQRSTUVWXYZ
- **OCR-B Travel Document 2 or 3-Line ID Cards Auto-Detect**  
!#\$%()\*+,-./0123456789<>ABCDEFGHIJKLMNOPQRSTUVWXYZ^\_`ñ
- **OCR-B Passport**  
-0123456789<ABCDEFGHIJKLMNOPQRSTUVWXYZñ
- **OCR-B Visa Type A**  
-0123456789<ABCDEFGHIJKLMNOPQRSTUVWXYZ
- **OCR-B Visa Type B**  
-0123456789<ABCDEFGHIJKLMNOPQRSTUVWXYZñ
- **OCR-B ICAO Travel Documents**

This allows reading either TD1, TD2, Passport, Visa Type A, or Visa Type B without switching between these options. It automatically recognizes the travel document read.

To choose a variant, scan one of the following bar codes. Selecting the following OCR-B variants automatically sets the appropriate [OCR Lines on page 13-20](#). These five variants invoke extensive special algorithms and checking for that particular document type:

Variant	OCR Lines Setting
Passport	2
TD1 ID Cards	3
TD2 ID Cards	2
Visa Type A	2
Visa Type B	2

Selecting one of the ISBN Book Numbers automatically applies the appropriate ISBN checksum, so you do not need to set this.

## OCR-B Variant (continued)

For the best performance in passport reading, fix the target passport and the scanner in place (6.5 - 7.5”).



**NOTE** Enable OCR-B before setting this parameter. If disabling OCR-B, set the variant to its default (OCR-B Full ASCII).



\*OCR-B Full ASCII  
(00h)



OCR-B Banking  
(01h)

**OCR-B Variant (continued)**



**OCR-B Limited  
(02h)**



**OCR-B ISBN 10-Digit Book Numbers  
(06h)**

**OCR-B Variant (continued)**



**OCR-B ISBN 10 or 13-Digit Book Numbers  
(07h)**



**OCR-B Travel Document Version 1 (TD1)  
3 Line ID Cards  
(03h)**

**OCR-B Variant (continued)**



**OCR-B Travel Document Version 2 (TD2)  
2-Line ID Cards  
(08h)**



**Travel Document 2 or 3-Line ID Cards Auto-Detect  
(14h)**

**OCR-B Variant (continued)**



**OCR-B Visa Type A  
(09h)**



**OCR-B Visa Type B  
(0Ah)**



**OCR-B Variant (continued)**



**OCR-B ICAO Travel Documents  
(0Bh)**

## Enable/Disable MICR E13B

### SSI # F1h AAh

### Parameter # 682

To enable or disable MICR E13B, scan one of the following bar codes.

MICR E 13B uses the following characters:

0 1 2 3 4 5 6 7 8 9 t a o d

TOAD characters (Transit, On Us, Amount, and Dash) output as the following representative characters:

t outputs as t

a outputs as a

o outputs as o

d outputs as d

✓ **NOTE** OCR is not as secure as a bar code. To decrease OCR misdecodes and speed OCR reading, set an accurate OCR template and character subset, and use a check digit. See [OCR Subset on page 13-23](#) and [OCR Template on page 13-25](#).

✓ **NOTE** All OCR fonts are disabled by default. Enabling OCR can slow bar code decoding. Enabling more than one OCR font could also slow OCR decoding and impact OCR decoding accuracy.

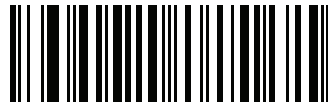

Enable MICR E13B



\*Disable MICR E13B

## Enable/Disable US Currency Serial Number

**SSI # F1h ABh**

**Parameter # 683**

To enable or disable US Currency Serial Number, scan one of the following bar codes.



**NOTES** OCR is not as secure as a bar code. To decrease OCR misdecodes and speed OCR reading, set an accurate OCR template and character subset, and use a check digit. See [OCR Subset on page 13-23](#) and [OCR Template on page 13-25](#).

All OCR fonts are disabled by default. Enabling OCR can slow bar code decoding. Enabling more than one OCR font could also slow OCR decoding and impact OCR decoding accuracy.



**Enable US Currency**

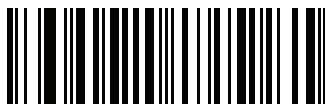

**\*Disable US Currency**

## OCR Orientation

### SSI # F1 AFh

### Parameter # 687

Select one of five options to specify the orientation of an OCR string to be read:

- 0° to the imaging engine (default)
- 270° clockwise (or 90° clockwise) to the imaging engine
- 180° (upside down) to the imaging engine
- 90° clockwise to the imaging engine
- Omnidirectional

Setting an incorrect orientation can cause misdecodes.



**\*OCR Orientation 0°  
(00h)**



**OCR Orientation 270° Clockwise  
(01h)**

**OCR Orientation (continued)**



**OCR Orientation 180° Clockwise  
(02h)**



**OCR Orientation 90° Clockwise  
(03h)**

**OCR Orientation (continued)**

**OCR Orientation Omnidirectional  
(04h)**

## OCR Lines

**SSI # F1 B3h**

**Parameter # 691**

To select the number of OCR lines to decode, scan one of the following bar codes. Selecting Visas, TD1, or TD2 ID cards automatically sets the appropriate **OCR Lines**. Also see [OCR-B Variant on page 13-8](#).



**\*OCR 1 Line  
(001h)**



**OCR 2 Lines  
(002h)**

**OCR Lines (continued)**



**OCR 3 Lines  
(003h)**



## OCR Minimum Characters

**SSI # F1 B1h**

**Parameter # 689**

To select the minimum number of OCR characters (not including spaces) per line to decode, scan the following bar code, then scan a three-digit number between 003 and 100 using the bar codes in [Appendix G, NUMERIC BAR CODES](#) representing the number of OCR characters to decode. Strings of OCR characters less than the minimum are ignored. The default is 003.



**OCR Minimum Characters**

## OCR Maximum Characters

**SSI # F1 B2h**

**Parameter # 690**

To select the maximum number of OCR characters (including spaces) per line to decode, scan the following bar code, then scan a three-digit number between 003 and 100 using the bar codes in [Appendix G, NUMERIC BAR CODES](#) representing the number of OCR characters to decode. Strings of OCR characters greater than the maximum are ignored. The default is 100.



**OCR Maximum Characters**

## OCR Subset

### SSI # F1 AEh

#### Parameter # 686

Set an OCR subset to define a custom group of characters in place of a preset font variant. For example, if scanning only numbers and the letters A, B, and C, create a subset of just these characters to speed decoding. This applies a designated OCR Subset across all enabled OCR fonts.

To set or modify the OCR font subset, first enable the appropriate OCR font(s). Next, scan the following bar code, then scan numbers and letters to form the OCR Subset from the alphanumeric keyboard in the *Advanced Data Formatting Guide*. Then scan **End of Message** in the *Advanced Data Formatting Guide*.

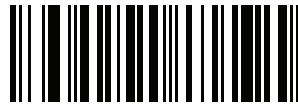

**OCR Subset**

To cancel an OCR subset, for OCR-A or OCR-B, scan OCR-A variant **Full ASCII**, or OCR-B variant **Full ASCII**.

For MICR E13B or US Currency Serial Number, create a subset which includes all allowed characters in that character set, or scan an option from the [Set Default Parameter on page 4-4](#) and re-program the scanner.

## OCR Reduced Quiet Zone

**SSI # F1h B7h**

**Parameter # 695**

This option sets the OCR reduced quiet zone. The decoder stops scanning a field when it detects a sufficiently wide blank space. The width of this space is defined by the End of Field option. Used with parsers that tolerate slanted characters, the End of Field count is roughly a count of 8 for a character width. For example if set to 15, then two character widths are an end of line indicator for the parser. Larger end of field numbers require bigger reduced quiet zones at each end of text line.

To set a reduced quiet zone, scan the following bar code, then scan a two-digit number using the numeric keypad in the *Advanced Data Formatting Guide*. The range of the reduced quiet zone is 20 - 99 and the default is 50, indicating a six character width reduced quiet zone.

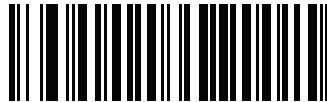

**OCR Reduced Quiet Zone**

## OCR Template

**SSI # F1 23h**

**Parameter # 547**

This option creates a template for precisely matching scanned OCR characters to a desired input format. Carefully constructing an OCR template eliminates scanning errors.

To set or modify the OCR decode template, scan the [OCR Template](#) bar code, then bar codes corresponding to numbers and letters on the following pages to form the template expression. Then scan **End of Message** in the *Advanced Data Formatting Guide*. The default is **54R** which accepts any character OCR strings.



**OCR Template**



**End of Message**

## OCR Template (continued)

### Required Digit (9)



9

Only a numeric character is allowed in this position.

Template	Valid data	Valid data	Invalid data
99999	12987	30517	123AB

### Required Alpha (A)



A

**OCR Template (continued)**

Only an alpha character is allowed in this position.

Template	Valid data	Valid data	Invalid data
AAA	ABC	WXY	12F

**Optional Alphanumeric (1)**

1

When this option appears in the template string, the data validator accepts an alphanumeric character if present. Optional characters are not allowed as the first character(s) in a field of like characters.

Template	Valid data	Valid data	Invalid data
99991	1234A	12345	1234<

**Optional Alpha (2)**

2

**OCR Template (continued)**

When this option appears in the template string, the data validator accepts an alpha character if present. Optional characters are not allowed as the first character(s) in a field of like characters.

Template	Valid data	Valid data	Invalid data
AAAA2	ABCDE	WXYZ	ABCD6

**Alpha or Digit (3)**

3

The data validator requires an alphanumeric character in this position to validate the incoming data.

Template	Valid data	Valid data	Invalid data
33333	12ABC	WXYZ34	12AB<

**Any Including Space & Reject (4)**

4

**OCR Template (continued)**

The template accepts any character in this position, including space and reject. Rejects are represented as an underscore (\_) in the output. This is a good selection for troubleshooting.

Template	Valid data	Valid data
99499	12\$34	34_98

**Any except Space & Reject (5)**

5

The template accepts any character in this position except a space or reject.

Template	Valid data	Valid data	Invalid data
55999	A.123	*Z456	A BCD

**Optional Digit (7)**

7



**OCR Template (continued)**

When this option appears in the template string, the template accepts a numeric character if present. Optional characters are not allowed as the first character(s) in a field of like characters.

Template	Valid data	Valid data	Invalid data
99977	12345	789	789AB

**Digit or Fill (8)**



**8**

The data validator accepts any numeric or fill character in this position.

Template	Valid data	Valid data	Valid data
88899	12345	>>789	<<789

**Alpha or Fill (F)**



**F**

**OCR Template (continued)**

The data validator accepts any alpha or fill character in this position.

Template	Valid data	Valid data	Valid data
AAAFF	ABCXY	LMN>>	ABC<5

**Optional Space ( )****Space**

When this option appears in the template string, the template accepts a space if present. Optional characters are not allowed as the first character(s) in a field of like characters.

Template	Valid data	Valid data	Invalid data
99 99	12 34	1234	67891

**Optional Small Special (.)**

## OCR Template (continued)

When this option appears in the template string, the data validator accepts a special character if present. Optional characters are not allowed as the first character(s) in a field of like characters. Small special characters are '-', ',' and '.'.

Template	Valid data	Valid data	Invalid data
AA.99	MN.35	XY98	XYZ12

## Other Template Operators

These template operators assist in capturing, delimiting, and formatting scanned OCR data.

### *Literal String (" and +)*



“



+

Use either of these delimiting characters surrounding characters from the alphanumeric keyboard in the *Advanced Data Formatting Guide* to define a literal string within a template that must be present in scanned OCR data. There are two characters used to delimit required literal strings; if one of the delimiter characters is present in the desired literal string, use the other delimiter.

Template	Valid data	Invalid data
"35+BC"	35+BC	AB+22

**OCR Template (continued)*****New Line (E)*****E**

To create a template of multiple lines, add **E** between the template of each single line.

Template	Valid data	Valid data	Invalid data
999EAAAA	321	987	XYZW
	BCAD	ZXYW	12

***String Extract (C)*****C**

## OCR Template (continued)

This operator combined with others defines a string of characters to extract from the scanned data. The string extract is structured as follows:

CbPe

Where:

- C is the string extract operator
- b is the string begin delimiter
- P is the category (one or more numeric or alpha characters) describing the string representation
- e is the string end delimiter

Values for b and e can be any scannable character. They are included in the output stream.

Template	Incoming data	Output
C>A>	XQ3>ABCDE>	>ABCDE>
	->ATHRUZ>123	>ATHRUZ>
	1ABCZXYZ	No Output

### ***Ignore to End of Field (D)***



**D**

This operator causes all characters after a template to be ignored. Use this as the last character in a template expression. Examples for the template 999D:

Template	Incoming data	Output
999D	123-PED	123
	357298	357
	193	193

### ***Skip Until (P1)***



**P**

**OCR Template (continued)**

1

This operator allows skipping over characters until a specific character type or a literal string is detected. It can be used in two ways:

`P1ct`

Where:

- P1 is the Skip Until operator
- c is the type of character that triggers the start of output
- t is one or more template characters

`P1"s"t`

Where:

- P1 is the Skip Until operator
- "s" is one or more literal string characters (see [Literal String \(" and +\) on page 13-32](#)) that trigger the start of output
- t is one or more template characters

The trigger character or literal string is included in output from a Skip Until operator, and the first character in the template should accommodate this trigger.

Template	Incoming data	Output
<code>P1"PN"AA9999</code>	123PN9876	PN9876
	PN1234	PN1234
	X-PN3592	PN3592

***Skip Until Not (P0)***

P

**OCR Template (continued)****O**

This operator allows skipping over characters until a specific character type or a literal string is not matched in the output stream. It can be used in two ways:

`P0ct`

Where:

- P0 is the Skip Until Not operator
- c is the type of character that triggers the start of output
- t is one or more template characters

`P0"s"t`

Where:

- P0 is the Skip Until Not operator
- "s" is one or more literal string characters (see [Literal String \(" and +\) on page 13-32](#)) that trigger the start of output
- t is one or more template characters

The trigger character or literal string is not included in output from a Skip Until Not operator.

Template	Incoming data	Output
P0A9999	BPN3456	3456
	PN1234	1234
	5341	No output
P0"PN"9999	PN3456	3456
	5341	No output
	PNPN7654	7654

***Repeat Previous (R)*****R**

## OCR Template (continued)

This operator allows a template character to repeat one or more times, allowing the capture of variable-length scanned data. The following examples capture two required alpha characters followed by one or more required digits:

Template	Incoming data	Output
AA9R	AB34	AB34
	PN12345	PN12345
	32RM52700	No output

### Scroll Until Match (S)



S

This operator steps through scanned data one character at a time until the data matches the template.

Template	Incoming data	Output
S99999	AB3	No Output
	PN12345	12345
	32RM52700	52700

### Multiple Templates

This feature sets up multiple templates for OCR decoding. To do this, follow the procedure described in [OCR Template on page 13-25](#) (scan the [OCR Template](#) bar code, then bar codes corresponding to numbers and letters to form the template expression, then **End of Message**) for each template in the multiple template string, using a capital letter **X** as a separator between the templates.

For example, set the [OCR Template](#) as **99999XAAAAA** to decode OCR strings of either **12345** or **ABCDE**. Up to 99 templates are permitted.

### Template Examples

Following are sample templates with descriptions of valid data for each definition.

Field Definition	Description
"M"99977	<b>M</b> followed by three digits and two optional digits.
"X"997777"X"	<b>X</b> followed by two digits, four optional digits, and an <b>X</b> .
9959775599	Two digits followed by any character, a digit, two optional digits, any two characters, and two digits.
A55"- "999"- "99	A letter followed by two characters, a dash, three digits, a dash, and two digits.
33A". "99	Two alphanumeric characters followed by a letter, a period, and two digits.
999992991	Five digits followed by an optional alpha, two digits, and an optional alphanumeric.
"PN98"	Literal field - <b>PN98</b>



## OCR Check Digit Modulus

**SSI # F1h B0h**

**Parameter # 688**

✓ **NOTE** This feature is currently only partially supported, and will be fully supported in future versions.

This option sets OCR module check digit calculation. The check digit is the last digit (in the right most position) in an OCR string and improves the accuracy of the collected data. The check digit is the end product of a calculation made on the incoming data. For check digit calculation, for example Modulus 10, alpha and numeric characters are assigned numeric weights (see [OCR Check Digit Multiplier on page 13-39](#)). The calculation is applied to the character weights and the resulting check digit is added to the end of the data. If the incoming data does not match the check digit, the data is considered corrupt.

The selected check digit option does not take effect until you set **OCR Check Digit Validation**.

To choose the Check Digit Modulus, such as 10 for modulo 10, scan the following bar code, then scan a three-digit number from 001 to 099 representing the check digit using the numeric keypad in the *Advanced Data Formatting Guide*. The default is 1.

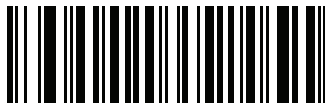

**OCR Check Digit**

## OCR Check Digit Multiplier

### SSI # F1h BCh

#### Parameter # 700

This option sets OCR check digit multipliers for the character positions. For check digit validation, each character in scanned data has an equivalent weight used in the check digit calculation. PL3307 OCR ships with the following weight equivalents:

0 = 0	A = 10	K = 20	U = 30
1 = 1	B = 11	L = 21	V = 31
2 = 2	C = 12	M = 22	W = 32
3 = 3	D = 13	N = 23	X = 33
4 = 4	E = 14	O = 24	Y = 34
5 = 5	F = 15	P = 25	Z = 35
6 = 6	G = 16	Q = 26	Space = 0
7 = 7	H = 17	R = 27	
8 = 8	I = 18	S = 28	
9 = 9	J = 19	T = 29	

All other characters are equivalent to one (1).

You can define the multiplier string if it is different from the default.

121212121212 (default)

123456789A (for ISBN, Product Add Right to Left. See [OCR Check Digit Validation on page 13-40](#))

For example:

ISBN	0	2	0	1	1	8	3	9	9	4	
Multiplier	10	9	8	7	6	5	4	3	2	1	
Product	0	18	0	7	6	40	12	27	18	4	
Product add	0+	18+	0+	7+	6+	40+	12+	27+	18+	4=	132

ISBN uses modulo 11 for its check digit. In this case, 132 is divisible by 11, so it passes the check digit.

To set the check digit multiplier, scan the following bar code, then scan numbers and letters to form the multiplier string from the alphanumeric keyboard in the *Advanced Data Formatting Guide*. Then scan **End of Message** in the *Advanced Data Formatting Guide*.



OCR Check Digit Multiplier

## OCR Check Digit Validation

### SSI # F1h B6h

#### Parameter # 694

Use **OCR Check Digit Validation** to protect against scanning errors by applying a check digit validation scheme. The following is a list of options.

#### None

No check digit validation, indicating no check digit is applied. This is the default.



**\*No Check Digit  
(00h)**

#### Product Add Left to Right

Each character in the scanned data is assigned a numeric value (see [OCR Check Digit Multiplier on page 13-39](#)). Each digit representing a character in the scanned data is multiplied by its corresponding digit in the multiplier, and the sum of these products is computed. The check digit passes if this sum modulo Check Digit Modulus is zero.

Example:

Scanned data numeric value is 132456 (check digit is 6)

Check digit multiplier string is 123456

Digit	1	3	2	4	5	6
Multiplier	1	2	3	4	5	6
Product	1	6	6	16	25	36
Product add	1+	6+	6+	16+	25+	36= 90

The Check Digit Modulus is 10. It passes because 90 is divisible by 10 (the remainder is zero).



**Product Add Left to Right  
(03h)**

## OCR Check Digit Validation (continued)

### Product Add Right to Left

Each character in the scanned data is assigned a numeric value (see [OCR Check Digit Multiplier on page 13-39](#)). The check digit multiplier is reversed in order. Each value representing a character in the scanned data is multiplied by its corresponding digit in the reversed multiplier, resulting in a product for each character in the scanned data. The sum of these products is computed. The check digit passes if this sum modulo Check Digit Modulus is zero.

Example:

Scanned data numeric value is 132459 (check digit is 9)

Check digit multiplier string is 123456

Digit	1	3	2	4	5	9
Multiplier	6	5	4	3	2	1
Product	6	15	8	12	10	9
Product add	6+	15+	8+	12+	10+	9= 60

The Check Digit Modulus is 10. It passes because 60 is divisible by 10 (the remainder is 0).



**Product Add Right to Left  
(01h)**

### Digit Add Left to Right

Each character in the scanned data is assigned a numeric value (see [OCR Check Digit Multiplier on page 13-39](#)). Each value representing a character in the scanned data is multiplied by its corresponding digit in the multiplier, resulting in a product for each character in the scanned data. The sum of each individual digit in all of the products is then calculated. The check digit passes if this sum modulo Check Digit Modulus is zero.

Example:

Scanned data numeric value is 132456 (check digit is 6)

Check digit multiplier string is 123456

Digit	1	3	2	4	5	6
Multiplier	1	2	3	4	5	6
Product	1	6	6	16	25	36
Digit add	1+	6+	6+	1+6+	2+5+	3+6= 36

The Check Digit Modulus is 12. It passes because 36 is divisible by 12 (the remainder is 0).



**Digit Add Left to Right  
(04h)**

## OCR Check Digit Validation (continued)

### Digit Add Right to Left

Each character in the scanned data is assigned a numeric value (see [OCR Check Digit Multiplier on page 13-39](#)). The check digit multiplier is reversed in order. Each value representing a character in the scanned data is multiplied by its corresponding digit in the reversed multiplier, resulting in a product for each character in the scanned data. The sum of each individual digit in all of the products is then calculated. The check digit passes if this sum modulo Check Digit Modulus is zero.

Example:

Scanned data numeric value is 132456 (check digit is 6)

Check digit multiplier string is 123456

Digit	1	3	2	4	5	6	
Multiplier	6	5	4	3	2	1	
Product	6	15	8	12	10	6	
Digit add	6+	1+5+	8+	1+2+	1+0+	6=	30

The Check Digit Modulus is 10. It passes because 30 is divisible by 10 (the remainder is 0).



Digit Add Right to Left  
(02h)

### Product Add Right to Left Simple Remainder

Each character in the scanned data is assigned a numeric value (see [OCR Check Digit Multiplier on page 13-39](#)). The check digit multiplier is reversed in order. Each value representing a character in the scanned data is multiplied by its corresponding digit in the reversed multiplier, resulting in a product for each character in the scanned data. The sum of these products **except for the check digit's product** is computed. The check digit passes if this sum modulo Check Digit Modulus is equal to the check digit's product.

Example:

Scanned data numeric value is 122456 (check digit is 6)

Check digit multiplier string is 123456

Digit	1	2	2	4	5	6	
Multiplier	6	5	4	3	2	1	
Product	6	10	8	12	10	6	
Product add	6+	10+	8+	12+	10=	46	6

The Check Digit Modulus is 10. It passes because 46 divided by 10 leaves a remainder of 6.



Product Add Right to Left Simple Remainder  
(05h)

## OCR Check Digit Validation (continued)

### Digit Add Right To Left Simple Remainder

Each character in the scanned data is assigned a numeric value (see [OCR Check Digit Multiplier on page 13-39](#)). The check digit multiplier is reversed in order. Each value representing a character in the scanned data is multiplied by its corresponding digit in the reversed multiplier, resulting in a product for each character in the scanned data. The sum of each individual digit in all of the products **except for the check digit's product** is then calculated. The check digit passes if this sum modulo Check Digit Modulus is equal to the check digit's product.

Example:

Scanned data numeric value is 122459 (check digit is 6)

Check digit multiplier string is 123456

Digit	1	2	2	4	5	9
Multiplier	6	5	4	3	2	1
Product	6	10	8	12	10	9
Digit add	6+	1+0+	8+	1+2+	1+0=	19 9

The Check Digit Modulus is 10. It passes because 19 divided by 10 leaves a remainder of 9.



**Digit Add Right to Left Simple Remainder  
(06h)**

### Health Industry - HIBCC43

This is the health industry module 43 check digit standard.



**Health Industry - HIBCC43  
(09h)**

## Inverse OCR

**SSI # F2h 58h**

**Parameter # 856**

Inverse OCR is white or light words on a black or dark background. Select an option for decoding inverse OCR:

- **Regular Only** - decode regular OCR (black on white) strings only.
- **Inverse Only** - decode inverse OCR (white on black) strings only.
- **Autodiscriminate** - decodes both regular and inverse OCR strings.

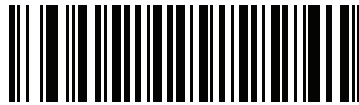

**\*Regular Only  
(00h)**



**Inverse Only  
(01h)**

**Inverse OCR (continued)**

**Autodiscriminate  
(02h)**





# CHAPTER 14 123SCAN2

---

## Introduction

123Scan<sup>2</sup> is an easy-to-use, PC-based software tool that enables the quick and easy setup of Zebra scanners.

123Scan<sup>2</sup> uses a wizard tool to guide users through a streamlined set up process. Once parameters are set, the values are saved to a configuration file that can be distributed via e-mail, electronically downloaded via a USB or RS-232 cable, or used to generate a sheet of programming bar codes that can be scanned. 123Scan<sup>2</sup> can generate multiple reports that can be easily re-branded using Microsoft Word or Access. Report options include programmed parameters, asset tracking information and proof of scanner output.

Additionally, 123Scan<sup>2</sup> can display scanned bar code data including non-printable characters. It can display, optimize and save pictures from an imaging scanner. It can also upgrade scanner firmware, automatically check online to enable support for newly released products, generate a single 2D bar code for one scan programming and stage large numbers of scanners simultaneously via USB hub(s).

---

## Communication with 123Scan<sup>2</sup>

To communicate with the 123Scan<sup>2</sup> program which runs on a host computer running a Windows XP SP2, Windows 7, and Windows 8 operating system, use a USB cable to connect the scanner to the host computer (see [Connecting a USB Interface on page 6-2](#)).

---

## 123Scan<sup>2</sup> Requirements

- Host computer with Windows XP SP2, Windows 7 or Windows 8
- Scanner
- USB cable.

To download 123Scan<sup>2</sup> software and for more information about 123Scan<sup>2</sup>, go to: <http://www.zebra.com/123Scan2>.

For a 1 minute tour of 123Scan<sup>2</sup>, go to: <http://www.zebra.com/ScannerHowToVideos>.

---

## Scanner SDK, Other Software Tools, and Videos

Tackle all your scanner programming needs with our diversified set of software tools. Whether you need to simply stage a device, or develop a fully featured application with image and data capture as well as asset management, these tools help you every step of the way. To download any of the free tools listed below, go to: [www.zebra.com/scannersoftware](http://www.zebra.com/scannersoftware).

- 123Scan<sup>2</sup> Configuration Utility (described in this chapter)
- Scanner SDK for Windows
- How-to-Videos
- Virtual Com Port Driver
- OPOS Driver
- JPOS Driver
- TWAIN Driver
- Scanner User Documentation.

# CHAPTER 15 ADVANCED DATA FORMATTING

---

## Introduction

Advanced Data Formatting (ADF) is a means of customizing data before transmission to the host device. Use ADF to edit scan data to suit requirements. Implement ADF by scanning a related series of bar codes which program the scanner with ADF rules.

For information and programming bar codes for ADF, refer to the *Advanced Data Formatting Programmer Guide*, p/n 72E-69680-xx. All guides are located on the web at: <http://www.zebra.com/support>.



# APPENDIX A STANDARD DEFAULT PARAMETERS

**Table A-1** Standard Default Parameters Table

Parameter	SSI Number <sup>1</sup>	Parameter Number <sup>2</sup>	Default	Page Number
<b>User Preferences</b>				
Set Default Parameter	N/A	N/A	Set Defaults	4-4
Parameter Bar Code Scanning	ECh	236	Enable	4-6
Beeper After Good Decode	38h	56	Enable	4-7
Beeper Tone	91h	145	High	4-9
Beeper Volume	8Ch	140	High	4-12
Beeper Duration	F1h 74h	628	Medium	4-13
Volume/Tone Button Control	F8h 05h 07h	1287	Enable	4-15
Suppress Power-up Beeps	F1h D1h	721	Do not suppress	4-17
Timeout Between Decodes, Same Symbol	89h	137	0.5 Sec	4-18
Timeout Between Decodes, Different Symbols	90h	144	0 Sec	4-18
Fuzzy 1D Processing	F1h 02h	514	Enable	4-19
Decode Mirror Images (Data Matrix Only)	F1h 19h	537	Auto	4-21
PDF Prioritization	F1h CFh	719	Disable	4-22
PDF Prioritization Timeout	F1h D0h	720	200 ms	4-22
Mobile Phone/Display Mode	F1h CCh	716	Enable	4-24

<sup>1</sup> SSI number hex values are used for programming via SSI commands.

<sup>2</sup> Parameter number decimal values are used for programming via RSM commands.

**Table A-1** Standard Default Parameters Table (Continued)

Parameter	SSI Number <sup>1</sup>	Parameter Number <sup>2</sup>	Default	Page Number
Field of View	F1h 61h	609	Full Field of View	4-26
<b>Miscellaneous Options</b>				
Transmit Code ID Character	2Dh	45	None	4-28
Prefix Value	63h, 69h	99, 105	7013 <CR><LF>	4-29
Suffix 1 Value Suffix 2 Value	62h, 68h 64h, 6Ah	98, 104 100, 106	7013 <CR><LF>	4-30
Scan Data Transmission Format	EBh	235	Data as is	4-32
FN1 Substitution Values	67h, 6Dh	103, 109	7013 <CR> <LF>	4-36
Unsolicited Heartbeat Interval	F8h 04h 5Eh	1118	Disable	4-38
<b>Imager Preferences</b>				
Operational Modes	N/A	N/A	N/A	5-4
Snapshot Mode Timeout	F0h 43h	323	0 (30 seconds)	5-5
Image Size (Number of Pixels)	F0h 2Eh	302	Full	5-6
Image Brightness (Target White)	F0h 86h	390	180	5-8
JPEG Image Options	F0h 2Bh	299	Quality	5-9
JPEG Target File Size	F1h 31h	561	160 kB	5-10
JPEG Quality and Size Value	F0h 31h	305	65	5-11
Image Enhancement	F1h 34h	564	Low (1)	5-12
Image File Format Selection	F0h 30h	304	JPEG	5-14
Image Rotation	F1h 99h	665	0	5-16
Bits per Pixel (BPP)	F0h 2Fh	303	8 BPP	5-24
Signature Capture	5Dh	93	Disable	5-20
Signature Capture Image File Format Selection	F0h 39h	313	JPEG	5-21
Signature Capture Bits per Pixel (BPP)	F0h 3Ah	314	8 BPP	5-24
Signature Capture Width	F4h F0h 6Eh	366	400	5-25
Signature Capture Height	F4h F0h 6Fh	367	100	5-26
Signature Capture JPEG Quality	F0h A5h	421	65	5-27
Video View Finder	F0h 44h	324	Disable	5-28
Video View Finder Image Size	F0h 49h	329	1700 bytes	5-29

<sup>1</sup> SSI number hex values are used for programming via SSI commands.

<sup>2</sup> Parameter number decimal values are used for programming via RSM commands.

Table A-1 Standard Default Parameters Table (Continued)

Parameter	SSI Number <sup>1</sup>	Parameter Number <sup>2</sup>	Default	Page Number
<b>USB Host Parameters</b>				
USB Device Type	n/a	n/a	USB Keyboard HID (Human Interface Device)	6-5
Symbol Native API (SNAPI) Status Handshaking	n/a	n/a	Enable	6-9
USB Keystroke Delay	n/a	n/a	No Delay	6-10
USB CAPS Lock Override	n/a	n/a	Disable	6-12
USB Ignore Unknown Characters	n/a	n/a	Send Bar Codes	6-13
USB Convert Unknown to Code 39	n/a	n/a	Disable	6-14
Emulate Keypad	n/a	n/a	Enable	6-15
Keypad Emulation with Leading Zero	n/a	n/a	Enable	6-16
USB Keyboard FN1 Substitution	n/a	n/a	Disable	6-17
Function Key Mapping	n/a	n/a	Disable	6-18
Simulated Caps Lock	n/a	n/a	Disable	6-19
Convert Case	n/a	n/a	Disable	6-20
USB Static CDC	n/a	n/a	Enable	6-22
<b>USB Transmission Speed Parameters</b>				
USB HID Polling Interval	n/a	n/a	3 msec	6-24
Fast HID Keyboard	n/a	n/a	Enable	6-28
Quick Keypad Emulation	n/a	n/a	Enable	6-29
IBM Specification Version	n/a	n/a	2.2	6-30
<b>Optional USB Parameters</b>				
Beep Directive	n/a	n/a	Ignore	6-31
Bar Code Configuration Directive	n/a	n/a	Ignore	6-32
<b>RS-232 Host Parameters</b>				
RS-232 Host Types	n/a	n/a	Standard	7-7
Baud Rate	n/a	n/a	9600	7-11
Parity	n/a	n/a	None	7-15
Check Receive Errors	n/a	n/a	Enable	7-16

<sup>1</sup> SSI number hex values are used for programming via SSI commands.

<sup>2</sup> Parameter number decimal values are used for programming via RSM commands.



**Table A-1** Standard Default Parameters Table (Continued)

Parameter	SSI Number <sup>1</sup>	Parameter Number <sup>2</sup>	Default	Page Number
Hardware Handshaking	n/a	n/a	None	7-18
Software Handshaking	n/a	n/a	None	7-21
Host Serial Response Time-out	n/a	n/a	2 Sec	7-24
RTS Line State	n/a	n/a	Low RTS	7-27
Stop Bit Select	n/a	n/a	1 Stop Bit	7-28
Data Bits	n/a	n/a	8-Bit	7-29
Beep on <BEL>	n/a	n/a	Disable	7-30
Intercharacter Delay	n/a	n/a	0 msec	7-31
Nixdorf Beep/LED Option	n/a	n/a	Normal Operation	7-34
Ignore Unknown Characters	n/a	n/a	Send Bar Codes	7-36
<b>IBM 468X/469X Host Parameters</b>				
Port Address	n/a	n/a	None Selected <sup>1</sup>	8-5
Convert Unknown to Code 39	n/a	n/a	Disable	8-7
Beep Directive	n/a	n/a	Ignore	8-8
Bar Code Configuration Directive	n/a	n/a	Ignore	8-9
<b>Keyboard Wedge Host Parameters</b>				
Keyboard Wedge Host Type	n/a	n/a	IBM AT Notebook	9-5
Ignore Unknown Characters	n/a	n/a	Send Bar Codes	9-6
Keystroke Delay	n/a	n/a	No Delay	9-7
Intra-Keystroke Delay	n/a	n/a	Disable	9-9
Alternate Numeric Keypad Emulation	n/a	n/a	Enable	9-10
Quick Keypad Emulation	n/a	n/a	Enable	9-11
Caps Lock On	n/a	n/a	Disable	9-12
Caps Lock Override	n/a	n/a	Disable	9-13
Convert Wedge Data	n/a	n/a	No Convert	9-15
Function Key Mapping	n/a	n/a	Disable	9-16
FN1 Substitution	n/a	n/a	Disable	9-17
Send Make Break	n/a	n/a	Send	9-18

<sup>1</sup> SSI number hex values are used for programming via SSI commands.

<sup>2</sup> Parameter number decimal values are used for programming via RSM commands.

Table A-1 Standard Default Parameters Table (Continued)

Parameter	SSI Number <sup>1</sup>	Parameter Number <sup>2</sup>	Default	Page Number
<b>SSI Host Parameters</b>				
Select SSI Host	n/a	n/a	n/a	10-10
Baud Rate	9Ch	156	9600	10-11
Parity	9Eh	158	None	10-16
Check Parity	97h	151	Do Not Check Parity	10-17
Stop Bits	9Dh	157	1	10-18
Software Handshaking	9Fh	159	Enable ACK/NAK	10-19
Host RTS Line State	9Ah	154	Low	10-20
Decode Data Packet Format	EEh	238	Send Raw Decode Data	10-21
Host Serial Response Time-out	9Bh	155	2 sec	10-22
Host Character Time-out	EFh	239	200 msec	10-24
Multipacket Option	F0h 4Eh	334	Option 1	10-26
Interpacket Delay	F0h 4Fh	335	0 ms	10-28
<b>SSI Event Reporting</b>				
Decode Event	F0h 00h	256	Disable	10-31
Boot Up Event	F0h 02h	258	Disable	10-32
Parameter Event	F0h 03h	259	Disable	10-33
<b>Auxiliary RSM Communication</b>				
Auxiliary RSM Communication	F8 05 4E	1358	Enable	11-3
<b>Symbology Parameters</b>				
<b>Enable/Disable All Code Types</b>				12-8
<b>UPC/EAN</b>				
UPC-A	01h	1	Enable	12-9
UPC-E	02h	2	Enable	12-10
UPC-E1	0Ch	12	Disable	12-11
EAN-8/JAN 8	04h	4	Enable	12-12
EAN-13/JAN 13	03h	3	Enable	12-13
Bookland EAN	53h	83	Disable	12-14

<sup>1</sup> SSI number hex values are used for programming via SSI commands.

<sup>2</sup> Parameter number decimal values are used for programming via RSM commands.

**Table A-1** Standard Default Parameters Table (Continued)

Parameter	SSI Number <sup>1</sup>	Parameter Number <sup>2</sup>	Default	Page Number
Bookland ISBN Format	F1h 40h	576	ISBN-10	12-15
Decode UPC/EAN/JAN Supplementals (2 and 5 digits)	10h	16	Ignore	12-17
User-Programmable Supplementals			n/a	12-24
Supplemental 1:	F1h 43h	579		
Supplemental 2:	F1h 44h	580		
UPC/EAN/JAN Supplemental Redundancy	50h	80	10	12-25
Decode UPC/EAN/JAN Supplemental AIM ID Format	F1h A0h	672	Combined	12-26
UPC Reduced Quiet Zone	F8h 05h 09h	1289	Disable	12-28
Transmit UPC-A Check Digit	28h	40	Enable	12-29
Transmit UPC-E Check Digit	29h	41	Enable	12-30
Transmit UPC-E1 Check Digit	2Ah	42	Enable	12-31
UPC-A Preamble	22h	34	System Character	12-32
UPC-E Preamble	23h	35	System Character	12-34
UPC-E1 Preamble	24h	36	System Character	12-36
Convert UPC-E to A	25h	37	Disable	12-38
Convert UPC-E1 to A	26h	38	Disable	12-39
EAN-8/JAN-8 Zero Extend	27h	39	Disable	12-40
UCC Coupon Extended Code	55h	85	Disable	12-41
Coupon Report	F1h DAh	730	New Coupon Symbols	12-43
ISSN EAN	F1h 69h	617	Disable	12-44
<b>Code 128</b>				
Code 128	08h	8	Enable	12-45
Set Length(s) for Code 128	D1h, D2h	209, 210	1 - 55	12-48
GS1-128 (formerly UCC/EAN-128)	0Eh	14	Enable	12-49
ISBT 128	54h	84	Disable	12-50
ISBT Concatenation	F1h 41h	577	Disable	12-51
Check ISBT Table	F1h 42h	578	Enable	12-53
ISBT Concatenation Redundancy	DFh	223	10	12-54

<sup>1</sup> SSI number hex values are used for programming via SSI commands.

<sup>2</sup> Parameter number decimal values are used for programming via RSM commands.

**Table A-1** Standard Default Parameters Table (Continued)

Parameter	SSI Number <sup>1</sup>	Parameter Number <sup>2</sup>	Default	Page Number
Code 128 Reduced Quiet Zone	F8h 04h B8h	1208	Disable	<a href="#">12-55</a>
Code 128 Security Level	F1h EFh	751	Security Level 1	<a href="#">12-56</a>
Ignore Code 128 <FNC4>	F8h 04h E6h	1254	Disable	<a href="#">12-58</a>
<b>Code 39</b>				
Code 39	00h	0	Enable	<a href="#">12-59</a>
Trioptic Code 39	0Dh	13	Disable	<a href="#">12-60</a>
Convert Code 39 to Code 32 (Italian Pharmacy Code)	56h	86	Disable	<a href="#">12-61</a>
Code 32 Prefix	E7h	231	Disable	<a href="#">12-62</a>
Set Length(s) for Code 39	12h, 13h	18, 19	Length Within Range: 2 - 55	<a href="#">12-65</a>
Code 39 Check Digit Verification	30h	48	Disable	<a href="#">12-66</a>
Transmit Code 39 Check Digit	2Bh	43	Disable	<a href="#">12-67</a>
Code 39 Full ASCII Conversion	11h	17	Disable	<a href="#">12-68</a>
Code 39 Security Level	F1h EEh	750	Security Level 1	<a href="#">12-69</a>
Code 39 Reduced Quiet Zone	F8h 04h B9h	1209	Disable	<a href="#">12-71</a>
<b>Code 93</b>				
Code 93	09h	9	Disable	<a href="#">12-72</a>
Set Length(s) for Code 93	1Ah, 1Bh	26, 27	Length Within Range: 1 - 55	<a href="#">12-75</a>
<b>Code 11</b>				
Code 11	0Ah	10	Disable	<a href="#">12-76</a>
Set Lengths for Code 11	1Ch, 1Dh	28, 29	4 to 55	<a href="#">12-79</a>
Code 11 Check Digit Verification	34h	52	Disable	<a href="#">12-80</a>
Transmit Code 11 Check Digit(s)	2Fh	47	Disable	<a href="#">12-82</a>
<b>Interleaved 2 of 5 (I 2 of 5)</b>				
I 2 of 5	06h	6	Enable	<a href="#">12-83</a>
Set Lengths for I 2 of 5	16h, 17h	22, 23	6 - 55	<a href="#">12-84</a>
I 2 of 5 Check Digit Verification	31h	49	Disable	<a href="#">12-87</a>
Transmit I 2 of 5 Check Digit	2Ch	44	Disable	<a href="#">12-89</a>

<sup>1</sup> SSI number hex values are used for programming via SSI commands.<sup>2</sup> Parameter number decimal values are used for programming via RSM commands.

Table A-1 Standard Default Parameters Table (Continued)

Parameter	SSI Number <sup>1</sup>	Parameter Number <sup>2</sup>	Default	Page Number
Convert I 2 of 5 to EAN 13	52h	82	Disable	12-90
I 2 of 5 Security Level	F8h 04h 61h	1121	I 2 of 5 Security Level 1	12-91
I 2 of 5 Reduced Quiet Zone	F8h 04h BAh	1210	Disable	12-93
<b>Discrete 2 of 5 (D 2 of 5)</b>				
Discrete 2 of 5	05h	5	Disable	12-94
Set Length(s) for D 2 of 5	14h, 15h	20, 21	1 - 55	12-97
<b>Codabar (NW - 7)</b>				
Codabar	07h	7	Disable	12-98
Set Lengths for Codabar	18h, 19h	24, 25	4 - 55	12-100
CLSI Editing	36h	54	Disable	12-102
NOTIS Editing	37h	55	Disable	12-103
Codabar Upper or Lower Case Start/Stop Characters Detection	F2h 57h	855	Upper Case	12-104
<b>MSI</b>				
MSI	0Bh	11	Disable	12-105
Set Length(s) for MSI	1Eh, 1Fh	30, 31	4 to 55	12-107
MSI Check Digits	32h	50	One	12-109
Transmit MSI Check Digit	2Eh	46	Disable	12-110
MSI Check Digit Algorithm	33h	51	Mod 10/Mod 10	12-111
<b>Chinese 2 of 5</b>				
Chinese 2 of 5	F0h 98h	408	Disable	12-112
<b>Matrix 2 of 5</b>				
Matrix 2 of 5	F1h 6Ah	618	Disable	12-113
Matrix 2 of 5 Lengths	F1h 6Bh F1h 6Ch	619, 620	4 - 55	12-115
Matrix 2 of 5 Check Digit	F1h 6Eh	622	Disable	12-116
Transmit Matrix 2 of 5 Check Digit	F1h 6Fh	623	Disable	12-117
<b>Korean 3 of 5</b>				
Korean 3 of 5	F1h 45h	581	Disable	12-118

<sup>1</sup> SSI number hex values are used for programming via SSI commands.

<sup>2</sup> Parameter number decimal values are used for programming via RSM commands.

**Table A-1** Standard Default Parameters Table (Continued)

Parameter	SSI Number <sup>1</sup>	Parameter Number <sup>2</sup>	Default	Page Number
<b>Postal Codes</b>				
US Postnet	59h	89	Disable	<a href="#">12-121</a>
US Planet	5Ah	90	Disable	<a href="#">12-122</a>
Transmit US Postal Check Digit	5Fh	95	Enable	<a href="#">12-123</a>
UK Postal	5Bh	91	Disable	<a href="#">12-124</a>
Transmit UK Postal Check Digit	60h	96	Enable	<a href="#">12-125</a>
Japan Post	F0h 22h	290	Disable	<a href="#">12-126</a>
Australia Post	F0h 23h	291	Disable	<a href="#">12-127</a>
Australia Post Format	F1h CEh	718	Autodiscriminate	<a href="#">12-128</a>
Netherlands KIX Code	F0h 46h	326	Disable	<a href="#">12-130</a>
USPS 4CB/One Code/Intelligent Mail	F1h 50h	592	Disable	<a href="#">12-131</a>
UPU FICS Postal	F1h 63h	611	Disable	<a href="#">12-132</a>
<b>Inverse 1D</b>	F1h 4Ah	586	Regular	<a href="#">12-133</a>
<b>GS1 DataBar</b>				
GS1 DataBar (GS1 DataBar Omnidirectional, GS1 DataBar Truncated, GS1 DataBar Stacked, GS1 DataBar Stacked Omnidirectional)	F0h 52h	338	Enable	<a href="#">12-135</a>
GS1 DataBar Limited	F0h 53h	339	Enable	<a href="#">12-136</a>
GS1 DataBar Expanded (GS1 DataBar Expanded, GS1 DataBar Expanded Stacked)	F0h 54h	340	Enable	<a href="#">12-137</a>
GS1 DataBar Limited Security Level	F1h D8h	728	3	<a href="#">12-139</a>
Convert GS1 DataBar to UPC/EAN	F0h 8Dh	397	Disable	<a href="#">12-140</a>
<b>Composite</b>				
Composite CC-C	F0h 55h	341	Disable	<a href="#">12-141</a>
Composite CC-A/B	F0h 56h	342	Disable	<a href="#">12-142</a>
Composite TLC-39	F0h 73h	371	Disable	<a href="#">12-143</a>
UPC Composite Mode	F0h 58h	344	UPC Never Linked	<a href="#">12-144</a>
Composite Beep Mode	F0h 8Eh	398	Beep As Each Code Type is Decoded	<a href="#">12-146</a>

<sup>1</sup> SSI number hex values are used for programming via SSI commands.

<sup>2</sup> Parameter number decimal values are used for programming via RSM commands.

**Table A-1** Standard Default Parameters Table (Continued)

Parameter	SSI Number <sup>1</sup>	Parameter Number <sup>2</sup>	Default	Page Number
GS1-128 Emulation Mode for UCC/EAN Composite Codes	F0h ABh	427	Disable	12-148
<b>2D Symbolologies</b>				
PDF417	0Fh	15	Enable	12-149
MicroPDF417	E3h	227	Disable	12-150
Code 128 Emulation	7Bh	123	Disable	12-151
Data Matrix	F0h 24h	292	Disable	12-152
Data Matrix Inverse	F1h 4Ch	588	Inverse Autodetect	12-154
GS1 Data Matrix	F8 05 38	1336	Disable	12-155
Decode Mirror Images (Data Matrix Only)	F1h 19h	537	Auto	12-157
Maxicode	F0h 26h	294	Disable	12-158
QR Code	F0h 25h	293	Enable	12-159
QR Inverse	F1h 4Bh	587	Regular	12-160
GS1 QR	F8 05 3E	1343	Disable	12-162
Micro QR	F1h 3Dh	573	Disable	12-163
Aztec	F1h 3Eh	574	Disable	12-164
Aztec Inverse	F1h 4Dh	589	Inverse Autodetect	12-166
Han Xin	F8h 04h 8Fh	1167	Disable	12-167
Han Xin Inverse	F8h 04h 90h	1168	Regular	12-168
<b>Symbology-Specific Security Levels</b>				
Redundancy Level	4Eh	78	1	12-171
Security Level (UPC/EAN and Code 93)	4Dh	77	1	12-173
Intercharacter Gap Size	F0h 7Dh	381	Normal	12-175
1D Quiet Zone Level	F8h 05h 08h	1288	1	12-176
<b>Macro PDF</b>				
Flush Macro PDF Buffer	n/a	n/a	n/a	12-178
Abort Macro PDF Entry	n/a	n/a	n/a	12-179

<sup>1</sup> SSI number hex values are used for programming via SSI commands.

<sup>2</sup> Parameter number decimal values are used for programming via RSM commands.

Table A-1 Standard Default Parameters Table (Continued)

Parameter	SSI Number <sup>1</sup>	Parameter Number <sup>2</sup>	Default	Page Number
<b>OCR Programming Parameters</b>				
OCR-A	F1h A8h	680	Disable	<a href="#">13-3</a>
OCR-A Variant	F1h ACh	685	Full ASCII	<a href="#">13-5</a>
OCR-B	F1h A9h	681	Disable	<a href="#">13-7</a>
OCR-B Variant	F1h ADh	685	Full ASCII	<a href="#">13-9</a>
MICR E13B	F1h AAh	682	Disable	<a href="#">13-15</a>
US Currency	F1h ABh	683	Disable	<a href="#">13-16</a>
OCR Orientation	F1h AFh	687	0°	<a href="#">13-17</a>
OCR Lines	F1h B3h	691	1	<a href="#">13-20</a>
OCR Minimum Characters	F1h B1h	689	3	<a href="#">13-22</a>
OCR Maximum Characters	F1h B2h	690	100	<a href="#">13-22</a>
OCR Subset	F1h AEh	686	Selected font variant	<a href="#">13-23</a>
OCR Reduced Quiet Zone	F1h B7h	695	50	<a href="#">13-24</a>
OCR Template	F1h 23h	547	54R	<a href="#">13-25</a>
OCR Check Digit Modulus	F1h B0h	688	1	<a href="#">13-38</a>
OCR Check Digit Multiplier	F1h BCh	700	1212121212	<a href="#">13-39</a>
OCR Check Digit Validation	F1h B6h	694	None	<a href="#">13-40</a>
Inverse OCR	F2h 58h	856	Regular	<a href="#">13-44</a>
<b>CJK Control Parameters</b>				
Unicode Output Control	F2 CD	973	Universal Output	<a href="#">D-2</a>
CJK Output Method to Windows Host	F2 CC	972	Universal CJK Output	<a href="#">D-3</a>
Non-CJK UTF Bar Code Output	F2 C0	960	n/a	<a href="#">D-8</a>

<sup>1</sup> SSI number hex values are used for programming via SSI commands.

<sup>2</sup> Parameter number decimal values are used for programming via RSM commands.





# APPENDIX B COUNTRY CODES

---

## Introduction

This chapter provides instructions for programming the keyboard to interface with a USB, or Keyboard Wedge host. The host can power the scanner. For host setup information, see [Chapter 6, USB INTERFACE](#) and [Chapter 9, KEYBOARD WEDGE INTERFACE](#).

Throughout the programming bar code menus, default values are indicated with asterisks (\*).

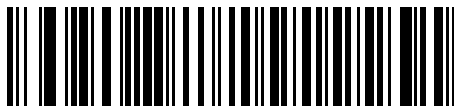

\*Indicates Default — \*US English (North American) Keyboard — Feature/Option

## USB and Keyboard Wedge Country Keyboard Types (Country Codes)

Scan the bar code corresponding to the keyboard type. For a USB host, this setting applies only to the USB Keyboard (HID) device. If the keyboard type is not listed, see [Emulate Keypad on page 6-15](#) for the USB HID host. For a Keyboard Wedge host, see [Alternate Numeric Keypad Emulation on page 9-10](#).



**NOTE** When changing USB country keyboard types the scanner automatically resets. The scanner issues the standard startup beep sequences.



**IMPORTANT** 1. Some country keyboard bar code types are specific to certain Windows Operating Systems (i.e., XP, and Windows 7, or higher). Bar codes requiring a specific Windows OS are noted so in their bar code captions.

2. Use the **French International** bar code for Belgium French keyboards.



**NOTE** For best results when using international keyboards, enable [Quick Keypad Emulation on page 6-29](#).

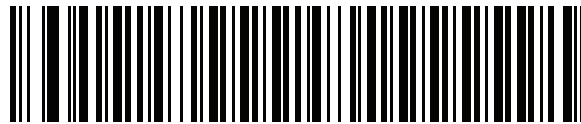

\*US English (North American)



**US English (Mac)**

**Country Codes (continued)**

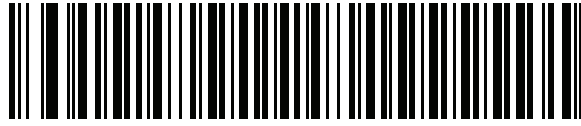

**Albanian**



**Arabic (101)**

**Country Codes (continued)**



**Arabic (102)**



**Arabic (102) AZERTY**

**Country Codes (continued)**

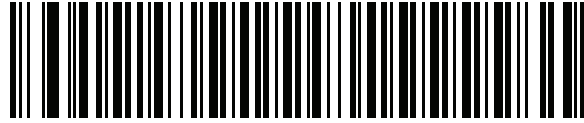

**Azeri (Latin)**



**Azeri (Cyrillic)**

**Country Codes (continued)****Belarusian****Bosnian (Latin)**



**Country Codes (continued)**

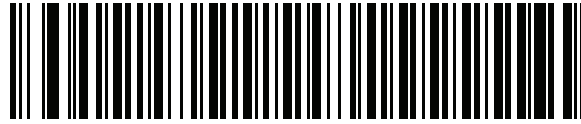

**Bosnian (Cyrillic)**



**Bulgarian (Latin)**

**Country Codes (continued)**

**Bulgarian Cyrillic (Typewriter)  
(Bulgarian -Windows XP  
Typewriter - Win 7, or higher)**

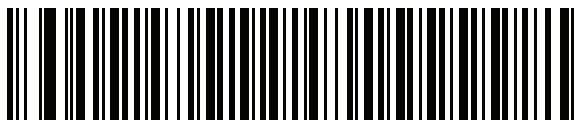

**Canadian French Win7**

**Country Codes (continued)**

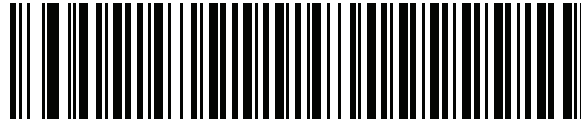

**Canadian French (Legacy)**



**Canadian Multilingual Standard**

**Country Codes (continued)****Chinese (Simplified)\*****Chinese (Traditional)\***

\*For CJK keyboard types, see [Appendix D, CJK DECODE CONTROL](#).

**Country Codes (continued)**

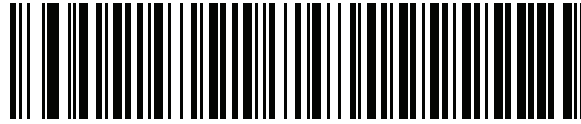

**Chinese (ASCII)**



**Croatian**

**Country Codes (continued)**



**Czech**



**Czech (Programmer)**

**Country Codes (continued)**



**Czech (QWERTY)**



**Danish**

**Country Codes (continued)**



**Dutch (Netherlands)**



**Estonian**



**Country Codes (continued)**

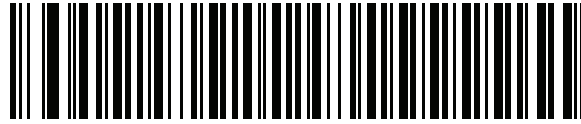

**Faeroese**



**Finnish**

**Country Codes (continued)**

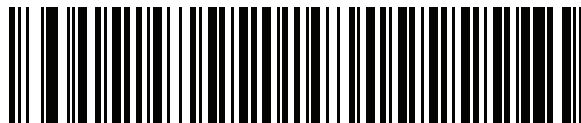

**French (France)**



**French International  
(Belgian French)**

**Country Codes (continued)**

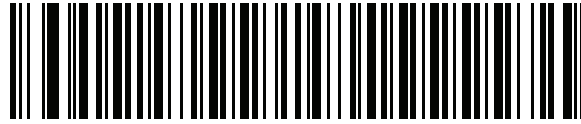

**French (Canada) 95/98**



**French (Canada) 2000/XP**

**Country Codes (continued)**



**Galician**



**German**

**Country Codes (continued)**

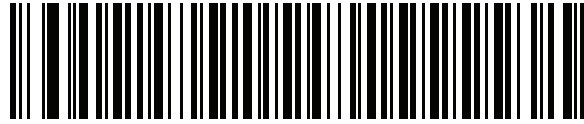

**Greek Latin**

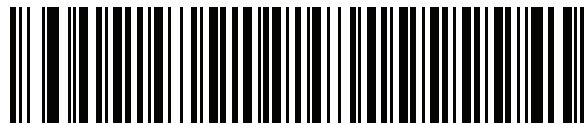

**Greek (220) Latin**

**Country Codes (continued)**



**Greek (319) Latin**



**Greek**

**Country Codes (continued)**

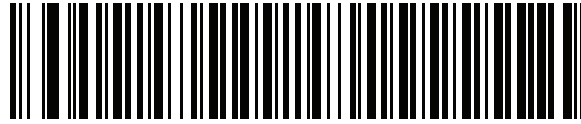

**Greek (220)**



**Greek (319)**

**Country Codes (continued)**



**Greek Polytonic**



**Hebrew Israel**



**Country Codes (continued)**

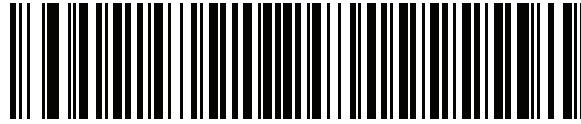

**Hungarian**



**Hungarian\_101KEY**

**Country Codes (continued)**



**Icelandic**



**Irish**

**Country Codes (continued)**

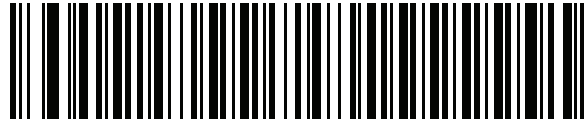

**Italian**



**Italian (142)**

**Country Codes (continued)****Japanese (ASCII)****Japanese (SHIFT-JIS)\***

\*For CJK keyboard types, see [Appendix D, CJK DECODE CONTROL](#).

**Country Codes (continued)**



**Kazakh**

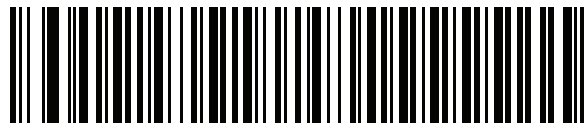

**Korean (ASCII)**

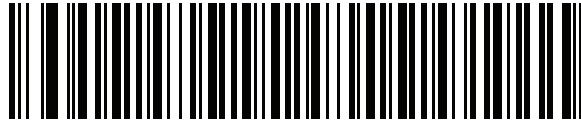
**Country Codes (continued)****Korean (Hangul)\***

\*For CJK keyboard types, see [Appendix D, CJK DECODE CONTROL](#).

**Kyrgyz**

**Country Codes (continued)**

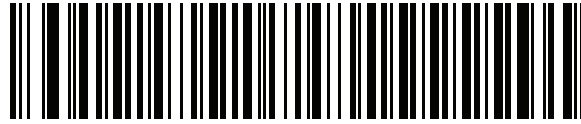

**Latin American**



**Latvian**

**Country Codes (continued)**



**Latvian (QWERTY)**



**Lithuanian**



**Country Codes (continued)**

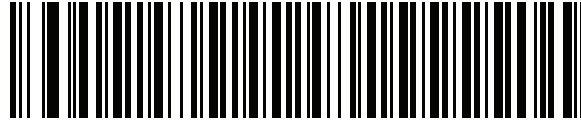

**Lithuanian (IBM)**



**Macedonian (FYROM)**

**Country Codes (continued)****Maltese\_47KEY****Mongolian**

**Country Codes (continued)**



**Norwegian**



**Polish (214)**

**Country Codes (continued)**

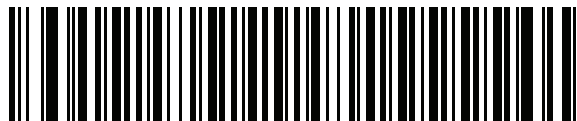

**Polish (Programmer)**

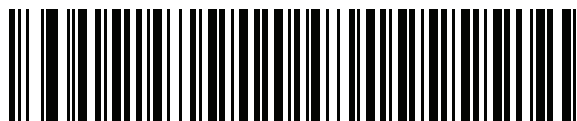

**Portuguese (Brazil)**

**Country Codes (continued)**

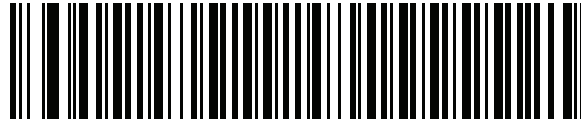

**Portuguese (Brazilian ABNT)**



**Portuguese (Brazilian ABNT2)**

**Country Codes (continued)**



**Portuguese (Portugal)**



**Romanian**

**Country Codes (continued)**

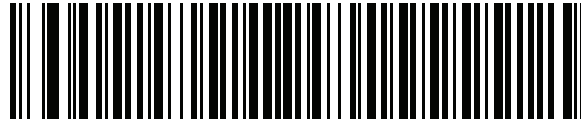

**Romanian (Legacy)**  
**(Win 7, or higher)**



**Romanian (Standard)**  
**(Win 7, or higher)**

**Country Codes (continued)**

**Romanian (Programmer)  
(Win 7, or higher)**



**Russian**



**Country Codes (continued)**



**Russian (Typewriter)**



**Serbian (Latin)**

**Country Codes (continued)**



**Serbian (Cyrillic)**



**Slovak**

**Country Codes (continued)**

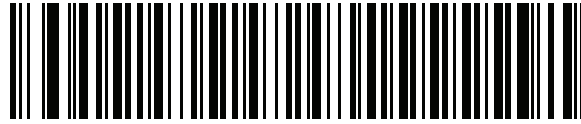

**Slovak (QWERTY)**



**Slovenian**

**Country Codes (continued)**

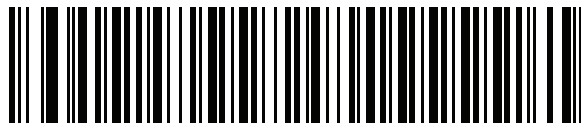

**Spanish**



**Spanish (Variation)**

**Country Codes (continued)**

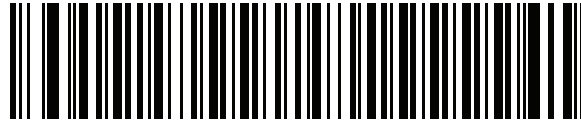

**Swedish**

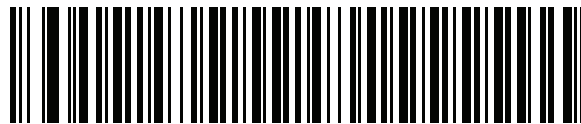

**Swiss French**

**Country Codes (continued)**



**Swiss German**

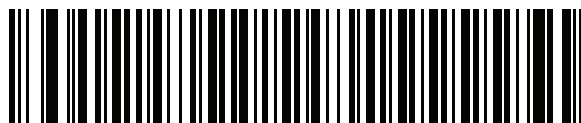

**Tatar**

**Country Codes (continued)**

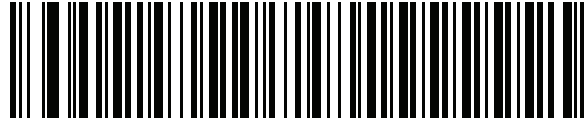

**Thai (Kedmanee)**



**Turkish F**

**Country Codes (continued)**



**Turkish Q**



**UK English**



**Country Codes (continued)**

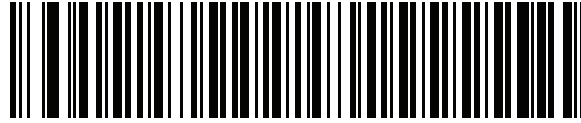

**Ukrainian**



**US Dvorak**

**Country Codes (continued)**

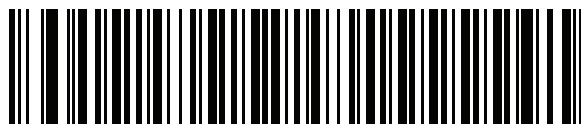

**US Dvorak Left**



**US Dvorak Right**

**Country Codes (continued)**

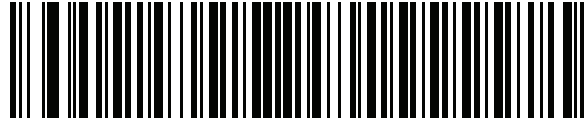

**US International**



**Uzbek**

**Country Codes (continued)**



**Vietnamese**



# APPENDIX C COUNTRY CODE PAGES

---

## Introduction

This chapter provides bar codes for selecting code pages for the country keyboard type selected in [Appendix B, COUNTRY CODES](#). If the default code page in [Table C-1](#) is appropriate for your selected country keyboard type, you do not need to scan a country code page bar code.

✓ **NOTE** ADF rules can also specify a code page based on the symbology and other ADF criteria. Refer to the *Advanced Data Formatting Programmer Guide*.

## Country Code Page Defaults

*Table C-1* lists the code page default for each country keyboard.

**Table C-1** *Country Code Page Defaults*

Country Keyboard	Code Page Default
US English (North American)	Windows 1252
US English (Mac)	Mac CP10000
Albanian	Windows 1250
Arabic 101	Windows 1256
Arabic 102	Windows 1256
Arabic 102 AZERTY	Windows 1256
Azeri Latin	Windows 1254
Azeri Cyrillic	Windows 1251
Belarusian	Windows 1251
Bosnian Latin	Windows 1250
Bosnian Cyrillic	Windows 1251
Bulgarian Latin	Windows 1250
Bulgarian Cyrillic	Windows 1251
Canadian French Win7	Windows 1252
Canadian French (Legacy)	Windows 1252
Canadian Multilingual	Windows 1252
Croatian	Windows 1250
Chinese ASCII	Windows 1252
Chinese (Simplified)	Windows 936, GBK
Chinese (Traditional)	Windows 950, Big5
Czech	Windows 1250
Czech Programmers	Windows 1250
Czech QWERTY	Windows 1250
Danish	Windows 1252
Dutch Netherland	Windows 1252
Estonian	Windows 1257
Faeroese	Windows 1252

**Table C-1** Country Code Page Defaults (Continued)

<b>Country Keyboard</b>	<b>Code Page Default</b>
Finnish	Windows 1252
French (France)	Windows 1252
French (Canada) 95/98	Windows 1252
French (Canada) 2000/XP	Windows 1252
French International (Belgian French)	Windows 1252
Galician	Windows 1252
German	Windows 1252
Greek Latin	Windows 1252
Greek220 Latin	Windows 1253
Greek319 Latin	Windows 1252
Greek	Windows 1253
Greek220	Windows 1253
Greek319	Windows 1253
Greek Polytonic	Windows 1253
Hebrew Israel	Windows 1255
Hungarian	Windows 1250
Hungarian_101KEY	Windows 1250
Icelandic	Windows 1252
Irish	Windows 1252
Italian	Windows 1252
Italian_142	Windows 1252
Japanese ASCII	Windows 1252
Japanese (Shift-JIS)	Windows 932, Shift-JIS
Kazakh	Windows 1251
Korean ASCII	Windows 1252
Korean (Hangul)	Windows 949, Hangul
Kyrgyz	Windows 1251
Latin America	Windows 1252
Latvian	Windows 1257
Latvian QWERTY	Windows 1257
Lithuanian	Windows 1257



**Table C-1** Country Code Page Defaults (Continued)

<b>Country Keyboard</b>	<b>Code Page Default</b>
Lithuanian_IBM	Windows 1257
Macedonian -FYROM	Windows 1251
Maltese_47KEY	Windows 1252
Mongolian-Cyrillic	Windows 1251
Norwegian	Windows 1252
Polish_214	Windows 1250
Polish Programmer	Windows 1250
Portuguese Brazil	Windows 1252
Portuguese Brazilian ABNT	Windows 1252
Portuguese Brazilian ABNT2	Windows 1252
Portuguese Portugal	Windows 1252
Romanian	Windows 1250
Romanian Legacy	Windows 1250
Romanian Standard	Windows 1250
Romanian Programmer	Windows 1250
Russian	Windows 1251
Russian Typewriter	Windows 1251
Serbian Latin	Windows 1250
Serbian Cyrillic	Windows 1251
Slovak	Windows 1250
Slovak QWERTY	Windows 1250
Slovenian	Windows 1250
Spanish	Windows 1252
Spanish Variation	Windows 1252
Swedish	Windows 1252
Swiss French	Windows 1252
Swiss German	Windows 1252
Tatar	Windows 1251
Thai-Kedmanee	Windows 874
Turkish F	Windows 1254
Turkish Q	Windows 1254

**Table C-1** *Country Code Page Defaults (Continued)*

<b>Country Keyboard</b>	<b>Code Page Default</b>
Ukrainian	Windows 1251
United Kingdom	Windows 1252
United States	Windows 1252
US Dvorak	Windows 1252
US Dvorak Left Hand	Windows 1252
US Dvorak Right Hand	Windows 1252
US International	Windows 1252
Uzbek Cyrillic	Windows 1251
Vietnamese	Windows 1258

---

## Country Code Page Bar Codes

Scan the bar code corresponding to the country keyboard code page.



**Windows 1250**  
**Latin 2, Central European**



**Windows 1251**  
**Cyrillic, Slavic**

**Country Code Pages (continued)**

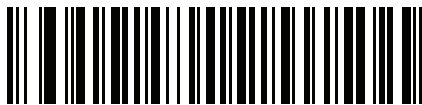

**Windows 1252  
Latin 1, Western European**



**Windows 1253  
Greek**

**Country Code Pages (continued)**



**Windows 1254  
Latin 5, Turkish**



**Windows 1255  
Hebrew**

**Country Code Pages (continued)**



**Windows 1256  
Arabic**



**Windows 1257  
Baltic**

**Country Code Pages (continued)**



**Windows 1258  
Vietnamese**

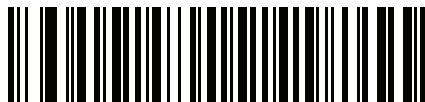

**Windows 874  
Thai**

**Country Code Pages (continued)**



**Windows 20866  
Cyrillic KOI8-R**



**Windows 932  
Japanese Shift-JIS**



**Country Code Pages (continued)**



**Windows 936  
Simplified Chinese GBK**

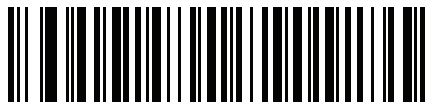

**Windows 54936  
Simplified Chinese GB18030**

**Country Code Pages (continued)**



**Windows 949  
Korean Hangul**



**Windows 950  
Traditional Chinese Big5**

**Country Code Pages (continued)**



**MS-DOS 437**  
**Latin US**



**MS-DOS 737**  
**Greek**

**Country Code Pages (continued)**



**MS-DOS 775**  
**Baltic**



**MS-DOS 850**  
**Latin 1**

**Country Code Pages (continued)**



**MS-DOS 852**  
**Latin 2**



**MS-DOS 855**  
**Cyrillic**

**Country Code Pages (continued)**

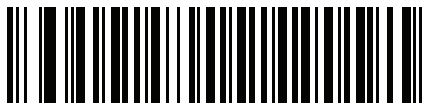

**MS-DOS 857  
Turkish**



**MS-DOS 860  
Portuguese**

**Country Code Pages (continued)**



**MS-DOS 861**  
**Icelandic**



**MS-DOS 862**  
**Hebrew**

**Country Code Pages (continued)**



**MS-DOS 863  
French Canada**



**MS-DOS 865  
Nordic**



**Country Code Pages (continued)**



**MS-DOS 866**  
**Cyrillic**



**MS-DOS 869**  
**Greek 2**

**Country Code Pages (continued)**



**ISO 8859-1**  
**Latin 1, Western European**



**ISO 8859-2**  
**Latin 2, Central European**

**Country Code Pages (continued)**

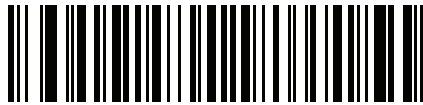

**ISO 8859-3  
Latin 3, South European**



**ISO 8859-4  
Latin 4, North European**

**Country Code Pages (continued)**



**ISO 8859-5  
Cyrillic**



**ISO 8859-6  
Arabic**

**Country Code Pages (continued)**



**ISO 8859-7  
Greek**



**ISO 8859-8  
Hebrew**

**Country Code Pages (continued)**



**ISO 8859-9**  
**Latin 5, Turkish**



**ISO 8859-10**  
**Latin 6, Nordic**

**Country Code Pages (continued)**



**ISO 8859-11**  
**Thai**



**ISO 8859-13**  
**Latin 7, Baltic**

**Country Code Pages (continued)**

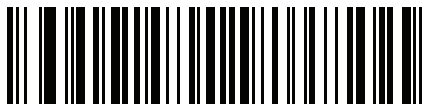

**ISO 8859-14**  
**Latin 8, Celtic**



**ISO 8859-15**  
**Latin 9**



**Country Code Pages (continued)**



**ISO 8859-16**  
**Latin 10, South-Eastern European**

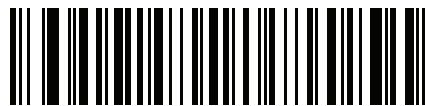

**UTF-8**

**Country Code Pages (continued)**

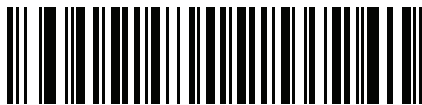

**UTF-16LE**  
**UTF-16 Little Endian**



**UTF-16BE**  
**UTF-16 Big Endian**

**Country Code Pages (continued)**

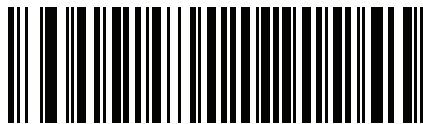

**Mac CP10000  
Roman**

# APPENDIX D CJK DECODE CONTROL

---

## Introduction

This appendix describes control parameters for CJK (Chinese, Japanese, Korean) bar code decode through USB HID Keyboard Emulation mode.

✓ **NOTE** Because ADF does not support CJK character processing, there is no format manipulation for CJK output.

---

## CJK Control Parameters

### Unicode Output Control

SSI # F2 CD

Parameter # 973

For a Unicode encoded CJK bar code, select one of the following options for unicode output:

- **Universal Output to Unicode and MBCS Application** - This default method applies to Unicode and MBCS expected applications, such as MS Word and Notepad on a Windows host.
- ✓ **NOTE** To support Unicode universal output, set up the registry table for the Windows host. See [Unicode/CJK Decode Setup with Windows Host on page D-10](#).
- **Output to Unicode Application Only** - This method applies only to Unicode expected applications, such as MS Word and WordPad, but not Notepad.

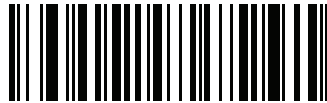

**\*Universal Output**  
**(0)**

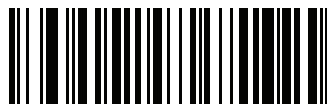

**Unicode Application Only**  
**(1)**

## CJK Output Method to Windows Host

### SSI # F2 CC

#### Parameter # 972

For a national standard encoded CJK bar code, select one of the following options for CJK output to a Windows host:

- **Universal CJK Output** - This is the default universal CJK output method for US English IME or Chinese/Japanese/Korean ASCII IME on a Windows host. This method converts CJK characters to Unicode and emulates the characters when transmitting to the host. Use the [Unicode Output Control](#) parameter to control Unicode output.
- ✓ **NOTE** To support universal CJK output, set up the registry table for the Windows host. See [Unicode/CJK Decode Setup with Windows Host on page D-10](#).
- **Other options for CJK output** - With the following methods, the scanner sends the CJK character hexadecimal internal code (Nei Ma) value to host, or converts the CJK character to Unicode and sends the hexadecimal Unicode value to host. When using these methods, the Windows host must select the corresponding IME to accept the CJK character. See [Unicode/CJK Decode Setup with Windows Host on page D-10](#).
  - **Japanese Unicode Output**
  - **Simplified Chinese GBK Code Output**
  - **Simplified Chinese Unicode Output**
  - **Korean Unicode Code Output**
  - **Traditional Chinese Big5 Code Output** (Windows XP)
  - **Traditional Chinese Big5 Code Output** (Windows 7)
  - **Traditional Chinese Unicode Code Output** (Windows XP)
  - **Traditional Chinese Unicode Code Output** (Windows 7)
- ✓ **NOTE** The Unicode emulate output method depends on the host system (Windows XP or Windows 7).



\*Universal CJK Output  
(0)

## **CJK Output Method to Windows Host (continued)**

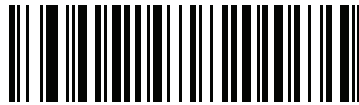

**Japanese Unicode Output  
(34)**

(for Japanese Unicode Output, select Simplified Chinese Unicode IME on the Windows host)

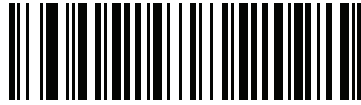

**Chinese (Simplified) GBK Output  
(1)**

**CJK Output Method to Windows Host (continued)**

**Chinese (Simplified) Unicode Output  
(2)**



**Korean Unicode Output  
(50)**

(for Korean Unicode Output, select Simplified Chinese Unicode IME on the Windows host)



## CJK Output Method to Windows Host (continued)



**Chinese (Traditional) Big5 Output (Windows XP)**  
**(17)**



**Chinese (Traditional) Big5 Output (Windows 7)**  
**(19)**

## CJK Output Method to Windows Host (continued)

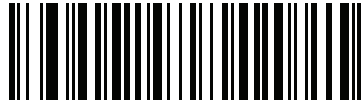

Chinese (Traditional) Unicode Output (Windows XP)  
(18)



Chinese (Traditional) Unicode Output (Windows 7)  
(20)

## Non-CJK UTF Bar Code Output

**SSI # F2 C0**

**Parameter # 960**

Some country keyboard type layouts contain characters that do not exist in the default code page (see [Country Keyboard Type Missing Characters on page D-9](#)). Although the default code page can not encode these characters in a bar code, they can be encoded in the UTF-8 bar code. Scan this parameter bar code to output the Unicode values by emulation mode.

✓ **NOTE** Use this special country keyboard type to decode the non-CJK UTF-8 bar code. After decoding, re-configure the scanner to use the original country keyboard type.

Use US English IME on Windows. See [Unicode Output Control on page D-2](#).

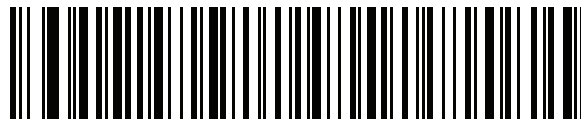

**Non-CJK UTF-8 Emulation Output**

**Country Keyboard Type Missing Characters**Country keyboard type: **Tatar, Uzbek, Mongolian, Kyrgyz, Kazakh and Azeri**

Default code page: CP1251

Missing characters:

ƒ	F
x	X
κ	Κ
h	Ĥ
ø	Ø
ə	Ə
Ÿ	Y
н	Ң
ж	Ж
ƒ	
н	Ң
Ÿ	Y
κ	Κ
ч	Ч
к	К

Country keyboard type: **Romanian (Standard)**

Default code page: CP1250

Missing characters:

ș	Ș
ț	Ț

Country keyboard type: **Portuguese-Brazilian (ABNT), Portuguese-Brazilian (ABNT2)**

Default code page: CP1252

Missing character: **€**Country keyboard type: **Azeri-Latin**

Default code page: CP1254

Missing characters: ə, Ə

---

## Unicode/CJK Decode Setup with Windows Host

This section describes how to set up CJK decode with a Windows host.

### Setting Up the Windows Registry Table for Unicode Universal Output

To support the Unicode universal output method, set up the Windows host registry table as follows:

1. Select **Start > Run > regedt32** to start the registry editor.
2. Under **HKEY\_Current\_User\Control Panel\Input Method**, set **EnableHexNumpad** to **1** as follows:  
[HKEY\_CURRENT\_USER\Control Panel\Input Method]  
"EnableHexNumpad"="1"  
If this key does not exist, add it as type **REG\_SZ** (string value).
3. Reboot the computer to implement the registry change.

### Adding CJK IME on Windows

To add the desired CJK input language:

1. Click **Start > Control Panel**.
2. If the Control Panel opens in category view, select **Switch to Classic View** in the top left corner.
3. Select **Regional and Language Options**.
4. Click the **Language** tab.
5. Under **Supplemental Language Support**, select the **Install Files for East Asian Languages** check box if not already selected, and click **Apply**. This may require a Windows installation CD to install the required files. This step ensures that the East Asian Languages (CJK) are available.
6. Under **Text Services and Input Language**, click **Details**.
7. Under **Installed Services**, click **Add**.
8. In the **Add Input Language** dialog box, choose the CJK input language and keyboard layout or Input Method Editor (IME) to add.
9. Click **OK** twice. The language indicator appears in the system tray (at bottom right corner of the desktop by default). To switch between input languages (keyboard languages) select the language indicator in the system tray.
10. Select the language indicator in the system tray to select the desired country keyboard type.
11. Verify that the characters displayed on each country's keyboard appear.

## Selecting the Simplified Chinese Input Method on the Host

To select the Simplified Chinese input method:

- Select Unicode/GBK input on Windows XP: **Chinese (Simplified) - NeiMa**, then click the input bar to select **Unicode** or **GBK NeiMa** input.

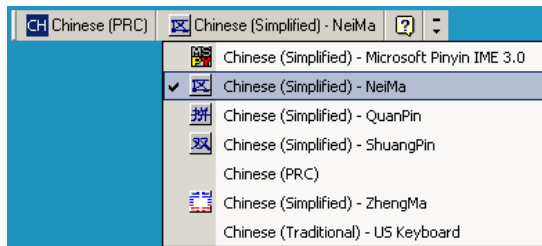

Or



- Select Unicode/GBK input on Windows7: **Chinese (Simplified) - Microsoft Pinyin New Experience Input Style**, then select **Tool Menu > Secondary Inputs > Unicode Input** or **GB Code Input**.

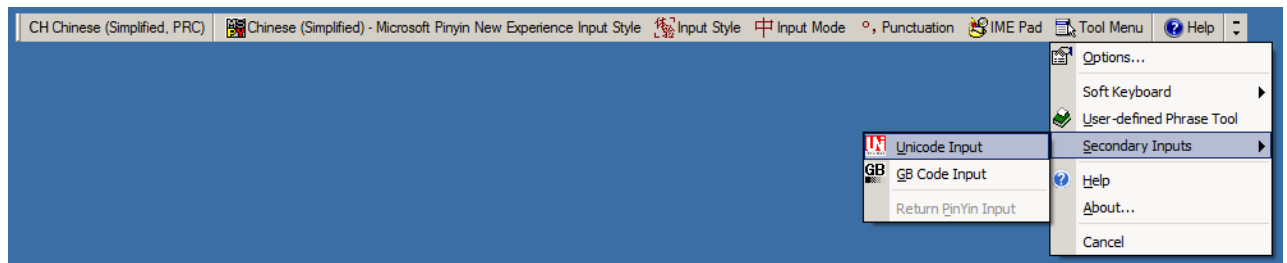

## Selecting the Traditional Chinese Input Method on the Host

To select the Traditional Chinese input method:

- Select Unicode input on Windows XP: **Chinese (Traditional) - Unicode**

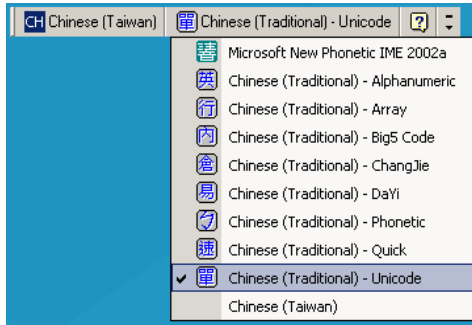

- Select Big5 input on Windows XP: **Chinese (Traditional) - Big5 Code**

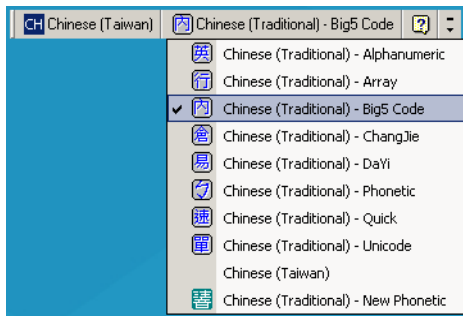

- Select Unicode/Big5 input on Windows 7: **Chinese (Traditional) - New Quick**. This option support both Unicode and Big5 input.



# APPENDIX E PROGRAMMING REFERENCE

---

## Symbol Code Identifiers

**Table E-1** *Symbol Code Characters*

<b>Code Character</b>	<b>Code Type</b>
A	UPC-A, UPC-E, UPC-E1, EAN-8, EAN-13
B	Code 39, Code 32
C	Codabar
D	Code 128, ISBT 128, ISBT 128 Concatenated
E	Code 93
F	Interleaved 2 of 5
G	Discrete 2 of 5, or Discrete 2 of 5 IATA
H	Code 11
J	MSI
K	GS1-128
L	Bookland EAN
M	Trioptic Code 39
N	Coupon Code
R	GS1 DataBar Family
S	Matrix 2 of 5
T	UCC Composite, TLC 39
U	Chinese 2 of 5



**Table E-1** *Symbol Code Characters (Continued)*

<b>Code Character</b>	<b>Code Type</b>
V	Korean 3 of 5
X	ISSN EAN, PDF417, Macro PDF417, Micro PDF417
z	Aztec, Aztec Rune
P00	Data Matrix
P01	QR Code, MicroQR
P02	Maxicode
P03	US Postnet
P04	US Planet
P05	Japan Post
P06	UK Postal
P08	Netherlands KIX Code
P09	Australia Post
P0A	USPS 4CB/One Code/Intelligent Mail
P0B	UPU FICS Postal
P0G	GS1 Data Matrix
P0H	Han Xin
P0Q	GS1 QR
P0X	Signature Capture

## AIM Code Identifiers

Each AIM Code Identifier contains the three-character string **jcm** where:

- j = Flag Character (ASCII 93)
- c = Code Character (see [Table E-2](#))
- m = Modifier Character (see [Table E-3](#))

**Table E-2** *Aim Code Characters*

Code Character	Code Type
jh0	Han Xin
A	Code 39, Code 39 Full ASCII, Code 32
C	Code 128, ISBT 128, ISBT 128 Concatenated, GS1-128, Coupon (Code 128 portion)
d	Data Matrix
d2	GS1 Data Matrix
E	UPC/EAN, Coupon (UPC portion)
e	GS1 DataBar Family
F	Codabar
G	Code 93
H	Code 11
I	Interleaved 2 of 5
L	PDF417, Macro PDF417, Micro PDF417
L2	TLC 39
M	MSI
Q	QR Code, MicroQR
Q3	GS1 QR
S	Discrete 2 of 5, IATA 2 of 5
U	Maxicode
z	Aztec, Aztec Rune
X	Bookland EAN, ISSN EAN, Trioptic Code 39, Chinese 2 of 5, Matrix 2 of 5, Korean 3 of 5, US Postnet, US Planet, UK Postal, Japan Post, Australia Post, Netherlands KIX Code, USPS 4CB/One Code/Intelligent Mail, UPU FICS Postal, Signature Capture

The modifier character is the sum of the applicable option values based on [Table E-3](#).

**Table E-3** *Modifier Characters*

Code Type	Option Value	Option
<b>Code 39</b>	0	No check character or Full ASCII processing.
	1	Reader has checked one check character.
	3	Reader has checked and stripped check character.
	4	Reader has performed Full ASCII character conversion.
	5	Reader has performed Full ASCII character conversion and checked one check character.
	7	Reader has performed Full ASCII character conversion and checked and stripped check character.
	Example: A Full ASCII bar code with check character W, <b>A+I+MI+DW</b> , is transmitted as <b>J</b> A7AIMID where 7 = (3+4).	
<b>Trioptic Code 39</b>	0	No option specified at this time. Always transmit 0.
	Example: A Trioptic bar code 412356 is transmitted as <b>J</b> X0412356	
<b>Code 128</b>	0	Standard data packet, no Function code 1 in first symbol position.
	1	Function code 1 in first symbol character position.
	2	Function code 1 in second symbol character position.
	Example: A Code (EAN) 128 bar code with Function 1 character <sup>FNC1</sup> in the first position, AIMID is transmitted as <b>J</b> C1AIMID	
<b>I 2 of 5</b>	0	No check digit processing.
	1	Reader has validated check digit.
	3	Reader has validated and stripped check digit.
	Example: An I 2 of 5 bar code without check digit, 4123, is transmitted as <b>J</b> I04123	
<b>Codabar</b>	0	No check digit processing.
	1	Reader has checked check digit.
	3	Reader has stripped check digit before transmission.
	Example: A Codabar bar code without check digit, 4123, is transmitted as <b>J</b> F04123	
<b>Code 93</b>	0	No options specified at this time. Always transmit 0.
	Example: A Code 93 bar code 012345678905 is transmitted as <b>J</b> G0012345678905	
<b>MSI</b>	0	Check digits are sent.
	1	No check digit is sent.
	Example: An MSI bar code 4123, with a single check digit checked, is transmitted as <b>J</b> M14123	

Table E-3 *Modifier Characters (Continued)*

Code Type	Option Value	Option
<b>D 2 of 5</b>	0	No options specified at this time. Always transmit 0.
	Example: A D 2 of 5 bar code 4123, is transmitted as <b>JS04123</b>	
<b>UPC/EAN</b>	0	Standard data packet in full EAN format, i.e. 13 digits for UPC-A, UPC-E, and EAN-13 (not including supplemental data).
	1	Two digit supplemental data only.
	2	Five digit supplemental data only.
	3	Combined data packet comprising 13 digits from EAN-13, UPC-A or UPC-E symbol and 2 or 5 digits from supplemental symbol.
	4	EAN-8 data packet.
	Example: A UPC-A bar code 012345678905 is transmitted as <b>JE00012345678905</b>	
<b>Bookland EAN</b>	0	No options specified at this time. Always transmit 0.
	Example: A Bookland EAN bar code 123456789X is transmitted as <b>JX0123456789X</b>	
<b>ISSN EAN</b>	0	No options specified at this time. Always transmit 0.
	Example: An ISSN EAN bar code 123456789X is transmitted as <b>JX0123456789X</b>	
<b>Code 11</b>	0	Single check digit
	1	Two check digits
	3	Check characters validated but not transmitted.
<b>GS1 DataBar Family</b>		No option specified at this time. Always transmit 0. GS1 DataBar-14 and GS1 DataBar Limited transmit with an Application Identifier "01". Note: In GS1-128 emulation mode, GS1 DataBar is transmitted using Code 128 rules (i.e., JC1).
	Example: A GS1 DataBar-14 bar code 0110012345678902 is transmitted as <b>Je00110012345678902</b> .	
<b>EAN.UCC Composites (GS1 DataBar, GS1-128, 2D portion of UPC composite)</b>		Native mode transmission. Note: UPC portion of composite is transmitted using UPC rules.
	0	Standard data packet.
	1	Data packet containing the data following an encoded symbol separator character.
	2	Data packet containing the data following an escape mechanism character. The data packet does not support the ECI protocol.
	3	Data packet containing the data following an escape mechanism character. The data packet supports the ECI protocol.
		GS1-128 emulation Note: UPC portion of composite is transmitted using UPC rules.
	1	Data packet is a GS1-128 symbol (i.e., data is preceded with JC1).

Table E-3 Modifier Characters (Continued)

Code Type	Option Value	Option
PDF417, Micro PDF417	0	Reader set to conform to protocol defined in 1994 PDF417 symbology specifications. <b>Note:</b> When this option is transmitted, the receiver cannot reliably determine whether ECIs have been invoked or whether data byte 92 <sub>DEC</sub> has been doubled in transmission.
	1	Reader set to follow the ECI protocol (Extended Channel Interpretation). All data characters 92 <sub>DEC</sub> are doubled.
	2	Reader set for Basic Channel operation (no escape character transmission protocol). Data characters 92 <sub>DEC</sub> are not doubled. <b>Note:</b> When decoders are set to this mode, unbuffered Macro symbols and symbols requiring the decoder to convey ECI escape sequences cannot be transmitted.
	3	The bar code contains a GS1-128 symbol, and the first codeword is 903-907, 912, 914, 915.
	4	The bar code contains a GS1-128 symbol, and the first codeword is in the range 908-909.
	5	The bar code contains a GS1-128 symbol, and the first codeword is in the range 910-911.
	Example: A PDF417 bar code ABCD, with no transmission protocol enabled, is transmitted as ]L2ABCD.	
Data Matrix	0	ECC 000-140, not supported.
	1	ECC 200.
	2	ECC 200, FNC1 in first or fifth position.
	3	ECC 200, FNC1 in second or sixth position.
	4	ECC 200, ECI protocol implemented.
	5	ECC 200, FNC1 in first or fifth position, ECI protocol implemented.
	6	ECC 200, FNC1 in second or sixth position, ECI protocol implemented.
MaxiCode	0	Symbol in Mode 4 or 5.
	1	Symbol in Mode 2 or 3.
	2	Symbol in Mode 4 or 5, ECI protocol implemented.
	3	Symbol in Mode 2 or 3, ECI protocol implemented in secondary message.

**Table E-3** *Modifier Characters (Continued)*

<b>Code Type</b>	<b>Option Value</b>	<b>Option</b>
<b>QR Code</b>	0	Model 1 symbol.
	1	Model 2 / MicroQR symbol, ECI protocol not implemented.
	2	Model 2 symbol, ECI protocol implemented.
	3	Model 2 symbol, ECI protocol not implemented, FNC1 implied in first position.
	4	Model 2 symbol, ECI protocol implemented, FNC1 implied in first position.
	5	Model 2 symbol, ECI protocol not implemented, FNC1 implied in second position.
	6	Model 2 symbol, ECI protocol implemented, FNC1 implied in second position.
<b>Aztec</b>	0	Aztec symbol.
	C	Aztec Rune symbol.



# APPENDIX F SAMPLE BAR CODES

---

## Code 39



123ABC

---

## UPC/EAN

### UPC-A, 100%



0 1 2 3 4 5 6 7 8 9 0 5



**EAN-13, 100%**

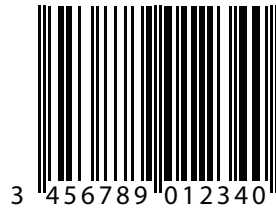

---

**Code 128**

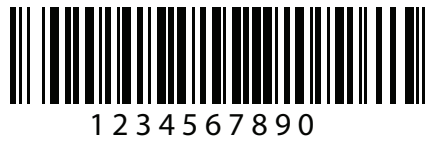

---

**Interleaved 2 of 5**



---

## GS1 DataBar-14

✓ **NOTE** DataBar-14 must be enabled to read the bar code below (see [GS1 DataBar on page 12-135](#)).



7612341562341

---

## PDF417



---

## Data Matrix



---

## Maxicode

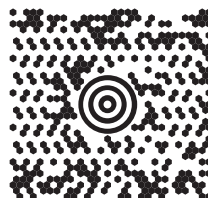

---

## QR Code

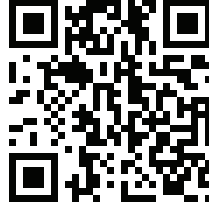

---

## Han Xin



---

## US Postnet



---

## UK Postal



# APPENDIX G NUMERIC BAR CODES

---

## Numeric Bar Codes

For parameters requiring specific numeric values, scan the appropriately numbered bar code(s).

**0**



**0**

**1**



**1**

2

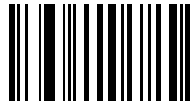

2

3



3

4



4

5



5



**6**



**6**

7



7

**8**



**8**

9



9

---

## Cancel

To correct an error or change a selection, scan the bar code below.



Cancel

# APPENDIX H SIGNATURE CAPTURE CODE

---

## Introduction

CapCode, a signature capture code, is a special pattern that encloses a signature area on a document and allows a scanner to capture a signature.

There are several accepted patterns that allow automatic identification of different signatures on the same form. For example, on the federal tax return 1040 form there are three signature areas, one each for two joint filers, and one for a professional preparer. By using different patterns, a program can correctly identify all three, so they can be captured in any sequence and still be identified correctly.

---

## Code Structure

### Signature Capture Area

A CapCode is printed as two identical patterns on either side of a signature capture box, as shown in [Figure H-1](#). Each pattern extends the full height of the signature capture box.

The box is optional, so you can omit it, replace it with a single baseline, or print a baseline with an "X" on top of it towards the left, as is customarily done in the US to indicate a request for signature. However, if an "X" or other markings are added in the signature box area, these are captured with the signature.



Figure H-1 CapCode

## CapCode Pattern Structure

A CapCode pattern structure consists of a start pattern followed by a separator space, a signature capture box, a second separator space, and then a stop pattern. Assuming that X is the dimension of the thinnest element, the start and stop patterns each contains 9X total width in 4 bars and 3 spaces. A 7X quiet zone is required to the left and to the right of the CapCode pattern.

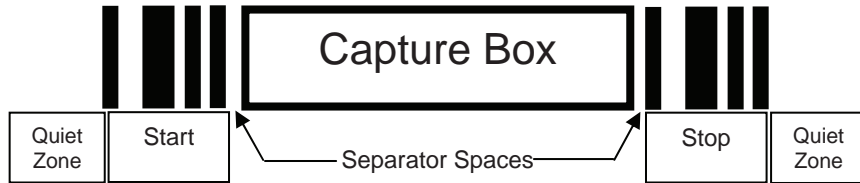

Figure H-2 CapCode Structure

The separator spaces on either side of the signature capture box can be between 1X and 3X wide.

## Start / Stop Patterns

Table H-1 lists the accepted start / stop patterns. The bar and space widths are expressed as multiples of X. You must use the same pattern on either side of a signature capture box. The type value is reported with the captured signature to indicate the purpose of the signature captured.

Table H-1 Start / Stop Pattern Definitions

Bar/Space Patterns							Type
B	S	B	S	B	S	B	
1	1	2	2	1	1	1	2
1	2	2	1	1	1	1	5
2	1	1	2	1	1	1	7
2	2	1	1	1	1	1	8
3	1	1	1	1	1	1	9

[Table H-2](#) lists selectable parameters used to generate the image of the captured signature.

**Table H-2** *User Defined CapCode Parameters*

Parameter	Defined
Width	Number of pixels
Height	Number of pixels
Format	JPEG, BMP, TIFF
JPEG quality	1 (most compression) to 100 (best quality)
Bits Per Pixel (not applicable to JPEG format)	1 (2 levels)
	4 (16 levels)
	8 (256 levels)

BMP format does not use compression, JPEG and TIFF formats do.

---

## Dimensions

The size of the signature capture box is determined by the height and separation of the start and stop patterns. The line width of the signature capture box is insignificant.

The thinnest element width, referred to here as X, is nominally 10 mils (1 mil = 0.0254 mm). Select this as an exact multiple of the pixel pitch of the printer used. For example, when using a 203 DPI (dots-per-inch) printer and printing 2 dots per module, the resulting X dimension is 9.85 mils.

---

## Data Format

The decoder output is formatted according to [Table H-3](#). Symbol Technologies decoders allow different user options to output or inhibit bar code type. Selecting "Symbol ID" as the bar code type for output identifies the CapCode with letter "i".

**Table H-3** *Data Format*

File Format (1 byte)	Type (1 byte)	Image Size (4 bytes, BIG Endian)	Image Data
JPEG - 1 BMP - 3 TIFF - 4	See <a href="#">Table H-1</a> , last column		(Same bytes as in a data file)



---

## Additional Capabilities

Regardless of how the signature is captured, the output signature image is de-skewed and right-side up.

A scanner that captures signatures automatically determines whether it is scanning a signature or a bar code. You can disable the signature capturing capability in a decoder.

---

## Signature Boxes

*Figure H-3* illustrates the five acceptable signature boxes:

Type 2:



Type 5:

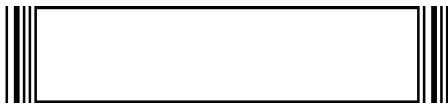

Type 7:

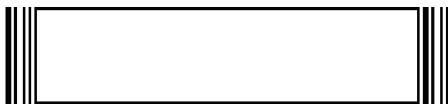

Type 8:



Type 9:



**Figure H-3** *Acceptable Signature Boxes*

# APPENDIX I NON-PARAMETER ATTRIBUTES

---

## Introduction

This appendix defines non-parameter attributes.

---

## Attributes

### Model Number

Attribute #533

Model number of the scanner. This electronic output matches the printout on the physical device label, for example **DS7708-SR00004ZCWW**.

<b>Type</b>	S
<b>Size (Bytes)</b>	18
<b>User Mode Access</b>	R
<b>Values</b>	Variable

### Serial Number

Attribute #534

Unique serial number assigned in the manufacturing facility. This electronic output matches the printout on the physical device label, for example **M1J26F45V**.

<b>Type</b>	S
<b>Size (Bytes)</b>	16
<b>User Mode Access</b>	R
<b>Values</b>	Variable

## Date of Manufacture

Attribute #535

Date of device manufacture assigned in the manufacturing facility. This electronic output matches the printout on the physical device label, for example **30APR14** (which reads the 30th of April 2014).

<b>Type</b>	S
<b>Size (Bytes)</b>	7
<b>User Mode Access</b>	R
<b>Values</b>	Variable

## Date of First Programming

Attribute #614

Date of first electronic programming represents the first time settings were electronically loaded to the scanner either by 123Scan<sup>2</sup> or via SMS, for example **18MAY14** (which reads the 18th of May 2014).

<b>Type</b>	S
<b>Size (Bytes)</b>	7
<b>User Mode Access</b>	R
<b>Values</b>	Variable

## Configuration Filename

Attribute #616

The name assigned to the configuration settings loaded electronically to the device either by 123Scan<sup>2</sup> or via SMS.



**NOTE** Scanning the **Set Defaults** bar code automatically changes the configuration filename to *factory defaults*.

To indicate the configuration settings loaded to the device were changed, the configuration filename changes to *Modified* upon scanning any parameter bar code.

<b>Type</b>	S
<b>Size (Bytes)</b>	17
<b>User Mode Access</b>	RW
<b>Values</b>	Variable

**Beep/LED**

Attribute #6000

Activate the beep and/or LED.

<b>Type</b>	X
<b>Size (Bytes)</b>	N/A
<b>User Mode Access</b>	W

Values:

<b>Beep / LED Action</b>	<b>Value</b>
1 high short beep	0
2 high short beeps	1
3 high short beeps	2
4 high short beeps	3
5 high short beeps	4
1 low short beep	5
2 low short beeps	6
3 low short beeps	7
4 low short beeps	8
5 low short beeps	9
1 high long beep	10
2 high long beeps	11
3 high long beeps	12
4 high long beeps	13
5 high long beeps	14
1 low long beep	15
2 low long beeps	16
3 low long beeps	17
4 low long beeps	18
5 low long beeps	19
Fast warble beep	20
Slow warble beep	21
High-low beep	22
Low-high beep	23
High-low-high beep	24
Low-high-low beep	25
High-high-low-low beep	26
Green LED off	42
Green LED on	43
Red LED on	47
Red LED off	48

## Parameter Defaults

Attribute #6001

This attribute restores all parameters to their factory defaults.

<b>Type</b>	X
<b>Size (Bytes)</b>	N/A
<b>User Mode Access</b>	W
<b>Values</b>	0 = Restore Defaults 1 = Restore Factory Defaults 2 = Write Custom Defaults

## Beep on Next Bootup

Attribute #6003

This attribute configures (enables or disables) beep on next boot up of scanner.

<b>Type</b>	X
<b>Size (Bytes)</b>	N/A
<b>User Mode Access</b>	W
<b>Values</b>	0 = Disable beep on next bootup 1 = Enable beep on next bootup

## Reboot

Attribute #6004

This attribute initiates a device reboot.

<b>Type</b>	X
<b>Size (Bytes)</b>	N/A
<b>User Mode Access</b>	W
<b>Values</b>	N/A

## Host Trigger Session

Attribute #6005

This attribute triggers a decode session similar to manually depressing the scanner trigger button.

<b>Type</b>	X
<b>Size (Bytes)</b>	N/A
<b>User Mode Access</b>	W
<b>Values</b>	0 = Start Host Trigger Session 1 = Stop Host Trigger Session

## Firmware Version

Attribute #20004

The scanner's operating system version. For example, **PAACHS00-001-R00**.

<b>Type</b>	S
<b>Size (Bytes)</b>	Variable
<b>User Mode Access</b>	R
<b>Values</b>	Variable

## Imagekit Version

Attribute #20013

Identifies 1D/2D decode algorithms resident on the device, for example **IMGKIT\_6.04T05.11**.

<b>Type</b>	S
<b>Size (Bytes)</b>	Variable
<b>User Mode Access</b>	R
<b>Values</b>	Variable



# INDEX

## Numerics

2D bar codes	
aztec	12-164
aztec inverse	12-165
code 128 emulation	12-151
data matrix	12-152
data matrix GS1	12-155
data matrix inverse	12-153
han xin	12-167
han xin inverse	12-168
maxicode	12-158
microPDF417	12-150
microQR	12-163
PDF417	12-149
QR code	12-159, 12-162
QR inverse	12-160

## A

ADF	15-1
advanced data formatting	15-1
aiming	2-3
aiming options	
snapshot mode timeout	5-5
video view finder	5-28
ASCII values	
keyboard wedge	9-19
RS-232	7-37
USB	6-33
attributes	
non-parameter	I-1
attributes, non-parameter	
beep on next bootup	I-4
configuration filename	I-2
date of first programming	I-2
date of manufacture	I-2

firmware version	I-5
host trigger session	I-4
imagekit version	I-5
model number	I-1
parameter defaults	I-4
reboot	I-4
serial number	I-1
auxiliary RSM communication bar codes	11-3
auxiliary scanner	
connecting	11-1

## B

bar codes	
Australia post	12-127
Australia post format	12-128
auxiliary RSM communication	11-3
aztec	12-164
aztec inverse	12-165
beep after good decode	4-7
beeper tone	4-8
beeper volume	4-11, 4-13
bits per pixel	5-18, 5-23
bookland EAN	12-14
bookland ISBN	12-15
cancel	G-10
Chinese 2 of 5	12-112
codabar	12-98
codabar CLSI editing	12-101
codabar lengths	12-99
codabar NOTIS editing	12-103
codabar start and stop characters	12-104
code 11	12-76
code 11 lengths	12-77
code 128	12-45
code 128 emulation	12-151
code 128 lengths	12-46



code 128 reduced quiet zone	12-55	ignore beep directive	8-8
code 128 security level	12-56	IBM 468X/469X parameters	
code 39	12-59	port address	8-5
code 39 check digit verification	12-66	ignore code 128 fnc4	12-58
code 39 full ASCII	12-68	image brightness (target white)	5-8
code 39 lengths	12-63	image enhancement	5-12
code 39 reduced quiet zone	12-71	image file format	5-21
code 39 transmit check digit	12-67	image file format selection	5-14
code 93	12-72	image resolution	5-6
code 93 lengths	12-73	image rotation	5-16
code39 security level	12-69	interleaved 2 of 5	12-83
composite CC-A/B	12-142	convert to EAN-13	12-56, 12-91
composite CC-C	12-141	lengths	12-84
composite TLC-39	12-143	inverse 1D	12-119, 12-133
convert GS1 databar to UPC/EAN	12-140	ISBT 128	12-50
convert UPC-E to UPC-A	12-38	ISBT concatenation	12-51, 12-53
convert UPC-E1 to UPC-A	12-39	ISBT concatenation redundancy	12-54
country code page defaults	C-2	ISSN EAN	12-44
country code pages	C-6	Japan post	12-126
coupon report	12-42	JPEG image options	5-9
data matrix	12-152	JPEG quality and size	5-11
data matrix inverse	12-153	JPEG target file size	5-10
decode mirror images	4-20, 12-156	keyboard wedge	
disable all code types	12-8	alternate numeric keypad emulation	9-10
discrete 2 of 5	12-94	caps lock on	9-12
EAN zero extend	12-40	caps lock override	9-13
EAN-13/JAN-13	12-13	default table	9-4
EAN-8/JAN-8	12-12	host types	9-5
emulate keypad	6-15	ignore unknown characters	9-6
enable all code types	12-8	intra-keystroke delay	9-9
event reporting		keystroke delay	9-7
boot up event	10-32	quick keypad emulation	9-11
decode event	10-31	Korean 3 of 5	12-118
parameter event	10-33	matrix 2 of 5	12-113
field of view	4-25	matrix 2 of 5 check digit	12-116
flush macro buffer/abort macro PDF entry	12-178	matrix 2 of 5 lengths	12-114
FN1 substitution values	4-36	maxicode	12-158
GS1 data matrix	12-155	microPDF417	12-150
GS1 databar	12-135	microQR	12-163
GS1 databar expanded	12-137	mobile phone/display mode	4-24
GS1 databar limited	12-136	MSI	12-105
GS1 databar limited security level	12-138	MSI check digit algorithm	12-111
GS1-128	12-49	MSI check digits	12-109
han xin	12-167	MSI lengths	12-106
han xin inverse	12-168	MSI transmit check digit	12-110
I 2 of 5 check digit verification	12-87	Netherlands KIX code	12-130
I 2 of 5 convert to EAN-13	12-90	numeric bar codes	G-10
I 2 of 5 reduced quiet zone	12-93	OCR	
I 2 of 5 security level	12-91	check digit	13-38
I 2 of 5 transmit check digit	12-89	check digit multiplier	13-39
IBM 468X/469X		check digit validation	13-40
convert unknown to code 39	8-7	default table	13-2
default parameters	8-4	inverse OCR	13-44
ignore bar code configuration directive	8-9	lines	13-20, 13-21

- maximum characters . . . . . 13-22
- MICR E13B . . . . . 13-15
- minimum character . . . . . 13-22
- OCR-A . . . . . 13-3
- OCR-A variant . . . . . 13-4
- OCR-B . . . . . 13-7
- OCR-B variant . . . . . 13-8
- orientation . . . . . 13-17
- parameters . . . . . 13-3
- reduced quiet zone . . . . . 13-24
- subset . . . . . 13-23
- template . . . . . 13-25
- US currency serial number . . . . . 13-16
- parameter scanning . . . . . 4-6
- PDF prioritization . . . . . 4-22
- PDF prioritization timeout . . . . . 4-23
- PDF417 . . . . . 12-149
- postal . . . . . 12-121
- prefix/suffix values . . . . . 4-29
- QR code . . . . . 12-159, 12-162
- QR inverse . . . . . 12-160
- quiet zone level . . . . . 12-176
- RS-232
  - ASCII format . . . . . 7-29
  - baud rate . . . . . 7-11
  - beep on bel . . . . . 7-30
  - check receive errors . . . . . 7-16
  - default table . . . . . 7-4
  - hardware handshaking . . . . . 7-17
  - host serial response time-out . . . . . 7-24
  - host types . . . . . 7-7, 7-8, 7-9, 7-10
  - intercharacter delay . . . . . 7-31
  - parity . . . . . 7-14
  - RTS line state . . . . . 7-27
  - software handshaking . . . . . 7-21
  - stop bit select . . . . . 7-28
- samples . . . . . F-1
- scan data options . . . . . 4-32
- set defaults . . . . . 4-4
- signature capture . . . . . 5-20
- signature capture height . . . . . 5-26
- signature capture JPEG quality . . . . . 5-27
- signature capture width . . . . . 5-25
- snapshot mode timeout . . . . . 5-5
- SSI
  - baud rate . . . . . 10-11
  - check parity . . . . . 10-17
  - data packet format . . . . . 10-21
  - host character timeout . . . . . 10-24
  - host RTS line state . . . . . 10-20
  - host serial response time-out . . . . . 10-22
  - interpacket delay . . . . . 10-28
  - multipacket option . . . . . 10-26
  - parity . . . . . 10-15
  - selecting . . . . . 10-10
  - software handshaking . . . . . 10-19
  - stop bit select . . . . . 10-18
- supplementals . . . . . 12-16
- suppress power-up beeps . . . . . 4-17
- symbologies
  - default table . . . . . 12-2
- timeout between decodes,
  - different symbols . . . . . 4-18
- timeout between decodes,
  - same symbol . . . . . 4-18
- transmit code ID character . . . . . 4-27
- transmit matrix 2 of 5 check digit . . . . . 12-117
- transmit UK postal check digit . . . . . 12-125
- transmit US postal check digit . . . . . 12-123
- UCC coupon extended code . . . . . 12-41
- UK postal . . . . . 12-124
- unicode output control . . . . . D-2
- unsolicited heartbeat interval . . . . . 4-37
- UPC composite mode . . . . . 12-144
- UPC reduced quiet zone . . . . . 12-28
- UPC/EAN
  - coupon code . . . . . 12-41
  - supp redundancy . . . . . 12-25
- UPC/EAN/JAN
  - supplemental redundancy . . . . . 12-25
- UPC/EAN/JAN supplemental
  - AIM ID format . . . . . 12-26
- UPC-A . . . . . 12-9
- UPC-A preamble . . . . . 12-32
- UPC-A/E/E1 check digit . . . . . 12-29, 12-30, 12-31
- UPC-E . . . . . 12-10
- UPC-E preamble . . . . . 12-34
- UPC-E1 . . . . . 12-11
- UPU FICS postal . . . . . 12-132
- US planet . . . . . 12-122
- US postnet . . . . . 12-121
- USB
  - bar code configuration directive . . . . . 6-32
  - caps lock override . . . . . 6-12
  - convert unknown to code 39 . . . . . 6-14
  - default table . . . . . 6-4
  - device type . . . . . 6-5
  - emulate keypad with leading zero . . . . . 6-16
  - fast HID keyboard . . . . . 6-28
  - IBM specification version . . . . . 6-30
  - ignore beep directive . . . . . 6-31
  - keystroke delay . . . . . 6-10
  - optional parameters . . . . . 6-31
  - polling interval . . . . . 6-23, 6-24, 6-25, 6-26, 6-27
  - quick keypad emulation . . . . . 6-29
  - SNAPI handshaking . . . . . 6-9
  - static CDC . . . . . 6-22

- transmission speed . . . . . 6-23
- unknown characters . . . . . 6-13
- USPS 4CB/One Code/Intelligent Mail . . . . . 12-131
- video image size . . . . . 5-29
- video view finder . . . . . 5-28
- volume/tone button control . . . . . 4-15
- beeper
  - beep after good decode . . . . . 4-7
  - duration . . . . . 4-13
  - suppress power-up beeps . . . . . 4-17
  - tone . . . . . 4-8
  - volume . . . . . 4-11
- beeper sequences . . . . . 2-4
- beeper volume . . . . . 2-4
- BPP . . . . . 5-18

**C**

- cables
  - installing . . . . . 1-4
- chapter descriptions . . . . . viii
- character sets
  - keyboard wedge . . . . . 9-19
  - RS-232 . . . . . 7-37
  - USB . . . . . 6-33
- Chinese 2 of 5 bar codes . . . . . 12-112
- CJK . . . . . D-1
- codabar bar codes
  - CLSI editing . . . . . 12-101
  - codabar . . . . . 12-98
  - lengths . . . . . 12-99
  - NOTIS editing . . . . . 12-103
  - start and stop characters . . . . . 12-104
- code 11 bar codes
  - code 11 . . . . . 12-76
  - lengths . . . . . 12-77
- code 128 bar codes
  - code 128 . . . . . 12-45
  - GS1-128 . . . . . 12-49
  - ignore fnc4 . . . . . 12-58
  - ISBT 128 . . . . . 12-50
  - ISBT concatenation . . . . . 12-51, 12-53
  - ISBT concatenation redundancy . . . . . 12-54
  - lengths . . . . . 12-46
  - reduced quiet zone . . . . . 12-55
  - security level . . . . . 12-56
- code 128 emulation bar codes . . . . . 12-151
- code 39 bar codes
  - check digit verification . . . . . 12-66
  - code 39 . . . . . 12-59
  - full ASCII . . . . . 12-68
  - lengths . . . . . 12-63
  - reduced quiet zone . . . . . 12-71
  - security level . . . . . 12-69

- transmit check digit . . . . . 12-67
- code 93 bar codes
  - code 93 . . . . . 12-72
  - lengths . . . . . 12-73
- code ID character . . . . . 4-27
- code identifiers
  - AIM code IDs . . . . . E-3
  - modifier characters . . . . . E-4
  - Symbol . . . . . E-1
- composite bar codes
  - composite CC-A/B . . . . . 12-142
  - composite CC-C . . . . . 12-141
  - composite TLC-39 . . . . . 12-143
  - UPC composite mode . . . . . 12-144
- country code page defaults . . . . . C-2
- country code pages . . . . . C-6

**D**

- data matrix bar codes . . . . . 12-152
- decode ranges . . . . . 2-3
- default parameters
  - IBM 468X/469X . . . . . 8-4
  - imaging preferences . . . . . 5-2
  - keyboard wedge . . . . . 9-4
  - OCR . . . . . 13-2
  - RS-232 . . . . . 7-4
  - SSI . . . . . 10-8
  - standard default table . . . . . A-1
  - symbolologies . . . . . 12-2
  - USB . . . . . 6-4
  - user preferences . . . . . 4-2
- discrete 2 of 5 bar codes
  - discrete 2 of 5 . . . . . 12-94
- documentation . . . . . x

**E**

- EAS . . . . . 2-7
- exposure options
  - field of view . . . . . 4-25

**F**

- features
  - back view . . . . . 1-2
  - bottom view . . . . . 1-2
  - front view . . . . . 1-2
  - mount accessories . . . . . 1-3
- field of view . . . . . 4-25
- full illumination . . . . . 2-2

**G**

- GS1 databar ..... 12-135
- convert GS1 databar to UPC/EAN ..... 12-140

**H**

- host types
  - keyboard wedge ..... 9-5
  - RS-232 ..... 7-7, 7-8, 7-9, 7-10

**I**

- IBM 468X/469X connection ..... 8-2
- IBM 468X/469X default parameters ..... 8-4
- IBM 468X/469X parameters ..... 8-5
- idle mode ..... 2-2
- image brightness (target white) ..... 5-8
- image enhancement ..... 5-12
- image options
  - bits per pixel ..... 5-18
  - file formats ..... 5-14, 5-21
  - image brightness (target white) ..... 5-8
  - image enhancement ..... 5-12
  - image resolution ..... 5-6
  - image rotation ..... 5-16
  - JPEG image options ..... 5-9
  - JPEG size/quality ..... 5-11
  - JPEG target file size ..... 5-10
- image resolution ..... 5-6
- imaging preferences parameters ..... 5-2
- indicator lights ..... 1-11
- installing cables ..... 1-5
- interleaved 2 of 5 bar codes
  - check digit verification ..... 12-87
  - convert to EAN-13 ..... 12-90
  - reduced quiet zone ..... 12-93
  - security level ..... 12-91
  - transmit check digit ..... 12-89

**J**

- JPEG image options ..... 5-9
  - size/quality ..... 5-11
- JPEG target file size ..... 5-10

**K**

- keyboard types (country codes)
  - Albanian ..... B-4
  - Arabic (101) ..... B-4
  - Arabic (102) ..... B-5
  - Arabic (102) Azerty ..... B-5
  - Azeri (Cyrillic) ..... B-6

- Azeri (Latin) ..... B-6
- Belarusian ..... B-7
- Bosnian (Cyrillic) ..... B-8
- Bosnian (Latin) ..... B-7, B-8
- Bulgarian (Latin) ..... B-8
- Bulgarian Cyrillic (Typewriter) ..... B-9
- Canadian French (Legacy) ..... B-10
- Canadian French Win7 ..... B-9
- Canadian Multilingual Standard ..... B-10
- Chinese (ASCII) ..... B-12
- Croatian ..... B-12
- Czech ..... B-13
- Czech (Programmer) ..... B-13
- Czech (QWERTY) ..... B-14
- Danish ..... B-14
- Dutch (Netherlands) ..... B-15
- Estonian ..... B-15
- Faeroese ..... B-16
- Finnish ..... B-16
- French (Canada) 2000/XP ..... B-18
- French (Canada) 95/98 ..... B-18
- French (France) ..... B-17
- French International ..... B-17
- Galician ..... B-19
- German ..... B-19
- Greek ..... B-21
- Greek (220) Latin ..... B-20
- Greek (319) Latin ..... B-21
- Greek 220 ..... B-22
- Greek 319 ..... B-22
- Greek Latin ..... B-20
- Greek Polytonic ..... B-23
- Hebrew Israel ..... B-23
- Hungarian ..... B-24
- Hungarian\_101KEY ..... B-24
- Irish ..... B-25
- Islandic ..... B-25
- Italian ..... B-26
- Italian (142) ..... B-26
- Japanese (ASCII) ..... B-27
- Kazakh ..... B-28
- Korean (ASCII) ..... B-28, B-29
- Kyrgyz ..... B-29
- Latin American ..... B-30
- Latvian ..... B-30
- Latvian (QWERTY) ..... B-31
- Lithuanian ..... B-31
- Lithuanian (IBM) ..... B-32
- Macedonian (FYROM) ..... B-32
- Maltese\_47KEY ..... B-33
- Mongolian ..... B-33
- Norwegian ..... B-34
- Polish (214) ..... B-34
- Polish (Programmer) ..... B-35

Portuguese (Brazil)	B-35
Portuguese (Brazilian ABNT)	B-36
Portuguese (Brazilian ABNT2)	B-36
Portuguese (Portugal)	B-37
Romanian	B-37
Romanian (Legacy)	B-38
Romanian (Programmer)	B-39
Romanian (Standard)	B-38
Russian	B-39
Russian (Typewriter)	B-40
Serbian (Cyrillic)	B-41
Serbian (Latin)	B-40
Slovak	B-41
Slovak (QWERTY)	B-42
Slovenian	B-42
Spanish	B-43
Spanish (Variation)	B-43
Swedish	B-44
Swiss French	B-44
Swiss German	B-45
Tatar	B-45
Thai (Kedmanee)	B-46
Turkish F	B-46
Turkish Q	B-47
UK English	B-47
Ukrainian	B-48
US Dvorak	B-48
US Dvorak Left	B-49
US Dvorak Right	B-49
US English	B-2, B-3
US International	B-50
Uzbek	B-50
Vietnamese	B-51
keyboard wedge connection	9-2
keyboard wedge default parameters	9-4
keypad emulation	6-15
Korean 3 of 5 bar codes	12-118

## L

LED indicators	2-4
led indicators	2-4

## M

macro PDF	12-178
flush buffer/abort PDF entry	12-178
maintenance	3-1
matrix 2 of 5 bar codes	12-113
check digit	12-116
lengths	12-114
transmit check digit	12-117
maxicode bar codes	12-158
microPDF417 bar codes	12-150

MSI bar codes	
check digit algorithm	12-111
check digits	12-109
lengths	12-106
MSI	12-105
transmit check digit	12-110

## N

non-parameter attributes	I-1
beep on next bootup	I-4
configuration filename	I-2
date of first programming	I-2
date of manufacture	I-2
firmware version	I-5
host trigger session	I-4
imagekit version	I-5
model number	I-1
parameter defaults	I-4
reboot	I-4
serial number	I-1
notational conventions	ix

## O

object detection wakeup system	2-2
OCR	
default parameters	13-2
parameters	13-3

## P

parameters	
IBM 468X/469X	8-5
RS-232	7-5
USB	6-5
PDF417 bar codes	12-149
PDF prioritization	4-22
pinouts	
scanner signal descriptions	3-7
ports	
auxiliary	1-4
host	1-4
postal codes	12-121
Australia post	12-127
Australia post format	12-128
Japan post	12-126
Netherlands KIX code	12-130
transmit UK postal check digit	12-125
transmit US postal check digit	12-123
UK postal	12-124
UPU FICS postal	12-132
US planet	12-122
US postnet	12-121

USPS 4CB/One Code/Intelligent Mail . . . . . 12-131  
 power level modes . . . . . 2-2

## Q

QR code bar codes . . . . . 12-159, 12-162

## R

ranges, decode . . . . . 2-3  
 related publications . . . . . x  
 routing cables . . . . . 1-5  
 RS-232 connection . . . . . 7-2  
 RS-232 default parameters . . . . . 7-4  
 RS-232 parameters . . . . . 7-5, 7-7, 7-8, 7-9, 7-10  
 RSM  
   commands and responses over SSI . . . . . 10-7

## S

sample bar codes . . . . . F-1  
 scanning  
   aiming . . . . . 2-3  
   bar codes on products . . . . . 2-2  
   decode ranges . . . . . 2-3  
   errors . . . . . 4-2, 5-2, 12-1  
   full illumination . . . . . 2-2  
   idle mode . . . . . 2-2  
   object detection wakeup system . . . . . 2-2  
   power level modes . . . . . 2-2  
   sequence example . . . . . 4-2, 5-2, 12-1  
 security  
   quiet zone level . . . . . 12-176  
 service information . . . . . x  
 setup  
   connecting a USB interface . . . . . 6-2  
   connecting an RS-232 interface . . . . . 7-2  
   connecting keyboard wedge interface . . . . . 9-2  
   connecting to an IBM 468X/469X host . . . . . 8-2  
   installing cables . . . . . 1-5  
   installing the auxiliary cable . . . . . 1-4  
   installing the host cable . . . . . 1-4  
   routing cables . . . . . 1-5  
   unpacking . . . . . 1-1  
 signal descriptions . . . . . 3-7  
 signature capture . . . . . 5-20  
   bits per pixel . . . . . 5-23  
   file format selection . . . . . 5-21  
   height . . . . . 5-26  
   JPEG quality . . . . . 5-27  
   width . . . . . 5-25  
 simple serial interface  
   baud rate . . . . . 10-11  
   commands . . . . . 10-2

communications . . . . . 10-1, 10-5  
 default parameters . . . . . 10-8  
 handshaking . . . . . 10-3, 10-5  
 RSM commands and responses . . . . . 10-7  
 RTS CTS . . . . . 10-5  
 selecting . . . . . 10-10  
 transactions . . . . . 10-3  
 snapshot mode timeout . . . . . 5-5  
 speaker tone  
   adjust . . . . . 1-11, 2-4  
 speaker volume  
   adjust . . . . . 1-11, 2-4  
 specifications . . . . . 3-4  
 SSI  
   baud rate . . . . . 10-11  
   commands . . . . . 10-2  
   communications . . . . . 10-1, 10-5  
   default parameters . . . . . 10-8  
   handshaking . . . . . 10-3, 10-5  
   RSM commands and responses . . . . . 10-7  
   RTS CTS . . . . . 10-5  
   selecting . . . . . 10-10  
   transactions . . . . . 10-3  
 standard default parameters . . . . . A-1  
 support . . . . . x  
 supported devices . . . . . 1-3  
 symbology default parameters . . . . . 12-2

## T

table mount template . . . . . 1-13  
 technical specifications . . . . . 3-4  
 templates  
   table mount . . . . . 1-13  
   wall mount . . . . . 1-12  
 transmission speed  
   USB . . . . . 6-23

## U

unicode  
   output control . . . . . D-2  
 unpacking . . . . . 1-1  
 UPC/EAN bar codes  
   bookland EAN . . . . . 12-14  
   bookland ISBN . . . . . 12-15  
   check digit . . . . . 12-29, 12-30, 12-31  
   convert UPC-E to UPC-A . . . . . 12-38  
   convert UPC-E1 to UPC-A . . . . . 12-39  
   coupon report . . . . . 12-42  
   EAN zero extend . . . . . 12-40  
   EAN-13/JAN-13 . . . . . 12-13  
   EAN-8/JAN-8 . . . . . 12-12  
   ISSN EAN . . . . . 12-44

reduced quiet zone .....	12-28
supplementals .....	12-16
UCC coupon extended code .....	12-41
UPC-A .....	12-9
UPC-A preamble .....	12-32
UPC-E .....	12-10
UPC-E preamble .....	12-34
UPC-E1 .....	12-11
USB connection .....	6-2
USB default parameters .....	6-4
USB parameters .....	6-5
user indicators	
beeper volume .....	2-4
led indicators .....	2-4
user preferences parameters .....	4-2

## V

video view finder .....	5-28
image size .....	5-29
volume .....	2-4

## W

wall mount template .....	1-12
---------------------------	------

## Z

Zebra Technologies support .....	x
----------------------------------	---

# *Tell Us What You Think...*

We'd like to know what you think about this Manual. Please take a moment to fill out this questionnaire and fax this form to: (631) 627-7184, or mail to:

Zebra Technologies, Inc.  
Lincolnshire, IL 60069 USA  
Attention: Technical Publications Manager  
Data Capture Solutions

**IMPORTANT:** If you need product support, please call the appropriate customer support number provided. Unfortunately, we cannot provide customer support at the fax number above.

Manual Title: \_\_\_\_\_  
(please include revision level)

How familiar were you with this product before using this manual?

- Very familiar     Slightly familiar     Not at all familiar

Did this manual meet your needs? If not, please explain.

---

---

---

---

What topics need to be added to the index, if applicable?

---

---

---

---

What topics do you feel need to be better discussed? Please be specific.

---

---

---

---

What can we do to further improve our manuals?

---

---

---

---

Thank you for your input—We value your comments.









Zebra Technologies Corporation  
Lincolnshire, IL U.S.A.  
<http://www.zebra.com>

Zebra and the stylized Zebra head are trademarks of ZIH Corp., registered in many jurisdictions worldwide. All other trademarks are the property of their respective owners.

©2015 ZIH Corp and/or its affiliates. All rights reserved.

