



Leitor Zebra LI3608

A produtividade depende da qualidade do scanner que você coloca em suas mãos. Quando os seus funcionários precisam capturar códigos de barra 1D, você pode oferecer o melhor a eles com o scanner Leitor Zebra LI3608-ER Laser USB.





LI36X8

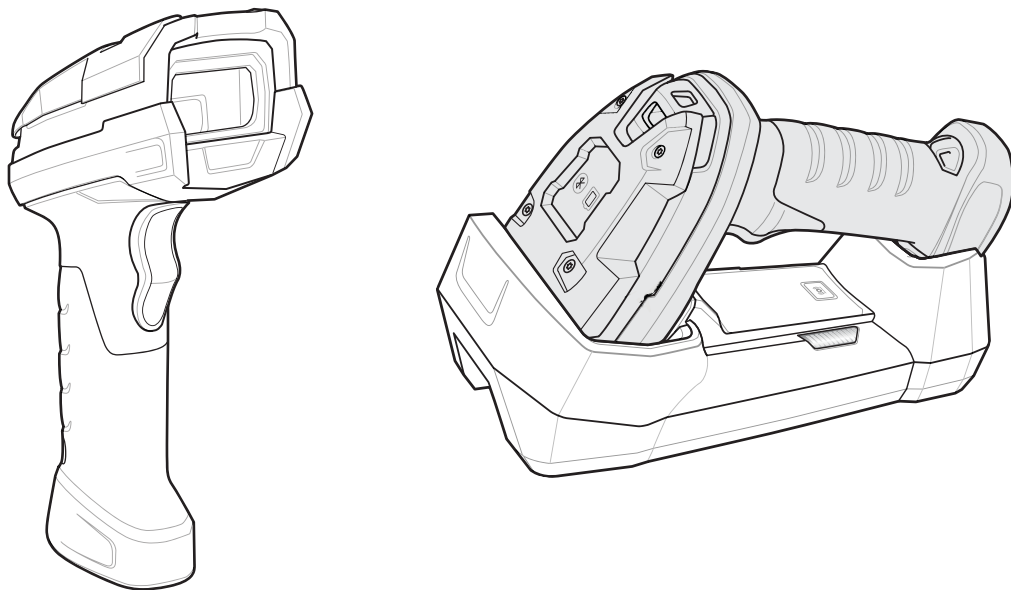

Linear Scanner

Product Reference Guide



LI36X8
PRODUCT REFERENCE GUIDE

MN001740A02

Revision A

March 2016

No part of this publication may be reproduced or used in any form, or by any electrical or mechanical means, without permission in writing from Zebra. This includes electronic or mechanical means, such as photocopying, recording, or information storage and retrieval systems. The material in this manual is subject to change without notice.

The software is provided strictly on an “as is” basis. All software, including firmware, furnished to the user is on a licensed basis. Zebra grants to the user a non-transferable and non-exclusive license to use each software or firmware program delivered hereunder (licensed program). Except as noted below, such license may not be assigned, sub-licensed, or otherwise transferred by the user without prior written consent of Zebra. No right to copy a licensed program in whole or in part is granted, except as permitted under copyright law. The user shall not modify, merge, or incorporate any form or portion of a licensed program with other program material, create a derivative work from a licensed program, or use a licensed program in a network without written permission from Zebra. The user agrees to maintain Zebra’s copyright notice on the licensed programs delivered hereunder, and to include the same on any authorized copies it makes, in whole or in part. The user agrees not to decompile, disassemble, decode, or reverse engineer any licensed program delivered to the user or any portion thereof.

Zebra reserves the right to make changes to any software or product to improve reliability, function, or design.

Zebra does not assume any product liability arising out of, or in connection with, the application or use of any product, circuit, or application described herein.

No license is granted, either expressly or by implication, estoppel, or otherwise under any Zebra Technologies Corporation, intellectual property rights. An implied license only exists for equipment, circuits, and subsystems contained in Zebra products.

Warranty

For the complete Zebra hardware product warranty statement, go to:
<http://www.zebra.com/warranty>.

Revision History

Changes to the original guide are listed below:

Change	Date	Description
-01 Rev. A	11/2015	Initial release (includes corded LI3608 only).
-02 Rev. A	03/2016	Add cordless LI3678.

TABLE OF CONTENTS

Warranty	iii
Revision History	iv

About This Guide

Introduction	xvii
Scanner Configurations	xvii
Related Product Line Configurations	xviii
Chapter Descriptions	xx
Notational Conventions	xxi
Related Documents	xxii
Service Information	xxii

Chapter 1: GETTING STARTED

Introduction	1-1
Imager Scanner	1-2
Configuring the Linear Imager Scanner	1-2
LI3608 Parts	1-2
LI3608 Corded Linear Imager Scanner	1-2
Setting Up LI3608 Corded Linear Imager Scanner	1-3
Installing the LI3608 Interface Cable	1-3
Removing the LI3608 Interface Cable	1-4
LI3678 Parts	1-6
LI3678 Cordless Linear Imager Scanner	1-6
The Cradle	1-7
Cradle Parts	1-8
Connecting the Cradle	1-9
Connecting STB3678/FLB3678 Cradles	1-9
Supplying Power to the Cradle	1-10
Mounting the Cradle	1-10
Inserting the Battery	1-11
Removing the Battery	1-11

Charging the LI3678 Battery	1-12
Inserting the Scanner in the Cradle	1-13
Sending Data to the Host Computer	1-14
Pairing	1-14
Lost Connection to Host	1-14
Configuring the Scanner	1-14
Radio Communications	1-14
Four Slot Spare Battery Charger	1-15
Inserting Batteries	1-16
Intellistand	1-17
Lanyard	1-18

Chapter 2: SCANNING

Introduction	2-1
Beeper and LED Definitions	2-1
Radio and Beeper LED Definitions	2-1
Cradle LED Definitions	2-5
Four Slot Battery Charger Definitions	2-6
Scanning	2-7
Aiming	2-7
Hand-Held Scanning	2-7
Hands-Free Scanning	2-8
Decode Ranges	2-9

Chapter 3: MAINTENANCE, TROUBLESHOOTING & TECHNICAL SPECIFICATIONS

Introduction	3-1
Maintenance	3-1
Known Harmful Ingredients	3-1
Approved Cleaning Agents	3-2
Tolerable Industrial Fluids and Chemicals	3-2
Cleaning the Linear Imager Scanner	3-2
Battery Maintenance	3-3
Troubleshooting	3-4
Technical Specifications	3-9
Signal Descriptions	3-12

Chapter 4: RADIO COMMUNICATIONS

Introduction	4-1
Scanning Sequence Examples	4-1
Errors While Scanning	4-1
Radio Communications Parameter Defaults	4-2
Wireless Beeper Definitions	4-4
Radio Communications Host Types	4-4
Classic Bluetooth vs. Low Energy Bluetooth	4-4
Cradle	4-4
Keyboard Emulation (HID)	4-5

Simple Serial Interface (SSI)	4-6
Serial Port Profile (SPP)	4-7
Bluetooth Technology Profile Support	4-8
Master/Slave Set Up	4-8
Master	4-8
Slave	4-8
Bluetooth Friendly Name	4-9
Discoverable Mode	4-10
Wi-Fi Friendly Mode	4-11
Notes	4-11
Wi-Fi Channel Exclusion	4-12
Radio Output Power	4-14
Link Supervision Timeout	4-15
Bluetooth Radio State	4-16
HID Host Parameters	4-17
Apple iOS Virtual Keyboard Toggle	4-17
HID Keyboard Keystroke Delay	4-18
HID CAPS Lock Override	4-18
HID Ignore Unknown Characters	4-19
Emulate Keypad	4-19
Fast HID Keyboard	4-20
Quick Keypad Emulation	4-21
HID Keyboard FN1 Substitution	4-21
HID Function Key Mapping	4-22
Simulated Caps Lock	4-22
Convert Case	4-23
Auto-reconnect Feature	4-24
Reconnect Attempt Beep Feedback	4-25
Reconnect Attempt Interval	4-26
Auto-reconnect	4-27
Out of Range Indicator	4-28
Beep on Insertion	4-28
Beep on <BEL>	4-29
Linear Imager Scanner(s) To Cradle Support	4-30
Modes of Operation	4-30
Point-to-Point Communication	4-30
Multipoint-to-Point Communication	4-30
Parameter Broadcast (Cradle Host Only)	4-31
Pairing	4-31
Pairing Modes	4-32
Lock Override	4-32
Pairing Methods	4-33
Unpairing	4-33
Toggle Pairing	4-34
Pairing Bar Code Format	4-34
Pairing Bar Code Example	4-34
Connection Maintenance Interval	4-35
Considerations	4-35
Batch Mode	4-38
Modes of Operation	4-38

Persistent Batch Storage	4-41
Page Button	4-42
Page Options	4-43
Page Mode	4-43
Page State Timeout	4-44
Classic Bluetooth and/or Low Energy (Cradle Host Only)	4-45
Bluetooth Security	4-46
PIN Code	4-46
Variable PIN Code	4-47
Bluetooth Security Levels	4-48
Bluetooth Radio, Linking, and Batch Operation	4-50
Setting Up an iOS or Android Product To Work With The Linear Imager Scanner	4-50

Chapter 5: USER PREFERENCES & MISCELLANEOUS SCANNER OPTIONS

Introduction	5-1
Scanning Sequence Examples	5-2
Errors While Scanning	5-2
User Preferences/Miscellaneous Option Parameter Defaults	5-2
User Preferences	5-5
Default Parameters	5-5
Report Version	5-6
Parameter Bar Code Scanning	5-6
Beep After Good Decode	5-7
Decode Illumination Indicator	5-8
Beeper Tone	5-9
Suppress Power Up Beeps	5-10
Beeper Volume	5-10
Beeper Duration	5-11
Decode Pager Motor	5-12
Decode Pager Motor Duration	5-12
Hand-Held Trigger Mode	5-14
Hands-Free Trigger Mode	5-15
Low Power Mode	5-15
Time Delay to Low Power Mode	5-16
Time Delay to Low Power Mode for Corded	5-16
Time Delay to Low Power Mode for Cordless	5-18
Time Delay to Presentation Sleep Mode	5-19
Timeout to Low Power Mode from Auto Aim	5-22
Linear Imager Picklist Mode	5-23
FIPS Mode	5-24
Aiming Illumination	5-25
Continuous Bar Code Read	5-26
Unique Bar Code Reporting	5-26
Decode Session Timeout	5-27
Timeout Between Decodes, Same Symbol	5-27
Timeout Between Decodes, Different Symbols	5-27
Decoding Illumination	5-28
Battery Threshold	5-29
Miscellaneous Scanner Parameters	5-31

Transmit Code ID Character	5-31
Prefix/Suffix Values	5-32
Scan Data Transmission Format	5-33
FN1 Substitution Values	5-34
Transmit “No Read” Message	5-35
Unsolicited Heartbeat Interval	5-36
Dump Scanner Parameters	5-37

Chapter 6: USB INTERFACE

Introduction	6-1
Connecting a USB Interface	6-2
LI3608 Corded Linear Imager USB Connection	6-3
LI3678 Cordless Linear Imager USB Connection	6-4
USB Host Parameters	6-7
USB Device Type	6-7
Symbol Native API (SNAPI) Status Handshaking	6-9
USB Keystroke Delay	6-10
USB CAPS Lock Override	6-10
USB Ignore Unknown Characters	6-11
USB Convert Unknown to Code 39	6-11
Emulate Keypad	6-12
Emulate Keypad with Leading Zero	6-12
Quick Keypad Emulation	6-13
USB Keyboard FN 1 Substitution	6-13
Function Key Mapping	6-14
Simulated Caps Lock	6-14
Convert Case	6-15
USB Static CDC	6-15
Optional USB Parameters	6-16
Ignore Beep	6-16
Ignore Bar Code Configuration	6-16
USB Polling Interval	6-17
USB Fast HID	6-19
IBM Specification Version	6-19
Toshiba TEC Host Parameters	6-20
Toshiba TEC Code Type Table Usage	6-20
Toshiba TEC Include Symbol Type	6-21
Toshiba TEC Include Character Counts	6-21
Toshiba TEC Include Header	6-21
Toshiba TEC Include Terminator	6-22
Toshiba TEC Header Character	6-22
Toshiba TEC Terminator Character	6-23
Toshiba TEC Light LED on Good Decode	6-23
Toshiba TEC Good Decode Beeper Timing	6-24
ASCII Character Set for USB	6-25

Chapter 7: SSI Interface

Introduction	7-1
Communications	7-1
SSI Transactions	7-3
General Data Transactions	7-3
ACK/NAK Handshaking	7-3
Transfer of Decode Data	7-4
ACK/NAK Enabled and Packeted Data	7-4
ACK/NAK Enabled and Unpacketed ASCII Data	7-4
ACK/NAK Disabled and Packeted DECODE_DATA	7-5
ACK/NAK Disabled and Unpacketed ASCII Data	7-5
Communication Summary	7-5
RTS/CTS Lines	7-5
ACK/NAK Option	7-5
Number of Data Bits	7-5
Serial Response Time-out	7-6
Retries	7-6
Baud Rate, Stop Bits, Parity, Response Time-out, ACK/NAK Handshake	7-6
Errors	7-6
Things to Remember When Using SSI Communication	7-6
Using Time Delay to Low Power Mode with SSI	7-7
Encapsulation of RSM Commands/Responses over SSI	7-8
Command Structure	7-8
Response Structure	7-8
Example Transaction	7-9
Simple Serial Interface Default Parameters	7-10
SSI Host Parameters	7-11
Select SSI Host	7-11
Baud Rate	7-12
Baud Rate (continued)	7-13
Parity	7-14
Check Parity	7-15
Stop Bits	7-15
Software Handshaking	7-16
Host RTS Line State	7-17
Decode Data Packet Format	7-17
Host Serial Response Time-out	7-18
Host Character Time-out	7-19
Multipacket Option	7-20
Interpacket Delay	7-21
Event Reporting	7-22
Decode Event	7-22
Boot Up Event	7-23
Parameter Event	7-23

Chapter 8: RS-232 INTERFACE

Introduction	8-1
Connecting an RS-232 Interface	8-2
Connecting an RS-232 Interface	8-3

LI3678 Cordless Linear Imager RS-232 Connection	8-3
RS-232 Parameter Defaults	8-4
RS-232 Host Parameters	8-5
RS-232 Host Types	8-7
Baud Rate	8-9
Parity	8-10
Stop Bit Select	8-11
Data Bits (ASCII Format)	8-12
Check Receive Errors	8-12
Hardware Handshaking	8-13
Software Handshaking	8-15
Host Serial Response Time-out	8-17
RTS Line State	8-18
Intercharacter Delay	8-19
Nixdorf Beep/LED Options	8-20
Ignore Unknown Characters	8-20
ASCII Character Set for RS-232	8-21

Chapter 9: IBM INTERFACE

Introduction	9-1
Connecting to an IBM 468X/469X Host	9-2
LI3608 Corded Linear Imager IBM Connection	9-2
To modify any other parameter options, scan the appropriate bar codes in this chapter.	9-2
LI3678 Cordless Linear Imager IBM Connection	9-3
IBM Parameter Defaults	9-4
IBM 468X/469X Host Parameters	9-5
Port Address	9-5
Convert Unknown to Code 39	9-6
Optional IBM Parameters	9-6
Ignore Beep	9-6
Ignore Bar Code Configuration	9-7

Chapter 10: KEYBOARD WEDGE INTERFACE

Introduction	10-1
Connecting a Keyboard Wedge Interface	10-2
LI3678 Cordless Linear Imager Keyboard Wedge Connection	10-3
Keyboard Wedge Parameter Defaults	10-4
Keyboard Wedge Host Parameters	10-5
Keyboard Wedge Host Types	10-5
Ignore Unknown Characters	10-6
Keystroke Delay	10-6
Intra-Keystroke Delay	10-7
Alternate Numeric Keypad Emulation	10-8
Quick Keypad Emulation	10-8
Caps Lock On	10-9
Caps Lock Override	10-9
Convert Wedge Data	10-10
Function Key Mapping	10-10

FN1 Substitution	10-11
Send Make and Break	10-11
Keyboard Map	10-12
ASCII Character Set for Keyboard Wedge	10-13

Chapter 11: SYMBOLOGIES

Introduction	11-1
Scanning Sequence Examples	11-2
Errors While Scanning	11-2
Symbology Parameter Defaults	11-2
UPC/EAN	11-7
Enable/Disable UPC-A	11-7
Enable/Disable UPC-E	11-7
Enable/Disable UPC-E1	11-8
Enable/Disable EAN-8/JAN-8	11-8
Enable/Disable EAN-13/JAN-13	11-9
Enable/Disable Bookland EAN	11-9
Decode UPC/EAN/JAN Supplementals	11-10
User-Programmable Supplementals	11-13
UPC/EAN/JAN Supplemental Redundancy	11-13
UPC/EAN/JAN Supplemental AIM ID Format	11-14
Transmit UPC-A Check Digit	11-15
Transmit UPC-E Check Digit	11-15
Transmit UPC-E1 Check Digit	11-16
UPC-A Preamble	11-17
UPC-E Preamble	11-18
UPC-E1 Preamble	11-19
Convert UPC-E to UPC-A	11-20
Convert UPC-E1 to UPC-A	11-20
EAN-8/JAN-8 Extend	11-21
Bookland ISBN Format	11-21
UCC Coupon Extended Code	11-22
Coupon Report	11-22
ISSN EAN	11-23
Code 128	11-24
Enable/Disable Code 128	11-24
Set Lengths for Code 128	11-24
Enable/Disable GS1-128 (formerly UCC/EAN-128)	11-26
Enable/Disable ISBT 128	11-26
ISBT Concatenation	11-27
Check ISBT Table	11-28
ISBT Concatenation Redundancy	11-28
Code 128 Security Level	11-29
Code 39	11-30
Enable/Disable Code 39	11-30
Enable/Disable Trioptic Code 39	11-30
Convert Code 39 to Code 32	11-31
Code 32 Prefix	11-31
Set Lengths for Code 39	11-32

Code 39 Check Digit Verification	11-33
Transmit Code 39 Check Digit	11-33
Code 39 Full ASCII Conversion	11-34
Code 39 Buffering - Scan & Store	11-34
Buffer Data	11-35
Clear Transmission Buffer	11-35
Transmit Buffer	11-36
Overfilling Transmission Buffer	11-36
Attempt to Transmit an Empty Buffer	11-36
Code 39 Security Level	11-37
Code 93	11-38
Enable/Disable Code 93	11-38
Set Lengths for Code 93	11-39
Code 11	11-40
Code 11	11-40
Set Lengths for Code 11	11-41
Code 11 Check Digit Verification	11-42
Transmit Code 11 Check Digits	11-43
Interleaved 2 of 5 (ITF)	11-44
Enable/Disable Interleaved 2 of 5	11-44
Set Lengths for Interleaved 2 of 5	11-44
I 2 of 5 Check Digit Verification	11-46
Transmit I 2 of 5 Check Digit	11-46
Convert I 2 of 5 to EAN-13	11-47
I 2 of 5 Security Level	11-48
Discrete 2 of 5 (DTF)	11-49
Enable/Disable Discrete 2 of 5	11-49
Set Lengths for Discrete 2 of 5	11-49
Codabar (NW - 7)	11-51
Enable/Disable Codabar	11-51
Set Lengths for Codabar	11-52
CLSI Editing	11-53
NOTIS Editing	11-53
Codabar Upper or Lower Case Start/Stop Characters Detection	11-54
MSI	11-55
Enable/Disable MSI	11-55
Set Lengths for MSI	11-56
MSI Check Digits	11-57
Transmit MSI Check Digit(s)	11-57
MSI Check Digit Algorithm	11-58
Chinese 2 of 5	11-59
Enable/Disable Chinese 2 of 5	11-59
Matrix 2 of 5	11-60
Enable/Disable Matrix 2 of 5	11-60
Set Lengths for Matrix 2 of 5	11-61
Matrix 2 of 5 Check Digit	11-62
Transmit Matrix 2 of 5 Check Digit	11-62
Korean 3 of 5	11-63
Enable/Disable Korean 3 of 5	11-63
Inverse 1D	11-64

GS1 DataBar	11-65
GS1 DataBar-14	11-65
GS1 DataBar Limited	11-65
GS1 DataBar Expanded	11-66
GS1 DataBar Limited Security Level	11-66
Convert GS1 DataBar to UPC/EAN	11-68
Redundancy Level	11-69
Redundancy Level 1	11-69
Redundancy Level 2	11-69
Redundancy Level 3	11-69
Redundancy Level 4	11-70
Security Level	11-71
Intercharacter Gap Size	11-72
Chapter 12: 123SCAN2	
Introduction	12-1
Communication with 123Scan2	12-1
123Scan2 Requirements	12-2
Scanner SDK, Other Software Tools, and Videos	12-2
Chapter 13: ADVANCED DATA FORMATTING	
Introduction	13-1
Appendix A: STANDARD DEFAULT PARAMETERS	
Introduction	B-1
Appendix B: Country Codes	
USB and Keyboard Wedge Country Keyboard Types (Country Codes)	B-2
Appendix C: PROGRAMMING REFERENCE	
Symbol Code Identifiers	C-1
AIM Code Identifiers	C-3
Appendix D: SAMPLE BAR CODES	
Code 39	D-1
UPC/EAN	D-1
UPC-A, 100%	D-1
EAN-13, 100%	D-2
Code 128	D-2
Interleaved 2 of 5	D-2
GS1 DataBar	D-3
GS1 DataBar-14	D-4

Appendix E: NUMERIC BAR CODES

Numeric Bar Codes E-1
Cancel E-3

Appendix F: ALPHANUMERIC BAR CODES

Alphanumeric Keyboard F-1

Appendix G: NON-PARAMETER ATTRIBUTES

Introduction G-1
Attributes G-1
 Model Number G-1
 Serial Number G-1
 Date of Manufacture G-2
 Date of First Programming G-2
 Configuration Filename G-2
 Beeper/LED G-3
 Parameter Defaults G-4
 Beep on Next Bootup G-4
 Reboot G-4
 Host Trigger Session G-4
 Firmware Version G-5
 Scankit Version G-5

Appendix H: ASCII CHARACTER SETS

Appendix I: COMMUNICATION PROTOCOL CAPABILITIES

Introduction I-1

Index

ABOUT THIS GUIDE

Introduction

The *LI36X8 Product Reference Guide* provides general instructions for setting up, operating, maintaining, and troubleshooting the LI3608 corded and LI3678 cordless linear imager scanners.

✓ **NOTE** The LI36X8 refers to both the corded LI3608 and cordless LI3678 linear imager scanners.

Scanner Configurations

The LI36X8 linear imager scanner configurations are as follows:

✓ **NOTE** Check Solution Builder for the latest available model configurations.

Part #:	Description
LI3608-SR00003VZWW	LI3608 Linear Imager, Standard Range, Corded, Industrial Green, Vibration Motor
LI3678-SR0F003VZWW	LI3678 Cordless Linear Imager, Standard Range, Cordless, FIPS, Green, Vibration Motor

Related Product Line Configurations

Table 2-1 lists the configurations of product lines related to the LI36X8 linear imager scanner.

- ✓ **NOTE** Check Solution Builder for:
- additional information regarding all available accessories
 - the complete selection of optional accessories
 - the latest available configurations.

Table 2-1 *Related Product Line Configurations*

Product	Part Number	Description
Accessories		
Intellistand	STND-AS0036-07	Stand: Adjustable Intellistand, Black
Tool Balancer Pulley	50-15400-031	Pulley: Tool Balancer Pulley
Clip on Belt Holster	11-59382-01	Holder: Clip on Belt
Fork Lift Holder	21-52612-01R	Holder: Fork Lift
Lanyard	50-12500-066	Lanyard Strap
Cradle	STB3678-C100F3WW	Standard Cradle, Charger, Bluetooth, Multiple Interface
Cradle	FLB3678-C100F3WW	IP65 Sealed Cradle, Charger, Bluetooth, Multiple Interface
Mounting Plate	21-84259-01	Mounting plate for FLB3678
Battery	BTRY-36IAB0E-00	Spare Battery
Battery Charger	SAC3600-4001CR	4 Slot Battery Charger, Includes Power Supply
Universal Cables		
Shielded USB	CBA-UF2-C12ZAR	Shielded USB: Series A Locking Connector for VC70, 12', Coiled, -30C
	CBA-U42-S07PAR	Shielded USB: Series A Connector, 7ft. (2.8m), Straight, 12V (Requires 12V Power Supply)
	CBA-U44-S15PAR	Shielded USB: Series A Connector, 15ft. (4.6m), Straight, 12V (Requires 12V Power Supply)
	CBA-U46-S07ZAR	Shielded USB: Series A Connector, 7ft. (2m), Straight, BC 1.2
	CBA-U47-S15ZAR	Shielded USB: Series A Connector, 15ft. (4.6m), Straight, BC 1.2
	CBA-U48-C15PAR	Shielded USB: Series A Connector, 15ft. (4.6m), Coiled, 12V (Requires 12V Power Supply)
	CBA-U49-C15ZAR	Shielded USB: Series A Connector, 15ft. (4.6m), Coiled, BC 1.2
	CBA-U43-S07ZAR	Shielded USB: Power Plus Connector, 7ft. (2.8m), Straight, 12V
	CBA-U45-S15ZAR	Shielded USB: Power Plus Connector, 15ft. (4.6m), Straight, 12V
	CBA-UF0-S07PAR	Cable - Shielded USB: Series A Connector, 7ft. (2m), Straight, 12V (Requires 12V Power Supply), Low Temp -30C
Keyboard Wedge	CBA-K63-S07PAR	Auto-Host Detect - Keyboard Wedge: 7ft. (2m) Straight, PS/2 Power Port, 12V (Requires 12V Power Supply)
	CBA-K65-S15PAR	Auto-Host Detect - Keyboard Wedge: 15ft. (4.6m) Straight, PS/2 Power Port, 12V (Requires External Power Supply)
IBM	CBA-M65-S07ZAR	Auto-Host Detect - IBM: 468x/9x, 7ft (2m) Straight, Port 9B, 12V
	CBA-M66-S15ZAR	Auto-Host Detect - IBM: 468x/9x, 15ft (4.6m) Straight, Port 9B, 12V

Table 2-1 Related Product Line Configurations

Product	Part Number	Description
RS-232	CBA-R07-S07PAR	RS232: DB9 Female Connector, 7 ft. (2m) Straight, TxD on 2, 12V (Requires 12V Power Supply)
	CBA-RF0-S07PAR	RS232: DB9 Female Connector, 9ft. (2.8m) Coiled, TxD on 2, 12V (Requires 12V Power Supply)
	CBA-R21-S15PAR	Cable - RS232: DB9 Female Connector, 15ft. (4.6m) Straight, TxD on 2, 12V (Requires 12V Power Supply)
	CBA-RF1-C09PAR	Cable - RS232: DB9 Female Connector, 9ft. (2.8m) Coiled, TxD on 2, 12V (Requires 12V Power Supply), -30C
	CBA-RF2-C09ZAR	Cable - RS232: DB9 Female Connector, 9ft (2.8m) Coiled, Power Pin 9, -30C
	CBA-RF3-C09ZAR	Cable - RS232: DB9 Female Connector, 9ft. (2.8m) Coiled, Power Pin 9, TxD on 2, True Converter, Low Temp -30C
Power Supplies/Line Cord	PWRS-14000-148R	Power Supply: 100-240 VAC, 12VDC, 4.16A
	23844-00-00R	AC Line Cord (for use with PWRS-14000-148R)
	PWRS-14000-251R	Power Supply: 18-75VDC, 12VDC, High
	PWRS-14000-252R	Power Supply: 9-30VDC, 12VDC, Low
	50-16002-043R	Cable Adapter (for use with PWRS-14000-251 and PWRS-14000-252)



NOTE **DO NOT** use cables designed for the LS3578 and DS3578 scanners as they are not compatible with the LI3678 linear imager scanner.

Chapter Descriptions

Topics covered in this guide are as follows:

- [Chapter 1, GETTING STARTED](#) provides a product overview, unpacking instructions, and cable connection information.
- [Chapter 2, SCANNING](#) describes parts of the linear imager scanner, beeper and LED definitions, and how to use the linear imager scanner.
- [Chapter 3, MAINTENANCE, TROUBLESHOOTING & TECHNICAL SPECIFICATIONS](#) provides information on how to care for the linear imager scanner, troubleshooting, and technical specifications.
- [Chapter 4, RADIO COMMUNICATIONS](#) provides information about the modes of operation and features available for wireless communication. This chapter also includes programming bar codes to configure the linear imager scanner.
- [Chapter 5, USER PREFERENCES & MISCELLANEOUS SCANNER OPTIONS](#) provides programming bar codes for selecting user preference features for the linear imager scanner and commonly used bar codes to customize how the data is transmitted to the host device.
- [Chapter 6, USB INTERFACE](#) provides information for setting up the linear imager scanner for USB operation.
- [Chapter 7, SSI Interface](#) describes the system requirements of the Simple Serial Interface (SSI), which provides a communications link between Symbol Technologies decoders and a serial host.
- [Chapter 8, RS-232 INTERFACE](#) provides information for setting up the linear imager scanner for RS-232 operation.
- [Chapter 9, IBM INTERFACE](#) provides all information for setting up the linear imager scanner with IBM 468X/469X POS systems.
- [Chapter 10, KEYBOARD WEDGE INTERFACE](#) provides information for setting up the linear imager scanner for Keyboard Wedge operation.
- [Chapter 11, SYMBOLOGIES](#) describes all symbology features and provides the programming bar codes necessary for selecting these features for the linear imager scanner.
- [Chapter 12, 123SCAN2](#) (PC based scanner configuration tool) enables rapid and easy customized setup of scanners.
- [Chapter 13, ADVANCED DATA FORMATTING](#) (ADF) describes how to customize scanned data before transmitting to the host. This chapter also contains the bar codes for advanced data formatting.
- [Appendix A, STANDARD DEFAULT PARAMETERS](#) provides a table of all host devices and miscellaneous linear imager scanner defaults.
- [Appendix B, Country Codes](#), Country Codes provides bar codes for programming the country keyboard type for the USB keyboard (HID) device and the keyboard wedge host.
- [Appendix C, PROGRAMMING REFERENCE](#) provides a table of AIM code identifiers, ASCII character conversions, and keyboard maps.
- [Appendix D, SAMPLE BAR CODES](#) includes sample bar codes.
- [Appendix E, NUMERIC BAR CODES](#) includes the numeric bar codes to scan for parameters requiring specific numeric values.
- [Appendix F, ALPHANUMERIC BAR CODES](#) includes the bar codes representing the alphanumeric keyboard, used when setting ADF rules.
- [Appendix G, NON-PARAMETER ATTRIBUTES](#) defines non-parameter attributes, such as Model Number and Serial Number.
- [Appendix H, ASCII CHARACTER SETS](#) provides ASCII character value tables.
- [Appendix I, COMMUNICATION PROTOCOL CAPABILITIES](#) includes a list of the functionality of each cabled communication interface.

Notational Conventions

The following conventions are used in this document:

- *Italics* are used to highlight chapters and sections in this and related documents.
- **Bold** text is used to highlight parameter names and options.
- bullets (•) indicate:
 - Action items
 - Lists of alternatives
 - Lists of required steps that are not necessarily sequential
- Sequential lists (e.g., those that describe step-by-step procedures) appear as numbered lists.
- Throughout the programming bar code menus, asterisks (*) are used to denote default parameter settings.



*Indicates Default — **Baud Rate 9600** — Feature/Option



NOTE This symbol indicates something of special interest or importance to the reader. Failure to read the note will not result in physical harm to the reader, equipment or data.



CAUTION This symbol indicates that if this information is ignored, the possibility of data or material damage may occur.



WARNING! This symbol indicates that if this information is ignored the possibility that serious personal injury may occur.

Related Documents

- The *LI3608 Quick Start Guide* (p/n MN002166Axx) provides general information to help the user get started with the corded linear imager scanner. It includes basic operation instructions and start up bar codes.
- The *LI3678 Quick Start Guide* (p/n MN002323Axx) provides general information to help the user get started with the cordless linear imager scanner. It includes basic operation instructions and start up bar codes.

The latest version of this guide and all guides, are available at: www.zebra.com/support.

Service Information

If you have a problem using the equipment, contact your facility's technical or systems support. If there is a problem with the equipment, they will contact the Zebra Global Customer Support Center at: <http://www.zebra.com/support>.

When contacting Zebra support, please have the following information available:

- Serial number of the unit
- Model number or product name
- Software type and version number

Zebra responds to calls by e-mail, telephone or fax within the time limits set forth in service agreements.

If your problem cannot be solved by Zebra support, you may need to return your equipment for servicing and will be given specific directions. Zebra is not responsible for any damages incurred during shipment if the approved shipping container is not used. Shipping the units improperly can possibly void the warranty.

If you purchased your business product from a Zebra business partner, please contact that business partner for support.

CHAPTER 1 GETTING STARTED

Introduction

The LI36X8 corded and cordless linear imagers combine excellent scanning performance and advanced ergonomics to provide the best value in a lightweight scanner, ensuring comfort and ease of use for extended periods of time.

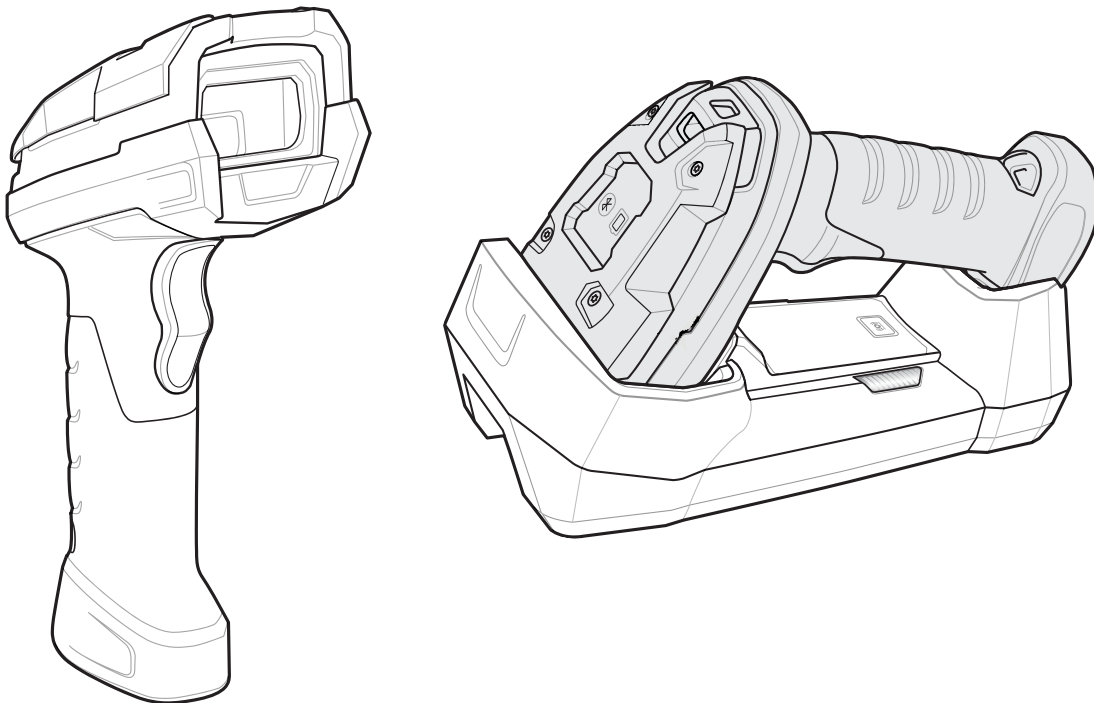

Figure 1-1 *LI36X8 Linear Imager*

Imager Scanner

Remove the scanner from packing and inspect for damage. If the scanner was damaged in transit, contact Zebra Support. See [page xxii](#) for contact information. **KEEP THE PACKING.** It is the approved shipping container and should be used if the equipment ever needs to be returned for servicing.

Configuring the Linear Imager Scanner

Use the bar codes in this manual or the 123Scan² configuration program to configure the linear imager scanner. See [Chapter 5, USER PREFERENCES & MISCELLANEOUS SCANNER OPTIONS](#) for information about programming the linear imager scanner using bar code menus. Also see each host-specific chapter to set up connection to a specific host type. See [Chapter 12, 123SCAN2](#) to configure the linear imager scanner using this configuration program.

LI3608 Parts

LI3608 Corded Linear Imager Scanner

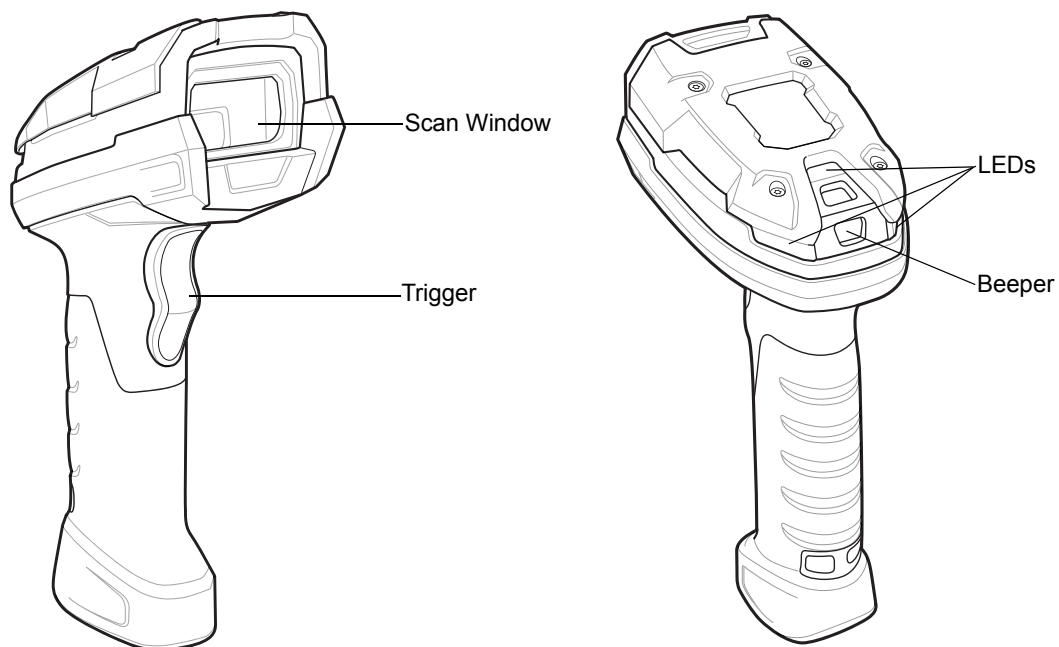

Figure 1-2 Parts of the LI3608 Corded Linear Imager Scanner

Setting Up LI3608 Corded Linear Imager Scanner

Installing the LI3608 Interface Cable

1. Insert cable fully so that the connector is flush with the scanner surface.

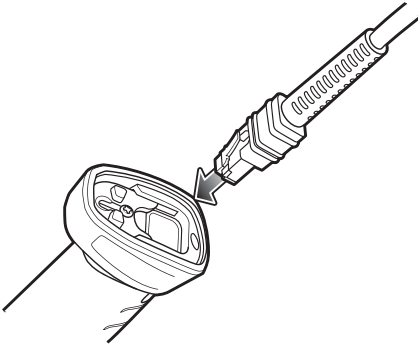

Figure 1-3 *Inserting Cable into LI3608*

2. Loosen metal lock plate screw using a PH1 driver.

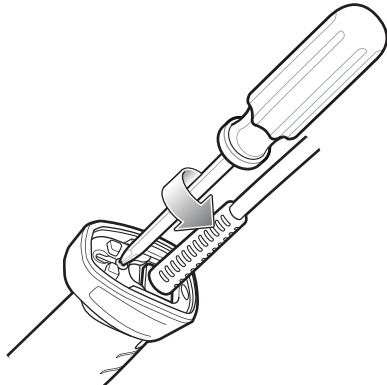

Figure 1-4 *Loosening LI3608 Lock Plate Screw*

3. Slide lock plate to fully locked position.

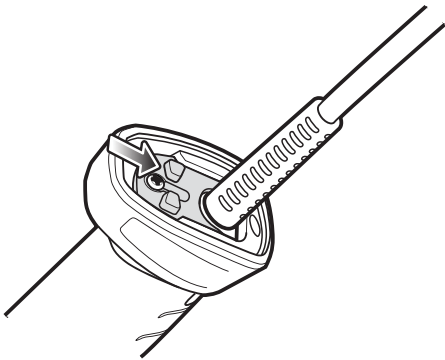

Figure 1-5 *Sliding Lock Plate into Locked Position*

4. Tighten lock plate screw using a PH1 driver (recommended torque: 5 in-lbs).

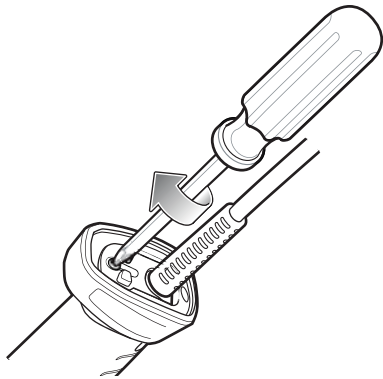

Figure 1-6 *Tightening Lock Plate*

Removing the LI3608 Interface Cable

1. Loosen lock plate screw using a PH1 driver.

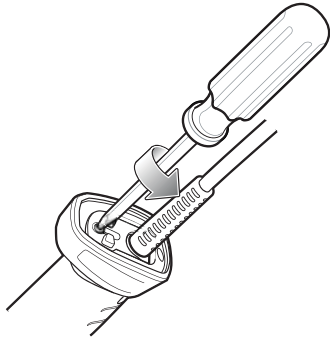

Figure 1-7 *Loosening Lock Plate*

2. Slide lock plate to fully unlocked position.

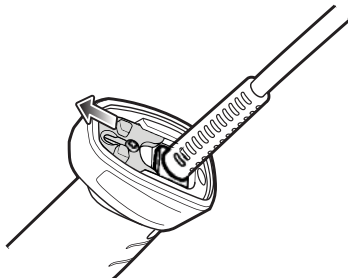

Figure 1-8 *Sliding Lock Plate into Unlocked Position*

3. Tighten lock plate to fully unlocked position.

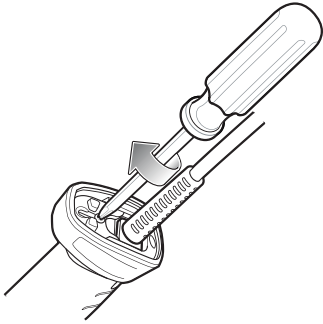

Figure 1-9 *Tightening Lock Plate into Unlocked Position*

4. Remove cable.

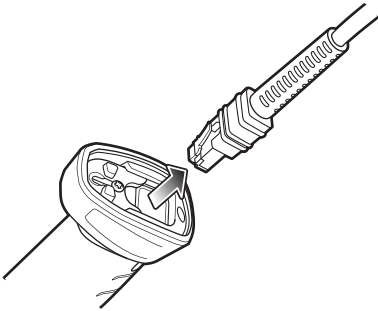

Figure 1-10 *Removing Cable from LI3608*

LI3678 Parts

LI3678 Cordless Linear Imager Scanner

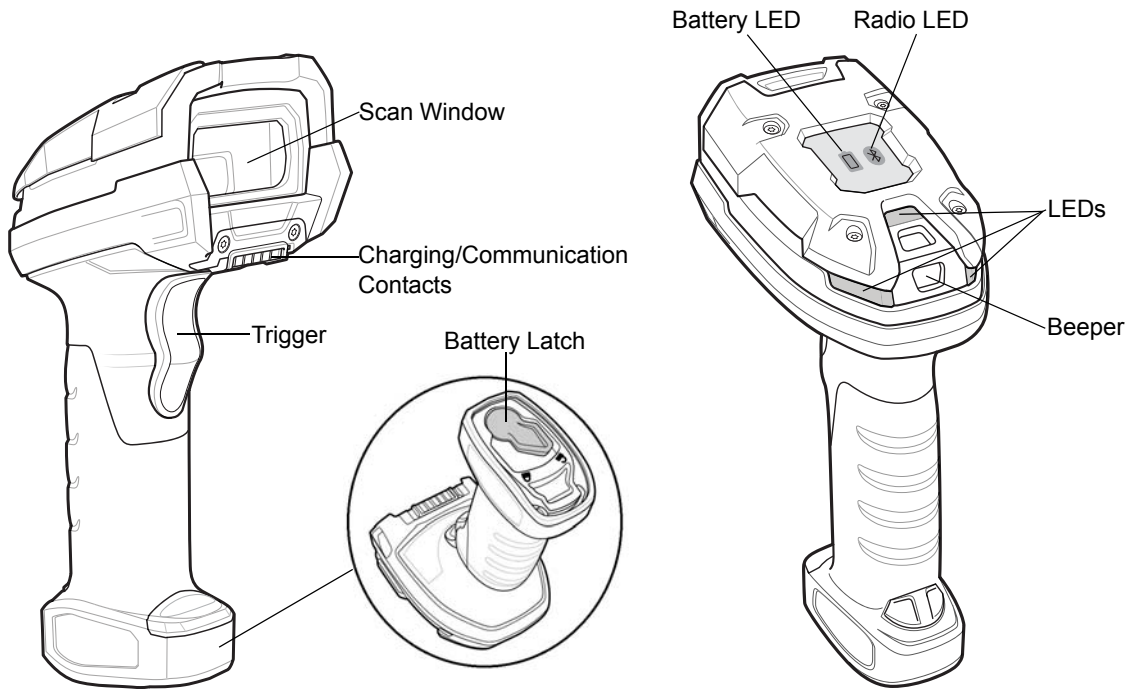

Figure 1-11 *Parts of the LI3678 Cordless Linear Imager Scanner*

The Cradle

The cradles serve as a charger, radio communication interface, and host communication interface for the LI3678 cordless linear imager scanner. There are two versions of the cradle:

- The **STB3678 cordless cradle** sits on a desktop or mounts on a wall, and charges the LI3678 cordless linear imager scanner. This cradle also provides host communication by receiving scanner data via a Bluetooth radio, and sending that data to the host through an attached cable. An external power supply or a powered host cable charges the linear imager scanner.
- The **FLB3678 cordless cradle** charges the LI3678 cordless linear imager scanner, and provides host communication by receiving scanner data via a Bluetooth radio, and sending that data to the host through an attached cable. The cradle attaches to a mounting bracket using three isolators, and the bracket then mounts on the forklift surface. A portable power supply on the forklift or a powered host cable provides power to the cradle.

DO NOT use cradles and cables designed for the LS3578 and DS3578 scanners as they are not compatible with the LI3678 linear imager scanner.

✓ **NOTE** For more information about communication between the linear imager scanner, cradle, and host, see [Chapter 4, Radio Communications](#).

For more information about mounting options and procedures, refer to the documentation included with the cradle.

Cradle Parts

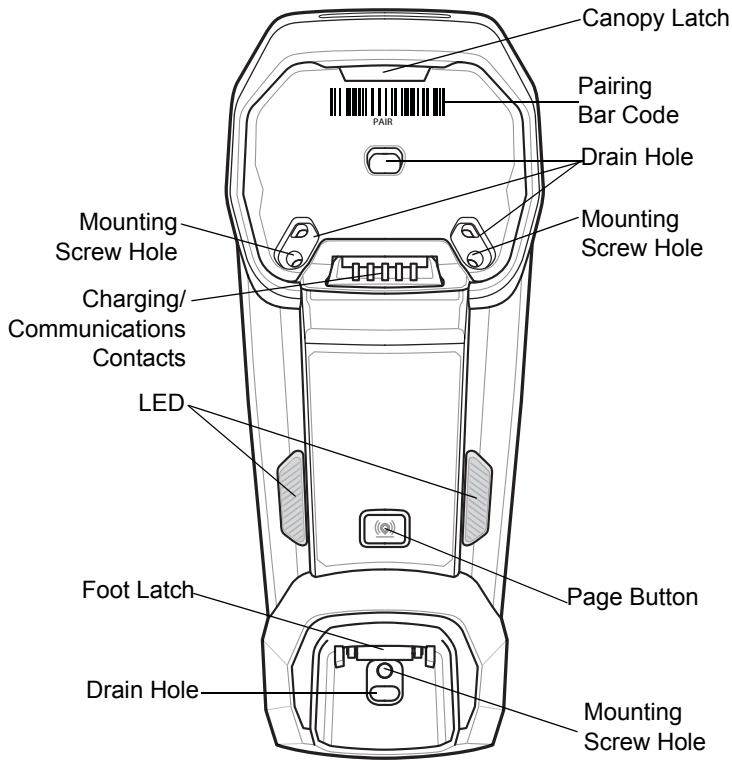

Figure 1-12 Cradle Front View

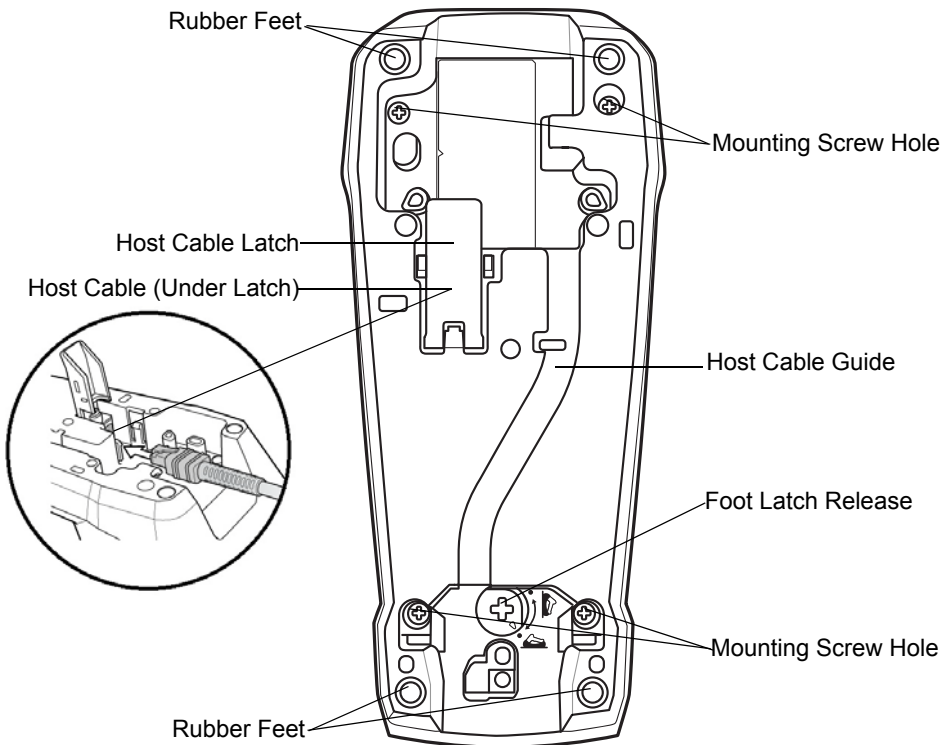

Figure 1-13 Cradle Back View

Connecting the Cradle

- ✓ **NOTE** Connect the interface cable and power supply (if necessary) in the following order to ensure proper operation of the linear imager scanner and cradle.

Connecting STB3678/FLB3678 Cradles

1. Connect the appropriate cable to the power supply and an AC power source, if necessary.
2. Insert the interface cable into the host port.
3. Lift the latch and connect the interface cable into the cradle's host port and then close the latch. See [Figure 1-14](#).
4. If applicable, thread the interface cable over the cable support hook and run the host cable into the cable groove.
5. Pair the linear imager scanner to the cradle either by inserting it in the cradle (if pair on contacts is enabled), or by scanning the pairing bar code.
6. If necessary, scan the appropriate host bar code (for non-autodetected interfaces). See the specific host chapter.

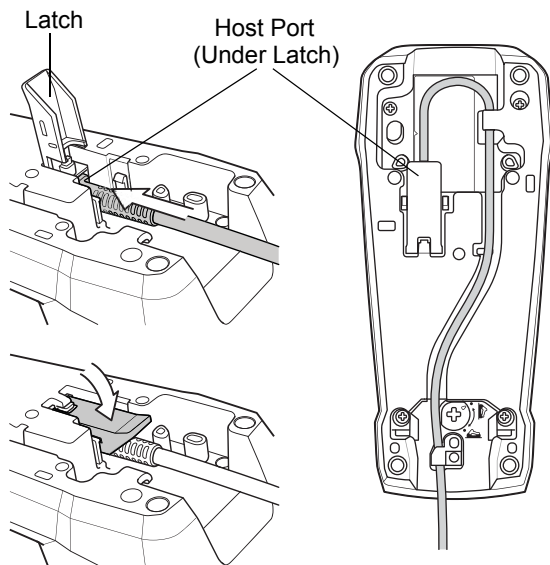

Figure 1-14 Connecting the Cables to the Cradle

- ✓ **NOTE** Always disconnect the DC power supply BEFORE disconnecting the cable to the host end or the cradle may not recognize the new host.
- ✓ **NOTE** Different cables are required for different hosts. The connectors illustrated in each host chapter are examples only. The connectors may be different from those illustrated, but the steps to connect the linear imager scanner remain the same.

Supplying Power to the Cradle

The cradle receives power from one of two sources:

- An external power supply.
- When connected to the host through an interface cable that supplies power.

The cradle detects whether the host or the external supply is supplying power. It always draws power from the external supply when available, regardless of the presence of power from a host.

✓ **NOTE** Supplying power from a USB host may take longer to charge the linear imager scanner.

Mounting the Cradle

For information on mounting the cradle, refer to the documentation included with the cradle.

For information on mounting the FLB3678 cradle to a vehicle using the Forklift Mounting Plate, refer to the Forklift Mounting Plate Template (p/n MN-002769-xx) enclosed in the mounting plate box.

Inserting the Battery

- ✓ **NOTE** Batteries are shipped in an **Off** mode and does not power the scanner. After inserting a new battery into the LI3678 linear imager scanner, you must insert the scanner into a cradle for the battery to turn **On**.
Alternatively, the battery can be placed in the four slot spare battery charger to charge and then inserted in the scanner for immediate use.

The battery resides in a chamber in the linear imager scanner handle. To insert the battery:

1. Lightly press down and slide the locking lever counterclockwise to unlock and release the battery door.
2. Open the battery door.
3. If a battery is already installed, turn the linear imager scanner upright to slide the battery out.
4. Slide the new battery into the chamber, with the rounded side toward the back and the contacts facing into the chamber.

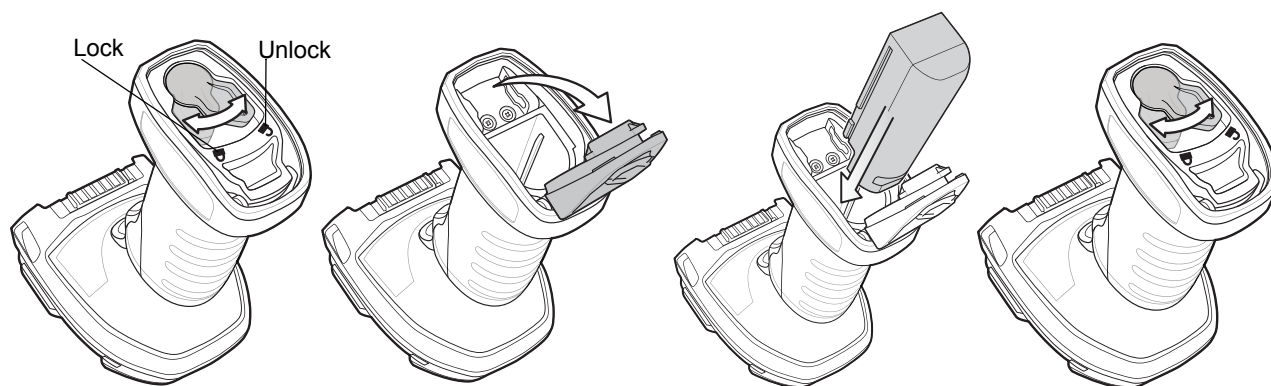

Figure 1-15 *Inserting the Battery (Add Illustration)*

5. Close the battery door.
6. Lightly press down and slide the locking lever clockwise to lock the battery door.
7. If using a brand new battery, insert the scanner into a cradle to turn the battery on.

Removing the Battery

To remove the battery:

1. Lightly press down and slide the locking lever counterclockwise to unlock the battery door.
2. Open the battery door.
3. Turn the linear imager scanner upright to slide the battery out.

Charging the LI3678 Battery

When using a new battery in the LI3678, the battery requires a charge to be enabled. Insert the battery (see [Inserting the Battery on page 1-11](#)) in the LI3678 and place the LI3678 in the STB/FLB3678 cradle (see [Inserting the Scanner in the Cradle on page 1-13](#)).

The battery begins charging when the cradle's LED indicator starts blinking amber. The LI3678's battery has completed a charge when the cradle's LED indicator is solid green. A complete charge of a fully discharged battery can take up to three hours using external power and up to ten hours using USB power over the USB interface cable.

See [Beeper and LED Definitions on page 2-1](#) for detailed LED indicator information.



CAUTION To avoid a battery temperature fault, always charge the battery in the linear imager scanner within the recommended temperature of 32° to 104° F (0° to 40° C) nominal, 41° to 95° F (5° to 35° C) ideal.

Inserting the Scanner in the Cradle

To insert the linear imager scanner in the cradle:

1. Insert the linear imager scanner into the cradle top first.
2. Push the handle until it clicks into place, engaging the contacts in the cradle and linear imager scanner.

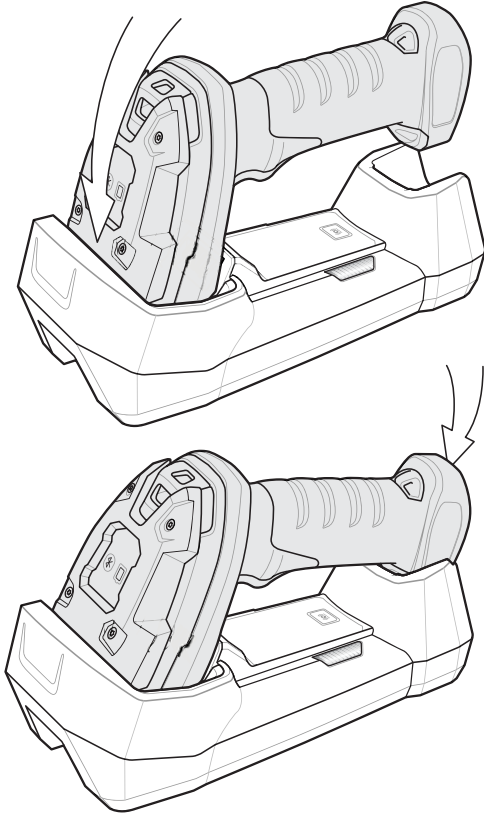

Figure 1-16 *Inserting the Scanner in the Cradle*

Sending Data to the Host Computer

The cradle receives data from the linear imager scanner via a wireless radio connection and transmits it to the host computer via the host cable. The linear imager scanner and cradle must be paired for successful wireless communication.

Pairing

Pairing registers a scanner to the cradle such that the scanner and cradle can exchange information. The STB3678 and FLB3678 operate in two modes: Point-to-Point and Multipoint-to-Point. In Point-to-Point mode, pair the linear imager scanner to the cradle either by inserting it in the cradle (if pair on contacts is enabled), or by scanning the pairing bar code. In Multipoint-to-Point mode, you can pair up to seven scanners to one cradle. To use this feature, scan the multipoint bar code in *Multipoint-to-Point Communication on page 4-19*.

To pair the linear imager scanner with the cradle, scan a pairing bar code. A high-low-high-low beep sequence followed by a low-high beep sequence indicates successful pairing and connection to the remote device. A long low, long high beep sequence indicates unsuccessful pairing.

✓ **NOTE** The pairing bar code that connects the linear imager scanner to a cradle is unique to each cradle.
Do not scan data or parameters until pairing completes.

Lost Connection to Host

If scanned data does not transmit to the cradle's host, ensure that all cables are firmly inserted and the power supply is connected to an appropriate AC outlet, if applicable. If scanned data still does not transmit to the host, reestablish a connection with the host:

1. Disconnect the power supply from the cradle.
2. Disconnect the host interface cable from the cradle.
3. Wait three seconds.
4. Reconnect the host interface cable to the cradle.
5. Reconnect the power supply to the cradle, if the host requires.
6. Reestablish pairing with the cradle by scanning the pairing bar code.

Configuring the Scanner

Use the bar codes in this manual or the 123Scan² configuration program to configure the linear imager scanner. See [Chapter 5, User Preferences](#) and each host chapter for information about programming the linear imager scanner using bar code menus. See [Chapter 11, 123Scan2](#) to configure the linear imager scanner using this configuration program. 123Scan² includes a help file.

Radio Communications

The linear imager scanner can communicate with remote devices via Bluetooth, or by pairing with a cradle. For radio communication parameters, detailed information about operational modes, Bluetooth and pairing, see [Chapter 4, Radio Communications](#).

Four Slot Spare Battery Charger

The SAC3600-4001CR four slot spare battery charger charges up to four single spare batteries. The charger can sit on a desktop or be mounted on a wall. This document provides basic instructions for charger set up and use. For best performance, fully charge the device battery before using the device for the first time. To charge the device battery, insert the battery in the cradle. The battery begins charging when the LED indicator on the battery charger starts flashing amber. A complete charge of a fully discharged battery can take up to five hours. Charge within the recommended temperature of 32° to 104° F (0° C to 40° C) nominal, 41° to 95° F (5° to 35° C) ideal.

For detailed LED definitions, see [Four Slot Battery Charger Definitions on page 2-6](#).

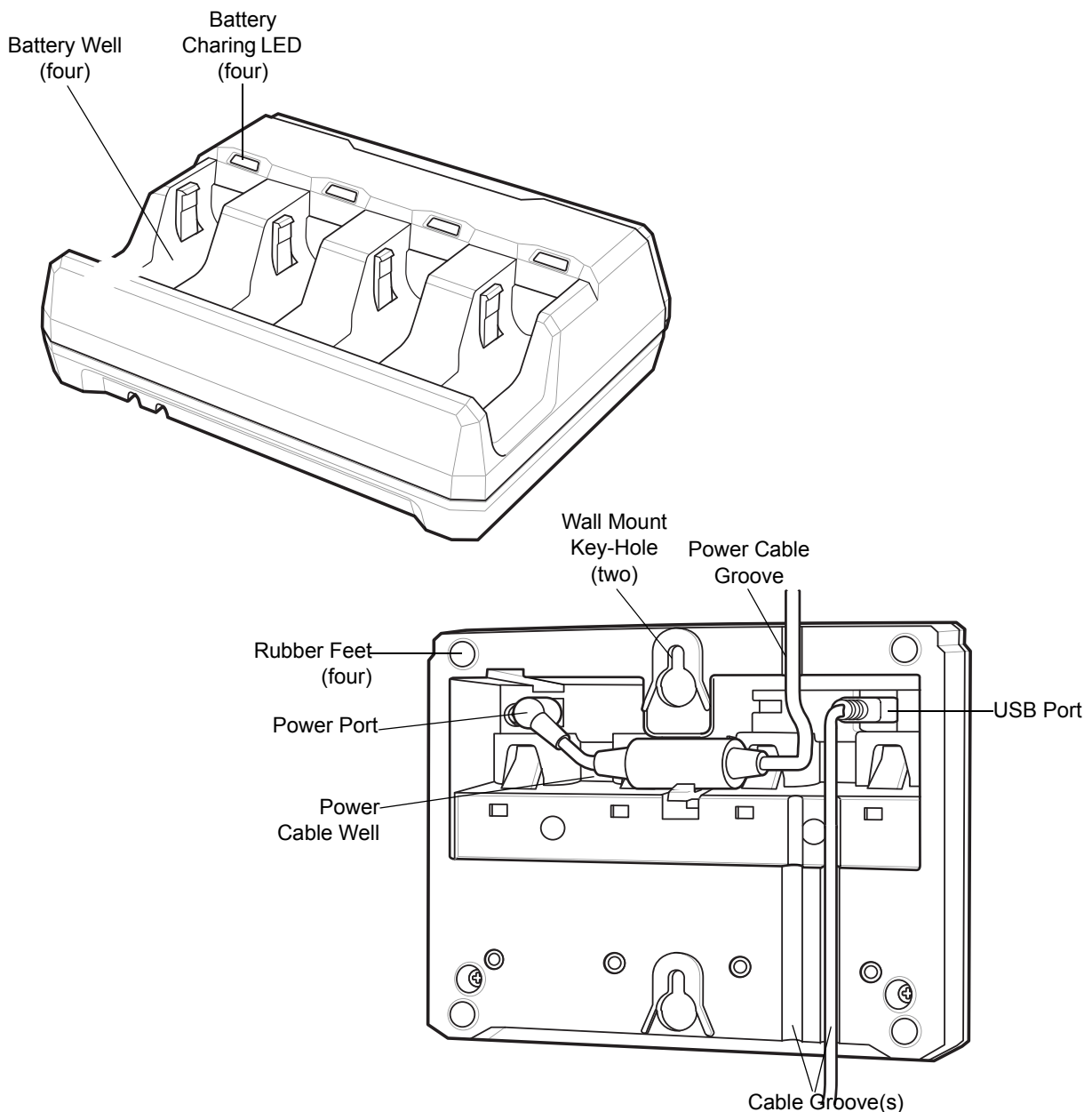

Figure 1-17 Four Slot Spare Battery Charger

Inserting Batteries

To insert batteries in the battery charger, angle the battery with the contacts facing up and slide the contact side of the battery under the LED indicator ledge as shown below. Push down on the label surface of the battery until it clicks in place, engaging the contacts in the battery charger.

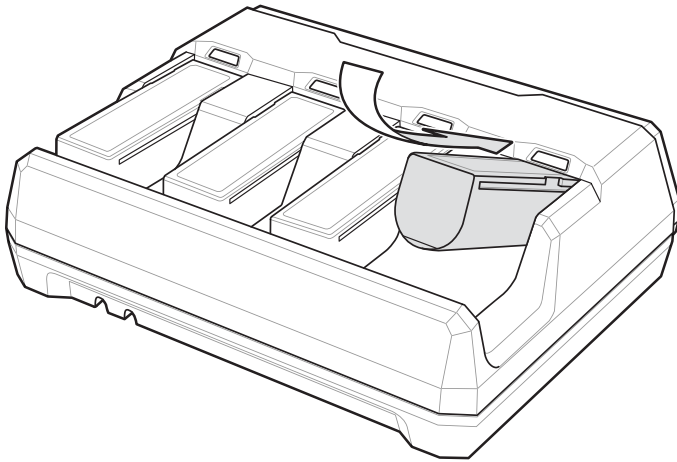

Figure 1-18 *Inserting Batteries*

Intellistand

The Intellistand is used for hands-free (presentation) scanning (see [Hands-Free Scanning on page 2-8](#)).

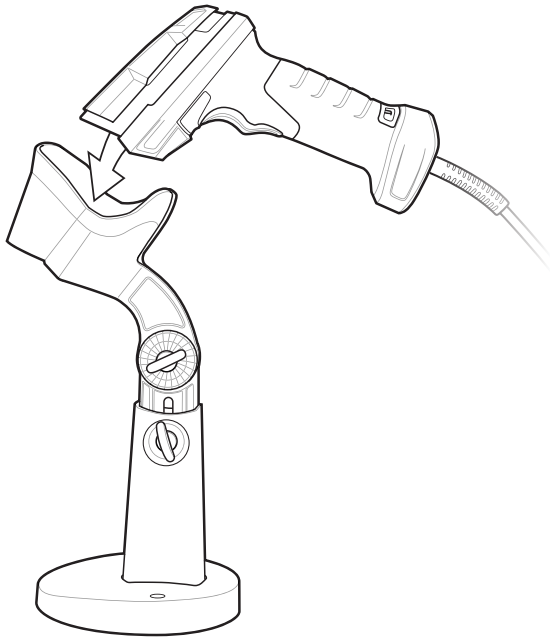

Figure 1-19 *Intellistand*

Lanyard

✓ **NOTE** Do not attach the tool balancer to the lanyard slot at the bottom of the device.

To install the optional lanyard:

1. Insert the loop on the lanyard into the slot at the bottom of the device handle.



Figure 1-20 *Insert Lanyard Loop*

2. Thread the upper portion of the lanyard into the loop.



Figure 1-21 *Thread the Loop*

3. Pull the clip through the loop over the tether point and tighten into place.

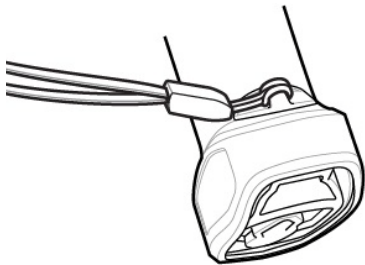

Figure 1-22 *Insert Loop into Tether Point*

CHAPTER 2 SCANNING

Introduction

This chapter provides beeper and LED definitions, scanning techniques, general instructions and tips about scanning, and decode ranges.

Beeper and LED Definitions

The linear imager scanner issues different beep sequences/patterns and an LED display to indicate status. [Table 2-1](#) defines beep sequences/patterns and LED displays which occur during both normal scanning and while programming the linear imager scanner.

Radio and Beeper LED Definitions

In addition to the System/Decode LEDs, the LI3678 cordless linear imager scanner has a Radio and Battery LED gauge (see [LI3678 Cordless Linear Imager Scanner on page 1-6](#)).

The Radio and Battery LED gauge is always active when inserted in the cradle. After the scanner is removed from the cradle, it is active for four seconds.

After the trigger is held for three seconds the Radio and Battery LED gauge remain active for four seconds after trigger release.

Table 2-1 Scanner Beeper and LED Definitions

Beeper Sequence	LED	Indication
Standard Use		
Low/medium/high beeps	Green	Power up.
Scanning		
None	Green solid	Presentation Mode on.
None	No LED; green LED is turned off	Presentation Mode off.
Medium beep (or as configured)	Green flash	A bar code was successfully decoded. (See Chapter 5-1, User Preferences Parameter Defaults for programming beeper sounds.)
Low/low/low/extra low beeps	Red	Parity error.
Four long low beeps	Red	A transmission error was detected in a scanned symbol. The data is ignored. This occurs if a unit is not properly configured. Check option setting.
Five long low beeps	Red	Conversion or format error.
High	None	A <BEL> character is received over RS-232.
Wireless Operation		
Low, high,low, high	Red	Out of batch storage memory, unable to store new bar code.
Radio Indications		
Low	System LED: None Radio LED: None	Scanner inserted into a cradle (may be disabled).
Low, high	System LED: Green Radio LED: Green (Stays on after trigger hold for 3 seconds)	Bluetooth connection established.
High, low	System LED: Red Radio LED: Red (Stays on at trigger pull)	Bluetooth disconnection event.
Long low, long high	System LED: Red Radio LED: Red (Stays on at trigger pull)	Bluetooth Page timeout; remote device is out of range/not powered.
Long low, long high, long low, long high	System LED: None Radio LED: Red (Stays on at trigger pull)	Bluetooth connection attempt was rejected by remote device.

Table 2-1 Scanner Beeper and LED Definitions (Continued)

Beeper Sequence	LED	Indication
None	System LED: None Radio LED: Red blinking	Bluetooth attempting reconnection.
Five high	System LED: None Radio LED: Red blinking	Bluetooth attempting reconnection (default is disable).
Six high	System LED: Blue (fast, fast, slow)	Paging state indication
Battery Indications		
Four short high beeps	Red (stays on)	Low battery indication (on trigger release)
	99-51% Green 21-50% Amber 0-20% Red	Battery LED status
	99-51% Green/red alternating 21-50% Amber/red alternating 0-20% Red blinking	Battery end of life
	Blue (fast, fast slow)	Paging state
Parameter Programming		
Long low/long high beeps	Red	Input error, incorrect bar code or Cancel scanned, wrong entry, incorrect bar code programming sequence; remain in program mode.
High/low beeps	Green	Keyboard parameter selected. Enter value using bar code keypad.
High/low/high/low beeps	Green	Successful program exit with change in the parameter setting.
ADF Programming		
Low/high/low beeps	None	ADF transmit error.
High/low beeps	Green	Number expected. Enter another digit. Add leading zeros to the front if necessary.
Low/low beeps	Green	Alpha expected. Enter another alphabetic character or scan the End of Message bar code.
High/high beeps	Green blinking	ADF criteria or action is expected. Enter another criteria or action or scan the Save Rule bar code.
High/low/low beeps	Green	All criteria or actions cleared for current rule, continue entering rule.

Table 2-1 Scanner Beeper and LED Definitions (Continued)

Beeper Sequence		LED	Indication
High/low/high/low beeps	Green (turns off blinking)		Rule saved. Rule entry mode exited.
Long low/long high beeps	Red		Rule error. Entry error, wrong bar code scanned, or criteria/action list is too long for a rule. Re-enter criteria or action.
Low beep	Green		Deleted last saved rule. The current rule is left intact.
Low/high/high beeps	Green		All rules deleted.
Long low/long high/long low/long high beeps	Red		Out of rule memory. Erase some existing rules, then try to save rule again.
Long low/long high/long low beeps	Green (turns off blinking)		Cancel rule entry. Rule entry mode exited because of an error or the user asked to exit rule entry.
Code 39 Buffering			
High/low beeps	None		New Code 39 data was entered into the buffer.
Three long high beeps	None		Code 39 buffer is full.
High/low/high beeps	None		The Code 39 buffer was erased/cleared.
Low/high/low beeps	None		The Code 39 buffer was erased or there was an attempt to clear or transmit an empty buffer.
Low/high beeps	None		A successful transmission of buffered data.
Host Specific			
USB only			
Four high beeps	None		Linear imager scanner has not completed initialization. Wait several seconds and scan again.
RS-232 only			
High/high/high/low beeps	Red		RS-232 receive error.
High beep	None		A <BEL> character is received when Beep on <BEL> is enabled (Point-to-Point mode only).

Cradle LED Definitions

Table 2-2 *Cradle LED Indications*

LED	Indication
Standard Use	
Green (stays on)	Power Up
Radio Indications	
Green (off then on)	Bluetooth connection established
Blue	Page button
Battery Indications	
Amber	Pre-charging
Amber blinking	Charging
Green (stays on)	Fully charged
Amber fast blinking	Charging Error
Battery End of Life Indications	
Red blinking	Charging
Red (stays on)	Fully charged
Red fast blinking	Charging error
Maintenance Indications	
Red (stays on; all four LEDs)	Enter boot loader
Red blinking (all four LEDs)	Firmware installation

Four Slot Battery Charger Definitions

Table 2-3 *Four Slot Battery Charger LED Definitions*

LED	Indication
Standard Use	
Red, amber, green, off (all four LEDs)	Power Up
Off	Idle
Battery Indications	
Amber blinking	Charging
Green (stays on)	Fully charged
Amber fast blinking	Charing error
Battery End of Life Indications	
Red blinking	Charging
Red (stays on)	Fully charged
Red fast blinking	Charging error
Maintenance Indications	
Red (stays on; all four LEDs)	Enter bootloader
Red blinking (all four LEDs)	Firmware installation

Scanning

To program the linear imager scanner, see the appropriate host chapter, and [Chapter 11, SYMBOLOGIES](#). (In addition to the parameters included in the chapters mentioned, user preference and miscellaneous linear imager scanner option parameters are also available in this guide.)

Aiming

When scanning, the linear imager scanner projects a red illumination which allows positioning the bar code within its field of view. See [Decode Ranges on page 2-9](#) for the proper distance to achieve between the linear imager scanner and a bar code.

Hand-Held Scanning

To scan:

1. Ensure all connections are secure (see appropriate host chapter).
2. Aim the linear imager scanner at the bar code.
3. Press the trigger.

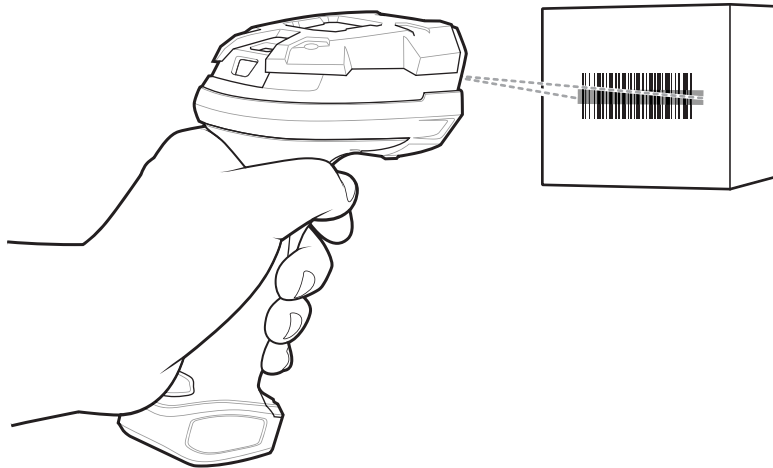

Figure 2-1 Scanning

4. Upon successful decode, the linear imager scanner beeps and the LED displays a single green flash. (For more information about beeper and LED definitions, see [Table 2-1](#).)

Hands-Free Scanning

The optional Intellistand adds greater flexibility to scanning operation. When you place the linear imager scanner in the stand's "cup", the scanner's built-in sensor places the scanner in hands-free (presentation) mode. When you remove the linear imager scanner from the stand it operates in its normal hand-held mode.

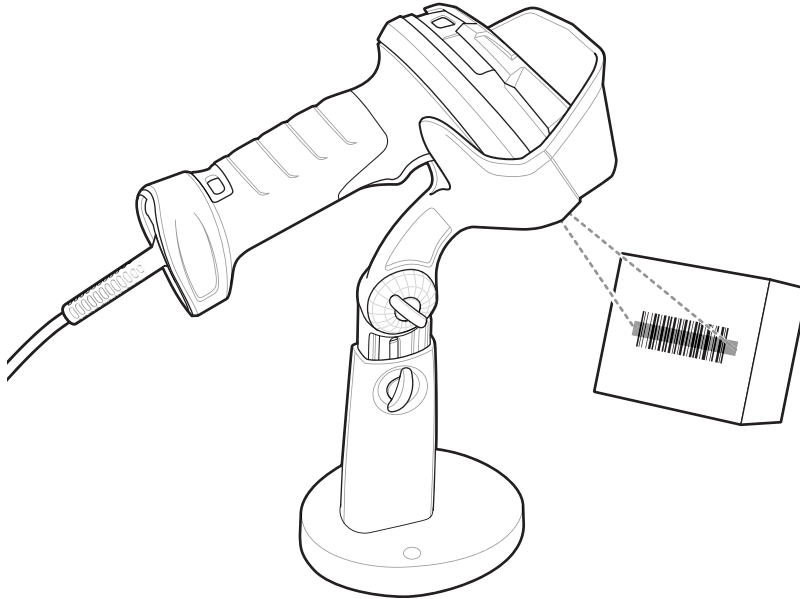

Figure 2-2 *Hands-Free (Presentation) Scanning*

To operate the linear imager scanner in the Intellistand:

1. Ensure all connections are secure (see appropriate host chapter).
2. Insert the linear imager scanner in the Intellistand by placing the front of the linear imager scanner into the stand's "cup" (see [Table 2-2](#)).
3. Use the Intellistand's adjustment knobs to adjust the height and angle of the linear imager scanner.
4. Center the symbol in the aiming pattern.
5. Upon successful decode, the linear imager beeps and the green LED momentarily turns off. (For more information about beeper and LED definitions, see [Table 2-1](#).)

Decode Ranges

Ranges are calculated on Code 39 except where noted.

Table 2-4 Decode Ranges

Symbol Density	Bar Code Type	Typical Working Ranges	
		Near	Far
4 mil	Code 39	4.0 in. (10.2 cm)	10.0 in. (25.4 cm)
5 mil	Code 39	3.0 in. (7.6 cm)	13.0 in. (33.0 cm)
7.5 mil	Code 39	1.5 in. (3.8 cm)	19.0 in. (48.3 cm)
13 mil	100% UPC-A	1.0 in. (2.5 cm)	31.0 in. (78.7 cm)
20 mil	Code 39	1.0 in. (2.5 cm)	42.0 in. (106.7 cm)
26 mil	200% UPC-A	3.0 in. (7.6 cm)	55.0 in. (140.0 cm)
100 mil (paper)			> 20 ft. (> 6 m)



NOTE When reading high density bar codes, users should attempt to read them slightly farther away from the scanner. Typically a 3 mil Code39 bar code begins reading at 5 in. (12.8cm).

CHAPTER 3 MAINTENANCE, TROUBLESHOOTING & TECHNICAL SPECIFICATIONS

Introduction

This chapter provides suggested linear imager scanner maintenance, troubleshooting, technical specifications, and signal descriptions (pinouts).

Maintenance

Known Harmful Ingredients

The following chemicals are known to damage the plastics on Zebra scanners and should not come in contact with the device:

- Acetone
- Ammonia solutions
- Aqueous or alcoholic alkaline solutions
- Aromatic and chlorinated hydrocarbons
- Benzene
- Bleach
- Carbolic acid
- Compounds of amines or ammonia
- Ethanolamine
- Ethers
- Ketones
- TB-lysoform
- Toluene
- Trichloroethylene.

Approved Cleaning Agents

The following cleaning agents are approved for cleaning the plastics on Zebra scanners:

- Pre-moistened wipes
- Isopropyl alcohol 70%

Tolerable Industrial Fluids and Chemicals

✓ **NOTE** Not all fluid variants and brands have been tested.

The following industrial fluids and chemicals were evaluated and deemed tolerable for the LI36X8:

- Motor/Engine Oil
- Automatic Transmission Fluid (ATF)
- Continuously Variable Transmission Fluid (CVT)
- Industrial De-Greaser (Engine Brite Heavy Duty)
- Brake Fluid (DOT4)

✓ **NOTE** It is recommended to clean the outside of the scanner daily using the [Approved Cleaning Agents on page 3-2](#) if the scanner comes in contact with the above fluids & chemicals frequently.

Cleaning the Linear Imager Scanner



CAUTION Avoid using cleansers directly on the linear imager scanner battery door and contacts. Use a cotton swab moistened with alcohol to gently clean contacts.

Routinely cleaning the exit window is required. A dirty window may affect scanning accuracy. Do not allow any abrasive material to touch the window.

To clean the scanner:

1. Dampen a soft cloth with one of the approved cleaning agents listed above or use pre-moistened wipes.
2. Gently wipe all surfaces, including the front, back, sides, top and bottom. Never apply liquid directly to the scanner. Be careful not to let liquid pool around the scanner window, trigger, cable connector or any other area on the device.
3. Be sure to clean the trigger and in between the trigger and the housing (use a cotton-tipped applicator to reach tight or inaccessible areas).
4. Do not spray water or other cleaning liquids directly into the exit window.
5. Wipe the scanner exit window with a lens tissue or other material suitable for cleaning optical material such as eyeglasses.
6. Immediately dry the scanner window after cleaning with a soft non-abrasive cloth to prevent streaking.
7. Allow the unit to air dry before use.
8. Scanner connectors:
 - a. Dip the cotton portion of a cotton-tipped applicator in isopropyl alcohol.
 - b. Rub the cotton portion of the cotton-tipped applicator back-and-forth across the connector on the Zebra scanner at least 3 times. Do not leave any cotton residue on the connector.
 - c. Use the cotton-tipped applicator dipped in alcohol to remove any grease and dirt near the connector area.
 - d. Use a dry cotton tipped applicator and rub the cotton portion of the cotton-tipped applicator back-and-forth across the connectors at least 3 times. Do not leave any cotton residue on the connectors.

Battery Maintenance

When batteries are stored over a year, battery cell manufacturers advise that some irreversible deterioration in overall battery quality may occur. To minimize this loss, they recommend storing batteries half charged in a dry, cool place between 41° and 77°F (5° and 25°C), the cooler the better, and removed from the equipment to prevent the loss of capacity. Batteries should be charged to half capacity at least once a year. In order to charge a battery to half capacity, take a fully discharged battery and charge it for 2 hours. If an electrolyte leakage is observed, avoid any contact with the affected area and properly dispose of the battery.

Troubleshooting



NOTE See [Dump Scanner Parameters on page 5-37](#) to debug scanner problems by creating a text file with all the scanner's asset tracking information, and parameter settings.

If after performing the possible solutions in [Table 3-1](#) the symbol still does not scan, contact the distributor or contact the Zebra Global Customer Support Center. See [page xxii](#) for contact information.

Table 3-1 *Troubleshooting*

Problem	Possible Causes	Possible Solutions
Battery		
Linear imager scanner displays solid red LED longer than X seconds when placed in cradle.	Battery may require pre-charge due to excess discharge.	Wait for the red LED to turn green indicating that the scanner has begun normal charging. Recommend allowing battery to fully recharge.
Linear imager scanner emits four high beeps on trigger release.	Low battery.	Place linear imager scanner in cradle to charge the battery.
Beeper Indications		
Linear imager scanner emits low/high/low beeps.	ADF transmit error.	See Chapter 13, ADVANCED DATA FORMATTING for information about ADF programming.
	Invalid ADF rule is detected.	See Chapter 13, ADVANCED DATA FORMATTING for information about ADF programming.
	The Code 39 buffer was erased or there was an attempt to clear or transmit an empty buffer.	Normal when scanning the Code 39 Buffering Clear Buffer bar code or upon attempt to transmit an empty Code 39 buffer.
Linear imager scanner emits a low/high/low/high beep sequence while it is being programmed.	Out of ADF parameter storage space.	Erase all rules and re-program with shorter rules.
Linear imager scanner emits long low/long high beeps.	Input error, incorrect bar code or Cancel bar code was scanned.	Scan the correct numeric bar codes within range for the parameter programmed.
	Page timeout; remote device is out of range/not powered.	Move the linear imager scanner back into range of the remote device; try to re-connect; check remote device configuration.

Table 3-1 Troubleshooting (Continued)

Problem	Possible Causes	Possible Solutions
Linear imager scanner emits long low/long high/long low/long high beeps.	Out of host parameter storage space.	Scan Default Parameters on page 5-5 .
	Out of memory for ADF rules.	Reduce the number of ADF rules or the number of steps in the ADF rules.
	Connection attempt was rejected by remote device.	Free up remote device resources.
Linear imager scanner emits high/high/high/low beeps.	RS-232 receive error.	Normal during host reset. Otherwise, set the linear imager scanner's RS-232 parity to match the host setting.
Linear imager scanner emits high/low beeps.	The linear imager scanner is buffering Code 39 data. Or Keyboard parameter selected.	Normal. Or Enter value using bar code keypad.
	Bluetooth disconnection event.	Move the linear imager scanner back into range of the remote device. In Master (SPP) mode, re-pair the linear imager scanner and cradle by scanning the PAIR bar code on the cradle; check cradle power. In Slave (SPP/HID mode, reestablish connection between the linear imager scanner and remote device from the remote device side.
Linear imager scanner emits three long high beeps.	Code 39 buffer is full.	Scan the Code 39 bar code without a leading space or scan Do Not Buffer Code 39 on Code 39 Buffering - Scan & Store on page 11-34 to transmit stored Code 29 data.
Linear imager scanner emits four long low beeps.	A transmission error was detected in a scanned symbol. The data is ignored.	This occurs if a unit is not properly configured. Check option setting.
	The linear imager scanner is either: - Out of Range - Not paired to the cradle - Not connected to a remote Bluetooth device.	Move the linear imager scanner back into range of the remote device. Or Scan the PAIR bar code on the cradle.
	Acknowledgment that transmitted data was not received by the cradle.	Data may have been received by the host. Check the host system for receipt of transmitted data. If data was not received by the host, re-scan the bar code.

Table 3-1 Troubleshooting (Continued)

Problem	Possible Causes	Possible Solutions
Linear imager scanner emits five low long beeps.	Conversion or format error.	Check ADF rules for the host.
Linear imager scanner emits a power-up beep after scanning a USB device type.	Communication with the bus was not established.	Communication with the bus must be established before the linear imager scanner can operate at the highest power level.
Power-up beep occurs more than once.	The host PC performed a cold boot.	The USB bus may put the linear imager scanner in a state where power to the linear imager scanner is cycled on and off more than once. This is normal and usually happens when the host PC cold boots.
Decoding Bar Codes		
Linear imager scanner projects red illumination, but does not decode the bar code.	Linear imager scanner is not programmed for the correct bar code type.	Program the linear imager scanner to read that type of bar code. See Chapter 11, SYMBOLOGIES .
	Bar code symbol is unreadable.	Scan test symbols of the same bar code type to determine if the bar code is defaced.
	Distance between linear imager scanner and bar code is incorrect.	Move the linear imager scanner closer to or further from the bar code. See Decode Ranges on page 2-9 .
	The scan line is not crossing every bar and space of the symbol.	Move the symbol until the scan line is within the acceptable aiming pattern. See Figure 2-1 on page 2-7 .
Linear imager scanner decodes bar code, but does not transmit the data to the host.	Linear imager scanner is not programmed for the correct host type.	Scan the appropriate host type programming bar code. See the chapter corresponding to the host type.
	Interface cable is loose.	Ensure all cable connections are secure.
	Cradle is not programmed for the correct host interface.	Check linear imager scanner host parameters or edit options.
	Linear imager scanner not paired to host-connected interface.	Pair the linear imager scanner to the cradle by scanning the PAIR bar code on the cradle.
	Cradle has lost connection to host.	<i>In this exact order:</i> disconnect power supply; disconnect host cable; wait three seconds; reconnect host cable; reconnect power supply; reestablish pairing.

Table 3-1 *Troubleshooting (Continued)*

Problem	Possible Causes	Possible Solutions
Linear imager scanner emits five long low beep after a bar code is decoded.	Conversion or format error was detected. The linear imager scanner's conversion parameters are not properly configured.	Ensure the linear imager scanner's conversion parameters are properly configured.
	Conversion or format error was detected. An ADF rule was set up with characters that can't be sent for the host selected.	Change the ADF rule, or change to a host that can support the ADF rule.
	Conversion or format error was detected. A bar code was scanned with characters that can't be sent for that host.	Change the bar code, or change to a host that can support the bar code.
Host Displays		
Host displays scanned data incorrectly.	Linear imager scanner is not programmed to work with the host.	Ensure the proper host is selected. Scan the appropriate host type programming bar code.
		For RS-232, ensure the linear imager scanner's communication parameters match the host's settings.
		For a USB HID keyboard or Keyboard Wedge configuration, ensure the system is programmed for the correct keyboard type and language, and turn off the CAPS LOCK key.
		Ensure editing options (e.g., ADF, UPC-E to UPC-A Conversion) are properly programmed.
		Check the linear imager scanner's host type parameters or editing options.
Trigger		
Nothing happens when the trigger is pulled.	No power to the linear imager scanner.	Check the system power. If the configuration requires a power supply, re-connect the power supply. Check the battery. Ensure that end cap to battery chamber is secured.
	Interface/power cables are loose.	Check for loose cable connections and re-connect cables.

Table 3-1 *Troubleshooting (Continued)*

Problem	Possible Causes	Possible Solutions
	Linear imager scanner is disabled.	For Synapse or IBM-468x mode, enable the linear imager scanner via the host interface.
The green illumination does not appear when the trigger is pulled.	No power to the linear imager scanner	Check battery and charging contacts; ensure that the battery door is secured; ensure all power and cable connections to the cradle are secure.
	Interface/power cables are loose.	Check battery and charging contacts; ensure power and cable connections to cradle are secure.

Technical Specifications

Table 3-2 *Technical Specifications of LI36X8 Linear Imager Scanner*

Item	Description
Physical Characteristics	
Dimensions	
Corded	7.3 in. H x 3.0 in. W x 5.2 in. D (18.5 cm H x 7.7 cm W x 13.2 cm D)
Cordless	7.3 in. H x 3.0 in. W x 5.6 in. D (18.5 cm H x 7.7 cm W x 14.3 cm D)
Weight	
Corded (without cable)	Approximately 10.1 oz./287 g
Cordless (with battery)	Approximately 13.6 oz./386.5 g
Color	Industrial Green
Input Voltage Range	Host powered: min 4.5 - max 5.5 External power supply: min 11.4 - max 12.6
Current	Operating current (5.0V): 170 mA Standby current (5.0V): 40 mA
Performance Characteristics	
Light Source	617 nm
Scan Speed	547 scans per second
Scan Pattern	Single bright aiming line
Scan Angle	Horizontal 35°
Scans Per Charge (LI3678 Only)	Up to 140,000
Roll Tolerance	± 45°
Pitch Tolerance	± 65°
Skew Tolerance	± 65°
Nominal Working Distance	(See Decode Ranges on page 2-9)
Decode Capability	UPC/EAN: UPC-A, UPC-E, UPC-E1, EAN-8/JAN 8, EAN-13/JAN 13, Bookland EAN, Bookland ISBN Format, UCC Coupon Extended Code, ISSN EAN Code 128 including GS1-128, ISBT 128, ISBT Concatenation, Code 39 including Trioptic Code 39, Convert Code 39 to Code 32 (Italian Pharmacy Code), Code 39 Full ASCII Conversion Code 93, Code 11, Matrix 2 of 5, Interleaved 2 of 5 (ITF), Discrete 2 of 5 (DTF), Codabar (NW - 7), MSI, Chinese 2 of 5, IATA, Inverse 1 D (except all GS1 DataBars), GS1 DataBar including GS1 DataBar-14, GS1 DataBar Limited, GS1 DataBar Expanded
Motion tolerance	25 in./ 63.5 cm per second

Table 3-2 *Technical Specifications of LI36X8 Linear Imager Scanner (Continued)*

Item	Description
User Environment	
Operating Temperature	
Corded	-22° F to 122°F (-30° C to 50° C)
Cordless	-4° F to 122°F (-20° C to 50° C)
Storage Temperature	-40° F to 158° F (-40° to 70° C)
Humidity	5 % to 95 % RH, non-condensing
Drop Specifications	
Corded/Cordless	Withstands multiple 8 ft / 2.4 m drops to concrete at room temperature.
Corded	Withstands multiple 6.5 ft / 2.0 m drops to concrete at -30° C to 50° C
Cordless	Withstands multiple 6.5 ft / 2.0 m drops to concrete at -20° C to 50° C
Ambient Light Immunity	0 to 10,037 Foot Candles 0 to 108,000 Lux
Environmental Sealing	IP65 and IP67
# of Cradle Insertions	250,000+ insertions
ESD	25kV Air Discharge and 10kV Contact Discharge
Utilities	123Scan ² , Remote Scanner Management (RSM), Scanner Management Services (SMS), Zebra Scanner SDK
Accessories	
Intellistand (corded only)	Optional stand that can automatically place the scanner into presentation (hands-free) mode

Table 3-3 *Technical Specifications - STB3678 and FLB3678 Cradles*

Item	Description
Power Requirements Host Powered: External Power Supply:	Min 4.5 - Max 5.5 Min 11.4 - Max 12.6
Typical Current Draw	
Not Charging:	80 mA @ 5V 30 mA @ 12V
Full Charging Mode:	1200 mA @ 5V (BC1.2), 475 mA (non-BC1.2) 700 mA @ 12V
Safe Charging Mode:	400 mA @ 5V 200 mA @ 12V
Interfaces Supported	Keyboard Wedge, RS-232, USB, IBM 468X/469X
Operating Temperature	-4° to 122° F (-20° to 50° C)
Storage Temperature	-40° to 158° F (-40° to 70° C)
Charging Temperature	32° to 104° F (0° to 40° C) nominal, 41° to 95° F (5° to 35° C) ideal
Humidity	5% to 95% (non-condensing)
ESD	25 kV air discharge 10 kV contact discharge
Weight STB3678 FLB3678 Mounting Plate (for use with FLB)	12 oz (340 grams) 13.7 oz (390 grams) 8.5 oz (240 grams)
Dimensions: STB3678 FLB3678	W 9.98 x L 22.94 x H 8.26 cm (W 99.8 x L 229.4 x H 82.6 mm) W 10.94 x L 27.69 x H 10.7 cm (W 109.4 x L 276.9 x H 107 mm) with Mounting Plate
Radio	Bluetooth, Up to 100 meters/300 ft. in open air range/environment Serial Port & HID Profiles 2.402 to 2.480 GHz Adaptive Frequency Hopping (co-existence with 802.11 wireless networks) Basic Data Rate: 720 kbps Enhanced Data Rate (EDR) for image transfer.
Electrical Safety	Certified Pending to UL1950, CSA C22.2 No.950. EN60950/IC950
Input Transient Protection	IEC 1000-4-(2,3,4,5,6,11)
EMI	FCC Part 15 Class B, ICES-003 Class B European Union EMC Directive, Australian SMA, Taiwan EMC, Japan VCCI/MITI/Dentori

Signal Descriptions

The signal descriptions in [Table 3-4](#) apply to the connector on the linear imager scanner and are for reference only.

Table 3-4 *Signal Pin-outs*

Pin	IBM	RS-232	Keyboard Wedge	USB
1	Cable ID	Cable ID	Cable ID	Cable ID
2	Power (+5V)	Power (+5V)	Power (+5V)	Power (+5V)
3	Ground	Ground	Ground	Ground
4	IBM_OUT	TxD	KeyClock	Reserved
5	IBM_IN	RxD	TermData	D +
6	IBM_T/R	RTS	KeyData	Reserved
7	Reserved	CTS	TermClock	D -
8	Reserved	Reserved	Reserved	Reserved
9	Reserved	Reserved	Reserved	Reserved
10	Power (+12V)	Power (+12V)	Power (+12V)	Power (+12V)

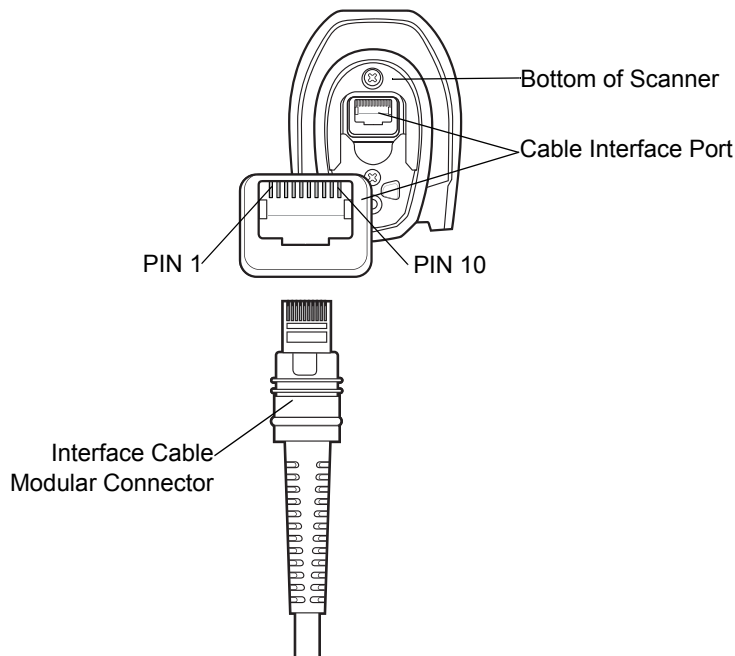

Figure 3-1 *Corded Scanner Cable Pinouts*

CHAPTER 4 RADIO COMMUNICATIONS

Introduction

This chapter provides information about the modes of operation and features available for wireless communication between the LI3678 cordless linear imager scanners, cradles and hosts. The chapter also includes the parameters necessary to configure the linear imager scanner.

The linear imager scanner ships with the settings shown in the [Radio Communication Default Table on page 4-2](#) (also see [Appendix A, STANDARD DEFAULT PARAMETERS](#) for all host device and miscellaneous linear imager scanner defaults). If the default values suit requirements, programming is not necessary.

To set feature values, scan a single bar code or a short bar code sequence. The settings are stored in non-volatile memory and are preserved even when the linear imager scanner is powered down.

If not using a Synapse or USB cable with the cradle, select a host type (see each host chapter for specific host information) after the power-up beeps sound. This is only necessary upon the first power-up when connected to a new host.

To return all features to default values, scan a default bar code in [Default Parameters on page 5-5](#). Throughout the programming bar code menus, default values are indicated with asterisks (*).



* Indicates Default * **Enable Pair on Contacts** Feature/Option

Scanning Sequence Examples

In most cases, scan one bar code to set a specific parameter value.

Errors While Scanning

Unless otherwise specified, to correct an error during a scanning sequence, just re-scan the correct parameter.

Radio Communications Parameter Defaults

[Table 4-1](#) lists the defaults for radio communication parameters. If you wish to change any option, scan the appropriate bar code(s) provided in the Radio Communications Parameters section beginning on [page 4-4](#).

✓ **NOTE** See [Appendix A, STANDARD DEFAULT PARAMETERS](#) for all user preferences, hosts, symbologies, and miscellaneous default parameters.

In this guide, the parameter numbers listed are the same as the attribute numbers for these parameters.

NOTE See [Appendix B, Country Codes](#) for Country Keyboard Types (Country Codes).

Table 4-1 Radio Communication Default Table

Parameter	Parameter Number	Default	Page Number
Radio Communications Host Types		Cradle Host	4-4
BT Friendly Name	607	n/a	4-9
Discoverable Mode	610	General	4-10
Wi-Fi Friendly Mode	1299	Disable	4-11
Wi-Fi Friendly Channel Exclusion		Use All Channels	4-13
Radio Output Power	1324	High	4-14
Link Supervision Timeout	1698	.5 Seconds	4-15
Bluetooth Radio State	1354	On	4-16
Apple iOS Virtual Keyboard Toggle	1114	Disable	4-17
HID Keyboard Keystroke Delay		No Delay (0 msec)	4-18
CAPS Lock Override		Disable	4-18
Ignore Unknown Characters		Enable	4-19
Emulate Keypad		Enable	4-19
Fast HID Keyboard	1361	Enable	4-20
Quick Keypad Emulation	1362	Enable	4-21
Keyboard FN1 Substitution		Disable	4-21
Function Key Mapping		Disable	4-22
Simulated Caps Lock		Disable	4-22
Convert Case		No Case Conversion	4-23
Beep on Reconnect Attempt	559	Disable	4-25
Reconnect Attempt Interval	558	30 sec	4-26
Auto-reconnect	604	Auto-reconnect Immediately	4-27

Table 4-1 Radio Communication Default Table (Continued)

Parameter	Parameter Number	Default	Page Number
Beep on Insertion	288	Enable	4-28
Beep on <BEL>	150	Enable	4-29
Modes of Operation (Point-to-Point/Multipoint-to-Point)	538	Point-to-Point	4-30
Parameter Broadcast (Cradle Host Only)	148	Enable	4-31
Pairing Modes	542	Unlocked	4-32
Pairing on Contacts	545	Enable	4-33
Toggle Pairing	1322	Disable	4-34
Connection Maintenance Interval		15 Minutes	4-36
Batch Mode	544	Normal (Do Not Batch Data)	4-39
Persistent Batch Storage	1399	Disable	4-41
Page Button	746	Enable	4-42
Page Options Page Mode Page State Timeout	1364 1365	Page Simple	4-43
Classic and/or Low Energy Bluetooth	1355	Classic and Low Energy	4-45
PIN Code (Set and Store)	552	12345	4-46
Variable Pin Code	608	Static (Default PIN code is 12345)	4-47
Bluetooth Security Levels	1393	Low	4-48

Wireless Beeper Definitions

When the linear imager scanner scans the pairing bar code it issues various beep sequences indicating successful or unsuccessful operations. See [Beeper and LED Definitions on page 2-1](#) for all beep sequences and LED displays including those which occur during pairing operations.

Radio Communications Host Types

To set up the linear imager scanner for communication with a cradle, or to use standard Bluetooth profiles, scan the appropriate host type bar code below.

Classic Bluetooth vs. Low Energy Bluetooth

Bluetooth Low Energy (LE) Bluetooth has a better Wi-Fi coexistence, as advertising and connection is done outside of the Wi-Fi channels 1, 6, and 11 (2402, 2426, 2480 MHz). Due to its lower data rate, Bluetooth Low Energy is up to seven times slower than Classic Bluetooth (0.27 Mbps versus 0.7-2.1 Mbps). Data intensive activities such as firmware updates, can take significantly longer over Bluetooth Low Energy.

Cradle

Select this host type when connecting a scanner to a communication cradle.

✓ **NOTE** The scanner automatically tries to reconnect to a remote device when a disconnection occurs that is due to the radio losing communication. See [Auto-reconnect Feature on page 4-24](#) for more information.

To establish a connection (for initial setup only):

1. Scan the **Cradle-Classic Bluetooth** or **Cradle-Low Energy** bar code.
2. Scan the pairing bar code on the cradle or place the scanner in the cradle.

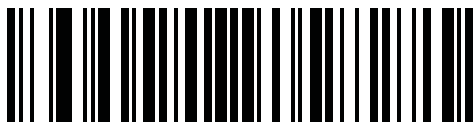

Cradle-Classic

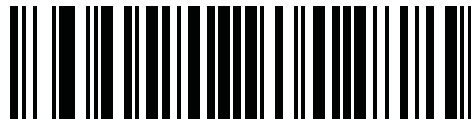

Cradle-Low Energy

Keyboard Emulation (HID)

Select this host type when connecting to a PC/tablet/phone emulating a Bluetooth keyboard.

- **HID BT Classic** - Enables the host and scanner to communicate using HID (Human Interface Device) Keyboard Profile over Bluetooth Classic radio. The scanner(s) are discoverable (Slave mode) and also support Master mode.

To establish a connection (initial setup only):

- Scan the **HID BT Classic** bar code.
 - Connect to master or slave mode.
 - Master mode - scan a pairing bar code with the MAC address of the host device.
 - Slave mode - from the host, discover Bluetooth devices and select your scanner from the discovered device list.
- **HID BT LE (Discoverable)** - Enables the host to establish a HID (Human Interface Device) Keyboard Profile connection with the scanner over Bluetooth Low Energy radio. The scanner is discoverable (Slave mode).

To establish a connection (initial setup only):

- Scan the **HID BT LE (Discoverable)** bar code.
- From the host, discover Bluetooth devices.
- Select your scanner from your discovered device list.

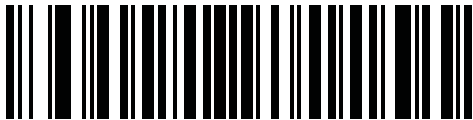

HID Bluetooth Classic

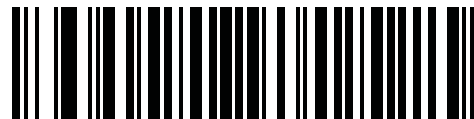

HID BT LE (Discoverable)

Simple Serial Interface (SSI)

Select this host type when connecting to a Zebra mobile device or PC/tablet/phone running a Zebra scanner SDK app.

- **SSI BT Classic (Non-discoverable)** - Enables communication with Zebra Mobile Computers. It enables the scanner(s) to establish a connection with the host over Classic Bluetooth radio. The scanner is NOT in discoverable (Master mode).

To establish a connection (initial setup only):

- Scan the **SSI BT Classic (Non-discoverable)** bar code.
- Scan a pairing bar code with the host device's MAC address.

✓ **NOTE** Additional steps may be necessary depending on host's Bluetooth stack.

- **SSI BT Classic (Discoverable)** - Enables communication with Scanner SDK for Android generated apps. It enables the host to establish a connection with the scanner over Classic Bluetooth radio. The scanner is in discoverable (Slave mode).

To establish a connection (initial setup only):

- Scan the **SSI BT Classic (Discoverable)** bar code.
- From the host, discover Bluetooth devices.
- Select your scanner from your discovered device list.

- **SSI BT LE** - Enables communication with Scanner SDK for iOS generated apps. It enables the host to establish a connection with the scanner over Bluetooth Low Energy radio. The scanner is in discoverable (Slave mode).

To establish a connection (initial setup only):

- Scan the **SSI BT LE** bar code.
- From the host's application, select your scanner from the discovered device list.

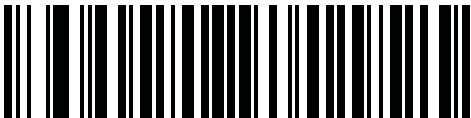

SSI BT Classic (Non-Discoverable)

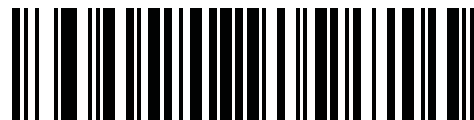

SSI BT Classic (Discoverable)

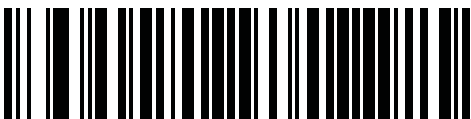

SSI BT LE

Serial Port Profile (SPP)

Select this host type when connecting to a PC/tablet/phone using a Bluetooth serial connection.

- **SPP BT Classic (Non-Discoverable)** - Enables the scanner to establish a Serial Port Profile (SPP) connection with the host over Classic Bluetooth radio. The scanner is NOT discoverable (Master mode). To establish a connection (initial setup only):
 - i. Scan the **SPP BT Classic (Non-discoverable)** bar code.
 - ii. Scan a pairing bar code with the MAC address of the host device.
- **SPP BT Classic (Discoverable)** - Enables the host to establish a Serial Port Profile (SPP) connection with the scanner over Classic Bluetooth radio. The scanner is discoverable (Slave mode). To establish a connection (initial setup only):
 - i. Scan the **SPP BT Classic (Discoverable)** bar code.
 - ii. From the host, discover Bluetooth devices.
 - iii. Select your scanner from the discovered device list.

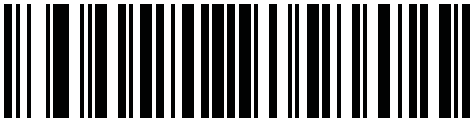

SPP BT Classic (Non-Discoverable)

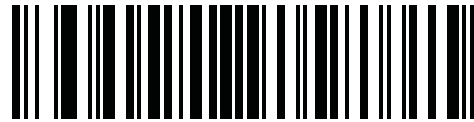

SPP BT Classic (Discoverable)

Bluetooth Technology Profile Support

With Bluetooth Technology Profile Support, the cradle is not required for wireless communication. The linear imager scanner communicates directly to the host using Bluetooth technology. The linear imager scanner supports the standard Bluetooth Serial Port Profile (SPP) and HID Profiles which enable the linear imager scanner to communicate with other Bluetooth devices that support these profiles.

- SPP - the linear imager scanner connects to the PC/host via Bluetooth and performs like there's a serial connection.
- HID - the linear imager scanner connects to the PC/host via Bluetooth and performs like a keyboard.

Master/Slave Set Up

The linear imager scanner can be set up as a Master or Slave. When the linear imager scanner is set up as a Slave, it is discoverable and connectable to other devices. When the linear imager scanner is set up as a Master, the Bluetooth address of the remote device to which a connection is requested is required. A pairing bar code with the remote device address must be created and scanned to attempt a connection to the remote device. See the [Pairing Bar Code Format on page 4-34](#) for information about creating a pairing bar code.

Master

When the linear imager scanner is set up as a Master (SPP), it initiates the radio connection to a slave device. Initiating the connection is done by scanning a pairing bar code for the remote device (see [Pairing Bar Code Format on page 4-34](#)).

Slave

When the linear imager scanner is set up as a Slave device (SPP), the linear imager scanner accepts an incoming connection request from a remote device.

- ✓ **NOTE** The number of linear imager scanners is dependent on the host's capability.

Bluetooth Friendly Name

Parameter # 607

You can set a meaningful name for the linear imager scanner that appears in the application during device discovery. The default name is the linear imager scanner name followed by its serial number, e.g., **LI3678123456789ABCDEF**. Scanning Set Defaults reverts the linear imager scanner to this name; use custom defaults to maintain the user-programmed name through a Set Defaults operation.

To set a new Bluetooth Friendly Name, scan the following bar code, then scan up to 23 characters from [Appendix F, ALPHANUMERIC BAR CODES](#). If the name contains less than 23 characters, scan [End of Message on page F-7](#) after entering the name.



NOTE If your application allows you to set a device name, this takes precedence over the Bluetooth Friendly Name.



Bluetooth Friendly Name

Discoverable Mode

Parameter # 610

Select a discoverable mode based on the device initiating discovery:

- Select **General Discoverable Mode** when initiating connection from a PC.
- Select **Limited Discoverable Mode** when initiating connection from a mobile device (e.g., Q), and the device does not appear in General Discoverable Mode. Note that it can take longer to discover the device in this mode.

The device remains in Limited Discoverable Mode for 30 seconds, and green LEDs flash while in this mode. It is then non-discoverable. To re-active Limited Discoverable Mode, press the trigger.

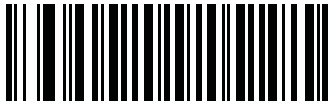

* **General Discoverable Mode**
(0)



Limited Discoverable Mode
(1)

Wi-Fi Friendly Mode

Parameter # 1299

Scanners configured for Wi-Fi friendly mode behave as follows:

- The scanner remains in sniff mode, and exits sniff mode only during firmware update.
- If any Wi-Fi channel is excluded from the hopping sequence, AFH turns off.
- Scanner (and cradle) avoid the selected Wi-Fi channels after establishing connection.

Notes

- If using this feature, configure all scanners in the area for Wi-Fi friendly mode.
- By default, no Wi-Fi channels are excluded.
- Since Bluetooth requires a minimum of 20 channels when Wi-Fi channels 1, 6, and 11 are excluded, a smaller number of channels are cut from the hopping sequence.
- Updating Wi-Fi friendly settings before Bluetooth connection is recommended.

Scan a bar code below to enable or disable **Wi-Fi Friendly Mode**, then see [Wi-Fi Channel Exclusion](#) to select any channels to exclude.

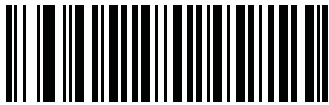

*** Disable Wi-Fi Friendly Mode
(0)**



**Enable Wi-Fi Friendly Mode
(1)**

Wi-Fi Channel Exclusion

Select the channels to exclude:

- **Exclude Wi-Fi channel 1:** Bluetooth channels 0-21 are excluded from hopping sequence (2402-2423 MHz).
- **Exclude Wi-Fi channel 6:** Bluetooth channels 25-46 are excluded from hopping sequence (2427 - 2448 MHz).
- **Exclude Wi-Fi channel 11:** Bluetooth channels 50-71 are excluded from hopping sequence (2452 - 2473 MHz).
- **Exclude Wi-Fi channel 1, 6 and 11:** Bluetooth channels 2-19 (2404-2421 MHz), 26-45 (2428 - 2447 MHz) and 51-69 (2453 - 2471 MHz) are excluded from hopping sequence.
- **Exclude Wi-Fi channels 1 and 6:** Bluetooth channels 0-21 (2402-2423 MHz) and 25-46 (2427 - 2448 MHz) are excluded from hopping sequence.
- **Exclude Wi-Fi channels 1 and 11:** Bluetooth channels 0-21 (2402-2423 MHz) and 50-71 (2452 - 2473 MHz) are excluded from hopping sequence.
- **Exclude Wi-Fi channel 6 and 11:** Bluetooth channels 25-46 (2427 - 2448 MHz) and 50-71 (2452 - 2473 MHz) are excluded from hopping sequence.

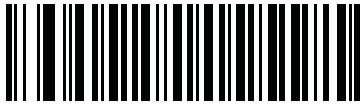

* Use All Channels (Standard AFH)

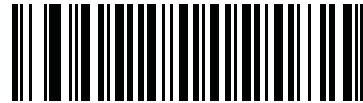

Exclude Wi-Fi Channel 1

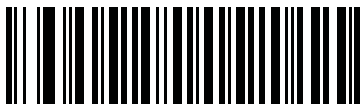

Exclude Wi-Fi Channel 6



Exclude Wi-Fi Channel 11

Wi-Fi Friendly Channel Exclusion (continued)



Exclude Wi-Fi Channels 1, 6, and 11

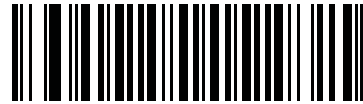

Exclude Wi-Fi Channels 1 and 6

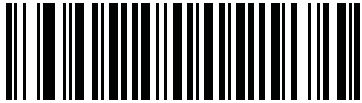

Exclude Wi-Fi Channels 1 and 11

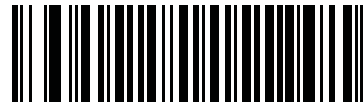

Exclude Wi-Fi Channels 6 and 11

Radio Output Power

Parameter # 1324

The cordless linear imager scanner uses a Class 1 Bluetooth radio. Optionally, reduce the radio's output power to restrict the transmission range and reduce the effect of the radio on neighboring wireless systems.

✓ **NOTE** Bluetooth stack resets on power change and the device loses connection.

Scan a bar code to select the desired power mode.

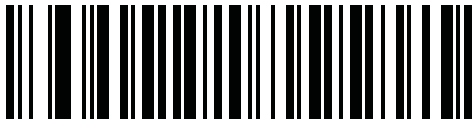

*** High Power Setting
(0)**

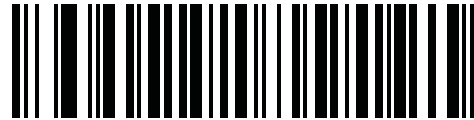

**Medium
(1)**

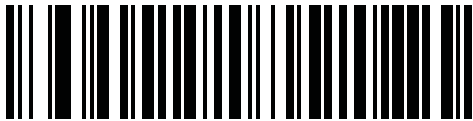

**Low Power Setting
(2)**

Link Supervision Timeout

Parameter # 1698

Link supervision timeout controls how quickly the scanner senses that the Bluetooth radio lost connection to the remote device. A lower value helps prevent data loss at the edge of the operating range while a larger value helps prevent disconnects due to the remote device not responding in time. If you are experiencing occasional disconnects and the scanner is able to reconnect, increase the link supervision timeout value.

✓ **NOTE** The scanner only controls Link Supervision Timeout in Master mode.

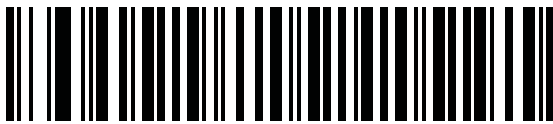

* .5 Seconds
(800)

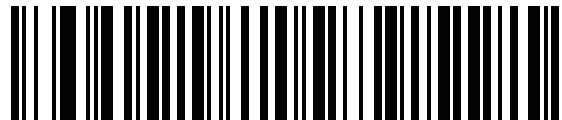

2 Seconds
(3200)

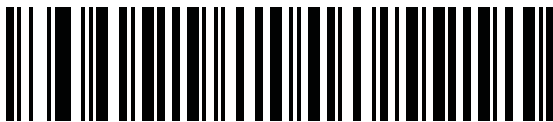

5 Seconds
(8000)

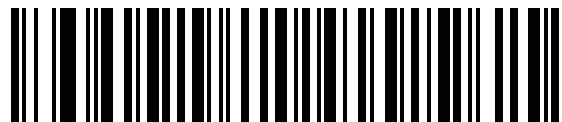

10 Seconds
(16000)

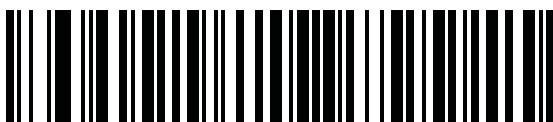

20 Seconds
(32000)

Bluetooth Radio State

Parameter # 1354

✓ **NOTE** The only option to turn the radio on after it is turned off on the cradle, is through the host.

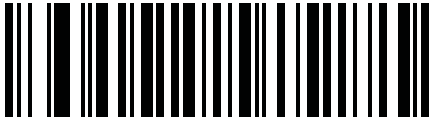

Bluetooth Radio Off
(0)

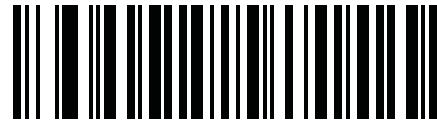

*** Bluetooth Radio On**
(1)

HID Host Parameters

The linear imager scanner supports virtual keyboard emulation for the Apple iOS, and keyboard emulation over the Bluetooth HID profile. In this mode the linear imager scanner can interact with Bluetooth enabled hosts supporting the HID profile as a Bluetooth keyboard. Scanned data is transmitted to the host as keystrokes.

Apple iOS Virtual Keyboard Toggle

Parameter # 1114

This option works with Apple iOS devices to enable the opening and closing of the iOS virtual keyboard by double-pressing the trigger.

✓ **NOTE** When this feature is enabled, the linear imager scanner may be incompatible with non-Apple iOS devices.



* **Disable**
(0)

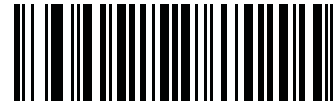

Enable
(1)

HID Keyboard Keystroke Delay

This parameter sets the delay, in milliseconds, between emulated keystrokes. Scan a bar code below to increase the delay when the HID host requires a slower transmission of data.



*** No Delay (0 msec)**



Medium Delay (20 msec)



Long Delay (40 msec)

HID CAPS Lock Override

When enabled, the case of the data is preserved regardless of the state of the caps lock key. This setting is always enabled for the “Japanese, Windows (ASCII)” keyboard type and can not be disabled.



*** Do Not Override Caps Lock Key
(Disable)**



**Override Caps Lock Key
(Enable)**

HID Ignore Unknown Characters

This option applies only to the HID Keyboard Emulation device and IBM device. Unknown characters are characters the host does not recognize. When Send Bar Codes With Unknown Characters is selected, all bar code data is sent except for unknown characters, and no error beeps sound. When Do Not Send Bar Codes With Unknown Characters is selected, bar code data is sent up to the first unknown character, then the linear imager scanner issues an error beep.



*** Send Bar Codes With Unknown Characters
(Enable)**



**Do Not Send Bar Codes With Unknown Characters
(Disable)**

Emulate Keypad

When enabled, all characters are sent as ASCII sequences over the numeric keypad. For example, ASCII A is sent as "ALT make" 0 6 5 "ALT Break."



Disable Keypad Emulation



*** Enable Keypad Emulation**

Fast HID Keyboard

Parameter # 1361

This option transmits Bluetooth HID keyboard data at a faster rate.

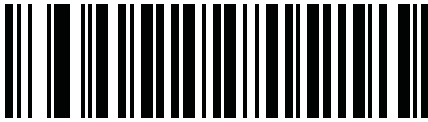

Fast HID Disable

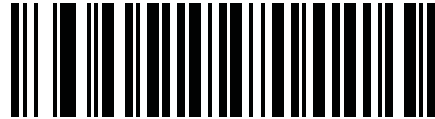

*** Fast HID Enable**

Quick Keypad Emulation

Parameter # 1362

- ✓ **NOTE** This option applies only to a HID Keyboard Emulation Device which has **Emulate Keypad** enabled (see [Emulate Keypad on page 4-19](#)).

This parameter enables a quicker method of keypad emulation where ASCII sequences are only sent for ASCII characters not found on the keyboard.

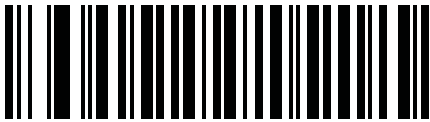

Quick Keypad Emulation Disable

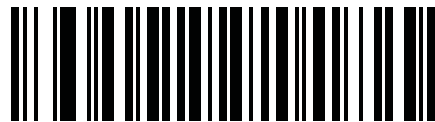

* Quick Keypad Emulation Enable

HID Keyboard FN1 Substitution

When enabled, this parameter allows replacement of any FN1 character in an EAN128 bar code with a Key Category and value chosen by the user. See [FN1 Substitution Values on page 5-34](#) to set the Key Category and Key Value.



* Disable Keyboard FN1 Substitution



Enable Keyboard FN1 Substitution

HID Function Key Mapping

ASCII values under 32 are normally sent as control-key sequences. When this parameter is enabled, the keys in bold are sent in place of the standard key mapping (see [Appendix H, ASCII CHARACTER SETS](#)).

Table entries that do not have a bold entry remain the same whether or not this parameter is enabled.



*** Disable Function Key Mapping**



Enable Function Key Mapping

Simulated Caps Lock

When enabled, the linear imager scanner inverts upper and lower case characters on the linear imager scanner bar code as if the Caps Lock state is enabled on the keyboard. This inversion is done regardless of the current state of the keyboard Caps Lock state.



*** Disable Simulated Caps Lock**



Enable Simulated Caps Lock

Convert Case

When enabled, the linear imager scanner converts all bar code data to the selected case.



*** No Case Conversion**



Convert All to Upper Case



Convert All to LowerCase

Auto-reconnect Feature

When in SPP Master, Cradle Host Mode, and Bluetooth Keyboard Emulation, the linear imager scanner automatically tries to reconnect to a remote device when a disconnection occurs that is due to the radio losing communication. This can happen if the linear imager scanner goes out of range with the remote device, or if the remote device powers down. The linear imager scanner tries to reconnect for the period of time specified by the Reconnect Attempt Interval setting. During that time the green LED continues to blink.

If the auto-reconnect process fails due to page time-outs, the linear imager scanner sounds a page timeout beep (long low/long high) and enters low power mode. The auto-reconnect process can be re-started by pulling the linear imager scanner trigger.

If the auto-reconnect process fails because the remote device rejects the connection attempt, the linear imager scanner sounds a connection reject beep sequence (see [Wireless Beeper Definitions on page 4-4](#)) and deletes the remote pairing address. If this happens, a pairing bar code must be scanned to attempt a new connection to the remote device.

- ✓ **NOTE** If a bar code is scanned while the auto-reconnect sequence is in process, a transmission error beep sequence sounds and the data is not transmitted to the host. After a connection is reestablished, normal scanning operation returns. For error beep sequence definitions, see [Beeper and LED Definitions on page 2-1](#).

The linear imager scanner has memory available for storing a remote Bluetooth address for each Master mode (SPP, Cradle). When switching between these modes, the linear imager scanner automatically tries to reconnect to the last device it was connected to in that mode.

- ✓ **NOTE** Switching between Bluetooth host types by scanning a host type bar code ([page 4-4](#)) causes the radio to be reset. Scanning is disabled during this time. It takes several seconds for the linear imager scanner to re-initialize the radio at which time scanning is enabled.

Reconnect Attempt Beep Feedback

Parameter # 559

When a linear imager scanner disconnects as it goes out of range, it immediately attempts to reconnect. While the linear imager scanner attempts to reconnect, the red LED continues to blink. If the auto-reconnect process fails, the linear imager scanner emits a page timeout beep (long low/long high) and stops blinking the LED. The process can be restarted by pulling the trigger.

The Beep on Reconnect Attempt feature is disabled by default. When enabled, the linear imager scanner emits 5 short high beeps every 5 seconds while the re-connection attempt is in progress. Scan a bar code below to enable or disable Beep on Reconnect Attempt.



*** Disable Beep on Reconnect Attempt
(0)**



**Enable Beep on Reconnect Attempt
(1)**

Reconnect Attempt Interval

Parameter # 558

When a linear imager scanner disconnects as it goes out of range, it immediately attempts to reconnect for the default time interval of 30 seconds. This time interval can be changed to one of the options below.

To set the Reconnect Attempt Interval, scan one of the bar codes below.



*** Attempt to Reconnect for 30 Seconds
(6)**



**Attempt to Reconnect for 1 Minute
(12)**



**Attempt to Reconnect for 5 Minutes
(60)**



**Attempt to Reconnect for 30 Minutes
(360)**



**Attempt to Reconnect for 1 Hour
(720)**



**Attempt to Reconnect Indefinitely
(0)**

Auto-reconnect

Parameter # 604

In Bluetooth Keyboard Emulation (HID) mode, SPP Master, and Cradle Host Mode, select a re-connect option for when the linear imager scanner loses its connection with a remote device:

- **Auto-reconnect on Bar Code Data:** The linear imager scanner auto-reconnects when you scan a bar code. With this option, a delay can occur when transmitting the first characters. The linear imager scanner sounds a decode beep upon bar code scan, followed by a connection, a page timeout, a rejection beep, or a transmission error beep. Select this option to optimize battery life on the linear imager scanner and mobile device. Note that auto-reconnect does not occur on rejection and cable unplug commands.
- **Auto-reconnect Immediately:** When the linear imager scanner loses connection, it attempts to reconnect. If a page timeout occurs, the linear imager scanner attempts reconnect on a trigger pull. Select this option if the linear imager scanner's battery life is not an issue and you do not want a delay to occur when the first bar code is transmitted. Note that auto-reconnect does not occur on rejection and cable unplug commands.
- **Disable Auto-reconnect:** When the linear imager scanner loses connection, you must re-establish it manually.

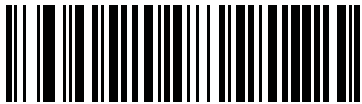

Auto-reconnect on Bar Code Data
(1)

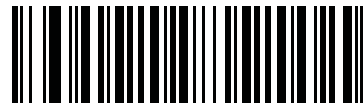

* Auto-reconnect Immediately
(2)

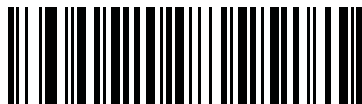

Disable Auto-reconnect
(0)

Out of Range Indicator

An out of range indicator can be set by scanning [Enable Beep on Reconnect Attempt \(1\) on page 4-25](#) and extending the time using the [Reconnect Attempt Interval on page 4-26](#).

For example, with Beep on Reconnect Attempt disabled while the linear imager scanner loses radio connection when it is taken out of range, the linear imager scanner attempts to reconnect silently during the time interval set by scanning a Reconnect Attempt Interval.

When Beep on Reconnect Attempt is enabled, the linear imager scanner emits 5 high beeps every 5 seconds while the re-connection attempt is in progress. If the Reconnect Attempt Interval is adjusted to a longer period of time, such as 30 minutes, the linear imager scanner emits 5 high beeps every 5 seconds for 30 minutes providing an out of range indicator.

Beep on Insertion

Parameter # 288

When a linear imager scanner is inserted into a cradle and detects power, it emits a short low beep. This feature is enabled by default.

To enable or disable beeping on insertion, scan the appropriate bar code below.



*** Enable Beep on Insertion
(00h)**



**Disable Beep on Insertion
(01h)**

Beep on <BEL>

Parameter # 150

When this parameter is enabled, the scanner issues a beep when a <BEL> character is detected on the serial line. <BEL> is issued to gain a user's attention to an illegal entry or other important events.



NOTE This parameter only applies to SPP (Serial Port Profile). The RS-232 interface on the cradle has this feature when Beep on <BEL> is enabled.
In Multipoint-to-Point mode only, the scanner that beeped last sounds Beep on <Bel>.

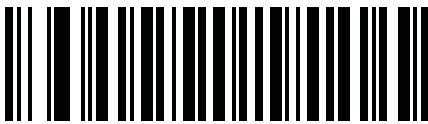

* Beep on <BEL> Enable
(1)

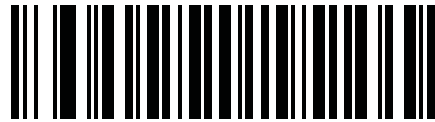

Beep on <BEL> Disable
(0)

Linear Imager Scanner(s) To Cradle Support

Modes of Operation

Parameter # 538

The charging cradle with radio supports two radio communication modes of operation, allowing the linear imager scanner to communicate wirelessly:

- Point-to-Point
- Multipoint-to-Point.

Point-to-Point Communication

In Point-to-Point communication mode, the cradle allows one linear imager scanner to connect to it at a time. In this mode, the linear imager scanner is paired to the cradle either by insertion into the cradle (if pairing on contacts is enabled, [page 4-33](#)), or by scanning the PAIR bar code. Communication can be locked, unlocked (default), or in a lock override state (see [Pairing Modes on page 4-32](#)). In locked mode, locking intervals must be set by scanning a connection maintenance interval bar code beginning on [page 4-35](#).

To activate this mode of operation, scan Point-to-Point.

Multipoint-to-Point Communication

Multipoint-to-Point communication mode allows up to seven linear imager scanners to pair to one cradle.

To activate this mode, the first linear imager scanner connected to the cradle must scan the Multipoint-to-Point bar code. This mode allows a parameter broadcast ([page 4-31](#)) feature that forwards parameter bar code settings to all connected linear imager scanners. In this mode, programming one linear imager scanner applies the settings to all connected linear imager scanners.

To select Point-to-Point or Multipoint-to-Point mode, scan the appropriate bar code.



Multipoint-to-Point Mode
(1)



*** Point-to-Point Mode**
(0)

Parameter Broadcast (Cradle Host Only)

Parameter # 148

- ✓ **NOTE** When Parameter Broadcast is disabled on one scanner in the piconet, **Parameter Broadcast** is disabled on all scanners in the piconet.

When in multipoint-to-point mode, enable Parameter Broadcast to broadcast all parameter bar codes scanned to all other linear imager scanners in the piconet. If disabled, parameter bar codes are processed by the individual linear imager scanner only, and the linear imager scanner ignores parameters broadcast from other linear imager scanners or from the cradle.



* **Enable Parameter Broadcast**
(1)



Disable Parameter Broadcast
(0)

Pairing

Pairing is the process by which a linear imager scanner initiates communication with a cradle. Scanning Multipoint-to-Point activates multi linear imager scanner-to-cradle operation and allows up to seven linear imager scanners to pair to one cradle.

To pair the linear imager scanner with the cradle, scan the pairing bar code. A high/low/high/low beep sequence indicates that the pairing bar code was decoded. When a connection between the cradle and linear imager scanner is established, a low/high beep sounds.

- ✓ **NOTE**
1. The pairing bar code that connects the linear imager scanner to a cradle is unique to each cradle.
 2. Do not scan data or parameters until pairing completes.
 3. Only when the linear imager scanner is paired to the cradle it automatically tries to reconnect to a remote device when a disconnection occurs that is due to the radio losing communication. For more information see [Auto-reconnect Feature on page 4-24](#).

Pairing Modes

Parameter # 542

When operating with the cradle, two modes of pairing are supported:

- **Locked Pairing Mode** - When a cradle is paired (connected) to the linear imager scanner (or up to seven linear imager scanners in Multipoint-to-Point mode), any attempt to connect a different linear imager scanner, by either scanning the **PAIR** bar code on the cradle or by inserting it into the cradle with the pairing on contacts feature enabled ([page 4-33](#)), is rejected. The currently connected linear imager scanner(s) maintain connection. In this mode, you must set a [Connection Maintenance Interval on page 4-35](#).
- **Unlocked Pairing Mode** - Unlocking works in Point-to-Point mode only. Pair (connect) a new linear imager scanner to a cradle at any time by either scanning the **PAIR** bar code on the cradle or by inserting it into the cradle with the pairing on contacts feature enabled. This unpairs the previous linear imager scanner from the cradle.

To set the cradle pairing mode, scan the appropriate bar code below.



* **Unlocked Pairing Mode**
(0)



Locked Pairing Mode
(1)

Lock Override



NOTE Lock Override is applicable in Point-to-Point mode only (does not apply to Multipoint-to-Point mode). In Multipoint-to-Point mode, if seven scanners are connected, the scanners must be disconnected for a new scanner to connect.

Lock Override overrides a locked linear imager scanner base pairing and connects a new linear imager scanner. To use Lock Override, scan the bar code below, followed by the pairing bar code on the cradle.



Lock Override

Pairing Methods

Parameter # 545

There are two pairing methods. The default method allows the linear imager scanner and cradle to pair (connect) when the pairing bar code on the cradle is scanned. A second method pairs the linear imager scanner and cradle when the linear imager scanner is inserted in the cradle. To enable this feature, scan Enable Pair On Contacts below. With this feature enabled it is not necessary to scan the pairing bar code on the cradle. If the pairing is successful, a low/high connection beep sequence sounds a few seconds after the linear imager scanner is placed in the cradle. See [Wireless Beeper Definitions on page 4-4](#) for other beep sequences.

To enable or disable pairing on contacts, scan the appropriate bar code below.



*** Enable Pair On Contacts
(1)**



**Disable Pair on Contacts
(0)**

Unpairing

Unpair the linear imager scanner from the cradle or PC/host to make the cradle available for pairing with another linear imager scanner. Scan the bar code below to disconnect the linear imager scanner from its cradle/PC host.

An unpairing bar code is also included in the *L13678 Quick Reference Guide*.



Unpairing

Toggle Pairing

Parameter # 1322

If the scanner is configured for Toggle Pairing, scanning the Pairing bar code a second time unpairs the scanner.



* Toggle Pairing Disable
(0)

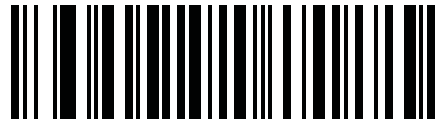

Toggle Pairing Enable
(1)

Pairing Bar Code Format

When the linear imager scanner is configured as an SPP Master, you must create a pairing bar code for the remote Bluetooth device to which the linear imager scanner can connect. The Bluetooth address of the remote device must be known. Pairing bar codes are Code 128 bar codes and are formatted as follows:

<Fnc 3>Bxxxxxxxxxxx

where:

- **B** (or **LNKB**) is the prefix
- **xxxxxxxxxxx** represents the 12-character Bluetooth address.

Pairing Bar Code Example

If the remote device to which the linear imager scanner can connect has a Bluetooth address of 11:22:33:44:55:66, then the pairing bar code is:



Connection Maintenance Interval

- ✓ **NOTE** The Connection Maintenance Interval only applies in locked pairing mode (see [page 4-32](#)).

When a linear imager scanner disconnects from a cradle due to a Link Supervision Timeout, the linear imager scanner immediately attempts to reconnect to the cradle for 30 seconds. If the auto-reconnect process fails, it can be restarted by pulling the linear imager scanner trigger.

To guarantee that a disconnected linear imager scanner can reconnect when it comes back in range, the cradle reserves the connection for that linear imager scanner for a period of time defined by the Connection Maintenance Interval. If the cradle is supporting the maximum three linear imager scanners and one linear imager scanner disconnects, a fourth linear imager scanner cannot pair to the cradle during this interval. To connect another linear imager scanner: either wait until the connection maintenance interval expires then scan the PAIR bar code on the cradle with the new linear imager scanner; or, scan Lock Override ([page 4-32](#)) with the new linear imager scanner then scan the PAIR bar code on the cradle.

- ✓ **NOTE** The cradle stores the remote pairing address of each linear imager scanner in memory regardless of the linear imager scanner condition (e.g., discharged battery). When you want to change the linear imager scanners paired to the cradle, unpair each linear imager scanner currently connected to the cradle by scanning the [Unpairing](#) bar code prior and reconnect each appropriate linear imager scanner by scanning the PAIR bar code on the cradle.

Considerations

The system administrator determines the Connection Maintenance Interval. A shorter interval allows new users to gain access to abandoned connections more quickly, but causes problems if users leave the work area for extended periods. A longer interval allows existing users to leave the work area for longer periods of time, but ties up the system for new users.

To avoid this conflict, users who are going off-shift can scan the unpair bar code on [page 4-33](#) to ignore the Connection Maintenance Interval and make the connection immediately available.

Connection Maintenance Interval (continued)

To set the Connection Maintenance Interval, scan one of the bar codes below.



*** Set Interval to 15 Minutes
(0)**



**Set Interval to 30 Minutes
(1)**



**Set Interval to 60 Minutes
(2)**



**Set Interval to 2 Hours
(3)**

Connection Maintenance Interval (continued)



**Set Interval to 4 Hours
(4)**



**Set Interval to 8 Hours
(5)**



**Set Interval to 24 Hours
(6)**



**Set Interval to Forever
(7)**

Batch Mode

Parameter # 544



IMPORTANT Batch mode does not apply to SPP Slave Mode.

The linear imager scanner supports five versions of batch mode. When the linear imager scanner is configured for any of the batch modes, it attempts to store bar code data (not parameter bar codes) until transmission is initialized, or the maximum number of bar codes are stored. When a bar code is saved successfully, a good decode beep sounds and the LED flashes green. If the linear imager scanner is unable to store a new bar code, a low/high/low/high out of memory beep sounds. (See page 2-2 for all beeper and LED definitions.)

In all modes, calculate the amount of data (number of bar codes) the linear imager scanner can store as follows: Number of storable bar codes = 9,000 bytes of memory / (number of characters in the bar code + 3).

- ✓ **NOTE** If the batch mode selection is changed while there is batched data, the new batch mode takes effect only after all the previously batched data is sent.

Modes of Operation

- **Normal (default)** - Do not batch data. The linear imager scanner attempts to transmit every scanned bar code.
- **Out of Range Batch Mode** - The linear imager scanner starts storing bar code data when it loses its connection to a remote device (for example, when a user holding the linear imager scanner walks out of range). Data transmission is triggered by reestablishing the connection with the remote device (for example, when a user holding the linear imager scanner walks back into range).
- **Standard Batch Mode** - The linear imager scanner starts storing bar code data after **Enter Batch Mode** is scanned. Data transmission is triggered by scanning **Send Batch Data**.

- ✓ **NOTE** Transmission is halted if the connection to the remote device is lost.

- **Cradle Contact Batch Mode** - The linear imager scanner starts storing bar code data when **Enter Batch Mode** is scanned. Data transmission is triggered by insertion of the linear imager scanner into the cradle.

- ✓ **NOTE** If the linear imager scanner is removed from the cradle during batch data transfer, transmission halts until the linear imager scanner is re-inserted in the cradle.

- **Batch Only Mode** - The scanner stores all bar code data. Data transmission is triggered by insertion of the scanner into the cradle.

- ✓ **NOTE** If the linear imager scanner is removed from the cradle during batch data transfer, transmission halts until the linear imager scanner is re-inserted in the cradle.

The radio may be turned off as batch data is transmitted over the cradle contacts.

This mode can only be exited by scanning **Normal** (default) mode.

- **Parameter Batch Mode** - When **Parameter Batch Mode** is entered and no connection to the cradle exists, the scanner starts storing parameter bar code data intended for the cradle. Parameter bar code transmission is triggered by insertion of the scanner into the cradle. Parameter Batch Mode is exited upon the end of the transmission. Alternatively, parameter bar code batching may be cancelled prior to insertion of the scanner into the cradle by scanning **Exit Parameter Batch Mode**. **Parameter Batch Mode** may be used when the cradle and/or scanner is configured with its radio turned off or connected to a non-cradle device.

In all modes, transmissions are halted if the linear imager scanner is moved out of range. The linear imager scanner resumes when it is back in range. If a bar code is scanned while batch data is transmitted it is appended to the end of the batched data; parameter bar codes are not stored.



*** Normal
(0)**



**Out of Range Batch Mode
(1)**



**Standard Batch Mode
(2)**



**Cradle Contact Batch Mode
(3)**

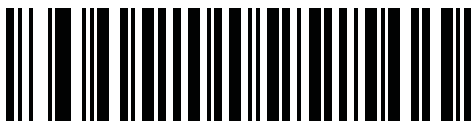

**Batch Only Mode
(4)**



Enter Batch Mode

Batch Mode (continued)



Send Batch Data



Enter Parameter Batch Mode

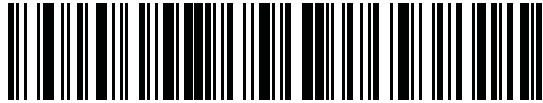

Exit Parameter Batch Mode

Persistent Batch Storage

Parameter #1399 (0x577 HEX)

When the scanner is configured for Persistent Batch Storage, batch data is stored in non-volatile memory and preserved even when the digital scanner is powered down. This parameter is Disabled by default.



NOTE Frequently storing batch data with this setting *Enabled* will shorten the life of the non-volatile memory.

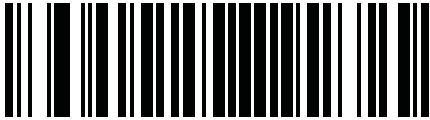

* Persistent Batch Disable
(0)

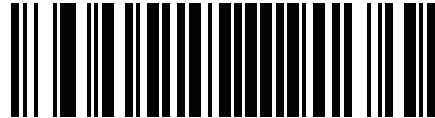

Persistent Batch Enable
(1)

Page Button

Parameter # 746

The cradle offers a page button. The page button is a sensor that when touched, causes paired scanners to emit a beeping sequence. The default is Enable Page Button.

1. Place your finger over the button sensor  .
2. Press down for approximately 1 second.
3. The cradle LED will turn blue when the scanner is out of the cradle. The paired scanner will beep, blink, and vibrate. If multiple scanners are paired to the cradle, all the scanners will beep, blink, and vibrate.
4. Repeat as necessary.

✓ **NOTE** Scanners out of radio range will not beep when paged. Refer to [Technical Specifications on page 3-9](#) for detailed radio range information.

Scan one of the following bar codes to enable or disable this feature.



**Disable Page Button
(0)**



*** Enable Page Button
(1)**

Page Options

To select a page option, select one of the bar codes below.

Page Mode

Parameter # 1364

- **Page State** - In this mode, the cradle sends a page state request to each scanner. It remains in Page State indication until every scanner sends an acknowledgment.

The scanner enters Page State when the LED indicator is blinking blue and the vibrator and beeper is activated. When the trigger is pressed, or the scanner is inserted into the cradle, or the requested timeout (default is 30 sec) is reached, the scanner sends the acknowledgment to the cradle and returns to its normal state.

- **Page Simple** - In this mode, the cradle sends a page indication request to each scanner, and returns to idle state. Each scanner issues a single Page State indication.

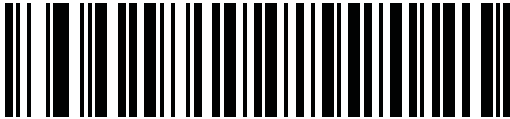

Page State
(1)



*** Page Simple**
(0)

Page State Timeout

Parameter # 1365

Page timeout is programmable in 1 second increments from 1 to 99 seconds. The default timeout is 30 seconds.

✓ **NOTE** Page State Timeout only applies to **Page State Mode**.

To set a page timeout:

1. Scan the **Page Timeout** bar code below.
2. Scan two numeric bar codes from [Numeric Bar Codes on page E-1](#) that correspond to the desired timeout duration. Enter a leading zero for single digit numbers (for example, for a 5 second page timeout, scan the 0 bar code and then the 5 bar code).
To correct an error or change the selection, scan [Cancel on page E-3](#).

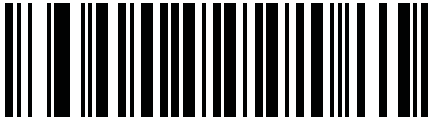

Page Timeout

Classic Bluetooth and/or Low Energy (Cradle Host Only)

Parameter # 1355

Set up cradle to accept both Bluetooth Classic and Low Energy connections or Low Energy Only connections.

✓ **NOTE** All Classic Bluetooth connections must be terminated before the setting can change to **Low Energy Only**.

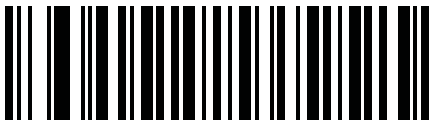

* Classic Bluetooth and Low Energy
(0)

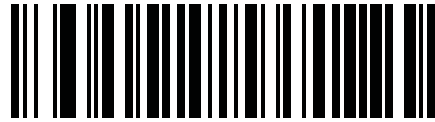

Low Energy Only
(1)

Bluetooth Security

The linear imager scanner supports Bluetooth Authentication. Authentication can be requested by either the remote device or the linear imager scanner.

✓ **NOTE** A remote device can still request Authentication.

PIN Code

Parameter # 552

To set and store a PIN code (e.g., password) on the linear imager scanner to connect to the host:

1. Scan the **Set & Store PIN Code** bar code below.
2. Scan five alphanumeric programming bar codes using the alphanumeric bar codes beginning on [page F-1](#).
3. Scan [End of Message on page F-7](#).

The default PIN code is 12345.

If the linear imager scanner communicates with a host with enabled, synchronize the PIN codes on the linear imager scanner and host. To achieve this, connect the linear imager scanner to the host when setting the PIN codes. If the linear imager scanner is not connected to a host, the PIN code change only takes affect on the linear imager scanner. If is required between the linear imager scanner and host, and the PIN codes do not match, pairing fails.

✓ **NOTE** An extended 16 character PIN code is available for additional with Open Bluetooth (SPP and HID).



Set and Store PIN Code

Variable PIN Code

Parameter # 608

- ✓ **NOTE** Variable PIN Code only applies when connecting to devices that are Bluetooth 2.0 or older. Do not use Variable PIN Code parameters when connecting to the STB3678/FLB3678 cradles or devices with Bluetooth 2.1 or above.

When switching to Cradle Host mode with authentication enabled, scan Static PIN Code below to avoid entering the PIN code manually. The PIN stored in memory is used. Scan the Variable PIN Code below to manually enter a PIN code with each connection.

The default PIN code is the user-programmed PIN set and stored above. Typically, however, HID connections require entering a Variable PIN Code. If, when attempting connection, the application presents a text box that includes a PIN, scan the Variable PIN Code bar code, then re-attempt connection. When you hear a beep indicating the linear imager scanner is waiting for an alphanumeric entry, enter the provided variable PIN using the [Alphanumeric Keyboard on page F-1](#), then scan [End of Message on page F-7](#) if the code is less than 16 characters. The linear imager scanner discards the variable PIN code after connection.



* **Static PIN Code**
(0)



Variable PIN Code
(1)

Bluetooth Security Levels

Parameter # 1393

- **Low Bluetooth Security** - The low security setting is designed for ease of connection with most devices. This setting may be unacceptable to some devices. If connection fails, try re-connecting after increasing security setting on the scanner.

If connecting to Bluetooth 2.1 device and above, *Just Works* method for secure and simple pairing is used.

✓ **NOTE** Data is encrypted using the **Low Bluetooth** security setting if connected to a Bluetooth 2.1 and above device.

- **Medium Bluetooth Security** - The medium security setting may require a passkey for the initial connection to pair scanner and device.
If connecting to Bluetooth 2.1 device and above, *Passkey Entry* method for secure and simple pairing is used.
- **High Bluetooth Security** - The high security setting enables *Man in the Middle* protection for Bluetooth 2.1 and above. Not all devices are able to support this mode.
- **Legacy Bluetooth Security** (Bluetooth 2.0 and below) - The legacy security setting enables authentication and encryption for legacy pairing.

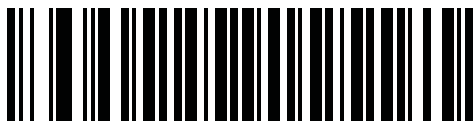

*** Low Bluetooth Security
(0)**

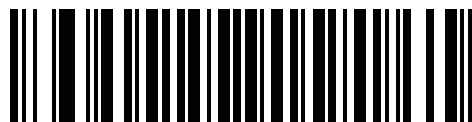

**Medium Bluetooth Security
(1)**

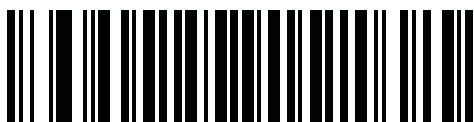

**High Bluetooth Security
(2)**

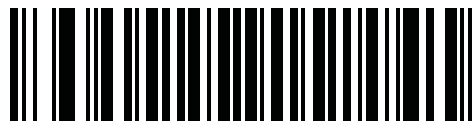

**Legacy Bluetooth Security
(3)**

Bluetooth Radio, Linking, and Batch Operation

The LI3678 linear imager scanner has a Bluetooth Class 1 radio which achieves a range of at least 135m / 440ft (open air, line of sight). The actual range you achieve is influenced by the presence of other radios, shelving and wall materials as well as which cradle is tested. The environments vary widely and often influence radio ranges.

When the linear imager scanner goes out of communications range to the base, it can be configured for Batch Mode (see [Batch Mode on page 4-38](#)). The linear imager scanner has sufficient onboard memory to store 500 bar codes of typical size (UPC/EAN).

Setting Up an iOS or Android Product To Work With The Linear Imager Scanner

Perform the following steps on each device to establish a link.

HID Keyboard Emulation

1. On the LI3678, scan [Keyboard Emulation \(HID\) on page 4-5](#).
2. On an iOS/iPad/iPhone, select *Settings > General > Bluetooth* and turn Bluetooth *On*. Choose the LI3678 linear imager scanner from the list of discovered devices. A link should be established allowing scanning into any application with keyboard entry.
3. On an Android/ET1/Droid, select *Settings > Wireless & networks > Bluetooth* (to turn Bluetooth on, if not already on). Select *Bluetooth Settings* and choose the LI3678 linear imager scanner from the list of discovered devices. (The LI3678 linear imager scanner normally displays as LI3678 - xxxxxx, where xxxxxx is the serial number.)



IMPORTANT Android devices, specifically the ET1, may require you to scan a PIN to connect. If so, a PIN displays on the device. To enter the required PIN, scan the bar code, [Variable PIN Code \(1\) on page 4-47](#) then re-attempt connection. When a beep sounds, indicating the scanner is waiting for PIN entry, scan the PIN using the [Alphanumeric Keyboard on page F-1](#). Incorrect scanned entries can be deleted by scanning [Cancel on page F-7](#).

For more information, read the section [Variable PIN Code on page 4-47](#).

CHAPTER 5 USER PREFERENCES & MISCELLANEOUS SCANNER OPTIONS

Introduction

If desired, program the linear imager scanner to perform various functions, or activate different features. This chapter describes imaging preference features and provides programming bar codes for selecting these features.

The linear imager scanner ships with the settings in [User Preferences Parameter Defaults on page 5-2](#) (also see [Appendix A, STANDARD DEFAULT PARAMETERS](#) for all host device and miscellaneous defaults). If the default values suit requirements, programming is not necessary.

To set feature values, scan a single bar code or a short bar code sequence. The settings are stored in non-volatile memory and are preserved even when you power down the linear imager scanner.

✓ **NOTE** Most computer monitors allow scanning the bar codes directly on the screen. When scanning from the screen, be sure to set the document magnification to a level where you can see the bar code clearly, and bars and/or spaces are not merging.

To return all features to default values, scan the [Default Parameters on page 5-5](#). Throughout the programming bar code menus, asterisks (*) indicate default values.

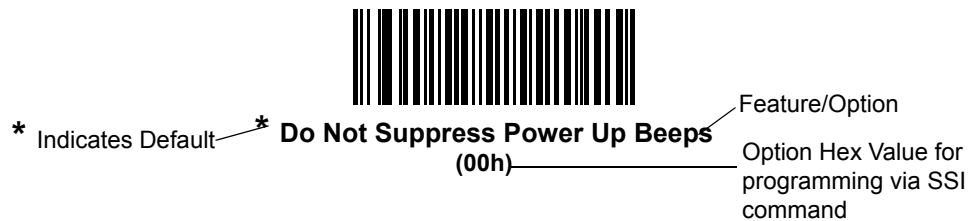

Scanning Sequence Examples

In most cases scanning one bar code sets the parameter value. For example, to set the beeper tone to high, scan the High Frequency (beeper tone) bar code listed under [Beeper Tone on page 5-9](#). The linear imager scanner issues a fast warble beep and the LED turns green, signifying a successful parameter entry.

Other parameters require scanning several bar codes. See these parameter descriptions for this procedure.

Errors While Scanning

Unless otherwise specified, to correct an error during a scanning sequence, just re-scan the correct parameter.

User Preferences/Miscellaneous Option Parameter Defaults

[Table 5-1](#) lists the defaults for preferences parameters. To change the default values:

- Scan the appropriate bar codes in this guide. These new values replace the standard default values in memory. To recall the default parameter values, scan the [Default Parameters on page 5-5](#).
- Configure the linear imager scanner using the 123Scan² configuration program (see [123SCAN2 on page 12-1](#)).

✓ **NOTE** See [Appendix A, STANDARD DEFAULT PARAMETERS](#) for all user preferences, hosts, symbologies, and miscellaneous default parameters.

In this guide, the parameter numbers listed are the same as the attribute numbers for these parameters.

Table 5-1 *User Preferences Parameter Defaults*

Parameter	Parameter Number ¹	SSI Number ²	Default	Page Number
User Preferences				
Set Default Parameter			Restore Defaults	5-5
Report Version			N/A	5-6
Parameter Bar Code Scanning	236	ECh	Enable	5-6
Beep After Good Decode	56	38h	Enable	5-7
Decode Illumination Indicator	859	F2h 5Bh	Disable	5-8
Beeper Tone	145	91h	Medium	5-9
Suppress Power Up Beeps	721	F1h D1h	Do Not Suppress (Disable)	5-10
Beeper Volume	140	8Ch	High	5-10
Beeper Duration	628	F1h 74h	Medium	5-11
Decode Pager Motor	613	F1h 65h	Enable	5-12
Decode Pager Motor Duration	626	F1h 72h	150 msec	5-12

Parameter	Parameter Number ¹	SSI Number ²	Default	Page Number
Hand-Held Trigger Mode	138	8Ah	Level	5-14
Hands-Free (Presentation) Mode	630	F1h 76h	Enable	5-15
Low Power Mode	128	80h	Enable	5-15
Time Delay to Low Power Mode				
Corded	146	92h	1 Hour	5-16
Cordless	146	92h	100 msec	5-18
Time Delay to Presentation Sleep Mode	662	F1h 96h	5 Min	5-19
Timeout to Low Power Mode from Auto Aim	729		15 sec	5-22
Linear Imager Picklist Mode	1211	F8h 04h BBh	Auto-discriminate	5-23
FIPS Mode	736	F1h E0h	Disable	5-24
Aiming Illumination	1187	F8h 04h A3h	Pulsing Pattern	5-25
Continuous Bar Code Read	649	F1h 89h	Disable	5-26
Unique Bar Code Reporting	723	F1h D3h	Enable	5-26
Decode Session Timeout	136	88h	9.9 sec	5-27
Timeout Between Decodes, Same Symbol	137	89h	0.5 sec	5-27
Timeout Between Decodes, Different Symbols	144	90h	0.1 sec	5-27
Decoding Illumination	298	F0h 2Ah	Enable	5-28
Battery Threshold				5-29
Battery Status High Threshold	1367		50%	
Battery Status Medium Threshold	1368		20%	
Battery Status Low Warning Threshold	1369		10%	
Battery Health Low Warning Threshold	1370		60%	

Miscellaneous Options

Transmit Code ID Character	45	2Dh	None	5-31
Prefix Value	99, 105	63h, 69h	7013 <CR><LF>	5-32
Suffix 1 Value	98, 104	62h, 68h	7013 <CR><LF>	5-32
Suffix 2 Value	100, 106	64h, 6Ah		
Scan Data Transmission Format	235	EBh	Data as is	5-33
FN1 Substitution Values	103, 109	67h, 6Dh	Set	5-34
Transmit "No Read" Message	94	5E	Disable	5-35

Parameter	Parameter Number ¹	SSI Number ²	Default	Page Number
Unsolicited Heartbeat Interval	1118	F8h 04h 5Eh	Disable	5-36
Dump Scanner Parameters				5-37

**NOTE**

1. Parameter number decimal values are used for programming via RSM commands.
2. SSI number hex values are used for programming via SSI commands.

User Preferences

Default Parameters

The scanner can be reset to two types of defaults: factory defaults or custom defaults. Scan the appropriate bar code below to reset the scanner to its default settings and/or set the scanner's current settings as the custom default.

- **Restore Defaults** - Resets all default parameters as follows:
 - If custom default values were configured (see **Write to Custom Defaults**), the custom default values are set for all parameters each time the **Restore Defaults** bar code below is scanned.
 - If no custom default values were configured, the factory default values are set for all parameters each time the **Restore Defaults** bar code below is scanned. (For factory default values, see [Appendix A, STANDARD DEFAULT PARAMETERS](#) beginning on [page A-1.](#))
- **Set Factory Defaults** - Scan the **Set Factory Defaults** bar code below to eliminate all custom default values and set the scanner to factory default values. (For factory default values, see [Appendix A, STANDARD DEFAULT PARAMETERS](#) beginning on [page A-1.](#))
- **Write to Custom Defaults** - Custom default parameters can be configured to set unique default values for all parameters. After changing all parameters to the desired default values, scan the **Write to Custom Defaults** bar code below to configure custom defaults.



* **Restore Defaults**



Set Factory Defaults



Write to Custom Defaults

Report Version

Scan the bar code below to report the version of software installed in the linear imager scanner.



Report Software Version

Parameter Bar Code Scanning

Parameter # 236 (SSI # ECh)

To disable the decoding of parameter bar codes, including the **Set Defaults** parameter bar codes, scan the **Disable Parameter Scanning** bar code below. To enable decoding of parameter bar codes, scan **Enable Parameter Scanning**.



* **Enable Parameter Bar Code Scanning**
(1)



Disable Parameter Bar Code Scanning
(0)

Beep After Good Decode

Parameter # 56 (SSI # 38h)

Scan a bar code below to select whether or not the linear imager scanner beeps after a good decode. If selecting **Do Not Beep After Good Decode**, the beeper still operates during parameter menu scanning and to indicate error conditions.



* **Beep After Good Decode**
(Enable)
(1)



Do Not Beep After Good Decode
(Disable)
(0)

Decode Illumination Indicator

✓ **NOTE** Decode Illumination Indicator only takes affect when *Hand-Held Trigger Mode* is set for Standard Level or Auto-Aim.

Parameter # 859 (SSI # F2h 5Bh)

Scan a bar code below to select optional blinking of the illumination on a successful decode.

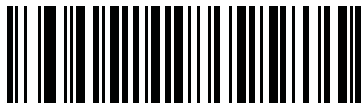

* Disable Decode Illumination Indicator
(0)



1 Blink
(1)

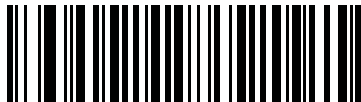

2 Blinks
(2)

Beeper Tone

Parameter # 145 (SSI # 91h)

To select a decode beep frequency (tone), scan one of the following bar codes.



Off
(3)

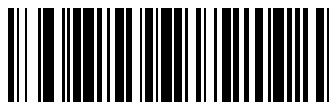

Low Tone
(2)



*** Medium Tone**
(1)

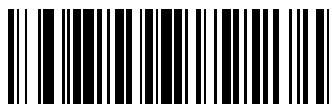

High Tone
(0)



Medium to High Tone (2-tone)
(4)

Suppress Power Up Beeps

Parameter # 721 (SSI # F1h D1h)

Scan a bar code below to select whether or not to suppress linear imager scanner beeps upon power up.



*** Do Not Suppress Power Up Beeps**
(0)



Suppress Power Up Beeps
(1)

Beeper Volume

Parameter # 140 (SSI # 8Ch)

To select a beeper volume, scan the **Low Volume**, **Medium Volume**, or **High Volume** bar code.



Low Volume
(2)



Medium Volume
(1)



*** High Volume**
(0)

Beeper Duration

Parameter # 628 (SSI # F1h 74h)

To select the duration for the beeper, scan one of the following bar codes.

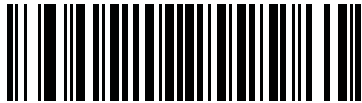

Short
(0)

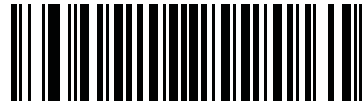

*** Medium**
(1)

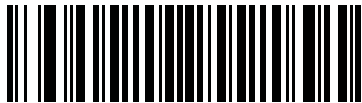

Long
(2)

Decode Pager Motor

Parameter # 613 (SSI # F1h 65h)

The scanner includes a pager motor which, when enabled, vibrates the scanner for a period of time when a successful decode occurs.



NOTE When the pager motor is enabled and the scanner is in the Intellistand, the pager motor disables until the scanner is removed from the Intellistand.

Scan a bar code below to enable or disable the pager motor. If enabled, scan the appropriate bar code to set the period of time in which to vibrate the scanner (see [Decode Pager Motor Duration](#) below).



**Pager Motor Disable
(0)**



*** Pager Motor Enable
(1)**

Decode Pager Motor Duration

Parameter # 626 (SSI # F1h 72h)

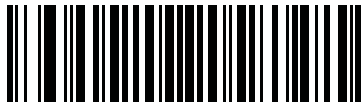

*** 150 msec
(15)**



**200 msec
(20)**

Decode Pager Motor Duration (continued)

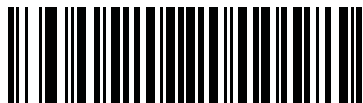

**250 msec
(25)**



**300 msec
(30)**



**400 msec
(40)**



**500 msec
(50)**

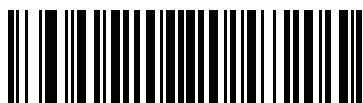

**600 msec
(60)**



**750 msec
(75)**

Hand-Held Trigger Mode

Parameter # 138 (SSI #8Ah)

Select one of the following trigger modes for the linear imager scanner:

- **Standard (Level)** - A trigger pull activates decode processing. Decode processing continues until the bar code decodes, you release the trigger, or the Decode Session Timeout occurs.
- **Presentation (Blink)** - The linear imager scanner activates decode processing when it detects a bar code in its field of view. After a period of non-use, the linear imager scanner enters a low power mode, in which the LEDs turn off until the linear imager scanner senses motion.
- **Auto Aim** - This trigger mode projects the red illumination when you lift the linear imager scanner. A trigger pull activates decode processing. After 2 seconds of inactivity the aiming pattern shuts off.



* **Standard (Level)**
(0)

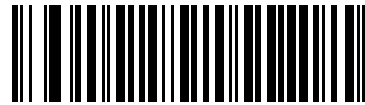

Presentation (Blink)
(7)



Auto Aim
(9)

Hands-Free Trigger Mode

Parameter # 630 (SSI # F1h 76h)

In hands-free mode, the linear imager scanner automatically triggers when presented with a bar code. Lifting the linear imager scanner causes it to behave according to the setting of the [Hand-Held Trigger Mode on page 5-14](#).

If you select **Disable Hands-Free Mode**, the linear imager scanner behaves according to the setting of the [Hand-Held Trigger Mode](#) regardless of whether it is hand-held or on a counter top.

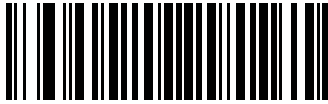

* **Enable Hands-Free Mode**
(1)



Disable Hands-Free Mode
(0)

Low Power Mode

Parameter # 128 (SSI #80h)

If enabled, the linear imager scanner enters a low power consumption mode after Time Delay to Low Power Mode has expired, in which the LEDs turn off in order to conserve energy and prolong the life of the scanner. The linear imager scanner wakes when it senses a trigger pull or when the host attempts to communicate.

If disabled, power remains on after each decode attempt.



Disable Low Power Mode
(0)



* **Enable Low Power Mode**
(1)

Time Delay to Low Power Mode

Parameter # 146 (SSI # 92h)

Time Delay to Low Power Mode for Corded

This parameter sets the time it takes the corded linear imager scanner to enter low power mode after any scanning activity. Scan the appropriate bar code below to set the time.



1 Second
(17)



10 Seconds
(26)



1 Minute
(33)



5 Minutes
(37)



15 Minutes
(43)

Time Delay to Low Power Mode (continued)



30 Minutes
(45)



45 Minutes
(46)



* 1 Hour
(49)



3 Hours
(51)



6 Hours
(54)



9 Hours
(57)

Time Delay to Low Power Mode for Cordless

This parameter sets the time it takes the cordless linear imager scanner to enter low power mode after any scanning activity. Scan the appropriate bar code below to set the time.



* 100msec
(65)



500 msec
(69)

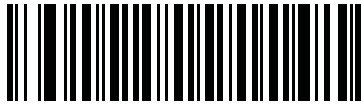

1 sec
(17)



2 sec
(18)

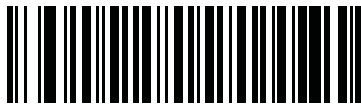

3 sec
(19)



4 sec
(20)



5 sec
(21)

Time Delay to Presentation Sleep Mode

Parameter # 662 (SSI # F1h 96h)

In Presentation Mode, this parameter sets the time the linear imager scanner remains active before entering sleep mode with no illumination. The linear imager scanner wakes when it senses motion, upon presentation of a bar code, or a trigger pull.



NOTE Linear imager scanner performance is not guaranteed in dim conditions.



Disable
(0)

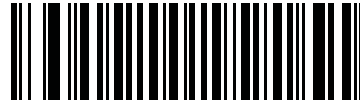

1 Second
(1)



10 Seconds
(10)

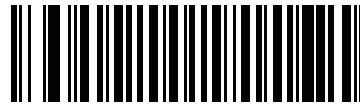

1 Minute
(17)



*** 5 Minutes**
(21)

Time Delay to Presentation Sleep Mode (continued)



**15 Minutes
(27)**



**30 Minutes
(29)**



**45 Minutes
(30)**



**1 Hour
(33)**



**3 Hours
(35)**

Time Delay to Presentation Sleep Mode (continued)



**6 Hours
(38)**



**9 Hours
(41)**

Timeout to Low Power Mode from Auto Aim

Parameter # 729

✓ **NOTE** Applicable for cordless LI3678 linear imager only.

This parameter sets the time the linear imager scanner remains in auto aim before entering low power mode.

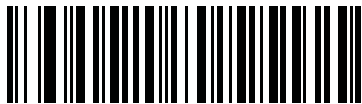

Disabled
(0)

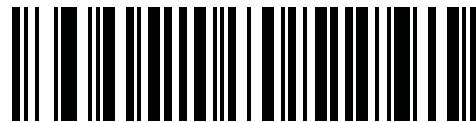

5 sec
(5)



*** 15 sec**
(11)



30 sec
(13)



1 minute
(17)

Linear Imager Picklist Mode

Parameter # 1211 (SSI # F8h 04h BBh)

Picklist Mode allows a user to pick and decode a bar code from multiple bar codes printed close together side by side, when the scan illumination intersects more than one bar code. The out-of-box default for this mode is **Auto-discriminate**.

There are three settings for this mode:

- **Always Enabled** - When multiple bar codes are close together in a row, the bar code decoded is always the one in the center of aiming beam.
- **Always Disabled** - When multiple bar codes are close together in a row, the bar code decoded is the first bar code that comes into scanner field of view.
- **Auto-discriminate** (default) - When there is only one bar code in the scanner field of view, decode is always attempted; when multiple bar codes are close together in a row, the bar code decoded is always the one in the center of the aiming beam.

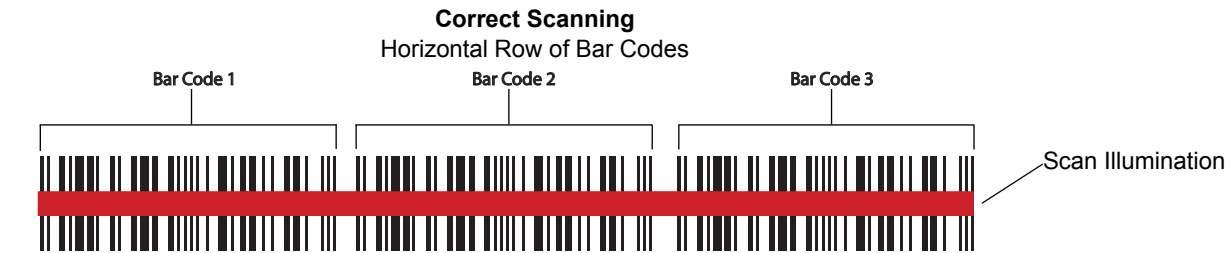

Figure 5-1 Bar Code Scanning Samples



* Auto-discriminate
(2)



Disable Picklist Mode
(0)



Enable Picklist Mode
(1)

FIPS Mode

Parameter # 736 (F1h E0h)

✓ **NOTE** Applicable for cordless LI3678 linear imager scanners and cradles only.

The Federal Information Processing Standard (FIPS) 140-2 is a U.S. government computer security standard used to accredit cryptographic modules. FIPS enabled LI3678 scanners and cradles offer this secure mode of operation.

To enable the FIPS mode of operation (disabled by default), scan the **Enable FIPS** bar code. The scanner attempts to establish a secure session with the cradle to which it is connected. On success, the scanner lights an amber LED on every trigger pull to signal that all data will be transmitted over Bluetooth in a secure fashion. On failure, the scanner will sound transmission failure error message on every attempt to transmit data.

To disable the FIPS mode, scan the **Disable FIPS** bar code at any time.



Enable FIPS
(1)



*** Disable FIPS**
(0)

Aiming Illumination

Parameter # 1187 (SSI # F8h 04h A3h)

Scan a bar code below to select a preferred aiming pattern. When solid aiming pattern is selected, the scanner LED is on steadily when aiming. When pulsing pattern is selected, a pulsing LED pattern displays when aiming.

✓ **NOTE** Applicable in **Hands-Free** and **Auto Aim** modes.



* Pulsing Pattern
(1)



Solid Pattern
(0)

Continuous Bar Code Read

Parameter # 649 (SSI # F1h 89h)

Enable this to report every bar code while the trigger is pressed.



* Disable Continuous Bar Code Read
(0)

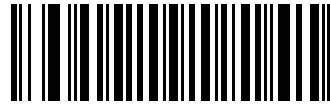

Enable Continuous Bar Code Read
(1)

Unique Bar Code Reporting

Parameter # 723 (SSI # F1h D3h)

Enable this to report only unique bar codes while the trigger is pressed. This option only applies when **Continuous Bar Code Read** is enabled.



Disable Continuous Bar Code Read Uniqueness
(0)



* Enable Continuous Bar Code Read Uniqueness
(1)

Decode Session Timeout

Parameter # 136 (SSI # 88h)

This parameter sets the maximum time decode processing continues during a scan attempt. It is programmable in 0.1 second increments from 0.5 to 9.9 seconds. The default timeout is 9.9 seconds.

To set a Decode Session Timeout, scan the bar code below. Next, scan two numeric bar codes from [Appendix E, NUMERIC BAR CODES](#) that correspond to the desired on time. Enter a leading zero for single digit numbers. For example, to set a Decode Session Timeout of 0.5 seconds, scan the bar code below, then scan the **0** and **5** bar codes. To correct an error or change the selection, scan **Cancel** on [page E-3](#).



Decode Session Timeout

Timeout Between Decodes, Same Symbol

Parameter # 137 (SSI # 89h)

Use this option in presentation mode and Continuous Bar Code Read mode to prevent the beeper from continuously beeping when a symbol is left in the linear imager scanner's field of view. The bar code must be out of the field of view for the timeout period before the scanner reads the same consecutive symbol. It is programmable in 0.1 second increments from 0.0 to 9.9 seconds. The default interval is 0.5 seconds.

To select the timeout between decodes for the same symbol, scan the bar code below, then scan two numeric bar codes from [Appendix E, NUMERIC BAR CODES](#) that correspond to the desired interval, in 0.1 second increments.



Timeout Between Decodes, Same Symbol

Timeout Between Decodes, Different Symbols

Parameter # 144 (SSI # 90h)

Use this option in presentation mode or Continuous Bar Code Read to control the time the scanner is inactive between decoding different symbols. It is programmable in 0.1 second increments from 0.1 to 9.9 seconds. The default is 0.1 seconds.

To select the timeout between decodes for different symbols, scan the bar code below, then scan two numeric bar codes from [Appendix E, NUMERIC BAR CODES](#) that correspond to the desired interval, in 0.1 second increments.



NOTE Timeout Between Decodes, Different Symbols cannot be greater than or equal to the Decode Session Timeout.



Timeout Between Decodes, Different Symbols

Decoding Illumination

Parameter # 298 (SSI # F0h 2Ah)

Scanning **Enable Decoding Illumination** enables LED Illumination and usually results in superior images and reading ranges. Scanning **Disable Decoding Illumination** disables LED illumination.



* **Enable Decoding Illumination**
(1)



Disable Decoding Illumination
(0)

Battery Threshold

Scan the appropriate bar code below to select the desired battery status threshold.

- **Battery Status High Threshold - Parameter #1367**

This parameter sets the threshold used to show the Battery Status is High. When the battery status is above the High Threshold, the battery indicator is green.

Scan this bar code followed by 2 digits from [Appendix E, NUMERIC BAR CODES](#) that correspond to the desired percentage from 00 to 99. The default is 50%.

- **Battery Status Medium Threshold - Parameter #1368**

This parameter sets the threshold used to show the Battery Status is Medium. When the battery status is above the Medium Threshold (and below the High Threshold), the Battery indicator is amber. When the battery status is below the Medium Threshold, the Battery indicator is red.

Scan this bar code followed by 2 digits from [Appendix E, NUMERIC BAR CODES](#) that correspond to the desired percentage from 00 to 99. The default is 20%.

- **Battery Status Low Warning Threshold - Parameter #1369**

This parameter sets the threshold to indicate Batter Status is Critically Low. When the battery status is below the Low Warning Threshold, on every trigger release the scanner issues 4 short beeps.

Scan this bar code followed by 2 digits from [Appendix E, NUMERIC BAR CODES](#) that correspond to the desired percentage from 00 to 99. The default is 10%.

- **Battery Health Low Warning Threshold - Parameter #1370**

This parameter sets the threshold to indicate Battery Health is Low. When the battery health is below the Low Health Threshold, all battery indication will alternate between Red and the appropriate Battery Status indication.

Scan this bar code followed by 2 digits from [Appendix E, NUMERIC BAR CODES](#) that correspond to the desired percentage from 00 to 99. The default is 60%.

✓ **NOTE** When Battery Health is Low, you should consider replacing the battery.

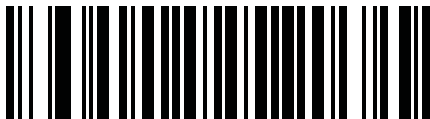

Battery Status High Threshold

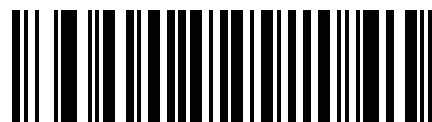

Battery Status Medium Threshold

Battery Threshold (continued)

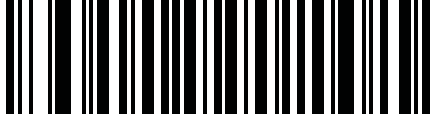

Battery Status Low Warning Threshold

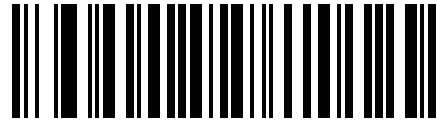

Battery Health Low Warning Threshold

Miscellaneous Scanner Parameters

Transmit Code ID Character

Parameter # 45 (SSI # 2Dh)

A Code ID character identifies the code type of a scanned bar code. This is useful when decoding more than one code type. In addition to any single character prefix already selected, the Code ID character is inserted between the prefix and the decoded symbol.

Select no Code ID character, a Symbol Code ID character, or an AIM Code ID character. For Code ID Characters, see [Symbol Code Characters on page C-1](#) and [Aim Code Characters on page C-3](#).

✓ **NOTE** If you enable Symbol Code ID Character or AIM Code ID Character, and enable [Transmit "No Read" Message on page 5-35](#), the linear imager scanner appends the code ID for Code 39 to the NR message.

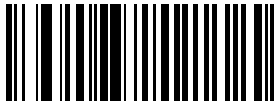

Symbol Code ID Character
(2)



AIM Code ID Character
(1)



* None
(0)

Prefix/Suffix Values

Key Category Parameter # P = 99 (SSI # 63h), S1 = 98 (SSI # 62h), S2 = 100 (SSI # 64h)

Decimal Value Parameter # P = 105 (SSI # 69h), S1 = 104 (SSI # 68h), S2 = 106 (SSI # 6Ah)

You can append a prefix and/or one or two suffixes to scan data for use in data editing. To set a value for a prefix or suffix, scan a four-digit number (i.e., four bar codes from [Appendix E, NUMERIC BAR CODES](#)) that corresponds to that value. See [Table H-1 on page H-1](#) for the four-digit codes.

When using host commands to set the prefix or suffix, set the key category parameter to 1, then set the 3-digit decimal value. See [Table H-1 on page H-1](#) for the four-digit codes.

To correct an error or change a selection, scan [Cancel on page E-3](#).

✓ **NOTE** To use Prefix/Suffix values, first set the [Scan Data Transmission Format on page 5-33](#).

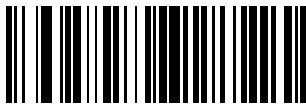

**Scan Prefix
(7)**



**Scan Suffix 1
(6)**



**Scan Suffix 2
(8)**



Data Format Cancel

Scan Data Transmission Format

Parameter # 235 (SSI # EBh)

To change the scan data format, scan one of the following eight bar codes corresponding to the desired format.

✓ **NOTE** If using this parameter do not use ADF rules to set the prefix/suffix.

To set values for the prefix and/or suffix, see [Prefix/Suffix Values on page 5-32](#).



* Data As Is
(0)



<DATA> <SUFFIX 1>
(1)



<DATA> <SUFFIX 2>
(2)



<DATA> <SUFFIX 1> <SUFFIX 2>
(3)



<PREFIX> <DATA >
(4)

Scan Data Transmission Format (continued)

<PREFIX> <DATA> <SUFFIX 1>
(5)



<PREFIX> <DATA> <SUFFIX 2>
(6)



<PREFIX> <DATA> <SUFFIX 1> <SUFFIX 2>
(7)

FN1 Substitution Values**Key Category Parameter # 103 (SSI # 67h)****Decimal Value Parameter # 109 (SSI # 6Dh)**

The Wedge and USB HID Keyboard hosts support a FN1 Substitution feature. Enabling this substitutes any FN1 character (0x1b) in an EAN128 bar code with a value. This value defaults to 7013 (Enter key).

When using host commands to set the FN1 substitution value, set the key category parameter to 1, then set the 3-digit keystroke value. See the ASCII Character Set table for the current host interface for the desired value.

To select a FN1 substitution value via bar code menus:

1. Scan the bar code below.

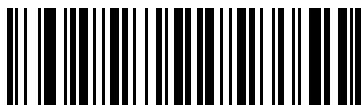

Set FN1 Substitution Value

2. Locate the keystroke desired for FN1 Substitution in the ASCII Character Set table for the current host interface. Enter the 4-digit ASCII Value by scanning each digit in [Appendix E, NUMERIC BAR CODES](#).

To correct an error or change the selection, scan **Cancel**.

To enable FN1 substitution for USB HID keyboard, scan the **Enable FN1 Substitution** bar code on page [5-34](#).

Transmit “No Read” Message

Parameter # 94 (SSI # 5E)

Scan a bar code below to select whether or not to transmit a No Read message. Enable this to transmit the characters NR when a successful decode does not occur before trigger release or the **Decode Session Timeout** expires. See [Decode Session Timeout on page 5-27](#). Disable this to send nothing to the host if a symbol does not decode.



NOTE If you enable **Transmit No Read**, and also enable Symbol Code ID Character or AIM Code ID Character for [Transmit Code ID Character on page 5-31](#), the linear imager scanner appends the code ID for Code 39 to the NR message.



**Enable No Read
(1)**



*** Disable No Read
(0)**

Unsolicited Heartbeat Interval

Parameter # 1118 (SSI # F8h 04h 5Eh)

The linear imager scanner supports sending *Unsolicited Heartbeat Messages* to assist in diagnostics. To enable this feature and set the desired unsolicited heartbeat interval, scan one of the time interval bar codes below, or scan **Set Another Interval** followed by four numeric bar codes from [Appendix E, NUMERIC BAR CODES](#) (scan sequential numbers that correspond to the desired number of seconds).

Scan **Disable Unsolicited Heartbeat Interval** to turn off the feature.

The heartbeat event is sent as decode data (with no decode beep) in the form of:

MOTEVTHB:nnn

where nnn is a three digit sequence number starting at 001 and wrapping after 100.

✓ **NOTE** For correct operation, you must disable Low Power Mode (see [Low Power Mode on page 5-15](#)).

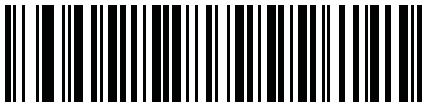

10 seconds
(10)

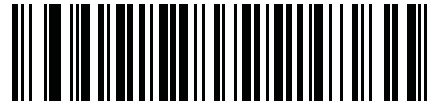

1 minute
(60)



Set Another Interval



*** Disable Unsolicited Heartbeat Interval**
(0)

Dump Scanner Parameters

For debugging a scanner problem, scan the programming bar code below to output all the scanner's asset tracking information, and parameter settings. The information is output to a text document in a human readable format.

Scan **STISCANPARAMS** with the scanner connected in USB HID keyboard mode to Microsoft® Windows Notepad or Wordpad, or with the scanner connected via RS232 to a Windows Hyperterminal. The parameter/attribute numbers in this output can be interpreted using parameter numbers in this guide, or the Attribute Data Dictionary (index of parameters). The Attribute Data Dictionary (72E-149786-xx) can be found using the Zebra Support site at: <http://www.zebra.com/support>.



NOTE It may be necessary to first scan "<DATA><SUFFIX1>" for proper formatting. (See [Scan Data Transmission Format on page 5-33](#).)

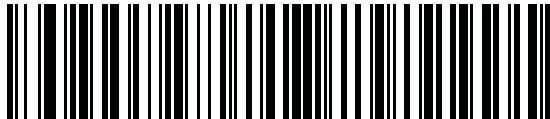

STISCANPARAMS

CHAPTER 6 USB INTERFACE

Introduction

This chapter provides instructions for programming the linear imager to interface with a USB host. The linear imager scanner connects directly to a USB host, or a powered USB hub. The USB host can power the linear imager.

Throughout the programming bar code menus, default values are indicated with asterisks (*).

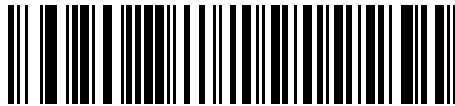

*Indicates Default — * **North American Standard USB Keyboard** — Feature/Option

Connecting a USB Interface

The linear imager scanner connects with USB capable hosts including:

- Desktop PCs and Notebooks
- Apple™ iMac, G4, iBooks (North America only)
- IBM SurePOS terminals
- Sun, IBM, and other network computers that support more than one keyboard.

The following operating systems support the linear imager scanner through USB:

- Windows 98, 2000, ME, XP, 7
- MacOS 8.5 and above
- IBM 4690 OS.

The linear imager (corded LI3608) and cradle (cordless LI3678) also interfaces with other USB hosts which support USB Human Interface Devices (HID).

LI3608 Corded Linear Imager USB Connection

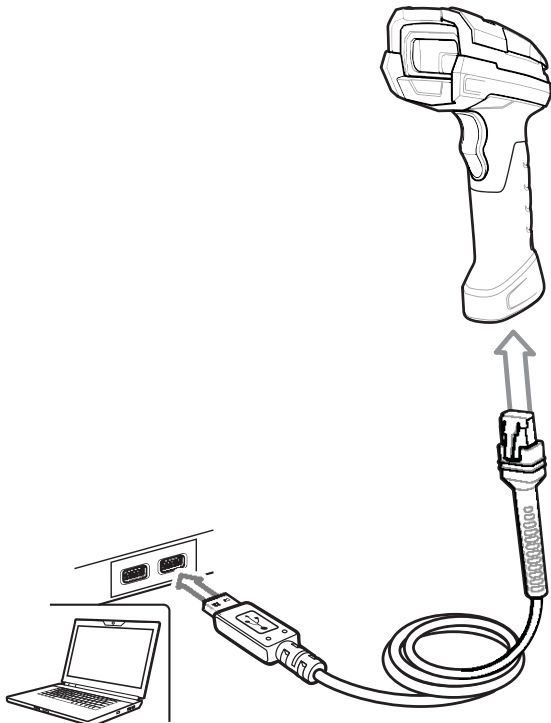

Figure 6-1 *LI3608 Corded Linear Imager USB Connection*

To connect the USB interface:

1. Attach the modular connector of the USB interface cable to the host port on the bottom of the linear imager.
2. Plug the series A connector in the USB host or hub, or plug the Plus Power connector in an available port of the IBM SurePOS terminal.
3. Select the USB device type by scanning the appropriate bar code from [USB Device Type on page 6-7](#).

✓ **NOTE** The interface cable automatically detects the host interface type and uses the default setting. If the default (*) does not meet your requirements, scan another host bar code.

4. On first installation when using Windows, the software prompts to select or install the Human Interface Device driver. To install this driver, provided by Windows, click **Next** through all the choices and click **Finished** on the last choice. The scanner powers up during this installation.
5. To modify any other parameter options, scan the appropriate bar codes in this chapter.

If problems occur with the system, see [Troubleshooting on page 3-4](#).

LI3678 Cordless Linear Imager USB Connection

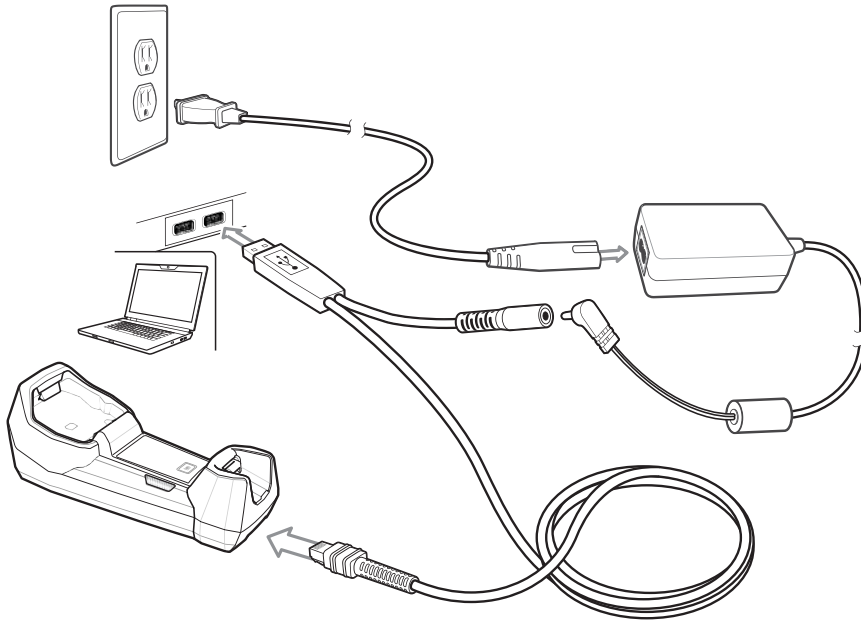

Figure 6-2 *LI3678 Cordless Linear Imager USB Connection*

To connect the cradle to a USB host:

1. Attach the modular connector of the USB interface cable to the cable interface port on the cradle. See [Connecting the Cradle on page 1-6](#).
2. Plug the series A connector in the USB host or hub, or plug the Plus Power connector in an available port of the IBM SurePOS terminal.
3. Connect an external power supply if desired
4. Ensure all connections are secure.
5. Pair the digital scanner to the cradle by scanning the bar code on the cradle.
6. Select the USB device type by scanning the appropriate bar code from [USB Device Type on page 6-7](#).
7. On first installation when using Windows, the software displays a prompt to select or install the *Human Interface Device* driver. To install the Human Interface Device driver provided by Windows, click **Next** through all the choices and click **Finished** on the last choice. The digital scanner powers up during this installation.
8. To modify any other parameter options, scan the appropriate bar codes in this chapter.

✓ **NOTE** Interface cables vary depending on configuration. The connectors illustrated in [Figure 6-2](#) are examples only. The connectors may be different from those illustrated, but the steps to connect the cradle remain the same.

✓ **NOTE** Disconnect the host cables before the power supply, or the linear imager scanner may not recognize the new host.

If problems occur, see [Troubleshooting on page 3-2](#). USB Parameter Defaults

Table 6-1 lists the defaults for USB host parameters. If any option needs to be changed, scan the appropriate bar code(s) provided in the Parameter Descriptions section beginning on page 6-7.

- ✓ **NOTE** See [Appendix A, STANDARD DEFAULT PARAMETERS](#) for all user preferences, hosts, symbologies, and miscellaneous default parameters.
- ✓ **NOTE** See [Appendix B, Country Codes](#) for USB Country Keyboard Types (Country Codes).

Table 6-1 USB Host Default Table

Parameter	Default	Page Number
USB Host Parameters		
USB Device Type	HID Keyboard Emulation	6-7
Symbol Native API (SNAPI) Status Handshaking	Enable	6-9
USB Keystroke Delay	No Delay	6-10
USB CAPS Lock Override	Disable	6-10
USB Ignore Unknown Characters	Send	6-11
USB Convert Unknown to Code 39	Disable	6-11
Emulate Keypad	Enable	6-12
Emulate Keypad with Leading Zero	Enable	6-12
Quick Keypad Emulation	Enable	6-13
USB FN1 Substitution	Disable	6-13
Function Key Mapping	Disable	6-14
Simulated Caps Lock	Disable	6-14
Convert Case	No Case Conversion	6-15
USB Static CDC	Enable	6-15
Ignore Beep	Enable	6-16
Ignore Bar Code Configuration	Enable	6-16
USB Polling Interval	3 msec	6-18
USB Fast HID	Disable	6-19
IBM Specification Version	Version 2.2	6-19
USB Toshiba TEC Host Parameters		
Code Type Table Usage	Use Table 0 Identifier	6-20
Include Symbol Types	Add Symbol Types	6-21
Include Character Counts	Add Character Counts	6-21

Table 6-1 *USB Host Default Table (Continued)*

Parameter	Default	Page Number
Include Header	Add Header Character	6-21
Include Terminator	Add Terminator Character (s)	6-22
Header Character	Add STX (0x02)	6-22
Terminator Character	Add ETX (0x03)	6-23
Light LED on Good Decode	Light LED on Good Decode	6-23
Good Decode Beeper Timer	Indicate Before Transmission	6-24

USB Host Parameters

USB Device Type

Select the desired USB device type.

- ✓ **NOTE 1**
1. When changing USB device types, the scanner automatically restarts. The linear imager issues a power-up beep sequence.
 2. Before selecting *USB CDC Host (Note 1) on page 6-8*, install the CDC INF file on the host to ensure the scanner does not stall during power up (due to a failure to enumerate USB).
To recover a stalled scanner:
 - a) Install the CDC INF file
 - or
 - b) Unplug USB cable and add power. Connect scanner via Bluetooth and scan **HID Keyboard** or another host.
 3. Select IBM **IBM Hand-Held USB** to disable data transmission when an IBM register issues a Scan Disable command. Aim, illumination, and decoding is still permitted. Select **USB OPOS Hand-Held** to completely shut off the scanner when an IBM register issues a Scan Disable command, including aim, illumination, decoding, and data transmission.
- ✓ **NOTE 2** Before selecting the Toshiba TEC Host, install the driver and connect to a Toshiba TEC register. Selecting this host without installing the driver causes the scanner to become unresponsive.

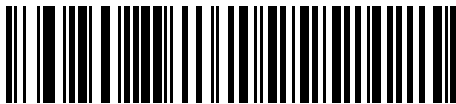

* HID Keyboard Emulation



IBM Table Top USB

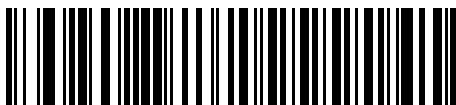

IBM Hand-Held USB



USB OPOS Hand-Held

USB Device Type (continued)



Simple COM Port Emulation



SSI over USB CDC

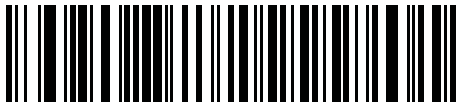

**USB CDC Host
(Note 1)**



Symbol Native API (SNAPI) without Imaging Interface



Symbol Native API (SNAPI) with Imaging Interface

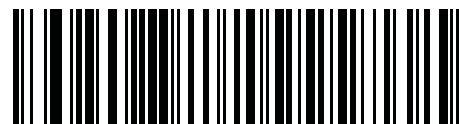

**Toshiba TEC Host
(Note 2)**

Symbol Native API (SNAPI) Status Handshaking

After selecting a SNAPI interface as the USB device type, select whether to enable or disable status handshaking.



*** Enable SNAPI Status Handshaking**



Disable SNAPI Status Handshaking

USB Keystroke Delay

This parameter sets the delay, in milliseconds, between emulated keystrokes. Scan a bar code below to increase the delay when hosts require a slower transmission of data.



*** No Delay**

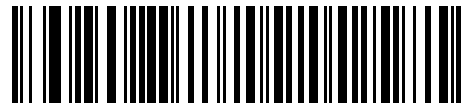

Medium Delay (20 msec)

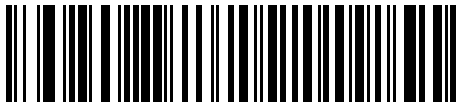

Long Delay (40 msec)

USB CAPS Lock Override

This option applies only to the HID Keyboard Emulation device. When enabled, the case of the data is preserved regardless of the state of the caps lock key. This setting is always enabled for the “Japanese, Windows (ASCII)” keyboard type and can not be disabled.



**Override Caps Lock Key
(Enable)**



*** Do Not Override Caps Lock Key
(Disable)**

USB Ignore Unknown Characters

This option applies only to the HID Keyboard Emulation device and IBM device. Unknown characters are characters the host does not recognize. When **Send Bar Codes With Unknown Characters** is selected, all bar code data is sent except for unknown characters, and no error beeps sound. When **Do Not Send Bar Codes With Unknown Characters** is selected, bar code data is sent up to the first unknown character, then the linear imager scanner issues an error beep.



* **Send Bar Codes with Unknown Characters**

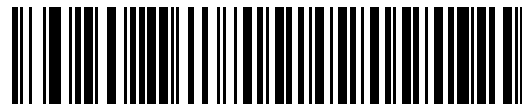

Do Not Send Bar Codes with Unknown Characters

USB Convert Unknown to Code 39

This option applies only to the IBM Handheld, IBM Tabletop, and OPOS devices. Scan a bar code below to enable or disable converting unknown bar code type data to Code 39.



* **Disable Convert Unknown to Code 39**



Enable Convert Unknown to Code 39

Emulate Keypad

When enabled, all characters are sent as ASCII sequences over the numeric keypad. For example ASCII A would be sent as “ALT make” 0 6 5 “ALT Break.”



Disable Keypad Emulation

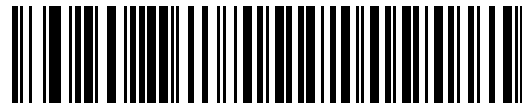

*** Enable Keypad Emulation**

Emulate Keypad with Leading Zero

Enable this to send character sequences sent over the numeric keypad as ISO characters which have a leading zero. For example ASCII A transmits as “ALT MAKE” 0 0 6 5 “ALT BREAK”.



Disable Keypad Emulation with Leading Zero



*** Enable Keypad Emulation with Leading Zero**

Quick Keypad Emulation

This option applies only to the HID Keyboard Emulation Device and if Emulate Keypad is enabled. This parameter enables a quicker method of keypad emulation where ASCII sequences are only sent for ASCII characters not found on the keyboard. The default value is **Enable**.



* **Enable**

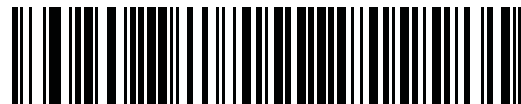

Disable

USB Keyboard FN 1 Substitution

This option applies only to the USB HID Keyboard Emulation device. When enabled, this allows replacement of any FN 1 characters in an EAN 128 bar code with a Key Category and value chosen by the user (see [FN1 Substitution Values on page 5-34](#) to set the Key Category and Key Value).



Enable FN1 Substitution



* **Disable FN1 Substitution**

Function Key Mapping

ASCII values under 32 are normally sent as a control-key sequences (see [Appendix H, ASCII CHARACTER SETS](#)). When this parameter is enabled, the keys in bold are sent in place of the standard key mapping. Table entries that do not have a bold entry remain the same whether or not this parameter is enabled.

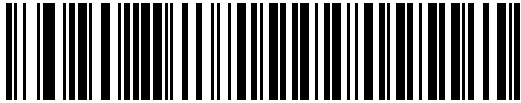

*** Disable Function Key Mapping**

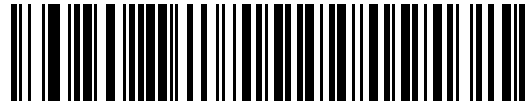

Enable Function Key Mapping

Simulated Caps Lock

When enabled, the linear imager scanner inverts upper and lower case characters on the linear imager scanner bar code as if the Caps Lock state is enabled on the keyboard. This inversion is done regardless of the current state of the keyboard's Caps Lock state.

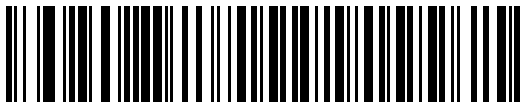

*** Disable Simulated Caps Lock**



Enable Simulated Caps Lock

Convert Case

When enabled, the linear imager scanner converts all bar code data to the selected case.

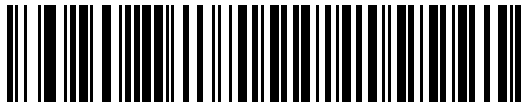

*** No Case Conversion**



Convert All to Upper Case

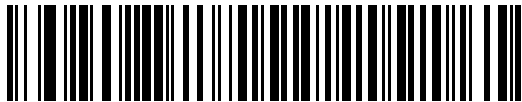

Convert All to Lower Case

USB Static CDC

Parameter # 670

When disabled, each device connected consumes another COM port (first device = COM1, second device = COM2, third device = COM3, etc.)

When enabled, each device connects to the same COM port.



*** Enable USB Static CDC
(1)**



**Disable USB Static CDC
(0)**

Optional USB Parameters

If you configure the linear imager scanner and find the settings were not saved, or changed, when the system is restarted scan the bar codes that follow to override USB interface defaults.

Scan a bar code below after setting defaults and before configuring the linear imager scanner.

Ignore Beep

The host can send a beep request to the linear imager scanner. When this parameter is enabled, the request is not sent to the attached linear imager scanner. All directives are still acknowledged to the USB host as if it were processed.



Disable



*** Enable**

Ignore Bar Code Configuration

The host has the ability to enable/disable code types. When this parameter is enabled, the request is not sent to the attached linear imager scanner. All directives are still acknowledged to the USB host as if it were processed.



Disable



*** Enable**

USB Polling Interval

Scan a bar code below to set the polling interval. The polling interval determines the rate at which data can be sent between the scanner and host computer. A lower number indicates a faster data rate.



NOTE When changing USB Device Types, the linear imager automatically restarts and issues a disconnect-reconnect beep sequence.



IMPORTANT Ensure your host machine can handle the selected data rate.



1 msec

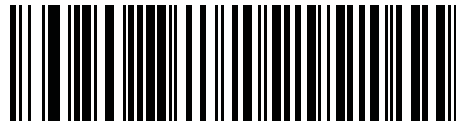

2 msec

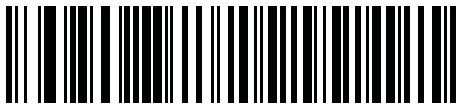

* 3 msec



4 msec

USB Polling Interval (continued)

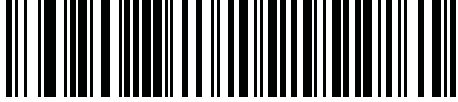

5 msec



6 msec

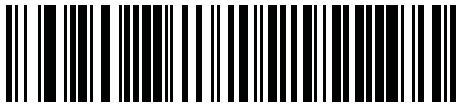

7 msec



8 msec

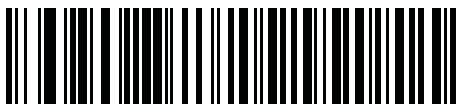

9 msec

USB Fast HID

This option transmits USB HID data at a faster rate.

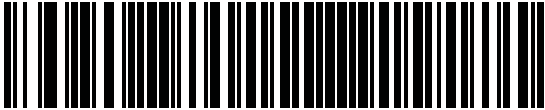

Enable



* Disable

IBM Specification Version

The IBM USB interface specification version selected defines how code types are reported over the IBM USB interface.

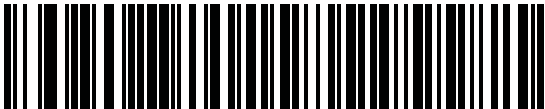

Original Specification



* Version 2.2

Toshiba TEC Host Parameters

This section only applies when the USB device type is set as Toshiba Tec Note 2 on page 6-7, and the scanner is connected to a Toshiba TEC register.

Toshiba TEC Code Type Table Usage

This single bit option chooses which Toshiba TEC specific Symbol Table is used for identifying bar code types.

Table 6-2 *Toshiba TEC Symbol Type Table*

Code Type	Table 0 Identifier	Table 1 Identifier
UPC-A	A	A
UPC-E	E	C
EAN-8	FF	B
EAN-13	F	A
Codabar (NW-7)	N	N
Code 39	M	M
I25	I	I
D25 (Standard 2 of 5)	H	H
Code 93	L	L
Code 128	K	K
RSS	R	R
All Others	X	X

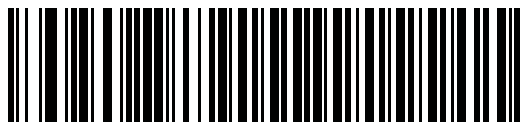

* Use Table 0 Identifier

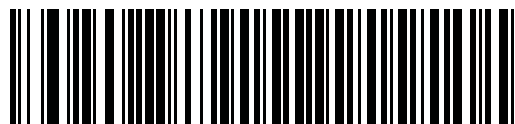

Use Table 1 Identifier

Toshiba TEC Include Symbol Type

This single bit option chooses whether or not the Toshiba TEC Symbol Table is used for identifying bar code types.



*** Add Symbol Types**

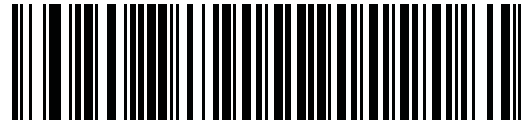

Do Not Add Symbol Types

Toshiba TEC Include Character Counts

This single bit option chooses whether or not the count of characters in the bar code is prefixed onto the decoded data before transmission. This applies to all the code types except the UPC and EAN families.

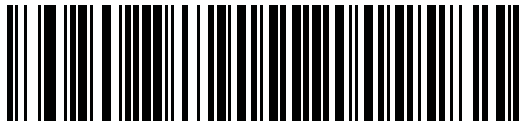

*** Add Character Counts**

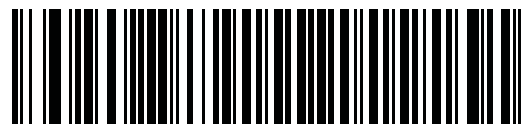

Do Not Add Character Counts

Toshiba TEC Include Header

This single bit option chooses whether or not the header character is prefixed onto the decoded data before transmission. The default header character is the STX (0x02) character. That can be changed with the Toshiba TEC Header Character parameters listed below.

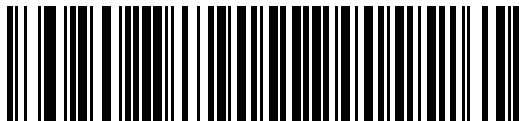

*** Add Header Character**

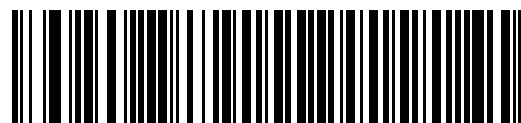

Do Not Add Header Character

Toshiba TEC Include Terminator

This single bit option chooses whether or not the terminator character(s) are appended onto the decoded data before transmission. The default terminator character is the ETX (0x03) character. That can be changed with the Toshiba TEC Terminator Character parameters listed below. Additionally, there is an ability to specify one or two terminator characters. The default is no second terminator.

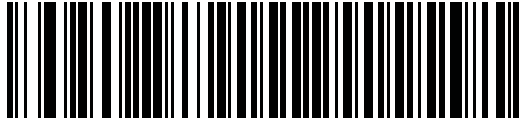

* Add Terminator Character (s)

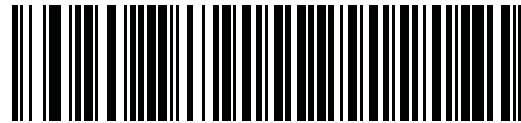

Do Not Add Terminator Character (s)

Toshiba TEC Header Character

This single byte option specifies the header character prefixed onto the decoded data before transmission. The default header character is the STX (0x02) character. Note that it is NOT POSSIBLE to use the NULL character (0x00) as the prefix as this is the default value and indicates that an STX must be used. To program a header character, scan the bar code below followed by two numeric bar codes in [Appendix E, NUMERIC BAR CODES](#).

Values:0 = Add STX (0x02),

All others specify the hex value to be prefixed.

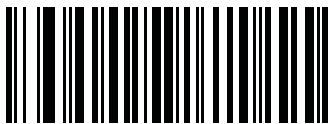

Toshiba TEC Header Character

Toshiba TEC Terminator Character

This two byte option specifies the terminator character(s) appended onto the decoded data before transmission. The default terminator character is the ETX (0x03) character. Note that it is NOT POSSIBLE to use the NULL character (0x00) as either of the terminators as this is the default value and indicates that an ETX must be used. If the first character is a NULL, then only the ETX is appended even if there is a second character defined. If the desired terminator is ETX followed by another character, then BOTH characters must be specified. To program a terminator character, scan the bar code below followed by two numeric bar codes in [Appendix E, NUMERIC BAR CODES](#).

Values: 0 = Add ETX (0x03),

All others specify the value to be appended in decimal format.

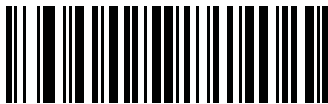

Terminator Character 1



Terminator Character 2

Toshiba TEC Light LED on Good Decode

This option specifies whether or not to light the *Good Decode LED* on a good decode.

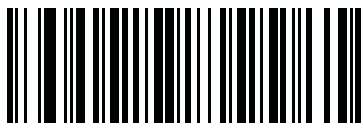

*** Light LED on Good Decode**

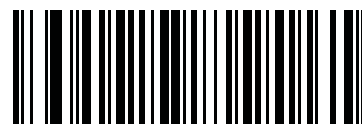

Do Not Light LED on Good Decode

Toshiba TEC Good Decode Beeper Timing

This option specifies when a good decode indication takes place. The options are to indicate the good decode either before or after the bar code was transmitted to the host.

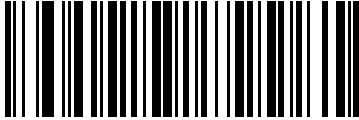

*** Indicate Before Transmission**

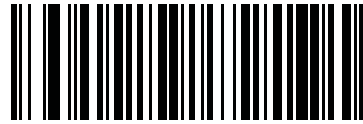

Indicate After Transmission

ASCII Character Set for USB

See [Appendix H, ASCII CHARACTER SETS](#) for the following:

- ASCII Character Set ([Table H-1 on page H-1](#))
- ALT Key Character Set ([Table H-2 on page H-6](#))
- GUI Key Character Set ([Table H-3 on page H-7](#))
- F Key Character Set ([Table H-5 on page H-11](#)).

CHAPTER 7 SSI INTERFACE

Introduction

This chapter describes the system requirements of the Simple Serial Interface (SSI), which provides a communications link between Symbol Technologies decoders (e.g., scan engines, slot scanners, hand-held scanners, two-dimensional scanners, hands-free scanners, and RF base stations) and a serial host. It provides the means for the host to control the decoder or scanner.

Communications

All communication between the linear imager scanner and host occurs over the hardware interface lines using the SSI protocol. Refer to the *Simple Serial Interface Programmer's Guide*, p/n 72-40451-xx, for more information on SSI.

The host and the linear imager scanner exchange messages in packets. A packet is a collection of bytes framed by the proper SSI protocol formatting bytes. The maximum number of bytes per packet that the SSI protocol allows for any transaction is 257 (255 bytes + 2 byte checksum).

Decode data can be sent as ASCII data (unpacketed), or as part of a larger message (packeted), depending on the linear imager scanner configuration.

SSI performs the following functions for the host device:

- Maintains a bi-directional interface with the linear imager scanner
- Allows the host to send commands that control the linear imager scanner
- Passes data from the linear imager scanner to a host device in SSI packet format or straight decode message.

The working environment of the SSI consists of a linear imager scanner, a serial cable which attaches to the host device, and in some instances, a power supply.

SSI transmits all decode data including special formatting (e.g., AIM ID). Parameter settings can control the format of the transmitted data.

The linear imager scanner can also send parameter information, product identification information, or event codes to the host.

All commands sent between the linear imager scanner and host must use the format described in the SSI Message Formats section. *SSI Transactions on page 7-3* describes the required sequence of messages in specific cases.

Table 7-1 lists all the SSI opcodes the linear imager scanner supports. It identifies the SSI partner allowed to send a message of each type. The host transmits opcodes designated type H. The linear imager scanner transmits type D opcodes, and either partner can transmit Host/Decoder (H/D) types.

Table 7-1 SSI Commands

Name	Type	Opcode	Description
AIM_OFF	H	0xC4	Deactivate aim pattern.
AIM_ON	H	0xC5	Activate aim pattern.
BEEP	H	0xE6	Sound the beeper.
CAPABILITIES_REPLY	D	0xD4	Reply to CAPABILITIES_REQUEST; contains a list of the capabilities and commands the decoder supports.
CAPABILITIES_REQUEST	H	0xD3	Request capabilities report from the decoder.
CMD_ACK	H/D	0xD0	Positive acknowledgment of received packet.
CMD_NAK	H/D	0xD1	Negative acknowledgment of received packet.
DECODE_DATA	D	0xF3	Decode data in SSI packet format.
EVENT	D	0xF6	Event indicated by associated event code.
LED_OFF	H	0xE8	De-activate LED output.
LED_ON	H	0xE7	Activate LED output.
PARAM_DEFAULTS	H	0xC8	Set parameter default values.
PARAM_REQUEST	H	0xC7	Request values of certain parameters.
PARAM_SEND	H/D	0xC6	Send parameter values.
REPLY_ID	D	0xA6	Reply to REQUEST_ID; contains decoder's serial number.
REPLY_REVISION	D	0xA4	Reply to REQUEST_REVISION contains decoder's software/hardware configuration.
REQUEST_ID	H	0xA3	Request the decoder's serial number.
REQUEST_REVISION	H	0xA3	Request the decoder's configuration.
SCAN_DISABLE	H	0xEA	Prevent the operator from scanning bar codes.
SCAN_ENABLE	H	0xE9	Permit bar code scanning.
SLEEP	H	0xEB	Request to place the decoder into low power.
START_DECODE	H	0xE4	Tell decoder to attempt to decode a bar code.
STOP_DECODE	H	0xE5	Tell decoder to abort a decode attempt.
WAKEUP	H	N/A	Wakeup decoder after it has entered low power mode.

For details of the SSI protocol, refer to the *Simple Serial Interface Programmer's Guide (72-40451-xx)*.

SSI Transactions

General Data Transactions

ACK/NAK Handshaking

If you enable ACK/NAK handshaking, all packeted messages must have a CMD_ACK or CMD_NAK response, unless the command description states otherwise. This parameter is enabled by default. Symbol Technologies recommends leaving this handshaking enabled to provide feedback to the host. Raw decode data and WAKEUP do not use ACK/NAK handshaking since they are not packeted data.

Following is an example of a problem which can occur if you disable ACK/NAK handshaking:

- The host sends a PARAM_SEND message to the linear imager scanner to change the baud rate from 9600 to 19200.
- The linear imager scanner cannot interpret the message.
- The linear imager scanner does not implement the change the host requested.
- The host assumes that the parameter change occurred and acts accordingly.
- Communication is lost because the change did not occur on both sides.

If you enable ACK/NAK handshaking, the following occurs:

- The host sends a PARAM_SEND message.
- The linear imager scanner cannot interpret the message.
- The linear imager scanner CMD_NAKs the message.
- The host resends the message.
- The linear imager scanner receives the message successfully, responds with CMD_ACK, and implements parameter changes.

Transfer of Decode Data

The Decode Data Packet Format parameter controls how decode data is sent to the host. Set this parameter to send the data in a DECODE_DATA packet. Clear this parameter to transmit the data as raw ASCII data.

✓ **NOTE** When transmitting decode data as raw ASCII data, ACK/NAK handshaking does not apply regardless of the state of the ACK/NAK handshaking parameter.

ACK/NAK Enabled and Packeted Data

The linear imager scanner sends a DECODE_DATA message after a successful decode. The linear imager scanner waits for a programmable time-out for a CMD_ACK response. If it does not receive the response, the linear imager scanner tries to send two more times before issuing a host transmission error. If the linear imager scanner receives a CMD_NAK from the host, it may attempt a retry depending on the cause field of the CMD_NAK message.

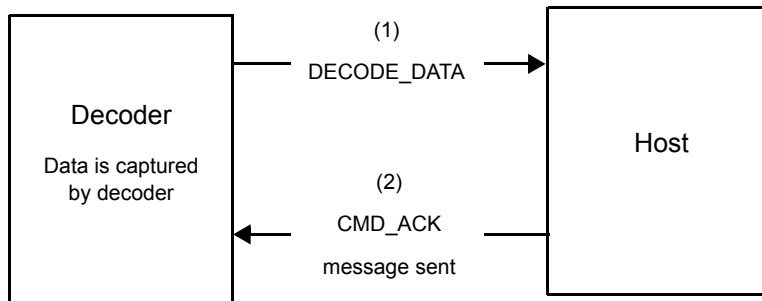

ACK/NAK Enabled and Unpacketed ASCII Data

Even though the ACK/NAK handshaking is enabled, no handshaking occurs because the handshaking applies only to packeted data. In this example the **packeted_decode** parameter is disabled.

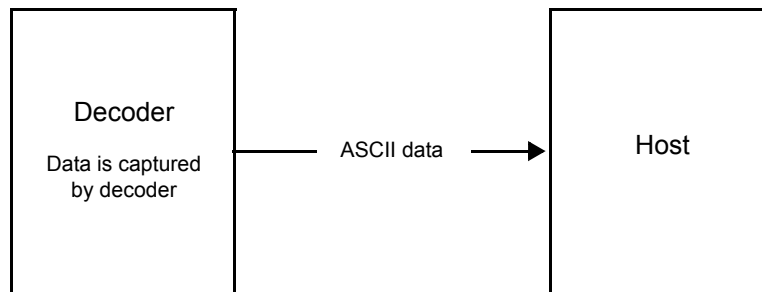

ACK/NAK Disabled and Packeted DECODE_DATA

In this example ACK/NAK does not occur even though `packeted_decode` is enabled because the ACK/NAK handshaking parameter is disabled.

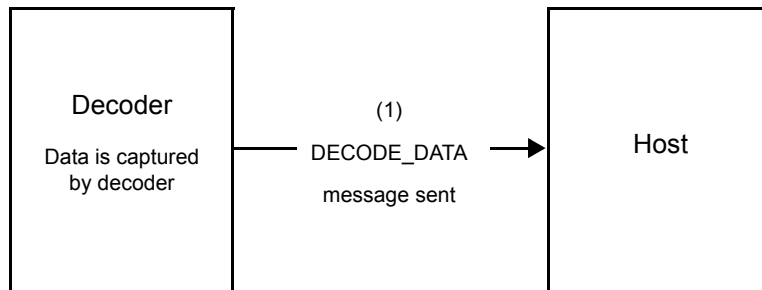

ACK/NAK Disabled and Unpacketed ASCII Data

Data captured by the linear imager scanner is sent to the host.

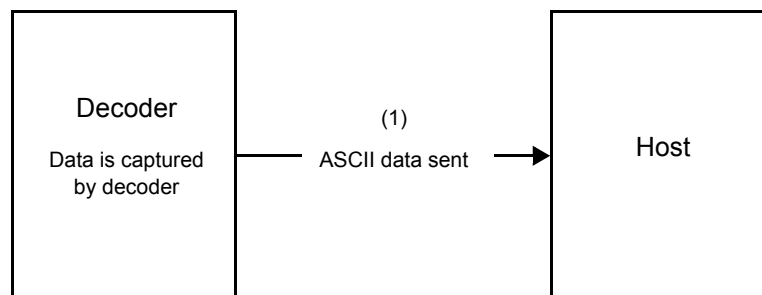

Communication Summary

RTS/CTS Lines

All communication must use RTS/CTS handshaking as described in the *Simple Serial Interface Programmer's Guide*, p/n 72-40451-xx. If hardware handshaking is disabled or bypassed, the WAKEUP command must be sent prior to all other communications, or the first byte of a communication message may be lost during the linear imager scanner wakeup sequence.

ACK/NAK Option

Enable or disable ACK/NAK handshaking. This handshaking is enabled by default and Symbol Technologies recommends leaving it enabled. Disabling this handshaking can cause communication problems, as handshaking is the only acknowledgment that a message was received, and if it was received correctly. ACK/NAK is not used with unpacketed decode data regardless of whether or not it is enabled.

Number of Data Bits

All communication with the linear imager scanner must use 8-bit data.

Serial Response Time-out

The Serial Response Time-out parameter determines how long to wait for a handshaking response before trying again, or aborting any further attempts. Set the same value for both the host and linear imager scanner.

- ✓ **NOTE** You can temporarily change the Serial Response Time-out when the host takes longer to process an ACK or longer data string. Symbol Technologies does not recommend frequent permanent changes due to limited write cycles of non-volatile memory.

Retries

When sending data, the host should resend twice after the initial send if the linear imager scanner does not respond with an ACK or NAK (if ACK/NAK handshaking is enabled), or response data (e.g., PARAM_SEND, REPLY_REVISION). If the linear imager scanner replies with a NAK RESEND, the host resends the data. All resent messages must have the resend bit set in the Status byte.

The linear imager scanner resends data two times after the initial send if the host fails to reply with an ACK or NAK (if ACK/NAK handshaking is enabled).

Baud Rate, Stop Bits, Parity, Response Time-out, ACK/NAK Handshake

If you use PARAM_SEND to change these serial parameters, the ACK response to the PARAM_SEND uses the previous values for these parameters. The new values then take effect for the next transaction.

Errors

The linear imager scanner issues a communication error when:

- The CTS line is asserted when the linear imager scanner tries to transmit, and is still asserted on each of 2 successive retries
- Failure to receive an ACK or NAK after initial transmit and two resends.

Things to Remember When Using SSI Communication

When not using hardware handshaking, space messages sufficiently apart. The host must not communicate with the linear imager scanner if the linear imager scanner is transmitting.

When using hardware handshaking, frame each message properly with the handshaking signals. Do not try to send two commands within the same handshaking frame.

There is a permanent/temporary bit in the PARAM_SEND message. Removing power from the linear imager scanner discards temporary changes. Permanent changes are written to non-volatile memory. Frequent changes shorten the life of the non-volatile memory.

Using Time Delay to Low Power Mode with SSI

[Time Delay to Low Power Mode on page 5-16](#) provides bar codes to select a general time delay. To program a more specific delay value, use an SSI command according to [Table 7-2](#).

Table 7-2 Values for Selecting Time Delay to Low Power

Value	Timeout	Value	Timeout	Value	Timeout	Value	Timeout
0x00	15 Mins	0x10	1 Sec	0x20	1 Min	0x30	1 Hour
0x01	30 Mins	0x11	1 Sec	0x21	1 Min	0x31	1 Hour
0x02	60 Mins	0x12	2 Secs	0x22	2 Mins	0x32	2 Hours
0x03	90 Mins	0x13	3 Secs	0x23	3 Mins	0x33	3 Hours
N/A	N/A	0x14	4 Secs	0x24	4 Mins	0x34	4 Hours
N/A	N/A	0x15	5 Secs	0x25	5 Mins	0x35	5 Hours
N/A	N/A	0x16	6 Secs	0x26	6 Mins	0x36	6 Hours
N/A	N/A	0x17	7 Secs	0x27	7 Mins	0x37	7 Hours
N/A	N/A	0x18	8 Secs	0x28	8 Mins	0x38	8 Hours
N/A	N/A	0x19	9 Secs	0x29	9 Mins	0x39	9 Hours
N/A	N/A	0x1A	10 Secs	0x2A	10 Mins	0x3A	10 Hours
N/A	N/A	0x1B	15 Secs	0x2B	15 Mins	0x3B	15 Hours
N/A	N/A	0x1C	20 Secs	0x2C	20 Mins	0x3C	20 Hours
N/A	N/A	0x1D	30 Secs	0x2D	30 Mins	0x3D	30 Hours
N/A	N/A	0x1E	45 Secs	0x2E	45 Mins	0x3E	45 Hours
N/A	N/A	0x1F	60 Secs	0x2F	60 Mins	0x3F	60 Hours



CAUTION With hardware handshaking disabled, the PL3307 wakes from low power mode upon receiving a character. However, the PL3307 does not process this character or any others it receives during the 7 ms period following wakeup. Wait at least 7 ms after wakeup to send valid characters.

Encapsulation of RSM Commands/Responses over SSI

The SSI protocol allows the host to send a command that is variable in length up to 255 bytes. Although there is a provision in the protocol to multi-packet commands from the host, the scan engine does not support this. The host must fragment packets using the provisions in the RSM protocol.

Command Structure

Byte	7	6	5	4	3	2	1	0
0	Length (not including the checksum)							
1	SSI_MGMT_COMMAND (0x80)							
2	Message Source (4 - Host)							
3	Reserved (0)			Reserved (0)		Reserved (0)	Cont'd packet	Retransmit
4	Payload data (see the following example)							
...								
Length -1								
Length	2's complement checksum (MSB)							
Length +1	2's complement checksum (LSB)							

The expected response in the positive case is SSI_MGMT_COMMAND which may be a multi-packet response. For devices that do not support the SSI_MGMT_COMMAND, the response is the standard SSI_NAK.

Response Structure

Byte	7	6	5	4	3	2	1	0
0	Length (not including the checksum)							
1	SSI_MGMT_COMMAND (0x80)							
2	Message Source (0 - Decoder)							
3	Reserved (0)			Reserved (0)		Reserved (0)	Cont'd packet	Retransmit
4	Payload data (see the following example)							
...								
Length -1								
Length	2's complement checksum (MSB)							
Length +1	2's complement checksum (LSB)							

Example Transaction

The following example illustrates how to retrieve diagnostic information (Diagnostic Testing and Reporting (Attribute #10061) decimal) from the engine using encapsulation of RSM commands over SSI. Before sending any RSM command, the host must send the RSM Get Packet Size command to query the packet size supported by the device.

Command from Host to Query Packet Size Supported by Device

```
0A 80 04 00 00 06 20 00 FF FF FD 4E
```

Where:

- 0A 80 04 00 is encapsulation of RSM commands over SSI command header
- 00 06 20 00 FF FF is RSM Get Packet Size command
- FD 4E is SSI command checksum

Response from Device with Packet Size Information

```
0C 80 00 00 00 08 20 00 00 F0 00 F0 FD 6C
```

Where:

- 0C 80 00 00 is encapsulation of RSM command over SSI command header
- 00 08 20 00 00 F0 00 F0 is RSM Get Packet Size response
- FD 6C is SSI response checksum

Command from Host to Retrieve Diagnostic Information

```
0C 80 04 00 00 08 02 00 27 4D 42 00 FE B0
```

Where:

- 0C 80 04 00 is encapsulation of RSM commands over SSI command header
- 00 08 02 00 27 4D 42 00 is attribute Get command requesting attribute 10061 decimal
- FE B0 is SSI command checksum

Response from Device with Diagnostic Information

```
21 80 00 00 00 1D 02 00 27 4D 41 01 42 00 0E 00 00 00 00 01 03 02 03 03 03 04 03 05 03 06 03 FF FF FC 15
```

Where:

- 21 80 00 00 00 1D 02 00 27 4D 41 01 42 00 0E 00 00 is encapsulation of RSM responses over SSI command header
- 00 00 01 03 02 03 03 03 04 03 05 03 06 03 is attribute Get response which includes diagnostic report value
- FF FF is attribute Get response, packet termination
- FC 15 is SSI response checksum

Simple Serial Interface Default Parameters

This section describes how to set up the linear imager scanner with an SSI host. When using SSI, program the linear imager scanner via bar code menu or SSI hosts commands.

Throughout the programming bar code menus, asterisks (*) indicate default values.

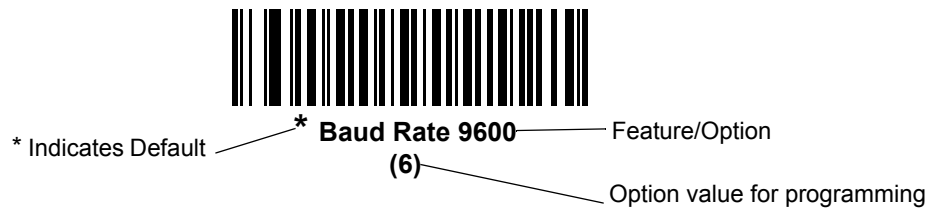

- ✓ **NOTE** Most computer monitors allow scanning the bar codes directly on the screen. When scanning from the screen, be sure to set the document magnification to a level where you can see the bar code clearly, and bars and/or spaces are not merging.

[Table 7-3](#) lists the defaults for the SSI host. There are two ways to change the default values:

- Scan the appropriate bar codes in this guide. These new values replace the standard default values in memory. To recall the default parameter values, scan the [* Restore Defaults](#) bar code on page [5-5](#).
- Download data through the device's serial port using SSI. Hexadecimal parameter numbers appear in this chapter below the parameter title, and options appear in parenthesis beneath the accompanying bar codes. Refer to the *Simple Serial Interface (SSI) Programmer's Guide* for detailed instructions for changing parameters using this method.

- ✓ **NOTE** See [Appendix A, STANDARD DEFAULT PARAMETERS](#) for all user preferences, hosts, symbologies, and miscellaneous default parameters.

Table 7-3 SSI Default Table

Parameter	Parameter Number	SSI Number	Default	Page Number
Select SSI Host	N/A	N/A	N/A	7-11
Baud Rate	156	9Ch	9600	7-12
Parity	158	9Eh	None	7-14
Check Parity	151	97h	Disable	7-15
Stop Bits	157	9Dh	1	7-15
Software Handshaking	159	9Fh	ACK/NAK	7-16
Host RTS Line State	154	9Ah	Low	7-17
Decode Data Packet Format	238	EEh	Send Raw Decode Data	7-17
Host Serial Response Time-out	155	9Bh	2 sec	7-18

Table 7-3 SSI Default Table (Continued)

Parameter	Parameter Number	SSI Number	Default	Page Number
Host Character Time-out	239	EFh	200 msec	7-19
Multipacket Option	334	F0h 4Eh	Option 1	7-20
Interpacket Delay	335	F0h 4Fh	0 ms	7-21
Event Reporting				
Decode Event	256	F0h 00h	Disable	7-22
Boot Up Event	258	F0h 02h	Disable	7-23
Parameter Event	259	F0h 03h	Disable	7-23

✓ **NOTE** SSI interprets Prefix, Suffix1, and Suffix2 values listed in [Table H-1 on page H-1](#) differently than other interfaces. SSI does not recognize key categories, only the 3-digit decimal value. The default value of 7013 is interpreted as CR only.

SSi Host Parameters

Select SSI Host

To select SSI as the host interface, scan the following bar code.



SSi Host

Baud Rate

Parameter # 156 (SSI # 9Ch)

Baud rate is the number of bits of data transmitted per second. Set the linear imager scanner's baud rate to match the baud rate setting of the host device. Otherwise, data may not reach the host device or may reach it in distorted form..



NOTE The corded LI3608 does not support Baud Rate 460,800 and Baud Rate 921,600.



* Baud Rate 9600
(6)



Baud Rate 19,200
(7)



Baud Rate 38,400
(8)



Baud Rate 57,600
(10)



Baud Rate 115,200
(11)

Baud Rate (continued)



**Baud Rate 230,400
(12)**



**Baud Rate 460,800
(13)**



**Baud Rate 921,600
(14)**

Parity

Parameter # 158 (SSI # 9Eh)

A parity check bit is the most significant bit of each ASCII coded character. Select the parity type according to host device requirements.

- Select **Odd** parity and the parity bit has a value 0 or 1, based on data, to ensure that an odd number of 1 bits is contained in the coded character.
- Select **Even** parity and the parity bit has a value 0 or 1, based on data, to ensure that an even number of 1 bits is contained in the coded character.
- If no parity is required, select **None**.



**Odd
(2)**



**Even
(1)**



*** None
(0)**

Check Parity

Parameter # 151 (SSI # 97h)

Select whether or not to check the parity of received characters. Use the Parity parameter to select the type of parity.



*** Do Not Check Parity
(0)**



**Check Parity
(1)**

Stop Bits

Parameter # 157 (SSI # 9Dh)

The stop bit(s) at the end of each transmitted character marks the end of transmission of one character and prepares the receiving (host) device for the next character in the serial data stream. Set the number of stop bits (one or two) to match host device requirements.



*** 1 Stop Bit
(1)**



**2 Stop Bits
(2)**

Software Handshaking

Parameter # 159 (SSI # 9Fh)

This parameter offers control of data transmission in addition to the control hardware handshaking offers. Hardware handshaking is always enabled; you cannot disable it.

- **Disable ACK/NAK Handshaking:** When this option is selected, the linear imager scanner neither generates nor expects ACK/NAK handshaking packets.
- **Enable ACK/NAK Handshaking:** When this option is selected, after transmitting data, the linear imager scanner expects either an ACK or NAK response from the host. The linear imager scanner also ACKs or NAKs messages from the host.

The linear imager scanner waits up to the programmable Host Serial Response Time-out to receive an ACK or NAK. If the linear imager scanner does not get a response in this time, it resends its data up to two times before discarding the data and declaring a transmit error.



**Disable ACK/NAK
(0)**



*** Enable ACK/NAK
(1)**

Host RTS Line State

Parameter # 154 (SSI # 9Ah)

This parameter sets the expected idle state of the Serial Host RTS line.

The SSI Interface is used with host applications which also implement the SSI protocol. However, you can use the linear imager scanner in a "scan-and-transmit" mode to communicate with any standard serial communication software on a host PC (see [Decode Data Packet Format on page 7-17](#)). If transmission errors occur in this mode, the host PC may be asserting hardware handshaking lines which interfere with the SSI protocol. Scan the **Host: RTS High** bar code to address this problem.



*** Host: RTS Low
(0)**



**Host: RTS High
(1)**

Decode Data Packet Format

Parameter # 238 (SSI # EEh)

This parameter selects whether to transmit decoded data in raw format (unpacketed), or with the packet format defined by the serial protocol.

Selecting the raw format disables ACK/NAK handshaking for decode data.



*** Send Raw Decode Data
(0)**



**Send Packeted Decode Data
(1)**

Host Serial Response Time-out

Parameter # 155 (SSI # 9Bh)

This parameter specifies how long the linear imager scanner waits for an ACK or NAK before resending. Also, if the linear imager scanner wants to send, and the host has already been granted permission to send, the linear imager scanner waits for the designated time-out before declaring an error.

To set the delay period (options are 2, 5, 7.5, or 9.9 seconds), scan one of the following bar codes.

✓ **NOTE** Other values are available via SSI command.



*** Low - 2 Seconds
(20)**



**Medium - 5 Seconds
(50)**



**High - 7.5 Seconds
(75)**



**Maximum - 9.9 Seconds
(99)**

Host Character Time-out

Parameter # 239 (SSI # EFh)

This parameter determines the maximum time the linear imager scanner waits between characters transmitted by the host before discarding the received data and declaring an error.

To set the delay period (options are 200, 500, 750, or 990 ms), scan one of the following bar codes.

✓ **NOTE** Other values are available via SSI command.



* Low - 200 ms
(20)



Medium - 500 ms
(50)



High - 750 ms
(75)



Maximum - 990 ms
(99)

Multipacket Option

Parameter # 334 (SSI # F0h 4Eh)

This parameter controls ACK/NAK handshaking for multi-packet transmissions.

- **Multi-Packet Option 1:** The host sends an ACK / NAK for each data packet during a multi-packet transmission.
- **Multi-Packet Option 2:** The linear imager scanner sends data packets continuously, with no ACK/NAK handshaking to pace the transmission. The host, if overrun, can use hardware handshaking to temporarily delay linear imager scanner transmissions. At the end of transmission, the linear imager scanner waits for a CMD_ACK or CMD_NAK.
- **Multi-Packet Option 3:** Option 3 is the same as option 2 with the addition of a programmable interpacket delay.



* Multipacket Option 1
(0)



Multipacket Option 2
(1)



Multipacket Option 3
(2)

Interpacket Delay

Parameter # 335 (SSI # F0h 4Fh)

This parameter specifies the interpacket delay if you selected **Multipacket Option 3**.

To set the delay period (options are 0, 25, 50, 75, or 99 ms), scan one of the following bar codes.

✓ **NOTE** Other values are available via SSI command.



* Minimum - 0 ms
(0)



Low - 25 ms
(25)



Medium - 50 ms
(50)



High - 75 ms
(75)



Maximum - 99 ms
(99)

Event Reporting

The host can request the linear imager scanner to provide certain information (events) relative to the linear imager scanner's behavior. Enable or disable the events listed in [Table 7-4](#) and on the following pages by scanning the appropriate bar codes.

Table 7-4 *Event Codes*

Event Class	Event	Code Reported
Decode Event	Non parameter decode	0x01
Boot Up Event	System power-up	0x03
Parameter Event	Parameter entry error	0x07
	Parameter stored	0x08
	Defaults set (and parameter event is enabled by default)	0x0A
	Number expected	0x0F

Decode Event

Parameter # 256 (SSI # F0h 00h)

When enabled, the linear imager scanner generates a message to the host upon a successful bar code decode. When disabled, no notification is sent.

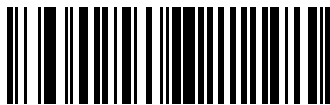

**Enable Decode Event
(1)**



*** Disable Decode Event
(0)**

Boot Up Event

Parameter # 258 (SSI # F0h 02h)

When enabled, the linear imager scanner generates a message to the host whenever power is applied. When disabled, no notification is sent.

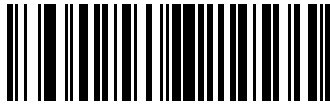

**Enable Boot Up Event
(1)**

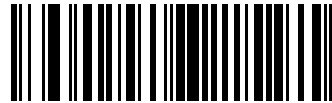

*** Disable Boot Up Event
(0)**

Parameter Event

Parameter # 259 (SSI # F0h 03h)

When enabled, the linear imager scanner generates a message to the host when one of the events specified in [Table 7-4 on page 7-22](#) occurs. When disabled, no notification is sent.

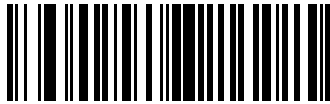

**Enable Parameter Event
(1)**

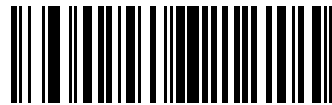

*** Disable Parameter Event
(0)**

CHAPTER 8 RS-232 INTERFACE

Introduction

This chapter provides instructions for programming the linear imager to interface with an RS-232 host interface. The RS-232 interface is used to attach the scanner to point-of-sale devices, host computers, or other devices with an available RS-232 port (i.e., COM port).

If the particular host is not listed in [Table 8-2](#), set the communication parameters to match the host device. Refer to the documentation for the host device.

- ✓ **NOTE** This linear imager scanner uses TTL RS-232 signal levels, which interface with most system architectures. For system architectures requiring RS-232C signal levels, Zebra offers different cables providing the TTL to RS-232C conversion. Contact Zebra Support for more information.

Throughout the programming bar code menus, default values are indicated with asterisks (*).

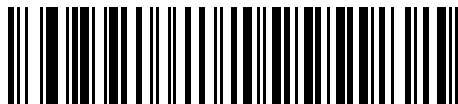

*Indicates Default * **Baud Rate 9600** Feature/Option

Connecting an RS-232 Interface

LI3608 Corded Linear Imager RS-232 Connection

This connection is made directly from the scanner to the host computer.

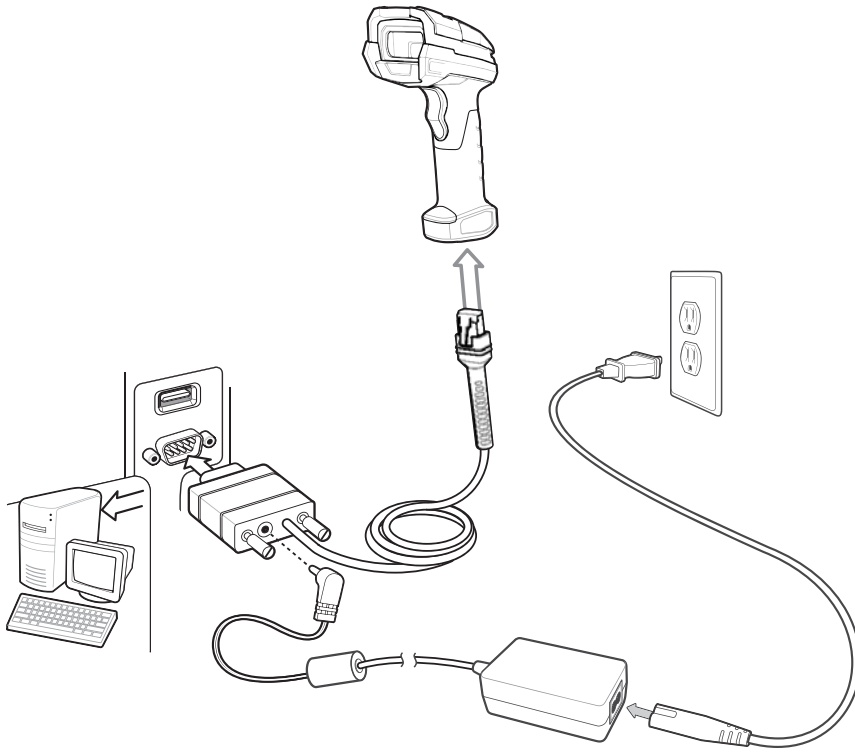

Figure 8-1 *LI3608 Corded Linear Imager RS-232 Connection*

To connect the RS-232 interface:

1. Attach the modular connector of the RS-232 interface cable to the host port on the bottom of the scanner.
2. Connect the other end of the RS-232 interface cable to the serial port on the host.
3. Connect the power supply to the serial connector end of the RS-232 interface cable. Plug the power supply into an appropriate outlet.
4. Select the RS-232 host type by scanning the appropriate bar code from [RS-232 Host Types on page 8-7](#).

✓ **NOTE** The interface cable automatically detects the host interface type and uses the default setting. If the default (*) does not meet your requirements, scan another host bar code.

5. To modify any other parameter options, scan the appropriate bar codes in this chapter.

Connecting an RS-232 Interface

LI3678 Cordless Linear Imager RS-232 Connection

This connection is made directly from the scanner to the host computer.

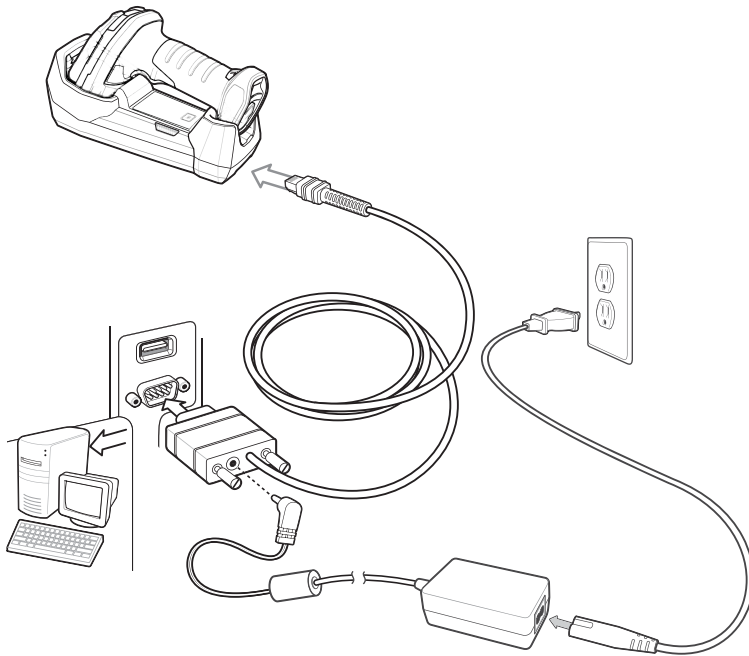

Figure 8-2 *LI3678 Cordless Linear Imager RS-232 Connection*

- ✓ **NOTE** Interface cables vary depending on configuration. The connectors illustrated in [Figure 8-2](#) are examples only. The connectors may be different from those illustrated, but the steps to connect the cradle remain the same.
- ✓ **NOTE** Disconnect the host cables before the power supply, or the linear imager scanner may not recognize the new host.

To connect the cradle with a RS-232 interface:

1. Connect the other end of the RS-232 interface cable to the serial port on the host.
 2. Attach the modular connector of the RS-232 interface cable to the cable interface port on the cradle. See [Connecting the Cradle on page 1-6](#).
 3. If required, connect the power supply.
 4. Ensure that all connections are secure.
 5. Pair the digital scanner to the cradle by scanning the bar code on the cradle.
 6. Select the RS-232 host type by scanning the appropriate bar code from [RS-232 Host Types on page 8-7](#).
- ✓ **NOTE** The interface cable automatically detects the host interface type and uses the default setting. If the default (*) does not meet your requirements, scan another host bar code.
7. To modify any other parameter options, scan the appropriate bar codes in this chapter.

RS-232 Parameter Defaults

Table 8-1 lists the defaults for RS-232 host parameters. If any option needs to be changed, scan the appropriate bar code(s) provided in the Parameter Descriptions section beginning on [page 8-5](#).



NOTE See [Appendix A, STANDARD DEFAULT PARAMETERS](#) for all user preferences, hosts, symbologies, and miscellaneous default parameters.

Table 8-1 *RS-232 Host Default Table*

Parameter	Default	Page Number
RS-232 Host Parameters		
RS-232 Host Types	Standard	8-7
Baud Rate	9600	8-9
Parity Type	None	8-10
Stop Bit Select	1 Stop Bit	8-11
Data Bits (ASCII Format)	8-Bit	8-12
Check Receive Errors	Enable	8-12
Hardware Handshaking	None	8-14
Software Handshaking	None	8-16
Host Serial Response Time-out	2 sec	8-17
RTS Line State	Low RTS	8-18
Beep on <BEL>	Disable	8-18
Intercharacter Delay	0 msec	8-19
Nixdorf Beep/LED Options	Normal Operation	8-20
Ignore Unknown Characters	Send Bar Code	8-20

RS-232 Host Parameters

Various RS-232 hosts are set up with their own parameter default settings ([Table 8-2](#)). Selecting the ICL, Fujitsu, Wincor-Nixdorf Mode A, Wincor-Nixdorf Mode B, Olivetti, Omron, or terminal sets the defaults listed below.

Table 8-2 Terminal Specific RS-232

Parameter	ICL	Fujitsu	Wincor-Nixdorf Mode A	Wincor-Nixdorf Mode B/OPOS/JPOS	Olivetti	Omron	CUTE
Transmit Code ID	Yes	Yes	Yes	Yes	Yes	Yes	Yes
Data Transmission Format	Data/Suffix	Data/Suffix	Data/Suffix	Data/Suffix	Prefix/Data/Suffix	Data/Suffix	Prefix/Data/Suffix
Suffix	CR (1013)	CR (1013)	CR (1013)	CR (1013)	ETX (1002)	CR (1013)	CR (1013) ETX (1003)
Baud Rate	9600	9600	9600	9600	9600	9600	9600
Parity	Even	None	Odd	Odd	Even	None	Even
Hardware Handshaking	RTS/CTS Option 3	None	RTS/CTS Option 3	RTS/CTS Option 3	None	None	None
Software Handshaking	None	None	None	None	ACK/NAK	None	None
Serial Response Time-out	9.9 Sec.	2 Sec.	9.9 Sec.	9.9 Sec.	9.9 Sec.	9.9 Sec.	9.9 Sec.
Stop Bit Select	One	One	One	One	One	One	One
ASCII Format	8-Bit	8-Bit	8-Bit	8-Bit	7-Bit	8-Bit	7-Bit
Beep On <BEL>	Disable	Disable	Disable	Disable	Disable	Disable	Disable
RTS Line State	High	Low	Low	Low = No data to send	Low	High	High
Prefix	None	None	None	None	STX (1003)	None	STX (1002)

In the Nixdorf Mode B, if CTS is low, scanning is disabled. When CTS is high, scanning is enabled.

If you scan Nixdorf Mode B without connecting the linear imager scanner to the proper host, it may appear unable to scan. If this happens, scan a different RS-232 host type within 5 seconds of cycling power to the linear imager scanner.

The CUTE host disables all parameter scanning, including Set Defaults. If you inadvertently select CUTE, scan * Enable Parameter Bar Code Scanning (1) on page 5-6, then change the host selection.

In ASCII format, when 7-bit is selected, Parity must be set to Odd or Even. If Parity is set to None, the scanner automatically operates in 8-bit mode, even if 7-bit is scanned.

RS-232 Host Parameters (continued)

Selecting the ICL, Fujitsu, Wincor-Nixdorf Mode A, Wincor-Nixdorf Mode B, OPOS terminal enables the transmission of code ID characters listed in [Table 8-3](#) below. These code ID characters are not programmable and are separate from the Transmit Code ID feature. The Transmit Code ID feature should not be enabled for these terminals.

Table 8-3 Terminal Specific Code ID Characters

Code Type	ICL	Fujitsu	Wincor-Nixdorf Mode A	Wincor-Nixdorf Mode B/ OPOS/JPOS	Olivetti	Omron	CUTE
UPC-A	A	A	A	A	A	A	A
UPC-E	E	E	C	C	C	E	None
EAN-8/JAN-8	FF	FF	B	B	B	FF	None
EAN-13/JAN-13	F	F	A	A	A	F	A
Code 39	C <len>	None	M	M	M <len>	C <len>	3
Code 39 Full ASCII	None	None	M	M	None	None	3
Codabar	N <len>	None	N	N	N <len>	N <len>	None
Code 128	L <len>	None	K	K	K <len>	L <len>	5
I 2 of 5	I <len>	None	I	I	I <len>	I <len>	1
Code 93	None	None	L	L	L <len>	None	None
D 2 of 5	H <len>	None	H	H	H <len>	H <len>	2
GS1-128	L <len>	None	P	P	P <len>	L <len>	5
MSI	None	None	O	O	O <len>	None	None
Bookland EAN	F	F	A	A	A	F	None
Trioptic	None	None	None	None	None	None	None
Code 11	None	None	None	None	None	None	None
IATA	H<len>	None	H	H	H <len>	H <len>	2
Code 32	None	None	None	None	None	None	None
GS1 Databar Variants	None	None	E	E	None	None	None

RS-232 Host Types

To select an RS-232 host interface, scan one of the following bar codes.

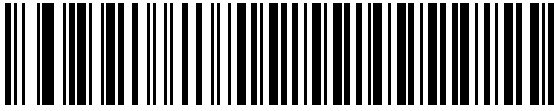

* Standard RS-232

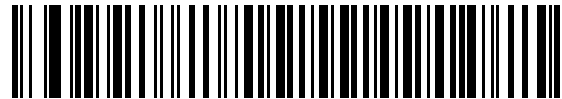

ICL RS-232

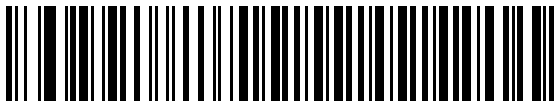

Wincor-Nixdorf RS-232 Mode A

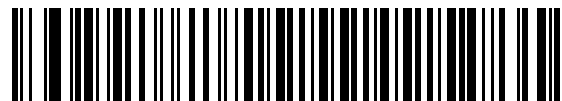

Wincor-Nixdorf RS-232 Mode B



Olivetti ORS4500

RS-232 Host Types (continued)



Omron



OPOS/JPOS

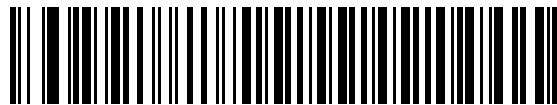

Fujitsu RS-232

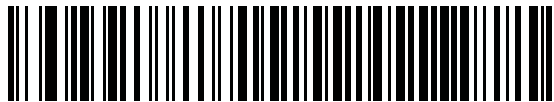

CUTE



NOTE The CUTE host disables all parameter scanning, including set defaults. If the CUTE parameter is inadvertently selected, scan [* Enable Parameter Bar Code Scanning \(1\) on page 5-6](#), then change the host selection.

Baud Rate

Baud rate is the number of bits of data transmitted per second. Set the linear imager scanner's baud rate to match the baud rate setting of the host device. Otherwise, data may not reach the host device or may reach it in distorted form.

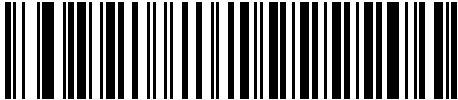

* Baud Rate 9600

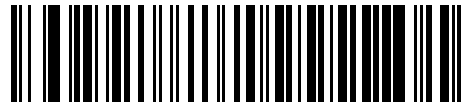

Baud Rate 19,200

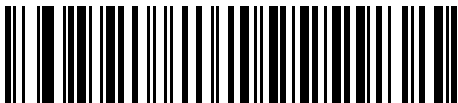

Baud Rate 38,400



Baud Rate 57,600



Baud Rate 115,200

Parity



NOTE Parity of **None** is not valid when Data Bits is set to **7-bit**.

A parity check bit is the most significant bit of each ASCII coded character. Select the parity type according to host device requirements.

- Select **Odd** parity and the parity bit value is set to 0 or 1, based on data, to ensure that an odd number of 1 bits are contained in the coded character.
- Select **Even** parity and the parity bit value is set to 0 or 1, based on data, to ensure that an even number of 1 bits are contained in the coded character.
- Select **None** when no parity bit is required.

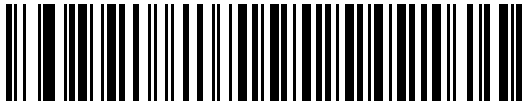

Odd



Even

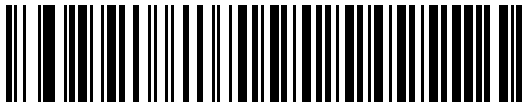

*** None**

Stop Bit Select

The stop bit(s) at the end of each transmitted character marks the end of transmission of one character and prepares the receiving device for the next character in the serial data stream. The number of stop bits selected (one or two) depends on the number the receiving terminal is programmed to accommodate. Set the number of stop bits to match host device requirements.

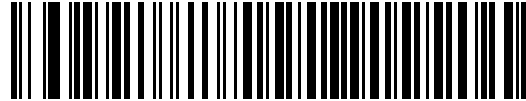

* 1 Stop Bit

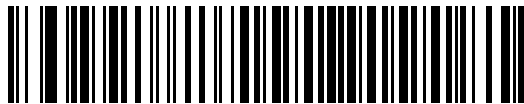

2 Stop Bits

Data Bits (ASCII Format)

This parameter allows the linear imager scanner to interface with devices requiring a 7-bit or 8-bit ASCII protocol.



NOTE When 7-bit is selected, Parity must be set to **Odd** or **Even**. If Parity is set to **None**, the scanner automatically operates in 8-bit mode, even if 7-bit is scanned.

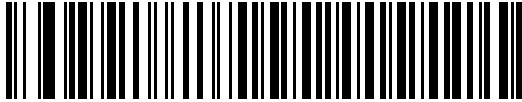

7-Bit



* 8-Bit

Check Receive Errors

Select whether or not the parity, framing, and overrun of received characters are checked. The parity value of received characters is verified against the parity parameter selected above.



* Check For Received Errors
(Enable)



Do Not Check For Received Errors
(Disable)

Hardware Handshaking

The data interface consists of an RS-232 port designed to operate either with or without the hardware handshaking lines, *Request to Send* (RTS), and *Clear to Send* (CTS).

If Standard RTS/CTS handshaking is not selected, scan data is transmitted as it becomes available. If Standard RTS/CTS handshaking is selected, scan data is transmitted according to the following sequence:

- The linear imager scanner reads the CTS line for activity. If CTS is asserted, the linear imager scanner waits up to Host Serial Response Time-out for the host to de-assert the CTS line. If, after Host Serial Response Time-out, the CTS line is still asserted, the linear imager scanner sounds a transmit error, and any scanned data is lost.
- When the CTS line is de-asserted, the linear imager scanner asserts the RTS line and waits up to Host Serial Response Time-out for the host to assert CTS. When the host asserts CTS, data is transmitted. If, after Host Serial Response Time-out, the CTS line is not asserted, the linear imager scanner sounds a transmit error, and discards the data.
- When data transmission is complete, the linear imager scanner de-asserts RTS 10 msec after sending the last character.
- The host should respond by negating CTS. The linear imager scanner checks for a de-asserted CTS upon the next transmission of data.

During the transmission of data, the CTS line should be asserted. If CTS is de-asserted for more than 50 ms between characters, the transmission is aborted, the linear imager scanner sounds a transmission error, and the data is discarded.

If the above communication sequence fails, the linear imager scanner issues an error indication. In this case, the data is lost and must be rescanned.

If Hardware Handshaking and Software Handshaking are both enabled, Hardware Handshaking takes precedence.

✓ **NOTE** The DTR signal is jumpered to the active state.

Hardware Handshaking (continued)

- **None:** Scan the bar code below if no Hardware Handshaking is desired.
- **Standard RTS/CTS:** Scan the bar code below to select Standard RTS/CTS Hardware Handshaking.
- **RTS/CTS Option 1:** When RTS/CTS Option 1 is selected, the linear imager scanner asserts RTS before transmitting and ignores the state of CTS. The linear imager scanner de-asserts RTS when the transmission is complete.
- **RTS/CTS Option 2:** When Option 2 is selected, RTS is always high or low (user-programmed logic level). However, the linear imager scanner waits for CTS to be asserted before transmitting data. If CTS is not asserted within Host Serial Response Time-out, the linear imager scanner issues an error indication and discards the data.
- **RTS/CTS Option 3:** When Option 3 is selected, the linear imager scanner asserts RTS prior to any data transmission, regardless of the state of CTS. The linear imager scanner waits up to Host Serial Response Time-out for CTS to be asserted. If CTS is not asserted during this time, the linear imager scanner issues an error indication and discards the data. The linear imager scanner de-asserts RTS when transmission is complete.

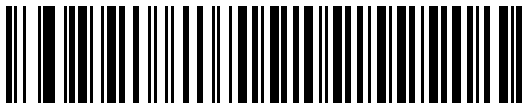

* None

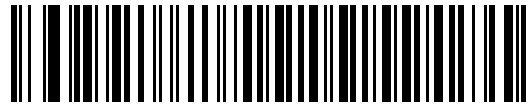

Standard RTS/CTS

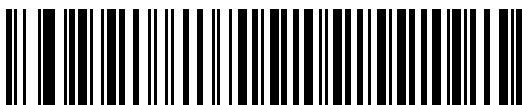

RTS/CTS Option 1



RTS/CTS Option 2

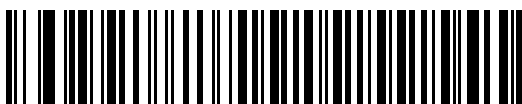

RTS/CTS Option 3

Software Handshaking

This parameter offers control of the data transmission process in addition to, or instead of, that offered by hardware handshaking. There are five options.

If Software Handshaking and Hardware Handshaking are both enabled, Hardware Handshaking takes precedence.

- **None:** When this option is selected, data is transmitted immediately. No response is expected from host.
- **ACK/NAK:** When this option is selected, after transmitting data, the linear imager scanner expects either an ACK or NAK response from the host. When a NAK is received, the linear imager scanner transmits the same data again and waits for either an ACK or NAK. After three unsuccessful attempts to send data when NAKs are received, the linear imager scanner issues an error indication and discards the data.

The linear imager scanner waits up to the programmable Host Serial Response Time-out to receive an ACK or NAK. If the linear imager scanner does not get a response in this time, it issues an error indication and discards the data. There are no retries when a time-out occurs.

- **ENQ:** When this option is selected, the linear imager scanner waits for an ENQ character from the host before transmitting data. If an ENQ is not received within the Host Serial Response Time-out, the linear imager scanner issues an error indication and discards the data. The host must transmit an ENQ character at least every Host Serial Response Time-out to prevent transmission errors.
- **ACK/NAK with ENQ:** This combines the two previous options. For re-transmissions of data, due to a NAK from the host, an additional ENQ is not required.
- **XON/XOFF:** An XOFF character turns the linear imager scanner transmission off until the linear imager scanner receives an XON character. There are two situations for XON/XOFF:
 - XOFF is received before the linear imager scanner has data to send. When the linear imager scanner has data to send, it waits up to Host Serial Response Time-out for an XON character before transmission. If the XON is not received within this time, the linear imager scanner issues an error indication and discards the data.
 - XOFF is received during a transmission. Data transmission then stops after sending the current byte. When the linear imager scanner receives an XON character, it sends the rest of the data message. The linear imager scanner waits up to 30 seconds for the XON.

Software Handshaking (continued)

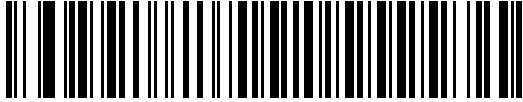

*** None**

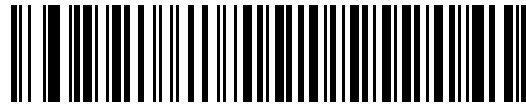

ACK/NAK

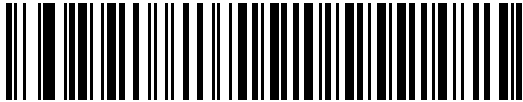

ENQ

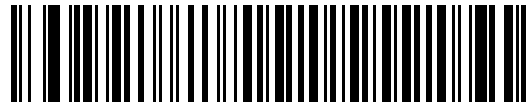

ACK/NAK with ENQ



XON/XOFF

Host Serial Response Time-out

This parameter specifies how long the linear imager scanner waits for an ACK, NAK, ENQ, XON, or CTS before determining that a transmission error occurred.



*** Minimum: 2 sec**



Low: 2.5 sec

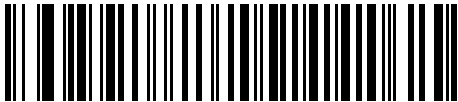

Medium: 5 sec

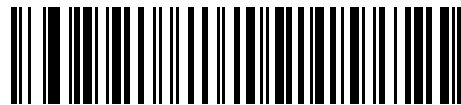

High: 7.5 sec

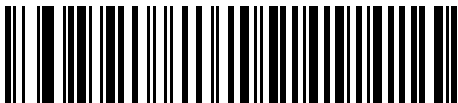

Maximum: 9.9 sec

RTS Line State

This parameter sets the idle state of the Serial Host RTS line. Scan a bar code below to select **Low RTS** or **High RTS** line state. Beep on <BEL>



* Host: Low RTS

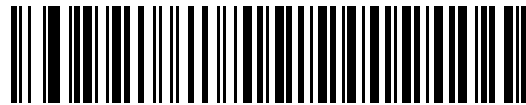

Host: High RTS

Point-to-Point Mode Only

When this parameter is enabled, the linear imager scanner issues a beep when a <BEL> character is detected on the RS-232 serial line. <BEL> is issued to gain a user's attention to an illegal entry or other important event.

✓ **NOTE** This parameter is not supported in Multipoint-to-Point mode.

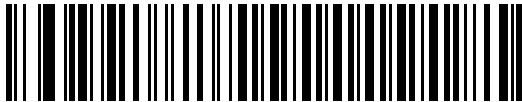

Beep On <BEL> Character
(Enable)



* Do Not Beep On <BEL> Character
(Disable)

Intercharacter Delay

This parameter specifies the intercharacter delay inserted between character transmissions.



*** Minimum: 0 msec**



Low: 25 msec

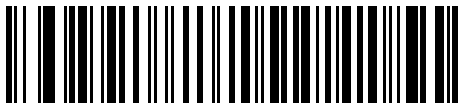

Medium: 50 msec



High: 75 msec

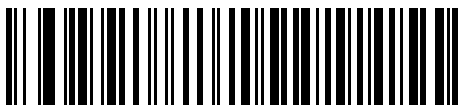

Maximum: 99 msec

Nixdorf Beep/LED Options

When Nixdorf Mode B is selected, this indicates when the linear imager scanner should beep and turn on its LED after a decode.

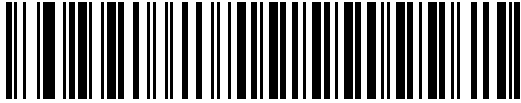

*** Normal Operation**
(Beep/LED immediately after decode)



Beep/LED After Transmission

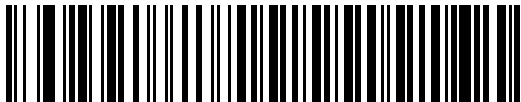

Beep/LED After CTS Pulse

Ignore Unknown Characters

Unknown characters are characters the host does not recognize. When **Send Bar Codes with Unknown Characters** is selected, all bar code data is sent except for unknown characters, and no error beeps sound on the linear imager scanner. When **Do Not Send Bar Codes With Unknown Characters** is selected, bar code data is sent up to the first unknown character and then an error beep sounds on the linear imager scanner.

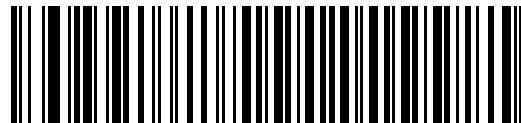

*** Send Bar Code with Unknown Characters**

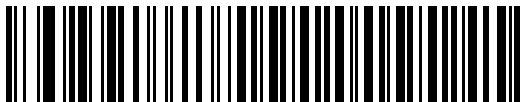

Do Not Send Bar Codes with Unknown Characters

ASCII Character Set for RS-232

See [Appendix H, ASCII CHARACTER SETS](#) for Prefix/Suffix values. The values in [Table H-1](#) can be assigned as prefixes or suffixes for ASCII character data transmission.

CHAPTER 9 IBM INTERFACE

Introduction

This chapter provides instructions for programming the linear imager to interface with an IBM 468X/469X host computer.

Throughout the programming bar code menus, default values are indicated with asterisks (*).



Connecting to an IBM 468X/469X Host

.LI3608 Corded Linear Imager IBM Connection

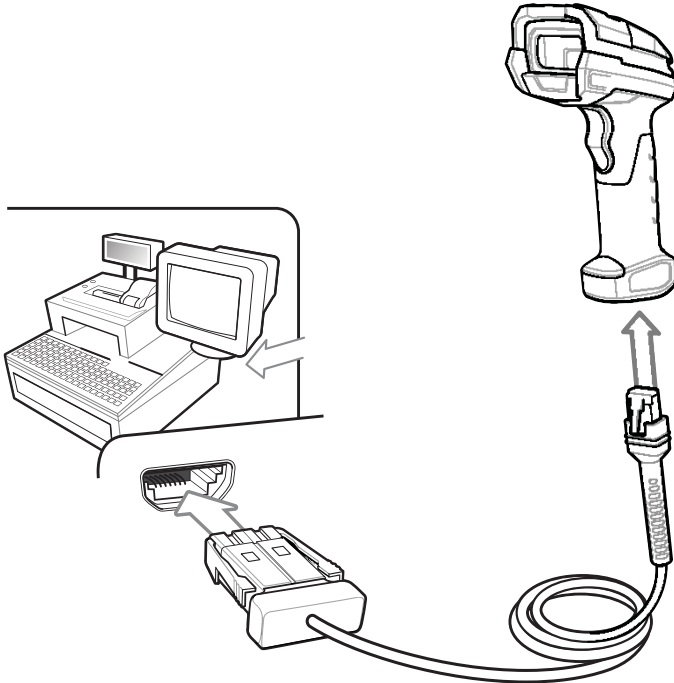

Figure 9-1 *LI3608 Corded Linear Imager IBM Connection*

To connect the IBM 46XX interface:

1. Attach the modular connector of the IBM 46XX interface cable to the host port on the bottom of the linear imager.
2. Connect the other end of the IBM 46XX interface cable to the appropriate port on the host (typically Port 9).
3. Select the port address by scanning the appropriate bar code from [Port Address on page 9-5](#).



IMPORTANT The Auto-Host Detect Cable feature automatically detects the host interface type, but there is no default setting. Scan one of the [IBM 468X/469X Host Parameters on page 9-5](#) to select the appropriate port.

To modify any other parameter options, scan the appropriate bar codes in this chapter.



NOTE The only required configuration is the port number. Other linear imager scanner parameters are typically controlled by the IBM system.

LI3678 Cordless Linear Imager IBM Connection

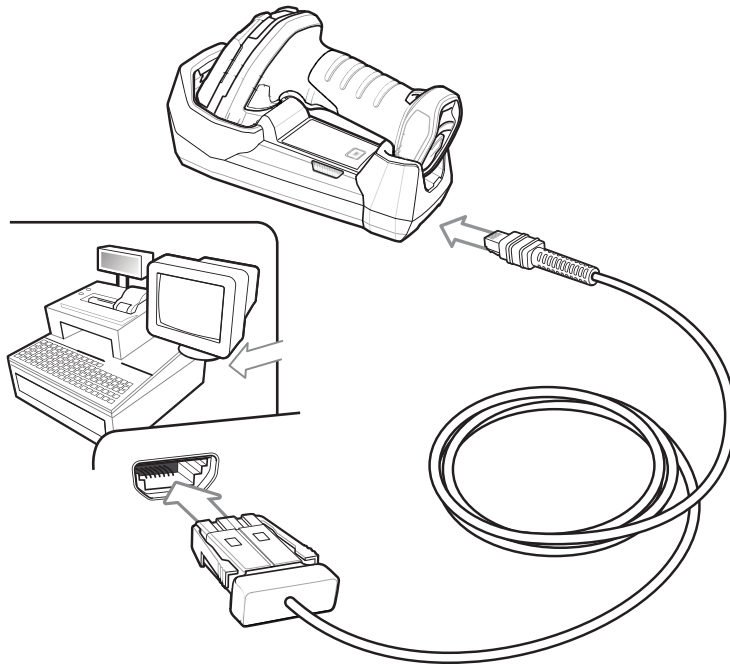

Figure 9-2 *LI3678 Cordless Linear Imager IBM Connection*

- ✓ **NOTE** Interface cables vary depending on configuration. The connectors illustrated in [Figure 9-2](#) are examples only. The connectors may be different from those illustrated, but the steps to connect the cradle remain the same.
 - ✓ **NOTE** Disconnect the host cables before the power supply, or the linear imager scanner may not recognize the new host.
1. Connect the other end of the IBM 46XX interface cable to the appropriate port on the host (typically Port 9).
 2. Connect the modular connector of the IBM 46XX interface cable to the cable interface port on the cradle. See [Connecting the Cradle on page 1-6](#).
 3. Ensure all connections are secure.
 4. Pair the digital scanner to the cradle by scanning the bar code on the cradle.
 5. Select the port address by scanning the appropriate bar code from [Port Address on page 9-5](#).
 6. To modify other parameter options, scan the appropriate bar codes in this chapter.
- ✓ **NOTE** The only required configuration is the port address. Most other digital scanner parameters are typically controlled by the IBM system.

IBM Parameter Defaults

Table 9-1 lists the defaults for IBM host parameters. To change any option, scan the appropriate bar code(s) provided in the Parameter Descriptions section beginning on [page 9-5](#).



NOTE See [Appendix A, STANDARD DEFAULT PARAMETERS](#) for all user preferences, hosts, symbologies, and miscellaneous default parameters.

Table 9-1 *IBM Host Default Table*

Parameter	Default	Page Number
IBM 468X/469X Host Parameters		
Port Address	None Selected	9-5
Convert Unknown to Code 39	Disable	9-6
Ignore Beep	Enable	9-6
Ignore Bar Code Configuration	Enable	9-7

IBM 468X/469X Host Parameters

Port Address

This parameter sets the IBM 468X/469X port used.

✓ **NOTE** Scanning one of these bar codes enables the RS-485 interface on the linear imager scanner.

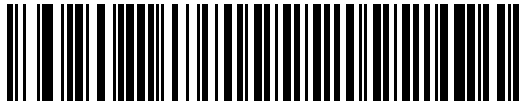

* None Selected

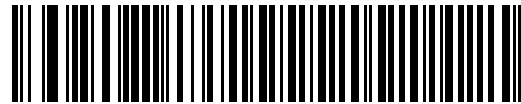

Hand-held Scanner Emulation (Port 9B)¹



Non-IBM Scanner Emulation (Port 5B)

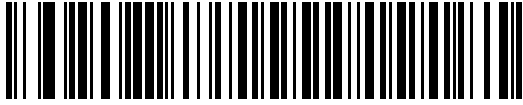

Table-top Scanner Emulation (Port 17)

✓ **NOTE** ¹User selection is required to configure this interface and this is the most common selection.

Convert Unknown to Code 39

Scan a bar code below to enable or disable the conversion of unknown bar code type data to Code 39.



Enable Convert Unknown to Code 39



*** Disable Convert Unknown to Code 39**

Optional IBM Parameters

If you configure the linear imager scanner and find the settings were not saved, or changed, when the system is restarted scan the bar codes that follow to override IBM interface defaults.

Scan a bar code below after setting defaults and before configuring the linear imager scanner.

Ignore Beep

The host can send a beep request to the linear imager scanner. When this parameter is enabled, the request is not sent to the attached linear imager scanner. All directives are still acknowledged to the IBM RS485 host as if it were processed.



Disable



*** Enable**

Ignore Bar Code Configuration

The host has the ability to enable/disable code types. When this parameter is enabled, the request is not sent to the attached linear imager scanner. All directives are still acknowledged to the IBM RS485 host as if it were processed.



Disable



*** Enable**

CHAPTER 10 KEYBOARD WEDGE INTERFACE

Introduction

This chapter provides instructions for programming the linear imager for keyboard wedge host interface, used to connect the scanner between the keyboard and host computer. The linear imager scanner translates the bar code data into keystrokes, and transmits the information to the host computer via the linear imager interface. The host computer accepts the keystrokes as if they originated from the keyboard.

This interface adds bar code reading functionality to a system designed for manual keyboard input. In this mode the keyboard keystrokes are simply passed through.

Throughout the programming bar code menus, default values are indicated with asterisks (*).



*Indicates Default — * **North American** — Feature/Option

Connecting a Keyboard Wedge Interface

LI3608 Corded Linear Imager Keyboard Wedge Connection

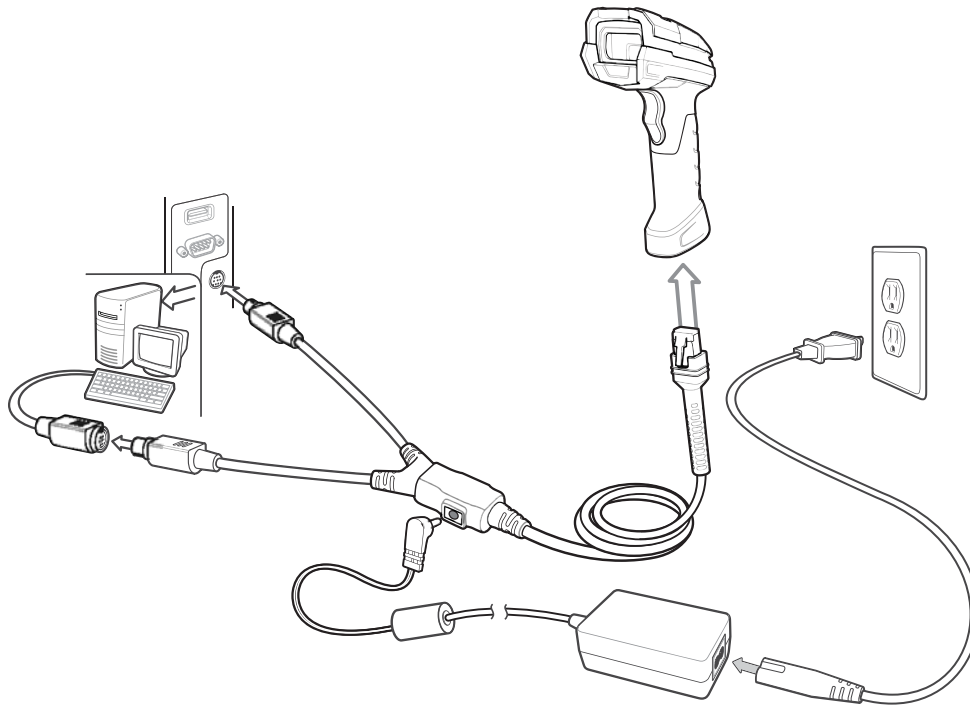

Figure 10-1 LI3608 Corded Linear Imager Keyboard Wedge Connection with Y-cable

To connect the Keyboard Wedge interface Y-cable:

1. Turn off the host and unplug the keyboard connector.
2. Attach the modular connector of the Y-cable to the host port on the bottom of the linear imager scanner.
3. Connect the round male DIN host connector of the Y-cable to the keyboard port on the host device.
4. Connect the round female DIN keyboard connector of the Y-cable to the keyboard connector.
5. If needed, attach the optional power supply to the connector in the middle of the Y-cable.
6. Ensure that all connections are secure.
7. Turn on the host system.
8. Select the Keyboard Wedge host type by scanning the appropriate bar code from [Keyboard Wedge Host Parameters on page 10-5](#).
9. To modify any other parameter options, scan the appropriate bar codes in this chapter.



NOTE Interface cables vary depending on configuration. The connectors illustrated in [Figure 10-1](#) are examples only.

LI3678 Cordless Linear Imager Keyboard Wedge Connection

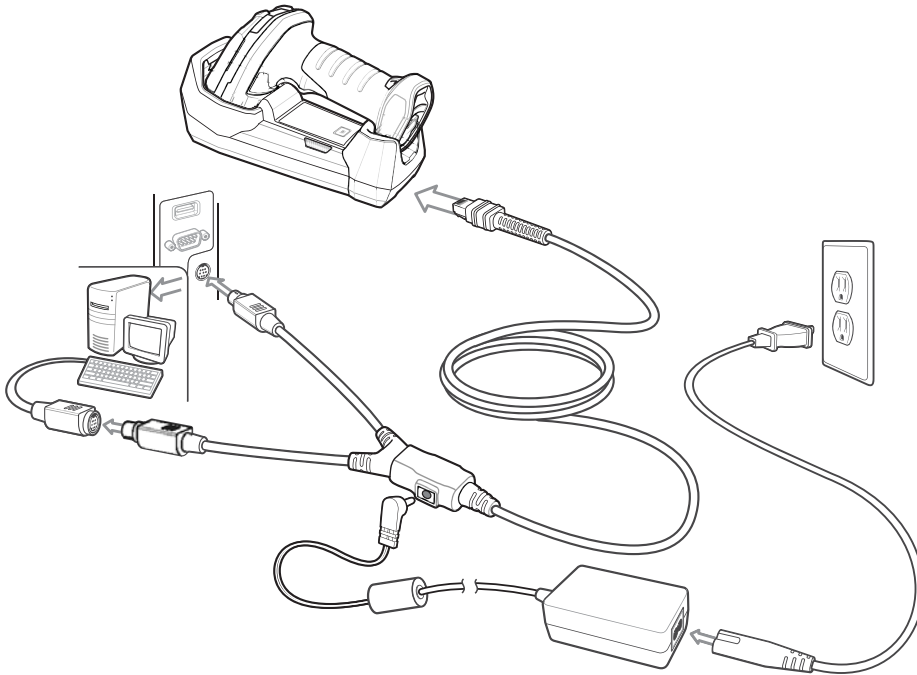

Figure 10-2 LI3678 Cordless Linear Imager Keyboard Wedge Connection with Y-cable

To connect the keyboard wedge interface Y-cable:

1. Turn off the host and unplug the keyboard connector.
2. Connect the round male DIN host connector of the Y-cable to the keyboard port on the host.
3. Connect the round female DIN keyboard connector of the Y-cable to the keyboard connector.
4. Attach the modular connector of the Y-cable to the cable interface port on the cradle. See [Connecting the Cradle on page 1-6](#).
5. Connect the power supply.
6. Ensure that all connections are secure.
7. Turn on the host system.
8. Pair the digital scanner to the cradle by scanning the bar code on the cradle.
9. Select the keyboard wedge host type by scanning the appropriate bar code from [Keyboard Wedge Host Parameters on page 10-5](#).
10. To modify any other parameter options, scan the appropriate bar codes in this chapter.

✓ **NOTE** Interface cables vary depending on configuration. The connectors illustrated in [Figure 10-2](#) are examples only. The connectors may be different from those illustrated, but the steps to connect the cradle remain the same.

✓ **NOTE** Disconnect the host cables before the power supply, or the linear imager scanner may not recognize the new host.

Keyboard Wedge Parameter Defaults

[Table 10-1](#) lists the defaults for Keyboard Wedge host parameters. To change any option, scan the appropriate bar code(s) in the Keyboard Wedge Host Parameters section beginning on [page 10-5](#).

- ✓ **NOTE** See [Appendix A, STANDARD DEFAULT PARAMETERS](#) for all user preferences, hosts, symbologies, and miscellaneous default parameters.
- ✓ **NOTE** See [Appendix B, Country Codes](#) for Keyboard Wedge Country Keyboard Types (Country Codes).

Table 10-1 Keyboard Wedge Host Default Table

Parameter	Default	Page Number
Keyboard Wedge Host Parameters		
Keyboard Wedge Host Type	IBM AT Notebook	10-5
Ignore Unknown Characters	Send	10-6
Keystroke Delay	No Delay	10-6
Intra-Keystroke Delay	Disable	10-7
Alternate Numeric Keypad Emulation	Enable	10-8
Quick Keypad Emulation	Enable	10-8
Caps Lock On	Disable	10-9
Caps Lock Override	Disable	10-9
Convert Wedge Data	No Convert	10-10
Function Key Mapping	Disable	10-10
FN1 Substitution	Disable	10-11
Send and Make Break	Send	10-11

Keyboard Wedge Host Parameters

Keyboard Wedge Host Types

Select the Keyboard Wedge host by scanning one of the bar codes below.



IBM PC/AT & IBM PC Compatibles

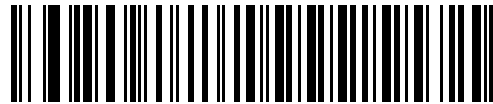

*** IBM AT Notebook**

Ignore Unknown Characters

Unknown characters are characters the host does not recognize. When **Send Bar Codes With Unknown Characters** is selected, all bar code data is sent except for unknown characters, and no error beeps sound on the linear imager scanner. When **Do Not Send Bar Codes With Unknown Characters** is selected, bar code data is sent up to the first unknown character, then the linear imager scanner issues an error beep.

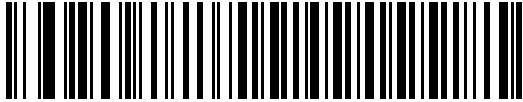

* **Send Bar Codes with Unknown Characters**

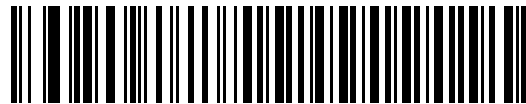

Do Not Send Bar Codes with Unknown Characters

Keystroke Delay

This is the delay in milliseconds between emulated keystrokes. Scan a bar code below to increase the delay when hosts require a slower transmission of data.

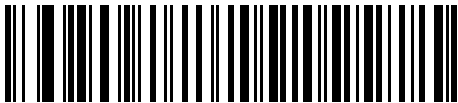

* **No Delay**



Medium Delay (20 msec)

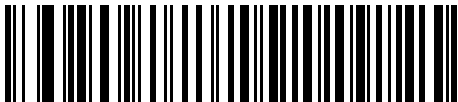

Long Delay (40 msec)

Intra-Keystroke Delay

When enabled, an additional delay is inserted between each emulated key depression and release. This sets the Keystroke Delay parameter to a minimum of 5 msec as well.



Enable Intra-Keystroke Delay

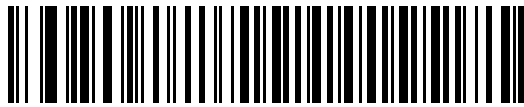

*** Disable Intra-Keystroke Delay**

Alternate Numeric Keypad Emulation

This allows emulation of most other country keyboard types not listed in [USB and Keyboard Wedge Country Keyboard Types \(Country Codes\) on page B-2](#) in a Microsoft® operating system environment.



* Enable Alternate Numeric Keypad

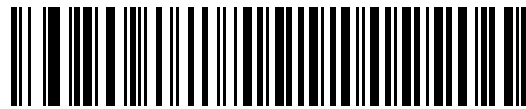

Disable Alternate Numeric Keypad

Quick Keypad Emulation

This parameter enables faster keypad emulation where character value sequences are only sent for characters not found on the keyboard.



NOTE This option applies only when [Alternate Numeric Keypad Emulation](#) is enabled.

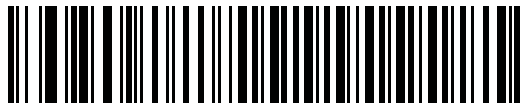

* Enable Quick Keypad Emulation

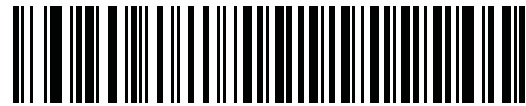

Disable Quick Keypad Emulation

Caps Lock On

When enabled, the linear imager scanner emulates keystrokes as if the Caps Lock key is always pressed. Note that if both **Caps Lock On** and **Caps Lock Override** are enabled, **Caps Lock Override** takes precedence



Enable Caps Lock On

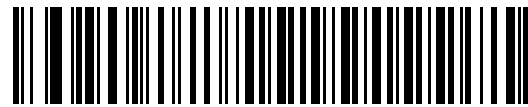

*** Disable Caps Lock On**

Caps Lock Override

When enabled, on AT or AT Notebook hosts, the keyboard ignores the state of the Caps Lock key. Therefore, an 'A' in the bar code is sent as an 'A' no matter what the state of the keyboard's Caps Lock key.

Note that if both **Caps Lock On** and **Caps Lock Override** are enabled, **Caps Lock Override** takes precedence.



Enable Caps Lock Override



*** Disable Caps Lock Override**

Convert Wedge Data

When enabled, the linear imager scanner converts all bar code data to the selected case.

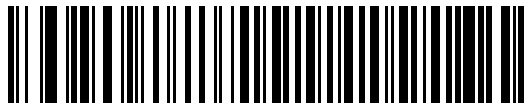

Convert to Upper Case



Convert to Lower Case

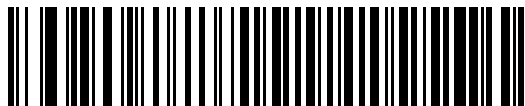

*** No Convert**

Function Key Mapping

ASCII values under 32 are normally sent as control key sequences (see [Appendix H, ASCII CHARACTER SETS](#)). When this parameter is enabled, the keys in bold are sent in place of the standard key mapping. Table entries that do not have a bold entry remain the same whether or not this parameter is enabled.

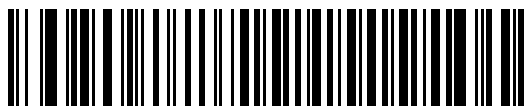

Enable Function Key Mapping



*** Disable Function Key Mapping**

FN1 Substitution

When enabled, the linear imager scanner replaces FN1 characters in an EAN128 bar code with a keystroke chosen by the user (see [FN1 Substitution Values on page 5-34](#)).



Enable FN1 Substitution

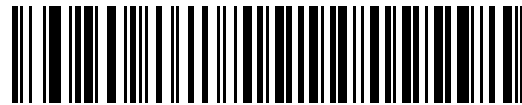

*** Disable FN1 Substitution**

Send Make and Break

When enabled, the scan codes for releasing a key are not sent.

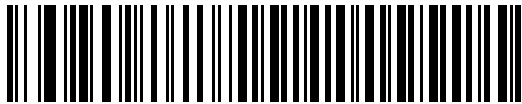

*** Send Make and Break Scan Codes**



Send Make Scan Code Only

Keyboard Map

Refer to the following keyboard map for prefix/suffix keystroke parameters. To program the prefix/suffix values, see the bar codes on [page 5-32](#).

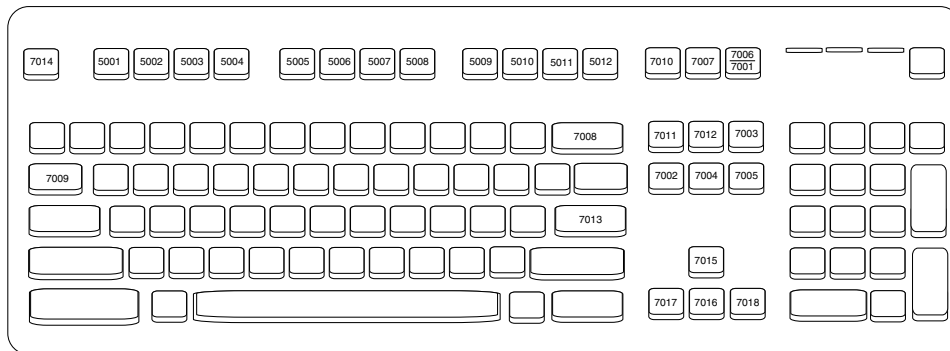

Figure 10-3 *IBM PS2 Type Keyboard*

ASCII Character Set for Keyboard Wedge

- ✓ **NOTE** Code 39 Full ASCII interprets the bar code special character (\$ + % /) preceding a Code 39 character and assigns an ASCII character value to the pair. For example, when Code 39 Full ASCII is enabled and a **+B** is scanned, it is interpreted as **b**, **%J** as **?**, and **%V** as **@**. Scanning **ABC%I** outputs the keystroke equivalent of **ABC >**.

See [Appendix H, ASCII CHARACTER SETS](#) for the following:

- ASCII Character Set ([Table H-1 on page H-1](#))
- ALT Key Character Set ([Table H-2 on page H-6](#))
- GUI Key Character Set ([Table H-3 on page H-7](#))
- F Key Character Set ([Table H-5 on page H-11](#)).
- Numeric Key Character Set ([Table H-6 on page H-12](#))
- Extended Key Character Set ([Table H-7 on page H-13](#)).

CHAPTER 11 SYMBOLOGIES

Introduction

This chapter describes symbology features and provides programming bar codes for selecting these features. Before programming, follow the instructions in [Chapter 1, GETTING STARTED](#).

To set feature values, scan a single bar code or a short bar code sequence. The settings are stored in non-volatile memory and are preserved even when the linear imager scanner powers down.

✓ **NOTE** Most computer monitors allow scanning the bar codes directly on the screen. When scanning from the screen, be sure to set the document magnification to a level where you can see the bar code clearly, and bars and/or spaces do not merge.

Select a host type (see each host chapter for specific host information) after the power-up beeps sound. This is only necessary upon the first power-up when connected to a new host.

To return all features to default values, scan the [Default Parameters on page 5-5](#). Throughout the programming bar code menus, asterisks (*) indicate default values.



* Indicates Default — * **Enable UPC-A** — Feature/Option
(01h) — Option Hex Value

Scanning Sequence Examples

In most cases, scanning one bar code sets the parameter value. For example, to transmit bar code data without the UPC-A check digit, simply scan the **Do Not Transmit UPC-A Check Digit** bar code under [Transmit UPC-A Check Digit on page 11-15](#). The linear imager scanner issues a fast warble beep and the LED turns green, signifying a successful parameter entry.

Other parameters, such as **Set Length(s) for D 2 of 5** require scanning several bar codes. See the individual parameter, such as **Set Length(s) for D 2 of 5**, for this procedure.

Errors While Scanning

Unless otherwise specified, to correct an error during a scanning sequence, just re-scan the correct parameter.

Symbology Parameter Defaults

[Table 11-1](#) lists the defaults for all symbologies parameters. To change the default values, scan the appropriate bar codes in this guide. These new values replace the standard default values in memory. To recall the default parameter values, scan the [Default Parameters on page 5-5](#).



NOTE See [Appendix A, STANDARD DEFAULT PARAMETERS](#) for all user preferences, hosts, and miscellaneous default parameters.

In this guide, the parameter numbers listed are the same as the attribute numbers for these parameters.

Table 11-1 *Parameter Defaults*

Parameter	Parameter Number	SSI Number	Default	Page Number
UPC/EAN				
UPC-A	1	01h	Enable	11-7
UPC-E	2	02h	Enable	11-7
UPC-E1	12	0Ch	Disable	11-8
EAN-8/JAN 8	4	04h	Enable	11-8
EAN-13/JAN 13	3	03h	Enable	11-9
Bookland EAN	83	53h	Disable	11-9
Decode UPC/EAN/JAN Supplementals (2 and 5 digits)	16	10h	Ignore	11-11
User-Programmable Supplementals			000 (zeroes)	11-13
Supplemental 1:	579	F1h 43h		
Supplemental 2:	580	F1h 44h		
UPC/EAN/JAN Supplemental Redundancy	80	50h	10	11-13

Table 11-1 *Parameter Defaults (Continued)*

Parameter	Parameter Number	SSI Number	Default	Page Number
UPC/EAN/JAN Supplemental AIM ID Format	672	F1h A0h	Combined	11-14
Transmit UPC-A Check Digit	40	28h	Enable	11-15
Transmit UPC-E Check Digit	41	29h	Enable	11-15
Transmit UPC-E1 Check Digit	42	2Ah	Enable	11-16
UPC-A Preamble	34	22h	System Character	11-17
UPC-E Preamble	35	23h	System Character	11-18
UPC-E1 Preamble	36	24h	System Character	11-19
Convert UPC-E to A	37	25h	Disable	11-20
Convert UPC-E1 to A	38	26h	Disable	11-20
EAN-8/JAN-8 Extend	39	27h	Disable	11-21
Bookland ISBN Format	576	F1h 40h	ISBN-10	11-21
UCC Coupon Extended Code	85	55h	Disable	11-22
Coupon Report	730	F1h DAh	New Coupon Format	11-22
ISSN EAN	617	F1h 69h	Disable	11-23
Code 128				
Code 128	8	08h	Enable	11-24
Set Length(s) for Code 128	209, 210	D1h, D2h	Length Within Range	11-25
GS1-128 (formerly UCC/EAN-128)	14	0Eh	Enable	11-26
ISBT 128	84	54h	Enable	11-26
ISBT Concatenation	577	F1h 41h	Autodiscriminate	11-27
Check ISBT Table	578	F1h 42h	Enable	11-28
ISBT Concatenation Redundancy	223	DFh	10	11-28
Code 128 Security Level	751	F1h EFh	Security Level 1	11-29
Code 39				
Code 39	0	00h	Enable	11-30
Trioptic Code 39	13	0Dh	Disable	11-30
Convert Code 39 to Code 32 (Italian Pharmacy Code)	86	56h	Disable	11-31
Code 32 Prefix	231	E7h	Disable	11-31

Table 11-1 *Parameter Defaults (Continued)*

Parameter	Parameter Number	SSI Number	Default	Page Number
Set Length(s) for Code 39	18, 19	12h, 13h	Length Within Range	11-32
Code 39 Check Digit Verification	48	30h	Disable	11-33
Transmit Code 39 Check Digit	43	2Bh	Disable	11-33
Code 39 Full ASCII Conversion	17	11h	Disable	11-34
Buffer Code 39	113	71h	Disable	11-35
Code 39 Security Level	750	F1h EEh	Security Level 1	11-37
Code 93				
Code 93	9	09h	Enable	11-38
Set Length(s) for Code 93	26, 27	1Ah, 1Bh	Length Within Range	11-39
Code 11				
Code 11	10	0Ah	Disable	11-40
Set Lengths for Code 11	28, 29	1Ch, 1Dh	Length Within Range	11-41
Code 11 Check Digit Verification	52	34h	Disable	11-42
Transmit Code 11 Check Digit(s)	47	2Fh	Disable	11-43
Interleaved 2 of 5 (ITF)				
Interleaved 2 of 5 (ITF)	6	06h	Enable	11-44
Set Lengths for I 2 of 5	22, 23	16h, 17h	Length Within Range	11-44
I 2 of 5 Check Digit Verification	49	31h	Disable	11-46
Transmit I 2 of 5 Check Digit	44	2Ch	Disable	11-46
Convert I 2 of 5 to EAN 13	82	52h	Disable	11-47
I 2 of 5 Security Level	1121	F8h 04h 61h	Security Level 1	11-48
Discrete 2 of 5 (DTF)				
Discrete 2 of 5	5	05h	Disable	11-49
Set Length(s) for D 2 of 5	20, 21	14h 15h	Length Within Range	11-49
Codabar (NW - 7)				
Codabar	7	07h	Enable	11-51

Table 11-1 *Parameter Defaults (Continued)*

Parameter	Parameter Number	SSI Number	Default	Page Number
Set Lengths for Codabar	24, 25	18h, 19h	Length Within Range	11-52
CLSI Editing	54	36h	Disable	11-53
NOTIS Editing	55	37h	Disable	11-53
Codabar Upper or Lower Case Start/Stop Characters Detection	855	F2h 57h	Upper Case	11-54
MSI				
MSI	11	0Bh	Disable	11-55
Set Length(s) for MSI	30, 31	1Eh, 1Fh	Length Within Range	11-56
MSI Check Digits	50	32h	One	11-57
Transmit MSI Check Digit	46	2Eh	Disable	11-57
MSI Check Digit Algorithm	51	33h	Mod 10/Mod 10	11-58
Chinese 2 of 5				
Chinese 2 of 5	408	F0h 98h	Disable	11-59
Matrix 2 of 5				
Matrix 2 of 5	618	F1h 6Ah	Disable	11-60
Matrix 2 of 5 Set Lengths	619, 620	F1h 6Bh F1h 6Ch	Length Within Range	11-61
Matrix 2 of 5 Check Digit	622	F1h 6Eh	Disable	11-62
Transmit Matrix 2 of 5 Check Digit	623	F1h 6Fh	Disable	11-62
Korean 3 of 5				
Korean 3 of 5	581	F1h 45h	Disable	11-63
Inverse 1D				
Inverse 1D	586	F1h 4Ah	Regular	11-64
GS1 DataBar				
GS1 DataBar-14	338	F0h 52h	Enable	11-65
GS1 DataBar Limited	339	F0h 53h	Enable	11-65
GS1 DataBar Expanded	340	F0h 54h	Enable	11-66
GS1 DataBar Limited Security Level	728	F1h D8h	Level 3	11-67
Convert GS1 DataBar to UPC/EAN	397	F0h 8Dh	Disable	11-68

Table 11-1 *Parameter Defaults (Continued)*

Parameter	Parameter Number	SSI Number	Default	Page Number
Symbology-Specific Security Levels				
Redundancy Level	78	4Eh	1	11-70
Security Level	77	4Dh	1	11-71
Intercharacter Gap Size	381	F0h 7Dh	Normal	11-72

UPC/EAN

Enable/Disable UPC-A

Parameter # 1 (SSI # 01h)

To enable or disable UPC-A, scan the appropriate bar code below.

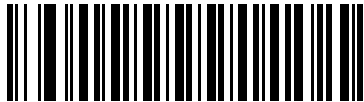

* Enable UPC-A
(1)

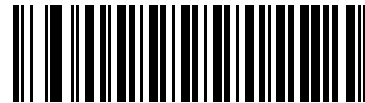

Disable UPC-A
(0)

Enable/Disable UPC-E

Parameter # 2 (SSI # 02h)

To enable or disable UPC-E, scan the appropriate bar code below.



* Enable UPC-E
(1)



Disable UPC-E
(0)

Enable/Disable UPC-E1

Parameter # 12 (SSI # 0Ch)

UPC-E1 is disabled by default.

To enable or disable UPC-E1, scan the appropriate bar code below.

✓ **NOTE** UPC-E1 is not a UCC (Uniform Code Council) approved symbology.

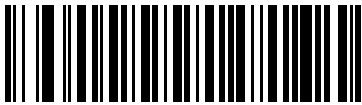

Enable UPC-E1
(1)

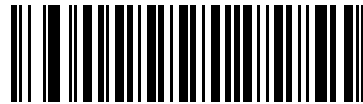

* Disable UPC-E1
(0)

Enable/Disable EAN-8/JAN-8

Parameter # 4 (SSI # 04h)

To enable or disable EAN-8/JAN-8, scan the appropriate bar code below.

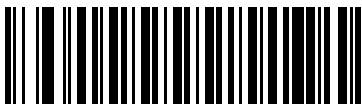

* Enable EAN-8/JAN-8
(1)



Disable EAN-8/JAN-8
(0)

Enable/Disable EAN-13/JAN-13

Parameter # 3 (SSI # 03h)

To enable or disable EAN-13/JAN-13, scan the appropriate bar code below.

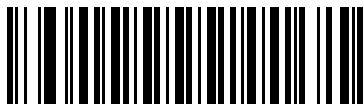

* Enable EAN-13/JAN-13
(1)



Disable EAN-13/JAN-13
(0)

Enable/Disable Bookland EAN

Parameter # 83 (SSI # 53h)

To enable or disable Bookland EAN, scan the appropriate bar code below.

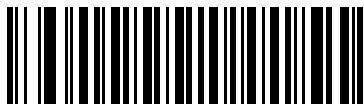

Enable Bookland EAN
(1)



* Disable Bookland EAN
(0)



NOTE If you enable Bookland EAN, select a [Bookland ISBN Format on page 11-21](#). Also select either Decode UPC/EAN Supplementals, Autodiscriminate UPC/EAN Supplementals, or Enable 978/979 Supplemental Mode in [Decode UPC/EAN/JAN Supplementals on page 11-10](#).

Decode UPC/EAN/JAN Supplementals

Parameter # 16 (SSI # 10h)

Supplementals are bar codes appended according to specific format conventions (e.g., UPC A+2, UPC E+2, EAN 13+2). The following options are available:

- If you select **Ignore UPC/EAN with Supplementals**, and the linear imager scanner is presented with a UPC/EAN plus supplemental symbol, the linear imager scanner decodes UPC/EAN and ignores the supplemental characters.
- If you select **Decode UPC/EAN with Supplementals**, the linear imager scanner only decodes UPC/EAN symbols with supplemental characters, and ignores symbols without supplementals.
- If you select **Autodiscriminate UPC/EAN Supplementals**, the linear imager scanner decodes UPC/EAN symbols with supplemental characters immediately. If the symbol does not have a supplemental, the linear imager scanner must decode the bar code the number of times set via [UPC/EAN/JAN Supplemental Redundancy on page 11-13](#) before transmitting its data to confirm that there is no supplemental.
- If you select one of the following **Supplemental Mode** options, the linear imager scanner immediately transmits EAN-13 bar codes starting with that prefix that have supplemental characters. If the symbol does not have a supplemental, the linear imager scanner must decode the bar code the number of times set via [UPC/EAN/JAN Supplemental Redundancy on page 11-13](#) before transmitting its data to confirm that there is no supplemental. The linear imager scanner transmits UPC/EAN bar codes that do not have that prefix immediately.
 - **Enable 378/379 Supplemental Mode**
 - **Enable 978/979 Supplemental Mode**

✓ **NOTE** If you select 978/979 Supplemental Mode and are scanning Bookland EAN bar codes, see [Enable/Disable Bookland EAN on page 11-9](#) to enable Bookland EAN, and select a format using [Bookland ISBN Format on page 11-21](#).

- **Enable 977 Supplemental Mode**
- **Enable 414/419/434/439 Supplemental Mode**
- **Enable 491 Supplemental Mode**
- **Enable Smart Supplemental Mode** - applies to EAN-13 bar codes starting with any prefix listed previously.
- **Supplemental User-Programmable Type 1** - applies to EAN-13 bar codes starting with a 3-digit user-defined prefix. Set this 3-digit prefix using [User-Programmable Supplementals on page 11-13](#).
- **Supplemental User-Programmable Type 1 and 2** - applies to EAN-13 bar codes starting with either of two 3-digit user-defined prefixes. Set the 3-digit prefixes using [User-Programmable Supplementals on page 11-13](#).
- **Smart Supplemental Plus User-Programmable 1** - applies to EAN-13 bar codes starting with any prefix listed previously or the user-defined prefix set using [User-Programmable Supplementals on page 11-13](#).
- **Smart Supplemental Plus User-Programmable 1 and 2** - applies to EAN-13 bar codes starting with any prefix listed previously or one of the two user-defined prefixes set using [User-Programmable Supplementals on page 11-13](#).

✓ **NOTE** To minimize the risk of invalid data transmission, select either to decode or ignore supplemental characters.

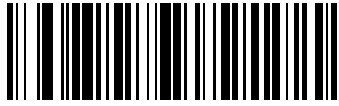
Decode UPC/EAN/JAN Supplementals (continued)

**Decode UPC/EAN/JAN Only With Supplementals
(1)**



*** Ignore Supplementals
(0)**

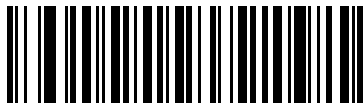

**Autodiscriminate UPC/EAN/JAN Supplementals
(2)**

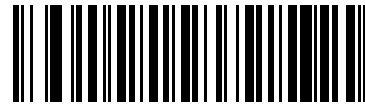

**Enable 378/379 Supplemental Mode
(4)**



**Enable 978/979 Supplemental Mode
(5)**



**Enable 977 Supplemental Mode
(7)**

Decode UPC/EAN/JAN Supplementals (continued)



**Enable 414/419/434/439 Supplemental Mode
(6)**



**Enable 491 Supplemental Mode
(8)**



**Enable Smart Supplemental Mode
(3)**



**Supplemental User-Programmable Type 1
(9)**



**Supplemental User-Programmable Type 1 and 2
(10)**



**Smart Supplemental Plus User-Programmable 1
(11)**



**Smart Supplemental Plus User-Programmable 1 and 2
(12)**

User-Programmable Supplementals

Supplemental 1: Parameter # 579 (SSI # F1h 43h)

Supplemental 2: Parameter # 580 (SSI # F1h 44h)

If you selected a Supplemental User-Programmable option from [Decode UPC/EAN/JAN Supplementals on page 11-10](#), select **User-Programmable Supplemental 1** to set the 3-digit prefix. Then select the 3 digits using the numeric bar codes beginning on [page E-1](#). Select **User-Programmable Supplemental 2** to set a second 3-digit prefix. Then select the 3 digits using the numeric bar codes beginning on [page E-1](#). The default is 000 (zeroes).



User-Programmable Supplemental 1



User-Programmable Supplemental 2

UPC/EAN/JAN Supplemental Redundancy

Parameter # 80 (SSI # 50h)

If you selected **Autodiscriminate UPC/EAN/JAN Supplementals**, this option adjusts the number of times to decode a symbol without supplementals before transmission. The range is from two to thirty times. Five or above is recommended when decoding a mix of UPC/EAN/JAN symbols with and without supplementals. The default is 10.

Scan the bar code below to set a decode redundancy value. Next, scan two numeric bar codes in [Appendix E, NUMERIC BAR CODES](#). Enter a leading zero for single digit numbers. To correct an error or change a selection, scan [Cancel on page E-3](#).

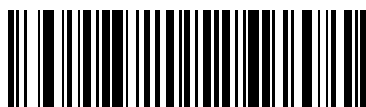

UPC/EAN/JAN Supplemental Redundancy

UPC/EAN/JAN Supplemental AIM ID Format

Parameter # 672 (SSI # F1h A0h)

Select an output format when reporting UPC/EAN/JAN bar codes with Supplementals with *Transmit Code ID Character* on page 5-31 set to **AIM Code ID Character**:

- **Separate** - transmit UPC/EAN with supplementals with separate AIM IDs but one transmission, i.e.:
]E<0 or 4><data>]E<1 or 2>[supplemental data]
- **Combined** – transmit UPC/EAN with supplementals with one AIM ID and one transmission, i.e.:
]E3<data+supplemental data>
- **Separate Transmissions** - transmit UPC/EAN with supplementals with separate AIM IDs and separate transmissions, i.e.:
]E<0 or 4><data>
]E<1 or 2>[supplemental data]



Separate
(0)



*** Combined**
(1)

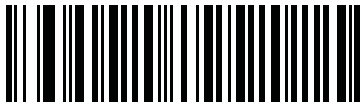

Separate Transmissions
(2)

Transmit UPC-A Check Digit

Parameter # 40 (SSI # 28h)

The check digit is the last character of the symbol used to verify the integrity of the data. Scan the appropriate bar code below to transmit the bar code data with or without the UPC-A check digit. It is always verified to guarantee the integrity of the data.

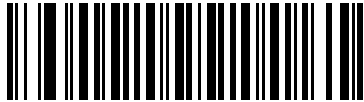

*** Transmit UPC-A Check Digit
(1)**

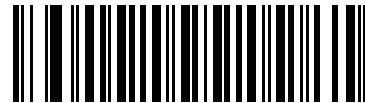

**Do Not Transmit UPC-A Check Digit
(0)**

Transmit UPC-E Check Digit

Parameter # 41 (SSI # 29h)

The check digit is the last character of the symbol used to verify the integrity of the data. Scan the appropriate bar code below to transmit the bar code data with or without the UPC-E check digit. It is always verified to guarantee the integrity of the data.

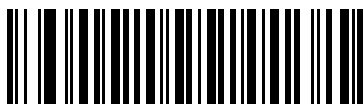

*** Transmit UPC-E Check Digit
(1)**

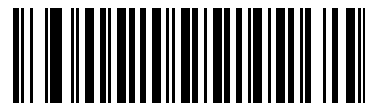

**Do Not Transmit UPC-E Check Digit
(0)**

Transmit UPC-E1 Check Digit

Parameter # 42 (SSI # 2Ah)

The check digit is the last character of the symbol used to verify the integrity of the data. Scan the appropriate bar code below to transmit the bar code data with or without the UPC-E1 check digit. It is always verified to guarantee the integrity of the data.

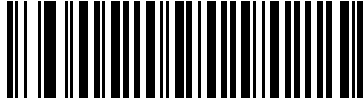

*** Transmit UPC-E1 Check Digit
(1)**

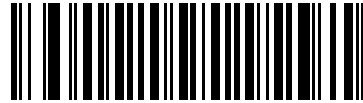

**Do Not Transmit UPC-E1 Check Digit
(0)**

UPC-A Preamble

Parameter # 34 (SSI # 22h)

Preamble characters are part of the UPC symbol, and include Country Code and System Character. There are three options for transmitting a UPC-A preamble to the host device: transmit System Character only, transmit System Character and Country Code ("0" for USA), and transmit no preamble. Select the appropriate option to match the host system.

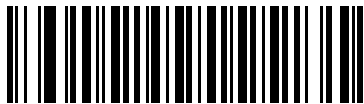

No Preamble (<DATA>)
(0)

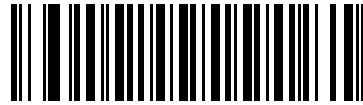

*** System Character (<SYSTEM CHARACTER>
<DATA>)**
(1)

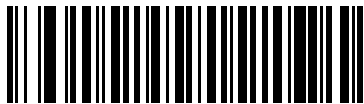

**System Character & Country Code
(< COUNTRY CODE> <SYSTEM CHARACTER>
<DATA>)**
(2)

UPC-E Preamble

Parameter # 35 (SSI # 23h)

Preamble characters are part of the UPC symbol, and include Country Code and System Character. There are three options for transmitting a UPC-E preamble to the host device: transmit System Character only, transmit System Character and Country Code ("0" for USA), and transmit no preamble. Select the appropriate option to match the host system.

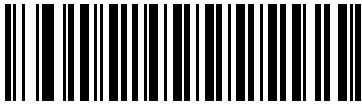

No Preamble (<DATA>)
(0)

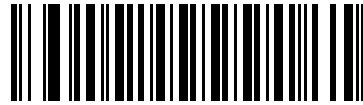

*** System Character (<SYSTEM CHARACTER>
<DATA>)**
(1)

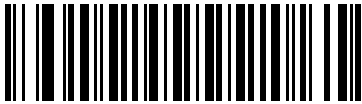

**System Character & Country Code
(< COUNTRY CODE> <SYSTEM CHARACTER>
<DATA>)**
(2)

UPC-E1 Preamble

Parameter # 36 (SSI # 24h)

Preamble characters are part of the UPC symbol, and include Country Code and System Character. There are three options for transmitting a UPC-E1 preamble to the host device: transmit System Character only, transmit System Character and Country Code ("0" for USA), and transmit no preamble. Select the appropriate option to match the host system.

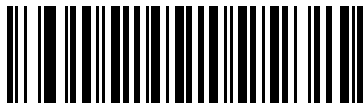

No Preamble (<DATA>)
(0)



*** System Character (<SYSTEM CHARACTER> <DATA>)**
(1)

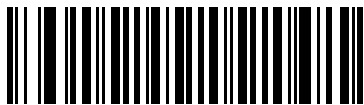

System Character & Country Code
(< COUNTRY CODE> <SYSTEM CHARACTER> <DATA>)
(2)

Convert UPC-E to UPC-A

Parameter # 37 (SSI # 25h)

Enable this to convert UPC-E (zero suppressed) decoded data to UPC-A format before transmission. After conversion, the data follows UPC-A format and is affected by UPC-A programming selections (e.g., Preamble, Check Digit).

Disable this to transmit UPC-E decoded data as UPC-E data, without conversion.



Convert UPC-E to UPC-A (Enable)
(1)

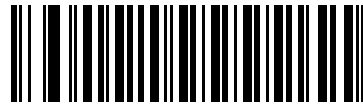

*** Do Not Convert UPC-E to UPC-A (Disable)**
(0)

Convert UPC-E1 to UPC-A

Parameter # 38 (SSI # 26h)

Enable this to convert UPC-E1 decoded data to UPC-A format before transmission. After conversion, the data follows UPC-A format and is affected by UPC-A programming selections (e.g., Preamble, Check Digit).

Disable this to transmit UPC-E1 decoded data as UPC-E1 data, without conversion.

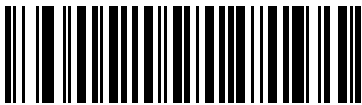

Convert UPC-E1 to UPC-A (Enable)
(1)

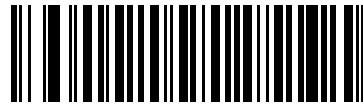

*** Do Not Convert UPC-E1 to UPC-A (Disable)**
(0)

EAN-8/JAN-8 Extend

Parameter # 39 (SSI # 27h)

Enable this parameter to add five leading zeros to decoded EAN-8 symbols to make them compatible in format to EAN-13 symbols.

Disable this to transmit EAN-8 symbols as is.

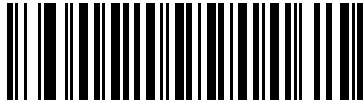

Enable EAN/JAN Zero Extend
(1)

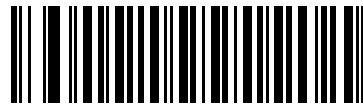

* Disable EAN/JAN Zero Extend
(0)

Bookland ISBN Format

Parameter # 576 (SSI # F1h 40h)

If you enabled Bookland EAN using [Enable/Disable Bookland EAN on page 11-9](#), select one of the following formats for Bookland data:

- **Bookland ISBN-10** - The linear imager scanner reports Bookland data starting with 978 in traditional 10-digit format with the special Bookland check digit for backward-compatibility. Data starting with 979 is not considered Bookland in this mode.
- **Bookland ISBN-13** - The linear imager scanner reports Bookland data (starting with either 978 or 979) as EAN-13 in 13-digit format to meet the 2007 ISBN-13 protocol.



* Bookland ISBN-10
(0)



Bookland ISBN-13
(1)



NOTE For Bookland EAN to function properly, first enable Bookland EAN using [Enable/Disable Bookland EAN on page 11-9](#), then select either Decode UPC/EAN Supplementals, Autodiscriminate UPC/EAN Supplementals, or Enable 978/979 Supplemental Mode in [Decode UPC/EAN/JAN Supplementals on page 11-10](#).

UCC Coupon Extended Code

Parameter # 85 (SSI # 55h)

Enable this parameter to decode UPC-A bar codes starting with digit '5', EAN-13 bar codes starting with digit '99', and UPC-A/GS1-128 Coupon Codes. UPCA, EAN-13, and GS1-128 must be enabled to scan all types of Coupon Codes.



Enable UCC Coupon Extended Code
(1)

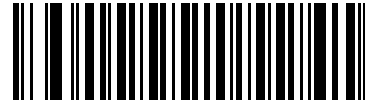

* Disable UCC Coupon Extended Code
(0)



NOTE See [UPC/EAN/JAN Supplemental Redundancy on page 11-13](#) to control autodiscrimination of the GS1-128 (right half) of a coupon code.

Coupon Report

Parameter # 730 (SSI # F1h DAh)

Select an option to determine which type of coupon format to support.

- Select **Old Coupon Format** to support UPC-A/GS1-128 and EAN-13/GS1-128.
- Select **New Coupon Format** as an interim format to support UPC-A/GS1-DataBar and EAN-13/GS1-DataBar.
- If you select **Autodiscriminate Format**, the linear imager scanner supports both **Old Coupon Format** and **New Coupon Format**.



Old Coupon Format
(0)

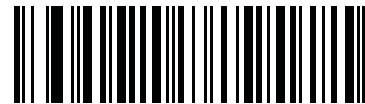

* New Coupon Format
(1)



Autodiscriminate Coupon Format
(2)

ISSN EAN**Parameter # 617 (SSI # F1h 69h)**

To enable or disable ISSN EAN, scan the appropriate bar code below.



**Enable ISSN EAN
(1)**

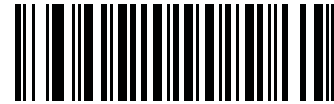

*** Disable ISSN EAN
(0)**

Code 128

Enable/Disable Code 128

Parameter # 8 (SSI # 08h)

To enable or disable Code 128, scan the appropriate bar code below.

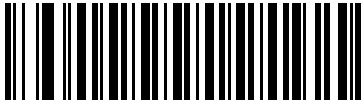

* Enable Code 128
(1)

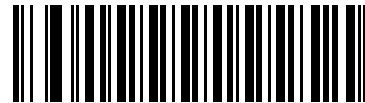

Disable Code 128
(0)

Set Lengths for Code 128

Parameter # 209, 210 (SSI # D1h D2h)

The length of a code refers to the number of characters (i.e., human readable characters), including check digit(s) the code contains. Set lengths for Code 128 to any length, one or two discrete lengths, or lengths within a specific range. Default is 1 to 80 (**Length Within Range**).

✓ **NOTE** When setting lengths for different bar code types, enter a leading zero for single digit numbers.

- **One Discrete Length** - Select this option to decode only Code 128 symbols containing a selected length. Select the length using the numeric bar codes in [Appendix E, NUMERIC BAR CODES](#). For example, to decode only Code 128 symbols with 14 characters, scan **Code 128 - One Discrete Length**, then scan **1** followed by **4**. To correct an error or change the selection, scan [Cancel on page E-3](#).
- **Two Discrete Lengths** - Select this option to decode only Code 128 symbols containing either of two selected lengths. Select lengths using the numeric bar codes in [Appendix E, NUMERIC BAR CODES](#). For example, to decode only Code 128 symbols containing either 2 or 14 characters, select **Code 128 - Two Discrete Lengths**, then scan **0, 2, 1**, and then **4**. To correct an error or change the selection, scan [Cancel on page E-3](#).
- **Length Within Range** - Select this option to decode a Code 128 symbol with a specific length range. Select lengths using numeric bar codes in [Appendix E, NUMERIC BAR CODES](#). For example, to decode Code 128 symbols containing between 4 and 12 characters, first scan **Code 128 - Length Within Range**. Then scan **0, 4, 1**, and **2** (enter a leading zero for single digit numbers). To correct an error or change the selection, scan [Cancel on page E-3](#).
- **Any Length** - Select this option to decode Code 128 symbols containing any number of characters within the linear imager scanner's capability.

Set Lengths for Code 128 (continued)

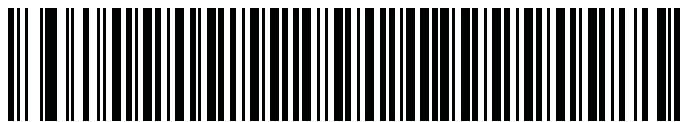

Code 128 - One Discrete Length



Code 128 - Two Discrete Lengths

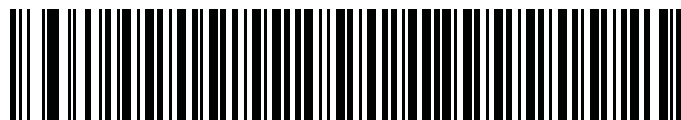

*** Code 128 - Length Within Range**



Code 128 - Any Length

Enable/Disable GS1-128 (formerly UCC/EAN-128)

Parameter # 14 (SSI # 0Eh)

To enable or disable GS1-128, scan the appropriate bar code below.

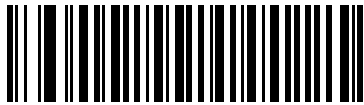

*** Enable GS1-128
(1)**



**Disable GS1-128
(0)**

Enable/Disable ISBT 128

Parameter # 84 (SSI # 54h)

ISBT 128 is a variant of Code 128 used in the blood bank industry. Scan a bar code below to enable or disable ISBT 128. If necessary, the host must perform concatenation of the ISBT data.



*** Enable ISBT 128
(1)**

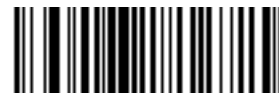

**Disable ISBT 128
(0)**

ISBT Concatenation

Parameter # 577 (SSI # F1h 41h)

Select an option for concatenating pairs of ISBT code types:

- If you select **Disable ISBT Concatenation**, the linear imager scanner does not concatenate pairs of ISBT codes it encounters.
- If you select **Enable ISBT Concatenation**, there must be two ISBT codes in order for the linear imager scanner to decode and perform concatenation. The linear imager scanner does not decode single ISBT symbols.
- If you select **Autodiscriminate ISBT Concatenation**, the linear imager scanner decodes and concatenates pairs of ISBT codes immediately. If only a single ISBT symbol is present, the linear imager scanner must decode the symbol the number of times set via [ISBT Concatenation Redundancy on page 11-28](#) before transmitting its data to confirm that there is no additional ISBT symbol.

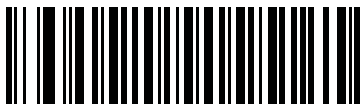

Disable ISBT Concatenation
(0)



Enable ISBT Concatenation
(1)



*** Autodiscriminate ISBT Concatenation**
(2)

Check ISBT Table

Parameter # 578 (SSI # F1h 42h)

The ISBT specification includes a table that lists several types of ISBT bar codes that are commonly used in pairs. If you set **ISBT Concatenation** to **Enable**, enable **Check ISBT Table** to concatenate only those pairs found in this table. Other types of ISBT codes are not concatenated.

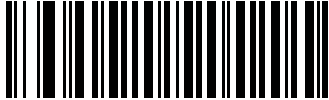

* Enable Check ISBT Table
(1)



Disable Check ISBT Table
(0)

ISBT Concatenation Redundancy

Parameter # 223 (SSI # DFh)

If you set **ISBT Concatenation** to **Autodiscriminate**, use this parameter to set the number of times the linear imager scanner must decode an ISBT symbol before determining that there is no additional symbol.

Scan the bar code below, then scan two numeric bar codes in [Appendix E, NUMERIC BAR CODES](#) to set a value between 2 and 20. Enter a leading zero for single digit numbers. To correct an error or change a selection, scan [Cancel on page E-3](#). The default is 10.



ISBT Concatenation Redundancy

Code 128 Security Level

Parameter # 751 (SSI # F1h EFh)

Code 128 bar codes are vulnerable to misdecodes, particularly when Code 128 Lengths is set to **Any Length**. The linear imager scanner offers four levels of decode Security for Code 128 bar codes. There is an inverse relationship between Security and digital scanner aggressiveness. Increasing the level of Security can reduce scanning aggressiveness, so select only the level of Security necessary.

- **Code 128 Security Level 0:** This setting allows the digital scanner to operate in its most aggressive state, while providing sufficient Security in decoding most in-spec bar codes.
- **Code 128 Security Level 1:** A bar code must be successfully read twice, and satisfy certain safety requirements before being decoded. This default setting eliminates most misdecodes.
- **Code 128 Security Level 2:** Select this option with greater bar code Security requirements if **Security Level 1** fails to eliminate misdecodes.
- **Code 128 Security Level 3:** If you selected **Security Level 2**, and misdecodes still occur, select this Security level to apply the highest safety requirements. A bar code must be successfully read three times before being decoded.

✓ **NOTE** Selecting this option is an extreme measure against mis-decoding severely out-of-spec bar codes. Selecting this level of Security significantly impairs the decoding ability of the digital scanner. If this level of Security is required, try to improve the quality of the bar codes.



Code 128 Security Level 0
(0)



* Code 128 Security Level 1
(1)



Code 128 Security Level 2
(2)



Code 128 Security Level 3
(3)

Code 39

Enable/Disable Code 39

Parameter # 0 (SSI # 00h)

To enable or disable Code 39, scan the appropriate bar code below.

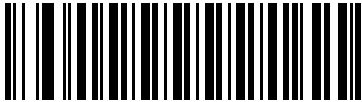

*** Enable Code 39
(1)**

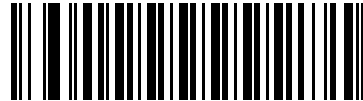

**Disable Code 39
(0)**

Enable/Disable Trioptic Code 39

Parameter # 13 (SSI # 0Dh)

Trioptic Code 39 is a variant of Code 39 used in the marking of computer tape cartridges. Trioptic Code 39 symbols always contain six characters. To enable or disable Trioptic Code 39, scan the appropriate bar code below.

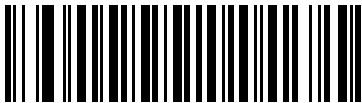

**Enable Trioptic Code 39
(1)**



*** Disable Trioptic Code 39
(0)**



NOTE You cannot enable Trioptic Code 39 and Code 39 Full ASCII simultaneously.

Convert Code 39 to Code 32

Parameter # 86 (SSI # 56h)

Code 32 is a variant of Code 39 used by the Italian pharmaceutical industry. Scan the appropriate bar code below to enable or disable converting Code 39 to Code 32.

✓ **NOTE** Code 39 must be enabled for this parameter to function.

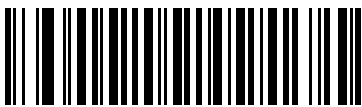

Enable Convert Code 39 to Code 32
(1)



*** Disable Convert Code 39 to Code 32**
(0)

Code 32 Prefix

Parameter # 231 (SSI # E7h)

Scan the appropriate bar code below to enable or disable adding the prefix character “A” to all Code 32 bar codes.

✓ **NOTE** Convert Code 39 to Code 32 must be enabled for this parameter to function.

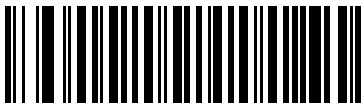

Enable Code 32 Prefix
(1)



*** Disable Code 32 Prefix**
(0)

Set Lengths for Code 39

Parameter # 18, 19 (SSI # 12h 13h)

The length of a code refers to the number of characters (i.e., human readable characters), including check digit(s) the code contains. Set lengths for Code 39 to any length, one or two discrete lengths, or lengths within a specific range. If Code 39 Full ASCII is enabled, **Length Within a Range** or **Any Length** are the preferred options. The default is 1 to 80 (**Length Within Range**).

✓ **NOTE** When setting lengths for different bar code types, enter a leading zero for single digit numbers.

- **One Discrete Length** - Select this option to decode only Code 39 symbols containing a selected length. Select the length using the numeric bar codes in [Appendix E, NUMERIC BAR CODES](#). For example, to decode only Code 39 symbols with 14 characters, scan **Code 39 - One Discrete Length**, then scan **1** followed by **4**. To correct an error or change the selection, scan [Cancel on page E-3](#).
- **Two Discrete Lengths** - Select this option to decode only Code 39 symbols containing either of two selected lengths. Select lengths using the numeric bar codes in [Appendix E, NUMERIC BAR CODES](#). For example, to decode only Code 39 symbols containing either 2 or 14 characters, select **Code 39 - Two Discrete Lengths**, then scan **0, 2, 1**, and then **4**. To correct an error or change the selection, scan [Cancel on page E-3](#).
- **Length Within Range** - Select this option to decode a Code 39 symbol with a specific length range. Select lengths using numeric bar codes in [Appendix E, NUMERIC BAR CODES](#). For example, to decode Code 39 symbols containing between 4 and 12 characters, first scan **Code 39 - Length Within Range**. Then scan **0, 4, 1**, and **2** (enter a leading zero for single digit numbers). To correct an error or change the selection, scan [Cancel on page E-3](#).
- **Any Length** - Select this option to decode Code 39 symbols containing any number of characters within the linear imager scanner's capability.



Code 39 - One Discrete Length



Code 39 - Two Discrete Lengths



* Code 39 - Length Within Range



Code 39 - Any Length

Code 39 Check Digit Verification

Parameter # 48 (SSI # 30h)

Enable this feature to check the integrity of all Code 39 symbols to verify that the data complies with specified check digit algorithm. Only Code 39 symbols which include a modulo 43 check digit are decoded. Enable this feature if the Code 39 symbols contain a Modulo 43 check digit.

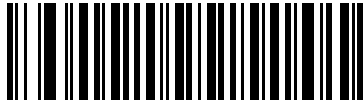

Enable Code 39 Check Digit
(1)

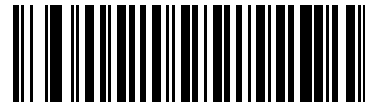

* Disable Code 39 Check Digit
(0)

Transmit Code 39 Check Digit

Parameter # 43 (SSI # 2Bh)

Scan a bar code below to transmit Code 39 data with or without the check digit.

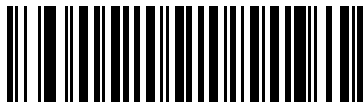

Transmit Code 39 Check Digit (Enable)
(01)



* Do Not Transmit Code 39 Check Digit (Disable)
(0)



NOTE Code 39 Check Digit Verification must be enabled for this parameter to function.

Code 39 Full ASCII Conversion

Parameter # 17 (SSI # 11h)

Code 39 Full ASCII is a variant of Code 39 which pairs characters to encode the full ASCII character set. To enable or disable Code 39 Full ASCII, scan the appropriate bar code below.

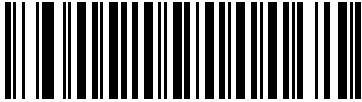

Enable Code 39 Full ASCII
(1)

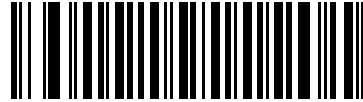

*** Disable Code 39 Full ASCII**
(0)



NOTE You cannot enable Trioptic Code 39 and Code 39 Full ASCII simultaneously.

Code 39 Full ASCII to Full ASCII Correlation is host-dependent, and is therefore described in the ASCII Character Set Table for the appropriate interface. See the [ASCII CHARACTER SETS on page H-1](#).

Code 39 Buffering - Scan & Store

Parameter # 113 (SSI # 71h)

This feature allows the linear imager scanner to accumulate data from multiple Code 39 symbols.

Selecting the Scan and Store option (Buffer Code 39) temporarily buffers all Code 39 symbols having a leading space as a first character for later transmission. The leading space is not buffered.

Decoding a Code 39 symbol with no leading space transmits in sequence all buffered data in a first-in first-out format, plus the “triggering” symbol. See the following pages for further details.

Select **Do Not Buffer Code 39** to transmit all decoded Code 39 symbols immediately without storing them in the buffer.

Code 39 Buffering - Scan & Store (continued)

This feature affects Code 39 only. If selecting **Buffer Code 39**, we recommend configuring the linear imager scanner to decode Code 39 symbology only.

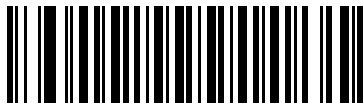

Buffer Code 39 (Enable)
(1)

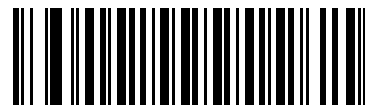

*** Do Not Buffer Code 39 (Disable)**
(0)

While there is data in the transmission buffer, you cannot select **Do Not Buffer Code 39**. The buffer holds 200 bytes of information.

To disable Code 39 buffering when there is data in the transmission buffer, first force the buffer transmission (see [Transmit Buffer on page 11-36](#)) or clear the buffer.

Buffer Data

To buffer data, enable Code 39 buffering and scan a Code 39 symbol with a space immediately following the start pattern.

- Unless the data overflows the transmission buffer, the linear imager scanner issues a low/high beep to indicate successful decode and buffering. (For overflow conditions, see [Overfilling Transmission Buffer on page 11-36](#).)
- The linear imager scanner adds the decoded data excluding the leading space to the transmission buffer.
- No transmission occurs.

Clear Transmission Buffer

To clear the transmission buffer, scan the **Clear Buffer** bar code below, which contains only a start character, a dash (minus), and a stop character.

- The linear imager scanner issues a short high/low/high beep.
- The linear imager scanner erases the transmission buffer.
- No transmission occurs.



Clear Buffer



NOTE The Clear Buffer contains only the dash (minus) character. In order to scan this command, set Code 39 lengths to include length 1.

Transmit Buffer

There are two methods to transmit the Code 39 buffer.

1. Scan the **Transmit Buffer** bar code below, which includes only a start character, a plus (+), and a stop character.
2. The linear imager scanner transmits and clears the buffer.
 - The linear imager scanner issues a low/high beep.



Transmit Buffer

3. Scan a Code 39 bar code with a leading character other than a space.
 - The linear imager scanner appends new decode data to buffered data.
 - The linear imager scanner transmits and clears the buffer.
 - The linear imager scanner signals that it transmitted the buffer with a low/high beep.
 - The linear imager scanner transmits and clears the buffer.

✓ **NOTE** The Transmit Buffer contains only a plus (+) character. In order to scan this command, set Code 39 lengths to include length 1.

Overfilling Transmission Buffer

The Code 39 buffer holds 200 characters. If the symbol just read overflows the transmission buffer:

- The linear imager scanner indicates that it rejected the symbol by issuing three long, high beeps.
- No transmission occurs. The data in the buffer is not affected.

Attempt to Transmit an Empty Buffer

If you scan the **Transmit Buffer** symbol and the Code 39 buffer is empty:

- A short low/high/low beep signals that the buffer is empty.
- No transmission occurs.
- The buffer remains empty.

Code 39 Security Level

Parameter # 750 (SSI # F1h EEh)

The digital scanner offers four levels of decode Security for Code 39 bar codes. There is an inverse relationship between Security and digital scanner aggressiveness. Increasing the level of Security can reduce scanning aggressiveness, so select only the level of Security necessary.

- **Code 39 Security Level 0:** This setting allows the digital scanner to operate in its most aggressive state, while providing sufficient Security in decoding most in-spec bar codes.
- **Code 39 Security Level 1:** This default setting eliminates most misdecodes.
- **Code 39 Security Level 2:** Select this option with greater bar code Security requirements if **Security Level 1** fails to eliminate misdecodes.
- **Code 39 Level 3:** If you selected **Security Level 2**, and misdecodes still occur, select this Security level to apply the highest safety requirements.

✓ **NOTE** Selecting this option is an extreme measure against mis-decoding severely out-of-spec bar codes. Selecting this level of Security significantly impairs the decoding ability of the digital scanner. If this level of Security is required, try to improve the quality of the bar codes.



Code 39 Security Level 0
(0)



* Code 39 Security Level 1
(1)

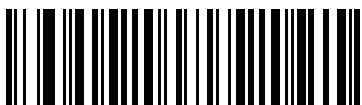

Code 39 Security Level 2
(2)



Code 39 Security Level 3
(3)

Code 93

Enable/Disable Code 93

Parameter # 9 (SSI # 09h)

To enable or disable Code 93, scan the appropriate bar code below.

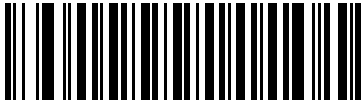

*** Enable Code 93**
(1)

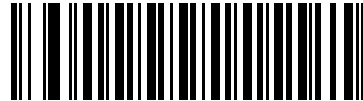

Disable Code 93
(0)

Set Lengths for Code 93

Parameter # 26, 27 (SSI # 1Ah 1Bh)

The length of a code refers to the number of characters (i.e., human readable characters), including check digit(s) the code contains. Set lengths for Code 93 to any length, one or two discrete lengths, or lengths within a specific range. The default is 1 to 80 (**Length Within Range**).

- **One Discrete Length** - Select this option to decode only Code 93 symbols containing a selected length. Select the length using the numeric bar codes in [Appendix E, NUMERIC BAR CODES](#). For example, to decode only Code 93 symbols with 14 characters, scan **Code 93 - One Discrete Length**, then scan **1** followed by **4**. To correct an error or to change the selection, scan [Cancel on page E-3](#).
- **Two Discrete Lengths** - Select this option to decode only Code 93 symbols containing either of two selected lengths. Select lengths using the numeric bar codes in [Appendix E, NUMERIC BAR CODES](#). For example, to decode only Code 93 symbols containing either 2 or 14 characters, select **Code 93 - Two Discrete Lengths**, then scan **0, 2, 1**, and then **4**. To correct an error or to change the selection, scan [Cancel on page E-3](#).
- **Length Within Range** - Select this option to decode a Code 93 symbol with a specific length range. Select lengths using the numeric bar codes in [Appendix E, NUMERIC BAR CODES](#). For example, to decode Code 93 symbols containing between 4 and 12 characters, first scan **Code 93 - Length Within Range**. Then scan **0, 4, 1**, and **2** (enter a leading zero for single digit numbers). To correct an error or change the selection, scan [Cancel on page E-3](#).
- **Any Length** - Scan this option to decode Code 93 symbols containing any number of characters within the linear imager scanner's capability.



Code 93 - One Discrete Length



Code 93 - Two Discrete Lengths



* Code 93 - Length Within Range



Code 93 - Any Length

Code 11

Code 11

Parameter # 10 (SSI # 0Ah)

To enable or disable Code 11, scan the appropriate bar code below.

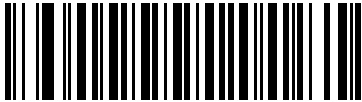

Enable Code 11
(1)

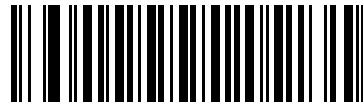

*** Disable Code 11**
(0)

Set Lengths for Code 11

Parameter # 28, 29 (SSI # 1Ch 1Dh)

The length of a code refers to the number of characters (i.e., human readable characters), including check digit(s) the code contains. Set lengths for Code 11 to any length, one or two discrete lengths, or lengths within a specific range. The default is 4 to 80 (**Length Within Range**).

- **One Discrete Length** - Select this option to decode only Code 11 symbols containing a selected length. Select the length using the numeric bar codes in [Appendix E, NUMERIC BAR CODES](#). For example, to decode only Code 11 symbols with 14 characters, scan **Code 11 - One Discrete Length**, then scan **1** followed by **4**. To correct an error or to change the selection, scan [Cancel on page E-3](#).
- **Two Discrete Lengths** - Select this option to decode only Code 11 symbols containing either of two selected lengths. Select lengths using the numeric bar codes in [Appendix E, NUMERIC BAR CODES](#). For example, to decode only Code 11 symbols containing either 2 or 14 characters, select **Code 11 - Two Discrete Lengths**, then scan **0, 2, 1**, and then **4**. To correct an error or to change the selection, scan [Cancel on page E-3](#).
- **Length Within Range** - Select this option to decode a Code 11 symbol with a specific length range. Select lengths using numeric bar codes in [Appendix E, NUMERIC BAR CODES](#). For example, to decode Code 11 symbols containing between 4 and 12 characters, first scan **Code 11 - Length Within Range**. Then scan **0, 4, 1**, and **2** (enter a leading zero for single digit numbers). To correct an error or change the selection, scan [Cancel on page E-3](#).
- **Any Length** - Scan this option to decode Code 11 symbols containing any number of characters within the linear imager scanner's capability.



Code 11 - One Discrete Length



Code 11 - Two Discrete Lengths



* Code 11 - Length Within Range



Code 11 - Any Length

Code 11 Check Digit Verification

Parameter # 52 (SSI # 34h)

This feature allows the linear imager scanner to check the integrity of all Code 11 symbols to verify that the data complies with the specified check digit algorithm. This selects the check digit mechanism for the decoded Code 11 bar code. The options are to check for one check digit, check for two check digits, or disable the feature.

To enable this feature, scan the bar code below corresponding to the number of check digits encoded in the Code 11 symbols.



*** Disable
(0)**

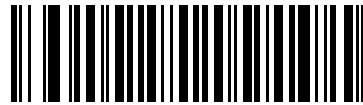

**One Check Digit
(1)**

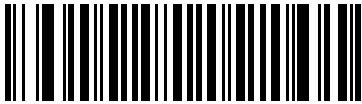

**Two Check Digits
(2)**

Transmit Code 11 Check Digits

Parameter # 47 (SSI # 2Fh)

This feature selects whether or not to transmit the Code 11 check digit(s).

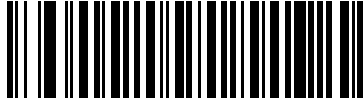

Transmit Code 11 Check Digit(s) (Enable)
(1)

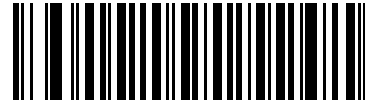

* Do Not Transmit Code 11 Check Digit(s) (Disable)
(0)



NOTE Code 11 Check Digit Verification must be enabled for this parameter to function.

Interleaved 2 of 5 (ITF)

Enable/Disable Interleaved 2 of 5

Parameter # 6 (SSI # 06h)

To enable or disable Interleaved 2 of 5, scan the appropriate bar code below, and select an Interleaved 2 of 5 length from the following pages.

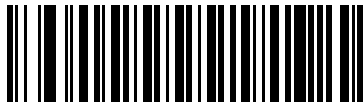

* Enable Interleaved 2 of 5
(1)



Disable Interleaved 2 of 5
(0)

Set Lengths for Interleaved 2 of 5

Parameter # 22, 23 (SSI # 16h 17h)

The length of a code refers to the number of characters (i.e., human readable characters), including check digit(s) the code contains. Set lengths for I 2 of 5 to any length, one or two discrete lengths, or lengths within a specific range. The default is 6 to 80 (**Length Within Range**).

- **One Discrete Length** - Select this option to decode only I 2 of 5 symbols containing a selected length. Select the length using the numeric bar codes in [Appendix E, NUMERIC BAR CODES](#). For example, to decode only I 2 of 5 symbols with 14 characters, scan **I 2 of 5 - One Discrete Length**, then scan **1** followed by **4**. To correct an error or to change the selection, scan [Cancel on page E-3](#).
- **Two Discrete Lengths** - Select this option to decode only I 2 of 5 symbols containing either of two selected lengths. Select lengths using the numeric bar codes in [Appendix E, NUMERIC BAR CODES](#). For example, to decode only I 2 of 5 symbols containing either 2 or 14 characters, select **I 2 of 5 - Two Discrete Lengths**, then scan **0, 2, 1**, and then **4**. To correct an error or to change the selection, scan [Cancel on page E-3](#).
- **Length Within Range** - Select this option to decode an I 2 of 5 symbol with a specific length range. Select lengths using numeric bar codes in [Appendix E, NUMERIC BAR CODES](#). For example, to decode I 2 of 5 symbols containing between 4 and 12 characters, first scan **I 2 of 5 - Length Within Range**. Then scan **0, 4, 1**, and **2** (enter a leading zero for single digit numbers). To correct an error or change the selection, scan [Cancel on page E-3](#).
- **Any Length** - Scan this option to decode I 2 of 5 symbols containing any number of characters within the linear imager scanner's capability.

✓ **NOTE** Due to the construction of the I 2 of 5 symbology, it is possible for a scan line covering only a portion of the code to transmit as a complete scan, yielding less data than is encoded in the bar code. To prevent this, select specific lengths (I 2 of 5 - One Discrete Length, Two Discrete Lengths) for I 2 of 5 applications.

Set Lengths for Interleaved 2 of 5 (continued)



I 2 of 5 - One Discrete Length



I 2 of 5 - Two Discrete Lengths



*I 2 of 5 - Length Within Range



I 2 of 5 - Any Length

I 2 of 5 Check Digit Verification

Parameter # 49 (SSI # 31h)

Enable this feature to check the integrity of all I 2 of 5 symbols to verify the data complies with either the specified Uniform Symbology Specification (USS), or the Optical Product Code Council (OPCC) check digit algorithm.



*** Disable
(0)**



**USS Check Digit
(1)**



**OPCC Check Digit
(2)**

Transmit I 2 of 5 Check Digit

Parameter # 44 (SSI # 2Ch)

Scan the appropriate bar code below to transmit I 2 of 5 data with or without the check digit.

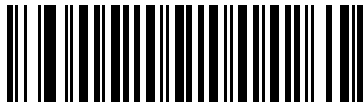

**Transmit I 2 of 5 Check Digit (Enable)
(1)**



*** Do Not Transmit I 2 of 5 Check Digit (Disable)
(0)**

Convert I 2 of 5 to EAN-13

Parameter # 82 (SSI # 52h)

Enable this parameter to convert 14-character I 2 of 5 codes to EAN-13, and transmit to the host as EAN-13. To accomplish this, the I 2 of 5 code must be enabled, and the code must have a leading zero and a valid EAN-13 check digit.

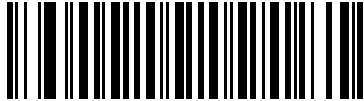

Convert I 2 of 5 to EAN-13 (Enable)
(1)

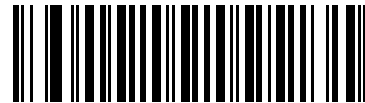

*** Do Not Convert I 2 of 5 to EAN-13 (Disable)**
(0)

I 2 of 5 Security Level

Parameter # 1121 (SSI # F8h 04h 61h)

Interleaved 2 of 5 bar codes are vulnerable to misdecodes, particularly when I 2 of 5 Lengths is set to **Any Length**. The digital scanner offers four levels of decode Security for Interleaved 2 of 5 bar codes. There is an inverse relationship between Security and digital scanner aggressiveness. Increasing the level of Security can reduce scanning aggressiveness, so select only the level of Security necessary.

- **I 2 of 5 Security Level 0:** This setting allows the digital scanner to operate in its most aggressive state, while providing sufficient Security in decoding most in-spec bar codes.
- **I 2 of 5 Security Level 1:** A bar code must be successfully read twice, and satisfy certain safety requirements before being decoded. This default setting eliminates most misdecodes.
- **I 2 of 5 Security Level 2:** Select this option with greater bar code Security requirements if **Security Level 1** fails to eliminate misdecodes.
- **I 2 of 5 Security Level 3:** If you selected **Security Level 2**, and misdecodes still occur, select this Security level. The highest safety requirements are applied. A bar code must be successfully read three times before being decoded.

✓ **NOTE** Selecting this option is an extreme measure against mis-decoding severely out-of-spec bar codes. Selecting this level of Security significantly impairs the decoding ability of the digital scanner. If this level of Security is required, try to improve the quality of the bar codes.



I 2 of 5 Security Level 0
(0)

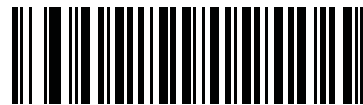

* I 2 of 5 Security Level 1
(1)

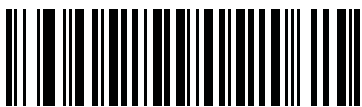

I 2 of 5 Security Level 2
(2)

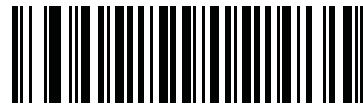

I 2 of 5 Security Level 3
(3)

Discrete 2 of 5 (DTF)

Enable/Disable Discrete 2 of 5

Parameter # 5 (SSI # 05h)

To enable or disable Discrete 2 of 5, scan the appropriate bar code below.

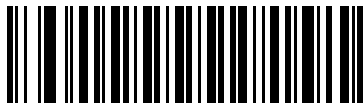

Enable Discrete 2 of 5
(1)

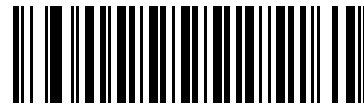

* Disable Discrete 2 of 5
(0)

Set Lengths for Discrete 2 of 5

Parameter # 20, 21 (SSI # 14h 15h)

The length of a code refers to the number of characters (i.e., human readable characters), including check digit(s) the code contains. Set lengths for D 2 of 5 to any length, one or two discrete lengths, or lengths within a specific range. The default range is 1 - 55 (**Length Within Range**).

- **One Discrete Length** - Select this option to decode only D 2 of 5 symbols containing a selected length. Select the length using the numeric bar codes in [Appendix E, NUMERIC BAR CODES](#). For example, to decode only D 2 of 5 symbols with 14 characters, scan **D 2 of 5 - One Discrete Length**, then scan **1** followed by **4**. To correct an error or to change the selection, scan [Cancel on page E-3](#).
- **Two Discrete Lengths** - Select this option to decode only D 2 of 5 symbols containing either of two selected lengths. Select lengths using the numeric bar codes in [Appendix E, NUMERIC BAR CODES](#). For example, to decode only D 2 of 5 symbols containing either 2 or 14 characters, select **D 2 of 5 - Two Discrete Lengths**, then scan **0, 2, 1**, and then **4**. To correct an error or to change the selection, scan [Cancel on page E-3](#).
- **Length Within Range** - Select this option to decode a D 2 of 5 symbol with a specific length range. Select lengths using numeric bar codes in [Appendix E, NUMERIC BAR CODES](#). For example, to decode D 2 of 5 symbols containing between 4 and 12 characters, first scan **D 2 of 5 - Length Within Range**. Then scan **0, 4, 1**, and **2** (enter a leading zero for single digit numbers). To correct an error or change the selection, scan [Cancel on page E-3](#).
- **Any Length** - Scan this option to decode D 2 of 5 symbols containing any number of characters within the linear imager scanner's capability.

✓ **NOTE** Due to the construction of the D 2 of 5 symbology, it is possible for a scan line covering only a portion of the code to transmit as a complete scan, yielding less data than is encoded in the bar code. To prevent this, select specific lengths (**D 2 of 5 - One Discrete Length, Two Discrete Lengths**) for D 2 of 5 applications.

Set Lengths for Discrete 2 of 5 (continued)



D 2 of 5 - One Discrete Length



D 2 of 5 - Two Discrete Lengths



*** D 2 of 5 - Length Within Range**



D 2 of 5 - Any Length

Codabar (NW - 7)

Enable/Disable Codabar

Parameter # 7 (SSI # 07h)

To enable or disable Codabar, scan the appropriate bar code below.

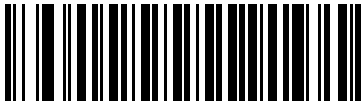

*** Enable Codabar
(1)**

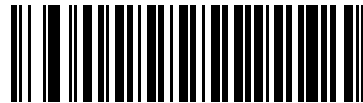

**Disable Codabar
(0)**

Set Lengths for Codabar

Parameter # 24, 25 (SSI # 18h 19h)

The length of a code refers to the number of characters (i.e., human readable characters), including check digit(s) the code contains. Set lengths for Codabar to any length, one or two discrete lengths, or lengths within a specific range. The default is 4 to 60 (**Length Within Range**).

- **One Discrete Length** - Select this option to decode only Codabar symbols containing a selected length. Select the length using the numeric bar codes in [Appendix E, NUMERIC BAR CODES](#). For example, to decode only Codabar symbols with 14 characters, scan **Codabar - One Discrete Length**, then scan **1** followed by **4**. To correct an error or to change the selection, scan [Cancel on page E-3](#).
- **Two Discrete Lengths** - Select this option to decode only Codabar symbols containing either of two selected lengths. Select lengths using the numeric bar codes in [Appendix E, NUMERIC BAR CODES](#). For example, to decode only Codabar symbols containing either 2 or 14 characters, select **Codabar - Two Discrete Lengths**, then scan **0, 2, 1**, and then **4**. To correct an error or to change the selection, scan [Cancel on page E-3](#).
- **Length Within Range** - Select this option to decode a Codabar symbol with a specific length range. Select lengths using numeric bar codes in [Appendix E, NUMERIC BAR CODES](#). For example, to decode Codabar symbols containing between 4 and 12 characters, first scan **Codabar - Length Within Range**. Then scan **0, 4, 1**, and **2** (enter a leading zero for single digit numbers). To correct an error or change the selection, scan [Cancel on page E-3](#).
- **Any Length** - Scan this option to decode Codabar symbols containing any number of characters within the linear imager scanner's capability.



Codabar - One Discrete Length



Codabar - Two Discrete Lengths



* Codabar - Length Within Range



Codabar - Any Length

CLSI Editing

Parameter # 54 (SSI # 36h)

Enable this parameter to strip the start and stop characters and insert a space after the first, fifth, and tenth characters of a 14-character Codabar symbol. Enable this feature if the host system requires this data format.

✓ **NOTE** Symbol length does not include start and stop characters.

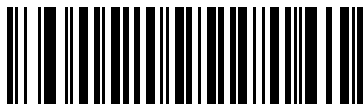

Enable CLSI Editing
(1)

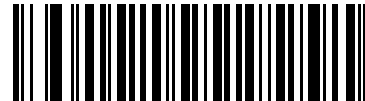

* Disable CLSI Editing
(0)

NOTIS Editing

Parameter # 55 (SSI # 37h)

Enable this parameter to strip the start and stop characters from a decoded Codabar symbol. Enable this feature if the host system requires this data format.

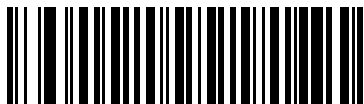

Enable NOTIS Editing
(1)

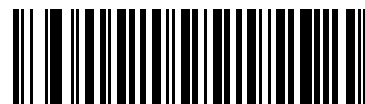

* Disable NOTIS Editing
(0)

Codabar Upper or Lower Case Start/Stop Characters Detection

Parameter # 855 (SSI # F2h 57h)

Select whether to detect upper case or lower case Codabar start/stop characters.

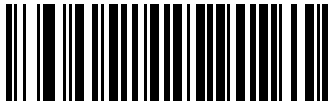

Lower Case
(1)

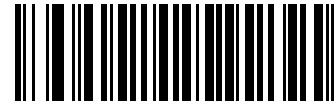

*** Upper Case**
(0)

MSI

Enable/Disable MSI

Parameter # 11 (SSI # 0Bh)

To enable or disable MSI, scan the appropriate bar code below.

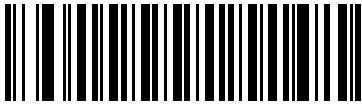

Enable MSI
(1)

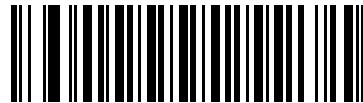

*** Disable MSI**
(0)

Set Lengths for MSI

Parameter # 30, 31 (SSI # 1Eh 1Fh)

The length of a code refers to the number of characters (i.e., human readable characters), including check digit(s) the code contains. Set lengths for MSI to any length, one or two discrete lengths, or lengths within a specific range. The default is 4 to 55 (**Length Within Range**).

- **One Discrete Length** - Select this option to decode only MSI symbols containing a selected length. Select the length using the numeric bar codes in [Appendix E, NUMERIC BAR CODES](#). For example, to decode only MSI symbols with 14 characters, scan **MSI - One Discrete Length**, then scan **1** followed by **4**. To correct an error or to change the selection, scan [Cancel on page E-3](#).
- **Two Discrete Lengths** - Select this option to decode only MSI symbols containing either of two selected lengths. Select lengths using the numeric bar codes in [Appendix E, NUMERIC BAR CODES](#). For example, to decode only MSI symbols containing either 2 or 14 characters, select **MSI - Two Discrete Lengths**, then scan **0, 2, 1**, and then **4**. To correct an error or to change the selection, scan [Cancel on page E-3](#).
- **Length Within Range** - Select this option to decode a MSI symbol with a specific length range. Select lengths using numeric bar codes in [Appendix E, NUMERIC BAR CODES](#). For example, to decode MSI symbols containing between 4 and 12 characters, first scan **MSI - Length Within Range**. Then scan **0, 4, 1**, and **2** (enter a leading zero for single digit numbers). To correct an error or change the selection, scan [Cancel on page E-3](#).
- **Any Length** - Scan this option to decode MSI symbols containing any number of characters within the linear imager scanner's capability.



NOTE Due to the construction of the MSI symbology, it is possible for a scan line covering only a portion of the code to transmit as a complete scan, yielding less data than is encoded in the bar code. To prevent this, select specific lengths (**MSI - One Discrete Length, Two Discrete Lengths**) for MSI applications.

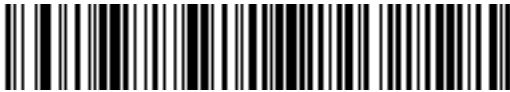

MSI - One Discrete Length



MSI - Two Discrete Lengths

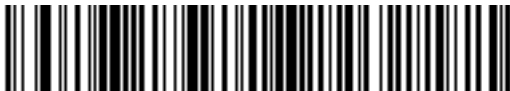

*** MSI - Length Within Range**



MSI - Any Length

MSI Check Digits

Parameter # 50 (SSI # 32h)

With MSI symbols, one check digit is mandatory and always verified by the reader. The second check digit is optional. If the MSI codes include two check digits, scan the **Two MSI Check Digits** bar code to enable verification of the second check digit.

See [MSI Check Digit Algorithm on page 11-58](#) for the selection of second digit algorithms.

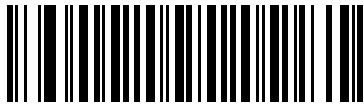

* One MSI Check Digit
(0)

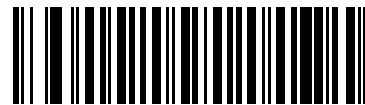

Two MSI Check Digits
(1)

Transmit MSI Check Digit(s)

Parameter # 46 (SSI # 2Eh)

Scan a bar code below to transmit MSI data with or without the check digit.

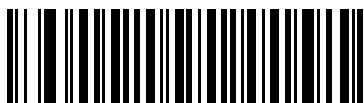

Transmit MSI Check Digit(s) (Enable)
(1)

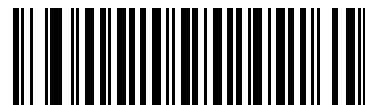

* Do Not Transmit MSI Check Digit(s) (Disable)
(0)

MSI Check Digit Algorithm

Parameter # 51 (SSI # 33h)

Two algorithms are possible for the verification of the second MSI check digit. Select the bar code below corresponding to the algorithm used to encode the check digit.



MOD 10/MOD 11
(0)

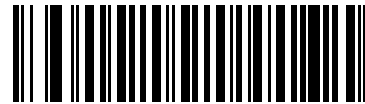

*** MOD 10/MOD 10**
(1)

Chinese 2 of 5

Enable/Disable Chinese 2 of 5

Parameter # 408 (SSI # F0h 98h)

To enable or disable Chinese 2 of 5, scan the appropriate bar code below.

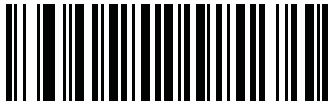

**Enable Chinese 2 of 5
(1)**

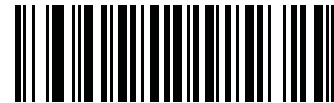

*** Disable Chinese 2 of 5
(0)**

Matrix 2 of 5

Enable/Disable Matrix 2 of 5

Parameter # 618 (SSI # F1h 6Ah)

To enable or disable Matrix 2 of 5, scan the appropriate bar code below.



**Enable Matrix 2 of 5
(1)**

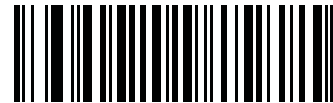

*** Disable Matrix 2 of 5
(0)**

Set Lengths for Matrix 2 of 5

Parameter # 619, 620 (SSI # F1h 6Bh, F1h 6Ch)

The length of a code refers to the number of characters (i.e., human readable characters), including check digit(s) the code contains. Set lengths for Matrix 2 of 5 to any length, one or two discrete lengths, or lengths within a specific range. The default is 4 to 80 (**Length Within Range**).

- **One Discrete Length** - Select this option to decode only Matrix 2 of 5 symbols containing a selected length. Select the length using the numeric bar codes in [Appendix E, NUMERIC BAR CODES](#). For example, to decode only Matrix 2 of 5 symbols with 14 characters, scan **Matrix 2 of 5 - One Discrete Length**, then scan **1** followed by **4**. To correct an error or to change the selection, scan [Cancel on page E-3](#).
- **Two Discrete Lengths** - Select this option to decode only Matrix 2 of 5 symbols containing either of two selected lengths. Select lengths using the numeric bar codes in [Appendix E, NUMERIC BAR CODES](#). For example, to decode only Matrix 2 of 5 symbols containing either 2 or 14 characters, select **Matrix 2 of 5 - Two Discrete Lengths**, then scan **0, 2, 1**, and then **4**. To correct an error or to change the selection, scan [Cancel on page E-3](#).
- **Length Within Range** - Select this option to decode a Matrix 2 of 5 symbol with a specific length range. Select lengths using the numeric bar codes in [Appendix E, NUMERIC BAR CODES](#). For example, to decode Matrix 2 of 5 symbols containing between 4 and 12 characters, first scan **Matrix 2 of 5 - Length Within Range**. Then scan **0, 4, 1**, and **2** (enter a leading zero for single digit numbers). To correct an error or change the selection, scan [Cancel on page E-3](#).
- **Any Length** - Scan this option to decode Matrix 2 of 5 symbols containing any number of characters within the linear imager scanner's capability.



Matrix 2 of 5 - One Discrete Length



Matrix 2 of 5 - Two Discrete Lengths

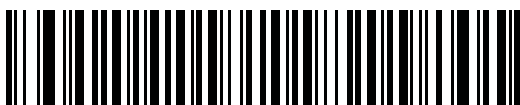

* Matrix 2 of 5 - Length Within Range



Matrix 2 of 5 - Any Length

Matrix 2 of 5 Check Digit

Parameter # 622 (SSI # F1h 6Eh)

The check digit is the last character of the symbol used to verify the integrity of the data. Scan the appropriate bar code below to transmit the bar code data with or without the Matrix 2 of 5 check digit.



**Enable Matrix 2 of 5 Check Digit
(1)**



*** Disable Matrix 2 of 5 Check Digit
(0)**

Transmit Matrix 2 of 5 Check Digit

Parameter # 623 (SSI # F1h 6Fh)

Scan a bar code below to transmit Matrix 2 of 5 data with or without the check digit.

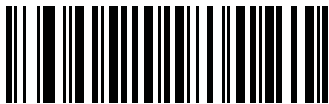

**Transmit Matrix 2 of 5 Check Digit
(1)**

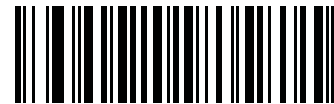

*** Do Not Transmit Matrix 2 of 5 Check Digit
(0)**

Korean 3 of 5

Enable/Disable Korean 3 of 5

Parameter # 581 (SSI # F1h 45h)

To enable or disable Korean 3 of 5, scan the appropriate bar code below.

✓ **NOTE** The length for Korean 3 of 5 is fixed at 6.

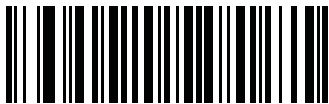

Enable Korean 3 of 5
(1)



*** Disable Korean 3 of 5**
(0)

Inverse 1D

Parameter # 586 (SSI # F1h 4Ah)

This parameter sets the 1D inverse decoder setting. Options are:

- **Regular Only** - the linear imager scanner decodes regular 1D bar codes only.
- **Inverse Only** - the linear imager scanner decodes inverse 1D bar codes only.
- **Inverse Autodetect** - the linear imager scanner decodes both regular and inverse 1D bar codes.



* Regular
(0)



Inverse Only
(1)



Inverse Autodetect
(2)

GS1 DataBar

The variants of GS1 DataBar are DataBar-14, DataBar Expanded, and DataBar Limited. The limited and expanded versions have stacked variants. Scan the appropriate bar codes to enable or disable each variant of GS1 DataBar.

GS1 DataBar-14

Parameter # 338 (SSI # F0h 52h)

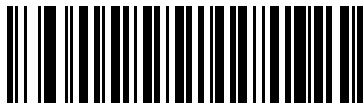

* Enable GS1 DataBar-14
(1)



Disable GS1 DataBar-14
(0)

GS1 DataBar Limited

Parameter # 339 (SSI # F0h 53h)

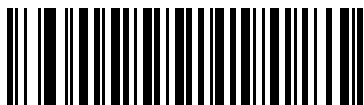

* Enable GS1 DataBar Limited
(1)



Disable GS1 DataBar Limited
(0)

GS1 DataBar Expanded

Parameter # 340 (SSI # F0h 54h)

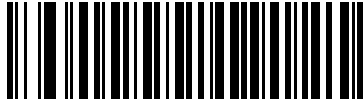

* Enable GS1 DataBar Expanded
(1)

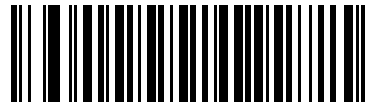

Disable GS1 DataBar Expanded
(0)

GS1 DataBar Limited Security Level

Parameter # 728 (SSI # F1h D8h)

The linear imager scanner offers four levels of decode Security for GS1 DataBar Limited bar codes. There is an inverse relationship between Security and linear imager scanner aggressiveness. Increasing the level of Security may result in reduced aggressiveness in scanning, so choose only that level of Security necessary.

- Level 1 – No clear margin required. This complies with the original GS1 standard, yet might result in erroneous decoding of the DataBar Limited bar code when scanning some UPC symbols that start with digits “9” and “7”
- Level 2 – Automatic risk detection. This level of Security may result in erroneous decoding of DataBar Limited bar codes when scanning some UPC symbols. The scanner defaults to Level 3, otherwise to Level 1.
- Level 3 – Security level reflects newly proposed GS1 standard that requires a 5 times trailing clear margin.
- Level 4 – Security level extends beyond the standard required by GS1. This level of Security requires a 5 times leading and trailing clear margin.



GS1 DataBar Limited Security Level 1
(1)



GS1 DataBar Limited Security Level 2
(2)



*** GS1 DataBar Limited Security Level 3**
(3)



GS1 DataBar Limited Security Level 4
(4)

Convert GS1 DataBar to UPC/EAN

Parameter # 397 (SSI # F0h 8Dh)

This parameter only applies to GS1 DataBar-14 and GS1 DataBar Limited symbols not decoded as part of a Composite symbol. Enable this to strip the leading '010' from DataBar-14 and DataBar Limited symbols encoding a single zero as the first digit, and report the bar code as EAN-13.

For bar codes beginning with two or more zeros but not six zeros, this parameter strips the leading '0100' and reports the bar code as UPC-A. The UPC-A Preamble parameter that transmits the system character and country code applies to converted bar codes. Note that neither the system character nor the check digit can be stripped.



Enable Convert GS1 DataBar to UPC/EAN
(1)

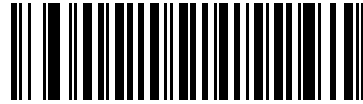

*** Disable Convert GS1 DataBar to UPC/EAN**
(0)

Redundancy Level

Parameter # 78 (SSI # 4Eh)

The linear imager scanner offers four levels of decode redundancy. Select higher redundancy levels for decreasing levels of bar code quality. As redundancy levels increase, the linear imager scanner's aggressiveness decreases.

Select the redundancy level appropriate for the bar code quality.

Redundancy Level 1

The following code types must be successfully read twice before being decoded:

Table 11-2 *Redundancy Level 1 Codes*

Code Type	Code Length
Codabar	8 characters or less
MSI	4 characters or less
D 2 of 5	8 characters or less
I 2 of 5	8 characters or less

Redundancy Level 2

The following code types must be successfully read twice before being decoded:

Table 11-3 *Redundancy Level 2 Codes*

Code Type	Code Length
All	All

Redundancy Level 3

Code types other than the following must be successfully read twice before being decoded. The following codes must be read three times:

Table 11-4 *Redundancy Level 3 Codes*

Code Type	Code Length
MSI	4 characters or less
D 2 of 5	8 characters or less
I 2 of 5	8 characters or less
Codabar	8 characters or less

Redundancy Level 4

The following code types must be successfully read three times before being decoded:

Table 11-5 *Redundancy Level 4 Codes*

Code Type	Code Length
All	All

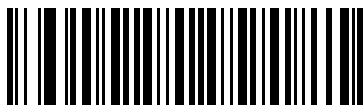

* Redundancy Level 1
(1)

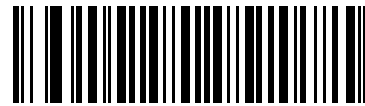

Redundancy Level 2
(2)

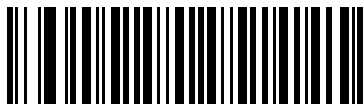

Redundancy Level 3
(3)

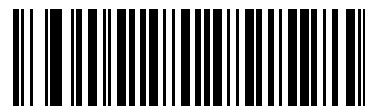

Redundancy Level 4
(4)

Security Level

Parameter # 77 (SSI # 4Dh)

The linear imager scanner offers four levels of decode Security for UPC/EAN, and Code 93. Select increasing levels of Security for decreasing levels of bar code quality. There is an inverse relationship between Security and linear imager scanner aggressiveness, so choose only that level of Security necessary for any given application.

- **Security Level 0:** This setting allows the linear imager scanner to operate in its most aggressive state, while providing sufficient Security in decoding most “in-spec” bar codes.
- **Security Level 1:** This default setting eliminates most misdecodes.
- **Security Level 2:** Select this option if Security level 1 fails to eliminate misdecodes.
- **Security Level 3:** If you selected Security Level 2 and misdecodes still occur, select this Security level. Be advised, selecting this option is an extreme measure against mis-decoding severely out of spec bar codes. Selecting this level of Security significantly impairs the decoding ability of the linear imager scanner. If you need this level of Security, try to improve the quality of the bar codes.

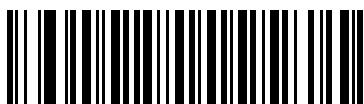

Security Level 0
(0)



*** Security Level 1**
(1)

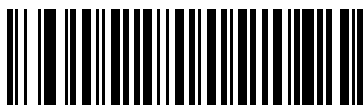

Security Level 2
(2)



Security Level 3
(3)

Intercharacter Gap Size

Parameter # 381 (SSI # F0h 7Dh)

The Code 39 and Codabar symbologies have an intercharacter gap that is typically quite small. Due to various bar code-printing technologies, this gap can grow larger than the maximum size allowed, preventing the linear imager scanner from decoding the symbol. If this problem occurs, scan the **Large Intercharacter Gaps** parameter to tolerate these out-of-specification bar codes.



* **Normal Intercharacter Gaps**
(6)



Large Intercharacter Gaps
(11)

CHAPTER 12 123SCAN2

Introduction

123Scan² is an easy-to-use, PC-based software tool that enables rapid and easy customized setup of Zebra scanners.

123Scan² uses a wizard tool to guide users through a streamlined set up process. Settings are saved in a configuration file that can be distributed via e-mail, electronically downloaded via a USB cable, or used to generate a sheet of scannable programming bar codes.

Additionally 123Scan² can upgrade scanner firmware, check online to enable support for newly released products, generate a collection of multi-setting bar codes if the number of settings is very large, stage large number of scanners simultaneously, generate reports with asset tracking information and create custom products.

Communication with 123Scan²

To communicate with the 123Scan² program which runs on a host computer running a Windows XP SP2 and Windows 7 operating system, use a USB cable to connect the scanner to the host computer (see [L13608 Corded Linear Imager USB Connection on page 6-3](#)).

123Scan² Requirements

- Host computer with Windows XP SP2 or Windows 7
- Scanner
- USB cable.

For more information about 123Scan², go to:

<http://www.zebra.com/123Scan>

Scanner SDK, Other Software Tools, and Videos

Tackle all your scanner programming needs with our diversified set of software tools. Whether you need to simply stage a device, or develop a fully featured application with image and data capture as well as asset management, these tools help you every step of the way. To download any of the free tools listed below, go to:

www.zebra.com/ScannerSoftware.

- 123Scan² Configuration Utility (described in this chapter)
- Scanner SDK for Windows
- How-to-Videos
- Virtual Com Port Driver
- OPOS Driver
- JPOS Driver
- Scanner User Documentation
- Archive of Older Drivers.

CHAPTER 13 ADVANCED DATA FORMATTING

Introduction

Advanced Data Formatting (ADF) is a means of customizing data before transmission to the host device. Use ADF to edit scan data to suit requirements. Implement ADF by scanning a related series of bar codes which program the imager with ADF rules.

For information and programming bar codes for ADF, refer to the *Advanced Data Formatting Programmer Guide*, p/n 72E-69680-xx.

APPENDIX A STANDARD DEFAULT PARAMETERS

✓ **NOTE** In this guide, the parameter numbers listed are the same as the attribute numbers for these parameters.

Table A-1 Standard Default Parameters Table

Parameter	Parameter Number	Default	Page Number
Radio Communications			
Radio Communications (Host Type)		Cradle Host	4-2
BT Friendly Name	607	n/a	4-9
Discoverable Mode	610	General	4-10
Wi-Fi Friendly Mode	1299	Disable	4-11
Wi-Fi Friendly Channel Exclusion		Use All Channels	4-12
Radio Output Power	1324	High	4-14
Link Supervision Timeout	1698	.5 Seconds	4-15
Bluetooth Radio State	1354	On	4-16
Apple iOS Virtual Keyboard Toggle	1114	Disable	4-17
HID Keyboard Keystroke Delay		No Delay (0 msec)	4-18
CAPS Lock Override		Disable	4-18
Ignore Unknown Characters		Enable	4-19
Emulate Keypad		Enable	4-19
Fast HID Keyboard	1361	Enable	4-20
Quick Keypad Emulation	1362	Enable	4-21

Table A-1 Standard Default Parameters Table (Continued)

Parameter	Parameter Number	Default	Page Number
Keyboard FN1 Substitution		Disable	4-21
Function Key Mapping		Disable	4-22
Simulated Caps Lock		Disable	4-22
Convert Case		No Case Conversion	4-23
Beep on Reconnect Attempt	559	Disable	4-25
Reconnect Attempt Interval	558	30 sec	4-26
Auto-reconnect	604	Auto-reconnect Immediately	4-27
Beep on Insertion	288	Enable	4-28
Beep on <BEL>	150	Enable	4-29
Modes of Operation (Point-to-Point/Multipoint-to-Point)	538	Point-to-Point	4-30
Parameter Broadcast (Cradle Host Only)	148	Enable	4-31
Pairing Modes	542	Unlocked	4-32
Pairing on Contacts	545	Enable	4-33
Toggle Pairing	1322	Disable	4-34
Connection Maintenance Interval		15 min	4-35
Batch Mode	544	Normal (Do Not Batch Data)	4-38
Persistent Batch Storage	1399	Disable	4-41
Page Button	746	Enable	4-42
Page Options Page Mode Page State Timeout	1364 1365	Page Simple	4-43
Classic and/or Low Energy Bluetooth	1355	Classic and Low Energy	4-45
PIN Code (Set and Store)	552	12345	4-46
Variable Pin Code	608	Static	4-47
Bluetooth Security Levels	1393	Low	4-48
User Preferences			
Set Default Parameter		Restore Defaults	5-5
Report Version		N/A	5-6
Parameter Bar Code Scanning	236	Enable	5-6
Beep After Good Decode	56	Enable	5-7

Table A-1 Standard Default Parameters Table (Continued)

Parameter	Parameter Number	Default	Page Number
Decode Illumination Indicator	859	Disable	5-8
Beeper Tone	145	Medium	5-9
Suppress Power Up Beeps	721	Do Not Suppress	5-10
Beeper Volume	140	High	5-10
Beeper Duration	628	Medium	5-11
Decode Pager Motor	613	Enable	5-12
Decode Pager Motor Duration	626	150 msec	5-12
Hand-Held Trigger Mode	138	Level	5-14
Hands-Free Mode	630	Enable	5-15
Low Power Mode	128	Enable	5-15
Time Delay to Low Power Mode			
Corded	146	1 Hour	5-17
Cordless	146	100 msec	5-18
Time Delay to Presentation Sleep Mode	662	5 Min	5-19
Timeout to Low Power Mode from Auto Aim	729	15 Seconds	5-22
Linear Imager Picklist Mode	1211	Auto-discriminate	5-23
FIPS Mode	736	Disable	5-24
Aiming Illumination	1187	Pulsing Pattern	5-25
Continuous Bar Code Read	649	Disable	5-26
Unique Bar Code Reporting	723	Enable	5-26
Decode Session Timeout	136	9.9 Sec	5-26
Timeout Between Decodes, Same Symbol	137	0.5 Sec	5-27
Timeout Between Decodes, Different Symbols	144	0.1 Sec	5-27
Decoding Illumination	298	Enable	5-28
Battery Threshold			5-29
Battery Status High Threshold	1367	50%	
Battery Status Medium Threshold	1368	20%	
Battery Status Low Warning Threshold	1369	10%	
Battery Health Low Warning Threshold	1370	60%	
Miscellaneous Options			
Transmit Code ID Character	45	None	5-31

Table A-1 Standard Default Parameters Table (Continued)

Parameter	Parameter Number	Default	Page Number
Prefix Value	99, 105	7013 <CR><LF>	5-32
Suffix 1 Value	98, 104	7013 <CR><LF>	5-32
Suffix 2 Value	100, 106		
Scan Data Transmission Format	235	Data as is	5-33
FN1 Substitution Values	103, 109	Set	5-34
Transmit "No Read" Message	94	Disable	5-35
Unsolicited Heartbeat Interval	1118	Disable	5-36
Dump Scanner Parameters			5-37
USB Host Parameters			
USB Device Type		HID Keyboard Emulation	6-7
Symbol Native API (SNAPI) Status Handshaking		Enable	6-9
USB Keystroke Delay		No Delay	6-10
USB CAPS Lock Override		Disable	6-10
USB Ignore Unknown Characters		Send	6-11
USB Convert Unknown to Code 39		Disable	6-11
Emulate Keypad		Enable	6-12
Emulate Keypad with Leading Zero		Enable	6-13
Quick Keypad Emulation		Enable	6-13
USB FN1 Substitution		Disable	6-13
Function Key Mapping		Disable	6-13
Simulated Caps Lock		Disable	6-14
Convert Case		No Case Conversion	6-15
USB Static CDC		Enable	6-15
Ignore Beep		Enable	6-16
Ignore Bar Code Configuration		Enable	6-16
USB Polling Interval		3 msec	6-18
USB Fast HID		Disable	6-19
IBM Specification Version		Version 2.2	6-19
USB Toshiba TEC Host Parameters			

Table A-1 Standard Default Parameters Table (Continued)

Parameter	Parameter Number	Default	Page Number
Code Type Table Usage		Use Table 0 Identifier	6-20
Include Symbol Types		Add Symbol Types	6-21
Include Character Counts		Add Character Counts	6-21
Include Header		Add Header Character	6-21
Include Terminator		Add Terminator Character (s)	6-22
Header Character		Add STX (0x02)	6-22
Terminator Character		Add ETX (0x03)	6-23
Light LED on Good Decode		Light LED on Good Decode	6-23
Good Decode Beeper Timer		Indicate Before Transmission	6-24
SSI Host Parameters			
Select SSI Host	N/A	N/A	7-11
Baud Rate	156	9600	7-12
Parity	158	None	7-14
Check Parity	151	Disable	7-15
Stop Bits	157	1	7-15
Software Handshaking	159	ACK/NAK	7-16
Host RTS Line State	154	Low	7-17
Decode Data Packet Format	238	Send Raw Decode Data	7-17
Host Serial Response Time-out	155	2 sec	7-18
Host Character Time-out	239	200 msec	7-19
Multipacket Option	334	Option 1	7-20
Interpacket Delay	335	0 ms	7-21
Decode Event	256	Disable	7-22
Boot Up Event	258	Disable	7-23
Parameter Event	259	Disable	7-23
RS-232 Host Parameters			
RS-232 Host Types		Standard	8-7
Baud Rate		9600	8-9
Parity Type		None	8-10

Table A-1 Standard Default Parameters Table (Continued)

Parameter	Parameter Number	Default	Page Number
Stop Bit Select		1 Stop Bit	8-11
Data Bits (ASCII Format)		8-Bit	8-12
Check Receive Errors		Enable	8-12
Hardware Handshaking		None	8-14
Software Handshaking		None	8-16
Host Serial Response Time-out		2 sec	8-17
RTS Line State		Low RTS	8-18
Beep on <BEL>		Disable	8-18
Intercharacter Delay		0 msec	8-19
Nixdorf Beep/LED Options		Normal Operation	8-20
Ignore Unknown Characters		Send Bar Code	8-20
IBM 468X/469X Host Parameters			
Port Address		None Selected	9-5
Convert Unknown to Code 39		Disable	9-6
Ignore Beep		Enable	9-6
Ignore Bar Code Configuration		Enable	9-7
Keyboard Wedge Host Parameters			
Keyboard Wedge Host Type		IBM AT Notebook	10-5
Ignore Unknown Characters		Send	10-6
Keystroke Delay		No Delay	10-6
Intra-Keystroke Delay		Disable	10-7
Alternate Numeric Keypad Emulation		Enable	10-8
Quick Keypad Emulation		Enable	10-8
Caps Lock On		Disable	10-9
Caps Lock Override		Disable	10-9
Convert Wedge Data		No Convert	10-10
Function Key Mapping		Disable	10-10
FN1 Substitution		Disable	10-10
Send and Make Break		Send	10-11

Table A-1 Standard Default Parameters Table (Continued)

Parameter	Parameter Number	Default	Page Number
UPC/EAN			
UPC-A	1	Enable	11-7
UPC-E	2	Enable	11-7
UPC-E1	12	Disable	11-8
EAN-8/JAN 8	4	Enable	11-8
EAN-13/JAN 13	3	Enable	11-9
Bookland EAN	83	Disable	11-9
Decode UPC/EAN/JAN Supplementals (2 and 5 digits)	16	Ignore	11-11
User-Programmable Supplementals		000 (zeroes)	11-13
Supplemental 1:	579		
Supplemental 2:	580		
UPC/EAN/JAN Supplemental Redundancy	80	10	11-13
UPC/EAN/JAN Supplemental AIM ID Format	672	Combined	11-13
Transmit UPC-A Check Digit	40	Enable	11-15
Transmit UPC-E Check Digit	41	Enable	11-15
Transmit UPC-E1 Check Digit	42	Enable	11-16
UPC-A Preamble	34	System Character	11-17
UPC-E Preamble	35	System Character	11-18
UPC-E1 Preamble	36	System Character	11-19
Convert UPC-E to A	37	Disable	11-20
Convert UPC-E1 to A	38	Disable	11-20
EAN-8/JAN-8 Extend	39	Disable	11-21
Bookland ISBN Format	576	ISBN-10	11-21
UCC Coupon Extended Code	85	Disable	11-22
Coupon Report	730	New Coupon Format	11-22
ISSN EAN	617	Disable	11-23
Code 128			
Code 128	8	Enable	11-24
Set Length(s) for Code 128	209, 210	Length Within Range	11-25
GS1-128 (formerly UCC/EAN-128)	14	Enable	11-26

Table A-1 Standard Default Parameters Table (Continued)

Parameter	Parameter Number	Default	Page Number
ISBT 128	84	Enable	11-26
ISBT Concatenation	577	Autodiscriminate	11-27
Check ISBT Table	578	Enable	11-28
ISBT Concatenation Redundancy	223	10	11-28
Code 128 Security Level	751	Security Level 1	11-29
Code 39			
Code 39	0	Enable	11-30
Trioptic Code 39	13	Disable	11-30
Convert Code 39 to Code 32 (Italian Pharmacy Code)	86	Disable	11-31
Code 32 Prefix	231	Disable	11-31
Set Length(s) for Code 39	18, 19	Length Within Range	11-32
Code 39 Check Digit Verification	48	Disable	11-33
Transmit Code 39 Check Digit	43	Disable	11-33
Code 39 Full ASCII Conversion	17	Disable	11-34
Buffer Code 39	113	Disable	11-35
Code 39 Security Level	750	Security Level 1	11-37
Code 93			
Code 93	9	Enable	11-38
Set Length(s) for Code 93	26, 27	Length Within Range	11-39
Code 11			
Code 11	10	Disable	11-40
Set Lengths for Code 11	28, 29	Length Within Range	11-41
Code 11 Check Digit Verification	52	Disable	11-42
Transmit Code 11 Check Digit(s)	47	Disable	11-43
Interleaved 2 of 5 (ITF)			
Interleaved 2 of 5 (ITF)	6	Enable	11-44
Set Lengths for I 2 of 5	22, 23	Length Within Range	11-44
I 2 of 5 Check Digit Verification	49	Disable	11-46
Transmit I 2 of 5 Check Digit	44	Disable	11-46

Table A-1 Standard Default Parameters Table (Continued)

Parameter	Parameter Number	Default	Page Number
Convert I 2 of 5 to EAN 13	82	Disable	11-47
I 2 of 5 Security Level	1121	Security Level 1	11-48
Discrete 2 of 5 (DTF)			
Discrete 2 of 5	5	Disable	11-49
Set Length(s) for D 2 of 5	20, 21	Length Within Range	11-49
Codabar (NW - 7)			
Codabar	7	Enable	11-51
Set Lengths for Codabar	24, 25	Length Within Range	11-52
CLSI Editing	54	Disable	11-53
NOTIS Editing	55	Disable	11-53
Codabar Upper or Lower Case Start/Stop Characters Detection	855	Upper Case	11-54
MSI			
MSI	11	Disable	11-55
Set Length(s) for MSI	30, 31	Length Within Range	11-56
MSI Check Digits	50	One	11-57
Transmit MSI Check Digit	46	Disable	11-57
MSI Check Digit Algorithm	51	Mod 10/Mod 10	11-58
Chinese 2 of 5			
Chinese 2 of 5	408	Disable	11-59
Matrix 2 of 5			
Matrix 2 of 5	618	Disable	11-60
Matrix 2 of 5 Lengths	619, 620	Length Within Range	11-61
Matrix 2 of 5 Check Digit	622	Disable	11-62
Transmit Matrix 2 of 5 Check Digit	623	Disable	11-62
Korean 3 of 5			
Korean 3 of 5	581	Disable	11-63
Inverse 1D			
Inverse 1D	586	Regular	11-64

Table A-1 Standard Default Parameters Table (Continued)

Parameter	Parameter Number	Default	Page Number
GS1 DataBar			
GS1 DataBar-14	338	Enable	11-65
GS1 DataBar Limited	339	Enable	11-65
GS1 DataBar Expanded	340	Enable	11-66
GS1 DataBar Limited Security Level	728	Level 3	11-67
Convert GS1 DataBar to UPC/EAN	397	Disable	11-68
Symbology-Specific Security Levels			
Redundancy Level	78	1	11-70
Security Level	77	1	11-71
Intercharacter Gap Size	381	Normal	11-72

APPENDIX B COUNTRY CODES

Introduction

This chapter provides instructions for programming the keyboard to interface with a USB, or Keyboard Wedge host. The host can power the scanner. For host setup information, see [Chapter 6, USB INTERFACE](#) and [Chapter 10, KEYBOARD WEDGE INTERFACE](#).

Throughout the programming bar code menus, default values are indicated with asterisks (*).



*Indicates Default — * **US English (North American) Keyboard** — Feature/Option

USB and Keyboard Wedge Country Keyboard Types (Country Codes)

Scan the bar code corresponding to the keyboard type. For a USB host, this setting applies only to the USB Keyboard (HID) device. If the keyboard type is not listed, see [Alternate Numeric Keypad Emulation on page 10-8](#) for the USB HID host. For a Keyboard Wedge host, see [Alternate Numeric Keypad Emulation on page 10-8](#).



NOTE When changing USB country keyboard types the linear imager automatically resets. The linear imager issues the standard startup beep sequences.



IMPORTANT 1. Some country keyboard bar code types are specific to certain Windows Operating Systems (i.e., XP, and Win 7, or higher). Bar codes requiring a specific Windows OS are noted so in their bar code captions.

2. Use the **French International** bar code for Belgian French keyboards.

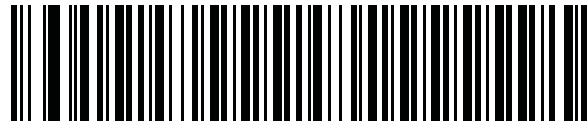

* US English (North American)

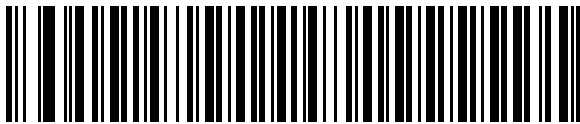

Albanian



Arabic (101)



Arabic (102)

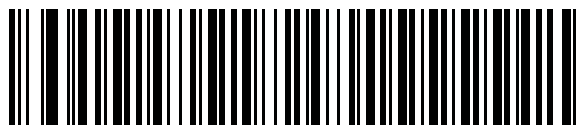

Arabic (102) AZERTY



Azeri (Latin)



Azeri (Cyrillic)

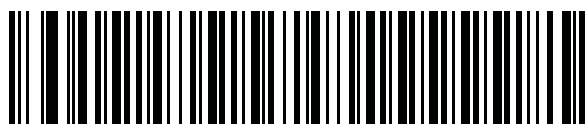

Belarusian



Bosnian (Latin)

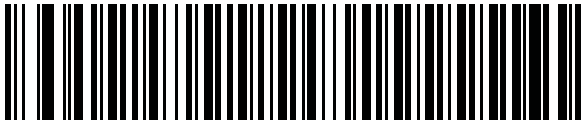

Bosnian (Cyrillic)

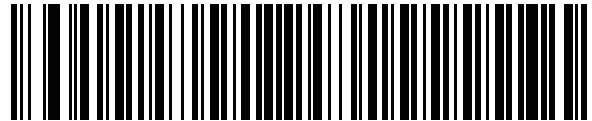

Bulgarian (Latin)

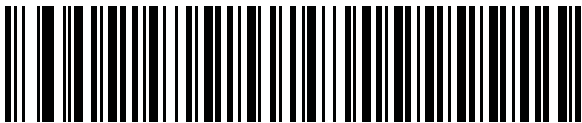

**Bulgarian Cyrillic (Typewriter)
(Bulgarian -Windows XP
Typewriter - Win 7, or higher)**



Canadian French Win7

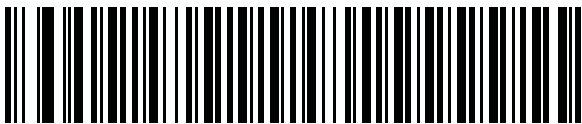

Canadian French (Legacy)

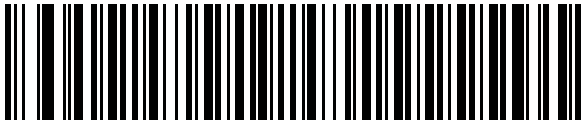

Canadian Multilingual Standard

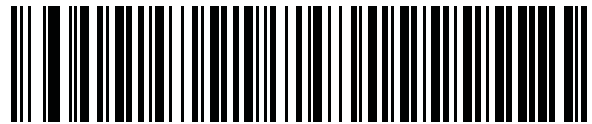

Chinese (ASCII)

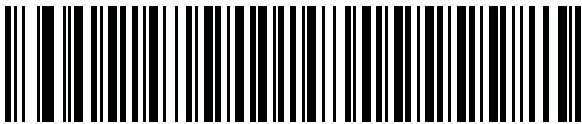

Croatian

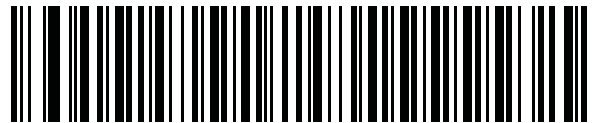

Czech

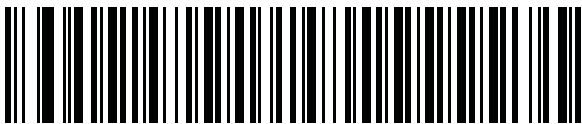

Czech (Programmer)



Czech (QWERTY)

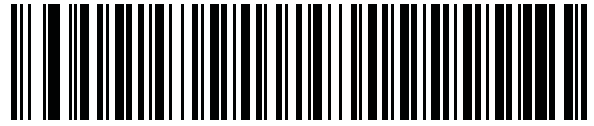

Danish

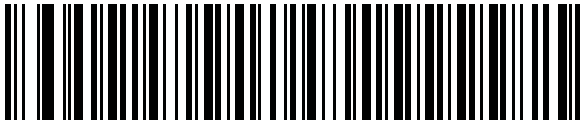

Dutch (Netherlands)

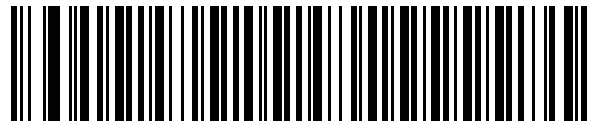

Estonian

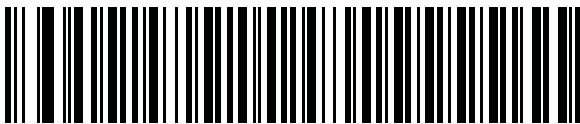

Faeroese



Finnish

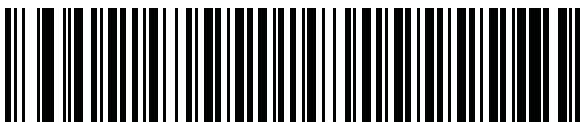

French (France)



**French International
(Belgian French)**

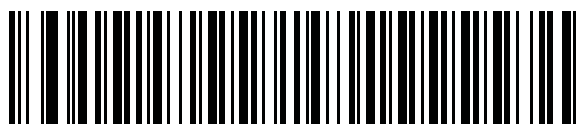

French (Canada) 95/98



French (Canada) 2000/XP

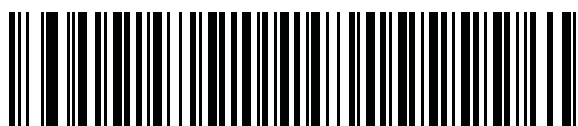

Galician



German

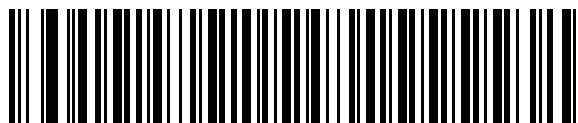

Greek Latin

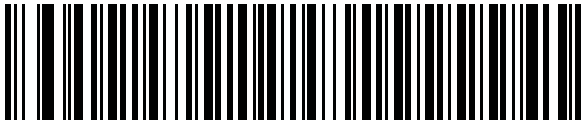

Greek (220) Latin

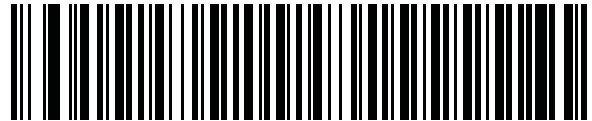

Greek (319) Latin

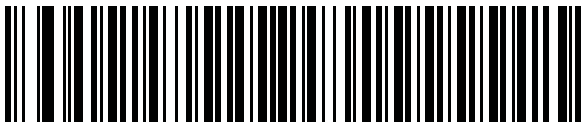

Greek

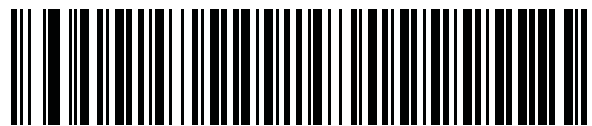

Greek (220)

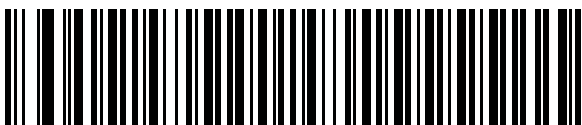

Greek (319)



Greek Polytonic



Hebrew Israel

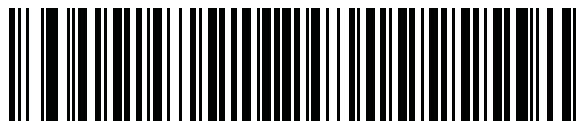

Hungarian



Hungarian_101KEY

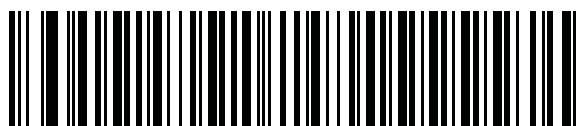

Icelandic



Irish

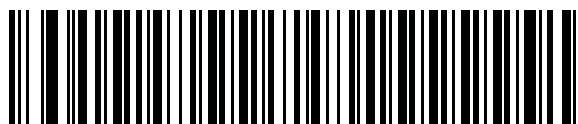

Italian

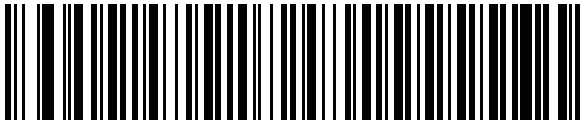

Italian (142)

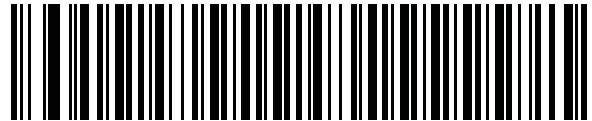

Japanese (ASCII)



Kazakh

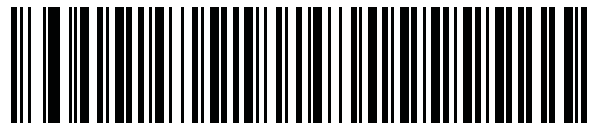

Korean (ASCII)



Kyrgyz



Latin American

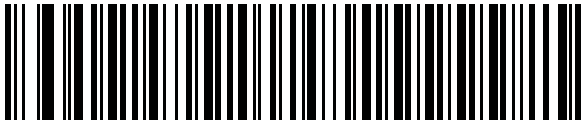

Latvian

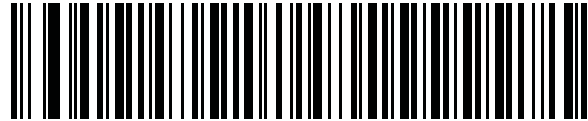

Latvian (QWERTY)

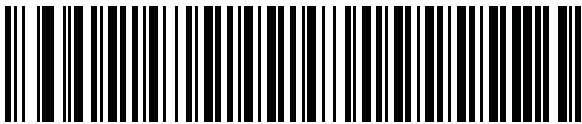

Lithuanian

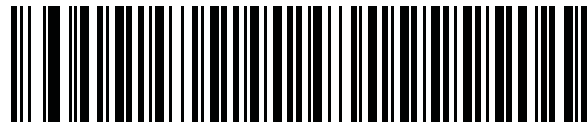

Lithuanian (IBM)



Macedonian (FYROM)



Maltese_47KEY



Mongolian

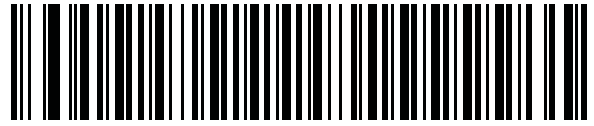

Norwegian

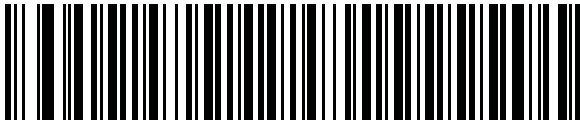

Polish (214)



Polish (Programmer)

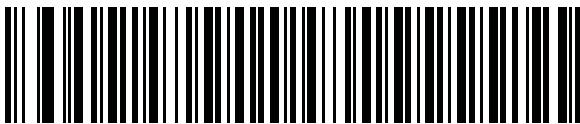

Portuguese (Brazil)



Portuguese (Brazilian ABNT)



Portuguese (Brazilian ABNT2)

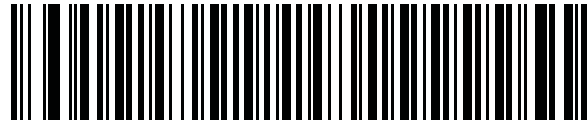

Portuguese (Portugal)



Romanian

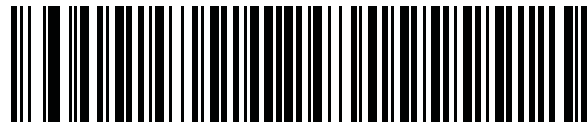

**Romanian (Legacy)
(Win 7, or higher)**

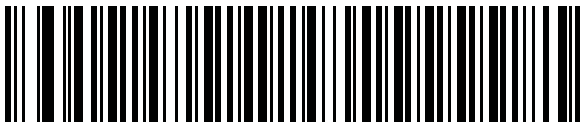

**Romanian (Standard)
(Win 7, or higher)**

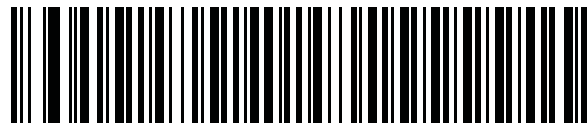

**Romanian (Programmer)
(Win 7, or higher)**

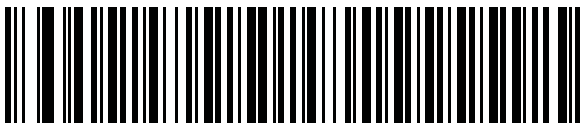

Russian

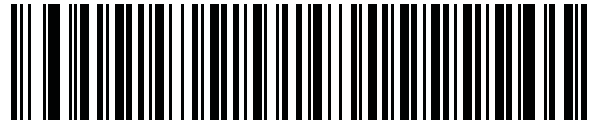

Russian (Typewriter)

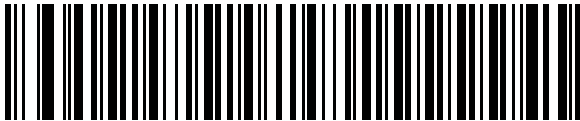

Serbian (Latin)

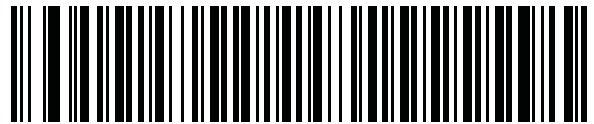

Serbian (Cyrillic)

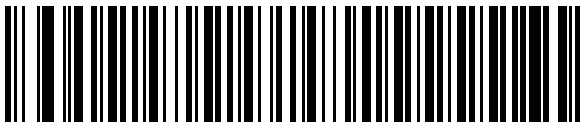

Slovak



Slovak (QWERTY)



Slovenian



Spanish



Spanish (Variation)



Swedish

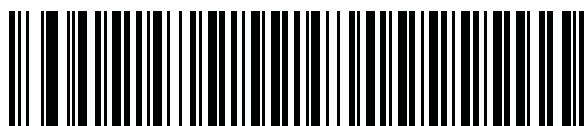

Swiss French



Swiss German



Tatar

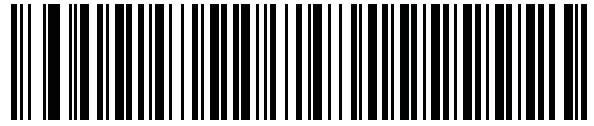

Thai (Kedmanee)

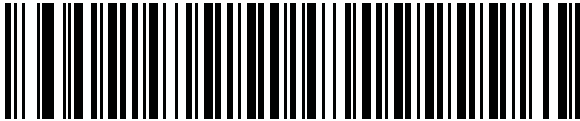

Turkish F

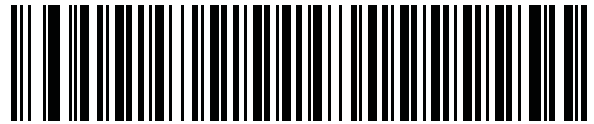

Turkish Q



UK English



Ukrainian



US Dvorak

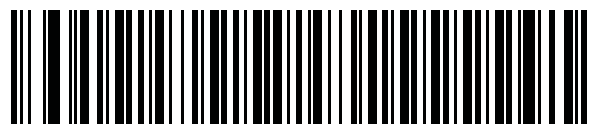

US Dvorak Left

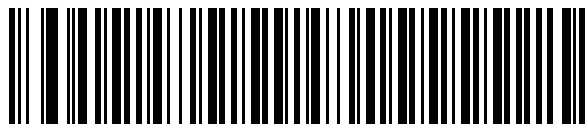

US Dvorak Right

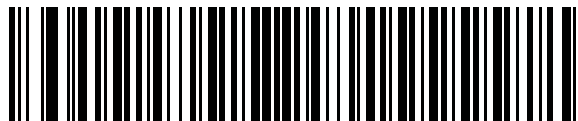

US International



Uzbek

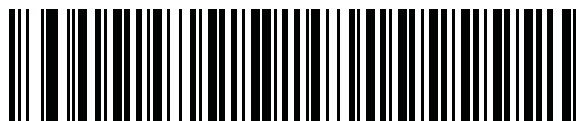

Vietnamese

APPENDIX C PROGRAMMING REFERENCE

Symbol Code Identifiers

Table C-1 *Symbol Code Characters*

Code Character	Code Type
A	UPC-A, UPC-E, UPC-E1, EAN-8, EAN-13
B	Code 39, Code 32
C	Codabar
D	Code 128, ISBT 128, ISBT 128 Concatenated
E	Code 93
F	Interleaved 2 of 5
G	Discrete 2 of 5, or Discrete 2 of 5 IATA
H	Code 11
J	MSI
K	GS1-128
L	Bookland EAN
M	Trioptic Code 39
N	Coupon Code
R	GS1 DataBar Family
S	Matrix 2 of 5

Table C-1 *Symbol Code Characters (Continued)*

Code Character	Code Type
U	Chinese 2 of 5
V	Korean 3 of 5
X	ISSN EAN

AIM Code Identifiers

Each AIM Code Identifier contains the three-character string **Jcm** where:

- J = Flag Character (ASCII 93)
- c = Code Character (see [Table C-2](#))
- m = Modifier Character (see [Table C-3](#))

Table C-2 *Aim Code Characters*

Code Character	Code Type
A	Code 39, Code 39 Full ASCII, Code 32
C	Code 128, ISBT 128, ISBT 128 Concatenated, GS1-128, Coupon (Code 128 portion)
E	UPC/EAN, Coupon (UPC portion)
e	GS1 DataBar Family
F	Codabar
G	Code 93
H	Code 11
I	Interleaved 2 of 5
M	MSI
S	Discrete 2 of 5, IATA 2 of 5
X	Bookland EAN, ISSN EAN, Trioptic Code 39, Chinese 2 of 5, Matrix 2 of 5, Korean 3 of 5

The modifier character is the sum of the applicable option values based on [Table C-3](#)

Table C-3 *Modifier Characters*

Code Type	Option Value	Option
Code 39	0	No check character or Full ASCII processing.
	1	Reader has checked one check character.
	3	Reader has checked and stripped check character.
	4	Reader has performed Full ASCII character conversion.
	5	Reader has performed Full ASCII character conversion and checked one check character.
	7	Reader has performed Full ASCII character conversion and checked and stripped check character.
	Example: A Full ASCII bar code with check character W, A+I+MI+DW , is transmitted as J A7AIMID where 7 = (3+4).	
Trioptic Code 39	0	No option specified at this time. Always transmit 0.
	Example: A Trioptic bar code 412356 is transmitted as J X0412356	
Code 128	0	Standard data packet, no Function code 1 in first symbol position.
	1	Function code 1 in first symbol character position.
	2	Function code 1 in second symbol character position.
	Example: A Code (EAN) 128 bar code with Function 1 character ^{FNC1} in the first position, AIMID is transmitted as J C1AIMID	
I 2 of 5	0	No check digit processing.
	1	Reader has validated check digit.
	3	Reader has validated and stripped check digit.
	Example: An I 2 of 5 bar code without check digit, 4123, is transmitted as J I04123	
Codabar	0	No check digit processing.
	1	Reader has checked check digit.
	3	Reader has stripped check digit before transmission.
	Example: A Codabar bar code without check digit, 4123, is transmitted as J F04123	
Code 93	0	No options specified at this time. Always transmit 0.
	Example: A Code 93 bar code 012345678905 is transmitted as J G0012345678905	
MSI	0	Check digits are sent.
	1	No check digit is sent.
	Example: An MSI bar code 4123, with a single check digit checked, is transmitted as J M14123	

Table C-3 *Modifier Characters (Continued)*

Code Type	Option Value	Option
D 2 of 5	0	No options specified at this time. Always transmit 0.
	Example: A D 2 of 5 bar code 4123, is transmitted as JS04123	
UPC/EAN	0	Standard data packet in full EAN format, i.e. 13 digits for UPC-A, UPC-E, and EAN-13 (not including supplemental data).
	1	Two digit supplemental data only.
	2	Five digit supplemental data only.
	3	Combined data packet comprising 13 digits from EAN-13, UPC-A or UPC-E symbol and 2 or 5 digits from supplemental symbol.
	4	EAN-8 data packet.
Example: A UPC-A bar code 012345678905 is transmitted as JE00012345678905		
Bookland EAN	0	No options specified at this time. Always transmit 0.
	Example: A Bookland EAN bar code 123456789X is transmitted as JX0123456789X	
ISSN EAN	0	No options specified at this time. Always transmit 0.
	Example: An ISSN EAN bar code 123456789X is transmitted as JX0123456789X	
Code 11	0	Single check digit
	1	Two check digits
	3	Check characters validated but not transmitted.
GS1 DataBar Family		No option specified at this time. Always transmit 0. GS1 DataBar-14 and GS1 DataBar Limited transmit with an Application Identifier "01". Note: In GS1-128 emulation mode, GS1 DataBar is transmitted using Code 128 rules (i.e.,]C1).
	Example: A GS1 DataBar-14 bar code 0110012345678902 is transmitted as Je00110012345678902 .	

APPENDIX D SAMPLE BAR CODES

Code 39



UPC/EAN

UPC-A, 100%



EAN-13, 100%



Code 128



Interleaved 2 of 5



GS1 DataBar

✓ **NOTE** GS1 DataBar variants must be enabled to read the bar codes below (see [GS1 DataBar on page 11-65](#)).



10293847560192837465019283746029478450366523
(GS1 DataBar Expanded Stacked)



1234890hjio9900mnb
(GS1 DataBar Expanded)



08672345650916
(GS1 DataBar Limited)

GS1 DataBar-14



55432198673467
(GS1 DataBar-14 Truncated)



90876523412674
(GS1 DataBar-14 Stacked)

APPENDIX E NUMERIC BAR CODES

Numeric Bar Codes

For parameters requiring specific numeric values, scan the appropriately numbered bar code(s).

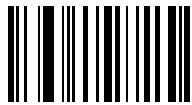

0



1



2



3



4



5



6

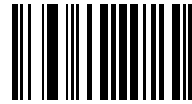

7



8



9

Cancel

To correct an error or change a selection, scan the bar code below.



Cancel

APPENDIX F ALPHANUMERIC BAR CODES

Alphanumeric Keyboard

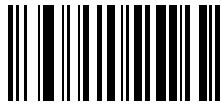

Space

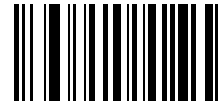

#

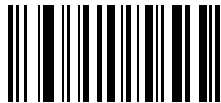

\$



%

Alphanumeric Keyboard (continued)



*



+



-

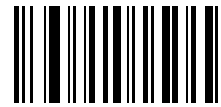

.

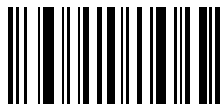

/

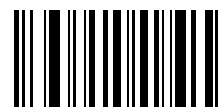

!

Alphanumeric Keyboard (continued)



“

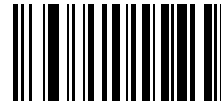

&



’

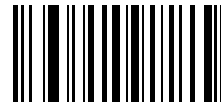

(



)



:

Alphanumeric Keyboard (continued)



;

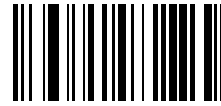

<



=

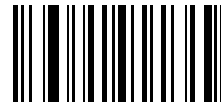

>



?



@

Alphanumeric Keyboard (continued)



[

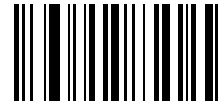

\

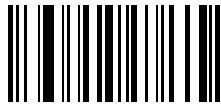

]

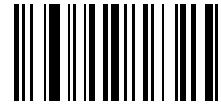

^



-

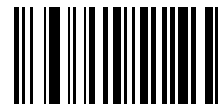

~

Alphanumeric Keyboard (continued)

✓ **NOTE** The bar codes that follow should not be confused with those on the numeric keypad.

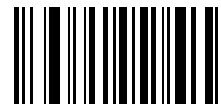

0



1

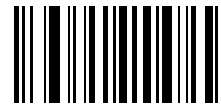

2

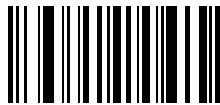

3



4



5

Alphanumeric Keyboard (continued)



6

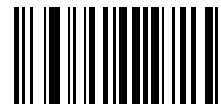

7



8

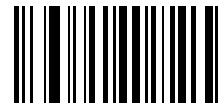

9



End of Message



Cancel

Alphanumeric Keyboard (continued)



A

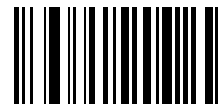

B

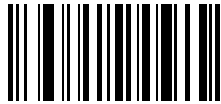

C



D



E



F

Alphanumeric Keyboard (continued)



G



H



I

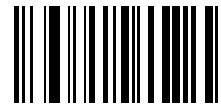

J



K



L

Alphanumeric Keyboard (continued)



M



N



O

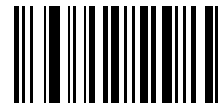

P

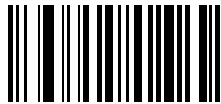

Q



R

Alphanumeric Keyboard (continued)



S

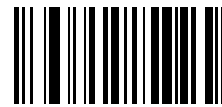

T



U

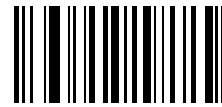

V



W



X

Alphanumeric Keyboard (continued)



Y



Z

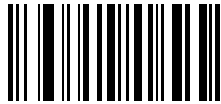

a

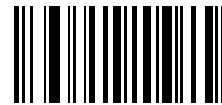

b



c



d

Alphanumeric Keyboard (continued)



e



f

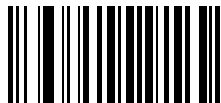

g

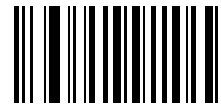

h



i



j

Alphanumeric Keyboard (continued)



k

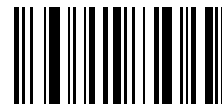

l



m

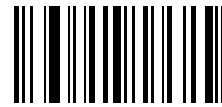

n



o

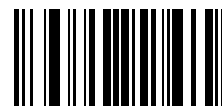

p

Alphanumeric Keyboard (continued)

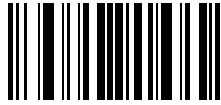

q

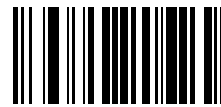

r

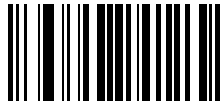

s

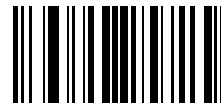

t

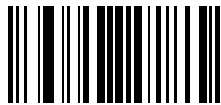

u

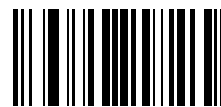

v

Alphanumeric Keyboard (continued)



w

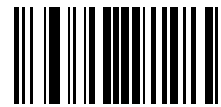

x

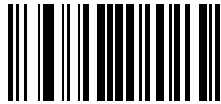

y

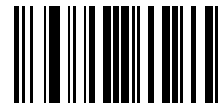

z



{

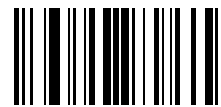

|

Alphanumeric Keyboard (continued)

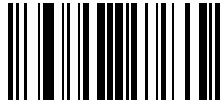

}

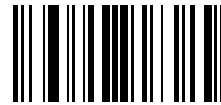

~

APPENDIX G NON-PARAMETER ATTRIBUTES

Introduction

This appendix defines non-parameter attributes.

Attributes

Model Number

Attribute #533

Model number of the scanner. This electronic output matches the printout on the physical device label, for example **LI2208-SR00006ZZWW**.

Type	S
Size (Bytes)	18
User Mode Access	R
Values	Variable

Serial Number

Attribute #534

Unique serial number assigned in the manufacturing facility. This electronic output matches the printout on the physical device label, for example **M1J26F45V**.

Type	S
Size (Bytes)	16
User Mode Access	R
Values	Variable

Date of Manufacture

Attribute #535

Date of device manufacture assigned in the manufacturing facility. This electronic output matches the printout on the physical device label, for example **30APR14** (which reads the 30th of April 2014).

Type	S
Size (Bytes)	7
User Mode Access	R
Values	Variable

Date of First Programming

Attribute #614

Date of first electronic programming represents the first time settings were electronically loaded to the scanner either by 123Scan or via SMS, for example **18MAY14** (which reads the 18th of May 2014).

Type	S
Size (Bytes)	7
User Mode Access	R
Values	Variable

Configuration Filename

Attribute #616

The name assigned to the configuration settings loaded electronically to the device either by 123Scan or via SMS.



NOTE Scanning the **Set Defaults** bar code automatically changes the configuration filename to *factory defaults*.

To indicate the configuration settings loaded to the device were changed, the configuration filename changes to *Modified* upon scanning any parameter bar code.

Type	S
Size (Bytes)	17
User Mode Access	RW
Values	Variable

Beeper/LED**Attribute #6000**

Activates the beeper and/or LED.

Type X
Size (Bytes) N/A
User Mode Access W

Values:

Beep / LED Action	Value
1 high short beep	0
2 high short beeps	1
3 high short beeps	2
4 high short beeps	3
5 high short beeps	4
1 low short beep	5
2 low short beeps	6
3 low short beeps	7
4 low short beeps	8
5 low short beeps	9
1 high long beep	10
2 high long beeps	11
3 high long beeps	12
4 high long beeps	13
5 high long beeps	14
1 low long beep	15
2 low long beeps	16
3 low long beeps	17
4 low long beeps	18
5 low long beeps	19
Fast warble beep	20
Slow warble beep	21
High-low beep	22
Low-high beep	23
High-low-high beep	24
Low-high-low beep	25
High-high-low-low beep	26
Green LED off	42
Green LED on	43
Red LED on	47
Red LED off	48

Parameter Defaults

Attribute #6001

This attribute restores all parameters to their factory defaults.

Type	X
Size (Bytes)	N/A
User Mode Access	W
Values	0 = Restore Defaults 1 = Restore Factory Defaults 2 = Write Custom Defaults

Beep on Next Bootup

Attribute #6003

This attribute configures (enables or disables) beep on next boot up of scanner.

Type	X
Size (Bytes)	N/A
User Mode Access	W
Values	0 = Disable beep on next bootup 1 = Enable beep on next bootup

Reboot

Attribute #6004

This attribute initiates a device reboot.

Type	X
Size (Bytes)	N/A
User Mode Access	W
Values	N/A

Host Trigger Session

Attribute #6005

This attribute triggers a decode session similar to manually depressing the scanner trigger button.

Type	X
Size (Bytes)	N/A
User Mode Access	W
Values	1 = Start Host Trigger Session 0 = Stop Host Trigger Session

Firmware Version

Attribute #20004

The scanner's operating system version. For example, **NBRFMAAC** or **PAAAABS00-007-R03D0**.

Type	S
Size (Bytes)	Variable
User Mode Access	R
Values	Variable

Scankit Version

Attribute #20008

Identifies the 1D decode algorithms resident on the device, for example **SKIT4.33T02**.

Type	S
Size (Bytes)	Variable
User Mode Access	R
Values	Variable

APPENDIX H ASCII CHARACTER SETS

Table H-1 *ASCII Character Set*

ASCII Value	Full ASCII Code 39 Encode Char	Keystroke
1000	%U	CTRL 2
1001	\$A	CTRL A
1002	\$B	CTRL B
1003	\$C	CTRL C
1004	\$D	CTRL D
1005	\$E	CTRL E
1006	\$F	CTRL F
1007	\$G	CTRL G
1008	\$H	CTRL H/ BACKSPACE ¹
1009	\$I	CTRL I/ HORIZONTAL TAB ¹
1010	\$J	CTRL J
1011	\$K	CTRL K
1012	\$L	CTRL L
1013	\$M	CTRL M/ ENTER ¹
1014	\$N	CTRL N
1015	\$O	CTRL O

The keystroke in bold transmits only if you enabled Function Key Mapping. Otherwise, the unbold keystroke transmits.

Table H-1 *ASCII Character Set (Continued)*

ASCII Value	Full ASCII Code 39 Encode Char	Keystroke
1016	\$P	CTRL P
1017	\$Q	CTRL Q
1018	\$R	CTRL R
1019	\$S	CTRL S
1020	\$T	CTRL T
1021	\$U	CTRL U
1022	\$V	CTRL V
1023	\$W	CTRL W
1024	\$X	CTRL X
1025	\$Y	CTRL Y
1026	\$Z	CTRL Z
1027	%A	CTRL [
1028	%B	CTRL \
1029	%C	CTRL]
1030	%D	CTRL 6
1031	%E	CTRL -
1032	Space	Space
1033	/A	!
1034	/B	"
1035	/C	#
1036	/D	\$
1037	/E	%
1038	/F	&
1039	/G	'
1040	/H	(
1041	/I)
1042	/J	*
1043	/K	+

The keystroke in bold transmits only if you enabled Function Key Mapping. Otherwise, the unbold keystroke transmits.

Table H-1 ASCII Character Set (Continued)

ASCII Value	Full ASCII Code 39 Encode Char	Keystroke
1044	/L	,
1045	-	-
1046	.	.
1047	/o	/
1048	0	0
1049	1	1
1050	2	2
1051	3	3
1052	4	4
1053	5	5
1054	6	6
1055	7	7
1056	8	8
1057	9	9
1058	/Z	:
1059	%F	;
1060	%G	<
1061	%H	=
1062	%I	>
1063	%J	?
1064	%V	@
1065	A	A
1066	B	B
1067	C	C
1068	D	D
1069	E	E
1070	F	F
1071	G	G

The keystroke in bold transmits only if you enabled Function Key Mapping. Otherwise, the unbold keystroke transmits.

Table H-1 ASCII Character Set (Continued)

ASCII Value	Full ASCII Code 39 Encode Char	Keystroke
1072	H	H
1073	I	I
1074	J	J
1075	K	K
1076	L	L
1077	M	M
1078	N	N
1079	O	O
1080	P	P
1081	Q	Q
1082	R	R
1083	S	S
1084	T	T
1085	U	U
1086	V	V
1087	W	W
1088	X	X
1089	Y	Y
1090	Z	Z
1091	%K	[
1092	%L	\
1093	%M]
1094	%N	^
1095	%O	_
1096	%W	'
1097	+A	a
1098	+B	b
1099	+C	c

The keystroke in bold transmits only if you enabled Function Key Mapping. Otherwise, the unbold keystroke transmits.

Table H-1 *ASCII Character Set (Continued)*

ASCII Value	Full ASCII Code 39 Encode Char	Keystroke
1100	+D	d
1101	+E	e
1102	+F	f
1103	+G	g
1104	+H	h
1105	+I	i
1106	+J	j
1107	+K	k
1108	+L	l
1109	+M	m
1110	+N	n
1111	+O	o
1112	+P	p
1113	+Q	q
1114	+R	r
1115	+S	s
1116	+T	t
1117	+U	u
1118	+V	v
1119	+W	w
1120	+X	x
1121	+Y	y
1122	+Z	z
1123	%P	{
1124	%Q	
1125	%R	}
1126	%S	~
1127		Undefined

The keystroke in bold transmits only if you enabled Function Key Mapping. Otherwise, the unbold keystroke transmits.

Table H-2 *ALT Key Standard Default Tables*

ALT Keys	Keystroke
2050	ALT 2
2054	ALT 6
2064	ALT @
2065	ALT A
2066	ALT B
2067	ALT C
2068	ALT D
2069	ALT E
2070	ALT F
2071	ALT G
2072	ALT H
2073	ALT I
2074	ALT J
2075	ALT K
2076	ALT L
2077	ALT M
2078	ALT N
2079	ALT O
2080	ALT P
2081	ALT Q
2082	ALT R
2083	ALT S
2084	ALT T
2085	ALT U
2086	ALT V
2087	ALT W
2088	ALT X
2089	ALT Y
2090	ALT Z

Table H-2 ALT Key Standard Default Tables (Continued)

ALT Keys	Keystroke
2091	ALT [
2092	ALT \
2093	ALT]

Table H-3 USB GUI Key Character Set

GUI Key	Keystroke
3000	Right Control Key
3001	PA 1
3002	PA 2
3003	CMD 1
3004	CMD 2
3005	CMD 3
3006	CMD 4
3007	CMD 5
3008	CMD 6
3009	CMD 7
3010	CMD 8
3011	CMD 9
3012	CMD 10
3013	CMD 11
3014	CMD 12
3015	CMD 13
3016	CMD 14
3048	GUI 0
3049	GUI 1
3050	GUI 2
3051	GUI 3

Note: GUI Shift Keys - The Apple™ iMac keyboard has an apple key on either side of the space bar. Windows-based systems have a GUI key to the left of the left ALT key, and to the right of the right ALT key.

Table H-3 *USB GUI Key Character Set (Continued)*

GUI Key	Keystroke
3052	GUI 4
3053	GUI 5
3054	GUI 6
3055	GUI 7
3056	GUI 8
3057	GUI 9
3065	GUI A
3066	GUI B
3067	GUI C
3068	GUI D
3069	GUI E
3070	GUI F
3071	GUI G
3072	GUI H
3073	GUI I
3074	GUI J
3075	GUI K
3076	GUI L
3077	GUI M
3078	GUI N
3079	GUI O
3080	GUI P
3081	GUI Q
3082	GUI R
3083	GUI S
3084	GUI T
3085	GUI U

Note: GUI Shift Keys - The Apple™ iMac keyboard has an apple key on either side of the space bar. Windows-based systems have a GUI key to the left of the left ALT key, and to the right of the right ALT key.

Table H-3 *USB GUI Key Character Set (Continued)*

GUI Key	Keystroke
3086	GUI V
3087	GUI W
3088	GUI X
3089	GUI Y
3090	GUI Z

Note: GUI Shift Keys - The Apple™ iMac keyboard has an apple key on either side of the space bar. Windows-based systems have a GUI key to the left of the left ALT key, and to the right of the right ALT key.

Table H-4 *PF Key Standard Default Table*

PF Keys	Keystroke
4001	PF 1
4002	PF 2
4003	PF 3
4004	PF 4
4005	PF 5
4006	PF 6
4007	PF 7
4008	PF 8
4009	PF 9
4010	PF 10
4011	PF 11
4012	PF 12
4013	PF 13
4014	PF 14
4015	PF 15
4016	PF 16

Table H-5 *F key Standard Default Table*

F Keys	Keystroke
5001	F 1
5002	F 2
5003	F 3
5004	F 4
5005	F 5
5006	F 6
5007	F 7
5008	F 8
5009	F 9
5010	F 10
5011	F 11
5012	F 12
5013	F 13
5014	F 14
5015	F 15
5016	F 16
5017	F 17
5018	F 18
5019	F 19
5020	F 20
5021	F 21
5022	F 22
5023	F 23
5024	F 24

Table H-6 *Numeric Key Standard Default Table*

Numeric Keypad	Keystroke
6042	*
6043	+
6044	Undefined
6045	-
6046	.
6047	/
6048	0
6049	1
6050	2
6051	3
6052	4
6053	5
6054	6
6055	7
6056	8
6057	9
6058	Enter
6059	Num Lock

Table H-7 *Extended Keypad Standard Default Table*

Extended Keypad	Keystroke
7001	Break
7002	Delete
7003	Pg Up
7004	End
7005	Pg Dn
7006	Pause
7007	Scroll Lock
7008	Backspace
7009	Tab
7010	Print Screen
7011	Insert
7012	Home
7013	Enter
7014	Escape
7015	Up Arrow
7016	Dn Arrow
7017	Left Arrow
7018	Right Arrow

APPENDIX I COMMUNICATION PROTOCOL CAPABILITIES

Introduction

[Table I-1](#) lists the functionality of each cabled communication interface for the LI3608.

Table I-1 *Communication Interface Functionality*

Communication Interfaces	Functionality		
	Data Transmission	Remote Management	Image and Video Transmission
USB			
HID Keyboard Emulation	Supported	n/a	n/a
Simple COM Port Emulation	Supported	n/a	n/a
CDC COM Port Emulation	Supported	n/a	n/a
HID POS	Supported	n/a	n/a
SSI over CDC COM Port Emulation	Supported	Supported	Supported
IBM Table Top USB	Supported	Supported	n/a
IBM Hand-held USB	Supported	Supported	n/a
USB OPOS Hand-held	Supported	Supported	n/a
Symbol Native API (SNAPI) without Imaging Interface	Supported	Supported	n/a
Symbol Native API (SNAPI) with Imaging Interface	Supported	Supported	Supported
Toshiba TEC	Supported	n/a	n/a
RS-232			
Standard RS-232	Supported	n/a	n/a

Table I-1 *Communication Interface Functionality (Continued)*

Communication Interfaces	Functionality		
	Data Transmission	Remote Management	Image and Video Transmission
ICL RS-232	Supported	n/a	n/a
Fujitsu RS-232	Supported	n/a	n/a
Wincor-Nixdorf RS-232 Mode A	Supported	n/a	n/a
Wincor-Nixdorf RS-232 Mode B	Supported	n/a	n/a
Olivetti ORS4500	Supported	n/a	n/a
Omron	Supported	n/a	n/a
CUTE	Supported	n/a	n/a
OPOS/JPOS	Supported	n/a	n/a
SSI	Supported	Supported	Supported
IBM 4690			
Hand-held Scanner Emulation (Port 9B)	Supported	n/a	n/a
Table Top Scanner Emulation (Port 17)	Supported	Supported	n/a
Non-IBM Scanner Emulation (Port 5B)	Supported	Supported	n/a
Keyboard Wedge			
IBM PC/AT & IBM PC Compatibles	Supported	n/a	n/a
IBM AT Notebook	Supported	n/a	n/a

INDEX

Numerics

123Scan2 12-1

A

ADF

invalid rule 3-4
transmit error 3-4

advanced data formatting 3-4

aiming illumination bar codes 5-25

ASCII values

RS-232 8-21

attributes

non-parameter G-1, I-1

attributes, non-parameter

beep on next bootup G-4
configuration filename G-2
date of first programming G-2
date of manufacture G-2
firmware version G-5
host trigger session G-4
model number G-1
parameter defaults G-4
reboot G-4
scankit version G-5
serial number G-1

auto-reconnect 4-24, 4-31, 4-35

B

bar code defaults

all A-1
IBM 9-4
keyboard wedge 10-4
misc options 5-3
radio communication 4-2

RS-232 8-4

USB 6-4

user preferences 5-2

user prefs 5-2

bar codes

aiming/illumination 5-25

auto-reconnect in Bluetooth keyboard

emulation (HID slave) mode 4-27

auto-reconnect interval 4-24

batch mode 4-38, 4-39

beep after good decode 5-7

beep on insertion 4-28

beeper tone 5-9

beeper volume 5-10, 5-11

Bluetooth friendly name 4-9

Bluetooth technology support 4-17

bookland EAN 11-9

bookland ISBN 11-21

buffering 11-34, 11-35

cancel E-3

Chinese 2 of 5 11-59

codabar 11-51

codabar CLSI editing 11-53

codabar lengths 11-52

codabar NOTIS editing 11-53

codabar start and stop characters 11-54

code 11 11-40

code 11 lengths 11-41

code 128 11-24

code 128 lengths 11-24

code 128 security level 11-29

code 39 11-30

transmit buffer 11-36

code 39 check digit verification 11-33

code 39 full ASCII 11-34

code 39 lengths 11-32

code 39 security level 11-37

Index - 2 LI36X8 PRODUCT REFERENCE GUIDE

- code 39 transmit check digit 11-33
- code 93 11-38
- code 93 lengths 11-39
- continuous bar code read 5-26
- convert GS1 databar to UPC/EAN 11-68
- convert UPC-E to UPC-A 11-20
- convert UPC-E1 to UPC-A 11-20
- decode illumination indicator 5-8
- decode pager motor 5-12
- decode pager motor duration 5-12
- decode session timeout 5-27
- discoverable mode 4-10
- discrete 2 of 5 11-49
 - lengths 11-50
- EAN zero extend 11-21
- EAN-13/JAN-13 11-9
- EAN-8/JAN-8 11-8
- event reporting
 - boot up event 7-23
 - decode event 7-22
 - parameter event 7-23
- FN1 substitution values 5-34
- GS1 databar 11-65
- GS1 databar expanded 11-66
- GS1 databar limited 11-65
- GS1 databar-14 11-65
- GS1-128 11-26
- hand-held mode 5-14
- hands-free mode 5-15
- I 2 of 5 check digit verification 11-46
- I 2 of 5 convert to EAN-13 11-47
- I 2 of 5 security level 11-48
- I 2 of 5 transmit check digit 11-46
- IBM 468X/469X
 - convert unknown to code 39 9-6
 - ignore bar code configuration 9-7
 - ignore beep 9-6
 - port address 9-5
- illumination 5-28
- interleaved 2 of 5 11-44
 - convert to EAN-13 11-47, 11-48
 - lengths 11-44
- inverse 1D 11-64
- ISBT 128 11-26
- ISBT concatenation 11-27, 11-28
- ISBT concatenation redundancy 11-28
- ISSN EAN 11-23
- keyboard wedge
 - alternate numeric keypad emulation 10-8
 - caps lock on 10-9
 - caps lock override 10-9
 - host types 10-5
 - ignore unknown characters 10-6
 - intra-keystroke delay 10-7
 - keystroke delay 10-6
 - quick keypad emulation 10-8
- Korean 3 of 5 11-63
- linear imager picklist mode 5-23
- lock override 4-32
- low power mode 5-15
- matrix 2 of 5 11-60
- matrix 2 of 5 check digit 11-62
- matrix 2 of 5 lengths 11-61
- MSI 11-55
- MSI check digit algorithm 11-58
- MSI check digits 11-57
- MSI lengths 11-56
- MSI transmit check digit 11-57
- numeric bar codes E-3
- pager motor 5-12
- parameter broadcast 4-31
- parameter scanning 5-6
- picklist mode 5-23
- prefix/suffix values 5-32
- radio output power 4-31
- reconnect attempt beep 4-25
- reconnect attempt interval 4-26
- RS-232
 - baud rate 8-9
 - beep on 8-18
 - check receive errors 8-12
 - data bits 8-12
 - hardware handshaking 8-13, 8-14
 - host serial response time-out 8-17
 - host types 8-7, 8-8
 - ignore unknown characters 8-20
 - intercharacter delay 8-19
 - Nixdorf Beep/LED options 8-20
 - RTS line state 8-18
 - stop bit select 8-11
- RS-232 parameters
 - parity 8-10
- scan data options 5-33
- scanner to cradle support 4-30
- set defaults 5-5
- SSI
 - baud rate 7-12
 - check parity 7-15
 - data packet format 7-17
 - host character timeout 7-19
 - host RTS line state 7-17
 - host serial response time-out 7-18
 - interpacket delay 7-21
 - multipacket option 7-20
 - parity 7-14
 - selecting 7-11
 - software handshaking 7-16
 - stop bit select 7-15

- supplementals 11-10
 - symbolologies
 - default table 11-2
 - GS1 DataBar limited 11-66
 - time delay to low power mode 5-16
 - time delay to presentation sleep mode . . 5-19, 5-20, 5-21
 - timeout between decodes, different symbols . . 5-27
 - timeout between decodes, same symbol 5-27
 - transmit code ID character 5-31
 - transmit matrix 2 of 5 check digit 11-62
 - transmit no read message 5-35
 - trigger modes 5-14, 5-15, 5-22
 - UCC coupon extended code 11-22
 - unique bar code reporting 5-26
 - unpair 4-33
 - UPC/EAN
 - coupon code 11-22
 - supp redundancy 11-13, 11-14
 - UPC/EAN/JAN
 - supplemental AIM ID format 11-14
 - supplemental redundancy 11-13
 - UPC-A 11-7
 - UPC-A preamble 11-17
 - UPC-A/E/E1 check digit 11-15, 11-16
 - UPC-E 11-7
 - UPC-E preamble 11-18
 - UPC-E1 11-8
 - USB
 - caps lock override 6-10
 - convert case 6-15
 - device type 6-7, 6-8
 - emulate keypad 6-12
 - emulate keypad with leading zero 6-12
 - fast HID 6-19
 - function key mapping 6-14
 - IBM specification version 6-19
 - keyboard FN 1 sub 6-13
 - keystroke delay 6-10
 - optional parameters 6-16
 - polling interval 6-17, 6-18
 - quick emulation 6-13
 - simulated caps lock 6-14
 - SNAPI handshaking 6-9
 - static CDC 6-15
 - unknown characters 6-11
 - variable PIN code 4-47
 - wi-fi friendly mode 4-11
 - bar codes RS-232
 - software handshaking 8-15
 - batch mode stored data 4-38
 - battery
 - charging 1-12
 - inserting 1-11
 - removing 1-11
 - beeper definitions
 - ADF programming 2-3
 - code 39 buffering 2-4
 - host specific 2-4
 - pairing 4-4
 - parameter programming 2-3
 - scanning 2-2
 - standard 2-2
 - wireless 4-4
 - Bluetooth
 - encryption 4-48
 - HID 4-8, 4-17, 4-27
 - pairing 4-34
 - pin code 4-46
 - profiles 4-4
 - secure simple pairing IO capability 4-48
 - serial port profile 4-8
 - set friendly name 4-9
 - SPP 4-24, 4-34
 - bluetooth 1-7, 1-14
 - bullets xxi
- ## C
- cable configurations xviii
 - cables
 - installing 1-9
 - character set 8-21
 - charging 1-12
 - codabar bar codes
 - CLSI editing 11-53
 - codabar 11-51
 - lengths 11-52
 - NOTIS editing 11-53
 - start and stop characters 11-54
 - code 11 bar codes
 - code 11 11-40
 - lengths 11-41
 - code 128 bar codes
 - code 128 11-24
 - GS1-128 11-26
 - ISBT 128 11-26
 - ISBT concatenation 11-27, 11-28
 - ISBT concatenation redundancy 11-28
 - lengths 11-24
 - security level 11-29
 - code 39 bar codes
 - buffering 11-34, 11-35
 - check digit verification 11-33
 - code 39 11-30
 - code 39 security Level 11-37
 - full ASCII 11-34
 - lengths 11-32

Index - 4 LI36X8 PRODUCT REFERENCE GUIDE

transmit check digit	11-33
code 93 bar codes	
code 93	11-38
lengths	11-39
code ID character	5-31
code identifiers	
AIM code IDs	C-3
modifier characters	C-4
Symbol	C-1
configurations	
product line	xviii
scanner	xvii
configuring scanner	1-14
connecting	
lost connection	1-14
conventions	
notational	.xxi
cradle	1-7
connecting	1-9
inserting scanner	1-13
mounting	1-10
supply power	1-10
cradle configurations	xviii

D

default parameters	
all	A-1
IBM	9-4
keyboard wedge	10-4
misc options	5-3
radio communication	4-2
RS-232	8-4
SSI	7-10
symbolologies	11-2
USB	6-4
user preferences	5-2
user prefs	5-2
discrete 2 of 5 bar codes	
discrete 2 of 5	11-49

E

encryption	4-48
error indications	
ack/nak	8-15
ADF	3-4
enq	8-15
format	3-7
input	3-4
miscellaneous scanner options	4-1
RS-232	3-5
RS-232 transmission	8-13
transmission	3-5, 8-17

unknown characters	6-11, 8-20, 10-6
xon/xoff	8-15
exposure options	
illumination	5-28

G

GS1 DataBar	11-65
GS1 databar	
convert GS1 databar to UPC/EAN	11-68

H

HID Profile	4-8
host types	
IBM (port address)	9-5
keyboard wedge	10-5
RS-232	8-7, 8-8
USB	6-7, 6-8

I

IBM 468X/469X connection	9-2
IBM 468X/469X parameters	9-5
IBM defaults	9-4
illumination	5-28
information, service	xxii
inserting battery	1-11
interleaved 2 of 5 bar codes	
check digit verification	11-46
convert to EAN-13	11-47
security level	11-48
transmit check digit	11-46

K

keyboard types (country codes)	
Albanian	B-2
Arabic (101)	B-2
Arabic (102)	B-2
Arabic (102) Azerty	B-3
Azeri (Cyrillic)	B-3
Azeri (Latin)	B-3
Belarusian	B-3
Bosnian (Cyrillic)	B-4
Bosnian (Latin)	B-3, B-4
Bulgarian (Latin)	B-4
Bulgarian Cyrillic (Typewriter)	B-4
Canadian French (Legacy)	B-4
Canadian French Win7	B-4
Canadian Multilingual Standard	B-5
Chinese (ASCII)	B-5
Croatian	B-5
Czech	B-5

Czech (Programmer)	B-5	Slovak	B-14
Czech (QWERTY)	B-5	Slovak (QWERTY)	B-14
Danish	B-6	Slovenian	B-14
Dutch (Netherlands)	B-6	Spanish	B-15
Estonian	B-6	Spanish (Variation)	B-15
Faeroese	B-6	Swedish	B-15
Finnish	B-6	Swiss French	B-15
French (Canada) 2000/XP	B-7	Swiss German	B-15
French (Canada) 95/98	B-7	Tatar	B-15
French (France)	B-6	Thai (Kedmanee)	B-16
French International	B-7	Turkish F	B-16
Galician	B-7	Turkish Q	B-16
German	B-7	UK English	B-16
Greek	B-8	Ukrainian	B-16
Greek (220) Latin	B-8	US Dvorak	B-16
Greek (319) Latin	B-8	US Dvorak Left	B-16
Greek 220	B-8	US Dvorak Right	B-17
Greek 319	B-8	US English	B-2
Greek Latin	B-7	US International	B-17
Greek Polytonic	B-8	Uzbek	B-17
Hebrew Israel	B-9	Vietnamese	B-17
Hungarian	B-9	keyboard wedge connection	10-2
Hungarian_101KEY	B-9	keyboard wedge defaults	10-4
Icelandic	B-9	keyboard wedge parameters	10-5
Irish	B-9	Korean 3 of 5 bar codes	11-63
Italian	B-9		
Italian (142)	B-10	L	
Japanese (ASCII)	B-10	lock override	4-32
Kazakh	B-10	locked pairing mode	4-32, 4-35
Korean (ASCII)	B-10	low power mode	4-24
Kyrgyz	B-10		
Latin American	B-10	M	
Latvian	B-11	maintenance	3-1
Latvian (QWERTY)	B-11	linear imager scanner	3-2
Lithuanian	B-11	master	4-8
Lithuanian (IBM)	B-11	master serial port profile	4-24, 4-31
Macedonian (FYROM)	B-11	matrix 2 of 5 bar codes	11-60
Maltese_47KEY	B-11	check digit	11-62
Mongolian	B-11	lengths	11-61
Norwegian	B-12	transmit check digit	11-62
Polish (214)	B-12	misc options defaults	5-3
Polish (Programmer)	B-12	mounting	
Portuguese (Brazil)	B-12	cradle	1-10
Portuguese (Brazilian ABNT)	B-12	MSI bar codes	
Portuguese (Brazilian ABNT2)	B-12	check digit algorithm	11-58
Portuguese (Portugal)	B-13	check digits	11-57
Romanian	B-13	lengths	11-56
Romanian (Legacy)	B-13	MSI	11-55
Romanian (Programmer)	B-13	transmit check digit	11-57
Romanian (Standard)	B-13	multipoint-to-point communication	4-30
Russian	B-13		
Russian (Typewriter)	B-14		
Serbian (Cyrillic)	B-14		
Serbian (Latin)	B-14		

N

non-parameter attributes G-1, I-1
 beep on next bootup G-4
 configuration filename G-2
 date of first programming G-2
 date of manufacture G-2
 firmware version G-5
 host trigger session G-4
 model number G-1
 parameter defaults G-4
 reboot G-4
 scankit version G-5
 serial number G-1
 notational conventions xxi

O

out of range indicator 4-28

P

pairing 1-14
 address 4-24
 bar code 4-4
 bar code format 4-34
 connection maintenance interval 4-35
 lock override 4-32
 master/slave setup 4-8
 methods 4-33
 modes 4-3, 4-31
 multipoint-to-point 4-30
 on contacts 4-3
 pin codes 4-46
 point-to-point 4-30
 radio communication 1-14
 unpair 4-33
 pairing beeper definitions 4-4
 parameter defaults
 all A-1
 IBM 9-4
 keyboard wedge 10-4
 misc options 5-3
 radio communication 4-2
 RS-232 8-4
 USB 6-4
 user preferences 5-2
 user prefs 5-2
 parameters
 batch mode 4-38, 4-39
 beep on insertion 4-28
 Bluetooth technology support 4-17
 IBM 468X/469X 9-5
 keyboard wedge 10-5

radio communication 4-4
 auto-reconnect interval 4-24
 batch mode 4-38, 4-39
 connection maintenance interval 4-35
 host types 4-4
 pairing 4-31
 parameter broadcast 4-31
 reconnect attempt beep 4-25
 reconnect attempt interval 4-26
 RS-232 8-5
 scanner to cradle support 4-30
 set defaults 5-5
 time delay to low power mode 5-16
 unpair 4-33
 USB 6-7

parts

scanner 1-2, 1-6, 1-8

PIN code

static 4-47
 variable 4-47

pinouts

cradle signal descriptions 3-12

point-to-point communication 4-30

power 1-10

product line configurations xviii

R

radio communication

bluetooth 1-7
 bluetooth technology profile support 1-14
 defaults 4-2
 multipoint-to-point 4-30
 pairing 1-14
 parameters 4-4
 point-to-point 4-30
 reconnect attempt 4-26
 reconnect attempt beep 4-25

range indicator 4-28

reconnect attempt 4-26

reconnect attempt beep 4-25

removing battery 1-11

RS-232 connection 8-2, 8-3

RS-232 defaults 8-4

RS-232 parameters 8-5

RSM

commands and responses over SSI 7-8

S

sample bar codes

code 128 D-2

code 39 D-1

GS1 DataBar D-3

- interleaved 2 of 5 D-2
- UPC/EAN D-1
- scanner configurations xvii
- scanner parts 1-2, 1-6, 1-8
- scanner to cradle support 4-30
- scanner(s) to cradle support 4-30
- scanning 2-7
 - errors 5-2, 6-11, 10-6, 11-2
 - radio communications sequence example 4-1
 - sequence example 5-2, 11-2
- secure simple pairing IO capability 4-48
- Serial Port Profile
 - master 4-24, 4-31
 - support 4-8
- service information xxii
- setup
 - connecting a USB interface 6-2
 - connecting an RS-232 interface 8-2, 8-3
 - connecting keyboard wedge interface 10-2
 - connecting to an IBM 468X/469X host 9-2
 - cradle 1-7
 - inserting scanner in cradle 1-13
 - installing the cable 1-9
 - lost host connection 1-14
 - mounting cradle 1-10
 - scanner 1-7
 - supplying power 1-10
- signal descriptions 3-12
- simple serial interface
 - baud rate 7-12
 - commands 7-2
 - communications 7-1, 7-5
 - default parameters 7-10
 - handshaking 7-3, 7-5
 - RSM commands and responses 7-8
 - RTS CTS 7-5
 - selecting 7-11
 - transactions 7-3
- slave 4-8
- specifications 3-9, 3-11
- SPP
 - master 4-24, 4-31
 - support 4-8
- SSI
 - baud rate 7-12
 - commands 7-2
 - communications 7-1, 7-5
 - default parameters 7-10
 - handshaking 7-3, 7-5
 - RSM commands and responses 7-8
 - RTS CTS 7-5
 - selecting 7-11
 - transactions 7-3
- stored data

- batch mode 4-38
- symbology default parameters 11-2

T

- technical specifications 3-9, 3-11
- Toshiba TEC host parameters 6-20
- troubleshooting 3-4

U

- unlocked pairing mode 4-32
- unpairing
 - bar code 4-33
- UPC/EAN bar codes
 - bookland EAN 11-9
 - bookland ISBN 11-21
 - check digit 11-15, 11-16
 - convert UPC-E to UPC-A 11-20
 - convert UPC-E1 to UPC-A 11-20
 - EAN zero extend 11-21
 - EAN-13/JAN-13 11-9
 - EAN-8/JAN-8 11-8
 - ISSN EAN 11-23
 - supplementals 11-10
 - UCC coupon extended code 11-22
 - UPC-A 11-7
 - UPC-A preamble 11-17
 - UPC-E 11-7
 - UPC-E preamble 11-18
 - UPC-E1 11-8
- USB connection 6-2
- USB defaults 6-4
- USB parameters 6-7
- user preferences bar codes
 - batch mode 4-38, 4-39
 - beep on insertion 4-28
 - set defaults 5-5
 - time delay to low power mode 5-16
- user preferences defaults 5-2
- user prefs defaults 5-2

W

- wi-fi friendly mode 4-11



Zebra Technologies Corporation, Inc.
3 Overlook Point
Lincolnshire, IL 60069, U.S.A.
<http://www.zebra.com>

Zebra and the stylized Zebra head are trademarks of ZIH Corp., registered in many jurisdictions worldwide. All other trademarks are the property of their respective owners.
©2016 Symbol Technologies LLC, a subsidiary of Zebra Technologies Corporation.
All rights reserved.



MN001740A02 Revision Rev A March 2016

