

**CAIRNS  
CITY IN A  
GARDEN  
MASTER PLAN  
CONTENTS**



# City in a Garden Master Plan 2007



Cairns City in a Garden  
Master Plan 2007

## Context

The city of Cairns is a fast growing regional city in Far North Queensland.

Cairns is the third largest international destination in Australia and attracts more than two million visitors every year, through its International Airport and Seaport.

The natural environment is the foundation for our tourism industry and Cairns maintains its status as a tourist haven because of its tropical character and spectacular natural setting, bounded by the Coral Sea and rainforested mountains.

Cairns residents are proud to be custodians of two of the world's greatest natural wonders, the Great Barrier Reef and the Wet tropics Rainforest, both of which are World Heritage listed sites. The community has an expectation that our unique environment will be safeguarded now and for the future.

**Cairns City Council – our corporate vision:**

***Cairns will be the best regional city in Australia and the Asia Pacific***



## Context

Cairns City in a Garden  
Master Plan 2007

<b>CITY IN A GARDEN MASTER PLAN 2007</b>	<b>2</b>	<b>Table of Contents</b>
<b>Context</b>	<b>2</b>	
<b>CAIRNS CITY IN A GARDEN PART A-INTRODUCTION</b>	<b>10</b>	
1. <b>Benefits of street trees</b>	<b>10</b>	
2. <b>Key objectives</b>	<b>11</b>	
3. <b>Who will use this Plan</b>	<b>12</b>	
4. <b>The structure of the Master Plan 2007</b>	<b>13</b>	
5. <b>Street Tree Policy documents</b>	<b>13</b>	
<b>CITY IN A GARDEN MASTER PLAN PART B-TREE SPECIES SELECTION</b>	<b>14</b>	
1. <b>How we have selected our street trees</b>	<b>14</b>	
1.1. Environmental criteria	<b>15</b>	
1.1.1. Climate	<b>15</b>	
1.1.2. Geology and soils	<b>15</b>	
1.1.3. Hydrology	<b>16</b>	
1.1.4. Topography	<b>16</b>	
1.1.5. Tolerance in paved areas - low levels of soil oxygen and soil compaction	<b>16</b>	
1.1.6. Sustainability	<b>16</b>	
1.1.7. Tolerance of pests and diseases	<b>16</b>	
1.1.8. Tolerance of atmospheric pollution	<b>17</b>	
1.1.9. Wildlife habitat	<b>17</b>	
1.1.10. Native versus exotic street tree selection	<b>17</b>	
1.2. <b>Functional criteria</b>	<b>18</b>	
1.2.1. Performance record	<b>18</b>	
1.2.2. Readily available and transplantable at advanced size	<b>18</b>	
1.2.3. Acceptable leaf and fruit fall characteristics	<b>18</b>	
1.2.4. Low risk of becoming an environmental weed	<b>18</b>	
1.2.5. Not prone to major limb shear	<b>18</b>	
1.2.6. Long lived	<b>18</b>	
1.2.7. Capacity to lift pavements and kerbing	<b>18</b>	

Cairns City in a Garden  
Master Plan 2007

Table of Contents

1.2.8.	Toxic or Harmful	18
<b>1.3.</b>	<b>Aesthetic / design criteria</b>	<b>19</b>
1.3.1.	Relationship with distinctive landscape characters	19
1.3.2.	Ultimate size of tree canopies	19
1.3.3.	Historic / Cultural associations	19
1.3.4.	Form of tree canopies	19
<b>1.4.</b>	<b>Factors that impact on street tree selection and establishment</b>	<b>20</b>
1.4.1.	Overhead Power Lines	20
1.4.2.	Underground services	20
1.4.3.	Space constraints	20
<b>1.5.</b>	<b>No street tree is perfect</b>	<b>21</b>
1.5.1.	Leaf and fruit drop	21
1.5.2.	Damage to pavements	21
1.5.3.	Damage during Cyclones	21
<b>2.</b>	<b>Design Principles</b>	<b>23</b>
2.1.	Consistency and Visual Uniformity for each street	23
2.2.	Precinct based approach	24
<b>3.</b>	<b>Planting Styles</b>	<b>25</b>
3.1.	Formal Avenue	25
3.2.	Alternative Avenue	25
3.3.	Grove	26
3.4.	Reinforced Existing Planting	26
3.5.	Special Planting	26
3.6.	Reinforce and celebrate Gateways to the CBD	26
3.7.	Allow the borrowed landscape to take precedence around existing parks and open space	27
3.8.	Provide buffers to protect and enhance areas of indigenous vegetation	27
3.9.	Provide corridors to link existing areas of indigenous vegetation or public open space	27
<b>3.10.</b>	<b>Heritage associations</b>	<b>27</b>

## Table of Contents

<b>CITY IN A GARDEN MASTER PLAN PART C- PRECINCT PLANS</b>	<b>30</b>
1. Cairns Beaches	32
2. Barron Smithfield	40
3. Redlynch Valley	53
4. Freshwater Stratford & Aeroglen	57
5. Cairns North and CBD	61
6. Portsmith Woree Industrial	65
7. Inner Suburbs	67
8. White Rock & Edmonton	81
9. Gordonvale & Goldsborough	86
10. Babinda	88
11. Rural Lands	90
<b>CITY IN A GARDEN MASTER PLAN PART D TECHNICAL GUIDELINES</b>	<b>99</b>
1. Street Trees Guidelines to Placement	99
2. Strategies for Improving Tree Planting within the Road Reserve	104
3. Streetscape Templates	108
4. Street Tree Specification and Installation Details	110
<b>CITY IN A GARDEN PART E- APPENDICES</b>	<b>128</b>
1. Trees for General use Picture Gallery	130
2. Species guide small to medium trees	152
3. Species guide large trees	154
4. Species guide for shrubs, flowering plants and bulbs	156
5. Cairns City in a Garden Tree Data Sheets	157
6. Cairns City in a Garden Palm Data Sheets	165
7. Cairns City in a Garden Street Priority Data Sheets	168
8. Cairns City in a Garden Data Sheets Street Tree Palette	172
9. Glossary of Terms	176
<b>CITY IN A GARDEN PART F-STREETScape TEMPLATES</b>	<b>178</b>

Cairns City in a Garden  
Master Plan 2007

Table of Contents

## **Acknowledgements**

Aerial photographs taken from Cairns Panorama by Daryl Jones  
Anton van Der Schans, Siteplan  
Cairns City Council Development Manual 2001  
Cairns Plan 2005  
JNP Pawsey and Prowse  
John van Grieken, Cairns City Council  
Kim Morris & Associates Pty Ltd  
Mulgrave Shire Council Street Tree Guidelines 2001  
Randwick City Council  
Robyn Holmes "My Place" local history articles, Cairns Post  
Specifying Trees, Ross Clark NATSPEC  
Urban Street Trees, 22 Benefits-Specific Applications by Dan Burden  
2006



Cairns City in a Garden  
Master Plan 2007





**CAIRNS  
CITY IN A  
GARDEN  
MASTER PLAN  
PART A-  
INTRODUCTION  
PART B-TREE  
SPECIES SELECTION**



# Cairns City in a Garden Part A-Introduction

## Benefits of street trees

### 1. Benefits of street trees

Street trees are an important urban element that can transform the city's streets and provide environmental, aesthetic, cultural and economic benefits. In the long term, they can create a sense of place and enhance public domain.

#### Street Tree Plantings:

- Improve environmental amenity by providing summer shade for the comfort of pedestrians and residents. Tree lined streets can see reductions in temperatures from 5-15 degrees.
- Improve environmental comfort as street tree canopies diminish traffic noise, screen unwanted views and reduce glare, asphalt and concrete streets can increase street temperatures by as much as 7 degrees.
- Improve environmental conditions as their leaves absorb heat and filter air pollution and dust from city streets. Trees in close proximity to the road can absorb nine times more pollutants than more distant trees.
- Create a sense of place - tree lined streets provide orientation and contribute to the city's character.
- Enhance property values as they establish and mature.
- Provide seasonal interest and natural beauty through foliage and their interesting leaf patterns, flowers, bark, fruit and canopy.
- Provide a link to nature and a source of delight.
- Provide habitat and a food source for urban fauna.
- Can help to reduce urban traffic speeds. Street trees help motorists guide their movement and assess their speed.
- Can increase the life of hard surfaces. The shade of urban street trees can add from 40-60% more life to asphalt, by reducing daily expansion and contraction.



Cairns City in a Garden  
Master Plan 2007

Part A  
Introduction

### 2. Key objectives

The key objectives of the City in Garden Master Plan 2006 are:

- Establish a street tree species palette suited to the environmental conditions of the City of Cairns' public realm.
- Create striking Gateways that reflect Cairns' unique Tropical environment, to include trees and plantings of suitable shrubs, bulbs and perennials.
- Reinforce and enhance the special characteristics of city precincts using distinct street tree planting.
- Direct the most appropriate species and planting techniques for the many potential tree sites in Cairns:  
***"The right tree for the right location"***.
- Establish green city corridors by providing high quality street trees.
- Increase the number of trees in Cairns' streets.
- Improve street tree establishment and survival rates.
- Guide the maintenance and management of existing and new trees to ensure that they survive and thrive in the harsh urban conditions.
- Provide clear guidelines to ensure a consistent approach towards the provision of street trees in the City of Cairns.
- Set and maintain high street tree establishment standards.



Cairns City in a Garden  
Master Plan 2007

Part A  
Introduction

### 3. Who will use this Plan?

The City in a Garden Master Plan 2006 is intended for use by:

- City of Cairns staff – as a guide for the provision and management of street trees within the city's public domain.
- Landowners and developers- to assist in the selection and installation of tree species.
- The Landscape Profession and Nursery Trade-technical guidance and preferred plant species.
- The general public – to foster a better understanding of the desired street tree character for city precincts.



### Who will use this Plan?

Cairns City in a Garden  
Master Plan 2007

Part A Introduction

**4. The structure of the Master Plan 2006**

The City in a Garden Master Plan 2007 provides a guide to the provision and planting of street trees in the City of Cairns.

The Master Plan consists of the following sections:

- A Introduction**
- B Species selection – including tree selection criteria, design principles**
- C Precinct Plans – nominates the tree palette and design objectives for each precinct across the City of Cairns**
- D Technical Guidelines – guides streetscape planting and indicates tree set out, tree planting and installation details and specifications.**
- E Appendices – includes tree and street data sheets.**
- F Streetscape Templates – includes a series of models for Cairns Streets and associated details for tree planting.**

**5. Street Tree Policy documents**

Barron River Delta and Marlin Coast Wildlife Management Strategy 2006
Cairns CBD Streetscape Master Plan 2006
Cairns City Council General Policy No.1:04:08 (Vegetation on Council's Road Verges)
Cairns City Council No.1:04:39 (Structures within the Road Reserve Including Subdivision Strata)
FNQROC Development Manual Operational Works Design Guidelines D9 & Specifications S8 Landscaping
Local Law No.03 (Vegetation Protection)
Local Law No.22 (Activities on Roads)
Local Law No.24 (Vegetation Protection)
Local law No.26 (Parks and Reserves)
Marlin Coast Landscape Master Plan



# City in a Garden Master Plan Part B-Tree Species Selection

## Tree Selection

### 1. How we have selected our street trees

Trees selected for our streets may occupy their planting sites for 50 to 200 years, so tree selection is vitally important.

Our area's streets are on average 30% planted with established trees. If these trees are performing well, are in scale with the street, and provide a consistent streetscape character then generally the City in a Garden Master Plan will follow the existing pattern. We will be endeavouring to adhere to the principle of the **"right tree for the right location"**.

Some exceptions to this general policy of the continuation of the existing pattern will occur in the case of particular species that have:

- **Performed poorly.**
- **Are not in scale with the street.**
- **Have proven to be particularly damaging to pavements, kerbs, gutters overhead or underground services.**

This provides the opportunity to introduce additional tree species to our area or experiment / trial new nursery tree cultivars.

#### **The right tree for the right location**

One of our key selection objectives is to ensure the selection of the **"right tree for the right location"**, in other words, to ensure that the selection of the species is appropriate to the local environmental conditions and the constraints of the planting location. The selection of species aims to ensure that trees make a positive contribution to environmental, amenity, aesthetic and heritage values of the area and any negative values are minimized.

There is no perfect street tree and so every selection has some compromise between positive and negative values.

The City in Garden Master Plan tree selection criteria is divided into three categories:

- **Environmental tolerances**
- **Functional requirements**
- **Aesthetic / Design Requirements**

Adherence to the selection criteria should ensure the selection of the species with the most desirable and appropriate characteristics will be selected, no matter what their origin or type.

In order to ensure the health and longevity of street trees planted, aesthetic and design considerations will be accommodated where optimum conditions for plant growth are available. The proven performance of the species in particular environmental conditions and functional requirements will be the prime considerations for street tree selection.

Cairns City in a Garden  
Master Plan 2007

Part A  
Introduction

### 1.1. Environmental criteria

The capacity of trees to establish depends heavily on whether the environmental conditions at the planting location are within the tolerance range of the species selected.

***Some of the environmental factors that affect tree selection are:***

#### 1.1.1. Climate

Cairns is located at latitude 16.9 degrees south and experiences a tropical wet climate. Parts of the Cairns area are subject to coastal influences depending on their proximity and orientation to the sea. It is an oasis in Tropical Australia, for the oblique orientation of the backing highlands relative to the prevailing south-easterly trade winds, result in between 2-7 m of annual rainfall.

The Cairns region is prone to a range of natural hazards including riverine floods, tropical cyclones and storm surge, landslides and possible tsunamis.

#### 1.1.2. Geology and soils

Local geology is dominated by the Middle Palaeozoic Hodgkinson Province metamorphic, a series of interbedded phyllite, schist, quartzite and chert which strike north-south, and the Lower Permian Mareeba granite that intrudes the metamorphic and varies mineralogy and texture throughout the region.

There are two distinct fan surfaces throughout the Cairns region: a series of fans between 5-10 m above the present flood plains and lower level modern alluvial plains and floodplains that grade to sea-level. These fan surfaces are virtually ubiquitous across the lowland plains where they abut against Quaternary shoreline deposits. Near Cairns City the fans emanating from the Macalister Range are composed predominantly of clayey gravels and gravelly clays (up to 15% gravel content). Further south the large Mulgrave fan, and those extending from the Bellenden Ker Range near Miriwinni have sediments derived from granites (have higher sand content).

Between Cairns and Ellis Beach, the wider coastal plain is covered by coalesced fans which appear to extend below sea-level. The weathering and stratigraphical characteristics of the sea fans suggest that they were composed of two distinct generations. The fine-grained sands and clays of the stratigraphically lower sequence of fans are bleached white with yellow mottles. Red and ochre coloured fine-grained sands form the upper fan unit. The older unit is evident from Kewarra north; to the south only the red unit is exposed.

North of Cairns where the coastal plain narrows considerably the truncated fans of the Macalister range now forms sea cliffs up to 3-4 m in height. These have high gravel content (up to 30%) and their matrix sands and clays are extensively weathered and display red and orange mottles. This section of the Cairns coastal plain is dominated by the Barron delta, which is comprised of up to 90m thickness of alluvial sediments. Along the eastern margin of the Barron fan Holocene marine sands and muds with a similar stratigraphy to the southern portion of the coastal plain have accumulated. Alluvial fan and colluvial deposits dominate the western or landward margin of the coastal plain.



Cairns City in a Garden  
Master Plan 2007

Part A  
Introduction

## Environment

### 1.1.3. Hydrology

The Mulgrave and the Barron Rivers are the main streams draining the region. Both rise on the plateau to the west of Cairns and have carved steep sided gorges into the plateau before flowing across broad alluvial plains. The Barron River enters the Coral Sea immediately north of Cairns and the Mulgrave River turns south on the coastal plain and enters the sea near Russell Heads

Areas of Cairns within the coastal strip have high salt water levels that can affect root systems.

### 1.1.4. Topography

Cairns is situated on a coastal plain bounded by the Whitfield Range to the west and the Coral Sea and the Trinity Inlet to the east.

There is an extensive cover of wet tropical rainforest on the steep slopes of the escarpment and across the broad plateau hinterland which extends from 400m to over 1000m above sea level. Most of the lowlands have been cleared of forest for agriculture and urban development.

To the north of Cairns development has followed the topographical constraints of the Barron River flood plain and delta, various creeks and the Macalister and Whitfield Ranges. This has resulted in smaller isolated settlements strung along the available foreshore from Machans to Palm Cove.

To the south settlement has spread from the original township of Cairns, established at the mouth of the Trinity Inlet and gradually filled in the remaining coastal plain focused around Edmonton, Gordonvale and the Goldsborough Valley.

### 1.1.5. Tolerance in paved areas - low levels of soil oxygen and soil compaction

In some urban areas selected trees will need to tolerate planting in hard paving areas and must have the ability to tolerate low oxygen levels and compacted, highly modified soil conditions.

### 1.1.6. Sustainability

All Tree Planting must seek to comply with the Water Demand Management Strategy. Established Street Trees selected need to be capable of surviving an average drought period in reasonable condition without irrigation or reliance on town water supplies.

Liaise with Cairns Water in the possible provision of re-cycled water outlets in key locations across the catchment area.

Use of water tubes and other water retention products to ensure the most efficient delivery of water to root zones, this practice also has the benefit of encouraging deep roots.

### 1.1.7. Tolerance of pests and diseases

The selected tree species should be resistant to pests and disease. A diversity of species is also important in reducing the impact of devastating diseases on specific tree species.



Cairns City in a Garden  
Master Plan 2007

Part A  
Introduction



### 1.1.8. Tolerance of atmospheric pollution

The CBD environment and areas traversed by busy arterial roads are subject to photochemical pollution produced by vehicle exhaust systems. Trees selected for these areas need to be able to tolerate these vehicle emissions.

Deciduous trees are generally considerably more tolerant than evergreen species due to the duration over which different species retain their leaves. The longer the life of a leaf the greater likelihood that the threshold levels for pollutant damage will be exceeded.

### 1.1.9. Wildlife habitat

Where appropriate, consideration will be given to planting trees which provide a connection between open spaces or other vegetated areas to assist in the movement of wildlife (fauna and birdlife) between those areas. These species should contain some benefits to wildlife including physical benefits of protection, shelter and food source.

Please note that plantings in and around the Airport should be carefully considered within the bird and bat strike hazard zones outlined in the Cairns Plan.

### 1.1.10. Native versus exotic street tree selection

When addressing this issue, a more useful division may be to view this point three ways:

- **Local Natives/Endemic Species**
- **Natives from distant parts of Australia**
- **Exotics**

**Local Natives/Endemic Species** have the advantage of being climatically suited and live in some degree of equilibrium with pest organisms such as insects and fungi. Use of local natives promotes biodiversity and the creation of wildlife corridors, can be drought resistant and reinforces a unique sense of place. These species will often have significant links to local Aboriginal Cultural Heritage.

**Natives** from other regions within Australia are less likely to be climatically adapted; they may enjoy freedom from local pest organisms but if they become infested are likely to succumb faster.

**Exotics** may be almost completely free of pests and diseases but run the risk of being devastated if these are accidentally introduced. They do however have historic cultural links to early settlement and period planting themes that can still be seen in the Cairns area. Exotic flowering trees add greatly to the character of Cairns as a Major Tourist Destination.

Regarding local or at least FNQ natives and their suitability as street trees species best adapted for inner urban areas are usually from drier rainforests, particularly littoral rainforests where most trees are long lived shade tolerant; and freshwater swamps and other areas that are poorly drained and aerated, where species from these environments are highly resistant to root rot organisms and their root systems are adapted to adverse conditions.

In summary both natives and exotics have their strengths and weaknesses for use as street trees.

The City in a Garden Master Plan will aim to adhere to the following:

- **Right tree**
- **Right location**
- **Right reason**

## Function

### 1.2. Functional criteria

Species selected for street tree planting also need to fulfil certain functional criteria to ensure successful establishment and reduced ongoing maintenance and management issues.

#### 1.2.1. Performance record

The proven performance of the species under the environmental conditions of the locality will be desirable.

#### 1.2.2. Readily available and transplantable at advanced size

The selected plant stock must be commercially grown and available in a suitable size for street planting. Generally the tree planting stock used will vary in size depending on planting location.

#### 1.2.3. Acceptable leaf and fruit fall characteristics

The selected species must have an acceptable level of nuisance created by the shedding of leaves and fruit for a street environment with consideration given to the cost of maintenance and clearing. Those with large or heavy seedpods, excessive leaf drop, or fleshy fruit or flowers which may lead to slip hazards will be avoided.

#### 1.2.4. Low risk of becoming an environmental weed

Some species are known to be, or have the potential to be serious environmental weeds due to their ability to self propagate and invade bushland areas. For a list of environmentally hazardous plant species refer to the following resource:

[www.deh.gov.au/biodiversity/invasive/weeds/alert-list.html](http://www.deh.gov.au/biodiversity/invasive/weeds/alert-list.html)

#### 1.2.5. Not prone to major limb shear

Limb loss occurs on an occasional basis for most trees due to wind induced mechanical breakage. Trees that are known to have brittle branches and regular branch drop will be avoided for use as street trees.

#### 1.2.6. Long lived

Many of the costs associated with the management of trees in the urban environment are associated with the establishment and over-maturity phase. Using long-lived species that require replacement on as infrequent a basis as possible will minimise tree management costs.

#### 1.2.7. Capacity to lift pavements and kerbing

Although no guarantees can be given that any particular street tree species will not interact with kerbs and pavements, species that are known for vigorous root systems and causing pavement uplift will be avoided.

#### 1.2.8. Toxic or Harmful

Plant species should be avoided that are known to have toxic seeds, fruit, sap or spines.

Cairns City in a Garden  
Master Plan 2007

Part A  
Introduction

## Aesthetics

### 1.3. Aesthetic / design criteria

Our city is a constructed cultural landscape consisting of streets, buildings and parks. Trees play an important role in enriching the cultural experience of a place and so aesthetic characteristics need to be an important selection consideration.

In many areas of Cairns views to the ocean and surrounding mountains often occur. The benefits of maintaining these views need to be balanced with the other benefits of street tree planting. Street tree planting can be designed in these areas to minimize the impact, and even enhance views by providing scale and enframement.

#### 1.3.1. Relationship with distinctive landscape characters

The selection of species may be made to reinforce historical, cultural or natural associations from the past, particularly early settlement era landscape planting and trees with traditional significance to the local Aboriginal communities.

#### 1.3.2. Ultimate size of tree canopies

Very large trees in confined spaces often result in unacceptably high management costs. Conversely small growing trees in broad streets rarely contribute significantly to visual quality.

Trees selected will be in scale with the streetscape and if allowed, utilise the largest growing species possible for the area.

Species should be selected such that the ultimate mature size of the tree is in scale with the street in consideration of the site constraints, such as nature strip widths, overhead powerlines, building alignments and vehicle clearances. The optimum range is not so small that it does not make a significant contribution to the amenity of the street, and not so large as to dominate and cause significant problems. In some instances the constraints imposed by the street environment will limit the optimum size of street trees or even restrict tree planting altogether. This is the case with the majority of narrow laneways and footpaths throughout the area.

#### 1.3.3. Historic / Cultural associations

The selection of species may have natural, historical or cultural associations with the locality. New plantings should consider the historical context of the locality.

#### 1.3.4. Form of tree canopies

Selected species should have an appropriate and predictable form with an upright trunk and stable branch structure. Street trees need to have a form that allows traffic and pedestrian movements around the tree. In the CBD desirable tree forms include trees with a single straight main trunk supporting a domed crown, or columnar form.



Cairns City in a Garden  
Master Plan 2007

Part A  
Introduction

### 1.4. Factors that impact on street tree selection and establishment

#### 1.4.1. Overhead Power Lines

Of all the factors that limit the benefits trees contribute to a streetscape, the most recurring is the conflict between overhead power cables and tree canopies.

One solution to this problem could be to select smaller tree species. This could be viable for narrow streets, however with wide streets these small trees are inevitably out of scale with the streetscape and present a poor outcome.

A second solution is to plant tall trees along the side without cables only and to create specific design schemes related to this principle. (Refer to City in a Garden Master Plan Part B-Design Principles)

Underground power cables are also an option and have been a condition of new Developments. In established areas costs at this stage could be prohibitive; however this high cost may in fact be a practical option when compared with the projected cost of repeated pruning, the risk that this work involves to operators, the negative impact on trees and loss of public amenity or Council assets in the form of the trees themselves.

#### 1.4.2. Underground services

Water and electricity easements sometimes prohibit establishment of trees due to the depth of the service and potential liabilities if the service was damaged. This is further exacerbated by the fact that the exact location of many inner city services was lost during 'amalgamation' in 1997. Each site will need to be assessed on its merits to determine the feasibility of establishing trees in relation to underground services.

(Refer City in a Garden Master Plan Part D-Technical Guidelines 2.0 Strategies for improving Tree Planting within the Road Reserve)

#### 1.4.3. Space constraints

Where site constraints limit the optimum size of street plantings, consideration may be given to mechanisms, which minimise or remove the impact of these constraints. These could include for example, replacing overhead powerlines with Aerial Bundle Conductors, planting trees within the median or road carriageway (where footpaths are narrow and streets are sufficiently wide) and increasing the root zone soil volume by use of structural soils or similar technologies.



### 1.5. No street tree is perfect

There is no such thing as a street tree that will fulfil perfectly all aspects of our selection criteria. Trees are living things that can present a variety of forms and habit even within the one species type.

It must be remembered that we are planting trees in an artificial, constructed environment that is far removed from their natural habitat. In this situation there are bound to be some negative aspects associated with trees in an urban environment, however it is generally considered that the benefits trees contribute to our environment far outweigh any negative aspects.

#### Frequent Negatives raised about Street Trees include:

##### 1.5.1. Leaf and fruit drop

All trees, including evergreens, drop leaves. Strategies to reduce the impact of leaf and fruit litter in our streets will be the coordination of plantings and our street sweeping resources to target problem areas.

Species with fleshy fruits or leaves that become mucilaginous on decomposition will be avoided for selection.

##### 1.5.2. Damage to pavements

Many old established trees in our area can cause footpath uplift and cracking. These trees generally are the vigorous, larger growing species, and those with a tendency to produce surface roots.

In adhering to the principle of the *"right tree for the right location"* future tree selection will be mindful of the potential of various tree species to cause pavement damage.

Also an important consideration is the site preparation and establishment techniques used for tree planting. The use of nature strips where possible, maximising the size of the planting "cut outs" in pavements and the correct use of deflection barriers will minimise future instances of pavement damage and associated risk management issues. This issue is further discussed in City in a Garden Master Plan Part D-Technical Guidelines.

The installation of tree islands of an adequate size to allow for healthy tree development will protect trees in shoulders, and allow for improved maintenance. It is recommended that these islands are best mulched, or planted with a suitable groundcover. The use of grass is not recommended on smaller islands as it compromises the health of the tree, and the use of mowers in the vicinity of tree trunks can cause damage and lead to tree failure.

##### 1.5.3. Damage during Cyclones

Tree failure during cyclones is a great concern; however stands of trees can often act as protection to surrounding property and in fact prevent damage.

Recent cyclones have identified a varying affect on different species that is not necessarily consistent with the same species. Some have been seriously damaged while the same species in another area have weathered the storm in tact.

Trees that have a history of susceptibility to high winds are noted in the City in a Garden Master Plan Street Tree List and should be



Cairns City in a Garden  
Master Plan 2007

Part A  
Introduction

considered before planting into specific locations or avoided completely.

Consistent pruning to establish well-balanced crowns and the promotion of healthy deep roots will encourage trees to develop greater stability and improved resistance to high winds.

## No Street Tree is Perfect



Cairns City in a Garden  
Master Plan 2007

Part A  
Introduction

### City in a Garden Master Plan Part B-Tree Species Selection

#### 2. Design Principles

As a collective; street trees are considered and planted to reinforce public realm design principles, in particular:

- **Consistency and visual uniformity for each street**
- **Enhance the local character of distinct areas by introducing a distinctive planting approach**
- **Reinforce and celebrate the gateways and key nodal intersections**
- **Enhance key cultural and commercial areas**
- **Allow the borrowed landscape to take precedence around existing parks and open space**
- **Provide buffers to protect and enhance areas of indigenous vegetation**
- **Provide corridors to link existing areas of indigenous vegetation or public open space**

In adhering to these design principles consideration must be given to any CPTED issues and the specific conditions, which determine tree specification. These include footpath widths, sightlines, overhead wires and the size and structure of the street in question. These are outlined in more detail in City in a Garden Master Plan Part D-Technical Guidelines.

##### 2.1. Consistency and Visual Uniformity for each street

The intention of this principle is to establish a uniform character for each street or area; a sense of identity or a **'sense of place'** that compliments architectural forms and provides a distinctive and recognisable character in keeping with local conditions. Inconsistent street plantings with a multiplicity of different species can add interest to the streetscape, but they are also more difficult to manage, they may be inappropriate to the location, or may have a negative impact on the amenity of the street.

In most cases the proposed species is an extension of the dominant existing species if that species has been deemed to be suitable in scale and growth habit, or of Heritage or Cultural Significance.

Many older streets closer to the inner city area consist of a range of species that should also be considered as a feature of that particular street for the diverse plantings over time. This does not provide consistency and uniformity, but is a 'street specific' character, and one that creates a more informal **"garden feel"** (please see below)

Streetscapes need also to balance deciduous flowering species with evergreen trees, which may lack seasonal interest but add sculptural form to the street. While streets of one specimen do allow for dramatic seasonal effect, the loss of amenity during dormant months, while the tree is left relatively leafless, can be detrimental to the appearance of the street. The inclusion of strategically placed evergreen species within a larger avenue of deciduous varieties can help to maintain an over-all streetscape structure, and act as a foil to flowering species.

The installation of ample median strips will create opportunities to create street-wide stands of trees, with more complex relationships being possible between species and allow for under-planting as demonstrated by the Gateway Project. The central portion of the road is often the most appropriate for major tree planting and has historic precedence in Cairns in Streets such as Shields Street, which now forms part of the City Place.



Cairns City in a Garden  
Master Plan 2007

Part B  
Tree Species  
Selection

### 2.2. Precinct based approach

Related to the principle of a consistent and coordinated theme for individual streets is the concept of “precinct” planting. All new planting will be based on a precinct approach where tree species selection and planting will reinforce the distinct physical character of each area and be responsive to its unique environmental conditions.

The following broad precincts are in accordance with the Cairns Plan; these are further divided into smaller precincts according to historical neighbourhoods and districts.

#### Precincts are as follows:

##### **Cairns Beaches**

- Palm Cove
- Clifton Beach
- Kewarra Beach
- Trinity beach

##### **Baron-Smithfield**

- Trinity Park
- Yorkeys Knob
- Holloways Beach
- Machans Beach
- Smithfield
- Caravonica

##### **Redlynch Valley**

- Kamerunga
- Redlynch

##### **Freshwater Stratford Aeroglen**

- Freshwater
- Stratford
- Aeroglen

##### **Cairns North-CBD**

- CBD (Please refer to the Cairns CBD Master Plan)
- Cairns North

##### **Portsmith Woree Industrial**

##### **Inner Suburbs**

- Edge Hill & Whitfield
- Kanimbla & Brinsmead
- Paramatta Park
- Manunda & Manoora
- Westcourt & Bungalow
- Earlville & Mooroolooloolo
- Bayview Heights & Woree

##### **Whiterock-Edmonton**

- White Rock
- Edmonton

##### **Gordonvale-Goldsborough**

##### **Babinda**

##### **Rural Lands**

Cairns City in a Garden  
Master Plan 2007

Part B  
Tree Species  
Selection



**3. Planting Styles**

**3.1. Formal Avenue**

Formal Avenue Planting is for areas where a consistent line of trees of the same species and scale is preferred.



**3.2. Alternative Avenue**

Where Formal Avenue Planting is limited to one side of the street only due to local constraints such as power lines or other services or infrastructure.



### 3.3. Grove

Grove Planting is for areas where dense informal groupings of trees are preferred, and where a more natural effect is desirable.



### 3.4. Reinforced Existing Planting

Reinforced Existing Planting is for streets containing existing species that have been nominated for infill planting. Planting layout will usually be consistent with existing scheme. In order that proposed street tree plantings will read as strong designs, all palette species are recommended as pure stands, avenues or groves. Mixed planting is not recommended unless otherwise stated.

### 3.5. Special Planting

Special Planting is for specific, designated areas where trees of special character are preferred, clearly distinguishable from the character of General Planting. This may be employed at key cultural sites (see also 3.7 and 3.10).

Extent is to be limited in order to maintain maximum effect. Key commercial strips and cultural areas should be enhanced and distinguished through special Tree planting.

There has historically been a degree of conflict between commercial properties and Street Tree Planting. Trees are often seen as undesirable as they obscure views of adjacent businesses from the road, and block out vital signage and advertising. Strategies need to be developed that resolve this conflict, perhaps through the use of Palms, and wider spacing for footpath trees.

### 3.6. Reinforce and celebrate Gateways to the CBD

These streets have been identified for their potential to herald major parks and important areas of open space, by providing landscape cues along the major routes leading from arterial roads.

These major roads form corridors of movement through our area and are considered as separate in character to the precincts and suburbs they divide or bound.



Cairns City in a Garden  
Master Plan 2007

Part B  
Tree Species  
Selection

## Planting Styles

These streets will be strengthened with consistent, unified tree and planting schemes.

Where the planting of street trees is prohibited by services, such as overhead power lines plantings of trees suitable for heavy shaping or low hedging along the nature strip may be a preferred landscape option, as in the case of McCoombe Street.

### **3.7. Allow the borrowed landscape to take precedence around existing parks and open space**

These streets have been identified for their potential to use adjacent open spaces for street tree planting. Tree planting in these streets could then be implemented with significantly less ongoing management costs, and contribute to both the street and the open space.

### **3.8. Provide buffers to protect and enhance areas of indigenous vegetation**

Streets are identified in this category for their potential to provide buffers to existing areas of indigenous vegetation and to protect and enhance these sensitive areas through sympathetic species selection. This would greatly increase the populations of some remnant species, enhancing their long-term survival. It will also act to signal to surrounding streets the unique character of the surviving habitat.

### **3.9. Provide corridors to link existing areas of indigenous vegetation or public open space**

Streets are identified in this category for their potential to link areas of existing indigenous vegetation or public open space.

### **3.10. Heritage associations**

If appropriate, street tree planting can be sympathetic to the heritage values of the built environment to further strengthen the sense of place for these areas; reinforcing heritage associated street tree plantings where possible. Trees should frame and not obscure Historic Sites, being used to enhance entrances and particular viewpoints.

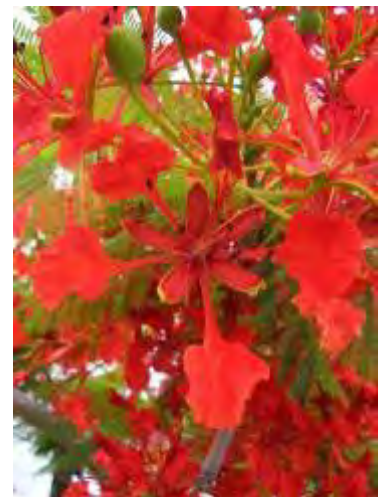

Cairns City in a Garden  
Master Plan 2007

Part B  
Tree Species  
Selection



**CAIRNS  
CITY IN A  
GARDEN  
MASTER PLAN  
PART C  
PRECINCT PLANS**



## City in a Garden Master Plan Part C- Precinct Plans

This section of the Cairns City in a Garden Master Plan provides a template for future tree planting in the key city streets (for a summary list of priority streets and tree species palettes refer to City in a Garden Master Plan Part E-Appendices)

The precinct approach is in line with the Cairns Plan and addresses local issues and provides a guide to appropriate tree species selection for each precinct and outlines key objectives.

For Central Cairns, the area defined by Florence Street to the north, the western footpath of the Esplanade to the east, the CBD side of the Wharf Street footpath to the south, and Bunda Street (east side of street) to the west, please refer to the Cairns CBD Master Plan 2007 for full planting details.

<b>CITY IN A GARDEN MASTER PLAN 2007</b>	<b>2</b>
<b>Vision Statement</b>	Error! Bookmark not defined.
<b>Context</b>	<b>2</b>
<b>CAIRNS CITY IN A GARDEN PART A-INTRODUCTION</b>	<b>10</b>
<b>CITY IN A GARDEN MASTER PLAN PART B-TREE SPECIES SELECTION</b>	<b>14</b>
<b>CITY IN A GARDEN MASTER PLAN PART C- PRECINCT PLANS</b>	<b>30</b>
<b>1. Cairns Beaches</b>	<b>32</b>
1.1. Palm Cove	32
1.2. Clifton Beach	34
1.3. Kewarra Beach	36
1.4. Trinity Beach	38
<b>2. Barron Smithfield</b>	<b>40</b>
2.1. Trinity Park	40
2.2. Yorkeys Knob	42
2.3. Holloways Beach	44
2.4. Machans Beach	46
2.5. Smithfield	48
2.6. Caravonica	51
<b>3. Redlynch Valley</b>	<b>53</b>
3.1. Kamerunga	53

Cairns City in a Garden  
Master Plan 2007

Part C  
Precinct Plans

## Table of Contents

3.2.	Redlynch	55
<b>4.</b>	<b>Freshwater Stratford &amp; Aeroglen</b>	<b>57</b>
4.1.	Freshwater	57
4.2.	Stratford & Aeroglen	59
<b>5.</b>	<b>Cairns North and CBD</b>	<b>61</b>
5.1.	CBD refer to Cairns CBD Streetscape Master Plan	61
5.2.	Cairns North	61
<b>6.</b>	<b>Portsmouth Woree Industrial</b>	<b>65</b>
6.1.	Portsmouth and Woree Industrial	65
<b>7.</b>	<b>Inner Suburbs</b>	<b>67</b>
7.1.	Edge Hill and Whitfield	67
7.2.	Kanimbla & Brinsmead	69
7.3.	Paramatta Park	71
7.4.	Manunda & Manoora	73
7.5.	Westcourt & Bungalow	75
7.6.	Earlville & Moorooloolo	77
7.7.	Bayview Heights & Woree	79
<b>8.</b>	<b>White Rock &amp; Edmonton</b>	<b>81</b>
8.1.	White Rock	81
8.2.	Edmonton	83
<b>9.</b>	<b>Gordonvale &amp; Goldsborough</b>	<b>86</b>
9.1.	Gordonvale	86
<b>10.</b>	<b>Babinda</b>	<b>88</b>
10.1.	Babinda	88
<b>11.</b>	<b>Rural Lands</b>	<b>90</b>
11.1.	Rural Lands	90
<b>CITY IN A GARDEN MASTER PLAN PART D TECHNICAL GUIDELINES</b>		<b>99</b>
<b>CITY IN A GARDEN PART E- APPENDICES</b>		<b>128</b>
<b>CITY IN A GARDEN PART F-STREETScape TEMPLATES</b>		<b>178</b>

Cairns City in a Garden  
Master Plan 2007

Part C  
Precinct Plans

## **1. Cairns Beaches**

### **General Description**

The Cairns Beaches Precinct is situated in the narrow coastal plain that stretches to the north of Cairns City. It is flanked to the east by the Coral Sea and to the west by the steep forested hill slopes of the Macalister Range.



### **1.1. Palm Cove**

#### **1.1.1 Precinct Description**

Palm Cove is a major tourist destination in Cairns and offers a wide range of luxury accommodation and numerous restaurants along the beach front.

As early as the 1930's palm Cove was a popular destination for a picnic or a swim. Most usable land here was put to sugar cane. By the early 1980's the area was still little more than a collection of shops, a post office and a couple of guest houses. The Ramada was one of the first of the luxury resorts to be built at palm Cove back in 1986. The 2.5 hectare site was originally an ancient grove of Melaleuca; and today huge Melaleuca trees still dominate the esplanade and give Palm Cove its unique setting.

#### **1.1.2 Precinct Objectives**

##### **General**

- **To enhance the streetscape with street trees of appropriate scale and form**
- **To respect established street tree character**
- **To create links with the remaining natural vegetation and establish wildlife corridors between the coastal areas and hill slopes.**
- **Encourage use of native and threatened species**

##### **Special**

- **To enhance the tropical feel of the main approach streets**
- **Continue theme of Melaleuca leucadendra where these occur on Esplanade**
- **North and South of Esplanade introduce Terminalia Catappa as regular street tree**



**1.1.3 Precinct Conditions**

**Existing Street Trees**

Planting is a major component of the Esplanade and contributes greatly to the resort character.

**Dominant Species**

*Melaleuca leucadendron* Weeping Paperbark  
*Cocos nucifera* Coconut Palm

**1.1.4 Built Form and Road Widths**

**1.1.5 Microclimate**

The area is exposed to strong coastal influences with prevailing south-easterly winds during the winter months.

**1.1.6 Geological/Soil Conditions**

The precinct comprises of beaches, fore dunes and swales together with riparian corridors. Soils are dominantly fine grained sands and clays.

**1.1.7 Street Name Themes**

Palms & Ferns, Tranquillity

**1.1.8 Street and Park Tree Species Palette Guide for Palm Cove**

<b>Acmena hemilampra</b>	<i>Blush Satinash</i>
<b>Calophyllum sil</b>	<i>Blush Touriga</i>
<b>Deplanchea tetraphylla</b>	<i>Golden Bouquet</i>
<b>Dictyosperma album</b>	<i>Princess Palm</i>
<b>Dillenea alata</b>	<i>Red Beech</i>
<b>Gmelina fasciculiflora</b>	<i>White Beech</i>
<b>Guettarda speciosa</b>	<i>Indian Funeral Flower</i>
<b>Gulubia costata</b>	<i>Gulubia Palm</i>
<b>Melaleuca leucadendra</b>	<i>Weeping Paperbark</i>
<b>Podocarpus grayae</b>	<i>Weeping Brown pine</i>
<b>Randia fitzalani</b>	<i>Native Gardenia</i>
<b>Syzygium angophoroides</b>	<i>Yarrabah Satinash</i>
<b>Syzygium forte ssp forte</b>	<i>White Apple</i>

**1.1.9 Street Tree Species Palette for Palm Cove**

Street Name	Between	Median	Verge	Footpath	P
<b>Argentea</b>	Capt. Cook	Syzygium in var.		Deplanchea tetraphylla	
	Triton				
<b>Cedar</b>	Warren			Tabebuia pallida	P
	Williams				
<b>Veivers</b>		Tibouchina (shrub)		Randia fitzalanii	P

P-indicates selected species for planting under power lines

## **1. Cairns Beaches**

### **General description**

The Cairns Beaches Precinct is situated in the narrow coastal plain that stretches to the north of Cairns City. It is flanked to the east by the Coral Sea and to the west by the steep forested hill slopes of the Macalister Range.



## **1.2. Clifton Beach**

### **1.2.1 Precinct Description**

In the 1930's Clifton had no transport to town and a one lane road into the city with no shops or schools, however people were attracted here by the surrounding rich soils and they settled to farm. Unlike much of Cairns many farms here grew bananas, mangos and pineapples.

It is primarily a residential area, with some scattered tourist accommodation concentrated along the Arlington Esplanade.

### **1.2.2 Precinct Objectives**

#### **General**

- To enhance the streetscape with street trees of appropriate scale and form
- To respect established street tree character
- To create links with the remaining natural vegetation and establish wildlife corridors between the coastal areas and hill slopes.
- Encourage use of native and threatened species

#### **Special**

- New street tree plantings of regular *Terminalia muelleri* on Upolu Esplanade when power lines are placed underground
- Replace *Melaleuca leucadendron* in tree islands along Endeavour Road with *Randia fitzalanii*

### **1.2.3 Precinct Conditions**

#### **Existing Street Trees**

#### **Dominant Species**

### **1.2.4 Built Form and Road Widths**

### 1.2.5 Microclimate

The area is exposed to strong coastal influences with prevailing south-easterly winds during the winter months.

## Cairns Beaches Clifton Beach

### 1.2.6 Geological/Soil Conditions

The precinct comprises of beaches, fore dunes and swales together with riparian corridors. Soils are dominantly fine grained sands and clays.

### 1.2.7 Street Name Themes

Reefs

### 1.2.8 Street and Park Tree Species Palette Guide for Clifton Beach

<b>Acmena hemilampra</b>	<i>Blush Satinash</i>
<b>Calophyllum sil</b>	<i>Touriga</i>
<b>Deplanchea tetraphylla</b>	<i>Golden Bouquet</i>
<b>Dictyosperma album</b>	<i>Princess Palm</i>
<b>Dillenea alata</b>	<i>Red Beech</i>
<b>Gmelina fasciculiflora</b>	<i>White Beech</i>
<b>Guettarda speciosa</b>	<i>Indian Funeral Flower</i>
<b>Gulubia costata</b>	<i>Gulubia Palm</i>
<b>Melaleuca leucadendra</b>	<i>Weeping Paperbark</i>
<b>Podocarpus grayae</b>	<i>Weeping Brown pine</i>
<b>Randia fitzalani</b>	<i>Native Gardenia</i>
<b>Syzygium angophoroides</b>	<i>Yarrabah Satinash</i>
<b>Syzygium forte ssp forte</b>	<i>White Apple</i>

### 1.2.9 Street Tree Species Palette for Clifton Beach

Street Name	Between	Median	Verge	Footpath	P
Endeavor	Capt. Cook		Cerbera manghas	Acmena hemilampra	P
	Upolu				

P-indicates selected species for planting under power lines

Cairns City in a Garden  
Master Plan 2007

Part C  
Precinct Plans

## **1.0 Cairns Beaches**

### **General description**

The Cairns Beaches Precinct is situated in the narrow coastal plain that stretches to the north of Cairns City. It is flanked to the east by the Coral Sea and to the west by the steep forested hill slopes of the Macalister Range.



### **1.3. Kewarra Beach**

#### **1.3.1 Precinct Description**

Kewarra is the youngest of all of Cairns Beach suburbs and has remained largely non-commercial throughout its years of development. In 1967 Cairns engineer Euan Bruce saw the potential at Kewarra and decided to acquire land. The name Kewarra was first used by local Aborigines and literally means **“foot of the rainbow”**, because they often saw rainbows here while they dug for “pippies” at nearby Clifton Beach.

The first house was built in 1972 but it was not until the 1980's that the area really grew into the suburb we see today.

It is primarily a residential area, with some scattered tourist accommodation concentrated along the Arlington Esplanade.

#### **1.3.2 Precinct Objectives**

##### **General**

- **To enhance the streetscape with street trees of appropriate scale and form**
- **To respect established street tree character**
- **To create links with the remaining natural vegetation and establish wildlife corridors between the coastal areas and hill slopes.**
- **Encourage use of native and threatened species**

##### **Special**

- **Respect existing Paradise Palms and Discovery Drive Themes**
- **Esplanade road to be planted with *Deplanchea tetraphylla***
- **Rainbow Theme to include Bush Food**

### 1.3.3 Precinct Conditions

#### Existing Street Trees

Few Street Trees and landscaping to the frontages of private gardens provide most of the planting interest.

#### Dominant Species

### 1.3.4 Built Form and Road Widths

Uniquely Kewarra has no esplanade and the beach front is dominated by luxury housing, locally known as millionaire's row.

### 1.3.5 Microclimate

The area is exposed to strong coastal influences with prevailing south-easterly winds during the winter months.

### 1.3.6 Geological/Soil Conditions

The precinct comprises of beaches, fore-dunes and swales together with riparian corridors. Soils are dominantly fine-grained sands and clays.

### 1.3.7 Street Name Themes

Beaches, Birds and Native Bush Food

#### Special Areas

- Vacant land at southern end of beach has good remnant woodland with mature *Melaleuca*, *Deplanchea*, *Pandanus* & *Livistonia muelleri*

### 1.3.8 for Street and Park Tree Species Palette Guide Kewarra Beach

<b>Acmena hemilampra</b>	<i>Blush Satinash</i>
<b>Barringtonia acutangula</b>	<i>Freshwater Mangrove</i>
<b>Barringtonia calyptrata</b>	<i>Cassowary Pine</i>
<b>Carallia brachiata</b>	<i>Corky bark</i>
<b>Corymbia ptychocarpa</b>	<i>Swamp Bloodwood</i>
<b>Deplanchea tetraphylla</b>	<i>Golden Bouquet</i>
<b>Dillenea alata</b>	<i>Red Beech</i>
<b>Ficus congesta</b>	<i>Red Leaf Fig</i>
<b>Gmelina fasciculiflora</b>	<i>White Beech</i>
<b>Melaleuca leucadendra</b>	<i>Weeping Paperbark</i>
<b>Melaleuca viridiflora</b>	<i>"Burgundy"</i>
<b>Melicope elleryana</b>	<i>Ulysses Butterfly Tree</i>
<b>Syzygium angophoroides</b>	<i>Yarrabah Satinash</i>

### 1.3.9 Street Tree Species Palette for Kewarra Beach

Street Name	Between	Median	Verge	Footpath	P
Poolwood	Capt. Cook		<i>Deplanchea tetraphylla</i>	<i>Barringtonia acutangula</i>	
	Kewarra				
Kewarra	start			<i>Plumeria rubra</i> var.	P
	finish				

P-indicates selected species for planting under power lines

## **1.0 Cairns Beaches**

### **General description**

The Cairns Beaches Precinct is situated in the narrow coastal plain that stretches to the north of Cairns City. It is flanked to the east by the Coral Sea and to the west by the steep forested hill slopes of the Macalister Range.



### **1.4. Trinity Beach**

#### **1.4.1 Precinct Description**

Trinity beach began life as Double Island Beach back in the early 1920's, it was so named because of the views it offered to the island. There was little more than a dirt road in to town in those days and it could take two hours to reach Cairns, that is, if the road was not flooded. The name persisted until the early 1970's

During WW2 troops were stationed here for training in preparation for the invasion of Borneo. In the 1970's and 80's the areas transformation from cane land to residential attracted many ex-Pats, hence the numerous street names that connect to Papua New Guinea.

Tourist accommodation all but dominates the beachfront and many of the streets behind. This is a popular beach suburb and a gathering place for tourists and locals alike.

#### **1.4.2 Precinct Objectives**

##### **General**

- **To enhance the streetscape with street trees of appropriate scale and form**
- **To respect established street tree character**
- **To create links with the remaining natural vegetation and establish wildlife corridors between the coastal areas and hill slopes.**
- **Encourage use of native and threatened species**

##### **Special**

- **To respect planting theme of WWII Regimental Colours along Trinity Beach Road**
- **Esplanade planting to be Barringtonia calyprata and Terminalia muelleri**

#### **1.4.3 Precinct Conditions**

##### **Existing Street Trees**

There is a highly landscaped entry road, and the volume of resort style apartments and complexes results over all in a highly landscaped streetscape.

### Dominant Species

<b>Barringtonia calyprata</b>	<i>Cassowary Pine</i>
<b>Terminalia Muelleri</b>	<i>Queensland Blue Almond</i>
<b>Peltophorum pterocarpum</b>	<i>Copper Pod</i>
<b>Melaleuca leucadendron</b>	<i>Paperbark</i>

### Cairns Beaches Trinity Beach

#### 1.4.4 Built Form and Road Widths

#### 1.4.5 Microclimate

The area is exposed to strong coastal influences with prevailing south easterly winds during the winter months.

#### 1.4.6 Geological/Soil Conditions

The precinct comprises of beaches, fore-dunes and swales together with riparian corridors. Soils are dominantly fine-grained sands

#### 1.4.7 Street Name Themes

Seashells and Papua New Guinea Locales

#### 1.4.8 Street and Park Tree Species Palette Guide for Trinity Beach

<b>Acmena hemilampra</b>	<i>Blush Satinash</i>
<b>Barringtonia acutangula</b>	<i>Freshwater Mangrove</i>
<b>Barringtonia calyprata</b>	<i>Cassowary Pine</i>
<b>Callistemon viminalis</b>	<i>Weeping Bottlebrush</i>
<b>Cupaniopsis anacardioides</b>	<i>Bush Tuckeroo</i>
<b>Decaspermum humile</b>	<i>Silky Myrtle</i>
<b>Melaleuca leucadendra</b>	<i>Weeping Paperbark</i>
<b>Peltophorum pterocarpum</b>	<i>Copper Pod</i>
<b>Syzygium jambos</b>	<i>Rose Apple</i>
<b>Terminalia arenicola</b>	<i>Beach Almond</i>
<b>Terminalia Muelleri</b>	<i>Queensland Blue Almond</i>

#### 1.4.9 Street Tree Species Palette for Trinity Beach

Street Name	Between	Median	Verge	Footpath	P
Trinity Bch	Esplanade	<b>Melaleuca</b> Acalypha/Gardenia		<b>Callistemon viminalis</b>	<b>P</b>
	Jameson				
Trinity Bch	Jameson	<b>Callistemon viminalis</b> Hymenocallis/Allamanda		<b>Randia fitzalanii</b>	
	Cstwatchers				
Trinity Bch	Cstwatchers	<b>Peltophorum pterocarpum</b>		<b>Xanthostemon chrysantha</b>	
	Rabaul				
Trinity Bch	Rabaul	<b>Peltophorum pterocarpum</b>		<b>Barringtonia acutangula</b>	
	Clayley				
Trinity Bch	Clayley	<b>Callistemon viminalis</b>		<b>Xanthostemon chrysantha</b>	
	Nautilus				
Trinity Bch	Nautilus	Bouganvillea/jasmine		<b>Callistemon viminalis</b>	
	Cook Hwy				
Miami	Poolwood		<b>Peltophorum pterocarpum</b>	<b>Cupaniopsis anacardioides</b>	
	Nova				
Miami	Nova	<b>Link to Centenary Park</b>			
	Trinity park				

P-indicates selected species for planting under power lines

## **2. Barron Smithfield**

### **General description**

The dominant natural features of the Barron-Smithfield precinct are the wetlands adjacent to the coastline and waterways; the floodplain of the Barron Delta with its extensive cane fields; and the extensive views across the floodplain to the Barron Gorge and the forested hill slopes of the Kuranda Range



### **2.1. Trinity Park**

#### **2.1.1 Precinct Description**

#### **2.1.2 Precinct Objectives**

##### **General**

- To enhance the streetscape with street trees of appropriate scale and form
- To respect existing natural vegetation with suitable indigenous species.

##### **Special**

- Esplanade tree theme *Ficus drupacea* and *Sterculia quadrifida*, and *Intsia bijuga* (wet areas only)
- Replace *Maniltoa lenticillata* from median on Reed Road as proving unsuitable to local conditions, replace with *Peltophorum pterocarpum*.

#### **2.1.3 Precinct Conditions**

##### **Existing Street Trees**

##### **Dominant Species**

#### **2.1.4 Built Form and Road Widths**

#### **2.1.5 Microclimate**

The area is exposed to strong coastal influences with prevailing south-easterly winds during the winter months.

#### **2.1.6 Geological/Soil Conditions**

The precinct comprises of beaches, fore-dunes and swales together with riparian corridors. Soils are dominantly fine-grained sands and clays.



2.1.7 Street Name Themes

Yachts

2.1.8 Street and Park Tree Species Palette Guide for Trinity Park

<b>Acmena hemilampra</b>	<i>Blush Satinash</i>
<b>Agathis robusta</b>	<i>Kauri Pine</i>
<b>Barringtonia acutangula</b>	<i>Freshwater Mangrove</i>
<b>Barringtonia calyptrata</b>	<i>Cassowary Pine</i>
<b>Callistemon viminalis</b>	<i>Weeping Bottlebrush</i>
<b>Canarium australianum</b>	<i>Scrub Turpentine</i>
<b>Cupaniopsis anacardioides</b>	<i>Tuckeroo</i>
<b>Deplanchea tetraphylla</b>	<i>Golden Bouquet Tree</i>
<b>Erythrina variegata</b>	<i>Mountain Ebony</i>
<b>Melaleuca leucadendra</b>	<i>Weeping Paperbark</i>
<b>Peltophorum pterocarpum</b>	<i>Copper Pod</i>
<b>Saraca thaipingensis</b>	
<b>Tabebuia ochracea</b>	<i>Greater Golden Trumpet Tree</i>

2.1.9 Street Tree Species Palette for Trinity Park

Street Name	Between	Median	Verge	Footpath	P
Reed Rd	Cook Hwy	Peltophorum pterocarpum	Deplanchea tetraphylla	Cupaniopsis anacardioides	P
	Harbour				
Smithfield Village Dr	Trinity Park	Agathis robusta		Deplanchea tetraphylla	
	Reed Rd				
Smithfield Village Dr	Reed Rd	Agathis robusta		Deplanchea tetraphylla	
	McGregor				
Cheviot	McGregor			Saraca thaipingensis	
	Reed				

P-indicates selected species for planting under power lines

## **2.0 Barron Smithfield**

### **General description**

The dominant natural features of the Barron-Smithfield precinct are the wetlands adjacent to the coastline and waterways; the floodplain of the Barron Delta with its extensive cane fields; and the extensive views across the floodplain to the Barron Gorge and the forested hill slopes of the Kuranda Range



## **2.2. Yorkeys Knob**

### **2.2.1 Precinct Description**

### **2.2.2 Precinct Objectives**

#### **General**

- To enhance the streetscape with street trees of appropriate scale and form
- To respect established street tree character
- To reflect the natural environment through the appropriate selection of tree species
- To create links with the remaining natural vegetation and establish wildlife corridors between the coastal areas and hill slopes.
- Encourage use of native and threatened species

#### **Special**

- Esplanade tree themes *Barringtonia calyptрата* and *Terminalia catappa*

### **2.2.3 Precinct Conditions**

#### **Existing Street Trees**

#### **Dominant Species**

***Barringtonia calyptрата***

*Cassowary Pine*

***Terminalia catappa***

*Pacific Almond*

### **2.2.4 Built Form and Road Widths**

### **2.2.5 Microclimate**

The area is exposed to strong coastal influences with prevailing south-easterly winds during the winter months.

### **2.2.6 Geological/Soil Conditions**

The precinct comprises of beaches, fore-dunes and swales together with riparian corridors. Soils are dominantly fine-grained sands and clays.

**2.2.7 Street Name Themes**  
Golf and Female Christian Names

**Barron Smithfield**  
**Yorkeys Knob**

**2.2.8 Street and Park Tree Species Palette Guide for Yorkeys Knob**

<b>Alstonia scholaris</b>	<i>Milky Pine</i>
<b>Alstonia spectabilis</b>	<i>Weipa Milky Pine</i>
<b>Barringtonia calyptata</b>	<i>Cassowary Pine</i>
<b>Cupaniopsis anacardioides</b>	<i>Bush Tuckeroo</i>
<b>Euroschinus falcata</b>	<i>Pink Poplar</i>
<b>Peltophorum pterocarpum</b>	<i>Copper Pod</i>
<b>Sterculia quadrifida</b>	<i>Peanut Tree</i>
<b>Syzygium forte ssp forte</b>	<i>White Apple</i>
<b>Tabebuia argentea</b>	<i>Silver Trumpet Tree</i>

**2.2.9 Street Tree Species Palette for Yorkeys Knob**

Street Name	Between	Median	Verge	Footpath	P
<b>Yorkeys Knob Rd</b>	Cook Hwy		<b>Peltophorum pterocarpum</b>	<b>Cupaniopsis anacardioides</b>	<b>P</b>
	Antonetta				
<b>Varley</b>	Antonetta		<b>Peltophorum pterocarpum</b>	<b>Cupaniopsis anacardioides</b>	<b>P</b>
	Evans				

P-indicates selected species for planting under power lines

## **2.0 Barron Smithfield**

### **General description**

The dominant natural features of the Barron-Smithfield precinct are the wetlands adjacent to the coastline and waterways; the floodplain of the Barron Delta with its extensive cane fields; and the extensive views across the floodplain to the Barron Gorge and the forested hill slopes of the Kuranda Range



### **2.3. Holloways Beach**

#### **2.3.1 Precinct Description**

#### **2.3.2 Precinct Objectives**

##### **General**

- To enhance the streetscape with street trees of appropriate scale and form
- To respect established street tree character

##### **Special**

- Esplanade tree theme *Terminalia catappa*

#### **2.3.3 Precinct Conditions**

##### **Existing Street Trees**

Holloways has a natural feel with mangroves and Melaleuca swampland trees along foreshore

##### **Dominant Species**

#### **2.3.4 Built Form and Road Widths**

#### **2.3.5 Microclimate**

The area is exposed to strong coastal influences with prevailing south-easterly winds during the winter months.

#### **2.3.6 Geological/Soil Conditions**

The precinct comprises of beaches, fore-dunes and swales together with riparian corridors. Soils are dominantly fine-grained sands and clays.

#### **2.3.7 Street Name Themes**

Trees and Plant Names

### 2.3.8 Street and Park Tree Species Palette Guide for Holloways Beach

### Barron Smithfield Holloways Beach

Acacia leptoloba	Irvinebank Wattle
Acacia oraria	
Banksia dentata	
Canarium vitiense	
Clerodendron longiflorum	
Corymbia phoenicea	Scarlet Gum
Corymbia tessellaris	Moreton Bay Ash
Darlingia darlingiana	Brown Silky Oak
Deplanchea tetraphylla	Golden Bouquet
Euroschinus falcata	Pink Poplar
Melaleuca dealbata	Blue Paperbark
Melaleuca leucadendra	Weeping Paperbark
Millettia pinnata	Indian Beech
Mimusops elengi	Tanjong
Plumeria rubra	Frangipani

### 2.3.9 Street Tree Species Palette for Holloways Beach

Street Name	Between	Median	Verge	Footpath	P
Holloways Bch	Capt. Cook			Corymbia tessellaris	
	Cassia				

P-indicates selected species for planting under power lines

Cairns City in a Garden  
Master Plan 2007

Part C  
Precinct Plans

## **2.0 Barron Smithfield**

### **General description**

The dominant natural features of the Barron-Smithfield precinct are the wetlands adjacent to the coastline and waterways; the floodplain of the Barron Delta with its extensive cane fields; and the extensive views across the floodplain to the Barron Gorge and the forested hill slopes of the Kuranda Range



## **2.4. Machans Beach**

### **2.4.1 Precinct Description**

Machans Beach is one of the oldest beach suburbs in Cairns, but the physical constraints of its surroundings has meant that development here has had less impact. Richard Machan first camped here with his family in 1924; and later settled here, moving from the Atherton tableland in search of a new life. Richard made his living by cutting timber from the almost impenetrable bloodwood forests that surrounded Machans at that time. Much of this timber was used for telephone poles between Stratford and Smithfield.

Until the construction of the bridge in 1925 the only access was via boat across the Barron River at Stratford. In 1932 land was subdivided into building allotments.

Machans Beach is a small residential community with the distinctive character of a coastal village.

### **2.4.2 Precinct Objectives**

#### **General**

- **To enhance the streetscape with street trees of appropriate scale and form**
- **To respect established street tree character**
- **To reflect the natural environment through the appropriate selection of tree species**
- **To create links with the remaining natural vegetation and establish wildlife corridors between the coastal areas and hill slopes.**
- **Encourage use of native and threatened species**

#### **Special**

### **2.4.3 Precinct Conditions**

#### **Existing Street Trees**

2.4.4 Built Form and Road Widths

2.4.5 Microclimate

The area is exposed to strong coastal influences with prevailing south-easterly winds during the winter months.

2.4.6 Geological/Soil Conditions

The precinct comprises of beaches, fore-dunes and swales together with riparian corridors. Soils are dominantly fine-grained sands and clays.

2.4.7 Street Name Themes

2.4.8 Street and Park Tree Species Palette Guide for Machans Beach

<b>Acacia oraria</b>	
<b>Acmena hemilampra</b>	<i>Blush Satinash</i>
<b>Archidendron grandiflorum</b>	<i>Pink Lace Flower</i>
<b>Banksia dentata</b>	
<b>Barringtonia asiatica</b>	<i>Box Fruit</i>
<b>Carallia brachiata</b>	<i>corky bark</i>
<b>Cerbera manghas</b>	<i>Sea Mango</i>
<b>Cerbera odolham</b>	<i>Pong-Pong Tree</i>
<b>Cordia sebestena</b>	
<b>Clerodendron longiflorum</b>	
<b>Clusia rosea</b>	<i>Pork Fat Tree</i>
<b>Coccoloba uvifera</b>	<i>Sea Grape</i>
<b>Cordia subcordiata</b>	<i>Sea Trumpet</i>
<b>Guettarda speciosa</b>	<i>Indian Funeral Flower</i>
<b>Hernandia nymphaefolia</b>	<i>Sea Hearse</i>
<b>Leptospermum madidum</b>	<i>Tea Tree</i>
<b>Ochrosia elliptica</b>	<i>Pokosola</i>
<b>Planchonia careyi</b>	<i>Cocky Apple</i>
<b>Pleiogynium timoriense</b>	<i>Burdekin Plum</i>
<b>Plumeria rubra</b>	<i>Frangipani</i>
<b>Syzygium suborbiculare</b>	<i>Lady Apple</i>

2.4.9 Street Tree Species Palette for Machans Beach

Street Name	Between	Median	Verge	Footpath	P
<b>Machans Beach Rd</b>	Capt. Cook			<b>Cerbera manghas</b>	<b>P</b>
	O'Shea				

P-indicates selected species for planting under power lines

## 2.0 Barron Smithfield

### General description

The dominant natural features of the Barron-Smithfield precinct are the wetlands adjacent to the coastline and waterways; the floodplain of the Barron Delta with its extensive cane fields; and the extensive views across the floodplain to the Barron Gorge and the forested hill slopes of the Kuranda Range



## Barron Smithfield Smithfield

### 2.5. Smithfield

#### 2.5.1 Precinct Description

Smithfield was founded as a small township established near the banks of the Barron River by the surveyor Warner who believed the high banks would protect the area during floods. The township was named in the 1870's after Bill Smith, a local hotel owner, miner and beche-de-mer fisherman. Smithfield grew so rapidly that it eclipsed Cairns. However its success was short-lived, as new tracks were opened up, and by 1877 Smithfield was all but abandoned; until in 1879 the settlement was finally washed out to sea by the rising currents of the Barron River.

In the 1900's the area began to attract pioneering families, who sought land for sugarcane farming. Sugar cane still dominates this area today; but development has been such that Smithfield is now a thriving satellite town with a growing commercial centre, which serves the entire northern beaches area.

There are significant remnants of natural wetland vegetation along the coastal districts including the Cattana Wetlands. The area is at the widest point in the coastal strip but limited by the flood waters of the Barron Delta. The landscape character of open floodplains and cane farms is still very dominant and gives this sub-precinct a unique character, with strong links to its natural and cultural heritage.

Smithfield is the centre for the growing campus of the James Cook University and the popular tourist attractions of Skyrail and Tjapukai Aboriginal Cultural Park.

Cairns City in a Garden  
Master Plan 2007

Part C  
Precinct Plans



### 2.5.2 Precinct Objectives

- To enhance the streetscape with street trees of appropriate scale and form
- To respect established street tree character
- To respect local native vegetation and enhance the character of local fauna
- To reflect the natural environment through the appropriate selection of tree species
- To create links with the remaining natural vegetation and establish wildlife corridors between the coastal areas and hill slopes.
- Encourage use of native and threatened species

### Special

- To increase local Aboriginal heritage values around Tjapuakai with selected tree planting
- Compliment the existing plantings around Smithfield Library

### 2.5.3 Precinct Conditions

### 2.5.4 Built Form and Road Widths

### 2.5.5 Microclimate

The area is still exposed to strong coastal influences with prevailing south-easterly winds during the winter months. Some protection is found along the numerous Creeks.

### 2.5.6 Geological/Soil Conditions

The precinct is set mainly within the Barron River Flood plain. Soils are dominated by marine sands and muds.

### 2.5.7 Street Name Themes

Mountains, Scottish Christian Names, Scholasticism and Learning

### 2.5.8 Street and Park Tree Species Palette Guide for Smithfield

<b>Cordia dichotoma</b>	<i>Glue Berry</i>
<b>Carallia brachiata</b>	<i>Corkwood</i>
<b>Cassia fistula</b>	
<b>Diploglottis diphylostegia</b>	<i>Native Tamarind</i>
<b>Ganophyllum falcatum</b>	<i>Scaly Ash</i>
<b>Glochidion herveyanum</b>	<i>Daphne Buttonwood</i>
<b>Harpullia pendula</b>	<i>Tulipwood</i>
<b>Randia fitzalanii</b>	<i>Native Gardenia</i>
<b>Syzygium jambos</b>	<i>Rose Apple</i>
<b>Syzygium tierneyanum</b>	<i>River Cherry</i>
<b>Tabebuia chrysantha</b>	<i>Golden Trumpet Tree</i>
<b>Xanthostemon chrysanthus</b>	<i>Golden Penda</i>

### Smithfield East of McGregor

<b>Acmena hemilampra</b>	<i>Blush Satinash</i>
<b>Acmena smithii</b>	<i>Lily Pilly</i>
<b>Cryptocarpa triplinervis</b>	<i>Brown Laurel</i>
<b>Darlingia darlingiana</b>	<i>Brown Silky Oak</i>
<b>Pongamia pinnata</b>	<i>Indian Beech</i>
<b>Syzygium angophoroides</b>	<i>Yarrabah Satinash</i>
<b>Syzygium jambos</b>	<i>Rose Apple</i>
<b>Syzygium leuhmannii</b>	<i>Cherry Satinash</i>
<b>Syzygium tierneyanum</b>	<i>River Cherry</i>
<b>Tabebuia chrysantha</b>	<i>Golden Trumpet Tree</i>
<b>Terminalia sericocarpa</b>	<i>Damson</i>
<b>Xanthostemon chrysanthus</b>	<i>Golden Penda</i>

**2.5.9 Street Tree Species Palette for Smithfield**

Street Name	Between	Median	Verge	Footpath	P
Mt Millman	Capt. Cook end	Darlingia darlingiana		Darlingia darlingiana	P
	Lydia Sidlaw				
McGregor	Sidlaw Dunn	Cassia fistula		Syzygium leuhmannii	

P-indicates selected species for planting under power lines

## **2.0 Barron Smithfield**

### **General description**

The dominant natural features of the Barron-Smithfield precinct are the wetlands adjacent to the coastline and waterways; the floodplain of the Barron Delta with its extensive cane fields; and the extensive views across the floodplain to the Barron Gorge and the forested hill slopes of the Kuranda Range



### **2.6. Caravonica**

#### **2.6.1 Precinct Description**

Caravonica and the neighbouring Lake Placid are small residential suburbs somewhat removed from the remaining precinct, nestled as they are among the foothills of the Kamerunga Range. Caravonica was named by its most famous resident Italian doctor of science and agriculture David Thomatis. Some believe the name derives from the Italian for “my dearest” and the shortened Vonica after his wife who died in 1884. At this same time Thomatis moved to Caravonica to make a fresh start, creating very successful new strains of cotton and coffee, as well as experimenting with rice and cocoa.

Caravonica is dominated by the Barron Gorge and the Barron River. There are extensive areas of remnant rainforest higher on the slopes of what is now the Barron Gorge National Park. Below lies the charming Lake Placid which offers boating and swimming, as well as camping. The area has few shops but does have the Caravonica State School.

It is a low density residential area developed mainly during the 1970's when former sugar cane farm land was sub-divided.

#### **2.6.2 Precinct Objective**

##### **General**

- **To enhance the streetscape with street trees of appropriate scale and form**
- **To respect established street tree character**
- **To respect natural vegetation**
- **To reflect the natural environment through the appropriate selection of tree species**
- **Encourage use of native and threatened species**

##### **Special**

#### **2.6.3 Precinct Conditions**

##### **Existing Street Trees**

##### **Dominant Species**

**2.6.4 Built Form and Road Widths**

**2.6.5 Microclimate**

The area can suffer from drought and exposure.

**2.6.6 Geological/Soil Conditions**

The precinct comprises of floodplain and hill slopes together with riparian corridors. Soils are dominantly well drained sands and heavy clays and clay loam mixes.

**2.6.7 Street Name Themes**

Aboriginal Words and Butterfly Names

**2.6.8 Street and Park Tree Species Palette Guide for Caravonica**

<b>Argyrodendron polyandrum</b>	<i>Tulip Oak</i>
<b>Arytera divaricata</b>	<i>Rose Tamarind</i>
<b>Barringtonia acutangula</b>	<i>Freshwater Mangrove</i>
<b>Brachychiton acerifolius</b>	<i>Flame Tree</i>
<b>Cryptocarya triplinervis</b>	
<b>Diploglottis diphylostegia</b>	<i>Wild Tamarind</i>
<b>Endiandra hypotephra</b>	<i>Blue Walnut</i>
<b>Grevillea baileyana</b>	<i>Findlay's Silky Oak</i>
<b>Neolitsea dealbata</b>	<i>Bolly Gum</i>
<b>Syzygium alliiligneum</b>	<i>Onionwood</i>
<b>Syzygium cormiflorum</b>	<i>Bumpy Satinash</i>
<b>Tabebuia argentea</b>	<i>Silver trumpet tree</i>

**2.6.9 Street Tree Species Palette for Caravonica**

Street Name	Between	Median	Verge	Footpath	P
					P

P-indicates selected species for planting under power lines

### **3. Redlynch Valley**



#### **3.1. Kamerunga**

##### **3.1.1 Precinct Description**

Kamerunga was first established in what was then known as Barronville in 1887. It was set up by the State Government as the site of an experimental nursery; to determine what crops could be suitable for cultivation in Far North Queensland. The name was soon after changed to Kamerunga, believed to be an Aboriginal name for the Barron River and its falls.

The nursery operated by a Mr Ebenezer Crowley, featured vanilla and oil palms; rubber producing plants; fibre plants including cotton, sisal, jute and kapok; and a host of fruits. Sadly most of these crops proved unreliable and were abandoned, but the nursery did test sugar cane during the 1890's and promoted the use of the Badilla variety that has had huge success.

During the construction of the railway line to Kuranda Kamerunga flourished as hundreds of workers and their families settled. By 1908 however the rail had reached Kuranda and the workers had moved on, leaving behind nothing but four meter high piles of empty bottles.

##### **3.1.2 Precinct Objectives**

###### **General**

- **To enhance the streetscape with street trees of appropriate scale and form**
- **To respect established street tree character**
- **To enhance remnant Riverine Vegetation**

###### **Special**

- **To enhance Exotic Fruit Tree Plantings at Kamerunga Station**

##### **3.1.3 Precinct Conditions**

###### **Existing Street Trees**

###### **Dominant Species**

##### **3.1.4 Built Form and Road Widths**

##### **3.1.5 Microclimate**

The area can suffer from drought and exposure.

### 3.1.6 Geological/Soil Conditions

The precinct comprises of floodplain and hill slopes together with riparian corridors. Soils are dominantly well drained sands and heavy clays and clay loam mixes with areas of water logging and thin skeletal soils.

### 3.1.7 Street Name Themes

### 3.1.8 Street and Park Tree Species Palette Guide for Kamerunga

<b>Buckinghamia celsissima</b>	<i>Ivory Curl</i>
<b>Castanopora alphanthi</b>	<i>Brown tamarind</i>
<b>Dimocarpus australianus</b>	<i>Native Lychee</i>
<b>Diploglottis diphylostegia</b>	<i>Native Tamarind</i>
<b>Dysoxylum gaudichaudianum</b>	<i>Ivory Mahogany</i>
<b>Euphoria longan</b>	<i>Longan</i>
<b>Ficus adenosperma</b>	<i>Creek Fig</i>
<b>Ficus virgata</b>	<i>Large Leaf Weeping Fig</i>
<b>Flacourtia inermis</b>	<i>Lovi Lovi</i>
<b>Gomphandra australianum</b>	
<b>Millettia pinnata</b>	<i>Creek Pongamia</i>
<b>Syzygium jambos</b>	<i>Rose Apple</i>
<b>Syzygium malaccense</b>	<i>Malay Apple</i>
<b>Syzygium samarangense</b>	<i>Wax Jambu</i>
<b>Syzygium tierneyaum</b>	<i>River Cherry</i>
<b>Tectona grandis</b>	<i>Teak</i>

### 3.1.9 Street Tree Species Palette for Kamerunga

Street Name	Between	Median	Verge	Footpath	P
					P

P-indicates selected species for planting under power lines



### 3.2. Redlynch

#### 3.2.1 Precinct Description

Freshwater Creek forms a riparian corridor through the sub-precinct and the surrounding hills provide a stunning backdrop. The upper section of the Redlynch Valley retains a rural feel while more intense residential development is concentrated around the Redlynch Valley Estate.

The sub-precinct is located along the Redlynch Valley. The upper section of Redlynch is characterised by Freshwater Creek bounded closely on both sides by steep forested hill slopes. The lower section opens out to the floodplains of Freshwater Creek and the Barron River.

#### 3.2.2 Precinct Objectives

##### General

- To enhance the streetscape with street trees of appropriate scale and form
- To respect established street tree character
- To reflect the background of forested hill slopes through the appropriate selection of native tree species

##### Special

- Enhance existing vegetation within the Freshwater Creek Riparian Corridor

#### 3.2.3 Precinct Conditions

##### Existing Street Trees

##### Dominant Species

#### 3.2.4 Built Form and Road Widths

#### 3.2.5 Microclimate

#### 3.2.6 Geological/Soil Conditions

#### 3.2.7 Street Name Themes

Rainforest and Water, Early Pioneering Families, Historical references and Sugar Cane Industry, Geomorphic

### 3.2.8 Street and Park Tree Species Palette Guide for Redlynch

<b>Bischofia javanica</b>	<i>Java Cedar</i>
<b>Cerbera floribunda</b>	<i>Cassowary Plum</i>
<b>Darlingia darlingiana</b>	<i>Brown Silky Oak</i>
<b>Evodiella Muelleri</b>	<i>Dwarf Ulysses Butterfly Tree</i>
<b>Flindersia ifflaiana</b>	<i>Cairns Hickory</i>
<b>Miliusa horsefieldii</b>	
<b>Palaquium galactoxylon</b>	<i>Pencil Cedar</i>
<b>Stockwellia quadrifida</b>	<i>Stockwell's Puzzle</i>
<b>Streblus brunonianus</b>	<i>Whalebone Tree</i>
<b>Syzygium bamagense</b>	<i>Bamaga Satinash</i>
<b>Syzygium cormiflorum</b>	<i>Bumpy Satinash</i>
<b>Syzygium cryptophlebia</b>	<i>Powderpuff Lilly</i>
<b>Syzygium leuhmanii</b>	<i>Small Leaf Lilly Pilly</i>
<b>Wrightia laevis ssp millgar</b>	<i>Millgar</i>

### 3.2.9 Street Tree Species Palette for Redlynch

Street Name	Between	Median	Verge	Footpath	P
<b>Redlynch Intake</b>	West Arterial			<b>Evodiella Muelleri</b>	<b>P</b>
	Jungara				
<b>Redlynch Intake</b>	Jungara	<b>Darlingia darlingiana</b>		<b>Flindersia ifflaiana</b>	
	Redlynch Co				
<b>Redlynch Intake</b>	Redlynch Co			<b>Flindersia ifflaiana</b>	
	Crystal Casc				

P-indicates selected species for planting under power lines



## 4. Freshwater Stratford & Aeroglen



## Freshwater, Stratford & Aeroglen Freshwater

### 4.1. Freshwater

#### 4.1.1 Precinct Description

Freshwater was named after the creek that provided fresh clean water to the bullock teams that journeyed these racks in the 1890's. The area was first settled by the Chinese in the 1880's, they grew rice, bananas and pineapples, but in time the rich soil was given over to growing sugar cane. The area really began to change in the 1970's with the building of the shopping centre and the sub-division of farms for residential development.

#### 4.1.2 Precinct Objectives

##### General

- To enhance the streetscape with street trees of appropriate scale and form
- To respect established street tree character
- To compliment established gardens with North Queensland Rainforest Species

#### 4.1.3 Precinct Conditions

##### Existing Street Trees

##### Dominant Species

#### 4.1.4 Built Form and Road Widths

#### 4.1.5 Microclimate

The area can suffer from drought and exposure.

#### 4.1.6 Geological/Soil Conditions

The precinct comprises of valley floor and hill slopes together with riparian corridors. Soils are dominantly well drained sands and heavy clays and clay loam mixes.

#### 4.1.7 Street Name Themes

Geographical Features dealing with Water, Significant Early Residents, Sites of WWII Battlefields

Cairns City in a Garden  
Master Plan 2007

Part C  
Precinct Plans

4.1.8 Street and Park Tree Species Palette Guide for Freshwater

<b>Acmena hemilampra</b>	<i>Blush Satinash</i>
<b>Arytera divaricata</b>	<i>Pink Tamarind</i>
<b>Archidendron lucyi</b>	<i>Scarlet Bean</i>
<b>Arytera lautereriana</b>	<i>Corduroy Tamarind</i>
<b>Argyrodendron polyandrum</b>	<i>Tulip Oak</i>
<b>Bischofia javanica</b>	<i>Java Cedar</i>
<b>Buchanania arborescens</b>	
<b>Diploglottis smithii</b>	<i>Pleated Tamarind</i>
<b>Elaeocarpus bancroftii</b>	<i>Kuranda Quandong</i>
<b>Melicope rubra</b>	<i>Dwarf Ulysses Butterfly Bush</i>
<b>Gmelina fasciculiflora</b>	<i>White Beech</i>
<b>Harpullia ramiflora</b>	<i>Claudie Tulipwood</i>
<b>Neolitsea dealbata</b>	<i>Hairy Leaf Bolly Gum</i>
<b>Ormosia ormondii</b>	<i>Yellow Bean</i>
<b>Storckiella australiensis</b>	<i>White Bean</i>
<b>Syzygium fibrosum</b>	<i>Fibrous Satinash</i>
<b>Terminalia sericocarpa</b>	<i>Damson</i>

1..1.1 4.1.9 Street Tree Species Palette for Freshwater

Street Name	Between	Median	Verge	Footpath	P
					P

P-indicates selected species for planting under power lines



#### **4.2. Stratford & Aeroglen**

##### **4.2.1 Precinct Description**

Stratford and Aeroglen are two of the oldest suburbs of Cairns. They are bounded by the Barron River and the Mount Whitfield Environmental Park; with the Cook Highway, Kuranda Rail and Cairns International Airport to the east following the thin coastal strip.

Aeroglen used to be called simply Quarry Siding, and indeed this area was used to generate fill for Central Cairns. The quarries were later used as Cairns Rubbish Tip, only being filled in to create the sports fields in the mid 1980's. In the 1940's the area was quite a rural setting with only a dairy and a paw-paw farm. Even by the 1960's only about 100 people were living here and remains to this day a small community. Stratford was a small community centred around the timber industry back in the early 1920s'; and workers would gather at the Stratford Hotel to cash pay cheques.

##### **4.2.2 Precinct Objectives**

###### **General**

- **To enhance the streetscape with street trees of appropriate scale and form**
- **To respect established street tree character**
- **To compliment established gardens with North Queensland Rainforest Species**

##### **4.2.3 Precinct Conditions**

###### **Existing Street Trees**

###### **Dominant Species**

##### **4.2.4 Built Form and Road Widths**

Stratford is typified by the older style housing; relatively narrow streets and remaining pockets of vegetation along numerous gullies. Stratford Village is designated as a character precinct with several key heritage buildings. There is some industrial activity and large scale retail outlets focused along the highway and rail line. Aeroglen is dominated by detached dwellings but has lost much of its heritage character.

#### 4.2.5 Microclimate

In spite of its proximity to the ocean Stratford and Aeroglen are quite sheltered from coastal influences.

## Freshwater, Stratford & Aeroglen

#### 4.2.6 Geological/Soil Conditions

The area where the airport now sits was once a series of salt pans and the remnants of mangrove swamps still remain. The numerous wet gullies testify to the natural heritage of the area and former swamps.

#### 4.2.7 Street Name Themes

#### 4.2.8 Street and Park Tree Species Palette Guide for Stratford and Aeroglen

<b>Acmena hemilampra</b>	<i>Blush Satinash</i>
<b>Albizia procera</b>	<i>Forest Siris</i>
<b>Archidendron lucyi</b>	<i>Scarlet Bean</i>
<b>Arytera divaricata</b>	<i>Pink Tamarind</i>
<b>Arytera Lautereriana</b>	<i>Corduroy Tamarind</i>
<b>Brachychiton acerifolius</b>	<i>Flame Tree</i>
<b>Bischofia javanica</b>	<i>Java Cedar</i>
<b>Buchanania arborescens</b>	
<b>Diploglottis smithii</b>	<i>Pleated Tamarind</i>
<b>Elaeocarpus bancroftii</b>	<i>Kuranda Quandong</i>
<b>Melicope rubra</b>	<i>Dwarf Ulysses Butterfly Bush</i>
<b>Gmelina fasciculiflora</b>	<i>White Beech</i>
<b>Harpullia ramiflora</b>	<i>Claudia Tulipwood</i>
<b>Neolitsea dealbata</b>	<i>Hairy Leaf Bolly Gum</i>
<b>Ormosia ormondii</b>	<i>Yellow Bean</i>
<b>Storckiella australiensis</b>	<i>White Bean</i>
<b>Syzygium fibrosum</b>	<i>Fibrous Satinash</i>
<b>Terminalia sericocarpa</b>	<i>Damson</i>

#### 4.2.9 Street Tree Species Palette for Stratford and Aeroglen

Street Name	Between	Median	Verge	Footpath	P
					P

P-indicates selected species for planting under power lines

Cairns City in a Garden  
Master Plan 2007

Part C  
Precinct Plans

**5. Cairns North and CBD**

**5.1. CBD refer to Cairns CBD Streetscape Master Plan**



**5.2. Cairns North**

**5.2.1 Precinct Description**

Cairns North is the northern most part of the original settlement of Cairns. The early settlers were forced to build their city atop the many parallel sand ridges that had formed along the coastal strip. The remaining low-lying swamps were later filled with quarry spoil from the Kuranda Railway and from nearby Edge Hill.

The precinct also contains several Historic Buildings and fine examples of Traditional Queenslander Homes from the early part of the last century. These mingle with luxury apartment blocks and Hotels.

There are key areas of public open space including the Esplanade and Munroe Park as well as remnant mangrove swamp at the northern most ends, adjacent to the Lily Street Reserves.

Swamps, mudflats, creeks and waterholes dominated the area prior to settlement. A series of parallel sand ridges follow the main streets north and south; the areas between having been extensively filled with sand and quarry spoil.

**5.2.2 Precinct Objectives**

**General**

- To enhance the streetscape with street trees of appropriate scale and form
- To respect heritage street tree character
- To enhance the tropical character
- To enhance views to the sea
- To create a high quality landscape that reflects the central location of the area.
- To protect and enhance growing conditions for existing street trees

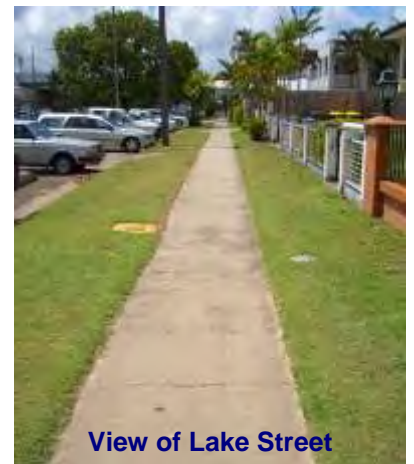

**View of Lake Street**

Cairns City in a Garden  
Master Plan 2007

Part C  
Precinct Plans

## Special

- Lake St (and other inner suburban streets) verges feature distinct *Cassia javanica* putative hybrids gradually being lost.
- Special Plantings to frame the historic churches and church buildings on Lake Street
- Allow the borrowed landscape to take precedence around the Tobruk Memorial Gardens and adjacent remnant swamp on Lake Street.
- Enhance existing native planting along Lily Creek corridor

### 5.2.3 Precinct Conditions

#### Existing Street Trees

Streets generally have a distinct tree theme, with a strong emphasis on flowering species both native and exotic. There is however a general lack of verge plantings; with little shade being provided for the pedestrian or cyclist alike.

Many of the existing street trees exhibit signs of stress and are struggling in the harsh conditions. Extensive hard surfacing and increased pressure from urban redevelopment has resulted in hostile environmental conditions.

Planting within this area must refer to Primary Light Control Plan and Bird and Bat Strike Overlay, Cairns Plan.

#### Dominant Species

<b>Delonix regia</b>	<i>Poinciana</i>
<b>Cassia in var.</b>	<i>Cassia in variety</i>

### 5.2.4 Built Form and Road Widths

The precinct is an area of high-density residential use for both locals and tourists. The streets follow a strong grid typical of early colonial settlement patterns, with wide road reserves (40 meters being typical). The area has heavy pedestrian use and footpaths throughout.

### 5.2.5 Microclimate

The area is exposed to strong coastal influences with prevailing south-easterly winds during the winter months.

### 5.2.6 Geological/Soil Conditions

The area consists of sand ridges running north south parallel with the esplanade, and infill throughout the remaining area.

### 5.2.7 Street Name Themes

Historic early Settlers and High Profile Personages from the Cairns of the 1800's.

Cairns City in a Garden  
Master Plan 2007

Part C  
Precinct Plans

### 5.2.8 Street and Park Tree Species Palette Guide for Cairns North

<b>Barringtonia acutangula</b>	<i>Freshwater Mangrove</i>
<b>Brachychiton acerifolius</b>	<i>Flame Tree</i>
<b>Brachychiton velutinosus</b>	<i>Lace Tree</i>
<b>Caesalpine ferrea</b>	<i>Leopard Tree</i>
<b>Cassia "Rainbow Shower"</b>	<i>Rainbow Shower</i>
<b>Cassia bakeriana</b>	<i>Thai Pink Cassia</i>
<b>Cassia fistula</b>	<i>Golden Shower Tree</i>
<b>Cassia javanica</b>	<i>Pink Cassia</i>
<b>Cassia Queenslandica</b>	
<b>Cerbera manghas</b>	<i>Pong-Pong</i>
<b>Corymbia ptychocarpa</b>	<i>Swamp Bloodwood</i>
<b>Cupaniopsis anacardioides</b>	<i>Bush Tuckeroo</i>
<b>Delonix regia</b>	<i>Poinciana</i>
<b>Flindersia ifflaiana</b>	<i>Cairns Hickory</i>
<b>Lagerstroemia speciosa</b>	<i>Pride of India</i>
<b>Peltophorum pterocarpum</b>	<i>Copper Pod</i>
<b>Plumeria obtusa</b>	<i>Evergreen Frangipani</i>
<b>Plumeria rubra</b>	<i>Frangipani</i>
<b>Plumeria rubra "June Bride"</b>	<i>Frangipani "June Bride"</i>
<b>Plumeria rubra "Sunbathed"</b>	<i>Frangipani "Sunbathed"</i>
<b>Pongamia pinnata</b>	
<b>Randia fitzalanii</b>	<i>Native Gardenia</i>
<b>Syzygium alliligneum</b>	<i>Onionwood</i>
<b>Tabebuia pallida</b>	<i>Evergreen Trumpet Tree</i>
<b>Toechima daemelianum</b>	<i>Cape Tamarind</i>
<b>Wodyetia bifurcata</b>	<i>Foxtail Palm</i>
<b>Xanthostemon chrysanthus</b>	<i>Golden Penda</i>

### 5.2.9 Street Tree Species Palette for Cairns North-North/South Streets

Street Name	Between	Median	Verge	Footpath	P
Lily	Sheridan		Cassia fistula	Cupaniopsis anacardioides	P
	Lake				
Lily	Lake		Pongamia pinnata	Cupaniopsis anacardioides	P
	Esplanade				
Smith	Esplanade		Corymbia ptychocarpa	Syzygium jambos	
	Sheridan				
McKenzie	Esplanade		Lagerstroemia speciosa	Tabebuia pallida	P
	Sheridan				
Charles	Esplanade		Cassia "Queenslandica"	Lagerstroemia speciosa	P
	Sheridan				
Grove	Esplanade	Peltophorum pterocarpum	Peltophorum pterocarpum	Cerbera manghas	P
	Sheridan				
Upward	Esplanade		Caesalpine ferrea	Cupaniopsis anacardioides Caesalpine ferrea	P
	Sheridan				
Minnie	Esplanade		Delonix regia	Xanthostemon chrysanthus	
	Sheridan				

Cairns City in a Garden  
Master Plan 2007

Part C  
Precinct Plans

## 5.2.9 Street Tree Species Palette for Cairns North-East/West Streets

Street Name	Between	Median	Verge	Footpath	P
Lake	Airport Dr	Pongamia pinnata	Cassia fistula	Barringtonia acutangula	
	Moffitt				
Lake	Moffitt	Pongamia pinnata	Cassia javanica	Barringtonia acutangula	
	Rutherford				
Lake	Rutherford	Link to Tobruk Memorial Gardens			
	Lilly				
Lake	Lilly	Pongamia pinnata	Cassia "Rainbow Shower"	Barringtonia acutangula	
	Grove				
Lake	Grove	Pongamia pinnata	Cassia "Rainbow Shower"	Barringtonia acutangula	
	Kerwin				
Lake	Kerwin	Pongamia pinnata	Cassia "Rainbow Shower"	Barringtonia acutangula	
	Florence				
Lake	Florence	Refer to Cairns CBD Streetscape Master Plan			
	Wharf				
Grafton	Upward	Syzygium alliligineum	Brachychiton acerifolius	Randia fitzalanii	
	Florence				
Grafton	Florence	Refer to Cairns CBD Streetscape Master Plan			
	Wharf				
Digger	Lily		Brachychiton velutinosus	Tabebuia pallida	P
	Upward				
Sheridan	Airport Dr	Gateway		Caesalpineia ferrea	
	Rutherford				
Sheridan	Rutherford	Gateway		Caesalpineia ferrea	
	Lily				
Sheridan	Lily	Gateway		Caesalpineia ferrea	
	Minnie				
Sheridan	Minnie	Gateway/Link to Munro Martin Park			
	Florence				
Sheridan	Florence	Refer to Cairns CBD Streetscape Master Plan			
	Wharf				
McLeod	Arthur		Cassia "Rainbow Shower"	Toechima daemelianum	
	Grove				
McLeod	Grove	Link to Pioneers Cemetery			
	Gatton				
McLeod	Gatton		Cassia "Rainbow Shower"	Toechima daemelianum	
	Florence				
McLeod	Florence	Refer to Cairns CBD Streetscape Master Plan			
	Wharf				

P-indicates selected species for planting under power lines



## 6. Portsmith Woree Industrial

## Portsmith Woree Industrial



### 6.1. Portsmith and Woree Industrial

#### 6.1.1 Precinct Description

Portsmith is the industrial face of Cairns. Industry is focused around the wharves and the railway yards, where in the early days families lived and worked among the mills and factories. Cairns Timber was established here in 1909 and was one of the largest in Queensland, preparing logs from rainforests at Redlynch, Freshwater and Fishery falls. Another large employer here before WW2 was the Great Northern Brewery, sadly all brewing ceased here in 1992.

Much of the area was reclaimed during the 1950's by using fill produced from the dredging of Trinity Bay. The area became known as "Perfume Creek" because of the smell of the stagnant sludge.

There is some public access, mainly to the boat ramps along the bay. These are very popular at the weekends.

Railway staff, who misunderstood the aboriginal word for shallow water or "wuree" to mean little girl, coined the name Woree.

In the early part of the last century this was a largely farming area, with dairy and cane farms dominating the landscape.

Swamps, mudflats, creeks and waterholes dominated the area prior to settlement. The precinct still contains significant mangrove and wetland areas adjacent to Chinaman Creek and Smith's Creek, these form a vital part of the Trinity Inlet ecosystem.

#### 6.1.2 Precinct Objectives

##### General

- To reflect the remnant vegetation with the selection of appropriate species (minimum 75% natives)
- To enhance views to the surrounding mountains and the Bay.
- Selected tree species should be tolerant of the growing conditions of the area.

##### Special

- Comport should maintain and reflect adjacent open space and remnant vegetation such as Chinaman Creek.

Cairns City in a Garden  
Master Plan 2007

Part C  
Precinct Plans

### 6.1.3 Precinct Conditions

#### Existing Street Trees

This area is exposed to heavy vehicular use and trees are in a high stress environment.

#### Dominant Species

**Terminalia catappa** *Beach Almond*

## Portsmith Woree Industrial

### 6.1.4 Built Form and Road Widths

The precinct is an industrial area with a mix of modern and historic industrial structures. Road reserves are wide but there are remnants of disturbed natural vegetation and some spectacular views to the mountains and glimpses of the Trinity Bay. These elements form an interesting, if uneasy relationship, which is unique to Portsmith and Woree.

### 6.1.5 Microclimate

The area is exposed to strong coastal influences with prevailing south-easterly winds during the winter months.

### 1.1.3 6.1.6 Geological/Soil Conditions

Much of this area is reclaimed swamp and soils here can be very heavy and waterlogged with a high salt water table.

### 6.1.7 Street Name Themes

### 6.1.8 Street and Park Tree Species Palette Guide for Portsmith and Woree

<b>Agathis robusta</b>	<i>Kauri Pine</i>
<b>Calophyllum inophyllum</b>	
<b>Cassia fistula</b>	<i>Golden Shower Tree</i>
<b>Casuarina glauca</b>	<i>Swamp She-oak</i>
<b>Cathormion umbellatum</b>	
<b>Dolichandrone spathacea</b>	<i>Mangrove Trumpet Flower</i>
<b>Ficus microcarpa</b>	
<b>Heretiera littoralis</b>	<i>Looking Glass Mangrove</i>
<b>Hibiscus tiliaceus 'rubra'</b>	<i>Purple Leaf Cottonwood</i>
<b>Livistonia decipiens</b>	<i>Weeping Cabbage Palm</i>
<b>Lysiloma latisiliquum</b>	
<b>Melaleuca leucadendra</b>	
<b>Terminalia catappa</b>	<i>Beach Almond</i>

### 6.1.9 Street Tree Species Palette for Portsmith and Woree Industrial

Street Name	Between	Median	Verge	Footpath	P
					P

P-indicates selected species for planting under power lines

Cairns City in a Garden  
Master Plan 2007

Part C  
Precinct Plans

## 7. Inner Suburbs



### 7.1. Edge Hill and Whitfield

#### 7.1.1 Precinct Description

Instead of the desirable suburb we know today, Edge Hill began life in the 1880's and 90's as Edge Cliff, where a quarry was excavated and the spoil carried along a small tramway to consolidate fill in central Cairns.

The area was dominated by cane and dairy farms until the 1940's and 50's when the tramlines, which transported the cane, were removed and farming began to decline. The area rapidly developed into what is now a highly distinctive and desirable area. Originally part of Edge Hill, the area that is now known as Whitfield was named in the 1970's, after the range that provides its spectacular backdrop.

One of the outstanding features of Edge Hill is the Flecker Botanical Gardens, established here in 1887 by a Mr Fitzalan. The gardens were further developed by the dedicated work of Dr Hugo Flecker after whom the gardens were renamed in 1970. The Gardens link to Centenary Lakes and the Cultural Hub centred round the Tanks Art Centre and other cultural activities located in Greenslopes.

#### 7.1.2 Precinct Objectives

##### General

- To enhance the streetscape with street trees of appropriate scale and form.
- To respect established street tree character
- To enhance native plantings along existing watercourses.

##### Special

- To maintain a mix of rainforest and exotic trees appropriate to the geological location and to enhance the character of the Botanic Gardens Precinct.
- To increase the use of indigenous species endemic to the Whitfield Range.

#### 7.1.3 Precinct Conditions

##### Existing Street Trees

This is one of the leafiest of the Cairns precincts, with well-established streetscapes

## Dominant Species

## Inner Suburbs Edge Hill & Whitfield

### 7.1.4 Built Form and Road Widths

Edge Hill has been designated as a character precinct because of the distinctive cultural significance of its built form.

The precinct is almost entirely residential with a scattering of local shops. Street patterns follow the rising contours of the lower slopes of the Whitfield Range.

### 7.1.5 Microclimate

In spite of its proximity to the ocean the precinct is quite sheltered from coastal influences.

### 7.1.6 Geological/Soil Conditions

The precinct comprises of remnant swamp floor and hill slopes together with riparian corridors. Soils are dominantly well drained sands and heavy clays and clay loam mixes.

### 7.1.7 Street Name Themes

### 7.1.8 Street and Park Tree Species Palette Guide for Edge Hill and Whitfield

<b>Buckinghamia celsissima</b>	<i>Ivory Curl</i>
<b>Corymbia ptychocarpa</b>	<i>Swamp Bloodwood</i>
<b>Flindersia ifflaiana</b>	<i>Cairns Hickory</i>
<b>Gustavia augusta</b>	<i>Membrillo</i>
<b>Lophanthera lactescens</b>	<i>Golden Chain Tree</i>
<b>Melaleuca leucadendra</b>	<i>Paperbark</i>
<b>Mesua ferrea</b>	<i>Ceylon Ironwood</i>
<b>Podocarpus grayae</b>	<i>Narrow-leaf Brown Pine</i>
<b>Randia fitzalanii</b>	<i>Native Gardenia</i>
<b>Saraca thiapingensis</b>	<i>Saffron Saraca</i>
<b>Taberbaemontana sp. Madang</b>	<i>'Orange Twister'</i>

### 7.1.9 Street Tree Species Palette for Edge Hill and Whitfield

Street Name	Between	Median	Verge	Footpath	P
<b>McManus</b>	Reservoir		<b>Lophanthera lactescens</b>	<b>Flindersia ifflaiana</b>	
	Woodward				
<b>Greenslopes</b>	Sheridan	<b>Melaleuca leucadendra</b>		<b>Corymbia ptychocarpa</b> <b>Randia fitzalanii</b>	<b>P</b>
	Pease				
<b>Pease</b>	Greenslopes	<b>Corymbia ptychocarpa</b>		<b>Buckinghamia celsissima</b>	
	Anderson				
<b>Pease</b>	Anderson		<b>Corymbia ptychocarpa</b>	<b>Buckinghamia celsissima</b>	
	Hoare				
<b>McNamara</b>	Greenslopes	<b>Link to Watsons Park</b>			
	Behan				
<b>McNamara</b>	Behan		<b>Corymbia ptychocarpa</b>	<b>Flindersia ifflaiana</b>	
	Anderson				

P-indicates selected species for planting under power lines

Cairns City in a Garden  
Master Plan 2007

Part C  
Precinct Plans

## **7.0 Inner Suburbs**



### **7.2. Kanimbla & Brinsmead**

#### **7.2.1 Precinct Description**

These suburbs were once populated by a few farming families during the 1930's Chinese farmers used the rich soils to grow vegetables until the landscape eventually became dominated by the production of sugar cane. The area was only opened to residential living in the late 1970's when the first sub-divisions of the valley began.

Kanimbla is named after the supply ship, built in 1936 that serviced the Australian coast from 1950 but was sold in Taiwan for scrap in 1973. Brinsmead is named after the Cairns pioneer Horace Brinsmead who started sugar farming in the Freshwater Estate in 1882.

#### **7.2.2 Precinct Objectives**

##### **General**

- **To enhance the streetscape with street trees of appropriate scale and form**
- **To respect established street tree character**

#### **7.2.3 Precinct Conditions**

##### **Existing Street Trees**

##### **Dominant Species**

#### **7.2.4 Built Form and Road Widths**

#### **7.2.5 Microclimate**

In spite of its proximity to the ocean Stratford and Aeroglen are quite sheltered from coastal influences.

#### **7.2.6 Geological/Soil Conditions**

The precinct comprises of reclaimed cane farms and hill slopes. Soils are unusually rich and fertile.

#### **7.2.7 Street Name Themes**

Early Explorers of the North Queensland Coast, Reef fish, Environmental Flora and Fauna

### 7.2.8 Street and Park Tree Species Palette Guide for Kanimbla and Brinsmead

### Inner Suburbs Kanimbla & Brinsmead

<b>Acmenospermum claviflorum</b>	<i>Grey Satinash</i>
<b>Castanospora alphandii</b>	<i>Brown Tamarind</i>
<b>Darlingia darlingiana</b>	<i>Brown Silky Oak</i>
<b>Diospyros cupulosa</b>	
<b>Diploglottis diphylostegia</b>	<i>Native Tamarind</i>
<b>Dysoxylum pettegrewianum</b>	<i>Spur Mahogany</i>
<b>Flindersia ifflaiana</b>	<i>Cairns Hickory</i>
<b>Ganophyllum falcatum</b>	<i>Scaly Ash</i>
<b>Homalium circumpinnatum</b>	
<b>Neonauclea gordoniana</b>	<i>Hard Leichhardt Tree</i>
<b>Pararchidendron pruinosum</b>	<i>Snow Wood</i>
<b>Phyllanthus cuscutiflorus</b>	
<b>Polyalthea longifolia</b>	<i>Indian Mast Tree</i>
<b>Synima cordierorum</b>	
<b>Syzygium cormiflorum</b>	<i>Bumpy Satinash</i>
<b>Syzygium leuhmanii</b>	<i>Small Leaf Lilly Pilly</i>
<b>Toechima erythrocarpum</b>	<i>Pink Tamarind</i>

### 7.2.7 Street Tree Species Palette for Kanimbla and Brinsmead

Street Name	Between	Median	Verge	Footpath	P
Ramsay	Irene			Flindersia ifflaiana	
	Reservoir				

P-indicates selected species for planting under power lines

Cairns City in a Garden  
Master Plan 2007

Part C  
Precinct Plans

## 7.0 Inner Suburbs



## Inner Suburbs Paramatta Park

### 7.3. Paramatta Park

#### 7.3.1 Precinct Description

Paramatta Park was established in the 1880's providing the most westerly development of Cairns possible at this time. Because of the many early colonial houses that still remain here the Cairns City Council Heritage Study has listed the entire area as a site of significance.

Central Swamp persists as a remnant of the natural plant communities that once dominated this low lying area of Cairns.

#### 7.3.2 Precinct Objectives

##### General

- To enhance the streetscape with street trees of appropriate scale and form
- To respect established street tree character
- To enhance heritage tree plantings

##### Special

- To compliment plant communities in Cairns Central Swamp through the use of appropriate tree species

#### 7.3.3 Precinct Conditions

##### Existing Street Trees

The increase in road traffic has put this historic precinct under huge pressure and has led to the widening of traffic lanes and the erosion of grass shoulders through excessive parking.

The wide roads and the mature trees that often line the shoulders do contribute greatly to the appearance of the area, as do the remnants of natural vegetation along Severin Street.

##### Dominant Species

#### 7.3.4 Built Form and Road Widths

Paramatta Park is built on a strong grid system with wide road reserves, typified by grass shoulders with established tree plantings. There is a mix of small businesses and some light industrial activity but the area is dominated by traditional Queenslander style homes.

Cairns City in a Garden  
Master Plan 2007

Part C  
Precinct Plans

### 7.3.5 Microclimate

The area is exposed to strong coastal influences with prevailing south-easterly winds during the winter months.

### 7.3.6 Geological/Soil Conditions

The precinct comprises of remnant swamp floor with dominantly well drained sands and water logged and disturbed soils.

### 7.3.7 Street Name Themes

### 7.3.8 Street and Park Tree Species Palette Guide for Paramatta Park

<b>Andira inerme</b>	<i>Angelin</i>
<b>Barringtonia acutangula</b>	<i>Freshwater Mangrove</i>
<b>Cassia sp Paluma Range</b>	<i>Paluma Golden Shower Tree</i>
<b>Cerbera manghas</b>	<i>Sea Mango</i>
<b>Delonix regia cv</b>	<i>Yellow Royal Poinciana</i>
<b>Dillenea alata</b>	<i>Red Beech</i>
<b>Melaleuca dealbata</b>	
<b>Peltophorum pterocarpum</b>	<i>Copper Pod</i>
<b>Peltphorum dubium</b>	<i>Brasiletto</i>
<b>Syzygium jambos</b>	<i>Rose Apple</i>
<b>Tabebuia argentea</b>	<i>Silver Trumpet Tree</i>

### 7.3.7 Street Tree Species Palette for Paramatta Park

Street Name	Between	Median	Verge	Footpath	P
<b>Aumuller</b>	Tingara	<b>Melaleuca dealbata</b>	<b>Cassia sp Paluma Range</b>	<b>Melaleuca dealbata Barringtonia acutangula</b>	<b>P</b>
	Hartley				
<b>Aumuller</b>	Hartley	<b>Melaleuca dealbata</b>	<b>Cassia sp Paluma Range</b>	<b>Melaleuca dealbata Barringtonia acutangula</b>	<b>P</b>
	Mulgrave				
<b>Aumuller</b>	Mulgrave	<b>Melaleuca dealbata</b>	<b>Cassia sp Paluma Range</b>	<b>Barringtonia acutangula</b>	
	Hoare				
<b>Martyn</b>	James	<b>Peltphorum pterocarpum</b>	<b>Peltphorum dubium Delonix regia cv</b>	<b>Cerbera manghas</b>	
	Florence				
<b>Severin</b>	James		<b>Cerbera manghas</b>	<b>Barringtonia acutangula</b>	
	Charles				
<b>Severin</b>	Charles	<b>Link to Cairns Central Swamp</b>			
	Upward				
<b>Severin</b>	Upward		<b>Cerbera manghas</b>	<b>Barringtonia acutangula</b>	
	Mulgrave				
<b>James</b>	Sheridan	<b>Archontophoenix alexandrae</b>		<b>Tabebuia argentea</b>	
	Martyn				

P-indicates selected species for planting under power lines



## **7.0 Inner Suburbs**



### **7.4. Manunda & Manoora**

#### **7.4.1 Precinct Description**

Manunda and Manoora were once part of the area known as Western Cairns, and started life as agricultural land with dairy and chicken farms and lush fields of cane. The suburbs began to be developed in the 1950' and 1960's and were renamed in the 1970's after ships that were part of the war effort during WW2.

The TAFCE College is located in Manunda along the northern end of Gatton Street behind Cairns Central Swamp.

#### **7.4.2 Precinct Objectives**

##### **General**

- **To enhance the streetscape with street trees of appropriate scale and form**
- **To respect established street tree character**

#### **7.4.3 Precinct Conditions**

##### **Existing Street Trees**

Hoare St Footpaths feature *Leptospermum madidum* (both ssp), with *Tabebuia argentea* & *Sabal palmetto* in the median, some of the best specimens occur in residential gardens (possibly due to high water table?) *Syzygium jambos* are common large trees around Macnamara St. Good specimens of *Barringtonia acutangula* on the Pease St verge are also present as street trees in this area.

##### **Dominant Species**

#### **7.4.4 Built Form and Road Widths**

#### **7.4.5 Microclimate**

The area is exposed to strong coastal influences with prevailing south-easterly winds during the winter months.

#### **7.4.6 Geological/Soil Conditions**

The precinct comprises of remnant swamp floor with dominantly well drained sands and water logged and disturbed soils.

#### **7.4.7 Street Name Themes**

Ships

#### 7.4.8 Street and Park Tree Species Palette Guide for Manunda and Manoora

#### Inner Suburbs Manunda & Manoora

<b>Acmenospermum claviflorum</b>	<i>Grey Satinash</i>
<b>Barringtonia acutangula</b>	<i>Freshwater Mangrove</i>
<b>Caesalpinia ferrea</b>	<i>Leopard tree</i>
<b>Castanospora alphandii</b>	<i>Brown Tamarind</i>
<b>Darlingia darlingiana</b>	<i>Brown Silky Oak</i>
<b>Diospyros cupulosa</b>	
<b>Diploglottis diphylostegia</b>	<i>Native Tamarind</i>
<b>Dysoxylum pettegrewianum</b>	<i>Spur Mahogany</i>
<b>Flindersia ifflaiana</b>	<i>Cairns Hickory</i>
<b>Ganophyllum falcatum</b>	<i>Scaly Ash</i>
<b>Homalium circumpinnatum</b>	
<b>Leptospermum madidum</b>	<i>Weeping Tea Tree</i>
<b>Nauclea orientalis</b>	<i>Leichhardt Tree</i>
<b>Neonauclea Gordoniana</b>	<i>Hard Nauclea</i>
<b>Pararchidendron pruinosum</b>	<i>Snow Wood</i>
<b>Peltophorum pterocarpum</b>	<i>Copper Pod</i>
<b>Synima cordierorum</b>	
<b>Syzygium cormiflorum</b>	<i>Bumpy Satinash</i>
<b>Syzygium forte ssp. forte</b>	
<b>Syzygium jambos</b>	<i>Rose Apple</i>
<b>Syzygium leuhmanii</b>	<i>Small Leaf Lilly Pilly</i>
<b>Toechima erythrocarpum</b>	<i>Pink Tamarind</i>

#### 7.4.7 Street Tree Species Palette for Manunda and Manoora

Street Name	Between	Median	Verge	Footpath	P
<b>Moody</b>	Hoare	<b>Peltophorum pterocarpum</b>		<b>Syzygium forte ssp. forte</b>	<b>P</b>
	Swallow				
<b>McGregor</b>	Swallow	<b>Peltophorum pterocarpum</b>		<b>Syzygium forte ssp. forte</b>	<b>P</b>
	Irene				
<b>Hoare</b>	Aumuller	<b>Tabebuia argentea</b> <b>Sabal palmetto</b>		<b>Syzygium jambos</b>	<b>P</b>
	Pease				
<b>James</b>	Sheridan	<b>Livistonia</b>			
	Martyn				
<b>Anderson</b>	Severin				
	Fearnley				
<b>Anderson</b>	Fearnley				
	Pease				

P-indicates selected species for planting under power lines

Cairns City in a Garden  
Master Plan 2007

Part C  
Precinct Plans

## 7.0 Inner Suburbs



### 7.5. Westcourt & Bungalow

#### 7.5.1 Precinct Description

#### 7.5.2 Precinct Objectives

##### General

- To enhance the streetscape with street trees of appropriate scale and form
- To respect established street tree character

#### 7.5.3 Precinct Conditions

##### Existing Street Trees

##### Dominant Species

#### 7.5.4 Built Form and Road Widths

#### 7.5.5 Microclimate

#### 7.5.6 Geological/Soil Conditions

Apart from isolated sand ridges in the area around Westcourt Plaza the area was dominated by open swamp with stands of Melaleuca and Tea Trees.

#### 7.5.7 Street name Themes

#### 7.2.8 Street and Park Tree Species Palette Guide for Westcourt and Bungalow

<b>Acmena hemilampra</b>	<i>Blush Satinash</i>
<b>Corymbia ptychocarpa</b>	<i>Swamp Bloodwood</i>
<b>Corymbia tessellaris</b>	<i>Moreton Bay Ash</i>
<b>Cupaniopsis anacardioides</b>	<i>Bush Tuckeroo</i>
<b>Millettia sp aff pinnata</b>	<i>Creek Pongamia</i>
<b>Plumeria rubra</b>	<i>Frangipani</i>
<b>Rhysotoechia robertsonii</b>	<i>Robbo's Tuckeroo</i>
<b>Syzygium angophoroides</b>	<i>Yarrabah Satinash</i>
<b>Syzygium minutiflorum</b>	<i>Grove Satinash</i>
<b>Tabebuia argentea</b>	<i>Silver Trumpet Tree</i>
<b>Tabebuia rosa</b>	<i>Tall Pink Trumpet Tree</i>
<b>Terminalia muellerii</b>	<i>Lesser Beach Almond</i>

7.5.7 Street Tree Species Palette for Westcourt & Bungalow

Street Name	Between	Median	Verge	Footpath	P
Scott	Bunda		Corymbia ptychocarpa	Tabebuia argentea	P
	McCoombe				

P-indicates selected species for planting under power lines

## **7.0 Inner Suburbs**



### **7.6. Earlville & Mooroolool**

#### **7.6.1 Precinct Description**

These are two of Cairns' most populated suburbs. They occupy land that once belonged to two of the regions most renowned cane farming estates. One was owned by Edward Earl, who lent his name to the suburb and the other was the Hap Wah Plantation.

The Hap Wah (Chinese for "Good Luck") was the first cane farming estate near Cairns and originated in 1879 when Chinese farmer and entrepreneur Andrew Lee On (later changed to Leon) took up 1280 acres. By 1885 he controlled some 2528 acres and Leon became a well known and influential figure in Cairns. In spite of the less than ideal soil conditions a large sugar mill was established in 1881 on the site now occupied by Stockland Cairns, but the whole venture was doomed and the land sold by 1886. Mulgrave Road used to be called Hap Wah Road.

Edward Earl's Balaclava Estate located to the west of Mulgrave Road as a far more successful venture. He became mayor at the age of 32 and was a leading figure in establishing a suitable port for Cairns. His son took over the estate but by the 1950's the subdivisions began centred around what is now Balaclava Road. The subdivisions grew more numerous during the 1960's and 1970's as the need to house the ever growing population of Cairns increased.

#### **7.6.2 Precinct Objectives**

##### **General**

- **To enhance the streetscape with street trees of appropriate scale and form**
- **To respect established street tree character**

##### **Special**

- **Respect local heritage value plantings around Balaclava area**

### 7.6.3 Precinct Conditions

#### Existing Street Trees

Balaclava Rd: *Tabebuia* spp mixed floral 'avenue'

Carnation Dr: good mature *Caesalpinia ferrea* (on red soil?)

#### Dominant Species

*Tabebuia pallida* Evergreen Trumpet Tree

*Tabebuia argentea* Silver Trumpet Tree

*Tabebuia palmeri*

*Tabebuia chrysantha* Golden Trumpet Tree

### 7.6.4 Built Form and Road Widths

Earlville and Mooroolool both have strong grid patterns with reasonably wide roads. Earlville still has much of its original housing and this contributes to the general character of the streets. Mooroolool is typified by few street trees.

### 7.6.5 Microclimate

#### 7.6.6 Geological/Soil Conditions

Poor sandy soils once open swamp and forest. Heavy, often stony clays on foothills, ridge of red soils through parts of City View & Koppen's Hill

#### 7.6.7 Street Name Themes

Tropical Fruits, Ancient Rome, Floral Theme, Birds, Female Christian Names, Gemstones, Spain, Italian Christian Names, Plants and Trees

### Special Areas

#### 7.6.8 Street and Park Tree Species Palette Guide for Earlville and Mooroolool

<b>Caesalpinia ferrea</b>	<i>Leopard Tree</i>
<b>Cassia sp Paluma Range</b>	<i>Paluma Golden Shower Tree</i>
<b>Lagerstroemia floribunda</b>	<i>Pride of India</i>
<b>Newboldia laevis</b>	<i>Boundary Tree</i>
<b>Parachidendron pruinosum</b>	<i>Snow Wood</i>
<b>Tabebuia argentea</b>	<i>Silver Trumpet tree</i>
<b>Tabebuia chrysantha</b>	<i>Golden trumpet Tree</i>
<b>Tabebuia palmeri</b>	
<b>Xanthostemon chrysanthus</b>	<i>Golden Penda</i>

#### 7.6.9 Street Tree Species Palette for Earlville & Mooroolool

Street Name	Between	Median	Verge	Footpath	P
Irene	Balaclava		Cassia sp Paluma Range	Xanthostemon chrysanthus	
	Beatrice				
Irene	Beatrice		Cassia sp Paluma Range	Tabebuia argentea	
	McGregor				
Balaclava	Mulgrave		Tabebuia var.	Tabebuia var.	
	Irene				
De Jarlais	Balaclava		Tabebuia chrysantha	Syzygium jambos	P
	Toogood				

P-indicates selected species for planting under power lines

## 7.0 Inner Suburbs



## Inner Suburbs Bayview Heights & Woree

### 7.7. Bayview Heights & Woree

#### 7.7.1 Precinct Description

#### 7.7.2 Precinct Objectives

##### General

- To enhance the streetscape with street trees of appropriate scale and form.
- To respect established street tree character.
- To enhance the surrounding hill slopes with appropriate species.

#### 7.7.3 Precinct Conditions

##### Existing Street Trees

##### Dominant Species

#### 7.7.4 Built Form and Road Widths

#### 7.7.5 Microclimate

The area can suffer from drought and exposure.

#### 7.7.6 Geological/Soil Conditions

The precinct comprises of remnant swamp floor, hill slopes and riparian corridors. Soils dominantly well drained sands heavy clays and clay loams.

#### 7.7.7 Street Name Themes

Birds, Female Christian Names, Gemstones, Spain, Italian Christian Names, Plants and Trees

Cairns City in a Garden  
Master Plan 2007

Part C  
Precinct Plans

7.7.8 Street and Park Tree Species Palette Guide for Bayview Heights and Woree

Caesalpina ferrea	Leopard Tree
Castanopora alphanthii	Brown Tamarind
Darlingia darlingiana	Brown Silky Oak
Diploglottis smithii	Native Tamarind
Eleoacarpus bancroftii	Kuranda Quandong
Melicope elleryana	Ulysses Butterfly Tree
Melicope rubra	Dwarf Ulysses Butterfly Tree
Mischocarpus pyriformis	Pear Fruit
Ormosia ormondii	Yellow Bean
Syzygium alliiiligneum	Onionwood
Syzygium cormiflorum	Bumpy Satinash
Syzygium fibrosum	Fibrous satinash
Toechimia erythrocarpum	Pink Tamarind
Xanthostemon chrysanthus	Golden Penda

7.7.9 Street Tree Species Palette for Bayview Heights and Woree

Street Name	Between	Median	Verge	Footpath	P
Toogood	Mulgrave		Darlingia darlingiana	Xanthostemon chrysanthus	P
	Yarra				
Toogood	Yarra		Xanthostemon chrysanthus	Xanthostemon chrysanthus	
	Fairview				
Anderson Rd	Bruce Hwy				
	Windarra				
Anderson Rd	Windarra				
	Fairview				
Tills/Lennon	Mulgrave	Caesalpina ferrea		Xanthostemon chrysanthus	
	Gatton				
Tills/Lennon	Gatton		Xanthostemon chrysanthus	Xanthostemon chrysanthus	
	English				
Tills/Lennon	English			Xanthostemon chrysanthus	
	McCormack				

P-indicates selected species for planting under power lines



## **8. White Rock & Edmonton**

### **General Description**

The precinct forms part of the Cairns Southern Corridor. It is located between the wetlands of the upper Trinity Inlet and the hill slopes of the coastal ranges. The hill slopes are a dominant feature, with a number of waterways which flow generally from west to east.



### **8.1. White Rock**

#### **8.1.1 Precinct Description**

White Rock is among the oldest suburbs, being established some time before 1900. It is one of the largest in area but it was not until the late 1970's that it began to develop as a residential suburb. It is named after a huge white boulder that protrudes from the Whitfield Range.

It occupies land that once formed the largest of Cairns many sugar cane farms, the White Rock Estate, owned by the Cannon family, the homestead can still be seen today as you drive along the Bruce Highway.

#### **8.1.2 Precinct Objectives**

##### **General**

- **To enhance the streetscape with street trees of appropriate scale and form**
- **To respect established street tree character**
- **To retain and rehabilitate existing water ways**

##### **Special**

- **To reflect local conditions through the selection of a distinct range of natives**
- **To reflect existing species from Railway Buffer strips and Cannon's Homestead Gardens**

#### **8.1.3 Precinct Conditions**

##### **Existing Street Trees**

##### **Dominant Species**

#### **8.1.4 Built Form and Road Widths**

#### **8.1.5 Microclimate**

The area can suffer from drought and exposure.

### 8.1.6 Geological/Soil Conditions

White Rock east typically has white clay soils with impeded drainage, which supports a distinctive range of native species.

## White Rock & Edmonton

### 8.1.7 Street Name Themes

Hollywood Films, Trees, North America

### 8.1.8 Street and Park Tree Species Palette Guide for White Rock

<b>Barringtonia acutangula</b>	<i>Freshwater mangrove</i>
<b>Brachychiton acerifolius</b>	<i>Flame Tree</i>
<b>Callistemon viminalis</b>	<i>Weeping Bottlebrush</i>
<b>Carallia brachiata</b>	<i>Corky bark</i>
<b>Corymbia ptychocarpa</b>	<i>Swamp Bloodwood</i>
<b>Deplanchea tetraphylla</b>	<i>Golden Bouquet</i>
<b>Dillenea alata</b>	<i>Red Beech</i>
<b>Eucalyptus tereticornis</b>	
<b>Ficus congesta</b>	<i>Red Leaf Fig</i>
<b>Gmelina dalrympleana</b>	<i>Darymple's White Beech</i>
<b>Lagerstroemia speciosa</b>	<i>Pride of India</i>
<b>Melaleuca dealbata</b>	<i>Blue Paperbark</i>
<b>Melaleuca viridiflora</b>	<i>"Burgundy"</i>
<b>Melicope elleryana</b>	<i>Ulysses Butterfly Tree</i>
<b>Polyalthia longifolia</b>	<i>Indian Mast Tree</i>
<b>Stenocarpus sinuatus</b>	<i>Firewheel Tree</i>

### 8.1.7 Street Tree Species Palette for White Rock

Street Name	Between	Median	Verge	Footpath	P
<b>Hardy</b>	Robert	<b>Polyalthia longifolia</b>		<b>Stenocarpus sinuatus</b> <b>Randia fitzalanii</b>	<b>P</b>
	Foster				
<b>Foster</b>	Bruce Hwy	<b>Brachychiton acerifolius</b>		<b>Randia fitzalanii</b>	<b>P</b>
	Hardy				

P-indicates selected species for planting under power lines

Cairns City in a Garden  
Master Plan 2007

Part C  
Precinct Plans

## **8.0 Whiterock & Edmonton General Description**

The precinct forms part of the Cairns Southern Corridor. It is located between the wetlands of the upper Trinity Inlet and the hill slopes of the coastal ranges. The hill slopes are a dominant feature, with a number of waterways which flow generally from west to east.



### **8.2. Edmonton**

#### **8.2.1 Precinct Description**

Edmonton fringes what was once the old Cairns Road, now relocated east to where the Bruce Highway is today. In the early days the journey to Edmonton from Cairns was a hard one, with eight major creeks to cross, with banks crowded with thickets of rainforest trees, with hickory and cedar.

In 1879 an Englishman called Thomas Kingsford Swallow came to find his fortune in the gold fields of Mount Peter. The Aplina was one of the richest mines and attracted many prospectors who lived in tents at the foot of the mountain.

After just two years he purchased some 95 square miles of land to the south of the township and named it Hambleton (perhaps in memory of Surrey where he came from). Here he started to grow sugar cane becoming the biggest producer in Cairns and establishing Swallows Biscuits that was later sold to Arnotts.

The Hambleton valley proved to be perfect for growing cane, and by 1883 Swallow was able to open the Swallows Sugar Mill, later sold to the giant CSR Company and eventually closed down in 1991. Part of the old Sugar World Gardens that once surrounded the mill is now owned by Cairns City Council has a growing collection of tropical fruit trees, building on the orchards that once stood here.

With the construction of the Cairns Road the township shifted south and changed its name to Edmonton.

This is one of the major growth areas of the city with an expanding population and plans for a new commercial heart. The precinct forms part of the southern corridor that will eventually extend to Gordonvale on the western side of the Bruce Highway.

The area is located between the wetlands of the upper reaches of the Trinity Inlet and the hill slopes of the coastal ranges.

### 8.2.2 Precinct Objectives

#### General

- To enhance the streetscape with street trees of appropriate scale and form
- To respect established street tree character
- To enhance local heritage and cultural associations with appropriate tree species.
- To reflect the local landscape character through the appropriate selection of tree species
- To retain and rehabilitate existing water ways

#### Special

- Edmonton North to be dominated by yellow flowering species
- Edmonton Central to reflect mature planting on former Hambledon Estate (Flowering and fruiting trees and timber species)

### 8.2.3 Precinct Conditions

#### Existing Street Trees

Hambledon estate features remnant Mango, Samanea & Delonix.

#### Dominant Species

### 8.2.4 Built Form and Road Widths

### 8.2.5 Microclimate

The area can suffer from drought and exposure.

### 8.2.6 Geological/Soil Conditions

Reclaimed cane farming land, once open swamp and forest with riparian corridors. Soils dominantly red clays.

### 8.2.7 Street Name Themes

Early District Settlers, Early England, Orchids, Scottish names historically linked to the Mann Family, Hambledon Employees, Sugar Cane.

### 8.2.8 Street and Park Tree Species Palette Guide for Edmonton

#### North

<b>Deplanchea tetraphylla</b>	<i>Golden Bouquet</i>
<b>Dillenea alata</b>	<i>Red Beech</i>
<b>Diploglottis diphylostegia</b>	<i>Wild Tamarind</i>
<b>Eucalyptus abergiana</b>	<i>Range Bloodwood</i>
<b>Ficus benjamina 'Aurea'</b>	<i>Golden Weeping Fig</i>
<b>Harpullia arborea</b>	<i>Cooktown Tulipwood</i>
<b>Harpullia pendula</b>	
<b>Polyscias nodosa</b>	<i>Noah's Basswood</i>
<b>Storckelia australiensis</b>	<i>White Bean</i>
<b>Tabebuia argentea</b>	<i>Silver Trumpet Tree</i>
<b>Tabebuia chrysantha</b>	<i>Golden trumpet Tree</i>
<b>Xanthostemon chrysanthus</b>	<i>Golden Penda</i>
<b>Xanthostemon whitei</b>	<i>Greater Golden Penda</i>

### Street and Park Tree Species Palette Guide Edmonton Central

<b>Agathis robusta</b>	<i>Kauri Pine</i>
<b>Brachychiton acerifolius</b>	<i>Flame Tree</i>
<b>Buchanania arborescens</b>	<i>Gooseberry Tree</i>
<b>Corymbia tessellaris</b>	<i>Moreton Bay Ash</i>
<b>Euphoria longan</b>	<i>Longan</i>
<b>Flacourtia inermis</b>	<i>Lovi-Lovi</i>
<b>Flindersia ifflaiana</b>	<i>Cairns Hickory</i>
<b>Lophanthera latescens</b>	<i>Golden Chain Tree</i>
<b>Melaleuca dealbata</b>	<i>Blue Papaerbark</i>
<b>Melaleuca quinquenervia</b>	
<b>Melicope elleryana</b>	<i>Ulysses Butterfly Tree</i>
<b>Michelia champaca</b>	<i>Himalayan magnolia</i>
<b>Pachira aquatica</b>	<i>Guyana Chestnut</i>
<b>Polyscias nodosa</b>	<i>Noah's Basswood</i>
<b>Syzygium alligineum</b>	<i>Onionwood</i>

### White Rock & Edmonton Edmonton

#### 8.2.7 Street Tree Species Palette for Edmonton

Street Name	Between	Median	Verge	Footpath	P
<b>Peterson</b>	Bruce Hwy	<b>Flindersia ifflaiana</b>		<b>Melicope elleryana</b>	<b>P</b>
	Mt Peter				
<b>Mill</b>	Bruce Hwy	<b>Tabebuia chrysantha</b>		<b>Syzygium forte ssp. forte</b>	<b>P</b>
	Woodlock				
<b>Walker</b>	Hambledon	<b>Flindersia ifflaiana</b>		<b>Flindersia ifflaiana</b>	
	Timberlea				
<b>Robert</b>	Bruce Hwy	<b>Agathis robusta</b>		<b>Brachychiton acerifolius</b>	
	Hardy				
<b>Bicentennial</b>	Robert		<b>Flindersia ifflaiana</b>	<b>Melaleuca quinquenervia</b>	
	Ravizza				
<b>Ravizza</b>			<b>Flindersia ifflaiana</b>	<b>Flindersia ifflaiana</b> <b>Randia fitzalanii</b>	<b>P</b>
<b>Hambledon</b>	Mill	<b>Tabebuia chrysantha</b>		<b>Syzygium alligineum</b>	
	Isabella				

P-indicates selected species for planting under power lines

### 9. Gordonvale & Goldsborough



#### 9.1. Gordonvale

##### 9.1.1 Precinct Description

Gordonvale nestles at the foot of the Pyramid Mountain flanked by the Mulgrave River. It took its name from prominent landowner John Gordon, whose main business was to supply meat to the miners of the Goldsborough Valley and the tin miners at Herberton.

However when first settled in 1885 it was known as Nelson, after the then State Premier. Under an agreement with sister city in New Zealand both agreed that one would have to change names, and Nelson Queensland became Gordonvale in 1886. The township quickly grew on both the success of the sugar cane industry and the trade which flowed up Gillies to the mining town of the Tablelands. While some made their fortunes in mining others made theirs from “red gold”, that is to say from the Red Cedar and the Kauri Pine that grew in this area. Large areas were felled and the local Yidindji Tribe were dispossessed of their traditional hunting grounds.

##### 9.1.2 Precinct Objectives

###### General

- To enhance the streetscape with street trees of appropriate scale and form
- To respect established street tree character
- To reference pre-settlement plant communities through appropriate tree selection
- A general colour theme of “Gold” flowers and foliage

###### Special

- Use of hardy species to compliment the hill slopes of The Pyramid

##### 9.1.3 Precinct Conditions

###### Existing Street Trees

The older town area is dominated by more traditional exotic flowering trees or figs, including some unusual species such as *Kigelia africana* (Sausage Tree) in the old mill manager’s house garden. The newer areas west of the highway tend to feature more native species.

Cairns City in a Garden  
Master Plan 2007

Part C  
Precinct Plans

The 'Green Patch' flood terrace recreation reserve features mature gallery vegetation (Melaleuca leucadendra, Syzygium tierneyanum, Ficus racemosa etc, with Delonix regia and Cassia fistula interplanted beside the highway.

**Dominant Species**

**Melaleuca leucadendra** Paperbark  
**Syzygium tierneyanum** River Cherry

**9.1.4 Built Form and Road Widths**

**9.1.5 Microclimate**

Lower rainfall levels

**9.1.6 Geological/Soil Conditions**

The precinct is characterised by the natural feature of the Mulgrave River, the Pyramid and adjacent ranges. Soils can often be poor and skeletal.

**9.1.7 Street Name Themes**

Early District settlers, Gold Mining

**Special Areas**

**9.1.8 Street and Park Tree Species Palette Guide for Gordonvale and Goldsbrough**

<b>Acacia leptoloba</b>	<i>Irvinebank Wattle</i>
<b>Agathis robusta</b>	<i>Kauri Pine</i>
<b>Barringtonia calyptrata</b>	<i>Cassowary Pine</i>
<b>Blepharocarya involucrigera</b>	<i>Rose Butternut</i>
<b>Bombax ceiba</b>	<i>Kapok Tree</i>
<b>Calliandra 'rosea'</b>	<i>Hot-pink Powderpuff Tree</i>
<b>Calliandra surinamensis</b>	<i>Powderpuff Tree</i>
<b>Callitris macleayana</b>	<i>Stringybark Cyprus</i>
<b>Cassia fistula</b>	<i>Golden Shower Tree</i>
<b>Casuarina torulosa</b>	<i>Rose She Oak</i>
<b>Delonix regia var. flava</b>	<i>Yellow Royal Poinciana</i>
<b>Eucalyptus torelliana</b>	<i>Cadaghi</i>
<b>Ficus racemosa</b>	<i>Cluster Fig</i>
<b>Grevillea baileyana</b>	<i>Findlay's Silky Oak</i>
<b>Lophostemon confertus</b>	<i>Brush Box</i>
<b>Parachidendron prunosum</b>	<i>Snow Wood</i>
<b>Paraserianthes toona</b>	<i>Red Siris</i>
<b>Peltophorum dubium</b>	<i>Brasiletto</i>
<b>Syncarpia glomulifera</b>	<i>Turpentine</i>
<b>Xanthostemon chrysanthus</b>	<i>Golden Penda</i>

**9.1.8 Street Tree Species Palette for Gordonvale and Goldsbrough**

Street Name	Between	Median	Verge	Footpath	P
<b>Goldsbrgh</b>	Gillies		<b>Cassia fistula</b>	<b>Xanthostemon chrysanthus</b>	
	Pan				
<b>Draper</b>	Bruce Hwy	<b>Agathis robusta</b>	<b>Cassia fistula</b>	<b>Xanthostemon chrysanthus</b>	
	Hickling				

P-indicates selected species for planting under power lines

### 10. Babinda



#### 10.1. Babinda

##### 10.1.1 Precinct Description

Early settlers arrived here in the 1870's and the railway arrived in 1911. It is dominated by steep forested hill slopes to the west; cane fields to the north east and south; and by the Sugar Mill. The Boulders swimming hole is popular recreational spot for all Cairns residents and is becoming increasingly popular with tourists travelling along the Bruce Highway. It is also near to the Twin Peaks and the surrounding wilderness of Bartle Frere and Belenden Ker.

Babinda survives as an example of a traditional Far North Queensland Sugar Township; the preservation of its cultural heritage is of great importance locally.

##### 10.1.2 Precinct Objectives

###### General

- To enhance the streetscape with street trees of appropriate scale and form
- To respect established street tree character

###### Special

- To respect the heritage values of the town by the selection of culturally appropriate tree species.
- Future planting should reflect the species endemic to this location.

##### 10.1.3 Precinct Conditions

###### Existing Street Trees

The Boulders scenic reserve features intact lowland complex mesophyll rainforest.

###### Dominant Species

##### 10.1.4 Built Form and Road Widths

##### 10.1.5 Microclimate

Babinda has the highest levels of rain fall in all of Australia.

##### 10.1.6 Geological/Soil Conditions

Soils tend to be well drained with high levels of clay and loam.



### 10.1.7 Street Name Themes

Early local family names

### 10.1.8 Street and Park Tree Species Palette Guide for Babinda

<b>Acmena graveolens</b>	<i>Cassowary Satinash</i>
<b>Backhousia bancroftii</b>	<i>Johnstone River Hardwood</i>
<b>Diploglottis bernieana</b>	<i>Bernie's Tamarind</i>
<b>Diploglottis harpullioides</b>	<i>Babinda Tamarind</i>
<b>Diploglottis smithii</b>	<i>Smith's Tamarind</i>
<b>Lindsayomyrtus racemoides</b>	<i>Daintree Penda</i>
<b>Placospermum coriaceum</b>	<i>Rose Silky Oak</i>
<b>Prunus turnerana</b>	<i>Almond Bark</i>
<b>Ristantia pachysperma</b>	<i>Yellow penda</i>
<b>Storckelia australiensis</b>	<i>White Bean</i>
<b>Synima cordierom</b>	<i>Pink Tamarind</i>
<b>Syzygium fibrosum</b>	<i>Fibrous Satinash</i>
<b>Syzygium gustavioides</b>	<i>Grey Satinash</i>
<b>Waterhousia hedraiophylla</b>	<i>Gully Satinash</i>
<b>Xanthostemon chrysanthus</b>	<i>Golden Penda</i>

### 10.1.9 Street Tree Species Palette for Babinda

Street Name	Between	Median	Verge	Footpath	P
					P

P-indicates selected species for planting under power lines

Cairns City in a Garden  
Master Plan 2007

Part C  
Precinct Plans

11. Rural Lands



11.1. Rural Lands

11.1.1 Precinct Description

The Rural Lands incorporate the lowland areas of the Mulgrave and Russell River Valleys: the rainforested coastal ranges; and the wetlands and coastline extending from Russell Heads to Bramston Beach.

It is an area of high landscape value, with significant remnants of natural vegetation, many of which are included in the Wet Tropics World Heritage Area.

It is sparsely populated and retains a distinctly rural quality that once typified the Cairns region.

11.1.2 Precinct Objectives

General

- To enhance the streetscape with street trees of appropriate scale and form
- To respect established street tree character
- To reflect the natural environment through the appropriate selection of tree species

Special

- Bramston Beach foreshore reserves include remnant trees from a coast rainforest on sand dunes with very high rainfall. Conspicuous spp include *Barringtonia asiatica*, *Barringtonia calyptata*, *Acmena hemilampra*, *Calophyllum inophyllum*, *Syzygium forte* ssp *forte*, *Deplanchea tetraphylla*, *Macadamia whelanii*
- Many of the scattered hamlets & townships are often close to gallery and swamp forest remnants. Conspicuous spp include: *Alstonia scholaris*, *Barringtonia calyptata*, *Barringtonia racemosa*, *Elaeocarpus angustifolius*, *Nauclea orientalis*, *Ormosia ormondii*, *Ristantia pachysperma*, *Syzygium tierneyanum*, *Terminalia sericocarpa*, *Tristaniopsis exiliflora*, *Archontophoenix alexandrae*, *Pandanus sp aff gemmifer* (Russell River), and the highly invasive *Annona glabra* (Pond Apple)

11.1.3 Precinct Conditions

Existing Street Trees  
Dominant Species

Cairns City in a Garden  
Master Plan 2007

Part C  
Precinct Plans

11.1.4 Built Form and Road Widths

11.1.5 Microclimate

11.1.6 Geological/Soil Conditions

11.1.7 Street Name Themes

Christian Names and Surnames, Trees

Special Areas

11.1.8 Street and Park Tree Species Palette Guide Mirriwinni

<b>Acmena graveolens</b>	<i>Cassowary satinash</i>
<b>Bischofia javanica</b>	<i>Java Cedar</i>
<b>Cardwellia sublimis</b>	<i>Northern Silky oak</i>
<b>Diploglottis benieana</b>	<i>Bernie's Tamarind</i>
<b>Ficus virgata</b>	<i>Large Leaf Weeping Fig</i>
<b>Palaquium galactoxylum</b>	<i>Pencil Cedar</i>
<b>Sphaerantia discolor</b>	<i>Tully Penda</i>
<b>Syzygium australe</b>	<i>Creek Cherry</i>
<b>Syzygium cannicortex</b>	<i>Yellow Satinash</i>
<b>Syzygium cormiflorum</b>	<i>Bumpy Satinash</i>
<b>Syzygium gustaviodes</b>	<i>Grey Satinash</i>

Street and Park Tree Species Palette Guide Bramston Beach

<b>Acmena hemilampra</b>	<i>Blush Satinash</i>
<b>Antidesma bunius</b>	<i>Herbert River Cherry</i>
<b>Barringtonia asiatica</b>	<i>Boxfruit</i>
<b>Barringtonia calyptrata</b>	<i>Cassowary Pine</i>
<b>Buchaniana arborescens</b>	
<b>Bursaria tenuifolia</b>	
<b>Deplanchea tetraphylla</b>	<i>Golden Bouquet</i>
<b>Dillenea alata</b>	<i>Red Beech</i>
<b>Disoxylum oppositifolium</b>	<i>Pink Mahogany</i>
<b>Euroschinus falcata</b>	<i>Pink Poplar</i>
<b>Gmelina dalrympleana</b>	<i>Dalrymple's White Beech</i>
<b>Melaleuca leucadendra</b>	<i>Weeping Paperbark</i>
<b>Randia fitzalanii</b>	<i>Native Gardenia</i>
<b>Sterculia quadrifida</b>	<i>Peanut Tree</i>
<b>Syzygium angophoroides</b>	<i>Yarrabah Satinash</i>
<b>Syzygium forte ssp forte</b>	<i>White Apple</i>
<b>Terminalia arenicola</b>	<i>Beach Almond</i>

11.1.9 Street Tree Species Palette for Rural Lands

Street Name	Between	Median	Verge	Footpath	P
					P

P-indicates selected species for planting under power lines



**CAIRNS  
CITY IN A  
GARDEN  
MASTER PLAN  
PART D  
TECHNICAL  
GUIDELINES**



## Table of Contents

<b>CITY IN A GARDEN MASTER PLAN 2007</b>	<b>2</b>
<b>Vision Statement</b>	Error! Bookmark not defined.
<b>Context</b>	<b>2</b>
<b>CAIRNS CITY IN A GARDEN PART A-INTRODUCTION</b>	<b>10</b>
<b>CITY IN A GARDEN MASTER PLAN PART B-TREE SPECIES SELECTION</b>	<b>14</b>
<b>CITY IN A GARDEN MASTER PLAN PART C- PRECINCT PLANS</b>	<b>30</b>
<b>CITY IN A GARDEN MASTER PLAN PART D TECHNICAL GUIDELINES</b>	<b>99</b>
<b>1. Street Trees Guidelines to Placement</b>	<b>99</b>
1.1. General	99
1.2. Trees within the Median	101
1.3. Trees within the Road Verge	102
1.4. Trees within the Footpath	103
<b>2. Strategies for Improving Tree Planting within the Road Reserve</b>	<b>104</b>
2.1. General	104
2.1.1. Water/Aeration Pipes	104
2.1.2. Tree Guards	104
2.1.3. Root Barriers/Root Directors	104
2.1.4. Root Disturbance	104
2.1.5. Tree Protection during on site works	104
2.1.6. Pruning to Establishment	105
2.1.7. Use of Soil Conditioners	105
2.1.8. Structural Soils and associated technologies	105
2.1.9. Nature Strips	105
<b>2.2. The Median</b>	<b>105</b>
2.2.1. Conflict with existing lighting	105

<b>2.3.</b>	<b>The Verge</b>	<b>106</b>
2.3.1.	Tree Islands	106
2.3.2.	Turf Cell and other Permeable Pavement Surfaces	106
2.3.3.	Soil Conditioners	106
2.3.4.	Special Treatments for Parking within the Road Shoulder	106
<b>2.4.</b>	<b>The Footpath</b>	<b>107</b>
2.4.1.	Strategies to Avoid Damage to Footpaths and Services	107
2.4.2.	Aerial Bundled Conductors	107
2.4.3.	Under grounding of Power Cables	107
<b>3.</b>	<b>Streetscape Templates</b>	<b>108</b>
<b>3.1.</b>	<b>Streetscape Templates</b>	<b>108</b>
<b>3.2.</b>	<b>Roundabouts</b>	<b>109</b>
<b>3.3.</b>	<b>Intersections</b>	<b>109</b>
<b>3.4.</b>	<b>Gateways</b>	<b>109</b>
<b>3.5.</b>	<b>Suburban Enhancement</b>	<b>109</b>
<b>3.6.</b>	<b>Local Area Traffic Management</b>	<b>109</b>
<b>4.</b>	<b>Street Tree Specification and Installation Details</b>	<b>110</b>
<b>4.1.</b>	<b>Quality of Nursery Stock</b>	<b>111</b>
4.1.1.	General Characteristics of Nursery Stock	111
4.1.2.	True to type	111
4.1.3.	Health and vigour	111
4.1.4.	Freedom from pests and disease	111
4.1.5.	Balance of crown	111
4.1.6.	Uniformity of growth	111
4.1.7.	Stem taper	112
4.1.8.	Pruning history	112
4.1.9.	Included bark	112
4.1.10.	Compatibility of graft unions	112
4.1.11.	Apical dominance	112
4.1.12.	Indication of north	112
4.1.13.	Root division	112

4.1.14. Root direction	112
4.1.15. Root ball occupancy	112
4.1.16. Non-suckering rootstock	112
4.1.17. Hardening off	112
4.1.18. Acclimatisation	113
4.1.19. Maintenance in Transit	113
4.1.20. Advanced Trees and Palms	113
<b>4.2. Tree Installation Specifications</b>	<b>113</b>
4.2.1. Inspection	113
4.2.2. Tests	113
4.2.3. Drainage Testing	113
4.2.4. Soil Testing	113
4.2.5. Sampling	113
4.2.6. Maintenance	113
4.2.7. Expertise	113
4.2.8. Structural soil mix	114
4.2.9. Required backfill soil properties	114
4.2.10. Additives	115
4.2.11. Aggregate	115
4.2.12. Transportation	115
4.2.13. Structural soil delivery	115
4.2.14. Soil	115
4.2.15. Sandy Loam	116
4.2.16. Organic matter	116
4.2.17. Backfill soil mix	116
4.2.18. Water	116
4.2.19. Horticultural chemicals	116
4.2.20. Herbicide	116
4.2.21. Compost and fertiliser	116
4.2.22. Fertiliser	116
<b>4.3. Tree stakes, supports, ties and guys guards</b>	<b>117</b>



4.3.1.	Stakes	117
4.3.2.	Ties	117
4.3.3.	Guards and Guys	117
<b>4.4.</b>	<b>Tree Pit Preparation</b>	<b>118</b>
4.4.1.	Excavation of tree pits	118
4.4.2.	Sub-grade preparation	118
4.4.3.	Tree Pit Construction	118
4.4.4.	Placing structural soil mix	118
4.4.5.	Compaction	119
4.4.6.	Existing services	119
4.4.7.	Installation of Root Barriers and Root Directors	119
4.4.8.	Irrigation manifold	119
4.4.9.	Protective sheeting / separation layer	120
4.4.10.	Remediation	120
4.4.11.	Contamination	120
<b>4.5.</b>	<b>Planting</b>	<b>121</b>
4.5.1.	Planting conditions	121
4.5.2.	Watering	121
4.5.3.	Tree pit	121
4.5.4.	Lifting	121
4.5.5.	Placing	121
4.5.6.	Alignment and orientation	121
4.5.7.	Container, wrapping and cage removal	121
4.5.8.	Root trimming	122
4.5.9.	Backfilling	122
4.5.10.	Watering	122
4.5.11.	Mulching	122
4.5.12.	Tree replacement	122
4.5.13.	Establishment maintenance	122
4.5.14.	Tree surgery	122
4.5.15.	Standard	123

4.5.16. Objectives	123
4.5.17. General procedures	123
4.5.18. Specific procedures	123
4.5.19. Tools and equipment	124
<b>4.6. Completion</b>	<b>125</b>
4.6.1. Planting establishment Period	125
4.6.2. Health monitoring	125
4.6.3. Recurrent works	125
4.6.4. Replacements	125
4.6.5. Cleaning	125
<b>CITY IN A GARDEN PART E- APPENDICES</b>	<b>128</b>
<b>CITY IN A GARDEN PART F-STREETScape TEMPLATES</b>	<b>178</b>

# City in a Garden Master Plan Part D Technical Guidelines

## Street Trees Guidelines to Placement

### 1. Street Trees Guidelines to Placement

#### 1.1. General

All landscaping within the road reserve must comply with the relevant standards and guidelines set out by the documents and authorities listed below:

**Cairns CBD Streetscape Master Plan 2006**

**FNQROC-Development Manual**

[www.fnqroc.qld.gov.au](http://www.fnqroc.qld.gov.au)

**Department of Main Roads-Road Planning and Design Manual**

[www.mainroads.qld.gov.au](http://www.mainroads.qld.gov.au)

**Ergon Code of Practice for Power line Clearance 2006**

**Crime Prevention through Design (CPTED)**

[www.cpted.com.au/home.html](http://www.cpted.com.au/home.html)

**CCC Policy Statement 1:04:06**

**Pedestrian All Mobility Access AS1428**

The alignment and placement of street trees measured from the tree at the estimated ultimate size of crown is limited by the following:

Limit	Clearance Required
street intersection	Trunk 10.0m from intersection kerb line
electricity/telegraph pole	Trunk 3.0m from centre of pole
stormwater inlet	Trunk 2.0m from edge of inlet
major underground service junction	Trunk 3.0m from edge of junction box
bus stops	no trees planted along length of bus zone
traffic lights	Trunk 10.0m from pole of traffic lights
Driveways	Trunk 3.0m from edge of drive
High voltage transmission lines	4.0m clearance
Street Light	7.0m from the light source

#### 1.1.4 Spacing of trees within the streetscape

Taking into account clearance requirements, street trees are generally to be planted as follows:

- **Median** -25-40 meter intervals (trees may be in groups)
- **Shoulder** -15 meter intervals
- **Verge** -10 meter intervals (6 meter under power lines)

Cairns City in a Garden Master Plan 2007

Part D  
Technical Guidelines

## Vegetation Clearance Space

Type of Power line	Near the Pole	Away from the Pole		
	All Spans	Span of Up to 40m	Span of 40-70	Span over 70m
Aerial bundled Cable	0.3m in all directions		0.6m in all directions	0.9m in all directions
Insulated Service Cables	0.3m in all directions		0.6m in all directions	0.9m in all directions
Urban Bare Low Voltage Lines	1.0m in all directions	1.5m in all directions	2.0m in all directions	
Urban Bare 11kV, 22kV, 33kV Lines	1.5m in all directions	2.0m in all directions	2.5m in all directions	
Important Trees on Rural lines Up to 33kV	1.5m in all directions	2.0m in all directions	2.5m in all directions	Vertically-Spans 70-200=2.5m Vertically-Spans>200m=3.5m Horizontally- 1.25xsag=0.5mor2.5m(whichever is greater)
Important Trees on 66kV & 132kV Lines	3.0m Vertically below or horizontally from any conductor allowing for the sway of vegetation/conductors and the sag of the conductors. <b>No vegetation over the top of Sub-Transmission Lines</b>			

Table taken from Ergon Code of Practice for Power line Clearance 2006

Cairns City in a Garden  
Master Plan 2007

Part D  
Technical Guidelines

**1.2. Trees within the Median**

**General**

Medians help to separate motorists from one another, pedestrians, buildings and other urban fabric. This green corridor adds significantly to the aesthetics of the streetscape and often occupies the least constrained area of the road reserve.

Urban area medians with trees are proven to be safer than those without and can reduce crashes by as much as 50%. (R. Ewing, Caltrans Study, 2003)

**Clear Zone**

Main Roads give the following guidelines for planting within state controlled roads:

***“.....all planting in the median within clear zones is to be frangible; trees with a maximum diameter at maturity of 80mm. There may be exceptions to this rule where roadways are separated and the median is of a sufficient width to meet the setback requirements for non-frangible trees.”***

(see table Part D-Technical Guidelines 1.3.1 Clearway)

**Width of median**

Median widths vary and trees are to be restricted to those with adequate space to allow for healthy tree development and not present a danger to motorists or pedestrians alike.

**Lighting within the median**

Lighting within the median varies according to road hierarchy and alignment but can be generalised as below:

Location	Spacing in metres
High use inner city	25
Other	40-50

Current requirements allow for the following number of trees between light poles:

**Lights @ 25 meter centres      1x8 meter diameter crown tree**

**Lights @40 meter centres      3x8 meter diameter crown trees**

**7.0 meters distance** of estimated crown of tree at maturity from light source

**Planting within the Median**

Planting should not obstruct sightlines. A maximum height of 600mm is recommended for all shrubs and plantings in areas where sightlines for drivers and or pedestrians are important.

The following statement is extracted from Department of Main Roads-Road Planning and Design manual-Chapter 17 Lighting:

***“The location and height of plants must not interfere with the overhead lighting or wires, cast undesirable shadows on the road formation or cause non-uniform illumination of the roadway during the day or night-time.”***

For further details refer to: Department of Main Roads-Road Planning and Design Manual-Chapter 9 Sightlines

### 1.3. Trees within the Road Verge

#### Clear Zone

The following table sets out the clearzones as specified for State Control Roads: (figures refer to a road with a level, straight horizontal alignment)

Limit traffic speed in km per hour	Clearance Required
60km per hour	3 metres
80 km per hour	6 metres
100 km per hour	8 metres

Table taken from QLD Gov-Department of Main Roads-Road Landscape Manual Version 2 October 2004

Please note that on State Control Roads shoulder plantings must also comply with the above table.

#### Width of shoulder

Shoulder widths range between 2 to 5 metres.

For the purposes of tree planting Council Shoulders can be divided into four categories:

- **Bitumen only** – trees are isolated in hard surfacing
- **Bitumen with tree islands** – trees are planted in tree islands
- **Grass and crushed stone only** – dominant in older established suburbs

**Bitumen only** – trees are isolated in hard surfacing

Conditions in these areas can be extremely harsh for trees and is not recommended for future plantings. The following problems can result from trees planted in these areas:

- **Trees become a hazard by lifting bitumen**
- **Trees cannot obtain enough moisture or nutrients**
- **Difficult to water and feed trees because of hard surfacing**
- **Trees suffer stress and can become diseased and even die**
- **Branch damage or scarring from contact with vehicles that can lead to infection and limb loss**
- **Contact with vehicles during early development can lead to a destabilising of the tree, creating an undesirable form and future instability.**
- **Compaction caused by parking can destabilise tree.**

**Bitumen with tree islands** – trees are planted in tree islands

The installation of tree islands within the hard surfacing has the following positive effects:

- **Trees are protected from vehicles by maintenance kerb**
- **Trees have room to develop healthy roots when islands are of an appropriate size**
- **Trees have access to water and can be mulched and fed appropriately**

**Grass and crushed stone only** – dominant in older established suburbs

Conditions in these areas:

- **Compaction of the ground around the tree base damages roots and leads to tree failure.**
- **Tree roots can become a nuisance and a hazard to vehicles and pedestrians.**



**Tree surrounded by bitumen**



**Example of tree island**



**Tree roots have spread across the verge**

Cairns City in a Garden Master Plan 2007

Part D  
Technical Guidelines

- *The appearance of the road edge is often very poor as eroded soil is washed away and causes the road surface to collapse*
- *The frequency of parking can impact adversely on the condition and appearance of the shoulder*
- *Erosion of the grass on the shoulder caused by excessive parking/traffic leads to high levels of dust during the dry season.*

#### 1.4. Trees within the Footpath

##### Width of footpath

Footpath widths range between 4.0 to 6.9 metres.

For the purposes of tree planting Council verges can be divided into four categories:

- **Pavement only** – restricted to CBD and other commercial areas.
- **Wide Footpath with grass strip** – 2 meter concrete footpath typical.
- **Narrow Footpath with grass strip** – 1.2-1.5 metre footpath typical.
- **Grass only** – dominant in older established suburbs and new developments on local streets.

**Pavement only** – restricted to CBD and other commercial areas

In footways that are paved from building line to kerb the tree hole has traditionally been cut immediately behind the kerb, allowing the area closer to the building line for underground services.

For the comfortable passage of pedestrians in single file, a clear width of at least 1200mm is needed between the back of the tree hole and the building line. As the minimum practical setback of tree holes from the kerb is 800mm, the minimum width of footway that can be safely planted is 2000mm (800mm plus 1200mm), subject to the following conditions:

- *That there are no obstructions overhanging the building line from the front yard of the adjacent property (e.g. awnings shrubs and vines)*
- *That the lower branches of the tree have been pruned to a height of at least 2000mm.*

**Wide Footpath with grass strip** – 2.0 metre concrete footpath typical

Generally this width of path is used on 4.5 metre verges and results in a planting strip of no more than 1.6 metres. In some cases where the verge width is less than 4.5 metres the nature strip, that is to say the area made available for the planting of street trees is reduced to as little as 1metre (or even less in severe cases)

**Narrow footpath with grass strip** – 1.2 -1.5 metre footpaths typical

The narrower footpaths are usually found in the older areas, the nature strips here tend to be wider and better suited to the planting of Street Trees, with 0.5 - 0.8 metres more space available on a 4.5 metre verge.

**Grassed footways** – dominant in older established suburbs

This treatment is most often seen in the smaller residential streets in the older suburbs of Cairns. Pedestrian movement and safety can often be impeded by inappropriate plantings within the verge of large shrubby plants or palms such as Golden Cane. This obviously is a great concern within areas of high pedestrian movement.

#### Trees within the Footpath



Trees planted in nature strip



Groups of palms planted in nature strip and boundary



The pendulous branches of this Tee Tree block the Footpath

Cairns City in a Garden  
Master Plan 2007

Part D  
Technical Guidelines

## 2. Strategies for Improving Tree Planting within the Road Reserve

### 2.1. General

#### 2.1.1. Water/Aeration Pipes

Water pipes help deliver water efficiently to the root zone and encourage the development of a healthy deep root system and discourage the tendency of urban trees to search for surface water. They also allow oxygen to penetrate down below hard surfacing and thus aerate the root zone.

#### 2.1.2. Tree Guards

These can be useful in inner city areas where the likelihood of vandalism is greater. The guards make opportune damage to young and susceptible trees more difficult.

#### 2.1.3. Root Barriers/Root Directors

Root barriers are a useful strategy in the minimisation of damage to pavements, kerbs, services and other infrastructure. The purpose of the root barrier or Root Director is to guide the growing tip of spreading roots in a direction that will cause the least damage, that is to say down.

The difference between a root barrier and a root director is quite simple.

A **root barrier** comes in a long roll and is laid along the length of the area to be protected, extending at least 1.0metre from the estimated limit of the tree canopy on maturity.

A **root director** is a barrier box which surrounds the tree on planting and restricts and “**directs**” the roots downwards.

Tree root management solutions will vary according to the tree species, its planting location and the depth of any adjacent services or foundations. Linear barriers are preferred where a row of trees are to be installed and kerbs need to be protected, remember that root barriers should extend 1000mm beyond the estimated drip line of the crown of the tree at maturity. Root barriers can be used to line kerbs or footpaths allowing the maximum growth area for roots, and protecting trees from future kerb or pavement upgrades.

For isolated trees, or trees planted in islands or medians a root director can be installed, they are easier to install and hard to install incorrectly.

(For further details see Part D- Technical Guidelines - 4.4.7 Installation of Root Barriers and Root Directors and Part F- Streetscape Templates - 25-27 Tree Planting Details)

#### 2.1.4. Root Disturbance

Any work carried out around the base of any tree must be kept to a minimum. Disturbance of root systems can be very harmful even to the largest of trees. The cutting of roots can lead to a progressive weakening of growth and stability that can result in disease and collapse.

#### 2.1.5. Tree Protection during on site works

Trees should be adequately protected during on site works. Trunks should be wrapped where appropriate and the root zone fenced off as far as the drip line of the crown of the tree to avoid unnecessary

## Improvements-General



Tree grill and guard with aeration/water pipes



Root barriers installed over root cells with irrigation pipe



Tree guards can protect young trees

Cairns City in a Garden  
Master Plan 2007

Part D  
Technical Guidelines



compaction of the root zone by heavy vehicles. Heavy compaction destroys the soils capacity for aeration and the tree can “suffocate”.

Exposed roots should be covered at all times and not allowed to dry out. Root stress can be very damaging and lead to tree failure.

#### 2.1.6. Pruning to Establishment

The early, formative pruning of a street tree is essential to their performance as a good street tree. Trees need to be shaped to suit their location with a good clean upright trunk and well-formed balanced crown. All pruning should be carried out in accordance with the relevant Australian Standards.

#### 2.1.7. Use of Soil Conditioners

Soil conditioners improve the growing conditions for plants in the root zone. They usually consist of fertilisers, hydro-absorbent copolymers and root stimulating organic fertilisers.

Soil Conditioners can improve the following:

- **Water and Nutrient retention capacity** by as much as 50%
- **Soil Structure**
- **Aeration-vital oxygen to the root zone**
- **Root and Plant Growth**

#### 2.1.8. Structural Soils and associated technologies

Structural soils can be employed to increase the potential area for root development while maintaining the structural integrity of hard surfaces. A matrix of gravels and soils are balanced to provide a suitable base for hard landscaping and a more hospitable environment for root development with improved aeration.

Structural soils are particularly useful when tree planting in areas of hard landscaping such as car parks and inner city areas.

Root cell systems provide a sub-surface matrix which can be loaded with 90% topsoil by volume, and sustain loads of up to 80 tonnes per square meter. In comparison structural soils can hold as little as 5% soil by volume. Root cells are ideal for use in areas of extensive hardscaping such as pedestrian malls and car parks.

#### 2.1.9. Nature Strips

The provision of a minimum nature strip of 2.0 metres would greatly increase the selection of street tree species and decrease the potential for damage to the streetscape infrastructure; that is to kerbs and underground services. Ideally trees should be set back 1000mm from the back of the kerb and 1000mm from the edge of the footpath.

### 2.2. The Median

#### 2.2.1. Conflict with existing lighting

Where conflict already exists between lighting and street trees which are deemed to be of benefit to the street, and where this does not create security risks to drivers or pedestrians it is preferable for street lighting to be relocated.

The coordination of median lighting and median tree planting programmes will increase the success of future landscaping.

## Improvements-General Median & Verge



Example of a typical root cell product



Root Directors have been installed in this median to minimise damage to infrastructure.

Cairns City in a Garden  
Master Plan 2007

Part D  
Technical Guidelines

### 2.3. The Verge

#### 2.3.1. Tree Islands

The use of tree islands has the following benefits:

- *Trees have room to develop healthy roots when islands are of an appropriate size*
- *Trees are easier to water and can be mulched and fed appropriately*
- *Root Barriers can be used to encourage appropriate root development*
- *Water manifolds can be installed at the time of planting to facilitate the efficient delivery of water to encourage deeper root development*
- *Kerbs protect tree from damage by vehicles*
- *Prevents potentially polluted run-off from contact with tree root zone*

#### 2.3.2. Turf Cell and other Permeable Pavement Surfaces

Council will commit to further research into the possible use in Cairns of the turf cell and other permeable surface products. These offer the following benefits:

- *Turf cell reduces the need for bitumen and leads to greener streets*
- *Water permeates the shoulder surface and percolates down to adjacent root systems, which can soak up excess water.*
- *Trees may be planted more directly into this structure with simple parking blocks to prevent damage to tree trunks*

#### 2.3.3. Soil Conditioners

These promote root development at the base of the tree pit and encourage deep root growth, providing the tree with a more acceptable medium within which to grow while providing a suitable sub-base for

#### 2.3.4. Special Treatments for Parking within the Road Shoulder

Parking layouts and the provision of parking should allow for the maximum provision of street trees. Trees within parking facilities need to have the protection of tree islands or parking kerbs. Some suggestions for parking layouts have been indicated in the City in a Garden Part D Streetscape Templates. The proper use of trees within parking has the following benefits:

- *It improves the visual appearance of the street*
- *It provides shade for parked vehicles*
- *The use of tree islands improves growing conditions (see above)*



A typical tree well

Cairns City in a Garden  
Master Plan 2007

Part D  
Technical Guidelines

**2.4. The Footpath**

**2.4.1. Strategies to Avoid Damage to Footpaths and Services**

Street trees unfortunately often cause damage to footways, overhead wires, and underground services. The damage can be minimised and even avoided in some cases with strategies such as those listed below.

Damage	Strategies for minimisation
Damage to underground services at time of planting	<ul style="list-style-type: none"> <li>•use of location plans provided by service authorities or “Dial before you Dig”</li> <li>•maximum size of tree root bag limited to 25 litre when insufficient space available</li> <li>•maximum depth of hole limited to 600mm</li> <li>•all holes to be dug with hand tools</li> </ul>
Damage to underground services as tree matures	<ul style="list-style-type: none"> <li>•mature size of selected trees appropriate for site</li> <li>•avoidance of species known to severely damage underground services</li> <li>•adequate allowance for nature strip at time of road construction</li> <li>•proper use of root barrier treatments</li> </ul>
Damage to pavements	<ul style="list-style-type: none"> <li>•mature size of selected species appropriate</li> <li>•avoidance of species known to severely damage pavements</li> <li>•proper use of root barrier treatments</li> <li>•adequate allowance for nature strip at time of road construction (in scale with road reserve)</li> </ul>
Damage to overhead wires	<ul style="list-style-type: none"> <li>•use of trees with open canopy growth habit</li> <li>•continuation of Aerial Bundled Conductor conversion</li> <li>•programme of under grounding power cables in key areas.</li> <li>•increased maintenance regime to include tip pruning</li> </ul>

**2.4.2. Aerial Bundled Conductors**

Ergon has been working together with Council in the installation of Aerial Bundled Conductors (ABCs). ABCs bundle the normal group of overhead services into a single, relatively thick cable coated with a tough plastic insulation. ABCs reduce the cross sectional area necessary for the provision of overhead services and therefore reduce the conflict with street tree branches. Pruning is required less frequently and the canopy branches can be trained around the ABC relatively easily.

**2.4.3. Under grounding of Power Cables**

The City of Cairns will seek to establish strategies for the under grounding of power cables in key areas.

### 3. Streetscape Templates

The purpose of the Streetscape Templates is to provide a more integrated approach to the structure of the road reserve. It aims to promote best practice for the planting of trees and associated landscaping, providing a set of models that guide the establishment and development of Cairns's Streets and Roads.

Trees are to be considered as a vital component of the streetscape; not as an additional item of "street furniture". The design of streets should incorporate the principles laid out in the templates; the provision of street trees should be regarded as an essential ingredient in the development of quality streetscapes for Cairns.

#### 3.1. Streetscape Templates

The Streetscape Templates establish models for the placement of trees within the road reserve as set out by the Cairns City Council Transport Network Plan (TNP) and the current guidelines to the Road Hierarchy. They indicate street structures and the relationship between street infrastructure and tree planting.

**The Templates are set out both in section at a scale of 1:200 and in plan at 1:500 in Part F-Streetscape Templates.**

The templates must be read as a guide. Street tree spacings are indicative and it is understood that these will not always be achievable, especially when dealing with existing road structures and the following constraints:

- **Access Drives**
- **On Street Parking Requirements**
- **Existing Street Furniture** including Power Poles
- **Underground Services**

To this effect we have suggested how these constraints may be dealt with, indicating alternative tree placements. While symmetry may be preferred it is understood that a site-specific approach may necessitate a more random or asymmetrical design outcome such as outlined in Part B Design Principles 2.3 Planting Styles:

- **Informal Avenue**
- **Alternative Avenue**
- **Grove Planting**
- **Special Planting**

The Street Tree Templates should be read in conjunction with the existing rules which govern the placement of trees within the road reserve; these are outlined in Part D 1.1 Street Trees – General Guidelines to Placement.

#### **Streetscape Templates:**

1. **TNP Type A**
2. **TNP Type B/B1**
3. **TNP Type C/C1**
4. **TNP Type D/D1**
5. **TNP Type E/E1**
6. **TNP Type G/G1**
7. **TNP Type V/V1**
8. **Road Hierarchy Access Street**
9. **Road Hierarchy Minor Collector**
10. **Road Hierarchy Major Collector**
11. **Road Hierarchy Trunk Collector**

- 12. Road Hierarchy Low Density Residential Road <29-30
- 13. Road Hierarchy Low Density Residential Road>31-70
- 14. Roundabout

**3.2. Roundabouts**

Roundabouts provide an ideal space for landscaping within the road reserve, offering the possibility of installing quality garden beds.

*Refer: Department of Main Roads-Road Planning and Design Manual - Chapter 14 Roundabouts*

**3.3. Intersections**

Planting at intersections can be an effective way of developing a consistent theme in a precinct to reinforce the character of the area. This can be achieved by developing setback treatments or truncations at corners to support vegetation. It is important that these plantings are low maintenance and require minimal manual watering.

*Refer: Department of Main Roads-Road Planning and Design Manual - Chapter 13 Intersections at Grade*

**3.4. Gateways**

Cairns has already established a definite tropical theme combining lush tropical flowers and foliage to create an intense landscaping to the main northern and southern entrances to the City. It is envisioned that these routes will be further reinforced and that other key roads will be similarly transformed though the installation of similar median plantings.

**3.5. Suburban Enhancement**

Further Planting can be achieved within the suburbs by incorporating opportunities for landscaping with modifications to the existing road structure, the installation of Local Area Traffic Management, and other works infrastructure proposals. This could incorporate roundabouts and intersections (see above).

**3.6. Local Area Traffic Management**

Landscaping can be incorporated into local traffic calming treatments. The use of trees and shrubs can beautify a streetscape and create a sense of narrowing to help drivers to discern the road geometry and warn of possible hazards. Such an enhanced LATM programme would also assist in the fulfilment of the Suburban Enhancement Programme.

**A list of appropriate trees, palms and plants are outlined in Part E- Appendices**

**Gateway planting in the median along Spence Street**

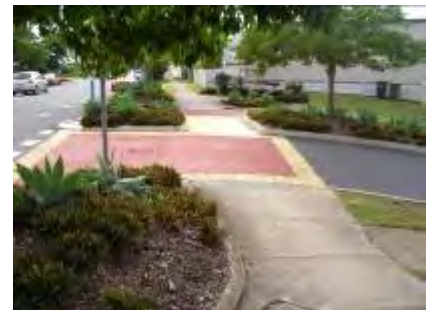

**Traffic calming incorporating landscaping in Brisbane**

Cairns City in a Garden  
Master Plan 2007

Part D  
Technical Guidelines

## 4. Street Tree Specification and Installation Details

## Street tree Specification

The planting of trees in footways is a time consuming process that can involve saw cutting of concrete, jack hammer work, excavation by hand, disposal of soil, planting, mulching, and installation of tree guards. If tree planting is carried out on major thoroughfares of either vehicle or pedestrian traffic, additional traffic control measures will be required including the scheduling of work in the early mornings or on weekends.

This amount of time and expense is largely wasted if the tree dies shortly after planting and must be replaced.

It is therefore essential that the tree is in optimal condition when planted, and the method of planting, protection and maintenance is of a high standard.

This section outlines the required steps to provide new street trees with the best possible chance for success. This section will act as a specification for the purchase, installation and maintenance of street trees for use by the City of Cairns and Developers carrying out work on the public domain.

Factors to consider include:

**Purchase of trees** - including required height, container size and pruning side branches

**Tree Installation Specification** - including size, backfill and provision of watering point

**Street Planting Technical Details**

**Specification and installation of tree guards**

**Maintenance Requirements**



Cairns City in a Garden  
Master Plan 2007

Part D  
Technical Guidelines

**4.1. Quality of Nursery Stock**

It is essential that trees supplied for street tree planting are grown to a standard which will allow them to establish rapidly and continue to grow as long term assets of the streetscape.

It is desirable that All trees to be provided to the City of Cairns are to conform to the NATSPEC guide and “Guide for assessing the quality of and purchasing of landscape trees” by Ross Clark 2003. Relevant requirements are summarised below.

It is desirable that Nursery stock meet design criteria for minimum dimensions, container size and shape, plant shape or special pruning requirements outlined in this document as is summarised below:

**Table 1 Height, given container volume and calliper at 300mm.**

Root ball volume	Height (above container)	Calliper (at300mm)	Clear trunk height
45 litre	1.9 - 2.3 metres	30mm - 35mm	1200mm
75 litre	2.2 - 2.4 metres	40mm - 45mm	1400mm
100 litre	2.4 metres	50mm	1500mm
200 litre	3.6 metres	60mm	1500mm
300 litre	4.2 metres	70mm	1500mm
400 litre	5.5 metres	70mm	1500mm
Palm trees	NA	NA	5 metres clear trunk

Source: Ross Clark 2 NATSPEC - Guide for assessing the quality of and purchasing of landscape trees 2003

In certain circumstances, criteria must vary to suit particular locations, ie.3-4m clear trunk for trees planted next to awnings.

**4.1.1. General Characteristics of Nursery Stock**

The general characteristics which are covered by the specification are as follows:

**4.1.2. True to type**

The trees supplied and planted must be the species (and variety if cultivars are used) that the purchaser has ordered.

**4.1.3. Health and vigour**

The trees supplied must be healthy and vigorous at the time of delivery.

**4.1.4. Freedom from pests and disease**

Trees should not be diseased or show evidence of pest attack that could affect the long-term health of the tree or adjoining plantings.

**4.1.5. Balance of crown**

This refers to the crown bulk on opposite sides of the stem axis which indicates the tree’s structural integrity and its aesthetic qualities. Trees that have an asymmetrical crown (nominally an imbalance of > 20%) are generally undesirable

**4.1.6. Uniformity of growth**

Trees should be grown at a steady rate to produce a better quality tree with an even branch structure. Over-fertilisation can often lead to irregular growth, which could cause aesthetic and structural problems.

### 4.1.7. Stem taper

This is a measure of the tree's ability to be self-supporting. Trees with insufficient stem taper may need artificial support (staking) and are prone to damage by vandals and wind throw. Adequate stem taper is generally a result of the tree having been given enough space to grow at the nursery without use of stakes.

### 4.1.8. Pruning history

Formative pruning of trees at the nursery to achieve a straight trunk, clear of branches, ensuring any pruning repairs are quick to recover, lessening the possible effect of long term damage to the tree.

### 4.1.9. Included bark

If bark is folding into the joint or crotch of a tree as it grows (often after damage) this can result in a structural weakness that could increase the risk of limbs falling in a storm.

### 4.1.10. Compatibility of graft unions

The scion and rootstock must be compatible, as a structural weakness will occur in an incomplete graft, causing retarded or excessive growth above ground (i.e. a top-heavy tree with poor root growth is more likely to fall in a storm).

### 4.1.11. Apical dominance

Tree species grown with a defined central leader will have an improved appearance and less possibility of splitting into a form less appealing.

### 4.1.12. Indication of north

When planting trees greater than 100L the orientation of the cambium must be maintained as it was in the nursery (i.e. the side of a tree previously sheltered from sun should not then be exposed to sun once planted).

### 4.1.13. Root division

Inadequate division of root systems will affect surface area. A strong and progressive root development will give a strong structural base. Roots held at length in containers may produce too much secondary division (i.e. root ball hydrophobic), producing watering problems for the plant.

### 4.1.14. Root direction

Any root distortion will ultimately become apparent in the tree at a later stage, causing a structural weakness in the root system (e.g. spiralling roots in a small tree, if left untreated at planting could strangle the developing roots).

### 4.1.15. Root ball occupancy

It is important that the volume of the root ball at purchase is fully occupied by the root system and when shaking the root ball unsupported, at least 90% of soil volume should remain.

### 4.1.16. Non-suckering rootstock

It is preferable that a naturally suckering tree species be grafted onto a rootstock which is non-suckering before planting.

### 4.1.17. Hardening off

For a minimum of eight weeks prior to delivery, all plants shall be grown in open areas receiving a minimum of 75% full sun. Watering and fertilising of plants shall be gradually reduced for a similar time period leading up to delivery to aid in hardening of plants.



### 4.1.18. Acclimatisation

If plants are being grown or propagated outside a 100km radius of Cairns then the contractor shall move all plant stock to a nursery within this radius so that the plants may become acclimatised for a period of not less than eight weeks to the date of delivery. The plants must then be hardened off in accordance with the preceding specification.

### 4.1.19. Maintenance in Transit

All plant material must be protected from the adverse effects of transportation and general handling. Plants are to be transported in fully enclosed pan technician type vehicles. Plants are to be adequately watered prior to moving and should be secured so as to avoid damage to branches.

### 4.1.20. Advanced Trees and Palms

Advanced specimens require craning by slinging the root ball. Plants lifted by slings attached to trunks or limbs will not be acceptable.

### Rejection of non conforming specimens

Any tree not conforming to this standard may be rejected and a replacement required.

## 4.2. Tree Installation Specifications

All work shall be in accordance with the relevant standards. The following standards are referred to in this section:

***AS4419 Soils for landscaping and garden use - 1998***

***AS4454 Composts, soil conditioners and mulches - 1997***

***AS4373 Pruning of amenity trees - 1996***

### 4.2.1. Inspection

### 4.2.2. Tests

### 4.2.3. Drainage Testing

Test Tree pit and continuous trench sub-soil is free draining. Install sub-soil drainage as specified if water drains from hole at rate of less than 5mm per hour. Connect sub-soil drainage lines to available stormwater system.

### 4.2.4. Soil Testing

### 4.2.5. Sampling

### 4.2.6. Maintenance

### 4.2.7. Expertise

All tree planting works will be carried out by a Landscape contractor who has demonstrated experience in the field of landscape work, tree planting and tree establishment. Allocate or engage the services of personnel experienced in each of the specialised trades as nominated at the time of the tender, including personnel with appropriate licenses for the operation of machinery and the use of chemical sprays.

It is desirable that All tree planting, tree establishment and maintenance work will be carried out by qualified horticulturists with a minimum of three years experience in the horticultural/landscape industry. It is desirable that the foreman will have the minimum qualification of a TAFE Course Certificate in Urban Horticulture, or its recognised equivalent, with a minimum five years demonstrable experience in similar landscape projects.

All tree surgery work will be carried out by an approved, qualified Arborist; defined as having as a minimum, the NSW TAFE Course Certificate in Urban Horticulture, including a pass in the elective Tree Care and Maintenance, or NSW TAFE Tree Surgery Certificate or its recognised equivalent. The Arborist shall also have a minimum of five years experience in practical arboriculture including demonstrated experience in tree diagnosis and tree surgery.

### Subsoil drainage

Drainage Pipe	-Slotted, flexible corrugated 100 P.V.C. pipe and fittings minimum to AS 2439.1.
Drainage Medium	-5-7mm Drainage Gravel filter material.
Line Flushing Points	-Provide flushing inlets and approved surface covers in pavement to permit flushing of Subsoil Drainage lines.

### 4.2.8. Structural soil mix

The structural soil-growing medium shall be a thoroughly combined mix of four parts aggregate to one part filler soil

### 4.2.9. Required backfill soil properties

Filler soil shall be thoroughly combined mix of one part sandy loam to one part screened dolerite with the following properties:

Organic matter	<1% by weight
Optimum Moisture Content	12.5%
Maximum dry density (t/m <sup>3</sup> )	1.95 STD
CBR	20-30%
Total Porosity	42%
pH in water	5.5-6.5
pH in CaCl <sub>2</sub>	5.5-6.5
Electrical conductivity	1.0 - 1.8 mS/cm
Chlorides	30-85mg/kg
Sodium	<5% ECEC
Potassium	5-15% ECEC
Calcium	60-75% ECEC
Magnesium	5-25% ECEC
Calcium / Magnesium ratio	3:6
Phosphorous	10-50mg/kg
Ammonium	<100mg/kg
Nitrate	<100mg/kg
Sulphate	40-100mg/kg

**4.2.10. Additives**

The following additives are to be thoroughly mixed with above filler soil prior to blending with crushed aggregate. Additives will be tested for compliance prior to blending with the crushed aggregate:

Additives	Rate
Magrilime	600g/m3 (to bring pH to 5.5-6.5)
Trace element mix	300g/m3
Potassium nitrate	500g/m3
Ammonium nitrate (Nitram)	500g/m3
Superphosphate	500g/m3
Iron sulphate	1500g/m3
8-9 month control release fertiliser	2000g/m3
Gypsum	500g/m3
Magnesium sulphate	400g/m3

**4.2.11. Aggregate**

Aggregate shall be 40mm crushed River gravel or crushed basalt. Gravel shall be clean and free from clay or other matter. The aggregate shall be of the following particle size distribution:

A.S Sieve (mm)	Percent passing
53.0	100
37.5	90-100
26.5	0-75
19.0	<15
13.2	<2
9.5	<2
6.7	<2
4.75	<2

**4.2.12. Transportation**

Structural soil mix shall be delivered to site pre-blended. The soil mix shall be transported in a moist condition to prevent segregation of components.

**4.2.13. Structural soil delivery**

All soil mixes installed on site shall be in accordance with the approved sample. All soil mixes which do not comply with the specification will be rejected and must be removed from site at the contractor's cost. On site remediation of non-complying soil mixes will not be accepted.

**4.2.14. Soil**

A good quality landscaping soil mix shall be imported from an approved source to the planting site for backfilling planting pits.

Landscaping soil mix shall be as follows:

- It will contain approximately 70% sandy loam and 30% composted or mature organic matter
- It shall be friable and not contain any clay
- The PH shall be between 5.5 and 7.0
- It shall be free from contaminants such as the seed of declared weeds, rocks, sticks and salts
- It shall not contain any chemical fertilisers

**4.2.15. Sandy Loam**

Commercially available premium grade sandy loam conforming to AS4454.

**4.2.16. Organic matter**

Commercially available aged and composted green waste or mature mill mud, free of weeds, debris or other deleterious material.

**4.2.17. Backfill soil mix**

Backfilling soil to trees will be as an “A” and “B” horizon comprising Type “A” and Type “B” soil mixes respectively.

Type A            30% imported topsoil  
                       60% coarse sand  
                       10% organic matter  
                       plus amendments as determined by soil chemical analysis to achieve pH and fertility suitable to promote vigorous growth and establishment.

Type B            40% imported topsoil  
                       60% coarse sand  
                       plus amendments as determined by soil chemical analysis to achieve pH and fertility suitable to promote vigorous growth and establishment.

**4.2.18. Water**

Temporary irrigation should then be provided as required to maintain the trees in peak condition at all times by having the capacity to apply a weekly target application of 25mm of water (approximately 12 to 13 litres of water per square metre).

**4.2.19. Horticultural chemicals**

Comply with legislation dealing with horticultural chemicals and apply in strict accordance with the manufacturer’s recommendations. Ensure that all appropriate protective equipment is provided including respirators etc during the application of any horticultural chemicals.

**4.2.20. Herbicide**

Remove by hand or by spraying with a suitable glyphosate based herbicide. Sprayed areas must remain undisturbed for a period of two weeks prior to planting.

**4.2.21. Compost and fertiliser**

**4.2.22. Fertiliser**

Provide proprietary fertilisers, delivered to the site in sealed bags marked to show manufacturer or vendor, weight, fertiliser type, N: P: K ratio, recommended uses and application rates.

**Fertiliser schedule**

Location	Chemical	Application	NPK Analysis
Tree Planting	Organic or Inorganic	Fertiliser tablets	N15-25 P 6-9 K10-20

Ensure tree root balls are adequately watered prior to liquid fertiliser applications. Flush any residual fertiliser solution from permeable pavement surface following liquid fertiliser applications.

### 4.3. Tree stakes, supports, ties and guys guards

#### 4.3.1. Stakes

Provide hardwood stakes that are straight, free from knots or twists, pointed at one end. Stakes are to be driven into the ground at least one third of their length, avoiding damage to the root system. The top 200mm of the stake should be neatly painted white.

Stake sizes should be as follows:

Tree Height m	Number of stakes	Size of stakes mm
2.5	X3	50x50x2400
1-2.5	X2	50x50x2400
1	X1	38x38x1200

#### 4.3.2. Ties

Provide ties fixed securely to the stakes, one tie at half the height of the main stem, others as necessary to stabilise the plant.

For trees over 2.5 metres high,

For trees less than 2.5 metres high, a proprietary tree plastic multi purpose chain tie will be used.

#### 4.3.3. Guards and Guys

Allow to provide tree guards, temporary support structures, guys or bracing as specified where necessary to protect trees and maintain stability.

Allow to provide purpose made cables and anchors to support the root ball within the tree pit in the event that root balls are damaged during unloading, temporary storage, and transport on site or during planting.

**4.4. Tree Pit Preparation**

**4.4.1. Excavation of tree pits**

**Requirement**

Excavate tree pits and linked continuous tree trenches to the required depths. Remove all excavated materials from site. Do not disturb services, excavate by hand around services as required.

**Excavation Depths**

Location	Depth
Tree pits	Equivalent to depth of new tree root ball measured from underside of concrete base slabs.
Linked continuous trenches	500mm measured from underside of concrete base slab.

Allow additional excavation as required to achieve specified falls to subsoil drainage lines where required.

**4.4.2. Sub-grade preparation**

**Cultivation**

Cultivate or rip sub-grade at base and sides of tree pits and continuous trenches to a minimum depth of 150mm. Cultivate manually within 300mm of existing structures or services. Do not disturb services, excavate by hand around services as required. During cultivation, thoroughly mix in any materials required to be incorporated into the subsoil. Remove stones greater than 50mm and any debris, rubbish or deleterious material brought to the surface during cultivation. Trim the base of tree pits and trenches to the required design levels falls and shapes after cultivation.

**Additives**

Where sub-grades are clay or clay fill, apply Gypsum during cultivation. Incorporate into the upper 100mm layer of the sub-grade of tree pits and trenches as scheduled.

**Soil Additives Schedule**

Location	Additive type	Rate
Upper 100mm of	Gypsum	0.2kg/sqm (1.6kg per tree pit)

**Placing soil mix**

**4.4.3. Tree Pit Construction**

Tree pits can be constructed by either placing and compacting structural soil initially and excavating material for later installation of Backfill Soil Mix or compacting structural soil within temporary formwork or shoring that conforms to inner and outer tree pit dimensions.

Remove all formwork prior to planting and backfilling.

**4.4.4. Placing structural soil mix**

General: Spread the structural soil on the prepared subsoil and grade evenly, making the necessary allowances to permit compliance with the required finished levels and contours.

Backfill and compact structural soil mix in areas other than tree pits in layers 150mm maximum thickness. Avoid differential subsidence and excess compaction.

The structural soil is to remain in a thoroughly blended composition and be kept moist during backfilling and compaction to prevent segregation of soil mix components. Watering in of the soil mix during installation is not permitted.

If any segregation of the aggregate and filler soil occurs, excavate the segregated material and re-mix to an even and uniform consistency prior to continuing backfilling and compaction.

#### 4.4.5. Compaction

Thoroughly and evenly consolidate each layer using approved mechanical equipment to achieve a uniform density of not less than 95% maximum dry density as determined by AS1289.5.1.1 at design levels.

#### 4.4.6. Existing services

Avoid damage to the installed irrigation manifold during compaction.

Do not disturb services during backfilling and compaction.

#### 4.4.7. Installation of Root Barriers and Root Directors

Root barriers and Root Directors must be installed according to the manufacturer's instructions. The following table is designed as a guide to root control selection only (professional advice should be sought from the manufacturer in regard to specific applications).

WHAT ARE YOU PROTECTING FROM TREE ROOTS?						
Building foundations	Footpaths			Underground services/utilities	Footpaths and underground services/utilities	
	Type of Barrier Surround (Director) or Linear			Depth of services determines barrier type		
	Surround (Director)		Linear	How deep are the services/utilities?		
	What is the predicted girth of the tree trunk at maturity?			Up to 450mm	Up to 800mm	Deeper than 800mm
	Up to 750mm	Greater than 750mm				
ROOT CONTROL	ROOT CONTROL	ROOT CONTROL	ROOT CONTROL	ROOT CONTROL	ROOT CONTROL	ROOT CONTROL
2000mm wide High density root barrier	Root Director 640mm/1050mm	Root Director 1050mm/1400mm	Linear Root Barrier 300-1000mm deep	Linear Root Barrier 600mm deep	Linear Root Barrier 1000mm deep	Linear Root Barrier 1500mm deep and greater

#### 4.4.8. Irrigation manifold

Install tree irrigation manifolds to tree pits or trenches over structural soil to the extent indicated on the drawings. Construct manifolds from 1000mm diameter rigid slotted UPVC fitted with filter sock and set in a horizontal position to enable an even distribution of water across the root zone. Fit upturns at nominated locations and connect to pavement inspection / inlet grates.

Grates shall be stainless steel types. Finish grates flush with adjoining pavement levels.

### **4.4.9. Protective sheeting / separation layer**

Prevent any contamination of the existing structural soil from concrete dust, mortar, excavated site soil or other debris.

Immediately following compaction of structural soil, install a layer of polymeric Protective Sheeting 200 microns thick (equivalent to Fortecon or similar approved PVC sheeting) over the structural soil to prevent contamination. Provide adequate fastenings to hold sheeting in place and maintain during the course of the works. Ensure all debris is removed from sheeting prior to the installation of aggregate base course and paving materials.

Prevent windblown materials such as cement lime or other chemicals from being deposited within the root zone.

### **4.4.10. Remediation**

Carry out all remediation measures of structural soil mix, as recommended in soil mix test results, prior to installation of concrete base slab.

### **4.4.11. Contamination**

Where diesel oil, cement or other phytotoxic materials have been spilt on the subsoil or soil mix, excavate the contaminated material, dispose off site and replace with new site subsoil and/or soil mix as directed to restore design levels.



### 4.5. Planting

#### 4.5.1. Planting conditions

Do not plant in unsuitable weather conditions such as extreme heat, cold, wind or rain. Avoid planting where unseasonable adverse weather is forecast within 24 hours of the operations. Suspend excavation following extended rain periods or when the structural soil mix or other soil mixes are wet.

#### 4.5.2. Watering

Thoroughly water the tree root balls before planting immediately after planting and prior to applying the mulch. Prevent the root balls from drying out during the planting phase. Water as required to maintain growth free of stress.

#### 4.5.3. Tree pit

Excavate the tree pit to a depth equal to the depth of the tree root ball. The contractor shall determine the root ball depth of each tree to determine the appropriate tree pit depth. Allow additional depth to achieve specified falls for subsoil drainage lines and to satisfy finished levels.

Excavate only as required and avoid excessive disturbance to the remaining compacted structural soil.

#### 4.5.4. Lifting

In the event that trees have to be repositioned or lifted by the trunk, provide adequate soft padding to the trunk(s) in the form of underfelt, carpet or rubber wrapping and use soft slings during the lifting.

#### 4.5.5. Placing

When the tree pit is excavated and the hole is the correct size, place the root ball in its final position. Ensure the trees are centred and plumb, and with the top of the root ball level with the finished surface of the surrounding soil mix.

Do not use trunk of tree as a lever in positioning or moving the tree in the planting hole.

#### 4.5.6. Alignment and orientation

Position trees at set out distances as indicated on the drawings. Ensure trunks are set vertically and aligned with other new or existing trees.

Orientate trees so that the lowest branches are aligned parallel with the kerb and roadway (NOT extending into the roadway).

#### 4.5.7. Container, wrapping and cage removal

For container grown trees, carefully remove root ball and tree from container before planting or cut away container sides within tree pit.

For field grown trees, correctly position tree in pit, carefully remove the wire cage and Hessian wrapping down to at least one third from the base of the root ball. Avoid disturbance to the root ball soil and roots. Where tree root ball soil is stable and not falling away continue to remove wire and wrapping to the base of the root ball.

Leave wire and Hessian beneath the root ball in place. Where there are signs that the root ball soil may fall away, discontinue removal of the wire cage. Continue to remove as much Hessian wrapping as possible without disturbing the root ball soil. Where Hessian must be retained in place, ensure that there are sufficient cuts in the Hessian to allow root growth into the backfill. Remove all cut wire, Hessian and other wrapping material from the tree pit.

### 4.5.8. Root trimming

Carry out root pruning only as directed by a qualified arborist. Where directed, prune/slice away turned roots using secateurs only.

Do not leave root balls exposed for extended periods. Avoid excessive disturbance to roots during trimming. Discontinue if root ball soil begins to fall away.

### 4.5.9. Backfilling

Backfill around the root balls with Backfill Soil Mix so as to reinstate the A and B soil horizons in the new locations.

Backfill the B horizon with Type B mix to a depth of approximately 300mm deep below the top of the root ball. Lightly compact. Compaction by flooding / watering is acceptable. Ensure all voids around and under root balls are filled and that no air pockets are retained.

Backfill the A horizon with amended Type A mix to a depth of approximately 200mm deep (maximum depth of 300mm) and level with top of root ball.

Lightly compact. Ensure all voids around root balls are filled and that no air pockets are retained.

Ensure that topsoil is not placed over the top of the root ball. The top of the root ball and plant stem should be level with the top of backfill.

### 4.5.10. Watering

Hand water immediately after planting. Direct water so as to not disturb soil. Raise soil moisture within the root ball to field capacity. Ensure root ball is thoroughly wetted through the entire soil profile. Continue watering at a rate and frequency as required to avoid water stress.

### 4.5.11. Mulching

Mulch shall be aged hardwood woodchip, stockpiled for a minimum of six weeks, free from rocks, non-biodegradable and toxic material. In paved footpaths it shall be installed to a depth of 75mm, in tree islands and grass verges to a depth of 150mm. the mulch should be left just clear of the trunk.

Peanut shell or forest litter is to be used only in Parks, Reserves or Buffer Mounds. The use of tree mulch is strictly prohibited due to its combustibility.

### 4.5.12. Tree replacement

Where trees are damaged or die or fail to maintain vigorous growth typical of the species due to neglect or inadequate maintenance, replace, replant and maintain trees of the same species, size and quality.

### 4.5.13. Establishment maintenance

Continue to maintain the trees in good health and vigour and without stress, immediately after planting. Continue to maintain all newly planted and existing trees in accordance with all requirements specified up to and until handover to the City of Cairns.

### 4.5.14. Tree surgery

The requirement and extent of tree surgery should be determined on site by a qualified arborist, and permission sought from a Cairns City Council Landscape officer. Where tree surgery is considered necessary, give notice and obtain instructions.

### 4.5.15. Standard

A qualified and experienced Arborist shall carry out pruning. All pruning work should be in accordance with the Australian Standard for Pruning of Amenity Trees AS4373

### 4.5.16. Objectives

Generally, young trees should be pruned to develop into trees that have a sturdy, tapered trunk with well-spaced branches that are smaller in diameter than the trunk. Under no circumstances shall more than thirty percent of the foliage from an individual tree be removed at any one time.

### 4.5.17. General procedures

Live branches greater than 25mm diameter shall not be removed unless directed by Cairns City Council.

Dead branches greater than 25mm in diameter (measured at the base of the branch) shall be removed from the canopy of trees.

Raise crowns, prune back lateral branches or reduce branches of trees where necessary to provide a clearance for new works.

Remove no more than 10 percent of live foliage from the trees unless indicated below.

Remove dead and decayed wood or limbs that have been broken. For deadwood removal, make cuts outside of live wood.

### 4.5.18. Specific procedures

**Codominant leaders** - For trees with codominant leaders and stems, particularly where included bark is present, the subordination (shortening using a drop-crotch cut) or removal of one side of a codominant leader shall be the primary objective.

Branches, trunks, or leaders not considered the main leader, 25mm diameter or larger should be subordinated or removed. The main leader shall not be subordinated or removed.

**Crown raising** - Branches over roadway areas should be shortened or removed to allow approximately 2.4 metres clearance for low vehicles as practical. Over pedestrian areas branches should also be shortened or removed to allow 2.4 metres clearance for pedestrian traffic. Shortening of branches is the preferred method for attaining adequate clearance. When pruning is completed, approximately one-half of the foliage should originate from branches on the lower two-thirds of each tree.

For branches over pedestrian areas, where main lateral branches are attached to trunks below 2.4 metres, do not remove as part of crown raising work unless the bulk of the limb and branch tips are also below 2.4 metres.

Shortening branches to allow clearance shall consist of reduction by removing some secondary branches toward the ends of the limbs and/or by removing the end of the branch using drop-crotch cuts. Prune branches back to laterals approximately two thirds the diameter of the branch being cut in accordance with Australian Standards.

## Tree Installation Specifications

Thinning - Interior branches may be removed where their removal will improve crown structure, branch spacing, improve air movement or avoid future problems from rubbing branches. Branches should be spaced vertically by approximately 150mm to 300mm.

Thinning is to include the following: remove dead or broken limbs and crossing branches. If two limbs are crossing or touch each other, shorten or remove the one in the less favourable position for future branch development. If two limbs (25mm diameter or larger) originate within 300mm of each other on the trunk, shorten or remove the one in the less favourable position for future branch development. Do not remove water sprouts or epicormic growth from the interiors of tree crowns.

Thinning by "lion-tailing," i.e. removing all or most of the smaller branches and inner foliage along branches is not acceptable.

Clearance from buildings, lights, or other structures should be a minimum of one metre or as practical. Use directional pruning where possible so future growth is directed away from buildings and lights.

Palms - All large-growing palms shall be pruned to remove dead fronds, and fronds with a petiole that droops below horizontal. Dead fronds are those with less than 50% green tissue. Only those fronds with petioles drooping below horizontal should be removed. When removing fronds and seedpods, care should be taken so those fronds that are to remain are not nicked or wounded.

### **4.5.19. Tools and equipment**

Pruning of all trees shall be via elevated platform vehicles or similar. No trees to be pruned shall be climbed.

Equipment and work practices that damage bark or cambium must be avoided.

Cairns City in a Garden  
Master Plan 2007

Part D  
Technical Guidelines

### 4.6. Completion

#### 4.6.1. Planting establishment Period

Works which are included in this establishment period are:

- **Rectification of defects.**
- **Provision of materials, labour and equipment.**
- **Watering.**
- **Fertilising**
- **Control of weed growth by means of appropriate herbicide.**
- **Replacement of dead, damaged or stolen plants.**

#### 4.6.2. Health monitoring

Continue to monitor the condition of the newly planted trees during the planting establishment period.

#### 4.6.3. Recurrent works

Throughout the planting establishment period, continue to maintain new trees. Carry out maintenance work including but not limited to, watering, weeding, rubbish removal, fertilising, pest and disease control, replanting, staking and tying, pruning and removing pruned material and keeping the site neat and tidy.

Ensure that the irrigation system is operational to achieve optimum plant growth in the prevailing environment conditions. Allow for supplementary hand/machine watering of the tree root balls and surrounding structural soil in continuous trenches, and where irrigation is not provided.

#### 4.6.4. Replacements

Replace failed or damaged trees.

#### 4.6.5. Cleaning

Stakes, ties, guys, supports and braces: Remove those no longer required once trees are established.



**CAIRNS  
CITY  
IN A GARDEN  
MASTER PLAN  
PART E  
APPENDICES**

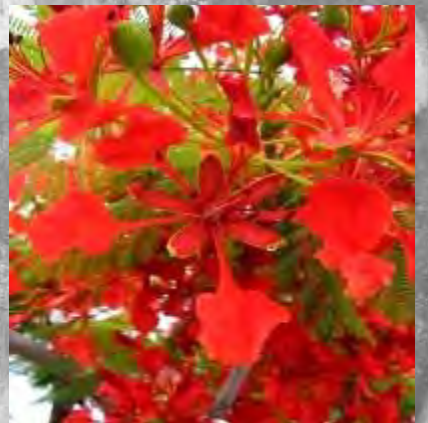

## City in a Garden Part E- Appendices

## Table of Contents

<b>CITY IN A GARDEN MASTER PLAN 2007</b>	<b>2</b>
<b>Vision Statement</b>	Error! Bookmark not defined.
<b>Context</b>	<b>2</b>
<b>CAIRNS CITY IN A GARDEN PART A-INTRODUCTION</b>	<b>10</b>
<b>CITY IN A GARDEN MASTER PLAN PART B-TREE SPECIES SELECTION</b>	<b>14</b>
<b>CITY IN A GARDEN MASTER PLAN PART C- PRECINCT PLANS</b>	<b>30</b>
<b>CITY IN A GARDEN MASTER PLAN PART D TECHNICAL GUIDELINES</b>	<b>99</b>
<b>CITY IN A GARDEN PART E- APPENDICES</b>	<b>128</b>
<b>1. Trees for General use Picture Gallery</b>	<b>130</b>
<b>2. Species guide small to medium trees</b>	<b>152</b>
<b>3. Species guide large trees</b>	<b>154</b>
<b>4. Species guide for shrubs, flowering plants and bulbs</b>	<b>156</b>
4.1. General Requirements	<b>156</b>
4.2. Mat Ground Covers	<b>156</b>
4.3. Small Shrubs (below 600mm)	<b>156</b>
4.4. Medium Shrubs (600 - 1500mm)	<b>157</b>
<b>5. Cairns City in a Garden Tree Data Sheets</b>	<b>157</b>
5.1. Trees for General Use Albizia-Cassia sp "Paluma Range"	<b>158</b>
5.2. Cairns City in a Garden Data Sheets-Trees for General Use Cassia Rainbow Shower-Melicope muellerii	<b>159</b>
5.3. Cairns City in a Garden Data Sheets-Trees for General Use Milletia pinnata-Xanthostemon chrysanthus	<b>160</b>
5.4. Cairns City in a Garden Data Sheets-Trees for site specific use due to tree characteristics	<b>161</b>
5.5. Cairns City in a Garden Data Sheets-Trees for Trialling and Assessment	<b>163</b>
5.6. Key to the City in a Garden Tree/Palm Data Sheets	<b>164</b>



<b>6.</b>	<b>Cairns City in a Garden Palm Data Sheets</b>	<b>165</b>
6.1.	Palms for General Use	165
6.2.	Palms for General Use	166
6.3.	Palms for General Use	167
<b>7.</b>	<b>Cairns City in a Garden Street Priority Data Sheets</b>	<b>168</b>
7.1.	Cairns City in a Garden Data Sheets-Street Priority List- Abbot-Hardy	168
7.2.	Cairns City in a Garden Data Sheets-Street Priority List- Hoare-Moody/McGregor	169
7.3.	Cairns City in a Garden Data Sheets-Street Priority List- MtMillman-Toogood	170
7.4.	Cairns City in a Garden Data Sheets-Street Priority List- Trinity Beach-Yorkeys Knob	171
<b>8.</b>	<b>Cairns City in a Garden Data Sheets Street Tree Palette</b>	<b>172</b>
8.1.	Cairns City in a Garden Data Sheets-Street Tree Palette List Abbot-Goldsborough	172
8.2.	Cairns City in a Garden Data Sheets-Street Tree Palette List-Gordon-McCormack	173
8.3.	Cairns City in a Garden Data Sheets-Street Tree Palette List-McGregor-Severin	174
8.4.	Cairns City in a Garden Data Sheets-Street Tree Palette List-Severin-Yorkeys Knob	175
<b>9.</b>	<b>Glossary of Terms</b>	<b>176</b>
	<b>CITY IN A GARDEN PART F-STREETScape TEMPLATES</b>	<b>178</b>

## 1. Trees for General use Picture Gallery

### *Albizia racemosa*

(COLVILLES GLORY)

**SIZE:** medium-large

**TYPE:** native, deciduous

**HABITAT:**

**FLOWG:**

**LEAVES:**

**FLOWERS:**

**FRUIT:** legume

**SALT TOL:** high

**USE:** median/shoulder/verge

Photo currently  
unavailable

### *Backhousia citriodora*

(LEMON-SCENTED MYRTLE)



**SIZE:** medium-large

**TYPE:** native, evergreen,

**HABITAT:** coastal forests and rain forests

**FLOWG:** summer and autumn

**LEAVES:** simple; rich green; broad lanceolate to narrow ovate; lemon scented

**FLOWERS:** showy; pale green to creamy white.

**FRUIT:** a capsule. to 2mm; 2-celled; held in persistent lobes of the calyx

**SALT TOL:** moderate

**USE:** shoulder/verge

***Barringtonia calyptrata***  
(CASSOWARY PINE)

**SIZE:** large

**TYPE:** indigenous, deciduous

**HABITAT:** coastal forest; lagoon shores; river estuaries; swamps

**FLOWG:** year-round

**LEAVES:** simple; deep green; to 38 x 8cm; spatulate; crowded at stem ends

**FLOWERS:** showy; white; with masses of crimson-tipped, white stamens; nocturnally fragrant

**FRUIT:** a drupe, to 10cm; a square, heart-shaped cube, with persistent calyx at tip; 1 toxic seed

**SALT TOL:** high

**USE:** median/shoulder/verge



***Bauhinia x blakeana***  
(HONG KONG ORCHID TREE)



**SIZE:** small

**TYPE:** exotic/deciduous

**HABITAT:** deciduous bamboo forests

**FLOWG:** winter to spring

**LEAVES:** dull green

**FLOWERS:** fragrant purple flowers

**FRUIT:** none

**SALT TOL:** moderate

**USE:** median/shoulder/verge

***Brachychiton acerifolius***  
(ILLAWARRA FLAME TREE)

**SIZE:** medium-large

**TYPE:** indigenous/deciduous

**HABITAT:** moist coastal forests and scrubland

**FLOWG:** late spring-summer

**LEAVES:** palmate

**FLOWERS:** very showy scarlet

**FRUIT:**

**SALT TOL:** low

**USE:** median/shoulder/verge/feature



***Brachychiton velutinosus***  
(LACE TREE)

**SIZE:** medium-large

**TYPE:** indigenous, deciduous

**HABITAT:** lowland vine thickets

**FLOWG:** late spring-summer

**LEAVES:** palmate

**FLOWERS:** showy deep pink

**FRUIT:** low

**USE:** median/shoulder/verge/feature



***Buckinghamia celsissima***  
(IVORY CURL TREE)

**SIZE:** small

**TYPE:** native, evergreen

**HABITAT:** rainforests and drier gullies

**FLOWG:** Jan-Apr

**LEAVES:** dark green

**FLOWERS:** creamy white

**FRUIT:**

**SALT TOL:**

**USE:** median/shoulder/verge

prefers well drained soils  
and lots of water, but  
tolerates drier conditions



***Caesalpine ferrea***  
(LEOPARD TREE)

**SIZE:** large

**TYPE:** exotic/evergreen

**HABITAT:**

**FLOWG:**

**LEAVES:** pinnate

**FLOWERS:** small yellow

**FRUIT:**

**SALT TOL:** medium to high

**USE:** median/shoulder/verge



***Callistemon polandii***  
(BOTTLE BRUSH)



**SIZE:** small

**TYPE:** native, evergreen

**HABITAT:**

**FLOWG:**

**LEAVES:**

**FLOWERS:** red bottle brush

**FRUIT:**

**USE:** median/verge

***Callistemon Sp. Harkness***  
(BOTTLE BRUSH)

**SIZE:** small

**TYPE:** native, evergreen

**HABITAT:**

**FLOWG:**

**LEAVES:**

**FLOWERS:** deep red bottle brush

**FRUIT:**

**USE:** median/verge



***Callistemon viminalis***  
(WEeping BOTTLE BRUSH)



**SIZE:** small

**TYPE:** native, evergreen

**HABITAT:** moist woodland  
riverbanks

**FLOWG:** intermittently after rain

**LEAVES:**

**FLOWERS:** showy red bottlebrush  
spikes

**FRUIT:**

**SALT TOL:** moderate

**USE:** verge under power lines

***Cassia Queenslandica***  
(GOLDEN SHOWER)

**SIZE:** medium

**TYPE:** indigenous, semi-deciduous

**HABITAT:** dry deciduous forests

**FLOWG:** early to late spring

**LEAVES:** pinnate

**FLOWERS:** showy clear yellow

**FRUIT:** legume

**SALT TOL:** moderate

**USE:** median/shoulder



***Cassia fistula***  
(RAINBOW SHOWER)



**SIZE:** medium-large

**TYPE:** exotic

**HABITAT:** dry deciduous forests

**FLOWG:** early to late spring

**LEAVES:** pinnate

**FLOWERS:** showy clear yellow

**FRUIT:** legume

**SALT TOL:** moderate

**USE:** median/shoulder

***Cassia javanica***  
(PINK CASSIA)

**SIZE:** medium-large

**TYPE:** exotic, semi-deciduous

**HABITAT:** dry deciduous forests

**FLOWG:** early to late spring

**LEAVES:** pinnate

**FLOWERS:** showy pink

**FRUIT:** legume

**SALT TOL:** moderate

**USE:** median/shoulder

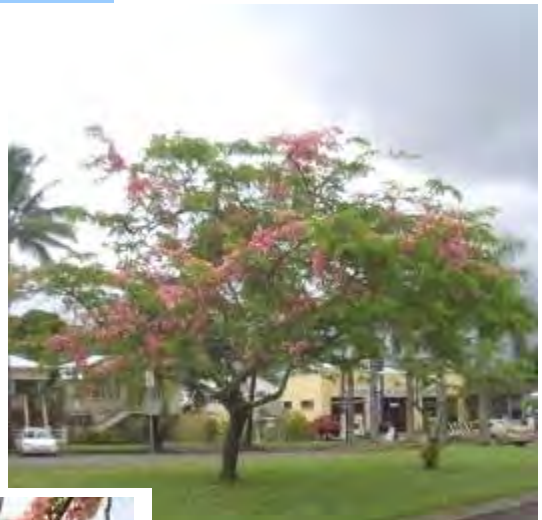



## ***Cassia Sp. Paluma Range*** (PALUMA GOLDEN SHOWER)



**SIZE:** small

**TYPE:** indigenous, semi-deciduous

**HABITAT:** margins of upland rainforests/eucalypt forests

**FLOWG:** early to late spring

**LEAVES:** pinnate

**FLOWERS:** showy yellow

**FRUIT:** legume

**SALT TOL:**

**USE:** median/shoulder

## ***Cassia siamea***



**SIZE:** medium

**TYPE:** exotic, deciduous

**HABITAT:** tolerates dry

**FLOWG:** early to late spring

**LEAVES:** pinnate

**FLOWERS:** bright yellow

**FRUIT:** legume

**SALT TOL:** medium

**USE:** median/shoulder/verge

## ***Cassia* “Rainbow Shower”**



**SIZE:** medium

**TYPE:** exotic, semi-deciduous

**HABITAT:**

**FLOWG:** early summer

**LEAVES:** pinnate

**FLOWERS:** showy trusses of apricot-orange

**FRUIT:** legume

**SALT TOL:** moderate

**USE:** median/shoulder/verge/feature

## ***Corymbia ptychocarpa* (SWAMP BLOODWOOD)**

**SIZE:** small-medium

**TYPE:** native, evergreen

**HABITAT:** lowland monsoon forests

**FLOWG:**

**LEAVES:** lanceolate

**FLOWERS:** deep-pale pink

**FRUIT:**

**SALT TOL:** moderate

**USE:** median/shoulder/verge



***Cupaniopsis anacardioides***  
(TUCKEROO)



- SIZE:** small
- TYPE:** indigenous, evergreen
- HABITAT:** coastal and inland scrub
- FLOWG:** early spring
- LEAVES:** pinnate
- FLOWERS:** small white
- FRUIT:** yellow seeds
- SALT TOL:** high
- USE:** verge under power lines

***Deplanchea tetraphylla***  
(GOLDEN BOUQUET TREE)

- SIZE:** medium
- TYPE:** indigenous, evergreen
- HABITAT:** sandy coastal scrub and rainforest margins
- FLOWG:** spring-year round
- LEAVES:** large rich green with wavy margin and golden underside
- FLOWERS:** showy rich yellow
- FRUIT:** flat woody pods
- SALT TOL:** high
- USE:** median/shoulder/verge

Photo currently  
unavailable

***Eugenia reinwardtiana* (BEACH CHERRY)**



**SIZE:** small-medium

**TYPE:** indigenous, evergreen

**HABITAT:** coastal scrub and  
rainforest, inland vine  
thickets

**FLOWG:** June - February

**LEAVES:** oval/new growth bronze  
red

**FLOWERS:** white clusters

**FRUIT:** red berry

**SALT TOL:** moderate

**USE:** verge under power lines

***Flindersia ifflaiana* (CAIRNS HICKORY)**



**SIZE:** medium-large

**TYPE:** indigenous, evergreen

**HABITAT:** lowland and highland  
rainforest

**FLOWG:** spring

**LEAVES:** pinnate

**FLOWERS:** white and strongly  
honey scented

**FRUIT:** woody capsule

**SALT TOL:** low

**USE:** median/shoulder/verge

## ***Gymnostoma australicum* (DAINTREE PINE)**

**SIZE:** small-medium

**TYPE:** indigenous, evergreen

**HABITAT:** riparian/rainforest margins

**FLOWG:** spring

**LEAVES:** needles

**FLOWERS:** small

**FRUIT:**

**SALT TOL:** moderate

**USE:** median



## ***Lagerstroemia floribunda* (LATECREPE MYRTLE)**



**SIZE:** medium-large

**TYPE:** exotic, deciduous

**HABITAT:** limestone hills

**FLOWG:** late autumn

**LEAVES:**

**FLOWERS:** foamy blooms  
lavender and pink fading  
to white

**FRUIT:**

**SALT TOL:** low

**USE:** shoulder/verge

## ***Lagerstroemia indica* (CREPE MYRTLE)**



**SIZE:** medium-large

**TYPE:** exotic, deciduous

**HABITAT:** moist forests

**FLOWG:** summer

**LEAVES:**

**FLOWERS:** showy purple-pink

**FRUIT:**

**SALT TOL:** low

**USE:** shoulder/verge

## ***Lagerstroemia speciosa* (PRIDE OF INDIA)**

**SIZE:** medium-large

**TYPE:** exotic, deciduous

**HABITAT:** moist forest

**FLOWG:** summer

**LEAVES:**

**FLOWERS:** showy purple-pink

**FRUIT:**

**SLT TOL:** low

**USE:** shoulder/verge



## Leptospermum 'Pink Cascade'

Photo currently  
unavailable

**SIZE:** small-medium

**TYPE:** native, evergreen

**HABITAT:**

**FLOWG:**

**LEAVES:**

**FLOWERS:**

**FRUIT:**

**SALT TOL:** moderate

**USE:** median/shoulder/verge

## *Leptospermum madidum* (TEE TREE)

**SIZE:** small-medium

**TYPE:** indigenous, evergreen

**HABITAT:** banks of lowland  
freshwater streams

**FLOWG:** spring

**LEAVES:** willow-like

**FLOWERS:** white

**FRUIT:**

**SALT TOL:** moderate

**USE:** median /shoulder/verge



***Leptospermum 'Cardwell'*** (TEE TREE)

Photo currently  
unavailable

**SIZE:** small-medium

**TYPE:** native, evergreen

**HABITAT:**

**FLOWG:**

**LEAVES:**

**FLOWERS:**

**FRUIT:**

**USE:** median/shoulder/verge

***Lophanthera lactescens***  
(GOLDEN CHAINTREE)

Photo currently  
unavailable

**SIZE:** small-medium

**TYPE:** exotic, evergreen

**HABITAT:** rainforests, river valleys

**FLOWG:** late summer

**LEAVES:** mid green obovate

**FLOWERS:** showy trusses of  
golden yellow

**FRUIT:**

**USE:** shoulder/verge



***Melaleuca viridiflora* “Bergundy”**  
(RED MELALEUCA)



**SIZE:** small-medium

**TYPE:** native, evergreen

**HABITAT:** streams swamps and  
billabongs

**FLOWG:** spring

**LEAVES:** weeping

**FLOWERS:** crimson

**FRUIT:**

**SALT TOL:** moderate

**USE:** median/shoulder/verge

***Melicope muelerii* (LITTLE EVODIA)**

Photo currently  
unavailable

**SIZE:** small-medium

**TYPE:** indigenous, evergreen

**HABITAT:** rainforest

**FLOWG:** January - April

**LEAVES:** trifoliate

**FLOWERS:** pink-mauve attracts  
Ulysses Butterfly

**FRUIT:**

**SALT TOL:** low

**USE:** shoulder/verge

***Peltophorum pterocarpum***  
(YELLOW PELTOPHORUM)



**SIZE:** medium-large

**TYPE:** indigenous, evergreen

**HABITAT:** dry or moist coastal forests

**FLOWG:** spring and summer

**LEAVES:** pinnate

**FLOWERS:** showy bright yellow

**FRUIT:** legume

**SALT TOL:** moderate-high

**USE:** median/shoulder/verge

***Randia fitzalanii*** (BROWN GARDENIA)

**SIZE:** small

**TYPE:** indigenous, evergreen

**HABITAT:** rainforest

**FLOWG:** August-October

**LEAVES:**

**FLOWERS:**

**FRUIT:** large globular fruit

**SALT TOL:** low

**USE:** shoulder/verge



## ***Syzygium forte* ssp. *forte* (WHITE APPLE)**



**SIZE:** large

**TYPE:** indigenous, evergreen

**HABITAT:** riverbanks among  
Melaleuca

**FLOWG:** late spring

**LEAVES:**

**FLOWERS:**

**FRUIT:** white (can be a nuisance)

**SALT TOL:** moderate

**USE:** median/shoulder/verge

## ***Syzygium hemilampra* (BLUSH SATINASH)**

**SIZE:** medium

**TYPE:** native, evergreen

**HABITAT:**

**FLOWG:**

**LEAVES:**

**FLOWERS:**

**FRUIT:**

**USE:** median

Photo currently  
unavailable

## ***Syzygium jambos* (ROSE APPLE)**



**SIZE:** medium

**TYPE:** exotic, evergreen

**HABITAT:** poor sandy soils

**FLOWG:**

**LEAVES:**

**FLOWERS:** cream

**FRUIT:** yellow-pink

**SALT TOL:**

**USE:** shoulder/verge

## ***Syzygium mallacense* (MALAY APPLE)**

**SIZE:** small-medium

**TYPE:** native, evergreen

**HABITAT:** moist coastal areas

**FLOWG:** late spring

**LEAVES:**

**FLOWERS:** pink apples

**FRUIT:** small reddish pink apples

**SAL TOL:**

**USE:** shoulder/verge

Photo currently  
unavailable

## ***Syzygium tierneyanum*** (RIVER CHERRY)



**SIZE:** medium-large

**TYPE:** indigenous, evergreen

**HABITAT:** stream banks in wet rainforests

**FLOWG:** summer

**LEAVES:** lanceolate

**FLOWERS:** cream

**FRUIT:** pink-red

**SALT TOL:** moderate

**USE:** median/shoulder

## ***Tabebuia argentea*** (SILVER TRUMPET TREE)

**SIZE:** small-medium

**TYPE:** exotic, deciduous

**HABITAT:** dry rocky lowland woodland

**FLOWG:** spring

**LEAVES:** silver green

**FLOWERS:** showy bright yellow

**FRUIT:**

**SALT TOL:** high

**USE:** median/shoulder/verge



**Tabebuia pallida**  
(EVERGREEN TRUMPET TREE)



**SIZE:** medium

**TYPE:** exotic, evergreen

**HABITAT:** dry leeward coastal forests

**FLOWG:** spring

**LEAVES:**

**FLOWERS:** pale pink-white

**FRUIT:**

**SALT TOL:** moderate

**USE:** median/shoulder/verge

**Tabebuia palmeri** (PINK TRUMPET TREE)

**SIZE:** large

**TYPE:** exotic, deciduous

**HABITAT:**

**FLOWG:**

**LEAVES:**

**FLOWERS:** showy bright pink

**FRUIT:**

**SALT TOL:**

**USE:** median/shoulder/verge

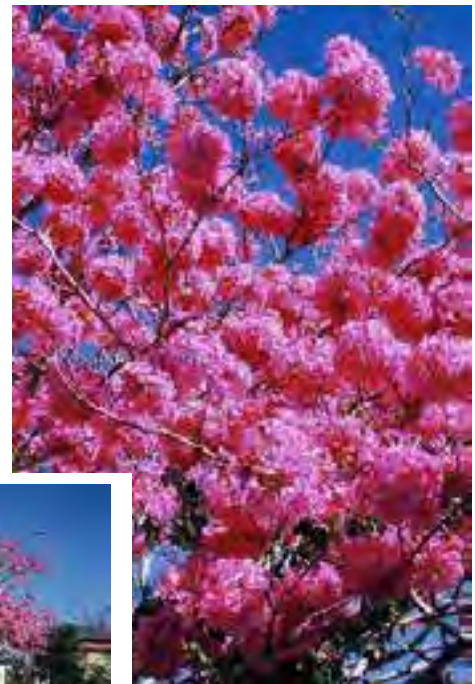

***Waterhousea floribunda***  
(WEEPING LILLY PILLY)



**SIZE:** small - medium

**TYPE:** native, evergreen

**HABITAT:** rainforest along streams

**FLOWG:** early summer

**LEAVES:**

**FLOWERS:** small cream in clusters

**FRUIT:** globular green with pink tinge

**SATLT TOL:** low

**USE:** median/shoulder/verge

needs plenty of water

***Xanthostemon chrysanthus*** (GOLDEN PENDA)



**SIZE:** medium

**TYPE:** native, evergreen

**HABITAT:** rainforest along streams

**FLOWG:** spring and summer

**LEAVES:**

**FLOWERS:** bright yellow

**FRUIT:** woody capsule

**SATLT TOL:** low

**USE:** median/shoulder/verge

**CAIRNS FLORAL EMBLEM**

### 2. Species guide small to medium trees

Table 1 contains species of trees that grow larger than three metres high, but less than ten meters tall. The tree species marked (S) are suitable for growing below the overhead power lines. Trees listed in Table 1 generally develop a trunk and a root system that is not likely to cause problems on a standard size nature strip in an urban street. These tree species may also be suitable for planting and growing on sites where there is more open space.

Most of these trees are known to be suitable for growing within the Cairns City Council local government area. They are all fairly hardy and should survive in places where they will not receive any special care after their initial establishment.

Other species, even though they may have aesthetic and environmental values, are not included in this table. They may not be suitable due to their growth habit, sensitivity to drought stress and their need for shelter, or they may have undesirable traits (poison parts, spines).

<i>Acmena hemilampra</i>	Blush Satinash
<i>Acmena smithii</i>	Lillypilly
<i>Archidendron lucyi</i>	Scarlet Bean
<i>Arytera divaricata</i>	Rose Tamarind
<i>Backhousia citriodora</i>	Lemon Scented Myrtle
<i>Barringtonia acutangula</i>	Freshwater Mangrove
<i>Brachychiton acerifolia</i>	Illawara Flame Tree
<i>Buckinghamia celsissima</i>	Ivory Curl
<i>Bursaria tenuifolia</i>	Bursaria
<i>Callistemon salignus</i> (S)	Pink-tipped Bottlebrush
<i>Callistemon viminalis</i> (S)	Weeping Bottlebrush
<i>Carallia brachtiata</i>	Corky Bark
<i>Castanospora alphanthii</i>	Brown Tamarind
<i>Cassia Queenslandica</i>	Queensland Cassia
<i>Cleistanthus hylandii</i>	Bernie's Cleistanthus
<i>Clusia rosea</i>	Pork Fat Tree
<i>Cordia subcordata</i>	Sea Trumpet
<i>Cryptocarya triplinervis</i>	Brown Laurel
<i>Cupaniopsis anacardioides</i> (S)	Bush Tuckeroo
<i>Cupaniopsis fovelata</i>	White Tamarind
<i>Darlingia darlingiana</i>	Brown Silky Oak
<i>Decaspermum humile</i>	Silky Myrtle
<i>Dillenea alata</i>	Red Beech
<i>Dimocarpus australianus</i>	Native Lychee
<i>Diploglottis berniana</i>	Bernie's Tamarind
<i>Diploglottis smithii</i>	Smith's Tamarind



## Species guide

<i>Eleocarpus johnsonii</i>	Kuranda Quandong
<i>Eleocarpus bancroftii</i>	Kuranda Quandong
<i>Eleocarpus culminicola</i>	
<i>Eucalyptus phoenicia</i>	Scarlet Gum
<i>Eucalyptus miniata</i>	Darwin Woollybutt
<i>Corymbia ptychocarpa</i>	Swamp Bloodwood
<i>Euphoria longan</i>	Longan
<i>Evodiella muelerii</i> (S)	Dwarf Butterfly Tree
<i>Ficus congesta</i> (S)	Red-leaf Fig
<i>Flindersia iffaiiana</i>	(Cairns) Hickory Ash
<i>Polyscias nodosa</i>	Noah's Basswood
<i>Glochidion harveyanum</i>	Daphne Buttonwood
<i>Gmelina dalrympleana</i>	Dalrymple's White Beech
<i>Gmelina fasciculiflora</i>	White Beech
<i>Grevillea baileyana</i>	Findlay's silky Oak
<i>Guettarda speciosa</i>	Indian Funeral Flower
<i>Harpullia arborea</i>	Cooktown Tulipwood
<i>Harpullia pendula</i>	Tulipwood
<i>Melaleuca viridiflora</i> "Burgundy" (S)	Red flowering Paperbark
<i>Michelia champaca</i>	Himalayan Magnolia
<i>Mimusops elengi</i>	Red Coonoo
<i>Ormosia ormondii</i>	Yellow Bean
<i>Pachira aquatica</i>	Guyana Chestnut
<i>Palaquium galactoxylum</i>	Pencil Cedar
<i>Parachidendron pruinatum</i>	Snow Wood
<i>Podocarpus grayae</i>	Weeping Brown Pine
<i>Randia fitzalani</i> (S)	Brown Gardenia
<i>Ristania pachysperma</i>	Yellow Penda
<i>Sandoricum koetjape</i>	Santol
<i>Scolopia braunii</i>	Brown Birch
<i>Stenocarpus sinuatus</i>	Wheel of Fire Tree
<i>Sterculia quadrifida</i>	Peanut Tree
<i>Syncarpia glomulifera</i>	Turpentine
<i>Syzygium alligineum</i>	Onionwood
<i>Syzygium angophoroides</i>	Yarrabah Satinash
<i>Syzygium australe</i>	Creek Cherry
<i>Syzygium banksia</i>	
<i>Syzygium wilsonii</i> cv. <i>Cryptiophlebia</i>	Powderpuff Lillypilly
<i>Syzygium fibrosum</i>	Fibrous Satinash
<i>Syzygium forte</i> ssp. <i>forte</i>	White Apple
<i>Syzygium jambos</i>	Rose Apple
<i>Syzygium leuhmannii</i>	Small-leaf Lillypilly

Cairns City in a Garden  
Master Plan 2007

Part E  
Appendices

Tabebuia Argentea	Silver Trumpet Tree
Terminalia muelleri	
Toechima daemelianum	Cape Tamarind
Toechima erythrocarpum	Pink Tamarind
Waterhousia hedraiophylla	Gully Satinash
Xanthostemon chrysanthus	Golden Penda

## Species guide

### 3. Species guide large trees

Table 2 contains species of trees that grow larger than ten meters tall. They generally develop a large trunk and a root system that is likely to cause problems on a standard size nature strip in an urban street. These tree species may be more suitable for planting and growing on sites where there is more open space for their proper development.

Most of these trees are known to be suitable for growing in the Cairns City Council local government area. They are all fairly hardy and should survive in places where they will not receive any special care after their initial establishment.

Other species, even though they may have aesthetic and environmental values, are not included in this table. They may not be suitable due to their growth habit, sensitivity to drought stress and their need for shelter, or they may have undesirable traits (poison parts, spines).

Acmena graveolens	Cassowary Satinash
Acmenosperma claviflorum	Grey Satinash
Agathis robusta	Kauri Pine
Albizzia procera	Forest Siris
Alstonia meullerana	Hard Milkwood
Alstonia scholaris	Milky Pine
Alstonia spectabilis	Weipa Milky Pine
Araucaria cunninghamii	Hoop Pine
Archidendron grandiflorim	Pink Lace Flower
Argyrodendron polyandrum	Brown Tulip Oak
Arytera lautereriana	Corduroy Tamarind
Azadirachta indica	Neem Tree
Backhousia bancroftii	Johnstone River Hardwood
Barringtonia asiatica	Boxfruit
Barringtonia calyprata	Cassowary Pine
Bischofia javanica	Java Cedar
Bombax ceiba	Bombax; Kapok Tree
Calophyllum inophyllum	Beauty-leaf Tree
Calophyllum sil	Touriga
Cardwellia sublimes	Northern Silky Oak
Caesalpineia ferrea	Leopard Tree
Casaurina cunninghamiana	River She Oak
Castanospermum australe	Black Bean

Cairns City in a Garden  
Master Plan 2007

Part E  
Appendices

<i>Cordia dichotoma</i>	Glue Berry
<i>Deplanchea tetraphylla</i>	Golden Bouquet Tree
<i>Endiandra hypotephra</i>	Blue Walnut
<i>Corymbia abergiana</i>	Range Bloodwood
<i>Eucalyptus platyphylla</i>	White Gum
<i>Eucalyptus tereticornis</i>	Northern Blue Gum
<i>Corymbia tessellaris</i>	Moreton Bay Ash
<i>Eucalyptus torrelliana</i>	Cadagha
<i>Corymbia ptychocarpa</i>	Swamp Bloodwood
<i>Ficus benjamina</i> "Aurea"	Golden Weeping Fig
<i>Ficus racemosa</i>	Cluster Fig
<i>Ficus virgata</i>	Large-leaf Weeping Fig
<i>Flindersia brayleana</i>	Queensland Maple
<i>Harpullia ramiflora</i>	
<i>Hernandia peltata</i>	Sea Hearse
<i>Lagerstroemia speciosa</i>	Pride of India
<i>Lophostemon conferta</i>	Brush Box
<i>Melaleuca leucadendra</i>	Weeping Paperbark
<i>Nauclea orientalis</i>	Leichhardt Tree
<i>Neonauclea gordoniana</i>	Hard Nauclea
<i>Paraserianthus toona</i>	Red Siris, Red Cedar
<i>Peltophorum pterocarpum</i>	Yellow Poinciana
<i>Planchonia careta</i>	Cocky Apple
<i>Pleiogynium timoriense</i>	Burdekin Plum
<i>Pongamia pinnata</i>	Indian Beach
<i>Sterculia quadrifida</i>	Peanut Tree
<i>Stockwellia australiensis</i>	White Bean
<i>Stockwellia stollyi</i>	Stockwell's Puzzle
<i>Syzygium alligineum</i>	Onionwood
<i>Syzygium bamagense</i>	Bamaga Satinash
<i>Syzygium canicortex</i>	Yellow Satinash
<i>Syzygium cormiflorum</i>	Bumpy Satinash
<i>Syzygium gustavioides</i>	Grey Satinash
<i>Syzygium malaccense</i>	Malay Apple
<i>Syzygium tierneyanum</i>	River Cherry
<i>Tabebuia chrysantha</i>	Yellow Trumpet Tree
<i>Tectona grandis</i>	(Indian) Teak
<i>Terminalia arenicola</i>	Beach Almond
<i>Terminalia catappa</i>	Beach Almond
<i>Terminalia sericocarpa</i>	Damson
<i>Waterhousia hedraiophylla</i>	Gully Satinash
<i>Xanthostemon whitei</i>	Greater Golden Penda

## Species guide

Cairns City in a Garden  
Master Plan 2007

Part E  
Appendices

## 4. Species guide for shrubs, flowering plants and bulbs

### 4.1. General Requirements

Any planting proposed for on-street tree guards, traffic islands, medians, in-ground and raised footpath planters and street tree planting, are subject to Council's approval. Generally, shrubs growing to a mature height exceeding 600mm should not be used in medians and traffic islands, etc. where they will interfere with vehicular sight lines.

The following lists are to guide plant selection only:

### 4.2. Mat Ground Covers

Alternanthera bettzickiana in variety  
 Arachis pintoie  
 Dianella caerulea variegata  
 Dianella caerulea (Green)  
 Dissotis rotundifolia  
 Evolvulus pilosus  
 Hemigraphis colorata  
 Hemigraphis minima  
 Ipomoeo "pes caprae"  
 Ophiopogon japonicus (Mondo Grass)  
 Ophiopogon japonicus Nana  
 Ophiopogon variegata (Variegated Mondo Grass)  
 Rhoeo "Hawaiian Dwarf"  
 Ruellia squarrosa  
 Zoysia tenuifolia (No-mow grass)

### 4.3. Small Shrubs (below 600mm)

#### Flowering:

Clerodendron splendens  
 Gardenia radicans  
 Heliconia "Jamaican Dwarf" (shade only)  
 Hymenocallis Littoralis  
 Ixora in variety (refer to 3.4)  
 Jasminum nitidum  
 Lonicera japonica  
 Pachystachys lutea  
 Pandorea jasminoides  
 Pentas lanceolata (Selected varieties)

#### Foliage:

Baeckea "Dwarf"  
 Crinum "Gold"  
 Microsorium scolopendrium (polypody fern)  
 Nephrolepis sp. (selected species only)  
 Phyllanthus multifolius

#### 4.4. Medium Shrubs (600 - 1500mm)

## Species guide

#### Flowering:

Allamanda cathartica cv. "Sunee"  
Duranta "Geisha Girl"  
Duranta "Blue Cascade"  
Duranta "Sheena's Gold"  
Euphorbia pulcherrima "Dwarf Cream"  
Euphorbia pulcherrima "Dwarf Red"  
Gardenia radicans (prostrate gardenia)  
Heliconia psittacorum cv. "St. Vincent Red"  
Heliconia densiflora cv. "Fireflash"  
Heliconia hybrid "Golden Torch"  
Ixora in variety examples below:  
Ixora coccinea exotica  
Ixora "Gold Fire"  
Ixora "Malay Pink"  
Ixora "Williamsii"  
Ixora "Pirates Gold"  
Ixora "Prince of Orange"  
Ixora "Prince of Orange" compact  
Ixora "Sunshine Dwarf"  
Ixora "Twilight Glow"  
Plumbago capensis "Alba"  
Plumbago capensis "Royal Cape"  
Tibouchina "Noeleen"  
Tibouchina "Jewels"

#### 4.4.1.Foliage:

Alpinia "Dwarf Red"  
Alpinia purpurata var "Eileen McDonald"  
Alpinia sanderai  
Alpinia Zerumbet variegata  
Codiaeum variegatum (in mass planting only)  
Cordyline terminalis (selected species only)  
Costus potierae (syn with costus speciosa)  
Dracaena marginata in variety (Use as accent plant only)  
*Can be grown among other shrubs /groundcovers*  
Hibiscus "Rose Flake"  
Hibiscus "Snow Flake"  
Philodendron "Millenium"  
Philodendron selloum  
Schefflera arboricola  
Schefflera arboricola variegatum  
Zamia  
Zingiber spectabile (Spectabilis Ginger)

### 5. Cairns City in a Garden Tree Data Sheets

The following data sheets relate to those trees which are generally acceptable to the City of Cairns.

Cairns City in a Garden  
Master Plan 2007

Part E  
Appendices

## 5.1. Cairns City in a Garden data Sheets-Trees for General Use Albizia racemosa-Cassia sp “Paluma Range”

BOTANICAL NAME COMMON NAME	HABITAT	TYPE	SIZE	FORM	SALT	MEDIAN	SHLDR	VERGE	ERGON	COMMENTS
<b>Albizia racemosa</b> <i>Colvilles Glory</i>		E	M-L			X	X	X		
<b>Backhousia citriodora</b> <i>Lemon Scented Myrtle</i>	rainforest	N	M-L	E	M		X	X		Showy pale green-white flowers.
<b>Barringtonia calyptrata</b> <i>Cassowary Pine</i>	Riparian coastal	Net	L	D	H	X	X	X		Leaves turn red and drop briefly before flowering with large cream scented night blooms.
<b>Bauhinia x blakeana</b> <i>Hong Kong Orchid Tree</i>		E	S-M	D		X	X	X		Spectacular purple pink flowers.
<b>Brachychiton acerifolius</b> <i>Illawara Flame Tree</i>	Coastal scrub/frst	N	M-L	D	M	X	X	X		Spectacular red flowers.
<b>Brachychiton velutinosus</b> <i>Lace Tree (grafted)</i>	Coast/vine thickets	N	M	D		X	X	X		Spectacular cerise pink flowers.
<b>Buckinghamia celsissima</b> <i>Ivory Curl</i>	Wet rainforest	Ne	M	E	M	X	X	X	X	Masses of creamy flowers.
<b>Caesalpinia ferrea</b> <i>Leopard Tree</i>	Limestone thickets	Et	M-L	E		X	X	X		Well behaved roots and light shade/interesting bark. Excellent street tree.
<b>Callistemon polandii</b> <i>Bottle Brush</i>	Garden cultivar	Nt	S	E		X		X	X	Attractive in groups.
<b>Callistemon sp. Harkness</b>	Garden cultivar	Nt	S	E		X		X	X	Attractive in groups.
<b>Callistemon viminalis</b> <i>Weeping Bottle Brush</i>	Riparian	Nt	S	E		X		X	X	Attractive in groups.
<b>Cassia “Queenslandica”</b> <i>Golden Shower</i>	Dry forests	Ne	M	D	M	X	X			Lemon yellow flowers.
<b>Cassia fistula</b> <i>Shower of Gold</i>	Dry forests	Et	M-L	D		X	X			Erratic growth but spectacular yellow flowers.
<b>Cassia javanica</b> <i>Pink Cassia</i>		Et	L	D		X	X			Erratic growth but spectacular apple blossom pink flowers.
<b>Cassia sp “Paluma Range”</b> <i>Paluma Shower of Gold</i>	Eucalypt forests	N	S-M	D		X	X	X		Compact crown of glossy dark green foliage and rich gold yellow chains of flowers.

## 5.2. Cairns City in a Garden Data Sheets-Trees for General Use *Cassia siamea*-*Lophanthera lactescens*

BOTANICAL NAME <i>COMMON NAME</i>	HABITAT	TYPE	SIZE	FORM	SALT	MEDIAN	SHLDR	VERGE	ERGON	COMMENTS
<b>Cassia siamea</b>		E	M	E	M	X	X	X		Bright yellow flower trusses.
<b>Cassia “Rainbow Shower”</b>		E	M	E	M	X	X			Spectacular flowers in varied shades from apricot to orange in large trusses.
<b>Corymbia ptychocarpa</b> <i>Swamp Bloodwood</i>	Riparian	N	M	E	M	X	X	X		Nectar rich deep to pale pink flowers, fast growing.
<b>Cupaniopsis anacardioides</b> <i>Tuckeroo</i>	Coastal scrub	N	M	E	H		X	X	X	Excellent verge tree.
<b>Deplanchea tetraphylla</b> <i>Golden Bouquet</i>	Dry scrub	N	S	E	H	X	X	X		Showy yellow flowers, very salt tolerant.
<b>Eugenia reinwardtiana</b> <i>Beach Cherry</i>	Vine thickets	N	M-L	E	M			X	X	Very slow growing and low maintenance.
<b>Flindersia ifflaiana</b> <i>Cairns Hickory</i>	Rainforest	Ne	M-L	E	M	X	X	X		Excellent street tree, with honey scented flowers.
<b>Gymnostoma australianum</b> <i>Daintree Pine</i>	Rainforest margin	N	S-M	E		X				Grows to a formal conical shape.
<b>Lagerstroemia floribunda</b> <i>Late Crepe Myrtle</i>	Limestone hills	E	M-L	D	L		X	X		Dense bushy conical tree with foamy blooms in lavender and pink.
<b>Lagerstroemia indica</b> <i>Crepe Myrtle</i>	Moist forests	Et	M-L	D			X	X	X	Spectacular purple flowers and easily pruned.
<b>Lagerstroemia speciosa</b> <i>Pride of India</i>	Swamp floor	E	L	D	L		X			Flowers are rich purple and pink and best on rich soils.
<b>Leptospermum “Pink Cascade”</b>	Sand streams	Nt	S-M	E		X	X	X	X	Weeping habit with pink flowers.
<b>Leptospermum madidum</b> <i>TeeTree</i>	Sand streams	Nt	S-M	E		X	X	X	X	Least weeping of the family.
<b>Leptospermum “Cardwell”</b>	Sand streams	N	S-M	E		X	X	X	X	Weeping habit.
<b>Lophanthera lactescens</b> <i>Golden Chain Tree</i>	Rainforest river valley	Et	M	E	L		X	X		Showy and rare in native Brazil.

### 5.3. Cairns City in a Garden Data Sheets-Trees for General Use *Melaleuca viridiflora*-*Xanthostemon chrysanthus*

BOTANICAL NAME COMMON NAME	HABITAT	TYPE	SIZE	FORM	SALT	MEDIAN	SHLDR	VERGE	ERGON	COMMENTS
<b>Melaleuca viridiflora</b> “Bergundy” <i>Red Melaleuca</i>	Streams swamps	N	S-M	E		X	X	X	X	Attractive in groups.
<b>Melicope muellerii</b> <i>Little Evodia</i>	Rainforest	N	S-M	E			X	X	X	Pink flowers are attractive to the Ulysses Butterfly.
<b>Peltophorum pterocarpum</b> <i>Copper Pod</i>	Coastal plains	Net	M-L	E	H	X	X	X		Large street tree with well behaved roots.
<b>Randia fitzalanii</b> <i>Brown Gardenia</i>	Rainforest	Ne	S	E			X	X	X	Compact tree but not good on sand.
<b>Syzygium forte ssp.Forte</b> <i>White Apple</i>	Coastal	Ne	L	E		X		X	X	Cyclone resistant, but messy fruit.
<b>Syzygium hemilampra</b> <i>Blush Satinash</i>		N	M	E		X				
<b>Syzygium Jambos</b> <i>Rose Apple</i>	Sandy	E	M	E				X	X	Tolerates dry areas and dense shade and has a neat spreading canopy.
<b>Syzygium mallacense</b> <i>Malay Apple</i>	Lowland rainforest	N	M-L	E	H	X	X			Conical shaped crown with dark leaves and bright rose pink flowers.
<b>Syzygium tierneyaum</b> <i>River Cherry</i>	Riparian	N	L	E		X	X			Large tree whose roots need ample room.
<b>Tabebuia argentea</b> <i>Silver trumpet Tree</i>	Rocky lowland	Et	M	D	L	X	X	X		Excellent en masse, but prone to cracking.
<b>Tabebuia pallida</b> <i>Evergreen Trumpet Tree</i>	Dry coastal	Et	L	E	H	X	X	X		Tall tree with delicate pale pink flowers.
<b>Tabebuia palmeri</b> <i>Ipe</i>	Upland	E	L	D		X	X	X		Spectacular flowers but can be erratic.
<b>Waterhousea floribunda</b> <i>Weeping Lilly Pilly</i>	Riparian	N	S-M	E	M	X	X	X	X	Good shade tree, easily pruned, needs lots of water but tolerates full sun.
<b>Xanthostemon chrysanthus</b> <i>Golden Penda</i>	Riparian	Nt	M	E	L	X	X	X		Dark foliage sets off the clusters of yellow blooms. Tree is the <b>Cairns Floral Emblem</b> .



#### 5.4. Cairns City in a Garden Data Sheets-Trees for site specific use due to tree characteristics

BOTANICAL NAME COMMON NAME	HABITAT	TYPE	SIZE	FORM	SALT	MEDIAN	SHLDR	VERGE	ERGON	COMMENTS
<b>Agathis robusta</b> <i>Queensland Kauri Pine</i>	Dry rainforest	Ne	L	E	M	X				Sculptural majestic upright tree
<b>Barringtonia acutangula</b> <i>Freshwater Mangrove</i>	Swamp Shore	N	S	D	H		X	X		Red nocturnal flowers, leaves drop briefly in spring
<b>Barringtonia asiatica</b> <i>Boxfruit Tree</i>	Coastal frst Swamp	Nt	M	D			X	X		Large white, nocturnally fragrant flowers with red tips, leaves drop briefly in spring
<b>Bombax ceiba</b> <i>Kapok Tree</i>	Humid low forests	Ne	M-L	D	L	X	X			Sculptural upright form with waxy flowers
<b>Calophyllum inophyllum</b> <i>Beauty Leaf</i>	Coastal woodland	Ne	M	E	H	X	X	X		Creamy white flowers, tree can be pollarded
<b>Calophyllum sil</b> <i>Touriga</i>	Wet vine thickets	Ne	M-L	E	H	X	X			Fragrant white flowers, but fruit can be a trip hazard
<b>Cassia roxbighii</b> <i>Weeping Cassia</i>	Coastal	E	M	D	M		X	X		Pink and white flowers and layered foliage
<b>Castanospermum australe</b> <i>Moreton Bay Chestnut</i>	Coastal forests	Nt	L	D	L	X	X			Nectar rich flowers born on old wood, a favourite with lorikeets but seeds are poisonous
<b>Cerbera manghas</b> <i>Sea Mango</i>	Dunes Headland	Ne	S-M	E	H		X	X		Waxy fragrant white flowers, but needs well drained soil. Seeds are toxic
<b>Delonix regia</b> <i>Royal Poinciana</i>	coastal	Et	M-L	D	H	X	X			Abundant red flowers before new leaves emerge, can be pruned but roots are invasive
<b>Delonix regia var. flava</b> <i>Yellow Royal Poinciana</i>	coastal	Et	M-L	D	H	X	X			As above but with yellow flowers, hard to grow from seed
<b>Ficus benjamina</b> <i>Weeping Fig</i>	rainforest	Et	M	E	L	X				Weeping broad tree with aerial roots
<b>Ficus destruens</b> <i>Strangler Fig</i>	Highland rainforest	Ne	S-M	E	L	X				Strangling roots but no aerials with bushy crown
<b>Ficus microcarpa</b>	Coastal forest	Ne	M	E	M	X				Strangling but no aerial roots, can be pruned
<b>Ganophyllum falcatum</b> <i>Scaly Ash</i>	coastal	Ne	M	E	H		X	X		Fast growing shade tree
<b>Instia bijuga</b> <i>Kwila</i>	Coastal swamps	Ne	M	E	H		X			Good shade tree, but needs water

#### 5.4 Cairns City in a Garden Data Sheets-Tree for site specific use due to tree characteristics

BOTANICAL NAME COMMON NAME	HABITAT	TYPE	SIZE	FORM	SALT	MEDIAN	SHLDR	VERGE	ERGON	COMMENTS
<b>Lophostemon confertus</b> <i>Brush Box</i>	Wet sclerophyll	N	M-L	E	L		X	X		Showy but delicate white flowers
<b>Mallotus philippensis</b> <i>Red Kamala</i>	Vine thickets	Ne	S-M	E	L		X	X		Fast growing bushy tree
<b>Maniltoa browneiodes</b> <i>Handkerchief Tree</i>	Lowland rainforest	E	S-M	E	L	X	X			Characteristic pendulous clusters of handkerchief-like flowers
<b>Maniltoa lenticillata</b> <i>Cascading Maniltoa</i>	Lowland rainforest	N	S-M	E	L	X	X			Similar to above but with a weeping habit
<b>Millettia pinnata</b> <i>Pongam</i>	Coastal forests	N	S	E	H		X	X		Good shade tree with wisteria-like lilac flowers, fruit is toxic and messy
<b>Parinari nonda</b> <i>Nonda Plum</i>	Open forest	N	S	E	L		X	X		Contorted branches and weeping habit (fine specimen at memorial in front of Civic Theatre)
<b>Plumeria obtusum</b> <i>Evergreen Frangipani</i>	Dry lowland	Et	S-M	E	H	X	X	X		Fragrant white flowers but brittle limbs while young
<b>Plumeria rubra</b> <i>Frangipani</i>	Dry lowland	Et	S-M	D	H	X	X	X		Fragrant flowers in a range of colours
<b>Podocarpus grayae</b> <i>Weeping Brown Pine</i>	Rainforest	Ne	L	E	L	X	X			Large foliage tree
<b>Polyalthea longifolia</b> <i>Indian Mast Tree</i>	Rainforest	E	M	E	L	X	X	X		Strong vertical accent, useful in limited space and able to regenerate at crown
<b>Pterocarpus indicus</b> <i>Indian Padauk</i>	Rainforest	E	M-L	E	L	X	X			Broad weeping habit, with good shade but needs space for crown
<b>Syzygium alliiignum</b> <i>Onionwood</i>	Wet rainforest	Ne	M-L	E	M	X	X			Papery bark and fluffy white flowers
<b>Syzygium bamagense</b> <i>Bamaga Satinash</i>	Coastal forests	N	M	E		X	X			Pink flaky bark, with nectar rich cream-white flowers and rounded crown
<b>Tabebuia chrysantha</b> <i>Golden tabebuia</i>	coastal	E	S-M	D	M	X	X	X		Very showy yellow flowers, repeated throughout spring, best on heavier soils
<b>Terminalia sericocarpa</b> <i>Damson</i>	Vine thickets	Ne	M-L	D	H		X			Scented white flowers, with a biennial leaf drop preceded by spectacular reddening of leaves

## 5.5. Cairns City in a Garden Data Sheets-Trees for Trialing and Assessment

BOTANICAL NAME COMMON NAME	HABITAT	TYPE	SIZE	FORM	SALT	MEDIAN	SHLDR	VERGE	ERGON	COMMENTS
<b>Albizia lebbek</b> <i>Siris</i>	River beds savannahs						X	X		Good coastal tree
<b>Alloxylon flammeum</b> <i>Tree Warratah</i>	Coastal	N	M	E	H	X	X	X		Showy flame red flowers
<b>Aryterya divaricata</b> <i>Rose Tamarind</i>	Rainforest	Ne	S	E	L		X	X		Food plant to <i>Six Line Blue Butterfly</i>
<b>Aryterya paucifolia</b> <i>Pink Tamarind</i>	Rainforest	Ne	S	E	L		X	X		Food Plant to <i>Bright Cerulean Butterfly</i>
<b>Brachychiton rupestris</b> <i>Bottle Tree</i>	Dry forest	N	M	D	L	X				Peculiar feature tree very slow growing with characteristic water storing bottle shaped trunk
<b>Cananga odorata</b> <i>Ylang-Ylang</i>	Evergreen woodland	N	S	E	L		X	X		Highly fragrant flowers born throughout year, vigorous growth with upright habit
<b>Erythrina variegata var. variegata</b> <i>Variiegated Coral Tree</i>	Lowland woods	E	M	E	H	X				Very showy green and yellow foliage with flame red flowers, no thorns unlike rest of species
<b>Eucalyptus phoenicea</b> <i>Scarlet Gum</i>	Stoney ridges	N	S	E	L		X	X		Nectar rich flowers all year round
<b>Michelia chapaca</b> <i>Tropical Magnolia</i>	Humid forests	E	M	E	L		X			Very fragrant waxy magnolia-like flowers
<b>Saraca thaipingensis</b> <i>Saraca</i>	rainforest	E	M	E	L	X	X			Large yellow and orange blooms
<b>Schotia brachypetalum</b> <i>Tree Fuchsia</i>	Dry savannahs	N	S	E	L			X	X	Fuchsia like flowers and ruby new foliage, easily pruned and shaped
<b>Stenocarpus sinuatus</b> <i>Firewheel Tree</i>	Dry rainforest	Ne	L	E	L	X	X			Showy red flowers rich in nectar
<b>Swietenia mahogani</b> <i>Mahogony</i>	Dry woodland	E	L	E	M	X	X			Excellent large shade tree (widely used in Florida)
<b>Tabernaemontana arborea</b> <i>Cojon</i>	Moist thickets	E	S-M	E	L		X	X		Orange blossom scented flowers, good shade tree
<b>Tabernaemontana pachysiphon</b> <i>Adams Apple Tree</i>	Wet coast	E	S	E	M			X	X	Heavily scented small tree
<b>Tamarindus indicus</b> <i>Tamarind</i>	Coastal plains	E	M-L	E	H	X	X			Smothered in tiny yellow and red blooms throughout year

<b>5.6. Key to the City in a Garden Tree/Palm Data Sheets</b>	
<b>TYPE</b>	<b>SIZE</b>
<b>N-Native to Australia</b>	<b>S-Small</b>
<b>E-Exotic (from outside Australia)</b>	<b>M-Medium</b>
<b>e-Endemic to Cairns area</b>	<b>L-Large</b>
<b>t-Traditional/Historical use in Cairns</b>	
<b>FORM</b>	<b>ERGON</b>
<b>E-Evergreen</b>	<b>Suitable for under power lines either by pruning or through natural size</b>
<b>D-Deciduous</b>	
<b>SALT-Tolerance to salt exposure</b>	
<b>H-High tolerance</b>	
<b>M-Medium tolerance</b>	
<b>L-Low tolerance</b>	

**6. Cairns City in a Garden Palm Data Sheets**  
**6.1. Palms for General Use**

<b>BOTANICAL NAME</b> <i>COMMON NAME</i>	<b>HABITAT</b>	<b>TYPE</b>	<b>SIZE</b>	<b>FORM</b>	<b>SALT</b>	<b>MEDIAN</b>	<b>SHLDR</b>	<b>VERGE</b>	<b>ERGON</b>	<b>COMMENTS</b>
<b>Archontophoenix alexandra</b> <i>Alexandra Palm</i>										
<b>Arenga australasica</b>										
<b>Areca catchu</b> <i>Betel Nut Palm</i>										
<b>Beccariophoenix madagascariensis</b> <i>Manarano Palm</i>										
<b>Bismarckia nobilis</b> <i>Bismarck Palm</i>										
<b>Calyptrocalyx sp.</b> <i>Sunset Palm</i>										
<b>Carpentaria acuminata</b> <i>Carpentaria Palm</i>										
<b>Caryota rhumpiana</b> <i>Single Stem Fishtail Palm</i>										
<b>Carpholoyylon sp.</b>										
<b>Cocos nucifera Dwarf</b> <i>Dwarf Malay Coconut</i>										
<b>Cyrtostachys renda</b> <i>Lipstick Palm</i>										
<b>Cyathea cooperii</b> <i>Scaly Tree Fern</i>										
<b>Cycas media</b> <i>Cairns Cycad</i>										
<b>Cycas revoluta</b> <i>Sago Palm</i>										

## 6.2. Palms for General Use

BOTANICAL NAME <i>COMMON NAME</i>	HABITAT	TYPE	SIZE	FORM	SALT	MEDIAN	SHLDR	VERGE	ERGON	COMMENTS
<b>Cycas thouarsii</b>										
<b>Dyctosperma album var.album</b> <i>Princess Palm</i>										
<b>Dioon spinulosum</b>										
<b>Dyopsis cabadae</b> <i>Blue Palm</i>										
<b>Dyopsis dareneii</b> <i>Red Neck Palm</i>										
<b>Dyopsis macdonaldiana</b>										
<b>Hyophorbe lagenicaulis</b> <i>Bottle Palm</i>										
<b>Laccospadix australasica</b> <i>Atherton Palm</i>										
<b>Lepidozamia hopei</b> <i>Zamia Palm</i>										
<b>Licuala ramsayi</b> <i>Cairns Fan Palm</i>		Ne								
<b>Linospadix minor</b> <i>Walking Stick Palm</i>										
<b>Livistonia chinensis</b> <i>Chinese Fan Palm</i>										

### 6.3. Palms for General Use

BOTANICAL NAME COMMON NAME	HABITAT	TYPE	SIZE	FORM	SALT	MEDIAN	SHLDR	VERGE	ERGON	COMMENTS
<b>Livistonia decipiens</b> <i>Weeping Cabbage Palm</i>		Ne								
<b>Livistonia muellerii</b> <i>Coastal Fan Palm</i>										
<b>Normanbya normanbyi</b> <i>Black Palm</i>										
<b>Pandanus baptista</b>										
<b>Pandanus spiralis</b>										
<b>Pinnanga pacifica</b> <i>Ivory Cane Palm</i>										
<b>Pritchardia pacifica</b> <i>Fiji Fan Palm</i>										
<b>Ptychosperma elegans</b> <i>Solitaire Palm</i>										
<b>Ptychosperma macarthii</b> <i>Mcarthur Palm</i>		E								
<b>Roystonea regia</b> <i>Regal palm</i>		E								
<b>Veitchii merelli</b> <i>Manilla Palm</i>		E								
<b>Wodyetia bifurcata</b> <i>Foxtail Palm</i>		N								

## 7. Cairns City in a Garden Street Priority Data Sheets

### 7.1. Cairns City in a Garden Data Sheets-Street Priority List-Abbot-Hardy

Priority	Street name	between		Precinct	TNP	Cairns Plan	Planting Style	Comment
	Abbot	Wharf	Upward	5.1	G	sub-arterial	<i>Alt Avenue</i>	
	Anderson Rd	Bruce Hwy	Windarra	7.7	C	sub-arterial	<i>Avenue</i>	Gateway
	Anderson Rd	Windarra	Fairview	7.7	A	sub-arterial	<i>Avenue</i>	Gateway
2a	Anderson St	Severin	Fearnley	5.3		State Control	<i>Special</i>	Cemetery
2b	Anderson St	Fearnley	Pease	5.3		State Control	<i>Avenue</i>	
1g	Aplin	Sheridan	Esplanade	5.1		collector	<i>Alt Avenue</i>	
	Aumuller	Tingara	Hartley	7.3	G	sub-arterial	<i>Alt Avenue</i>	Gateway (link to McCormack)
	Aumuller	Hartley	Mulgrave	7.3	G	sub-arterial	<i>Alt Avenue</i>	Gateway (link to McCormack)
	Aumuller	Mulgrave	Hoare	7.3	G	sub-arterial	<i>Alt Avenue</i>	Gateway (link to McCormack)
	Balaclava	Mulgrave	Irene	7.6	D	sub-arterial	<i>Avenue</i>	Enhance existing themes
	Bicentennial	Robert	Ravizza	8.2	D	sub-arterial	<i>Alt Avenue</i>	
	Cairns Rd	Draper	Riverstone	9.0	B	sub-arterial	<i>Alt Avenue</i>	
1d	Charles	Sheridan	Esplanade	5.2		sub-arterial	<i>Alt Avenue</i>	
	Cheviot	McGregor	Reed Rd	2.1		sub-arterial	<i>Alt Avenue</i>	
	Dempsey	Patrick	Draper	9.0		sub-arterial	<i>Grove</i>	
	Draper	Bruce Hwy	Hickling	9.0	C	sub-arterial	<i>Avenue</i>	
	Fig Tree	Kamerunga	Red Peak	2.6		sub-arterial	<i>Avenue</i>	
1i	Florence	Sheridan	Esplanade	5.1	G1	sub-arterial	<i>Special</i>	Link to Mulgrave/Sheridan Gateways
	Forest Garden blvd	Bruce Hwy	Sawpit	8.2		sub-arterial	<i>Avenue</i>	Enhance existing themes
16	Foster	Bruce Hwy	Hardy	8.2	C	sub-arterial	<i>Alt Avenue</i>	
	Gatton	Tills	Birch	7.5	A	sub-arterial	<i>Avenue</i>	Complete
	Gatton	Birch	Aumuller	7.5	A	sub-arterial	<i>Avenue</i>	Complete
	Gatton	Aumuller	Buchan	7.5	A	sub-arterial	<i>Avenue</i>	Complete
	Gatton	Buchan	Severin	7.5	A	sub-arterial	<i>Avenue</i>	Complete
	Gatton	Severin	Martyn	7.5	A	sub-arterial	<i>Avenue</i>	Complete
	Goldsborough	Gillies Hwy	Pan	9.0	E	sub-arterial	<i>Grove</i>	
	Gordon	Balaclava	Henley	9.0	D	sub-arterial	<i>Alt Avenue</i>	
	Grafton	Upward	Florence	5.2	G	collector	<i>Avenue</i>	
	Grafton	Florence	Spence	5.1	G1	collector	<i>Avenue</i>	Refer to CBD Master Plan
5a	Greenslopes (Arthur)	Sheridan	Pease	7.1	C	sub-arterial	<i>Special</i>	Centenary Lakes
1h	Grove	Sheridan	Esplanade	5.2	G	sub-arterial	<i>Alt Avenue</i>	
	Hambledon	Mill	Isabella	8.2	A	sub-arterial	<i>Avenue</i>	Gateway (Hambledon Botanic Garden)
14	Hardy	Robert	Foster	8.2	C	sub-arterial	<i>Alt Avenue</i>	



## 7.2. Cairns City in a Garden Data Sheets-Street Priority List-Hoare-Moody/McGregor

Priority	Street name	between		Precinct	TNP	Cairns Plan	Planting Style	Comment
	<b>Hoare</b>	Aumuller	Pease	7.3	C		<b>Alt Avenue</b>	Gateway (link to Aumuller)
	<b>Holloways Beach</b>	Captain Cook	Cassia	2.3		sub-arterial	<b>Grove</b>	
9a	<b>Irene</b>	Balaclava	Beatrice	7.6	D	sub-arterial	<b>Alt Avenue</b>	
9b	<b>Irene</b>	Beatrice	McGregor	7.6	D	sub-arterial	<b>Alt Avenue</b>	
	<b>James</b>	Sheridan	Martyn	7.4		State Control	<b>Avenue</b>	Gateway
	<b>Kingsford/Beatrice</b>	McCoombe	Irene	7.6		sub-arterial		
4a	<b>Lake</b>	Airport Dr	Moffitt	5.2	V1	sub-arterial	<b>Avenue</b>	Gateway/Future Development
4b	<b>Lake</b>	Moffitt	Rutherford	5.2	V1	sub-arterial	<b>Avenue</b>	Gateway (future link to Airport Dr)
4c	<b>Lake</b>	Rutherford	Lily	5.2	V1	sub-arterial	<b>Special</b>	Gateway (Memorial Gardens)
4d	<b>Lake</b>	Lily	Grove	5.2	G	sub-arterial	<b>Avenue</b>	Gateway
4e	<b>Lake</b>	Grove	Kerwin	5.2	G	sub-arterial	<b>Special</b>	Gateway (Cairns Base Hospital)
4f	<b>Lake</b>	Kerwin	Florence	5.2	G	Sub-arterial	<b>Avenue</b>	Gateway
4g	<b>Lake</b>	Florence	Wharf	5.2	G	Sub-arterial	<b>Avenue</b>	Gateway
1a	<b>Lily</b>	Sheridan	Lake	5.2	A	sub-arterial	<b>Avenue</b>	Gateway
1a	<b>Lily</b>	Lake	Esplanade	5.2		sub-arterial	<b>Avenue</b>	Gateway
	<b>Lyons</b>	Ray Jones	Mulgrave	7.5	G	sub-arterial	<b>Alt Avenue</b>	
	<b>Machans Beach</b>	Captain Cook	Christensen	2.4	B	sub-arterial	<b>Grove</b>	Entry Statement
	<b>Martyn</b>	James	Florence	7.3	G	Sub-arterial	<b>Alt Avenue</b>	
	<b>McCoombe</b>	Cava	Mulgrave	7.3	C	sub-arterial	<b>Alt Avenue</b>	
	<b>McCormack</b>	Hoare	McCoombe	7.5		State Control	<b>Avenue</b>	Gateway (link to Anderson/Pease)
	<b>McGregor</b>	Lydia	Sidlaw	2.5	C	sub-arterial	<b>Avenue</b>	
	<b>McGregor</b>	Sidlaw	Dunne	2.5	A	sub-arterial	<b>Avenue</b>	Future Development
1c	<b>McKenzie</b>	Sheridan	Esplanade	5.2		sub-arterial	<b>Alt Avenue</b>	
3a	<b>McLeod</b>	Arthur	Grove	5.2		sub-arterial	<b>Avenue</b>	
3b	<b>McLeod</b>	Grove	Gatton	5.2		sub-arterial	<b>Avenue</b>	
3c	<b>McLeod</b>	Gatton	Florence	5.2		sub-arterial	<b>Avenue</b>	
3d	<b>McLeod</b>	Florence	Wharf	5.1	G	sub-arterial	<b>Special</b>	
10	<b>Mcmanus</b>	Reservoir	Woodward	7.1		collector	<b>Grove</b>	
8a	<b>McNamara</b>	Greenslopes	Behan	7.1		sub-arterial	<b>Grove</b>	Link to Watsons Park
8b	<b>McNamara</b>	Behan	Anderson	7.1		sub-arterial	<b>Grove</b>	
	<b>Miami</b>	Poolwood	Nova	1.4	C	sub-arterial	<b>Alt Avenue</b>	
	<b>Miami</b>	Nova	Trinity Beach	1.4	C		<b>Avenue</b>	Future Development
7	<b>Mill</b>	Bruce Hwy	Woodlock	8.2	C	sub-arterial	<b>Avenue</b>	Gateway
1f	<b>Minnie</b>	Sheridan	Esplanade	5.2		collector	<b>Alt Avenue</b>	
	<b>Moody/McGregor</b>	Hoare	Irene	7.3	C	sub-arterial	<b>Alt Avenue</b>	Gateway (link to Aumuller/Ramsay)

**7.3. Cairns City in a Garden Data Sheets-Street Priority List-Mt Millman-Toogood**

Priority	Street name	between		Precinct	TNP	Cairns Plan	Planting Style	Comment
	<b>Mt Millman</b>	Captain Cook	end of street	<b>2.5</b>		sub-arterial	<b>Alt Avenue</b>	
<b>12a</b>	<b>Pease</b>	Greenslopes	Anderson	<b>7.1</b>	<b>C</b>	sub-arterial	<b>Grove</b>	Gateway (link to Anderson/McCormack)
<b>12b</b>	<b>Pease</b>	Anderson	Hoare	<b>7.1</b>		State Control	<b>Avenue</b>	Gateway (link to Anderson/McCormack)
	<b>Peterson</b>	Bruce Hwy	Mt Peter	<b>8.2</b>	<b>B</b>	sub-arterial	<b>Alt Avenue</b>	
	<b>Poolwood</b>	Captain Cook	Miami	<b>1.3</b>	<b>D</b>	sub-arterial	<b>Alt Avenue</b>	
	<b>Ramsay Dr</b>	Irene	Reservoir	<b>7.2</b>	<b>A</b>	sub-arterial	<b>Avenue</b>	
	<b>Ravizza Dr</b>	Bicentennial	Mill	<b>8.2</b>		Sub-arterial	<b>Avenue</b>	Link to Park (Massey St-Ravizza Cl)
	<b>Redlynch Intake</b>	West Arterial	Jungara	<b>3.1</b>	<b>E</b>	sub-arterial	<b>Avenue</b>	Future Development
	<b>Redlynch Intake</b>	Jungara	Redlynch Co	<b>3.1</b>	<b>C</b>	sub-arterial	<b>Avenue</b>	Future Development
	<b>Redlynch Intake</b>	Redlynch Co	Crystal Ccads	<b>3.1</b>	<b>E</b>	sub-arterial	<b>Avenue</b>	Future Development
	<b>Reed Rd</b>	Captain Cook	Harbour	<b>2.1</b>	<b>A</b>	sub-arterial	<b>Avenue</b>	Complete
<b>6</b>	<b>Riverstone</b>	Bruce Hwy	Church	<b>9.0</b>	<b>D</b>	State Control	<b>Avenue</b>	Entry Statement
<b>15</b>	<b>Robert</b>	Bruce Hwy	Hardy	<b>8.2</b>	<b>C</b>	sub-arterial	<b>Alt Avenue</b>	
	<b>Severin</b>	James	Charles	<b>7.4</b>		sub-arterial	<b>Grove</b>	
	<b>Severin</b>	Charles	Upward	<b>7.4</b>		sub-arterial	<b>Grove</b>	Cairns Central swamp
	<b>Severin</b>	Upward	Mulgrave	<b>7.4</b>		sub-arterial	<b>Grove</b>	
	<b>Sheridan</b>	Rutherford	Lily	<b>5.2</b>		State Control	<b>Special</b>	Gateway (Memorial Gardens)
	<b>Sheridan</b>	Lily	Minnie	<b>5.2</b>		State Control	<b>Alt Avenue</b>	Gateway
	<b>Sheridan</b>	Minnie	Florence	<b>5.2</b>		State Control	<b>Special</b>	Gateway (Munro Martyn Park)
	<b>Sheridan</b>	Florence	Wharf	<b>5.1</b>	<b>G</b>	sub-arterial	<b>Alt Avenue</b>	Gateway
	<b>Shields</b>	Esplanade	McLeod	<b>5.1</b>			<b>Alt Avenue</b>	
<b>1b</b>	<b>Smith</b>	Sheridan	Esplanade	<b>5.2</b>		sub-arterial	<b>Alt Avenue</b>	
	<b>Smithfield Village Dr</b>	Trinity Park	Reed Rd	<b>2.1</b>	<b>D</b>	sub-arterial	<b>Avenue</b>	Future Development
	<b>Smithfield Village Dr</b>	Reed Rd	McGregor	<b>2.1</b>	<b>D</b>	sub-arterial	<b>Avenue</b>	Future Development
	<b>Spence</b>	Lyons	Fearnley	<b>5.2</b>	<b>G</b>	sub-arterial	<b>Alt Avenue</b>	Future Development
	<b>Spence</b>	Fearnley	Bunda	<b>5.2</b>	<b>G</b>	sub-arterial	<b>Alt Avenue</b>	Future Development
	<b>Spence</b>	Bunda	Esplanade	<b>5.1</b>	<b>G</b>	sub-arterial	<b>Alt Avenue</b>	Future Development
	<b>Swallow</b>	Bruce Hwy	Dalla Costa	<b>8.2</b>		sub-arterial	<b>Alt Avenue</b>	
	<b>Tills/Lennon</b>	Mulgrave	Gatton	<b>7.5</b>	<b>A</b>	sub-arterial	<b>Alt Avenue</b>	
	<b>Tills/Lennon</b>	Gatton	English	<b>7.5</b>	<b>D</b>	sub-arterial	<b>Alt Avenue</b>	
	<b>Tills/Lennon</b>	English	McCormack	<b>7.5</b>		sub-arterial	<b>Alt Avenue</b>	
<b>11a</b>	<b>Toogood</b>	Mulgrave	Yarra	<b>7.7</b>	<b>C</b>	sub-arterial	<b>Avenue</b>	
<b>11b</b>	<b>Toogood</b>	Yarra	Fairview	<b>7.7</b>	<b>D</b>	sub-arterial	<b>Avenue</b>	

7.4. Cairns City in a Garden Data Sheets-Street Priority List-Trinity Beach-Yorkeys Knob								
Priority	Street name	between		Precinct	TNP	Cairns Plan	Planting Style	Comment
13a	Trinity Beach	Esplanade	Jameson	1.4		sub-arterial	<i>Avenue</i>	
13b	Trinity Beach	Jameson	Coastwatchrs	1.4		sub-arterial	<i>Avenue</i>	
13c	Trinity Beach	Coastwatchrs	Rabaul	1.4		sub-arterial	<i>Avenue</i>	
13d	Trinity Beach	Rabaul	Clayley	1.4		sub-arterial	<i>Avenue</i>	
13e	Trinity Beach	Clayley	Nautilus	1.4		sub-arterial	<i>Avenue</i>	
13f	Trinity Beach	Nautilus	Capt. Cook	1.4		sub-arterial	<i>Avenue</i>	
1e	Upward	Sheridan	Esplanade	5.2		sub-arterial	<i>Alt Avenue</i>	
	Varley	Yorkeys Knob	Evans	2.2	D	sub-arterial	<i>Alt Avenue</i>	
	Veivers	Hambledon	Timberlea	1.1	A	sub-arterial	<i>Avenue</i>	
	Warren/Cedar	Captain Cook	Esplanade	1.1		sub-arterial	<i>Alt Avenue</i>	
	Wharf	Bunda	Abbot	5.1	G	sub-arterial	<i>Special</i>	Boat Terminal
	Windarra	Toogood	Anderson	8.2		sub-arterial	<i>Avenue</i>	
	Yorkeys Knob	Capt. Cook	Antonetta	2.2		sub-arterial	<i>Alt Avenue</i>	Entry Statement
	Yorkeys Knob	Antonetta	Varley	2.2	V	sub-arterial	<i>Alt Avenue</i>	

## 8. Cairns City in a Garden Data Sheets Street Tree Palette

8.1. Cairns City in a Garden Data Sheets-Street Tree Palette List Abbot-Goldsborough								
Priority	Street name	between		Precinct	Median	Verge	Footpath	Ergon
	Abbot	Wharf	Upward	5.1	<i>Refer to Cairns CBD Streetscape Master Plan</i>			
	Anderson Rd	Bruce Hwy	Windarra	7.7				
	Anderson Rd	Windarra	Fairview	7.7				
2a	Anderson St	Severin	Fearnley	5.3		Melaleuca leucadendra	Calophyllum inophyllum	
2b	Anderson St	Fearnley	Pease	5.3		Melaleuca leucadendra	Syzygium angophoroides	
1g	Aplin	Sheridan	Esplanade	5.1	<i>Refer to Cairns CBD Streetscape Master Plan</i>			
	Aumuller	Tingara	Hartley	7.3	Melaleuca dealbata	Cassia sp Paluma Range	Melaleuca dealbata Barringtonia acutangula	P
	Aumuller	Hartley	Mulgrave	7.3	Melaleuca dealbata	Cassia sp Paluma Range	Melaleuca dealbata Barringtonia acutangula	P
	Aumuller	Mulgrave	Hoare	7.3	Melaleuca dealbata	Cassia sp Paluma Range	Barringtonia acutangula	P
	Balaclava	Mulgrave	Irene	7.6		Tabebuia var.	Tabebuia var.	
	Bicentennial	Robert	Ravizza	8.2		Flindersia ifflaiana	Melaleuca quinquenervia	
	Cairns Rd	Draper	Riverstone	9.0				
1d	Charles	Sheridan	Esplanade	5.2		Cassia "Queenslandica"	Lagerstroemia speciosa	
	Cheviot	McGregor	Reed Rd	2.1			Saraca thaipingensis	
	De Jarlais			7.6		Tabebuia chrysantha	Syzygium jambos	P
	Dempsey	Patrick	Maitland					
	Digger	Lilly	Upward	5.2		Brachychiton velutinosus	Tabebuia pallida	P
	Draper	Bruce Hwy	Hickling	9.0	Peltophorum dubium	Cassia fistula	Xanthostemon chrysantha	
	Fig Tree	Kamerunga	Red Peak	2.6				
1i	Florence	Sheridan	Esplanade	5.1	<i>Link to Munro Martyn park</i>			
	Forest Garden blvd	Bruce Hwy	Sawpit	7				
16	Foster	Bruce Hwy	Hardy	8	Brachychiton acerifolius		Randia fitzalanii	P
	Gatton	Tills	Birch	7.5		Acmena hemilampra	Randia fitzalanii Buchanania arborescens	N S
	Gatton	Birch	Aumuller	7.5		Syzygium tierneyanum	Randia fitzalanii Buchanania arborescens	N S
	Gatton	Aumuller	Buchan	7.4		Peltophorum pterocarpum	Randia fitzalanii	P
	Gatton	Buchan	Severin	7.4	<i>Link to Cairns Central Swamp</i>			
	Gatton	Severin	Martyn	7.4		Cassia siamea	Randia fitzalanii	P
	Goldsborough	Gillies Hwy	Pan	9.0		Cassia fistula	Xanthostemon chrysanthus	

8.2. Cairns City in a Garden Data Sheets-Street Tree Palette List-Gordon-McCormack								
Priority	Street name	between		Precinct	Median	Verge	Footpath	Ergon
	<b>Gordon</b>	Balaclava	Henley	<b>9.0</b>		<b>Tabebuia chrysantha</b>	<b>Tabebuia chrysantha</b>	
	<b>Grafton</b>	Upward	Florence	<b>5.2</b>	<b>Syzygium alliligneum</b>	<b>Brachychiton acerifolius</b>	<b>Randia fitzalanii</b>	<b>P</b>
	<b>Grafton</b>	Florence	Spence	<b>5.1</b>	<b>Refer to Cairns CBD Streetscape Master Plan</b>			
<b>5</b>	<b>Greenslopes (Arthur)</b>	Sheridan	Pease	<b>7.1</b>	<b>Melaleuca leucadendra</b>		<b>Corymbia ptychocarpa Randia fitzalanii</b>	<b>P</b>
<b>1h</b>	<b>Grove</b>	Sheridan	Esplanade	<b>5.2</b>	<b>Peltophorum pterocarpum</b>	<b>Peltophorum pterocarpum</b>	<b>Cerbera manghas</b>	<b>P</b>
	<b>Hambledon</b>	Mill	Isabella	<b>8.2</b>	<b>Tabebuia chrysantha</b>		<b>Syzygium alliligneum</b>	
<b>14</b>	<b>Hardy</b>	Robert	Foster	<b>8.2</b>	<b>Polyalthia longifolia</b>		<b>Stenocarpus sinuatus Randia fitzalanii</b>	<b>P</b>
	<b>Hoare</b>	Aumuller	Pease	<b>7.3</b>	<b>Tabebuia argentea Sabal palmetto</b>		<b>Syzygium jambos</b>	
	<b>Holloways Beach</b>	Capt Cook	Cassia	<b>2.3</b>			<b>Corymbia tessellaris</b>	
<b>9a</b>	<b>Irene</b>	Balaclava	Beatrice	<b>7.6</b>		<b>Cassia sp Paluma Range</b>	<b>Xanthostemon chrysanthus</b>	
<b>9b</b>	<b>Irene</b>	Beatrice	McGregor	<b>7.6</b>		<b>Cassia sp Paluma Range</b>	<b>Tabebuia argentea</b>	
	<b>James</b>	Sheridan	Martyn	<b>5.4</b>	<b>Archontophoenix alexandrae</b>		<b>Tabebuia argentea</b>	
	<b>Kingsford/Beatrice</b>	McCoombe	Irene	<b>7.6</b>				
<b>4a</b>	<b>Lake</b>	Airport Dr	Moffitt	<b>5.2</b>	<b>Pongamia pinnata</b>	<b>Cassia fistula</b>	<b>Barringtonia acutangula</b>	<b>P</b>
<b>4b</b>	<b>Lake</b>	Moffitt	Rutherford	<b>5.2</b>	<b>Pongamia pinnata</b>	<b>Cassia javanica</b>	<b>Barringtonia acutangula</b>	
<b>4c</b>	<b>Lake</b>	Rutherford	Lily	<b>5.2</b>	<b>Link to Tobruk Memorial Gardens</b>			
<b>4d</b>	<b>Lake</b>	Lily	Grove	<b>5.2</b>	<b>Pongamia pinnata</b>	<b>Cassia "Rainbow Shower"</b>	<b>Barringtonia acutangula</b>	
<b>4e</b>	<b>Lake</b>	Grove	Kerwin	<b>5.2</b>	<b>Pongamia pinnata</b>	<b>Cassia "Rainbow Shower"</b>	<b>Barringtonia acutangula</b>	
<b>4f</b>	<b>Lake</b>	Kerwin	Florence	<b>5.2</b>	<b>Pongamia pinnata</b>	<b>Cassia "Rainbow Shower"</b>	<b>Barringtonia acutangula</b>	
<b>4g</b>	<b>Lake</b>	Florence	Wharf	<b>5.1</b>	<b>Refer to Cairns CBD Streetscape Master Plan</b>			
<b>1a</b>	<b>Lily</b>	Sheridan	Lake	<b>5.2</b>		<b>Cassia fistula</b>	<b>Cupaniopsis anacardioides</b>	<b>P</b>
<b>1a</b>	<b>Lily</b>	Lake	Esplanade	<b>5.2</b>		<b>Pongamia pinnata</b>	<b>Cupaniopsis anacardioides</b>	<b>P</b>
	<b>Lyons</b>	Ray Jones	Mulgrave	<b>7.5</b>		<b>Cassia sp Paluma Range</b>	<b>Corymbia ptychocarpa</b>	
	<b>Machans Beach</b>	Captain Cook	Christensen	<b>2.4</b>			<b>Cerbera manghas</b>	<b>P</b>
	<b>Martyn</b>	James	Florence	<b>7.3</b>	<b>Peltophorum pterocarpum</b>	<b>Peltophorum dubium Delonix regia var. flava</b>	<b>Cerbera manghas</b>	<b>P</b>
	<b>McCoombe</b>	Cava	McCormack	<b>7.3</b>	<b>Flindersia ifflaiana</b>		<b>Flindersia ifflaiana</b>	
	<b>McCormack</b>	Hoare	McCoombe	<b>7.5</b>			<b>Flindersia ifflaiana</b>	

### 8.3. Cairns City in a Garden Data Sheets-Street Tree Palette List-McGregor-Severin

Priority	Street name	between		Precinct	Median	Verge	Footpath	Ergon
	McGregor	Lydia	Sidlaw	2.5	Xanthostemon chrysanthus		Syzygium leuhmannii	
	McGregor	Sidlaw	Dunne	2.5	Xanthostemon chrysanthus		Syzygium leuhmannii	
1c	McKenzie	Sheridan	Esplanade	5.2		Lagerstroemia speciosa	Tabebuia pallida	
3a	McLeod	Arthur	Grove	5.2		Cassia "Rainbow Shower"	Toechima daemelianum	
3b	McLeod	Grove	Gatton	5.2	Link to Pioneers Cemetery			
3c	McLeod	Gatton	Florence	5.2		Cassia "Rainbow Shower"	Toechima daemelianum	
3d	McLeod	Florence	Wharf	5.2	Refer to Cairns CBD Streetscape Master Plan			
10	Mcmanus	Reservoir	Woodward	7.1		Lophanthera lactescens	Flindersia iffaiiana	
	McNamara	Greenslps	Behan	7.1	Link to Watsons Park			
	McNamara	Behan	Anderson	7.1				
	Miami	Poolwood	Nova	1.4		Peltophorum pterocarpum	Cupaniopsis anacardioides	P
	Miami	Nova	Trinity Bch	1.4	Link to Centenary Park			
7	Mill	Bruce Hwy	Woodlock	8.2	Tabebuia chrysantha		Syzygium forte ssp.forte	
1f	Minnie	Sheridan	Esplanade	5.2				
	Moody/McGregor	Hoare	Irene	7.3	Peltophorum pterocarpum		Syzygium forte ssp. forte	
	Mt Millman	Captain Cook	end	2.5	Darlingia darlingiana		Darlingia darlingiana	
12a	Pease	Greenslopes	Anderson	7.1	Corymbia ptychocarpa		Buckinghamia celsissima	P
12b	Pease	Anderson	Hoare	7.1		Corymbia ptychocarpa	Buckinghamia celsissima	P
	Peterson	Bruce Hwy	Mt Peter	8.2	Flindersia iffaiiana		Melicope elleryana	
	Poolwood	Captain Cook	Miami	1.3		Deplanchea tetraphylla	Barringtonia acutangula	P
11	Ramsay Dr	Irene	Reservoir	7.2	Polyalthia longifolia			
	Ravizza	Bicentennial	Mill	8.2		Flindersia iffaiiana	Flindersia iffaiiana Randia fitzalanii	P
	Redlynch Intake	West Arterial	Jungara	3.1			Flindersia iffaiiana	
	Redlynch Intake	Jungara	Redlynch C	3.1	Darlingia darlingiana		Flindersia iffaiiana	
	Redlynch Intake	Redlynch Co	Crystal Cds	3.1			Flindersia iffaiiana	
	Reed Rd	Captain Cook	Harbour	2.1	Peltophorum pterocarpum	Deplanchea tetraphylla	Cupaniopsis anacardioides	P
6	Riverstone	Bruce Hwy	Church	9.0				
15	Robert	Bruce Hwy	Hardy	8.2	Agathis robusta		Brachychiton acerifolius	
	Scott	Bunda	McCoombe	7.5		Corymbia ptychocarpa	Tabebuia argentea	P
	Severin	James	Charles	7.4		Cerbera manghas	Barringtonia acutangula	
	Severin	Charles	Upward	7.4	Link to Cairns Central Swamp			

8.4. Cairns City in a Garden Data Sheets-Street Tree Palette List-Severin-Yorkeys Knob								
Priority	Street name	between		Precinct	Median	Verge	Footpath	Ergon
	Severin	Upward	Mulgrave	7.4		Cerbera manghas	Barringtonia acutangula	
	Sheridan	Airport	Rutherford	5.2	Gateway		Caesalpineia ferrea	
	Sheridan	Rutherford	Lily	5.2	Gateway		Caesalpineia ferrea	
	Sheridan	Lily	Minnie	5.2	Gateway		Caesalpineia ferrea	
	Sheridan	Minnie	Florence	5.2	Gateway/Link to Munro Martin Park			
	Sheridan	Florence	Wharf	5.1	Refer to Cairns CBD Streetscape Master Plan			
	Shields	Esplanade	McLeod	5.1	Refer to Cairns CBD Streetscape Master Plan			
1b	Smith	Sheridan	Esplanade	5.2		Corymbia ptychocarpa	Syzygium jambos	P
	Smithfield Village Dr	Trinity Park	Reed Rd	2.1	Agathis robusta		Deplanchea tetraphylla	
	Smithfield Village Dr	Reed Rd	McGregor	2.1	Agathis robusta		Deplanchea tetraphylla	
	Tills/Lennon	Mulgrave	Gatton	7.5	Caesalpineia ferrea		Xanthostemon chrysanthus	
	Tills/Lennon	Gatton	English	7.5		Xanthostemon chrysanthus	Xanthostemon chrysanthus	
	Tills/Lennon	English	McCormack	7.5			Xanthostemon chrysanthus	
11a	Toogood	Mulgrave	Yarra	7.7		Xanthostemon chrysanthus	Xanthostemon chrysanthus	
11b	Toogood	Yarra	Fairview	7.7		Xanthostemon chrysanthus	Xanthostemon chrysanthus	
13a	Trinity Beach	Esplanade	Jameson	1.4	Melaleuca Acalypha/Gardenia		Callistemon viminalis	P
13b	Trinity Beach	Jameson	Cstwtr park	1.4	Callistemon viminalis Hymenocallis/Allamanda		Randia fitzalanii	P
13c	Trinity Beach	Cstwtr park	Rabaul	1.4	Peltophorum pterocarpum		Xanthostemon chrysantha	
13d	Trinity Beach	Rabaul	Clayley	1.4	Peltophorum pterocarpum		Barringtonia acutangula	
13e	Trinity Beach	Clayley	Nautilus	1.4	Callistemon viminalis		Xanthostemon chrysantha	
13f	Trinity Beach	Nautilus	Capt. Cook	1.4	Bouganvillea/jasmine		Callistemon viminalis	P
1e	Upward	Sheridan	Esplnd	5.2		Caesalpineia ferrea	Cupaniopsis anacardioides Caesalpineia ferrea	P
	Varley	Yorkeys Knb	Evans	2.2		Peltophorum pterocarpum	Cupaniopsis anacardioides	
	Veivers	Capt. Cook	Williams	1.1	Tibouchina (shrub)		Randia fitzalanii	
	Walker			8.2	Flindersia iffliana		Flindersia iffliana	
	Warren/Cedar			1.1			Tabebuia pallida	P
	Wharf	Bunda	Abbot	5.1	Refer to Cairns CBD Streetscape Master Plan			
	Windarra	Toogood	Anderson	7.7		Darlingia darlingiana	Toechimia erythrocarpum	
	Yorkeys Knob	Capt. Cook	Antoinetta	2.2			Peltophorum pterocarpum	
	Yorkeys Knob	Antoinetta	Varley	2.2		Peltophorum pterocarpum	Cupaniopsis anacardioides	P

## 9. Glossary of Terms

## Glossary of Terms

<b>Apical Dominance</b>	of growth, the dominance of the terminal bud to lateral buds
<b>Cambium</b>	the outer layer of bark on a trunk
<b>CBD</b>	Central Business District
<b>CCC</b>	Cairns City Council
<b>Codominant</b>	of tree trunks, where a single trunk has two or more divisions or branches
<b>CPA</b>	Cairns Port Authority
<b>CPTED</b>	Crime Prevention through Environmental Design
<b>Endemic</b>	for the purposes of this document, endemic refers to a species native to the Cairns area
<b>FNQROC</b>	Far North Queensland Regional Organisation of Councils
<b>Footpath</b>	the area located between the property boundary and the adjacent kerb and channel
<b>Graft</b>	the union of living parts from different origins to form a structure physiologically acting as a single unit
<b>Median</b>	island central to road reserve
<b>NATSPEC</b>	National Association of Tree Specification
<b>Phytotoxic</b>	poisonous to plant material
<b>Riparian</b>	relates to rivers and streams
<b>Scion</b>	of a graft, the part (usually a shoot or bud) from a source external to the grafting
<b>Stem Taper</b>	the increase in calliper down the stem (trunk)
<b>Verge</b>	the area located between the road edge and the kerb and channel



**CAIRNS  
CITY  
IN A GARDEN  
MASTER PLAN  
PART F  
STREETScape  
TEMPLATES**



**City in a Garden Part F-Streetscape Templates**

<b>CITY IN A GARDEN MASTER PLAN 2007</b>	<b>2</b>
<b>CITY IN A GARDEN MASTER PLAN PART B-TREE SPECIES SELECTION</b>	<b>14</b>
<b>CITY IN A GARDEN MASTER PLAN PART C- PRECINCT PLANS</b>	<b>30</b>
<b>CITY IN A GARDEN MASTER PLAN PART D TECHNICAL GUIDELINES</b>	<b>99</b>
<b>CITY IN A GARDEN PART E- APPENDICES</b>	<b>128</b>
<b>CITY IN A GARDEN PART F-STREETScape TEMPLATES</b>	<b>178</b>
<b>1</b>	<b>TNP TYPE A 180</b>
<b>2</b>	<b>TNP TYPE B 181</b>
<b>3</b>	<b>TNP TYPE C 182</b>
<b>4</b>	<b>TNP TYPE D 183</b>
<b>5</b>	<b>TNP TYPE D1 184</b>
<b>6</b>	<b>TNP TYPE E 185</b>
<b>7</b>	<b>TNP TYPE G 186</b>
<b>8</b>	<b>TNP TYPE G1 187</b>
<b>9</b>	<b>TNP TYPE V 188</b>
<b>10</b>	<b>TNP TYPE V1 189</b>
<b>11</b>	<b>ACCESS STREET 20-74 190</b>
<b>12</b>	<b>MINOR COLLECTOR 75-229191</b>
<b>13</b>	<b>MAJOR COLLECTOR 300-599 192</b>
<b>14</b>	<b>TRUNK COLLECTOR 193</b>
<b>15</b>	<b>LOW DENSITY RESIDENTIAL 194</b>
<b>ROAD ≤ 29</b>	

16	HIGH DENSITY RESIDENTIAL	
ROAD ≥ 30	195	
17	FOOTPATH WIDTHS	196
18	ROUNDBABOUTS-SIGHTLINES	
	197	
19	INTERSECTIONS-SIGHTLINES	
	198	
20	PARKING IN ROAD RESERVE	
	199	
21	ON STREET PARKING FOR	
MULTIPLE RESIDENTIAL AND COMMERCIAL UNITS	200	
22	TREE IN MEDIAN OR ISLAND	
	201	
23	TREE IN FOOTPATH WITH	
NATURE STRIP	202	
24	TREE IN HARDSCAPE	204
25	TABLE TO GUIDE THE	
SELECTION OF ROOT MANAGEMENT SYSTEMS.	206	
26	TREES IN CARPARKS	207

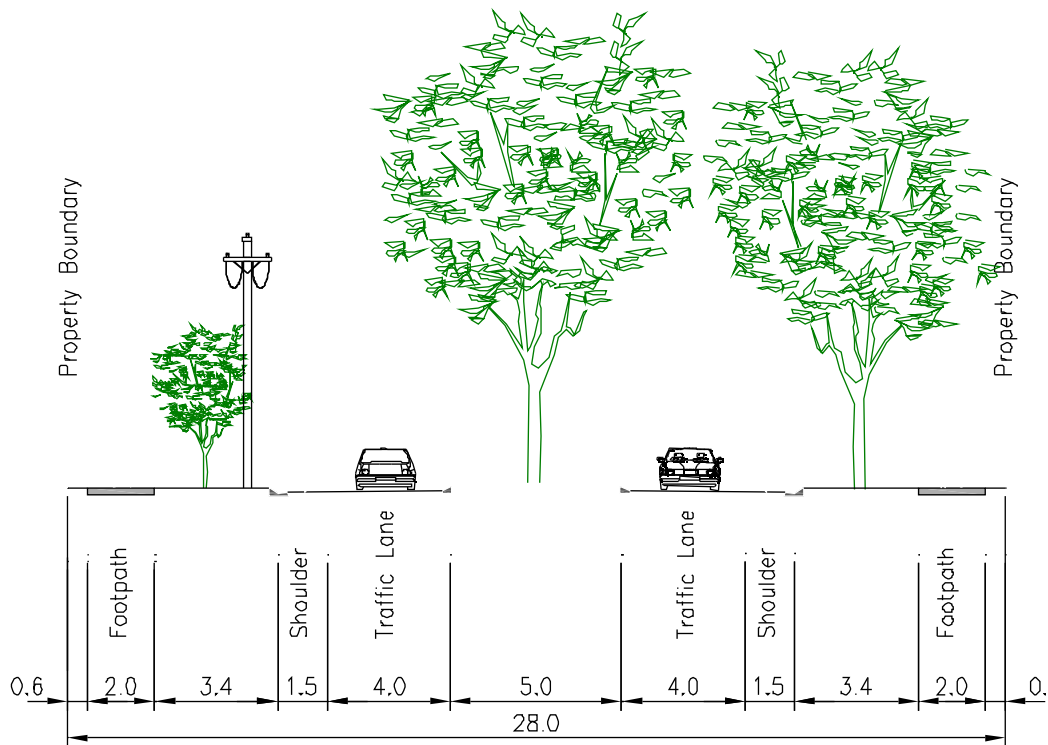
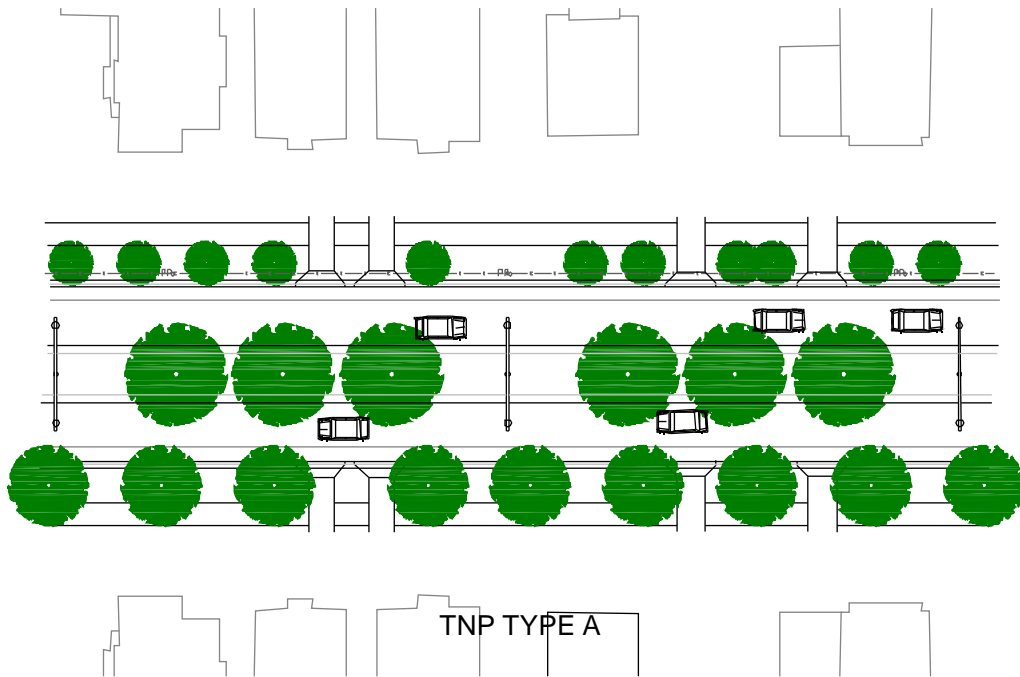

# 1 TNP TYPE A

Cairns City in a Garden  
Master Plan 2007

Part F  
Streetscape Templates

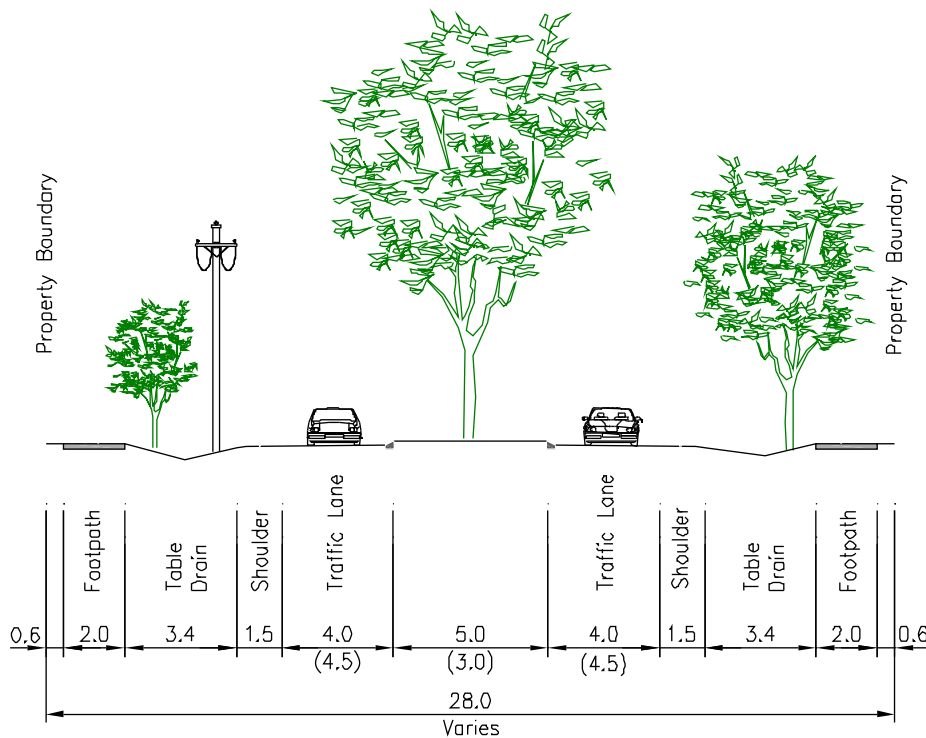
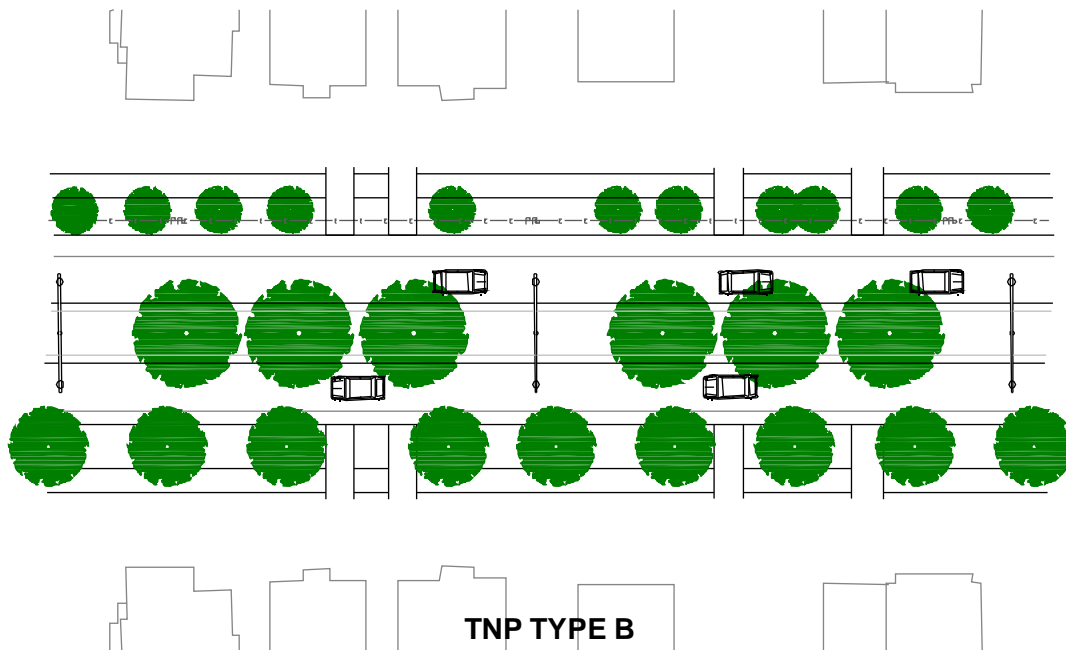

## 2 TNP TYPE B

Cairns City in a Garden  
Master Plan 2007

Part F  
Streetscape Templates

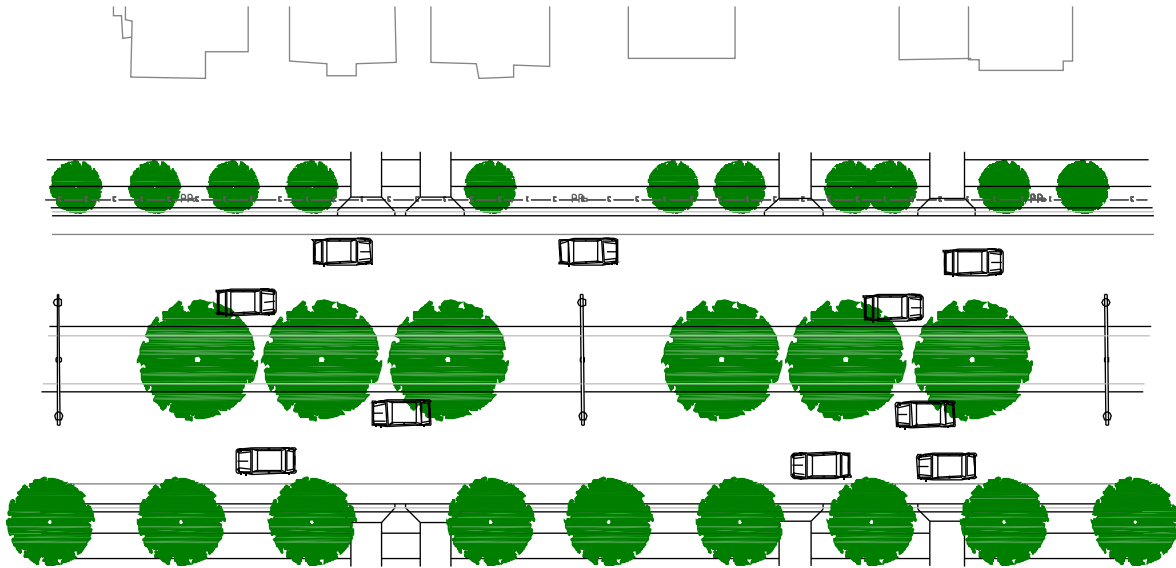

**TNP TYPE C**

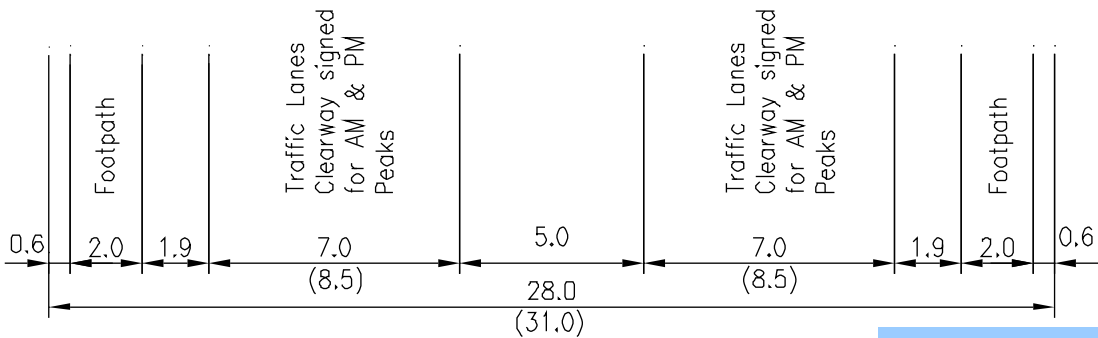
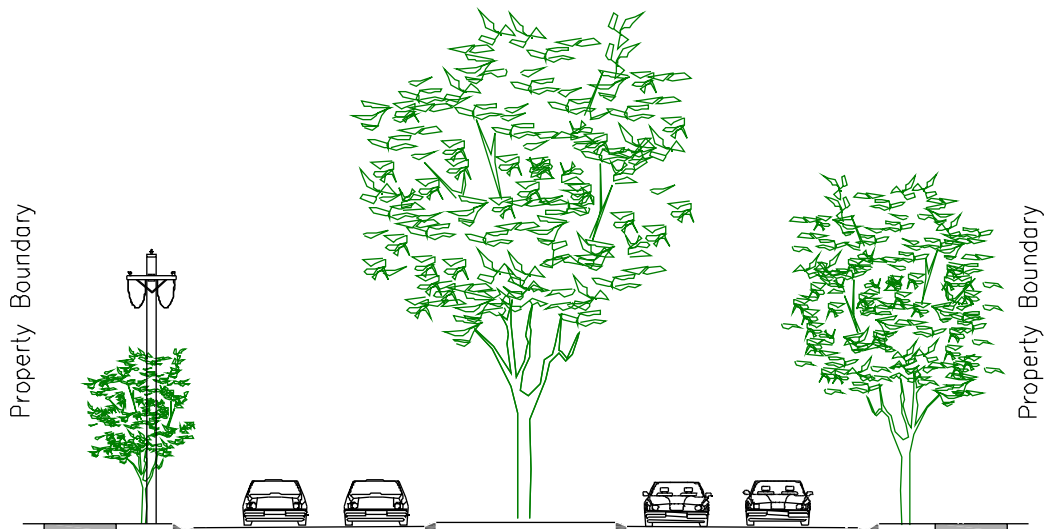

**3 TNP TYPE C**

Cairns City in a Garden  
Master Plan 2007

Part F  
Streetscape Templates

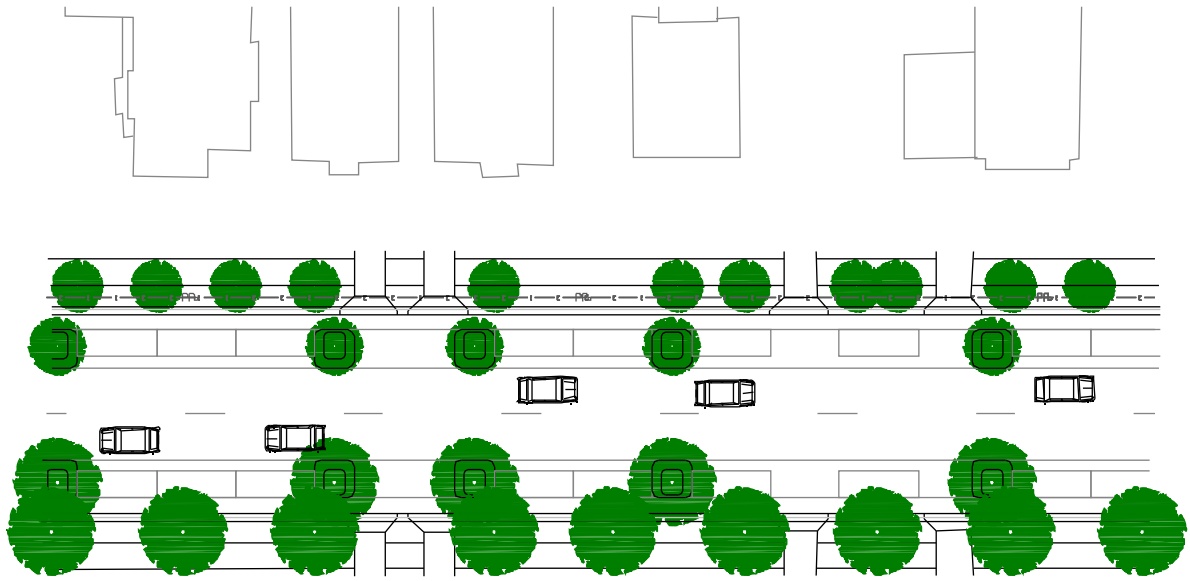

**TNP TYPE D**

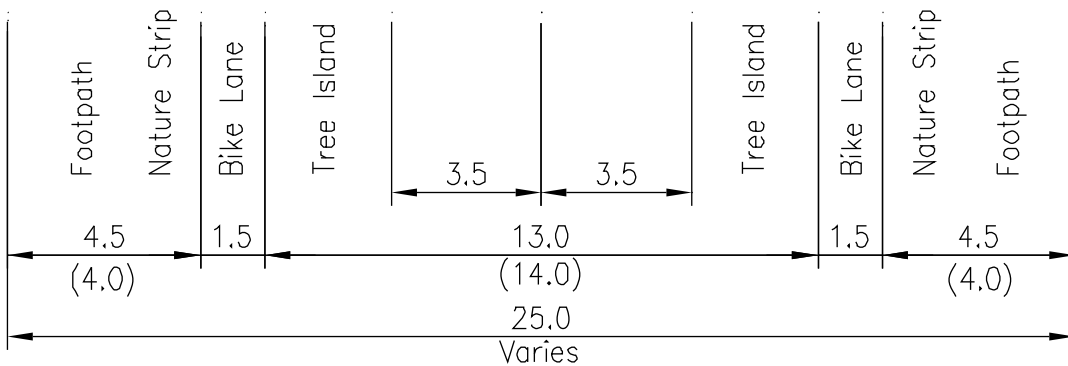
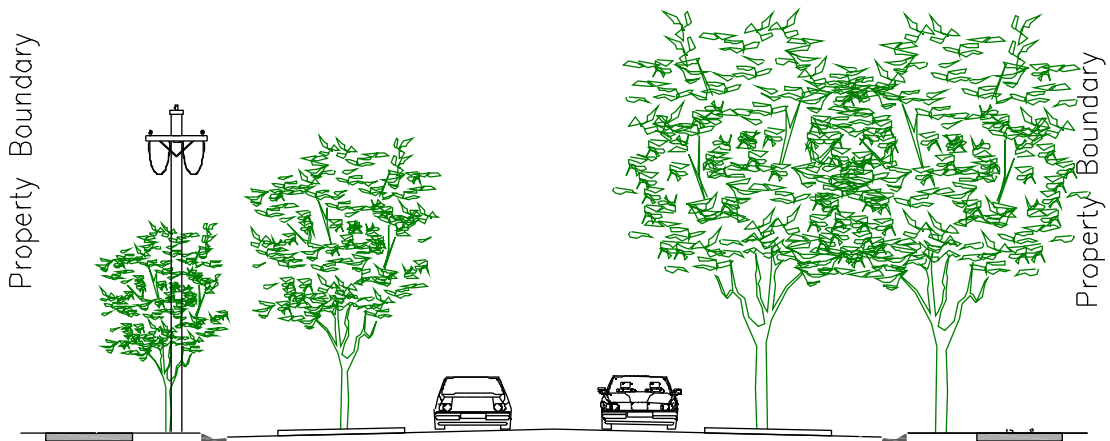

**4 TNP TYPE D**

Cairns City in a Garden  
Master Plan 2007

Part F  
Streetscape Templates

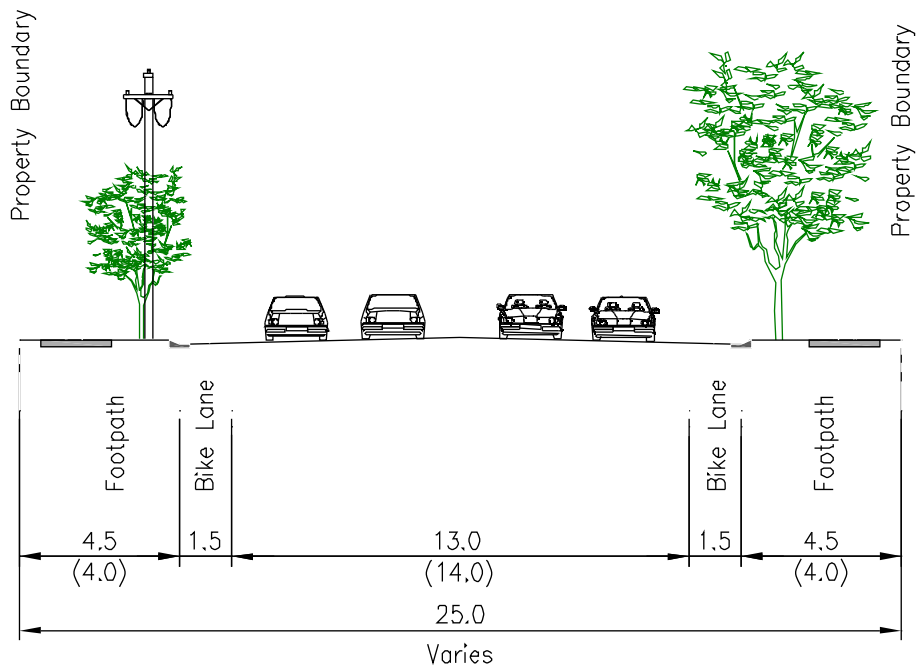
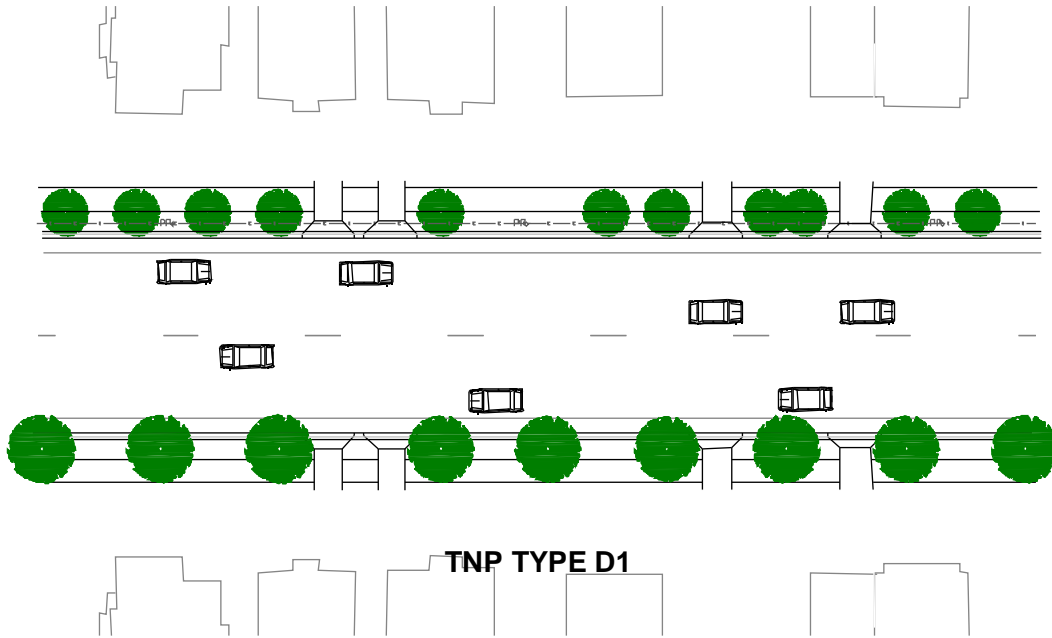

## 5 TNP TYPE D1



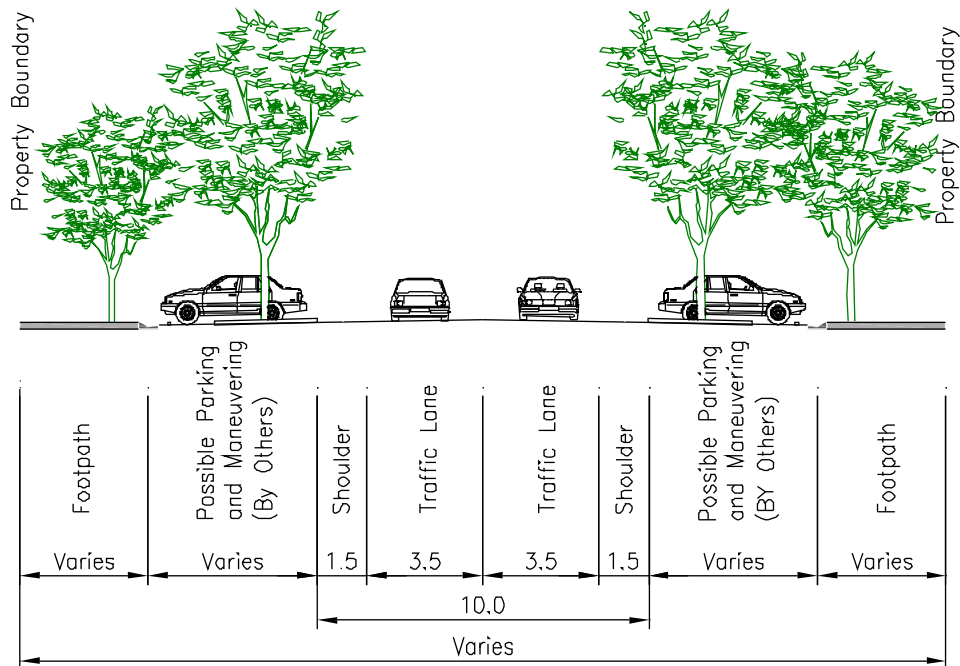
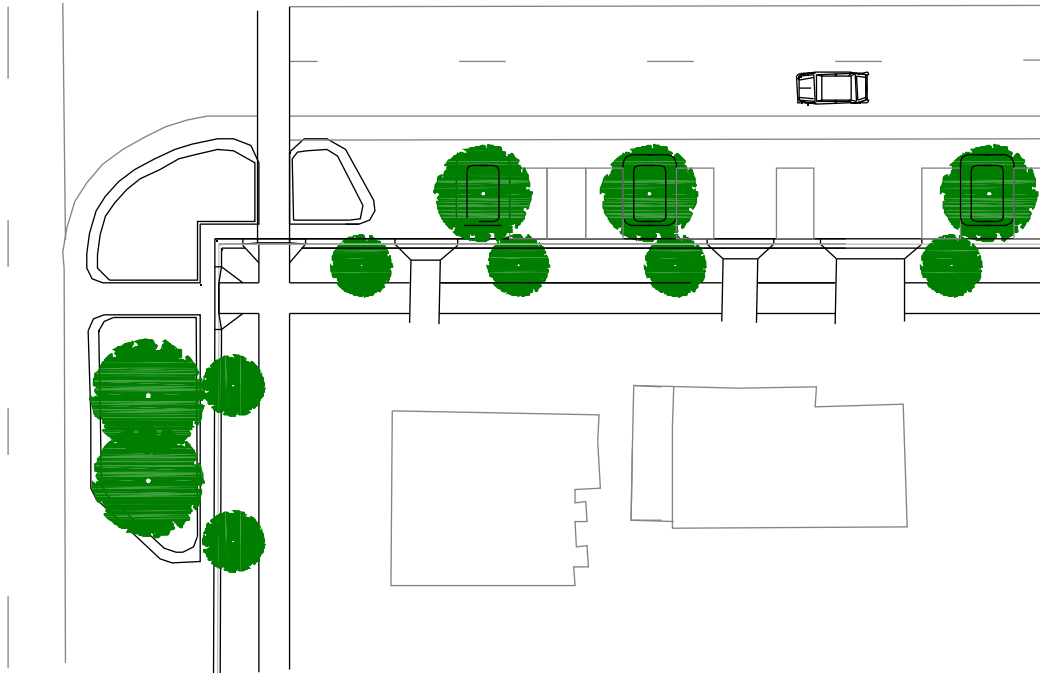

## 6 TNP TYPE E

Cairns City in a Garden  
Master Plan 2007

Part F  
Streetscape Templates

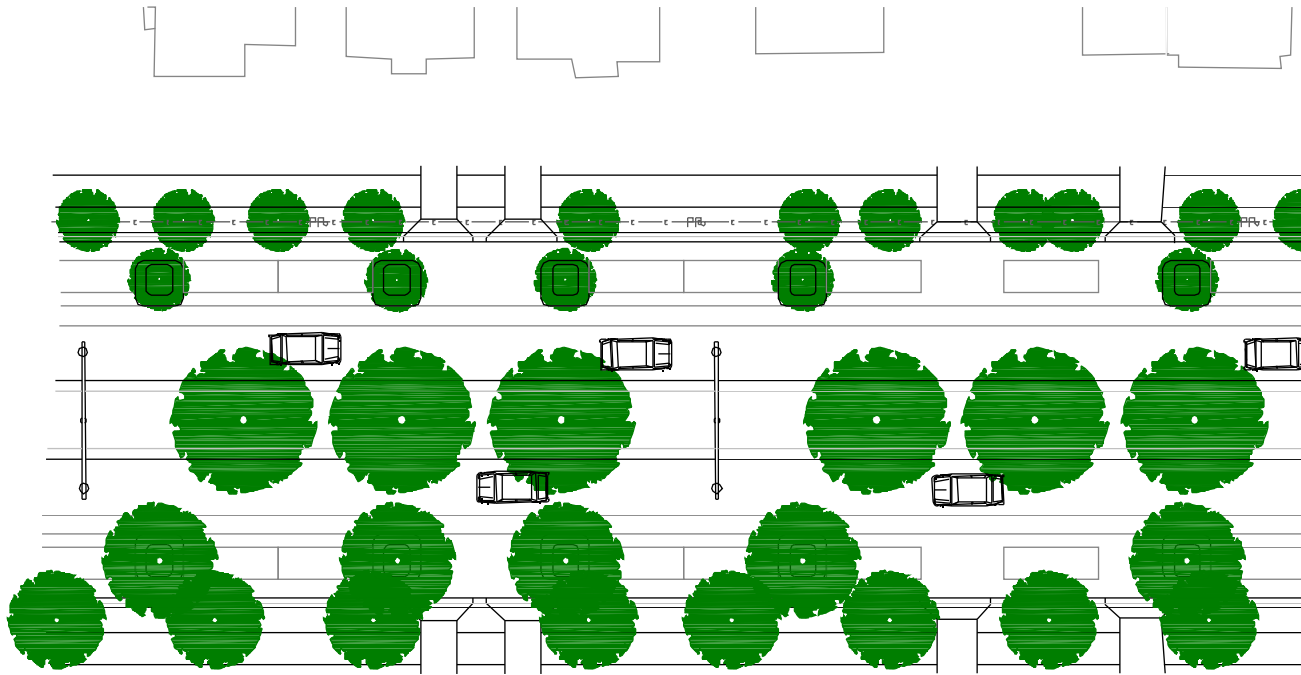

## 7 TNP TYPE G

Cairns City in a Garden  
Master Plan 2007

Part F  
Streetscape Templates

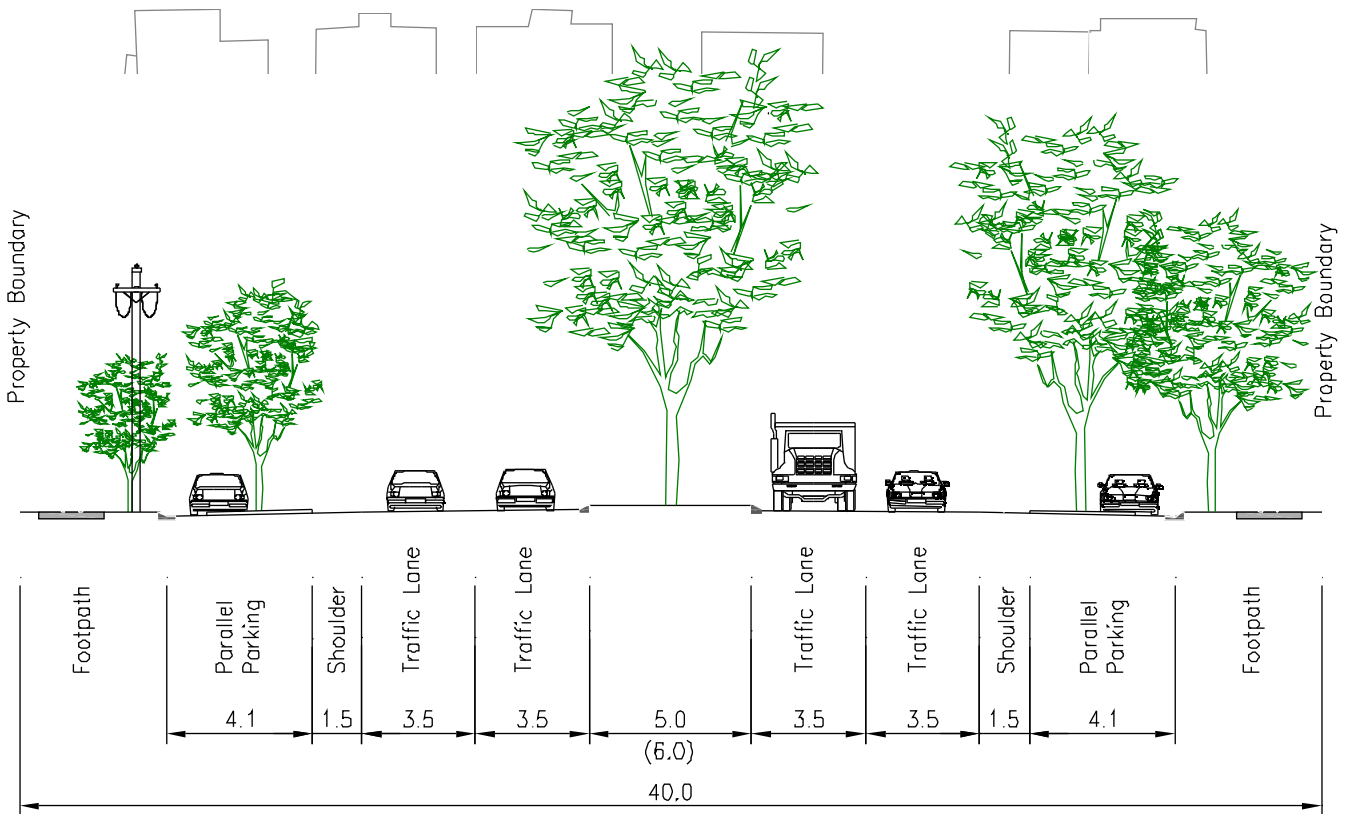

## 8 TNP TYPE G1

Cairns City in a Garden  
Master Plan 2007

Part F  
Streetscape Templates

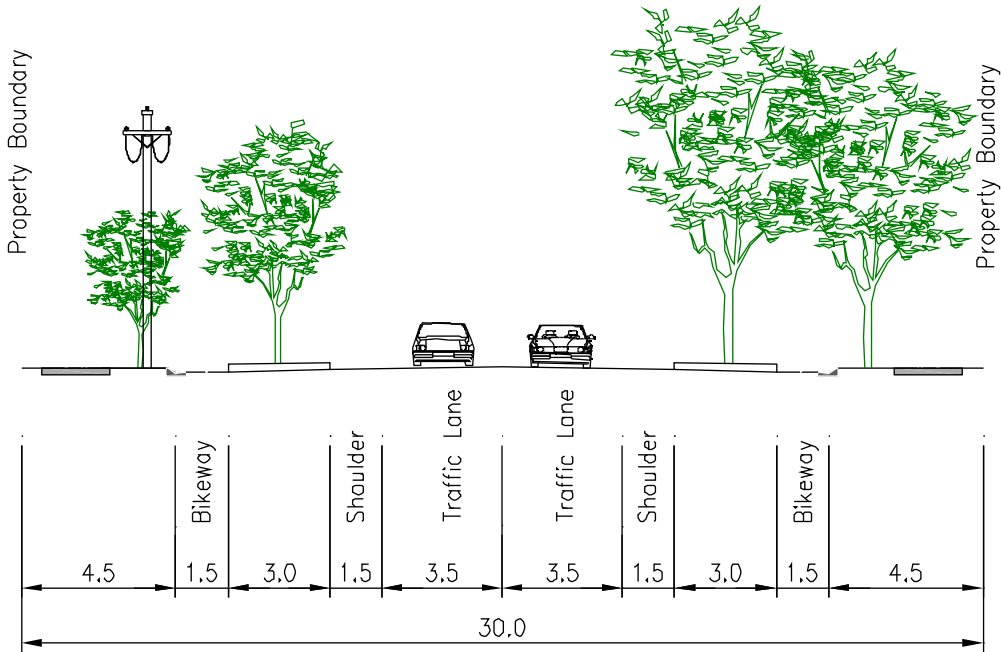

## 9 TNP TYPE V

Cairns City in a Garden  
Master Plan 2007

Part F  
Streetscape Templates

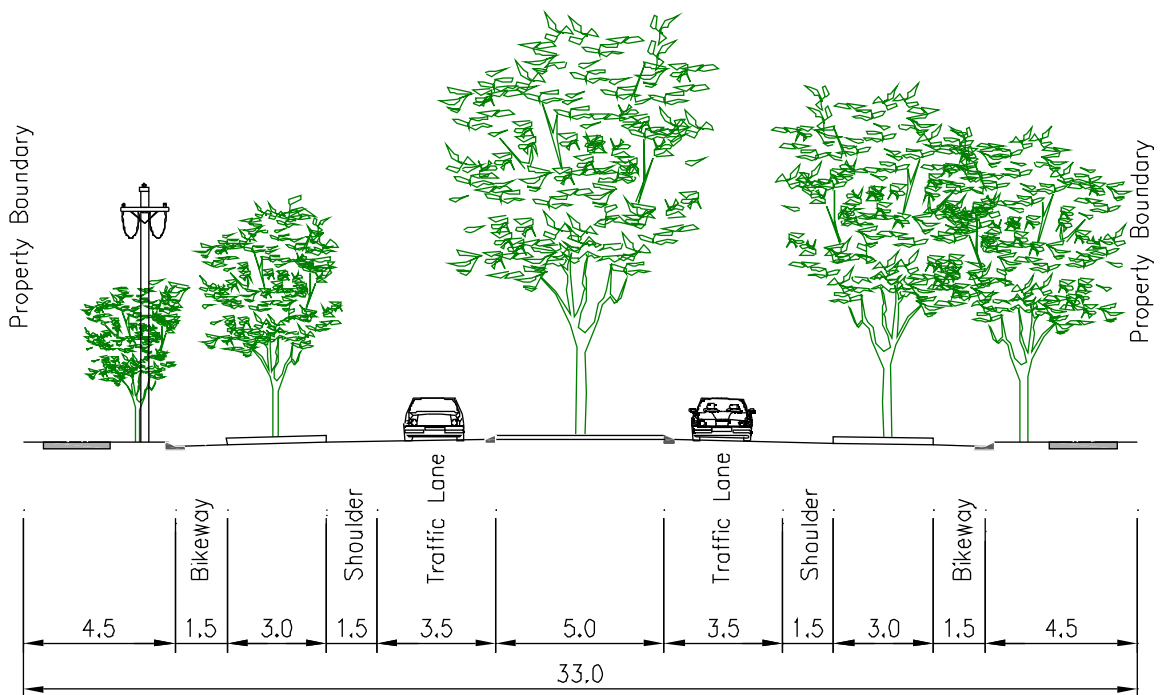
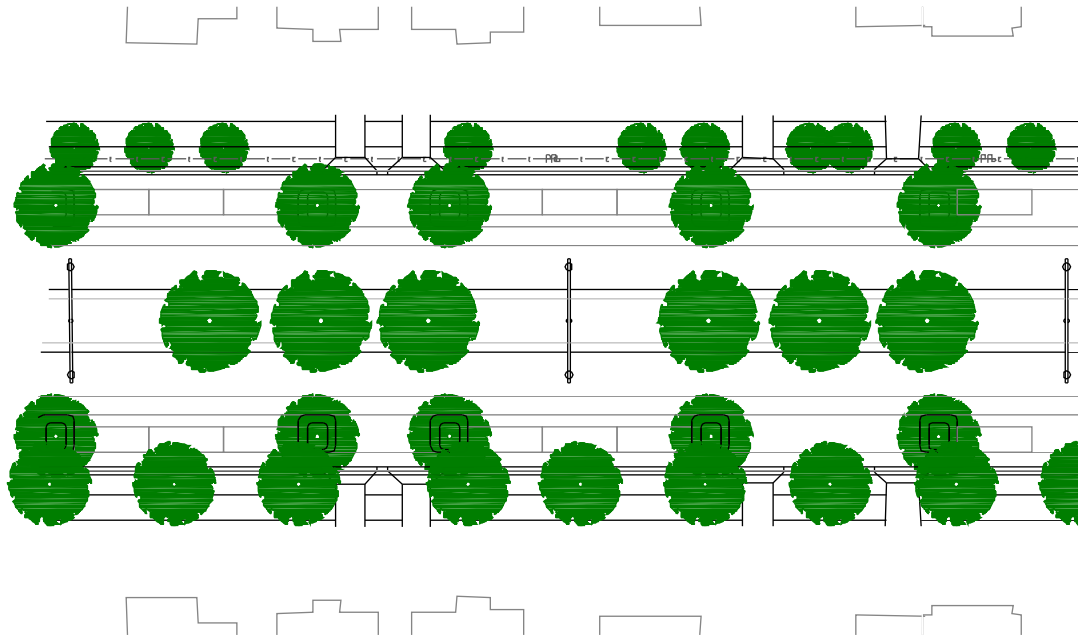

## 10TNP TYPE V1

Cairns City in a Garden  
Master Plan 2007

Part F  
Streetscape Templates

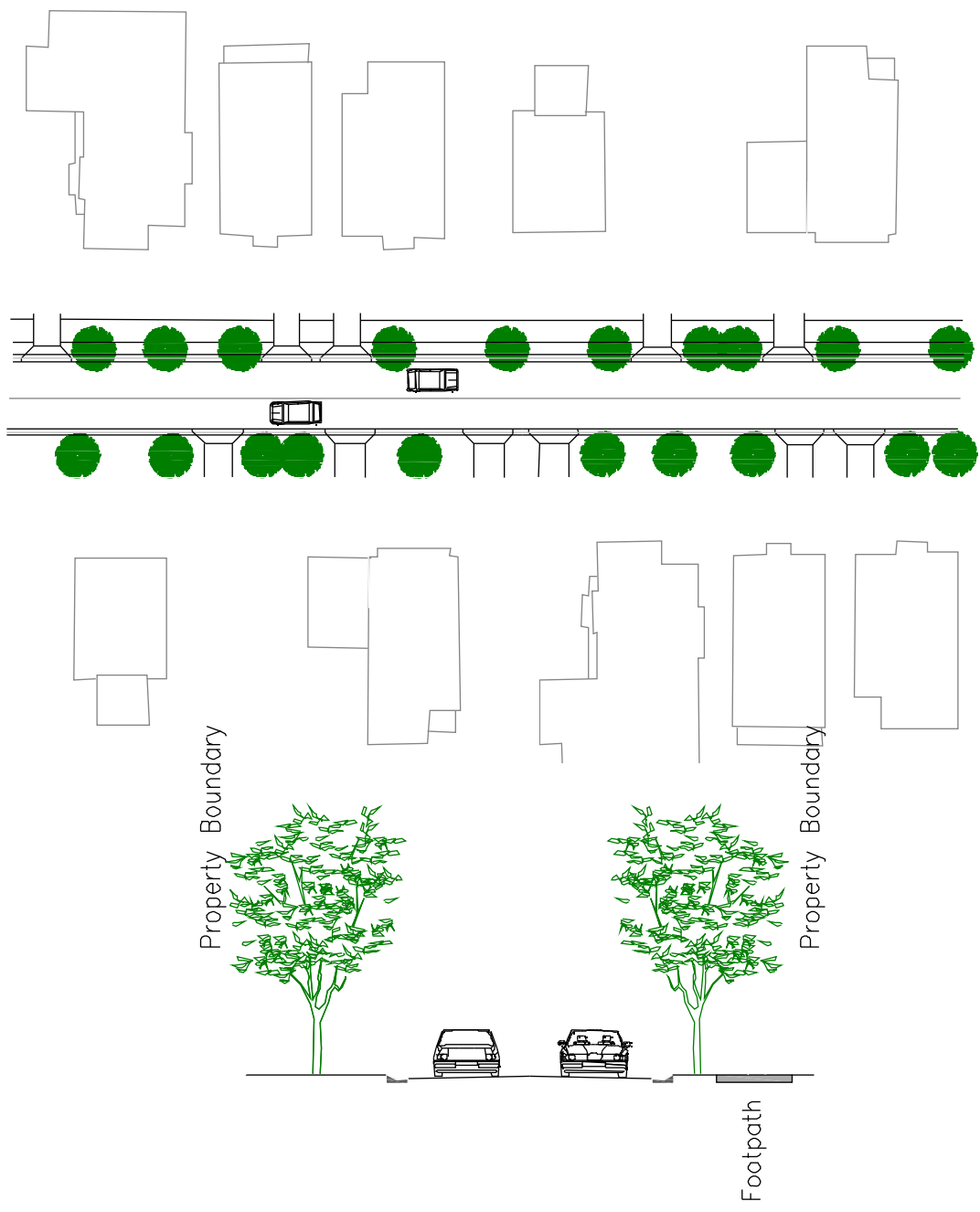

## 11 ACCESS STREET 20-74

Cairns City in a Garden  
Master Plan 2007

Part F  
Streetscape Templates

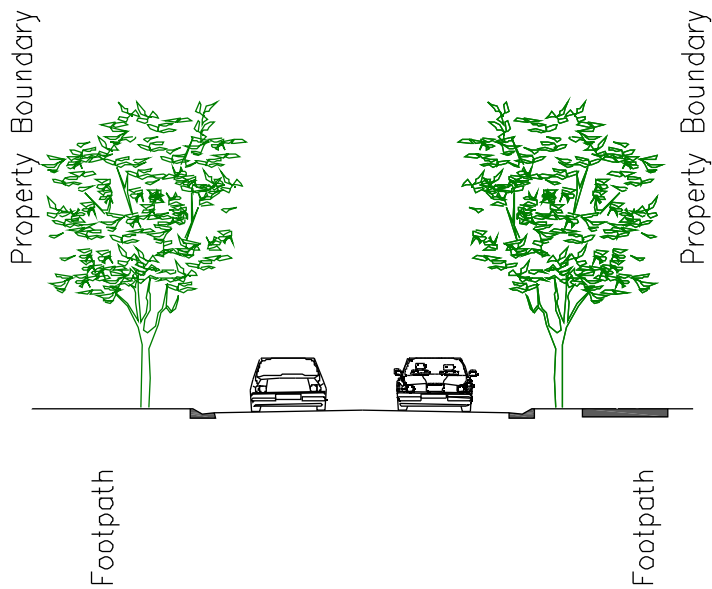

## 12MINOR COLLECTOR 75-229

Cairns City in a Garden  
Master Plan 2007

Part F  
Streetscape Templates

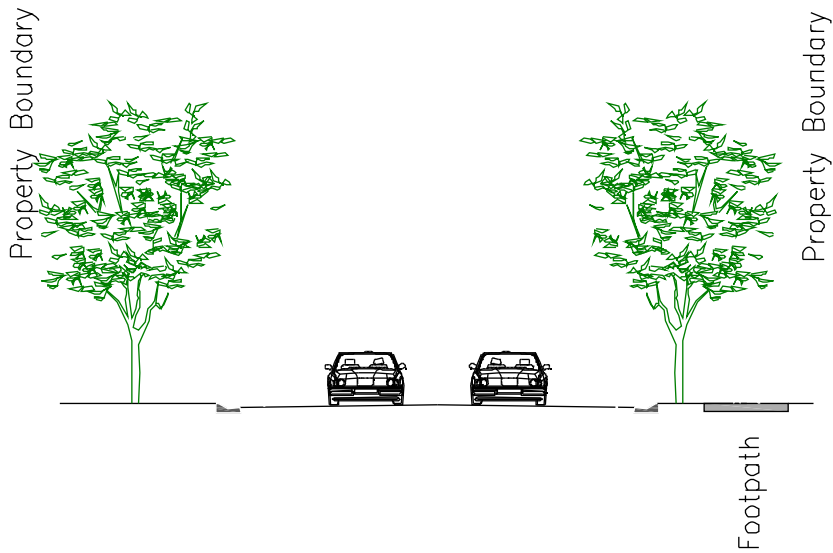
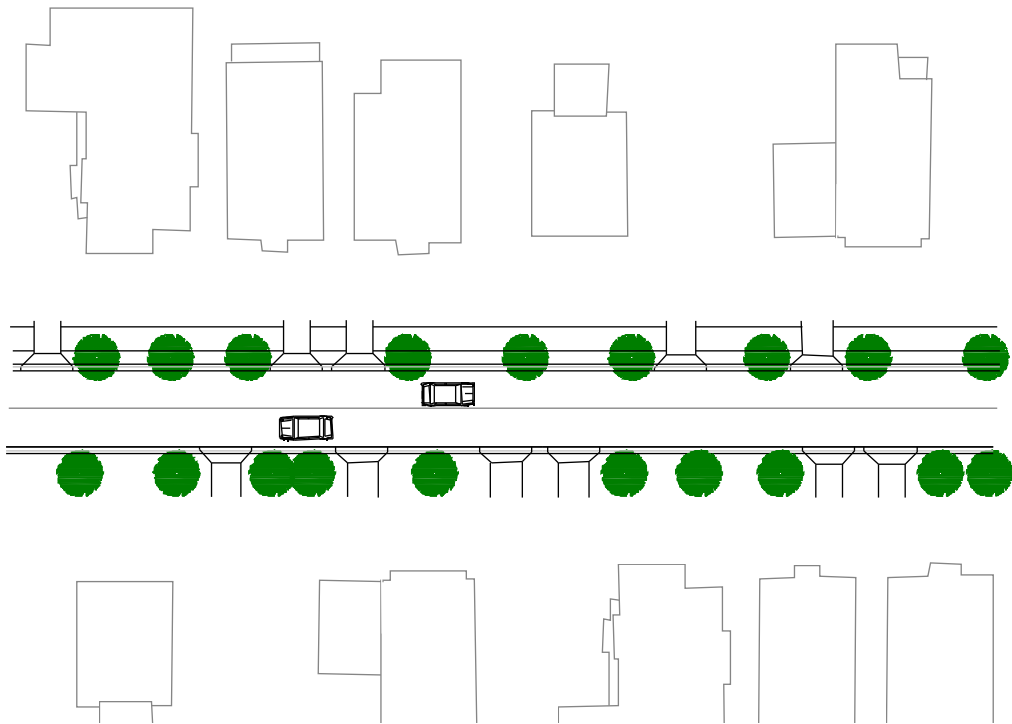

## 13 MAJOR COLLECTOR 300-599

Cairns City in a Garden  
Master Plan 2007

Part F  
Streetscape Templates



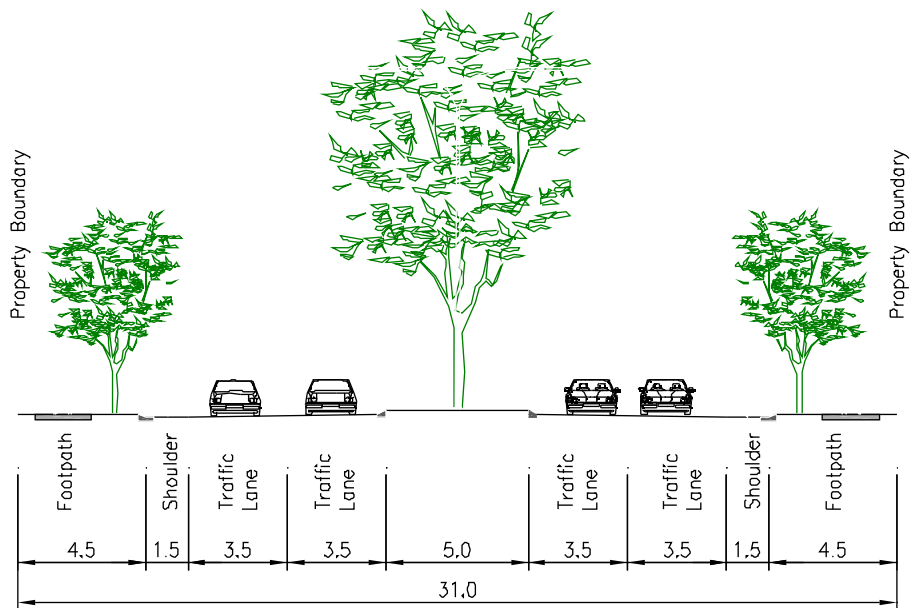
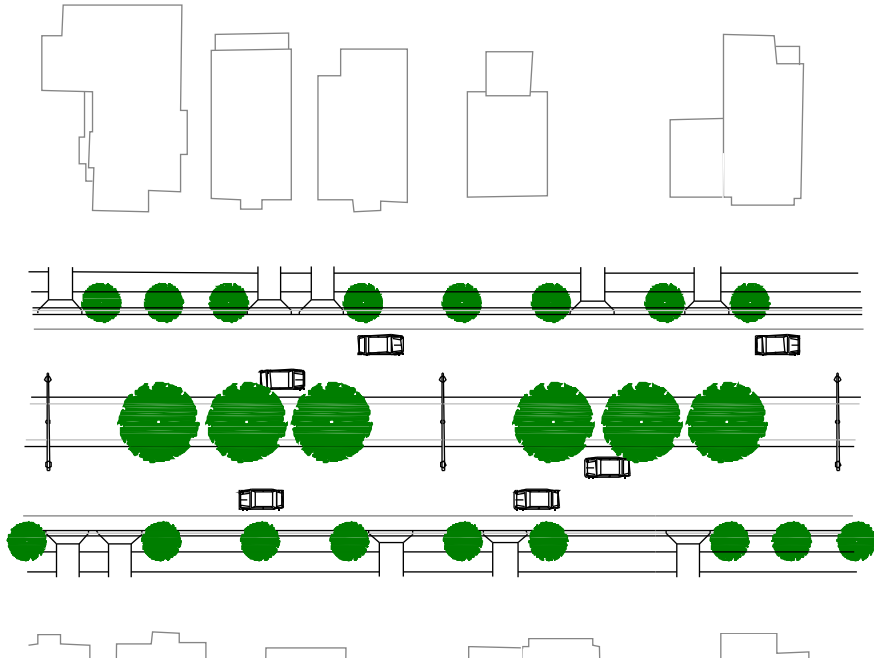

## 14TRUNK COLLECTOR

Cairns City in a Garden  
Master Plan 2007

Part F  
Streetscape Templates

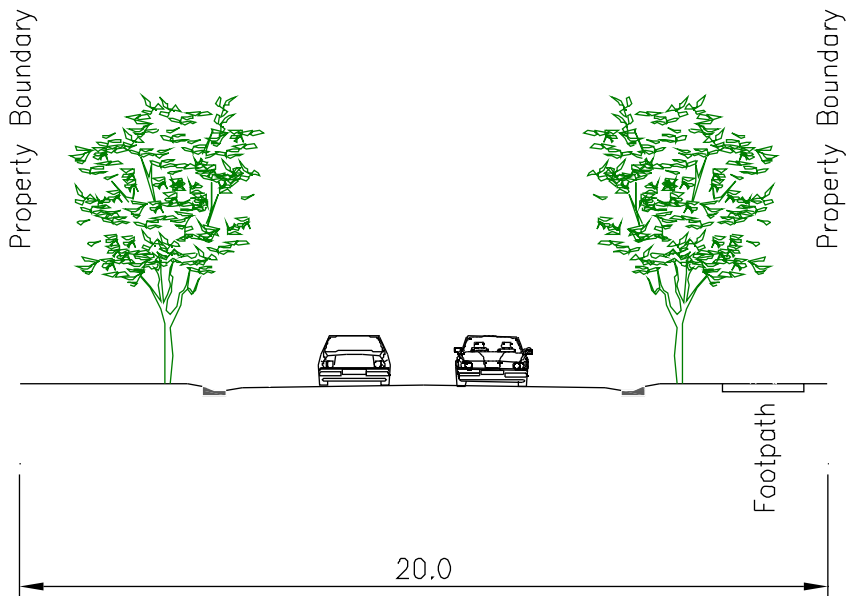

**15 LOW DENSITY RESIDENTIAL  
ROAD ≤ 29**

Cairns City in a Garden  
Master Plan 2007

Part F  
Streetscape Templates

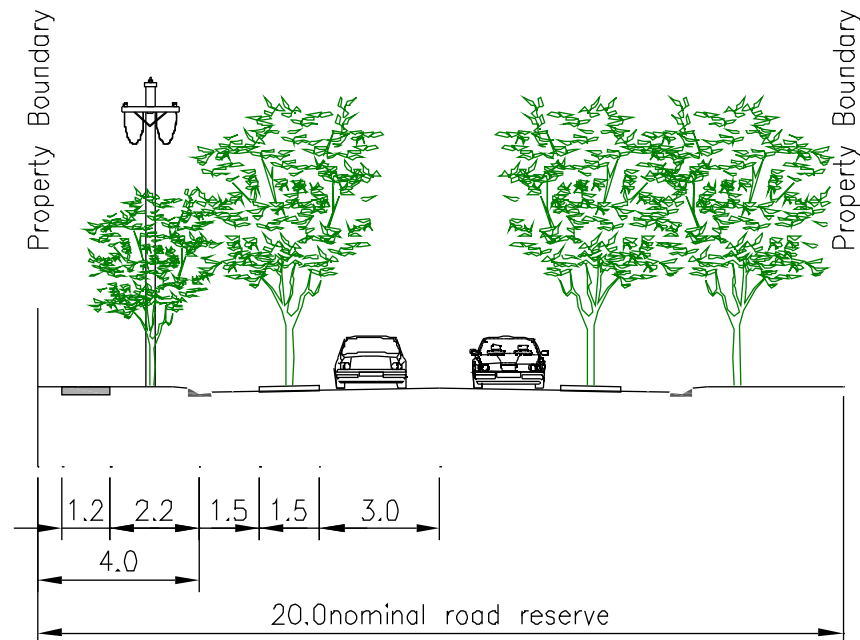
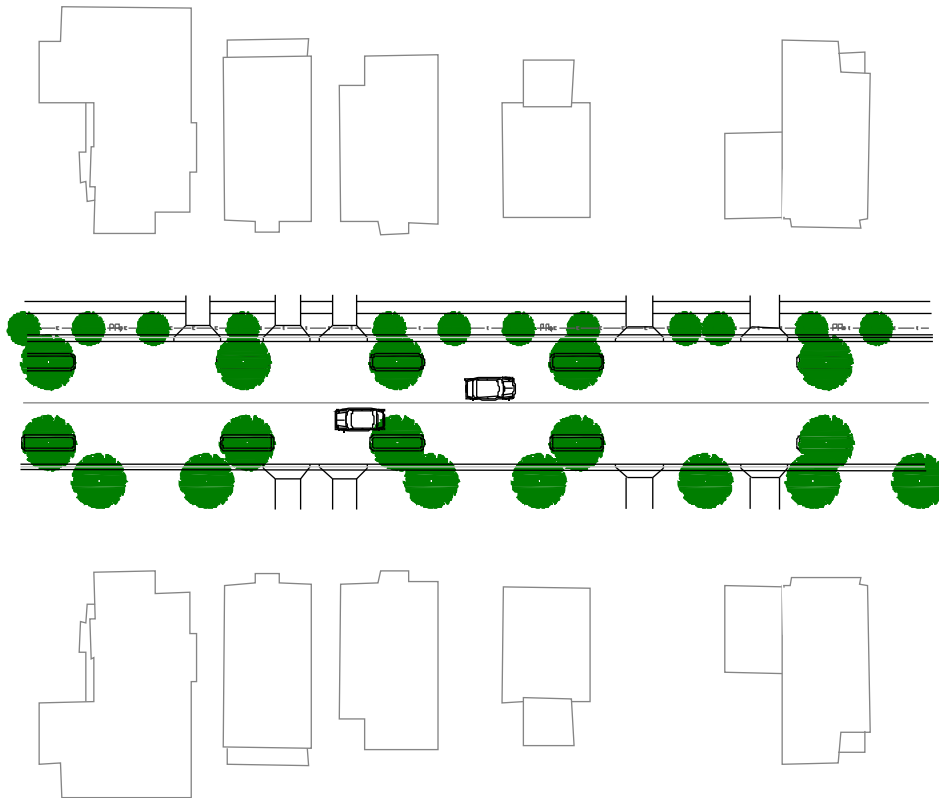

## 16 HIGH DENSITY RESIDENTIAL ROAD ≥ 30

Cairns City in a Garden  
Master Plan 2007

Part F  
Streetscape Templates

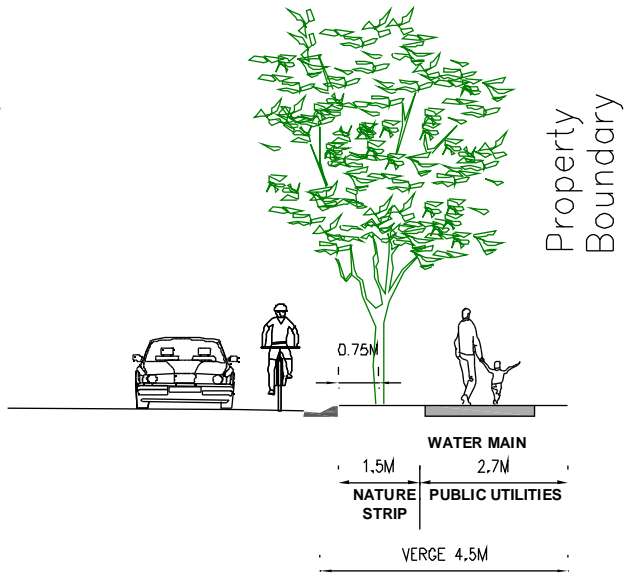
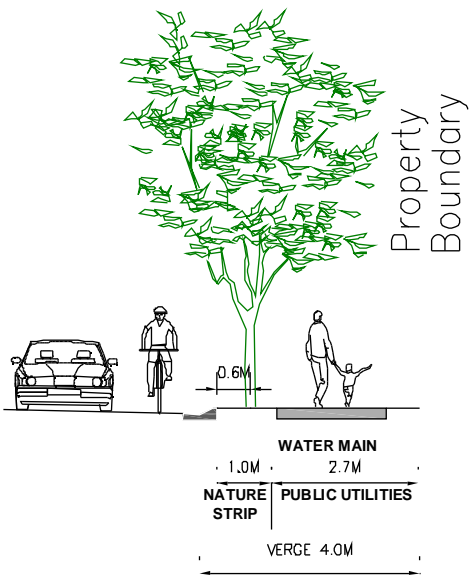

**EXISTING MINIMUM VERGE WIDTHS**

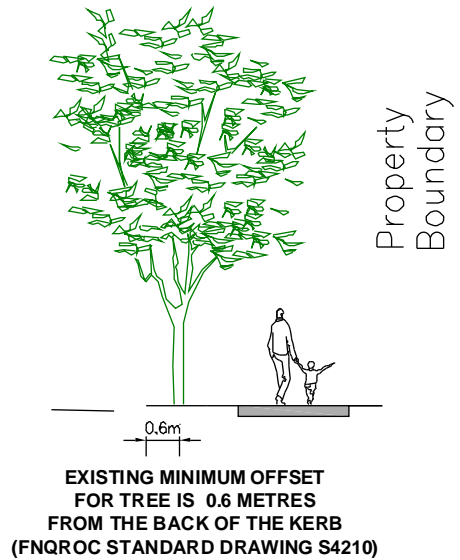
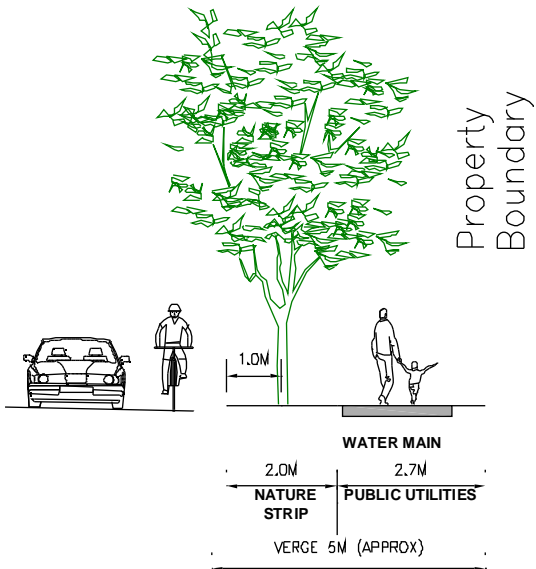

**PREFERRED MINIMUM VERGE WIDTHS**

PLEASE NOTE:  
WATER MAIN IS INDICATED AT PREFERRED DEPTH OF 0.6M

**17FOOTPATH WIDTHS**

Cairns City in a Garden  
Master Plan 2007

Part F  
Streetscape Templates

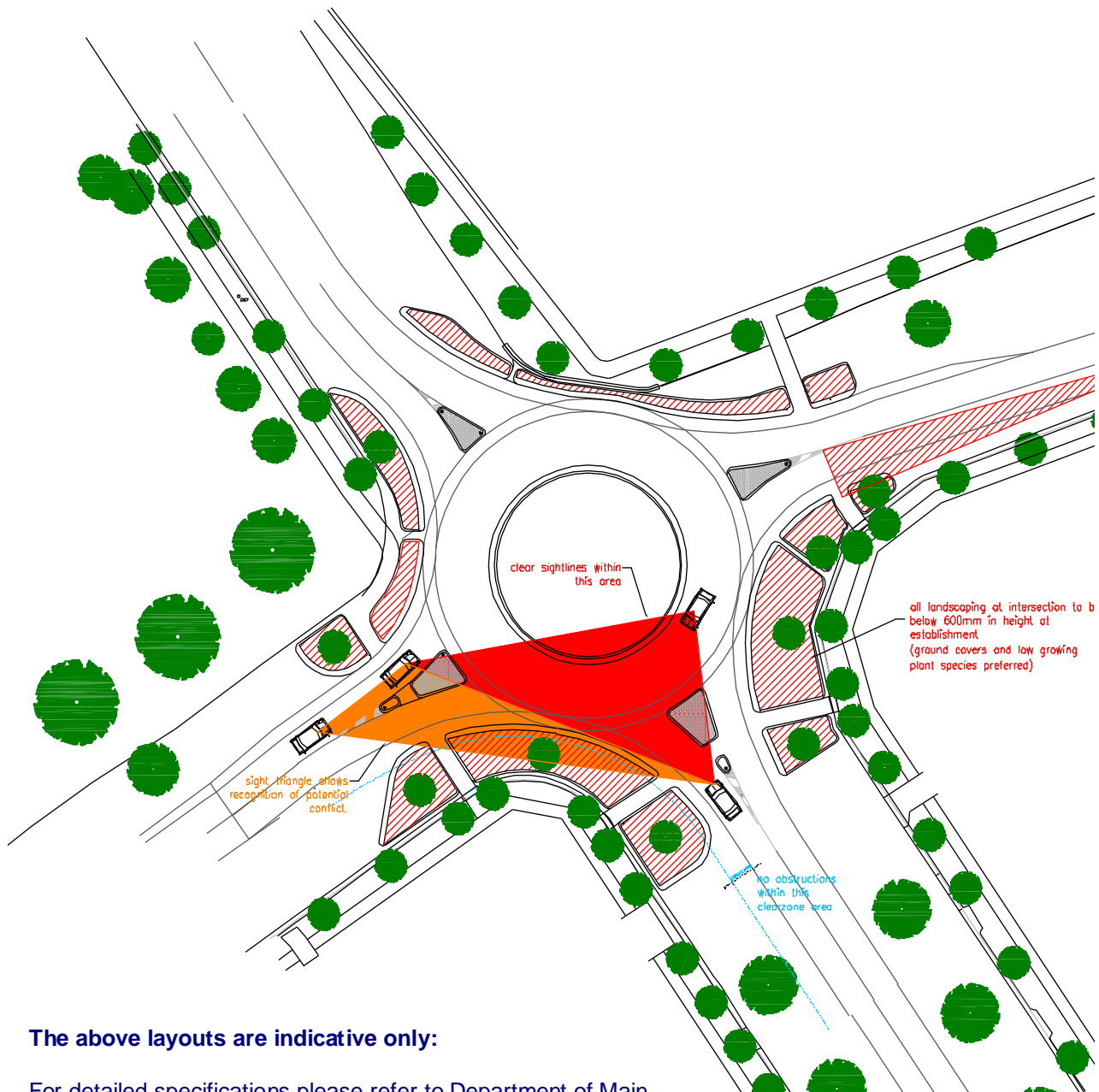

**The above layouts are indicative only:**

For detailed specifications please refer to Department of Main Roads, Road Planning and Design Manual, Chapter 9-Sight Distance and Chapter 14-Roundabouts

## 18 ROUNDABOUTS-SIGHTLINES

Cairns City in a Garden  
Master Plan 2007

Part F  
Streetscape Templates

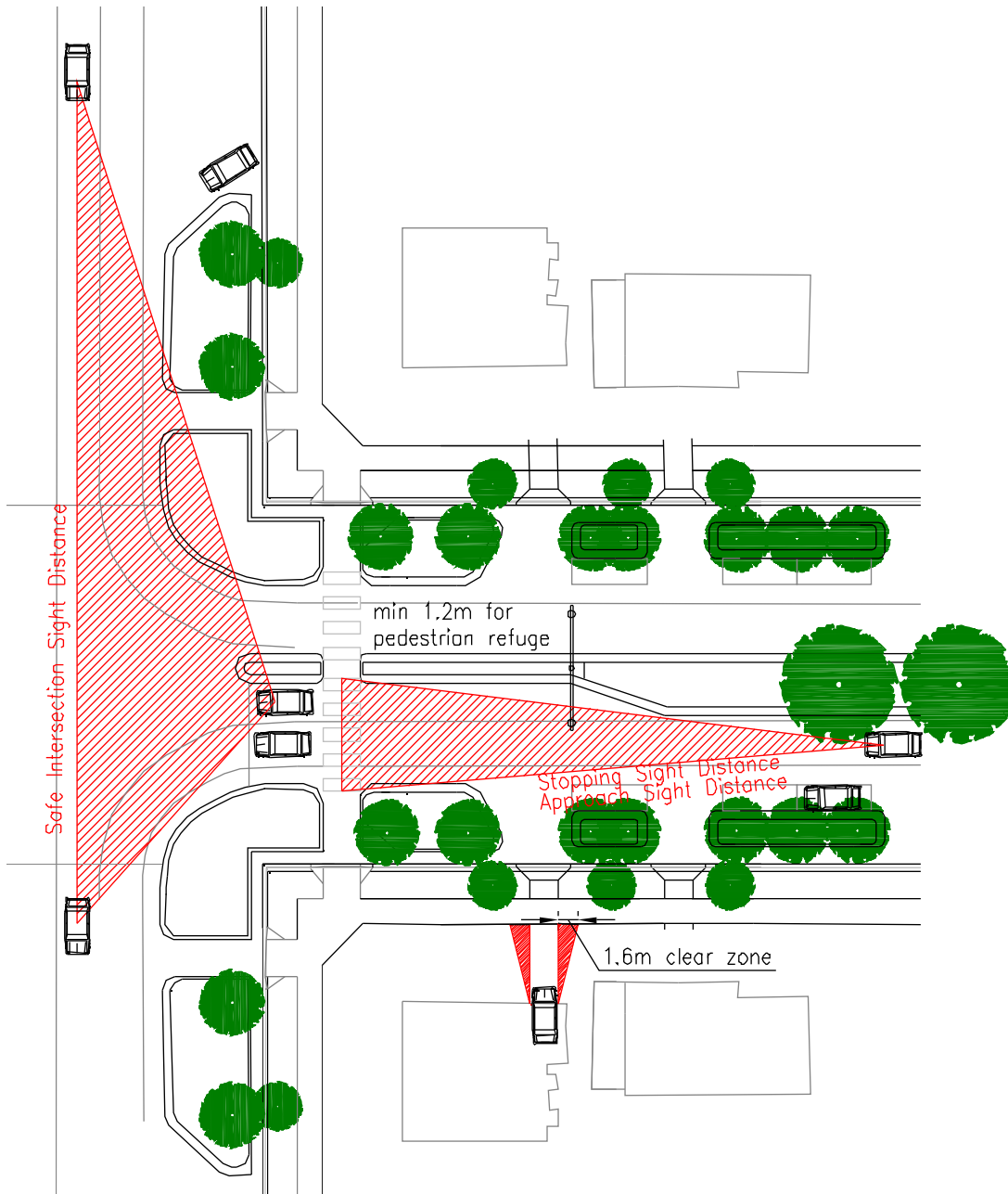

**The above layouts are indicative only:**

For detailed specifications please refer to Department of Main Roads, Road Planning and Design Manual, Chapter 9-Sight Distance and Chapter 13-Intersections at Grade.

## 19 INTERSECTIONS-SIGHTLINES

Cairns City in a Garden  
Master Plan 2007

Part F  
Streetscape Templates

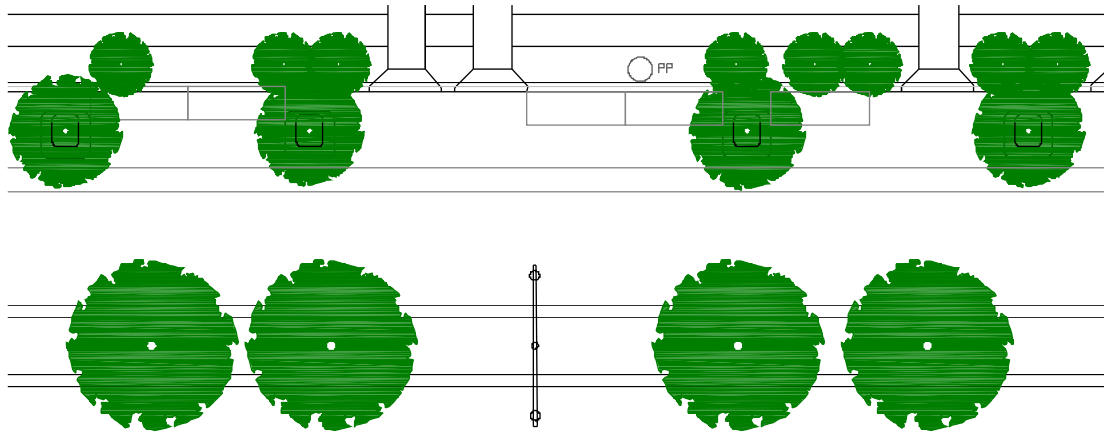

Tree planting should provide shade to parked vehicles and reduce heat and glare from the roadway.

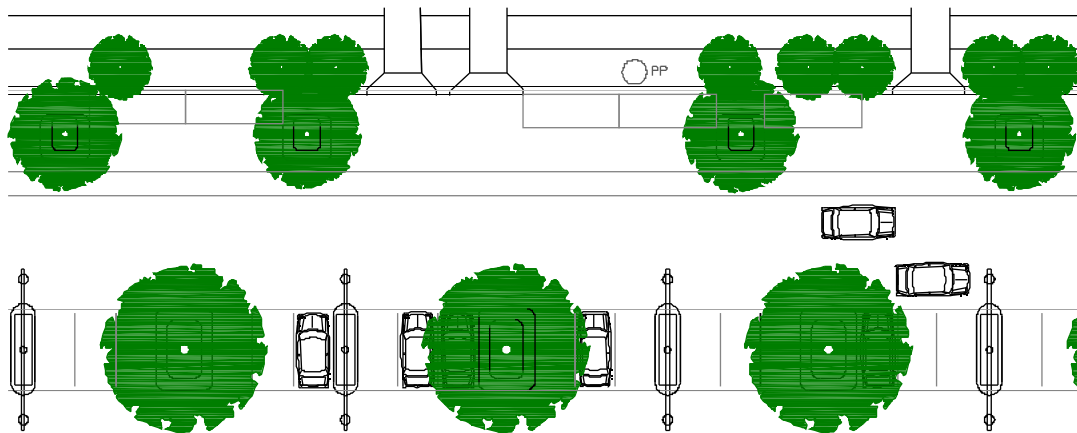

Tree planting should provide shade to parked vehicles and reduce heat and glare from the roadway

## 20 PARKING IN ROAD RESERVE

Cairns City in a Garden  
Master Plan 2007

Part F  
Streetscape Templates

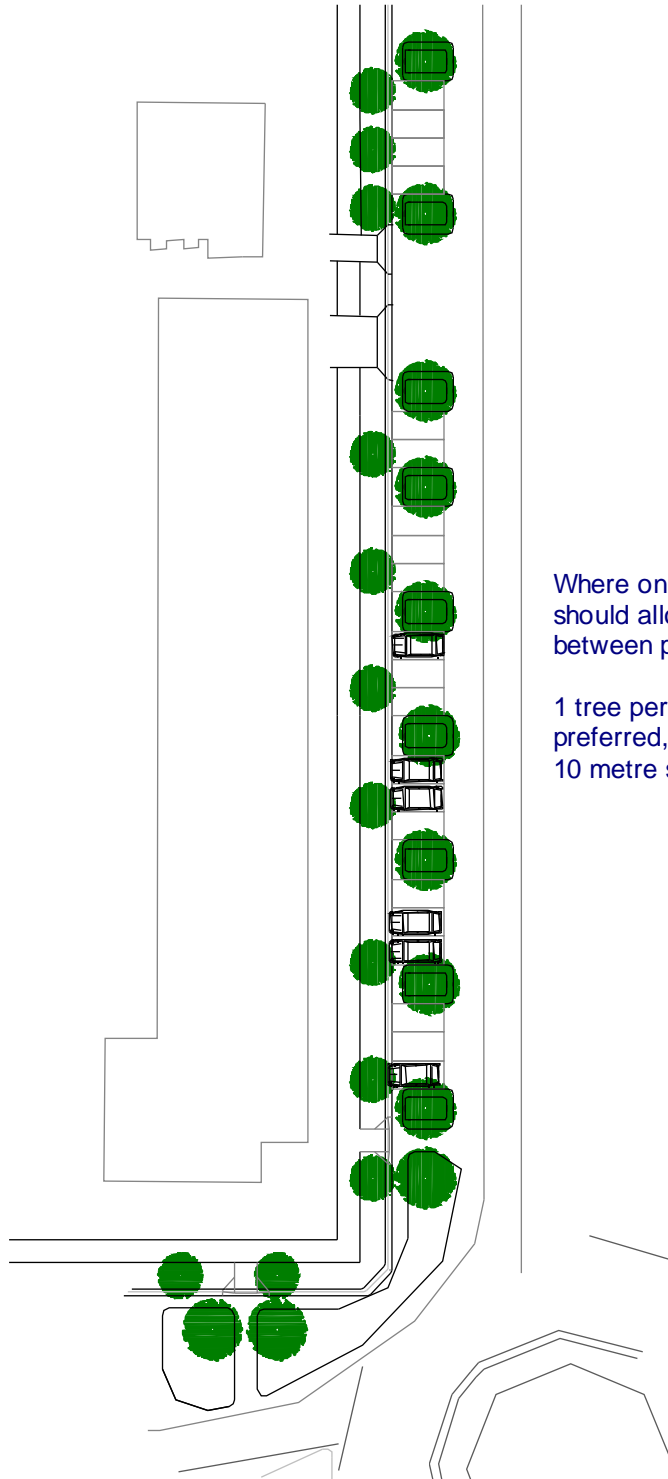

Where on street parking is required it should allow for a good balance between parking and shade trees.

1 tree per 3 parking spaces is preferred, with trees at approximately 10 metre spacings.

## 21 ON STREET PARKING FOR MULTIPLE RESIDENTIAL AND COMMERCIAL UNITS

Cairns City in a Garden  
Master Plan 2007

Part F  
Streetscape Templates



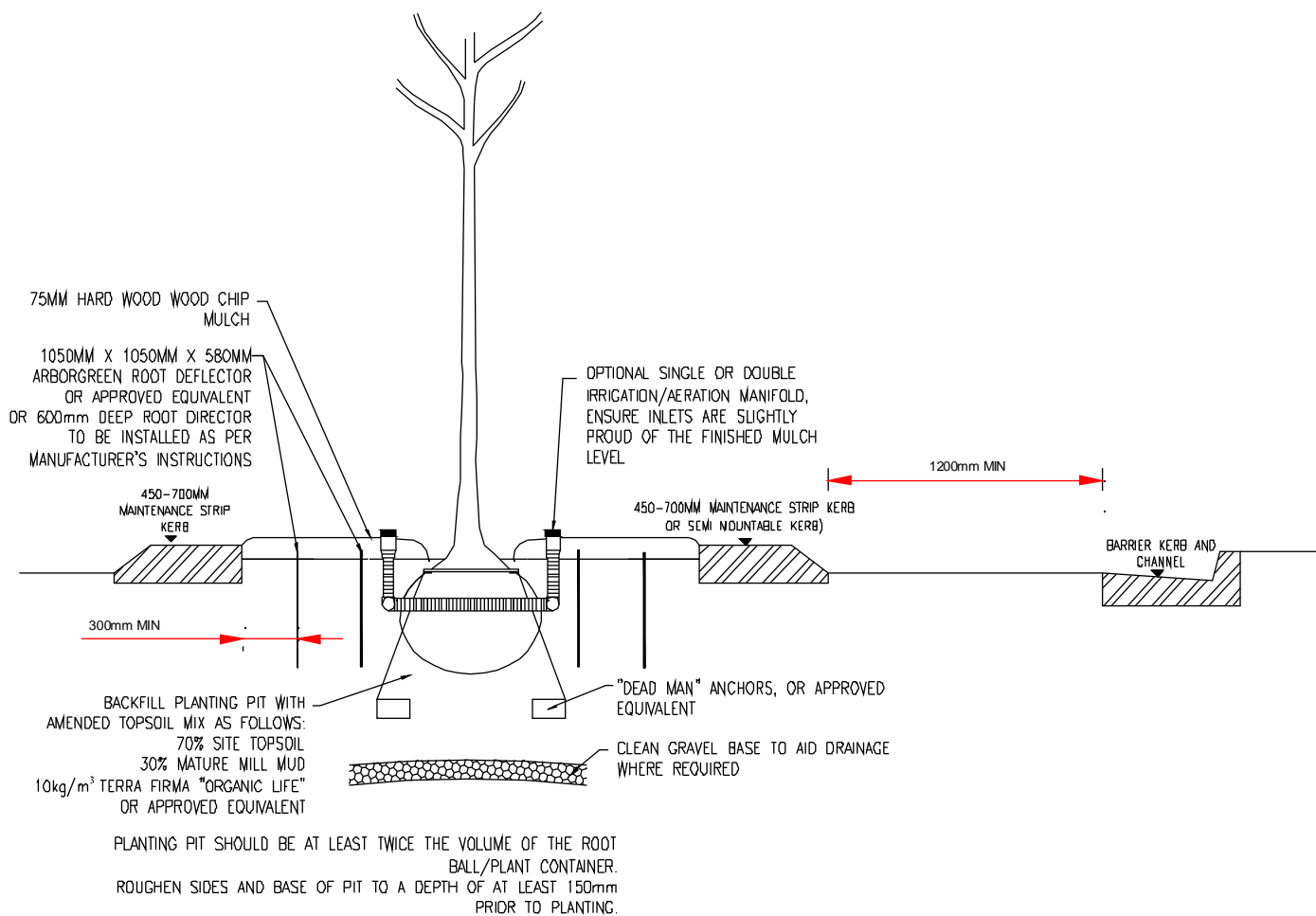

## SECTION NOT TO SCALE

## 22 Tree in Median or Island

Tree to be secured by the use of *dead man's anchor* or approved equivalent.

The type and depth of root barrier used will vary according to local conditions and tree species selection. Refer to table on page 206 for further guidance.

Linear root barriers should extend at least 300mm behind the back of the kerb and at least 1000mm beyond the estimated drip line of the tree canopy at maturity (in the case of median planting and where a root deflector/surround is not employed).

Structural soils or "Arboregreen" *root cells* may be required where site constraints could be detrimental to root expansion, to provide a break out zone for root development under adjacent pavement.

Cairns City in a Garden  
Master Plan 2007

Part F  
Streetscape Templates

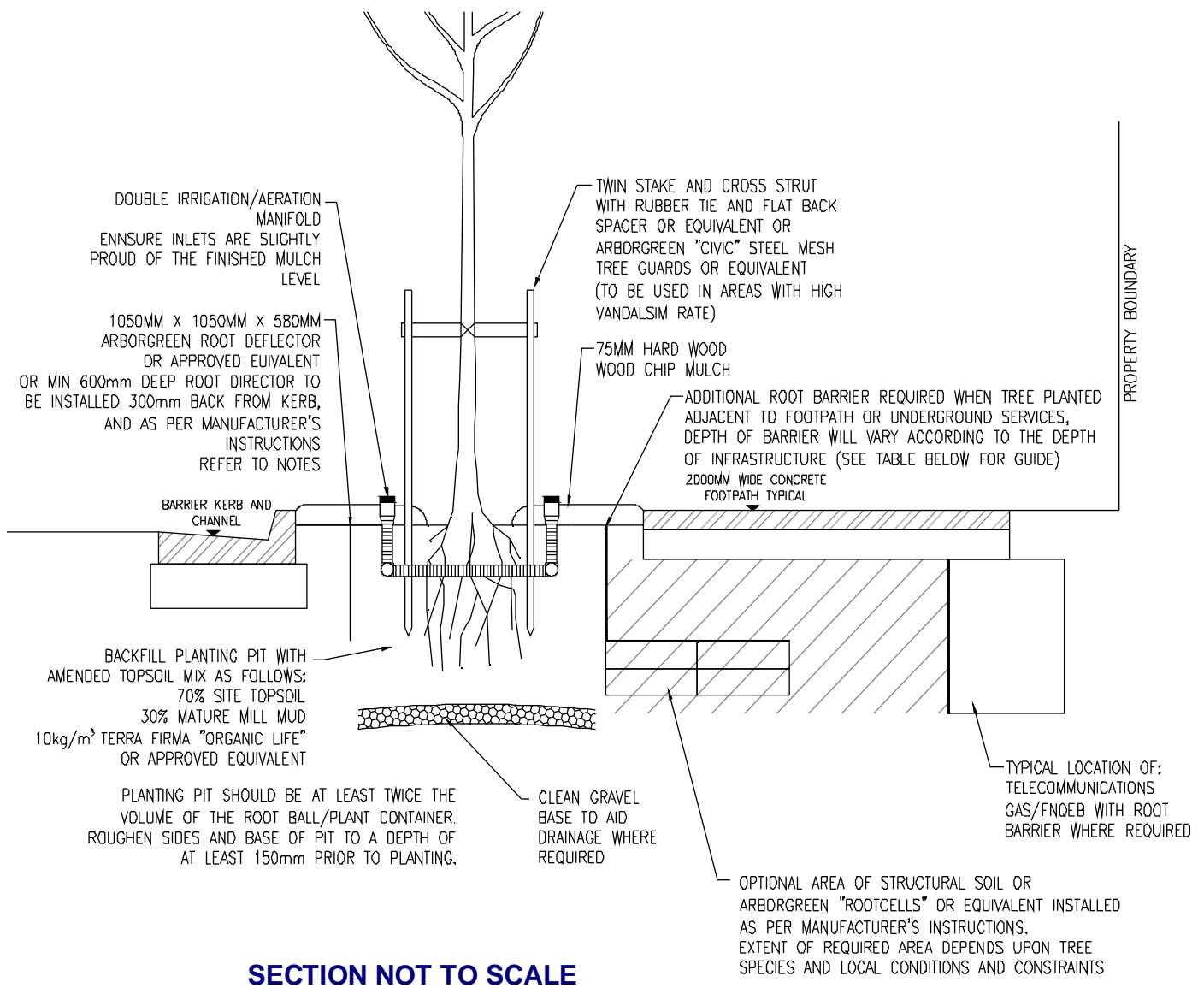

## 23 Tree in Footpath with Nature Strip

Tree to be protected above ground by the installation of twin stakes and cross strut, with rubber ties and flat back spacer. CCC may require the use of welded mesh tree guard for added protection in areas of high vandalism.

The type and depth of root barrier used will vary according to local conditions and tree species selection. (Refer to table on page 206 for further guidance).

Linear root barriers should extend at least 1000mm beyond the estimated drip line of the tree canopy at maturity.

Structural soils or "Arborgreen" *root cells* may be required where site constraints could be detrimental to root expansion, to provide a break out zone for root development under adjacent footpaths or to adjacent landscape areas.

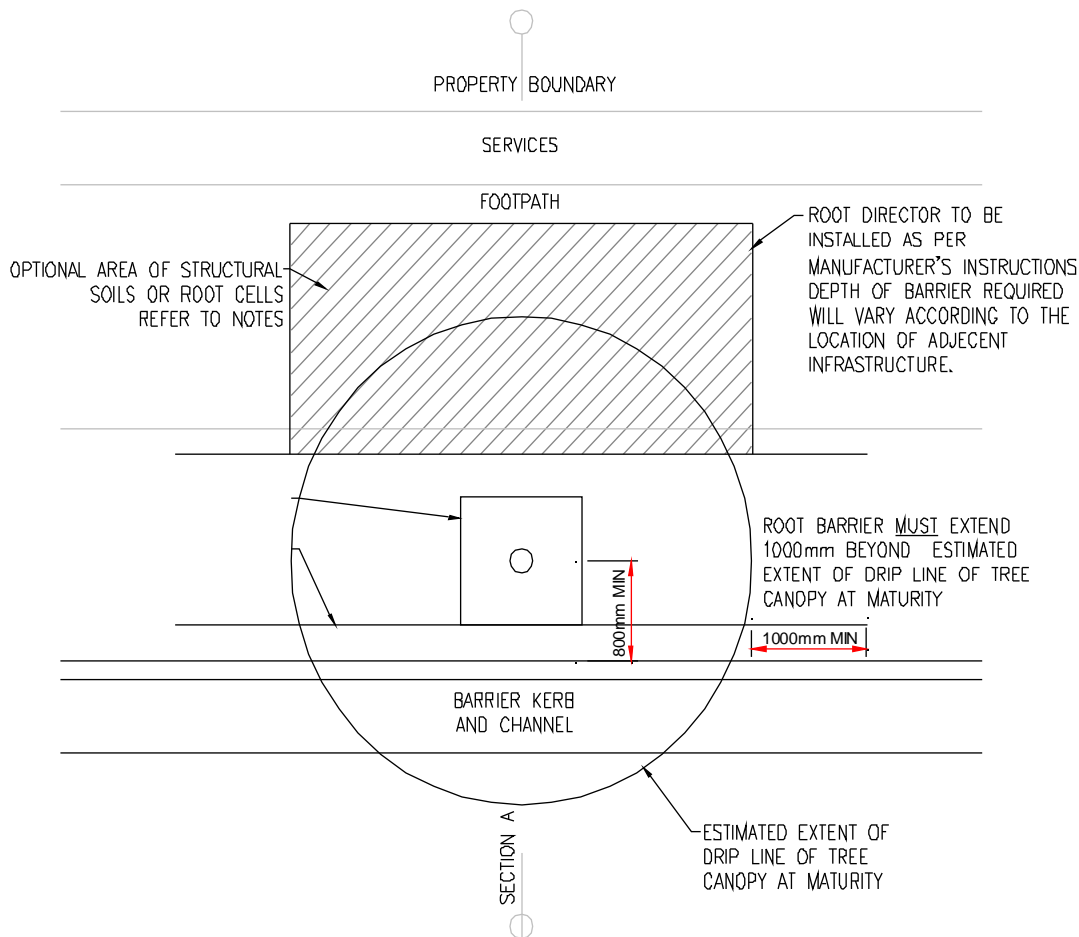

**PLAN NOT TO SCALE**

## Tree in Footpath with Nature Strip

The type and depth of root barrier used will vary according to local conditions and tree species selection. (Refer to table on page 206 for further guidance).

Linear root barriers should extend at least 1000mm beyond the estimated drip line of the tree canopy at maturity.

Structural soils or “Arboreen” *root cells* may be required where site constraints could be detrimental to root expansion, to provide a break out zone for root development under adjacent footpaths or to adjacent landscape areas.

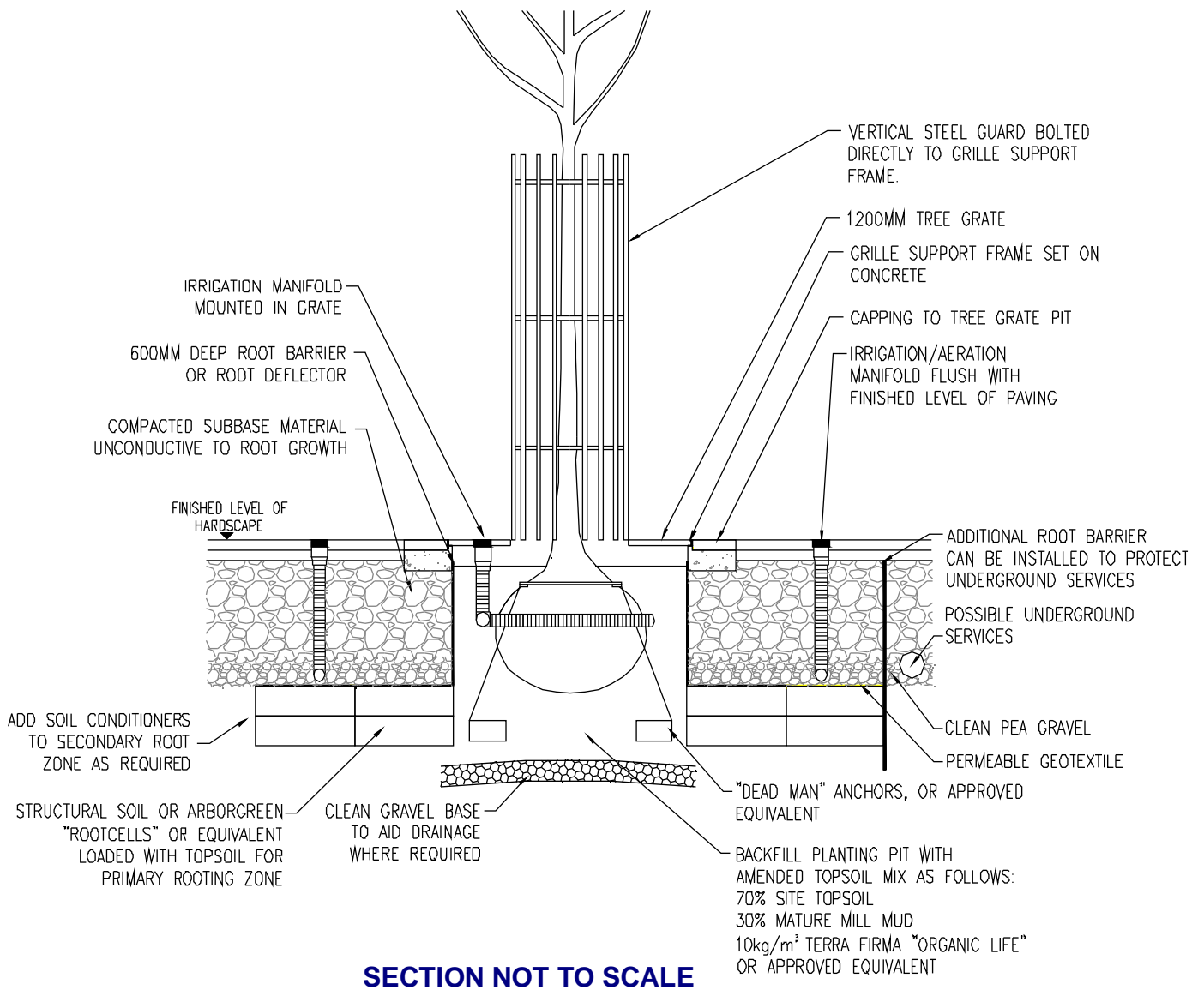

## 24 TREE IN HARDSCAPE

To be used where trees are to be planted within paved pedestrian areas (such as exist in the C.B.D) or within road reserve where rooting zone is restricted (i.e. where tree islands are not of an appropriate scale).

Tree to be protected above ground by the installation of a tree grate and tree guard (refer to CBD Master Plan Appendix B f19 and f20 for full details).

The type and depth of root barrier used will vary according to local conditions and tree species selection. (Refer to table on page 206 for further guidance). Solutions to site specific root management issues should be sought from a reputable root control manufacturer or specifier.

Structural soils or "Arborgreen" *root cells* are required to aid root growth and to reduce the detrimental effects of compaction within the root zone.

Irrigation and aeration manifolds assist in delivering oxygen to the root zone beneath hardscape areas.



**Indicative photo of planting area only.**

Cairns City in a Garden  
Master Plan 2007

Part F  
Streetscape Templates

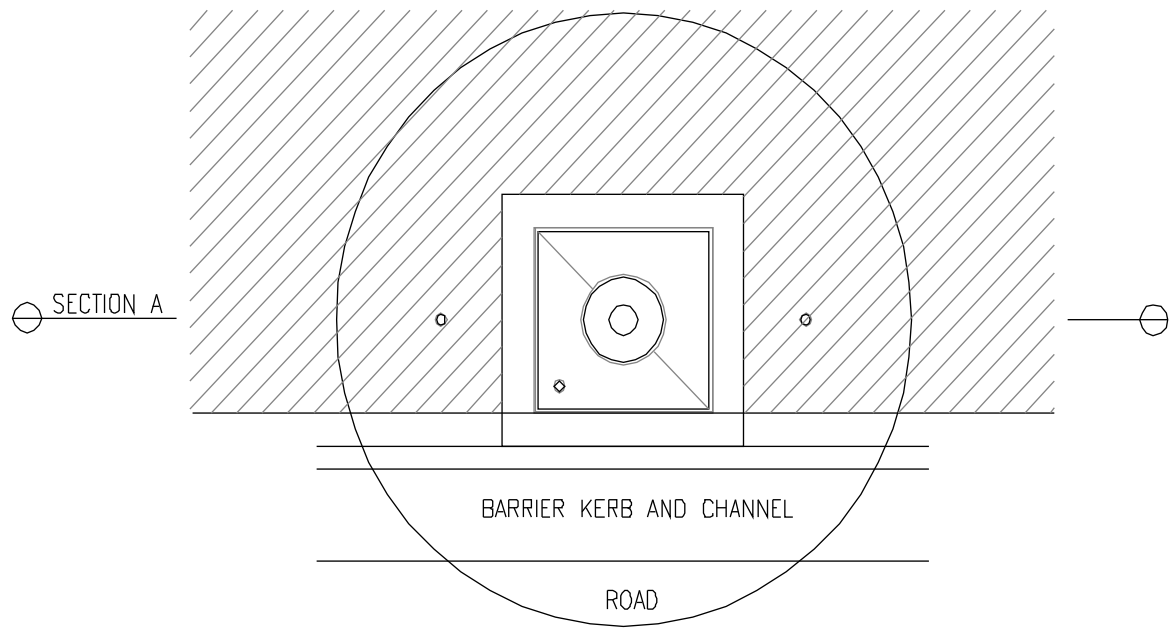
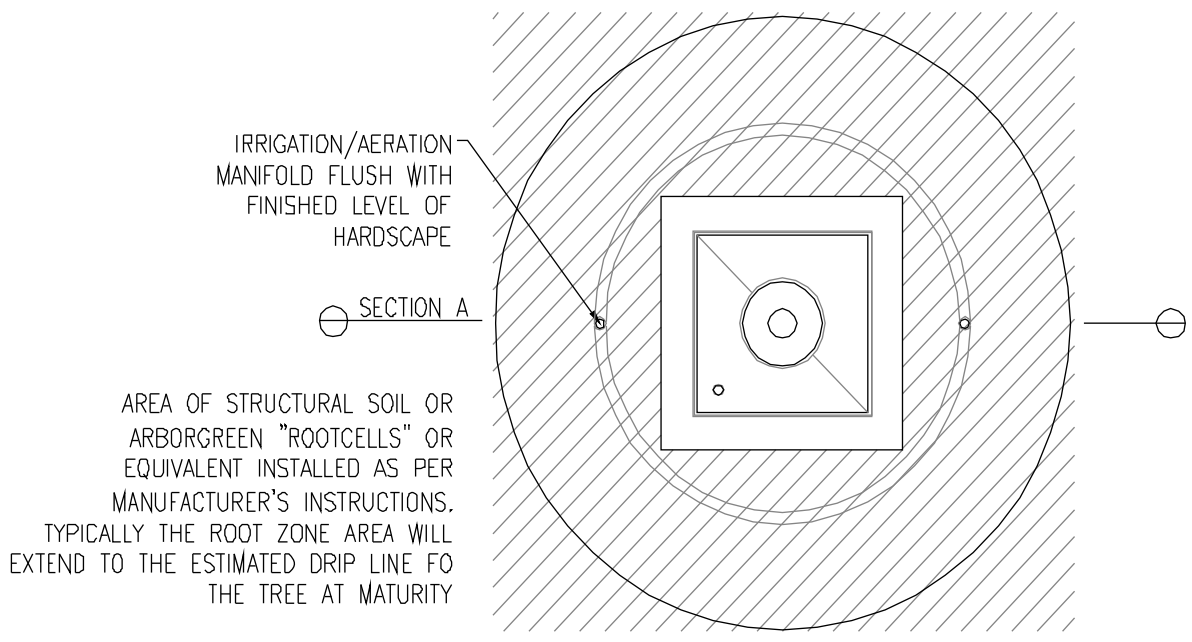

**PLAN NOT TO SCALE**

## TREE IN HARDSCAPE

The hatched areas indicate how *root cells* or structural soils may be installed to assist healthy root development.

Tree to be protected above ground by the installation of a tree grate and tree guard (refer to CBD Master Plan Appendix B f19 and f20 for full details).

The type and depth of root barrier used will vary according to local conditions and tree species selection. (Refer to table on page 206 for further guidance). Solutions to site specific root management issues should be sought from a reputable root control manufacturer or specifier.

## 25 Table to guide the selection of root management systems.

WHAT ARE YOU PROTECTING FROM TREE ROOTS?						
Building foundations	Footpaths			Underground services/utilities	Footpaths and underground services/utilities	
	Type of Barrier Surround (Director) or Linear			Depth of services determines barrier type		
	Surround (Director)			How deep are the services/utilities?		
	What is the predicted girth of the tree trunk at maturity?		Linear	Up to 450mm	Up to 800mm	Deeper than 800mm
	Up to 750mm	Greater than 750mm				
ROOT CONTROL	ROOT CONTROL	ROOT CONTROL	ROOT CONTROL	ROOT CONTROL	ROOT CONTROL	
2000mm wide High density root barrier	Root Director 640mm/1050mm	Root Director 1050mm/1400mm	Linear Root Barrier 300-1000mm deep	Linear Root Barrier 600mm deep	Linear Root Barrier 1000mm deep	Linear Root Barrier 1500mm deep and greater

The type and depth of root barrier used will vary according to local conditions and tree species selection.

If in doubt, solutions to site specific root management issues should be sought from a reputable root control manufacturer or specifier.

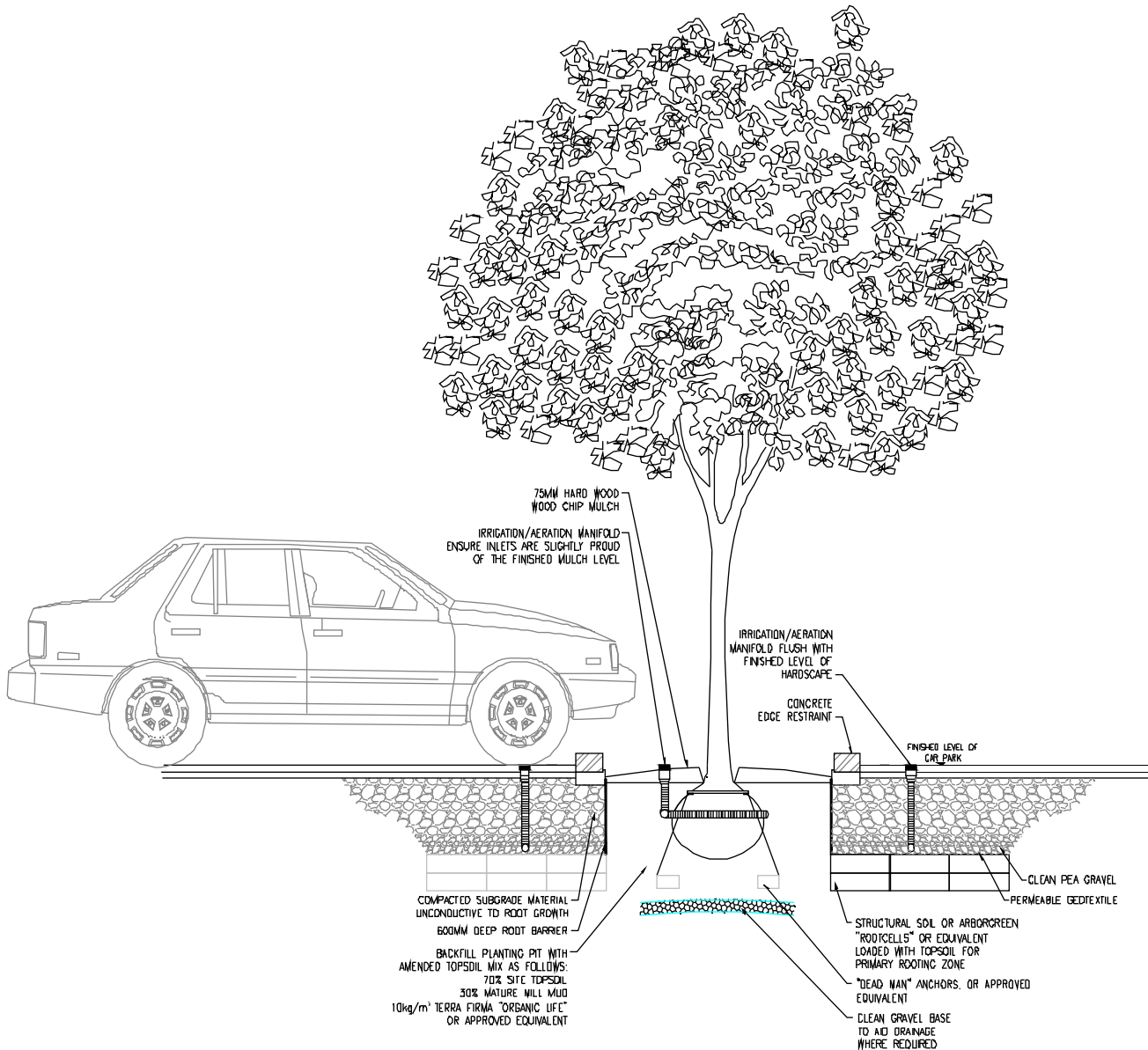

## SECTION NOT TO SCALE

### 26 Trees in Carparks

Trees should be located to provide shade to vehicles and reduce heat and glare from surrounding pavement. Trees with messy fruit or heavy seeds should be avoided.

Trees to be supported by dead man's anchors or timber stakes.

The type and depth of root barrier used will vary according to local conditions and tree species selection. (Refer to table on page 206 for further guidance).

Structural soils or "Arborgreen" *root cells* may be required where site constraints could be detrimental to root expansion, to provide a break out zone for root development under adjacent pavement, and avoid future damage to pavement surface.

Cairns City in a Garden  
Master Plan 2007

Part F  
Streetscape Templates

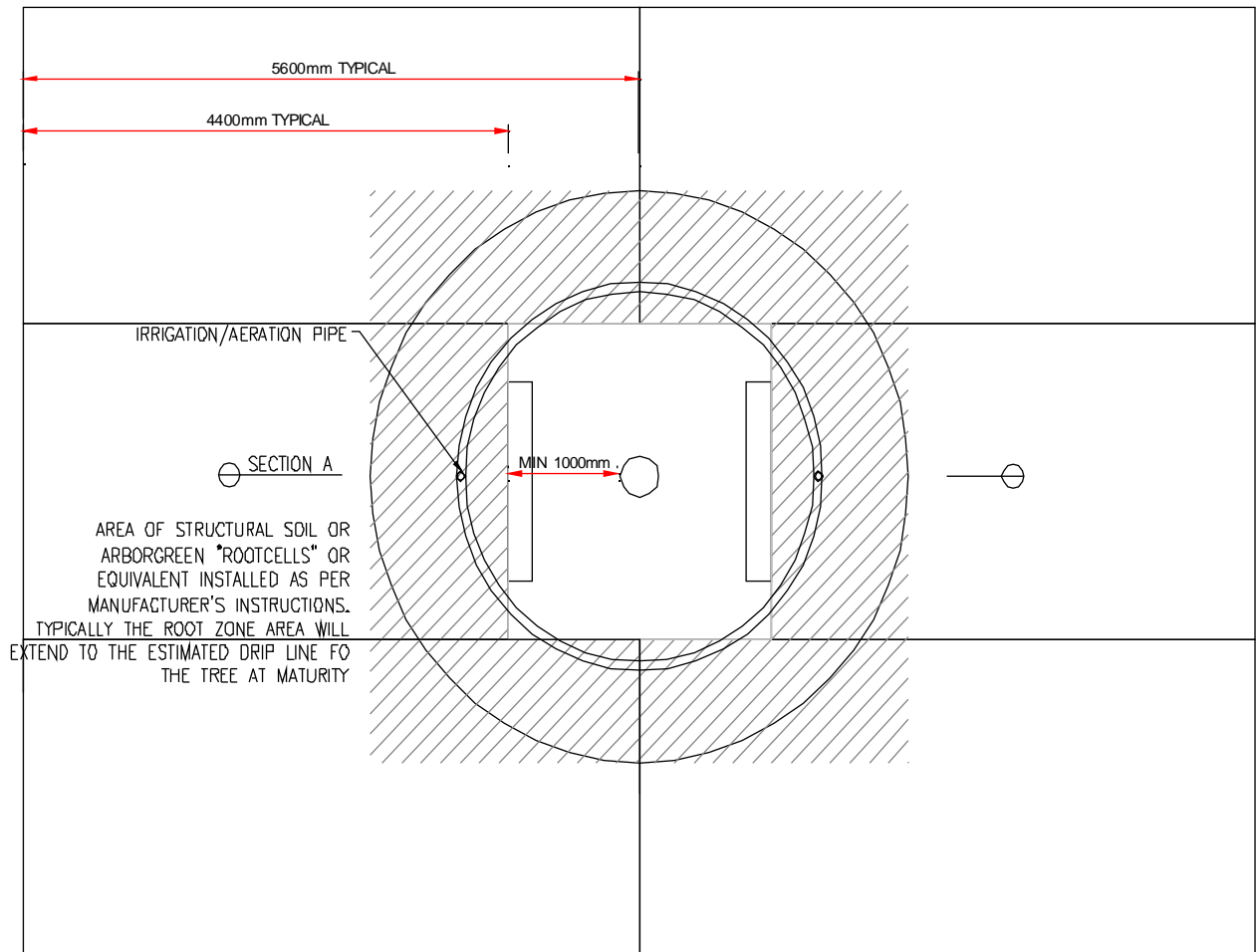

### PLAN NOT TO SCALE

#### OPTION A

Parking layout with one tree per six car allocations. Structural soils or **root cells** should extend to the estimated drip line of the crown of the tree at maturity, allowing for healthy and extensive root development.

Irrigation and aeration manifolds assist in delivering oxygen to the root zone beneath hardscape areas.

Where larger trees are planted then a continuous trench of structural soils or **root cells** may be preferred.



**CAIRNS  
CITY  
IN A GARDEN  
MASTER PLAN  
PART F  
STREETSCAPE  
TEMPLATES**



**City in a Garden Part F-Streetscape Templates**

<b>CITY IN A GARDEN MASTER PLAN 2007</b>	<b>2</b>
<b>CITY IN A GARDEN MASTER PLAN PART B-TREE SPECIES SELECTION</b>	<b>14</b>
<b>CITY IN A GARDEN MASTER PLAN PART C- PRECINCT PLANS</b>	<b>30</b>
<b>CITY IN A GARDEN MASTER PLAN PART D TECHNICAL GUIDELINES</b>	<b>99</b>
<b>CITY IN A GARDEN PART E- APPENDICES</b>	<b>128</b>
<b>CITY IN A GARDEN PART F-STREETSCAPE TEMPLATES</b>	<b>178</b>
<b>1</b>	<b>TNP TYPE A 180</b>
<b>2</b>	<b>TNP TYPE B 181</b>
<b>3</b>	<b>TNP TYPE C 182</b>
<b>4</b>	<b>TNP TYPE D 183</b>
<b>5</b>	<b>TNP TYPE D1 184</b>
<b>6</b>	<b>TNP TYPE E 185</b>
<b>7</b>	<b>TNP TYPE G 186</b>
<b>8</b>	<b>TNP TYPE G1 187</b>
<b>9</b>	<b>TNP TYPE V 188</b>
<b>10</b>	<b>TNP TYPE V1 189</b>
<b>11</b>	<b>ACCESS STREET 20-74 190</b>
<b>12</b>	<b>MINOR COLLECTOR 75-229191</b>
<b>13</b>	<b>MAJOR COLLECTOR 300-599 192</b>
<b>14</b>	<b>TRUNK COLLECTOR 193</b>
<b>15</b>	<b>LOW DENSITY RESIDENTIAL 194</b>
<b>ROAD ≤ 29</b>	

16	ROAD ≥ 30	HIGH DENSITY RESIDENTIAL	
		195	
17		FOOTPATH WIDTHS	196
18		ROUNDBABOUTS-SIGHTLINES	
		197	
19		INTERSECTIONS-SIGHTLINES	
		198	
20		PARKING IN ROAD RESERVE	
		199	
21		ON STREET PARKING FOR	
	MULTIPLE RESIDENTIAL AND COMMERCIAL UNITS	200	
22		TREE IN MEDIAN OR ISLAND	
		201	
23	NATURE STRIP	TREE IN FOOTPATH WITH	
		202	
24		TREE IN HARDSCAPE	204
25		TABLE TO GUIDE THE	
	SELECTION OF ROOT MANAGEMENT SYSTEMS.	206	
26		TREES IN CARPARKS	207

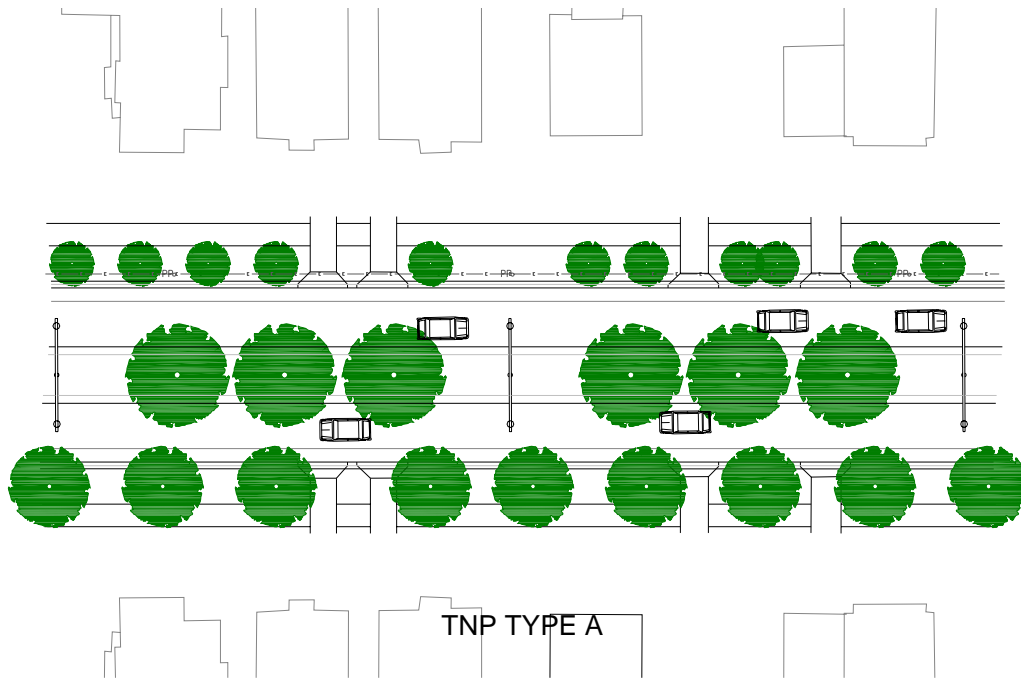

# 1 TNP TYPE A

Cairns City in a Garden  
Master Plan 2007

Part F  
Streetscape Templates

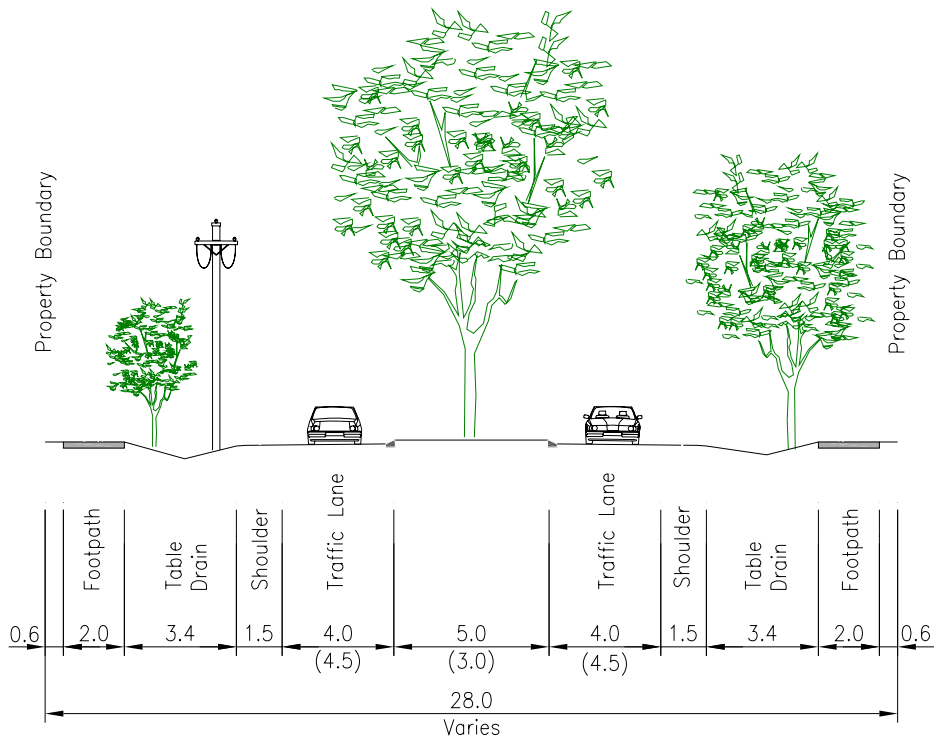
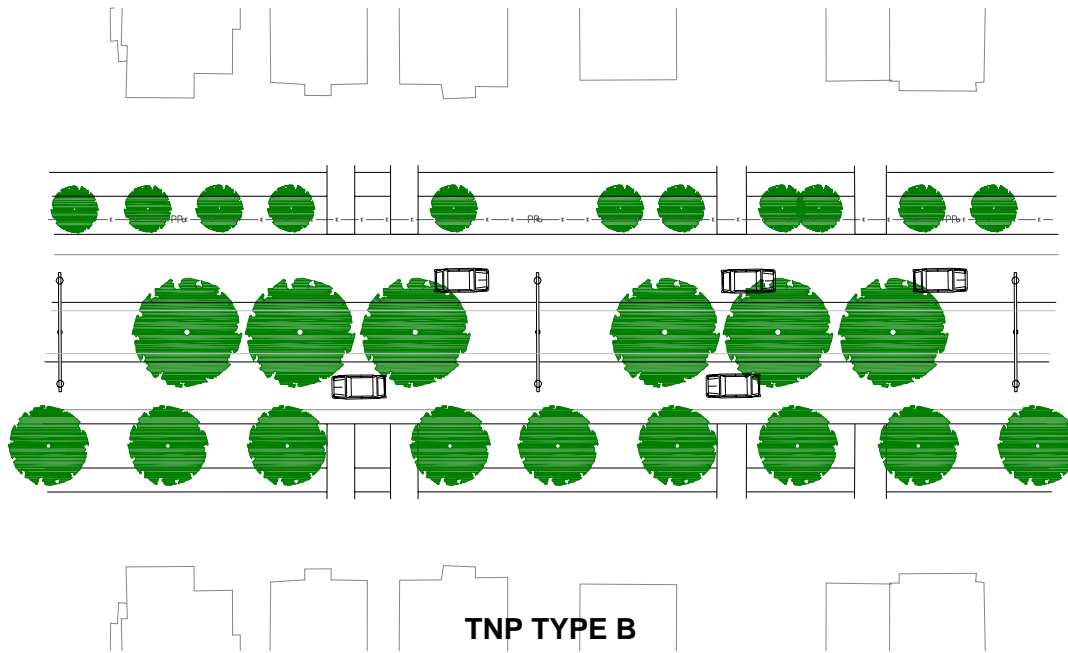

## 2 TNP TYPE B

Cairns City in a Garden  
Master Plan 2007

Part F  
Streetscape Templates

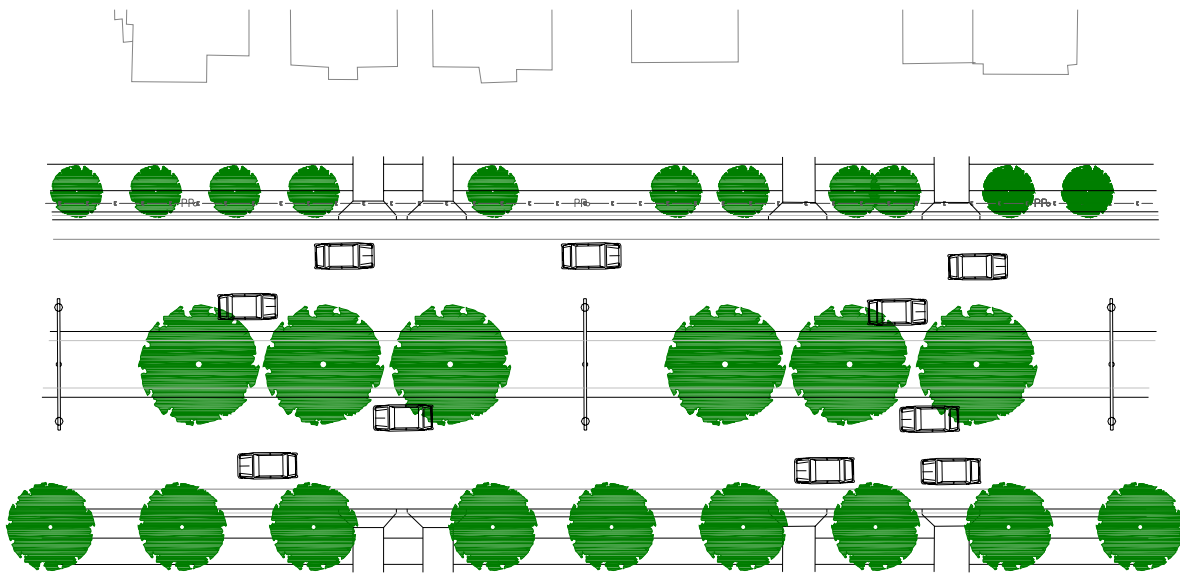

**TNP TYPE C**

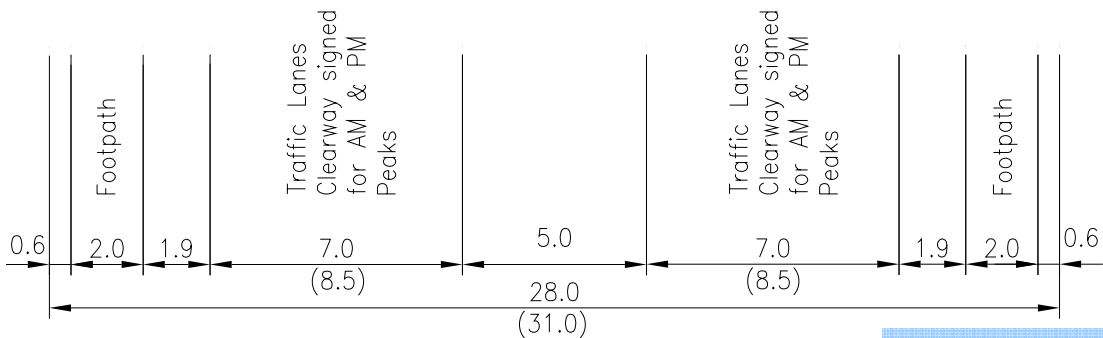
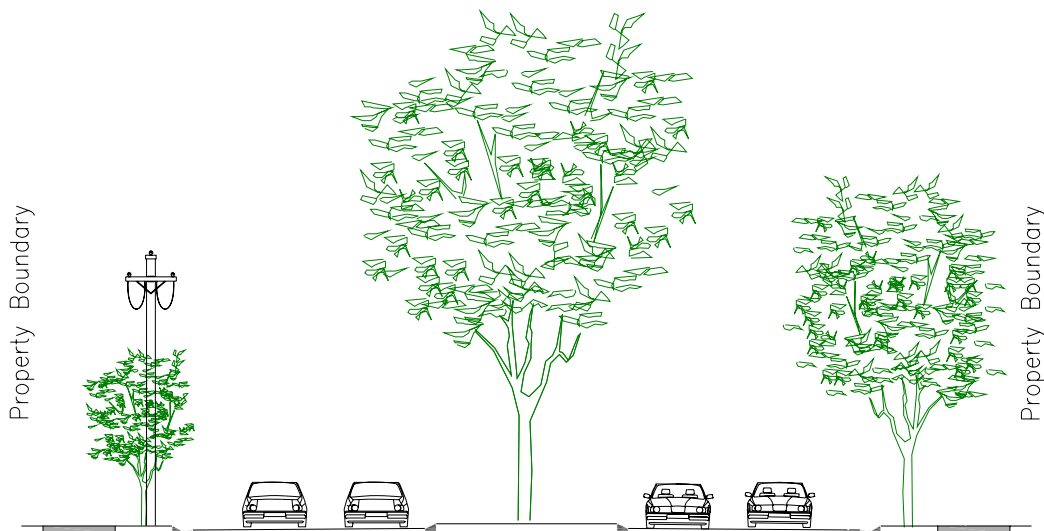

**3 TNP TYPE C**

Cairns City in a Garden  
Master Plan 2007

Part F  
Streetscape Templates



**TNP TYPE D**

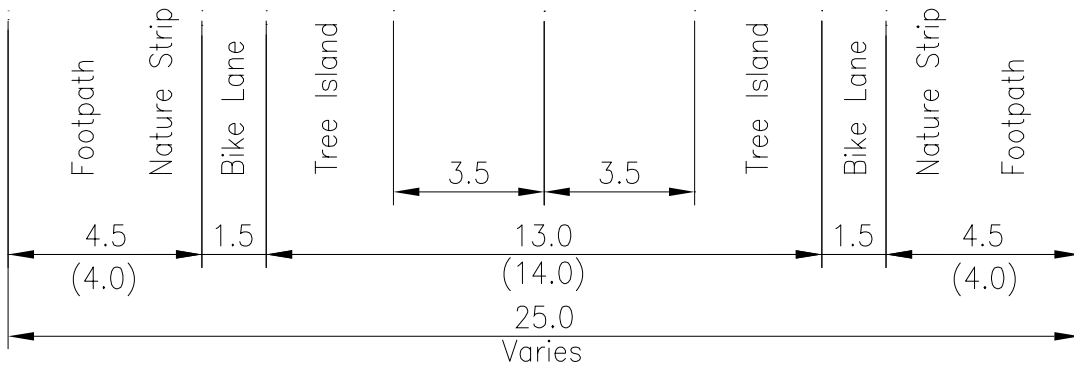

**4 TNP TYPE D**

Cairns City in a Garden  
Master Plan 2007

Part F  
Streetscape Templates

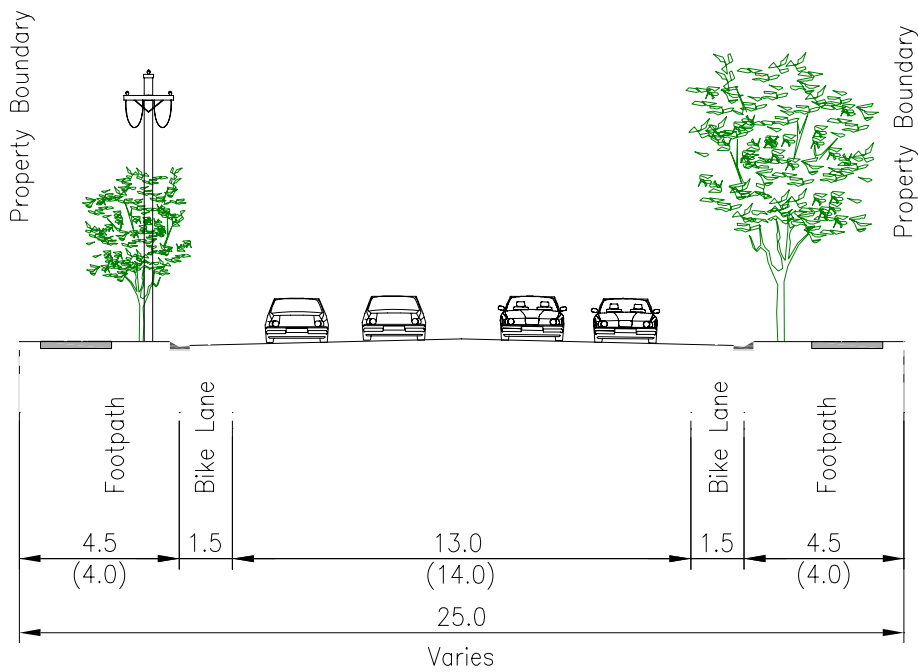
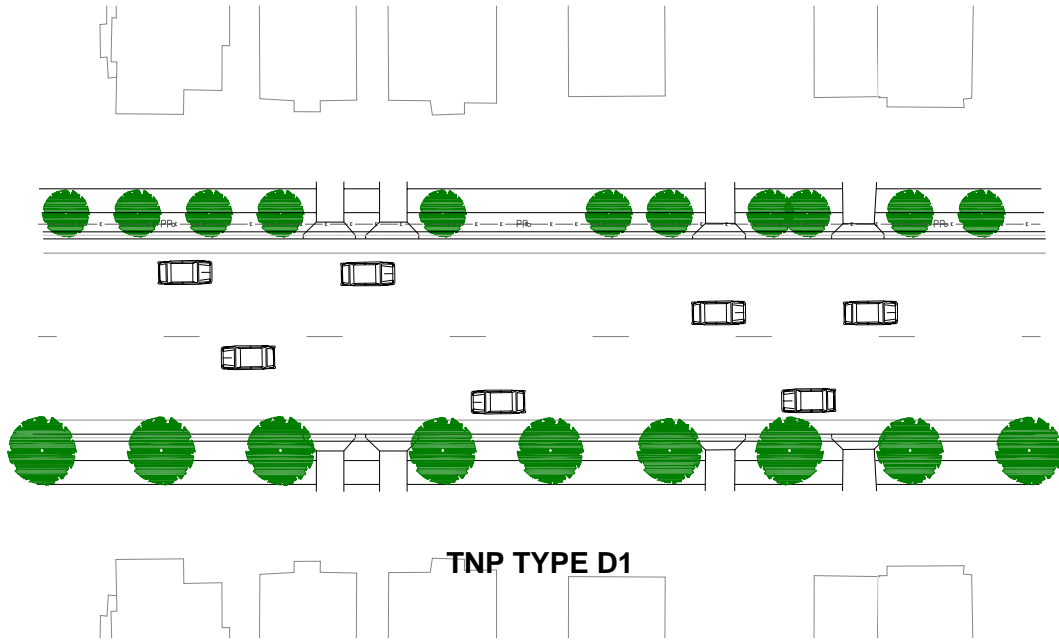

## 5 TNP TYPE D1

Cairns City in a Garden  
Master Plan 2007

Part F  
Streetscape Templates



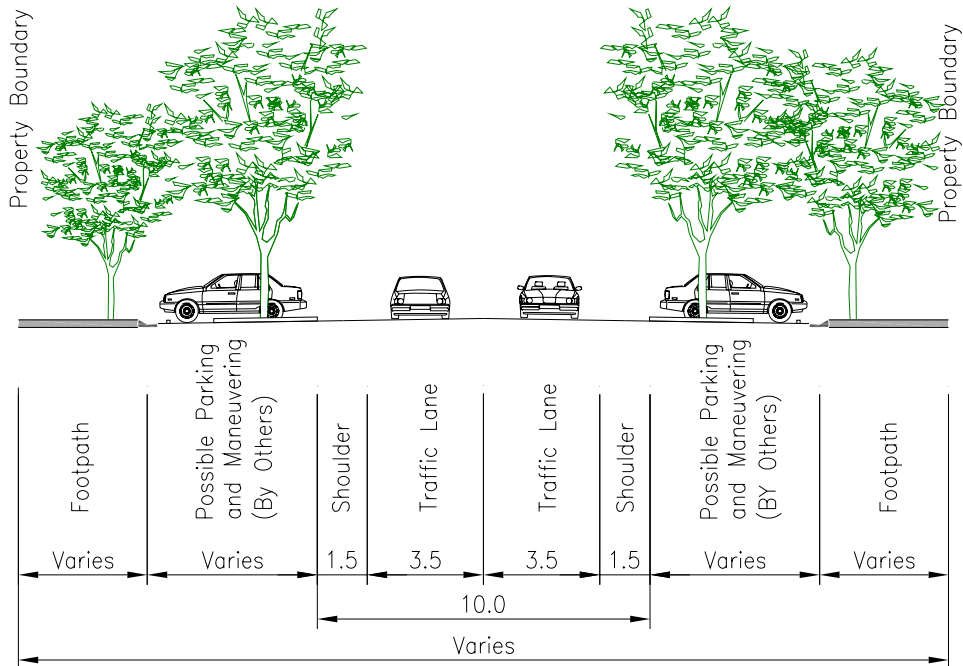
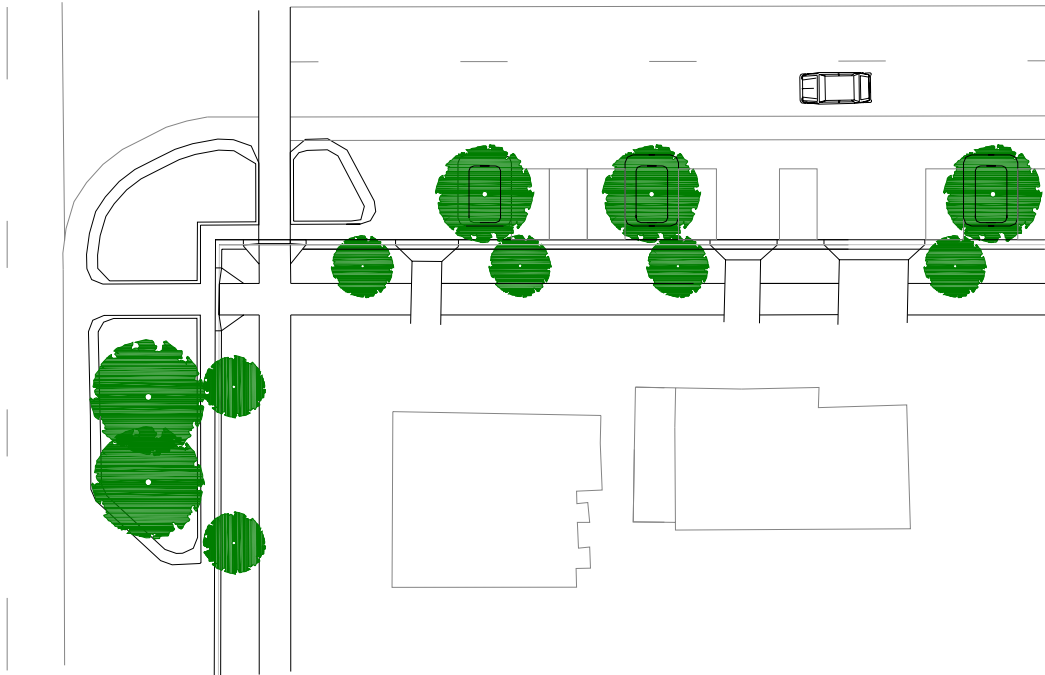

## 6 TNP TYPE E

Cairns City in a Garden  
Master Plan 2007

Part F  
Streetscape Templates

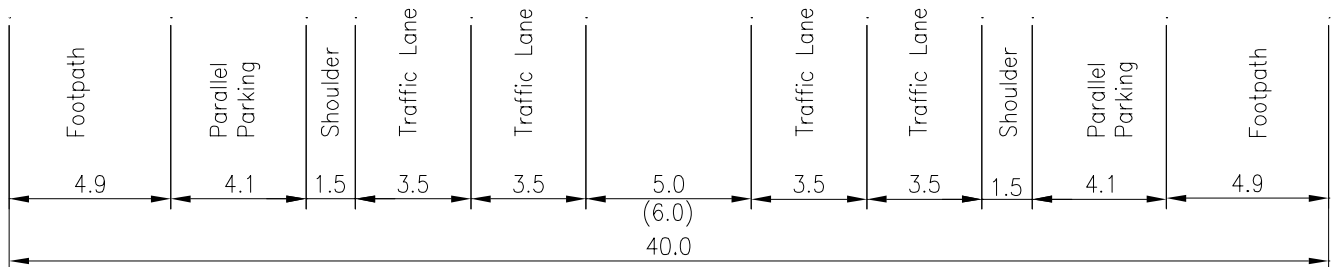
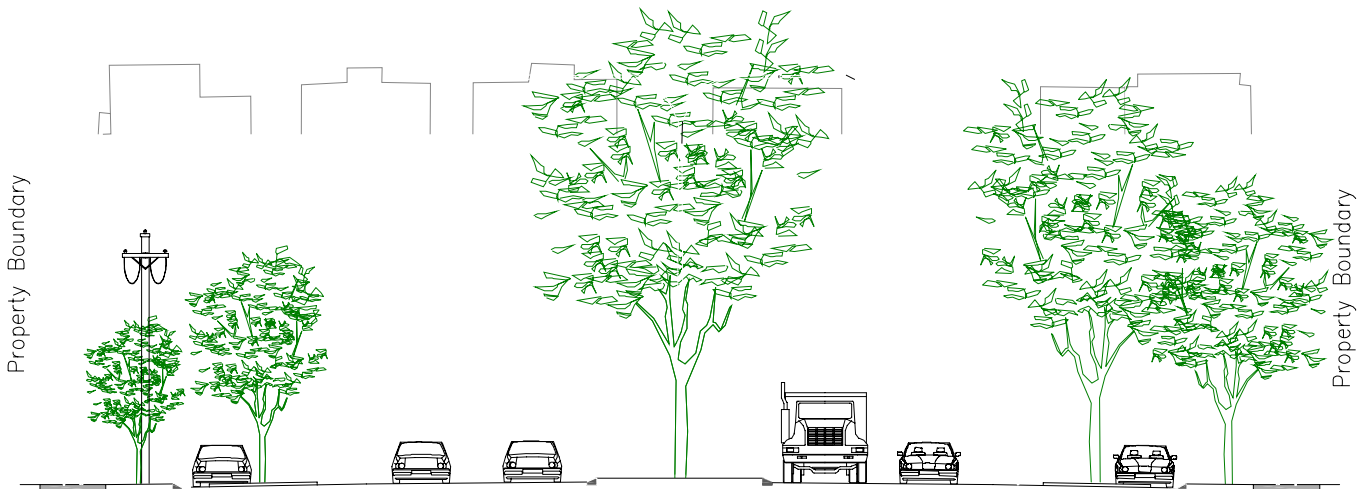

## 7 TNP TYPE G

Cairns City in a Garden  
Master Plan 2007

Part F  
Streetscape Templates



## 8 TNP TYPE G1

Cairns City in a Garden  
Master Plan 2007

Part F  
Streetscape Templates

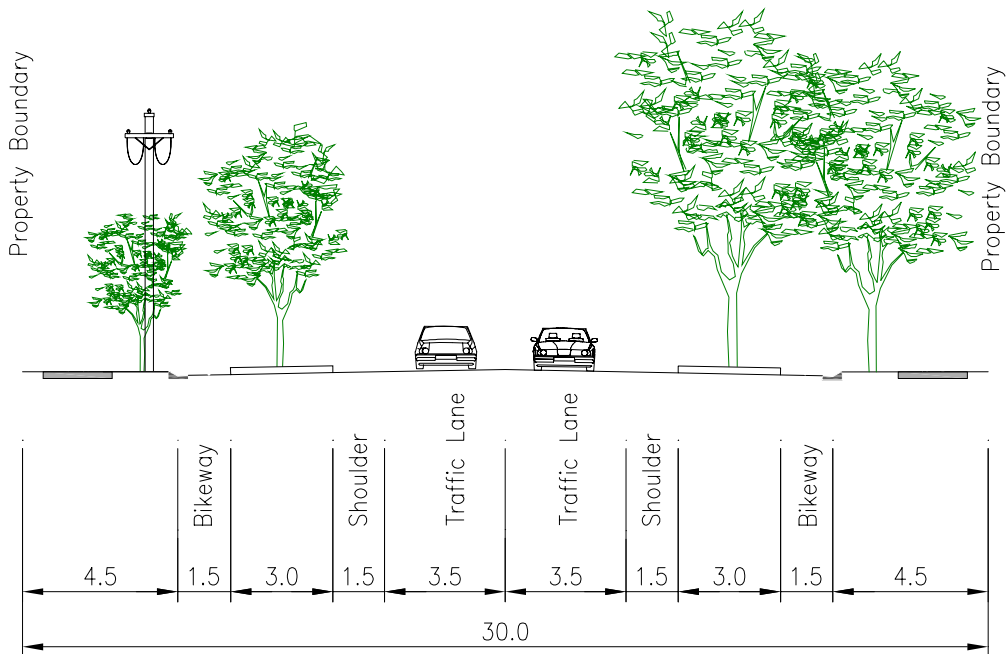

## 9 TNP TYPE V

Cairns City in a Garden  
Master Plan 2007

Part F  
Streetscape Templates



## 10TNP TYPE V1

Cairns City in a Garden  
Master Plan 2007

Part F  
Streetscape Templates

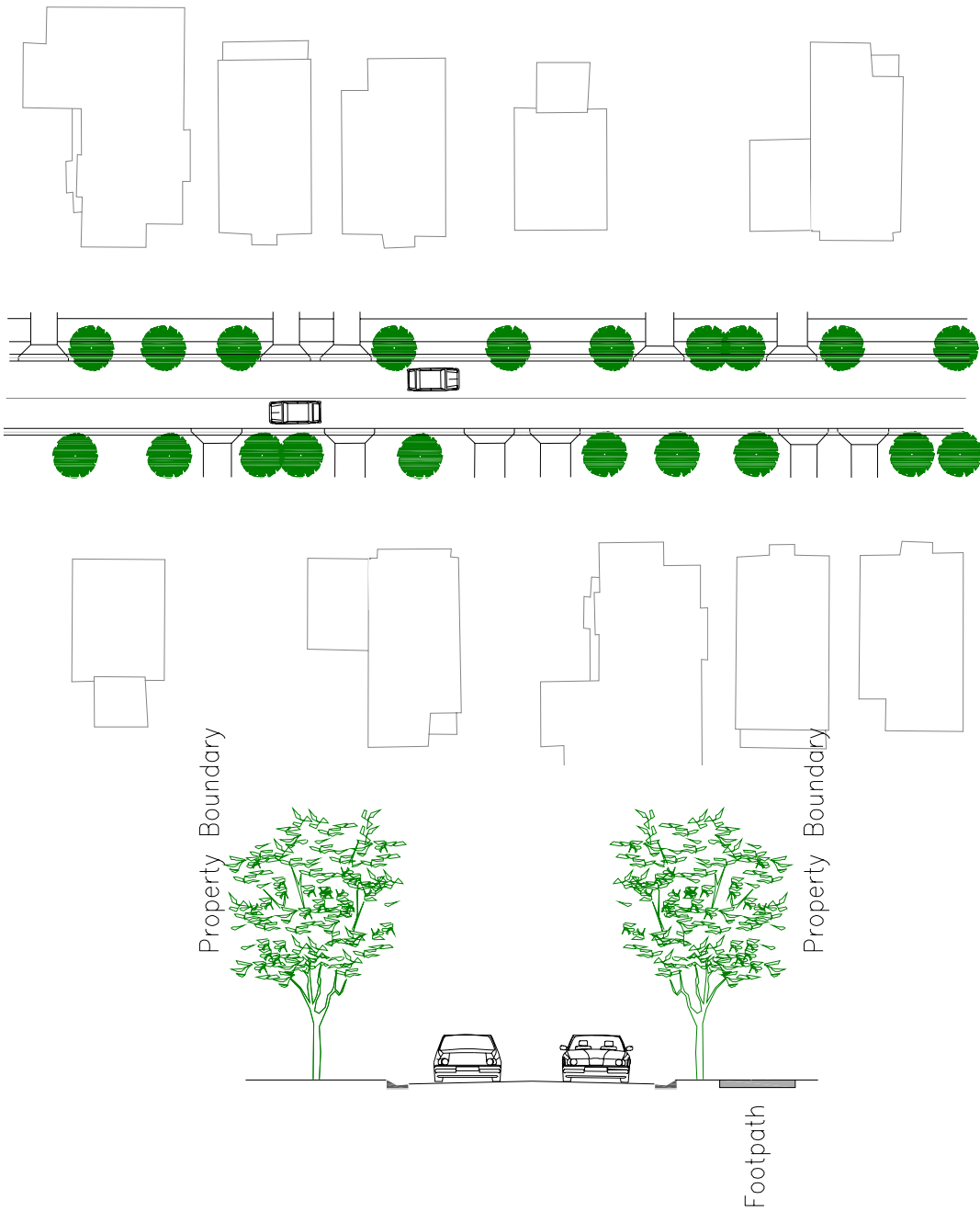

## 11 ACCESS STREET 20-74

Cairns City in a Garden  
Master Plan 2007

Part F  
Streetscape Templates

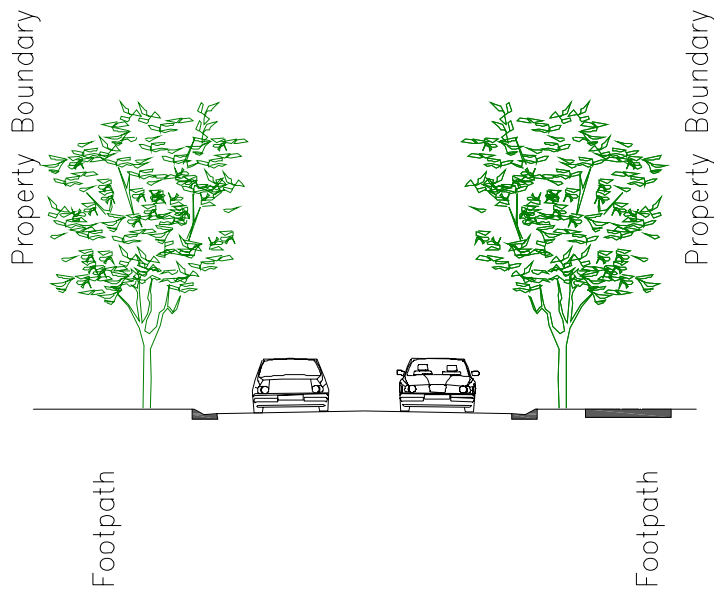

## 12MINOR COLLECTOR 75-229

Cairns City in a Garden  
Master Plan 2007

Part F  
Streetscape Templates

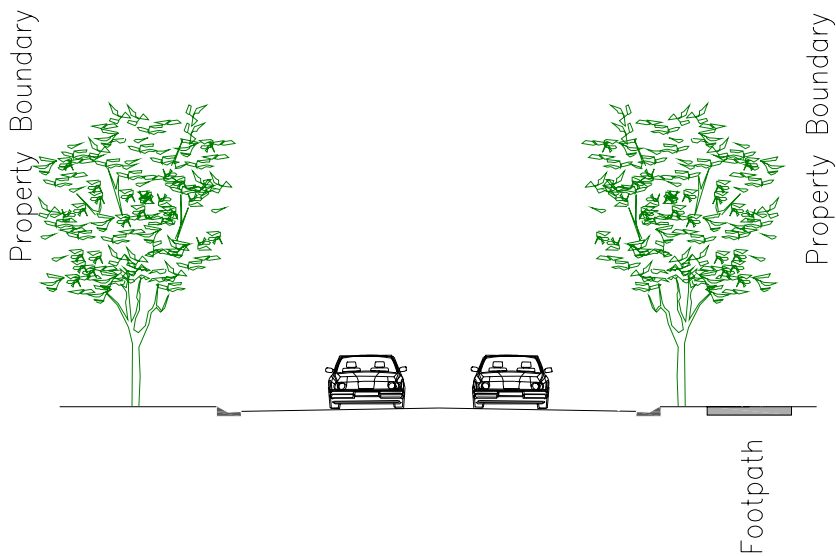
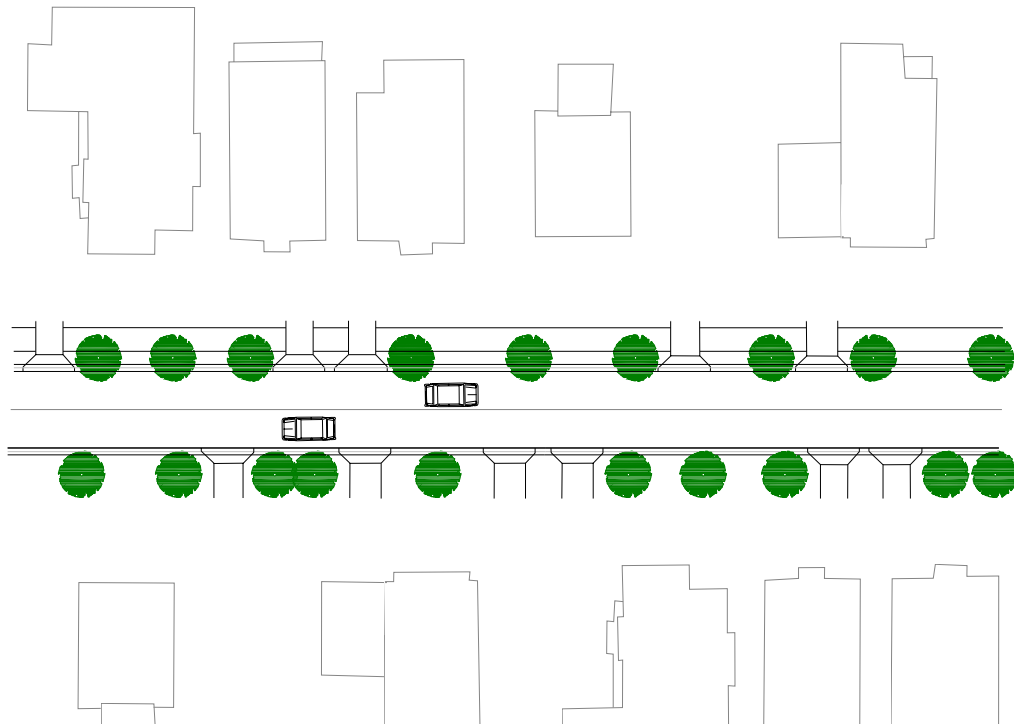

## 13 MAJOR COLLECTOR 300-599

Cairns City in a Garden  
Master Plan 2007

Part F  
Streetscape Templates



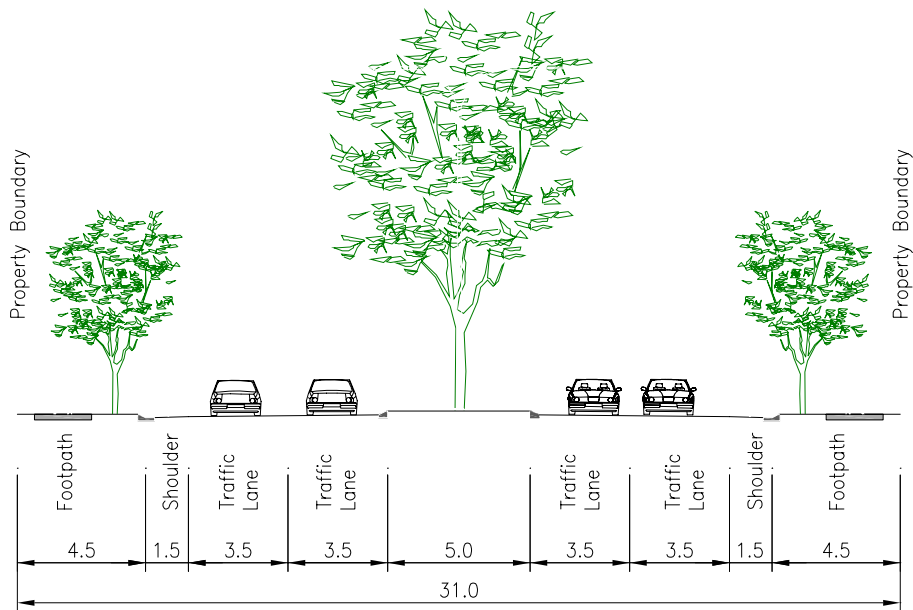
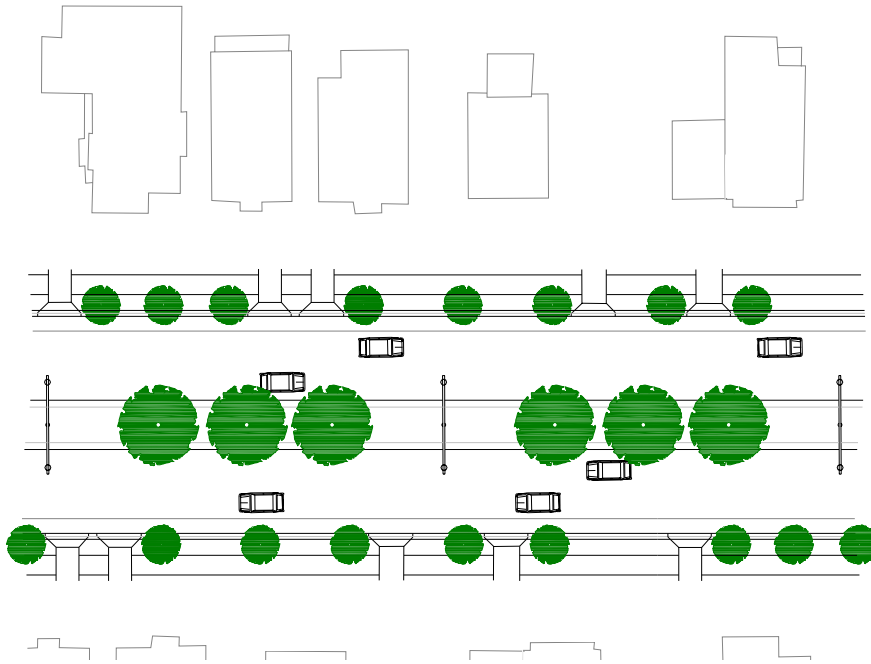

# 14 TRUNK COLLECTOR

Cairns City in a Garden  
Master Plan 2007

Part F  
Streetscape Templates

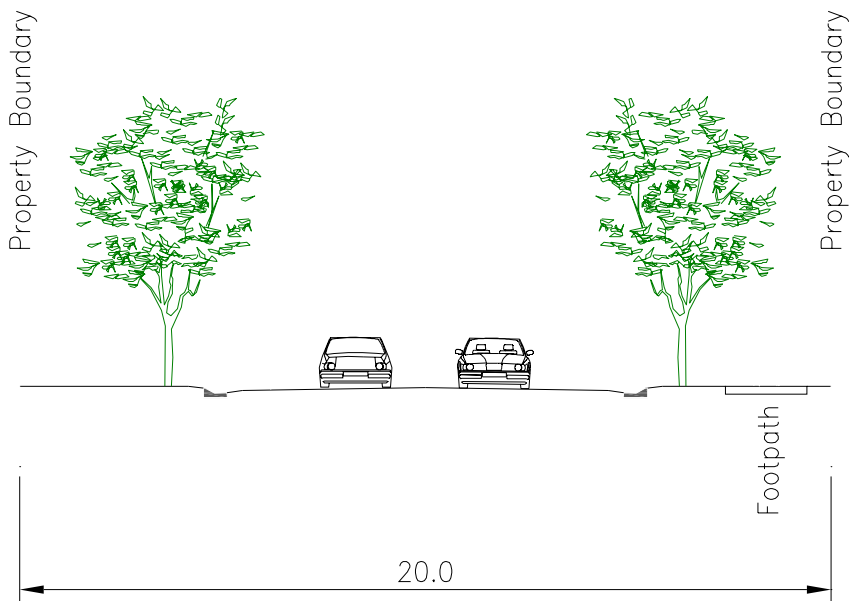
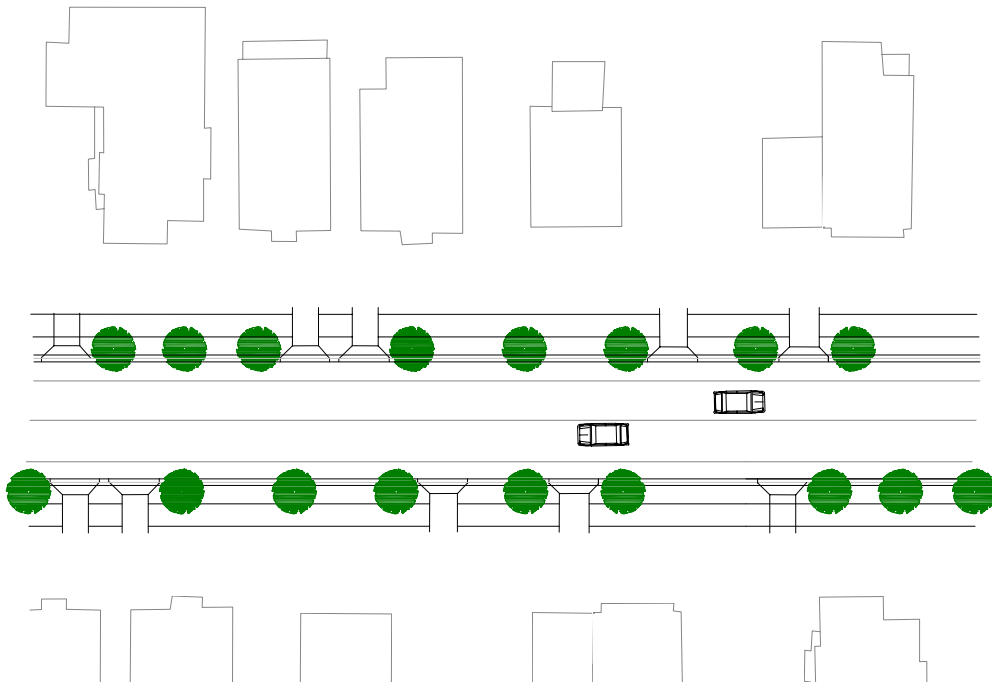

## 15 LOW DENSITY RESIDENTIAL ROAD $\leq 29$

Cairns City in a Garden  
Master Plan 2007

Part F  
Streetscape Templates

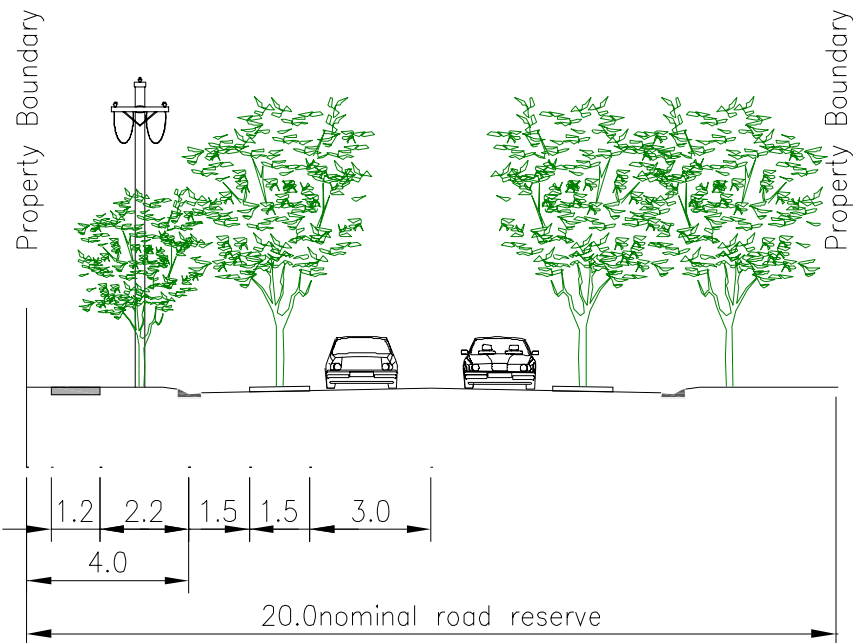
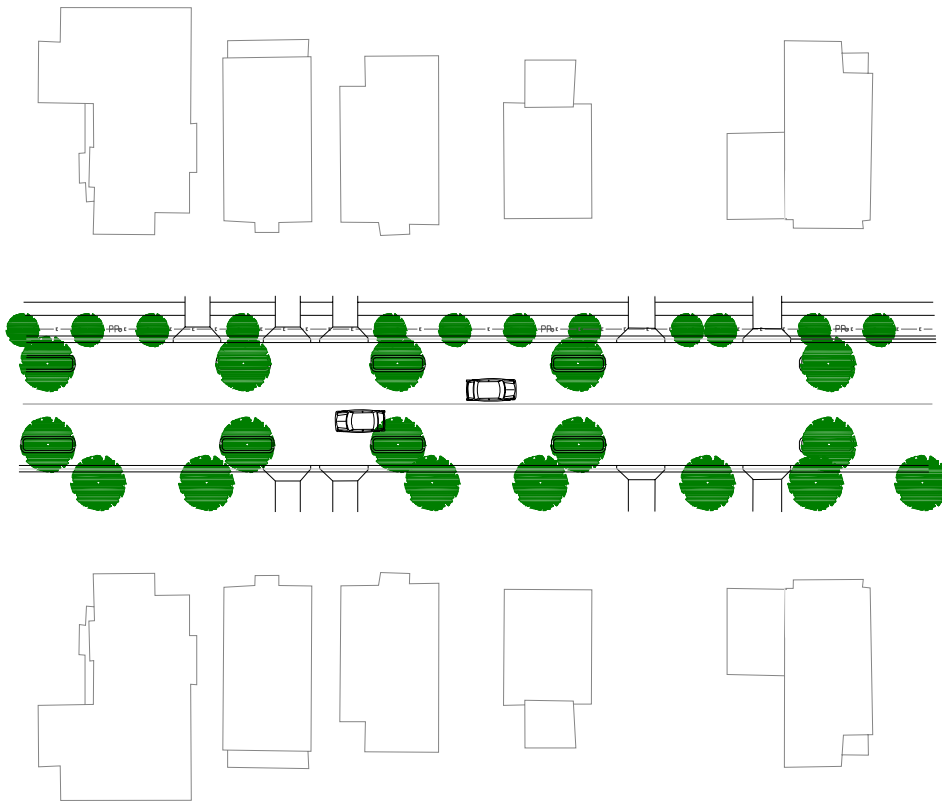

## 16 HIGH DENSITY RESIDENTIAL ROAD $\geq$ 30

Cairns City in a Garden  
Master Plan 2007

Part F  
Streetscape Templates

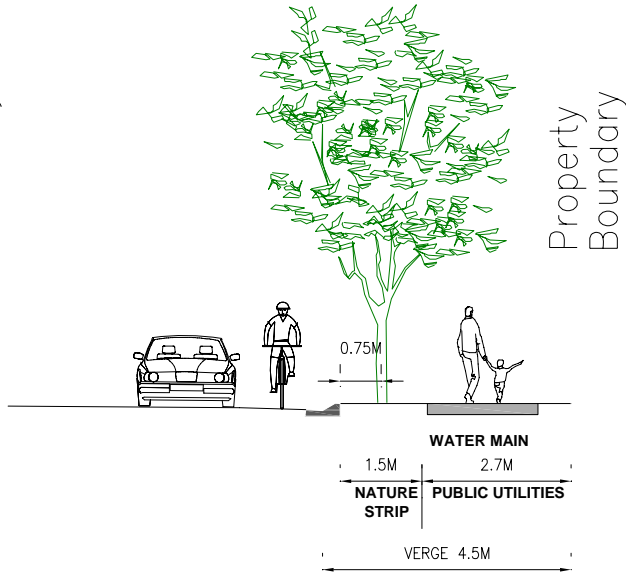
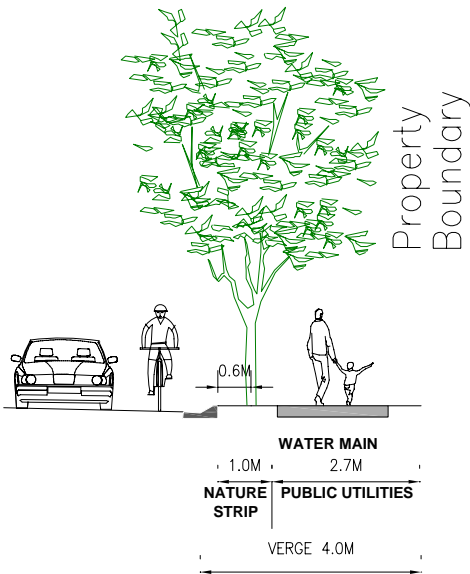

**EXISTING MINIMUM VERGE WIDTHS**

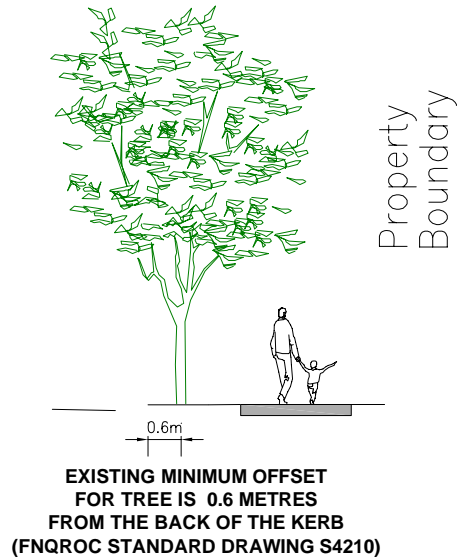
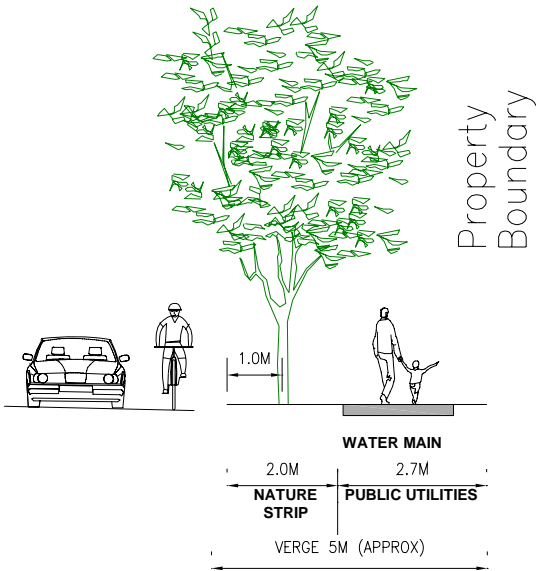

**PREFERRED MINIMUM VERGE WIDTHS**

PLEASE NOTE:  
WATER MAIN IS INDICATED AT PREFERRED DEPTH OF 0.6M

**17FOOTPATH WIDTHS**

Cairns City in a Garden  
Master Plan 2007

Part F  
Streetscape Templates

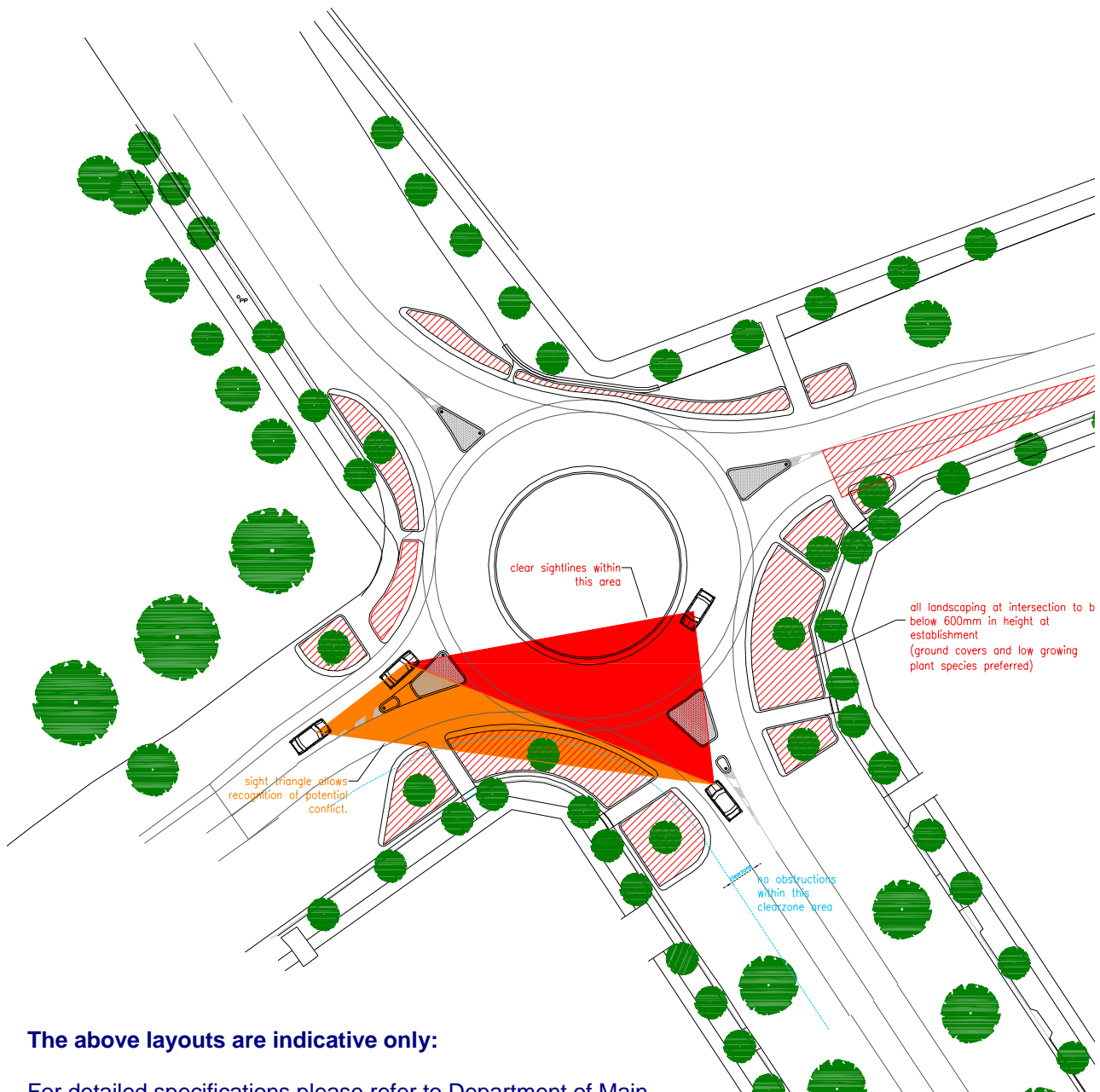

**The above layouts are indicative only:**

For detailed specifications please refer to Department of Main Roads, Road Planning and Design Manual, Chapter 9-Sight Distance and Chapter 14-Roundabouts

## 18 ROUNDABOUTS-SIGHTLINES

Cairns City in a Garden  
Master Plan 2007

Part F  
Streetscape Templates

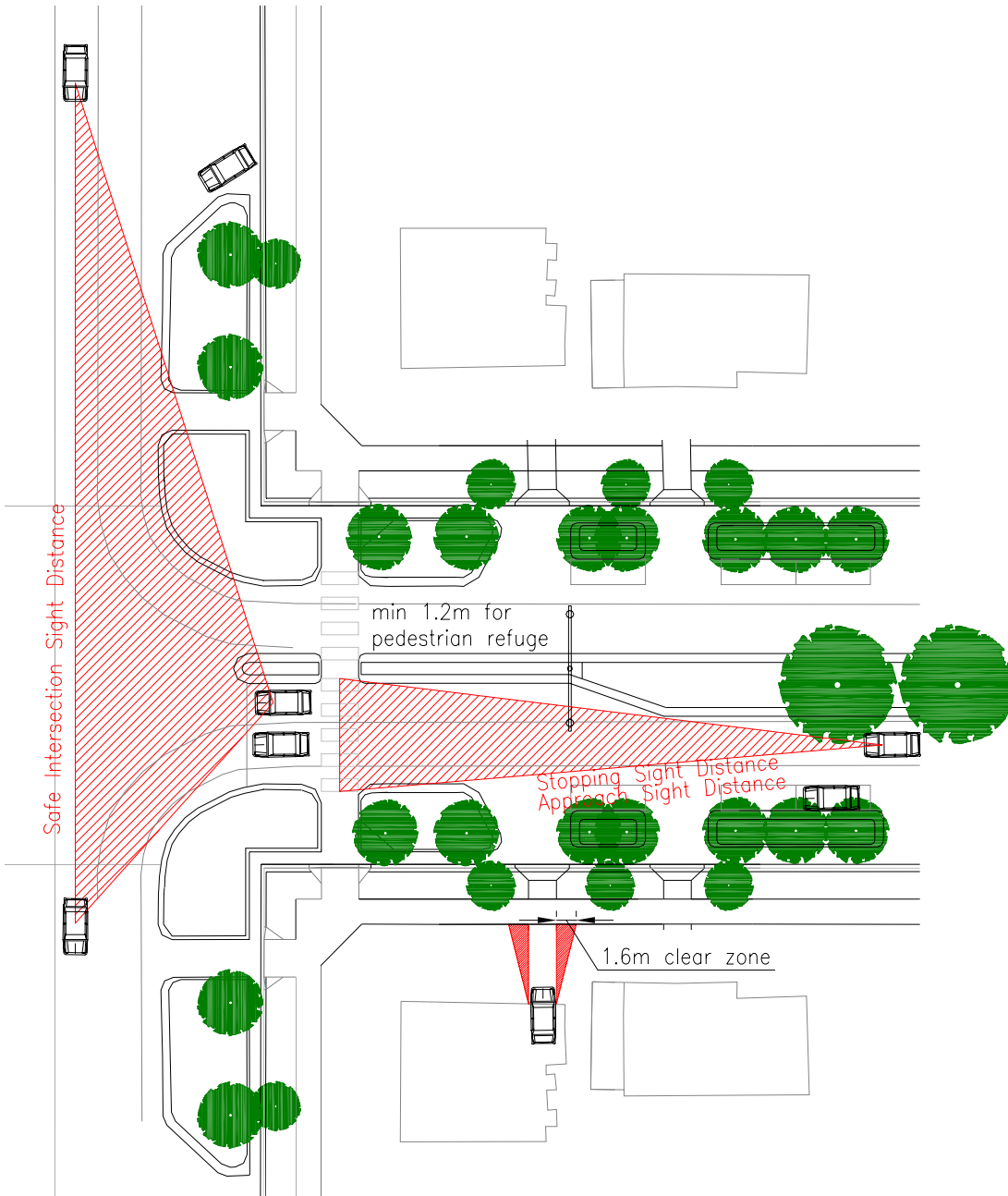

**The above layouts are indicative only:**

For detailed specifications please refer to Department of Main Roads, Road Planning and Design Manual, Chapter 9-Sight Distance and Chapter 13-Intersections at Grade.

## 19 INTERSECTIONS-SIGHTLINES

Cairns City in a Garden  
Master Plan 2007

Part F  
Streetscape Templates

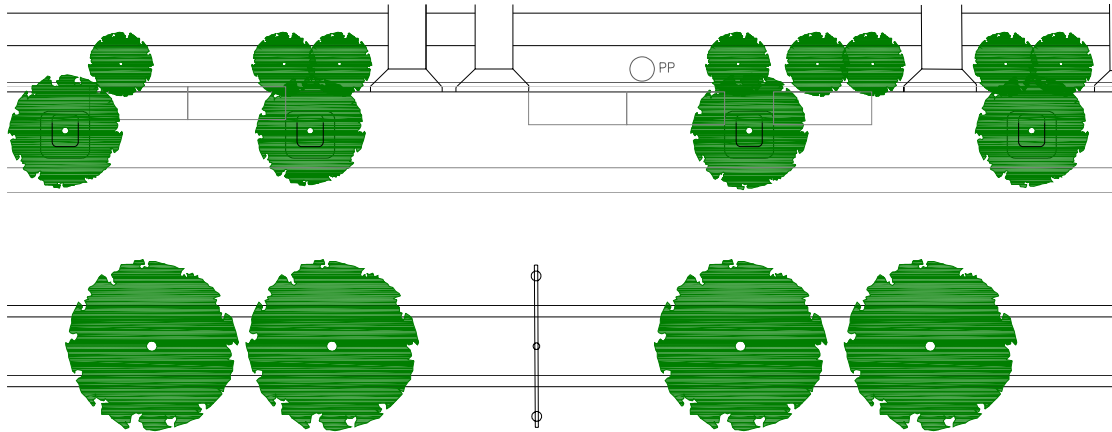

Tree planting should provide shade to parked vehicles and reduce heat and glare from the roadway.

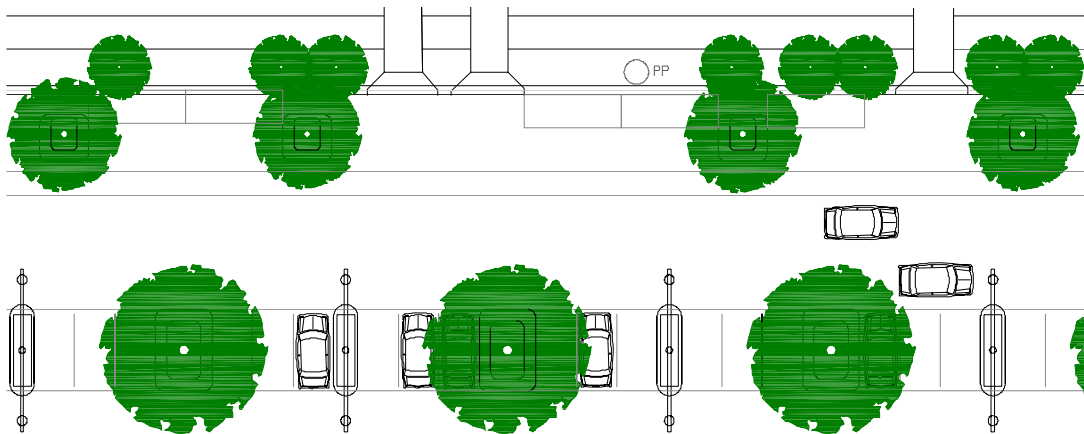

Tree planting should provide shade to parked vehicles and reduce heat and glare from the roadway

## 20 PARKING IN ROAD RESERVE

Cairns City in a Garden  
Master Plan 2007

Part F  
Streetscape Templates

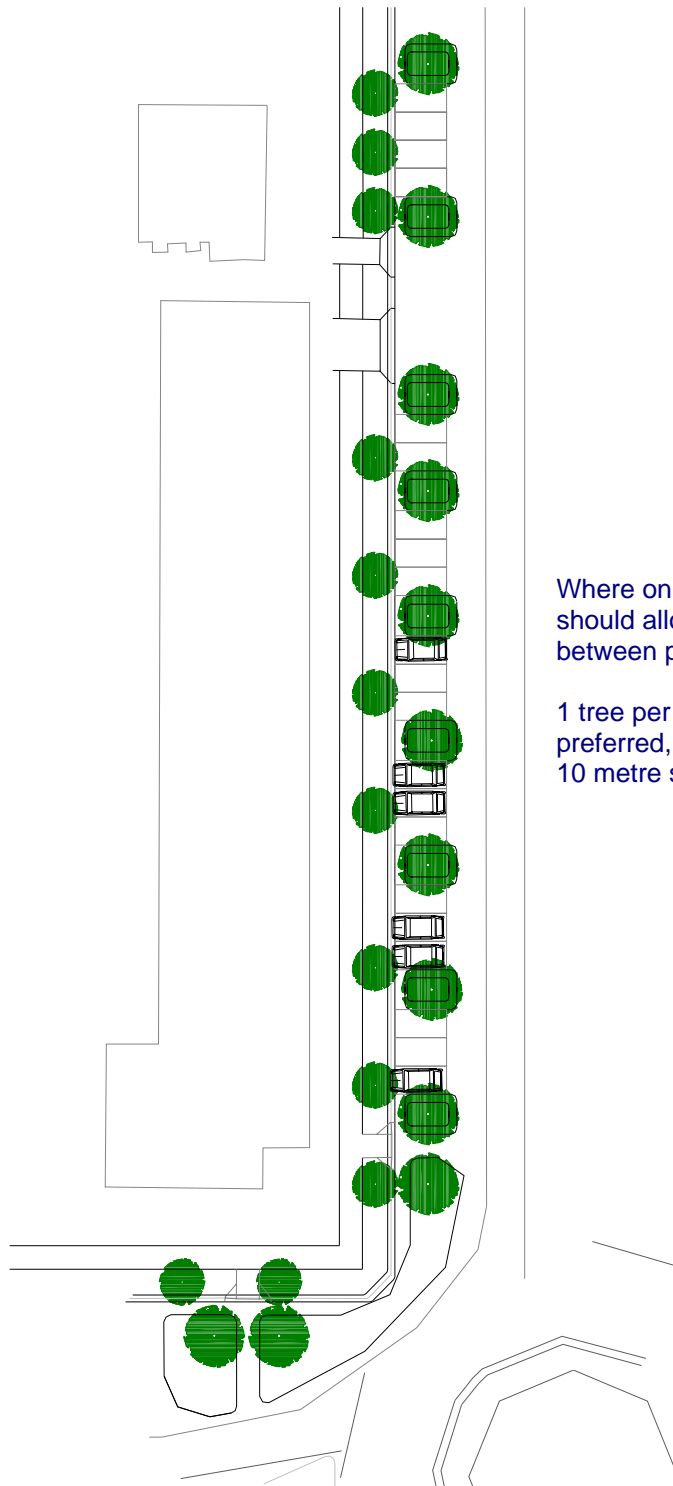

Where on street parking is required it should allow for a good balance between parking and shade trees.

1 tree per 3 parking spaces is preferred, with trees at approximately 10 metre spacings.

## 21 ON STREET PARKING FOR MULTIPLE RESIDENTIAL AND COMMERCIAL UNITS

Cairns City in a Garden  
Master Plan 2007

Part F  
Streetscape Templates



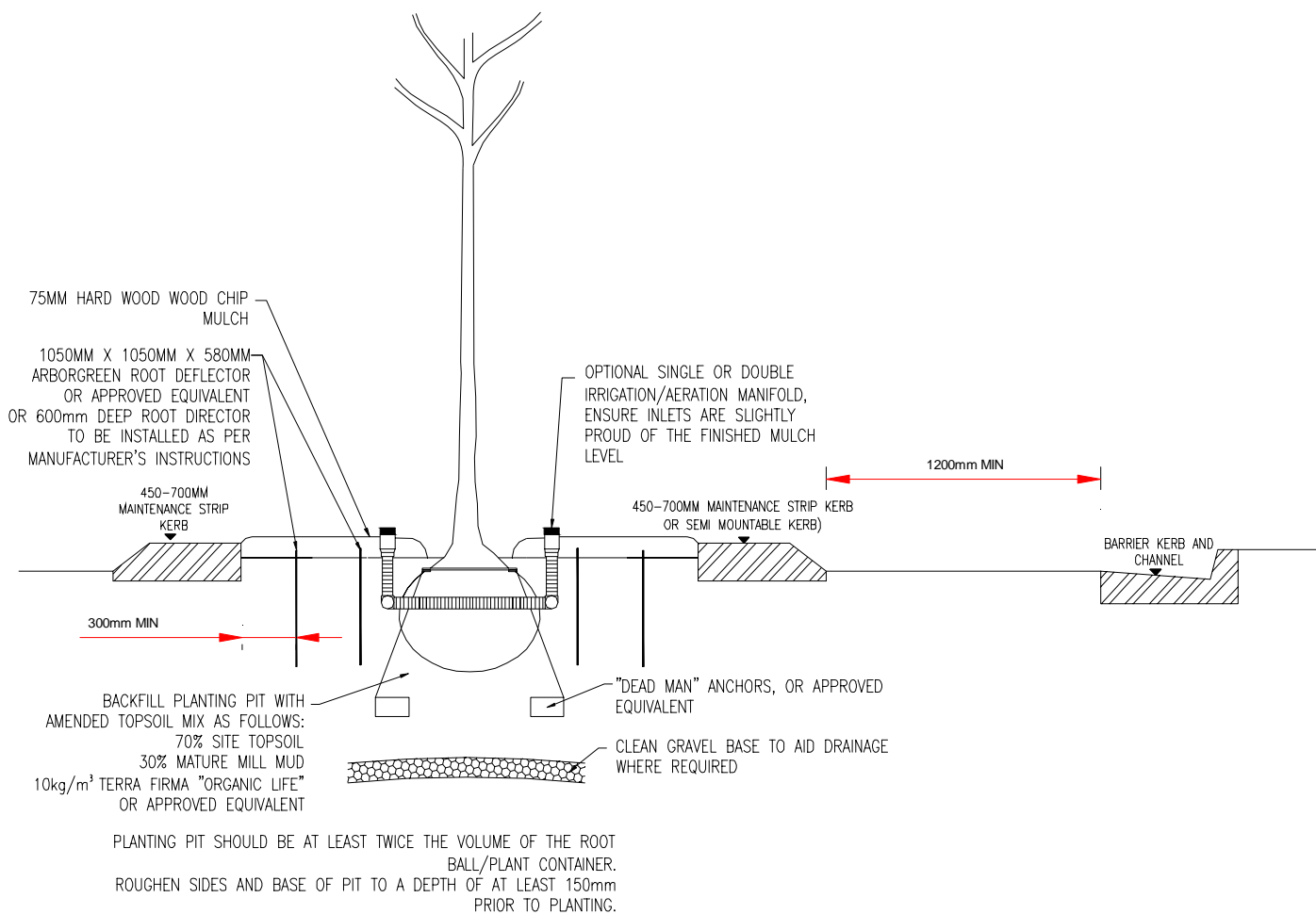

## SECTION NOT TO SCALE

## 22 Tree in Median or Island

Tree to be secured by the use of **dead man's anchor** or approved equivalent.

The type and depth of root barrier used will vary according to local conditions and tree species selection. Refer to table on page 206 for further guidance.

Linear root barriers should extend at least 300mm behind the back of the kerb and at least 1000mm beyond the estimated drip line of the tree canopy at maturity (in the case of median planting and where a root deflector/surround is not employed).

Structural soils or "Arboregreen" *root cells* may be required where site constraints could be detrimental to root expansion, to provide a break out zone for root development under adjacent pavement.

Cairns City in a Garden  
Master Plan 2007

Part F  
Streetscape Templates

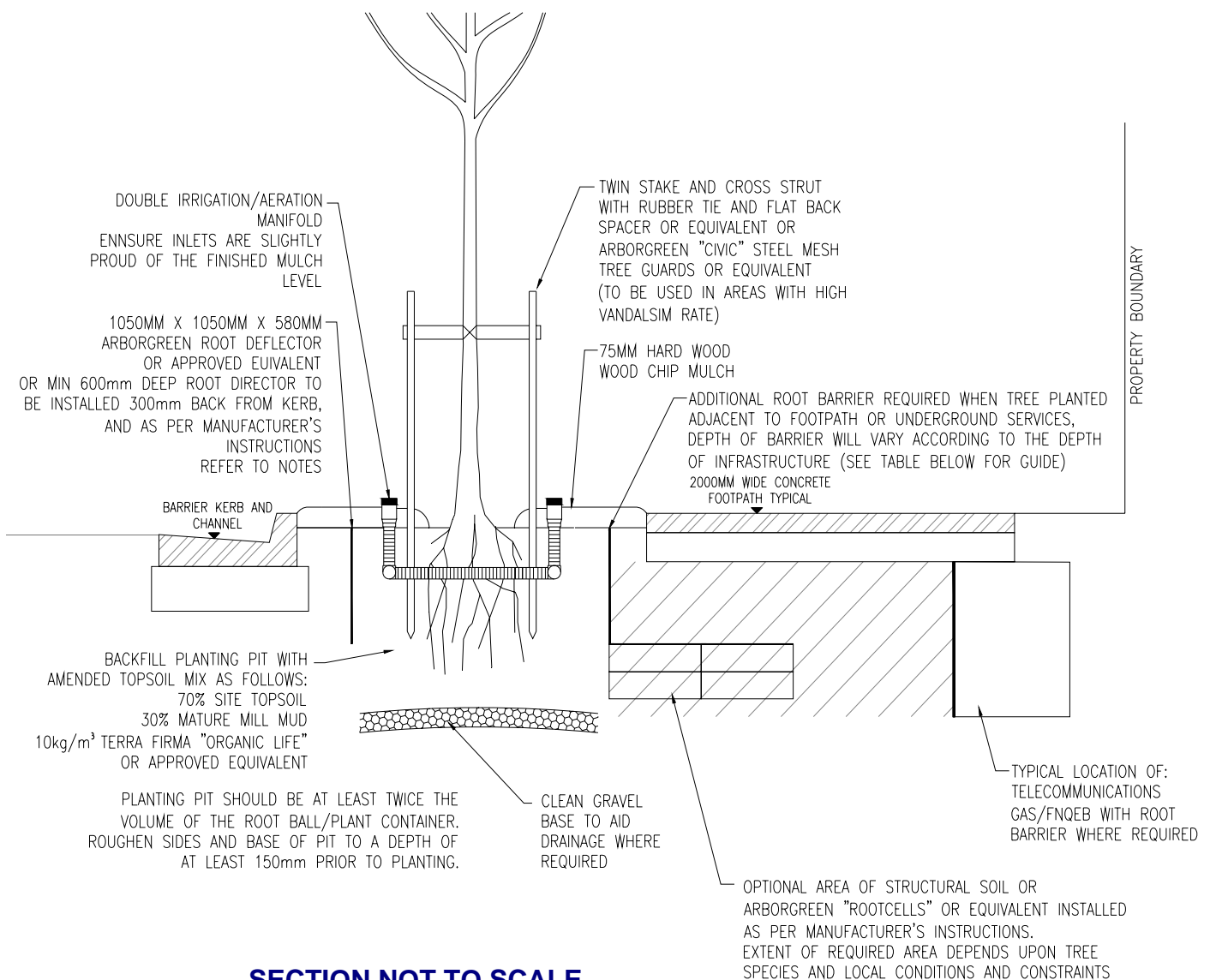

## 23 Tree in Footpath with Nature Strip

Tree to be protected above ground by the installation of twin stakes and cross strut, with rubber ties and flat back spacer. CCC may require the use of welded mesh tree guard for added protection in areas of high vandalism.

The type and depth of root barrier used will vary according to local conditions and tree species selection. (Refer to table on page 206 for further guidance).

Linear root barriers should extend at least 1000mm beyond the estimated drip line of the tree canopy at maturity.

Structural soils or "Arboreen" *root cells* may be required where site constraints could be detrimental to root expansion, to provide a break out zone for root development under adjacent footpaths or to adjacent landscape areas.

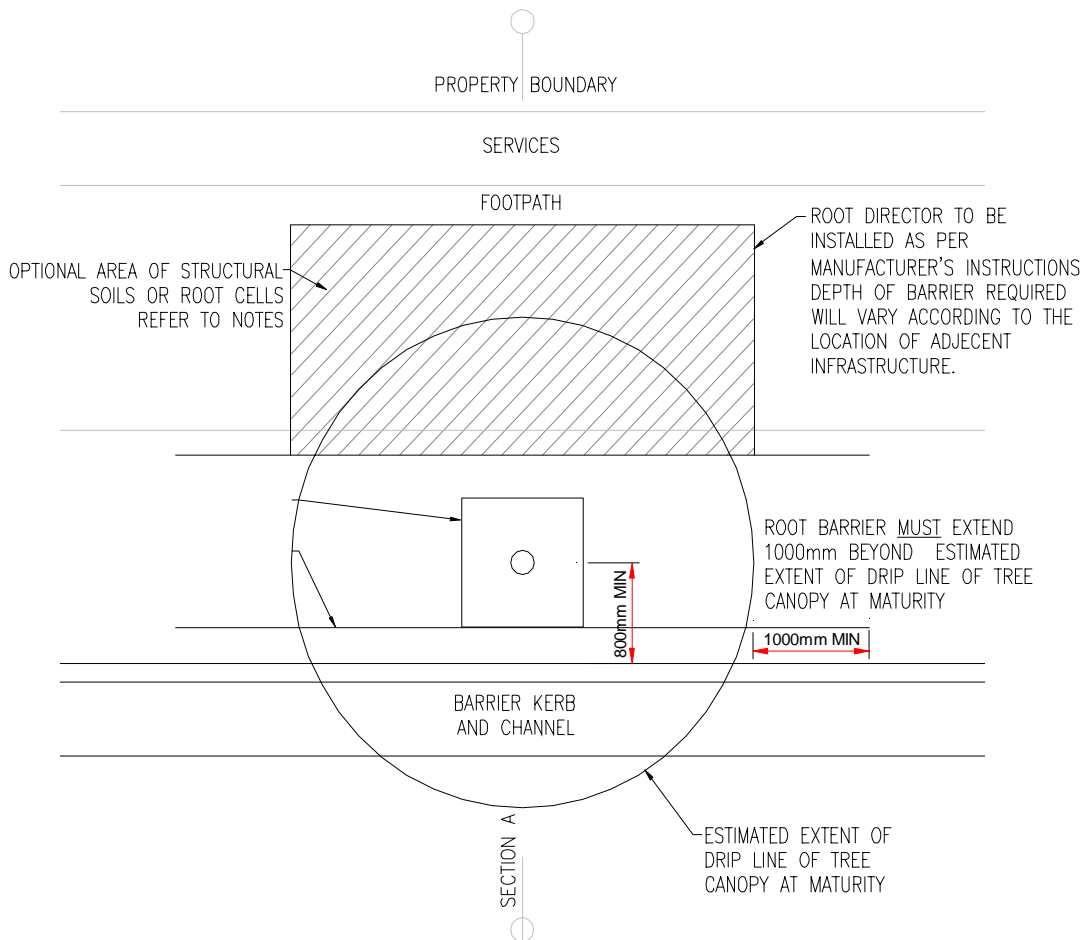

**PLAN NOT TO SCALE**

## Tree in Footpath with Nature Strip

The type and depth of root barrier used will vary according to local conditions and tree species selection. (Refer to table on page 206 for further guidance).

Linear root barriers should extend at least 1000mm beyond the estimated drip line of the tree canopy at maturity.

Structural soils or “Arborgreen” *root cells* may be required where site constraints could be detrimental to root expansion, to provide a break out zone for root development under adjacent footpaths or to adjacent landscape areas.(

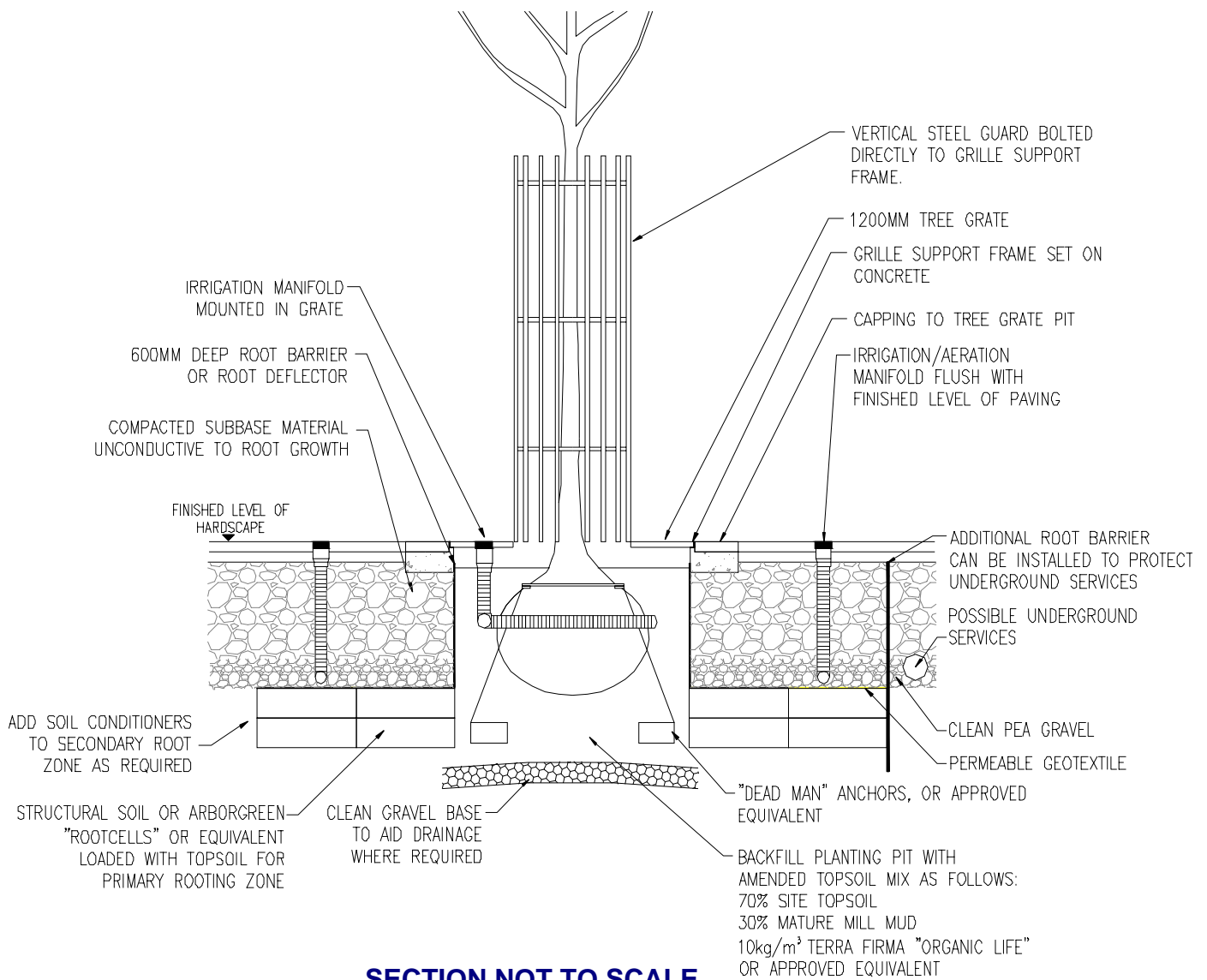

## 24 TREE IN HARDSCAPE

To be used where trees are to be planted within paved pedestrian areas (such as exist in the C.B.D) or within road reserve where rooting zone is restricted (i.e. where tree islands are not of an appropriate scale).

Tree to be protected above ground by the installation of a tree grate and tree guard (refer to CBD Master Plan Appendix B f19 and f20 for full details).

The type and depth of root barrier used will vary according to local conditions and tree species selection. (Refer to table on page 206 for further guidance). Solutions to site specific root management issues should be sought from a reputable root control manufacturer or specifier.

Structural soils or "Arborgreen" *root cells* are required to aid root growth and to reduce the detrimental effects of compaction within the root zone.

Irrigation and aeration manifolds assist in delivering oxygen to the root zone beneath hardscape areas.

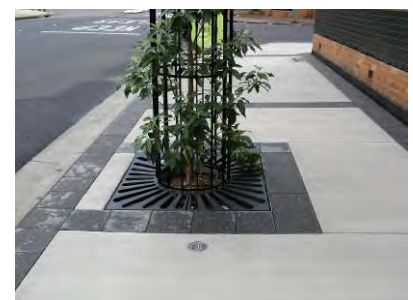

**Indicative photo of planting area only.**

Cairns City in a Garden  
Master Plan 2007

Part F  
Streetscape Templates

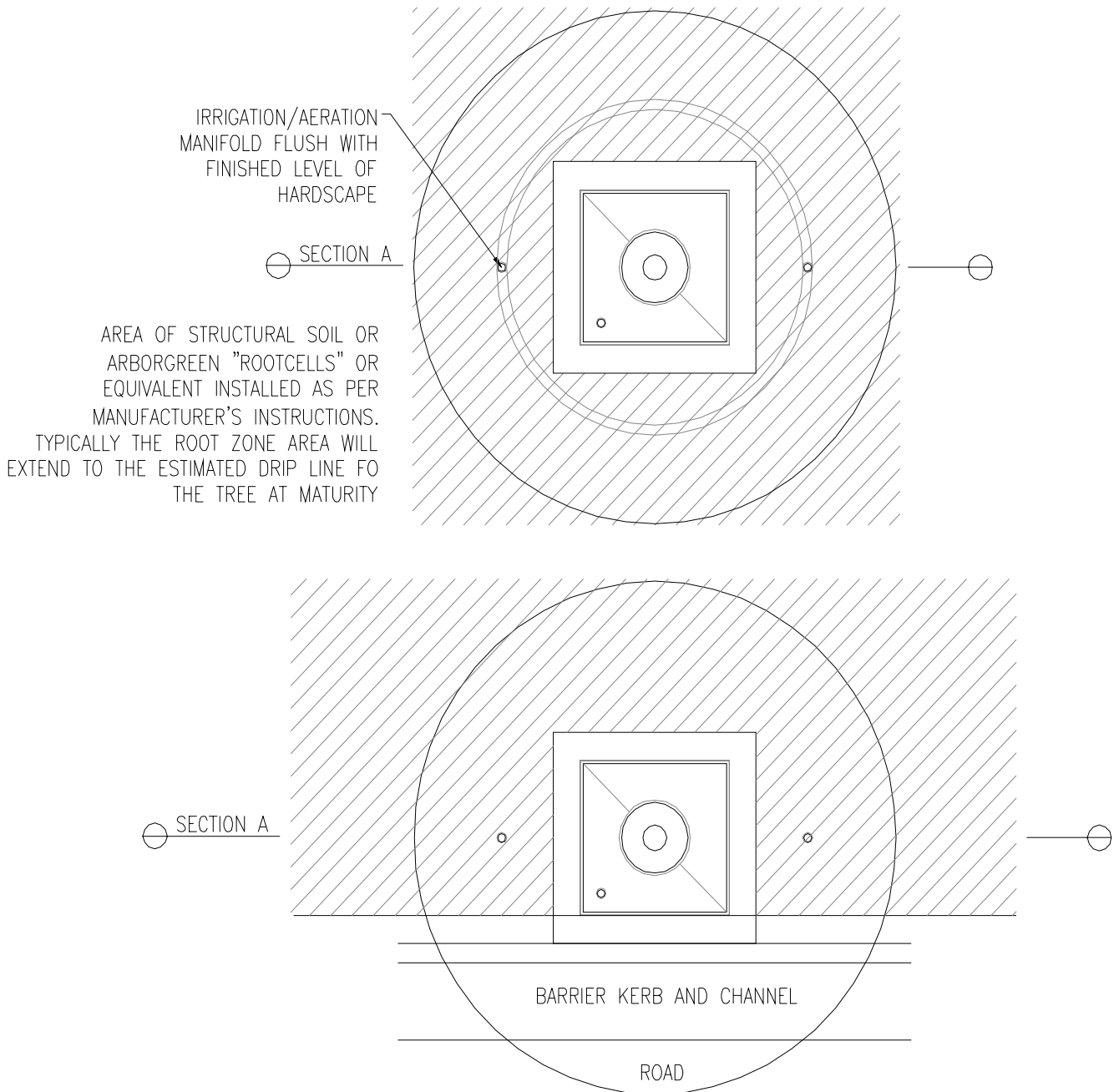

**PLAN NOT TO SCALE**

## TREE IN HARDSCAPE

The hatched areas indicate how *root cells* or structural soils may be installed to assist healthy root development.

Tree to be protected above ground by the installation of a tree grate and tree guard (refer to CBD Master Plan Appendix B f19 and f20 for full details).

The type and depth of root barrier used will vary according to local conditions and tree species selection. (Refer to table on page 206 for further guidance). Solutions to site specific root management issues should be sought from a reputable root control manufacturer or specifier.

Cairns City in a Garden  
Master Plan 2007

Part F  
Streetscape Templates

## 25 Table to guide the selection of root management systems.

WHAT ARE YOU PROTECTING FROM TREE ROOTS?						
Building foundations	Footpaths			Underground services/utilities	Footpaths and underground services/utilities	
	Type of Barrier Surround (Director) or Linear			Depth of services determines barrier type		
	Surround (Director)		Linear	How deep are the services/utilities?		
	What is the predicted girth of the tree trunk at maturity?			Up to 450mm	Up to 800mm	Deeper than 800mm
	Up to 750mm	Greater than 750mm				
ROOT CONTROL	ROOT CONTROL	ROOT CONTROL	ROOT CONTROL	ROOT CONTROL	ROOT CONTROL	ROOT CONTROL
2000mm wide High density root barrier	Root Director 640mm/1050mm	Root Director 1050mm/1400mm	Linear Root Barrier 300-1000mm deep	Linear Root Barrier 600mm deep	Linear Root Barrier 1000mm deep	Linear Root Barrier 1500mm deep and greater

The type and depth of root barrier used will vary according to local conditions and tree species selection.

If in doubt, solutions to site specific root management issues should be sought from a reputable root control manufacturer or specifier.

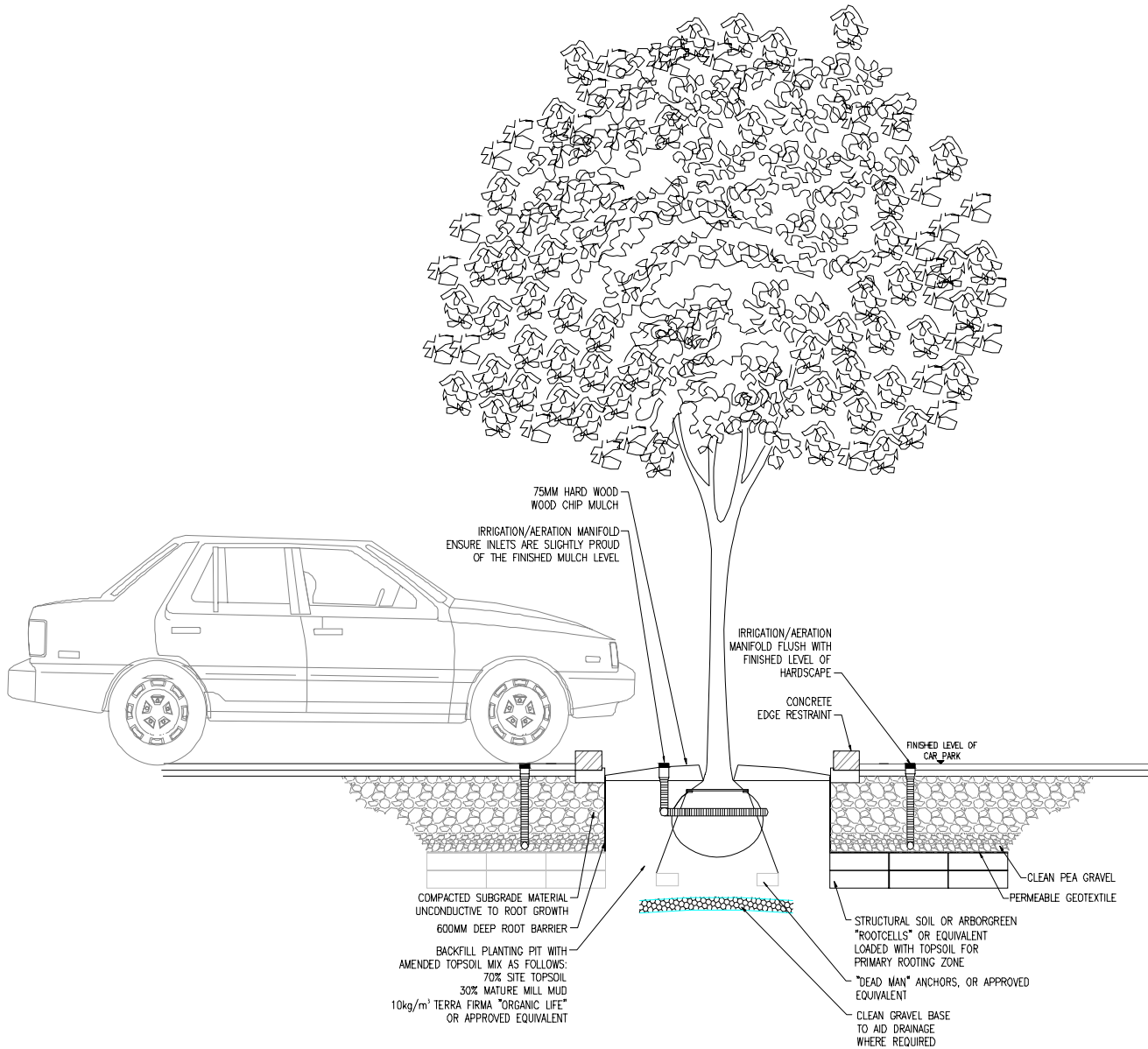

**SECTION NOT TO SCALE**

## 26 Trees in Carparks

Trees should be located to provide shade to vehicles and reduce heat and glare from surrounding pavement. Trees with messy fruit or heavy seeds should be avoided.

Trees to be supported by dead man's anchors or timber stakes.

The type and depth of root barrier used will vary according to local conditions and tree species selection. (Refer to table on page 206 for further guidance).

Structural soils or "Arboregreen" *root cells* may be required where site constraints could be detrimental to root expansion, to provide a break out zone for root development under adjacent pavement, and avoid future damage to pavement surface.

Cairns City in a Garden  
Master Plan 2007

Part F  
Streetscape Templates

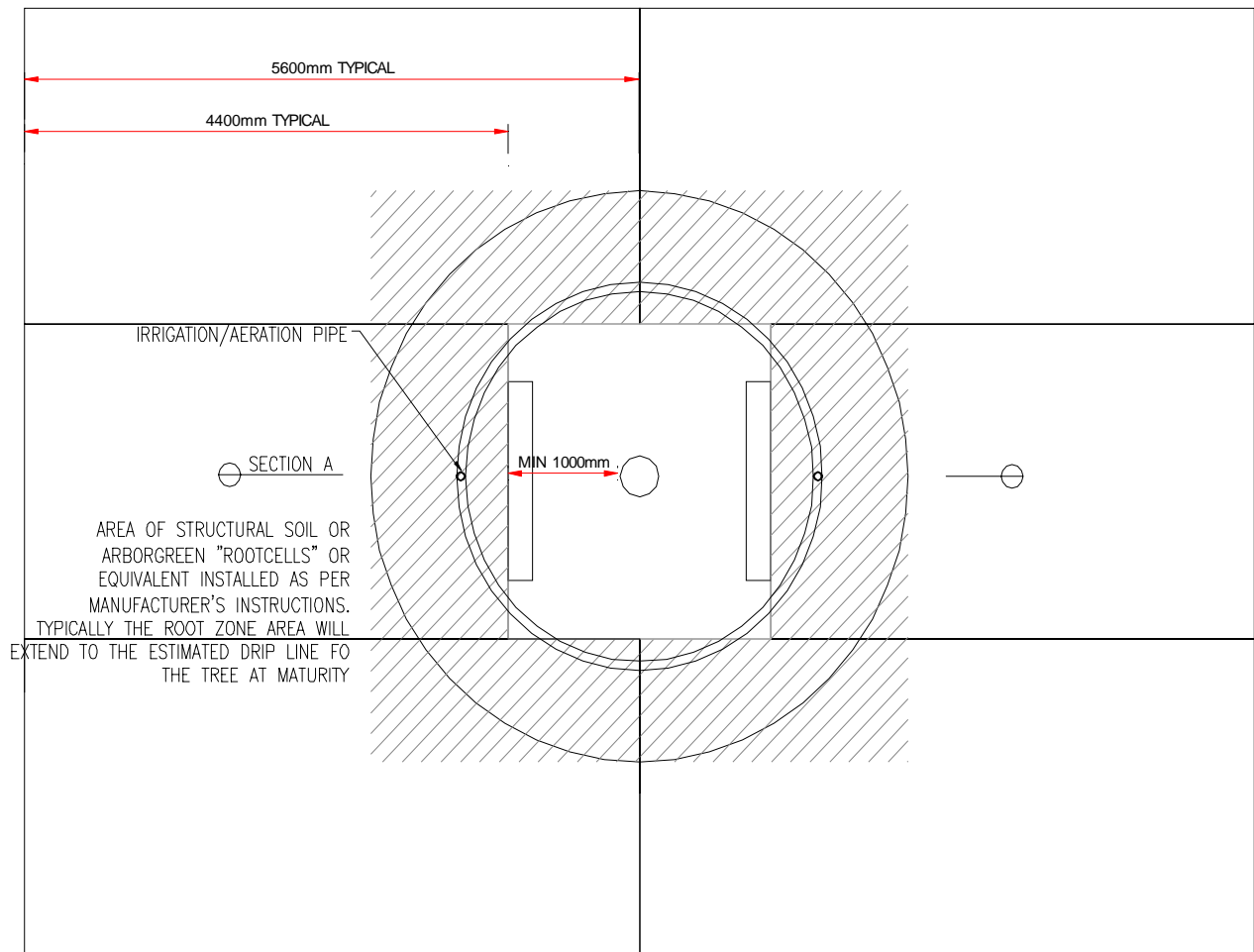

**PLAN NOT TO SCALE**

**OPTION A**

Parking layout with one tree per six car allocations. Structural soils or **root cells** should extend to the estimated drip line of the crown of the tree at maturity, allowing for healthy and extensive root development.

Irrigation and aeration manifolds assist in delivering oxygen to the root zone beneath hardscape areas.

Where larger trees are planted then a continuous trench of structural soils or **root cells** may be preferred.



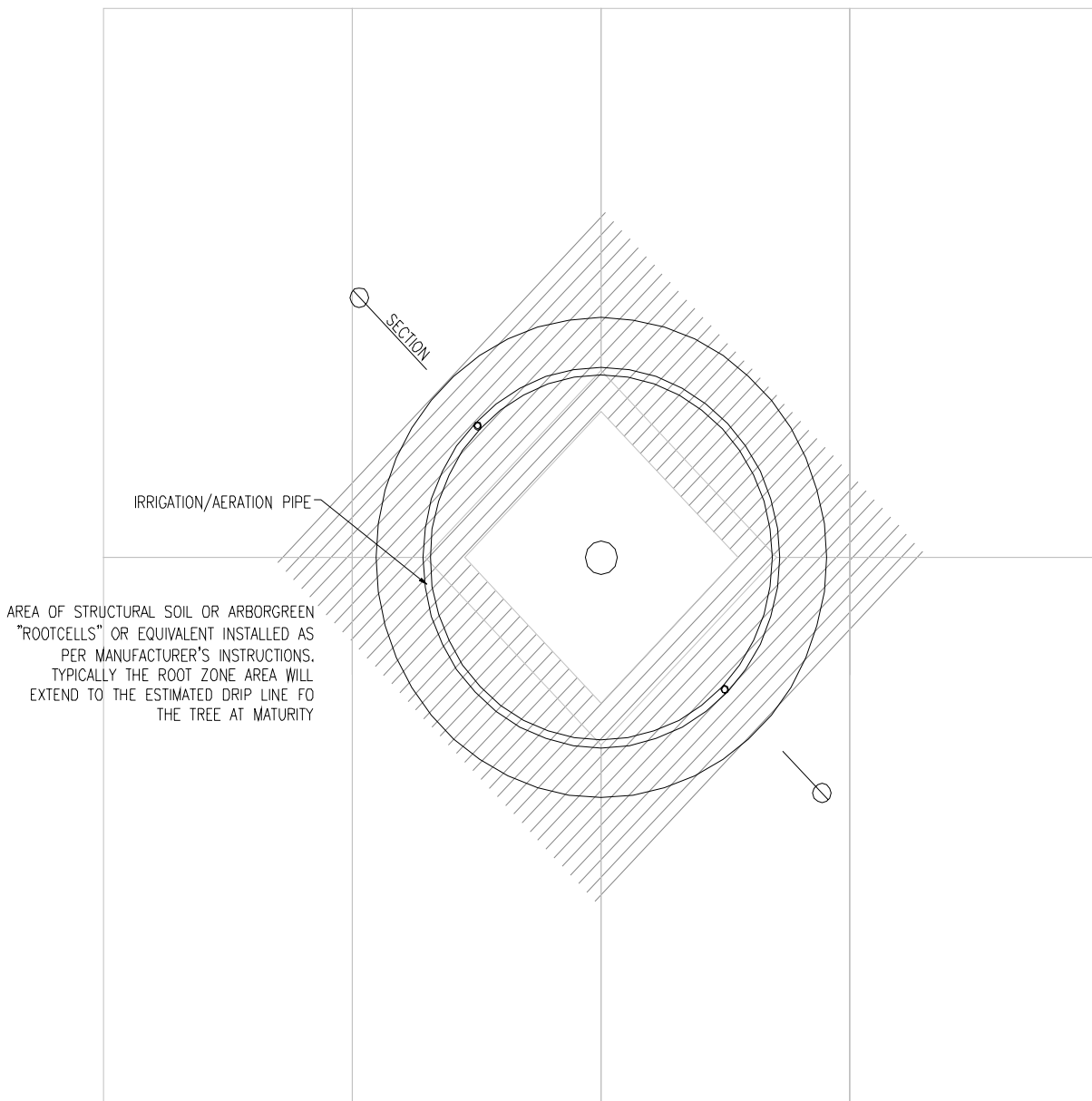

## OPTION B

Parking layout with one tree per eight car allocations. Structural soils or **root cells** should extend to the estimated drip line of the crown of the tree at maturity, allowing for healthy and extensive root development.

Irrigation and aeration manifolds assist in delivering oxygen to the root zone beneath hardscape areas.

Where larger trees are planted then a continuous trench of structural soils or **root cells** may be preferred.

Cairns City in a Garden  
Master Plan 2007

Part F  
Streetscape Templates



Planning Scheme Policy

**EAST WOREE DEVELOPMENT STRATEGY**

**Application**

This Policy applies to all freehold lands included in the East Woree Development Precinct identified on the Planning Area Map in the Portsmouth – Woree Industrial District.

**Intent**

This Policy is intended to describe the external works necessary within the East Woree Development Precinct and to allow the costs of these works to be apportioned equally.



**This policy is to remain in force until otherwise determined by Council.**

**General Manager Responsible for Review:**

**Infrastructure Services**

**ORIGINALLY ADOPTED: 27/1/2005**  
**COMMENCEMENT: 1/03/2005**  
**CURRENT ADOPTION: 5/12/2012**  
**DUE FOR REVISION: 31/12/2014**  
**REVOKED/SUPERSEDED:**

**Cairns City Council**  
March 2001

## **East Woree Development Strategy**

Policy

**Final**

Sinclair Knight Merz Pty. Ltd.  
A.C.N. 001 024 095  
2 James Street  
PO Box 1062  
Cairns QLD  
Australia 4870  
Telephone: +61 7 4031 4599  
Facsimile: +61 7 4031 3967  
<http://www.skm.com.au>



**SINCLAIR KNIGHT MERZ**

COPYRIGHT: The concepts and information contained in this document are the property of Sinclair Knight Merz Pty Ltd. Use or copying of this document in whole or in part without the written permission of Sinclair Knight Merz Pty Ltd constitutes an infringement of copyright.

# Contents

---

<b>1. East Woree Development Strategy</b>	<b>1</b>
1.1 General	1
1.2 Provisions	2
1.2.1 Roads	2
1.2.2 Drainage	2
1.2.3 Water Supply and Sewerage	2
1.2.4 Subdivision	3
1.2.5 Credits	3
1.2.6 Rate of Contributions	3
1.2.7 Time for Payment	4
1.3 Supporting Information	4

---



# 1. East Woree Development Strategy

---

## **Intent**

The Cairns City Council is supportive of the material change of use of the various freehold blocks within the area covered by this strategy to permit Industrial uses.

The policy is formulated to describe the external works necessary to allow orderly development of the relevant area, under progressive changes of use, and to allow the cost of these works to be equitably apportioned to all applicants for material change of use within the relevant area.

## **Scope**

The policy is applicable to all freehold lands east of the Bruce Highway as far as Trinity Inlet, south of the Cairns Southern Access Road and north of the Cairns golf Club and is to be referred to and have its contents and intent applied to all material changes of use from Rural to industrial or other approved use.

Due to the configuration of the individual blocks and installed infrastructure, there is a need to undertake certain works to enable the land to be developed. These are of benefit to all landowners and include:

- roadworks
- drainage
- sewerage
- water supply.

## **1.1 General**

This policy does not affect Council's power to impose as a condition of development approval for a material change of use, the requirement for land, works or a contribution towards the cost of supplying infrastructure not covered by this policy.

The council proposes to design and construct the necessary works as required by specific developments, to be paid for as a contribution levied on approval of an application for material change of use.

A formula has been developed to enable these costs to be fairly recovered from individual developers. The formula requires contributions from developers/owners based on the proportion of their land to the total area benefited from water supply, sewerage, and open channel drainage while roadworks and piped drainage contributions are to be based on length of frontage. The land covered by existing and proposed easements for electricity transmission lines, drainage, water supply or sewerage will be included in the land calculation at one-half equivalent area, in recognition of the constraints to development of such land.

---

These proportions are called the 'proportion of contribution', (POC). POC (A) covers the area-based proportion while POC (B) covers the frontage element.

The policy covers the provision of permanent frontage roadworks including kerb and channel, sewerage and water reticulation and stormwater drainage.

Any sewerage and water supply infrastructure included in the Cairns City Council Water Supply and Sewerage Headworks Policy has been excluded from the costs in this policy. Water Supply and Sewerage Headworks Contributions or infrastructure charges are payable in addition to any contributions under this policy.

Internal works within the boundaries of the existing lots (other than drainage works specifically detailed in the policy drawings) are not included in the policy and are the responsibility of the relevant landowner.

## **1.2 Provisions**

### **1.2.1 Roads**

Council will upgrade the appropriate roads on the property frontages to an 8 metre asphalt standard (6.5 m nearest the centreline and 1.5 m opposite) for the case of 13 metre roads and 7 metres (5.5 m plus 1.5 m as above) for 11 metre roads. Kerb and channel will be constructed along the full frontage. These works will be paid for by each developer/owner on the basis of their POC (B).

### **1.2.2 Drainage**

All necessary open drains and endwalls etc will be constructed by Council as required and paid for by each developer/owner on the basis of their POC (A). Drainage easements as required are to be transferred to Council free of charge.

Piped drainage as detailed in this Policy shall be paid for by each developer/owner on the basis of their POC (B).

### **1.2.3 Water Supply and Sewerage**

Water supply and sewerage reticulation will be constructed by Council as required to service the various allotments. The cost will be paid for by each developer/owner on the basis of their POC (A).

Water supply and sewerage headworks infrastructure has been excluded from this Policy. Council headworks contributions or infrastructure charges will be additional to this Policy.



---

#### 1.2.4 Subdivision

All subdivision and works internal to each property except stormwater drains specified in this policy are the responsibility of the property owner and excluded from this Policy.

Each owner will be responsible for the cost of all filling to achieve required flood immunity on their individual property in accordance with Council Policy on this matter. No allowance has been made for filling (other than on roads).

#### 1.2.5 Credits

Credits are to be established in accordance with the cost of the component infrastructure which has been constructed by the developer as determined in the relevant section of the Strategy. All credits shall be determined by Council's Chief Executive Officer.

Should a developer wish to construct works to a different design or standard from that detailed in the policy (for example, to pipe an open drain), such works shall be subject to the approval of Council's Chief Executive Officer and policy credits shall be assessed on the lesser of the works in the policy and the works actually constructed.

The credits for works constructed by developers in lieu of payment of contributions will be allowed against the East Woree Development Contribution set out in **Table 1.1**.

Credits will accrue to developers at the time Council accepts works on maintenance. Hence, the credits priority for each developer will be set solely by the on-maintenance date.

Any reimbursement to the developer of credits accrued in excess of the East Woree Development Contribution set out in **Table 1.1** shall be subject to negotiation between the developer and Council's Chief Executive Officer.

#### 1.2.6 Rate of Contributions

The estimated capital cost of the relevant works is apportioned to each freehold property in accordance with the formula. The amount actually paid at the time of material change of use will be as indicated in **Table 1.1**, adjusted by RICl (Roadworks Input Cost Index) movements effective from the base date of estimation, March 2001.

---

### **1.2.7 Time for Payment**

Unless specified otherwise in the relevant condition of approval, a contribution under this policy is payable as follows:

- (a) where it is proposed to subdivide the land – prior to the approval and dating of the survey plan, or
- (b) where it is proposed not to subdivide the land – prior to lodgement of an application for building works
- (c) where no building work is associated with the land – prior to the commencement of the use.

Council may as part of the conditions of approval require the developer to provide security to cover the estimated contribution, with such security being payment at the time set out in the condition of approval.

### **1.3 Supporting Information**

The supporting information for this policy comprises the East Woree Development Strategy 2001 Review.

**Table 1.1: Contributions**

Ref	Owner	Lot	RP	Gross	Area (m <sup>2</sup> )			POC (A) %	Frontage (m)	POC (B) %	Calculated Contribution Share (\$)		Contribution Payable March 2001	Existing Credits** \$
					Resumption	Easement	Less 50% Easement				A Area	B Frontage		
1	Carpentaria Transport Pty Ltd	8	CP857680	4.5700		0.4115	4.3643	12.7942%	439.677	12.7462%	156,026	411,462	Paid *	nil
1	Carpentaria Transport Pty Ltd	8	CP857680	1.8960		0.1464	1.8228	5.3436%	141.027	4.0884%	65,165	131,978	197,143	
2	WS & GT Price	84	C19830	1.9885	0.0287	0.3316	1.7940	5.2592%	266.967	7.7394%	64,136	249,837	313,973	
3	PP & PL Malaponte	81	C19830	1.9845			1.9845	5.8177%	140.937	4.0858%	70,947	131,894	202,841	
4	Cairns Earthmoving Contractors Pty Ltd	94	C19830	1.9858			1.9858	5.8215%	141.032	4.0885%	70,993	131,982	202,975	
5	PR Poppi, Poppi Investments Pty Ltd	91	C19830	1.9845		1.2190	1.3750	4.0309%	43.000	1.2466%	49,157	40,242	89,399	
6	RT & CR Rhodes	42	C19830	1.9861			1.9861	5.8224%	281.842	8.1706%	71,004	263,757	334,761	
7	RT & CR Rhodes	41	C19830	1.9858			1.9858	5.8215%	140.843	4.0830%	70,993	131,804	202,797	
8	Cairns Earthmoving Contractors Pty Ltd	1-12	RP899546	1.9837	0.0032		1.9805	5.8059%	276.976	8.0295%	70,803	259,202	Paid *	95,676
9	FA Champion	52	C19830	1.9855	0.0287		1.9568	5.7365%	266.446	7.7242%	69,957	249,346	319,303	
10	PP & PL Malaponte	53	C19830	1.9890		0.6445	1.6668	4.8863%	282.152	8.1796%	59,589	264,047	323,636	
11	Poppi Investments Pty Ltd	54	RP749186	1.9543		0.5822	1.6632	4.8758%	266.343	7.7213%	59,461	249,253	308,714	
12	Old Electricity Transmission Corp	3	RP749188	1.2833		0.7277	0.9195	2.6956%	128.000	3.7107%	32,873	119,786	152,659	
13	Old Electricity Transmission Corp	22	C19830	1.9896		0.1872	1.8960	5.5582%	282.133	8.1790%	67,782	264,028	331,810	
14	Willi K Pty Ltd	2	RP749190	2.3200		0.6029	2.0186	5.9176%	185.250	5.3704%	72,165	173,363	Paid *	nil
16	Trackgate Pty Ltd	4	SP101278	1.3400		0.0786	1.3007	3.8131%			46,501	-	46,501	
17	Trackgate Pty Ltd	12	SP101278	1.2120		0.5609	0.9316	2.7310%	37.675	1.0922%	33,305	35,258	68,563	92,520
18	Old Dept of Industrial Development	13	SP101278	2.4860		0.3084	2.3318	6.8358%	56.965	1.6514%	83,363	53,309	136,672	35,980
19	Old Dept of Industrial Development	726	RP866954	0.1478			0.1478	0.4333%	72.210	2.0934%	5,284	67,577	72,861	
	Cairns Earthmoving Contractors Pty Ltd		Credit for road reconstruction											55,000
					34.1116			100.000%	3,449.475	100.000%	1,219,504	3,228,118	3,304,608	

Note: The following parcels of land have been excluded for the reasons indicated:

20	Crown	495	NR4951	Conservation
21	Cairns City Council	31	C19830	Sewage Treatment
22	Cairns City Council	603	NR835483	Sewage Treatment and conservation

Note: Contributions are based on estimated costs as at March 2001 and may be reviewed by Council from time to time in line with movement of the Roadworks Input Cost Index.

\* Material change of use has occurred. Contributions have been paid or works in lieu completed.

\*\* Any reimbursement of credits accrued is subject to negotiation between the developer and Council's Chief Executive Officer.

**Planning Scheme Policy**

**Cairns CBD Streetscape Masterplan**

**Application** This policy applies to development undertaken in the Cairns Business District (CBD) as identified on the CBD – North Cairns Planning Area Map in the CairnsPlan.

**Intent** This Policy is intended to promote an integrated streetscape and enhance the tropical character within the CBD.

This is a certified copy of the Cairns CBD Streetscape Masterplan Planning Scheme Policy which was adopted on the 24 January 2008. A Public Notice was published in the Cairns Post on the 2 February 2008.



John Hawkes  
Acting Chief Executive Officer  
Cairns City Council.

◆◆◆◆◆

**This policy is to remain in force until otherwise determined by Council.**

**General Manager Responsible for Review:**

**General Manager City  
Development.**

**ADOPTED: 24 JANUARY 2008  
COMMENCEMENT: 2 FEBRUARY 2008  
DUE FOR REVISION: 30 JUNE 2012  
REVOKED/SUPERSEDED:**

*Adoption 24 January 2008*

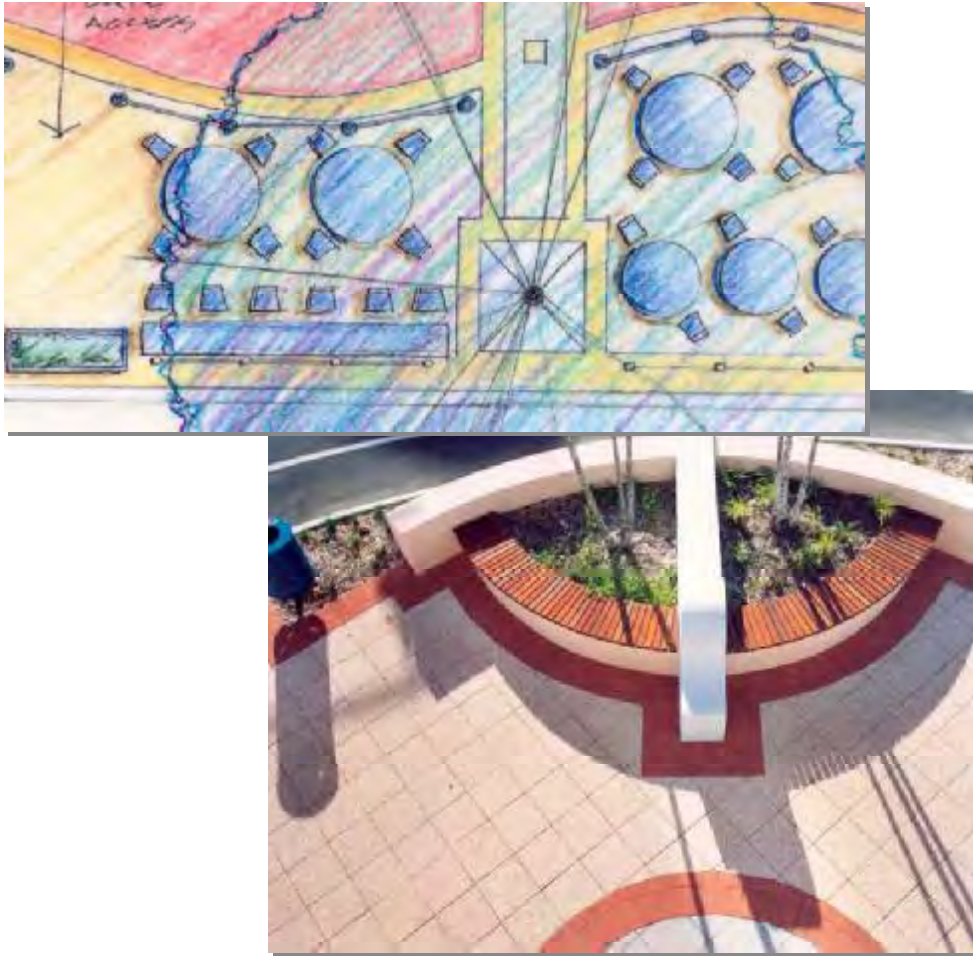

## **CAIRNS CBD STREETScape MASTERPLAN PLANNING SCHEME POLICY**



## TABLE OF CONTENTS

1.0	INTRODUCTION .....	6
1.1	Overview .....	6
1.2	Statement of Intent .....	8
2.0	ANALYSIS .....	9
2.1	Description of the Study Area .....	9
2.2	The Existing Situation .....	10
2.3	<b>Esplanade and Cityport Interface</b> .....	19
2.4	Significant Vegetation to be Retained .....	20
3.0	A VISION FOR THE CAIRNS CBD .....	21
3.1	Intent .....	21
3.2	Key Proposals .....	22
4.0	DESIGN STRATEGY DESCRIPTION .....	30
4.1	Planting Strategy .....	30
4.2	Pavement Strategy .....	34
4.3	Furniture Strategy .....	39
4.4	Water Features .....	40
4.5	Orientation & Wayfinding in the CBD .....	41
4.6	Interpretation .....	41
4.7	Public Artwork .....	42
4.8	Built Forms .....	44
5.0	GUIDELINES .....	45
5.1	FNQROC Development Manual .....	45
5.2	All Mobility Access and Other Australian Standards .....	45
5.3	Crime Prevention Through Environmental Design (CPTED) .....	46
6.0	ESTABLISHMENT AND MAINTENANCE .....	47
6.1	General .....	47
6.2	Plant Procurement .....	49
6.3	Quality of Nursery Stock .....	50
6.4	Strategies for Improving Tree Planting .....	53
6.5	Irrigation .....	56
7.0	REFERENCES .....	51

**APPENDIX 1 (Existing Street Trees to be Retained)****APPENDIX 2 (Tree Planting)****APPENDIX A*****SECTION 2.0 SITE ANALYSIS***

---

- a1 THE STUDY AREA
- a2 EXISTING SITUATION – MAJOR USES
- a3 EXISTING SITUATION – USE ZONES
- a4 PEDESTRIAN HIERARCHY
- a5 TRAFFIC HIERARCHY
- a6 ESPLANADE AND CITYPORT INTERFACE
- a7 SIGNIFICANT VEGETATION TO BE RETAINED (as at 2000)

***SECTION 3.0 A VISION FOR THE CAIRNS CBD***

---

- v1 PROPOSED COMPONENTS 1
- v2 PROPOSED COMPONENTS 2
- v3 KEY NODE SHIELDS ST PLAZA (2003)
- v4 KEY NODE SPENCE STREET PLAZA (2003)
- v5 KEY NODE CITY PLACE (2002)
- v6 CITY GATEWAYS
- v7 TYPICAL STREET LAYOUTS (Collector and Sub-arterial Roads)
- v8 TYPICAL STREET LAYOUTS (Modified Collector)

**APPENDIX B*****SECTION 4.0 DESIGN STRATEGY DESCRIPTION***

---

**PLANTING STRATEGY**

---

- n1 STREET TREE MENU (Intersections)
- n2 STREET TREE MENU (North/South Streets)
- n3 STREET TREE MENU (East/West Streets)
- n4 UNDERSTOREY PLANTING (Intersections)
- n5 UNDERSTOREY PLANTING (North/South Streets)
- n6 UNDERSTOREY PLANTING (East/West Streets)
- n7 UNDERSTOREY PLANTING (Mid-Block Crossings)

## PAVEMENT STRATEGY

---

- s1 TYPICAL SUB-ARTERIAL STREET
- s2 TYPICAL COLLECTOR STREET
- s3 TYPICAL COLLECTOR STREET (MODIFIED)
- s4 TYPICAL CORNER CONFIGURATION
- s5 TYPICAL FOOTPATH CONFIGURATION
- s6 CBD PAVING TREATMENT MATRIX

## FURNITURE STRATEGY

---

- f1 PRECINCT MENU MATRIX
- f2 CONFIGURATION OF ELEMENTS – FOOTPATH
- f3 CONFIGURATION OF ELEMENTS - MEDIAN
- f4 SEATING DETAIL – PARK BENCH STYLE
- f5 SEATING DETAIL – CUSTOM TYPE 1 (Shields Street)
- f6 SEATING DETAIL – CUSTOM TYPE 2 (Hartley Street)
- f7 SEATING DETAIL – CUSTOM TYPE 3 (City Wide)
- f8 SEATING DETAIL – CUSTOM TYPE 4 (City Place)
- f9 REFUSE BIN DETAIL
- f10 BOLLARD DETAIL
- f11 BOLLARD DETAIL – CUSTOM TYPE 1 (Hartley Street)
- f12 BOLLARD DETAIL – CUSTOM TYPE 2 (City Place)
- f13 TYPICAL BICYCLE STAND – TYPICAL DETAIL
- f14 LIGHTING DETAIL – CUSTOM TYPE 1 (Shields Street)
- f15 LIGHTING DETAIL – CUSTOM TYPE 2 (City Wide)
- f16 LIGHTING DETAIL – PARK LIGHTS (Post Top)
- f17 LIGHTING DETAIL – ESPLANADE LIGHTS
- f18 TREE PROTECTION – GUARD
- f19 TREE PROTECTION – GRATE CUSTOM TYPE 1
- f20 TREE PROTECTION – GRATE CUSTOM TYPE 2
- f21 BANNER POLE – DETAIL (CITY-WIDE)
- f22 DRINKING FOUNTAIN – DETAIL TYPE 1
- f23 BALUSTRADE & OUTDOOR DINING DETAIL
- f24 TELEPHONE BOOTHS
- f25 SURVEILLANCE CAMERA POLE
- f26 STREET SIGNAGE
- f27 INFORMATION TOTUM

## BUILT FORM

---

- b1 AWNING DESIGN (Full Width)
- b2 AWNING EXTENSIONS
- b3 CANOPY DESIGN



**APPENDIX C**

- i1 1990 CHARACTER UNITS
- i2 EXISTING WEATHER PROTECTION
- i3 EXISTING SPECIES TO BE RETAINED
- i4 IMPORTANT HISTORIC BUILDINGS
- i5.1 PROPOSED SPECIES – COMMON NAMES (Understorey)
- i5.2 PROPOSED SPECIES – COMMON NAMES
- i5.3 PROPOSED SPECIES – COMMON NAMES
- i5.4 PROPOSED SPECIES – COMMON NAMES
- i5.5 PROPOSED SPECIES – COMMON NAMES
- i6 EXISTING PAVEMENT TYPES (2003)

**GLOSSARY OF TERMS**

## 1.0 INTRODUCTION

### 1.1 Overview

---

In 1990, Cairns City Council adopted the Cairns CBD Landscape Masterplan. This document was produced at a time when the city was experiencing unprecedented changes as a result of the rapidly expanding tourism industry. Since its inception, the document formed an effective framework for subsequent projects undertaken in the CBD.

This first revision of the 1990 Masterplan responds to the factors currently influencing the CBD. Revision 1, carried out in 2000 subsequently differs from the original document. The original Masterplan, having served a vital function in guiding and initiating the development of the CBD, is in many respects a superseded document.

Landscape Units identified in the original Masterplan (refer *Appendix plan i1*) that have experienced significant development includes:

- Unit 1 (The Foreshore), which has been completed for The Esplanade Redevelopment and Cityport North project, with the Cityport South project to complete the unit works.
- The successful upgrading of the western end of Shields Street, along with the City Place and the eastern end of Shields Street, which has now set the tone for the strengthening and continuation of this link from Cairns Central to the Esplanade.
- The western edge of Unit 2 (the CBD Core) now contains the Cairns Central development,
- The southern portion of Unit 3 (CBD Frame) now contains the Cairns Convention Centre, and William McCormack Place (State Government Offices) with the remaining portions earmarked as a potential site for the Cairns Performing Arts Centre (otherwise known as CPAC) to complete this precinct.
- The relocation of the Cairns City Council necessitates physical linkage of the new chambers with the CBD via Spence Street.

Each of these developments has major implications with regard to the balance of the CBD. This can be illustrated by looking at completed projects (Shields Street, Cairns Central, Council Chambers, City Place, The Esplanade and Cityport North) and the impacts resulting from these developments. Similarly, the undeveloped projects (CPAC, Transit Hub & Cityport South) will have major impacts.

In addition to identifying the existing attributes of the CBD and using the positive aspects as the building blocks for the enhancement of the city's streetscape character, the potential impacts of proposed developments need to be addressed to ensure that the CBD remains as a vibrant entity. Streetscape development within the CBD should be guided, in principle, by this document.

The identified 'undeveloped' projects are of a scale and magnitude unprecedented in Cairns' history. They have the potential to affect the CBD to the same (or greater) magnitude as the Cairns Central development. In this respect the review of the CBD Landscape Masterplan is timely and significant. This Masterplan does not address Unit 1 as identified in the 1990 Masterplan.

The Esplanade Project and the Cityport Masterplan cover these areas. Although the Esplanade and Cityport precincts will promote and guide a great deal of the future developments adjacent these areas, this document focuses primarily on the remainder of the CBD and the development of guidelines that will bring the CBD and its surrounding influences together as a unified, readily identifiable entity.

## 1.2 Statement of Intent

The **Aim** of the Cairns CBD Streetscape Masterplan - is to provide a framework of design elements that:

- Promote the tropical character of Cairns as its key attribute,
- Develop a matrix of design elements that contribute to an integrated CBD streetscape, cognisant of the city's tropical context,
- Introduce and reinforce plantings in public areas to better promote the city's tropical image,
- Improve pedestrian amenity and visitor experience,
- Provide a safe public environment.

The **Key Landscape Objectives** as determined within the project brief are:

- To identify a suitable theme or themes that accurately portray the intrinsic character of the CBD or precincts within the CBD, respectively, and develop an integrated set of design principles and guidelines based on these themes.
- To address the following for each street or the streets within a precinct:
  - ~ Footpath pavement treatments,
  - ~ Footpath, verge and median tree species,
  - ~ Plant selection guidelines for mid-storey, understorey and groundcover species.
- To produce selection menus for each street or streets within a precinct addressing the following streetscape elements:
  - ~ Shade structures/awnings
  - ~ Bicycle racks
  - ~ Public seating
  - ~ Planter boxes
  - ~ Bins
  - ~ Tree protection (grilles and barriers)
  - ~ Lighting (street and footpath)
  - ~ Outdoor dining furniture (excluded)
  - ~ Street signage
  - ~ Flag / banner poles
  - ~ Bollards / barriers.
- To develop a colour palette as a guide for new works and refurbishment within the CBD built environment.
- To integrate public art into the CBD.
- To reinforce heritage elements of the CBD.
- To provide a seamless connection between the CBD and the Esplanade redevelopment and its associated themes.

*NOTE – It is recommended that this document is adopted by Council as a Planning Scheme Policy under Schedule 3 of the "Integrated Planning Act 1997", to support the implementation of the Cairns Plan.*

## 2.0 ANALYSIS

### 2.1 Description of the Study Area

---

*Figure a1* identifies the Study Area referred to as the Cairns CBD. The Study Area is bound by Florence Street to the north, the western footpath of The Esplanade to the east, the CBD side of the Wharf Street footpath to the south, and Bunda Street (east side of street) to the west.

The Study Area is flanked to the east by the Esplanade redevelopment site and to the east / south by the Cityport development. These two areas are not considered as part of the Study Area however some overlapping of the Study boundary occurs with Cityport. The successful linkage of these projects with the city centre is essential to ensure that these projects become an integral part of the CBD.

Study Area character units have been identified and are generally in accordance with Council's previously proposed Cairns City Centre Plan.

*Refer Figure a2*

#### Unit 1 Tourism

This area offers a wide range of infrastructure and facilities focusing on tourists and visitors. The area reinforces the traditional tourism role of the Esplanade and waterfront and contains hotels, retail activities, dining and takeaway food facilities and entertainment venues. High pedestrian use characterises this unit, and its current user focus has been heavily reinforced with the development of the Esplanade Lagoon and associated precincts, and the development and Cityport. The future development of Cityport South will further reinforce this focus on tourism. The eastern periphery of this unit is dominated by the presence of water, enhanced by the close proximity to the Esplanade waterfront, the Trinity Inlet and the Esplanade Lagoon.

#### Unit 2 Tourism Focus

This area is the dominant area of retail, business and pedestrian activity in the city. It is characterised by a high degree of street level interaction and activity.

#### Unit 3 CBD Frame

The CBD frame exists as two distinct areas, to the north and south of the Retail Core. These areas are characterised by a mixture of uses that are generally not of a retail nature. The northern frame acts as a transition zone between the more intense activity of the Retail Core and the predominantly residential / accommodation areas north of the CBD.

The southern frame area has undergone significant redevelopment in the past decade, transforming a generally derelict, industrial zone to an area characterised by a mix of commercial activities, government facilities and uses such as the Cairns Convention Centre. Significantly, the southern edge of this area will interface directly with Cityport South.

## 2.2 The Existing Situation

---

### 2.2.1 Overview

Key components identified in the 1990 CBD Landscape Masterplan have been implemented, including the planning for the redevelopment of the Esplanade as a key CBD precinct, the Cityport Masterplan which addresses the remaining waterfront areas, the consolidation of Shields Street as a major pedestrian boulevard and the redevelopment of Anzac Park. The Cairns Central shopping centre now occupies the old railway station site and defines the western edge of the CBD.

Cairns retains a positive tropical ambience primarily as a result of climate and a spectacular natural setting surrounded by water and rain forested hill slopes. This pervading presence of lush tropical vegetation and an air of relaxation further enhance the highly tropical 'flavour' of Cairns.

It could be said that the evolution of Cairns and the ensuing development has resulted, at least in part, in a fragmented character within the city centre.

In saying this, Council's Planning & Development department have placed considerable emphasis on the continuity of character elements required to achieve the primary aims of this document, when considering development applications involving streetscape upgrading and implementation within the CBD in recent years. Likewise, Council's Cairns Works section have carried out considerable works within the CBD and associated areas within the basic framework of the intent of this document.

This fragmented character, is partially the result of development that has occurred since 1990 which has placed pressure on the CBD to retain its traditional role as a key retail, commercial and entertainment centre. Significant development peripheral to the CBD and in Cairns' suburbs has resulted in a reduction in the use of the city for shopping which has subsequently affected the capacity for businesses in the CBD to sustain profitable trade. The role of the CBD as a retail centre however in recent years has been re-activated and renewed interest in the area is seen as a positive step towards achieving vibrancy and character once again.

Significant parts of the CBD are 'inactive' in that they are lacking the vitality and vibrancy that attractions, healthy businesses and people bring to a place. Importantly, the crucial contributing element to 'character' in the urban environment is people, and for the CBD to be vibrant, it must attract a diversity of users including residents and visitors.

Whilst improving the visual character of the city is both necessary and important to revitalisation, and a key focus of the masterplan, the encouragement of activity and greater use of the CBD is vital. In this respect, the Streetscape Masterplan can provide an improved environment for users in conjunction with the identification of elements that attract use. The integration of the Esplanade redevelopment and Cityport also becomes crucial.

This Masterplan is one element in a series of initiatives necessary to revitalize the Cairns CBD.

*Figure a3* illustrates general areas within the CBD that are characterised by similar current uses, pedestrian activity and vehicular traffic patterns. It should be noted that significant 'inactive' areas occur in the Retail Core.

In general, the CBD is characterized by a lack of integrated elements. A wide variety and variable quality of streetscape elements is found in surface treatments, furniture elements and plant types.

### 2.2.2 Key Issues

The following analysis focuses on the existing character of the CBD, as defined by a number of key factors, and sets the framework for the following sections of the Masterplan.

#### Entrances

---

##### *Issues*

- In conjunction with the clear articulation of the road hierarchy, the definition of city gateways is required. Entry points are currently not well defined and there is a limited sense of arrival or departure in the city. Existing cues in the form of land uses and buildings exist which identify the edges of the CBD, however these local 'landmarks' are generally not reinforced with landscape treatments and do not provide an obvious sense of entry to visitors.
- Primary city gateways occur at Mulgrave Road and Florence Streets, Kenny and Wharf Streets, and Spence Street. Secondary entry points include roundabouts on Florence Street at the Abbott and Lake Street intersections.
- In some instances, the definition of city entry points is constrained by current traffic arrangements, overhead wires and current land uses.

##### *Approach*

- Themed planting is preferred as the most practical method of defining entry points, creating strong 'entry corridors' into the CBD. Lighting, well-considered signage and banner poles should complement this treatment. The incorporation of structures is not recommended as such elements are likely to date.
- The Mulgrave Road and Florence Street entry requires carefully considered treatment as a result of recent development that dominates this important city gateway.
- Underground power supply should be implemented where possible to address and assist some of the issues outlined above.

#### Road Hierarchy

---

##### *Issues*

- The identified road hierarchy for the CBD consists of a system of sub-arterial roads and collector streets. Arterial roads (Sheridan, Bunda and Kenny Streets) direct traffic into and provide a by-pass around the CBD. The sub-arterial roads (Sheridan, Spence, Abbott, Wharf and Florence Street) provide access into and through the CBD. The remaining collector streets are essentially 'shopping streets' intended to provide a more intimate pedestrian environment where day-to-day CBD activities occur.
- Currently, this proposed road hierarchy is not reflected consistently in streetscape or associated road layout treatments.



### *Approach*

- In order to strengthen the identity of the city, the clear articulation of the road hierarchy is required through the rationalization of on-street car parking, improved planting and landscape treatment and accommodating pedestrian and bicycle uses appropriate to road classifications. The site-specific nature of individual streets needs to be accommodated in this rationalized approach. *Refer Figure a5.*

## **Dominance of Vehicles**

---

### *Issues*

Cars and car parking spaces continue to dominate the Cairns streetscape. This dominance of vehicles over pedestrians results in conflict with Cairns' relaxed tropical image. Traditional one-per-bay parking meters are a negative element, adding considerably to the unnecessary visual clutter in the city.

- The wide (40 metre) road reserves of the CBD are currently spatially inefficient and biased in favour of vehicles.

### *Approach*

- Strategies are required to reduce vehicle dominance whilst maintaining convenient parking access in the CBD. In order to establish a stronger tropical identity, more planting is required in the city centre at the expense of some car parking bays. The introduction of a more centralised parking metering system is recommended (currently being implemented).
- The generous dimensions of the road reserves offer the potential to create an environment where the pedestrian and landscape treatments are prominent and bicycles can be accommodated. A good, working example of this is the Shields Street Boulevard, which includes the redevelopment of the City Place, (implementation 1997 to 2001).

## **Pedestrian Hierarchy**

---

### *Issues*

- Pedestrian dominated areas coincide with (and help to create) the more vibrant areas of the CBD and respond to the activity nodes identified in *Figure a4*. Pedestrian activity is concentrated on the Shields Street axis and the Esplanade with parts of Abbott, Lake and Grafton Streets exhibiting a second tier of activity. Periodically, heavy pedestrian activity is experienced at Rusty's Market on market days and on parts of Lake, Shields, Spence (taxi ranks, dining and entertainment venues) and Grafton (cinemas) Streets and the Esplanade at night.
- Many areas experience minimal pedestrian activity after hours and on weekends.
- Intense pedestrian use on the Esplanade continues to create conflict with vehicles. Whilst adding greatly to the vibrancy of this area, the increase in outdoor dining on the esplanade has created further pedestrian congestion.

***Approach***

- Identify opportunities, through streetscape works, to promote pedestrian activity in the CBD.
- Current proposals to reduce vehicle dominance on the Esplanade (one-way northbound traffic) in conjunction with the Esplanade redevelopment are an attempt to alleviate pedestrian/vehicle conflicts. Designated pedestrian crossing points are essential as part of this remodelling of the roadway in order to provide safe pedestrian access and to physically connect the pedestrian network proposed on the Esplanade parklands with the CBD.
- The current Cityport Masterplan has allowed for a high degree of pedestrian permeability to provide good connections with the city centre. The creation of the Reef Fleet Square and Gateway Plaza will in themselves generate pedestrian activity, however it is also necessary to activate strong pedestrian pathways 'across town', between the Shields Street Boulevard and Cityport.

**Views**

---

***Issues***

Views of the surrounding forested hill slopes and glimpses of water and activities associated with the port contribute positively to the character of the city.

***Approach***

The retention of these views (to the south) has been accommodated in the Cityport Masterplan and should be maintained throughout the CBD where possible.

**Vacant Land**

---

***Issues***

- Whilst some derelict / industrial land has been in-filled, particularly in the southern frame area, vacant land and idle infrastructure exist in the Retail Core, particularly the former library site, former Coles supermarket site and land in the southern portion of Sheridan Street. The inactive and often unkempt nature of such sites has a strong negative impact on the city image.

***Approach***

- Consideration should be given to the temporary landscape treatment of long-term vacant sites (turfing and tree planting) to improve this situation. Such basic approaches work well in other cities and provide attractive, albeit temporary green space in lieu of empty, detracting lots. They can also be the location for temporary art installations.

**Inactive Frontages**

---

***Issues***

- Recent development has resulted in an increase in vacant buildings and shops in the CBD. This situation is prevalent in the northwest portion of the Retail Core between Shields and Aplin Streets.

***Approach***

- Planning strategies to encourage appropriate changes in land use, to encourage more residential development in the CBD has the potential to partially address this issue whilst preserving the integrity of the remaining vibrant (active) areas of the city.
- In conjunction with planning strategies, temporarily vacant shop fronts can become a place for the introduction of public artworks to enliven otherwise inactive sites.

**Existing Landscape Treatments**

---

***Issues***

- The 1990 Landscape Masterplan prescribed a street tree matrix for the CBD. Despite development that has responded to this matrix, the streets in the city do not present a coordinated green image. Inappropriate planting locations and in some cases questionable selections have resulted in some poorly performed species, contributing to a disparate image.
- Inappropriate planting situations, which do not provide an adequate growing environment, continue to prevail. In combination, the lack of vigour in some plantings could be attributed to an inadequate level of maintenance. Attempts to grow inappropriate species on the edge of footpaths below awnings also contribute to the poor presentation of vegetation in some locations.
- A relatively small palette of species dominates existing understorey planting in the city. Hedged species are particularly predominant.

***Approach***

- In general, the provision of optimal growing conditions, appropriate plant selections and vigorous maintenance is required as a minimum prerequisite for healthy plants and a lush tropical character.
- As is the case in renowned garden cities such as Singapore, a culture should be fostered whereby the natural elements of the city landscape (plantings) are regarded as being the central constraint around which engineering requirements are made to fit.
- Plant selections should respond to the requirements of CPTED (Crime Prevention Through Environmental Design) and existing plantings require case-by-case analysis to progressively upgrade garden areas.
- Greater variation is required in the understorey palette to avoid repetition and add variety.
- Understorey species should be selected and located to minimise the need for continued hedging which is incongruous with a flamboyant tropical image and creates considerable maintenance. Hedging should only occur to maintain sight lines at intersections.

**Level Changes**

---

***Issues***

Recent developments have incorporated amended footpath levels in response to flood level and drainage investigations in the CBD. The ramifications of these requirements are significant, resulting in steps, ramps and balustrades on footpaths. Of particular concern is

the impact on clear pedestrian flows, disabled access and infill development that responds to these requirements, resulting in disjointed footpath treatments, with varying longitudinal and cross falls on footpaths.

- This situation is further complicated due to the random nature of development. In other words, the practical adjustment in footpath levels can only occur with development that involves significant street frontage. Minor redevelopment that responds to amended floor level requirements will only impact on a small area of street frontage. Amendment in footpath levels is not possible (or practical) in such situations.

#### ***Approach***

- Clear guidelines are required from Council to address this situation.

Ideally, it is best to deal with the issue of disabled and pedestrian access within the boundary of a new or refurbished development, rather than raise the level of the entire footpath to meet newly imposed flood-immunity building levels. Steps inside the entrance of the building combined with the use of ramps or lifts to meet mandatory all-mobility access requirements should be used where possible and such measures investigated fully before alternative options are explored.

Alternative designs, such as the increase in kerb heights, and therefore footpath surface levels are not desired by Council as the preferred method of treatment.

*NOTE – Make References to Council's current Policy on this issue prior to on-street works design, and other current related guidelines.*

## **City Place**

---

#### ***Issues***

- The upgrade of the City Place carried out in 2001/2002 again defined the area as a key node within the city's CBD and although somewhat controversial, the elements comprising the new-look City place continue to attract large numbers of locals and visitors to the city heart.

#### ***Approach***

- City Place redevelopment will not be fully complete without the extension in Lake Street (north) completed as planned. This area incorporates the existing sound shell and needs to be improved or replaced in keeping with the remaining works recently carried out in the City Place.

## Activity Spaces

---

### *Issues*

Anzac Park, City Place, and the City Library currently provide a significant public open space recreation resource within the CBD, with Fogarty Park, the Esplanade Lagoon and Munro Martin Park on the peripheries.

### *Approach*

Treatment of the city streets needs to take into consideration the provision of 'special use zones' to increase the amount of viable open space in the city, thus providing the opportunity for on-street activities such as outdoor dining, passive recreation like chatting and meeting, busking and so on, to occur and contribute to the character and overall ambience of the city.

## Street Furniture and Surface Treatments

---

### *Issues*

- Street furniture in the city is generally not coordinated and of varying type and quality. In most streets, the location of street furniture appears to be ad-hoc. Seating is generally not logically placed. Paving is also variable, providing a mixture of surfaces, patterns and colours which do not combine together to provide a coordinated, high quality city image.

### *Approach*

- A coordinated approach to all furniture elements is required on a citywide and per area basis.

## Maintenance

---

### *Issues*

- Maintenance is a key issue in the city and the importance of effective maintenance cannot be underestimated. All streetscape elements, hard and soft, require a program of focused maintenance to ensure longevity and health (*Example - Shields Street Maintenance Manual prepared by Siteplan for CCC in 2001*).
- Capital expenditure to improve streetscape quality is pointless without an appropriate commitment to maintenance. Whilst our tropical climate exposes streetscape elements to specific problems such as mould growth, it is a positive contributing factor in terms of allowing spectacularly fast plant growth and the unique tropical atmosphere of Cairns.

### *Approach*

- The effects of our environment are inevitable, however with appropriate maintenance they should not detract from the city image. Effective maintenance programs are required.

## Safety

---

### *Issues*

- A feeling of safety is vital in the city area to encourage use at all times.

### *Approach*

- In conjunction with the existing video surveillance systems, good lighting, clear sight lines and streets which promote activity combine to create a safer environment, as has been found in the recently upgraded areas of Shields Street, the City Place and the Esplanade Lagoon.

## Orientation & Wayfinding

---

### *Issues*

- Cairns' position as a major tourism destination demands appropriate signage and information systems to provide clear direction and information to users.

### *Approach*

- To ensure that Cairns maintains its current status as a growing, vibrant regional tropical city littered with destinations for all to enjoy, it is critical that orientation and way finding strategies and the associated signage facilities are developed and implemented throughout the city areas. Refer also Page 42.

## Weather Protection

---

### *Issues*

- The areas of generally continuous awnings in the CBD coincide with areas of heavy pedestrian use. Within these areas, however, some openings occur at driveways and between properties. Refer *Appendix C, Plan i2*.

### *Approach*

- Considering Cairns tropical climate, continuous awnings are necessary and where practical, their provision and the infilling of open areas will provide a significant benefit to the pedestrian experience in the city.

### 2.3 Esplanade and Cityport Interface

---

As discussed, the Esplanade and Cityport projects represent two of the most significant developments to occur in Cairns. Their effect is potentially of great benefit to the CBD. These two projects themselves have a significant interface, which has been addressed in the planning for both projects. Refer *Figure a6*.

#### The Esplanade

The Esplanade project, in its entirety, covers the area between Shields and Minnie Streets. Direct interface with the study area occurs at the Shields Street intersection, at various points along the Esplanade in the form of pedestrian crossings and at the RSL building on the corner of Florence Street. The mix of uses proposed for the project will complement the CBD by enhancing the recreation experience of this foreshore area.

The proposed layout of the Esplanade parkland includes a variety of strong pedestrian and bicycle paths north south along the Esplanade. The Shields Street pedestrian boulevard provides a strong connection from the city centre into the site and is a future link with Cityport. Proposed linkages across Fogarty Park and at the waters edge further enhance the strong connections between the Esplanade and Cityport.

The boundary of the project should not be seen as the eastern kerb line of the Esplanade. Strong physical connection with the western footpath of the Esplanade is necessary in the form of pedestrian pathways crossing the roadway, providing safe, legible access. This treatment is not only required to physically and visually tie the Esplanade parkland to the adjacent edge of the CBD, but to address the continued unsafe traffic and pedestrian conflict in the area. Whilst a one-way north traffic flow is proposed between Shields and Florence Streets, pedestrian conflict with moving and parked vehicles will remain.

In addition, the surface treatment at the intersection of Shields Street and the Esplanade (a major interface with the CBD) should continue across the road to avoid this prominent space being divided by a road. It should be noted that these linkages were proposed in the development of the Esplanade concepts but have not been included in stage one works.

#### Cityport

The continued redevelopment of Cityport South following the success of Cityport North is expected to occur over the next several years due to the scale of redevelopment proposed. The project aims to redevelop the Cairns wharf and associated waterfront areas into a series of well-planned, tourism and operational seaport precincts, which integrate with the CBD and reinvigorates the waterfront – a key attribute of the city. The ongoing redevelopment of the CBD streets (especially the southern ones) to accompany this is a key in providing the required links.

Key planning principles include:

- The extension of Shields Street into a pedestrian boulevard linking Cityport and the CBD (completed)
- Adopting Spence Street as the major vehicular access street, extending it to the waterfront (completed)

- Creating a waterfront square - The Reef Fleet Plaza - between the extended Spence Street and the Shangri La Hotel (completed)
- Linking this plaza to the Esplanade by redesigning Fogarty Park (completed)
- Forming view access corridors between the city centre and the water along Abbott, Grafton and Lake Streets,
- Connecting the CBD and Cityport via Shields, Spence, Abbott and Lake Streets,
- Increasing permeability with pedestrian linkages through the site,
- Creating a 'Gateway Plaza' at the southern end of Cityport,
- Providing a continuous promenade along the water frontage,
- Transforming Wharf Street into a boulevard of world class standard, a continuous linear spine recognisable as the major interface with the city centre.

Cityport South is proposed to include a mix of commercial, retail, accommodation and recreation facilities. Cityport will physically improve access from the CBD to the water. The Masterplan aims to ensure that Cityport, like the Esplanade is well connected to the city centre in terms of streetscape elements, and is seen as a precinct within the greater CBD.

#### 2.4 Significant Vegetation to be Retained

---

*Figure a7* identifies vegetation within the CBD that should be retained on the basis of the following attributes:

- Contribution to the character and amenity of the street,
- Rarity,
- Special interest (e.g. flowering, form, bird attracting),
- Historic value,
- Conformity with the revised plant palette for the CBD,
- Longevity and cyclone resistance.

Whilst many of these specimens do not conform to the proposed tree palette for the city, it is common-sense to retain them not only for their inherent characteristics, but to provide points of interest in the street. It is envisaged that the retained vegetation will fit within the framework of the revised tree palette. In some cases, existing species have provided the cue for the specification of special intersection treatments.

With ongoing redevelopment of the CBD streets, engineering works associated with the adjustment of road and median widths may affect some specimens. In such cases, the trees identified should be assessed on a case-by-case basis and the necessary adjustments made to road alignments, where possible, or to determine their suitability for relocation.

Note: *Figure a7* and the accompanying list (*Refer Appendix C, Plan i3*) are not exhaustive.



### 3.0 A VISION FOR THE CAIRNS CBD

#### 3.1 Intent

The Cairns CBD should be vibrant and rich in character, reflecting the lifestyle of Cairns. It should express a strong botanical focus which provides a framework for streetscape elements that provide interest and comfort and which promote activity. It should be welcoming, easy to move around in and safe.

The Masterplan presents a long-term vision. The framework that it sets in place has the potential to serve the city well into the future. Trees that are planted today should be done so with a long term view they will become signature elements of the city. The Masterplan aims to identify and promote a distinctive character for the city by introducing a number of changes to the streetscape of the city. These treatments focus on addressing the following key issues:

##### **Improving Pedestrian Amenity and Creating Activity Spaces**

Widening footpaths, coordinating street furniture, improving facilities, promoting covered links and providing flexible spaces that promote street activity.

##### **Promoting Strong Linkages**

Ensuring strong links with the Esplanade redevelopment and Cityport at key locations and through elements of the streetscape.

##### **Developing Key Activity Nodes**

Identifying major people places and reinforcing strong links between these activity nodes to promote movement through the CBD.

##### **Improving Legibility**

Using elements of the streetscape to provide a high level of legibility and an identifiable character in the city.

##### **Creating Permeability**

Using mid block crossings to pedestrianise streets, link with arcades and provide special use zones on footpaths.

##### **Introducing Botanical Diversity**

Within a strong grid of signature street trees, introduce a broad palette of plant material to reflect Cairns' unique tropical setting with a particular emphasis on shade trees.

##### **Providing Variety**

Within a strong framework of streetscape elements, express a diversity and variety of elements that avoids blandness and repetition.

##### **Promoting Cultural Richness**

Recognizing a wide range of public art as significant focus of the city.

##### **Interpreting Heritage**

Promoting the recognition and interpretation of our cultures and history.

##### **Improving Safety**

Through design that recognises CPTED principles, improve safety.

*Figures v1 and v2* diagrammatically identify the key components of the Masterplan.

Note: Make reference to the *Cairns Style* document for more information regarding the future design principles to be adopted by the City.

## 3.2 Key Proposals

---

### 3.2.1 CBD Precincts

The study has identified the following precincts. Whilst the majority contain existing unifying elements, others have been created to fulfil specific objectives.

The intent of the Masterplan is that each of these precincts should display a subtle yet unique character within a framework of streetscape elements common to the whole CBD. In this way, diversity is provided without losing a coherent identity for the city. The precincts have been derived from an analysis of existing character, natural boundaries, and current uses.

The precincts, as illustrated in *Figure v1*, include:

1. CITY PLACE
2. THE REGIONAL ART GALLERY
3. THE CITY LIBRARY
4. THE SHIELDS STREET BOULEVARD
5. THE LAKE STREET WATER BOULEVARD \*
6. THE GOVERNMENT / CIVIC PRECINCT
7. THE GRAFTON STREET MARKET PRECINCT\*
8. THE ABBOTT STREET HISTORIC PRECINCT\*
9. THE WHARF STREET MARITIME PRECINCT

These precincts combine with the Esplanade and Cityport precincts to provide the opportunity for the expression of a broad range of themes within the city centre.

It should be noted that not all areas within the CBD fall within a precinct as such. It is proposed to enliven the character of such areas predominantly through unifying paving treatments, street plantings, furnishings and improving safety through design.

The proposed function and character of each precinct is described in the following Section 3.2.2.

\* Denotes precincts identified as reliant on specific art projects for the expression of their character.

## Precinct Descriptions

### 1. CITY PLACE

City Place fulfils a role as the perceived 'City Heart' of Cairns.

#### **Key Functions**

- A meeting and socializing place,
- A place for community gatherings,
- The hub of the Cairns retail core,
- The key node on the Shields / Lake Street axes,
- A public venue retaining flexible performance space, suitable for the staging of special events,
- A theatre.

#### **Key Elements and Character**

- A feeling of safety, achieved by removing clutter and opening sight lines to reinstate views along Shields and Lake Streets and to showcase surrounding buildings, and improving lighting,
- Flexible performance space,
- Weather protection, particularly as covered links between building awnings,
- Activity spaces and elements to attract different age groups,
- A unique botanical focus,
- Water feature(s),
- A park-like atmosphere incorporating both soft and hard landscape elements.

### 2. THE REGIONAL ART GALLERY PRECINCT

A small, yet key cultural precinct dominated by the Art Gallery building.

#### **Key Functions**

- A public space reflecting the use and role of the Regional Art Gallery,
- A signature art location reinforcing the role of Shields Street and the connection of the Esplanade to the city centre.

#### **Key Elements and Character**

- Improved pedestrian amenity on surrounding footpaths including shade tree(s) and seating,
- Pavement treatment to enhance the precinct character,
- Signature public artworks.

### **3. THE CITY LIBRARY PRECINCT**

The recent completion of this project has resulted in the successful creation of a small CBD precinct.

#### **Key Functions**

- A public park designed as a useable, yet appropriate setting for an important civic building,
- A civic space with landscape elements reflecting current and past uses.

#### **Key Elements and Character**

- A place for public art appropriate to the setting,
- Botanical diversity through retention of existing trees and additional plantings of interest,
- A highly accessible space that invites passive recreation, games and use by passers-by.

### **4. THE SHIELDS STREET PROMENADE**

A significant and lively pedestrian artery, Shields Street was the traditional link between the town and the Cairns railway station. This boulevard retains this important linking function, connecting the CBD with the Esplanade and Cairns Central.

#### **Key Functions**

- A connecting, tree lined boulevard,
- The key link between the Esplanade and City Place.
- The upgraded portion of Shields Street has developed a strong character as a dining precinct, dominated by historic pubs, restaurants and outdoor dining whilst retaining some traditional retail and commercial uses.

#### **Key Elements and Character**

- A continuation of the Shields Street theme,
- Widened footpaths to promote of a continuation of outdoor dining,
- A signature public art spine between City Place and the Esplanade.

### **5. THE ABBOTT STREET HISTORIC PRECINCT**

Abbott Street has historically played a key role in the evolution of Cairns as part of the traditional business centre. The street and peripheral areas (Wharf and Spence Streets) retain some historic buildings.

*(Refer Appendix i4).*

#### **Key Functions**

- Abbott Street, in conjunction with Lake Street has the potential to provide a strong link between the city centre and the port.

#### **Key Elements and Character**

- The key element of this precinct is the interpretation of the history of Cairns and our cultural heritage through one or more distinctive public art projects.

- Whilst it is not intended that references to our heritage be confined to this location, it is proposed that this precinct is the focal area for the expression of history and culture through elements such as signage and public art.

## **6. THE LAKE STREET WATER PROMENADE**

### **Key Functions**

- A key link between the CBD, the Inlet and Cityport,
- Through the use of a strong 'people attracting' element, encourage pedestrian activity 'across' the CBD.

### **Key Elements and Character**

- A promenade characterised by elements based on the theme of water, incorporating actual water features/public artworks extending from Aplin Street through to Wharf Street.
- It is envisaged that the Water Promenade will become a feature of the CBD culminating in key water features at City Place and The Gateway Plaza.
- The use of feature lighting along Water Promenade will enhance the character of this precinct, which is an active pedestrian zone at night.
- Water elements along the street may range from small in scale to key features, to those that are based on the theme but do not actually incorporate water, to functional water elements and so on.

## **7. THE GOVERNMENT / CIVIC PRECINCT**

### **Key Functions**

- Located on the edge of the CBD, this area is also an important gateway into the city.
- Uses and buildings of a Government and civic character and grand scale (the Law Courts, Cairns Convention Centre) dominate this precinct, with the proposed Performing Arts Centre likely to strengthen this character.

### **Key Elements and Character**

- Streetscape elements reflective of the scale and character of the precinct such as large growing, signature tree plantings.
- Pedestrian amenity of an appropriate scale to accommodate large numbers of day and night-time users in an environment similar to the George Street QUT precinct in Brisbane.

## **8. THE GRAFTON STREET MARKET PRECINCT**

Formerly Sachs Street, this area has a rich history and a continued rich mix of international diversity and uses, retaining a 'fringe' atmosphere. Rusty's Market, a major contributing element to the character of this area is a vital melting pot in the city for residents and visitors.

### **Key Functions**

- A vibrant shopping and market area characterised by a diversity of smaller traders and businesses. This diversity is reflected in a variety of architectural styles.

**Key Elements and Character**

- It is proposed that the character of this precinct is expressed through a major art project,
- The key themes of the art projects are the location's Chinese heritage, 'red light' notoriety, and the cultural diversity and produce unique to the markets. These aspects are also reflected in themed street plantings.

**9. THE WHARF STREET MARITIME PRECINCT****Key Functions**

- Wharf Street is identified as a continuous spine recognizable as the major interface between the city centre and Cityport.
- A continuous awning, shops and cafes are proposed along the Cityport edge of Wharf Street to generate a strong commercial and leisure character.

**Key Elements and Character**

- To complement this linear character a strong, tree lined boulevard is proposed.
- The incorporation of integrated artwork based on the theme of the port and its importance in the development of Cairns.

## 3.2.2 Key Nodes

Key Nodes include the Reef Fleet Square, Gateway Plaza, Shields Street Plaza, Spence Street Plaza, and City Place.

Each site is characterised as a pedestrian dominated zone. With the exception of City Place and to an extent the Spence Street Plaza, the Key Nodes are contained within the Esplanade and Cityport project areas.

Reef Fleet Square and Gateway Plaza are described in the Cityport Masterplan as follows:

*"Reef Fleet Square* replaces the existing coach terminal. This space, to be shared with reef fleet service vehicles in mornings and evenings, is conceived as Cityport's major public focus and as a grand waterfront plaza in the spirit of great waterfronts around the world. It acts as a gathering space for reef fleet users, as a node from the waterfront to the Esplanade and as the major plaza along the waterfront promenade."

"A triangular zone between White's Shed and the Lake Street view corridor (at the southern end of Lake Street) forms a Cityport *Gateway Plaza*. This space is intended to act as a 'gateway' at Cityport's southern end and to link future development across Wharf Street to the waterfront.

A pedestrian link is extended off this square into the existing Port Authority site to the Convention Centre. Grafton Street between Hartley and Wharf Streets is proposed to become a high quality pedestrian mall and forecourt to the Convention Centre." *Refer Figure v3*

The **Shields Street Plaza** is a key interface zone between the city centre and the redeveloped Esplanade. This site is a key node on the extended Shields Street axis which connects the CBD and Cityport. It is the transition point between the shared activity zone of Shields Street and the pedestrian-only Shields Street Promenade. It is a key node and intersection point, a nexus of the north-south pedestrian and cycle network, the intersection of access paths leading to the Reef Fleet Square and the facilities of the Esplanade Lagoon.

This space has been designed as a flexible pedestrian plaza dominated by a strong grid of plantings and signature public artwork.

**Figure v3 and v4** reiterates the important requirement to physically connect this space with Shields Street.

The **Spence Street Plaza** represents a key transition point between the CBD and surrounding parkland areas. Spence Street's revised role as a key vehicular access corridor into Cityport is likely to result in a subsequent increase in pedestrian activity. The proposed function of the re-opened section of Spence Street as a bus lay-by zone will result in intense bus activity at morning and evening peak times. For the remainder of the day, however, the opportunity exists for this zone to express a strong, pedestrian-oriented feel. It is essential that the character of this area has a pedestrian focus rather than the feel of an empty parking lot. **Figure v5** identifies the key design elements considered necessary to create a pedestrian friendly character for this area.

**City Place** has been identified as an important pedestrian node in the CBD. It is proposed that the design of City Place reinforces a distinctive precinct character. (Refer 3.2.1). **Figure v6** identifies the key design elements of a revision of this important node.

### 3.2.3 Focal Areas

Focal Areas present a second layer of activity nodes in the CBD and have been proposed to serve a variety of functions. Their predominant role is to create opportunities in pedestrian areas for a variety of activities to occur. Focal Areas are located at mid-block crossings and at street corners.

#### **Street Corners**

Street corner focal areas result from a widening of footpaths and optimize the area available for pedestrian activities to occur without impacting on traffic requirements.

Spatially, the configuration of pedestrian space on street corners will vary dependant on the designation of the intersecting streets, e.g.

- Collector/Collector
- Collector/Sub-Arterial
- Sub-Arterial/Sub-Arterial.

Generally, however footpaths can be widened to approximately 12 metres at these locations.

Street corner focal areas are reinforced in the Planting Strategy, which proposes intersections (corners) as a key location for the presentation of feature planting, creating further variety in the landscape.

Along with a range of other potential activities, street corners are key orientation points in the city and as such are logical locations for information signage and street maps to be displayed.

### **Mid-Block Crossings**

Mid-block crossings are proposed on some Collector Streets and Abbott Street. These typical blocks of 200 metres in length in general currently lack focal points. Mid-block crossings are aimed at addressing this lack of interest and providing a safe point of crossing in these longer city blocks. They also take advantage of widened footpaths to create special activity zones for a range of activities, including:

- Outdoor dining,
- Performance,
- Public utilities (telephones, parking ticket vending machines),
- Seating,
- Information signage,
- Bicycle parking.

It is proposed to carry paving treatments across the street and to further emphasise crossing points with a small structure in the median location. These structures are intended to provide a brief respite for pedestrians from the weather and to provide the opportunity to introduce trellis structures into the city to display flowering tropical climbing plants. Seating is not provided at this location for safety reasons.

Similar small trellis structures could be located on footpath areas to reinforce the presence of this horizontal plane of planting. Trellises are also encouraged in City Place.

Mid-block crossings already exist in the CBD at Abbott Street and have previously existed in Lake Street and the northern section and Abbott Street.

The precise location of this element is dependant upon the street layout, the nature and configuration of adjacent frontages and importantly, the location of existing arcades to promote logical pedestrian connections.

The principal of crossings points as key streetscape elements directly applies to The Esplanade where it is vital that crossing points from the active retail/commercial edge connect with the proposed Esplanade pathway network.



### 3.2.4 Gateways

The treatment of key gateways is required to improve the identity of the CBD. It is proposed that treatments are coordinated and consist of elements of a timeless quality to avoid the reliance on structures that may date.

Planting is proposed as the key component of entry treatment. In order for a distinctive entry message to be conveyed however, it is proposed that planting is not confined to an isolated 'planting feature', but consists of a well-structured entrance sequence. Such an approach has been partially implemented at the Kenny Street entrance to the CBD. It is proposed to combine plantings with feature lighting and signage elements that may incorporate banner poles.

Entry corridors vary greatly in character and traffic configurations generally constrain treatment opportunities. Refer *Figure v6*.

Entry points occur at 'secondary' locations, (roundabouts);

- Florence and Abbott, Florence and Lake Streets and at 'primary' locations,
- Sheridan Street,
- Mulgrave Road,
- Spence Street,
- Kenny / Wharf Street.

## 4.0 DESIGN STRATEGY DESCRIPTION

The DESIGN STRATEGY describes the following elements of the Masterplan in detail.

- PLANTING STRATEGY
- PAVEMENT STRATEGY
- FURNITURE STRATEGY
- WATER FEATURES
- ORIENTATION IN THE CBD
- INTERPRETATION
- PUBLIC ART
- CITY ENTRANCE TREATMENTS
- BUILT FORM IN THE CBD

### 4.1 Planting Strategy

---

#### 4.1.1 Components

The Planting Strategy consists of three distinctive components:

- Street Trees
- Intersection Treatments
- Understorey

#### ***Street Trees***

The street tree palette includes:

- Signature species for medians, verges and footpaths for all streets,

#### ***Intersection Treatments***

- Identify focal species to provide diversity and points of interest at all intersections.

#### ***Understorey Planting***

- Proposes dominant understorey species for medians, verges and footpaths for all streets, intersections, and mid-block crossings.

**NOTE:** A list of all common names and individual plant characteristics has been included in ***Appendix i5***.

#### 4.1.2 Street Plantings

Planting in the CBD is the single element that has the ability to contribute most effectively to a unique and recognizable tropical identity for the city. As such, it is a major component of the Masterplan.

In accordance with the objectives of the Cairns CBD Revitalisation Project, the City should express:

- A powerful grid of CBD streets,
- Tropical ambience and a celebration of the location of the city,
- Tropical vegetation characteristic of the city being predominant in the CBD.

The Flecker Botanic Gardens is widely respected for its collection and accompanying tropical ambience. It is intended that the CBD Planting Strategy will reflect this character in the city streets.

Improved street plantings will reduce the perceived dominance of vehicles in the CBD without taking away the convenience of on-street car parking. As noted in the 1990 Masterplan

“While adequate car circulation and parking is necessary, it should not be allowed to dominate the pedestrian in Cairns.”

It is proposed to increase the opportunities for street plantings by designating typical median, verge, footpath and corner planters. In addition to providing shade, softening architectural forms and improving the visual quality of the streets, these measures will reinforce an identifiable character for Cairns. It is acknowledged that this street revitalization will result in a reduction of parking spaces across the CBD.

It should be noted, however, that the CBD Road Hierarchy Alternative Treatments report (Flanagan Consulting Group, July 1998, reference 98128\PFKF2312) identifies a potential reduction of approximately 820 spaces across the CBD with the ultimate implementation of its recommendations.

The typical spacing and sizes of proposed planters are as follows:

TYPE	COLLECTOR	SUB ARTERIAL
Median Planter	25m centres	Continuous, trees @ 12m centres
Verge Planters	every 5 carparks, 6m wide	every 6 carparks, 3m wide
Footpath Planter	12m ccs	25m ccs

*Figures s1-s5* illustrates typical street layouts and planter configurations.

Key issues including irrigation, maintenance and plant procurement are addressed in **Section 6.0**.

The 1990 Landscape Masterplan Street Tree Matrix and the Cityport Masterplan have been referred to in the compilation of the revised tree palette. Several other factors have influenced the selection of species including the CBD Revitalisation vision statement; a greatly increased range of suitable species being available, and analysis of the damage resulting from cyclones on species previously relied upon for their ‘signature’ qualities.

#### 4.1.3 Selection Criteria

Species have been selected based on the following criteria with the overriding intent of creating a memorable tropical ambience in the city centre.

- Growth habit and growth rate
- Storm resistance,
- Flowering habit,
- Perfume,
- Maintenance requirements,
- Compatibility and coordination with existing suitable vegetation,
- CPTED principles.

#### 4.1.4 Themes

Different tree themes have been derived for each street in the CBD. This grid of trees overlays the entire city to provide a cohesive tropical character. Themes have been derived from suitable existing dominant vegetation, precinct themes and to provide a coherent yet diverse character across the city centre.

##### ***Street Tree Themes ~ Signature Species***

North – South Streets	Theme
▪ Abbott Street	Pink flowering, yellow foliage
▪ Lake Street	Weeping form (water related), purple and burgundy
▪ Grafton Street	Perfumed, Chinese heritage, red flowering
▪ Sheridan Street	Large scale, upright form, highly tolerant
▪ McLeod Street	Orange and pink flowering
East – West Streets	Theme
▪ Florence Street	Red flowering
▪ Aplin Street	Yellow flowering
▪ Shields Street	Orange flowering
▪ Spence Street	White flowering
▪ Wharf Street	Coastal

#### 4.1.5 Intersection Treatments

Intersections have received distinctive treatment to create focal planting areas. These locations also provide the opportunity to feature palm species that are a vital element in showcasing a tropical character.

Species have been selected to complement street tree themes, to accommodate suitable existing vegetation, and to provide diversity.

In some situations, where widened footpaths / reconfigured kerb lines conflict with the location of existing species, specimens are to be assessed on a case by case basis, with sufficient lead time to allow transplanting if required.

Refer also Section 2.4 SIGNIFICANT VEGETATION TO BE RETAINED.

#### 4.1.6 Understorey Plantings

It is important that planting works in the CBD are undertaken in a coordinated manner. The understorey and groundcover layer provides the opportunity to provide a high level of quality in the detail planting in the city, adding sensory variety particularly at crossing points and in areas of heavy pedestrian use.

The Dominant Understorey matrix has been provided as a guide to the selection of low level planting at medians, verges, corners and mid block crossings. Species have been selected for their hardiness, appropriateness to themes, on the basis of attributes such as flowering, perfume and CPTED compatibility.

The selections are provided as a guide only.

## 4.2 Pavement Strategy

---

### 4.2.1 Intent

The proposed surface treatment of pedestrian areas has been devised to provide a system that is of an appropriate standard suitable for the Cairns CBD, which adds to the character of the city centre. The Paving Strategy seeks to identify a coordinated paving system which:

- Coordinates the city streets so that individual properties benefit from a shared and recognizable identity,
- Provides the opportunity for subtle variations within the prescribed paving palette to provide interest,
- Eliminates inappropriate and incongruous surface treatments thus improving the quality of the CBD streetscape,
- Recognises all public areas as part of a larger whole rather than discreet entities.

The objective is to provide the CBD with a uniform, versatile and durable paving material.

### 4.2.2 Background

Since the late 1980's, red clay paving has been prescribed as the preferred pedestrian paving system for footpath areas in the CBD. This widespread use of a single colour clay paving has been revised in consideration of difficulties with consistency in supply, lack of recognizable variations in patterns, longevity and product quality which has resulted in footpaths characterized by non-matching unit sizes, abrasion, chipping, breakages and variations in colour.

### 4.2.3 A Unifying Element

Streetscape re-development within the CBD is imminent and the linking of various precincts is a major objective of this Masterplan. One of the means to achieve such unification is the installation of a distinct paving treatment throughout the city and although the paving design for the footpath areas throughout the CBD varies, one paving type will occur typically in most CBD streets.

### 4.2.4 Footpath Treatments

As well as acting as a pedestrian thoroughfare, the CBD footpath areas fulfil a range of important urban functions. Some activities require a dedicated space within the footpath area whilst others take place randomly. Certain activities occur typically in certain streets, some activities take place in specific locations within each street.

To emphasize the spatial differentiation of footpath functions an informal structure has been proposed for footpaths, by using contrasting paving materials and patterns. This patterning is also aimed at reflecting the organic forms of the surrounding hill slopes and ocean, and is appropriate to the relaxed ambience of the city. The use of contrasting material identifies thoroughfare zones, furniture and special use zones, nodes and crossing points.

Footpath treatments respond to the proposed reorganization of the elements within the road reserve areas. Two distinct footpath configurations result from the articulation of sub-arterial roads and collector streets, in accordance with current Council Road Traffic Hierarchy documents.

The proposed typical layouts (footpath treatments) of these types of streets reflect their intended functions. Refer *Figure v2*.

The footpath widths that result, after considering traffic and bicycle lanes, manoeuvring space and median plantings are 4.9m for Sub-arterial streets (no change) and 6.2m for Collector streets (previously 4.9m). Considerable space is also gained on all street corners.

#### 4.2.5 Description of Paving Types

The following identifies paving types proposed for the CBD.

### **Material Specification**

---

#### **Honed Concrete Units**

The units (400 x 400mm) are of a scale appropriate to the urban environment and can be replaced unobtrusively. Concrete units of this size provide an even pedestrian surface and when laid over concrete bases are appropriate for vehicular crossovers and delivery bay locations.

A honed finish to the pavers further enhances textural variation by exposing aggregates.

<b>Size:</b>	400mm x 400mm x 60mm (or 40mm in pedestrian areas) ( $\pm 2$ mm) angles no greater than 90°. Reduced thickness will be considered in certain circumstances and on the basis of compliance with other requirements. Banding and edge pavers 200 X 200mm x 60mm ( $\pm 2$ mm).
<b>Strength:</b>	Compressive strength: 40Mpa (28 days). Transverse strength: min. 2Mpa.
<b>Surface:</b>	Honed and or Shot Blasted (in some cases). Flat surface ( $\pm 2$ mm, measured between corners, including diagonals). Slip resistance (in accordance with AS 3661.1). Minimum coefficient of friction = 0.47 subject to max. 5% slope, Preferred coefficient of friction = 0.56 subject to max 12% slope.
<b>Abrasion:</b>	Maximum characteristic abrasion resistance: 3.5cm <sup>3</sup> .
<b>Colour:</b>	Comply with BS 1014 Pigments for Portland Cement & Cement Products. Pigmentation shall be uniform through the full depth of each paving unit. Proposed colours <b>to be approved by Council officers</b> .
<b>Chamfer:</b>	5-8mm arris.
<b>Cement:</b>	Comply with AS 3972-1991 Portland and Blended Cements.
<b>Aggregate:</b>	Comply with AS 2758.1 – 1985 Concrete Aggregates. Surface aggregate shall be uniform through the full depth of each paving unit. Aggregate type, size and colour.
<b>Admixtures:</b>	Comply with AS 1478 – 1992 Chemical Admixtures for Concrete.

**Installation:** Banding and panels as shown (refer Figures.)  
 Paving body (panels) in running bond (across footpath).  
 (Typical): Pavers to be laid on compacted sub base, min. 150mm compacted base course, 30 mm screeded sand bed.  
 Where vehicle access can be expected, installation of pavers is required to be on mortar bed on min. 150mm thickness F72 reinforced concrete slab. Joints to be filled with 6:1 sand/cement mix.  
 Alternative installation may be considered subject to circumstances and compliance with other requirements.

### **Porphyry**

Porphyry is a natural stone product, consisting of volcanic rock. It has a distinctive structure, has natural colour variations, it is non-porous and has a naturally rough, non-slip surface. Apart from particular physical characteristic, natural stone has an inherent visually pleasing quality.

It is proposed to use irregularly shaped (random) segments, mortared onto a concrete base (slab), in a random pattern. The width of the joints and the colour of the grouting are important factors determining the appearance of this paving material.

**Size:** Irregular shape, surface areas max. 0.15m<sup>2</sup> (1,500cm<sup>2</sup>), min. 0.005m<sup>2</sup> (50cm<sup>2</sup>)  
 Thickness may vary from 25 – 50mm.

**Surface:** Natural breakage  
 Flat surface ( $\pm 3$ mm, measured between corners, including diagonals)

**Installation:** Random Pattern  
 At least 30 % of paving body to consist of segments larger than 0.1m<sup>2</sup>  
 At least 85% of paving body to consist of segments larger than 0.07m<sup>2</sup>  
 Installation on mortar bed on min. 100mm thickness F72 reinforced concrete slab (150mm under vehicle crossings). Grouting between segments to be 2mm under pavement surface.  
 Nominal joint width 20mm. Joints not to be narrower than 5mm and not to be wider than 50mm.

Alternative installation may be considered subject to circumstances and compliance with other requirements.



**Exposed Aggregate**

This paving material consists of a single in-situ concrete slab from which the surface is washed (just prior to curing) causing the fines to wash out, exposing the gravel particles and providing a rough pavement surface. This type of concrete is generally rich in colour as both the colour of the concrete and the natural hues of the exposed stones combine.

- Size:** Poured as in situ concrete slab over entire pavement area, using existing kerbs and edges or formwork.  
Thickness min.125mm for pedestrian area. 175mm where vehicle access is required.  
Reduced thickness will be considered in certain circumstances and on an as need basis and subject to compliance with other requirements.
- Strength:** Compressive strength: 25Mpa (28 days).  
F72 reinforcement mesh centrally placed.
- Surface:** Water washed finish.  
Even fall (min. 1: 100) over the entire pavement area.  
Slip resistance (in accordance with AS 3661.1)
- Abrasion:** Maximum characteristic abrasion resistance: 3.5cm<sup>3</sup>.
- Colour:** Comply with BS 1014 Pigments for Portland Cement & Cement Products  
Pigmentation shall be uniform through the full depth of each paving unit  
Proposed colours **to be approved by Council officers.**
- Cement:** Comply with AS 3972-1991 Portland and Blended Cements.
- Aggregate:** Comply with AS 2758.1 – 1985 Concrete Aggregates.  
Surface aggregate shall be uniform through the full depth of each paving unit  
Proposed aggregate type, size and colours **to be approved by Council officers.**
- Admixtures:** Comply with AS 1478 – 1992 Chemical Admixtures for Concrete.
- Installation:** (Typical): Concrete poured in situ and water washed prior to initial set of the concrete. Paving to include all necessary joints, including isolation/control joints and tied construction joints as per engineer's specification.

#### 4.2.6 Design Issues and Details

##### **Vehicle Crossings**

To reflect pedestrian priority over vehicles, pavement materials shall extend over driveway crossovers and other driveway areas. Vehicle access onto the footpath area is provided by a lowered kerb and paved threshold area (in accordance with AS 1428, 'Design for Access and Mobility'). To provide structural stability the pavement in the driveway and threshold area is to be laid over a reinforced concrete base as follows:

**Concrete pavers** ~ on mortar bed on minimum 150mm thickness F72 reinforced concrete slab.

**Segmental porphyry** ~ on mortar bed on min.150mm thickness F72 reinforced concrete slab.

**Exposed aggregate** ~ 175mm thickness F72 reinforced concrete slab.

##### **Pits and covers**

Wherever possible, pit lids shall be housed in an angle surround frame, which enables paving to be brought up to its edges. Lids shall be filled with an in-situ concrete mix to match adjacent paving colour and finish. Where a lid would interrupt a band of continuous colour, the colour band shall run continuously through the lid. Joint patterns may extend through the lids if desired. Set out of pit lids shall be parallel to kerb-line and/or paver coursing where possible. Where the replacement of old lids by new pit lids is not possible, pit surrounds are to be kept/reduced to a minimum width.

##### **Paving Colours**

*See Appendix B, Figure s6 for details of proposed paving colours.*

##### **Pram Crossings (Kerb Ramp)**

Similar to the vehicle crossing detail, the ramped threshold may match the pattern of the adjacent pedestrian pavement. The pavement installation is as described for typical material specification.

Generally, kerb ramps shall be:

- In compliance with AS 1428, 'Design for Access and Mobility',
- Installed facing the direction of travel where possible,
- Located to suit line of pedestrian flow and position of traffic light/signal button.

##### **Posts and Street Furniture**

Bollards, posts and poles shall be placed centrally in paving bands as much as practical and appropriate. The top of the concrete footings for all poles and street furniture shall be minimum 200mm below finished surface level, unless required otherwise by relevant authority guidelines.

##### **Paving Edges to Planting Areas**

Unit paving edges to planting areas shall have a concrete haunch. Edges to tree planting locations shall accommodate tree grate frame as shown in the furniture elements.

##### **Garden Edging**

Garden edges to the areas identified shall consist of 200 x 200 precast concrete units to match paving bands.

### 4.3 Furniture Strategy

---

#### 4.3.1 Intent

Develop, implement and maintain a clearly defined direction for design and construction of furniture elements within the streetscape. Each precinct or group of precincts may have different furniture elements to another based on themes developed, or changing CBD conditions or Council policies.

#### 4.3.2 Precinct Menu Matrix

*See Appendix B, Figure f1 for details of proposed street furniture.*

#### 4.3.3 Lighting

Lighting serves a variety of important functions including improving safety, as a stand-alone design element, and to highlight features of interest.

Key Locations include:

- mid-block crossing structures,
- up lighting feature vegetation on corners,
- up lighting trees on sub-arterial boulevards,
- illuminating public artwork,
- as an element of public artwork,
- existing specimen trees of note in the CBD,
- historic building facades.

#### 4.4 Water Features

---

Water has been identified as a key design element for the CBD. Despite a tropical climate suited to the use of water as an integral streetscape component, Cairns has only one water feature, the Fogarty Park fountain, which is not operational.

A negative perception of water features in Cairns in the past has been ongoing maintenance requirements and associated costs, and inappropriate use of these elements for bathing. With appropriate design and siting, combined with a commitment to maintenance, these negative perceptions can be overcome. The positive attributes of world-class water features will add greatly to the character of the CBD.

The Lake Street Water Promenade has been identified as a CBD Precinct. It is proposed that the location of water features in the CBD be limited to this precinct to consolidate a unique character for this area.

The proposed reconfiguration of Lake Street (a Collector Street) provides opportunities for water to be incorporated at mid-block crossings and corner activity zones. As the proposed final footpath width on Collector Streets is 6.2 metres, incidental water features could also be located in the passive footpath zone. City Place is located along the Water Promenade and water is seen as an integral element of this Key Node.

Detailed planning and design is required to identify the actual siting and form of these elements.

Water is a strong people-attracting feature. Its use has been promoted in the Masterplan for the wide variety of benefits and opportunities offered:

- For visual, aural and tactile experiences,
- To create a strong pedestrian axis between Aplin Street and Cityport by creating the Lake Street Water Promenade,
- As key points of interest,
- As memorable night-time features incorporating state of the art lighting,
- As stand alone public art works and as components of larger public art zones,
- As 'cooling' elements,
- For play and interaction.

It is envisaged that water features will be of a variety of sizes and forms ranging from larger signature features to small incidental works.

*NOTE – Make reference to Council's policy regarding Structures in Road Reserves for guidelines and recommendations for public structures including water features.*

## **4.5 Orientation & Wayfinding in the CBD**

---

### 4.5.1 Street Signage

Street signs can become messy in the CBD, especially when signage is incorporated with advertising and the design and construction of the standard streetscape elements are carried out by (for example Cairns Works) and the design and fabrication of the advertising street signs are contracted to another supplier. This is particularly problematic when there is little or no co-ordination between the source of both signage types.

It is critical to ensure proper co-ordination to include signage elements and other 'additional streetscape elements' are considered in the overall design process in order to maintain consistency in the streetscape.

### 4.5.2 City Maps

*NOTE – Council has a need to develop a Signage, Orientation and Wayfinding Strategy for the city which focuses on the related elements of the CBD.*

### 4.5.3 Event Boards

Events and public notice display boards are important elements in the provision of current information to the public. Too often, these elements become a prime target for vandalism, and often appear unclean, untidy due to the ad-hoc nature of their design, placement and maintenance.

It is important to include signage elements, events boards, banner poles, and other 'additional streetscape elements' in the overall design process in order to ensure these are not forgotten when it comes time to construct the streetscape. Such items must be considered so that the forms, materials, colours proposed become part of the overall design themes for the precinct, and that the items are constructed in accordance with an approved scheme.

## **4.6 Interpretation**

---

Interpretive signage and references add interesting aspects to a City's streetscape. It can provide opportunities for Public Art and provide a place for historical and cultural interpretation and interaction.

Interpretive signage, like the Public Art Management process, needs to be addressed as a separate issues, and run as a unique project, alongside the streetscape design process.

## 4.7 Public Artwork

---

### 4.7.1 Intent

This document does not present a Public Art Strategy for the CBD or attempt to specify in detail public artwork. It does however identify a range of opportunities for the melding of artwork with the public spaces in the city.

In keeping with the objectives of the Queensland Government Public Art Policy (Art Built-in), a public artwork should create direct and meaningful relationships between its physical location and the local culture or community who use it.

Public artwork is proposed as a major characteristic of a vibrant Cairns CBD. It should excite interest, be interactive, evocative, educational and thought provoking.

It has a significant role to play in enhancing the interpretation of the city's historic and cultural heritage and should be as relevant and inspiring to local residents as it is to visitors, exploring themes beyond the typical reef and rainforest tourism image. It should engage all of the senses.

It is envisaged that public art will greatly enhance and in some instances create the character of CBD Precincts. A Public Art Strategy for the CBD should engage local and regional artists and include local indigenous and Torres Straits Islander artisans.

"Public art projects are for the public and should be sensitive to the diverse perspectives, experiences and heritage of the local community, including those of Aboriginal peoples or Torres Strait Islanders, culturally diverse community groups and youth." 1

### 4.7.2 Implementation

The success of public art within the CBD is dependant upon the development and management of a definitive Public Art Strategy. A curatorial approach is required whereby a project manager is appointed to coordinate a detailed CBD-wide Art Strategy, to prepare and implement project briefs, and to oversee selection procedures the implementation and ongoing management of artworks in accordance with the approach of Arts Queensland's Public Art Agency.

### 4.7.3 Opportunities for Public Artwork

The range of types of artwork that should be accommodated in the CBD includes:

- Performance,
- Major Signature Works,
- Incidental works,
- Temporary installations,
- Water features,
- Banners,
- Furniture.

#### 4.7.4 Potential Locations for Public Artworks

Whilst the following list identifies key locations, it is vital that public artwork, merely through its location, does not become repetitious and predictable. Public artwork should occur subtly throughout the whole of the CBD to provide a sense of discovery and surprise.

Key locations appropriate in the context of the Cairns CBD Streetscape Masterplan include:

##### **Major Signature Works (At Key Nodes)**

- City Place
- Shields Street / Esplanade junction (Esplanade project)
- Reef Fleet Square (Cityport)
- Gateway Plaza (Cityport)
- Cairns Regional Art Gallery
- Spence Street / Esplanade junction

##### **Along Key Axes**

- Lake Street Water Promenade
- Shields Street

##### **Artworks to enliven CBD Precincts**

- Shields Street
- At major street corners (all streets),
- Mid-block crossings (collector streets and Abbott Street if applicable),
- In vacant premises (in shop windows),
- As street furniture (street lights, seating, tree grates, bins & bollards).

##### **Performance, 'Live Art' zones and temporary works**

(Note: power should be provided at these locations)

##### **And at other Locations such as;**

- Street corners,
- Mid-block crossings,
- Vacant premises (shop fronts etc)
- Vacant Lots.

*Reference Council's current Public Art Policy document for more details.*

## 4.8 Built Forms

---

*This section has been included as a guide only and cannot be used as a definitive or policy document for future structural works.*

### 4.8.1 Colour

Proposed colours, forms, textures and design of built forms on the Council-controlled road reserve areas must be presented as part of the overall approval process prior to construction.

Awnings are built structures and therefore must conform to all the relevant design and construction guidelines as set down by Council and the relevant authorities.

*Reference Council's current Policy or references to relevant documents and guidelines relating to Built Forms in the CBD.*

### 4.8.2 Awnings – Form & Character

Awnings are built structures and therefore must conform to all the relevant design and construction guidelines as set down by Council and the relevant authorities. See plans b01 and b02 in Appendix B for examples of awning designs.

### 4.8.3 Outdoor Dining Structures

Awnings are built structures and therefore must conform to all the relevant design and construction guidelines as set down by Council and the relevant authorities.

*Reference Council's current Policy relevant to documents and guidelines for Building applications.*



## 5.0 GUIDELINES

### 5.1 FNQROC Development Manual

---

The Far North Queensland Regional Organisation of Councils (FNQROC) has recognised the need to develop comprehensive, structured and practical guidelines to promote consistency in development standards throughout the Far North Queensland region.

#### 5.1.1 Scope

The objectives of FNQROC Development Manual are;

- To provide a comprehensive, practical and authoritative guide through the development approval process from inception to completion for Developers, Consultants, Contractors and Council officers,
- To provide consistency in the requirements of the participating Councils for development within the region.

The requirements and guidelines contained within this document should form part of the design and documentation of all works proposed in the Cairns CBD streetscapes.

One of the most effective ways to access the FNQROC manual and its components is via the Council website – see below for the links.

[www.fnqroc.qld.gov.au](http://www.fnqroc.qld.gov.au)

### 5.2 All Mobility Access and Other Australian Standards

---

*The current Australian Standards relating to Pedestrian All Mobility Access is AS1428*

All pedestrian areas in public open spaces should be installed with Indicator and Directional Tactile markers in accordance with the relevant Australian Standards.

The tactile (raised dots) should be installed at all locations along pedestrian activity zones where a change in direction or surface conditions occur. The directional (raised lines/stripes) shall be installed adjacent the tactile indicators in the direction of intended pedestrian travel. Tactile and directional units can be included as either concrete paving units with the built-in tactiles to conform to the relevant Australian Standards, or may be retro-fitted using a system whereby the individual dots and stripes are set into holes made in the surface materials following installation.



*Tactile Indicators (where clay paving units have been retro-fitted with the product – see supplier details below).*



*Tactile Indicators (dots adjacent kerb) and Directional Indicators (stripes) in the Cairns CBD (where concrete paving units are used to match footpath paving surface).*

*The current Australian Standards relating to Tactile and Directional Indicators is as follows AS 1428 Part 4 (2002).*

### **5.3 Crime Prevention Through Environmental Design (CPTED)**

CPTED principles are designed to promote the consideration of design features within new developments and the redevelopment of existing areas, which will enhance the safety from crime for the community, including visitors to the city.

#### **5.3.1 Scope**

The objectives are;

- To enhance public safety by reducing for crime to occur,
- To reduce the fear of crime through the provision of safe, well designed and maintained buildings, facilities and public spaces,
- To optimise the community use of public spaces and facilities,
- To encourage development on private land which promotes safety on neighbouring public and private land.

*Note - Reference Council's current Policy Statement relating to CPTED policies (reference 1:04:06)*

## 6.0 ESTABLISHMENT AND MAINTENANCE

### 6.1 General

---

As previously noted, capital expenditure intended to improve streetscape quality demands an appropriate commitment to maintenance. All streetscape elements, hard and soft, require a detailed program of focused maintenance to ensure longevity and health.

Whilst our tropical climate exposes streetscape elements to specific problems such as mould growth, it is a positive contributing factor in terms of allowing spectacularly fast plant growth and providing the unique tropical atmosphere of Cairns. Such growth, in itself necessitates specific maintenance and management.

The effects of our environment are inevitable, however with appropriate maintenance they should not detract from the city image. Two of the most fundamental requirements are;

- The maintenance of all areas in a neat and tidy condition at all times, and;
- Attending immediately to any areas / items that have been vandalized or damaged as the highest priority.

Whilst the following list is not definitive, it identifies items requiring effective maintenance programs.

#### *PAVEMENTS*

- Regular power cleaning to remove mould, bird droppings and other material,
- Replacement of damaged paving,
- Removal of graffiti, stains and other marks.

#### *FURNITURE AND STRUCTURES*

- Upgrading of timber preservatives / stains as required on timber furniture,
- Regular cleaning of all walls and structures,
- Removal and repair / replacement of damaged furniture,
- Touch up of paintwork as required.

#### *INFRASTRUCTURE*

- Monitoring of irrigation systems,
- Monitoring of drainage systems,
- Rubbish removal,
- Regular checking of all landscape lighting.

*SOFT LANDSCAPE*

Maintenance of soft landscape elements must consider;

- Fertilising,
- Appropriate pruning, trimming,
- Removal of spent fronds, dead or damaged vegetation,
- Replacement of dead or dying plants,
- Staking,
- Ongoing mulching,
- Mowing,
- Weed and pest control,
- De-nutting of mature coconut palms,
- Checking and adjustment of topsoil levels in garden areas,
- Checking and adjustment of mulch levels in garden areas.

*PUBLIC ART*

Public artworks will have specific maintenance requirements dependent upon materials, location, size and so on. An important criteria for the selection of public artwork is the robustness of the work in the context of its' setting. Prior to implementing public artworks, an analysis of maintenance requirements should be considered and a program of ongoing maintenance prepared.

It is recommended that detailed and all-encompassing maintenance schedules be produced for streetscape elements within the CBD. Such schedules should be itemized per streetscape elements and address scope of works, tasks, responsibilities and frequency of maintenance.

## 6.2 Plant Procurement

---

Despite the climate of Cairns offering premium plant growing conditions, the availability of advanced tree stock is relatively poor. This lack of availability of stock at hand results in either smaller than acceptable stock being used in streetscape works, or substitutions being made which defeats the purpose of endorsing a preferred street tree palette for the CBD. Understorey plant stock need not be available 'off the shelf', however advanced plant procurement should be mandatory, again to ensure the availability of healthy, well grown stock.

It is proposed that a program of plant procurement for tree and palm stock in the CBD be undertaken by Council to ensure that the appropriate species are available. It is understood that the implementation of planting works is tied to the upgrading of streets, which in itself is dependent upon funding and priorities. Despite this, a program of plant procurement will enable Council to maintain a source of tree species that could be redirected to areas outside the CBD (to parks, residential areas, other infrastructure projects) if the procured stock reaches its optimal bag size and requires planting out. Council may also be able to sell this stock to developers undertaking works in the CBD.

Contract growing is recommended, as Council has neither the facilities nor manpower to maintain a nursery. This approach will also benefit local businesses. The success of such a program will depend on the ability of Council to administer such Plant Procurement Contracts with ongoing quality inspections of stock and close contact with the growers.

The optimal size of stock for planting out is well grown 100-litre stock. Dependent upon demand, 100 litre stock may be 'bagged-up' to 200 litres and even 400 litres and held for a longer period.

Typical plant procurement contracts require clear articulation of the responsibilities of all parties, including;

- Scope of works,
- Division of responsibility,
- Commencement and completion dates,
- Adherence to regulations and relevant standards,
- Detailed specifications for the growing and ongoing maintenance of stock and storage conditions,
- Financial management.

### 6.3 Quality of Nursery Stock

It is essential that trees supplied for street tree planting are grown to a standard which will allow them to establish rapidly and continue to grow as long term assets of the streetscape.

All trees to be provided to the City of Cairns are to conform to the NATSPEC guide and "Guide for assessing the quality of and purchasing of landscape trees" by Ross Clark 2003. Relevant requirements are summarised below.

Nursery stock must meet design criteria for minimum dimensions, container size and shape, plant shape or special pruning requirements outlined in this document as is summarised below:  
Height, given container volume and calliper at 300mm.

Root ball volume	Height (above container)	Calliper (at300mm)	Clear trunk height
45 litre	1.9 - 2.3 metres	30mm - 35mm	1200mm
75 litre	2.2 - 2.4 metres	40mm - 45mm	1400mm
100 litre	2.4 metres	50mm	1500mm
200 litre	3.6 metres	60mm	1500mm
300 litre	4.2 metres	70mm	1500mm
400 litre	5.5 metres	70mm	1500mm
Palm trees	NA	NA	5 metres clear trunk

Source: Ross Clark 2 NATSPEC - Guide for assessing the quality of and purchasing of landscape trees 2003

In certain circumstances, criteria must vary to suit particular locations, ie.3-4m clear trunk for trees planted next to awnings, where trees are expected to be clear of structures.

#### *General Characteristics of Nursery Stock*

The general characteristics which are covered by the specification are as follows:

#### *True to type*

The trees supplied and planted must be the species (and variety if cultivars are used) that the purchaser has ordered.

#### *Health and vigour*

The trees supplied must be healthy and vigorous at the time of delivery.

#### *Freedom from pests and disease*

Trees should not be diseased or show evidence of pest attack that could affect the long-term health of the tree or adjoining plantings.

*Balance of crown*

This refers to the crown bulk on opposite sides of the stem axis which indicates the tree's structural integrity and its aesthetic qualities. Trees that have an asymmetrical crown (nominally an imbalance of > 20%) are generally undesirable

*Uniformity of growth*

Trees should be grown at a steady rate to produce a better quality tree with an even branch structure. Over-fertilisation can often lead to irregular growth, which could cause aesthetic and structural problems.

*Stem taper*

This is a measure of the tree's ability to be self-supporting. Trees with insufficient stem taper may need artificial support (staking) and are prone to damage by vandals and wind throw. Adequate stem taper is generally a result of the tree having been given enough space to grow at the nursery without use of stakes.

*Pruning history*

Formative pruning of trees at the nursery to achieve a straight trunk, clear of branches, ensuring any pruning repairs are quick to recover, lessening the possible effect of long term damage to the tree.

*Included bark*

If bark is folding into the joint or crotch of a tree as it grows (often after damage) this can result in a structural weakness that could increase the risk of limbs falling in a storm.

*Compatibility of graft unions*

The scion and rootstock must be compatible, as a structural weakness will occur in an incomplete graft, causing retarded or excessive growth above ground (i.e. a top-heavy tree with poor root growth is more likely to fall in a storm).

*Apical dominance*

Tree species grown with a defined central leader will have an improved appearance and less possibility of splitting into a form less appealing.

*Indication of north*

When planting trees greater than 100L the orientation of the cambium must be maintained as it was in the nursery (i.e. the side of a tree previously sheltered from sun should not then be exposed to sun once planted).

*Root division*

Inadequate division of root systems will affect surface area. A strong and progressive root development will give a strong structural base. Roots held at length in containers may produce too much secondary division (i.e. root ball hydrophobic), producing watering problems for the plant.

*Root direction*

Any root distortion will ultimately become apparent in the tree at a later stage, causing a structural weakness in the root system (e.g. spiralling roots in a small tree, if left untreated at planting could strangle the developing roots).

*Root ball occupancy*

It is important that the volume of the root ball at purchase is fully occupied by the root system and when shaking the root ball unsupported, at least 90% of soil volume should remain.

*Non-suckering rootstock*

It is preferable that a naturally suckering tree species be grafted onto a rootstock which is non-suckering before planting.

*Hardening off*

For a minimum of eight weeks prior to delivery, all plants shall be grown in open areas receiving a minimum of 75% full sun. Watering and fertilising of plants shall be gradually reduced for a similar time period leading up to delivery to aid in hardening of plants.

*Acclimatisation*

If plants are being grown or propagated outside a 100km radius of Cairns then the contractor shall move all plant stock to a nursery within this radius so that the plants may become acclimatised for a period of not less than eight weeks to the date of delivery. The plants must then be hardened off in accordance with the preceding specification.

*Maintenance in Transit*

All plant material must be protected from the adverse effects of transportation and general handling. Plants are to be transported in fully enclosed pan technician type vehicles. Plants are to be adequately watered prior to moving and should be secured so as to avoid damage to branches.

*Advanced Trees and Palms*

Advanced specimens require craning by slinging the root ball. Plants lifted by slings attached to trunks or limbs will not be acceptable.

*Rejection of non conforming specimens*

Any tree not conforming to this standard will be rejected and a replacement will be required.



**6.4 Strategies for Improving Tree Planting**

*GENERAL*

*Water/Aeration Pipes*

Water pipes help deliver water efficiently to the root zone and encourage the development of a healthy deep root system and discourage the tendency of urban trees to search for surface water. They also allow oxygen to penetrate down below hard surfacing and thus aerate the root zone.

*Tree Guards*

These can be useful in inner city areas where the likelihood of vandalism is greater. The guards make opportune damage to young and susceptible trees more difficult.

*Root Barriers/Root Directors*

Root barriers are a useful strategy in the minimisation of damage to pavements, kerbs, services and other infrastructure. The purpose of the root barrier or Root Director is to guide the growing tip of spreading roots in a direction that will cause the least damage, that is to say down.

The difference between a root barrier and a root director is quite simple.

- A root barrier comes in a long roll and is laid along the length of the area to be protected, extending at least 1.0metre from the estimated limit of the tree canopy on maturity.
- A root director is a barrier box which surrounds the tree on planting and restricts and "directs" the roots downwards.

WHAT ARE YOU PROTECTING FROM TREE ROOTS?						
Building foundations	Footpaths			Underground services/utilities	Footpaths and underground services/utilities	
	Type of Barrier Surround (Director) or Linear			Depth of services determines barrier type		
	Surround (Director)		Linear	How deep are the services/utilities?		
	What is the predicted girth of the tree trunk at maturity?			Up to 450mm	Up to 800mm	Deeper than 800mm
	Up to 750mm	Greater than 750mm				
ROOT CONTROL	ROOT CONTROL	ROOT CONTROL	ROOT CONTROL	ROOT CONTROL	ROOT CONTROL	ROOT CONTROL
2000mm wide High density root barrier	Root Director 640mm/1050mm	Root Director 1050mm/1400mm	Linear Root Barrier 300-1000mm deep	Linear Root Barrier 600mm deep	Linear Root Barrier 1000mm deep	Linear Root Barrier 1500mm deep and greater

Tree root management solutions will vary according to the tree species, its planting location and the depth of any adjacent services or foundations. Linear barriers are preferred where a row of trees are to be installed and kerbs need to be protected, remember that root barriers should extend beyond the drip line of the crown of the tree at maturity. Root barriers can be used to line kerbs or footpaths allowing the maximum growth area for roots, and protecting trees from future kerb or pavement upgrades.

For isolated trees, or trees planted in islands or medians a root director can be installed, they are easier to install and hard to install incorrectly.

*NOTE - (See Appendix 2 - Type A-Tree in Median/ Island, Type B-Tree in Footpath with Nature Strip, Type C-Tree in Hardscape & F20)*

#### *Root Disturbance*

Any work carried out around the base of any tree must be kept to a minimum. Disturbance of root systems can be very harmful even to the largest of trees. The cutting of roots can lead to a progressive weakening of growth and stability that can result in disease and collapse. Consult with a qualified arborist before commencing large scale operations.

#### *Tree Protection during on site works*

Trees should be adequately protected during on site works. Trunks should be wrapped where appropriate and the root zone fenced off as far as the drip line of the crown of the tree to avoid unnecessary compaction of the root zone by heavy vehicles. Heavy compaction destroys the soils capacity for aeration and the tree can "suffocate".

Exposed roots should be covered at all times and not allowed to dry out. Root stress can be very damaging and lead to tree failure.

#### *Pruning to Establishment*

The early, formative pruning of a street tree is essential to their performance as a good street tree. Trees need to be shaped to suit their location with a good clean upright trunk and well-formed balanced crown. All pruning should be carried out in accordance with the relevant Australian Standards.

#### *Use of Soil Conditioners*

Soil conditioners improve the growing conditions for plants in the root zone. They usually consist of fertilisers, hydro-absorbent copolymers and root stimulating organic fertilisers.

Soil Conditioners can improve the following:

- Water and Nutrient retention capacity by as much as 50%
- Soil Structure
- Aeration-vital oxygen to the root zone
- Root and Plant Growth

*Structural Soils and associated technologies*

Structural soils can be employed to increase the potential area for root development while maintaining the structural integrity of hard surfaces. A matrix of gravels and soils are balanced to provide a suitable base for hard landscaping and a more hospitable environment for root development with improved aeration.

Structural soils are particularly useful when tree planting in areas of hard landscaping such as car parks and inner city areas.

Root cell systems provide a sub-surface matrix which can be loaded with 90% topsoil by volume, and sustain loads of up to 80 tonnes per square meter. In comparison structural soils can hold as little as 5% soil by volume. Root cells are ideal for use in areas of extensive hardscaping such as pedestrian malls and car parks.

## 6.5 Irrigation

---

Gardens without irrigation become, over time, increasingly prone to depletion of the quality and in some species, the quantity of the planting within them. Automatic irrigation systems (preferably pop-up sprinklers) are recommended in all new developments where gardens are exposed to the public pedestrian traffic, and where it is important to maintain a high standard of finish for extended periods.

New irrigation systems will need to be linked to existing CCC watering systems and be controlled by CCC. CCC reserves the right to install / supervise the installation of any system and make any necessary connections to existing infrastructure.

An irrigation plan will need to be submitted to CCC for prior approval.

Sub-surface drip-style irrigation systems may be more suitable in some locations where the system elements (such as sprinkler heads) may be more prone to damage due to vandalism.

*NOTE – All irrigation must meet the standards set out by the FNQROC Development Manual D9.23 and S8 15-24*

**7.0 REFERENCES**

- Terms of Reference for Consultancy No. AMS 20/99 - Cairns City Council.
- Cairns CBD Landscape Masterplan – Siteplan, 1988.
- Queensland Governments Public Art Policy – Public Art Agency
- Cityport Masterplan Volume 3 – Cairns Port Authority, June 1999.
- Cairns CBD Revitalisation Project – Planning Far North, Buckley Vann Town Planning Consultants, Connybeare Morrison and Partners, January 2000.
- Statement of Proposals for Development Control Plan No.7, Cairns City Centre Plan - Cairns City Council, 1998.
- The Cairns CBD and Environs Drainage Management Plan, Phase 1 Final Report, Volume 2-Drawings – WBM Oceanics Australia.
- CBD Road Hierarchy Alternative Treatments – Flanagan Consulting Group, 1988.
- Cairns City Council CBD Parking Sub Strategy- GHD, 1999.
- FNQROC Development Manual
- Cairns Plan
- Cairns - City in a Garden Strategy
- Cairns Style

# APPENDIX 1

## APPENDIX 1 EXISTING TREES TO BE RETAINED (as at April 2005)

### FLORENCE STREET

---

01	Delonix regia
02	Delonix regia
03	Delonix regia
04	Delonix regia
05	Delonix regia
06	Delonix regia
07	Delonix regia

### APLIN STREET

---

51	Pterospermum acerifolium
52	Gustavia superba
53	Ficus elastica (x3) Parkia javanica
55	Xanthostemon chrysanthus
56	Xanthostemon chrysanthus
57	Xanthostemon chrysanthus
58	Xanthostemon chrysanthus
59	Xanthostemon chrysanthus
60	Xanthostemon chrysanthus
61	Xanthostemon chrysanthus Tabebuia rosea Tabebuia argentea Dimocarpus longan (landscape to Aplin Street) Harpullia pendula (frontage of Cairns Central) Brachychiton acerifolius

### SHIELDS STREET

---

101	Barringtonia asiatica
102	Calophyllum inophyllum
103	Ficus benjamina
104	Ficus benjamina
105	Barringtonia asiatica
106	Barringtonia asiatica
107	Normanbya normanbyi (x3)
108	Calophyllum inophyllum
109	Calophyllum inophyllum
110	Ficus benjamina
111	Pandanus sp.

112 *Barringtonia asiatica* Avenue (new)

### SPENCE STREET

---

- 151 *Calophyllum inophyllum*  
 152 *Roystonea regia*, + 103  
 153 *Barringtonia asiatica*  
 154 *Ficus virens*  
 155 *Barringtonia calyptrata*  
 156 *Calophyllum inophyllum*  
 157 *Schefflera actinophylla* + *Delonix regia*  
 158 *Archontophoenix alexandrae* (5 of)  
 159 *Archontophoenix alexandrae* (9 of) + *Livistona rotundifolia*  
 160 *Cerbera manghas*  
 161 *Pandanus baptistii* (transplant to Abbot Street ?)  
 162 *Veitcha joannis* (3 of)  
 163 *Agathis robusta*  
 164 *Ravenala madagascariensis* (2of)  
 + *Carpentaria acuminata* (3 of)  
 + *Elaeis guineensis*  
 165 *Livistona saribus*  
 166 *Calophyllum inophyllum*  
 167 *Thrinax* sp. (transplantable)  
 168 *Grevillea baileyana*  
 169 *Buckinghamia celsissima*  
 170 *Normanbya normanbyi* (2 of)  
 171 *Ficus benjamina*

### HARTLEY STREET

---

- 225 *Ficus* ?  
 226 *Ficus hilli*  
 227 *Dillenia indica* (x2)  
 228 *Ficus hilli* - avenue  
 229 *Wodyetia bifurcata* - avenue  
 230 *Livistona Muelleri*

### WHARF STREET

---

- 201 *Callophyllum inophyllum*  
 + *Ficus drupacea*  
 + *Ficus benjamina*  
 202 *Barringtonia asiatica*  
 203 *Pongamia pinnata*  
 204 *Roystonea regia*  
 205 *Livistona decipiens*

**ABBOTT STREET**

---

252	<i>Normanbya normbyi</i>
253	<i>Barringtonia asiatica</i>
254	<i>Ficus longifolia</i>
255	<i>Syzygium branderhorstii</i>
256	<i>Ptychosperma elegans</i>
257	<i>Ravenala madagascariensis</i>
258	<i>Mangifera indica</i>
259	<i>Pandanus baptistii</i>
260	<i>Strelitzia nicolae</i>
261	<i>Castanospermum australe</i>
262	<i>Strelitzia nicolae</i> + <i>Ravenala madagascariensis</i>
263	<i>Schefflera actinophylla</i>
264	<i>Ficus hilli</i>
265	<i>Ficus virgata</i>

**ESPLANADE**

---

275	<i>Terminalia muelleri</i>
-----	----------------------------

**LAKE STREET**

---

301	<i>Roystonea regia</i>
302	<i>Ficus longifolia</i>
303	<i>Eucalyptus ptychocarpa</i>
304	<i>Mangifera indica</i>
305	<i>Albizia lebbek</i>
306	<i>Calophyllum inophyllum</i>
307	<i>Roystonea regia</i>
308	<i>Roystonea regia</i>
309	<i>Xanthostemosn chrysanthus</i>
310	<i>Wodyetia bifurcata</i>



**GRAFTON STREET**

---

- 351 *Brachychiton populneus*
- 352 *Barringtonia asiatica*
- 353 *Calophyllum inophyllum*
- 354 *Melaleuca minutifolia*
- 355 *Intsia bijuga*
- 356 *Parinari nonda*
- 357 *Calophyllum inophyllum*
- 358 *Plumeria obtusa*
- 359 *Tabebuia palmeri*
- 360 *Calophyllum inophyllum*
- 361 *Schefflera actinophylla*  
+ *Jacaranda mimosifolia*
- 362 *Pongamia* sp. aff. *pinnata*
- 363 *Wodyetia bifurcata*
- 364 *Fragrea crenulata*

**SHERIDAN STREET**

---

- 401 *Livistona mariae*
- 402 *Latania* sp.
- 403 *Xanthostemon chrysanthus*
- 404 *Buckinghamia celsissima*
- 405 *Delonix regia*  
+ *Lagerstroemia loudonii*  
+ *Lagerstroemia duperreana*  
+ *Calophyllum inophyllum*
- 406 *Buckinghamia celsissima*
- 407 *Jacaranda mimosifolia*
- 408 *Xanthostemon chrysanthus*
- 409 *Xanthostemon chrysanthus*
- 410 *Mimusops elengi*
- 411 *Livistona decipiens*
- 412 *Livistona decipiens*
- 413 *Syzygium jambos*

**McLEOD STREET**

---

- 451 *Barringtonia asiatica*
- 452 *Brachychiton velutinosus*
- 453 *Brachychiton velutinosus*

## APPENDIX 2

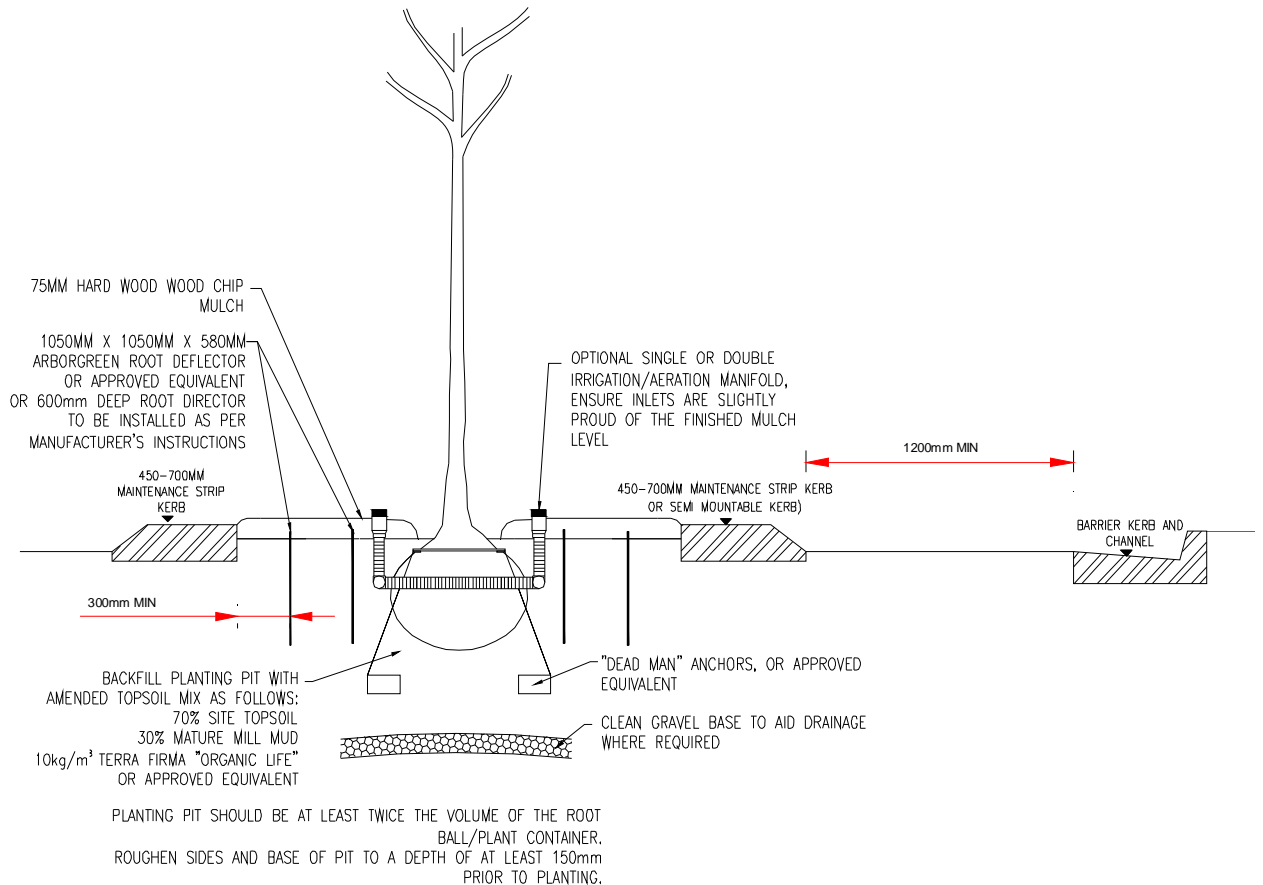

**SECTION NOT TO SCALE**

### Type A-Tree in Median or Island

Tree to be secured by the use of dead man's anchor or approved equivalent.

The type and depth of root barrier used will vary according to local conditions and tree species selection. Refer to table on page 206 for further guidance.

Linear root barriers should extend at least 300mm behind the back of the kerb and at least 1000mm beyond the estimated drip line of the tree canopy at maturity (in the case of median planting and where a root deflector/surround is not employed).

Structural soils or "Arborganic" root cells may be required where site constraints could be detrimental to root expansion, to provide a break out zone for root development under adjacent pavement.

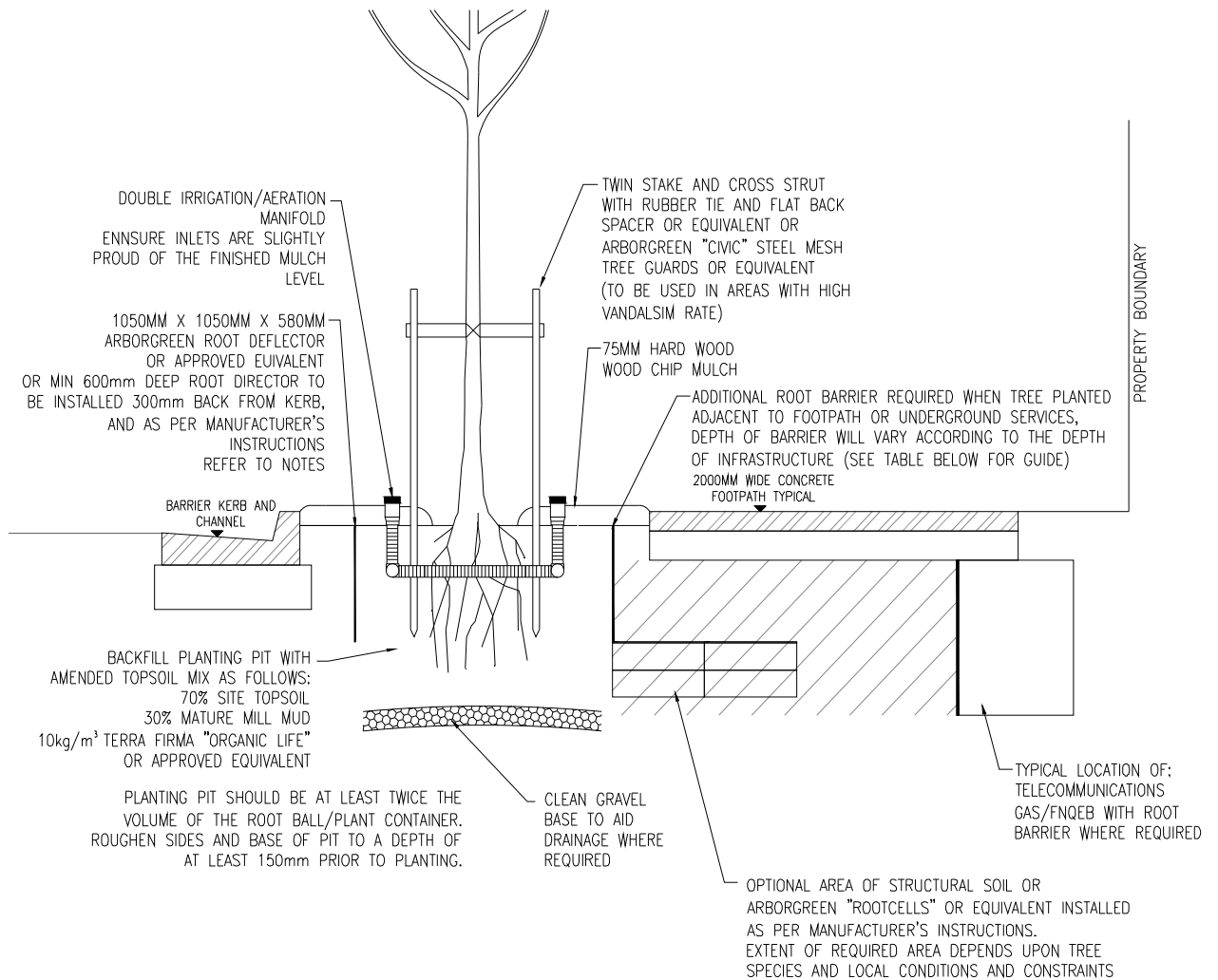

## Type B-Tree in Footpath with Nature Strip

Tree to be protected above ground by the installation of twin stakes and cross strut, with rubber ties and flat back spacer. CCC may require the use of welded mesh tree guard for added protection in areas of high vandalism.

The type and depth of root barrier used will vary according to local conditions and tree species selection. (Refer to table on page 206 for further guidance).

Linear root barriers should extend at least 1000mm beyond the estimated drip line of the tree canopy at maturity.

Structural soils or “Arboregreen” root cells may be required where site constraints could be detrimental to root expansion, to provide a break out zone for root development under adjacent footpaths or to adjacent landscape areas.

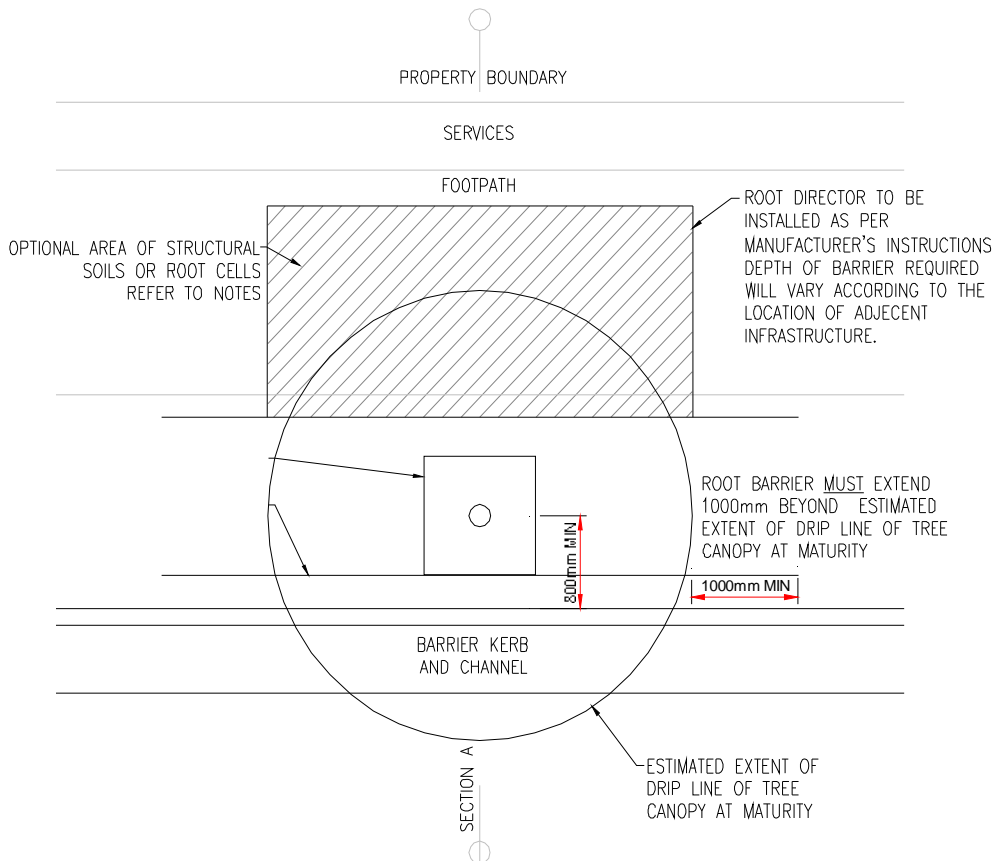

PLAN NOT TO SCALE

### Type B-Tree in Footpath with Nature Strip

The type and depth of root barrier used will vary according to local conditions and tree species selection. (Refer to table on page 206 for further guidance).

Linear root barriers should extend at least 1000mm beyond the estimated drip line of the tree canopy at maturity.

Structural soils or “Arboregreen” root cells may be required where site constraints could be detrimental to root expansion, to provide a break out zone for root development under adjacent footpaths or to adjacent landscape areas.

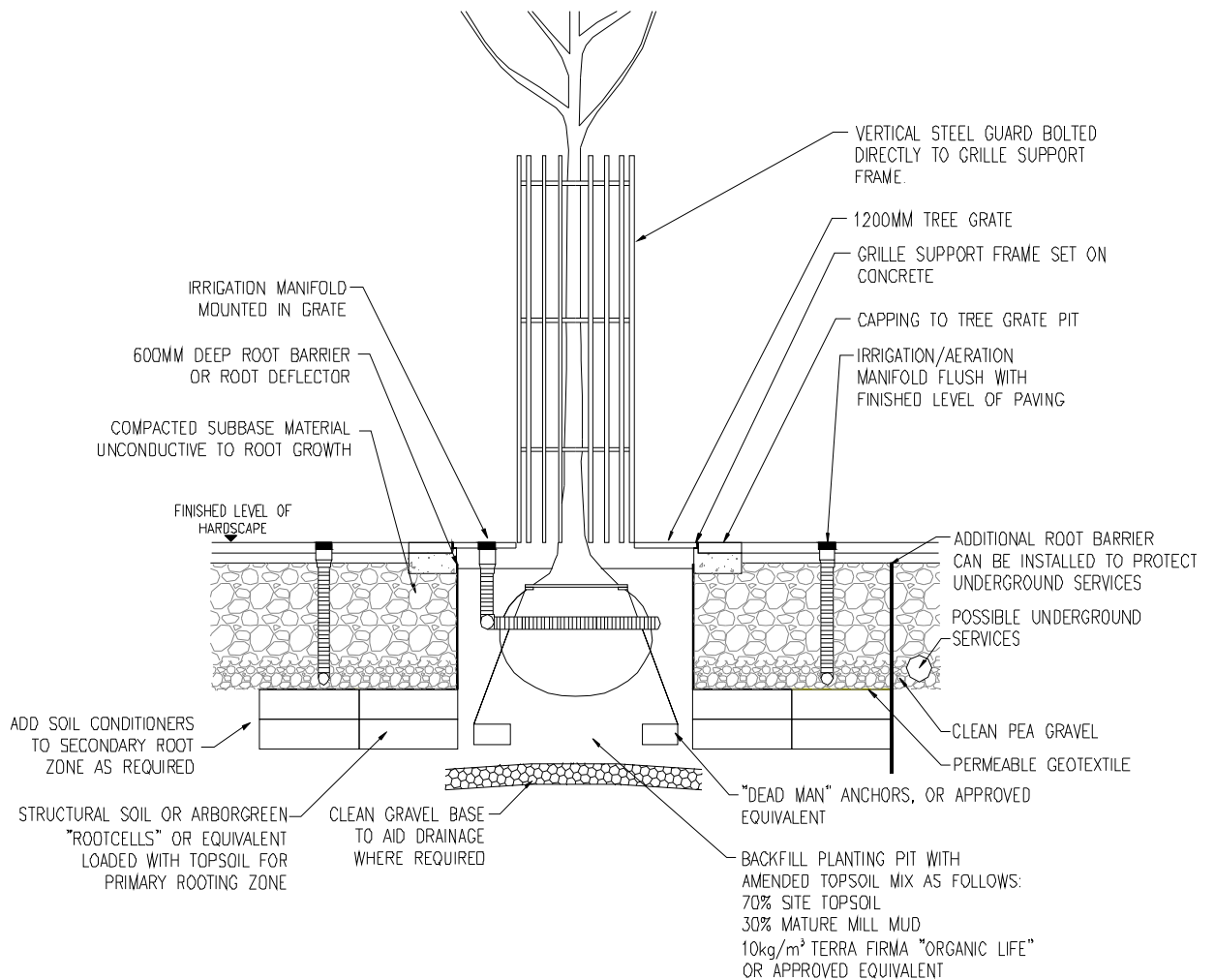

SECTION NOT TO SCALE

### Type C-Tree in Hardscape

To be used where trees are to be planted within paved pedestrian areas (such as exist in the C.B.D) or within road reserve where rooting zone is restricted (i.e. where tree islands are not of an appropriate scale).

Tree to be protected above ground by the installation of a tree grate and tree guard (refer to CBD Master Plan Appendix B f19 for full details).

The type and depth of root barrier used will vary according to local conditions and tree species selection. (Refer to table on page 206 for further guidance). Solutions to site specific root management issues should be sought from a reputable root control manufacturer or specifier.

Structural soils or "Arboregreen" root cells are required to aid root growth and to reduce the detrimental effects of compaction within the root zone.

Irrigation and aeration manifolds assist in delivering oxygen to the root zone beneath hardscape areas.

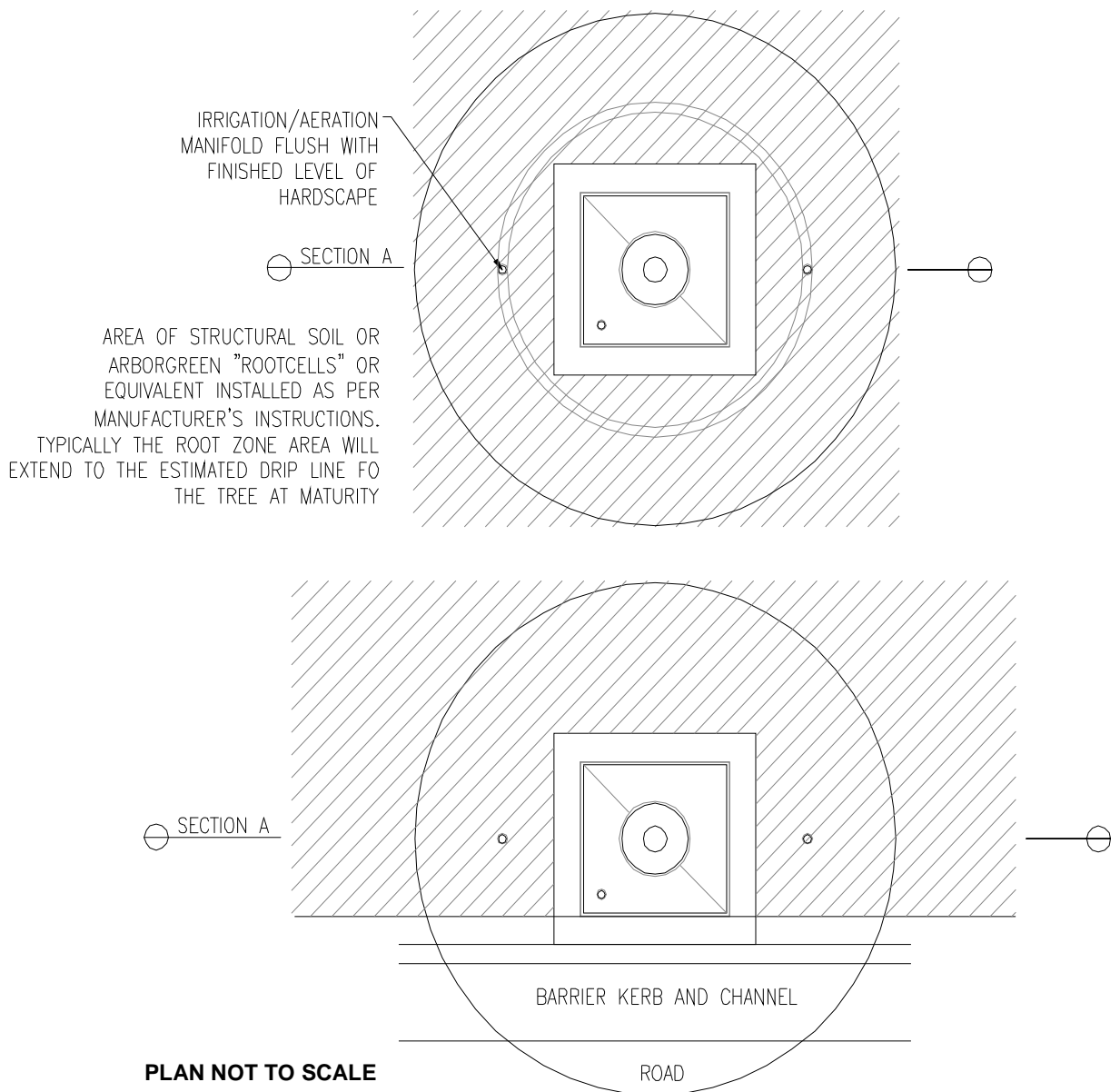

### Type C- Tree in Hardscape

The hatched areas indicate how *root cells* or structural soils may be installed to assist healthy root development.

Tree to be protected above ground by the installation of a tree grate and tree guard (refer to CBD Master Plan Appendix B f19 full details).

The type and depth of root barrier used will vary according to local conditions and tree species selection. (Refer to table on page 206 for further guidance). Solutions to site specific root management issues should be sought from a reputable root control manufacturer or specifier.

# APPENDIX A

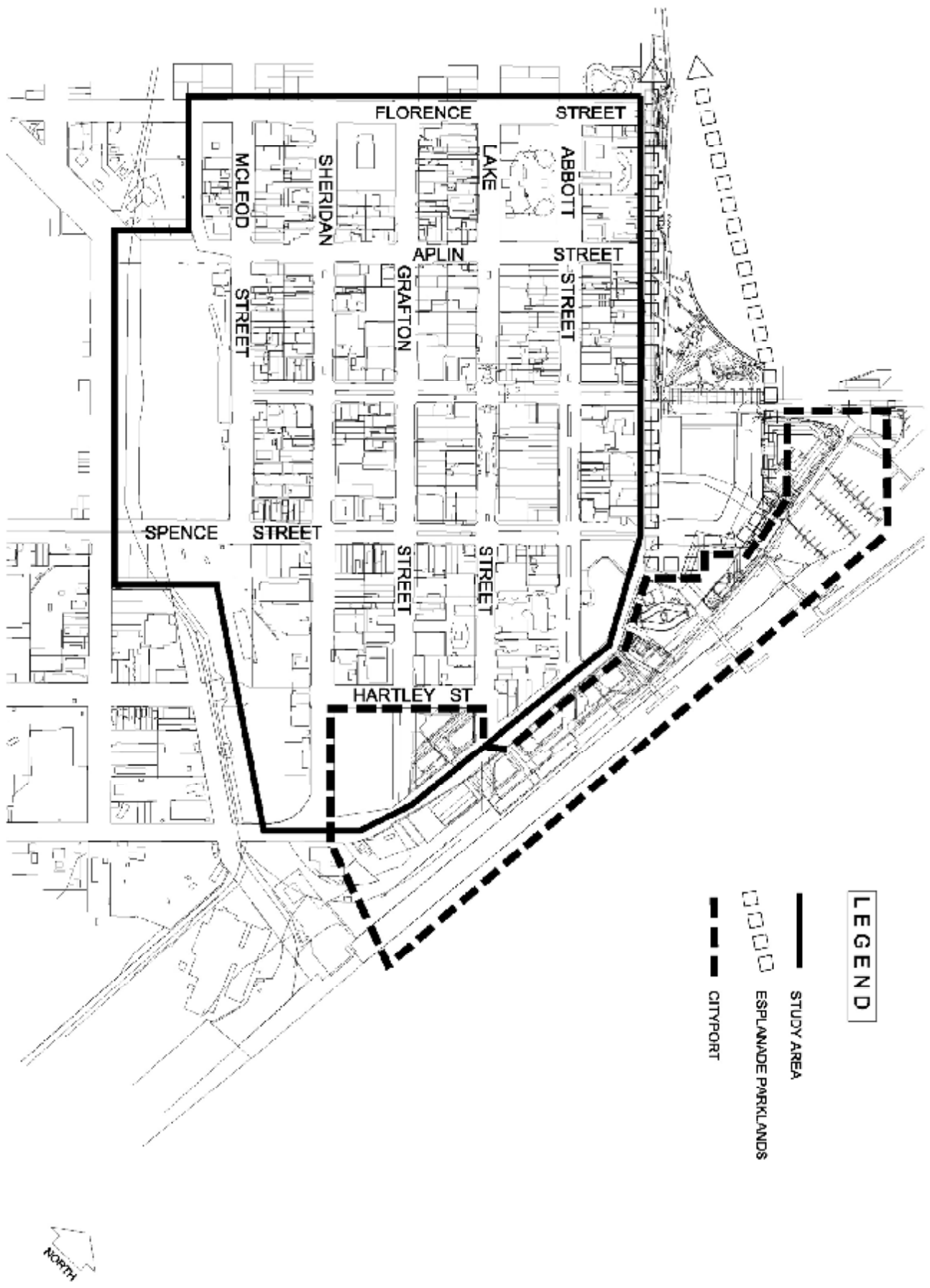

**LEGEND**

- STUDY AREA
- - - - - ESPLANADE PARKLANDS
- - - - - CITYPORT



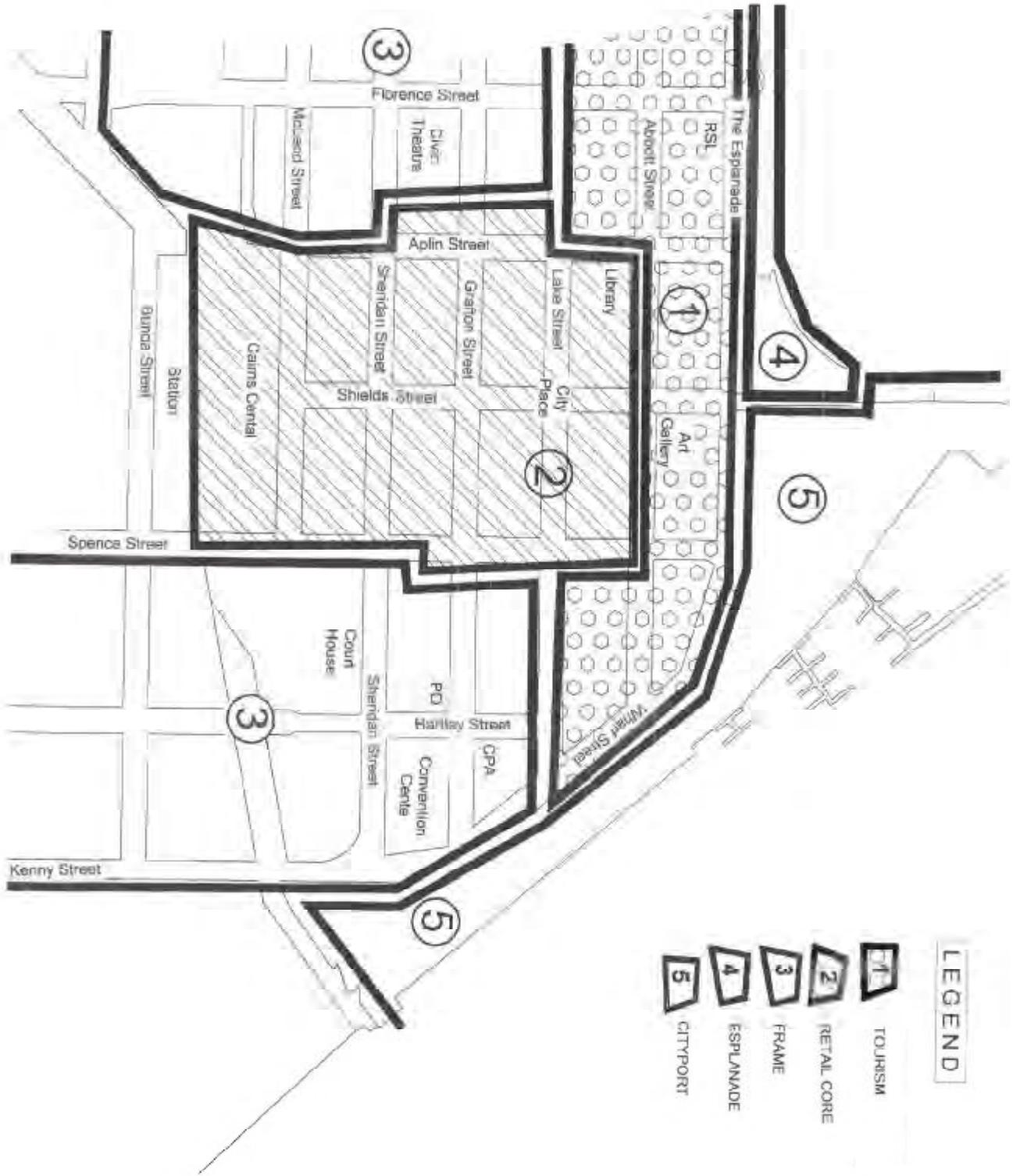

**CAIRNS CBD STREETScape MASTERPLAN**  
**EXISTING SITUATION - MAJOR NODES**



**a2**

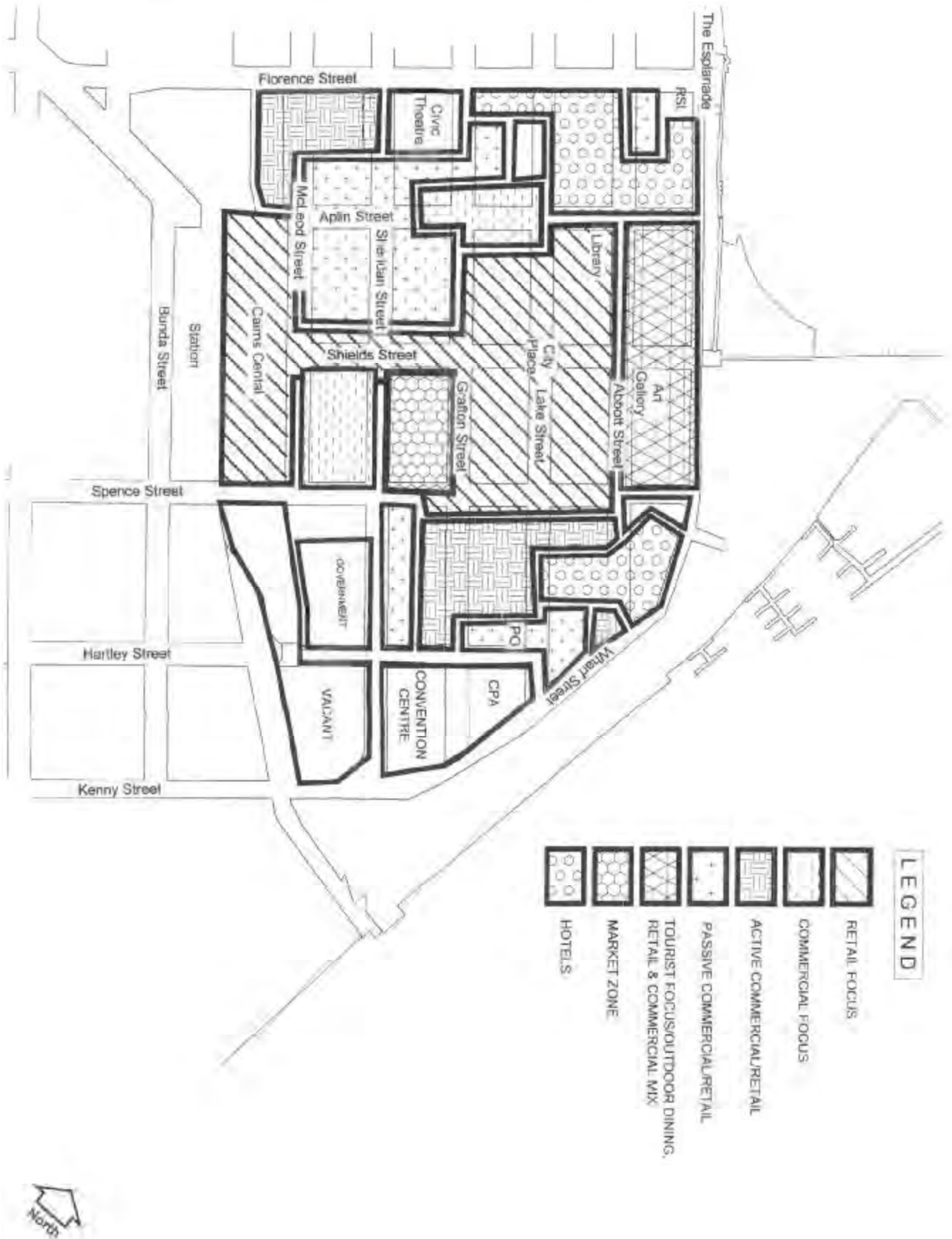

**CAIRNS CBD STREETScape MASTERPLAN**  
**EXISTING SITUATION - USE ZONES**



**a3**

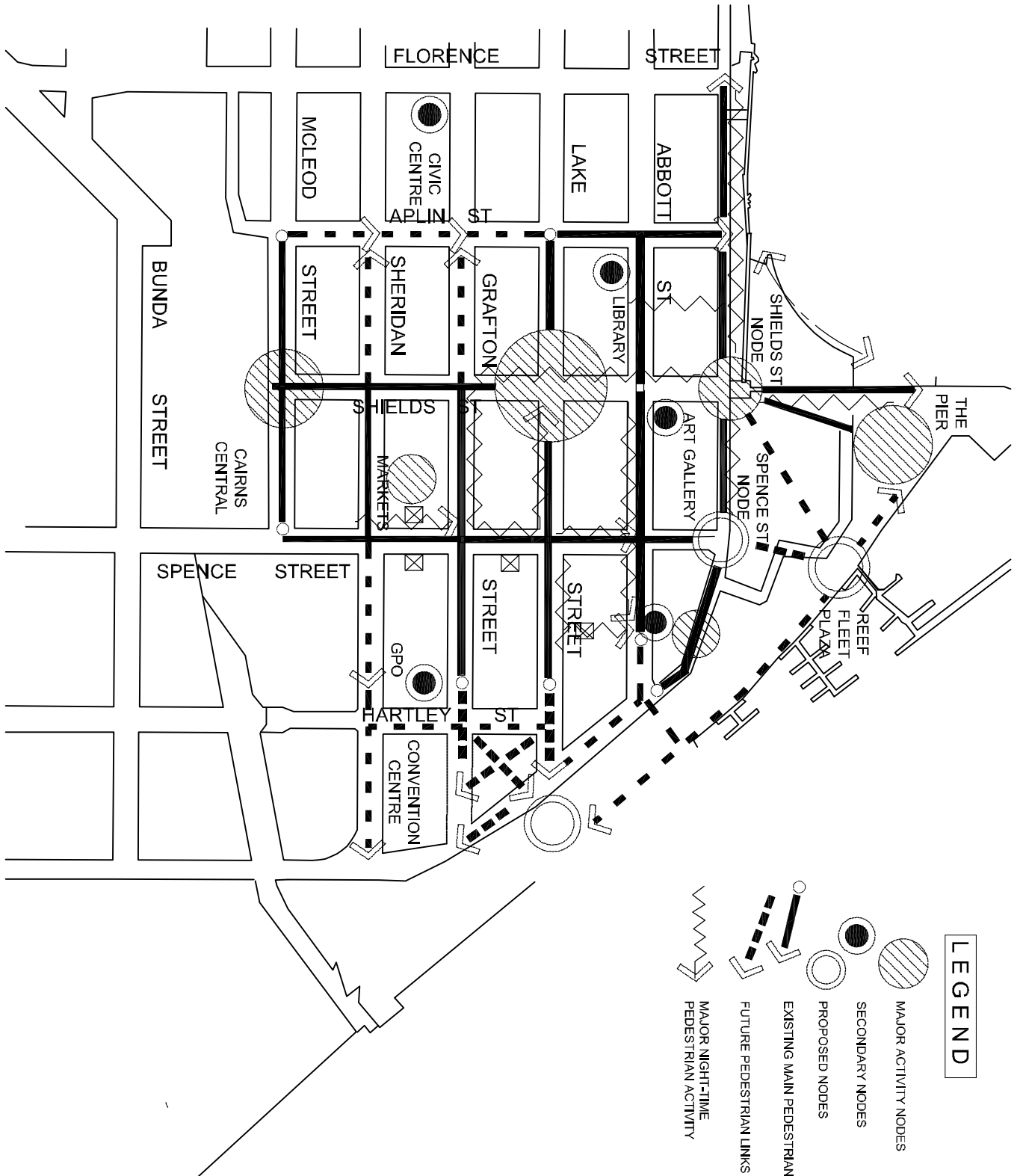

**LEGEND**

- MAJOR ACTIVITY NODES
- SECONDARY NODES
- PROPOSED NODES
- EXISTING MAIN PEDESTRIAN ACTIVITY
- FUTURE PEDESTRIAN LINKS
- MAJOR NIGHT-TIME PEDESTRIAN ACTIVITY

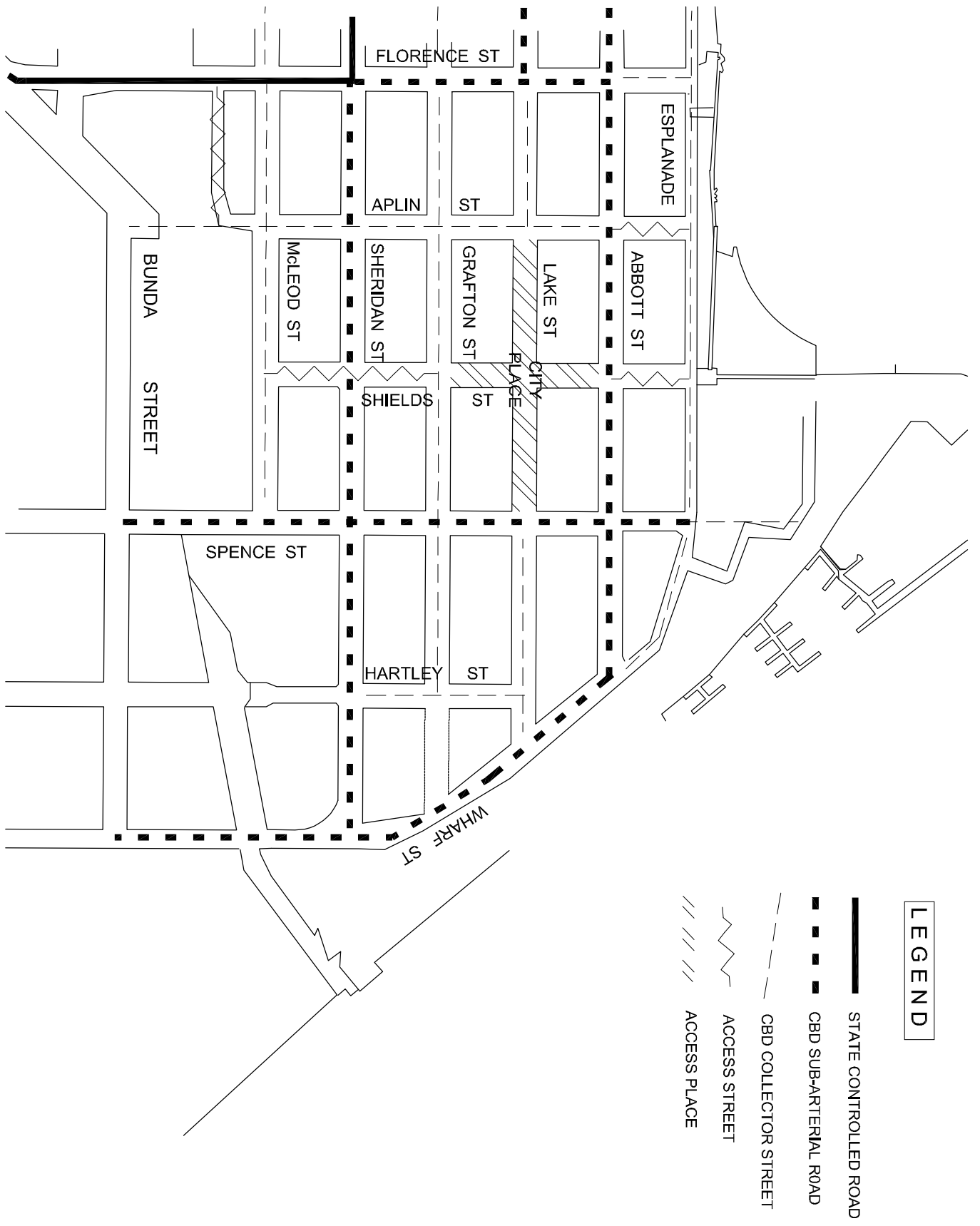

**LEGEND**

- STATE CONTROLLED ROAD
- - - CBD SUB-ARTERIAL ROAD
- · · CBD COLLECTOR STREET
- ACCESS STREET
- ~ ACCESS PLACE
- /// ACCESS PLACE

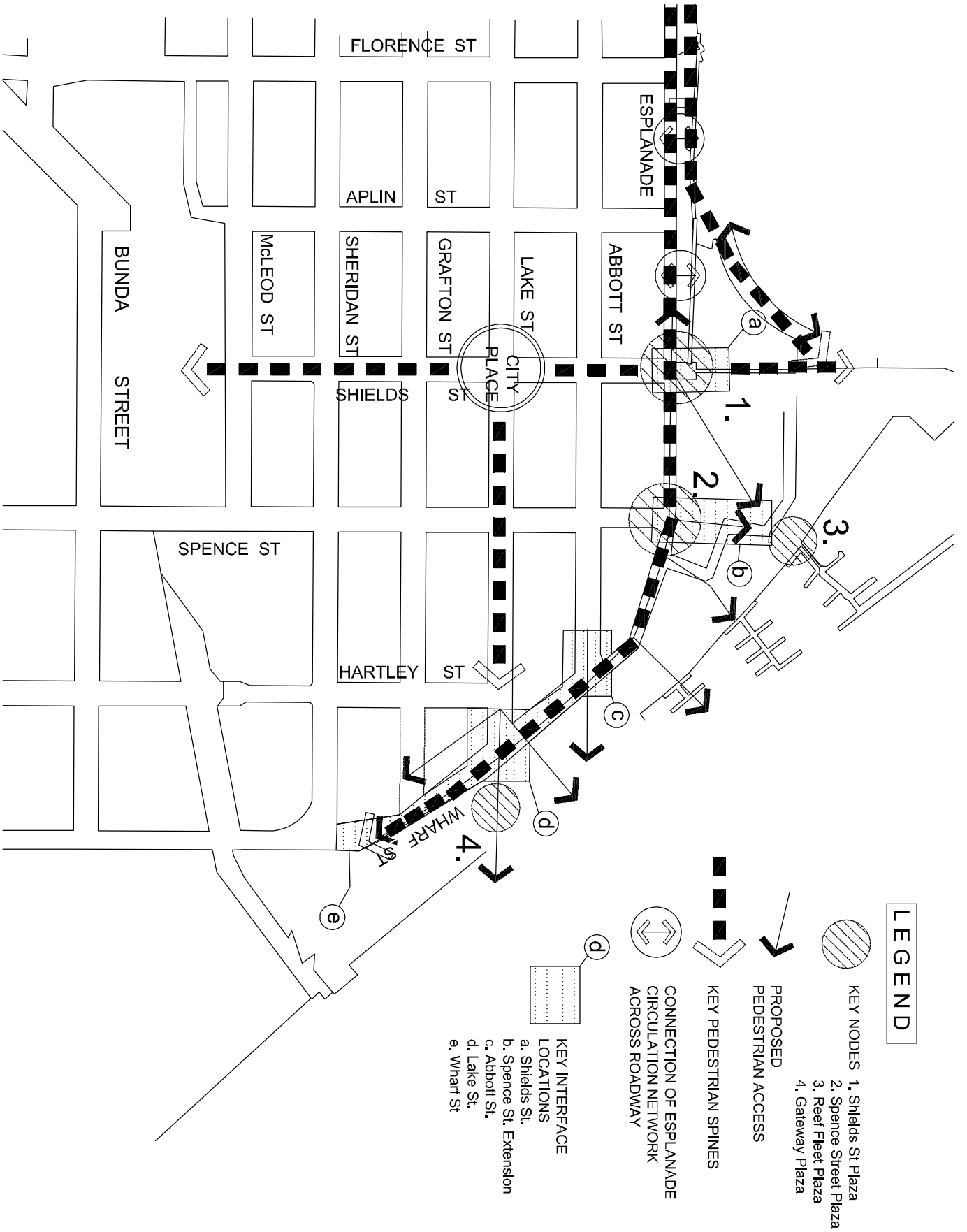

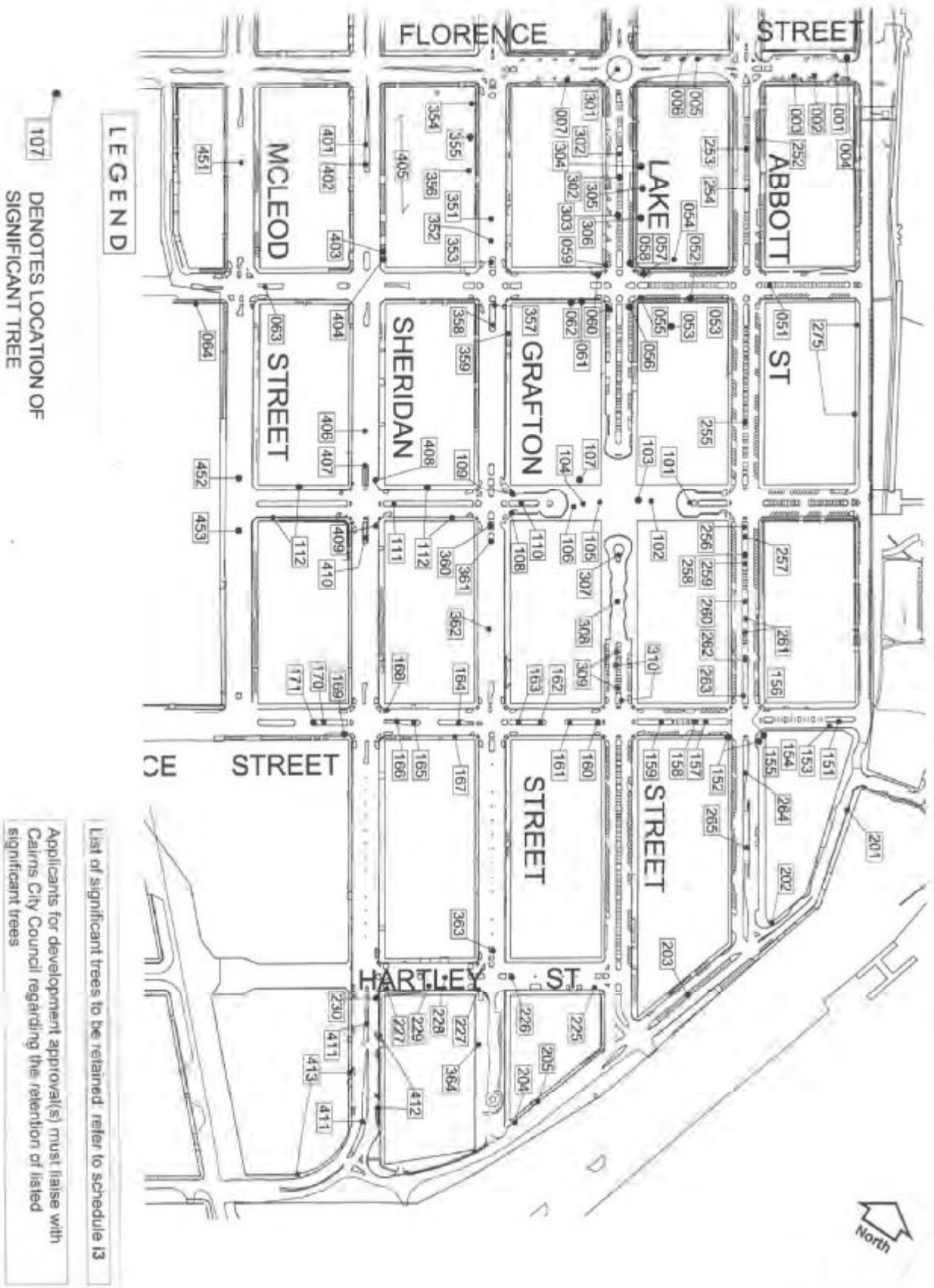

107 DENOTES LOCATION OF SIGNIFICANT TREE

List of significant trees to be retained refer to schedule 13

Applicants for development approval(s) must liaise with Cairns City Council regarding the retention of listed significant trees

1. City Place
2. The Regional Art Gallery
3. The City Library
4. The Shields Street Boulevard
5. The Lake Street Water Boulevard
6. The Government Civic Precinct
7. The Grafton Street Precinct
8. The Abbot Street Historic Precinct
9. The Wharf Street Maritime Precinct

## Precincts

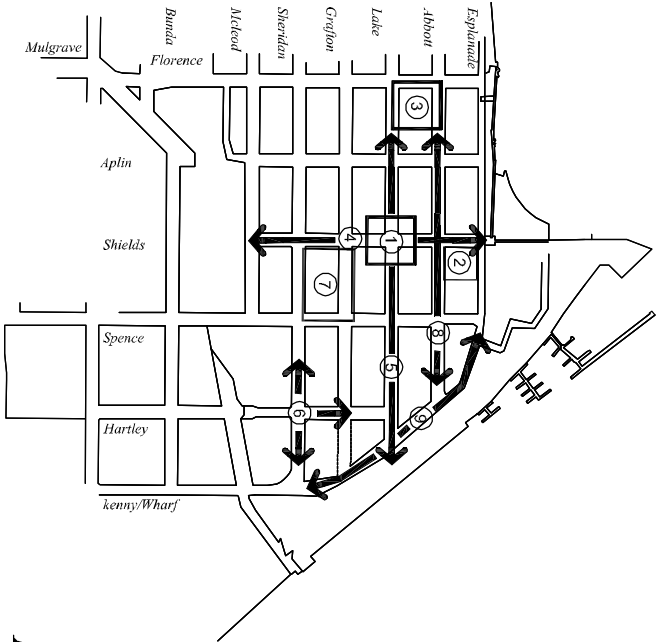

- Key
- Intersections

## Focal Points

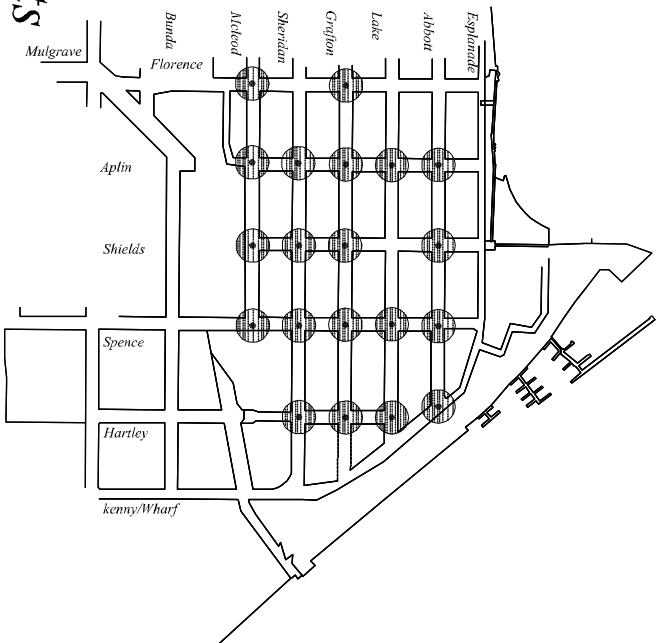

- Key
1. City Place
  2. Shields Street Plaza
  3. Reef Fleet Plaza
  4. Spence Street
  5. Gateway Plaza

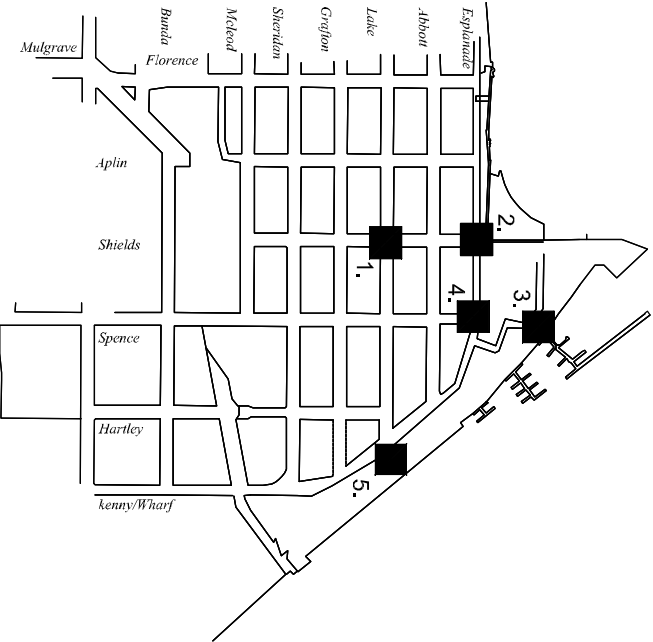

## Key Nodes



- Key
- Primary Gateways
  - Secondary Entries

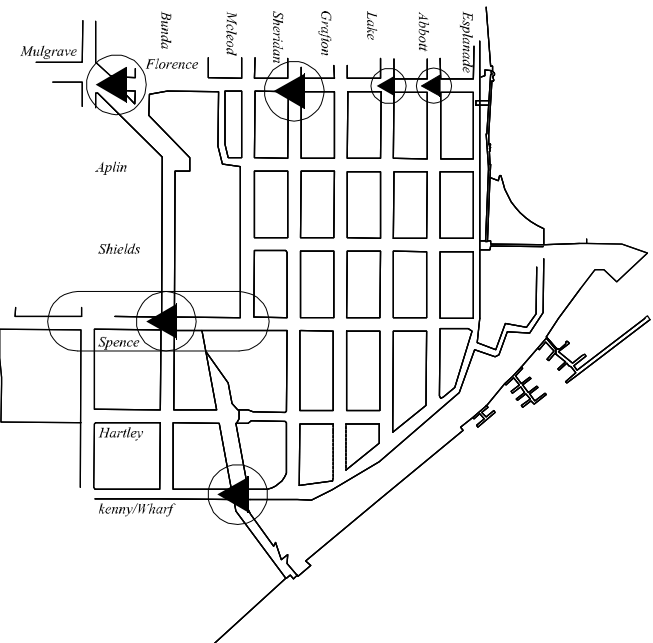

## Gateways



- Key**
-  Boulevard Planting
  -  Intersection Treatment

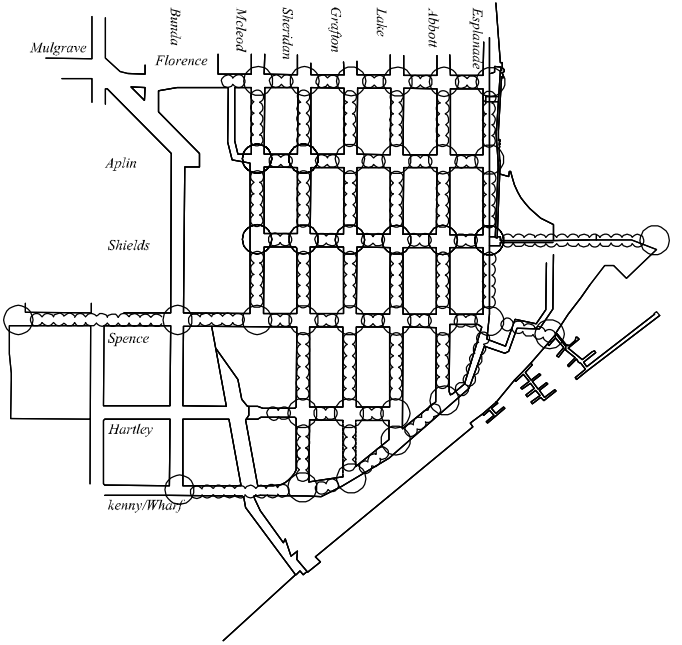



## Street Planting

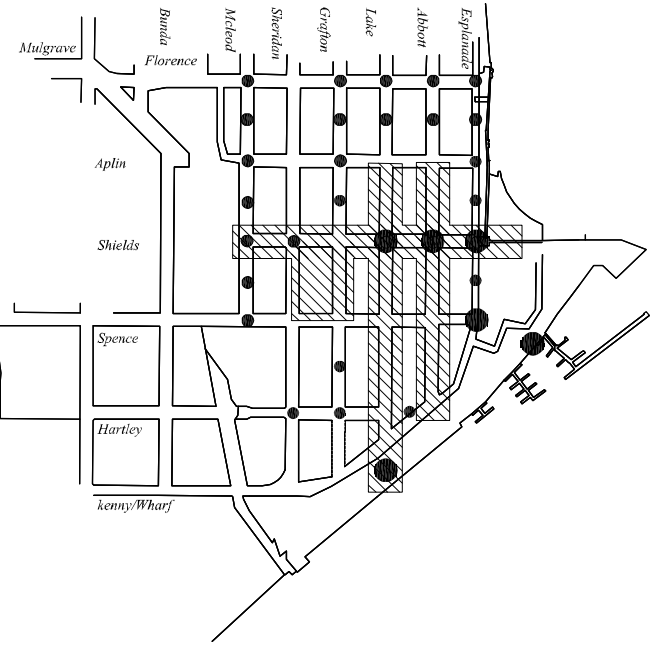

- Key**
-  Signature Artworks
  -  Art at Focal Points
  -  Art as key element in Precincts

## Public Art



- Key**
-  Sub Arterial Modified Style
  -  Collector Road
  -  Full Paving
  -  Sub Arterial Full Paving
  -  Collector Road (Modified Style)

## Footpath Treatments

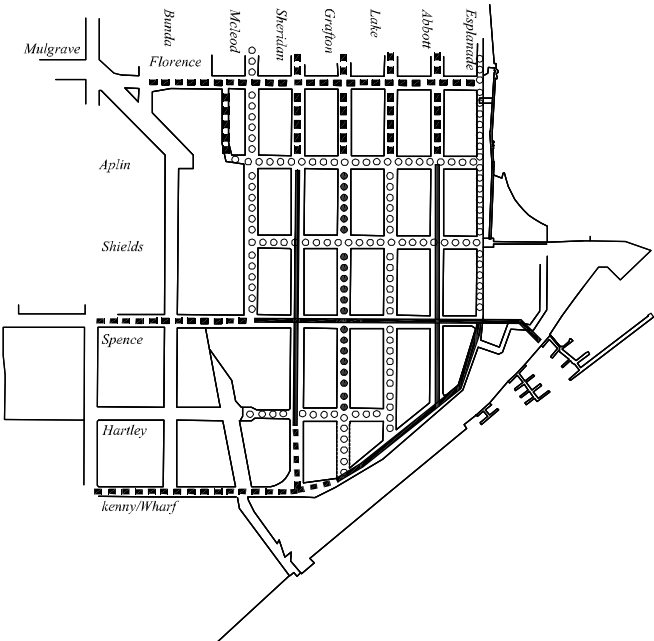



THIS PAGE HAS BEEN LEFT INTENTIONALLY BLANK



THIS PAGE HAS BEEN LEFT INTENTIONALLY BLANK



# APPENDIX B

**City Place** is a key node in the CBD. This diagram illustrates the current configuration.

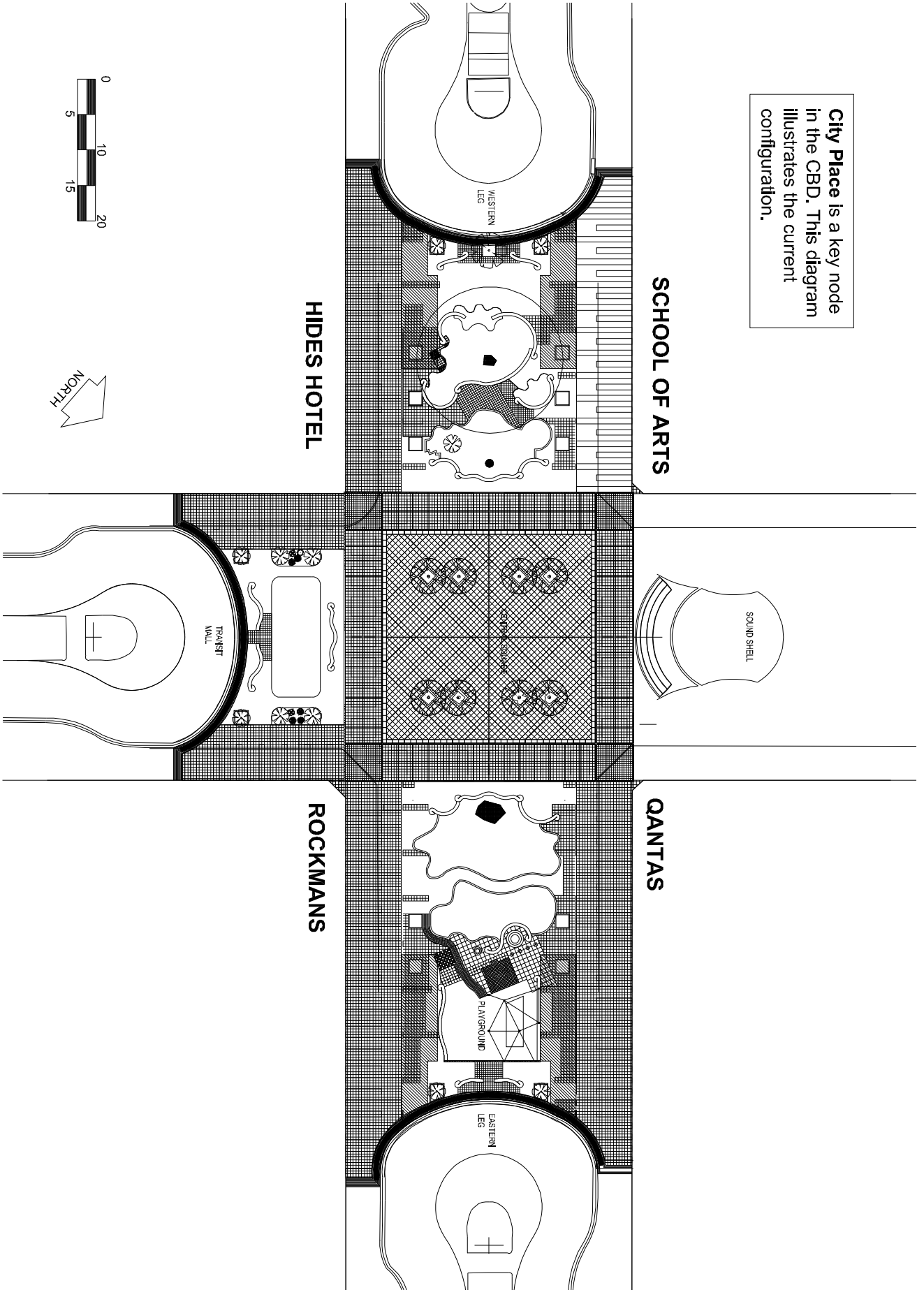

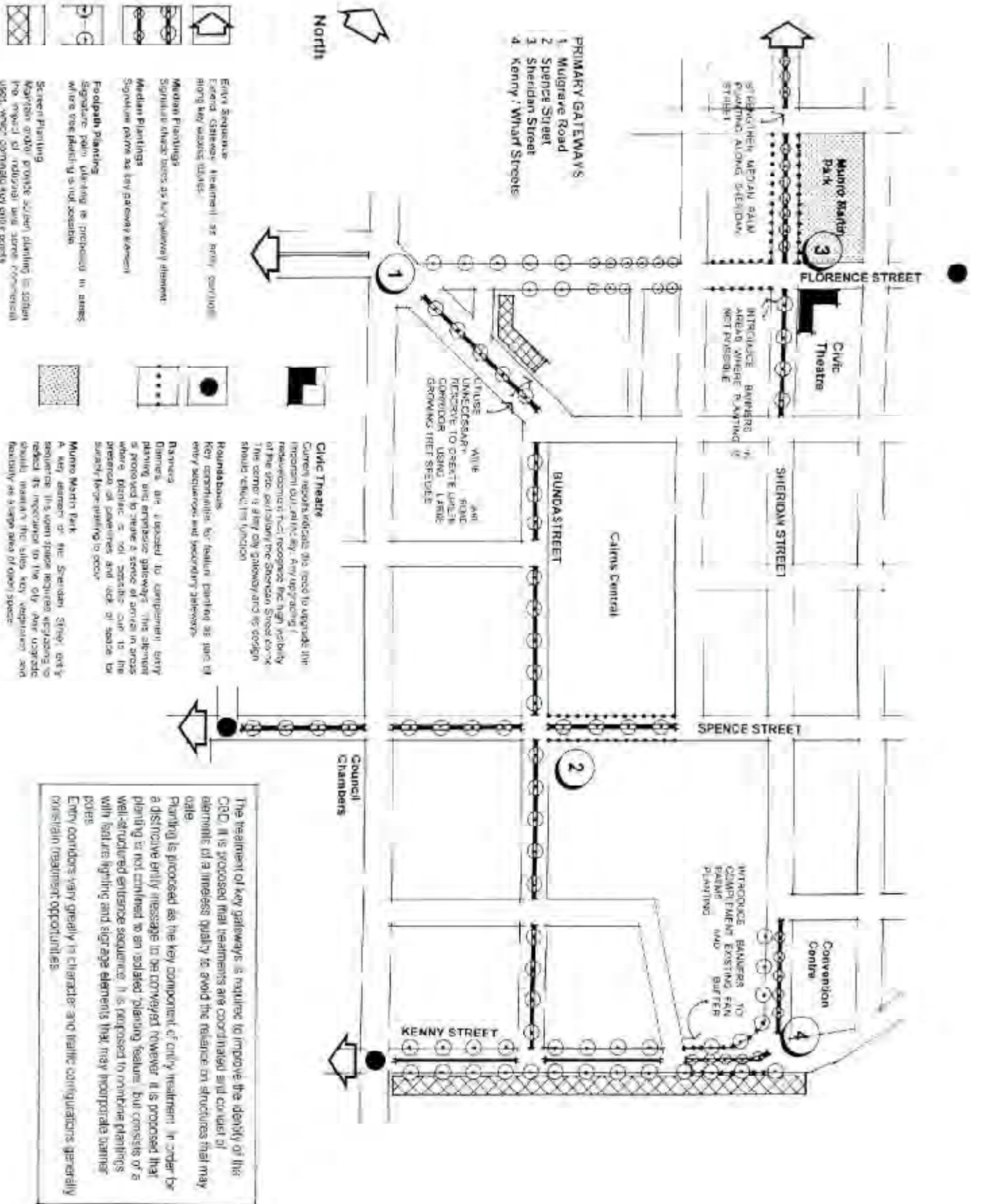

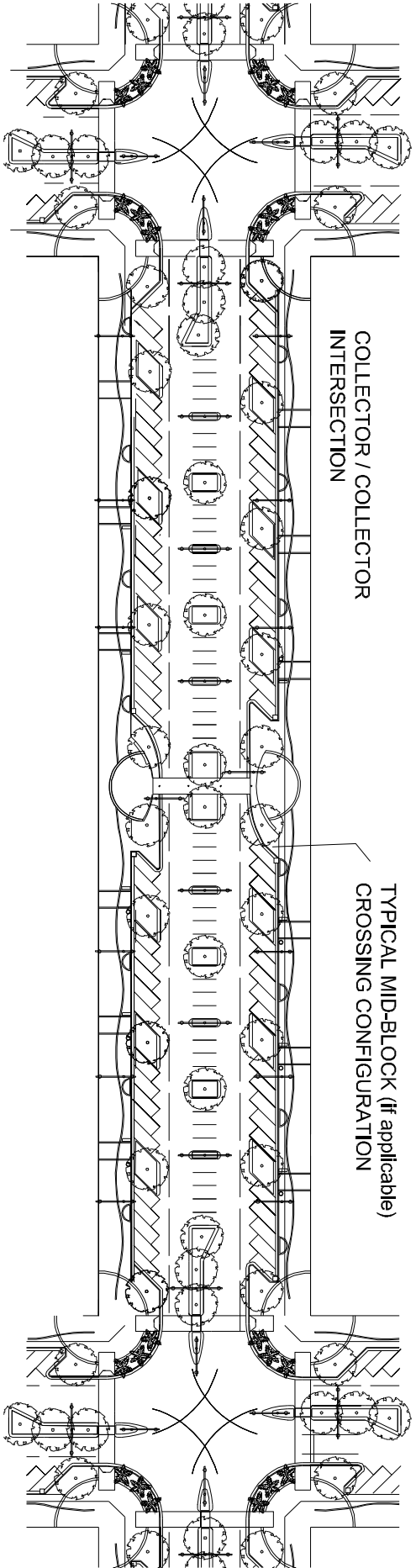

TYPICAL COLLECTOR LAYOUT - PLAN

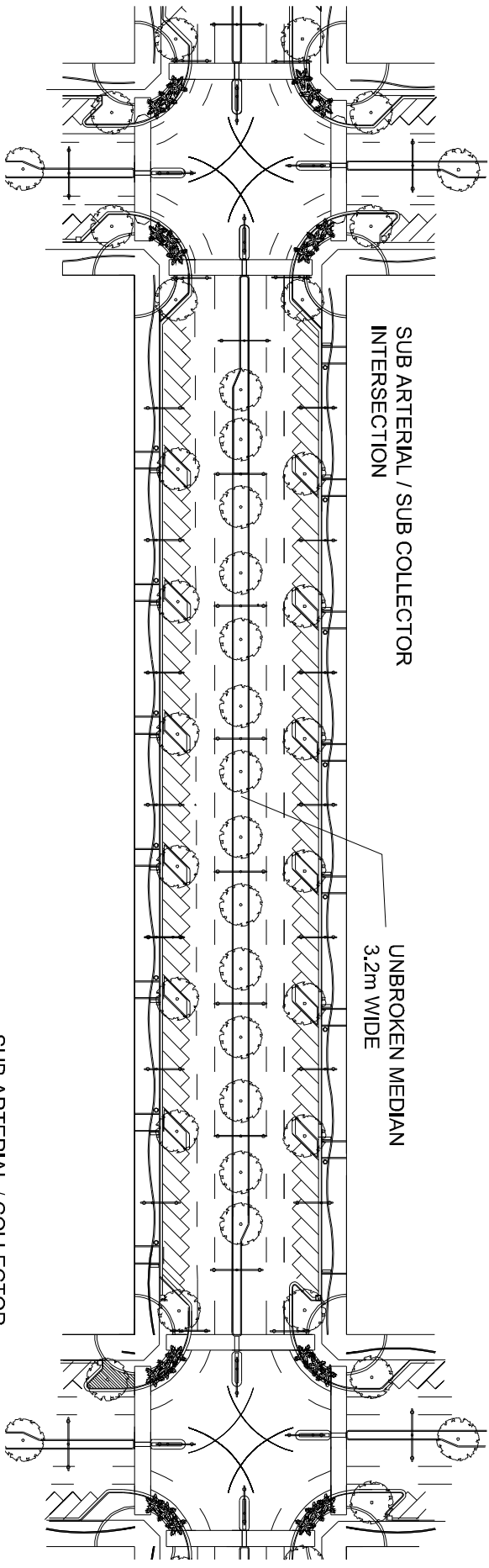

TYPICAL SUB ARTERIAL LAYOUT - PLAN

SUB ARTERIAL / COLLECTOR INTERSECTION

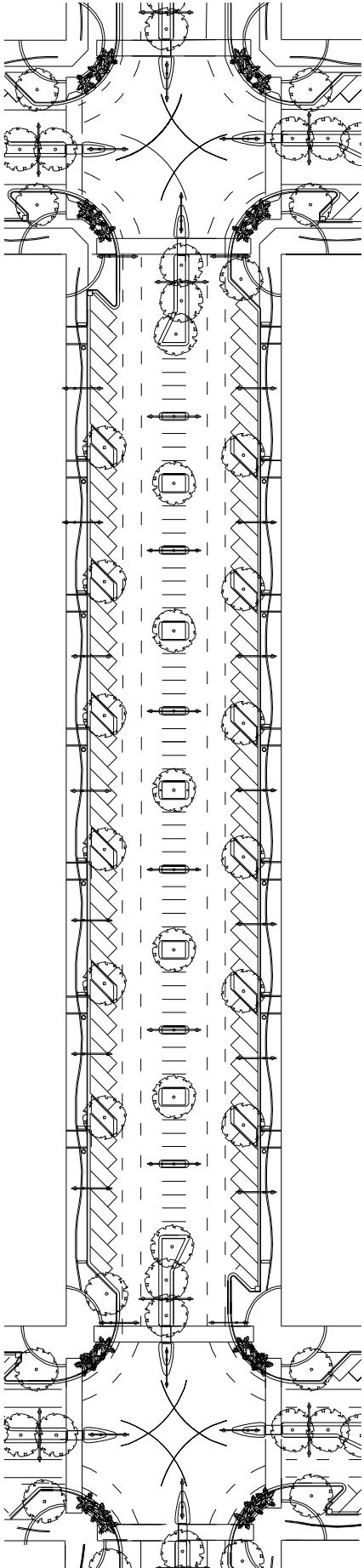

MODIFIED COLLECTOR / COLLECTOR  
INTERSECTION

TYPICAL MODIFIED COLLECTOR LAYOUT - PLAN  
(EXAMPLE - GRAFTON STREET; HARTLEY TO SPENCE STREETS)



## STREET TREE MATRIX - INTERSECTIONS

STREET	FLORENCE	APLIN	SHIELDS	SPENCE	HARTLEY	WHARF/KENNY
<b>ESPLANADE</b>	IM Cupaniopsis flagelliformis (Mangeth) IV Dictyosperma album IC Dictyosperma album	IM Butea monosperma IV Dictyosperma album IC Dictyosperma album	IM Woodyetia bifurcata IV Sterculia shillinglawii IC Dypsis decaryi	IM Pandanus bairdii IV Hernandia nymphaeifolia IC Dictyosperma album		
<b>ABBOTT</b>	IR Bismarkia nobilis IM Erythrina variegata var. parveili IV Pisonia grandis 'Alba' IC Carpentaria acuminata	IM Pterospermum acerifolium IV Plumeria rubra 'Hot Pink' IC Pritchardia pacifica	IM Plumeria obtusa IV Stermnadenia gallicotii IC Normandya normandyi	IM Cardwellia sublimis IV Darlingia ferruginea IC Ptychosperma elegans		
<b>LAKE</b>	IR Bismarkia nobilis IM Erythrina variegata var. parveili IV Pisonia grandis 'Alba' IC Carpentaria acuminata	IM Storkelia australiensis IV Xanthostemon chrysanthus IC Livistona rotundifolia	SPECIAL PROJECT SITE CITY PLACE IM Emmenosperma aliphitonoides IV Michelia champaca IC Hydrastele wendlandiana	IM Cerbera manghas IV Kopsia arborea IC Ptychosperma elegans	IM Pandanus zea IV Heritiera littoralis IC Archontophoenix alexandrae	IM Pandanus zea IV Heritiera littoralis IC Archontophoenix alexandrae
<b>GRAFTON</b>	IM Alloxylon flammeum IV Marssonioiciza coccinea IC Hyophorba verschaffeltii	IM Calophyllum inophyllum IV Xanthostemon chrysanthus IC Livistona australis	IM Plumeria rubra 'Orange' IV Cordia sebestena IC Hydrastele wendlandiana	IM Agathis robusta IV Podocarpus grayae IC Areca catechu	IM Dillenia indica IV Dillenia indica IC Ptychosperma elegans	IM Livistona decipiens
<b>SHERIDAN</b>		IM Livistona muelleri IV NA IC Areca triandra	IM Plumeria rubra 'Orange' IV Cordia sebestena IC Hydrastele wendlandiana	IM Calophyllum inophyllum IV Podocarpus grayae IC Areca catechu	IM Xylocarpus granatum IV Xylocarpus granatum IC NA	IM Livistona decipiens
<b>MCLEOD</b>		IM Tabebuia argentea IV Brachycthon veulinosus IC Sabal palmetto	IM Brachycthon veulinosus IV Brachycthon veulinosus IC Hydrastele wendlandiana	IM Tabebuia coriacea IV Brachycthon veulinosus IC Vethia merrilli		
<b>BUNDA</b>		IM Brachycthon acerifolius IV Terminalia muelleri IC Terminalia muelleri Livistona chinensis	IM Ficus drupacea Barringtonia calypttrata IV Terminalia muelleri IC Terminalia muelleri Livistona chinensis	IM Ficus drupacea Barringtonia calypttrata IV Terminalia muelleri IC Terminalia muelleri Livistona chinensis	IM Ficus drupacea Barringtonia calypttrata IV Terminalia muelleri IC Terminalia muelleri Livistona chinensis	IM Ficus drupacea Barringtonia calypttrata IV Terminalia muelleri IC Terminalia muelleri Livistona chinensis

### LOCATION KEY

IM	intersection medium
IV	intersection verge
IC	intersection corner
IR	roundabout



**STREET TREE MATRIX - NORTH / SOUTH STREETS**

STREET	BLOCK	FLORENCE TO APLIN	APLIN TO SHIELDS	SHIELDS TO SPENCE	SPENCE TO HARTLEY	HARTLEY TO WHARF
ABBOTT (SA)		M Omocia emondii Pandanus bapsella	M Omocia emondii Pandanus bapsella	M Omocia emondii Pandanus bapsella	M Ficus microcarpa 'Hill' Ficus rubrocarpa 'Aurea'	
		V Tabebuia palmieri F Syzygia conduplicatum A na	V Tabebuia palmieri F Syzygia conduplicatum A Eucodialis muelleri	V Tabebuia palmieri F Eucodialis muelleri A Pipometia 'Song of India'	V Tabebuia palmieri F Barringtonia asiatica A Plectranthe 'Song of India'	V Tabebuia palmieri F Barringtonia asiatica A Plectranthe 'Song of India'
LAKE (C)		M Pongamia sp. aff. pinnata V Syzygium forte ssp. potamocephalum F Barringtonia acutangula	M Pongamia sp. aff. pinnata V Syzygium forte ssp. potamocephalum F Barringtonia acutangula A Cleistanthus hylandi	M Pongamia sp. aff. pinnata V Syzygium forte ssp. potamocephalum F Barringtonia acutangula A Cleistanthus hylandi	M Pongamia sp. aff. pinnata V Syzygium forte ssp. potamocephalum F Barringtonia acutangula A na	M Pongamia sp. aff. pinnata V Syzygium forte F Barringtonia acutangula A na
		M Sycyugum alligatum V Brachycthon acantholus F Cryptocarya mackinnoniana A Randia fissilami	M Brachycthon acantholus V Barringtonia acutangula F Cryptocarya mackinnoniana A Randia fissilami	M Brachycthon acantholus V Barringtonia acutangula F Cryptocarya mackinnoniana A Randia fissilami	M Brachycthon acantholus V Barringtonia acutangula F Cryptocarya mackinnoniana A Randia fissilami	M Brachycthon acantholus V Barringtonia acutangula F Cryptocarya mackinnoniana A Randia fissilami
SHERIDAN (SA)		M Livistona decipiens V Darlingia darlingiana F Buckinghamia celastroides A na	M Itisia bijuga V Darlingia darlingiana F Buckinghamia celastroides A na	M Itisia bijuga V Darlingia darlingiana F Buckinghamia celastroides A na	M Itisia bijuga V Darlingia darlingiana F Buckinghamia celastroides A na	M Livistona decipiens V Livistona decipiens F Syzygium jambos A na
		M Cassia javanica V Cassia x 'Rainbow Shower' F Toechima daemelianum A na	M Cassia javanica V Cassia x 'Rainbow Shower' F Toechima daemelianum A na	M Cassia javanica V Cassia x 'Rainbow Shower' F Toechima daemelianum A na	M Cassia javanica V Cassia x 'Rainbow Shower' F Toechima daemelianum A na	M Cassia javanica V Cassia x 'Rainbow Shower' F Toechima daemelianum A na
BUNDA (Ar)		M to be confirmed V na F Terminalia muelleri Livistona chinensis	M Ficus drupacea V na F Terminalia muelleri Livistona chinensis	M Ficus drupacea V na F Terminalia muelleri Livistona chinensis	M Ficus drupacea Barringtonia celystrata V na F Terminalia muelleri Livistona chinensis	M Ficus drupacea Barringtonia celystrata V na F Terminalia muelleri Livistona chinensis

**Location Key**

- M median
- V verge
- F footpath
- A awning

## STREET TREE MATRIX - EAST/ WEST STREETS

STREET	BLOCK					
	ESPLANADE TO ABBOTT	ABBOTT TO LAKE	LAKE T O GRAFTON	GRAFTON TO SHERIDAN	SHERIDAN TO MCLEOD	MCLEOD TO BUNDA
<b>FLORENCE (SA)</b>	M NA V Delonix regia F Stenocarpus sinuatus A Harpullia rarniflora	M NA V Delonix regia F Stenocarpus sinuatus A Randia fitzalanii	M NA V Delonix regia F Stenocarpus sinuatus A Randia fitzalanii	M NA V Delonix regia F Stenocarpus sinuatus A Harpullia rarniflora	M NA V NA F Carpentaria acuminata Syzgium jambos A NA	M NA V NA F Carpentaria acuminata Syzgium jambos A NA
<b>APLIN (C)</b>	M Peltophorum dubium V Delonix regia F Gustavia superba A NA	M Peltophorum dubium V Delonix regia F Gustavia superba A NA	M Peltophorum dubium V Delonix regia F Gustavia superba A NA	M Peltophorum dubium V Delonix regia F Tabebuia rosea A NA	M Peltophorum dubium V Delonix regia F Tabebuia rosea A NA	
<b>SHIELDS (C)</b>	M Ficus longifolia V Toechima pterocarpum F Barringtonia asiatica A NA	M Ficus longifolia V Toechima pterocarpum F Barringtonia asiatica A NA	M Ficus longifolia V Toechima pterocarpum F Barringtonia asiatica A NA	M Ficus longifolia V Toechima pterocarpum F Barringtonia asiatica A NA	M Ficus longifolia V Toechima pterocarpum F Barringtonia asiatica A NA	
<b>SPENCE (SA)</b>	M Calophyllum inophyllum V Calophyllum sil F Barringtonia asiatica A Randia fitzalanii	M Flindersia itfalana Syzgium minutiflorum V Calophyllum sil F NA A Randia fitzalanii	M Flindersia itfalana Syzgium minutiflorum V Calophyllum sil F NA A Randia fitzalanii	M Flindersia itfalana Syzgium minutiflorum V Calophyllum sil F NA A Randia fitzalanii	M Flindersia itfalana Syzgium minutiflorum V Calophyllum sil F NA A Randia fitzalanii	M Flindersia itfalana Ficus benjamina V Calophyllum sil F Randia fitzalanii A NA
<b>HARTLEY (C)</b>			M Ficus hillii V Dillenia indica Livistona muelleri F Carallia brachialata A NA	M Ficus hillii V Dillenia indica Livistona muelleri F Dillenia indica Wodyetia biturcata A NA		
<b>WHARF (SA)</b>	M Pongamia pinnata V Cerbera odollam Inocarpus edulis F Barringtonia asiatica A NA	M Pongamia pinnata V Cerbera odollam Inocarpus edulis F Barringtonia asiatica A Randia fitzalanii	M Pongamia pinnata V Cerbera odollam Inocarpus edulis F Barringtonia asiatica A Randia fitzalanii	M Pongamia pinnata V Cerbera odollam Inocarpus edulis F Barringtonia asiatica A NA	M Livistona decipiens V NA F Syzygium jambos A NA	M Livistona decipiens V NA F Syzygium jambos A NA

### LOCATION KEY

M	median
V	verge
F	footpath
A	awning



## DOMINANT UNDERSTOREY - INTERSECTIONS

STREET	FLORENCE	APLIN	SHIELDS	SPEENCE	HARTLEY	WHARF/ KENNY
<b>ABBOTT</b>	IR Ixora 'Malay Pink' Ipomoea batatas Rhoeo discolor Dwarf IV Ophiopogon japonicus variegata Ixora 'Gold Superb' IC Ixora 'Sunset'	IM Clerodendron quadriloculare Costus erythrophyllus IV Peristrophe hyscipholia variegata IV Justicia carnea discolor Peristrophe hyscipholia variegata	IM Hedychium orange hyp Dianella atraxis IV Hedychium longicornutum Torenia 'Blue Magic' IC Ruellia tuberosa	IM Whiteflida longifolia Ixora Splash Gardenia radicans IV Aechmea garmsprata 'Lucky Stripes' IC Trachelospermum asiaticum variegatum		
<b>LAKE</b>	IR Ixora 'Malay Pink' Rhoeo discolor Dwarf IV Ophiopogon japonicus variegata Ixora 'Gold Superb' IC Ixora 'Sunset'	IM Hedychium gardenianum Allemanda 'Sunee' IV Diereffia yellow Dietes bicolor IC Ixora 'Gold Superb'	CITY PLACE (SEE DETAILED DOCUMENTATION FOR CITY PLACE PLANNING)	IM Cinnam pedunculatum variegatum Catharranthus rosea alba IV Hymenocallis littoralis variegata IC Pseuderanthemum sinuatum Hemigraphis repanda	IM Cinnam pedunculatum var IV Hymenocallis littoralis var. IC Pseuderanthemum sinuatum Hemigraphis repanda	
<b>GRAFTON</b>	IV Ophiopogon japonicus variegata Ixora 'Gold Superb' IC Ixora 'Sunset'	IM Mussaenda 'Lakambini' Coleus 'Burgundy' IV Quisqualis mussaendiflora Alternanthera dentata 'Island Sunset' IC Calliandra 'Red Flash'	IM Aphelandra terragona Hedychium longicornutum Gloriosa superba IV Hedychium longicornutum Torenia 'Blue Magic'	IM Hibiscus 'Snowflake' Hemigraphis colorata IV Zingibe zerumbet variegata Gardenia radicans IC Ophiopogon jaburan variegata	IM Hibiscus 'Snowflake' Hemigraphis colorata IV Zingibe zerumbet variegata Gardenia radicans IC Ophiopogon jaburan var.	
<b>SHERIDAN</b>	IV Ophiopogon japonicus variegata Ixora 'Gold Superb' Rhoeo discolor Dwarf IC Ixora 'Sunset'	IM Mussaenda 'Lakambini' Alternanthera dentata 'Island Sunset' IV Quisqualis mussaendiflora Coleus IC Calliandra 'Red Flash'	IM Dichorisandra thyrifolia Costus productus IV Pycnostachyis unctifolius	IM Dracaena marginata tricolor Neomarica bicolor IV Pedilanthus tithymalioides Rhoeo discolor sp. IC Dianella ensifolia variegata	IM Dracaena marginata tricolor Neomarica bicolor IV Pedilanthus tithymalioides Rhoeo discolor sp. IC Dianella ensifolia variegata	
<b>MCLEOD</b>	IV Ophiopogon japonicus variegata Ixora 'Gold Superb' Rhoeo discolor Dwarf IC Ixora 'Sunset'	IM Aphelandra sinclairiana Rondeletia speciosa Centradenia rosea IV Tecomania capensis 'Salmon' Malpighia cocugera IC Zephyranthes rosea	IM Aphelandra sinclairiana Eranthemum pulchellum (dark blue) IV Medinella scotesehni Hemigraphis colorata IC Ruellia tuberosa	IM Aphelandra sinclairiana Whiteflida longifolia IV NA IC Barleria albostellata Setraesia purpurea	IM Aphelandra sinclairiana Whiteflida longifolia IV NA IC Barleria albostellata Setraesia purpurea	
<b>BUNDA</b>				IV Pedilanthus tithymalioides Rhoeo discolor sp. IC Dianella ensifolia variegata		

LOCATION KEY	
IM	intersection medium
IV	intersection verge
IC	intersection corner
IR	roundabout

## DOMINANT UNDERSTOREY - NORTH/ SOUTH STREETS

STREET	BLOCK		SHIELDS TO SPENCE	SPENCE TO HARTLEY	HARTLEY TO WHARF
	FLORENCE TO APLIN	APLIN TO SHIELDS			
<b>ABBOTT (SA)</b>	M Ixora 'Malay Pink' Asystasia 'Enchanting Bells' V Cordyline 'Red Sister' Pseuderanthemum reticulatum Barleria repens 'Coral Bells' F Medinella micans Cordyline 'Kiwi Multi' Cuphea mexicana compacta pink	M Ixora 'Malay Pink' Asystasia 'Enchanting Bells' V Cordyline 'Red Sister' Pseuderanthemum reticulatum Barleria repens 'Coral Bells' F Medinella micans Cordyline 'Kiwi Multi' Cuphea mexicana compacta pink	M Ixora 'Malay Pink' Asystasia 'Enchanting Bells' V Cordyline 'Red Sister' Pseuderanthemum reticulatum Barleria repens 'Coral Bells' F Medinella micans Cordyline 'Kiwi Multi' Cuphea mexicana compacta pink	M Philodendron 'Goldlocks' Barleria repens V Duranta 'Squatters Gold' Sourtelaria ventrali Loropetalum chinense 'Rudra' F Osmanthus linearis 'Magos' Philodendron 'Millenium' Rhoeo 'Hawaiian Dwarf'	M Hymenocallis littoralis Hemigraphis colorata V Zantedeschia aethiopica Hypolyrtum nemorum Phalaris arundinacea variegata F Homalomena rubescens Cordyline 'Dolly' Caretax horstfieldii
<b>LAKE (C)</b>	M Medinella micans Hemigraphis colorata V Brunfelsia 'Sweet Petite' Dietes grandiflora F Dianella ensifolia variegata Ophiopogon japonicus	M Medinella micans Hemigraphis colorata V Brunfelsia 'Sweet Petite' Philodendron 'Millenium' F Dianella ensifolia variegata Ophiopogon japonicus	M Medinella micans Hemigraphis colorata V Brunfelsia 'Sweet Petite' Dietes grandiflora F Liriope 'Evergreen Giant' Zephyranthes candida	M Hymenocallis littoralis Hemigraphis colorata V Zantedeschia aethiopica Hypolyrtum nemorum Phalaris arundinacea variegata F Homalomena rubescens Cordyline 'Dolly' Caretax horstfieldii	M Hymenocallis littoralis Hemigraphis colorata V Zantedeschia aethiopica Hypolyrtum nemorum Phalaris arundinacea variegata F Homalomena rubescens Cordyline 'Dolly' Caretax horstfieldii
<b>GRAFTON (C)</b>	M Ixora coccinea Gardenia 'Ocean Pearl' V Ixora 'Sunkist Compacta' Gardenia radicans F Jasminum sambac 'Grand Duke of Tuscany' Ruellia elegans Ophiopogon laburan	M Ixora coccinea Gardenia 'Ocean Pearl' V Ixora 'Sunkist Compacta' Gardenia radicans F Jasminum sambac 'Grand Duke of Tuscany' Ruellia elegans Ophiopogon laburan	M Ixora coccinea Gardenia 'Ocean Pearl' V Ixora 'Sunkist Compacta' Gardenia radicans F Ardisia crenata Nandina domestica 'Gulf Stream'	M Ixora coccinea Gardenia 'Ocean Pearl' V Ixora 'Sunkist Compacta' Gardenia radicans F Jasminum sambac 'Grand Duke of Tuscany'	M Ixora coccinea Gardenia 'Ocean Pearl' V Ixora 'Sunkist Compacta' Gardenia radicans F Jasminum sambac 'Grand Duke of Tuscany'
<b>SHRIDAN (SA)</b>	M Belamcanda chinensis Portea petropollitana Pitcairnia wendlandii V Arundina graminifolia Rhoeo discolor sp. Portea petropollitana F Dracaena thalictoides Epidendrum 'Red Crucifix' Spathoglottis paulinae	M Belamcanda chinensis Portea petropollitana Pitcairnia wendlandii V Arundina graminifolia Rhoeo discolor sp. Portea petropollitana F Dracaena thalictoides Epidendrum 'Red Crucifix' Spathoglottis paulinae	M Heliconia 'Fireflash' Rhoeo discolor sp. V Clousotia sp. Sectraesia purpurea F Dracaena thalictoides Epidendrum 'Red Crucifix' Spathoglottis paulinae	M Zamia furfuracea Sectraesia purpurea V Arundina graminifolia Rhoeo discolor sp. Portea petropollitana F Philodendron 'Millenium' Epidendrum 'Red Crucifix' Spathoglottis paulinae	M Hymenocallis caribaea Rhoeo 'Hawaiian Dwarf' V Philodendron 'Millenium' F Turf
<b>MCLEOD (C)</b>	M Ixora 'Malay Pink' Crossandra 'Mona Wallhead' Rhoeo 'Hawaiian Dwarf' V Ixora 'Sheena' Dianthera nodosa Alternanthera dentata F Canna 'Tropicanna' Ophiopogon laburan variegatum	M Ixora 'Malay Pink' Crossandra 'Mona Wallhead' Rhoeo 'Hawaiian Dwarf' V Ixora 'Sheena' Dianthera nodosa Alternanthera dentata F Canna 'Tropicanna' Ophiopogon laburan variegatum	M Ixora 'Malay Pink' Crossandra 'Mona Wallhead' Rhoeo 'Hawaiian Dwarf' V Ixora 'Sheena' Dianthera nodosa Alternanthera dentata F Canna 'Tropicanna' Ophiopogon laburan variegatum		
<b>BUNDA (A)</b>		M Hymenocallis littoralis Ixora 'Malay Pink'	M Hymenocallis littoralis Ixora 'Malay Pink'		

LOCATION KEY	
M	median
V	verge
F	footpath
A	awning

## DOMINANT UNDERSTOREY - EAST/ WEST STREETS

STREET	BLOCK					
	ESPLANADE TO ABBOTT	ABBOTT TO LAKE	LAKE TO GRAFTON	GRAFTON TO SHERIDAN	SHERIDAN TO MCLEOD	MCLEOD TO BUNDA
<b>FLOR-ENCE (SA)</b>	M Philodendron 'Millennium' Alliameda 'Sunee' V Ruella colorata Hemigraphis colorata F NA	M Philodendron 'Millennium' Alliameda 'Sunee' V Ruella colorata Hemigraphis colorata F NA	M Philodendron 'Millennium' Alliameda 'Sunee' V Ruella colorata Hemigraphis colorata F NA	M Philodendron 'Millennium' Alliameda 'Sunee' V Ruella colorata Hemigraphis colorata F NA	M Philodendron 'Millennium' Alliameda 'Sunee' V Ruella colorata Hemigraphis colorata F NA	(McLeod to Martyr) M Philodendron 'Millennium' Alliameda 'Sunee' V Ruella colorata Hemigraphis colorata
<b>APLIN (C)</b>	M Kosia fruticosa Alliameda 'Sunee' Hemigraphis colorata V Hypericum patulum Hemigraphis alternata metalica Ixora 'Kampong Pride' Ixora 'Gold Superb' F Pentas 'Candy Stripe'	M Pachystachys lutea Malpighia coccoligera Hemigraphis colorata V Stroblanthus dyerianus Philodendron 'Millennium' Pilea cadleri	M Pachystachys lutea Malpighia coccoligera Hemigraphis colorata V Medinella myrianthus Alpinia mutica	M Pachystachys lutea Malpighia coccoligera Hemigraphis colorata V Medinella myrianthus Alpinia mutica	M Pachystachys lutea Malpighia coccoligera Hemigraphis colorata V Medinella myrianthus Alpinia mutica	M Pachystachys lutea Malpighia coccoligera Hemigraphis colorata V Medinella myrianthus Alpinia mutica
<b>SHIELDS (C)</b>	M Ixora 'Coral Fire' Ixora 'Sheena' V Ixora 'Twilight Glow' Pseudanthemum andersonii F Ixora 'Wee Willie' Torenia 'Blue Magic'	M Ixora 'Coral Fire' Ixora 'Sheena' V Ixora 'Twilight Glow' Pseudanthemum andersonii F Ixora 'Wee Willie' Torenia 'Blue Magic'	M Ixora 'Coral Fire' Thunbergia erecta V Ixora 'Twilight Glow' Pseudanthemum andersonii F Ixora 'Wee Willie' Torenia 'Blue Magic'	M Ixora 'Coral Fire' Thunbergia erecta V Ixora 'Twilight Glow' Pseudanthemum andersonii F Ixora 'Wee Willie' Torenia 'Blue Magic'	M Ixora 'Coral Fire' Thunbergia erecta V Ixora 'Twilight Glow' Pseudanthemum andersonii F Ixora 'Wee Willie' Torenia 'Blue Magic'	M Ixora 'Coral Fire' Thunbergia erecta V Ixora 'Twilight Glow' Pseudanthemum andersonii F Ixora 'Wee Willie' Torenia 'Blue Magic'
<b>SPENCE (SA)</b>	M Hymenocallis littoralis	M Gardenia grandiflora 'Star' Hedyochium coronarium Cuphea mexicana compacta alba V Gardenia 'Ocean Pearl' Dracaena sanderiana F Whiteclia longifolia Zephyranthes candida Ophiopogon jaburan variegatum	M Gardenia grandiflora 'Star' Hedyochium coronarium Cuphea mexicana compacta alba V Gardenia 'Ocean Pearl' Dracaena sanderiana F Whiteclia longifolia Zephyranthes candida Ophiopogon jaburan variegatum	M Gardenia grandiflora 'Star' Hedyochium coronarium Cuphea mexicana compacta alba V Gardenia 'Ocean Pearl' Dracaena sanderiana F Whiteclia longifolia Zephyranthes candida Ophiopogon jaburan variegatum	M Gardenia grandiflora 'Star' Hedyochium coronarium Cuphea mexicana compacta alba V Gardenia 'Ocean Pearl' Dracaena sanderiana F Whiteclia longifolia Zephyranthes candida Ophiopogon jaburan variegatum	M Gardenia grandiflora 'Star' Hedyochium coronarium Cuphea mexicana compacta alba V Gardenia 'Ocean Pearl' Dracaena sanderiana F Whiteclia longifolia Zephyranthes candida Ophiopogon jaburan variegatum
<b>HARTLEY (G)</b>			M Scutellaria ventenatii Belamchanda chinensis Philodendron 'Millennium' V Gardenia 'Glenne River' Hymenocallis littoralis F Rhoec discolor dwarf	M Scutellaria ventenatii Belamchanda chinensis Philodendron 'Millennium' V Gardenia 'Glenne River' Hymenocallis littoralis F Rhoec discolor dwarf	M Scutellaria ventenatii Belamchanda chinensis Philodendron 'Millennium' V Gardenia 'Glenne River' Hymenocallis littoralis F Rhoec discolor dwarf	M Scutellaria ventenatii Belamchanda chinensis Philodendron 'Millennium' V Gardenia 'Glenne River' Hymenocallis littoralis F Rhoec discolor dwarf
<b>WHARF (SA)</b>	M Ficus okinowensis Crinum xanthophyllum V Jasminum nitidum F Hymenocallis littoralis	M Ficus okinowensis Crinum xanthophyllum V Jasminum nitidum F Hymenocallis littoralis	M Ficus okinowensis Crinum xanthophyllum V Jasminum nitidum F Hymenocallis littoralis	M Ficus okinowensis Crinum xanthophyllum V Jasminum nitidum F Hymenocallis littoralis	M Ficus okinowensis Crinum xanthophyllum V Jasminum nitidum F Hymenocallis littoralis	

LOCATION KEY	
M	median
V	verge
F	footpath
A	awning

## DOMINANT UNDERSTOREY - MIDBLOCK CROSSOVERS

STREET	BLOCK	FLORENCE TO APLIN	APLIN TO SHIELDS	SHIELDS TO SPENCE	SPENCE TO HARTLEY	HARTLEY TO WHARF/ KENNY
<b>ABBOTT</b>	M Philodendron 'Millenium' Philodendron 'Goldlocks' V Cordyline 'Inscripta' Ixora 'Tropic Blush' Pandanus 'Ioi variegates' F Dracaena gold sanderiana	M Heliconia Jamaican dwarf V Cordyline 'Inscripta' Ixora 'Tropic Blush' Pandanus 'Ioi variegates' F Dracaena gold sanderiana	M Heliconia Jamaican dwarf V Cordyline 'Inscripta' Ixora 'Tropic Blush' Pandanus 'Ioi variegates' F Dracaena gold sanderiana	M Heliconia Jamaican dwarf V Cordyline 'Inscripta' Ixora 'Tropic Blush' Pandanus 'Ioi variegates' F Dracaena gold sanderiana	M Heliconia Jamaican dwarf V Cordyline 'Inscripta' Ixora 'Tropic Blush' Pandanus 'Ioi variegates' F Dracaena gold sanderiana	M Crinum pedunculatum variegatum Hemigraphis (upright) V Hymenocallis littoralis variegatus F Dracaena sanderiana Cordyline 'Dolly'
<b>LAKE</b>	M Philodendron 'Millenium' Philodendron cannaefolia Philodendron 'Red Imperial' V Strobilanthes wallichii Alternanthera dentata 'Island Sunset'	M Xanthosoma monstrosium variegatum Spathiphyllum cannaefolia Marantia arundinaceae variegata V Strobilanthes wallichii Alternanthera dentata 'Island Sunset'	M Xanthosoma monstrosium variegatum Spathiphyllum cannaefolia Marantia arundinaceae variegata V Strobilanthes wallichii Alternanthera dentata 'Island Sunset'	M Xanthosoma monstrosium variegatum Spathiphyllum cannaefolia Marantia arundinaceae variegata V Strobilanthes wallichii Alternanthera dentata 'Island Sunset'	M Crinum pedunculatum variegatum Hemigraphis (upright) V Hymenocallis littoralis variegatus F Dracaena sanderiana Cordyline 'Dolly'	M Crinum pedunculatum variegatum Hemigraphis (upright) V Hymenocallis littoralis variegatus F Dracaena sanderiana Cordyline 'Dolly'
<b>GRAFTON</b>	M Ixora 'Global' V Belamcanda chinensis	M Ixora 'Global' V Belamcanda chinensis	M Ixora 'Global' V Belamcanda chinensis	M Ixora 'Global' Gloxinia sylvatica V Belamcanda chinensis	M Ixora 'Global' V Belamcanda chinensis	M Ixora 'Global' V Belamcanda chinensis
<b>SHERIDAN</b>						
<b>MCLEOD</b>	M Belamcanda chinensis pink Ixora 'Peach Delight' V Belamcanda chinensis orange Mirabilis jalapa Crossandra 'Mona Wallhead'	M Belamcanda chinensis pink Ixora 'Peach Delight' V Belamcanda chinensis orange Mirabilis jalapa Crossandra 'Mona Wallhead'	M Belamcanda chinensis pink Ixora 'Peach Delight' V Belamcanda chinensis orange Mirabilis jalapa Crossandra 'Mona Wallhead'	M Belamcanda chinensis pink Ixora 'Peach Delight' V Belamcanda chinensis orange Mirabilis jalapa Crossandra 'Mona Wallhead'		
<b>BUNDA</b>						

LOCATION KEY	
M	median
V	verge
F	footpath
A	awning

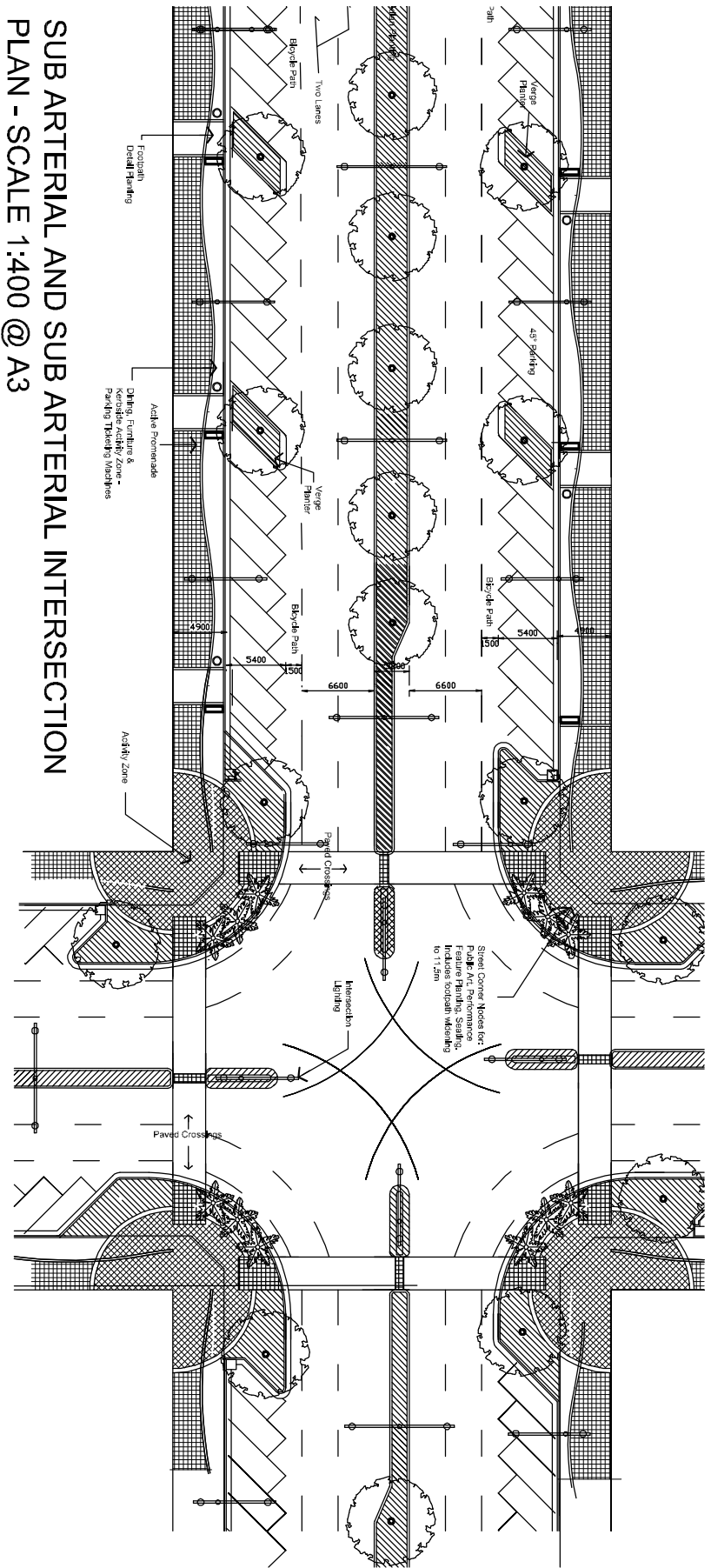

**SUB ARTERIAL AND SUB ARTERIAL INTERSECTION**  
**PLAN - SCALE 1:400 @ A3**

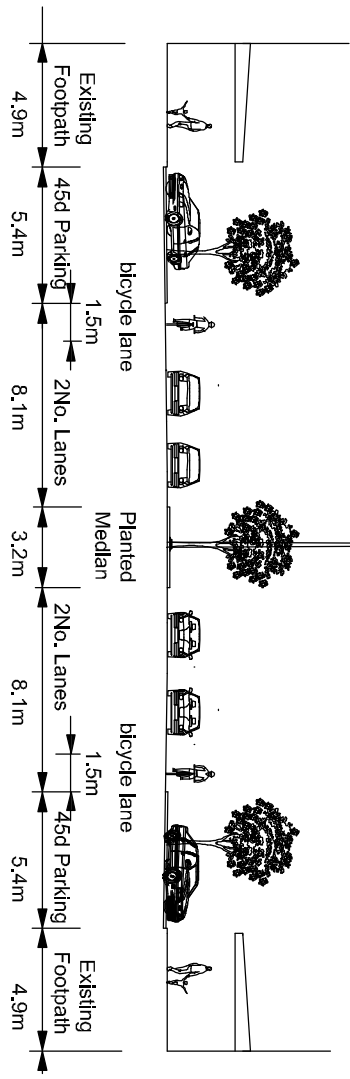

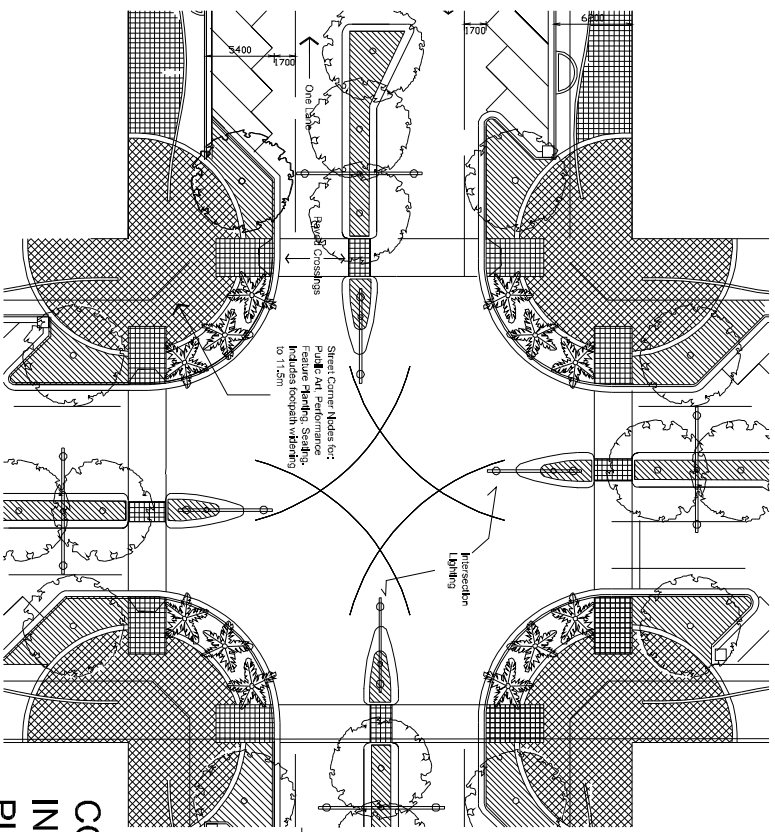

COLLECTOR STREET INTERSECTION  
PLAN - SCALE 1:400 @ A3

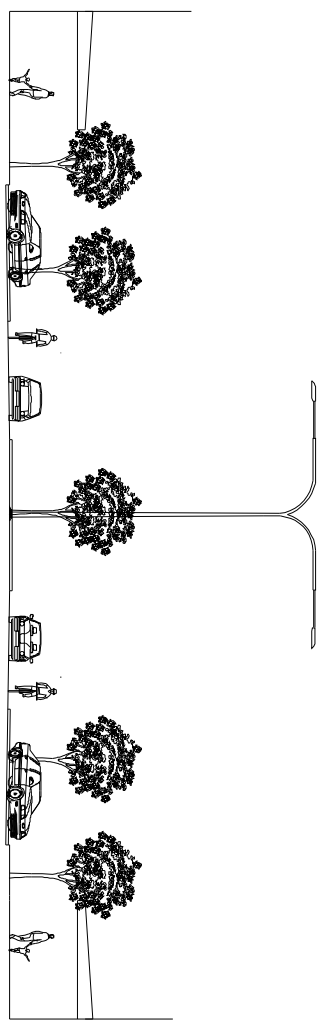

COLLECTOR STREET CROSS SECTION  
SCALE 1:200 @ A3

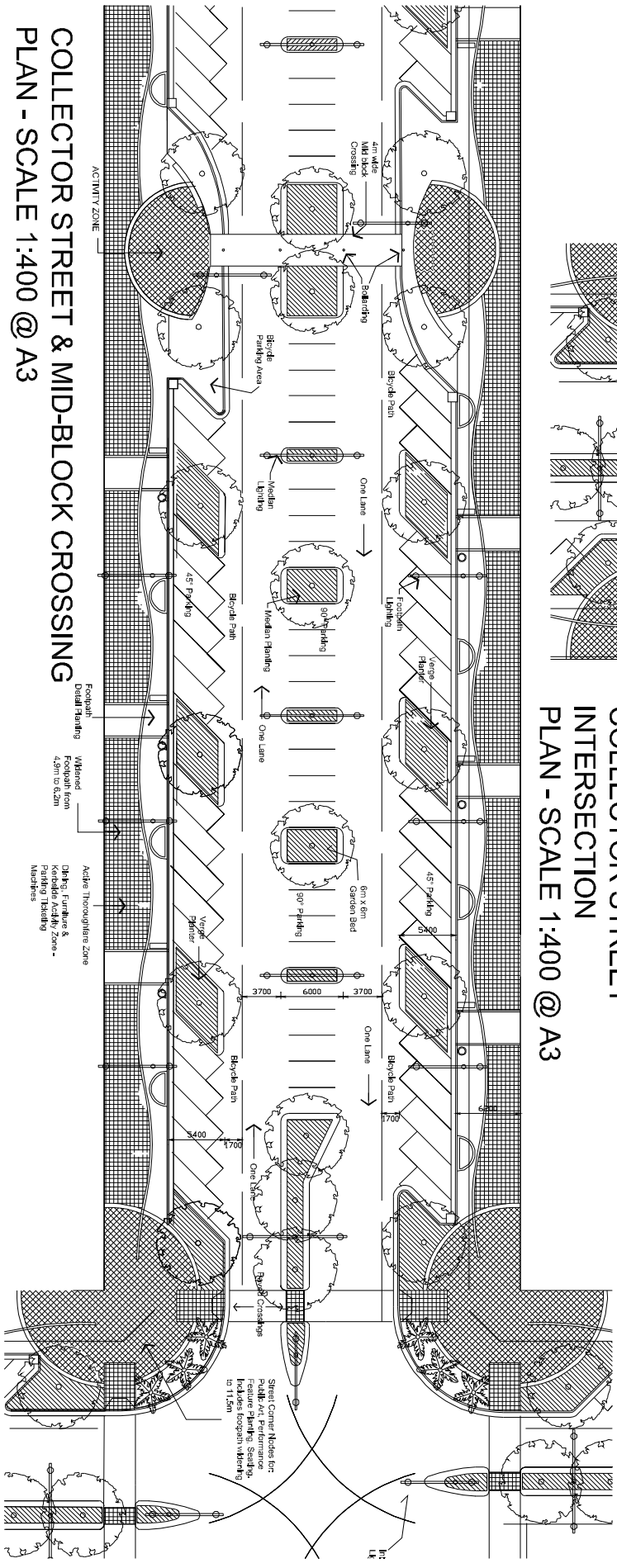

COLLECTOR STREET & MID-BLOCK CROSSING  
PLAN - SCALE 1:400 @ A3



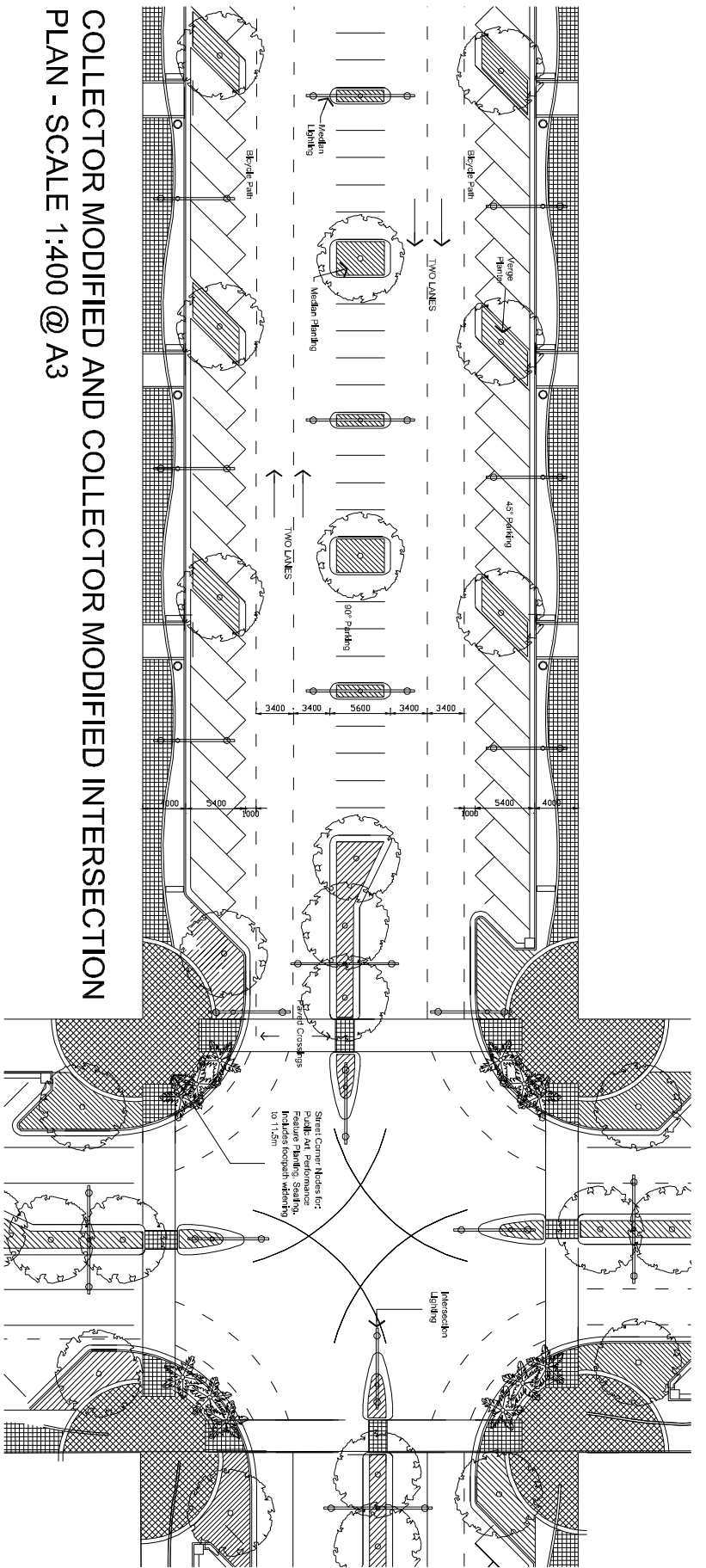

**COLLECTOR MODIFIED AND COLLECTOR MODIFIED INTERSECTION  
PLAN - SCALE 1:400 @ A3**

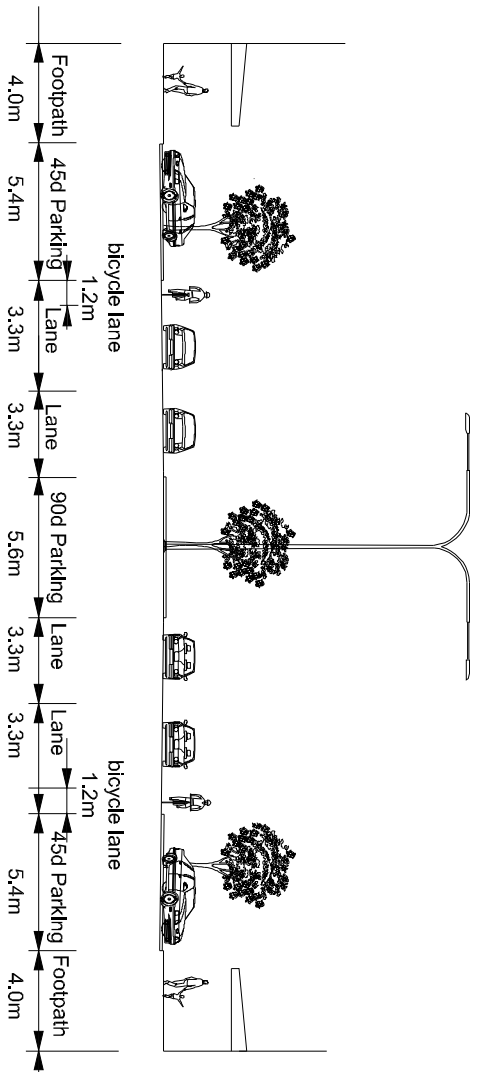





CBD Paving Treatment Matrix									
	Active Thoroughfare		Passive Zone		Street Corner Zones		Activity Zone (Mid-Block)		
	Colour	Finish	Colour	Finish	Colour	Finish	Colour	Finish	
1	City Plaza (Access Place)								
2	Access Street	Sandstone	Off Form	Charcoal	Off Form	Charcoal	Honed	NA	
3	Collector Street	Sandstone	Off Form	Charcoal	Off Form	Charcoal	Honed	Sandstone	
4	Modified Collector Street	Sandstone	Off Form	Charcoal	Off Form	Charcoal	Honed	Sandstone	
5	Sub-Arterial Road	Sandstone	Off Form	Charcoal	Off Form	Charcoal	Honed	Sandstone	
6	Wharf Street	Ex Ag Concrete (with contrasting feature bands)	Charcoal	Off Form	Charcoal	Honed	Sandstone	Honed	
7	Esplanade	Special materials, patterns, colours and finishes used. (submit to Council prior to approval)							
8	Cityport	Special materials, patterns, colours and finishes used. (submit to Council prior to approval)							

#### Exposed Aggregate Concrete

- The above specifications are for unit paving except where exposed aggregate concrete or another material is specified.
- All special pedestrian crossings, and other roadway paving treatments (other than standard asphalt) shall be "Blue Heeler" exposed aggregate concrete and must conform to all relevant guidelines and Standards prior to approval.

#### Paving Sizes

- All paving shall be 400x400x40mm concrete units unless otherwise specified on the enclosed streetscape plans.

#### Paving Types

- Proposed paving types, colours, styles and finishes must be submitted to Council and approved by the Chief Executive Officer prior to the commencement of On-Street works.
- The above paving colours and finishes do not constitute the use of a particular supplier, brand or manufacturer, thereby giving applicants the right to submit for approval by Council the proposed surface treatments.

Proposed CBD Furnishings														
Precinct/Theme		Furnishing Elements												
	Seats	Colour	Bin	Colour	Roller	Colour	Bin	Colour	Roller	Colour	Bin	Colour		
1	City Place	Custom Type 4	ST	Custom Bin	ST	Custom Type 2	ST	Type 1	ST	MA	Existing	PSP	Type 2	BL
2	Regional Gallery	REFER SHIELDS STREET												
3	City Library	Park Bench Style A	BL	Detail R9 Refuse Bin	BL	Enland Type 3	BL	Types 1 & 2	ST	MA	Km Park Lights	WH	Type 1	BL
4	Shields Street	Custom Type 1	Mosaics	Detail R9 Refuse Bin	GB	Custom Type 2	GB	Types 1 & 2	GB	Custom Type 1	SFG	TBA	Type 1	BL
5	Lake Street	Custom Type 3	ST	Detail R9 Refuse Bin	BL	Enland Type 3	PSP	Type 1	ST	Custom Type 2	TBA	SFG	Type 1	BL
6	Government/Civic	Custom Type 2	HB	Detail R9 Refuse Bin	BL	Custom Type 1	BL	Type 1	ST	Custom Type 2	TBA	SFG	Type 1	BL
7	Grafton Street	Art Project	TBA	Detail R9 Refuse Bin	BL	Enland Type 3	PSP	Type 1	ST	Custom Type 2	TBA	SFG	Type 1	BL
8	Abbot Historical	REFER LAKE STREET												
9	Wharf Street	Custom Type 3	ST	Custom Design	ST	Enland Type A	ST	Types 1 & 2	ST	Custom Type 2	MA	MA	Type 1	BL
10	General Parks	Park Bench Style A	BL	Detail R9 Refuse Bin	BL	Enland Type 3	BL	Type 2	SI	MA	Km Park Lights	WH	Type 1	BL
11	City Wide	Park Bench Style A	ST	Detail R9 Refuse Bin	BL	Enland Type 3	PSP	Types 1 & 2	ST	Custom Type 2	SFG	Detail 117 Light	Type 1	BL
12	Españade	Custom Type 3	ST	Custom Design	ST	Enland Type A	ST	Types 1 & 2	ST	Custom Type 2	PSP	Detail 117 Light	Type 1	BL
13	C tyoon	Custom Type 3	ST	Custom Design	ST	Enland Type A	ST	Types 1 & 2	ST	Custom Type 2	PSP	Detail 117 Light	Type 1	BL

**Colour Codes**

- GB Dulux' Gulf Blue
- BL Black Gloss
- HB Honed Black Base (see detail f6)
- ST Stainless Steel (316)
- W/H White Gloss
- PSP Precious Silver Pearl
- HDG Hot Dipped Galvanised
- SPG Super-GAL Finis1
- NA Not Applicable
- TBA To Be Advised

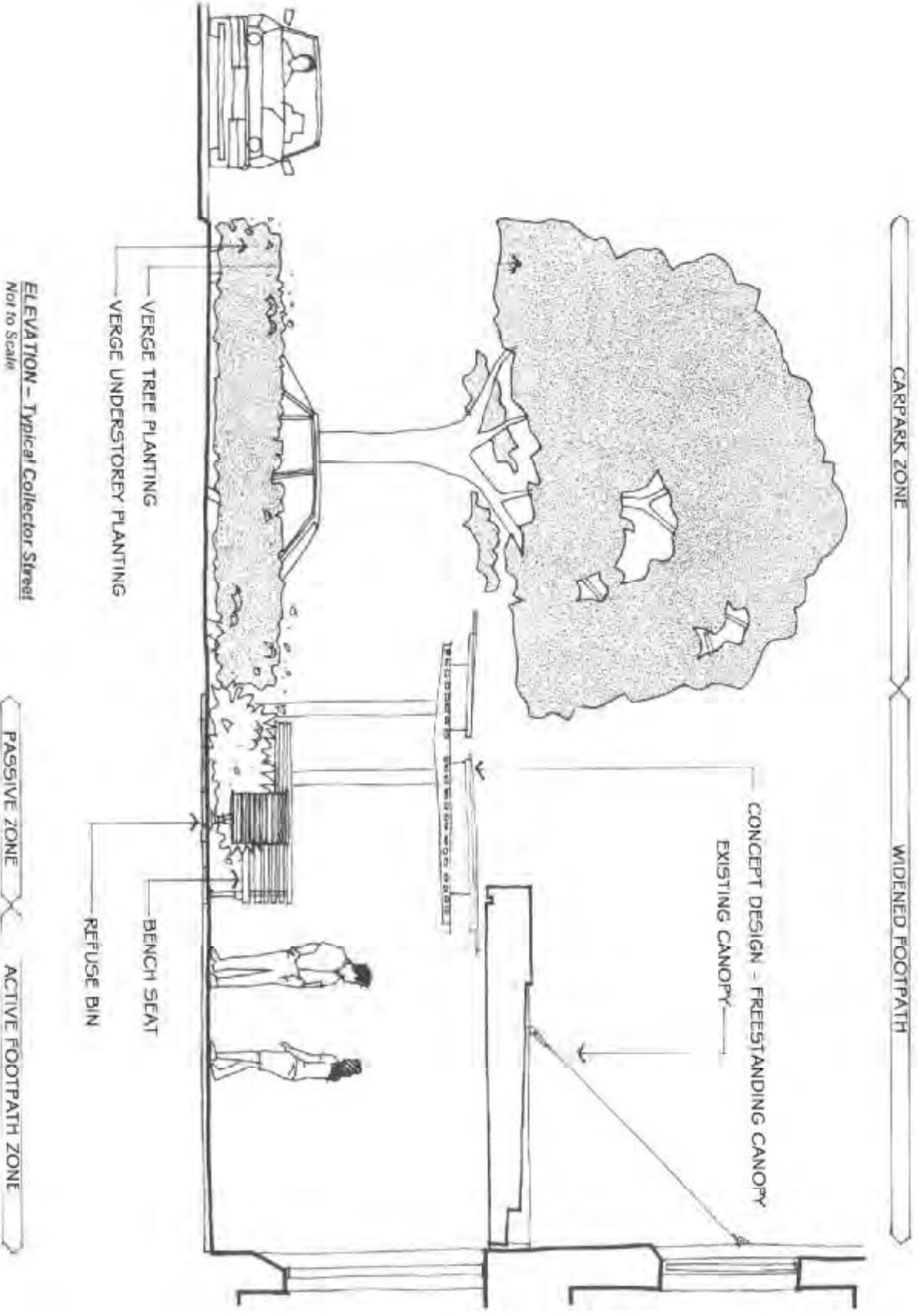

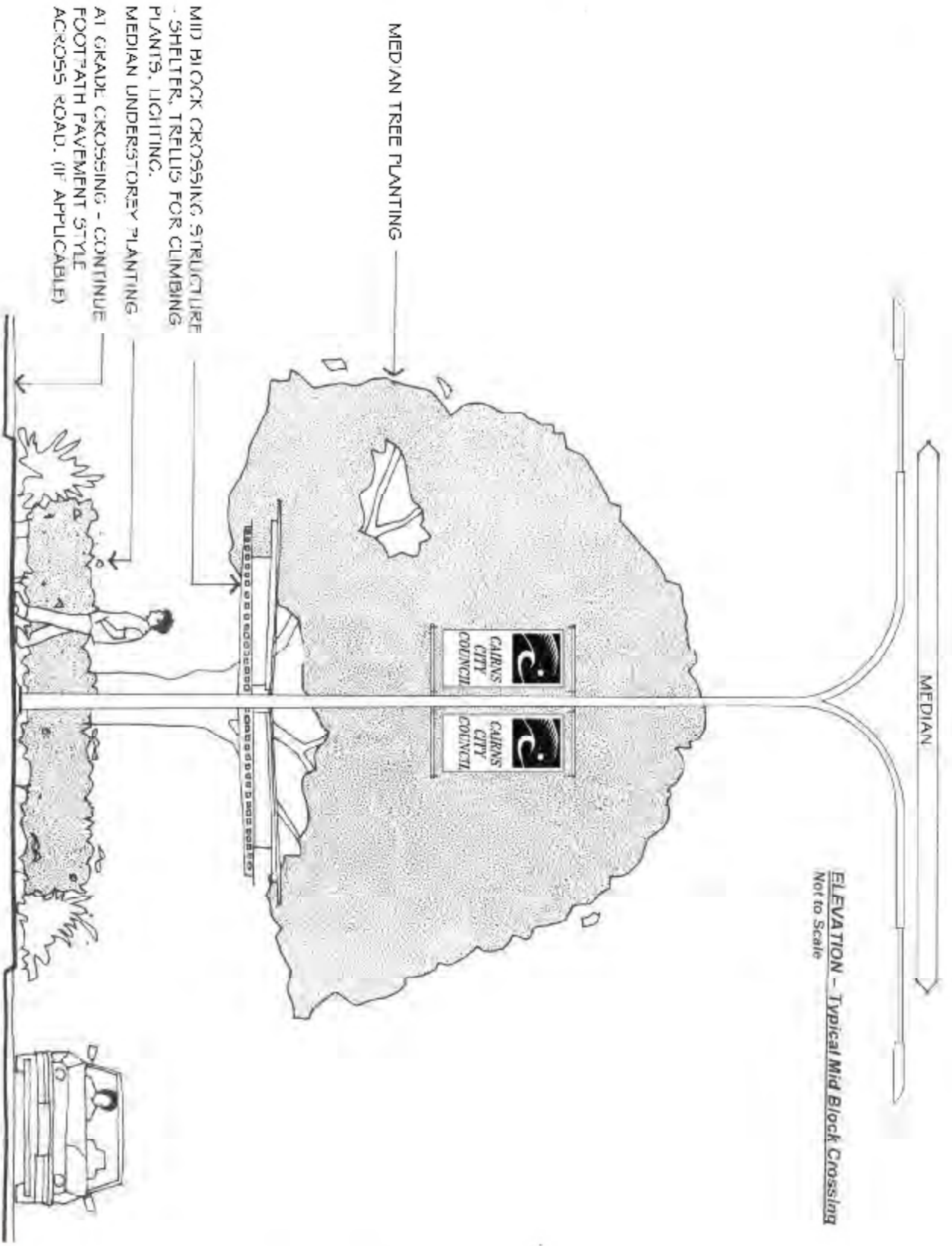

- Special batter finish option:
    - Aluminium (clear anodised)
  - Upper seat profile material:
    - Cast aluminium
  - Upper seat profile finish options:
    - Powdercoat (standard); colour TDA
    - 2 pass finish (gloss); colour TDA
    - White brush
  - Leg profile:
    - 62 leg - 1600 leg
  - Leg material:
    - Cast aluminium
  - Leg finish options:
    - as per upper seat profile finishes
  - Mounting options:
    - Free-standing, with nylon spade 5 mm high
    - 50x100 fixed
    - Subsurface fixed, with tamper-resistant living and top hat shoes attached
  - Other options:
    - Armrests (single or pair)
    - Logo disk to armrests
- Options may incur extra cost**

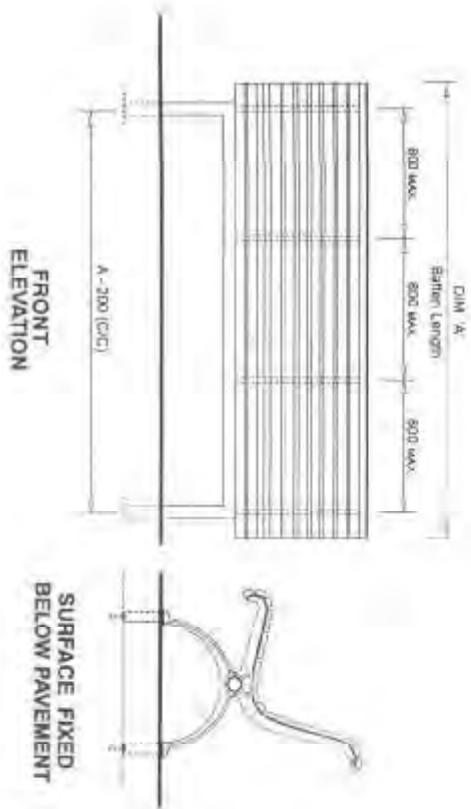
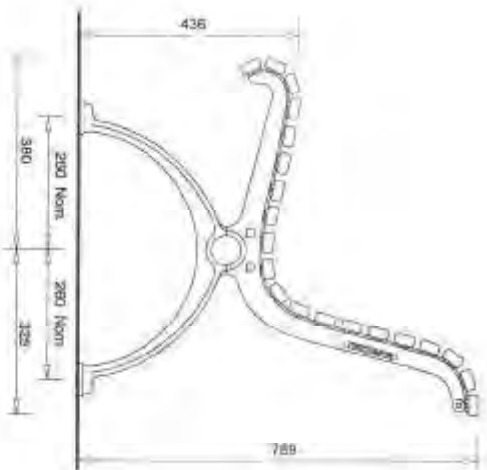



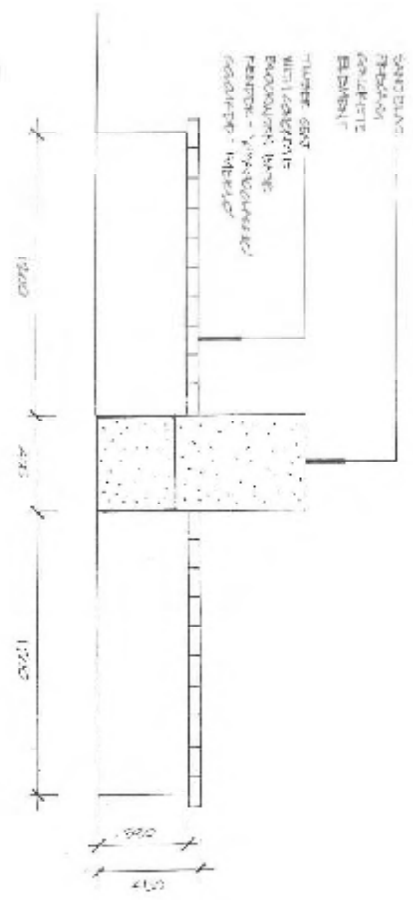
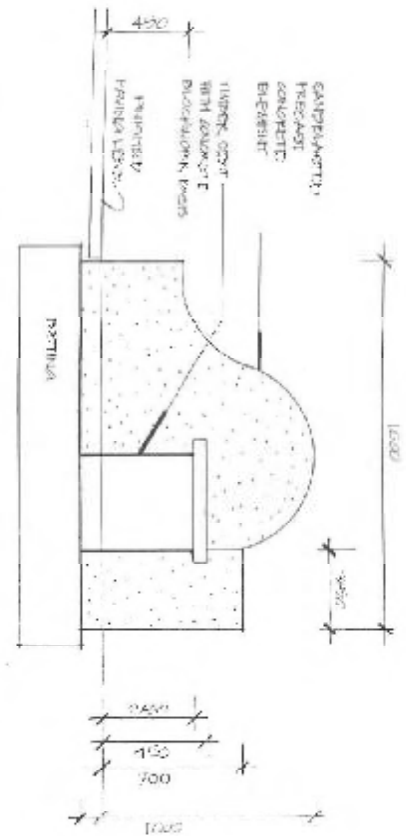

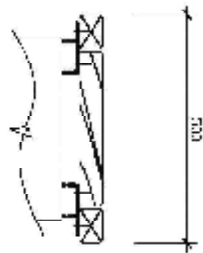

### 1. TYPICAL SEAT SECTION

**Galix Frame**  
 Connect (Vandy) 9x10 75 x 40mm PFC with 40L x 75 x 230mm cross members at 500mm positions on slabs. Provide 2No. nails thru timber members at end members only for M12 lag-bolt connection system to blockwork base. Weld continuous 40 x 60L to PFC to collect perimeter timber as shown. Provide holes for screws to timber slats thru frame as req'd.

**Timber**  
 50 x 75 F11 HWD (E. maculata - Spotted Gum or Blue Gum) timber slats & perimeter piece. 15mm nail to all exposed edges. 2No. coats of Silver's clear water repellent or approved equivalent.

Connect timber to galix frame with 1xk screws as shown at 150 CTS for perimeter piece and 2No per and for central slats.

200 Series Hotted blockwork to match constructed Hartley St seats.

Y12 Continuous Bond Beam  
 Lap 450mm min.

Y12@900 CTS

100mm Compressed basecourse material

Filler cone fill block work

Y12 Perimeter Bar Lap 450mm

F8TM 95 Cover

### 2. TYPICAL SEAT SECTION

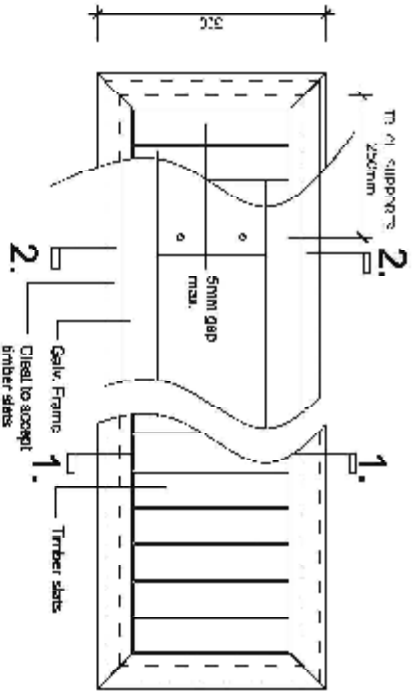
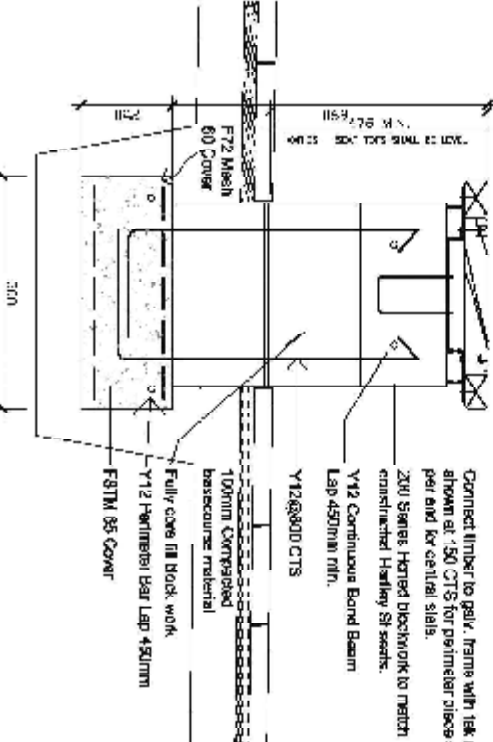

### SECTIONAL PLAN

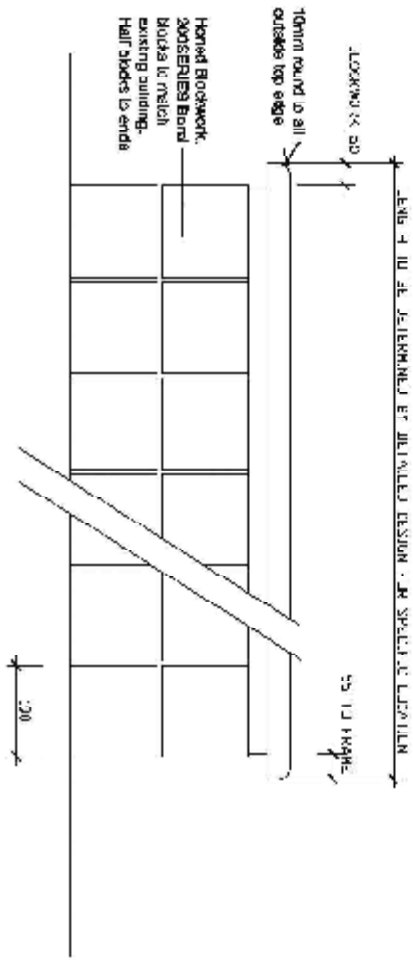

### ELEVATION



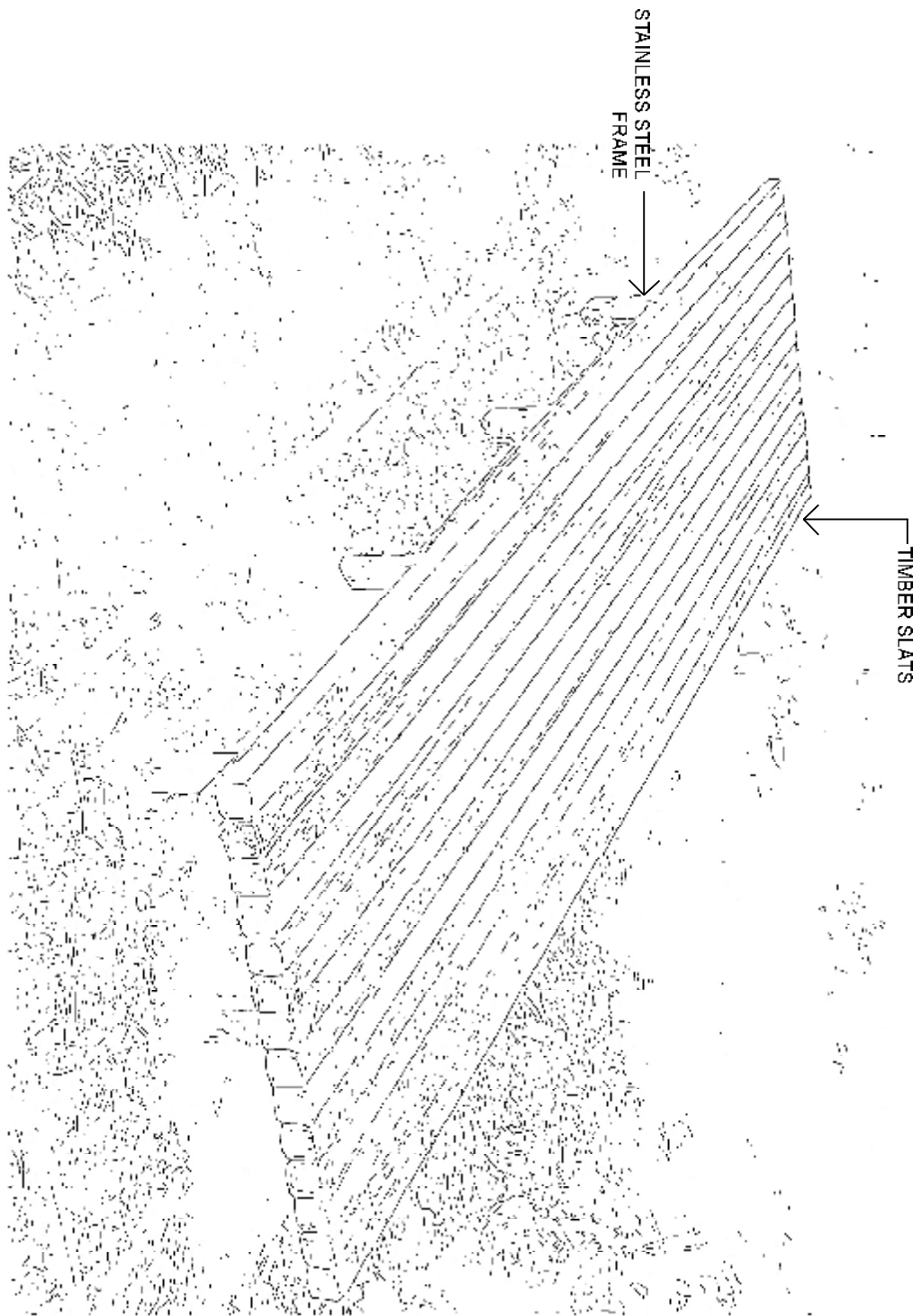



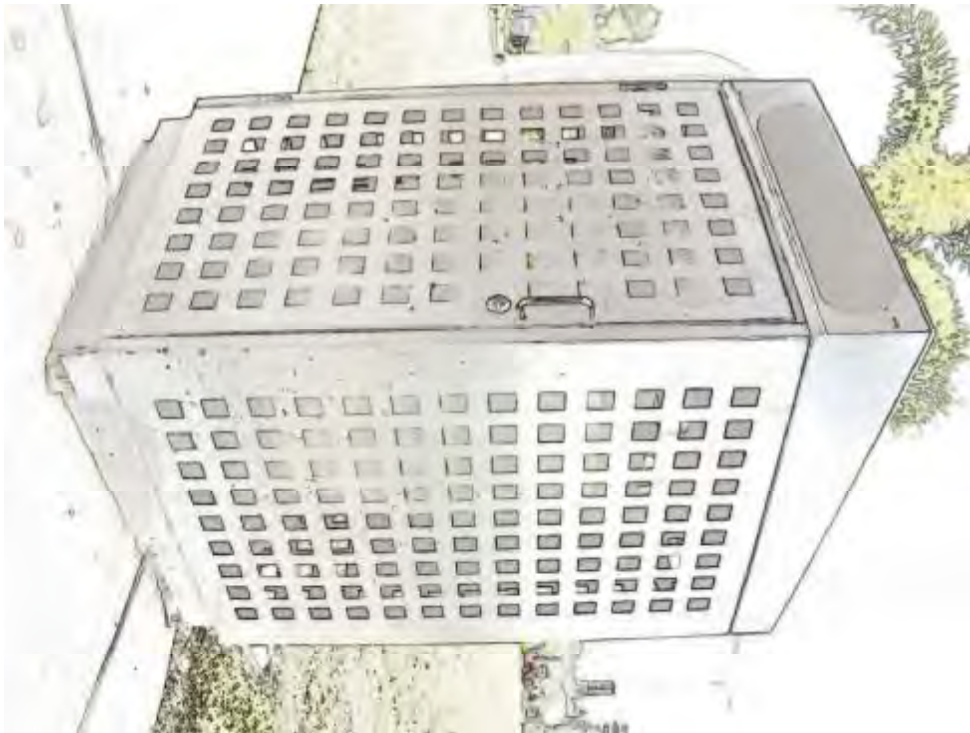

## BOLLARD TYPE A

## BOLLARD TYPE B

Leda Securapost Stainless Steel bollard

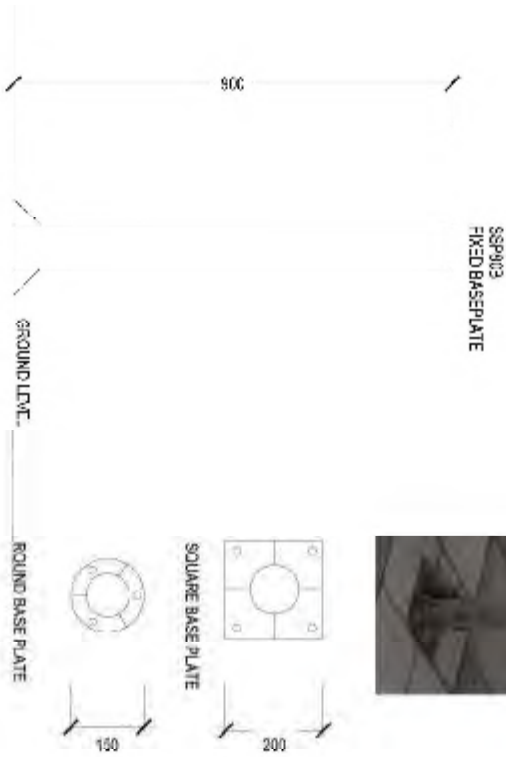

**Material**  
 B0NB (65.5mm) x 3.05x5.48x7.62mm  
 grade 304 Stainless Steel Pipe

Note: Alternative Brand and Models may be considered, providing the general specifications detailed above are met

### General Description

Modern style all metal bollard with pipe body and decorative head and double recessed collar.

### Specification

#### Body options:

- Aluminium tube 165mm (standard)
- Galvanised steel tube 165mm

#### Head/ collar options:

- Cast aluminium (standard)
- Cast LG2 'Gun Metal' (reddish)
- Cast HTB1 'High Tensile Brass' (yellowish)
- Cast CX3 'Brass'

#### Finish Options

- Powdercoat (standard)
- 2 pack finish
- Polished head/ collar

#### Height options

- 900mm above ground level
- as specified

#### Mounting options

- Fixed surface
- Fixed sub-surface (150mm standard)
- Demountable (with demounting plate and pin)
- Lockable with padlock/ key provided in others.
- Removable (with PS2 prevent box and socket assembly). Lockable with universal key provided

#### Other options

- Eyebolts (1 or 2) for chains ect

Some options may incur extra cost

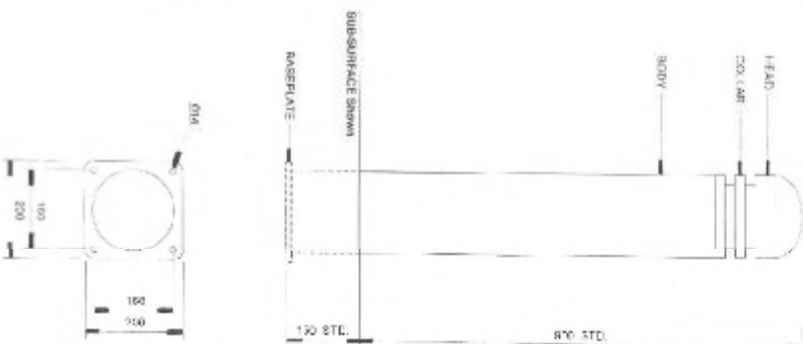



Note: Alternative Brand and Models may be considered, providing the general specifications detailed above are met!

## BOLLARD DETAIL

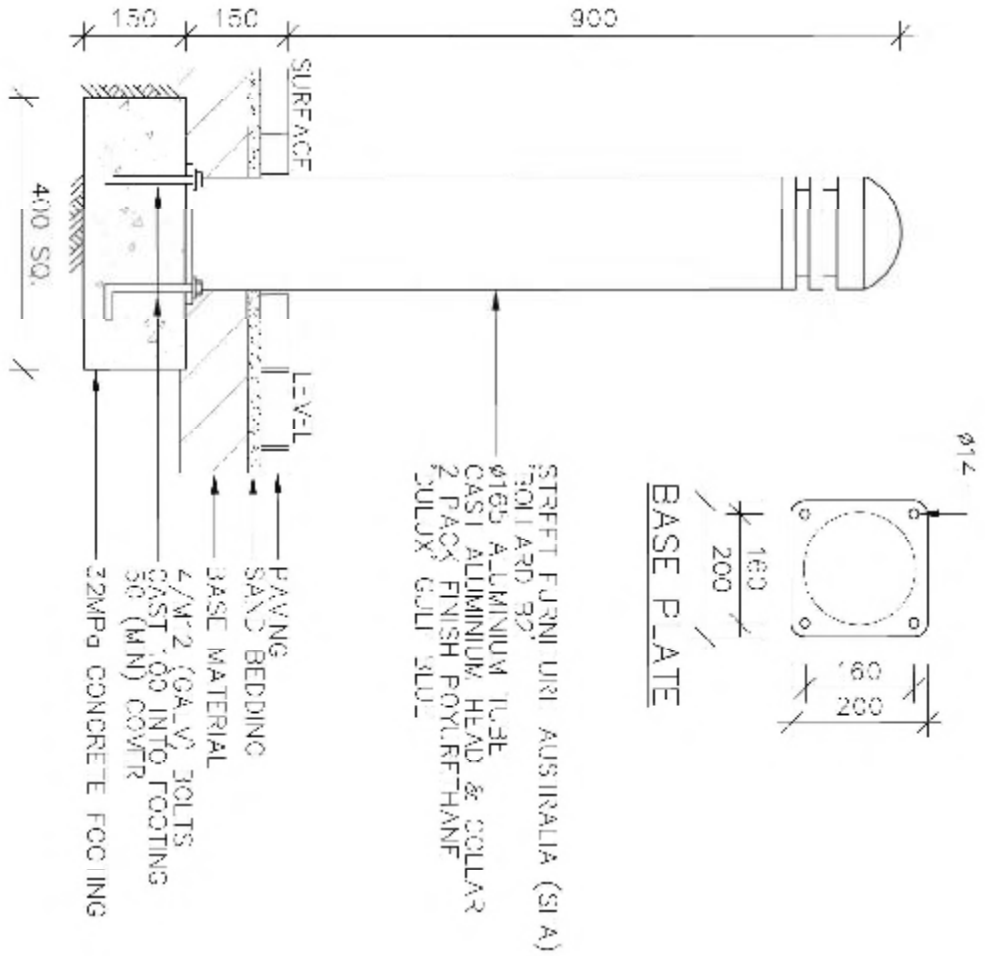





## CORA EXPO SERIES BIKE STANDS

### General Description

- 3 sizes depending on required bike capacity  
(3-5 Bikes 800mm, 5-7 Bikes 1250mm,  
8-10 Bikes 1900mm)
- Double sided access Bike rack

### Specification

- Heavy duty high quality steel
- Mainframe; 50NB 3.6mm MD Pipe
- Hangers; 19mm round bar

### Fixing Details

- 2 x 12 125mm stainless steel M12 Dynabolts  
with tamper resistant fasteners

### Finish

- Stainless Steel (high grade 316 stainless steel  
with an electro-polish finish)

Note: Alternative Brand and Models may be considered providing the general specifications detailed above are met.

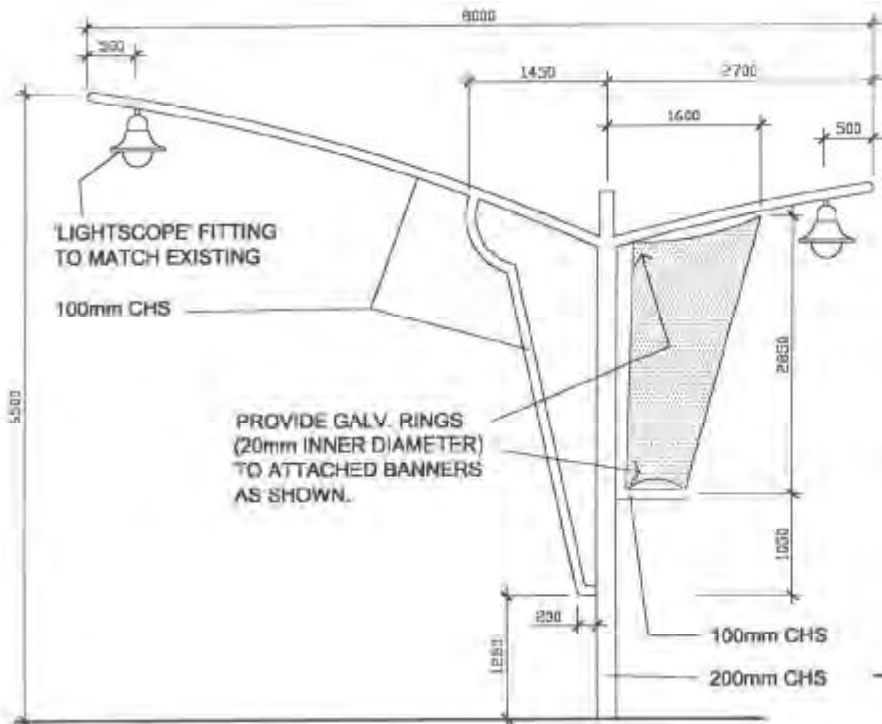

INTERSECTION LIGHTING

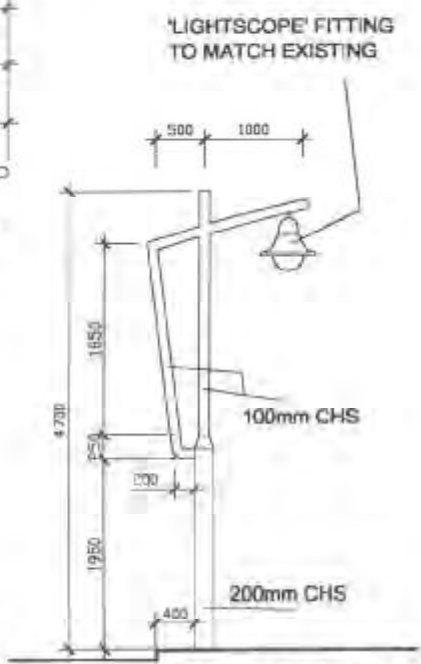

FOOTPATH LIGHTING

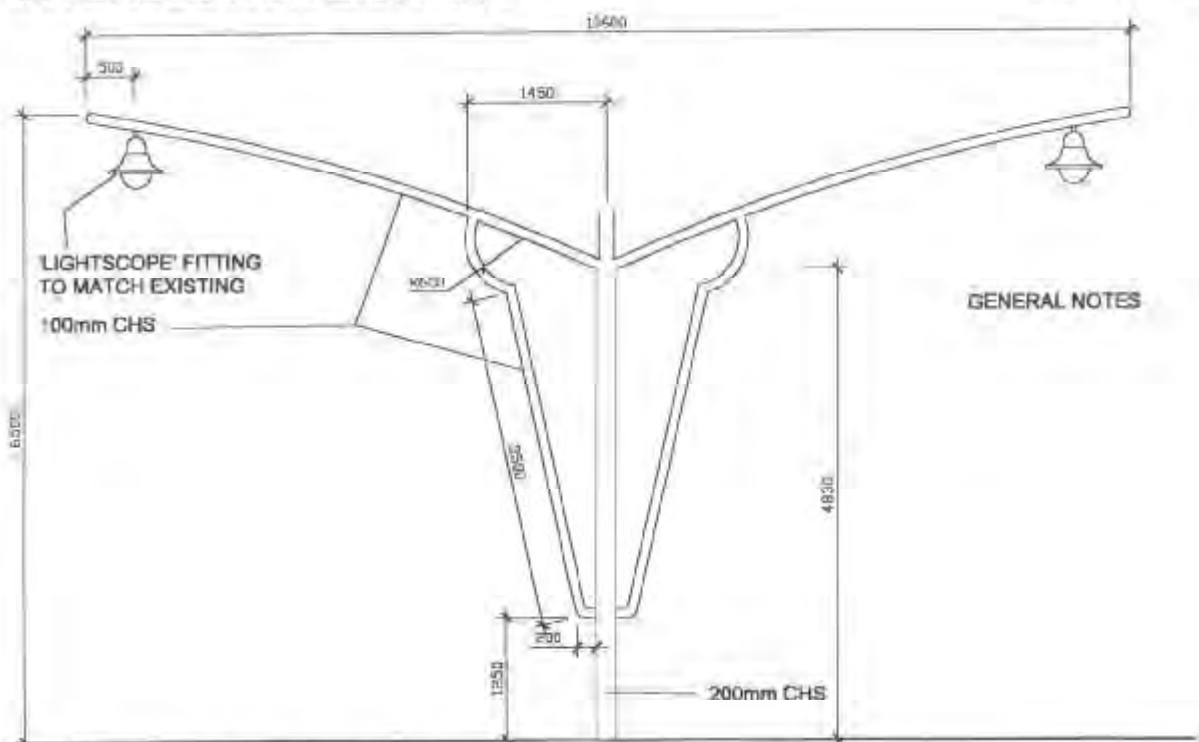

CENTRE MEDIAN LIGHTING

GENERAL NOTES

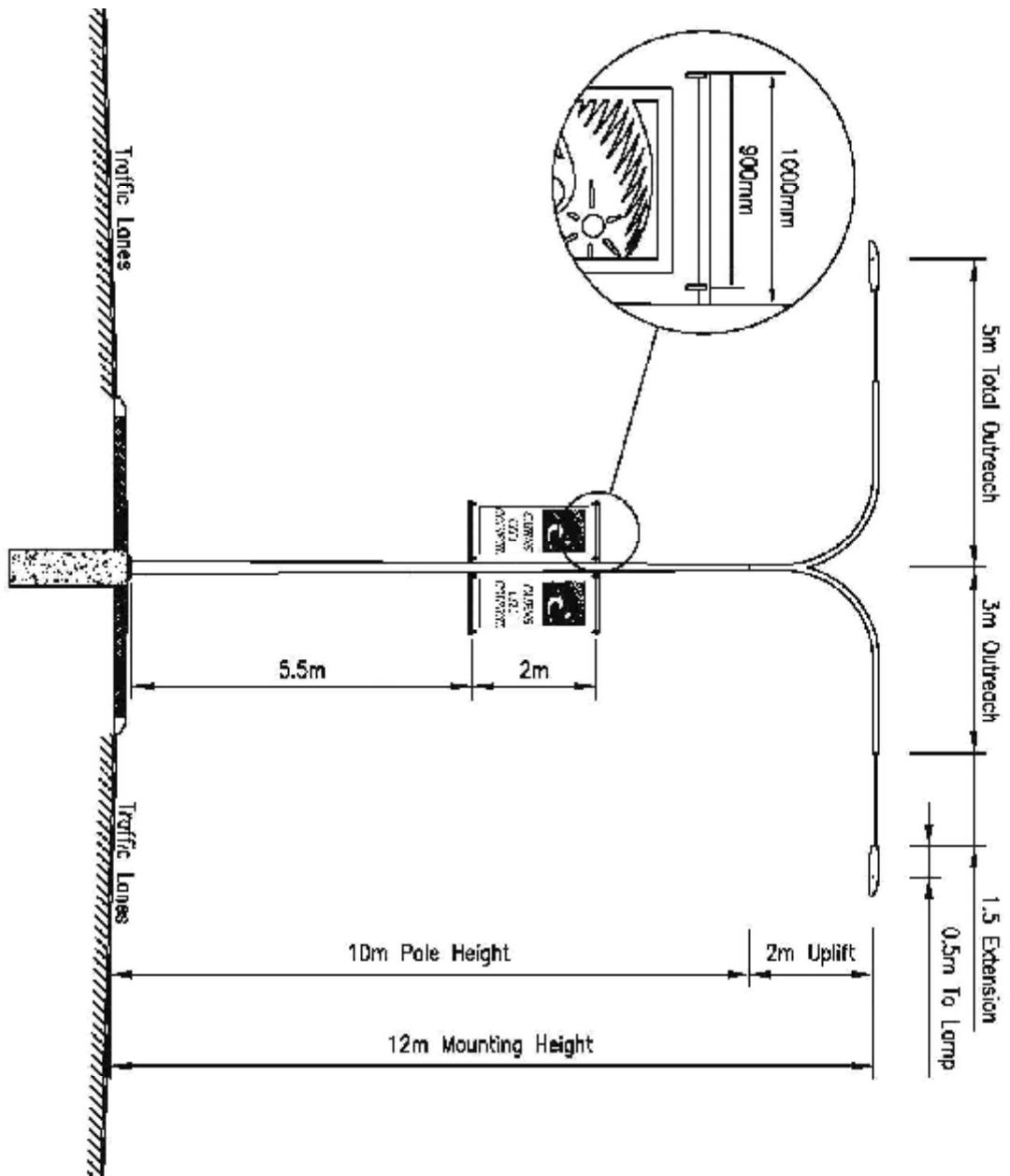



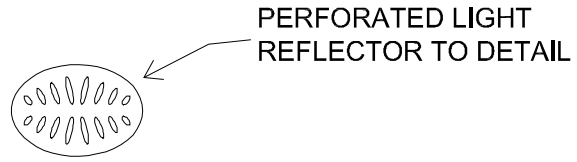

PLAN VIEW

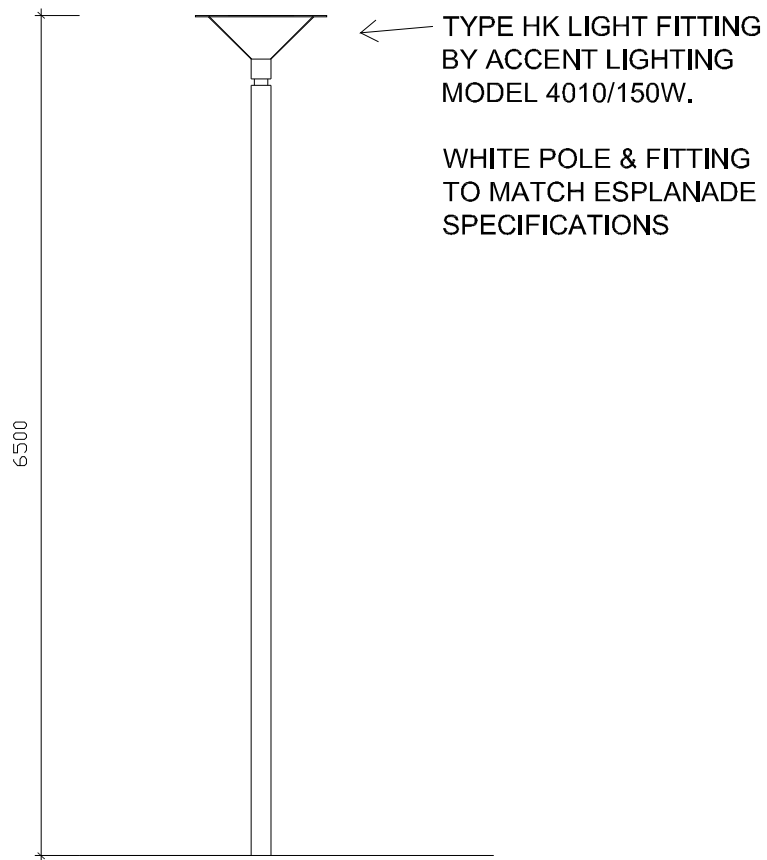

ELEVATION

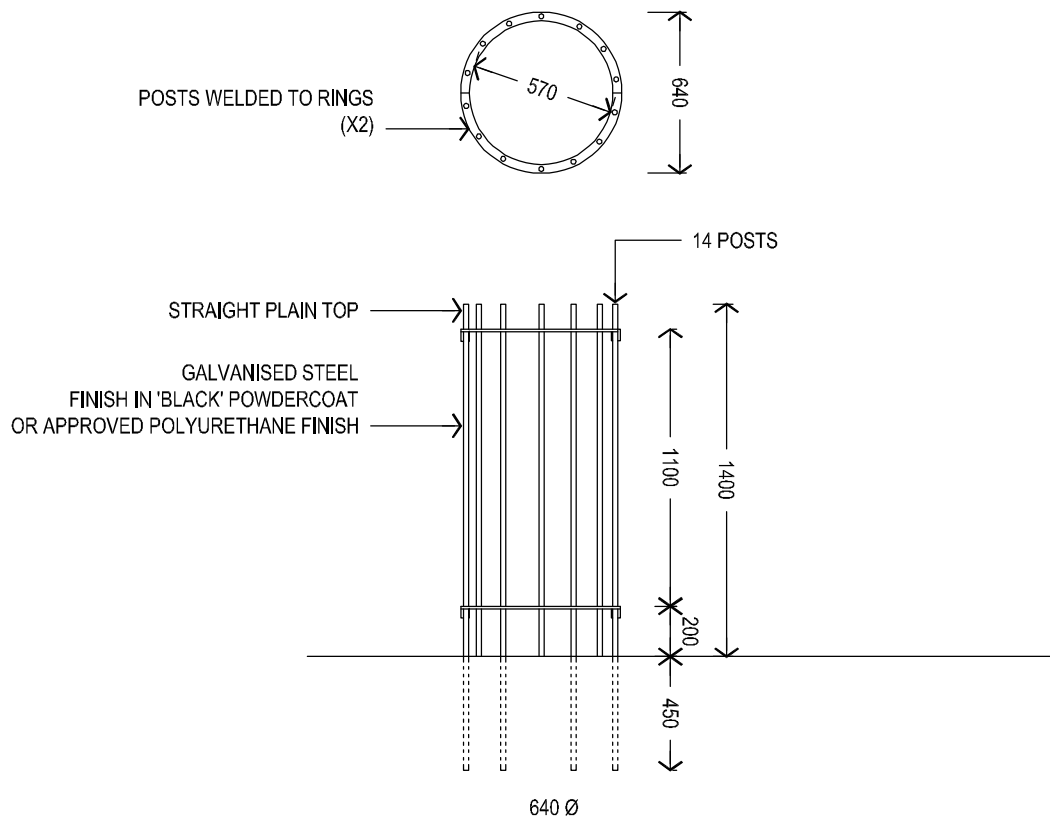

TO SEEK APPROVAL FROM CCC PRIOR TO  
COMMENCEMENT OF WORKS

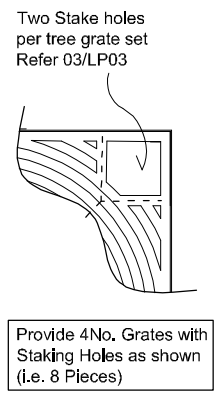
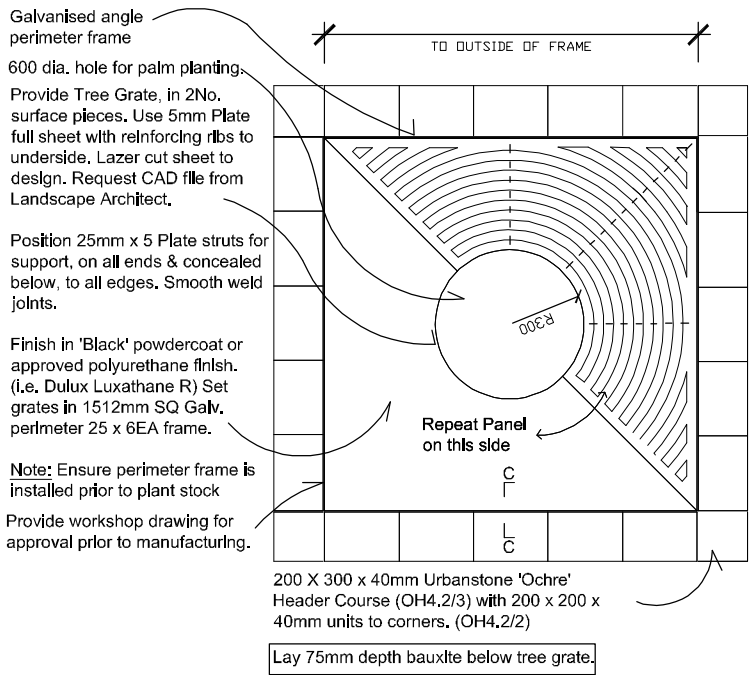

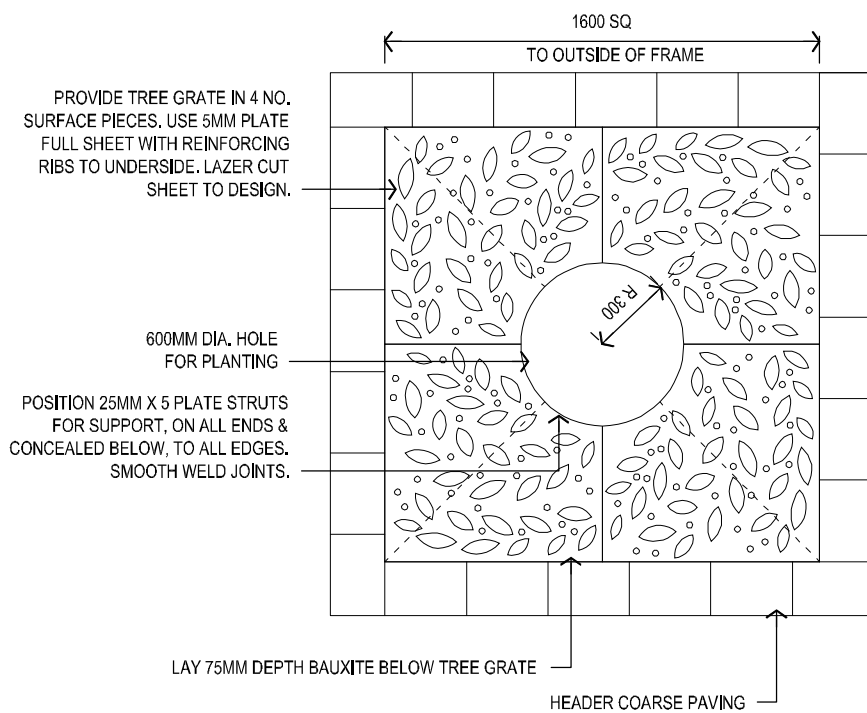



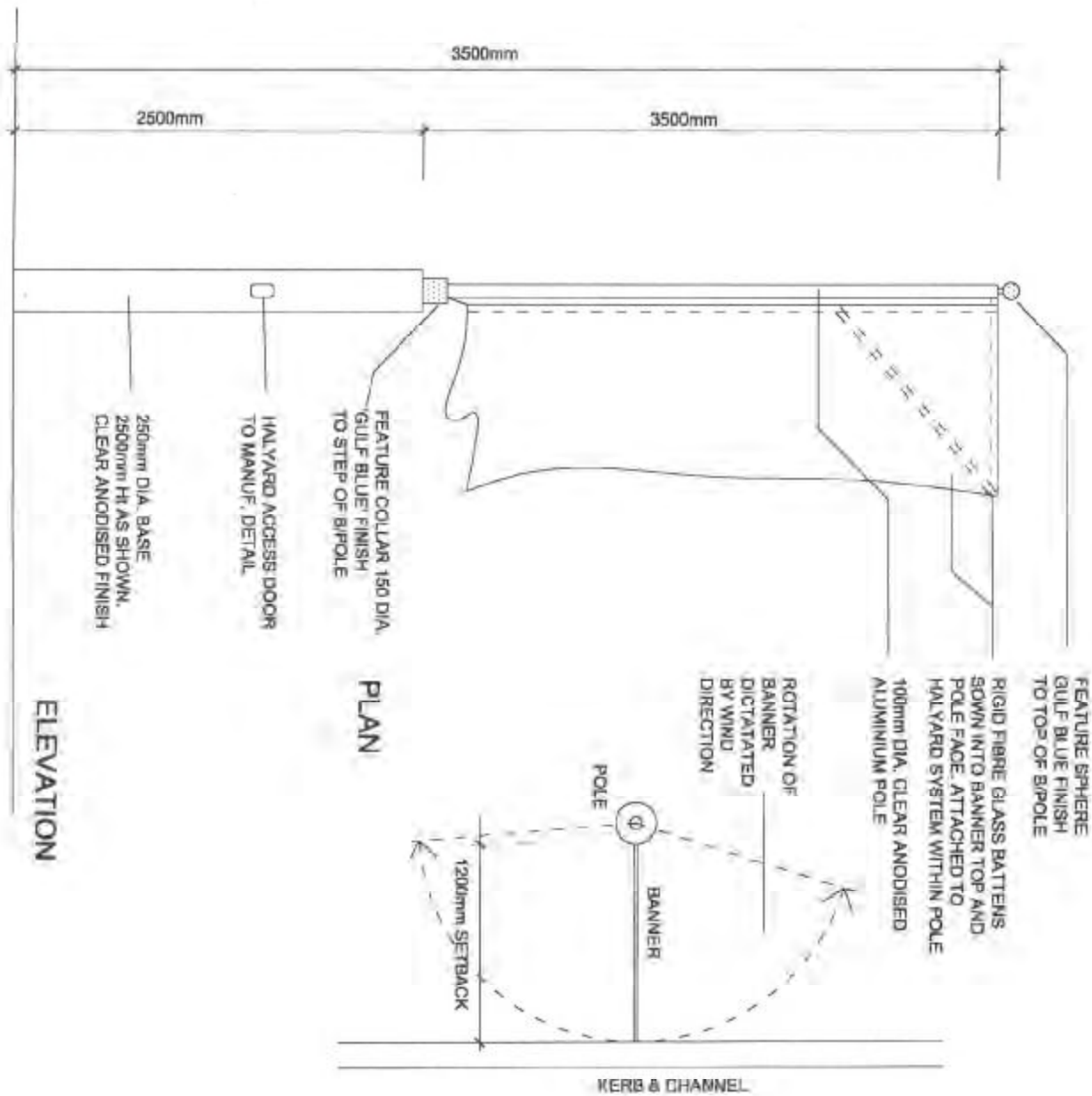

**Wallmounted  
Drinking Fountain**  
Wheelchair  
accessible

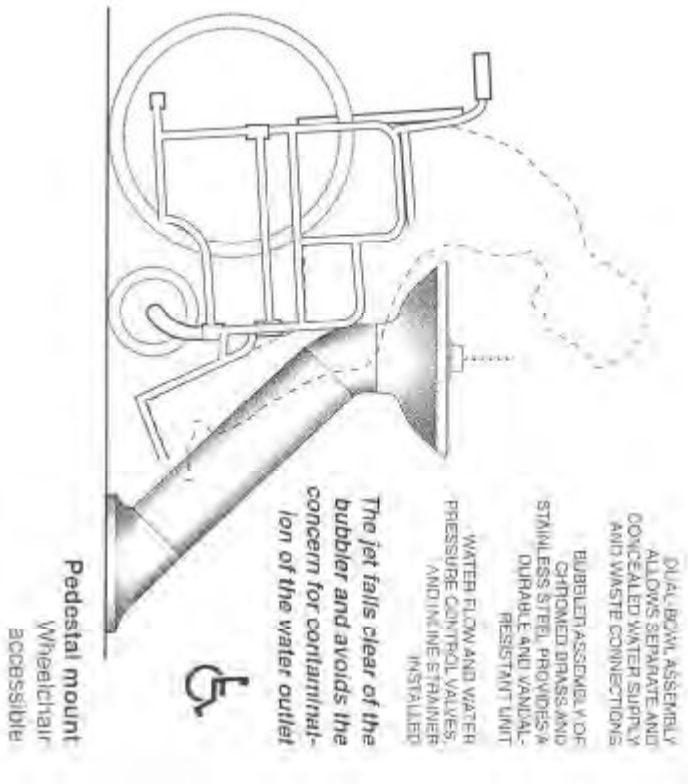

**Pedestal mount**  
Wheelchair  
accessible

*The jet falls clear of the  
bubbler and avoids the  
concern for contamination  
of the water outlet*

DUAL-BOWL ASSEMBLY  
ALLOWS SEPARATE AND  
CONCEALED WATER SUPPLY  
AND WASTE CONNECTIONS

BUBBLER ASSEMBLY OF  
CHROMED BRASS AND  
STAINLESS STEEL PROVIDES A  
DURABLE AND VANDAL-  
RESISTANT UNIT

WATER FLOW AND WATER  
PRESSURE CONTROL VALVES  
AND IN-LINE STRAINER  
INSTALLED

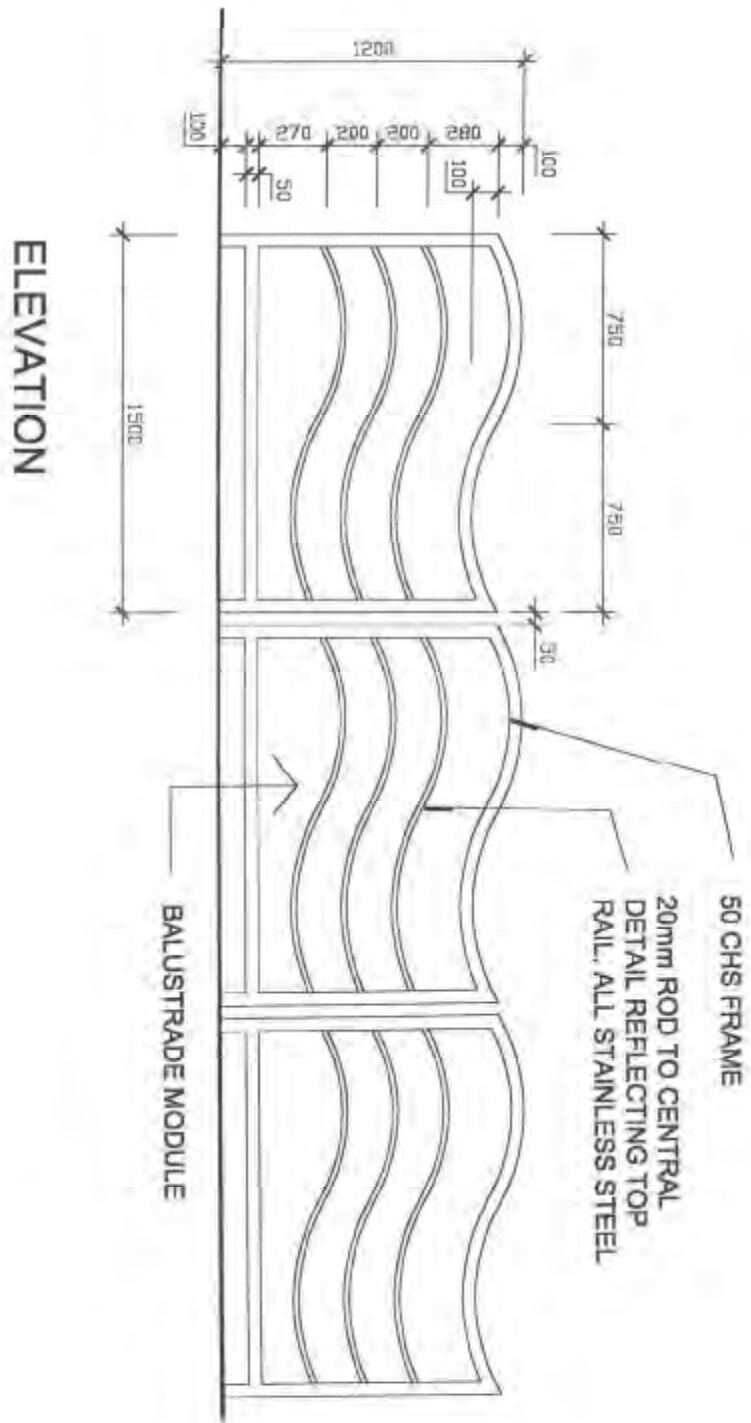

# Boulevard

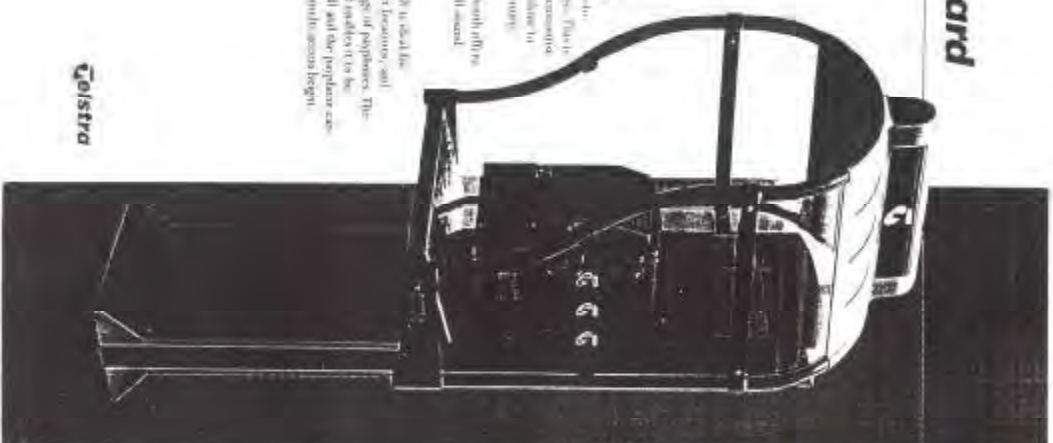

The length of the Boulevard booth is designed to suit the needs of the user, whether it is for a single person or for a group of people. The booth is designed to be used in a variety of settings, including public areas, private areas, and all-weather settings for the office.

The interior of the booth is designed to be comfortable and functional, with a large mirror and a full range of amenities. The booth is designed to be used in a variety of settings, including public areas, private areas, and all-weather settings for the office.

**Geolstra**

### Sound Insulation

The booth is designed to provide excellent sound insulation, ensuring that your conversations are private and secure. The booth is constructed from high-quality materials, including soundproofing panels, which are designed to absorb and reflect sound, reducing noise levels and providing a quiet environment for your calls.

### Dimensions

Width	1.1m
Depth	0.8m
Height	2.1m

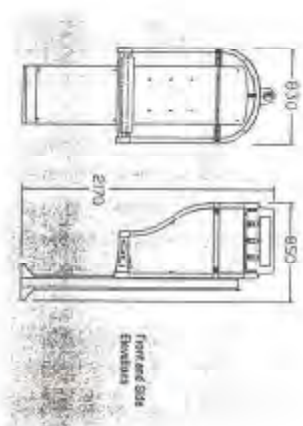

### Colour Selection

- Front and Side Elevation
- Top and Bottom Elevation
- Wood Grains (Optional)



For more information contact the sales office in your State

**NSW** Sydney Tel: 02 9550 1111 Fax: 02 9550 1112  
**QLD** Brisbane Tel: 07 3251 1111 Fax: 07 3251 1112  
**SA** Adelaide Tel: 08 8251 1111 Fax: 08 8251 1112  
**VIC** Melbourne Tel: 03 9550 1111 Fax: 03 9550 1112  
**WA** Perth Tel: 08 9451 1111 Fax: 08 9451 1112  
**NT** Darwin Tel: 08 9451 1111 Fax: 08 9451 1112

**Geolstra**

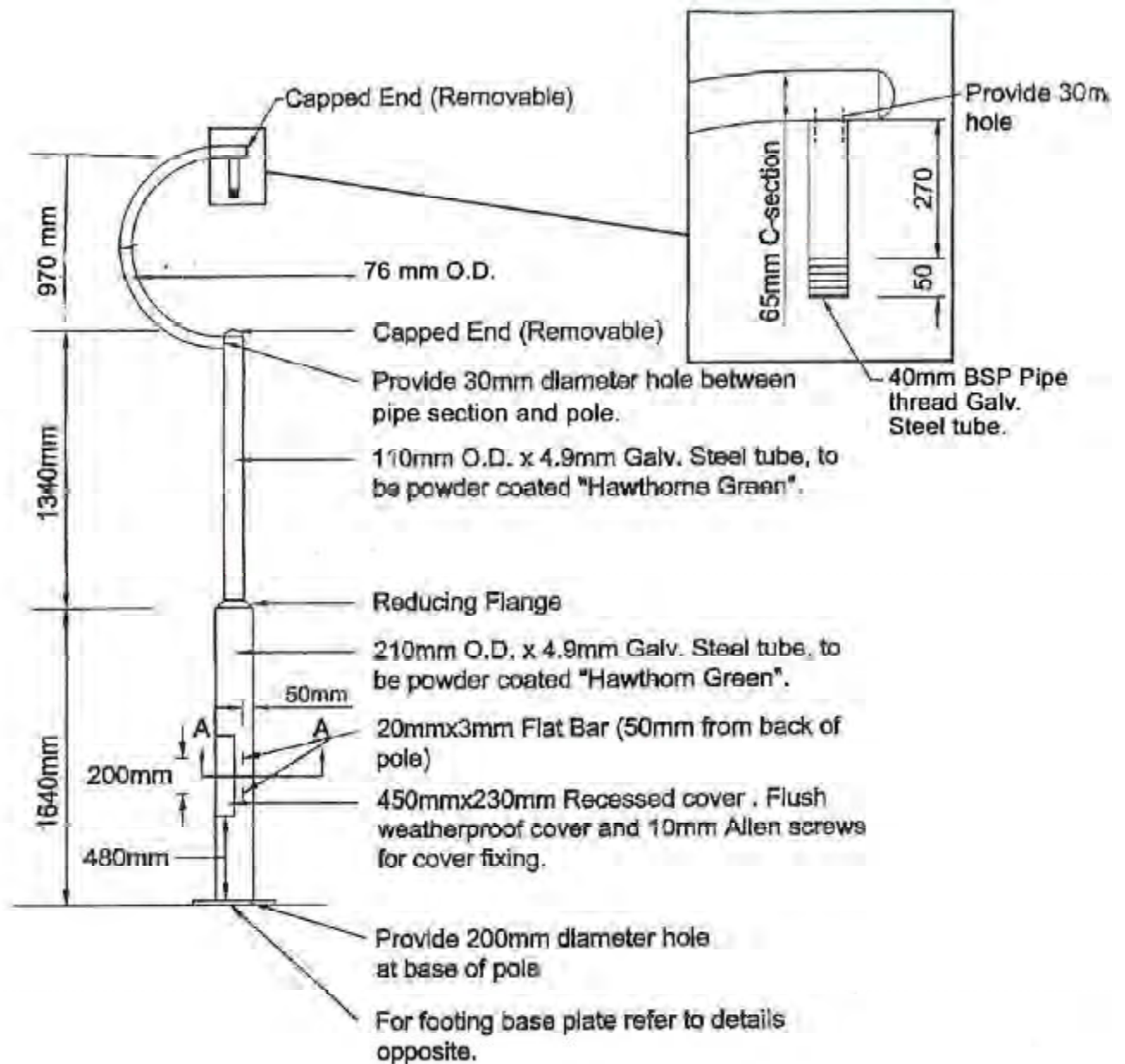

## SECURITY CAMERA POLE

NTS

NOTE: STANDARD STREET SIGNAGE POLE DETAILS TO BE SUPPLIED BY CAIRNS CITY COUNCIL

**NOTE: STANDARD INFORMATION TOTEM DETAILS TO BE SUPPLIED BY CAIRNS CITY COUNCIL**





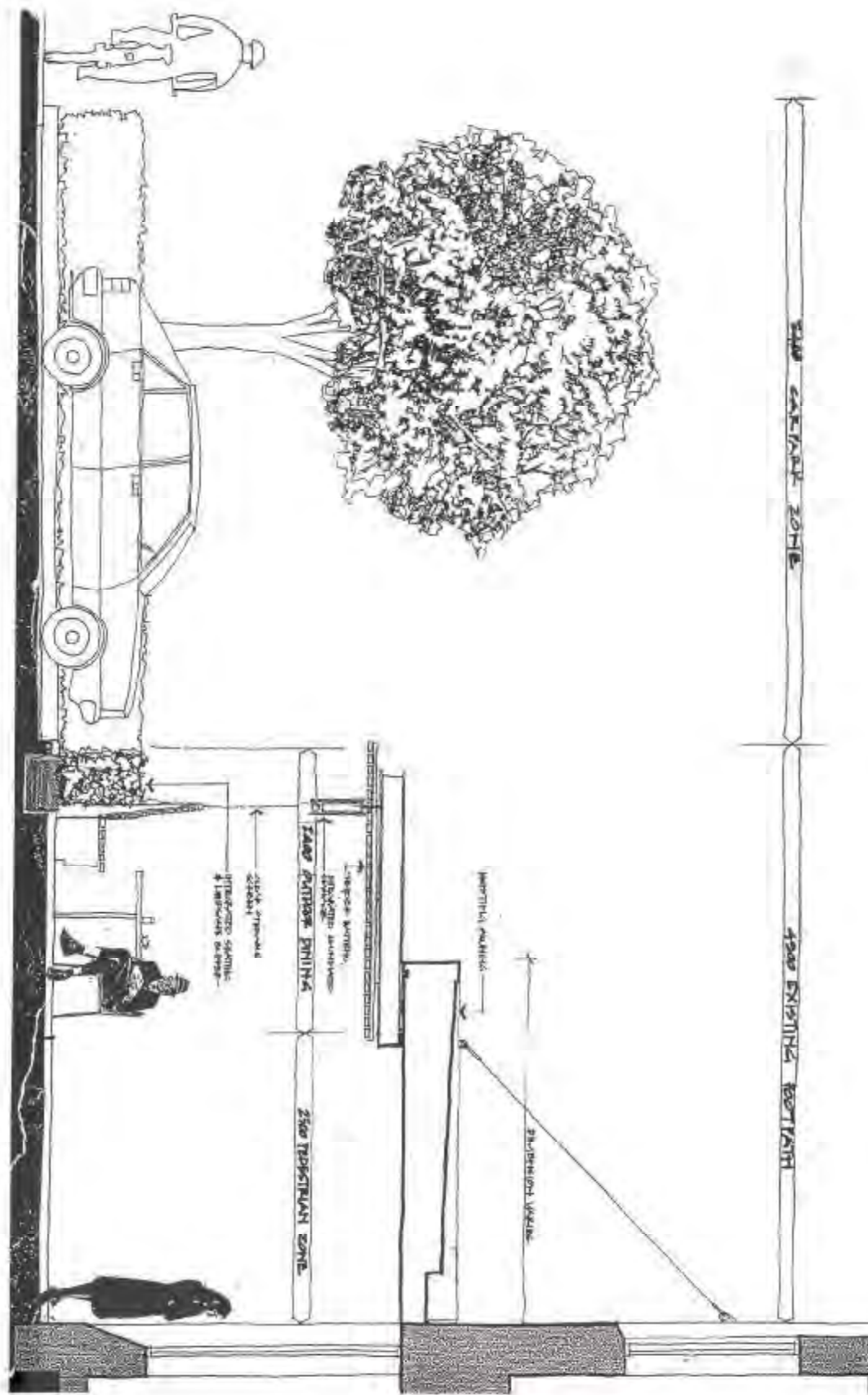

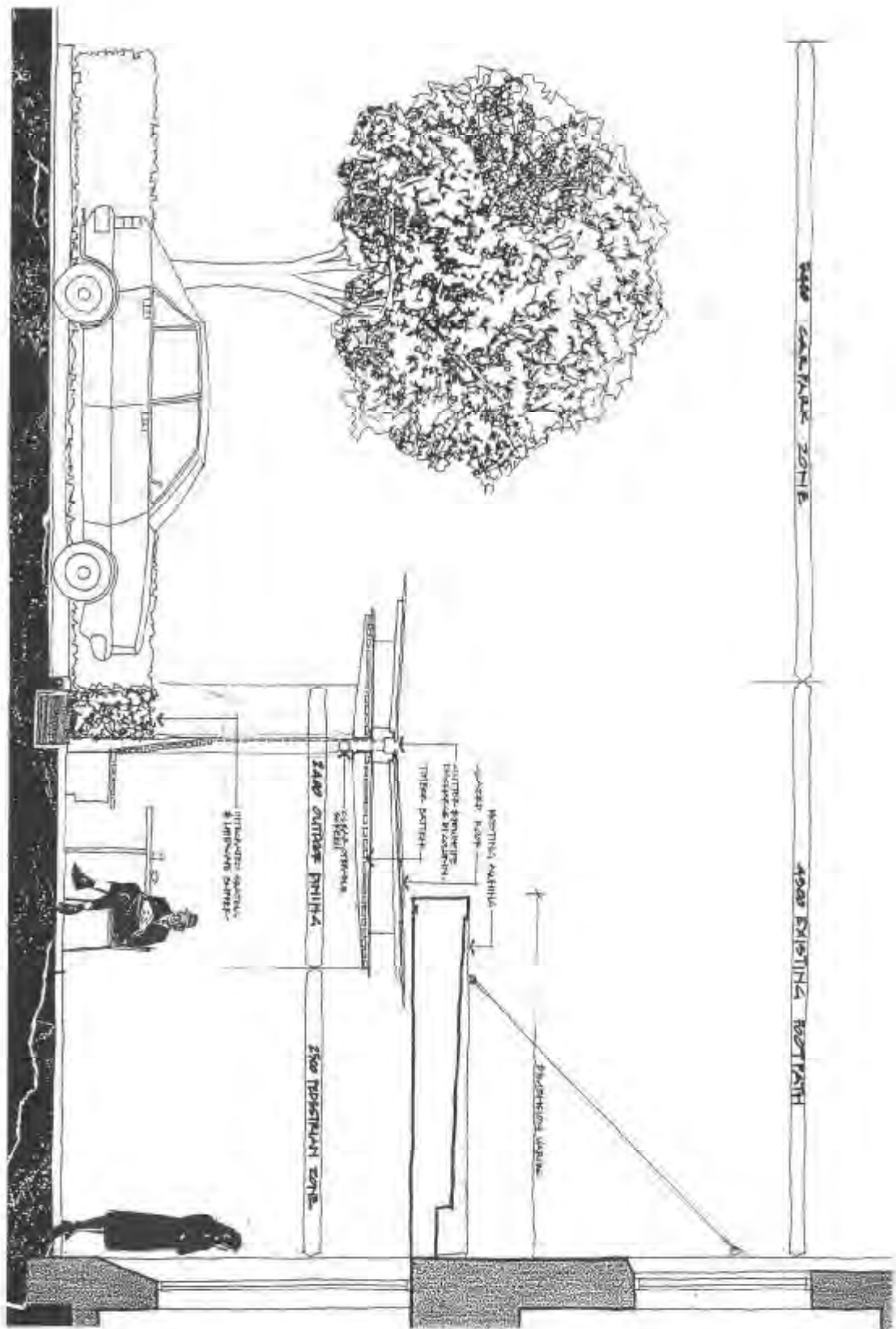

# APPENDIX C

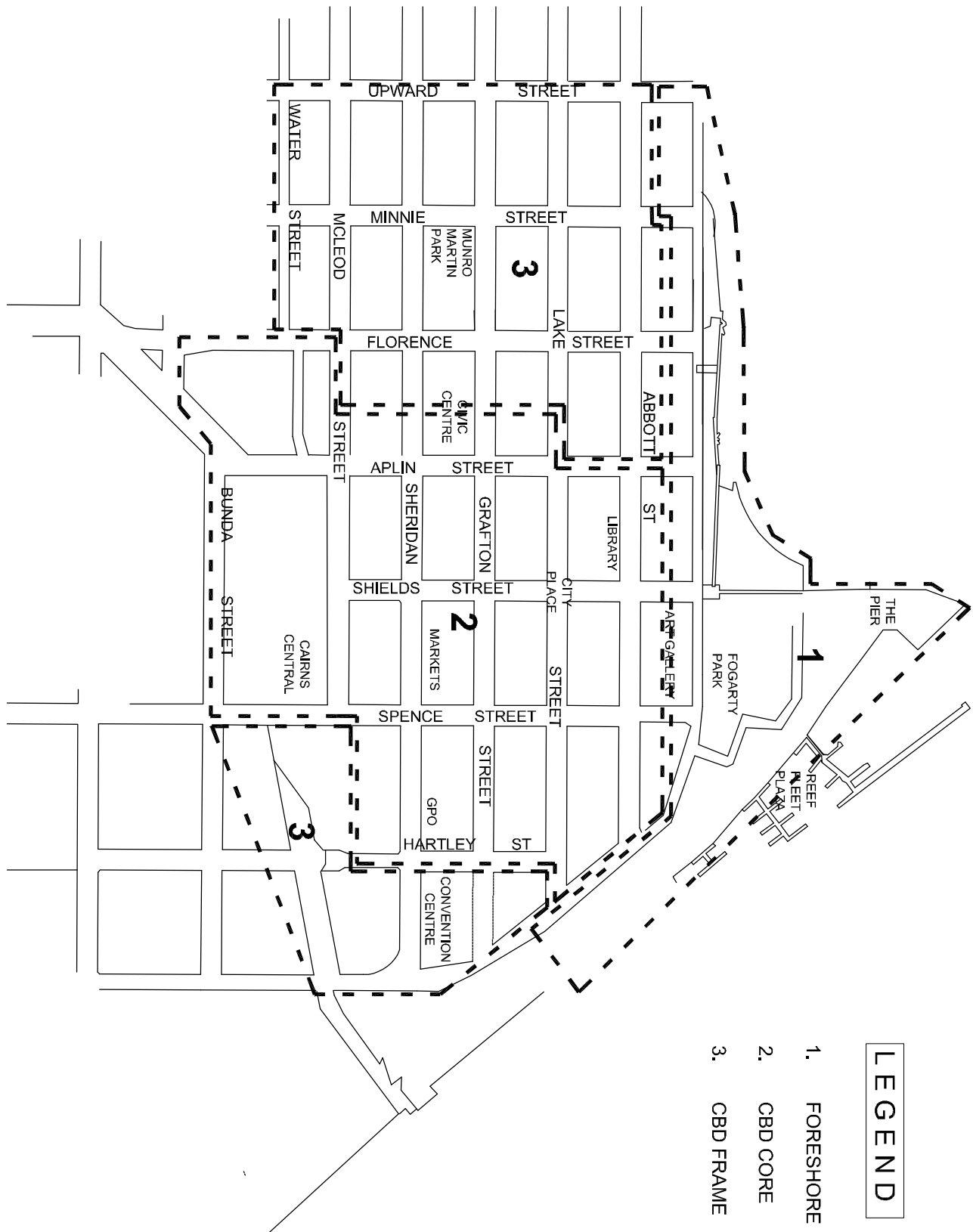

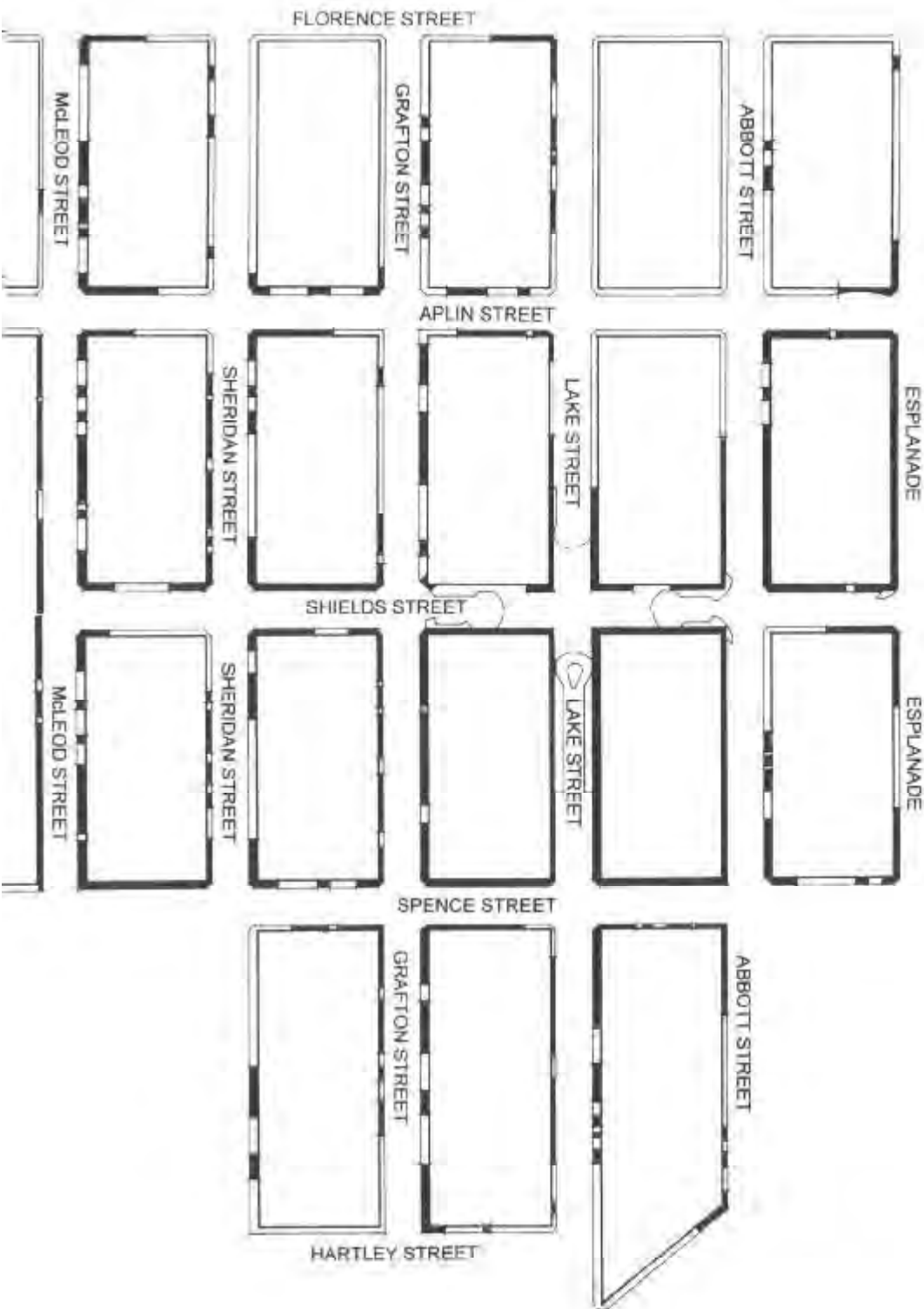



## EXISTING TREES TO BE RETAINED (as at 2000)

FLORENCE STREET	
01	Delonix regia
02	Delonix regia
03	Delonix regia
04	Delonix regia
05	Delonix regia
06	Delonix regia
07	Delonix regia
APLIN STREET	
51	Pterospermum acerifolium
52	Gustavia superba
53	Ficus elastica (X3) Parkia javanica
55	Xanthostemon chrysanthus
56	Xanthostemon chrysanthus
57	Xanthostemon chrysanthus
58	Xanthostemon chrysanthus
59	Xanthostemon chrysanthus
60	Xanthostemon chrysanthus
61	Xanthostemon chrysanthus Tabebuia rosea Tabebuia argentea Dimocarpus longan landscape to Aplin Street Harpullia pendula frontage of Cairns Central
SHIELDS STREET	
101	Barringtonia asiatica
102	Calophyllum inophyllum (note: 4 smaller specimens also in city place)
103	Ficus benjamina
104	Ficus benjamina
105	Barringtonia asiatica
106	Barringtonia asiatica
107	Normanbya normanbyi (X3)
108	Calophyllum inophyllum
109	Calophyllum inophyllum
110	Ficus benjamina
111	Pandanus sp.
112	Barringtonia asiatica Avenue (new)
SPENCE STREET	
151	Calophyllum inophyllum
152	Roystonia regia, + 103
153	Barringtonia asiatica
154	Ficus virens
155	Barringtonia calyptrata
156	Calophyllum inophyllum
157	Schefflera actinophylla + Delonix regia
158	Archontophoenix alexandrae (5 of)
159	Archontophoenix alexandrae (9 of) + Livistona rotundifolia
160	Cerbera manghas
161	Pandanus baptisii (transplant to Abbot Street?)
162	Vertcha joannis (3 of)
163	Agathis robusta
164	Ravenala madagascariensis (2of) + Carpentaria acuminata (3 of) + Elaeis guineensis
165	Livistona saribus
166	Calophyllum inophyllum
167	Thrinax sp. (transplantable)
168	Grevillea baileyana
169	Buckinghamia celssima
170	Normanbya normanbyi (2 of)
171	Ficus benjamina
HARTLEY STREET	
225	Ficus ?
226	Ficus hilli
227	Dillenia indica (X2)
228	Ficus hilli - avenue
229	Wodyetia bifurcata - avenue
230	Livistona muelleri
WHARF STREET	
201	Callophyllum inophyllum + Ficus drupacea + Ficus benjamina
202	Barringtonia asiatica
203	Pongamia pinnata
204	Roystonia regia
205	Livistona decipiens

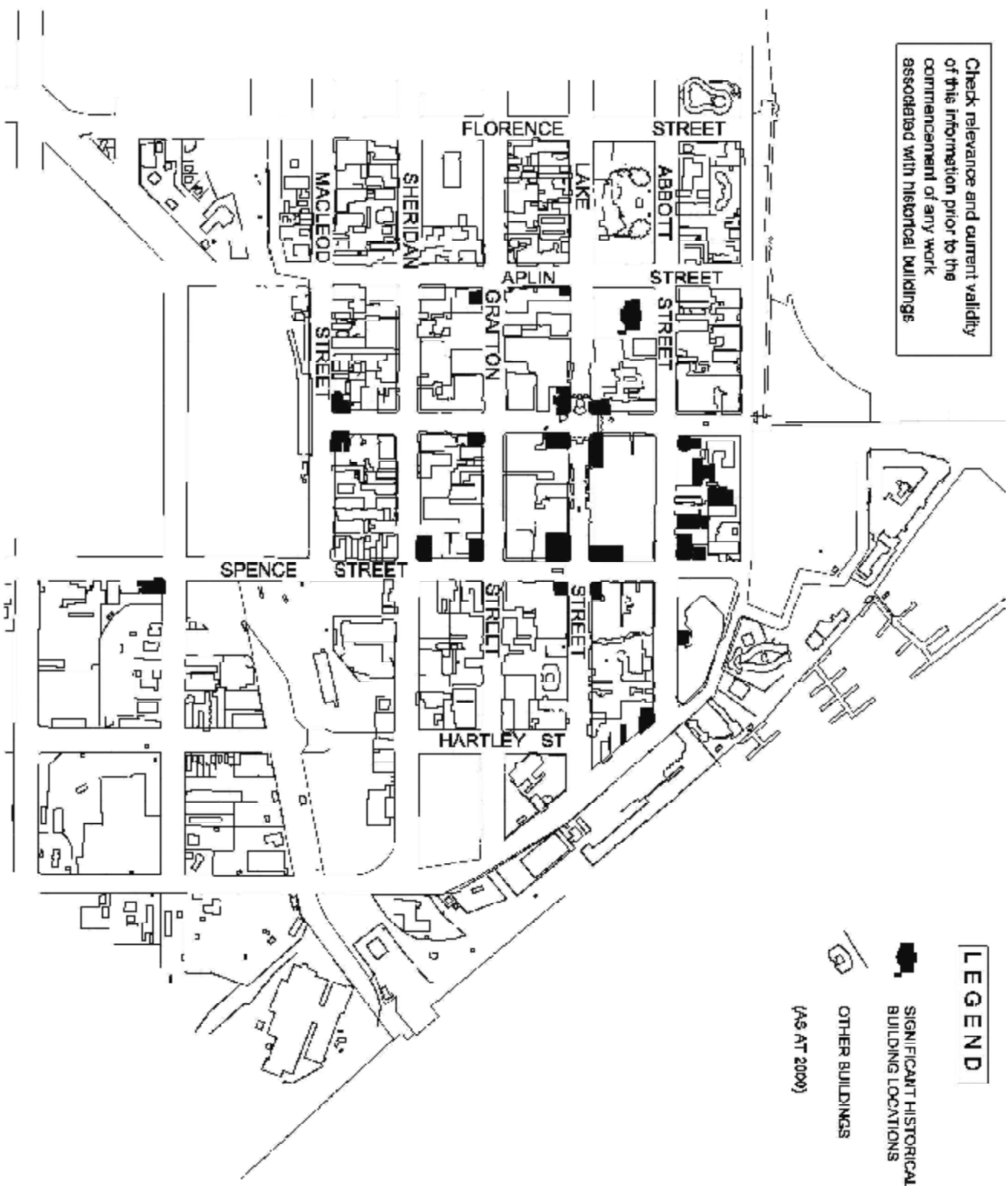
Check relevance and current validity of this information prior to the commencement of any work associated with historical buildings



**LEGEND**

 SIGNIFICANT HISTORICAL BUILDING LOCATIONS

 OTHER BUILDINGS

(AS AT 2009)

# UNDERSTOREY

Species	Common Name	Height x Spread	Type	Flower	Location
Aechmea gamosepala 'Lucky Stripes'	Variegated Matchstick Bromeliad	300 x 400	Tufting / bromeliad	Blue / pink	IV
Altemandra cathartica dwarf	'Sunee'	1000 x 1000	Shrub / climber	Yellow	IM
Alpinia nutica	Lesser Shell Ginger	1200 x 800	Ginger	Pink / white	V
Altemanthera dentata	Copperleaf	500 x 800	Subshrub	White	V
Aobelandra sinclairiana	Coral Ape/landra	2500 x 1200	Shrub	Pink / orange	IM
Aobelandra tetragona		2000 x 800	Shrub	Orange / red	IM
Ardisia crenata	Coral Berry	800 x 400	Shrub	White	F
Arundina graminifolia	Bamboo Orchid	1800 x 600	Tufting / caney	Pink / mauve	V
Asystasia gangetica variegated	'Enchanting Belts'		Groundcover / climber	Yellow	M
Barleria albostriata	'Silver Barleria'	800 x 400	Subshrub	White	IC
Barleria repens	'Coral Belts'	300 x 1000	Groundcover / climber	Pink	V
Belamcanda chinensis orange	Leopard Lily	1000 x 600	Tufting lily	Salmon orange	V
Belamcanda chinensis pink	Leopard Lily	1000 x 600	Tufting lily	Salmon pink	M
Brunfelsia latifolia dwarf	'Sweet Petite'	1000 x 400	Shrub	Mauve / white	V
Calliandra tweedii	'Red Flash'	400 x 1000	Subshrub	Red	IC
Canna 'Tropicanna'	Canna Lily	1200 x 600	Tufting lily	Orange	F
Carex horstfeldii	Flying Fox Sedge	400 x 400	Tufting sedge	White	F
Cathartus rosea alba	Madagascar Periwinkle	600 x 800	Subshrub	White	IM
Centradenia rosea		600 x 1000	Subshrub	Mauve	IM
Clerodendron quadriloculare		2500 x 1500	Shrub	Pink	IM
Coleus 'Burgundy'		800 x 600	Subshrub	NA	IM
Cordyline 'Dolly'	Ti Plant	1000 x 400	Tufting / caney	White	F
Cordyline 'Inscripta'	Ti Plant	1500 x 600	Tufting / caney	White / pink	V
Cordyline 'Kiwi Multi'	Ti Plant	1000 x 800	Tufting / caney	White / pink	F
Cordyline 'Red Sister'	Ti Plant	1500 x 600	Tufting / caney	White / pink	V
Costus erythrophyllus	Redback Spiral Ginger	800 x 600	Tufting / ginger	White / pink	IM
Costus productus	Dwarf Orange Ginger	800 x 600	Tufting / ginger	Orange	IM
Crinum pedunculatum variegatum	Variegated Swamp Lily	1200 x 1500	Tufting / lily	White	IM
Crinum xanthophyllum	Gold crinum	1000 x 1500	Tufting / lily	White	M
Crocasmia sp.	Montbretia	1000 x 1500	Tufting / lily	Orange / red	V
Crossandra infundibuliformis	'Mona Wallhead'	300 x 500	Subshrub	Orange	M / V
Cuphea mexicana compacta alba	'Madhatter'	300 x 600	Subshrub / groundcover	White	M
Cuphea mexicana compacta pink	'Madhatter'	300 x 600	Subshrub / groundcover	Pink	F
Dianella atraxis	Broadleaf Flax Lily	500 x 800	Tufting lily	Blue	IM
Dianella ensifolia variegata	Variegated Flax Lily	500 x 600	Tufting lily	Blue	IC / F
Dianella nodosa	'Pretty in Pink'	1000 x 1200	Shrub	Pink	V
Dichorandra thyrsofolia	Blue Ginger	1500 x 600	Tufting / caney	Blue	IM
Dietes bicolor	Spanish Iris	600 x 800	Tufting / lily	Yellow	IV
Dietes grandiflora	Wild Iris	600 x 500	Tufting / lily	White / mauve / yellow	V
Dracaena canneliata	'Gold Sanderiana'	600 x 600	Tufting / caney	White	F
Dracaena marginata tricolor	'White Sanderiana'	1500 x 600	Tufting / caney shrub	NA	IM
Dracaena canneliata		800 x 600	Tufting / caney	White	V
Dracaena thalictroides		800 x 600	Tufting / caney	White	F
Drejelia guttata	'Yellow' Shrimp Plant	600 x 800	Subshrub	Yellow / white	IV
Duranta repens	'Blue Cascade'	800 x 1200	Shrub	Blue	M
Duranta repens	'Squatters Gold'	800 x 1200	Shrub	Blue	V
Epidendrum hybrid	'Red Crucifix' orchid	600 x 600	Tufting / caney	Red	F
Eranthemum pulchellum (dark blue)	Blue Acanthus	800 x 1000	Shrub	Blue	IM
Ficus oklawomensis	'Green Island' Fig	800 x 1500	Shrub	NA	M
Gardenia veitchii	'Ocean Pearl'	600 x 1000	Shrub	White	M
Gardenia grandiflora 'Star'		1000 x 1000	Shrub	White	M
Gardenia radicans	Prostrate Gardenia	300 x 800	Shrub / groundcover	White	IM / V
Gloriosa superba	Climbing Lily	600 x 1000	Climber / Bulb	Orange / Bulb	IM
Gloxinia sylvatica	Jingies	400 x 600	Groundcover	Orange / Red	M
Hedychium coronarium	White Scented Ginger	1500 x 1000	Ginger	White	M

LOCATION KEY	
M	median
V	verge
F	footpath
A	awning
IM	intersection median
IV	intersection verge
IC	intersection corner
IR	roundabout



## UNDERSTOREY - Continued

Species	Common Name	Height x Spread	Type	Flower	Location
Hedychium gardnerianum	Kahliliu Ginger	1500 x 1000	Ginger	Yellow	IM
Hedychium longicomutum	Dwarf Epiphytic Ginger	500 x 600	Tufting / ginger	Yellow / orange	IV / M
Hedychium orange hybrid		1500 x 1000	Ginger	Orange	IM
Heliconia densiflora	'Trafalgar'	1200 x 1000	Tufting / running	Orange / red	M
Heliconia stricta	'Jamaican Dwarf'	600 x 600	Tufting / running	Pink	M
Hemigraphis (upright) sp.		400 x 500	Groundcover	White	M
Hemigraphis alternata	'Heavy Metal'	200 x 400	Groundcover	NA	V
Hemigraphis colorata	Red Ivy	400 x 1000	Groundcover	White	IV / M
Hemigraphis repanda		150 x 300	Groundcover	NA	IC
Hibiscus 'Snowflake'		1800 x 1500	Shrub	Red	IM
Homalomena rubescens		800 x 800	Tufting	NA	F
Hymenocallis caribaea	Broad Leaf Spider Lily	1000 x 1500	Tufting / lily	White	M
Hymenocallis littoralis	Narrow leaf Spider Lily	1000 x 1500	Tufting / lily	White	M
Hymenocallis littoralis variegatus	Variegated Spider Lily	600 x 600	Tufting / lily	White	IV
Hypericum patulum		800 x 1000	Shrub	Yellow	V
Hydrolytrum nemorum	Dwarf Pandan Sedge	1000 x 1200	Tufting / sedge	White	V
Ixora 'Coral Fire'		1000 x 1000	Shrub	Red	M
Ixora 'Global'	New Compact Red	1500 x 1200	Shrub	Red	M
Ixora 'Gold Superb'	New Dwarf Yellow Ixora	600 x 600	Shrub	Yellow	IC / F
Ixora 'Kampong's Pride'	New Malay Pink Sport	1500 x 1500	Shrub	White	V
Ixora 'Malay Pink'		1500 x 1500	Shrub	Pink	M
Ixora 'Peach Delight'		1000 x 1200	Shrub	Apricot / peach	M
Ixora 'Sheena'		1500 x 1500	Shrub	Apricot / orange	V
Ixora 'Splish'	Variegated Ixora	1000 x 600	Shrub	Cream	IM
Ixora 'Sunset Compacta'		600 x 600	Shrub	Orange / red	V
Ixora 'Tropic Blush'	New Pigmy Pink Sport	1000 x 800	Shrub	Pink	V
Ixora 'Willight Glow'		1000 x 600	Shrub	Orange	V
Ixora 'Wee Willie'		600 x 600	Shrub	Orange	F
Ixora coccoinea	Headging Ixora	1500 x 1500	Shrub	Red	M
Jasminum sambac double	'Grand Duke of Tuscany'	1200 x 1500	Shrub / climber	White	F
Jasminum nitidum	Angelwings Jasmine	1200 x 1500	Shrub / climber	White	IM
Justicia carnea discolor	Pink Justicea	600 x 400	Subshrub	Pink	IV
Kopsia fruticosa	Pink Periwinkle Tree	2000 x 1500	Shrub	Pink	M
Litorea muscari	'Evergreen Giant'	500 x 600	Tufting / lily	White	F
Litopetalum chinense 'Rujira'		1500 x 1500	Shrub	White	V
Malpighia coccinea	Chinese Holly	1500 x 1500	Shrub	Pink	IV
Maranta arundinacea variegata	Variegated Arrowroot	600 x 600	Tufting	NA	M
Medinella myrianthus	Lesser Medinella	1000 x 1200	Shrub	Pink	F / M
Medinella scorrechinii	Orange Medinella	800 x 1000	Shrub	Orange	IV
Mirabilis jalapa	Four O'Clock	800 x 800	Subshrub / tuber	Pink	V
Monocostus unibrus	Dwarf Yellow Spiral Ginger	500 x 500	Tufting / ginger	Yellow	F
Mussaenda philippica x erythrophylla	'Lakambini'	1500 x 1500	Shrub	Red	IM
Nandina domestica 'Gulf Stream' hybrid	Dwarf Sacred Bamboo	500 x 1000	Shrub	NA	F
Neomarica bicolor	Walking Iris	500 x 600	Tufting	White / blue / gold	IM
Ophiopogon jaburan	Giant Mondo Grass	300 x 400	Tufting	White	F
Ophiopogon jaburan variegatum	White Mondo Grass	300 x 400	Tufting	White	IC / F
Ophiopogon japonicus	Mondo Grass	200 x 300	Tufting	White	F
Osmoxylon lineare 'Milegoss'	Thai Lane	1000 x 1200	Shrub	White	F
Pachystachys lutea	Golden Candles	1500 x 1000	Subshrub	Yellow / white	M
Pandanus toei variegatus	Pigmy Pandanus	400 x 800	Tufting / groundcover	NA	IV
Pedicularis thymalioides	White Zig Zag Plant	1000 x 600	Shrub	Red	IV
Pentas 'Candy Stripe'		600 x 600	Subshrub	Pink	F
Peristrophe ryssopifolia variegata		300 x 1000	Groundcover	Mauve / crimson	IM / V
Platanus arundinacea variegata	Gardener's Garters	400 x 600	Tufting / canopy grass	NA	V
Philodendron erubescens gold	Goldlocks	300 x 1000	Climber / groundcover	NA	M

### LOCATION KEY

M	median
V	verge
F	footpath
A	awning
IM	intersection median
IV	intersection verge
IC	intersection corner
IR	roundabout

## UNDERSTOREY - Continued

Species	Common Name	Height x Spread	Type	Flower	Location
Philodendron 'Millenium'		600 x 1000	Tufting subshrub	NA	V
Philodendron 'Red Imperial'		300 x 400	Tufting groundcover	Red	M
Philodendron carneaefolia	Water Hyacinth Philodendron	400 x 600	Tufting groundcover	NA	M
Pilea cadieri	Aluminum Plant	300 x 500	Groundcover	White	V
Pitcairnia wendlandii	Scarlet Comet	600 x 800	Tufting bromeliad	Orange red	M
Portea petropolitana		800 x 1000	Tufting bromeliad	Pink / mauve	M / V
Pseuderanthemum andersoni	New Blue Pseuderanthemum	800 x 1000	Shrub / subshrub	Blue	V
Pseuderanthemum reticulatum	Yellow Vein Eranthemum	1000 x 800	Shrub	White	V
Pseuderanthemum sinuatum	Orchid Princess	600 x 300	Subshrub	White	IC
Psychotriachys urticifolius	Blue Spears	1500 x 1200	Shrub	Blue	IV
Quisqualis musseandiflora		1500 x 1500	Shrub / climber	Red	IV
Rhoeo 'Hawaiian Dwarf'		300 x 800	Groundcover	NA	M
Rhoeo discolor sp.	Boat Lily	300 x 300	Tufting / groundcover	White	IV
Rondeletia speciosa		1500 x 1200	shrub	Orange / red	IM
Ruellia colorata	Brazilian Red Torch	1200 x 1000	Subshrub	Orange / red	V
Ruellia elegans		200 x 400	Groundcover	Red	F
Ruellia tuberosa		200 x 200	Groundcover	Blue / mauve	IC
Scutellaria vertenatii	'Crimson Carnival'	300 x 600	Groundcover	Crimson	V
Setcreasea purpurea	Purple Heart	300 x 600	Groundcover	Mauve	V
Spathiphyllum cannaefolia	Greenback Peace Lily	800 x 1000	Tufting / groundcover	White	M
Spathoglottis paulinae	Native Ground Orchid	300 x 300	Tufting / groundcover	Pink / mauve	F
Strobilanthes dyerianus	Persian Shield	800 x 1000	Subshrub	Mauve	V
Strobilanthes wallichii	Pacific Bells	1500 x 1500	Subshrub	Pink / mauve	V
Tecomania capensis 'Salmori'		1500 x 1000	Shrub / climber	Salmon orange	IV
Thunbergia erecta	King's Mantle	1000 x 1500	Shrub	Blue / purple	M
Torenia surretibou	Blue Magic'	200 x 600	Groundcover	Blue / purple	IV
Trachelospermum asiaticum variegatum	Dwarf Star Jasmine	200 x 500	Groundcover / climber	White	IC
Whitfeldia longifolia		1200 x 800	Subshrub	White	IM
Xanthosoma monstrosorum variegatum	Pocket Taro	1000 x 1000	Tufting	NA	M
Zamia furfuracea	Cardboard Cycad	1000 x 1500	Tufting / cycad	NA	M
Zantedeschia aethiopica	White Arum Lily	500 x 500	Tufting / lily	White	V
Zephyranthes candida	Storm Crocus	200 x 300	Tufting lily	White	F
Zephyranthes rosea	Storm Crocus	200 x 300	Tufting lily	Pink	IC
Zingiber zerumbet variegata		800 x 1000	Ginger	Red / white	IV

LOCATION KEY	
M	median
V	verge
F	footpath
A	awning
IM	intersection median
IV	intersection verge
IC	intersection corner
IR	roundabout

STREET TREES					
Species	Common Name	Height x Spread	Flower	Location	
Agathis robusta	Kauri	20 x 10	NA	IM	
Alloxylon flammulum	QLD Tree Waratah	10 x 6	Red	IM	
Archontophoenix alexandrinae	Alexander Palm	20 x 4	Cream	IC	
Areca catechu	Betel Nut Palm	15 x 3	White	IC	
Areca triandra	Clumping Betel	8 x 2	White	IC	
Barringtonia acutangula	Freshwater Mangrove	5 x 6	Red	F	
Barringtonia asiatica	Boxfruit	8 x 10	Pink / white	F	
Barringtonia calyptrata	Cassowary Pine	10 x 6	White	M	
Bismarkia nobilis		15 x 6	White	IR	
Bixa orellana	Lupstick Tree	4 x 4	Pink	A	
Brachychiton acerifolius	Flame Tree	10 x 5	Red	IM	
Brachychiton velutinosus		8 x 6	Pink	IV	
Buckinghamia celastroides	Ivory Curl	6 x 5	White	IV	
Bullea monosperma	Flame of the Forest	6 x 4	Orange	IM	
Calophyllum inophyllum	Beauty Leaf	12 x 5	White	IM	
Calophyllum sil	Brush Touranga	10 x 6	White	V	
Carallia brachialata	Darkbark	8 x 6	Green	F	
Cardwellia sublimis	Northern Silky Oak	8 x 10	White	IM	
Carpentaria acuminata	Darwin Palm	12 x 3	White	IC / F	
Cassia grandis	Horse Cassia	12 x 15	Pink	M	
Cassia x 'Rainbow Shower'		8 x 10	Pink / cream	V	
Carberia floribunda	Cassowary Plum	8 x 6	White	IV	
Carberia manghas	Native Frangipani	6 x 6	White	IM	
Carberia odolam	Pong – Pong Tree	6 x 8	White	V	
Cinnamomum zeylanicum	Cinnamon	6 x 4	White	V	
Cleistanthus hylandi	Bernie's Cleistanthus	3 x 3	White	A	
Cordia sebestena	Geiger Tree	4 x 3	Orange	IV	
Crylocarya mackinnoniana	Rusty Laurel	10 x 6	White	F	
Cupaniopsis flagelliformis (Wangelli)	Blue Tuckeroo	4 x 3	White	IM	
Darlingia darlingiana	Brown Silky Oak	10 x 5	White	V	
Darlingia ferruginea		10 x 5	Cream	IV	
Delonix regia	Poinciana	10 x 15	Red	V	
Didyosperma album	Princess Palm	12 x 5	White	IC	
Dillenia indica	Elephant Apple	15 x 10	White	F / V	
Dimocarpus longan	Longan	8 x 10	White	M	
Dyopsis decaryi	Triangle Palm	8 x 5	White	IC	
Emmenosperma alphonoides	Bonewood	8 x 4	White	IM	
Enfirtina variegata var. parcellii	Varegated Coral Tree	10 x 6	Red	A	
Evodia muelleri	Dwarf Evodia	6 x 6	Pink	A	
Ficus benjamina	Weeping Fig	10 x 15	NA	M	
Ficus drupacea		15 x 15	NA	M	
Ficus barreii	F 'longifolia'	10 x 12	NA	M	
Ficus microcarpa 'Aurea'		8 x 10	NA	M	
Ficus microcarpa 'Hill'	Hill's Weeping Fig	12 x 15	NA	M	
Filindesia filiana	Cairns Hickory	15 x 10	White	M	
Gustavia superba		3 x 4	Pink / white	F	
Harpullia rarniflora	Culcic Tulipwood	5 x 6	White	A	
Hentria littoralis	Looking Glass Mangrove	10 x 5	White	IV	
Hernandia nymphaeifolia	Sea Hearse	8 x 6	White	IV	
Hydrastele wendlandiana	Water Palm	8 x 3	White	IC	
Hypophorbe verschaffelii	Spindle Palm	8 x 3	White	IC	
Inocarpus edulis	Pacific Chestnut	10 x 8	White	V	
Inisia biljuga	Kwila	10 x 8	White / red	M	
Kopasia arborea	Periwinkle Tree	4 x 3	White	IV	
Livistona australis	Cabbage Palm	30 x 4	Cream	IC	

LOCATION KEY	
M	median
V	vege
F	footpath
A	awning
IM	intersection median
IV	intersection verge
IC	intersection corner
IR	roundabout

## STREET TREES - Continued

Species	Common Name	Height x Spread	Flower	Location
<i>Livistona chinensis</i>	Chinese Fan Palm	12 x 3	Cream	F
<i>Livistona decipiens</i>	Ribbon Fan Palm	15 x 5	Cream	IM
<i>Livistona muelleri</i>	Cairns Fan Palm	8 x 3	Burgundy	IV
<i>Livistona rotundifolia</i>	Footstool Palm	20 x 4	Cream	IC
<i>Michelia champaca</i>	Himalayan Magnolia	10 x 6	Gold	IV
<i>Normanbya normandyi</i>	Black Palm	15 x 5	White	IC
<i>Ormosia ormondii</i>	Yellow Bean	10 x 8	Pink	M
<i>Pandanus bairdii</i>	Variegated Screw Palm	8 x 6	White	IM
<i>Pandanus zea</i>	Concub Screw Palm	10 x 5	White	IM
<i>Peltophorum dubium</i>	Glossy Yellow Poinciana	8 x 10	Yellow	M
<i>Pisonia grandis 'Alba'</i>	Moonlight Tree	4 x 3	NA	IV
<i>Pleomele reflexa</i>	Song of India	4 x 2	White	A
<i>Plumeria obtusa</i>	Evergreen Frangipanni	6 x 6	White	IM
<i>Plumeria rubra 'Hot Pink'</i>	Frangipanni	6 x 6	Pink	IV
<i>Plumeria rubra 'Orange'</i>	Frangipanni	6 x 6	Orange	IM
<i>Podocarpus grayae</i>	Brown Pine	10 x 3	NA	IV
<i>Polyalthia longifolia pendula</i>	Indian Mast Tree	12 x 2	NA	IM
<i>Pongamia pinnata</i>	Beach Pongamia	10 x 12	White	M
<i>Pongamia sp aff. pinnata</i>	Creek Pongamia	8 x 10	Pink / white	M
<i>Pritchardia pacifica</i>	Fiji Fan Palm	12 x 4	White	IC
<i>Pterospermum acerifolium</i>	Bayur Tree	12 x 8	Gold / white	IM
<i>Psychosperma elegans</i>	Soilatre Palm	10 x 2	White	IC
<i>Randia fitzalanii</i>	Native Gardenia	5 x 4	White	A
<i>Sabal palmeto</i>	Sabal Palm	8 x 3	Cream	IC
<i>Sternmaderia gallectii</i>	Sabal Palm	5 x 4	White	IV
<i>Stenocarpus gallectii</i>	Wheel of Fire	10 x 4	Red	IV
<i>Stenocarpus sinuatus</i>	White Bean	10 x 8	Yellow	IM
<i>Strochialia australiensis</i>	Pink Tamarind	10 x 6	White	F
<i>Synlma cordierum</i>	Onionwood	15 x 10	White	M
<i>Syzygium alligatum</i>	White Apple	12 x 8	White	V
<i>Syzygium forte ssp potanophilum</i>	Flakybark Satinash	12 x 8	White	V
<i>Syzygium jambos</i>	Rose Apple	6 x 8	White	F
<i>Syzygium minutiflorum</i>	Gove Satinash	10 x 6	White	M
<i>Tabebuia argentea</i>	Silver Trumpet Tree	8 x 4	Yellow	IM
<i>Tabebuia chrysantha</i>	Gold Trumpet Tree	8 x 10	Yellow	V
<i>Tabebuia coriacea</i>	Tabebuia	8 x 6	Yellow	IM
<i>Tabebuia palmeri</i>	Mauve Trumpet Tree	12 x 8	Mauve	V
<i>Tabebuia rosea</i>	Dwf. Evergreen Trumpet Tree	5 x 4	Mauve	F
<i>Terminalia muelleri</i>	Lesser Beach Almond	6 x 8	White	F
<i>Theobroma cacao</i>	Cocoa	5 x 4	White	F
<i>Toechima daemelianum</i>	Cape Tamarind	6 x 5	White	F
<i>Toechima plerocarpum</i>	Bushy Creek Tamarind	8 x 6	White	V
<i>Velichia merillii</i>	Christras Palm	8 x 3	White	IC
<i>Warsowiczia coccinea</i>	Jungle Poinsetta	6 x 4	Red	IV
<i>Wodyetia bifurcata</i>	Foxtail Palm	12 x 5	White	IM
<i>Xanthostemon chrysanthus</i>	Golden Penda	8 x 6	Yellow	IV
<i>Xylocarpus granatum</i>	Cannonball Mangrove	8 x 6	White	IV

### LOCATION KEY

M	median
V	verge
F	footpath
F	awning
A	intersection median
IM	intersection verge
IV	intersection corner
IC	intersection
IR	roundabout

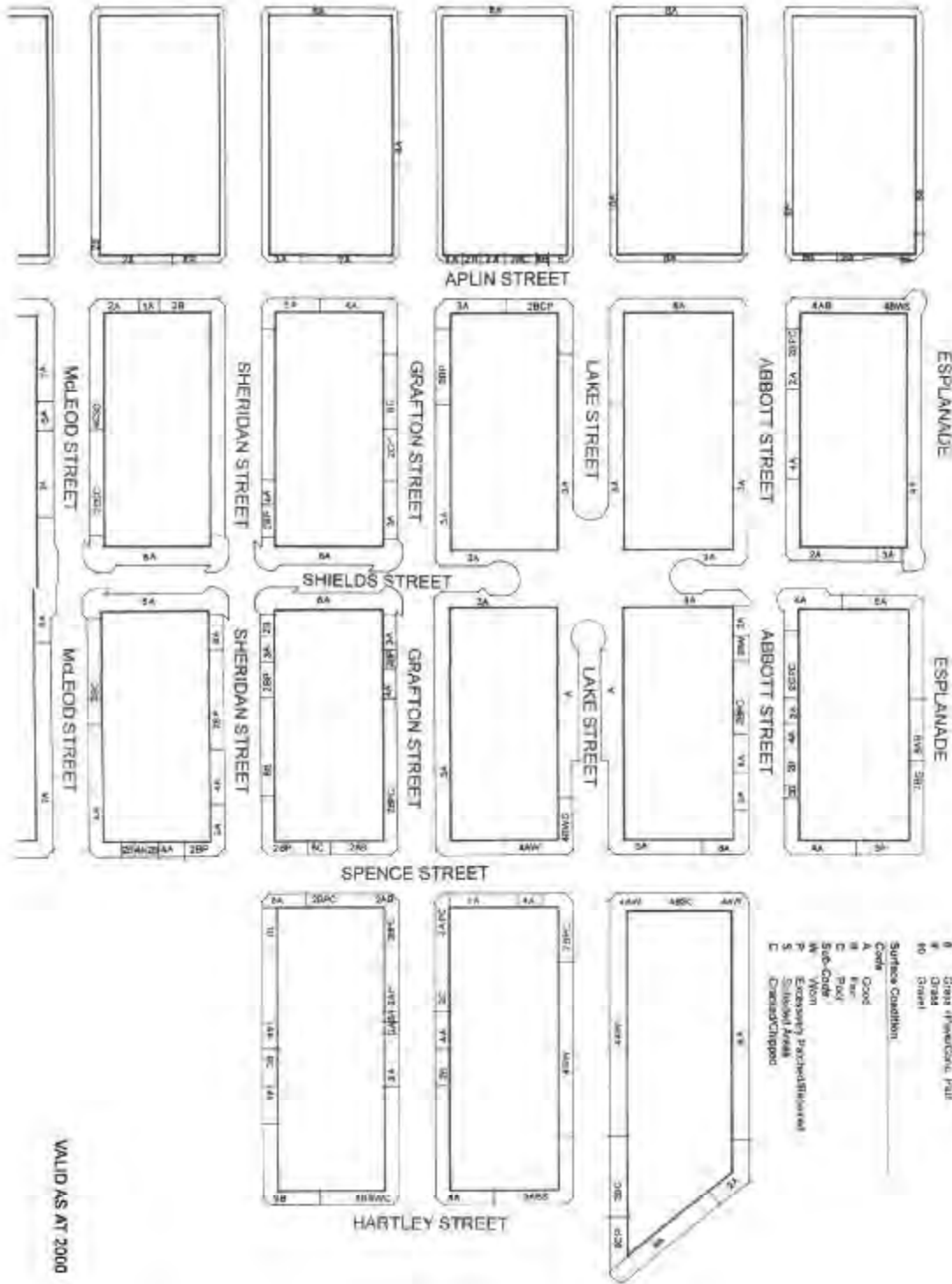

VALID AS AT 2000

**GLOSSARY OF TERMS**

ACCESS PLACE & ACCESS STREET	These are new terms in the CBD Masterplan which relate to the traffic hierarchy, the City Place and its relationship to the surrounding collector streets. For the purposes of this document, both Access Streets and Access Places are to be considered a collector Street. See also specific City Place treatments and diagram v5.
CBD	Central Business District
CCC	Cairns City Council
CPA	Cairns Port Authority
CPTED	Crime Prevention Through Environmental Design
FNQROC	Far North Queensland Regional Organisation of Councils
FOOTPATH	The area of road reserve between the property boundary (or buildings) & the adjacent kerb and channel (or road edge); also referred to in documents such as the FNQROC as the verge.
NODE	For the purposes of this document, a node shall be defined as a key public space which is characterised by a collection of pedestrian traffic directions; generally physically larger spaces such as street corners and plazas where pedestrian traffic gathers.
VERGE	In this document, the verge is the area located between the road lane/s and the kerb and channel. Verge garden planters are common in both Collector and Sub-Arterial roads in the CBD.

**Planning Scheme Policy**

**CAIRNS CITY IN A GARDEN MASTERPLAN**

**Application** This policy applies to development undertaken in all Districts within the CairnsPlan with the exception of the Cairns Business District (CBD) as identified on the CBD – North Cairns Planning Area Map.

**Intent** This Policy is intended to establish a tree and plant species palette together with guidelines for appropriate planting methods and complement the Cairns CBD Streetscape Masterplan planning scheme policy.



**This policy is to remain in force until otherwise determined by Council.**

**General Manager Responsible for Review:**

**Works and Services.**

**ADOPTED: 25/2/2009**

**COMMENCEMENT: 1/3/2009**

**DUE FOR REVISION: 30/6/2012**

**REVOKED/SUPERSEDED:**

Planning Scheme Policy

**NOMINATIONS FOR THE INCLUSION OR REMOVAL OF A PLACE FROM THE LOCAL HERITAGE REGISTER**

**Application**

This Policy applies to the whole area covered by the CairnsPlan, Planning Scheme for the City of Cairns.

**Intent**

This Policy is intended to support the local dimension of the Planning Scheme by ensuring that places of cultural heritage significance are nominated to the local heritage register on a continuous basis.

**Objectives**

The objective of this policy are:

- Establish the criteria for entry of a place in the local heritage register;
- Identify the procedure for making a nomination to include a place in the local heritage register; and
- Identify the procedure for removing a place from the local heritage register.

**Definitions**

In this policy the following definitions apply:

“Cultural Heritage Significance” denotes the importance of a Cultural Heritage Place, which may be based on aesthetic, architectural, archaeological, educational, historical, scientific, social, technological or traditional values.

“Owner” of a place means all persons listed as registered owners on the certificate of title of the place, or the land on which the place is situated.

“Place” includes a site, building, structure or item.

“Statement of Significance” is a brief statement detailing the significance of a Cultural Heritage Place.



## Criteria for Entry in Local Heritage Register

In determining if a place is worthy of listing in the Heritage Register it must satisfy one or more of the following criteria:-

- (a) The place is important in demonstrating the evolution or pattern of the City's history; or
- (b) The place demonstrates rare, uncommon or endangered aspects of the City's cultural heritage; or
- (c) The place has potential to yield information that will contribute to an understanding of the City's history; or
- (d) The place is important in demonstrating the principal characteristics or a particular class of cultural places; or
- (e) The place is important in exhibiting particular aesthetic characteristics valued by the community or a particular community group; or
- (f) The place is important in demonstrating a high degree of creative or technical achievement at a particular period; or
- (g) The places has a strong or special association with a particular community or cultural group for social, cultural or spiritual reasons; or
- (h) The place has a special association with the life or work of a particular person, group or organisation of importance in the City's history.

A place is not to be excluded from the Local Heritage Register on the ground that a place or places with similar characteristics have already been entered in the Local Heritage Register.

## Making a Nomination

The Local Government may on its own initiative or by written nomination by any person consider whether a particular place should be entered in the Local Heritage Register.

The Local Government may require an applicant who seeks the entry of a particular place in the Local Heritage Register to:

- Describe the nature of the place
- Identify its specific location
- Have a statement of significance prepared by a qualified heritage professional.

The Local Government may invite written submissions in relation to a place that it has under consideration for possible entry to the Local Heritage Register from

- The Owner of the place if the owner was not the person to make the nomination;
- Any person or body with a special knowledge of, or interest in, the place; or

- Any person or body with a special interest in the City's cultural heritage.

If the Local Government is of the opinion that a place is of cultural significance and satisfies one or more of the criteria for entry, the Local Government may resolve to enter the place in the Local Heritage Register<sup>1</sup>.

### **Nomination to Remove a Place from the Local Heritage Register**

The Local Government may, on its own initiative or by nomination by any person consider whether a particular place in the Local Heritage Register should be removed from the Register.

The Local Government may require an applicant who seeks the removal of a particular place from the Local Heritage Register to

- Describe the nature of the place;
- Identify its specific location;
- Provide information to support that the place is no longer of cultural heritage significance.

The Local Government may invite written submissions in relation to a place that it has under consideration for possible removal from the Local Heritage Register from

- The Owner of the place if the owner was not the person to make the nomination;
- Any person or body with a special knowledge of, or interest in, the place; or
- Any person or body with a special interest in the City's cultural heritage.

If the Local Government is of the opinion that a place no longer justifies the retention in the Local Heritage Register, the Local Government may resolve to remove the place from the Local Heritage Register<sup>2</sup>.

---

<sup>1</sup> If the Local Government resolves to enter the place in the Local Heritage Register it must:

- A. Give the rateable owner of the place a written notice:
  - a. Stating that the Local Government proposes to enter the place in the Local Heritage Register; and
  - b. Stating the reasons on which the proposal is based (including a statement of the relevant criteria); and
  - c. Explaining the right to lodge a submission in relation to the proposal.

<sup>2</sup> If the Local Government resolves to remove the place from the Local Heritage Register it must:

- A. Give the rateable owner of the place a written notice:
  - a. Stating that the Local Government proposes to remove the place from the Local Heritage Register; and
  - b. Stating the reasons on which the proposal is based; and
  - c. Explaining the right to lodge a submission in relation to the proposal; and
- B. Give the person who made the submission where that person is not the owner of the place, a written notice:
  - a. Stating that the Local Government proposes to remove the place from the Local Heritage Register; and
  - b. Stating the reasons on which the proposal is based; and
  - c. Explaining the right to lodge a submission in relation to the proposal.



**This policy is to remain in force until otherwise determined by Council.**

**General Manager Responsible for Review:**

**Development Assessment**

**ORIGINALLY ADOPTED: 27/1/2005**

**COMMENCEMENT: 1/03/2005**

**CURRENT ADOPTION: 5/12/2012**

**DUE FOR REVISION: 31/12/2014**

**REVOKED/SUPERSEDED:**

---

**CAIRNS REGIONAL COUNCIL****NO. 4:04:05**

---

**Planning Scheme Policy****REQUIREMENTS FOR TOWN CENTRE MASTER PLANS****Application**

This Policy applies to the whole area covered by the CairnsPlan, Planning Scheme for the former City of Cairns.

**Intent**

This Policy is intended to support the local dimension of the Planning Scheme by identifying the information required to assist the assessment of a development application within a Town Centre and to assist in establishing full facts about the Town Centre to support a well informed decision. This will ensure that the Town Centre meets the district intent and desired development outcomes.

**Objectives**

The objectives of this policy are:

- To ensure that all necessary information is provided to enable the assessment of a proposed development.
- To establish the detailed design parameters for the Town Centre.
- To ensure the creation of a sustainable transit oriented community including the co-location of compatible land uses.
- To ensure that land uses are of a scale and density that is commensurate with the capacity of the transport network and reflect capital and recurrent infrastructure requirements
- To ensure the Town Centre is planned and developed in an orderly and sequential fashion and has the necessary infrastructure and services provided in an efficient and timely manner.
- To minimise adverse impacts and maximise community benefits including enhancing liveability and community cohesion.
- To inform the community and facilitate participation by the community in the planning process.

### Preparation of a Master Plan

A Master Plan provides the necessary planning framework to ensure that development is planned and developed in an orderly and integrated manner.

A master plan is required to accompany the first development application for land within the Town Centre Planning Area. Once endorsed by Council, the Master Plan will guide and inform subsequent development applications within the Town Centre.

The Master Plan is to be designed with consideration of this broader context. It must demonstrate how the Town Centre will integrate with the surrounding community and with the existing parks and infrastructure networks and the movement system (road network, public transport facilities and pedestrian and cyclist network).

The Master Plan is to contain plans and supporting information detailing:

- the nature and extent of the issues associated with the site and the immediate locality surrounding the site, such as land uses, availability of infrastructure, topographical features, movement systems, natural features and demographic data.
- the composition of uses within the Town Centre, the sequence of development and external impacts such as stormwater quality and quantity management, traffic generation, public transport availability, infrastructure capacity, wildlife corridor linkages and social and economic impacts.

### Expertise Required to Prepare Master Plan

The Master Plan must be prepared by a competent team. A competent team must have appropriate tertiary design qualifications in disciplines of:

- urban design, architecture, landscape architecture, town planning, engineering and social policy.

### Site and Context Analysis

Plans and supporting information addressing the following features as a minimum:

- topography – contours and site levels
- Constraints and opportunities (eg waterways, vegetation and drainage corridors)
- existing street network and intersections, and their treatments and public transport routes and stops
- existing land uses and approvals on surrounding sites (including subdivision layout), including the location of schools, shopping centres, employment generators and other community facilities
- location of surrounding open space network and pedestrian and cyclist network (existing and proposed).

## Design Response

The Master Plan must demonstrate integration, namely:

- Integration of surrounding land uses (existing and proposed) with the spatial arrangement of uses within the Master Plan
- How the Master Plan addresses the overall road hierarchy, transport network and pedestrian and cycle networks. This may be supported by the submission of a Transport Land Use Report and simulation modelling.
- Consideration to potential subdivision and development of adjoining and surrounding allotments;

The Master Plan, including land use allocation, access and movement networks, and open space network provision, must actively promote the achievement of the District Intent and relevant planning scheme provisions. The Master Plan must at a minimum map and report on:

- approximate lot or dwelling yield for each part of the site (density)
- location of each proposed land use, including where applicable, the extent of facilities proposed such as community facilities, centres, employment and schools
- broad physical infrastructure to be provided including capacity analysis e.g. water, sewerage and stormwater and integrated water management
- general location and size of open space networks
- existing and proposed pedestrian and cycle networks
- existing and proposed road network, including level in the hierarchy
- existing and proposed public transport routes and stops
- proposed staging of the development
- Key gateways, nodes and vistas
- Landmark building sites
- Landmark building sites with a height exceeding 12 metres with a maximum height of 18 metres. Note: not all landmark buildings will exceed 12 metres in height.
- Climatically responsive design eg. prevailing breezes and solar orientation.
- The promotion of safety, security and accessibility within the Town Centre
- The desired architectural character and themes to create identity and visual interest

The Master Plan must contain a streetscape plan identifying the following elements:

- a suitable theme or themes that accurately portray the character of precincts within the Town Centre, and develop an integrated set of design principles and guidelines for each street or streets within a precinct:
  - Footpath pavement treatments

- Footpath, verge and median tree species
- Plant selection guidelines for mid-storey, understorey and groundcover species.
- A palette of outcomes for each street or streets within a precinct addressing the following streetscape elements:
  - Shade structures/awnings
  - Bicycle parking and end of trip facilities
  - Public seating/ tables
  - Planter boxes
  - Refuse and recycling bins
  - Tree protection (grilles and barriers)
  - Lighting (street and footpath)
  - Street signage
  - Bollards / barriers
  - On-street parking configuration

#### Economic and Need Assessment

Undertake an employment, floor space and land use mix analysis for the proposed development and all other developments within its catchment.

The report will need to demonstrate that on balance the proposed development will not have a significant adverse effect on the economic viability of existing Centres. In particular, the report will need to demonstrate how:

- the development of the site can occur on a staged basis in line with population growth and agreed population triggers in the catchment area.
- future retail and commercial development within the Town Centre is aligned to population triggers developed by Council's Planning Department to the satisfaction of Council

The Economic Need and Impact report must be prepared by a suitably qualified economist and will be subject to a peer review.

#### Community Engagement

Community engagement will be required as an integral part of preparing a Town Centre Master Plan, or in providing additional information in support of a planning application where this additional information takes the form a Commercial Impact Assessment Report.

The processes and results of the engagement program should be documented and form part of the development application.

Cairns Regional Council understands community engagement to contain the following three elements:

- Information: To provide the community and key stakeholders with balanced and objective information on decisions, policies, plans and strategies.
- Consultation: To obtain feedback from the community and key stakeholders on analysis and alternatives to inform a decision.
- Participation: Responsibility for the final decision rests with Council but may, in some instances be shared with the community and key stakeholders. It is critical that the final decision maker is predetermined and agreed in the planning process and recognised in the community engagement plan. Participation is made up of several parts:-
  - Involvement: To work directly with the community and key stakeholders so that their concerns/issues are consistently understood and considered.
  - Collaboration: To partner with the community and key stakeholders in each aspect of the decision process – including the development of alternatives and identification of a solution.
  - Empowerment: All final decisions rest with Council or a delegated officer of Council; Council may adopt recommendations from the community, unchanged, should the circumstances warrant such an approach, or authorise a community entity to proceed with a task that requires the entity to exercise a degree of decision making in dealing with matters contained within the task.

It is recommended that the following steps be followed in planning and undertaking the engagement program.

#### 1.0 Clarify the purpose

Identify what the engagement is intended to achieve and communicate this clearly to everyone involved. In planning the engagement program and determining the level of engagement needed, the following criteria should be considered:

#### 2.0 Identify who to involve

Identify the communities who may need to be consulted. These may include:

- geographically based communities, local and surrounding.
- special interest groups
- Relevant Government Agencies
- new communities, e.g. greenfield development and urban infill sites. It can be difficult to involve people who are not yet resident. However, an effective alternative is to consult people who now occupy recently developed areas to learn from them what impacts need to be managed.

Affected communities often include people from a geographic area and non-geographic communities of interest.



3.0 Establish a time frame

Ensure that engagement events occur at appropriate times to enable the information gathered to inform the critical decision making stages.

4.0 Decide the resource requirements

Ensure that there are sufficient resources available to support the engagement program being designed.

5.0 Plan the process

Plan a program to meet the requirements defined in the preceding steps. Keep the program flexible to enable it to be adjusted to changing needs as the process unfolds.

Table 1 describes the types of techniques that could be used to achieve different objectives of the engagement spectrum.

<i>Community Engagement Spectrum</i>				
<i>Information Education</i>	<i>Consultation</i>	<i>Participation</i>		
		<i>Involvement</i>	<i>Collaboration</i>	<i>Empowerment</i>
<b>Examples:</b> -Briefings -Fact sheets -Websites -Media campaigns -Shop front -Shopping centre displays -Letters to the Editor	<b>Examples:</b> -Road shows -Interviews -Surveys -Public meetings -Web based consultation -Research -Focus Groups	<b>Examples:</b> -Workshops -Deliberate polling	<b>Examples:</b> -Citizen advisory committees -Consensus building -Participatory decision making -Community reference / advisory groups	<b>Examples:</b> -Delegated decisions -Community entities undertaking defined tasks on Council's behalf

6.0 Implement and monitor

Continually evaluate how well the engagement program is achieving its stated objectives and adjust events, techniques, timing or resources as required.

7.0 Present the results

Show how the results of the engagement have informed the final decision and communicate this to all parties involved. These results should clearly indicate:

- who was consulted and how
- the issues they raised
- how the results of engagement informed the project outcome.

State interests

The report should include reference to any applicable State policy contexts.

Format of Data

An electronic copy of spatial data produced, including maps and diagrams should be provided in a MapInfo format (.Mid/.Mif) for ease of use in Council's GIS. To ensure the spatial data aligns to the DCDB in Council's GIS, MGA Zone 55 (GDA94) should be used for the maps and diagrams.



**This policy is to remain in force until otherwise determined by Council.**

**General Manager Responsible for Review: Planning and Environment**

**ADOPTED:**

**COMMENCEMENT:**

**DUE FOR REVISION:**

**REVOKED/SUPERSEDED:**

**Planning Scheme Policy**

**REPORTS AND INFORMATION COUNCIL MAY REQUEST**

**Application**

This Policy applies to the whole area covered by the CairnsPlan, Planning Scheme for the City of Cairns.

**Intent**

This Policy is intended to support the local dimension of the Planning Scheme by identifying the information which the Council may request a proponent to provide to demonstrate that a proposal for development meets the performance criteria and will be ecologically sustainable.

**Objectives**

The objectives of this policy are:

- To ensure that all necessary information is provided to enable the assessment of the impacts of a proposed development or to confirm that impacts of a proposed development can be minimised;
- To ensure that any potential impacts associated with development can be identified and minimised to an acceptable level to protect the biodiversity and environmental integrity of the City.

**Information Council May Request**

The Council may request the following information from the applicant to assist in the assessment of a development application:

- Architectural Report
- Bushfire Hazards Assessment
- Cultural Heritage Report
- Engineering Report
- Environmental Report
- Erosion and Sediment Control Plan
- Flood Study Report
- Geotechnical Engineering Report

**Endnote - Amendments**

Section B – Preparation of a Cultural Heritage Report and Archival Report. 06/12/2007, Amendment 2007, No. 1. Amendment to cultural heritage report requirements and insertion of archival reporting requirements.

- Landscape Plan
- Parking Assessment Report
- Plans Showing True Perspective Views
- Rehabilitation Report
- Site Management Plan Report
- Site Opportunity and Constraints Analysis
- Site Survey Report
- Social and Community Impacts Assessment
- Vegetation Audit Report
- Visual Assessment Report
- Waste Water Management Report
- Water Quality Report

This is a certified copy of the Reports and Information Council May Request Planning Scheme Policy. Council adopted the amendment to Part B – Preparation of a Cultural Heritage Report and Archival Report on the 6 December 2007. A Public Notice was published in the Cairns Post on the 15 December 2007.



Bruce Gardiner  
Acting Chief Executive Officer  
Cairns City Council.



**This policy is to remain in force until otherwise determined by Council.**

**General Manager Responsible for Review:**

**Development Assessment**

**ORIGINAL ADOPTION: 27/01/2005**  
**ORIGINAL COMMENCEMENT: 01/03/2005**  
**CURRENT ADOPTION: 05/12/2012**  
**CURRENT COMMENCEMENT: 05/12/2012**  
**DUE FOR REVISION: 31/12/2014**

**Endnote - Amendments**

Section B – Preparation of a Cultural Heritage Report and Archival Report. 06/12/2007, Amendment 2007, No. 1. Amendment to cultural heritage report requirements and insertion of archival reporting requirements.

**Contents of the Policy**

PART A – Ecological Assessment Reports and Environmental Management Plans.....4

PART B - Preparation of a Cultural Heritage Report and Archival Report.....9

PART C - Preparation of a Development Plan for Reconfiguration of a Lot.....14

PART D – Hillslopes Assessment Report .....15

PART E – Extractive Industry Environmental Management Plan .....19

PART F – Hydrological Study .....21

PART G - Vegetation Conservation / Waterway Significance .....24

PART H - Natural Hazard (Bushfire) Management Plan.....25

PART I - Landscape Plan .....27

PART J – Social and Community Impact Assessment Report .....28

**Endnote - Amendments**

Section B – Preparation of a Cultural Heritage Report and Archival Report. 06/12/2007, Amendment 2007, No. 1. Amendment to cultural heritage report requirements and insertion of archival reporting requirements.

## **PART A – Ecological Assessment Reports and Environmental Management Plans**

### **Purpose**

- To encourage more ecologically sustainable development;
- To provide or expand on existing ecological information known about a site in order to assist in the development assessment process;
- To minimise adverse impacts on areas of ecological significance and to maximise the beneficial impacts of the development;
- To provide guidance on the preparation and assessment of Ecological Assessment Reports and Environmental Management Plans.

### **Preparation of an Ecological Assessment Report**

#### Report to be prepared by a suitably qualified person

The Ecological Assessment Report will be prepared by a suitably qualified person and references naming other similar reports prepared by the consultant or consultants should also be included.

#### State interests

The report should include reference to any applicable State policy contexts.

#### Report format and content

It is recommended that the proponent should consult with the Council prior to preparation of the report in order to ensure that all issues are covered in the report. As a general guide the following format and contents description indicates the depth of detail required:

### **Summary and Conclusions:**

- Site location - a brief description of the site and surrounding areas, including the location of associated infrastructure development and figures/maps of all locations;
- Project description - summarise the objectives of the project and proposals for the construction and operation of the project and associated infrastructure developments;
- Alternatives to proposed development (for major or intensive development projects) - summarise the features of alternatives investigated and detail the reasons for choosing the preferred option;
- Existing environment - summarise the features of the physical, biophysical and built environment relating to the proposed development and associated infrastructure;
- Principal potential environmental impacts - summarise the main potential impacts of the project (direct, indirect and cumulative), both beneficial and detrimental, and any alternatives, on the existing environment;
- Environmental monitoring, protection and management procedures - summarise the safeguards, standards and management procedures proposed to protect the

### **Endnote - Amendments**

Section B – Preparation of a Cultural Heritage Report and Archival Report. 06/12/2007, Amendment 2007, No. 1. Amendment to cultural heritage report requirements and insertion of archival reporting requirements.

environment, including environmental monitoring and the methods proposed to ameliorate or alleviate the potential impacts;

- Conclusions - summarise the key strategies and amendments to the proposal to address any adverse environmental impacts.

### **Background and Scope of Proposal:**

- Outline the purpose and objectives of the proposed development;
- Discuss the following to illustrate the background of the proposal:
  - the need for the proposed development or works;
  - the history of proposal formulation;
  - any alternatives considered and reasons for choosing the preferred option;
  - action already taken;
- Description of the project:
  - the precise nature and scale of works;
  - the location and site requirements;
  - the plant and/or building layout, size and design and the development staging program;
  - the range and quantity of materials to be produced;
  - the production process;
  - possible waste discharges;
  - on-site works and operations;
  - off-site works and operations;
  - transport systems;
  - infrastructure requirements (water, sewerage, energy, waste disposal);
  - the workforce;
  - project life and time scale for completion;
  - the possible future expansion of associated development/works;
- Use of resources - detail the implications of the proposal for the use of natural resources, including the quantity and source of water, raw materials and energy to be used.

### **Existing Environment:**

- Site and locality;
- Landform, geology and geomorphology;
- Hydrology (surface water and groundwater);
- Climate;
- Air quality;
- Noise environment;
- Coastal processes (if applicable);
- Ecological status/significance including:
  - types, structure and location of vegetation associations on the site and surrounding areas, including measures of foliage cover, health and natural regeneration;
  - species of flora and fauna (aquatic and terrestrial, native and introduced), weed and pest species, including the location and abundance of each species, especially the presence of rare or endangered species;
  - conservation significance - bioregional status, local and national status;
  - special ecological values of the site such as refuge habitat, a breeding habitat, a corridor for wildlife movement and use by migratory species;
- Social cultural and economic characteristics;
- Landscape character and visual amenity;
- Infrastructure;

### **Endnote - Amendments**

Section B – Preparation of a Cultural Heritage Report and Archival Report. 06/12/2007, Amendment 2007, No. 1. Amendment to cultural heritage report requirements and insertion of archival reporting requirements.

- Transport;
- Water supply;
- Effluent treatment and disposal;
- Solid waste;
- Power and communications.

#### Potential impacts of the development on the existing environment

Identify and detail the nature of any potential impacts, including cumulative impacts of the development on the existing environment (adverse or beneficial, direct or indirect, short or long term or incremental) including potential impacts on:

- Geology and geomorphology;
- Hydrology (surface and groundwater);
- Ecological status/significance;
- Air quality;
- Noise levels;
- Coastal processes (if applicable);
- Infrastructure;
- Potential events;
- Safety program.

#### Impact monitoring, protection, risk management and post development management procedures

- An Environmental Management Plan should be prepared for the development (refer below).

#### Consultation

- The applicant/consultant should consult with relevant interest groups and parties likely to be affected by the proposal, and issues generated should be documented along with any proposed measures to address these issues.

#### References

- Listing other reference material and literature used;
- List authorities consulted and contributors to the report;
- Cross-reference the reference material in the text to allow easier access to information.

#### Appendices

- Include detailed technical information collected through the investigation; and
- Include relevant documents or correspondence from government authorities.

### **Preparation of Environmental Management Plans**

An Environmental Management Plan (EMP) seeks to ensure that the impacts of development on the environment are adequately controlled. This can include construction, operational and decommissioning stages of a development.

#### The range of issues

The range of issues that may be requested to be addressed in an EMP include:

#### **Endnote - Amendments**

Section B – Preparation of a Cultural Heritage Report and Archival Report. 06/12/2007, Amendment 2007, No. 1. Amendment to cultural heritage report requirements and insertion of archival reporting requirements.



- Acid sulfate soil;
- Air quality;
- Biting insects;
- Buffer area management;
- Building/structure conservation or retention;
- Energy efficiency and management;
- Erosion and sediment control;
- Management of activities and events, including monitoring and corrective action;
- Management of the impacts of land uses on surrounding sites;
- Natural and cultural heritage preservation/management;
- Noise control;
- Rehabilitation/landscaping;
- Rehabilitation of sites;
- Resource and waste management;
- Stormwater management;
- Vegetation management;
- Visual amenity;
- Water quality/waterway health;
- Weed control.

#### Essential components

Essential components of an EMP are:

- Establishment of agreed performance criteria and objectives in relation to environmental and social impacts;
- Detailed prevention, minimisation and mitigation strategies (including design standards) for controlling environmental impacts at specific sites;
- Details of the proposed monitoring of the effectiveness of remedial measures against the agreed performance criteria in consultation with relevant government agencies and the community;
- Details of implementation responsibilities for environmental management;
- Timing (milestones) of environmental management initiatives;
- Reporting requirements and auditing responsibilities for meeting environmental performance objectives; and
- Corrective actions to rectify any deviation from performance standards.

#### Report format and content

The following provides a guide to the type of information that might be included in an EMP and how it could be structured.

#### Introduction

- Description of the development proposal;
- The need for the EMP in relation to the development;
- Structure and scope.

#### Aims of the EMP

- As a framework for practically addressing and monitoring the significant environmental impacts of the proposal;
- Compliance with legislative requirements and government policies;
- Evidence that the works and operations are being conducted in an environmentally responsible manner.

#### **Endnote - Amendments**

Section B – Preparation of a Cultural Heritage Report and Archival Report. 06/12/2007, Amendment 2007, No. 1. Amendment to cultural heritage report requirements and insertion of archival reporting requirements.

### Identification of environmental issues

For each issue or environmentally impacting activity:

- Policy for addressing the issue/activity;
- Performance criteria;
- Implementation strategy;
- Monitoring program;
- Details of how reporting will influence mitigation measures and how reporting is to take place.

A Site Rehabilitation Plan is prepared addressing the following matters:

- After use options, including the most likely or preferred option;
- Conceptual design of after use infrastructure;
- Proposed final surface contours;
- Capping material to be used;
- Drainage system including final discharge point;
- Provision for irrigation measures to promote vegetation growth; and
- Anticipated period of after care.

### **Endnote - Amendments**

Section B – Preparation of a Cultural Heritage Report and Archival Report. 06/12/2007, Amendment 2007, No. 1. Amendment to cultural heritage report requirements and insertion of archival reporting requirements.

## **PART B - Preparation of a Cultural Heritage Report and Archival Report**

A Cultural Heritage Report (CHR) seeks to ensure that development, redevelopment on, or alterations to, a Local Heritage site are undertaken in a sensitive manner that conserves and manages the cultural heritage values and significance of the site.

The purpose of the CHR is to:

- Review the cultural heritage significance assessment for the purpose of determining in detail the significance of the Local Heritage Site identified on the Cultural Heritage Areas Overlay;
- Identify the measures that will be included in the development proposal to ensure that it will not cause irreversible damage to the cultural heritage significance; and
- Demonstrate how the development will protect and promote the cultural heritage values and significance of the Local Heritage Site.

### Report to be prepared by a suitably qualified person

The Cultural Heritage Report must be prepared by a suitably qualified and experienced heritage consultant with references naming other similar reports prepared by the consultant or consultants should also be included. A conservation architect may be required to be involved.

### State interests

The report should include reference to any applicable State policy contexts.

### Industry Standards

The report should include reference to, and be guided by the principles in the ICOMOS Australia Charter for the Conservation of Places of Cultural Heritage Significance (Burra Charter).

### Report format and content

It is recommended that the proponent should consult with the Council prior to preparation of the report in order to ensure that all issues are covered in the report. As a general guide the following format and contents description indicates the depth of detail required.

### Summary Introduction

Include name of developer and the heritage professional.

- Site location and description – brief statement of the location of the site and briefly outline nature of the heritage items or aspects of the site.
- Project description - summarise the proposed development.
- Include details of heritage consultant team and qualifications/ experience.

### Background

- Contextual history of the site.
- Architectural/ landscape assessment;
- An analysis of the documentary and physical evidence.
- Description of the current site conditions in detail including any buildings, or structures or historic items on the site, the vegetation on the site, any prior impacts on the site, the

### **Endnote - Amendments**

Section B – Preparation of a Cultural Heritage Report and Archival Report. 06/12/2007, Amendment 2007, No. 1. Amendment to cultural heritage report requirements and insertion of archival reporting requirements.

condition of all buildings, structures and items on the site, and the landscape character and visual amenity of the site.

- Outline of any conservation constraints and management issues.

### Statement of Significance

- A review of the cultural heritage significance should be undertaken to determine in more detail the significance of the site. The review should have reference to the eight significance criteria set out in the 'Definitions' section of the CairnsPlan .

### Scope of proposal

- Outline the nature of the proposed development:
  - the precise nature and scale of works;
  - the location of new structures, buildings or works;
  - the type of building materials to be used;
  - the possible future expansion of associated development/works.

### Impact Assessment

- Identify and detail the nature of any potential impacts on the site and its significance. These impacts should show that the development has aimed to preserve, or minimise the impact on, the significance of the site. The impact assessment should show that the design of the new work has considered the following heritage considerations:
  - The design of, and materials used in, the development or redevelopment of a Cultural Heritage Site complement and not detract from the cultural heritage significance of the site.
  - The design of any new building or structure has regard to the form, bulk, height, scale, siting, orientation, roof profiles, materials and detailing of the existing buildings or structures on the site, without necessarily repeating any of the elements and decorative detailing, in particular.
  - The design incorporates such basic design features, materials and detailing as to give the development or redevelopment an external appearance in a complementary design idiom to existing buildings without necessarily repeating existing designs, in particular.
  - New development does not obscure the appearance or prominence of the Cultural Heritage Site when viewed from adjoining streets or public rights of way or obscure important vistas of the Cultural Heritage Site.
  - New development is sited so that it does not detract from or conflict with the Cultural Heritage Site. The spacing between a new building, structure or item and a listed building, structure or item is sympathetic to, and respectful of, the listed building, structure or item. The setback of any new development from the street is compatible with the existing setback of the listed building, structure or item from the street.
  - The design of alterations to a listed building, structure or item respects the location of the Cultural Heritage site within the streetscape to ensure the final development is compatible with the existing streetscape.
  - The alteration of a listed building, structure or item retains and enhances any existing external and internal architectural features or elements which are representative of the era of the Cultural Heritage site.

### **Endnote - Amendments**

Section B – Preparation of a Cultural Heritage Report and Archival Report. 06/12/2007, Amendment 2007, No. 1. Amendment to cultural heritage report requirements and insertion of archival reporting requirements.

10

#956408v3

- The external and internal alteration is sympathetic to the architectural style of the listed building, structure or item and the streetscape so that the altered place maintains the setting in which it is located.
- Ancillary buildings and structures (particularly garages and carports) are designed and constructed in a manner which is sympathetic with, and respectful of, the character of the Cultural Heritage Site, and the existing streetscape.
- Landscape features which are a component of the integrity of the significance of the Cultural Heritage Site are retained and enhanced in the development, redevelopment or alteration of the place.
- The impact of the proposal on the archaeological resources on the site.

### Mitigation Measures

- Outline the mitigation measures that will help to preserve, or minimise the impact of the development on, this significance of the site. This may include recording of historic elements prior to removal or alteration, and/or the public interpretation of aspects of the place prior to removal or alteration.

### References

- Listing other reference material and literature used;
- List authorities consulted and contributors to the report;
- Cross-reference the reference material in the text to allow easier access to information.

### Appendices

- Include detailed technical information collected through the investigation; and
- Include relevant documents or correspondence from government authorities.

## **Preparation of an Archival Report**

An Archival Report is required before a Local Heritage Site is demolished or partly demolished.

Demolition shall only be undertaken after the Archival report has been submitted to Council and accepted. If special dispensation is considered necessary; for example, where a structure is deemed unsafe, Council may waive this requirement on production of certification by a Structural Engineer or similar competent authority.

Minimum requirements for archival recording include:

**Title page** with subject, author, client, date, copyright etc

**Statement of why the record was made.**

**Outline history of the site** and associated items, structures and people.

**Statement of cultural heritage significance**

**Inventory of archival documents** related to the item and their location (e.g. company records, original drawings and photographs), when available.

As part of the archival record, a minimum requirement would be to establish the existence of such documents and to prepare a bibliography. If a site or structure is to be demolished determine the possibility of having these documents or reproductions deposited within the library or museum.

### **Endnote - Amendments**

Section B – Preparation of a Cultural Heritage Report and Archival Report. 06/12/2007, Amendment 2007, No. 1. Amendment to cultural heritage report requirements and insertion of archival reporting requirements.

### **Location plan**

Show relationship to surrounding geographical features, structures, roads etc. Include a north point. A site plan or floor plan should show any movable items.

**Base plans**, drafted or hand-drawn.

This should be cross-referenced to photographs and name the relevant features, structures and spaces. The base plans should show a north point and be easy to read.

### **Photographic Record**

A photographic recording can be made using either film based technology or digital technology. (Note: colour negative film and prints are unacceptable as they are not able to sustain colours long term)

Images should include:

- views to and from the site (possibly from four compass points)
- views showing relationships to other relevant structures, landscape
- features and movable items
- all external elevations
- views of all external and internal spaces (e.g. courtyards, rooms, roof spaces etc.)
- external and internal details (e.g. joinery, construction joints, decorative features, paving types etc.).
- views and details of external and internal colour schemes as appropriate.

### **Black and white photographic record**

One set of 35 mm black and white negatives, labelled and cross-referenced to base plans and accompanied by informative catalogues and two copies of A4 proof sheets.

Selected prints to give an overall picture of the item may be required. They should be dated and include descriptive labels.

Negatives, proofs and prints should be kept in waxed paper envelopes, not in plastic folders.

All technical details including camera, lenses, film type and processing should be recorded

### **Colour slides**

One set of slides mounted in archival stable slide pockets, clearly labelled and cross-referenced to base plans.

Selected prints to give an overall picture of the item may be required. They should be dated and include descriptive labels.

### **Digital Photographic Record**

Preferably use a 8 mega pixel or more resolution as this can produce high quality A4 or A3 images.

Photographs should be taken at the highest quality and recorded in the RAW format to capture the maximum amount of information. The image can be converted to TIFF format, a universal format. Do not save images as JPEG format as this degrades the image to some extent.

### **Endnote - Amendments**

Section B – Preparation of a Cultural Heritage Report and Archival Report. 06/12/2007, Amendment 2007, No. 1. Amendment to cultural heritage report requirements and insertion of archival reporting requirements.

Three sets of thumbnail images sheets showing images and file numbers. Thumbnail sheets should be processed with archival stable inks using approved archival photographic paper. The thumbnail sheets should be cross-referenced to the base plans.

Three copies of archival quality CD-R discs containing electronic images and associated metadata, cross referenced to catalogue sheets. If there are a large number of images than DVD media can be used.

A set of A5 prints using archival quality paper and archival stable inks. If there are a large number of images then key or representative images may be reproduced.

***Additional Requirements May Include:***

**Catalogue or Inventory of Significant Items**

Where individual items make significant contributions to the heritage significance of a place or be of significance in their own right a catalogue of these should be prepared.

The catalogue should be compiled by a heritage consultant or conservation specialist and include information on location, history, designer, creator and previous owners. A condition report may be required.

**Other Records**

Such as oral histories, videos or films, measured drawings or samples of material and finishes.

**Storing the Archival Record**

Three copies of the archival record including the photographic record will be provided to Cairns City Council. One copy will be kept with Council, one copy provided to the Cairns City Library for its reference section and one copy provided to the Cairns Historical Society, in accordance with Article 28 of the Burra Charter.

*For Further Information refer to the following guidelines from the NSW Heritage Information Series:*

- *How To Prepare Archival Records of Heritage Items, Heritage Information Series, NSW Heritage Office 1998, Sydney; and*
- *Photographic Recording of Heritage Items using Film or Digital Capture, Heritage Information Series, NSW Heritage Office 2006, Sydney*

**Interpretative Material**

If a place is to be demolished or partially demolished interpretive material may be required. It is recommended that the proponent should consult with Council prior to preparing the interpretive material to ensure the signage is suitable

**Endnote - Amendments**

Section B – Preparation of a Cultural Heritage Report and Archival Report. 06/12/2007, Amendment 2007, No. 1. Amendment to cultural heritage report requirements and insertion of archival reporting requirements.

## **PART C - Preparation of a Development Plan for Reconfiguration of a Lot**

A Development Plan provides the necessary planning framework to ensure that new development is planned and developed in an orderly and integrated manner.

Generally a Development Plan is prepared to obtain preliminary approval that will guide subsequent development applications.

The major components of the site are to be designed with consideration of the surrounding area. It should be clear how the proposed development will integrate into the existing or proposed planning framework of the surrounding community. However, at the Development Plan stage, site development may be shown conceptually with flexibility to allow the proposal to be refined and improved as detailed design considerations come to light.

### State interests

The report should include reference to any applicable State policy contexts.

### Report format and content

Each Development Plan is to contain the degree of detail appropriate to the particular proposal and its circumstances. At a minimum, it is to include a plan and/ or statement that:

- Provides a site description of the land;
- Addresses key issues including:
  - Topography, landscape, and significant vegetation and watercourses;
  - Existing environmental constraints and opportunities;
  - Existing streets and localities;
  - Existing land uses surrounding sites and their compatibility with the proposed development;
- Indicates an approximate lot or dwelling yield for the proposed development;
- Shows the location, mix and density of the range of proposed land uses;
- Illustrates how the proposal fits into the overall road hierarchy and transport network;
- Demonstrates that consideration has been given to potential subdivision and development of adjoining allotments;
- Illustrates, where applicable, the approximate location and extent of facilities proposed such as community, retail, child care, service and educational facilities;
- Illustrates the general location of public open space including open space linkages and networks;
- Shows, where applicable, the pedestrian/ cycle network and links to internal facilities, adjacent neighbourhoods and facilities i.e. Schools, places of employment, centres;
- Broadly shows physical infrastructure to be provided;
- Shows the location of major stormwater flow paths;
- Illustrates the initial concept for staging of the development;
- Demonstrates that consideration has been given to all relevant environmental issues, including those pertaining to any short term or cumulative impacts on biodiversity and cultural heritage values.

### **Endnote - Amendments**

Section B – Preparation of a Cultural Heritage Report and Archival Report. 06/12/2007, Amendment 2007, No. 1. Amendment to cultural heritage report requirements and insertion of archival reporting requirements.



## **PART D – Hillslopes Assessment Report**

The purpose of the Hillslopes Assessment Report is to ensure that any proposed development is based on a thorough site survey and site analysis that identifies all environmental constraints in order to preserve and prevent depletion of the hillslope character.

### State interests

The report should include reference to any applicable State policy contexts.

### Report format and content

It is recommended that the proponent should consult with the Council prior to preparation of the report in order to ensure that all issues are covered in the report. As a general guide the following format and contents description indicates the depth of detail required:

## **Hillslopes Assessment Report**

### Site Survey

The site survey of the land shall include but not necessarily be limited to the following:

1. Contours (at least 2 metre intervals) and slope steepness categories:
  - less than 1:6,
  - between 1:6-1:3,
  - steeper than 1:3.
2. Geotechnical details;
3. Bush fire risk;
4. Existing vegetation (areas of woodland, rainforest, scrub and grasslands);
5. Existing buildings and structures;
6. Existing land use/s;
7. Existing services infrastructure;
8. Existing roads/tracks or benches;
9. Sites of cultural heritage significance;
10. Drainage lines;
11. Other natural or built form features;
12. Ecological values (e.g. Habitat, rare and vulnerable flora);
13. Rare or endangered fauna including categories of Regional Ecosystems.

### Site Analysis

The analysis task shall identify:

1. Areas that are too sensitive to develop due to the presence of gradients greater than 1 in 3 or significant vegetation or slope stability problems. ;
2. Slopes facing northeast through north to northwest as these are the most suitable locations for orientation of buildings, terraces, and other open space to the sun;
3. Areas that are visually exposed to other locations;
4. Major views within the site and vistas beyond;
5. Areas exposed to strong winds and areas sheltered from wind to assist in locating buildings and buffer planting;

## **Endnote - Amendments**

Section B – Preparation of a Cultural Heritage Report and Archival Report. 06/12/2007, Amendment 2007, No. 1. Amendment to cultural heritage report requirements and insertion of archival reporting requirements.

15

6. Areas that may require special protection, e.g. sites of cultural heritage significance;
7. Shady area which will be cool in summer; and
8. Bush fire hazard.

### **Geotechnical / Natural Hazard Assessment – Landslide / Slope Stability**

#### Report to be prepared by a suitably qualified person

A geotechnical report and Natural Hazard Assessment – Landslide report will be prepared by a qualified and experienced geotechnical engineer and references naming other similar reports prepared by the consultant or consultants should also be included.

This report/s shall include, but not be limited to assessment of the following:

1. Existing site conditions, including:
  - soil type, depth and properties;
  - rock type and properties;
  - depth of weathering;
  - angles of dip of rock bedding planes and fault planes;
  - slope stability;
  - erosion stability;
  - existing surface water characteristics;
  - proposed treatments for surface water;
  - location of and concentration of ground water;
  - disposal of sewage;
  - allotment specific geotechnical assessments;
  - history of any known geological problems or occurrences on the site or adjoining property.
2. Details of measures proposed to be incorporated in the development to ensure safe and otherwise satisfactory construction practices, including:
  - Measures to be adopted to control soil and rock movement from future weathering and saturated conditions; and
  - Design matters to be considered during the construction of building foundations, roads, driveways or any other works involving the excavation or filling of any land.
  - Development of allotments and dwellings outside Landslide prone areas.
3. A slope stability report including revegetation and stabilisation measures shall be provided. The measures shall address the driveway batters (existing and any further proposed works) as well as the earthworks to be undertaken for the construction of within proposed development envelopes.

All hillslope development proposals shall include a preliminary grading plan with summary field data and analysis relative to the topography, soils and drainage aspects, vegetation, rock outcropping.

#### **Endnote - Amendments**

Section B – Preparation of a Cultural Heritage Report and Archival Report. 06/12/2007, Amendment 2007, No. 1. Amendment to cultural heritage report requirements and insertion of archival reporting requirements.

The report/s shall include a statement of methodology regarding the testing procedures adopted, the scope of the report and the tests undertaken to ensure the findings of the report are representative of the site.

## **Visual Assessment Report**

### Report to be prepared by a suitably qualified person

The Visual Assessment Report will be prepared by a suitably qualified Landscape Architect or an approved professional, and references naming other similar reports prepared by the consultant or consultants should also be included.

This report shall include, but not be limited to, the following:

1. Location plan and site identification details;
2. Site survey plan,
3. Details of the proposal, with plans, levels, elevations, sections and perspectives, (where appropriate) and include:
  - site layout and design;
  - site works (including excavation and fill works);
  - building design, form, colours, materials and finishes;
  - services to be provided on site;
  - method, siting and design of effluent and stormwater drainage systems;
  - access (vehicular, pedestrian and parking within the site);
  - likely construction time and details of on-site management of buildings and works (if possible);
  - maintenance programme especially for effluent system and landscaping;
  - photographs of the site from significant public viewing points indicating the relative visibility of the site.

## **Natural Hazard Assessment - Bush Fire Hazards Report**

The Bushfire Hazards Report will be prepared by a suitably qualified person and references naming other similar reports prepared by the consultant or consultants should also be included.

This report shall address the requirements of State Planning Policy 1/03 Mitigating the Adverse Impacts of Flood Bushfire and Landslide and include, but not be limited to, the following details and assessments:

- Site survey plan.
- Slope and aspect analysis.
- Details of the proposed ingress/egress.
- Details of the vegetation type and flammability and statements on the level of disturbance of the vegetation.
- Details of previous fires in the locality and the direction of travel.

## **Endnote - Amendments**

Section B – Preparation of a Cultural Heritage Report and Archival Report. 06/12/2007, Amendment 2007, No. 1. Amendment to cultural heritage report requirements and insertion of archival reporting requirements.

17

- An assessment of the bushfire hazard for the subject site.
- Any existing fire protection plans or strategies endorsed by Council or State Government Agency.
- The presence of watercourses, gullies and the like on the land.
- The potential presence of underground water in the localities.
- Buildings and structures are to be located downhill from the bushfire hazard, and this is to be demonstrated on a site by site basis and building envelopes determined.

**Endnote - Amendments**

Section B – Preparation of a Cultural Heritage Report and Archival Report. 06/12/2007, Amendment 2007, No. 1. Amendment to cultural heritage report requirements and insertion of archival reporting requirements.

## **PART E – Extractive Industry Environmental Management Plan**

An Environmental Management Plan shall be prepared to ensure that the extractive industry utilises mitigation measures that minimise any likely adverse impact on ecological and hydrological processes.

### Report to be prepared by a suitably qualified person

The Environmental Management Plan will be prepared by a suitably qualified person and references naming other similar reports prepared by the consultant or consultants should also be included.

### State interests

The report should include reference to any applicable State policy contexts.

### Report format and content

The Environmental Management Plan shall address the following matters:

- Site establishment works;
- Type and quantity of materials to be excavated per year and the time period involved;
- Limits of the area proposed to be excavated;
- Method and staging of operations;
- Depth and extent of excavations;
- Existing contours of the land;
- Estimated depth and description of overburden;
- Energy efficiency measures and ongoing management plan;
- Erosion and sediment control measures during start up and for the life of the extractive industry;
- Natural and cultural heritage preservation/management during start up and for the life of the extractive industry;
- Noise control during start up and for the life of the extractive industry;
- Air quality during start up and for the life of the extractive industry;
- Vibration impacts during start up and for the life of the extractive industry;
- Resource and waste management;
- Stormwater management during start up and for the life of the extractive industry;
- Vegetation management during start up and for the life of the extractive industry;
- The capacity of the existing road system to carry the type and volume of traffic likely to use the road, during the life of the use; and
- The capacity of the proposed haul routes to carry the type and volume of traffic generated by the proposed use;
- Landscaping Plan shall be provided that details the landscaping and buffer treatments for the life of the extractive industry. The plan must provide adequate buffering of the proposed excavation from nearby drains, waterways,

### **Endnote - Amendments**

Section B – Preparation of a Cultural Heritage Report and Archival Report. 06/12/2007, Amendment 2007, No. 1. Amendment to cultural heritage report requirements and insertion of archival reporting requirements.

roads, footpaths, buildings and other structures and buffer area management during start up and for the life of the extractive industry;

- Rehabilitation to be undertaken following completion of identified stages of extraction in accordance with a Rehabilitation Management Plan which identifies:
  - a) the final landform and levels of the rehabilitated site;
  - b) the location, shape and depth of any water bodies;
  - c) that the site will be stable and will not be subject to erosion;
  - d) that the site will be free of contaminants;
  - e) that water quality downstream of the site will not be adversely affected in the future;
  - f) that the water quality of any water bodies on the site will be of a standard which can support fish life and other aquatic invertebrates;
  - g) the areas of the site to be revegetated and the species to be used in the revegetation;
- That the visual amenity of the rehabilitated site is consistent with the visual amenity expected for the alternative uses;
- The landform is suitable for alternative uses.

**Endnote - Amendments**

Section B – Preparation of a Cultural Heritage Report and Archival Report. 06/12/2007, Amendment 2007, No. 1. Amendment to cultural heritage report requirements and insertion of archival reporting requirements.

## **PART F – Hydrological Study**

### Report to be prepared by a suitably qualified person

The Hydrological Study will be prepared by a suitably qualified person and references naming other similar reports prepared by the consultant or consultants should also be included.

### Introduction

A detailed hydrologic and hydraulic study is required to demonstrate that the proposed development would not create adverse flooding impacts upon external properties during design flood events ranging from 2 year ARI to 100 year ARI (in terms of peak water level, discharge or velocity). Modelling shall also demonstrate that flood immunity consistent with the requirements of FNQROC Development Manual will be provided.

### Model Development

Development of detailed hydrologic and hydraulic models is required. These models may be based upon those previously developed and accepted by Council.

### Sensitivity Testing

In recognition of the sparsity of calibration information, a sensitivity test shall be undertaken using both the hydrologic and hydraulic models to investigate the impact of model parameters upon peak water level predictions. Parameters shall be varied within generally accepted ranges. Parameters to be varied include the storage lag parameter ( $\infty$ ) within URBS and the hydraulic roughness coefficient (n) within MIKE11. Simulations shall be undertaken assuming upper bound, lower bound and median values as discussed further below.

### Existing Case Simulations

Existing case model results shall be produced for The Waterway flood events ranging from 2 year ARI to 100 year ARI, assuming model parameters determined from the sensitivity tests. A range of tailwater levels shall be investigated (with reference to the Drainage Management Plan as available) to confirm any impact upon peak water levels at the site. The existing case simulations shall assume that current and already approved development is in place. The adopted existing case flood level predictions shall assume median values for the model parameters ( $\infty$  and n).

### Developed Case Simulations

Developed case hydrologic and hydraulic modes shall be produced. The proposed development shall be represented in the hydrologic and hydraulic models, considering:

- any earthworks within the extent of 100 year ARI flood event inundation; and
- urbanisation of the site.

### **Endnote - Amendments**

Section B – Preparation of a Cultural Heritage Report and Archival Report. 06/12/2007, Amendment 2007, No. 1. Amendment to cultural heritage report requirements and insertion of archival reporting requirements.

Design event simulations consistent with the existing case shall be undertaken using the developed case models.

#### Impact Assessment

Comparisons of the developed case results and existing case results shall be used to demonstrate that proposed development would not adversely impact properties external to the site under Waterway flood events of the magnitudes specified. Impacts shall be calculated assuming median and upper bound model parameter values ( $\infty$  and  $n$ ).

Particular locations where this should be demonstrated, shall be agreed to by the applicant/owner and Council prior to finalising the Study, and shown on a plan.

#### Flood Immunity

Model results from the developed case simulations must demonstrate that flood immunity consistent with the requirements of Council's Development Manual. Fill level and floor level requirements shall be determined assuming median model parameter values ( $\infty$  and  $n$ ). Additionally, floor levels shall be checked against upper bound water levels.

#### Deliverables

A Hydraulic Report shall be submitted to Council to describe the methodologies used, assumptions made and present the modelling results. The report shall include Figures to illustrate models details and results. Sufficient information shall be provided in the report to facilitate independent review of the assessment. Electronic copies of the final models shall be provided to Council for independent review.

#### Development in the Barron Delta

Council intends to control the management of future development within the Barron Delta in particular the effects of flooding. It is intended that the findings of the Barron Delta Study will form the basis on which Council will consider development proposals with regard to flooding.

The documents "Barron River Delta Flood Study – Development in the Delta" Parts A and B are a guide by which potential developers, consultants and other technical users can gain an understanding of how Council will deal with future development and provide protection to existing properties.

The "Barron River Delta Flood Study – Development in the Delta" Parts A and B (Revision A October 94) includes the following components.

##### Part A – Technical Guide

Part A explains the aims and results of the study and describes the computer model, which was developed as part of the study. Various drawings are included to provide information on design flows and flood levels.

##### Part B – Policy

#### **Endnote - Amendments**

Section B – Preparation of a Cultural Heritage Report and Archival Report. 06/12/2007, Amendment 2007, No. 1. Amendment to cultural heritage report requirements and insertion of archival reporting requirements.



This document sets out Council's policy on development in the Barron River Delta. Included with this document are details of the procedure to be followed in using the model in association with any development application or when undertaking detailed design.

Council has adopted the numerical hydraulic model developed during the Barron River Flood Study and subsequently updated as the yardstick by which all development proposals are judged. The adoption of a single model operated and interpreted by those skilled in its development and use is intended to ensure that all proposals are dealt with in a consistent and objective manner.

Individual development applications are to be considered in detail using the Barron Delta Flood Model so that the effects on flooding can be assessed both in respect to the project itself and to other areas within the delta.

**Endnote - Amendments**

Section B – Preparation of a Cultural Heritage Report and Archival Report. 06/12/2007, Amendment 2007, No. 1. Amendment to cultural heritage report requirements and insertion of archival reporting requirements.

## **PART G - Vegetation Conservation / Waterway Significance**

### Report to be prepared by a suitably qualified person

The Reports will be prepared by a suitably qualified person and references naming other similar reports prepared by the consultant or consultants should also be included.

### State interests

The report should include reference to any applicable State policy contexts.

### Report format and content

It is recommended that the proponent should consult with the Council prior to preparation of the report in order to ensure that all issues are covered in the report. As a general guide the following format and contents description indicates the depth of detail required:

#### Vegetation Conservation

A detailed vegetation survey and assessment of the existing vegetation is required to identify the impacts on existing vegetation as a result any proposed development.

#### Waterway Significance

Demonstrate that no lining or engineering of the waterway channel, bed or banks will occur or if engineering works are essential because of pre-existing conditions:

- a) demonstrate the environmental management measures to mitigate the impacts of the works;
- b) demonstrate that in-stream habitat elements such as fallen logs, overhangs and rocks are to be left in situ, replaced or restored;
- c) provide channel designs which simulate, as near as practicable, natural waterway conditions with meanders, pools, riffles and bars;
- d) provide hydraulic calculations which allow for the presence or establishment of a vegetated (closed canopy) waterway area to improve bank stability and in-stream ecological values and to restrict weed growth.
- e) Demonstrate that development does not damage the root zone of vegetation through compaction, excavation or filling.

Other matters are to be determined on a site by site basis.

### **Endnote - Amendments**

Section B – Preparation of a Cultural Heritage Report and Archival Report. 06/12/2007, Amendment 2007, No. 1. Amendment to cultural heritage report requirements and insertion of archival reporting requirements.

## **PART H - Natural Hazard (Bushfire) Management Plan**

### Report to be prepared by a suitably qualified person

The Bushfire Management Plan will be prepared by a suitably qualified person and references naming other similar reports prepared by the consultant or consultants should also be included.

### State interests

The report should include reference to any applicable State policy contexts.

### Report format and content

It is recommended that the proponent should consult with the Council prior to preparation of the report in order to ensure that all issues are covered in the report. As a general guide the following format and contents description indicates the depth of detail required:

### **For Development in High Bushfire Hazard Areas (except single dwellings on existing lots)**

The Bushfire Management Plan shall include the following:

1. a. An assessment of the nature and severity of the bushfire hazard affecting the site. The key factors to be considered are vegetation type, slope and aspect as described in Appendix 3 of the State Planning Policy Mitigating the Adverse Impacts of Flood, Bushfire and Landslide Guideline. The assessment should also address other site-specific factors that are important in devising suitable bushfire mitigation strategies. These factors could include matters such as: likely direction of bushfire attack, environmental values that may limit mitigation options, location of evacuation routes and/or safety zones.
- b. An assessment of the specific risk factors associated with the development proposal, including matters such as the nature of activities and materials to be conducted/stored on the site, numbers and types of persons likely to be present, particular warning and/or evacuation requirements.
- c. A plan for mitigating the bushfire risk identified in (a) and (b). The plan should address all of the matters raised in Appendix 5B of the State Planning Policy Mitigating the Adverse Impacts of Flood, Bushfire and Landslide Guideline and recommend specific mitigation actions for the proposed development including:
  - road and lot layout and land use allocations;
  - firebreaks and buffers;
  - building locations or building envelopes;
  - landscaping treatments;
  - warning and evacuation procedures and routes;
  - fire fighting requirements including infrastructure;
  - any other specific measures such as external sprinkler systems and alarms;
  - purchaser/resident education and awareness programs; and

### **Endnote - Amendments**

Section B – Preparation of a Cultural Heritage Report and Archival Report. 06/12/2007, Amendment 2007, No. 1. Amendment to cultural heritage report requirements and insertion of archival reporting requirements.

25

- ongoing maintenance and response awareness programs.
2. The level of detail required will vary with the nature of the development proposal and site, and with the type of development application.
  3. If the application must be followed up by another application before works can commence (e.g. a Material Change of Use application that must be followed by a Reconfiguring a Lot application), then matters of detail could be dealt with at the latter application stage.
  4. The level of detail required to accompany a particular application should be determined in consultation with the assessment manager. However, it is recommended that, at a minimum items (a), (b) and (c) (1) – (3) outlined above should be addressed in and BMP.

**Endnote - Amendments**

Section B – Preparation of a Cultural Heritage Report and Archival Report. 06/12/2007, Amendment 2007, No. 1. Amendment to cultural heritage report requirements and insertion of archival reporting requirements.

## **PART I - Landscape Plan**

### Report to be prepared by a suitably qualified person

The Landscape Plan will be prepared by a suitably qualified person and references naming other similar reports prepared by the consultant or consultants should also be included.

### Report format and content

It is recommended that the proponent should consult with the Council prior to preparation of the report in order to ensure that all issues are covered in the report. As a general guide the following format and contents description indicates the depth of detail required:

The landscape plan should show, where relevant:

- a. all existing trees with a girth of greater than 0.5 m measured at 1.5 m above Ground Level or of greater than 4 m Height (and indicating which trees are proposed to be retained) and other natural features, such as watercourses and rock formations;
- b. the function of planting areas (e.g. screen planting, enhancement etc.), plant spacing and species to be used;
- c. the general surface treatment of landscaped areas e.g. paving, mulched gardens, lawn;
- d. the location and type of fencing to the frontage and boundaries (e.g. 2 m mesh security fence, 1.8 m timber fence etc.);
- e. existing and proposed finished ground levels indicating in particular:
  - i. the approximate Height of any mounding;
  - ii. the extent of any Excavation and/or Filling greater than 0.5 m in Height and greater than 150 mm where within the drip line of any existing tree;
  - iii. the location and type of any retaining walls; and
  - iv. site drainage.
- f. where the development adjoins a residence, or other use that is sensitive to amenity considerations such as aesthetics, light spill, noise or dust pollution, overshadowing or reduction in privacy, the location of the adjacent impact sensitive buildings and areas e.g. show the location of the child care building and play area if it is adjacent to a proposed industrial or commercial development; and
- g. where the development is of a type that is likely to be adversely impacted upon by an existing or proposed use or development on adjacent land, the location and type of that impact's source, e.g. show any open storage area or industrial use adjacent to the proposed development if the proposed development is for a residence or other sensitive use.

### **Endnote - Amendments**

Section B – Preparation of a Cultural Heritage Report and Archival Report. 06/12/2007, Amendment 2007, No. 1. Amendment to cultural heritage report requirements and insertion of archival reporting requirements.

## **PART J – Social and Community Impact Assessment Report**

Social Impact Assessment (SIA) is the analysis and management of social changes and impacts on individuals, groups and communities that are likely to occur as a result of a particular development, planning scheme, or policy decision (Department of Families, Youth, and Community Care 1998).

Social impacts are significant events experienced by people as changes in one or all of the following (Armour 1992):

- people's way of life – how they live, work, play and interact with one another on a day-to-day basis;
- their culture – shared beliefs, customs, values, and practices;
- their community – its cohesion, stability, character, networks, services and facilities.

### Purpose of this information request

- To encourage more socially sustainable development;
- To provide or expand on existing information about a site and a local community in order to assist in the development assessment process;
- To minimise adverse impacts on individuals, groups, and local communities, and to maximise the beneficial impacts of the development;
- To inform and involve community members in decisions which affect them.
- Principles

### The steps involved in the SIA process are underpinned by a specific set of principles

- Involve the diverse public in all stages of the SIA;
- Analyse impact equity;
- Focus the assessment;
- Develop methods and assumptions in collaboration with the Council;
- Identify both the positive and negative impacts;
- Use professional SIA practitioners to undertake assessments;
- Plan for gaps in data;
- Focus on the desired outcome of sustainability.

### Key Elements of Social Impact Assessment

SIA has three broad functions:

- Identifying social issues and potential social impacts relevant to particular developments and policies for particular communities and circumstances;
- Assessing those impacts, in terms of their magnitude, duration and the probability of their occurrence;
- Recommending measures that will reduce negative impacts and enhance positive impacts of a development or a decision;
- What developments require social and community impact assessment?;
- Developments that require an EIS;
- Development that is inconsistent with the planning scheme provisions for the local area;
- Development that has a cumulative (time and space) impact, e.g. boarding house redevelopment or demolition, caravan park redevelopment or demolition, loss of agricultural land to residential development, new residential suburbs or other large housing developments, loss of character areas and community space to new development;
- Development that is of regional significance and/or of significant public interest, e.g. large scale infrastructure projects, hospital or health care extension or development, shopping centres, transport links and interchanges;

### **Endnote - Amendments**

Section B – Preparation of a Cultural Heritage Report and Archival Report. 06/12/2007, Amendment 2007, No. 1. Amendment to cultural heritage report requirements and insertion of archival reporting requirements.

28

- Development that is likely to result in a significant change in population characteristics (numbers, densities, profile), e.g. large-scale residential developments, tourist developments;
- Development that may impact on the need for or existing capacity and operation of community infrastructure, e.g. expansion and development of sports facilities, expansion or development of educational facilities, intensive residential developments, loss of existing parklands and community recreational areas to new development;
- Development that may impact on a particular target group, e.g. amusement centres, child care centres, housing for older people and people with a disability, group homes, large cultural or religious centres, public open space, refuges and shelters, youth centres;
- Development that has the potential to have substantial impacts on the existing social fabric, character or wellbeing of the immediate and surrounding area, e.g. commercial development, industrial development, relocatable home parks, tourist development;
- Any other circumstances where there is likely to be significant community concern, e.g. brothels, redevelopment of old industrial sites.

### Preparation of a Social Impact Assessment Report

#### Report to be prepared by a suitably qualified person

The report should be prepared by a person qualified and experienced in carrying out social impact assessment.

#### State interests

The report should include reference to any applicable State policy contexts. The Department of Communities has lead agency status in terms of social impact assessment in Queensland, and employs a Social Planner in their Regional Office in Cairns.

#### Steps in social impact assessment

Summary of steps involved in social impact assessment for Cairns City Council	
Step 1	<p><b>Screening</b> – <i>does the development proposal require a social impact assessment?</i></p> <p>A designated council officer will decide which development applications require some form of social impact assessment (SIA). It is at this stage that the level of assessment should be defined in line with available resources and significance of the proposal. An agreed Terms of Reference (ToR) for the assessment process is established by the proponent in consultation with the Council officer. Any decision not to conduct a SIA needs to be noted on the file.</p>
Step 2	<p><b>Scoping</b> – <i>identifying issues and affected groups.</i></p> <p>The proponent undertakes scoping activities that identify the main issues of concern and the range of likely potential social impacts. This stage of the assessment process includes notification and consultation with all relevant stakeholders including local community leaders and members.</p>

### Endnote - Amendments

Section B – Preparation of a Cultural Heritage Report and Archival Report. 06/12/2007, Amendment 2007, No. 1. Amendment to cultural heritage report requirements and insertion of archival reporting requirements.

Step 3	<p><b>Profiling</b> – data collection, identifying historical trends, assessing current social context.</p> <p>To assess the potential social impact/s of a proposed development, it is important to understand and analyse the existing social conditions within the community. The proponent uses profiling methods to establish base line information. Social profiles, social plans, safety audits, community needs assessments, cultural plans, community infrastructure plans, local area plans, the strategic sport and recreation plan, and the Corporate Plan can all be used to determine what impact a project may have on the social wellbeing of people in the community.</p>
Step 4	<p><b>Predicting</b> – identifying future possible impacts.</p> <p>Using the baseline data, the type of impacts that are likely to occur are determined by the proponent. At this stage, a number of questions should be asked:</p> <p>Who will be affected? In what way? How long will the impacts last? What level of social change would occur if the development did not go ahead?</p> <p>Also, different scenarios should be addressed, including:</p> <p>the future social environment <u>with</u> the development; the future social environment <u>without</u> the development.</p>

#### Summary of steps involved in social impact assessment for Cairns City Council

Step 5	<p><b>Assessing</b> – analysis of the impacts.</p> <p>The predicted impacts from step 4 are assessed by the proponent based on their level of importance. Significant impacts should be separated from the less significant ones. The significance of a predicted impact will have been determined through the process of consultation and negotiation with key interest groups.</p> <p>Assessing can be done by categorising impacts against different criteria, including:</p> <p>Magnitude, Weighting, Duration, Current conditions, Future conditions, Local policy goals or community sustainability indicators.</p>
Step 6	<p><b>Evaluating</b> – evaluate social impacts and develop mitigation measures.</p> <p>The proponent evaluates impacts of the proposal, which takes into account measures for managing impacts that might help prevent or alleviate negative social and community impacts, as well as maximising any benefits.</p>
Step 7	<p><b>Recommending</b> – whether the development should be approved and what mitigating measures should be adopted.</p>

#### Endnote - Amendments

Section B – Preparation of a Cultural Heritage Report and Archival Report. 06/12/2007, Amendment 2007, No. 1. Amendment to cultural heritage report requirements and insertion of archival reporting requirements.



	<p><b>Recommending approval:</b> The assessment undertaken by the proponent needs to address specific management measures. These measures should include appropriate conditions of approval relating to the development designed to prevent or alleviate negative social impacts and/or maximise social benefits. This should be negotiated with Council.</p> <p><b>Recommending refusal:</b> if the recommendation by the proponent or the Council is for refusal, the social impact assessment should fully justify this course of action. This should be based on the evidence presented in the assessment and the level of significance of the impacts. The assessment must be able to stand up in the Planning and Environment Court.</p>
Step 8	<p><b>Deciding</b> – <i>the Council either approves the development, with or without conditions, or it refuses the application.</i></p> <p>If the development is refused the process ends here; otherwise the next stage is entered into – that is, monitoring. All relevant stakeholders should be informed about any conditions of consent. This should include the conditions themselves and what steps will be taken to ensure they are fully complied with.</p>

#### Summary of steps involved in social impact assessment for Cairns City Council

Step 9	<p><b>Monitoring</b> – <i>monitoring both conditions of consent and the social impacts of the development.</i></p> <p><b>Monitoring conditions of consent:</b> all social impact conditions should be followed up by the relevant Council officer. Failure to comply with conditions needs to be resolved early. Some developments may have conditional consents for a period of time, so a follow up social impact assessment may be required at the end of a trial period.</p> <p><b>Monitoring social impacts:</b> the social impacts of particular developments and categories of development should be routinely monitored. This may involve establishing databases on various types of information. Special studies may be commissioned, such as post-occupancy surveys of new housing estates, recreational needs studies, and housing studies.</p>
--------	--

#### Report format and content

It is required that the proponent consults with the Council prior to preparation of the report in order to identify an appropriate and agreed **Terms of Reference** for the report. As a general guide the following format and contents description indicates the depth of detail required.

**Site location** - a brief description of the site and surrounding areas, including the location of associated infrastructure development and figures/maps of all locations.

**Project description** - summarise the objectives of the project and proposals for the construction and operation of the project and associated infrastructure developments.

**Alternatives to proposed development** - summarise the features of alternatives investigated and detail the reasons for choosing the preferred option.

#### **Endnote - Amendments**

Section B – Preparation of a Cultural Heritage Report and Archival Report. 06/12/2007, Amendment 2007, No. 1. Amendment to cultural heritage report requirements and insertion of archival reporting requirements.

**Define the scope of the issues and impacts of the proposal** – identify key interest groups, and the significant positive and negative issues and impacts relating to the proposed development.

**Existing social and community environment** – establish baseline community characteristics and conditions of the agreed catchment area, including: an overview of the socio-demographic profile and changes over time; key interest groups and their characteristics and needs; a review of the provision and capacity of existing community services, networks and infrastructure; cultural heritage and Indigenous interests and issues; local development and economic trends affecting different groups; housing issues; accessibility and mobility issues; safety issues; and other relevant local social and community issues.

**The predicted social and community impacts** - summarise the main potential impacts of the project (direct, indirect and cumulative), both beneficial and detrimental, and any alternatives, on particular groups and communities likely to be affected.

**The communities or groups likely to be affected** – outline the existing and future communities likely to be affected by the immediate and long-term impacts of the project in a local, regional and city-wide context.

**The proposed response to manage the impacts** - summarise the strategies and amendments proposed to minimise any adverse impacts and maximise the community benefit of the proposal. Include any links to such things as community infrastructure contributions, and clear recommendations for progressing the proposal.

**The affected community's perspective of the proposed responses** – summarise the process of gaining the community's perspective on these responses and their feedback. Include how this feedback has been considered in refining responses and final recommendations.

**Documentation of the methods and rationale for the conclusions reached** – include in this an outline of your Community Engagement Plan and findings, and any measures taken to advise the affected communities of the findings of this SIA.

**Appendix** – detailed information and findings should be outlined in an Appendix document attached to the main report.

#### Assessing the likely impacts

Council will assess the level of importance of the predicted impacts and examine the proposed responses to the impacts, taking into account alternatives that are proposed. Consideration in determining the significance of the social and community impacts includes:

- the number of people likely to be affected;
- principles of social justice, i.e. equity, access, fairness, intergenerational impacts;
- the extent to which the interests of the community as a whole are enhanced or sustained;
- the degree of change likely to arise as a result of the development relative to the existing circumstances, and the significance of this change;
- the duration and nature of the impact/s;
- the importance of the objectives of the proposal in relation to Council's Corporate goal of achieving sustainability;
- whether the impacts would represent a good planning outcome for Cairns.

#### Social Impact Management Plans

### **Endnote - Amendments**

Section B – Preparation of a Cultural Heritage Report and Archival Report. 06/12/2007, Amendment 2007, No. 1. Amendment to cultural heritage report requirements and insertion of archival reporting requirements.

Once a development is approved, a Social Impact Management Plan (SIMP) may be required to document measures to be implemented to manage the predicted impacts of a proposal. These can apply for the life of the project, including construction and operational stages. The plan is to establish required levels of performance for the development, a monitoring regime for checking performance and strategies for rectifying any diversion from these levels.

The information requested by the assessment manager and/or referral agencies to be included in the plan will vary for each development proposal. The content of the plan will vary depending on the nature and scale of the development, the characteristics of the site and surrounding community, and the impacts generated by the proposal.

The plan must detail the management strategies to be implemented for identified impacts, and must include specific performance indicators. The plan will include:

- All potential impacts;
- Performance criteria establishing acceptable levels of impact;
- Mitigating strategies for minimising identified impacts;
- Monitoring and reporting processes to enable performance against the performance criteria to be measured;
- A contingency plan or corrective actions to be implemented if an undesirable or unforeseen level of impact occurs;

Procedures for monitoring and reporting, and periodic review and updating of the plan.

Useful references that may assist in preparing the Social Impact Assessment Report and Social Impact Management Plan are:

- *Social Impact Assessment for Queensland Local Government*, Wendy Bell and Andrew Jones. Available from Local Government Association of Queensland.
- *Social Impact Assessment for Local Government: A Handbook for Councillors, Towns Planners and Social Planners*, New South Wales Government. Available from the Local Government and Shires Associations of New South Wales.
- *Mina Mir Lo Ailan Mun: Proper Communication with Island People*, Office of Aboriginal and Torres Strait Islander Affairs. Available from Department of Communities.
- *Protocols for Consultation and Negotiation with Aboriginal People*, Office of Aboriginal and Torres Strait Islander Affairs. Available from Department of Communities.
- *Getting Started: A Consultation Guide for Queensland Local Government*, The Public Practice Pty Ltd. Available from Local Government Association of Queensland.
- *Community Participation, A Practical Guide*, Wendy Sarkissian, A Cook and K Walsh. Available from Institute for Science and Technology Policy, Murdoch University.
- *A Guide to Effective Community Engagement*, Community Engagement Unit, Department of Emergency Services. Available from Department of Emergency Services.