

**Carrera**<sup>®</sup>







***MOTORSPORTS  
AT HOME...***



# ... SINCE 1963

The only thing that hasn't changed since back then is the chequered flag at the start and finish. For 50 years now in every other field Carrera has consistently focused on the continual optimisation of its materials and technologies. This is precisely why this globally respected name, uniting tradition and innovation, has been the classic brand for the young at heart for so many years.

2013 marks the company's 50th anniversary and to kick off the year in style Carrera is now offering innovative, leading-edge Porsche technology. The legendary racing classic, Porsche 904 Carrera GTS, has been pitted against the new Porsche 918 Spyder. Sons, fathers and grandfathers alike are all guaranteed thrilling starts, breathtaking drifts and spectacular passing manoeuvres. In other words – action and excitement for all ages from start to finish!

But of course Carrera is a hallmark of variety, too. The top teams – Red Bull Racing and Ferrari – are back again in 2013 featuring a worldwide exclusive license in the slot car racing segment as they battle for pole. Blockbusting screen celebrities will also be out on the track in the shape of Mario Kart, Teenage Mutant Ninja Turtles, Disney/Pixar Cars and Spider-Man. The anniversary year also sees Carrera serving up additional technical features. WIRELESS+ for the Evolution system now offers even more racetrack freedom. As you see, Carrera has made a dynamic leap ahead with top quality technology, top speeds and top ideas to keep them far in front of the competition!



**Carrera**  
DIGITAL 124 10

**Carrera**  
DIGITAL 132 26

**Carrera**  
EVOLUTION 58

ACCESSORIES 84  
Scale 1:24/1:32

**Carrera**  
DIGITAL 143 98

**Carrera**  
GO!!! 110

ACCESSORIES 132  
Scale 1:43

THE WORLD OF  
**Carrera** 136



**Carrera**<sup>®</sup>  
**DIGITAL 124**



**Carrera**<sup>®</sup>  
**DIGITAL 132**



**Carrera**<sup>®</sup>  
**EVOLUTION**



**Carrera**<sup>®</sup>  
**DIGITAL 143**



**Carrera**<sup>®</sup>  
**GO!!!**



**CARS IN ACTUAL SIZE**



**THE ULTIMATE IN RACING**



**CARRERA DIGITAL 124**  
RACE UP TO **4** DRIVERS

- Digital racetrack system for teens, adults and hobbyists from 10 years and up
- Pass and change lanes at FULL SPEED with up to 4 cars at the push of a button
- Racetrack freedom - with 2.4 GHz WIRELESS+
- BIG SIZE - tracks and cars scale 1:24
- Cars with front light (xenon) and rear/brake light\*
- Unlimited extension possibilities with track material scale 1:24
- A wide range of DIGITAL accessories guarantees genuine race feeling at home

**PASSING ACTION ON MEGA TRACKS**



**CARRERA DIGITAL 132**  
RACE UP TO **6** DRIVERS

- Digital racetrack system for teens, adults and hobbyists from 8 years and up
- Pass and change lanes at FULL SPEED with up to 6 cars at the push of a button
- Racetrack freedom - with 2.4 GHz WIRELESS+
- Worldwide unique racetrack system combining tracks to race 1:24 and 1:32 scale cars
- Cars with front light (xenon) and rear/brake light\*
- Cars compatible with Carrera Evolution series
- Unlimited extension possibilities with track material scale 1:24
- A wide range of DIGITAL accessories guarantees genuine race feeling at home

**RACING ON MEGA TRACKS**

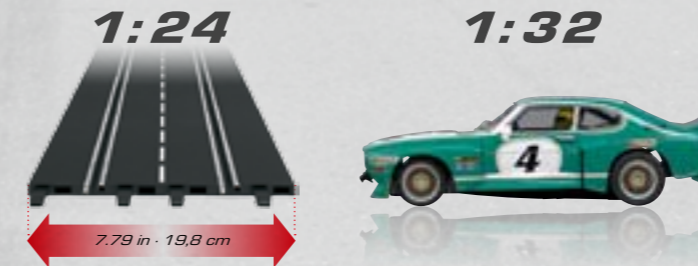

- Analogue racetrack system for teens, adults and hobbyists from 8 years and up
- Unique racetrack system combining tracks to race 1:24 and 1:32 scale cars
- Cars ready for digital upgrade\*
- Track can be expanded from 4-, 6- up to 8-lanes
- Unlimited extension possibilities with track material scale 1:24
- NEW: 2.4 GHz WIRELESS+ technology for Carrera Evolution

**THRILLING PASSING ACTION**



**CARRERA DIGITAL 143**  
RACE UP TO **3** DRIVERS

- Digital racetrack system for kids from 8 years and up
- Pass and change lanes at FULL SPEED with up to 3 cars at the push of a button
- Starter system to the Carrera digital world of racing, scale 1:43
- Digital lane change sections in special red colour
- Action features, track material and accessories from Carrera GO!!! can also be used

**FEEL THE TURBO SPEED**

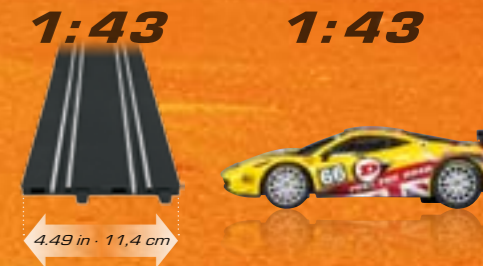

- Analogue racetrack system for kids from 8 years and up
- Through the loop at TURBO SPEED at the push of a button
- Starter system to the Carrera world of racing, scale 1:43
- All basic sets include Turbo Power controllers
- Numerous action features for enhanced racing
- Attractive car licences and racing themes





**Carrera**  
**DIGITAL 124**

50 Anos · 50 Anni · 50 Jahre · 50 Years · 50 Ans · 50 Años · 50 Anni · 50 Jahre · 50 Years · 50 Ans · 50 Años · 50 Anni · 50 Jahre · 50 Years · 50 Ans · 50 Años · 50 Anni · 50 Jahre · 50 Years · 50 Ans · 50 Años · 50 Anni · 50 Jahre · 50 Years

**1:24 1:24**

- For teens, adults and hobbyists from 10 years and up
- Digital racetrack system allows changing the lane and passing with up to 4 cars
- Racetrack freedom - with 2.4 GHz WIRELESS+
- BIG SIZE - Tracks and cars scale 1:24
- Cars with front light (xenon) and rear/brake light\*
- Unlimited extension possibilities with track material scale 1:24
- A wide range of DIGITAL accessories guarantees genuine race feeling at home

**CARRERA DIGITAL 124**  
**THE ULTIMATE IN RACING**



\* model-specific · Subject to technical and design-related changes. Errors excepted.

© www.fredlewisphotos.com







Including Control Unit and



For more info - go to:  
[carrera-toys.com/wirelessplus-us](http://carrera-toys.com/wirelessplus-us)



Including Control Unit and



For more info - go to:  
[carrera-toys.com/wirelessplus-us](http://carrera-toys.com/wirelessplus-us)



© Porsche Werkfoto



© Lucien Harmegnies



8.37 x 10.14 ft. 30.51 ft.  
255 x 309 cm 9,3 m

**CLASSIC SPEED**

Item no. 23609 · L · T · s  
Ford GT40 Mk. II "No.2", 1966 · Porsche 917K  
"J.W. Automotive Engineering, No.2", Daytona 24h 1971

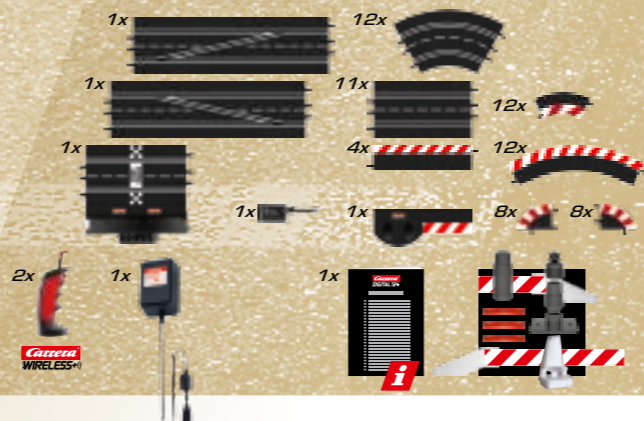

11.75 x 6.20 ft. 26.25 ft.  
358 x 189 cm 8,0 m

**ULTIMATE RACE**

Item no. 23610 · B · T  
Porsche GT3 RSR Team Falken  
Audi R8 LMS "Audi Sport Team WRT, No.33", 24h Spa 2011

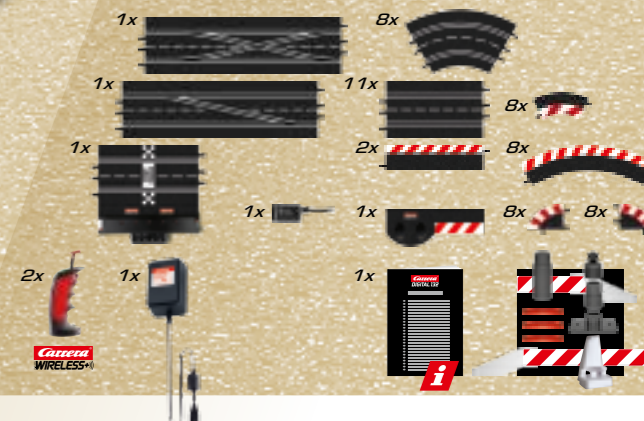





**NEW**



23781 · B · E · ·   
Audi R8 LMS "Phoenix Racing Racetaxi"

**NEW**



23782 · B · ·   
Audi R8 LMS "Team Phoenix,  
No.1A", Winner 12h Bathurst 2012



23774 · B · ·   
Audi R8 LMS "Team Phoenix,  
No.98", 24h Nürburgring 2009

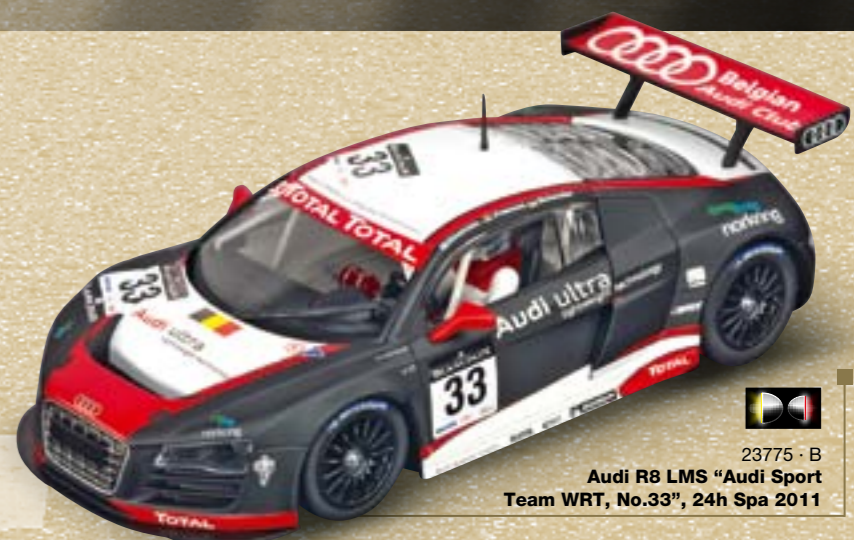

23775 · B · ·   
Audi R8 LMS "Audi Sport  
Team WRT, No.33", 24h Spa 2011



**NEW**

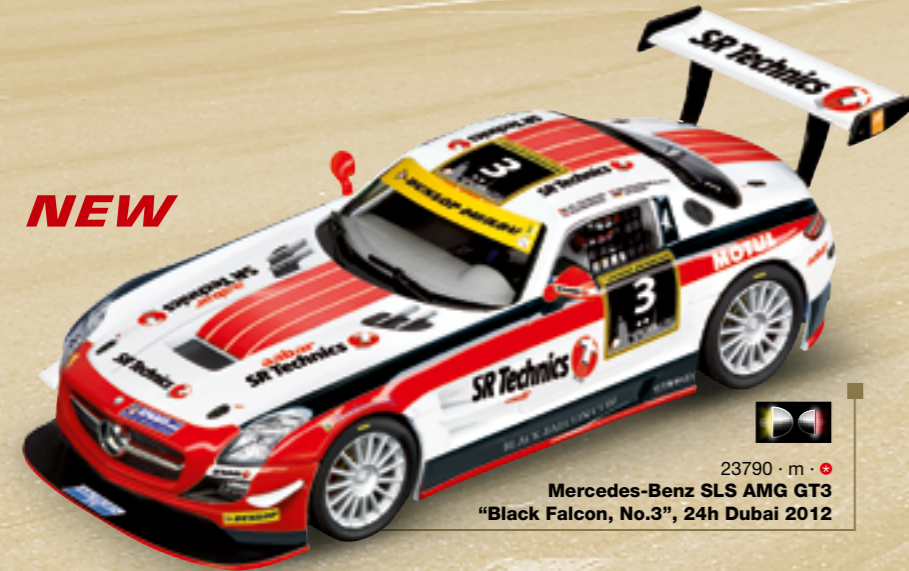

23790 · m · Mercedes-Benz SLS AMG GT3  
"Black Falcon, No.3", 24h Dubai 2012

**NEW**



23791 · m · Mercedes-Benz SLS AMG GT3  
"Heico Motorsports, No.1", VLN 2012

**NEW**



23785 · e · Aston Martin DBR9 "Team Modena, No.59"



23759 · T Porsche GT3 RSR Team Falken



23770 · T Porsche GT3 RSR  
"BMS Scuderia Italia, No.97", 2010



23772 · Q Ferrari 599XX,  
Ferrari Racing Days "No.88"



23756 · Q Ferrari 599XX  
"As seen at Geneva Motorshow 2009"









23751 · m  
AVUS - Mercedes-Benz Stromlinie

**AVUS**

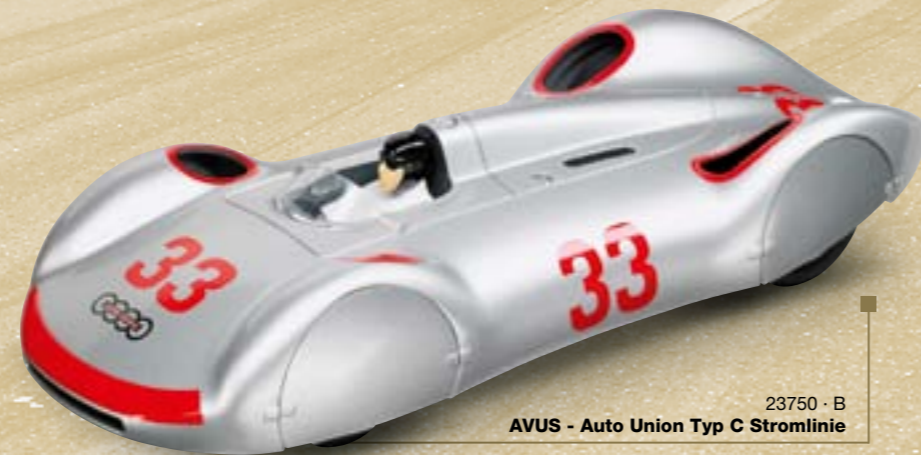

23750 · B  
AVUS - Auto Union Typ C Stromlinie

**AVUS**



23749 · O  
Maserati 4CL 1500 "No.38", Tripoli 1939

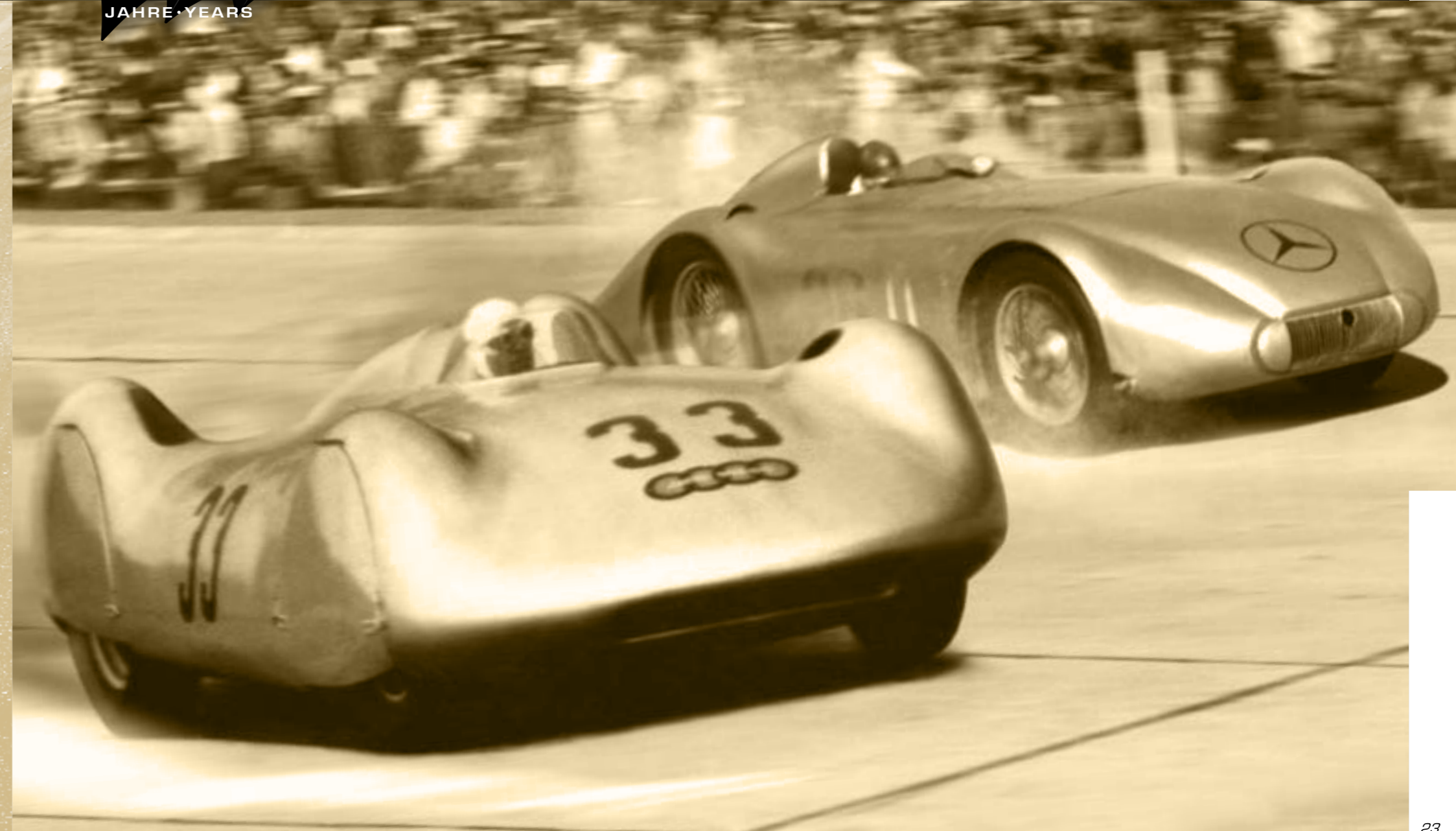



**NEW**

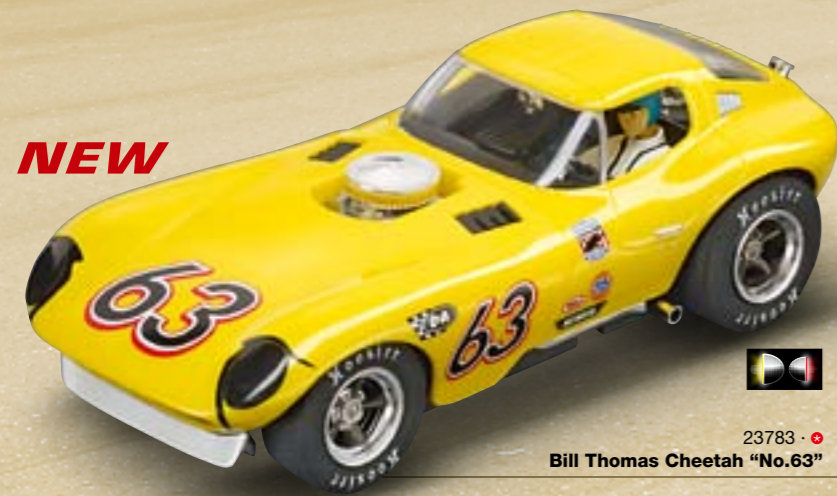

23783 · Q  
Bill Thomas Cheetah "No.63"



23761  
Bill Thomas Cheetah



23755 · Q  
Ferrari 250 GT Berlinetta passo corto  
"Breadvan" 1962 Coppa Gallenga 1965, "No.482"

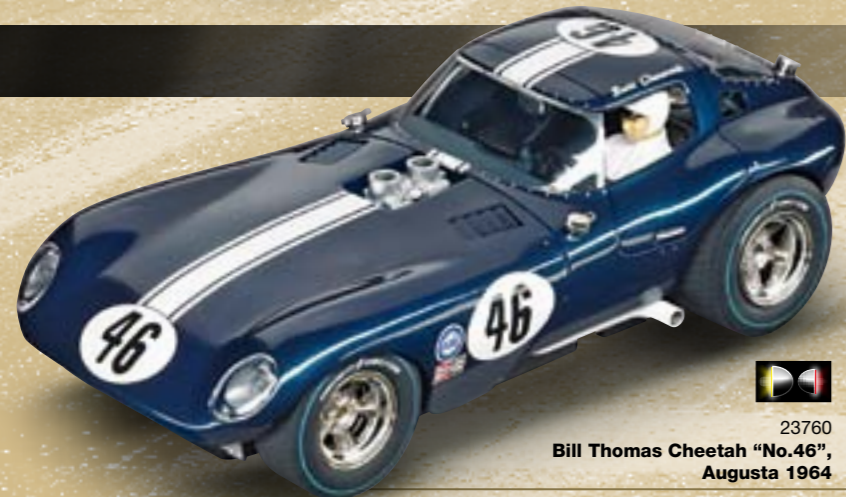

23760  
Bill Thomas Cheetah "No.46",  
Augusta 1964



23771 · Q  
Ferrari 250 GT Berlinetta passo corto  
"Breadvan" 1962, Testcar Monaco



23754 · Q  
Ferrari 250 GT Berlinetta passo corto  
"Breadvan" 1962 Contemporary Version

**LIMITED  
EDITION  
2013**

Limited to 999 pieces  
worldwide!

For more information on  
LIMITED EDITIONS please visit:  
[carrera-toys.com/limited-us](http://carrera-toys.com/limited-us)

PIT · LANE



1:32 | 1:24

- For teens, adults and hobbyists from 8 years and up
- Digital racetrack system allows changing the lane and passing with up to 6 cars
- Racetrack freedom - with 2.4 GHz WIRELESS+
- Worldwide unique racetrack system combining tracks to race 1:24 and 1:32 scale cars
- Cars with front light (xenon) and rear/brake light\*
- Cars compatible with Carrera Evolution series
- Unlimited extension possibilities with track material scale 1:24
- A wide range of DIGITAL accessories guarantees genuine race feeling at home

**CARRERA DIGITAL 132**

**PASSING ON MEGA TRACKS**







Basic Photo © Dave Dyer



8.00 x 5.00 ft. 18.04 ft.  
240 x 160 cm 5,5 m

**NEW**

**ROAD HAMMERS**

Item no. 30170 · T · p  
Porsche 917/30 "No.5", 1973  
Lola T222 Orwell SuperSports Cup, "No.4"

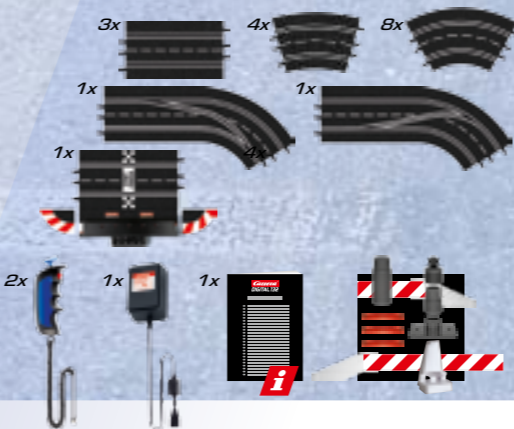



**Carrera**  
DIGITAL 132

50 Jahre · 50 Years · 50 Ans

Including Control Unit and

**Carrera**  
WIRELESS+™

For more info - go to:  
[carrera-toys.com/wirelessplus-us](http://carrera-toys.com/wirelessplus-us)



\*

50 Jahre · 50 Years · 50 Ans · 50 Años · 50 Anni · 50

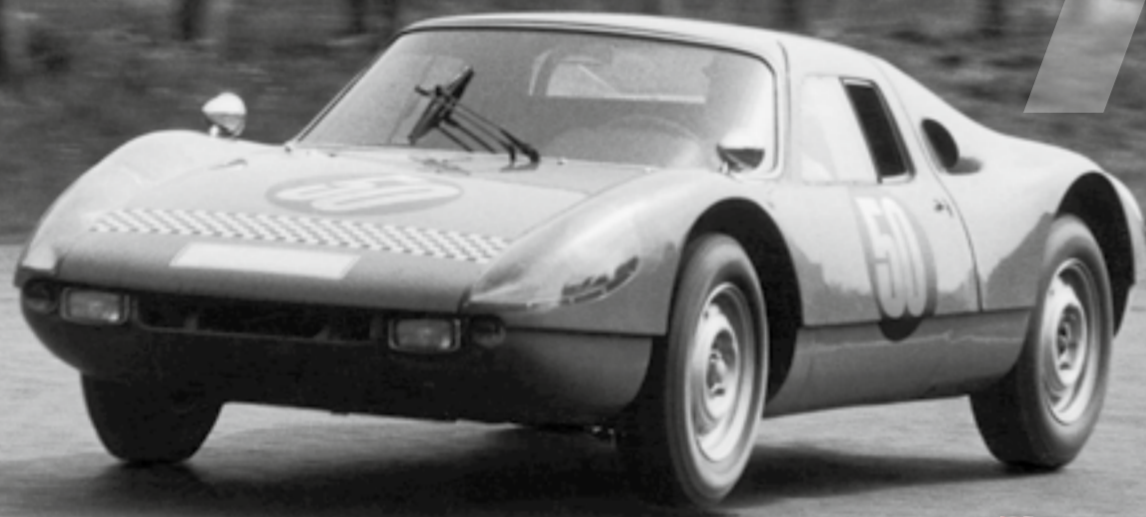

© Porsche Werkfoto



9.84 x 5.91 ft. 26.90 ft.  
300 x 180 cm 8.2 m

**NEW**

**TIME RACE**

Item no. 30168 · T  
Porsche 918 Spyder  
Porsche 904 Carrera GTS

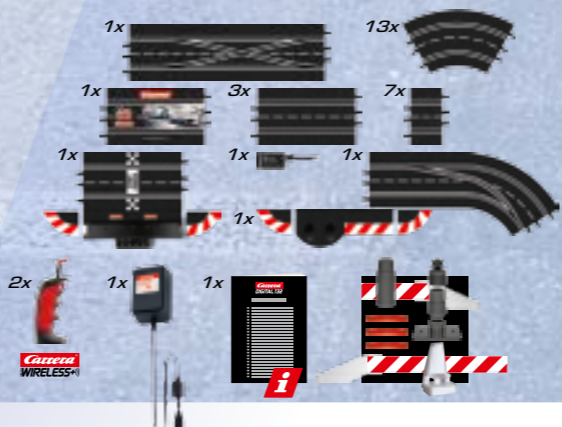

Years





© Bob Heathcote



7.97 x 3.58 ft. 17.72 ft.  
243 x 109 cm 5,4 m

**RACING PREDATORS**

Item no. 30156 · b  
Shelby Cobra 289 '63, Sebring 12h "No.16"  
Bill Thomas Cheetah, Daytona Continental  
1964, "No.14"

1x 10x

3x 2x

1x

2x 1x 1x







© smp-motorsport-fotos



11.48 x 5.87 ft. 29.52 ft.  
350 x 179 cm 9,0 m

**NEW**

**POWER RACING**

Item no. 30167 · Q · e  
Ferrari 458 Italia GT2 "AF Corse, No.71",  
2012 · Aston Martin V12 Vantage GT3  
"Young Driver, No.007"

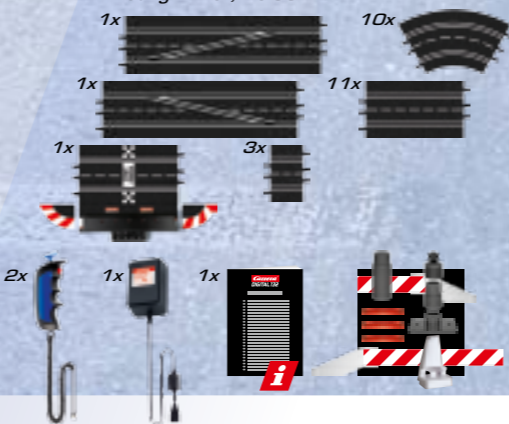

**EXCLUSIVE**  
WORLDWIDE LICENCE  
FOR SLOT RACING



© racevision.de · Burkhard Kasan

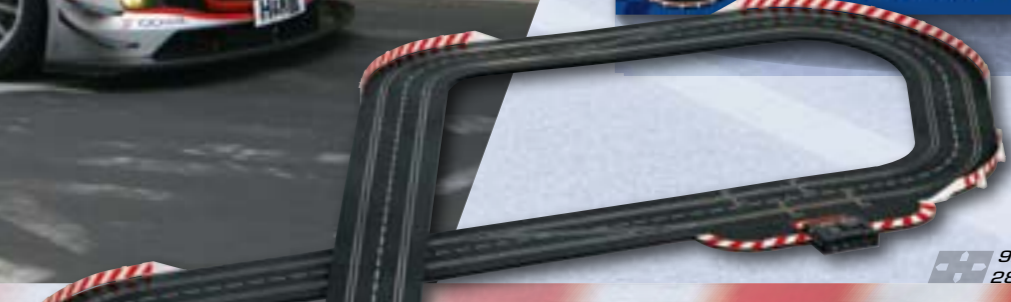

9.22 x 5.54 ft. 22.64 ft.  
281 x 169 cm 6,9 m

**EXCLUSIVE**  
WORLDWIDE LICENCE  
FOR SLOT RACING



**GT POWER**

Item no. 30161 · Q · m  
Ferrari 458 Italia GT2 "Risi Competizione,  
No.062", 2011 · Mercedes-Benz SLS AMG  
GT3 "Team Black Falcon, No.2", VLN 2011

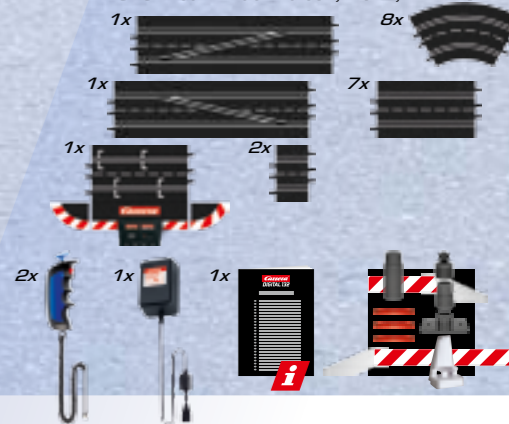















**NEW**



30639 · Q ·   
**Ferrari 458 Italia GT2**  
 "AF Corse, No.71", 2012



30607 · Q ·   
**Ferrari 458 Italia GT2**  
 "No.3" GT Open 2011



30602 · B ·   
**Audi R8 LMS**  
 "Audi Sport Italia, No.32", 2011



30601 · B ·   
**Audi R8 LMS "Prosperta Team Brinkmann,**  
 No.39", UHC Speed ADAC GT Masters 2011



30554 · Q ·   
**Ferrari 458 Italia GT2 "Hankook**  
 Team Farnbacher, No.123", 2011



30553 · Q ·   
**Ferrari 458 Italia GT2**  
 "Risi Competizione, No.062", 2011



30606 · Q ·   
**Ferrari 458 Italia GT2**  
 "JMW Motorsports, No.66", 2011



30608 · Q ·   
**Ferrari 599XX Ferrari Racing Days "No.4"**















**NEW**



30647 · J ·   
Alfa Romeo GTA Silhouette Gr. 5, Race 3



30625 · J ·   
Alfa Romeo GTA Silhouette Race 2



30610 · G ·   
BMW 2002 Touringcar '76, "No.48"



30547 · G ·   
BMW 2002 "Team Warsteiner", '76



30624 · J ·   
Alfa Romeo GTA Silhouette Race 1



30574 · L ·   
Ford Capri RS Group 2, 1975



30617 · A ·   
Citroën DS3 WRC "Van Merksteijn, No.20"



30615 · F ·   
MINI Countryman WRC Equipe  
Palmeirinha Rally "No.14", RMC 2012









© Bob Heathcote



**NEW**

End pipes with light effect!

30653 · p · ◻  
Lola T222 "No.88", Mont-Tremblant '71



**NEW**

End pipes with light effect!

30654 · T · ◻  
Porsche 917/30 "No.5", 1973



End pipes with light effect!

30587 · P  
McLaren M20 "No.3" Interserie, '74



30550 · p  
Lola T222 "No.51", Laguna Seca '71



30549 · p  
Lola T222 Orwell SuperSports Cup, "No.4"



End pipes with light effect!

30572 · T  
Porsche 917/30 "No.48"





© Disney/Pixar



30556 · w  
Francesco Bernoulli



30558 · m  
AVUS - Mercedes-Benz Stromlinie

**AVUS**



**LIMITED EDITION 2013**

Limited to 1.999 pieces worldwide!

For more information on LIMITED EDITIONS please visit: [carrera-toys.com/limited-us](http://carrera-toys.com/limited-us)



30555 · w  
Lightning McQueen



30613 · w  
Max Schnell



30557 · B  
AVUS - Auto Union Typ C Stromlinie

**AVUS**

PIT-LANE









Basic photo © Eric Gilbert - motorsport.com



6.73 x 5.81 ft. 20.67 ft.  
205 x 177 cm 6.3 m

**NEW**

**FAST CLASSICS**  
Item no. 25201 · L · b  
Shelby Cobra 289 "No.21"  
Ford Mustang "No.289"

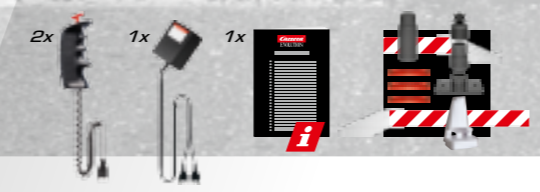

Basic Photo © fotolia - Colin Fox





© Porsche Werkfoto



7.12 x 4.56 ft. 17.39 ft.  
217 x 139 cm 5.3 m

**NEW**

**CELEBRACERS**  
Item no. 25197 · T  
Porsche 904 Carrera GTS  
Porsche 918 Spyder

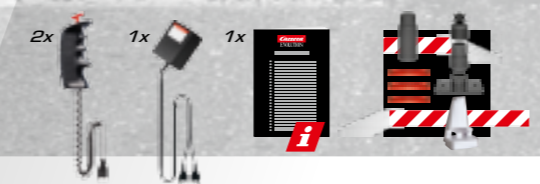
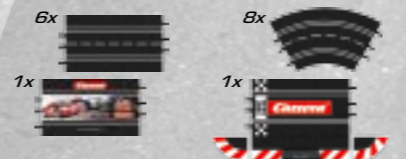

1963

YEARS PT





© Porsche Werkfoto



7.12 x 4.56 ft.  
217 x 139 cm      17.3 9 ft.  
5.3 m

**NEW**

**ROLLING THUNDER**

Item no. 25199 · T · p  
Lola T222 "No.88", Mont-Tremblant '71  
Porsche 917/30 Sunoco Porsche Audi  
"No.6", '73

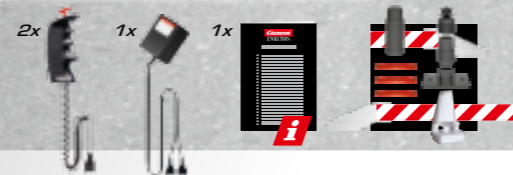

Ⓢ Ⓢ



© Dave Dyer



6.0 x 2.62 ft.  
183 x 80 cm      13.12 ft.  
4.0 m

**RACING LEGENDS**

Item no. 25184 · b  
Shelby Cobra 289 Hardtop Coupé '63, "No.4"  
Bill Thomas Cheetah, "Yeakel Racing, No.8"

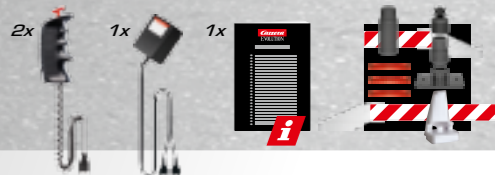
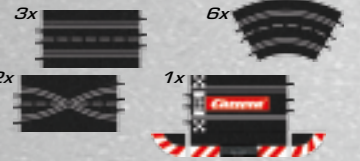

Ⓢ













**NEW**



27435 · 1 ·   
Dodge Charger Daytona "No.30", 1970



27377 · 1 ·   
Dodge Charger Daytona "No.55", 1970



9.58 x 5.54 ft. 24.30 ft.  
292 x 169 cm 7,4 m

**WINGED WARRIORS**

Item no. 25186 · 1  
Dodge Charger Daytona "No.55", 1970  
Dodge Charger Daytona  
Last Aero Warrior "71", "No.22"

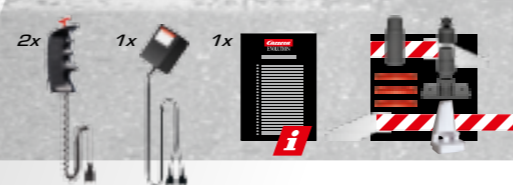
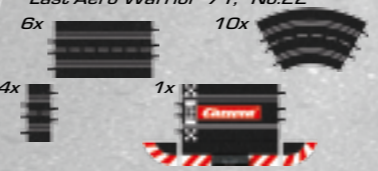

 Preliminary model - Colors/final design subject to change



**NEW**



**3D**  
27427 · m · ◊  
Mercedes-Benz SLS AMG GT3  
"Black Falcon, No.3", 24h Dubai 2012

**NEW**



**3D**  
27429 · T · ◊  
Porsche GT3 RSR  
"Team Falken, No.17", 2009

**NEW**



**3D**  
27426 · Q · ◊  
Ferrari 458 Italia GT2  
"AF Corse, No.71", 2012

**NEW**



**3D**  
27399 · Q  
Ferrari 458 Italia GT2  
"JMW Motorsports, No.66", 2011



**3D**  
27403 · m  
Mercedes-Benz SLS AMG GT3  
"Black Falcon, No.35" 24h Spa 2011



**3D**  
27401 · T  
Porsche GT3 RSR "Manthey  
Racing, No.18", 24h Nürburgring 2011,



**3D**  
27384 · Q  
Ferrari 458 Italia GT2 "Hankook  
Team Farnbacher, No.123", 2011



**3D**  
27383 · Q  
Ferrari 458 Italia GT2  
"Risi Competizione, No.062", 2011



**NEW**



**SD**  
27446 · Q · ◊  
Ferrari "New limited edition"



**NEW**  
**SD**  
27447 · e · ◊  
Aston Martin V12  
Vantage GT3 "Young Driver, No.007"



**SD**  
27395 · B  
Audi R8 LMS "Prosperia Team Brinkmann,  
No.39", UHC Speed ADAC GT Masters 2011



**SD**  
27405 · F  
MINI Countryman WRC  
"Daniel Sordo, No.37", RMC 2012



**SD**  
27400 · Q  
Ferrari 599XX Ferrari Racing Days "No.4"



**SD**  
27362 · Q  
Ferrari 458 Italia



**SD**  
27407 · A · E  
Citroën DS3 WRC  
"Sebastian Loeb, No.1", RMC 2012





With flashing lights!

**SD**  
27252 · I  
Dodge Charger 2006 "Police"



**SD**  
27334 · L  
32 Ford Hot Rod "Fire Engine"

**NEW**



**SD**  
27431 · J · ◉  
Alfa Romeo GTA Silhouette Gr. 5, Race 3



**SD**  
27402 · G  
BMW 2002 Touringcar '76, "No.48"



**SD**  
27415 · J  
Alfa Romeo GTA Silhouette Race 1



**SD**  
27369 · L  
Ford Capri RS Group 2, 1975



**NEW**



27436 · p · ◦  
Lola T222 "No.88", Mont-Tremblant '71

**NEW**



27437 · T · ◦  
Porsche 917/30 "No.5", 1973



27352 · p  
Lola T222 "No.51", Laguna Seca '71



27351 · p  
Lola T222 Orwell SuperSports Cup, "No.4"



27380 · P  
McLaren M20 "No.3" InterSerie, '74



27367 · T  
Porsche 917/30 "No.48"



27372 · T  
Porsche 935/78 "PPG Industries, No.09", Riverside '83



27371 · Q  
Ferrari 512 BB LM NART "No.68", Daytona '79



**NEW**



27433 · b · **Shelby Cobra 289 "Universal Memories"**

**NEW**



27434 · b · **Shelby Cobra 289 "No.21"**

**NEW**



27450 · L · **Ford Mustang "No.289"**

**NEW**



27451 · L · **Ford Mustang "No.67"**



27411 · b · **Shelby Cobra 289 Hardtop Coupé '63, "No.4"**



27412 · b · **Shelby Cobra 289 '63, Sebring 12h "No.16"**



















**1:24**

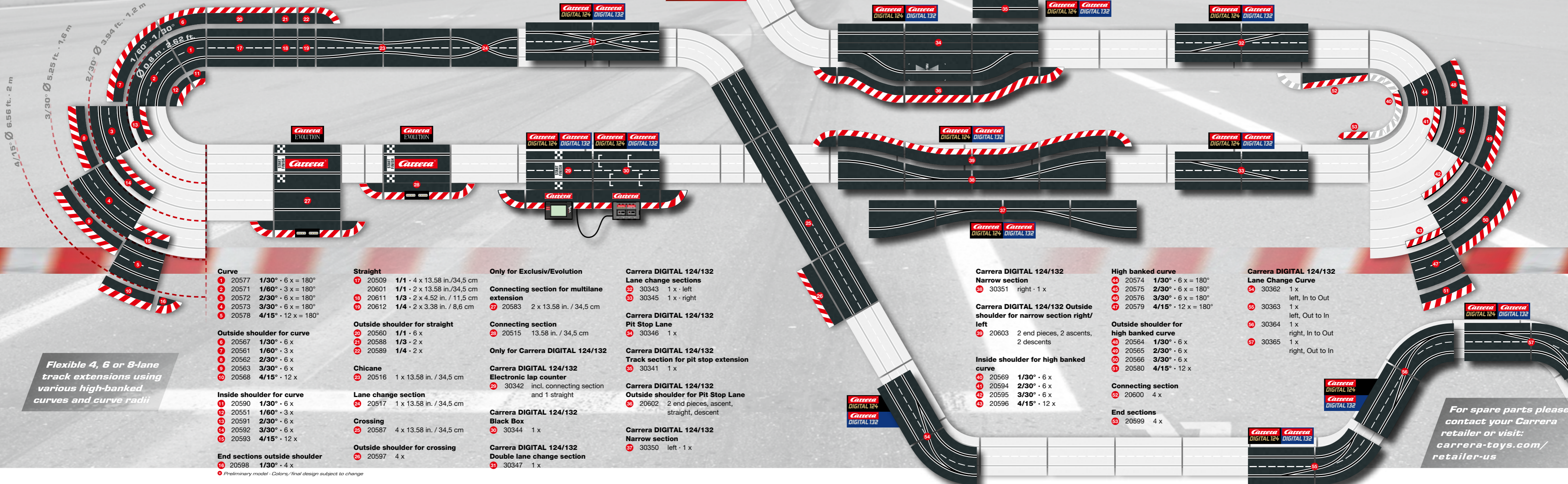

*Flexible 4, 6 or 8-lane track extensions using various high-banked curves and curve radii*

- |   |   |   |  |   |  |  |
|---|---|---|--|---|--|--|
| <p><b>Curve</b></p> <ul style="list-style-type: none"> <li>1 20577 1/30° · 6 x = 180°</li> <li>2 20571 1/60° · 3 x = 180°</li> <li>3 20572 2/30° · 6 x = 180°</li> <li>4 20573 3/30° · 6 x = 180°</li> <li>5 20578 4/15° · 12 x = 180°</li> </ul> <p><b>Outside shoulder for curve</b></p> <ul style="list-style-type: none"> <li>6 20567 1/30° · 6 x</li> <li>7 20561 1/60° · 3 x</li> <li>8 20562 2/30° · 6 x</li> <li>9 20563 3/30° · 6 x</li> <li>10 20568 4/15° · 12 x</li> </ul> <p><b>Inside shoulder for curve</b></p> <ul style="list-style-type: none"> <li>11 20590 1/30° · 6 x</li> <li>12 20551 1/60° · 3 x</li> <li>13 20591 2/30° · 6 x</li> <li>14 20592 3/30° · 6 x</li> <li>15 20593 4/15° · 12 x</li> </ul> <p><b>End sections outside shoulder</b></p> <ul style="list-style-type: none"> <li>16 20598 1/30° · 4 x</li> </ul> | <p><b>Straight</b></p> <ul style="list-style-type: none"> <li>17 20509 1/1 · 4 x 13.58 in./34,5 cm</li> <li>20601 1/1 · 2 x 13.58 in./34,5 cm</li> <li>18 20611 1/3 · 2 x 4.52 in. / 11,5 cm</li> <li>19 20612 1/4 · 2 x 3.38 in. / 8,6 cm</li> </ul> <p><b>Outside shoulder for straight</b></p> <ul style="list-style-type: none"> <li>20 20560 1/1 · 6 x</li> <li>21 20588 1/3 · 2 x</li> <li>22 20589 1/4 · 2 x</li> </ul> <p><b>Chicane</b></p> <ul style="list-style-type: none"> <li>23 20516 1 x 13.58 in. / 34,5 cm</li> </ul> <p><b>Lane change section</b></p> <ul style="list-style-type: none"> <li>24 20517 1 x 13.58 in. / 34,5 cm</li> </ul> <p><b>Crossing</b></p> <ul style="list-style-type: none"> <li>25 20587 4 x 13.58 in. / 34,5 cm</li> </ul> <p><b>Outside shoulder for crossing</b></p> <ul style="list-style-type: none"> <li>26 20597 4 x</li> </ul> | <p><b>Only for Exclusiv/Evolution</b></p> <p><b>Connecting section for multilane extension</b></p> <ul style="list-style-type: none"> <li>27 20583 2 x 13.58 in. / 34,5 cm</li> </ul> <p><b>Connecting section</b></p> <ul style="list-style-type: none"> <li>28 20515 13.58 in. / 34,5 cm</li> </ul> <p><b>Only for Carrera DIGITAL 124/132</b></p> <p><b>Carrera DIGITAL 124/132 Electronic lap counter</b></p> <ul style="list-style-type: none"> <li>29 30342 incl. connecting section and 1 straight</li> </ul> <p><b>Carrera DIGITAL 124/132 Black Box</b></p> <ul style="list-style-type: none"> <li>30 30344 1 x</li> </ul> <p><b>Carrera DIGITAL 124/132 Double lane change section</b></p> <ul style="list-style-type: none"> <li>31 30347 1 x</li> </ul> | <p><b>Carrera DIGITAL 124/132 Lane change sections</b></p> <ul style="list-style-type: none"> <li>32 30343 1 x · left</li> <li>33 30345 1 x · right</li> </ul> <p><b>Carrera DIGITAL 124/132 Pit Stop Lane</b></p> <ul style="list-style-type: none"> <li>34 30346 1 x</li> </ul> <p><b>Carrera DIGITAL 124/132 Track section for pit stop extension</b></p> <ul style="list-style-type: none"> <li>35 30341 1 x</li> </ul> <p><b>Carrera DIGITAL 124/132 Outside shoulder for Pit Stop Lane</b></p> <ul style="list-style-type: none"> <li>36 20602 2 end pieces, ascent, straight, descent</li> </ul> <p><b>Carrera DIGITAL 124/132 Narrow section</b></p> <ul style="list-style-type: none"> <li>37 30350 left · 1 x</li> </ul> | <p><b>Carrera DIGITAL 124/132 Narrow section</b></p> <ul style="list-style-type: none"> <li>38 30351 right · 1 x</li> </ul> <p><b>Carrera DIGITAL 124/132 Outside shoulder for narrow section right/left</b></p> <ul style="list-style-type: none"> <li>39 20603 2 end pieces, 2 ascents, 2 descents</li> </ul> <p><b>Inside shoulder for high banked curve</b></p> <ul style="list-style-type: none"> <li>40 20569 1/30° · 6 x</li> <li>41 20594 2/30° · 6 x</li> <li>42 20595 3/30° · 6 x</li> <li>43 20596 4/15° · 12 x</li> </ul> | <p><b>High banked curve</b></p> <ul style="list-style-type: none"> <li>44 20574 1/30° · 6 x = 180°</li> <li>45 20575 2/30° · 6 x = 180°</li> <li>46 20576 3/30° · 6 x = 180°</li> <li>47 20579 4/15° · 12 x = 180°</li> </ul> <p><b>Outside shoulder for high banked curve</b></p> <ul style="list-style-type: none"> <li>48 20564 1/30° · 6 x</li> <li>49 20565 2/30° · 6 x</li> <li>50 20566 3/30° · 6 x</li> <li>51 20580 4/15° · 12 x</li> </ul> <p><b>Connecting section</b></p> <ul style="list-style-type: none"> <li>52 20600 4 x</li> </ul> <p><b>End sections</b></p> <ul style="list-style-type: none"> <li>53 20599 4 x</li> </ul> | <p><b>Carrera DIGITAL 124/132 Lane Change Curve</b></p> <ul style="list-style-type: none"> <li>54 30362 1 x left, In to Out</li> <li>55 30363 1 x left, Out to In</li> <li>56 30364 1 x right, In to Out</li> <li>57 30365 1 x right, Out to In</li> </ul> |
|---|---|---|--|---|--|--|

*For spare parts please contact your Carrera retailer or visit: [carrera-toys.com/retailer-us](http://carrera-toys.com/retailer-us)*

• Preliminary model - Colors/final design subject to change



### A REAL RACING FEEL AT HOME WITH DIGITAL ACCESSORIES

Experience the Carrera racetrack feeling with our state-of-the-art Carrera DIGITAL accessories! The lap counter offers you real speed thrills with a display including position, fastest lap times and the exact overall time with time difference! Start your personal training with the special training and racing mode and leave your rivals far behind! The Driver Display combined with the Pit Lane shows each driver his fuel level, the number of pitstops (max. 10) and current race position. The start light triggers the first rush of adrenaline then it's pedal-to-the-metal time. The Position Tower means racers always have a race position overview.

### Real Racing – More Fun!

The Control Unit forms  
the basis for great  
digital racing fun



#### 1 Carrera DIGITAL 124/132 Control Unit

- Possibility to programme:
  - braking performance
  - power (maximum speed)
  - tank capacity
- Pit Stop functions
- Pace Car functions

#### 2 Carrera DIGITAL 124/132 Lap Counter

- (only in combination with Control Unit 30352)
- Direct link-up to the Control Unit (no additional track required)
- Stopwatch - also in the pit lane (only with Pit Lane 30356)

- Car position information on the display
- Backlite display for improved legibility
- Position listing, fastest lap, total race time, time gap to the leader.
- Stopwatch times for 6 cars - accurate to 1/1000 sec.
- Training and racing modes
- Racing modes divided into lap and time-based racing
- Lap limit races from 0 to 9999 laps
- Time runs from 00:00'01" to 99:59'59"

#### 3 Carrera DIGITAL 124/132 Driver Display

- (Only in combination with Control Unit 30352 and Pit Lane 30356)
- LED-display shows tank capacity and allocation of cars as well as latest race position
- LED-control display for up to 10 pit stops in the Pit Lane 30356

#### 4 Carrera DIGITAL 124/132 Startlight

- (Only in combination with Control Unit 30352)
- LED-display indicating start sequence

#### 5 Carrera DIGITAL 124/132 Position Tower

- (Only in combination with Control Unit 30352)
- LED-display of latest race position
- Information on each leading car's laps having been driven



30352 Carrera DIGITAL 124/132 Control Unit • incl. 2 end pieces

30353 Carrera DIGITAL 124/132 Driver Display  
incl. Adapter Unit and 2 end pieces

30354 Carrera DIGITAL 124/132 Startlight  
incl. Adapter Unit and 2 end pieces left/right

30357 Carrera DIGITAL 124/132 Position Tower  
incl. Adapter Unit

30355 Carrera DIGITAL 124/132 Lap Counter  
Only in combination with Control Unit 30352

30556 Carrera DIGITAL 124/132 Pit Lane  
Only in combination with Control Unit 30352

30358 Carrera DIGITAL 124/132 Shoulder connecting section  
6.79 in./17,25 cm • incl. shoulder complement (30359), possibility to connect Position Tower 30357

30359 Carrera DIGITAL 124/132 Shoulder complement • 6.79 in./17,25 cm

30360 Carrera DIGITAL 124/132 Adapter Unit • 13.58 in./34,5 cm • Connecting section for Driver Display 30353, Startlight 30354 and Position Tower 30357

30361 Carrera DIGITAL 124/132 Pit Stop Adapter Unit • 13.58 in./34,5 cm • Only in combination with Control Unit 30352 • to retrofit the Pit Stop Lane 30346 for operating the Driver Display 30353





















© motorsportpressebild.de



6.40 x 2.46 ft. 18.37 ft.  
195 x 75 cm 5,6 m

**NEW**

**CHAMPIONS COCKPIT**  
Item no. 40023 · E · Q  
Red Bull Racing RB7 "Sebastian Vettel, No.1"  
Ferrari 150° Italia "Fernando Alonso, No.5"

- 4x
- 8x
- 1x
- 1x
- 6x
- 8x
- 1x
- 1x
- 1x
- 

**EXCLUSIVE**  
WORLDWIDE LICENCE  
FOR SLOT RACING

**EXCLUSIVE**  
WORLDWIDE LICENCE  
FOR SLOT RACING



© motorsportpressebild.de





© Eberhard Strähle



7.87 x 4.03 ft. 23.94 ft.  
240 x 123 cm 7.3 m

**NEW**

**POWER RACE**

Item no. 40021 · B · G · m · Y  
BMW M3 DTM "M.Tomczyk, No.1"  
Audi A5 DTM "M.Ekström, No.3"  
AMG Mercedes C-Coupe DTM "J.Green, No.5"



© Eberhard Strähle

••



© Eberhard Strähle

••



© Eberhard Strähle

••



© Eberhard Strähle





Ferrari © Eric Gilbert - motorsport.com



7.00 x 3.02 ft. 20.66 ft.  
213 x 92 cm 6.3 m

**NEW**

**HIGH SPEED CHASE**

Item no. 40024 · Q · m  
Ferrari F12 Berlinetta  
AMG Mercedes SL 63 "Polizei"



**EXCLUSIVE**  
WORLDWIDE LICENCE  
FOR SLOT RACING

**With flashing lights!**



41363 · Q  
Ferrari 458 Italia GT2  
JMW Motorsports "No.66" 2011



41352 · Q  
Ferrari 458 Italia GT2 Risi  
Competizione "No.062", 2011



41353 · Q  
Ferrari 458 Italia GT2  
Hankook Team Farnbacher  
"No.123", 2011



41373 · Q  
Ferrari 458 Italia GT2  
"AF Corse, No.71"

**NEW**



41374 · Q · ·   
Ferrari F12 Berlinetta



50 Anos · 50 Anni · 50 Jahre · 50 Years · 50 Ans · 50 Años · 50 Anni · 50 Jahre · 50 Years · 50 Ans · 50 Años · 50 Anni · 50 Jahre · 50 Years · 50 Ans · 50 Años · 50 Anni · 50 Jahre · 50 Years · 50 Ans · 50 Años · 50 Anni · 50 Jahre · 50 Years



41365 · T  
Porsche GT3 Cup  
"Seyffarth Motorsport"



**NEW**

41371 · T · ★  
Porsche GT3 "Haribo Racing"



41360 · E  
Red Bull Racing RB7  
"Sebastian Vettel, No.1"



41361 · Q  
Ferrari 150° Italia  
"Fernando Alonso, No.5"



**NEW**

41370 · e · ★  
Aston Martin V12 Vantage GT3  
"Young Driver, No.007"

**With  
flashing  
lights!**



41366 · L  
Ford Crown Victoria  
"Police Interceptor"

**With  
flashing  
lights!**



41334 · m  
AMG Mercedes SL 63  
"Safety Car"



41362 · P  
Vodafone McLaren  
Mercedes Race Car 2011, "No.3"





50 Anos · 50 Anni · 50 Jahre · 50 Years · 50 Ans · 50 Años · 50 Anni · 50 Jahre · 50 Years · 50 Ans · 50 Años · 50 Anni · 50 Jahre · 50 Years · 50 Ans · 50 Años · 50 Anni · 50 Jahre · 50 Years · 50 Ans · 50 Años · 50 Anni · 50 Jahre · 50 Years

For further track pieces  
and action elements see  
pages 133-135

For spare parts please contact  
your Carrera retailer or visit:  
[carrera-toys.com/retailer-us](http://carrera-toys.com/retailer-us)



42003  
Carrera DIGITAL 143 Switch · left



42004  
Carrera DIGITAL 143 Switch · right



42010  
Carrera DIGITAL 143  
Double lane change section



42008  
Carrera DIGITAL 143 Lap counter

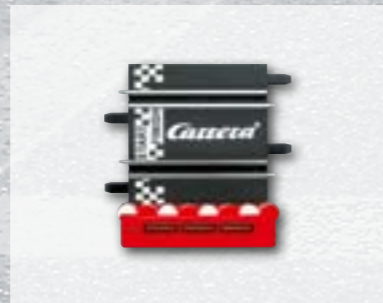

42001  
Carrera DIGITAL 143 Black Box



42002  
Carrera DIGITAL 143 Speed Controller



42006 (USA) · 14,8 V  $\rightarrow$  10,36 VA  
Carrera DIGITAL 143 Transformer











5.74 x 4.00 ft. 20.66 ft.  
175 x 122 cm 6,3 m



4.95 x 2.69 ft. 11.81 ft.  
151 x 82 cm 3,6 m

**EXCLUSIVE**  
WORLDWIDE LICENCE  
FOR SLOT RACING



**EXCLUSIVE**  
WORLDWIDE LICENCE  
FOR SLOT RACING



**FORMULA COMPETITION**

Item no. 62272 · E · Q  
Red Bull Racing RB7 "Sebastian Vettel, No.1"  
Ferrari 150° Italia "Fernando Alonso, No.5"

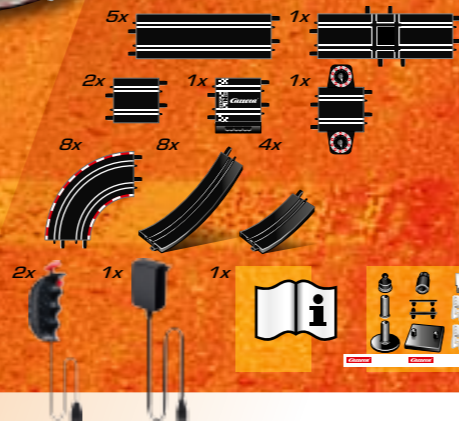

**EXCLUSIVE**  
WORLDWIDE LICENCE  
FOR SLOT RACING



**EXCLUSIVE**  
WORLDWIDE LICENCE  
FOR SLOT RACING



**EMPIRE CHALLENGE**

Item no. 62308 · E · Q  
Red Bull Racing RB7 "Sebastian Vettel, No.1"  
Ferrari 150° Italia "Fernando Alonso, No.5"

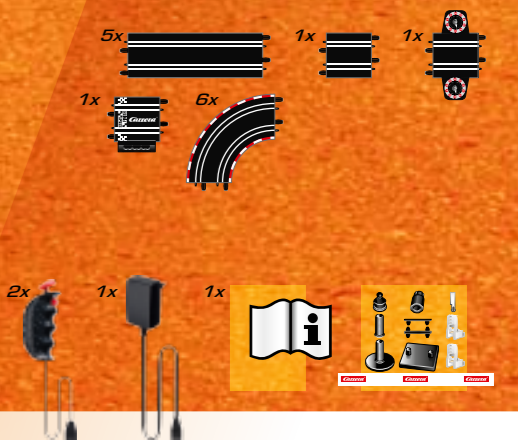

**NEW**





© motorsportpressebild.de



**EXCLUSIVE**  
WORLDWIDE LICENCE  
FOR SLOT RACING



6.30 x 1.97 ft. 17.71 ft.  
192 x 60 cm 5,4 m

With customized guard-rails and decorations



**FERRARI F1 MASTERS**

Item no. 62280 · Q  
Ferrari 150° Italia "Fernando Alonso, No.5"  
Ferrari 150° Italia "Felipe Massa, No.6"

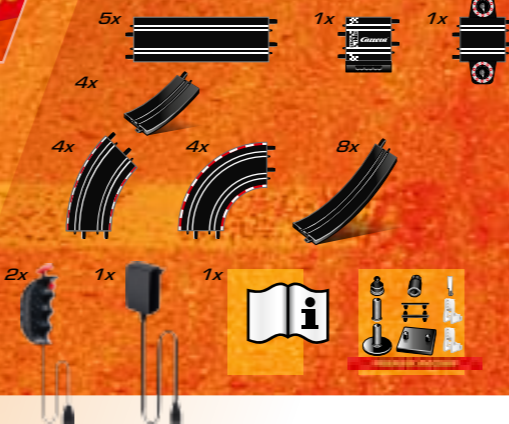

© motorsportpressebild.de



**EXCLUSIVE**  
WORLDWIDE LICENCE  
FOR SLOT RACING



6.30 x 1.97 ft. 17.71 ft.  
192 x 60 cm 5,4 m

With customized guard-rails and decorations



**WORLD CHAMPIONS**

Item no. 62278 · E  
Red Bull Racing RB7 "Sebastian Vettel, No.1"  
Red Bull Racing RB7 "Mark Webber, No.2"

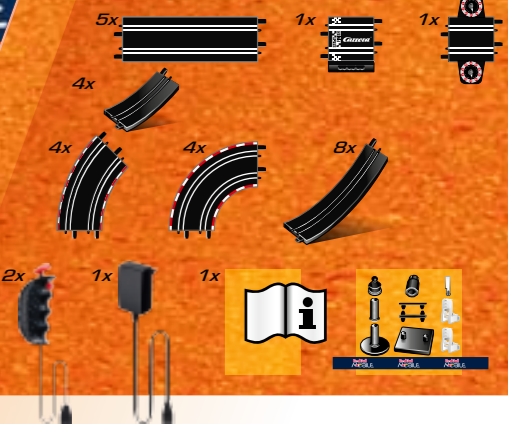





© jamesballardsmith



8.76 x 2.62 ft. 23.62 ft.  
267 x 80 cm 7.2 m



**EXCLUSIVE**  
WORLDWIDE LICENCE  
FOR SLOT RACING



© Eric Gilbert - motorsport.com



4.66 x 2.56 ft. 11.81 ft.  
142 x 70 cm 3.6 m



**EXCLUSIVE**  
WORLDWIDE LICENCE  
FOR SLOT RACING



© Art Fleischmann

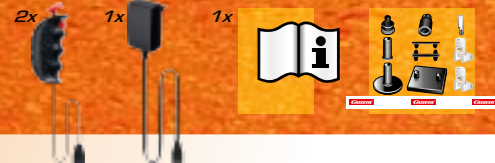





With customized guardrails and decorations

6.40 x 2.46 ft. 18.37 ft.  
195 x 75 cm 5,6 m

**NEW**

Marvel – Ultimate Spider-Man  
**SPIDER RACE**  
Item no. 62320 · X  
Ultimate Spider-Man – Spider Speed Shifter  
Ultimate Spider-Man – Goblin Getaway



**WORK IN PROGRESS**







nickelodeon  
**TEENAGE MUTANT NINJA  
TURTLES**



4.59 x 3.38 ft. 20.01 ft.  
140 x 103 cm 6.1 m

**NEW**

Teenage Mutant Ninja Turtles  
**NINJA X-LOOP**  
Item no. 62324 · D  
Teenage Mutant Ninja Turtles  
Turtle Trike · Shredder Racer

With customized guard-rails and decorations

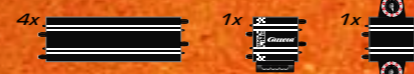

CONCEPT ONLY,  
SUBJECT TO APPROVAL

WORK IN  
PROGRESS



Light  
Effect



nickelodeon  
**TEENAGE MUTANT NINJA  
TURTLES**



50 Ans · 50 Jahre · 50 Jahre · 50 Years · 50 Jahre · 50 Years · 50 Ans · 50 Años · 50 Anni · 50 Jahre · 50 Years · 50 Ans · 50 Años · 50 Anni · 50 Jahre · 50 Years · 50 Ans



**MARIOKART 7**



7.68 x 2.23 ft. 20.34 ft.  
234 x 68 cm 6.2 m

**NEW**

**MARIO KART 7**  
Item no. 62318 - V  
Mario Kart™ 7 - Mario  
Mario Kart™ 7 - Yoshi

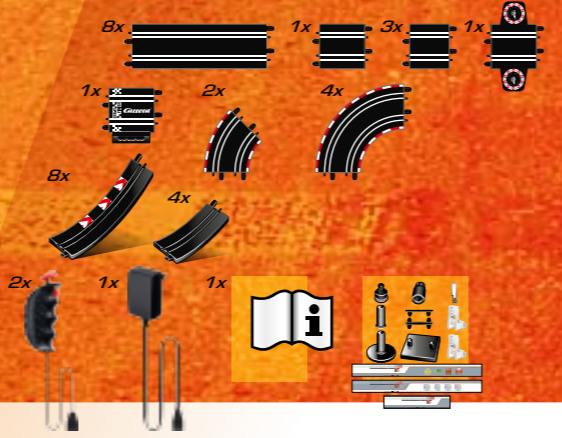

With customized guardrails and decorations



**MARIOKART 7**





© Disney/Pixar



With customized guard-rails and decorations

**NEW**

Disney/Pixar Cars  
**SILVER SPEEDERS**  
Item no. 62302 - w  
Silver Lightning McQueen  
Silver Francesco Bernoulli

- 2x [Track Piece]
- 1x [Track Piece]
- 1x [Track Piece]
- 2x [Track Piece]
- 1x [Track Piece]
- 1x [Track Piece]
- 6x [Track Piece]
- 4x [Track Piece]
- 4x [Track Piece]
- 2x [Track Piece]
- 1x [Track Piece]
- 1x [Track Piece]
- 1x [Track Piece]
- 1x [Track Piece]

6.07 x 1.48 ft. 13.78 ft.  
185 x 45 cm 4.2 m



© Disney/Pixar









61244 · Q  
Ferrari 458 Italia GT2  
"JMW Motorsports, No.66" 2011



61211 · Q  
Ferrari 458 Italia GT2  
"Risi Competizione, No.062", 2011



61212 · Q  
Ferrari 458 Italia GT2  
"Hankook Team Farnbacher,  
No.123", 2011



**NEW**

61277 · Q  
Ferrari 458 Italia GT2  
"AF Corse, No.71"



61246 · T  
Porsche GT3 Cup  
"Seyffarth Motorsport"



**NEW**

**WORK IN PROGRESS**

61288 · T ·   
Porsche GT3 "Haribo Racing"



**NEW**

61280 · e ·   
Aston Martin V12 Vantage GT3  
"Young Driver, No.007"



**NEW**

**WORK IN PROGRESS**

61289 · T ·   
Porsche GT3 "MAOAM Racing"



**NEW**

**WORK IN PROGRESS**

61278 · X ·   
Ultimate Spider-Man -  
Spider Speed Shifter



**NEW**

61279 · X ·   
Ultimate Spider-Man -  
Goblin Getaway



**NEW**

**CONCEPT ONLY, SUBJECT TO APPROVAL**

61286 · D ·   
Teenage Mutant Ninja Turtles -  
Turtle Trike

**WORK IN PROGRESS**



**NEW**

**Light Effect**

61287 · D ·   
Teenage Mutant Ninja Turtles -  
Shredder Racer









50 Anos · 50 Years · 50 Ans · 50 Años · 50 Anni · 50 Jahre · 50 Jahre · 50 Anos · 50 Anni · 50 Jahre · 50 Jahre · 50 Anos · 50 Anni · 50 Jahre · 50 Jahre · 50 Anos · 50 Anni · 50 Jahre · 50 Jahre · 50 Anos · 50 Anni · 50 Jahre · 50 Jahre · 50 Anos · 50 Anni · 50 Jahre · 50 Jahre



61652 · w  
**Disney/Pixar Cars 2 Extension / Car Set "Mater"**  
 2 Straight 13.46 in. / 342 mm, 2 Lane change sections, 6 Flags, 3 Banner, 2 Guardrails

61653 · w  
**Disney/Pixar Cars 2 Extension / Car Set "Francesco Bernoulli"**  
 2 Straight 13.46 in. / 342 mm, 2 Lane change sections, 6 Flags, 3 Banner, 2 Guardrails

61654 · w  
**Disney/Pixar Cars 2 Extension / Car Set "Max Schnell"**  
 2 Straight 13.46 in. / 342 mm, 2 Lane change sections, 6 Flags, 3 Banner, 2 Guardrails

61660 · w  
**Disney/Pixar Cars 2 Extension / Car Set "Security Finn McMissile"**  
 2 Straight 13.46 in. / 342 mm, 2 Lane change sections, 6 Flags, 3 Banner, 2 Guardrails



61511 GO!!!  
**Mechanical speed controller**



61537 (USA) GO!!!  
**Transformer**  
 14,8 V == 10,4 VA



61512 GO!!!  
**Connecting section**



71595 GO!!!  
**Electronic lap counter**  
 Battery-operated,  
 3 batteries AA/LR6 (not included)

- Lap counts from 1 to 99 laps
- Shows best lap times
- Big display
- Winner-fanfare
- Tone signals when crossing the finishing line
- For two lane operation
- Automatically switches off after 3 minutes

With light and sound!



61661 · \*  
**LED Looping Set with light and sound**  
 8 looping sections, 3 x straights 114 mm / 4.49 in. with supports



71590 GO!!!/Exclusiv/Evolution  
**Electronic lap counter**  
 Battery-operated, 4 batteries AA/LR6 (not included)

- Records times exactly (1/100 sec.)
- Can be used with all current Carrera racing track product lines
- Adjustable width to suit various track size
- For two lane operation
- Cars are identified via infrared light barrier
- Time trials from 1 seconds to 99 min.
- Lap counts from 1 to 999 laps
- Tone signals when crossing the finishing line
- False start function

For spare parts please contact your Carrera retailer or visit: [carrera-toys.com/retailer-us](http://carrera-toys.com/retailer-us)



61655  
**Lane change curve 1/90°**  
 2 x



61656  
**Straight 6.73 in. / 171 mm**  
 4 x



61657  
**Single-lane bends / Straight section extension set**  
 8 single-lane bends, 4 single-lane straights 13.46 in. / 342 mm



61658  
**Straights 3.94 in./100 mm · 4.49 in/114 mm**  
 3 x Straights 3.94 in./100 mm, 3 x Straights 4.49 in/114 mm



61659  
**See-saw**





For spare parts please contact  
your Carrera retailer or visit:  
[carrera-toys.com/retailer-us](http://carrera-toys.com/retailer-us)



61647  
Chicane



61648  
Single lane circle



61649  
Hump track · Bridge

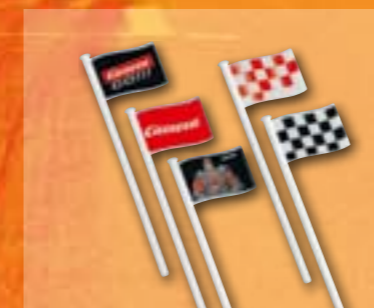

61650  
Flags  
10 x

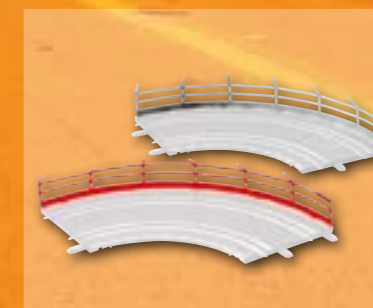

61651  
Guardrail fence  
10 x



61510  
Double sliding  
contact



61604  
Bridge set  
4 Bridge parts with cross struts



61641  
Jump ramp



61602  
Straight 13.46 in. / 342 mm  
2 x

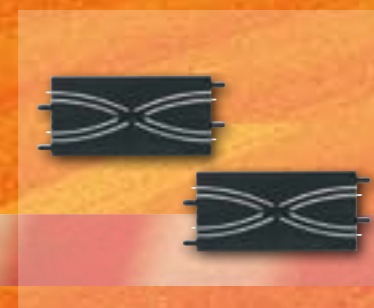

61609  
Lane change section  
2 x



61610  
Narrow section  
2 x

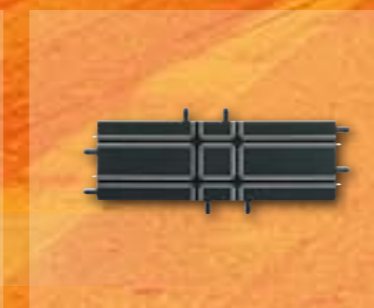

61616  
Junction  
2 x



61618  
Mechanical lane change section  
left and right

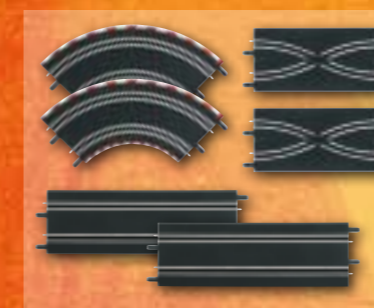

61600  
Extension set 1 · 2 curves 1/90°, 2 lane change  
sections, 2 straights 13.46 in./342 mm



61601  
Extension set 2 · 4 straights 13.46 in./342 mm, 2 straights 4.48 in./114 mm,  
2 Fly Over incl. supports, 1 narrow section, 2 lane change sections

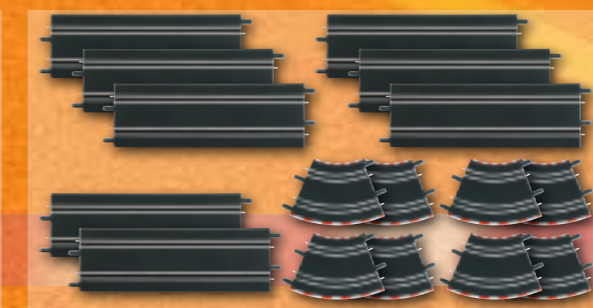

61614  
Extension set 3 · 8 straights 13.46 in./342 mm, 4 curves 1/45°,  
4 high banked curves 1/45° incl. supports

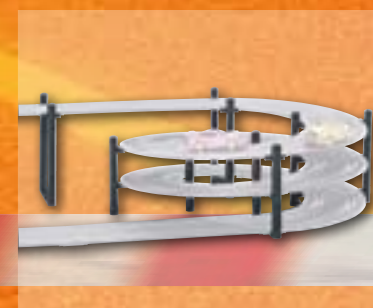

61642  
3D support



61603  
Curve 1/90°  
2 x



61611  
Curve 1/45°  
4 x



61612  
High banked curve 1/45°  
4 x · incl. supports



61617  
Curve 2/45°  
4 x



61646  
High banked curve 2/45°  
4 x · incl. supports



61645  
Curve 3/45°  
4 x



61639  
Rallye curve 1/90°  
2 x



61640  
Rallye narrow section  
2 x



61643  
Rallye extension set · 2 Rallye curves 1/90°, 2 Rallye narrow sections,  
2 crossover straights 13.46 in./342 mm



61613  
Looping set · 8 looping  
sections with supports



## KNOW MORE: CARRERA-TOYS.COM

Experience Carrera in our gigantic virtual world. Browse through our entire product portfolio and gather all the most important facts about our latest products. Click your way around the big Carrera event schedule and you'll never miss another event organised by your favourite brand ever again. The "Live&Racing" section offers a lot more too, such as numerous competitions and great prizes!

Also online: Carrera track layout proposals and decorative cut-out sheets to customise your race circuit!

In the Carrera Support section there are quick and simple answers to your questions and download options for operating instructions and spare parts lists!

Subscribe to the Carrera Newsletter and regularly be the first to access the latest offers from Carrera and read the latest information.



Last website update 2012



## CARRERA – SIMPLY MORE!

- More highlights on carrera-toys.com:**
- Carrera Dealer Search – a quick and easy way to find your nearest local official Carrera trader
  - Carrera shopping list – Never forget an item again! Add it to the list!
  - Carrera Partner Service – the site for dealers and media partners!



Know more:  
[carrera-toys.com](http://carrera-toys.com)



Discover more:  
[facebook.com/  
CarreraofAmerica](https://facebook.com/CarreraofAmerica)



See more:  
[youtube.com/  
CarreraHome](https://youtube.com/CarreraHome)





POS

50 Anos · 50 Anni · 50 Jahre



Our Carrera POS-brand display units enable you to assemble a matching, branded display in order to enhance the impression made by your sales and display areas. Our POS units enable you to create your own perfect POS and display set-up!

For further information on our decoration possibilities please visit [carrera-toys.com/us/partner-service/](http://carrera-toys.com/us/partner-service/)

## POS-BRAND DISPLAY - CUSTOM-BUILD YOUR OWN CARRERA BRANDING SET-UP



**Customer stopper flag**  
70773 27.6 x 9.8 in. · 70 x 25 cm plus fixing magnet



**LCD Screen** · Our LCD 15" screen is ideal for TV spots and product animation. This is a great way of introducing Carrera goods.



**Shelf strips**  
to fix at the shelf front  
70861 39 x 1.1 in. · 99 x 2,8 cm  
70862 48.8 x 1.1 in. · 124 x 2,8 cm



**Lighting box**  
70732 Side panels black mini-perl, rear slot hooks for hanging on existing display unit systems. Compatible with all the main standard shelf systems. Exchangeable backlight foils



JAHRE · YEARS

50 Anni · 50 Jahre · 50 Anos · 50 Anni · 50 Jahre · 50 Years · 50 Ans · 50 Anos · 50 Anni · 50 Jahre · 50 Years



Race Track



70957  
**Catalogue 2013**  
Oblong format approx. A4



70962  
**Consumer Folder Box**  
Preliminary model



70959  
**Logo sheet self-adhesive**  
Oblong format approx. A4



**Carrera fabric**  
70488 787.4 x 27.55 in. · 2000 x 70 cm

## DESIGN YOUR OWN CARRERA RACE TRACK!

You can decorate your show track as you like with grandstands, buildings and figures. To learn more about the Carrera show track and possibilities for decorating it, visit our homepage [carrera-toys.com/partnerservice](http://carrera-toys.com/partnerservice) or see page 96/97 in the catalogue. Orders may only be made through or by retail dealers. Delivery time approx. 3 weeks.



70912  
**Carrera DIGITAL 132 race track**  
Dimensions assembled:  
13 x 4.6 ft./4,0 x 1,4 m

Wooden plate: three-pieces, track material premounted · Two-track including Control Unit, 2 Driver Displays, Start light and 4 vehicles  
Decoration not included.

Discover even more Carrera promotional material on our website [carrera-toys.com/us/partner-service/](http://carrera-toys.com/us/partner-service/)









JAHRE • YEARS



*carrera-toys.com*