

# Pierce's Disease Control Program



# Symposium Proceedings

## 2005 Pierce's Disease Research Symposium

December 5 - 7, 2005  
San Diego Marriott  
Hotel & Marina  
San Diego, CA



California Department of Food & Agriculture

***Proceedings of the  
2005 Pierce's Disease  
Research Symposium***

December 5 – 7, 2005  
San Diego Marriott Hotel & Marina  
San Diego, California

Organized by:  
California Department of Food and Agriculture

**Proceedings Compiled by:**

M. Athar Tariq, Peggy Blincoe, Melinda Mochel, Stacie Oswalt, and Thomas Esser

**Cover Design:**

Peggy Blincoe

**Cover Photograph:**

Sean Veling

**Printer:**

Copeland Printing, Sacramento, CA

**Funds for Printing Provided by:**

CDFA Pierce's Disease and Glassy-winged Sharpshooter Board

**To order additional copies of this publication, please contact:**

Pierce's Disease Control Program  
California Department of Food and Agriculture  
1220 N Street, Room 325  
Sacramento, California 95814  
Telephone: (916) 651-0267  
Fax: (916) 651-0275  
<http://www.cdfa.ca.gov/phpps/pdcp>  
E-mail: [atariq@cdfa.ca.gov](mailto:atariq@cdfa.ca.gov)

**Revision History**

- Nov. 23, 2005 --- pages 115 and 116

**NOTE:** The reports in this publication have not been subject to independent scientific review. The California Department of Food and Agriculture makes no warranty, expressed or implied, and assumes no legal liability for the information in this publication. The publication of the Proceedings by CDFA does not constitute a recommendation or endorsement of products mentioned.

## TABLE OF CONTENTS

<b>Section 1: Crop Biology and Disease Epidemiology</b>
---

<b>Significance of Riparian Plants as Reservoirs of <i>Xylella fastidiosa</i> for Infection of Grapevines by the Blue-green Sharpshooter</b> Kendra Baumgartner.....	3
<b>Functional Genomics of the Grape-<i>Xylella</i> Interaction: Towards the Identification of Host Resistance Determinants</b> Douglas Cook .....	7
<b>Evaluation of Signal Sequences for the Delivery of Transgene Products into the Xylem</b> Abhaya M. Dandekar.....	12
<b>Isolation and Functional Testing of Pierce’s Disease-Specific Promoters from Grape</b> David Gilchrist, Douglas Cook, and James E. Lincoln.....	15
<b>Evaluation of Genes Isolated by a Functional Genetic Screen for Suppression of Bacterial Growth or Symptoms in Pierce’s Disease</b> David Gilchrist and James E. Lincoln .....	18
<b>Epidemiology of Pierce’s Disease in the Central San Joaquin Valley of California: Factors Affecting Pathogen Distribution and Movement</b> Russell L. Groves and Jianchi Chen .....	22
<b>The Effect of Dormant Season Survival of <i>Xylella fastidiosa</i> in Grapevines on Pierce’s Disease Epidemics in California</b> Barry L. Hill .....	26
<b>Glassy-winged Sharpshooter Impact on ‘Washington’ Navel Orange Yield, Fruit Size, and Quality</b> Raymond L. Hix .....	30
<b>Linking the Model of the Development of Pierce’s Disease in Grapevines to an Understanding of the Dynamics of Glassy-winged Sharpshooter Transmission of <i>Xylella fastidiosa</i> to Grapevines and Grapevine Gene Expression Markers of Pierce’s Disease</b> John Labavitch, Elaine Backus, Mark Matthews, and Ken A. Shackel .....	34
<b>Characterization and Identification of Pierce’s Disease Resistance Mechanisms: Analysis of Xylem Anatomical Structures and of Natural Products in Xylem Sap among <i>Vitis</i></b> Hong Lin.....	39
<b>Developing Transcriptional Profiles and Gene Expression Analysis of Grape Plant Response to <i>Xylella fastidiosa</i></b> Hong Lin.....	43
<b>Comparative Proteomic Analysis of Stem Tissue and Xylem Sap from Pierce’s Disease Resistant and Susceptible Grapevines</b> Hong Lin and Felix Fritschi.....	47
<b>Epidemiological Analyses of Glassy-winged Sharpshooter and Pierce’s Disease Data</b> Thomas M. Perring .....	50
<b>Improving Our Understanding of Substance Transport Across Graft Unions</b> Bruce I. Reisch and Peter Cousins.....	54

<b>Testing Transgenic Grapevines for Resistance to Pierce’s Disease</b> Bruce I. Reisch and Julie R. Kikkert.....	58
<b>Mechanisms of Pierce’s Disease Transmission in Grapevines: The Xylem Pathways and Movement of <i>Xylella fastidiosa</i>. Xylem Structure and Connectivity in Grapevine Shoots Suggests a Passive Mechanism for the Systemic Spread of Bacteria in Grape Plants Infected with Pierce’s Disease</b> Thomas L. Rost and Mark A. Matthews .....	62
<b>Magnetic Resonance Imaging: A Non-destructive Approach for Detection of Xylem Blockages in <i>Xylella fastidiosa</i> Infected Grapevines</b> Ken A. Shackel and John Labavitch .....	66
<b>Map-based Identification and Positional Cloning of <i>Xylella fastidiosa</i> Resistance Genes from Known Sources of Pierce’s Disease Resistance in Grape</b> Andrew Walker and Summaira Riaz.....	72
<b>Breeding Pierce’s Disease Resistant Winegrapes</b> Andrew Walker and Alan Tenschler .....	77
<b><u>Abstract Only</u></b>	
<b>Variation of <i>Xylella fastidiosa</i> Colonization in Tolerant and Susceptible Grape Cultivars</b> Dulce Carbajal and Lisa Morano .....	81

<p><b>Section 2:</b> <b>Vector Biology and Ecology</b></p>
--

<b>Where, When, and How Do Ingestion and Other Feeding Behaviors of the Glassy-winged Sharpshooter Allow Inoculation of <i>Xylella fastidiosa</i>?</b> Elaine Backus .....	85
<b>Monitoring the Seasonal Incidence of <i>Xylella fastidiosa</i> in Glassy-winged Sharpshooter Populations</b> Steve Castle.....	89
<b>Development of an Artificial Diet for the Glassy-winged Sharpshooter</b> Thomas A. Coudron.....	93
<b>Biology and Ecology of the Glassy-winged Sharpshooter in the San Joaquin Valley</b> Kent M. Daane and Marshall W. Johnson .....	97
<b>Effect of Host Plant Fertilization on the Developmental Biology and Feeding Preference of the Glassy-winged Sharpshooter</b> John A. Goolsby .....	101
<b>Dispersal and Movement of the Glassy-winged Sharpshooter and Associated Natural Enemies in a Continuous, Deficit-Irrigated Agricultural Landscape</b> Russell L. Groves, Marshall W. Johnson, James Hagler, and Robert Luck.....	105
<b>Progress Toward Quantifying Landscape-Scale Movement Patterns of the Glassy-winged Sharpshooter and Its Natural Enemies Using a Novel Mark-Capture Technique</b> James Hagler, Jackie Blackmer, Thomas Henneberry, Russell Groves, and Kent Daane.....	109

<b>Spatial Population Dynamics and Overwintering Biology of the Glassy-winged Sharpshooter in California’s San Joaquin Valley</b> Marshall W. Johnson, Kent Daane, Russell Groves, and Elaine Backus.....	113
<b>Population Dynamics and Interactions Between the Glassy-winged Sharpshooter and Its Host Plants in Response to California Phenology</b> Russell F. Mizell, III, Peter C. Andersen, and Phil A. Phillips.....	117
<b>Relationship Between Olfactory and Visual Stimuli During Host Plant Recognition in Immature and Adult Glassy-winged Sharpshooters</b> Joseph M. Patt and Mamoudou Sétamou.....	122
<b>Effects of Feeding Substrate on Retention and Transmission of <i>Xylella fastidiosa</i> Strains by the Glassy-winged Sharpshooter</b> Thomas M. Perring, Heather S. Costa, and Donald A. Cooksey .....	124
<b>Evaluation of Blue-green Sharpshooter Flight Height</b> Ed Weber .....	128
<b>Reproductive Biology and Physiology of Female Glassy-winged Sharpshooters: Effect of Host Plant Type on Fecundity and Development</b> Frank G. Zalom, Christine Y.S. Peng, and Natalie A. Hummel .....	131
<b>Reproductive Biology and Physiology of Female Glassy-winged Sharpshooters: Morphology and Vitellogenesis Cycles</b> Frank G. Zalom, Christine Y.S. Peng, and Natalie A. Hummel .....	135

<p><b>Section 3:</b> <b>Pathogen Biology and Ecology</b></p>
--

<b>Xylem Chemistry Mediation of Resistance to Pierce’s Disease</b> Peter C. Andersen and Breno Leite.....	141
<b>Quantitative Aspects of the Transmission of <i>Xylella fastidiosa</i> by the Glassy-winged Sharpshooter</b> Blake Bextine, Matthew J. Blua, and Thomas A. Miller.....	145
<b>Aspects of Pierce’s Disease Risk in Texas</b> Mark C. Black and James S. Kamas.....	150
<b>Evaluation of Single Nucleotide Polymorphisms and Sample Preparation Procedures in the Detection of <i>Xylella fastidiosa</i> Strains Important to California</b> Jianchi Chen and Edwin L. Civerolo .....	152
<b>Culture-Independent Analysis of Endophytic Microbial Communities in Grapevine in Relation to Pierce’s Disease</b> Donald A. Cooksey and James Borneman.....	155
<b>Role of Type I Secretion in Pierce’s Disease</b> Dean W. Gabriel.....	158
<b>Evaluating the Roles of Pili in Twitching and Long Distance Movement of <i>Xylella fastidiosa</i> in Grape Xylem and in the Colonization of Sharpshooter Foregut</b> Harvey C. Hoch and Thomas J. Burr.....	162

<b>Characterization of PD0528: A Potential Type V Autotransporter in the <i>Xylella fastidiosa</i> Outer Membrane</b> Michele M. Igo .....	166
<b>Multi-locus Simple Sequence Repeat (SSR) Markers for Genotyping and Assessing Genetic Diversity of <i>Xylella fastidiosa</i> in California</b> Hong Lin .....	170
<b>Effects of Fimbrial (FimA, FimF) and Afimbrial (XadA, HxfB) Adhesins on the Adhesion of <i>Xylella fastidiosa</i> to Surfaces</b> Steven E. Lindow .....	173
<b>Role of Unique Genes of <i>Xylella fastidiosa</i> Grape Strain in Host Specificity and Virulence to Grape and to Insect Using Microarray</b> Steven E. Lindow and William S. Feil .....	177
<b>Multi-locus Sequence Typing (MLST) to Identify Reservoirs of <i>Xylella fastidiosa</i> Diversity in Natural Hosts in California</b> Robert F. Luck, Richard Stouthamer, Danel Vickerman, Leonard Nunney, and Donald A. Cooksey .....	181
<b>A Genome-wide Approach to Plant-Host Pathogenicity in <i>Xylella fastidiosa</i>: Multigenic Methods for Identifying Strains, for Studying the Role of Inter-strain Recombination, and for Identifying Pathogenicity Candidate Genes</b> Leonard Nunney .....	185
<b>Effects of Chemical Milieu on Attachment, Aggregation, Biofilm Formation, and Vector Transmission of <i>Xylella fastidiosa</i> Strains</b> Alexander H. Purcell .....	189
<b>A Screen for <i>Xylella fastidiosa</i> Genes Involved in Transmission by Insect Vectors</b> Alexander H. Purcell and Steven E. Lindow .....	193
<b>Patterns of <i>Xylella fastidiosa</i> Infection in Plants and Effects on Acquisition by Insect Vectors</b> Alexander H. Purcell and Steven E. Lindow .....	196
<b>Documentation and Characterization of <i>Xylella fastidiosa</i> Strains in Landscape Hosts</b> Frank Wong, Donald A. Cooksey, and Heather S. Costa .....	200
<b>Plasmid Addition as a Novel Approach to Develop a Stable Plasmid Vector for <i>Xylella fastidiosa</i></b> Glenn M. Young and Michele Igo .....	208
<b><u>Abstract Only</u></b>	
<b>Responses of <i>Nicotiana tabacum</i> cv. SR-1 to <i>Xylella fastidiosa</i> Strains</b> Marta Francis, Edwin L. Civerolo, and George E. Bruening .....	211
<b>Twitching Motility among Various Wild-Type Isolates and Pilus-Defective Mutants of <i>Xylella Fastidiosa</i></b> Harvey C. Hoch and Thomas J. Burr .....	211
<b>Comparative Study of <i>Xylella fastidiosa</i> Surface Proteins Exhibiting High Contents Cysteine Residues: Impact in Pathogenicity</b> Breno Leite, Peter C. Andersen, and Maria L. Ishida .....	212
<b>Induction of Aggregation <i>In Vitro</i> of <i>Xylella fastidiosa</i> Cells by Divalent Ions</b> Breno Leite, Peter C. Andersen, and Elliot W. Kitajima .....	212
<b>The Influence of the Cell Suspension Redox Potential on the Capacity of <i>Xylella fastidiosa</i> to Aggregate</b> Breno Leite and Peter C. Andersen .....	213
<b><i>Xylella fastidiosa</i> Growth on CHARD2, 3G10R, and XF-26 Chemically-defined Media</b> Breno Leite, Lyriam Marques, Peter C. Andersen, and Merle Olson .....	213

<b>Identification of Traits of <i>Xylella fastidiosa</i> Conferring Virulence to Grape and Insect Transmission by Analysis of Global Gene Expression Using DNA Microarrays</b> Steven Lindow .....	214
<b>Evaluation of Genetic Diversity within <i>Xylella fastidiosa</i> Strains Across Texas</b> Marlin Mathews, Borislava Tsanova, and Lisa Morano .....	214
<b>Genes Required for Type IV Pili Formation and Twitching Motility in <i>Xylella fastidiosa</i></b> Y. Li, G. Hao, C. D. Galvani, Y. Meng, T. J. Burr, and H. C. Hoch .....	215

<p><b>Section 4:</b> <b>Pathogen and Disease Management</b></p>
---

<b>Symbiotic Control of Pierce’s Disease: Testing Reagents Against <i>Xylella fastidiosa</i></b> Arinder K. Arora, Timothy S. Yolo, and Thomas A. Miller .....	219
<b>Exploiting <i>Xylella fastidiosa</i> Proteins for Pierce’s Disease Control</b> George Bruening and Edwin L. Civerolo .....	221
<b>Siderophore Production of <i>Alcaligenes xylooxidans denitrificans</i> and Potential Biological Control Against <i>Xylella fastidiosa</i></b> Surachet Chareonkajonchai, Paulo Teixeira Lacava, and Thomas A. Miller .....	225
<b>Effects of Group, Cultivar, and Climate on the Establishment and Persistence of <i>Xylella fastidiosa</i> Infections Causing Almond Leaf Scorch</b> Kent M. Daane and Alexander Purcell .....	226
<b>Importance of Ground Vegetation in the Dispersal and Overwintering of <i>Xylella fastidiosa</i></b> Kent M. Daane and Alexander Purcell .....	229
<b>Design of Chimeric Anti-microbial Proteins for Rapid Clearance of <i>Xylella</i></b> Abhaya M. Dandekar, Goutam Gupta, Karen McDonald, and Elizabeth Hong-Geller .....	233
<b>Evaluation of Grapevine Endophytic Bacteria for Control of Pierce’s Disease</b> Bruce Kirkpatrick .....	237
<b>Identification of Mechanisms Mediating Cold Therapy of <i>Xylella fastidiosa</i> Infected Grapevines</b> Bruce Kirkpatrick .....	242
<b>Interaction Between <i>Xylella fastidiosa</i> and <i>Curtobacterium flaccumfaciens</i>, an Endophytic Bacterium</b> Paulo T. Lacava, João Lúcio Azevedo, and John S. Hartung .....	247
<b>Soluble Forms of an Anti-<i>Xylella</i> Antibody and Strains of <i>Alcaligenes xylooxidans denitrificans</i> Capable of Secreting Them</b> David Lampe .....	251
<b>Ecological and Genetic Characteristics Associated with <i>Alcaligenes xylooxidans denitrificans</i></b> Carol R. Lauzon .....	254
<b>Management of Pierce’s Disease of Grape by Interfering with Cell-Cell Communication in <i>Xylella fastidiosa</i></b> Steven E. Lindow .....	258
<b>Environmental Fate of a Genetically Marked Endophyte in Grapevines</b> Thomas A. Miller .....	263



<b>Genotypic Characterization of <i>Alcaligenes xylooxidans</i> subsp. <i>denitrificans</i> (Axd Hc01) and Four Related Strains</b>		
Jennifer Parker and Thomas A. Miller .....	266	
<b>Development of a Field Sampling Plan for Glassy-winged Sharpshooter Vected Pierce’s Disease</b>		
Thomas M. Perring, Jennifer Hashim, and Carmen Gispert.....	269	
<b>Fate of a Genetically Modified Bacterium in the Foregut of the Glassy-winged Sharpshooter</b>		
Jose Luis Ramirez and Thomas A. Miller.....	273	
<b>Fate of <i>Xylella fastidiosa</i> in the Foregut of Glassy-winged Sharpshooters Fed on Two Host Plants</b>		
Jose Luis Ramirez and Thomas A. Miller.....	276	
<b><u>Abstract Only</u></b>		
<b>Inhibition of <i>Xylella fastidiosa</i> Biofilm Formation via Metal Chelators</b>		
Mipha L. Koh and Jeffrey H. Toney .....	279	
<b>Site-directed RPFA Gene Disruption in <i>Xylella fastidiosa</i>: Effect on Biofilm Formation via Quorum Sensing in Pierce’s Disease</b>		
Janice D. Thomas and Jeffrey H. Toney .....	279	
<table border="1" style="margin: 20px auto; width: 30%; border-collapse: collapse;"> <tr> <td style="text-align: center; padding: 10px;"> <b>Section 5: Vector Management</b> </td> </tr> </table>		<b>Section 5: Vector Management</b>
<b>Section 5: Vector Management</b>		
<b>Manipulation of <i>Hirsutella</i> as a Biological Control of the Glassy-winged Sharpshooter</b>		
Drion Boucias and Russell F. Mizell, III .....	283	
<b>Characterization of Neonicotinoids and Their Plant Metabolites in Citrus Trees and Grapevines, and Evaluation of Their Efficacy Against the Glassy-winged Sharpshooter and the Egg Parasitoid <i>Gonatocerus ashmeadi</i></b>		
Frank J. Byrne and Nick C. Toscano .....	287	
<b>Evaluation of Resistance Potential in the Glassy-winged Sharpshooter Using Toxicological, Biochemical, and Genomics Approaches</b>		
Frank J. Byrne, Nick C. Toscano, Brian Federici, and Cynthia LeVesque.....	290	
<b>Development of Molecular Diagnostic Markers for Glassy-winged and Smoketree Sharpshooters for Use in Predator Gut Content Examinations</b>		
Jesse H. de León, Valerie Fournier, James R. Hagler, and Kent Daane.....	293	
<b>The Utility of Inter-simple Sequence Repeat Polymerase Chain Reaction to Distinguish Geographic Populations of the Smoketree Sharpshooter and Egg Parasitoid Species of the Genus <i>Gonatocerus</i></b>		
Jesse H. de León, James R. Hagler, Guillermo Logarzo, and David J.W. Morgan.....	298	
<b>Discovery of a Cryptic Species Complex in <i>Gonatocerus morrilli</i>, a Primary Egg Parasitoid of the Glassy-winged Sharpshooter</b>		
Jesse H. de León, Walker A. Jones, Mamoudou Sétamou, and David J.W. Morgan.....	302	
<b>Small-scale Post-release Evaluations of a <i>Gonatocerus morrilli</i> Program in California Against the Glassy-winged Sharpshooter: Utility of Developed Molecular Diagnostic Tools</b>		
Jesse H. de León and David J.W. Morgan .....	306	
<b>The Alimentary Track of the Glassy-winged Sharpshooter as a Target for Control of Pierce’s Disease and Development of Mimetic Insecticidal Peptides for Glassy-winged Sharpshooter Control</b>		
Brian A. Federici.....	310	

<b>Identifying Key Predators of the Various Glassy-winged Sharpshooter Lifestages</b> Valerie Fournier, James Hagler, Kent Daane, and Jesse de León.....	314
<b>Exploration for Biological Control Agents in the Native Range of the Glassy-winged Sharpshooter</b> John Goolsby .....	318
<b>Progress Toward Developing a Novel Immunological Approach for Quantifying Predation Rates on the Glassy-winged Sharpshooter</b> James Hagler, Thomas Henneberry, Russell Groves, Valerie Fournier, Kent Daane, and Marshall Johnson .....	321
<b>Oviposition and Native Parasitoids of the Blue-green Sharpshooter, and Host Specificity of <i>Gonatocerus ashmeadi</i> on the Smoketree Sharpshooter and the Blue-green Sharpshooter</b> Mark S. Hoddle.....	325
<b>Realized Lifetime Parasitism of Glassy-winged Sharpshooter Egg Masses by <i>Gonatocerus ashmeadi</i></b> Mark S. Hoddle.....	330
<b>Reproductive and Developmental Biology of <i>Gonatocerus ashmeadi</i>, an Egg Parasitoid of the Glassy-winged Sharpshooter</b> Mark S. Hoddle.....	334
<b>Is the Glassy-winged Sharpshooter Parasitoid <i>Gonatocerus morrilli</i> One Species or a Complex of Closely Related Sibling Species?</b> Mark S. Hoddle and Richard Stouthamer .....	338
<b>Maintaining and Evaluating Quarantine Cultures of <i>Gonatocerus</i> spp., Promising Egg Parasitoids from Argentina and Mexico, for the Classical Biological Control of the Glassy-winged Sharpshooter in California</b> Mark S. Hoddle and Serguei V. Triapitsyn.....	341
<b>Environmental Risk Assessment of Egg Parasitoids from South America: Nontarget Field and Laboratory Host Range in Argentina and the United States</b> Walker A. Jones, Guillermo A. Logarzo, Eduardo G. Virla, and Erica Luft .....	343
<b>Evaluation of Some Fungal Pathogens for Control of the Glassy-winged Sharpshooter</b> Harry K. Kaya.....	345
<b>The Influence of Temperature on Development and Reproduction of the Egg Parasitoid <i>Gonatocerus ashmeadi</i></b> Roger A. Leopold .....	349
<b>Refrigerated Storage of Glassy-winged Sharpshooter Eggs Used for Propagation of the Parasitoid <i>Gonatocerus ashmeadi</i></b> Roger A. Leopold .....	354
<b>Glassy-winged Sharpshooter's (GWSS) Population Dynamics as a Means of Gaining Insight into the Management of GWSS Populations</b> Robert F. Luck.....	359
<b>Effects of Juvenile Hormone Analogs on Survival and Reproduction Status of the Glassy-winged Sharpshooter</b> Russell F. Mizell, III, and Peter C. Andersen .....	364
<b>Mycopathogens and Their Exotoxins Infecting the Glassy-winged Sharpshooter: Survey, Evaluation, and Storage</b> Russell F. Mizell, III, and Drion G. Boucias .....	367
<b>Seasonal Population Dynamics of Glassy-winged Sharpshooter Egg Parasitoids: Variability Across Sites and Host Plants</b> Joseph G. Morse .....	370

<b>The <i>Anagrus epos</i> Complex: A Likely Source of Effective Classical Biological Control Agents for Glassy-winged Sharpshooter Control</b>	
Joseph G. Morse and Richard Stouthamer .....	373
<b>Area-wide Pest Management of the Glassy-winged Sharpshooter in Tulare County</b>	
Beth Stone-Smith, Judy Stewart-Leslie, Gary Kunkel, Sean Hardy, Bill Appleby, Don Borges, Dennis Haines, and Jesse Churchill .....	376
<b>Laboratory and Field Evaluations of Neonicotinoid Insecticides Against the Glassy-winged Sharpshooter</b>	
Nick C. Toscano and Frank J. Byrne .....	380
<b>Riverside County Glassy-winged Sharpshooter Area-wide Management Program in the Coachella and Temecula Valleys</b>	
Nick C. Toscano and Carmen Gispert.....	384
<b>Compatibility of Select Insecticides with Natural Enemies of the Glassy-winged Sharpshooter and Other Pests</b>	
Nick C. Toscano, Joseph G. Morse, and Timothy J. Henneberry .....	388
<b>Preparing and Submitting for Publication a Pictorial, Annotated Key to <i>Gonatocerus</i> Species and Other Genera and Species of Mymaridae (Hymenoptera) - Egg Parasitoids of <i>Homalodisca</i> spp. and Other Proconiine Sharpshooters in North America, with Emphasis on the Species Native or Introduced to California</b>	
Serguei V. Triapitsyn .....	392
<b>Optimization of Admire Applications in North Coast Vineyards</b>	
Ed Weber, Frank J. Byrne, and Nick C. Toscano .....	395
<b>AUTHOR INDEX .....</b>	<b>399</b>

---

---

***Section 1:  
Crop Biology  
and Disease  
Epidemiology***





# SIGNIFICANCE OF RIPARIAN PLANTS AS RESERVOIRS OF *XYLELLA FASTIDIOSA* FOR INFECTION OF GRAPEVINES BY THE BLUE-GREEN SHARPSHOOTER

**Project Leader:**  
Kendra Baumgartner  
USDA, ARS  
Davis, CA 95616

**Cooperator:**  
Alexander H. Purcell  
Division of Insect Biology  
University of California  
Berkeley, CA 94720

**Reporting Period:** The results reported here are from work conducted April 1, 2004 to March 31, 2005.

## ABSTRACT

On California's North Coast, plant species in natural habitats adjacent to vineyards, namely riparian areas, are non-crop hosts of *Xylella fastidiosa* (*Xf*). The importance of a riparian host as a pathogen reservoir is related to its ability to support pathogen populations and its attractiveness to the vector, *Graphocephala atropunctata* (blue-green sharpshooter [BGSS]). We quantified BGSSs on five species (California blackberry, California grapevine, elderberry, Himalayan blackberry, periwinkle) of naturally-established plants adjacent to vineyards. We assessed the ability of the same species to support *Xf*, using controlled inoculations of potted plants kept in screenhouses in the field. No species were characterized by both an abundance of BGSSs and a high frequency of *Xf* detection. A 71% frequency of *Xf* detection in periwinkle suggests that, regardless of having the fewest BGSS (0.4 nymphs and 0.9 adults per sample), infrequent visitations may result in a high acquisition rate. California grapevine supported eight times as many nymphs and three times as many adults as periwinkle, suggesting that frequent visitations may offset its significantly lower infection rate (19%). California blackberry, elderberry, and Himalayan blackberry are likely less important pathogen reservoir because *Xf* was infrequently detected in their tissues and they hosted few BGSSs.

## INTRODUCTION

In the north-coastal grape-growing region of California, *Xylella fastidiosa* (*Xf*), the bacterium that causes Pierce's disease (PD) (Freitag 1951), is spread to grapevines by a native vector, *Graphocephala atropunctata* (Signoret) (Hemiptera: Cicadellidae) (blue-green sharpshooter [BGSS]; Hewitt et al. 1949; Purcell 1975). Purcell (1974, 1975) demonstrated a direct relationship between incidence of PD and proximity to riparian vegetation bordering vineyards. The distribution of diseased grapevines is associated with a high concentration of BGSS in spring in vinerows adjacent to riparian vegetation, which serves as feeding and reproductive habitat for the BGSS (Hewitt et al. 1949; Purcell 1975). Not only do some riparian plants provide habitat for BGSSs, but they also host *Xf* (Wells et al. 1987).

The spread of *Xf* from riparian hosts to grapevines is, in part, a function of the proportion of BGSSs that acquire the pathogen when feeding on infected riparian hosts. Acquisition of *Xf* is directly related to the concentration of the pathogen within the host. The minimum threshold for acquisition is  $10^4$  CFU of *Xf* per gram of plant tissue, increases above which result in proportionally higher transmission rates (Hill and Purcell 1997). Baumgartner and Warren (2005) found that *Rubus discolor* Weihe & Nees (Himalayan blackberry), *Vinca major* L. (periwinkle), and *Vitis californica* Benth. (California grapevine) supported populations  $\geq 10^4$  CFU/g tissue, whereas *R. ursinus* Cham. & Schldl. (California blackberry) and *Sambucus mexicana* C. Presl (elderberry) did not. California grapevine, Himalayan blackberry, and periwinkle may be more important as pathogen reservoirs not only due to the high pathogen populations they support during part of the year (Baumgartner and Warren 2005), but also because they are systemic hosts of *Xf* (Purcell and Saunders 1999).

The importance of a riparian host as a pathogen reservoir is determined by the pathogen populations it supports and by the frequency of visitation by the vector. A common riparian host of *Xf* that is fed upon frequently by the BGSS likely will contribute more to the spread of PD because there will be more opportunities for acquisition of the pathogen from infected tissue. In this regard, it is noteworthy that some of the same riparian hosts that were previously recognized in field surveys as feeding hosts of the BGSS (Purcell 1976; Raju et al. 1983), namely California grapevine, Himalayan blackberry, and periwinkle, have since been identified as hosts in which *Xf* reaches high populations (Baumgartner and Warren 2005; Purcell and Saunders 1999).

## OBJECTIVES

The goal of our research was to identify riparian hosts of greatest importance in the transmission of *Xf* to grapevines in the north-coastal grape-growing region of California. Our first objective was to determine if the BGSS is more abundant on some riparian hosts than others. We measured abundance of adults and nymphs in riparian areas adjacent to vineyards on five feeding and reproductive hosts: California blackberry, California grapevine, elderberry, Himalayan blackberry, and periwinkle. All five hosts are potentially important in the spread of PD because they are also systemic hosts of *Xf* (Purcell and Saunders 1999). Our second objective was to examine a possible relationship between the ability of riparian hosts to support both the BGSS and *Xf*. To address this second objective, we inoculated plants of the same riparian host species with *Xf*, transferred them to the field after confirming infection, and tested them afterwards for the presence of the pathogen. This approach was preferable to testing for *Xf* in the same naturally-established plants that we examined for BGSSs because (i) our

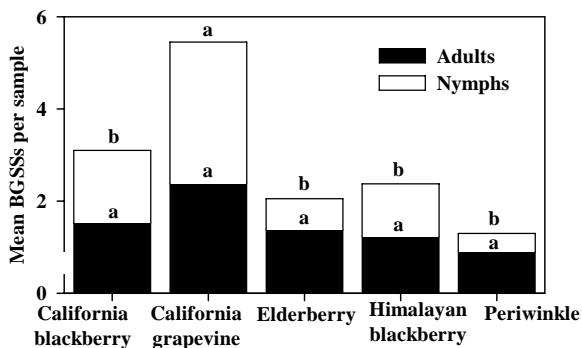
inoculation technique ensured that all plants were challenged by the pathogen; (ii) by sampling tissues distal to the inoculation site, *Xf*-positive identifications were known to represent systemic infections; and (iii) plants were inoculated once and, therefore, the presence of *Xf* was known to result from a single infection. In other words, our approach did not rely on natural infection by the BGSS, which likely reflects not only the hosts' abilities to maintain *Xf* infections, but also BGSS feeding behavior.

## RESULTS

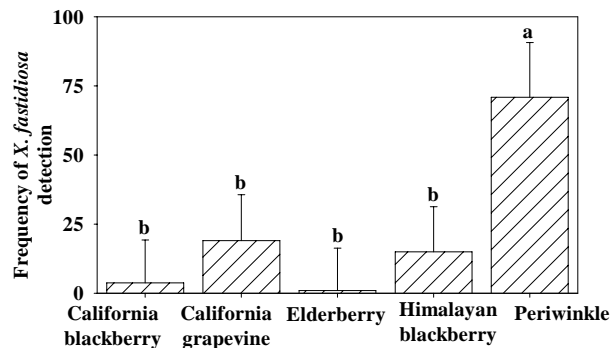
Abundance of nymphs varied significantly among species ( $P < 0.0001$ ). Nymphs were significantly more abundant on California grapevine which had a mean of 3.1 nymphs per sample, compared to all other hosts, but especially compared to periwinkle and elderberry, which had means of 0.4 nymphs per sample and 0.7 nymphs per sample, respectively (Figure 1). Abundance of adults was not significantly different among species ( $P = 0.0676$ ). California grapevine, the species with the most nymphs, also had the most adults, 2.4 per sample (Figure 1). In contrast, periwinkle, the species with the fewest nymphs, also had the fewest adults, 0.9 per sample (Figure 1).

Frequency of detection of *Xf* varied significantly among species ( $P < 0.0001$ ). Periwinkle had the highest frequency of detection with 70.8% of all tested plants, averaged across three sampling periods, found to be *Xf*-positive (Figure 2). Frequency of detection of *Xf* did not vary significantly between the two detection methods, colony counts in culture and real-time PCR ( $P = 0.09$ ). Results from both detection methods showed the same relative differences among species; the interaction of species x detection method was not significant ( $P = 0.3582$ ). For example, periwinkle had the highest percentage of plants that were found to be *Xf*-positive by culture (113 out of 160 total samples tested, summed across sampling periods) and by real-time PCR (140 out of 160 total samples tested, summed across sampling periods). In contrast, none of the 202 culture attempts from elderberry samples yielded *Xf* colonies, and real-time PCR analyses of the same tissues resulted in only six *Xf*-positive samples.

Despite the lack of statistical significance for differences in abundance of adults among riparian hosts from ANOVA ( $P = 0.07$ ), there was a significant positive correlation between abundance of adults and nymphs ( $r = 0.96$ ,  $P = 0.01$ ). Samples with many nymphs also had many adults (Figure 3). There were no correlations between detection frequency of *Xf* and abundance of adults ( $r = -0.44$ ,  $P = 0.45$ ) or nymphs ( $r = -0.34$ ,  $P = 0.58$ ).

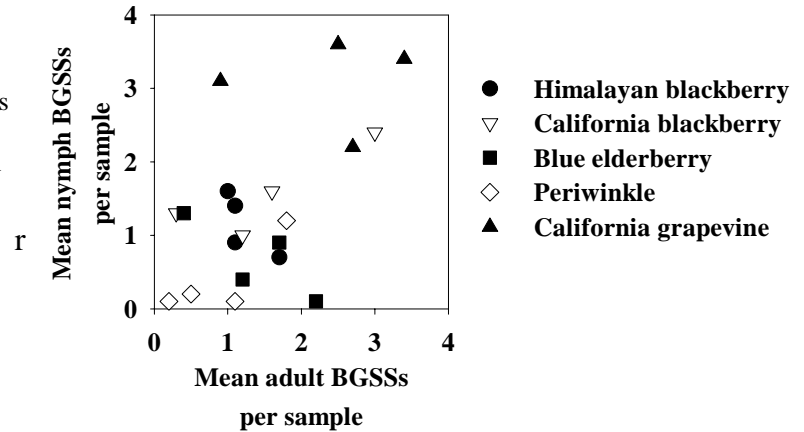


**Figure 1.** Abundance of BGSSs on naturally-established riparian hosts adjacent to vineyards in northern California. A sample consisted of 25 sweeps per plant;  $n = 13$  to 95 samples per species per year. Each column is the sum of the mean number of adults and nymphs per sample per species, averaged over years. Columns within each life stage with different letters are significantly different at  $P \leq 0.05$  (Tukey's test).



**Figure 2.** Frequency of detection of *Xf* from riparian hosts. Plants were inoculated in the greenhouse. Infected plants were placed in the field and subsequently tested at 3, 11, & 13 mos., by culture and real-time PCR;  $n = 45$ -76 plants per species per sampling period. Each column is the mean percentage of plants that were *Xf*-positive, averaged over sampling periods and detection methods. Columns with different letters are significantly different at  $P \leq 0.05$  (Tukey's test).

**Figure 3.** Correlation of abundance of adult BGSSs with mean abundance of nymph BGSSs ( $r=0.96$ ,  $P=0.0093$ ) on naturally-established riparian hosts adjacent to vineyards in northern California. A sample consisted of 25 sweeps per plant;  $n=13$  to 95 samples per species per year. Each symbol represents abundance of BGSSs per sample per species per year.



### CONCLUSIONS

We measured abundance of the BGSS on five species (California blackberry, California grapevine, elderberry, Himalayan blackberry, and periwinkle) of naturally-established plants in riparian areas adjacent to vineyards on the North Coast of California. We assessed the ability of the same species to support *Xf*, based on results from controlled inoculations of potted plants kept in screenhouses in the field. None of the species were characterized by both an abundance of BGSSs and a high frequency of *Xf* detection. California grapevine and periwinkle may be more important pathogen reservoirs than California blackberry, elderberry, and Himalayan blackberry. Despite a significantly lower frequency of *Xf* detection in California grapevine, 19%, this species supported eight times as many nymphs and three times as many adults as periwinkle, suggesting that more frequent visitations by the BGSS may result in a high probability of acquisition of *Xf* from California grapevine. While periwinkle supported the fewest BGSSs, 71% of tested plants were *Xf*-positive, suggesting that a high percentage of transmission events result in systemic infection and that infrequent visitation by the vector may, nonetheless, result in a high acquisition rate. California blackberry, elderberry, and Himalayan blackberry are likely less important pathogen reservoirs because *Xf* was infrequently detected in their tissues and BGSSs were rare on these species.

Our finding that abundance of nymphs, but not that of adults, differed significantly among the riparian hosts we examined are consistent with those of Purcell (1976) who found that nymphs utilize fewer species than do adults. We might expect that nymph BGSSs have more restricted host ranges than adults based on different feeding requirements, as has been demonstrated for *Homalodisca coagulata* (Say) (glassy-winged sharpshooter) (Brodbeck et al. 1995), an introduced vector of PD in southern California (Blua et al. 1999). The significance of nymph BGSSs in the spread of PD is not known. Although nymphs lose infectivity after molting (Purcell and Finlay 1979), this may not preclude their importance in the epidemiology of PD relative to that of adults, which are infective for life once they acquire *Xf* (Purcell and Finlay 1979). The low mobility of nymphs, due to their flightlessness and small size, likely results in more transmission of *Xf* within an infected host than between hosts. Consequently, nymphs may spread *Xf* to new tissues within an infected host faster than the pathogen can move systemically. Systemic hosts of *Xf* on which nymphs are abundant, such as California grapevine, may support infections in more tissues than hosts on which nymphs are rare and, therefore, may serve as important sources of *Xf* for acquisition by adults.

It is possible that *Xf* infection of the species we examined through controlled inoculations are different in naturally-established plants of the same species. Natural levels of infection are related to a host's ability to support *Xf* and its attractiveness to the BGSS. California grapevine, for example, may have higher levels of infection in the field than we measured in our inoculated plants, based on the high number of BGSSs we found on this species. There are few published surveys of *Xf* in naturally-established plants (Raju et al. 1983; Raju et al. 1980). In one such study of 28 native and non-native species in riparian areas in Napa County, *Xf* was detected in only four species: Himalayan blackberry, periwinkle, *Fragaria vesca* L. (wood strawberry), and *Claytonia perfoliata* Willd. (miner's lettuce) (Raju et al. 1983). Although they surveyed California grapevine and elderberry, hosts that we also examined, their study was designed with the objective of identifying reservoir hosts, as opposed to comparing natural levels of infection among species.

Throughout the growing season, BGSSs occur in both riparian areas and vineyards (Freitag and Frazier 1954; Purcell 1975, 1976). Their whereabouts and behavior outside the growing season, when the population consists of adults (Purcell 1975; Severin 1949), are not well understood, mainly because cold temperatures limit BGSS flight activity (Feil et al. 2000) and, thus, hamper monitoring efforts. We measured BGSS abundance from spring to early summer, as this time of the year is characterized by BGSS flight activity, the presence of both adults and nymphs, and active growth of the five riparian host species we examined. Although we detected no significant differences in abundance of BGSSs on the five riparian hosts we



examined, a previous survey of 16 species in riparian areas in Napa showed that BGSSs were more common on California blackberry, California grapevine, elderberry, and Himalayan blackberry, than on periwinkle from April to July (Purcell 1976). From September to March, BGSSs were more common on periwinkle (Purcell 1976). Differences in our results may be due to differences in locations, study years, or sampling methods.

Successful long-term management of PD may require removal of certain reservoir hosts, given that insecticides do not significantly reduce the spread of the disease (Purcell 1979) and that resistant winegrape varieties are not available. Wistrom and Purcell (2005) ranked the most important reservoir hosts, in terms of vector acquisition, as those that are feeding hosts of the BGSS, are frequently infected after transmission events, are systemic hosts of *Xf*, and support high pathogen populations. Revegetation of a riparian area adjacent to a diseased vineyard offers the potential to reduce the pathogen reservoir outside the vineyard, but it may be of limited efficacy in controlling the disease when infected grapevines remain in the vineyard. Grapevines satisfy all of Wistrom and Purcell's (2005) criteria of important reservoir hosts and, thus, serve as a source of the pathogen for acquisition by BGSSs, even if riparian hosts are removed from an adjacent riparian area. Furthermore, removal of reservoir hosts may not diminish the ability of a riparian area to support BGSSs. Riparian areas are considered to be a habitat of the BGSS; they harbor many feeding and reproductive hosts (Freitag and Frazier 1954; Purcell 1975, 1976), in addition to plants that provide shelter for the overwintering adults.

## REFERENCES

- Baumgartner, K. and J. G. Warren. 2005. Persistence of *Xylella fastidiosa* in riparian hosts near northern California vineyards. *Plant Dis.* 89: 1097-1102.
- Blua, M. J., P. A. Phillips and R. A. Redak. 1999. A new sharpshooter threatens both crops and ornamentals. *California Agric.* 53: 22-25.
- Brodbeck, B. V., P. C. Andersen and R. F. Mizell. 1995. Differential utilization of nutrients during development by the xylophagous leafhopper, *Homalodisca coagulata*. *Entomol. Exp. Appl.* 75: 279-289.
- Feil, H., W. S. Feil and A. H. Purcell. 2000. Effects of temperature on the flight activity of *Graphocephala atropunctata* (Hemiptera: Cicadellidae). *J. Econ. Entomol.* 93: 88-92.
- Freitag, J. H. 1951. Host range of Pierce's disease virus of grapes as determined by insect transmission. *Phytopathology* 41: 920-934.
- Freitag, J. H. and N. W. Frazier. 1954. Natural infectivity of leafhopper vectors of Pierce's disease virus of grape in California. *Phytopathology* 44: 7-11.
- Hewitt, W. B., N. W. Frazier and J. H. Freitag. 1949. Pierce's disease investigations. *Hilgardia* 19: 207-264.
- Hill, B. L. and A. H. Purcell. 1997. Populations of *Xylella fastidiosa* in plants required for transmission by an efficient vector. *Phytopathology* 87: 1197-1201.
- Purcell, A. H. 1974. Spatial patterns of Pierce's disease in the Napa Valley. *Amer. J. Enol. Vitic.* 25: 162-166.
- Purcell, A. H. 1975. Role of the blue-green sharpshooter, *Hordnia circellata*, in the epidemiology of Pierce's disease of grapevines. *Environ. Entomol.* 4: 745-752.
- Purcell, A. H. 1976. Seasonal changes in host plant preference of the blue-green sharpshooter *Hordnia circellata* (Homoptera: Cicadellidae). *Pan-Pacif. Entomol.* 52: 33-37.
- Purcell, A. H. 1979. Control of the blue-green sharpshooter and effects on the spread of Pierce's Disease of grapevines. *J. Econ. Entomol.* 72: 887-892.
- Purcell, A. H. and A. Finlay. 1979. Evidence for noncirculative transmission of Pierce's disease bacterium by sharpshooter leafhoppers. *Phytopathology* 69: 393-395.
- Purcell, A. H. and S. R. Saunders. 1999. Fate of Pierce's Disease strains in common riparian plants in California. *Plant Dis.* 83: 825-830.
- Raju, B. C., A. C. Goheen and N. W. Frazier. 1983. Occurrence of Pierce's disease bacteria in plants and vectors in California. *Phytopathology* 73: 1309-1313.
- Raju, B. C., S. F. Nomé, D. M. Docampo, A. C. Goheen, G. Nyland and S. K. Lowe. 1980. Alternative hosts of Pierce's disease of grapevines that occur adjacent to grape growing areas in California. *Amer. J. Enol. Vitic.* 31: 144-148.
- Severin, H. H. P. 1949. Life history of the blue-green sharpshooter, *Neokolla circellata*. *Hilgardia* 19: 187-189.
- Wells, J. M., B. C. Raju, H. Y. Hung, W. G. Weisberg, L. Mandelco-Paul and D. J. Brenner. 1987. *Xylella fastidiosa* gen. nov., sp. nov.: gram-negative, xylem-limited, fastidious plant bacteria related to *Xanthomonas* spp. *Int. J. Sys. Bacteriol.* 37: 136-143.
- Wistrom, C. and A. H. Purcell. 2005. The fate of *Xylella fastidiosa* in vineyard weeds and other alternate hosts. *Plant Dis.* 89: 994-999.

## FUNDING AGENCIES

Funding for this project was provided by the USDA Agricultural Research Service, and the CDFA Pierce's Disease and Glassy-winged Sharpshooter Board.

# FUNCTIONAL GENOMICS OF THE GRAPE-*XYLELLA* INTERACTION: TOWARDS THE IDENTIFICATION OF HOST RESISTANCE DETERMINANTS

## Project Leader:

Douglas Cook  
Department of Plant Pathology  
University of California  
Davis, CA 95616

## Collaborators:

Francisco Goes da Silva and Hong Kyu Choi  
Department of Plant Pathology  
University of California  
Davis, CA 95616

Alberto Iandolino  
University of California  
Davis, CA 95616  
(Currently with Monsanto Corp.)

**Reporting Period:** The results reported here are from work conducted October 2004 to October 2005.

## ABSTRACT

*In silico* mining of EST data, Real Time PCR, and Affymetrix GeneChip technology was used to characterize the transcriptional response of *Vitis vinifera* to the Pierce's disease (PD) pathogen *Xylella fastidiosa* (*Xf*). We have determined that susceptible *V. vinifera* responds to *Xylella* infection with a massive re-direction of gene transcription. This transcriptional response includes the up regulation of transcripts for phenylpropanoid and flavonoid biosynthesis, ethylene production, adaptation to oxidative stress, and homologs of pathogenesis related (PR) proteins. In addition to highlighting potential metabolic and biochemical changes that are correlated with disease, the results suggest that susceptible genotypes respond to *Xylella* infection by induction of limited defense response.

A long-standing hypothesis states that PD results from pathogen-induced drought stress, with the consequent development of disease symptoms. To test this hypothesis, we compared the transcriptional and physiological response of plants treated by pathogen infection, low or moderate water deficit, or a combination of pathogen infection and water deficit. We determined that the transcriptional response of plants to *Xylella* infection is not the same as the response of healthy plants to moderate water stress. However, there is an apparent synergistic interaction between water stress and disease, such that water stressed plants exhibit a stronger physiological and transcriptional response to the pathogen. Qualitative and quantitative estimates of gene expression derived from the Affymetrix gene chip were confirmed by a combination of Real Time PCR and *in situ* hybridization analysis with ~20 candidate marker genes.

Real Time PCR analysis involving six marker genes was used to survey the specificity of *Xylella*-induced gene expression under field conditions. The results demonstrate that the marker genes are up-regulated in response to *Xylella* infection but not in response to the other pathogens assayed, including common viral, nematode and fungal pathogens, or by *Phylloxera* infestation or herbicide damage. Similarly, moderate drought stress did not result in increased transcript levels for these marker genes. By contrast, each of the marker genes was strongly induced in non-infected leaves where the vascular system was compromised by biotic or abiotic factors, including girdling by insect damage and severe drought stress leading to death. We hypothesize that an aspect of xylem dysfunction, but not drought stress per se, is one trigger for *Xylella*-induced gene expression.

## INTRODUCTION

All organisms adapt to external stressors by activating the expression of genes that confer adaptation to the particular stress. In the case of Pierce's disease (PD), such genes are likely to include those coding for resistance or susceptibility to *Xylella fastidiosa* (*Xf*).

Genomics technology offers an opportunity to monitor gene expression changes on a massive scale (so-called "transcriptional profiling"), with the parallel analysis of thousands of host genes conducted in a single experiment. In the case of PD of grapes, the resulting data can reveal aspects of the host response that are inaccessible by other experimental strategies. In May of 2004, the first Affymetrix gene chip was made available for public use, with ~15,700 *Vitis* genes represented. This gene chip has been developed based primarily on a collaboration between the Cook laboratory and researchers at the University of Nevada-Reno (Goes da Silva et al., 2005). With the arrival of the Affymetrix gene chip, we are poised to make a quantum leap in the identification of host gene expression in response to *Xf*.

In addition to enumerating differences between susceptible and resistant genotypes of *Vitis*, this research is testing a long-standing but largely untested hypothesis that pathogen-induced drought stress is one of the fundamental triggers of PD symptom development. The utility of this type of data will be to inform the PD research community about the genes and corresponding protein products that are produced in susceptible, tolerant and resistant interactions. Differences in the transcriptional profiles between these situations are expected to include host resistance and susceptibility genes, and thus

provide the basis for new lines of experimental inquiry focused on testing the efficacy of specific host genes for PD resistance. It should be possible, for example, to determine the extent to which resistance responses in grapes are related to well-characterized defense responses in other plant species (e.g., Maleck et al., 2002; Tao et al., 2003; de Torres et al., 2003).

Three co-lateral benefits from the identification of pathogen-induced genes are: (1) the promoters for such genes are candidates to control the expression of transgenes for resistance to PD, (2) the protein products of induced genes may have roles in disease resistance, and (3) knowledge of host gene expression can be used to develop improved diagnostic assays for disease. In a related project, we are currently characterizing pathogen-responsive promoters, which will facilitate testing of candidate genes for resistance phenotypes.

## OBJECTIVES

1. Identify genes and gene pathways in susceptible *V. vinifera* correlated with *Xf* infection: (a) identify *Xylella*-responsive genes in *V. vinifera*, (b) distinguish early from late gene expression, and (c) determine the correlation between drought stress and PD.
2. Determine host genotype effects on gene expression in response to *Xylella* infection: (a) susceptible *V. vinifera* compared to resistant genotypes of *Vitis* and *Muscadinia* species, and (b) comparison of pathogen-induced gene expression with gene expression triggered by salicylic acid and ethylene.
3. Detailed analysis of candidate genes: (a) Real Time PCR to validate candidate genes identified in objectives 1 and 2, (b) Real Time PCR to study kinetics and specificity of the host response in susceptible and resistant genotypes, and (c) *in situ* hybridization to establish precise location of plant gene expression relative to bacterial infection.

## RESULTS

### Testing the effect of plant water status on PD

Two lines of evidence suggest that plant water status may have a significant impact on the development of PD symptoms. First, it is frequently observed that well-watered plants develop reduced symptoms relative to water-stressed plants. Thus, one might expect to see an enhanced transcriptional response in plants that are both water-stressed and infected by the pathogen. Second, it has been proposed that *Xylella* infection of xylem elements obstructs water flow, leading to whole-plant water stress and consequently to symptom development. Despite the logic of this reasoning, a causal relationship between *Xylella* infection and water stress has not been established. It is noteworthy, that the “water stress” hypothesis does not explain the absence of symptoms early in the season, even though high pathogen titers can be observed at this phase of disease, and it does not explain the absence of symptoms in tolerant genotypes of grapes, which can be heavily infected by the pathogen but without disease.

The experimental design described below permits a comparison of (1) pre-symptomatic and post-symptomatic host responses, (2) drought stressed versus diseased individuals, and (3) the interaction between drought stress and pathogen infection. In total, fourteen different transcriptional states that were compared to address these issues.

The experimental design involved 42 three-year-old vines of Cabernet Sauvignon clone 8 grafted to Freedom rootstock. In the spring of 2004, potted vines were moved from greenhouse to growth chamber prior to budbreak. Subsequent to a 3 to 4 week acclimation period, vines were pruned to produce a uniform shoot architecture consisting of two shoots per plant and ten leaves per shoot. Plants were grown in a block design of 3 rows with all treatments randomized in each row. Water use was calculated by watering 5 plants to field capacity and using a mini-lysimeter to establish water usage over a 24-hour period. The resulting average value was used to define 100% estimated water use. Plants were watered either at 100% water usage, 50% water usage (mild stress), or 25% water usage (moderate stress) throughout the remainder of the experiment. For each plant, measurements were made on the second leaf opposite to cluster to infer the level of drought stress pre- and post-veraison. Gas exchange and stomatal conductance values were obtained with a Licor 6400 gas exchange analyzer.  $C^{13}:C^{12}$  ratios were measured on the same leaf samples used for transcriptional profiling to estimate long term effects of treatments on stomatal conductance, gas exchange and water use efficiency. On April 12, corresponding to full bloom, plants were either inoculated with a suspension of *Xf* or mock inoculated with water. Four weeks following inoculation, the third and fourth leaves were harvested from three plants of each treatment type. At 8 weeks following inoculation, when symptoms were evident on infected individuals, the remaining plants (3 from each treatment) were harvested. On the day of harvest for arrays the 5<sup>th</sup> leaf from each plant was destructively sampled to measure “pre-dawn” water potential. Symptom development was recorded using a visual scale.

RNA was extracted from tissue using protocols that we have optimized for quality and yield of RNA from grape (Iandolino et al., 2004). cRNA synthesis was carried out according to procedures described in the Affymetrix technical manual. Hybridization and data collection were performed using standard Affymetrix protocols, with the aid of the University of California, Davis microarray facility in the University of California, Davis Genome Center. Technical and biological replicates demonstrated highly consistent results within and between similarly treated samples. Quality control analyses were conducted using GCOS 1.2 (Affymetrix), Dchip (Li and Wong, 2001), and the Affy R package. Robust Multichip Average or RMA (Irizarre et al., 2003) was used to estimate differentially expressed genes by two different strategies: a) application of t-test and fold change filters (Sottosanto et al., 2004); and b) false discovery rate determinations using Significance

Analysis of Microarray (SAM) Data (Aubert et al., 2004). Differential regulation was assessed by comparison to uninoculated control plants grown under identical conditions.

In total, 238 genes were identified as being differentially expressed (T-test  $\alpha < 0.05$ ;  $\geq 2$ -fold induction) in response to *Xf* treatment or drought stress (Figure 1). There are 2 primary conclusions from this study: First, we have identified several genes where expression is induced strongly in diseased tissue and where drought stress does not appear to impact this transcriptional response. The majority of such genes have predicted roles in defense and cell wall metabolism. Second, a large fraction of the *Xylella*-induced transcriptome is synergistically modified in plants that are doubly-treated by pathogen infection and moderate drought stress. These genes fall into two categories: synergistically upregulated are primarily from the flavonoid biosynthesis pathway, while synergistically down regulated are primarily from the photosynthesis pathway. These results are consistent with the existence of two distinct classes of transcriptional response in grapes to *Xylella*. One response is sensitive to plant water status and results in redirection of flavonoid synthesis and photosynthesis genes, and one response is independent of plant water status leading to the activation of defense-related transcripts. Although we observed limited overlap in the genes induced in response to moderate drought stress and the genes induced in diseased tissue, we cannot rule out the possibility that a more severe drought stress may lead to an increase in the coincidence of PD and drought-associated gene expression.

As shown in Table 1, physiological measurements of the plants used for microarray analysis also suggest an additive interaction between water stress and PD. We note that the level of water stress imposed in these experiments induced an acclimation response in treated plants, as evidenced by measurements of stomatal conductance, internal CO<sub>2</sub> concentrations and transpiration rates. However, reductions to pre-dawn water potential and net assimilation rates document a clear water stress response. By contrast, pathogen infection had a strong influence on virtually all of these parameters. Moreover, drought stress combined with pathogen infection tended to increase the magnitude of change in all parameters assayed. These results suggest a reduced capacity for acclimation to water stress in infected plants and they agree well with the results of gene expression, described below.

A 2-Dimensional hierarchical cluster generated with the DChip software (Li and Wong, 2001) was used to depict the expression 238 genes that were responsive to one or more of the treatments. The most striking aspect of this particular analysis is the massive transcriptional response that occurs in infected and symptomatic plants. Major categories and/or expression patterns of genes identified so far are described briefly below.

### ***I. Disease related gene expression.***

Seventeen transcripts were annotated as disease related genes, including many pathogenesis related or PR protein genes. On average these genes were up regulated 7-fold in response to pathogen infection. Expression of these genes was not influenced by drought either in healthy or diseased plants. The sole exception are two PR protein genes that were down regulated 2.5-fold in response to drought stress, but up regulated  $>10$ -fold in response to the pathogen. These results suggest the occurrence of a pathogen-specific defense response in susceptible *V. vinifera*.

### ***II. Photosynthetic gene expression.***

One of the most common responses of plants to drought stress is a down regulation of photosynthesis. Consistent with physiological measurements, 11 photosynthesis-related transcripts were significantly down regulated in *Xylella*-infected plants. While moderate water stress had little or no effect on expression of these genes, the combination of pathogen infection and water stress resulted in an even greater reduction in gene expression compared with either treatment alone. *Xylella* causes a decrease in photosynthetic gene expression that is accentuated by reduced water availability.

### ***III. Flavonoid pathway gene expression.***

The largest transcriptional effect of *Xylella* infection was a massive re-direction of enzymes and regulatory proteins for flavonoid biosynthesis. In total, 27 genes were 4-fold upregulated in *Xylella* infected plants, compared to healthy control plants. Approximately 50% of these transcripts were induced an additional 2.5-fold when drought stress and *Xylella* infection were combined. The transcription of flavonoid pathway genes was not significantly affected by drought stress alone. *Xylella* causes an increase in flavonoid gene expression that is accentuated by reduced water availability.

### ***IV. Genes induced uniquely in the interaction between disease and drought.***

Twelve genes were unaffected by either drought or *Xylella* infection, but were significantly induced in plants that were challenged with both *Xylella* and water stress simultaneously. On average, these genes were induced 3.5-fold in double-treated plants. Annotations for these genes do not suggest function in a common pathway.

### **V. Osmotic stress and cell wall modifying enzymes.**

Eleven *Xylella*-associated transcripts have predicted roles in cell wall metabolism (e.g., expansins, enzymes involved in pectin degradation and pectin modification) or osmotic stress (e.g., galactinol synthase, dehydrin proteins and several aquaporins). These genes were induced an average of 5-fold in *Xylella* infected tissues. None of these 11 genes were up-regulated in response to water stress alone, and only the dehydrin and galactinol synthase genes showed evidence of synergy between *Xylella* and drought stress. Cell wall modification genes (expansins, pectin esterases, pectatelyases, polygalacturonases, etc.) were among the major class of water stress repressed genes in *Arabidopsis* (Bray, 2004). In the current study, these genes were induced by the pathogen, providing a possible counterpoint to the argument in favor of *Xylella*-induced drought stress.

### **CONCLUSIONS**

In summary, a wide array of genes are up regulated (or in some cases down regulated) in grapes in response to *Xylella* infection. We found limited correlation between the nature of genes induced by moderate drought stress and the genes induced by pathogen infection. Interestingly, however, the results suggest a synergistic effect of drought stress on *Xylella*-induced gene expression. We have also identified numerous genes where induction was specific to the pathogen, and not synergistic with drought. This later class of genes included pathogenesis related protein genes and genes involved in plant cell wall metabolism. Ongoing experiments are using Real Time PCR to validate and extend the Affymetrix GeneChip results (data not shown) and to determine the spatial pattern of gene expression for the various classes of transcriptional response, as shown by example for gene 8946 in Figure 2.

Our earlier work with a small set of pathogen-induced genes has permitted us to characterize the kinetics and specificity of the host response to *Xylella*, and to isolate and begin the characterization of *Xylella*-responsive gene promoters. The recent results, reported above, provide a large suite of new genes and predicted biochemical pathways for investigation. We suggest that these results are a first step toward a comprehensive understanding of host responses to PD, and the relationship of disease to whole plant physiology including water relations, photosynthesis and defense responses. Our continuing work will explore in detail the relationship between gene expression in resistant and susceptible plants, and to begin more precise analysis of the spatial relationship between gene expression and pathogen localization. Moreover, we anticipate providing many additional and potentially useful gene promoters to Dave Gilchirst's project to develop a pathogen-inducible transgene system. How will these technologies help in solving PD? In the short term they will:

1. Provide gene-promoters for effective genetic engineering in grapes.
2. Inform us about the nature of host responses to *Xylella* infection.
3. Allow pathogen detection based on Real Time PCR using a "biomarker" strategy.
4. *In the long term*, transcriptional profiling will identify candidate genes and gene pathways that may confer resistance to the pathogen (*Xf*).

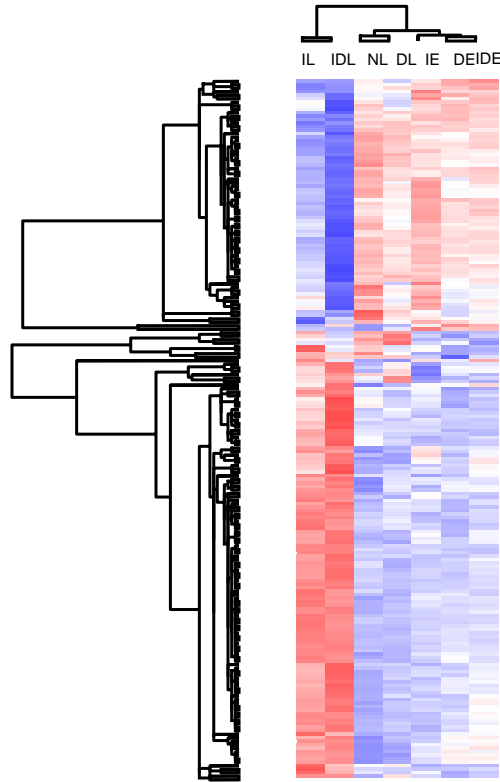
Other strategies, such as reverse genetics and analysis of natural genetic variation, will be needed to establish a causal role for candidate genes.

### **REFERENCES**

- Aubert, J., et al. 2004. Determination of the differentially expressed genes in microarray experiments using local FDR. *BMC Bioinformatics* 5:125.
- Bray, E.A. 2004. Genes commonly regulated by water-deficit stress in *Arabidopsis thaliana*. *Journal of Experimental Botany* 55:2331-2341.
- de Torres, M., et al. 2003. Expression profiling of the host response to bacterial infection: the transition from basal to induced defence responses in RPM1-mediated resistance. *The Plant Journal* 33:665-676.
- Goes da Silva, F. et al. 2005. Characterizing the grape transcriptome: Analysis of ESTs from multiple *Vitis* species and development of a compendium of gene expression during berry development *Plant Physiology* 139: *In press*.
- Iandolino, A. et al. 2004. A rapid and efficient protocol for the isolation of high-quality total RNA from grapevine (*Vitis vinifera* L.) tissues containing high concentrations of polyphenols, polysaccharides and proteins. *Plant Molecular Biology Reporter* 22:269-278.
- Irizarry, R.A., et al. 2003. Exploration, normalization, and summaries of high density oligonucleotide array probe level data. *Biostatistics* 4:249-264.
- Li, C. and Wing, W.H. 2001. Model-based analysis of oligonucleotide arrays: Expression index computation and outlier detection *PNAS* 98: 31-36.
- Maleck, K., et al. 2001. The transcriptome of *Arabidopsis thaliana* during systemic acquired resistance. *Nature Genetics* 26:403-410.
- Tao, Y., et al. 2003. Quantitative nature of *Arabidopsis* responses during compatible and incompatible interactions with the bacterial pathogen *Pseudomonas syringae*. *The Plant Cell* 15:317-330.
- Sottosanto J.B., et al. 2004 DNA array analyses of *Arabidopsis thaliana* lacking a vacuolar Na<sup>+</sup>/H<sup>+</sup> antiporter: impact of AtNHX1 on gene expression. *Plant Journal* 40:752-71.

## FUNDING AGENCIES

Funding for this project was provided by the CDFA Pierce's Disease and Glassy-winged Sharpshooter Board.

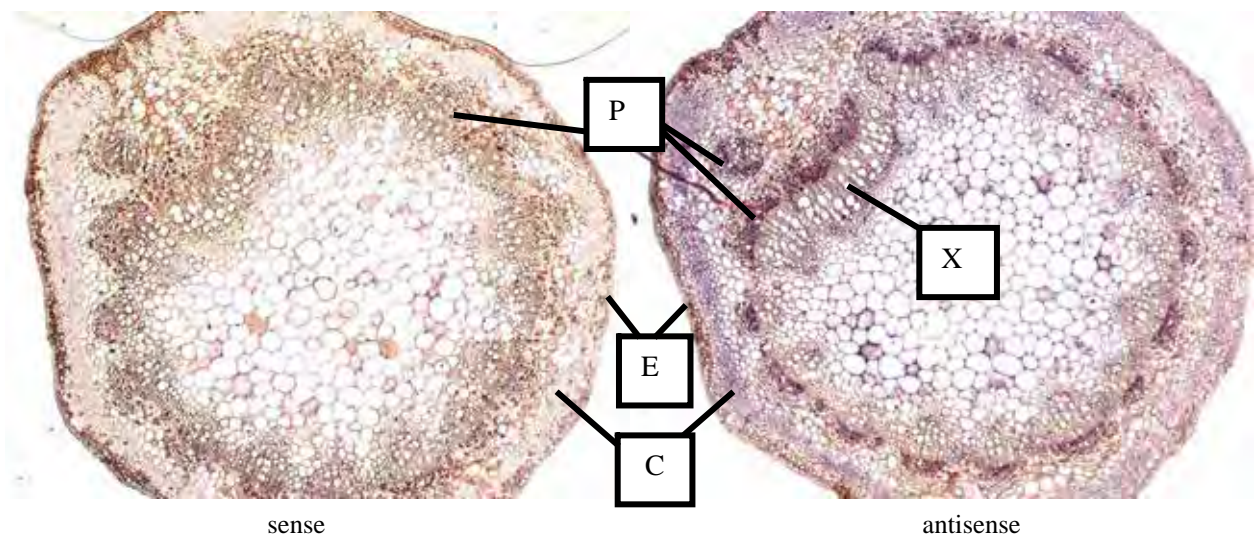


**Table 1.** Summary of physiological measurements for water relations and photosynthesis.

Treatment	plants	Physiological parameter <sup>b</sup>				
		$Y_p$	$A_{n,max}$	$g_s$	$C_i$	E
Non-inoculated	6	0.27	25.11	0.2612	1239.17	4.34
Mock-inoculated	6	0.317	25.75	0.2211	1188.34	3.79
<i>Xf</i> -inoculated	8	0.49	16.22	0.0721	817.00	1.50
Mild stress	7	0.434	19.98	0.2196	1245.00	3.78
Double treatment	8	0.583	12.14	0.0261	556.5	0.64

<sup>b</sup>Physiological parameters were measured 8 weeks after the treatment.  $Y_p$ : pre-dawn water potential (-MPa),  $A_{n,max}$ : net assimilation ( $\text{mmol CO}_2/\text{m}^2/\text{s}$ ) (measured at saturating  $\text{CO}_2$  and light),  $g_s$ : Stomatal conductance ( $\mu\text{mol H}_2\text{O}/\text{m}^2/\text{s}$ ),  $C_i$ : Internal  $\text{CO}_2$  concentration ( $\text{mmol CO}_2/\text{mol air}$ ), E: transpiration rate ( $\text{mmol H}_2\text{O}/\text{m}^2/\text{s}$ ).

**Figure 1.** 2-Dimensional hierarchical cluster analysis of 24 microarrays from the moderate drought stress condition. 238 transcripts were identified with a minimum of 2-fold induction and a T-test score of  $\alpha=0.05$ . Red = increased expression; Blue = decreased expression; White = no change in expression. I=infection; D=drought; N=healthy; E= prior to symptom development; L=subsequent to symptom development.



**Figure 2.** *In situ* localization of candidate gene 8946. Note intense staining in phloem and xylem associated pith, indicating *Xylella*-induced gene expression in living tissue adjacent to differentiated xylem.

## EVALUATION OF SIGNAL SEQUENCES FOR THE DELIVERY OF TRANSGENE PRODUCTS INTO THE XYLEM

### Project Leader:

Abhaya M. Dandekar  
Department of Plant Sciences  
University of California  
Davis, CA 95616

### Cooperators:

David Gilchrist  
Department of Plant Pathology  
University of California  
Davis, CA 95616

John Labavitch  
Department of Plant Sciences  
University of California  
Davis, CA 95616

Rejane Guimarães  
Department of Plant Pathology  
University of California  
Davis, CA 95616

Cecilia Agüero  
Department of Plant Sciences  
University of California  
Davis, CA 95616

**Reporting Period:** The results reported here are from work conducted July 2005 to September 2005.

### ABSTRACT

*Xylella fastidiosa* (*Xf*), a gram-negative bacterium, is the causative agent of Pierce's disease in grapevines. Because *Xf* is xylem-limited, it will be essential that any anti-*Xylella* gene product be present in the xylem in an effective concentration. Work on understanding the mechanism of how proteins are targeted to this plant compartment will be relevant for the delivery of therapeutic proteins into the xylem. In addition, it will be a useful tool for *Xylella* and glassy-wing sharpshooter (GWSS) gene function studies.

We collected xylem exudate from grapevines and analyzed its protein composition by two-dimensional gel electrophoresis. Peptide spectrum and Blast analysis showed that the proteins found in the exudates are secreted proteins that share function similarities with proteins found in xylem exudates of other species. The corresponding cDNA sequences of 5 of them were found in the TIGR *Vitis vinifera* gene index. The signal sequences of xylem proteins Chi1b and similar to NtPRp27 were fused to the mature pear polygalacturonase inhibiting protein (pPGIP)-encoding gene. The expression of these chimeric genes will be evaluated in transient and permanent transformations in order to evaluate their ability to target pPGIP to the xylem. The results of this research will not only be applied in projects that test anti-*Xylella* gene products that should be delivered into the xylem but also in functional studies that are intended to target the products of *Xf* and GWSS genes to the xylem.

### INTRODUCTION

Signal peptides control the entry of virtually all proteins to the secretory pathway, both in eukaryotes and prokaryotes. They comprise the N-terminal part of the amino acid chain and are cleaved off while the protein is translocated through the membrane of the endoplasmic reticulum (1). Generally, signal peptides are interchangeable and secretion of non-secreted proteins becomes possible by the fusion of a signal peptide at the N-terminus of the mature protein; however, changing the signal sequence of recombinant proteins can affect the degree of protein production (2).

In previous research, we fused the sequence coding for the signal peptide of XSP30, a xylem-specific protein from cucumber (3), to the green fluorescent protein (GFP) reporter gene. Contrary to what we expected, fluorescence was only detected inside the cells. Our results suggested that either the XSP30 signal peptide is not recognized by the grape secretory machinery or GFP is not secretion competent. If the first hypothesis is correct, signal sequences obtained from proteins present in grape xylem sap would constitute better candidates for delivery of transgene products to the xylem.

Interestingly, we have also found that the product of the pPGIP encoding gene from pear fruit, heterologously expressed in transgenic grapevines, is present in xylem exudates and moves through the graft union (4). These results show that pPGIP is secretion competent in grapes and constitutes a good alternative to GFP. We intend to use the sequence encoding the mature pPGIP fused to the signal peptides to be analyzed.

We have collected xylem exudate from plants of *Vitis vinifera* 'Chardonnay' and analyzed its protein composition by two-dimensional gel electrophoresis. The purpose of this project is to fuse the signal sequences of these grape xylem sap proteins to the mature pPGIP-encoding gene in order to evaluate their ability to target pPGIP to the xylem.

## OBJECTIVES

1. Obtain partial sequences of proteins found in grape xylem exudates and search cDNA databases for signal sequence identification and selection.
2. Design and construct chimeric genes by fusing the selected signal sequences to a sequence coding for a mature secreted protein (pPGIP).
3. Transform grapevines with the chimeric genes via *Agrobacterium tumefaciens* and *A. rhizogenes*.
4. Evaluate the efficiency of the different signal sequences in targeting protein products to the xylem tissue of grapevine through the:
  - 4.a. analysis of the expression and secretion of pPGIP in transiently transformed grapevines.
  - 4.b. analysis of the expression and secretion of pPGIP in grapevines bearing roots transformed via *A. rhizogenes*.

## RESULTS

Peptide spectrum and Blast analysis showed that the proteins found in grape xylem exudates are secreted and share function similarities with proteins found in xylem exudates of other species (5). cDNA sequences of 5 of them were found in the TIGR *v. vinifera* gene index. However, it was possible to predict the signal peptide in 2 contigs only (TC 39929 and TC 45857, annotated as Chi1b and similar to NtPRp27 respectively). Based on their sequences, we designed primers that were used to amplify the predicted fragments from genomic DNA of 'Chardonnay' and 'Cabernet Sauvignon'. Those fragments were fused to the mature pPGIP gene through the gene splicing by overlap extension method (SOE) (6) and cloned into the pCR2.1-TOPO vector. These two chimeric genes will be ligated into a plant expression vector containing the 35S cauliflower mosaic virus promoter and the octopine synthase terminator and the resultant expression cassettes will be then ligated into the binary vector pDU99.2215, which contains an *nptII*-selectable marker gene and a *uidA* ( $\beta$ -glucuronidase, GUS) scorable marker gene. The resultant binary vectors will be transformed into the disarmed *A. tumefaciens* strain EHA105 by electroporation.

SOE was also used to produce the following chimeric genes:

- 1) pPGIPsignal peptide(sp)-GFP
- 2) XSP30sp-mpPGIP
- 3) RAmysp-mpPGIP
- 4) pPGIPsp-mpPGIP
- 5) mpPGIP

Construct 1 will help to elucidate if GFP is secretion competent in grape. In construct 2, mpPGIP has been fused to the signal sequence of cucumber XSP30, which is a xylem-specific protein. In construct 3 mpPGIP has been fused to the signal sequence of rice amylase 3 (Ramy), which has been very effective in secretion of human  $\alpha$ 1-antitrypsin in rice cell cultures (7). Constructs 4 and 5 will be controls. All five genes have been ligated into the plant expression vector described above and then ligated into binary vector pDU99.2215 and the resulting plasmids have been transformed into the disarmed *A. tumefaciens* strain EHA 105.

The next step will be the permanent and transient transformation of *V. vinifera* 'Thompson Seedless' followed by the analysis of the expression and secretion of pPGIP.

## CONCLUSIONS

Through the study of the proteins present in xylem exudates of 'Chardonnay', we have found 2 good candidates to investigate the effect of using grape signal sequences on xylem targeting. In addition we have produced 2 other chimeric genes containing the signal peptide of a xylem-specific protein in cucumber and the signal sequence of rice amylase. The results obtained with transient and permanent transformations with these genes will provide, in the short term, valuable information for the identification of signal peptides that will deliver proteins to grapevine xylem with high efficiency. In the long term, the development of an efficient secretory system will be essential to target therapeutic proteins to the xylem of grapevine. In addition, the results of this research will also be applied in functional studies that are intended to target the products of *Xylella fastidiosa* and glassy-winged sharpshooter genes to the xylem.

## REFERENCES

1. Nielsen, H., Engelbrecht, J, Brunak, S, and von Heijne, G. 1997. Identification of prokaryotic and eukaryotic signal peptides and prediction of their cleavage sites. *Protein Engineering* 10:1-6.
2. Yoshida K., Matsui, T., and Shinmyo, A. 2004. The plant vesicular transport engineering for production of useful recombinant proteins. *Journal of Molecular Catalysis B: Enzymatic* 28:167-171.
3. Masuda, S., Saskuta, C., and Satoh, S. 1999. cDNA cloning of a novel lectin-like xylem sap proteinits root-specific expression in cucumber. *Plant Cell Physiol* 40, 1177-1181.
4. Aguero, C.B., Uratsu, S.L., Greve, C., Powell, A.L.T., Labavitch, J.M., and Dandekar, A.M. 2005. Evaluation of tolerance to Pierce's disease and Botrytis in transgenic plants of *Vitis vinifera* L. expressing the pear PGIP gene. *Mol. Plant Path.* 6:43-51.
5. Buhtz, A., Kolasa, A., Arlt, K., Walz, C., and Kehr, J. 2004. Xylem sap protein composition is conserved among different plant species. *Planta* 219:610-618.



6. Horton, R.M., Cai, Z.L., Ho, S.N., and Pease, L.R. 1990. Gene splicing by overlap extension: tailor-made genes using the polymerase chain reaction. *Biotechniques* 8:528-535.
7. Trexler, M.M., McDonald, K.A., and Jackman, A.P. (2002). Bioreactor production of human  $\alpha_1$ -antitrypsin using metabolically regulated plant cell cultures, *Biotechnol. Prog.* 18: 501-508.

**FUNDING AGENCIES**

Funding for this project was provided by the University of California Pierce's Disease Grant Program.

## ISOLATION AND FUNCTIONAL TESTING OF PIERCE'S DISEASE-SPECIFIC PROMOTERS FROM GRAPE

### Project Leaders:

David Gilchrist, Douglas Cook, and James E. Lincoln  
Department of Plant Pathology  
University of California  
Davis, CA 95616

**Reporting Period:** The results reported here are from work conducted October 1, 2004 to September 30, 2005.

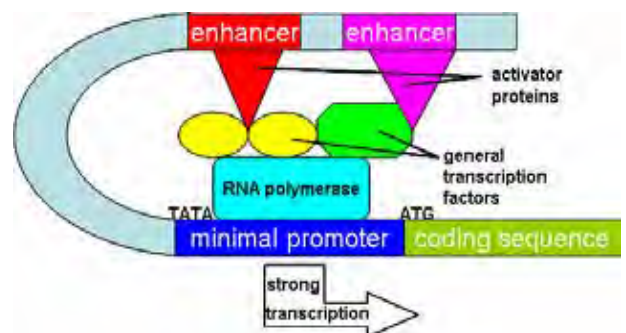
### ABSTRACT

We identified a set of plant genes whose expression is correlated with infection by *Xylella fastidiosa* (*Xf*) as part of a recent study of expressed sequence tags from *Xf*-infected and healthy *Vitis vinifera* plants in the Napa Valley. The genes are essentially off (silent) in plants that have not been exposed to the pathogen, but strongly induced prior to the occurrence of symptoms in both natural field infections and greenhouse inoculated plants. The transcriptional regulatory elements of these genes (i.e., promoters) hold great potential to fulfill a critical and, as yet, unmet need for control of Pierce's disease (PD) namely, the identification of gene promoters that can drive transgene expression only in *Xylella*-infected tissues both for basic research on PD responsive genes and for developing tactics for assessing potential genes conferring resistance to PD. We have focused on three promoters for grape genes whose expression analysis reveals a specific dramatic increase in expression in PD diseased grape compared to healthy or other inductions (called G8946, G9353 and G7061). The plasmid pBG8946minGFP has been transformed into *Agrobacterium tumefaciens* strain GV2260 and infiltrated using a needleless syringe into both healthy and *Xf*-infected grape (Thompson seedless) leaves. After five days the leaves were imaged with a confocal microscope, which revealed the GFP fluorescence can be detected in *Agrobacterium*-infiltrated leaves of *Xf*-infected plants but not healthy plants.

### INTRODUCTION

A major limitation in using transgenes to study and alter the effect of pathogens on disease processes in plants is the absence of the ability to regulate the expression of the transgene in either a tissue or pathogen specific response. We and many other researchers of grape (or any plant) to assess the effect of a transgene on a specific trait (susceptibility to Pierce's disease [PD]) is the absence of suitable promoters, sequences that regulate gene expression in particular tissues (e.g., vascular tissue) or in response to particular situations (e.g., sharpshooter feeding or *Xylella* infection). In the absence of tissue or response-specific promoters, transgenic strategies for control of PD can use only so-called constitutive promoters. The basic problem associated with the use of constitutive promoters is that the transgene is expressed in all cells all the time, not just in the tissue or cells where the gene is needed. This can lead to unintended phenotypes and/or sickly transgenic plants. Highly controlled induction is needed if the interest is in altering gene expression to avoid a cellular change (disease) that is initiated in one or a few isolated cells. The isolation and characterization of *Xylella fastidiosa* (*Xf*)-responsive promoters has immediate and direct application to several current PD projects that are studying the molecular genetic basis of PD at the cellular and tissue levels in grape. It also is of practical importance that these promoters will be useful in either the up- or down-regulation of the expression of a specific gene-of-interest. The difference in presence or absence of the target gene product is determined by whether the promoter is used to drive a sense or an anti-sense construct of the gene of interest.

The objective of promoter analysis is to identify and characterize cis-acting DNA (adjacent) sequences that, when induced, regulate PD-associated gene expression in grapes. Although regulatory sequences frequently occur just upstream of the transcription start site, they can also be found much further upstream (Figure 1). Thus, the challenge in our studies is to demonstrate that the cis-acting sequences have a unique functional role in PD symptom development. It is not the goal of this proposal to understand mechanisms of transcriptional regulation, but rather to isolate and confirm sequences that are active in the regulation of gene expression when *Xf* is present as an inducer of a select set of genes. To test whether a particular DNA sequence, that lies adjacent to a gene of interest, is involved in the regulation of that gene, it is necessary to introduce such putative regulatory sequences into a cell and then determine if they are activated when the inducer (in our case, *Xf*) is introduced into the system. This is done by combining a regulatory sequence with a reporter sequence (in our case, GFP is the test gene) that can be used to monitor the effect of the regulatory (promoter) sequences in the presence of *Xf*.



**Figure 1.** Diagram of a eukaryotic promoter showing a minimal promoter containing TATA and CAAT boxes. Activator proteins bind to enhancer elements for strong transcription.

We have identified a set of plant genes whose expression is correlated with infection by *Xf* as part of a recent study of expressed sequence tags from *Xf*-infected and healthy *V. vinifera* plants in the Napa Valley. The genes are essentially off (silent) in plants that have not been exposed to the pathogen, but strongly induced in both natural field infections and greenhouse inoculated plants. Three of these genes (G8946, G9353, and G7061) are induced early during disease development, prior to the occurrence of symptoms. The protein products of such genes are interesting in their own right, including what their predicted functions may suggest about the nature of host responses to this important pathogen. However, their transcriptional regulatory elements (i.e., promoters) hold great potential to fulfill a critical and, as yet, unmet need for control of PD - namely, the identification of gene promoters that can drive transgene expression only in *Xylella*-infected tissues. Identifying plant promoters is important if developing transgenic solutions to PD will have significant benefit, both in terms of public perception and transgene efficacy, if we use promoters that are expressed only in tissues that are infected by the pathogen (i.e., the transgene products should be spatially and temporally restricted to those times and places where the protein products are needed for disease resistance).

## OBJECTIVES

1. Identify and determine sequence of promoters driving genes specifically transcribed in grape tissue or cells of plants infected with *Xf*.
2. Construct transformation-ready vectors containing *Vitis* promoter-GFP reporter gene fusions that will be used for the functional assay of putative promoters. (GFP=green fluorescent protein)
3. Conduct transient functional assays of the promoter-GFP fusions in stems, leaves and roots infected with *Xf*.
4. Produce stable transgenic grape plants with promoters that functioned effectively in the transient assays and characterize the strength of the selected promoters using the GFP-reporter.

## RESULTS

The first step taken was to utilize a Bacterial Artificial Chromosome (BAC) set of libraries of *V. vinifera* on high density filters for gene identification in grapes through the UC Davis California and ES Genomics Facility (<http://cgf.ucdavis.edu/>). Our specific interest is in sequences immediately 5' to the candidate genes (maximum 5 kbp), but to be conservative we sequenced regions beyond where we believe the promoters to reside. We then proceeded with Sublibrary preparation and clone management, wherein BAC DNA was isolated using the Qiagen Large Construct kits, sheared fragments generated by HydroShear (Gene Machines, Inc.) and blunt-ended using a fill-in approach and cloned *en masse* into a SmaI-digested pUC18 sequencing vector. The next step was to generate paired-end sequence reads from the pUC18 subclone library, with two 384-well plates analyzed for each BAC clone. Theoretically this equated to 8.5X coverage of a typical 125 Kb BAC clone. To generate ordered contigs and facilitate the finishing phase of the project, we designed PCR primers from the ends of contigs using an automated Primer 3 software pipeline. All templates are to be sequenced a minimum of both directions.

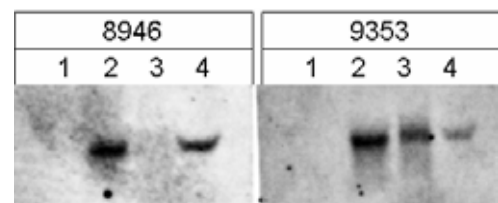
Identify 5' promoter regions in the sequenced genomic clones based on comparison to cDNA sequences currently in hand for the three genes: We used PCR to isolate and clone the potential 5' regulatory sequences into transformation ready vector constructs (see below). These plasmids have been used to construct a collection of binary vectors containing grape 5' promoters for expression of GFP genes. Analysis of the sequence of the appropriate BAC clones will allow the design of PCR primers to amplify and clone the 5' promoter and 3' sequences of the transcriptionally regulated grape genes into novel binary vectors. (Details of the plasmids are available upon request.)

### Systems for analysis of the PD responsiveness of the isolated promoters

We are using three different but functionally related approaches to testing and characterizing the isolated promoter regions derived above. These include transient assays on infected and healthy leaves, transgenic hairy roots and whole plant transgenics. All three of the approaches will be initiated simultaneously in the interest of time. Each of the promoters of the three genes have been assembled in several different configurations with the reporter gene (GFP) and will be evaluated in conjunction with a constitutive promoter (CaMV 35S or FMV 34S).

### Identify and determine sequence of promoters

We have focused on three promoters for grape genes whose expression analysis reveals a specific dramatic increase in expression in PD diseased grape compared to healthy or other inductions (Figure 2). These three genes (called G8946, G9353 and G7061) have each been used to isolate by hybridization a BAC clone of grape genomic DNA containing the gene. These BAC clones were then subjected to shotgun sequencing. The resulting sequence, once assembled and annotated for the location of the hybridizing cDNA, were used to make PCR primers for approximately 1200bp of sequence just 5' of the cDNA start codon.



**Figure 2.** Northern analysis of *Xf*-inducible gene expression. RNA isolated from leaves of healthy Thompson seedless (lane 1), *Xf*-infected Thompson seedless (lane 2 and 3), and *Xf*-infected Chardonnay (lane 4) were hybridized with labeled 8946 cDNA or 9353 cDNA.

### Construct transformation-ready vectors

PCR primers were used to amplify grape (Chardonnay) genomic DNA. We readily obtained the promoter of G8946 with a single PCR reaction. However G9353 and G7061 are proving to be more difficult. The promoter regions of G9353 and G7061 are very AT-rich and PCR efficiency is poor for AT-rich sequences. Repeated attempts to PCR the entire promoter region have failed. Therefore, we have divided the promoter regions of G9353 and G7061 into three smaller overlapping regions for PCR. So far, for both promoter regions of G9353 and G7061, two of the three fragments have been successfully cloned. After isolation and sequence verification, these three fragments will be put back together by overlap extension PCR to recreate the whole promoter region. The promoter of G8946 has been cloned upstream of a GFP reporter gene in a transformation ready vector and called pBG8946minG (Figure 3).

### Transient functional assays of the promoter-GFP fusions

The plasmid pBG8946minG has been transformed into *A. tumefaciens* strain GV2260 and infiltrated using a needleless syringe into both healthy and *Xf*-infected grape (Thompson seedless) leaves. After five days the leaves were imaged with a confocal microscope. We find that GFP fluorescence can be detected in *Agrobacterium*-infiltrated leaves of *Xf*-infected plants but not healthy plants (Figure 4).

### Produce stable transgenic grape plants

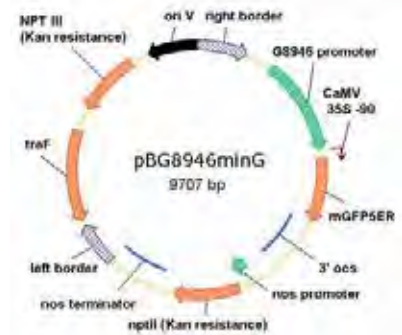
The plasmid pBG8946minG has also been transformed into *A. tumefaciens* strain LBA4404 and is currently being used by the UCD Transformation Facility to create transgenic Thompson seedless plants.

### CONCLUSIONS

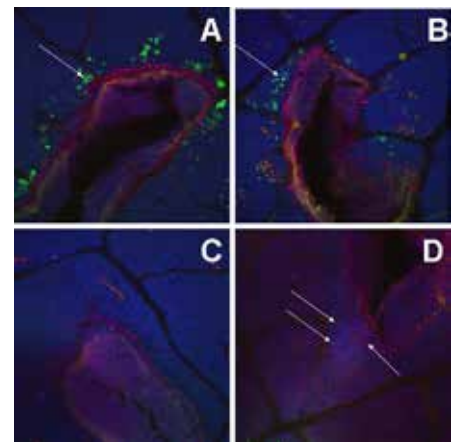
In addition to their utility for engineering PD resistance in grape, the advent of *Xf*-induced reporter gene expression would provide an extremely powerful tool to examine other host responses in their intact cellular and tissue context. With such tools, it should be possible to examine the chemical and/or physical cues from the insect or pathogen that trigger host gene expression and the deleterious effect of the disease. Moreover, the recent development of *Xf*-GFP strains by Dr. Steven Lindow at UC Berkeley offers the possibility of dual labeling to simultaneously monitor pathogen spatial distribution and host gene expression. Such dual labeling experiments are made possible by the availability of multiple forms of GFP protein engineered to fluoresce with distinct spectral characteristics. It is conceivable, for example, that host genes might be induced specifically in live cells, adjacent to sites of pathogen colonization of xylem elements, and this technology would provide the means to test such hypotheses.

### FUNDING AGENCIES

Funding for this project was provided by the CDFA Pierce's Disease and Glassy-winged Sharpshooter Board, and the American Vineyard Foundation.



**Figure 3.** Map of binary vector pBG8946minG. This vector uses the grape promoter G8946 to drive expression of a GFP gene. In *Agrobacterium* this vector will transfer DNA into grape cells.



**Figure 4.** *Agrobacterium*-mediated transient gene expression in grape leaves. *Agrobacterium tumefaciens* GV2260 containing pBG8946minG (panels C and D) or a control plasmid, pCB5minG, using the CaMV 35S promoter (panels A and B) were infiltrated into Thompson seedless healthy (panels A and C) and *Xf*-infected (panels B and D) leaves. After 5 days, confocal microscopy was used to detect GFP expression. In these micrographs, green is GFP expression; blue is chlorophyll autofluorescence; and red is polyphenolics accumulation. Arrows show individual cells expressing GFP.

# EVALUATION OF GENES ISOLATED BY A FUNCTIONAL GENETIC SCREEN FOR SUPPRESSION OF BACTERIAL GROWTH OR SYMPTOMS IN PIERCE'S DISEASE

## Project Leaders:

David Gilchrist and James E. Lincoln  
Department of Plant Pathology  
University of California  
Davis, CA 95616

**Reporting Period:** The results reported here are from work conducted October 2004 to September 2005.

## ABSTRACT

Our overall objective is to identify genes from cDNA libraries of either grape or heterologous plants that, when up regulated in grape, will disrupt infection, spread or symptom development by the xylem-limited bacteria, *Xylella fastidiosa* (*Xf*). Hence, we are interested in the effect of the genetic disruption of Pierce's disease (PD) symptoms on the movement or establishment of the bacterium in the xylem of susceptible grape plants. Recent published information from our laboratory established that specific transgenes from homologous or heterologous hosts that block programmed cell death (PCD) during plant disease development, can arrest both symptom development and microbial growth *in planta* in a range of plant-microbe interactions. A functional screen was used to evaluate cDNA libraries of grape and tomato for genes that, when overexpressed in tissues stimulated to undergo PCD, would block the death and therefore represent potential anti-PCD (anti-disease symptom) genes. Collectively, more than 500,000 cDNAs were screened and 12 genes were cloned that when overexpressed as transgenes in tomato or grape blocked PCD. Three of these genes when overexpressed as transgenes blocked PCD triggered by a verified ceramide-derived inducer of plant PCD. One of these gene, designated as PR1A in grape, was chosen for further direct characterization. This gene has high sequence homology to a gene family from humans, nematodes, hookworms and several plant species, wherein its expression is correlated with situations in which PCD is blocked in both animal and plant diseases. When overexpressed as a transgene in grape, the PCD sensitive grape tissues is now insensitive to microbial inducers of PCD. We believe that examination of the molecular basis of cell death in pre-symptomatic and symptomatic tissues, along with the immediate assessment of the effect of expressing anti-apoptotic transgenes in PD infected tissues on the development of death-related symptoms in grape, will be very informative in the short run in terms of PD biology and physiology. In a longer time frame these data will likely yield genetic strategies for protection of grape against infection by *Xf* in years not decades.

## INTRODUCTION

Published information from our laboratory confirms that specific transgenes from homologous or heterologous plants, that block PCD during plant disease development (4), as well as chemical inhibitors of apoptotic proteases (3), can arrest both symptom development and microbial growth *in planta* in a range of plant-microbe interactions (3, 4, 5). The conserved genetically determined PCD process can be studied by biochemical, cytological and genetic techniques and can be transgenically manipulated by techniques developed in our laboratory (3, 4). PCD is now well established as a key pathway involving many gene products in numerous diseases of animals and plants. We further established that expression of the anti-apoptotic p35 gene in transgenic grape tissue blocked cell death (PD) symptoms in *Xf* infected tissue. This demonstrates that the anti-apoptotic genes to be recovered from the cDNA library screens have excellent potential to provide protection in grape against PD. Based on previous results we tested the effect of the p35 transgene from baculovirus on viability of roots, produced on *Xf* infected chardonnay and observed protection of the roots against death in the presence of *Xf*. This indicates a role for PCD in PD and provides optimism that novel genetic determinants of resistance can be identified using this screen. Given the strategies used it is likely the genes will function in grape by altering the effect of *Xf* infection in grape through suppression of symptoms either directly on cell death or indirectly by modifying the behavior of the bacterial in the xylem. It should be emphasized that the effect of anti-apoptotic transgenes on plants is not to induce so-called systemic acquired resistance (SAR) as no markers of SAR are induced in the presence of anti-apoptotic genes such as the p35 gene (4). We believe that the effect of expressing anti-apoptotic transgenes in PD infected tissues on the development of death-related symptoms in grape will contribute significant information in terms of PD biology and physiology. In a longer time frame these data will likely yield genetic or chemical-based signaling strategies for protection of grape against infection by *Xf* in years not decades, perhaps similar to the effects we reported previously in tomato (4).

## OBJECTIVES

1. Create grape transgenic plants over-expressing candidate anti-apoptotic plant genes obtained through cDNA library screens.
2. Evaluate these specific anti-apoptotic plant genes in grape for effect on *Xf* and PD symptoms.
3. Apply signal molecule discovery tactics to elucidation of the molecular basis of susceptibility, focusing first on grape PR1A.

## RESULTS

### Creation of grape (Thompson seedless) transgenic plants over-expressing genes of interest

Although the construction of a grape cDNA libraries initially proved much more difficult than we had experienced in making libraries from 4 other plant species, we have isolated a number of genes from screens of Chardonnay cDNA libraries as well as tomato cDNA libraries that potentially regulate programmed cell death in plants (Table 1). The inserts for all libraries are cloned into the binary vector B5 for direct transformation into the *A. tumefaciens* for generation of transgenic grape plants by the UCD plant transformation facility. It is important to emphasize that the screens were not dependent on the presence or role of PCD in PD but will detect any gene that affects the integrity of the bacterium in the infected tissue or the ability of the bacterium to elicit symptoms of PD, regardless of whether the step being affected is strictly dependent on the induction of PCD.

**Table 1.** “Short list” of plant anti-apoptotic genes, derived from functional screen of cDNA libraries, for transformation into grape

Construct	Gene	Originating organism
CBWG3	secretory leader of chitinase but not ORF	Chardonnay
CBWG8	glutathione-S-transferase	Chardonnay
CBWG23	EST of grape, Arabidopsis, rice	Chardonnay
CBWG29	Expressed ORF without significant match	Chardonnay
CBWG33	Expressed ORF without significant match	Chardonnay
CBWG71	cytokine-like	Chardonnay
CBWG75	germin-like	Chardonnay
CBPRIA	PR1A	Chardonnay
CBI35	intron p35 (anti-PCD control gene)	baculovirus
CBP14LD	P14 leader (wild type)	tomato
CB376	mycorrhizal induced	tomato
CB456	nematode induced	tomato
CBMT	metallothionine	tomato

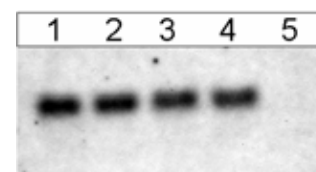
Our goal is to rapidly identify resistance genes in grape genotypes that block any one of several required steps in the infection and spread of *Xf* in the xylem, steps which logically will include genetic factors regulating PCD induced by disease stress in grape. We have begun to evaluate the effect of experimental transgenes both from tomato and from grape on grape tissue bearing GFP-*Xf* in xylem elements with various cell death markers and GFP-marked bacteria. By using the GFP-tagged *Xf*, this also is a direct functional assay for genes that block bacterial movement or accumulation in the xylem of newly differentiated grape tissue (6).

### Evaluate transgenic grape (cv. Freedom) plants over-expressing specific anti-apoptotic plant genes for effect on *Xf* and PD symptoms

Last year, over-expressing transgenics of grape (Freedom) were created for several of these cDNAs. Although both Chardonnay and Freedom transgenics were initiated only Freedom transgenics survived. Northern analysis confirmed the over-expression of transgene mRNA in these Freedom lines (Figure 1). Pathogenicity tests with any isolated disease-disrupting cDNA will first involve a system using micro-propagated (MP) plants that are vegetative clones of sterile grape plants in small plastic boxes that can be infected with *Xf* under sterile conditions. This ensures that these plants will have uniform physiology without confounding by stress inductions as would likely occur in the field or greenhouse grown plants. The MP plants show foliar symptoms typical of infected plants under field and greenhouse conditions.

### Resistance of grape transgenics to PCD induction

Collectively, more than 500,000 cDNAs were screened and 12 genes were cloned that when overexpressed as transgenes in tomato or grape blocked PCD. Three of these genes when overexpressed as transgenes blocked PCD triggered by a verified ceramide-derived inducer of plant PCD, FB1. One of these gene, designated as PR1A in grape, was chosen for further direct characterization. This gene has high sequence homology to a gene family from humans, nematodes, hookworms and several plant species, wherein its expression is correlated with situations in which PCD is blocked in both animal and plant diseases (Table 2). When overexpressed as a transgene in grape, the PCD sensitive grape tissues is now insensitive to microbial inducers of PCD. The use of PCD inducers other than *Xf* may allow a rapid analysis for anti-PCD activity of an over-expressed gene in grape. The fungal mycotoxin FB1 has previously been shown by our lab to trigger PCD in tomato and can be protected against by anti-PCD genes (4). We investigated the possibility that grape transgenics can also be assayed by FB1 insensitivity. Both Freedom and Thompson seedless showed high sensitivity to FB1. The symptoms (Figure 2) included necrosis at the leaf margins (at 250nM FB1) and leaf drop (at 1000nM FB1). Interestingly expression of the tomato P14 gene in transgenic grape protects the grape from PCD induced by FB1. (Figure 3)



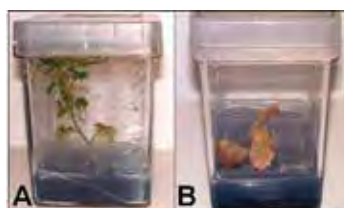
**Figure 1.** Northern analysis of transgenic grape. RNA isolated from transgenic grape plants (Freedom) were hybridized to a labeled P14 probe. Lanes 1 thru 4 are P14 transgenics; lane 5 is a GFP transgenic.

**Table 2.** PR1 family amino acid lineup displaying domains of high conservation

	(1)	1	10	20	30	40	50	60	70	80
Dog hookworm (AcASP2)	(1)	---	MLTLPFLALAYVHGSH	RCGNGMTDEARQK	EDVHNSYRSM	AKGQAKDAISGNAP	KAAK	KKKIYDCM	E	
Human PR (GliPR1)	(1)	---	RYTLATLANNMSPYSNYRTAII	PD IEN---	EDFIK	CYR	RMKFRSEV	KPTAS	---	DLYITGCPAL
Grape (VvPR1)	(1)	---	GLGCRSPFLALDCEHGLADARIC	CCQNS	PC	---	DLNARHATA	RAQV	---	GGPMSWQNTYT
Tomato (P14)	(1)	---	GLFNISLLDTCLNVLAFHSC	CAQNS	PC	---	DYLA	RVDA	FAQV	---
Plant nematode (MIMSP1)	(1)	---	MSNKLIIESTLITLITTYTVVSH	TVPE	---	QN	---	AVYDC	INKY	ES
Consensus	(1)	M L	LLL ILMLLAISH	NAL PQ				DYL VHN YRSQVA		M MSWD L
	(81)	81	90	100	110	120	130	140	150	160
Dog hookworm (AcASP2)	(76)	---	TAMANA	---	KKCVFAHS	---	NRKQ	---	VGEHIMSTAR	QMDKAQA
Human PR (GliPR1)	(66)	---	IAIAANA	---	SNCQFSHT	---	TKKPPH	---	KDRFPF	TSL
Grape (VvPR1)	(55)	---	YACNYA	---	QKIGDCN	---	LVHSGG	---	PYSE	HLAMGSP
Tomato (P14)	(55)	---	RACNYA	---	NSRAGDCN	---	LHSGG	---	AGE	MLAKSGG
Plant nematode (MIMSP1)	(71)	---	KSAQAWA	---	NKCI	---	FHHGTDLYSGG	---	KFY	GENL
Consensus	(81)	S AQNWA		N R I D N	LHSGG		GENLW GS		TG AVN WF E	NY Y T
	(161)	161	170	180	190	200	210	220	230	240
Dog hookworm (AcASP2)	(139)	---	WNR	---	QVMIGRIT	---	QCV	---	QCE	---
Human PR (GliPR1)	(129)	---	I	---	IKV	---	CGHY	---	QVVMAD	---
Grape (VvPR1)	(109)	---	S	---	CVG	---	QC	---	GHY	---
Tomato (P14)	(107)	---	Q	---	VG	---	KKK	---	RH	---
Plant nematode (MIMSP1)	(144)	---	K	---	ENDE	---	PEAV	---	GH	---
Consensus	(161)	N	C KG		CGHYTQVVA		SYKLGCAV		C	
									G F I CNY P GNYIGS	PY G S C



**Figure 2.** Induction of PCD in grape by sphinganine analog mycotoxin FB1, a widely used inducer of PCD in plants and animals. Left = 0, Right = 250nm.



**Figure 3.** FB1 sensitivity assay. The terminal four nodes of a P14 transgenic (A) or a GFP transgenic (B) grape shoot was pushed into growth media containing 250nM of the programmed cell death inducing FB1. Photo was taken after 2 months. Non transgenic plant is killed while the plant transgenic for the P14 gene is protected and survives

## CONCLUSIONS

The goal of this project is to identify novel genes from cDNA libraries of either grape or heterologous plants that, when expressed in grape, will disrupt infection, spread or symptom development by *Xf*. From a functional screen of more than 500,000 cDNAs, a total of 12 genes were scored as capable of blocking PCD in both yeast surrogate system and a plant disease-based system. Significantly we demonstrated that expression of the p35 gene and the PR1A gene, when up-regulated in transgenic grape tissue blocked programmed cell death. Additional potential anti-PCD genes from the functional screen are currently being transformed into whole grape plants (Thompson seedless) for further characterization. We believe that examination of the molecular basis of cell death in symptomatic tissues will be very informative in the short run in terms of PD biology and physiology. In a longer time frame these data will likely yield genetic or chemical strategies for protection of grape against infection by *Xf* in years not decades.

## REFERENCES

1. Gilchrist, D.G. 1997. Mycotoxins reveal connections between plants and animals in PCD and ceramide signaling. *Cell Death and Differentiation* 4:1312-1317.
2. Gilchrist, D.G. 1998. Programmed cell death in plant disease: the purpose and promise of cellular suicide. *Ann. Rev. Phytopathology* 36:393-414
3. Richael, C., Lincoln, J., Bostock, R., and Gilchrist, D.G. 2001. Caspase inhibitors reduce symptom development in compatible plant-pathogen interactions and limit pathogen multiplication *in planta*. *Physiol. and Mol. Plant Pathol.* 59: 213-221.

4. Lincoln J.E., Richael, C., Overduin, B., Smith, K., Hall, B.D. Bostock, R.M., and Gilchrist D. G. 2002. Expression of the anti-apoptotic baculovirus p35 gene in tomato results in inhibition of cell death and a decreased susceptibility to a variety of pathogens. *Proc Natl Acad Sci* . 99: 15217-15221.
5. Gilchrist, D., J. E. Lincoln, and C. Richael, 2001. Inhibiting apoptosis in plants using a baculovirus p35 protease inhibitor gene. Patent # 6310273, United States Patent Office.
6. Gilchrist, D., J. E. Lincoln, A. Walker, B. Kirkpatrick. 2002. Application of *Agrobacterium rhizogenes*-mediated transformation strategies for a rapid high throughput screen for genetic resistance to Pierce's Disease in grape that maintains the clonal integrity of the recipient host. Symposium Proceedings, p 11-12, Pierce's Disease Research Symposium. San Diego, CA December 15-18.

#### **FUNDING AGENCIES**

Funding for this project was provided by the CDFFA Pierce's Disease and Glassy-winged Sharpshooter Board, and the American Vineyard Foundation.



# EPIDEMIOLOGY OF PIERCE'S DISEASE IN THE CENTRAL SAN JOAQUIN VALLEY OF CALIFORNIA: FACTORS AFFECTING PATHOGEN DISTRIBUTION AND MOVEMENT

## Project Leaders:

Russell L. Groves and Jianchi Chen  
USDA, ARS, SJVASC, CDPG  
Parlier, CA 93648

## Collaborators:

Ed Civerolo  
USDA, ARS, SJVASC  
Parlier, CA 93648

Kent Daane  
Division of Insect Biology  
University of California  
Berkeley, CA 94720

Marshall Johnson  
Department of Entomology  
University of California  
Riverside, CA 92521

Daniel Bigham  
Tulare County  
Agricultural Commissioner Office  
Tulare, CA 93274

Hong Lin  
USDA, ARS, SJVASC, CDPG  
Parlier, CA 93648

**Reporting Period:** Results reported here are from work conducted July 2004 to September 2005.

## ABSTRACT

The primary objective of this research was to characterize the seasonal abundance, dispersal, and overwintering biology of the glassy-winged sharpshooter (GWSS), a primary vector of *Xylella fastidiosa* (*Xf*). Moreover, to estimate the incidence of *Xf* detected from GWSS collected in different perennial cultivated and non-cultivated plant species. Based on results of seasonal plant utilization 2004-05, we conclude that host plant species significantly influences GWSS population biology. GWSS adult, nymph, and egg mass densities varied among perennial, cultivated crop plant species and non-cultivated weed species examined in this study. Perennial crop species examined included sweet cherry, navel orange, Spanish lemon, olive, avocado, plum, and pomegranate. Dispersing populations of adult GWSS were highest in citrus (lemon and navel) and pomegranate. Adult GWSS were also regularly collected from and observed feeding upon a wide range of non-crop weed species within and surrounding orchard crops. Overwintering adult GWSS were regularly collected in relatively low population densities on citrus (navel and lemon), pomegranate, avocado, plum, and non-crop annual weed species. Spatial patterns of adult GWSS capture within survey orchards varied among perennial crop species. Random distributions of adult GWSS were often observed in reproductive hosts including navel orange and Spanish lemon compared to population aggregates observed in avocado and olive. The presence of *Xf* in a subsample of GWSS collected among different perennial crops and on non-crop species was determined for collections in 2004 using PCR formats and the frequency of *Xf* detection in populations of GWSS varied among season in 2004.

## INTRODUCTION

The glassy-winged sharpshooter (GWSS, *Homalodisca coagulata*) was introduced into southern California around 1990 and has continued to expand its range in the state (Varela et al. 2001). Populations of the GWSS are becoming widely distributed and the insect will reportedly feed and oviposit on a wide range of perennial crop and ornamental plant species as well as numerous non-crop wild plant species (Adlerz and Hopkins 1979, Daane and Johnson 2003, Groves and Chen, 2003). Strains of *Xylella fastidiosa* (*Xf*) have a complex pathogenic relationship with a diverse host range including members of both monocots and dicots (Pooler and Hartung 1995). In addition, the genetic relationships associated with the ability to cause disease on a primary host and the ability to survive within reservoir hosts is not well understood (Hill and Purcell 1997, Purcell and Saunders 1999). Knowledge of the genetic diversity of strains that comprise the population of *Xf* in the central San Joaquin Valley (SJV) of California, especially as it relates to insect vectors, will help in devising effective strategies for managing Pierce's disease (PD), as well as other diseases caused by this bacterium. An accurate knowledge of GWSS host utilization in the central SJV, where they acquire the pathogen, when they move into susceptible crops, and when they spread the pathogen is critical to understanding and managing the spread of *Xf* diseases.

## OBJECTIVES

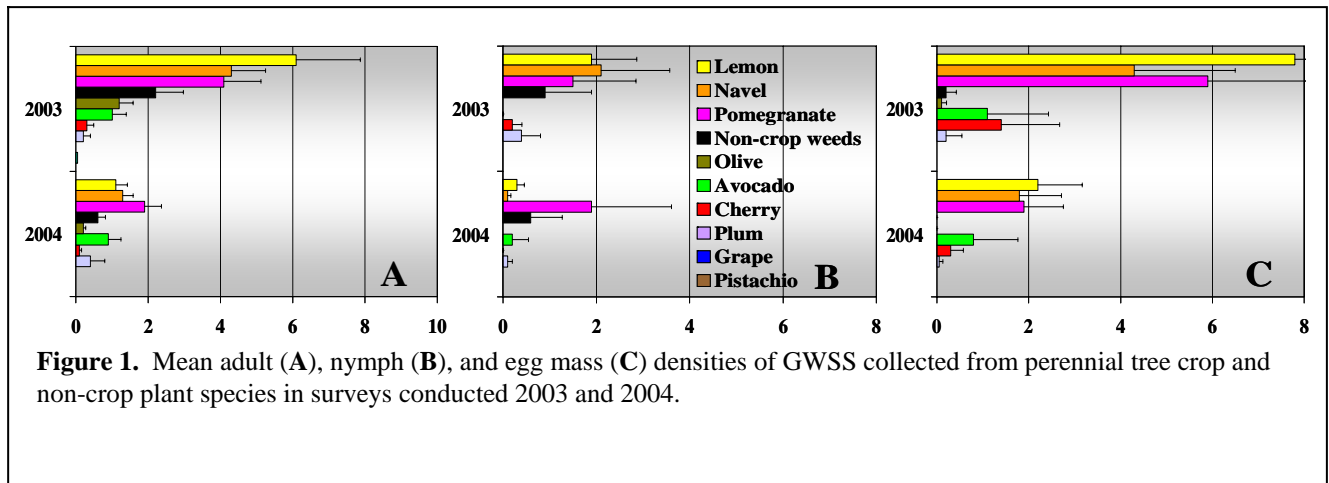
1. Identify and characterize the seasonal abundance of the primary vectors of *Xf* and seasonal patterns of insect dispersal.
2. Compare the incidence and genetic structure of *Xf* strains isolated from GWSS and other potential insect vector species collected from perennial, cultivated and non-cultivated plant species.

## RESULTS

### Objective 1

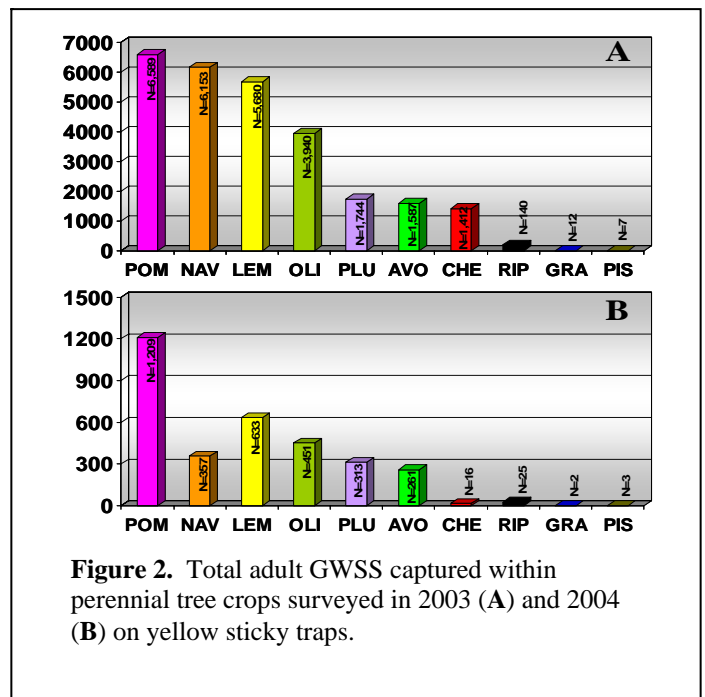
Seasonal host utilization patterns and dispersal of GWSS within and among a variety of perennial crop plant species was examined March 2003 to March 2005. Replicated experimental sites were located in GWSS-infested regions of Tulare County, California. Temporal and spatial patterns of crop utilization were monitored within perennial crop species including

citrus (navel orange and Spanish lemon), stonefruit (sweet cherry and plum), olive, pomegranate, and avocado at each of three, replicate locations for each crop type. Non-crop weed vegetation was monitored throughout the season at three experimental sites along with a single riparian habitat (Kaweah River). Throughout the sample interval, crops were sampled weekly for GWSS lifestages using a combination of yellow sticky traps, beat sampling, and timed visual counts. Beat-net counts, egg mass counts and visual inspections of all GWSS lifestages were used to estimate the seasonal patterns of host utilization within the various crop and non-crop species.



Results over both years of this study indicate that host plant species influences GWSS population biology. The greatest mean number of adult GWSS was collected from citrus (navel and lemon) and pomegranate (Figure 1). More nymphs were present in navel orange and pomegranate with fewer nymphs collected in olive, avocado, cherry, plum, and peach. Non-crop plant species upon which adult and nymphal GWSS were collected included red-root pigweed, prickly lettuce, annual sowthistle, little mallow, lambsquarters, field bindweed, blue morning glory, curly dock, evening primrose, johnsongrass, and ground cherry. The greatest mean number of GWSS egg masses were collected from both citrus and pomegranate.

Seasonal dispersal of adult GWSS was monitored using yellow sticky traps suspended 2 m above the ground at each of 3 experimental locations for each crop sampled (Figure 2). Since March 2003, a total of 30,534 adult GWSS, 32 green sharpshooters (*GSS*, *Draeculacephala minerva*), and an additional 351 unidentified leafhopper species were captured on yellow sticky cards. In both years, the number of dispersing GWSS varied among crops species surveyed. Spatial patterns of GWSS capture, represented by plots of semivariance over distance, were dissimilar among crop species examined. For example, spatial dependence in GWSS capture was observed in pomegranate where the shape of the semivariogram were best fit by linear models with non-zero slopes. In contrast linear models with zero slopes best fit semivariance plots in navel orange in 2003. Specifically, partial variance in mean capture varied little among distances and transects within GWSS-reproductive citrus hosts compared to pomegranate where aggregations were detected along crop margins and mean capture rates declined with distance into fields away from citrus.



Throughout the winter periods (November-March) in 2003-04 and 2004-05, overwintering host utilization patterns of adult GWSS were monitored among the previously listed species. Overwintering adult GWSS were sampled monthly through this interval in perennial tree crops by beating/shaking all scaffolds over two, 80 ft<sup>2</sup> white, PVC tarps that flank both sides of the tree stem and in non-crop weed species using sweep net collections described previously. Adult GWSS were collected overwintering on citrus (lemon and navel), pomegranate, peach, plum, and avocado averaging 0.2, 0.4, 0.9, 0.02, 0.05, and 0.5 adult GWSS/tree, respectively, over the four month sample interval, 2003-04. Mean populations of adult GWSS swept from non-crop annual vegetation have averaged 1.1, 2.4, 0.9, and 0.3 adult GWSS/50-sweep sample over the same interval,

respectively. Very few (N=68) adult GWSS were collected during the 2004-05 winter period among the species surveyed presumably as a result of the GWSS area-wide control program administered in Spring, 2004

## Objective 2

The presence of *Xf* in a subsample of vectors collected from different perennial crops and on non-crop species was completed for collections obtained in 2004. The bacterium was detected in populations of green sharpshooter (GSS, *Draeculacephala minerva*), watercress leafhopper (*Acinopterus angulatus*), and GWSS. Among a total of 452 adult *D. minerva* subjected to standard PCR detection with primers HL 5/6 (Francis et al. 2004), approximately 10% (N= 42) produced an amplicon size (221 bp) in gels. Among 96 adult *A. angulatus* tested to date, approximately 6% (N=6) produced a similar amplicon size indicative of infection by *Xf*. Among 731 adult GWSS tested in 2004, a similar amplicon was produced in 95 insects (13.0 %) collected among 7 perennial crop and non-crop habitats (Table 1). Averaging over plant species, the seasonal *Xf* detection frequency varied among the crops reported in 2004 with the highest detection occurring among overwintered, adult GWSS. Differences in *Xf* detection were not as apparent among the different plant species averaging over season ranging between

**Table 1.** Seasonal *Xf* detection summary among adult GWSS collected in different crop and non-crop habitats of Tulare County, 2004.

Season	Crop							TOTAL
	AVO	LEM	NAV	OLI	PLU	POM	RIP	
Winter (Jan-Mar)	13.8% (N=65)	16.7% (N=78)	11.1% (N=91)	0.0% (N=23)	6.3% (N=16)	7.7% (N=33)	0.0% (N=3)	7.9% (N=309)
Spring (Apr-Jun)	33.3% (N=42)	30.2% (N=53)	38.1% (N=25)	42.9% (N=14)	45.5% (N=22)	32.5% (N=40)	22.2% (N=9)	35.0% (N=205)
Summer (Jul-Sep)	0.0% (N=51)	3.9% (N=66)	5.6% (N=18)	5.9% (N=17)	38.5% (N=13)	9.5% (N=21)	0.0% (N=12)	9.1% (N=198)
Winter (Oct-Dec)	0.0% (N=1)	0.0% (N=2)	0.0% (N=9)	0.0% (N=0)	0.0% (N=2)	0.0% (N=5)	0.0% (N=0)	0.0% (N=19)
TOTAL	11.8% (N=159)	12.7% (N=199)	13.7% (N=143)	12.2% (N=54)	22.6% (N=53)	12.4% (N=99)	5.6% (N=24)	13.0% (N=731)

5.6% – 22.6%. We are currently processing samples collected in 2003 from the same set of crops species and these results will be compared to those obtained in 2004. The diversity of amplified *Xf* will further be assessed using SSR markers deduced from the available genome sequences (Lin and Walker, 2004). Previous studies have demonstrated that these protocols generate sufficient polymorphisms within *Xf* to enable grouping of genotypes. Strain specific primers will also be used to investigate the pathotype profile of amplified products. Results from the 2004 season's research indicate substantial amounts of detectable *Xf* in GWSS populations, however further pathotype analyses are needed to differentiate the proportion of PD versus non-PD strains detected in potentially infectious vectors (Table 1). Finally, attempts will also be made to quantify *Xf* in selected insect vectors to identify the population dynamics of *Xf* within the vector populations. With recent improvements in technology, PCR-based techniques appear increasingly promising for bacterial pathogen detection in GWSS and other insect vector species. The bottleneck, however, lies in the preparation of inhibitor-free template DNA. We have recently developed a simple, sample preparation procedure for PCR amplification of *Xf* DNA. Adult insect heads were freeze-dried and used for PCR immediately. For PCR, the dried heads were pulverized and powder suspension used. Appropriate dilutions of powder suspension further minimized the effect of possible DNA polymerase inhibition. This recently developed PCR method will provide a more rapid and much less labor intensive platform for evaluating the infectious nature of potential vector species bypassing the laborious steps of whole-DNA extraction.

## CONCLUSIONS

Results obtained from our two year study have generated significant new information regarding the seasonal host utilization patterns, dispersal, and overwintering biology of GWSS in the central SJV of California. This information will improve our understanding of the epidemiology of Pierce's disease and will also be useful in understanding the epidemiology of other economically important diseases caused by *Xf* for which GWSS may become an important vector. This objective directly addresses gaps in our present understanding that must be filled in order to develop comprehensive PD and GWSS management strategies. This research has expanded on previous work by documenting important aspects of the population biology of GWSS in the agricultural landscape of the central San Joaquin Valley of California. An improved knowledge of the genetic diversity of strains that comprise the population of *Xf* detected from potentially infectious GWSS will further help in devising effective strategies for managing Pierce's disease, as well as other important diseases caused by this bacterium.

## REFERENCES

- Adlerz, W.C. and Hopkins, D.L. 1979. Natural infectivity of two sharpshooter vectors of Pierce's disease in Florida. *J. Econ. Entomol.* 72: 916-919.
- Daane, K. M. and Johnson, M. W. 2003. Biology and ecology of the glassy-winged sharpshooter in the San Joaquin Valley, pp. 247-249. *In. Proceedings, Pierce's Disease Research Symposium, M. Athar Tariq, S. Oswald, P. Blincoe, R. Spencer, L. Houser, A. Ba, and T. Esser (eds.), 8-11 Dec. 2003, San Diego, CA. Calif. Dept Food and Agric., Sacramento, CA.*
- Groves, R. L. and Chen J. I. 2003. Epidemiology of Pierce's Disease in the Central San Joaquin Valley of California: factors affecting pathogen distribution and movement, pp. 92-94. *In. Proceedings, Pierce's Disease Research Symposium, M. Athar Tariq, S. Oswald, P. Blincoe, R. Spencer, L. Houser, A. Ba, and T. Esser (eds.), 8-11 Dec. 2003, San Diego, CA. Calif. Dept Food and Agric., Sacramento, CA.*
- Francis, M. L., Cabrera, J. C., Lin, H. and Civerolo, E. L. 2004. Detection of *Xylella fastidiosa* in insect vectors in California, p. 275. *In. Proceedings, Pierce's Disease Research Symposium, M. Athar Tariq, S. Oswald, P. Blincoe, R. Spencer, L. Houser, A. Ba, and T. Esser (eds.), 7-10 Dec. 2004, San Diego, CA. Calif. Dept Food and Agric., Sacramento, CA.*
- Lin, H. and Walker, A. 2004. Development of SSR markers for genotyping and assessing the genetic diversity of *Xylella fastidiosa* in California, pp. 206-209. *In. Proceedings, Pierce's Disease Research Symposium, M. Athar Tariq, S. Oswald, P. Blincoe, R. Spencer, L. Houser, A. Ba, and T. Esser (eds.), 7-10 Dec. 2004, San Diego, CA. Calif. Dept Food and Agric., Sacramento, CA.*
- Hill, B.L. and Purcell, A.H. 1997. Populations of *Xylella fastidiosa* in plants required for transmission by an efficient vector. *Phytopathology* 87: 1197-1201.
- Pooler, M.R. and Hartung, J.S. 1995. Genetic relationships among strains of *Xylella fastidiosa* from RAPD-PCR data. *Curr. Microbiol.* 31:134-137.
- Purcell, A.H. and Saunders, S.R. 1999. Fate of Pierce's disease strains of *Xylella fastidiosa* in common riparian plants in California. *Plant Dis.* 83:825-830.
- Varela, L.G., R.J. Smith and P.A. Phillips. 2001. Pierce's Disease. Univ. California. Agric. and Nat. Res. Publ 21600.

## FUNDING AGENCIES

Funding for this project was provided by the University of California Pierce's Disease Grant Program, the CDFA Pierce's Disease and Glassy-winged Sharpshooter Board, and the USDA Agricultural Research Service.

# THE EFFECT OF DORMANT SEASON SURVIVAL OF *XYLELLA FASTIDIOSA* IN GRAPEVINES ON PIERCE'S DISEASE EPIDEMICS IN CALIFORNIA

## Project Leader:

Barry L. Hill  
CDFA, PDCP  
Sacramento, CA 95832

## Cooperators:

Jennifer Hashim  
UC Cooperative Extension  
Kern County, CA

William Peacock  
UC Cooperative Extension  
Tulare County, CA

**Reporting Period:** The results reported here are from work conducted May 2005 to October 2005.

## ABSTRACT

The two California Pierce's disease (PD) epidemics associated with population outbreaks of glassy-winged sharpshooter, at Temecula in the mid 1990s and in Kern County peaking in 2002, differed dramatically in the number of vineyards lost and the grapevine varieties affected. It is postulated that vine-to-vine (secondary spread) of infections occurred throughout all vineyards in both areas but the survival and progression to disease of these infections differed between the two areas. In Temecula, many of the resulting infections survived vine dormancy and progressed to chronic disease resulting in the loss of half or more of the area's vineyards of all varieties. In Kern County only some of the infections in only two varieties, Redglobe and Crimson Seedless, survived vine dormancy and progressed to disease, and vineyards of all other varieties were unaffected. A hypothetical explanation of this epidemiological pattern is presented and experiments are begun to test this hypothesis. The benefit to grape growers in the southern San Joaquin Valley will be to provide reliable ways to reduce risk of loss by PD epidemics.

## INTRODUCTION

Following the appearance in the mid 1980s of the glassy-winged sharpshooter (GWSS) in California, there have been two major epidemics of Pierce's disease (PD) associated with large populations outbreaks of GWSS, first in Temecula in the mid 1990s, and second in the General Beale area of Kern County peaking in 2002. The patterns of PD incidence and vineyard loss differed dramatically between these two epidemics. In Temecula, the site with the milder winter climate and shorter dormant season, more than half of the region's vineyards were lost, and most or all the varieties had substantial losses resulting in removal of vineyards. In Kern County (which has a colder winter climate and longer dormant season), only a small percentage of the vineyards were lost, and all of the lost vineyards were in only 2 of the 6 varieties in the area, Redglobe and Crimson Seedless. The losses to vineyards of the other 4 varieties were very small, in most cases less than 1 in 10,000 vines. By contrast, all 12 of the Redglobe vineyards in the General Beale area were significantly damaged with from 2% to more than 50% of the vines lost (Hashim, et.al., 2003), and most of these vineyards were ultimately removed.

Grapevines acquire new *Xylella fastidiosa* (*Xf*) infections either by primary spread or secondary spread. Primary spread occurs when vector insects acquire the bacterium from source plants outside the vineyard, then fly into the vineyard to infect vines. Secondary spread occurs when vector insects acquire *Xf* from an infected vine in the vineyard and then spread the infection to other vines, vine-to-vine spread. The risk associated with these two kinds of spread is different. The patterns of spread associated with primary spread are linear, that is a typically small and relatively constant number of vines per year become infected, and the accumulation of infected vines increases additively. The result is usually small but manageable losses each year. The patterns of spread associated with secondary spread are typically logarithmic, and the accumulation of infected vines increases as a multiple of the infected source vines that are present. The result can be the rapid loss of entire vineyards within just a few years.

Secondary spread can not begin to occur until that time in the growing season when the bacterial cells in diseased vines have multiplied and moved within the vine from the refuge site where they survived the dormant season, up into the new growth where vector insects can feed and acquire them. Secondary spread of infection can then continue until the end of the growing season. However infection does not equal disease. The phenomenon of over-winter curing of *Xf* infections is well documented in most viticulture areas of California (Fiel et.al., 2003). Early season inoculations can result in infections that survive the dormant season and progress to chronic disease and vine death. However later season infections do not become sufficiently established to survive the dormant season, and the vines are free of infection the following year (Fiel et.al., 2003). In most viticulture areas of California (Napa Valley, for example) secondary spread of infection regularly occurs, but it cannot begin early enough in the season such that the infection can survive vine dormancy and progress to chronic PD. In these areas secondary spread occurs but does not result in disease.



Figure 1

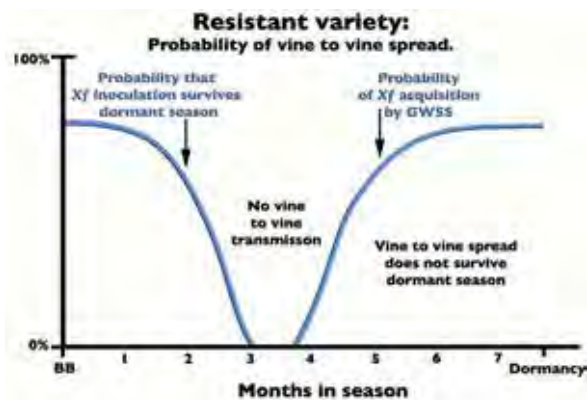


Figure 2

Our hypothesis is that in the General Beale area secondary spread of infection occurred in all varieties, possibly infecting large numbers of vines in every vineyard. The rate of *Xf* multiplication and movement varies within plant hosts (Hill and Purcell, 1995), and presumably varies between grapevine varieties. In the most susceptible varieties, Redglobe and Crimson, the rate of bacterial multiplication and spread was faster and the result was that the bacteria had a window of opportunity sometime in mid season when secondary spread could progress to disease. Secondary spread infections could not occur before this time window, and secondary spread infections after this time window did not survive vine dormancy. Thus in the two susceptible varieties some, but not all, of the secondary infections progressed to chronic disease. In the resistant varieties however, by the time secondary spread could begin, it was too late for the infections to become well enough established to survive vine dormancy, and virtually all of those infections died out leaving the vines free of disease the following year. This is illustrated in the two hypothetical figures below. The position and shape of the left hand curves in each of the figures, labeled “Probability that *Xf* inoculation survives dormant season,” is affected by the rate of multiplication and movement of the bacterium as influenced by the characteristics of the variety. The position and shape of the right hand curves in the figures, labeled “Probability of *Xf* acquisition by GWSS,” is also affected by the varietal’s characteristic rate of multiplication and movement of the bacterium. The position and shape of these curves can also be influenced by the severity of winter climate and the length of the dormant season. A milder and shorter dormant season would move the curves for all varieties toward each other, resulting in a greater probability of overlap and thus a greater probability of a window of opportunity when secondary spread could result in chronic disease. A colder and longer dormant season would move the curves further apart, thereby reducing overlap and reducing or eliminating the possibility of secondary spread. This would account for the dramatic difference between the epidemiological patterns observed in the Temecula vs. the General Beale epidemics. In the General Beale area most of the varieties would be “resistant” to secondary spread of PD, and thus the vineyards were not lost to disease. Those same varieties, if grown in the Temecula area, would have a shift in their probability curves such that the curves would overlap, the varieties would then be “susceptible” to secondary spread, and the vineyards would be lost.

Current research efforts on PD being funded by the viticulture industry and by government are directed toward finding a solution to the threat of PD to viticulture in California, a cure if possible. While a cure is desirable, it is also likely to be a long-term effort, expensive, and possibly impractical. The risk from PD, even in the presence of GWSS is not uniform throughout the state because the epidemiology characteristics are different in various areas. If the epidemiological risk could be reliably defined for each area and effective control measures devised and adopted to reduce or eliminate risk, the threat could be reduced to economic unimportance. Ideally we could know enough specific epidemiology to provide the following advice to growers in each area: “Your risk of loss from primary spread is X, and by adopting these control measures at cost Y your risk can be reduced to Z. Furthermore your risk of loss from secondary spread is A, and by adopting these control measures at cost B, your risk can be reduced to C.” This knowledge would satisfy the need of almost all California grape growers.

This project addresses the risk of loss from secondary spread in the southern San Joaquin area, and should identify a window of vulnerability when protections against secondary spread would be most effective. These experiments will provide actual data to help convert the hypothetical curves proposed here, to real curves for susceptible and resistant varieties in the southern San Joaquin Valley. If the timing and duration of the time window when susceptible varieties are vulnerable to secondary spread is identified, then chemical protections, such as systemic insecticides, may reduce the risk during that window of time to economic unimportance.

Based on historical experience the risk from primary spread appears to be negligible in Kern County and is confined to localized pockets in Tulare and Fresno Counties (pers. com. W. Peacock, J. Hashim). Primary spread during the General Beale GWSS/PD epidemic would have affected all the varieties, but there is no epidemiological evidence that this occurred

(Hashim et.al., 2003). Areas of southern Kern County where GWSS has been present in low numbers for more than 5 years have rates of new PD infections that are less than 1 vine in 10,000 in all varieties.

Ideally the same kind of experiments should be conducted in various regions of California. However there are both practical and political impediments to conducting such experiments, and it is beyond the capacity of this laboratory to expand into other areas. The magnitude of these experiments requires plots with several hundred mature grapevines that are being cultivated as a commercial vineyard, and there are concerns about experimentally introducing PD into viticulture areas close to commercial production. This project was delayed due to these concerns and was eventually located in a mature vineyard in the Kerney Agricultural Field station near Parlier, California. Other similar safe and acceptable locations are yet to be located in other major viticulture areas.

## OBJECTIVES

The hypothesis regarding differences among varieties regarding susceptibility to secondary spread will be experimentally tested by:

1. Determining the “Probability that *Xf* inoculation survives dormant season” curves for 4 different varieties, a resistant, a susceptible, and three unknowns, and
2. Determining the “Probability of *Xf* acquisition by GWSS” curves for the same 4 varieties.

Objective one will involve needle inoculations of 20 to 35 vines at a time, of each variety, at twice a month intervals for 4 months beginning at the end of April. Systemic infections will be confirmed by ELISA testing of each vine during the year that they are inoculated. The following year they will be tested to see whether the infections persisted over the dormant season. Objective two will involve inoculating 50 vines of each variety early in the season, then testing the vines at various time intervals the following year to determine when the bacterium appears in the new foliage such that GWSS could acquire the bacterium by feeding on the foliage. The experiments for objective one have been done previously, but not with sample sizes and frequencies that would allow the reliable depiction of bacterial survival curves. Objective two has not been done before, nor has the combination of the two curves been done together to determine the possibility and timing of a potential window of time when secondary spread would be possible.

## RESULTS

The inoculation and monitoring experiments are being done at the University of California Kearney Research and Extension Center at Parlier, California on a 3.2-acre plot that had 1260 mature (ca.10 year old) Thompson Seedless vines. On 180 of these vines two grafts each of another variety (Selma Pete) were grafted 3 years ago on the mature Thompson roots. These 180 Selma Pete vines (now in their 4<sup>th</sup> season) and another 320 Thompson Seedless vines were needle-inoculated this year at twice per month intervals beginning the end of April through the middle of August, 8 total inoculations. The vines inoculated in May and June (4 inoculation times, 220 vines) have been tested so far, and 100% of the inoculations have resulted in *Xf* infections that have multiplied and moved beyond the inoculation site. The remaining vines will be tested before the vines go dormant this year.

The remaining 760 mature Thompson Seedless vines that were not involved in inoculation experiments this year were cut off about 30 cm above the soil and grafted with Redglobe, Thompson Seedless, or Princess cuttings in early April of this year. About 80% of these grafts were successful, and are therefore now near the end of their first year of growth. In three years these vines will be ready for the same kind of experiments that are being conducted this year with the currently mature Thompson's and Selma Pete vines. It was unfortunate that a site could not be obtained this year with sufficient mature Redglobe and Thompson vines to enable the experiments to be done now without waiting for three years, but the concerns of the PD control programs in the southern San Joaquin Valley prevented obtaining such a site.

Each needle inoculation introduced a droplet with at least 10,000 viable *Xf* cells into the plant xylem. Each plant was needle inoculated at two different sites, on shoots that were on different scaffolds or branches of the vine, and the inoculation sites were flagged so that they could be found again. The inoculations were near the base of the shoots, about 3 internodes (usually about 15 to 20 cm) from the mature wood. At each inoculation site both the stem and the closest petiole were inoculated. The intent was to make the inoculations with many thousands more cells than a vector insect would transmit, and at sites comparable to where a feeding GWSS might inoculate close to the old wood. The idea was to maximize the probability that the needle inoculation would result in infections that might survive the dormant season. If this intensive needle inoculation does not result in infections that survive the dormant season, then surely inoculations by GWSS would not result in infections that survive.

## CONCLUSIONS

These experiments have just begun. We have established that the inoculation protocol is at or close to 100% effective at producing infections of *Xf*. There have been many speculative theories about why GWSS inoculations would be more likely than traditional California vectors to produce *Xf* infections that survived vine dormancy and progressed to disease. These experiments are even more likely than GWSS to produce infections that survive. If under these circumstances it is found that secondary spread in resistant varieties in the southern San Joaquin cannot begin until after the time when the new infections

can survive the dormant season (i.e. the curves do not overlap) then it could be asserted that the risk of secondary spread in this region in resistant varieties with GWSS as a vector is not economically significant.

#### **REFERENCES**

- Feil, H., Feil, W. S., Purcell, A. H. (2003). Effects of date of inoculation on the within-plant movement of *Xylella fastidiosa* and persistence of Pierce's disease within field grapevines. *Phytopath.* 93: 244-251.
- Hashim, J.; Hill, B.L.; Kelly, M; Shaari, D; Purcell, A.H.. 2003. Monitoring and Control Measures for Pierce's Disease in Kern County, and Epidemiological Assessments of Pierce's Disease. Proceedings, 2003, Pierce's Disease Research Symposium, Calif. Dept. of Food and Ag. Sacramento, CA
- Hill, B. L., Purcell, A. H. (1995). Multiplication and movement of *Xylella fastidiosa* within grape and four other plants. *Phytopath.* 85: 1368-1372

#### **FUNDING AGENCIES**

Funding for this project was provided by the CDFA Pierce's Disease and Glassy-winged Sharpshooter Board.



# GLASSY-WINGED SHARPSHOOTER IMPACT ON 'WASHINGTON' NAVEL ORANGE YIELD, FRUIT SIZE, AND QUALITY

## Project Leader:

Raymond L. Hix  
Center for Viticulture and Small Fruit Research  
Florida Agricultural and Mechanical University  
Tallahassee, FL

## Cooperators:

Mary Lu Arpaia  
Department of Botany and Plant Science  
University of California, Riverside  
Kearny Agricultural Center  
Parlier, CA

Carol Lovatt  
Department of Botany and Plant Science  
University of California  
Riverside, CA

Beth Grafton-Cardwell  
Department of Entomology  
University of California, Riverside  
Kearny Agricultural Center  
Parlier, CA

Phil Phillips  
UC Cooperative Extension  
Ventura, CA

**Reporting Period:** The results reported here are from work conducted March 2004 to September 2005.

## ABSTRACT

Prior to this study, it was unknown what impact the glassy-winged sharpshooter (GWSS), *Homalodisca coagulata*, had on fruit yield, fruit size, and quality as well as tree vigor. The effects of the high feeding populations of GWSS on navel orange peel nutrient status and metabolism have been consistent for the four years of the study. High GWSS feeding populations significantly reduced peel Ca and Mg concentrations all years of the study: year 1 ( $P \leq 0.05$ ) and year 2 compared to the low GWSS population ( $P \leq 0.001$ ). High GWSS feeding populations significantly disrupted N metabolism causing high peel nitrate-N or total N in years 1 and 2, respectively ( $P \leq 0.05$ ). High GWSS feeding populations significantly increased peel arginine and putrescine concentrations in four years of the study with the magnitude of the difference between the two treatments greater in years 2 and 3 ( $P \leq 0.05$ ). High GWSS feeding populations resulted in a numerically higher concentration of proline in year 1 and a significantly higher proline concentration in year 2 ( $P \leq 0.05$ ). Although GWSS feeding causes changes in peel Ca, Mg and N status, high levels of feeding and the induced changes occur after maximum peel thickness and, thus far, have not affected external fruit quality. The changes in metabolism induced by GWSS feeding are indicative of tree stress. The increased magnitude and statistical significance of these metabolic changes over the first two years of high GWSS feeding pressure is consistent with cumulative stress to the trees. High feeding pressure resulted in significant yield losses in 'Washington' navel oranges.

## INTRODUCTION

Prior to this study, it was unknown what impact the glassy-winged sharpshooter (GWSS), *Homalodisca coagulata*, had on fruit yield, fruit size, and quality as well as tree vigor. The goals of this project were to determine the usefulness of management of GWSS to prevent yield loss, fruit size reduction, and degraded fruit quality. This information is paramount before we can even begin to incorporate these into conventional IPM programs. First we have to know what impact GWSS has on citrus, and second we need to know how to use the currently available materials against the GWSS in IPM programs to prevent potential losses without disrupting citrus IPM programs. Prior to this study, efforts to manage GWSS in citrus were primarily to suppress populations to limit the spread of *Xylella fastidiosa* in areawide management programs.

## OBJECTIVES

This research was initiated to:

1. Address the impact of GWSS on fruit yield, and distribution of fruit size when GWSS are controlled compared to untreated blocks of Valencia oranges, and 'Washington' navel oranges;
2. Evaluate the effects of high GWSS populations have on fruit quality (sugar/acid ratios, peel thickness, sugar/acid ratio, juice quality, peel texture and firmness, susceptibility to post-harvest disorders) in Valencia and Navel oranges;
3. Evaluate the effects of large GWSS populations have on water stress, nutrient loss (Ca etc.), metabolite loss (amino acids, xylem translocated PGRs) due to xylem feeding and fruit drop and fruit quality, and fruit drop;
4. Determine if Admire enhances fruit size, tree health and vigor in the absence of GWSS.

## RESULTS AND DISCUSSION

### Objectives 1 and 2

The Navel orange experiment was initiated on August 21, 2001 for 'Washington' Navel oranges. A site was established in Mentone with a completely random design with five replications with high and low GWSS populations. Each population level has three rows of 43 trees (two guard rows and one central harvest row). The low populations (as close to '0' as possible) were established by applying 32 oz. of Admire 2F via drip irrigation on August 21, 2001, April 7, 2002, and May 6, 2003. Insects were monitored weekly by trapping, and visually counting adults, nymphs and egg masses. Efforts to establish differential populations were successful. On July 3, 2003, visual searches revealed 139.6 adults/3 minute search/tree ( $\pm 3.7$  SEM) in the high population trees versus 3.0/3 minute search/tree ( $\pm 0.5$  SEM) in the low population trees (Figure 1). The adult peak for 2002 occurred on June 25 with 104.6 GWSS/3 minute count ( $\pm 6.5$  SEM). The high and low population trees had 2.7 ( $\pm 0.6$  SEM) and 0.9 ( $\pm 0.2$  SEM) egg masses/25 leaf turns respectively. One tree from a guard row was tented and fumigated for absolute counts on August 27, 2002. The absolute counts ranged from 1,149-4,999 GWSS/tree in the high population trees and 10-21 GWSS/tree in the low population trees.

The data from the four seasons of this study indicate that chronic high feeding of GWSS on orange reduces overall yield and size distribution. At the beginning of the study, two population levels were established in a 'Washington' navel orange grove. The low population level had essentially 0 GWSS/tree and the high population level trees had more than 1,100 GWSS/tree during July, August, and September of 2001, 2002, and 2003. At the beginning of this study, there were no differences in the mean number of cartons packed by total yield or size distributions (Hix et al. 2002). However, as the influences of chronic high GWSS feeding were removed, differences were detected (Hix et al. 2003, 2004a, and 2004b). For unknown reasons, the populations at the Mentone grove began to decline during the summer of 2004 and the trend continued during the summer of 2005. A neighbor treated a 35-acre grove across the street in June 2004. The counts peaked on August 12, 2004 with the high population trees at 38.7 ( $\pm 8.7$  SEM) adult GWSS per three minute count compared to 1.1 ( $\pm 0.82$ ) in the treated trees. The counts peaked on August 12, 2005 with the high population trees at 2.4 ( $\pm 0.7$  SEM) adult GWSS per three minute count compared to 0.7 ( $\pm 0.22$ ) in the treated trees. As a result, the January 2005 harvest essentially became a "tree recovery" evaluation. The yield seemed to recover because the separation in the mean yield was not as significant in January 2005 as in previous harvests (Figure 2).

Navel oranges were harvested from 37 trees within the harvest rows January 21, 2005 and sent to the California Citrus Packing House in Riverside for packout and evaluation. Two cartons from two sizes (88 and 113) and two grades (Choice & Export) from each replication (total of 96 cartons) were selected. Trans-Pacific shipment was simulated by storing the 96 cartons from at the packinghouse for 21 days at 37° F after which time the fruit was sent to Kearney Agricultural Center (KAC) for storage at 68° F for four days followed by 55° F for five days. For post-harvest evaluation at harvest, initial measurements of general appearance, pitting, puff and crease, peel firmness, thickness, color, TA, TSS, and % juice were taken from a 20 fruit sub-sample. Fruit was evaluated for general appearance, rind pitting, and decay following simulated shipment.

### Objective 3

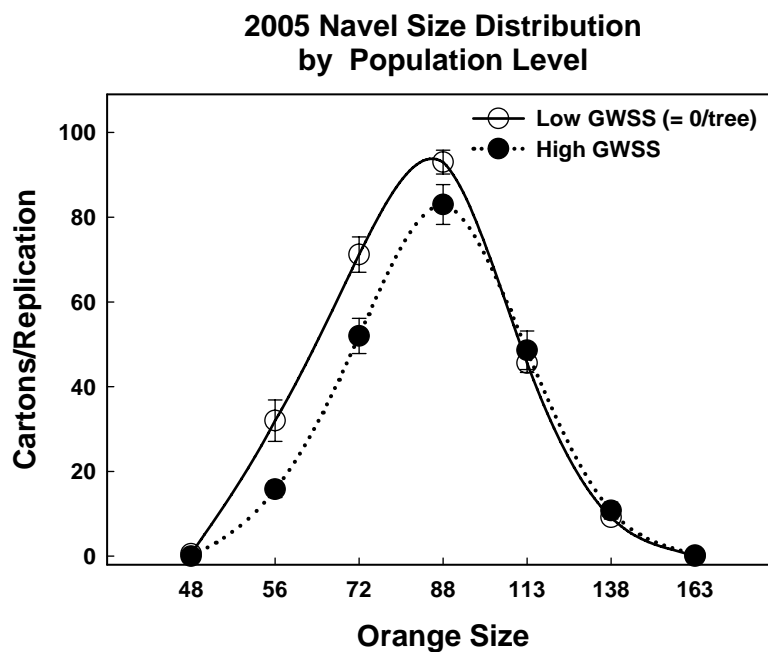
The results provide significant evidence that (1) the peel nutrient status of navel and oranges is reduced in a manner related to GWSS population density and (2) peel metabolite concentrations indicative of stress also change in a manner related to GWSS population density.

The peel nutrient status of navel orange fruit collected from the high and low GWSS treatments at Mentone during a period of low population density in July 2002 were not significantly different. At this site the GWSS population density increased on approximately Aug 8 and remained high through the end of August-early September. Peels from navel oranges collected at the time of intensive GWSS feeding on shoots in the high GWSS treatment had significantly lower concentrations of the Ca, Mg and NO<sub>3</sub> than peels of fruit collected from the low GWSS treatment. The results are consistent with reports in the literature that high concentrations of Ca and Mg are found in GWSS excretions. In addition, peel samples of fruit collected from trees with high populations of GWSS tended to have a 10% and 12% less Mn and Mo, respectively. However, these differences were not statistically significant. For fruit samples collected from the high GWSS treatment on August 11, 2002 just three days after the GWSS populations began to increase, the two contrasting population densities had no significant effect on peel arginine concentration. However, for navel orange fruit collected during the period of high GWSS populations (August 20, 2002), peel arginine concentration was significantly greater for fruit from the high GWSS treatment than the low GWSS treatment. It is worth noting that arginine tends to accumulate in parallel with the build up of the GWSS population over time. Elevated arginine concentrations are indicative of biotic and abiotic stress conditions. The accumulation of arginine in navel orange peels in response to increasing GWSS population density also paralleled the increase in peel putrescine concentration. Arginine is the immediate precursor for the biosynthesis of putrescine, which is also known to accumulate under stress conditions. Depending on the regulation found in different plant species, concentrations of spermidine increase, decrease or remain the same during stress. Spermine, which is typically found in lower concentrations than putrescine and spermidine, is usually unaffected by stress. These results strongly suggest that high population of GWSS cause significant stress. Proline concentrations decrease under stress when carbohydrates become limiting. Whereas peel proline concentrations tended to be lower for fruit collected from the high GWSS treatment, there was no significant

difference in peel proline concentration between the two GWSS population densities. For both GWSS populations, the proline concentration decreased with time.

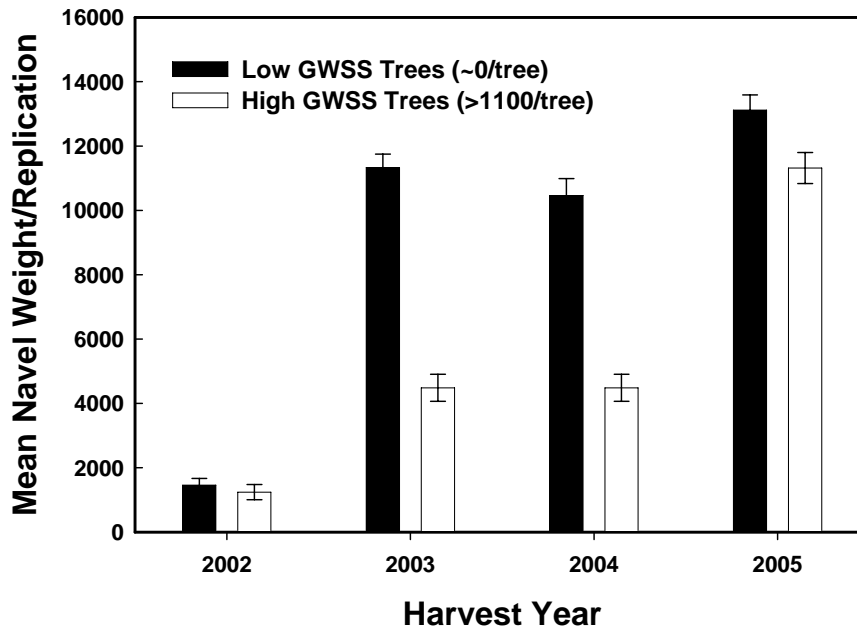
The effects of the high feeding populations of GWSS on navel orange peel nutrient status and metabolism have been consistent for the four years of the study. High GWSS feeding populations significantly reduced peel Ca and Mg concentrations all years of the study: year 1 ( $P \leq 0.05$ ) and year 2 compared to the low GWSS population (control trees treated with Admire) ( $P \leq 0.001$ ). High GWSS feeding populations significantly disrupted N metabolism causing high peel nitrate-N or total N in years 1 and 2, respectively ( $P \leq 0.05$ ). (Note that nitrate-N concentration is lower than that of total N and easier to perturb.) High GWSS feeding populations significantly increased peel arginine and putrescine concentrations in four years of the study with the magnitude of the difference between the two treatments greater in year 2 and 3 ( $P \leq 0.05$ ). High GWSS feeding populations resulted in a numerically higher concentration of proline in year 1 and a significantly higher proline concentration in year 2 ( $P \leq 0.05$ ). In year 1, the yield of the 24 data trees in the high GWSS feeding population treatment has numerically lower than the yield of the 24 control trees treated with Admire (low GWSS feeding population). In year 2, the yield reduction caused by the high GWSS feeding population was approximately 50% and significant ( $P \leq 0.05$ ). The effect of GWSS feeding appears to be cumulative over the first three years of the study as the magnitude of the changes tended to increase in magnitude and significance from year 1 to year 2 and year 2 to year 3. Although GWSS feeding causes changes in peel Ca, Mg and N status, high levels of feeding and the induced changes occur after maximum peel thickness and, thus far, have not affected external fruit quality. The changes in metabolism induced by GWSS feeding are indicative of tree stress. The increased magnitude and statistical significance of these metabolic changes over the two years of high GWSS feeding pressure is consistent with cumulative stress to the trees.

Yield (kg/tree) for the individual navel orange trees sampled for fruit peel analyses was similar to the whole row harvest (37 trees/row) data obtained at Mentone. Trees in the high GWSS populations tended to have fewer commercially valuable large size fruit as some function of yield (Figures 1 and 2).



**Figure 1.** Mean number of cartons packed fresh (choice and export) between the high and low GWSS populations for the 21 Jan 2005 Navels. Low population (virtually 0 GWSS) trees were treated on April 7, 2002, May 1, 2003, and May 5, 2004. 5 reps (Each rep = 37 trees)  $\pm$  SEM.

## Total Orange Yield by Year



**Figure 2.** The low population trees produced more gross weight (pounds) of navels than the high population trees.  $N = 5 \pm \text{SEM}$ . 1 replication = 37 trees.

### REFERENCES

- Hix, R. L., M. L. Arpaia, C. Lovatt, E. Grafton-Cardwell, and P. A. Phillips. 2004. Glassy-winged Sharpshooter Impact on Orange Yield, Fruit Size, and Quality. Citrus Research Board 2003 Annual Report. pp 40-43.
- Hix, R. L., Mary Lu Arpaia, Carol Lovatt, and Beth Grafton Cardwell 2004. Glassy-winged Sharpshooter Impact on Yield, Size, and Quality. 2004 Pierce's Disease Research Symposium, Dec 7-10, San Diego, Ca. pp 11-14.
- Hix, R. L., Mary Lu Arpaia, Carol Lovatt, Beth Grafton Cardwell, and Phil Philips. 2003. Glassy-winged Sharpshooter Impact on Yield, Size, and Quality. 2003 Pierce's Disease Research Symposium, Dec 8-11, San Diego, Ca. pp 217-220.
- Hix, R. L., Mary Lu Arpaia, Beth Grafton Cardwell, and Phil Philips. 2002. Glassy-winged Sharpshooter Impact on Yield, Size, and Quality. 2002 Pierce's Disease Research Symposium, Dec 15-18, San Diego, Ca. pp 103-104.

### FUNDING AGENCIES

Funding for this project was provided by the California Citrus Research Board, and the University of California Pierce's Disease Grant Program.

**LINKING THE MODEL OF THE DEVELOPMENT OF PIERCE'S DISEASE IN GRAPEVINES  
TO AN UNDERSTANDING OF THE DYNAMICS OF GLASSY-WINGED SHARPSHOOTER  
TRANSMISSION OF *XYLELLA FASTIDIOSA* TO GRAPEVINES AND GRAPEVINE  
GENE EXPRESSION MARKERS OF PIERCE'S DISEASE**

**Project Leaders:**

John Labavitch  
Dept. of Plant Sciences  
University of California  
Davis, CA 95616

Elaine Backus  
Exotic Pests and Diseases Lab  
USDA, ARS  
Parlier, CA 93648

Mark Matthews  
Dept. of Viticulture and Enology  
University of California  
Davis, CA 95616

Ken A. Shackel  
Dept. of Plant Sciences  
University of California  
Davis, CA 95616

**Cooperators:**

L. Carl Greve  
Dept. of Plant Sciences  
University of California  
Davis, CA 95616

Bruce Kirkpatrick  
Dept. of Plant Pathology  
University of California  
Davis, CA 95616

David Morgan  
CDFA, PDCP  
Mount Rubidoux Field Station  
Riverside, CA 92501

Alonso Pérez  
Dept. of Plant Sciences  
University of California  
Davis, CA 95616

Caroline Roper  
Dept. of Plant Pathology  
University of California  
Davis, CA 95616

**Reporting Period:** The results reported here are from work conducted October 2004 to October 2005.

**ABSTRACT**

**INTRODUCTION**

For several years we have been studying the development of Pierce's disease (PD) in grapevines. Our studies have been guided by a model of PD development that was proposed with our initial application for funding. The Model proposed several "steps" in disease development following introduction of the PD causal agent, the bacterium *Xylella fastidiosa* (*Xf*):

***Xf* introduction to vessels =>vessel cavitation =>initial water deficit => *Xf* population increase =>  
production of enzymes by *Xf* =>cell wall digestion => oligosaccharide signals => ethylene synthesis rise =>  
a "wave" of vessel occlusion beyond the infection site => collapse of vine water transport =>  
leaf abscission => vine death**

Although some aspects of the model are still being tested (the current project), our hypotheses have proven to be quite accurate. We have shown that xylem vessel obstruction (tyloses, plant cell wall component-derived gels, and, perhaps, bacterial extracellular polysaccharides) and consequent reductions in stem water transport capacity are early consequences of infection with *Xf*, before bacterial populations are substantial and have spread far from the inoculation point. We have shown that ethylene treatment of vines also triggers vessel obstruction development and reduced water movement and that ethylene emanation from vines may increase following infection. We have also developed data for xylem vessel length distributions in grapevines and shown that *Xf* must pass through vessel pit membranes if the bacterial population is to develop systemically, thus suggesting that digestion of cell wall polymers in the pit membranes is likely to be important to disease spread. These findings are reported in several reports at the annual PD Symposium (Labavitch et al., 2001, 2002; Labavitch and Matthews, 2003) and, more recently, at disciplinary scientific society meetings (Perez et al., 2004; Roper et al., 2004) and in referred reports (Stevenson et al., 2004).

This research has drawn together an assortment of UC Davis (UCD) researchers, each bringing a different disciplinary research orientation to the study. In addition, through regular discussions at UCD and with other researchers who have become colleagues as a result of meetings at the annual PD Symposia, we have begun to see how important connections can be made between our studies and those of other PD researchers. In this progress report, we discuss the successes we have had in filling the gap in the portion of the model that proposes the links:

***Xf* population increase => production of enzymes by *Xf* => cell wall digestion =>  
oligosaccharide signals => ethylene synthesis rise**

These successes include the demonstration that the putative *Xf* polygalacturonase (PG) gene actually encodes a PG and the fact that this PG contributes to symptom development in inoculated grapevines. We also discuss work designed to determine whether xylem vessels become non-functional when the glassy-winged sharpshooter (GWSS) feeds. Our project also attempts to link the grapevine PD-related gene expression studies of Doug Cook et al. (UCD Plant Pathology) with the developmental, biochemical and physiological characterization of PD development that is part of our continuing work. That effort will be discussed briefly.

## OBJECTIVES

1. Complete testing of our model of PD development in grapevines.
2. Determine whether GWSS feeding on grapevines is accompanied by xylem vessel cavitation.
3. Determine whether the grapevine “regulators” that we have identified as important to development of PD affect the expression of grapevine genes that have been shown to be important markers of *Xf* presence/PD infection.

## RESULTS

### Objective 1. Complete testing of our model of PD development in grapevines.

Efforts in this research year have examined three aspects of the model not previously tested. The first is the idea that cell wall breakdown caused by the action of bacterial enzymes like the pectin-degrading enzyme PG that was putatively encoded by an identified *Xf* open reading frame did, in fact, encode a PG that was important in PD development. The second is related to work designed to show whether *Xf* wall-digesting enzymes are present in the xylem of infected vines. The third pertains to descriptions of the porosity of the pit membranes that separate one vessel from its neighbors.

### Does the *Xf* “PG” gene encode PG and what role does the gene product play in infection?

The progress report for one of our companion proposals (PIs Labavitch, Backus and Morgan) provides a detailed description of the experiments and data that are relevant to this topic. In short:

1. The PG sequence was cloned and then expressed in transgenic *E. coli*. Protein was isolated from the transformed *E. coli* and shown to have PG activity. Because we want to use the isolated *Xf* PG in tests of its effects on grapevine xylem integrity and we have been able to isolate only a small amount of the PG thus far, we will continue to work to obtain more of the enzyme.
2. The PG gene of *Xf* was functionally knocked out by insertion of an interrupting DNA sequence in it. The resulting PG-minus *Xf* bacteria were still viable, both *in vitro* and in grapevines, but they were not able to induce PD symptoms when inoculated into vines. This provides important proof that some process involving PG action that occurs in grapevines is crucial for PD development! We will continue to work to determine what the PG is doing.

The data suggesting that *Xf* PG plays an important role in disease development is consistent with the report of our PD research colleagues (Aguero et al., 2005) showing that the expression in *V. vinifera* of the pear fruit PG-inhibiting protein (a gene cloned in our labs several years ago) leads to decreased PD symptom development in inoculated vines.

### Are *Xf* cell wall-digesting enzymes found in the vessels of infected vines?

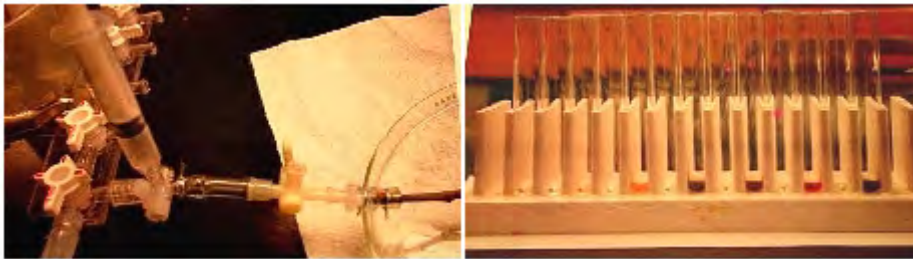
At the 2003 PD Symposium, we reported on the efforts of Ph.D. candidate Caroline Roper which led to the cloning of one of the putative *Xf* endo- $\beta$ -1,4-glucanase (BGase)-encoding genes, expression of that sequence in transgenic *E. coli*, and demonstration that the expressed gene did code for a BGase activity (Labavitch and Matthews, 2003). We are interested in factors that may open the cell wall meshwork of pit membranes to permit passage of *Xf* in diseased vines. However, as with the PG discussed above, we do not know the role (if any) of the BGase in grapevine xylem. This question is being addressed in this year’s work from the biochemical and anatomical perspectives. However, an important adjunct to those direct tests of *in vivo* enzyme function would be the demonstration that the proteins are present in infected vines. We have developed some of the immuno-histochemical tools and expertise needed to address this important question.

Antibodies were generated to recombinant *Xf* PG and BGase. The open reading frames encoding these enzymes were cloned, over-expressed in *E. coli* and then purified by nickel column chromatography. The purified recombinant proteins were separately injected into rabbits to generate antibodies. The resulting antisera were tested by ELISA against the respective purified *Xf* BGase or PG to confirm the rabbits’ production of anti-BGase or anti-PG antibodies.

Western blots using the anti-BGase antibodies as a probe detected the production of BGase by cultured *Xf* cells. This is the first demonstration that *Xf* makes a BGase in culture. Western blots using the anti-PG antibodies as a probe did not detect the production of PG by cultured *Xf*. We infer from our results with the PG-knockout *Xf* line (above) that PG is made in grapevines when infective *Xf* (i.e., the wild-type “Fetzer” strain) are growing in vines. Thus we conclude that factors present in the vine, but not in culture, are required for induction of the expression of the *Xf* PG gene. Experiments are currently underway to use both of these antibodies to test for the presence of the *Xf* wall polysaccharide-degrading enzymes in the tissues of infected vines. In order to optimize this line of investigation, Caroline Roper participated in an immuno-histochemistry techniques course at Woods Hole Oceanographic Institute in late Fall, 2004.

### Does *Xf* presence in grapevines affect pit membrane porosity?

In previous reports, we have described tests that indicate the porosity (i.e., the space between the polysaccharides) of vessel pit membranes is between 5 and 29 nm, much too small to permit passage of *Xf*. We have refined those tests by using colloidal gold particles having diameters of 5 and 20 nm. While the particles are very difficult to see under the microscope, their presence can be readily detected chemically by reacting samples containing the particles with Sigma Chemical Company's "silver enhancer". A segment of grapevine stem is fitted into a tube attached to a valve device that permits introduction of a small volume of water containing colloidal gold particles to the stem while maintaining pressure on a water line that drives water through the vessels of the segment. Introduction of food coloring, whose movement through the stem is not impeded by pit membranes; to the system and collection of the water + dye exiting the stem at the distal end indicates that the volume of water needed to move from one end of a 50 cm stem segment is less than 200  $\mu$ l. Colloidal gold particles with a 5 nm can move through healthy stem segments, particles of 20 nm diameter cannot (Figure 1). However, when we used a vine that was showing the initial visible symptoms of PD at its base (i.e., its older internodes) and tested the movement of colloidal gold particles through a stem segment cut from the younger portion of the stem that had not yet begun to show PD symptoms, particles of 20 nm diameter moved through the xylem and were collected at the distal end. These results suggest that decreased pit membrane polymer integrity, hence increased pit membrane porosity, occurs in healthy-appearing stems on infected vines. This suggests that pit membranes are being opened up in infected vines, perhaps to permit the systemic movement of *Xf*.

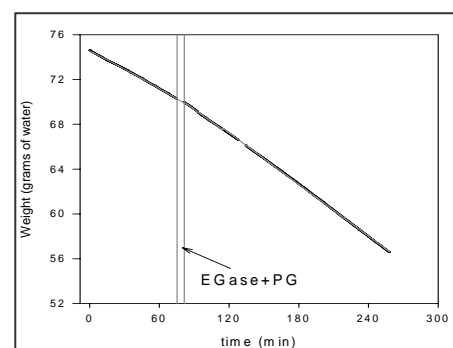


**Figure 1.** The photo on the left shows the valve system that permits the introduction of a small volume of colloidal gold particle-containing water to a pressurized stream that moves water, particles, and, if added, food coloring through grapevine stem segments. The segment is at the lower right in the picture. The photo on the right shows a series of test tubes, each containing 100 mL of the water (+ gold particles) flushed from the distal end of the segment shown in the left-hand photo. The first 4 tubes from the left in the tube rack show no color. The emergence of gold particles, beginning with tube 5 from the left, is revealed by the addition of silver enhancer which gives a colored reaction product in the presence of gold.

A pulse (2 mL) of two pure cell wall-degrading enzymes, a  $\beta$ -1,4-glucanase (EGase) extracted from *Xf*, and a recombinant polygalacturonase (PG) from *A. niger*, have been flushed through stems using the same device described in Figure 1. The combination of EGase + PG, but not the use of either, alone, allowed the passage of the 20 nm gold particles, indicating that these enzymes in conjunction were able to increase the size of the pit membrane pores (Figure 2) and the water flow rate through the stem (Figure 3). Also, the analysis of serial fractions collected at the end of the stem has revealed the presence of polysaccharides containing uronic acid in the eluding fluid after the enzymes were added. This is further evidence supporting the possibility that *Xf* uses cell wall-degrading enzymes to cross the intervessel pit membranes and to move systemically in grapevine shoots.

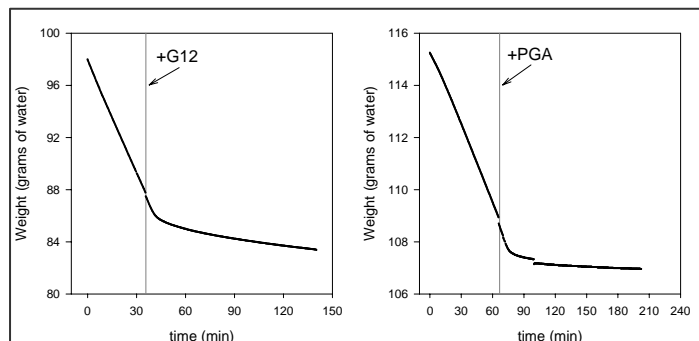


**Figure 2.** After a pulse of pure PG+EGase, the 20 nm gold particles pass through. The gold can be seen immediately after adding both enzymes, although it concentrates in the second fraction collected after the addition.



**Figure 3.** The reduction in weight of the reservoir that delivers water to the system depicted in Figure 1 is used to monitor water flow rate through the stem. The flow rate is faster after the enzymes' addition, as noted by the change in the slope.

CDTA is a chelating agent that can release charged uronides (pectins) from the pit membranes. When CDTA was introduced into the stems it also allowed the passage of the 20 nm gold particles. This is a confirmation that pectins are involved in regulating the size of the pit membrane pores. Thus the “putative” pectinase activity described for *Xf* could indeed result in an increase of the porosity size. On the other hand, after oligogalacturonides (G12) or polygalacturonic acid (PGA) were introduced into grapevine stems they partially or completely stopped the water flow (Figure 4). The possibility that pectic materials may participate in the occlusion of vessels of *Xf*-infected vines is being currently assessed.



**Figure 4.** The addition of G12 reduced greatly the flow rate through the stem, whereas PGA completely stopped the flow about half an hour after its addition. G12 contains shorter chains than PGA; but both have a degree of polymerization that likely makes them much larger than the pores in the pit membranes. The addition times of G12 and PGA are indicated by the vertical bars. PG action on PGA would convert it into oligomers smaller than those in G12.

As our tests of the ability of 5 and 20nm beads to pass through stem segments continued into the summer months (2005) we noted a transition in the apparent porosity of pit membranes. Beginning in mid-July we noted a substantially increased stem water conductivity (tested as shown in the “flow rate” studies described by Figure 4) and the ability of both 5 and 20 nm particles to pass the length of the stem, with no prior enzyme treatments required. Work by Eleanor Thorne in a Rost and Matthews project showed that bacteria were able to travel from stem segment explants a relatively long distance, including passage through petioles and into 2° and 3° leaf veins. It is not clear exactly when in the season these studies were done. Thus it becomes important to determine if seasonal changes in pit membrane porosity, perhaps reflecting a change in the pit membrane porosity of more recently developed vessels, is a factor contributing to a (perhaps) “seasonal” change in the ability of *Xf* to move systemically through a grapevine. Although we are at the end of this season, we are hoping to determine if this apparent “opening” of pit membrane pores is sufficient to permit passage of bacteria without enzyme “assistance.” This is a question that requires further study.

**Objective 2. To determine whether GWSS feeding on grapevines is accompanied by xylem vessel cavitation.**

This Objective will be addressed by a combination of researchers (details in the second-year proposal submitted) who will combine expertise in monitoring of the electrical signals produced by sharpshooters as they feed on grapevine xylem (Backus and colleagues), and characterizing the water-moving capacity of xylem vessels (Shackel, Matthews and Labavitch). Our time in the first year was spent primarily in establishing the techniques and infrastructure required to bring an assortment of techniques together.

Progress was made this year in developing the research infrastructure and protocols needed for the insect portion of the cavitation project. However, this proved to be more challenging than was foreseen at the time the proposal was written. Co-PI Backus’s lab renovation in Parlier was delayed due to unforeseen problems acquiring building materials. The lab became fully functional in August 2004, whereupon work began immediately to perfect EPG protocols with the smoke tree sharpshooter (STSS), *Homalodisca liturata*. These protocols were successfully developed.

At the UC Davis end, Ph.D. candidate Alonso Pérez has developed the MRI techniques that will be used to determine whether vessels that the insect has been feeding become air-filled (i.e., cavitated) following the end of feeding (see the progress report for Shackel and Labavitch). Alonso Pérez also attended Dr. Backus’ EPG Workshop at the State University of California, Fresno in July, 2005. At the workshop he was trained specifically in the recording and analysis of STSS probing waveforms. We have been also tuning and testing a device for monitoring the acoustic emissions produced at the time of a vessel cavitation. Now that the acoustic monitoring instrumentation is ready for our use and tested, we will combine its use with Backus’ EPG techniques and Pérez’ MRI approaches to obtain the answer to the question about feeding-related vessel cavitation. The first attempts at these experiments are scheduled for October, 2005. The information we obtain should be of substantial value for understanding how GWSS transmission to grapevines occurs.

**Objective 3.: To determine whether the grapevine “regulators” that we have identified as important to development of PD affect the expression of grapevine genes that have been shown to be important markers of *Xf* presence/PD infection.**

As discussed in this and previous PD research reports, we have now developed a substantial data set describing events in the development of PD in grapevines. We will work in the coming year to focus on two important PD development steps proposed by the model, but not yet fully tested. These relate to the potential roles of the plant hormone ethylene and



oligosaccharides digested from grapevine cell walls in influencing the spread of the *Xf* population in vines or the vine's response to *Xf* presence. We have obtained the supplies needed to follow expression of the set of 4 grapevine genes that are expressed relatively early following *Xf* introduction into vines (Cook et al., 2003). The testing of the timing of expression will be based on real-time PCR of these 4 genes in relation to the appearance of early PD symptoms, most specifically the growth and spread of *Xf* in the weeks early after inoculation and development of vascular system occlusions as followed by MRI.

## CONCLUSIONS

Our demonstration that the *Xf* PG gene actually encodes a pectin-degrading enzyme is important. Adding to that importance is our observation that *Xf* that lacks a functional PG gene is unable to induce PD symptoms in grapevines places *Xf* cell wall degradation capacity in a key position in PD development, consistent with the suggestion of the model that has served as the central thread of our research. However, we have not actually shown that the PG or, for that matter, the *Xf* BGase actively digests grapevine pit membrane-localized polysaccharides. That will be a focus of our studies in the coming year. In fact, Alonso Perez has recently been developing the histochemical analytical skills needed to answer some of these questions. Interaction with the projects of Tom Rost and Mark Matthews will add additional power to the analysis.

Our group of cooperating PD researchers feels that the best way to effectively deal with the threat caused by the disease is to fully understand its development in grapevines. It is our view that a full understanding of the interaction of GWSS, *Xf* and *Vitis vinifera* should identify aspects of disease development that can be targeted by control measures that can be exploited using genetic approaches or new field management practices. We feel that the identification of a key role for *Xf* PG in PD development reported here and in a companion progress report may provide a useful target toward which PD control measures could be directed. Should work to determine the extent to which grapevine ethylene production is a response to infection confirm our model's prediction, we will have another valuable marker of PD development as well as another potential target to exploit in terms of interrupting the systemic spread of *Xf*.

## REFERENCES

- Aguero, C. B., S. L. Uratsu, L. C. Greve, A. L. T. Powell, J. M. Labavitch, C. P. Meredith, and A. M. Dandekar. 2005. Evaluation of tolerance to Pierce's Disease and *Botrytis* in transgenic plants of *Vitis vinifera* L. expressing the pear PGIP gene. *Molecular Plant Pathology* 6:43-51.
- Cook D., F. Goes-da-Silva, and H. Lim. 2003. Functional genomics of the grape-*Xylella* interaction: Towards the identification of host resistance determinants. 2003 Pierce's Disease Research Symposium. p. 10-13.
- Labavitch J. M., and M. A. Matthews. 2003. The development of Pierce's Disease in xylem: the roles of vessel cavitation, cell wall metabolism and vessel occlusion. 2003 Pierce's Disease Research Symposium. p. 150-153.
- Labavitch J. M., E. Backus, M. A. Matthews, and K. A. Shackel. 2004. Linking the model of the development of Pierce's disease to an understanding of the dynamics of glassy-winged sharpshooter transmission of *Xylella fastidiosa* to grapevines and grapevine gene expression markers of Pierce's disease. 2004 Pierce's Disease Research Symposium, p. 19-21.
- Labavitch J. M., E. Backus, and D. Morgan. 2004. The contribution of the pectin-degrading enzyme polygalacturonase (PG) in transmission of *Xylella fastidiosa* to grape and the use of PG-inhibitor proteins for transgenic resistance to Pierce's disease. 2004 Pierce's Disease Research Symposium, p. 22-24.

## FUNDING AGENCIES

Funding for this project was provided by the CDFA Pierce's Disease and Glassy-winged Sharpshooter Board, and the USDA Animal and Plant Health Inspection Service.

**CHARACTERIZATION AND IDENTIFICATION OF PIERCE'S DISEASE RESISTANCE MECHANISMS:  
ANALYSIS OF XYLEM ANATOMICAL STRUCTURES AND OF NATURAL PRODUCTS  
IN XYLEM SAP AMONG VITIS**

**Project Leader:**

Hong Lin  
Crop Diseases, Pests, and Genetics Research Unit  
USDA, ARS  
Parlier, CA 93648

**Cooperators:**

Felix Fritschi  
Crop Diseases, Pests, and Genetics Research Unit  
USDA, ARS  
Parlier, CA 93648

Andrew Walker  
Department of Viticulture and Enology  
University of California  
Davis, CA, 95616

**Reporting Period:** The results reported here are from work conducted October 2004 to September 2005.

**ABSTRACT**

Grapevine genotypes differ in their susceptibility/tolerance to Pierce's disease (PD). This may be related to the concentration and presence or absence of chemical compounds in the xylem sap and/or due to anatomical features of the xylem. Here we report on a three-pronged comparative approach investigating various grapevine species ranging in PD tolerance. Results from *in vitro* xylem sap assays indicate a broad range of *Xylella fastidiosa* (*Xf*) growth responses in both planktonic growth and biofilm formation. Investigations into *Xf* population dynamics in the stem tissues of greenhouse grown plants, confirm large differences in the size of *Xf* populations between susceptible and tolerant genotypes. Microscopic investigations into xylem vessel occlusions document the differences in occlusion percentages as well as the kinds of occlusions prevalent among four different *Vitis* genotypes.

**INTRODUCTION**

Experimental, as well as anecdotal, information indicate a considerable range in tolerance to PD among grapevine genotypes. It appears that a number of *Vitis* as well as *Muscadinia* species evolved mechanisms allowing them to tolerate infection by *Xf*. More precisely, while it is often thought that many wild genotypes evolved tolerance mechanisms, it is also possible that it is the induction of a deleterious response by *V. vinifera* genotypes that renders them more susceptible than a number of other genotypes which may not respond to a challenge by *Xf*. Understanding of the causes of the mechanisms responsible for differential sensitivity is a critical component of crop improvement. The rich diversity of grapevine genotypes tolerant to PD can and is being utilized to serve as a source for PD resistance for breeders. While PD resistant species have been identified (Mortensen et al., 1977; Kirvanek and Walker, 2004), the mechanisms of resistance have not been identified. Breeding of resistant genotypes is likely the most sustainable means of combating PD. In order to generate highly PD tolerant grape cultivars, knowledge of the kind and function of resistance mechanisms is paramount. This research was initiated to investigate host-pathogen interactions and to screen for mechanisms of PD resistance in a range of *Vitis* species. It appears that multiple mechanisms of PD resistance mechanisms are present in wild genotypes and/or genotypes utilized in the southeastern USA. *Xf* is xylem limited and appears to kill vines by inducing or creating vessel blockage leading to disease (Goodwin et al 1988a, 1988b) and may also involve the production of toxins (Lu et al., 2004; Matthews et al., 2004). While the importance of the physical and/or the chemical environment in the xylem is unclear, xylem-related factors are undoubtedly involved in host-pathogen interactions and the mechanisms of host tolerance. Therefore, this project focuses on: 1) host-pathogen interactions using comparative analyses of *Xf* population dynamics among a group of grapevine genotypes; 2) examination of xylem anatomical factors using microscopic approaches; and 3) investigation of xylem sap chemistry by employing bioassays that will be followed by analytical approaches.

**OBJECTIVES**

1. Determine the effect of xylem sap collected from various grape genotypes with differential sensitivity to PD on *Xf* colony number and biofilm formation.
2. Evaluate *Xf* population dynamics in 20 grape genotypes.
3. Examine xylem structure of selected grape genotypes using SEM.

**RESULTS**

**Objective 1**

Xylem sap extracted from 14 grape genotypes was used in a bioassay to determine if there are differences in *Xf* growth characteristics associated with xylem sap source (Figures 1 and 2). The sap extracted from the field-grown plants was filter sterilized and inoculated with *Xf* ('Stags Leap') and incubated at 28°C. The number of colony forming units was evaluated using plating and biofilm formation was assessed by the crystal violet method. CFU counts and biofilm formation are summarized in Figures 1 and 2. A large range in terms of *Xf* growth and biofilm formation was found in response to xylem

sap from different grape genotypes. Both, planktonic growth and biofilm formation were influenced by the source of xylem sap. Xylem sap from some genotypes like 8909-17 (*V. rupestris* x *V. arizonica*) and 9621-67 (*V. rupestris* x *V. arizonica*) suppressed *Xf* growth very strongly, while *Xf* flourished in sap from various genotypes including *V. rufotomentosa*, *V. nesbitiana*, and *V. tiliifolia*. The differences in *Xf* growth characteristics indicate that xylem sap composition is genotype specific and that there are xylem sap compositional aspects that strongly influence *Xf* growth. However, it is still not clear if the differences are due to the presence of inhibitory and/or the absence of growth promoting compounds.

## Objective 2

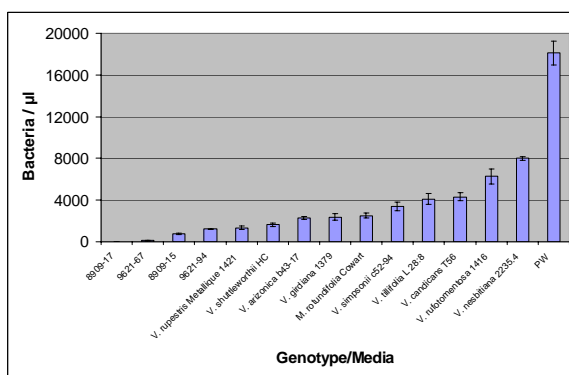
Twenty grape genotypes were grown under greenhouse conditions to investigate host-pathogen interactions. Leaf and petiole samples from bottom, middle and top third of each plant were collected from *Xf* inoculated and control (water inoculated) plants at 34, 77, and 113 days post inoculation. Stem samples were collected at the last sampling only. These samples are being used to determine *Xf* populations in the different plant fractions using quantitative ELISA. Kirvanek and Walker (2004) reported that stem *Xf* numbers were highly correlated with field PD performance and suggested that it would be a useful tool to predict PD resistance. Populations of *Xf* in the stems varied greatly (Figure 3). The predicted average *Xf* populations in infected 8909-19, 9621-94 (both *V. rupestris* x *V. arizonica*), 'Chardonnay', 'Metallique' (*V. rupestris*), and *V. aestivalis* plants were larger than 250,000 cells per 0.1g of stem tissue. Most other genotypes did not exhibit *Xf* populations beyond a positive detection threshold determined by the mean plus three standard deviations from samples collected from water-inoculated control plants.

## Objective 3

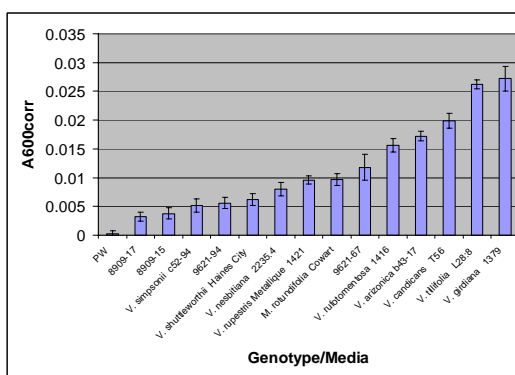
Petioles samples collected 113 days post inoculation from *V. vinifera* (Chardonnay), *V. smalliana*, *V. arizonica*, and *V. rufotomentosa* genotypes were examined by SEM to investigate if there are differences in the xylem vessel occlusion pattern between genotypes. Preliminary results of this ongoing investigation are summarized in Table 1. Vessel occlusion was classified into four categories: occlusion by tyloses, *Xf* aggregates, gum, or a filamentous net (Figure 4). In addition, we differentiated here between completely occluded and partially occluded vessel elements. In general, xylem vessel occlusion was less in *V. smalliana* and *V. arizonica* than in *V. vinifera* and *V. rufotomentosa*. Tyloses formation in *V. rufotomentosa* appeared to be more pronounced than in the other genotypes while the presence of vessels completely occluded by *Xf* aggregates was more prominent in Chardonnay.

## CONCLUSIONS

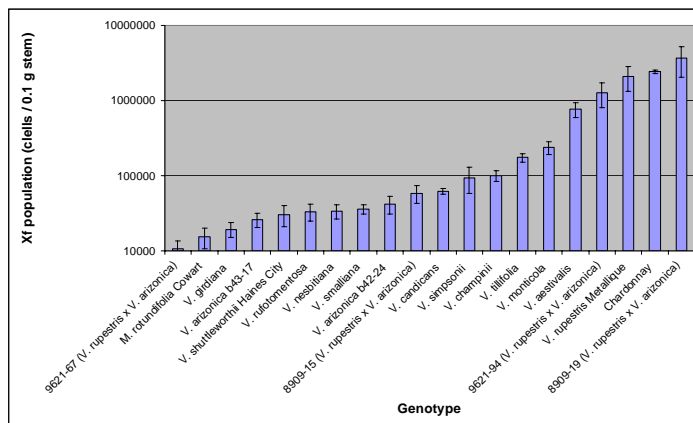
1. Xylem sap from a number of grapevine genotypes considered tolerant to PD supports *Xf* growth to varying degrees. Both planktonic growth and biofilm formation are responsive to the source of the xylem sap. Information on the distinct responses of *Xf* growth to xylem sap source allows for the selection of suitable representative genotypes for detailed investigations into xylem sap composition.
2. Large genotypic variations exist among the examined grape genotypes in respect to stem *Xf* populations.
3. Petiole xylem vessel occlusion differs between susceptible Chardonnay and tolerant *V. smalliana*, *V. arizonica* and *V. rufotomentosa*. However, even within the tolerant genotypes there appear to be differences in the number of vessels occluded and the type of occlusions present.



**Figure 1.** To determine the effect of xylem sap on colony formation, each mixture was further diluted and 100 µl diluted mixture was plated onto PW solid media for colony development. Plates were incubated at 28°C for 14 days. Bacterial count was based on the numbers of colonies per plate and a bacterial density per µl was then calculated.



**Figure 2.** To determine the effect of xylem sap on biofilm formation, the same microfuge tubes after removal of aliquots for plating on solid media were rinsed several times with ddH<sub>2</sub>O Crystal followed by an addition of 150µl of 1% incubation, violet each tube. After 15 min of Crystal violet solution was removed and microfuge tubes were rinsed 3 x with ddH<sub>2</sub>O. After elution with 95% ethanol, absorbance was read at 600 nm wavelengths.



**Figure 3.** Predicted mean number of *Xf* bacteria per 100 µg of stem tissue in 20 different grape genotypes. Samples were taken from the bottom, middle, and top third of the stem 113 days after inoculation. Results reported represent mean values across all stem-locations within a stem. Bacterial populations were predicted based on a standard calibration curve. Error bars represent standard error of the mean.

**Table 1.** Characterization of xylem vessel occlusion in petioles collected from four different genotypes 113 days after inoculation with *Xf*.

<i>Vitis</i>	Occl	<i>Xf</i> aggregate		Matrix		Tyloses		Filament net		Total	
		Avg	SE	Avg	SE	Avg	SE	Avg	SE	Avg	SE
% vessels completely or partially occluded											
<i>vinifera</i>	cplt.	6.0	3.1	8.7	1.8	6.0	2.3	0.7	0.7	21.3	1.8
	part	9.3	4.7	6.0	2.0	5.3	3.3	5.3	3.5	26	8.7
<i>smalliana</i>	cplt.	0		0.7	0.7	5.3	4.4	0.7	0.7	6.7	4.1
	part	0		1.3	0.7	4.0	2.0	8.0	2.0	13.3	3.5
<i>arizonica</i>	cplt.	0		0		0		1.3	1.3	1.3	1.3
	part	0		2.7	1.3	3.3	1.8	4.7	1.8	10.7	1.3
<i>rufotomentosa</i>	cplt.	0		3.3	2.4	17.3	9.0	6.7	3.5	27.3	12.7
	part	0		3.3	3.3	6.0	3.5	10.7	2.9	20.0	4.2

**REFERENCES**

Lu, J., K. Bloem, O. Paraiso, M. Sheikh, H. Yun, and D. Hopkins. 2004. Correlation between resistance to Pierce’s Disease and *Xylella* strain virulence using partially purified culture filtrate. 2004 Pierce’s Disease Symposium. p. 28-30.

Matthews, M.A., T.L. Rost, and E.T. Thorne. 2004. Mechanisms of Pierce’s Disease transmission in grapevines: the xylem pathways and movement of *Xylella fastidiosa*. Progress report number one: comparison with symptoms of water deficit and the impact of water stress. 2004 Pierce’s Disease Symposium. p. 37-40.

Goodwin, P.H., J. E. DeVay, and C. P. Meredith. 1988a. Roles of water stress and phytotoxins in the development of Pierce’s disease of the grapevine. *Physiol. Molec. Plant Pathol.* 32:1-15.

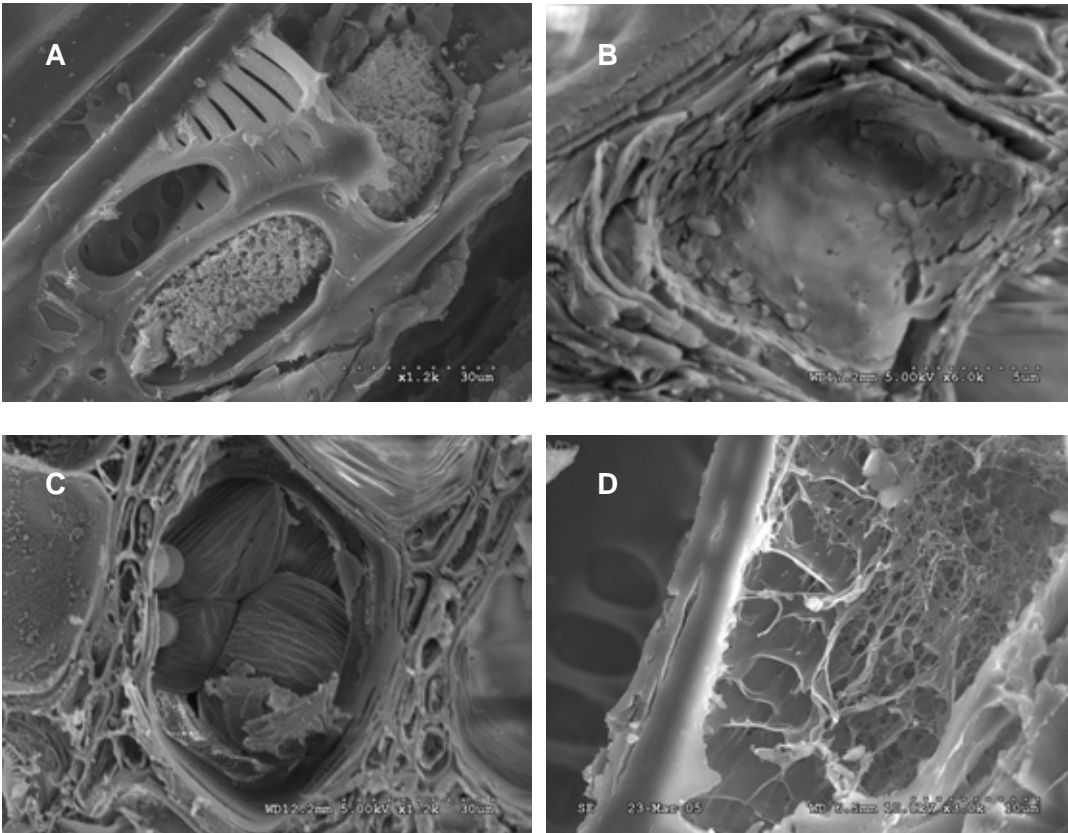
Goodwin, P.H., J. E. DeVay, and C. P. Meredith. 1988b. Physiological responses of *Vitis vinifera* cv. Chardonnay to infection by the Pierce’s disease bacterium. *Physiol. Molec. Plant Pathol.* 32:17-32

Mortensen, J.A., L.H. Stover, and C.F. Balerdi. 1977. Sources of resistance to Pierce’s Disease in *Vitis* American Soc. Hort. Sci. 102:695-697.

Kirvanek, A.F., and M.A. Walker. 2004. *Vitis* resistance to Pierce’s Disease is characterized by differential *Xylella fastidiosa* populations in stems and leaves. *Phytopathology* 95:44-52.

**FUNDING AGENCIES**

Funding for this project was provided by the University of California Pierce’s Disease Grant Program.



**Figure 4.** SEM images of complete xylem vessel occlusions by a large bacterial aggregate (A), matrix embedded bacteria (B), tyloses (C), and a filamentous network (D).

## DEVELOPING TRANSCRIPTIONAL PROFILES AND GENE EXPRESSION ANALYSIS OF GRAPE PLANT RESPONSE TO *XYLELLA FASTIDIOSA*

### Project Leader:

Hong Lin  
Crop Diseases, Pests, and Genetics  
USDA, ARS  
Parlier, CA 93648

### Cooperators:

Harsha Doddapaneni and Andrew Walker  
Department of Viticulture and Enology  
University of California  
Davis, CA, 95616

**Reporting Period:** The results reported here are from work conducted October 2004 to September 2005.

### ABSTRACT

In the present study, a set of 1,942 non-redundant SSH ESTs in response to *Xylella fastidiosa* (*Xf*) infection were cloned from susceptible and resistant sibling genotypes from a *Vitis rupestris* x *Vitis arizonica* genetic mapping population. The majorities (54 %) of these ESTs were novel and the rest included genes known to be involved in defense responses. Transcriptional profiling using a custom high-density (382,900 probes) microarray chip of 20,020 *Vitis* transcripts showed a significant variation in response between the susceptible and resistant genotypes to *Xf* infection. Out of the 793 transcripts that showed significant response to *Xf* infection, 28.1% (223 ESTs) were derived from this project.

### INTRODUCTION

The impact of Pierce's Disease (PD) on the California grape industry has been significant since the introduction and establishment of a more effective vector, *Homalodisca coagulata* (*H. coagulata*), the glassy-winged sharpshooter (GWSS) (Almeida and Purcell 2003). Development of resistance in grape is stymied by the relatively limited amount of genetic and molecular information regarding genotype specific resistance to PD infection (Davis et al. 1978). Breeding efforts confirm that resistance is inheritable and molecular mapping has linked DNA markers to *Xf* resistance (Krivanek et al. 2005). Once cloned, the next step is to incorporate PD resistance genes into traditional grape cultivars. This objective can be achieved in fewer generations by elucidating the molecular basis of resistance and pathogenicity, which prompted us to develop a functional genomic approach for PD research.

SSH (Suppression Subtractive Hybridization) DNA cloning is one of the most efficient and comprehensive methods used for identifying genes involved in differentially regulated conditions. This is particularly important in host-pathogen interactions where many pathogen-related genes are expressed at low abundance and limited to particular tissues or cell types at certain times (Caturla et al., 2002). Some of these genes are less likely to be cloned by standard EST cloning methods. Here, we explored the utility of subtractive DNA cloning to characterize differentially expressed genes in response to *Xf* infection between highly susceptible and resistant sibling genotypes segregating from the *Vitis rupestris* x *Vitis arizonica* population. To maximize the chances of cloning expression profiles associated with the tissues and at various stages of host-pathogen interactions, we designed a time course sampling scheme and constructed tissue specific cDNA libraries.

Plants respond to pathogen attack through a variety of signaling pathways consisting of a large number of regulatory as well as effector genes. Microarrays facilitate automated analysis of transcriptional profiling data to enable complete understanding of such gene function and interactions. A custom 60-mer high-density oligoarray chip was designed using the generated EST collection as well as incorporating the entire *Vitis* transcriptome information in the public domain to understand the *Xf*/*Vitis* interaction.

### OBJECTIVES

1. Sequence analyses of SSH cDNA libraries.
2. Design of high-density expression array.
3. Microarray gene expression analysis.

### RESULTS

#### Objective 1: Sequence analyses of SSH cDNA libraries

##### *Sequencing, EST assembling and dbEST submission*

A total of 5,794 ESTs, with ~500 ESTs from the libraries, were sequenced from 12 constructed SSH libraries (Figure 1). The average EST size was 282 bp with more than 5,400 sequences of at least 100 bp in length. In order to reduce the transcript redundancy, the EST collection was subjected to PHRED, PHRAP and BLAST analysis to do clustering, first within each library and then among all 12 libraries. The final assembling resulted in 1,942 unique sequences including 993 clusters (contigs) and 949 singleton ESTs. All the sequenced ESTs that are at least 100 bp in length (5421 ESTs) were submitted to the NCBI's ESTdb under the accession numbers DN942225 to DN947645.

### ***EST similarity search and functional assignments***

Comparison of the 1,942 non-redundant sequences against the non-redundant protein database of the NCBI revealed that 716 sequences have significant similarity ( $\leq 1E^{-5}$ ) and the remaining had no hits. A list of EST hits against the known disease resistance related proteins are presented in Table 1. Functional annotation was carried out using an ontology database available in the USDA-ARS system that is based on the functional classification schemes such as Gene Ontology (GO), Enzyme Commission numbers (EC), BioCarta Pathways, and Kyoto Encyclopedia of Genes and Genomes (KEGG) pathways. All the non-redundant sequences were searched against this database using default blast parameters and a cut off E value of  $10^{-4}$ . Based on the generated GO information, 906 sequences were divided into the three principal GO categories: molecular function (30%), cellular component (9%) and biological process (7%) (Figure 2).

Under the molecular function category, ligand binding and carrier contributed for 25% of the total contigs followed by the ribosomal coding transcripts. Similarly, transport followed by signal transduction and defense response formed majority of the total numbers in the biological process category, while chloroplast, membrane and nucleus subsections had major contributions in the cellular component category. More than half of the sequences (54 %) could not be annotated due to lack of significant similarity with the known proteins.

### ***EST cluster analysis***

Co-expressivity of the transcripts was accessed across the 12 SSH libraries, using hierarchical clustering based on the transcript abundance. A matrix file for 437 contigs that are represented by 5 or more ESTs across the 12 libraries were selected out of the total 993 contigs similar to Ewing et al. (1999). A total of 11 clusters were generated using partitional clustering (Qtclust algorithm) to divide the data into clusters of coexpressed contigs with the maximal inter-contig Pearson correlation of 0.99 and with the minimal cluster size of 5. There were 5 to 73 member contigs per cluster. To reduce the bias resulting from outliers, the distances used for computing clusters were jackknifed. Hierarchical tress was next generated from these data sets by calculating the Euclidean distance with complete linkage option. Based on the above parameters, 37% (174 contigs) could not be assigned to any cluster.

In general, across all the clusters, the level of expression for a particular contig was significantly different between the tissue types that were used as tester and driver populations suggesting that the preparation of the subtractive libraries was optimal. For instance, Cluster-A had 73 contigs which were abundantly expressed in four libraries, Lib 2, Lib 5, Lib 4 and Lib 6, out of which, 12 contigs (top left, including 11 with 'no hit' and 1 metallothionin like protein) showed abundant expression only in the Lib 2 (Stem library from resistant genotype infected with *Xylella*) and are potential candidates from the PD point of view. Similarly, a set of 11 contigs enriched with pathogen responsive P-rich protein genes showed hyper expression in the non-infected stem library from the same genotype. Cluster-B has groups of contigs abundantly expressed in the infected stem tissue library from susceptible genotype (Lib 3), all of which interesting are known to play a role in the defense mechanism. This cluster also groups contigs over expressed in non-infected leaf tissue from the resistant genotype (Lib 4) and all of them appear to be novel.

## **Objective 2: Design of high-density expression array**

### ***EST assembly***

To maximize gene discovery, we have designed a custom microarray chip based on our ESTs and the publicly available EST sequences from all *Vitis* (*V.*) varieties and species. From the public domain, a total of 33,933 ESTs -12,593 unigene set from the *V. vinifera*, 10,704 accessions of *V. shuttleworthii*, 6,533 of *V. rupestris* 'A. de Serres' x *V. sp.*, 2,117 of *V. aestivalis* and 1,986 sequences of *V. riparia* were collected. Redundancy in each of the non-*vinifera* EST sets was reduced based on BLAST analysis and the longest EST from each cluster was selected. Next, repeat ESTs between the sets were removed and at this step between matching ESTs, and the *vinifera* ESTs were discarded to facilitate enrichment of the final set with non-*vinifera* ESTs.

These efforts resulted in a total of 20,020 ESTs with 1,947 from the SSH libraries, including 40 from the cDNA-AFLP experiments, 10,014 from *V. vinifera*, 5,470 from *V. shuttleworthii*, 1,219 from *V. aestivalis*, 780 from *V. rupestris* x *V. sp.* and 588 from *V. riparia*.

### ***Probe design***

Probe design was carried out in collaboration with Nimblegen Inc., with active input from our group. Nine individual 60-mer probes were designed for each EST and for 1,634 ESTs, probes were designed from both the strands. A total of 191,450 probes were selected for the entire set and there were two spots for each probe on the slide totaling 382,900 spots per slide.

## **Objective 3: Microarray gene expression analysis**

### ***Experimental set-up***

A total of 18 slides (9 of genotype 9621-67 (resistant) and 9 of genotype 9621-94 (susceptible)) were hybridized in a two color hybridization experiment using the monochromatic dyes Cy 5 and Cy 3. Total RNA from stem tissues at three stages of

disease development- week-1, week-6 and week-10 from both control (non-infected) and experimental (infected) was used. There were three biological replications for each stage and this included a dye flip.

### Data analysis

Following normalization, data from the hybridization experiments were statistically analyzed using Perl scripts and Excel package. For each gene there were 54 data points per each stage (18 per slide x 3 biological replications) of disease development. Only signal ratios that had less than 20% SE across the measured values were included for results interpretation. A cut-off value of 2-fold response was considered significant and as evident from Table 2, the response was more surprising for the susceptible genotype both in terms of numbers and magnitude in the later stages of disease development. Further experiments based on RT-PCR are in progress to confirm the observed microarray results.

### CONCLUSIONS

Characterizing the molecular basis of the grape response to *Xf* is critical to understanding the mechanisms of PD resistance and pathogenesis. The generated EST pool and subsequent microarray based genome-wide transcription profiles have identified, for the first time, a pool of ESTs expressed under defined conditions and might be the candidates in determining resistant and susceptible interactions. Efforts are underway to generate transcription profiles in leaf tissue. Currently, we are developing a relational database incorporating the generated transcriptional data that will be open to public access.

### REFERENCES

- Almeida, R.P. and A.H. Purcell. 2003. Transmission of *Xylella fastidiosa* to grapevines by *Homalodisca coagulata* (Hemiptera: Cicadellidae). *J Econ Entomol.* 96:264-271.
- Caturla, M., C. Chaparro, K. Schroyers, and M. Holsters. 2002. Suppression subtractive hybridization to enrich low-abundance and submergence-enhanced transcripts of adventitious root primordia of *Sesbania rostrata*. *Plant Science* 162:915-921.
- Davis, M. J., A. H. Purcell, and S. V. Thomson. 1978. Pierce's disease of grapevines: isolation of the causal bacterium. *Science* 199: 75-77.
- Ewing, R.M., A. B. Kahla, O. Poirot, F. Lopez, S. Audic, and J.M. Claverie. 1999. Large-scale statistical analyses of rice ESTs reveal correlated patterns of gene expression. *Genome Res* 9:950-959
- Krivanek, A.F., T. R. Famula, A. Tenschler, and M.A. Walker. 2005. Inheritance of resistance to *Xylella fastidiosa* within a *Vitis rupestris* x *Vitis arizonica* hybrid population. *Theor Appl Genet.* Apr 28; [Epub ahead of print]

### FUNDING AGENCIES

Funding for this project was provided by the CDFR Pierce's Disease and Glassy-winged Sharpshooter Board.

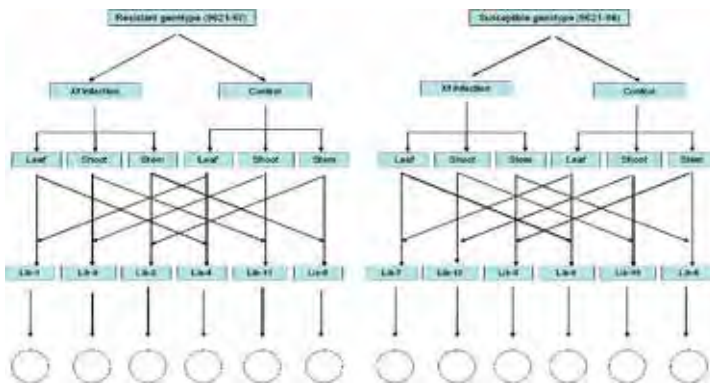
**Table 1.** Blast hits of a sub-set of the ESTs showing high similarity to known disease resistant genes.

EST I.D.	Length	BlastX- top Hit	E-value
EST-1	737	emb CAA95857.1  S-adenosyl-L-methionine synthetase 2 [ <i>Catharanthus roseus</i> ]	1.00E-122
EST-2	610	emb CAC14015.1  chitinase [ <i>Vitis vinifera</i> ]	5.00E-98
EST-3	535	gb AAR13304.1  phytochelatin synthetase-like protein [ <i>Phaseolus vulgaris</i> ]	4.00E-87
EST-4	468	emb CAB91554.1  beta 1-3 glucanase [ <i>Vitis vinifera</i> ]	6.00E-64
EST-5	448	emb CAC16165.1  pathogenesis-related protein 10 [ <i>Vitis vinifera</i> ]	4.00E-53
EST-6	302	dbj BAA76424.1  rac-type small GTP-binding protein [ <i>Cicer arietinum</i> ]	5.00E-48
EST-7	842	ref NP_850638.1  zinc finger (DHHC type) family protein [ <i>Arabidopsis thaliana</i> ]	3.00E-32
EST-8	348	pir  T07139 cysteine proteinase inhibitor - soybean dbj BAA19608.1	2.00E-30
EST-9	456	gb AAN71733.1  WRKY transcription factor IId-4 [ <i>Lycopersicon esculentum</i> ]	2.00E-21
EST-10	265	gb AAM21199.1  pathogenesis-related protein 5-1 [ <i>Helianthus annuus</i> ]	3.00E-21
EST-11	171	gb AAD55090.1  thaumatin [ <i>Vitis riparia</i> ]	1.00E-19
EST-12	372	gb AAN75467.1  mitogen-activated protein kinase [ <i>Lycopersicon esculentum</i> ]	1.00E-14
EST-13	418	gb AAN15621.1  O-methyltransferase-like protein [ <i>Arabidopsis thaliana</i> ]	4.00E-14
EST- 14	116	gb AAP23944.1  leucine-rich repeat protein [x <i>Citrofortunella mitis</i> ]	1.00E-13

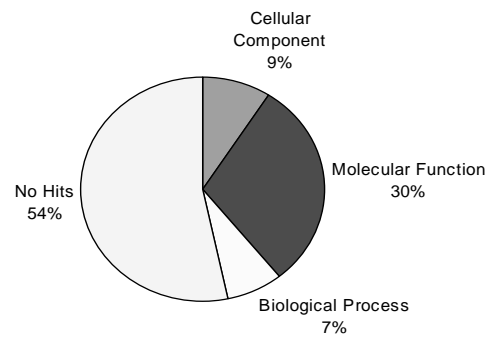


**Table 2.** Microarray hybridization response of *Vitis* stem tissue to *Xf* infection in both susceptible and resistant genotypes. Numbers in parenthesis represent the ESTs generated from SSH experiments.

Stage	Response	Genotype			
		9621-67		9621-94	
		# Of ESTs	Fold-Change	# Of ESTs	Fold-Change
Week-1	Up-regulated	38 (4)	2.0 - 3.1	2 (2)	2.1 - 2.36
	Down-regulated	24 (11)	0.49 - 0.33	1 (1)	0.49
Week-6	Up-regulated	19 (11)	2.0 -2.43	152 (48)	2.0 - 37
	Down-regulated	11 (2)	0.49 - 0.33	71 (15)	0.49 - 0.12
Week-10	Up-regulated	81 (5)	2.0 -3.57	99 (24)	2.0 - 22.38
	Down-regulated	61 (33)	0.49 - 0.15	234 (67)	0.49 - 0.11



**Figure 1.** Strategy for SSH library construction.

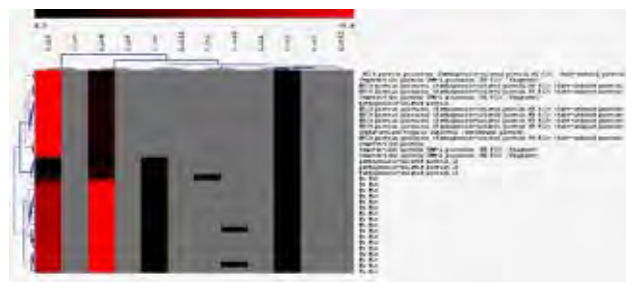


**Figure 2.** EST distribution among the three GO principles.

**Cluster A**



**Cluster B**



## COMPARATIVE PROTEOMIC ANALYSIS OF STEM TISSUE AND XYLEM SAP FROM PIERCE'S DISEASE RESISTANT AND SUSCEPTIBLE GRAPEVINES

### Project Leaders:

Hong Lin  
Crop Diseases, Pests, and Genetics Research Unit  
USDA, ARS  
Parlier, CA 93648

Felix Fritschi  
Crop Diseases, Pests, and Genetics Research Unit  
USDA, ARS  
Parlier, CA 93648

### Cooperators:

Litao Yang  
Crop Diseases, Pests and Genetics Research Unit  
USDA, ARS  
Parlier, CA 93648

Andrew Walker  
Department of Viticulture and Enology  
University of California  
Davis, CA, 95616

**Reporting Period:** The results reported here are from work conducted July 2005 to September 2005.

### ABSTRACT

Both xylem sap and stem tissue are key components in the *Xylella fastidiosa* (*Xf*)-grapevine interaction. In this research we investigate protein expression in xylem sap and stem tissue of highly tolerant and susceptible grape genotypes. Ten sequential samplings of stem tissues have been conducted from infected and non-infected grapevines ranging from 1 day to 12 weeks post inoculation. Protein extraction and analyses on these tissues has recently been initiated. Plants for xylem sap extraction are currently being grown in the greenhouse. Xylem sap will be extracted multiple times post inoculation from *Xf* and water-inoculated plants. Differentially expressed proteins in both stem tissue and xylem sap will be identified and investigated in more detail in the coming months. Results obtained will deepen our understanding of host-pathogen interactions, a key component in fighting Pierce's disease (PD).

### INTRODUCTION

Xylem sap is very important for *Xf* growth *in planta*. Be it as individual cells at the beginning of an infection or later in biofilms, *Xf* not only obtain their nutrients from xylem sap but also are in constant contact with it. Andersen et al. (2004a) and Toscano et al. (2004) reported that the source of xylem sap affects *Xf* growth rates and growth characteristics. Results from bioassays conducted in our lab also indicate that xylem sap collected from various PD resistant *Vitis* genotypes has dramatically different effects on *Xf* growth in comparison with controls consisting of artificial media (PW) and xylem sap from 'Chardonnay' (*V. vinifera*).

To date, numerous studies have investigated inorganic and organic solutes in grape xylem sap showing that xylem sap chemistry is a function of temperature and fertilization, and changes over time (Andersen and Brodbeck, 1989a, 1989b, 1991; Andersen et al., 1995, 2004b). Although some xylem sap compounds have been suggested to be related to the susceptibility, i.e. [P]\*[citrate] to [Ca]\*[Mg] ratio (Andersen et al. 2004a), a complete understanding of the influence of xylem sap chemistry on the host pathogen interaction is missing. Specifically, as of now, the protein composition of the xylem sap has not been investigated in detail.

The direct contact between sap and *Xf* makes xylem sap a promising venue to interfere with a successful pathogen colonization of the host. In other host plant - pathogen systems, extracellular/apoplasmic proteins were found to be responsive to disease pressure and in some instances important in suppressing disease development (Ceccardi et al., 1998; Guo et al., 1993; Nemeč, 1995; Reimers and Leach, 1991; Reimers et al., 1992; Rep et al., 2002; Young et al., 1995). Combined with the evidence for xylem sap effects on *Xf* growth, these examples suggest that the analysis of the xylem sap proteome is likely to result in the identification of protein(s) influencing the interaction of grapevines and *Xf*. Identified proteins may provide information to develop approaches and/or be part of strategies to improve grapevine tolerance or resistance to *Xf*. In addition, the identification of PD-specific proteins would allow the production of specific antibodies which may potentially be used for serological diagnostic tests for PD.

Recent findings of genotypic differences in symptomatology and *Xf* populations in stems (canes) of resistant and susceptible grapevine genotypes highlight the importance of this tissue in the host-pathogen interaction. Krivanek et al. (2005) developed a cane maturation index (CMI) to quantify the uneven cane maturation manifested in the green-island symptoms that arise in PD infected plants. They found "green-island" formation as measured by the CMI to correlate better with PD resistance than other phenotypic symptoms. The irregular nature of the symptoms suggests that localized, rather than systemic signals are responsible for the spatial patterns observed. Thus, signal and signal recognition as well as signal transduction events appear to occur localized in stem tissue since a systemic signal transaction and recognition is unlikely to result in the characteristic green-island symptomatology. Furthermore, in a companion study Krivanek and Walker (2005) found that, in resistant genotypes, *Xf* populations in stem internodes were significantly smaller than in leaves. In contrast, corresponding samples from susceptible genotypes were not significantly different. The two studies highlight the importance

of plant-pathogen interactions occurring in the stem for PD susceptibility characteristics of the different genotypes. Therefore, detailed examination of stem proteins extracted from susceptible and resistant genotypes of *Xf* infected and healthy plants is a very promising approach to identify important components involved in host-pathogen interactions as well as the plant response.

Examination of the protein content of stem tissue and xylem sap is a new approach with distinct advantages complementing other strategies currently pursued in the fight against PD. Using this approach, we focus on key components: stem and xylem sap protein content rather than the entire grapevine proteome. In addition, regulatory mechanisms including transcriptional, post-transcriptional, and translational events which can constitute significant confounding effects in functional genomics approaches, are already integrated in the proteomic approach. Furthermore, it is possible to identify post-translational protein modifications (e.g. phosphorylation, acetylation, methylation, glycosylation, cleavage, etc.) which play key roles in protein function.

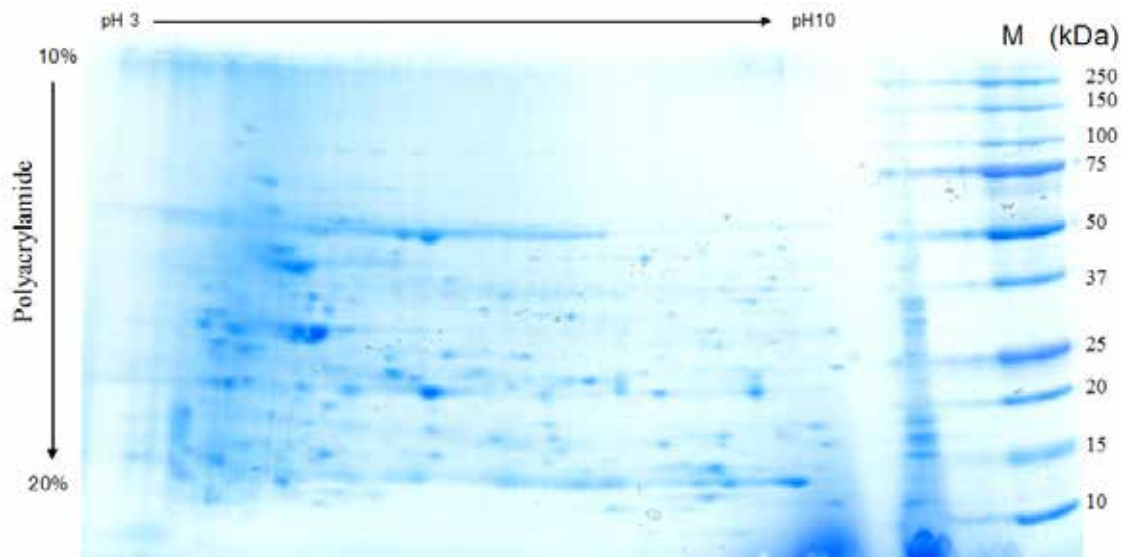
## OBJECTIVES

1. Identify xylem sap and stem proteins differentially expressed in healthy grapevines from resistant and susceptible genotypes.
2. Identify xylem sap and stem proteins induced by *Xf* in resistant and susceptible grapevines.
3. Determine the relationship of identified proteins to PD.

## RESULTS

Highly susceptible (9621-94) and resistant genotypes (9621-67) selected from a segregating population of *V. rupestris* x *V. arizonica* as well as *vinifera* grape, Chardonnay are being used in this study. An expression experiment was conducted in the greenhouse where treatment and control grapevines were mechanically inoculated with *Xf* suspension and culture medium respectively. Leaf and stem tissues were then collected at day one, two, and five post inoculation, and subsequently at three one-week and four two-week intervals for a total of ten collections with three biological replicates in both treatment groups. Leaf and stem tissues collected at each time point were immediately stored at  $-80^{\circ}\text{C}$  for later protein extraction.

Stem and leaf protein extraction and 2-DE (Figure 1) have recently been initiated and will be conducted over the coming few months. A new set of plants (same genotypes and treatments as above) was recently established in the greenhouse and will be used to extract xylem sap and investigate protein expression pattern in the xylem sap.



**Figure 1.** Grape leaf protein profiles from two dimensional SDS-PAGE gel. Electrophoresis was carried out using a Bio-Rad Criterion<sup>TM</sup> Cell and gel was stained by BioSafe Coomassie blue.

## CONCLUSION

We have initiated a study to investigate stem and xylem sap protein expression in one highly resistant and two susceptible grape genotypes. Investigation of the xylem sap and stem proteome are of particular interest because of the importance of both xylem sap and grape stem in the host-pathogen interaction. Examination of the interaction between *Xf* and grapevine hosts at the protein level is of particular importance since there often is a lack of correlation between gene and protein expression. This study will complement ongoing efforts in transcriptional level of gene expression analyses and provide a more integrative picture of the nature of PD resistance.

## REFERENCES:

- Andersen, P.C. and B.V. Brodbeck. 1989a. Diurnal and temporal changes in the chemical profile of xylem exudate from *Vitis rotundifolia*. *Physiol. Plant.* 75: 63-70.
- Andersen, P.C. and B.V. Brodbeck. 1989b. Temperature and temperature preconditioning on flux and chemical composition of xylem exudate from muscadine grapevines. *J.Amer.Soc.Hort.Sci.* 114: 440-44.
- Andersen, P.C. and B.V. Brodbeck. 1991. Influence of fertilization on xylem fluid chemistry of *Vitis rotundifolia* Noble and *Vitis* hybrid Suwannee. *Am. J. Enol. Vitic.* 42:245-251.
- Andersen, P.C., B.V. Brodbeck, and R.F. Mizell, III. 1995. Water stress- and nutrient solution-mediated changes in water relations and amino acids, organic acids, and sugars in xylem fluid of *Prunus salicina* and *Lagerstroemia indica*. *J. Amer. Soc. Hort. Sci.* 120:36-42.
- Andersen, P.C., B. Leite, and M.L. Ishida. 2004a. Xylem chemistry mediation of resistance to Pierce's Disease. 2004 Pierce's Disease Research Symposium. p. 3-6.
- Andersen, P.C., M.L. Ishida, E.A. Momol, B.V. Brodbeck, B. Leite, M.T. Momol. 2004b. Influence of *Vitis* xylem fluid and xylem fluid plus cecropin on growth of *Xylella fastidiosa*. *Vitis* 43:19-25.
- Ceccardi, T.L., G.A. Barthe, and K.S. Derrick. 1998. A novel protein associated with citrus blight has sequence similarities to expansion. *Plant Mol. Biol.* 38:775-783.
- Guo, A., P.J. Reimers, and J.E. Leach. 1993. Effect of light on incompatible interactions between *Xanthomonas oryzae* pv. *oryzae* and rice. *Physiol Mol Plant Pathol.* 42:413-425.
- Krivanek, A.F., J.F. Stevenson, and M.A. Walker. 2005a. Development and comparison of symptom indices for quantifying grapevine resistance to Pierce's Disease. *Phytopathology* 95:36-43.
- Krivanek, A.F., and M.A. Walker. 2005b. *Vitis* resistance to Pierce's Disease is characterized by differential *Xylella fastidiosa* populations in stems and leaves. *Phytopathology* 95:44-52.
- Nemec, S. 1995. Stress-related compounds in xylem fluid of blight-diseased citrus containing *Fusarium solani* naphthazarin toxins and their effects on the host. *Can. J. Microbiol.* 41:515-524.
- Reimers, P.J., A. Guo, and J.E. Leach. 1992. Increased activity of a cationic peroxidase associated with an incompatible interaction between *Xanthomonas oryzae* pv. *oryzae* and rice (*Oryza sativa*). *Plant Physiol.* 99:1044-1050.
- Reimers, P.J., and J.E. Leach. 1991. Race-specific resistance to *Xanthomonas oryzae* pv. *oryzae* conferred by bacterial blight resistance gene *Xa-10* in rice (*Oryza sativa*) involves accumulation of a lignin-like substance in host tissues. *Physiol. Mol. Plant Pathol.* 38:39-55.
- Rep, M. et al. 2002. Mass spectrometric identification of isoforms of PR proteins in xylem sap of fungus-infected tomato. *Plant Phys.* 130:904-917.
- Toscano, N., D. Cooksey, J. Bi, K. Dumenyo, and R.H. Martinez. Impact of host plant xylem fluid on *Xylella fastidiosa* multiplication, aggregation, and attachment. 2004 Pierce's Disease Research Symposium. p. 60-63.
- Young, S.A. et al. 1995. Rice cationic peroxidase accumulates in xylem vessels during incompatible interactions with *Xanthomonas oryzae* pv. *oryzae*. *Plant Physiol.* 107:1333-1341.

## FUNDING AGENCIES

Funding for this project was provided by the University of California Pierce's Disease Grant Program.

# EPIDEMIOLOGICAL ANALYSES OF GLASSY-WINGED SHARPSHOOTER AND PIERCE'S DISEASE DATA

## Project Leader:

Thomas M. Perring  
Department of Entomology  
University of California  
Riverside, CA 92521

## Cooperators:

Yong-Lak Park, Charles A. Farrar, and Rayda K. Krell  
Department of Entomology  
University of California  
Riverside, CA 92521

Murry P. Pryor  
UC Cooperative Extension  
University of California  
Bakersfield, CA 93307

Barry Hill  
CDFA, PDCP  
Sacramento, CA 95814

Jennifer Hashim  
UC Cooperative Extension  
Bakersfield, CA 93307

Maggi Kelly  
Department of Environmental Sciences, Policy and Management  
University of California  
Berkeley, CA 94720

**Reporting Period:** The results reported here are from work conducted July 1, 2004 to September 30, 2005.

## ABSTRACT

Analyses of spatiotemporal interactions between vector insects and pathogens are critical to understanding disease epidemiology. Sampling projects to assess *Xylella fastidiosa* (*Xf*) incidence in vineyards and sharpshooter trap catches from varying habitats were implemented in the Coachella Valley and lower San Joaquin Valley in California. Sampling was done at landscape and vineyard scales. Data from work in the Coachella Valley revealed low sharpshooter trap catches and two sharpshooter species had different spatial distributions at the landscape scale. Pierce's disease is relatively rare throughout the Coachella Valley and did not occur near patches where sharpshooters were trapped. Analyses of similar data from the lower San Joaquin Valley are currently underway.

## INTRODUCTION

The progression of Pierce's disease (PD) across a landscape and in vineyards is dependent upon factors related specifically to four components: vector insects, *Xf* inducing PD, grapevines, and the environment. When conditions in all four of these areas are optimal, disease spread occurs. Conversely, sub-optimization within any of the four categories can slow or stop disease progress. The science of epidemiology seeks to determine how the four components interact, with the goal of creating long-term, sub-optimal conditions for disease spread. Achieving this goal will enable California producers to continue growing grapes in areas with PD and vector insects. Recently, the global positioning system, the geographic information system, and geostatistics have been applied to entomological and epidemiological studies. These technologies combined with advanced statistical methods can facilitate creation of insect and pathogen distribution maps and analyses of spatial distribution to understand epidemiology.

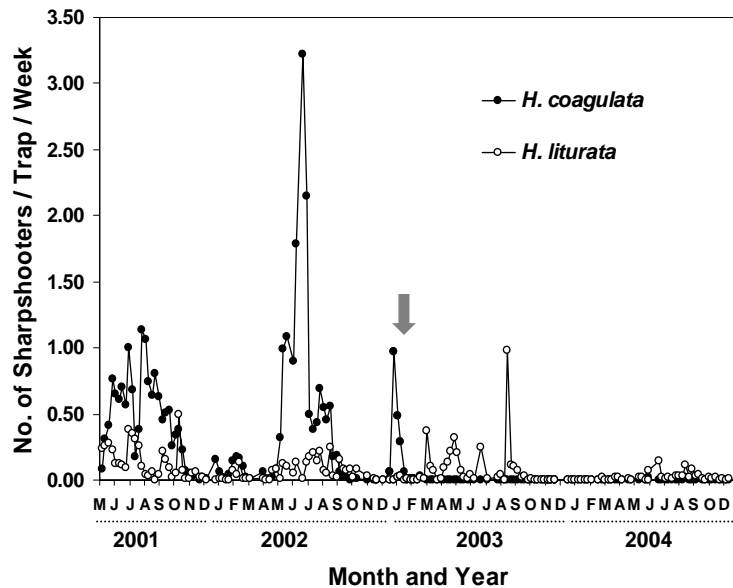
## OBJECTIVES

1. Determine the spatial distribution of sharpshooter vectors and PD, and use these data to create statistical distribution maps.
2. Analyze spatial relationships between sharpshooter vectors and PD incidence.
3. Relate the epidemiology of *Xf* to environmental components, and identify characteristics of areas with varying PD incidences.

## RESULTS

### Sharpshooter Temporal and Spatial Distribution

Coachella Valley data from four years of sharpshooter monitoring were analyzed (2001-2004) to investigate dynamics of the temporal and spatial distributions of *Homalodisca coagulata* Say and *Homalodisca liturata* Ball and their spatial associations with the surrounding vegetation (Park et al. 2005a). Temporal trap catches of *H. liturata* and *H. coagulata* showed two peaks per year, and the peaks of the two species coincided (Figure 1).



**Figure 1.** Trap catches of two sharpshooter species. Arrow indicates first application of insecticide to citrus.

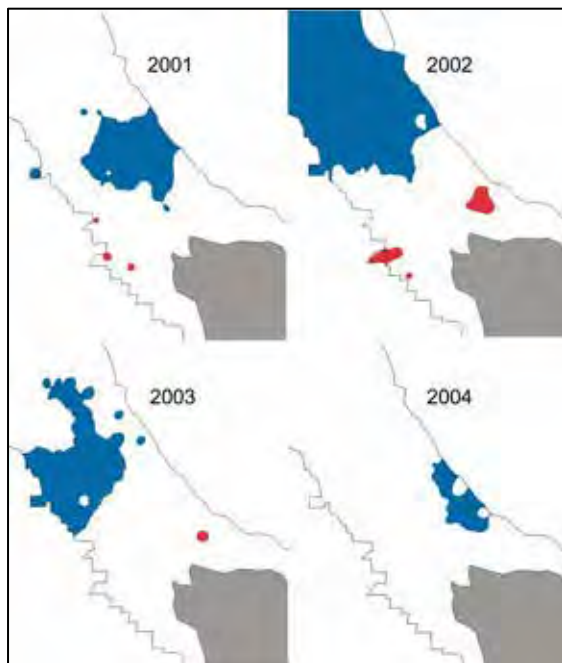
A relatively new method, spatial analysis with distance indices (SADIE) (Perry 1995), was used to analyze sharpshooter spatial distribution. SADIE showed that spatial distributions of *H. coagulata* (Figure 2) and *H. liturata* (Figure 3) were significantly consistent between years (Index of Association [X] ranged from 0.310-0.685,  $P \leq 0.001$ ), except for *H. coagulata* from 2003 vs. 2004. All patches (i.e. clusters of significantly high trap catches) of *H. coagulata* were located near citrus, and no patches were found in urban landscapes (Table 1). Major patches of *H. liturata* were located in desert saltbush scrub and urban areas where major gaps (i.e. clusters of significantly lower trap catches) of *H. coagulata* were located (Table 1), resulting in negative spatial association between the two species (Figures 2 and 3). Similar analyses for *H. coagulata* trap catches in Kern County are currently underway.

**Table 1.** Percentage occurrence of patches and gaps of *H. coagulata* and *H. liturata* in each type of surrounding vegetation from 2001-2004 combined data

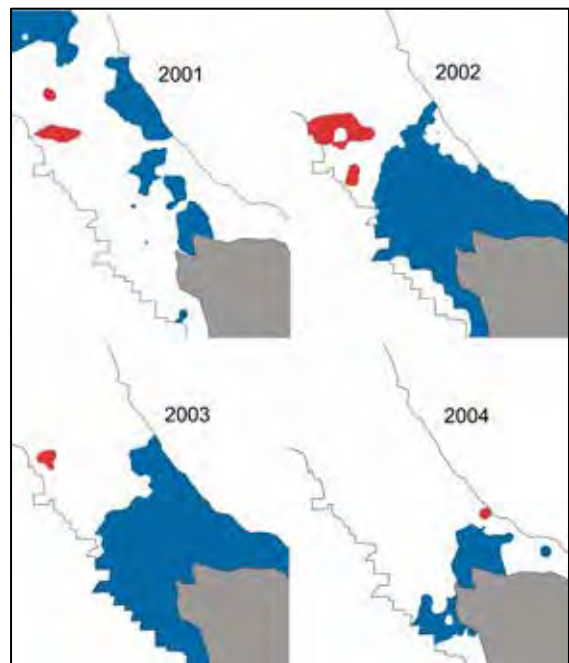
Types of surrounding environment	<i>H. coagulata</i>		<i>H. liturata</i>	
	Patch ( $n^a = 11$ )	Gap ( $n^b = 154$ )	Patch ( $n^a = 15$ )	Gap ( $n^b = 234$ )
Urban landscape	0.0%	26.1%	80.0%	14.7%
Desert saltbush scrub	36.4%	56.5%	86.7%	45.7%
Desert	27.3%	27.2%	26.7%	24.1%
Citrus	100.0%	19.6%	33.3%	34.5%
Grape	90.9%	27.2%	6.7%	41.4%

<sup>a</sup> Total number of sample locations (i.e. sum of each year's sample locations) included within patches.

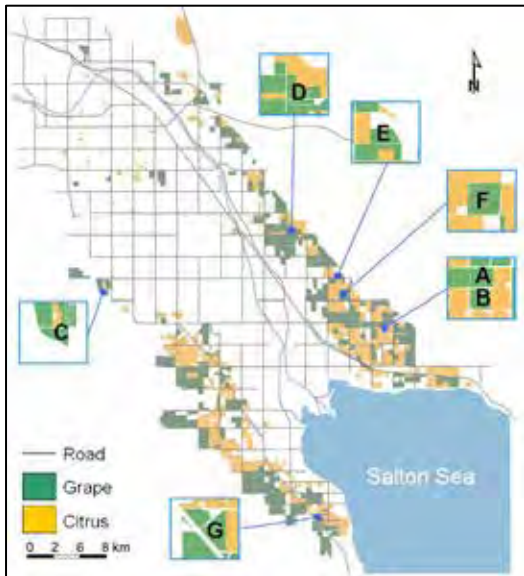
<sup>b</sup> Total number of sample locations (i.e. sum of each year's sample locations) included within gaps.



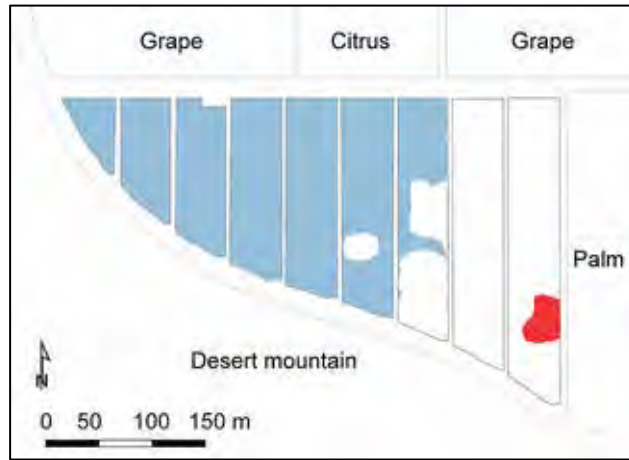
**Figure 2.** *H. coagulata* patches (red) and gaps (blue) in the Coachella Valley.



**Figure 3.** *H. liturata* patches (red) and gaps (blue) in the Coachella Valley.



**Figure 4.** Locations of vineyards with PD identified in surveys from 2001-2004. A total of 13 diseased grapevines were identified; two in vineyard A (2002), one in vineyard B (2002), four in vineyard C (2003), one in vineyard D (2003), one in vineyard E (2004), two in vineyard F (2004), and two in vineyard G (2004).



**Figure 5.** Spatial distribution of grapevines with PD in vineyard C. Red area indicates a significantly high cluster of PD incidence (patch) and the blue area indicates an area with significantly low PD incidence (gap).

#### Pierce's Disease Spatial Distribution at the Landscape and Vineyard Scale

The spatial distribution of PD in the Coachella Valley was analyzed at two spatial scales, landscape and vineyard, with data collected from 2001–2004 (Park et al. 2005b). At the landscape scale, seven vineyards were identified (A–G) with diseased grapevines (Figure 4). A total of 13 diseased grapevines were identified from seven vineyards during the landscape-scale survey. For these seven vineyards, the mean distance between a citrus orchard and the closest diseased grapevine in the vineyards was 143 m (Figure 4). PD was found in three varieties, Perlette, Flame, and Superior Seedless.

One vineyard, vineyard C, was further studied to characterize the vineyard-scale spatial distribution of PD because it had high disease incidence (3.8%) compared with the other vineyards. This vineyard was relatively flat with 2 m of maximum elevation difference, and it was surrounded by palm trees to the east, citrus and grapes to the north and arid mountains with desert saltbush scrub to the west and south (Figure 5). Geostatistical analysis showed that a power model fit the semivariogram for PD distribution in the vineyard, indicating strong aggregation of PD. SADIE also showed that the distribution pattern of PD in the vineyard was aggregated ( $I_a = 2.12$ ,  $P = 0.013$ ) with a significant patch (area of 1680 m<sup>2</sup>) in the eastern edge of the vineyard (Figure 5). Similar analyses are currently underway for PD distribution in Kern County at the landscape and vineyard scales.

#### Spatial Relationship Between Sharpshooters and PD Distribution

In the Coachella Valley, no vineyard with PD (Figure 4) overlapped with any sharpshooter patches (Figures 2 and 3), indicating no spatial relationship between sharpshooters and PD at the landscape scale. While possible associations may exist at a scale finer than we examined, we believe that PD distribution may be related to vector species other than *H. coagulata*. We have documented *Xf* transmission with a desert cicada species, and there are several other sharpshooter species present in the Coachella Valley that may be involved with spreading this bacterium. In Kern County, we have acquired data from sticky traps that were placed in vineyards with PD. We have begun analyzing these data and we are hopeful that relationships between disease distribution and *H. coagulata* distribution will be elucidated through this process.

#### CONCLUSIONS

- *H. coagulata* and *H. liturata* trap catches were spatially consistent between years.
- *H. coagulata* and *H. liturata* spatial relationships with surrounding vegetation imply that areawide management targeting specific habitat types may be possible by identifying sharpshooter patches and gaps in space and time.
- Overall, PD incidence in the Coachella Valley was low and infected vineyards were distributed throughout the area.
- PD was aggregated within one vineyard in the Coachella Valley.
- There was no spatial relationship between sharpshooter trap catches and PD incidence at the landscape scale in the Coachella Valley.
-

**REFERENCES**

- Park, Y. L., T. M. Perring, C. A. Farrar, and C. Gispert. 2005a. Spatial and temporal distributions of two sympatric *Homalodisca* spp. (Hemiptera: Cicadellidae): Implications for areawide pest management. *Agric. Ecosyst. Environ.* (*In Press*).
- Park, Y. L., T. M. Perring, R. K. Krell, C. A. Farrar, and C. Gispert. 2005b. Spatial Distribution of Pierce's Disease in the Coachella Valley: Implications for Sampling. *Am. J. Enol. and Vitic.* (*In Review*).
- Perry, J. N. 1995. Spatial analysis by distance indices. *J. Anim. Ecol.* 64:303-314.

**FUNDING AGENCIES**

Funding for this project was provided by the CDFFA Pierce's Disease and Glassy-winged Sharpshooter Board.



## IMPROVING OUR UNDERSTANDING OF SUBSTANCE TRANSPORT ACROSS GRAFT UNIONS

### Project Leaders:

Bruce Reisch  
Department of Horticultural Sciences  
NYSAES- Cornell University  
Geneva, NY 14456

Peter Cousins  
USDA, ARS, Plant Genetic Resources Unit  
NYSAES- Collier Drive  
Geneva, NY 14456

### Cooperators:

Seok-Hyun Eom and Julie R. Kikkert  
Cornell University  
NYS Agric. Experiment Station  
Geneva, NY 14456

**Reporting Period:** The results reported here are from work conducted September 1, 2004 to August 31, 2005.

### ABSTRACT

The goal of this project is to determine whether it is possible to mobilize proteins from rootstocks to scions via xylem transport. Xylem-mobile gene products may provide a means for control of Pierce's disease (PD). Multiple lines of transgenic grapevines containing NPT-II, endochitinase, and GUS/NPT-II fusion genes are being used to investigate the movement of transgene products across graft unions into non-transgenic scions. These transgenic lines produce proteins that differ in molecular weight [29 kDa (NPT-II), 42 kDa (endochitinase), and 97 kDa (GUS/NPT-II fusion product)] as well as concentration. Lines were chosen for either high or low levels of expression in order to determine whether the root concentration of each protein would affect levels found in non-transgenic scions. To determine transgenic protein concentrations in root tissues, protein assays were conducted using in-vitro grown transgenic vines corresponding to the lines grown in the field. ELISA assays were used to determine NPT-II protein concentrations ( $\mu\text{g/g}$  protein). Chitinase activity was determined according to a fluorescence assay. As results of these assays, selected transgenic lines were chosen for use as rootstocks with non-transgenic Chardonnay scions. More than five grafted vines of each desired combination were created via either chip-budding or approach grafting. Non-transgenic scion tissues will be assayed for the presence of rootstock-produced transgenic proteins to enhance our understanding of substance transport across graft unions. Initial testing indicates that the 97 kDa GUS/NPT-II fusion product does not move across graft unions.

### INTRODUCTION

*Xylella fastidiosa* (*Xf*) is a Gram-negative xylem-limited bacterium known to cause PD of grapevines. One potential approach to the control of PD is to use transgenic proteins that travel with the xylem fluid and control the proliferation of *Xf*. Protein size and concentration are important factors that may affect xylem transport.

It has generally been shown that proteins are transported mainly via the phloem for long distance distribution within the whole plant, while protein transport via the xylem tissue has not been studied in as much detail. However, some studies reported that proteins can be transported within the xylem system although distance mechanisms have not been reported. Ten to twenty proteins, including peroxidases, chitinase and serine proteases, were detected in xylem sap from vegetables (Buhtz et al. 2004). The proteins detected in the xylem sap ranged from 10 to 100 kDa in weight. A polygalacturonase-inhibiting protein (36.5 kDa) was detected in the xylem sap of scions grafted on PGIP-transgenic grapevines (Agüero et al. 2005). Some disease related proteins (10 to 60 kDa) were also detected in xylem sap of diseased tomatoes (Rep et al. 2002). Xylem sap proteins are likely related to plant defense systems, including repair, as well as pathogen and stress resistance (Buhtz et al. 2004, Rep et al. 2002).

The protein concentration in the xylem sap is likely the most important factor to consider in the use of transgenic proteins to control *Xf*. Although the total protein in xylem sap is relatively small, it is also true that there are not very many proteins (Buhtz et al. 2004, Rep et al. 2002). Also the sap protein concentration likely fluctuates depending on the circumstances of plant growth and the environment (Rep et al. 2002, Oda et al. 2003).

With so much to be learned about xylem protein transport, utilization of transgenic rootstocks and non-transgenic scions will be effective to help delineate some of the features of xylem protein movement. Our hypothesis is that cellular proteins, especially those secreted to the extracellular spaces, can move into the xylem sap and be transported across a graft union and into the scion, depending on either protein size or concentration in the rootstock. Three transgenic proteins, neomycin phosphotransferase II (NPT-II, 29 kDa), endochitinase (42 kDa), and the GUS/NPT-II fusion protein (97 kDa) under control of constitutive promoters (35S, *Arabidopsis* ubiquitin, and *Nos* promoters), were transformed into grapevines. The relation between protein concentration in the rootstock and the resultant concentration in a non-protein producing scion will be examined. The GUS/NPT-II gene fusion is available only in the cultivar Chancellor, whereas all other transformed vines used in this project were developed from 'Chardonnay' (clone 95) and 'Merlot.'

We report here results concerning the selection of transgenic vines for either high or low root tissue concentrations of the mentioned proteins, and for creating grafted vines for further experiments to learn whether protein size and concentration in the rootstock affect levels found in the scion.

## OBJECTIVES

1. Selection of transgenic lines with either high or low levels of transgenic proteins in root tissues.
2. Development of graft combinations between the transgenic lines selected (#1 above) and non-transgenic scions.
3. Study substance transport across the graft union, especially in relation to xylem transport.

## RESULTS

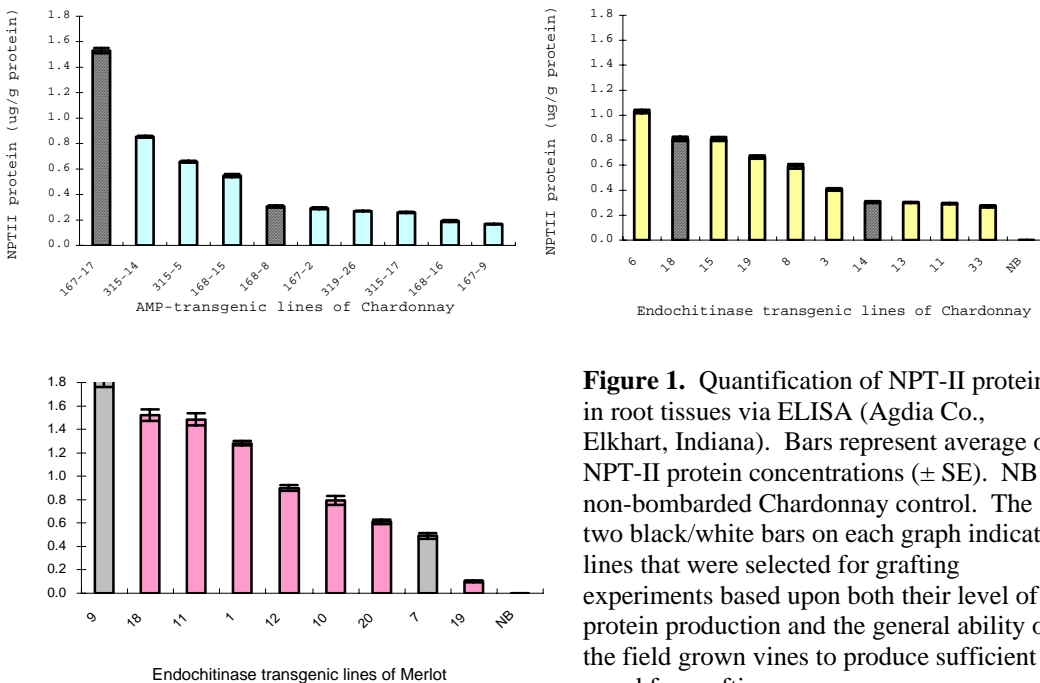
### Selection of transgenic lines with either high or low levels of transgenic proteins in root tissues

NPT-II protein levels in roots of in-vitro cultures lines were determined using an ELISA assay (Agdia, Elkhart, Indiana). Endochitinase activities were measured using the umbelliferyl fluorescence assay (Carsolio et al. 1994). Transgenic grapevines analyzed were chosen from the following three groups: 1. A series of lines of Chardonnay producing NPT-II along with one of three antimicrobial peptides; 2. Multiple lines of Chardonnay and Merlot producing both NPT-II and endochitinase; 3. Two lines of Chancellor with GUS/NPT-II gene fusion producing a fused protein product. All of these lines produce transgenic products under control of constitutive promoters described previously (Reisch et al. 2004).

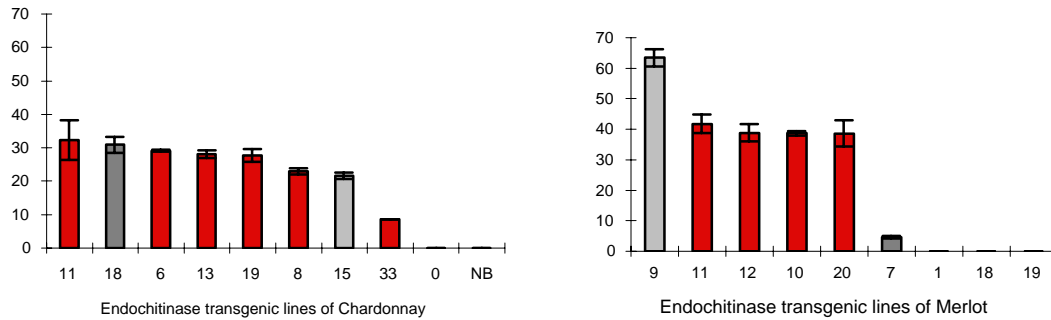
Expression of NPT-II protein in roots of transgenic lines varied between 0.1 and 1.9  $\mu\text{g/g}$  protein (Figure 1), while no expression was found in either non-transgenic Chardonnay or Merlot.

Seven of nine lines of Chardonnay showed endochitinase activity ranging from 21.5 to 32.3 nM/min/ $\mu\text{g}$  protein. One line (CdEN33) exhibited low activity and also showed very poor growth among in-vitro, greenhouse, and field grown vines (Figure 2). Merlot endochitinase-transformed vines varied greatly for chitinase activity, ranging from 65 nM/min/ $\mu\text{g}$  protein (line MEN9) to under 5 nM/min/ $\mu\text{g}$  protein (MEN7).

Two lines of Chancellor transformed with GUS/NPT-II gene fusion producing a fused protein product (97 kDa) were evaluated using a histochemical GUS detection assay (Jefferson et al. 1987). One line (Chan 1055) strongly expressed GUS activity in all tissues, while the other line (Chan 1134) showed no GUS expression, even though the gene was present.



**Figure 1.** Quantification of NPT-II protein in root tissues via ELISA (Agdia Co., Elkhart, Indiana). Bars represent average of NPT-II protein concentrations ( $\pm$  SE). NB: non-bombarded Chardonnay control. The two black/white bars on each graph indicate lines that were selected for grafting experiments based upon both their level of protein production and the general ability of the field grown vines to produce sufficient wood for grafting.



**Figure 2.** Root endochitinase activities according to the umbelliferyl fluorescence assay (Carsolio et al. 1994). Bars represent the average of endochitinase activities ( $\pm$  SE). EN: endochitinase. NB: non-bombarded Chardonnay control. The two black/white bars on each graph indicate lines that were selected for grafting based upon level of endochitinase production.

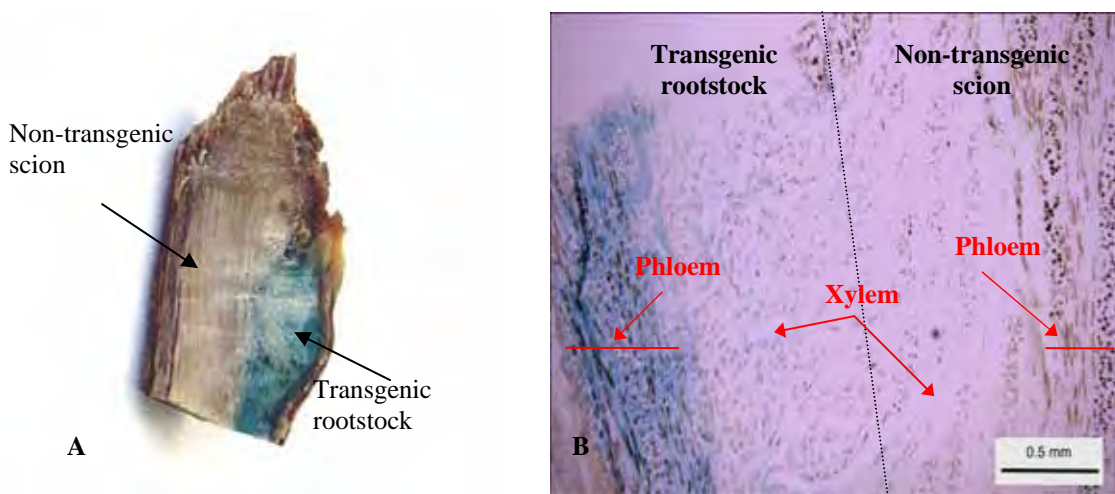
### Development of graft combinations between selected transgenic lines and non-transgenic scions

Transgenic lines to be grafted with non-transgenic Chardonnay scions were selected considering not only the level of protein produced but also the availability of healthy wood for bench-grafting. With regards to cultivars and type of transgenic proteins, two lines of each were chosen, based on having either high or low transgenic protein levels, in addition to non-transgenic controls.

The selected transgenic lines were grafted with non-transgenic Chardonnay using chip-budding and green stem-approach grafting techniques. One line of Chardonnay and two lines of Merlot were suitable for both NPT-II and endochitinase analyses. A total of ten rootstock/scion combinations were grafted, including negative controls, and more than five grafted vines of each combination were established. Xylem sap and leaf tissues from scions will be analyzed for presence of transgenic proteins.

### Transport of GUS/NPT-II fusion products

GUS/NPT-II fusion products (97 kDa) were strongly expressed in phloem vascular tissues as well as xylem parenchyma cells in Chancellor line 1055. In a three-month old graft union of a transgenic rootstock and non-transgenic scion, GUS expression could only be detected in transgenic rootstock tissues, but not in scion tissues (Figure 3A, 3B). It appears that the GUS/NPT-II fusion protein is not transported from transgenic rootstock cells to non-transgenic scion cells, nor can it be detected in the xylem vessel elements. This result is not surprising given the very large size of the protein.



**Figure 3A and 3B.** GUS expression at the graft union between a transgenic rootstock (Chancellor 1055) and non-transgenic scion (Chardonnay) three months after grafting. GUS protein was detected by histochemical methods using vertical stem sections and visualized by the blue color of tissues.

## CONCLUSIONS

1. Transgenic rootstocks with either high or low expression of three different proteins were grafted with non-transgenic Chardonnay scions and more than five grafted vines of each combination were established.
2. Grafted vines are growing in a greenhouse for further analysis. Initial data show that 97 kDa protein is not transported across the graft union. Enhancing our understanding of substance transport across graft unions will be of great use in designing strategies to deploy rootstocks for control of PD.

## REFERENCES

- Agüero, C.B., S.L. Uratsu, C. Greve, A.L.T. Powell, J.M. Labavitch, C.P. Meredith, and A.M. Dandekar. 2005. Evaluation of tolerance to Pierce's disease and *Botrytis* in transgenic plants of *Vitis vinifera* L. expressing the pear PGIP gene. *Mol. Plant Path.* 6: 43-51.
- Buhtz, A., A. Kolasa, K. Arlt, C. Walz, and J. Kehr. 2004. Xylem sap protein composition is conserved among different plant species. *Planta* 219: 610-618.
- Carsolio, C., A. Gutiérrez, B. Jiménez, M. Van Montagu, and A. Herrera-Estrella. 1994. Characterization of *ech-42*, a *Trichoderma harzianum* endochitinase gene expressed during mycoparasitism. *Proc. Natl. Acad. Sci. USA* 91: 10903-10907.
- Jefferson, R.A., T.A. Kavanagh, and M.W. Bevan. 1987. GUS fusions:  $\beta$ -glucuronidase as a sensitive and versatile gene fusion marker in higher plants. *EMBO J.* 6: 3901-3907.
- Oda, A., C. Sakuta, S. Masuda, T. Mizoguchi, H. Kamada, and S. Satoh. 2003. Possible involvement of leaf gibberellins in the clock-controlled expression of *XSP30*, a gene encoding a xylem sap lectin, in cucumber roots. *Plant Phys.* 133: 1779-1790.
- Reisch, B., P. cousins, J.R. Kikkert and J. Vidal. 2004. Improving our understanding of substance transport across graft unions, pp. 47-49. In *Proceedings, 2004 Pierce's Disease Research Symposium*. 7-10 Dec. 2004. Coronado, CA, USA. Calif. Dept. of Food and Agriculture, Sacramento.
- Rep, M., H.L. Dekker, J.H. Vossen, A.D. de Boer, P.M. Houterman, D. Speijer, J.W. Back, C.G. de Koster, and B.J.C. Cornelissen. 2002. Mass spectrometric identification of isoforms of PR proteins in xylem sap of fungus-infected tomato. *Plant Phys.* 130: 904-917.

## FUNDING AGENCIES

Funding for this project was provided by the University of California Pierce's Disease Grant Program.

## TESTING TRANSGENIC GRAPEVINES FOR RESISTANCE TO PIERCE'S DISEASE

### Project Leaders:

Bruce I. Reisch and Julie Kikkert  
Department of Horticultural Sciences  
NYSAES, Cornell University  
Geneva, NY 14456

### Cooperators:

Andrew Walker  
Department of Viticulture and Enology  
University of California  
Davis, CA 95616

Claire-Lise Rosenfield  
Department of Horticultural Sciences  
NYSAES, Cornell University  
Geneva, NY 14456

**Reporting Period:** The results reported here are from work conducted July 1, 2004 to September 30, 2005.

### ABSTRACT

Magainins are small antimicrobial peptides (AMPs) that inhibit growth of numerous bacteria and fungi. Some AMP-transgenic lines of 'Chardonnay' have improved resistance to tumorigenic strains of crown gall (*Agrobacterium vitis*). Other researchers have claimed that similar AMPs induce grapevine resistance to Pierce's disease (PD). Sixteen 'Chardonnay' lines transformed with the magainin-type AMP genes, mag-2 and MSI99, and with a PGL class gene, were produced and tested for PD resistance using a greenhouse needle inoculation technique. Most lines were susceptible, but several showed reductions in symptom development and reductions in plant tissue bacterial counts. These vines are being propagated for a field trial to test for resistance under conditions of natural inoculation. Tests are also underway to quantify the level of peptide production in each transgenic line. In addition, *in vitro* assays are being conducted to evaluate the relative effect of these and other peptides on growth of *Xylella fastidiosa* (*Xf*). MSI99 and ESF39 inhibit *Xylella* growth more effectively than do the other peptides tested, according to results obtained to date.

### INTRODUCTION

Numerous genes involved in plant disease defense have been isolated (Punja 2001; Mourgues et al. 1998). When disease resistance genes are introduced and expressed in transgenic plants, fungal and bacterial diseases have been greatly reduced (Mourgues et al. 1998; Punja, 2001; Van der Biezen 2001). We have developed a set of transformed grapevines in which AMP genes are transcribed into RNA. About 80 'Chardonnay' lines transformed with the magainin-type genes, mag-2 and MSI99, and with a PGL class gene, were produced (Vidal et al. 2003). Magainins are small peptides with strong inhibitory activity against numerous bacteria and fungi (Zaslhoff et al. 1988; Smith et al. 1998; DeGray et al. 2001; Smith et al. 2001). The MSI99 peptide expressed in tobacco and banana was shown to be highly effective against several pathogens (Chakrabarti et al. 2003). Some AMP-transgenic lines of 'Chardonnay' demonstrated improved resistance to tumorigenic strains of crown gall (*Agrobacterium vitis*) (Vidal et al. 2005), suggesting that these lines may harbor resistance to other bacterial diseases, as well.

Some AMP producing genes such as Shiva-1 are effective against PD (Scorza and Gray, 2001) but the subject warrants further study. It is the purpose of the present project to study the potential resistance of our AMP-producing vines to PD; learn more about the effects of various AMPs on *Xf* growth; and develop new sets of transgenic vines with the potential to resist PD.

### OBJECTIVES

1. Analyze AMP (anti-microbial peptide) expression in transgenic 'Chardonnay' vines.
2. Understand the relationship between AMP levels and disease resistance; design improved transformation vectors based on results.
3. Evaluate resistance to PD among these transgenic vines.

### RESULTS

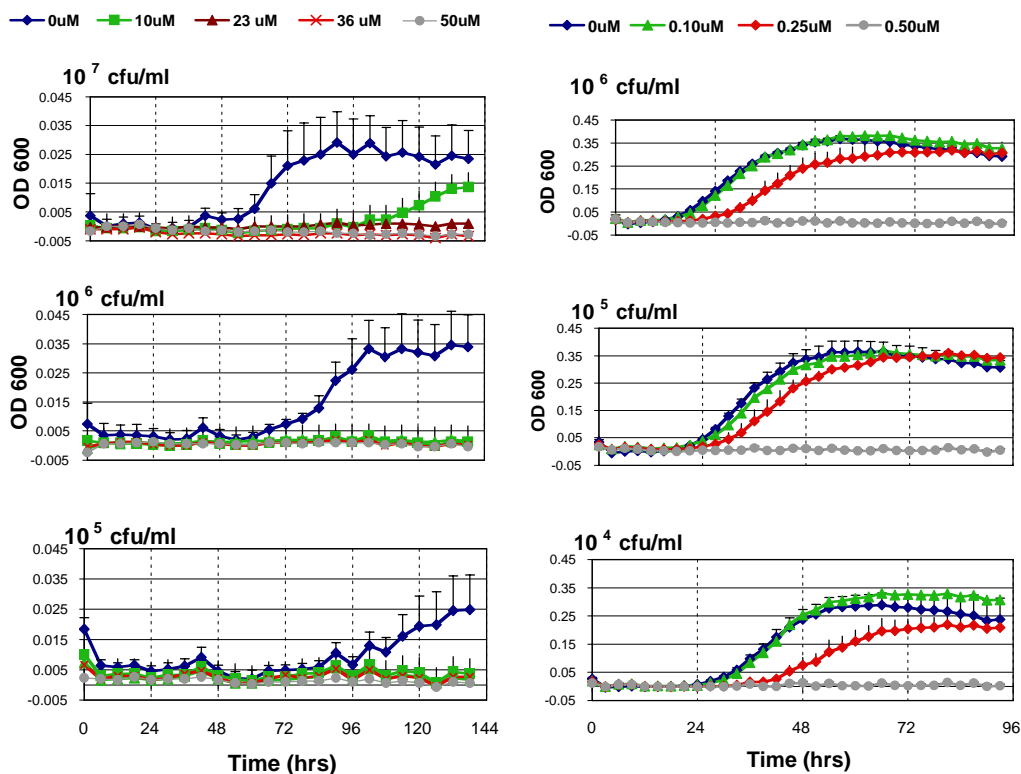
#### Objective 1: Analyze AMP (anti-microbial peptide) expression in transgenic 'Chardonnay' vines

Transgene expression in leaves was quantified by ELISA. For the mag-2 and MSI99 peptides, an antibody was developed that recognized an antigenic sequence common to both. In a series of preliminary ELISA tests (during 2003; methods per Li et al. 2001), low levels of peptide production were detected in 8 of 22 lines, in agreement with previous RT-PCR results. However we were unable to detect the peptide consistently, suggesting the methodology required some improvement. In spring 2004, a series of ELISA tests for peptide detection were carried out using very young leaves from greenhouse plants. Chardonnay lines transformed with either the gene for mag-2 or for MSI99 production (ten of each), plus two non transformed lines, were assayed in three separate experiments. Despite rapid sample preparation, oxidation was an erratic problem among samples, and there were inconsistencies in the data collected. Among the ten lines expressing mag-2, lines

167-3 and 167-9 were significantly different from the non transgenic controls. There were no significant differences in the ELISA assay among lines transformed with MSI99, however the highest ELISA readings were with lines 168-8 and 168-15.

With the inconsistency of results from the ELISA assays, two other methods for detecting peptide expression were investigated. Using the Bioscreen C Microbiological Workstation, conditions to bioassay for peptide activity in plant tissue extracts were investigated. Tissue extracts from non transgenic vines plus known amounts of mag-2 peptide were incubated with bacterial cultures and growth following the incubation period was measured. Peptide degradation was reduced with a protease inhibitor cocktail. Small amounts of plant extract were found to stimulate bacterial growth and large amounts completely inhibited growth. So this line of research is proceeding to establish the proper conditions to bioassay for peptide activity in transgenic plant tissues.

Direct quantification of peptide production is also being investigated using a BioLC Chromatograph in the chemistry laboratory of Dr. Terry Spittler, Horticultural Sciences, Cornell University. This system can be used to determine species and quantity of peptides by highly sensitive ion chromatographic techniques and electrochemical detection. Plant tissue extracts have been collected and stored at -20 C. Control experiments are underway to determine elution times for detection of the peptides of interest. Results are not yet available.



**Figure 1.** Growth of *Xf* (left side) and *Agrobacterium vitis* (right side) in the presence of varying concentrations of MSI 99. Initial bacterial concentrations ranged from  $10^7$  to  $10^5$  cfu/ml.

**Objective 2: Understand the relationship between AMP levels and disease resistance; design improved transformation vectors based on results**

The following AMPs were grown in the presence of varying concentrations of *Xf* (Stag's Leap strain) in vitro: ESF12, ESF39, mag-2, MSI99 and PGL. At least one additional AMP, MsrA3, is still to be tested. Replicated testing was conducted in a Bioscreen C Microbiological Workstation. Initial *Xf* concentrations were adjusted to  $10^5$ ,  $10^6$  and  $10^7$  cfu/ml in PW (Periwinkle Wilt) liquid medium.

The Bioscreen C microplate reader was found to be suitable for automated measurements of growth of *Xf*. At OD600, the range of readings was very low as compared to the range obtained with *Agrobacterium vitis* (see Figure 1), yet the readings were consistent and indicative of the effects of increasing concentrations of antibacterial compounds. Among the five peptides tested to date, MSI99 was the most effective inhibitor of growth (Table 1). Since it was only tested at concentrations ranging from 10 to 50  $\mu$ M, further testing will be necessary at lower concentrations. The amino acid sequence of MSI99 is very similar to that of mag-2. However, it is a much more potent inhibitor of *Xf*, and this is consistent with

reports that it was developed to be a more potent analog of mag-2. PGL and ESF12 had very little effect on the growth of *Xf*, even at the very high concentration of 50  $\mu$ M. ESF39, reported to be a more potent analog of ESF12, was much more inhibitory to *Xf* growth than was ESF12.

**Table 1.** Effects of five antimicrobial peptides on growth of *Xylella fastidiosa*.

AMP ( $\mu$ M)	<i>Xylella</i> conc. (cfu/ml)	grows well at or below:	grows slowly or erratically at:	does not grow at or above:
Magainin-2 1; 5; 10; 15	$10^7$	1 $\mu$ M	5 to 15 $\mu$ M	n.a.
	$10^6$	n.a.	1 to 15 $\mu$ M	n.a.
	$10^5$	1 to 5 $\mu$ M	10 $\mu$ M	15 $\mu$ M
MSI-99 10; 23; 36; 50	$10^7$	n.a.	10 $\mu$ M	23 $\mu$ M
	$10^6$	n.a.	n.a.	10 $\mu$ M
	$10^5$	n.a.	n.a.	10 $\mu$ M
PGL 10; 23; 36; 50	$10^7$	50 $\mu$ M	n.a.	n.a.
	$10^6$	36 $\mu$ M	50 $\mu$ M	n.a.
	$10^5$	23 $\mu$ M	36 $\mu$ M	50 $\mu$ M
ESF-12 10; 23; 36; 50	$10^7$	50 $\mu$ M	n.a.	n.a.
	$10^6$	50 $\mu$ M	n.a.	n.a.
	$10^5$	n.a.	50 $\mu$ M	n.a.
ESF-39 10; 23; 36; 50	$10^7$	n.a.	10 $\mu$ M	23 $\mu$ M
	$10^6$	n.a.	10 $\mu$ M	23 $\mu$ M
	$10^5$	n.a.	10 $\mu$ M	23 $\mu$ M

n.a. = not applicable

Further work during the course of the present project will focus on the development of improved transformation vectors for resistance to PD. The present work to assess the four groups of transgenic vines plus the ongoing project to evaluate the effects of a range of AMPs on growth of *Xf* in vitro will be used as a knowledge base to contribute to the design of new plasmids or gene cassettes. Consideration will be given toward optimizing the promoters and signal peptides in each construct.

### Objective 3 - Evaluate resistance to PD among these transgenic vines

Previous efforts to test peptide-producing transgenic lines of Chardonnay for resistance to *Xf* showed that, using the greenhouse needle-inoculation technique, most lines were susceptible to PD, and just a few showed reduced symptom development and reductions in the number of *Xf* bacteria (Reisch et al. 2004). It is not yet known how these vines will respond in the field under conditions of natural inoculation. Vines are now being propagated for planting of a trial of AMP-producing vines in Texas, where they will be observed for field resistance to PD. This trial will include at least two lines of each of four types of transformants. The four types are those transformed with genes for the production of peptides mag-2, MSI99, PGL, and mag-2 + PGL. The trial will be replicated and will include control susceptible and resistant vines. Planting is scheduled for spring 2006.

### CONCLUSIONS

Transgenic vines harboring genes that produce substances inhibitory to growth of *Xf* are being propagated to test for field resistance to PD. Work is underway to quantify the production of these inhibitory substances in grapevine tissues. These and other similar substances are being tested in vitro for their relative effects on the growth of *Xf*. Based on the data being produced, new gene constructs will be designed with the goal of providing improved levels of resistance to PD.

### REFERENCES

- Chakrabarti, A., T.R. Ganapathi, P.K. Mukherjee, and V.A. Bapat. 2003. MSI-99, A magainin analogue, imparts enhanced disease resistance in transgenic tobacco and banana. *Planta* 216: 587-596.
- DeGray, G., K. Rajasekaran, F. Smith, J. Sanford, and H. Daniell. 2001. Expression of an antimicrobial peptide via the chloroplast genome to control phytopathogenic bacteria and fungi. *Plant Phys.* 127: 852-862.
- Li, Z., S. Jayasankar, and D.J. Gray. 2001. An improved enzyme-linked immunoabsorbent assay protocol for the detection of small lytic peptides in transgenic grapevines (*Vitis vinifera*). *Plant Mol. Biol. Rep.* 19: 341-351.
- Mourgues, F., M.N. Brisset, and E. Chevreau. 1998. Strategies to improve plant resistance to bacterial diseases through genetic engineering. *Trends in Biotechnology* 16: 203-210.
- Punja, Z.K. 2001. Genetic engineering of plants to enhance resistance to fungal pathogens – a review of progress and future prospects. *Can. J. Plant Pathol.* 23: 216-235.

- Reisch, B.I., J.R. Kikkert, M.A. Walker, and J. Vidal. 2004. Testing transgenic vines for resistance to Pierce's disease. Testing transgenic grapevines for resistance to Pierce's disease, pp. 367-370. In Proceedings, 2004 Pierce's Disease Research Symposium. 7-10 Dec. 2004. Coronado, CA, USA. Calif. Dept. of Food and Agriculture, Sacramento.
- Scorza, R. and D.J. Gray. 2001. Disease resistance in *Vitis*. United States Patent 6,232,528
- Smith, F.D., D.M. Gadoury, J.M. Van Eck, A. Blowers, J.C. Sanford, J. Van der Meij, and R. Eisenreich. 1998. Enhanced resistance to powdery mildew in transgenic poinsettia conferred by antimicrobial peptides. *Phytopathology* 88: S83.
- Smith, F., A.D. Blowers, J. Van Eck, and J.C. Sanford. 2001. Expression of magainin and PGL classes of antimicrobial peptide genes in plants, and their use in creating resistance to multiple plant pathogens. United State Patent 6,235,973.
- Van der Biezen, E.A. 2001. Quest for antimicrobial genes to engineer disease-resistant crops. *Trends Plant Sci.* 6: 89-91.
- Vidal, J.R., J.R. Kikkert, P.G. Wallace, and B.I. Reisch. 2003. High-efficiency biolistic co-transformation and regeneration of 'Chardonnay' (*Vitis vinifera* L.) containing npt-II and antimicrobial peptide genes. *Plant Cell Rep.* 22: 252-260.
- Vidal, J.R., J.R. Kikkert, M.A. Malnoy, P.G. Wallace, J. Barnard, and B.I. Reisch. 2005. Evaluation of transgenic 'Chardonnay' (*Vitis vinifera*) containing magainin genes for resistance to crown gall and powdery mildew diseases. *Transgenic Research (In Press)*
- Zasloff, M., B. Martin, and H.C. Chen. 1988. Antimicrobial activity of synthetic magainin peptides and several analogues. *Proc. Natl. Acad. Sci. USA* 85: 910-913.

### **FUNDING AGENCIES**

Funding for this project was provided by the University of California Pierce's Disease Grant Program, and by the CDFCA Pierce's Disease and Glassy-winged Sharpshooter Board.



# MECHANISMS OF PIERCE'S DISEASE TRANSMISSION IN GRAPEVINES: THE XYLEM PATHWAYS AND MOVEMENT OF *XYLELLA FASTIDIOSA*. XYLEM STRUCTURE AND CONNECTIVITY IN GRAPEVINE SHOOTS SUGGESTS A PASSIVE MECHANISM FOR THE SYSTEMIC SPREAD OF BACTERIA IN GRAPE PLANTS INFECTED WITH PIERCE'S DISEASE

## Project Leaders:

Thomas L. Rost  
Section of Plant Biology  
University of California  
Davis, CA 95616

Mark A. Matthews  
Department of Viticulture and Enology  
University of California  
Davis, CA 95616

## Cooperator:

David S. Chatelet  
Section of Plant Biology  
University of California  
Davis, CA 95616

**Reporting Period:** The results reported here are from work conducted September 2004 to June 2005.

## ABSTRACT

Grapevine xylem is composed of vessels connected by intervessel bordered pits with pit membranes that prevent the passive movement of particles, especially at the stem-leaf junction where most vessels end. The traditional view of *Xylella fastidiosa* (*Xf*) movement within the xylem requires the digestion of the intervessel pit membrane to move from one vessel to another. However, bacteria such as *Yersinia enterocolitica* (*Ye*) and fluorescent beads have been observed moving rapidly within the grapevine xylem, suggesting a pathway for passive movement. In this report, we used air and latex paint to confirm the existence a xylem vessel pathway from stems into the leaf lamina. Anatomical investigation of the leaf xylem revealed a switch from vessels to tracheids at about 50-60% the length of the leaf lamina. In addition, inoculations of *gfp-Xf* showed that bacteria never reached the leaf margin where the symptoms appear, suggesting that tracheids inhibited the free movement of *Xf*.

## INTRODUCTION

Particle movement is limited by the frequency of vessel endings, especially at the stem-leaf junction, where most vessels have been thought to end, with a few exceptions (Andre, 2002; Larson and Isebrands, 1978; Tyree and Zimmermann, 2002). Indeed a bacterium such as *Xf* (0.1-0.5 x 1-5  $\mu\text{m}$ , Nyland et al., 1973) is too big to move through the intervessel pit membrane pores (<0.2  $\mu\text{m}$ , Siau, 1984) with water flow. The colonization of a plant by *Xf* requires that the bacteria move within the xylem between vessels across pit membranes and from one organ to another (Stevenson et al., 2004). A favored hypothesis to explain how bacteria become systemic is that the bacteria digest the pit membrane cell wall (Roper et al., 2002; Stevenson et al., 2004). Another more recent twist in the mechanism is that bacteria might also move through torn or remnant pit pore membranes (Carlquist and Schneider, 2004; Stevenson et al., 2004). This propagation by digestion could be rather slow if vessels are short and if numerous membranes have to be crossed. Bacterial movement in grape stem can be relatively easy because vessels can be very long, up to 1m (Sperry et al., 1987). However, there is still the problem of bacterial passage into leaves if most of the vessels end at the stem-petiole and petiole-lamina junctions.

Recent experiments on the passive movement of *Ye* and fluorescent beads showed the existence of open, continuous xylem conduits (one or more xylem vessels allowing free movement of particles of at least one micrometer in size) from the stem to the leaf lamina of grapevine (Thorne et al., personal communication). They found that *Ye* and beads were moving freely with the transpiration stream from the stem into primary and secondary veins of the leaf blade in three leaves above the loading point. In addition, they showed that *Ye* and beads traveled to about 50-60% of the length of the leaf lamina. This shows an open xylem conduit all the way from the stem through the petiole and into the leaf blade without the need to digest a pit membrane, but also suggests that a feature of xylem structure precluded the movement of bacteria all the way to the leaf blade periphery.

In this study, we verified the presence of the open xylem conduits by studying the movement of air and latex paint. We also looked at the xylem anatomy of the leaf blade to identify the change in the vascular structure causing the halt of *Ye*, beads, air and paint within 50-60% of the leaf blade length. Leaves were also inoculated with *Xf* engineered by the addition of the green fluorescent protein (*gfp-Xf*) to check its movement within the leaf at different times after inoculation. The question was whether *Xf* would be affected by the change in xylem structure. Since *Xf* possess the ability to digest cell walls, we would theoretically expect the bacteria to be able to move farther than 50-60% of the leaf blade length and eventually be found at the leaf margin.

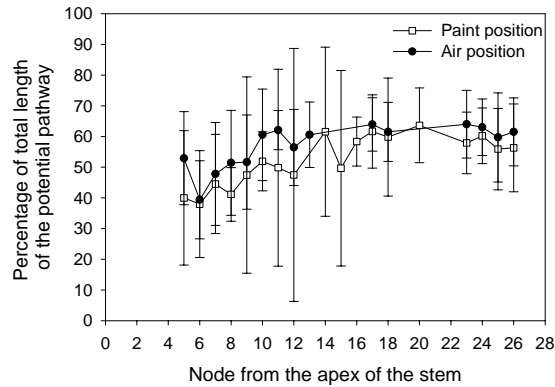
## OBJECTIVES

1. Confirm the presence of open, continuous vessels from stem to leaf by using air and latex paint.
2. Identify the change in the leaf xylem structure that inhibits movement of air, paint and bacteria.
3. Study the effect of the leaf xylem structure on *gfp-Xf* movement.

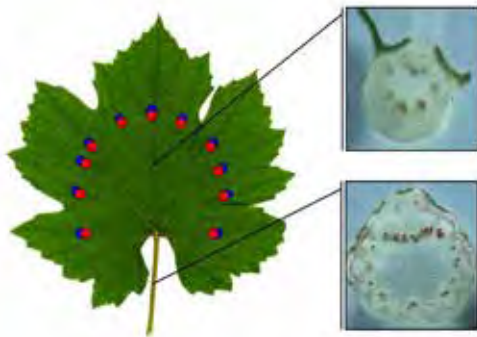
## RESULTS

### Objective 1: Open, continuous vessels

When air or paint was loaded in the petiole base, the distance traveled ranged from 40 - 60% of the total length of the xylem path from petiole base toward the leaf margin (Figure 1). Since neither air nor paint can move from one intact vessel to another across intervessel pit membrane, the similar results obtained with air and paint suggest that both moved through open, continuous conduits until they reach a zone in the leaf blade where a change occurs in leaf xylem structure (Figure2).

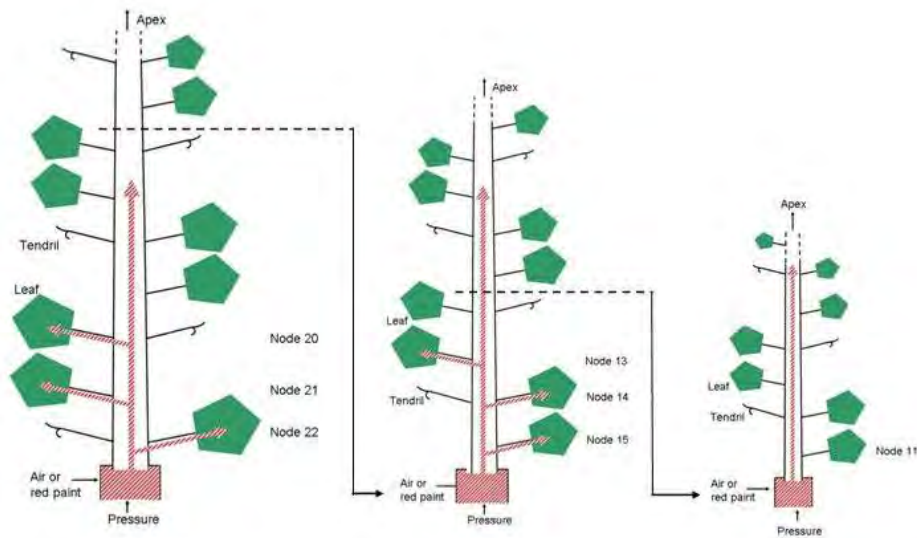


**Figure 1.** Air and paint position in the leaf veins calculated as percentage of the total length of the vascular pathway. Air and paint were loaded at the base of the petiole of leaves from different nodes. For each node, the farthest position of the air or paint inside the five major veins and ten secondary veins of five leaves was recorded.



**Figure 2.** Map of a leaf showing the longest distance traveled by air and paint in the primary and secondary veins when loaded into the petiole base. Images on the right are cross sections of the petiole (bottom) and of the central vein (top) showing paint-filled vessels. Notice the decrease in the number of paint-filled vessels as we get closer to the margin of the leaf.

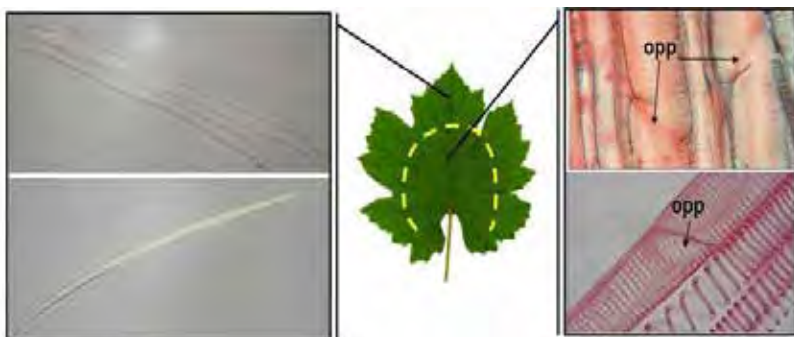
When air and paint were loaded in the stem, only the three leaves immediately apical to the loading point had air or paint in their veins (Figure 3). No air or paint was observed going into petioles beyond these three leaves, but both could be observed up to 1m past the loading point within the stem axis. The progression of air and paint inside the three leaves was comparable to that seen when air or paint were loaded into an individual isolated leaf via the petiole (Figure 2). This suggests that the open, continuous conduits present from petiole to leaf blade are also continuous from stem to leaf blade. This also shows that these xylem conduits are open for three internodes. However these open conduits connecting stem to leaves were not present at all stages of development of the vines. When air and paint were loaded in the stem below the nodes 10-12, air and paint was observed in the first three leaves above the loading point (Figure 3). But when air and paint was loaded in the stem above these nodes, nothing moved into any leaves but paint and air did continue to move up the stem. The open conduits from stem to petiole connected around nodes 10 to 12.



**Figure 3.** Diagram representing the movement of air or paint within the stem and into the leaves when loaded at different internodes. Below node 10 to 12, air and paint moved into the three leaves above the loading point and into the stem. From node 10-12, air and paint moved only in the stem. A pressure of 35 KPa was used and the presence of air and paint was first checked into the leaves then into the stem starting from the apex of the stem toward its base.

**Objective 2: Tracheary elements of the leaf blade**

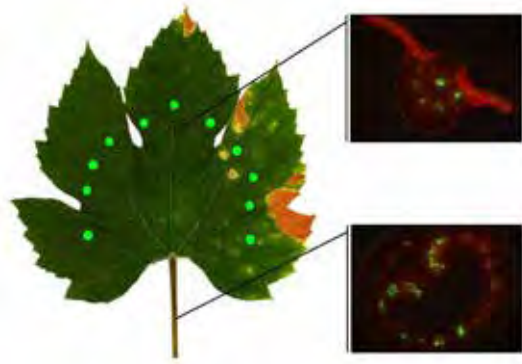
Air and paint are not able to move past about 50-60% of the leaf blade (Figure 2). Since air and paint cannot cross the pit membrane between vessels, this means that the open, continuous conduits must end at this boundary (see dotted line in Figure 4). Consequently, the type of tracheary element was studied before this limit, at this limit and past this limit. Vessel elements with helical secondary walls and simple, open perforation plates were predominant in the first 50-60% of the leaf blade (Figure 4). However, past the limit, closer to the leaf margins, no open perforation plates were observed in any tracheary elements. Macerations revealed that the xylem was composed of short, close-ended tracheids (Figure4).



**Figure 4.** Map of a leaf showing the change in its xylem structure in relation to the limit set by air and paint movement. Images on the right show the presence of open perforation plates (OPP) within the mid vein xylem. The images on the left show the presence of tracheids in the central vein near the margin of the leaf.

**Objective 3: Movement of Gfp-Xf fastidiosa in leaves**

In all examined leaves, the bacteria was observed at 50-60% of the leaf blade, but never closer to the leaf margin (Figure 5). The bacteria reached this limit at five weeks and were not found closer after eleven weeks when symptoms developed at the margins. In addition, bacteria were loaded at different places on leaves to determine if the loading site influenced the distance the bacteria could travel or the outer limit of its travel. The results showed that *gfp-Xf* could not be found past this limit in leaves infected in the petiole or at mid-distance of the mid vein, regardless of the presence of symptoms or not. But the green fluorescence was observed in the petiole of leaves infected in the mid vein, signifying that the bacteria moved against the transpiration stream. However, the green fluorescent bacteria could not be observed in leaves that had been infected near the leaf blade margin. The bacteria may not have survived as their propagation was hindered by the tracheids, or possibly no xylem elements were infected during the needle inoculation as there are few of them near the margin.



**Figure 5.** Map of a leaf showing the distance traveled by *gfp-Xft* in the xylem vessels when injected into the petiole base. Images on the right are cross-sectional views of the infected petiole (bottom) and the central vein (top).

## CONCLUSIONS

1. The presence of open xylem conduits from petiole base to 50-60% of the leaf lamina is confirmed.
2. These conduits are present in the stem for three internodes before diverging into mature leaves. However, the conduits present in young leaves are not continuous in the stem, although the stem possesses some.
3. Tracheids replace vessels at 50-60% of the lamina.
4. *gfp-Xf* movement is similar to the movement of air and paint.
5. *gfp-Xf* is stopped or slowed by the tracheids and never reached the leaf margins where necrosis appears. Therefore, necrosis could result from a signal originating from the bacteria and targeting some specific cells near the margin.
6. The open conduits offer easy long distance pathways bridging stem to leaves without interruption, which could facilitate the systemic spread of the bacteria in the plant.

## REFERENCES

- Andre J.P. 2002. Organisation vasculaire des angiospermes: une vision nouvelle. INRA ed.
- Carlquist S. and E.L. Schneider 2004. Pit membrane remnants in perforation plates of Hydrangeales with comments on pit membrane remnant occurrence, physiological significance and phylogenetic distribution in dicotyledons. *Bot. J. Lin. Soc.* 146: 41-51.
- Larson P.R. and J.G. Isebrands 1978. Functional significance of the nodal constricted zone in *Populus deltoids*. *Can. J. Bot.* 56: 801-804.
- Nyland G.A., A.C. Goheen, S.K. Lowe and H.C. Kirkpatrick 1973. The ultrastructure of a rickettsia-like organism from a peach-tree affected with phony disease. *Phytopathology*, 63: 1275-1278.
- Roper M.C., L.C. Greve, J.M. Labavitch and B. Kirkpatrick 2002. Analysis of grapevine xylem sap for evidence of host cell wall degrading enzymes associated with colonization by *Xylella fastidiosa*. *Phytopathology*, 92(6 supplement): S70-S71.
- Siau J.F. 1984. Transport processes in wood. Springer-Verlag, Berlin.
- Sperry J.S., N.M. Holbrook, M.H. Zimmermann and M.T. Tyree 1987. Spring filling of xylem vessels in wild grapevine. *Plant Physiol.* 83: 414-417.
- Stevenson J.F., M.A. Matthews, L.C. Greve, J.M. Labavitch and T.L. Rost 2004. Grapevine susceptibility to Pierce's disease II: the progression of anatomical symptoms. *Am. J. Enol. Vit.* 55(3): 238-245.
- Tyree M.T. and M.H. Zimmermann 2002. Xylem structure and the ascent of sap. Springer, New York.

## FUNDING AGENCIES

Funding for this project was provided by the CDFR Pierce's Disease and Glassy-winged Sharpshooter Board.

# MAGNETIC RESONANCE IMAGING: A NON-DESTRUCTIVE APPROACH FOR DETECTION OF XYLEM BLOCKAGES IN *XYLELLA FASTIDIOSA* INFECTED GRAPEVINES

## Project Leaders:

Ken Shackel and John Labavitch  
 Department of Plant Sciences  
 University of California  
 Davis, CA 95616

## Cooperators:

Mark Matthews	L. Carl Greve	Jeffrey Walton	Alonso Pérez
Dept. of Vitic. and Enology	Dept. of Plant Sciences	NMR Facility	Dept. of Plant Sciences
University of California	University of California	University of California	University of California
Davis, CA 95616	Davis, CA 95616	Davis, CA 95616	Davis, CA 95616

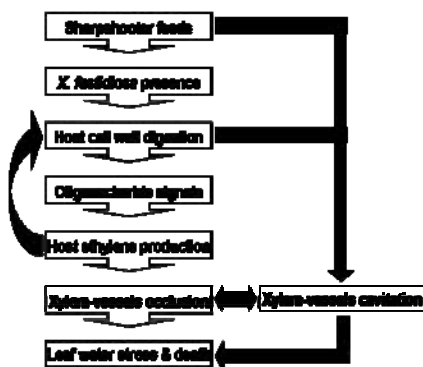
**Reporting Period:** The results reported here are from work conducted October 2004 to October 2005.

## ABSTRACT

It is conventionally thought that multiplication of the xylem-limited bacterium *Xylella fastidiosa* (*Xf*) within xylem vessels is the sole factor responsible for the blockage of water movement in grapevines (*Vitis vinifera* L.) affected by Pierce's disease (PD). However, results from our studies have provided substantial support for the idea that vessel obstructions, and likely other aspects of the PD syndrome, result from the grapevine's active responses to the presence of *Xf*, rather than to the direct action of the bacterium. The use of magnetic resonance imaging (<sup>1</sup>H-MRI) to observe the distribution of water within the xylem has allowed us to test the role of the plant hormone ethylene in promoting xylem obstruction development, and the consequent reduction in vine water transport. In both infected and ethylene-exposed plants, MRI shows that an important proportion of the xylem vessels become progressively air-embolized (the magnetic signal is lost from these vessels) after the treatments. The loss of xylem water-transporting function, assessed by MRI, has been also correlated with a decrease in stem specific hydraulic conductivities ( $K_s$ ) and the presence of tyloses in the lumen of water conduits. We propose that ethylene may be involved in a series of cellular events that allows the plant to sense the presence of *Xf* and stimulates a plant response that includes the production of tyloses and gels, perhaps in an effort to slow systemic movement of the bacteria.

## INTRODUCTION

Results from PD research programs led by Matthews, Rost and Labavitch (reported in 2001, 2002, 2003 and 2004 in San Diego) support the idea that obstructions in the vine's water-transporting xylem tissue develop rapidly post-inoculation, before an appreciable bacterial population has been established. Thus, careful analysis of the timing of changes in xylem element anatomy and function relative to *Xf* introduction, as well as to external symptoms of disease development, is important for establishing reliable indicators of the "stage" of PD development. The analyses done thus far have been based on destructive tissue sampling. Such sampling can be particularly "blind" when it is done on vines in which (based on our earlier results) internal PD symptoms are present but external, visible symptoms, are not yet present. In the report of the year 1 work of our study (Shackel and Labavitch, 2003), the success of Mr. Pérez and Dr. Walton in imaging non-functional vessels in the stems of PD-infected and ethylene-treated grapevine stems was demonstrated. In this report we elaborate on those studies, showing the correlation of reduced vine water transport capacity with the locations of PD and ethylene effects on vessel functionality, as determined by MRI analysis. In addition, because interpretation of the true meaning of the MRIs in relationship to the anatomy and functioning of vessels is a crucial aspect of our work, we have described the approach that we are taking to efficiently derive information about the extent of changes in xylem water conducting capacity that can be deduced from MRIs. Our experimental work is organized around the hypothetical model for the development of the disease described in Figure 1.



**Figure 1.** Hypothetical model for PD development. PD starts with infection caused by the glassy-winged sharpshooter's introduction of *Xf* locally (i.e., into one or a few vessels). Once *Xf* is in the xylem the bacteria become systemic, which implies that *Xf* must be able to cross (digest away?) the cell wall in the pit membranes that separate two neighboring vessels. The digestion of the cell wall by bacterial enzymes would generate transient oligosaccharides with biological activity. The presence of these oligosaccharides is detected by the plant triggering a series of defensive responses, including a raise in ethylene production. Ethylene has been shown to induce tylose formation. Cavitation of vessels may be also important for the disruption of water transport in the plant. Cavitations may happen during insect feeding or during PD progression. The "bottom line" of our thinking is that PD is primarily caused by the grapevine's responses (local and systemic) to *Xf* presence.

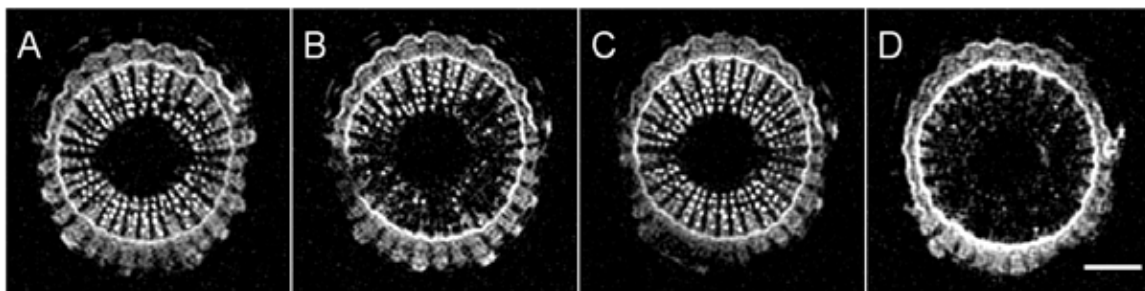
## OBJECTIVES

1. Optimize the use of MRI (Magnetic Resonance Imaging) and to spatially visualize altered water movement in grapevines.
2. Test correlations of observed vascular system obstructions (based on grapevine dissection and microscopy techniques) with predictions based on MRI data.
3. Use MRI to follow the development of grapevine obstructions over time in vines infected with *Xf* or treated with ethylene, bacterial wall-degrading enzymes or plant cell wall oligosaccharides, all of which may be important intermediates in regulating the vine's response to infection and the eventual development of PD symptoms.
4. Use NMR imaging to determine whether localized xylem cavitation occurs at the site and time of *Xf* inoculation or introduction by the glassy-winged sharpshooter.

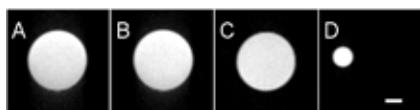
## RESULTS

### Objective 1: Optimization of MRI for visualizing water transport deficiencies in PD-infected grapevines.

Magnetic Resonance Imaging (MRI) allows us to visualize, non-destructively, vessels that are functional and full of movable water. Functional vessels appear as small bright circles in an MRI view of the stem cross-section; non-functional vessels lack water and appear as dark spots in the area of the stem where water conduits are found (the magnetic signal is lost from cavitated vessels). Cavitation of xylem vessels is of potential importance in PD development. Our analysis can reveal vessels that have cavitated. In Figure 2 we can see the presence of functional vessels in an intact stem, empty vessels after the stem is severed to cause cavitation, and the re-filling of cavitated vessel with pressurized water. On the other hand, MRI can make no clear distinction between pure water, a saline solution (KCl), and a pectin gel. Figure 3 shows that their signal intensities are quite similar. This suggests that MRI cannot differentiate between vessels filled with regular xylem sap and vessels filled with pectic materials from plant gels and tyloses.



**Figure 2.** (A) MRI of an intact stem segment in a healthy shoot. (B) Image of the same stem portion after an important part of the cross section below has been severed, thus causing cavitation of many vessels. (C) The same stem segment after it has been refilled with water. (D) Stem segment after flushing with air to completely empty the xylem vessels. Scale bar = 1 mm.



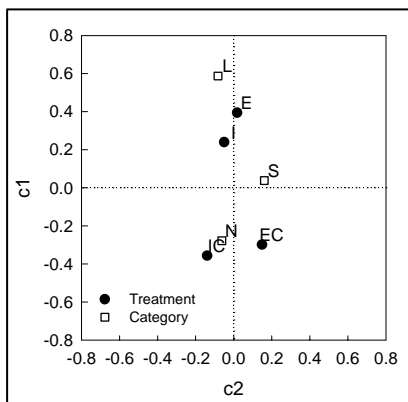
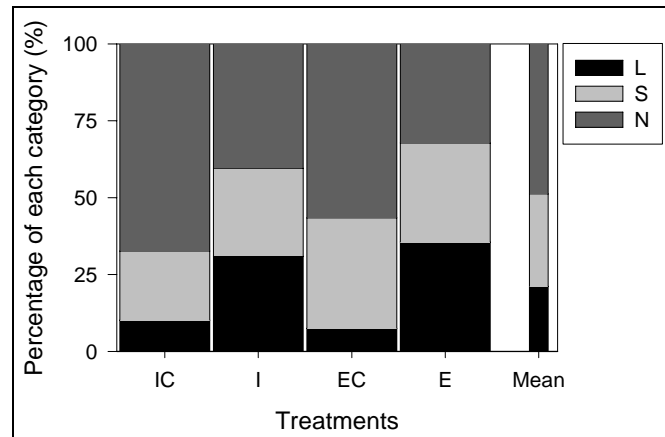
**Figure 3.** Glass tubes containing either (A) distilled water, (B) 10 mM KCl solution, or (C) a pectin gel, were put in the magnet at the same time and imaged. (D) Small glass capillary filled with a pectin gel next to an empty glass tube that does not appear in the image. The signal intensities  $\pm$  1SD were  $195.4 \pm 15.2$ ,  $202.8 \pm 12.2$ , and  $196.1 \pm 4.4$  for A, B, and C, respectively. Scale bar = 1 mm.

MRI has been used to assess the xylem function of control (buffer-inoculated) and infected (*Xf*-inoculated) vines up to seven months after treatment. MRIs of the control vines show well defined xylem, in which individual vessels can be clearly observed. As in previous experiments, stem cross section MRIs of infected plants show that major sectors of the xylem appear dark, indicating that they are no longer water-filled. Furthermore, MRIs of plants infected with *Xf* become less sharp, making it more difficult to discriminate structure, particularly of individual, probably still functional, vessels (see also results for Objectives 2 and 3). Efforts to explain this will be a

feature of the work as this project continues. MRI also has been used to follow changes in the functionality of the xylem of plants exposed to ethylene in enclosed chambers ( $10 \text{ mg L}^{-1}$  of air for 48 hours). This experiment has allowed us to confirm that, after seven months of exposure to ethylene, gassed plants show progressive xylem disruption along the stem (see also results for Objective 3). The images taken along the vines in these experiments were classified in three categories. If the xylem disc appeared full of bright vessel, the image was categorized as “normal” (N). However, if the image was showing one or few small dark spots, in which a few vessels were missing, the image was categorized as “small” (S). If one or more evident dark spots were present, compromising an important area of the xylem, the image was categorized as “large” (L). The Likelihood ratio (Chi-square) test was used to analyze the distribution of the proportions of each category (Figure 4) across the treatments. Inoculated and ethylene-treated vines showed a higher proportion of the “L” category and a reduction in the proportion of the “N” category compared with the controls. The results of the test indicate that there is a significantly

different distribution in the proportion of each category ( $p = 0.0002$ ) among the group treatments (Figure 4). A correspondence analysis (Figure 5) confirmed that inoculated and ethylene-treated vines are more closely associated with the presence of “large” dark spots in the xylem; whereas the control groups are clearly associated with “normal”-looking MRIs.

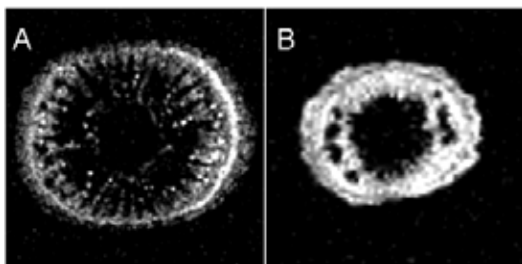
**Figure 4.** The mosaic plot depicts the percentages of the image categories normal (N), small (S), and large (L) for each treatment. The treatments were labeled IC (control for inoculation), I (inoculated), EC (control for ethylene) and E (ethylene-gassed). Treatments E and I show a higher percentage of “L” and a lower percentage of “N” than the controls. The narrow bar to the right is the mean category percentage across all treatments. The distribution of the categories proportions for the treatments was analyzed using the Likelihood Ratio Chi-square test, which concluded that the treatments have different pattern distributions ( $p=0.0002$ ). Sampling size was 49, 42, 53 and 59 internode images for IC, I, EC and E respectively.



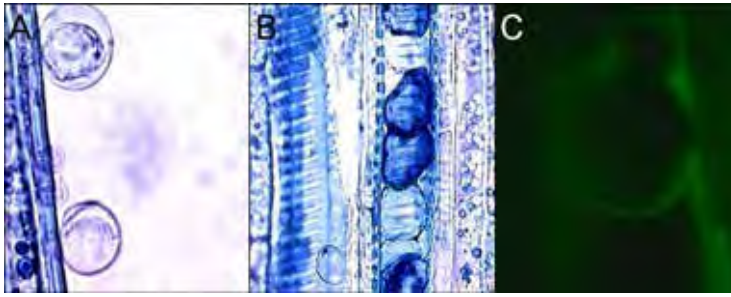
**Figure 5.** The Correspondence Analysis for the proportions of categories (N, S, and L) across treatments (E, EC, I, and IC) indicates that most of the variation (92%) of the response variable (category) happens in the c1-axis. L, S and N categories align respectively from the positive (top) to the negative range of c1-axis, establishing the directionality of the response. Thus the treatments located in the c1-axis positive range (E and I) are associated with the “L” category, and treatments in the negative range (EC and IC) are associated with the “N” category. The c2-axis explains only about 8% of the variability in the category variable. “L” and “N” are located fairly neutrally in the c2-axis whereas “S” locates in the positive range. Thus treatments in c2-axis positive range, like EC, are more associated to the “S” category.

**Objective 2: To test for correlations of observed vascular system obstructions with predictions based on MRI data**

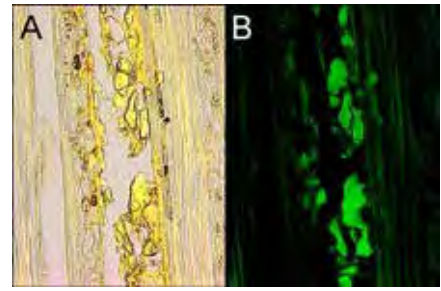
MRI is capable of showing xylem disruption and non-functional vessels well before external symptoms appear in infected plants. Dark spots, indicative of vessel embolisms, can be observed in an image of an infected vine at a basal internode where leaf symptoms of PD are apparent (Figure 6A). Closer to the stem apex, at a point where the leaves show no sign of PD symptoms, MRI can also reveal the presence of extensive cavitations in the xylem (Figure 6B). Compare these images with that for a healthy vine (Figure 2A) in which the xylem appears as a full disc of bright vessels. Conventional (destructive) optic microscopy of stem sections has shown that dark spots seen with MRI are frequently associated with the presence of tyloses (Figure 7) and gels (Figure 8) filling the lumen of the water conduits.



**Figure 6.** MRI of a PD-infected stem (A) in a basal internode and (B) closer to the apex. Bright spots between the central pith (dark) and the ring of vascular cambium show functional vessels. (B) Dark pockets within the vascular tissue indicate areas in which vessels are not water-filled (compare the image to the healthy stem in Fig. 2A).

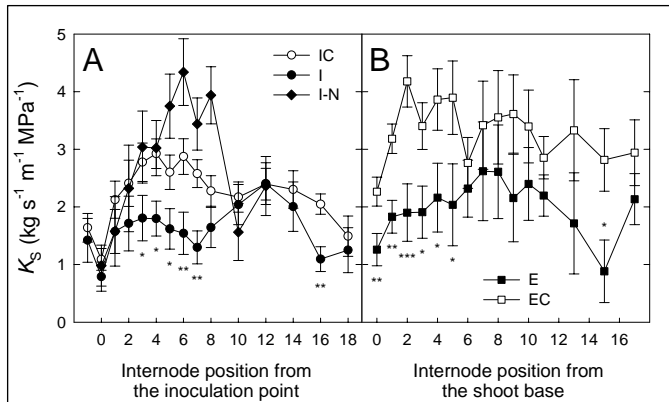


**Figure 7.** Tyloses are balloon-like outgrowths from living parenchyma cells that expand into adjacent vessels and permanently plug them. Tyloses are often associated with dark spots in MRIs of infected and ethylene-exposed vines. (A) New tyloses bulging into a vessel from neighboring xylem ray parenchyma (100X). (B) Tyloses can completely fill the vessel lumen (40X). (C) The use of a green fluorescent dye (coriphosphin O) allows visualization of the pectic nature of tyloses' newly synthesized cell wall (100X).

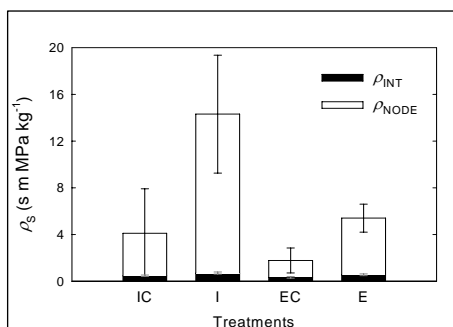


**Figure 8.** (A) Vessels of infected and ethylene-exposed vines are also filled with amorphous materials (10X). (B) This amorphous material stains intensely with coriphosphin O, which is a strong indication that they probably correspond to pectin gels (10X).

The impression of a loss in xylem function that is given by the MRIs of *Xf*-inoculated and ethylene-gassed vines should indicate that there will be a decrease in the hydraulic conductivity of internodes ( $K_S$ ) (Figure 9). This is a destructive technique to measure the rate of movement of pressurized water through stem segments. Whole stems of the treated vines also showed an increase in the hydraulic resistivity ( $\rho_S$ , the reciprocal of conductivity) relative to the controls (Figure 10), although this difference was statistically significant only for the ethylene experiment. The lack of statistical difference in the inoculation experiment is mainly due to the great variability found in the hydraulic resistivity of inoculated plants. In turn, this might be explained because these vines were in a gradation of early stages of PD infection when examined (they were not showing external symptoms). While we have found a general correlation between the MRIs showing localized areas of empty vessels and reduced hydraulic conductivity in regions of infected stems, the correlations are not perfect. This is due to at least two factors that will be tested more fully in our continuing work. First, an empty vessel shown in the MRI at one level in the plant's stem could be the result of a vessel obstruction or cavitation above or below the point on the stem where the MRI observation was made. Hence, there may be no impediment to water flow in the empty vessel that is being imaged. Second, while cavitation may be an important factor in PD development, because the tests of water conductivity are carried out using water under pressure, cavitated vessels will be re-filled during the test and no reduction in water flux would be revealed.



**Figure 9.** Specific hydraulic conductivities ( $K_S$ ) for individual internodes ( $\pm 1$  SE) in grapevines stems. (A) *Xf*-inoculated vines showing xylem disruptions detected by MRI (I), inoculated vines with normal xylem appearance (I-N), and controls (IC). The comparison was only made between "I" and "IC". (B) Vines exposed to ethylene (E) and controls (EC). A one-sided ANOVA test was used to determine whether the treatments "I" and "E" had significantly lower means than "IC" and "EC". The symbols \*, \*\*, and \*\*\* indicate statistical significance at a given internode position with a probability inferior to 0.05, 0.01 and 0.001 respectively.

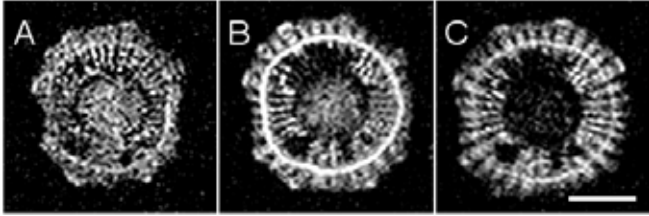


**Figure 10.** Whole-stem specific hydraulic resistivities ( $\rho_S$ ) for vines inoculated with *Xf* and exposed to ethylene. Total bar height represents  $\rho_S \pm 1$  SE (in black).  $\rho_S$  components,  $\rho_{NODE}$  and  $\rho_{INT}$ , are also shown ( $\pm 1$  SE in gray). The nodes are a major component of  $\rho_S$  (the reciprocal of conductivity). It can be noted that  $\rho_S$  is about 3-fold higher for stems of infected plants than for controls, even when infected plants have no external symptoms. This observation agrees with the information provided by MRI.

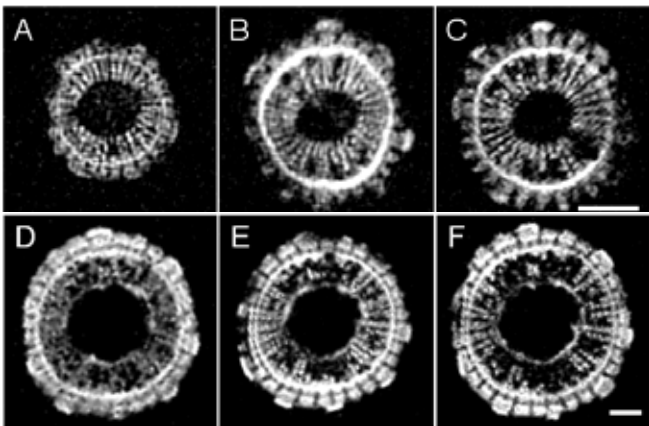


**Objective 3: Use of MRI to follow the development of grapevine obstructions over time in vines infected with *Xf* or treated with ethylene.**

MRI has confirmed that the dark sectors in the xylem of inoculated (Figure 11) and ethylene-gassed grapevines (Figure 12) which are found after seven months of treatment, start to develop gradually, progressively increasing in size after imposing the treatments. Initial signs of embolisms in the xylem can be seen 20 to 50 days after treating the vines, as can be seen in Figure 12, which shows two internodes in independent experiments, imaged over a period of about 40 or 60 days after treatment with ethylene. We expect to perform similar experiments to test the proposed role for cell wall-degrading enzymes and oligosaccharides as regulators of the plant response to PD infection.



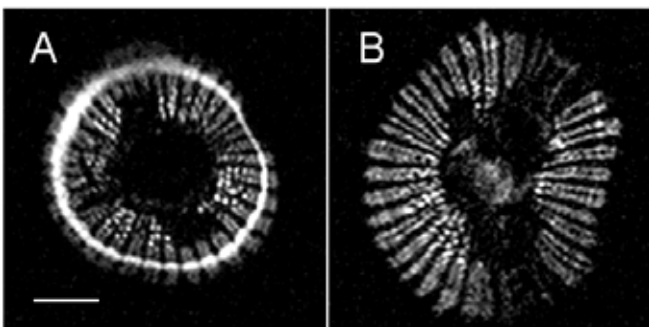
**Figure 11.** Temporal image sequence of a *Xf*-inoculated vine. Images were taken at the same internode (A) 18, (B) 54, and (C) 97 days after inoculation (September 2003). The progressive development of dark spots due to the presence of embolized vessels is clear from A to C. Scale bar = 1 mm.



**Figure 12.** Temporal image sequences for two vines from two different ethylene-gassing experiments (A to C and D to F). Images were taken at the same internodes (A) 19, (B) 47, and (C) 61 days after treatment (September 2003); and (D) 10, (E) 19, and (F) 39 days after treatment (January 2003). The progressive development of dark spots due to the presence of embolized vessels is clear from left to right in both image sequences. Scale bars = 1 mm.

**Objective 4: Use of MRI to determine whether localized xylem cavitation occurs at the site and time of *Xf* inoculation or introduction by the glassy-winged sharpshooter.**

Both control-inoculated and *Xf*-inoculated vines show cavitated sectors in the xylem at the inoculation point, even seven months after treatment (Figure 13). Inoculation-related cavitations can be seen up to two internodes above the inoculation site. We have started the use of a glass micro-capillary probe (similar in size to the Sharpshooter's stylet) to mimic insect feeding, and we started studies of real insect feeding during 2005, in collaboration with Dr. Elaine Backus' group.



**Figure 13.** Images taken at the inoculation sites of a (A) buffer-inoculated and a (B) *Xf*-inoculated vine. Both vines were inoculated using a syringe needle to puncture the stem throughout a droplet of "inoculum" until reaching the xylem. The difference in water potential between the xylem and the atmosphere allowed the "inoculum" to be introduced into the xylem. The cavitation of vessels associated with the inoculation event extends above and below the inoculation site; and it can be seen even seven months after inoculation. Scale bar = 1 mm.

**CONCLUSIONS**

We expect that our combined approach (use of non-destructive and destructive methods) to study xylem function will determine which kind of disruption (tyloses, pectin gels, or air embolisms) exists predominantly in PD-infected stems; as well as its developmental progression during the different stages of the disease.

## REFERENCES

- Clearwater, M. J., and C. J. Clark. 2003. *In vivo* magnetic resonance imaging of xylem vessel contents in woody lianas. *Plant, Cell and Environment* 26: 1205-1214.
- Fry, S. M., and R. D. Milholland. 1990. Response of resistant, tolerant and susceptible grapevine tissues to invasion by the Pierce's bacterium, *Xylella fastidiosa*. *Phytopathology* 80: 66-69.
- Holbrook, N. M., E. T. Ahrens, M. J. Burns, and M. A. Zwieniecki. 2001. *In vivo* observation of cavitation and embolism repair using magnetic resonance imaging. *Plant Physiol.* 126: 27-31.
- Lo Gullo, M. A., P. Trifilo, and F. Raimondo. 2000. Hydraulic architecture and water relations of *Spartium junceum* branches affected by a mycoplasma disease. *Plant, Cell and Environment* 23: 1079-1088.
- McElrone, A. J., J. L. Sherald, and I. N. Forseth. 2003. Interactive effects of water stress and xylem-limited bacterial infection on the water relations of a host vine. *J. Exp. Bot.* 54: 419-430.
- Melotto, E., L. C. Greve, and J. M. Labavitch. 1994. Cell wall metabolism in ripening fruit. VII. Biologically active pectin oligomers in ripening tomato (*Lycopersicon esculentum* Mill.) fruits. *Plant Physiology* 106: 575-581.
- Newbanks, D., A. Bosch, and M. H. Zimmermann. 1983. Evidence of xylem dysfunction by embolization in Dutch elm disease. *Phytopathology* 73: 1060-1063.
- Ridley, B. L., M. A. O'Neill, and D. Mohnen. 2001. Pectins: structure, biosynthesis, and oligogalacturonide-related signaling. *Phytochemistry* 57: 929-967.
- Shackel K. A., and J. M. Labavitch. 2003. Magnetic resonance imaging: A non-destructive approach for detecting xylem blockages in *Xylella fastidiosa*-infected grapevines. 2003 Pierce's Disease Research Symposium. p. 33-35.
- Stevenson, J. F., M. A. Matthews, L. C. Greve, J. M. Labavitch, and T. L. Rost. 2004. Grapevine susceptibility to Pierce's disease II: Progression of anatomical symptoms. *American Journal of Enology and Viticulture* 55: 238-245.
- VanderMolen, G. E., J. M. Labavitch, L. L. Strand, and J. E. DeVay. 1983. Pathogen-induced vascular gels: ethylene as a host intermediate. *Physiologia Plantarum* 59: 573-580.

## FUNDING AGENCIES

Funding for this project was provided by the CDFR Pierce's Disease and Glassy-winged Sharpshooter Board.

# MAP-BASED IDENTIFICATION AND POSITIONAL CLONING OF *XYLELLA FASTIDIOSA* RESISTANCE GENES FROM KNOWN SOURCES OF PIERCE'S DISEASE RESISTANCE IN GRAPE

## Project Leaders:

Andrew Walker and Summaira Riaz  
Department of Viticulture and Enology  
University of California  
Davis, CA 95616

## Reporting Period:

## ABSTRACT

Development of a framework SSR genetic linkage map based on the 9621 family (D8909-15 (*V. rupestris* x *V. arizonica*) x (*V. rupestris* x *V. arizonica/candicans*)) is complete. The mapping population segregates for Pierce's disease (PD) resistance and was expanded from 116 to 188 genotypes. The current genetic linkage map consists of 236 non-AFLP markers (SSR, EST-SSR and ESTP-RFLP) in 19 linkage groups. The PD resistance locus, *PdR1*, maps to linkage group 14 of the male parent (F8909-17), which now consists of 30 markers, 9 of which are localized within 10 cM of *PdR1*. To avoid confounding effects from resistance inherited from D8909-15 a new population has been chosen and is being prepared for mapping. This population (04190) is a cross of *V. vinifera* F2-7 x F8909-08 (sibling of F8909-17). We have confirmed a heterozygous *Xylella fastidiosa* (*Xf*) resistance inheritance (the same as F8909-17) on a subset and produced 4,500 seeds in this population for use in our mapping and positional cloning efforts. A set of 220 plants were selected for DNA extraction (to add PD group markers) and cuttings were collected from 160 plants for screening for *Xf* resistance; resistance segregates 1:1 in this population. In order to understand the stability and segregation of resistance to PD from different sources, 6 different mapping populations are under study. We are also continuing mapping efforts in the 0023 population a cross of D8909-15 x *V. vinifera* B90-116, so that we can compare these resistance sources. Extensive data for cluster and berry traits, and *Xf* resistance exists for about 200 plants in the 0023 population. A preliminary map, locates QTLs on a number of the linkage groups.

## INTRODUCTION

This project expands upon and continues a genetic mapping effort initiated with funding from the California Grape Rootstock Improvement Commission, the Fruit tree, Nut tree and Grapevine Improvement Advisory Board, the California Table Grape Commission and the American Vineyard Foundation. We have been mapping resistance to *Xiphinema index*, the dagger nematode, and *Xf* in the 9621 and 0023 populations mentioned above. The preliminary AFLP-based 9621 genetic map has been published (Doucleff et al. 2004). We then focused on adding more informative markers, such as microsatellites or simple sequence repeats (SSR) because these markers provide a more reliable and repeatable framework for initial mapping of candidate genes and quantitative trait loci (QTLs). In addition, tightly linked SSR markers are ideal for marker-assisted selection (MAS) due to their applicability across different genetic backgrounds and ease of use. This year, mapping efforts within the 9621 have concentrated on linkage group 14 which contains the *PdR1* resistance locus (Krivanek et al. submitted). The addition of SSR markers to this linkage group was greatly aided by the existence of other SSR-based genetic maps of grape that have been developed within *V. vinifera* populations and by the availability of expressed sequence tag polymorphism (ESTP) markers developed by other grape researchers and available on various genetic databases. We are now applying fine-scale mapping techniques to saturate a narrow region around the primary *PdR1* resistance locus, which will lead to efforts to genetically engineer susceptible *V. vinifera* grapes with the *PdR1* gene.

## OBJECTIVES

1. Complete a framework genetic linkage map of 9621 mapping population. Add SSR and ESTP markers from the PD linkage group (Chromosome 14) to additional genotypes of the 9621 population (more recombinants reduce the distance between markers).
2. Screen an additional 100-150 EST derived SSR markers for which functions are known after their comparison to homologues in available EST databases.
3. Study marker segregation linked to *PdR1* in different genetic backgrounds. Initiate genetic mapping of 04190 population (*V. vinifera* F2-7 x (*V. rupestris* x *V. arizonica/candicans* F8909-08)) with markers on linkage group 14. Apply this information in the development of a MAS system for PD resistance to assist ongoing wine grape breeding efforts.

## RESULTS

### Objective 1

This project began with an AFLP-based genetic map developed from 116 individuals from the 9621 population (Doucleff et al. 2004). We expanded the core set of individuals from the 9621 to 188 genotypes to take advantage of 96-well plate based techniques and to increase resolution on the map to improve marker association with PD resistance. A paper on the portion of the AFLP-based map with *PdR1* (Krivanek, Riaz and Walker. Identification and molecular mapping of *PdR1*, a primary resistance gene to Pierce's Disease in *Vitis*. Theor. Appl. Genet.) has been submitted. Efforts have moved ahead with the use of SSR markers linked to *PdR1* in our breeding program. The framework map of 9621 population is now complete with 236

primarily SSR markers (210 mapped and 26 linked). The consensus map spans 1154 cM in 19 linkage groups. Linkage group 14 is the largest group with 30 markers. The average distance between markers is 5.5 cM (a manuscript is in preparation for publication in Genome). Table 1 provides the main features of the completed SSR-based 9621 genetic linkage map. It contains 60 new EST-SSR and EST-RFLP markers that have not been mapped on any other published grape map.

**Table 1.** 9621 Consensus map details of the 19 chromosomes

Chromo.	Linked Markers	Mapped	Unmapped	Distance (cM)	New Markers	
1	18	16	m-VMC8a7, fm-AF378125	2	91.2	8
2	11	10	VMC5g7	1	50.97	0
3	8	8		0	65.87	4
4	15	14	VMC2e10	1	79.95	4
5	17	11	f-VrZag89a, fm-VMC16d4, m-VrZag89b, f-VrZag79a, West-9, VMC4c6	6	46.77	4
6	16	10	f-VMC3f12, m-VMC3a8, fm-VVC7, fm-CF205720, f-VMC2h9	6	75.8	3
7	9	8	fm-VMC16f3	1	71.38	1
8	9	7	f-VMC1b11, f-VMC1e8	2	56.34	2
9	10	10		0	71.05	2
10	9	7	fm-ctg9946, f-vest235	2	30.87	3
11	8	8		0	48.86	4
12	13	12	fm-VMC5c6	1	33.16	4
13	9	9		0	57.29	3
14	30	28	m-VVIQ32, fm-ctg1008359	2	76.83	5
15	4	4		0	17.8	0
16	9	9		0	51.5	2
17	9	9		0	61.13	4
18	15	15		0	105.66	4
19	17	15	fm-VVIM03, m-VMC1a7	2	61.25	3
<b>TOTAL</b>	<b>236</b>	<b>210</b>		<b>26</b>	<b>1153.68</b>	<b>60</b>

We have extracted DNA from 300 additional genotypes from the 9621 population and will be analyzing the DNA from these plants for the markers that are contained within 15 cM of the PdR1 on linkage group 14. This increased number of individuals should yield more recombination around the PdR1 locus, finer scale positioning of markers, and get us closer to physically locating PdR1. Fine scale placement of markers in relation to a resistance locus is the first step toward screening of BAC library clones that contain the resistance gene and allows integration of a genetic linkage map to a physical map capable of locating the *PdR1* gene. This approach to clone resistance genes is termed “map-based positional cloning of genes” and it has been effectively used in other organisms to clone genes of interest. Bulk-segregant analysis (BSA) efforts are also underway with a subset of the 9621 population and 12 highly resistant and 12 highly susceptible siblings.

## Objective 2

We continue to select EST-SSR markers, with known function based on comparisons of homologs from other EST databases, and to test their polymorphism for parents of two main mapping populations (9621 and 04190). This process is coupled with our efforts to increase the number of individuals on the map detailed below. In summer of 2005, we screened an additional 150 EST-SSR markers developed in Dr. Doug Cook’s lab. The majority of these markers amplified successfully and 41 of them were polymorphic and useful for mapping in the 9621 and 04190 mapping populations (Table 2).

**Table 2.** EST-SSR markers applied to the 9621 consensus map and the linkage group they are located on

Accession No.	Putative Function	Map Location
CTG1009904	Similar to olfactory receptor MOR111-4	1
CTG1010271	AF349963_1 endoxyloglucan transferase	
CTG1011774	Nodulin-like protein [ <i>Arabidopsis thaliana</i> ]	
CTG1012992	Putative heat-shock protein [ <i>Arabidopsis thaliana</i> ]	
CTG1008034	Putative myosin heavy chain protein	
AF378125	AF378125_1 GAI-like protein 1 [ <i>Vitis vinifera</i> ]	
CTG1026392	Nuclear transport factor 2 -related	
CTG1026282	AP2 domain transcription factor, putative	
CTG1009171	RNA binding protein	3
CTG1012753	AC098693_13 Putative ubiquitin protein	
CTG1015137	S42868 serine/threonine protein kinase	
CF206266	Unknown	
CTG1007333	Probable peptidylprolyl isomerase	4
BM438035	Dehydration-induced protein RD22-like protein	
CTG1009180	Unknown	5
CTG1026305	Plastid-lipid associated protein PAP/fibrillin family	
CB923226	Protein disulphide isomerase	6
CF205720	Unknown	
CTG1026316	Amygdalin hydrolase isoform AH I precursor	
CTG1010450	ADP-RIBOSYLATION FACTOR -like protein	7
CTG1008985	Putative arabidopsis protein	8
CB918037	Glycosyl hydrolase family 5/cellulase	9
CTG1029984	Auxin-responsive protein (Indoleacetic acid-induced protein)	
CTG1009946	Cell-cell signaling protein csgA - like	10
CTG1009141	Putative arabidopsis protein	11
CTG1009274	Putative protein arabidopsis	
CTG1013410	Histone H1-like protein	
CTG1009382	Putative ring protein	12
CTG1010863	3-isopropylmalate dehydrogenase	
CTG1013230	Expressed protein	12
CTG1026135	S17P_SPIOL Sedoheptulose-1,7-bisphosphatase, chloroplast precursor	13
CTG1008359	Unknown	14
CTG1010193	AF448467_1 alpha-expansin	
CTG1025882	AF406809_1 glutaredoxin	
CTG1026876	Chalcone synthase	
CTG1009244	Putative protein arabidopsis	16
CTG1010557	Leaf development protein Argonaute	17
CTG1008270	Glycosyl hydrolase family 17	
AF143283	Glucose-inhibited division protein B-like protein	
CTG1007085	Putative translation initiation factor eIF-1A	18
CB915120	Eukaryotic peptide chain release factor subunit 1 (ERF1)	
CD009354	Polyadenylate-binding protein (PABP), putative	19

### Objective 3

Because both parents of the 9621 population are *Xf* resistant and because the D8909-15 parent contains different *Xf* resistance loci (which derive from *V. arizonica* b42-26), we began mapping in the 04190 population to avoid confounding effects on our ability to positionally clone the *PdRI* locus. In summer 2005, we extracted DNA from 220 plants in the 04190 population before they were planted in our breeding blocks. A set of 37 SSR and EST-SSR markers were tested on small subset of eight samples (including both parents) to verify polymorphisms. Thirty-five of these markers were known to be linked to linkage group 14 based on comparisons with other published grape maps. Although all of these 35 markers were polymorphic for the 9621 population, only 29 markers were polymorphic for the 04190 and these were added to the 220 genotypes from the 04190 population. Marker order for linkage group 14 is consistent between F8909-17 (parental map) and 04190 (consensus map). A total of 111 plants inherited resistant alleles from 3 markers covering the 11 cM around the *PdRI* locus derived from F8909-08. From this observation, we conclude that resistance is segregating 1:1 in this population. Based on the presence of these resistance markers, we are now testing all resistant and 30 susceptible plants from the 04190 to verify these results with whole plant screening. These plants will be screened as part of the PD winegrape breeding effort and results are expected before the end of 2005

We are studying the expression, penetration, segregation and stability of resistance to PD from different genetic sources so that we can better predict its durability in crosses and how this locus interacts within the chromosomes. So far we have used two resistance sources (b42-26 and b43-17). The populations and genotypes we are examining are noted below.

**Table 3.** Parentage and species information for populations and genotypes being used to map PD resistance

Population / Genotype	Species / Parentage
b42-26	<i>V. arizonica</i>
b43-17	<i>V. arizonica/candicans</i>
D8909-15	<i>V. rupestris</i> A. de Serres x <i>V. arizonia</i> b42-26
F8909-08 and F8909-17	<i>V. rupestris</i> A. de Serres x <i>V. arizonica/candicans</i> b43-17
F2-7 and F2-35 (both females)	<i>V. vinifera</i> (Carignane x Cabernet Sauvignon)
9621	D8909-15 x F8909-17
0023	F8909-15 x <i>V. vinifera</i> B90-116
03300/5	101-14Mgt ( <i>V. riparia</i> x <i>V. rupestris</i> ) x F8909-08
04190	F2-7 x F8909-08
04191	F2-7 x F8909-17
04373	F2-35 x b43-17

Expected or Known Segregation Patterns:

1. 9621 Population: *PdR1* single locus for F8909-17 and multiple QTLs for D8909-15.
2. 0023 Population: multiple QTLs.
3. 03-300/5 population: *PdR1* resistance segregates 1:1 (single gene model) *Xf* greenhouse screening for entire population is in process.
4. 04-190 population: results based on resistant alleles from 6 markers, *PdR1* segregates as 1:1 (single gene model), *Xf* greenhouse screening for entire population is in process.
5. 04-191 population: *PdR1* resistance should segregate 1:1; plant DNA extraction and addition of PD group markers are in process.
6. 04-373 population: *PdR1* resistance should segregate 1:1; plant DNA extraction and addition of PD group markers are in process.
7. 045554 population: progeny should be 93.75% *V. vinifera* and an excellent test of *PdR1* in 4 backcross generations

The stability of resistance is key issue for breeding new winegrape cultivars; only genotypes that carry the resistant alleles as well as other important horticultural traits need to be selected. Therefore, it is essential to understand how resistance from different sources segregates in population. Testing of the six populations in Table 3 (9621, 0023, 03300, 04190, 04191, and 04373) that derive *Xf* resistance from both backgrounds (b42-26 and b43-17) for the presence of DNA markers and screening them for resistance to *Xf* will provide us with an understanding of resistance in different background as well as provide confidence with the stability of these resistance sources in our ongoing breeding project.

We continue to map in the 0023 population and the map results were reported last year. Since then we have determined that 75 more SSR markers are mapable. These markers are in the process of being mapped. If their addition results in a better definition of QTL location and effect we will saturate the appropriate linkage groups with markers known to exist on those groups.

We continue to study the Olmo Mexican Collection to verify its identity and the extent to which *Xf* resistance and the *PdR1* locus exist in the population. We have not resolved all the confusion between the original and the USDA National Clonal Repository collections, but the work will soon be finished. We have tested all of the 51 genotypes in this collection for the presence of six SSR markers linked to the *PdR1* locus. The results are being analyzed and will provide important information allowing us to correlate *Xf* screening results with the resistant alleles, distinguish new resistant alleles for breeding purposes, and determine the distribution of known resistant alleles in the entire set.

## CONCLUSION

This project has enabled us to develop a framework genetic map for *Xf* resistance and now we can make progress towards physical mapping of resistance trait. Other maps are also in development in different genetic backgrounds and they will focus only on Linkage Group 14 on which *PdR1* resides, except in the case QTL analysis in the 0023. These genetic linkage maps will enable us to characterize and clone genes conferring resistance to PD, ultimately leading to genetic transformation of susceptible grape varieties with grape-based resistance genes. PD resistance makers generated in this study are used in our breeding program to optimize selection and allow the screening of larger populations and thus greater progress in the production of resistant winegrapes.

## REFERENCES

- Doucleff, M, Y. Jin, F. Gao, S. Riaz, A.F. Krivanek and M.A. Walker. 2004. A genetic linkage map of grape utilizing *Vitis rupestris* x *Vitis arizonica*. *Theoretical and Applied Genetics* 109:1178-1187.
- Krivanek, A.F., S. Riaz and M.A. Walker. Identification and molecular mapping of *PdR1*, a primary resistance gene to Pierce's Disease in *Vitis*. *Theoretical and Applied Genetics* (revised 7/05)

## FUNDING AGENCIES

Funding for this project was provided by the CDFR Pierce's Disease and Glassy-winged Sharpshooter Board. Previous mapping efforts upon which this research is based received funding from the American Vineyard Foundation, the California Grape Rootstock Improvement Commission, and the Louis P. Martini Endowed Chair in Viticulture.

## BREEDING PIERCE'S DISEASE RESISTANT WINEGRAPES

### Project Leaders:

Andrew Walker and Alan Tenschler  
Dept. of Viticulture and Enology  
University of California  
Davis, CA 95616-8749

**Reporting Period:** The results reported here are from work conducted October 2004 to September 2005.

### ABSTRACT

Strong and continued progress is being made breeding Pierce's disease (PD) resistant winegrapes. We have been able to markedly improve fruit quality while maintaining high levels of PD resistance. At this point we have third generation backcrosses of our 8909-08 (*Vitis arizonica/candicans*) resistance source onto *V. vinifera* grapes. This will be the first time that PD resistant selections with so great a percentage (87.5%) of *V. vinifera* have been produced. We continue to make many crosses, produce thousands of seeds, and plant about 2,000 plants in the field each year. The greenhouse screening system continues to be refined and we have moved to smaller pots and more rapid evaluation to increase the number of seedlings and high fruit quality selections we test. This screening is very severe, but material that passes the screen is reliably resistant and dramatically restricts *Xylella fastidiosa* (*Xf*) movement. We are also co-screening for powdery mildew resistance. Strong progress on the development of *Xf* resistance markers has allowed us to use our *PdRI* markers for marker-assisted selection. This year's crosses will produce up to 14,000 seeds – many with >75% *V. vinifera* parentage. We have high expectations for strong resistance and excellent wine quality in this and the next generation of seedlings.

### INTRODUCTION

The PD threat in California has greatly increased with the establishment and spread of the glassy-winged sharpshooter (GWSS). All of California's winegrapes are susceptible to PD and no effective prevention or cure currently exists. Under severe PD pressure, culture of *V. vinifera* grapes is not possible and new PD resistant cultivars are needed. PD resistance exists in a number of *Vitis* species and in the related genus, *Muscadinia*. Many resistant cultivars, which derive their resistance from these sources exist, but they lack *V. vinifera* fruit quality and have very complex resistance genetics. This complex genetics greatly limits the number of resistant progeny they produce when crossed to *V. vinifera* cultivars, which dramatically slows breeding progress.

At UC Davis, we are uniquely poised to undertake this important breeding effort. We have developed rapid screening techniques for *Xf* resistance and have optimized ELISA and PCR detection of *Xf* (Buzkan et al. 2003, Buzkan et al. 2005, Krivanek et al. 2005a 2005b, Krivanek and Walker 2005). We have unique and highly resistant *V. rupestris* x *V. arizonica* selections, as well as an extensive collection of southeastern grape hybrids, that offer the introduction of extremely high levels of *Xf* resistance into commercial grapes. We also have several years' worth of seedlings in the ground that need evaluation as winegrape types. We are now breeding in a broad range of PD resistant backgrounds with most of our activity directed at resistance from *V. arizonica/candicans* b43-17, for which we have located a resistance locus that maps as a single dominant gene (*PdRI* – detailed in the companion report "Map-based identification and positional cloning of *Xylella fastidiosa* resistance genes from known sources of Pierce's disease resistance in grape"). We have seed that is 87.5% *V. vinifera*, from winegrape cultivars, with resistance from the b43-17 resistance source and progress has been dramatically improved with marker-assisted selection.

### OBJECTIVES

1. Breed PD resistant winegrapes through backcross techniques using high quality *V. vinifera* winegrape cultivars and *Xf* resistant selections and sources characterized from our previous efforts.
2. Continue the characterization of *Xf* resistance and winegrape quality traits (color, tannin, ripening dates, flavor, productivity, etc) in novel germplasm sources, in our breeding populations, and in our genetic mapping populations.

### RESULTS

#### Objective 1

2005 Crosses – We made a wide range of crosses this year detailed in Table 1. Thus far in 2005, we have extracted 2,308 seeds and expect to extract another 11,725. These crosses were made in five groups. The first group (Table 1a) utilizes the b43-17 *V. arizonica/candicans* resistance source in a third generation backcross to produce progeny with 87.5% *V. vinifera* parentage. These plants have great potential and will contain more *V. vinifera* parentage than has been produced in past PD winegrape breeding programs. We will be testing this population with our *PdRI* genetic markers. This population will contain not only dramatically increased fruit quality, but also verify the utility of the *PdRI* markers in later generations. The second group (Table 1b) also utilizes the b43-17 resistance source and its progeny will contain 75% *V. vinifera*. The 03188 and 0062 selections used in these crosses are 50% F2-7 or F2-35 both female flowered selections from a Carignane x Cabernet Sauvignon cross. We have used a variety of "classic" winegrape cultivars in these crosses to promote productivity



and fruit quality traits (Airen, Alicante Bouschet, Barbera, Cabernet franc, Cabernet Sauvignon, Chardonnay, Sauvignon blanc, Syrah, Tempranillo and Viognier).

The third group of crosses (Table 1c) utilized the b42-26 *V. arizonica* PD resistance source. This genotype is the strong *Xf* resistance source for the 8909-15 parent in the 9621 genetic mapping progeny (detailed in the companion report – “Map-based identification and positional cloning of *X. fastidiosa* resistance genes from known sources of Pierce’s disease resistance in grape”). This group of crosses will include progeny with 50% *V. vinifera* and 75% *V. vinifera* parentage. This source of resistance is multi-genic and we are attempting to establish quantitative trait loci (QTL) markers for its resistance in our mapping program. Although this resistance source is not as amenable to marker-assisted selection, it does produce progeny with very high levels of resistance. It may also be more valuable given its multi-gene resistance, making it more difficult for *Xf* to overcome its resistance mechanisms. Our current plan is to advance both the b43-17 and b42-26 sources of resistance and then intercross advanced resistant selections to broaden, and thus increase the durability, of PD resistance in their offspring. The use of selections from the 03188 (this cross was made in 2003) was only possible with our accelerated growing and screening conditions and techniques).

The fourth group (Table 1d) continues our efforts to use a broad range of southeastern US (SEUS) PD resistant cultivars. None of these sources has proven to be simple genetically and they produce widely ranging percentages of resistant progeny when crossed to *V. vinifera* cultivars. This inconsistent and low inheritance of PD resistance has greatly impeded the progress of past PD resistance breeding programs because very few resistant progeny are produced making it very difficult to get the numbers of seedlings required for selection of resistance in combination with high fruit quality. We are placing less emphasis on using SEUS parents, but continue with several to ensure that the base of our resistance is not too narrow. We also made crosses with two very promising VR (*vinifera* x *rotundifolia*) hybrids that have had strong resistance in our screens. The fifth group (Table 1e) are crosses we made to support mapping effort and increase the number of individuals in two specific mapping populations (further detailed in our report on fine-scale mapping).

Table 2 presents the number of progeny from the 2004 crosses that went to the field for evaluation of fruit traits and for *Xf* resistance screening. The populations with resistance from 8909-17 and 8909-08 were screened for the presence of the *PdR1* *Xf* resistance marker and segregated in the expected 1 resistant: 1 susceptible ratio. The b43-36 and b43-56 *V. arizonica* selections performed very well in a resistance screen and were chosen as parents. Testing for the presence of *PdR1* in these plants is under way. The crosses to the *V. smalliana*, *simponii* and Midsouth resistance sources were made to address breadth of resistance issues as noted in regard to Table 1d above. These plants will be evaluated for fruit quality and then tested for *Xf* resistance. Only 25 progeny from the *M. rotundifolia* resistance sources were planted in the field, displaying the difficulty in making these crosses and their low fertility and viability.

## Objective 2

We optimized our *Xf* screening system using smaller pots and a shortened period before ELISA and symptom evaluation. These efficiencies are allowing us to test more seedlings, selections, and genotypes for the mapping and gene characterization project. We are also testing a wide range of seed germination techniques to not only hasten germination, but to also increase the rate and make germination more uniform. We tested about 300 seedlings from a wide range of *Xf* resistance backgrounds including *V. champinii*, *M. rotundifolia*, *V. shuttleworthii*, *V. simpsonii*, *V. smalliana*, and a variety of more complex SEUS cultivars. The only seedling populations with predictable segregation ratios of resistant to susceptible plants were those from *V. arizonica/candicans* b43-17. This result has concentrated our efforts on this resistance source, while fewer plants from other resistance sources are being evaluated as noted above.

Table 3 presents the groups of genotypes currently under *Xf* resistance screening. The 0023 group testing completes *Xf* resistance testing of this mapping population (*V. vinifera* x *V. arizonica* b42-26). This group is currently under study for mapping of QTLs for *Xf* resistance. The 03300/5 group is a cross of 101-14Mgt x F8909-08. This group has been screened for *PdR1* and it segregated 1:1 (n=30), confirming the use of these markers in a non-winegrape background. It will also produce PD resistant rootstocks on which PD resistant winegrapes will have to be grafted. The 04190 population is also under testing to help refine *PdR1* markers and for winegrape production. We are testing a number of 89 series seedlings that are crosses of *V. rupestris* to *V. arizonica* and *V. arizonica/candicans*. Additional sources of strong *Xf* resistance sources might be discovered from these results and the results should clarify the extent of resistance from other selections of these species. We have 32 new SEUS and *V. arizonica* type genotypes under test to evaluate potential parental germplasm.

We have many seedlings going to the field in Spring 2006 that will be 87.5% *V. vinifera* (Table 1a) and many more that will be 75% *V. vinifera* (Table 1b). These plants will begin fruiting in summer 2007. *PdR1* testing will identify *Xf* resistant individuals by early spring 2006. We take potted greenhouse plants of resistant selection and convert their tendrils to clusters with cytokinins. Pollen from these plants will be crossed onto *V. vinifera* winegrapes to produce seeds with 93.75% *V. vinifera*. This process will be combined with evaluation for the *PdR1* marker and decrease the traditional breeding cycle by several years.

As a prelude to much larger scale fruit quality evaluations, we tested the juice quality of 42 genotypes this year. This group included the *V. vinifera* parents we used in the 2005 crosses, the *Xf* resistant parents, and selections from a number of our populations with clusters that appeared to have high wine quality potential. Table 4 presents examples of the juice from *Xf* resistant selections from the 0058 Midsouth (*V. champinii*) resistance source and from the 03188 b43-17 resistance source; both sets of selections are 50% *V. vinifera*.

## CONCLUSIONS

This project is developing PD resistant winegrapes, evaluating novel and known sources of PD resistance, and providing testing and support for our genetic mapping efforts. New winegrape selections will likely be available for wine and field-testing in about two years and will continue to be refined. The first phase of winegrape releases is aimed at use for planting in PD hot spots to act as buffers and have their fruit blended with traditional wine varieties.

## REFERENCES

- Buzkan, N., L. Kocsis and M.A. Walker. 2005. Detection of *Xylella fastidiosa* from resistant and susceptible grapevine by tissue sectioning and membrane entrapment immunofluorescence. *Microbiol. Res.* 160:225-231.
- Krivanek, A.F., J.F. Stevenson and M.A. Walker. 2005. Development and comparison of symptom indices for quantifying grapevine resistance to Pierce's disease. *Phytopathology* 95:36-43.
- Krivanek, A.F. and M.A. Walker. 2005. *Vitis* resistance to Pierce's disease is characterized by differential *Xylella fastidiosa* populations in stems and leaves. *Phytopathology* 95:44-52.
- Krivanek, A.F., T.R. Famula, A. Tenschler and M.A. Walker. 2005. Inheritance of resistance to *Xylella fastidiosa* within a *Vitis rupestris* x *Vitis arizonica* hybrid population. *Theor. Appl. Genet.* 111:110-119.
- Lin, H, E.L. Civerolo, R. Hu, S. Barros, M. Francis and M.A. Walker. 2005. Multi-locus simple sequence repeat (SSR) markers for differentiating strains and evaluating genetic diversity of *Xylella fastidiosa*. *Appl. Environ. Microbiol.* 71:4888-4892.

## FUNDING AGENCIES

Funding for this project was provided by the CDFA Pierce's Disease and Glassy-winged Sharpshooter Board.

**Table 1.** 2005 PD breeding program crosses and the number of seeds collected or expected (in italics).

Female	Male	# Seeds	Comments
<b>1a.</b> Monterrey <i>V. arizonica/candicans</i> resistance source to produce progeny with 87.5% <i>V. vinifera</i> parentage.			
A81-138	Cab Sav, Chard, SB, Syrah	307	Highly resistant table grape selection by classic wine grape cultivars
<b>1b.</b> Monterrey <i>V. arizonica/candicans</i> resistance source (8909-08) to produce progeny with 75% <i>V. vinifera</i> parentage.			
03188-06	Airen, Barb, Chard, Temp, Viog,	419	03188 population is 50% <i>V. vinifera</i> with resistance from 8909-08 and contains the <i>PdRI</i> locus.
03188-07	Barb, Syrah, Viog, Zin	472	" "
03188-12	Alic Bousch, Barb, CF, Chard, Syrah, Temp, Viog	664	" "
03188-32	Airen, Syrah, Viog	331	" "
CS, F2-7, -35	03188-25	1,250	" "
F2-7, F2-35	03188-01	2,000	" "
F2-35	03188-30	500	" "
F2-7, F2-35	0062-81	1,250	" "
F2-7	03188-30	1250	" "
Sauv. blanc	03188-25	69	" "
Sauv. blanc	0062-81	46	" "
<b>1c.</b> Baja California <i>V. arizonica</i> resistance sources.			
D8909-15	Airen	500	Potential mapping population
D8909-15	Barbara	25	Winegrape breeding
F2-7	0023-019	350	75% <i>V. vinifera</i> breeding population
F2-35	0023-019	250	75% <i>V. vinifera</i> breeding population
F2-35	b42-26	600	Eliminates <i>V. rupestris</i> from resistance
<b>1d.</b> Other resistance sources.			
0028-44	0028-35, 0058-09, 0058-23, 0078-01	275	Midsouth resistance source and >50% <i>V. vinifera</i>
F2-35	b59-45	50	<i>M. rotundifolia</i> resistance and >75% <i>V. vinifera</i>
NC-11J	Cabernet Sauvignon	25	<i>M. rotundifolia</i> resistance and >75% <i>V. vinifera</i>
<b>1e.</b> Miscellaneous wine crosses with PD resistance sources.			
F2-7	F8909-08	2400	Remake 04190 mapping population
F2-35	F8909-08	1000	Remake 03188 as mapping population

**Table 2.** 2004 progeny that went to UCD breeding blocks for evaluation.

Female Parent	Male Parent	Resistance Source	Seeds	Seedlings to field
BO2SG	Cabernet Sauvignon	<i>V. smalliana</i>	376	25
BO2SG	Carignane	<i>V. smalliana</i>	196	25
BO2SG	Sauvignon blanc	<i>V. smalliana</i>	404	40
BO3SG	Chambourcin	<i>V. smalliana/simpsonii</i>	412	20
BO3SG	Petite Sirah	<i>V. smalliana/simpsonii</i>	419	20
BO3SG	Cabernet Sauvignon	<i>V. smalliana/simpsonii</i>	371	20
BO3SG	Carignane	<i>V. smalliana/simpsonii</i>	350	40
BO3SG	Sauvignon blanc	<i>V. smalliana/simpsonii</i>	223	25
F2-7	Midsouth	<i>V. champinii</i>	522	50
F2-7	F8909-08	<i>V. arizonica/candicans</i>	4,500	220
F2-7	F8909-17	<i>V. arizonica/candicans</i>	300	107
F2-35	b43-17	<i>V. arizonica/candicans</i>	323	65
F2-35	b43-36	<i>V. arizonica</i>	141	65
F2-35	b43-56	<i>V. arizonica</i>	56	25
F2-35	Midsouth	<i>V. champinii</i>	522	25
NC-11J	0124-01	<i>M. rotundifolia</i> x SEUS complex	175	21
0110-050	0124-01	SEUS complex x SEUS complex	750	65
Midsouth	Midsouth	<i>V. champinii</i>	500	10
NC6-15	Sauvignon blanc	<i>M. rotundifolia</i>	50	4
Total			10,590	872

**Table 3.** Seedling populations currently under *Xf* resistance testing. Five replicates of each genotype are being tested and results are expected between mid Oct and January.

Group Name	Resistance source	Genotypes tested	Comments
0023	D8909-15	75	b42-26 mapping population
03305	b43-17	20	Production of PD resistant rootstock
03188	b43-17	33	Resistant winegrape breeding and also verifies <i>PdRI</i> markers
04190	b43-17	114	Resistant winegrape breeding and mapping to refine <i>PdRI</i> markers
89 series untested	<i>V. rupestris</i> x <i>V. arizonica</i> / <i>candicans</i> types	56	Completes <i>Xf</i> resistance survey
Misc. types	SEUS or <i>V. arizonica</i>	32	types for wine breeding

**Table 4.** Juice quality data from *Xf* resistant selections and three *V. vinifera* cultivars. Absorbance readings were made in 1 cm cuvettes.

Genotype	Sample Date	Brix	pH	TA (g/l)	Juice Hue	Juice Intensity	Absorbance 420nm	Absorbance 520nm
0058-03	27-Sep	23.3	3.95	6.8	1.04	9.64	4.905	4.730
0058-09	27-Sep	21.0	3.53	5.8	2.01	1.67	1.113	0.554
0058-23	27-Sep	23.4	3.96	4.5	1.24	6.44	3.566	2.876
0028-35	27-Sep	21.8	3.74	5.3	1.38	2.89	1.673	1.215
03188-02	27-Sep	26.9	3.23	10.5	0.73	3.24	1.368	1.869
03188-05	2-Sep	24.3	3.36	11.4	1.17	10.44	5.635	4.805
03188-06	24-Aug	22.0	3.25	10.2	1.20	8.51	4.645	3.860
03188-07	16-Sep	27.0	3.20	15.2	0.96	13.38	6.550	6.825
03188-09	16-Sep	24.2	3.50	8.6	1.21	8.26	4.530	3.730
03188-17	2-Sep	25.0	3.44	12.2	1.03	10.91	5.540	5.365
03188-32	24-Aug	24.5	3.34	11.9	1.20	13.76	7.510	6.245
F2-35 ( <i>V. vinifera</i> )	27-Sep	26.2	3.46	5.6	1.75	1.23	0.781	0.446
Cabernet Sauvignon	16-Sep	24.4	3.81	6.6	1.38	8.81	5.105	3.700
Chardonnay	27-Sep	26.7	3.51	7.2	1.72	4.24	2.684	1.558

## VARIATION OF *XYLELLA FASTIDIOSA* COLONIZATION IN TOLERANT AND SUSCEPTIBLE GRAPE CULTIVARS

Dulce Carbajal and Lisa Morano  
Department of Natural Sciences  
University of Houston  
Downtown Houston, TX 77002

### ABSTRACT

Pierce's disease in grapevines is a major factor hindering the Texas wine industry and is responsible for thousands of dollars worth of crop loss nationwide. The disease, caused by *Xylella fastidiosa* (*Xf*), a gram-negative bacterium, invades the plant's water conducting vessels leading to severe water stress. Disease mechanisms are not clearly understood; however, several studies have pointed to differences in disease susceptibility between grape cultivars. This study investigated whether levels of bacterial colonization were responsible for differences in disease susceptibility and whether those levels were influenced by anatomical differences between varieties. Three grape cultivars, Cabernet Sauvignon, Chardonnay and Blanc du Bois, were inoculated with isolates of *Xf* and monitored using ELISA, immunofluorescence microscopy and PCR to measure bacterial levels with disease progression. We expected Chardonnay to have the highest bacterial levels due to observations that this cultivar dies most quickly in vineyards followed by Cabernet Sauvignon. We also hypothesized that Blanc du Bois would have little or no bacterial invasion of the xylem based on the fact that it is a hybrid of the cultivated *Vitis vinifera* and the wild grapevine *Vitis aestivalis*. After an eighteen-week period, our results showed the levels of bacterial colonization were highest for Chardonnay, then Blanc du Bois and lowest for Cabernet Sauvignon. Furthermore, Chardonnay varieties developed symptoms at 8 weeks, followed by cabernet sauvignon at 10 weeks and Blanc du Bois, which showed few symptoms. Our results indicate that the ability of a variety to harbor *Xf* does not affect its susceptibility to Pierce's disease. As Blanc du Bois is able to harbor high bacterial levels and show little symptoms, it must have some mechanism for tolerating bacterial levels with out xylem blockage. We are currently investigating differences xylem anatomy as a mechanism by which the Blanc du Bois hybrid might tolerate high levels of the *Xf*.



---

---

***Section 2:***  
***Vector Biology***  
***and Ecology***





## WHERE, WHEN AND HOW DO INGESTION AND OTHER FEEDING BEHAVIORS OF THE GLASSY-WINGED SHARPSHOOTER ALLOW INOCULATION OF *XYLELLA FASTIDIOSA*?

### Project Leader:

Elaine Backus  
USDA, ARS, PWA  
Crop Diseases, Pests & Genetics  
Parlier, CA 93648

### Personnel:

P. Houston Joost  
Dept. of Entomology  
University of California  
Riverside, CA 92521

Holly Shugart  
USDA, ARS, PWA  
Crop Diseases, Pests & Genetics  
Parlier, CA 93648

### Cooperators:

William H. Bennett  
Private Consultant  
Otterville, MO 65348

Thomas Miller  
Department of Entomology  
University of California  
Riverside, CA 92521

Gregory Walker  
Department of Entomology  
University of California  
Riverside, CA 92521

David Morgan  
CDFA, PDCP  
Mount Rubidoux Field Station  
Riverside, CA 92501

Jianchi Chen  
USDA, ARS, PWA  
Crop Diseases, Pests & Genetics  
Parlier, CA 93648

**Reporting Period:** The results reported here are from work conducted October 1, 2004 to September 30, 2005.

### ABSTRACT

Many nagging questions about the mechanisms of transmission of *Xylella fastidiosa* (*Xf*) by the glassy-winged sharpshooter (GWSS) exist, hindering development of predictive epidemiological models for ultimate GWSS impact on California crops, as well as rapid development of resistant crops. This new grant seeks to complete our answers to these questions. Only five months of funding from this grant was available to Backus this year, due to bureaucratic hurdles. Nonetheless, we were able to accomplish significant work with support from Backus's in-house ARS funds. Efforts focused on developing research infrastructure such as simultaneous availability of plants, insects and bacteria, and protocols for the experiments. We now receive monthly shipments of adult GWSS, housed in a CDFAs-approved quarantine facility at CSU Fresno, fed on greenhouse-reared cowpea, sorghum and grape. We also maintain green fluorescent protein (GFP)-transformed *Xf* in colony and are mechanically inoculating it into grape (cv. 'Cabernet Sauvignon') on a regular basis. GWSS are caged on these acquisition plants for 6-8 days, and are assayed for presence and location of bacteria using protocols we developed for confocal laser scanning microscopy (CLSM). All protocols for electrical penetration graph (EPG)-monitoring of identified probes, including artificial termination of probes, marking of probe locations, and recovery of tissues and processing for CLSM, have been perfected. In addition, a protocol that was very difficult to develop has been nearly perfected, wherein a wired GWSS that has acquired GFP-*Xf* is monitored while probing transparent artificial diet. Views of its stylets and salivary sheath are simultaneously video-captured and synchronized with EPG waveforms. Preliminary results show that GFP-*Xf* is present and visually resolvable following injection by the stylets into artificial diet, but synchronization between video and EPG recording of behavior was not perfect in these earliest tests. The experiment to determine the time course of inoculation and movement of GFP-*Xf* from the site of injection is about to begin. However, completion of most of the other experiments will await start of a new post-doc in January 2006, to replace the previous post-doc after his departure from the project in May 2005.

### INTRODUCTION

The behaviors comprising within-plant feeding (a.k.a. stylet penetration) of hemipteran vectors are intricate and complex, and vary enormously among species. Yet, a deep understanding of stylet penetration is particularly important for sharpshooter vectors because behavior plays a crucial role in transmission of non-circulatively transmitted pathogens like *Xf*. Thanks to EPG monitoring, sharpshooter stylet penetration can now be observed in detail, in real-time. Once we complete our definition of EPG waveforms in the present project, EPG will provide a powerful tool for development of crop resistance. Information gained also can be assembled into a predictive model for risk assessment, with implications for all levels of the *Xylella*-sharpshooter-grape pathosystem, including ecological, epidemiological and management. The overall goal of PI Backus's research is to identify the stylet penetration behaviors of the glassy-winged sharpshooter that contribute to *Xf* transmission, infection success and disease development, and to use that information for epidemiological risk assessment and to help develop new methods of host plant resistance. Two stylet penetration behaviors crucial for *Xf* inoculation are uptake of plant fluids into the gut (ingestion) and expulsion of bacteria-laden fluids (extravasation).

### OBJECTIVES

1. Characterize ingestion behavior, especially to: (a) identify in which cell types various durations of ingestion (C) are occurring, and (b) how to recognize that by EPG alone.
2. Characterize extravasation behavior, especially to: (a) correlate the B1 waveform with fluid flow in and out of the stylets, and (b) determine in which plant cells this behavior occurs.



3. Characterize behavior-*Xf* interactions that permit inoculation, especially to: (a) identify the behaviors (ingestion, extravasation or both) during which bacteria are expelled, and (b) whether bacterial expulsion is into xylem, or any plant cell type penetrated, or both.

## RESULTS

This new grant was funded in July 2004. The start of this project was delayed significantly due to circumstances beyond our control. Nevertheless, we still managed to make significant progress on some of the objectives.

### General Methodologies

This year, we solved all previous problems with availability of experimental plants, insects and bacteria. Our quarantine insect facility at CSU Fresno was put into operation in October 2004, and has been receiving monthly shipments of cowpea/sorghum-reared adult GWSS from D. Morgan (CDFA Riverside) since December 2004. Cowpea and sorghum, as well as rooted cuttings of grape, cv. 'Cabernet Sauvignon,' are reared in disease-free, pesticide-free exclusion cages in a quarantine greenhouse at ARS Parlier. GFP-expressing *Xf* STL were kindly provided by S. Lindow (UC Berkeley), and are being maintained in culture by JC Chen (ARS Parlier). Protocols have been developed for mechanically inoculating grape with GFP *Xf*, establishing and maintaining PD infections, and sufficient acquisition by GWSS to allow inoculation of GFP *Xf* to be studied. The intensive infrastructure effort to make all of these experimental subjects available (simultaneously) has required more than half the effort of Backus's ARS-funded, full-time technician, H. Shugart, for the last year.

### Objective 1 – Correlation of Ingestion with EPG Waveforms

#### *Study a: Cell types in which ingestion occurs*

Joost, Shugart and Backus developed most of the protocols needed for this experiment, including timing and collection of excretory droplets from EPG-recorded sharpshooters and histology of probed grape tissues. We have perfected the art of artificially terminating probes in mid-waveform (Backus et al. 2005); appropriate repetition of this simple but time-consuming protocol will be performed by the new post-doc. Shugart will perform the histology of salivary sheaths in probed plant tissue.

#### *Study b: Recognizing ingestion from waveforms alone*

Backus and W. H. Bennett completed testing and design of the final prototype AC-DC EPG monitor (ms. in prep.). The level of detail about waveform fine-structure is unprecedented, and will allow minor sub-types (possibly correlated with ingestion tissues) to be characterized. Also, Backus organized and taught an international workshop on principles and applications of EPG to 20 scientists from the US, Europe, S. America and Asia, in August 2005. Research performed during the workshop stimulated groundbreaking plans for future projects and collaboration with other researchers in Asia and S. America. Among other developments, the collaborative findings identified how to distinguish active vs. passive ingestion from waveforms alone, and showcased new technologies in computerized pattern recognition for extremely rapid waveform measurement and analysis. These developments will make possible near-future development of the Stylet Penetration Index and very rapid analysis by novice EPG users.

### Objective 2 – Correlation of Extravasation with EPG Waveforms

#### *Study a: Correlate B1 waveform with fluid flow in and out of stylets, muscle movements*

The first test was completed by Joost. Movement of markers in a probed artificial diet solution shows indirectly that fluid flows both in and out of the stylets during B1. However, so far only sheath saliva flow is directly viewable (Joost et al. 2006). For the second test, preliminary attempts at electromyography of the precibarial valve and cibarial dilator muscles (by Joost with help from Miller) have been partially successful. They suggest that B1 spikelets (B1s) represent precibarial valve muscle contractions, while C plateaus represent cibarial dilator muscle contractions. If so, this complements findings from our first UC PD grant (Backus et al. 2006) showing that the B1 waveform is ubiquitous during stylet penetration, interspersed within and among all other waveforms, and is performed in virtually all cell types. Thus, B1 may include movement of the precibarial valve (at least in part), which controls uptake of fluid into the precibarium for tasting, as well as expulsion (extravasation) of fluid after tasting is completed. However, protocols must be further fine-tuned before electromyography can be repeated. Work to complete the remainder of this objective will also be performed by the new post-doc.

#### *Study b: Determine in which plant cells B1 occurs*

Once the extravasation waveform is definitively identified in Exp. 2a, we will use artificially terminated, EPG-monitored probes coupled with histology to pinpoint the cell types in which it occurs during stylet penetration of grape. Like experiment 1a above, EPG will be done by the post-doc, the tissues processed by Shugart, and the data compiled and analyzed by the post-doc. Again, all protocols are developed.

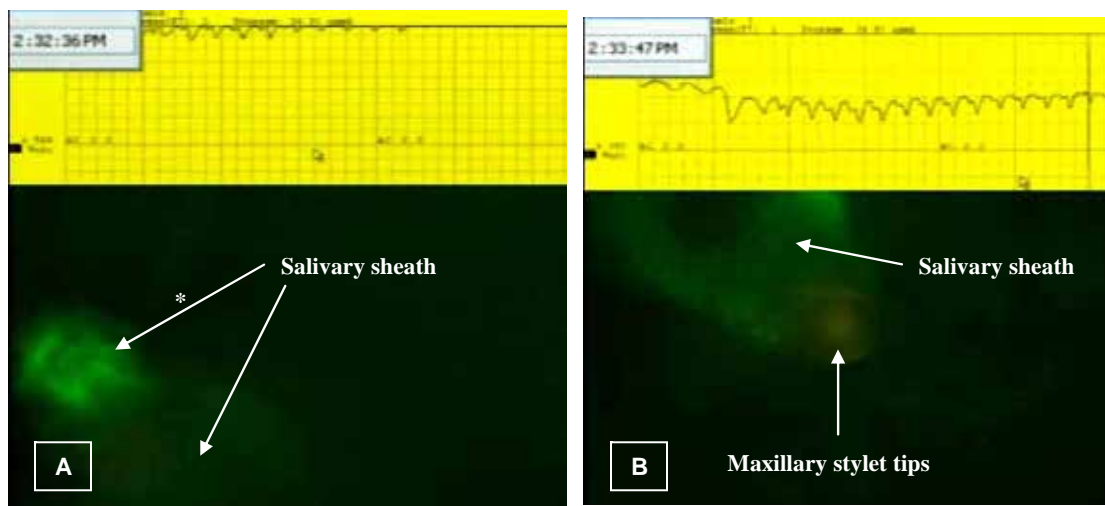
### Objective 3 – Characterize behavior-*Xf* interactions that permit inoculation

#### *Study a: Identify the behaviors (ingestion, extravasation or both) during which bacteria are expelled*

In the interest of time, we spent several months this year developing the protocols of this final and most difficult experiment. Joost, with help from Shugart and Backus, developed a technique for visualizing (via high-resolution epifluorescence microscopy) individual cells or clumps of GFP-*Xf* cells injected into transparent, artificial diet by an adult, wired GWSS held

in a specially-built apparatus. Activities of the stylets and bacteria in solution are simultaneously EPG-recorded and images captured via a microscope-mounted digital video camera and MediaCruise software.

Over 40 probes were simultaneously EPG-recorded and video-captured by Joost prior to his departure. Of those, two tantalizing probes expelled GFP-*Xf* into the diet, although visualization of each was not optimal. In the first case, an insect was rapidly removed from the acquisition plant in mid-probe, immediately wired up, and then placed directly into the diet/microscope apparatus. Within 2 sec of stylet insertion, both clumps and individual, rod-shaped cells of glowing, green bacteria were clearly seen as they were injected into the diet, presumably from a column of liquid that had been held in the food canal of the stylets. The expelled bacteria quickly dispersed in the liquid diet. Unfortunately, in that very early test, the bacteria were viewed but not video-captured, and the EPG waveform was not recording properly. In the second case, an insect was removed from the plant, allowed to feed for a few hours on diet to clear its gut, then placed on a new diet in the test apparatus. It probed so rapidly that EPG waveforms were recorded, but the stylet tips were off-screen at the instant of the bacterial expulsion. About a minute later, when the stylet tips were brought on-screen (and by then, the insect was performing B2, sawing out of the hardened salivary sheath), the entire length of the sheath was found to be glowing green, in some places very brightly (Figure 1A, B). The sheath is normally transparent, does not fluoresce at the same excitation wavelengths as GFP, and is dark against the dark confocal background. This insect had not yet begun ingesting. Evidently, bacterial expulsion occurred during pathway activities, when B1 is a prevalent waveform. This matches our findings from last year's inoculation studies (Backus et al. 2006).



**Figure 1A.** GFP-*Xf*-containing salivary sheath in the lower left corner of the screen, with a basal portion that is glowing bright green (arrow with \*), and more apical portion that is glowing less brightly (unstarred arrow). Sheath is slightly out of focus. The stylets are still in the sheath, but their tip is out of view. B2 waveform is being performed by the stylets (elsewhere), but the waveform has nearly peaked out. **B.** 1 min 11 sec later, the view has been adjusted and refocused to reveal the tip of the stylets, and the offset has been adjusted to bring the waveform, once again in B2, back into view. The stylet tips are orangish-brown, just appearing out of the sheath at its tip. The apical area of the sheath is glowing slightly green, presumably with dispersed, perhaps fragmented, GFP-*Xf*.

These tantalizing preliminary results suggest that: 1) free-floating bacteria can be held in a water column in the stylets, then expelled immediately upon initiation of a probe, and 2) non-free-floating bacterial cells, presumably within biofilm adhering to the cuticular surface of the precibarium, can come loose during pathway (i.e. pre-ingestive) behaviors and be injected into the feeding substrate. These expelled bacteria can become lodged in or adhere to the salivary sheaths. These exciting results must now be replicated with improved focus and waveform synchronization.

We believe the low rate of success of inoculation (2/40 probes) in Joost's preliminary work was due to a low rate of acquisition by his experimental insects, because his acquisition plants were very unhealthy. Therefore, we performed tests to improve GFP-*Xf* acquisition success. GFP-expressing *Xf* were inoculated into two grape plants, and onset and severity of symptoms were observed. Once clear symptoms had developed but plants were still relatively healthy (about 3 weeks after inoculation), adult GWSS were caged on individual plants and allowed acquisition access periods (AAPs) of 3, 6, 9 and 12 days. Twenty heads were prepared, dissected, and examined via confocal laser scanning microscopy (CLSM) by Shugart, using protocols she has spent the last several months developing. We found that every insect had acquired *Xf* into the area of the precibarium and cibarium by 3 days, but that the *Xf* colony size and distribution increased during subsequent days on the plant, especially between days 6 and 9. On the other hand, GWSS mortality was significant (50% by day 9, 100% by day 12). Therefore, we decided to use 6-8 days' AAP as a standard for future inoculation tests.

The rest of the video-EPG correlation recordings will be performed by the new post-doc within the next year. All insect heads will be dissected and examined via CLSM by Shugart, to verify whether insects were or were not inoculative.

#### **Study b: Determine into which plant cells bacteria are expelled**

Again in the interest of time, we have developed all protocols for histologically tracing bacterial spread from an EPG-identified probe terminated after likely bacterial expulsion has occurred. This experiment is planned to be performed by Shugart in fall 2005. The major objective of this experiment is to determine the grape cell types into which bacteria are first inoculated, during a single probe. Therefore, we seek to maximize the likelihood of inoculation. Results from our previous study (Backus et al. 2006) suggest that 1 hour of ingestion (C) waveform following pathway results in a very high likelihood of *Xf* inoculation. Therefore, we have modified this objective's experimental design slightly, to use a 1-hour ingestion period as the decision point to artificially terminate an EPG-identified probe. Cowpea-reared GWSS will be given 7 days AAP on GFP-*Xf* infected grape. Selected insects will be wired each day. Shugart then will perform the experiment as outlined in the proposal, except that plant holding durations will be increased to 0, 10, 20 and 40 days.

#### **CONCLUSIONS**

These findings will help solve the PD/GWSS problem by:

- Answering questions about transmission mechanisms and vector efficiency that are crucial for epidemiological modeling for risk assessment, such as:
  - the mechanism of *Xf* inoculation and using EPG to observe it real-time as it occurs,
  - one determinant of inoculation efficiency, i.e. the role(s) of inoculation behavior vs. bacterial presence and/or detachment in the foregut,
  - when, for how long, and under what circumstances, GWSS ingests from xylem vs. other cell types
  - probability that bacteria will be inoculated into xylem (or other cell types) when inoculative vectors probe those cells.
- Answering questions about bacterial movement and establishment in the plant following natural inoculation by vectors, such as:
  - where in the plant the *Xf* bacterial cells are first inoculated, and how far they move from that point
  - the probability that one inoculation event by a vector will lead to spread of the bacterium and, ultimately, chronic infection.
- In a future grant, developing a Stylet Penetration Index for testing among host and non-host species or cultivars, diets, etc. for performance of transmission behaviors, ultimately leading to improved host plant resistance.

#### **REFERENCES**

- Backus, E. A., J. Habibi, F. Yan and M. R. Ellersieck. 2005. Stylet penetration by adult glassy-winged sharpshooter on grape: EPG waveform characterization, tissue correlation and possible implications for transmission of *Xylella fastidiosa*. *Ann Entomol Soc. Amer.* 11: (*In Press*).
- Joost, P. H., E. A. Backus and F. Yan. 2006. Correlation of stylet activities by the glassy-winged sharpshooter, *Homalodisca coagulata* (Say), with electrical penetration graph (EPG) waveforms. *J. Ins. Physiol.* (*Accepted, In Revision*).
- Backus, E. A., F. Yan, J. Habibi and H. Shugart. 2006. Certain stylet penetration behaviors recorded by EPG are correlated with inoculation of *Xylella fastidiosa* into grape by the glassy-winged sharpshooter. *Entomol. Exp. Appl.* (*In Preparation*).

#### **FUNDING AGENCIES**

Funding for this project was provided by the University of California Pierce's Disease Grant Program..

## MONITORING THE SEASONAL INCIDENCE OF *XYLELLA FASTIDIOSA* IN GLASSY-WINGED SHARPSHOOTER POPULATIONS

### Project Leader:

Steve Castle  
USDA, ARS, Western Cotton Research Lab  
Phoenix, AZ 85040

### Cooperators:

Nilima Prabhaker and Nick Toscano  
University of California  
Riverside, CA 92521

**Reporting Period:** The results reported here are from work conducted August 2004 to August 2005.

### ABSTRACT

The incidence of *Xylella fastidiosa* (*Xf*) in GWSS populations was monitored between August 2004 and February 2005 using various analytical techniques as indirect measures and transmission to grapevines as a direct measure of GWSS inoculativity. Field collections of GWSS made between August 2004 and February 2005 showed an increasing proportion of the population positive for *Xf*. The mean titer of *Xf* in the field samples also increased through the fall months, but then diminished from peak levels during 3 collections made in the winter months of December and February. Differences among collection locations were observed in the proportion of the respective populations positive for *Xf*. Results from a transmission experiment conducted 6 February 2005 demonstrated that field-collected adults not only test positive for *Xf* by ELISA, but also transmit *Xf* to grapevine test plants (var. Chardonnay). An initial evaluation of xylem fluid collected from multiple branches per test plant revealed 11 plants out of 15 exposed to individual field-collected STSS adults and 5 out of 8 plants exposed to GWSS adults became infected with *Xf*. Analysis of the STSS and GWSS adults used in the 6 February 2005 transmission tests yielded absorbance readings in the lower positive range similar to levels observed in the *Xf* monitoring of the general population study. Further tests of the titers of *Xf* in these test insects and future test insects will be conducted once a real-time PCR test has been successfully developed.

### INTRODUCTION

Information on the prevalence of GWSS adults positive for *Xf* and the rate they transmit to grapevines is among the most fundamental pieces of knowledge required to improve understanding of *Xf* epidemiology. The paucity of information regarding the degree of *Xf* incidence in GWSS populations is partly responsible for rampant speculation about the future of the GWSS/PD crisis in California. Certain fears have been expressed that even low densities of GWSS in a region could have a significant impact on the incidence of PD or other diseases caused by *Xf*. While adoption of worst case scenarios may be considered prudent and defensive, it can also lead to important policy decisions that, in the absence of accurate information, result in unnecessary and expensive actions. A compilation of data from many sources has contributed to a decent understanding of the distribution of GWSS populations within California and the relative intensities of regional infestations. Additional information on the proportions of individuals within these populations that are inoculative with *Xf* will help to complete a more realistic picture of the risks of *Xf* spread associated with various levels of GWSS infestation.

Although GWSS nymphs are capable of transmitting *Xf* (Almeida and Purcell, 2003), it is the transmission of the bacterium by adults that is of greatest concern in the epidemiology of *Xf*. GWSS adults are flight mobile and capable of moving long distances across the landscape, and therefore represent a potential threat of primary spread of *Xf* from an external host plant into an uninfected vineyard. To estimate the rate that such events may be occurring requires large numbers of GWSS adults to be collected in the field and tested to determine the proportion that transmit *Xf*. Estimates of the rate that field-collected GWSS adults transmit *Xf* can be made by both direct and indirect methods. Direct methods involve the classical approach of confining one or more live insects onto an uninfected test plant, holding them for a period of time on the plant before removing, then retaining the plant for a sufficient period of time to allow disease development. When carried out well, this approach provides the most accurate determination of the natural rate that GWSS adults transmit *Xf* to uninfected host plants. In contrast, indirect methods are capable of detecting the presence of *Xf* in a vector, but do not necessarily represent a measure of the rate of transmission to a plant. Analytical tests such as ELISA and PCR are being used to detect and quantify the titer of *Xf* in GWSS adults. In addition, *Xf* culturing media is being used to assess whether the bacterium was present in a test insect.

Current understanding of the mechanisms of acquisition and inoculation of *Xf* by GWSS adults, either in the controlled conditions of the laboratory and greenhouse, or in the more challenging setting of their natural habitat, are in reality quite limited. While the laboratory approach can provide essential answers to questions regarding the rate of acquisition and efficiency of transmission, it ultimately reflects the conditions imposed by the researcher. For example, the type and age of the acquisition source plant, the isolate of *Xf* used and period of time that the acquisition source plant has been infected, as well as the source of the experimental GWSS individuals and the conditions under which they are provided access to the *Xf* source plant are all variables controlled by the researcher. A dual approach that balances the findings from the laboratory with monitoring information from the field will improve our understanding of how epidemics of *Xf* occur in vineyards and elsewhere. A compilation of data from many sources has contributed to a good understanding of the distribution of GWSS populations within California and the relative intensities of regional infestations. By evaluating the proportion of individuals within these populations infected with *Xf*, a critical deficiency in our understanding of *Xf* epidemiology will be addressed.

## OBJECTIVES

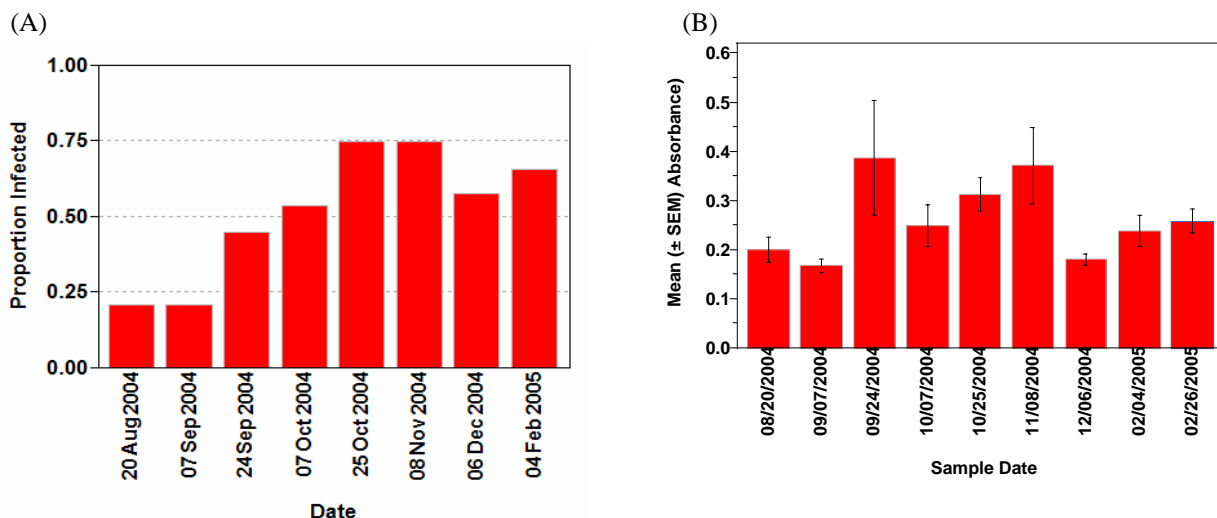
- 1) Monitor GWSS adults from citrus and other sources year-round to determine the proportion positive for *Xf* using ELISA, PCR, and media culturing techniques.
- 2) Perform transmission experiments on a portion of the field-collected adults using grapevine seedlings to determine the seasonal transmission rate.
- 3) Quantify the titer of *Xf* in GWSS adults that transmitted *Xf* to grape seedlings using quantitative ELISA and RT-PCR, and determine the relationship between transmission rate and titer in the vector.

## RESULTS

Collections of live GWSS adults began in August 2004 and were made in Riverside and Redlands at bimonthly or monthly intervals until densities dropped in February to levels too low to sample. Numbers of GWSS adults were particularly low through the late winter and early spring period of 2005 and collection attempts were hampered by wet weather. Sampling resumed in July 2005 as the spring generation of adults emerged to repopulate citrus and the surrounding landscape, although not nearly at levels seen in previous years. The discrete nature of GWSS generations, i.e. the nearly synchronous emergence of adults beginning in mid-June and continuing through mid-July, results in what is effectively a single generation per year that emerges and then ages through time until the following spring when a relatively few remaining adults from the previous summer give rise to the next generation. The second, or summer generation of GWSS in essence fails to materialize due to heavy parasitism and other mortality factors. The contribution of the second generation to the total population appears to be rather small based on data collected in field 5 of Ag Ops in Riverside during 2001-02. Hence, the present evaluations of the incidence of *Xf* in GWSS adults have assumed that systematic samplings of GWSS adults from the time of their beginning emergence in mid-June represents an aging population of adults with only limited perturbation of the age structure due to a subsequent emergence of the summer generation of adults.

Results from the 2004-05 (Figure 1) season support previous data from 2002-03 (Naranjo et al., 2003) concerning the incidence of *Xf* in populations of GWSS adults. While both data sets indicated that the proportion of the adult population positive for *Xf* increased through time, a clear trend of increasing mean titers of *Xf* in GWSS adults was apparent during the 2002-03 season only. In 2004, the mean titers of *Xf* also increased from the time of the first collections in late summer through early November. Subsequent collections in December and February 2005, however, yielded lower mean titers compared to the fall 2004 samples (Figure 1b). While a decline in mean titers may represent no more than a sampling phenomenon, it could also represent an environmental interaction whereby growth of *Xf* within foreguts of GWSS adults is reduced relative to other times of the year. Hence, acquisition of *Xf* by individual GWSS adults may not necessarily result in colonization of the foregut and progressive growth thereafter, but instead may produce both increases and decreases in *Xf*

colony growth depending on nutritional or perhaps temperature conditions. Colder temperatures may affect *Xf* growth within foreguts of GWSS adults through reduced feeding by the insects or by altering the nutritional quality of xylem fluid that



**Figure 1.** Incidence of *Xf* in GWSS adults collected from citrus orchards at UC Riverside's Ag Ops from August 2004 through February 2005. The proportion of GWSS positive for *Xf* (A) is based on ELISA absorbance values for field collected individuals in excess of the mean absorbance + 4 standard deviations of non-infected control GWSS adults. The mean titer of *Xf* (B) is based on the mean absorbance of individual GWSS adults collected each date using an *Xf*-specific ELISA test (n=18 for each date).

nourishes both GWSS and *Xf* colonies that may be present in their foreguts. Alternatively, because GWSS insects are ectodermic, colder ambient temperatures and colder xylem fluid ingested by the GWSS adult hosts of *Xf* could lead to

reduced colony growth and a temporal pattern as observed in Figure 1a. Closer attention will be paid to environmental conditions in 2005 as they may relate to changing titers of *Xf* within GWSS adults.



**Figure 2.** Vegetatively propagated grapevines (var. Chardonnay) grown in perlite within a misted propagation chamber.

Transmission tests are currently in progress using field-collected GWSS and STSS adults that are given 3 day inoculation access periods to grapevine test plants. A propagation chamber is being used to grow experimental grapevines to serve as test plants in the transmission studies. Lateral branch shoots consisting of 4-5 leaves are being cut from certified disease-free parental grapevines (var. Chardonnay) and placed in propagation media until roots are generated (Figure 2). These are transplanted to 8" pots (Figure 3) and allowed a minimum of 3-4 weeks to establish before being used in transmission experiments. Ventilated corsage cages are then used to enclose each grapevine plant and provide full access to the entire plants by GWSS adults (Figure 4). Following the 3 day IAP, tests insects are collected from each plant and frozen (-80°C) for subsequent PCR and ELISA analysis. Grapevine test plants are held for 4 months to allow disease development. Xylem fluid collected from each plant for PCR and ELISA analyses is then used as an independent evaluation to compare with the visual assessments. An essential component of this approach is the availability of clean GWSS (in rearing) to serve as ELISA and PCR controls. Experimental and analytical results will be collated to determine which analytical procedure provides the closest agreement with transmission test results and help provide essential perspective.



**Figure 3.** Established grapevines vegetatively propagated from certified disease free Chardonnay grapevines that have been used in transmission experiments with field collected GWSS adults.

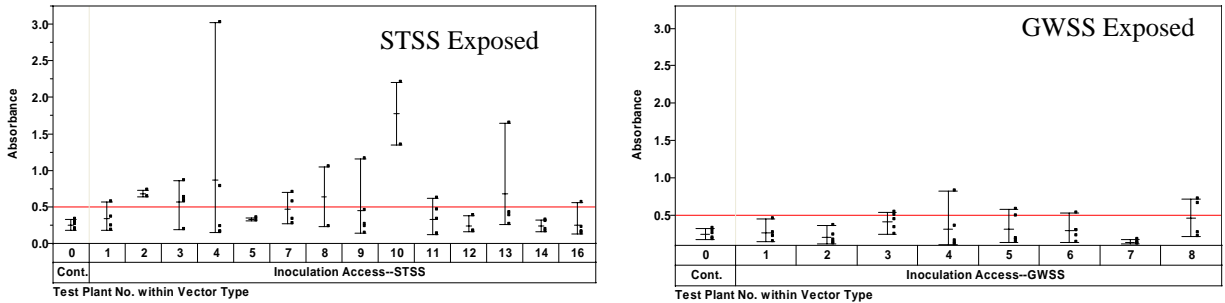


**Figure 4.** Ventilated corsage cages use to enclose field-collected sharpshooter adults on test grapevines.

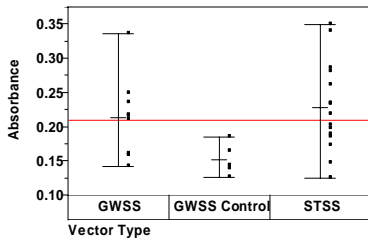
To date, a single transmission experiment using field-collected GWSS adults has been performed and analyzed for the presence of *Xf* in the test grapevines as well as the test insects. A major impediment to performing more transmission tests was the absence of GWSS adults in the field since early February 2005. In the one transmission experiment that has been completed, only 9 GWSS adults were collected, with a balance of 15 smoke-tree sharpshooters being used to complete the test. These insects were collected in the field and placed on the test grapevines on 6 February 2005. Additional attempts to collect GWSS adults through late winter and spring were defeated by the absence of GWSS adults. The test grapevines exposed to STSS and GWSS adults on 6 February were held in an insect free greenhouse for 3 months before taking samples to test for the presence of *Xf*. Up to 5 branches from each plant were sampled for xylem fluid using a pressure bomb. ELISA results for these samples indicate variability in absorbance readings among different branches even within a single plant, not to mention differences among plants in terms of being positive or negative for *Xf*. A higher number of positive readings occurred from branches collected from grapevines exposed to STSS adults than to GWSS adults (Figure 5).

Analysis of the STSS and GWSS adults used in the transmission test conducted 6 February 2005 revealed that more than 50% of both STSS and GWSS adults represented a statistical positive based on ELISA absorbance readings using clean GWSS insects as controls (Figure 6). Absorbance readings for each insect were not as high in the positive range as for some

insects collected in the field during fall 2004, but this is in accord with the earlier observation of reduced titers of *Xf* in adults collected during the winter compared to fall collected insects. Samples from these insects have been preserved for subsequent analysis by real-time PCR.



**Figure 5.** ELISA test results for the presence of *Xf* in xylem fluid collected from individual branches on grapevines exposed to either a single field-collected STSS adult or GWSS adult. Each point along the vertical range lines represent the absorbance<sub>490</sub> reading for a single branch with the mean absorbance for each plant represent by the horizontal dash at or near the midpoint of each vertical range line. Up to 5 branches were sampled from each plant, but some plants had only 2 branches (e.g. plant no. 8 in the STSS-exposed chart). The horizontal red line represents a reference line at twice the absorbance of the uninfected control grapevine xylem samples; any points above this line constitute a positive result for *Xf*.



**Figure 6.** ELISA results for test insects used in the transmission test of 6 February 2005. Each point represents the absorbance for an individual insect with the horizontal dash representing the mean for each species. Points above the horizontal red line indicate statistical positives.

## REFERENCES

- Almeida, R.P.P., and A.H. Purcell. 2003. Transmission of *Xylella fastidiosa* to grapevines by *Homalodisca coagulata* (Hemiptera: Cicadellidae). *J. Econ. Entomol.* 96:264-271.
- Naranjo, S. N., Castle, S. J., and Toscano, N. C. 2003. Sampling, seasonal abundance, and comparative dispersal of glassy-winged sharpshooters in citrus and grapes: Sampling progress report, pp. 196-199. In *Proceedings of the Pierce's Disease Research Symposium*, San Diego, CA December 8-11, 2003.

## FUNDING AGENCIES

Funding for this project was provided by the University of California Pierce's Disease Grant Program.

## DEVELOPMENT OF AN ARTIFICIAL DIET FOR THE GLASSY-WINGED SHARPSHOOTER

### Project Leader:

Thomas A. Coudron  
USDA, ARS, BCIRL  
Columbia, MO 65203

### Researchers:

Sandra L. Brandt and Maureen K. Wright  
USDA, ARS, BCIRL  
Columbia, MO 65203

### Cooperators:

Joe Patt  
USDA, ARS, KDLG Subtropical Agricultural  
Resource Center  
Beneficial Insects Research Unit  
Weslaco, TX 78596

Elaine Backus  
USDA, ARS, PWA  
SJV Agricultural Sciences Cntr.  
Parlier, CA 93648

Wayne Hunter  
USDA, ARS,  
Horticultural Res. Lab  
Subtropical Insects Research  
Ft. Pierce, FL 34945

**Reporting Period:** The results reported here are from work conducted November 2004 to September 2005.

### ABSTRACT

The intent of this project was to advance the development of an artificial rearing system for the glassy-winged sharpshooter, GWSS (*Homalodisca coagulata*), the primary vector of Pierce's disease, PD (*Xylella fastidiosa*; *Xf*). In order to accomplish this, the simultaneous development of an artificial diet and diet delivery system suitable for insect feeding are needed. Diet formulations based, in part, on previous studies using GWSS (unpublished data), as well as on artificial diets developed for other Hemiptera (Mitsuhashi, 1979; Fu *et al.*, 2001; Coudron *et al.*, 2002) and on the xylem chemistry of GWSS host plants (Andersen, *et al.*, 1992; Gollan *et al.*, 1992) were tested. Diets were evaluated based on their effects on life history analyses. Nitrogen may represent a nutrient limitation for xylem feeders. Therefore, three potential sources of nitrogen, i.e. proteins, peptides and amino acids, were evaluated via artificial diets. The ability of salivary and midgut proteolytic enzymes to digest proteins/peptides (Brandt, *et al.*, 2004; Wright, *et al.*, 2006) is another important aspect of this project that would determine whether less costly nitrogen sources could be substituted for those commonly found in plants.

### INTRODUCTION

Presently, the rearing of GWSS is labor-intensive and costly because of its dependence on the production of appropriate host plants, with researchers often needing to grow several species of plants to enable them to rear GWSS under optimal conditions. The development of an artificial diet would likely be more cost effective and portable, decreasing the costs and time-constraints associated with maintaining the insect in culture, thereby increasing the availability of high quality insects for Pierce's disease research and enabling researchers to rear this insect on site. The increased availability of GWSS to researchers will likely lead to more rapid developments in novel control measures for this major vector of PD. Furthermore, the coupling of an artificial diet with a suitable delivery system could improve our understanding of the relationship between GWSS nutrition, movement and host range and how they affect PD (including GWSS' varying abilities to acquire/maintain/transmit infectious *Xf* under different circumstances, e.g., via artificial membranes vs. plants, Redak *et al.*, 2004). In addition, the diet delivery system alone would have other potential uses, such as studying the interactions between GWSS, *Xf*, and the host plant, as well as in testing potential anti-GWSS and anti-*Xf* control agents. This could be accomplished by incorporating into the feeding system: 1) selected host plant-associated compounds; 2) media containing the causative agent of PD (*Xylella fastidiosa*, *Xf*); 3) control agents including anti-GWSS or -*Xf* compounds (such as proteins to be engineered into host plants to control either GWSS or *Xf*; Dandekar *et al.*, 2003; Lin, 2003; Meredith and Dandekar, 2003; Reisch *et al.*, 2003) or anti-GWSS microbials (Kaya, 2003; Mizell and Boucias, 2003). In summary, the development of an artificial diet and a corresponding delivery system for GWSS could lead to insights that can be used to generate improved methods for controlling GWSS and, therefore, Pierce's Disease.

### OBJECTIVES

1. Evaluate artificial diet delivery systems for rearing the glassy-winged sharpshooter.
2. Formulate and evaluate artificial diets for the development and reproduction of glassy-winged sharpshooter.

### RESULTS

#### Objective 1. Evaluate artificial diet delivery systems for rearing GWSS.

Adult and immature GWSS were presented with over 25 variations of a diet delivery system (modifying both the membrane and presentation) and survivorship was recorded. An effective delivery system was then selected for further adult studies in diet formulation (details summarized below). For the adult delivery system preparation, a 2.5 cm wide and 15 cm long piece of Parafilm was cut, folded along its length and sealed. Approximately 25 ml of each diet formulation was put into the tube. Each tube was hung inside a polycarbonate culture vessel (each single unit measuring 77mm x 77 mm x 77mm, Phyto Technology Laboratory, Shawnee Mission, KS) using a plastic closure (Figure 1). The bottom portion of the tube was folded to exert pressure on the liquid diet inside the tube. The diet tubes were replaced twice a week. Observations on the fate of the adults were made daily.



Immature GWSS preferred a horizontal diet presentation with the most effective delivery a stretched Parafilm pouch that was placed over a screen at the top of the rearing system (Figure 2). In addition, development from 1<sup>st</sup> through 5<sup>th</sup> instars was also achieved using a plant surface-based delivery system.

Studies, in collaboration with Jones and Setamou at ARS in Weslaco, have demonstrated continuous feeding by adult GWSS for up to 39 days on artificial diets (Figure 3) presented through the specialized feeding tube that is prepared from Parafilm. In addition, molting was observed with immature GWSS that also fed from this system.



**Figure 1.** Double rearing system



**Figure 2.** Single rearing system

### **Objective 2. Formulate and evaluate artificial diets for the development and reproduction of GWSS**

Numerous artificial diet formulations that contained differing combinations and concentrations of fructose, glucose, sucrose, asparagine, glutamine, lysine, cysteine, methionine, arginine, aspartic and glutamic acids, proteins and vitamins were evaluated. These treatment diets were compared to control diets that included plant-reared (cowpea) or artificial presentations that contained sucrose/fructose solutions or xylem extracted from cowpea or sunflower plants. An example of five dietary formulations evaluated for the development of adult GWSS depicts different survival responses by GWSS adults to changes in the carbohydrate and amino acid content of the diet (Figure 3).

[Control diet (5% sucrose) resulted in 50% survivorship of adult GWSS at 11 days. In comparison, 50% of adults feed Diet 5 were alive for 25 days. A significant increase in adult survival was noted with the addition of certain amino acids, such as glutamic acid and aspartic acid (Diet 5). The addition of 1% methionine resulted in a decrease in adult survival (Diet 4). Removal of fructose and glucose from the diet formulation did not reduce survivorship (Diet 3)].

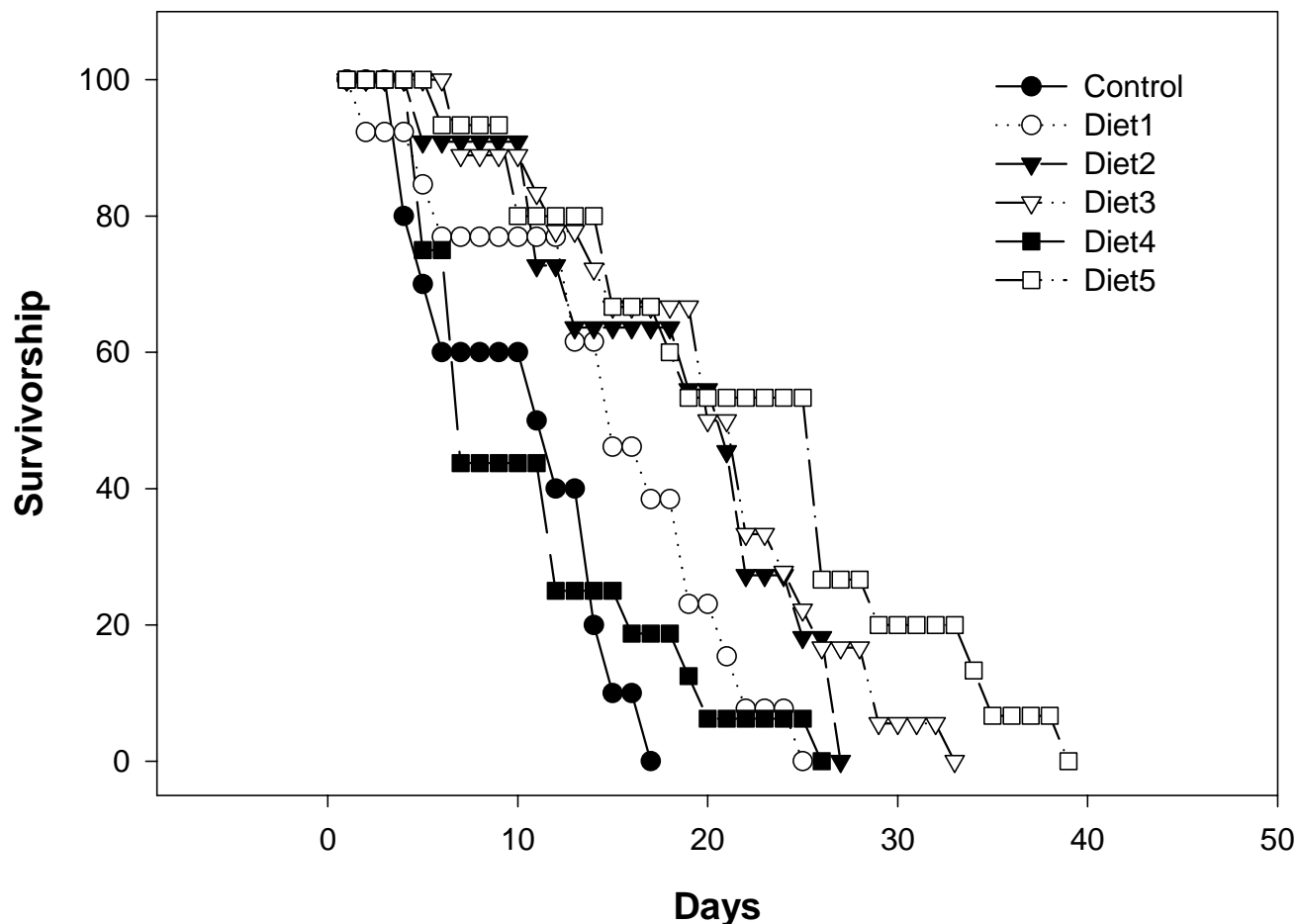


Figure 3. Survival of adult GWSS on artificial diets.

### CONCLUSIONS

Our studies provide novel insights for advancing the development of an artificial rearing system: the best performance of GWSS reared on an artificial diet was accomplished through the simultaneous testing of different formulations and delivery system designs, i.e., testing of over 25 diet delivery systems in combination with over 10 diet formulations, and the best performance by nymphal and adult stages was not achieved with the same formulation or delivery system design. Our progress to date makes us confident that the development of an artificial rearing system for GWSS is achievable in the near future. As described in the original proposal, this achievement extends beyond the expectation of the project awarded.

### REFERENCES

- Anderson, P.C., Brodbeck, B.V., and Mizell, R.F., 1992. *J. Insect Physiol.* 38: 611-612.
- Brandt, S.L., Coudron, T.A., Habibi, J., Brown, G.R., Ilagan, O.M., Wright, M.K., Wagner, R.M., Backus, E.A., and Huesing, J.E., 2004. *Curr. Microbiol.* 48:1-9.
- Coudron, T.C., Wittmeyer, J.L., and Kim, Y., 2002. *J. Econ. Entomol.* 95: 1159-1168.
- Dandekar, A., Gupta, G., McDonald, K., and Hong-Geller, E., 2003. *Proc. Pierce's Disease Research Symp.*, pp. 87-88.
- Fu, Q., Zhang, Z., Hu, C., Fengxiang, L., and Sun, Z., 2001. *Appl. Entomol. Zool.* 36: 111-116.
- Gollan, T., Schurr, V., and Schulze, E-D, 1992. *Plant Cell Environ.* 15: 551-559.
- Kaya, H., 2003. *Proc. Pierce's Disease Research Symp.*, pp. 263-264.
- Lin, H., 2003. *Proc. Pierce's Disease Research Symp.*, 158-159.
- Meredith, C. and Dandekar, A., 2003. *Proc. Pierce's Disease Research Symp.*, pp. 23-25.
- Mitsuhashi, J., 1979. In: *Leafhopper Vectors and Plant Disease Agents* (Maramarosch, K, Harris, K.F., eds). Academic Press: NY; pp. 369-412.

- Mizell, R.F. and Boucias, D.G., 2003. Proc. Pierce's Disease Research Symp., pp. 274-275.
- Reisch, B., Walker, A., and Kikkert, J.R., 2003. Proc. Pierce's Disease Research Symp., pp. 30-32.
- Redak, R.A., Purcell, A.H., Lopes, J.R.S., Blua, M.J., Mizell III, R.F. and, Andersen, P.C., 2004. Ann. Rev. Entomol. 48:243-70.
- Wright, M.K., Wagner, R.M., Huesing, J.E., Brandt, S.L., Habibi, J., Coudron, T.A., and Backus, E.A. 2005. J. Insect Physiol. (*In Preparation*).

#### **FUNDING AGENCIES**

Funding for this project was provided by the CDFR Pierce's Disease and Glassy-winged Sharpshooter Board, and the USDA Agricultural Research Service.

# BIOLOGY AND ECOLOGY OF THE GLASSY-WINGED SHARPSHOOTER IN THE SAN JOAQUIN VALLEY

## Project Leaders:

Kent M. Daane  
Division of Insect Biology  
University of California  
Berkeley, CA 94720

Marshall W. Johnson  
Department of Entomology  
University of California, Riverside  
Kearney Agricultural Center  
Parlier, CA 93648

## Cooperators:

Glenn Yokota  
Division of Insect Biology  
University of California  
Berkeley, CA 94720

Murray Pryor  
Division of Insect Biology  
University of California  
Berkeley, CA 94720

Elaine Shapland  
Division of Insect Biology  
University of California  
Berkeley, CA 94720

James Hagler  
USDA, ARS, WCRL  
Phoenix, AZ

Valerie Fournier  
University of California, Berkeley  
(USDA, ARS, WCRL, Phoenix AZ)

Jennifer Hashim  
UC Cooperative Extension  
Kern County, Bakersfield, CA

Russell Groves  
USDA, ARS, PWA, SJVASC  
Parlier, CA

Youngsoo Son  
University of California, Riverside  
Kearney Agricultural Center  
Parlier, CA 93648

Alexander Purcell  
Division of Insect Biology  
University of California  
Berkeley, CA 94720

**Reporting Period:** The results reported here are from work conducted May 2003 to October 2005.

## ABSTRACT

We followed glassy-winged sharpshooter (GWSS) preference and age structure on ornamental host plants in Bakersfield, California. Averaging data across all sampling sites and collection dates, grape, citrus, apple, *Xylosma*, cherry and flowering pear were the most preferred ovipositional sites. GWSS nymphs were most often collected on oleander, flowering pear, *Xylosma*, crabapple, *Abelia*, and crape myrtle. Adults were most often collected on oleander, *Xylosma*, *pyracanthum*, crape myrtle, and crabapple. Over the 3 year period, population patterns were clearly evident: new egg masses were first found in mid-March, followed by a strong April-May oviposition period, the resulting nymph and adult GWSS populations follow in sequence. A summer decline in GWSS density was primarily the result of high egg parasitism during the second oviposition period. Throughout the field survey, we sampled resident GWSS predators and parasitoids. Emerged parasitoids were primarily *Gonatocerus ashmeadi*. Predators were primarily spiders and the Argentine ant. In 2004-05, we manipulated combinations of GWSS host plant species, to investigate year-long GWSS survival and age structure. Treatments were: citrus, euonymus, grape, oleander, crape myrtle, citrus and grape, and oleander and crape myrtle. Only in the combination of citrus and grape was there an increase in GWSS density. During the urban surveys, we also collected plant material (e.g., potential vector host plants) and potential insect vectors to determine the incidence of *Xylella fastidiosa* (*Xf*). This material was processed in the laboratory using "immunocapture DNA extraction" to determine the presence of *Xf*. Results showed that GWSS collected in urban regions often ( $\approx 10\%$ ) carried *Xf*, however, it was not the strain that causes Pierce's disease.

## INTRODUCTION

Glassy-winged sharpshooter (GWSS), *Homalodisca coagulata*, has a wide host range (Redak et al. 2004) on which it can survive outside of pesticide-treated agricultural crop systems. Elimination of alternate host plants for the blue-green sharpshooter, *Graphocephala atropunctata*, was an effective method for controlling the spread of Pierce's disease (PD) in coastal wine grape regions. Because the GWSS host species range is so extensive, such similar habitat manipulation requires knowledge of GWSS biology and ecology on common host plants. To improve GWSS management in the largely untreated urban areas of the Central Valley, we studied GWSS host preference, egg deposition, age structure, and levels of natural regulation on different host plants. To develop a more complete description of host plant influence on GWSS age structure and natural enemy impact, we conducted both urban surveys and manipulative experiments. Specifically, we sought to determine the potential of common plant species used in residential landscaping to either reduce or increase GWSS densities. The developed information will provide a better understanding of GWSS seasonal movement and infestation foci. Of primary concern to regional control programs is whether or not untreated urban GWSS populations serve as an inoculum source for either the insect vector or the bacterial pathogen, *Xylella fastidiosa* (*Xf*). Therefore, we also screened common plants and GWSS collected for the presence of *Xf*. When completed, information on the abundance, host plant use, and seasonal dispersal patterns of GWSS and natural enemies in urban settings will better enable researchers to predict GWSS movement and host plant succession in the SJV, and the data may be useful for modification of surrounding vegetation, such as trap crops, to suppress GWSS movement into vineyards.

## OBJECTIVES

1. Determine GWSS biology and ecology throughout the season, particularly its age structure on and utilization of the different host plants that represent common breeding or dispersion refuges for GWSS in the San Joaquin Valley.
2. Determine the contribution of resident natural enemies on glassy-winged sharpshooter mortality and whether natural enemy abundance or species composition varies significantly on different GWSS host plants or ecosystems in the San Joaquin Valley.
3. Determine the presence of *Xf* in GWSS collected from different host plant species and in selected ecosystems in the San Joaquin Valley.

## RESULTS

### Objective 1 - Survey

GWSS numbers, age structure and natural enemies were surveyed in seven residential areas in Bakersfield, California. Each site was selected for its combination of different plant species that host both GWSS and *Xf*. Most of the sampled sites had 3-8 individual plants of each plant species, with 3 or more GWSS host plant species in close proximity. The 30 host plant species surveyed included: rose, star jasmine, Chinese elm, flowering pear, apple, pink lady, ivy, nectarine, photinia, citrus, gardenia, privet, euonymus, hibiscus, agapanthus (lily of the Nile), grape, crape myrtle, eucalyptus, oleander, *Xylosma* and Wheeler's dwarf. Each month, samples were taken to determine densities of GWSS and natural enemies (samples consisted of a 1 min beating-collection of the foliage into a large sweep net). We also recorded plant condition. None of the sampled sites were treated with insecticides for GWSS. From April 2003 to August 2005, we made >9000 plant samples (sample plant × sample date). There was an significant impact of sample site on GWSS density, as one site had more GWSS (nymphs and adults) ( $2.81 \pm 0.16$  per sample) than the other six sites (range  $0.16 \pm 0.02$  to  $0.61 \pm 0.04$  GWSS per sample) ( $F = 79.73$ ,  $df = 6, 9116$ ,  $P < 0.0001$ ). Overall, GWSS densities were not high enough to be an economically important problem in these urban landscapes. The data presented were averaged across all sample sites.

GWSS adults and nymphs exhibited strong host plant feeding preferences (Figure 1B, C). GWSS females were highly selective relative to ovipositional hosts, but there was not a strong correlation between those plant species that were fed upon and upon which egg masses were deposited (Figure 1A, 1C). This was especially true with respect to oleander, as reported by other researchers. When data were averaged across all sampling sites, grape, citrus, apple, *Xylosma*, cherry, and flowering pear were preferred oviposition sites (Figure 1A). Summarizing the data across all sample locations reduced the apparent importance of crape myrtle as an oviposition host, because it was common at survey sites with low GWSS density. Oleander and privet may be the most important overwintering hosts in the urban regions, however, they were not preferred oviposition hosts. In contrast, crape myrtle and crabapple were dormant throughout winter and, according to our samples, played no role in the GWSS overwintering; however, they were excellent hosts for oviposition and nymphal development during late spring and summer time.

Host plant feeding preferences of adults and nymphs were not identical. GWSS nymphs were most often collected on oleander, flowering pear, *Xylosma*, crabapple, abelia, and crape myrtle (Figure 1B). Adults were most often collected on oleander, *Xylosma*, pineapple guava, pyracanthum, crape myrtle, and crabapple (Figure 1C). In 2004, we also began separately monitoring GWSS density on the "suckers" that grew from the base of plants, where GWSS nymphal and adult densities were commonly high. These plant parts were only occasionally available because of management practices.

Field surveys began in June 2003, with samples taken every 2-4 weeks. Over the three year period, population patterns were clearly evident. New egg masses were first found in mid- to late-March (in the Bakersfield region), followed by a strong April-May ovipositional period (Figure 2A). The resulting nymphal and adult GWSS populations followed in sequence in each year (Figure 2B, 2C). The second ovipositional period was strongest between mid-June through October. In 2003, there appeared to be a large fall ovipositional period, but this reflected (i) fewer sites surveyed in this initial year, causing a greater influence of the site with higher GWSS densities, and ii) decreasing GWSS populations since 2003 (a result of egg parasitism). The summer decline in GWSS density was primarily a result of high egg parasitism during the second ovipositional period and, secondarily, mortality of GWSS from predation and abiotic factors.

### Objective 1 – Manipulative experiments.

In 2003 and 2004, we used uncaged, potted plots to categorize the resident GWSS population dynamics on different perennial and annual host plant species (Daane et al. 2004). Here, we report on a second experiment in which we manipulated combinations of GWSS host plant species, planted in the soil and enclosed in large cages, to investigate year-long GWSS survival and age structure. Individual treatments were: citrus, Euonymus, grape, oleander, and crape myrtle. Combinations were: citrus + grape and oleander + crape myrtle. Each cage was inoculated with 43-55 GWSS nymphs (3<sup>rd</sup> instars) in July 2004.

In all cages, there was considerable mortality after the initial inoculation, with GWSS density dropping from an inoculum of ca. 45 nymphs to < 6 nymphs per cage (Figure 3) as transfer of GWSS nymphs proved difficult. From this initial inoculum, some individuals reached the adult stage and deposited eggs during the fall period (Figure 4). Only in the citrus + grape combination treatment was there a steady GWSS population from late summer through the following spring, resulting in an

increase in GWSS density (Figure 3). When the experiment was terminated in June 2005, there had been  $> 47.3 \pm 23.3$  egg masses per cage in the citrus + grape treatment (Figure 4), which would have produced 100's of nymphs.

### **Objective 2 – Natural enemies**

During the surveys of GWSS population dynamics in non-agricultural regions, described previously, we collected information on GWSS natural enemies, using sampling techniques such as GWSS egg mass collections (>100 leaves per perennial plant species per collection) and potential GWSS predator collections (beat and sweep samples). As in all studies, we recorded host plant species and seasonal period. *Gonatocerus ashmeadi* and *G. triguttatus* (Triapitsyn et al. 1998) comprised about 98 and 2% of reared parasitoids from GWSS egg masses, respectively. Parasitism levels were lower in 2005 than reported in 2004 (Daane et al. 2004) and were  $0.25 \pm 0.25$ ,  $0.90 \pm 0.45$ ,  $39.5 \pm 4.3$ , and  $24.3 \pm 4.3\%$  for March, April, June, and July, respectively (no egg masses were collected in May; August samples have not yet been processed). On common oviposition hosts, there was a significant impact of host plant species on percentage parasitism for flowering pear –  $2.4\% \pm 2.4\%$  (only 8 egg masses), photinia –  $5.5 \pm 3.2\%$ , euonymus –  $25.0 \pm 6.5\%$ , *Xylosma* –  $49.5 \pm 5.8\%$ , crape myrtle –  $78.9 \pm 4.6\%$ , and “other”  $9.7 \pm 5.2\%$ . This difference was significantly and positively correlated to oviposition period; for example, crape myrtle was a common oviposition site in June and July samples. There was also an impact of collection site on percentage parasitism, which was significantly and positively correlated to the GWSS egg mass density.

Predators were also observed feeding on GWSS egg masses, nymphs, and adults. The most common predators were jumping spiders and the Argentine ant. Samples of these predators were sent to the Western Cotton Research Laboratory, where the predator gut content is being assayed with immunologically-based assays that employ pest-specific monoclonal antibodies (MAbs) for the presence of GWSS egg protein using the ELISA by Drs. Hagler, Fournier, and Leon (Hagler et al. 2004). These studies will provide direct evidence of predation by generalist predators.

### **Objective 3 - *Xylella*.**

We have collected  $\approx 2000$  GWSS nymphs and adults from ornamental plants in Bakersfield for testing of *Xf* presence; of these, 210 adult GWSS have been processed, with each trial using a batch of 4-8 GWSS. Of these, 16.5% of the processed lots tested positive for *Xf*. All of the *Xf* positives that were tested for *Xf* strain were found to carry a *Xf* strain resembling the oleander *Xf* strain. A summary of these trials will be included in later reports.

## **CONCLUSIONS**

We have described GWSS population density and age structure on ornamental plants common in residential landscaping in the SJV. We have further described natural enemy presence. This research adds significant information to that collected in Riverside and Ventura counties to help predict GWSS movement and develop control programs. The research has broader implications for use of ornamental landscape and riparian plants within agricultural settings (e.g., landscaping around farm buildings and homes). Plants which act as preferred hosts for both vector and pathogen can be targeted for control. By testing GWSS for the presence of *Xf*, researchers will identify potential sources of the pathogen, thereby preventing potential epidemic spread of Pierce's disease causing *Xf* throughout a reservoir of ornamental host plants. A thorough analysis of this data set will be made at the end of the residential survey (May 2006).

## **REFERENCES**

- Daane, K. M. and M. W. Johnson. 2004. Biology and ecology of the glassy-winged sharpshooter in the San Joaquin Valley, pp. 93-96. In M. Athar Tariq, S. Oswalt, P. Blincoe, R. Spencer, L. Houser, A. Ba, T. Esser [eds.], Proceedings, Pierce's Disease Research Symposium. California Department of Food and Agriculture, Sacramento, CA.
- Hagler, J., T. Henneberry, K. Daane, V. Fournier and R. Groves. 2004. A novel immunological approach for quantifying predation rates on glassy-winged sharpshooter, pp. 106-110. In M. Athar Tariq, S. Oswalt, P. Blincoe, R. Spencer, L. Houser, A. Ba, T. Esser [eds.], Proceedings, Pierce's Disease Research Symposium. California Department of Food and Agriculture, Sacramento, CA.
- Redak, R. A., A. H. Purcell, J.R.S. Lopes, M. J. Blua, R. F. Mizell, and P.C. Andersen. 2004. The biology of xylem-fluid feeding vectors of *Xylella fastidiosa* and their relation to disease epidemiology. *Annu. Rev. Entomol.* 49: 243-270.
- Triapitsyn S. V., R. F. Mizell III, J. L. Bossart and C. E. Carlton. 1998. Egg parasitoids of *Homalodisca coagulata* (Homoptera: Cicadellidae). *Fl. Entomol.* 81: 241-243.

## **FUNDING AGENCIES**

Funding for this project was provided by the CDFA Pierce's Disease and Glassy-winged Sharpshooter Board.



# EFFECT OF HOST PLANT FERTILIZATION ON THE DEVELOPMENTAL BIOLOGY AND FEEDING PREFERENCE OF THE GLASSY-WINGED SHARPSHOOTER

**Project Leader:**

John A. Goolsby  
USDA, ARS  
Beneficial Insects Research Unit  
Weslaco, Texas 78596

**Researcher:**

Mamoudou Sétamou  
USDA, ARS  
Beneficial Insects Research Unit  
Weslaco, Texas 78596

**Cooperator:**

Joseph Patt  
USDA, ARS  
Beneficial Insects Research Unit  
Weslaco, Texas 78596

**Reporting Period:** The results reported here are from work conducted November 1, 2004 to September 30, 2005.

**ABSTRACT**

The main objective of this research was to evaluate the effect of host plant fertilization on the survival, immature development, adult fecundity, and the feeding of the glassy-winged sharpshooter (GWSS), a primary vector of *Xylella fastidiosa* (Xf). The development biology of GWSS was studied on cowpea plants, *Vigna unguiculata* treated with three fertilization regimes (NPK alone, urea alone, and a combination of NPK and urea) along with a non-fertilized control. Fertilization affected cowpea plant growth, the total protein content and the profile of free amino-acids in the xylem sap. The ultimate nymphal survivorship was significantly higher on fertilized plants than on control plants. In addition, newly emerged adult weight significantly increased with fertilization; specifically, GWSS nymphs reared on plants fertilized with urea yielded adults with the highest weight. NPK fertilization significantly reduced the nymphal development period for females but not for males. Females maintained on fertilized plants showed higher oviposition frequency and number of egg masses laid compared to unfertilized plants with highest oviposition potential recorded on urea treated plants. In addition, significantly bigger egg mass sizes were obtained from fertilized plants. Consequently, GWSS populations that developed on fertilized plants and more so on urea treated plants had a higher intrinsic rate of increase compared to those developing on unfertilized control plants. In choice tests, adult GWSS showed a preference for fertilized cowpea plants. The number of GWSS adults per plant and the proportion of plants infested were significantly higher for plants that received fertilization compared to the non-fertilized control plants. However, no feeding preference was recorded for nymphs.

**INTRODUCTION**

The pest status of glassy-winged sharpshooter (GWSS), *Homalodisca coagulata* (Say), has been exacerbated since its introduction, establishment, and continued spread in California. GWSS is a highly polyphagous xylem-feeder indigenous to the southern United States and to the northern Mexico (Turner and Pollard 1959). It effectively transmits the bacterium *Xylella fastidiosa*, a causal agent of economically important diseases of several agronomic, horticultural and landscape ornamental crops. The development of efficient rearing methods will greatly improve our knowledge of the pest biology and enhance implementation of adequate control programs. A simple method for rearing GWSS on cowpea plants has been developed (Sétamou and Jones 2005), but a rapid deployment of novel control methods required increased accessibility of GWSS to researchers.

So far, no artificial diet for rearing GWSS has been commercialized and most diets are at either at the development or formulation stages. Thus, rearing methods of GWSS rely heavily on the use of plants. Although nymphs and adults have different nutritional requirements and often required different host plants for their successful development (Brodbeck et al. 1996), Sétamou and Jones (2005) showed that cowpea or black-eyed pea (*Vigna unguiculata*) is a suitable host plant that supports the development of both immature and adults stages. But development of GWSS populations in laboratory colonies depends on many factors such as host plant quality. Plant nitrogen content has been identified as an indication of host plant quality for herbivorous insects (Mattson 1980). It is widely reported in the literature that nitrogen content of host plants influences the survival, development and reproduction of insects, particularly homopteran and also other insects orders (van Emden 1966). Nitrogen content of plants is directly related to the level of fertilization (Jauset et al. 1998).

In this project we are testing the effects of host plant fertilization on the bionomics of GWSS in order to find the most suitable host plant fertilization regimes for maximizing the production of GWSS. Two types of fertilizers, i.e., water soluble NPK (20-20-20) from Peter Professional® and agrillane urea (46-0-0) from Magic Carpet™ were used individually or in combination at the recommended doses for cowpea production to fertilize potted plants used in the experiments.

**OBJECTIVES**

1. Evaluate the effects of nitrogen fertilization on plant growth and on N content and free amino-acid composition of xylem exudates.
2. Determine the influence that fertilization of cowpea plants has on the survival, growth and development of both immature and adult GWSS.
3. Test whether GWSS exhibit any feeding and oviposition preferences for fertilized plants.



## RESULTS

### Objective 1 – Effect of fertilization on plant growth and chemistry

As expected NPK and urea fertilization of plants significantly increased their growth parameters. Plant height, stem diameter, number of leaves, and leaf thickness were higher for plants that received fertilization compared to the control plants. Although plants of different treatments in the experiments were not water-stressed and received the same irrigation regime, the total water potential of non-fertilized cowpea stems (-4.08 bars) was lower than those obtained for fertilized plants (-3.62 bars for NPK alone, -3.70 bars for urea-alone and -3.55 bars for a combination of NPK and urea). This suggests that fertilized plants were more succulent than control plants, thus facilitating xylem sap uptake by GWSS. Total N concentration of xylem fluid significantly increased with fertilization from 265  $\mu\text{g N g}^{-1}$  in the control to 420-506  $\mu\text{g N g}^{-1}$  in the fertilized plants. Studies are underway to determine the free amino-acid composition and levels in xylem fluids collected from the different treatments.

### Objective 2 – GWSS biology as affected by host plant fertilization

Host plant fertilization significantly affected the ultimate nymphal survival of GWSS. Almost all nymphs reached the adult stage on fertilized cowpea plants whereas 15% of nymphs died on non-fertilized control plants (Table 1). Although nymphal development of male GWSS was not affected by the host plant treatment, the nymphal period of females was significantly reduced when host plant received NPK fertilization (Table 1). Similarly, the weight of newly emerged adult GWSS varied with host plant treatment. Both adult males and females emerging from fertilized plants were significantly heavier than their counterparts on control plants (Table 1). However, the sex ratio of adults obtained was not related to host plant treatments and did vary from a 1:1 sex ratio.

**Table 1.** Biological parameters of GWSS reared on cowpea plants treated with different fertilization regimes.

Treatment	Proportion of adults emerged	Nymphal developmental period (days)		Adult Weight (mg)		Sex ratio (% Females)
		♂♂	♀♀	♂♂	♀♀	
Control	85.0 a	30.9 a	33.3 ab	29.6 c	37.4 c	44.2 a
NPK-only	98.3 b	28.8 a	30.6 b	32.1 b	40.1 b	50.8 a
Urea-only	96.7 b	31.1 a	34.9 a	34.5 a	43.0 a	46.6 a
NPK + Urea	96.7 b	32.1 a	31.4 b	32.4 ab	42.8 a	46.4 a
<i>Statistic</i>	$G = 17.1, P < 0.01$	$F_{sex} = 7.59, P = 0.006$		$F_{sex} = 21.35, P < 0.0001$		$G = 3.2, P > 0.05$
		$F_{treat} = 4.45, P = 0.005$		$F_{treat} = 293.43, P < 0.0001$		

<sup>a</sup> Means followed by the same small case letter within each column are not significantly different ( $P > 0.05$ ), Student Newman Keuls test.

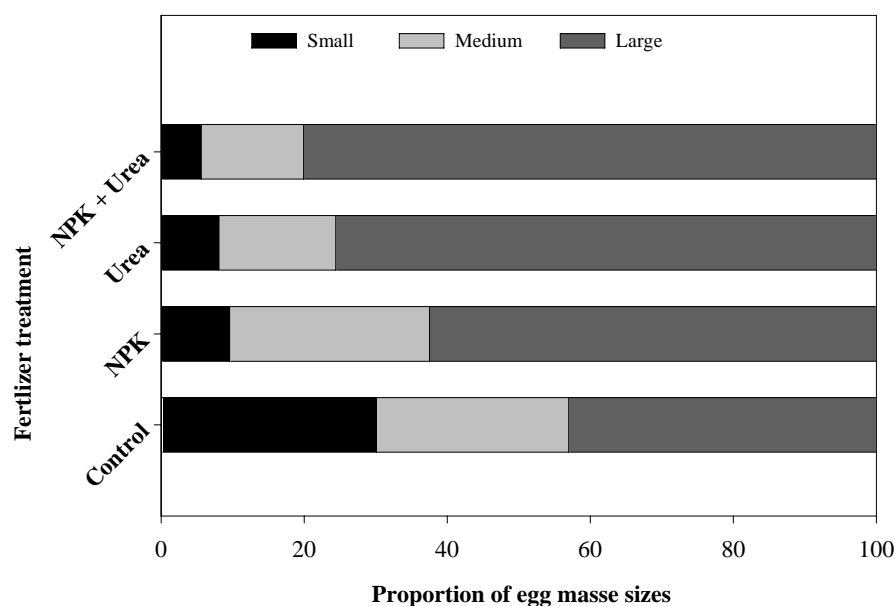
Adult female oviposition frequency and potential were dramatically improved with urea fertilization. GWSS developing on fertilized plants laid more egg masses on a weekly basis and the total fecundity of 10 females of GWSS females has almost doubled on urea treated plants compared to control plants (Table 2). In addition, the proportion of larger egg masses (containing > 10 eggs) was higher with fertilization (Figure 1).

**Table 2.** Oviposition parameters of GWSS adults<sup>a</sup> reared on potted cowpea plants treated with different fertilization regimes over the first 10-wk period.

Treatment	Weekly Percentage of plants with egg masses <sup>b</sup>	Weekly no. egg masse per pot	Total number of egg masses
Control	24.0 c	1.7 b	93
NPK-only	28.4 bc	1.9 ab	104
Urea-only	47.5 a	3.1 a	172
NPK + Urea	38.3 ab	3.2 a	161

<sup>a</sup> In each treatment, 10 pairs of adults were maintained per cage.

<sup>b</sup> Means followed by the same letter within each column are not significantly different ( $P > 0.05$ ), Student Newman Keuls test.



**Figure 1.** Distribution of egg masses laid by GWSS reared on plants treated with different fertilization regimes (Small = 1-5 eggs/mass, medium = 6-10 eggs/mass, and L => 10 eggs/mass).

### Objective 3 – GWSS host plant preference

The host plant preference of GWSS nymphs and adults was studied in separate experiments. Two potted cowpea plants of each fertilization treatment (8 cowpea pots in total) were simultaneously provided to GWSS for assessing their host plant preference. Cowpea plants of different treatments were equally preferred by nymphs, whereas adult GWSS preferentially fed on fertilized plants. Both the proportion of plants selected for feeding and the number of adults per plant were significantly higher for fertilized plants (Table 3).

### CONCLUSIONS

We have shown that cowpea plant growth parameters, water potential, and total N concentration of xylem fluid have been improved by NPK and urea fertilization. We will be analyzing the free amino-acid profile of xylem and this will improve our understanding of the effects that fertilization has on xylem chemistry and subsequently on the development biology of GWSS. The results obtained from this study showed that adequate fertilization dramatically improves the survival, growth, development and reproduction of GWSS. These findings can directly be used to improve the production of GWSS in laboratory. In addition, more insights can be gained on the GWSS-host plant interaction.

**Table 3.** Host plant selection and number of GWSS per plant in choice experiment with potted cowpea treated with different fertilizers.

Treatment	Nymphs		Adults	
	% plants infested	Mean no. GWSS per plant	% plants infested	Mean no. GWSS per plant
Control	42.0 a	2.5 a	35.5 a	2.0 a
NPK-only	41.8 a	2.6 a	49.5 ab	3.3 b
Urea-only	45.7 a	2.6 a	52.7 b	3.3 b
NPK + Urea	46.2 a	2.3 a	43.5 ab	2.6 ab

Means followed by the same letter within each column are not significantly different ( $P > 0.05$ ), Student Newman Keuls test.

## REFERENCES

- Brodbeck, B. V., P C. Andersen, and R. F. Mizell, III. 1996. Utilization of primary nutrients by the polyphagous xylophage, *Homalodisca coagulata*, reared on single host species. Arch. Insect Biochem. Physiol. 32: 65–83.
- Jauset, A. M., M. J. Sarasúa, J. Avilla, and R. Albajes 1998. The impact of nitrogen fertilization on feeding site selection and oviposition by *Trialeurodes vaporariorum*. Entomol. Exp. Appl. 86: 175-182.
- Mattson, W. J. 1980. Herbivory in relation to plant nitrogen content. Ann. Rev. Ecol. Systems 11: 119-161.
- Sétamou, M. and W. A. Jones 2005. Biology and Biometry of sharpshooter *Homalodisca coagulata* (Homoptera: Cicadellidae) reared on cowpea. Ann. Entomol. Soc. Am. 98: 322-328.
- Turner, W. F., and H. N. Pollard. 1959. Life histories and behavior of five insect vectors of phony peach disease. U.S. Dep. Agric. Tech. Bull. 1188:28.
- van Emden, H. F. 1966. Studies of the relations of insect and host plant. III. A comparison of the reproduction of *Brevicoryne brassicae* and *Myzus persicae* (Hemiptera: Aphididae) on brussels sprout plants supplied with different rates of nitrogen and potassium. Entomol. Exp. Appl. 9: 440-460.

## FUNDING AGENCIES:

Funding for this project was provided by the USDA Agricultural Research Service.

# DISPERSAL AND MOVEMENT OF THE GLASSY-WINGED SHARPSHOOTER AND ASSOCIATED NATURAL ENEMIES IN A CONTINUOUS, DEFICIT-IRRIGATED AGRICULTURAL LANDSCAPE

## Project Leaders:

Russell L. Groves  
USDA, ARS, SJVASC, CDPG  
Parlier, CA 93648

Marshall W. Johnson  
Department of Entomology  
University of California, Riverside  
Kearney Agricultural Center  
Parlier, CA 93648

James Hagler  
USDA, ARS, PWA  
Western Cotton Research Lab  
Phoenix, AZ 85040

Robert Luck  
Department of Entomology  
University of California  
Riverside, CA 92521

## Collaborators:

Rodrigo Kruegner  
Department of Entomology  
University of California  
Riverside, CA 92521

David Morgan  
CDFA, PDCP  
Riverside, CA 92501

**Reporting Period:** Results reported here are from work conducted July 2005 to September 2005.

## ABSTRACT

Outlined experiments in this study have only recently begun and are designed to advance our ability to define the operative host-plant factors utilized by adult glassy-winged sharpshooter (GWSS) and associated natural enemies as long-range cues to locate feeding and oviposition hosts in a complex agricultural landscape. Specifically, experiments are underway to determine how continuous deficit irrigation regimes in Valencia oranges influence the population dynamics of GWSS and other associated natural enemies. Populations of GWSS were monitored in a citrus orchard maintained under continuous irrigation schedules receiving 60%, 80%, and 100% of evapo-transpiration ( $ET_c$ ) rates. Throughout the season, citrus trees irrigated at 60%  $ET_c$  had warmer leaves and higher water potential than the trees irrigated with 80% and 100%  $ET_c$ . Mean numbers of adults collected on beat samples, caught on sticky traps, and observed during the visual inspection, and egg masses within foliage were higher in the 80% and 100%  $ET_c$  treatments than the 60%  $ET_c$  treatment. Preliminary caged experiments using grape and oleander conducted in Riverside, California, illustrated GWSS population shifts that occurred between plants. Individual plants maintained under a well-watered treatment ( $ET_c=100%$ ) exhibited higher insect counts compared with a continuous deficit-irrigated treatment ( $ET_c=50%$ ). Identifying how the dispersing lifestages of GWSS locate and exploit specific host species will begin to provide the necessary information required to develop strategies for control of this highly mobile insect and further to limit the spread of *Xf* movement into susceptible crops.

## INTRODUCTION

The GWSS is a highly polyphagous and mobile insect utilizing numerous plant species as both feeding and oviposition hosts (Adlerz, et al. 1979, Daane et al. 2003, Groves et al. 2003). Recent research has documented that different host plant species are not equally utilized by all GWSS lifestages. Mizell and Anderson (2003) report that host plant xylem chemistry plays a key role in the regulation of GWSS feeding and oviposition over a wide range of host plant species. Similarly, Daane and Johnson (2003) concluded that ornamental landscape plant species greatly influence GWSS seasonal population biology. Specifically, ornamental species which favorably support adult GWSS oviposition and feeding do not equally support comparable nymphal populations. Although significant new information has become available regarding the sequence of hosts in which GWSS populations thrive, little is understood about the host-location strategies of GWSS, which are critical behavioral responses that assist the insect in locating suitable hosts. Successful insect-host associations depend upon an insect's ability to locate a suitable host(s) in a complex, heterogeneous landscape. Mechanisms of host location in many phytophagous insects are often mediated by long-range, semiochemical cues arising from their host plant(s), which vary by plant physiological conditions including nutrition (available nitrogen and carbohydrate), xylem water potential, and plant age or developmental stage (Finch 1986). Similarly, we have an incomplete understanding of host-selection cues utilized by the mymarid egg parasitoids of GWSS, which may involve the host (GWSS egg mass), the host plant, or a combination of both.

The outlined experiments in this study are designed to advance our ability to define the operative host-plant factors utilized by adult GWSS and associated natural enemies as long-range cues to locate feeding and oviposition hosts in a complex agricultural landscape. Identifying how the dispersing lifestages of GWSS locate and exploit specific host species will begin to provide the necessary information required to develop strategies for control of this highly mobile insect and further limit the spread of *Xf* movement into susceptible crops.

## OBJECTIVES

1. Evaluate host-plant factors utilized by adult GWSS and associated natural enemies as long-range cues to locate feeding and oviposition hosts in a complex agricultural landscape.
2. Monitor adult GWSS movement and host selection behavior, ovipositional preference, and nymphal population performance on host plants maintained under continuous irrigation deficits

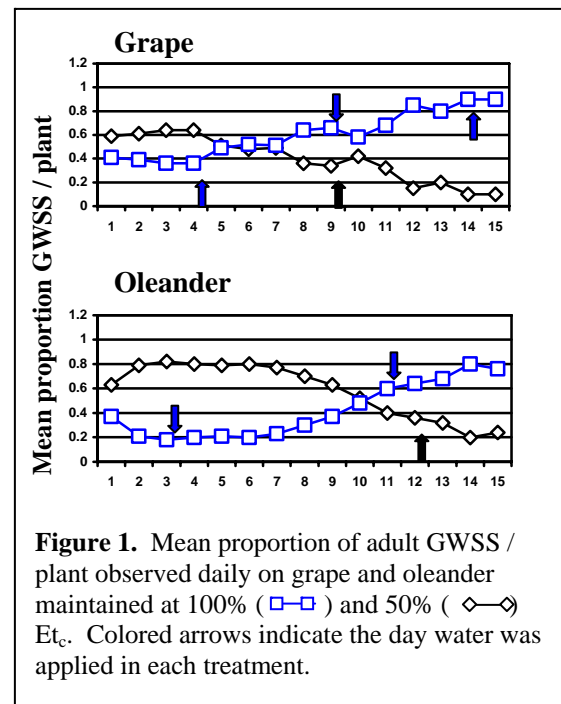
## RESULTS

### Objective 1

The response(s) of adult GWSS to olfactory cues and their corresponding host-selection behavior will be comparatively examined in a modified, four-chamber, air-flow olfactometer large enough to accommodate movement of adult GWSS (Vet et al. 1983). In these laboratory experiments, we will investigate GWSS orientation responses to odor fields of varying levels of humidified air in combination with selected host plant species. In addition, the host selection behavior of gravid and nongravid adult female GWSS representing two ages (10 and 50 day-old) will be comparatively examined. A total of 30 experimental replicates will be conducted with adult GWSS representing both age classes in a factorial design containing three levels of relative humidity (10, 50, and 100%) in combination with two host plant species including lemon and avocado. A set of experimental replicates will be performed to evaluate the host-selection behavior of the GWSS mymarid parasitoid *Gonatocerus ashmeadi* in a similar factor-level design containing the three humidity levels in combination with the presence of GWSS egg masses oviposited on leaves of lemon and avocado. Adult female parasitoids reared from parasitized GWSS egg-masses laid on lemon and avocado, respectively, will be used for these assays. As an additional control, *G. asmeadi* reared from parasitized GWSS egg masses on cowpea will be included in the bioassays. Personnel have recently been hired to conduct these analyses.

### Objective 2

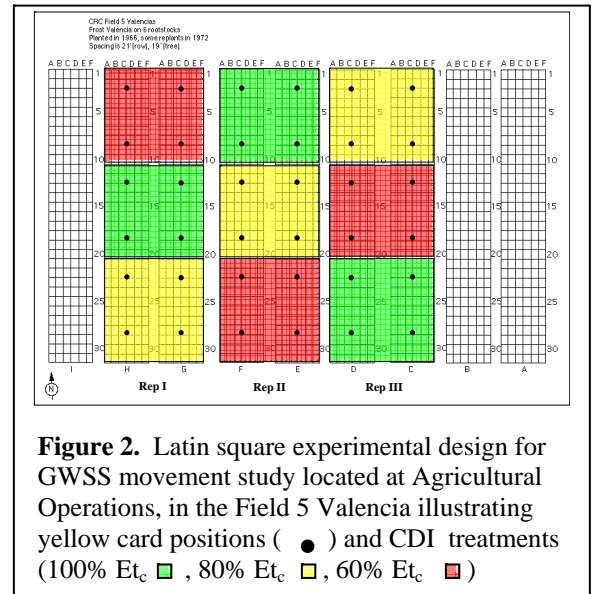
A complementary set of screen-house and field experiments are underway to define the relative importance of host-plant cues for GWSS host selection and oviposition. GWSS population dynamics were monitored on selected host plant species including oleander and grape. This experiment was constructed as a randomized complete block design with 2 levels of water stress as main effects: a well-watered treatment ( $ET_c=100\%$ ), and a continuous deficit-irrigated treatment ( $ET_c=50\%$ ). Potted (10.6 liter) plants of each host species were randomly placed in screened cages, and infested with 50 even-aged GWSS adults. Detailed daily observations of adult GWSS feeding and resting preference were recorded throughout the experiment. These results illustrate GWSS population shifts that occurred between plants maintained under a well-watered treatment ( $ET_c=100\%$ ) compared with a continuous deficit-irrigated treatment ( $ET_c=50\%$ ) (Figure 1). The pattern of insect movement within the oleander did not follow that observed with the grape. The number of GWSS feeding on deficit-irrigated plants increased until day 3, when the first irrigation took place and the number of insects feeding on the plants slowly changed until day 10, when the proportion of insects in each plant reached 0.5. The second irrigation did not cause a quick insect response as observed with grapevines, the insects continued to slowly switch from non-irrigated to irrigated plants. Oleander plants are known to be somewhat more resistant to water stress than grapevines, and such a characteristic might have played a role in differential patterns of GWSS movement between plants.



**Figure 1.** Mean proportion of adult GWSS / plant observed daily on grape and oleander maintained at 100% (□-□) and 50% (◇-◇)  $ET_c$ . Colored arrows indicate the day water was applied in each treatment.

A second set of field experiments were recently established to determine the effects of continuous, deficit-irrigation (CDI) practices on the population dynamics of GWSS over the course of a two year study, within the UC Riverside, Valencia Field 5 Citrus Research Block (Figure 2). The experiment is designed as a Latin square with 3 irrigation treatments and 3 replications, each consisting of 120 trees in a replicated block under micro-sprinkler irrigation. The CDI schedules evaluated in this experiment include: 1) trees irrigated at 100%  $ET_c$ ; 2) a continuous deficit-irrigated treatment maintained at 80%  $ET_c$ , and 3) a continuous deficit treatment irrigated at 60% of  $ET_c$  throughout the crop year. The severity of water stress is being characterized by measurements of soil water content, pre-dawn leaf water potential ( $\Psi$ ), and mid-canopy, leaf surface temperatures. GWSS populations within experimental blocks are sampled weekly during the growing season and will be sampled bimonthly during the upcoming winter period. Different sampling techniques will be used throughout the year to detect different development stages of GWSS. GWSS nymphs and natural enemies will be sampled using systematic beat-sample methods at cardinal points around sample trees methods as developed for GWSS on citrus.

The seasonal movement patterns of adult GWSS within and among the experimental blocks is being monitored using a combination of directional, yellow sticky cards collected and replaced weekly coupled with a set of novel proteins for mark-capture. Together, systematically placed traps and protein signatures will record any shifts in plant use of adult populations (Figure 2). The field portion of this research will focus on the role of CDI conditions on GWSS host-selection strategy and dispersal. At regular intervals during the 2005 season, CDI replicates were sprayed with inexpensive proteins using conventional spray equipment. In turn, insects that are contacted by the protein solutions or that encounter plant material containing protein residues will obtain enough protein to be detected by protein-specific enzyme-linked immunosorbent assays (ELISA). Because the three marking ELISAs (chicken egg whites, soy milk, and non-fat dry milk) do not cross-react, we can apply the materials to the three different treatments in close proximity to one another. Then, insects can be collected using temporal and spatial sampling schemes and analyzed for the presence of each respective protein mark to determine not only the insect's point of origin, but the timing and extent to which portions of the population move among different plant species.



## CONCLUSIONS

We believe that findings from this recently funded project will generate significant new information regarding the host selection behavior and movement patterns of GWSS in California. Preliminary results from greenhouse studies illustrate that GWSS population shifts occurred between plants maintained under varying, CDI treatments. Further, measurements of in-field plant condition suggested no differences in leaf temperatures and water potentials between trees irrigated at 80% and 100%  $ET_c$ . Trees irrigated with 60%  $ET_c$  had warmer leaves, higher water potential, and also hosted fewer GWSS than the well irrigated trees. Patterns of adult GWSS capture throughout the 2005 sampling interval (July – August), estimated from a combination of yellow traps, beat samples, and visual inspections, suggest comparatively higher population densities of GWSS in CDI treatments 80 and 100%  $ET_c$ . Furthermore, higher counts of GWSS adults and egg masses were found on trees irrigated at 80%  $ET_c$  compared with the 100%  $ET_c$  treatment.

This research will provide more information about sharpshooter feeding, host-finding behavior, preferences, and the factors that influence reproductive success and natural-enemy-caused mortality. Elucidation of the preference for and performance upon host plant species under differential water stress will aid our understanding of the mechanism of spread of PD and speed with which pathogen spread might occur. A more complete understanding of the operative host-plant cues that influence GWSS population dynamics may result in the deployment of strategies to focus control efforts, enhance the efficacy of biological control, and effectively limit the spread of *Xf* induced diseases to susceptible crops.

## REFERENCES

- Adlerz, W.C. and Hopkins, D.L. 1979. Natural infectivity of two sharpshooter vectors of Pierce's disease in Florida. *J. Econ. Entomol.* 72: 916-919.
- Daane, K. M. and Johnson, M. W. 2003. Biology and ecology of the glassy-winged sharpshooter in the San Joaquin Valley, pp. 247-249. *In. Proceedings, Pierce's Disease Research Symposium*, M. Athar Tariq, S. Oswalt, P. Blincoe, R. Spencer, L. Houser, A. Ba, and T. Esser (eds.), 8-11 Dec. 2003, San Diego, CA. Calif. Dept Food and Agric., Sacramento, CA.
- Groves, R. L. and Chen J. I. 2003. Epidemiology of Pierce's Disease in the Central San Joaquin Valley of California: factors affecting pathogen distribution and movement, pp. 92-94. *In. Proceedings, Pierce's Disease Research Symposium*, M. Athar Tariq, S. Oswalt, P. Blincoe, R. Spencer, L. Houser, A. Ba, and T. Esser (eds.), 8-11 Dec. 2003, San Diego, CA. Calif. Dept Food and Agric., Sacramento, CA.
- Finch, S. 1986. Assessing host-plant finding by insects, pp. 23-63. *In. Insect-Plant Interactions*, J. R. Miller and T. A. Miller (eds.) Springer-Verlag, New York.
- Mizell, R. F. and Anderson, P. C. 2003. Keys to management of the glassy-winged sharpshooter: interactions between host plants, malnutrition, and natural enemies, pp. 271-273. *In. Proceedings, Pierce's Disease Research Symposium*, M. Athar Tariq, S. Oswalt, P. Blincoe, R. Spencer, L. Houser, A. Ba, and T. Esser (eds.), 8-11 Dec. 2003, San Diego, CA. Calif. Dept Food and Agric., Sacramento, CA.
- Varela, L.G., R.J. Smith and P.A. Phillips. 2001. Pierce's Disease. *Univ. California. Agric. & Nat. Res. Publ* 21600.

**FUNDING AGENCIES**

Funding for this project was provided by the University of California Pierce's Disease Grant Program, the CDFA Pierce's Disease and Glassy-winged Sharpshooter Board, and the USDA Agricultural Research Service.

# PROGRESS TOWARD QUANTIFYING LANDSCAPE-SCALE MOVEMENT PATTERNS OF THE GLASSY-WINGED SHARPSHOOTER AND ITS NATURAL ENEMIES USING A NOVEL MARK-CAPTURE TECHNIQUE

## Project Leaders:

James Hagler, Jackie Blackmer, and  
Thomas Henneberry  
USDA, ARS  
Phoenix, AZ 85040

Kent Daane  
University of California  
Berkeley, CA 94720

Russell Groves  
USDA, ARS  
Parlier, CA

## Cooperator:

Vince Jones  
Washington State University  
Wenatchee, WA

**Reporting Period:** The results reported here are from work conducted September 1, 2004 to September 1, 2005.

## ABSTRACT

Here we present the results of the first year of our research targeted at quantifying the landscape-level movement patterns of GWSS and its natural enemies. We showed that protein markers can be rapidly acquired and retained on insects for several weeks after marking directly in the field. Specifically, we sprayed a large citrus plot and a large olive tree plot with different inexpensive proteins using conventional air blast sprayer. In turn, insects that were hit by the protein solutions or that were exposed to marked plant tissue obtained enough protein to be detected by a protein-specific ELISA. Because the various protein specific ELISAs do not cross-react, we can apply the various proteins to different host plants in close proximity to one another. This marking technique provides the necessary tool to distinguish GWSS and its natural enemies so that studies of dispersal, migration, longevity, and density can be conducted. Additionally, different protein markers can be used to identify insect movement from different areas within a crop or from different crops.

## INTRODUCTION

Glassy-winged sharpshooter (GWSS), *Homalodisca coagulata* (Say) feed on a variety of plants, and in the process transmit the bacterium, *Xylella fastidiosa*, which is the causal agent of Pierce's disease (PD) (Varela, 2001). Due to the polyphagous feeding habit and high dispersal capability of GWSS, control of this pest will require an areawide management approach. Such an approach requires extensive knowledge of the host plant preferences and dispersal characteristics of GWSS and its natural enemies. Unfortunately, very little is known about the dispersal characteristics of GWSS (Blua & Morgan, 2003; Blackmer *et al.*, 2004) and its associated natural enemy complex. This is due, in part, to the lack of an effective technique for studying insect dispersal at the landscape level.

The development of a protein marking technique (Hagler, 1997ab; Blackmer *et al.*, 2004) solved many of the problems associated with other marking techniques for marking insects. The procedure is simple, sensitive, safe, rapid, inexpensive (for MRR type studies), invisible, and stable (Hagler & Jackson, 2001). Moreover, several distinct proteins are available which facilitate the simultaneous marking of different cohorts of individuals (Hagler 1997a; Hagler & Naranjo, 2004). Recently, we identified several inexpensive proteins that can be used to mark insects for mark-capture type studies. The proteins are casein (from non-fat dry milk), chicken egg whites (Egg Beaters™ or All Whites™), and soy milk (Silk™ Soymilk). In collaboration with Vincent Jones we have developed anti-casein, anti-egg white, and anti-soy enzyme-linked immunosorbent assays (ELISA) to each of these proteins. In turn, these ELISAs can be used to detect the presence of each protein on protein-marked insects. In this paper, we report on the efficacy of this marking procedure for marking GWSS and its natural enemies directly in the field for mark-capture type studies.

## OBJECTIVES

1. Quantify GWSS and natural enemy dispersal patterns in a complex landscape.
2. Determine which factors influence their dispersal.

To accomplish these objectives we must first develop a reliable mark-capture protein marking technique and quantify the protein marking retention intervals for the targeted insects. Field application of better mark-capture techniques will enhance our understanding of the area-wide dispersal patterns of GWSS and its natural enemies. The first phase (year 1 of 2) of our research consisted of optimizing a mark-capture procedure for GWSS and its natural enemies that will facilitate future studies (years 2 and 3) of intracrop and intercrop dispersal. Here we described three experiments that were conducted to validate the efficacy of the protein marking procedure on GWSS and one of its potential natural enemies, *Hippodamia convergens*.

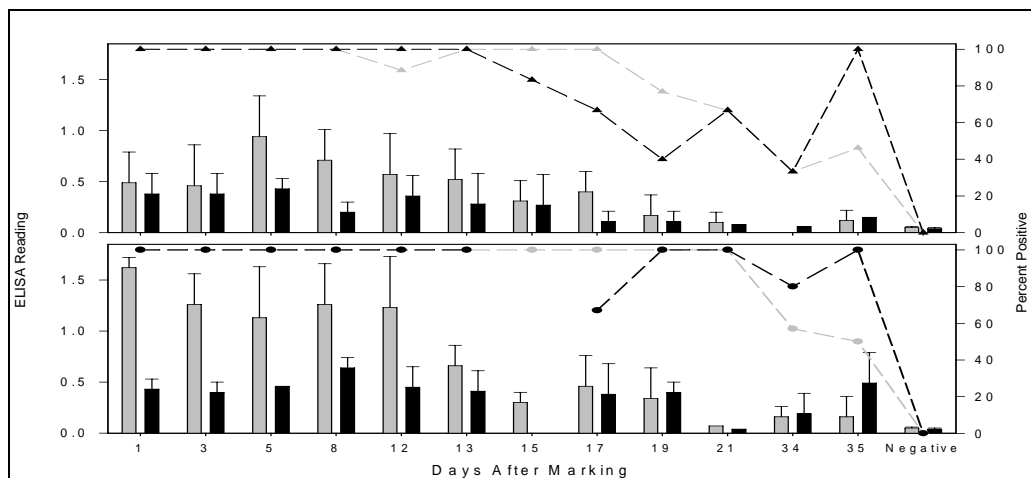


## RESULTS

### Experiment 1

The first experiment was conducted to determine the retention time of two different proteins, non-fat dry milk (NFDM) and chicken egg whites (CEW) on GWSS and *Hippodamia convergens* under field conditions. Here we tested the efficacy of two marking procedures. The first procedure was a residual contact marking method. Randomly selected citrus branches were sprayed with a 5.0% solution of NFDM or CEW (All Whites™). The branches were allowed to dry for 2 h, and then 15 nylon-meshed sleeve cages (66 X 70-cm, 19-cm dia.) were placed on the branches. Adult GWSS ( $\approx 20$  per cage) and *H. convergens* ( $\approx 30$  per cage) were then introduced into each cage. A single cage was randomly selected on 12 different sampling dates for up to 35 days after marking. All surviving GWSS and *H. convergens* in the randomly selected cages were assayed by an anti-NFDM or an anti-CEW ELISA to detect the presence of each respective protein marker. The second procedure was a direct contact marking method. Fifteen nylon-meshed sleeve cages were placed on randomly selected citrus branches. Adult GWSS ( $\approx 20$  per cage) and *H. convergens* ( $\approx 30$  per cage) were then introduced into each cage and sprayed with a 5.0% solution of NFDM or CEW. The sampling scheme and assays were as described above.

The ELISA results for the protein marked GWSS are given in Figure 1. Data indicate that both marking procedures, regardless of the type of protein marker used, were retained well on GWSS. As expected, the topical marking procedure yielded higher ELISA values and had longer retention times than the residual contact marking method. The markers were retained on 100% of the GWSS for  $\approx 2$  and 3 weeks by the residual and topical marking procedures, respectively. *H. convergens* ELISA reactions were very similar to the reactions yielded by GWSS (data not shown).



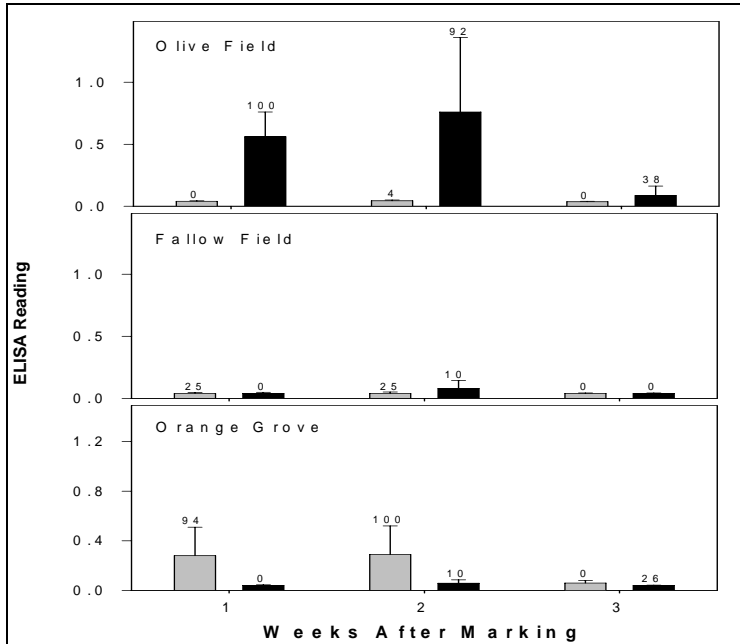
**Figure 1.** The mean  $\pm$  SD ELISA values (vertical bars read from the left y-axis) and percentage of GWSS (line plot read from the right y-axis) scoring positive for the presence of CEW (gray bars) or NFDM (black bars). The top graph represents the insects marked by contact exposure and the bottom graph represents the insects marked by topical spray. GWSS were scored positive for the presence of each marker if the ELISA value exceeded the mean negative control value by 3 standard deviations (note: the day 15 NFDM topical spray samples were lost).

### Experiment 2

The second study was conducted to determine the efficacy of the marking procedure under realistic open field conditions. The field site was a commercial farm located near Porterville, CA. The field was  $\approx 20$  acres, split equally into  $\approx 10$  acres of 8-year-old olive trees and 16-year-old navel orange trees. An 8-m wide fallow border divided the two crops. Eight nylon-meshed sleeve cages were placed uniformly in the field. Three sleeve cages were placed in each of the crops and two cages were attached to six ft poles and placed in the fallow border region. Adult *H. convergens* (note: GWSS were not used in this experiment due to very low populations at the study site) were then introduced into each cage ( $n=30$ /cage) the day before the fields were sprayed with their designated protein solution (see below). On Sept. 9, 2004  $\approx 3$  acres of the olive field were sprayed with a 5.0% solution of NFDM @ 100 gal/acre and  $\approx 3$  acres of the orange grove were sprayed with a 5.0% solution of CEW @ 250 gal/ac using a 500 gal conventional air blast sprayer. Individual beetles were removed from each sentinel cage on Sept. 10 ( $n=10$ ), Sept. 17 ( $n=10$ ), and Sept. 24 ( $n$ =the surviving beetle population) and assayed by an anti-NFDM and an anti-CEW ELISA to detect for the presence of each respective protein mark.

The ELISA results for *H. convergens* marked directly in the field using a commercial spray rig are given in Figure 2. Markers were retained well on the beetles, regardless of the marker used or the crop that the marker was applied to for two weeks after application. In a few instances, we obtained false positive ELISA reactions (e.g., beetles collected from the unsprayed fallow field or from the crop where the specific marker was not applied). In almost all instances, the false positive

reactions were barely above the threshold value used (mean + 3SD of negative control beetles) to score a positive reaction. The occasional false positive ELISA reactions were probably due to spray drift of the markers or human error which can occur while conducting an ELISA.

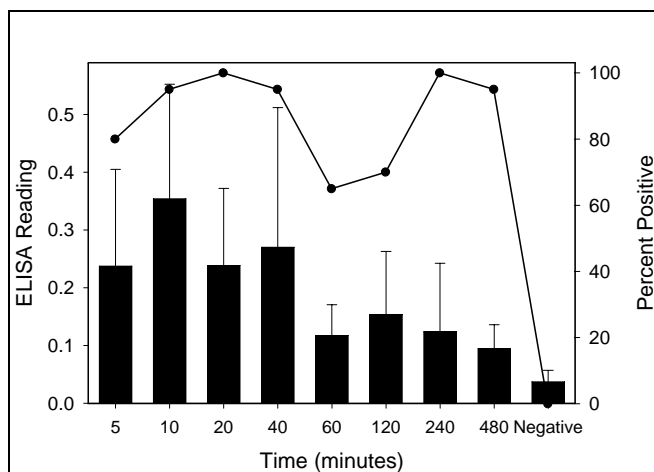


**Figure 2.** The mean ( $\pm$ SD) ELISA readings of protein-marked *H. convergens* held in sentinel cages. The grey bars are the CEW ELISA reactions and the black bars are the NFDM ELISA reactions. The numbers above each error bar are the percentage of positive ELISA responses for each treatment.

### Experiment 3

The third study was a laboratory study conducted to determine how long it takes for an insect to become marked after residual contact exposure to marked plant tissue. The insect used in this study was adult *H. convergens*. Individual greenhouse grown cotton plants,  $\approx$ 80-cm tall ( $\approx$  20 leaves per plant), were sprayed with 35 ml of a 10% CEW solution using a standard hand sprayer. The cotton plants were allowed to dry for 1 h at 45°C. After drying, randomly selected leaves were pulled from the plant and cut to fit inside a 3.5-cm Petri dish (insect arena). An individual beetle was placed in an arena for 5, 10, 20, 40, 60, 120, 240, or 480 min. After each holding interval, the beetles were assayed by an anti-CEW ELISA to detect the presence of the marker.

The ELISA results for the protein marked *H. convergens* are given in Figure 3. Data indicate that the majority of beetles acquired the mark by residual contact within 5 minutes after exposure.



**Figure 3.** The mean  $\pm$  SD ELISA values (vertical bars read from the left y-axis) and percentage of *H. convergens* (line plot read from the right y-axis) scoring positive for the presence of chicken egg whites (n = 20 per time interval).

## CONCLUSIONS

In the first phase of our research described here, we showed that protein marks can be rapidly acquired and retained on insects several weeks after marking in the field. This marking technique provides the necessary tool to distinguish GWSS and its natural enemies so that studies of dispersal, migration, longevity, and density can be conducted. Additionally, different protein markers can be used to identify insects released at different times, in different areas, or in different crops. Currently (e.g., summer/fall of 2005), we are using this technique for several different projects to investigate the landscape-level movement of GWSS (nymphs and adults) and its natural enemies.

## REFERENCES

- Blackmer, J. L., J.R. Hagler, G. Simmons and L. Canas. 2004. Comparative dispersal of *Homalodisca coagulata* and *Homalodisca liturata*. *Environ. Entomol.* 33: 88-99.
- Blua, M.J. and D. Morgan. 2003. Dispersion of *Homalodisca coagulata* a vector of *Xylella fastidiosa*, into vineyards in southern California. *J. Econ. Entomol.* 96: 1369-1374.
- Hagler, J. R. 1997a. Field retention of a novel mark-release-recapture method. *Environ. Entomol.* 26: 1079-1086.
- Hagler, J. R. 1997b. Protein marking insects for mark-release-recapture studies. *Trends Entomol.* 1: 105-115.
- Hagler, J.R. and C.G. Jackson. 2001. Methods for marking insects: Current techniques and future prospects. *Annual Rev. Entomol.* 46: 511-543.
- Hagler, J.R. and S.E. Naranjo. 2004. A multiple ELISA system for simultaneously monitoring intercrop movement and feeding activity of mass-released predators. *International J. of Pest Management.* 50: 100-207.
- Varela, L. G., R. J. Smith, and P. A. Phillips. 2001. Pierce's Disease, 20 pp. University of California, Agriculture and Natural Resources Publication 21600.

## FUNDING AGENCIES

Funding for this project was provided by the University of California Pierce's Disease Grant Program, and the USDA Agricultural Research Service.

# SPATIAL POPULATION DYNAMICS AND OVERWINTERING BIOLOGY OF THE GLASSY-WINGED SHARPSHOOTER IN CALIFORNIA'S SAN JOAQUIN VALLEY

## Project Leaders:

Marshall W. Johnson  
Department of Entomology  
University of California, Riverside  
Kearney Agricultural Center  
Parlier, CA 93648

Kent Daane  
Division of Insect Biology  
Department of ESPM  
University of California  
Berkeley, CA 94720

Russell Groves  
USDA, ARS, PWA, SJVASC  
Parlier, CA 93648

Elaine Backus  
USDA, ARS, PWA, SJVASC  
Parlier, CA 93648

Youngsoo Son  
Department of Entomology  
University of California, Riverside  
Kearney Agricultural Center  
Parlier, CA 93648

**Reporting Period:** The results reported here are from work conducted October 2004 to September 2005.

## ABSTRACT

The purpose of this project is to define specific environmental constraints that influence glassy-winged sharpshooter (GWSS) population dynamics and overwintering success. Experiments were conducted to determine effects of constant temperatures on the survival of GWSS adults for various exposure times under three different conditions: water-only, no water or host plant, and host plant. When only provided water, adults survived the longest ( $16.3 \pm 1.8$  days) at  $15^{\circ}\text{C}$ , with the shortest longevities at 0 and  $40^{\circ}\text{C}$  ( $1.5 \pm 0.1$  and  $2.5 \pm 0.3$  days, respectively). Overall, the longevity patterns implied that lack of a suitable host plant would result in greater reductions in survival at higher temperatures (e.g.,  $\geq 25^{\circ}\text{C}$ ). When adults were provided with a preferred host plant ('Frost Eureka' lemon), percent adult survival was significantly influenced by temperature and exposure time with a significant interaction between time and treatment. Unlike the initial study where only water was provided, adult survival decreased drastically at low temperatures ( $0\text{-}10^{\circ}\text{C}$ ), while survival between  $15\text{-}30^{\circ}\text{C}$  averaged  $> 68\%$ . Findings suggest that mortality at low temperatures could result from starvation or lack of feeding, and the critical threshold temperature required for ingestion lies between  $10\text{-}15^{\circ}\text{C}$ . In a third experiment comparing host plant presence and absence, 100% mortality occurred at 3, 21, 24 days exposure at 0, 5, and  $10^{\circ}\text{C}$ , respectively. This implies that GWSS adults cannot feed on a host plant at low temperatures ( $0\text{-}10^{\circ}\text{C}$ ), and further suggests that the threshold temperature for feeding falls between 10 and  $15^{\circ}\text{C}$ . Results from these experiments will be coupled with climatological data to help to spatially define where GWSS can be expected to persist in the agricultural landscape and identify where continued management efforts can be directed to limit introductions into currently non-infested areas.

## INTRODUCTION

Climate appears to play a significant role in the geographic distribution of diseases caused by *Xylella fastidiosa* (Xf) in California and throughout the southeastern United States (Purcell 1997). Similarly, populations of glassy-winged sharpshooter (GWSS), *Homalodisca coagulata*, in the southeastern United States appear to be constrained by climatic factors that limit the pest's establishment and persistence (Pollard and Kaloostian 1961, Hoddle 2004). Presently, limited information exists on the overwintering biology and ecology of GWSS in the San Joaquin Valley of California. A conclusion emerging is that GWSS may be limited by certain temperature thresholds at, or below which feeding may be discontinued and overwintering survivorship reduced. In turn, we are conducting experiments to carefully determine the thresholds below which feeding stops and to further determine the critical duration of time spent in this non-feeding state which may result in increased mortality. The results below and future experiments will advance our ability to define the specific environmental constraints that influence GWSS population dynamics and overwintering success by increasing our present understanding of the overwintering requirements of GWSS with a focus on critical environmental and host species factors that may limit population distribution in the Central Valley of California.

## OBJECTIVES

1. Identify the critical environmental constraints that influence the spatial population dynamics and overwintering success of GWSS in California's Central Valley.
2. Characterize the impact of host plant species succession on the overwintering survivorship of GWSS populations that constrain the insect's ability to become established and persist throughout the San Joaquin Valley.

## RESULTS

### Objective 1:

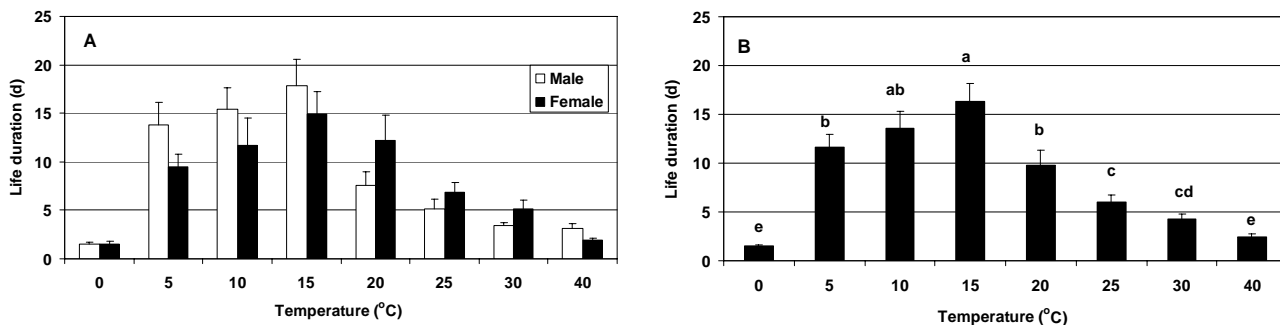
#### (1) *Effects of temperature on the survival of GWSS adults*

Experiments were conducted to determine effects of constant temperatures on the survival of GWSS adults for various exposure times under three different conditions: water-only, no water or host plant, and access to host plant. Laboratory-reared young adults were transferred from a field station of the California Department of Food Agriculture (CDFA), Arvin,

California, and maintained at the GWSS Experimental Laboratory on the campus of California State University Fresno (CSUF). Insects were about 2-weeks old when initially used in experiments.

#### Adult longevity when provided water only

An experiment was conducted to determine temperature effects on GWSS adult longevity with access only to water. Adults were sexed and individually placed in clear plastic tubes (33 ml) provisioned with moist cotton balls to allow constant access to water. Insects were held under the following temperature regimes: 0, 5, 15, 20, 25, 30, and 40 ( $\pm 1$ ) °C. Insect survival was monitored daily. Longevity of GWSS adults was significantly influenced by temperature ( $F = 18.99$ ;  $df = 7$ ;  $P < 0.001$ ) (Figure 1A). However, there was no significant effect relative to sex or interaction between sex and temperature. Because no significant difference between sexes was found, data for both sexes were pooled to compare the means among temperature treatments (Figure 1B). At 15 °C, adults survived the longest ( $16.3 \pm 1.8$  days). The shortest longevitys were at 0 and 40 °C (i.e.,  $1.5 \pm 0.1$  and  $2.5 \pm 0.3$  days, respectively). Overall, the longevity patterns imply that lack of a suitable host plant would result in greater reductions in survival at higher temperatures ( $\geq 25$  °C), where insects feed at higher rates due to an elevated metabolism. In comparison, adult longevitys at low temperature (5-15 °C) could result from both reduced feeding and a reduced metabolism. Because adults were prevented from feeding on suitable host plants, further experiments using suitable host plants were conducted to determine temperature impacts on survival that may be caused by reduced feeding (see results below).



**Figure 1.** GWSS adult longevity (days)(mean  $\pm$  SEM) when only provided access to a water source: (A) males and females separately (B) data pooled for both males and females. Values followed by different letters indicates significantly different mean values among treatments (SNK test,  $P < 0.05$ ).

Quantitative models were developed to describe the survivorship of GWSS in relation to the constant temperatures and exposure duration. Percentages of surviving adults were calculated at each time interval and the time to 50% mortality at each temperature was estimated by fitting the survivorship curve at each temperature to a sigmoid (polynomial) function. The survivorship curves illustrate a typical type III curve (Figure 2A), describing high initial loss followed by a period of much lower, relatively constant mortality (Pearl, 1928). Because the estimated curves were similar regardless of temperature conditions, the temperature-independent survivorship curve at normalized time (days/ days to 50% mortality) was also well described by the sigmoid function (Figure 2B;  $r^2 = 0.984$ ). The estimated times to 50% mortality were 0.6, 9.2, 9.6, 13.3, 6.1, 3.8, 2.8, and 1.5 exposure days at 0, 5, 10, 15, 20, 25, 30, and 40 °C, respectively. The same equation was also used to describe a temperature-independent survivorship curve at the normalized time, which was acquired by dividing the exposure time by the “time to 50% mortality” at each temperature. The relationship between temperature and the estimated time to 50% mortality was described by an extreme-value function. The model estimated that the longest time (12 days) to 50% mortality occurs at 11.1 °C (Figure 2C). The skewed bell shape of the time to 50% mortality indicates that the survival of this species was more seriously impaired by the exposure to high temperature in the given condition where this species only have access to a water source.

#### Adult longevity when provided with host plant

Temperature effects on adult GWSS longevity were determined for individuals provided a preferred overwintering host plant. Adults were sexed and placed in a clear plastic cylinder (60 cm X 15 cm diam.) provisioned with a ‘Frost Eureka’ lemon plant, *Citrus limon*. Ten adults (males and females) were separately placed within cylinders and held at the following temperature regimes: 0, 5, 10, 15, 20, 30, and 40 °C. The numbers of surviving adults were routinely monitored up to 21 days. Repeated measures ANOVA revealed that adult percent survival was significantly influenced by temperature ( $F = 70.93$ ;  $df = 6$ ;  $P < 0.001$ ) and exposure time ( $F = 133.03$ ;  $df = 5$ ;  $P < 0.001$ ), with a significant interaction between time and treatment ( $F = 8.94$ ;  $df = 30$ ;  $P < 0.001$ ) (Fig. 3). However, there was no significant effect of sex at any observation time ( $P > 0.05$ ). Regardless of sex, 100% mortality occurred at 7 days exposure at 0 °C. At 21 days exposure, mortality was higher than 80% at 0, 5, 10, and 40 °C. Unlike the initial study where only water was provided, adult survival decreased drastically at low

temperatures (0-10°C), while survival between 15-30°C remained > 68%. As an indicator of feeding activity, production of xylem excreta was not observed at temperatures ≤ 10°C, where most adults were found on the soil surface rather than on the plant stem or leaves. These findings suggest that mortality at low temperatures could result from starvation (or lack of feeding), and the critical threshold temperature lies between 10-15°C. Mortality at 40°C probably results from heat stress on the insect and / or possible plant deterioration caused by the highly active stylet penetration on plant stems, although no visible plant stress symptoms were observed.

***Comparison of survival between host and no-host conditions***

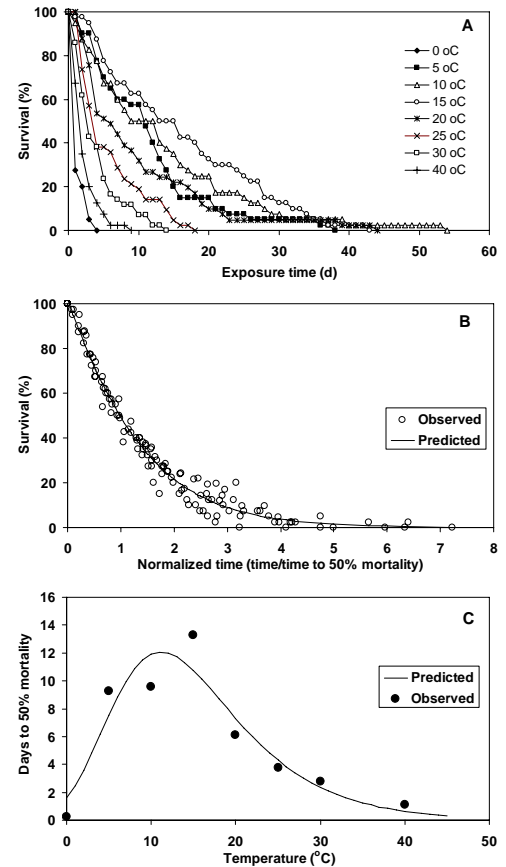
Because rapid mortality was observed at low temperatures, where xylem excretion did not occur, we hypothesized that lack of feeding was a major mortality factor. A third experiment was conducted to determine whether the presence of a host plant was a critical factor at certain temperatures, with a reasonable expectation that survival would not be different between host present and host absent conditions at temperatures where feeding does not occur. Because sex was not a significant factor in previous experiments, 10 GWSS adults (males and females combined) were observed when provided a lemon plant and denied a lemon plant. The numbers of surviving adults were routinely monitored until 100% mortality was obtained in all replications. Repeated measures ANOVA revealed that percent adult survival was significantly different between treatments at 20, 30, and 40°C ( $P < 0.001$ ). However, no significant treatment effects were observed at 0, 5, and 10°C ( $P > 0.05$ ). In all treatments, exposure time significantly affected survival ( $P < 0.0001$ ). Under both host and no-host conditions, 100% mortality occurred at 3, 21, and 24 days exposure at 0, 5, and 10°C, respectively. This implies that GWSS adults cannot feed on the host plant at low temperatures (0-10°C), and the threshold temperature for feeding falls between 10 and 15°C. This is consistent with the results of the previous experiment. Notably, host plant availability was a highly critical factor for survival at high temperatures ≥ 20°C, with 100% mortality observed at 7, 3, and 2 days at 20, 30, and 40°C, respectively. In the presence of a host plant, >70% of adults survived 7 weeks exposure time at 20 and 30°C. Currently, we are completing this trial, and further analysis will be conducted on the resulting data.

***(2) Effects of temperature on the feeding of GWSS adults***

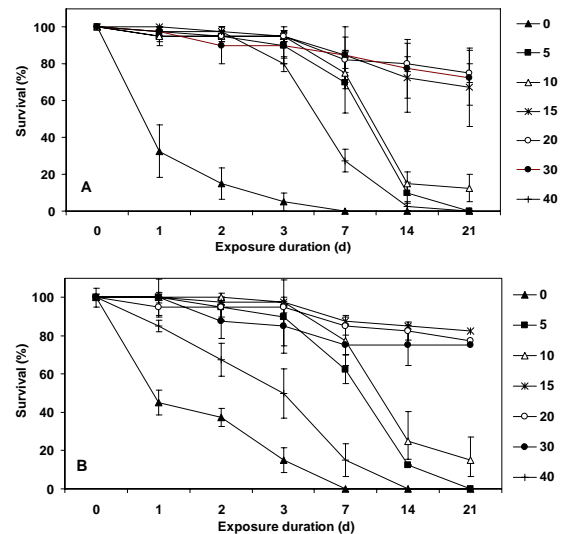
Laboratory experiments are underway to determine temperature effects on xylem excreta production by GWSS adults using a Parafilm sachet method (Pathak et al. 1982). Young GWSS adults (ca. 2 wk old) were individually confined inside a Parafilm sachet (7.5 x 6.5 cm) attached to the side of host plant ('Frost Eureka' lemon). Insects were held at 0, 5, 15, 20, 25, 30, and 40 (± 1)°C. Following 48-hr feeding, xylem excreta production (mg) was determined. At ≤ 15°C, no adults produced xylem excreta during the 48 hour period. The largest amount of xylem excreta production (2,200 mg) was at 40°C. We are currently replicating treatments for proper statistical analysis. After analysis, we will estimate the threshold temperature for production of xylem excreta of GWSS adults.

**Objective 2**

We encountered one challenge due to the legal restriction on maintaining live, caged GWSS adults in the field in quarantined areas in the San Joaquin Valley. Because of this, we plan to conduct the work in the infested areas of Kern County, where other related work has been conducted by our labs. Seasonal population dynamics of GWSS will be monitored on selected host plants placed in different micro-climatic areas of Kern County. In these experiments, we will



**Figure 2.** Survivorship curve at constant temperatures (A); the survivorship curve at normalized exposure time (days ÷ days to 50% mortality) (B); and temperature-dependent model for the time to 50% mortality (C). Adults had access to water only (i.e. from moist cotton) for feeding.



**Figure 3.** Percent survival (mean ± SEM) of GWSS adults provided a host plant ('Frost Eureka' lemon) at constant temperatures during 21 days exposure time: (A) males and (B) females.

examine GWSS survivorship in caged experiments on selected host plant species. In each cage, fifty 2<sup>nd</sup> generation GWSS adults, nearing reproductive diapause in the fall season, will be collected from natural infestations and released onto caged plants. Insects will be introduced onto potted plants placed in cages and populations monitored monthly throughout the winter period and in the subsequent spring. At each location, four caged replicates of host plant species including the plant species navel orange, grape, and peach will be evaluated individually and in combination. A detailed record of adult GWSS feeding and resting preference will be maintained from November 2005 to March 2006.

## **CONCLUSIONS**

Findings from the survival tests clearly indicate that the survival and feeding activity GWSS adult is significantly influenced by temperature and exposure duration. In particular, low temperatures caused rapid mortality. Availability of feeding was a critical factor for survival at high temperatures ( $\geq 20$  °C). This project has a high probability of success in terms of generating significant new information regarding the thermo-biology of GWSS in California. Models generated from the experiments on survival and feeding will allow for the spatial estimation of overwintering success of GWSS.

## **REFERENCES**

- Hoddle, M. S. 2004. *Crop Prot.* 23:691-699.  
Pathak, P.K, Saxena, R.C. and Heinrichs, E.A. 1982. *J. Econ. Entomol.* 75: 194-195.  
Pearl, R. 1928. *The Rate of Living.* Knopf, New York.  
Pollard, H. N., and Kaloostian, G. H. (1961). *J. Econ. Entomol.* 54: 810-811.  
Purcell, A. H. (1997). *J. Plant Pathology* 79: 99-105.

## **FUNDING AGENCIES**

Funding for this project was provided by the CDFR Pierce's Disease and Glassy-winged Sharpshooter Board.

# POPULATION DYNAMICS AND INTERACTIONS BETWEEN GLASSY-WINGED SHARPSHOOTER AND ITS HOST PLANTS IN RESPONSE TO CALIFORNIA PHENOLOGY

## Project Leaders:

Russell F. Mizell, III, and Peter C. Andersen  
University of Florida, NFREC  
Quincy, FL 32351

Phil A Phillips  
UC Cooperative Extension  
Ventura, CA 93003

## Cooperators:

Pascal Oevinger  
UC Cooperative Extension  
Ventura, CA 93003

Kent M. Daane  
University of California, Berkeley  
Division of Insect Biology  
Berkeley, CA 94720

Marshall W. Johnson  
Kearney Agricultural Station  
Parlier, CA 93648

Brent V. Brodbeck  
University of Florida, NFREC  
Quincy, FL 32351

Ben Faber  
UC Cooperative Extension  
Ventura, CA 93003

Peggy Mauk  
UC Cooperative Extension  
Moreno Valley, CA 92557

Gary S. Bender  
UC Cooperative Extension  
San Diego, CA 92123

**Reporting Period:** The results reported here are from work conducted November 2003 to July 2005.

## ABSTRACT

We determined the relative phenology of host plant use by glassy-winged sharpshooter (GWSS), other leafhopper vectors, natural enemies, and *Xylella fastidiosa* (*Xf*) in ornamental, agricultural and California native host plants in key California locations in climatically different regions: Coastal (Piru, Ventura County), Inland (Redlands, San Bernardino County), and South (Pauma Valley, San Diego County). In this study, the only host plant used frequently in all life stages was cottonwood. On grape and crape myrtle, nymphs and eggs were frequently recorded, while photinia, cherry and sycamore frequently hosted egg masses but not the other life stages. This research will be used to develop a GWSS performance database on the host plant species that are identified as truly critical to GWSS survival.

## INTRODUCTION

The focus of this research was to determine the relative phenology (the timing of biological events as influenced by the environment and intrinsic biological phenomena) of host plants use by GWSS, other leafhopper vectors, natural enemies, and *Xylella fastidiosa* (*Xf*) in ornamental, agricultural and California native host plants in key California locations in climatically different regions: Coastal (Piru, Ventura County), Inland (Redlands, San Bernardino County), and South (Pauma Valley, San Diego County). As year one of a three year study, we plan to replicate this years' observations (only if continued CDFR funding is reinstated and received) using fresh host plants at the same locations. Full analyses of results will not be available until after all data is collected and analyzed. The findings of this one season are therefore presented as preliminary results but serve as the final report for the funded research project. This research will be used to develop a GWSS performance database on the host plant species that are identified as truly critical to GWSS survival, which is needed to fully support decision making, and to supplement what is observed in the field. Currently, no quantitative data is available on the relative suitability of single or multiple hosts most relevant in southern California's agriculture, landscape or native vegetation, to GWSS growth and development. This project will provide this baseline information, identify host plant limitations at different life stages and will ultimately identify key nutrients responsible for this phenomenon.

## OBJECTIVES

1. Use 25 different host plant species in 4 replicates per location at 3 locations: Coastal (Piru, Ventura County), Inland (Redlands, San Bernardino County), and South (Pauma Valley, San Diego County) to determine: the age structure and utilization of GWSS on the host plants throughout the season; GWSS egg parasitization and mortality; GWSS fecundity and feeding rate on selected host plants; the presence of *Xf* in host plants; and the chemical composition of the host plant xylem fluids at tree times during the season.



## RESULTS

From April onwards, the GWSS age structure and resident generalist predators on 25 different host plants were observed weekly. In four replications, 25 potted (5gal) host plants were used to test the preference of resident GWSS at 3 southern California locations within unsprayed citrus orchards. For each replication, 25 plant pots were placed in a completely randomized block design within the rows. Each block was enclosed in a square 1.5x1.5 m pen made with chicken wire. Plants were hand watered 2-3 times per week. The plant species were selected for their common ornamental or agricultural use or their status as orchard weeds or their occurrence in foothill and riparian environments in southern California (Table 1). Batch samples from each of the host plant species were tested for the presence of *Xf* on three occasions between April and July. With the exception of one *Hedera helix* batch sample in May, all batch samples tested negative. In follow-up tests of single *Hedera helix* plants, no individual plant tested positive for *Xf*.

**Table 1.** Mean number of egg masses, adults and nymphs recorded per GWSS host plant species in Piru, Redlands and Pauma Valley, California.

Plant	Plant name	Common name	Egg masses <sup>1</sup>	Adults <sup>2</sup>	Nymphs <sup>3</sup>
1	<i>Hibiscus</i> sp.	'Mrs. J. E. Hendrey' hibiscus	3.42 ± 1.064 abc	10.50 ± 4.265 a	3.42 ± 0.908 ab
2	<i>Lagerstroemia indica</i>	Crape Myrtle	9.58 ± 1.607 de	34.25 ± 20.350 a	17.92 ± 5.113 d
3	<i>Nerium oleander</i>	Oleander (white)	O	19.75 ± 8.294 a	10.17 ± 2.925 bc
4	<i>Gardenia jasminoides</i>	'Mystery' Gardenia	1.50 ± 0.832 ab	0.42 ± 0.193 a	2.17 ± 0.842 ab
5	<i>Citrus</i> sp.	Valencia Orange	2.42 ± 1.314 abc	13.15 ± 3.175 a	11.17 ± 3.164 c
6	<i>Photinia</i> sp.	Red Tip Photinia	6.67 ± 2.021 cd	2.08 ± 0.763 a	4.92 ± 1.681 abc
7	<i>Eucalyptus cinerea</i>	Silver Dollar Tree	0.50 ± 0.167 a	0.33 ± 0.188 a	0.50 ± 0.289 a
8	<i>Vitis vinifera</i>	Thompson Seedless Grape	11.17 ± 2.49 e	14.42 ± 3.019 a	29.75 ± 6.516 e
9	<i>Euonymus japonica</i>	Silver Queen	1.92 ± 0.654 ab	0.92 ± 0.358 a	0.25 ± 0.131 a
10	<i>Ligustrum japonicum</i>	'Texanum' Wax Leaf Privet	1.58 ± 0.617 ab	1.25 ± 0.494 a	3.25 ± 0.970 ab
11	<i>Agapanthus africanus</i>	Lily of the Nile	2.00 ± 0.834 ab	1.08 ± 0.336 a	0.42 ± 0.193 a
12	<i>Hedera helix</i>	English ivy	0.33 ± 0.243 a	1.08 ± 0.763 a	0.83 ± 0.297 a
13	<i>Sonchus oleraceus</i>	Sowthistle	O	O	0.08 ± 0.083 a
14	<i>Chenopodium berlandieri</i>	Lambsquarter	O	0.33 ± 0.188 a	0.33 ± 0.256 a
15	<i>Malva neglecta</i>	Cheeseweed	O	O	0.92 ± 0.288 a
16	<i>Senecio vulgaris</i>	Common Groundsel	O	O	O
17	<i>Rhus integrifolia</i> *	Lemonade Berry	0.33 ± 0.263 a	0.58 ± 0.193 a	1.17 ± 0.767 a
18	<i>Heteromeles arbutifolia</i> *	Toyon	2.00 ± 0.872 ab	0.33 ± 0.188 a	0.67 ± 0.497 a
19	<i>Baccharis pilularis</i> *	Coyote Brush	1.25 ± 0.740 ab	0.92 ± 0.609 a	1.42 ± 0.434 a
20	<i>Lonicera subspicata</i> *	Honeysuckle	0.08 ± 0.083 a	0.17 ± 0.112 a	0.08 ± 0.083 a
21	<i>Opuntia basilaris</i> *	Beavertail Cactus	O	O	0.33 ± 0.333 a
22	<i>Oenothera speciosa</i>	Mexican Evening Primrose	0.33 ± 0.067 a	0.25 ± 0.131 a	1.42 ± 0.452 a
23	<i>Populus candicans</i>	Cottonwood	4.92 ± 1.493 bc	205.67 ± 96.643 b	54.25 ± 8.927 f
24	<i>Platanus occidentalis</i>	"Bloodgood" Sycamore	13.33 ± 3.404 e	12.75 ± 4.961 a	6.58 ± 1.694 abc
25	<i>Prunus subhirtella</i>	Akebone Ornamental Cherry	13.83 ± 4.606 e	17.08 ± 8.164 a	4.67 ± 1.689 abc

\*: California native plant

O: life stage not recorded on host plant species

<sup>1</sup> Mean number of egg masses recorded on host plant species over all three locations (different letters indicate significant differences, Kruskal Wallis  $t=133.69$ ,  $P<0.0001$ ).

<sup>2</sup> Mean number of adults recorded on host plant species over all three locations (different letters indicate significant differences, Kruskal Wallis  $t=154.54$ ,  $P<0.0001$ ).

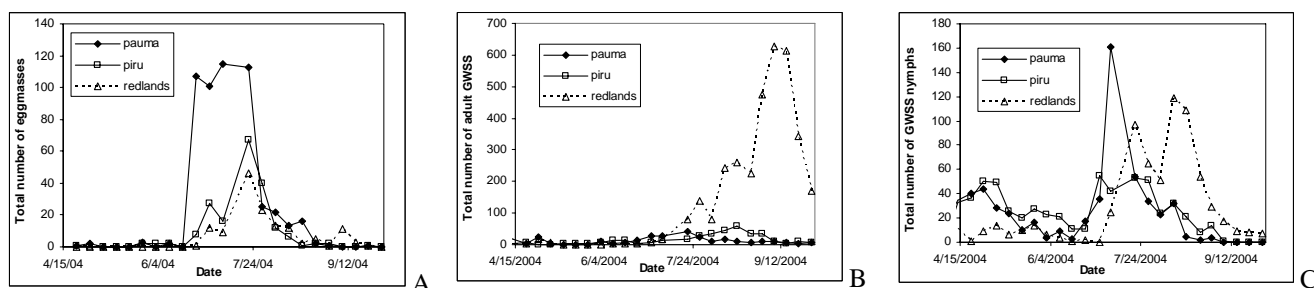
<sup>3</sup> Mean number of nymphs recorded on host plant species over all three locations (different letters indicate significant differences, Kruskal Wallis  $t=194.54$ ,  $P<0.0001$ ).

When considering life stages at the different locations, more egg masses were found on the host plants in Pauma Valley between June 24 and August 19 compared to both Piru and Redlands in the same period (unequal variance: Kruskal Wallis:  $t=7.237$ ,  $P=0.027$ ) (Figure 1A). The numbers of eggs per egg mass were significantly higher in Pauma (ANOVA  $df=2$ ,  $F=10.93$ ,  $P<0.001$ ), a larger proportion of the eggs were parasitized in Pauma (ANOVA  $df=2$ ,  $F=10.67$ ,  $P<0.001$ ), with no difference in emergence of eggs masses (ANOVA  $df=2$ ,  $F=3.04$ ,  $P=0.05$ ). The portion survival of eggs per egg mass is lowest in Pauma (ANOVA  $df=2$ ,  $F=10.80$ ,  $P<0.001$ ) (Table 2). Of the parasitized egg masses recorded in Piru, all were *Gonatocerus* sp., but in Redlands 6% were parasitized by *Trichogramma* sp as were 4% of the egg masses from Redlands. The survival of *Trichogramma* parasitized egg masses was  $0.595 \pm 0.0544$  significantly lower than the survival of *Gonatocerus* parasitized egg masses  $0.764 \pm 0.011$  (unequal variance: Kruskal Wallis  $t=11.89$ ,  $P=0.000563$ ). No differences were found between the egg mass size and the fraction parasitized for *Trichogramma* or *Gonatocerus* (results not shown).

**Table 2.** The survival, fraction parasitized and fraction emerged parasitoids recorded in GWSS egg masses in Piru, Redlands and Pauma Valley, California.

	Location			ANOVA		
	Piru	Redlands	Pauma Valley	df	F	P
N	197	172	557			
#eggs/egg mass	11.56 ± 0.467 a	12.02 ± 0.499 a	13.81 ± 0.278 b	2	10.93	<0.001
Survival	0.847 ± 0.024 b	0.795 ± 0.025 b	0.725 ± 0.014 a	2	10.80	<0.001
Fraction parasitized	0.666 ± 0.029 b	0.676 ± 0.031 b	0.545 ± 0.020 a	2	10.67	<0.001
Fraction emerged parasitoids	0.804 ± 0.029 a	0.848 ± 0.031 a	0.762 ± 0.019 a	2	3.04	0.051

No egg masses were recorded on oleander, sowthistle, cheeseweed, lambsquarter, common groundsel or beavertail cactus. Over all sites, the mean number of egg masses recorded was largest on sycamore, cherry and grape, followed by crape myrtle and photinia (Table 1). The number of egg masses per host plant species differed significantly for crape myrtle, eucalyptus, grape, primrose and cottonwood, on which fewer egg masses were found in Piru and Redlands than in Pauma (results not shown). In Piru, most egg masses were recorded on sycamore and cherry, followed by grape. In Redlands, most egg masses were recorded on grape, followed by crape myrtle and photinia, which had more egg masses than sycamore and cherry. In Pauma, most egg masses were recorded on crape myrtle, grape, sycamore and cherry followed by photinia. Because of unequal variances, the Kruskal Wallis test was used for these analyses with  $P < 0.0001$  in all cases (results not shown).



**Figure 1.** Total number of GWSS egg masses (A), adults (B) and nymphs (C) recorded between April and October 2004, on 100 plants located in a citrus orchard in Piru, Redlands and Pauma Valley, CA.

When considering GWSS adults at the different locations, more were found on the host plants in Redlands between June 16 and October 1 compared to both Piru and Pauma in the same period (unequal variance: Kruskal Wallis:  $t=8.4481$ ,  $P=0.0146$ ) (Figure 1B). Adults were not recorded on sowthistle, cheeseweed, common groundsel or beavertail cactus. Over all sites, the mean number of adults recorded was largest on cotton wood (Table 1). In Redlands, more adults were found on hibiscus, oleander, Valencia orange, photinia, euonymus, ligustrum, cottonwood and cherry than in Piru or Pauma (results not shown). In Piru and in Redlands, more adults were recorded on cottonwood than on any other host plant species ( $t=59.75$ ,  $P < 0.00001$  and  $t=72.05$ ,  $P < 0.00001$  respectively). In Pauma, most adults were recorded on cotton wood, but these did not differ significantly from sycamore and grape ( $t=63.61$ ,  $P < 0.00001$ ). Because of unequal variances the Kruskal Wallis test was used for these analyses (results not shown). The data on the immature GWSS were collected as small, medium and large GWSS nymphs. For the purpose of these preliminary analyses, the stages were added to present one number per host plant per observation at each location. The number of GWSS nymphs at the different locations changed through the season. From April though June, significantly fewer nymphs were recorded in Redlands when compared to Pauma and Piru in the same period (unequal variance: Kruskal Wallis:  $t=10.04$ ,  $P=0.0066$ ) (Figure 1C). From late July through October, significantly fewer nymphs were recorded in Piru, when compared to Redlands and Pauma in the same period (unequal variance: Kruskal Wallis:  $t=7.78$ ,  $P=0.0204$ ) (Figure 1B). No nymphs were recorded on common groundsel. Over all sites the mean number of nymphs recorded was largest on cotton wood, followed by significantly lower numbers on grape, crape myrtle, and Valencia orange (Table 1). No differences were found when comparing numbers of nymphs per host plant species between the locations (results not shown). In Piru, most nymphs were recorded on cottonwood, followed by grape and citrus ( $t=70.3$ ,  $P < 0.00001$ ). In Redlands, most nymphs were also recorded from cottonwood, followed by grape and crape myrtle ( $t=72.49$ ,  $P < 0.00001$ ). In Pauma Valley, most nymphs were found on cottonwood and grape, followed by crape myrtle and Valencia orange ( $t=68.92$ ,  $P < 0.00001$ ). Because of unequal variances the Kruskal Wallis test was used for these analyses (results not shown).

On June 30, July 1-2, August 10-12, and September 28-30, xylem fluid samples were taken from all host plants except oleander, amaranthus, ivy, sowthistle, common groundsel, cheeseweed, lambsquarter, honey suckle, primrose and beavertail. These species were omitted because experience has shown that they do not comply with the technique used for xylem extraction, rendering the sampling impossible. With the use of a nitrogen gas pressure chamber, 150-600 $\mu$ l was collected per plant and frozen for storage. The xylem fluid from five host species (cottonwood, crape myrtle, cherry, grape, and sycamore) was chemically analyzed for amino acid content (four replications for each species per site per date). Species were selected based on GWSS utilization and consistency of xylem extraction (healthy hardwoods of each species were present at all sites). The five species varied greatly in amino acid composition with cottonwood consistently (8 of the 9 site/date combinations)

having the highest titers of total amino acids. Amino acid profiles (ratios of individual amino acids) varied greatly with host species (mean values for each species are shown in Table 3). Concentrations of amino acids were also site and date dependent. When the chemical composition of each host species was analyzed separately as a factorial (3 locations x 3 sites for each of the five species), concentrations of individual amino acids were found to be greatly impacted by site and time of year. For the models analyzed (95 = 5 host species x 19 dependent variables (individual amino acids)) over 40% of the models showed significant effects ( $P < 0.05$ ) of site and location. Date has significant effects ( $P < 0.05$ ) in over 30% of these analyses, location was significant 26% and interactions (date\*location) was significant in 17% of the models. We are currently entering all nutritional data (xylem chemistry) and insect data into an ongoing database to determine nutritional correlates to GWSS host utilization. This analysis is ongoing, but it is clear that our preliminary data is consistent with previous nutritional studies of GWSS. For example, cottonwood is consistently the host providing the highest overall concentrations of amino acids (Table 3) and is also the host most frequently utilized by GWSS in our plots. Cottonwood also has amide-rich (glutamine plus asparagine) profiles which have been previously shown to be correlated with GWSS abundances and feeding rates (Brodbeck et al. 1990, Andersen et al. 1992). We will continue to analyze this data to determine nutritional correlates to other aspects of GWSS life history.

**Table 3.** Mean  $\mu\text{M}$  concentrations of amino acids for five host species averaged over the collection locations and three sampling dates.

Amino Acid	Cottonwood	Crape Myrtle	Grape	Cherry	Sycamore
Aspartic Acid	54 $\pm$ 6	22 $\pm$ 5	35 $\pm$ 3	108 $\pm$ 18	32 $\pm$ 5
Glutamic Acid	75 $\pm$ 9	27 $\pm$ 4	30 $\pm$ 3	84 $\pm$ 14	47 $\pm$ 7
Asparagine	204 $\pm$ 77	5 $\pm$ 2	5 $\pm$ 1	93 $\pm$ 19	51 $\pm$ 24
Serine	34 $\pm$ 4	10 $\pm$ 1	17 $\pm$ 2	30 $\pm$ 6	26 $\pm$ 4
Glutamine	629 $\pm$ 143	33 $\pm$ 11	164 $\pm$ 49	45 $\pm$ 11	28 $\pm$ 6
Glycine	24 $\pm$ 3	6 $\pm$ 1	12 $\pm$ 2	17 $\pm$ 4	13 $\pm$ 2
Histidine	21 $\pm$ 4	2 $\pm$ 0.5	13 $\pm$ 3	8 $\pm$ 3	21 $\pm$ 4
Arginine	72 $\pm$ 13	22 $\pm$ 10	57 $\pm$ 15	188 $\pm$ 38	56 $\pm$ 20
Threonine	25 $\pm$ 7	4 $\pm$ 1	7 $\pm$ 1	15 $\pm$ 3	9 $\pm$ 1
Alanine	60 $\pm$ 7	20 $\pm$ 4	25 $\pm$ 3	32 $\pm$ 4	44 $\pm$ 6
Proline	19 $\pm$ 2	8 $\pm$ 1	17 $\pm$ 3	20 $\pm$ 3	16 $\pm$ 2
Valine	62 $\pm$ 17	10 $\pm$ 2	12 $\pm$ 2	12 $\pm$ 2	17 $\pm$ 2
Isoleucine	38 $\pm$ 11	9 $\pm$ 1	10 $\pm$ 1	10 $\pm$ 1	12 $\pm$ 1
Leucine	15 $\pm$ 2	7 $\pm$ 2	7 $\pm$ 1	5 $\pm$ 0.5	10 $\pm$ 1
Phenylalanine	6 $\pm$ 1	2 $\pm$ 1	2 $\pm$ 0.3	4 $\pm$ 1	4 $\pm$ 1
Lysine	4 $\pm$ 0.4	2 $\pm$ 0.2	2 $\pm$ 0.3	4 $\pm$ 1	5 $\pm$ 1
Total	1344 $\pm$ 213	189 $\pm$ 32	415 $\pm$ 62	673 $\pm$ 90	391 $\pm$ 58

## CONCLUSIONS

The data thus far indicates that the most eggs, nymphs and adults are not necessarily recorded on the same plant species as has been reported before (Brodbeck et al. 1999). In this study the only host plant used frequently in all life stages is cottonwood. On grape and crape myrtle, nymphs and eggs are frequently recorded, while photinia, cherry and sycamore frequently hosted egg masses but not the other life stages. The suitability of the host plants for these GWSS life stages may be linked to the chemical composition of the xylem fluids (Andersen et al. 1992, Brodbeck et al. 1990, 1993, 1995, 1996, 1999). Sawthistle, common groundsel, lambsquarter, cheeseweed, primrose and beavertail did not host large GWSS numbers, if any. During 2005, the location influenced the size of GWSS egg masses (larger egg masses in the south), survival (lower in the south) and parasitism (lower in the south). The underlying factors may be related to temperature and humidity which have been recorded but have not been correlated to the findings yet. The major difference between the coastal and inland locations at similar latitude is the number of second generation adults, and all life stages from the second generation are responsible for most of the location differences. Aside from the egg masses, there are no obvious differences in the other life stages recorded in the coastal and southern location. The results of the xylem fluid analyses support our hypotheses that the phenology of host plants needs to be considered at each location, as this data clearly shows that the underlying host physiology varies with location as well as time of year.

## REFERENCES

- Andersen, P. C., B. Brodbeck and R. F. Mizell, III. 1992. Feeding by the leafhopper, *Homalodisca coagulata* in relation to xylem fluid chemistry and tension. *J. Insect Physiol.* 38: 611-622.
- Brodbeck, B. V., P. C. Andersen & R. F. Mizell, III. 1993. Physiological and behavioral adaptations of three species of leafhoppers in response to the dilute nutrient content of xylem fluid. *J. Ins. Physiol.* 39:73-81.
- Brodbeck, B. V., P.C. Andersen & R.F. Mizell, III. 1995. Differential utilization of nutrients during development by the xylophagous leafhopper, *Homalodisca coagulata*. *Ent. Exp. & Appl.* 75:279-289.
- Brodbeck, B. V., P. C. Andersen & R. F. Mizell, III. 1996. Utilization of primary nutrients by the polyphagous xylophage, *Homalodisca coagulata*, reared on single host species. *Arch. Biochem. and Physiol.* 32:65-83.

Brodbeck, B.V., P. C. Andersen & R. F. Mizell, III. 1999. The effects of total dietary nitrogen and amino acid balance on the development of xylophagous leafhoppers. Arch. of Ins. Biochem. & Physiol. 42:37-50.

Brodbeck, B. V., R. F. Mizell, III & P.C. Andersen. 1990. Amino acids as determinants of host preference for the xylem-feeding leafhopper, *Homalodisca coagulata*. Oecologia 83:338-345.

#### **FUNDING AGENCIES**

Funding for this project was provided by the CDFFA Pierce's Disease and Glassy-winged Sharpshooter Board.

# RELATIONSHIP BETWEEN OLFACTORY AND VISUAL STIMULI DURING HOST PLANT RECOGNITION IN IMMATURE AND ADULT GLASSY-WINGED SHARPSHOOTERS

## Project Leaders:

Joseph M. Patt and Mamoudou Sétamou  
USDA, ARS, Beneficial Insects Research Unit  
Weslaco, TX 78596

## Research Personnel:

Rosa I. Ruiz  
USDA, ARS, Beneficial Insects Research Unit  
Weslaco, TX 78596

**Reporting Period:** The results reported here are from work conducted October 2004 to September 2005.

## ABSTRACT

The interactive effects between visual and olfactory stimuli in host plant recognition and location by glassy-winged sharpshooter (GWSS) may be subtle. Thus, observation and evaluation of these interactions will require the development of behavioral assays that take into account host searching behaviors specific to GWSS. A prototype behavioral assay in which adult and immature GWSS are presented with combinations of visual and olfactory stimuli has been developed. Protocols for the presentation of various combinations of stimuli have been evaluated and standardized. Information generated from this approach may provide insight into processes (such as host plant selection and interplant movement by GWSS) that may be otherwise difficult to detect because of the complexity inherent at larger spatial scales.

## INTRODUCTION

Although visual cues are of primary importance in host location and selection behavior in leafhoppers (Todd, et al. 1990a; Mizell 2001; Mizell and Andersen 2001; Hix et al. 2003; Tipping, et al. 2004), very little is known about possible interactions between visual and olfactory stimuli in this regard. That plant volatiles can strongly influence host searching and recognition behavior in cicadellids was demonstrated by Todd et al. (1990b) who examined the maize specialist *Dalbulus maidus*. However, the high degree of polyphagy observed in GWSS will challenge efforts to determine the role of volatile stimuli in this insect's searching behavior (Leal 2001). Preliminary results have been reported on volatiles emitted by GWSS host plants (Leal et al. 2001), but the relative importance of plant volatiles in host plant location and recognition in GWSS has not been demonstrated with certainty (Leal et al. 2001; Mizell 2001; Mizell and Andersen 2001). Since other highly polyphagous insects utilize plant volatiles in concert with visual cues to locate host plants (Metcalf and Metcalf 1992) it is not inconceivable that plant volatiles play some role in GWSS host location behavior (Leal et al. 2001).

The interactive effects between visual and olfactory stimuli may be subtle and their observation and evaluation will require the development of behavioral assays that take into account host searching behaviors specific to GWSS (as was done by Todd et al. (1990b) for *D. maidus*). Information generated from this approach may provide insight into processes (such as interplant movement by GWSS) that may be otherwise very difficult to detect because of the complexity inherent in larger scale phenomena. Since nymphs can easily move between plants it is important to understand the nature of the stimuli they use to locate host plants (Tipping et al. 2004). As well, information derived from studies of nymphs can help inform the design of experiments for adults.

## OBJECTIVES

1. Develop a behavioral assay that permits observation and evaluation of responses of adult and immature GWSS to combinations of olfactory and visual stimuli.
2. Determine the relative importance and possible synergistic effects of combinations of olfactory and visual cues in host plant recognition in adult and immature GWSS.

## RESULTS

Preliminary results showed a positive interactive effect between visual and olfactory stimuli in host plant recognition and selection by both immature and adult GWSS. A manuscript describing the design of the behavioral chamber and the results of ongoing experiments will be submitted for publication in the near future.

## CONCLUSIONS

We have developed a laboratory assay designed to accommodate the behavioral attributes of immature and adult GWSS. This approach will prove useful in determining the relative importance and interactive effects of olfactory and visual cues in GWSS searching behavior. This information will, in turn, provide insights into the complex set of cues utilized by GWSS during movements between plants and habitats.

## REFERENCES

- Hix, R. L., McGuire, M. R., and Puterka, G. (2003) Development of trapping systems to trap glassy-winged sharpshooter (*Homalodisca coagulata*) adults and nymphs in grape. (2003) Proceedings of the 2003 Pierce's Disease Research Symposium. California Department of Food and Agriculture.
- Leal, W. S. Developing a novel detection and monitoring system for the GWSS. (2001) Glassy-Winged Sharpshooter and Pierce's Disease Research Summaries FY 2000-2001/2001-2002. California Department of Food and Agriculture.

- Leal, W. S., Zalom, F. G., and Phillip, P. A. (2001) Developing a novel detection and monitoring system for the GWSS. (2001) Proceedings of the 2001 Pierce's Disease Research Symposium. California Department of Food and Agriculture.
- Metcalf, R. L., and Metcalf, E. R. (1992) Japanese Beetle. *In*: Plant Kairomones in Insect Ecology and Control, pp. 52-63. Chapman and Hall, New York.
- Mizell, R. W. III. (2001) Keys to Management of GWSS: Interactions between host plants, malnutrition, and natural enemies. Glassy-Winged Sharpshooter and Pierce's Disease Research Summaries FY 2000-2001/2001-2002. California Department of Food and Agriculture.
- Mizell, R. W. III, and Andersen, P. C. (2001). Host selection behavior and improved detection for glassy-winged sharpshooter, *Homalodisca coagulata* (Say). Proceedings of the 2001 Pierce's Disease Research Symposium. California Department of Food and Agriculture.
- Tipping, C., Mizell, R.F. III, and Andersen, P. C. (2004) Dispersal adaptations of immature stages of three species of leafhopper (Hemiptera: Auchenorrhyncha: Cicadellidae). *Florida Entomol.* 87: 372-379.
- Todd, J. L., Harris, M. O., and Nault L. R. (1990a) Importance of color stimuli in host finding by *Dalbulus* leafhoppers. *Entomol. Exp. Appl.* 54: 245-255.
- Todd, J. L., Phelan, P. L., and Nault, L. R. (1990b). Interaction between visual and olfactory stimuli during host-finding by leafhopper *Dalbulus maidus* (Homoptera: Cicadellidae). *J. Chem. Ecol.* 16: 2121-2133.

#### **FUNDING AGENCIES**

Funding for this project was provided by the USDA Agricultural Research Service.

# EFFECTS OF FEEDING SUBSTRATE ON RETENTION AND TRANSMISSION OF *XYLELLA FASTIDIOSA* STRAINS BY THE GLASSY-WINGED SHARPSHOOTER

## Project Leaders:

Thomas M. Perring and Heather S. Costa  
Department of Entomology  
University of California  
Riverside, CA 92521

Donald A. Cooksey  
Department of Plant Pathology  
University of California  
Riverside, CA 92521

**Reporting Period:** The results reported here are from work conducted September 2004 to September 2005.

## ABSTRACT

This is a continuation of our three year project designed to study the effect of feeding substrate on the acquisition and retention of *Xylella fastidiosa* (*Xf*) by the glassy-winged sharpshooter (GWSS), *Homalodisca coagulata*. We are using two strains of *Xf* that are present in California: a Pierce's disease (PD) strain that infects grape, and an oleander leaf scorch (OLS) strain that infects oleander. Last year we reported that GWSS that acquired the PD strain from grape or the OLS strain from oleander and subsequently confined to chrysanthemum (a non-*Xf* host), retained the bacterium at least seven days after exclusive feeding on the non-host. Thus, *Xf* in the GWSS foregut does not need continual access to host plant xylem. Secondly, we reported that GWSS transmitted PD and OLS strains when they acquired the bacteria from a plant, but they did not transmit either strain when media-grown bacteria were delivered through the cut-stem system. This result forces us to use whole plants as our bacterial source in transmission experiments.

This past year, we focused on objectives 3-5. Studies showed that GWSS given access to PD, followed by OLS, retained both PD and OLS and transmitted PD at a higher rate than OLS. When GWSS were given access to OLS followed by PD, they retained PD at a much higher rate than OLS and transmission to plants was poor. Results suggest that PD may have become established in the foregut better than OLS or that it out-competed the OLS strain. Further analyses showed that sharpshooters which tested positive for only the OLS strain had a higher percentage inoculation rate of the PD strain. Possible explanations for these results are provided. For objective 4, we found that antibiotics effectively killed *Xf* in the GWSS foregut by treating either before or after bacterial acquisition. In our last objective, there was no difference in survival of PD at pH ranging from 4.5 to 9.8.

## INTRODUCTION

The GWSS is capable of acquiring and transmitting several strains of *Xf* from a variety of host plants. In this project we are testing the effects of feeding substrate on the acquisition, retention and transmission of *Xf* by GWSS. Two strains of the pathogen present in California are being used in these experiments: a PD strain that infects grapevine, and an OLS strain that infects oleander. These two strains have different host ranges; the PD strain does not infect oleander, and the OLS strain does not infect grape. It is known that both strains are capable of multiplying in GWSS mouthparts, because the insect is capable of retaining and transmitting both strains of the pathogens (Purcell and Hopkins, 1996, Purcell et al. 1999, Costa et al. 2000). It is assumed that *Xf* in the insect mouthparts are surviving on nutrients obtained from the host plant xylem, and would be exposed to other chemical components present in the xylem fluid. Thus, we might expect that the retention and replication of a particular strain of the pathogen in an individual insect would be dependant on the xylem content of the plant host on which it is feeding. For example, it would be expected that the oleander strain would grow better in insects feeding on oleander, the grape strain would grow better in insects feeding on grape, and alternate feeding on both hosts might increase the incidence of retention of both strains in an individual.

The exact mechanism of *Xf* successful attachment and replication in insect mouthparts is unknown. However, a variety of components have been identified as contributing to the initial adhesion and subsequent growth of *Xf* in plants and in media culture. The goal of the last two objectives of this proposal is to alter the feeding substrate with a resultant change in the environment in the insect mouthparts, and examine the subsequent effects on attachment, retention, and transmission of *Xf*. For example, we have used pre-treatments antimicrobials to determine if other microbes present in biofilms of the GWSS mouthparts play a significant role in the successful attachment and transmission of *Xf*. Post-acquisition treatments can identify the types of materials that can successfully kill or stop the growth of the organisms once they are present in insect mouthparts. In addition, if ionic bonding is involved in the initial attachment of *Xf* in insect mouthparts, we can modify substrate pH or vary the amount of free radicals available in substrates, and examine the effect on acquisition rate. The results of these studies will provide information on susceptibility of *Xf* to environmental disruption in insect mouthparts.

## OBJECTIVES

1. Compare retention times of *Xf* when infected GWSS are subsequently fed on plants that are either hosts or non-hosts of the strain they carry.
2. Compare acquisition and transmission efficiency of insects fed on infected plants to those fed on media-grown cultures delivered through cut stems.

3. Compare retention times of two strains of *Xf* in GWSS when they are acquired through sequential exposure to infected oleander and grape plants on alternating hosts of each strain.
4. Test the effects of antibacterial materials on acquisition and transmission of *Xf* by GWSS.
5. Test the effects of variation in substrate pH and free ion availability on the acquisition and transmission of *Xf* by GWSS.

## RESULTS

### Objective 3

In our studies we used clean GWSS from our greenhouse culture. Two treatment groups were established; 1 group was given a 48 hour acquisition access period (AAP) to grape plants infected with PD, followed by a 48 hr. AAP to oleander infected with OLS. The other group was exposed to OLS followed by exposure to PD. After the AAP, insects were individually transferred to grape and oleander test plants, where they were allowed to feed for 24 hrs. The insects then were moved to the alternate host plant for the successive 24 hr period. This serial transmission was repeated every 24 hrs, until the insect died. Once the insects were dead, the heads were processed, DNA was extracted, and PCR was performed with strain-specific primers to verify the bacterial strain infecting them. The test plants were grown in a greenhouse and once per month for a period of three months, tissue was collected and submitted to ELISA testing.

Our studies show that GWSS given access to PD, followed by OLS, retained PD in 9 of 20 cases, OLS in 6 of 20 cases and had both strains in 3 of 20 cases (Table 1). In 2 insects we did not amplify any DNA. These insects transmitted OLS to 8 of 50 oleander test plants (16%) and they transmitted PD to 23 of 57 grape test plants (40.4%). When GWSS were given access to OLS followed by PD, they retained PD in 13 of 20 cases and OLS in 2 of 20 cases. Five of the 20 GWSS retained both strains. Interestingly, transmission to plants was poor, with only 4 OLS positives out of 45 oleander test plants (8.9%) and 3 PD infections out of 44 grape test plants (6.8%). The fact that transmission of PD was substantially greater than OLS transmission, even when insects were given access to OLS after PD, suggests that the PD strain may have become established in the foregut better than the OLS strain or that it out-competed the OLS strain. The converse did not occur when the first access was to the OLS strain, and transmission in this situation was nearly the same between PD and OLS (Table 1).

**Table 1.** Results from retention and transmission studies where GWSS were given access to PD followed by OLS and to OLS followed by PD.

Order of acquisition (n)	# with PD	# with OLS	# with PD and OLS	PD Inoculation Rate # infected / # tested (%)	OLS Inoculation Rate # infected / # tested (%)
PD – OLS (18)	9	6	3	23 / 57 (40.4%)	8 / 50 (16.0%)
OLS – PD (20)	13	2	5	3 / 44 (6.8%)	4 / 45 (8.9%)

Further analyses were conducted after we categorized the data by *Xf* strain retained by the insects. When PD acquisition was followed by OLS, the GWSS that tested positive for only the PD strain transmitted both strains with 19.4% transmission of PD and 4.8% transmission of OLS (Table 2). The insects that tested positive for only OLS transmitted both strains as well; 28.6% and 14.3% for PD and OLS, respectively. It is interesting that the sharpshooters that tested positive for only the OLS strain had a higher percentage infection of the PD strain. A possible explanation for these results is that during the serial transmissions, there was bacteria of both strains in the insects, thus they inoculated both strains in the test plants. As time progressed, insect lost one of the strains and when they died (the time they were collected for PCR assay) there was only a single strain left in the foregut. It also is possible that interactions between the strains in the foregut played a role in which strain was transmitted and which strain was retained in the foregut until the end of the insect's life. In the OLS followed by PD treatment, only PD was found in 13 of the 20 insects and of these 3 inoculated PD and 1 inoculated OLS. For the GWSS which contained only OLS, there was a single infection of OLS in the serial transmissions.

**Table 2.** Results from retention and transmission studies where GWSS were given access to PD followed by OLS and to OLS followed by PD, categorized by the strain that was identified in the insect after it died.

Order of acquisition (n)	Strain in Insect (n)	PD Inoculation Rate # infected / # tested (%)	OLS Inoculation Rate # infected/# tested (%)
PD – OLS (18)	PD (9)	12 / 62 (19.4%)	3 / 62 (4.8%)
	OLS (6)	8 / 28 (28.6%)	4 / 28 (14.3%)
	Mixed (3)	2 / 8 (25.0%)	0 / 8 (0%)
	Unknown (2)	1 / 11 (9.1%)	1 / 11 (9.1%)
OLS – PD (20)	PD (13)	3 / 60 (5.0%)	1 / 60 (1.7%)
	OLS (2)	0 / 10 (0%)	1 / 10 (1.0%)
	Mixed (5)	0 / 19 (0%)	2 / 19 (10.5%)



We also learned that both strains were retained by GWSS (“mixed” in Table 2). However, transmission to plants by these multiply-infected GWSS was very low, just 4 of 27 infections (1.5%). In all cases only one strain was transmitted, further suggesting that there is an interaction between strains in the GWSS foregut. The low transmission rate raises questions about the interactions between the two strains when they are in the same insect and the subsequent consequence on transmission of the strains. We will continue addressing these questions in future studies.

#### Objective 4

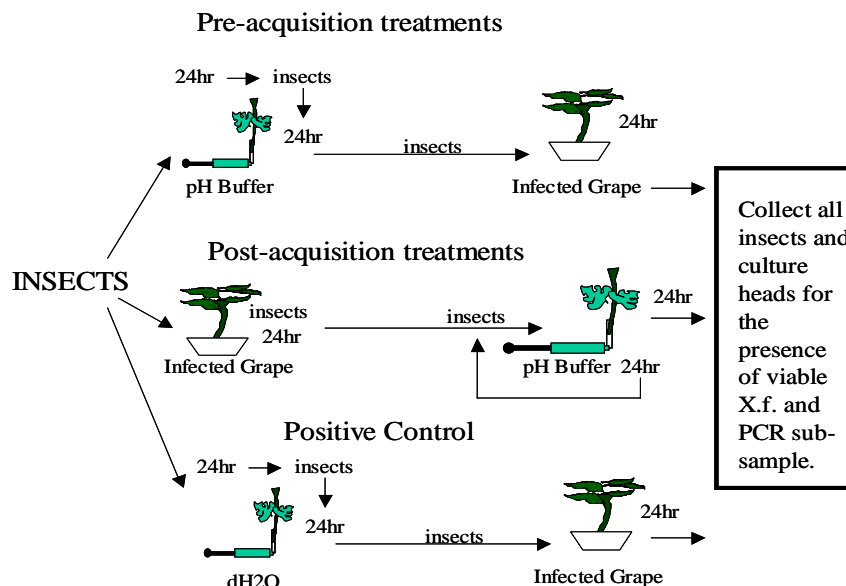
Initial studies were conducted to test the effects of an antibiotic treatment on the ability of GWSS to acquire and retain *Xf*. Two experiments were done. In the first, insects were treated with an antibiotic before being given a 24 hr. AAP on grape infected with PD. In the second experiment, insects were treated with the antibiotic after being given a 24 hr. AAP. Our positive control insects were fed on grape plants infected with PD for 24 hrs. Surviving insects were moved to a *Chrysanthemum* stem that was infused with a buffer (0.005 M Phosphate buffer, pH 7.0) in a cut stem delivery system. The negative control consisted of clean adult insects that were fed for 24 hours on a *Chrysanthemum* stem infused with buffer only using the cut stem delivery system. Surviving insects were subsequently fed on clean grape plants for 24 hours. For our post-acquisition treatment, insects were fed on grape plants infected with PD strain of *Xf* for 24 hr. Surviving insects were moved to a *Chrysanthemum* stem that was infused with a 0.01 % solution of oxytetracycline in a weak phosphate buffer (0.005 M phosphate buffer, pH 7.0) using the cut stem delivery system. And the pre-acquisition treatment used insects that were fed for 24 hours on a *Chrysanthemum* stem infused with a 0.01 % solution of oxytetracycline in a weak phosphate buffer (0.005 M phosphate buffer, pH 7.0). Surviving insects were subsequently fed on grape plants infected with PD strain of *Xf* for 24 hours. All insects were subsequently moved to *Chrysanthemum* plants to feed for 48 hours to allow the antibiotic plenty of time to be washed out from the gut. Heads of all insects were cultured on PD3 media, and a sub-sample from the heads was used for PCR to detect the presence of *Xf*. The studies showed that both pre- and post-acquisition treatments effectively reduced survival of *Xf* in the GWSS (Table 3).

**Table 3.** Effects of antibiotics on the acquisition and transmission of *Xf* by GWSS.

Treatments	Insects				
	Total	Mortality	Survival	PCR	Culture
Positive control grape- buffer	30	8	22	0	4
Positive control buffer-grape	30	15	15	0	1
Negative control grape-buffer	30	3	27	0	0
Negative control buffer-grape	30	6	24	0	0
Post-acquisition, grape-antimicrobial	30	17	13	0	0
Pre-acquisition, antimicrobial-grape	30	6	24	0	0

#### Objective 5

Insects were fed on infected plants of *Xf* suspended in a series of substrates with pH ranging from 4.8 to 9.8. This range includes a value that is considered optimal for the growth of *Xf* (6.5-6.9, Wells et al. 1987). The conditions of the treatments and control are described in Figure 1.



**Figure 1.** Effects of pH treatments on acquisition and transmission.

In this study, we found that *Xf* survived at all pH ranges tested. It doesn't appear that high pH impacts the survival of bacteria in the foregut of GWSS (Table 4). We are planning transmission experiments to see if these treatments impact acquisition and inoculation of bacteria.

**Table 4.** Effects of pH on the acquisition and transmission of *Xf* by GWSS.

Treatments		Insects				
		Total	Mortality	Survival	PCR	Culture
Negative control	clean plant	10	0	10	0	0
Positive control	inf. Plant	10	0	10	3	10
pH buffer/infected grape	pH 4.48	5	2	3	0	3
	pH 5.60	5	0	5	0	5
	pH 8.00	5	0	5	3	4
	pH 9.80	5	1	4	0	4
Infected grape/pH buffer	pH 4.48	5	0	5	2	1
	pH 5.6	5	0	5	2	4
	pH 8.00	5	0	5	1	2
	pH 9.80	5	1	4	4	1

## CONCLUSIONS

We showed that pH did not influence survival of *Xf*. Antibiotic treatments applied either pre- or post-acquisition effectively kill the bacteria in the foregut of GWSS. Studies on acquisition, transmission, and retention of PD and OLS showed that both strains can be simultaneously acquired and retained in GWSS. Interestingly, the strain that was found at the end of the insect's life did not always coincide with the strain that it transmitted to test plants. We are continuing our investigation into the possible reasons for this result, which may shed light on the interaction of these two strains in GWSS vectors. Our hope is to learn more about bacterial interaction with the insect foregut, and to use this knowledge to reduce transmission of PD and OLS by GWSS.

## REFERENCES

- Costa, H. S., M. S. Blua, J. A. Bethke, and R. A. Redak. 2000. HortScience 35: 1265-1267.
- Purcell, A.H., and D. L. Hopkins. 1996. Ann. Rev. Phytopathol. 34: 131-51.
- Purcell, A. H., S. R. Saunders, M. Henderson, M. E. Grebus, and M. J. Henry. 1999. Phytopathology. 89: 53-58.
- Wells, J. M., B .C. Raju, H.-Y. Hung, W. G. Weisburg, L. Mandelco-Paul, and D.J. Brenner. 1987. Int. J. Systematic Bacteriol. 37: 136-143.

## FUNDING AGENCIES

Funding for this project was provided by the CDFA Pierce's Disease and Glassy-winged Sharpshooter Board.

## EVALUATION OF BLUE-GREEN SHARPSHOOTER FLIGHT HEIGHT

### Project Leader:

Ed Weber  
UC Cooperative Extension  
Napa, CA 94559

**Reporting Period:** The results reported here are from work conducted February 2004 to September 2005.

### ABSTRACT

Flight heights of blue-green sharpshooters (BGSS) were monitored in the Napa Valley from March through September 2004 and 2005 using pole towers to position yellow sticky cards at heights up to 24 feet. Towers were located adjacent to vineyards at the edge of a riparian zone. Eleven towers were monitored in 2004 and twelve in 2005. Overall trap catches in 2004 were considerably greater than in 2005. For the March-May period, 99% of the catches were made at 15 feet or lower in 2005. For this period in 2004, 76% of the catches were made at 15 feet or lower. This figure increases to 88% with the exclusion of data from one tower in early March (discussed below). These data support the possible use of screen or natural barriers to reduce the number of BGSS entering vineyards in the spring.

### INTRODUCTION

Where the BGSS, *Graphocephala atropunctata*, is the primary vector of Pierce's disease (PD), control measures should be aimed at reducing the number of BGSS entering vineyards (4), especially early in the growing season. Early-season infections (March-May) are responsible for most chronic cases of PD (6, 9). Infections resulting from BGSS feeding later in the growing season are not likely to result in PD because most will be eliminated with normal pruning. This is unlike the situation with PD caused by glassy-winged sharpshooter (GWSS) feeding, where chronic infections may occur nearly year-round (1).

Vector control measures in the North Coast include the use of insecticides (4) as well as management of riparian plant communities to reduce the number of favorable BGSS breeding host plants (5).

Another method of reducing vector numbers is to block their flight into vineyards through the use of physical barriers. This could include the use of tall fences made with insect screening materials, as well as natural barriers created by planting dense stands of conifers or other non-host tree species. Both of these approaches are already being employed in a few vineyards in the North Coast, although there are currently no data to show their impacts. The use of barriers has also been suggested as a management tactic to keep GWSS out of vineyards (2).

For barriers to be effective, they would need to block the majority of BGSS from entering vineyards, since small numbers of insects can still lead to significant disease development (8). Unfortunately, little is known about the overwintering behavior of BGSS and its preferred winter plant hosts (7). Therefore, it is not clear how tall a barrier would need to be in order to be effective. Most trapping by both researchers and growers has been done from the ground at the 5-6 foot level.

This project addresses the question of BGSS flight height by installing and monitoring pole towers that can accommodate yellow sticky card trapping up to a height of approximately 24 feet.

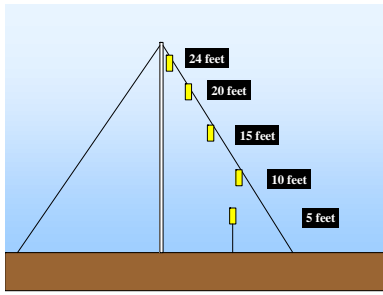
### OBJECTIVES

1. Evaluate the predominant flight height of BGSS entering vineyards from adjacent riparian habitats through the use of yellow sticky cards positioned at heights from 5 to 24 feet.

### RESULTS

Eleven pole towers were installed and monitored in the Napa Valley in 2004, and twelve towers were monitored in 2005. Two of the towers monitored in 2004 were not used in 2005 due to the low number of BGSS trapped at those locations. Three additional towers were installed in 2005. Tower locations covered a distance of approximately 25 miles from the Carneros region in southern Napa County to outskirts of Calistoga at the north end of Napa Valley. Towers were positioned along riparian zones adjacent to vineyards that had a history of PD.

A diagram of a pole tower is shown in Figure 1. Towers were 25 feet in height, constructed from Schedule 40 PVC pipe with a pulley at the top and a rope running through it. Yellow sticky cards were attached to clips on the rope at the following heights: 24 feet, 20 feet, 15 feet and 10 feet. An additional trap at 5 feet was clipped to a metal stake mounted in the ground.



**Figure 1.** Pole tower diagram.

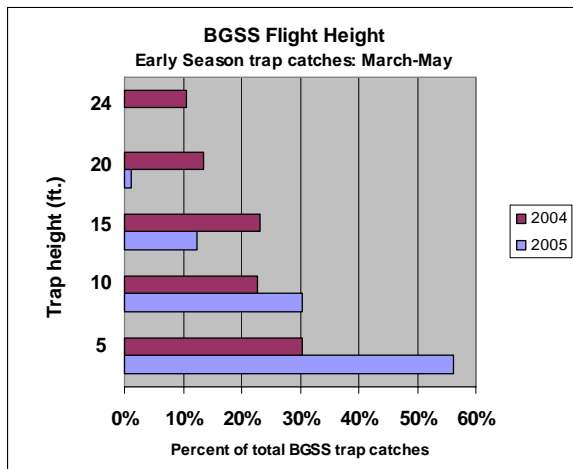
Towers were installed prior to March 9 in both years. Traps were monitored on a weekly basis through September and numbers of BGSS were recorded. Traps were replaced every two weeks or as needed.

Figure 2 shows the percentage of BGSS trapped at various heights during the early season period of March-May. This is the critical time period in which most infections leading to chronic cases of PD are likely to occur (6, 9).

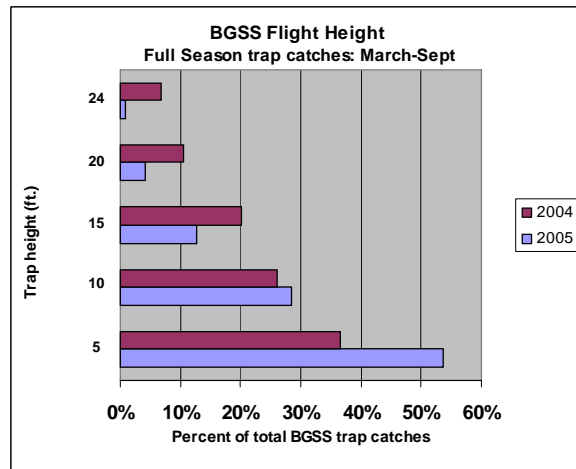
From March to May 2005, 99% of BGSS were caught at 15 feet and lower. During this same time period in 2004, 76% of BGSS were caught in traps 15 feet and lower. With the exclusion of unusual trap catch data from Tower 10 prior to budbreak in March 2004, this figure rises to 88%. As noted in last year’s report (10), Tower 10

was installed adjacent to a Coast Live Oak tree (*Quercus agrifolia*), an evergreen species that was apparently a preferred host plant prior to budbreak of nearby deciduous species. A record heat wave in early March 2004 (70-85°F) led to significant BGSS flight activity in the vicinity of this tree as evidenced by larger numbers of BGSS caught in the upper traps. This was the only case of greater numbers of BGSS in the upper traps compared to the lower traps during the two years of this study at all towers.

Figure 3 shows the percentage of BGSS trapped at various heights during the entire trapping period of March-September for 2004 and 2005. The data in Figures 2 and 3 show similar trends with most BGSS being caught in traps at 15 feet and lower. In 2004, 83% of BGSS were trapped at 15 feet or below. In 2005, 95% were trapped at 15 feet or below. This trend of most BGSS being caught in the lower traps was stronger in 2005 than in 2004, primarily due to the results from Tower 10 noted above.



**Figure 2.**



**Figure 3.**

Total BGSS trap catches were over three times greater in 2004 than in 2005. Figures 4 and 5 show the total trap catches for the March-May and March-September periods respectively. The data included in these figures are from the nine towers that were monitored at the same locations in both years. The average cumulative trap catch per tower in 2004 was 36.1 BGSS; in 2005 it was 10.1 BGSS.

The results from this project suggest that a 15-18 foot high barrier could be effective at greatly reducing the number of BGSS entering vineyards. However, previous work with insecticides showed that even with 70-90% reductions in BGSS trap counts, the incidence of PD was not significantly reduced in vineyards planted with highly sensitive varieties (8). Even with a 10-18 foot screen barrier, the number of BGSS flying over the top could still result in significant amounts of PD in an adjacent vineyard.

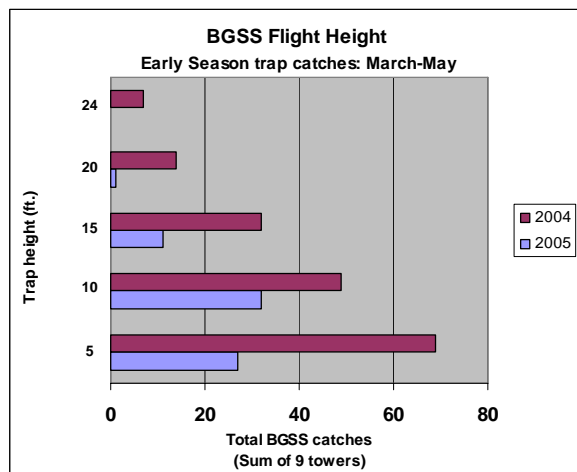


Figure 4.

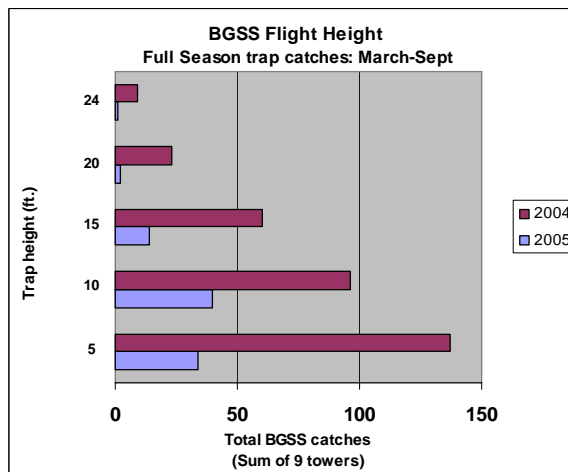


Figure 5.

## CONCLUSIONS

Nearly 90% of the BGSS trapped in this study were caught on traps at 15 feet or lower. This suggests that barriers could have a significant impact on reducing the numbers of BGSS entering vineyards. However, this may not be enough to have a major impact on reducing the incidence of PD. In addition, results from one tower indicated that BGSS may reside in some trees early in the season. This could allow for higher than normal flight activity, allowing more BGSS to enter vineyards by flying over a barrier. The effectiveness of barriers at reducing the incidence of PD will likely depend upon the nature of the adjacent riparian plant community, its mix of host plant species and the number of tall host trees.

## REFERENCES

- Almeida, R.P.P. and A.H. Purcell. 2003. Transmission of *Xylella fastidiosa* to grapevines by *Homalodisca coagulata* (Hemiptera: Cicadellidae). *J. Econ. Ent.* 96(2):264-271.
- Blua, M.J. and D.J.W. Morgan. 2003. Dispersion of *Homalodisca coagulata* (Hemiptera: Cicadellidae), a vector of *Xylella fastidiosa*, into vineyards in southern California. *J. Econ. Ent.* 96(5):1369-1374.
- Feil, H., et al. 2000. Effects of temperature on the flight activity of *Graphocephala atropunctata* (Hemiptera: Cicadellidae). *Journal of Economic Entomology* 93(1): 88-92.
- Goodwin, P., A. H. Purcell. 1992. Pierce's disease. *Grape Pest Management*, 2nd Edition. Oakland, University of California, Division of Agriculture and Natural Resources: 76-84.
- Insley, E., et al. 2000. Riparian vegetation management for Pierce's disease in North Coast California Vineyards. An information manual from the North Coast PD Task Force. 46pp.
- Purcell, A.H. 1975. Role of the blue-green sharpshooter, *Hordnia circellata*, in the epidemiology of Pierce's disease of grapevines. *Env. Ent.* 4:745-752.
- Purcell, A.H. 1976. Seasonal changes in host plant preference of the blue-green sharpshooter *Hordnia circellata*. *Pan-Pacific Ent.* 52:33-37.
- Purcell, A.H. 1979. Control of the blue-green sharpshooter and effects of spread of Pierce's disease of grapevines. *J. Econ. Ent.* 72(6):887-892.
- Purcell, A.H. 1981. Vector preference and inoculation efficiency as components of resistance to Pierce's disease in European grape cultivars. *Phytopath.* 71(4):429-435.
- Weber, E.A. 2004. Evaluation of Blue-green Sharpshooter flight height. *Proceedings, Pierce's Disease Research Symposium, San Diego*, pp157-159.

## FUNDING AGENCIES

Funding for this project was provided by the CDFA Pierce's Disease and Glassy-winged Sharpshooter Board.

# REPRODUCTIVE BIOLOGY AND PHYSIOLOGY OF FEMALE GLASSY-WINGED SHARPSHOOTERS: EFFECT OF HOST PLANT TYPE ON FECUNDITY AND DEVELOPMENT

## Project Leaders:

Frank G. Zalom and Christine Y.S. Peng  
Department of Entomology  
University of California  
Davis, CA 95616

Natalie A. Hummel  
USDA, ARS, KBUSLIRL  
2700 Fredricksburg Road  
Kerrville, TX 78029

## Cooperator:

Nick C. Toscano  
Department of Entomology  
University of California  
Riverside, CA 92521

**Reporting Period:** The results reported here are from work conducted March 2002 to June 2005.

## ABSTRACT

Our study found that *Homalodisca coagulata* can successfully produce multiple generations when confined to a single host species: grape, citrus, or oleander, and that oviposition and development can occur successfully on any of these hosts. In 2002, more egg masses and adults were found on citrus than on grape or oleander. In 2004, there was no significant difference in the number of egg masses on the hosts, but more adults were produced on grape, than on citrus or oleander. Our study confirms that oleanders can serve as a reproductive host for *H. coagulata*. Oviposition on oleander was different than on grape and citrus, with most eggs being laid singly or in pairs in the epidermis on the underside of leaves. Because citrus and oleanders are commonly found in close proximity both to one another and to grapes in California, it is important to consider their contribution as sources of *H. coagulata* as it relates to Pierce's disease epidemiology.

## INTRODUCTION

The glassy-winged sharpshooter (GWSS), *H. coagulata* (Say), was first detected in California in 1989 (Sorenson and Gill 1996) and quickly spread throughout the state (CDFA 2005). In California, *H. coagulata* movement patterns, breeding habitats and host preferences differ from native vectors of *Xylella fastidiosa* (Purcell 1999, Hopkins and Purcell 2002). *H. coagulata* has a wide host range, feeding on over 150 host plants ranging from herbaceous annuals to woody perennials (CDFA 2005).

*H. coagulata* belongs to the Proconiini tribe of the family Cicadellidae and is a xylem feeder (Nielson 1979). Xylem is a very dilute nutrient source and high volume feeding rates are required for survival and reproduction of insects. Florida studies indicate that nutritional requirements are different for nymphal and adult *H. coagulata* (e.g. Andersen et al. 1989, Andersen et al. 1992, Brodbeck et al. 1990, Brodbeck et al. 1993, Brodbeck et al. 1995, Brodbeck et al. 1996). These studies infer that regulation of consumption rates and assimilation efficiencies is necessary to accumulate nutrients required for development, suggesting that polyphagy is required for development. Field observations in California indicate a preference for different plant species at different times of the year, with choice observed to be linked to new vegetative growth of the preferred host plants (Daane and Johnson 2004).

In this study, we test the hypothesis that *H. coagulata* require multiple hosts to successfully produce additional generations by examining female fecundity and sex ratio of surviving adults of the subsequent generation when reared on a single host: grape (*Vitis vinifera* L.) (Vitidaceae), citrus (*Citrus sinensis* (L.) Osbeck.) (Rutaceae), or oleander (*Nerium oleandrum* L.) (Apocynaceae).

## OBJECTIVES

1. Collect and prepare GWSS specimens for studying the morphology and anatomy of females.
2. Study and describe the sensory structures located on the female ovipositor.
3. Characterize the reproductive cycle of female GWSS in Riverside, CA..
4. Study the effects of location on female GWSS reproductive cycle.
5. Study the effect of host plant type on female GWSS fecundity.

## RESULTS

The results presented here address objective 5 of our *H. coagulata* research.

Adult female and male *H. coagulata* collected from citrus hosts were confined to a single host, either grape, citrus or oleander, and their fecundity and success of progeny followed for a full generation. We made one infestation in 2002, while in 2004 we made four infestations. Females oviposited successfully and the resulting offspring developed to the adult stage

on all three host plants. In addition, *H. coagulata* were successfully reared without reinfestation on all three host species from 3 March 2004 to 18 November 2004.

There was a significant difference in the mean number of egg masses for each of the host species in 2002 ( $F_{2,40} = 21.54$ ;  $P < 0.0001$ ). Oviposition was greatest on citrus (mean  $\pm$  SD number of egg masses =  $52.20 \pm 32.27$ ;  $n = 15$ ), followed by grape ( $20.54 \pm 15.08$ ;  $n = 13$ ), and oleander ( $8.07 \pm 7.18$ ;  $n = 15$ ) (Figure 1). The mean number of female nymphs maturing to the adult stage was significantly different between hosts in 2002 ( $F_{2,41} = 8.64$ ;  $P = 0.0007$ ) (Figure 2). The mean number of females was significantly different between citrus and grape ( $P = 0.0005$ ), but there was no significant difference between grape and oleander ( $P = 0.0690$ ) or citrus and oleander ( $P = 0.1864$ ) (Figure 2). The mean number of male nymphs maturing to the adult stage was significantly different between hosts in 2002 ( $F_{2,41} = 9.96$ ;  $P = 0.0003$ ). The mean number of males was significantly different between citrus and grape ( $P = 0.0002$ ), and grape and oleander ( $P = 0.0355$ ), but there was no significant difference between citrus and oleander ( $P = 0.1876$ ) (Figure 2).

There was no significant difference in the mean number of egg masses between host species in 2004 ( $F_{2,39} = 1.16$ ;  $P = 0.3250$ ) (Figure 1). The mean number of female nymphs maturing to the adult stage was significantly different between hosts in 2004 ( $F_{2,43} = 5.08$ ;  $P = 0.0104$ ). The mean number of females was significantly different between citrus and grape ( $P = 0.0115$ ), and grape and oleander ( $P = 0.0450$ ), but there was no significant difference between citrus and oleander ( $P = 0.8379$ ) (Figure 2). The mean number of male nymphs maturing to the adult stage was significantly different between hosts in 2004 ( $F_{2,43} = 3.24$ ;  $P = 0.0489$ ) (Figure 2), but mean separation did not reveal significant differences between hosts.

The mean  $\pm$  SD number of egg masses was greatest on citrus in the spring generation of 2004 ( $23.67 \pm 21.57$ ;  $n = 6$ ), on grape in the summer generation (first infestation) ( $18.83 \pm 8.35$ ;  $n = 6$ ), and oleander in the summer generation (second infestation) ( $27.67 \pm 46.20$ ;  $n = 3$ ) (Figure 1). It is interesting to note that egg masses are typically much smaller on oleander (one to two eggs per egg mass) than on citrus or grape (10+ eggs per egg mass). The greatest nymphal survival was observed on grape for the first two infestations, and the survival of nymphs on all host species was low in the third infestation (Figure 2).

## CONCLUSIONS

Multiple generations of *H. coagulata* are possible when confined to grape, citrus or oleander, indicating that a compulsory movement of adults between hosts is not necessary to maintain a population. Nymphal survival and female fecundity were greatest on grapes relative to citrus and oleander in the summer generation (first infestation) of 2004. This observation is consistent with field observations by Hix (2002) that adult *H. coagulata* enter vineyards, often after exiting citrus groves, in May and June and can complete a generation in grapes during July and August. *H. coagulata* typically leave vineyards in the winter, and are thought to be sustained on citrus and other non-deciduous hosts including ornamentals such as oleanders.

In southern California, *H. coagulata* are observed on citrus year around where they produce two to three generations per year (Hummel et al. 2005). Proximity of citrus groves near vineyards has proven significant in the epidemiology of some Pierce's Disease epidemics (Perring et al. 2001). In our study, fecundity was greatest on citrus in 2002, but this was not the case for all studies conducted in 2004. The inconsistency may be due to differences in host quality. Even though all plants were uniformly irrigated and fertilized, there may have been inherent seasonal differences in plant physiology. Anderson et al. (1992) suggested that high amide concentrations in host plants may be responsible for oviposition preference by *H. coagulata*, but these were not measured in our study.

Our study confirms that oleander can serve as a reproductive host for *H. coagulata* and support multiple generations. This is significant as oleanders are often found in association with grape and other agricultural crops as well as in landscape situations. Nymphal survival on oleander was relatively high, and multiple generations of *H. coagulata* were produced on oleander alone. Oviposition was different on oleander than on grape and citrus, with most eggs being laid singly or in pairs in the epidermis on the underside of oleander leaves.

Results of our study refute our original hypothesis that *H. coagulata* require multiple hosts to successfully produce additional generations.

## REFERENCES

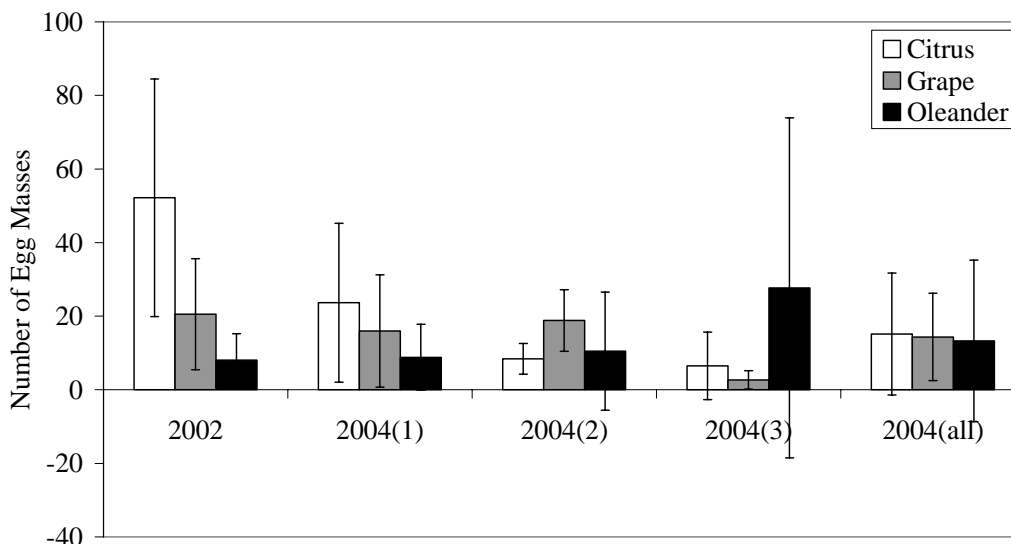
- Almeida, R. P., and A. H. Purcell. 2003. Transmission of *Xylella fastidiosa* to grapevines by *Homalodisca coagulata* (Hemiptera, Cicadellidae). *Jour. Econ. Entom.* 96: 264-271.
- Andersen, P. C., B. V. Brodbeck, and R. F. Mizell III. 1989. Metabolism of amino acids, organic acids and sugars extracted from the xylem fluid of four host plants by adult *Homalodisca coagulata*. *Entomol. Exp. Appl.* 50: 149-159.
- Andersen, P. C., B. V. Brodbeck, and R. F. Mizell. 1992. Feeding by the leafhopper, *Homalodisca coagulata*, in relation to xylem fluid chemistry and tension. *Jour. Ins. Phys.* 38: 611-622.
- Brodbeck, B. V., R. F. Mizell, W. J. French, P. C. Andersen, and J. H. Aldrich. 1990. Amino acids as determinants of host preference for the xylem feeding leafhopper, *Homalodisca coagulata* (Homoptera: Cicadellidae). *Oecologia.* 83: 338-345.

- Brodbeck, B. V., R. F. Mizell, and P. C. Andersen. 1993. Physiological and behavioral adaptations of three species of leafhoppers in response to the dilute nutrient content of xylem fluid. *Jour. Insect Physiol.* 39: 73-81.
- Brodbeck, B. V., P. C. Andersen, and R. F. Mizell. 1995. Differential utilization of nutrients during development by the xylophagous leafhopper, *Homalodisca coagulata*. *Entomol. Exp. App.* 75: 279-289.
- Brodbeck, B. V., P. C. Andersen, and R. F. Mizell. 1996. Utilization of primary nutrients by the polyphagous, *Homalodisca coagulata*, reared on single host species. *Archiv. Insect Biochem. Physiol.* 32: 65-83.
- California Department of Food and Agriculture. 2005. <http://www.cdffa.ca.gov/phpps/pdcp/gwmap.htm>.
- Daane, K. M., and M. W. Johnson. 2004. Biology and ecology of the glassy-winged sharpshooter in the San Joaquin Valley. pp. 93-96 In. M. A. Tariq, S. Oswalt, P. Blincoe, B. Amadou, T. Lorick, and T. Esser (eds.) *Pierce's Disease Research Symposium Proceedings*. Sacramento, CA.
- Hix, R. L., 2002. Development of trapping systems to trap Glassy-winged Sharpshooter (*Homalodisca coagulata*) adults and nymphs in grape. pp. 151-152. In. M. A. Tariq, S. Oswalt, P. Blincoe, T. Esser (eds.) *Pierce's Disease Research Symposium Proceedings*.
- Hopkins, D. L., and A. H. Purcell. 2002. *Xylella fastidiosa*: cause of Pierce's disease of grapevine and other emergent diseases. *Plant Dis.* 86: 1056-1066.
- Hummel, N. A., F. G. Zalom, and C. Y. S. Peng. 2005. Structure and functions of the female genitalia and associated abdominal segments of *Homalodisca coagulata* (Hemiptera: Cicadellidae). *Arthr. Struct. Devel.* (Submitted).
- Nielson, M. W. 1979. Taxonomic relationships of leafhopper vectors of plant pathogens. pp. 3-23. In. K. Maramorosch, and K. F. Harris (eds.) *Leafhopper Vectors and Plant Disease Agents*, Academic Press, New York.
- Perring, T. M., C. A. Farrar, and M. J. Blua. 2001. Proximity to citrus influences Pierce's disease in Temecula Valley vineyards. *Calif. Agric.* 55(4): 13-18.
- Sorenson, J. T. and R. J. Gill. 1996. A range extension of *Homalodisca coagulata* (Say) (Hemiptera: Clypeorrhyncha: Cicadellidae) to southern California. *Pan-Pac Entomol.* 72(3): 160-161.

#### FUNDING AGENCIES

Funding for this project was provided by the University of California Pierce's Disease Grant Program.

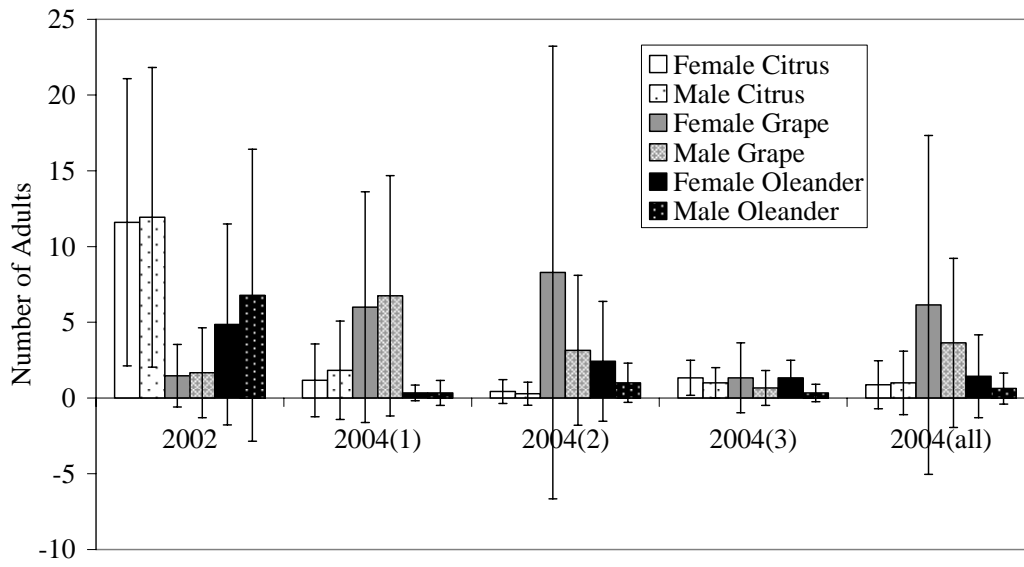
Mean  $\pm$  SD Number Per Plant on Citrus, Grape and Oleander



**Figure 1.** Mean  $\pm$  SD number of egg masses per plant produced on citrus, grape, and oleander in 2002 and 2004; 2004(1): the spring generation of 2004; 2004(2): the summer generation (first infestation) of 2004; 2004(3): the summer generation (second infestation) of 2004; 2004(all): the mean for the three infestations of 2004.



Mean  $\pm$  SD Number Per Plant on Citrus, Grape and Oleander



**Figure 2.** Mean  $\pm$  SD number of progeny per plant successfully maturing to the adult stage on citrus, grape and oleander in 2002 and 2004; 2004(1): the spring generation of 2004; 2004(2): the summer generation (first infestation) of 2004; 2004(3): the summer generation (second infestation) of 2004; 2004(all): the mean for the three infestations of 2004.

# REPRODUCTIVE BIOLOGY AND PHYSIOLOGY OF FEMALE GLASSY-WINGED SHARPSHOOTERS: MORPHOLOGY AND VITELLOGENESIS CYCLES

## Project Leaders:

Frank G. Zalom and Christine Y.S. Peng  
Department of Entomology  
University of California  
Davis, CA 95616

Natalie A. Hummel  
USDA, ARS, KBUSLIRL  
2700 Fredricksburg Road  
Kerrville, TX 78029

## Cooperator:

Nick C. Toscano  
Department of Entomology  
University of California  
Riverside, CA 92521

**Reporting Period:** The results reported here are from work conducted October 2001 to August 2005.

## ABSTRACT

Female *Homalodisca coagulata* (Say) were collected from October 2001 to February 2005 from citrus at the University of California, Riverside, Agricultural Operations (UCR, Ag. Ops.). Between five and twenty females per sampling date were dissected, and each was assigned an ovarian rank: previtellogenic, vitellogenic, or postvitellogenic. Ovarian ranking was used to characterize *H. coagulata* reproductive activity. Results of these dissections revealed consistent annual patterns in the proportion of previtellogenic females present in this field population. These patterns indicate that there are two distinct generations annually, with an occasional third generation. A step-wise regression model of *H. coagulata* vitellogenesis cycles in southern California was developed, which makes it possible to predict the appearance of the subsequent generation based on previous observed peaks in oviposition activity.

## INTRODUCTION

The glassy-winged sharpshooter (GWSS), *H. coagulata* (Say), is a serious pest of many tree and vine crops (Turner and Pollard 1959, Nielson 1968). The GWSS is of primary concern to California growers because of its capacity to vector the bacterium, *Xylella fastidiosa* (*Xf*), which causes vascular disease in a number of crops, including grapes, citrus and almonds, as well as landscape plants including oleander and mulberries (Meadows 2001, Hopkins 1989, Purcell and Hopkins 1996). An adult GWSS need only acquire *Xf* once while feeding on an infected plant to then become a vector of *Xf* for the remainder of its life (Frazier 1965, Purcell 1979, Severin 1949).

Little is known about the reproductive biology of the GWSS. It has been reported that GWSS has two generations per year in Southern California (Blua et al. 1999). Oviposition occurs in late winter to early spring, and again in mid-to-late summer. Adult females can live several months and lay their eggs side by side in groups of about 10, ranging from 1 to 27 (Turner and Pollard 1959). The greenish, sausage-shaped eggs are inserted into the leaf epidermis of the host plants.

Our research is focused on the reproductive morphology and physiology of the GWSS. We are examining the seasonal differences in female GWSS reproduction between summer and overwintering populations by studying oögenesis cycles. This knowledge is important in determining how GWSS might choose plant hosts in the landscape, which host plants are particularly good for GWSS ovarian development and why they are good, and finally how control measures might best be implemented based upon season and stage of reproductive development. Better knowledge of reproductive biology might also lead to better decision support including improved choices and timing of chemical or non-chemical approaches to GWSS control.

## OBJECTIVES

1. Collect and prepare GWSS specimens for studying the morphology and anatomy of females.
2. Study and describe the sensory structures located on the female ovipositor.
3. Characterize the reproductive cycle of female GWSS in Riverside, CA.
4. Study the effects of location on female GWSS reproductive cycle.
5. Study the effect of host plant type on female GWSS fecundity.

## RESULTS

Objectives 1 and 2 have been reported in prior symposia. The results presented here address objective 3 of our *H. coagulata* research.

Female and male GWSS were collected from October 2001 to February 2005. Samples were taken on monthly, bimonthly or weekly intervals. Dissections of female specimens collected from citrus hosts at UCR, Ag. Ops. have revealed repeated patterns related to the proportion of previtellogenic females in the field (Figure 1). Based on our dissections, a step-wise

regression model was developed to predict the appearance of previtellogenic females based on previous reproductive activity. Dissections of female *H. coagulata* showed that there were two distinct peaks of previtellogenic females each year on citrus at UCR, Ag. Ops., with a third peak occurring in both December 2002 and December 2004 (Figure 1). We define a peak in the proportion of previtellogenic females as the beginning of a generation. A peak in the proportion of previtellogenic females also occurred in October 2001. Peaks in the proportion of previtellogenic females were subsequently observed in July, October, and December 2002, in June and October 2003, and in June, October, and December 2004. We ceased sampling in February 2005. Egg-laying activity was greatest in March and August 2002, March and July 2003, and April and July 2004. Egg-laying activity began increasing again in February 2005 when collections were finally terminated.

An inverse relationship between the peaks in the proportion of previtellogenic females and vitellogenic (egg-laying) females occurred in each year (Figure 2). In June, the proportion of vitellogenic females declined as the proportion of previtellogenic females increased. This decline was followed by a sharp increase in vitellogenic activity, resulting in the greatest annual levels of egg production, presumably from the first adult generation. In October, vitellogenic activity decreased, as the proportion of previtellogenic females increased, marking the appearance of the second generation. We also observed this period to coincide with the highest annual levels of egg parasitism. Vitellogenic activity remained low during the winter, until temperatures began to increase in spring. The annual cycle was then repeated, with the initiation of egg production beginning again in February.

Our dissections showed that egg laying activity occurred at some level throughout the year in the study population of *H. coagulata*. Egg-laying activity was not observed in November 2001, but some egg-laying was recorded in January 2002. The proportion of vitellogenic females remained between five and ten percent during winter 2002-2003. Egg-laying was not recorded in December 2003, but increased through the spring of 2004. The percentage of previtellogenic females remained at or above five percent during winter 2004-2005. The proportion of vitellogenic females present during winter appeared to be related to higher minimum temperatures in a given year. These results suggest that although vitellogenic activity decreases in December, there is not a clear reproductive diapause in the population of GWSS in Riverside, California. The majority of the female GWSS that overwinter are postvitellogenic, suggesting that they have matured and oviposited before entering a reproductive rest period.

## CONCLUSIONS

In summary, the ovarian ranking method that we developed appears to be reliable for characterizing *H. coagulata* reproductive activity. Applying this method to our dissection data indicates that two to three generations occur each year in southern California citrus. Adult peak densities typically occur in June and October, and again in December in years when there occurs third generation. Periods of greatest egg production occur in March and July. A model based on our 3.5 year study of ovarian development predicts peaks in previtellogenic females based on oviposition activity four months previous to time *t*. Based on reproductive development times from our dissections and knowledge that most Cicadellidae begin egg production about seven days post-eclosion (Nielson 1968, Nielson and Toles 1968, Raine 1960, Stoner and Gustin 1967, Tonks 1960), we conclude that the interval from a peak in egg production to the appearance of the next generation of young adults is between three and four months. A stepwise regression-based model resulting from analysis of our dissection data indicates that vitellogenic activity, four months prior, has the most significant effect on the proportion of previtellogenic females at time *t*. A lag time of four months between peaks in vitellogenic females and peaks in previtellogenic females is consistent with our observation that *H. coagulata* have three generations per year, which correspond to three peaks in the proportion of previtellogenic females. The level of oviposition activity in February and June appears to be the most important in the model to predict the appearance of peaks in previtellogenic females. There is also a less significant effect of the amount of oviposition activity in the month of April.

Our study of the oögenesis cycle has defined the timing and number of generations of GWSS in California. Clarification of the timing of reproductive events including peak periods of egg production and mating activity, can improve the timing of control activities, particularly applications of insecticides with ovicidal action and releases of egg parasitoids.

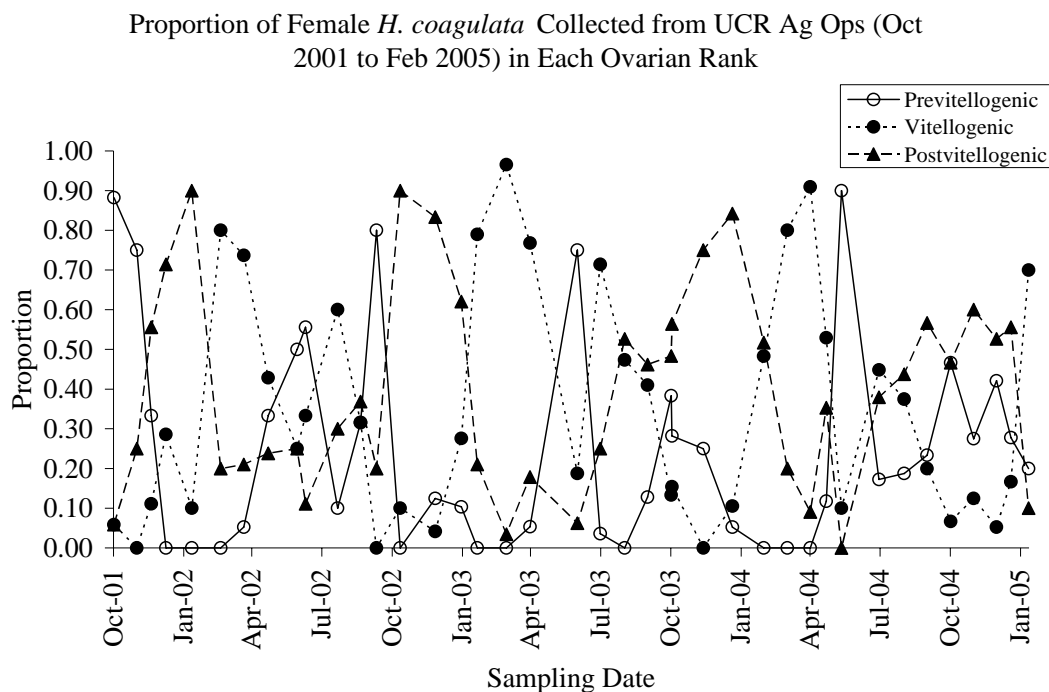
## REFERENCES

- Blua, M. J., P. A. Phillips, and R. A. Redak. 1999. A new sharpshooter threatens both crops and ornamentals. *Calif. Agric.* 53(2): 22-25.
- Frazier, N. W. 1965. Proceedings of the International Conference on Virus and Vector on Perennial Hosts, with Special Reference to *Vitis*. Division of Agricultural Science, University of California, Davis. pp. 91-99.
- Hopkins, D. L. 1989. *Xylella fastidiosa*: xylem-limited bacterial pathogen of plants. *Ann. Rev. Phytopath.* 27: 271-90.
- Meadows, R. 2001. Scientists, state aggressively pursue Pierce's Disease. *Calif. Agric.* 55(4): 8-11.
- Nielson, M. W. 1968. The leafhopper vectors of phytopathogenic viruses (Homoptera, Cicadellidae) taxonomy, biology, and virus transmission. *USDA Tech. Bull.* 1382.
- Nielson, M. W., and S. I. Toles. 1968. Observations on the biology of *Acinopterus angulatus* and *Aceratagallia curvata* in Arizona (Homoptera: Cicadellidae). *Ann. Entom. Soc. Am.* 61: 54-56.
- Purcell, A. H. 1979. Leafhopper vectors of xylem-borne plant pathogens, pp. 603-625. In K. E. Harris and K. Maramorosch (eds.) *Leafhopper Vectors and Plant Disease Agents*. Academic Press, New York.

- Purcell, A. H., and D. L. Hopkins. 1996. Fastidious xylem-limiting bacterial plant pathogens. *Ann. Rev. Phytopath.* 34:131-151.
- Raine, J. 1960. Life history and behavior of the bramble leafhopper, *Ribautiana dtenerrima* (H.-S.) (Homoptera: Cicadellidae). *Can. Entomol.* 93: 10-20.
- Severin, H. P. 1949. Transmission of the virus of Pierce's Disease of grapevines by leafhoppers. *Hilgardia* 19: 190.
- Stoner, W. N., and R. D. Gustin. 1967. Biology of *Graminella nigrifons* (Homoptera: Cicadellidae), a vector of corn (maize) stunt virus. *Ann. Entom. Soc. Am.* 60: 496-505.
- Tonks, N. V. 1960. Life history and behaviour of the leafhopper *Macropsis fuscula* (Zett.) (Homoptera: Cicadellidae) in British Columbia. *Can. Entomol.* 93: 707-713.
- Turner, W. F., and H. N. Pollard. 1959. Life histories and behavior of five insect vectors of phony peach disease. *USDA Tech. Bull.* 1188.

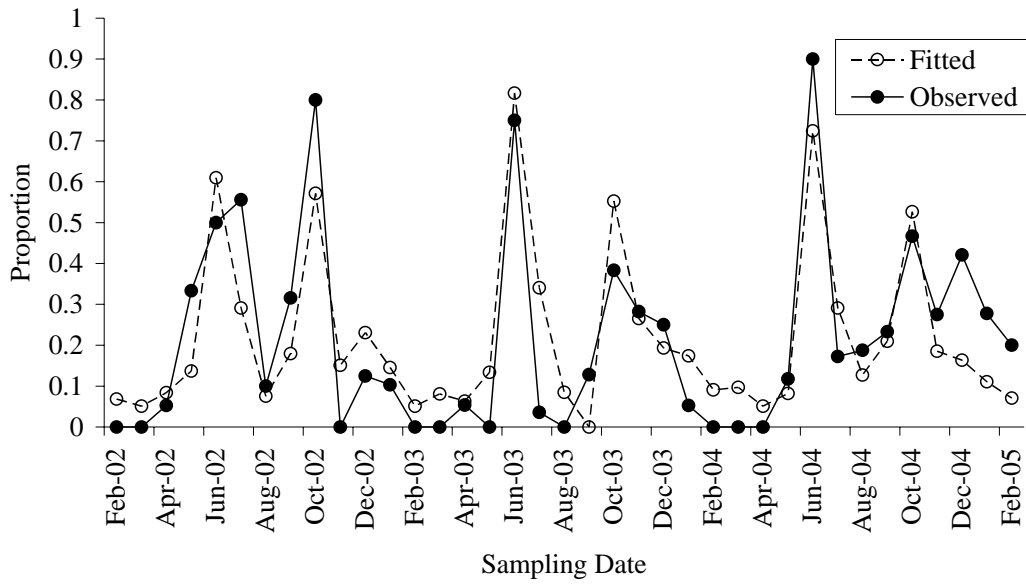
### FUNDING AGENCIES

Funding for this project was provided by the University of California Pierce's Disease Grant Program.



**Figure 1.** Proportion of female *H. coagulata* in each ovarian rank collected and dissected per month from citrus at the University of California, Riverside Agricultural Operations from October 2001 to February 2005. Previtellogenic females have not yet ovulated. Vitellogenic females have mature or maturing eggs in their ovarioles. Postvitellogenic females have ovulated and have a corpus luteum in their ovarioles.

Fitted and Observed Proportion of Previtellogenic Female *H. coagulata*  
 Collected from UCR Ag Ops (Feb 2002 to Feb 2005)



**Figure 2.** Step-wise regression model of the proportion of previtellogenic female *H. coagulata* per sample date: fitted values are indicated by the dashed line, and observed values are indicated by the solid line.

---

---

***Section 3:***  
***Pathogen Biology***  
***and Ecology***





## XYLEM CHEMISTRY MEDIATION OF RESISTANCE TO PIERCE'S DISEASE

### Project Leaders:

Peter C. Andersen  
University of Florida, NFREC  
Quincy, FL 32351

Breno Leite  
Florida A & M University, CVSFR  
Tallahassee, FL 32317

### Cooperator:

Maria L. Ishida  
University of Florida, NFREC  
Quincy, FL 32351

**REPORTING PERIOD:** The results reported here are from work conducted September 2004 to September 2005.

### ABSTRACT

*Xylella fastidiosa* (*Xf*) is the causal agent of Pierce's disease (PD) of grapevines. The mechanism involved in pathogenicity is largely due to the occlusion of xylem vessels by aggregates of *Xf* cells and biofilm. Increasing concentrations of CaCl<sub>2</sub> and MgCl<sub>2</sub> consistently induced aggregation of *Xf* *in vitro* and differences in aggregation patterns occurred when comparing strains of *Xf*. A solution (100 mg/Liter) of divalent cation (calcium or magnesium) increased *Xf* aggregation by about 10 fold. A pre-treatment of *Xf* cells with the reduced form of glutathione (an antioxidant present in the xylem fluid) significantly enhanced the attraction of *Xf* cells for calcium and resulted in more cell aggregation. By contrast, pre-treatment of cells with oxidized glutathione virtually eliminated aggregation. Our data indicate that cell aggregation and biofilm formation in grapevine vessels may be dependent on: a) the presence of free divalent ions and b) the proper redox environment, which in turn modulates surface characteristics (particularly thiol moieties) of *Xf*. These results support the contention that *Xf* pathogenicity mechanisms may involve rapid aggregation in early stages and biofilm formation induced by xylem fluid constituents.

### INTRODUCTION

Previous studies have showed that a suspension of *Xf* aggregate when exposed to xylem fluid of grapevine. The formation of cell aggregates is significantly greater in *Vitis vinifera* cv. Chardonnay (PD-susceptible) than in *Vitis rotundifolia* cv. Noble (PD-resistant). In addition, cell aggregation was analyzed and compared to the xylem fluid chemistry profiles from nine grape cultivars. The most significant observable fact was the ratio involving calcium, magnesium, phosphate and citric acid. Susceptible varieties were higher in calcium and poor in phosphate. Resistant plants had equivalent levels of calcium and phosphate (Leite et al., 2004; Andersen et al., 2004). It is important to know at this point that, calcium and phosphate are extremely attracted by each other and the formation of calcium phosphates is influenced by pH. Further experimentation demonstrated that the ratio of the concentration of calcium and magnesium and citric acid and phosphate [Ca].[Mg]/[Cit].[P], i.e., aggregation inducers/aggregation inhibitors may be used to separate susceptible and resistant plants growing in California but not in Florida. We have shown that xylem fluids collected in Florida are more likely to be acidic compared to more variable xylem fluid (pH 5.5 to 7.4) from California. These results encourage us to advance the studies of the "Calcium Bridging Hypothesis" (CBH) (Leite et al., 2002) critical to understand its implications and applicability towards management of PD.

### OBJECTIVES

1. Determine the effects of calcium chloride and magnesium chloride on aggregation of *Xf* cells.
2. Investigate the influence of oxidized and reduced glutathione on aggregation of *Xf* cells.
3. Search for genomic information that is relevant to "Calcium Bridging Hypothesis".

### RESULTS

#### 1. Effect of calcium and magnesium on *Xf* aggregation

Two *Xf* strains were used during the aggregation experiments (UCLA and STL). CaCl<sub>2</sub> and MgCl<sub>2</sub> were prepared in three different concentrations (0, 20, 50 and 100 mg/L). The SEM images revealed that large aggregates usually congregate 100 cells or more, compared to medium aggregates ( $\pm$  50 cells), small aggregates ( $\pm$  25 cells) and free cells (less than 10-cells aggregates or isolated cells) (Figure 1). Highly significant strain by treatment interactions were found for all the aggregate sizes ( $p > 0.0001$ ). The number of large sized aggregates was dependent on the concentrations of CaCl<sub>2</sub> and MgCl<sub>2</sub>. The aggregation of *Xf* in both strains was induced at 100 mg/L of CaCl<sub>2</sub> (Figures 2A and 2B); however, the number of large aggregates was not consistently proportional to the MgCl<sub>2</sub> concentrations. For the UCLA strain the optimum concentration of MgCl<sub>2</sub> to induce aggregation was 50 mg/L (Figure 2A). The aggregation response of the STL strain to CaCl<sub>2</sub> only occurred for concentrations of 50 and 100 mg/L (Figure 2B); however the concentrations of 20 to 100 mg/L CaCl<sub>2</sub> was effective in inducing significant aggregation of the UCLA strain. The same levels of aggregation of the STL strain occurred with 50 mg/L.

Overall, the experiment revealed that the increasing concentrations of CaCl<sub>2</sub> and MgCl<sub>2</sub> consistently induced *Xf* aggregation. The relationship of calcium in aggregation (calcium bridging) and increased pathogenicity has been described for



streptococcus bacteria and *Pseudomonas aeruginosa* (Rose, 2000, Sarkisova et al., 2005). Similarly, the capacity to form stable and massive amounts of biofilm may help the establishment and colonization by *Xf*. The influence of phosphates and citric acid on calcium availability within the xylem vessel due their high reactivity with this divalent cation has been discussed (Leite et al., 2002, Leite et al., 2004). In addition to other ions or organic acids, the xylem fluid pH and the redox status may affect calcium and magnesium availability (Leite et al., 2003; Leite et al., 2004, Andersen et al., 2004). A fast and vigorous biofilm formation would help to colonize the grapevine xylem vessels. The masses of cells consuming and trapping nutrients may also explain some of the symptomatology of *Xf*-mediated diseases.

Glutathione is a tripeptide that is present in the xylem fluid of many plant species. The presence of reduced glutathione in a chemically-defined medium resulted in an increasing of *Xf* biofilm (Leite et al., 2004). Subsequently, we showed that *Xf* cells aggregated and formed biofilm patterns distinctly according the composition of chemically defined media. The medium CHARD2 promoted biofilm (Leite et al., 2004; Marques et al, 2005). We also showed that aggregated cells cultivated in different chemically defined media were less affected by the activity of lytic peptide cecropin B (Ishida et al, 2004). Finally, with the optimization of a procedure to evaluate aggregation of *Xf*, based on Rose (2000), we were able to visualize and quantify aggregates. *Xf* aggregation patterns are believed to be a resultant of the cell surface characteristics alteration due the redox status; these differences can influence cell receptivity toward interactions with cations in the xylem fluid.

## **2. Influence of oxidized and reduced glutathione on aggregation of *Xf*.**

As previously demonstrated through X ray microanalysis, sulfur moieties are present on the *Xf* surface. Free cells exhibited sulfur as a surface signal. When treated with calcium solution, aggregated cells were observed and calcium was confirmed as predominant surface signal. These observations could indicate that (1) calcium was attracted by cell surface characteristics/properties and (2) this attraction promoted the cell aggregation (Leite et al., 2005).

Previous results suggest that these interactions between cells and calcium are dependent on the redox status of xylem fluid (Leite et al., 2003; Leite et al., 2004; Andersen et al., 2004, Ishida et al., 2004b). Glutathione (GSH) induces *Xf* aggregation. Our working hypothesis assumes in surface proteins containing thiol residues affect how these cells interact with calcium and other cells.

Maximum aggregation was obtained by treating cells with GSH 10 mM for 20 min followed by CaCl<sub>2</sub> 50 mg/L (Figure 3, bottom). These results support confirm that a reducing environment facilitates calcium bridging between *Xf* cells. GSH seems to have a profound effect on *Xf* surface chemistry and aggregation. Calcium promotes aggregation by linking negative charges (thiols) on *Xf* cell surface after redox status modification. These observations sustain our previous findings showing that in xylem fluid (PD-resistant) with low calcium concentration, less *Xf* aggregation was observed; in high calcium concentration (PD-susceptible plants), more *Xf* aggregation occurred (Leite et al., 2004). We envision that these results will allow a potential search for environmental conditions (water quality, soil fertility etc) to help reduce the severity of PD symptomatology. Xylem fluid chemistry may mediate the initial steps of cell aggregation and may inhibit or stimulate disease development. Additional research is needed before we can draw definitive conclusions on physiological and genetic basis of PD resistance.

## **3. Genomic evidence supporting the “calcium bridging hypothesis” (CBH).**

Calcium and magnesium are common cation nutrients in the soil and xylem fluid. In 2002, we proposed that calcium and magnesium, when available in the free form within the xylem fluid, may facilitate cell aggregation, vessel plugging and symptom development of PD (Leite et al., 2002).

SDS PAGE of *Xf* proteins labeled with 5-IAF before the cell lysis, showed that thiol proteins are present on the surface of the *Xf* cells (Andersen et al., 2003). We also showed that thiol proteins varied among strains of *Xf* tested (Ishida et al., 2003; Andersen et al., 2004). These data support the contention that differences in the behavior of *Xf* strains may be attributed to distinct cell surface-protein profiles. In other words, differences in the cell surface proteins of *Xf* may determine the behavior of this bacterium will behave. Thiol moieties present in the outer membrane proteins could possibly carry the residues (cystein or methionine) responsible for the external negatively charge of the *Xf* membrane. We have selected several candidate proteins with these characteristics. Most of them are cell structural surface proteins and adhesins. These proteins have variable numbers of cysteine (thiol) and methionine (negatively charged) residues located at the cell external loop region. These findings confirm the existence of surface proteins that may expose the proper chemical features to maintain the *Xf* surface ready for interaction with other cells and the xylem wall.

We were particularly interested in the hemagglutinin-like secreted proteins due its molecular weight and the number of residues (cysteine and methionine) displayed on the surface of *Xf*. Proteins with these characteristics are strong candidates to be the mediators of adhesion and aggregation of *Xf* cells. Our search suggests that filamentous hemagglutinin-like adhesins are broadly important virulence factors in both plant and animal pathogens. The *Erwinia chrysanthemi* EC16 *hecA* gene predicts a 3,850-aa product which is similar to a member of the *Bordetella pertussis* filamentous hemagglutinin, a family of adhesins. These adhesins are known to be involved in attachment and aggregation processes (Rojas et al., 2002). In addition, recent results obtained with Cowpea Mosaic Virus (CMV), by the Scripps Research Institute, showed that particles with

different patterns of surface proteins, containing cysteine residues, may exhibit distinct attachment properties. It is possible that hemagglutin-like adhesins play a decisive role in PD, by allowing pathogenic cells to aggregate, form biofilm and successfully colonize the xylem vessels. Cysteine residues may be more important in the general context of the CBH. Methionine residues, originally included in the model, may contribute only to charge the cell surface negatively. Type IV pili was recently presented as surface protein on the surface of *Xf* mediating twitching motility (Meng et al., 2005). The type IV pili also exhibits cysteine residues in the external loop sequence. The involvement of type IV pili in aggregation or the behavior of these structures in distinct redox conditions or in the presence of divalent ions has yet to be determined.

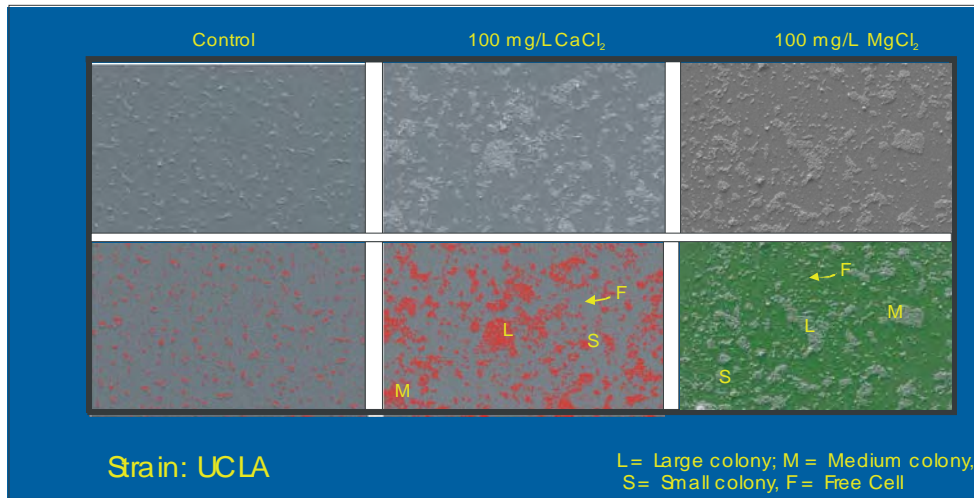


Figure 1: SEM images of *Xylella fastidiosa* cells in different concentration of  $\text{CaCl}_2$  or  $\text{MgCl}_2$ . Results show the contrast between control and cell suspensions treated with salts that release divalent cations:  $\text{CaCl}_2$ , 100 mg/L and  $\text{MgCl}_2$ , 100 mg/L. Images were software treated (Image J and Corel Draw 10) to facilitate the identification of large, medium, and small aggregates or free cells. The quantification of the number of large colonies is presented in Figure 3 for UCLA and Figure 4 for STL. There is a significant difference observed for aggregate formation when comparing treated and untreated cell suspensions.

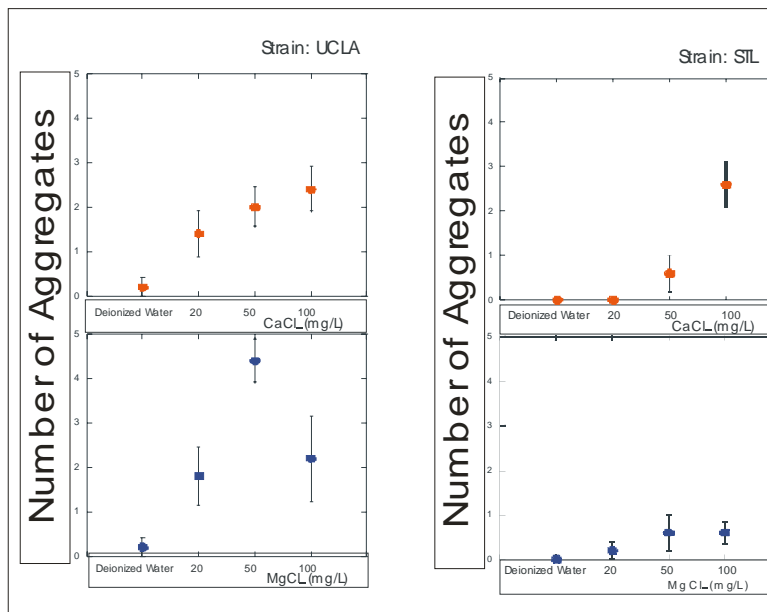
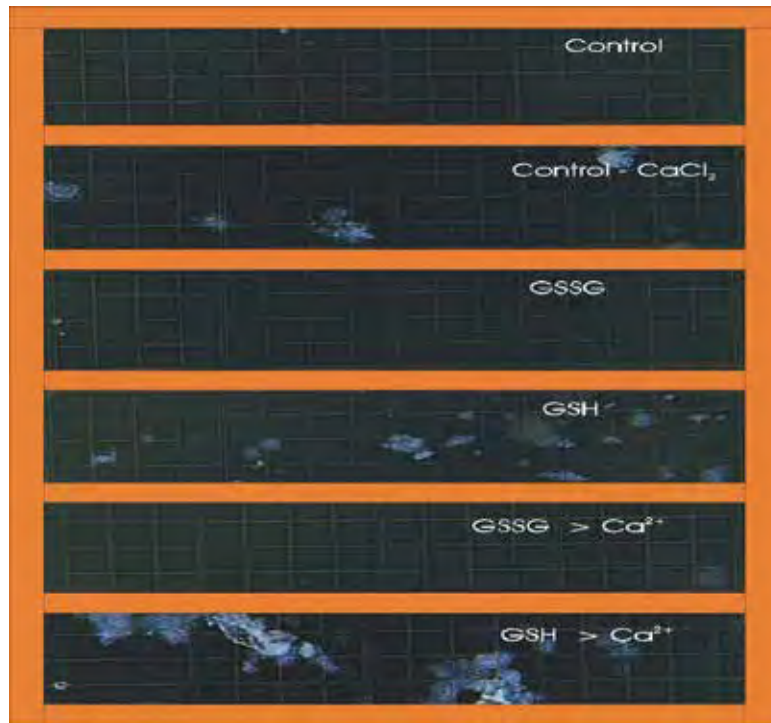


Figure 2A: Number of large aggregates formed by *X. fastidiosa* (strain UCLA) after the treatment with  $\text{CaCl}_2$  (red) and  $\text{MgCl}_2$  (blue). The calcium ions were more consistent in terms of inducing the formation of large aggregates as denoted by smaller standard errors. Nevertheless, the aggregation induced by magnesium should not be overlooked. Figure 2B: Number of large aggregates formed by *Xf* (strain STL) after treatment with  $\text{CaCl}_2$  (red) and  $\text{MgCl}_2$  (blue). For strain STL, calcium ions produced more aggregates than magnesium ions.



**Figure 3: Aggregation of *Xylella fastidiosa* under different conditions (top to bottom). Aggregation was measured with: deionized water (negative control),  $\text{CaCl}_2$  50 mg/L (positive control) Reduced Glutathione 10 mM (GSH), Oxidized Glutathione 10 mM (GSSG), GSH 10  $\mu\text{M}$  for 20 min +  $\text{CaCl}_2$  50 mg/L and GSSG 10 mM for 20 min +  $\text{CaCl}_2$  50 mg/L. Maximum aggregation was obtained with GSH 10 mM for 20 min followed by  $\text{CaCl}_2$  50 mg/L. Notice the large sized aggregates formed with the treatment GSH followed by a source of calcium (bottom figure).**

## REFERENCES

- Alves, E., Marucci, R. C., Lopes, J. R. S. and Leite, B., 2004. J. Phytopathology. 152: 291-297.
- Andersen, P. C., Momol, E. A., Leite, B., Momol, M. T Ishida, and M. L. 2004. Vitis 43: 19-25.
- Ishida, M. L., Andersen, P. C., and Leite, B. 2004. Phytopathology 94: S44.
- Ishida, M.L., Andersen, P. C. and Leite, B. 2004. Physiol. Mole. Plant Path.. 64:73-81.
- Leite, B., Andersen, P. C. and Kitajima, E. W. 2005. Phytopathology 95:963.
- Leite, B., Andersen, P. C. and M. L. Ishida. Phytopathology 95:962.
- Leite, B. and Andersen, P. C. 2005. Phytopathology 95:963.
- Leite, B., Andersen, P. C. and Ishida, M. L. 2004. FEMS Microbiol. Lett. 230:283-290.
- Leite, B., Ishida, M. L., Alves, E.1, Carrer, H., Pascholati, S. F. and Elliot W. Kitajima. 2002. Braz. J. Med. Biolog. Sci. 36:645-650.
- Leite, B., Ishida, M. L., Brodbeck, B., Marques, L., Olson M. E, Braga, M. R. and Andersen, P. C. 2004. Phytopathology 94: S59.
- Leite, B., M. L. Ishida, and P.C. Andersen. 2003. Phytopathology 95:963.
- Leite, B., P.C. Andersen, and M. L. Ishida. 2003. Phytopathology 93:S50.
- Marques, L., Leite, B., Andersen, P. C. and Olson, M. 2005. Phytopathology 95:963.
- Meng, Y., Li, Y., Cheryl, D. G., Hao, G., Turner, J. N., Burr, T. J., and Hoch, H. C. 2005. J Bacteriol. 187:5560-7.
- Rose, R. K. 2000. Biochimica Biophysica Acta 1475: 76-82.
- Rojas CM, Ham JH, Deng WL, Doyle JJ, Collmer A. 2002. Proc Natl Acad Sci U S A. 99:13142-7.
- Sarkisova S, Patrauchan MA, Berglund D, Nivens DE, Franklin MJ. 2005. J. Bacteriol. 187:4327-37.

## FUNDING AGENCIES

Funding for this project was provided by the University of California Pierce's Disease Grant Program, and the University of California Pierce's Disease Grant Program.

# QUANTITATIVE ASPECTS OF THE TRANSMISSION OF *XYLELLA FASTIDIOSA* BY THE GLASSY-WINGED SHARPSHOOTER

## Project Leaders:

Blake Bextine  
Department of Biology  
University of Texas  
Tyler, TX 75799

Matthew J. Blua and Thomas A. Miller  
Department of Entomology  
University of California  
Riverside, CA 92521

**Reporting Period:** The results reported here are from work conducted July 2004 to October 2005.

## ABSTRACT

Transmission of *Xylella fastidiosa* (*Xf*) by the glassy-winged sharpshooter (GWSS) involves a series of events from acquisition of the bacterium to inoculation of *Xf* to a new host. While this process is often over-simplified, certain insect/pathogen interactions may be necessary to achieve a successful transmission event and the number of *Xf* cells acquired or inoculated may govern whether or not transmission will occur. In our preliminary studies, neither higher titers of *Xf* nor longer feeding periods by GWSS result in higher rates of transmission nor a greater number of bacteria transmitted.

## INTRODUCTION

Solutions to PD are coming out of an understanding of basic biological aspects of the vector, the pathogen, and their hosts. The most important of these interactions is the transmission of the pathogen by the vector to a non-infected plant. The process that leads to pathogen transmission by an insect can be broken down into three separate events; (1) acquisition from an infected plant, (2) inoculation into a naive potential host, and (3) infection following inoculation. In this report, we describe the development of an artificial disease cycle for study of these relationships and have begun to describe transmission events in a quantitative fashion. Positive correlations were detected between acquisition events and total ingestion time or AAP length, but not increased number of probes. On the other end of the disease cycle, positive were detected between inoculation of *Xf* and number of probes or IAP length, but not increased total ingestion time.

## OBJECTIVES

Our long-term goal is to understand quantitative aspects of the process of *Xylella fastidiosa* (*Xf*) transmission by *Homalodisca coagulata* (GWSS) in order to develop a means of reducing the efficiency with which spreads the pathogen from an infected plant to a non-infected one. Our specific objectives for this project are to:

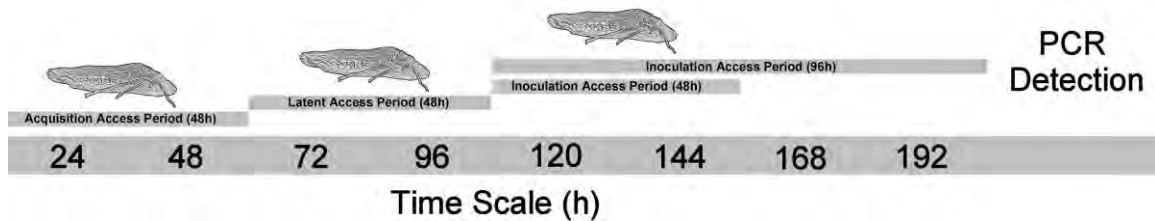
1. Determine relationship between time a GWSS spends on a PD-infected grapevine and titer of *Xf* they acquire.
2. Determine the relationship between time a GWSS spends in post-acquisition on a non-*Xf* host and titer of *Xf* they contain.
3. Determine the relationship between time an infectious GWSS (ie, one that had acquired *Xf*) spends on a non-infected grapevine and the titer of *Xf* it inoculates into the grapevine.
4. Determine the relationship between titer of *Xf* inoculated into a plant and the probability that it will become diseased by developing a transmission index.

## RESULTS

### The Artificial Feeding System

We developed a simple and efficient transmission cycle for the study of *Xf* transmission by GWSS that allows detection of specific numbers of cells in plant tissue and within the insect vector by QRT PCR (3). A QRT PCR protocol for detecting the citrus variegated chlorosis strain of *Xf* has already been established (9).

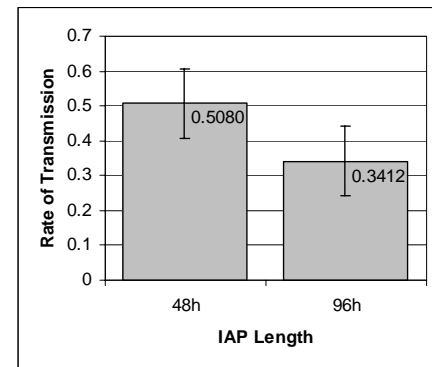
QRT PCR was performed in a Rotor Gene 3000 (Corbett Research, Australia) using iQ Supermix (Bio-Rad Laboratories Inc., Hercules, CA) in 20 $\mu$ l reactions with *Xf*-specific 16S-23S ITS primers and the ITS probe (11). *Xf* was cultured on PD3 medium, a modification of PW medium (7,8) for 7-10 days. Bacterial cultures were scraped from a PD3 plate and suspended in sterile phosphate buffered saline (PBS). This bacterial suspension was diluted in sterile PBS to OD<sup>600</sup>=2.0. Five cm sections of cut *Chrysanthemum grandiflora* stems were used for bacterial inoculations (4). The bacterial suspension was forced through the cut stem by attaching a 10cc syringe to one cut end of stem and applying pressure until the fluid was seen coming out of the other cut end. The cut ends of the stem were sealed with parafilm to prevent leakage during the acquisition access period (AAP). Five GWSS per 5 cm of stem were caged in snap cap vials for 48 h, about 250 insects placed on 50 cuttings per trial (Figure 1). Survival through the acquisition access period (AAP) indicated effective feeding because starving these insects for 48 h resulted in 100% mortality (4). After the AAP, GWSS were placed on *Xf*-free chrysanthemums for 48 h, so that any detection of bacteria would be associated with transmission and not stylet contamination.



**Figure 1.** Artificial PD cycle for determination of *Xf* transmission.

Pairs of surviving GWSS were transferred to sterile vials containing a fresh chrysanthemum stem cutting, about 100 cuttings per trial. The insects were exposed to a stem for an inoculation access period (IAP) of 48 or 96 h. Finally, GWSS were removed from the vial and stored at 4°C until tested by PCR. DNA was extracted from the inoculation targets with the XNAR Extract-N-Amp kit (Sigma-Aldrich, St. Louis, MO) and PCR was run following a standard QRT-PCR protocol (11).

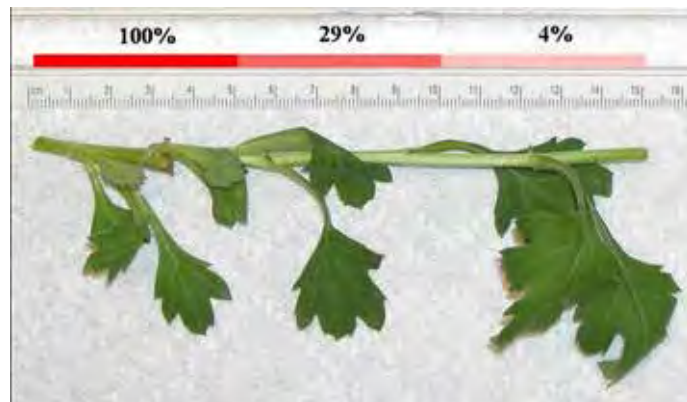
Across 9 replicates using a 48h IAP, the mean transmission rate of *Xf* by GWSS was  $0.508 \pm 0.122$ , while the mean rate when given a 96h IAP was  $0.341 \pm 0.138$  (Figure 2). Using Chi-square analysis, these ratios were significantly different ( $\chi^2=16.281$ ,  $df=1$ ,  $p \leq 0.001$ ). The lower rate associated with the longer IAP is probably due to the non-hospitable environment of the test plant stems. While the rate of *Xf* transmission was higher than previously reported (1,2,6), we feel this is a fair assessment of the insects' ability to move the bacterium from one place to another.



**Figure 2.** Rate of *Xf* transmission by the GWSS in an artificial disease cycle when given a 48 or 96 h IAP.

#### Distribution of Cells in the AAP Stem

In preliminary acquisition experiments using cut chrysanthemum stems with *Xf* pushed through the vascular system, great variation *Xf* cell numbers was noted, despite similar feeding times and behavior. In these experiments, 15cm cuttings were used during the “push through” portion of the process; then, stems were cut into 5cm sections and offered to GWSS. Originally, we conceptualized the push trough delivery stem as a straw that would have equally distributed cells throughout the stem. However, empirical assays determined that the stem acts more like a sieve (catching more cells at the beginning), resulting in much higher cell numbers in the first 5cm cutting (Figure 3). Therefore, we altered the “push through” step by using 5cm cuttings, without trimming the stems. We also offered GWSS a much smaller portion of the stem, affectively standardizing the access area.

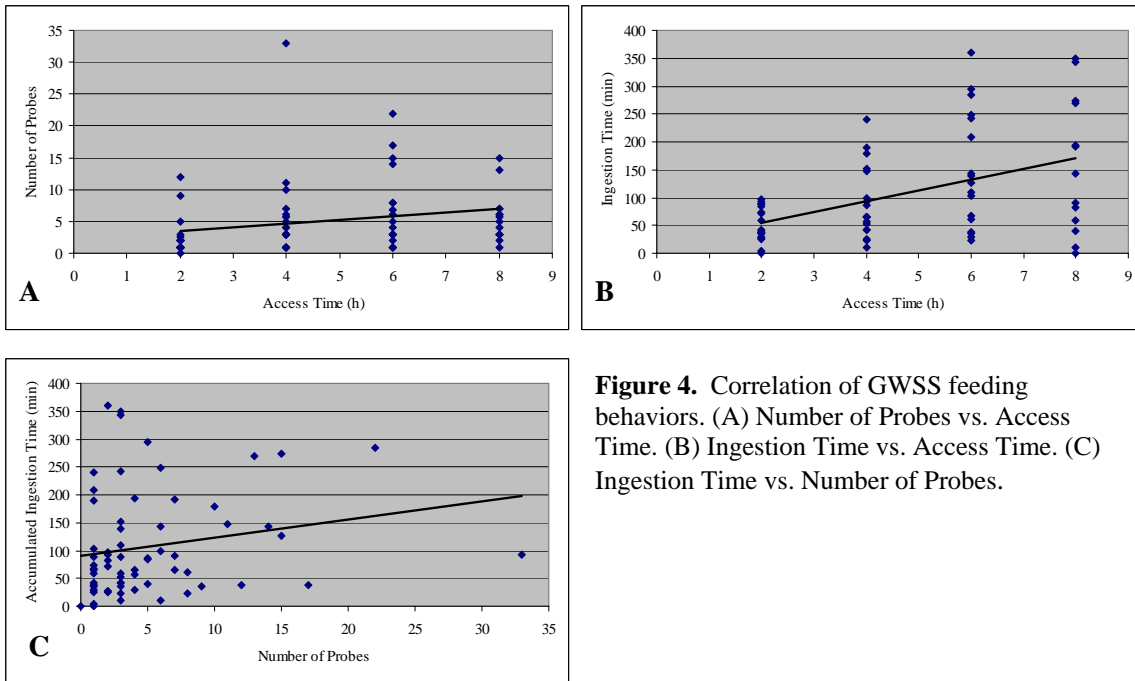


#### Access Period/Probe Number Correlation

GWSS were exposed to plants for 2, 4, 6, or 8 hr periods of time and monitored for two distinct feeding behaviors that could impact the transmission efficiency of the pathogen. There were strong correlations between access time and either ingestion time ( $r=0.97$ ) or number of probes ( $r=0.76$ ) (Figure 4, A and B respectively). Additionally, there was a positive correlation between number of probes and ingestion time ( $r=0.85$ ).

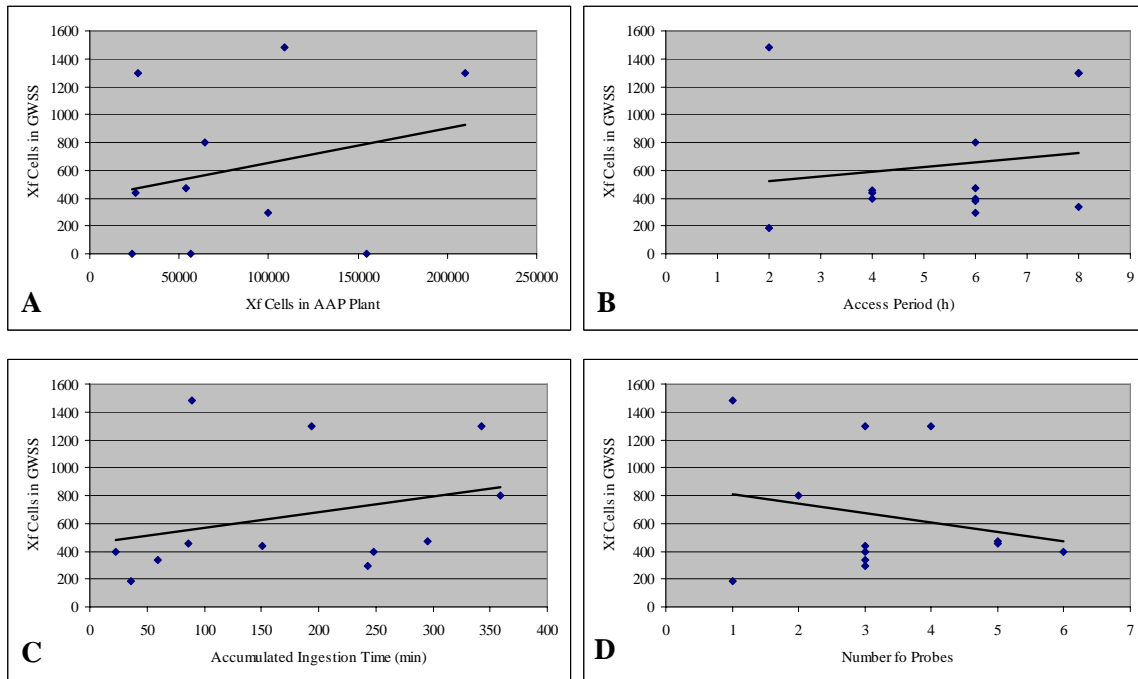
#### AAP Experiments (Objective 1)

Chronologically, we started these experiments after the IAP experiments, so we have completed fewer trials, resulting in fewer data points. Despite the limited data, interesting trends have begun to surface. The ability of GWSS to acquire *Xf*



**Figure 4.** Correlation of GWSS feeding behaviors. (A) Number of Probes vs. Access Time. (B) Ingestion Time vs. Access Time. (C) Ingestion Time vs. Number of Probes.

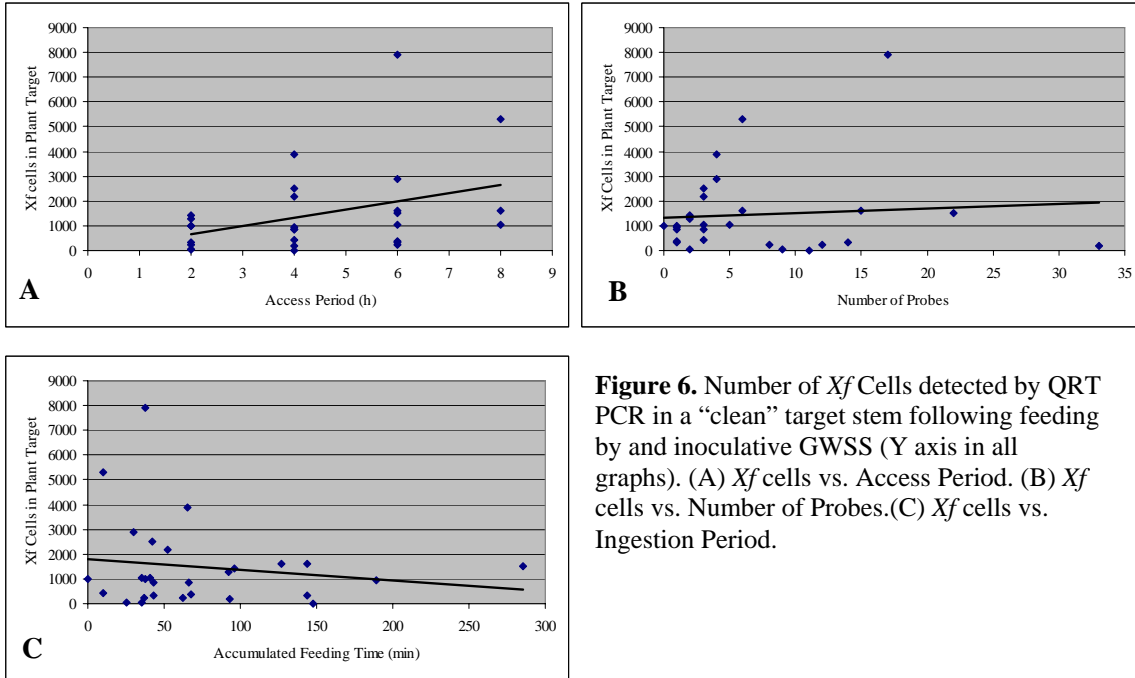
from a standardized acquisition host was tested by allowing the insects to feeding on an *Xf* “push through” stem for varied periods of time (2, 4, 6, or 8 hr). During these AAP’s, number of probes and total ingestion time were also recorded (Figure 5). Weak positive correlations were made between *Xf* cells in GWSS and *Xf* cells in AAP host ( $r=0.27$ ), AAP length ( $r=0.16$ ), and ingestion time ( $r=0.30$ ). Interestingly, a negative correlation between number of probes and *Xf* cells in GWSS was made ( $r=-0.23$ ). While these data are preliminary, they do follow our hypothesis that GWSS that feed longer will come in contact with more *Xf* cells. GWSS that retract their mouthparts and re-probe multiple times are less likely to ingest more *Xf* cells based on there reduced feeding time. Conversely, the more xylem fluid an insect ingests from an *Xf* infected host plant, the more *Xf* cells the insect would be expected to ingest.



**Figure 5.** Number of *Xf* cells detected in GWSS by QRT PCR following feeding on a “push through” acquisition stem (Y axis in all graphs). (A) *Xf* cells vs. Number of *Xf* cells in plant. (B) *Xf* cells vs. AAP period. (C) *Xf* cells vs. Ingestion Time. (D) *Xf* cells vs. Number of Probes.

### IAP Experiments (Objective 3)

The ability of GWSS to inoculate *Xf* into a target host was tested by allowing “*Xf*-positive” insects to feeding on a “clean” stem for varied periods of time (2, 4, 6, or 8 hr). During these IAP’s, number of probes and total ingestion time were also recorded (Figure 6). A positive correlations was made between *Xf* cells in the target host and the length of the IAP ( $r=0.37$ ). There was also a slight positive correlation between *Xf* cells in the target host and the number of probes the insects made on the target ( $r=0.08$ ). This was unexpected because our hypothesis was that the more time an insect probed a host, the more cells would be transmitted. This hypothesis was based on the ingestion/egestion principle where the insect’s initial contact with the xylem vessels, which are under negative pressure, would result in a backflow of foregut contents into the host. By the law of averages, the more an insect probes, the more transmission events would occur. For this reason we expected a more positive correlation. Following this line of hypothesis, we also expected a negative correlation between the total ingestion time and the number of transmitted *Xf* cells, based on the idea that active ingestion results in material moving into the GWSS foregut and not out (i.e. back into the plants xylem). Empirically, a negative correlation was made ( $r=-0.15$ ), although less dramatic than we expected.



**Figure 6.** Number of *Xf* Cells detected by QRT PCR in a “clean” target stem following feeding by and inoculative GWSS (Y axis in all graphs). (A) *Xf* cells vs. Access Period. (B) *Xf* cells vs. Number of Probes.(C) *Xf* cells vs. Ingestion Period.

### CONCLUSIONS

Movement of *Xf* from one plant to another depends on the transmission of the bacterium from an infected host to an uninfected host by the insect vector. For transmission to occur, two major events have to occur, ACQUISITION and INOCULATION. In these studies are determining behaviors and timed events that are associated with successful movement of the bacterium. Understanding these associations will allow epidemiology studies of inoculative GWSS to be more accurate and help develop a means of reducing the efficiency with which the pathogen is spread from an infected plant to a non-infected one.

### REFERENCES

1. Almeida, R.P.P. and A.H. Purcell. 2003. *Homalodisca coagulata* (Hemiptera, Cicadellidae) transmission of *Xylella fastidiosa* to almond. *Plant Dis.* 87:1255-1259.
2. Almeida, R.P.P. and A.H. Purcell. 2003. Transmission of *Xylella fastidiosa* to grapevines by *Homalodisca coagulata* (Hemiptera : Cicadellidae). *J. Econ. Entomol.* 96:264-271.
3. Bextine, B., D. Lampe, C. Lauzon, B. Jackson and T.A. Miller. In press. Establishment of a genetically marked insect-derived symbiont in multiple host plants. *Curr. Microbiol.*
4. Bextine, B., C. Lauzon, S. Potter, D. Lampe and T.A. Miller. 2004. Delivery of a genetically marked *Alcaligenes* sp. to the glassy-winged sharpshooter for use in a paratransgenic control strategy. *Curr. Microbiol.* 48:327-331.
5. Bextine, B. and T.A. Miller. 2004. Comparison of whole-tissue and xylem fluid collection techniques to detect *Xylella fastidiosa* in grapevine and oleander. *Plant Dis.* 88:600-604.
6. Costa, H.S., M.S. Blua, J.A. Bethke and R.A. Redak. 2000. Transmission of *Xylella fastidiosa* to oleander by the glassy-winged sharpshooter, *Homalodisca coagulata*. *Hortscience* 35:1265-1267.
7. Davis, M.J., A.H. Purcell and S.V. Thomson. 1980. Isolation media for the Pierce's disease bacterium. *Phytopathology.* 70:425-429.

8. Hill, B.L. and A.H. Purcell. 1995. Multiplication and movement of *Xylella fastidiosa* within grapevine and four other plants. *Phytopathology* 85:1368-1372.
9. Oliveira, A.C., M.A. Vallim, C.P. Semighini, W.L. Araujo, G.H. Goldman and M.A. Machado. 2002. Quantification of *Xylella fastidiosa* from citrus trees by real-time polymerase chain reaction assay. *Phytopathology* 92:1048-1054.
10. Purcell, A.H. and A.H. Finlay. 1979. Acquisition and transmission of bacteria through artificial membranes by leafhopper vectors of Pierce's disease. *Entomol. Exp. Appl.* 25:188-195.
11. Schaad, N.W., D. Opgenorth and P. Gauth. 2002. Real-time polymerase chain reaction for one-hour on-site diagnosis of Pierce's disease of grape in early season asymptomatic vines. *Phytopathology* 92:721-728.

#### **FUNDING AGENCIES**

Funding for this project was provided by the CDFR Pierce's Disease and Glassy-winged Sharpshooter Board.



## ASPECTS OF PIERCE'S DISEASE RISK IN TEXAS

### Project Leaders:

Mark C. Black  
Department of Plant Pathology & Microbiology  
Texas A&M University  
Agricultural Research and Extension Center  
Uvalde, TX 78802

James S. Kamas  
Department of Horticultural Sciences<sup>2</sup>  
Texas A&M University  
Fredericksburg, TX

### Researchers:

Alfred M. Sánchez and James L. Davis  
Department of Plant Pathology & Microbiology  
Texas A&M University  
Agricultural Research and Extension Center  
Uvalde, TX 78802

Penny Adams  
Department of Horticultural Sciences<sup>2</sup>  
Texas A&M University  
Texas Cooperative Extension  
Fredericksburg, TX

**Reporting Period:** The results reported here are from work conducted September 2004 to September 2005.

### ABSTRACT

Granite-based and limestone-based vineyard soils are being compared in a greenhouse test for possible effects on Pierce's disease (PD) following mechanical inoculation of *Xylella fastidiosa* (*Xf*) in 'Chardonnay'. The twelve most common root stocks used in Texas vineyards are being evaluated a 3-year field test with endemic *Xf*. Texas sites with native *Vitis vulpina* nearby may have increased PD risk.

### INTRODUCTION

Pierce's disease (PD), caused by the bacterial pathogen *Xylella fastidiosa* (*Xf*), is the most limiting factor for growing grapes in much of Texas. Multiple PD control and management strategies are needed, including genetic resistance, site selection, and vegetation management.

Some Texas vineyards (e.g., with granite-based soils) do not have PD but nearby vineyards (limestone-based soils) have high disease incidence and severity. We do not yet know if reduced site risk is directly or indirectly related to the soils at vineyards with no history of PD. The reduced risk may be partly explained by soil effects on plant species composition (Black et al., 2005) and absence of species susceptible to *Xf* and highly utilized by vectors.

Vineyards in southern and southeastern Texas where PD risk is consistent utilize cultivars with native American *Vitis* species backgrounds (*V. aestivalis*, *V. simpsonii*, *V. labrusca*, etc.) but *V. vinifera* scion cultivars are often used in other parts of the state. In cooler regions of Texas (including regions with PD problems), *V. vinifera* cultivars are grafted on rootstocks with native American *Vitis* sp. backgrounds. Little is known about rootstock PD reactions, and influence of rootstock on performance of scion cultivars during epidemics. Phytosanitary concerns in Texas should include both scion and rootstock because of risk for *Xf* introduction into uninfested regions.

Many *Vitis* species are native in Texas, and wild grapes are common near many vineyards. An understanding of PD reaction among native *Vitis* species will contribute to site risk assessment, and recommendations for selective vegetation management.

### OBJECTIVES

1. Compare PD progress in a susceptible cultivar grown in a greenhouse in soils from vineyards with or without PD histories.
2. Evaluate *Xf* reactions among the most commonly planted grape rootstocks in Texas at a vineyard site with known risk for PD.
3. Test native Texas *Vitis* species in central to southwest Texas for *Xf* infections.

### RESULTS

Soil from two vineyards with no history of PD (granite-based; Gillespie Co., McCulloch Co.) and soil from two vineyards with PD histories (limestone-based; Gillespie Co., Blanco Co.) were collected in the spring of 2005. These were compared to a commercial peat moss-based potting medium (Metro-Mix 366) in a white shaded greenhouse to exclude vectors (62% total shade) in black plastic pots (0.082 m<sup>3</sup>) irrigated with distilled water. PD-susceptible 'Chardonnay' (own-rooted) was inoculated 22-23 August 2005 with log-phase *Xf* cells isolated from *V. vinifera* in Gillespie Co (SCP buffer control). Symptoms and ELISA data will be collected in late 2005 and early 2006.

The 3-yr rootstock study was planted in 2005 in Llano County, TX at a site where two previous plantings of *V. vinifera* cultivars were lost to PD. Entries are 5BB, 5C, 110R, 1103P, 1613C, 1616C, Champanel, Dog Ridge, Freedom, Harmony, Salt Creek and SO4 (five plants/plot, five replications). Leaves with PD symptoms in cv. 'Black Spanish' adjacent to this

test were positive with ELISA in September 2005. Data to be collected includes symptoms and ELISA reactions in 2006 and 2007.

*Vitis mustangensis* (the most common native grape species in most of Texas) and *V. cinerea* var. *helleri* (syn. *V. berlandieri*) were negative for numerous ELISA tests and several *Xf* isolation attempts in 2003 and 2004. Rooted cuttings of *V. mustangensis* were mechanically inoculated in the greenhouse with *Xf* in 2005, with data to be collected later this year. Symptomatic *V. vulpina* (with GWSS egg masses) samples from near the PD-vineyard in Llano Co. were positive in 2005 for *Xf* with ELISA; *Xf* isolation attempts were unsuccessful in 2004 on very few asymptomatic samples, and are underway on 2005 samples. Work on other wild grapes in Texas is planned to better understand roles of native *Vitis* in vineyard PD epidemics.

## CONCLUSIONS

Assessing PD risk in Texas vineyards is a complex problem. Knowledge of *Xf* sources in Texas increases prospects for disease control locally and in other wine grape production regions. Native vegetation may be an important source of *Xf*, and some susceptible species are absent at certain vineyards without PD (Black et al., 2005). We are concerned about planting stock as a means of disseminating *Xf*. Infected but tolerant (few if any acute symptoms) cultivars grown in Texas and other southern states can be reservoirs of *Xf* (Harkness and Moreno, 2004). Infected planting stocks of these varieties are potential sources of initial inoculum if planted adjacent to *V. vinifera* and in previously PD-free areas. Pathogen-free *Xf*-tolerant planting materials may become infected and a source for nearby *V. vinifera*.

## REFERENCES

- Black, M. C., A. M. Sanchez, J. L. Davis, J. S. Kamas, and S. E. Ortiz. 2005. Supplemental *Xylella fastidiosa* hosts found near four central Texas vineyards with or without Pierce's disease histories. *Phytopathology* 95:S10 (Abstr.).
- Harkness, M., and L. Morano. 2004. Initial analysis of hybrid varieties Blanc du Bois, Cynthiana, and Black Spanish within a Pierce's disease hot zone. *Amer. J. Enol. Vitic.* 55:318A (Abstr.).

## FUNDING AGENCIES

Funding for this project was provided by the USDA Animal and Plant Health Inspection Service.

# EVALUATION OF SINGLE NUCLEOTIDE POLYMORPHISMS AND SAMPLE PREPARATION PROCEDURES IN THE DETECTION OF *XYLELLA FASTIDIOSA* STRAINS IMPORTANT TO CALIFORNIA

## Project Leaders:

Jianchi Chen and Edwin L. Civerolo  
USDA, ARS, PWA  
Crop Diseases, Pests, & Genetics  
Parlier, CA 93648

**Reporting Period:** The results reported here are from work conducted October 1, 2004 to September 30, 2005.

## ABSTRACT

The main objective of this project is to develop a PCR-microarray-based system for accurate and quick identification of *Xylella fastidiosa* (*Xf*) strains important to California crops. The major part of the current work focused on identification of important DNA sequences based on single nucleotide polymorphisms (SNPs) for the detection of *Xf* Pierce's disease (PD) and almond leaf scorch disease strains. We expanded the previous SNP analysis in 16S rDNA to other house-keep genes, such as those coding for TCA cycle enzymes. *Xf*-specific primers were designed and real-time PCR was employed. Melting point analysis was used to confirm the presence of SNPs in the amplicons and to detect different genotypic strains. A second effort was to develop and improved procedure of sample preparation, the bottleneck of PCR detection of *Xf in planta*. We developed two simple sample preparation procedures for PCR amplification of *Xf* DNA from infected almond and grape petioles using freshly squeezed petiole sap and freeze-dried tissue. The detection efficiency of the two PCR methods was similar to that of the pathogen isolation procedure.

## INTRODUCTION

Because of the availability of the complete genome sequences, considerable bioinformatics knowledge has been obtained by comparing four *Xf* strains, including strain Temecula for Pierce disease (PD) of grapevine, strain 9a5c for citrus variegated chlorosis, strain Dixon for almond leaf scorch disease (ALSD) and strain Ann-1 for oleander leaf scorch disease. One of the most direct benefits from the study of the genome sequences is the development of a highly accurate and efficient systems for pathogen identification and detection. We have proposed a PCR-microarray approach to develop such a system. In this study, we focused on two sub-components: identification of unique and informative sequences for each pathogen strain (genotype) and development of efficient procedures to prepare samples for detection of *Xf in planta*.

DNA sequence variations include insertions, deletions, transitions, transversions, sequence rearrangements, distribution of random repeats (restriction fragment length polymorphism or RFLP, random amplified polymorphic DNA or RAPD), variable tandem repeats, etc. Sequence analyses showed that single nucleotide polymorphisms (SNPs) are commonly found in almost all genes and intergenic regions in *Xf* populations. We previously used the SNPs in the 16S rDNA locus to define two genotypes correlated to *Xf* pathotypes associated with ALS in California (Chen et al., 2005). The A-genotype only causes ALS and the G-genotype causes both ALS and PD. While the sequences of 16S rDNA are of taxonomic value, the reliability of a pathogen detection system will be improved based on comparisons of more genetic loci, ideally the whole genome.

Sequences of house-keeping genes are conserved and present in all bacterial strains, making them good candidates for bacterial species identification. For *Xf*, SNPs exist within these genes. They could be used for strain differentiation in a PCR or/and microarray format. The value of each SNP, however, varies. Validation is necessary to avoid the selection of false SNPs and to determine the taxonomic specificity of the target SNPs. On the other hand, for a nucleic acid-based pathogen detection system, sample preparation can be a bottleneck for a successful detection. Low efficiency of DNA extraction and the presence of DNA polymerase inhibitors are among the many factors leading to the failure of pathogen detection using PCR.

## OBJECTIVES

The objectives of this project are to:

1. Use the complete and annotated genome sequences of the four *Xf* strains to identify SNPs in selected house-keeping genes.
2. Evaluate the potential of these SNPs for *Xf* pathotype / genotype identification.
3. Developed a simple but effective sample preparation procedure that minimize the presence of inhibitors and maximize the availability of nucleic acid.

## RESULTS AND CONCLUSIONS

A BLAST search with randomly selected ORFs or intergenic sequences from strain Temecula against the four *Xf* whole genome sequence database showed that SNPs existed in every section of the bacterial genomes. One question was whether some SNPs might simply be due to sequence errors. The use of published genome sequences reduced the possibility of sequence error because of the high number of base coverage during the sequencing effort. Further confirmation was

performed using a large number of *Xf* strains. We found that some regions of the genome have more SNPs than other regions, suggesting different rates of sequence evolution. The strategy for *Xf* detection was to use the more conserved regions to secure the correct identification of the bacterial species (Chen et al., 2005). For *in planta* detection, this is particularly important because bacterial species of unknown taxonomy were expected to occur in the host tissue along with the pathogen. For this reason, we focused on the house-keeping genes.

Among the many house-keeping genes, five genes involving in tri-carboxylic acid cycle were selected. They were: PD0492 for malate dehydrogenase, PD0750 for citrate synthase, PD0234 for aconitase, and PD2056 for isocitrate dehydrogenase. Sequence lengths of the five genes ranged from 873 nt to 2232 nt with the number of SNPs ranging from 19 to 55. As expected from existing phylogenetic data, there were more SNPs between strain 9a5c (CVC) and the three other North American strains (Temecula, Ann-1 and Dixon) as a group than among the three North American strains. PD0234 (aconitase) showed the highest number of SNPs (55). PD2056 (isocitrate dehydrogenase) ranked second with 44 SNPs. These two genes were selected for further evaluation.

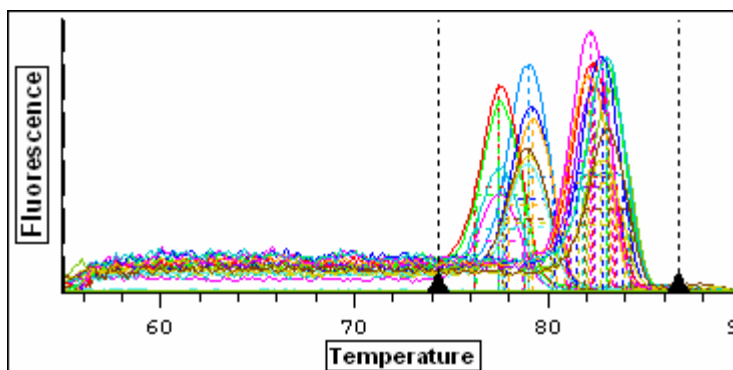
Although higher in number, SNPs in PD0234 (aconitase) were more evenly distributed along the gene sequences in strains Temecula and Dixon. All the SNPs occurred singly with the exception of a doubled SNP between strain Ann-1 and the group of strains Temecula and Dixon. In PD2056 (isocitrate dehydrogenase), most SNPs were singly present. Positions 1,225 and 1,226 were doubled SNPs with an additional SNP occurring at position 1,228. To test the value of these SNPs, PCR primers were made by placing the double or near-triple SNPs in the center of the amplicons with the size of 97 and 90 nt for PD0234 and PD2056, respectively, using Primer 3 software. Primer specificity was checked by performing BLASTn search against all published DNA sequences in GenBank using concatenated primer sequences as queries (Chen et al., 2005). The results confirmed that these primers were specific to *Xf* with respect to known bacterial species.

**Table 1.** Comparative DNA amplification and melting temperature (Max  $T_m$ ) of *Xf* A- and G-genotypes using PCR Primers targeting SNPs in the aconitase gene.

Strain	Genotype	$C_t$	Max $T_m$
Ju04	A	21.959	83.1
RL A2	A	21.772	83
Dixon	A	23.356	82.8
M12	A	21.496	83
RL 47	A	21.117	83.1
McC 9BL	A	25.974	82.7
MTO 4L	G	18.840	82.4
Price 19	G	20.466	82.3
M23	G	18.828	82.1
RS	G	19.938	82.2
Neg. Ctrl.	None		81.3

**Table 2.** Comparative DNA amplification and melting temperature (Max  $T_m$ ) of *Xf* A- and G genotypes using PCR primers targeting SNPs in the isocitrate dehydrogenase gene.

Strain	Genotype	$C_t$	Max $T_m$
Ju04	A	21.846	79
RL A2	A	22.856	79.2
Dixon	A	24.232	79.2
M12	A	22.755	79
RL 47	A	21.889	79
McC 9BL	A	24.679	79
MTO 4L	G	20.790	77.5
Price 19	G	23.059	77.5
M23	G	24.413	77.5
RS	G	26.157	77.4
Neg. Ctrl.	None		83.4

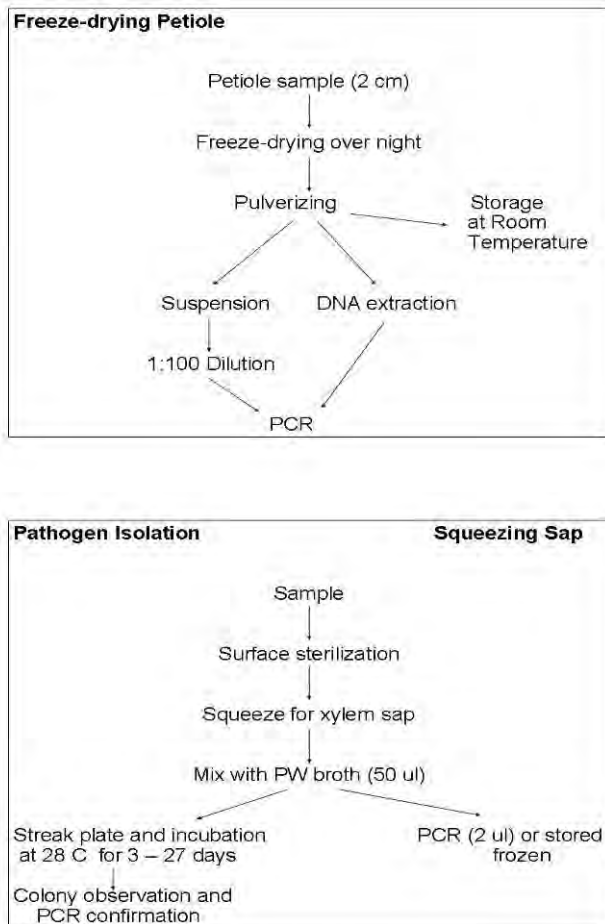


**Figure 1.** Capacity of genotype differentiation between the ICO primer set (two peaks on the left) and the ACO primer set (two peaks on the right) in melting point analysis. Also refer to Table 1 and 2.

Our working experience indicates that, while primer design and selection are important, sample preparation is currently the bottleneck for *Xf* detection *in planta*. Inhibitor(s) from host tissue and the efficiency of obtaining template DNA can directly

influence the success of PCR detection. Therefore, we developed two efficient sample preparation procedures for PCR amplification of *Xf* DNA from infected almond and grape petioles. A schematic illustration of the two procedures is shown in Figure 2.

In the freeze-dried method, petioles were pulverized into small particles (< 0.1mm in diameter based on our microscopic



**Figure 2.** Procedures of sample preparation for PCR detection of *Xf*.

measurement). This increased the efficiency of DNA release from host tissue. Because the petiole was dried, oxidation and enzymatic degradation of samples during pulverization were minimal. Dilution reduced the effect of DNA polymerase inhibitors. But a balance was kept to avoid excessive dilution of the bacterial DNA beyond the detection range of PCR. The squeeze-sap method was often coupled with the bacterial isolation procedure. The amount of PW broth used did not seem to inhibit PCR. The squeeze-sap procedure has been routinely used in our laboratory as a quick check during the pathogen isolation.

In summary, our study indicates that SNPs are a good resource for the study of bacterial genome variation. They are particularly useful when whole genome sequence information becomes available, as in the case of *Xf*. When combined with the phylogenetic data, SNP analysis can be highly versatile and reliable. We have also developed simple procedures to prepare samples for *in planta* pathogen detection. Such procedures will contribute significantly towards the development of an efficient and accurate system for *Xf* identification and detection.

## REFERENCES

Chen, J., R. Groves, E.L. Civerolo, M. Viveros, M. Freeman and Y. Zheng. 2005. Two *Xylella fastidiosa* genotypes associated with almond leaf scorch disease on the same location in California. *Phytopathology* 95:708-714.

## FUNDING AGENCIES

Funding for this project was provided by the University of California Pierce's Disease Grant Program.

## CULTURE-INDEPENDENT ANALYSIS OF ENDOPHYTIC MICROBIAL COMMUNITIES IN GRAPEVINE IN RELATION TO PIERCE'S DISEASE

### Project Leaders:

Donald A. Cooksey and James Borneman  
Department of Plant Pathology  
University of California  
Riverside, CA 92521

**Reporting Period:** The results reported here are from work conducted October 2004 to September 2005.

### ABSTRACT

Culture-independent, nucleic acid-based methods of assessing microbial diversity in natural environments have revealed far greater microbial diversity than previously known through traditional plating methods. If true for grapevines, then this has important consequences for Pierce's disease (PD) management strategies that involve the establishment of introduced bacteria systemically in the grapevine xylem. Such establishment will likely be influenced by the presence of yet uncharacterized microorganisms, and knowledge of endophytic communities and their dynamics will therefore be important to the successful implementation of these strategies. In addition, analysis of microbial community composition in different hosts and conditions could lead to the identification of new biological control agents. We are employing a novel method, called oligonucleotide fingerprinting of rRNA genes (OFRG), that was recently developed by the Co-PI for analyzing microbial community composition in environmental samples. In a replicated comparison of symptomatic and asymptomatic grapevines, 558 OFRG fingerprint clusters, or taxonomic groups, were revealed in an analysis of 8,094 total clones, and several clusters were significantly correlated with healthy vs. diseased plants.

### INTRODUCTION

In recent years, culture-independent, nucleic acid-based methods of assessing microbial diversity in natural environments have revealed far greater microbial diversity than previously known through traditional plating methods (Amann et al., 1995). This is true for water, soil, the plant rhizosphere, and the plant leaf surface (Yang et al. 2001). A recent culture-independent analysis of bacterial populations inside of citrus plants in relation to *Xylella fastidiosa* (*Xf*) also suggested that bacterial endophytic populations are much more diverse than previously realized (Araújo et al., 2002). If true for grapevines, then this has important consequences for Pierce's disease management strategies. Several strategies are being investigated to biologically control *Xf* in grapevines, including the use of antibiotic-producing endophytes (Kirkpatrick et al., 2001), endophytes that disrupt cell-to-cell signaling by the pathogen (Lindow, 2002), endophytes that degrade xanthan gum (Cooksey, 2002a), and the use of nonpathogenic strains of *Xylella* for competitive exclusion of pathogenic strains (Cooksey, 2002b). These strategies have in common the need to establish an introduced strain systemically in the grapevine xylem. Such establishment will likely be influenced by the presence of yet uncharacterized microorganisms, and knowledge of endophytic communities and their dynamics will therefore be important to the successful implementation of these strategies. In addition, analysis of microbial community composition in different hosts and conditions could lead to the identification of new biological control agents.

We are employing a novel method that was recently developed by the Co-PI for analyzing microbial community composition in environmental samples. This method can be used to characterize both bacterial and fungal communities (Valinsky et al., 2002a; 2002b). Previous culture-independent methods, such as denaturing gradient gel electrophoresis (DGGE), generate only superficial descriptions of microbial community composition (Araújo et al., 2002). A far more complete view of total microbial community composition can be achieved by amplifying, cloning, and sequencing of conserved rRNA genes from the hundreds or thousands of microorganisms present in an environmental sample, but this is prohibitively expensive for any significant number of experiments. The new methodology, called oligonucleotide fingerprinting of rRNA genes (OFRG), represents a significant advance in providing a cost-effective means to extensively analyze microbial communities. The method involves the construction of clone libraries of rDNA molecules that are PCR amplified from environmental DNA, arraying of the rDNA clones onto nylon membranes or specially-coated glass slides, and subjecting the arrays to a series of hybridization experiments using 37 different end-labeled DNA oligonucleotide discriminating probes (Borneman et al., 2001). The process generates a hybridization fingerprint and identification for each clone that is essentially like sequencing the individual clones.

The state of knowledge of the relationship between *Xf* and the resident endophytic flora of grapevines is at a very early stage. Work to date has been limited to the culturing of endophytes from grapevines, but even this has led to the realization that grapevine xylem sap contains a complex community of microorganisms. Bell et al. (1995) cultured over 800 bacterial strains from grapevine xylem fluid in Nova Scotia. Bruce Kirkpatrick has also isolated several hundred bacterial strains from grapevine xylem fluid in two counties of California (Kirkpatrick et al., 2001). In citrus, the culture-independent DGGE method of microbial community analysis was compared with culturing of endophytes in relation to the citrus variegated chlorosis strain of *Xf* (Araújo et al., 2002). It was found that DGGE detected the major bacteria that were cultured from citrus xylem, but it also detected other bacterial species that had not been cultured. In addition, this method showed differences in

microbial communities in different plant varieties, and most importantly, between citrus that was infected vs. non-infected with *Xf*. This provides support to our hypothesis that there are likely to be important interactions between *Xylella* and indigenous microflora in grapevines. With the greater resolving power of the oligonucleotide fingerprinting technique proposed in our study, we expect to make considerable advances in our knowledge of grapevine microbial communities and their interactions with *Xylella* or with other endophytes being considered for establishment as biological control agents.

## OBJECTIVES

1. Characterize the diversity and community structure of endophytic microorganisms in healthy and infected grapevines.
2. Compare endophytic microbial populations in different susceptible and tolerant grapevine cultivars, in different hosts that support high or low populations of *Xylella*, and in plants grown under different conditions.
3. Characterize the potential interactions of endophytic populations with *Xylella* and introduced biological control agents through experimental manipulations.

## RESULTS

Last year, several DNA extraction and PCR amplification protocols were tested, and a method involving differential centrifugation to remove DNA of plant origin was developed. This year, a full-scale extraction and amplification from symptomatic and asymptomatic grapevines from the field was conducted. Plant sap was extracted with a pressure pump and analyzed from six replicates of grapevines with Pierce's disease symptoms (three plants per replicate) and six replicates of asymptomatic plants. Isolated DNA was amplified with rDNA primers and cloned, and 768 clones were picked from each sample. Amplified rDNA from the clones were arrayed onto nylon membranes and subjected to a series of hybridization experiments with 37 different end-labeled DNA oligonucleotide discriminating probes. The quality of some of the hybridizations was poor, so we were not able to use data from all 37 probes. These will be repeated to obtain more definitive identification of the clones. However, from the data we were able to analyze from 8,094 of the clones, 558 different OFRG fingerprint clusters, or taxonomic groups, were identified. Further, eight of the groups were more significantly more prevalent in asymptomatic vs. symptomatic grapevines. Tentative identification of these seven groups placed six of these groups in the Proteobacteria and one in the Firmicutes. The only bacteria that were more prevalent in symptomatic vs. asymptomatic plants belonged to the Xanthomonadaceae, and were probably *Xylella*. A phylogenetic tree showing the different clusters and more definitive identification of clones will be constructed after data from all 37 probes are analyzed. The following table shows the numbers of clones belonging to groups that were more prevalent in asymptomatic vs. symptomatic grapevines.

**Table 1.** Numbers of clones belonging to groups significantly ( $P<0.1$ ) more prevalent in healthy vs. diseased grapevines.

Group number	General classification	Diseased	Healthy
Gp192	Proteobacteria	23	60
Gp277	Proteobacteria	9	25
Gp196	Gamma-Proteobacteria	2	14
Gp14	Firmicutes	1017	1769
Gp153	Proteobacteria	14	20
Gp316	Beta-Proteobacteria	4	28
Gp107	Proteobacteria	4	13
Gp284	Proteobacteria	4	12

## CONCLUSIONS

Last year, our preliminary analysis of just 58 clones revealed 16 different species, including several that had not been detected in previous culture-based approaches to identify endophytes in grapevine (Bell et al., 1995; Kirkpatrick, 2003). This year, our larger-scale analysis of symptomatic and asymptomatic grapevines confirmed that there is considerable diversity of endophytes in grapevines, with 558 bacterial taxa out of 8,094 clones. We also showed that some bacterial groups were more prevalent in healthy vs. diseased plants. An additional experiment with samples taken from healthy and diseased grapevines at different times during the season is in progress. Researchers working on biological control of the pathogen, as well as disease resistance in grapevine cultivars, will benefit from the information gained in this work. The work should enhance discovery of potential biological control agents for Pierce's disease and the implementation of biological control efforts underway.

## REFERENCES

- Amann, R. I, W. Ludwig, and K. H. Schleifer. 1995. Phylogenetic identification and in situ detection of individual microbial cells without cultivation. *Microbiol. Rev.* 59:143-169.
- Araújo, W. L., J. Marcon, W. Maccheroni, J. D. van Elsas, J. W. L. van Vuurde, and J. L. Azevedo. 2002. Diversity of endophytic bacterial populations and their interaction with *Xylella fastidiosa* in citrus plants. *Appl. Environ. Microbiol.* 68:4906-4914.
- Bell, C. R., Dickie, G. A., Harvey, W.L.G., and J.W.Y.F. Chan. 1995. Endophytic bacteria in grapevine. *Can. J. Microbiol.* 41:46-53.
- Borneman, J., M. Chrobak, G. Della Vedova, A. Figueroa, and T. Jiang. 2001. Probe selection algorithms with applications in the analysis of microbial communities. *Bioinformatics* 17 (Suppl. 1):S39-S48.
- Cooksey, D.A. 2002a. Biological control of Pierce's disease through degradation of xanthan gum. Pages 25-26. In: Proceedings of the Pierce's Disease Research Symposium, December 15-18, 2002, San Diego, CA, California Department of Food and Agriculture.
- Cooksey, D.A. 2002b. Biological control of Pierce's disease with non-pathogenic strains of *Xylella fastidiosa*. Pages 23-24. In: Proceedings of the Pierce's Disease Research Symposium, December 15-18, 2002, San Diego, CA, California Department of Food and Agriculture.
- Kirkpatrick, B. 2003. Characterize and assess the biocontrol potential of bacterial endophytes of grapevines in California. Pages 99-100. In: Proceedings of the Pierce's Disease Research Symposium, December 8-11, 2003, San Diego, CA, California Department of Food and Agriculture.
- Kirkpatrick, B., E. A. Weber, P. C. Andersen, A. H. Purcell, and M. A. Walker. 2001. Biological, cultural, and chemical management of Pierce's disease. Pages 52-57. In: Proceedings of the Pierce's Disease Research Symposium, December 5-7, 2001, San Diego, CA, California Department of Food and Agriculture.
- Lindow, S. E. 2002. Management of Pierce's disease of grape by interfering with cell-cell communication in *Xylella fastidiosa*. Pages 20-22. In: Proceedings of the Pierce's Disease Research Symposium, December 15-18, 2002, San Diego, CA, California Department of Food and Agriculture.
- Valinsky, L., G. Della Vedova, A. J. Scupham, S. Alvey, A. Figueroa, B. Yin, J. Hartin, M. Chrobak, D. E. Crowley, T. Jiang, and J. Borneman. 2002a. Analysis of bacterial community composition by oligonucleotide fingerprinting of rRNA genes. *Appl. Environ. Microbiol.* 68:3243-3250.
- Valinsky, L., G. Della Vedova, T. Jiang, and J. Borneman. 2002b. Oligonucleotide fingerprinting of rRNA genes for analysis of fungal community composition. *Appl. Environ. Microbiol.* 68:5999-6004.
- Yang, C. H., D. E. Crowley, and J. Borneman. 2001. Microbial phyllosphere populations are more complex than previously realized. *Proc. Natl. Acad. Sci. USA* 98:3889-3894.

## FUNDING AGENCIES

Funding for this project was provided by the University of California Pierce's Disease Grant Program, and the University of California Agricultural Experiment Station.



## ROLE OF TYPE I SECRETION IN PIERCE'S DISEASE

### Project Leader:

Dean W. Gabriel  
Department of Plant Pathology  
University of Florida  
Gainesville, FL 32611

### Cooperator:

Don Hopkins  
Department of Plant Pathology  
University of Florida  
Gainesville, FL 32611

### Researcher:

Joseph D. Reddy  
Department of Plant Pathology  
University of Florida  
Gainesville, FL 32611

**Reporting Period:** The results reported here are from work conducted September 31, 2004 to October 1, 2005.

### ABSTRACT

*Xylella fastidiosa* (*Xf*) Temecula sequence information reveals no type III, but two type I secretion systems, both dependent on a single *tolC* homologue. Marker exchange mutagenesis using pGEM-T as delivery vector and *nptII* as marker was employed to generate *tolC* disruptions. PCR and Southern blot analyses confirmed marker exchange at the *tolC* locus. Grape (var. Carignane) plants inoculated with mutant (*tolC::nptII*) strains exhibited no symptoms of PD, indicating that pathogenic ability of PD strains may be dependant on *tolC* and type I secretion. Further, these *tolC*<sup>-</sup> mutant strains were unable to multiply in mechanically inoculated grape plants, indicating that strain survival in grape may be dependent on type I efflux pump activity. Both *in planta* growth and pathogenic symptoms were restored when the mutant was transformed with a broad host range vector expressing wild type *tolC*. This is the first report of a completely non-pathogenic mutant of *Xf* due to a single gene knockout and it is also the first report of complementation of a gene knockout using an autonomously replicating plasmid in *Xf*.

### INTRODUCTION

*Xylella fastidiosa* (*Xf*) is a xylem-inhabiting Gram-negative bacterium that causes serious diseases in a wide range of plant species (Purcell and Hopkins, 1996). Two of the most serious of these are Pierce's disease (PD) of grape and Citrus Variegated Chlorosis (CVC). The entire genomes of both PD and CVC have been sequenced (Simpson et al., 2000). Availability of the complete genomic DNA sequence of both a PD and a CVC strain of *Xf* should allow rapid determination of the roles played by genes suspected of conditioning pathogenicity of CVC and/or PD. For example, analyses of the CVC and PD genomes showed that there was no type III secretion system, but there were at least two complete type I secretion systems present, together with multiple genes encoding type I effectors in the RTX (repeats in toxin) family of protein toxins, including bacteriocins and hemolysins. RTX proteins form pores in lipid bilayers of many prokaryotic and eukaryotic species and cell types; at least one is associated with pathogenicity in plants. However, lack of useful DNA cloning vectors and/or techniques for working with either CVC or PD strains have impeded progress in functional genomics analyses.

Last year we used marker-interruption to generate site directed mutations in *tolC* in *Xf* PD strain Temecula and found that *tolC* was absolutely required for PD pathogenicity. This year we complemented the *tolC* mutation using an autonomously replicating shuttle vector.

### OBJECTIVES

The primary objective of this work is to determine the effect of type I secretion gene knockouts on pathogenicity of a PD strain on grape.

### RESULTS

*Xf* strain Temecula (Guilhabert, 2001), was grown in PD3 (Davis et al., 1981) and confirmed to be pathogenic on Madagascar periwinkle and Grape (var. Carnignane). Symptoms appeared after 2 months. Marker-exchange mutagenesis of *tolC* was performed using pJR6.3. This plasmid carries an internal fragment of PD1964 (*tolC* of Temecula) interrupted at an internal *BamHI* site by an *nptII* gene from pKLN18 (kindly provided by K. Newman and S. Lindow). One microgram of pJR6.3 DNA was used to transform electrocompetent cells (prepared by washing 10 ml of four day old PD3 broth culture of *Xf* Temecula, serially with 10, 5, 2 ml of ice-cold deionized water and resuspending in 100 µl the same) by electroporation (1mm gap cuvettes; 1800 volts). Electroporated cells were allowed to recover in 1 ml of PD3 broth for 24 hours at 28 °C and were spread on PD3 plates amended with kanamycin (50 µg/ml). Plates were incubated at 28 °C for 10 days and single colonies were screened for interruption of *tolC* by PCR analysis and by Southern blot hybridization. The results (Figure 1) indicate that *tolC* gene can be disrupted and marker-exchange was efficient in generating gene-disruptions in *Xf*.

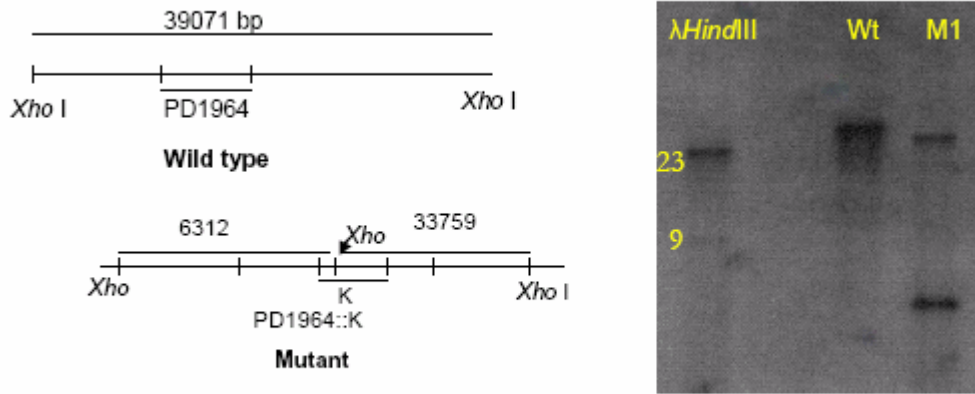


Fig. 1: Southern blot of *tolC::nptII* mutant (M1) and wild type total DNA cut with *XhoI*. *Xho I* is internal to the *nptII* gene. The probe was PD1964 (wild type *tolC* from Temecula, 1459 bp).

Plant inoculation assays were performed in collaboration with Don Hopkins, at the Mid-Florida Research and Education Center, Apopka, Florida. Grape plants (var. Carnignae) were inoculated with the wild-type *Xf* Temecula strain and the mutant (*tolC::nptII*) strain in triplicates. The plants were maintained under green-house conditions and were evaluated for Pierce's disease symptoms at 60 and 90 days after inoculation. The results (Figure 2) showed loss of pathogenicity of *Xf tolC::nptII* mutants on grapes. All the three plants inoculated with the wild-type Temecula strain exhibited typical PD.



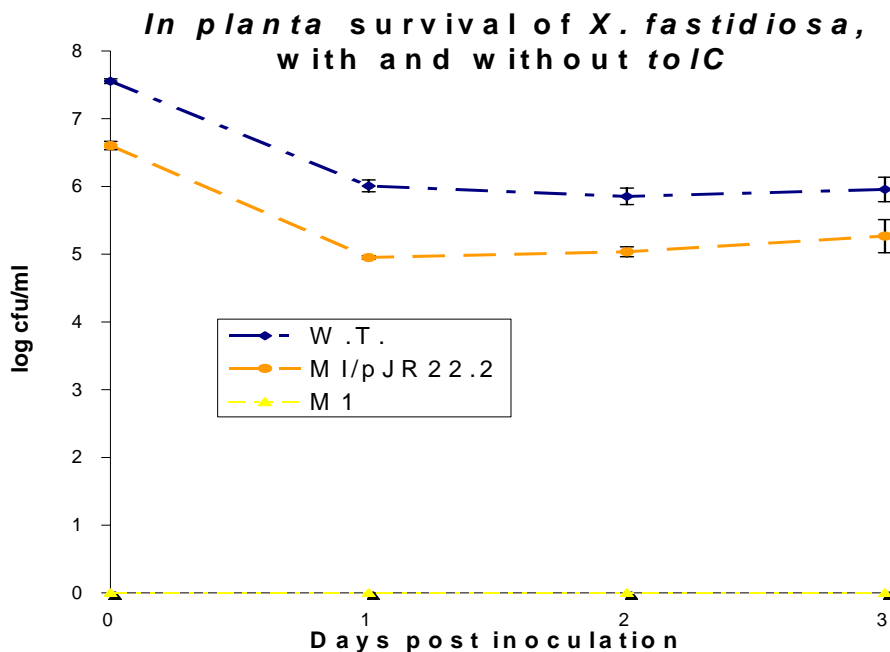
Fig. 2. Grape var. Carnignane 90 days after inoculation with wild type Temecula (left) and *tolC::nptII* mutant M1 (right)

### Complementation assays

PD1964 was amplified by PCR, cloned into pGEM-T, verified by sequencing and sub-cloned into pUFR47, a wide host range replicon based on *repW* (DeFeyter et al., 1993) and pBBR1MCS-5, a wide host range replicon based on a *Bordatella* replication origin (Kovach et al., 1995). pUFR47 and pBBR1MCS-5 containing the entire *tolC* gene are referred as pJR13.2 and pJR22.2 respectively. Non-pathogenic Temecula mutant M1 was transformed with pJR13.2 and pJR22.2 independently by electroporation as described above. The cells were recovered in 1 ml of PD3 broth for 6 hours and were spread on PD3 plates amended with Gentamycin (5 µg/ml). The plates were incubated at 28 °C for 10 days and single colonies were screened for the presence of pJR13.2 /pJR22.2 and also for the integrity of *nptII* integration, by PCR assay. Grape plants (var Carnignane) were inoculated in triplicates with wild-type *Xf* Temecula, mutant M1, M1/pJR13.2, and M1/pJR22.2. Both pJR13.2 and pJR22.2 complemented the mutant *tolC* strain M1, but symptoms were stronger with pJR22.2 in repeated experiments (Figure 3).



**Figure 3.** Leaves above the inoculation point on the stem of grape plants inoculated with wild type, *tolC*-mutant and *tolC*-mutant complemented using an autonomously replicating vector. A, wild-type PD strain Temecula, B, *tolC*-mutant strain M1 and C, M1 /pJR22.2. Photo taken 60 days after inoculation.



**Figure 4.** *In planta* survival of *Xf* Temecula wild-type (W.T.) and the complementation of *tolC*<sup>-</sup> mutant strain M1 with pJR22.2 (*tolC*<sup>+</sup>).

***In planta* stability of pJR22.2.**

Perhaps surprisingly, mutant M1 could not be re-isolated from inoculated grape xylem, even 2 hrs after inoculation. It seems likely that grape xylem sap is toxic to M1. However, eight randomly isolated colonies from the sap of Carignane grape plants inoculated 60 days earlier with M1/pJR22.2 were positive for the presence of the vector by PCR analysis. pJR22.2 was isolated from two of the positive colonies and was confirmed by restriction digestion (data not shown). Stability studies *in planta* demonstrate that *tolC* is required for the survival of *Xf* in grape (Figure 4). Taken together with the re-isolation of the plasmid pJR22.2, these stability studies also demonstrate that the *Bordatella* replication origin on pBBR1MCS-5 is sufficiently stable as an autonomously replicating vector in *Xf* strain Temecula over a 60 day period to be useful for complementation (Figure 4).

## CONCLUSIONS

Type I secretion gene *tolC* (PD1964) of *Xf* Temecula was disrupted by marker exchange mutagenesis. The mutant strains lost all pathogenicity and were rapidly killed in grape, indicating a critical role of *tolC* in both pathogenicity and survival of *Xf* in grape. Complementation assays using an autonomously replicating vector demonstrated: 1) that an autonomously replicating vector is available for complementation studies in *Xf* and 2) that *tolC* is required for pathogenicity, confirming a role of Type I secretion in both survival and pathogenicity of *Xf* in grape.

## REFERENCES

1. Davis MJ, French WJ, and Schaad NW, 1981. Axenic culture of the bacteria associated with phony disease of peach and plum leaf scald. *Current Microbiology* 6:309-314.
2. De Feyter R., Yang Y, and Gabriel DW, 1993. Gene-for-genes interactions between cotton *R* genes and *Xanthomonas campestris* pv. *malvacearum* *avr* genes. *Molecular Plant-Microbe Interactions* 6:225-237.
3. Feil H, Feil WS, Detter JC, Purcell AH, and Lindow SE, 2003. Site-directed disruption of the *fimA* and *fimF* fimbrial genes of *Xylella fastidiosa*. *Phytopathology* 93: 675-682.
4. Gaurivaud P, Souza LC, Virgilio AC, Mariano AG, Palma RR, and Monteiro PB, 2001. Gene disruption by homologous recombination in the *Xylella fastidiosa* citrus variegated chlorosis strain. *Applied Environmental Microbiology* 68:4658-65.
5. Guilhabert MR, Hoffman LM, Mills DA, and Kirkpatrick BC, 2001. Transposon mutagenesis of *Xylella fastidiosa* by electroporation of Tn5 synaptic complexes. *Molecular Plant-Microbe Interactions* 14:701-706.
5. Kovach ME, Elzer PH, Hills DS, Robertson GT, Farris MA, Roop RM, and Peterson KM, 1995. Four new derivatives of the broad-host range cloning vector pBBR1MCS, carrying different antibiotic resistance cassettes. *Gene* 166:175-176.
6. Purcell AH, and Hopkins DL, 1996. Fastidious, xylem limited plant pathogens. *Annual Review of Phytopathology* 34:131-151.
7. Simpson AJG. et al. 2000. The genome sequence of the plant pathogen *Xylella fastidiosa*. *Nature* 406:151-159.

## FUNDING AGENCIES

Funding for this project was provided by the University of California Pierce's Disease Grant Program.

**EVALUATING THE ROLES OF PILI IN TWITCHING AND LONG DISTANCE MOVEMENT  
OF *XYLELLA FASTIDIOSA* IN GRAPE XYLEM AND IN THE COLONIZATION  
OF SHARPSHOOTER FOREGUT**

**Project Leaders:**

Harvey C. Hoch and Thomas J. Burr  
Department of Plant Pathology  
Cornell University, NYSAES  
Geneva, NY 14456

**Researcher:**

Yizhi Meng  
Department of Plant Pathology  
Cornell University, NYSAES  
Geneva, NY 14456

**Cooperators:**

A.H. Purcell  
ESPM-Division of Insect Biology  
University of California  
Berkeley, CA 94720

Steven E. Lindow  
Department of Plant and Microbial Biology  
University of California  
Berkeley, CA 94720

**Reporting Period:** The results reported here are from work conducted October 2004 to October 2005.

**ABSTRACT**

*Xylella fastidiosa* cells were shown to exhibit twitching motility ‘upstream’ in microfabricated ‘artificial xylem vessels’. Such motility is due to extension and retraction of type IV pili present on the poles of the bacteria. Importantly, such upstream migration was subsequently demonstrated *in planta*. A survey of isolates from California, Texas and South Carolina revealed that all possessed motility characteristics. A number of mutants deficient in genes associated with type IV pilus functions were created, many of which may be useful in exploring targets for slowing development of the bacterial mass in xylem vessels. Type IV and type I pili were shown to have pronounced effects on colony and biofilm development.

**INTRODUCTION**

Once *Xylella fastidiosa* is introduced into xylem vessels in leaf, petiole, or other susceptible green tissues, how does it move in xylem elements farther upstream, e.g., into petioles from the leaf or down shoots and canes? This has long been a particularly puzzling and important question since xylem sap flow during the growing season is nearly always down the pressure gradient, viz., toward the leaf. It is seldom stagnant. Since *Xf* are non-flagellated bacteria, the consensus (albeit unproven) for their appearing in previously non-invaded regions upstream has been through the slow expansion of the colony through repeated cell division along xylem vessel walls. Lateral movement, from xylem element to element, has been proposed through dissolution of border pit membranes (Newman et al., 2004); but again, this does not explain long distance upstream movement.

Our investigations have focused on the effects of physical and chemical environments on attachment, colony development, and biofilm formation by *Xf* in microfluidic chambers fabricated to mimic xylem elements. This has resulted in identifying unmistakable long distance migration of individual bacteria. Even more interesting was the observation that they were able to migrate against a strong current of flowing media (Meng et al., 2005; Hoch, 2005). The movement was characteristic of twitching motility that occurs in some gram-negative bacterial species (Mattick, 2002). There are several important implications of this observation: this is not only the first observation of twitching movement by a non-flagellated plant pathogenic bacterium (albeit, *Ralstonia solanacearum*, that sometimes has flagella has been shown to exhibit colony features characteristic of twitching (Liu et al., 2001; Roine et al., 1996)), it is also the first time that such movement by *Xf* has been observed. Such motile behavior may be important in explaining how the bacteria spread in the grapevine from an inoculation point to upstream locations.

Type IV pili are filamentous appendages (fimbriae) located at either one or both poles, depending on the species (Bradley, 1980; Henrichsen, 1983), are generally 5-7 nm in diameter, and may be up to several micrometers in length. They are assembled primarily from single structural protein subunits, pilin (PilA) (Mattick, 2002). Twitching movements are generated as the pili are retracted and disassembled. Because the pili tips are attached to the substratum, the cell moves toward that point of contact as the pili shorten (Mattick, 2002; Skerker and Berg 2001; Wall and Kaiser, 1999; Wolfgang et al., 2000). Type IV pili function and biogenesis in *Pseudomonas aeruginosa* involves more than 35 genes with conserved homologs existing in other bacteria that express twitching via type IV pili (Mattick, 2002). *Xf* likely produces type IV pili as its genome carries at least 26 genes that are related to pili synthesis and function (Simpson et al., 2000).

*Xylella* produces fimbriae that are thought to function in adhesion of the bacterium. Biofilm deficient mutants (e.g., 6E11), the result of a disruption of the *fimA* gene, continue to migrate since they still possess the type IV pili; whereas, mutants deficient in genes that code for type IV pili are migration deficient and develop robust biofilms (Meng et al., 2005).

Attachment of *Xylella* cells at their polar ends is well documented in the precibarium region of the sharpshooter foregut. At this point, however, little is known about how they attach in this orientation (other than the conjecture that the pili may be involved) to this preferred region, as opposed to other foregut regions. Additionally, nothing is known about how they detach from this region.

## OBJECTIVE

Our goal is to understand how *Xf* colonizes plant and insect habitats. One aim is to identify factors that contribute to attachment (and detachment) and migration of *Xf* cells on habitat surfaces. Using wild-type and mutants of *Xf*, we will examine temporal and spatial interactions on both native and artificial surfaces using a microfabricated in vitro system that has thus far provided significant new insight into the dynamics of *Xf* cell-surface relationships.

## RESULTS

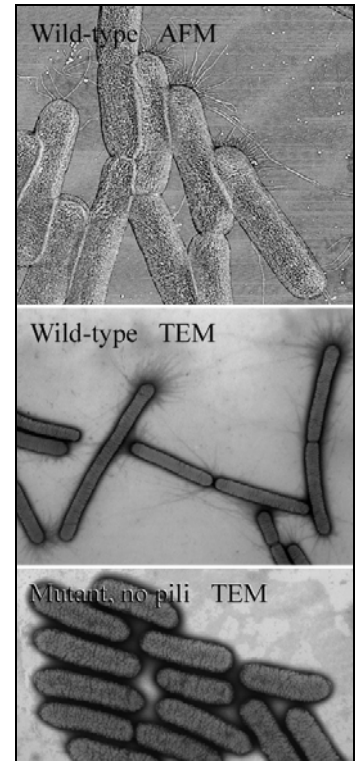
### Pili and fimbria mutants

The EZ::TN Transposome system was used to generate Kanamycin-resistant mutants from the Temecula isolate of *Xf* (Guilhabert et al., 2001). Mutants were sought with deficiencies in pilus and/or fimbrial gene products that would affect colony and biofilm development, and the ability to migrate via type IV pilus twitching motility. We previously reported that *Xf* mutants, designated as 1A2, 5A7, and 6E11 were deficient in the genes pilB (pilus biogenesis protein), pilQ (pilus assembly protein), and fimA (fimbrial subunit precursor), respectively (Meng et al., 2005). The first two mutants are deficient in twitching motility characteristics since they lack type IV pili, while the later mutant retains its motility feature, having type IV pili, but lacking the shorter-class of pili that we tentatively correlate with type I pili. Now, we have generated more than 30 single-site mutations representing deficiencies in more than 14 genes associated with pili and fimbria function. In addition, several others are yet to be sequenced. A second round of mutagenesis using trimethoprim (as the selection agent) of the 6E11 (*fimA*) *Xf* mutant has resulted in several ‘double’ mutants deficient for the genes *fimA/pilC*, *fimA/pilO*, *fimA/pilX*, and *fimA* and other second genes that have yet to be fully characterized. All are deficient for twitching motility as evidenced by colonies lacking a ‘peripheral fringe.’

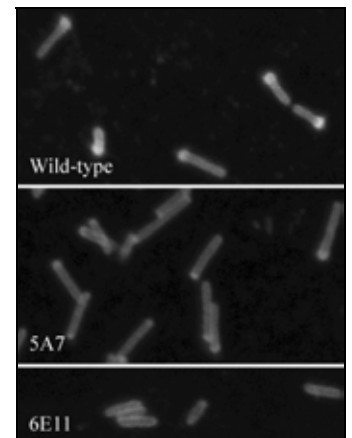
Presence or absence of pili were assessed by transmission electron microscopy (TEM), atomic force microscopy (AFM), and/or by confocal microscopy (LSCM) using Agdia’s antibody to *Xylella* (Carbajal et al., 2004). *Xf* type IV pili are 1-6  $\mu\text{m}$  in length as seen in wild-type *Xf* and mutants such as 6E11. In addition to the longer type IV pili, 0.4-1.0  $\mu\text{m}$  long pili are also present on wild-type strains and on mutants such as 5A7 (Figure 1). *Xylella* strains with the abundant ‘tuft’ of type I pili (wild-type, and mutants, e.g., 1A2, 5A7) revealed a brightly staining spot at one pole of the cells when exposed to the Agdia antibody; whereas, those mutants, e.g., 6E11, with only the more sparse type IV pili or no pili at all did not have a polar staining spot (Figure 2).

### Upstream movement in planta

*Vitis vinifera* cv. Chardonnay plants were needle-inoculated at the seventh internode from the shoot apex with cell suspensions of wild-type and mutant (1A2, 5A7, and 6E11) *Xf*. After 11 weeks, vines were cut from the main trunk, surface sterilized, and 1-cm sections aseptically excised at measured distances basipetally from the original point of inoculation. The sections were crushed and the triturate was spread onto PW agar and subsequently examined for the presence of *Xf*. The wild-type bacteria and the 6E11 mutant were recovered from grapevine sections considerably more basipetal from their respective sites of inoculation than were the non-twitching mutants 1A2 or 5A7 (Figure 3). Fluorescent latex beads similarly introduced into grapevines were observed in xylem vessels 10-20 cm basipetal from the introduction sites after 2 hours, indicative of ‘initial’ passive transport following cavitation of the xylem water column. The bacteria were also likely transported this distance as well; thus, the meaningful distance that the bacteria moved over the 11-week period is beyond this range.



**Figure 1.** Pili of wild-type and mutant *Xf*. AFM and TEM images. Wild-type cells have an abundance of short pili, and fewer long type IV pili.



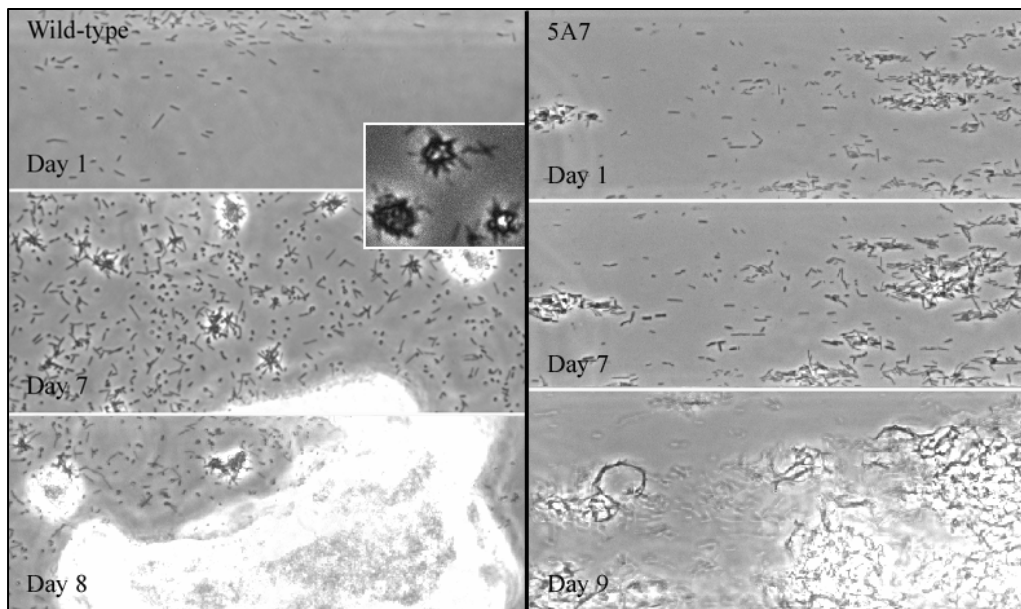
**Figure 2.** Antibody staining of cell surface and polar regions (wild-type, 5A7) bearing type I pili; polar staining is absent in 6E11 which lacks type I pili.

### ***Xf* cell aggregation, colony and biofilm development**

Cell movement and colonization characteristics were evaluated in microfabricated ‘artificial’ xylem chambers (Meng et al., 2005). As previously reported, isolates and mutants with functional type IV pili exhibit twitching motilities, whereas mutants with only type I pili, or no pili, do not migrate. Morphological characteristics of the developing colonies is also dependent upon the type of pili present. Wild-type isolates of *Xf* and mutants with only type IV pili, e.g., 6E11, initially develop ‘star-shaped’ aggregates of cells (Figure 4). These aggregates retain functionality of the type IV pili and frequently move as a cell mass on the surface of the observation chamber. Individual cells or aggregates of cells frequently move and become associated with other aggregates, adding to the cell mass. Subsequently, as the cells divide and the mass enlarges, the colony become compact and fixed in situ. *Xylella fastidiosa* mutants with only type I pili, e.g., 5A7, do not form star-shaped aggregates, but instead develop looser aggregates of cells attached end-to-end and side-by-side (Figure 4).

### **Colonization of xylem**

We have developed hybrid microfabricated chambers in which we are able to insert bona fide grape xylem (as well as insect parts) and observe *Xf* cell movement and association. This work is preliminary and ongoing; however, already we have made some interesting observations. *Xf* cells appear to have a preference for xylem walls as opposed to other cell walls of grape, and they have a preference for attaching to xylem vessel walls over that of the glass and polydimethylsiloxane (PDMS) of our microfluidic chambers, although they do attach to the latter. *Xf* cells adhere to the xylem walls predominately by their polar ends (Figure 5), much as seen in the precibarium of the sharpshooter (Newman et al., 2004).

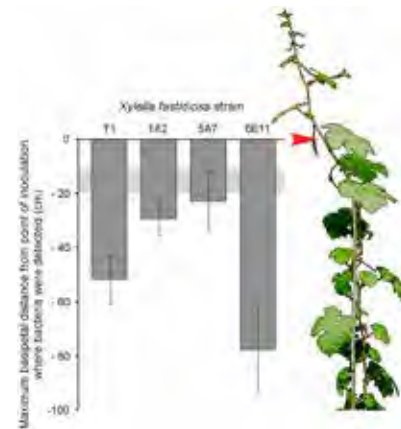


**Figure 4.** Colony development of wild-type *Xf* and mutant 5A7 over a period of several days

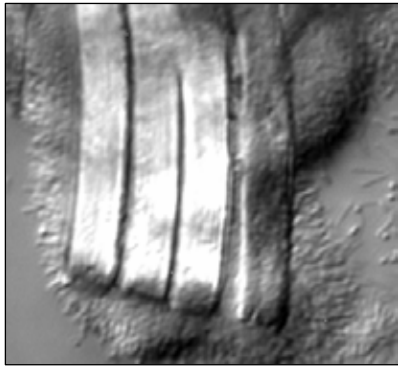
### **Pilus-mediated twitching among wild-type *Xf* isolates**

To ascertain that the twitching motility behavior of the Temecula isolate of *Xf* that we have been investigating is characteristic of all or most other *Xf* wild-type strains, we surveyed a range of isolates for this feature. Recently isolated bacteria from infected grapevines were obtained from California, Texas and South Carolina courtesy of A. Purcell, D. Appel, and C.J. Chang, respectively).

All isolates exhibited a colony ‘fringe’ which we have associated with twitching motility behavior and the presence of type IV pili (Meng et al., 2005 Hoch, 2005) (Figure 6). There was a marked difference in the width of the fringe as well as colony vigor (diameter) between the various isolates; nevertheless, they all twitched, thus having implications for movement *in planta*.



**Figure 3.** Basipetal translocation of *Xf* in *planta*. Maximum distance wild-type and mutant *Xf* cells were recovered from grapevine regions basipetal to the inoculation sites (represented by 0 of y-axis; arrow of illustrated vine) after 11 weeks. Light gray horizontal band represents max distance that 0.2  $\mu$ m fluorescent latex beads traveled passively.



**Figure 5.** *Xylella* cells grown and attached to secondary xylem in a microfabricated chamber after 8 days.



**Figure 6.** Representative *Xf* grapevine isolates from California, Texas, and South Carolina. All except mutant 1A2, which lacks type IV pili, exhibit twitching motility as evidenced by a ‘fringe’ at the colony periphery.

## CONCLUSIONS

We have demonstrated that ‘artificial xylem vessels’ can be used to gain valuable information about the biology of *Xf*. Temporal and spatial data are not possible to obtain in the same plant, but with these devices we have been able to show that *Xf* moves via twitching motility, that small aggregates of cell can also migrate which likely occurs *in planta* and possibly promotes vessel plugging, and we have been able to extend and confirm these observations to ‘upstream’ movement of the bacteria *in planta*. Importantly, pili and fimbria have been shown to play important roles in *Xf* cell aggregation, cell movement, and in colony development. It may be possible to take advantage of these cell appendages to develop approaches that decrease or possibly control *Xf* expansion in the grapevine.

## REFERENCES

- Bradley, D. E. 1980. A function of *Pseudomonas aeruginosa* PAO pili: twitching motility. *Can. J. Microbiol.* 26: 146-54
- Carbajal, D., K. A. Morano, and L. D. Morano. 2004. Indirect immunofluorescence microscopy for direct detection of *Xylella fastidiosa* in xylem sap. *Curr.-Microbiol.* 49: 372-375.
- Guilhbert, M. R., Hoffman, L. M., Mills, D. A. and Kirkpatrick, B. C. 2001. Transposon mutagenesis of *Xylella fastidiosa* by electroporation of Tn5 synaptic complexes. *Mol. Plant Microbe In.* 14:701-706.
- Henrichsen, J. 1983. Twitching motility. *Annu. Rev. Microbiol.* 37: 81-93
- Hoch, H. C. 2005. <http://www.nysaes.cornell.edu/pp/faculty/hoch/movies/>.
- Liu H., Y. Kang, S. Genin, M. A. Schell, Denny T. P. 2001. Twitching motility of *Ralstonia solanacearum* requires a type IV pilus system. *Microbiology* 147:3215-3229.
- Mattick, J. S. 2002. Type IV pili and twitching motility. *Annu. Rev. Microbiol.* 56:289-314.
- Meng, Y., Li, Y., Galvani, C.D., Hao, G., Turner, J.N., Burr, T.J., and Hoch, H.C. Upstream migration of *Xylella fastidiosa* via pilus-driven twitching motility, *Journal of Bacteriology.* 187: 5560-5567.
- Newman, K. L., Almeida, R. P. P., Purcell, A. H. and Lindow, S. E. 2004. Cell-cell signaling controls *Xylella fastidiosa* interactions with both insects and plants. *P. Natl. Acad. Sci. U.S.A.* 101:1737-1742.
- Roine E., D. N. Nunn, L. Paulin, and, M. Romantschuk. 1996. Characterization of genes required for pilus expression in *Pseudomonas syringae* pathovar phaseolicola. *J. Bacteriol.* 178: 410-417.
- Simpson, A. J. G., et al., 2000. The genome sequence of the plant pathogen *Xylella fastidiosa*. *Nature* 406: 151-157.
- Skerker, J. M. and H. C. Berg. 2001. Direct observation of extension and retraction of type IV pili. *PNAS* 98: 6901-6904
- Wall, D. and D. Kaiser. 1999. Type IV pili and cell motility. *Mol. Microbiol* 32: 1-10
- Wolfgang, M., J. P. van Putten, S. F. Hayes, D. Dorward, and D. Koomey. 2000. Components and dynamics of fiber formation define a ubiquitous biogenesis pathway for bacterial pili. *EMBO J* 19: 6408-6418

## FUNDING AGENCIES

Funding for this project was provided by the University of California Pierce’s Disease Grant Program.



# CHARACTERIZATION OF PD0528: A POTENTIAL TYPE V AUTOTRANSPORTER IN THE *XYLELLA FASTIDIOSA* OUTER MEMBRANE

## Project Leader:

Michele M. Igo  
Section of Microbiology  
University of California  
Davis, CA 95616

## Cooperators:

Ayumi Matsumoto  
Department of Food Science and Technology  
University of California  
Davis, CA 95616

Bruce Kirkpatrick  
Department of Plant Pathology  
University of California  
Davis, CA 95616

**Reporting Period:** The results reported here are from work conducted September 1, 2004 to September 30, 2005.

## ABSTRACT

Autotransporters are multi-domain proteins that are responsible for secreting a single specific polypeptide (the passenger domain) across the outer membrane of Gram-negative bacteria. Here, we report our studies on the putative autotransporter protein PD0528. The passenger domain of PD0528 contains six tandem repeats of a 50-60 amino acid motif that is found only in *Xf* species. To determine the role of these species-specific tandem repeats in *Xf* virulence, we have begun a detailed characterization of PD0528. Using primer extension analysis, we have located the transcriptional start-site of the PD0528 mRNA. We have also generated a deletion mutation in PD0528 and shown that the PD0528 protein is not present in the outer membrane of this mutant strain. Finally, we have examined the *in vitro* phenotype of the PD0528 deletion mutant. This analysis suggests that the absence of PD0528 in the outer membrane has a profound effect on *Xf* colony morphology and in the ability of this mutant to form cell-to-cell aggregates in liquid culture.

## INTRODUCTION

*Xylella fastidiosa* (*Xf*) is a Gram-negative, endophytic bacterium, which is the causative agent of Pierce's disease (PD) of grapevine, citrus variegated chlorosis (CVC), almond leaf scorch (ALS), and oleander leaf scorch (OLS) (reviewed in Purcell and Hopkins 1996, Hopkins and Purcell 2002). The genomes of four different *Xf* strains isolated from host plants exhibiting disease symptoms have been sequenced (Simpson et al. 2000, Bhattacharyya et al. 2002, Van Sluys et al. 2003). The availability of these sequences has allowed detailed comparisons of these genomes and has greatly facilitated studies aimed at understanding the underlying mechanisms involved in the different diseases. Genes conserved among all four strains are predicted to be responsible for functions central to *Xf* metabolism and cell physiology and for general properties associated with plant and insect colonization and pathogenicity. In contrast, genes exhibiting a higher degree of divergence and strain-specific genes are predicted to be associated with specific interactions between a particular strain of *Xf* and its plant host.

Comparison of the four *Xf* genomes with other bacterial pathogens has also resulted in the identification and characterization of a number of genes that are potential virulence factors. Many of these virulence determinants are proteins that are either secreted to the bacterial cell surface or released into the external environment (Meidanis et al. 2002, Smolka et al. 2003). In Gram-negative bacteria, secretion occurs through one of five major secretion pathways, numbered I to V (Pallen et al. 2003, Preston et al. 2005). These pathways are highly conserved and exhibit functionally distinct mechanisms of protein secretion. The current focus of our research is the Type V secretion autotransporters (AT-1) of *Xf*-PD. Type V secretion systems have been divided into three subcategories: the autotransporter system (Type Va or AT-1; TC#1.B.12), the two-partner secretion pathway (Type Vb or TSP; TC#1.B.20), and the Oligomeric Coiled Adhesions family (Type Vc or AT-2; TC#1.B.40) (for recent reviews, see Desvaux et al. 2004, Henderson et al. 2004, Newman and Stathopoulos 2004). The importance of Type V secretion in bacterial pathogenicity was highlighted in a recent review, which stated "To date, all of the functionally characterised autotransporters have been implicated in bacterial virulence (Desvaux et al. 2004)."

The simplest secretion mechanism is exhibited by the AT-1 proteins. AT-1 systems are dedicated to the secretion of a single specific polypeptide across the outer membrane. Proteins secreted by this mechanism have a similar structure, comprised of four functional domains: (1) an unusually long signal sequence; (2) a passenger domain; (3) a linker region; and (4) the  $\beta$ -domain. The autotransported protein is synthesized and targeted for export through the inner membrane by its signal sequence. After export across inner membrane by the general secretory (Sec) machinery, the N-terminal signal sequence is removed and the C-terminal  $\beta$ -domain is inserted into the outer membrane, where it forms a  $\beta$ -barrel channel. The covalently attached N-terminal passenger domain is then translocated through this channel to the cell surface. Once the passenger domain is on the cell surface, it may undergo further maturation. Some passenger domains remain covalently attached to the  $\beta$ -domain and protrude from the bacterial cell surface. Other passenger domains are cleaved and either remain loosely associated with the cell surface or become released into the external environment. Virulence functions associated with

different passenger domains include proteolytic activity, adherence, biofilm formation, intracellular motility, cytotoxic activity, or maturation of another virulence determinant (Henderson et al. 2004, Newman and Stathopoulos 2004).

One goal of our research is to understand the role of the AT-1 proteins in the virulence of *Xf*-PD. Genomic analysis has identified six members of the AT-1 autotransporter family in *Xf*-PD. Four of these AT-1 proteins were first identified in *Xf*-CVC (Meidanis et al. 2002, Yen et al. 2002) and orthologs are present in all four sequenced *Xf* genomes. The passenger domains of three of these proteins (PD0218, PD0313, PD0950) are predicted to encode subtilisin-like serine proteases (Bateman et al. 2004). The passenger domain of the fourth protein (PD1879) is predicted to encode a member of the GDSL family of esterase/lipases (Bateman et al. 2004). The passenger domains of the last two *Xf*-PD AT-1 proteins, PD1379 and PD0528, contain tandem repeats of a 50-60 amino acid motif. This motif is designated as Pfam-B 3566 (Bateman et al. 2004) and ProDom Family PD25532 (Servant et al. 2002) and is found only in *Xf* species. PD1379 contains three copies of this repeat, whereas PD0528 contains six copies. PD1379 has orthologs in all four sequenced *Xf* strains. In contrast, PD0528 has orthologs in both *Xf*-ALS and *Xf*-OLS. However, in *Xf*-CVC, two adjacent genes exhibit homology to PD0528. The protein encoded by XF1265 shows homology to the PD0528 passenger domain, whereas the protein encoded by XF1264 shows homology to the PD0528 autotransporter domain. The absence of an intact PD0528 ortholog in *Xf*-CVC may be significant and could account for some of the observed differences in the pathogenicity and host ranges of *Xf*-CVC and *Xf*-PD. To address this and other questions concerning the role of these species-specific tandem repeats in *Xf* virulence, we have begun a detailed characterization of the putative autotransporter protein, PD0528.

## OBJECTIVES

The long-term goal of this project is to analyze the outer membrane protein composition of *Xf* and to determine the role of the major outer membrane proteins in *Xf* cell physiology and virulence. Our specific objectives include:

1. Identifying the major outer membrane proteins of *Xf* and assigning them to a specific gene on the *Xf* chromosome.
2. Generating mutations in the genes encoding these outer membrane proteins and examining their impact on *Xf* cell physiology and virulence.

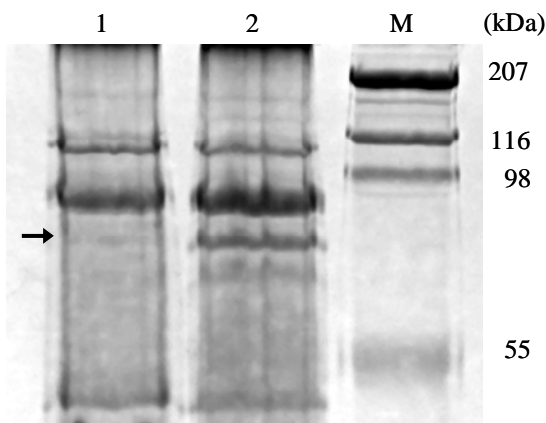
Here, we report on our characterization of one of these proteins, the putative type V autotransporter PD0528.

## RESULTS

In the Symposium Proceedings for 2004, we described our assignment of one of the most abundant, integral *Xf* outer membrane proteins to the PD0528 locus (Igo 2004). Based on its predicted amino acid sequence, PD0528 is a putative AT-1 autotransporter protein that has a passenger domain containing six tandem repeats of a species-specific 50-60 amino acid motif. Our identification of PD0528 as an integral outer membrane protein was based on the characterization of tryptic-digest generated fragments by MALDI-TOF mass spectrometry. This analysis also revealed that at least three of the six repeats in the PD0528 passenger domain are still attached to the C-terminal  $\beta$ -barrel domain. This would suggest that at least a portion of the PD0528 passenger domain is still anchored to the *Xf* cell surface.

In order to investigate the role of PD0528 in *Xf* cell physiology and virulence, we generated a null mutation in the PD0528 gene using the gene replacement method described by Feil et al. (2003). This procedure involved generating a plasmid, which carried a kanamycin resistance marker flanked on each side by ~800 base pairs of chromosomal sequences from immediately upstream and downstream of the PD0528 opening reading frame (ORF). This plasmid was then introduced into *Xf* by electroporation. The resulting kanamycin resistant transformants were screened by PCR to identify a mutant strain in which the PD0528 ORF was completely removed and replaced by the kanamycin resistance marker.

We next examined the impact of the PD0528 deletion mutation on the *Xf* membrane protein profile. In the Symposium Proceedings for 2003, we described our protocol for analyzing the protein profile of the *Xf* outer membrane (Igo 2003). This protocol requires a substantial quantity of *Xf* cells, since it involves rupturing the *Xf* cells with a French pressure cell and isolating the outer membrane fractions by sucrose density gradient centrifugation. During the past year, we have begun to use a new protocol that requires fewer *Xf* cells. Although this method does not allow us to distinguish between outer and inner membrane proteins, it allows us to quickly compare the total membrane profiles of different *Xf* strains. In this procedure, *Xf* membrane proteins were extracted using the BioRad ReadyPrep™ Protein Extraction Kit (Membrane 1) and then treated using the BioRad ReadyPrep 2-D Cleanup Kit. The proteins were then analyzed using SDS-polyacrylamide (PAGE) gel electrophoresis. In Figure 1, we compare the membrane profiles of a wild-type *Xf*-PD strain and an *Xf*-PD strain carrying the PD0528 deletion mutation. As expected, comparison of these profiles indicates that the band corresponding to the PD0528 protein is missing in the strain carrying the PD0528 null mutation.

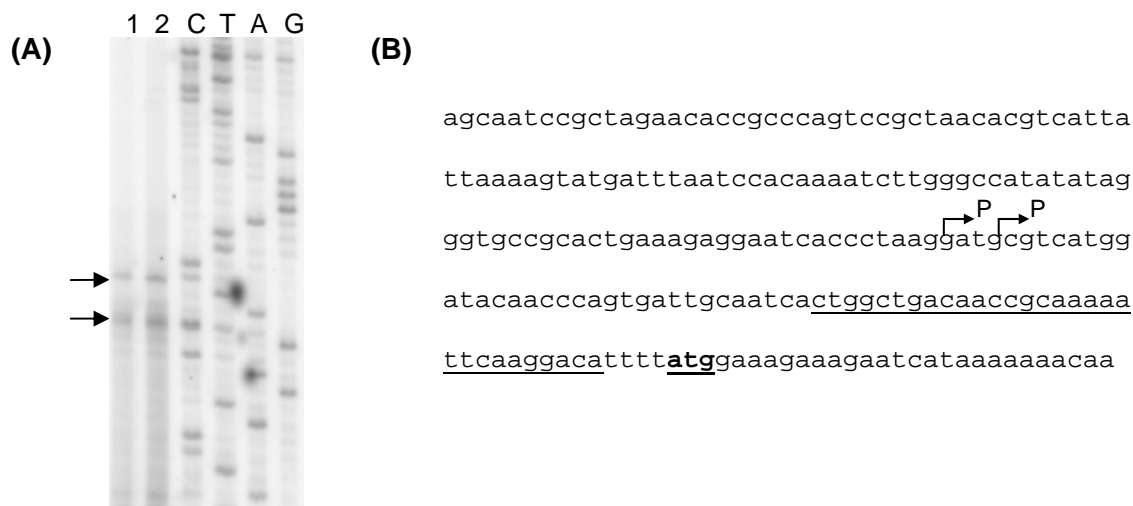


**Figure 1.** Membrane protein profile of the PD0528 deletion mutant.

Membrane proteins were isolated from both the PD0528 deletion mutant (Lane 1) and from the isogenic wild-type *Xf* Travers strain (Lane 2). The membrane proteins were separated on a 10% SDS-PAGE gel and stained with Coomassie blue. The sizes of the molecular weight standards (lane M) are indicated on the right. The position of the missing outer membrane protein in the PD0528 deletion mutant is indicated by the arrow.

Once we had generated the PD0528 null mutation and confirmed that PD0528 is not present on the *Xf* cell surface, we began to investigate the impact of this mutation on *Xf* cell physiology. Our preliminary characterization indicates that strains carrying the PD0528 deletion have a number of distinctive phenotypic properties. First, PD0528 null mutants grow faster than wild-type strains. Second, PD0528 null mutants are impaired in their ability to form cell-to-cell aggregates in liquid culture. Third, PD0528 null mutants are able to form a continuous lawn on solid medium. These *in vitro* properties are similar to those reported by Guilhabert and Kirkpatrick (2005) for a Tn5 insertion in PD2118, which encodes the putative hemagglutinin adhesion HxfA. The next step in our analysis will be to determine the impact of the PD0528 deletion mutation on adhesion to various substrates and on the progression of PD symptoms *en planta*.

Finally, we have begun to examine the genetic organization and the regulatory region of the PD0528 gene (Figure 2B).



**Figure 2.** Identification of the PD0528 transcription start site: (A) Primer extension analyses were carried out for RNA extracted from the exponentially growing *Xf* cells. Primer extension products from 12  $\mu$ g (lane 1) and from 24  $\mu$ g (lane 2) total RNA were subjected to electrophoresis on 8% DNA sequencing gel. The arrows indicate the positions of primer extension products. Lanes C, T, A and G show the results of a dideoxy sequencing reaction using the same primer on a plasmid carrying the PD0528 regulatory region. (B) The nucleotide sequence of the region immediately upstream of the PD0528 open reading frame is shown. The arrows indicate the location of the two major start site of transcription. The putative ATG start codon of the PD0528 gene is indicated in bold and underlined. The primer for primer extension experiment and the DNA sequencing reaction is underlined.

To determine the location of the PD0528 promoter, we have performed primer extension analysis using a primer that mapped slightly upstream of the PD0528 translation initiation codon. This primer was labeled with  $\gamma$ - $^{32}$ P and hybridized to total RNA extracted from an exponentially growing culture of *Xf* Temecula 1. The resulting products of the primer extension reactions were then analyzed on a standard 8% DNA sequencing gel. As shown in Figure 2A, two major bands were observed in our primer extension reactions. The sizes of these bands allowed us to map the PD0528 mRNA start site to approximately 70 bases upstream of the PD0528 translational initiation codon (ATG). Experiments are currently underway to identify the bases important for PD0528 promoter activity and to determine the form of RNA polymerase responsible for generating the PD0528 mRNA.

## REFERENCES

- Bateman, A., et al. 2004. The Pfam protein families database. *Nucleic Acids Res* 32:D138-41.
- Bhattacharyya, A., S. et al. 2002. Draft sequencing and comparative genomics of *Xylella fastidiosa* strains reveal novel biological insights. *Genome Res* 12:1556-63.
- Desvaux, M., N. J. Parham, and I. R. Henderson. 2004. The autotransporter secretion system. *Res Microbiol* 155:53-60.
- Feil, H., W. Feil, J. Detter, A. Purcell, and S. Lindow. 2003. Site-directed disruption of the *fimA* and *fimF* fimbrial genes of *Xylella fastidiosa*. *Phytopathol* 93:675-682.
- Guilhabert, M., and B. Kirkpatrick. 2005. Identification of the *Xylella fastidiosa* antivirulence genes: Hemagglutinin adhesions contribute to *Xf* biofilm maturation and colonization and attenuate virulence. *Mol Plant Micro In* 18:856-868.
- Henderson, I. R., F. Navarro-Garcia, M. Desvaux, R. C. Fernandez, and D. Ala'Aldeen. 2004. Type V protein secretion pathway: the autotransporter story. *Microbiol Mol Biol Rev* 68:692-744.
- Hopkins, D., and A. Purcell. 2002. *Xylella fastidiosa*: Cause of Pierce's disease of grapevine and other emergent diseases. *Plant Disease* 86:1056-1066.
- Igo, M. 2003. The *Xylella fastidiosa* Cell Surface, p. 56-58. In M. Athar Tariq et al. (eds.), Proceedings of the 2003 Pierce's Disease Research Symposium. 8-11 December 2003, Coronado, CA.
- Igo, M. 2004. The *Xylella fastidiosa* Cell Surface, p. 200-202. In M. Athar Tariq et al. (eds.), Proceedings of the 2004 Pierce's Disease Research Symposium. 7-10 December 2004, Coronado, CA.
- Meidanis, J., M. D. Braga, and S. Verjovski-Almeida. 2002. Whole-genome analysis of transporters in the plant pathogen *Xylella fastidiosa*. *Microbiol Mol Biol Rev* 66:272-99.
- Newman, C. L., and C. Stathopoulos. 2004. Autotransporter and two-partner secretion: delivery of large-size virulence factors by gram-negative bacterial pathogens. *Crit Rev Microbiol* 30:275-86.
- Pallen, M. J., R. R. Chaudhuri, and I. R. Henderson. 2003. Genomic analysis of secretion systems. *Curr Opin Microbiol* 6:519-27.
- Preston, G., D. Studholme, and I. Caldelari. 2005. Profiling the secretomes of plant pathogenic Proteobacteria. *FEMS Microbiol Rev* 29:331-360.
- Purcell, A., and D. Hopkins. 1996. Fastidious xylem-limited bacterial plant pathogens. *Ann Rev Phytopathol* 34:131-151.
- Servant, F. et al. 2002. ProDom: Automated clustering of homologous domains. *Briefings in Bioinformatics* 3:246-251.
- Simpson, A. J. et al. 2000. The genome sequence of the plant pathogen *Xylella fastidiosa*. *Nature* 406:151-7.
- Smolka, M. B. et al. 2003. Proteome analysis of the plant pathogen *Xylella fastidiosa* reveals major cellular and extracellular proteins and a peculiar codon bias distribution. *Proteomics* 3:224-37.
- Van Sluys, M. A. et al. 2003. Comparative analyses of the complete genome sequences of Pierce's disease and citrus variegated chlorosis strains of *Xylella fastidiosa*. *J Bacteriol* 185:1018-26.
- Yen, M. R. et al. 2002. Protein-translocating outer membrane porins of Gram-negative bacteria. *Biochim Biophys Acta* 1562:6-31.

## FUNDING AGENCIES

Funding for this project was provided by the University of California Pierce's Disease Grant Program.

# MULTI-LOCUS SIMPLE SEQUENCE REPEAT (SSR) MARKERS FOR GENOTYPING AND ASSESSING GENETIC DIVERSITY OF *XYLELLA FASTIDIOSA* IN CALIFORNIA

## Project Leader:

Hong Lin  
Crop Disease, Pest, & Genetics Research Unit  
USDA, ARS, SJVAC  
Parlier, CA 93648

## Cooperators:

Edwin Civerolo  
USDA, ARS, SJVAC  
Parlier, CA 93648

Russell Groves  
USDA, ARS, SJVAC  
Parlier, CA 93648

Andrew Walker  
Department of Viticulture & Enology  
University of California  
Davis, CA 95616

**Reporting Period:** The results reported here are from work conducted October 2004 to September 2005

## ABSTRACT

We have designed and developed *Xylella fastidiosa* (*Xf*) Simple Sequence Repeat (SSR) primers. Thirty-four of them have been validated and are available to public (Lin et al. 2005). These primers are *Xf*-specific and powerful for detecting polymorphism among and within crop-associated *Xf* strains and can be used for *Xf* genotyping, population structure and genetic diversity studies. Recently, we used fluorescent-labeled primers for PCR and an ABI 3100 genetic analyzer in combination with our rapid sample preparation protocol to create a high-throughput *Xf* pathogen diagnostic and genetic analysis platform. We used this marker system to study the geographic population structures of grape *Xf* strains in California. We also used this marker system as a tool to study interactions between *Vitis* and *Xf* in Pierce's disease (PD) resistant and susceptible grapes.

## INTRODUCTION

Understanding pathogen genetic diversity is critical in developing an effective disease control strategy. Host plant resistance is one of the most important components in integrated crop management. However, the durability of disease resistance depends upon the variability and adaptability of pathogen populations and their interactions with host plant resistance genes. Variation in pathogen population structure can lead to resistance breakdown and disease outbreak under suitable environmental conditions. The molecular basis of plant host-*Xf* interactions needs to be investigated to better understand the epidemiology of *Xf*-induced diseases and how *Xf* strains interact to cause PD in different grape cultivars. Given the fact that diseases caused by *Xf* are complex patho-systems with a wide range of symptomatic as well as asymptomatic hosts, a number of insect vectors with wide host ranges, and variable environmental factors, the genetic diversity and biological relationships of *Xf* strains with different grape cultivars needs to be better understood. The goal of this project is to develop a reliable marker system that unambiguously identifies *Xf* strains from various geographic locations and host plants. Coletta-Filho et al. (2001 and 2003) developed simple sequence repeat markers from CVC *Xf* sequences and used them for CVC *Xf* population genetic studies. Here we designed SSR markers from four available *Xf* genomic sequences that work with all *Xf* strains. We further developed this marker system into a fluorescent-based multiplex genotyping format. Using a rapid DNA isolation method, we directly analyze *Xf* from infected plant tissues therefore avoiding the time-consuming bacterial isolation step and reducing the chance of sample loss due to contamination and culture difficulties. This system has proven to be powerful and reliable for distinguishing genetic relatedness. The sensitivity, specificity, and power in detecting polymorphism, as well as its adaptability to a high through-put diagnostic platform makes this system an ideal tool for large scale studies of *Xf* population genetics and epidemiological risk assessment analyses.

## OBJECTIVES

1. Develop a high through-put multi-locus *Xf* genetic analysis system for genotyping and analyzing population structures of *Xf* in California.
2. Analyze genetic diversity and structure of *Xf* populations. Construct a large *Xf* allele frequency database for use as an *Xf* strain identification system.
3. Use the SSR Marker analysis system to study the interactions between hosts and *Xf* including adaptation, host selection and pathogenicity of *Xf* strains.

## RESULTS

### Objective 1

To develop an accurate and high through-put system for *Xf* genetic analysis, we combined fluorescent- labeled primers for PCR and analyzed them with a 16-capillary DNA sequence analyzer (ABI 3100). Each dye set consists of four primers labeled with FAM, NED, HEX and VIC respectively (Figure 1A). Therefore, data output is four times (96 x 4 = 384) more than that obtained with a single dye (96 samples) per run. To be accurate in determining allele size, an internal molecular sizing marker labeled with LIZ was co-separated with samples through each capillary tube. GeneMapper software identifies

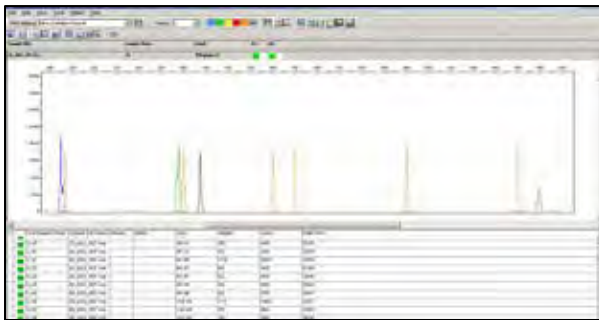
alleles generated by fluorescent-labeled amplicons and reports sizes in base pairs. Software automatically generates a data sheet for further analysis. Because the primers are *Xf* specific, we can directly analyze *Xf* from infected plant tissues, therefore significantly increasing the speed of the work and reducing chances of sample loss during the pathogen isolation process. This system is able to identify samples in which multiple strains coexist (Figure 1B). We have optimized the system for large scale sample processing and data analysis.

### Objective 2

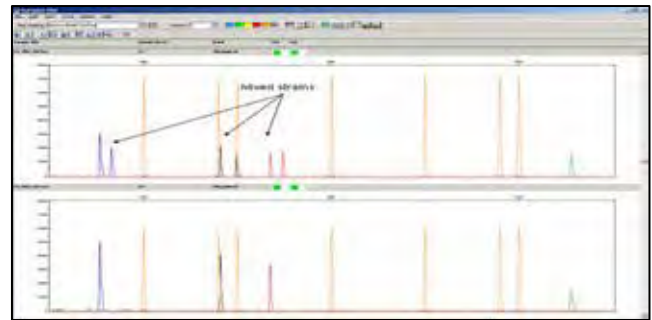
Genetic diversity and population structures of PD *Xf* were analyzed by SSR primers. Eighty-three *Xf* samples collected from California representing four geographic populations of Napa, Sonoma, Kern and Riverside counties. Depending on availability, multiple samples were collected from each vineyard and 2-8 vineyards were sampled from each county for this study. Haplotypes and allele frequencies from each population and subpopulations were recorded. Genetic distances among populations were estimated (Figure 2). This hierarchical dataset allows partitioning of the genetic differentiation among counties, among vineyards within a county, and among individuals (Table 1). A larger proportion of total genetic diversity (68.89 %) is attributed to genetic diversity among different host plants suggesting genetic differentiation of *Xf* was partly driven by host selection.

### Objective 3

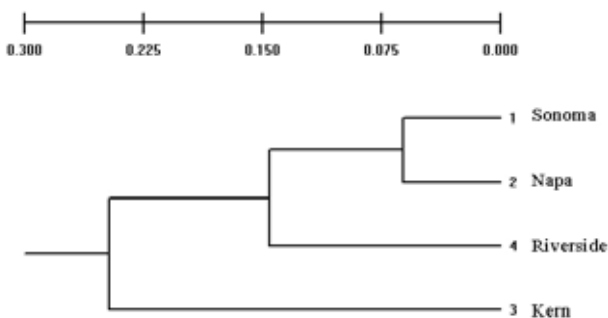
To study the interactions of *Xf* with grape hosts, three grapevines (PD resistant 9621-67, PD susceptible 9621-94, and highly susceptible Chardonnay) were used for this study. Two strains of *Xf*, Stag's leap and Talcott were used for single and mixed infections. Samples were harvested at 6 and 12 weeks post inoculation. ELISA assay and Mixed *Xf* SSR genotyping will be performed to evaluate interactions between host and pathogens in single and mixed strain infections in PD resistant and susceptible grapes. The last sample harvest was in September, 2005. We are currently working on sample assay.



**Figure 1A.** Multi-locus genotyping analysis. Four alleles are presented in red, black, green, and blue peaks respectively. A molecular sizing standard is in yellow.



**Figure 1B.** Two mixed strains were detected by three primers as peaks shown in red, black and blue.



**Figure 2.** UPGMA cluster analyses using Nei's coefficient presented the genetic distances among four geographic populations.

**Table 1.** Analysis of molecular variance of the SSR haplotypes for *Xf* populations isolated from three grapevine growing counties in California. Total variance was partitioned into hierarchical components indicating larger proportion of total genetic diversity (68.89 %) is attributed to genetic diversity among different host plants

Source of variation	Sum of squares	Variance components	Percentage of variation*	$\Phi$ -statistics*
Among counties	203.997	2.06592	11.03	0.110
Among vineyards/counties	371.787	3.75837	0.07	0.225
Within vineyards	877.203	12.90004	68.89	0.311
Total	1452.988	18.72433	100	

\* Probability of having larger variance component and  $\Phi$ -statistic than the observed values by chance alone based on 1,000 random permutation ( $P < 0.001$ ).

## CONCLUSIONS

In conclusion, the SSR marker system presented here is useful for strain identification, examining genetic diversity, and can aid in epidemiological and strain virulence studies. This multi-locus marker system is particularly suitable for studying *Xf* population genetics because it unambiguously reveals the variability of independent genetic loci. When this multiplex format is combined with a fluorescence-based automated sequencing analyzer, it provides an accurate and high-through-put platform for large scale pathogen detection. In addition, all the SSR primers we designed flank conserved sequence regions across *Xf* strains. Therefore, they are not only useful for *Xf* grape PD strains, but also for strains from other agronomic, horticultural and ornamental crops. Finally, each SSR primer detects a specific locus in the genome and the allelic information is recorded digitally. These features allow researchers at different sites, using different equipment, to share and compare results unambiguously when the same sets of multi-locus primers are used. Therefore, it is possible to compile global data sources for worldwide epidemiological and population genetic studies.

## REFERENCES

- Coletta-Filho, H. D., M. A. Takita, A. A. de Souza, C. I. Aguilar-Vildoso, and M. A. Machado. 2001. Differentiation of strains of *Xylella fastidiosa* by a variable number of tandem repeat analysis. *Applied & Environmental Microbiology* 67:4091-4095.
- Coletta-Filho, H.D., and M. A. Machado. 2003. Geographical genetic structure of *Xylella fastidiosa* from citrus in Sao Paulo State, Brazil. *Phytopathology* 93:28-34.
- Lin, H., E.L. Civerolo, R. Hu, S. Barros, M. Francis, and M.A. Walker. 2005. Multilocus simple sequence repeat markers for differentiating strains and evaluating genetic diversity of *Xylella fastidiosa*. *Applied & Environmental Microbiology* 71: 4888-4892.

## FUNDING AGENCIES

Funding for this project was provided by the CDFa Pierce's Disease and Glassy-winged Sharpshooter Board.

# EFFECTS OF FIMBRIAL (FIMA, FIMF) AND AFIMBRIAL (XADA, HXFB) ADHESINS ON THE ADHESION OF *XYLELLA FASTIDIOSA* TO SURFACES

**Project Leader:**

Steven E. Lindow  
Division of Plant and Molecular Biology  
University of California  
Berkeley, CA 94720

**Researcher:**

Helene Feil  
University of California  
Berkeley, CA 94720

**Reporting Period:** The results reported here are from work conducted November 2004 to October, 2005

**ABSTRACT**

We investigated the role of fimbrial and afimbrial adhesions in the attachment of *Xylella fastidiosa* (*Xf*) to grape. We have individually disrupted FimA, FimF, XadA, and HxfB to assess their role in adhesion to plants and in the disease process. We performed adhesion assays using each mutant and wild-type separately as well as a combination of two mutants at one time to observe the phenotypes of these mutants using fluorescence or confocal microscopy. The fimbrial mutants FimA- or FimF- did not aggregate nor did they attach to the glass surface whereas the adhesion mutants XadA- or HxfB- did not attach to glass but did form aggregates and attached to cells that had adhered to a surface. All mutants had fewer single cells or aggregates that remained attached to glass than wild-type cells did after washing steps. We observed that afimbrial mutant cells (i.e. XadA- or HxfB-) were clumped on top of fimbrial mutant cells (i.e. FimA- or FimF-). Both afimbrial and fimbrial proteins thus apparently play a role in attachment of cells to glass in the early phases of adhesion while fimbrial proteins appear more important in cell-to-cell aggregations than afimbrial proteins. To determine if these adhesions are important in virulence, rooted grapevine cuttings were inoculated with FimA-, FimF-, XadA-, HxfB-, and wild-type *Xf* 'Temecula' or 'STL'. A higher incidence and severity of disease was observed in vines inoculated with the wild-type *Xf* strain compared with FimA-, FimF-, XadA- or HxfB- mutant strains. Similarly, wild-type strain *Xf* 'STL' resulted in more vines with symptoms than FimA-, FimF- or XadA- mutants of this strain indicating that the process of attachment appears to involve similar genes in both the 'Temecula' and 'STL' strains. It thus appears that successful colonization of plants by *Xf* requires both cell-to-cell and cell-to-surface attachment.

**INTRODUCTION**

Attachment is the first step in the colonization process of bacterial pathogens. Attachment of *Xf* to xylem vessels and insect vectors may be required for both virulence and transmission. We therefore investigated the role of various fimbrial and afimbrial adhesions produced by *Xf*. Amongst the afimbrial adhesions, *Xf* has a homolog to XadA, an adhesion shown to be important in virulence of *Xanthomonas oryzae* pv. *oryzae* to rice. Since *Xf* is also a xylem inhabiting plant pathogen we hypothesized that XadA would also be a virulent determinant for *Xf* in grape. Similarly HecA was shown to be a virulent factor for *Erwinia chrysanthemi* to tobacco seedlings. *Xf* has four homologs to the HecA adhesion, among them are HxfA (PD2118) and HxfB (PD1792). These hemagglutinins are the largest genes of the *Xf* genome and we hypothesized that these adhesions are important in the colonization process. Previous studies showed that HxfA and HxfB caused early grapevine death (hypervirulence) and mediated contact between *Xf* cells, which resulted in colony formation and biofilm maturation within the xylem vessels (Guilhabert and Kirkpatrick 2005). In the present study, inoculations were performed several times, and to ensure virulence was not diminished due to a high number of passage in the laboratory, we recreated the mutants multiple times using a low passage wild-type strain of *Xf* 'Temecula'. Inoculations were repeated several times with either low passage wild-type cells or each of the recreated mutants (FimA-, FimF-, XadA-, and HxfB-).

**OBJECTIVES**

1. Determine the role of adhesions, in particular of the adhesion XadA and hemagglutinin HxfB in the attachment and virulence of *Xf* in grape.
2. Develop adhesion assays to characterize the behavior of the fimbrial and adhesion mutants of *Xf*.

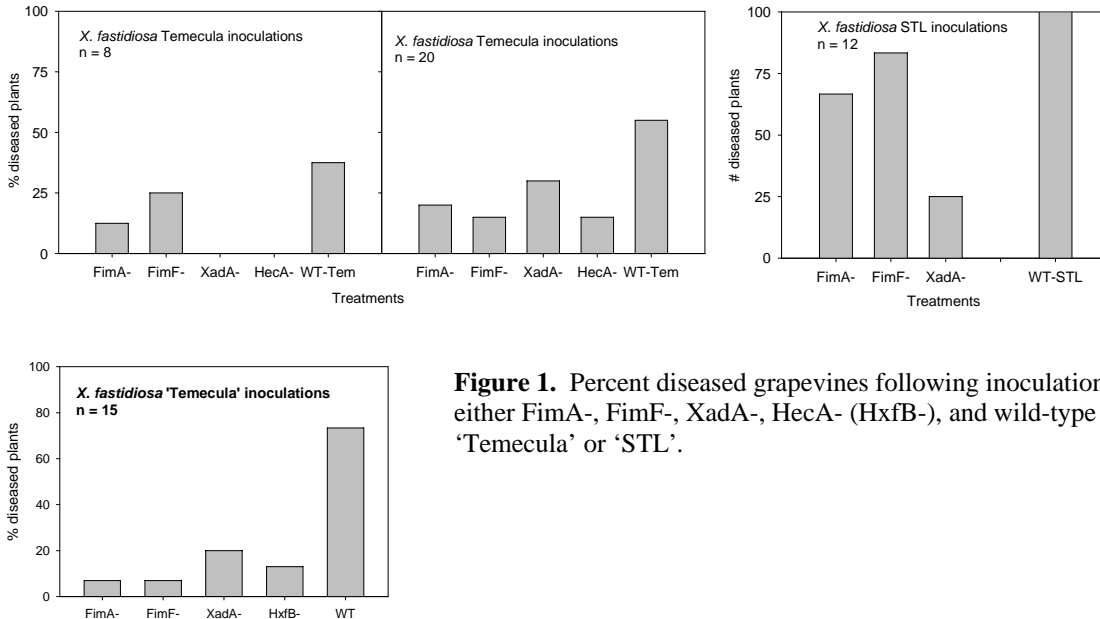
**RESULTS****Objective 1**

XadA and HxfB (PD1792) mutants of *Xf* grape strains 'Temecula' and 'STL' were produced using the method described previously (Feil et al. 2003). Because the hemagglutinin HxfB is a large gene (10 kb), we constructed several vectors to disrupt this gene to maximize our chance to disrupt an important domain in the HxfB protein. Characterization of HxfB mutants was done by PCR and sequencing.

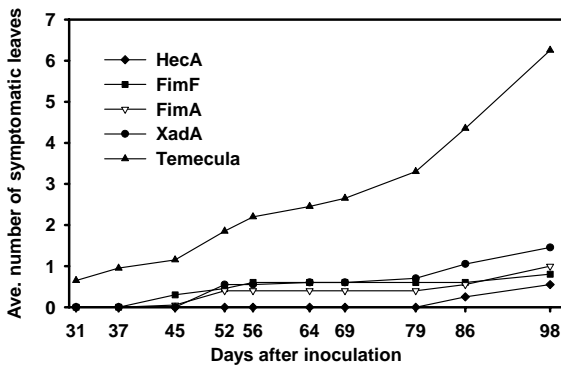
To assess the virulence of adhesion mutants we have infected grape with each of these mutants FimA, FimF, XadA, and HxfB (mutants were derived from both grape strains of *Xf* 'Temecula' or 'STL') and wild-type cells of the 'Temecula' or 'STL' grape strain and recorded the number of diseased plants over time. We created the mutants two separate times in a low-passage 'Temecula' background and repeated the inoculations twice for a total of three separate experiments. All these experiments gave the same results. Specifically, HxfB- mutants were always less virulent than wild-type cells. This result contrasts with previous studies on HxfB- mutant by Guilhabert and Kirkpatrick (2005). One reason could be that the site of



disruption in this large gene was different for the two mutants in these two studies and could therefore lead to different phenotypes. Samples were tested for the presence of *Xf* by culturing. The percent diseased grapevines following inoculation with either FimA-, FimF-, XadA-, or HxfB- was reduced compared to the percent diseased vines inoculated with the wild-type *Xf* 'Temecula' or 'STL.' At a given sample time wild-type *Xf* incited a higher incidence of disease in grapevines than either FimA-, FimF-, XadA-, or HxfB- mutants.



**Figure 1.** Percent diseased grapevines following inoculation with either FimA-, FimF-, XadA-, HecA- (HxfB-), and wild-type *Xf* 'Temecula' or 'STL.'



**Figure 2.** Average number of symptomatic leaves following inoculation with either FimA-, FimF-, XadA-, HecA- (HxfB-), and wild-type *Xf* 'Temecula' or 'STL.'

Disease severity was much reduced for each mutant compared to wild-type cells. For all mutant- inoculated grapevines, onset of symptom development was delayed by at least two weeks from the one for wild-type-inoculated grapevines. These results were confirmed by taking samples from all vines and culturing the bacteria from the samples.

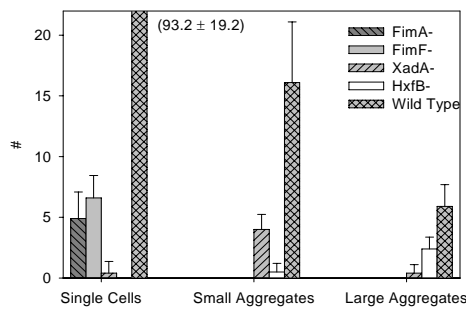
## Objective 2

Wild-type, FimA-, FimF-, XadA-, and HxfB- cells were scrapped from plates and placed in PWG broth to an OD of 1 (~ 10<sup>8</sup> cells per ml). 300 µl of each suspension was placed on a glass slide and incubated at room temperature in a moist chamber for four hours. The slide was then rinsed with sterile deionized water by submerging it in water twice. 20 µl of DAPI stain was placed on the slide to stain any attached cells. The stained cells were viewed under a fluorescent microscope and the number of cells attached counted.



**Figure 3.** FimA-, FimF-, XadA-, HxfB- or Wild-type cells remaining attached to glass after four hours.

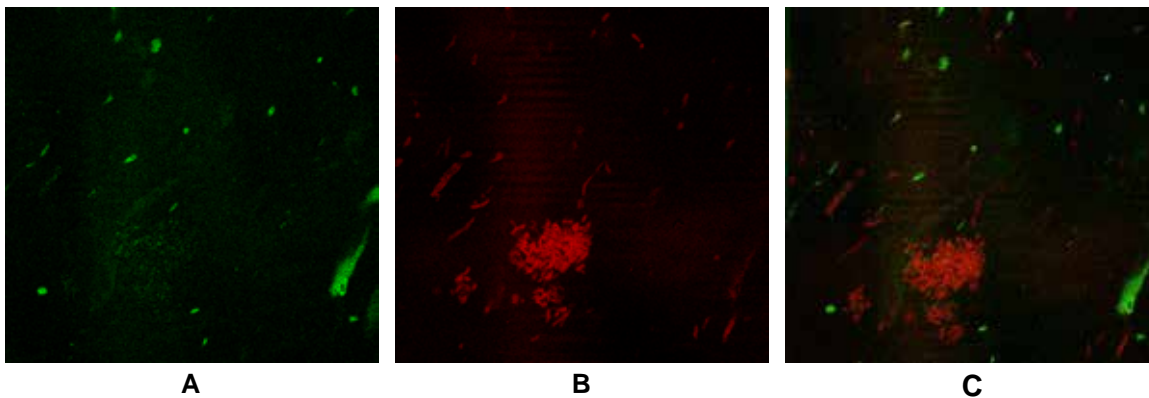
Wild-type cells remained attached to glass after four hours either as single cells, or small or large aggregates. Neither small nor large aggregates of FimA- or FimF- cells could be observed attached to glass whereas XadA- or HxfB- cells remained attached in aggregates to the glass surface if rinsing was gentle (but not if more vigorous rinsing was employed.). XadA- or HxfB- had fewer single cells remaining attached to glass after rinsing than FimA- or FimF- cells. Overall, the fimbrial and non-fimbrial mutants were attachment deficient when compared to the wild-type cells. This indicates that attachment of *Xf* requires both fimbrial and afimbrial adhesions.



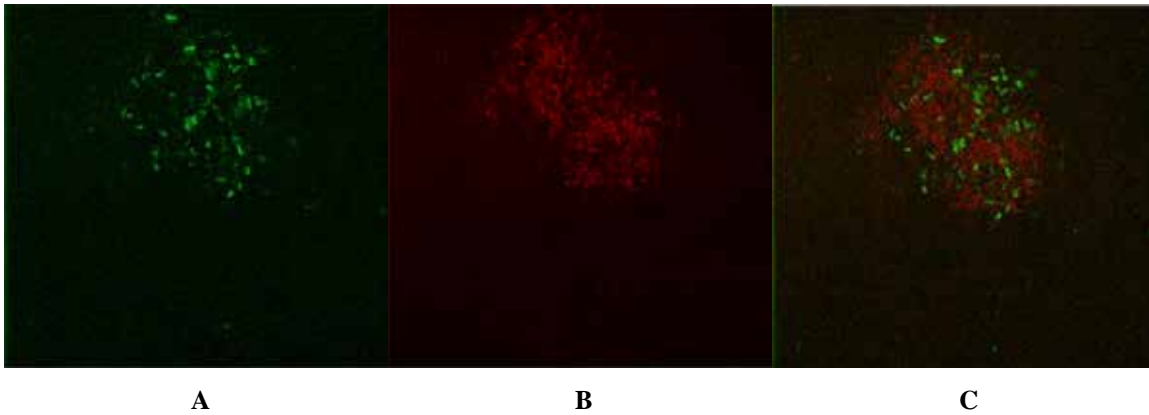
**Figure 4.** Number of cells remaining attached to glass after four hours for FimA-, FimF-, XadA-, HxfB- or wild-type cells.

#### Co-inoculation experiments with epifluorescence microscopy

Mutant cells were stained using PKH67 green fluorescent dye for FimA- FimF- or wild-type ‘Temecula’ and PKH26 red fluorescent dye for XadA- or HxfB-. Cells were mixed two by two as follows: combination 1, FimA- and XadA-; combination 2, FimA- and HxfB-; combination 3, FimF- and XadA-, and combination 4, FimF- and HxfB-. Mixtures were placed on glass slides, placed in a moist chamber for eight hours, rinsed, and examined under the confocal laser scanning microscope. Confocal microscopy of cells stained with metabolic dyes revealed that FimA- or FimF- did not form aggregates and attached sparingly to glass whereas XadA- or HecA- did not attach to glass but were found in aggregates on top of the FimA- or FimF- cells (Figures 5 and 6). This confirms that adhesion necessitates for types of adhesions and that the fimbrial adhesions are more important in cell-to-cell aggregation than the afimbrial adhesions.



**Figure 5.** FimA- cells green (A) and XadA- cells red (B) separated or together (C) using the confocal with the meta detector



**Figure 6.** FimF-, green cells (A), HecA-, red cells (B), and FimF- mixed with HecA-, green and red cells, respectively (C).

## CONCLUSIONS

The results show that attachment is a complex process, probably involving the contribution of both fimbrial and afimbrial adhesion factors. These results should help enable an understanding of the over-all process of formation of cell aggregates in xylem vessels, which presumably are major determinants of disease symptoms. Fimbrial adhesions appear more important in cell-to-cell aggregation than the afimbrial adhesions but both are responsible for attachment of *Xf* cell-to-surface. The importance in virulence for these mutants was determined by doing grapevine inoculation experiments. Inoculations were repeated three times with freshly recreated mutants each time. We counted the percent grapes vines infected following inoculation with wild-type of the two grape strains ‘Temecula’ or ‘STL’ or with either one of the four mutants tested (i.e. FimA-, FimF-, XadA-, or HxfB-). Since disease development was reduced in grapevines inoculated with FimA-, FimF-, XadA- or HxfB-, mutants compared to the wild type *Xf* strain we have shown that attachment is important for disease development. Targeting the FimA, FimF, XadA, or HxfB genes could be one way to reduce disease incidence in grapevine-growing regions affected by Pierce’s disease.

## REFERENCES

- Feil, H., Feil, W. S., Detter, J. C., Purcell, A. H., and S. E. Lindow. 2003. Site-directed disruption of the *fimA* and *fimF* fimbrial genes of *Xylella fastidiosa* Phytopathology 93:675-682.
- Guilhbert, M. R., and Kirpatrick, B. C. 2005. Identification of *Xylella fastidiosa* antivirulence genes: hemagglutinin adhesions contribute to *Xf* biofilm maturation and colonization and attenuate virulence. Mol. Plant-Microbe Interact. 18:856-868.

## FUNDING AGENCIES

Funding for this project was provided by the CDFR Pierce’s Disease and Glassy-winged Sharpshooter Board.

# ROLE OF UNIQUE GENES OF *XYLELLA FASTIDIOSA* GRAPE STRAIN IN HOST SPECIFICITY AND VIRULENCE TO GRAPE AND TO INSECT USING MICROARRAY

## Project Leader:

Steven E. Lindow  
Division of Plant and Molecular Biology  
University of California  
Berkeley, CA 94720

## Cooperator:

William S. Feil  
Division of Plant and Molecular Biology  
University of California  
Berkeley, CA 94720

**Reporting Period:** The results reported here are from work conducted December 2004 to September 2005.

## ABSTRACT

*Xylella fastidiosa* (*Xf*) is a group of genetically similar strains that infect a wide range of plants. We hypothesized that differing genetic factors among the strains determine the ability of a strain to infect a particular host plant. To better understand what makes grape a good host for all grape strains but not for strains such as oleander and almond that cannot colonize grape, we conducted experiments to look for host specific genes of the grape strain. Through our microarray and *in silico* genomic studies, we have so far identified 52 potential *Xf* grape strain virulence genes.

We have constructs for knocking out 12 of the 52 identified genes. The genes we chose from our list were greater than 300 bp and were not part of a remnant phage. Our constructs have a Kanamycin gene inserted near the 5' end of the gene for optimum efficiency in knocking out our gene and preventing *Xf* from making partial transcripts. We plan to inoculate plants with our knock-out mutants once they are confirmed.

We noticed that the microarray studies have produced fewer genes than expected, indicating that the similarity between *Xf* 'Temecula' and other non-grape strains must be greater than expected. Our *in silico* comparisons revealed a high level of similarity as well. Because of this, we are now using dual labeling with our microarray studies. This is a more sensitive way to identify differences in gene sequence between the strains.

## INTRODUCTION

*Xf* is a group of genetically similar strains that infect a wide range of plants. A particular strain often has a relatively reduced and distinct host range when compared to other strains. Some strains of *Xf* originating from host plants other than grape do not sustain viable populations or are not virulent in grape. In particular, many of the almond strains of *Xf* do not infect grape (Almeida and Purcell 2003). This strongly suggests that differing genetic factors among the strains determine the ability of a strain to infect a particular host plant. Other studies provide evidence for host specificity among the *Xf* strains (Chen et al. 1992; Chen et al. 1995; Pooler and Hartung 1995; Henderson et al. 2001; Bhattacharyya et al. 2002a, 2002b). For example, cross inoculations in greenhouse studies showed that the oleander and grape strains of *Xf* were not pathogenic to citrus and that the almond strain was not pathogenic to oleander (Feil et al. *unpublished*). In California, we have three identified groups of strains of *Xf* as designated by their host range; the grape strains, the almond strains, and the oleander strains.

To better understand the underlying genetics of *Xf* as it relates to pathogenesis, several strains have been sequenced. Strain *Xf* '9a5c', a citrus pathogen, was fully sequenced in Brazil (Simpson, 2000). The draft-genome sequences of the almond and oleander strains of *Xf*, 'Dixon' and 'Ann1', respectively, are also publicly available. We used this information to identify a list of genes present in the grape strain genome but missing in other strains that do not sustain viable colonies in grape.

We used target DNA from non-grape strains for hybridizing to probes designed from the sequenced reference strain, *Xf* 'Temecula', which are affixed to epoxy slides. During this process, we determined that most strains are highly similar to each other and require a much more sensitive approach to identify genetic distinctions with the grape strain. That is, few genes are completely missing in non-grape strains compared to grape strains and vice versa. We are thus using a dual labeling approach where the reference strain and the target strain are labeled differentially and co-hybridized on the same array, and sequence differences are revealed by competitive hybridization.

## OBJECTIVES

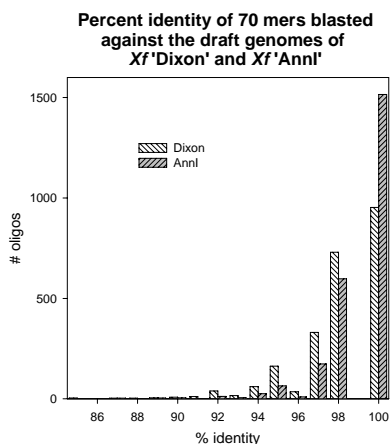
1. Complete our initial work on host-specific gene identification using DNA/DNA microarray studies and to better define the role of 52 genes thus far identified as unique to the grape strain.
2. Produce knock-outs of the unique genes to the grape strain and to test for virulence of these knock-outs in grape.

## RESULTS

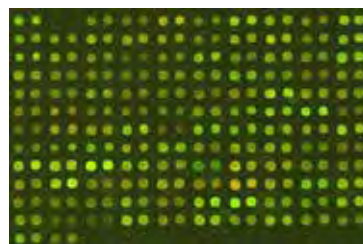
### Objective 1

To arrive at a list of 52 genes unique to the grape strain, we have hybridized DNA from six different strains to the DNA on the grape strain array. These strains were isolated from almond (two different isolates), oleander (two different isolates), oak, plum, olive, and maple. We also used two other grape isolates ('STL' and 'Fetzer') in our studies. Eighteen of these 52 genes are presented here (Table 1). There are 34 additional genes not listed that are either less than 300 bp in size or are

phage related. Also, many of the remaining genes are predicted to have only a hypothetical function. Our microarray work has thus far resulted in fewer than expected differences between *Xf* grape strain and other non-grape strains. Because of this we checked our oligonucleotide probes through blast analysis and determined that 93% of the oligos designed for our array have an 86% or higher sequence identity across at least 40 bases with that of the almond or oleander strain (Figure 1). Of the remaining 107, 63 had hits of fewer than 40 bases and only 44 had no hits at all. Many of these did not correspond to missing spots on our array, indicating that the oligos probably fell within regions of the almond or oleander genome that are poorly covered in the draft sequence. We also determined that this identity is too high for single labeling experiments since we would observe hybridization under the low stringent conditions that we use; thus gene variants may be present that would be overlooked in this strategy. Because of this, we are now using a dual labeling approach for our arrays (Figure 2). This should give us more ability to distinguish genes that might vary somewhat (but be present in) *Xf* strains from hosts other than grape. We illustrate this issue in an image of a small part of one microarray in Figure 2, in which *Xf* grape ‘Temecula’ DNA is labeled with Cy3 (green) and *Xf* oleander ‘AnnI’ DNA was labeled with Cy5 (red). Bright green spots indicate a potential unique gene for the grape strain, whereas yellow indicates a gene with close sequence identity across the 70 mer oligo is present in both genomes.



**Figure 1**



**Figure 2**

**Table 1.** Partial list of genes missing in *Xf* oleander ‘AnnI’ and *Xf* almond ‘Dixon’ compared to ‘Temecula1’ using microarray analysis.

RXFZ gene #	gene function
146	Hypothetical protein
105	Hypothetical protein
676	Hypothetical protein
733	No known function
734	No known function
809	Conserved membrane spanning protein
1099	No known function
1116	Hypothetical protein
1174	Iron-sulfur flavoprotein
1216	No known function
1291	No known function
1299	Hypothetical secreted protein
1327	Cell filamentation protein fic
1328	No known function
1613	Hypothetical membrane associated protein
2150	No known function
2737	No known function
2744	No known function

## Objective 2

We chose to knock out 12 potential virulence genes noted in Table 1 and have disrupted these genes by inserting a kanamycin resistance gene into them (Table 2). We focused on those genes that were larger than 300 bp in size, reasoning that they are more likely to be functional genes rather than pseudogenes. We also eliminated some genes from Table 1 based on the fact that they were apparently genes associated with a remnant phage or clearly encoded a housekeeping function that could not plausibly be associated with virulence. We then compared the identity of these genes to the genes present in the almond or oleander strains. While some of these identified genes from *Xf* 'Temecula' are shown to have high identity with the almond or oleander strain, these genes were chosen because of differences in the location of the start or stop codon, or there were major differences in small sections within the gene. These differences could produce highly different protein products. Gene knock-out mutants in *Xf* 'Temecula' are being made using the method of marker-exchange mutation developed in our lab. This method is highly efficient and does not require the numerous sub-transfers that are needed with other systems to completely knock-out the gene function. We are now characterizing these knock-outs as they are being made.

**Table 2.** List of selected genes for knock-out mutants.

Gene ID	Function	identity to grape	
		Almond	Oleander
PD0028	Hypothetical protein	.957	.960
PD0105	Hypothetical protein	.908	.908
PD0515	Hypothetical protein	.667	.538
PD0540	Hypothetical protein	.922	.954
PD0829	Hypothetical protein	.948	No hits
PD0872	Iron-sulfur flavoprotein	No hits	No hits
PD1434	Hypothetical protein	No hits	No hits
PD1510	Hypothetical protein	No hits	.884
PD1511	Hypothetical protein	.750	.789
PD1606	Hypothetical protein	No hits	No hits
PD1607	Modification methylase NspV	No hits	No hits
PD1608	Type II restriction enzyme NspV	No hits	No hits
PD2071	Type I restriction-modification system specificity determinant	.947	.983

The relative contribution of each of these unique genes will be studied by inoculating gene knock-out mutants into a grape host plant. Those genes that affect the growth and virulence of *Xf* more will naturally become a higher priority for further study. Bacterial growth will be analyzed monthly over the four months by removing and grinding a petiole to extract the bacteria. We will select petioles from the region where the initial inoculation occurred to ensure that local growth is not overlooked.

## CONCLUSIONS

The identification of the genes unique to the *Xf* grape strain and the understanding of how these unique genes confer host specificity and virulence to grape will help researchers with their breeding programs for resistance to Pierce's disease (PD). These genes could also be studied to find targets for chemical or other forms of control. Knowing those unique genes necessary for grape virulence should also prove valuable for the design of specific primers for the detection of all *Xf* grape strains.

Since there are only a few sequenced strains available for a direct comparison, finding the unique genes in grape required us to examine hybridization profiles from other non-sequenced strains and determine the absences of genes in those genomes. All grape strains of *Xf* should carry the same suite of genes for growth and virulence in grape. However, the grape strain has other hosts than grape. Some of the unique genes we find may be used for other reasons than just grape related virulence. If we determine those genes uniquely needed for virulence in grape, we will also determine what constitutes a grape strain. Knowing what every grape strain processes genetically will allow us to develop better molecular screens, especially for strains collected from non-grape hosts, and may allow us to work towards the discovery of more specific remedies to PD.

## REFERENCES

- Almeida, R. P. P., and Purcell, A. H. 2003. Biological traits of *Xylella fastidiosa* strains from grapes and almonds. *Microbiology* 69:7447-7452.
- Bhattacharyya, A, Stilwagen, S., Ivanova, N., et al. 2002a. Whole-genome comparative analysis of three phytopathogenic *Xylella fastidiosa* strains. *Proc. Natl. Acad. Sci.* 99:12403-12408.

- Bhattacharyya, A, Stilwagen, S., Reznik, G., Feil, H., Feil, W. S., et. al. 2002b. Draft sequencing and comparative genomics of *Xylella fastidiosa* strains reveal novel biological insights. *Genome Res.* 12:1556-1563.
- Chen, J., Chang, C. J., Jarret, R. L., and Gawel, N. 1992. Genetic variation among *Xylella fastidiosa* strains. *Phytopath.* 82:973-977.
- Chen, J., Lamikanra, O. Chang, C. J., and Hopkins, D. L. 1995. Randomly amplified polymorphic DNA analysis of *Xylella fastidiosa* Pierce's disease and oak leaf scorch pathotypes. *App. Environ. Microbiol.* 61:1688-1690.
- Hendson, M., Purcell, A. H., Chen, D., Smart, C., Guilhabert, M., and Kirkpatrick, B. 2001. Genetic diversity of Pierce's disease strains and other pathotypes of *Xylella fastidiosa*. *App. and Environ. Microbiol.* 67:895-903.
- Pooler, M. R., and Hartung, J. S. 1995. Genetic relationships among strains of *Xylella fastidiosa* from RAPD-PCR data. *Current Microbiol.* 31:134-137.
- Simpson, A. J. G., et al. 2000. The genome sequence of the plant pathogen *Xylella fastidiosa*. *Nature* 406:151-159.

#### **FUNDING AGENCIES**

Funding for this project was provided by the CDFR Pierce's Disease and Glassy-winged Sharpshooter Board.

# MULTI-LOCUS SEQUENCE TYPING (MLST) TO IDENTIFY RESERVOIRS OF *XYLELLA FASTIDIOSA* DIVERSITY IN NATURAL HOSTS IN CALIFORNIA

## Project Leaders:

Robert F. Luck, Richard Stouthamer, and  
Danel Vickerman  
Department of Entomology  
University of California  
Riverside, CA 92521

Leonard Nunney  
Department of Biology  
University of California  
Riverside, CA 92521

Donald A. Cooksey  
Department of Plant Pathology  
University of California  
Riverside, CA 92521

**Reporting Period:** The results reported here are from work conducted October 2004 to August 2005.

## ABSTRACT

The ability to identify accurately and track the strains of an important infectious agent causing a plant disease is fundamental to the surveillance and management of that disease. Therefore, it is critical that we determine what type of *Xylella fastidiosa* (*Xf*) disease reservoir exists in uncultivated habitats and identify potential new variants of *Xf* and their host plants. Our plant collection and xylem extraction efforts have targeted native and naturalized plants in riparian habitats that may harbor *Xf* which is spread from cultivated plants such as grapes by infected blue green sharpshooter (BGSS), *Graphocephala atropunctata* (Signoret) as they move from the riparian vegetation into the vineyards and adjacent plant communities (Purcell 1975). In order to detect and characterize the *Xf* strains from field collected plants, we have first developed a protocol using the real-time polymerase chain reaction (PCR), which has been proven to detect *Xf* at much lower levels than is possible with traditional PCR, and is a one step process reducing the possibility of error (Oliveira et al. 2002, Bextine and Miller 2005). Furthermore, we are using a technique for whole genome amplification which allows us to boost the amount of DNA in low concentration samples so that traditional PCR can be used to amplify and sequence a series of genes. We have detected *Xf* and determined the strain in several common native plant species, including *Encelia farinosa* (brittlebush), *Xanthium strumarium* (cocklebur), *Salvia mellifera* (black sage), *Pluchea odorata* (sweetscent) and *Vitis girdiana* (wild grape). This information is essential for fully understanding the potential for recombination and the generation of new strains. The results of this project will allow for a rational control of the pathogen by either planting or removing particular host plants in the proximity of the *Xf* reservoirs.

## INTRODUCTION

Little is known about the potential reservoir of *Xf* contained in native and naturalized plants. Since the insect vectors of *Xf* move freely between cultivated and uncultivated areas, an accurate identification of these *Xf* variants is critical to our understanding of the epidemiology of this disease, and hence to its control. We are using the Multilocus Sequence Typing (MLST) as the basis 1) to unambiguously and uniquely characterize *Xf* strains and clonal diversity, 2) to associate an *Xf* strain and clone with its host plant(s), and 3) to associate an *Xf* strain with its geographic location. MLST is a technique that is currently used to characterize strains and clones of 12 different human bacterial pathogens and to trace their epidemiology based on differences in their nucleotide sequences in one or more genes (<http://www.mlst.net/mixc/further.asp>) (Maiden *et al.* 1998, Enright and Spratt, 1999). In a related project funded by UC DANR, this technique is being used to document within and among-strain variation in *Xf* using the DNA sequence of seven target genes found in all *Xf* strains (Scally *et al.*, in press). The MLST site for *Xylella* ([www.mlst.net](http://www.mlst.net)) will be functional within the next six months (Scally pers. com). The genes used were chosen based on their informative pattern of evolution, and they are distributed throughout the *Xf* genome, summing to 9,307 base pairs. We are using the results of this project to characterize those strains we encounter in the riparian plants and in the BGSS, *Graphocephala atropunctata* (Signoret).

## OBJECTIVES

1. Collect *Xf* samples from a diversity of native and naturalized introduced plants in and around the riparian zones in southern California
2. Collect *Xf* samples from adult BGSS
3. Characterize the *Xylella* strains that are recovered using MLST
4. Determine the associations between specific *Xf* strains, their plant hosts, and their geographic distributions

## RESULTS

We have sampled a range of riparian plant species known to be host to BGSS or to harbor *Xf* (Purcell 1975, 1976) from riparian sites and sites near citrus groves and cultivated grapes in southern California. The plants in Table 1 were collected from October 2004 – August 2005. All of the plants listed as native are native to the continental United States, except those noted as being native to Central and South America. Xylem was extracted by the pressure bomb method. Plants were identified by botanist Andrew Sanders (UC, Riverside Herbarium) with reference to the Jepson Manual (Hickman 1993). Adult BGSS were collected from a riparian site in August of 2005; only the head was processed in order to avoid diluting the sample with additional insect DNA. DNeasy Plant or Tissue Extraction kits (Qiagen, Valencia, CA USA) were used to extract DNA. We performed real-time PCR using *Xf* specific ITS primers (*Xf1*) (Schaad *et al.* 2002) in order to determine the



presence or absence of the bacteria. The number of *Xf* positive and *Xf* negative samples for each plant are reported in Table 1. Additionally, we detected *Xf* in 4 out of 62 BGSS samples.

We have sequenced the two most variable MLST genes for each of the positive plant and insect samples. Strains that possess one or more genes that manifest a uniquely different sequence in any of these genes are treated as a different strain. Our preliminary results have revealed different *Xf* strains in common native plant species and in BGSS collected from the same location. We have identified the Pierce's disease strain in *Vitis girdiana* (wild grape), *Pluchea odorata* (sweetscent) and three BGSS from a riparian area in Temecula, California. The multiplex strain was identified from *Xanthium strumarium* (cocklebur), *Salvia mellifera* (black sage) and a BGSS collected in Temecula. Additionally, *Salvia mellifera* collected from Emerson Oaks Reserve and on the UC, Riverside campus also contained the multiplex strain. However, *Encelia farinosa* (brittlebush) collected in the Riverside area (on the UC, Riverside campus and in Two Trees Trail (a riparian area near the UC, Riverside campus) contained a new variant of the multiplex strain.

## CONCLUSIONS

Until recently, the identified strains in California have been those associated with agricultural or ornamental host plants. We do not know how many asymptomatic indigenous strains exist in California, especially in native or naturalized alien plants because they have not, as yet, given rise to a recognizable syndrome. Our plant collection and xylem extraction efforts have targeted native and naturalized plants in riparian habitats that may harbor *Xf* which is spread from them to cultivated plants by infected BGSS. Additionally, the possibility of invasions by novel strains from other parts of the Americas cannot be ignored. Therefore, it is critically important that we characterize the diversity of *Xf* strains present in California, especially those presumed to be the ancestral strains, i.e., those in native and naturalized alien plant hosts. This information is essential for fully understanding the potential for recombination and the generation of new and potentially more virulent strains.

## REFERENCES

- Bextine, B., and T. A. Miller. 2005. Laboratory-based monitoring of an insect-transmitted plant pathogen system. *BioTechniques* 38: 184-186.
- Enright, M. C., and B. G. Spratt. 1999. Multilocus sequence typing. *Trends Microbiol.* 7: 482-7.
- Hickman, J. C. 1993. *The Jepson Manual Higher Plants of California*. Univ. of California Press. Berkeley, CA.
- Maiden, M. C. J., J. A. Bygraves, E. Feil, G. Morelli, J. E. Russell, R. Urwin, Q. Zhang, J. Zhou, K. Zurth, D. A. Caugant, I. M. Feavers, M. Achtman, and B. G. Spratt. 1998. Multilocus sequence typing: a portable approach to the identification of clones within population of pathogenic microorganisms. *Proc. Natl. Acad. Sci. USA.* 95: 3140-45.
- Oliveira, A. C., M. A. Vallim, C. P. Semighini, W. L. Araujo, G. H. Goldman, and M. A. Machado. 2002. Quantification of *Xylella fastidiosa* from citrus trees by real-time polymerase chain reaction assay. *Phytopath.* 92: 1048-1054.
- Purcell, A. H. 1975. Role of blue-green sharpshooter, *Hordnia circellata* in the epidemiology of Pierce's disease of grapevines. *Environ. Entomol.* 4: 745-52.
- Purcell, A. H. 1976. Seasonal changes in host plant preference of the blue-green sharpshooter, *Hordnia circellata*, (Homoptera: Cicadellidae). *Pan-Pac. Entomol.* 52: 33-7.
- Scally, M., E.L. Schuenzel, R. Stouthamer, and L. Nunney. Estimating the relative contribution of recombination versus point mutation in the plant pathogen *Xylella fastidiosa* using MLST. *Appl. Envir. Microbiol.* (in press).
- Schaad, N. W., D. Opgenorth, and P. Gaush. 2002. Real-time polymerase chain reaction for one-hour on-site diagnosis of Pierce's Disease of grape in early season asymptomatic vines. *Phytopath.* 70: 721-728.

## FUNDING AGENCIES

Funding for this project was provided by the CDFR Pierce's Disease and Glassy-winged Sharpshooter Board.

**Table 1.** Number of positive *Xf* and negative *Xf* plants sampled October 2004 - August 2005

Native	Family	+	-	Native	Family	+	-
<i>Abutilon palmeri</i>	Malvaceae	0	1	<i>Dudleya pulverulenta</i>	Crassulaceae	0	2
<i>Adenostoma fasciculatum</i>	Rosaceae	0	1	<i>Encelia californica</i>	Asteraceae	0	1
<i>Amaranthus albus</i>	Amaranthaceae	0	1	<i>Encelia farinosa</i>	Asteraceae	5	19
<i>Ambrosia acanthacarpa</i>	Asteraceae	0	1	<i>Epilobium ciliatum</i>	Onagraceae	0	1
<i>Ambrosia confertiflora</i>	Asteraceae	0	3	<i>Equisetum arvense</i>	Equisetaceae	0	2
<i>Ambrosia psilostachya</i>	Asteraceae	0	21	<i>Eriodictyon trichocalyx</i>	Hydrophyllaceae	0	2
<i>Amorpha fruticosa</i>	Fabaceae	0	2	<i>Eriogonum elongatum</i>	Polygonaceae	0	1
<i>Amsinckia menziesii</i> v. <i>intermedia</i>	Boraginaceae	0	3	<i>Eriogonum fasciculatum</i> var. <i>undet.</i>	Polygonaceae	0	4
<i>Antirrhinum coulterianum</i>	Scrophulariaceae	0	1	<i>Eriogonum fasciculatum</i> v. <i>polifolium</i>	Polygonaceae	0	5
<i>Antirrhinum nuttallianum</i>	Scrophulariaceae	0	2	<i>Eriogonum fasciculatum</i> var. <i>foliosum</i>	Polygonaceae	0	8
<i>Apocynum cannabinum</i>	Apocynaceae	0	7	<i>Eriophyllum confertiflorum</i>	Asteraceae	0	4
<i>Araujia sericofera</i> †	Asclepiadaceae	0	2	<i>Eucrypta chrysanthemifolia</i>	Hydrophyllaceae	0	6
<i>Arctostaphylos</i> sp.	Polygonaceae	0	2	<i>Fallugia paradoxa</i>	Rosaceae	0	1
<i>Artemisia californica</i>	Asteraceae	0	17	<i>Galium aparine</i>	Rubiaceae	0	1
<i>Artemisia douglasiana</i>	Asteraceae	0	33	<i>Gnaphalium californicum</i>	Asteraceae	0	1
<i>Artemisia tridentata</i>	Asteraceae	0	4	<i>Gnaphalium canescens</i>			
<i>Atriplex canescens</i>	Chenopodiaceae	0	1	<i>ssp.microcephalum</i>	Asteraceae	0	7
<i>Atriplex polycarpa</i>	Chenopodiaceae	0	1	<i>Gnaphalium stramineum</i>	Asteraceae	0	1
<i>Atriplex triangularis</i>	Chenopodiaceae	0	3	<i>Haplopappus squarrosus</i>	Asteraceae	0	2
<i>Baccharis salicifolia</i>	Asteraceae	0	17	<i>Helianthemum scoparium</i>	Cistaceae	0	1
<i>Baccharis sergiloides</i>	Asteraceae	0	2	<i>Helianthus annuus</i>	Asteraceae	0	5
<i>Berlandiera lyrata</i>	Asteraceae	0	1	<i>Heterotheca grandiflora</i>	Asteraceae	0	4
<i>Bidens pilosa</i>	Asteraceae	0	3	<i>Heteromeles arbutifolia</i>	Rosaceae	0	2
<i>Brickellia</i> sp.	Asteraceae	0	1	<i>Hyptis emoryi</i>	Lamiaceae	0	1
<i>Brickellia californica</i>	Asteraceae	0	1	<i>Juncus rugulosus</i>	Juncaceae	0	2
<i>Calyptridium monandrum</i>	Portulacaceae	0	1	<i>Juniperus californica</i>	Cupressaceae	0	1
<i>Camissonia bistorta</i>	Onagraceae	0	1	<i>Justicia californica</i>	Acanthaceae	0	1
<i>Camissonia brevipes</i>	Onagraceae	0	1	<i>Justicia leonardii</i>	Acanthaceae	0	2
<i>Camissonia californica</i>	Onagraceae	0	1	<i>Helianthus gracilentus</i>	Asteraceae	0	2
<i>Camissonia hirtella</i>	Onagraceae	0	1	<i>Keckiella antirrhinoides</i>	Scrophulariaceae	0	1
<i>Cardiospermum corindum</i>	Sapindaceae	0	2	<i>Larrea tridentata</i>	Zygophyllaceae	0	1
<i>Ceanothus (greggii?)</i>	Rhamnaceae	0	1	<i>Lathyrus vestitus</i>	Fabaceae	0	2
<i>Ceanothus tomentosus</i>	Rhamnaceae	0	1	<i>Lavatera assurgentiflora</i>	Verbenaceae	0	1
<i>Celtis reticulata</i>	Ulmaceae	0	1	<i>Lessingia filaginifolia</i>	Asteraceae	0	1
<i>Cercocarpus betuloides</i>	Rosaceae	0	3	<i>Lippia wrightii</i>	Verbenaceae	0	2
<i>Chaenactis artemisiifolia</i>	Asteraceae	0	1	<i>Lotus heermannii</i>	Fabaceae	0	9
<i>Chamomilla suaveolens</i>	Asteraceae	0	1	<i>Lotus purshianus</i>	Fabaceae	0	1
<i>Chenopodium berlandieri</i>	Chenopodiaceae	0	3	<i>Lotus scoparius</i> var. <i>brevialatus</i>	Fabaceae	0	11
<i>Chilopsis linearis</i>	Bignoniaceae	0	2	<i>Lotus strigosus</i>	Fabaceae	0	1
<i>Chrysothamnus nauseosus</i>	Asteraceae	0	1	<i>Lupinus bicolor</i>	Fabaceae	0	2
<i>Conyza canadensis</i>	Asteraceae	0	9	<i>Lupinus truncatus</i>	Fabaceae	0	1
<i>Croton californicus</i>	Euphorbiaceae	0	2	<i>Malacothamnus</i> sp.	Malvaceae	0	1
<i>Cryptantha intermedia</i>	Boraginaceae	0	1	<i>Malacothamnus fasciculatus</i>	Malvaceae	0	2
<i>Cryptantha muricata</i>	Boraginaceae	0	4	<i>Malosma laurina</i>	Anacardiaceae	0	8
<i>Cyperus eragrostis</i>	Cyperaceae	0	2	<i>Marah macrocarpus</i>	Cucurbitaceae	0	6
<i>Datura wrightii</i>	Solanaceae	0	5	<i>Mentha arvensis</i>	Lamiaceae	0	1
<i>Delphinium cardinale</i>	Ranunculaceae	0	1	<i>Mirabilis californica</i>	Nyctaginaceae	0	1
<i>Dryopteris arguta</i>	Dryopteridaceae	0	2	<i>Mimulus aurantiacus</i>	Scrophulariaceae	0	8
				<i>Mimulus aurantiacus</i> var. <i>puniceus</i>	Scrophulariaceae	0	8

**Table 1** continued

<b>Native</b>	<b>Family</b>	<b>+</b>	<b>-</b>	<b>Naturalized</b>	<b>Family</b>	<b>+</b>	<b>-</b>
<i>Mimulus brevipes</i>	Scrophulariaceae	0	1	<i>Anagallis arvensis</i>	Primulaceae	0	2
<i>Mimulus cardinalis</i>	Scrophulariaceae	0	5	<i>Apium graveolens</i>	Apiaceae	0	3
<i>Nicotiana glauca</i> <sup>†</sup>	Solanaceae	0	18	<i>Erosa saracophera</i>	Asclepiadaceae	0	2
<i>Oenothera elata</i>	Onagraceae	0	3	<i>Brassica geniculata</i>	Brassicaceae	0	8
<i>Parkinsonia aculeata</i>	Fabaceae	0	2	<i>Chenopodium murale</i>	Chenopodiaceae	0	2
<i>Penstemon spectabilis</i>	Scrophulariaceae	0	1	<i>Chenopodium ambrosioides</i>	Chenopodiaceae	0	7
<i>Plantago major</i>	Plantaginaceae	0	5	<i>Cirsium vulgare</i>	Asteraceae	0	1
<i>Platanus racemosa</i>	Platanaceae	0	16	<i>Cnicus benedictus</i>	Asteraceae	0	1
<i>Pluchea odorata</i>	Asteraceae	1	1	<i>Cirsium vulgare</i>	Asteraceae	0	1
<i>Polygonum lapathifolium</i>	Polygonaceae	0	9	<i>Cnicus benedictus</i>	Asteraceae	0	1
<i>Prunus caroliniana</i>	Rosaceae	0	3	<i>Conyza floribunda</i>	Asteraceae	0	2
<i>Prunus fasciculata</i>	Rosaceae	0	2	<i>Cotula australis</i>	Asteraceae	0	1
<i>Prunus virginia</i>	Rosaceae	0	2	<i>Cyperus involucratus</i>	Cyperaceae	0	3
<i>Phacelia minor</i>	Hydrophyllaceae	0	1	<i>Eremocarpus setigerus</i>	Euphorbiaceae	0	2
<i>Phacelia distans</i>	Hydrophyllaceae	0	2	<i>Erodium cicutarium</i>	Geraniaceae	0	3
<i>Phacelia ramosissima</i>	Hydrophyllaceae	0	6	<i>Erodium moschatum</i>	Geraniaceae	0	2
<i>Prosopis (glandulosa?)</i>	Fabaceae	0	2	<i>Euphorbia peplis</i>	Euphorbiaceae	0	1
<i>Psoralea macrostachya</i>	Fabaceae	0	1	<i>Foeniculum vulgare</i>	Apiaceae	0	1
<i>Pteridium aquilinum</i>	Dennstaedtiaceae	0	1	<i>Gnaphalium luteo-album</i>	Asteraceae	0	3
<i>Purshia neomexicana</i>	Rosaceae	0	1	<i>Lactuca serriola</i>	Asteraceae	0	3
<i>Quercus agrifolia</i>	Fagaceae	0	1	<i>Lonicera japonica</i>	Caprifoliaceae	0	2
<i>Ribes divaricatum</i>	Grossulariaceae	0	1	<i>Lonicera subspicata</i>	Caprifoliaceae	0	1
<i>Robinia neomexicana</i>	Fabaceae	0	1	<i>Malva parviflora</i>	Malvaceae	0	5
<i>Romneya coulteri</i>	Papaveraceae	0	2	<i>Marrubium vulgare</i>	Lamiaceae	0	5
<i>Rorippa nasturtium-aquaticum</i>	Brassicaceae	0	2	<i>Melilotis alba</i>	Fabaceae	0	3
<i>Rosa californica</i>	Rosaceae	0	8	<i>Mentha suaveolens</i>	Lamiaceae	0	3
<i>Rubus ursinus</i>	Rosaceae	0	9	<i>Metrosideros sp</i>	Myrtaceae	2	2
<i>Rumex salicifolius</i>	Polygonaceae	0	2	<i>Metrosideros kermadecensis</i>	Myrtaceae	0	6
<i>Rubus parviflorus</i>	Rosaceae	0	2	<i>Nerium oleander</i>	Apocynaceae	1	1
<i>Salix lasiolepis</i>	Salicaceae	0	18	<i>Oxalis rubra</i>	Oxalidaceae	0	1
<i>Salix laevigata</i>	Salicaceae	0	8	<i>Picris echioides</i>	Asteraceae	0	4
<i>Salvia apiana</i>	Lamiaceae	0	13	<i>Plantago lanceolata</i>	Plantaginaceae	0	1
<i>Salvia mellifera</i>	Lamiaceae	3	21	<i>Prunus dulcis</i>	Rosaceae	0	1
<i>Sambucus mexicana</i>	Caprifoliaceae	0	6	<i>Phragmites australis</i>	Poaceae	0	1
<i>Samolus parviflorus</i>	Primulaceae	0	1	<i>Ricinus communis</i>	Euphorbiaceae	0	2
<i>Sanicula crassicaulis</i>	Apiaceae	0	1	<i>Raphanus sativus</i>	Brassicaceae	0	1
<i>Scrophularia californica</i>	Scrophulariaceae	0	1	<i>Rhaphiolepis sp.</i>	Rosaceae	0	2
<i>Stachys ajugoides</i>	Lamiaceae	0	12	<i>Rhaphiolepis indica</i>	Rosaceae	0	5
<i>Solanum americanum</i>	Solanaceae	0	1	<i>Rumex crispus</i>	Polygonaceae	0	1
<i>Solanum douglasii</i>	Solanaceae	0	4	<i>Rumex conglomeratus</i>	Polygonaceae	0	1
<i>Solanum xanti</i>	Solanaceae	0	1	<i>Rumex salicifolias</i>	Polygonaceae	0	1
<i>Symphoricarpos sp.</i>	Caprifoliaceae	0	1	<i>Silybum marianum</i>	Asteraceae	0	1
<i>Typha domingensis</i>	Typhaceae	0	1	<i>Sisymbrium erysimoides</i>	Brassicaceae	0	2
<i>Urtica dioica</i>	Urticaceae	0	4	<i>Salsola tragus</i>	Chenopodiaceae	0	1
<i>Venegasia carpesioides</i>	Asteraceae	0	1	<i>Sisymbrium irio</i>	Brassicaceae	0	6
<i>Vitis girdiana</i>	Vitaceae	1	27	<i>Sonchus oleraceus</i>	Asteraceae	0	1
<i>Xanthium strumarium</i>	Asteraceae	1	29	<i>Vinca major</i>	Apocynaceae	0	3

<sup>†</sup> native to Central or South America

**A GENOME-WIDE APPROACH TO PLANT-HOST PATHOGENICITY IN *XYLELLA FASTIDIOSA*:  
MULTIGENIC METHODS FOR IDENTIFYING STRAINS, FOR STUDYING THE ROLE OF  
INTER-STRAIN RECOMBINATION, AND FOR IDENTIFYING PATHOGENICITY CANDIDATE GENES**

**Project Leader:**

Leonard Nunney  
Department of Biology  
University of California  
Riverside, CA 92521

**Cooperators:**

Richard Stouthamer and Robert Luck  
Department of Entomology  
University of California  
Riverside, CA 92521

**Reporting Period:** The results reported here are from work conducted September 31, 2004 to August 31, 2005.

**ABSTRACT**

We have developed a multilocus sequence typing (MLST) system for identifying the known pathovars of *Xylella fastidiosa* (including subsp. *fastidiosa* that causes Pierce's disease). This identification system is based on allelic variation at seven housekeeping genes (*holC*, *nuoL*, *leuA*, *gltT*, *cysG*, *petC* and *lacF*) and a public MLST database has been established at [www.mlst.net](http://www.mlst.net) (see Scally et al. 2005). This easily accessible system will allow for the rapid recognition of novel variants as they arise, since it can be continuously updated by researchers who have sequenced new isolates for the seven genes. We tested the effectiveness of the MLST system using 25 isolates of *Xylella fastidiosa* (*Xf*) from five different host plants: grapevine (Pierce's disease, PD), oleander (oleander leaf scorch, OLS), oak (oak leaf scorch, OAK), almond (almond leaf scorch, ALS) and peach (phony peach scorch, PP). An eBURST analysis identified six clonal complexes (CCs), using the grouping criterion that each member of a CC must be identical to at least one other member at five or more of the seven loci. These clonal complexes corresponded to phylogenetic clades that we had previously identified (Schuenzel et al. 2005), including subspecific clades of *fastidiosa* and *sandyi* (CC1 & 2), while CC3-5 defined host-specific sub-clades of the subsp. *multiplex*. CC6 identified a *multiplex*-like group characterized by a high frequency of inter-subspecific recombination. To begin to understand the potential role of recombination in the creation of new pathovars, we also used the MLST data (plus three additional loci) to estimate the relative contribution of recombination and mutation to the observed variability. Recombination between different alleles was estimated to give rise to 76% of the nucleotide changes and 31% of the allelic changes observed. However, sequence data also suggests that inter-subspecific recombination has started relatively recently. This new phenomenon may lead to an increased rate of pathovar formation.

**INTRODUCTION**

The availability of four genome sequences of *Xf* (two completely annotated and two non-annotated), allows us to exploit the extraordinary power of genomic research to investigate *Xf*'s genetic diversity. This diversity can provide information essential for understanding the plant-host specificity of the *Xf* subspecies. So far, the only form implicated in causing PD is subspecies *fastidiosa*, however a very real possibility exists that new pathovars may arise by recombination among the three North American subspecies. Sequence data from the *Xf* genomes suggests that recombination was historically rare; however this has never been quantified.

We have shown that the PD pathovar (subsp. *fastidiosa*) has very low sequence variability (Schuenzel et al. 2005). This suggests that the PD pathovar has been subject to intense selection- a result probably reflecting significant genetic constraint imposed by the grapevine host on the bacterium. Identifying this constraint is likely to lead to a mechanism for pathogen control.

Our first priority was to place the PD strain within a statistically robust phylogeny, extending earlier work defining the interrelationships of the plant-host strains of *Xf* (e.g. Henderson et al. 2001; Lin et al. 2005). Schaad et al. (2004) identified two North American subspecies based on DNA hybridization: subsp. *multiplex*, found on a range of hosts including almond, peach and plum, plus the PD pathovar, subspecies *fastidiosa* (initially named *piercei*). Using DNA sequence data, we added a third North American subsp. (*sandyi*) isolated originally from oleander and we estimated that these three subspecies have been separated for more than 15,000 years (Schuenzel et al. 2005).

Given a robust phylogeny, our challenge was to develop an effective method for identifying the known host pathovars. The "state-of-the-art" approach is to use MLST (multiple locus sequence typing) (Maiden et al. 1998). This technique has been applied primarily in the identification of pathovars of human pathogens, and a public database has been established at [www.mlst.net](http://www.mlst.net), which is located at Imperial College, London and is funded by the Wellcome Trust.

Unambiguous identification of strains is of considerable importance for understanding the epidemiology of PD and the other plant diseases caused by this bacterium. Previously, this has been approached using a variety of DNA based methods (Banks et al. 1999; Henderson et al. 2001; Rodrigues et al. 2003; Meinhardt et al. 2003; Lin et al. 2005). As yet, it has not been established if results from these methods have a clear relationship to the true underlying phylogenetic relationships. The simple sequence repeat (SSR) approach of Lin et al. (2005) shows up high variability, useful for uniquely distinguishing isolates, however it relies on many (34) loci. In contrast, MLST methods rely on the allelic variability of just seven

housekeeping genes, and so measure variation more conservatively than SSR methods, but at a level designed to clearly identify significant phylogenetic pathovar groupings.

New pathovars can develop via horizontal transfer of new genetic material or via changes in existing genes. Changes in existing areas can accumulate via mutation within a pre-existing variant, or via recombination among the known pathovars. Recombination in particular has great potential to rapidly create new and very different forms. *Xf* is generally assumed to be clonal, although we know that virally-mediated horizontal transfer of genes must occur since some regions of DNA are unique to one subspecies (Van Sluys et al. 2003). The possibility of homologous recombination is more difficult to detect, but Schuenzel et al. (2005) found evidence of such genetic exchange. Since recombination could lead to the very rapid evolution of novel pathogenic forms, we were interested in quantifying how much of the genetic variation seen within subspecies was likely to be due to recombination, as well as further examining the possibility of inter-subspecific transfer.

## OBJECTIVES

1. To develop a multilocus sequence typing (MLST) system for identifying pathovars of *Xf*. Our objective was to develop an MLST method that unambiguously identifies the known host pathovars, and that can provide for the efficient recognition of new forms.
2. Estimate the frequency of recombination. Our objective was to measure the effect of homologous recombination. Genetic transfer can dramatically increase the rate of evolution, and rapidly create new host strains.

## RESULTS

### Objective 1: To develop a multilocus sequence typing (MLST) system for identifying pathovars of *Xf*

MLST is a recently devised method for identifying strains of bacteria based solely on nucleotide sequence differences across a small number of housekeeping genes (Maiden et al. 1998). Usually seven genes are used and each allele identified is given its own locus-specific number, so that each isolate characterized is represented by its sequence type (ST)- the set of seven numbers defining the alleles at each locus (Table 1). In contrast to prior DNA-based methods, MLST sequence data is unambiguous, can be easily interpreted and replicated between labs, and is generally made available on a public database. MLST typically has higher resolution than most previous methods, while avoiding the problems of excessive variability associated with use of microsatellite loci (i.e. SSRs).

**Table 1.** MLST allelic profiles of 25 *Xf* isolates based on seven housekeeping genes. The resulting 15 sequence types (STs) were divided into six clonal complexes (CCs).

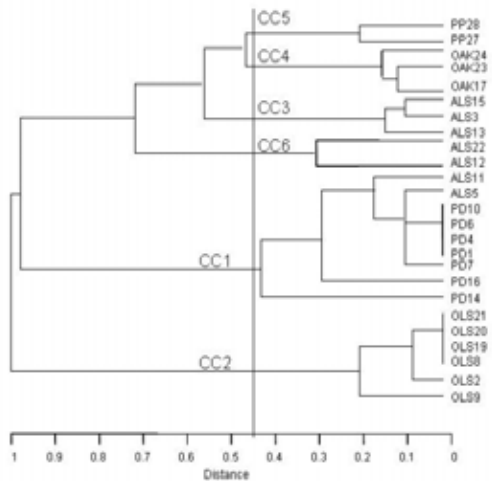
Clonal Complex <sub>x</sub>	Isolate (grouped by Sequence Type)	Gene						
		holC	nuoL	gltT	cysG	petC	leuA	lacF
CC1	PD1,4,6,10,7, ALS5	1	1	1	1	1	1	1
	ALS11	1	1	1	1	1	4	1
	PD16	1	4	1	1	1	1	4
	PD14	1	1	1	4	1	1	1
CC2	OLS 8, 19,20, 21	2	2	2	2	2	2	2
	OLS 2	2	5	2	2	2	2	2
	OLS9	2	6	2	2	2	2	2
CC3	ALS13, 15	3	3	3	3	3	3	3
	ALS3	3	7	3	3	3	3	3
CC4	OAK17, 23	4	7	4	5	3	3	5
	OAK24	5	7	4	5	3	3	5
CC5	PP27	6	7	5	3	4	3	5
	PP28	6	7	6	3	4	5	5
CC6	ALS12	7	7	7	6	3	6	5
	ALS22	7	8	7	7	3	6	5

The MLST data is used to group closely related strains into clonal complexes (CCs). We adopted the definition of a clonal complex suggested by Feil et al. (2001): it is a group in which every member shares at least five identical alleles across the seven loci with at least one other genotype in the group.

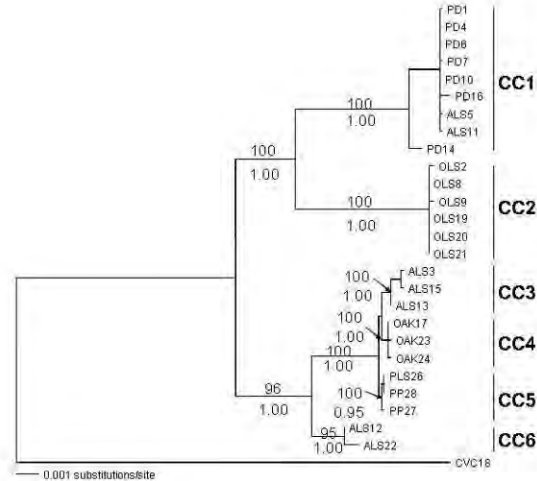
We examined the effectiveness and robustness of our MLST method at detecting subspecies and plant-host pathovars by comparing the clonal complexes defined from the analysis of 25 isolates to our pre-existing phylogeny (Shuenzel et al. 2005). The strains used in the analysis originated from symptomatic individuals of five plant species, grape (PD), oleander (OLS), oak (OAK), almond (ALS) and peach (PP). The allelic profiles of these 25 strains produced 15 different sequence types (STs) (Table 1). The eBURST program (Feil et al. 2004) assigned these to six clonal complexes (CCs) (Figure 1). All

strains from grapevine plus two from almond (ALS5 and ALS11) formed the clonal complex 1 (CC1), corresponding to subsp. *fastidiosa*. Similarly, the six OLS strains of subsp. *sandyi* formed CC2. The MLST method divided isolates of the subsp. *multiplex* into three plant-host groups: ALS3, 13, 15 formed the complex CC3, and the OAK and PP strains formed groups CC4 and CC5. Finally, the strains ALS12 and ALS22 formed CC6. These last two isolates are unusual because they exhibit clear signs of recent inter-subspecific recombination (Schuenzel et al. 2005).

The six clonal complexes identified corresponded to six statistically significant clades in our original maximum likelihood tree (Figure 2, see also Schuenzel et al. 2005). Thus our MLST system identified meaningful phylogenetic groupings. Note however that the phenetic tree derived from the MLST relationships can be misleading; note the incorrect position of OLS strains in the UPGMA tree (Figure 1). This same problem can be seen in the SSR-based tree of Lin et al. (2005).



**Figure 1.** Dendrogram showing the relationships among the clonal complexes based on the unweighted pair-group method with arithmetic averages (UPGMA). The dashed line indicates region demarcating the designation of six clonal complexes.



**Figure 2.** Maximum likelihood phylogeny of *Xf* strains based on 9,307 base pairs. Numbers above and below branches refer to bootstrap support and Bayesian posterior probabilities respectively. The phylogenetic placement of the clonal complexes (CCs) is also shown.

### Objective 2: Estimate the frequency of recombination

Several methods have been suggested for estimating the frequency of recombination. One method uses MLST data directly (Feil et al. 2001). In this method, the alleles within a clonal complex are compared to the alleles of its “ancestral” sequence type. (The ancestral sequence type is the ST within the CC that has the largest number of STs that differ at just a single locus). Allelic differences due to a single base pair are used to approximate the number of point mutations, whereas those differing at multiple sites are assumed to reflect recombination events. The role of recombination, relative to mutation, in creating clonal diversity can then be measured in two ways: by the ratio of recombination to mutation ( $r/m$ ) per allele (where each event results in one change) and by the ration per nucleotide (where each mutation results in one change, but each recombination results in more than one change). This method implicitly assumes that detectable recombination is between (and not within) clonal complexes. We also estimated recombination between clonal complexes by looking directly for congruence between alleles in different clonal complexes both by using the DnaSP software (see Betran et al. 1997) and by visual inspection of the data.

**Table 2.** Number of recombination events estimated from the sample of 25 isolates, each sequenced for 10 genes (the seven MLST loci plus *rfbD*, *nuoN*, and *pilU*). Three different methods were used (see text).

Method	No of recombination events	Genes featuring recombination events
Visual inspection	4	holC, cysG (2), pilU
DnaSP	5	holC, cysG (2), pilU, leuA
MLST	10	holC, cysG (2), pilU, leuA, rfbD, nuoL (4)

All methods identified four clear examples of recombination among the clonal complexes, and the DnaSP and MLST methods identified an additional event in the *leuA* gene (Table 2). An additional five potential examples of homologous recombination were identified by the MLST method alone (mainly in the *nuoL* gene). These examples involved 2-4 base pair changes and additional sampling of isolates would help determine if these are true recombination events, or examples of

multiple point mutations within the same gene within a clonal complex. The total of 10 events detected by MLST involved 71 base pair substitutions compared to 10 allelic changes due to single base pair substitutions. This converts to an estimate of 31% of new alleles arising from recombination and of 76% of DNA base changes within a clonal complex due to recombination. In comparison to many other bacteria, *Xf* has low recombination to point mutation ratio both per allele (0.46:1) and per nucleotide (3.23:1). For example, *Streptococcus pneumoniae* (8.9:1, 61.0:1) and *Neisseria meningitidis* (4.75:1, 100.0:1) (Feil et al. 2001) have ratios shifted more than 10 fold in favor of recombination. However, the clear phylogenetic separation of the clonal complexes, and particularly of the three subspecies, combined with our current estimates, suggests that recombination in *Xf* may be increasing in frequency, possibly due to the effects of agriculture and new insect vectors mixing previously separated subspecies.

## CONCLUSIONS

1. We have established a MLST system for *Xf* based on seven housekeeping genes. The database is publicly available at [www.mlst.net](http://www.mlst.net), an Imperial College London website supported by the Wellcome Trust.
2. The MLST system groups North American *Xf* isolates into six clonal complexes (CCs) that correspond to the six statistically-supported host-related clades identified using phylogenetic methods. Any isolate can be classified within this framework as a previously recognized sequence type or as novel. If it is a new sequence type then it may be within one of the already identified clonal complexes, or recognized as defining a new clonal complex. This will allow host shifts and/or the emergence of new pathovars to be easily tracked.
3. We estimated that 31% of new alleles arose from recombination, and that 76% of DNA base changes within a clonal complex arose from inter-complex recombination. These results suggest that the possibility of novel pathovars arising by recombination is high.

## REFERENCES

- Banks, D, R Albibi, J Chen, O Lamikanra, R. Jarret, BJ Smith. 1999. Specific detection of *Xylella fastidiosa* Pierce's disease strains. *Curr. Microbiol.* 39:85-88.
- Betran, E., J. Rozas, A. Navarro and A. Barbadilla. 1997. The estimation of the number and the length distribution of gene conversion tracts from population DNA sequence data. *Genetics* 146:88-99.
- Feil, E.J., E.C. Holmes, D.E. Bessen, M.-S. Chan, N.P.J. Day, M.C. Enright, R. Goldstein, D.W. Hood, A. Kalia, C.E. Moore, J. Zhou and B.G. Spratt. 2001. Recombination within natural populations of pathogenic bacteria: short-term empirical estimates and long-term phylogenetic consequences. *Proc. Natl. Acad. Sci. USA.* 98:182-187.
- Feil, E.J., B.C. Li, D.M. Aanensen, W.P. Hanage and B.G. Spratt. 2004. eBURST: inferring patterns of evolutionary descent among clusters of related bacterial genotypes from multilocus sequence typing data. *J. Bacteriol.* 186:1518-1530.
- Hendson, M, AH. Purcell, D Chen, C Smart, M Guilhabert, B Kirkpatrick. 2001. Genetic diversity of Pierce's disease strains and other pathotypes of *Xylella fastidiosa*. *Appl. Environ. Microbiol.* 67: 895-903.
- Lin, H, E.L. Civerolo, R. Hu, S. Barros, M. Francis, and M. A. Walker. 2005. Multilocus Simple Sequence Repeat Markers for Differentiating Strains and Evaluating Genetic Diversity of *Xylella fastidiosa*. *Appl. Env. Microbiol.* 71: 4888-4892.
- Maiden, MCJ, JA Bygraves, E Feil, G Morelli, JE Russell, et al. 1998. Multilocus sequence typing: A portable approach to the identification of clones within populations of pathogenic microorganisms. *Proc. Nat. Acad. Sci.* 95: 3140-3145.
- Meinhardt LW, MPMA Ribeiro, HD Coletta, CK Dumenyo, SM Tsai, CD Bellato. 2003. Genotypic analysis of *Xylella fastidiosa* isolates from different hosts using sequences homologous to the *Xanthomonas rpf* genes. *Mol. Plant Path.* 4: 327-335
- Rodrigues JLM, ME Silva-Stenico, JE Gomes, JRS Lopes, SM Tsai. 2003. Detection and diversity assessment of *Xylella fastidiosa* in field-collected plant and insect samples by using 16S rRNA and *gyrB* sequences. *Appl Env. Microbiol.* 69: 4249-4255.
- Scally, M., E. L. Schuenzel, R. Stouthamer, and L. Nunney. 2005. A multilocus sequence type system for the plant pathogen *Xylella fastidiosa*, and the relative contribution of recombination versus point mutation to clonal diversity. *Appl. Environ. Microbiol.* In Press.
- Schaad, N.W., E. Pastnikova, G. Lacey, M. Fatmi, C.J. Chang. 2004. *Xylella fastidiosa* subspecies: *Xf* subsp. *piercei*, subsp. nov., *Xf* subsp. *multiplex* subsp. nov., and *Xf* subsp. *pauca* subsp. nov. *Syst. Appl. Microbiol.* 27: 290-300; & 763-763 (correction).
- Scheunzel, EL, M. Scally, R. Stouthamer, L. Nunney. 2004. A multi-gene phylogenetic study of clonal diversity and divergence in North American strains of the plant pathogen *Xylella fastidiosa*. *Appl. Env. Microbiol.* 71: 3832-3839.
- Van Sluys MA, MC de Oliveira, CB Monteiro-Vitorello, CY Miyaki, LR Furlan, et al. 2003. Comparative analyses of the complete genome sequences of Pierce's disease and citrus variegated chlorosis strains of *Xylella fastidiosa*. *J. Bacteriol.* 185: 1018-1026.

## FUNDING AGENCIES

Funding for this project was provided by the University of California Pierce's Disease Grant Program.

# EFFECTS OF CHEMICAL MILIEU ON ATTACHMENT, AGGREGATION, BIOFILM FORMATION, AND VECTOR TRANSMISSION OF *XYLELLA FASTIDIOSA* STRAINS

## Project Leader:

Alexander H. Purcell  
ESPM-Division of Insect Biology  
University of California  
Berkeley CA 94720

## Researcher:

Clytia Montllor Curley  
ESPM-Division of Insect Biology  
University of California  
Berkeley CA 94720

## Cooperators:

Steven E. Lindow  
Department of Plant and Microbial Biology  
University of California  
Berkeley CA 94720

Harvey Hoch and Thomas Burr  
Department of Plant Pathology, NYSAES  
Barton Laboratory, Cornell University  
Geneva, NY 14456

**Reporting Period:** The results reported here are from work conducted October 2004 to September 2005.

## ABSTRACT

We have measured *in vitro* survival, growth and biofilm formation of wild-type and mutant strains of *Xylella fastidiosa* (*Xf*) under a variety of conditions. The mutant strains are deficient in their production of the signaling molecule DSF. The role of DSF in biofilm formation is not clear, but these strains cannot attach and/or form biofilms in insect mouthparts (strains KLN 61 or 62, “*rpjF*-mutant”; Newman et al. 2004). Our attachment studies of these strains indicate that the DSF-deficient strain is also less proficient at biofilm formation *in vitro* compared to the *gfp*-Temecula strain. Population studies of wild-type and mutant strains grown separately or together show similar patterns of growth, and no evident competition between strains *in vitro* for up to 14 days. Complementary *in vivo* studies in our laboratory are looking at both strain competition and transmissibility of wild-type and mutant strains of *Xf* co-inoculated into grapevines.

In order to more closely approximate conditions in the insect mouth, we have also assayed attachment of *gfp*-Temecula or wild-type Temecula strain on sterile insect wings, which have a cuticular surface like the interior of the mouthparts to which *Xf* attaches. We have so far not observed bacterial attachment to wings that were incubated in PW broth or in a media deemed more optimal for *in vitro* biofilm formation in preliminary studies. Insect mouthparts and wings (from glassy-winged sharpshooter (GWSS)) are also being investigated as an attachment surface in flow chambers by our collaborators at Cornell University.

## INTRODUCTION

Studies from this lab (R. P. P. Almeida and Purcell, unpublished) showed that sharpshooters could acquire cultured *Xf* cells added to expressed xylem sap in an artificial feeding medium (sachet), but subsequently did not transmit these bacteria to grapevines (as measured by subsequent symptom development). The assumption was that these cells did not attach to the foregut of the feeding insects. This sort of circumstantial evidence points up the complexity of the bacterial, insect, and plant factors necessary for transmission (uptake and delivery, followed by plant infection) to occur. The importance of attachment and subsequent biofilm formation of the vector transmission process is also suggested by the behavior of mutants that do not aggregate in the vector mouthparts and are not insect transmissible (Newman et al. 2004). Studies of *Xf* biofilm formation *in vitro* indicate that chemical make-up of media, substrate, and bacterial genotype/phenotype all play roles in aggregation behavior of *Xf* (e.g. Marques et al. 2002, Leite et al. 2004, Feil et al. 2003, Hoch et al. 2004). Our ultimate objective is to understand the factors that affect the process of attachment and biofilm formation of *Xf* under different environmental conditions. Investigating the conditions, be they environmental or genetic, that promote attachment and subsequent detachment from insect mouthparts is crucial to understanding transmission from insects to plants.

## OBJECTIVES

1. Determine whether vector retention (and subsequent delivery) of *Xf* is related to the chemical and physical environment from which the bacteria are grown or acquired.
2. Investigate how *Xf* cells attach (and detach) to specific foregut regions of sharpshooter vectors. NB: this objective is similar to one proposed from the Hoch/Burr labs with which we propose to collaborate.

## RESULTS

It has been important to optimize growth conditions for *Xf* in order to produce repeatable, accurate assays, and also to begin to determine what environmental factors might be important to manipulate in attachment studies (below). We have tested the effects of pH (5.2-8.0), media (from minimal media through enriched undefined media), vessel (glass, plastic; from 200 $\mu$ L to 30 mL), and source of inoculum (age; from solid or liquid media) on subsequent survival and growth of populations of *Xf* in liquid media. As part of these studies, we have done both short-term survival assays, as well as longer-term population studies. *Xf* populations were measured both by determining absorbance of bacterial suspensions by spectrophotometry (OD<sub>600</sub>), and by dilution plating of suspensions onto solid media and counting colony forming units per ml (cfu).

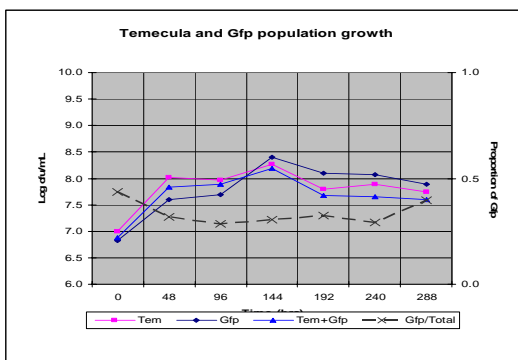


Preliminary evidence suggested that xylem sap and a minimal defined medium at a pH of 5.2-5.3 was lethal to *Xf* within 1-24 hours. This was a potentially important finding because it highlighted an area that might be explored as a means of therapy or protection in vines, such as during the dormant season when the vine may be able to best tolerate such acid pHs. Subsequent assays showed that when bacteria were grown under optimal conditions in the laboratory, populations at the lowest pH were slow to grow, but reached population sizes comparable to those at higher pH after six days. This was true for bacteria grown in two quite different liquid media, PW (see Almeida et al. 2004) and CHARD2 (Leite et al. 2004) (data not shown). It is important to note however that the bacteria changed the pH of the media over the course of the assay: after six days, the media that started at pH 5.3 were 6.3 and 5.9 respectively; media of pH 6 became 6.5 and 6.3; and media of pH 7 became 7.2 and 7.1.

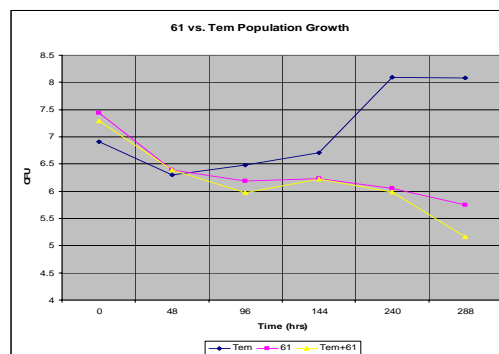
The existence of other bacteria is an important part of the chemical and physical milieu in which *Xf* grow, and bears further study. Ongoing studies in our laboratory have pointed to some potentially very interesting interactions between strains of *Xf* in plants. For example, when wild-type strain Temecula and a *gfp* mutant (KLN59.3; Newman et al. 2003) of this same strain were co-inoculated into plants, in no case was both the mutant and the wild-type strain recovered from plants into which they had both been needle inoculated; further, in most cases it was the wild type that persisted (C. Wistrom, unpublished). Researchers in the Lindow laboratory discovered subsequently that the *gfp* gene in this strain had been inserted in a functional area of the genome; hence these results are perhaps not surprising. However, we had also been conducting growth studies of mixed-strain populations of *Xf* in liquid media to see whether we could replicate the competition phenomenon *in vitro*. Experiments with mixed populations of *gfp*-Temecula and wild-type *Xf*, and *gfp*-Temecula and the *rpfF* mutants KLN62 all grown in broth, showed little difference in the growth of the strains separately or together. Populations were sampled at regular intervals, and dilution plated for determination of population sizes. Both *gfp* and *rpfF* mutants can be selectively detected by plating on media containing the antibiotic kanamycin, and the *gfp* mutant can also be detected by epifluorescence microscopy. The proportion of *gfp* bacteria typically dipped but recovered when grown with wild-type or *rpfF* mutant strains (e.g. Figure 1).

Because of the possibility that KLN59.3 (*gfp*) is inherently less competitive, at least *in planta*, we are no longer using this strain in competition experiments. Our experiments with the *gfp* strain have been instructive, nonetheless, as they show that *in vivo* and *in vitro* results can and do differ. All combinations of strains co-inoculated into plants to date indicate that it is rare for two strains to coexist for long periods in plants.

Current experiments, in conjunction with C. Wistrom and C. Baccari in this laboratory, are focusing on *in vivo* and *in vitro* co-inoculations of the *rpfF* mutants (KLN61 and KLN62) and the wild-type Temecula. The first *in vitro* experiment with KLN61 is shown in Figure 2. Although we were not able to determine the proportion of each strain in the co-inoculated broth (due to technical problems), the population size of Temecula was two orders of magnitude greater than that of KLN61 after eight days in PW broth (Figure 2). An earlier experiment with KLN62 showed roughly parallel growth of the two strains when grown separately in PW (not shown). These assays will be repeated, and additional media will be used to determine whether chemical constituents affect competition potential. *In vivo* experiments with these strains are in progress.



**Figure 1.** Population growth (log CFU) of Temecula and *gfp*-Tem grown alone and/or together



**Figure 2.** Population growth (log CFU) of KLN61 and Temecula grown alone and/or together

We are interested in the factors that affect attachment and subsequent aggregation behaviors of *Xf*. We have used the information gained on optimization of growth of *Xf* in part to design assays in order to address this question. Using young cultures from plates to inoculate relatively large volumes (30 ml) of liquid PW media, we have examined short-term attachment of 1-3 days, and longer-term aggregation of *Xf* over 7-10 days. We have investigated attachment of *Xf* to vessels of various types using a crystal violet assay (Leite et al. 2004, Espinosa-Urgel et al. 2000). This assay is appropriate for visualization of aggregations of cells *in vitro*, but has not been satisfactory for quantification of attachment in our assays. We

have found that the dye interacts with media and adheres to the substrate without bacteria present, making it difficult to determine whether there are real differences in attachment in the media we are testing.

We also worked with a simpler assay using insect wings glued to glass cover slips, which can be easily manipulated for sterilization, incubation in small amounts of media (with *Xylella*), and mounting on a slide for microscopy. We have carried out these assays with *gfp*-Temecula and wild-type Temecula strain. The *gfp*-Temecula was detected in broth with an epifluorescence microscope, and the wild-type bacteria were stained with DAPI, a fluorescent dye, but were not detected in broth. Neither type of bacteria aggregated on wings in large enough numbers to be detected. We are working to manipulate media, population sizes, and length of incubation to determine which factors will allow for attachment and aggregation. We are also working with dissected mouthparts from the GWSS as a substrate for attachment. Heads and wings of GWSS have been provided to Harvey Hoch as well.

Our interest in the *rpfF* mutants has also extended to our attachment assays. These mutants are deficient in production of the cell-cell signaling molecule DSF (diffusible signal factor), and in biofilm production under certain conditions. In insects they are apparently unable to attach to the mouthparts and form a biofilm there, but in plants mats of bacteria have been seen occluding vessels (Newman et al. 2004). Our attempts to grown biofilms of KLN61 *in vitro* have been occasionally successful, but inconsistent. Our intentions were to compare *in vitro* biofilm production of KLN61 with the wild-type Temecula strain. In order to more easily compare these strains we initially used the *gfp*-Temecula strain (future experiments will use wild-type Temecula because of the problems with the *gfp* strain mentioned above). In two experiments so far we grew the strains separately and together in different media and looked at the proportion of each strain in broth (planktonic cells) compared to in the film itself (a ring of bacteria at the fluid-air interface). In one experiment, KLN61 was not found at all in the biofilm (i.e., the ring consisted of 100% *gfp*-Temecula), even when they made more than half of the planktonic cells (Table 1).

**Table 1.** Planktonic and biofilm (ring) populations in two liquid media

Medium	Log CFU in broth ( <i>gfp</i> -Tem plus KLN61)	% Tem- <i>gfp</i> broth / ring
BHF	2.1x10 <sup>7</sup>	45% / 100%
XfD2	1.2x10 <sup>7</sup>	92% / 100%

In the second experiment, KLN61 was detected in the biofilm, but *gfp*-Temecula made up a disproportionately larger percent of biofilm compared to planktonic cells (25% compared to 16%; Table 2). KLN61 alone also made less biofilm (as quantified by spectrophotometry of dislodged ring cells) than *gfp*-Temecula, in spite of the fact that there were more cells of KLN61 than of *gfp*-Temecula in their respective flasks.

**Table 2.** Quantification of biofilm production of *gfp*-Temecula and KLN-61 alone and together

	Broth- cfu	% Tem- <i>gfp</i> broth / ring	Sonicate (diluted 1/4)- OD <sub>600</sub>
<i>Gfp</i> -Tem	4x10 <sup>4</sup>	NA	0.065
<i>rpfF</i> (KLN61)	1x10 <sup>6</sup>	NA	0.004
Both (BHF)	4.3x10 <sup>5</sup>	16% / 25%	0.053
Both (XfD2)	1.8x10 <sup>6</sup>		No film

We will continue to explore biofilm production of wild-type *Xf* and *rpfF* mutants to see whether we can find conditions that will change the propensity to form, and the proportions of bacterial strains found, in biofilms *in vitro*.

## CONCLUSIONS

Our overall objective is to understand the role of aggregation phenomena in acquisition, retention and delivery of *Xf* by vectors. By manipulating the environment in which *Xf* is cultured, we have found differences in the propensity for different strains to form biofilms *in vitro*. The use of *Xf* mutants with impaired or enhanced ability to perform some part of the aggregation behavior will be important to understanding the interaction between environment and bacterial behavior affecting vector retention and delivery. We have been particularly interested in documenting the behavior of *rpfF* mutants and wild-type bacteria alone and together in different liquid media. We are now ready to see how some of these same factors affect acquisition and retention of bacteria by vectors feeding on sachets. Interfering with vector acquisition and inoculation (reducing or avoiding vector populations) are currently the major control methods for Pierce's disease in California. Our findings may reveal currently unanticipated ways of interfering with vector transmission and elucidate features of *Xf* biofilms applicable to this bacterium in plants.

## REFERENCES

- Almeida, R.P.P., R. Mann, and A.H. Purcell. 2004. *Xylella fastidiosa* cultivation on a minimal solid defined medium. *Curr. Microbiol.* 2004. 48:368-372.
- Davis, M.J., W.J. French, and N.W. Schaad. 1981. Axenic culture of the bacteria associated with phony peach of peach and plum leaf scald. *Curr. Microbiol.* 6:309-314.
- Espinosa-Urgel, M., A. Salido, and J.L. Ramos. 2000. Genetic analysis of functions involved in adhesion of *Pseudomonas putida* to seeds. *J. Bacteriol.* 182:2363-2369.
- Feil, H., W. S. Feil, J. C. Detter, A. H. Purcell, and S. E. Lindow. 2003. Site directed disruption of the *fimA* and *fimF* genes of *Xylella fastidiosa*. *Phytopathology* 93:675-682.
- Hoch, H.C., T.J. Burr, Y. Meng, and J. Turner. 2004. Understanding *Xylella fastidiosa* colonization and communication in xylem lumina. *Pierce's Disease Research Symposium Proceedings*, p.195-197.
- Leite, B., P.C. Andersen, and M. L. Ishida. 2004. Colony aggregation and biofilm formation in xylem chemistry-based media for *Xylella fastidiosa*. *FEMS Microbiol. Lett.* 230:283-290.
- Marques, L.L.R., H. Ceri, G.P. Manfio, M. Reid, and M.E. Olson. 2002. Characterization of biofilm formation by *Xylella fastidiosa* in vitro. *Plant Disease* 86:633-638.
- Newman, K.L., R.P.P. Almeida, A.H. Purcell and S.E. Lindow. 2003. Use of a green fluorescent strain for analysis of *Xylella fastidiosa* colonization of *Vitis vinifera*. *Appl. Env. Microbiol.* 69:7319-7327.
- Newman, K.L., R.P.P. Almeida, A.H. Purcell, and S.E. Lindow. 2004. Cell-cell signaling controls *Xylella fastidiosa* interactions with both insects and plants. *Proc. Nat. Acad. Sci.* 101:1737-1742.

## FUNDING AGENCIES

Funding for this project was provided by the CDFR Pierce's Disease and Glassy-winged Sharpshooter Board.

## A SCREEN FOR *XYLELLA FASTIDIOSA* GENES INVOLVED IN TRANSMISSION BY INSECT VECTORS

### Project Leaders:

Alexander H. Purcell  
ESPM-Division of Insect Biology  
University of California  
Berkeley, CA 94720

Steven E. Lindow  
Plant and Microbial Biology  
University of California  
Berkeley, CA 94720

### Researcher:

Clelia Baccari  
ESPM-Division of Insect Biology  
University of California  
Berkeley, CA 94720

**Reporting Period:** The results reported here are from work conducted November 2004 to September 2005.

### ABSTRACT

A strategy is being pursued that will identify genes involved in insect transmission of *Xylella fastidiosa* (*Xf*) by both gain of function and loss of function mutagenesis of a *Xf* mutant that is unable to be transmitted by sharpshooters. KLN61 is an *rpfF* mutant strain of *Xf* (Newman et al. 2004) that cannot be transmitted to plants by the sharpshooter leafhopper, *Graphocephala atropunctata*, a common vector of the wild-type strain of this bacterium. This mutant, which did not form biofilm and was not retained in the vector mouthparts (Figure 1), was hypervirulent and formed biofilm when mechanically inoculated into grapevines (Newman et al. 2004). In this work, we are further investigating the *rpfF* mutant non-transmissible phenotype.

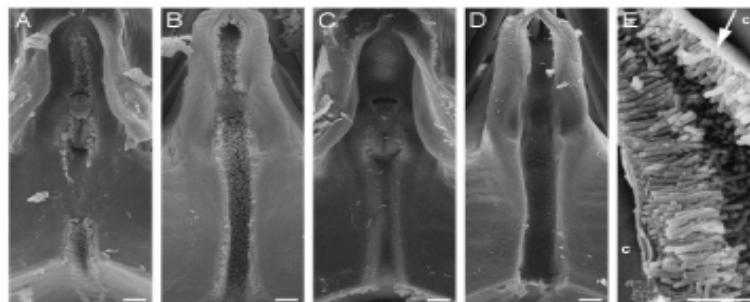
A molecular approach is being used to further mutate this mutant using a transposome-mediated mutagenesis technique. We created a mutant library compatible with the KLN61 mutant background in order to identify other *Xf* genes involved in the complex process of transmission. We designed and successfully constructed a Streptomycin EZ::TN custom transposome mutagenesis system in order to further mutate the *Xf rpfF* mutant strain, KLN61. We introduced our transposome into KLN61 by electroporation, yielding  $5 \times 10^3$  mutants per  $\mu\text{g}$  of DNA. To date we have mechanically inoculated grapevines with about a thousand mutants.

In complementary studies we are examining the process of colonization of plants by *Xf* and determining the extent to which cell-cell communication via signal molecule production occurs *in planta* in *Xf*. We are testing whether production of a signaling molecule in the plant by the wild-type *Xf* strain would restore the transmissibility of the mutant. The finding that co-inoculations with two different *Xf* strains results in infections in which each strain is equally likely to be found as the dominant strain suggests that Pierce's disease (PD) is characterized by a process by which many sequential occurrences of movement of a few cells to neighboring xylem vessels occurs in the process of colonizing grape plants.

### INTRODUCTION

In *Xf*, the *rpf* (regulation of pathogenicity factors) system likely regulates genes that are important for colonization and transmission by insect vectors. The *rpfF* gene is one of the essential genes of the *rpf* cell-cell signaling system. KLN61 which is an *rpfF* knockout, could not perform cell-cell signaling. The *rpfF* gene catalyzes the synthesis of the signaling system molecular DSF (diffusible signal factor) (Newman et al. 2004). Importantly, while still pathogenic to grape, such strains do not colonize and hence are not vectored by sharpshooters (Figure 1).

In order to understand the function of other *Xf* genes involved in the complicated process of transmission, it is important to use techniques that knock out and consequently make possible the identification of related genes. Transposome-mediated mutagenesis is an effective tool for this purpose.



**Figure 1.** A, B, E: leafhopper foreguts colonized with wild type *Xf* acquired from infected plants. C, D: lack of biofilm in leafhoppers that probed plants with *rpfF* mutant (from Newman et al. 2004)

The first year, our research objective was to construct a library of *Xf* transposon-disrupting mutants through transposome-mediated mutagenesis in an *Xf rpfF* mutant background. Our first approach involved creating a library in strain KLN61 which could be screened for restoration of transmissibility by inoculating mutants into plants on which vectors could subsequently feed. Any mutant strains of the non-transmissible KLN61, which could be transmitted to healthy grape plants by insect vector, would have incorporated genome changes implicated in the transmission of *Xf*. The isolation and identification of these mutants would allow us to better understand what *Xf* genes are involved in vector transmissibility.

In complementary studies, we are addressing the process by which DSF signal molecule is produced and recognized by cell populations in plants. If DSF signal molecule is actually excreted into the plant after production it should enable functional complementation of an *rpfF* mutant *in planta*. An understanding of how DSF is perceived by bacteria *in planta* is central to our understanding of how it affects both plant virulence factors, presumably in a density-dependent fashion, and affects insect transmission. To test this model we are interested in how *rpfF*<sup>+</sup> and *rpfF*<sup>-</sup> strains coexist in plants and how they might affect vector transmission. Mutants of PD strains of *Xf* are relatively new and not much is known regarding their behavior with regard to transmission and coexistence *in planta*. *In vitro* experiments on solid media have shown that coexistence with wild-type can restore DSF signaling production in *Xanthomonas campestris* (Barber C. E., 1997). The purpose of this experiment is to see if the wild-type strain DSF signal is able to restore the mutant biofilm formation in the mouthparts of the vector and therefore promote transmission.

## OBJECTIVES

1. Create a library of *Xf* mutants in the *rpfF* mutant background using a disrupting transposon mutagenesis to block gene function
2. Create a library of *Xf* mutants in the *rpfF* mutant background using an activating transposon mutagenesis to enhance gene function
3. Design and carry out a screen for mutations in *Xf* that restore transmissibility in the non-transmissible *rpfF* mutant
4. Identify the genes affected in the screen. These will be genes that are important for transmission of PD by insect vectors

## RESULTS

### Objective 1

It has been shown that transposome-mediated mutagenesis was successful in the Kirkpatrick's laboratory when applied to wild type *Xf* (Guilhabert et al. 2001). The commercially available transposome system confers Kan<sup>R</sup>, which was not compatible with our KLN61 strain. In our studies we could not use this vector and had to construct a novel transposon in order for it to be compatible with our Kan<sup>R</sup> *rpfF*<sup>-</sup> mutant. Our laboratory designed and successfully constructed a Streptomycin resistant EZ::TN transposome mutagenesis system in order to further mutate the *Xf rpfF* mutant strain. We introduced our Strep EZ::TN Transposome in the strains KLN61 by electroporation techniques to create mutants. Electroporation with our Strep EZ::TN Transposome yielded 5 X 10<sup>3</sup> mutants per µg of DNA in *Xf* strain KLN61.

### Objective 2

Because of the high yield of mutants produced with this disrupting transposon we have opted to focus our work on screening the existing library, thereby postponing the construction of an activating transposon library of mutants.

### Objective 3

The first step of the screening of mutants has begun. Mutants have been needle-inoculated into the plants that will be used as source plants for transmission experiments. The source plants are starting to show symptoms. We also have begun culturing the source plants for monitoring bacteria population. The mutants are screened by placing the insect vectors in contact with the source plants that retain the mutant library. The *Xf*-free insect vectors (blue-green sharpshooter (BGSS) and glassy-winged sharpshooter (GWSS)) will be fed on the grapevines containing the mutant collection. The *Xf* that has regained the ability to be retained and transmitted by the insect vector, to a healthy plant seedling, will be then identified.

With the intention of testing if the wild-type strain could restore transmissibility in the *rpfF* mutant strain we have co-inoculated a total of 47 cuttings of Cabernet Sauvignon with an equal mixture of both strains or with only a single strain, in two separate experiments. We needle co-inoculated grape cuttings with a suspension of Temecula (wild-type), KLN61 (*rpfF*<sup>-</sup>/*Kan* resistant) *Xf*, or a mixture of equal proportions of each (C. Baccari and C. Wistrom) (Table 1).

**Table 1.** Inoculations of Cuttings

Set I		Set II	
Treatment	No. vines inoculated	Treatment	No. vines inoculated
Temecula	10	Temecula	6
KLN61	10	KLN 61	6
Tem+KLN61	9	Tem + 61	6

Confirmation of infection will be tested by culturing symptomatic petioles from the plants. Growth of *rpfF* and Tem will be tested by dilution plating on culture media and PCR. *Xf RpfF* is Kan<sup>R</sup> and can grow on kanamycin selective media whereas

wild-type *Temecula* grows only on un-amended PWG. Colonies that grow on plain PWG can be replica plated onto PWG media with 30µg/l kanamycin, and the number of transferred colonies will be compared. Populations will be estimated via dilution plating and counted with a stereoscope. When source plants have reached a high bacteria population they will be used for transmission experiments. BGSS and GWSS will be fed on the source plant containing both *rpfF* and Tem. By culturing and PCR we will be able to distinguish both or one of the strains in the insect vector mouthparts. The insect vectors will then be placed on healthy seedlings for transmission.

Of 15 Cabernet Sauvignon plants we infected with a mixture of both strains, 46% became infected with only KLN61 and 20% with only wild type *Temecula*. The remaining 34% of the plants were not infected with either strain. On the first set only KLN61 was recovered from plants co-inoculated with both *Temecula* and KLN61 after four weeks. Populations of KLN61 in plants co-inoculated with *Temecula* as well as in plants inoculated only with KLN61 were approximately equal after two ( $8.5 \times 10^4$  and  $1.0 \times 10^5$ , respectively) and four ( $1.5 \times 10^6$  and  $8.5 \times 10^6$ ) weeks. In the second set, 50% of the co-inoculate plants contained KLN61 only and 50% contained *Temecula* only, after eight weeks. More culturing is in progress, on both set of plants, to further survey the bacteria populations.

Our preliminary results are strongly supportive of a model of progressive and sequential colonization of a large number of xylem vessels after inoculation of a single vessel by *Xf*. It is generally agreed that symptoms of PD do not occur until large numbers of vessels are colonized by *Xf*. Studies by Newman et al. 2003 found a very high correlation between incidence of highly colonized vessels and symptom development in grape. Thus *Xf* must move through many (perhaps hundreds) of different xylem cells before such high levels of colonization were to occur. If only a few cells were transferred to adjacent xylem vessels as suggested by the microscopy analyses of Newman et al. 2003, then with time it is likely that only one genotype of an originally mixed genotype inoculum might be present after such large numbers of “bottlenecks” incurred during movement in the plant. These studies are the first to support such a model and thus provide new insight into the infection process.

#### **Objective 4**

When restoration of transmission by the insect vectors occurs, we will determine what genes were affected in the screen that resulted in restored transmission. To establish which genes, when inactivated, restored the ability of the *rpfF*- strain to be transmitted by sharpshooters were affected, we will clone and sequence the transposon DNA flanking, using standard molecular biology protocols. This will determine where the transposition insertion occurred in the *Xf* genomic DNA and which particular genes were involved in the process.

#### **CONCLUSIONS**

Past experiments with the *rpfF*- mutant KLN61 (Newman et al.2004) have shown that this mutant is hypervirulent and capable of forming biofilm in grapevines. More studies on this subject are being conducted in Dr. Steven Lindow’s laboratory. With this work we are primarily focusing on the interaction between this mutant and the insect vectors during transmission. Is it the lack of bacterial DSF production that makes an *rpfF* mutant not transmissible? And if so, why? Further investigation is needed to answer this important aspect of bacteria- insect-vector interaction.

We also believe that identification of the genes in *Xf* which are responsible for transmission is an essential step to understand vector transmission and bacterial-vector interaction. The identity of these genes may enable us to identify key features of the bacterial mechanism driving transmission. More specifically, this research is seeking to identify the genes regulated by the *rpf* system and subsequent work should enable understanding of the environmental stimuli affecting them. Better understanding of the required genes and how they interact may lead to new control strategies.

#### **REFERENCES**

- Newman, K. L., R. P.P. Almeida, A. H. Purcell and S. E. Lindow. 2004. Cell-cell signaling controls *Xylella fastidiosa* interaction with both insects and plants Proc. Nat. Acad. Sci. 101: 1737-1742.
- Newman, K. L., R. P.P. Almeida, A. H. Purcell and S. E. Lindow. 2003. Use of a green fluorescent strain for analysis of *Xylella fastidiosa* colonization of *Vitis vinifera*. Appl. Environ. Microbiol. 69:7319-7327.
- Dow, J.M. and M.J. Daniels. 2000. *Xylella* genomics and bacterial pathogenicity to plants. Yeast 17: 263-271.
- Gullharbert, M. R., L. M. Hoffman, D. A. Mills, and B. C. Kirkpatrick. 2001. Transposon mutagenesis of *Xylella*. MPMI Vol. 14, N 6 pp 701-706.
- Simpson, A.J.G, F.C. Reinach, P. Arruda, 97 other authors. 2000. The genome sequence of the plant pathogen *Xylella fastidiosa*. Nature 406: 151-157.
- Barber,C., E. Tang, J. L. Feng, M. Q. Pan, T. J. G. Wilson, H. Slater, J. M. Dow, P. Williams, and M. J. Daniels. 1997. A novel regulatory system required for pathogenicity of *Xanthomonas Campestris* is mediated by small diffusible signal molecule. M. M.24 (3): 555-566.

#### **FUNDING AGENCIES**

Funding for this project was provided by the Pierce’s Disease and Glassy-winged Sharpshooter Board, and the College of Natural Resources, University of California, Berkeley.

## PATTERNS OF *XYLELLA FASTIDIOSA* INFECTION IN PLANTS AND EFFECTS ON ACQUISITION BY INSECT VECTORS

### Project Leaders:

Alexander H. Purcell  
ESPM – Division of Insect Biology  
University of California  
Berkeley, CA 94720

Steven E. Lindow  
Plant and Molecular Biology  
University of California  
Berkeley, CA 94720

### Researcher:

Christina Wistrom  
ESPM – Division of Insect Biology  
University of California  
Berkeley, CA 94720

**Reporting Period:** The results reported here are from work conducted October 2004 to September 2005.

### ABSTRACT

This project investigates the effects of host plant tolerance on insect vector acquisition and spread of *Xylella fastidiosa* (*Xf*) from plants with a range of susceptibility to Pierce's disease (PD). By characterizing vascular anatomy, bacterial populations, and sharpshooter acquisition of *Xf* from those plants, we may assess their ability to provide inoculum for PD spread. Previously reported data from paint infusion experiments did not identify significant anatomical measures as an explanation for tolerance or resistance differences among grape varieties. There were significant differences in vascular anatomy between alternate host species, and vessels of all alternate hosts were much shorter than in grapevines. In morning glory, 71% of vessels were less than 3cm, and the other species had between 40% and 63% of vessels <3cm. The longest vessel measured in any alternate host was 32cm (sunflower), and on average, sunflower and quinoa had longer vessels than mugwort and morning glory. Mugwort had roughly twice as many vessels at the stem base than morning glory, quinoa or sunflower stems of comparable diameter and age. Sunflower, mugwort and quinoa had vascular tissues in evenly distributed bundles with wide regions of parenchyma between them. Annual morning glory had a smaller number of large vessels distributed evenly along the cambium, compared to large numbers of small vessels in mugwort. As grapevines, most susceptible to *Xf* infection, had the longest vessels, and sunflower, the second most susceptible, had the next-longest vessels. The relationship between vascular anatomy and *Xf* host status appears complicated, and additional comparisons of overall vascular area and vessel distribution are required to generalize further.

Plants were inoculated with an *Xf* strain that continually expressed green fluorescent protein (*Gfp-Xf*), or, as a control, the wild-type parent strain. Six weeks after inoculation, *Xf*-free sharpshooters were placed on the inoculation site for a 4-day acquisition access period, and tested for bacterial acquisition. Next, the inoculation site was examined with confocal microscopy and bacterial presence determined by culture. Six percent of grapes and 17% of alternate hosts had *Gfp-Xf* infections, compared to 50% of grapevines and 16% of alternate hosts inoculated with wild-type *Xf*. There was no difference in infection rate of wild-type *Xf* between grape cultivars. No colonized vessels were seen in plants infected with *Gfp-Xf*. Wild-type *Xf* populations were at least seven times lower in inoculated grape stems ( $10^5$  to  $10^6$  CFU/g) compared to populations in distal petioles ( $10^6$  to  $10^8$  CFU/g). Data analysis from those experiments is ongoing to determine the acquisition rate of *Xf* from inoculated stems.

### INTRODUCTION

Plants with varying degrees of susceptibility to PD were assessed for their ability to provide inoculum for disease spread by characterizing their vascular anatomy, bacterial populations, and sharpshooter acquisition of *Xf* from them. Three grape cultivars and four alternate hosts were selected for their pattern of *Xf* colonization following vector inoculation, lack of stem lignification, morphology, and absence of autofluorescence. In previous experiments, *Xf*-carrying sharpshooters infected more than 80% of the morning glory and sunflower inoculated. *Xf* spread systemically throughout both plants and reached populations over  $10^5$  colony-forming units (CFU)/gram. Quinoa and mugwort were less-frequently infected (32% and 16%, respectively) by *Xf* and supported lower bacterial populations ( $10^3$  CFU/g for quinoa,  $10^6$  CFU/g for mugwort). *Xf* moved systemically to a limited extent in quinoa, but not in mugwort (Hill and Purcell 1995b, Wistrom and Purcell 2005). Tolerant 'Sylvaner', moderately susceptible 'Cabernet Sauvignon' and highly susceptible 'Pinot Noir' cultivars of *Vitis vinifera* were selected for evaluation (Purcell 1981, Raju and Goheen 1981). Blue green sharpshooters (BGSS) were used to infect plants and assess insect acquisition efficiency (Almeida and Purcell 2003, Hill and Purcell 1995a, Hill and Purcell 1997, Purcell et al. 1979).

Vessel length was measured by infusion of diluted latex paint into cut stems at approximately 100kPa, pressure sufficient to displace sap in vessels but not strong enough to damage pit membranes between vessels (Ewers and Fisher 1989). Stems were infused ~48 hours, until displaced sap stopped exuding from the distal end. Stems were sectioned at regular intervals

and the number of vessels with paint counted at each interval. The number of vessels in each length class was determined from the raw vessel count by the double-difference correction (Ewers and Fisher 1989).

Wild type and transformed isolates of Temecula *Xf* were used for inoculations. The transformed isolate continually expressed green fluorescent protein (Gfp-*Xf*) when illuminated with blue light. In previous tests, Gfp-*Xf* was transmitted by BGSS, retained typical virulence in grape, and was visible in grape petioles via confocal microscopy. Gfp-*Xf* was observed individually and in large colonies, and passing through bordered pits between vessels of grape petioles (Newman et al. 2003). Electron and confocal microscopy with *in situ* DNA hybridization shows *Xf* densely packed in individual vessels, with adjacent vessels empty (Newman et al. 2003, Tyson et al. 1984). We hypothesize that alternate hosts or tolerant grape cultivars with low overall populations may have just a few vessels completely colonized with bacteria, leading to lower acquisition rates that are dependant upon sharpshooters encountering the colonized vessels while feeding. *Xf* inoculation, acquisition, and colonization were measured similarly in all plants. Groups of four BGSS inoculated a 3cm stem section with either wild-type or Gfp-*Xf*, and the plants were held in the greenhouse for six weeks to develop infections. New groups of four *Xf*-free BGSS were confined to the inoculation site for four days to acquire the bacteria, and then moved to a grape seedling for four days to determine their acquisition efficiency. After sharpshooter feeding, the stem site was examined with confocal microscopy. Three stem cross-sections per plant were suspended in 50% glycerol on a depression slide. Stem sections were illuminated with blue and ultraviolet light, to show green Gfp-*Xf* and blue vessel walls, and scanned for the presence of *Xf*. Bacterial populations were determined from remaining plant material of the inoculation site by culture on PWG media (Davis et al. 1983, Hill and Purcell 1995a).

One-way ANOVA was used to compare the number, length and distribution of xylem elements in grape varieties and alternate host species. Since acquisition efficiency has been related to bacterial populations (Hill and Purcell 1997), regression analysis will be used to qualitatively assess the contributions of bacterial distribution, proportion of colonized vessels, and bacterial population on acquisition.

## OBJECTIVES

1. Describe the bacterial colonization of asymptomatic alternate host species and grape varieties of varying tolerance to PD.
2. Determine the relationship between the pattern of colonization of a plant by *Xf* and the ability of that plant to be a source for bacterial acquisition by sharpshooter vectors.

## RESULTS

Anatomical comparisons between the various alternate hosts and grape cultivars included measurements of vessel length and number, and vascular bundle number and distribution (Table 1). The longest vessel measured in any alternate host was 15cm long (mugwort). In sunflower, 71% of vessels were less than 3cm long. Other species had between 63% and 40% of vessels <3cm. Mugwort had roughly twice as many vessels at the stem base than morning glory, quinoa or sunflower stems of comparable diameter and age. Sunflower, mugwort and quinoa had vascular tissues in evenly distributed vascular bundles with wide interfascicular regions of parenchyma.

In *Xf* inoculations by BGSS (Table 2), grapes were infected with Gfp-*Xf* less frequently than the parental wild type (11 of 22 grapes infected with Temecula, 1 of 16 infected with Gfp-*Xf*,  $P < 0.01$ , Chi-Square with Yates' correction). Infection rates of alternate hosts were similar (3 of 18 infected with Gfp-*Xf*, 3 of 19 infected with Temecula). Gfp-*Xf* was not observed in plant stems with low bacterial populations ( $10^2$  CFU/g for grape, between  $10^3$  and  $10^4$  CFU/g in sunflower and mugwort, respectively). In all microscopy sessions, Gfp-*Xf* was observed in the symptomatic grape petioles used as positive controls to adjust microscope settings, which contained bacterial populations between  $10^7$  and  $10^8$  CFU/g. Insect-inoculated plants were used to compare sharpshooter acquisition and bacterial distribution from alternate host stems because the distribution of *Xf* in an insect-inoculated stem is likely different from a mechanically inoculated stem. Analysis of acquisition test plants is ongoing.

**Table 1:** Anatomical comparisons of canes/ stems of similar length, age, and diameter in four alternate hosts of *Xf*.

Species	Total # vessels at stem base (SE)	% Vessels < 3cm (SE)	Longest vessel (SE)	# Rays/ Bundles (SE)
<i>one-way ANOVA</i>	(n = 27, $P = 0.67$ )	(n = 27, $P = 0.84$ )	(n = 27, $P = 0.35$ )	(n=27, $P = 0.01$ )
Morning Glory	236 (24) <b>c</b>	71 (6) <b>b</b>	9 (1) <b>a</b>	84 (4) <b>a</b>
Mugwort	593 (58) <b>a</b>	63 (6) <b>a,b</b>	11 (1) <b>a</b>	19 (2) <b>b</b>
Quinoa	415 (29) <b>b</b>	40 (4) <b>a</b>	18 (2) <b>b</b>	26 (2) <b>b</b>
Sunflower	311 (25) <b>b,c</b>	41 (3) <b>a</b>	23 (3) <b>b</b>	19 (1) <b>b</b>
<i>one-way ANOVA</i> *	(n = 48, $P < 0.001$ )	(n = 46, $P = 0.002$ )	(n = 47, $P < 0.001$ )	(n = 48, $P < 0.001$ )

\* Letters in bold indicate means are significantly different in pairwise comparisons with Tukey-Kramer HSD.



**Table 2:** BGSS transmission of wild-type (Temecula) and Gfp-expressing (Gfp-*Xf*) *Xf* to three grape cultivars and four alternate hosts.

Cultivar	<i>Xf</i> Isolate	No. Infected/ No. Inoculated	[ <i>Xf</i> ] Stem CFU/g <sup>a</sup>	% vessels colonized <sup>b</sup>	No.Systemic/ No. Infected <sup>c</sup>	[ <i>Xf</i> ] Systemic (petiole) <sup>d</sup>
Cabernet Sauvignon	Gfp- <i>Xf</i>	1/5	2.5 x 10 <sup>2</sup>	0	0/1	-
	Temecula	4/8	1.6 x 10 <sup>5</sup>	-	4/4	1.2 x 10 <sup>8</sup>
Sylvaner	Gfp- <i>Xf</i>	0/6	0	0	-	-
	Temecula	3/7	1.0 x 10 <sup>6</sup>	-	1/3	7.3 x 10 <sup>6</sup>
Pinot Noir	Gfp- <i>Xf</i>	0/5	0	0	-	-
	Temecula	4/7	6.0 x 10 <sup>6</sup>	-	3/4	9.2 x 10 <sup>7</sup>
Alternate Host Plant						
Morning Glory	Gfp- <i>Xf</i>	0/2	0	0	-	-
	Temecula	-	-	-	-	-
Mugwort	Gfp- <i>Xf</i>	1/4	4.5 x 10 <sup>4</sup>	0	0/1	-
	Temecula	1/6	3.2 x 10 <sup>2</sup>	-	0/1	-
Quinoa	Gfp- <i>Xf</i>	0/6	0	0	-	-
	Temecula	0/8	0	-	-	-
Sunflower	Gfp- <i>Xf</i>	2/4	1.2 x 10 <sup>3</sup>	0	0/2	-
	Temecula	2/5	1.7 x 10 <sup>5</sup>	-	1/2	4.1 x 10 <sup>3</sup>

<sup>a</sup> *Xf* populations (colony-forming-units/ gram of plant material) in inoculated stems six weeks after vector inoculation

<sup>b</sup> Proportion of vessels colonized by *Xf* in inoculated stems

<sup>c</sup> Number of infections that moved beyond the inoculation site throughout the plant, as detected by culture of petioles 10-15cm distal from inoculation site

<sup>d</sup> Population of *Xf* in distal petioles

## CONCLUSIONS

Three things are required for the development of PD in grape: the pathogen *Xylella*, a sharpshooter insect vector, and a susceptible plant host. By systematically examining the interactions between plants and the pathogen, we may better understand the role that host resistance plays in the vector's ability to acquire *Xf* and spread PD. The vessels of alternate hosts were approximately 75% shorter than vessels of grapes, limiting the passive spread of *Xf* via xylem sap movement, and are found in bundles separated by parenchyma cells (Esau 1977), which may also limit the lateral spread of *Xf*. As grapevines, most susceptible to *Xf* infection, had the longest vessels, and sunflower, the second most susceptible, had the next-longest vessels, the relationship between vascular anatomy and *Xf* host status appears complicated. Additional comparisons of overall vascular area and vessel distribution are required before further generalization. Recent studies present conflicting data on whether *Xf* movement between bordered pits is an active or passive process (E. Thorne, G. Young, M. Matthews and T. Rost – *personal communication*; Newman et al 2003, Stevenson et al 2004); anatomical and biochemical differences in pit structure may explain differences between cultivar susceptibility to *Xf*.

Previous studies with symptomatic grape petioles, electron and confocal microscopy showed *Xf* densely packed in individual vessels, with adjacent vessels empty or containing a few cells (Newman et al. 2003, Stevenson et al. 2004). Alternate hosts or tolerant grape cultivars with low overall populations may have just a few vessels with bacteria, so acquisition would be highly variable and dependant upon sharpshooters encountering the few colonized vessels while feeding. In symptomatic grape petioles, 13% of vessels were colonized to some extent with Gfp-*Xf*, though only 2.1% of all vessels were completely blocked with bacteria (Newman et al. 2003). In this study, no Gfp-*Xf* was observed via confocal microscopy of the four infected stems; one grape, one mugwort, and two sunflower stems. The overall populations of Gfp-*Xf* in infected stems were at least 1,000-fold lower than Gfp-*Xf* populations in the symptomatic grape petioles used in previous experiments, and as positive controls in this experiment. It does not appear possible to detect Gfp-expressing *Xf* in infected stems at such low titers.

Though it is not known how many probes a sharpshooter makes in a given feeding session, glassy-winged sharpshooter can generate multiple salivary sheaths in one insertion, adjacent to vessels and xylem parenchyma cells (Leopold et al. 2003). Sharpshooter acquisition of *Xf* increased along with bacterial populations in infected grapes (Hill and Purcell 1997), and a similar positive relationship is expected if the proportion of colonized vessels increases insect acquisition of *Xylella*. Analysis of test grapes is ongoing to determine sharpshooter acquisition from the *Xf*-infected grapes and alternate hosts reported in Table 2.

## REFERENCES

- Almeida, R.P.P. and A. H. Purcell. 2003. Transmission of *Xylella fastidiosa* to grapevines by *Homalodisca coagulata*. J. Econ. Entomology 96(2): 264-271.
- Davis, M. J., B. C. Raju, R. H. Brlansky et al. 1983. Periwinkle wilt bacterium: axenic culture, pathogenicity, and relationships to other gram-negative, xylem-inhabiting bacteria. Phytopathology 73: 1510-1515.
- Esau, K. 1977. Anatomy of Seed Plants. John Wiley and Sons, New York, NY. p. 308, 310.
- Ewers, F.W. and J. B. Fisher. 1989. Techniques for measuring vessel lengths and diameters in stems of woody plants. Am. J. Botany 76: 645-656.
- Hill, B.L. and A.H. Purcell. 1995a. Acquisition and retention of *Xylella fastidiosa* by an efficient vector, *Graphocephala atropunctata*. Phytopathology 85: 209-212.
- Hill, B.L. and A.H. Purcell. 1995b. Multiplication and movement of *Xylella fastidiosa* within grape and four other plants. Phytopathology 85: 1368-1372.
- Hill B.L. and A.H. Purcell, 1997. Populations of *Xylella fastidiosa* in plants required for transmission by an efficient vector. Phytopathology 87: 1197-1201.
- Leopold, R.A., T. P. Freeman, J. S. Bruckner, and D. R. Nelson. 2003. Mouthpart morphology and stylet penetration of host plants by the glassy-winged sharpshooter, *Homalodisca coagulata*. Arthro. Struc. Devel. 32: 189-199.
- Newman, K.L., R.P.P Almeida, A. H. Purcell, and S.E. Lindow, 2003. Use of a green fluorescent strain of analysis of *Xylella fastidiosa* colonization of *Vitis vinifera*. App. and Env. Microbiol. 69: 7319-7327.
- Purcell, A.H., 1981. Vector preference and inoculation efficiency as components of resistance to Pierce's disease in European grape cultivars. Phytopathology 71: 429-435.
- Purcell A.H., A. H. Finlay, and D.L. McLean. 1979. Pierce's disease bacterium: mechanism of transmission by leafhopper vectors. Science 206: 839-841.
- Purcell, A.H. and S.E. Lindow. 2004. Patterns of *Xylella fastidiosa* infection in plants and effects on acquisition by insect vectors, pp. 234-237. In Proc. of Pierce's Disease Res. Symposium, San Diego, CA, Dec. 7-10, 2004.
- Raju, B.C., and A.C. Goheen. 1981. Relative sensitivity of selected grapevine cultivars to Pierce's disease bacterial infections. Am. J. Enol. Vitic. 32: 155-158.
- Stevenson, J.F., M. A. Matthews, and T. L. Rost. 2004. Grapevine susceptibility to Pierce's disease I: relevance to hydraulic architecture. A. J. Enol and Vitic. 55: 228-237
- Tyson, G.E., B. J. Stojanovic, R. F. Kuklinski, T. J. DiVittorio, and M.L. Sullivan. 1984. Scanning electron microscopy of Pierce's disease bacterium in petiolar xylem of grape leaves. Phytopath. 75: 264-9.
- Wistrom, C., and A. H. Purcell. 2005. Fate of *Xylella fastidiosa* in vineyard weeds and other alternate hosts in California. Plant Disease. Plant Disease 89:994-999.

## FUNDING AGENCIES

Funding for this project was provided by the CDFR Pierce's Disease and Glassy-winged Sharpshooter Board, and the College of Natural Resources, University of California, Berkeley.

## DOCUMENTATION AND CHARACTERIZATION OF *XYLELLA FASTIDIOSA* STRAINS IN LANDSCAPE HOSTS

### Project Leaders:

Frank Wong and Donald A. Cooksey  
Department of Plant Pathology  
University of California  
Riverside, CA 92521

Heather S. Costa  
Department of Entomology  
University of California  
Riverside, CA 92521

**Reporting Period:** The results reported here are from work conducted October 1, 2004 to September 30, 2005.

### ABSTRACT

Strains of *Xylella fastidiosa* (*Xf*) were characterized using random amplified polymorphic (RAPD)-PCR and sequence analysis of the 16S-23S rDNA intergenic spacer regions (ISR). Results indicated that all mulberry leaf scorch (MLS) strains and the heavenly bamboo strain formed a cluster. Strains isolated from daylily, jacaranda and magnolia clustered with the *Xf* subspecies *sandyi*; strains isolated from spanish broom, a redbud strain, two new peach strains and several almond strains clustered with *Xf* subspecies *fastidiosa*, and the oak strains formed a separate cluster. Predicted members of the *Xf* subspecies *multiplex* were the strains isolated from purple leafed-plum, olive, peach, plum, some almond, sweet gum, maidenhair tree, crape myrtle and one redbud. Pathogenicity of MLS strains was demonstrated in glasshouse assays by stem inoculating mulberry, grape and oleander with *Xf* isolate morus059 grown for 7 days on PW. Three months post-inoculation, only inoculated mulberries exhibited leaf scorch symptoms and bacteria were recovered from most of the inoculated mulberries but not from oleander or grape. Given that strains isolated from magnolia (MG038), jacaranda (JM028), and daylily (HEM034) always grouped with oleander strains, we tested their ability to produce disease in oleander and grape. The three strains MG038, JM028, and HEM034 caused oleander leaf scorch (OLS) but not Pierce's disease (PD) symptoms and bacteria were re-isolated from oleanders that were diseased. This study served as a confirmation of our genetic results, as well as an indirect demonstration that the *Xf* subspecies *sandyi* might be found in other hosts than oleander. More cross inoculation experiments are underway.

### INTRODUCTION

*Xf* multiplies and survives in a large number of plants species and its vectors, including the glassy-winged sharpshooter (GWSS), which feeds on a broad range of plants (Purcell and Saunders 1999, Wistrom and Purcell 2005). It has been shown that a single strain is able to infect and produce disease in different hosts (Almeida and Purcell 2003, Costa et al. 2004, Chen et al. 2005) and that the bacterium is able to infect and colonize a wide range of alternate hosts without causing disease (Purcell and Saunders 1999, Costa et al. 2004, Wistrom and Purcell 2005). The broad host range of *Xylella* and its ability to hide inside unaffected hosts make it a constant menace for agricultural crops. Very little was known previously about the fate of *Xylella* in ornamentals, the strains they are harboring and their ability to cause disease losses in plants of agronomic importance. To find some information in this subject, we characterized strains isolated from ornamental hosts using RAPD and 16S-23S rDNA Intergenic Spacer Region (ISR) analyses. Our results identified new hosts for the *Xf* subspecies *fastidiosa*, *Xf* subspecies *multiplex*, *Xf* subspecies *sandyi*, and for the MLS type strains.

Our knowledge of host range of *Xf* strains is still restricted. Some strains appear to have a very limited host range and some have a broader range of hosts, but for most strains the possible host-strain combination has not been extensively tested. Symptomless hosts harboring bacteria are potential inoculum sources for vectors to acquire *Xf* and spread the disease into economically important plants.

### OBJECTIVES

1. Characterize genetically the strains of pathogen in landscape plant species.
2. Confirm pathogenic infection through inoculation studies with specific isolates.
3. Test the ability of new strains to infect agricultural crops including grape, and almond.

### RESULTS

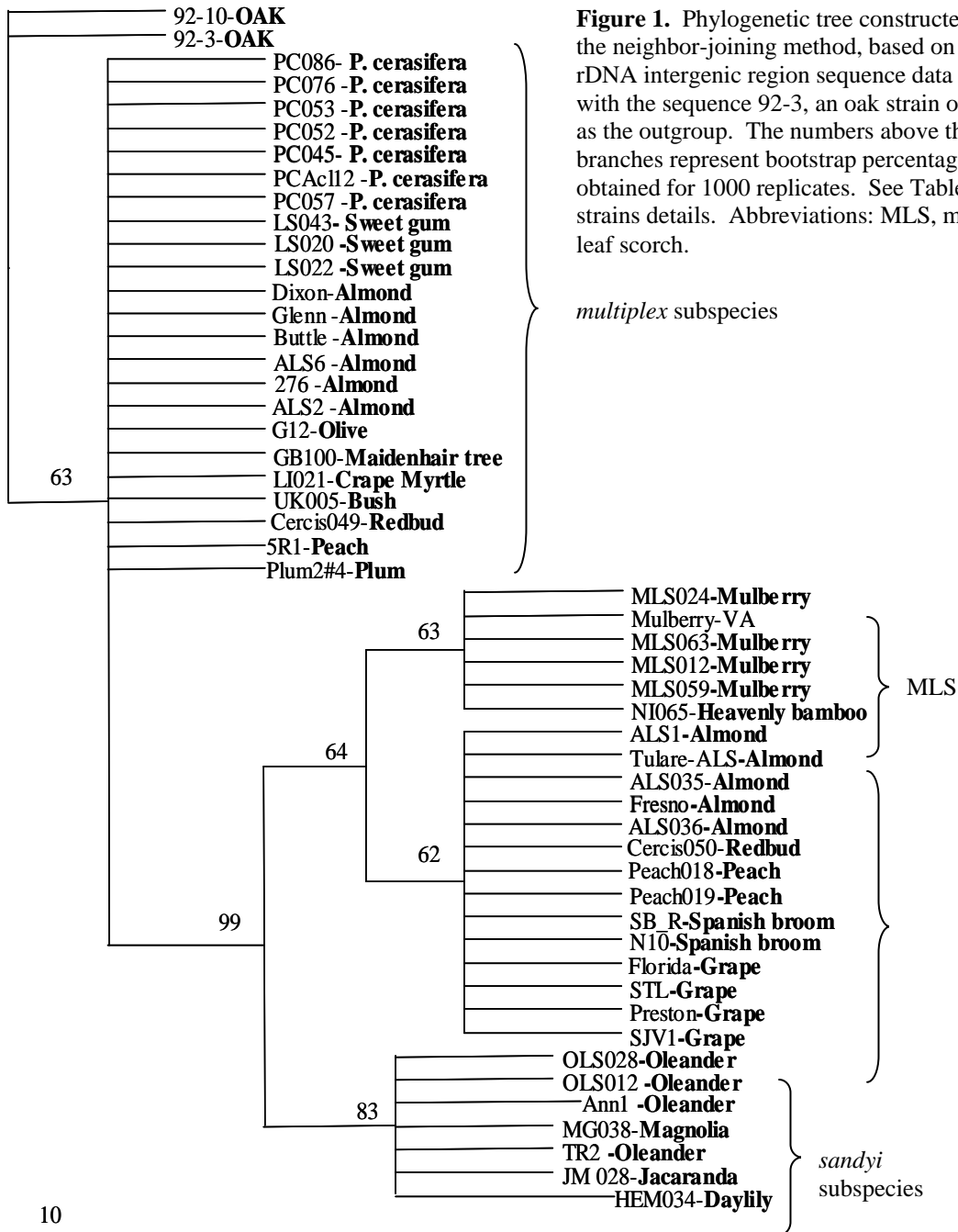
**Objective 1. Characterization of *Xf* strains by analysis of the 16S-23S rDNA intergenic spacer region (ISR)** Excluding Mulberry-VA (GeneBak accession number AY196794), a DNA region of 513 bases containing the 16S-23S rDNA ISR was amplified, cloned and sequenced from all the *Xf* strains listed in Table 1.

**Table 1.** Strains used in this study and their host sources

<b>Scientific name</b>	<b>Common name</b>	<b>Isolate designation</b>	<b>County of CA or state from which strain was isolated</b>	<b>Reference or source</b>
<i>Cercis occidentalis</i>	Western redbud	Cercis050	Riverside	This study
<i>Cercis occidentalis</i>	Western redbud	Cercis049	Riverside	This study
<i>Ginkgo biloba</i>	Maidenhair tree	GB100	Riverside	This study
<i>Hemerocallis sp.</i>	Daylily	HEM034	Riverside	This study
<i>Jacaranda mimosifolia</i>	Jacaranda	JM028	Riverside	This study
<i>Lagerstroemia indica</i>	Crape Myrtle	LI021	San Bernardino	This study
<i>Liquidambar styraciflua</i>	Sweet gum	LS020	San Bernadino	This study
<i>Liquidambar styraciflua</i>	Sweet gum	LS022	San Bernadino	This study
<i>Liquidambar styraciflua</i>	Sweet gum	LS043	San Bernadino	This study
<i>Magnolia grandiflora</i>	Magnolia	MG038	San Bernadino	This study
<i>Morus alba</i>	White mulberry	MLS063	San Bernardino	This study
<i>Morus alba</i>	White mulberry	MLS059	San Bernardino	This study
<i>Morus alba</i>	White mulberry	MLS012	San Bernadino	This study
<i>Morus alba</i>	White mulberry	MLS024	Riverside	This study
<i>Morus alba</i>	White mulberry	Mulberry-VA	Virginia	(Huang and Sherald 2004)
<i>Nandina domestica</i>	Heavenly bamboo	NI065	San Bernardino	This study
<i>Nerium oleander</i>	Oleander	OLS012	Riverside	This study
<i>Nerium oleander</i>	Oleander	OLS028	Riverside	This study
<i>Nerium oleander</i>	Oleander	Ann1	Palm Springs	(Hendson et al. 2001)
<i>Nerium oleander</i>	Oleander	TR2	Orange	A. Purcell
<i>Olea europaea</i>	Olive	G12	Riverside	This study
<i>Prunus cerasifera</i>	Purple leafed-plum	PC057	Riverside	This study
<i>Prunus cerasifera</i>	Purple leafed-plum	PC086	Riverside	This study
<i>Prunus cerasifera</i>	Purple leafed-plum	PC045	Riverside	This study
<i>Prunus cerasifera</i>	Purple leafed-plum	PC052	Riverside	This study
<i>Prunus cerasifera</i>	Purple leafed-plum	PC053	Riverside	This study
<i>Prunus cerasifera</i>	Purple leafed-plum	PC076	San Bernardino	This study
<i>Prunus cerasifera</i>	Purple leafed-plum	PC012	Riverside	This study
<i>Prunus domestica</i>	Plum	Plum 2#4	Georgia	(Hendson et al. 2001)
<i>Prunus dulcis</i>	Almond	ALS2	San Joaquin	(Hendson et al. 2001)
<i>Prunus dulcis</i>	Almond	ALS1	San Joaquin	(Hendson et al. 2001)
<i>Prunus dulcis</i>	Almond	Tulare-ALS	Tulare	(Hendson et al. 2001)
<i>Prunus dulcis</i>	Almond	Fresno	Fresno	(Almeida and Purcell 2003)
<i>Prunus dulcis</i>	Almond	ALS6	San Joaquin	(Hendson et al. 2001)
<i>Prunus dulcis</i>	Almond	276	Temecula	(Costa et al. 2004)
<i>Prunus dulcis</i>	Almond	Dixon	Solano	(Hendson et al. 2001)
<i>Prunus dulcis</i>	Almond	Butte	Butte	(Hendson et al. 2001)
<i>Prunus dulcis</i>	Almond	Glenn	Glenn	(Almeida and Purcell 2003)
<i>Prunus dulcis</i>	Almond	ALS035	San Bernardino, CA	This study
<i>Prunus dulcis</i>	Almond	ALS036	San Bernardino, CA	This study
<i>Prunus persica</i>	Peach	Peach018	San Bernardino, CA	This study
<i>Prunus persica</i>	Peach	Peach.019	San Bernardino, CA	This study
<i>Prunus persica</i>	Peach	5R1	Georgia	(Hendson et al. 2001)
<i>Quercus sp.</i>	Oak	92-10	Florida	(Hendson et al. 2001)
<i>Quercus sp.</i>	Oak	92-3	Florida	(Hendson et al. 2001)
<i>Spartium junceum</i>	Spanish broom	N10	Temecula, CA	(Costa et al. 2004)
<i>Spartium junceum</i>	Spanish broom	SB-R	Riverside, CA	This study
Unknown	Bush	UK005	Riverside, CA	This study
<i>Vitis vinifera</i>	Grape	95-2	Florida	(Hendson et al. 2001)
<i>Vitis vinifera</i>	Grape	SJV1	Florida	A. Purcell
<i>Vitis vinifera</i>	Grape	Florida	Florida	Cooksey's lab collection
<i>Vitis vinifera</i>	Grape	STL	Napa, CA	(Hendson et al. 2001)
<i>Vitis vinifera</i>	Grape	Preston	Sonoma, CA	(Hendson et al. 2001)

A phylogenetic tree was constructed using those sequence data (Figure 1). The analysis of the tree revealed five groupings of strains. The first clade included two strains 92-10 and 92-3 isolated from oak. The second clade included strains from purple-leafed plum (PC086, PC045, PCAc112, PC057, PC052, PC076 and PC053), olive, almond (Dixon, Butte, ALS6,

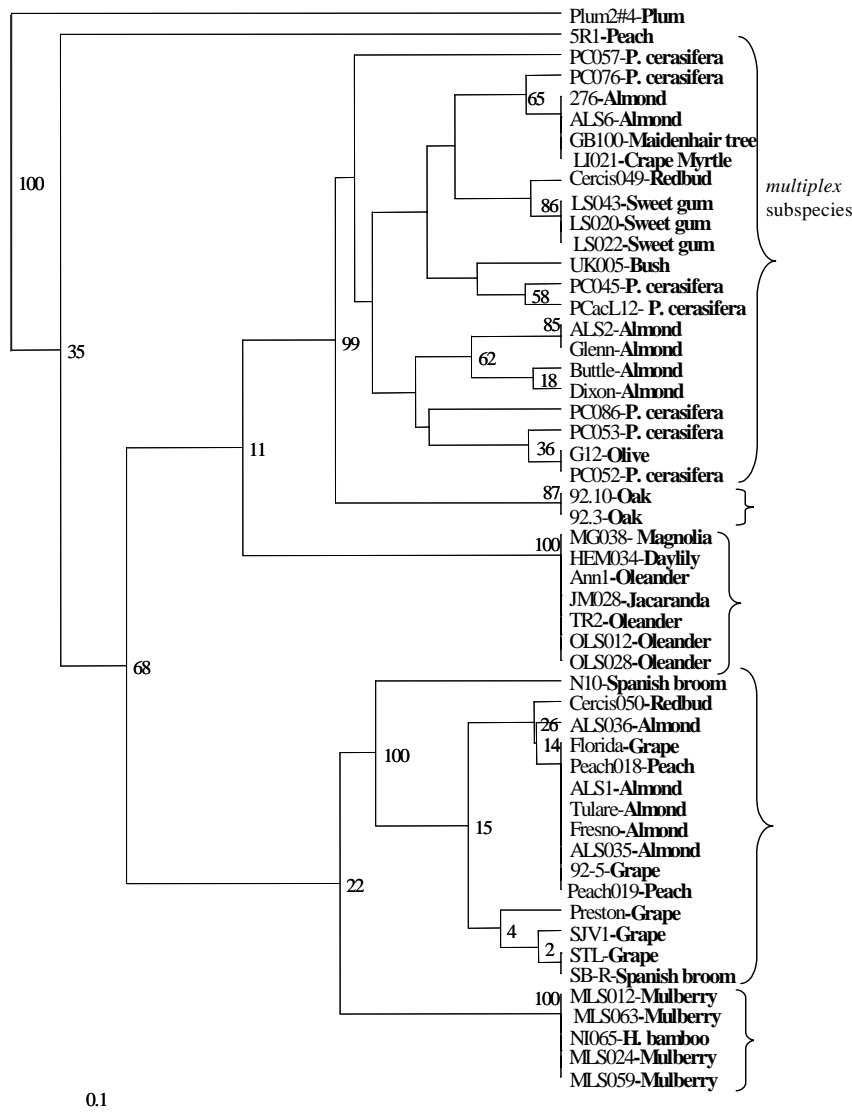
ALS2, 276 and Glenn), sweet gum (LQ020, LQ022, LQ043), peach (5R1), plum (Plum2#4), western redbud (cercis049), maidenhair tree and the UK005 strain. The third clade included mulberry strains (MLS024, MLS063, MLS012, MLS059, and Mulberry-VA) as well as the heavenly bamboo strain (NI065). The fourth clade included strains isolated from grape (Florida, STL, Preston, 92-5 and SJV1), almond (ALS1, Tulare, ALS035, ALS036 and Fresno), peach (Peach018 and Peach019), spanish broom (N10 and SB-R) and one western redbud strain (cercis050). And the last, included strains isolated from oleander (OLS028, OLS012, Ann1 and TR2), daylily (HEM034), magnolia (MG038) and Jacaranda (JM028).



### Characterization of *Xf* strains by RAPD analysis

The PCR products were compared, and a distance matrix was constructed. Phylogenetic relationships based on 80 scorable RAPD characters were analyzed by the UPGMA method (Figure 2). Analysis of the phylogenetic tree revealed six main clades. The first clade comprised strains isolated from plum and peach (plum2#4 and 5R1). All members of the multiplex

subspecies clustered into the second clade. However, this clade seems to be subdivided into smaller ones. The most noticeable were: I) PC076, 276, AIS6, GB100 and LI021; II) LS043, LS022, LS020; III) ALS2 and Glenn; and IV) Butte and Dixon. The third clade included strains isolated from oak (92-10 and 92-3). The fourth included all the strains isolated from oleander (OLS028, OLS012, and Ann1), as well as the strains isolated from daylily (HEM034), Jacaranda (JM028) and Magnolia (MG038). The fifth included strains isolated from grape (92-5, Florida, STL, Preston and SJV1), almond (ALS036, ALS035, ALS1 and Fresno), peach (Peach019 and Peach018), spanish broom (N10 and SB-R) and redbud (Cercis50). The last clade was integrated from strains isolated from mulberry (MLS024, MLS063, MLS012 and MLS059) and heavenly bamboo (NI065).



**Figure 2.** Phylogenetic tree constructed using the neighbor-joining method, based on RAPD data for *Xf* with the sequence 92-3, an oak strain of *Xf* used as the out-group. The numbers above the branches represent bootstrap percentages obtained from 1000 replicates. See Table 1 for strain details.

### Objectives 2 and 3: Mechanical inoculation of novel strains into ornamental hosts, 12-month evaluation

In 2004, selected isolates of *Xf* from landscape host plants *Ginkgo biloba*, *Liquidambar styraciflua*, *Morus alba*, *Nandina domestica*, *Olea europea*, *Prunus cerasifera* and *Prunus dulcis* were inoculated into their respective hosts of origin, grape and oleander to confirm pathogenicity and to see if any were also known PD or OLS types. Plants were tested at 3 month intervals by ELISA and for plants testing positive (at least two-times background), direct culturing of the pathogen was attempted (Table 2).

**Table 2.** Inoculation results for glasshouse tests (3, 6, 9 and 12--month evaluation)

Test Strain	Inoculum Source Plant	Test Plant	# Inoculated	ELISA Positive Samples								Recovered Strain ID
				3-month		6-month		9-month		12-month		
				+	tested	+	tested	+	tested	+	tested	
276	Almond	Almond	25	7	23	4	23	1	24	0	24	ALS <sup>b</sup>
276	Almond	Grape	25	3	21	0	25	0	25	1	24	
276	Almond	Oleander	15	2	15	0	15	0	15	2	15	
GB100	Ginkgo	Ginkgo	25	2	25	1	24	4	24	6	24	
GB100	Ginkgo	Grape	25	1	24	0	24	0	24	0	14	
GrapeA05	Grape	Grape	25	10	10	25	25	2	2 <sup>a</sup>	0	0 <sup>a</sup>	PD <sup>b</sup>
LI021	Crapemyrtle	Crapemyrtle	25	8	24	6	25	3	25	2	25	
LI021	Crapemyrtle	Grape	25	4	25	1	24	0	20	1	20	
LI021	Crapemyrtle	Oleander	15	1	14	4	14	2	12	1	13	OLS <sup>b</sup>
LiquidambarUI12	Liquidambar	Grape	25	2	22	0	24	0	24	0	24	
LiquidambarUI12	Liquidambar	Liquidambar	25	0	24	0	25	2	25	0	25	
LiquidambarUI12	Liquidambar	Oleander	15	1	14	1	13	0	10	0	10	
NI065	Nandina	Grape	25	3	23	2	23	0	19	0	15	
NI065	Nandina	Nandina	25	2	25	0	25	2	25	0	25	
NI065	Nandina	Oleander	15	0	14	0	14	0	15	0	14	
G12	Olive	Grape	25	3	17	1	25	0	24	0	20	
G12	Olive	Oleander	10	1	9	0	10	0	10	0	10	
G12	Olive	Olive	25	1	25	4	25	23	24	21	24	
PC076	Plum	Grape	25	3	24	2	25	0	18	0	15	
PC076	Plum	Oleander	10	0	10	0	10	0	10	0	10	
PC076	Plum	Plum	25	1	25	0	25	1	25	1	25	
Riverside3	Oleander	Oleander	25	9	10	24	25	21	21	10 <sup>a</sup>	10 <sup>a</sup>	OLS <sup>b</sup>
Control	PBS buffer	Almond	10	0	2	0	3	0	3	1	3	
Control	PBS buffer	Crape Myrtle	10	0	4	2	9	1	10	2	10	
Control	PBS buffer	Ginkgo	15	0	4	0	10	0	8	0	8	
Control	PBS buffer	Grape	15	2	10	0	10	0	10	0	10	
Control	PBS buffer	Liquid amber	10	0	4	0	10	0	10	0	10	
Control	PBS buffer	Mulberry	10	4	10	0	10	0	10	0	10	
Control	PBS buffer	Nandina	10	0	4	0	10	0	10	0	10	
Control	PBS buffer	Oleander	10	0	2	1	10	4	9	0	9	
Control	PBS buffer	Olive	10	1	4	3	10	9	10	9	10	
Control	PBS buffer	Plum	10	0	4	0	10	0	10	0	10	

<sup>a</sup> after 9- and 12-month incubation periods after infection, the majority of the test plants were dead from *Xf* infection

<sup>b</sup> when *Xf* was successfully cultured from plants testing positive from ELISA, isolates were characterized by 16S-23S rDNA sequencing into known strain-types

Generally, the mechanical inoculation technique described by Hill and Purcell (1995) worked extremely well on grape, oleander and almond, but had mixed results for the other isolates and host species tested. With the exception of mulberry (discussed below), none of the new isolates from liquidambar, crape myrtle, ginkgo, nandina, olive or plum were able to cause systemic infections from which the bacteria could be isolated. Interestingly, olive plants tested consistently positive by ELISA for *Xf*, even for the PBS-inoculated plants, indicating perhaps that for this plant type, there may be a high number of false positives or that the plants may have been already infected before testing, with a long latent period that prevented us from detecting the presence of the bacteria in initial experiments. Almond leaf scorch (ALS), PD, and OLS strains were easily recovered from inoculated almond, grape and oleander (respectively) indicating that the general inoculation protocol was successful, yet for liquidambar, crape myrtle, ginkgo, nandina, olive or plum, we will continue to test at 3-month intervals. For isolate LI021, from crape myrtle, it was found to cause symptoms on oleander and further characterization indicated it was of OLS-type, suggesting that OLS-strains are capable of using crape myrtle as an alternate host, although we have not yet completed Koch's postulates for this isolate in crape myrtle.

### Mechanical inoculations of putative (MLS) strains into mulberry, grape, and oleander plants

For inoculation purposes, three strains were chosen; Morus063, isolated from a mulberry with MLS symptoms; A05, isolated from a PD-affected grapevine in Temecula Valley area (Costa et al. 2004) and Riverside3 isolated from an oleander-affected plant in Riverside, CA. A 7 days old culture of *Xf* was grown on PW medium and resuspended to get a turbid solution in phosphate-buffered saline (PBS) solution. Plants were inoculated by pipetting a small drop of the bacterial solution onto a stem and probing the drop with a #1 insect pin until observed uptake from the drop. Morus063 strain was inoculated into 25 mulberries, 25 grapevines and 15 oleanders plants. A05 and Riverside3 strains were needle-inoculated into 25 grapevine or oleander plants respectively and served as positive controls. Inoculations with PBS served as negative controls. After three months of the inoculation, only inoculated mulberries exhibited leaf scorch symptoms and bacteria were recovered from most of the inoculated mulberries but not from oleander or grape (Table 3).

**Table 3.** Evaluation of mulberry, grape and oleander plants inoculated with *Xylella fastidiosa* isolated from mulberry plant.

<i>Xf</i> strain/ subspecies	Inoculum source plant	Tested Plant	Number inoculated	No. of positive plants <sup>a</sup>			No. of plants with <sup>b</sup>		
				ELISA	Culture	PCR	PD	OLS	MLS
Morus059*	Mulberry	Mulberry	25	21	21	21	0	0	21
Morus059*	Mulberry	Grape	25	1	0	0	0	0	0
Morus059*	Mulberry	Oleander	15	1	0	0	0	0	0
A05	Grape	Grape	25	25	16	16	25	0	0
Riverside3	Oleander	Oleander	25	25	16	16	0	25	0
Control	PBS Buffer	Mulberry	10	0	0	0	0	0	0
Control	PBS Buffer	Grape	10	0	0	0	0	0	0
Control	PBS Buffer	Oleander	10	0	0	0	0	0	0

\* Putative MLS strains

<sup>a</sup> Number of plants tested positive for the presence of *Xf* based on the number of plants inoculated using commercial enzyme-linked immunosorbent assay (ELISA) kits, media culturing methods, and RST31-33 primers for polymerase chain reaction (PCR) analysis (Minsavage et al. 1994)

<sup>b</sup> Number of plants exhibiting symptoms out of total of inoculated plants. Abbreviations: PD, Pierce's disease; OLS, oleander leaf scorch; MLS, mulberry leaf scorch

### Mechanical inoculations of putative *Xf* subspecies *sandyi* strains into grape and oleander plants

Since the strains from jacaranda, magnolia and daylily (JM028, MG038 and HM034) always clustered with OLS strains, our hypothesis was that they should be able to infect oleander but not grape (Purcell et al. 1999). To probe this hypothesis, they were inoculated into oleanders and grape plants. We also inoculated the OLS strain Riverside3 and the PD strain A05 as positive controls. All oleanders inoculated with the strains Riverside3, JM028, MG038 and HM034 showed symptoms after two months of inoculation (Table 4). On the other hand, only the grapes inoculated with the A05 strain presented disease symptoms. At that point ELISA gave strong positive results from positive plants ( $\leq 2X$  the positive control) and bacteria were recovered from all infected plants. Colonies did not differ morphologically (light microscope), serologically (ELISA), or by growth in PD3 medium with the original strains used as inoculum. For confirmation of identity, reisolated bacteria were tested with primers RST31 and RST33, and all of them produced a band of 733 bp as expected (data not shown). Strains JM028, MG038, HM034 and Riverside3 inoculated into grapes were unable to produce disease symptoms or give ELISA-positive results, and the same was true when the A05 strain was inoculated into oleanders. No control plants gave positive ELISA or PCR reactions, and *Xf* was never isolated from any control plants.



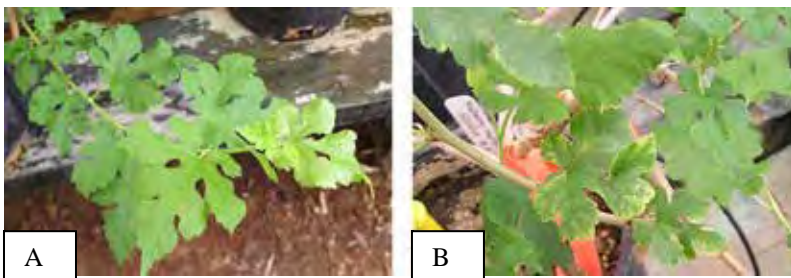
**Table 4.** Evaluation of grape and oleander plants inoculated with *Xf* isolated from oleander, grape, jacaranda, magnolia, and daylily.

<i>Xf</i> strain/ subspecies	Inoculum source plant	Tested Plant	Number inoculated	No. of positive plants <sup>a</sup>			No. of plants with <sup>b</sup>	
				ELISA	Culture	PCR	PD	OLS
A05/ <i>fastidiosa</i>	Grape	Oleander	15	0	0	0	0	0
A05/ <i>fastidiosa</i>	Grape	Grape	10	10	10	10	10	0
Riverside3/ <i>sandyi</i>	Oleander	Oleander	15	15	15	15	0	15
Riverside3/ <i>sandyi</i>	Oleander	Grape	10	0	0	0	0	0
JM028/ <i>sandyi</i> *	Jacaranda	Oleander	15	15	15	15	0	15
JM028/ <i>sandyi</i> *	Jacaranda	Grape	10	0	0	0	0	0
MG038/ <i>sandyi</i> *	Magnolia	Oleander	15	15	15	15	0	15
MG038/ <i>sandyi</i> *	Magnolia	Grape	10	0	0	0	0	0
HEM034/ <i>sandyi</i> *	Daylily	Oleander	15	15	15	15	0	15
HM034/ <i>sandyi</i> *	Daylily	Grape	10	0	0	0	0	0
Control	PBS Buffer	Oleander	15	0	0	0	0	0
Control	PBS Buffer	Grape	10	0	0	0	0	0

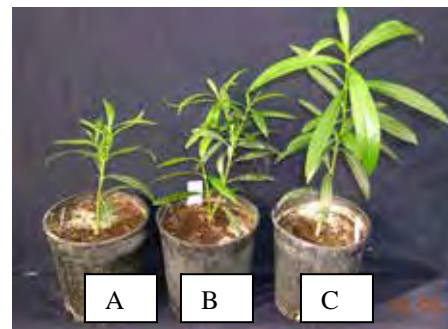
\* Putative members of the *sandyi* subspecies

<sup>a</sup> Number of plants tested positive for the presence of *Xf* based on the number of plants inoculated using commercial enzyme-linked immunosorbent assay (ELISA) kits, media culturing methods, and RST31-33 primers for polymerase chain reaction (PCR) analysis (Minsavage et al. 1994)

<sup>b</sup> Number of plants exhibiting symptoms out of total of inoculated plants. Abbreviations: PD, Pierce's disease; OLS, oleander leaf scorch.



**Figure 3.** A. Mulberries inoculated with PBS buffer. B. Mulberries inoculated strain Morus059 of *Xylella fastidiosa*.



**Figure 4.** A. Oleander infected with a strain isolated from magnolia. B. oleander infected with a strain isolated from jacaranda. C. Oleander inoculated with PBS buffer.

## CONCLUSIONS

The methods used here indicated that ornamental hosts are able to harbor different strains of *Xylella*. Our findings revealed new hosts for the subspecies *fastidiosa* (peach and redbud) *multiplex* (crape myrtle, maidenhair tree, olive, liquidambar, purple-leaf plum and redbud), *sandyi* (daylily, magnolia and jacaranda) and MLS (heavenly bamboo). We have the first report of MLS in California, expanding the number of strains present in this state, and found evidences that MLS strains are likely non-pathogenic to grape or oleander. We also showed that strains isolated from jacaranda, daylily, and magnolia are able to produce disease in oleander but not in grape. More studies are underway to fulfill the Koch's postulates of the strains characterized here as well as to reveal their fate on grape, almond and oleander plants. Since knowledge of the source of inoculum is essential in developing effective disease management strategies, additional studies must be done to elucidate the full host range of *Xf*. For now, the results of this work increased our information about the hosts range spectrum of the pathogen and their latent risk in ornamentals.

## REFERENCES

- Almeida, R. P. P., and A. H. Purcell. 2003. Biological traits of *Xylella fastidiosa* strains from grapes and almonds. *Appl. Environ. Microbiol.* 69: 7447-7452.
- Chen, J., R. Groves, E. L. Civerolo, A. Viveros, A. Freeman, and Y. Zheng. 2005. Two *Xylella fastidiosa* genotypes associated with almond leaf scorch disease on the same location in California. *Phytopathology.* 95: 708-714.
- Costa, H. S., E. Raetz, T. R. Pinckard, C. Gispert, R. Hernandez-Martinez, C. K. Dumenyo, and D. A. Cooksey. 2004. Plant Hosts of *Xylella fastidiosa* in and Near Southern California Vineyards. *Plant Dis.* 88: 1255-1261.
- Hendson, M., A. H. Purcell, D. Q. Chen, C. Smart, M. Guilhabert, and B. Kirkpatrick. 2001. Genetic diversity of Pierce's disease strains and other pathotypes of *Xylella fastidiosa*. *Appl. Environ. Microbiol.* 67: 895-903.

- Hill, B. L. and A. H. Purcell. 1995. Multiplication and movement of *Xylella fastidiosa* within grapevine and four other host plants. *Phytopath.* 85:1368-1372.
- Huang, Q., and J. L. Sberald. 2004. Isolation and phylogenetic analysis of *Xylella fastidiosa* from its invasive alternative host, porcelain berry. *Curr. Microbiol.* 48: 73-76.
- Minsavage, G. V., C. M. Thompson, D. L. Hopkins, R. M. V. B. C. Leite, and R. E. Stall. 1994. Development of a polymerase chain reaction protocol for detection of *Xylella fastidiosa* in plant tissue. *Phytopathology* 84: 456-461.
- Purcell, A. H., and S. R. Saunders. 1999. Fate of Pierce's disease strains of *Xylella fastidiosa* in common riparian plants in California. *Plant Dis.* 83: 825-830.
- Purcell, A. H., S. R. Saunders, M. Henderson, M. E. Grebus, and M. J. Henry. 1999. Causal role of *Xylella fastidiosa* in oleander leaf scorch disease. *Phytopathology* 89: 53-58.
- Wistrom, C., and A. H. Purcell. 2005. The Fate of *Xylella fastidiosa* in Vineyard weeds and other alternate hosts in California. *Plant Dis.* 89: 994-999.

#### **FUNDING AGENCIES**

Funding for this project was provided by the CDFA Pierce's Disease and Glassy-winged Sharpshooter Board.

## PLASMID ADDICTION AS A NOVEL APPROACH TO DEVELOP A STABLE PLASMID VECTOR FOR *XYLELLA FASTIDIOSA*

### Project Leaders:

Glenn M. Young  
Dept. of Food Science and Technology  
University of California  
Davis, CA 95616

Michele Igo  
Section of Microbiology  
University of California  
Davis, CA 95616

### Cooperators:

Ayumi Matsumoto  
Dept. of Food Science and Technology  
University of California  
Davis, CA 95616

Bruce Kirkpatrick  
Dept. of Plant Pathology  
University of California  
Davis, CA 95616

**Reporting Period:** The results reported here are from work conducted October 1, 2004 to September 30, 2005.

### ABSTRACT

Understanding the progression of Pierce's Disease (PD) has been limited by the lack of genetic and molecular tools that can be used to study the biology of *Xylella fastidiosa* (*Xf*). Although a number of potential plasmid vectors have been developed that are capable of replicating in *Xf*, none of these plasmids are stably maintained in *Xf* without antibiotic selection. To solve this problem, we have introduced two different types of stabilizing elements into the *Xf* plasmid vectors pXF004 and pXF005. These stabilizing elements include the plasmid addiction systems, *hok/sok* and *parDE*, and the active partitioning system, *parA*. Our preliminary studies indicate that the addition of the *hok/sok* addiction module to plasmid, pXF004, greatly increases its stability in *Xf*.

### INTRODUCTION

*Xylella fastidiosa* (*Xf*) is a fastidious, xylem-limited, Gram-negative bacterium, which is the causative agent of numerous economically important plant diseases (Hopkins and Purcell 2002). Diseases that are important to the California agricultural economy include PD of grapevine, almond leaf scorch, alfalfa dwarf, and oleander leaf scorch. An important feature of the *Xf* infectious cycle is the ability of this pathogen to colonize and interact with the xylem tissue of plants and the foregut of insect vectors (Hopkins and Purcell 2002). Successful colonization of these hosts is dependent on the ability of *Xf* to subvert host defense networks and to acquire essential nutrients.

Many research laboratories have been working to identify genes important for virulence and nutrient acquisition. However, rapid progress in this area is affected by the lack of genetic and molecular tools necessary to investigate the contribution of *Xf* genes to the infection process. In recent years, a number of plasmid vectors have been developed that are capable of replicating in *Xf*. These plasmids have different origins of replication and belong to different incompatibility groups (Qin and Hartung 2001, Vanamala, A. *et al.* 2002, Guilhabert and Kirkpatrick 2003, Guilhabert *et al.* 2005). However, in the absence of antibiotic selection, none of these plasmids are stably maintained in *Xf*. Therefore, one extremely important tool that is needed to advance studies investigating *Xf* virulence is a plasmid that is stably maintained by *Xf* throughout the infectious cycle.

The goal of our project is to develop a plasmid that is stably maintained in *Xf* both *in vitro* and *en planta* in the absence of antibiotic selection. In our initial studies, we constructed these stable plasmids using the pXF plasmids, pXF004 and pXF005 (Guilhabert and Kirkpatrick 2003). These pXF plasmids contain the replicon from RSF1010 and confer resistance to kanamycin. They also are autonomously maintained with antibiotic selection and structurally unchanged by propagation in *Xf*. In fact, the only real problem with these vectors is that they are not maintained in *Xf* in absence of antibiotic selection. To circumvent this problem, we are evaluating whether stability can be achieved by introducing plasmid-addiction systems and plasmid partitioning elements into these existing *Xf* vectors. During the past year, we focused on plasmid addiction modules, which have been shown to dramatically increase plasmid stability in many Gram-negative bacteria (Engelbaerg-Kulka and Glaser 1999, Zielenkiewicz and Ceglowski 2001, Hayers 2003). A plasmid addiction system is a two-component stable toxin-unstable antitoxin system. Examples of these systems include the *hok/sok* system of plasmid R1 and the *parDE* system of plasmid RK2 (Burkhardt *et al.* 1979, Saurugger *et al.* 1986, Gerdes 1988). When a bacterium loses the plasmid harboring either of these addiction systems, the cured cells lose the ability to produce the unstable antitoxin and the lethal effect of the stable toxin quickly kills the bacterium. Thus, a plasmid addiction system guarantees that all living bacteria maintain the plasmid throughout infectious cycle. Recently, we have initiated studies to examine whether or not active partitioning systems enhance plasmid maintenance. Specifically, we plan to test the plasmid partitioning system, *parA*, which consist of a centromere-like region adjacent to two co-regulated genes that encode an ATPase and a centromere specific DNA-binding protein, which is required for faithful plasmid segregation at cell division (Gerdes *et al.* 2000). Addition of this system to unstable plasmids has been demonstrated to increase plasmid stability in many Gram-negative bacteria (Zielenkiewicz and Ceglowski 2001).

## OBJECTIVES

1. Develop a stable plasmid vector for *Xf*
  - a. Evaluate the potential of various plasmid addiction systems for ability to convert plasmids known to replicate in *Xf* into stable vectors.
  - b. Evaluate how plasmid maintenance by *Xf* is affected by other genetic mechanisms known to affect plasmid stability, such as systems for multimer resolution and active partitioning systems.
2. Evaluate the stability of the newly development plasmid vectors when propagate in *Xf en planta*.

## RESULTS

During the past year, a series of 22 stability plasmids were constructed. This initial set of plasmids contains the *hok/sok* locus or other elements in combination with origins of replication from RSF1010 (derived from pXF vectors-Guilhabert and Kirkpatrick 2003) and *ori15A* (derived from pGEN vectors-Galen *et al.* 1997). The stability of each of these plasmids was then examined in *E. coli* to provide a preliminary evaluation of these vectors' long term inheritance properties. Significantly, twelve of these new plasmids display increased stability in *E. coli* relative to the pXF plasmid controls. Each of these plasmids, along with other representative control plasmids, is now being transferred into *Xf* using published protocols (Guilhabert and Kirkpatrick 2003). Once a plasmid has been introduced into *Xf*, we will then evaluate the effect of these addiction modules on plasmid stability in *Xf* using previously established methods (Guilhabert and Kirkpatrick 2003). The results for one series of constructs are shown in Table 1. The pXF plasmids were not stable in *Xf* after 1 passage (1-week-incubation without antibiotics). The instability we observed for the pXF plasmids is similar to that previously reported by Guilhabert and Kirkpatrick (2003). In contrast, plasmid pAM24, which is a derivative of pXF004 and carries the *hok/sok* module, is very stable in *Xf* after one generation (Table 1). Although our analysis of this plasmid is still at an earlier stage, we speculate that the addition of the *hok/sok* system to other *Xf* vectors will improve their stability in *Xf*.

**Table 1.** Series of stable plasmids based on RSF1010 plasmid.

	Antibiotic Marker	Addiction system	Partitioning system	GFP <sup>c</sup>	% of plasmid retention in <i>Xf</i> in generation 1
pXF004 <sup>a</sup>	Kan	-	-	-	40 <sup>b</sup>
pXF005 <sup>a</sup>	Kan	-	-	-	39
pAM24	Kan	<i>hok/sok</i>	-	<i>gfp</i>	~100
pAM18	Kan	<i>hok/sok, parDE</i>	-	-	In progress
pAM27	Kan	<i>hok/sok</i>	<i>parA</i>	<i>gfp</i>	In progress

<sup>a</sup> Plasmids were developed by Guilhabert and Kirkpatrick 2003

<sup>b</sup> Data from Guilhabert and Kirkpatrick 2003

<sup>c</sup> GFP= green fluorescent protein

Although our studies with the *hok/sok* system are promising, it is worth pointing out that the *hok/sok* system by itself is not capable of completely stabilizing plasmids in other Gram-negative bacteria under all conditions. Interestingly, placing more than one type of addiction system onto the same plasmid has been found to provide an additive effect on plasmid stability (Pecota *et al.* 1997). Based on this observation, we constructed the plasmid pAM18, which carries both the *hok/sok* system and the *parDE* system (Table 1). Another strategy for increasing plasmid stability is to introduce both a plasmid addiction system (*hok/sok*) and an active partitioning system (*parA*) in a plasmid (Galen *et al.* 1999). To examine whether or not these stabilizing elements will increase plasmid stability in *Xf*, we generated pAM27, which carries both the *hok/sok* system and the *parA* system (Table 1). Both pAM18 and pAM27 are stably maintained in *E. coli*. The next step will be to introduce these plasmids into *Xf* and then evaluate whether the presence of multiple stability elements on the same plasmid will result in further increases in plasmid stability in *Xf*.

In addition to plasmids based on the pXF vectors, we have also generated a series of plasmids based on pRL1342, which carries a chloramphenicol resistance gene (Table 2). Like pXF004 and pXF005, pRL1342 is not stable in *Xf* in the absence of antibiotic selection. However, we have recently generated derivatives of pRL1342 that carry either *hok/sok* alone or *hok/sok* in combination with *parA*. Since this series of plasmid vectors confer resistance to chloramphenicol, they will be particularly useful for genetic complementation analysis using *Xf* mutants that are resistant to kanamycin.

**Table 2.** Development of alternative RSF1010-based vectors

	Antibiotic Marker	Addiction system	Partitioning system	GFP <sup>b</sup>
pRL1342 <sup>a</sup>	Cam	-	-	-
pLLC005	Cam	<i>hok/sok</i>	-	<i>gfp</i>
pAM59	Cam	<i>hok/sok</i>	<i>parA</i>	<i>gfp</i>

<sup>a</sup> The plasmid was developed by Peter C. Wolk, based on pMMB66EH (Furste *et al.* 1986) with chloramphenicol resistance. DNA sequence is available at NCBI #AF403427

<sup>b</sup> GFP= green fluorescent protein

Finally, to facilitate future stability studies *en planta*, we have also included in the new stability plasmids a copy of *gfp*, which encodes a bacterial optimized green fluorescent protein (GFP) (Tables 1 and 2). Although this phenotypic marker does not aid in plasmid stability, it provides a convenient marker for tagging individual cells and provides an alternative tool for researchers to track the location of *Xf* during an infection. GFP has been used by others, such as the Lindow lab at UC-Berkeley, for tracking *Xf* during plant infections (Newman *et al.* 2003) and its inclusion in this new generation of stable *Xf* plasmids will expand the usefulness of this valuable molecular biology tool.

## REFERENCES

- Burkhardt, H., G. Riess, and A. Puhler. 1979. Relationship of group P1 plasmids revealed by heteroduplex experiments: RP1, RP4, R68, and RK2 are identical. *J. Gen. Microbiol.* 114:341-348.
- Engelberg-Kulka, H., and G. Glaser. 1999. Addiction modules and programmed cell death and antideath in bacterial cultures. *Annu. Rev. Microbiol.* 53:43-70.
- Furste, J. P., W. Pansegrau, R. Frank, H. Blocker, P. Scholz, M. Bagdasarian, and E. Lanka. 1986. Molecular cloning of the plasmid RP4 primase region in a multi-host range *tacP* expression vector. *Gene* 48:119-131.
- Galen, J. E., J. Nair, J. Y. Wang, S. S. Wasserman, M. K. Tanner, M. B. Sztein, and M. M. Levine. 1999. Optimization of plasmid maintenance in the attenuated live vector vaccine strain *Salmonella typhi* CVD 908-htrA. *Infect. Immun.* 67:6424-6433.
- Gerdes, K. 1988. The *parB* (*hok/sok*) locus of plasmid R1: a general purpose plasmid stabilization system. *Bio. Technology* 6:1402-1405.
- Gerdes, K., J. Moller-Jensen, and R. Bugge Jensen. 2000. Plasmid and chromosome partitioning: surprises from phylogeny. *Mol. Microbiol.* 37:455-466.
- Guilhabert, M. R., L. M. Hoffman, D. A. Mills, and B. C. Kirkpatrick. 2001. Transposon mutagenesis of *Xylella fastidiosa* by electroporation of Tn5 synaptic complexes. *Mol. Plant-Microbe Interact.* 14:701-706.
- Guilhabert, M. R., and B. C. Kirkpatrick. 2003. Transformation of *Xylella fastidiosa* with broad host range RSF1010 derivative plasmids. *Mol. Plant Pathol.* 4:279-285.
- Guilhabert, M. R., V. J. Stewart, and B. C. Kirkpatrick. 2005. Characterization of putative Rolling-Circle plasmids from the Gram-negative bacterium *Xylella fastidiosa* and their use as shuttle vectors. *Plasmid* (in press).
- Hayes, F. 2003. Toxins-antitoxins: plasmid maintenance, programmed cell death, and cell cycle arrest. *Science* 301:1496-1499.
- Hopkins, D. L., and A. H. Purcell. 2002. *Xylella fastidiosa*: Cause of Pierce's disease of grapevine and other emergent diseases. *Plant Dis.* 86:1056-1066.
- Newman, K. L., R. P. Almeida, A. H. Purcell, and S. E. Lindow. 2003. Use of a green fluorescent strain for analysis of *Xylella fastidiosa* colonization of *Vitis vinifera*. *Appl. Environ. Microbiol.* 69:7319-7327.
- Pecota, D. C., C. S. Kim, K. Wu, K. Gerdes, and T. K. Wood. 1997. Combining the *hok/sok*, *parDE*, and *pnd* postsegregational killer loci to enhance plasmid stability. *Appl. Environ. Microbiol.* 63:1917-1924.
- Qin, X., and J. S. Hartung. 2001. Construction of a shuttle vector and transformation of *Xylella fastidiosa* with plasmid DNA. *Curr. Microbiol.* 43:158-162.
- Sauruger, P., O. Hrabak, H. Schwab, and R. M. Lafferty. 1986. Mapping and cloning of the *par*-region of broad-host range plasmid RP4. *J. Biotechnol.* 4:333-343.
- Summers, D. 1998. Timing, self-control and a sense of direction are the secrets of multicopy plasmid stability. *Mol. Microbiol.* 29:1137-1145.
- Vanamala, A., R. Harakava, and D. W. Gabriel. 2002. Transformation of *Xylella fastidiosa* using replicative shuttle vector pUFR047. *Phytopathology* 92:S83.
- Zielenkiewicz, U., and P. Ceglowski. 2001. Mechanisms of plasmid stable maintenance with special focus on plasmid addiction systems. *Acta Biochimica Polonica* 48:1003-1023.

## FUNDING AGENCIES

Funding for this project was provided by the University of California Pierce's Disease Grant Program, and the CDFA Pierce's Disease and Glassy-winged Sharpshooter Board.

## RESPONSES OF *NICOTIANA TABACUM* CV. SR-1 TO *XYLELLA FASTIDIOSA* STRAINS

### Project Leaders:

Marta Francis  
Department of Plant Pathology  
University of California  
Davis, CA 95616

Edwin L. Civerolo  
USDA, ARS  
SJV Ag. Sci. Center  
Parlier, CA 93648

George E. Bruening  
Department of Plant Pathology  
University of California  
Davis, CA 95616

### ABSTRACT

*Nicotiana tabacum* genotype (SR-1), was evaluated as a susceptible host for the bioassay of *Xylella fastidiosa* strains. Readily transformable *N. tabacum* cv. SR-1 plants were propagated *in vitro*. Transplanted plants were inoculated with various *Xf* strains. Inocula consisted of aqueous suspensions of bacterial cells harvested from 7-10 day old cultures on solid PWG medium. Inoculations were made by needle puncture through 20 $\mu$ L of inoculum (10<sup>8</sup> bacteria/mL) placed in the axils of three basal leaves. Inoculated plants were maintained in a growth room (27-28°C, 12 hour photoperiod provided by GE High Output fluorescent lights) for 1 month, and subsequently transferred to a greenhouse. Generally, symptoms on plants inoculated with *Xf* strain Temecula-1 included necrosis at the margins with chlorotic zones extending toward the midvein after 6-8 weeks. Some affected leaves became cupped and curled downward. As infections became systemic, leaves that developed on new shoots were chlorotic and smaller. These symptoms did not develop on water-inoculated control plants. The presence of *Xf* in stems and leaf petioles of affected plants was confirmed by ELISA and real-time (RT) PCR. ELISA and RT-PCR assays of similar tissues from water-inoculated control plants were negative. Bacteria were observed by TEM and SEM in xylem cells in affected plants. No bacterial cells were observed in control plants. *Xf* was isolated from systemically infected tobacco leaf petioles from plants inoculated with *Xf* strain Temecula-1 and re-inoculated into grape plants cv. Ruby Seedless. Typical Pierce's disease symptoms developed four weeks post-inoculation in the greenhouse, confirming the retention of pathogenicity of this strain to grapes after passage through *N. tabacum* cv. SR-1. *N. tabacum* cv. SR-1 plants with other *Xf* strains are being evaluated. Several factors, including plant age at the time of inoculation, method, and plant handling after inoculation, are being determined.

## TWITCHING MOTILITY AMONG VARIOUS WILD-TYPE ISOLATES AND PILUS-DEFECTIVE MUTANTS OF *XYLELLA FASTIDIOSA*

### Project Leaders:

Harvey C. Hoch and Thomas J. Burr  
Department of Plant Pathology  
Cornell University, NYSAES  
Geneva, NY 14456

### Researchers:

C. D. Galvani, Y. Li, De La Fuente, and G. Hao  
Department of Plant Pathology  
Cornell University, NYSAES  
Geneva, NY 14456

### ABSTRACT

The genome of *Xylella fastidiosa* (*Xf*) contains at least thirty genes responsible for pilus assembly or function. Recently, it was shown that *Xf* possesses two distinct types of polar pili: long, type IV pili and short, type I pili. It was also demonstrated that the bacteria of the Temecula strain are able to move on a solid agar surface via type IV-pilus mediated twitching motility that results in the presence of a 'fringe' surrounding the expanding bacterial colony. Since our research had been limited to the Temecula strain, and since such colony morphologies had not been previously reported it was not known whether the fringe we observed in culture was an anomaly of the Temecula strain or if it was also a characteristic of other wild-type strains. We therefore examined fourteen isolates from California, Texas, and South Carolina. All but one *Xf* isolate developed a fringe around the colony periphery, suggesting that twitching motility may be a critical factor in the spread of the bacteria *in planta* and development of Pierce's disease. We further discovered that fringe formation on PW agar is dramatically affected by the concentration of bovine serum albumin (BSA) in the medium. Type IV pilus-defective mutants, e.g., *pilB* did not develop a colony fringe. Mutants defective for the shorter type I pili, e.g., *fimA* continued to exhibit a fringe; and, in fact had a wider fringe.

## COMPARATIVE STUDY OF *XYLELLA FASTIDIOSA* SURFACE PROTEINS EXHIBITING HIGH CONTENTS CYSTEINE RESIDUES: IMPACT IN PATHOGENICITY

### Project Leaders:

Breno Leite  
CVSFR, Florida A&M University  
Tallahassee, FL 32317

Peter C. Andersen and Maria L. Ishida  
NFREC, IFAS, University of Florida  
Quincy, FL 32351

### ABSTRACT

The Calcium Bridging Hypothesis (CBH) validity is highly dependent on the existence of thiol moieties on the surface of *Xylella fastidiosa* (*Xf*) cells. The major question that remains to be addressed is how surface thiol and divalent ions would mediate aggregation. Strong evidence was revealed from studies with the Cowpea Mosaic Virus (CMV), by the Scripps Research Institute, California. Dissimilar patterns of surface cysteine on the surface of CMV particles resulted in distinct attachment properties. Likewise, cell-cell and cell-xylem interactions may also be mediated by the establishment of ionic bonds involving  $\text{Ca}^{++}$ , and  $\text{Mg}^{++}$ . Cysteine residues located on the outer membrane region of *Xf* surface proteins can form covalent disulfide linkages with thiol residues from other cells. Calcium and magnesium ions could also bridge negatively charged surface areas. Our objective in the present work was to search for potential surface proteins with thiols (negative charge) on the *Xf* cell surface. Several adhesion related proteins were investigated. We especially targeted domains localized outside the cell, and focused on the extracellular cysteine-rich residues regions. Hemagglutinin-like proteins presented the desired characteristics to fit the hypothesis. Other surface proteins are discussed, including type IV fimbriae, recently demonstrated to be involved in *Xf* twitching.

## INDUCTION OF AGGREGATION *IN VITRO* OF *XYLELLA FASTIDIOSA* CELLS BY DIVALENT IONS

### Project Leaders:

Breno Leite  
CVSFR, Florida A & M University  
Tallahassee, FL 32317

Peter C. Andersen  
NFREC, IFAS, University of Florida  
Quincy, FL 32351

Elliot W. Kitajima  
ESALQ, University of São Paulo  
Piracicaba, SP 13418, Brazil

### ABSTRACT

*Xylella fastidiosa* (*Xf*) aggregates within xylem vessels. Aggregation is followed by biofilm formation and ultimately vessel plugging. Characteristic Pierce's disease (PD) symptoms are visualized right after vessel plugging. Nutritional and water stress are the most common deficiencies and may result in leaf yellowing, leaf scorching and interveinal chlorosis. We hypothesize that xylem fluid chemical composition strongly influences aggregation and biofilm formation. Divalent ion availability is dissimilar in susceptible and resistant plants. In order to clarify these findings, we assayed aggregation of *Xf* in different concentrations of  $\text{MgCl}_2$  and  $\text{CaCl}_2$  (20, 50 and 100 mg/L) with two *Xf* PD strains (UCLA and STL). Our results indicate that calcium or magnesium induced approximately a 10-fold increase in aggregation of *Xf* cells. Controls were treated with deionized water. Aggregation of UCLA cells was greater than for STL cells either with calcium or magnesium treatments. However, calcium and magnesium induced aggregation. These results support the hypothesis that divalent ion availability is important in determining PD susceptibility and or resistance.

## THE INFLUENCE OF THE CELL SUSPENSION REDOX POTENTIAL ON THE CAPACITY OF *XYLELLA FASTIDIOSA* TO AGGREGATE

### Project Leaders:

Breno Leite  
CVSFR, Florida A & M University  
Tallahassee, FL 32317

Peter C. Andersen  
NFREC, IFAS, University of Florida  
Quincy, FL 32351

### ABSTRACT

The Calcium Bridging Hypothesis (CBH) implies that surface redox changes on cells of *Xylella fastidiosa* (*Xf*) may influence the capacity of these cells to aggregate. A series of experiments were designed to challenge the proposed CBH. In this hypothesis, thiols (SH) located at the outer membrane level or in adhesion related structures of *Xf* could increase or decrease the cells attraction to the xylem wall surface and/or other *Xf* cells. The focus of this investigation was to address the possibility to alter the surface status of SH groups by exposing cells to reduced and oxidized forms of the tripeptide glutathione (commonly found in xylem fluid). CBH also assumes that divalent ions would mediate the interaction between thiols and other negative charges. *Xf* aggregation was measured after the following treatments: deionized water (negative control), CaCl<sub>2</sub> 100 mg/L (positive control), reduced glutathione 10 mM (GSH), oxidized glutathione 10 mM (GSSG), GSH 10 μM for 20 min + CaCl<sub>2</sub> 50 mg/L and GSSG 10 mM for 20 min + 50 mg/L. Maximum aggregation was obtained with pre-treatment with GSH 10 mM for 20 min followed by exposure of cells to CaCl<sub>2</sub> 50 mg/L. Results indicate that a reducing environment is essential for cell aggregation. A reducing environment apparently modified the surface of *Xf* cells and predisposed them to interact with divalent ions.

## *XYLELLA FASTIDIOSA* GROWTH ON CHARD2, 3G10R AND *Xf*-26 CHEMICALLY-DEFINED MEDIA

### Project Leaders:

Breno Leite  
CVSFR, Florida A&M University  
Tallahassee, FL 32317

Lyriam Marques  
MBEC Bioproducts, Inc.  
Calgary, AB, Canada

Peter C. Andersen  
NFREC, IFAS, University of Florida  
Quincy, FL 32351

Merle Olson  
MBEC Bioproducts, Inc.  
Calgary, AB, Canada

### ABSTRACT

Pierce's disease (PD) in grapevines is caused by the bacterium *Xylella fastidiosa* (*Xf*). *Xf* is injected into xylem vessels by leafhoppers. *Xf* can grow planktonic (free cells) or can form aggregates or biofilm (colonies). Growth and biofilm formation of UCLA and STL PD strains was compared in three chemically-defined media, *Xf*-26 (22 components), CHARD2 (10 components) and 3G10R (9 components). PW<sup>+</sup>, a rich non-defined medium, was used as a control. Both planktonic growth and biofilm formation were assessed during the incubation period. CHARD2, which has the amino acid cysteine as a component, was by far the best medium inducing biofilm formation. CHARD2 and *Xf*-26 differed in planktonic growth; CHARD2 exhibited no detectable planktonic growth, whereas *Xf*-26 cultures were predominantly planktonic. 3G10-R performance was below the expectations, since this medium has performed satisfactorily before as an aggregation inducer. 3G10-R has reduced glutathione (reducing agent), however it contains glucose, which is not present in CHARD2. We hypothesize that the redox environment, in each medium, induced the differences in biofilm architecture verified.



## IDENTIFICATION OF TRAITS OF *XYLELLA FASTIDIOSA* CONFERRING VIRULENCE TO GRAPE AND INSECT TRANSMISSION BY ANALYSIS OF GLOBAL GENE EXPRESSION USING DNA MICROARRAYS

### Project Leader:

Steven Lindow  
Department of Plant and Microbial Biology  
University of California  
Berkeley, CA 94720

### Cooperators:

Nian Wang and Bill Feil  
Department of Plant and Microbial Biology  
University of California  
Berkeley, CA 94720

### ABSTRACT

*Xylella fastidiosa* (*Xf*) regulates virulence factors important in both virulence to grape as well as colonization of sharpshooter vectors via its production of a fatty acid molecule (known as DSF) whose production is encoded by *rpfF*. The *rpfF* homologue of *Xf* strains that cause Pierce's disease (PD), synthesizes a fatty acid cell-cell signal (DSF) that is apparently similar to that produced by *Xanthomonas campestris* *pv. campestris*. *Xf rpfF* mutants exhibit increased virulence to plants; however, they are unable to be spread from plant to plant by their insect vectors. While we have identified a key regulator of virulence and insect transmission in *Xf* we lack an understanding of the traits that are regulated by this pathogen in response to the DSF signal molecule. We thus are initiating studies to determine the *rpfF*-regulation in *Xf*. The objectives of our study are: 1) determine those genes in *Xf* whose transcription is controlled by *rpfF*, the regulator of virulence and insect transmission, by assessing global gene expression using DNA microarrays, 2) determine the number and identity of genes in *Xf* that are expressed in grape plants but not in culture by assessing global gene expression using DNA microarrays, and 3) assess the contribution of individual genes of *Xf* whose transcription is dependent on *rpfF* to its virulence and insect transmissibility. We are exploiting a DNA microarray developed in another project that addresses host specificity genes in *Xf* to assess gene expression differences in isogenic *rpfF*<sup>+</sup> and *rpfF*<sup>-</sup> strains of *Xf* strain Temecula. The microarray contains 2,555 gene-specific 70 bp oligodeoxynucleotides including negative and positive controls. We have isolated RNA from *Xf* strains grown both in culture as well as isolated from plants. After differential labeling with the fluorescent cyanine dyes Cy3 and Cy5, cDNAs made from these RNAs have been hybridized to the microarray. Preliminary results reveal that at least 150 genes are up-regulated in response to *rpfF* in *Xf* while at least 40 genes are repressed. Clearly this regulator has a large effect on the physiological function of *Xf*. Microarray-based gene expression results are being verified using quantitative Reverse Transcriptase-PCR. Work is also underway to determine the subset of *Xf* genes that might be plant-inducible and the identity of those whose expression is dependent on DSF production.

## EVALUATION OF GENETIC DIVERSITY WITHIN *XYLELLA FASTIDIOSA* STRAINS ACROSS TEXAS

### Project Leaders:

Marlin Mathews, Borislava Tsanova, and Lisa Morano  
Department of Natural Sciences  
University of Houston - Downtown  
Houston, TX 77002

### ABSTRACT

Strains of *Xylella fastidiosa* have been isolated from infected grapevines and the vegetation surrounding vineyards. The *gyraseB* gene has been sequenced for approximately 20 strains and most of the strains fall into one of two categories, the grape group and the mulberry/ragweed group. Strains isolated from grape typically matched grape strains in the database and strains isolated from weeds and trees around vineyards closely matched the mulberry/ragweed sequences. However, one isolate from an infected grapevine was found to be a mulberry/ragweed strain suggesting that strains typically found in weeds can move into nearby grapevines. Due to the highly conserved nature of the *gyraseB* gene within strains we are also evaluating our cultures by PCR amplicon size for several small subunit repeats as suggested by Dr. Lin of USDA, ARS in California. This method creates a DNA fingerprint of each strain. Using this technique we are able to demonstrate that there are multiple mulberry/ragweed strains and multiple grape strains across Texas. We hope to combine these fingerprints with information about strain location to better understand the epidemiology of disease spread into newly infected vineyards. With fingerprint information on strains we also hope to create a phylogenetic tree of Texas strains to combine with similar data in other states allowing us to further understand the natural history and epidemiology of Pierce's disease.

## GENES REQUIRED FOR TYPE IV PILI FORMATION AND TWITCHING MOTILITY IN *XYLELLA FASTIDIOSA*

### Project Leaders:

Y. Li, G. Hao, C. D. Galvani, Y. Meng, T. J. Burr, and H. C. Hoch  
Department of Plant Pathology  
Cornell University, NYSAES  
Geneva, NY 14456

### ABSTRACT

*Xylella fastidiosa* (*Xf*) (Temecula isolate), an important phytopathogen causing Pierce's disease (PD) of grapevine, was recently shown to possess both type I and type IV pili. It was also shown that the bacteria exhibit type IV pili-mediated twitching motility on modified PW agar, and possess the ability to migrate preferentially against a flowing current. The EZ::TN transposome system was used to develop twitching-defective mutants. Cloning and sequencing analysis revealed seven associated genes residing in three *pil* gene clusters, including the *pilX* cluster (*fimT* and *pilX* and *pilY1*), *pilQ* cluster (*pilQ* and *pilO*) and *pilA* cluster (*pilB* and *pilR*). The *fimT*, *pilX*, *pilQ*, *pilO*, *pilB* and *pilR* mutants lack the twitching phenotype, while the *pilY1* mutant colony exhibited significantly reduced twitching. Transmission electron microscopy revealed that no type IV pili were present on the non-twitching mutants, although type I pili were present. Both types of pili are present at one pole of wild type cells. The results suggest that the *pil* genes disrupted in this study are required for type IV pili formation and twitching motility in *Xf*.



---

***Section 4:  
Pathogen  
and Disease  
Management***





# SYMBIOTIC CONTROL OF PIERCE'S DISEASE: TESTING REAGENTS AGAINST *XYLELLA FASTIDIOSA*

## Project Leader:

Arinder K. Arora and Timothy S. Yolo  
Department of Entomology  
University of California  
Riverside, CA 92521

## Project Director:

Thomas A. Miller  
Department of Entomology  
University of California  
Riverside, CA 92521

## Collaborators:

Carol Lauzon  
Department of Biological Sciences  
California State University,  
Hayward, CA 94542

David Lampe  
Department of Biological Sciences  
Duquesne University  
Pittsburg, PA 19219

## Consultant:

Frank Richards  
Yale Medical School  
New Haven, CT 06520

**Reporting Period:** The results reported here are from work conducted June 2005 to September 2005.

## ABSTRACT

Pierce's disease (PD) is caused by a xylem limited gram-negative *Xylella fastidiosa* (*Xf*) bacterium. Various species of sharpshooters, including the important glassy-winged sharpshooter (GWSS), transmit *Xf*. Currently, there is no cure for PD. Paratransgenesis is a new tool for the management of PD. Acquisition efficiency of GWSS to acquire *Xf* is about 80% when tested with Real-Time PCR. Results of selected phage antibody specific to *Xf* PD-strain to disrupt the pathogen are underway.

## INTRODUCTION

Strains of *Xylella fastidiosa* (*Xf*), a gram-negative bacterium, cause a number of important plant diseases including Pierce's disease (PD) in grapevine, citrus variegated chlorosis (CVC) in citrus, phoney peach disease, periwinkle wilt, and leaf scorch disease in plum, elm, maple, sycamore, and coffee (Hopkins 1989).

The principal vector for the transmission of *X. fastidiosa* is the glassy-winged sharpshooter (GWSS) (*Homalodisca coagulata*). The pathogen attaches to the cibarium and precibarium of sharpshooters by means of an extracellular matrix (ECM) and is transmitted from infected plants to healthy plants when the sharpshooters feed (Brlansky et al. 1983).

Symbiotic control identifies a symbiont that is genetically modified to produce a gene product that inhibits transmission of a pathogen. Recent examples of symbiotic control are the control of Chagas' disease caused by *Trypanosoma cruzi* and transmitted by the Triatomid bug *Rhodnius prolixus* (Durvasula et al. 1997), the prevention of Colitis in mammals (Beninati et al. 2000, Steidler et al. 2001), and to interfere with HIV transmission (Chang et al. 2003).

This approach is being developed for the management of PD. *Alcaligenes xylosoxidans* subsp. *denitrificans* (*Axd*) was chosen for genetic modification to deliver an anti-*Xylella* product. *Axd* is appropriate because it shares the same niche as *Xf* in the foregut of the GWSS and cycles well between the insect and plant system. Also, this bacterium has been described as a non-pathogenic soil-borne microbe and a non-pathogenic endophyte (Meade et al. 2001).

Single chain antibody (scFV S1), which is expressed on the surface of a M13 bacteriophage, has been selected against *Xf* PD-strains by using a panning technique. S1 is supposed to bind to the surface of a *Xf* PD-strain. Currently we are testing S1 in an *in vitro* insect-plant-pathogen system.

## OBJECTIVES

1. Test the acquisition of *Xf* by GWSS feeding on infected *Vinca major*.
2. Test the efficiency of S1 to inhibit *Xf* transmission on *V. major*.

## RESULTS

Field collected GWSS from a citrus orchard were put into an artificial feeding system (AFS) to acquire S1. Afterwards the GWSS were allowed an acquisition access period (AAP) on a *Xf* PD-strain infected *V. major* for 48 hours. Then, these sharpshooters were transferred onto clean test *V. major* plants and allowed an inoculation access period (IAP) of 48 hours. After 6 weeks these test plants were tested for *Xf* colonization by Real-Time PCR (rt-PCR). Negative controls were an anti-BSA phage and PBS. Each of the three treatment groups was mixed with 0.2% dextrose in a 1:4 ratio, respectively. The AFS consists of multiple plastic vials each with a vinyl tube both closed with wrapped parafilm and filled with the appropriate above said solution.

In another set of experiments the field collected GWSS were allowed an AAP of 48 hours on the *Xf* PD-strain infected *V. major*. Then these GWSS were transferred to the AFS to acquire S1, anti-BSA phage, and PBS solution for 48 hours.

Thereafter these GWSS were allowed an IAP on clean *V. major* for 48 hours. And then these plants were tested for *Xf* colonization via rt-PCR after 6 weeks.

In both sets of experiments the transmission of *Xf* by GWSS was tested by allowing the sharpshooters to feed first on the *Xf* PD-strain infected *V. major* for 48 hours. Then these test insects were transferred onto clean test plants to feed for 48 hours. The results of the experiments are pending.

Samples of the GWSS that fed on the *Xf* PD-strain infected plant for 48 hours were taken and then their heads were tested for the presence of *Xf* via rt-PCR. Eighty percent (range 70-100%) of GWSS heads shows the presence of *Xf*. The field collected GWSS were also tested for the presence of *Xf* via rt-PCR. Only 0-10% (mean = 5%) of the field collected GWSS were found to be infected with *Xf*.

## CONCLUSION

An effective AFS has been developed to allow the GWSS to acquire S1. *V. major* was selected as the model plant for our insect-plant-pathogen system to test S1. Eighty percent of the GWSSs acquire *Xf* after 48 hours of AAP. Experiments on the disruption of *Xf* by S1 are ongoing.

## REFERENCES

- Beninati, C., M. R. Oggioni, M. Boccanera, M. R. Spinosa, T. Maggi, S. Conti, W. Magliani, F. De Bernardis, G. Teti, A. Cassone, G. Pozzi and L. Polonelli. 2000. Therapy of mucosal candidiasis by expression of an anti-idiotypic in human commensal bacteria. *Nat. Biotechnol.* 18:1060-1064
- Brlansky, R. H., L. W. Timmer, W. J. French and R. E. McCoy. 1983. Colonization of the sharpshooter vectors *Oncometopia-nigricans* and *Homalodisca-coagulata* by xylem limited bacteria. *Phytopathology* 73: 530-535.
- Chang, T. L., C. H. Chang, D. A. Simpson, Q. Xu, P. K. Martin, L. A. Lagenaur, G. K. Schoolnik, D. D. Ho, S. L. Hillier, M. Holodniy, J. A. Lewicki and P. P. Lee. 2003. Inhibition of HIV infectivity by a natural human isolate of *Lactobacillus jensenii* engineered to express functional two-domain CD4. *Proc. Natl. Acad. Sci. U. S A.* 100:11672-11677.
- Durvasula, R. V., A. Gumbs, A. Panackal, O. Kruglov, S. Aksoy, R. B. Merrifield, F. F. Richards and C. B. Beard. 1997. Prevention of insect-borne disease: An approach using transgenic symbiotic bacteria. *Proc. Natl. Acad. Sci. USA.* 94: 3274-3278
- Hopkins, D. L. 1989. *Xylella fastidiosa*: xylem limited bacterial pathogen of plants. *Ann. Rev. Phytopath.* 27: 271-290.
- Meade, M J, R. L. Waddell and T. M. Callahan. 2001. Soil bacteria *Pseudomonas putida* and *Alcaligenes xylosoxidans* subsp. *denitrificans* inactivate triclosan in liquid and solid substrates. *FEMS Microbiol Lett.* 204:45-48.
- Steidler, L., W. Hans, L. Schotte, S. Neiryneck, F. Obermeier, W. Falk, W. Fiers and E. Rmaut. 2000. Treatment of Murine Colitis by *Lactococcus lactis* secreting Interlukin-10. *Science* 289: 1352-1354.

## FUNDING AGENCIES

Funding for this project was provided by the USDA Animal and Plant Health Inspection Service, and the CDFA Pierce's Disease and Glassy-winged Sharpshooter Board.

## EXPLOITING XYLELLA FASTIDIOSA PROTEINS FOR PIERCE'S DISEASE CONTROL

### Project Leaders:

George Bruening  
Department of Plant Pathology  
University of California  
Davis, CA 95616

Edwin L. Civerolo  
USDA, ARS  
San Joaquin Valley Agricultural Sciences Center  
Parlier, CA 93648

### Cooperators:

Paul Feldstein and Marta Francis  
Department of Plant Pathology  
University of California  
Davis, CA 95616

Abhaya M. Dandekar  
Department of Pomology  
University of California  
Davis, CA 95616

Goutam Gupta  
MS M888, Biol. Division  
Los Alamos National Lab.  
Los Alamos, NM 87544

**Reporting Period:** The results reported here are from work conducted October 15, 2004 to September 30, 2005.

### ABSTRACT

The principal objective of this project is to construct and express in test plants, and then in grapevine rootstock, a protein or protein chimera capable of inactivating *Xylella fastidiosa* (*Xf*), the causative agent of Pierce's disease (PD) of grapevine. Prior results from this project identified MopB as a, or possibly the, major outer membrane protein of *Xf*. We have shown that MopB is accessible on the *Xf* cell exterior and is a member of the OmpA family of outer membrane proteins of Gram-negative bacteria. The abundance of MopB in *Xf* cell extracts, known packing density of OmpA in a crystal, and *Xf* cell dimensions allowed us to estimate that MopB probably accounts for at least 10% of the *Xf* cell exterior. Thus, MopB is a highly suitable target for inactivation of *Xf* cells. Previous results suggested that some portion of the intact MopB gene from *Xf* is sickening to *E. coli*. Nevertheless, two *E. coli* strains were generated by substitution into the endogenous *OmpA* gene, one expressing mature MopB and the other a MopB-OmpA chimera with the amino-terminal half from MopB. Cells of both strains display MopB antigen on their surface, though accumulation is to a level much lower than MopB achieves in *Xf*. The strains are immune to bacteriophage K3, for which OmpA is the receptor. We modified and randomly mutated the OmpA-binding gp38 adhesin protein of bacteriophage K3 and will use *Xf* cells and the MopB-surface *E. coli* strains described above to select bacteriophage K3 variants that use MopB as the receptor. The selected gp38 gene will form the core of an anti-*Xf* protein. A readily transformed and regenerated tobacco line, SR-1, was identified as being susceptible to *Xf* and producing PD-like symptoms and cytology. SR-1 will be used to test anti-*Xf* proteins and optimize constructions for grapevine transformation. High level expression of a fragment of MopB has been achieved and the same technology will be used to obtain sufficient quantities of MopB to complete its biological characterization.

### INTRODUCTION

Resistant grapevine cultivars present the best approach to long term, effective, economical and sustainable control of Pierce's disease (PD). This project has developed data showing that the OmpA class protein MopB of *Xylella fastidiosa* (*Xf*) is a major outer membrane protein of the bacterium. The demonstrated accessibility of parts of the MopB molecule on the cell surface and its abundance identify MopB as a high priority potential target for inactivation of the *Xf* cell or interference with the *Xf* infection cycle. As background, results from our prior research are summarized below (Bruening et al. 2005):

- a. *Xf* cells, fresh or heat-killed, when pressure-infiltrated into *Chenopodium quinoa* leaves, induce within two days chlorosis (chloroplast bleaching) that is limited to the infiltrated area of the leaf (CqC activity).
- b. The CqC activity is protease sensitive and was associated with a gel electrophoresis band that was found, by mass spectrometry, to contain predominantly the putative (OmpA class) *Xf* outer membrane protein MopB.
- c. The mature, 38.5K MopB protein was found to result from the release of a 22 amino acid leader peptide. The bulk of mature MopB molecules have a pyroglutaminyl amino end.
- d. MopB was partially purified in soluble form using sodium dodecyl sulfate (SDS) solutions but reducing, at the last step, SDS to very low levels.
- e. Application of anti-MopB antibody demonstrated that MopB is accessible on the *Xf* cell exterior and appears to be evenly distributed over the *Xf* cell surface.
- f. MopB is an abundant protein of *Xf* and may be the major outer membrane protein of the bacterium.
- g. *E. coli* did not tolerate plasmid constructions bearing the entire MopB gene from *Xf*. However, placing the MopB open reading frame under control of a bacteriophage-derived promoter allowed the production of low amounts of MopB in *E. coli*.
- h. Both purified MopB and MopB still embedded in *Xf* cells showed a strong propensity to associate tightly with porous materials of a variety of chemical types. This result is reminiscent of the observed association of a *Pseudomonas fluorescens* OmpA protein, OprF, with root surfaces (De Mot and Vanderleyden 1991, Deflaun et al. 1994), MopB may be involved in the association of *Xf* cells with the interior of xylem elements in the inoculated plants.

Our principal objective is to construct and express in test plants, and then in grapevine rootstock, a MopB-binding protein (MBP) or protein chimera capable of inactivating *Xf*. We expect that a construction of suitable design will confer, on the



grapevine scion, resistance to *Xf*. If rootstock expression does not confer scion resistance to *Xf*, we will turn to transformation of the scion. To obtain a high affinity MBP, we are modifying a protein of a T2-like bacteriophage: the tail fiber adhesion gp38 (Riede et al. 1987). The gp38 protein of bacteriophages K3, M1 and OX2 recognizes and binds to *E. coli* OmpA, the receptor for bacteriophage infection. Based on the rapidity and irreversibility of bacteriophage association with *E. coli*, gp38 likely binds very tightly to OmpA. Bacteriophage mutants with “shifted allegiance” away from OmpA and to other *E. coli* surface proteins were selected using *E. coli* mutants with altered or missing OmpA. In one instance, the new receptor was a polysaccharide rather than an outer membrane protein (Drexler et al. 1991). The mutations controlling affinity for the new receptor mapped to four polypeptide loops of gp38 (Drexler et al. 1989). We believe a mutated gp38 could have a high affinity for MopB. OX2 apparently has been lost. M1 has been more readily adapted than has K3 to new receptors (Henning and Hashemolhosseini 1994). We obtained inocula of bacteriophage K3 and bacteriophage M1 from a former postdoctoral associate in the laboratory of Ulf Henning (deceased) in Germany.

The predominant conformation of a typical OmpA protein, as it resides in the outer membrane of *E. coli*, almost certainly has the polypeptide chain composed of amino acid residues 1-171 inserted into the outer membrane with 8 trans-membrane segments and four external loops (Pautsch and Schulz 1998, Singh et al. 2003). We have cast MopB into a similar conformation based on the crystallographic structure of OmpA (Pautsch and Schulz 1998) and computer predictions of folding for OmpA and MopB and have initiated research aimed at converting gp38 from a OmpA-binding protein to a MBP. That is, our initial aim is to select a version of gp38 that has been modified in its receptor-binding four loops to recognize and adhere tightly to the cell-external four loops of MopB.

## OBJECTIVES

The goal of this project is to generate *Xf*-resistant grapevine rootstock and plants based on expression of a MBP.

### Specific objectives:

1. Discover or develop low molecular weight MBPs with high affinity for portions of the MopB protein that are displayed on the *Xf* cell exterior.
2. Test MopB-binding proteins for their ability to coat *Xf* cells, for possible bactericidal activity, and for interference with disease initiation following inoculation of grape with *Xf*.
3. In collaboration with the Gupta laboratory, develop gene constructions for chimeric proteins designed to bind tightly to and inactivate *Xf* cells; express and test the chimeric proteins for their effects on *Xf* cells in culture.
4. In collaboration with the Dandekar laboratory, prepare transgenic grape expressing the candidate anti-*Xf* proteins; test the transgenic plants for resistance to infection by *Xf*.

## RESULTS

### Under Objective 1 (discover MBPs)

#### *Expression of MopB on the E. coli cell surface*

Obtaining *E. coli* cells that express MopB sequences and display MopB surface polypeptide loops, as is characteristic of MopB in *Xf*, is central to our selection procedure for MBPs. As was reported in the previous period, we created an *E. coli* strain that was designed to display MopB sequences on the cell exterior but to otherwise be compatible with expression in *E. coli*. Using a gene-replacement approach, a recombinational event replaced the amino terminal region, residues 1-171, of the chromosomal *OmpA* gene of *E. coli* with the corresponding region of MopB. This construction retains the OmpA signal peptide and the OmpA carboxyl half of the molecule, which includes the trans-periplasmic space sequences and the sequence that is inserted into the peptidoglycan layer. The replacement was confirmed by sequence analysis after PCR amplification of the chimeric gene region from chromosomal DNA. A similar approach has now produced an OmpA replacement which was designed to generate the entire mature MopB molecule. Cells of the new *E. coli* strains were found to be entirely resistant to bacteriophage K3 and to be agglutinated by beads displaying anti-MopB IgG, as expected. Immunoblots were prepared after SDS-PAGE of *E. coli* hot-SDS cell extracts for the two strains. Results (not shown) revealed the accumulation of MopB-like proteins of the expected mobility. However, the MopB-immunoreactive material from the *E. coli* strains amounted to no more than a few percent of the signal observed for similar amounts (total protein) of *Xf* cells. Expression of mature MopB and MopB-OmpA chimera proteins appears to be below the level of OmpA accumulation in wildtype *E. coli*. We suspect that there is a codon usage problem for the synthesis of MopB and MopB-OmpA chimera in *E. coli* and are taking steps to introduce the cognate tRNAs.

#### *Modification of gp38 for adhesion to MopB.*

We attempted to find bacteriophage K3 variants capable of infecting MopB-OmpA chimera-bearing *E. coli* cells. The cells were exposed to  $10^{10}$  plaque forming units of untreated bacteriophage K3 and to bacteriophage K3 populations that had been treated with the mutagen hydroxylamine or that had been increased in cells exposed to the *in vivo* mutagen 2-aminopurine. No infecting K3 variant was found. Henning and Hashemolhosseini (1994) report that bacteriophage M1 is more suited than K3 to adaptation to receptors other than OmpA. We obtained bacteriophage M1 inoculum, but found it to behave similarly to K3 in our tests. PCR amplification of a gp38 sequence from the “M1” DNA revealed the sequence of K3 gp38, suggesting that bacteriophage M1, like bacteriophage OX2, may no longer be available. We are in the process of creating a library of mutated gp38 sequences based on the published M1 gp38 sequence. These will be introduced into bacteriophage K3 to create

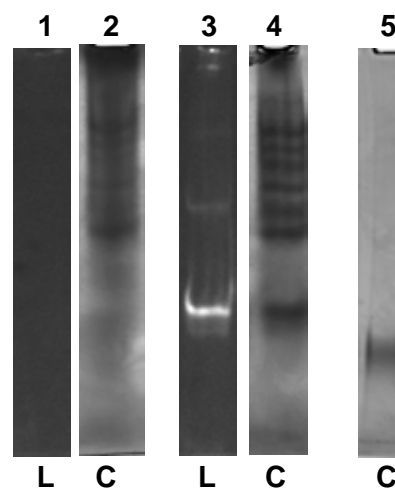
a library of mutants for selection of MopB-binding gp38. Selection will use *Xf* cells as well as the MopB-surface *E. coli* strains.

### **MopB and the CqC assay**

Cell suspensions from the chimeric MopB-OmpA and mature MopB *E. coli* strains were pressure infiltrated into *C. quinoa* leaves. Both cell suspensions, as well as wildtype *E. coli* cell suspensions, behaved similarly. A CqC reaction was observed at the higher cell suspension densities, and the reaction was similar for all three suspensions. That is, *E. coli* appears to have an endogenous CqC-like activity. Given the demonstrated low accumulation of MopB-OmpA chimeric protein and MopB in the *E. coli* strains, CqC activity from the expressed proteins, if any, most likely was overshadowed by the endogenous CqC-like activity of *E. coli*.

We are preparing constructions for expression of intact MopB and specific MopB fragments using the high level expression (Dubendorff and Studier 1991) pET160 plasmid system. The first to be completed produced the carboxyl half of MopB, as indicated in Figure 1. The CqC assay of the purified protein preparation (analyzed at Figure 1, lane 5) failed to induce chlorosis when infiltrated into *C. quinoa* leaves, whereas control preparations of *Xf* cells induced the usual CqC reaction, suggesting that CqC activity does not reside in the carboxyl half of MopB alone.

**Figure 1.** Production of microgram amounts of the carboxyl half of *Xf* outer membrane protein MopB in transformed *E. coli*. Sequence encoding the carboxyl half of the mature MopB protein was inserted into a pET160 plasmid vector on the 3'-side of tetracycline- and hexahistidine-encoding sequences and under control of a bacteriophage T7 promoter and *lac* operator sequence. The construction was transformed into an *E. coli* strain that lacks a bacteriophage T7 RNA polymerase gene for characterization and propagation of the clone. This approach is intended to prevent even basal level expression of the insert sequences. For high level expression, purified plasmid is transformed into BL21 Star *E. coli* cells, which encode T7 RNA polymerase under control of a *lacUV5* promoter. Cultures were grown up directly without isolation of individual colonies and were exposed (lanes 3-5) or not exposed (lanes 1, 2) to the gratuitous inducer IPTG. Protein extracts were incubated with the tetracycline-binding fluorescent lumio reagent prior to electrophoresis through 12% polyacrylamide in SDS. Detection was by lumio fluorescence (lanes 1 and 3, L) or by staining of the gel with coomassie brilliant blue (lanes 2, 4, and 5, C). Lanes 1-4 are from one gel. Material for lane 5 was purified from lane 3 material by nickel column chromatography in urea solution.



### **Under Objective 4 (transgenic plant expression of anti-Xf protein)**

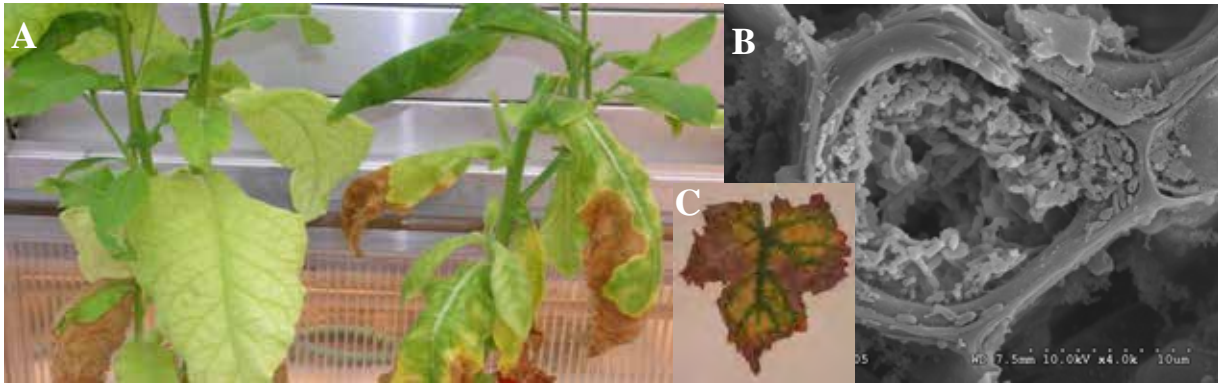
#### ***Test bed for analysis of constructions designed to express anti-Xf protein***

To facilitate our goal of creating grape rootstock that can confer resistance to *Xf* on its grafted scion, we developed a plant model system for rapid transformation with anti-*Xf* constructions and rapid testing for phenotype (Francis et al. 2005), compared to grapevine. Constructions discovered to have promising anti-*Xf* activity will be used to transform a grapevine rootstock line. We have demonstrated that tobacco (*Nicotiana tabacum*) line SR-1, which is routinely transformed and regenerated at the UC Davis College of Agricultural and Environmental Sciences Plant Transformation Facility, is readily infected by needle inoculation into the petiole axil or stem. *Xf* was recovered from the petiole above inoculation points, whereas no bacteria were recovered from water-inoculated controls. Symptoms developed (Figure 2A) and *Xf* accumulated, as indicated by ELISA, quantitative PCR, and clogging of xylem vesicles (Figure 2B), providing unequivocal evidence of infection. Others have succeeded in infecting *N. tabacum* strains with *Xf* (Lopes et al. 2000, Alves et al. 2003). The symptoms we observe appear to be more dramatic than those reported. *Xf* isolated from SR-1 tobacco caused typical PD symptoms following artificial inoculation to grapevines (Figure 2C).

### **CONCLUSIONS**

The goal of this project is to create genes encoding anti-*Xf* proteins for transformation of grape rootstock and protection of the grafted scion against PD. *E. coli* strains were created that display on the cell exterior portions of a *Xf* major outer membrane protein, MopB. These strains are expected to be suitable hosts for a bacteriophage that will accept a displayed portion of MopB as a receptor. A synthetic bacteriophage gp38 adhesin gene has been randomly mutated and will be incorporated into a population of bacteriophage K3 to produce a library from which bacteriophage strains that use MopB as a receptor will be selected. The selected gp38 gene will form the core of an anti-*Xf* protein. High level expression of a fragment of MopB has been achieved and will be applied to full length MopB to complete its biological characterization. A

readily transformed and regenerated tobacco line, SR-1, has been identified as a suitable platform for testing and optimizing anti-*Xf* protein gene constructions.



**Figure 2.** SR-1 tobacco as a host for *Xf*. A. Water-infiltrated (left) and *Xf*-inoculated plants 3 months after inoculation at the 6 leaf stage. Although leaves of control plants developed senescence, none developed the downward curvature, cupping and tip- and margin-necrosis with chlorotic halo that are characteristic of the *Xf*-inoculated plants. 4/4 leaves from two control plants were negative for *Xf* by ELISA and PCR. Extracts of 7/7 leaves from three *Xf*-inoculated plants generated ELISA signals averaging 4x the control level; quantitative PCR signals exceeded the threshold product accumulation at 19-31 cycles. B. Electron microscopy of SR-1 petiole sections at 10-12 nodes above the inoculated leaf revealing bacterial cells occluding a xylem element. C. Sap from Temecula-1 *Xf*-inoculated, symptomatic SR-1 tobacco was inoculated to grapevine cuttings, resulting in typical PD symptoms and accumulation of *Xf*.

## REFERENCES

- Alves, E., E. W. Kitajima, and B. Leite. 2003. Interaction of *Xylella fastidiosa* with different cultivars of *Nicotiana tabacum*: A comparison of colonization patterns. *Journal of Phytopathology* (Berlin) 151: 500-506.
- Bruening, G., E. L. Civerolo, Y. Lee, J. M. Buzayan, P. A. Feldstein, and E. Re. 2005. A major outer membrane protein of *Xylella fastidiosa* induces chlorosis in *Chenopodium quinoa*. *Phytopathology* 95: S14.
- De Mot, R., and J. Vanderleyden. 1991. Purification of a root-adhesive outer membrane protein of root-colonizing *Pseudomonas fluorescens*. *FEMS Microbiology Letters* 81: 323-328.
- Deflaun, M. F., B. M. Marshall, E. P. Kulle, and S. B. Levy. 1994. Tn5 insertion mutants of *Pseudomonas-fluorescens* defective in adhesion to soil and seeds. *Applied and Environmental Microbiology* 60: 2637-2642.
- Drexler, K., I. Riede, D. Montag, M. L. Eschbach, and U. Henning. 1989. Receptor specificity of the *Escherichia-coli* T-even type phage Ox2 mutational alterations in host range mutants. *Journal of Molecular Biology* 207: 797-804.
- Drexler, K., J. Dannull, I. Hindennach, B. Mutschler, and U. Henning. 1991. Single mutations in a gene for a tail fiber component of an *Escherichia coli* phage can Cause an extension from a protein to a carbohydrate as a receptor. *Journal of Molecular Biology* 219: 655-664.
- Dubendorff, J. W., and F. W. Studier. 1991. Controlling basal expression in an inducible T7 expression system by blocking the target T7 promoter with lac repressor. *Journal of Molecular Biology* 219: 45-60.
- Francis, M., E. L. Civerolo, and G. E. Bruening. 2005. *Nicotiana tabacum* cv. SR-1 is highly susceptible to *Xylella fastidiosa* associated with Pierce's disease in California. *Phytopathology* 95: S31.
- Henning, U., and S. Hashemolhosseini. 1994. 23. Receptor recognition by T-even-type coliphages, pp. 291-298. In J. D. Karam (ed.), *Molecular biology of bacteriophage T4*. American Society for Microbiology, Washington, D.C.
- Lopes, S. A., D. M. Ribeiro, P. G. Roberto, S. C. Franca, and J. M. Santos. 2000. *Nicotiana tabacum* as an experimental host for the study of plant-*Xylella fastidiosa* interactions. *Plant Disease* 84: 827-830.
- Pautsch, A., and G. E. Schulz. 1998. Structure of the outer membrane protein A transmembrane domain. *Nature Structural Biology* 5: 1013-1017.
- Riede, I., K. Drexler, H. Schwarz, and U. Henning. 1987. T-even-type bacteriophages use an adhesin for recognition of cellular receptors. *Journal of Molecular Biology* 194: 23-30.
- Singh, S. P., Y. U. Williams, S. Miller, and H. Nikaido. 2003. The C-terminal domain of *Salmonella enterica* serovar *Typhimurium* OmpA is an immunodominant antigen in mice but appears to be only partially exposed on the bacterial cell surface. *Infection & Immunity* 71: 3937-3946.

## FUNDING AGENCIES

Funding for this project was provided by the CDFA Pierce's Disease and Glassy-winged Sharpshooter Board, and the USDA Agricultural Research Service.

# SIDEROPHORE PRODUCTION OF *ALCALIGENES XYLOSOXIDANS DENITRIFICANS* AND POTENTIAL BIOLOGICAL CONTROL AGAINST *XYLELLA FASTIDIOSA*

## Project Leaders:

Surachet Chareonkajonchai  
CMDB Graduate Program  
University of California  
Riverside, CA 92521

Paulo Teixeira Lacava  
Department of Entomology  
University of California  
Riverside, CA 92521

## Project Director:

Thomas A. Miller  
Department of Entomology  
University of California  
Riverside, CA 92521

## Collaborators:

Carol Lauzon  
Department of Biological Sciences  
California State University  
Hayward, CA 94542

David Lampe  
Department of Biological Sciences  
Duquesne University  
Pittsburgh, PA 19219

## Consultant:

Frank Richards  
Yale University  
New Haven, CT 06520

**Reporting Period:** The results reported here are from work conducted June 2005 to October 2005.

## ABSTRACT

Our overall objective is to determine siderophores produced from *Alcaligenes xylosoxidans denitrificans* (*Axd*), isolated from glassy-winged sharpshooter (GWSS), *Homalodisca coagulata* Say (Hemiptera: Cicadellidae) (Bextine et al. 2004), and to investigate the ability of *Xylella fastidiosa* (*Xf*) to obtain iron from siderophores produced by *Axd*. We are also interested in the effect of siderophores as a potential biological control against *Xf*.

## INTRODUCTION

Most bacteria must acquire iron by competing with environmental chelation. One mechanism for bacterial iron acquisition utilizes siderophores (Kline et al. 2000). Siderophores are small molecules that bind extracellular iron with high affinity (Neilands 1995). The presence of coding genes for iron uptake membrane receptors in *Xf* (Simpson et al. 2000) suggest that *Xf* biosynthesize and uptake siderophores (Silva-Stenico et al. 2005).

## OBJECTIVES

1. Determine if *Axd* produces siderophores that *Xf* can binds.
2. Investigate the interaction between *Axd* and *Xf* in iron-restricted environment.

## RESULTS AND CONCLUSIONS

By using CAS-agar assay (Schwyn and Neilands 1987), the difference strains of *Axd* have been tested for siderophores production. This is due to the difficulty of promoting production of siderophores suggesting that siderophores are crucial for biosynthesis. We are investigating a potential biological control of siderophores against *Xf*.

## REFERENCES

- Bextine, B., C. Lauzon, S. Potter, D. Lampe, and T. A. Miller. 2004. Delivery of a genetically marked *Alcaligenes* sp. to the glassy-winged sharpshooter for use in a paratransgenic control strategy. *Curr. Microbiol.* 48: 327-331.
- Silva-Stenico, M. E., F. T. H. Pacheco, J. L. M. Rodrigues, E. Carrilho, and S. M. Tsai. 2005. Growth and siderophore production of *Xylella fastidiosa* under iron-limited conditions. *Microbiol. Res.* 160: 429-436.
- Kline, T., M. Fromhold, T. E. McKennon, S. Cai, J. Treiberg, N. Ihle, D. Sherman, W. Schwan, M. J. Hickey, P. Warrenner, P. R. Witte, L. L. Brody, L. Goltry, L. M. Barker, S. U. Anderson, S. K. Tanaka, R. M. Shawar, L. Y. Nguyen, M. Langhorne, A. Bigelow, L. Embuscado, and E. Naeemi. 2000. Antimicrobial effects of novel siderophores linked to beta-lactam antibiotics. *Bioorg. Med. Chem.* 8: 73-93.
- Neilands, J. B. 1995. Siderophores: structure and function of microbial iron transport compounds. *J. Biol. Chem.* 270: 26723-26726.
- Schwyn, B., and J. B. Neilands. 1987. Universal chemical assay for the detection and determination of siderophores. *Anal. Biochem.* 160: 47-56.
- Simpson, A. J., F. C. Reinach, et al. 2000. The genome sequence of the plant pathogen *Xylella fastidiosa*. *Nature* 406: 151-157.

## FUNDING AGENCIES

Funding for this project was provided by the USDA Animal and Plant Health Inspection Service, and the CDFA Pierce's Disease and Glassy-winged Sharpshooter Board.

**Additional Notes:** All of the field tests were conducted under a permit from the Environmental Protection Agency (TERA R-03-01). A report of the tests was submitted to EPA and the sponsors.

# EFFECTS OF GROUP, CULTIVAR, AND CLIMATE ON THE ESTABLISHMENT AND PERSISTENCE OF *XYLELLA FASTIDIOSA* INFECTIONS CAUSING ALMOND LEAF SCORCH

## Project Leaders:

Kent M. Daane and Alexander Purcell  
Department of Environmental Science, Policy and Management  
University of California  
Berkeley, CA 94720

## Cooperator:

Bruce Kirkpatrick  
Department of Plant Pathology  
University of California  
Davis, CA 95616

## Cooperating Researcher:

Christina Wistrom  
Department of Environmental Science, Policy and Management  
University of California  
Berkeley CA 94720

**Reporting Period:** The results reported here are from work conducted July 2004 to September 2005.

## ABSTRACT

Almonds are one of the most widely-grown crops that can host *Xylella fastidiosa* (*Xf*), so it is useful to assess the potential for almonds to serve as a source of *Xf* infections in grapes, and to explain why *Xf* dispersal between almond orchards and vineyards is uncommon. We are comparing infection establishment and survival at two field sites and in a controlled test with potted plants, varying three factors that may influence almond leaf scorch in almonds: cultivar, genetics of the pathogenic bacteria, and winter severity. In spring and summer 2005, we inoculated grape type and two almond types of *Xf* into highly susceptible 'Peerless' and less-susceptible 'Butte' almond trees. After vector inoculation, *Xf* must survive multiple winters in an almond tree to reach sufficient populations for sharpshooter acquisition and economic impact disease levels. Therefore, field sites were selected with moderate and severe winter temperatures. We also initiated a controlled dormancy test with potted plants and cold storage rooms at Kearny Agricultural Center, Parlier, California. Almond trees in the field were inoculated with buffer or *Xf* belonging to the grape type or two almond types, and will be held at different chill temperatures for varying lengths of time.

## INTRODUCTION

Because almonds are one of the most widely-grown crops that can host *Xf* in the Central Valley, they might serve as a source of *Xf* infections in grapes, although for unknown reasons *Xf* dispersal between almond orchards and vineyards is uncommon (A. Purcell – *unpublished data*). Almond leaf scorch (ALS) is caused when *Xf* multiplies extensively within the xylem of infected trees, eventually severely limiting nut production (Davis et al. 1980). The disease was first formally described in 1974, though outbreaks occurred in Los Angeles and Contra Costa counties in the 1950's (Moller et al. 1974). Symptoms of ALS are similar to Pierce's disease (PD) in grapes and include leaves with marginal necrosis and chlorosis and the lack of terminal growth. Initial infections spread slowly and often occur only on one branch, but after a few years are easily visible on the entire tree (Almeida and Purcell 2003c), reducing almond productivity (Mircetich et al. 1976, Moller et al. 1974). In both grapes and almonds, *Xf* multiplies to high populations (1,000,000 bacteria per gram of plant tissue) and is acquired and transmitted by insect vectors (Almeida and Purcell 2003a, Almeida and Purcell 2003c, Purcell 1980a). In laboratory tests, *Xf* was transmitted to almonds by 5 species of xylem-feeding insects, including the glassy-winged sharpshooter (GWSS), *Homalodisca coagulata* (Almeida and Purcell 2003b, 2003c).

In previous studies, almond cultivars varied greatly in their susceptibility to ALS, with some developing extensive leaf scorch, and others showing little disease. *Xf* inoculations made from May through July had the best odds of surviving the following winter. (B. Kirkpatrick – *unpublished data*). We compared *Xf* infection establishment and survival in two cultivars, highly susceptible 'Peerless' and less-susceptible 'Butte,' both on Nemaguard rootstock.

The genetic type of *Xf* may also impact almond susceptibility, and will certainly impact formation of PD. Three genetic types of *Xf* have been identified from almond trees. One type was identical to *Xf* from PD-infected grapevines. The other two genetic types were unique to almonds (Hendson et al. 2001). The three types were distinguished by growth on selective media and DNA digestion with restriction enzymes (Almeida and Purcell 2003c). Recent cross-inoculation studies in the greenhouse showed that the genetic type influenced the ability of the bacteria to over winter in grapes or almonds, as almond types died in grapes and grape types died in almonds (Almeida and Purcell 2003c). For this reason, we also used different genetic types of *Xf* in our field trials.

After vector inoculation, *Xf* must survive multiple winters in an almond tree to reach sufficient populations for sharpshooter acquisition and economic impact disease levels. Growth chamber and field studies with grapevines showed that the degree of plant dormancy, as well as severe cold, affected the over winter survival of *Xf* (Feil and Purcell 2001, Purcell 1980b). To date, there is no information available on the effects of winter dormancy on *Xf* infections in almonds. Growth chamber and

field studies with grapevines showed that the degree of plant dormancy, as well as severe cold, affected the over winter survival of *Xf* infections. To date, there is no information available on winter dormancy effects on *Xf* infections in almonds.

We are comparing infection establishment and survival at two field sites and in a controlled test with potted plants, varying three factors that may influence almond leaf scorch in almonds: cultivar, genetics of the pathogenic bacteria, and winter severity. Therefore, field sites were selected with moderate and severe winter temperatures (Armstrong Farm at University of California, Davis, and Intermountain Research and Extension Center at Tulelake, California, respectively) in order to study treatment impact under different winter temperatures. A controlled dormancy severity test with potted plants and growth chambers was also started at Kearny Agricultural Center, near Parlier, California.

## OBJECTIVES

1. Compare the establishment and multi-year persistence of *Xf* isolates belonging to three ALS genetic groups in almond cultivars with either low or high susceptibility to almond leaf scorch.
2. Compare effects of winter severity and the degree of plant dormancy on the infection rate, symptom severity, and titer of *Xf* in inoculated almonds.
3. Use collected data on almond leaf scorch development to determine if almond orchards may serve as a reservoir of *Xf*.

## RESULTS

### Field trials

One hundred bare-root almond trees, fifty of each cultivar, were planted in spring 2005 at two different field sites: Armstrong Farm at University of California, Davis, (hereafter referred to as UCD), and Intermountain Research and Extension Center, Tulelake, CA (hereafter referred to as IRC). Trees were planted in a complete randomized block design with a split plot (almond cultivars) in each block. There are ten replicates of each treatment combination (*Xf* isolate x almond cultivar). Trees are drip irrigated at UCD and sprinkler irrigated at IRC.

The almonds trees were inoculated with different genetic types of *Xf*. In our study, each tree was inoculated with one of five treatments: Fresno-ALS (isolated from almonds but genetically similar to *Xf* that causes PD in grapes; PD-*Xf*), Dixon (ALS-*Xf* type 1) and ALS 6 (ALS-*Xf* type 2), Medeiros (from grapes), or buffer control. All isolates of *Xf* were isolated from infected plants in Solano, Fresno, or San Joaquin Counties, and were pathogenic in recent greenhouse tests. Inoculations were done in early May (UCD) and early July (IRC) when the young shoots were at least 6 mm in diameter. Inoculum was prepared in the field from two week old cultures *Xf* grown on solid media. Each isolate was mechanically inoculated into 3 or 4 sites in 1 stem per plant by placing a 10  $\mu$ L drop of bacteria suspended in sodium-citrate-phosphate buffer (approximately 10,000,000 bacteria/ mL). The drop was placed on a green, growing shoot and probed with a #2 insect pin until it was drawn into the stem. Inoculation sites were marked with permanent metal tags and paint.

Leaves immediately adjacent to the inoculation sites were tested for *Xf* in fall 2005 to see if inoculations were successful. The severity of infection was rated by the number of scorched leaves on the inoculated stem. Almond petioles from each tree were cultured to determine *Xf* infection and population. Subsequent strain identification of *Xf* was accomplished by re-streaking growing bacteria on two different artificial media, PD3 and PWG (Davis et al 1983, Davis et al 1980, Hill and Purcell 1995). All types of *Xf* grow on PWG, while ALS-*Xf* type 2 and PD types grow on PD3 as well. ALS-*Xf* type 1 does not (Almeida and Purcell 2003c). To separate ALS and PD isolates, polymerase chain reaction (PCR) was used to amplify DNA from the bacteria, and DNA was digested with *Rsa* I, a restriction enzyme that cuts the DNA of ALS-*Xf* isolates into two pieces, but does not cut the DNA of PD-*Xf* (Almeida and Purcell 2003c). We will be able to know what infections overwintered by summer 2006, and compare infection establishment, bacterial titer, and rate of disease development in field-grown almond trees. Trees will also be evaluated for the presence of *Xf* in 2007 and 2008.

A preliminary screening found that almond leaf scorch symptoms were much more severe at the UCD site, especially in 'Peerless' trees, with an average of 4.6 scorched leaves per tree, compared to 0.8 in 'Butte.' Both cultivars at IRC had no scorched leaves, an average of 0.2 and 0.1 leaf per tree for 'Butte' and 'Peerless,' respectively. However, there was no difference in the proportion of infected trees at UCD (32 of 78 infected at UCD, 41 of 96 infected at IRC; Chi-square  $P > 0.05$ ), nor in the median populations of *Xf* present in inoculated trees at UCD ( $6.2 \times 10^6$  CFU/g) or IRC ( $1.3 \times 10^7$ ;  $\log_{10}$ -transformed;  $P = 0.26$ ). The difference in symptoms may have two explanations: i) trees at UCD were tested for *Xf* 3.5 mos after inoculation and had longer to develop symptoms, compared to trees at IRC, which were tested 2 months after inoculation; or ii) the infected trees were under more moisture stress at UCD, which led to the development of disease symptoms.

There were not large differences between infection percentage (41% of 'Butte,' 38% of 'Peerless'; Chi-Square  $P > 0.05$ ), or *Xf* population ( $2 \times 10^6$  CFU/g for 'Peerless' and  $9 \times 10^6$  CFU/g for 'Butte';  $\log_{10}$ -transformed;  $P = 0.11$ ) for the two cultivars. 'Peerless' had much fewer scorched leaves than 'Butte' at UCD, but not at IRC, as discussed in the previous paragraph.

One significant difference was the infection percentage of the various isolates, as grape strain *Xf* was more frequently recovered from inoculated trees than either almond strain. Fresno and Medeiros were recovered from 64 and 77% of trees, respectively, whereas ALS6 and Dixon were recovered from 27 and 28% of trees. Leaf scorch symptoms were more severe

in trees inoculated with grape-type isolates Fresno and Medeiros (an avg. of 2.8 and 3.2 scorched leaves/tree), compared to almond isolates Dixon and ALS6 (0.3 and 0.9 scorched leaves/tree), and background leaf scorch in buffer-inoculated trees (0.1/ tree).

Bacterial populations in trees infected with grape and almond isolates were similar, even though infection percentage and symptom severity was greater in grape isolates of *Xf*. Median populations of *Xf* in infected trees were:  $6.2 \times 10^6$  CFU/g (ALS6),  $2.8 \times 10^6$  CFU/g (Dixon),  $5.5 \times 10^6$  CFU/g (Fresno),  $2.4 \times 10^7$  CFU/g (Medeiros), and 0 CFU/g (buffer). Bacterial populations were high even in only a few trees in the treatment were infected with *Xf*, as in ALS6 inoculated plants at UCD. In the future, ArcSin transformation may be necessary with infection data, and log10 transformation may be necessary to analyze population data. We will use ANOVA where applicable to detect differences in infection percentage and bacterial populations between cultivars and bacterial isolates.

### **Glasshouse and Growth Chamber trial**

An additional experiment was initiated to examine the effect of over wintering temperature in the survival of *Xf* infections in controlled environments. We inoculated 155 potted two-year-old 'Peerless' almond trees in spring 2005. One hundred twenty five trees were inoculated with the ALS 6 isolate of *Xf* and 30 with buffer alone, in the same manner as for the field plots. Trees were kept in the greenhouse at Kearny Agricultural Center (Parlier, CA) and were tested for infection in fall 2005. Only trees positive for *Xf* will be used for the rest of the experiment (108 infected trees total, 27 buffer-inoculated). Trees will be allowed to go dormant in screen cages outside.

In December 2005, plants will be divided equally between treatments. One-third will remain outside in the field, 1/3 will be kept at 7°C (45°F), and 1/3 at 1.7°C (35°F). *Xf* dies at these temperatures in grapevines (Almeida and Purcell 2003c, Feil and Purcell 2001). Trees will be removed from each cold treatment at intervals of 1, 2 and 4 months, and allowed to break bud in the greenhouse. These intervals are reflective of dormancy periods used in previous studies with almonds and grapevines (1 mo.; Almeida and Purcell 2003c, Feil and Purcell 2001), typical dormancy in the Central Valley (2 mos.; going fully dormant in December and flowering in February) and an extreme treatment for abnormally long dormancy (4 months). Plants will be kept in the greenhouse until they develop almond leaf scorch symptoms, and then sampled via culture as previously described.

### **CONCLUSIONS**

As this is the first year of a three-year study, with the over wintering portion of the treatment yet to be applied, it would be premature to draw conclusions from our data at this time. The effect of overwintering conditions on *Xf* infections will be determined by culturing in summer 2006. Inoculations for plants where *Xf* was not recovered will be repeated in May 2006, and isolations will be repeated in August and September 2006 and 2007. These preliminary results were collected at UCD and the IRC in August and September 2005. Further samples remain to be taken from UC Davis and Kearny Agric. Center.

### **REFERENCES**

- Almeida, R.P.P. and A.H. Purcell.. 2003a. *Homalodisca coagulata* transmission of *Xylella fastidiosa* to almond. Plant Disease 87: 1255-1259.
- Almeida, R.P.P. and A.H. Purcell. 2003b. Transmission of *Xylella fastidiosa* to grapevines by *Homalodisca coagulata*. J. Econ. Entomol. 96: 264-271.
- Almeida, R.P.P. and A.H. Purcell. 2003c. Biological traits of *Xylella fastidiosa* strains from grapes and almonds. Appl. Environ. Microbiol. 69: 7447-7452.
- Davis, M.J., B.C. Raju, R.H. Brlansky, R.F. Lee, L.W. Timmer, R.C. Norris and R.E. McCoy. 1983. Periwinkle wilt bacterium: Axenic culture, pathogenicity, and relationships to other gram-negative, xylem-inhabiting bacteria. Phytopathology 73: 1510-1515.
- Davis, M.J., S.V. Thomson and A.H. Purcell. 1980. Etiological role of the xylem-limited bacterium causing Pierce's disease in almond leaf scorch. Phytopathology 70: 472-475.
- Feil, H. and A.H. Purcell. 2001. Temperature-dependent growth and survival of *Xylella fastidiosa* in vitro and in potted grapevines. Plant Disease 85: 1230-1234.
- Hendson, M., A.H. Purcell, D. Chen, C. Smart, M. Guilhabert and B. Kirkpatrick. 2001. Genetic diversity of Pierce's disease strains and other pathotypes of *Xylella fastidiosa*. Appl. Environ. Microbiol. 67: 895-903.
- Hill, B.L. and A.H. Purcell. 1995. Multiplication and movement of *Xylella fastidiosa* within grapevine and four other plants. Phytopathology 85: 1368-1372.
- Mircetich, S.M., S.K. Lowe, W.J. Moller, and G. Nyland. 1976. Etiology of almond leaf scorch disease and transmission of the causal agent. Phytopathology 66:17-24.
- Moller, W.J., R.R. Sanborn, S.M. Mircetich, H.E. Williams and J.A. Beutel. 1974. A newly recognized and serious leaf scorch disease of almond. Plant Dis. Rep.58: 99-101.
- Purcell, A.H. 1980a. Almond leaf scorch: Leafhopper and spittlebug vectors. J. Econ. Entomology 73: 834-83.
- Purcell, A.H. 1980b. Environmental therapy for Pierce's disease of grapevines. Plant Disease 64: 388-390.

### **FUNDING AGENCIES**

Funding for this project was provided by the University of California Pierce's Disease Grant Program.

## IMPORTANCE OF GROUND VEGETATION IN THE DISPERSAL AND OVERWINTERING OF *XYLELLA FASTIDIOSA*

### Project Leaders:

Kent M. Daane and Alexander Purcell  
Division of Insect Biology  
Dept. of Environ. Science, Policy, & Management  
University of California  
Berkeley, CA 94720

### Cooperators:

Elaine Shapland, Christina Wistrom, and Glenn Yokota  
Division of Insect Biology  
University of California  
Berkeley, CA 94720

Joe Connell, Roger Duncan, and Mario Viveros  
UC Cooperative Extension  
Butte Co., Stanislaus Co., and Kern Co., respectively

**Reporting Period:** The results reported here are from work conducted May 2004 to October 2005.

### ABSTRACT

Our goal is to determine the ability of alternate host plants, specifically “ground vegetation,” in or near almond orchards or vineyards to serve as reservoirs for *Xylella fastidiosa* (*Xf*). We surveyed ground vegetation in ALS-infected almond orchards in California’s Central Valley. Plant tissue samples were collected throughout a 2 year period and processed for *Xf* presence using restriction enzyme digestion of RST31-RST33 polymerase chain reaction (PCR) products and bacterial culture on selective media. Overall incidence of *Xf* was low in the ground vegetation species, only 63 of 1369 plant samples tested positive. Of the 37 species of common ground vegetation sampled, 11 tested positive for *Xf*, including such common species as Sheperd’s purse (*Capsella bursa-pastoris*), filaree (*Erodium* spp.), cheeseweed (*Malva parvifolia*), burclover (*Medicago polymorpha*), annual bluegrass (*Poa annua*) London rocket (*Sisymbrium irio*), chickweed (*Stellaria media*). There was a seasonal component to bacterial presence, with positive samples found only between November and March. Both ground vegetation and almond trees were most commonly infected with the almond strain of *Xf* (6 of 7 surveyed sites). ALS-infected almond samples had a *Xf* concentration within reported ranges, however, we were unable to accurately measure *Xf* titer in sampled ground vegetation for comparison.

### INTRODUCTION

The epidemiological factors of Pierce’s disease (PD) and almond leaf scorch (ALS), which lead to economic damage, requires more than the presence of susceptible crop cultivars, insect vectors, and plant species suitable for vector feeding and/or breeding. After the pathogen, *Xylella fastidiosa* (*Xf*) is inoculated into a host plant, bacterial multiplication, systemic movement, and expression of disease symptoms depends on many factors including temperature, date of infection, and the *Xf* strain and concentration. We hypothesize that a reservoir population of *Xf* can reside in and around grape or almond orchards without the outward expression of plant disease. *Xf* reservoirs in adjacent vegetation may increase the window of vulnerability for nearby susceptible crops to become infected by providing enough inoculum for vectors at critical periods. For this reason, removal of blue green sharpshooter breeding hosts was an effective method for controlling the spread of PD in coastal wine grape regions. As yet, there have not been similar studies of vegetation management for controlling the spread of ALS, which has been increasing in prevalence and severity in California’s interior valleys. By identifying the seasonal presence and incidence of *Xf* in common ground vegetation in or near almond orchards, weed control efforts can be appended to also reduce reservoir *Xf* host species and reduce the level of bacterial inoculum.

We report here are sample collections of annual plant species in almond orchards, where ALS incidence had been recorded for more than 2 years (all sites reporting PD and/or GWSS were heavily treated with insecticides in 2005).

### OBJECTIVE

1. Determine the presence of *Xf* in alternate host plants that are commonly visited by glassy-winged and native sharpshooters in selected ecosystems in the San Joaquin Valley; with samples representing different seasons and annual or perennial hosts.

### RESULTS

#### Ground vegetation survey

Surveyed almond orchards were located in California’s north Central Valley (Butte Co., Glenn Co.), the middle of the Central Valley (Stanislaus Co.) and the south Central Valley (Kern C.). Every 2 to 6 weeks, depending on the seasonal availability of ground vegetation, a visual survey and collection of the four most abundant weed species was conducted. A total of 58 collections were made. There were 37 species of ground vegetation commonly found (Table 1), with most material collected in winter and spring when ground vegetation was common.



### Bacterial detection and strain identification

Each sample (orchard site, sample date, plant species, n = 1369) was processed separately for the presence of *Xf*, using immunocapture DNA separation and PCR amplification procedures developed by B.C. Kirkpatrick (UC Davis, pers. comm.). After gel electrophoresis, a preliminary strain difference analysis was carried out according to Minsavage et al. (1994).

Sixty three of 1369 samples from the six orchards were positive for *Xf* (4.6%). *Xf* was recovered from 11 of the 37 ground vegetation plant species, including 5 species from which it had not previously been recovered in the field (Table 1). There was a strong seasonal component to bacterial presence in ground vegetation, with no *Xf* positive samples found between April and mid-October during the two years of the study (Figure 1). Results from both PCR and culture on selective media showed that almond trees in 6 of 7 experimental orchards were infected with the almond strain of *Xf*. At one site (Stanislaus Co.), a grape strain of *Xf* was isolated from all weeds and almond trees sampled. At each site, tissue samples from both almond trees and surrounding weeds was either the grape or almond strain of *Xf*, but never both.

### Bacterial titer and incidence

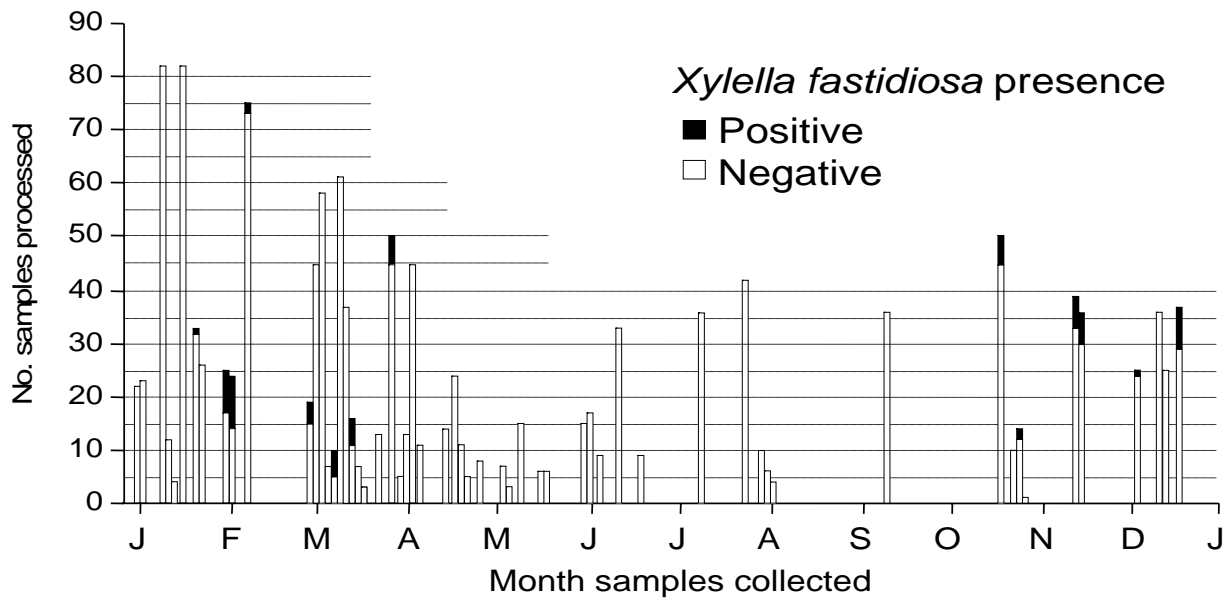
Attempts were made to culture *Xf* from symptomatic almond trees, as well as fresh samples of alternate host plants, using procedures described by Hill and Purcell (1997), in order to determine both the strain and concentration of bacteria in almond and ground vegetation samples.

Petioles from ALS infected almond trees containing the grape strain of *Xf* had an average concentration of  $2.15 \times 10^7$  CFU/g, which is significantly greater than the concentrations at other sites sampled ( $1.84 \times 10^6$  -  $1.19 \times 10^7$  CFU/g) ( $P = 0.014$ ). Previous studies also showed average *Xf* titer in ALS-symptomatic almond leaves (Almeida and Purcell 2003) is lower than the average *Xf* titer in PD-symptomatic grapes (Hill and Purcell 1997). All ground vegetation samples were contaminated with other bacteria species and *Xf* presence could be determined. Previous researchers have also encountered difficulty in culturing *Xf* from field samples (Wistrom and Purcell 2005).

**Table 1.** Presence of *Xylella fastidiosa* in ground vegetation in ALS-infected almond orchards (using immunocapture DNA extraction and PCR) in this study are compared against previous field surveys near PD-infected vineyards, except for references marked \* which refer to greenhouse studies <sup>1</sup>.

Scientific Name (Common Name)	This study	Other studies	Reference
<i>Capsella bursa-pastoris</i> (Shepherd's purse), <i>Senecio vulgaris</i> (common groundsel), <i>Sisymbrium irio</i> (London rocket), <i>Stellaria media</i> (Chickweed), <i>Urtica urens</i> (burning nettle), <i>Veronica persica</i> (Speedwell),	+	None	
<i>Chamaesyce maculate</i> , (spotted spurge), <i>Chenopodium album</i> , (lambsquarter), ( <i>Conyza bonariensis</i> , (fleabane), <i>Coronopus didymus</i> , (lesser swine cress), <i>Festuca spp.</i> , (fescue grass), <i>Ranunculus spp.</i> , (buttercup), <i>Salsola tragus</i> , (Russian thistle), <i>Typha spp.</i> (cat tail)	-	None	
<i>Erodium spp.</i> (filaree)	+	+	2*, 4*
<i>Medicago polymorpha</i> (burclover), <i>Poa annua</i> (annual bluegrass)	+	+	2
<i>Erodium spp.</i> (filaree), <i>Sonchus spp.</i> (sowthistle), <i>Malva parvifolia</i> (cheeseweed),	+	-	1
<i>Avena fatua</i> (wild oat), <i>Cyperus esculentus</i> (yellow nutsedge), <i>Escallonia montevidensis</i> (escallonia), <i>Hordeum murinum</i> (hare barley), <i>Rumex crispus</i> (curly dock)	-	+	2*
<i>Brassicaceae spp.</i> (mustards), <i>Helianthus spp.</i> (sunflower)	-	+	1
<i>Claytonia perfoliata</i> (miner's lettuce)	-	+	3
<i>Amaranthus spp.</i> (pigweed), <i>Conyza canadiensis</i> (horseweed), <i>Echinochloa crus-galli</i> (barnyard grass), <i>Lactuca serriola</i> (prickly lettuce), <i>Portulaca oleracea</i> (common purselane), <i>Sonchus oleraceus</i> (annual sowthistle), <i>Xanthium strumarium</i> (cocklebur)	-	+	4*
<i>Amaranthus spp.</i> (pigweed), <i>Amsinckia spp.</i> (fiddleneck), <i>Anagallis arvensis</i> (scarlet pimpernel)	-	-	1
<i>Lactuca serriola</i> (prickly lettuce), <i>Sorghum halepense</i> (Johnson grass)	-	-	3
<i>Portulaca oleracea</i> Common purselane	-	-	2*

<sup>a</sup> References cited are 1 = Costa et al. 2004, 2 = Freitag 1951, 3 = Raju et al. 1983, 4 = Wistrom and Purcell 2005



**Figure 1.** Survey of vegetation in almond orchards for *Xf*. Data show combined results from six almond orchards in Butte, Glenn, Stanislaus, and Kern Counties from June 2003 to April 2005.

## CONCLUSIONS

All previous field surveys for *Xf* in alternate host plants have focused on PD management. With the recent increase of ALS in California, there was an even greater need to survey plants in almond orchards for *Xf*. This will be of prime importance as GWSS moves northward into areas dominated by nut and vineyard crops. We showed the presence of *Xf* were present in 29.7% of the ground vegetation species sampled. Numerous studies have documented the survival of *Xf* in different plant species; however, fewer have included field surveys (but see Raju et al. 1983, Hopkins and Alderz 1988, Costa et al. 2004), or the season-long incidence of *Xf* in non-symptomatic ground vegetation.

Of the *Xf* positive plant species in our survey, 9 of the 11 were present in the orchards on most of the sampling dates and thus comprised the largest sample sizes of all ground vegetation species. There was a positive and significant relationship between the number of samples taken per plant species and the percentage of samples positive for *Xf* ( $y = 0.0553x - 0.2074$ ,  $r^2 = 0.8935$ ). Some plant species in the sampled orchards were common hosts of *Xf* in other surveys, but were negative in our 2 year survey (Table 1).

We found the almond strain of *Xf* was most common in the surveyed ALS-infected orchards. Recent studies on the biology of different strains of *Xf* have shown varying abilities to infect different hosts (e.g., Almeida and Purcell 2003). A recent study near Fresno, California, showed that characteristics of different varieties of almonds as well as strain type result in differing severity of ALS (Groves et al. 2005). A parallel study found both the almond and grape genotypes of *Xf* in the same plant, pointing out the presence of a less virulent strain does not preclude the existence of a more virulent strain (Chen et al. 2005). We found significantly higher *Xf* titers in almond petioles containing the grape strain, as compared to petioles with almond strain *Xf* ( $P < 0.014$ ), as has been reported previously (Hill and Purcell 1997, Almeida and Purcell 2003).

Perhaps most important for the relationship between ALS and PD epidemiology and resident ground vegetation is that we detected *Xf* in weeds only between October and April. Other field surveys, conducted primarily during the growing season, detected *Xf* during the summer (Costa et al. 2004, Freitag 1951, Wistrom and Purcell 2005). Seasonality and temperature is important for ALS or PD epidemiology as *Xf* survives best in the plants at a moderate temperature and plants inoculated on leaf tissue late in the growing season may not develop chronic disease symptoms. Ground vegetation in the surveyed orchards best harbored *Xf* at a temperature that was most consistent during the winter months, and when these fall/winter ground covers were newly formed and in good condition. A possible reason for the difference between these studies is that, during the late spring and summer months, most ground vegetation in the almond orchard was small and in poor condition due, in part, to almond management practices of preparing the orchard floor for harvest operations. Therefore, cultural practices may also impact *Xf* levels in alternative host plants.

These results suggest further investigation of the seasonal presence and concentration of *Xf* in ground covers with the seasonal presence and abundance of potential insect vectors. Unlike in vineyards where a clear edge effect has been found with PD incidence, most previous work has not revealed any clear spatial patterns with ALS. As ground vegetation can harbor *Xf* on the almond floor, our results suggest that a year-round vegetation management may assist in PD or ALS

management. Also, the feeding behavior and plant preference of insects could be a more important factor in controlling the spread of PD and ALS.

## REFERENCES

- Almeida, R. P. P., and A. H. Purcell. 2003. *Homalodisca coagulata* (Hemiptera, Cicadellidae) transmission of *Xylella fastidiosa* to almond. *Plant Disease* 87:1255-1259.
- Chen, J., R. Groves, E. L. Civerolo, M. Viveros, M. Freeman, and Y. Zheng. 2005. Two *Xylella fastidiosa* genotypes associated with almond leaf scorch disease on the same location in California. *Phytopathology* 95:708-714.
- Costa, H. S., E. Raetz, T. R. Pinckard, C. Gispert, R. Hernandez-Martinez, C. K. Dumenyo, and D. A. Cooksey. 2004. Plant hosts of *Xylella fastidiosa* in and near southern California vineyards. *Plant Disease* 88:1255-1261.
- Freitag, J. H. 1951. Host range of the Pierce's Disease virus of grapes as determined by insect transmission. *Phytopathology* 41:920-934.
- Groves, R. L., J. Chen, E. L. Civerolo, M. W. Freeman, and M. A. Viveros. 2005. Spatial analysis of almond leaf scorch disease in the San Joaquin Valley of California: Factors affecting pathogen distribution and spread. *Plant Disease* 89:581-589.
- Hill, B. L., and A. H. Purcell, A. H. 1997. Populations of *Xylella fastidiosa* in plants required for transmission by an efficient vector. *Phytopathology* 87:1197-1201.
- Hopkins, D. L., and W. C. Alderz. 1988. Natural hosts of *Xylella fastidiosa* in Florida. *Plant Dis.* 72:429-431.
- Minsavage, G. V., C. M. Thompson, D. L. Hopkins, B. C. Leite, and R. E. Stall. 1994. Development of a polymerase chain reaction protocol for detection of *Xylella fastidiosa* in plant tissue. *Phytopathology* 84:456-461.
- Raju, B. C., A. C. Goheen, and N. W. Frazier. 1983. Occurrence of Pierce's disease bacteria in plants and vectors in California. *Phytopathology* 73:1309-1313.
- Wistrom, C., and A. H. Purcell. 2005. The fate of *Xylella fastidiosa* in vineyard weeds and other alternate hosts in California. *Plant Disease* 89:994-999.

## FUNDING AGENCIES

Funding for this project was provided by the CDFR Pierce's Disease and Glassy-winged Sharpshooter Board, and the Almond Board of California.

## DESIGN OF CHIMERIC ANTI-MICROBIAL PROTEINS FOR RAPID CLEARANCE OF *XYLELLA*

### Project Leaders:

Abhaya M. Dandekar  
Department of Pomology  
University of California  
Davis, CA 95616

Goutam Gupta  
B-1, MS M888, LANL  
Los Alamos, NM 87545

Karen McDonald  
Chem. Engr. and Material Sci.  
University of California  
Davis, CA 95616

Elizabeth Hong-Geller  
B-1, MS M888, LANL  
Los Alamos, NM 87545

### Collaborators:

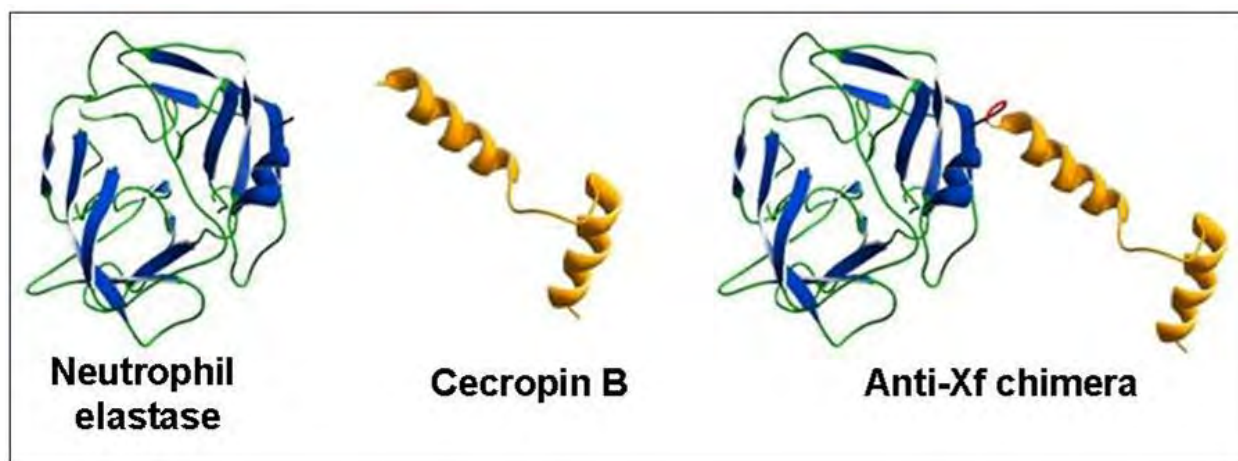
George Bruening  
Department of Plant Pathology  
University of California  
Davis, CA 95616

Edwin L. Civerolo  
USDA, ARS  
Parlier, CA 93468

**Reporting Period:** The results reported here are from work conducted October 2004 to September 2005.

### ABSTRACT

*Xylella fastidiosa* (*Xf*) is a gram-negative xylem-limited bacterium and causative agent of Pierce's disease (PD) in California grapevines. During very early stages of *Xf* infection, specific carbohydrates/lipids/proteins on the outer membrane of *Xf* interact with plant cells and are important for virulence (1). Design of a protein inhibitor that interrupts this step of the plant-*Xf* interaction will be useful in anti-microbial therapy and controlling PD. In this UC/LANL project, we propose a novel protein-based therapy that circumvents the shortcomings of an antibiotic. We have designed a chimeric anti-microbial protein with two functional domains. One domain (called the surface recognition domain or SRD) will specifically target the bacterium outer-membrane whereas the other will lyse the membrane and kill *Xf*. In this chimera, human neutrophil Elastase (5-10) is the SRD that recognizes MopB, the major outer membrane protein of *Xf* (11). The second domain is Cecropin B, a lytic peptide that targets and lyses gram-negative bacteria. We have combined Elastase and CecropinB using a flexible linker such that both components can simultaneously bind to their respective targets. This chimeric gene was synthesized and cloned into different vectors for insect and plant transformation. Five transformed insect cell lines are being evaluated and production and processing of the protein is being optimized in in liter size preps. Plant transformation experiments have been completed and we have obtained plants of *Nicotiana tabacum* var *benthamiana* and plants of *Vitis vinifera* 'Thompson Seedless' transformed with this gene that are currently being analyzed for gene expression and protein production. The proteins obtained from the transgenic insect and plant cell lines will be used to test for antimicrobial activity against *Xf*.



### INTRODUCTION

Globally, one-fifth of potential crop yields is lost due to plant diseases primarily of bacterial origin. *Xylella fastidiosa* (*Xf*) is a devastating bacterial pathogen that causes PD in grapevines, citrus variegated chlorosis (CVC) in citrus, and leaf scorch disease in numerous other agriculturally significant plants including almonds in California (<http://danr.ucop.edu/news/speeches>). Since the glassy-winged sharpshooter (an insect vector) efficiently transmits PD, a great deal of effort has been focused on using insecticides to localize and eliminate the spread of this disease. However, the

availability of the whole genome sequences of PD and CVC strains of *Xf* offer new avenues to directly target and inactivate the pathogen. In this project, we propose a structure-based approach to develop chimeric anti-microbial proteins for rapid destruction of *Xf*. The strategy is based upon the fundamental principle of innate immunity that plants recognize and clear pathogens in rapid manner (1-2). Pathogen clearance by innate immunity occurs in three sequential steps: pathogen recognition, activation of anti-microbial processes, and finally pathogen destruction by anti-microbial processes. Different sets of plant factors are involved in different steps of innate immunity. Our strategy of combining a pathogen recognition element and a pathogen killing element in the chimeric molecule is a novel concept and has several short and long term impacts.

## OBJECTIVES

### Objective 1:

- a) Utilize literature data and computer modeling to identify an SRD that specifically targets MopB (Elastase)
- b) Utilize literature data and computer modeling to identify a useful Cecropin (i.e., Cecropin B)
- c) *In vitro* testing of anti-*Xylella* activity of the MopB-specific SRD (Elastase) and *Xylella*-specific Cecropin B and demonstration of synergistic killing effect due to the combined use of Elastase and Cecropin B.

### Objective 2:

- a) Design and construction of synthetic gene encoding Elastase-Linker-Cecropin B Chimeric protein.
- b) Expression Elastase-Linker-Cecropin B in insect and plant cells and testing activity *in vitro*.

### Objective 3:

- a) Expression in transgenic plants
- b) Testing for anti-*Xylella* activity *in planta* and testing for graft transmissibility.

## RESULTS

Following our successful accomplishment of Objectives 1a, b & c in the first year of our project, where functional activity of Elastase (SRD for MopB) and Cecropin B (defensin) components were tested individually, we designed a chimeric protein of Cecropin B and HNE (Objective 2a). The covalent attachment of Cecropin B to HNE is proposed to increase the stability of the peptide by lowering the conformational entropy of its unfolded state and to increase the overall affinity for the bacterial surface by minimizing the degrees of motion at the binding site, thereby increasing binding between the ligands and the surface.

The HNE-Cecropin B chimera gene was synthesized and cloned into pBacPAK8 baculovirus vector. The chimeric gene inserted into pBacPAK8 was co-transfected with BacPAK6 viral DNA into Sf21 cells. Recombinant viruses formed by homologous recombination were amplified, and the protein expression was optimized in High Five cells (Invitrogen, Carlsbad, CA), derived from *Trichoplusia ni* egg cell homogenates. High Five cells have been shown to be capable of expressing significantly higher levels of secreted recombinant proteins compared to Sf9 and Sf21 insect cells. Optimal conditions for the expression have been worked out in HighFive cells; suspension cells in logarithmic growth are infected with recombinant *Xf* chimera baculovirus, with a multiplicity of infection of 10, and grown for 72 hours. About 25-50% of the expressed chimeric protein is secreted into the supernatant and is detected on a Western Blot as a single band. The supernatant is collected, concentrated and dialyzed. Concentrated supernatant is then run on a weak cation exchange column, chimeric protein containing fractions are pooled and dialyzed, and the dialyzed fractions are run on an elastin affinity column. All chromatography steps are carried out by gravity flow. Chimeric protein containing fractions are pooled and dialyzed and tested for elastase activity. By these methods, we are able to purify ~250  $\mu$ g active protein from 50mL supernatant. These conditions are being scaled up to produce the amounts required for testing against *Xylella fastidiosa* (currently purifying liter size preps).

We have also cloned the chimera into a plant vector (Figure 1) that was electroporated into disarmed *Agrobacterium tumefaciens* strain EHA 105 creating a functional plant transformation system that has been used to transform pre-embryogenic callus of *Vitis vinifera* ‘Thompson Seedless’ and the rootstock ‘Freedom’.



**Figure 1.** Schematic representation of binary plasmid pDU04.6105

We have obtained more than 40 seedlings of ‘Thompson Seedless’ from independent lines and expect that, based in our experience with grape transformation, the majority of them will develop into normal plants. Those plants will be micropropagated and acclimated in the greenhouse and analyzed for gene expression, PD tolerance and graft transmissibility.

In addition, the same experiments have been performed using a second construct in which the coding sequence of the signal peptide of HNE was replaced with that of the pear polygalacturonase inhibiting protein (pPGIP). The aminoacid sequence of this chimeric gene product is shown in Figure 2. Our hypothesis is that the pPGIP signal peptide will direct/improve the secretion of the chimeric protein and, as a consequence, increase its concentration in the xylem. This hypothesis is based in previous results that have shown that the product of the pPGIP encoding gene, heterologously expressed in transgenic

grapevines, is present in xylem exudates and moves through the graft union (14). Leaf discs of *Nicotiana tabacum* 'benthamiana' and 'RT1' have also been transformed with HNE-Cecropin and pPGIP-HNE-Cecropin B genes. The plants obtained are currently being analyzed for gene expression.

**MELKFS~~TFLSL~~TL~~LLFSS~~V~~LN~~PAL~~SV~~GGRRARPHAWPFMVSLQLRGGHF~~CGATLIAPNFVMSAAHCVANVNVRAV~~  
RVVLGAHNLSRREPTRQVFAVQRIFEDGYDPV~~LLNDIVILQLNGSATINANVQVAQLPAQGRRLGNGVQCL~~  
AMGWLLGRNRGIASV~~LQELNVT~~V~~VTSLCRRSNVCTLRGRQAGV~~CFGDSGSPLVCNGLIHGIASFV~~RGGCA~~  
SGLYPDAFAPVAQFVNWID~~SI~~QGSTAKW~~KVFKKIEK~~MGRNIRNGIVKAGPAIAVLGEAKAL**

**Figure 2.** pPGIP-HNE-Cecropin B chimeric amino acid sequence. The signal peptide of HNE (MTLGRRLACLFLACVLPALLGGTALASE) has been replaced with the predicted signal peptide of pPGIP (*italics*) which has been fused to the N-terminal of the mature HNE (**bold**). HNE is attached to Cecropin B (**bold italics**) by the GSTA linker, which is underlined.

## CONCLUSIONS

The main objective of this project is to develop a potent therapy against *Xf* by utilizing the principles of innate immunity by which plants recognize pathogens using their surface characteristics and then rapidly clear them by cell lysis. We have developed a chimeric anti-microbial protein containing two functional domains. One domain (called the surface recognition domain or SRD) will specifically target the *Xylella* outer-membrane whereas the other will lyse the membrane and kill *Xylella*. In this chimera, elastase is the SRD that recognizes mopB, the major outer membrane protein of *Xf*. The second domain is cecropin B, a lytic peptide that targets and lyses gram-negative bacteria. We have successfully tested each of these components individually and demonstrated that they each (elastase and cecropin B) display activity against *Xf*, which is synergistic when both proteins are combined. We have tested the protease activity of elastase against the purified mopB and intact *Xf* cells to demonstrate that the *Xylella* protein is degraded and therefore, a target for elastase. We have successfully combined the elastase and cecropinB using a flexible linker such that both components can simultaneously bind to their respective targets. This chimeric gene has been synthesized, cloned into a pBacPAK8 baculovirus vector, and packaged into recombinant baculovirus in Sf21 insect cells. Optimization of chimeric protein production is ongoing. We have also transformed pre-embryogenic callus of *V.vinifera* L. 'Chardonnay' and 'Thompson Seedless' and the rootstock 'Freedom'. Transgenic callus will be cultured in bioreactors designed to optimize protein production by secretion into the medium. We plan to use this system as well as the insect bioreactors to validate the anti-*Xylella* properties of the chimeric protein. Transgenic plants will be obtained from transgenic callus cultured in germination medium. After acclimation in the greenhouse, they will be inoculated with *Xf* and tested for PD tolerance/resistance.

## REFERENCES

- Pieters, J. (2001). Evasion of host cell defense by pathogenic bacteria. *Curr. Opin. Immunol.* 13:37-44.
- Baquero, F. and Blazquez, J. (1997). Evolution of antibiotic resistance. *Trends Ecol. Evol.* 12:482-487.
- Cohn, J., Sessa, G., and Martin, G.B. (2001). Innate immunity in plants. *Curr. Opin. Immunol.* 13:55-62.
- Magor, B.G. and Magor, K.E. (2001). Evolution of effectors and receptor of innate immunity. *Dev. Comp. Immunol.* 25:651-682.
- Sinha, S., W. Watorek, et al. (1987). Primary structure of human neutrophil elastase. *Proc. Natl. Acad. Sci. USA* 84: 2228-2232.
- Elsbach, P., and Weiss, J. (1988). Phagocytic cells: oxygen-independent anti-microbial systems. In: *Inflammation: basic principles and clinical correlates*. Gallin, J.L., Goldstein, I.M. and Snuderman, R. (Ed.). Raven Press, New York, USA, pp 445-470.
- Wasiluk, K. R., K. M. Skubitz, et al. (1991). Comparison of granule proteins from human polymorphonuclear leukocytes which are bactericidal toward *Pseudomonas aeruginosa*. *Infection and Immunity* 59: 4193-4200.
- Garcia, R., L. Gusmani, et al. (1998). Elastase is the only human neutrophil granule protein that alone is responsible for in vitro killing of *Borrelia burgdorferi*. *Infection and Immunity* 66: 1408-1412.
- Lusitani, D., S. E. Malawista, et al. (2002). *Borrelia burgdorferi* are susceptible to killing by a variety of human polymorphonuclear leukocyte components. *J. Infect. Dis.* 185: 797-804.
- Miyasaki, K. T. and Bodeau, A.L. (1991). In vitro killing of *Actinobacillus actinomycetemcomitans* and *Capnocytophaga* spp. by human neutrophil cathepsin G and Elastase. *Infection and Immunity* 59: 3015-3020.
- Bruening, G., Civerelo, E., Kirkpatrick, B., and Gilchrist, D. (2002). Virulence analysis of The Pierce's Disease Agent *Xf*. PD research symposium Dec 15-18 2002, San Diego, CA.
- Fontenot, J.D., Gatewood, J.M., Mariappan, S.V., Pau, C.P., Parekh, B.S., George, J.R., and Gupta, G. (1995) Human immunodeficiency virus (HIV) antigens: structure and serology of multivalent human mucin MUC1-HIV V3 chimeric proteins. *Proc. Natl. Acad. Sci. USA* 92:315-9.
- Lehnert, N., Allen, D.L., Allen B.L., Catasti, P., Shiflett, P.R., Chen, M., Lehnert, B., and Gupta, G. (2001). Structure-based design of receptor mimics that block the pathogenesis of bacterial superantigens. *Biochemistry*, 40:4222-4228.

14. Aguero, C.B., Uratsu, S.L., Greve, L.C., Powell, A.L.T., Labavitch, J.M., Meredith, C.P. and Dandekar, A.M. ( 2005). Evaluation of tolerance to Pierce's Disease and Botrytis in transgenic plants of *Vitis vinifera* L. Expressing the Pear PGI gene. Mole. Plant Path. 6: 43-51.

#### **FUNDING AGENCIES**

Funding for this project was provided by the CDFR Pierce's Disease and Glassy-winged Sharpshooter Board.

## EVALUATION OF GRAPEVINE ENDOPHYTIC BACTERIA FOR CONTROL OF PIERCE'S DISEASE

### Project Leader:

Bruce Kirkpatrick  
Department of Plant Pathology  
University of California  
Davis, CA 95616

### Cooperators:

Cheryl Whistler and Margot Wilhelm  
Department of Plant Pathology  
University of California  
Davis, CA 95616

**Reporting Period:** The results reported here are from work conducted October 2004 to October 2005.

### ABSTRACT

We continued to screen our endophyte library for *in vitro* antagonism of *Xylella fastidiosa* (*Xf*) growth. Approximately 16 isolates exhibited antagonism out of the 150 strains that were screened. To date, we have screened approximately 650 isolates and identified 66 that showed some level of *Xf*-antagonism. We are continuing to screen the rest of the library and will conduct grapevine movement assays on all antagonists in the coming year.

Greenhouse testing of six grapevine endophytes that began in 2003 showed that three isolates provided statistically significant reduction in Pierce's disease (PD) symptom severity. Five months after these vines were removed from the greenhouse and planted in the field, all but one of the non-protected, *Xf*-inoculated, positive control vines were dead or had PD symptoms. No symptoms were observed in any of the ten vines that were inoculated with a *Cellulomonas* endophyte nor eight of ten vines inoculated with a *Bacillus* spp. These results indicate that these two endophytes have the ability to suppress populations of *Xf* within grapevines, because these vines initially tested positive for *Xf* four months following inoculation nor after transplanting these vines in the field.

A large greenhouse biocontrol experiment involving four of the Pseudomonads, or combinations of the Pseudomonads with *Pseudomonas viridiflava* to act as a movement facilitator, were established in August 2004. Unfortunately it appears that there was a low efficiency of inoculation using blue-green sharpshooters (BGSS) as well as mechanical inoculation because PD symptoms were not evident on the positive control vines four months following inoculation. The vines will be rated again for symptoms and planted in the field, which may help to induce PD symptoms.

Additional endophytes were isolated from "escape" vines; i.e. vines without apparent symptoms in vineyards with large PD losses on two occasions in Fall 2004. Representative colonies were grown in liquid media and stored at -80°C. During 2005 these isolates, as well as others from the original endophyte library will be screened for *Xf*-antagonism *in vitro*.

### INTRODUCTION

*Xf*, the bacterium that causes PD, colonizes only xylem vessels, an ecologically distinct niche which supports the growth of comparatively few microbes. However, previous research conducted in Nova Scotia and in our lab has shown that a number of bacterial species can be isolated from grapevine xylem sap. While some of these bacteria are most likely wound inhabitants that cannot systemically colonize xylem elements, other species have been shown to move over 30cm, a distance that likely would involve the active degradation of xylem pit membranes that separate individual xylem elements. Previous research showed that some of the systemic colonizers were antagonistic to *Xf* in *in vitro* growth inhibition assays (see previous progress reports). Greenhouse grown grapevines that were inoculated with some of these strains did not prevent initial multiplication of mechanically inoculated *Xf*, however some of these strains prevented the subsequent development of PD (see below). If additional testing substantiates the protective properties of these bacterial endophytes against PD, these strains may provide a novel and environmental benign approach for minimizing losses to PD.

### OBJECTIVES

1. Finish evaluating our existing library of grape endophytic bacteria to identify antagonists of *Xf* *in vitro*.
2. Evaluate the biocontrol abilities of endophytes against *Xf* including:
  - i) prevention of infection
  - ii) suppression of PD symptom development
  - iii) long term health and survival of infected vines in field experiments.
3. Isolate additional endophytes from asymptomatic vines in infected vineyards (escape vines) and characterize these isolates for antagonistic traits.

### RESULTS AND CONCLUSIONS

#### Continue *in vitro* screening the library of grape endophytic bacteria to identify antagonists of *Xylella fastidiosa* growth.

Details regarding the methods we used for the *in vitro* antagonism assay have been presented in previous progress reports. In brief, 100ul of a 10<sup>8</sup> CFU culture of the Fetzter or Temecula strain of *Xf* are spread over a plate of solid PD3 medium. A small amount of each endophyte isolate is removed from the -80°C glycerol stock and streaked out on the medium in which it was originally isolated to obtain single colonies. The *Xf* plates are incubated for approximately four days and then a small amount



of the endophyte is applied to the center of the *Xf* plate. The plate is then incubated for seven days until *Xf* colonies are clearly visible. If the endophyte has the ability to inhibit the growth of *Xf*, the size of the inhibition zone is measured and recorded.

During this period we screened approximately 150 more endophytes, bringing the total number of screened isolates to 650, which is approximately 2/3 of the total number of isolates that Dr. Darjean collected. Approximately 16 of the 150 isolates showed some degree of antagonism towards *Xf* growth *in vitro*. This brings the total number of endophytes that exhibited some degree of *in vitro* antagonism towards *Xf* to 66, or approximately 1/10 of the isolates that were screened. If this trend continues we would expect to identify approximately 100 endophytes that exhibit some degree of antagonism towards *Xf* from the entire library.

**Table 1.** Grapevine endophytes screened during 2004 that showed some degree of antagonism towards *Xf*.

Endophyte	RFLP Group	Zone of clearing
75	37	25 mm
110	15	25 mm
122	15	6 mm
127	15	10 mm
128	15	10 mm
138	15	15 mm
145	16	5 mm
174	Group 28	slower/complt
176	28	18 mm
178	19	6 mm
184	Group 80	3 mm
197	Group 7	20 mm
200	Group 7	5 mm
220	7	slower growth
221	7	5mm
310	33	10mm

**Assess the ability of antagonists to colonize and move systemically in grape xylem.**

Prior to her departure in October, 2004, Dr. Whisler screened 16 of the *Pseudomonas* endophytes for their ability to move in Chardonnay grapevines growing in the greenhouse. The vines were trained as a single cane and the cane was grown to approximately 1m. The endophytes were suspended in phosphate buffer to a density of approximately 10<sup>7</sup> CFU/ml and approximately 20ul of the suspension was pinprick inoculated into the stem using the same methods that we use to mechanically inoculate vines with *Xf*. Two grapevines were inoculated with each strain. After six weeks of growth in the greenhouse, 1cm stem sections were removed at 10cm and 30cm above the point of inoculation. The second petiole above the point of inoculation was also removed to assess whether the endophyte had the ability to cross the xylem pit membrane and enter into the petiole. The stem sections and petiole were surface sterilized in 10% bleach and 80% ethanol for 1 min each and then rinsed three times in sterile di-water. The stem sections were placed in sterile grinding bags with 2 mls of sterile phosphate buffer and the tissue was ground using a ball bearing grinder. One hundred ul of the homogenate was plated on the medium on which the endophyte was originally isolated. Colonies with morphologies that were similar to the inoculated endophyte were counted and one or two representative colonies were chosen at random for strain identification. As described in previous progress reports, the 16S rDNA from these colonies was PCR-amplified and sequenced to verify the identity of the putative endophyte. Table 2 summarizes the results of the movement assays for these 16 isolates.

**Table 2.** Movement and other characteristics of 16 *Pseudomonad* grapevine endophytes.

<i>Pseudomonas</i> subgroup	# of isolates	Vine Health <sup>1</sup>	Antagonism <sup>2</sup>	Movement <sup>3</sup>
1	5	Healthy	Complete <sup>4</sup>	10 cm
2	5	Healthy	Complete <sup>4</sup>	10 cm
3	3	Escape/Healthy	20-25 mm	Petiole/ 30 cm
4	1	Healthy	Complete <sup>4</sup>	10 cm
5	2	Healthy	5 mm	N/D <sup>5</sup>

<sup>1</sup>Condition of vine of origin at time of endophyte isolation.

<sup>2</sup>Antagonism of *Xf* growth is the zone of inhibition or the distance from the endophyte to the visible growth of *Xf*.

<sup>3</sup>Re-colonization and movement in grape xylem was assessed at 10cm and 30cm from the point of inoculation, and from the second petiole above the point of inoculation.

<sup>4</sup>Complete: no growth of *Xf* visible.

<sup>5</sup>N/D: not yet determined.

All of the *Pseudomonads* moved at least 10cm above the point of inoculation, however work done in the Labavitch laboratory has shown that a small proportion of xylem elements are greater than 10cm in length thus these positive isolations may reflect inoculation into some of the longer elements. Isolates from subgroup 3, which were phylogenically most similar to *Pseudomonas viridiflava*, moved the greatest distance, at least 30cm from the point of inoculation. These isolates were also the only ones recovered from the petiole, suggesting they had the ability to degrade pit membranes that presumably occur between xylem vessels in the stem and the petiole. These isolates were plated on a sodium polypectate medium that can detect the production of polygalacturonase (PG), an enzyme that degrades pectin-like polymers. Clearing zones around the colonies proved that these isolates, like true *Pseudomonas viridiflava* strains produce PG. Ms. Caroline Roper, a student working jointly in the Labavitch and Kirkpatrick labs, has shown that the production of PG is absolutely necessary for the movement of *Xf* in grapevines (2004 PD/GWSS Conference). It would appear that *Pseudomonas viridiflava* would be an excellent candidate as a potential *Xf*-antagonist or it could act as a “movement facilitator” which, when co-inoculated with a stronger *Xf* antagonist, could facilitate the movement of the stronger antagonist by degrading xylem pit membranes.

#### Continued evaluations of biocontrol experiment initiated by Dr. Darjean-Jones in 2003

A previous PD progress report presented many details about a biocontrol project that was initiated by Dr. Darjean-Jones in 2003. The following provides an update of the field evaluation of these plants that was done in October 2004 and 2005.

Six bacterial grapevine endophytes that exhibited antagonism to *Xf in vitro* and which moved 15cm from the point of inoculation into grapevines growing in the greenhouse were evaluated as potential biocontrol agents for PD. Each strain was inoculated into 10 Cabernet Sauvignon vines in April, 2003 and allowed to colonize the vines for six weeks in the greenhouse. With the assistance of Purcell’s group at UC Berkeley, the vines were then exposed to *Xf*-infectious BGSS. The vines were returned to UC Davis and kept in a greenhouse. Four months later, in September 2003, they were tested for *Xf* by IC-PCR and their symptoms were rated on a severity scale of 0 (healthy) to 4(dead). These results are shown below:

**Table 3.** Greenhouse evaluation of endophyte vines four months following *Xf* inoculation (10 reps each endophyte).

Endophyte Inoculated	<i>Xf</i> PCR (+)	Average Disease Severity (0-4) <sup>z</sup>
<i>Bacillus megaterium</i>	9/10	2.0
<i>Streptomyces</i> spp	7/10	2.3
<i>Bacillus</i> spp –147	9/10	1.5*
<i>Bacillus</i> spp –161	9/10	1.4*
<i>Cellulomonas</i>	9/10	1.5*
<i>Agrobacterium</i> F25	10/10	2.2
Control, no endophyte	9/10	2.1

<sup>z</sup> disease severity calculated with PCR (+) only. 0=healthy; 4=dead.

\* statistically significant difference at p=0.05.

PCR analysis showed that: 1) there was a high rate of successful transmission using the BGSS and 2) none of the endophytes provided protection against initial infection by *Xf*. However, three of the endophytes provided a statistically significant reduction in the severity of PD symptoms after four months of growth in the greenhouse. These vines were kept in the greenhouse over the winter, during which time some of the vines died from PD. In spring 2004, all of the remaining vines were planted in the field at UC Davis. The vines were fertilized and watered with a drip system. In October 2004 and 2005 the vines were rated for PD symptoms. Table 4 presents those results.

**Table 4.** Disease evaluation of endophyte-inoculated vines planted in the field approximately 1 ½ and 2 ½ years following inoculation with *Xf*.

Endophyte Inoculated	Healthy/Vine Vigor <sup>z</sup>		PD Symptomatic		Dead
	October 04	October 05	October 04	October 05	
<i>Bacillus megaterium</i>	0/NA	1/3	1	0	9
<i>Streptomyces</i> spp.	5/2.6	6/2.5	1	0	4
<i>Bacillus</i> spp –147	6/2.5	6/2.8			4
<i>Bacillus</i> spp –161	8/2.8	8/2.4	1	0	1
<i>Cellulomonas</i>	10/2.8	10/2.8			0
<i>Agrobacterium</i> F <sub>25</sub>	5/2.5	5/3			5
Control, no endophyte	1/1.8		2	2	7

z. Vigor rated on a scale of 3= comparable to other non-endophyte inoculated vines;  
1= poor growth

The *Cellulomonas* and *Bacillus*-161 strains provided good suppression of PD symptoms in the field. Petioles from these vines also tested negatively for *Xf* by PCR while symptomatic leaves from some of the other vines tested positively for *Xf*. This would suggest that these strains greatly suppressed the growth of *Xf* from the time when they tested positive four months following inoculation to the time they were tested one and two years later. Xylem sap from a few of the *Cellulomonas*- and *Bacillus*-inoculated vines was plated on endophyte media and some colonies that morphologically resembled these strains were seen. However, the identity of these colonies was not proven by analysis of their 16S rDNA. Additional xylem sap has been extracted from these vines and identity of isolated bacteria is now being done by a new graduate student, Margot Wilhelm. We will re-inoculate these endophyte strains into young and five year old Cabernet Sauvignon and Chardonnay, which is more susceptible to PD, in 2006. Budwood will be collected from the *Cellulomonas* and *Bacillus*-161 vines during the winter and rooted in spring 2006. Xylem sap will be examined for the presence of the endophytes in some of the rooted vines while others will be mechanically inoculated with *Xf* to determine if propagated vines possess any resistance to PD.

#### 2004 biocontrol experiment initiated by Dr. Whistler

A large biocontrol experiment was initiated by Dr. Whistler beginning in July 2004. This experiment focused on the *Pseudomonad* group 7 that exhibited good *in vitro* inhibition. There were a total of 24 treatments with 10 Chardonnay vines per treatment. Four strains, 197 (*Pseudomonas viridiflava*, a strong grapevine colonizer), 205, 329 and 403 (strains that strongly inhibited *Xf in vitro*) were individually inoculated in 10 vines/trmt using the pinprick inoculation procedure routinely used to inoculate *Xf*. In addition, a movement facilitator treatment using strain 197 in combination with 205 or 329 or 403 was also inoculated into 10 vines/trmt. To assess the potential impact of the endophyte on grapevine growth, the strains were also individually inoculated into 10 vines/trmt. Ten vines of each endophyte individual or combination treatment were mechanically inoculated with *Xf* and ten vines of each treatment were insect inoculated using putatively infectious BGSS in cooperation with Sandy Purcell's lab. Ten vines not inoculated with anything served as controls to monitor greenhouse environmental conditions. Ten vines each were inoculated with buffer alone, or buffer then *Xf* inoculated mechanically or with BGSS. In total this experiment had 240 potted vines.

Unfortunately, subsequent infectivity tests by the Purcell lab found that the batch of BGSS that was used to inoculate the vines had poor transmission rates to test plants kept at Berkeley. Because of the long latent period, typically 12 to 14 weeks, for PD symptoms to show, we did not know these results until it was too late to acquire more BGSS for another inoculation attempt. In addition, the mechanically inoculated, positive control vines still appeared healthy in December 2004 and April 2005, three and seven months after *Xf* inoculation. In May 2005, the vines were transplanted into the field in the hope that PD symptoms would develop in the fall. Unfortunately none of the non-protected, positive control vines developed symptoms, which indicates that, for reasons unknown, the *Xf* inoculation was unsuccessful. In addition, because the vines were inadvertently sprayed with *Bacillus thuringiensis* (BT) to control a caterpillar infestation and BT has very resilient endospores, attempts to at least measure how effectively the endophytes colonized the control vines were ruined because

surface sterilization failed to kill the BT spores and isolation plates were completely contaminated with BT. This was obviously a great disappointment for all involved. Because the Pseudomonads looked so promising in the initial screening process we will repeat this screen in 2006.

**Isolate additional endophytes from asymptomatic vines in vineyards with a high incidence of PD**

Two isolations from 10 “escape vines” were made in late August and early October 2004 in order to verify that the vines were truly asymptomatic. Xylem sap was expressed from these vines using the pressure chamber as previous described. Aliquots of the sap were plated on the same media that we have used throughout this study. Representative colonies were individually grown in liquid medium, the culture was adjusted to 15% glycerol and frozen and -80°C. In 2006, we will screen these isolates for anti-*Xf* *in vitro* activity in the manner previously described.

**FUNDING AGENCIES**

Funding for this project was provided by the CDFA Pierce’s Disease and Glassy-winged Sharpshooter Board.

# IDENTIFICATION OF MECHANISMS MEDIATING COLD THERAPY OF *XYLELLA FASTIDIOSA*- INFECTED GRAPEVINES

**Project Leader:**

Bruce Kirkpatrick  
Department of Plant Pathology  
University of California  
Davis, CA 95616

**Cooperator:**

Melody Meyer  
Department of Plant Pathology  
University of California  
Davis, CA 95616

**Reporting Period:** The results reported here are from work conducted October 2004 to September 2005.

**ABSTRACT**

During October/November 2004, 11 control and 11 *Xylella fastidiosa* (*Xf*) infected Pinot Noir and Cabernet Sauvignon grapevines grown in five gallon pots were transported to four locations in Northern California with different winter severities. Another set of similar healthy and *Xf*-infected vines were placed in four different cold rooms with varying temperatures. These vines were rated for mortality and remission of Pierce's disease (PD) symptoms in fall 2005. A high level of mortality occurred at the coldest location (Fall River, Shasta County), moderate mortality occurred at UC Blodgett Research Station, while little mortality occurred at the UC Davis and Hopland sites. Disease ratings were lower in vines from the three cold temperature sites compared to vines grown at UC Davis, however the large discrepancy in the number of vines surviving at each location prevented meaningful comparisons between the field sites. Unexpectedly, mortality of vines in the warmest and coldest chamber regimes was greater than the two intermediate temperatures. Disease severity was also greatest in the warmest temperature which may have contributed to the observed high mortality when the vines were subsequently planted in the field. All three cold chamber regimes had lower disease ratings than the warmest temperature.

Comparisons of xylem sap pH and osmolarity in Cabernet vines growing in a vineyard in Placer County and UC Davis were not consistent with results obtained in 2004. Differences in the date of collection may have influenced these results. Effects of buffer and xylem sap on the survival of *Xf* and various cold temperatures were reported in the Proceedings of the 2004 Pierce's Disease Research Symposium. Abscisic acid (ABA) levels are elevated in many cold-treated plants and ABA has been shown to induce the synthesis of certain pathogenesis related (PR) proteins that in some case possess anti-fungal properties. ABA concentrations were lower in xylem sap collected from vines growing in El Dorado County compared to UC Davis, which suggests ABA is probably not directly mediating the cold therapy phenomenon. However, we are proceeding with experiments to determine if exogenous applications of ABA on non-chilled grapevines can elicit PR proteins.

**INTRODUCTION**

The geographical distribution of PD in North America is strongly associated with the severity of winter temperatures, i.e. PD does not occur in New York, the Pacific Northwest nor at high altitudes in South Carolina, Texas, and California (Hopkins and Purcell, 2002). Sandy Purcell demonstrated that relatively brief exposures to sub-freezing temperatures can eliminate *Xf* in some percentage of cold treated *Vitis vinifera* grapevines; however some of the coldest temperatures he used killed the vines (Purcell 1977, 1980). He also found that a higher percentage of vines that were moderately susceptible to PD such as Cabernet Sauvignon, were cured by cold therapy treatments compared to susceptible varieties such as Pinot Noir. Purcell's group also showed that whole, potted vines exposed to low temperatures had a higher rate of recovery than PD-affected, detached bud sticks exposed to the same cold temperatures (Feil, 2002).

Clearly, some factor(s) expressed in the intact plant, but not in detached bud sticks, helped eliminate *Xf* from the plants. Our objective is to elucidate the physiological/biochemical basis that mediates cold therapy and to identify the physiological/biochemical factor(s) that occur or are expressed in cold treated vines that eliminate *Xf*. If such factor(s) are found, it may be possible to induce their expression under non-freezing temperatures and potentially provide a novel approach for managing PD.

**OBJECTIVES**

1. Develop an experimental, growth chamber temperature regime that can consistently cure PD affected grapevines without causing unacceptable plant mortality.
2. Analyze chemical changes such as pH, osmolarity, total organic acids, proteins and other constituents that occur in the xylem sap of cold-treated versus non-treated susceptible and less susceptible *V. vinifera* varieties.
3. Assess the viability of cultured *Xf* cells growing in media with varying pH and osmolarity and cells exposed to xylem sap extracted from cold- and non-treated grapevines.
4. Determine the effect of treating PD-affected grapevines with cold plant growth regulators, such as ABA, as a possible therapy for PD.

## RESULTS AND CONCLUSIONS

### Objective 1

Using the same varieties used by Purcell (1977, 1980) and Feil (2002) in previous cold therapy studies, Pinot Noir (PD-susceptible) and Cabernet Sauvignon (moderately resistant to PD) grapevines grafted onto 101-14 rootstock were inoculated with *Xf* in the spring using a pinprick inoculation procedure (Hill and Purcell, 1995; Purcell and Saunders, 1999). The vines were grown in five gallon pots in a greenhouse using a nutrient-supplemented irrigation regime. Treatment vines were inoculated with the Stagg's Leap strain of *Xf*, whereas control vines were inoculated with water. During late summer and fall, the plants were moved into a screen house in order to acclimatize them to decreasing temperatures. While in the screen house, plants were watered by drip irrigation and supplemental fertilizer application until the first week of October 2004. Twelve weeks after inoculation, the plants were rated for symptom development.

In the spring of 2005, new plants of Pinot Noir and Cabernet Sauvignon grafted on 101-14 rootstock were planted in 5-gallon pots, inoculated by the same procedure used in the spring of 2004 mentioned above. Plants were placed in the same greenhouse, subjected to a similar temperature regime, and were watered using the same nutrient-supplemented regime. Plants were moved to the same screen house as the 2004 plants and will continue to be watered by drip irrigation and receive supplemental fertilizer applications until the first week of October 2005.

During October/November, 2004, 11 inoculated and 11 controls of each variety (44 plants total) were transported to three sites that were selected because of their relatively cold winter temperatures, as well as UC Davis, which was the control. Plot sites include: Fall River (Shasta County), UC Hopland Research Station (Mendocino County), and UC Blodgett Forest Research Station (El Dorado County). Potted grapevines were planted in the ground to the top of the pot in order to maintain uniform soil type, prevent roots in the pots from exposure to abnormally cold temperatures, and to prevent the plants from falling over. Plants were irrigated as needed until rain provided adequate moisture for the vines. Vines were allowed to undergo natural dormancy during the fall and experience ambient temperatures during the winter. Temperature, ETo, and other weather data for each plot was monitored using CIMIS weather data (<http://www.cimis.water.ca.gov/cimis/data.jsp>). The plants prepared in 2005 will be used to replicate the 2004 study. This data, and previous temperature profiles at these sites, will be used to determine a growth chamber temperature regime that can consistently cure PD affected grapevines without causing unacceptable plant mortality.

Grapevines, using the same varieties and inoculated as described above, but grown in 6" standard pots were exposed to different temperature regimes in cold rooms located at the Department of Pomology, UC Davis during the winter of 2005. Plants prepared in 2004 were subjected to one of four temperature regimes:

Regime 1: -5°C day; -5°C night	Regime 2: +0°C day; -5°C night	Regime 3: +2.2°C day; -5°C night	Regime 4: +5°C day; -5°C night
-----------------------------------	-----------------------------------	-------------------------------------	-----------------------------------

There were 40 plants per treatment regime (10 inoculated plants and 10 control plants for both varieties). In regimes where there were differences in day and night temperatures, plants were moved twice daily by carts to simulate daily temperature fluctuations. After three months of treatment, xylem sap was extracted from the plants, and then the plants were moved and planted in the Plant Pathology field at UC Davis. Late in the summer of 2005, the plants were evaluated for symptoms to determine the most effective temperature regime for curing without causing unacceptable plant mortality. The field plant evaluation shows higher disease ratings for the warmer temperature treatments, Davis and Hopland, when compared to the colder treatments, Fall River and Blodgett (Table 1). As we expected, plant mortality was the highest at the colder locations (Table 2). Fall River vines had very high mortality when compared to the other treatments. To try to reduce the mortality in Fall River vines, plants for the 2005-2006 trials will be planted later in the fall to allow the plants to acclimate prior to planting. Cold room treated vines show a similar relationship with the exception of the mortality rate of the +5 day/ -5 night treatment (Tables 3 and 4). This high rate of mortality could be due to rabbits burrowing under the fence and feeding on these plants.

**Table 1:** Mean PD ratings<sup>z</sup> for PD-infected plants

	Davis	Hopland	Fall River	Blodgett
Pinot Noir	2.17	1.45	1.00	1.33
Cabernet Sauvignon	2.33	2.33	2.00	1.40

<sup>z</sup>Vines were rated for the severity of disease symptoms, 0= healthy to 5= dead.

**Table 2:** Plant mortality rate

	Davis	Hopland	Fall River	Blodgett
Pinot Noir	0%	2%	91%	41%
Cabernet Sauvignon	0%	2%	55%	36%

**Table 3:** Mean PD ratings<sup>z</sup> for PD-infected plants

	+5°C Day/ -5°C Night	2.2°C Day/ -5°C Night	0°C Day/ -5°C Night	-5°C Day/ -5°C Night
Pinot Noir	3.00	1.17	1.40	1.00
Cabernet Sauvignon	2.50	1.56	1.29	1.00

z. Vines were rated for the severity of disease symptoms, 0= healthy to 5= dead.

**Table 4:** Plant mortality rate

	+5°C Day/ -5°C Night	2.2°C Day/ -5°C Night	0°C Day/ -5°C Night	-5°C Day/ -5°C Night
Pinot Noir	45%	27%	32%	59%
Cabernet Sauvignon	14%	9%	0%	14%

## Objective 2

Preliminary work from Pinot Noir and Cabernet Sauvignon field materials collected from El Dorado County and Yolo County showed some differences in xylem sap pH and osmolarity (Tables 5 and 6). These results were obtained from Pinot Noir and Cabernet Sauvignon vines growing at Clos des Knoll vineyard in El Dorado County and at the Foundation Plant Services (FPS) vineyard at UC Davis (Yolo County). Both varieties were grown in the same manner at each site; however management practices at the two sites were not identical. It is also important to note that the El Dorado County vines and the Yolo County vines were not the same clones. In 2004, dormant cuttings were collected in late February and xylem sap was extracted using a custom-made pressure bomb. Differences were noted in xylem sap pH, ABA concentration, and osmolarity. These same parameters were examined again in 2005 from grapevines found at the same two locations in late March.

Although only preliminary findings, we found that the pH of xylem sap collected in 2004 in late February was lower, 5.37 for Pinot and 5.23 for Cabernet vines in El Dorado County (colder winter temperatures) than vines growing at FPS (UC Davis), 6.35 and 6.06, respectively. Small differences in osmolarity were also noted in xylem sap from Placerville, 55.2 and 55.5, versus the osmolarity of xylem sap from UC Davis vines, 58.3 and 60.8 respectively. This is different from the xylem sap collected in late March of 2005. The pH of sap from El Dorado County was higher than Yolo County vines. The osmolarity was again similar, but lower at both sites than in 2004. Differences in pH and osmolarity could possibly be due to the difference in timing of collection. The significance and reproducibility of these differences needs to be confirmed with sampling in late February and again in late March of 2006.

In 2004 and 2005, field grown and growth chamber plants prepared as stated in Objective 1, were sampled for potential changes in pH, osmolarity, protein profile and other constituents that occur in xylem sap. Our hypothesis is that changes in xylem sap components in vines that undergo cold treatment may have significant effects on *Xf* viability. Previous research on several plant species has shown that a number of plant genes are expressed in response to freezing temperatures (reviewed by Thomashow, 1998). In some plants, these freeze-induced proteins are structurally related to proteins that plants produce in response to pathogens, i.e. pathogenesis-related proteins (Hon, et al. 1995; Kuwabara, et al, 2002). Thus it maybe possible that cold-stressed grapevines produce proteins that are deleterious to *Xf*.

To investigate this possibility, after three months of treatments, xylem sap was extracted from plants from each location/ treatment, for both growth chamber and field plants, using the pressure bomb. Xylem sap osmolarity and pH were determined for each location/treatment (Tables 7 and 8). We are in the process of concentrating the proteins by acetone precipitation and running the protein precipitate using a 1-dimensional polyacrylamide gel electrophoresis (PAGE). If unique proteins are found in the cold stressed plants, these proteins will be cut from the gel, end terminally sequenced by the UC Davis Molecular Structure Facility and their sequences will be compared to others in the database. The potential effect of these proteins on *Xf* viability will be assessed as described in Objective 3. After sampling, the plants were moved and planted in the Plant Pathology field at UC Davis. Plants are currently being evaluated for symptoms to determine the most effective temperature regime for curing. This process will be repeated for the plants prepared for growth chamber and field studies in the fall/winter of 2005.

**Table 5:** Osmolarity and pH of xylem sap collected from grapevines in El Dorado County (Clos de Knoll Vineyard) and Yolo County (FPS) in 2004 (late February).

		El Dorado	Yolo
pH	Pinot Noir	5.37	6.35
	Cabernet Sauvignon	5.23	6.06
Osmolarity mmol/kg	Pinot Noir	55.2	58.3
	Cabernet Sauvignon	55.5	60.3

**Table 6:** Osmolarity and pH of xylem sap collected from grapevines in El Dorado County (Clos de Knoll Vineyard) and Yolo County (FPS) in 2005 (late March).

		El Dorado	Yolo
pH	Pinot Noir	5.87	5.79
	Cabernet Sauvignon	5.81	5.55
Osmolarity mmol/kg	Pinot Noir	34.80	37.50
	Cabernet Sauvignon	27.17	30.61

**Table 7:** Osmolarity and pH of xylem sap from grapevines from four locations around California- Field.

			Davis		Hopland		Fall River		Blodgett	
			1 <sup>st</sup> *	2 <sup>nd</sup> **	1 <sup>st</sup> *	2 <sup>nd</sup> **	1 <sup>st</sup> *	2 <sup>nd</sup> **	1 <sup>st</sup> *	2 <sup>nd</sup> **
pH	Pinot Noir	Control	5.81	5.79	5.96	5.73	4.94	5.97	5.88	5.23
		Inoculated	5.95	5.77	5.65	5.53	5.29	6.14	5.49	5.36
	Cabernet Sauvignon	Control	6.23	5.43	5.84	5.73	6.38	5.93	5.90	5.52
		Inoculated	6.16	5.58	5.93	5.61	6.99	5.92	6.12	5.57
Osmolarity mmol/kg	Pinot Noir	Control	44.91	37.50	42.30	54.67	59.11	35.36	67.20	69.91
		Inoculated	59.60	36.56	49.10	43.17	73.33	50.00	71.33	41.73
	Cabernet Sauvignon	Control	45.11	40.00	61.40	68.09	94.33	55.44	79.45	53.45
		Inoculated	33.33	34.80	88.30	76.00	61.00	51.00	76.33	34.64

\*1<sup>st</sup> collection occurred between 2/24/05 and 3/6/05.

\*\*2<sup>nd</sup> collection occurred between 4/15/05 and 4/22/05.

**Table 8:** Osmolarity and pH of xylem sap from grapevines treated with four different cold regimes- Growth Chamber.

			-5°C day; - 5 °C night	+0°C day; - 5°C night	+2.2°C day; - 5°C night	+5°C day; - 5°C night
pH	Pinot Noir	Control	5.41	5.46	5.44	5.11
		Inoculated	5.42	5.42	5.45	5.19
	Cabernet Sauvignon	Control	5.51	5.33	5.66	5.34
		Inoculated	5.54	5.66	5.59	5.72
Osmolarity mmol/kg	Pinot Noir	Control	36.5	45.3	58.5	37.6
		Inoculated	38.3	33.0	49.9	34.6
	Cabernet Sauvignon	Control	42.3	38.9	41.6	33.7
		Inoculated	45.8	45.1	37.2	25.5

### Objective 3

We have assessed the effect of pH and osmolarity on the viability of *Xf* cells *in vitro* using various buffers and media such as PD3 and new chemically defined media (Leite, et al., 2004). The liquid solutions used for these viability experiments included: water, extracted xylem sap, PD3, HEPES, sodium and potassium phosphate buffers.

In order to further examine these conditions, cultures of *Xf* Stagg's Leap strain were grown at 28°C on PD3 for 11 days. Cells were scraped from the culture plates and suspended at concentrations of  $1.5 \times 10^7$  bacteria per milliliter of liquid medium. One milliliter of the suspension was then placed into each 1.5 mL micro-centrifuge tubes and placed at various temperatures. Samples were diluted and plated out onto PD3 and allowed to grow for seven days. After seven days, colonies were counted to determine the potential effect each treatment had on the viability of *Xf* cells.

Results of these experiments indicate that *Xf* can survive at 28°C in most media (except water). The results also indicate that *Xf* can survive at -5°C for 8 weeks. At lower temperatures, our results were similar to those found by Feil (2002). *Xf* survived the best in HEPES and sodium phosphate buffers and the worse survival occurred in water and xylem sap at -5°C. At -10°C and -20°C, *Xf* rapidly died in all liquid media tested.



Potassium phosphate buffer was used to determine the effects of pH on the survival of *Xf*. Samples were prepared like above, the cells were placed in potassium phosphate buffer at the pH levels of: 5.0, 5.4, 5.8, 6.2, 6.6 and 6.8. The cells were placed at -5°C for up to seven days. Everyday, samples were collected and diluted and plated out onto PD3 and allowed to grow for seven days. After seven days, colonies were counted to determine the potential effect each treatment had on the viability of *Xf* cells. Results for Objective 3 are reported in the 2004 Pierce's Disease Research Symposium Proceedings.

#### **Objective 4**

Previous research has shown that herbaceous and woody plants exposed to sub-lethal cold conditions have significantly elevated levels of plant hormones, such as ABA, which induces the synthesis of a number of cold shock proteins (Bravo, et al., 1998; Thomashow, 1998). Preliminary studies, involving samples of Pinot Noir and Cabernet Sauvignon field materials collected from El Dorado County and Yolo County in February 2004, and again in March 2005, showed ABA concentrations were lower in El Dorado County, cold-exposed vines, than in vines from Yolo County. ABA concentrations were lower in Pinot Noir than Cabernet Sauvignon for both El Dorado County and Yolo County vines.

We are in the process of determining ABA concentrations of xylem sap in cold-stressed and control vines growing both in the growth chamber and in the field-grown plants in the four sites using the temperature regimes described in Objective 1.

This fall, Cabernet and Pinot vines prepared as stated in Objective 1, will be sprayed with 100µM solutions of ABA, a concentration that elicited cold-shock proteins at 23°C in winter wheat (Kuwabara, et. al 2002). Additional concentrations up to 500µM may also be evaluated if no response is noted at 100µM. The pH and osmolarity of xylem sap from the treated vines will be determined as described above. The concentration of ABA in the sap will be determined using a commercially available immunoassay that has a sensitivity of 0.02-0.5 picomole/0.1 ml (Plant Growth Regulator Immunoassay Detection Kits, Sigma Chemical Co.). Preliminary work has shown that ABA concentrations in grapevine xylem sap are detectable using this kit. Xylem sap proteins will be collected, concentrated and analyzed by 1- and 2-dimensional PAGE as previously described. Unique proteins expressed in ABA-treated vines will be removed from the gels and end terminally sequenced and analyzed as previously described. We will also determine the pH, osmolarity and protein profiles of xylem sap from ABA-treated vs. non-treated vines and assess the potential of this sap for anti-*Xf* activity.

#### **REFERENCES**

- Bravo, L.A., Zuniga, G.E., Alberdi, M., and Carcuera L.S. 1998. The role of ABA in freezing tolerance and cold acclimation in barley. *Physiol. Plant.* 103:17-23.
- Feil, H., 2002. Effect of sub-freezing temperature on the survival of *Xylella fastidiosa* in vitro and in plants. Ph.D. dissertation, University of California, Berkeley.
- Hill, B.L. and Purcell, A.H. 1995 Multiplication and movement of *Xylella fastidiosa* within grapevine and four other plants. *Phytopathology* 85: 1368-1372.
- Kuwabara, C., Takezawa, D., Shimada, T., Hamada, T., Fujikawa, S., and Arakawa, K. 2002. Abscisic acid- and cold-induced thaumatin-like protein in winter wheat has an antifungal activity against snow mold, *Microdochium nivale*. *Physiol. Plant.* 115: 101-110.
- Purcell, A.H. 1977. Cold therapy of Pierce's disease grapevines. *Plant Dis. Repr.* 61:514-518.
- Purcell, A.H. 1980. Environmental therapy for Pierce's disease of grapevines. *Plant Disease* 64:388-390.
- Purcell, A.H. and Saunders, S.R. 1999. Fate of Pierce's disease strains of *Xylella fastidiosa* in common riparian plants in California. *Plant Disease* 83: 825-830.
- Thomashow, M.F. 1998. Role of cold responsive genes in plant freezing tolerance. *Plant Physiol.* 118:1-7.

#### **FUNDING AGENCIES**

Funding for this project was provided by the CDFR Pierce's Disease and Glassy-winged Sharpshooter Board.

## INTERACTION BETWEEN *XYLELLA FASTIDIOSA* AND *CURTOBACTERIUM FLACCUMFACIENS*, AN ENDOPHYTIC BACTERIUM

### Project Leaders:

Paulo T. Lacava  
Department of Entomology  
University of California  
Riverside, CA 92521

João Lúcio Azevedo  
Department of Genetics  
University of São Paulo  
Piracicaba, SP 13400-970

John S. Hartung  
Fruit Laboratory  
USDA  
Beltsville, MD 20705

### Collaborators:

Wen B. Li  
Fruit Laboratory  
USDA  
Beltsville, MD 20705

Welington L. Araújo  
Department of Genetics  
University of São Paulo  
Piracicaba, SP 13400-970

Thomas A. Miller  
Department of Entomology  
University of California  
Riverside, CA 92521

**Reporting Period:** The results reported here are from work conducted January 20, 2004 to January 20, 2005.

### ABSTRACT

*Xylella fastidiosa* (*Xf*) is a fastidious gram-negative, xylem-limited bacterium that causes diseases in many crops of economic importance, such as grape (Pierce's disease), almond, peach, coffee, plum and citrus. *Xf* can infect all known *Citrus sinensis* cultivars and causes Citrus variegated chlorosis (CVC). One major endophyte isolated from CVC-asymptomatic plants is the bacterium *Curtobacterium flaccumfaciens* (*Cf*). *Catharanthus roseus* (*Cr*) plants were inoculated together with *Cf* and *Xf* and in a similar experiment, plants were inoculated alone with *Xf* and *Cf*. Three phytopathology parameters, including number of flowers, height of plants, and disease symptoms were evaluated. Primers for *Cf* were designed to detect this endophytic bacterium in plant tissue when inoculated with *Xf*. These primers were able to detect *Cf* in the presence of *Xf* after inoculation in *Cr*. *In planta* interaction studies where *Cf* was inoculated together with *Xf* showed that there was an inhibition of disease symptoms caused by *Xf*.

### INTRODUCTION

Endophytes are microorganisms that do not visibly harm the host plant but can be isolated from surface-disinfected plant tissue or the inner parts of plants (Hallmann et al. 1997). Since they colonize an ecological niche similar to that of phytopathogens, endophytes are candidates for biocontrol agents (Hallmann et al. 1997). Members of the genus *Curtobacterium* have been isolated as endophytic bacteria from many plants, including red clover (Sturz & Christie, 1998), rice (Elbeltagy et al. 2000), potato (Sturz & Matheson, 1996), yam (Tor et al. 1992), citrus (Araújo et al. 2002; Lacava et al. 2004), and are associated with control of plant diseases in tobacco (Park & Kloeppe, 2000), cucumber (Raupach & Kloeppe, 2000) and potato (Sturz & Matheson, 1996); and plant growth-promotion of red clover (Sturz et al. 1997) or interacting with other bacteria in plant growth-promotion (Bent & Chanway, 1998).

CVC is a disease of sweet orange trees (*Citrus sinensis* L.) caused by one strain of the xylem-limited bacterium *Xf* (Hartung et al. 1994). *Xf* is transmitted by xylem-feeding sharpshooter leafhoppers (*Homoptera: Cicadellidae, Cicadellinae*; Roberto et al., 1996; Brlansky et al., 2002) or through seeds (Li et al., 2003). In Brazil, CVC is responsible for losses to the citrus industry of US \$ 100 million per year (Coletta-Filho et al., 2001). In spite of the fact that *Xf* was the first plant pathogen to have its genome completely sequenced (Simpson et al. 2000), much remains to be learned about its pathogenesis, biology and ecology.

Araújo et al. (2002) and Lacava et al. (2004) demonstrated that *Cf* is isolated more frequently from CVC-asymptomatic than CVC-symptomatic orange and tangerine plants. Also, Lacava et al. (2004) found, through the use of *in vitro* interaction experiments that the growth of *Xf* could be inhibited by the presence of endophytic *Cf*.

### OBJECTIVES

1. Evaluate, *in planta*, the interaction between *Xf* and *Cf* and the potential use of this endophytic bacterium in biological control

### RESULTS

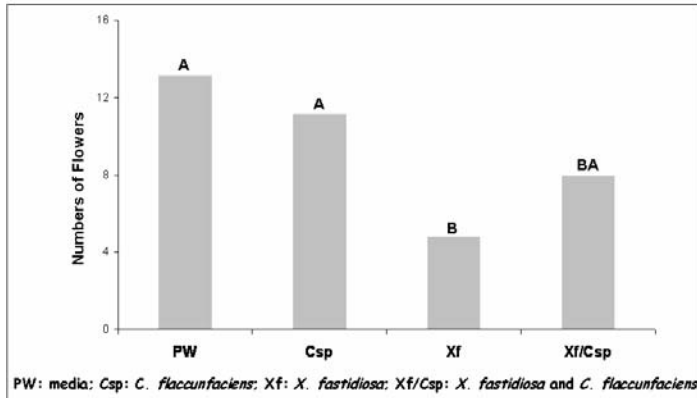
Sixty days after the inoculation of *Cr* seedlings, *Cf* was detected by PCR using primers CFC1 and CFC2. *Xf* was also specifically detected using primers 271-int and 272-int on extracts of *Cr* inoculated with *Xf*. In seedlings simultaneously inoculated (doubly-inoculated), *Cf* was detected by PCR with primers CFC1 and CFC2 and *Xf* with primers 271-int and 272-int respectively.

The first parameter analyzed to check the effects of inoculation of *Xf* and *Cf* was the number of flowers. Plants inoculated with sterile PW medium (negative control) and plants inoculated with *Cf* did not demonstrate a statistically significant difference ( $< P 0.05$ ) in the number of flowers. Plants inoculated with *Xf* alone had a reduced number of flowers ( $< P 0.05$ )

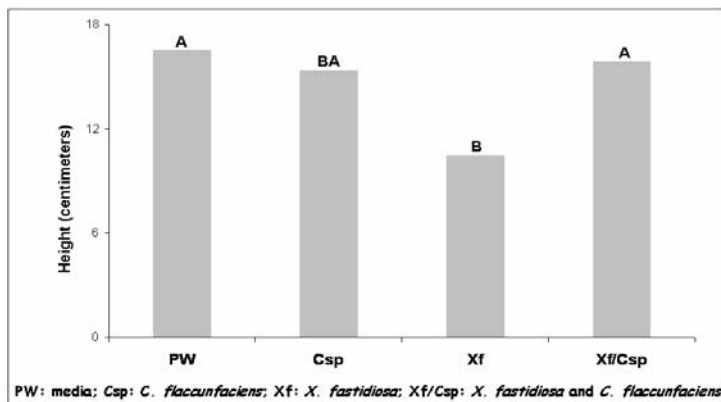
during the same period (Figure 1). However, plants inoculated with both *Xf* and *Cf* demonstrated a number of flowers similar (< P 0.05) to those inoculated with PW media, *Cf* and *Xf* (Figure 1).

In the second parameter analyzed, the height of plants were statistically similar in plants inoculated with PW medium and plants inoculated with *Xf* and *Cf* (< P 0.05) (Figure 2), but plants inoculated with *Xf* demonstrated reduced height after 60 days (Figure 2).

After sixty days, plants inoculated with sterile PW medium (negative control) did not demonstrate symptoms of disease and neither did plants inoculated with *Cf* or with both *Xf* and *Cf* (double-inoculation). However, plants inoculated with just *Xf* demonstrated characteristic symptoms of disease (Figures 3 and 4).



**Figure 1.** Interaction between *Cf* and *Xf* inside of host plant, *Cr*, after two months. The phytopathology parameter used to evaluate the interaction was number of flowers. Different letters on bars show statistical difference by Tukey's test at 5% of significance.



**Figure 2.** Interaction between *Cf* and *Xf* inside of host plant, *Cr*, after two months. The phytopathology parameter used to evaluate the interaction was height. Different letters on bars show statistical difference by Tukey's test at 5% of significance



**Figure 3.** *Cr* plants two months after inoculation with *Xf* (right) in comparison with *Xf* and *Cf* inoculated together doubly-inoculated (left).



**Figure 4.** *Cr* leaves two months after inoculation with *Xf* (left) and doubly-inoculated with *Xf* and *Cf* (right) in inoculated in plant.

## CONCLUSIONS

The endophytic bacterium *Cf* was detected in extracts of *Cr* 60 days after inoculation using the primer pair CFC1/CFC2 in a PCR assay. In a similar experiment, where both *Cf* and *Xf* were inoculated into *Cr*, it was possible to detect both the endophyte and the pathogen using PCR. These data demonstrate that *Cf* has the ability to colonize plant tissue in presence of *Xf*. This is an important point to consider when evaluating this endophyte as a potential biocontrol agent for CVC.

The parameters measured to check the potential use of *Cf* against *Xf* include number of flowers, height, and disease symptoms. This study suggested that this endophyte was able to reduce the effect of the colonization of *Xf*. In plants inoculated with *Xf* and *Cf*, symptom remission probably occurred compared with plants inoculated just with *Xf*.

Recently, an interaction between *Cf* and *Xf* was strongly indicated (Araújo et al., 2002; Lacava et al., 2004). These authors suggested this interaction based in the frequency of isolation of *Cf* and in interaction experiments *in vitro* using both *Xf* and *Cf*. This article describes how *Cf* can reduce symptoms caused by *Xf* *in planta* when both the phytopathogen and the endophytic bacterium colonize the same plant.

This work described the effect of a possible interaction of *Cf* and *Xf* *in planta* under controlled conditions and the results reinforce the idea that endophytic bacteria, that colonize a similar niche as does *Xf*, could contribute to the reduction of the symptoms in the field.

## REFERENCES

- Araújo, W., J. Marcon, W. Maccheroni Jr., J. D. v. Elsas, J. W. L. v. Vuurde, and J. L. Azevedo. 2002. Diversity of endophytic bacterial populations and their interaction with *Xylella fastidiosa* in citrus plants. *Appl. Environ. Microbiol.* 68: 4906-4914.
- Bent, E., and C. P. Chanway. 1998. The growth-promoting effects of a bacterial endophyte on lodgepole pine are partially inhibited by the presence of other rhizobacteria. *Can. J. Microbiol.* 44: 980-988.
- Brlansky, R. H., V. D. Damsteegt and J. S. Hartung. 2002. Transmission of the citrus variegated chlorosis bacterium *Xylella fastidiosa* with the sharpshooter *Oncometopia nigricans*. *Plant Dis.* 86: 1237-1239.
- Coletta-Filho, H. D., M. A. Takita, A. A. Souza, C. I. Aguilar-Vildoso, M. A. Machado. 2001. Differentiation of strains of *Xylella fastidiosa* by a variable number of tandem repeat analysis. *Appl. Environ. Microbiol.* 67: 4091-4095.
- Elbeltagy, A., K. Nishioka, H. Suzuki, Y. I. Sato, H. Morisaki, H. Mitsui, K. Minamisawa. Isolation and characterization of endophytic bacteria from wild and traditionally cultivated rice varieties. *Soil Sci. Plant Nutr.* 46: 617-629.
- Hallmann, J., A. Quadt-Hallmann, W. F. Mahaffee, and J. W. Kloepper. 1997. Bacterial endophytes in agricultural crops. *Can. J. Microbiol.* 43: 895-914.
- Hartung, J. S., J. Beretta, R. H. Brlansky, J. Spisso, and R. F. Lee, 1994. Citrus variegated chlorosis bacterium: axenic culture, pathogenicity, and serological relationships with other strains of *Xylella fastidiosa*. *Phytopathology* 84: 591-597.
- Lacava, P. T., W. L. Araujo, J. Marcon, W. Maccheroni Jr., and J. L. Azevedo, 2004. Interaction between endophytic bacteria from citrus plants and the phytopathogenic bacterium *Xylella fastidiosa*, causal agent of citrus variegated chlorosis. *Letters in Applied Microbiology* 39: 55-59.

- Li, W. B., Pria Jr., L. P. M. W.D., X. Qin, and J. S. Hartung, 2003. Presence of *Xylella fastidiosa* in sweet orange fruit and seeds and its transmission to seedlings. *Phytopathology* 93: 953-958.
- Monteiro, P. B., J. Renaudin, S. Jagoueix-Eveillard, A. J. Ayres, M. Garnier, and J. M. Bové, 2001. Madagascar periwinkle (*Catharanthus roseus*): an experimental host plant for the citrus strain of *Xylella fastidiosa*. *Plant Dis.* 85: 246-251.
- Park, K. S., J. W. Kloepper. 2000. Activation of PR-1a promoter by rhizobacteria that induce systemic resistance in tobacco against *Pseudomonas syringae* pv. *tabaci*. *Biol. Control* 18: 2-9.
- Sturz, A. V., B. R. Christie, and B. G. Matheson. 1998. Association of bacterial endophyte populations from red clover and potato crops with potential for beneficial allelopathy. *Can J. Microbiol.* 44: 162–167.
- Sturz, A. V., B. R. Christie, B. G. Matheson, J. Nowak. 1997. Biodiversity of endophytic bacteria which colonize red clover nodules, roots, stems and foliage and their influence on host growth. *Biol. Fertil. Soils* 25: 13-19.
- Sturz, A. V., and B. G. Matheson. 1996. Populations of endophytic bacteria which influence host-resistance to *Erwinia*-induced bacterial soft rot in potato tubers. *Plant Soil* 184: 265–271.
- Raupach, G. S., J. W. Kloepper. 2000. Biocontrol of cucumber diseases in the field by plant growth-promoting rhizobacteria with and without methyl bromide fumigation. *Plant Dis.* 84: 1073-1075.
- Roberto, S. R., A. Coutinho, J. E. O. Lima, V. S. Miranda, and E. F. Carlos. 1996. Transmissao de *Xylella fastidiosa* pelas cigarrinhas *Dilobopterus costalimai*, *Acogonia terminalis* e *Oncometopia facialis* (Hemiptera: Cicadellidae) em citros. *Fitopatol. Bras.* 21: 517-518.
- Simpson, A. J. G., F. C. Reinach, P. Arruda, F. A. Abreu, M. Acencio, R. Alvarenga, L. M. C. Alves, J. E. Araya et al. 2000. The genome sequence of the plant pathogen *Xylella fastidiosa*. *Nature* 406: 151-157.

#### **FUNDING AGENCIES**

Funding for this project was provided by the Fundação de Amparo à Pesquisa do Estado de São Paulo (FAPESP), and the USDA Agricultural Research Service.

# SOLUBLE FORMS OF AN ANTI-XYLELLA ANTIBODY AND STRAINS OF *ALCALIGENES XYLOSOXIDANS DENITRIFICANS* CAPABLE OF SECRETING THEM

## Project Leader:

David Lampe  
Department of Biological Sciences  
Duquesne University  
Pittsburgh, PA 19219

## Collaborators:

Carol Lauzon  
Department of Biological Sciences  
California State University  
Hayward, CA 94542

Thomas A. Miller  
Department of Entomology  
University of California  
Riverside, CA 92521

## Consultants:

Frank Richards  
Yale University  
New Haven, CT 06520

Bob Rose  
Frederick, MD

**Reporting Period:** The results reported are from work conducted October 2004 to October 2005.

## ABSTRACT

Several methods were used to create soluble forms of a single chain antibody (scFv S1) that binds to the surface of the grape strains of *Xylella fastidiosa* (*Xf*). S1 fused to a *pelB* leader and secreted from *E. coli*. These forms were not secreted correctly and could not bind *Xf* in an ELISA. Maltose binding protein fusions of S1 were soluble and could be used to detect *Xf* in an ELISA. We also successfully secreted S1 from *Alcaligenes xylosoxidans denitrificans* (*Axd*) using a leader sequence that directed S1 to the periplasmic space. Strains of *Axd* that secrete anti-*Xylella* factors are being developed for use in a strategy to prevent the spread of *Xf*.

## INTRODUCTION

The glassy-winged sharpshooter (GWSS) is the principal vector of the xylem-limited bacterium *Xylella fastidiosa* (*Xf*), which causes Pierce's disease (PD) in grapes. Limiting the spread of this pathogen by rendering GWSS incapable of pathogen transmission (paratransgenesis) is a promising method of pathogen control. Paratransgenesis seeks to modify the phenotype of an organism indirectly by modifying its symbiotic bacteria to confer vector-incompetence

Paratransgenic approaches to disrupt pathogen infection of humans are being developed by several groups. These include interference with the ability of triatomid bugs to transmit pathogens causing Chagas' disease (Beard et al., 2001), interference with HIV attachment to its target cells in the reproductive tracts of humans (Chang et al., 2003; Rao et al., 2005), and the elimination of persistent *Candida* infections from biofilms in chronically infected patients (Beninati et al., 2000). Paratransgenesis has also been applied to deliver cytokines mammalian guts to relieve colitis (Steidler et al., 2000; Steidler, 2001). Thus, the method has wide applicability.

*Alcaligenes xylosoxidans denitrificans* (*Axd*) is Gram negative, beta proteobacterial species that can colonize the GWSS foregut and cibarium, as well as various plant tissues, including xylem. It is non-pathogenic in insects, plants and healthy humans. Given these characteristics, *Axd* has become the focus of our paratransgenesis efforts to control PD in grapes. Over the past several years we developed the technology to stably modify *Axd* by inserting genes into its chromosome, have developed methods to suppress horizontal gene transfer, and have isolated a single chain antibody (scFv) that recognized an epitope on the surface of the PD strain of *Xf*. (Bextine et al., 2004). We are currently engaged in combining these systems in order to produce strains of *Axd* that are suitable for environmental release in a practical strategy symbiotic control strategy for PD.

We report here the evaluation of various S1 constructs for solubility and the construction of a prototype *Axd* strain capable of secreting S1.

## OBJECTIVES

1. To create soluble and functional forms of the S1 single chain antibody.
2. To construct strains of *Axd* capable of secreting scFvs.

## RESULTS

### Objective 1: Soluble forms of the S1 scF.

We expressed a soluble form of the S1 scFv in two ways. S1 was expressed from a construct carrying a *pelB* leader sequence which targets the protein to the periplasm of the cell, from which it can "leak" out into the growth medium and be collected. Several strains of *E. coli* were used for this test. We also fused the S1 sequence to *E. coli* maltose binding protein and purified the fusion protein using affinity chromatography. S1 proteins expressed in these two ways were assayed in a western blot to see if they could be detected at all and were also used in an ELISA to determine whether or not they could still bind to the surface of *Xf*. The results of these assays are shown in Table 1.

**Table 1.** Constructs, expression, and ELISA details for soluble S1 anti-*Xylella* scFv.

Protein expression Species / Strain	S1 construct	Detectable in Western?	Detectable in <i>Xylella</i> ELISA?
<i>E. coli</i> Top10F'	pAM5: Plac-driven expression of S1.	Yes-Strong expression <sup>1</sup>	No
<i>E. coli</i> HB2151	pAM5: Plac-driven expression of S1.	Yes- Weak expression	No
<i>E. coli</i> TB1	pAM5: Plac-driven expression of S1.	Yes- Weak expression	No
<i>E. coli</i> Top10F'	pAM62: Plac-driven expression of MBP <sup>2</sup> - full-length S1.	Yes (purified protein)	Yes
<i>E. coli</i> Top10F'	pAM63: Plac-driven expression of MBP-S1 lacking periplasmic S1 targeting sequence.	Yes (purified protein)	Yes

<sup>1</sup>. The non-pMAL constructs used in this table are meant to secrete a soluble scFv into the supernatant of the culture by leakage from the periplasmic space.

<sup>2</sup>. MBP = maltose binding protein.

As can be seen in Table 1, there was a strong strain-specific effect on the amount of expression of S1. Furthermore, in each case, the proteins secreted from *E. coli* were of the wrong size (see below) and did not bind to the surface of *Xylella* in an ELISA. On the other hand, purified maltose binding protein-S1 fusion proteins were easily detected on westerns and retained the S1 binding activity which is present when S1 is fused to the gIII protein of M13 phage and is present as part of a viral particle.

### Objective 2: Secretion of an S1 scFv construct from *Axd*

Secretion from Gram negative bacteria is complicated by the fact that these species have two membranes that a protein must cross before appearing outside the cell. Gram negatives contain at least six identified types of secretion systems.

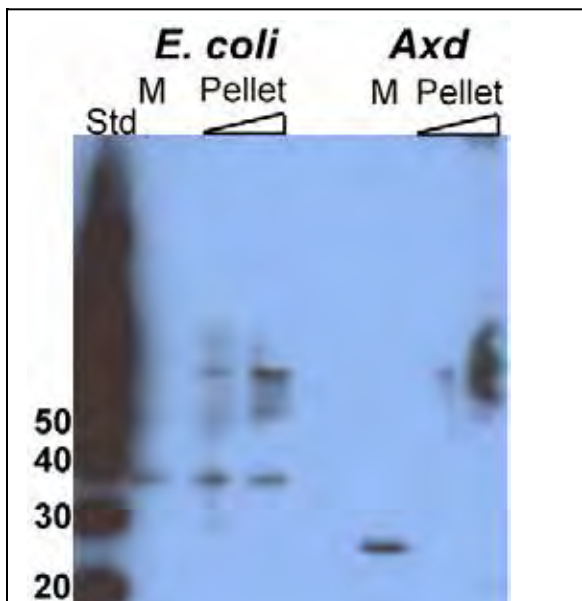
Unfortunately, these systems are unpredictable when expressed heterologously. In other words, there is no “one-size-fits-all” system that can be used in all species. Periplasmic targeting, however, can be achieved easily by using leader sequences that are functional in a broad range of organisms. We used the *pelB* leader from *Erwinia caratovora* to target S1 to the periplasm of *E. coli* and *Axd*. Constructs were made as single-copy insertions into the chromosome delivered on a *mariner* transposon. Cultures of these strains were allowed to grow overnight for *E. coli* and for two days for *Axd*. Western analysis was used to detect the S1 in the medium. The results are shown in Figure 1.

As noted above, *E. coli* expressed S1 incorrectly when fused with a *pelB* leader for periplasmic expression. Material of ca. 40kD, from the media and the pellet could be detected in the western. Furthermore, higher molecular weight material of ca. 70 kD could be detected only in the pellet. Media in which S1-*Axd* strains were grown, however, secreted a protein of the correct size for monomeric S1 (ca. 26 kD). In overloaded lanes of pellet (= cell lysate) material, a product of 70 kD could

also be detected as it was in *E. coli*. These results indicate that periplasmic targeting and “leakage” from the periplasmic space can be used as a kind of secretion system in *Axd*. The difference in expression and secretion of S1 in two different Gram-negative bacterial species clearly indicates that species-specific factors are at work and need to be carefully evaluated when constructing strains for use in symbiotic control.

### CONCLUSIONS

Paratransgenesis to control PD in grapevine requires that several conditions be met. First, a suitable microorganism must be found. Second, anti-*Xylella* factors must be isolated. Third, strains of the microorganism must be constructed that can deliver the anti-*Xylella* factor appropriately and in an environmentally-safe way. We previously isolated an anti-*Xylella* single chain antibody by panning a scFv phage library. The phage antibody reacts strongly only with grape strains of *Xf*. We converted the scFv from phage-form to soluble form by targeting the scFv to the periplasmic space without the phage gIII protein. In *E. coli*, this results in an incorrectly produced protein that lacks the ability to bind *Xf*. Expression of S1 as a maltose binding protein fusion results in a soluble protein that retains *Xf* binding ability. We thus conclude that it is possible to convert the phage antibody to a soluble form; however we will need to evaluate different constructs for proper binding and secretion behavior. Finally, we were able to successfully secrete S1 from transgenic strains of *Axd* by using the very simple method of targeting the protein to



**Figure 1.** Western analysis of *pelB*-S1 scFv from *E. coli* and *Axd*. Std = size standards in kD. M = material from media. Pellet = pelleted and lysed cell material. Two different concentrations were used for the pellet preparations.

the periplasmic space. Protein collected from the medium after two days was of the correct size. We conclude that secreting strains of *Axd* are possible routes to the creation of usable bacterial strains targeting *Xf* in a paratransgenesis approach to controlling PD.

## REFERENCES

- Beard, C. B., E. M. Dotson, P. M. Pennington, S. Eichler, C. Cordon-Rosales and R. V. Durvasula, 2001. Bacterial symbiosis and paratransgenic control of vector-borne Chagas disease. *Int J. Parasitol* 31: 621-627.
- Beninati, C., M. R. Oggioni, M. Boccanera, M. R. Spinosa, T. Maggi, S. Conti, W. Magliani, F. De Bernardis, et al., 2000. Therapy of mucosal candidiasis by expression of an anti-idiotypic in human commensal bacteria. *Nat Biotechnol* 18(10): 1060-1064.
- Bextine, B., C. Lauzon, S. Potter, D. Lampe and T. A. Miller, 2004. Delivery of a genetically marked *Alcaligenes* sp. to the glassy-winged sharpshooter for use in a paratransgenic control strategy. *Curr Microbiol* 48: 327-331.
- Chang, T. L., C. H. Chang, D. A. Simpson, Q. Xu, P. K. Martin, L. A. Lagenaur, G. K. Schoolnik, D. D. Ho, et al., 2003. Inhibition of HIV infectivity by a natural human isolate of *Lactobacillus jensenii* engineered to express functional two-domain CD4. *Proc Natl Acad Sci U S A* 100: 11672-11677.
- Rao, S., S. Hu, L. McHugh, K. Lueders, K. Henry, Q. Zhao, R. A. Fekete, S. Kar, et al., 2005. Toward a live microbial microbicide for HIV: commensal bacteria secreting an HIV fusion inhibitor peptide. *Proc Natl Acad Sci U S A* 102(34): 11993-11998.
- Steidler, L., 2001. *Lactococcus lactis*, A Tool for the Delivery of Therapeutic Proteins Treatment of IBD. *Sci. World J.* 1: 216-217.
- Steidler, L., W. Hans, L. Schotte, S. Neiryneck, F. Obermeier, W. Falk, W. Fiers and E. Remaut, 2000. Treatment of murine colitis by *Lactococcus lactis* secreting interleukin-10. *Science* 289: 1352-1355.

## FUNDING AGENCIES

Funding for this project was provided by the USDA Animal and Plant Health Inspection Service, and the CDFA Pierce's Disease and Glassy-winged Sharpshooter Board.



# ECOLOGICAL AND GENETIC CHARACTERISTICS ASSOCIATED WITH *ALCALIGENES XYLOSOXIDANS DENITRIFICANS*

## Project Director:

Carol R. Lauzon  
Department of Biological Sciences  
California State University East Bay  
Hayward, CA 94568

## Collaborators:

Thomas A. Miller	David Lampe
Department of Entomology	Department of Biological Sciences
University of California	Duquesne University
Riverside, CA 92551	Pittsburgh, PA 19219

## Research Personnel:

Ranjana Ambannavar and Lavanya Telunktula  
California State University  
Hayward, CA 94568

**Reporting Period:** The results reported here are from work conducted April 2005 to October 2005.

## ABSTRACT

A bacterium isolated from *Homalodisca coagulata* Say, found also to inhabit xylem of citrus and grape (Lauzon et al. unpubl.), shows potential for use in Symbiotic Control strategies against *Xylella fastidiosa* (Xf), the causal organism of Pierce's disease (PD). The biology and "behavior" of the bacterium, identified as *Alcaligenes xylosoxidans denitrificans* (Axd), is under study to gather information that can be used to assess its efficacy and risk of use in the field. Real Time-Polymerase Chain Reaction (RT-PCR) was used as a semi-quantitative means of monitoring Axd growth in lake water under semi-natural conditions. Axd grew better in autoclaved lake water than in lake water that contained indigenous microbial populations. Axd growth was also monitored in soil and on leaf surfaces under semi-natural conditions using microbiological and molecular techniques. Axd was not retrieved from soils containing indigenous microbial populations unless the soil was autoclaved. Axd was retrieved from leaf surfaces from citrus, strawberry, sage, and basil. We are currently examining the effect of introducing Axd to citrus leaf microbial communities using denaturing gradient gel electrophoresis and terminal restriction fragment length polymorphism. We have also monitored transfer and uptake of two plasmid vectors, DsRed (pIRES-DsRed Express, Invitrogen) and pTZ18r (Amersham Biotech). Transformation attempts included both chemical and electroporation protocols. *E. coli* was used as a control. In both cases, Axd resisted transformation while *E. coli* was successfully transformed. In addition, Axd was screened for the presence of endogenous plasmids. A strain of *E. coli* containing a single copy plasmid was used as a control. Our data suggest that Axd does not contain any endogenous plasmids from 5-150 kb. We are currently examining horizontal gene transfer potential between Axd and strains of *E. coli* and *Shigella* sp. that carry fluorescent and antibiotic-marked endogenous plasmids. Horizontal gene transfer is yet one factor used to assess harm and risk. It has been inferred that Axd is a potential new human pathogen based in part on its association with *Pseudomonas aeruginosa* (*P. aeruginosa*) infections in Cystic Fibrosis patients. We used RT-PCR to compare the growth of Axd and *P. aeruginosa* individually and in co-culture. We found that Axd and *P. aeruginosa* significantly affect each others' growth. Our data suggest that Axd has the potential to mitigate harm associated with *P. aeruginosa* infections.

## INTRODUCTION

Axd is a potential candidate for Symbiotic Control of PD. Symbiotic Control strategies engage beneficial microorganisms to control pathogenic microorganisms. This includes the use of a symbiont to deliver an antimicrobial product (i.e. Beard et al. 2002). The use of Axd in the management or control of PD requires that Axd remain in ecosystems for limited but effective periods of time and cause minimal and reversible, or no disruption to a host or ecosystem. To begin to assess efficacy and risk associated with the use of Axd in the field, we conducted studies aimed to monitor the fate of Axd in soil, water, and plant ecosystems under semi-natural conditions. We also examined the potential of Axd to engage in horizontal gene transfer. Finally, because Axd has been reported as a possible new human pathogen based in part on its association with *P. aeruginosa* infections in Cystic Fibrosis, we examined growth of both bacterial species alone and in co-culture using Real Time PCR.

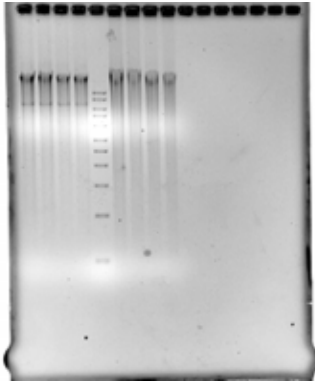
## OBJECTIVES

1. Determine if Axd possesses plasmids of high, medium-low, and very low copy number.
2. Determine if Axd participates in horizontal gene transfer, namely transformation.
3. Assess the impact of adding GM Axd to microbial communities present in various ecosystems.
4. Assess the competitive vigor of Axd when grown in co-culture with *P. aeruginosa*.

## RESULTS

### Objective 1: Determine if *Axd* possesses plasmids

No plasmids were found in *Axd* (Figures 1-3). *E. coli* containing a single copy plasmid/cell was used in all detection preparations as a positive control. High, medium-low and very low copy number procedures were employed including the use of Field Inversion Gel Electrophoresis for improved separation and resolution of DNA (i.e. discerning between a mix of genomic and plasmid DNA). *Axd* does not possess plasmids ranging in size from 5 to 150 kb.



**Figure 1:** 5 ml and 10 ml culture volumes of *Axd* used for high copy plasmid preparation. A 5 ml– 10 ml culture volume is generally enough to detect a high copy plasmid in bacteria. No DNA bands are present in the lanes 2-5. Lane 1- 10 kb DNA marker. The highest band is 10 kb and the lowest is 1 kb. Lane 2,3 –5 ml culture volume of *Axd* plasmid prep. Lane 4,5 -10 ml culture volume of *Axd* plasmid prep. Note: 5ml and 10 ml refer to the culture volumes that were subjected to plasmid prep and not the amounts that were actually loaded onto the gel.



**Figure 2:** 500 ml culture volume of *E. coli* containing pBeloBac plasmid DNA and *Axd* were used for medium-low plasmid prep. A 500 ml culture volume is generally enough to detect a medium copy plasmid (30-300 copies/cell), low copy (5 – 30 copies/cell) and very low copy (less than 5 copies/cell) of plasmid DNA. Lanes 1-4 –500 ml culture volume of *E. coli* containing pBeloBac plasmid DNA. Lane 5- 10 kb DNA marker with the highest band at 10 kb, and the lowest at 1 kb. The sizes from top to bottom are 10 kb, 8 kb, 6 kb, 5 kb, 4kb, 3 kb, 2.5 kb, 2 kb, 1.5 kb and 1 kb. Lane 6 -9 –500 ml culture volume of *Axd* plasmid prep. No bands were detected below the 10 kb marker.



**Figure 3:** A 2 liter culture volume of *Axd* used for a very low plasmid prep. A 500 ml culture volume is generally enough to detect a very low copy plasmid such as a single copy plasmid/cell, however, we also performed a 2 liter plasmid prep for *Axd* to be thorough. No bands were observed in lanes 5-8. Lanes 1- 3 – empty. Lane 4- 10 kb DNA marker. The highest band is 10 kb, the lowest is 1 kb. Lanes 5-8 –2 liter culture volume *Axd* plasmid prep. Some bands can be seen above the 10 kb marker size in Lanes 5-7, however, we don't know if this is plasmid DNA or sheared genomic DNA. Therefore, the plasmid prep sample was subjected to FIGE – field inversion gel electrophoresis which helps separate distinct plasmid DNA from smears of genomic DNA much better than separation on an agarose gel. We conclude that *Axd* does not have plasmids of sizes ranging from 5- 150 kb.

### Objective 2: Determine if *Axd* participates in horizontal gene transfer, namely transformation

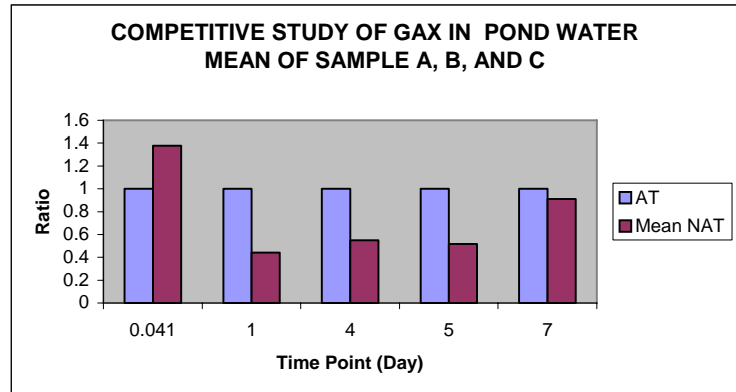
*Axd* was subjected to chemical ( $\text{CaCl}_2$ ) and electroporation techniques in attempts to transform *Axd* with two different plasmids. Plasmids pIRES2-DsRedExpress (Invitrogen) and pTZ18r (Amersham Biotech) were used for all procedures. A strain of *E. coli* amenable to transformation was used as a control. Results show that *Axd* was not easily amenable to transformation. There is a slight possibility that promoters do not work in *Axd* for these plasmids, although this is doubtful. Similar results have been found in the Lampe laboratory (personal communication).



**Figure 2.** *Axd* plated onto Luria Bertani (left) agar post-transformation protocols. Notice that no growth occurred for *Axd* on a medium that would support the growth of a transformed strain. *E. coli* were transformed (right), grew well, and thus, procedures were conducted properly.

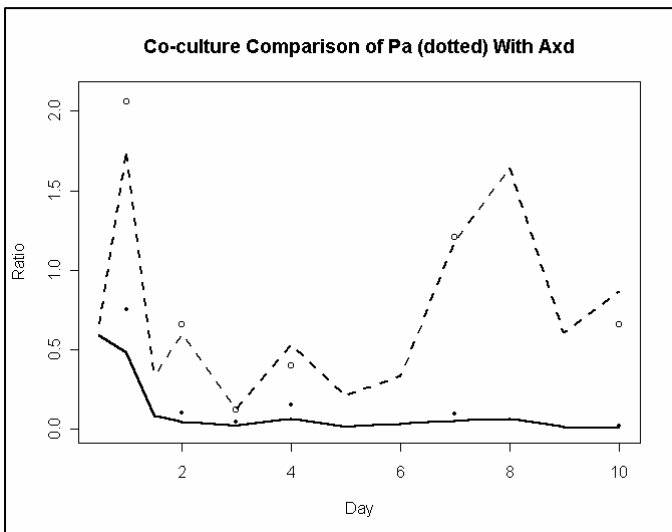
**Objective 3: Assess the impact of adding GM *Axd* to microbial communities of various ecosystems**

GM *Axd* containing EGFP fluorescent gene was used in all studies. GM *Axd* was applied to leaf surfaces of three different hosts and detected using microbiological and molecular techniques. GM *Axd* was also added to autoclaved and non autoclaved lake water and detected over time using molecular means (Figure 4). Real Time PCR was used to monitor the growth of GM *Axd* over time using primers for EGFP and 16 S rRNA genes. Data reveal poor growth of GM *Axd* in lake water (complete data not shown).



**Figure 4.**

Studies have recently commenced for determining the impact of inoculating citrus and grape leaf surfaces with *Axd* on community structure. Meyer Lemon leaves were inoculated with both 10 and 100  $\mu$ L volumes of an 18 h culture of GM *Axd* to confirm detection of *Axd* using both primers for 16S rDNA and primers for EGFP. Detection was successful (data not shown).



**Objective 4: Assess the competitive vigor of *Axd* when grown in co-culture with *P. aeruginosa***

Real Time PCR revealed that when grown together in liquid medium, *P. aeruginosa* and *Axd* significantly affect (decrease) each others' growth. Ratios were generated for mixed samples in relation to individual growth values over time and ranked. Treatments (batches) were replicated and two trials were conducted. No differences were found statistically in batches. ANOVA on ranks were used because residuals in ANOVA on ratios indicated non-normal data. ANOVA ranks showed that *P. aeruginosa* grew better in the presence of *Axd* than did *Axd* in the presence of *P. aeruginosa*; however, *P. aeruginosa* growth was less than that in pure culture. After 24 h, the presence of *Axd* significantly decreases the growth of *P. aeruginosa* but after 7 days of interactions, *P. aeruginosa* cell numbers increase significantly.

**CONCLUSIONS**

We have found that *Axd* is not easily transformed and does not contain plasmids ranging in size from 5-150 kb. *Axd* also does not establish well in established ecosystems but likely remains in an environment long enough to exert an effect on *Xf* (Bextine et al. 2005). When grown in the presence of the human pathogen, *P. aeruginosa*, *Axd* growth is less than that seen in pure culture. In addition, the presence of *Axd* decreases growth of *P. aeruginosa*. These data question recent inferences that *Axd* is a nosocomial or harmful bacterium to humans. While our findings provide important information regarding risk assessment and use of *Axd* in the field, further studies are necessary, including those that monitor the fate of *Axd* through successive field seasons and changing environmental and plant physiological conditions. To date, no concrete evidence exists that show *Axd* as a harmful bacterium to any ecosystem or host.

**REFERENCES**

- Beard, C.B., C. Cordon-Rosales, and R.V. Durvasula. 2002. Bacterial symbionts of the Triatominae and their potential use in control of Chagas disease transmission. *Ann. Rev. Entomol.* 47: 123-141.
- Bextine, B., D. Lampe, C. Lauzon, B. Jackson and T.A. Miller. 2005. Establishment of a genetically marked insect-derived symbiont in multiple host plants. *Curr. Microbiol.* 50: 1-7.
- Velicer, G.J. 1999. Pleiotropic effects of adaptation to a single carbon source for growth on alternative substrates. *Appl. Environ. Microbiol.* 65: 264-269.

**FUNDING AGENCIES**

Funding for this project was provided by the USDA Animal and Plant Health Inspection Service.

# MANAGEMENT OF PIERCE'S DISEASE OF GRAPE BY INTERFERING WITH CELL-CELL COMMUNICATION IN *XYLELLA FASTIDIOSA*

## Project Leader:

Steven E. Lindow  
Department of Plant and Microbial Biology  
University of California  
Berkeley, CA 94720

## Cooperators:

Subhadeep Chatterjee and Karyn Newman  
Department of Plant and Microbial Biology  
University of California  
Berkeley, CA 94720

Alexander Purcell  
Department of Environmental Science, Policy, & Management  
University of California  
Berkeley, CA 94720

**Reporting Period:** The results reported here are from work conducted October 2004 to October 2005.

## ABSTRACT

*Xylella fastidiosa* (*Xf*) has homologs of the cell-cell signaling genes found in the important plant pathogen *Xanthomonas campestris* pathovar *campestris* (*Xcc*) and produces a similar alpha,beta unsaturated fatty acid signal molecule called DSF that coordinates gene expression. We have investigated DSF-mediated cell-cell signaling in *Xf* with the aim of developing cell-cell signaling disruption as a means of controlling Pierce's disease (PD). The *rpfF* gene is necessary and sufficient for DSF signal synthesis and *rpfF* mutants of *Xf* are hypervirulent and non-transmissible. Lack of transmissibility was linked to an inability of the *rpfF* mutant to form a biofilm in the insect foregut; while taken up by insects, the mutant strain is not retained. *Xf* strains that overproduce DSF produce disease symptoms in grape, but only at the site of inoculation and the cells do not move within the plant as do wild-type strains. Thus elevating DSF levels in plants should reduce movement of *Xf* in the plant and also reduce the likelihood of transmission by sharpshooters. We identified bacterial strains that can interfere with *Xf* signaling both by producing large amounts of DSF, by degrading DSF, or by in some way interfering with recognition of DSF. When co-inoculated into grape with *Xf*, both DSF-producing strains and DSF-degrading strains greatly reduced the incidence and severity of disease in grape; DSF-producing strains consistently were the most effective in reducing disease. Disease was also reduced when some of these strains were simply sprayed onto grape before inoculation with *Xf*, indicating that they can alter behavior of the pathogen even when not co-inoculated. To verify that disease control is due to DSF interference, we have constructed mutants of these strains that disrupt the ability of these strains to produce or degrade DSF and show that the mutants are deficient in PD control. Both mutants unable to produce DSF as well as mutants deficient in degradation of DSF exhibited less ability to control PD when co-inoculated with *Xf*, suggesting that altering DSF abundance within the plant was a major factor contributing to disease control by these DSF-interfering strains. Given that DSF overabundance appears to mediate an attenuation of virulence in *Xf* we have transformed grape with the *rpfF* gene of *Xf* to enable DSF production in planta. Transgenic plants are being assayed for DSF production and susceptibility to *Xf* infection. The bacterial genes required for DSF degradation have been cloned and identified in antagonist *Pseudomonas* strain G, enabling their exploitation for disease control by over-expression in various bacterial endophytes of grape as well as by expression within plants themselves. Non-endophytic bacterial species were also established in high numbers inside grape leaves and petioles following spray application to plants with a high concentration of a silicon-based surfactant with a low surface tension. PD was reduced in plants after topical application of a DSF-producing strain of *Erwinia herbicola* (*E. herbicola*).

## INTRODUCTION

Endophytic bacteria such as *Xf* colonize the internal tissues of the host, forming a biofilm inside the plant. A key determinant of success for an endophyte is the ability to move within the plant. We expect activities required for movement to be most successful when carried out by a community of cells since individual cells may be incapable of completing the feat on their own. Cells assess the size of their local population via cell-cell communication and coordinately regulate the expression of genes required for such processes. Our study aims to determine the role of cell-cell communication in *Xf* in colonization and pathogenicity in grapevines and transmission by the insect vector. *Xf* shares sequence similarity with the plant pathogen *Xcc* (1). In *Xcc*, expression of pathogenicity genes is controlled by the *rpf* system of cell-cell communication, enabling a population of cells to launch a pathogenic attack in a coordinated manner (1). Two of the *rpf* proteins, *rpfB* and *rpfF*, work to produce a diffusible signal factor (DSF) (2) which has recently been described as an alpha,beta unsaturated fatty acid (3) (Figure 1).

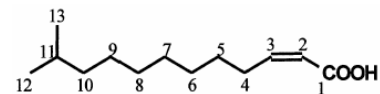


Figure 1

As the population grows, the local concentration of DSF increases. Other *rpf* proteins are thought to sense the increase in DSF concentration and transduce a signal, resulting in expression of pathogenicity factors. The *Xf* genome not only contains homologs of the *rpf* genes most essential for cell-cell signaling in *Xcc*, but also exhibits striking colinearity in the arrangement of these genes on the chromosome. We now have shown that *Xf* makes a molecule that is recognized by *Xcc* but

probably slightly different than the DSF of *Xcc*. Based on our knowledge of density-dependent gene regulation in other species, we predict the targets of *rpf* regulation would be genes encoding extracellular polysaccharides, cellulases, proteases and pectinases necessary for colonizing the xylem and spreading from vessel to vessel. Similarly, we would expect the density-dependent genes to be expressed during the time when a population of *Xf* is ready to move into un-colonized areas.

Other organisms can apparently interfere with the density-dependent behaviors of *Xf*. Several recent studies indicate that other organisms can disrupt or manipulate the cell-cell signaling system of bacteria. Our preliminary work revealed that several other bacterial species can both positively and negatively interact with the DSF-mediated cell-cell signaling in *Xf*, but until this study we did not know of the manner in which the interaction occurred nor whether such strains had the potential to affect the virulence of *Xf* in grape. In this period we have extensively investigated both the role of DSF-production by *Xf* on its behavior within plants, the manner in which other bacterial strains affect such cell signaling, the extent to which other endophytes could modulate density-dependent behaviors and virulence in *Xf* by interfering with cell-cell signaling, initiated genetic transformation of grape to express DSF, and explored other means to alter DSF abundance in plants to achieve PD control.

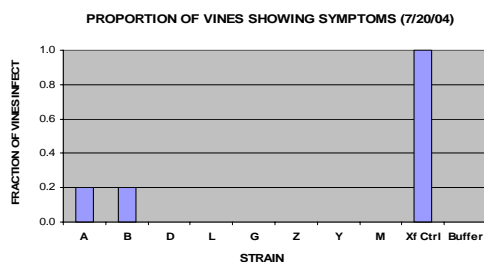
## OBJECTIVES

1. Identify bacteria that interfere with DSF-mediated cell-cell signaling in *Xf*, and conduct pathogenicity tests on grapevines colonized by DSF-interfering bacteria to determine potential for PD control
2. Isolation of mutant strains of DSF-degrading and DSF-producing bacteria that can no longer interfere in cell-cell signaling to verify that disease control is linked to cell-cell signal interference
3. Molecular identification of genes conferring DSF-degrading activity
4. Engineer the grapevine endophytes *Alcaligenes xylooxidans denitrificans* and *Agrobacterium vitis* to express genes conferring DSF-degradation and DSF-synthesis activities and test whether the resulting transgenic endophytes are capable of disease control
5. Creation of grapevines expressing genes conferring DSF-degradation and DSF-synthesis activity to test for PD resistance
6. Evaluate topical application of DSF-degrading and DSF-producing bacteria with penetrating surfactants for PD control

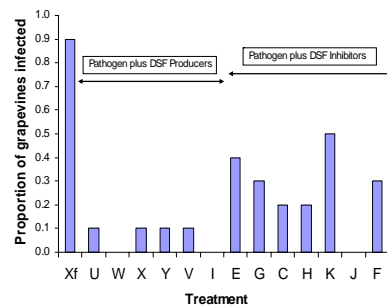
## RESULTS

We have isolated a variety of bacteria from grapevine vineyards affected by PD as well as tomato and cruciferous crop plants infected with the signal-producing pathogens *Xanthomonas campestris* pv. *vessicatoria* and *Xcc*, respectively and tested them for their ability to interfere with cell-cell signaling in *Xf* in an assay using the signal-sensing strain described above. We found several strains that negatively affected signaling in *Xcc* while several strains were found to produce DSF. By adding purified DSF to either cell-free extracts of the strains with a negative influence on signaling or to whole cells we found that at least two mechanisms of interference with signaling could be observed. Some strains such as strains C,E,G, H, and J are able to degrade DSF while other inhibitor strains did not do so, and apparently have another means of interfering with DSF perception by *Xcc*. The several strains that produced DSF were all identified as *Xanthomonas* species. We sequenced the 16S rRNA gene from these strains to determine their species identity.

To test the ability of bacteria that alter *Xf* signaling to alter the process of disease in plants, we co-inoculated grapevines with *Xf* and strains that either inhibit or activate cell-cell signaling in greenhouse studies. The incidence of PD was greatly reduced by all of the signaling interfering strains that we tested (Figures 2 and 3). As we had expected, DSF-producing strains generally reduced disease severity more than did strains that interfered with signaling in *Xf*. These results were highly repeatable, having been observed in five separate experiments. We find these results to be very exciting in that they suggest that alteration of signal molecules within plants can have a profound effect on the disease process.

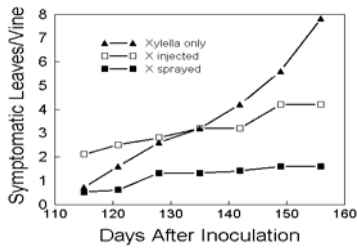


**Figure 2.** Incidence of PD in grape co-inoculated with *Xf* Temecula and various DSF-producing and degrading bacterial strains.

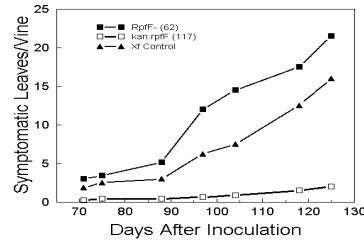


**Figure 3.** Incidence of PD in grape co-inoculated with *Xf* Temecula and various DSF-producing and degrading bacterial strains.

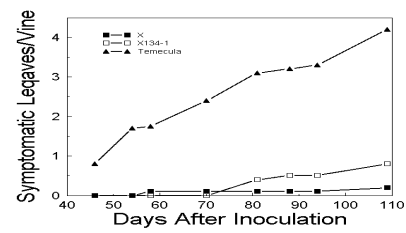
We also have been able to provide disease control by topical inoculation of DSF-producing bacteria such as DSF-producing strains X and 8004 to the foliage of plants where they colonize and presumably produce DSF as well as by pre-treatment of plants by injection of these antagonists before inoculation with *Xf* (Figure 4).



**Figure 4.** Severity of PD in grape co-inoculated with DSF-producing strain X or sprayed with this strain before inoculation with Temecula compared to plants inoculated only with Temecula.



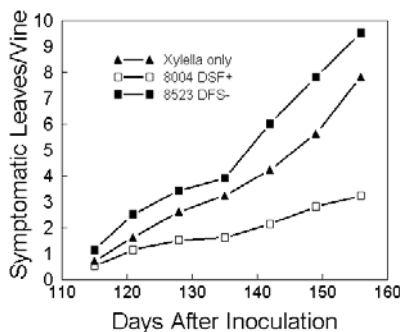
**Figure 5.** Severity of PD in grape co-inoculated with a DSF over-producing strain of *Xf* or with an *rpfF* mutant compared to plants inoculated with Temecula.



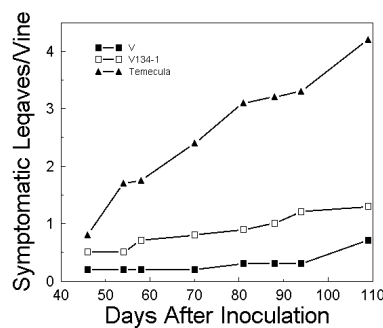
**Figure 6.** Severity of PD in grape co-inoculated with DSF-producing strain X or a mutant of X that does not produce DSF compared to plants inoculated only with Temecula.

To determine the extent to which altered DSF abundance in plants would alter the progress of PD we also made mutants of *Xf* that were either blocked in DSF production or over-expressed DSF. A strain of *Xf* Temecula in which the *rpfF* gene, which is required for production of the signal in *Xcc*, is knocked out was constructed using exchange of the wild-type allele for a deleted copy carrying an antibiotic resistance gene on a suicide plasmid. The *rpfF* mutant of *Xf* does not make DSF as determined using previously constructed “signal-sensing” strains of *Xcc* to determine DSF production by *Xf* and other bacterial strains. We also over-expressed DSF by introducing the *rpfF* gene driven by a constitutive *kan* promoter into the genome of *Xf*. This strain produced much higher levels of DSF than the parental strain. The strains altered in DSF production were tested for their ability to infect and move within host plants and to cause PD symptoms. The *rpfF* gene appears to play a role in modulating disease progress because the timing and severity of symptom development are greatly exacerbated in grapevines infected with *rpfF*-deficient mutants when compared to the wild type (Figure 5). In contrast, the *Xf* strain that overproduced DSF caused disease symptoms in grape, but only at the site of inoculation. The mutant cells did not move within the plant as did wild-type strains (Figure 5). These results all support our model that DSF regulates genes required for movement of *Xf* from colonized vessels. We hypothesize that *rpfF*-deficient mutants may be causing increased vessel blockage in the grapevine, leading to increased symptom expression.

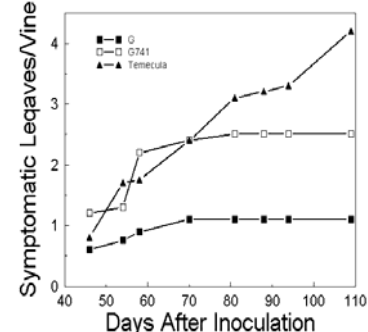
To establish a rigorous connection between DSF production and disease control, we have constructed mutant strains of those DSF-producing bacteria that perform best in the disease control assays that no longer could produce DSF. These mutants were then compared to their parent strains in disease control assays. We also made mutants of DSF-degrading strains that no longer could degrade DSF. We expected that if DSF interference can provide disease control, then strains no longer able to interfere with DSF signaling will also no longer be able to control disease. All mutants unable to produce DSF were diminished in ability to reduce PD when co-inoculated with *Xf* compared to their DSF-producing wild-type strain (Figures 7-8).



**Figure 7.** Severity of PD on grape co-inoculated with an *Xcc* DSF-producing strain or a mutant *Xcc* strain unable to produce DSF and Temecula compared to plants inoculated only with Temecula.



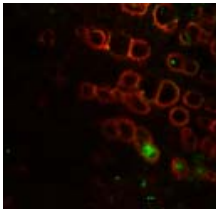
**Figure 8.** Severity of PD on grape co-inoculated with DSF-producing strain V or a mutant unable to produce DSF and Temecula compared to plants inoculated only with Temecula.



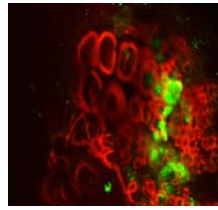
**Figure 9.** Severity of PD on grape co-inoculated with DSF-degrading strain G or a mutant unable to degrade DSF and Temecula compared to plants inoculated only with Temecula.

Likewise, mutant strain G741, a mutant of DSF-degrading parental strain G that no longer could degrade DSF also was greatly reduced in ability to control PD when co-inoculated with *Xf* compared to its parental strain (Figure 9). These results suggest strongly that it is the production of, or degradation of DSF in plants by these antagonistic bacteria that makes a large contribution to their ability to reduce PD. The results thus strongly suggest that any method that either increases or decreases DSF abundance in *Xf*-infected plants will have a large effect on the incidence and/or severity of PD.

We have recently made a green fluorescent *rpfF* mutant to investigate the pattern of colonization by the mutant and will compare it to that of the wild type. Preliminary results show that this hypervirulent mutant moves more rapidly through grape and also more rapidly fills xylem vessels, suggesting that virulence factors are de-repressed in an *rpfF*- mutant (Figures 10 and 11).



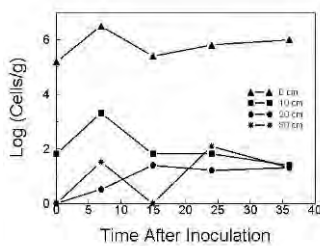
**Figure 10.** Presence of *gfp*-marked cells of wild-type *Xf* strain Temecula visualized as green fluorescence in cross sections of grape petiole viewed with confocal microscopy.



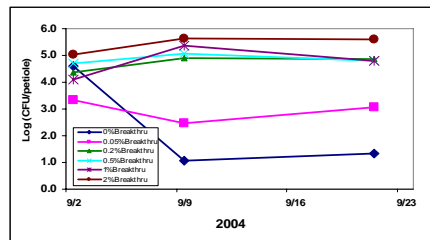
**Figure 11.** Presence of cells of an *rpfF* mutant of *Xf* Temecula visualized as green fluorescence in cross sections of grape viewed with confocal microscopy.

To increase the usefulness of any interfering agents identified in this screen, we are molecularly identifying the genes conferring the DSF-interference phenotypes. We have inactivated the genes for interference in *Pseudomonas* strain G individually by random Tn5 mutagenesis and cloned the disrupted loci. Mutations of the *carAB* genes, encoding carbamoyl-phosphate synthetase activity, in antagonist G abolishes DSF degradation. Multiple mutants of these two genes (and only these two genes) have been found to disrupt DSF production; we are currently investigating how this enzyme confers DSF degradation by over expressing it. The *carAB* genes have been cloned, shown to restore DSF interference in strain G mutants, and are being assessed for their ability to confer DSF interference in other bacterial strains when over expressed.

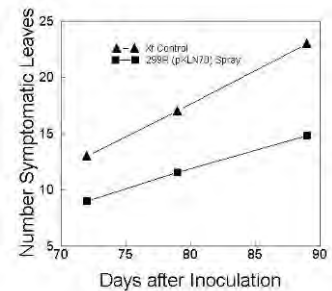
Disease control by DSF-interfering strains will be optimized if they are good colonists of grapevine. To maximize disease control we are expressing the various genes conferring DSF interference in effective non-pathogenic endophytic colonists of grapevine such as *Alcaligenes xylosoxidans denitrificans* (*Axd*) and *Agrobacterium vitis* (*Av*). We expect that this strategy will deliver the disease control agent directly to the site of the pathogen and result in highly effective control. Since the *rpfF* gene of *Xf* is sufficient to confer expression of DSF in other bacteria we are introducing it into these two species. Preliminary studies showed that while *Av* strains established large populations in grape near the inoculation site, they did not move extensively in the plant (Figure 12).



**Figure 12.** Population size of *A. vitis* strain 210R sampled at different distances from point of inoculation at different times after inoculation into stems of grape.



**Figure 13.** Population size of *E. herbicola* strain 299R in petioles at different times after spray inoculation with different concentrations of Breakthru.



**Figure 14.** Severity of PD in grape sprayed with DSF-producing *E. herbicola* 299R harboring the *rpfF* of *Xf* Temecula compared to plants inoculated only with Temecula.

We have initiated expression of the *rpfF* gene in grape at the Ralph M. Parsons Foundation Plant Transformation Facility at the University of California, Davis. Initially, we submitted a tested but un-optimized *rpfF* construct to the facility; the first transformed plants are now mature and are being tested for DSF production. Initial assays reveal that DSF is rapidly degraded by damaged plant tissue. Therefore assays are being developed to avoid this complication in assessing DSF abundance. Mature plants have now been rooted to produce large numbers of clonal plants that will be inoculated with *Xf* as they grow large enough (late November).

We have found that it is possible to establish large populations of bacteria within grape leaves, stems and petioles by simple topical applications of bacterial suspensions to plants in solutions of organosilicon surfactants having very low surface tensions. A variety of bacteria were found to colonize grape at very high population sizes ( $> 10^6$  cells/petiole) for extended



periods of time following topical application (Figure 13). While these bacteria apparently do not spread throughout the plant after inoculation as does *Xf*, by introducing it into the intercellular spaces and perhaps even the xylem of the plant by use of the surfactants that stimulate spontaneous infiltration of the plant, we can inoculate the bacteria into all sites within the plant. Initial studies have shown that topical applications of an *Erwinia herbicola* strain harboring the *Xf rpfF* gene can provide some control of PD (Figure 14).

## CONCLUSIONS

Substantial data now show that cell-cell signaling plays a major role in the epidemiology and virulence of *Xf* and that disruption of cell signaling is a promising means of controlling PD. Strikingly, *Xf* strains that cannot signal are also not transmissible by nor colonize an efficient insect vector. This result reveals an important and previously unappreciated connection between cell-cell signaling and transmission as well as the requirement for biofilm formation for transmission. These new findings will be helpful for those interested in targeting transmission as a means of disease control. We also found that mutants unable to signal are hypervirulent. Conversely, strains of *Xf* that overproduce DSF have low virulence and do not move within grape. This suggests that, it will be more efficient to elucidate and target *Xf*'s colonization strategies rather than traits predicted to contribute to virulence based on studies of other plant pathogens. We have identified bacterial strains that can interfere with *Xf* signaling. These strains proved very effective as protective agents for grapevines when co-inoculated with *Xf*. Both positive and negative interference with DSF signaling reduced disease in grape suggesting that signaling is normally finely balanced in the disease process; such a finely balanced process might be readily disrupted. Since in bacteria *rpfF* is sufficient to encode a synthase capable of DSF production, expression of DSF directly in plants is an attractive approach for disease control. Preliminary results are very encouraging that DSF can be made in plants. Alternatively, the use of various bacteria to express DSF in plants may prove equally effective in altering *Xf* behavior and hence disease control. Our observation that large numbers of bacteria could be introduced into grape plants by simple topical applications of cell suspensions in a penetrating surfactant has enabled us to pursue a new strategy of disease control that will enable us to efficiently test those strains that are found to be effective in PD control in Objective 1 by a method that should prove practical for commercial use. Thus our investigation of the fundamental issues associated with interactions of *Xf* with grape has led to several very practical possible control measures of PD that can be evaluated over the short term.

## REFERENCES

1. Simpson, A. J. G., F. C. Reinach, P. Arruda, *et al.* 2000. *Nature* 406:151-157.
2. Barber, C. E., J. L. Tang, J. X. Feng, M. Q. Pan, T. J. Wilson, H. Slater, J. M. Dow, P. Williams, and M. J. Daniels. 1997. *Molecular Microbiology* 24:555-66
3. Wang, Lian-Hui, He, Y., Y. Gao, J. E. Wu, Y. H. Dong, C. He, S. X. Wang, L. X. Weng, J. L. Xu, L. Tay, R. X. Fang, and L. H. Zhang. 2004. 51: 903-912.
4. Newman, K.L., R. P. P. Almeida, A. H. Purcell, and S. E. Lindow. 2004. Cell-cell signaling controls *Xylella fastidiosa* interactions with both insects and plants. *Proc. Natl. Acad. Sci. (USA)* 101:147-152.

## FUNDING AGENCIES

Funding for this project was provided by the CDFR Pierce's Disease and Glassy-winged Sharpshooter Board.

## ENVIRONMENTAL FATE OF A GENETICALLY MARKED ENDOPHYTE IN GRAPEVINES

### Project Leader:

Thomas A. Miller  
Department of Entomology  
University of California  
Riverside, CA 92521

### Collaborators:

Carol Lauzon  
Department of Biological Sciences  
California State University  
Hayward, CA 94542

David Lampe  
Department of Biological Sciences  
Duquesne University  
Pittsburgh, PA 19219

### Consultants:

Frank Richards  
Yale University  
New Haven, CT 06520

Bob Rose  
Frederick, MD

**Reporting Period:** The results reported here are from work conducted October 2004 to October 2005.

### ABSTRACT

*Alcaligenes xylooxidans denitrificans* (*Axd*), an insect and plant symbiotic bacterium, was genetically altered to carry a red fluorescent protein gene, *DsRed*. The marked *Axd* (*RAxd*) was detected in stems of several grapevines two weeks post-inoculation at commercial vineyards in Temecula, Napa and UC Riverside. The amount detected at four weeks post-inoculation declined, and *RAxd* was absent six weeks post-inoculation. *RAxd* was not detected in grape berries, or in soil samples collected around *RAxd* positive grapevines nor in the roots of test plants. *RAxd* was found readily in the buccal cavity of the vector insect and in citrus xylem.

### INTRODUCTION

Replacement therapy or symbiotic control (Beard et al., 2002) employs symbiotic bacteria to deliver anti-disease gene products to target pathogens to make vector insects unable to harbor the pathogen or to prevent pathogens from being transmitted. We are testing *Alcaligenes xylooxidans denitrificans* (*Axd*), a xylem-limited endophytic symbiont and a commensal of glassy-winged sharpshooter (GWSS), *Homalodisca coagulata*, for use in symbiotic control of Pierce's disease (PD) (Bextine et al. 2004). The marked recombinant strain was produced by inserting the *DsRed* marker gene into *Axd* (to make *RAxd*) into mariner element plasmids (Ruben et al. 1999), which was the insertion vehicle. This field project was designed to determine the fate of *RAxd* when injected into grapevines in a future control strategy.

Vines in commercial vineyards were used to locate the test in as realistic a setting as possible and because we are aware that laboratory behavior of these plants and microbes does not reflect field behavior. We chose widely separated locations in California and more than one variety of grapevines to test. A top priority was to determine if the transgenic endophyte lodged in the grape berries or otherwise contaminated the product of the vineyards. These results follow similar protocols followed the year before. Permits from the Environmental Protection Agency (EPA) were required to conduct the field tests (Miller, 2004).

### OBJECTIVES

1. Track the movement of *Alcaligenes xylooxidans denitrificans* (*Axd*) in plants and the environment.
2. Characterize transmission of *Axd* by GWSS, *Homalodisca coagulata*.
3. Treat plants with excessive amounts of *Axd* to assess the effect on the plant and longevity of *Axd*.

### RESULTS

In July 2004, field sites were arranged at commercial vineyards in Napa and Temecula Valleys and at UC Riverside. *RAxd* was applied to grapevines using the inoculation techniques used in previous years on this project. Grapevines were covered with insect-free screening (Figure 1A), to exclude arthropods from test plants. Samples were taken throughout the growing season and processed. Plants were burned at the end of trials (Figure 1B) as required by EPA permits.

Grapevines were needle inoculated with *RAxd* (Bextine and Miller 2004, Bextine et al. 2005) according to the schedule shown in Table 1. Over a 4.5 month period, from June 11 to October 15, 2004, grapevines, grape berries or roots were sampled every other week (Table 1).



**Figure 1A.** Experimental field cage.



**Figure 1B.** Burning grapevines at the end of the experiment as required by EPA (Miller, 2004).

**Table 1.** Schedule of events.

	Weeks After First Inoculation									
	0	2	4	6	8	10	12	14	16	18
Injected	YES	YES	YES	YES	YES	YES	YES			
Plant Samples Tested		YES	YES	YES	YES	YES	YES	YES		
Fruit Tested								YES	YES	YES
Root Tested										YES

### Grapevine samples

Although the grapevines were consistently inoculated at two week intervals, these grapevines were not consistently positive throughout the growing season (Tables 2 and 3). In fact, nearly all grapevines tested positive two, four, and six weeks after the initial inoculations were made. No grapevines tested positive on the last two sample dates, despite the same inoculation treatments. These data are not consistent with error in the sampling methodology but may indicate incompatibility with the host during later stages of fruit development. No control grapevines tested positive.

**Table 2.** Number of RAXD positive shoots per cordon (n=30).

Bacterial Concentration Inoculated	Weeks After First Inoculation						
	2	4	6	8	10	12	14
$10^9$	19	22	19	8	5	0	0
$10^6$	20	23	23	5	3	0	0
$\chi^2$	0.073	0.089	1.270	0.884	0.577	30	30
<i>p</i> -value	0.787	0.765	0.259	0.347	0.447	1	1

**Table 3.** Number of RAXD positive grapevines (n=15).

Bacterial Concentration Inoculated	Weeks After First Inoculation						
	2	4	6	8	10	12	14
$10^9$	12	15	12	8	5	0	0
$10^6$	13	13	14	4	2	0	0
$\chi^2$	0.240	2.143	1.154	2.220	1.677	30	30
<i>p</i> -value	0.624	0.143	0.283	0.136	0.195	1	1

### Fruit samples

No fruit samples were confirmed positive on any date (Table 4). Fruit extracts were tested three times by two QRT PCR methodologies (twice with TaqMan and once with SYBR® Green). During the initial screening of fruit about 14% of samples (52 of 360) from week 14 were labeled “questionable.” Upon re-testing these samples, no *RAXd* was detected. No fruit samples from the other two collection dates tested positive.

**Table 4.** Fruit samples tested for the presence of RAXD.

	Weeks After First Inoculation		
	14	16	18
Individual Grapes	0/300	0/300	0/300
Bunch Stem	0/60	0/60	0/60

As with all PCR-based detection systems, QRT PCR comes with a certain degree of ambiguity so positive samples have to be confirmed. In the case of the week 14 fruit samples, fluorescence increased at the end of the reaction, slightly below the positive threshold using the *TaqMan* chemistry. Because these samples were close to the threshold, they were tested twice more (again by *TaqMan* and using the SYBR® Green chemistry). In these subsequent reactions, no samples tested positive.

### Root samples

No root samples tested positive.

### CONCLUSIONS

*DsRed Alcaligenes xylosoxidans* var. *denitrificans* (*RAXd*) survives in grapevines in commercial vineyards as a recombinant endophyte for less than one month following injections; titers decline below detectable levels after a few weeks. Re-treatment restores the titer. *RAXd* does not spread extensively throughout the grapevine and was not found in the roots, in the petioles or in grapevine berries. From a regulatory and residue standpoint, this is an ideal result. Moreover, the grapevines withstood injection of large amounts of this endophyte with no ill-effects. These tests were not designed to demonstrate control of PD, merely the possibility of delivery of a “biopesticide.” Regulatory permission to test the ability of *RAXd* to deliver an anti-PD strategy would require increased pressure from the grape and wine industry in California. The possibility of delivering an anti-PD strategy with the symbiotic control approach using trap crops associated with vineyards and the possibility of native leafhoppers acquiring and moving the recombinant endophyte to other plant hosts were to be the subject of further testing in 2005-2006; however, the funding needed was not obtained, so those tests were cancelled.

### REFERENCES

- Beard, C. B., C. Cordon-Rosales, and R. V. Durvasula. 2002. Bacterial symbionts of the Triatominae and their potential use in control of Chagas disease transmission. *Ann. Rev. Entomol.* 47:123-141.
- Bextine, B., and T. A. Miller. 2004. Comparison of whole-tissue and xylem fluid collection techniques to detect *Xylella fastidiosa* in grapevine and oleander. *Plant Disease* 88: 600-604.
- Bextine, B., C. Lauzon, S. Potter, D. Lampe, and T. A. Miller. 2004. Delivery of a genetically marked *Alcaligenes* sp. to the glassy-winged sharpshooter for use in a paratransgenic control strategy. *Curr. Microbiol.* 48:327-331.
- Bextine, B., M. Blua, D. Harshman, and T. A. Miller. 2005b. A SYBR green-based real-time polymerase chain reaction protocol and novel DNA extraction technique to detect *Xylella fastidiosa* in *Homalodisca coagulata*. *J. Econ. Entomol.* 98: 667-672.
- Bextine, B., D. Lampe, C. Lauzon, B. Jackson, and T. A. Miller. 2005a. Establishment of a genetically marked insect-derived symbiont in multiple host plants. *Curr. Microbiol.* 50: 1-7.
- Miller, T. A. 2004. Rachel Carson and the adaptation of biotechnology to crop protection. *Amer. Entomol.* 50: 194-198.
- Rubin, E. J., B. J. Akerley, V. N. Novik, D. J. Lampe, R. N. Husson, and J. J. Mekalanos. 1999. *In vivo* transposition of mariner-based elements in enteric bacteria and mycobacteria. *Proc. Nat'l. Acad. Sci.* 96:1645-1650.

### FUNDING AGENCIES

Funding for this project was provided by the USDA Animal and Plant Health Inspection Service, and the CDFA Pierce's Disease and Glassy-winged Sharpshooter Board.

**Additional Note:** All of the field tests were conducted under a permit from the EPA. A report of the tests was submitted to the EPA and the sponsors.

**GENOTYPIC CHARACTERIZATION OF *ALCALIGENES XYLOSOXIDANS* SUBSP.  
*DENITRIFICANS* (AXD HC01) AND FOUR RELATED STRAINS**

**Project Leader:**

Jennifer Parker  
Department of Entomology  
University of California  
Riverside, CA 92521

**Project Director:**

Thomas A. Miller  
Department of Entomology  
University of California  
Riverside, CA 92521

**Cooperators:**

Carol R. Lauzon  
Department of Biological Sciences  
California State University  
Hayward, CA 95452

David J. Lampe  
Department of Biological Sciences  
Duquesne University  
Pittsburgh, PA 15282

**Reporting Period:** The results reported here are from work conducted March 2004 to August 2005.

**ABSTRACT**

In symbiont therapy, an insect's natural symbionts are genetically modified to prevent the transmission of a pathogen, and this strategy is currently under investigation as a way to control the spread of Pierce's disease. The glassy-winged sharpshooter (*Homalodisca coagulata*) symbiont used in this research was identified through metabolic tests as *Alcaligenes xylosoxidans denitrificans* Hc01 (*Axd* Hc01). Since *Axd* Hc01 has the potential to be used agronomically, fully describing it genetically as well as metabolically is important for regulatory purposes. In this study, we used sequence data from two highly conserved prokaryotic genes, the 16S rDNA gene and the gyrase B gene, to genetically characterize *Axd* Hc01 and four of its relatives. These sequences were aligned and used to generate three neighbor-joining phylogenetic trees, two for the 16S gene and one for the gyrase B gene. A preliminary analysis of this data indicates that *Axd* Hc01 is most closely related to members of the genus *Pseudomonas*.

**INTRODUCTION**

One new potential management strategy for Pierce's disease (PD) of grapevine is the use of symbiont therapy. Symbiont therapy exploits the interactions among a pathogen-transmitting organism, its bacterial symbionts, and the pathogenic organism itself (Beard 2002). First, a bacterial symbiont that occupies the same niche as the pathogen must be identified. These symbionts are genetically modified to produce a molecule that hinders the spread of the pathogen in question. The genetically modified bacteria are re-introduced into the vector so that they can reduce its ability to transmit the pathogen in question. For this approach to be successful, the bacterial symbiont must be easily cultured and manipulated *in vitro*, and the genetic modification cannot alter their value to the host organism or their ability to occupy their niche. In addition, the bacterial symbionts cannot be pathogenic to either their host or to non-target organisms before or after the genetic modification (Durvasula 2003). Symbiont therapy has been investigated as a way to control the spread of Chagas Disease (Beard 2002; Durvasula 2003), murine colitis (Steidler 2000), and HIV (Chang 2003).

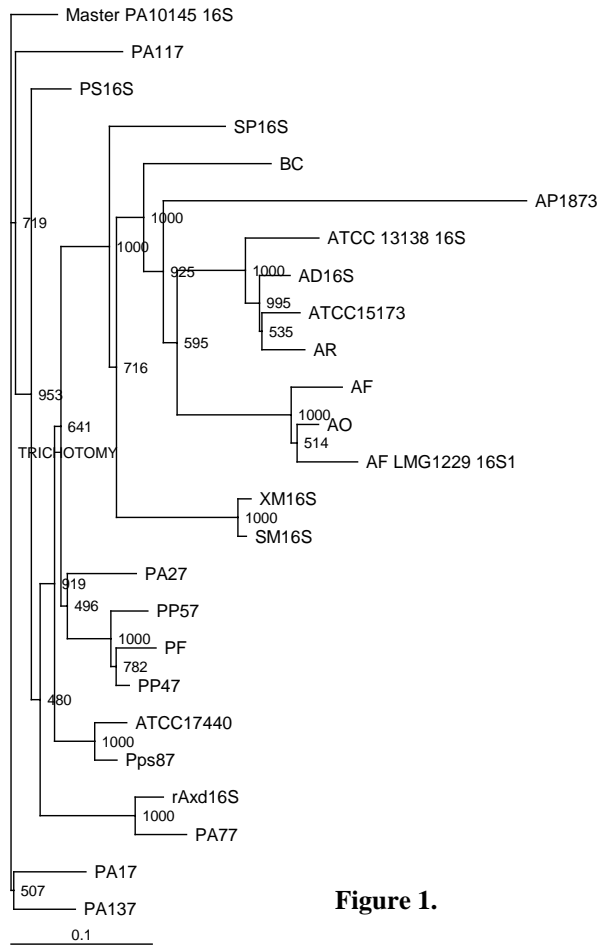
For symbiont therapy to be effective in limiting the spread of PD, a culturable symbiont that inhabits the pre-cibarium and cibarium of *Homalodisca coagulata* (*H. coagulata*) is required, since these areas are colonized by the pathogen, *Xylella fastidiosa*. Three bacterial species that meet these requirements are *Chryseomonas* spp, *Ralstonia* spp, and *Alcaligenes* spp (Bextine 2004). The *Alcaligenes* species were of particular interest because they were frequently isolated from wild *H. coagulata* (Kuzina 2004) and because they could also successfully colonize the xylem of various plants, including citrus (Araujo 2002, Bextine 2005). Using standard morphological and biochemical tests, one of the *Alcaligenes* species isolated from *H. coagulata* was designated as *Axd* Hc01 and selected for further study (Bextine 2004). However, the classification of *Axd* Hc01 remains unsettled.

**OBJECTIVES**

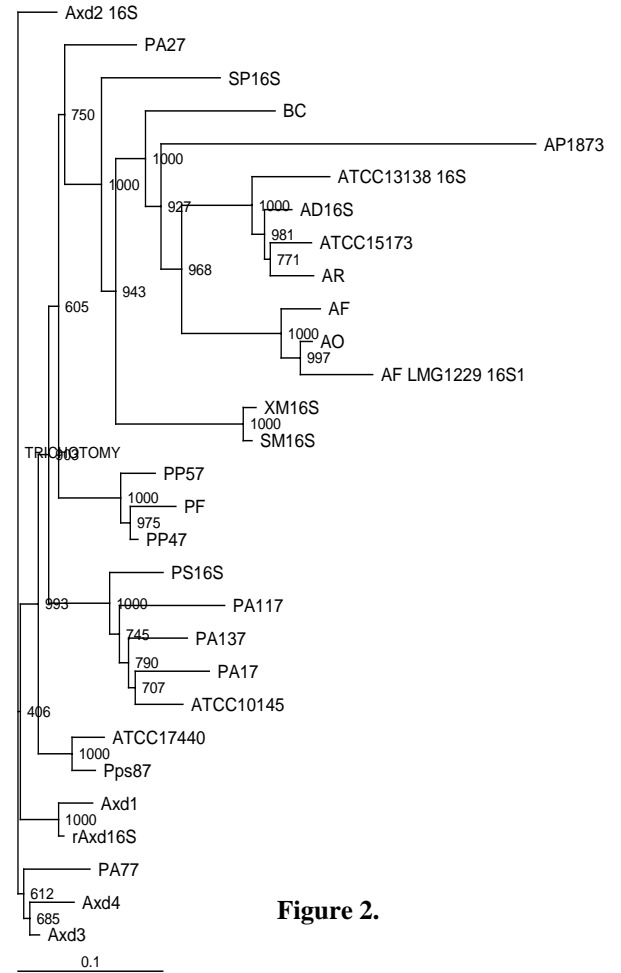
If *Axd* Hc01 is to be used as part of a symbiont therapy program, the issues surrounding its taxonomic identity must be resolved. One way to help clarify its identity and relationship to other identified *Axd* strains is to construct phylogenetic trees based on the sequences of universally present, highly conserved prokaryotic genes (Laguerre 1994). The goal of this research is to help identify *Axd* Hc01 and its relatives by placing them in phylogenetic trees based on the 16S, gyrase B, and 16S-23S intergenic spacer region sequences.

**RESULTS**

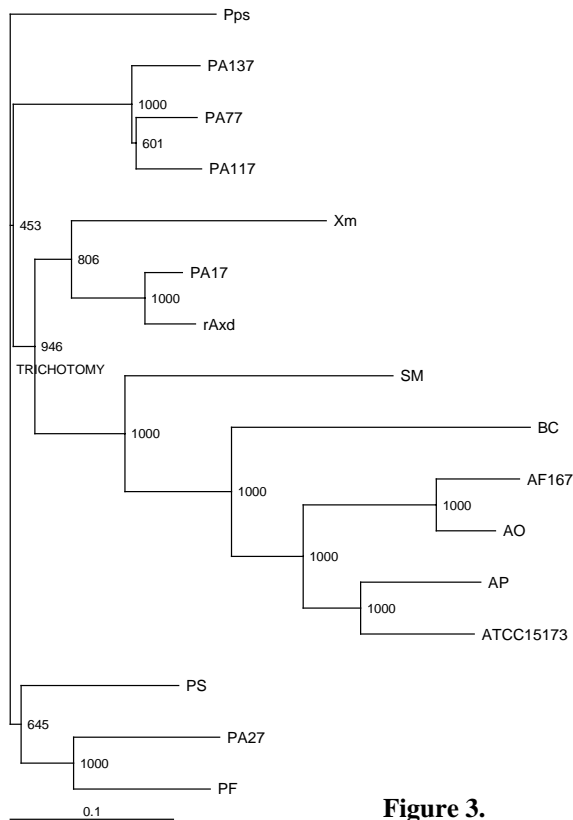
The phylogenetic tree based on 16S sequences shown in Figure 1 and the tree based on gyrase B sequences in Figure 3, indicate that *Axd* Hc01 groups with members of the genus *Pseudomonas*. In addition, the phylogenetic tree based on 16S sequences shown in Figure 2 indicates that *Axd1* is more closely related to *Axd* Hc01 than *Axd3* and *Axd4*. Abbreviations used are as follows: rAxd, *Axd* Hc01; PA, *Pseudomonas aeruginosa*; AP, *Achromobacter piechaudii*; AR, *A. ruhlandii*; AD, *A. denitrificans*; PP, *Pseudomonas putida*; PF, *P. fluorescens*; Pps, *P. pseudoalcaligenes*; PS, *P. stutzeri*; AF, *Alcaligenes faecalis*; AO, *Alcaligenes odorans*; BC, *Burkholderia cepacia*; SP, *Shewinella putrefaciens*; SM, *Stenotrophomonas maltophilia*; and XM, *Xanthomonas maltophilia*.



**Figure 1.**



**Figure 2.**



**Figure 3.**

## CONCLUSIONS

From a preliminary analysis of these results, it can be concluded that *Axd* Hc01 and its relatives are related to members of the genus *Pseudomonas*. However, more work will be necessary to provide more information concerning the identity of *Axd* Hc01 at the species and subspecies level and to clarify its relationship to *Axd1*, *Axd2*, *Axd3*, and *Axd4*. The successful identification of the *Axd* Hc01 bacterium and its relatives will help contribute to a strategy based on symbiont therapy to control PD.

## REFERENCES

- Araujo, W., Marcon, J., Maccheroni, W., Elsas, J., Vuurde, J., and Azvedo, J. (2002). Diversity of Endophytic Bacterial Populations and Their Interaction with *Xylella fastidiosa* in Citrus Plants. *Applied and Environmental Microbiology* 68: 4906-4914.
- Beard, C., Cordon-Rosales, C., and Durvasula, R. (2002). Bacterial Symbionts of the Triatominae and Their Potential Use in Control of Chagas Disease Transmission. *Annual Review of Entomology* 47: 123-141.
- Bextine, B., Lampe, D., Lauzon, C., Jackson, B., and Miller, T. (2005). Establishment of a Genetically Marked Insect-Derived Symbiont in Multiple Host Plants. *Current Microbiology* 50: 1-7.
- Bextine, B., Lauzon, C., Potter, S., Lampe, D., and Miller, T. (2004). Delivery of a Genetically Marked *Alcaligenes* sp. to the Glassy-Winged Sharpshooter for Use in a Paratransgenic Control Strategy. *Current Microbiology* 48: 327-331.
- Chang, T., Chang, C., Simpson, D., Xu, Q., Martin, P., Lagenaur, L., Schoolnik, G., Ho, D., Hillier, S., Holodniy, M., Lewicki, J., and Lee, P. (2003). Inhibition of HIV Infectivity by a Natural Human Isolate of *Lactobacillus jensenii* Engineered to Express Functional Two-Domain CD4. *Proceedings of the National Academy of Sciences of the USA* 100: 11672-11677.
- Durvasula, R., Sundaram, R., Cordon-Rosales, C., Pennington, P., and Beard, C. (2003). *Rhodnius prolixus* and Its Symbiont, *Rhodococcus rhodnii*: A Model for Paratransgenic Control of Disease Transmission. *Insect Symbiosis*. K. Bourtzis, and Miller, T. Boca Raton, CRC Press: 347.
- Kuzina, L., Lauzon, C., Miller, T., and Cooksey, D. (2004). Bacterial Symbionts of the Glassy-winged Sharpshooter and Their Potential Use in Control of Pierce's Disease Transmission. The 2004 Entomological Society of America Annual Meeting, Salt Lake City, Utah.
- Laguette, G., Rigottier-Gois, L., and Lemanceau, P. (1994). Fluorescent *Pseudomonas* Species Categorized by Using Polymerase Chain Reaction (PCR)/Restriction Fragment Analysis of 16S rDNA. *Molecular Ecology* 3: 479-487.
- Steidler, L., Hans, W., Schotte, L., Neiryck, S., Obermeier, F., Falk, W., Fiers, W., and Remaut, E. (2000). Treatment of Murine Colitis by *Lactococcus lactis* Secreting Interleukin-10. *Science* 289: 1352-1354.

## FUNDING AGENCIES

Funding for this project was provided by the USDA Animal and Plant Health Inspection Service, and the CDFA Pierce's Disease and Glassy-winged Sharpshooter Board.

**Additional Note:** All of the field tests were conducted under a permit from the Environmental Protection Agency (TERA R-03-01). A report of the tests was submitted to the EPA and the sponsors.

## **DEVELOPMENT OF A FIELD SAMPLING PLAN FOR GLASSY-WINGED SHARPSHOOTER VECTORED PIERCE'S DISEASE**

### **Project Leaders:**

Thomas M. Perring  
Department of Entomology  
University of California  
Riverside, CA 92521

Jennifer Hashim  
UC Cooperative Extension  
Bakersfield, CA 93307

Carmen Gispert  
UC Cooperative Extension  
Indio, CA 92201

### **Cooperators:**

Yong-Lak Park  
Department of Entomology  
University of California  
Riverside, CA 92521

Charles A. Farrar  
Department of Entomology  
University of California  
Riverside, CA 92521

Rayda K. Krell  
Department of Entomology  
University of California  
Riverside, CA 92521

Murry P. Pryor  
Cooperative Extension  
University of California  
Bakersfield, CA 93307

Barry Hill  
CDFA, PDCP  
Sacramento, CA 95814

Maggi Kelly  
Environmental Sciences, Policy and  
Management Department  
University of California  
Berkeley, CA 94720

**Reporting Period:** The results reported here are from work conducted July 1, 2004 to September 30, 2005.

### **ABSTRACT**

Determining the location of grapevines infected with Pierce's disease (PD) in vineyards is a major objective of growers and researchers. Currently, there are no sampling protocols available except for field surveys based on PD symptoms. The work reported here was conducted in Kern County and the Coachella Valley towards developing a sampling plan to detect the locations of diseased grapevines within vineyards. Spatial distribution patterns of PD were characterized with spatial statistics. Results from Kern County sampling suggest that knowing the percentage of PD infection and the location of vineyards relative to citrus can predict the distribution pattern of PD in the vineyard. Research in the Coachella Valley suggests that PD distribution is highly localized within vineyards, and diseased grapevines are associated with two or more dead, replanted, or missing adjacent grapevines. These results bring us closer to developing reliable sampling protocols for PD in vineyards.

### **INTRODUCTION**

A common sampling technique to detect the presence of PD in vineyards is to visually examine vines, collect symptomatic leaves from potentially infected vines, and confirm the presence of PD with enzyme-linked immunosorbent assay (ELISA). Locating vines infected with PD in a vineyard is required for current PD management, and the only reliable method for finding PD-infected vines is to examine every vine in the vineyard. A PD census was used in Kern County and this provided a cost-effective method (< \$5 per acre) for identifying infected vines in vineyards when PD infection was very low (Hashim and Hill 2003). As the infection level in a vineyard exceeded 1%, and more vines showed symptoms, it became increasingly difficult to observe and sample every symptomatic vine. It was especially difficult to distinguish PD symptoms when other stress factors, such as drought and salt damage, existed in vineyards. Such difficulties increase the sampling costs because many samples must be taken and confirmed with ELISA. Thus, the development of a cost-effective sampling program appropriate for the needs of growers and researchers is critical for PD monitoring and management.

The sampling plan we propose is a multi-step or sequential procedure using a series of grids with different spatial resolutions. For the first step we use a coarse grid to determine the overall proportion of infected vines, the spatial distribution patterns, and the spatial structure. This coarse grid also can locate patch areas if PD is aggregated in the vineyard. The information from the coarse grid is used to determine the next step in the sampling program. In step 2, we create intensive sampling grids ("fine" grids) around PD-infected vines determined in step 1. For every plant in the fine grid, we collect tissue for ELISA determination of *Xylella fastidiosa* (*Xf*) infection. It is essential that we make a correct assessment of PD infection for each vine, thus we do not depend on symptom expression that can be unreliable (Krell et al. 2005). The number of fine grids is determined by the distribution of infected vines determined in step 1, coupled with the size of the vineyard. Sampling within the fine grid reveals detailed structures and patterns of PD distribution, and identifies patch areas where PD is aggregated, the size of patch, and the direction of trends, if they exist. The fine grid also provides information to generate probability maps of PD incidence in the vineyard. Such maps guide where, and how intensively, we need to sample to find individual vines infected with *Xf* in the vineyard.

To develop our sequential grid-sampling programs, the construction and placement of coarse and fine grids is essential. We have been evaluating various sizes and patterns of sample grids based on the categorization of the spatial structure of PD distribution. Grids with different spatial resolutions have been superimposed on the census data to test the efficiency of



grids. This efficiency can be calculated by quantifying how well the grids match the PD incidence from the census data. These grids then are incorporated into the sequential grid-sampling program. Grids have been validated in Kern County and the Coachella Valley. Type I error (i.e., a vine is not infected but sampled with grids) and type II error (i.e., a vine is infected but not sampled with grids) will be calculated to evaluate the precision and accuracy of the sequential grid-sampling program. This procedure will allow us to choose the best series of grids to be used for the sampling program. Sensitivity analysis and cost analysis also will be used to optimize the sequential grid-sampling program. Sensitivity analysis identifies the effect of the grid size on the precision and accuracy of the sampling program, while cost analysis evaluates the economy of the sampling program by considering sampling costs, and accuracy and precision of the sampling program.

## **OBJECTIVES**

The goal of this project is to develop a grid-sampling program for PD that can characterize the spatial distribution and determine the location of grapevines with PD based on the spatial structures and patterns of PD distribution in the vineyard. The objectives include:

1. Characterization of the spatial distribution of PD in vineyards.
2. Development of a sequential grid-sampling program.
3. Validation and optimization of the sampling program with cost analysis and sensitivity analysis.

## **RESULTS**

We have conducted landscape-scale censuses and vineyard-scale sampling in Bakersfield (Kern County) and in the Coachella Valley (Riverside County) for the past four growing seasons (2001-2004) to identify vineyards with PD. Data from this year (2005) are still being collected and analyzed.

### **Kern County sampling**

Census data from 215 vineyard blocks in Kern County showed a total of 52 blocks with PD. Most of the infected blocks (82%) were within ¼ mile of citrus, suggesting that proximity to citrus is an important criterion to consider when sampling for PD in this area. Of 10 cultivars that we sampled, we found that “Flame” had the highest number of vineyards with a PD incidence greater than 1% (Table 1). Spatial analyses with geostatistics and spatial analysis with distance indices (SADIE) found that the distribution of diseased grapevines was dependent on the overall PD incidence in the vineyard. When the incidence was < 0.1%, there was no spatial structure to the infection. Vineyards that had 0.1 - 1% incidence showed a “trend” distribution pattern, with areas of low to high infection. When the PD incidence was between 1% and 5%, the pattern of disease was random, and a clumped distribution existed when disease incidence was > 5%. A couple of vineyards showed enough PD every year to examine year-by-year PD distributions. In these vineyards, we found that the PD distribution patterns were consistently PD-incidence dependent. For example, disease distribution in a vineyard was random when the disease incidence was 0.8% in 2001. In 2002 disease incidence exceeded 5% and distribution was clumped. In 2003 and 2004, disease incidence was 1.3% and 0.8%, respectively, and distributions were random. Further investigation of vineyards with > 5% PD incidence revealed that the diseased grapevines were aggregated and they were spatially correlated within ca. 23-28 m (the “range” in Table 2). This suggests an appropriate size for coarse and fine grids for grid sampling plans to find diseased grapevines. We are continuing our work of constructing and testing coarse (ca. 21 m sampling distance) and fine grids (sample every vine within 25 m from a known diseased vine) in Kern County vineyards, and we will begin sampling in the second week of October.

### **Coachella Valley sampling**

Each year from 2001-2004, we have surveyed all vineyards in the Coachella Valley. Consistent with our work in Kern County, we found that “Flame” vineyards had the highest number of PD-infected sites with an incidence greater than 1% (Table 1). One vineyard had a higher disease incidence (3.8%) than the other 6 vineyards (<0.01%), and in this field, the diseased grapevines were spatially aggregated, forming a patch. Further investigation of this vineyard at the interplant scale (using fine grids) revealed that PD within the patch was aggregated, and diseased grapevines were spatially correlated within 26 m (“range” in Table 2). This result is consistent with the aggregation size of the vineyards in Kern County. All vineyards with PD in the Coachella Valley were located adjacent to citrus groves indicating that citrus affects the incidence and severity of PD in nearby grapes. However, proximity to citrus did not affect PD distribution in all vineyards, similar to the findings in the Temecula vineyards (Perring et al. 2001) and Kern County vineyards. Coarse grid sampling detected spatial aggregation of PD in the one vineyard that had sufficient PD incidence. Fine grid sampling showed that 82% of the infected vines in the Coachella Valley were adjacent to two to six consecutive missing, dead, or replanted grapevines in a row (Figure 1). This potential signature of PD symptomatic areas can be used to locate where to examine plants for disease symptoms, or where to take samples to test with ELISA. We hypothesized that such areas might be detectable with remote sensing and in 2005, we tested this hypothesis in the Coachella Valley. We used three aerial images (1-m resolution natural color image taken in August 2000, 1-m resolution IR natural color image taken in spring 2002, and 2-foot resolution natural color image taken in August 2004). From these images we identified 122 signature areas with inconsistent canopies that contained potential missing, dead, or replanted grapevines. We referred to these areas as “holes”, and we visited each hole identified by the images. This sampling revealed that 57 of the holes still existed; some had been replanted, some were holes created by other factors in the field (like power poles), and others were in vineyards that had been removed since the images were taken.

Sampling these 57 holes, we confirmed the presence of PD-infected vines in 14% of them. Preliminary studies in Kern County indicate that remote sensing of holes can be used to identify PD-sampling areas.

## CONCLUSIONS

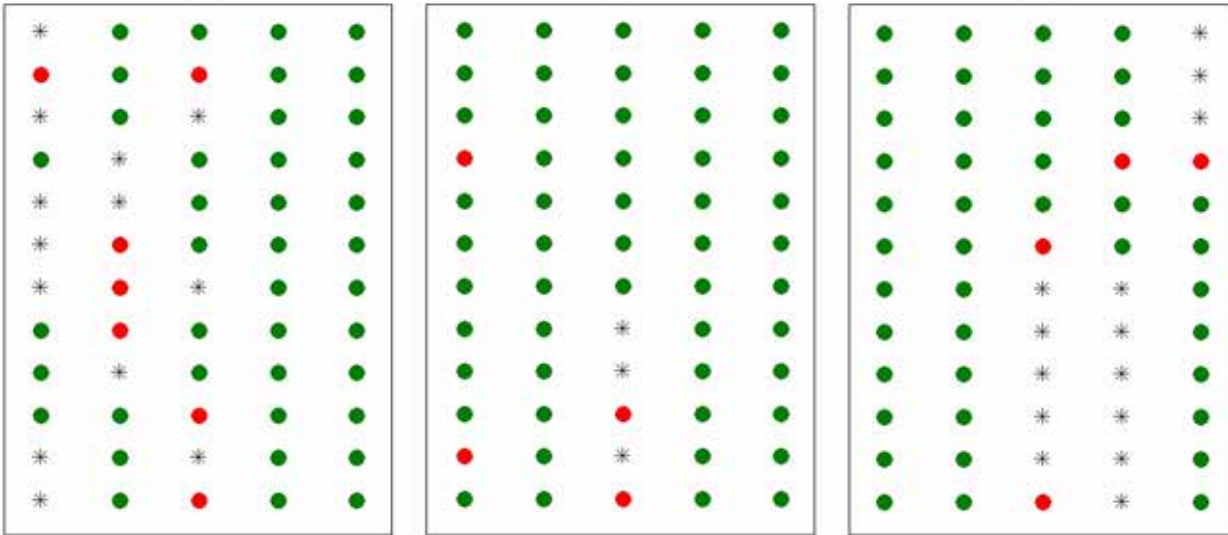
The results showed that patches of PD were detected with big grids and most diseased vines were located with small grids. Validation of sampling grids will be continued and sampling plans will be optimized with sensitivity and cost-benefit analyses. Our work from Kern County suggests that knowing the percentage of PD infection and the location of vineyards relative to citrus can predict the distribution pattern of PD in the vineyard. Coachella Valley data suggests PD distribution is highly localized within vineyards and diseased grapevines were associated with two or more dead, replanted, or missing adjacent grapevines. Such inferences can be used to develop a spatially-oriented sampling program with sampling grids. The development of this sequential grid-sampling program provides three fundamental roles in PD management and research. First, it enables growers to locate vines infected with PD in the vineyard when the high incidence of infected vines precludes a vineyard census. Second, growers will be able to identify problem areas in their vineyards. Third, the sampling program provides a method for standardizing PD sampling statewide. Progress in these areas, i.e. locating individual vines, identifying problem areas in a vineyard, and standardizing areawide monitoring, not only will help growers make informed decisions in their own vineyards, but will assist researchers trying to understand the epidemiology of glassy-winged sharpshooter (GWSS) *Xf* in California. The incidence-dependent spatial distribution of PD and signature areas (i.e. “holes”) found in the Coachella Valley are very important discoveries, because they imply that by knowing the percentage of PD incidence or signature areas for PD, we can predict the distribution pattern of PD in the vineyard. These patterns then become the foundation upon which a spatially-oriented sampling program with sampling grids can be developed. Ultimately, this program will reduce cost and increase efficiency of PD sampling.

**Table 1.** *Vitis vinifera* cultivar in vineyards with  $\geq 1\%$  PD grapevine in Kern County and the Coachella Valley.

Location	Cultivar	Number of vineyards
Kern County	Flame	17
	Red Globe	14
	Thompson Seedless	8
	Crimson	3
	Perlette	3
	Jade	2
	Superior	2
	Autumn Royal and Princess	1
	Black Emerald	1
	French Colombard	1
Coachella Valley	Flame	3
	Perlette	2
	Superior Seedless	1
	Thompson Seedless	1

**Table 2.** Semivariograms for within-block spatial structure of high PD incidence distribution from Kern County and the Coachella Valley.

Vineyard	Model	Nugget	Sill	Range	$R^2$
Kern County A	Spherical	0.139	0.176	23.4 m	0.95
Kern County B	Exponential	0.020	0.188	27.5 m	0.87
Coachella Valley	Spherical	0.053	0.118	26.0 m	0.88



**Figure 1.** Examples of area symptoms of PD found by grid sampling. Red and green circles indicate diseased and healthy grapevines, respectively, and asterisks indicate missing, dead, and replanted grapevines.

## REFERENCES

- Hashim, J. M., and B. L. Hill. 2003. Monitoring and control measures for Pierce's disease in Kern County, and epidemiological assessment of Pierce's disease, pp. 95-98. *In* CDFA (ed.), Proceedings of Pierce's disease research symposium 2003, Coronado, CA.
- Krell, R. K, T. M. Perring, C. A. Farrar, Y. L. Park, and C. Gispert. 2005. Intraplant sampling of grapevines for Pierce's disease diagnosis. *Plant Disease* (in review).
- Perring, T. M, C. A. Farrar, and M. J. Blua 2001. Proximity to citrus influences Pierce's disease in the Temecula valley. *Calif. Agric.* 55: 13-18.

## FUNDING AGENCIES

Funding for this project is being provided by the University of California Pierce's Disease Grant Program.

# FATE OF A GENETICALLY MODIFIED BACTERIUM IN THE FOREGUT OF THE GLASSY-WINGED SHARPSHOOTER

## Project Leader:

Jose Luis Ramirez  
Department of Entomology  
University of California  
Riverside, CA 92521

## Project Director:

Thomas A. Miller  
Department of Entomology  
University of California  
Riverside, CA 92521

## Collaborators:

Thomas M. Perring  
Department of Entomology  
University of California  
Riverside, CA 92521

Carol Lauzon  
Department of Biological Sciences  
California State University  
Hayward, CA 94542

David Lampe  
Department of Biological Sciences  
Duquesne University  
Pittsburgh, PA 19219

**Reporting Period:** The results reported here are from work conducted July 2005 to September 2005.

## ABSTRACT

The use of genetically modified symbionts is a new approach to control the spread of insect-transmitted pathogens by reducing vector competence. A symbiont-control strategy is being developed to reduce the spread of *Xylella fastidiosa* (*Xf*) by *Homalodisca coagulata* (*H. coagulata*), glassy-winged sharpshooter (GWSS). In this study, the fate of a transformed symbiotic bacterium inside the foregut of the sharpshooter when fed on citrus and grape was assessed. TaqMan-based quantitative real-time PCR was used to detect and quantify bacterial cells remaining in the foregut at the end of four time periods. GWSS pre-exposed to the transformed bacterium (*S1Axd*) were observed to maintain an infectivity ratio of 40-50% at the end of a 12 day period. We observed a trend for lower *S1Axd* infection rate in GWSS that fed on citrus although not statistically different from the group that fed on grapevines.

## INTRODUCTION

A recent approach to control the spread of insect transmitted pathogens is symbiotic control. This relies on genetically modified symbionts capable of releasing a gene product that is toxic to the pathogen (Beard *et al* 2002) to reduce vector competence.

A symbiotic bacterium, *Alcaligenes xylosoxidans* var. *denitrificans* (*Axd*), isolated from the cibarium of *H. coagulata* is currently being engineered to express anti-pathogenic products against *Xf* (Pierce's disease strain) to control Pierce's disease (PD). *Axd* was found to colonize citrus (Bextine *et al.* 2004) but a transformed variety of the same bacterium did not colonize grape over long periods. Here, we tested the fate of a genetically transformed *Axd* (*S1Axd*) inside the foregut of GWSS when fed on an optimal *Axd* host plant (citrus) and suboptimal *Axd* host plant (grapevines).

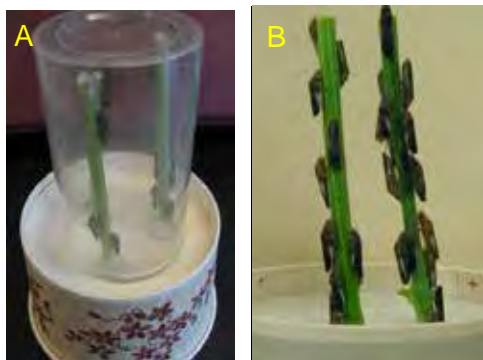
## OBJECTIVES

1. Investigate the fate of a genetically modified *Axd* (*S1Axd*) in a population of GWSS after acquisition when fed on two host plants.

## RESULTS

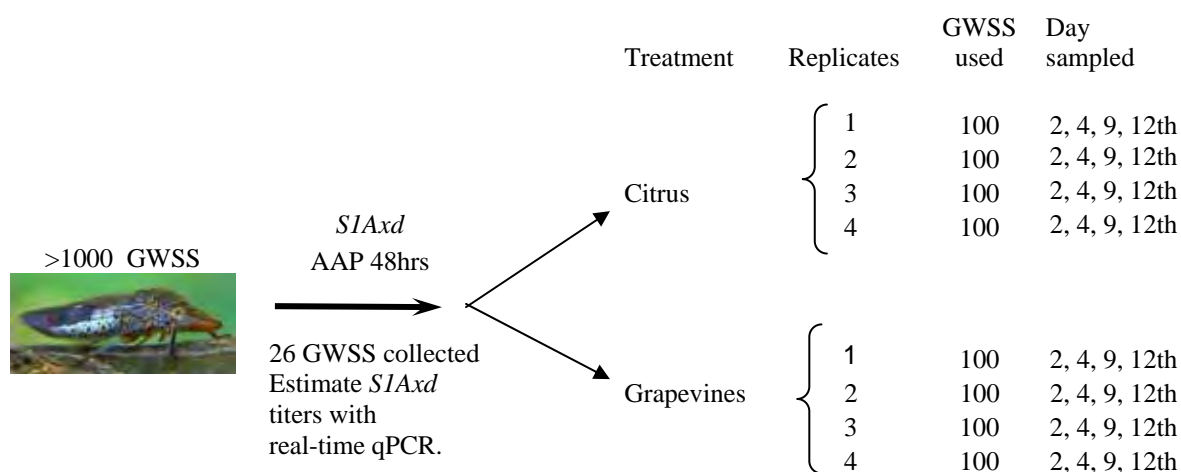
Field-collected GWSS adults were allowed to acquire the transformed endophyte (*S1Axd*) from an artificial acquisition system for a period of 48hr acquisition access period (AAP). The artificial system consisted of black-eyed pea stems placed in a 1.5 ml microcentrifuge tube containing about 500 µl of bacterial suspension (Figure 1). Subsequently, they were transferred to either grapevines or citrus (sweet orange). A pool of 26 sharpshooters was collected at 0hr. post-AAP and 10 sharpshooters were collected from each host plant and replicate at days 2, 4, 9 and 12<sup>th</sup> post-acquisition (Figure 2). GWSS collected were stored at -80°C until processed.

After a standard surface sterilization procedure the head and eyes of each sharpshooter was removed and DNA extracted using the DNeasy Tissue Kit (Qiagen Inc.). Detection and quantitation of bacterial titers was done in a real-time quantitative PCR (qPCR) assay by using a set of primers and TaqMan probe designed for the target insert. The qPCR assay included 5 ten-fold dilution points (ranging from 115,940 to 5 copies/µl) that served as standards for our quantification purposes.



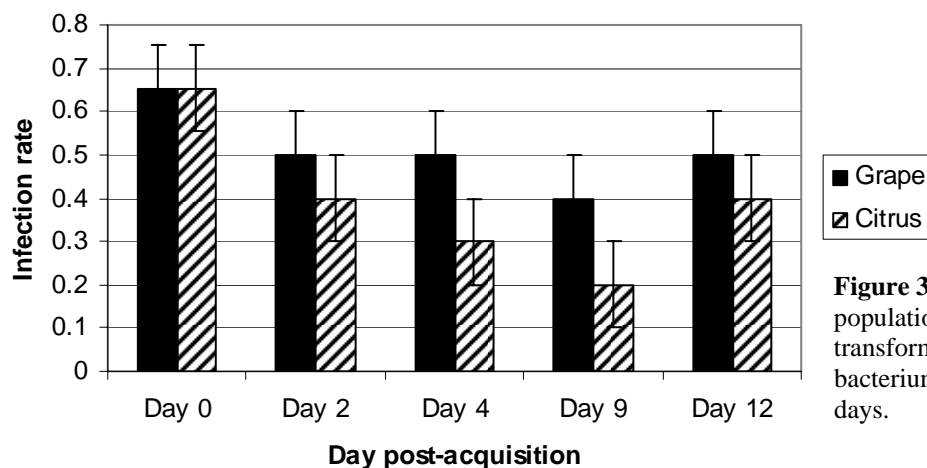
**Figure 1.** Acquisition of *S1Axd* by GWSS adults.  
**A.-** Complete set-up of the acquisition system.  
**B.-** GWSS feeding on a bacterial suspension.

Bacterial titers acquired by GWSS after the 48hr. acquisition period ranged from 3 to 28,407copies/ul of GWSS head sample. This variation declined over the next testing periods and by day 12 post-acquisition sharpshooters carried from about 1 to 14 copies/μl of sharpshooter head sample.



**Figure 2.** Partial diagram of the experimental procedure.

The infection rate (number of GWSS testing positive/total # of GWSS tested) was about 65% at 0hr. post-acquisition and decreased slightly over time with no significant difference between sharpshooters feeding on grapes or citrus. Infectivity of GWSS on day 12 remained at about 50 % for GWSS feeding on grape and 40% for GWSS feeding on citrus. These two results are not statistically significant.



**Figure 3.** Infection rate of a population of GWSS by the transformed *Axd* (*S1Axd*) bacterium during a period of 12 days.

## **CONCLUSIONS**

The wide variation in the bacterial titers acquired by GWSS might be due to feeding behavior, age difference or physiological state of the sharpshooter foregut. The infection rate data suggest that *S1Axd* was able to colonize the foregut of GWSS and maintain an infection rate of about 40-50 % independent of what host plant they fed on.

## **REFERENCES**

- Beard, C. B., C. Cordon-Rosales, and R. V. Duvarsula. 2002. Bacterial symbionts of the Triatominae and their potential use in control of Chagas disease transmission. *Ann. Rev. Entomol.* 47:123-141
- Bextine, B., C. Lauzon, S. Potter, D. Lampe, and T. A. Miller. 2004. Delivery o a genetically marked *Alcaligenes* sp. to the glassy-winged sharpshooter for use in a paratransgenic control strategy. *Curr. Microbiol.* 48:327-331

## **FUNDING AGENCIES**

Funding for this project was provided by the USDA Animal and Plant Health Inspection Service, and the CDFA Pierce's Disease and Glassy-winged Sharpshooter Board.

## FATE OF *XYLELLA FASTIDIOSA* IN THE FOREGUT OF GLASSY-WINGED SHARPSHOOTERS FED ON TWO HOST PLANTS

### Project Leader:

Jose Luis Ramirez  
Department of Entomology  
University of California  
Riverside, CA 92521

### Project Director:

Thomas A. Miller  
Department of Entomology  
University of California  
Riverside, CA 92521

### Collaborators:

Thomas M. Perring  
Department of Entomology  
University of California  
Riverside, CA 92521

Carol Lauzon  
Department of Biological Sciences  
California State University  
Hayward, CA 94542

David Lampe  
Department of Biological Sciences  
Duquesne University  
Pittsburgh, PA 19219

**Reporting Period:** The results reported here are from work conducted July 2005 to September 2005.

### ABSTRACT

Here we test to see the influence that feeding on citrus might have on the infection rate in an adult glassy-winged sharpshooter (GWSS) population that has been pre-exposed to *Xylella fastidiosa* (*Xf*). A GWSS population that was pre-exposed to *Xf*-infected grapevines remained infective for at least 12 days after feeding in either grapevines or citrus host plants. Infection rate was about 65% in the population of sampled GWSS after 12 days with no differences between the groups feeding on citrus or grapevines.

### INTRODUCTION

The GWSS is one of the main vectors of *Xf*. It is a xylophagous insect that has a wide array of host plants, including many ornamental and crop plants (Purcell and Hopkins 1996, Purcell and Saunders 1999). Among its hosts, citrus has been found to be one of the preferred reproductive and overwintering host plants (Blua et al. 1999). In some cases citrus groves are grown adjacent to vineyards, and given *Homalodisca coagulata*'s capability of dispersion (Redak et al. 2004), this sharpshooter moves within and between these two crops readily. A study conducted by Perring et al (2001) found citrus influencing Pierce's disease (PD) incidence and an increase of disease severity in vines growing adjacent to citrus.

Although *Xf* has been found to survive and form clumps in a media containing citrus xylem fluid (Toscano et al. 2004), it is still unknown how the switching of host plants, from grape (suitable for *Xf* growth) to citrus, affects the growth of *Xf* inside the foregut of GWSS once the insect acquires this bacterium. Understanding this question can be useful for elucidating the fate of *Xf* or retention of infectivity in sharpshooters moving back to citrus and for those overwintering in citrus and then potentially moving back to dormant grapevines.

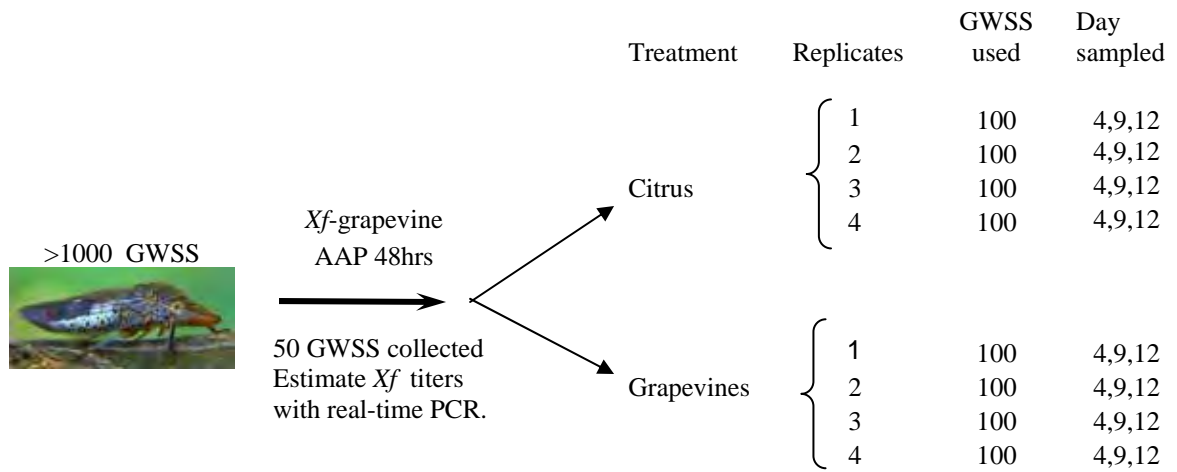
### OBJECTIVES

1. Track the fate of *Xf* in a population of GWSS, *Homalodisca coagulata*, when fed on citrus and grape host plants.
2. Quantify *Xf* titers in sharpshooters feeding in these two host plants.

### RESULTS

GWSS adults were collected from citrus groves in Riverside and allowed to feed on *Xf*-infected grapevines. After an acquisition access period (AAP) of 48 hours they were transferred to either *Xf*-free grapevines (var. Chardonnay) or sweet orange plants. Grapevines and citrus seedlings, as well as a group of 30 sharpshooters, tested negative for the presence of *Xf* prior to the start of the experiments. Subsequently, a pool of 50 sharpshooters was collected at 0 hrs. post-AAP and 15 sharpshooters were collected from each host plant and replicate at days 4, 9 and 12 post-acquisition (Figure 1). Sharpshooters collected were stored at -80°C until processed.

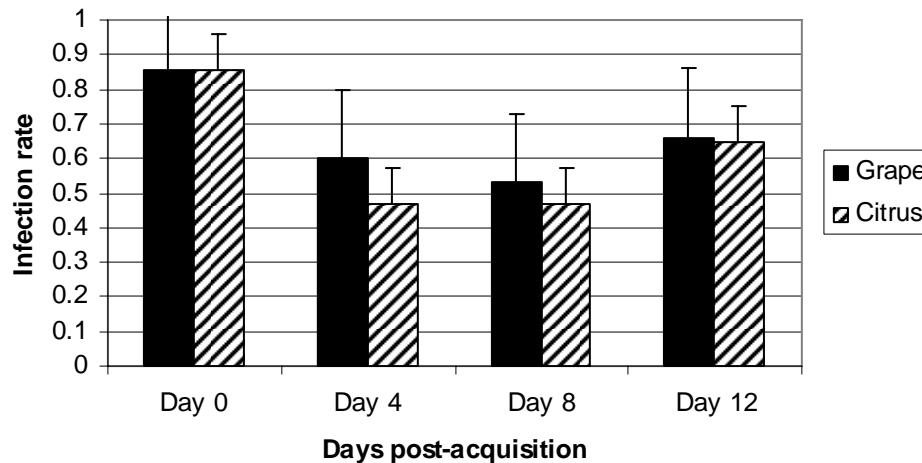
Following a standard surface sterilization procedure, the head and eyes of each sharpshooter was removed and DNA extracted using the DNeasy Tissue Kit (Qiagen Inc.). Detection and quantization of bacterial cells was done using a TaqMan-based real-time PCR assay that included 5 ten-fold dilution points (from about 1100000 to 10 copies/ul of sample) that served as standards for our quantification purposes.



**Figure 1.** Partial diagram of the experimental procedure.

Quantification of bacterial loads after a 48 hr. acquisition period showed that GWSS acquired from an estimated 50 to 95,000 *Xf* bacterial cells per sharpshooter head. We observed similar bacterial load ranges in GWSS sampled for each post-acquisition sample period. By the 12<sup>th</sup> day, some sharpshooters contained an estimated 930,000 bacterial cells/head.

Infection rate was about 86% at 0 hrs. post-acquisition, declining slightly over the next sampled days but staying at about 65% in the population of sampled GWSS after 12 days. There were no differences of infection rate in the population of GWSS feeding on grapevines or citrus.



**Figure 2.** Infection rate of sharpshooters by *Xylella fastidiosa* fed on citrus and grapes during a 12 day period

## CONCLUSIONS

*H. coagulata* population remained infective for at least 12 days after feeding in either grapevines or citrus host plants. This suggests that feeding on citrus plants does not result in loss of infection in a population of GWSS that have pre-acquired this bacterium. This does not tell us yet if transmission of this plant pathogen by GWSS is affected by citrus xylem and studies currently are under investigation to test this hypothesis. Further analyses of the data collected in the present study are still being conducted and they will be presented at the symposium.

## REFERENCES

- Blua, M. J., P.A. Phillips, and R. A. Redak. 1999. A new sharpshooter threatens both crops and ornamentals. Calif. Agric. 53(2): 22-25
- Perring, T. M., C. A. Farrar and M. J. Blua. 2001. Proximity to citrus influences Pierce's disease in Temecula Valley vineyards. Calif. Agr. 55:13-18
- Purcell, A. H., and D. L. Hopkins. 1996. Fastidious xylem-limited bacterial plant pathogens. Annu. Rev. Phytopathol. 34: 131-151
- Purcell, A. H., and S. R. Saunders. 1999. Fate of Pierce's disease strains of *Xylella fastidiosa* in common riparian plants in California. Plant. Dis. 83: 825-830.



- Redak, R. A., A. H. Purcell, J. R. S. Lopes, M. J. Blua, R. F. Mizell III, and P.C. Andersen. 2003. The biology of xylem sap-feeding insect vectors of *Xylella fastidiosa* and their relation to disease epidemiology. *Annu. Rev. Entomol.* 49: 243-270.
- Toscano, N. C., Cooksey, D., Bi, J., Dumenyo, K., and Hernandez-Martinez, R. 2004. Impact of Host Plant Xylem Fluid on *Xylella fastidiosa* Multiplication, Aggregation, and Attachment. *Pierce's Disease Research Symposium Proceedings.* 60-63

#### **FUNDING AGENCIES**

Funding for this project was provided by the USDA Animal and Plant Health Inspection Service, and the CDFA Pierce's Disease and Glassy-winged Sharpshooter Board.

## INHIBITION OF XYLELLA FASTIDIOSA BIOFILM FORMATION VIA METAL CHELATORS

### Project Leaders:

Mipha L. Koh and Jeffrey H. Toney  
Department of Chemistry and Biochemistry  
Montclair State University  
Montclair, New Jersey

Pierce's disease (PD) is a lethal disease for a variety of crops caused by *Xylella fastidiosa* (*Xf*). *Xf* is a gram-negative phytopathogen that forms biofilms. One of the twelve genes that regulate exopolysaccharides, a major component of biofilm, is aconitase which seems to respond to intracellular iron levels. It has been reported that lactoferrin can cause deprivation of iron, thus inhibition of biofilm formation in *Pseudomonas aeruginosa*. We have observed that biofilm formation can be blocked using iron chelators such as lactoferrin, EDTA (ethylenediaminetetraacetic acid), and EDDS (ethylenediaminedisuccinic acid). Conalbumin was used in a parallel manner with lactoferrin during a 6.5 day incubation period due to its availability. During our study, incubation of *Xf* in the presence of lactoferrin at 1000 µg/mL for 3.5 days showed the greatest biofilm inhibition of 42%, as well as planktonic (liquid phase bacteria) inhibition of 32%. EDTA at a concentration of 15 mg/mL inhibited 99.7% of biofilm and 98.9% of planktonic in a 24 hour incubation. In contrast, EDDS at a concentration of 38.2mg/mL showed 64.7% inhibition of biofilm and 33.6% inhibition of planktonic. Iron deprivation could serve as a first step towards eradication of PD via blockage of biofilm formation.

## SITE-DIRECTED *RPFA* GENE DISRUPTION IN *XYLELLA FASTIDIOSA*: EFFECT ON BIOFILM FORMATION VIA QUORUM-SENSING IN PIERCE'S DISEASE

### Project Leaders:

Janice D. Thomas and Jeffrey H. Toney  
Department of Chemistry and Biochemistry  
Montclair State University  
Montclair, NJ 07043

The shuttle DNA vector pSP3 was constructed to generate mutations by DNA insertion. This construct can replicate in *E. coli* and in *Xylella fastidiosa* (*Xf*). If a DNA fragment containing part of the *Xf rpfA* gene encoding for aconitase is cloned into pSP3, specific integration of this construct into the *rpfA* gene will be induced. Previous results with the *Xf xpsD* gene, using a pSP3(xpsD600) construct, indicate that this vector is useful in generating gene disruption by homologous recombination. We are currently investigating the potential role of the *rpfA* gene in biofilm production using this gene disruption technique.



---

***Section 5:***  
***Vector***  
***Management***





# MANIPULATION OF *HIRSUTELLA* AS A BIOLOGICAL CONTROL OF THE GLASSY-WINGED SHARPSHOOTER

## Project Leaders:

Drion Boucias  
University of Florida  
Gainesville, FL 32611

Russell F. Mizell, III,  
University of Florida, NFREC  
Quincy, FL 32351

## Cooperators:

Verena Blaeske  
University of Florida  
Gainesville, FL 32611

**Reporting Period:** The results reported here are from work conducted March 1, 2005 to September 15, 2005.

## ABSTRACT

A series of greenhouse experiments were conducted during 2005 to examine horizontal transmission of *Hirsutella homalodisca* infection to healthy GWSS. In addition, a series of different treatments were conducted to optimize the production of *Hirsutella*-infected GWSS. Hyphal body injection, topical spore application, and exposure to mycosed GWSS successfully produced both *Hirsutella* and *Beauveria* infections to a varying degree. Exposure to mummies collected this season was more efficient in disease transmission than exposure to last year's (frozen) cadavers. Results demonstrated that *H. homalodisca* is pathogenic to all GWSS stages and can be readily transmitted under glasshouse conditions. Furthermore, both our greenhouse and related field studies demonstrated that the fungus *Pseudogibellula formicarum* is a mycoparasite colonizing a high proportion of GWSS cadavers after mycosis by *H. homalodisca*.

## INTRODUCTION

The goal of this research is to manipulate the primary GWSS mycopathogens as classical biological agents. Examples where this approach has been successful is the dissemination of the friendly fungus *Aschersonii* spp. for citrus whitefly control in Florida (McCoy et al., 1988) and the recent accidental introduction of *Entomophaga maimaiga* into gypsy moth populations (Hajek, 1999). In both cases, introductions of the mycopathogens resulted in successful long-term suppression of pest populations. This approach would be well suited for the introduction of highly fastidious pathogens and field and/or lab infected insects could serve as potential inocula. Over the past several years, field research has clearly demonstrated that the most common pathogen infecting in GWSS populations in southeastern US is the fungus *Hirsutella homalodisca* (Boucias et al., 2005). This subject area has great potential but has received virtually no research attention. Based on our preliminary experimentation and given the rapid colonization of CA by GWSS, the contributions of biological control (parasite spread) and the similarities of climate and weather (same horticultural zones occur in Florida and California) that are enabling the GWSS invasion of California, it is logical to conclude that the mycopathogens of GWSS collected from the Southeast will be equally adaptive to California.

## OBJECTIVES

The major objective of this project is to identify the route of *Hirsutella homalodisca* disease transmission. A series of experiments have or will be conducted to determine the spatial and temporal factors required to transmit this agent from diseased to healthy insects under controlled greenhouse conditions. Specific experiments have examined:

1. Production of *Hirsutella* GWSS mummies.
2. Examining horizontal transmission of the disease. The transmission data will establish the protocols necessary to introduce this pathogen.
3. Analyzing the fate appearance and fate of *H. homalodisca* on the GWSS cadavers. The data on the overwintering biology of the pathogen in the GWSS mummies will provide insight into how this disease persists over a multi-seasonal time-frame.

## RESULTS

During the field season of 2005 (June - September), varying numbers of adult GWSS (total = 490) from sweep-net collections in Quincy, Florida, were transported on sleeve-caged plants to the laboratory in Gainesville, Florida. Hemolymph samples were collected by removal of an antenna and examined for the presence of hyphal bodies. Healthy insects were maintained on potted plants placed in 1-m<sup>3</sup> screened cages in the greenhouse. Plants used for adult rearing were soy bean (*Glycine max* (L.) 'D90-9216'), cotton (*Gossypium hirsutum* L. 'Deltapine 88'), and cowpea (*Vigna unguiculata* (L.) 'California #5'). Leaves with egg masses were transferred to water agar Petri dishes and incubated at constant conditions (26 ± 1 °C, 12:12 h light/dark photoperiod, 85 ± 5% RH). Hatching neonates were transferred to caged lemon basil (*Ocimum basilicum* L. 'Lemon') plants in the greenhouse. Greenhouse temperature ranged from 26-30 °C, and indoor lighting maintained a 14:10 h light/dark photoperiod. The soil medium for all plants was watered to saturation once daily. For all experiments, individual plants were covered with clear acrylic cylinders (13 or 15 cm diameter x 45 cm high) with several holes (5 cm diameter) and the top covered with fine mesh gauze to allow air exchange. In order to introduce insects to the cylinders, the insects were chilled on ice for 15-30 min and transferred to filter paper, which was placed on the soil surface of

the plant pot. All bioassays were conducted in the greenhouse. In most experiments with nymphs, mortality was not recorded, since dead individuals could not be recovered from the soil. Mortality data for these assays refer only to mycosed cadavers found on the plant after termination of the experiment.

Second to fifth instar nymphs, reared on lemon basil from eggs, were injected with 50 nl of *H. homalodisca* hyphal body preparation (originating from in vitro cultures of strains 3A and 11B) or filter-sterilized Ringer's physiological solution for treatment or control, respectively. For nano-injections, glass needles were mounted to a nanomanipulator. Adult GWSS were injected with 1 µl of hyphal body preparation (originating from different in vitro cultures of *H. homalodisca*) or filter-sterilized Ringer's physiological solution for treatment or control, respectively. Groups of 10-21 insects were transferred to a cylinder containing a host plant and maintained in the greenhouse for 3 weeks. Adult mortality was recorded daily and the hemolymph of dead individuals was examined for hyphal body propagation. After 3 weeks, all plants (from nymph and adult experiments) were examined for mycosed cadavers, and surviving GWSS were subjected to hemolymph examination. A total of seven injection experiments (three controls, four treatments) were conducted.

Different approaches were taken to apply spores of different fungi (*Hirsutella*, *Beauveria*, *Sporothrix/Pseudogibellula*) to healthy nymphs or adults of *H. coagulata*. Initially, spores of *Beauveria bassiana* (strain 6185) were suspended 0.005% Tween 80 and 1-µl droplets applied to the ventral surface of the thorax and abdomen of nymphs or adults. Control insects were treated with Tween 80 solution only. One group of adults was immersed in Tween 80 suspension for 5 sec. In a second series of assays, adult GWSS were treated by touching their ventral surface to sporulating colonies of different in vitro cultures of *Hirsutella*, *Beauveria*, *Pseudogibellula*, or *Verticillium*. A control group was exposed to UV-irradiated *Beauveria* spores. In a third series of bioassays, the ventral surface of adult GWSS was touched to sporulating GWSS cadavers displaying spores of *Hirsutella*, *Beauveria*, or *Sporothrix (Pseudogibellula?)*. Groups of 5-20 insects were transferred to an acrylic cylinder containing a host plant and maintained in the greenhouse for 3 weeks. Adult mortality was recorded daily, and dead individuals that had fallen onto the soil surface were removed to examine their hemolymph for hyphal body propagation. After 3 weeks, all plants (from nymph and adult experiments) were examined for mycosed cadavers, and surviving GWSS were subjected to hemolymph examination. A total of 15 different topical application experiments (four controls, eleven treatments) were conducted.

The majority of the experiments examined the ability to transmit fungal infection from field-collected, mycosed cadavers to healthy GWSS. During the first part of the season (until mid July), overwintered, weathered cadavers collected in January (stored at 4°C) were used. During the second part of the season, new cadavers collected in July and August were used. Cadavers were pinned to different plants (10-16 per plant), which were covered with an acrylic cylinder and maintained in the greenhouse. Groups of *H. coagulata* nymphs ( $N = 21-45$ ) or adults ( $N = 12-16$ ) were introduced to the cylinders and observed for mortality daily. Dead adults were removed from the soil surface and hemolymph samples were examined for the presence of fungal hyphal bodies. After 2-3 weeks, all plants (from nymph and adult experiments) were examined for mycosed cadavers, and surviving GWSS were subjected to hemolymph examination. Several plants with sporulating cadavers were re-used for additional exposure of healthy GWSS. A total of 20 cadaver exposure experiments were conducted. Groups of healthy adult GWSS subjected to antennal bleeding were used as controls for mortality comparisons.

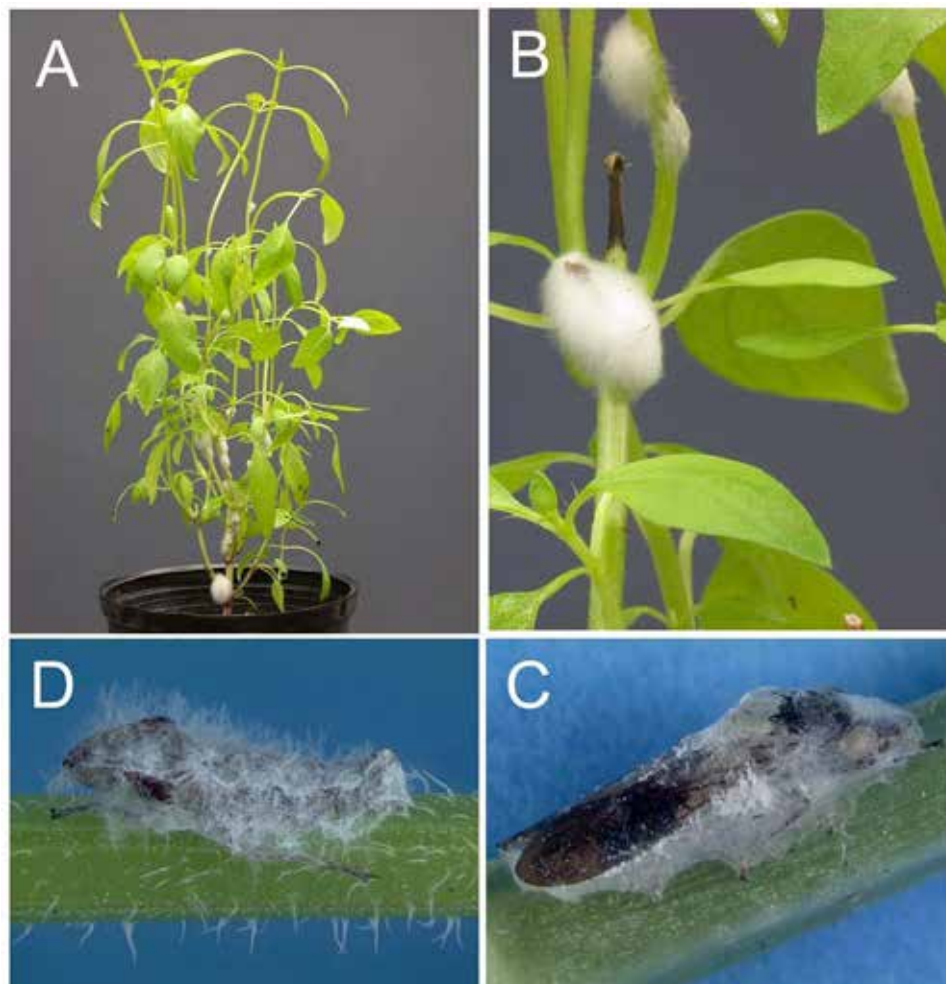
Five out of 490 adults field-collected GWSS were diagnosed by antennal bleeds to be infected with *Hirsutella* hyphal bodies and all five died within four days post bleeding. The low incidence of disease in these samples corresponds to population/disease data collected from North Florida plots in 2005.

Hyphal body injection, topical spore application, and cadaver exposure treatments successfully produced *Hirsutella* and *Beauveria* infections in *H. coagulata*. However, infection rates varied greatly between different and among similar treatments. The injection of nymphs with 50 µl of a hyphal body preparation (glass needles) from strains 3A and 11B (collected 2003, 2004) did not result in infection. Of the 21 injected nymphs, 15 uninfected nymphs were recovered after 3 weeks. In the corresponding 19 control nymphs, 15 uninfected nymphs were recovered. Most likely, the dosage used was too low. The same hyphal body preparation caused 47% (7/15) infection when injected at 1 µl per inject into adult GWSS, and 93% of the injected adults died during the observation period of 3 weeks. However, no mycosis was observed. Mortality in the corresponding control was 67% (8/12). Injection of strain 6197 (collected 2005) resulted in 100% mortality and 93% (14/15) infection. Four infected adults mycosed on the plant. In the corresponding control assay, mortality was 70% (7/10), and the hemolymph one dead adult contained hyphal bodies (the same individual was scored negative 3 days before). Injection of a second preparation from strain 6197 resulted in 78% (27/30) mortality and 19% infection. Three of the five infected adults mycosed on the plant.

Using several different techniques, GWSS nymphs or adults were exposed to spores of different fungi (*Hirsutella*, *Beauveria*, *Sporothrix/Pseudogibellula*). Topical application of a *Beauveria* spore suspension produced low infection (8%, 1/12) in treated nymphs, whereas no infection was induced in adults ( $N = 20$ ). Adult mortality did not differ between treatment and control (60 and 70%, respectively). Contact with sporulating colonies successfully transmitted *Beauveria* to adult GWSS producing 27% (12/45) infection, but no transmission was found with the poorly sporulating *H. homalodisca* cultures. Mortality in *Beauveria* treatments was significantly higher (91%, 41/45) than in *H. homalodisca* and control treatments (50

and 67%, respectively). Results from contact treatments with sporulating cadavers (*Hirsutella*, *Beauveria*, *Sporothrix/Pseudogibellula*) are pending. *Sporothrix*: no transmission, but 100% mortality within 11 d suggesting the production of toxins. The introduction of healthy GWSS to plants harboring either one-year old, weathered cadavers or this year's new cadavers resulted in transmission of *H. Homalodisca* infection within 3 weeks to both nymphs and adults of *H. coagulata*. The majority of the cadavers that were pinned to the plant displayed sporulating *H. homalodisca* mycelium within a week. This year's cadavers developed an unusually thick, white mycelium overgrowing the entire insect appearing like cotton balls. After 3-4 weeks, other fungi such as *Beauveria* and *Pseudogibellula* were observed on several cadavers or newly induced mycosed adults. Dead exposed nymphs or adults attached to the plant and displaying *Hirsutella*-induced mycosis were seen as early as 7 or 12 d after exposure in, respectively. Hyphal bodies were found in the hemolymph of dead adults as early as 8 d after exposure.

This year's cadavers were more efficient in disease transmission. When nymphs (regardless of instar) were exposed to this year's cadavers, no survivors were found and all dead insects were overgrown with *H. homalodisca* mycelium. The experiment was initially conducted with different instars on the same plant and repeated 4 times using an even-aged cohort of nymphs (neonate, 2<sup>nd</sup>, 4<sup>th</sup>, or 5<sup>th</sup> instar) each time. Exposure of nymphs to last year's cadavers yielded only  $3 \pm 6\%$  infection (ranging from 0-10%). The mycelium growing on these mycosed nymphs was light and flat, not nearly as thick as on mycosed nymphs induced by this year's cadavers. Adult mortality after exposure to this year's cadavers ( $N = 4$ ) was  $96 \pm 5\%$  and significantly higher than in the corresponding controls ( $32 \pm 37\%$ ); disease transmission was  $48 \pm 30\%$  (ranging from 7-73%). Adult mortality in experiments using last year's cadavers ( $N = 4$ ) was high ( $76 \pm 8\%$ ) but disease transmission was  $13 \pm 11\%$  (ranging from 0-25%), significantly lower compared with transmission from this year's cadavers.



**Figure 1.** Cadaver exposure experiments. (A) Lemon basil plant 3 weeks after exposure of *H. coagulata* nymphs to this year's cadavers on a lemon basil plant. (B) Note the white, thick mycelium overgrowing the cadaver in the center and the introduced, mycosed nymphs. (C) Adult GWSS 4 weeks after exposure to last year's cadavers displaying *Hirsutella* mycelium and an emerging, secondary unknown (*Beauveria*?) mycelium. (D) Mycosed nymph 3 weeks after exposure of *H. coagulata* neonates to last year's cadavers on a lemon basil plant.



## CONCLUSIONS

The research was directed at developing the technologies required to transmit *H. homalodisca* to healthy GWSS. Our findings demonstrated the following: 1) Kochs postulate was fulfilled; 2) the fastidious nature of *H. homalodisca* was confirmed; and 3) technologies required to amplify infectious material were established. Future research involving a combination of greenhouse and field studies will optimize *in vivo* produced *H. homalodisca* as an inoculum substrate.

## REFERENCES

- Boucias, D.G., D. W. Scharf, S. E. Breaux, D. H. Purcell, and R. F. Mizell III 2005 Studies on the fungi associated with the glassy-winged sharpshooter *Homalodisca coagulata* with emphasis on a new species *Hirsutella homalodisca*. Biocontrol (submitted).
- Hajek, A. 1999. Pathology and epizootiology of *Entomophaga maimaiga* infections in forest Lepidoptera. Microbiology Molecular Biology Reveiw 63: 814–835.
- McCoy, C. W., R. A. Samson, and D. G. Boucias. 1988. Entomogenous fungi. In: "CRC Microbial Insecticides" (C. Ignoffo, ed.). CRC Press, Orlando, FL. pp. 156-236.

## FUNDING AGENCIES

Funding for this project was provided by the CDFR Pierce's Disease and Glassy-winged Sharpshooter Board.

# CHARACTERIZATION OF NEONICOTINOIDS AND THEIR PLANT METABOLITES IN CITRUS TREES AND GRAPEVINES, AND EVALUATION OF THEIR EFFICACY AGAINST THE GLASSY-WINGED SHARPSHOOTER AND THE EGG PARASITOID *GONATOCERUS ASHMEADI*

## Project Leaders:

Frank J. Byrne and Nick C. Toscano  
Department of Entomology  
University of California  
Riverside, CA 92521

**Reporting Period:** The results reported here are from work conducted October 2004 to September 2005.

## ABSTRACT

The neonicotinoids are highly effective insecticides for the management of glassy-winged sharpshooters (GWSS). The systemic activity of the insecticides exploits the feeding behavior of the sharpshooter at all life stages. Imidacloprid was also toxic to the egg stages. This toxicity was manifested at the time of emergence of the 1<sup>st</sup> instar from the egg mass, and not during the development of the embryo. Imidacloprid metabolites were found to be effective against adult and egg stages of the sharpshooter. In accordance with data from studies on aphids and whiteflies, the olefin and 5-hydroxy metabolites were most toxic, while the desnitro and diol derivatives lacked any toxic effect. Metabolites were detected in the xylem fluid extracted from citrus trees that had been treated with Admire. The source of these metabolites is not yet clear – they may originate from imidacloprid metabolism within the soil before uptake by the trees, or they may have been formed within the trees themselves. Nevertheless, our results confirm that sharpshooters feeding on citrus will encounter imidacloprid metabolites that will contribute to its toxicity. We are currently evaluating the metabolic fate of the other neonicotinoids.

## INTRODUCTION

Without a cure for PD, the primary means of controlling its spread in California vineyards is through the elimination of its vector using insecticides. Systemic insecticides are currently being evaluated on both citrus and grapes. Of the various classes of insecticide under consideration, the neonicotinoids, especially imidacloprid, have proven to be the most effective at suppressing GWSS populations. Like all neonicotinoids, imidacloprid is a nicotinic acetylcholine receptor agonist that combines high potency with low mammalian toxicity and favorable persistence. As a systemic treatment, it has proved to be especially effective against the GWSS. The success of imidacloprid in controlling GWSS is due largely to its excellent systemic properties, which exploit the xylophagous feeding behavior of the insect, and thereby disrupt the transmission of PD and other *Xylella fastidiosa*-related diseases. The ability to deliver imidacloprid to the specific feeding zone of the GWSS is an extremely favorable attribute of imidacloprid, and one that has led to the widespread use of this chemical in area-wide management programs conducted in the Temecula Valley, southern Kern County (the General Beale Road Project), and the Coachella Valley.

We are currently evaluating the toxicity of several neonicotinoid insecticides against adult GWSS. These include acetamiprid, clothianidin, dinotefuran and thiamethoxam. Of particular interest to us are thiamethoxam and clothianidin, which are being evaluated for use against citrus and grape pests. Recently, it has been established that thiamethoxam is converted into clothianidin by insects and cotton plants (Nauen et al., 2003). This is an important finding, as it could have ramifications for the use of these products on grapes and citrus.

From a pest management perspective, there are legitimate reasons why it is important to study the neonicotinoid class of insecticides within the citrus and grapevine systems. Little consideration has been given to the impact of neonicotinoids on the eggs of the GWSS. It is important to establish this for two reasons. Firstly, egg mortality will contribute to the suppression of the population. And secondly, an impact on sharpshooter eggs could have a direct knock-on effect on parasitism levels. It remains to be determined whether or not the parasitoid can emerge successfully from a systemically treated plant after the parasitoid has reached the adult stage. This could be an important source of parasitoid mortality in treated citrus, where parasitism is reported to contribute, in some orchards, as much as 90% to overall mortality in the Summer generation. If the parasitoid can survive emergence from the egg, then this is good news for the integration of neonicotinoids and biological control. Parasitism by *G. ashmeadi*, for example, is especially effective against GWSS in Riverside orchards, at a time when insecticide titers arising from early applications of neonicotinoids are diminishing.

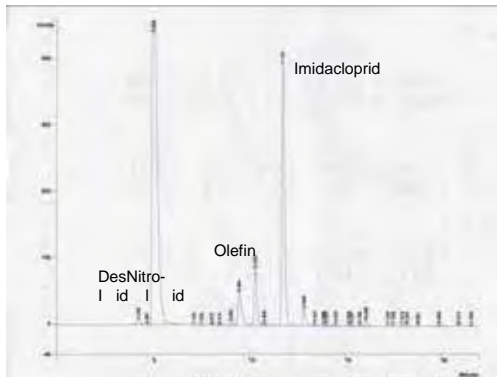
## OBJECTIVES

1. Determine the metabolic fate of neonicotinoids within citrus trees and grapevines;
2. Determine the relative toxicities of neonicotinoids and their metabolites to the adult and egg stages of the GWSS;
3. Determine the impact of neonicotinoid metabolites on the egg parasitoid *Gonatocerus ashmeadi*.

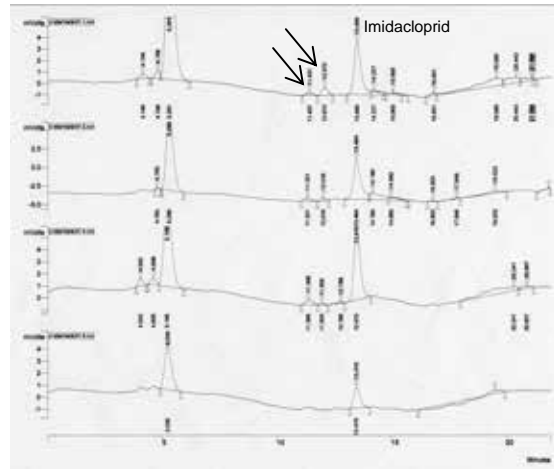
## RESULTS

### Metabolic fate of neonicotinoids within citrus trees and grapevines

We are currently processing xylem fluid collected from treated citrus and grapes in order to quantify imidacloprid and its metabolites by HPLC. In Figure 1, the chromatogram of imidacloprid and two of its metabolites are shown. There are clear differences in retention time, enabling us to distinguish between metabolites and the parent compound. In Figure 2, chromatograms for 4 samples from Admire-treated citrus trees are shown. The main peak in each is parent imidacloprid, while there is evidence of metabolites in three of the samples (arrowed). As expected, the metabolites are more polar than the parent compound.



**Figure 1.** Chromatograms of imidacloprid and two of its metabolites - desnitro imidacloprid and imidacloprid olefin.



**Figure 2.** Chromatograms of 4 xylem fluid extracts from citrus trees treated with Admire. The arrows indicate polar metabolites that were detected in three of the extracts. Imidacloprid was the major peak in each chromatogram. The initial peak (at 5 min) is acetone. The presence of the olefin metabolite was also confirmed by TLC.

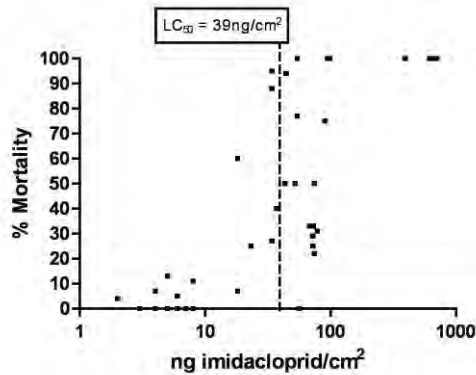
This is the first evidence that the GWSS feeding on xylem fluid from citrus will encounter metabolites. Furthermore, the presence of the metabolites in the xylem fluid indicates that they are likely to be deposited in the leaf tissue. It is at this location that their impact on the developing egg will be manifested.

### Relative toxicities of neonicotinoids and their metabolites to the adult and egg stages of the GWSS

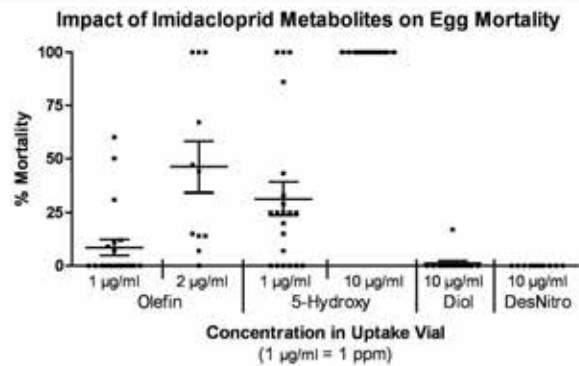
The results from our metabolic fate study vindicate the determination of toxicity profiles for the neonicotinoids and their metabolites. The GWSS are likely to encounter these chemicals during feeding, and so their toxicity is of interest. Furthermore, chemicals detected within the xylem system will be deposited within the leaves and there is, therefore, a strong likelihood that these chemicals could impact the egg stage of the sharpshooter.

The first phase of the study (presented in the 2004 PD/GWSS Report) focused on determining the general contact toxicity (topical application) of the neonicotinoids and some of the key metabolites. Data from that study showed that imidacloprid was highly toxic to GWSS adults. Two important plant metabolites of imidacloprid, the olefin and 5-OH derivatives, also showed high toxicity, while the diol and desnitro derivatives showed no toxicity. These data suggest that, if these metabolites are formed *in planta*, the efficacy of imidacloprid could extend beyond the lifetime of the parent material within the plant. Furthermore, because the metabolism of imidacloprid by microsomal oxidases within the insect is likely to produce the olefin and mono-hydroxy metabolites, this will also contribute to the lethal effects of imidacloprid.

We have completed a study of the effects of leaf residues of imidacloprid and its metabolites on GWSS eggs. Even at extremely high doses, the parent compound does not confer toxicity against the developing embryo. However, there is a lethal effect upon emergence of the immature from the egg that is dose-dependent (Figure 3).



**Figure 3.** Dose response for GWSS eggs developing on imidacloprid-treated cotton leaves. The vertical line indicates the LC<sub>50</sub> concentration.



**Figure 4.** Impact of imidacloprid metabolites on GWSS egg survival. Horizontal bars indicate mean mortality at that dose. Vertical bars indicate the standard errors.

We have not developed full dose-response curves for the metabolites of imidacloprid. Instead, we have selected certain doses based on our results with imidacloprid. The toxicity profiles for the metabolites were the same for the emerging immature as for the adults (Figure 4). Both the olefin and 5-OH metabolites exhibited toxicity, while the diol and desnitro derivatives had no effect. The significance of these results is two-fold. Firstly, they indicate that the GWSS egg receives no nourishment from the leaf during development. In Figure 5, the toxic effects of imidacloprid are evident in emerging immatures. And secondly, they raise the concern about the likely impact of these residues on a developing parasitoid. It would seem likely that the developing parasitoid would be protected inside the egg. However, during emergence from the egg, the parasitoid must pass through leaf tissue. This objective is currently under investigation.

**Figure 5.** Mortality of emerging immature GWSS on cotton leaf treated systemically with imidacloprid. Immatures develop fully within the egg mass, but succumb upon emergence.



## CONCLUSIONS

The significance of our findings for the PD/GWSS problem is clearcut. Our data provides important information on the behavior of the neonicotinoids and their metabolites on the PD vector. The impact of this important chemical class extends to all stages of the GWSS, including the egg stage. In this report, we have provided the first evidence for a toxic effect of imidacloprid on the embryo as it emerges from the egg. Prior to emergence, the developing embryo remains protected within the confines of the egg. Our work now will focus on evaluating the potential toxic effect of imidacloprid against the developing parasitoid within the sharpshooter egg. The egg parasitoid adult may suffer the same fate as emerging nymphs as it passes from the egg through contaminated leaf tissue.

## REFERENCES

- Byrne, F.J. and N.C. Toscano. 2004. Characterization of neonicotinoids and their plant metabolites in citrus trees and grapevines, and evaluation of their efficacy against the glassy-winged sharpshooter. *In* Proceedings of the Pierce's Disease Research Symposium, pp 290-291, Coronado island Marriott Resort, San Diego, California, Dec7-10, 2004.
- Byrne F.J., S.J. Castle, J.L. Bi and N.C. Toscano. 2005. Application of competitive ELISA for the quantification of imidacloprid titers in xylem fluid extracted from grapevines. *Journal of Economic Entomology* 98: 182-187.
- Castle, S.J., F.J. Byrne, J.L. Bi and N.C. Toscano. 2005. Spatial and temporal distribution of imidacloprid and thiamethoxam in citrus and impact on *Homalodisca coagulata* Wells populations. *Pest Management Science* 61: 75-84.
- Nauen, R., U. Ebbinghaus-Kintscher, V.L. Salgado, and M. Kaussmann, 2003. Thiamethoxam is a neonicotinoid precursor converted to clothianidin in insects and plants. *Pesticide Biochemistry and Physiology* 76: 55-69.

## FUNDING AGENCIES

Funding for this project was provided by the University of California Pierce's Disease Grant Program.

# EVALUATION OF RESISTANCE POTENTIAL IN THE GLASSY-WINGED SHARPSHOOTER USING TOXICOLOGICAL, BIOCHEMICAL, AND GENOMICS APPROACHES

## Project Leaders:

Frank Byrne, Nick Toscano, Brian Federici, and Cynthia LeVesque  
Dept of Entomology,  
University of California,  
Riverside, CA 92521

**Reporting Period:** The results reported here are from work conducted October 2004 to September 2005.

## ABSTRACT

We used microarray expression profiling to identify genes that were differentially regulated in glassy-winged sharpshooters in response to treatment with the pyrethroid insecticide esfenvalerate. Targets were prepared from insects treated at both LD<sub>50</sub> and sub-lethal doses. Of the 1,536 cDNAs in the array, only eight were differentially regulated in response to esfenvalerate. Of these, three aligned significantly with ferritin, lysozyme i-1, and polynucleotide phosphorylase. Additional pyrethroids have been included in our bioassay program. In topical application bioassays, LD<sub>50</sub>s for bifenthrin and fenpropathrin were 1.2 and 3.6 ng/insect, respectively. Esfenvalerate, with an LD<sub>50</sub> of 0.75 ng/insect, is the most toxic of the pyrethroids we have tested against the GWSS. Populations of insects have been selected with these insecticides at LD<sub>50</sub> and sublethal doses for microarray analyses.

## INTRODUCTION

Without an effective cure for PD, insecticides remain an important component of PD/GWSS management. There are several classes of insecticides available to growers for the management of the GWSS, providing them with options for control under various situations. Thus, the systemic attributes of the neonicotinoids have been exploited to provide long-term management of the insect on citrus and grapevines, whereas pyrethroid chemicals are more effective at dealing with incipient outbreaks, and for the disinfestation of nursery stock and fruit prior to shipment to non-GWSS areas of California.

Pyrethroids play an important part in GWSS management. They are quick-acting insecticides with modest persistence, making them ideal for pre-harvest cleaning of citrus trees. It is important to retain their efficacy for this purpose and, therefore, any evidence of regional variations in toxicological response should be evaluated in order to avoid resistance problems. This would involve assessment of tolerance levels and cross-resistance patterns, both within the pyrethroid class and across chemical classes, with the ultimate goal of eliminating all at-risk chemicals from the recommended treatment schedules.

By elucidating the resistance mechanism(s), we will have valuable information that can be used for better management of pyrethroid use. An analysis of target site resistance is especially important because of the potential for cross-resistance to other pyrethroids. If the target site mutation is not present in the populations showing increased tolerance, then this will lower the risk of substantial resistance problems. The presence of target-site resistance genes not only would present problems with pyrethroid use, but this type of resistance can provide a basis upon which other mechanisms can develop, particularly metabolic mechanisms. The latter mechanisms then have the opportunity to enhance the resistance problem within the pyrethroid group, but more significantly to extend the resistance problem to other insecticide classes. In this way, even modest use of one compound can have serious consequences for a more widely used product.

The genomics component of the study will identify genes that are differentially regulated as a consequence of insecticide exposure and, therefore, likely to contribute to resistance or tolerance of treated insects. DNA microarrays provide a format for the simultaneous measurement of the expression level of thousands of genes in a single hybridization assay. Hybridization intensities for each DNA sequence on the array are converted to a quantitative read-out of relative gene expression levels. The utility of this method lies in its ability to identify variation in expression patterns that correlate with events such as insecticide selection. It is an ideal technique for determining whether significant differences exist in the expression profiles of GWSS populations. By highlighting genes whose expression levels are affected, subsequent analyses can identify the gene function, allowing us to determine the relevance of that gene in resistance/tolerance to the selecting insecticide and the likelihood of that gene conferring cross resistance to chemically unrelated insecticides.

## OBJECTIVES

1. Monitor toxicological responses of geographically distinct populations of GWSS to pyrethroid insecticides.
2. Measure biochemical activity of putative resistance-causing enzymes in these populations.
3. Clone and sequence the sodium-channel genes in GWSS populations differing in susceptibility to insecticides.
4. Perform microarray gene expression profiles in GWSS populations differing in susceptibility to insecticides to isolate novel genes involved in resistance.

## **RESULTS**

### **Response of GWSS in Bioassays**

Topical application bioassays have been conducted against the GWSS (adults only tested) with bifenthrin and fenpropathrin. The LD<sub>50</sub>s for these compounds were 1.2 and 3.6 ng/insect, respectively. These compounds were less toxic to the adults than esfenvalerate, which has an LD<sub>50</sub> of 0.75 ng/insect (Byrne et al., 2004). These three pyrethroid insecticides will now be used to determine the effect of insecticide dose (at LD<sub>50</sub> and sublethal concentrations) on gene expression changes (both up-regulation and down-regulation) in GWSS populations.

### **Selections**

Thus far, selections of GWSS populations from Riverside and Redlands locations have been completed for esfenvalerate, using 0.75 and 0.075 ng/insect as selecting concentrations. RNA extracted from the survivors of these selections is being prepared for subsequent hybridization to microarrays in our gene expression profiling studies.

### **Microarrays**

The LD<sub>50</sub> concentration for esfenvalerate for the Riverside population of GWSS was determined to be 0.75ng per insect. This concentration and a sub lethal concentration of 0.075 ng per insect were used to generate samples for microarray target preparations. To identify a few genes differentially regulated by pesticide treatment, cDNA microarray hybridizations were performed using a subset of 1,536 clones of the 10,848 clones isolated from the GWSS cDNA library. Overall, the expression of most genes was not significantly altered. Figure 1 shows the complete dendrogram of the 1,274 genes, which are clustered on the basis of expression profiles in response to pesticide treatment at different doses. The expression data were consistent between duplicate spots and between the dye swap experiments and were, therefore, averaged for each clone. They are displayed in red (overexpressed) and green (under-expressed), relative to the control. Only eight genes were shown to be differentially regulated in response to esfenvalerate (Figure 1). Of these genes, only three showed significant homology to genes of other organisms. These genes aligned significantly with ferritin, polynucleotide phosphorylase, and lysozyme i in the NCBI databases. Ferritin was up-regulated in response to both treatment levels, while polynucleotide phosphorylase and lysozyme i were down-regulated in response to the LD<sub>50</sub> dose only. Of the remaining gene clones, which showed significant changes in expression, one was down-regulated in response to the sub-lethal dose. Four genes were up-regulated in response to the LD<sub>50</sub> dose of esfenvalerate, and one was up-regulated in response to both concentrations of the pesticide.

## **CONCLUSIONS**

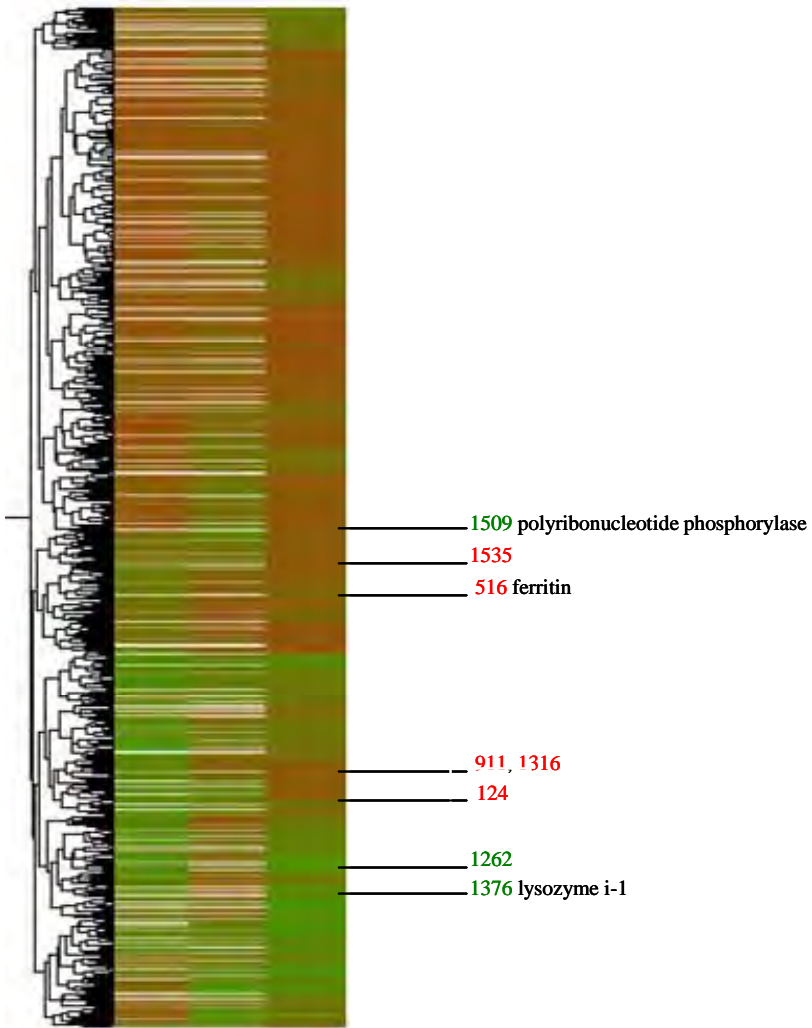
Management of sharpshooter populations is key to minimizing the spread of PD. This project will benefit the PD program by characterizing the pattern of resistance observed in GWSS populations, and by identifying the mechanisms involved. The potential for cross-resistance will also be evaluated. The cDNA microarray hybridization experiment utilizing a subset of the GWSS library provided the first insight into broad genome responses of GWSS to esfenvalerate, and identified a few important genes that are differentially regulated. For example, the increase in ferritin RNA levels observed in GWSS treated with esfenvalerate is indicative of a generalized stress response, while the observed down-regulation of lysozyme in our studies suggests that the pesticide has a direct effect on the immunity of the GWSS. Thus far, we have not detected any significant up-regulation of genes that are known, from studies on other insect pests, to confer metabolic resistance to pyrethroids. These include esterases, cytochrome P<sub>450</sub>s, and glutathione transferases. Although the activity of these enzymes can be detected biochemically, our current data suggests that none of these genes is over-expressed following selection with esfenvalerate. The lack of detection of significant up-regulation of esterase genes concurs with our biochemical data, which shows no difference in esterase levels in the survivors of esfenvalerate selections relative to untreated controls (Byrne et al., 2004). We have a GWSS carboxylesterase clone in hand that will serve as a control when our microarray experiments are expanded to include all 10,848 library clones.

## **REFERENCES**

- Byrne, F. J., Toscano, N. C., and Federici, B. A., 2004. Evaluation of resistance potential in the glassy-winged sharpshooter using toxicological, biochemical, and genomics approaches. Proceedings of the Pierces Disease Research Symposium, December 7-10, 2004. Coronado Island Marriott Resort, Coronado, California. pp. 292-293.
- Toscano, N. C., Prabhaker, N., Byrne, F. J., and Castle, S. J. 2003. Chemical control of the glassy-winged sharpshooter: Establishment of baseline toxicity and development of monitoring techniques for detection of early resistance to insecticides. Proceedings of the Pierces Disease Research Symposium, December 8-11, 2003. Coronado Island Marriott Resort, Coronado, California. pp. 318-321.

## **FUNDING AGENCIES**

Funding for this project was provided by the CDFR Pierce's Disease and Glassy-winged Sharpshooter Board.



**Figure. 1.** Microarray analysis of esfenvalerate dosage responses. Total RNA from insects treated with no pesticide, 0.075 ng, and 0.75 ng of esfenvalerate were used to generate fluorescent targets which were hybridized in dye swap experiments to 6,144 cDNA microarrays representing 1,536 cDNAs spotted in quadruplicate. Data was filtered on fold change with two fold considered to be significant. Gene clones labeled were significantly up-regulated (red) or down-regulated (green) in reciprocal dye experiments.

# DEVELOPMENT OF MOLECULAR DIAGNOSTIC MARKERS FOR GLASSY-WINGED AND SMOKETREE SHARPSHOOTERS FOR USE IN PREDATOR GUT CONTENT EXAMINATIONS

## Project Leaders:

Jesse H. de León  
USDA, ARS  
BIRU  
Weslaco, Texas 78596

James Hagler, Valerie Fournier  
USDA, ARS  
Western Cotton Research Lab  
Phoenix, AZ 85040

Kent Daane  
Division of Insect Biology  
University of California  
Berkeley, CA 94720

**Reporting Period:** The results reported here are from work conducted fiscal year 2004 to fiscal year 2005.

## ABSTRACT

To aid in identifying key predators of Proconiini sharpshooter species present in California, we developed and tested molecular diagnostic markers for the glassy-winged sharpshooter *Homalodisca coagulata* (Say) and smoke-tree sharpshooter *Homalodisca liturata* (Ball) (Homoptera: Cicadellidae: Proconiini). Two different types of markers were compared, those targeting single-copy sequence characterized amplified regions (SCAR) and mitochondrial markers targeting the multi-copy cytochrome oxidase subunit genes I (COI) and II (COII). A total of six markers were developed, two SCAR and four mitochondrial COI or COII markers. Specificity assays demonstrated that SCAR marker HcF5/HcR7 was *H. coagulata*-specific and HcF6/HcR9 was *H. coagulata/H. liturata*-specific. COI (HcCOI-F/R) and COII (HcCOII-F4/R4) markers were *H. coagulata*-specific, COII (G/S-COII-F/R) marker was *H. coagulata/H. liturata*-specific, and lastly, COII marker (HI-COII-F/R) was *H. liturata*-specific. Sensitivity assays using genomic DNA showed the COI marker to be the most sensitive marker with a detection limit of 6 pg of DNA. This marker was 66-fold more sensitive than marker HI-COII-F/R that showed a detection limit of 400 pg of DNA. In addition, the COI marker was 4.2-fold more sensitive than the COII marker. In predator gut assays, the COI and COII markers demonstrated significantly higher detection efficiency than the SCAR markers. Furthermore, the COI marker demonstrated slightly higher detection efficiency over the COII marker. Lastly, we describe the inclusion of an internal control (28S amplification) for predation studies performing predator gut analyses utilizing PCR. This control was critical in order to monitor reactions for PCR failures, PCR inhibitors, and for the presence of DNA.

## INTRODUCTION

Effective control of *H. coagulata* requires an area-wide, multi-tactic pest management program. A major component of such an approach is the exploitation of the pest's natural enemies, which, when utilized to their greatest potential, can increase the effectiveness of other control tactics. A classical biological control program is currently in progress in California against *H. coagulata*, utilizing parasitoid species that attack *H. coagulata* egg masses (CDFA 2003, Triapitsyn et al. 1998). However, little is known about the predaceous enemies that feed on eggs, nymphs, or adult *H. coagulata* (Triapitsyn et al. 1998). Direct visual field observations of predation are difficult to obtain and the field study of insect predation has often relied on indirect techniques for measurement and analysis. A sensitive approach to detect prey in predator gut contents is the use of monoclonal antibodies (MAb) in enzyme-linked immunoassays (ELISA) (Hagler et al. 1991, 1993, Hagler and Naranjo 1994). More recently, PCR-based methods have been developed that allow for rapid detection of prey in predator gut contents (reviewed in Symondson 2002, Harper et al. 2005). These methods include, 1) sequence characterized amplified region-polymerase chain reaction assays (SCAR-PCR), where RAPD-PCR species-specific bands are excised from gels and sequenced, and primers are designed toward those DNA fragments (Agustí et al. 1999, de León et al. 2005 submitted), 2) targeting genes that are present in the cell in high copy number, such as, mitochondrial genes (COI and COII) (Agustí et al. 2003, Chen et al. 2000, de León et al. 2005 submitted) and internal transcribed spacer regions (ITS1), and 3) a sensitive and efficient multiplex PCR procedure incorporating fluorescent markers (Harper et al. 2005).

## OBJECTIVES

The aim of this work was to develop species-specific molecular diagnostic markers that were specific toward the invasive *H. coagulata* and the closely related *H. liturata*. Ultimately, the markers developed here will be used to detect *H. coagulata* and/or *H. liturata* remains in the guts of field-collected predators (Fournier et al., unpubl. data). Identifying the key predators of these sharpshooters will help towards establishing a conservation or augmentation biological control program, and will be useful in identifying the impact of natural enemies in field studies. In addition, these markers will be useful in identifying any life stage of *H. coagulata* and/or *H. liturata*, even before they emerge from egg masses, thus saving time and money required to rear these insects to the adult stage for morphological identification.

## RESULTS AND CONCLUSIONS

### *Homalodisca coagulata*, *H. liturata*, and *H. coagulata/H. liturata* molecular diagnostic markers

RAPD-PCR DNA fingerprinting was performed with various sharpshooters and an *H. coagulata*-specific band (674-bp) was excised, sequenced, and SCAR markers were designed toward it (data not shown). Both *H. coagulata/H. liturata*- (HcF6/HcR9) and *H. coagulata*-specific (HcF5/HcR7) primer sets were designed from this sequence and they produced amplification products of 166- and 302-bp sizes, respectively. Table 1 shows the optimized amplification reaction conditions for each diagnostic primer set and the name, the expected amplification product size, the MgCl<sub>2</sub> concentration, the annealing



temperature (T<sub>m</sub>), and the number of cycles. The amplification reaction conditions are highly specific to each primer set in order to prevent cross-reactivity with any of the non-target species. If the specific reaction conditions are modified, those new conditions must be tested with all species of interest to test for cross-reactivity. An *H. coagulata*-specific primer set was developed toward the COI sequence, whereas, two sets of primers were developed toward the COII sequence, an *H. coagulata*/*H. liturata*- and an *H. coagulata*-specific set. Lastly, a COII-specific primer set was developed toward *H. liturata*.

### Species specificity of the molecular diagnostic markers

To test the specificity of the diagnostic markers, amplification assays were performed with stock genomic DNA from various sharpshooter species, several of them present in California, along with lacewing, earwig, and ground beetle predators. The results of the specificity assays for all six diagnostic markers that were designed toward the RAPD-PCR fragment and the COI and COII partial sequences are given in Figure 1. For the size of the expected amplification products and the specific reaction conditions of each marker refer to Table 1. As seen each diagnostic marker was highly specific toward its target(s) (Figure 1). All diagnostic markers amplified DNA fragments of the correct size and none crossed-reacted with other sharpshooter species or the predators of interest. The internal control, 28S amplification is seen across all samples indicating that PCR inhibitors or failures did not play a role in the reactions (Figure 1G).

### Detection of *H. coagulata* DNA in predator guts

The results of the amplification assays of predators from the laboratory feeding trails showed that all diagnostic markers, *H. coagulata*/*H. liturata*-, *H. coagulata*-, and *H. liturata*-specific detected prey in predator gut contents (Figure 2, A-E). As demonstrated, amplification was not seen in predators not fed on *H. coagulata*, whereas the 28S amplifications (Figure 2G) were positive. The marker set targeting the COI gene, HcCOI-F/R exhibited the highest sensitivity (6.0 pg of DNA); whereas marker HI-COII-F/R was the least sensitive (400 pg of DNA), a 66-fold difference. The difference in sensitivity between *H. coagulata* COI (HcCOI-F/R) and COII (HcCOII-F4/R4) was about 4.2-fold. The sensitivity limits for each marker is shown on Table 2 in brackets.

### Efficiency of molecular diagnostic markers at detecting *H. coagulata* remains in the guts of predators

Between the two SCAR markers, marker HcF6/HcR9 was slightly more efficient than marker HcF5/HcR7, a significant difference was seen with lacewing at the 0 h time point (Table 2). Marker HcF6/HcR9 produced an amplification product size of 166-bp, whereas, marker HcF5/HcR7 produced one of 302-bp; a difference of 136-bp. In lacewings at the 0 h retention interval the percentage detection was 8.3 and 58.0% for marker HcF5/HcR7 and HcF6/HcR9, respectively. Since the detection efficiency was low for SCAR markers we did not further test the rest of the time intervals. Detection of *H. coagulata* in earwig gut contents was equally low with both SCAR markers. *Homalodisca coagulata* could not be detected in ground beetles whether it fed on one or two *H. coagulata* adults using SCAR marker HcF5/HcR7; whereas, SCAR marker HcF6/HcR9 was more efficient. The detection efficiency was slightly higher for ground beetles that fed on two *H. coagulata* adults (25.0%) than on one (9.10%) at 0 h digestion (Table 2).

The detection efficiency of the markers targeting the multi-copy mitochondrial genes (COI, II) was significantly higher than the single-copy SCAR markers (Table 2). This was observed even though the number of amplification cycles was higher with the SCAR markers. In general, the detection efficiency of COI (197-bp) was better than COII (295-bp) using markers HcCOI-F/R and HcCOII-F4/R4, respectively. At the 0 and 8 h time point of lacewings that fed on *H. coagulata* eggs, the COI marker detection efficiency was 91.7 and 86.4% efficient as compared to 83.3 and 47.6% for COII, respectively. Only the 8 h time point was highly significant. The detection efficiency was the same for both the COI and COII markers at the 4, 16, and 24 h retention intervals. The detection efficiency of earwigs that fed on *H. coagulata* eggs at 0 h was significantly higher for the COI marker (87.5%) and than the COII marker (25.0%). A similar, but non-significant pattern was also observed in ground beetles that fed on adult *H. coagulata*. The detection efficiency was slightly higher with the COI marker in ground beetles that fed on one adult *H. coagulata*, 33.3% for COII as compared to 54.5% for COI. The detection efficiency reached 100.0% for the COI marker with ground beetles that fed on two *H. coagulata* adults. In both types of markers (SCAR and mitochondrial), a direct correlation between detection efficiency and amplification product size was observed.

For lacewings that fed on *H. liturata* eggs the detection efficiency was between 80-90% at 0 h with both *H. liturata*- and *H. coagulata*/*H. liturata*-specific markers. The *H. coagulata*/*H. liturata*-specific COII marker (G/S-COII-F/R) that produced an amplification product size of 178-bp was slightly more efficient than the COII marker (HI-COII-F/R) that produced a size of 295-bp; 90 and 80%, respectively.

**Table 1.** Summary and optimized conditions of diagnostic primer sets showing primer name, sequence, DNA fragment size, MgCl<sub>2</sub> concentration, annealing temperature (T<sub>m</sub>), cycle number, and species specificity. F, forward; R, reverse; COII, mitochondrial cytochrome oxidase subunit gene II; COI, mitochondrial cytochrome oxidase subunit gene I; Hc, *H. coagulata*; Hl, *H. liturata*; G/S, *H. coagulata/H. liturata*.

Primer name	Frag. size	MgCl <sub>2</sub> (mM)	T <sub>m</sub> (°C)	Cycle number	Designed toward
<i>SCAR</i>					
HcF5/ HcR7	302-bp	2.0	65	45	Hc
HcF6/ HcR9	166-bp	2.0	59	45	Hc/Hl
<i>Mitochondrial</i>					
HcCOII-F4/R4	295-bp	1.6	55	35	Hc
G/S-COII-F/R	178-bp	1.5	56	30	Hc/Hl
HcCOI-F/R	197-bp	1.4	60	31	Hc
Hl-COII-F/R	295-bp	1.6	56	33	Hl

**Table 2.** Detection efficiency of molecular diagnostic markers in predators; small scale analysis. The specificity of the marker and the expected size of the DNA fragment are included below the marker name. Lacewings and earwigs fed on *H. coagulata* eggs and ground beetles fed on *H. coagulata* adults. Individual lacewings for retention the time experiment fed on 2 to 3 eggs, as did lacewing feeding on *H. liturata* eggs. Individual earwigs fed on 5 to 20 eggs. np, not performed; n/a, not applicable. Numbers in parenthesis are number of individuals tested. Shown in brackets are the sensitivity limits of the diagnostic markers measure as pg of DNA. Statistics were performed with Fisher's Exact Test using two-sided *p*-values. Hc, *H. coagulata*; Hl, *H. liturata*

	HcF5/R7 <sup>c</sup> Hc 302-bp	HcF6/R9 <sup>c</sup> Hc/Hl 166-bp	HcCOII-F4/R4 <sup>d</sup> Hc 295-bp	G/S-COII-F/R <sup>d</sup> Hc/Hl 178-bp	HcCOI-F/R Hc 197-bp	Hl-COII-F/R Hl 295-bp
Hc	[100]	[50]	[25]	[50]	[6]	[400]
Lacewing <sup>a</sup>						
0 h	8.3% (12)	58.0% (12)	83.3% (12) <sup>h</sup>	83.3% (12)	91.7% (12) <sup>e, h</sup>	n/a
4 h	np	np	27.3% (11)	18.2% (11)	27.3% (11)	n/a
8 h	np	np	47.6% (21)	86.4% (22)	86.4% (22)	n/a
16 h	np	np	37.5% (8)	50.0% (8)	37.5% (8)	n/a
24 h	np	np	9.10% (11)	9.10% (11)	9.10% (11)	n/a
Lacewing <sup>b</sup>	25.0% (4)	50.0% (4)	50.0% (4)	50.0% (4)	50.0% (4)	n/a
Earwig <sup>b</sup>	12.5% (8)	12.5% (8)	25.0% (8)	25% (8)	87.5% (8) <sup>g, j</sup>	n/a
Beetle <sup>b</sup> :						
1 adult GWSS	0.0% (11)	9.10% (11)	33.3% (12)	16.7% (12)	54.5% (11) <sup>e, j</sup>	n/a
2 adult GWSS	0.0% (8)	25.0% (8)	87.5% (8)	100.0% (8)	100.0% (8) <sup>e, h</sup>	n/a
Hl						
Lacewing <sup>a</sup> n/a	80.0% (10)	n/a	90.0% (10)	n/a	80.0% (10)	

<sup>a</sup>Crude DNA extract procedure; <sup>b</sup>Qiagen preparation of DNA of insects at 0 h; <sup>c</sup>Primers designed toward same SCAR sequence; <sup>d</sup>Primers designed toward same COII (*H. coagulata*) sequence; <sup>e</sup>Not significantly different from HcCOII-F4/R4 (COII), *P* = 1.0000; <sup>f</sup>Very significantly different from COII, *P* < 0.001; <sup>g</sup>Significantly different from COII, *P* < 0.05; <sup>h</sup>Extremely significantly different from HcF5/R7, *P* < 0.001; <sup>i</sup>Very significantly different from HcF5/R7, *P* < 0.005; <sup>j</sup>Significantly different from HcF5/R7, *P* < 0.05

Figure 1

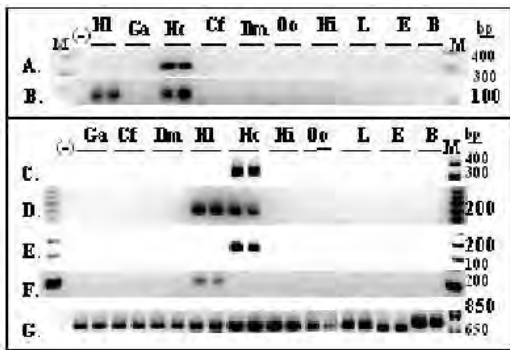
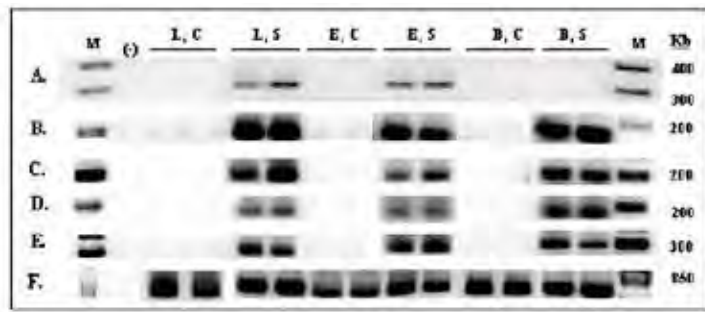


Figure 2



**Figure 1.** Specificity of molecular diagnostic markers. **A and B).** RAPD-PCR DNA fingerprinting was performed with the following sharpshooters: *Homalodisca liturata* (**HI**); *Graphocephala atropunctata* (**Ga**); *H. coagulata* (**Hc**); *Carneocephala fulgida* (**Cf**); *Draeculacephala minerva* (**Dm**); *Oncometopia orbona* (**Oo**); and *H. insolita* (**Hi**). The optimal amplification conditions for all reactions are listed on Table 1. **A).** *H. coagulata*-specific marker, HcF5/HcR7 (302-bp) and **B).** *H. coagulata/H. liturata*-specific marker, HcF6/HcR9 (166-bp). Predators included in the analysis were: *Chrysoperla carnea* [green lacewing larvae (**L**)]; *Forficula auricularia* [earwig (**E**)]; and *Calosoma sp.* [ground beetle (**B**)]. **C).** *H. coagulata*-COII-specific primers, HcCOII-F4/R4 (295-bp). **D).** *H. coagulata/H. liturata*-COII-specific primers, G/S-COII-F/R (178-bp). **E).** *H. coagulata*-COI-specific primers, HcCOI-F/R (197-bp). **F).** *H. liturata*-COII-specific primers, HI-COII-F/R (295-bp); **G)** 28S internal control. **M:** 1.0 Kb Plus DNA Ladder.

**Figure 2.** Detection of *H. coagulata* eggs or adults in predator gut contents by diagnostic amplification assays. (-), negative control (no DNA template); C, control (not fed on *H. coagulata*); S, sample (fed on *H. coagulata*). Lacewings and earwigs fed on *H. coagulata* eggs and ground beetles fed on *H. coagulata* adult(s). **A)** HcF5/HcR7 (*H. coagulata*-specific; 302-bp); **B)** HcF6/HcR9 (*H. coagulata/H. liturata*-specific; 166-bp); **C)** HcCOII-F4/R4 (*H. coagulata*-COII-specific; 295-bp); **D)** G/S-COII-F/R (*H. coagulata/H. liturata*-specific; 178-bp); **E)** HcCOI-F/R (*H. coagulata*-COI-specific; 197-bp); **F)** 28S internal control.

## REFERENCES

- Agustí, N., M. C. De Vicente, and R. Gabarra. 1999. Development of sequence amplified characterized region (SCAR) markers of *Helicoverpa armigera*: a new polymerase chain reaction-based technique for predator gut analysis. *Mol. Ecol.* 8:1467-1474.
- Agustí, N., S. P. Shayler, J. D. Harwood, I. P. Vaughan, K. D. Sunderland, and W. O. C. Symondson. 2003. Collembola as alternative prey sustaining spiders in arable ecosystems: prey detection within predators using molecular markers. *Mol. Ecol.* 12: 3467-3475.
- CDFA. 2003. Pierce's Disease Program Report to the Legislature. California Department of Food and Agriculture.
- Chen, Y., K. L. Giles, M. E. Payton and M. H. Greenstone. 2000. Identifying key cereal aphid predators by molecular gut analysis. *Mol. Ecol.* 9: 1887-1898.
- de León, J. H., V. Fournier, J. R. Hagler, and K. M. Daane. 2005. Development of molecular diagnostic markers for sharpshooters *Homalodisca coagulata* and *H. liturata* (Homoptera: Cicadellidae: Proconiini) for use in predator gut content examinations. (Submitted).
- Hagler, J. R., A. G. Brower, Z. Tu, D. N. Byrne, D. Bradley-Dunlop, and F. J. Enriquez. 1993. Development of a monoclonal antibody to detect predation of the sweetpotato whitefly, *Bemisia tabaci*. *Entomol. Exper. Appl.* 68: 231-236.
- Hagler, J. R., A. C. Cohen, F. J. Enriquez and D. Bradley-Dunlop. 1991. An egg-specific monoclonal antibody to *Lygus hesperus*. *Biol. Control* 1: 75-80.
- Hagler, J. R., and S. E. Naranjo. 1994. Qualitative survey of two Coleopteran predators of *Bemisia tabaci* (Homoptera: Aleyrodidae) and *Pectinophora gossypiella* (Lepidoptera: Gelechiidae) using a multiple prey gut content ELISA. *Biol. Control* 23: 193-197.
- Harper, G. L., R. A. King, C. S. Dodd, J. D. Harwood, D. M. Glen, M. W. Bruford, and W. O. C. Symondson. 2005. Rapid screening of invertebrate predators for multiple prey DNA targets. *Mol. Ecol.* 14: 819-827.
- Triapitsyn, S., R. F. Mizell, J. L. Bossart, and C. E. Carlton. 1998. Egg parasitoids of *Homalodisca coagulata* (Homoptera: Cicadellidae). *Florida Entomol.* 81: 241-243.
- Symondson, W. O. C. 2002. Molecular identification of prey in predator diets. *Mol. Ecol.* 11: 627-641.

**FUNDING AGENCIES**

Funding for this project was provided by the USDA Agricultural Research Service.

**Additional Note:** We acknowledge Marissa González, Lisa A. Ledezma, and Rosa I. Ruiz from Weslaco, TX, and Elaine Shapland from Berkeley, CA, for their excellent technical assistance

**THE UTILITY OF INTER-SIMPLE SEQUENCE REPEAT-POLYMERASE CHAIN REACTION (ISSR-PCR)  
TO DISTINGUISH GEOGRAPHIC POPULATIONS OF THE SMOKE-TREE SHARPSHOOTER AND  
EGG PARASITOID SPECIES OF THE GENUS *GONATOCERUS***

**Project Leader:**

Jesse H. de León  
USDA, ARS  
Beneficial Insect Research Unit  
Weslaco, TX 78596

**Cooperators:**

James R. Hagler USDA, ARS Western Cotton Res. Lab. Phoenix, AZ 85040	Guillermo Logarzo USDA, ARS South American Biological Control Lab. Buenos Aires, Argentina	David J. W. Morgan CDFA, PDCP Mount Rubidoux Field Station Riverside, CA 92501
---	---	---

**Reporting Period:** The results reported here are from work conducted fiscal year 2004 to fiscal year 2005.

**ABSTRACT**

In the current study, we tested the utility of the inter-simple sequence repeat-polymerase chain reaction (ISSR-PCR) DNA fingerprinting method in distinguishing geographic populations of the smoke-tree sharpshooter (STSS) (*Homalodisca liturata* Ball) and in distinguishing several egg parasitoid species in the genus *Gonatocerus*. Four geographic populations of the STSS were analyzed and they included: near Central (Ogilby Rd.) CA, Riverside CA, Imperial CA, and Phoenix, AZ. Five unique or population-specific markers were identified in the population from Riverside with minor genetic variation within the population. Another five population-specific markers were identified in the rest of the STSS populations (near Central and Imperial CA and Phoenix AZ). Extensive genetic variation was detected in these STSS populations. Population-specific markers are an indication of subdivided populations and decreased gene flow. The following *Gonatocerus* (Hymenoptera: Mymaridae) egg parasitoid species were analyzed: *G. triguttatus* (TX), *G. morrilli* (CA), *G. ashmeadi* (CA), *G. fasciatus* (LA), *G. metanotalis* (Argentina), near *G. ashmeadi* (Argentina), near *G. triguttatus* (Argentina), and *G. tuberculifemur* (Argentina). Each *Gonatocerus* species was associated with a unique ISSR-PCR banding pattern. In general, not much variation was seen within each species. Some variation was seen in *G. tuberculifemur*, while extensive variation was seen in *G. fasciatus*. The current results confirm the utility of using the sensitive ISSR-PCR method to distinguish geographic populations of the STSS and to distinguish several egg parasitoid species in the genus *Gonatocerus*. Rapid distinction of egg parasitoid species will speed up the identification process in a biological control program, thus saving time and cost.

**INTRODUCTION**

*Homalodisca liturata* Ball (Homoptera: Cicadellidae), the smoke-tree sharpshooter (STSS) is distributed in Arizona, southern California, Baja California, Mexico, Guatemala, and Costa Rica (Young 1958, 1968, Turner and Pollard 1959, Ball 1979). Prior to the arrival of the glassy-winged sharpshooter (GWSS) (*H. coagulata* Say) in California, one of the most common sharpshooter vectors of Pierce's disease in California were native sharpshooters, such as, the STSS (Varela et al. 2001, Redak et al. 2004). Both the GWSS and the STSS are xylem feeding leafhoppers that transmit a strain of *Xylella fastidiosa* Wells et al., a bacterium that causes Pierce's disease in grapevines (*Vitis vinifera* L. and *V. labrusca* L.), as well as diseases in many other plants (Hopkins and Mollenhauer 1973).

Mymarid wasps, on the other hand, are the best-known egg parasitoids for controlling populations of leafhoppers (Huber 1986, Döbel and Denno 1993). Detailed taxonomic and biological studies are crucial to biological controls programs (Logarzo et al. 2004, Virla et al. 2005). Release of unidentified and uncharacterized strains could make it impossible to document their establishment and dispersal; therefore, genetic typing of strains prior to their release in the field is necessary. Accurate identification of natural enemies is critical to the success of classical biological control programs, as it is essential for 1) selecting the most suitable natural enemy, 2) evaluating establishment, dispersal, and efficacy of natural enemies, and 3) improving mass production. Lack of proper identification procedures has affected several projects (Messing and Aliniazev 1988, Löhr et al. 1990, Narang et al. 1993).

There is a need for molecular markers to provide new characters for studies of phylogenetic relatedness, for identification of cryptic species and biotypes, and for the assessment of heritable variation for population genetics and ecological investigations (Unruh and Woolley 1999). Studies of allele or marker frequencies in naturally occurring parasitoid populations are important, not only for identifying genetic variation of potential benefit, but also for the detection of genetic markers indicative of specific biological traits or geographic origins. Furthermore, the recognition of intraspecific variation can be as crucial for the success of biological control programs as is sound species determination (Powell and Walton 1989, Narang et al. 1993, Unruh and Woolley 1999).

Recently, we developed DNA markers for *H. coagulata* for the purpose of estimating genetic variation in natural populations (de León and Jones 2004). Inter-simple sequence repeat-polymerase chain reaction (ISSR-PCR) (Zietkiewicz et al. 1994) was shown to be a sensitive and efficient procedure with *H. coagulata* and several egg parasitoid species in the genus *Gonatocerus* (de León et al. 2004b, de León et al. 2005 submitted) This DNA fingerprinting procedure permits detection of DNA variation in simple sequence repeats (SSR) without the need to isolate and sequence specific DNA fragments.

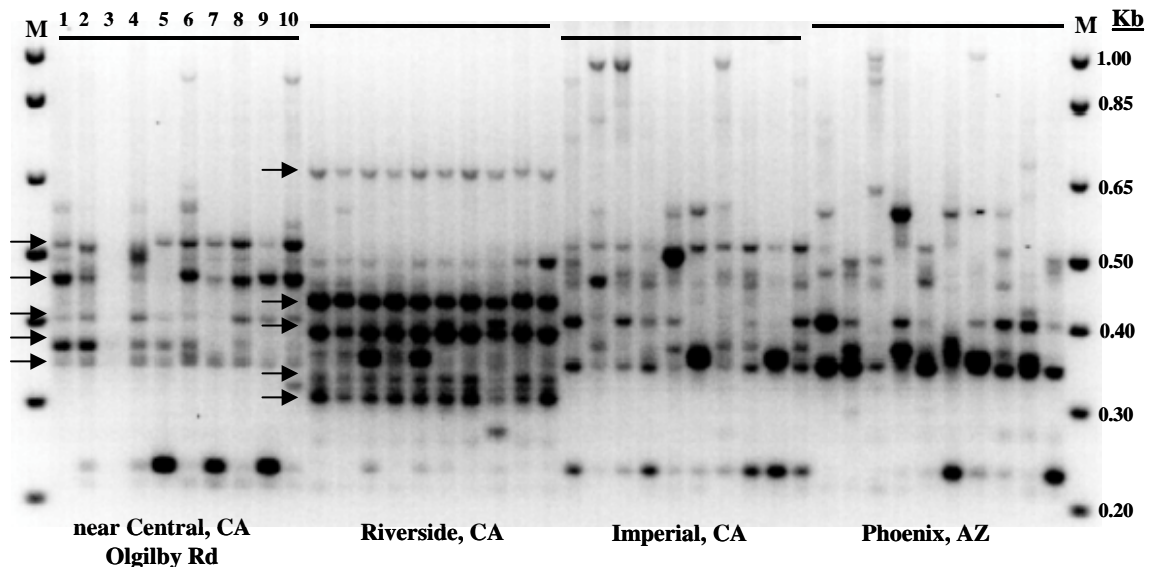
## OBJECTIVES

1. Determine if the inter-simple sequence repeat-polymerase chain reaction (ISSR-PCR) DNA fingerprinting method was suitable or sensitive enough to detect genetic variation and distinguish geographic populations of the smoke-tree sharpshooter (*Homalodisca liturata*) and
2. Determine if ISSR-PCR was suitable enough to distinguish several *Gonatocerus* species of egg parasitoids that attack the glassy-winged sharpshooter (GWSS) (*Homalodisca coagulata*).

## RESULTS AND CONCLUSIONS

### ISSR-PCR DNA fingerprinting of smoke-tree sharpshooter geographic populations

Amplification reactions were performed with total genomic DNA from ten separate individuals per population with a 5'-anchored ISSR primer (Zietkiewicz et al. 1994, de León and Jones 2004, de León et al. 2004, de León and Jones 2005). The populations analyzed included: Riverside CA, Imperial CA, near Central (Ogilby Rd) CA, and Phoenix AZ. Five population-specific markers (indicated by the arrows) were identified in the STSS population from Riverside CA with minor genetic variation within the population (Figure 1). Population-specific markers are an indication of subdivided populations and decreased gene flow. Decreased gene flow leads to increased genetic differentiation among populations. The results also show some evidence of reproductive isolation. Another five population-specific markers were also identified within the rest of the STSS populations (near Central CA, Imperial CA, and Phoenix AZ). These populations shared several bands, indicating that there are genetic similarities among them. Extensive variation is also seen in these populations. In addition, these populations are located in an area closer to each other than to the Riverside CA population.



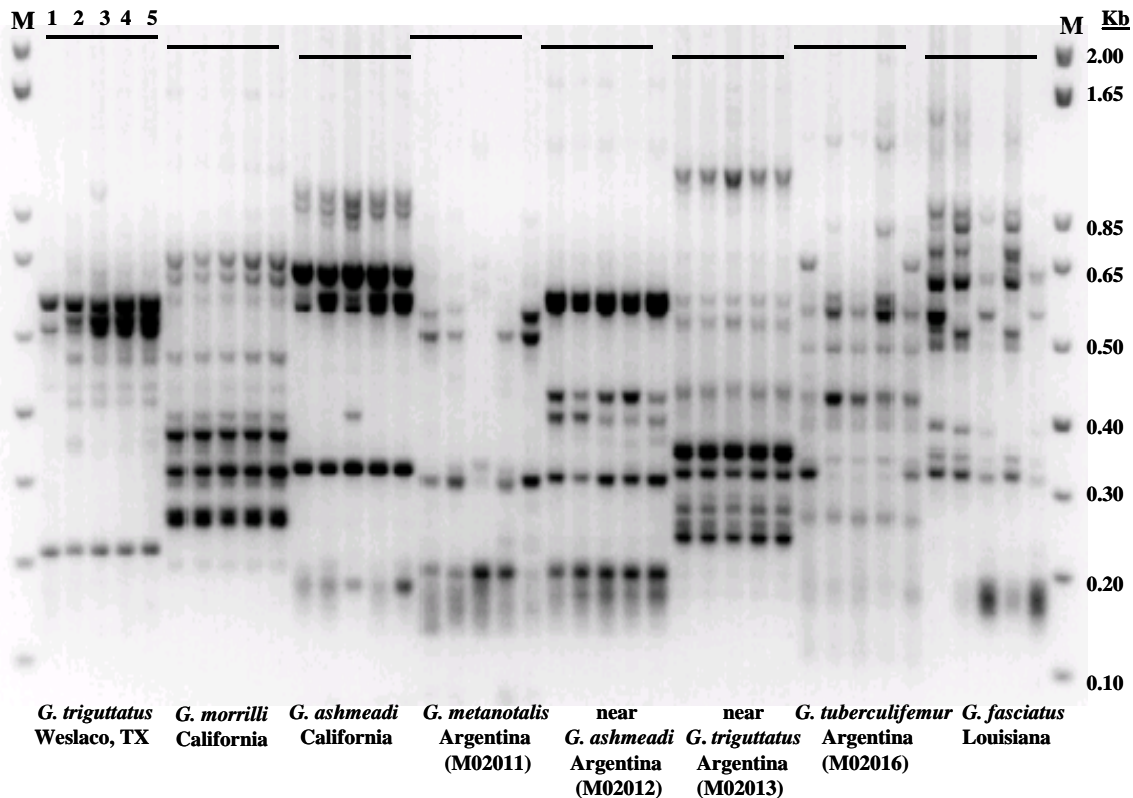
**Figure 1.** ISSR-PCR DNA fingerprinting of smoke-tree sharpshooter geographic populations from California and Arizona. Reactions were performed with total genomic DNA from 10 separate field collected individuals and a 5'-anchored ISSR primer (Zietkiewicz et al. 1994, de León et al. 2004). Arrows point out the unique markers identified in the populations. Smoke-tree sharpshooter geographic populations are indicated above. M: 1.0 Kb Plus DNA Ladder.

### ISSR-PCR DNA fingerprinting of *Gonatocerus* egg parasitoid species

Amplification reactions were performed with total genomic DNA from five separate individuals per species with a 5'-anchored ISSR primer (Zietkiewicz et al. 1994, de León and Jones 2004, de León et al. 2004a, 2004b, de León and Jones 2005, de León et al. 2005 submitted). *Gonatocerus* species analyzed from both North and South America included: *G. triguttatus* Girault (TX), *G. morrilli* Howard (CA), *G. ashmeadi* Girault (CA), *G. fasciatus* Girault (LA), *G. metanotalis* Ogloblin (Argentina), near *G. ashmeadi* (Argentina), near *G. triguttatus* (Argentina), and *G. tuberculifemur* Ogloblin (Argentina). The results of this analysis are shown on Figure 2. As seen, each *Gonatocerus* species was associated with a unique ISSR-PCR banding pattern. In general, not much variation was seen within each species. Some variation was seen in *G. tuberculifemur*, while extensive variation was seen in *G. fasciatus*. The present results confirm that the ISSR-PCR DNA

fingerprinting method is an excellent method to distinguish haplodiploid egg parasitoid *Gonatocerus* species and is also a good tool for distinguishing geographic populations of STSS.

Even though ISSR-PCR markers are scored as dominant, the ISSR-PCR technique using 5'-anchored or compound ISSR primers is still a very sensitive and useful technique because it targets random SSR or microsatellites (Zietkiewicz et al. 1994, de León and Jones 2004). An additional advantage is that the same ISSR primer can be rapidly applied across several different orders (e.g., insects, plants, fungi, bacteria) without prior knowledge of DNA sequences (de León, unpublished data), a capability not found with microsatellites. Banding patterns are consistent because the anchors serve to fix the annealing of the primer to a single position of the target site, thus resulting in a low level of slippage during amplification (Zietkiewicz et al. 1994, reviewed in Karp and Edwards 1997).



**Figure 2.** ISSR-PCR DNA fingerprinting of several *Gonatocerus* egg parasitoid species from both the U. S. and South America (Argentina). Reactions were performed with total genomic DNA from five separate field collected individuals and a 5'-anchored ISSR primer (Zietkiewicz et al. 1994; de León et al. 2004). *Gonatocerus* egg parasitoid species are indicated above. **M:** 1.0 Kb Plus DNA Ladder.

## REFERENCES

- Ball, J. C. 1979. Seasonal patterns of activity of adult leafhopper vectors of phony peach disease in north Florida. *Environ. Entomol.* 8: 686-689.
- de León, J. H., and W. A. Jones. 2004. Detection of DNA polymorphisms in *Homalodisca coagulata* (Homoptera: Cicadellidae) by Polymerase Chain Reaction-based DNA fingerprinting methods. *Ann. Entomol. Soc. Am.* 97: 574-585.
- de León, J. H., W. A. Jones, and D. J. W. Morgan. 2004a. Population genetic structure of *Homalodisca coagulata* (Homoptera: Cicadellidae), the vector of the bacterium *Xylella fastidiosa* causing Pierce's disease in grapevines. *Ann. Entomol. Soc. Am.* 97: 809-818.
- de León, J. H., W. A. Jones, and D. J. W. Morgan. 2004b. Molecular distinction between populations of *Gonatocerus morrilli*, egg parasitoids of the glassy-winged sharpshooter *Homalodisca coagulata*, from Texas and California: Do cryptic species exist? 7pp. *J. Insect Sci.* 4:39, Available online: [insectscience.org/4.39](http://insectscience.org/4.39).
- de León, J. H., and W. A. Jones. 2005. Genetic differentiation among geographic populations of *Gonatocerus ashmeadi* (Hymenoptera: Mymaridae), the predominant egg parasitoid of *Homalodisca coagulata* (Homoptera: Cicadellidae). 9pp. *J. Insect Sci.* 5:2, Available online: [insectscience.org/5.2](http://insectscience.org/5.2).

- de León, J. H., W. A. Jones, Mamoudou Sétamou, and D. J. W. Morgan. 2005. *Gonatocerus morrilli* (Hymenoptera: Mymaridae), a primary egg parasitoid of the glassy-winged sharpshooter (*Homalodisca coagulata*) exists in nature as a cryptic species complex. (Submitted).
- Döbel, H., and R. Denno. 1993. Predator-plant-hopper interactions, pp. 325-399 In R. Denno and T. Perfect [eds], *Planthoppers, Their Ecology and Management*. Chapman & Hall, New York.
- Hopkins, D. L., and H. H. Mollenhauer. 1973. Rickettsia-like bacterium associated with Pierce's disease of grapes. *Science* 179: 298-300.
- Huber, J. T. 1986. Systematics, biology and hosts of the Mymaridae and Mymarommatidae (Insecta-Hymenoptera): 1758-1984. *Entomography* 4: 185-243.
- Karp, A., and J. Edwards. 1997. DNA markers: a global overview. In: *DNA markers- protocols, applications, and overviews* (eds Caetano-Anolles G, P. M. Gresshoff PM), (eds.), pp. 1-13. Wiley-Liss, Inc., New York, NY.
- Logarzo, G. A., E. G. Virla, S. V. Serguei, and W. A. Jones. 2004. Biology of *Zagella delicata* (Hymenoptera: Trichogrammatidae), an egg parasitoid of the sharpshooter *Tapajosa rubromarginata* (Hemiptera: Clypeorrhyncha: Cicadellidae) in Argentina. *Florida Entomol.* 87: 511-516.
- Löhr, B. A., M. Varela, and B. Santos. 1990. Exploration for natural enemies of the cassava mealybug, *Phenacoccus manihoti* (Homoptera: Pseudococcidae), in South America for the biological control of this introduced pest in Africa. *Bull. Entomol. Res.* 80: 417-425.
- Messing, R. H., and M. T. Aliniaze. 1988. Hybridization and host suitability of two biotypes of *Trioxys pallidus* (Hymenoptera: Aphidiidae). *Ann. Entomol. Soc. Am.* 81: 6-9.
- Narang, S. K., W. J. Tabachnick, and R. M. Faust. 1993. Complexities of population genetic structure and implications for biological control programs. In: *Applications of Genetics to Arthropods of Biological Control Significance* (eds Narang SK, Barlett AC, Faust RM), pp. 19-52. CRC Press Inc, Boca Raton, Florida.
- Powell, W., and M. P. Walton. 1989. The use of electrophoresis in the study of hymenopteran parasitoids of agricultural pest. In: *Loxdale HD, den Hollander J, editors. Electrophoretic Studies on Agricultural Pests*, 443-65. Oxford, Clarendon.
- Redak, R. A., A. H. Purcell, J. R. S. Lopes, M. J. Blua, R. F. Mizell III, and P. C. Anderson. 2004. The biology of xylem fluid-feeding insect vectors of *Xylella fastidiosa* and their relationship to disease epidemiology. *Ann. Rev. Entomol.* 49: 243-270.
- Turner, W. F., and H. N. Pollard. 1959. Life histories and behavior of five insect vectors of phony peach disease. *USDA Technical Bull.* 1188: 28 pp.
- Varela, L. G., R. J. Smit, and P. A. Phillips. 2001. Pierce's Disease. University of California Agricultural Natural Research - Publication 21600.
- Virla, E. G., G. A. Logarzo, W. A. Jones, and S. Triapitsyn. 2005. Biology of *Gonatocerus tuberculifemur* (Hymenoptera: Mymaridae), an egg parasitoid of the sharpshooter, *Tapajosa rubromarginata* (Hemiptera: Cicadellidae). *Florida Entomol.* 88: 67-71.
- Young, D. A. 1958. A synopsis of the species of *Homalodisca* in the United States (Homoptera: Cicadellidae). *Bull. Brooklyn Entomol. Soc.* 53: 7-13.
- Young, D. A. 1968. *U. S. National Bulletin* 261, 193-204.
- Unruh, T. R., and J. B. Woolley. 1999. Molecular Methods in Classical Biological Control. In: *Biological Control* (eds Van Driesche RG, Bellows TS, Jr.), pp. 57-85. Chapman and Hall, NY.
- Zietkiewicz, E., A. Rafalski, and D. Labuda. 1994. Genomic fingerprinting by simple sequence repeat (SSR)-anchored polymerase chain reaction amplification. *Genomics* 20: 176-183.

## FUNDING AGENCIES

Funding for this project was provided by the USDA Agricultural Research Service.

**Additional Note:** We acknowledge Marissa González and Lisa A. Ledezma for their excellent technical assistance



# DISCOVERY OF A CRYPTIC SPECIES COMPLEX IN *GONATOCERUS MORRILLI*, A PRIMARY EGG PARASITOID OF THE GLASSY-WINGED SHARPSHOOTER

## Project Leaders:

Jesse H. de León, Walker A. Jones, and Mamoudou Sétamou  
USDA, ARS  
Beneficial Insects Research Unit  
Weslaco, TX 78596

David J.W. Morgan  
CDFA, PDCP  
Mount Rubidoux Field Station  
Riverside, CA 92501

**Reporting Period:** The results reported here are from work conducted fiscal year 2004 to fiscal year 2005.

## ABSTRACT

We investigated the differentiation and reproductive isolation among different geographic populations of *Gonatocerus morrilli*, an egg parasitoid of the glassy-winged sharpshooter (GWSS) (*Homalodisca coagulata* Say) (Homoptera: Cicadellidae), to confirm previous observations that there may exist a cryptic species complex. Two mitochondrial genes [cytochrome oxidase subunits I (COI) and II (COII)] and the internal transcribed spacer region 2 (ITS2) of several individuals per population were sequenced. *Gonatocerus morrilli* populations from Texas (TX), Florida (FL), California (CA), and an outgroup (*G. ashmeadi*) were analyzed. For comparison, a population from Argentina identified as near *G. morrilli* (= *G. annulicornis*) was also included. For all three sequence fragments, percentage sequence divergence (%D) demonstrated that both the TX and FL populations (TX/FL) were closely related and therefore, determined to be the same species; in contrast, the %D between TX/FL and CA fell within the range of the outgroup, making the CA population a novel species (nov. sp. *G. morrilli*). Neighbor-joining distance trees clustered the TX/FL and CA populations or species into two well supported distinctive clades. The *G. morrilli* (nov. sp.) was more closely related to *G. annulicornis* than to the TX/FL species. Mating studies demonstrated that the populations or species from CA and TX were reproductively incompatible, producing no female offspring in both direct and reciprocal crosses; whereas, the heterogamic crosses between TX and FL produced fertile offspring and relative compatibility indices similar to the homogamic crosses. These results are important to the PD/GWSS biological control program in California.

## INTRODUCTION

Accurate identification of natural enemies is critical to the success of classical biological control programs, as it is essential for 1) selecting the most suitable natural enemy, 2) evaluating establishment, dispersal, and efficacy of natural enemies, and 3) improving mass production. Lack of proper identification procedures has affected several projects (Rosen 1977, Messing and Aliniaze 1988, Löhr et al. 1990, Narang et al. 1993, Miller and Rossman 1995, Schauf and LaSalle 1998, Gordh and Beardsley 1999, Unruh and Woolley 1999). Phylogenetics has become a widespread approach for delineating and identifying morphologically similar or cryptic species. Correct identification of the pest is also extremely important in biological control. Geographic populations of the same species may differ in relevant biological characteristics of importance to biological control. In addition, pin-pointing the native origin of an exotic pest is crucial for collection of natural enemies in the native range of the pest (Rosen 1977, Narang et al. 1993, Unruh and Woolley 1999, Brown 2004, Roderick 2004). We demonstrated that the GWSS that invaded CA is of TX origin, but more than one founding event occurred (de León et al. 2004a). Our data also showed that GWSS populations in the U. S. were genetically distinct, clustering into two main groups or clades, a 'southeastern' and a 'southwestern and western' clade. Similarly, molecular studies of *Gonatocerus morrilli* Howard (Hymenoptera: Mymaridae) populations from CA and TX using inter-simple sequence repeat-polymerase chain reaction (ISSR-PCR) DNA fingerprinting and amplification of the internal transcribed spacer 2 region (ITS2) showed that these populations were highly differentiated ( $G_{ST} = 0.92$ ) with restricted gene flow (de León et al. 2004b, de León et al. 2005). These results strongly suggested that *G. morrilli* exists in nature as a cryptic species complex. Furthermore, the different sizes of the ITS2 amplification fragments between the geographic populations raised concerns over the reproductive compatibility of these populations and its implications in a biological control program.

## OBJECTIVES

The objective of the present study was to confirm whether *G. morrilli* exists in nature as a cryptic species complex. We extended our previous observations (de León et al. 2004b) by implementing a phylogenetic approach by sequencing two mitochondrial genes [cytochrome oxidase subunit I and II genes (COI) and (COII)] and one ribosomal DNA spacer region fragment (ITS2). Reproductive compatibility studies were performed with populations of *G. morrilli* from three origins: California, Florida, and Texas.

## RESULTS AND CONCLUSIONS

### ISSR-PCR DNA fingerprinting

Previously, we (de León et al. 2004b) determined that *G. morrilli* populations from TX and CA had different ISSR-PCR banding patterns, suggesting that these populations were reproductively isolated. In the present study a population from FL was included and we asked whether ISSR-PCR was a suitable method to predict the species status of this *G. morrilli* population. Figure 1 shows the results of this analysis where five randomly chosen field collected individuals per population from TX, CA, and FL were analyzed. The results showed that the population of *G. morrilli* from FL had the same ISSR-PCR banding pattern as the population from TX, whereas the CA population had a banding pattern that differed from TX and FL. Recently (de León et al. 2004, de León and Jones 2005) and in the current report, we observed a powerful correlation in DNA banding patterns and distinct species with the ISSR-PCR DNA fingerprinting method with Mymaridae egg parasitoids. The method has been used to distinguish about ten *Gonatocerus* egg parasitoid species (unpublished data). In the present study, based on ISSR-PCR banding patterns, we were able to predict the species status of the *G. morrilli* population from FL. The results demonstrated populations from FL and TX as distinct from the CA populations. Even though ISSR-PCR markers are scored as dominant, the ISSR-PCR technique using 5'-anchored or compound ISSR primers is still a very sensitive and useful technique because it targets random SSR or microsatellites (Zietkiewicz et al. 1994, de León and Jones 2004). An additional advantage is that the same ISSR primer can be rapidly applied across several different orders (e.g., insects, plants, fungi, bacteria) without prior knowledge of DNA sequences (de León, unpublished data), a capability not found with microsatellites. Banding patterns are consistent because the anchors serve to fix the annealing of the primer to a single position of the target site, thus resulting in a low level of slippage during amplification (Zietkiewicz et al. 1994, reviewed in Karp and Edwards 1997).

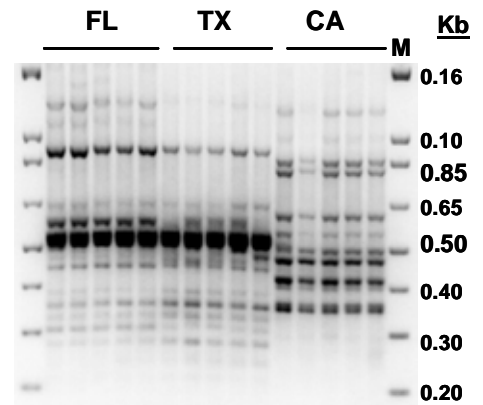


Figure 1. ISSR-PCR

### Sequence divergence in gene fragments (COI, COII, and ITS2) in *G. morrilli* geographic populations

Levels of genetic divergence in the gene fragments among populations were determined by calculating the pairwise estimates for genetic distance. Sequences were aligned with the program ClustalX and the neighbor-joining trees were reconstructed with the phylogenetic program PAUP 4.0. Dendrograms for the gene fragments are shown in Figures. 2 (COI), 3 (COI), and 4 (ITS2). Trees display branch lengths (below branches, underlined) and bootstrap values (above branches) as a percentage of 1000 replications. For all three gene sequence fragments, percentage sequence divergence (%D) demonstrated that both the TX and FL populations (TX/FL) were closely related and therefore, determined to be the same species; in contrast, the %D between TX/FL and CA fell within the range of the outgroup, making the CA population a novel species (nov. sp. *G. morrilli*) (data not shown). Neighbor-joining distance trees clustered the TX/FL and CA populations or species into two well supported distinctive clades. The *G. morrilli* (nov. sp.) was more closely related to *G. annulicornis* than to the TX/FL species. Sequence data from the mitochondrial COI and COII partial genes and the ITS2 rDNA fragment indicate that the studied populations of *G. morrilli* contain two distinct evolutionary groups. Populations from TX and FL formed one well-supported clade, while populations from CA formed another well-supported clade. Variation between the two clades with all three genes was greater between clades than within them.

### Reproductive compatibility studies

Mated *G. morrilli* females from the various crosses successfully parasitized eggs of *H. coagulata*, but the percentages varied significantly with treatment ( $F = 12.54$ ,  $df = 5, 82$ ,  $P < 0.0001$ ). Nearly all *H. coagulata* eggs exposed were successfully parasitized in all the direct and reciprocal crosses, except for the ♀TX × ♂CA treatment for which only 65% of eggs were successfully parasitized (Figure 5a). The crosses ♀CA × ♂CA and ♀CA × ♂TX yielded the longest immature developmental period for males; the lowest periods were obtained for immatures from ♀FL × ♂TX, ♀TX × ♂FL and ♀TX × ♂TX. Percentage of females produced varied significantly with treatment ( $F = 115.05$ ,  $df = 5, 82$ ,  $P < 0.0001$ ). The sex ratios of *G. morrilli* progeny produced from the homogamic (♀CA × ♂CA and ♀TX × ♂TX) and the heterogamic (♀TX × ♂FL and ♀FL × ♂TX) crosses were female-biased and similar with > 70% of female offsprings (Fig 5b). In contrast, the heretogamic cross ♀CA × ♂TX and its reciprocal cross ♀TX × ♂CA did not produce any female progeny. Relative to their ♀TX × ♂TX homogamic cross, the relative compatibility indices (ratio between the proportion of females in heterogamic and homogamic cross) of ♀TX × ♂CA and ♀TX × ♂FL were 0 and 0.95, respectively. Similarly, the relative compatibility index of the ♀CA × ♂TX was 0. The immature developmental time of *G. morrilli* within eggs of *H. coagulata* significantly varied with treatment ( $F = 212.04$ ,  $df = 5, 1018$ ,  $P < 0.0001$ ) but not with sex ( $F = 0.08$ ,  $df = 1, 1018$ ,  $P = 0.78$ ). For females, the longest immature developmental time was recorded for ♀CA × ♂CA, whereas no significant differences were recorded for the three crosses ♀FL × ♂TX, ♀TX × ♂FL and ♀TX × ♂TX (Fig. 5c).

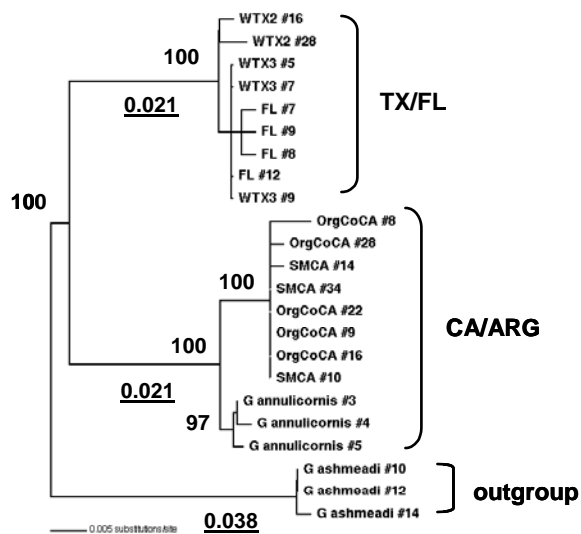


Figure 2. COI

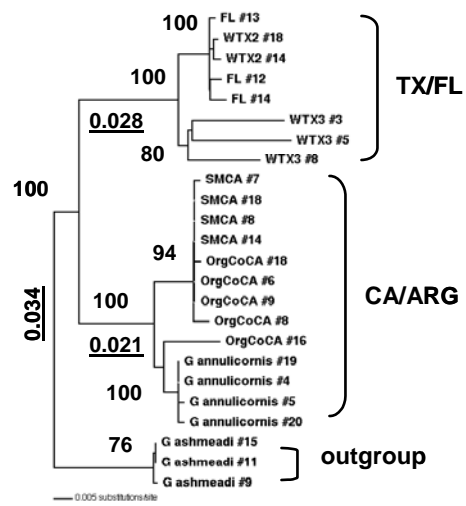


Figure 3. COII

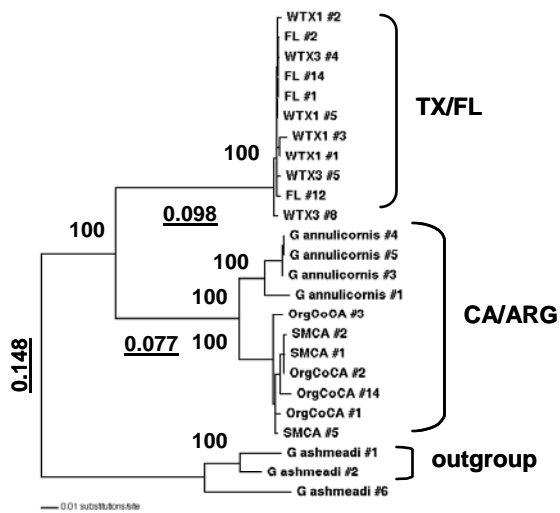


Figure 4. ITS2

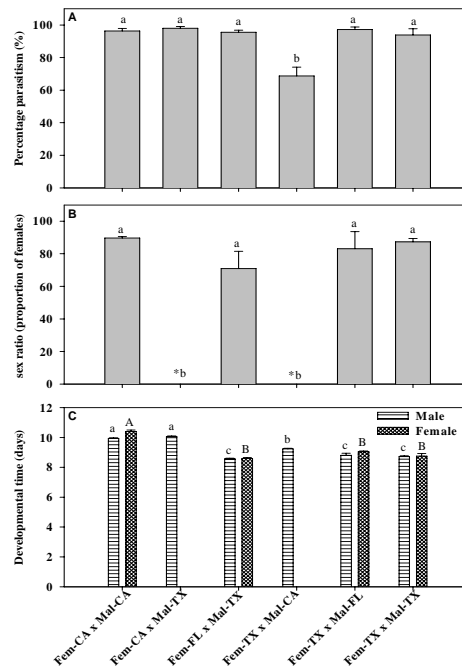


Figure 5. Crossing studies

## REFERENCES

- Brown, J. K. 2004. Tracing the origin of cryptic insect pests and vectors, and their natural enemies. In: *Genetics, Evolution, and Biological Control* (eds Ehler LE, Sforza R, Mateille T), pp. 113-132. CABA International, Wallingford, UK.
- de León, J. H., and W. A. Jones. 2004. Detection of DNA polymorphisms in *Homalodisca coagulata* (Homoptera: Cicadellidae) by Polymerase Chain Reaction-based DNA fingerprinting methods. *Ann. Entomol. Soc. Am.* 97: 574-585.
- de León, J. H., W. A. Jones, and D. J. W. Morgan. 2004a. Population genetic structure of *Homalodisca coagulata* (Homoptera: Cicadellidae), the vector of the bacterium *Xylella fastidiosa* causing Pierce's disease in grapevines. *Ann. Entomol. Soc. Am.* 97: 809-818.
- de León, J. H., W. A. Jones, and D. J. W. Morgan. 2004b. Molecular distinction between populations of *Gonatocerus morrilli*, egg parasitoids of the glassy-winged sharpshooter *Homalodisca coagulata*, from Texas and California: Do cryptic species exist? *J. Insect Sci.* 4:39, Available online: [insectscience.org/4.39](http://insectscience.org/4.39).
- de León, J. H., and W. A. Jones. 2005. Genetic differentiation among geographic populations of *Gonatocerus ashmeadi* (Hymenoptera: Mymaridae), the predominant egg parasitoid of *Homalodisca coagulata* (Homoptera: Cicadellidae). 9pp. *J. Insect Sci.* 5:2, Available online: [insectscience.org/5.2](http://insectscience.org/5.2).
- de León, J. H., W. A. Jones, Mamoudou Sétamou, and D. J. W. Morgan. 2005. *Gonatocerus morrilli* (Hymenoptera: Mymaridae), a primary egg parasitoid of the glassy-winged sharpshooter (*Homalodisca coagulata*) exists in nature as a cryptic species complex. (Submitted).
- Gordh, G., and J. W. Beardsley. 1999. Taxonomy and biological control. In: *Handbook of Biological Control* (eds Bellows TS, Jr., Fisher TW), pp. 45-56. Academic Press, San Diego.
- Karp, A., and J. Edwards. 1997. DNA markers: a global overview. In: *DNA markers- protocols, applications, and overviews* (eds Caetano-Anolles G, P. M. Gresshoff PM), (eds.), pp. 1-13. Wiley-Liss, Inc., New York, NY.
- Löhr, B. A., M. Varela, and B. Santos. 1990. Exploration for natural enemies of the cassava mealybug, *Phenacoccus manihoti* (Homoptera: Pseudococcidae), in South America for the biological control of this introduced pest in Africa. *Bull. Entomol. Res.* 80: 417-425.
- Messing, R. H., and M. T. Aliniaze. 1988. Hybridization and host suitability of two biotypes of *Trioxys pallidus* (Hymenoptera: Aphidiidae). *Ann. Entomol. Soc. Am.* 81: 6-9.
- Miller, D. R., and A. Y. Rossman. 1995. Systematics, biodiversity, and agriculture. *BioScience* 45: 680-686.
- Narang, S. K., W. J. Tabachnick, and R. M. Faust. 1993. Complexities of population genetic structure and implications for biological control programs. In: *Applications of Genetics to Arthropods of Biological Control Significance* (eds Narang SK, Barlett AC, Faust RM), pp. 19-52. CRC Press Inc, Boca Raton, Florida.
- Roderick, G. K. 2004. Tracing the origins of pests and natural enemies: Genetic and statistical approaches. In: *Genetics, Evolution, and Biological Control* (eds Ehler LE, Sforza R, Mateille T), pp. 97-112. CABA International, Wallingford, UK.
- Rosen, D. 1977. The importance of cryptic species and specific identifications as related to biological control. In: *Biosystematics in agriculture. Beltsville Symposium of Agricultural Research* (ed Romberger JA), pp. 23-35. Allanheld, Osmun, Montclair, NJ.
- Schauff, M. E., and J. LaSalle. 1998. The relevance of systematics to biological control: protecting the investment in research. In: *Pest Management- Future Challenges*, vol. 1., pp. 425-436. Proceedings of the 6<sup>th</sup> Australian Applied Entomological Conference, 29 September-2 October, Brisbane, Australia.
- Unruh, T. R., and J. B. Woolley. 1999. Molecular Methods in Classical Biological Control. In: *Biological Control* (eds Van Driesche RG, Bellows TS, Jr.), pp. 57-85. Chapman and Hall, NY.
- Zietkiewicz, E., A. Rafalski, and D. Labuda. 1994. Genomic fingerprinting by simple sequence repeat (SSR)-anchored polymerase chain reaction amplification. *Genomics* 20: 176-183.

## FUNDING AGENCIES

Funding for this project was provided by the USDA Agricultural Research Service.

**Additional Note:** We acknowledge Marissa González, Lisa A. Ledezma, and Rosie Ruiz for their excellent technical assistance.

**SMALL SCALE POST-RELEASE EVALUATION OF A *GONATOCERUS MORRILLI* PROGRAM  
IN CALIFORNIA AGAINST THE GLASSY-WINGED SHARPSHOOTER:  
UTILITY OF DEVELOPED MOLECULAR DIAGNOSTIC TOOLS**

**Project Leaders:**

Jesse H. de León  
USDA, ARS  
Beneficial Insects Research Unit  
Weslaco, TX 78596

David J.W. Morgan  
CDFA, PDCP  
Mount Rubidoux Field Station  
Riverside, CA 92501

**Reporting Period:** The results reported here are from work conducted fiscal year 2004 to fiscal year 2005.

**ABSTRACT**

Previously we discovered a cryptic species complex in *Gonatocerus morrilli* (Howard) and developed molecular diagnostic markers that distinguished the two cryptic species. In the current study we tested the utility of the two developed molecular diagnostic markers to evaluate the establishment of *G. morrilli* in California. In the two cryptic species, the size of the internal transcribed spacer 2 region (ITS2) varies by about 212 base pairs; the Texas *G. morrilli* species is associated with a size of about 851-853 base pairs and the California *G. morrilli* (nov.) species with a size of about 1063-1067 base pairs. Secondly, the two cryptic species do not share any inter-simple sequence-polymerase chain reaction (ISSR-PCR) bands or markers. Initially releases were made from what was thought to be a Mexico culture, but contamination was suspected to have occurred from a Texas culture and therefore, the culture was named "TX/MX". Post-released collections from years 2002 and 2003 were made from the following locations: San Juan Capistrano, Glen Ivy, Pauma, Temecula, and San Marcos. Amplification of the ITS rDNA fragments demonstrated that all or 100% of the randomly chosen individuals (125 total) were of the California ITS2 genotype and none were of the Texas ITS2 genotype. ISSR-PCR DNA fingerprinting of the TX/MX colony along with native California and Texas *G. morrilli* species demonstrated that the TX/MX ISSR-PCR banding pattern was superimposable to that of the California *G. morrilli* (nov.) species. The results demonstrated that the TX/MX colony was contaminated with the California species, indicating that what was being released in California was California's own native species. Therefore, this is why screening with the ITS2 fragment detected only the California ITS2 genotype. The present results confirm the utility of the two developed molecular diagnostic methods in monitoring the success of the *G. morrilli* biological control program in California. In addition, this molecular technology will allow us to monitor egg parasitoid colonies to eliminate unwanted species.

**INTRODUCTION**

Accurate identification of natural enemies is critical to the success of classical biological control programs, as it is essential for 1) selecting the most suitable natural enemy, 2) evaluating establishment, dispersal, and efficacy of natural enemies, and 3) improving mass production. Lack of proper identification procedures has affected several projects (Rosen 1977, Messing and Aliniazee 1988, Löhr et al. 1990, Narang et al. 1993, Miller and Rossman 1995, Schauff and LaSalle 1998, Gordh and Beardsley 1999, Unruh and Woolley 1999). Correct identification of the pest is also extremely important in biological control. Geographic populations of the same species may differ in relevant biological characteristics of importance to biological control. In addition, pin-pointing the native origin of an exotic pest is crucial for collection of natural enemies in the native range of the pest (Rosen 1977, Narang et al. 1993, Unruh and Woolley 1999, Brown 2004, Roderick 2004). Recently, we demonstrated that the glassy-winged sharpshooter (GWSS) (*Homalodisca coagulata* Say) (Homoptera: Cicadellidae) that invaded California (CA) is of Texas (TX) origin, but more than one founding event occurred (de León et al. 2004a). Our data also showed that GWSS populations in the U. S. were genetically distinct, clustering into two main groups or clades, a 'southeastern' and a 'southwestern and western' clade. Similarly, molecular studies of *Gonatocerus morrilli* Howard (Hymenoptera: Mymaridae) populations from CA and TX using inter-simple sequence repeat-polymerase chain reaction (ISSR-PCR) DNA fingerprinting and amplification of the internal transcribed spacer region 2 (ITS2) showed that these populations were highly differentiated ( $G_{ST} = 0.92$ ) with restricted gene flow (de León et al. 2004b). Additional studies indeed confirmed that *G. morrilli* exists in nature as a cryptic species complex (de León et al. 2005 submitted and accompanying report).

**OBJECTIVES**

To examine the utility of developed molecular diagnostic markers in evaluating the establishment of *Gonatocerus morrilli* after release in California. Two molecular methods were tested: ISSR-PCR DNA fingerprinting and amplification of the internal transcribed spacer region 2 (ITS2).

**RESULTS AND CONCLUSIONS**

**The use of the ITS2 rDNA fragment as a molecular diagnostic tool to evaluate post-released populations**

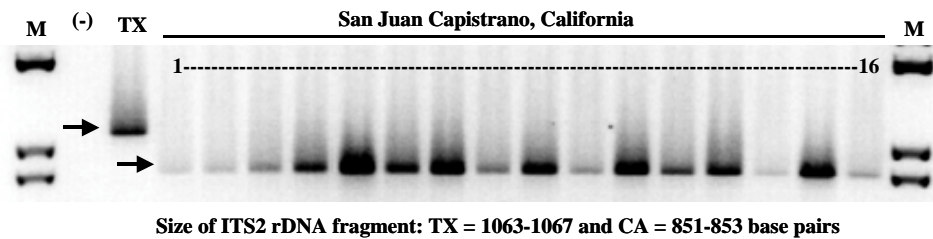
Initially releases were made from a Mexico culture but contamination was suspected to have occurred from a Texas culture and therefore, the culture was named "TX/MX". Post-released collections were made from the following locations: San Juan Capistrano (Orange Co.); Glen Ivy (Riverside Co.); Pauma (San Diego Co.); Temecula (Riverside Co.); and San Marcos (San Diego Co.). The ITS2 rDNA fragment was amplified with standard primers from several individuals per population. A

representative example is shown on Fig. 1. The expected ITS2 fragment sizes are: TX = 1063-1067 bp and CA = 851-853 bp. A TX *G. morrilli* individual was included for comparison. The data showed that all or 100% of individuals within this population (San Juan Capistrano) were of the ITS2-CA genotype. Analyses of the rest of the populations shown the same trend, that is, 100% of populations were of the ITS2-CA genotype and none were of the ITS2-TX genotype (Table 1).

**Molecular diagnostic analysis of the TX/MX culture by ISSR-PCR DNA fingerprinting**

Since the post-release evaluation of *G. morrilli* populations showed that what was being recovered were individuals with the ITS2-CA genotype, the question was asked, ‘were these egg parasitoids not establishing or could the initial release culture be contaminated with the TX culture as previously suspected’. Though, none of the individuals tested carried the ITS2-TX genotype, so it was possible that these egg parasitoids were not establishing. To answer this question we performed ISSR-PCR DNA fingerprinting with several individuals (7) per culture. Included for comparison were native *G. morrilli* species from Texas and California. Fig. 2 shows the results of this experiment. The ISSR-PCR banding pattern of the TX/MX culture was superimposable with that of the native California *G. morrilli* (nov.) species, demonstrating that the TX/MX individuals were not of the Texas *G. morrilli* species. These results were in accord with those seen with the amplification of the ITS2. This is confirmed by comparing the ISSR-PCR banding pattern of the native Texas species. Individuals of *G. morrilli* from Mexico were not available for analysis, but we have previously shown a powerful correlation between egg parasitoid species (*G. morrilli*) and ISSR-PCR banding patterns (de León et al. 2004b, de León et al. 2005 submitted). Furthermore, we present an accompanying proceeding/report demonstrating the correlation of ISSR-PCR banding patterns and egg parasitoid species in the genus *Gonatocerus*. Based on these results it is assumed that if individuals from Mexico were a different species, the ISSR-PCR method would have detected it. These results indicate that what was being released in California was the native California *G. morrilli* (nov.) species, and therefore, offers the explanation for the detection of only the ITS2-CA genotype as shown on Fig. 1 and Table 1. So the answer to our question was that contamination of the culture did in fact occur with the California *G. morrilli* (nov.) species and not with the Texas species as originally suspected. These results also indicate that the California species out competed the TX/MX individuals in the colony.

**Figure 1**

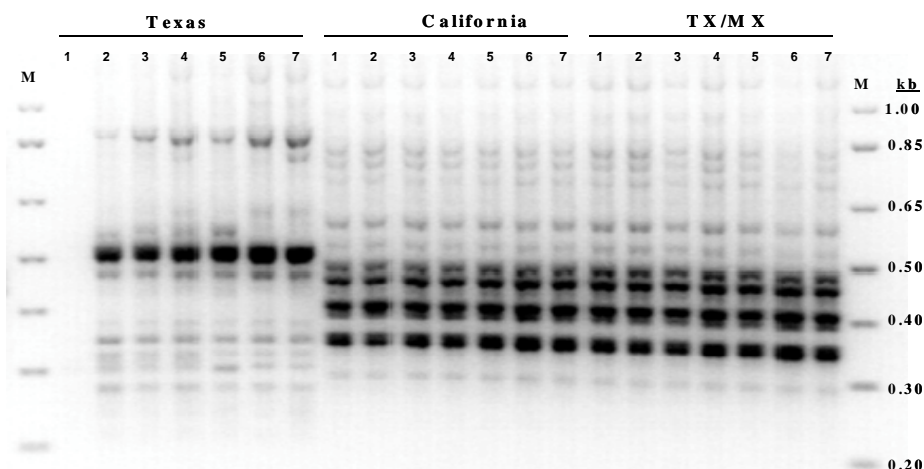


**Figure 1.** Representative example of the use of the ITS2 rDNA fragment as a molecular diagnostic tool to evaluate post-released populations of *Gonatocerus morrilli* in California. The ITS2 rDNA fragment was amplified with standard primers from 16 individuals as previously demonstrated (de León et al. 2004b, de León et al. 2005 submitted). The size of the expected ITS2 amplification products are shown above and the arrows indicate the products for both Texas (TX) and the California population. A difference of about 212 base pairs is seen between TX and CA individuals. **M:** 1.0 Kb Plus DNA Ladder.

**Table 1.** Summary of populations from California evaluated by amplification of the ITS2 rDNA fragment. A total of 125 individuals were included from the various populations. No. ind., number of individuals; #ITS2-CA, number of individuals with the CA *G. morrilli* ITS2 genotype; #ITS2-TX; number of individuals with the TX *G. morrilli* ITS2 genotype. Populations were collected in years 2002 and 2003 and were randomly chosen for analysis.

Population	County	No. ind.	#ITS2-CA	#ITS2-TX
San Juan Capistrano	Orange	30	30	0
Glen Ivy	Riverside	17	17	0
Pauma	San Diego	30	30	0
Temecula	Riverside	14	14	0
San Marcos	San Diego	34	34	0

**Figure 2**



**Figure 2.** Evaluation of the *G. morrilli* (TX/MX) culture that was used for release in California. Inter-simple sequence repeat-polymerase chain reaction (ISSR-PCR) was utilized as a molecular diagnostic tool to evaluate or monitor the *G. morrilli* (TX/MX) culture. Releases were made from a Mexico culture but contamination was suspected to have occurred from a Texas culture. For comparison, individuals or species native from Texas and California were included. DNA fingerprinting was performed as previously described (Zietkiewicz et al. 1994, de León et al. 2004, de León et al. 2005 submitted). M: 1.0 Kb Plus DNA Ladder.

## REFERENCES

- Brown, J. K. 2004. Tracing the origin of cryptic insect pests and vectors, and their natural enemies. In: *Genetics, Evolution, and Biological Control* (eds Ehler LE, Sforza R, Mateille T), pp. 113-132. CABA International, Wallingford, UK.
- de León, J. H., W. A. Jones, and D. J. W. Morgan. 2004a. Population genetic structure of *Homalodisca coagulata* (Homoptera: Cicadellidae), the vector of the bacterium *Xylella fastidiosa* causing Pierce's disease in grapevines. *Ann. Entomol. Soc. Am.* 97: 809-818.
- de León, J. H., W. A. Jones, and D. J. W. Morgan. 2004b. Molecular distinction between populations of *Gonatocerus morrilli*, egg parasitoids of the glassy-winged sharpshooter *Homalodisca coagulata*, from Texas and California: Do cryptic species exist? 7pp. *J. Insect Sci.* 4:39, Available online: [insectscience.org/4.39](http://insectscience.org/4.39).
- de León, J. H., and W. A. Jones. 2005. Genetic differentiation among geographic populations of *Gonatocerus ashmeadi* (Hymenoptera: Mymaridae), the predominant egg parasitoid of *Homalodisca coagulata* (Homoptera: Cicadellidae). 9pp. *J. Insect Sci.* 5:2, Available online: [insectscience.org/5.2](http://insectscience.org/5.2).
- de León, J. H., W. A. Jones, Mamoudou Sétamou, and D. J. W. Morgan. 2005. *Gonatocerus morrilli* (Hymenoptera: Mymaridae), a primary egg parasitoid of the glassy-winged sharpshooter (*Homalodisca coagulata*) exists in nature as a cryptic species complex. (Submitted).
- Gordh, G., and J. W. Beardsley. 1999. Taxonomy and biological control. In: *Handbook of Biological Control* (eds Bellows TS, Jr., Fisher TW), pp. 45-56. Academic Press, San Diego.
- Karp, A., and J. Edwards. 1997. DNA markers: a global overview. In: *DNA markers- protocols, applications, and overviews* (eds Caetano-Anolles G, P. M. Gresshoff PM), (eds.), pp. 1-13. Wiley-Liss, Inc., New York, NY.
- Löhr, B. A., M. Varela, and B. Santos. 1990. Exploration for natural enemies of the cassava mealybug, *Phenacoccus manihoti* (Homoptera: Pseudococcidae), in South America for the biological control of this introduced pest in Africa. *Bull. Entomol. Res.* 80: 417-425.
- Messing, R. H., and M. T. Aliniaze. 1988. Hybridization and host suitability of two biotypes of *Trioxys pallidus* (Hymenoptera: Aphidiidae). *Ann. Entomol. Soc. Am.* 81: 6-9.
- Miller, D. R., and A. Y. Rossman. 1995. Systematics, biodiversity, and agriculture. *BioScience* 45: 680-686.
- Narang, S. K., W. J. Tabachnick, and R. M. Faust. 1993. Complexities of population genetic structure and implications for biological control programs. In: *Applications of Genetics to Arthropods of Biological Control Significance* (eds Narang SK, Barlett AC, Faust RM), pp. 19-52. CRC Press Inc, Boca Raton, Florida.
- Roderick, G. K. 2004. Tracing the origins of pests and natural enemies: Genetic and statistical approaches. In: *Genetics, Evolution, and Biological Control* (eds Ehler LE, Sforza R, Mateille T), pp. 97-112. CABA International, Wallingford, UK.

- Rosen, D. 1977. The importance of cryptic species and specific identifications as related to biological control. In: Biosystematics in agriculture. *Beltsville Symposium of Agricultural Research* (ed Romberger JA), pp. 23-35. Allanheld, Osmun, Montclair, NJ.
- Schauff, M. E., and J. LaSalle. 1998. The relevance of systematics to biological control: protecting the investment in research. In: *Pest Management- Future Challenges*, vol. 1., pp. 425-436. Proceedings of the 6<sup>th</sup> Australian Applied Entomological Conference, 29 September-2 October, Brisbane, Australia.
- Unruh, T. R., and J. B. Woolley. 1999. Molecular Methods in Classical Biological Control. In: *Biological Control* (eds Van Driesche RG, Bellows TS, Jr.), pp. 57-85. Chapman and Hall, NY.
- Zietkiewicz, E., A. Rafalski, and D. Labuda. 1994. Genomic fingerprinting by simple sequence repeat (SSR)-anchored polymerase chain reaction amplification. *Genomics* 20: 176-183.

#### **FUNDING AGENCIES**

Funding for this project was provided by the USDA Agricultural Research Service.

**Additional Note:** We acknowledge Marissa González and Lisa A. Ledezma for their excellent technical assistance.



# THE ALIMENTARY TRACK OF THE GLASSY-WINGED SHARPSHOOTER AS A TARGET FOR CONTROL OF PIERCE'S DISEASE AND DEVELOPMENT OF MIMETIC INSECTICIDAL PEPTIDES FOR GLASSY-WINGED SHARPSHOOTER CONTROL

## Project Leader:

Brian A. Federici  
Department of Entomology  
University of California  
Riverside, CA 92521

**Reporting Period:** The results reported here are from work conducted December 2004 through August 2005.

## ABSTRACT

Toxin technology using *Bacillus sphaericus* has been used to control the important vectors of human diseases, the *Aedes aegypti* and *Culex quinquefasciatus* mosquito species. Agricultural pests such as caterpillars and beetles have been targeted by transgenic insecticidal crops expressing *Bacillus thuringiensis* (*Bt*) toxin. However, a *Bt* technology would be ineffective in controlling xylem-and phloem-sucking insect pests, such as the glassy-winged sharpshooter, *Homalodisca coagulata* (GWSS), because their feeding habit circumvents the tissues in which the toxins are expressed in transgenic plants and they are likely immune to the *Bt* toxins. Our research is developing mimetic peptides to target the exposed active domains of transport proteins on the surface of the GWSS midgut microvillar membrane and GWSS salivary enzymes. We are using a genomics approach to develop proteins cloned from the variable binding domains of immunoglobulin molecules specific to GWSS gut and salivary proteins. To isolate targets we have used degenerate PCR to amplify genes characterized in other insect species, and are screening a cDNA microarray to identify novel gut and saliva protein encoding genes. Our first mimetic peptides are targeting the GWSS V-ATPase c subunit.

## INTRODUCTION

Examples of medical uses of mimetic technology include the inactivation of disease-related enzymes (Burke et al. 2001), blockage of metabolic receptors important to disease (Berezov et al. 2000), and the use of antibodies developed against disease constituents (Moe et al. 1999). Human cancers (Monzayi-Karbassi and Keiber-Emmons, 2001), diabetes (Deghenghi, 1998), and heart disease (Lincoff et al. 2000) all have been treated successfully through these applications of mimetics. Antibody proteins have been synthesized successfully in plants (Larrick et al. 2001; Stoger et al. 2002), and promoters directing expression to the cell wall and vascular structures of plants (Shi et al. 1994; Springer, 2000), are available, so we can assure that our antibody peptides are synthesized in a tissue-specific manner in transformed plant lines. During the last year we isolated two full length cDNA clones of the V-ATPase c subunits of GWSS. The V-ATPase c protein is an excellent target for mimetic inactivation in insects because they provide the electromotive force which drives  $H^+/K^+$  transport, which in turn maintains gut pH. V-ATPases have been successfully targeted by highly specific bafilomycin/concanamycin antibiotics in the inhibition of human tumor cells (Boyd et al. 2001) and osteoporosis (Farina et al., 2001), and these antibiotics have been shown to specifically bind to the V-ATPase c subunit, demonstrating that binding and blocking the active site of this subunit can effectively inactivate the transporter.

## OBJECTIVES

1. Determine the structure and cell types in the midgut epithelium and salivary glands of the glassy-winged sharpshooter (GWSS), *Homalodisca coagulata*;
2. Prepare a normalized cDNA microarray of GWSS using pooled cDNAs isolated from each developmental stage.
3. Screen the microarray using cDNA probes derived from midgut and salivary gland tissue-specific probes to determine the tissue-specific expression of key midgut microvillar and saliva proteins;
4. Clone and sequence genes encoding one or more key midgut microvillar and saliva proteins and determine their suitability as targets for a molecular biological approach to GWSS and Pierce's disease control.
5. Predict functional domains of key GWSS midgut epithelium- and salivary gland-specific proteins based on sequences of genes using bioinformatics;
6. Express functional domain peptides for antibody production;
7. Clone single-chain fragment variable antibody genes into recombinant phage libraries and screen the libraries;
8. Conduct feeding studies to identify efficacious mimetic peptides effective in killing or deterring GWSS.

## RESULTS

While we are still in the process of screening our cDNA microarray to identify clones encoding novel midgut and salivary gland protein genes, we have isolated two full length cDNAs of the V-ATPase c subunit from our GWSS cDNA library using clone capture (Shepard and Rae, 1997). These clones differ in several positions in the coding region, as well as in the 3'- and 5'-untranslated regions (Figure 1.). The protein sequences align significantly with the V-ATPase c subunit proteins of several other insect species (Figure 2). Antibodies to the gut lumen exposed N-terminus and external loop have been produced in rabbits and affinity purified by New England Peptide. These antibodies are being used in feeding studies to determine the efficacy of our approach. Antibody RNAs were extracted from the spleens of the immunized rabbits and the

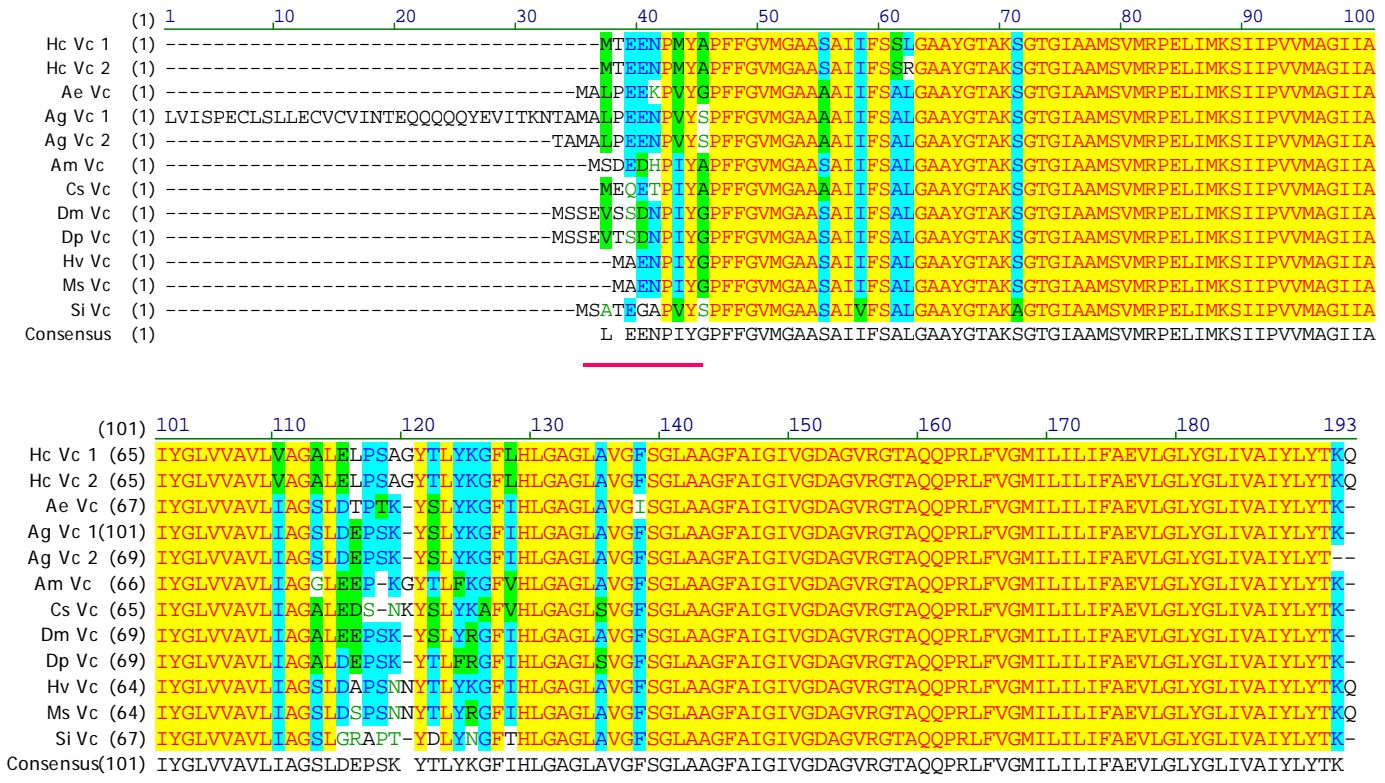
variable regions cloned into a phage display library for isolation of the mimetic peptides that bind most efficiently to the GWSS V-ATPase c peptides. Ultimately these antibody peptides will be used to develop transgenic plants.

**Figure 1.** Protein and cDNA alignments of the V-ATPase c subunit clones of GWSS. Shading denotes where codons and amino acids differ. Numbers on left and right denote cDNA and amino acid positions, respectively.

```

1                                     gactttaggccatatttgacagtgggctg
g
25  attactttgtgctgtgaagtgtagtgtagaatagttctgcagagtcctccgagcctgtaaaactcgcgtaaaaagtgaaa
2  attactttgtgctgtgaagtgtagtgtagaatagttctgcagagtcctccgagcctgtaaaactcgcgtaaaaagtgaaa
105 ATG ACA GAA GAA AAT CCA ATG TAC GCA CCC TTC TTT GGA GTT ATG GGG GCT GCC TCG GCA
82  ATG ACA GAA GAA AAT CCA ATG TAC GCA CCC TTC TTT GGA GTT ATG GGG GCT GCC TCA GCA
M T E E N P M Y A P F F G V M G A A S A 20
165 ATT ATT TTC AGT TCG CGG GGG GCG GCG TAC GGC ACA GCC AAG TCC GGC ACT GGT ATC GCA
115 ATT ATT TTC AGT TCG CTG GGG GCG GCG TAC GGC ACA GCC AAG TCC GGC ACC GGT ATC GCA
I I F S S L G A A Y G T A K S G T G I A 40
225 GCC ATG TCG GTG ATG CGG CCA GAG CTG ATC ATG AAA TCC ATC ATC CCC GTC GTC ATG GCG
163 GCC ATG TCG GTG ATG CGG CCG GAG CTG ATC ATG AAA TCC ATC ATC CCC GTC GTC ATG GCG
A M S V M R P E L I M K S I I P V V M A 60
285 GGT ATC ATC GCC ATC TAC GGC CTG GTG GTG GCC GTC CTG GTG GCC GGT GCT CTG GAG CTG
259 GGT ATC ATC GCC ATC TAC GGC CTG GTG GTG GCC GTC CTG GTG GCC GGT GCT CTG GAG CTG
G I I A I Y G L V V A V L V A G A L E L 80
345 CCC TCC GCT GGC TAC ACC TTA TAC AAG GGA TTT CTA CAC CTG GGG GCT GGG TTA GCT GTA
307 CCC TCC GCT GGC TAC ACC TTA TAC AAG GGA TTT CTA CAC CTG GGG GCT GGG TTA GCT GTA
P S A G Y T L Y K G F L H L G A G L A V 100
405 GGG TTC AGT GGG CTG GCG GCA GGC TTT GCC ATC GGC ATC GTG GGA GAC GCC GGC GTG CGA
355 GGG TTC AGT GGG TTG GCG GCA GGC TTT GCC ATC GGC ATC GTG GGA GAC GCC GGC GTG CGA
G F S G L A A G F A I G I V G D A G V R 120
465 GGG ACT GCT CAA CAG CCT CGC CTG TTC GTC GGT ATG ATC CTC ATC CTT ATC TTC GCT GAG
403 GGG ACT GCT CAA CAG CCT CGC CTG TTC GTC GGT ATG ATC CTC ATC CTT ATC TTC GCT GAG
G T A Q Q P R L F V G M I L I L I F A E 140
525 GTG TTG GGT CTG TAC GGT CTG ATC GTA GCC ATC TAC CTC TAC ACA AAG CAA taagcctgtggc
499 GTG TTG GGT CTG TAC GGT CTG ATC GTA GCC ATC TAC CTC TAC ACA AAG CAA taagcctgtggc
V L G L Y G L I V A I Y L Y T K Q 157
588 cgtcgtctcatcatccccactaccatctgaatttcattgttttga----ggcaatttagaaagaaattgtacaacctgg
547 cgtcgtctcatcatccccactaccatctgaatttcattgttttgcgtaggcaatttagaaagaaattgtacaacctgg
663 aagcaacaaaaaatgttggaggacttgttttttgaatgggtgatttcacatcatcagatgacttgcacaataatttattt
608 aagcaacaaaaaatgttggaggacttgttttttgaatgggtgatttcacatcatcagatgacttgcacaataatttattt
742 taaattagtttttaactttattttaattgattttt--cagattccggatcagttcttttaaaaagttaactttcattgttaa
671 taaattagtttttaactttattttaattgattttt--cagattccggatcagttcttttaaaaagttaactttcattgttaa
821 ggaacttagaactaaagtgtgaaccacatcatgatattatattcagtgtagtacatatgtctattttgtaaatatagtg
797 ggaacttagaactaaagtgtgaaccacatcatgatattatattcagtgtagtacatatgtctattttgtaaatatagtg
902 gagatatcctcagtagacaagcagtgctatgaccctggtagctttaagcctgtgtaaatatctgagccgagttacaa
860 gagatatcctcagtagacaagcagtgctatgaccctggtagctttaagcctgtgtaaatatctgagccgagttacaa
982 aaatgtatttttatgttgtacgtacaatttaaagctgtaacgatcataaccttcttagtgtaatgtaggaaaattcatat
923 aaatgtatttttatgttgtacgtacaatttaaagctgtaacgatcataaccttcttagtgtaatgtaggaaaattcatat
1060 agcatttgaagtgtaaaaatcctgaagtatttggtaagtggataaattatgtaaacaaatgaaggacagacggacc--g
1049 agcatttgaagtgtaaaaatcctgaagtatttggtaagtggataaattatgtaaacaaatgaaggacagacggaccdg
1142 gagctgtacttcgaaaaagactctgtagaattagtgatgatcggttctgcggatgtggcaagtttcgggagcagattat
1112 gagctgtacttcgaaaaagactctgtagaattagtgatgatcggttctgcggatgtggcaagtttcgggagcagattat
1222 aaggttagaagcttagagtgtttgtaagctatgaataatttgcattccatattgtgtaaaaaccctaataaagaatta
1175 aaggttagaagcttagagtgtttgtaagctatgaataatttgcattccatattgtgtaaaaaccctaataaagaatta
1302 ttgttacgcacaaaaaaaaaaaaaaaaaaaaa
1238 ttgttacgcacctgtgtgtttggcctactgttgagggtgttctgttccacttcaactgtattgtataccgtagcattgttg
1364 tactgtgcgtagcgtggtgacgtgttgggtggtgtgctgcacactagtggtgcgatgacagctccttgcacgccatcacttca
1427 gttcactgccatctagtcattgcccgcgggtgactcaaaccttagcaacagtcattgtcaataaattcaacattaaattag
1490 gtcattttgtgatttattttttttttttgtagtagttatataatagttgcctgttattctttctatgctgtatgcagta
1616 ggcatgtcagtcctgttatatttgggtgtatgaatggatcaaatgtaataatattatgaaaacaaaactgttagtattatt
1679 cttoctggctctgtctctgaaaagtgttttagagcttcttccctctcaacggctgcttgatgttttaagtatttttt
1742 atccggtttttggtagtacttaactgtcctgtttttcttagaattcattgttattgtatttgggttaaaaggtttaaa
1804 aaaaagctatctgtttttcaaaaaaaaaaaaaaaaaaaaaa

```



**Figure 2.** Sequence alignments of the cloned portions of V-ATPase c subunit genes of *H. coagulata* (Hc), *Aedes aegypti* (Ae), *Anopheles gambiae* (Ag), *Apis mellifera* (AM), *Culicoides sonorensis* (Cs), *Drosophila melanogaster* (Dm), *Drosophila pseudoobscura* (Dp), *Heliothis virescens* (Hv), *Manduca sexta* (Ms) and *Solenopsis invicta* (Si) where:

X = a non similar residue, X = a consensus residue from a block of similar residues, X = a consensus residue of greater than 50%, X = a consensus residue completely conserved, X = a residue weakly similar to the consensus, and the regions to which peptides have been synthesized are underlined.

**CONCLUSIONS**

As with *M. sexta* (Dow et al.1992), the GWSS genome encodes two different transcripts for the V-ATPase c subunit. Sequence comparison suggests that these represent two members of a gene family. Alternatively, this could result from alternate splicing. Alternate splicing of Ion/proton exchangers has been documented in *Drosophila* and *Aedes* (Giannakou and Dow, 2001; Hart et al., 2002). We are using DNA blot hybridization and genome walking to resolve this issue and determine the copy number of the GWSS V-ATPase c subunit gene. The V-ATPase c subunit is the only V-ATPase subunit which spans the apical membrane of the K<sup>+</sup> secreting goblet cells (Harvey et al., 1983) that, along with amino acid absorbing columnar cells (Hanozet et al. 1989), make up the monolayered epithelium lining the gut in insects such as *M. sexta* (Wieczorek, 2003). In Situ hybridization studies have demonstrated the localization of the GWSS V-ATPase c to the same epithelial layer. This subunit should, therefore, be an ideal target for mimetic inactivation.

**REFERENCES**

Berezov, A., H-T. Zhang, M. Greene, and R. Murali. 2001. Disabling ErbB receptors with rationally designed exocyclic mimetics of antibodies: structure-function analysis. *J. Med. Chem.* 44: 2565-2574.

Boyd, M. R., C. Farina, P. Belfiore, S. Gagliardi, J. W. Kim, Y. Hayakawa, J. A. Beutler, T. C. McKee, B. J. Bowman, and E. J. Bowman. 2001. Discovery of a Novel Antitumor benzolactone amide class that selectively inhibits mammalian vacuolar-type (H1)-ATPases. *J Pharmacol Exp Ther.* 129: 114-120.

Burke, T., Z-J. Yao, D-G. Liu, J. Voigt, and Y. Gao. 2001. Phosphoryltyrosyl mimetics in the design of peptide-based signal transduction inhibitors. *Biopolymers.* 60: 32-44.

Deghenghi, R. 1998. Synthetic peptides and their non-peptidyl mimetics in endocrinology: From synthesis to clinical perspectives. *J. Endocrin. Invest.* 21: 787-793.

Dow, J. A. T., S. F. Goodwin, and K. Kaiser. 1992. Analysis of the gene encoding a 16-kDa proteolipid subunit of the vacuolar proton ATPase from *Manduca sexta* midgut and tubules. *Gene.* 122: 355-360.

Farina, C., S. Gagliardi, G. Nadler, M. Morvan, C. Parini, P. Belfiore, L. Visentin, and M. Gowen. 2001. Novel bone antiresorptive agents that selectively inhibit the osteoclast V-H+-ATPase. *Farmaco.* 56: 113-116.

- Giannakou, M. E., and J. A. T. Dow. 2001. Characterization of the *Drosophila melanogaster* alkali-metal/proton exchanger (NHE) gene family. *J. Exp. Biol.* 204: 3703-3716.
- Hanozet, G. M., B. Giordana, V. F. Sacchi, and P. Parenti. 1989. Amino acid transport systems in brush-border membrane vesicles from Lepidopteran enterocytes. *J. Exp. Biol.* 143: 87-100
- Hart, S. J., J. A. Knezetic, and D. H. Petzel. 2002. Cloning and tissue distribution of two Na<sup>+</sup>/H<sup>+</sup> exchangers from the Malpighian tubules of *Aedes aegypti*. *Arch. Insect Biochem. Physiol.* 51: 121-135.
- Harvey, W. R., M. Cioffi, M. G. Wolfersberger. 1983. Chemi osmotic potassium ion pump of insect epithelia. *Am. J. Physiol.* 244(2). R163-R175.
- Larrick, J., L. Yu, C. Naftzger, S. Jaiswal, and K. Wycoff. 2001. Production of secretory IgA antibodies in plants. *Biomol. Eng.* 18. 87-94.
- Lincoff, A., R. Califf, and E. Topol. 2000. Platelet glycoprotein IIb/IIIa receptor blockade in coronary artery disease. *J. Amer. Coll. Card.* 35: 1103-1115.
- Moe, G., S. Tan, and D. Granoff. 1999. Molecular mimetics of polysaccharide epitopes as vaccine candidates for prevention of *Neisseria meningitidis* serogroup B disease. *FEMS Immun. Med. Micro.* 26: 209-226.
- Monzayi-Karbassi, B., and T. Kieber-Emmons. 2001. Current concepts in cancer vaccine strategies. *Biotechniques.* 30: 170-189.
- Shepard, A., and J. Rae. 1997. Magnetic bead capture of cDNAs from double-stranded plasmid cDNA libraries. *Nucleic Acids Res.* 25, 3183-3185.
- Shi, Y., M. Wang, K. Powell, E. Van Damme, V. Hilder, A. Gatehouse, D. Boulter, and J. Gatehouse. 1994. Use of the rice sucrose synthase-1 promotor to direct phloem-specific expression of  $\beta$ -glucuronidase and snowdrop lectin genes in transgenic tobacco plants. *J. Exp. Bot.* 45: 623-631.
- Springer, P. 2000. Gene traps: Tools for plant development and genomics. *Plant Cell.* 12: 1007-1020.
- Stoger, E., M. Sack, R. Fischer, and P. Christou. 2002. Plantibodies: Applications, advantages and bottlenecks. *Curr. Opin. Biotechnol.* 13: 161-166.
- Wieczorek, H., M. Huss, H. Merzendorfer, S. Reineke, O. Vitavska, and W. Zeiske. 2003. The insect plasma membrane H<sup>+</sup>V-ATPase: Intra-, inter-, and supramolecular aspects. *J. Bioenerg. Biomembr.* 35: 359-366.

#### **FUNDING AGENCIES**

This project was funded by the University of California Exotic-Invasive Pests and Diseases Research Program, and the University of California Pierce's Disease Grant Program.

## IDENTIFYING KEY PREDATORS OF THE VARIOUS GLASSY-WINGED SHARPSHOOTER LIFESTAGES

### Project Leaders:

Valerie Fournier  
Division of Insect Biology  
University of California  
Weslaco, TX 78596

James Hagler  
Western Cotton Research Lab  
USDA, ARS  
Phoenix, AZ 85040

Kent Daane  
Division of Insect Biology  
University of California  
Berkeley, CA 94720

Jesse de León  
Beneficial Insects Research Unit  
USDA, ARS  
Weslaco, TX 78596

### Cooperators:

Nilima Prabhaker and Heather Costa  
Department of Entomology  
University of California  
Riverside, CA 92521

**Reporting Period:** The results reported here are from work conducted October 1, 2004 to October 1, 2005.

### ABSTRACT

Using glassy-winged sharpshooter (GWSS) egg-specific monoclonal antibody (MAb) and GWSS-specific genetic markers that we previously developed and optimized, the guts of field-collected predators were screened for the presence of GWSS remains. We have examined the guts of over 700 generalist predators and our analyses revealed that frequent predators of the GWSS include spiders, assassin bugs, lacewings and praying mantis.

### INTRODUCTION

Effective control of GWSS will require an area-wide integrated pest management approach (AW-IPM). A major component of Area-wide-Integrated Pest Management is the exploitation of the pest's natural enemies, which, when utilized to their greatest potential, can increase the effectiveness of other control tactics. Very little information exists on GWSS's predaceous natural enemies. Identifying the impact of predators can be challenging as they are usually small, elusive, nocturnal or cryptic. Direct visual field observations of predation are rare and often difficult to obtain. While predation studies using enclosures can provide some indication of predator impact, it fails to recreate natural conditions and can result in an overestimation of predation. A more valid method to qualitatively identify predators of key pests in nature is by the molecular analysis of predator gut contents for pest remains (reviewed in Sheppard and Harwood 2005). The state-of-the-art predator stomach content analyses include both MAb-based enzyme-linked immunosorbant assays (ELISA), which detect prey-specific proteins (Hagler et al. 1994ab, Schenk and Bacher 2004), and polymerase chain reaction (PCR)-based assays, which detect prey-specific DNA (Zaidi et al. 1999, Agustí et al. 2003). While DNA-based approaches reveal the prey identity at the species-level, they are unable to indicate which prey life stage is consumed. In contrast, pest-specific and life stage-specific MAbs can target a particular life stage of a given species, providing a higher level of precision to document predation (Hagler and Naranjo 1996). Combining both assays can provide a powerful tool to study predation on the GWSS.

To this end, genetic markers were designed using the cytochrome oxidase gene subunit I (COI) to detect and amplify a GWSS-specific fragment (de León et al. 2004, de León et al. submitted), and a GWSS-egg specific MAb was developed to detect GWSS egg-specific protein (Hagler et al. 2002, Fournier et al. 2004, Fournier et al. submitted).

### OBJECTIVE

The main objective of this research is to identify the key predators of the different life stages of GWSS. More specifically, our aim is to determine the proportion of predators feeding on the various GWSS life stages in nature. Using GWSS-specific ELISA and PCR assays, we examined the guts of several hundred field-collected generalist predators. Results obtained from this research will aid in evaluating the efficacy of generalist predators for a conservation or an inundative biological control program.

### RESULTS

From 2002 to 2004, generalist arthropod predators were collected from various species of shrubs and ornamental trees located in 20 sites in urban areas of Bakersfield, California. For each group of predators, lab trials were conducted to generate negative controls (i.e. individuals with no GWSS remains in their guts) and positive controls (i.e. individuals fed GWSS). Frozen specimens were shipped to USDA-ARS, Phoenix and screened by a GWSS egg-specific ELISA and a GWSS-specific PCR assay. All individuals were first homogenized in phosphate buffered saline and then aliquoted into two Eppendorf tubes in order to perform the two different assays (ELISA and PCR). For PCR assays, DNA was extracted using DNeasy tissue kit (Qiagen, protocol for insects). DNA samples were then subjected to the primer set HcCOI (forward 5'-

GGGCCGTAAATTTTACC-3' and reverse 5'-ACCACCTGAGGGGTCAAAA-3'; GenBank accession number AY959334) which amplifies a 197-bp GWSS fragment (de León et al. submitted). A sandwich ELISA was conducted on each predator using the modified protocol described by Hagler (1998). Predators were scored positive for prey remains if they yielded an ELISA response five standard deviations above that of their respective negative control mean (Sutula et al., 1986).

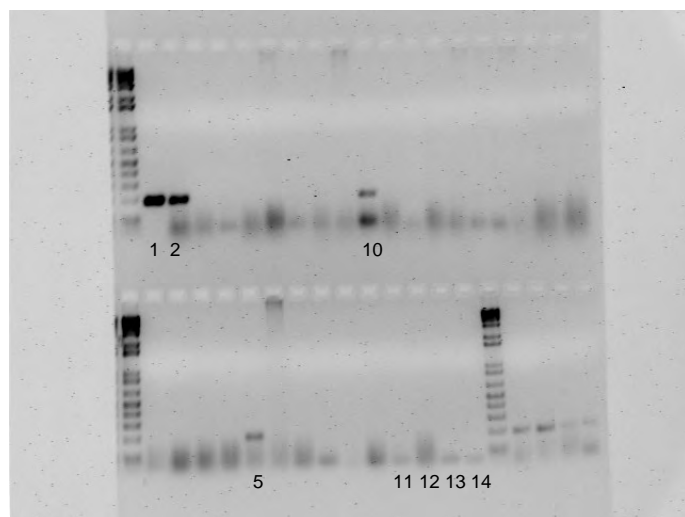
Table 1 reports the results of both PCR and ELISA tests for a sub-sample of field-collected predator specimens (N=795). We found that: 1) spiders, true bugs and praying mantis are common predators of motile GWSS life stages, and 2) lacewing is a common predator of the egg stage. Figure 1 shows the PCR results for the assassin bugs (*Zelus renardii* Kolenati) assayed. The analysis revealed that 2 of the 27 individuals contained sharpshooter DNA in their guts. Figure 2 shows the ELISA results for the field-collected lacewings (*Chrysoperla carnea* Stephens) assayed. The ELISA revealed that 8 of the 98 individuals tested contained sharpshooter egg antigen in their guts. The relatively high frequency of positive ELISA reactions suggests that lacewing may be a potential biological control candidate for GWSS eggs. Further ELISA and PCR assays are underway testing thousands of predators representing many additional species (e.g. beetles, ants, earwigs, other groups of spiders, etc), as well as specimens collected from different GWSS-infested crops (e.g., citrus).

**Table 1.** Results from predator gut content analyses using GWSS-specific PCR and ELISA. Predators were collected from GWSS-infested trees in Bakersfield CA.

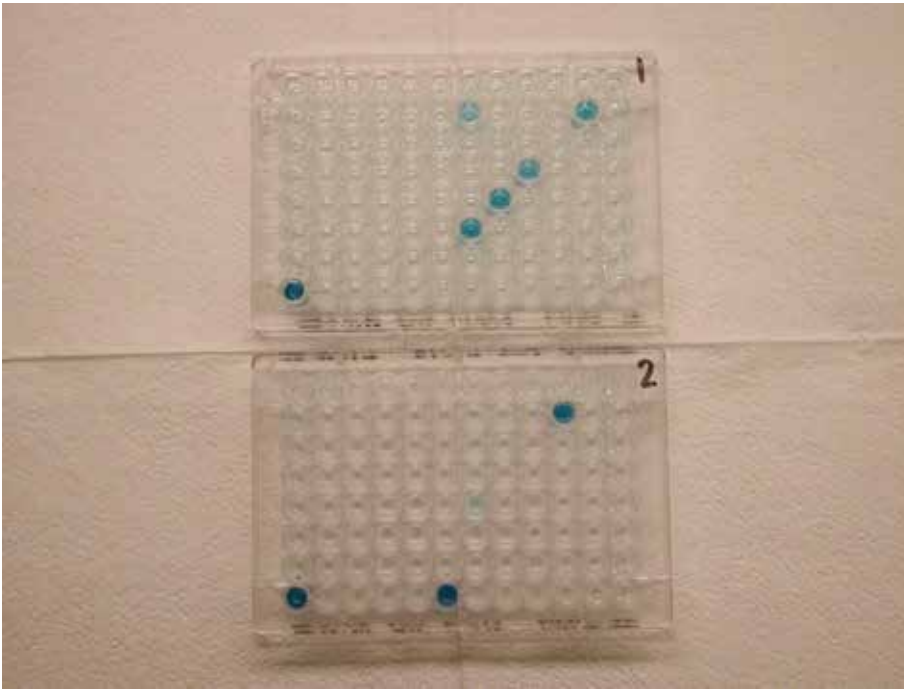
Predator Group	N	PCR positive <sup>a</sup> (%)	ELISA positive <sup>b</sup> (%)
Arachnids (Spiders)	588	40 (7%)	66 (11%)
Hemipterans (True bugs)	61	13 (21%)	8 (12%)
Lacewings	98	8 (8%)	8 (8%)
Praying mantis	48	5 (10%)	2 (4%)
Total	795	66 (8%)	84 (10.5%)

<sup>a</sup> an individual was determined “positive” if GWSS-specific fragment was successfully amplified from its gut.

<sup>b</sup> an individual was determined “positive” if GWSS egg-specific MAb detected egg protein in its gut.



**Figure 1.** This gel presents the results of a PCR assay designed to detect GWSS remains in the gut of field-collected assassin bugs (N=27) using a GWSS-specific COI primer. The gel shows that GWSS DNA fragment (197 bp) was amplified from the following samples: positive control #1 (GWSS; the 1<sup>st</sup> sample of the upper gel), positive control #2 (*Z. renardii* that ate GWSS; the 2<sup>nd</sup> sample of the upper gel); two field-collected specimens (10<sup>th</sup> and 5<sup>th</sup> sample of the upper and lower gel, respectively). No amplification occurred for any of the negative controls (individuals that did not consume any GWSS: the 11<sup>th</sup> and 12<sup>th</sup> sample of the lower gel; and controls in which DNA extract was replaced by water: the 13<sup>th</sup> and 14<sup>th</sup> sample of the lower gel). Beyond the 14<sup>th</sup> sample, the lower gel reports results for a different species of predator.



**Figure 2.** These ELISA plates present the results of an immunoassay designed to detect GWSS remains in the gut of field-collected lacewings (N=98) using a GWSS egg-specific MAb. Each plate included 1 positive control (=GWSS egg located in the lower left corner of each plate) and 24 negative controls (=C. carnea individuals that did not consume any GWSS egg located in columns 2, 3, and 4 of each plate). Blue coloration indicates that GWSS egg protein was detected in the sample (=positive reaction). The immunoassay revealed that 8 of the field-collected individuals examined here contained GWSS egg antigen in their gut. No positive reactions were recorded for the negative controls.

## CONCLUSIONS

There has been increasing awareness over the past decade of the importance of generalist predators for biological control of insect pests (reviewed in Symondson et al. 2002) and predator gut content analyses offer a unique means for studying trophic interactions between predators and prey. Here we successfully implemented a GWSS-specific ELISA and PCR assay to analyze the guts of field-collected predators. Once the key predators of the various life stages of GWSS are identified, this information can be used to develop more ecologically-based management programs to control GWSS in California.

## REFERENCES

- Agustí, N., S.P. Shayler, J.D. Harwood, I.P. Vaughan, K.D. Sunderland, and W.O.C. Symondson. 2003. Collembola as alternative prey sustaining spiders in arable ecosystems: prey detection within predators using molecular markers. *Mol. Ecol.* 12: 3467-3475.
- de León, J.H., V. Fournier, J. Hagler, K. Daane, and W.A. Jones. 2004. Development of molecular diagnostic markers for *Homalodisca* sharpshooters present in California to aid in the identification of key predators, pp. 326-329. In: M. Athar Tariq, S. Oswald, P. Blincoe, A. Ba, T. Lorick and T. Esser (eds.), Proceedings, Pierce's Disease Research Symposium, San Diego, CA.
- Fournier, V., J.R. Hagler, K.M. Daane, J.H. de León, and R.L. Groves. 2004. Identifying key predators of the various glassy-winged sharpshooter life stages, pp. 97-99. In: M. Athar Tariq, S. Oswald, P. Blincoe, A. Ba, T. Lorick and T. Esser (eds.), Proceedings, Pierce's Disease Research Symposium, San Diego, CA.
- Hagler, J.R., 1998. Variation in the efficacy of several predator gut content immunoassays. *Biol. Control* 12: 25-32.
- Hagler, J.R., K. Daane, and H. Costa. 2002. Progress on the development of a monoclonal antibody specific to glassy-winged sharpshooter egg protein: A tool for predator gut analysis and early detection of pest infestation, pp. 79-80. In: M. Athar Tariq, S. Oswald, P. Blincoe, and T. Esser (eds.), Proceedings, Pierce's Disease Research Symposium, San Diego, CA.
- Hagler, J.R. and S.E. Naranjo. 1994a. Determining the frequency of heteropteran predation on sweetpotato whitefly and pink bollworm using multiple ELISAs. *Entomol. Exp. Appl.* 72: 59-66.
- Hagler, J.R. and S.E. Naranjo. 1994b. Qualitative survey of two Coleopteran predators of *Bemisia tabaci* (Homoptera: Aleyrodidae) and *Pectinophora gossypiella* (Lepidoptera: Gelechiidae) using a multiple prey gut content ELISA. *Biol. Control* 23:193-197.
- Hagler, J.R., and S.E. Naranjo. 1996. Using gut content immunoassays to evaluate predaceous biological control agents: a case study, pp. 383-399. In: W.O.C. Symondson and J.E. Liddell (eds.), *The Ecology of Agricultural Pests*, Chapman and Hall, New York.
- Hagler, J.R. 1998. Variation in the efficacy of several predator gut content immunoassays. *Biol. Control.* 12: 25-32.
- Schenk, D., and S. Bacher. 2004. Detection of shield remains in predators using a monoclonal antibody. *J. Appl. Entomol.* 128: 273-278.
- Sheppard, S.K., and J.D. Harwood. 2005. Advances in molecular ecology: tracking trophic links through complex predator-prey food webs. *Funct. Ecol. (In Press)*.
- Sutula, C.L., J.M. Gillett, S.M. Morrissey, and D.C. Ramsdell. 1986. Interpreting ELISA data and establishing the positive-negative threshold. *Plant Dis.* 70: 722-726.

Symondson, W.O.C., K.D. Sunderland, and M.H. Greenstone. 2002. Can generalist predators be effective biocontrol agents? *Annu. Rev. Entomol.* 47: 561-594.

Zaidi, R.H., Z. Jaal, N.J. Hawkes, J. Hemingway, and W.O.C. Symondson. 1999. Can multiple-copy sequences of prey DNA be detected amongst the gut contents of invertebrate predators? *Mol. Ecol.* 8: 2081-2087.

#### **FUNDING AGENCIES**

Funding for this project was provided by the CDFFA Pierce's Disease and Glassy-winged Sharpshooter Board, the University of California Pierce's Disease Grant Program, and the USDA Agricultural Research Service.



## EXPLORATION FOR BIOLOGICAL CONTROL AGENTS IN THE NATIVE RANGE OF THE GLASSY-WINGED SHARPSHOOTER

### Project Leader:

John Goolsby  
USDA, ARS, Beneficial Insects Research Unit  
Weslaco, TX 78596

### Researcher:

Mamoudou Sétamou  
USDA, ARS, Beneficial Insects Research Unit  
Weslaco, TX 78596

**Reporting Period:** The results reported here are from work conducted January 1, 2005 to September 30, 2005

### ABSTRACT

A new initiative to study the ecology of GWSS in its native non-crop habitat is underway. Several sites in southeastern Texas have been selected each with stands of native *Vitis* spp. Monthly trapping will be used to determine the phenology of GWSS and other proconine sharpshooters. Several methods including hand collection, egg and nymphal sentinels, sweeping, and baits will be used to assess the diversity of natural enemies at each location. Since previous biological control efforts have focused on egg parasitoids of GWSS, these exploration efforts will be emphasize discovery of nymphal parasitoids.

### INTRODUCTION

The glassy-winged sharpshooter (GWSS), *Homalodisca coagulata* is native to Northeastern Mexico and the Southeastern U.S., and the origin of the invasive California populations is reported by de León et al. (2004) to be Texas. Most of the entomological and epidemiological information regarding this pest are derived from its status as a vector of Pierce's Disease, *Xyllela fastidiosa* in cultivated hosts. Much less is known about the field ecology and phenology of GWSS and its natural enemies in its native habitat in the Southeastern U.S. Recent surveys in the native range and research on biological control agents has focused on egg parasitoids of GWSS (Mizzell and Andersen 2003, Hoddle and Tripitsyn 2004, Luck et al. 2004, Irwin and Hoddle 2005, Jones et al. unpublished data). *Gonatocerus* spp. egg parasitoids have been collected from the native range of Texas, Florida and Northeastern Mexico, released in California where several species are now established (CDFA 2004). Nymphal parasitoids of *H. coagulata* are thought to exist, but have not been documented from the native range.

Based on what we know about other leafhopper species, *H. coagulata* should have a suite of nymphal parasitoids including chalcid wasps in the family Hymenoptera: Dryinidae, the big-headed flies, Diptera: Pipunculidae, and possibly the twisted-winged wasps, Strepsiptera. For the apple leafhopper, *Edwardsiana froggatti* (Homoptera, Cicadellidae), Clausen (1978) reported that this pest was attacked by the nymphal-adult parasitoid, *Aphelopus typhlocybae* (Dryinidae) and that they often attained high rates of parasitism in North America. Jervis (1980) described the life history of an *Aphelopus* species (Dryinidae) and *Chalarus* species (Pipunculidae), primary parasites of typhlocybine leafhoppers in mixed oak woodlands of Wales. Gandolfo and Richman (1996) found several species dryinid and strepsipteran nymphal parasitoids of leafhoppers feeding on invasive broom snake weed in the rangelands of New Mexico. Moya-Rayagoza et al. (2004) found three nymphal parasitoids (Dryinidae, Pipunculidae, and Strepsiptera) of the corn leaf hopper, *Dalbulus maidis* in cultivated corn in Mexico and noted increased levels of parasitism at higher, cooler altitudes. The pipunculid parasitoid had the broadest geographic and temporal distribution. Skevington and Marshall (1997) review the natural history and rearing of Pipunculidae. They indicate that many pipunculids are oligophagous and show specificity at the genus level. They also document of the first pipunculid-host association for a Cicadellinae leaf hopper, *Cuerna striata* in the Nearctic region. This is significant because *Cuerna* is in the same tribe Proconini, with *Homalodisca*. In summary, nymphal parasitoids in the groups Pipunculidae, Dryinidae, and Strepsiptera are the most common parasitoids of leafhoppers and in some cases they are known to cause high levels of parasitism in both natural and agricultural settings.

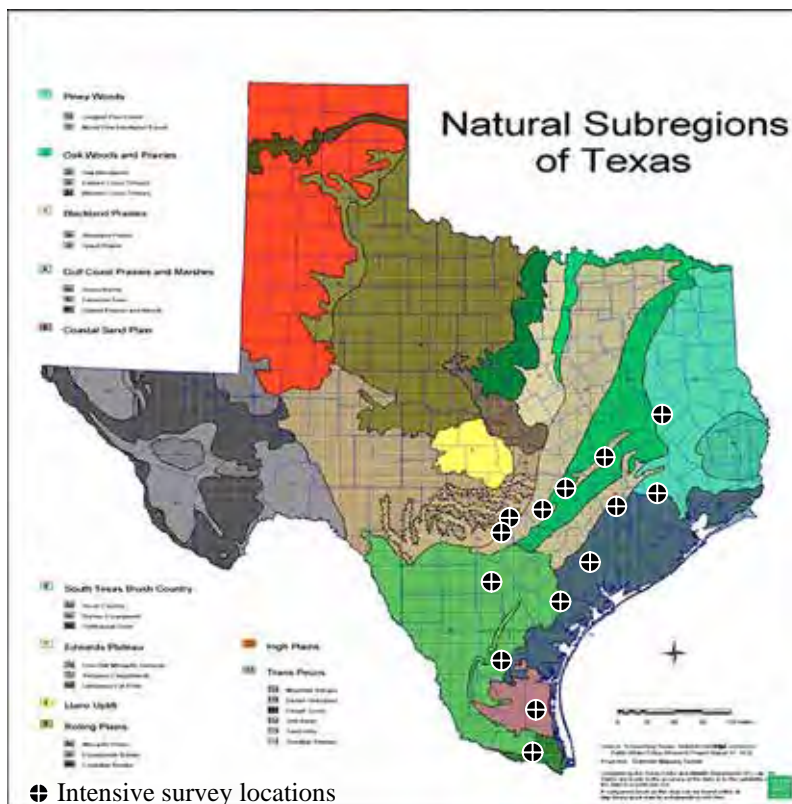
Our studies are aimed at finding nymphal parasitoids of GWSS in native range that can be used as biological control agents in California. Parasitoids in the families Dryinidae and Pipunculidae may be the most suitable candidates if they have a sufficiently narrow host range to warrant release in California. In addition, the nymphal parasitoids must be able to cope with the lack of immature hosts during the winter when only adults are available. Many species of Pipunculidae are known to over winter as pupae which may make them pre-adapted to California agroecosystem.

### OBJECTIVES

1. Establish field sites in the native range of GWSS for intensive monthly surveys and evaluation of natural enemies, in particular nymphal parasitoids.
2. Determine the phenology of GWSS.
3. Determine the species composition of GWSS natural enemies in their native habitat.
4. Develop methods for collection of parasitized GWSS nymphs and adult parasitoids.
5. Investigate the biology and biological control potential of GWSS nymphal parasitoid species.

## RESULTS

Fifteen field sites have been established in southeastern Texas (Figure 1). The sites are located in eight different biogeographic zones. The transect starts at the southern tip of Texas in the Lower Rio Grande Valley in Weslaco, extending northwest to the Texas Hill Country near New Braunfels, northeast to the Piney Woods near Houston and south along the coastal plain. Each site has natural stands of native *Vitis* spp. Four to five yellow sticky cards were placed monthly at each location starting in June 2005.



**Figure 1.** Biogeographic zones and survey sites in southeastern Texas.

Map compiled by Texas Parks and Wildlife, GIS Division  
[http://www.tpwd.state.tx.us/landwater/land/maps/gis/map\\_downloads/](http://www.tpwd.state.tx.us/landwater/land/maps/gis/map_downloads/)

During the surveys five *Vitis* species have found in southeastern Texas, but *V. mustangensis* was the most common one found in all the sites except one (Table 1). *Vitis rotundifolia* and *V. cinerea* were restricted in their distribution, and were only present in the pine forests of east Texas.

**Table 1.** Presence of major sharpshooters on various *Vitis* species collected in southeastern Texas

Host plant	Presence per site	<i>H. coagulata</i>	<i>H. insolita</i>	<i>O. nigricans</i>	<i>O. orbona</i>
<i>V. aestivalis</i>	3/15	×			×
<i>V. berlandieri</i>	3/15	×			×
<i>V. cineriae</i>	1/15	×			
<i>V. mustangensis</i>	14/15	×		×	×
<i>V. rotundifolia</i>	2/15	×	×	×	

Data from the first three collections indicate the presence of four major sharpshooter species; GWSS being the most abundant and widely distributed throughout the survey area. In trap catches, GWSS represented approximately 74% of the sharpshooters. *Oncometopia nigricans* and *O. orbona* constituted 19% and 6% respectively, of the sharpshooter populations but their distribution were restricted to 2 to 4 sites, where they were the most common species. *Homolodisca insolita* was the least abundant in yellow sticky cards with approximately 1% of sharpshooter populations and only present at two sites. Other sharpshooter species i.e., *Graphocephala atropunctata*, *G. coccinea*, *Ferrariana trivittata* and *Draeculacephala* sp. were found in few occasions, but their numbers represented less than 0.1% of all sharpshooters trapped.

Yellow sticky cards were efficient in trapping adult sharpshooters. For each of the 4 major species, the proportion of adults collected was > 90% of the total population suggesting that either yellow traps attracted more adults and/or nymphs are less

frequent on *Vitis* plants compared to adults. In fact, adults sharpshooters are known to be highly polyphagous while nymphs are relative immobile and restricted to a narrower host range (Turner & Pollard 1959). The sex ratio of adults trapped was also male biased.

GWSS was collected from all *Vitis* species but *V. mustangensis* was the most common host from which adult GWSS and *O. nigricans* were captured. Direct observations and hand collections revealed that nymphs were less frequent on *Vitis* spp, corroborating trap catches data. Most adult sharpshooters were found in pairs (>95%) aggregated on young growing vines.

Out of >500 nymphs collected no parasitoids have been collected, but two specimens of Pipunculidae were recovered from yellow sticky cards at one of the survey sites. Studies are underway to collect and dissect more nymphs as well deploy sentinel nymphs for intensive studies at specific sites.

## CONCLUSIONS

GWSS adults are common in their natural habitat on native *Vitis* spp. Because of the low relative abundance of nymphs on native *Vitis*, surveys will be expanded to find host plants which are preferred by GWSS nymphs. Intensive surveys on host plants that harbor higher densities of GWSS nymphs will be conducted. This should maximize the likelihood that the full complement of nymphal parasitoids will be discovered. The recovery of two pipunculid specimens from habitats where GWSS is common suggests that further efforts to recover this parasitoid are warranted. Plans are to continue the surveys and exploration for new natural enemies for the next two years until June of 2007.

## REFERENCES

- Clausen, C.P. 1978. Entomophagous Insects. McGraw-Hill Book Company, Inc., New York 688 pp.
- Gandolfo, D.E. and D.B. Richman. 1996. The biology of the snakeweed leafhopper, *Empoasca biturbera* (Homoptera: Cicadellidae), in New Mexico. *Southwestern Entomologist* 22: 117-126
- CDFA 2004. Pierce's Disease Control Report to the Legislature: p. 20-24.
- de León, J.E., W.A. Jones, and D.J.W. Morgan. 2004. Population genetic structure of *Homalodisca coagulata* (Homoptera: Cicadellidae), the vector of the bacterium *Xylella fastidiosa* causing Pierce's disease in grapevines. *Annals Entomological Society America*. 97: 809-818.
- Hoddle, M.S. and S.V. Tripietsyn. 2004. Searching for and collecting egg parasitoids of the glassy-winged sharpshooter in the Central and Eastern USA. In: *Pierce's Disease Program: Symposium Proceeding, Coronado, CA.*
- Irwin, N.A. and M.S. Hoddle. 2005. Determination of *Homalodisca coagulata* (Homoptera: Cicadellidae) egg ages suitable for oviposition by *Gonatocerus ashmeadi*, *Gonatocerus triguttatus*, and *Gonatocerus fasciatus* (Hymenoptera: Mymaridae). *Biological Control* 32: 391-400.
- Jervis, M.A. 1980. Life history of *Aphelopus* species (Hymenoptera: Dryinidae) and *Chalarus* species (Diptera: Pipunculidae) primary parasites of typhlocybine leafhoppers (Homoptera: Cicadellidae). *J. Natural History* 14: 769-780.
- Luck, R.F., C.E. Coviella, and D. Morgan. 2004. Evaluation of olfactory responses by *Gonatocerus ashmeadi*, a parasitoid of glassy-winged sharpshooter egg masses on various host plants. In: *Pierce's Disease Program: Symposium Proceeding, Coronado, CA.*
- Mizell, R.F. and P.C. Andersen. 2003. Keys to management of the glassy-winged sharpshooter: interactions between host plants, malnutrition, and natural enemies. In: *Pierce's Disease Program: Symposium Proceeding, Coronado, CA.*
- Skevington, J. and S.A. Marshall. 1997. First record of a big-headed fly, *Eudorylas alternatus* (Cresson) (Diptera: Pipunculidae), reared from the subfamily Cicadellinae (Homoptera: Cicadellidae), with an overview of pipunculid-host associations in the Nearctic region. *Canadian Entomologist* 129: 387-398.

## FUNDING AGENCIES

Funding for this project was provided by the USDA Agricultural Research Service.

# PROGRESS TOWARD DEVELOPING A NOVEL IMMUNOLOGICAL APPROACH FOR QUANTIFYING PREDATION RATES ON THE GLASSY-WINGED SHARPSHOOTER

## Project Leaders:

James Hagler and Thomas Henneberry  
USDA, ARS  
Phoenix, AZ 85040

Russell Groves  
USDA, ARS  
Parlier, CA

Valerie Fournier and Kent Daane  
University of California  
Berkeley, CA 94720

Marshall Johnson  
University of California  
Riverside, CA 92521

## Cooperator:

David Morgan  
CDFA, PDCP  
Mount Rubidoux Field Station  
Riverside, CA 92501

**Reporting Period:** The results reported here are from work conducted September 1, 2004 to September 1, 2005.

## ABSTRACT

We just completed the first year of a multi-year research project dedicated to quantifying predation rates on GWSS nymphs and adults and qualifying predation on eggs. There are enough protein/antibody complexes commercially available that each GWSS in a field cage can be marked with a specific protein. We marked two GWSS adults and two GWSS nymphs, each separately with a unique protein and released them into small field cages (N=60) placed in a citrus orchard for 8 hours. Each cage also contained a sentinel GWSS egg mass and an assemblage of six potential GWSS predators. The experiment contained a day and night treatment. Observed mortality for each GWSS life stage and predator species was determined by simply counting the number of survivors remaining in each cage after 8 hours. Results showed that GWSS adults were preyed upon three times more frequently than nymphs and mostly during the day light cycle. Ultimately, the gut contents of each predator will be analyzed by four protein-specific ELISAs to determine how many GWSS each individual predator consumed (note: we are currently conducting these assays). Additionally, the gut contents of each predator will be examined by a GWSS egg-specific sandwich ELISA to determine the frequency of predation on GWSS eggs.

## INTRODUCTION

Very little information exists on predaceous natural enemies of GWSS because identifying the feeding choices and amount of prey consumed by generalist predators is very difficult. Predators and GWSS are small, elusive, cryptic, and the predators may feed exclusively at night (Pfannenstiel & Yeorgan, 2002). Moreover, predators do not leave evidence of attack. Perhaps the most frequently used experimental approach for evaluating natural enemies in the field are through studies conducted in field cages (Luck *et al.*, 1988). Such studies require manipulation of either the natural enemy or the targeted prey population(s) within the cage (e.g., the removal or introduction of the organism of interest). Mortality of the pest can be estimated based on the presence or absence of the pest (Luck *et al.*, 1988). Such studies have documented the qualitative impact of manipulated predator assemblages on many types of pests, but they do not provide quantitative information on predation rates or evidence of which predator in the assemblage is exerting the greatest biological control. Often the only direct evidence of arthropod predation can be found in the stomach contents of predators. Currently, the state-of-the-art predator stomach content assays include enzyme-linked immunosorbent assays (ELISA) for the detection of pest-specific proteins (Hagler, 1998) and PCR assays for the detection of pest-specific DNA (Symondson, 2002).

ELISAs have been widely used to identify key predators of certain pests, including GWSS (Hagler *et al.*, 1992; Hagler & Naranjo, 1994; Fournier *et al.*, submitted). The simplicity and low cost of conducting an ELISA lends itself to the efficient screening of hundreds of field-collected predators per day. However, polyclonal antibody-based ELISAs often lack species specificity and monoclonal antibody (MAB)-based ELISAs are too technically difficult, costly, and time consuming to develop for wide scale appeal (Greenstone, 1996). Moreover, pest-specific ELISAs share the same limitation as the other predator evaluation methods; the quantification of predation rates is impossible (see Hagler & Naranjo, 1996 for a review). PCR assays using pest-specific DNA probes might be less expensive to develop (Greenstone & Shufran, 2003), but PCR assays are also not quantifiable and they are more costly, technical, tedious, and time consuming to conduct than ELISAs (de Leon *et al.*, In Press).

The many shortcomings of each method of predator assessment described above were the impetus for us to develop a technique to quantify predator activity. The technique combines our previous research using pest-specific MAB-based ELISAs to detect predation (Hagler *et al.*, 2003) with protein marking ELISAs we developed to study arthropod dispersal (Hagler & Jackson, 1998). Previously, we described a technique for marking individual GWSS, each with a unique protein (Hagler *et al.*, 2004). In turn, the gut contents of predators were examined by a multitude of protein-specific ELISAs to

determine how many GWSS were consumed and which predator species consumed them. The advantages of immunomarking prey over prey-specific ELISAs are: (1) prey-specific antibodies (or PCR probes) do not need to be developed, (2) the protein-specific sandwich ELISAs are more sensitive than the indirect prey-specific ELISAs, (3) a wide variety of highly specific protein/antibody complexes are available, (4) the specificity of each antibody to its target protein facilitates the labeling of many individual pests and examination of the gut contents of every predator in the assemblage by a myriad of protein-specific ELISAs, and (5) all of the proteins and their complimentary antibodies are commercially available at an affordable price.

## OBJECTIVES

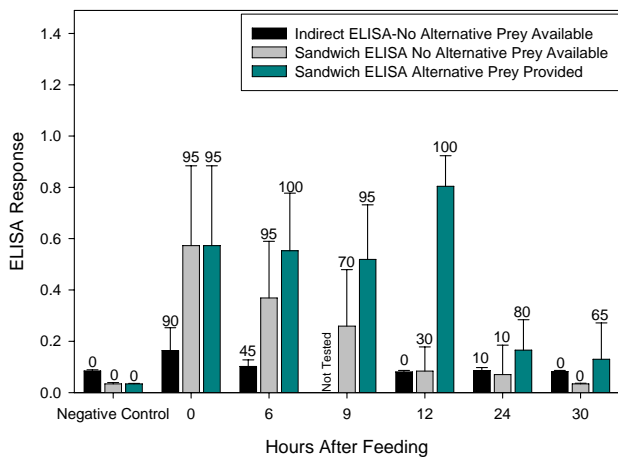
1. Quantify predation on GWSS nymphs and adults.
2. Qualify predation on GWSS eggs.
3. Determine the circadian feeding activity of the predators.

Results obtained from this research will enhance our basic understanding of predator-prey interactions and aid in evaluating the efficacy of generalist predators for a conservation or an inundative biological control program.

## RESULTS

We improved the detection capability of a MAb-based ELISA developed to detect GWSS egg protein in the guts of predators (Hagler et al., 2003; Fournier et al., submitted). Preliminary feeding studies revealed that the conventional indirect ELISA was not very effective at detecting GWSS egg remains in predator guts. To this end, we developed a more sensitive sandwich ELISA (e.g., we conjugated our GWSS-specific MAb to horseradish peroxidase). A comparative study of the efficacy of both ELISA formats was conducted on the green lacewing, *Chrysoperla carnea*. Feeding trials were conducted to determine how long GWSS egg antigen can be detected by ELISA in a predator's gut after consumption, and if consumption of alternative prey items affects the sensitivity of the ELISA for detecting GWSS. The predator tested was third-instar *C. carnea*. *Chrysoperla carnea* was selected for this study because it: (1) is commonly found in California, (2) is a voracious predator, and (3) has been directly (e.g., direct focal observation) (Kent Daane, pers. obs.) and indirectly (e.g., by gut content ELISA) observed feeding on GWSS eggs in the wild (Fournier et al., submitted).

The sandwich ELISA was much better at detecting GWSS egg remains in lacewing guts, particularly for those individuals that were provided with supplemental prey after consuming GWSS eggs (Figure 1). Specifically, the sandwich ELISA format consistently yielded higher ELISA reactions and a higher percentage of positive responses for GWSS remains in lacewing guts. Moreover, the sandwich ELISA had a much longer prey detection interval than the indirect ELISA (Figure 1). We are now confident that we can readily detect GWSS egg remains in field collected predators for at least 8 hours (e.g., the length of time that the predators were in the field cages) after feeding.



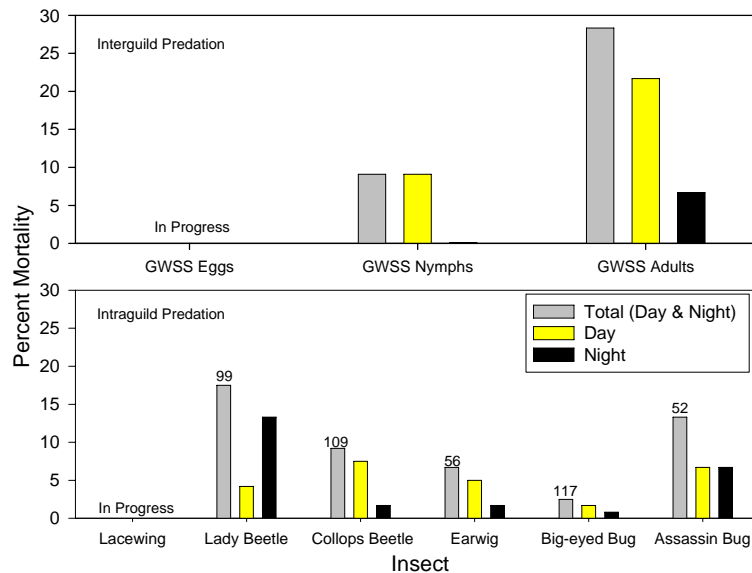
**Figure 1.** ELISA results testing for the presence of GWSS egg antigen in the gut of *C. carnea* using an indirect and sandwich ELISA format. Following the consumption of 3 GWSS eggs, *C. carnea* were held for 0 to 30 hours in Petri dishes that did not contain additional prey (indirect and sandwich ELISA format) or in Petri dishes that contained an unlimited supply of pink bollworm eggs (sandwich ELISA format only). The numbers above the error bars are the percentage of individual positive GWSS egg remains.

During the summer of 2005, multi-faceted field cage studies were conducted to quantify predation on GWSS nymphs and adults and qualify predation on GWSS eggs. Additionally, the degree of interguild (e.g., predation on GWSS) and intraguild predation (e.g., predation on the predators inhabiting the assemblage) occurring in the assemblage was assessed during day and night light cycles by simply conducting a visual count of the number of dead insects in each cage after 8 h. The field cages contained an arthropod assemblage consisting of six species of predaceous insects (Figure 2) and the various life stages of GWSS. The GWSS introduced into each cage included a sentinel egg mass; two 2<sup>nd</sup> or 3<sup>rd</sup> instar nymphs marked with rabbit IgG or chicken egg white, respectively; and two adults marked with soy milk or nonfat dry milk, respectively. The visual insect counts revealed that approximately 28% and 9% of the GWSS adults and nymphs were preyed upon, respectively. Moreover, 2.5% (big-eyed bug, *Geocoris punctipes*) to 17.5% (lady beetle, *Hippodamia convergens*) of the generalist predators introduced into the cages were also preyed upon (Figure 2). With the exception of *H. convergens*,

predation was more common during the day light cycle than the night light cycle. In the near future (this fall), we will determine which predators in the assemblage fed on the various life stages of GWSS. Specifically, we will conduct five highly specific post mortem gut content ELISAs on each individual predator. Egg predation events will be detected using an established GWSS egg-specific ELISA (Hagler et al., 2003; Fournier et al., submitted) nymph predation events will be detected using rabbit IgG and chicken IgG specific ELISAs (Hagler, 1997), and adult predation events will be detected using soy and nonfat dry milk specific ELISAs (Jones et al., submitted).

## CONCLUSIONS

Although it is widely accepted that predators play a role in pest regulation, we still have an inadequate understanding of, and ability to predict their impact in cropping systems. Frequently parasitoids are given major credit for suppressing pest populations; however, the impact that predators have on suppressing GWSS populations goes unrealized due to the difficulties of assessing arthropod predation as discussed above. The prey marking technique described here circumvents many of the shortcomings of the current methods used to study predation. Over the next two years we will analyze the gut contents of thousands of predators using five separate ELISAs to qualify and quantify predation events on GWSS eggs, nymphs and adults. Ultimately, this information can be used to improve the efficacy of conservation and inundative biological control of GWSS.



**Figure 2.** Percent mortality of GWSS nymphs and adults inhabiting the field cages (e.g., interguild predation) (**Top graph**). Percent mortality of the predator assemblage inhabiting the field cages (e.g., intraguild predation) (**Bottom graph**). Note: the percent mortality for the GWSS egg stage and lacewing larvae could not be determined visually directly in the field due to their cryptic nature. We are currently assessing their mortalities as we go through the cage samples in the laboratory.

## REFERENCES

- Greenstone, M.H. 1996. Serological analysis of arthropod predation: Past, present and future, pp. 265-300. In: W.O.C. Symondson, W.O.C. and J.E. Liddell (eds.), *The Ecology of Agricultural Pests: Biochemical Approaches*. Chapman and Hall, New York, NY.
- Greenstone, M.H. and K.A. Shufran. 2003. Spider predation: Species-specific identification of gut contents by polymerase chain reaction. *J. Arachnology*. 31: 131-134.
- de León, J., V. Fournier, J. Hagler and K. Daane. 2005. Development of molecular diagnostic markers for the glassy-winged sharpshooter *Homalodisca coagulata* (Homoptera: Cicadellidae) for use in predator gut content examinations. *Entomol. Exp. et Appl.* (accepted for publication).
- Hagler, J. R. 1997. Field retention of a novel mark-release-recapture method. *Environ. Entomol.* 26:1079-1086.
- Hagler, J. R. 1998. Variation in the efficacy of several predator gut content immunoassays. *Biol. Control* 12:25-32.
- Hagler, J. R. and C. G. Jackson. 1998. An immunomarking technique for labeling minute parasitoids. *Environ. Entomol.* 27:1010-1016.
- Hagler, J. R. and S. E. Naranjo. 1994. Determining the frequency of Heteropteran predation on sweetpotato whitefly and pink bollworm using multiple ELISAs. *Entomol. Exp. et Appl.* 72:59-66.
- Hagler, J. R. and S. E. Naranjo. 1996. Using gut content immunoassays to evaluate predaceous biological control agents: a case study, pp. 383-399. In: W.O.C Symondson and J. E. Liddell, (eds.), *The Ecology of Agricultural Pests*. Chapman and Hall, New York, NY.
- Hagler, J. R., A. C. Cohen, D. Bradley-Dunlop, and F. J. Enriquez. 1992. Field evaluation of predation on *Lygus hesperus* (Hemiptera: Miridae) using a species- and stage-specific monoclonal antibody. *Environ. Entomol.* 21:896-900.

- Hagler, J.R., D. Daane, and H. Costa. 2003. A monoclonal antibody specific to glassy-winged sharpshooter egg protein. Proceedings, Pierce's Disease Research Symposium, 9-11 December 2003, San Diego, CA. Compiled by M. Athar Tariq, Stacie Oswald, Peggy Blincoe, and Tom Esser, Sacramento, CA. pp. 188-191.
- Hagler, J., T. Henneberry, K. Daane, V. Fournier and R. Groves. 2004. A novel immunological approach for quantifying predation rates on glassy-winged sharpshooter. Proceedings, Pierce's Disease Research Symposium, 7-10 December 2004, San Diego, CA. Compiled by M. Athar Tariq, Stacie Oswald, Peggy Blincoe, Amadou Ba. Terrance Lorick, and Tom Esser, Sacramento, CA. pp. 106-110.
- Luck, R.F., B.M. Shepard and P.E. Kenmore. 1988. Experimental methods for evaluating arthropod natural enemies. Ann. Rev. Entomol. 33: 367-391.
- Pfannenstiel, R.S. and K.V. Yeagan. 2002. Identification and diel activity patterns of predators attacking *Helicoverpa zea* eggs in soybean and sweet corn. Environ. Entomol. 31: 232-241.
- Symondson, W.O.C. 2002. Molecular identification of prey in predator diets. Molecular Ecol. 11: 627-641.

#### **FUNDING AGENCIES**

Funding for this project was provided by the University of California Pierce's Disease Grant Program, and the USDA Agricultural Research Service.

**OVIPOSITION AND NATIVE PARASITOIDS OF THE BLUE-GREEN SHARPSHOOTER,  
AND HOST SPECIFICITY OF *GONATOCERUS ASHMEADI* ON THE SMOKETREE SHARPSHOOTER  
AND THE BLUE-GREEN SHARPSHOOTER**

**Project Leader:**

Mark S. Hoddle  
Department of Entomology  
University of California  
Riverside, CA 92521

**Researcher:**

Elizabeth A. Boyd  
Department of Entomology  
University of California  
Riverside, CA 92521

**Reporting Period:** The results reported here are from work conducted May 2003 to September 2005.

**ABSTRACT**

The studies outlined below represent two years of a three year project. We have determined the oviposition preferences of *Graphocephala atropunctata* (Signoret) (Hemiptera: Cicadellidae), blue-green sharpshooter, (BGSS) on wild grape, have documented its associated egg parasitoids, and provide data on host specificity of *Gonatocerus ashmeadi*, a parasitoid being used as part of the classical biological control program against glassy-winged sharpshooter (GWSS), *Homalodisca coagulata* Say (Hemiptera: Cicadellidae) on the target's congener, the native *Homalodisca liturata* Ball, smoketree sharpshooter (STSS), as well as the BGSS. To determine the oviposition of female BGSS, a survey was conducted on southern California wild grape, *Vitis girdiana* Munson (Vitaceae) growing near Temecula, CA in August 2003 and 2004 where populations of BGSS were known to occur. Female BGSS oviposited into new growth, primarily the succulent tendrils and stems. Two parasitoids, *Gonatocerus latipennis* Girault and a *Polynema* sp. (Hymenoptera: Mymaridae) were reared from BGSS eggs. Deployment of sentinel plants and reciprocal tests were implemented to further confirm the parasitization of BGSS eggs by these parasitoids. Collectively the *Polynema* sp. and *Gonatocerus latipennis* constitute the first documented natural enemies of BGSS eggs. Additional studies, commencing in January 2004, of the activity of BGSS and its parasitoids in southern California is currently underway. Blue-green sharpshooter adult activity reached its peak in July while bi-weekly samples of wild grape canes and tendrils revealed peak emergence of BGSS nymphs and parasitoids occurred from mid-July to mid-August. These peaks were found to be significantly correlated. Choice and no-choice tests of *Gonatocerus ashmeadi* Girault and *G. fasciatus*, (Hymenoptera: Mymaridae) parasitoids of GWSS with the native smoketree sharpshooter (STSS), and BGSS eggs as part of a retrospective non-target impact assessment have yielded interesting results. Parasitism of STSS eggs by *G. ashmeadi* and *G. fasciatus* does not appear to be significantly different when compared to the GWSS control in no-choice experiments. Additionally, it appears *G. ashmeadi* exercises no preference of host eggs for parasitization when presented with a choice of STSS and GWSS simultaneously.

**INTRODUCTION**

Examining possible non-target effects of biological control agents is becoming a more common requirement for many biological control programs targeting arthropod pests. Currently, for classical biological control of weeds, the Wapshere centrifugal method provides an excellent means for eliminating possible natural enemies that could cause harm to non-target plants. However, a rigorous, reliable, and broadly applicable testing standard for arthropod biological control is currently lacking. No-choice and choice testing strategies are a common way to test for possible non-target effects of new biological control organisms. However, these lab studies are often carried out in small testing arenas where the study organism is forced onto the host which may be adequate for determining physiological host range but may seriously overestimate its ecological host range in nature. Our research involves the use of rigorous testing strategies utilizing standard Petri dish test arenas, coupled with larger-scale entire plant test arenas in no-choice and choice comparisons. As retrospective studies in ongoing biological control programs can yield valuable information on non-target impacts, we chose the GWSS classical biological control program in California as a model for our non-target studies. We are examining the possible non-target impacts of the self-introduced *G. ashmeadi* and the recently introduced *G. fasciatus* Girault, egg-parasitoids of GWSS, and three sharpshooters native to California, U.S.A.: (1) STSS (2) BGSS; and (3) green sharpshooter (GSS), *Draeculocephala minerva* Ball (Hemiptera: Cicadellidae). Our experiments with small-scale Petri dish studies and larger-scale full plant studies are supplemented with sentinel plants and habitat surveys to determine the invasiveness of GWSS parasitoids.

**OBJECTIVES**

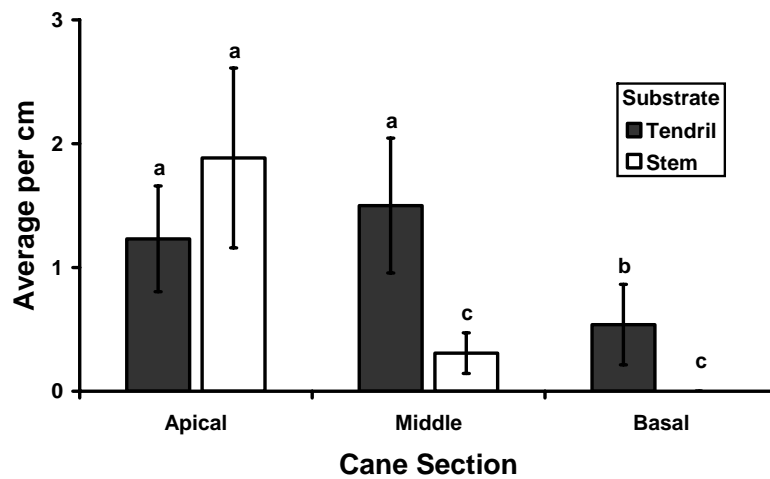
1. Classify the native egg-parasitoid fauna in California associated with sharpshooters native to California, primarily the smoketree sharpshooter (STSS): *Homalodisca liturata* Ball (Hemiptera: Clypeorrhyncha: Cicadellidae: Cicadellinae: Proconiini), blue-green sharpshooter (BGSS): *Graphocephala atropunctata* (Signoret), and green sharpshooter (GSS): *Draeculocephala minerva* Ball (the latter three, all Hemiptera: Clypeorrhyncha: Cicadellidae: Cicadellinae: Cicadellini).
2. Assess the possible non-target impacts of *Gonatocerus ashmeadi* and *G. fasciatus*, parasitoids being used for the classical biological control of GWSS, on the above mentioned native sharpshooters.



## RESULTS

### Oviposition Survey

Please see Hoddle (2004) for a detailed overview of BGSS parasitoids and oviposition on *V. girdiana*. Ten entire grape canes were sampled on 14 August 2003. These canes were cut into thirds (apical, middle and basal), then placed into 10 cm of water in a Mason jar which left approximately 25 cm of cane exposed for emergence of nymphs and parasitoids. Canes and mason jars were then placed into three separate cages, according to their stem position. Cane sections were examined daily for emergence. In total, two BGSS nymphs and 16 *Polynema* sp. emerged from the canes. As there were so few insects emerged from these cane sections, the stems, leaves, petioles and tendrils were examined under the microscope for recent emergence holes by BGSS nymph and associated parasitoids. A total of 65 emergence holes were counted. The majority of emergence holes were on the apical stems ( $n = 37$ ) and on tendrils ( $n = 6, 13, 7$ , for apical, middle and basal portions, respectively) occurring along the length of the entire canes. Only two emergence holes were counted from leaf petioles and none were counted from middle and basal stems and leaves. This survey was repeated in 2004. A total of two BGSS nymphs and 52 *Polynema* sp. emerged from the 16 full canes sampled on 6 August 2004. A total of 95 emergence holes were counted. The majority of emergence holes were on the apical stems and on tendrils occurring along the length of the canes. Fifteen emergence holes were counted from leaf petioles (not shown) and only one was counted from a leaf midrib from a middle 45cm cane section. The cumulative results of this survey are presented in Figure 1. Cane sections of the same substrate type with the same letter are not significantly different ( $p > 0.05$ ). Substrate type within the same cane section with the same letter are not significantly different ( $p > 0.05$ ). Statistical analysis was carried out by use of Kruskal-Wallis one-way ANOVA (Proc nonpar1way, SAS Institute 1999) for on average ranks for cane sections and substrate types.



**Figure 1.** BGSS oviposition inferred from average nymph and *Polynema* sp. emergence per centimeter of grape cane.

### Sentinel Plant Study

To confirm the host association of the emerged parasitoids with the BGSS, sentinel plants were exposed to BGSS lab colonies for 3 days to allow for oviposition. Plants were removed from the colonies and transported to the oviposition survey site to allow for parasitization of BGSS eggs by native parasitoids. After three days, the deployed plants were brought back from the field, cleaned of any insects and placed into separate cages. Plants were observed daily for any emerging insects. A combined total of 197 BGSS and *Polynema* sp. emerged from the five sentinel plants in 2003. Of these, 55 were BGSS nymphs and 142 were *Polynema* sp. (54 males, 88 females). Parasitism rates of BGSS eggs by *Polynema* sp. ranged from 33% on Chrysanthemum to 78% and 86% on wild grape and basil, respectively. A total of 23 BGSS and *Polynema* sp. emerged from the six sentinel plants in 2004. Of these, five were BGSS nymphs and 18 were *Polynema* sp. (2 males, 16 females). Parasitism rates of BGSS eggs by *Polynema* sp. ranged from 50% to 100%.

### Reciprocal Tests

To confirm association of the correct parasitoid species with BGSS, sentinel plants bearing BGSS eggs were deployed at field sites and returned to the lab where parasitoids were reared out. Parasitoids that emerged from 2004 sentinel plant studies were captured into small vials and released into cages containing a basil plant with <48 hr old BGSS eggs and allowed 48 hrs to parasitize the eggs. Parasitism was confirmed by emergence of 11 male *Polynema* sp. No *G. latipennis* emerged from the sentinel plants, and thus no reciprocal tests were conducted on the BGSS with this parasitoid. Separate emerged *Polynema* sp. exposed to GWSS and STSS eggs on citrus and Chrysanthemum leaves in Petri dishes yielded no parasitism by this native parasitoid.

### BGSS and Parasitoid Activity

A total of 12 yellow sticky card traps (11 x 15 cm), were placed at the 2003 oviposition survey site to monitor BGSS adult and parasitoid flight activity. Traps were set up on 9 January 2004 and collected at bi-weekly intervals. Peak trap catch of BGSS adults occurred over the two week period of 11 June to 25 June 2004. Additionally, as soon as wild grape had sprouted and was available for collection, starting on 16 April 2004, twelve 30 cm cane sections were collected at bi-weekly sampling intervals. Tendrils were cut from the cane and placed into individual Petri dishes while stems were placed into dual 50 dram vials (25 cm of cane above water to allow for emergence). Plant material was checked daily for emergences of nymphs and parasitoids. Peak emergence of BGSS nymphs and parasitoids was spread over a four week period from 24 July to 20 August 2004. Emergence data from 14 May 2004 to 29 October 2004 was highly correlated to trap catch data from 16 April 2004 to 1 October 2004 (Pearson Correlation Coeff. = 0.92,  $p < 0.0001$ , Proc corr, SAS Institute, 1999). For those time periods trap data explains 84% of variation in emergence data and vice versa. Data compilation for 2005 is still in progress however some of the results are shown below in Figure 2.

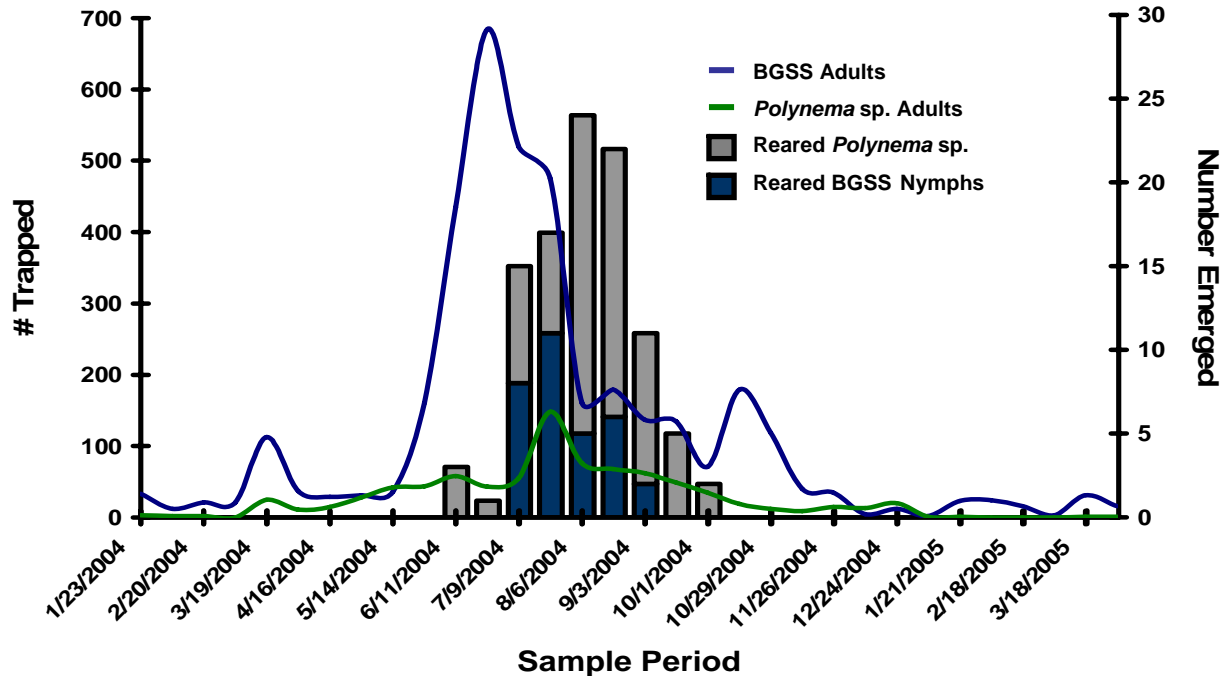
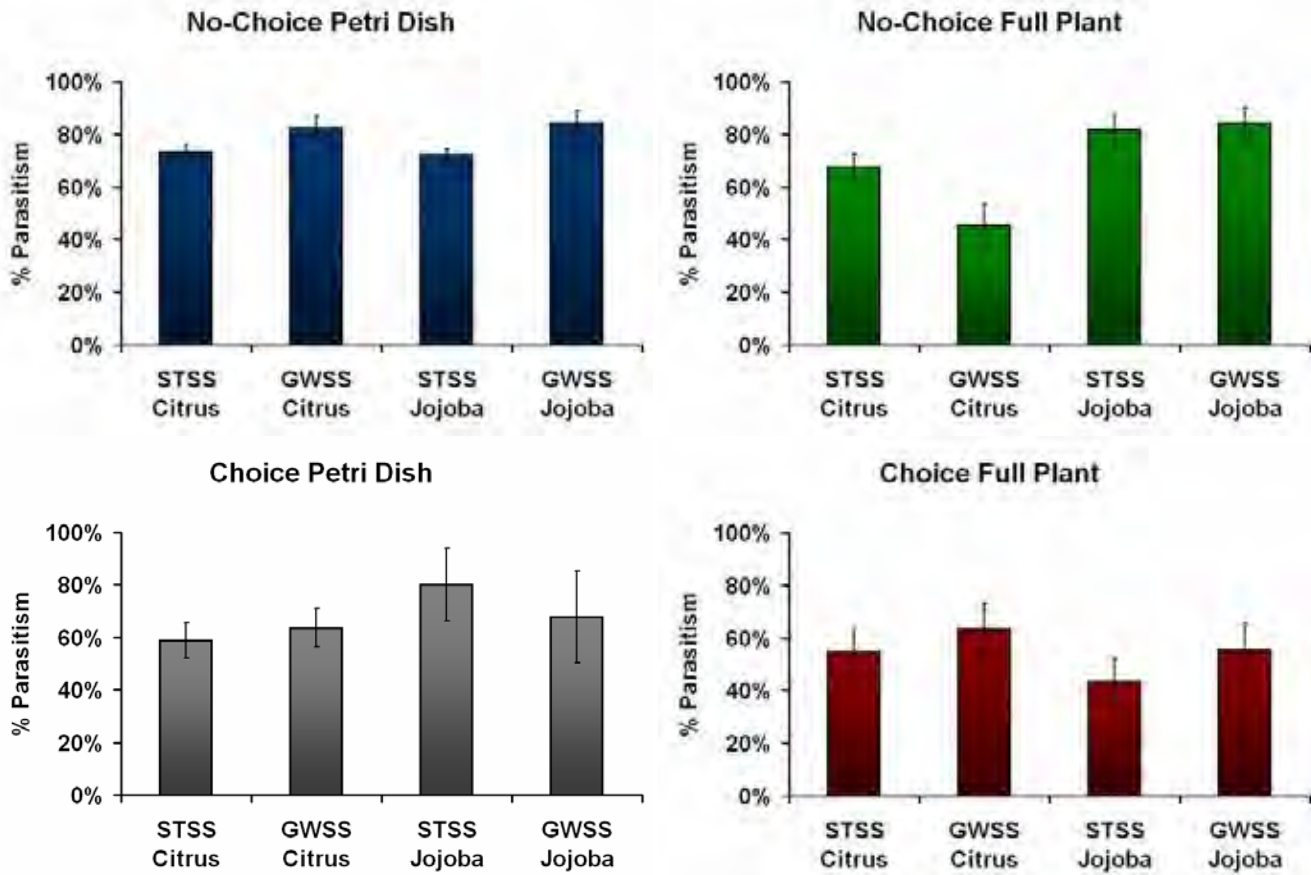


Figure 2. Flight activity and phenology of BGSS and *Polynema* sp.

### Host specificity testing

Choice and no-choice tests were conducted with *G. ashmeadi* and *G. fasciatus* on BGSS and STSS eggs using GWSS eggs as a control. Tests were conducted on two scales, micro (= Petri dish, 100 x 15 mm) and macro (= full plant, approximately 30 cm height), using single, one day old, mated, honey water-fed *G. ashmeadi* or *G. fasciatus*. BGSS eggs were not tested at the micro scale nor were they tested in a choice arena. Each test was conducted utilizing two different host plants. For STSS, Eureka Lemon and Jojoba were used, while sweet basil and wild grape (*V. girdiana*) were utilized for the BGSS. In Petri dish choice tests, the parasitoid was exposed to approximately 20 of each STSS and GWSS eggs simultaneously. Full plant choice tests included approximately 40 of each STSS and GWSS eggs presented simultaneously to the parasitoid on one type of host plant at a time. For no-choice testing each parasitoid was supplied approximately 40 target eggs. All target eggs were less than 48 hours of age. In all tests the parasitoid was provided honey water as a food source and allowed 24 hr to parasitize the eggs before removal from the testing arena. Percent parasitism of egg masses ranged from 0-100% for both STSS and GWSS. Many replicates are still in progress; however, preliminary results of completed tests are shown below for *G. ashmeadi* (Figure 3). Parasitism of STSS eggs by *G. ashmeadi* and *G. fasciatus* does not appear to be statistically different as compared to the GWSS control in no-choice experiments. Additionally, it appears *G. ashmeadi* exercises no preference of host eggs for parasitization when presented with a choice of STSS and GWSS simultaneously. No parasitism of BGSS eggs by *G. ashmeadi* or *G. fasciatus* was observed for either the sweet basil or wild grape host plants.



**Figure 3.** Percent parasitism of STSS and GWSS eggs by *G. ashmeadi* in choice and no-choice studies.

## CONCLUSIONS

While results for laboratory choice and no-choice tests with *G. ashmeadi* and *G. fasciatus* are still being tabulated for STSS and BGSS, preliminary data shows neither parasitoid will parasitize BGSS eggs, but will parasitize STSS eggs. In fact, STSS egg masses appear to be attacked as readily as the GWSS control in no-choice tests at both Petri and whole plant scales and with no preference for either host eggs in choice tests at both scales. Given the substantial availability of GWSS eggs, these parasitoids may impact the native *Ufens* spp. (Hymenoptera: Trichogrammatidae) parasitoid complex if large numbers of *G. ashmeadi* spill out of GWSS infested areas and attack STSS eggs, the preferred host for *Ufens* spp. Furthermore, *G. ashmeadi* emerging from STSS eggs are smaller and less fecund than those developing from GWSS eggs (N. Irvin unpublished data – but see this report). We would speculate these ‘runts’ may have an overall reduced fitness, and that STSS eggs may ultimately be a dead-end host for *G. ashmeadi*, especially if no selection of evolutionary significance occurs for use of STSS eggs. However, if these parasitoids were to establish in large numbers in the xeric habitats where STSS is most abundant, and if these larval parasitoids are able to out-compete larval *Ufens* spp., then we might expect a drastic impact on the natural enemy fauna of STSS in desert regions. For example, the establishment of these exotic parasitoids in the fragile ecosystems of the desert oases at Joshua Tree National Park, where the STSS and *Ufens* spp. coexist in a delicate balance, could have significant impacts. Presently, we suspect that *G. ashmeadi* and most likely *G. fasciatus* are unlikely to physiologically withstand the harsh environments of desert areas of eastern California, but the possibility and the consequences of such an incursion, should it occur, are worth consideration.

Our research approach with GWSS parasitoids attempts to include not only the physiological, ecological, but also the temporal and spatial elements in determining possible native sharpshooter (and associated native parasitoids) non-target effects. Via choice and no-choice testing at two scales, parasitoid behavioral studies in the field, non-target habitat monitoring and natural enemy classification, and by determining oviposition, egg, and habitat characteristics of the possible non-target species, we are obtaining important information for retroactively assessing the possible risk posed by these exotic natural enemies of GWSS to native members of the receiving ecosystem.

## **REFERENCES**

- Hill, B. L., Purcell, A. H. (1995). Acquisition and retention of *Xylella fastidiosa* by an efficient vector. *Phytopathology* 85: 209-212.
- Hodde, M. S. (2004). Identification of the native parasitoid fauna associated with *Graphocephala atropunctata* (Signoret) (Hemiptera: Cicadellidae) and host specificity testing of *Gonatocerus ashmeadi* Girault (Hymenoptera: Mymaridae) on *Homalodisca liturata* Ball (Hemiptera: Cicadellidae). Pages 111-114 *In Proc Pierce's Disease Research Symposium*, M. Athar Tariq, et al. [eds.], December 7-10, 2004, Coronado, CA.
- Severin, H.H.P. (1949) Life history of the blue-green sharpshooter, *Neokolla circellata*. *Hilgardia* 19: 187-189.

## **FUNDING AGENCIES**

Funding for this project was provided by the University of California Agriculture and Natural Resources.

**REALIZED LIFETIME PARASITISM OF GLASSY-WINGED SHARPSHOOTER  
EGG MASSES BY *GONATOCERUS ASHMEADI***

**Project Leader:**

Mark S. Hoddle  
Department of Entomology  
University of California  
Riverside, CA 92521

**Cooperators:**

Nic Irvin and Robert Luck  
Department of Entomology  
University of California  
Riverside, CA 92521

**Reporting Period:** The results reported here are from work conducted February 2005 to September 2005.

**ABSTRACT**

The relationship between female *Gonatocerus ashmeadi* size (hind tibia length) and <24 hr egg load was determined for spring and summer *G. ashmeadi* generations in Riverside, CA. Female size was positively correlated with egg load for both spring and summer generations with egg load varying from 23-108 eggs per female in spring and 29-118 eggs per female in summer. The use of near infrared spectroscopy (NIRS) and a wing deterioration index to estimate parasitoid age was also investigated and preliminary results demonstrated that both techniques may show potential for estimating the age of field collected *G. ashmeadi*.

**INTRODUCTION**

The self introduced *G. ashmeadi* (Vickerman et al. 2004) is the key natural enemy of glassy-winged sharpshooter, *Homalodisca coagulata*, (GWSS) egg masses in California at present (Pilkington et al. 2005). Over summer, parasitism levels of GWSS egg masses and individual eggs in masses by *G. ashmeadi* approaches 100% but parasitism levels of the spring generation of GWSS are substantially lower (Pilkington et al., 2005; Triapitsyn and Phillips 2000). Naturally occurring populations of *G. ashmeadi* in California have been augmented with mass reared individuals from populations found in the southeastern United States and northeastern Mexico which encompasses the home range of GWSS (CDFA 2003).

Substantial laboratory work with *G. ashmeadi* has been conducted in an attempt to understand and parameterize basic aspects of this parasitoid's reproductive biology, and host selection behaviors. Irvin and Hoddle (2005a) have evaluated oviposition preferences of *G. ashmeadi* when presented GWSS eggs of various ages. Interspecific competition between *G. ashmeadi* with *G. triguttatus* and *G. fasciatus* for GWSS egg masses of different ages has been assessed (Irvin and Hoddle 2005b, 2005c) along with factors influencing the sex ratio of offspring (N.A.I., unpublished data). The effect of resource provisioning and nutrient procurement on the longevity of *G. ashmeadi* has also been determined (N.A.I., unpublished data). Furthermore, Hoddle and Pilkington (2004) have assessed laboratory-level fecundity rates of *G. ashmeadi* under different constant temperature regimens.

The GWSS-*Gonatocerus* system has benefited from this intensive laboratory study to generate a basic understanding of factors influencing host selection and parasitism success. The next step that is now required is to test hypotheses generated from lab studies in the field. Field level assessments will help determine the most important aspect of the GWSS biological control program: "How big an impact do individual female *G. ashmeadi* parasitoids have on GWSS population growth via parasitization of eggs?" Addressing this question will allow us to form a much better understanding of the levels of control we can expect from *G. ashmeadi* individually and collectively on GWSS population growth in the field during the spring and summer generations.

**OBJECTIVES**

To measure real life time contributions of individual female *G. ashmeadi* to the parasitism of GWSS egg masses in citrus orchards. Before field assessments can be conducted, laboratory studies will be run to ascertain and verify the four critical factors outlined below. Answers to these four critical factors will allow us to develop a composite index that describes the correlative relationship of these four factors that will predict parasitoid age and egg load in the field and to assess the contribution of individual female parasitoids to GWSS suppression under field conditions.

- a) Determine the relationship between adult female *G. ashmeadi* size as measured by right hind tibia length (HTL) and 24 hr egg load (mature + non-mature eggs) for spring and summer generations.
- b) Ascertain the extent to which oosorption occurs, and the length of time without ovipositing that is required to initiate this physiological response if it does occur.
- c) Determine whether female parasitoids can mature eggs in excess of those they are born with.
- d) Estimate parasitoid age using near infrared spectroscopy (NIRS) (Perez-Mendoza et al. 2002) and develop an alternative measure for comparison by developing a wing deterioration index that estimates parasitoid "age" through visually grading the severity of 'wear and tear' (i.e., numbers of broken setae) of setae on wings.

## RESULTS

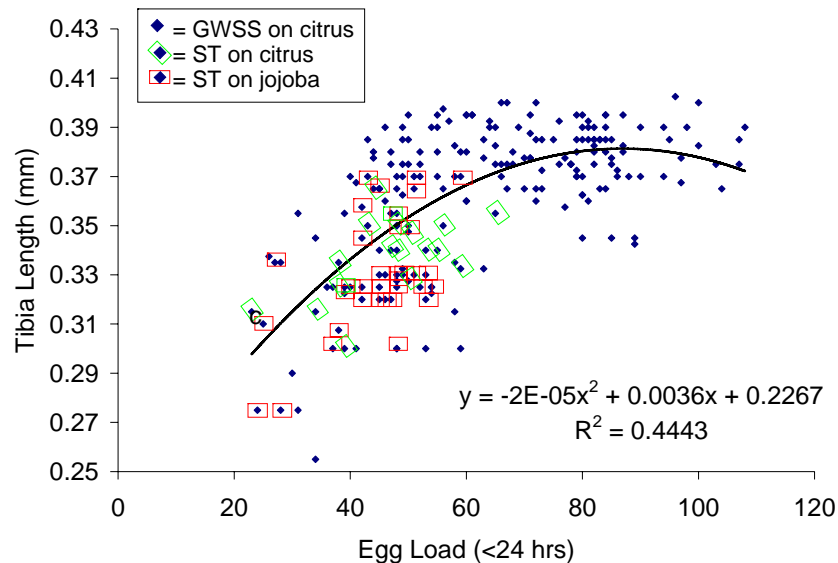
During the reporting period described above, we have conducted hundreds of dissections of female *G. ashmeadi* emerging from GWSS and smoketree sharpshooter (STSS) (*Homalodisca liturata*) eggs collected from the field to obtain different sized adults and determine the relationship between HTL and <24 hr egg load for both spring and summer generations. We have also determined a wing wear index for laboratory aged *G. ashmeadi* and have compiled initial data on the estimation of parasitoid age using NIRS. Results reported here are preliminary as we are still working on more thorough statistical analyses. Research on oosporion and egg maturation rates for *G. ashmeadi* is ongoing.

### Relationship between *G. ashmeadi* size and egg load

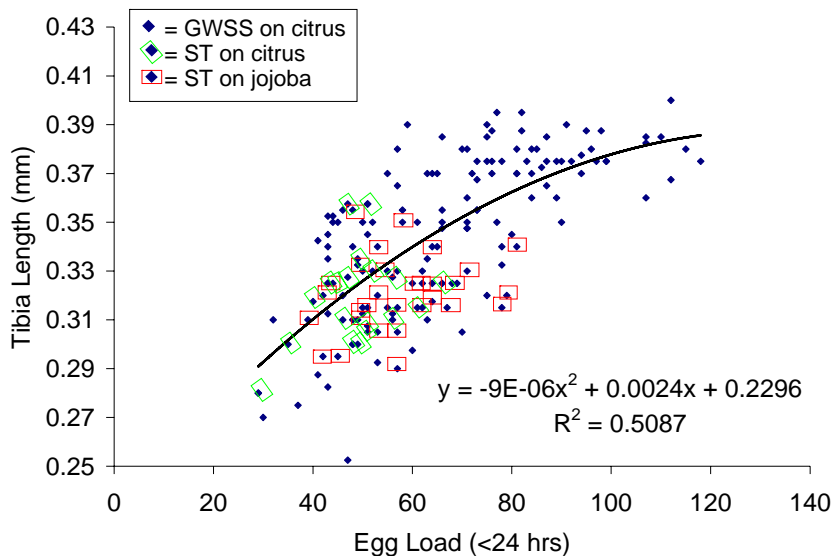
The <24 hr egg load of female *G. ashmeadi* emerging from GWSS and STSS eggs collected from the field was positively correlated with mean HTL for both spring ( $R^2 = 0.36$ ,  $n = 214$ ;  $F = 121.50$ ,  $df = 1$ ,  $p < 0.0001$ ) and summer generations ( $R^2 = 0.49$ ,  $n = 162$ ;  $F = 155.00$ ,  $df = 1$ ,  $p < 0.0001$ ) (Figures 1 and 2). Egg load varied from 23-108 eggs per female in spring and 29-118 eggs per female in summer. The summer generation (mean =  $0.36 \text{ mm} \pm 0.00$ ) contained on average significantly smaller females than the spring generation ( $0.34 \text{ mm} \pm 0.00$ ) ( $t = 5.82$ ,  $df = 374$ ,  $p < 0.0001$ ), whereas, egg load was statistically equivalent between seasons (spring mean =  $62.3 \pm 1.3$ ; summer =  $65.2 \pm 1.5$ ;  $t = -1.41$ ,  $df = 374$ ,  $p = 0.08$ ). Female *G. ashmeadi* emerging from GWSS eggs over spring and summer were on average 12% larger and contained 40% more eggs than those emerging from STSS eggs (Table 1). This can be attributable to the smaller size of STSS eggs in comparison to GWSS eggs.

**Table 1:** Mean hind tibia length ( $\pm$  SEM) and <24 hr egg load ( $\pm$  SEM) for female *G. ashmeadi* emerging from GWSS and STSS eggs collected from the field.

	GWSS	STSS	t	df	p
Hind tibia length (mm)	$0.36 \pm 0.00$	$0.33 \pm 0.00$	-12.23	375	< 0.0001
<24-hr egg load	$69.2 \pm 1.2$	$49.2 \pm 1.0$	-10.06	375	< 0.0001



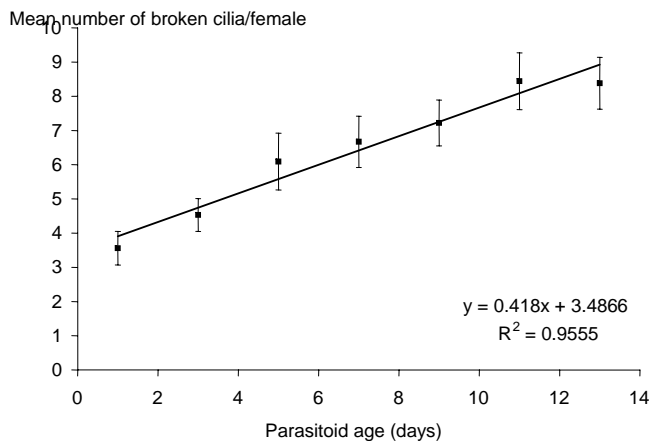
**Figure 1.** Relationship between hind tibia length (y) and the 24 hour egg complement (x) of female *G. ashmeadi* emerging from GWSS and STSS eggs laid on citrus and jojoba in the field during spring (April-June, 2005).



**Figure 2.** Relationship between hind tibia length (y) and the 24 hour egg complement (x) of female *G. ashmeadi* emerging from GWSS and STSS eggs laid on citrus and jojoba in the field during summer (August 2005).

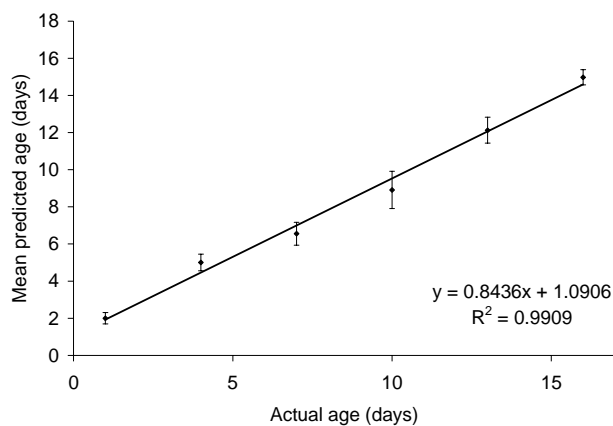
### Age estimates of *G. ashmeadi*

Female parasitoids were aged in cages with citrus trees at 26°C and destructively sampled at set intervals. There was a strong positive linear correlation between the mean number of broken setae (hairs) on the forewings of female *G. ashmeadi* and parasitoid age ( $R^2 = 0.96$ ;  $F = 107.27$ ,  $df = 1$ ,  $p < 0.001$ ) (Fig. 3). This suggests that wing wear may be useful for predicting the “age” of adult *G. ashmeadi* in the field. However, further research is underway to determine how laboratory results correlate to field-aged *G. ashmeadi* since laboratory and field conditions vary significantly. The mean number of broken setae per female *G. ashmeadi* aged in the laboratory ranged from 3.6 to 8.4, whereas, wing damage in the field may be more severe. Field collected parasitoids are being analyzed now for wing wear. We anticipate being able to develop a “physiological age” wing wear index using degree-day models developed for *G. ashmeadi* by Pilkington and Hoddle (see report in this proceedings).



**Figure 3.** The relationship between mean number of broken setae (hairs) on the forewings of female *G. ashmeadi* and parasitoid age (error bars indicate  $\pm$  SEM).

Preliminary analyses conducted with 15 female *G. ashmeadi* of each of the age categories 1, 4, 7, 10, 13 and 16 demonstrated that NIRS may show potential as a predictor of parasitoid “age” ( $R^2 = 0.99$ ;  $F = 436.22$ ,  $df = 1$ ,  $p < 0.0001$ ) (Fig. 4). An analysis containing a further 50 parasitoids for each age category is currently underway to strengthen this relationship.



**Figure 4.** The relationship between mean age, as predicted by NIRS, and the actual age of female *G. ashmeadi* reared in the laboratory at 26°C (error bars indicate  $\pm$  SEM).

## CONCLUSIONS

Female size was positively correlated with egg load for both spring and summer generations with egg load varying from 23-108 eggs per female in spring and 29-118 eggs per female in summer. The use of near infrared spectroscopy (NIRS) and a wing deterioration index to estimate parasitoid age was also investigated and preliminary results showed that both techniques may show potential for estimating the age of field collected *G. ashmeadi*. Together with oosporion and maturation data, these components will be used to develop a composite index that will predict parasitoid age and egg load in the field and help determine how many eggs individual female *G. ashmeadi* parasitize in the field up to the time of death. In 2006 we will be collecting dead parasitoids from the field, aging them, assessing size, and estimating egg load at time of birth. The egg load at time of death (when oosorption and egg maturation are figured into the model) will allow us to estimate the average number of GWSS eggs females parasitize before dying. These estimates of realized field fecundity will allow us to form a much better understanding of what levels of control individual *G. ashmeadi* in the field are achieving.

## REFERENCES

- CDFFA. 2004. Pierce's Disease Program Report to the Legislature, February, 2004. California Department of Food and Agriculture.
- Hoddle, M. S., and L. J. Pilkington. 2004. Reproductive and developmental biology of *Gonatocerus ashmeadi* (Hymenoptera: Mymaridae), an egg parasitoid of *Homalodisca coagulata* (Hemiptera: Cicadellidae), pp. 336-338. *In* Proceedings, Pierce's Disease Research Symposium, December 7 - 10, 2004, San Diego, CA.
- Irvin, N. A., and M. S. Hoddle. 2005a. Determination of *Homalodisca coagulata* (Hemiptera: Cicadellidae) egg ages suitable for oviposition by *Gonatocerus ashmeadi*, *Gonatocerus triguttatus*, and *Gonatocerus fasciatus* (Hymenoptera: Mymaridae). *Biological Control* 32: 391-400.
- Irvin, N. A., and M. S. Hoddle. 2005b. The competitive ability of three mymarid egg parasitoids (*Gonatocerus* spp.) for glassy-winged sharpshooter (*Homalodisca coagulata*) eggs. *Biological Control* 34: 204-214.
- Irvin, N. A., M. S. Hoddle, and D. J. W. Morgan. 2005c. Competition between *Gonatocerus ashmeadi* and *G. triguttatus* for glassy winged sharpshooter (*Homalodisca coagulata*) egg masses. *Biocontrol, Science and Technology* (in press).
- Perez-Mendoza, J., F. E. Dowell, A. B. Broce, J. E. Throne, R. A. Wirtz, F. Xie, J. A. Fabrick, and J. E. Baker. 2002. Chronological age-grading of house flies using near infrared spectroscopy. *Journal of Medical Entomology* 39: 499-508.
- Pilkington, L. J., N. A. Irvin, E. A. Boyd, M. S. Hoddle, S. V. Triapitsyn, B. G. Carey, W. A. Jones, and D. J. W. Morgan. 2005. Biological control of glassy-winged sharpshooter in California. *California Agriculture*. (in press).
- Vickerman, D. B., M. S. Hoddle, S. Triapitsyn, and R. Stouthamer. 2004. Species identity of geographically distinct populations of the glassy-winged sharpshooter parasitoid *Gonatocerus ashmeadi*: morphology, DNA sequences, and reproductive compatibility. *Biological Control* 31: 338-345

## FUNDING AGENCIES

Funding for this project was provided in part by the CDFFA Pierce's Disease and Glassy-winged Sharpshooter Board.

**Additional Note:** We would like to acknowledge Floyd Dowell (USDA, ARS, Grain Marketing and Production Research Center, Manhattan, KS) for his collaboration on the NIRS project, and thank Ruth Vega, Bryan Carey, Mike Lewis and Lisa Gonzalez for their assistance in the field.



**REPRODUCTIVE AND DEVELOPMENTAL BIOLOGY OF *GONATOCERUS ASHMEADI*,  
AN EGG PARASITOID OF THE GLASSY-WINGED SHARPSHOOTER**

**Project Leader:**

Mark Hoddle  
Department of Entomology  
University of California  
Riverside, CA 92521

**Cooperator:**

Leigh Pilkington  
Department of Entomology  
University of California  
Riverside, CA 92521

**Reporting Period:** The results reported here are from work conducted October 2004 to July 2005.

**ABSTRACT**

The reproductive and developmental biology of *Gonatocerus ashmeadi* Girault, a parasitoid of the glassy-winged sharpshooter *Homalodisca coagulata* (Say), was determined at five constant temperatures in the laboratory; 15; 20; 25; 30; and 33°C. At 30°C, *G. ashmeadi* maintained the highest successful parasitism rates with 46.1% of parasitoid larvae surviving to adulthood. Lifetime fecundity was greatest at 25°C. Temperature had no effect on sex ratio of parasitoid offspring. Mean adult longevity was inversely related to temperature with a maximum of 20 days at 15°C to a minimum of eight days at 33°C. Developmental rates increased nonlinearly with increasing temperatures. Developmental rate data was fitted with the modified Logan model for oviposition to adult development times to determine lower developmental threshold (1.1°C, and 7.16°C estimated by linear regression), optimal developmental temperature (30.5°C), and upper lethal temperature threshold (37.6°C). Linear regression of developmental rate for temperatures 15-30°C indicated that 222 degree-days were required above a minimum threshold of 7.16°C to complete development. Demographic parameters were calculated and pseudoreplicates for intrinsic rate of increase ( $r_m$ ), net reproductive rates ( $R_0$ ), generation time ( $T_c$ ), population doubling time ( $T_d$ ), and finite rate of increase ( $\lambda$ ) were generated using the bootstrap method. Mean bootstrap estimates of demographic parameters were compared across temperatures using ANOVA and nonlinear regression.

**INTRODUCTION**

The mymarid parasitoid species *Gonatocerus ashmeadi* Girault, *G. triguttatus* Girault, *G. morrilli* Howard, and *G. fasciatus* Girault are the most common natural enemies associated with the insect pest *Homalodisca coagulata*, the glassy-winged sharpshooter (GWSS), in its home range of southeastern USA and northeastern Mexico (Triapitsyn and Phillips, 2000). The parasitoid *G. ashmeadi* is a self-introduced resident of California and most likely came into the state in parasitized *Homalodisca coagulata* eggs (Vickerman *et al.*, 2004) and has established widely in association with *H. coagulata*.

One factor that can limit the success of the establishment of natural enemies is mismatching the environmental conditions favored by the introduced agent with those that predominate in the receiving range (Hoddle, 2004). Quantification of the reproductive and developmental biology of a natural enemy is paramount to predicting, planning, and promoting the establishment and population growth of introduced agents. This can be enhanced by determining demographic characteristics such as day-degree requirements for immature development, population doubling times and lifetime fecundity for estimating population growth rates at various temperatures and for comparison with the target pest and other species of biological control agents. Determining the introduced control agent's reproductive and developmental biology and environmental requirements with that of the host will allow for a greater understanding of factors affecting biological control of GWSS.

The following work was undertaken to provide information on the reproductive and developmental biology of the solitary endoparasitoid of GWSS eggs, *G. ashmeadi*. These data will provide knowledge of the natural enemy's life cycle in relation to utilization of GWSS eggs at different temperatures, and may improve the understanding of optimal timings of releases for biological control purposes, as well as improve the efficiency of mass rearing of these insects. In addition to improving release and rearing strategies, this information will target foreign exploration for strains of *G. ashmeadi* for possible introduction into California and also identify geographical areas that will be conducive to the use of this species as biological control agent following GWSS establishment in various parts of California and in areas such as Tahiti and Hawaii where GWSS has recently invaded, and perhaps elsewhere in the South Pacific if GWSS continues to invade additional tropical islands.

**OBJECTIVES**

1. Examine the developmental and reproductive biology of *G. ashmeadi* at five different temperatures in order to determine its day-degree requirements, and demographic statistics, and to better understand this parasitoid's developmental and reproductive biology.

**RESULTS**

Life tables were constructed for the number of *G. ashmeadi* entering each age class and their realized and actual mortality rates. Analysis of variance showed that mean adult longevity, the length of time from adult emergence to natural death, was significantly different between temperatures ( $F=6.155$ ,  $df=4$ ,  $44$ ,  $P<0.001$ ) and longevity was greatest with a value of 20.0 days at 15°C, declining to a low of 7.9 days at 33°C (Table 1).

Mean net reproductive rate ( $R_0$ ) ( $F=73857.9$ ,  $df=4$ , 4995,  $P<0.001$ ), intrinsic rate of increase ( $r_m$ ) ( $F=732354$ ,  $df=4$ , 4995,  $P<0.001$ ) and finite rate of increase ( $\lambda$ ) ( $F=683820$ ,  $df=4$ , 4995,  $P<0.001$ ) were all significantly higher for *G. ashmeadi* reared at a constant 25°C, 30°C and 30°C, respectively (Table 2). Population doubling times,  $T_d$ , showed a statistically significant difference ( $F=178515$ ,  $df=4$ , 4995,  $P<0.001$ ) and were lowest when parasitoids were reared at 30°C. Mean generation time,  $T_c$ , was significantly lower at 33°C ( $F=1821157$ ,  $df=4$ , 4995,  $P<0.001$ ) (Table 2). Quadratic lines were fitted to the means for each life table parameter and accounted for 79.6% to 99.7% of the observed variance (Figure 1).

The developmental rate for *G. ashmeadi* was nonlinear and the fitted Modified Logan model was highly significant ( $F=1292.27$ ,  $df=4$ , 495,  $P<0.005$ ) (Figure 2). The fitted model converged on a lower developmental threshold for *G. ashmeadi* of 1.1°C. The upper maximum lethal temperature for development was estimated at 37.6°C, and 30.5°C was the estimated as the optimal temperature for development. Linear regression indicated immature *G. ashmeadi* required a total of 222 degree-days to complete development of from oviposition to adult emergence and the lower temperature threshold for development was estimated at 7.16°C from this linear regression analysis.

**Table 1.** Mean adult longevity ( $\pm$ SE), mean preoviposition period ( $\pm$  SE), mean daily fecundity, lifetime fecundity ( $\pm$  SE) and female sex ratio of progeny of mated female *Gonatocerus ashmeadi* at each experimental temperature.

	Temperature (°C)				
	15	20	25	30	33
Adult longevity (days)	20.00 $\pm$ 2.69a	15.90 $\pm$ 2.02ab	12.00 $\pm$ 1.23bc	10.56 $\pm$ 1.36bc	7.90 $\pm$ 0.98c
Preoviposition period (days)	4.53 $\pm$ 0.486a	0.61 $\pm$ 0.293b	0.182 $\pm$ 0.125b	0.227 $\pm$ 0.113b	0.235 $\pm$ 0.106b
Total progeny	7.07 $\pm$ 1.767a	46.35 $\pm$ 8.387b	63.75 $\pm$ 8.362b	59.88 $\pm$ 6.931b	10.37 $\pm$ 1.562a
Mean daily progeny	0.24 $\pm$ 0.098a	1.66 $\pm$ 0.353ab	2.24 $\pm$ 0.685b	2.10 $\pm$ 0.685b	0.37 $\pm$ 0.152a
Sex ratio (% female offspring)	65.11 $\pm$ 7.348a	65.03 $\pm$ 6.807a	71.54 $\pm$ 6.020a	64.54 $\pm$ 5.690a	65.08 $\pm$ 6.461a

**Table 2.** Mean demographic statistics ( $\pm$  standard error) generated from  $l_x m_x$  life tables that were bootstrapped to produce pseudo-values for *G. ashmeadi*.  $R_0$  = net reproductive rate;  $T_c$  = generation time;  $r_m$  = intrinsic rate of increase;  $\lambda$  = finite rate of increase;  $T_d$  = doubling time in days. Values with different letters indicate significant differences at 0.05 level of confidence.

Temp °C	$R_0$	$T_c$	$r_m$	$\lambda$	$T_d$
15	8.30 $\pm$ 0.291a	44.49 $\pm$ 0.097a	0.05 $\pm$ 0.001a	1.02 $\pm$ 0.001a	14.51 $\pm$ 0.249a
20	35.70 $\pm$ 0.856b	25.77 $\pm$ 0.161b	0.15 $\pm$ 0.001b	1.16 $\pm$ 0.001b	4.62 $\pm$ 0.033b
25	55.94 $\pm$ 1.023c	16.61 $\pm$ 0.029c	0.26 $\pm$ 0.001c	1.30 $\pm$ 0.001c	2.66 $\pm$ 0.011c
30	45.33 $\pm$ 1.014d	12.61 $\pm$ 0.103d	0.33 $\pm$ 0.001d	1.39 $\pm$ 0.002d	2.11 $\pm$ 0.009d
33	9.20 $\pm$ 0.142e	12.37 $\pm$ 0.038e	0.18 $\pm$ 0.001e	1.20 $\pm$ 0.002e	3.80 $\pm$ 0.029e

## CONCLUSIONS

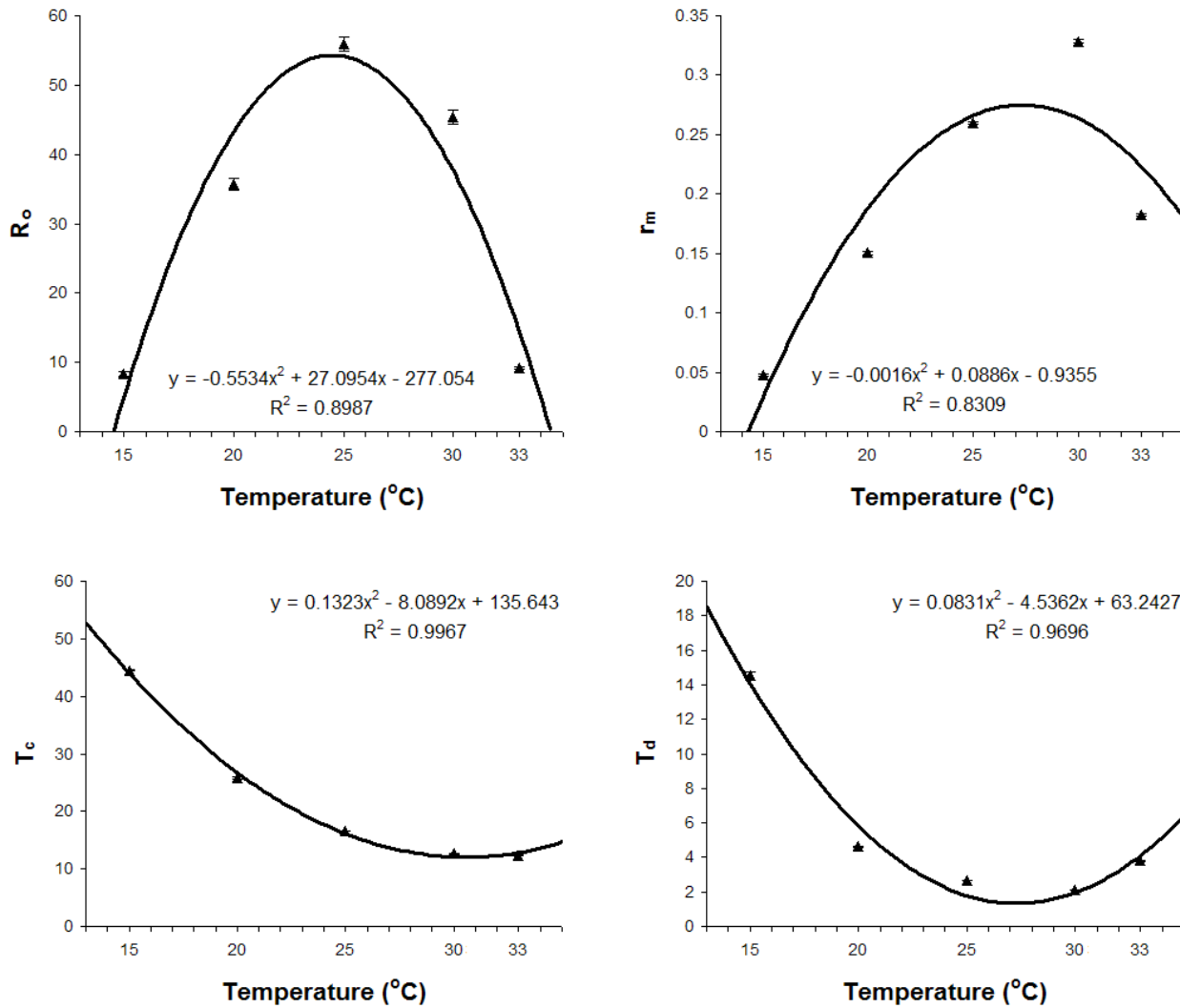
*Gonatocerus ashmeadi* is the key mymarid parasitoid species contributing to the biological suppression *H. coagulata* in its native area of southeastern U.S.A. and northeastern Mexico (Triapitsyn and Phillips, 2000). The impact of *G. ashmeadi* as a regulating factor of populations of *H. coagulata* in California is, in contrast to efficacy in the home range, substantially lower (Pilkington et al., In Press).

Temperature can have a significant impact on  $R_0$  estimates for *G. ashmeadi*. The fitted quadratic model for  $R_0$ , a measure of a population's growth rate, indicated that at approximately 14.6°C the value of  $R_0$  falls below 1.0, indicating that parasitoid population increase will cease and begin to contract. Host availability notwithstanding, this suggests populations of *G. ashmeadi* in Riverside California would contract markedly over the period November-March each year because of impaired reproductive performance at temperatures below 14.6°C periods for prolonged periods.

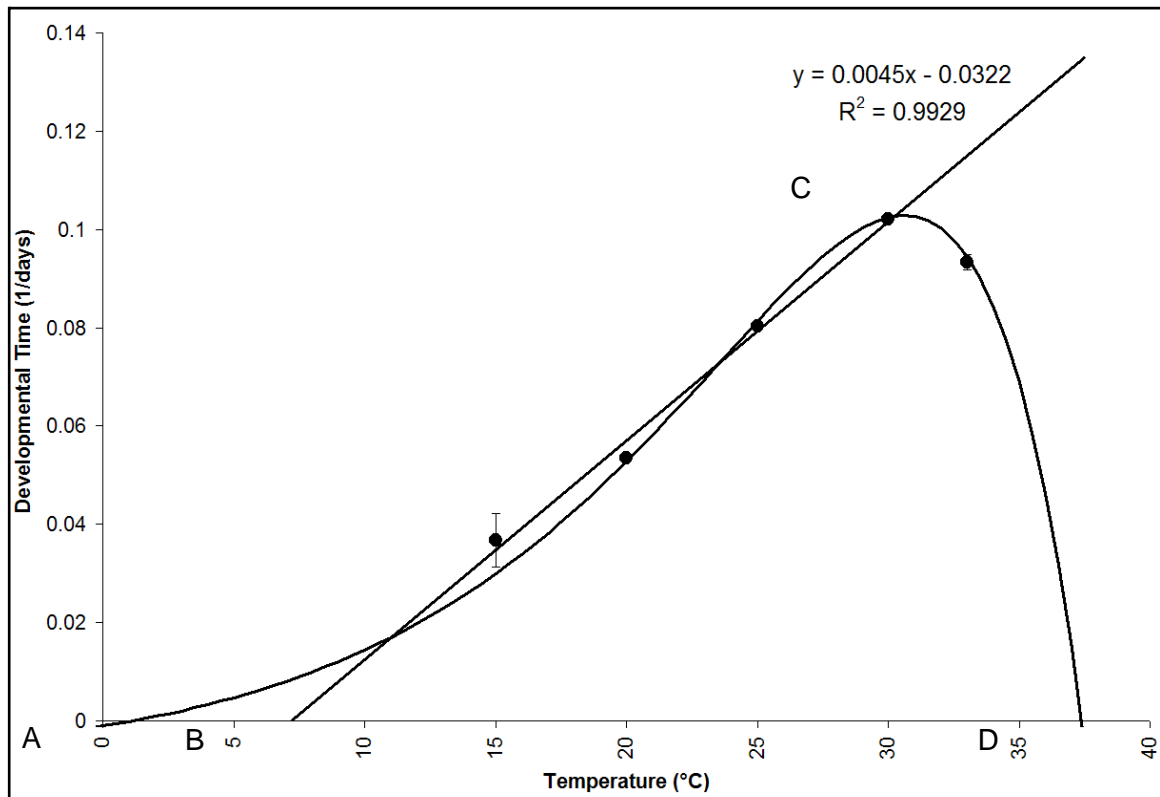
The success of a biological control agent is measured by the mortality it inflicts on its target which is in part a function of its reproductive and developmental activity across a range of temperatures (Nahrung and Murphy, 2002). The results from this study suggest that *G. ashmeadi* operates most effectively at moderate to high temperatures. Identifying the optimal temperature for reproduction and development of *G. ashmeadi*, will greatly aid mass-rearing efforts, using day-degree models to predict geographic range, to assess generational turnover in various locales in comparison to GWSS and to optimize releases of natural enemies into a field environment.

There is a need for this type of work on population demographics, developmental and reproductive biology to be reproduced for *G. triggatus* and particularly *H. coagulata*. Efforts towards meeting these two shortcomings are either underway or will be commenced very soon. There is a large gap in the knowledge regarding the biology of the pest and its temperature

requirements and identifying and understanding the areas of overlap, or lack thereof, between the pest and biological control agents. A greater degree of precision in the prediction of the efficacy of biological control agents in areas yet to be invaded by *H. coagulata* would be possible with improved understanding of the performance of GWSS at various temperatures.



**Figure 1.** Fitted quadratic lines for life table statistics  $R_0$ ,  $r_m$ ,  $T_c$  and  $T_d$  for *Gonatocerus ashmeadi* at each experimental temperature.



**Figure 2.** The developmental rate of *Gonatocerus ashmeadi* from time of oviposition to adult emergence expressed as the relationship of developmental rates and temperature fitted to the modified Logan model as described by Lactin et al. (1995) and using linear regression (Campbell et al., 1974). Lower developmental threshold (calculated with modified Logan model [A = 1.1°C] and linear regression [B = 7.16°C]), optimal development (C = 30.5°C) and upper lethal threshold (D = 37.6°C) are indicated.

## REFERENCES

- Campbell A., Frazer, B.D., Gilbert, N., Gutierrez, A.P., Mackauer, M., 1974. Temperature requirements of some aphids and their parasites. *J. Appl. Ecol.* 11, 431-438.
- Hoddle M.S., 2004. The potential adventive geographic range of glassy-winged sharpshooter, *Homalodisca coagulata* and the grape pathogen *Xylella fastidiosa*: Implications for California and other grape growing regions of the world. *Crop Protection* 23, 691-699.
- Lactin D.J., Holliday, N.J., Johnson, D.L., Craigen, R., 1995. Improved rate model of temperature-dependent development by arthropods. *Environ. Entomol.* 24, 68-75.
- Nahrung H.F., Murphy, B.D., 2002. Differences in egg parasitism of *Chrysophtharta agricola* (Chapuis) (Coleoptera : Chrysomelidae) by *Enoggera nassau* Girault (Hymenoptera : Pteromalidae) in relation to host and parasitoid origin. *Aust. J. Entomol.* 41, 267-271.
- Pilkington L.J., Irvin, N.A., Boyd, E.A., Hoddle, M.S., Triapitsyn, S.V., Carey, B.G., Jones, W.A., Morgan, D.J.W., In Press. Biological control of glassy-winged sharpshooter in California. *Calif. Agric.*
- Triapitsyn S.V., Phillips, P.A., 2000. First record of *Gonatocerus triguttatus* (Hymenoptera: Mymaridae) from eggs of *Homalodisca coagulata* (Homoptera: Cicadellidae) with notes on the distribution of the host. *Florida Entomol.* 83, 200-203.
- Vickerman D.B., Hoddle, M.S., Triapitsyn, S.V., Stouthamer, R., 2004. Species identity of geographically distinct populations of the glassy-winged sharpshooter parasitoid *Gonatocerus ashmeadi*: Morphology, DNA sequences and reproductive compatibility. *Biol. Control* 31, 338-345.

## FUNDING AGENCIES

Funding for this project was provided in part by the CDFA Pierce's Disease and Glassy-winged Sharpshooter Board.

# IS THE GLASSY-WINGED SHARPSHOOTER PARASITOID *GONATOCERUS MORRILLI* ONE SPECIES OR A COMPLEX OF CLOSELY RELATED SIBLING SPECIES?

## Project Leaders:

Mark S. Hoddle and Richard Stouthamer  
Dept. of Entomology  
University of California  
Riverside, CA 92521

## Cooperators:

Serguei Triapitsyn and Herman van Oosten  
Dept. of Entomology  
University of California  
Riverside, CA 92521

**Reporting Period:** The results reported here are from work conducted December 2004 to October 2005.

## ABSTRACT

The aim of the present study was to determine whether the egg parasitoid *Gonatocerus morrilli* Howard is one species or a complex of closely related sibling species. To unravel their identity we sampled specimens from Texas (TX), California (CA), Veracruz in Mexico (MX), and Tucuman in Argentina (AG) and compared them using three approaches: 1) morphological differences; 2) molecular differences in ribosomal regions: ITS1, ITS2 and 28SD2, and the mitochondrial cytochrome oxidase I (CO1); and 3) by performing cross mating compatibility studies between parasitoids from the four regions. According to the obtained large differences in sequences and the reproductive incompatibility between the four populations, these near *morrilli* populations are best treated as distinct species.

## INTRODUCTION

The glassy-winged sharpshooter (GWSS), *Homalodisca coagulata* (Say) (Hemiptera: Cicadellidae), is an exotic pest in southern California (CA) and is the main vector strains of the bacterium *Xylella fastidiosa* Wells *et al.*, that causes the Pierce's disease in grapevines (*Vitis vinifera*) (Freitag *et al.*, 1952; Davis *et al.*, 1978; Blua *et al.*, 1999). In CA, GWSS were first observed in Orange and Ventura Counties during 1990. GWSS occurs naturally from Florida to Texas and northeastern Mexico (Young, 1958; Triapitsyn & Phillips, 2000). It was probably introduced from the southeastern United States as eggs on imported plants (Sorensen and Gill, 1996). A major Pierce's disease epidemic was first noticed in CA in 1997 (Blua *et al.*, 1999) and during a survey in 2000 up to 87% of grapevines in Temecula were infected (Perring *et al.*, 2001). Since then, GWSS has been observed as far north as Sacramento County (California Department of Food and Agriculture, 2003) suggesting that this pest is continuing to spread in CA. To perform a successful classical biological control program, species of GWSS egg parasitoids are currently being prospected for in the native range of GWSS and promising species are being released in CA (Triapitsyn *et al.*, 1998; Triapitsyn & Hoddle, 2001). One of the promising GWSS egg parasitoids is the small (1.5-2mm) egg parasitoid *Gonatocerus morrilli* Howard (Hymenoptera: Mymaridae). This parasitoid occurs in the native range of GWSS in the southeastern United States (Huber, 1998). The outcome of classical biological control programs often depends on correct identification of both the pest insect and its parasite. Misidentification has negatively affected several incipient biological control programs (Messing & Aliniaze, 1988; Gordh & Beardsley, 1999). Hence, to avoid misidentification of cryptic species it is important to design molecular markers to correctly identify species (Stouthamer *et al.*, 2000; de Leon *et al.*, 2005) when consistent distinguishing morphological characters are difficult or expensive to ascertain. *Gonatocerus morrilli* has been imported from Texas (TX) and has been released in CA since 2001 with the assumption that this is one species and not an aggregation of morphologically very similar sibling species. However, light microscopy suggests that differences between the different *G. morrilli* populations may exist, which may indicate the existence of a species complex. Indeed, a closely related species has recently been found in CA (de Leon *et al.*, 2005). Here, we sort to determine whether *G. morrilli* is one species or that it is in fact a group of closely related similar looking species. Specimens from the southeastern U.S., California, Mexico, and Argentina were received from collaborators; if possible, colonies were established. We tried to determine their relationship using three approaches: (1) comparing molecular features by extracting DNA and sequencing of four different gene regions of the mitochondrial and ribosomal DNA, (2) comparing morphological characters, and (3) by investigating whether the different populations are reproductively compatible by conducting mating experiments between the geographic populations (Vickerman *et al.*, 2004). The outcome of these three approaches was evaluated to determine whether *G. morrilli* is a valid species as such or if it is better treated as a complex of closely related species.

## OBJECTIVES

To determine the species status of geographically different *Gonatocerus morrilli* populations by 1) morphology, 2) sequencing of two Internally Transcribed Spacer regions (ITS1 and ITS2), the mitochondrial gene cytochrome oxidase I (CO1) and the ribosomal D2 gene, and 3) by crossing compatibility studies with four different geographic populations of which we maintain colonies.

## RESULTS AND CONCLUSIONS

### Comparisons in morphology

The MX near *morrilli* female differs from all other groups by showing a distinctive fifth funicle segment of the female antenna. This segment is partially brown (basally) and white (apically). *Gonatocerus morrilli* and the CA near *morrilli* have a completely white fifth funicle segment. *Gonatocerus* sp. 6 from Argentina differs from all groups in having the entire funicle of the female antenna dark brown. *Gonatocerus morrilli* and the CA near *morrilli* show more consistent differences when compared: the submedial carinae on the propodeum are close to each other in *G. morrilli* but conspicuously more apart in the CA near *morrilli*.

### Comparisons in sequences

The levels of genetic divergence between *G. morrilli* (from Texas, TX), the two near *morrilli* populations we studied (from Riverside County, California, CA, and from Veracruz Mexico, MX) and *Gonatocerus* sp. 6 from Argentina are summarized in Table 1.

The differences in the two spacer-regions between the group *G. morrilli*-MX and CA-ARG were very large which made it impossible to align them properly. However, the two spacer-regions within these two groups could be aligned. The CO1 and D2 genes could be aligned for all groups since these are conservative genes. For the ITS1, ITS2, CO1 and D2, the MX type differed from *G. morrilli* with resp. 29%, 29%, 5% and 3%. The CA type differed from the Arg type 6%, 8%, 2% and 1%, respectively. Intragroup variation was <1.5% for both the ITS1 and ITS2 regions, <0.9% for the CO1 gene and no variation was found within the groups using the D2 gene. For each region at least 8 individuals were sequenced.

As shown in Table 1, divergences between the different near *morrilli* populations and *G. morrilli* are high. Intragroup variation is minimal, despite the fact that we sequenced *G. morrilli* from very different areas of their distribution. The obtained sequences from *G. morrilli* originating from Florida (FL), northeastern MX and from our TX colony differ <1.5% at most. These large differences and the homogenous near *morrilli* groups might indicate that *G. morrilli* is not a monotypic species, but indeed, that it is better treated as a complex of closely related species.

**Table 1.** The percentage difference between *G. morrilli* from TX and the near-*morrilli* from MX, Arg. and CA as measured for the ITS1 and ITS2 region, the CO1 gene and the D2 gene.

	ITS1	ITS2	CO1	D2
	<i>G. morrilli</i>	<i>G. morrilli</i>	<i>G. morrilli</i>	<i>G. morrilli</i>
near <i>morrilli</i> MX	29%	29%	5%	3%
<i>Gonatocerus</i> sp. 6 from Argentina	x	x	6%	8%
near <i>morrilli</i> CA	x	x	6%	8%

### Comparisons in reproductive compatibility

To test whether the four types were reproductively compatible, we performed mating experiments as described in Vickerman *et al.* (2004). We did the following crosses: ♀ *G. morrilli* (Gm) x ♂ MX, ♀ Gm x ♂ CA, ♀ Gm x ♂ Arg and all the reciprocal crosses to test for unidirectional incompatibility. At least 13 replicates were used per crossing. In addition, we performed control crosses for each group: ♀ Gm x ♂ Gm, ♀ MX x ♂ MX, ♀ Arg. x ♂ Arg and ♀ CA x ♂ CA (at least 10 replicates each) and virgin females (10 replicates each) were set up to determine whether the females used in the crossings were virgins and whether a species could be infected with an endosymbiont like *Wolbachia* (Stouthamer *et al.* 1999). All virgin females produced only sons, proving that they were unmated and that they reproduce arrhenotokously. All interspecific crosses produced only sons while the intraspecific control crosses produced both males and females as shown in Table 2.

**Table 2.** The sex ratios of the produced offspring per crossing measured as the proportion females. At least 10 replicates per crossing were performed. Differences between interspecific crosses were highly significant (Kruskal-Wallis,  $H=102.75$ ,  $df=11$ ,  $P<0.0001$ , followed by individual Mann-Whitney *U*-tests,  $P \leq 0.0001$ )

	Gm	MX	Arg	Ca
Gm	0.86			
MX	0.03	0.77		
Arg	0	0	0.81	
CA	0	0	0	0.86

Since all interspecific crosses produced only sons, the different geographic populations are mutually incompatible with each other. The observed highly significant differences in reproductive compatibility between the control crossings and the interspecific crossings confirm our findings after analysis of the molecular data, namely that these four different taxa are best treated as four different species instead of local forms of the species *G. morrilli*.

Our findings can be of importance considering the introduction of *G. morrilli* in CA as a natural enemy of the glassy-winged sharpshooter. A major reason for introduction of *G. morrilli* was to enrich the local *G. morrilli* populations by alleged increasing genetic variability (Pilkington *et al.*, *in press*). However, since the different species, which we assume them to be, do not successfully interbreed, the genetic variability of the CA species will not increase and indeed, as far as we are aware of, nothing is known of interspecific competition in the field between the different *G. morrilli* types. Since the different species, which we assume them to be, do not successfully interbreed, the genetic variability of the CA species will not increase.

## REFERENCES

- Blua, M.J., P.A. Philips, and R.A. Redak. 1999. A new sharpshooter threatens both crops and ornamentals. *Calif. Agric.* 53: 22-25.
- California Department of Food & Agriculture. 2004. Pierce's Disease Control Program Report to the Legislature, February 2004 [online]. Available at: <http://www.cdfa.ca.gov/phpps/pdcp/lrReport/RptLeg03.pdf>
- Davis, M.J., A.H. Purcell, and S.V. Thomson. 1978. Pierce's disease of grapevines: isolation of the causal bacterium. *Science* 199: 75-77.
- de León J.H., W.A. Jones, and D.J.W. Morgan. 2004. Molecular distinction between populations of *Gonatocerus morrilli*, egg parasitoids of the glassy-winged sharpshooter from Texas and California: Do cryptic species exist? *Journal of Insect Science* 4:39, 1-7.
- Freitag, J.H., N.W. Frazier, and R.A. Flock. 1952. Six new leafhopper vector's of Pierce's disease virus. *Phytopathology* 42: 533-534.
- Gordh, G., and J.W. Beardsley. 1999. Taxonomy and biological control. In: Bellows, T.S. Jr., Fisher, T.W. (Eds.), *Handbook of Biological Control*. Academic Press, San Diego, pp. 45-46.
- Huber J.T. 1998. The species groups of *Gonatocerus* Nees in North America with a revision of the sulphuripes and ater groups (Hymenoptera: Mymaridae). *Memoirs of the Entomological Society of Canada* 141: 1-109.
- Irvin, N.A., and M.S. Hoddle. 2005. The competitive ability of three mymarid egg parasitoids (*Gonatocerus* spp.) for glassy-winged sharpshooter (*Homalodisca coagulata*) eggs. *Biological Control* 34: 204-214.
- Messing R. H, and M.T. Aliniaze. 1998. Hybridization and host suitability of two biotypes of *Trioxys pallidus* (Hymenoptera: Aphidiidae). *Annals of the Entomological Society of America* 81: 6-9.
- Perring, T.M., C.A. Farrar, and M.J. Blua. 2001. Proximity to citrus influences Pierce's disease in Temecula Valley vineyards. *Calif. Agric.* 55: 13-18.
- Pilkington L.J., N.A. Irvin, E.A. Boyd, M.S. Hoddle, S.V. Triapitsyn, B.G. Carey, W.A. Jones, and D.J.W. Morgan. Biological control of glassy-winged sharpshooter in California. *Calif. Agric.* In press.
- Sorensen, S.J., and R.J. Gill. 1996. A range extension of *Homalodisca coagulata* (Say) (Hemiptera: Clypeorrhyncha: Cicadellidae) to southern California. *Pan-Pac. Entomol.* 72: 160-161.
- Stouthamer, R., Hu, J., Van Kan, F.J.P.M., Platner, G.R., and J.D. Pinto. 1999. The utility of the internally transcribed spacer 2 DNA sequences of the nuclear ribosomal gene for distinguishing sibling species of *Trichogramma*. *BioControl* 43: 421-440.
- Stouthamer, R., P. Jochemsen, G.R. Platner, and J.D. Pinto. 2000. Crossing incompatibility between *Trichogramma minutum* and *Trichogramma platneri* (Hymenoptera: Trichogrammatidae): implications for application in biological control. *Environ. Entomol.* 29:832-837.
- Triapitsyn, S.V., and M.S. Hoddle. 2001. Search for and collect egg parasitoids of glassy-winged sharpshooter in southeastern USA and northeastern Mexico, In: Tariq, M.A., Osawlt, S., Esser, T. (Eds.), (Organized by California Department of Food and Agriculture), *Proceedings of the Pierce's Disease Research Symposium, December 5-7, 2001, Coronado Island Marriott Resort, San Diego, CA*. Copeland Printing, Sacramento, California, pp. 133-134.
- Triapitsyn, S.V., R.F. Mizell, III, J. L. Bossart, and C.E. Carlton 1998. Egg parasitoids of *Homalodisca coagulata*. *Florida Entomol.* 81: 241-243 .
- Triapitsyn, S.V., and P. A. Phillips. 2000. First record of *Gonatocerus triguttatus* (Hymenoptera: Mymaridae) from eggs of *Homalodisca coagulata* (Homoptera: Cicadellidae) with notes on the distribution of the host. *Florida Entomol.* 83: 200-203.
- Vickerman, D.B., M.S. Hoddle, S. Triapitsyn, and R. Stouthamer. 2004. Species identity of geographically distinct populations of the glassy-winged sharpshooter parasitoid *Gonatocerus ashmeadi*: morphology, DNA sequences, and reproductive compatibility. *Biological Control* 31: 338-345.
- Young, D.A., Jr. 1958. A synopsis of the species of *Homalodisca* in the United States (Homoptera: Cicadellidae). *Brooklyn Entomol. Soc. Bull.* 53: 7-13.

## FUNDING AGENCIES

Funding for this project was provided in part by the University of California Pierce's Disease Grant Program.

**MAINTAINING AND EVALUATING QUARANTINE CULTURES OF *GONATOCERUS* SPP.,  
PROMISING EGG PARASITOIDS FROM ARGENTINA AND MEXICO, FOR THE CLASSICAL  
BIOLOGICAL CONTROL OF THE GLASSY-WINGED SHARPSHOOTER IN CALIFORNIA**

**Project Leaders:**

Mark S. Hoddle and Serguei Triapitsyn  
Department of Entomology  
University of California  
Riverside, CA 92521

**Cooperators:**

David J. W. Morgan  
CDFA, PDCP  
Mt. Rubidoux Field Station  
Riverside, CA

Guillermo A. Logarzo  
USDA, ARS  
South American Biological Control Laboratory  
Washington, D.C.

**Reporting Period:** The results reported here are from work conducted July 1, 2005 to September 29, 2005.

**ABSTRACT**

This is a new project, which is expected to be completed within one year. Cultures of two species of mymarid (Hymenoptera: Mymaridae) egg parasitoids of proconiine sharpshooters (Hemiptera: Cicadellidae; Proconiini) of Argentina origin (*Gonatocerus tuberculifemur* (Ogloblin) and *Gonatocerus* “sp. 6”) as well as of two species of *Gonatocerus* of Mexico origin (*G. morrilli* (Howard) and *G. new sp. near morrilli*) are being maintained in a UC Riverside quarantine laboratory. Basic biological data are being collected on these species, which are candidate agents for “classical” biological control against the glassy-winged sharpshooter (GWSS), *Homalodisca coagulata* (Say).

**INTRODUCTION**

Recommendation 3.12 of the National Research Council report on research priorities for Pierce’s disease (NRC 2004, p. 74) suggests that support for “classical” biological control is preferred over augmentation if inoculative releases result in self-sustaining populations and can be shown to be less costly than augmentation. Currently, we have two candidate species of *Gonatocerus* for classical biological control of GWSS in California, *Gonatocerus tuberculifemur* (Ogloblin) and *Gonatocerus* “sp. 6”, both of Argentina origin (Jones 2001; Logarzo et al. 2003; Pilkington 2004). These species were collected in Argentina by G. Logarzo and sent to S. Triapitsyn and are being held in the UC Riverside quarantine. Their colonies were successfully established using GWSS eggs as a host. We are continuing to rear these parasitoids until appropriate release permits are received; then the cultures will be turned over to the CDFA GWSS Biological Control Program for mass-rearing and inoculative releases in California against GWSS. Both parasitoids are very promising, aggressive natural enemies of GWSS, its fictitious host under the quarantine lab conditions. In their native range, *G. tuberculifemur* occurs both in the temperate South and the arid, hot North-West of Argentina. Both species readily and effectively attack GWSS eggs of almost any age. Biology of *G. tuberculifemur* was studied both in Argentina (Virla et al. 2005) and under quarantine conditions in the United States (Jones et al. 2005), who also studied its host range for non-target impact studies.

Additionally, two different species of *Gonatocerus*, *G. morrilli* (Howard) and *G. new species near morrilli* (Howard), were collected by L. Pilkington and S. Triapitsyn during the spring of 2005 in the course of our foreign exploration in Mexico (Hoddle & Triapitsyn 2004); their cultures were then established in UC Riverside quarantine. These Mexican species may also be promising agents for the “classical” biological control program against GWSS in California (Hoddle & Triapitsyn 2004).

**OBJECTIVES**

This project has two main objectives:

1. Maintain quarantine cultures of two species of egg parasitoids of GWSS of Argentina origin (*Gonatocerus tuberculifemur* and *G. “sp. 6”*) as well as two species of *Gonatocerus* of Mexico origin (*G. morrilli* and *G. new sp. near morrilli*); and
2. Collect basic biological data on these species for their initial evaluation, necessary for obtaining necessary permits for their release and potential establishment in California.

The following experimental procedures are being used to accomplish these objectives, respectively: (1) Two species of *Gonatocerus* from Argentina and two species of the same genus from Mexico are being maintained in cages at UC Riverside quarantine facility. Fresh egg masses of the host (GWSS) in *Euonymus* leaves are supplied by D. Morgan. (2) Collected are data on the biological traits on these species of *Gonatocerus*, necessary for obtaining proper State and Federal release



permits. Alternate leafhopper hosts (e.g., eggs of *Homalodisca liturata* Ball, a native sharpshooter in California) may be tested to determine their potential host ranges.

## RESULTS

Currently, we are at the beginning stage of this project. The Mexican cultures have been identified taxonomically as *G. morrilli* and *G. new species near morrilli*. The latter has a partially white, partially brown fifth funicle segment of the female antenna. Quarantine cultures of these two species, as well as of *G. tuberculifemur* and *G. "sp. 6"* from Argentina, have been successfully maintained by the quarantine technician employed by this project, Vladimir Berezovskiy, using GWSS eggs as a host.

Experiments conducted in quarantine revealed the negative role of superparasitism of the same egg mass on the egg parasitoid colonies, particularly on *G. tuberculifemur*, in which different female funicle segments may fuse under intense larval competition for resources. Vladimir Berezovskiy also discovered that in *G. tuberculifemur*, superparasitism of the few available eggs of GWSS by numerous, competing females may also result in low quality progeny (such as a much lower survival rate and often smaller size of the emerging adult wasps) than in cases when females have an abundant supply of host eggs and competition for hosts is not intense.

## CONCLUSIONS

This research project would be of benefit primarily to the CDFA GWSS Biological Control Program as well as to other biocontrol specialists and agencies conducting projects against GWSS in California such as the USDA. Ultimately, this project may be beneficial to California's agriculture.

## REFERENCES

- Hoddle, M. S. and S. V. Triapitsyn. 2004. Searching for and collecting egg parasitoids of the glassy-winged sharpshooter and other *Homalodisca* species in southeastern and southwestern Mexico, pp. 339-341. *In: Proceedings of the 2004 Pierce's Disease Research Symposium, December 7-10, 2004, Coronado Island Marriott Resort, Coronado, California.* Copeland Printing, Sacramento, California, 391 p.
- Jones, W. A. 2001. Classical biological control of the glassy-winged sharpshooter, pp. 50-51. *In: Proceedings of the Pierce's Disease Research Symposium, December 5-7, 2001, Coronado Island Marriott Resort, San Diego, California.* California Department of Food and Agriculture, Copeland Printing, Sacramento, California, 141 pp.
- Jones, W. A., Logarzo, G. A., Triapitsyn, S. V., Casas, M., Virla, E. G. and Purcell, A. H. 2005. Biology and host range of 2 South American egg parasitoids (Hymenoptera: Mymaridae), possible biocontrol agents for Glassy-Winged Sharpshooter, *Homalodisca coagulata* (Say) (Hemiptera: Cicadellidae; Proconiini). Submitted Papers T7-T8. *In: Submitted Papers T1-T21, 12th International Auchenorrhyncha Congress and 6th International Workshop on Leafhoppers and Planthoppers of Economic Significance, University of California, Berkeley, 8-12 August 2005.* Available online (.pdf) at <http://nature.berkeley.edu/hoppercongress/>.
- Logarzo, G., S. V. Triapitsyn and W. A. Jones. 2003. New host records for two species of *Gonatocerus* (Hymenoptera: Mymaridae), egg parasitoids of proconiine sharpshooters (Hemiptera: Clypeorrhyncha: Cicadellidae), in Peru. *Florida Entomologist* 86 (4): 486-487.
- NRC. 2004. California Agricultural Research Priorities: Pierce's Disease. National Research Council of the National Academies, National Academies Press, Washington, D.C. 161 pp.
- Pilkington, L. J., N. Irvin, E. A. Boyd, M. S. Hoddle, S. Triapitsyn, B. G. Carey and D. J. W. Morgan. 2004. Biological control of glassy-winged sharpshooter in California, pp. 133-136. *In: [Proceedings] California Conference on Biological Control IV, held July 13-15, 2004 at UC Berkeley, California (M. S. Hoddle, Ed.), 152 pp.*
- Virla, E. G., G. A. Logarzo, W. A. Jones and S. Triapitsyn. 2005. Biology of *Gonatocerus tuberculifemur* (Hymenoptera: Mymaridae), an egg parasitoid of the sharpshooter, *Tapajosa rubromarginata* (Hemiptera: Cicadellidae). *Florida Entomologist* 88 (1): 67-71.

## FUNDING AGENCIES

Funding for this project was provided in part by the CDFA Pierce's Disease and Glassy-winged Sharpshooter Board.

# ENVIRONMENTAL RISK ASSESSMENT OF EGG PARASITOIDS FROM SOUTH AMERICA: NONTARGET FIELD AND LABORATORY HOST RANGE IN ARGENTINA AND THE UNITED STATES

## Project Leaders:

Walker A. Jones (Coordinator)  
USDA, ARS  
European Biological Control Laboratory  
Montferrier-sur-Lez, France

Guillermo A. Logarzo  
USDA, ARS  
South American Biological Control Laboratory  
Buenos Aires, Argentina

Eduardo G. Virl  
CONICET-PROIMI  
Avda Belgrano y Pasaje Caseros  
S. M. de Tucumán, Argentina

Erica Luft  
CONICET-PROIMI  
Avda Belgrano y Pasaje Caseros  
S. M. de Tucumán, Argentina

**Reporting Period:** The results reported here are from work conducted October 2004 to October 2005.

## ABSTRACT

Specific areas in South America were surveyed from 2000-2005 for egg parasitoids of sharpshooters that are pre-adapted to California's climate and glassy-winged sharpshooter (GWSS) habitats. At least 20 species were collected; 4 from Argentina readily attacked and bred on GWSS eggs in quarantine. To ensure that the most promising exotic species do not also attack nontarget leafhoppers and other taxa, tests were conducted in both Argentina and the United States to determine effective host range. Laboratory tests with native fauna in Argentina demonstrated that one promising species, *Gonatocerus tuberculifemur*, did not attack leafhoppers or other insects outside the sharpshooter tribe, Proconiini. Similar results were found in U.S. quarantine using California and Texas leafhoppers. Field host range tests in Argentina showed that *G. tuberculifemur* emerged from small numbers of leafhoppers within a different tribe (Cicadellini). Questions regarding the taxonomic status of this parasitoid must be resolved. It is that *G. tuberculifemur* can attack GWSS but not unrelated leafhoppers.

## INTRODUCTION

Egg parasitoids are the most important known natural enemies of the glassy-winged sharpshooter (GWSS) across its native range through the Gulf States to northeastern Mexico. To be equally effective in their California environment, these parasitoids need to possess the ability to suppress populations of the GWSS under this region's unique array of climatic conditions. Since leafhoppers related to GWSS (Tribe Proconiini) uniquely occupy subclimate areas in South America that are identical to those of California, parasitoids from this region might be better preadapted to California and thus possibly more effective if they readily attack GWSS. Beginning in 2000, collections of egg parasitoids from leafhoppers closely related to GWSS were made in climate-matched areas in South America to determine if any would attack GWSS under quarantine conditions (Jones 2001).

Collections in Argentina, Chile, and Peru yielded 20 species of parasitoids from eggs of proconiine sharpshooters: 12 *Gonatocerus* spp., 1 *Polynema* sp. (Mymaridae), 1 *Paracentrobia* sp., 2 *Oligosita* spp., and 2 *Zagella* spp. (Trichogrammatidae), and 1 species of Aphelinidae (Logarzo et al. 2005, Virla et al. 2005). *Gonatocerus tuberculifemur* Ogloblin was the most abundant species within the best climate match, while *G. annulicornis* (Ogloblin) was the most abundant parasitoid recovered from citrus.

In U.S. quarantine, 4 of the imported *Gonatocerus* spp. readily accepted GWSS eggs: *G. tuberculifemur*, *G. annulicornis*, *G. metanotalis* (Ogloblin), and *Gonatocerus* sp. Since these exotic parasitoids would represent new associations, a rigorous screening for environmental risks associated with possible release into the North American environment was initiated. Thus, host range testing was begun for nontarget taxa in both South and North America.

## OBJECTIVE

1. Determine potential host range of the most promising South American parasitic wasps found to successfully attack GWSS eggs in U.S. quarantine.

## RESULTS AND CONCLUSIONS

Nontarget tests were conducted in both Argentina and the U.S. Laboratory host range studies in Argentina were conducted using *G. tuberculifemur* to test for oviposition and successful development in eggs of 20 species among the orders Hemiptera, Lepidoptera and Coleoptera. *G. tuberculifemur* successfully attacked only the eggs of the 4 included Argentine proconiine leafhoppers; no other taxa were attacked.

In U.S. quarantine (USDA, APHIS, Edinburg, TX), seven species of native Cicadellidae representing 3 subfamilies and 4 tribes were evaluated for susceptibility to parasitization by 2 species of South American wasps, *G. tuberculifemur* and *G. metanotalis* (Ogloblin) (Jones et al. 2005). From California: *Colladonus montanus* (Van Duzee) and *Euscelidius variegatus*

(Kirschbaum) [Deltocephalinae; Athysanini]; *Macrosteles fascifrons* Stål and *M. quadrilineatus* Forbes [Deltocephalinae; Macrostelini]; and *Homalodisca liturata* Ball [Cicadellinae; Proconiini]. From Texas: *Homalodisca insolita* (Walker) and *Oncometopia* sp. [Cicadellinae; Proconiini]. Both parasitoid species successfully attacked and emerged from *H. liturata* and *Oncometopia* sp. eggs. Eggs of the other species, including *H. insolita*, were not attacked.

Field host range tests in Argentina were conducted to determine if free-living parasitoids could locate and successfully parasitize eggs of 13 species among 4 subfamilies of Cicadellidae: 5 Cicadellinae; Cicadellini; 3 Cicadellinae; Proconiini; 3 Deltocephalinae; Macrostelini and Euscelini; 1 Agallinae; and 1 Xerophloeinae. Over 50% of the exposed egg masses of all 3 proconiine sharpshooters were attacked by 3 spp. of parasitic wasps, *G. tuberculifemur*, *G. annulicornis*, and *Gonatocerus* sp. Contrary to the laboratory host range studies, a small proportion (0.6%) of the 5 Cicadellini were successfully attacked by *G. tuberculifemur*.

Laboratory host range tests of South American *Gonatocerus* spp. showed that these wasps are evidently restricted to sharpshooters within the leafhopper tribe Proconiini in both South and North America. Field host range tests indicated that *G. tuberculifemur* can have limited development on some Cicadellini as well. The latter results suggest that the use of laboratory tests to determine host range might not be an accurate method for screening for nontarget hosts. However, separate biological and molecular studies suggest that there may be significant genetic variation among *G. tuberculifemur* populations in the test region, and that the conflicting host range results could be due to the existence of sympatric cryptic species of *G. tuberculifemur* in the test area. Future studies should be directed at resolving the taxonomic status of species selected as candidates for evaluation for release, identifying and rigorously screening any additional nontarget species of concern, and conducting interspecific competition tests between exotic and native parasitoids.

## REFERENCES

- Jones, W. A. 2001. Classical biological control of the glassy-winged sharpshooter, pp. 50-51. *In* Proceedings of the Pierce's Disease Research Symposium, December 5-7, 2001, Coronado Island Marriott Resort, San Diego, CA. California Department of Food and Agriculture.
- Jones, W. A., G. A. Logarzo, S. V. Triapitsyn, M. Casas, E. G. Virla and A. H. Purcell. 2005. Biology and host range of 2 South American egg parasitoids (Hymenoptera: Mymaridae), possible biocontrol agents for glassy-winged sharpshooter (Say) (Hemiptera: Cicadellidae; Proconiini). *In*: Proc. 12<sup>th</sup> International Auchenorrhyncha Congress and 6<sup>th</sup> International Workshop on Leafhoppers and Planthoppers of Economic Significance, August 7-12, University of California, Berkeley, Berkeley, California. *In press*.
- Logarzo, G. A., E. G. Virla and W. A. Jones. 2005. Egg parasitoids from Argentina, potential candidates for the biological control of glassy-winged sharpshooter *Homalodisca coagulata* (Cicadellidae) in the United States. Second International Symposium on Biological Control of Arthropods, 12-16 September 2005, Davos, Switzerland, USDA Forest Service, Morgantown, West Virginia, USA.
- Virla, E. G., G. A. Logarzo, W. A. Jones and S. Triapitsyn. 2005. Biology of *Gonatocerus tuberculifemur* (Hymenoptera: Mymaridae), an egg parasitoid of the sharpshooter, *Tapajosa rubromarginata* (Hemiptera: Cicadellidae). *Fla. Entomol.* 88 (1): 67-71.

## FUNDING AGENCIES

Funding for this project was provided by the USDA Agricultural Research Service.

**Additional Note:** We acknowledge Marilyn Casas for her excellent technical assistance.

## EVALUATION OF SOME FUNGAL PATHOGENS FOR THE CONTROL OF THE GLASSY-WINGED SHARPSHOOTER

### Project Leader:

Harry K. Kaya  
Department of Nematology  
University of California  
Davis, CA 95616

### Researcher:

Surendra K. Dara  
University of California, Davis  
Shafter Research and Extension Center  
Shafter, CA 93263

### Cooperator:

Michael R. McGuire  
USDA, ARS  
Shafter Research and Extension Center  
Shafter, CA 93263

**REPORTING PERIOD:** The results reported here are from work conducted October 2004 to September 2005.

### ABSTRACT

Several isolates of the hyphomycetous fungi, *Beauveria bassiana* (Balsamo) Vuillemin and *Metarhizium anisopliae* (Metschnikoff) Sorokin, were recovered from the glassy-winged sharpshooter (GWSS), *Homalodisca coagulata* (Say), habitats and other insect hosts in southern California. Some of these isolates were evaluated against GWSS along with other fungal pathogens isolated from GWSS in Texas, Mississippi and Florida. Growth of the selected isolates was also evaluated at 15, 23, 28 and 32°C. Two California isolates and a Texas isolate of *B. bassiana* were significantly more virulent to GWSS than other isolates. Although no natural fungal infections have been found in GWSS populations in California to date, we continue to search for them by periodical sampling in Kern, Riverside and Ventura counties.

### INTRODUCTION

A collaborative project between UC Davis and USDA-ARS is aimed at identifying suitable entomopathogenic fungi for the control of the glassy-winged sharpshooter (GWSS), *Homalodisca coagulata* (Say), a pest that threatens the grape industry in California as a vector of the Pierce's disease causing bacterium, *Xylella fastidiosa*. Entomopathogenic fungi, which enter the host through the cuticle, are ideal candidates for insects like GWSS with piercing and sucking mouthparts. Entomopathogenic fungi were isolated from GWSS in the southeastern United States (Mizell and Boucias 2002, Kanga et al. 2004), but no fungal pathogen has so far been reported in California GWSS populations. However, we recovered several isolates of two generalist fungi, *Beauveria bassiana* (Balsamo) Vuillemin and *Metarhizium anisopliae* (Metschnikoff) Sorokin, from GWSS habitats in California and tested them against GWSS (Kaya et al. 2004). We also isolated *B. bassiana* from California harvester ant, *Pogonomyrmex californicus* (Buckley), three-cornered alfalfa hopper, *Spissistilus festinus* (Say) and a darkling beetle from Kern, Fresno and Riverside counties, respectively. Bioassay protocols were improved and experiments were conducted to compare efficacy of several fungi against GWSS.

### OBJECTIVES

1. Conduct surveys to find fungal infections in GWSS populations or insects closely related to GWSS.
2. Culture and isolate the fungi and evaluate their pathogenicity against GWSS.
3. Assess environmental effects like temperature and sunlight on conidial survival and germination, fungal growth, and infectivity.
4. Evaluate the host range of fungi that infect GWSS.
5. Conduct small-scale field tests to evaluate selected pathogens against GWSS on citrus in fall and winter.

### RESULTS

#### Natural infections in GWSS populations

We continue to search for natural infections in GWSS populations in southern California. GWSS adults were periodically collected from Kern, Riverside and Ventura counties on citrus, oleander and some weed hosts like mare's tail, mule-fat and Spanish tobacco. Insects were monitored in the laboratory for at least two weeks in attempts to recover infected individuals, but no entomopathogenic fungi have been found in these insects.

We tested several previously received isolates of *B. bassiana* recovered in Texas (Walker Jones, USDA-ARS now in Montpellier, France) and Mississippi (Russell Mizell and Drion Boucias, University of Florida) and a new species of *Hirsutella* recovered in Florida and Mississippi (Mizell and Boucias). We recently received GWSS infected with *Pseudogibbellula formicarum* (Mains) Samson & Evans collected in Poplarville, MS by John Goolsby (USDA-ARS, Weslaco, TX) and have conducted preliminary experiments with the isolate.

### Virulence of entomopathogenic fungi to GWSS

#### *Beauveria bassiana*

Laboratory-reared GWSS adults supplied by CDFA, Riverside were used for the bioassays. Seven isolates of *B. bassiana* - two from California GWSS habitats, one each from the California harvester ant, three-cornered alfalfa hopper, GWSS from Weslaco, TX, GWSS from Jackson, MS and a commercial isolate GHA (Emerald BioAgriculture) - were evaluated against GWSS. GWSS were anesthetized by exposing them to CO<sub>2</sub> for 20 sec and then inoculated by rolling them in a 10 µl drop of conidial suspension at 1 X 10<sup>9</sup> conidia/ml concentration. Controls were treated with 0.01% of SilWet, an adjuvant used for preparing conidial suspensions. GWSS were incubated on potted cowpea plants covered with cylindrical cages and their mortality was recorded daily for two weeks. Cadavers were surface sterilized in 3% sodium hypochlorite solution and incubated on water agar for fungal emergence. These assays were repeated four times. Three of the isolates - Texas isolate from GWSS (TxBb) and California isolates from three-cornered alfalfa hopper and soil (Bb 41) - caused significantly higher ( $P < 0.01$ ) infections than others (Figure 1).

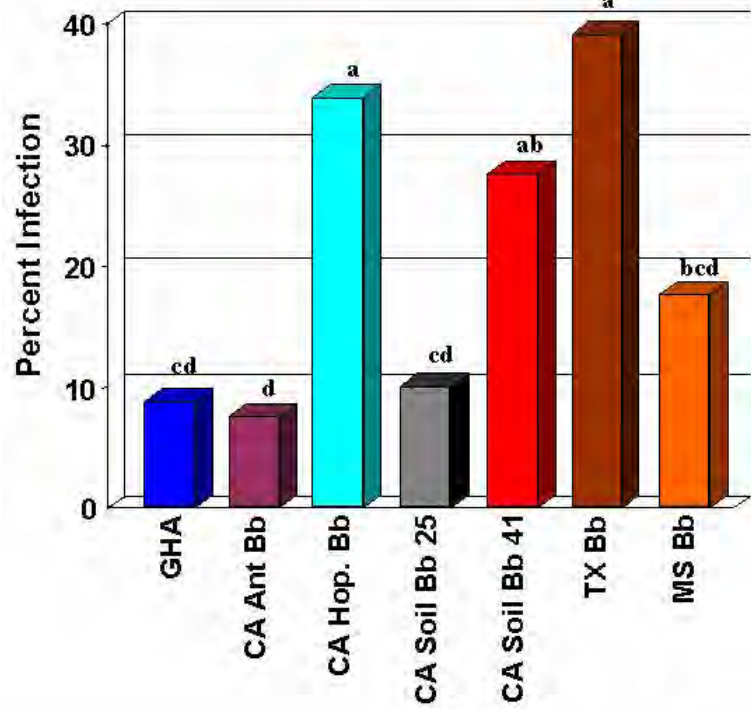


Figure 1. Virulence of *B. bassiana* to GWSS

#### *Hirsutella* spp.

An assay was conducted to compare different isolates of *Hirsutella* spp., an isolate of *B. bassiana* and an unknown fungus, all recovered from natural infections in GWSS in Mississippi and Florida (provided by Mizell and Boucias). Due to poor conidial production of some of these isolates on standard culture media, hyphal bodies for all isolates were cultured on liquid glucose medium enriched with yeast extract. Treatments were administered either by injecting about 1 µl of the suspension at 1 X 10<sup>9</sup> hyphal bodies/ml through intersegmental membrane in the abdomen using a capillary tube or by rolling the insects in a 10 µl drop of the suspension (Figure 2). The rest of the procedure was similar to the one explained above. In general, higher mortality and infection resulted from injection than topical application (Figure 3).

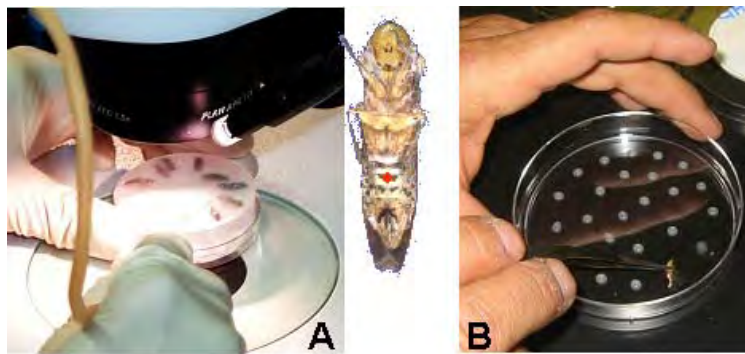
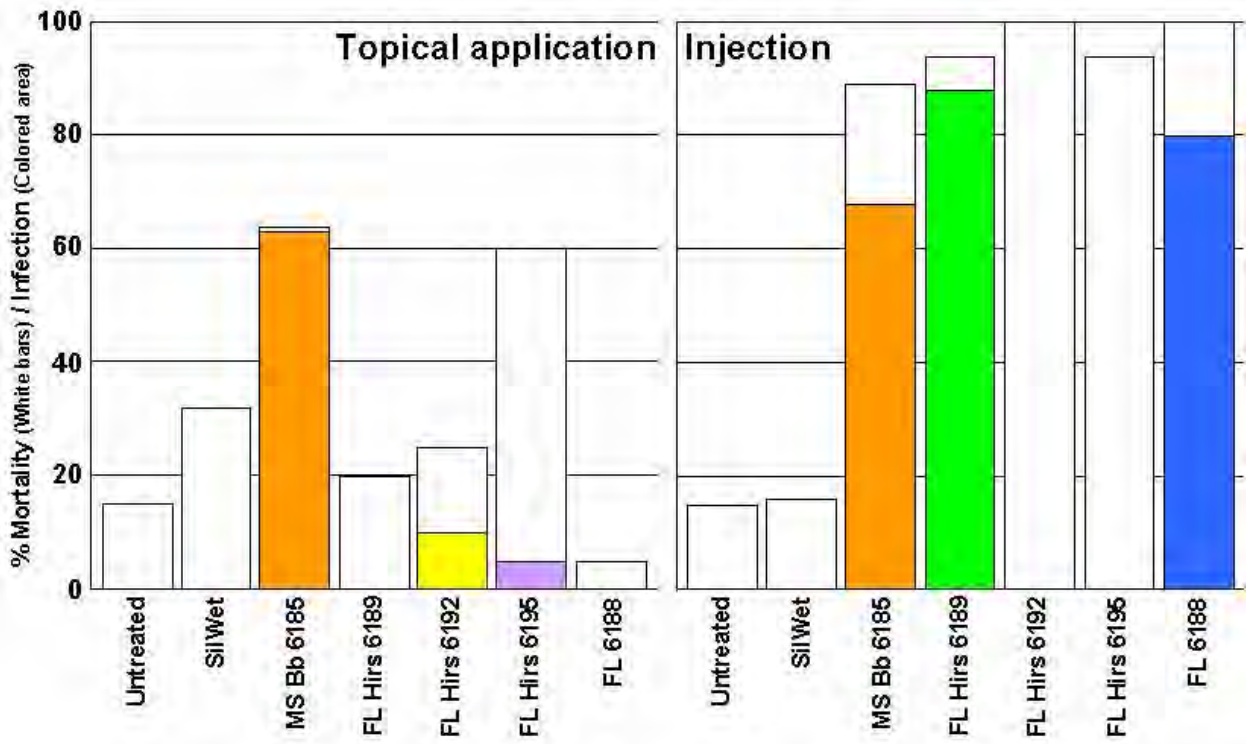


Figure 2. Injection (A) and topical application (B) of hyphal bodies.



**Figure 3.** Pathogenicity of *B. bassiana* and *Hirsutella* spp to GWSS. White bars indicate percent mortality and colored area indicates percent infected among dead.

#### *Pseudogibellula formicarum*

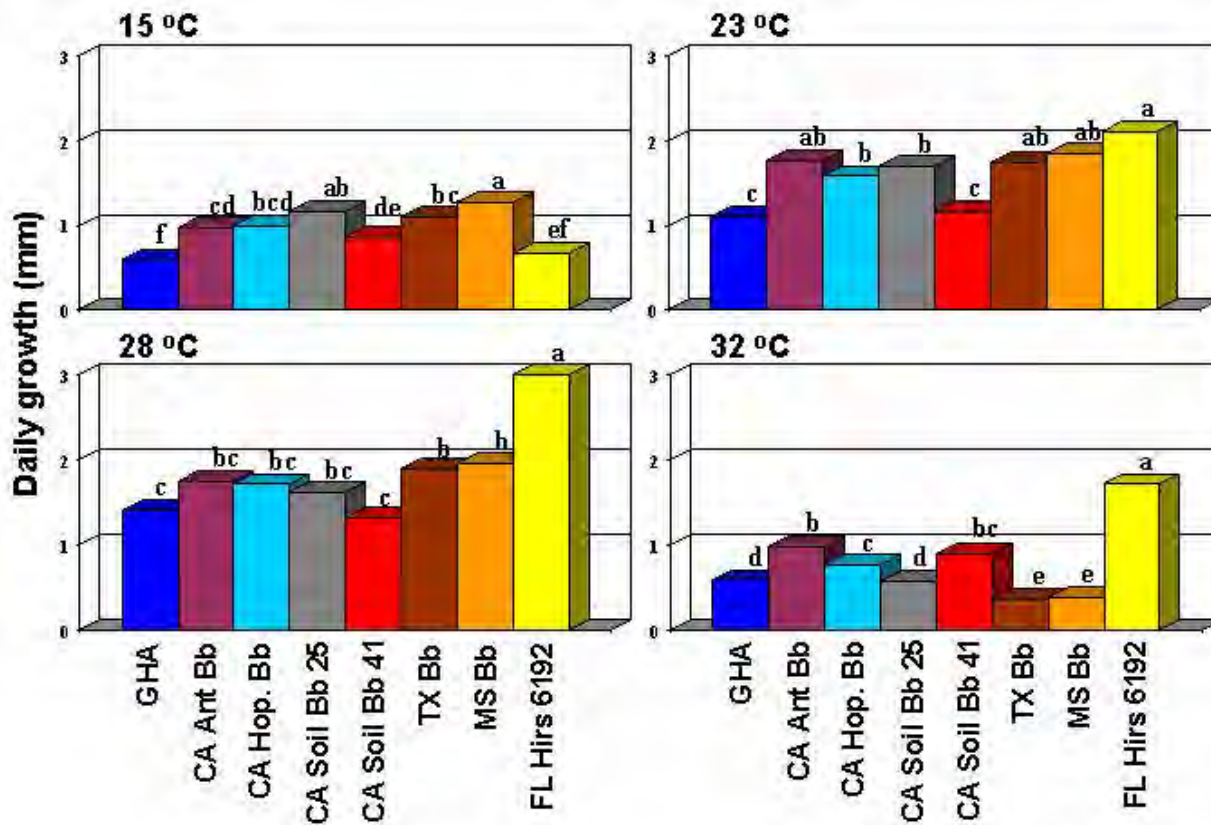
Cadavers of GWSS with this fungus are frequently seen in the southeastern United States (Kanga et al. 2004, Mizell and Boucias, personal communication; Figure 4). Two small-scale assays were conducted where GWSS cadavers with sporulating *P. formicarum* were rubbed against healthy insects and incubated individually in clip cages attached to potted euonymus plants. So far no infection has been found in the treated insects.



**Figure 4.** GWSS infected with *P. formicarum*

#### Radial growth of some fungal isolates

An assay was conducted to determine the effect of temperature on the growth of some of the selected fungal isolates at 15, 23, 28 and 32 °C. A 9 mm disc was cut out from 3-5 d old fungal culture and incubated on Sabouraud dextrose agar medium enriched with yeast extract. Fungal growth was monitored for four weeks and average daily growth was determined. This assay was repeated thrice. Significant differences were found among the isolates ( $P < 0.001$ ; Figure 5). Florida isolate of *Hirsutella* sp. (6192) outgrew *B. bassiana* isolates at higher temperatures. Among the three isolates that showed higher virulence against GWSS, growth rate of Bb 41 was lower than the other two isolates at all temperatures except 32°C while TxBb had the slowest growth rate at this temperature.



**Figure 5.** Radial growth of *B. bassiana* and *Hirsutella* sp. at different temperatures. Bars with the same letter are not significantly different ( $P < 0.001$ ).

## CONCLUSIONS

The *B. bassiana* isolates from GWSS from Texas (TxBb) and three-cornered alfalfa hopper and soil (Bb 41) from California were significantly more virulent than other isolates against GWSS. However, their growth varied at different temperatures. These isolates will be thoroughly evaluated for their potential for GWSS control through various laboratory and field experiments. Search for natural infections in California populations of GWSS will continue.

## REFERENCES

- Kanga, L.H.B., W. A. Jones, R. A. Humber, and D. W. Boyd, Jr. 2004. Fungal pathogens of the glassy-winged sharpshooter *Homalodisca coagulata* (Homoptera: Cicadellidae). Fla. Entomol. 87: 225-228.
- Kaya, H. K., S. K. Dara, and M. R. McGuire. 2004. Microbial control of glassy-winged sharpshooter, *Homalodisca coagulata* (Homoptera: Cicadellidae) with entomopathogenic fungi. In Pierce's Disease Research Symposium, Coronado Island, CA, Dec 7-10, 2004, pp. 349-351.
- Mizell, R.F. and D.G. Boucias. 2002. Mycopathogens and their exotoxins infecting glassy-winged sharpshooter: survey, evaluation, and storage. In Pierce's Disease Research Symposium, Coronado Island, CA Dec 15-18, 2002, pp. 161-162.

## FUNDING AGENCIES

Funding for this project was provided by the CDFR Pierce's Disease and Glassy-winged Sharpshooter Board.

# THE INFLUENCE OF TEMPERATURE ON DEVELOPMENT AND REPRODUCTION OF THE EGG PARASITOID *GONATOCERUS ASHMEADI*

## Project Leader:

Roger A. Leopold  
USDA, ARS  
Biosciences Research Laboratory  
Fargo, ND 58105

## Cooperators:

Wenlong Chen  
Department of Entomology  
Fargo, ND 58105

David J. Morgan  
CDFA, PDCP  
Mt. Rubidoux Field Station  
Riverside, CA

**Reporting Period:** The results reported here are from work conducted March 2005 to September 15, 2005.

## ABSTRACT

The effect of temperature on the development and reproduction of *Gonatocerus ashmeadi* (*G. ashmeadi*) Girault was studied in environmentally-controlled chambers set at 12°C, 16°C, 20°C, 24°C, 28°C and 32°C. Our results showed that the parasitoid developed the fastest at 28°C. The parasitoid took 27.1 days at 16°C and 9.5 days at 28°C to complete the development from egg to adult. The embryonic stage was 6.3 days at 12°C, about 2 days at 16-20°C, and 1 day at 24-32°C. At 16-32°C, the length of the first instar larval stage was about 1 day, but 6 days at 12°C. The development of the second and third instars also varied with temperature. At 16°C, the second and third instars were approximately 2 and 3 days in length, respectively, and 1 and 1.5 days at 28°C. Continued exposure to 32°C arrested the development of the third instar larvae. Prepupae developed faster as temperature increased, but slowed down when held at 32°C. Pupae also developed faster as the temperature increased, but without slowing at 32°C. Linear regression analysis showed that the threshold temperature for development was 5.5°C, 3.4°C, 8.3°C, 5.2°C, and 5.4°C for embryos, first, second, third instar larvae, prepupae and pupae, respectively. The lower temperature threshold was 8.2°C for egg to adult development. A total of 219.2 degree days above the minimum temperature threshold were needed to complete the development from egg to adult. Temperature also affected the emergence pattern of the *G. ashmeadi* adults. At 16°C and 20°C, adult emergence lasted 10 days and 5 days at 28°C and 32°C. The maximum emergence occurred on the first day of emergence at 20-32°C while the emergence peaked on the second day at 16°C. At 28°C and 32°C, about 92 and 88% parasitoids emerged within the first two days. At 20°C and 24°C, nearly 84 and 85% parasitoids emerged within the first three days. Temperature did not influence the sex ratio of the emerging *G. ashmeadi*, but significantly affected the longevity of both sexes. At 16°C, the life spans of female and male adults were 27 and 19 days, respectively, while at 28-32°C, their life spans ranged from 6 to 8 days. The maximum lifetime fecundity of the female parasitoid occurred at 24°C, with an average total of 105 eggs deposited. High temperature shortened parasitoid longevity and reduced lifetime fecundity. At 24°C and 32°C, *G. ashmeadi* deposited >10 eggs/day. At 16°C and 20°C, parasitoid oviposition was 3 and 7 eggs/day, respectively.

## INTRODUCTION

Over the past decade, the glassy-winged sharpshooter (GWSS), *Homalodisca coagulata* (*H. coagulata*) (Say), has become a serious economic threat to many agricultural and ornamental crops in California by serving as a key vector of the xylem-inhabiting bacterium, *Xylella fastidiosa* (Xf) Wells (Sorensen and Gill, 1996). The egg parasitoid, *G. ashmeadi* Girault, is one of the most common natural enemies against the GWSS. *G. ashmeadi* has established its population since it was discovered in 1978 and was most likely dispersed to California with the GWSS from the southeastern USA (Irvin and Hoddle 2005; Vickerman, *et al.* 2004). The parasitoid may have a considerable potential as an effective biological control agent of the GWSS because it accounts for 80-95% of the observed parasitism on the sharpshooter eggs in California (Phillips 2000). Previous studies on *G. ashmeadi* have focused on host age preference and parasitism (Irvin and Hoddle 2005), gene-related geographical population (Vickerman *et al.* 2004), mymarid taxonomy (Triapitsyn 2003), overwintering biology (López *et al.* 2004) and functional responses and superparasitism (Chen *et al.* submitted). To date, no studies have been conducted on establishing the relationship between temperature and the development and reproductive biology of *G. ashmeadi*.

Among other factors, temperature has dominant influence on developmental rate, survival and fecundity of animals. Some temperature-related analyses, such as temperature threshold, optimal and upper temperature, and thermal constant for development have been extensively used as the index for studies of behavior, abundance and geographical distribution of arthropods (Messenger 1959). On the other hand, determination of relationship between development and reproduction in response to temperature is vital to an understanding of the life history and population dynamics of the insects. Our research on *G. ashmeadi* will assist us to assess parasitoid laboratory production and colony management. Meanwhile, knowledge of temperature threshold and thermal constant will be helpful to design the protocol for cold storage of parasitized eggs used in later augmentative release in the biological control program.

## OBJECTIVES

1. Determine the effect of temperature on the rate of development from the egg to the adult stage.
2. Determine the temperature threshold and thermal constant of immature stages of *G. ashmeadi*.
3. Determine the emergence pattern, lifetime and daily fecundity and longevity of *G. ashmeadi* at a range of temperatures.



## RESULTS AND CONCLUSIONS

### Developmental rate determination

To determine the length of time required for development of *G. ashmeadi* at various temperatures, 250-700 *H. coagulata* eggs (< 24 h old) were exposed to the mated female parasitoids (< 24 h old) at a parasitoid/host ratio of 1: 25 in order to reduce the effect of super-parasitism (22 ±1°C and 10 L: 8 D). After 4 h, the parasitized eggs were transferred into six environmentally-controlled chambers set at a constant 12°C, 16°C, 20°C, 24°C, 28°C, and 32°C while operating on a 16 L: 8 D photoperiod and 60% RH. At least 10 parasitized eggs were dissected daily for each temperature to determine the development rates of the parasitoids. Dissections were performed in an alcoholic solution of 0.02% eosin under a stereomicroscope. Our results showed that the developmental rate of *G. ashmeadi* varied with temperature (Table 1). The duration of parasitoid development at 16°C from egg to adult emergence was significantly longer than that at 20°C, 24°C, 28°C and 32°C ( $F = 1687.06.40$ ,  $df = 4,195$ ,  $P < 0.0001$ ). There was no significant difference between developmental times at 28°C and 32°C or between 20°C and 24°C from oviposition to adult emergence. The duration of the individual stages was also significantly affected by temperature as evidenced by the following values: embryonic ( $F = 293.75$ ,  $df = 5,234$ ,  $P < 0.0001$ ), first instar larval ( $F = 1456.57$ ,  $df = 5,230$ ,  $P < 0.0001$ ), second instar larval ( $F = 27.96$ ,  $df = 4,193$ ,  $P < 0.0001$ ), third instar larval ( $F = 52.47$ ,  $df = 4,195$ ,  $P < 0.0001$ ), prepupal ( $F = 58.03$ ,  $df = 1,194$ ,  $P < 0.0001$ ) and pupal ( $F = 952.93$ ,  $df = 4,195$ ,  $P < 0.0001$ ) (Table 1). The time to complete embryonic development at 12°C was highly significantly longer than those of the other temperatures, but there was no difference in embryonic development time between 16°C and 20°C or among the range of temperatures from 24°C to 32°C. The developmental rate for first instar larvae was similar at 16-32°C, but they were significantly faster than those held at 12°C. Second instar larvae developed significantly slower at 16°C than that at other temperatures. At 28°C and 32°C, second instar larvae developed faster than they did at 20°C and 24°C. Third instar larvae at 16°C took 3 days to complete their development, and 2 days at 20°C, 24°C and 32°C. When held at 28°C, third instar larvae developed faster than the other temperatures. The prepupae developed at the same rate as third instar larvae. Pupae developed faster as the temperature increased. At 28°C and 32°C, the pupal stage was nearly 3 days, but at 24°C, 20°C and 16°C, the pupal stage is 6.9 and 16 days, respectively (Table 1).

**Table 1.** Developmental duration of *G. ashmeadi* as a function of temperature

(°C)	Duration of Parasitoid Stages (Day ± S.E.)*						
	Embryonic	1 <sup>st</sup> instar	2 <sup>nd</sup> instar	3 <sup>rd</sup> instar	prepupal	pupal	Egg to female adult emergence
12	6.3 ± 0.4a	10.8 ± 0.4a	In progress	In progress	In progress	In progress	In progress
16	1.9 ± 0.1b	1.3 ± 0.1b	2.2 ± 0.2a	3.1 ± 0.4a	2.7 ± 0.1a	16.1 ± 0.7a	27.1 ± 0.9a
20	1.7 ± 0.2b	1.3 ± 0.2b	1.9 ± 0.1b	2.1 ± 0.1b	1.9 ± 0.2b	9.3 ± 0.5b	18.6 ± 0.5b
24	1.2 ± 0.1c	1.3 ± 0.1b	1.5 ± 0.1c	1.9 ± 0.1b	1.5 ± 0.1c	5.9 ± 0.5c	13.4 ± 0.5c
28	1.1 ± 0.1c	1.0 ± 0.1b	1.1 ± 0.1d	1.5 ± 0.2c	1.2 ± 0.1d	3.3 ± 0.2d	9.5 ± 0.5d
32	1.1 ± 0.1c	1.2 ± 0.1b	1.3 ± 0.1d	2.1 ± 0.1b	1.3 ± 0.1cd	2.8 ± 0.4e	9.6 ± 0.3d

\*Duration for each parasitoid instar, prepupa and pupa was determined by subtracting the mean day of a given stage from the mean day of the following stage. For each experiment, between 280 to 350 *H. coagulata* eggs (at 12°C, > 700 eggs) were dissected. A one-way ANOVA followed by the LSD test ( $P < 0.05$ ) was used to determine if there were significant differences in developmental time. Means within columns followed by a different letter are significantly different.

**Table 2.** Threshold temperatures and thermal constants for *G. ashmeadi* calculated by linear regression analysis.

Stage	Temperature threshold (°C)	Fitting regression equation	R <sup>2</sup>	Thermal constant (K) (degree-day) <sup>a</sup>
Egg <sup>b</sup>	5.48	$R_T = 0.0241 * T - 0.1325$	0.26	23.75
First instar <sup>b</sup>	3.44	$R_T = 0.0308 * T - 0.1058$	0.47	21.61
Second instar	8.30	$R_T = 0.0322 * T - 0.2667$	0.28	20.74
Third instar	5.20	$R_T = 0.0313 * T - 0.1626$	0.41	34.37
Prepupal	5.44	$R_T = 0.0391 * T - 0.2129$	0.52	27.33
Pupal	13.16	$R_T = 0.0177 * T - 0.2328$	0.82	55.57
Egg to adult	7.49	$R_T = 0.0046 * T - 0.0348$	0.88	219.21

<sup>a</sup>Thermal constants were calculated by using the mean temperature method proposed by Soto et al. (1999).

<sup>b</sup>Data collected at 12°C were used in calculating the linear regression.

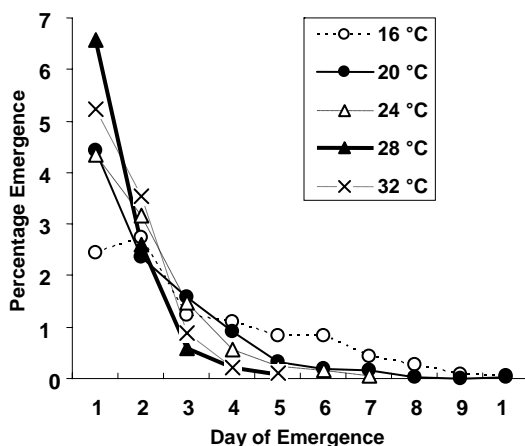
### Temperature threshold and thermal constant

The minimum temperature thresholds for the various stages were determined by using the linear regression model of Campbell *et al.* (1974), and the thermal constants were calculated using the mean temperature method of Soto *et al.* (1999). Our results show that the lower temperature threshold for development was 7.49°C for egg to adult development and that a total of 219.21 degree days above the minimum temperature threshold were needed to complete the development from egg to adult (Table 2). For first instar larvae, the minimum temperature threshold (3.44°C) was lower than other stages, suggesting that this stage may be more cold tolerant than other stages. Embryos required 23.75 degree days above the minimum temperature threshold (5.48°C) to complete development. The temperature thresholds for the development of second and third instar larvae were 8.3°C and 5.2°C, respectively. The temperature thresholds for completion of prepupal and pupal development were 5.44°C and 13.16°C, respectively. Pupae needed 57.57 degree days above temperature threshold to complete development. Our previous research on cold storage of parasitized eggs also showed that no *G. ashmeadi* survive storage temperatures at 2°C, about 7% survive 10 days at 4°C and nearly 35% survive for 20 days at 4.5°C (Leopold *et al.* 2004).

### Emergence patterns

After *H. coagulata* eggs were exposed to *G. ashmeadi* (parasitoid-to-egg ratio, 1: 80) for 24 hrs, they were placed at chambers set at 16°C, 20°C, 24°C, 28°C and 32°C. The parasitized eggs were examined daily and the date of emergence, the number of adults emerging, and the sex of the emerging adults were recorded. Our results (Figure 1) show that temperature not only influenced when emergence occurred, but also length of time it took for the majority of the adults to emerge from their hosts. Adult emergence spanned 10 days at 16°C and 20°C, 7 days at 24°C and 5 days at 28°C and 32°C (Figure 1). Temperature also affected the day on which emergence peaked. At 20°C, 24°C, 28°C and 32°C, the maximum emergence occurred on the first day of emergence, with approximately 44%, 43%, 66%, and 52% parasitoids emerged, respectively. The percentage emergence on the 1<sup>st</sup> day of emergence at 20-32°C was significantly higher than that on other days of emergence by comparing the emergence within the first four days (20°C,  $F = 13.76$ ,  $df = 4,56$ ,  $P < 0.0001$ ) or first three days (24°C,  $F = 9.20$ ,  $df = 2,42$ ,  $P = 0.0005$ ; 28°C,  $F = 31.66$ ,  $df = 2,48$ ,  $P < 0.0001$ ; 32°C,  $F = 20.54$ ,  $df = 2,45$ ,  $P < 0.0001$ ). At 28°C and 32°C, about 92 and 88% parasitoids emerged within the first two days. At 20°C and 24°C, nearly 84 and 85% parasitoids emerged within the first three days. At 16°C, emergence peaked on the second day though there was no difference in percentage emergence between the first and second day. The percentage emergence on the third to sixth day of emergence was significantly less than that on the first (24%) or second (27%) day ( $F = 4.24$ ,  $df = 5,60$ ,  $P = 0.0023$ ). From the seventh day on, only < 8% parasitoids emerged at 16°C.

On the first day of emergence, the percentage emergence at 28°C was significantly higher than that at 16-24°C ( $F = 4.93$ ,  $df = 4, 69$ ,  $P = 0.0015$ ). On the second day of emergence, there was no difference in the percentage emergence among five temperatures ( $F = 0.96$ ,  $df = 4,69$ ,  $P = 0.44$ ). On the third day of emergence, there were still 16 and 15% parasitoids emerging at 20°C and 24°C, respectively, significantly greater than the 6% of emergence at 28°C ( $F = 2.45$ ,  $df = 4,69$ ,  $P = 0.0474$ ). On the fourth day, 11 and 9% of the parasitoids emerged from *H. coagulata* eggs, significantly higher than at 28°C and 32°C ( $F = 4.14$ ,  $df = 4,69$ ,  $P = 0.0046$ ). On the fifth day of emergence, < 4% parasitoids emerged from hosts held at 20-32°C, significantly lower than 8% of those held at 16°C ( $F = 4.38$ ,  $df = 4,69$ ,  $P = 0.0032$ ).



**Figure 1.** Emergence patterns of *G. ashmeadi* as a function of the holding temperature. Each point equals the means of at least 12 separate replicates. To avoid confusion, standard errors are not displayed. However, for any given point, the value of the standard error was < 8% of the point's value. The difference in percentage emergence among temperatures was analyzed using one-way ANOVA followed by LSD test (PROC GLM, SAS). The percentage emergences occurring on the day of emergence at same temperature were also compared using one-way ANOVA followed by LSD.

### Reproduction, sex ratio and longevity

Temperature did not significantly influence the sex ratio of *G. ashmeadi* (Table 3). The male-female sex ratios ranged from 3.4 to 5.6 when the temperature was at 16-32°C. However, longevity of female and male adults varied significantly with the temperature at which they were held. Their life spans were extended as the temperature was decreased. For both female and male adults, longevity at 16°C was significantly longer than that at the other temperatures. Further, the longevity of insects held at 20°C was also significantly longer than those held at 24°C, 28°C and 32°C. Employing two-way ANOVA analysis,

using sex and temperature as factors, showed that the longevity not only varied significantly with sex ( $F = 8.26$ ,  $df = 1,178$ ,  $P = 0.0045$ ) and temperature ( $F = 94.24$ ,  $df = 4, 178$ ,  $P < 0.0001$ ), but also with interaction of sex X temperature ( $F = 45.20$ ,  $df = 9, 178$ ,  $P < 0.0001$ ).

Daily fecundity also varied significantly with temperature (Table 3). At 24°C, *G. ashmeadi* deposited about 105 eggs during its lifetime, significantly greater than 80, 81 and 55 eggs at 16°C, 28°C, and 32°C, respectively. There was no difference in lifetime fecundity between females ovipositing at 20°C and 24°C. At 24-32°C, the parasitoids deposited more than 10 eggs per day. There was no difference in daily fecundity among 24-32°C. At 16°C, the females oviposited only about 3 eggs per day, and at 20°C about 7 eggs per day (Table 3).

**Table 3.** Fecundity, sex ratio and longevity of *G. ashmeadi* as a function of temperature

°C)	Fecundity/female <sup>a</sup> (means ±S. E.)			Sex ratio (female/male)	Longevity (day ±S. E.) <sup>b</sup>	
	n	Lifetime fecundity	Daily fecundity		female	male
16	20	79.5 ± 3.2 c	3.5 ± 0.2 c	5.6 ± 1.2 (n = 12)	27.1 ± 1.2 a (n = 16)	19.0 ± 2.2 a (n = 10)
20	20	94.3 ± 4.5 ab	6.9 ± 0.5 b	3.4 ± 0.7 (n = 15)	16.0 ± 0.1 b (n = 29)	14.0 ± 0.2 b (n = 20)
24	24	105.2 ± 6.2 a	10.3 ± 0.8 a	3.9 ± 0.6 (n = 17)	9.4 ± 0.9 c (n = 23)	9.0 ± 0.7 c (n = 18)
28	28	81.3 ± 5.6 bc	10.7 ± 1.1 a	5.3 ± 0.6 (n = 20)	8.2 ± 0.6 cd (n = 20)	7.3 ± 1.0 c (n = 16)
32	32	55.3 ± 4.8 d	10.3 ± 1.4 a	5.4 ± 0.7 (n = 16)	6.4 ± 0.7 d (n = 19)	6.9 ± 0.8 c (n = 17)
<i>F</i>		13.50	13.26	1.75	68.05	25.45
<i>df</i>		4,93	4,93	4,75	4,102	4,76
<i>P</i>		< 0.0001	< 0.0001	0.1480	< 0.0001	< 0.0001

<sup>a</sup>Females were provided water and *H. coagulata* eggs (< 23 h) on excised euonymus leaves.

<sup>b</sup>Female and male adults were provided with water and excised euonymus leaves.

A one-way ANOVA followed by LSD test ( $p < 0.05$ ) was used to determine whether there were significant differences in developmental duration. Means within columns followed by a different letter are significantly different.

## REFERENCES

- Campbell, A., B. D. Frazer, N. Gilbert, A. P. Gutierrez and M. MacKauer. 1974. Temperature requirements of some aphids and their parasites. *J. Appl. Ecol.* 1: 431-438.
- Chen, W. L., R. A. Leopold and M. O. Harris. 2005. Parasitism of the Glassy-winged Sharpshooter, *Homalodisca coagulata* (Say) (Homoptera: Cicadellidae): Functional Responses and Superparasitism by *Gonatocerus ashmeadi* (Hymenoptera: Mymaridae). (submitted)
- Irvin, N. and M. Hoddle. 2005. Determination of *Homalodisca coagulata* (Hemiptera:Cicadellidae) egg ages suitable for oviposition by *Gonatocerus ashmeadi*, *Gonatocerus triguttatus* and *Gonatocerus fasciatus* (Hymenoptera Mymaridae). *Bio. Control.* 32: 391-400.
- Leopold, R.A., W. Chen and G. D. Yocum. 2004. Effects of constant and cyclic stepwise-increasing temperatures on parasitized and unparasitized eggs of the glassy-winged sharpshooter, *Homalodisca coagulata*, during cold storage. pp 1241-127. In Tariq, M. A.; S. Oswalt, P. Blincoe & T. Esser (eds). Proc. of Pierce's Disease Research Symposium, Dec.7-10, San Diego, CA.
- López, R., R. F. Mizell III, P. C. Anderson and B. V. Brodbeck. 2004. Overwintering biology, food supplementation and parasitism of eggs *Homalodisca coagulata* (Say) (Homoptera: Cicadellidae) by *Gonatocerus ashmeadi* Girault and *Gonatocerus morrilli* (Howard)(Hymenoptera: Mymaridae). *J. Entomol. Sci.*, 39: 214-222.
- Messenger, P. S. 1959. Bioclimatic studies with insects. *Ann. Rev. Entomol.*, 4, 183-206.
- Phillips, P. A. 2000. Protecting vineyards from Pierce's disease vectored by the glassy-winged sharpshooter: preliminary observation. *KAC Plant Protect. Quarterly*, 10: 6-7.
- Sorensen, S. J., and R. J. Gill. 1996. A range extension of *Homalodisca coagulata* (Say) (Hemiptera: Clypeorrhyncha: Cicadellida) Southern California. *Pan-pacific Entomol.* 72: 160-161.
- Sota, A., J. Apablaza, A. Noreroy, P. Estay. 2001. Requerimientos térmicos para el desarrollo de *Encarsia formaosa* (Hymenoptera: Aphelinidae) criado en *Trialeurodes vaporariorum* (Hemiptera: Aleyrodidae). *Ciencia e Investigación Agraria* 28: 103-106.
- Triapitsyn, S. V. 2003. Taxonomic notes on the genera and species of Trichogrammatidae (Hymenoptera)—egg parasitoids of the proconiine sharpshooters (Homoptera: Cicadellidae: Proconiini) in southeastern USA. *Trans. American Entomol.Soc.* 129: 245-265.

Vickerman, D.B., M. S. Hoddle, S. V. Triapitsyn, and R. Stouthamer. 2004. Species identity of geographically distinct populations of the glassy-winged sharpshooter parasitoid *Gonatocerus ashmeadi*: morphology, DNA sequences and reproductive compatibility. *Biol. Control*, 3: 338-345.

**FUNDING AGENCIES**

Funding for this project was provided by the USDA Animal and Plant Health Inspection Service, and the USDA Agricultural Research Service.

# REFRIGERATED STORAGE OF GLASSY-WINGED SHARPSHOOTER EGGS USED FOR PROPAGATION OF THE PARASITOID, *GONATOCERUS ASHMEADI*

## Project Leader:

Roger A. Leopold  
USDA, ARS  
Biosciences Research Laboratory  
Fargo, ND 58105

## Cooperator:

Wenlong Chen  
Department of Entomology  
North Dakota State University  
Fargo, ND 58105

**Reporting Period:** The results reported here are from work conducted October 1, 2004 to September 15, 2005.

## ABSTRACT

The studies investigated the storage of glassy-winged sharpshooter (GWSS) eggs below the temperature threshold for embryonic development and host acceptability and emergence from cold-stored hosts by *Gonatocerus ashmeadi* (*G. ashmeadi*). Our results showed that GWSS embryos failed to hatch after storage at 2°C for 5 days and 5°C for 11 days. *G. ashmeadi* parasitized dead *Homalodisca coagulata* (*H. coagulata*) eggs and completed development in hosts killed at 1, 3, 5, and 7 days post oviposition. Host age and length of time in cold storage were factors that influenced host acceptability and progeny production. After exposure to 2°C for 5 days and storage at 10°C for 10-60 days, parasitism of 1 day old GWSS eggs by *G. ashmeadi* ranged from 95% to 45%. Only 10% of 9 day old GWSS eggs were accepted as hosts by the parasitoids after 10 days and none after 25 days storage. *G. ashmeadi* progeny successfully emerged from 60% of 1 day old host eggs that were stored for 25 days while only about 11% of the 7 day old eggs supported parasitoid development after 25 days storage at 10°C. The parasitoid progeny reared using refrigerated dead GWSS eggs have the same fecundity and lifespan as wasps reared from live hosts that have not been exposed to cold storage.

## INTRODUCTION

The egg parasitoid, *G. ashmeadi* Girault, is one of the most common natural enemies against the GWSS, *H. coagulata* (Say) in California and southeastern USA (Irvin and Hoddle 2005). The parasitoid may have a considerable potential as an effective biological control agent of the GWSS because it accounts for 80-95% of the observed parasitism on the sharpshooter eggs in California (Phillips 2000). However, the propagation of this parasitoid for an augmentative release program is dependent on sustainable supply of host eggs. Cold storage of insects during the rearing process of insects has proved to be a valuable tool to bio-control when implementing an IPM program (Leopold 1998). Low temperature storage of insects and natural enemies can help synchronize many aspects of the rearing procedure and fill the gaps between parasitoid production and the targeted pest populations when demands become high. During the rearing process, *H. coagulata* eggs may be overproduced and discarded when demands for parasitoids are low or under-produced when demands are high. Therefore, methods for storing host eggs can be useful for improving the production efficiency of a parasitoid to be used later for augmentative release.

Leopold *et al.* (2004) showed that storage of GWSS eggs under a temperature regime that cycled daily had potential for propagating *G. ashmeadi* colonies. However, storage above the temperature threshold for GWSS development resulted in high hatch during the storage period (Leopold *et al.* 2003). Studies have shown that parasitoids can utilize moribund hosts after cold storage and can complete their development and reproduction normally (Legner 1979, Petersen and Matthews 1984, Rueda and Axtell 1987, Roth *et al.* 1991, Floate 2002). Further, these results implied that some parasitoids may adjust to the physiological status of their hosts and maximize their fitness under less than ideal conditions.

## OBJECTIVES

1. Determine cold tolerance of GWSS eggs stored at a constant temperature below the temperature threshold for development and evaluate survival after cold storage.
2. Determine the suitability and acceptability of dead GWSS eggs as hosts for propagating *G. ashmeadi*.
3. Assess the quality of *G. ashmeadi* progeny reared by using dead GWSS eggs and evaluate progeny fecundity and lifespan.

## RESULTS AND CONCLUSIONS

### Survival of host eggs

To determine the effect of storage temperature on the survival of *H. coagulata*, egg masses (< 24 hrs old) deposited on plant cuttings (*Euonymus japonica*) were placed into incubators that were set at constant temperatures at 2°C, 5°C, and 10°C under an 8L:16D photoperiod. Leopold *et al.* (2003, 2004) had previously studied the influences of constant temperatures above developmental threshold and cycled temperature regimes on survival of the GWSS eggs and their acceptability by *G. ashmeadi*. Here, we mainly report on the suitability and acceptability of GWSS eggs for parasitoid propagation after storage at temperatures below the developmental temperature threshold over time. Our results show that hatching of *H. coagulata* eggs after low temperature exposure varied significantly with temperature over storage time (Table 1). Hatching of GWSS eggs did not occur after storage at 2°C for 5 days or 5°C for 11 days. After 1 day of storage, <50% of GWSS eggs at 2°C

failed to hatch, whereas approximately 95% eggs successfully hatched at 10°C and 5°C. After 3 days of storage, 68% and 45% of the eggs stored at 10°C and 5°C hatched, respectively. After storage at 10°C for 7 days, hatching was about twice that at 5°C (50% vs. 26%). After 11 days at 10°C, the hatching percentage sharply dropped to 20% (Table 1).

A two-way ANOVA analysis, using storage time and temperature as factors, showed that the hatching percentage of the GWSS eggs was not only significantly influenced by storage temperature ( $F = 34.28$ ,  $df = 2,274$ ,  $P < 0.0001$ ) and storage time ( $F = 38.52$ ,  $df = 5,274$ ,  $P < 0.0001$ ), but by the interaction of temperature X storage time ( $F = 4.07$ ,  $df = 8,274$ ,  $P = 0.0003$ ). Therefore, exposure to temperatures below the embryonic developmental temperature threshold for a sufficient length of time causes developmental arrest and death of the GWSS eggs.

**Table 1.** Hatching percentage of *H. coagulata* eggs at three temperatures over storage time (days).

Storage temp.	Hatch percentage (means $\pm$ S.E.) <sup>a</sup>					
	1 d <sup>b</sup>	3d <sup>b</sup>	5d <sup>b</sup>	7d <sup>c</sup>	9d <sup>c</sup>	11d <sup>c</sup>
10°C	95.7 $\pm$ 1.3 Aa	67.8 $\pm$ 4.3 Aab	68.1 $\pm$ 6.9 Aab	50.1 $\pm$ 4.5*bc	47.1 $\pm$ 6.7*c	19.8 $\pm$ 6.9 *d
5°C	94.5 $\pm$ 1.5 Aa	44.6 $\pm$ 7.2 Ab	29.2 $\pm$ 6.9 Bbc	25.9 $\pm$ 9.2c	9.4 $\pm$ 6.5d	0.0 $\pm$ 0.0 d
2°C	49.9 $\pm$ 4.3 Ba	9.8 $\pm$ 2.9 Bb	0.0 $\pm$ 0.0 Cc			
<i>F</i>	57.18	22.85	36.86	$t = 2.73$	$t = 3.82$	$t = 3.33$
<i>df</i>	2,48	2,52	2,47	22	36	15
<i>P</i>	< 0.0001	< 0.0001	< 0.0001	0.0123	0.0005	0.0046

<sup>a</sup>Hatching percentages were log-transformed before analysis to meet the assumptions of normality and homogeneity of variances because the size of the egg masses was not constant. <sup>b</sup>A one-way ANOVA followed by the LSD test ( $P < 0.05$ ) (PROC GLM, SAS) was used to determine if there were significant differences in hatch percent. Means in the same column followed by a different capital letter and in same row followed by a different small letter are significantly different. <sup>c</sup>The T-test was used to determine if there was a significant difference between two sets of treatments (PROC TTEST, SAS). Asterisks indicate the percentages between the two treatments were significantly different ( $P < 0.05$ ).

#### Host acceptability by *G. ashmeadi*

Host acceptability (parasitism) was assessed by microscopically examining each GWSS egg within an egg mass for presence of a developing parasitoid. We found that the GWSS eggs killed by chilling were still utilized by *G. ashmeadi* as egg hosts under no-choice conditions. However, extending the holding time at the killing temperature was found to be detrimental. For example, approximately 18% of the dead host eggs caused by exposure to 5°C for 11 days were parasitized as opposed to >90% of those eggs killed by exposure to 2°C for only 5 days. Further, within these moribund GWSS eggs, the developing parasitoids successfully complete development to adulthood. To further determine the effectiveness of using moribund hosts in propagation of *G. ashmeadi*, GWSS eggs deposited on euonymus cuttings were killed by placing at 2°C for 5 days after holding for 1, 3, 5, 7 or 9 days post oviposition. They were then stored in an incubator set at 10°C with a photoperiod of 8L:16D. Next, these eggs were exposed to colonies (about 200 individuals/ cage) for 2 days at room temperature. After removal from the parasitoid cages, the acceptability of the dead GWSS eggs was evaluated by assessing the incidence of parasitism by physically examining each host for presence of a parasitoid.

A two-way ANOVA analysis, using host age and storage time as factors, showed that percentage parasitism varied significantly with storage time ( $F = 10.59$ ,  $df = 6, 474$ ,  $P < 0.0001$ ) and host age ( $F = 84.53$ ,  $df = 4,474$ ,  $P < 0.0001$ ). Also, the interaction between storage time and host age also significantly influenced the incidence of parasitism ( $F = 2.13$ ,  $df = 16,474$ ,  $P = 0.0066$ ) (Table 2).

After storage at 10°C for 10-25 days, parasitism of dead 1 day old GWSS eggs by *G. ashmeadi* was statistically similar, ranging from 65-95%. Also, there were no differences in parasitism among 1 day old eggs having a storage time between 30-60 days. This range was 45-55% parasitism. For 3 day old hosts, only after storage for 30 days did the parasitism significantly decrease. After storage of 60 days, only 25% of 3 day old GWSS eggs were parasitized. The 5 day old eggs had a similar incidence of parasitism when stored for 10-20 days. The parasitism for 5 day old eggs stored 25 days was significantly lower than those having a 10-day storage period. For 7 day old eggs, parasitism also decreased significantly after storage for 25 days. After storage for 10 days, only 11% of dead 9 day old eggs were parasitized by *G. ashmeadi* (Table 2). At 25 days of storage at 10°C, 9 day old eggs displayed no parasitism by the wasps, even under the no-choice conditions.

Host age significantly affected acceptance by *G. ashmeadi* of dead GWSS eggs over a storage time of 10-60 days (Table 2). After storage for 10 days, 95% of 1 day old eggs were parasitized, significantly higher than 57% and 10% of 7 and 9 day old eggs, respectively ( $F = 36.56$ ,  $df = 4,94$ ,  $P < 0.0001$ ). There were no differences in parasitism among 1, 3 and 5 day old

embryos. After storage for 15 days at 10°C, 86% of dead 1 day old eggs were successfully parasitized by the wasps, and 74, 62, 51 and 5% for 3, 5, 7, and 9 day old eggs. There were significant differences in parasitism between 7 and 9 day old and 1 day old eggs ( $F = 16.95$ ,  $df = 4,90$ ,  $P < 0.0001$ ). *G. ashmeadi* had a similar parasitism of 1,3 and 5 day old eggs that were stored for 20-25 days (Table 2). Percentage parasitism of 7 and 9day old eggs significantly decreased (20days,  $F = 29.93$ ,  $df = 4,83$ ,  $P < 0.0001$ ; 25 days,  $F = 21.27$ ,  $df = 4, 74$ ,  $P < 0.0001$ ). *G. ashmeadi* displayed 47-57% parasitism of 1, 3 and 5 day old eggs stored for 30 days, 45-56%, and 24-45% of 1 and 3 day old eggs for 50 and 60 days, respectively. There were no differences in parasitism among refrigerated 1, 3 and 5 day old eggs after storage for 30 days ( $F = 0.23$ ,  $df = 2,61$ ,  $P = 0.80$ ), and between 1and 3 day old eggs after storage between 50 and 60 days (Table 2).

**Table 2.** Effect of the age of refrigerated *H. coagulata* eggs on parasitism by *G. ashmeadi* over time (days).

Host Age (d)	Percentage parasitism over storage time <sup>a</sup> (means ± S. E.) <sup>b</sup>					
	10	20	25	30	50	60
1	94.5 ± 1.6Aa	78.3 ± 4.9Aa	65.4 ± 6.3Aab	48.1 ± 6.1Abc	55.8 ± 6.6Abc	45.2 ± 10.5Ac
3	83.7 ± 4.0ABa	73.4 ± 7.7Aab	60.6 ± 6.8Aab	57.2 ± 8.0Aab	45.7 ± 4.9Ab	23.5 ± 8.1Ac
5	64.7 ± 7.6BCa	62.0 ± 5.9Aab	52.2 ± 8.4Ab	47.3 ± 6.7Ab	Not available	Not available
7	57.1 ± 6.3Ca	48.6 ± 8.0Ba	19.8 ± 8.2Bb	Not available	Not available	Not available
9	10.8 ± 7.6Da	3.0 ± 2.1Ca	0 Ca			

<sup>a</sup> Storage time is represented by the days the time was 10°C. <sup>b</sup> A one-way ANOVA followed by the LSD test ( $P < 0.05$ ) (PROC GLM, SAS) was used to determine significant differences. Means in the same column followed by a different capital letter and in same row followed by a different small letter are significantly different. Percentage parasitism was log transformed before statistical analysis to meet the assumptions of normality and homogeneity of variances because the size of egg masses was not constant.

### Emergence

A two-way ANOVA analysis, using host age and storage time as factors, showed that the percentage emergence of *G. ashmeadi* not only varied significantly with host age ( $F = 80.35$ ,  $df = 4, 474$ ,  $P < 0.0001$ ) and storage time ( $F = 14.50$ ,  $df = 6, 474$ ,  $P < 0.0001$ ), but also with the interaction between storage time and host age ( $F = 1.84$ ,  $df = 16, 474$ ,  $P = 0.0243$ ) (Table 3). When storage was for 10 and 15 days before parasitism, percentage wasp emergences from 1 and 3 day old eggs were significantly greater than that for 5 or 9 day old hosts (10 days,  $F = 75.43$ ,  $df = 4, 94$ ,  $P < 0.0001$ ; 15 days,  $F = 25.05$ ,  $df = 4, 90$ ,  $P < 0.0001$ ). About 90 and 80% of *G. ashmeadi* adults emerged from 1 and 3 day old eggs stored for 10 days and 71 and 66% for 15 days, respectively (Table 3). After storage for 20 days, percentage emergence of the parasitoids from 1 day old eggs was significantly higher than that from 3 to 9 day old eggs ( $F = 20.85$ ,  $df = 4, 83$ ,  $P < 0.0001$ ). About 60 and 51% of the parasitoids successfully emerged from refrigerated 1 and 3 day old eggs, significantly more than that from 7 and 9 day old eggs ( $F = 16.91$ ,  $df = 4,74$ ,  $P < 0.0001$ ). After storage for 30-60 days, no significant differences were found among 1, 3, and 5 day old eggs (30 days,  $F = 0.49$ ,  $df = 2,61$ ,  $P = 0.62$ ), or between 1- and 3-d-old eggs (50days,  $P = 0.08$ ; 60 days,  $P = 0.21$ ).

Storage time at 10°C also significantly affected the percentage emergence of the wasp progeny from the dead GWSS eggs. The maximum emergence occurred for 1 day old parasitized eggs that were previously stored for 10 days (Table 3). For 1 day old eggs, the percentage wasp emergence remained statistically similar when they were stored for 10-25 days and it was significantly higher than that for 30-60 days ( $F = 8.21$ ,  $df = 6,145$ ,  $P < 0.0001$ ). Only 28% of *G. ashmeadi* emerged from 1 day old eggs stored for 60 days. For 3 day old eggs, the wasps had similar percentage emergences after storage for 10-20 days and they were also significantly higher than those for 30-60 days ( $F = 5.56$ ,  $df = 6,114$ ,  $P < 0.0001$ ). For 5 day old eggs, the emergence percentages remained stable when they were stored for 10-30 days ( $F = 0.88$ ,  $df = 4,89$ ,  $P = 0.48$ ), ranging from 38 to 58%. Percentage emergence from 7 day old eggs stored for 10-20 days was 37-46%, and only 11% for 25 days. No *G. ashmeadi* emerged from stored 9 day old hosts.

**Table 3.** Effect of age of refrigerated *H. coagulata* eggs on emergence of *G. ashmeadi* over storage time<sup>a</sup>(days).

Age (d)	Percentage emergence over storage time in days (means ± S. E.) <sup>b</sup>						
	10 d	15 d	20 d	25 d	30 d	50 d	60 d
1	90.4 ± 2.2Aa	75.7 ± 5.1Aa	70.6 ± 5.2Aa	60.2 ± 5.6Aa	40.6 ± 8.1Ab	48.7 ± 5.2Ab	27.8 ± 8.9Ac
3	79.9 ± 4.3Aa	66.0 ± 9.5Aab	59.2 ± 8.4ABab	51.2 ± 5.8ABbc	43.8 ± 8.9Abc	26.0 ± 5.5Acd	19.0 ± 8.5Ad
5	56.7 ± 7.2Ba	48.8 ± 8.4Ba	45.7 ± 7.6ABa	46.9 ± 5.6Ba	37.6 ± 6.4Aa	N.A.	N.A.
7	46.3 ± 5.5Ba	38.5 ± 7.1Ba	37.4 ± 6.4Ba	11.3 ± 6.1Cb	N.A.		
9	0.8 ± 0.8Ca	0 Ca	0 Ca	0 Da			

<sup>a</sup>Storage time represented the duration in the refrigerator set at 10°C. <sup>b</sup>A one-way ANOVA followed by the LSD test ( $P < 0.05$ ) (PROC GLM, SAS) was used to determine if there were significant differences in percentage parasitism. Means in the same column followed by a different capital letter and in same row followed by a different small letter are significantly different. Percentage parasitism was log-transformed before analysis to meet the assumptions of normality and homogeneity of variances because the size of the egg masses was not constant.

### Quality assessment of *G. ashmeadi* progeny

There is no significant difference in the number of GWSS eggs deposited by *G. ashmeadi* females that were reared using untreated eggs (control) and those reared from 1 day old eggs stored for 50 days ( $t = 2.2, P = 0.068$ ), or 7 day old eggs stored for 10 days ( $t = 2.5, P = 0.066$ ) (Figure 1). Dissections of parasitized GWSS eggs showed that within the first three days single females deposited from 50-58 eggs. Also, there is no difference in the female or male lifespan of parasitoids reared from untreated host eggs compared to that of wasps reared from 1 day old host eggs previously stored for 50 days at 10°C ( $P > 0.05$ ) (Figure 2). In the laboratory, the female lifespan was about 18 days and that of males, 15 days.

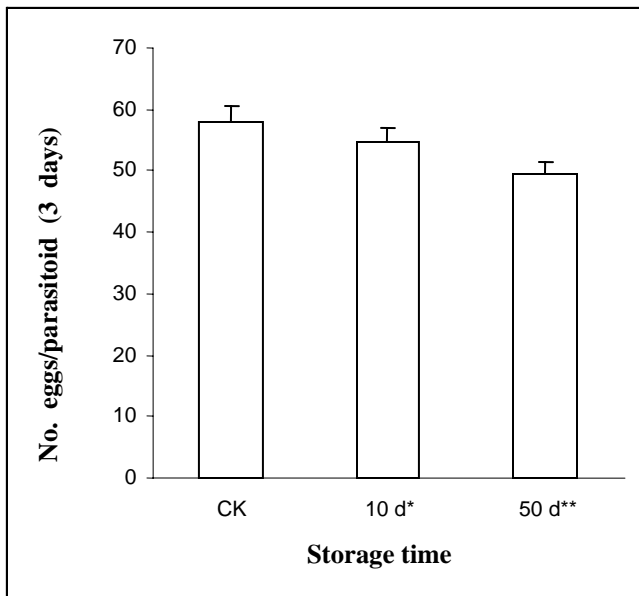
### REFERENCES

- Al-Wahaibi, A. K. and J. G. Morse. 2003. *Homalodisca coagulata* (Hemiptera: Cicadellidae) embryonic development at constant temperature. Florida Entomol., 86, 477-478.
- Floate, K. D. 2002. Production of filth fly parasitoid (hymenoptera: Pteromalidae) on fresh and on freeze-killed and stored house fly pupae. Biocontrol Sci.Tech. 12, 595-603.
- Irvin, N. and M. Hoddle. 2005. Determination of *Homalodisca coagulata* (Hemiptera:Cicadellidae) egg ages suitable for oviposition by *Gonatocerus ashmeadi*, *Gonatocerus triguttatus* and *Gonatocerus fasciatus* (Hymenoptera: Mymaridae). Bio. Control. 32: 391-400.
- Legner, E. F. 1979. Reproduction of *Spalangia endius*, *Muscidifurax raptor* and *M. zaraptor* on fresh vs. refrigerated fly hosts. Ann. Entomol. Soc. Am. 72, 155-157.
- Leopold, R. A. 1998. Cold storage of insects for integrated pest management. In: Temperature sensitivity in insects and application in integrated pest management. G. J. Hallman and D. L. Denlinger (eds). Westview Press, Boulder. pp. 235-267.
- Leopold, R. A, W. Chen , D. J. W. Morgan and G. D. Yocum. 2003. Cold storage of parasitized and unparasitized eggs of the glassy-winged sharpshooter, *Homalodisca coagulata*. pp 221-224. In Tariq, M. A.; S. Oswalt, P. Blincoe & T. Esser (eds). Proc. of Pierce's Disease Research Symposium, Dec. 8-11, San Diego
- Leopold, R. A, W. Chen , and G. D. Yocum. 2004. Effects of constant and cyclical stepwise-Increasing temperatures on parasitized and unparasitized eggs of the glassy-winged sharpshooter, *Homalodisca coagulata*, during cold storage. pp. 124-127. In Tariq, M. A.; S. Oswalt, P. Blincoe & T. Esser (eds). Proc. of Pierce's Disease Research Symposium, Dec. 7-10, San Diego
- Petersen, J. J. and J. R. Matthews. 1984. Effects of freezing of host pupae on the production of progeny by the filth fly parasite *Muscidifurax zaraptor* (Hymenoptera: Pteromalidae). J. Kansas. Entomol. Soc. 57, 387-393.
- Phillips, P. A. 2000. Protecting vineyards from Pierce's disease vectored by the glassy-winged sharpshooter: preliminary observation. KAC Plant Protect. Quarterly, 10: 6-7.
- Roth, J. P., G. T. Fincher & J. W. Summerlin. 1991. Suitability of irradiated or freeze-killed horn fly (Diptera: Muscidae) pupae as hosts for hymenopteran parasitoids. J. Econ. Entomol. 84, 94-98.
- Rusda, L. M. and R. C. Axtell. 1987. Reproduction of Pteromalidae (Hymenoptera) parasitic on fresh and frozen house fly (*Musca domestica* Linn) pupae. Philippine J. Sci. 116, 313-326.

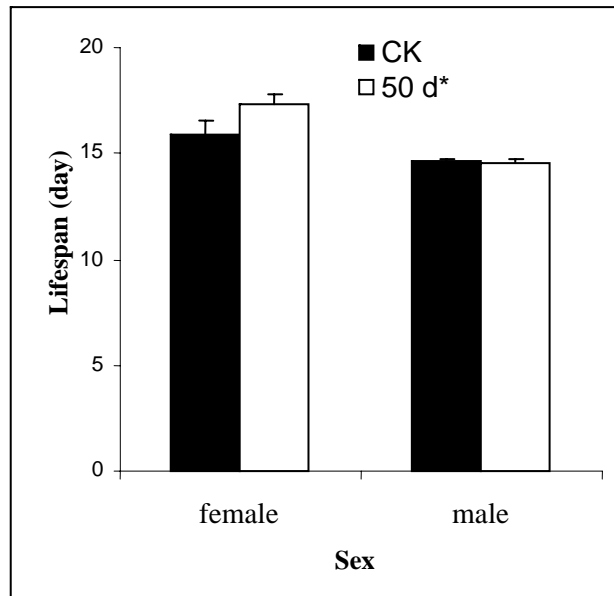
### FUNDING AGENCIES

Funding for this project was provided by the USDA Animal and Plant Health Inspection Service, and the USDA Agricultural Research Service.





**Figure 1.** The fecundity of *G. ashmeadi* females that had emerged from 7 day old\* *H. coagulata* eggs after storage at 10°C for 10 days and from 1 day old\*\* eggs stored 50 days compared to females emerged from untreated eggs. The number of parasitoid eggs was collected within first three days. The T-test was used to determine that there were no significant differences in fecundity of *G. ashmeadi* between the groups ( $P < 0.05$ , PROC TTEST, SAS).



**Figure 2.** The lifespan of *G. ashmeadi* females and males having emerged from untreated eggs (black bar) compared to 1 day old *H. coagulata* eggs (white bar) after storage at 10°C for 50 days. The T-test was used to determine that there were no significant differences in lifespan between the treated and the control groups ( $P < 0.05$ , PROC TTEST, SAS).

# GLASSY-WINGED SHARPSHOOTER'S (GWSS) POPULATION DYNAMICS AS A MEANS OF GAINING INSIGHT INTO THE MANAGEMENT OF GWSS POPULATIONS

## Project Leader:

Robert F. Luck  
Department of Entomology  
University of California  
Riverside, CA 92521

## Cooperators:

Carlos E. Coviella  
Laboratorio de Ecología  
Universidad Nacional de Luján, (6700)  
Luján, Argentina

Mark Hoddle  
Department of Entomology  
University of California  
Riverside, CA 92521

Peter Andersen and Russell Mizell, III  
Southern Region Pest Management Center  
University of Florida  
Quincy, FL 32351

**Reporting Period:** The results reported here are from work conducted January 2002 to June 2005.

## ABSTRACT

Our results indicate that:

1. Glassy-winged sharpshooter (GWSS) populations in untreated groves at University of California, Riverside (UCR) Agricultural Operations have been declining steadily since the beginning of 2002 through mid 2005 when sampling ceased. Current population densities are only 10% as dense as those during 2001-2002.
2. Forecast analysis indicates that, if current trends continue, untreated GWSS populations should decrease to their minimum densities sometime after winter 2008 and prior to summer 2013, depending on the *Citrus* species on which they are feeding.
3. Forecast analyses indicate that adult GWSS densities are cycling around an equilibrium density of 600 adults per Valencia tree and 950 adults per lemon tree when left untreated.
4. Population analyses indicate that 30% of the first instar nymphs survive to become fifth instar nymphs and less than 15% become adults on the citrus cultivar. Egg mortality is not included.
5. Current estimates of GWSS' impact on citrus production and fruit quality is an overestimate because the GWSS densities under which these measurements were made are 9 to 25 times more dense per tree than those that currently prevail in most untreated commercial orchards.

## INTRODUCTION

In late 1989, the GWSS, *Homalodisca coagulata* (Say) (Hemiptera: Cicadellidae), was detected in Irvine, California, most likely having arrived from the southeastern US as egg masses on imported ornamental plants (Sorensen and Gill 1996). Following its initial detection, GWSS spread throughout the inland coastal valleys of southern California (Orange, Riverside, and Ventura Counties) and, by 1997, had spread to the southern San Joaquin Valley, where it was first detected east of Bakersfield, Kern County, CA (Hill and Hashim 2004). Incipient populations were also detected at several San Joaquin and Sacramento Valley locations between 2000 and 2002, areas that encompass or are near several important table and wine grape growing regions in northern California. Of particular concern was the coincident distribution of GWSS in central and northern California with a portion of the distribution of *Xylella fastidiosa* (Xf) (Wells et al.), the causative agent of Pierce's disease (PD).

Citrus is considered to be the main source of GWSS adults migrating into the vineyards (Perring et al. 2001, Blua and Morgan 2003). In southern and central California, *Citrus* spp. is an important over-wintering host for GWSS, generating substantial GWSS populations on this host each spring (Coviella et al. In review). Using mark-release-recapture data obtained during June and July, 2001, Coviella et al. (In review) estimated that 1.2 million adult GWSS occurred per ha at a San Joaquin Valley citrus grove (Kern Co.) and 2.2 million adult GWSS occurred per ha at a southern California citrus grove (UCR, Ag Ops, Riverside Co). GWSS has two annual generations on citrus: one in late winter through spring and a second beginning in early summer and lasting through late autumn (Al-Wahaibi 2004, Coviella et al. In review). It is the adults arising from the spring generation produced on citrus that then disperse to the adjacent vineyards which has become of great concern to grape growers (Blua and Morgan 2003). The adult GWSS produced in autumn are the over-wintering population that initiates reproduction during the late winter or early spring, principally on citrus (Covella and Luck unpubl. data).

To prevent PD epidemics, GWSS population densities must become extremely scarce if PD's spread and transmission are to be disrupted. Thus, identifying whether critical periods in GWSS' two annual generations occur in which an appropriately

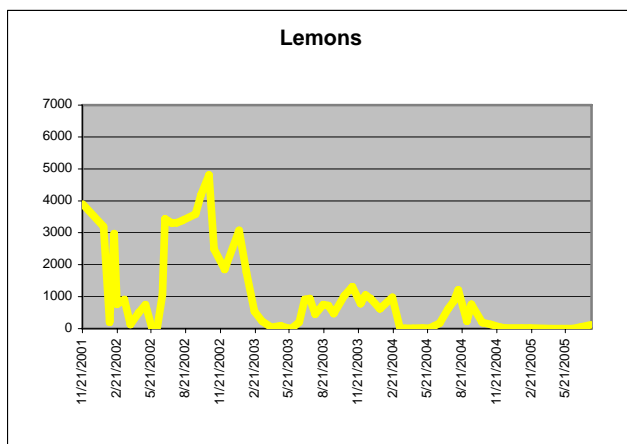
timed treatment will drive GWSS nearly extinct while minimizing disruption of the associated citrus arthropods is an important pest management concern. Similarly, assessing the impact of established and/or introduced egg parasitoids on GWSS population dynamics is also an important issue. It is with these issues in mind that we began a sampling program to determine GWSS' population dynamics on untreated citrus. We sought to determine whether GWSS densities were remaining static or decreasing during our three and a half year study, and if they were decreasing what likely densities they would attain.

## RESULTS

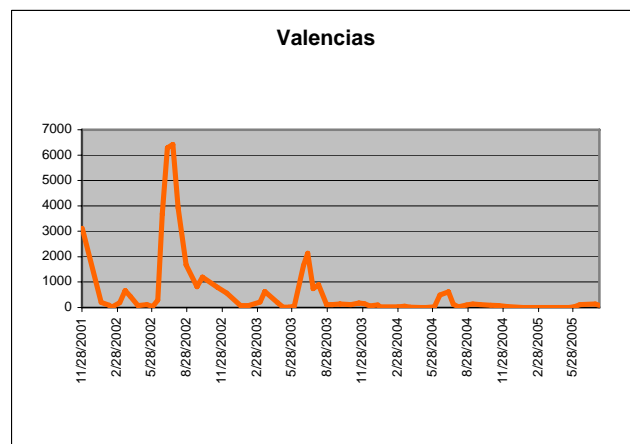
Our results to date suggest that GWSS has two major reproductive periods, one during the spring and a second during late summer-early autumn. The late summer-early autumn generation involves a dense egg population laid by GWSS females arising from the spring generation. Interestingly, very few of these eggs mature to become adult GWSS. Nevertheless the few females that do mature from this generation lay the eggs that initiate the late winter-spring generation the following year. We have measured egg parasitism ranging from 78% to 92% during this second generation, i.e. during the summer-autumn generation. In contrast, the eggs laid during the late winter early spring period appear to suffer less parasitism than those laid during the late summer or early autumn (Al Wahabi 2004). Our results also show substantial nymphal mortalities. Only about 30% of the first instar nymphs reach the last (fifth) nymphal stage, and less than 15% of the first instar nymphs survive to become adult GWSS, but this varies between the citrus varieties.

Our studies also show that the GWSS populations have declined substantially by July 2005 when compared to those in July 2002. The adult GWSS populations on orange trees at UCR Agricultural Operations in July, 2005, was 3% (= 200 GWSS per tree) of the adult GWSS population that we measured in July, 2002 (= 6,500 GWSS per tree) (Figure 1). By comparison, the GWSS population that we measured on lemons in October, 2004 was 16% (= 800 GWSS per tree) of that we measured in October, 2002 (= 5,000 GWSS per tree) (Figure 2). In general, an 80-90% decline occurred in the GWSS adult density during the last three years in Valencias and lemons. The 1.5 year period during which we sampled GWSS populations on tangerines and grapefruit is of insufficient duration to make a similar analysis of GWSS populations on these citrus varieties meaningful (Figures 3 and 4).

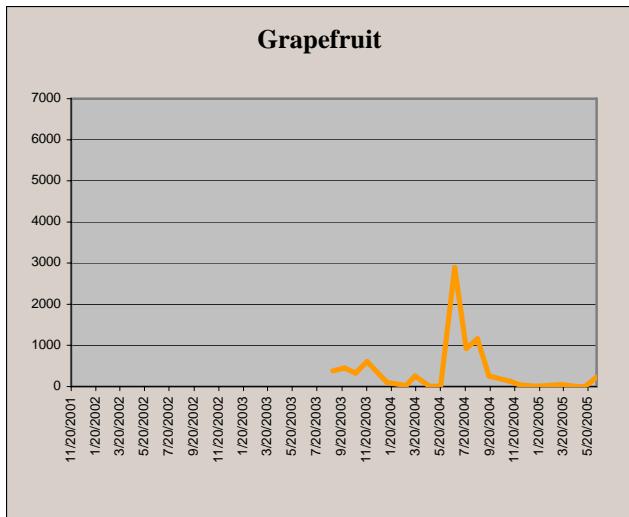
We also subjected the densities of the adult GWSS population densities and their trend during the 3.5 year sampling period on Valencia oranges to a forecast analysis (Figure 5). We also conducted a forecast analysis for the GWSS population densities and trend on lemons (Figure 6). We plotted the total adult and the newly emerged (red-veined) adult densities using a logarithmic scale. We then applied a forecasting technique to the GWSS adult density data from Valencia and lemons separately. Figures 5 and 6 show the results of this analysis if current trends were to continue and these density trends are extrapolated until they reach zero. Although these values will never reach zero, we use the plots to estimate a minimum and a maximum "extinction" date. The two extinction dates (defined by the points where the lines cross the X-axis in each graph) encompass the time period (interval in years) during which we estimate that GWSS adult populations will likely reach their minimum densities.



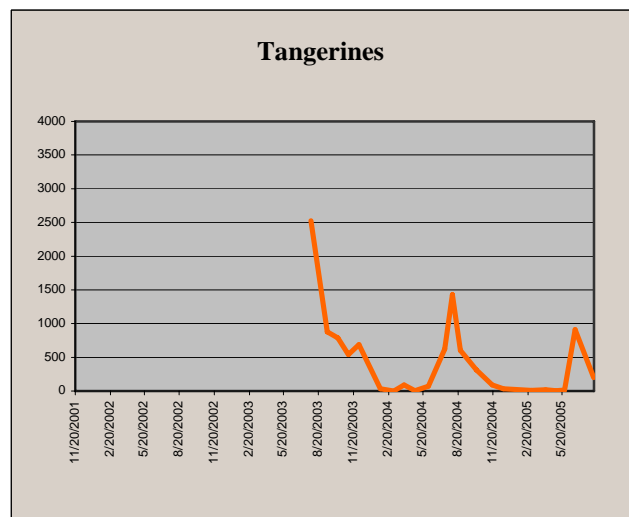
**Figure 1.** Actual adult GWSS densities in an untreated lemon grove (adults per tree).



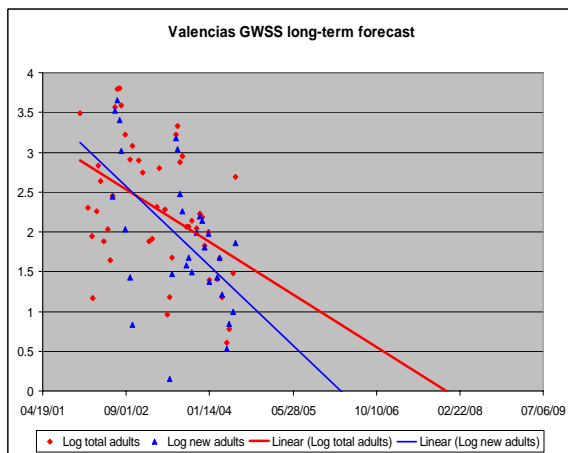
**Figure 2.** Actual adult GWSS densities in an untreated orange grove (adults per tree).



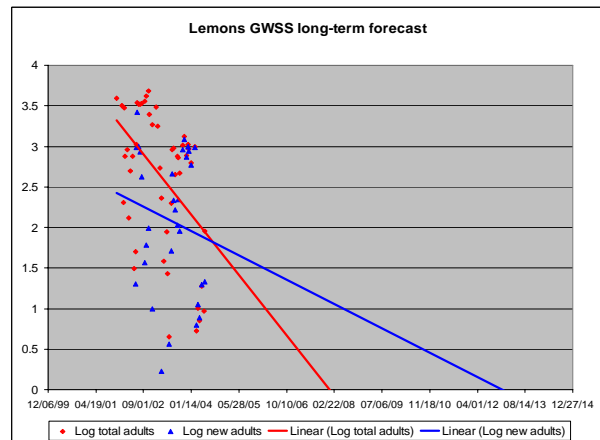
**Figure 3.** Actual adult GWSS densities in an untreated grapefruit grove (adults per tree) since fall 2003.



**Figure 4.** Actual adult GWSS densities in an untreated tangerine grove (adults per tree), since fall 2003.



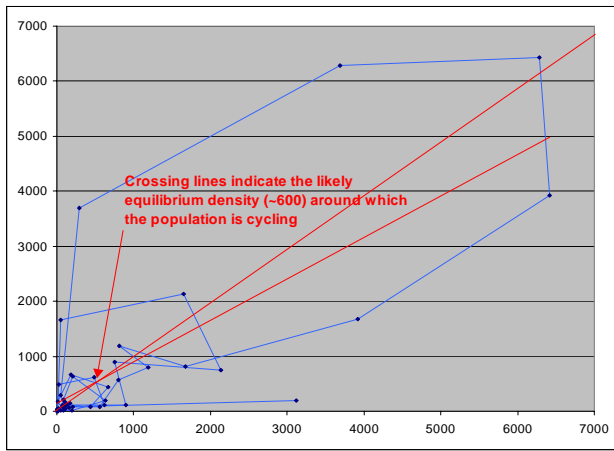
**Figure 5.** Logarithm of total and new adults with trend lines showing expected “zero density” dates (Valencia).



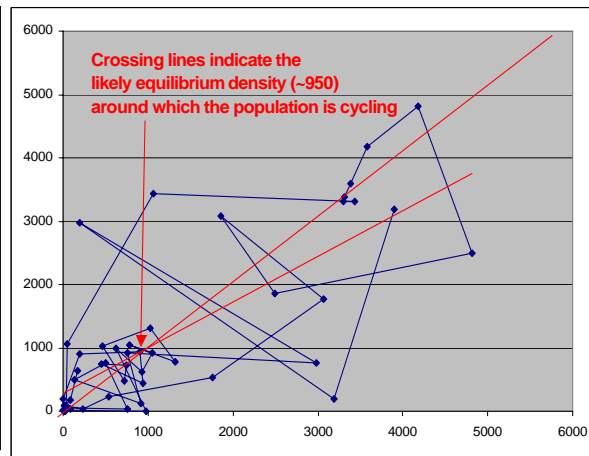
**Figure 6.** Logarithm of total and new adults with trend lines showing expected “zero density” dates (lemons).

If current trends continue, we estimate that the adult GWSS densities will reach their minimum densities within the next three to six years. We can also use a second and even more powerful technique to analyze the GWSS dynamics; a phase diagram (Figures 7 and 8). Each phase diagram shows a plot of adult GWSS densities during the current time interval as a function of their density during the previous time interval. In our case, it is the density of adult GWSS during a given week as a function of their density two weeks prior. The plotting is continued for each successive pair of sample dates and we obtain a phase diagram that shows whether the GWSS population density is cycling, and if it is cycling, an estimate of the density around which it will likely cycle. Figure 7 shows the phase diagram for Valencias.

The point at which the two diagonal lines cross indicates the equilibrium density, that is, the density around which the adult GWSS population is estimated to cycle, generation after generation. It is the density at which the population will occur generation after generation. For Valencias, this equilibrium density is about 600 adults per tree; for lemons (Figure 8), it is about 950 adults per tree. The analysis indicates that GWSS will never reach “zero density,” rather it will cycle above and below this density at different times of the year and in different years. The actual density in any given year can be as high as a thousand GWSS adults per tree or as low as 100 or less. GWSS population data for tangerines and grapefruit encompass too few generations to allow forecasting analysis to be applied to GWSS population using these hosts. We will need at least another year of GWSS data before we can conduct this analysis for these two citrus varieties.



**Figure 7.** Phase diagram for adult GWSS dynamics in Valencia (see text).



**Figure 8.** Phase diagram for adult GWSS dynamics in lemons (see text).

## CONCLUSIONS

Our results clearly show that the adult populations of GWSS have declined substantially during the 3.5 years of this study. In early summer of 2005, the 200 GWSS adults per tree were only 3% as dense as they were per tree in 2002 on untreated Valencia orange trees at UCR Agricultural Operations. Similarly, at this same location in 2005, the 800 adults were only 16% as dense as they were per tree on untreated lemon trees in 2002. These densities are estimated by enclosing the entire crown of a sample tree in two parachutes, fogging the enclosed tree with a pyrethrum insecticide, and, after vigorously shaking the tree, collecting all of the GWSS adults and immature nymphs on a ground cloth 24 hours after fogging the tree. Each sample date (twice a month) involved three replicate sample trees per citrus cultivar.

Our results also show that GWSS has two generations per year. The first generation comprises the GWSS adults which mature in the autumn and survive the winter to initiate egg-laying the following spring. The adults arising from this generation lay their eggs during the summer-fall period of the same year which give rise to the GWSS adults that over-winter and initiate oviposition the following spring period. Parasitization of the eggs laid during the spring is less than that which occurs to the eggs laid during the summer-autumn generation (Al Wahabi 2004). The autumn egg generation suffers between 78% (lemons) and 92% (Valencia) parasitism.

Currently, the suppression tactics directed against GWSS seeks to prevent emigration of the adults from a citrus grove to nearby vineyards. Movement of GWSS adults poses a risk of spreading PD to the vineyard and among the vines within a vineyard (Hill and Hashim 2004, Perring et al. 2001). If the immigrant GWSS adults also oviposit in the vineyard, then the immature nymphs may also spread PD among the vines. Thus, citrus growers are encouraged to treat the spring GWSS generation to prevent this movement. They are also compensated for these treatments. However, treating citrus during the period is highly disruptive of a sustainable pest management program that has been developed for citrus in California (Forster and Luck 1997; Luck et al. 1997). Pesticide applications during the spring period pose a dilemma for citrus growers practicing sustainable pest management. Such spring treatments often disrupt natural control and prevent the use of augmentative releases of natural enemies for control of California red scale, *Aonidiella aurantii* (Maskell) (Diaspididae: Hemiptera) (Forster and Luck 1997; Luck et al. 1997). Thus, a grower is often faced with an additional pesticide application because the timing of the GWSS treatment disrupts the natural control present in a grove under sustainable pest management or prevents the augmentative release of natural enemies. Thus a grower faces additional costs for which he/she does not receive compensation.

Lastly, even though GWSS densities are much lower than three years ago, data from June-July 2005 show that untreated citrus groves still sustain GWSS densities which peak at 13,000 (oranges), 20,000 (lemons), 12,000 (grapefruit), and 90,000 (tangerines) adults per acre. The uncertainty with the declining GWSS populations, especially in orange, lemon, and grapefruit, is whether these densities will decrease fruit quality as has been suggested by Hix et al. (2003). Their untreated trees supported 1,149-4,999 GWSS per tree in 2002 which converts to 114,900 to 499,000 if one assumes 100 trees to the acre. This ranges between 9.5 and 25 times more GWSS adults per acre than we measured at the peak GWSS densities in 2005. If the densities we measured in our experimental plots in 2005 are typical of those to which GWSS will decline, then we strongly suspect that the estimated impact of GWSS feeding is over estimated and is unlikely to be economic in the absence of citrus variegated chlorosis (the *Xf* induced disease in citrus). Thus experiments conducted by Hix et al. (2003) are unlikely to be relevant to untreated GWSS population densities in citrus if the GWSS population densities that we have measured are typical of those that will prevail in the presence of the GWSS egg parasitoids.

## REFERENCES

- Al-Wahaibi, A. K. 2004. Studies on two *Homalodisca* species (Hemiptera: Cicadellidae) in southern California: Biology of the egg stage, host plant and temporal effects on oviposition and associated parasitism and the biology and ecology of two of their egg parasitoids, *Ufens* A and *Ufens* B (Hymenoptera: Trichogrammatidae). Ph.D. Thesis, University of California, Riverside, 435 pp.
- Blua, M. J. and D. J. W. Morgan 2003. Dispersion of *Homalodisca coagulata* (Hemiptera: Cicadellidae) a vector of *Xylella fastidiosa* into vineyards of southern California. Jour Econ Entomol. 96: 1369-1374.
- Coviella, C. E., J. F. Garcia, D. R. Jeske, R. A. Redak and R. F. Luck. In Review. The feasibility of tracking within field movements of *Homalodisca coagulata* (Say) (Hemiptera: Cicadellidae) and estimating its densities using fluorescent dusts in mark-release-recapture experiments. Jour. Econ. Entomol. 28 ms pp.
- Forster, L. D. and R. F. Luck. 1997. The role of natural enemies of California red scale in an IPM program. Proceedings of the International Society of Citriculture VIII International Citrus Congress, May 12-17, 1996, Sun City, South Africa. 1:504-507.
- Hill, B. L. and J. Hashim. 2004. Epidemiological assessments of Pierce's disease and monitoring and control measures for Pierce's disease in Kern County. Proceed. Pierce's Disease Research Symp. Dec 7-10, 2004, Coronado, Calif. pg. 260-3.
- Hix, R. L., M. L. Arpaia, C. Lovatt, B. Grafton-Cardwell, and P. Philips. 2003. Glassy-winged Sharpshooter impact on orange yield, fruit size and quality. Proceed. Pierce's Disease Research Symp. Dec 8-11, 2004, Coronado, Calif. pg. 217-220.
- Luck, R. F., L. D. Forster, and J. G. Morse. 1997. A ecologically based IPM program for citrus in California's San Joaquin Valley. Proceedings of the International Society of Citriculture VIII International Citrus Congress, May 12-17, 1996, Sun City, South Africa. 1:499-503.
- Perring, T. M., C. A. Farrar, and M. J. Blua. 2001. Proximity to citrus influences Pierce's disease in Temecula Valley vineyards. Calif. Agric. 55; 13-18.
- Sorensen, J. T., and R. J. Gill. 1996. A range extension of *Homalodisca coagulata* (Say) (Hemiptera: Clypeorrhyncha: Cicadellidae) to southern California. Pan-Pacific Entomol. 72: 160-161.

## FUNDING AGENCIES

Funding for this project was provided by the CDFA Pierce's Disease and Glassy-winged Sharpshooter Board.

# EFFECTS OF JUVENILE HORMONE ANALOGS ON SURVIVAL AND REPRODUCTION STATUS OF THE GLASSY-WINGED SHARPSHOOTER

## Project Leaders:

Russell F. Mizell, III, and Peter C. Andersen  
University of Florida, NFREC  
Quincy, FL

## Cooperators:

Chris Tipping and Tobin Northfield  
University of Florida, NFREC  
Quincy, FL 32351

Wayne Hunter  
USDA, ARS  
Ft. Pierce, FL, 34945

**Reporting Period:** The results reported here are from work conducted February 25, 2005 to September 25, 2005.

## ABSTRACT

The impact of all of the currently recommended chemicals registered for use against glassy-winged sharpshooter (GWSS) is by direct or indirect mortality to the targeted life stages. One of the biggest problems in efforts to contain the spread of GWSS is the lack of effective treatments for GWSS egg masses that occur on many different host plants. Juvenile hormone analogs may have potential to suppress reproduction in GWSS. We have discovered that methoprene and perhaps other registered juvenile hormone analogs affect the reproduction of GWSS. This report summarizes our results to date which most notably include the observation of complete suppression by methoprene at label rates of the reproduction of GWSS females when treated during their diapause or preoviposition period.

## INTRODUCTION

The primary tools available for regulatory suppression and eradication are early detection followed by chemical pesticide applications (Redak and Blua 2003). Containing the spread of GWSS could be improved by the availability of effective treatments for GWSS eggs. The CDFA web site containing the GWSS nursery shipping protocol lists the following chemicals with efficacy against GWSS: acephate, cyfluthrin, methiocarb, bifenthrin, deltamethrin, permethrin, fenprothrin, carbaryl, chlorpyrifos and imidaclopid. Many of these chemicals have logistical limitations including long reentry intervals and other potential side effects that restrict their use or result in added environmental costs, as well as elicit severe negative reactions from the public. The impact of the currently-recommended pesticides registered for use against GWSS is by direct or indirect (feeding suppression by neonicotinoids, repellency by kaolin clay, Surround) mortality to the targeted life stages.

Redak and Bethke (2003) summarized the results of the previous evaluations of pesticides against the GWSS. A large number of chemicals have been evaluated against GWSS life stages that include commercially-available organic, biorational and reduced-risk chemicals. Evaluations of the efficacy of the chemicals were based primarily on mortality to the target stages. Moreover, the results from most previous evaluations were based on short-term tests using typical laboratory and field protocols whereby the mortalities of untreated control organisms are compared to treated individuals over a period of hours or days. Some insect growth regulators, primarily synthetic chitin inhibitors, have been tested over a period of several weeks and found to be effective against GWSS nymphs but caused no adult mortality. However, Redak and Bethke (2003) concluded that the activity of these compounds (buprofizen, novaluron and pyriproxifen) was too slow to be useful for eradication purposes. Other researchers (Akey et al. 2003) have evaluated certain biorationals including cinnamon oil, pyrethrum and piperonyl butoxide - for use in organic production and found limited efficacy against GWSS. To our knowledge, evaluation of the efficacy of the currently registered formulations of the juvenile hormone analogs methoprene, kinoprene and hydroprene has not been reported. These materials may have direct and indirect impacts on the behavior, reproduction or other physiological systems of GWSS. Moreover, the potential long-term impact of treatments to nymphs on the subsequent reproductive activities of adult GWSS has not been evaluated.

## OBJECTIVES

1. Determine the effects of the synthetic juvenile hormones methoprene (Diacon II), kinoprene (Enstar II) and hydroprene (Gentrol) on the survival and reproductive status of the life stages of GWSS.
2. Determine the effects of these hormones on GWSS parasitoids and two related leafhopper vectors.
3. Provide recommendations for use of these biorational chemicals against GWSS for eradication and other management objectives.

## RESULTS

### Parasitoids

We screened the compounds methoprene (1x rate= 0.009 ml/l AI), kinoprene (1x rate= 0.71 ml/l AI) and hydroprene (1x rate = 0.52 ml/l AI) in water solutions at concentrations of 0.1x, 1.0x and 10x the recommended rates for their impact on the GWSS egg parasitoids, *G. ashmeadi* and *G. morrelli*, by treating GWSS eggs containing the parasitoid larvae and by

topically treating the adult parasitoids. We observed no effect of the juvenile hormones tested on any life stage of either parasitoid species.

### Adult GWSS females in diapause

All GWSS used in the experiments were taken from a greenhouse culture and were in the process of terminating winter reproductive diapause. Female GWSS in groups of 10 were sprayed until visibly wet with methoprene at the label rate described above. They were then placed into a wooden 1m screened cage that was provisioned with five males and glabrous soybean, *Glycine max* (L.). A similar untreated control cage was also set up with females sprayed with distilled water. Females were checked daily for the presence of brochosomes and plants were checked for egg masses. Cages were in a greenhouse maintained at 32°C and equipped with artificial lighting for a 14:10 photoperiod. Surviving females were dissected after 30 days and their reproductive status was evaluated. No eggs were produced by any treated GWSS females. Dissections revealed that all surviving treated females had not begun reproductive activity, even after 30 days. There was little or no brochosome material in the Malpighian tubules and no development of ova. All control females when dissected were reproductively active.

### Newly-eclosed adult GWSS females treated during the preoviposition period

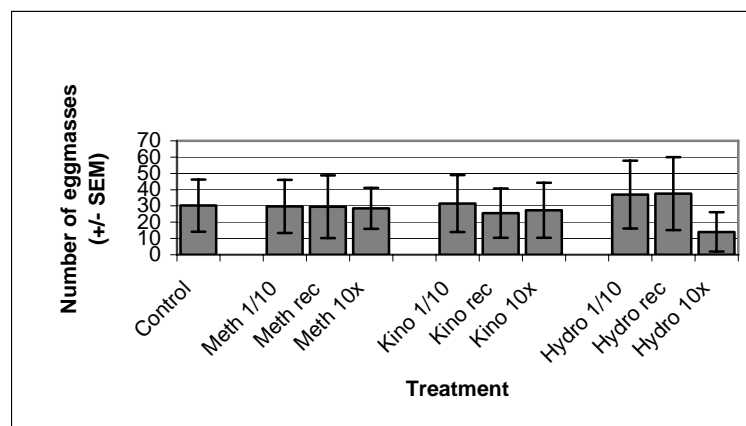
All GWSS used in the experiment were reared under summer conditions in a greenhouse from 4-5 instar to eclosion. Newly eclosed adult female GWSS in groups of 10 were treated until visibly wet with methoprene at the labeled rate. After treatment, females were placed in a 1m-screen cage that was provisioned with crape myrtle, eastern saltbush, and soybean. Five males of unknown ages were added to each cage. Females were dissected after 36 days. Males were discarded. No eggs were produced by any treated GWSS females. Dissection of treated females indicated that ovariole (reproductive) development was inhibited. Under normal green house conditions, untreated female GWSS begin to oviposit 10-12 days after eclosion. A few days prior to oviposition, their bodies swell and they begin to display brochosomes on the forewings. The treated females did not display any of these traits while the untreated females were reproductively active.

### Actively-reproducing female GWSS

Female GWSS collected in the field during the months of July and August in north Florida, were divided into ten groups of 15 and treated with either a juvenile hormone analog or distilled water as the control. Juvenile hormone analogs consisted of hydroprene, methoprene and kinoprene, each with concentrations as described above of the recommended label rate, 0.1x the recommended rate, and 10x the recommended rate. Each cohort of 15 leafhoppers was randomly assigned to a treatment, sprayed until visibly wet and placed in a 1.3m long sleeve cage on a crape myrtle branch. This experiment was replicated four times. After one week the leafhoppers were removed, mortality was assessed and females were dissected to evaluate their reproductive status. In addition, the number of egg masses on the leaves within the cages was determined. There was no significant effect of the juvenile hormones on GWSS egg production by active females (Figure 1).

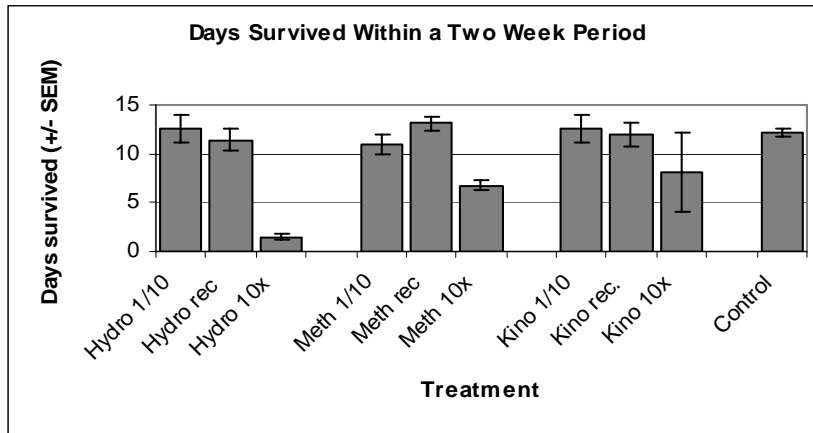
### GWSS nymphs

Ten cohorts of five nymphs, consisting of fourth and fifth instar GWSS were collected from a greenhouse culture and placed on a cowpea, soy or lemon basil plant in a plexiglass cylindrical cage 46cm in length and 15cm in diameter. The plants were placed in a laboratory next to a window to provide adequate sunlight. Each cohort was sprayed either with distilled water or a juvenile hormone analog until visibly wet. Juvenile hormone analogs consisted of hydroprene, methoprene and kinoprene, each with concentrations as described above of the recommended label rate, 0.1x the recommended rate, and 10x the recommended rate. Daily observations were taken to record survivorship and the number of individuals developing into adults. This experiment was replicated twice. Hydroprene at the 1x and 10x rates and methoprene at the 10x rate caused significant mortality to GWSS nymphs (Figure 2 and Figure 3).

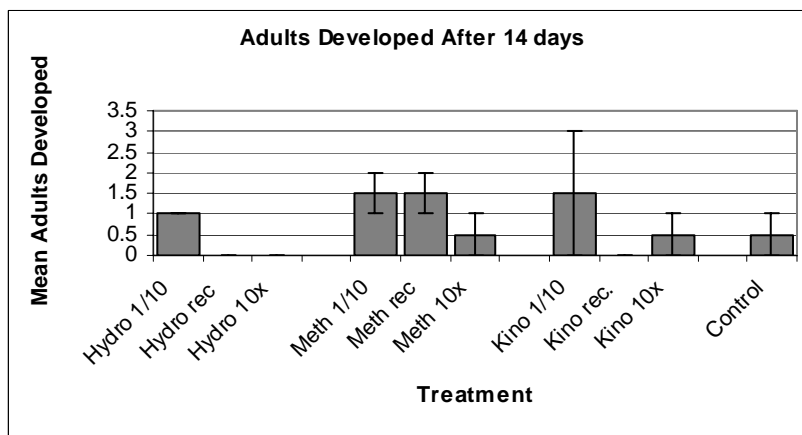


**Figure 1.** Number of egg masses produced by reproducing GWSS females following treatment with juvenile hormones and a water control.





**Figure 2.** Survival of GWSS females after treatment with three juvenile hormones at 3 concentrations.



**Figure 3.** The number of treated nymphs developing into adults after treatment with juvenile hormones at three concentrations.

## CONCLUSIONS

We tested the effects of three juvenile hormones on GWSS females in several different physiological states. While high mortality to nymphs was observed from hydroprene and methoprene at the 10X rate, no other direct mortality was observed. However, methoprene at the 1x labeled rate caused complete sterilization for at least 30-35 days when applied to GWSS females in diapause or during their preoviposition stage just after eclosion to adults. We are continuing these evaluations with the other JV analogs on female GWSS and other species of leafhopper vectors in different physiological states.

## REFERENCES

- Akey, D., M. Blua and T. Henneberry. 2003. Control of immature and adult glassy-winged sharpshooters: evaluation of biorational insecticides for organic use. Proc. 2003 CDFA Pierce's disease research symposium. Pp. 278-281.
- Redak, R. and J. Bethke. 2003. Pesticide screening against the glassy-winged sharpshooter, *Homalodisca coagulata* (Say), using commercially-available biorational, organic and reduced risk pesticides. Proc. 2003 CDFA Pierce's disease research symposium. Pp. 302-307.
- Redak, R. and M. Blua. 2003. Impact of layering control tactics on the spread of Pierce's disease by the glassy-winged sharpshooter. Proc. 2003 CDFA Pierce's disease research symposium. Pp. 311-313.

## FUNDING AGENCIES

Funding for this project was provided by the CDFA Pierce's Disease and Glassy-winged Sharpshooter Board.

**MYCOPATHOGENS AND THEIR EXOTOXINS INFECTING  
THE GLASSY-WINGED SHARPSHOOTER: SURVEY, EVALUATION, AND STORAGE.**

**Project Leaders:**

Russell F. Mizell, III  
University of Florida, NFREC  
Quincy, FL 32351

Drion G. Boucias  
Department of Entomology and Nematology  
University of Florida  
Gainesville FL 32611

**Cooperator:**

Chris Tipping  
University of Florida, NFREC  
Quincy, FL 32351

**Reporting Period:** The results reported here are from work conducted January 1, 2005 to June 30, 2005.

**ABSTRACT**

A species of *Hirsutella*, the primary pathogen of glassy-winged sharpshooter (GWSS) in the southeastern US, has been the major focus of our research this past year. Due to the fastidious growth requirements of this fungus and the presence of numerous saprobic fungi associated with mycosed GWSS, a major effort has been made to design a series of gene-specific primers to be used to detect these diseases in field collected samples. Molecular-based diagnosis is being used to examine the hundreds of mycosed insects collected during the 2003 and 2004 regional surveys. A second effort has been directed at examining the seasonal incidence of this disease in an experimental crape myrtle plot. A number of parameters such as crape myrtle variety, host density, and mist irrigation (humidity) have been found to influence the onset of *Hirsutella* in GWSS populations. Current laboratory research is being directed at examining transmission of the lab culture to both GWSS and to alternate insect hosts. In addition, culture filtrates of all of the fungi collected from GWSS are being assessed for the presence of active metabolites.

**INTRODUCTION**

We are not aware of any studies that have examined the dynamics of pathogens associated with populations of GWSS in its native range. In general, the lack of pathogens (viral, bacterial, or protozoan) in leafhopper populations may be related to their piercing-sucking feeding behavior. In most cases, these pathogen groups are transmitted orally and would likely need to inhabit the xylem tissue to infect leafhoppers. Pathogens that are transmitted *per os* are typically affiliated with insects with chewing mouthparts. Thus, entomopathogenic fungi, which do not need to be ingested in order to infect insects, are considered to contain the primary pathogens of sucking insects. Indeed, the primary pathogens operating against insects such as whiteflies, scales, aphids, spittlebugs, plant hoppers, and leafhoppers are insect fungi (for listing see USDA-ARS Collection of Entomopathogenic Fungal Cultures at <http://www.ppru.cornell.edu/mycology/catalogs/catalog>). We commonly observe all mobile stages of GWSS exhibiting mycoses in north Florida and we are identifying them and assessing their impact. Since the last report we have concentrated on an assessment of the population dynamics of fungi and GWSS in the field. The incidence of *Hirsutella homalodisca* (*H. homalodisca*) in a GWSS population on crape myrtle was monitored in a preliminary manner in 2004 and then as part of a more exhaustive approach in 2005. Disease incidence was significantly lower in 2005. GWSS population levels were moderately lower at all sample dates available for comparison. One cultivar group was preferred to a significant level, but it is suspected that this was due to the effects of immigration. Most diseased cadavers appeared after the conclusion of the F<sub>1</sub> generation population peak, but at much lower incidence than in 2004. *Pseudogibbellula formicarum* was found to colonize a high proportion of GWSS cadavers after mycosis by *H. homalodisca*.

**OBJECTIVES**

1. Identify and archive all the major pathogens affiliated with GWSS populations.
2. Estimate the distribution, frequency and seasonality of the major diseases of GWSS.
3. Screen the pathogens for exotoxins with potential toxicity to GWSS and other arthropods.
4. Confirm infectivity of the isolates and the exotoxins and determine which if any pathogens may serve as microbial controls of GWSS and other leafhopper vectors.

**RESULTS**

The presence of various opportunistic fungi on field-collected samples has limited our abilities to culture the more fastidious slow growing species of *Hirsutella*, *Sporothrix*, and *Pseudogibbellula*. The aforementioned fungi were identified last year to be key entomopathogens isolated from GWSS populations. We have developed and optimized PCR primers within unique intron motifs of both the actin and tubulin genes that have been matched with primers from the open-reading frame. Control reactions have demonstrated that these primer combinations are able to specifically amplify the GWSS *Hirsutella* from DNA extracted from mummies. This technology is being used to screen the more than 250 DNA samples extracted from mycosed GWSS collected from throughout the southeastern U.S. This work has been summarized and submitted for publication.

A crape myrtle field plot was utilized to track a population of GWSS over the course of the 2005 summer season. The plot consisted of 4 replicates of 14 crape myrtle cultivars, with each cultivar represented by 4 adjacent trees in each replicate. Based on data collected in 2004, 4 cultivars were selected for intensive sampling and observation of both live and diseased GWSS. "Biloxi", "Osage", "Miami", and "Tonto" cultivars were selected, as they had demonstrated the highest incidence of mycosed GWSS in the previous season. Cultivar group position was completely randomized within the plot. The 4 replicates were divided into two treatments, misted and ambient. In the misted replicates, a 6' diameter emitter was staked above each tree in 10 of the 14 cultivars. This system was controlled by an automatic timer, which allowed the misters to run the first 15 min. of every hour, 24 hours a day, 7 days a week. This ensured that each misted tree remained under very high humidity conditions. The remaining two replicates were subjected only to the prevailing environmental conditions. Each replicate was sampled on a weekly basis. The individual trees were visually sampled for live GWSS by running a curved tool behind each branch and counting the insects as they displayed evasive behaviors. Sampling was performed between 08:00 and 12:00, a period of lower GWSS activity. Immediately following live sampling, each branch of the tree was visually inspected on all sides for the presence of mycosed insects. Those found were marked by tying a piece of surveyor's tape around the branch 10-15 cm below the cadaver. The tape was then marked with a number. This enabled development of detailed records on each individual mummy and monitoring of any change in its condition.

In addition, a 229 m grid with 51 locations was set up in the 60 ha area surrounding the field plot and 27 yellow sticky traps consisting of 7.5 x 15 cm mailing tubes on 1 m stakes were distributed to half the grid points at random. Trap placement was randomized each week among the 51 locations. The GWSS on the traps were counted weekly. Sticky trap counts indicated two peaks in GWSS numbers over the course of the 2005 study, the highest coming in week 7 and a much smaller peak at week 16. Visual GWSS counts in the misted portion of the first replicate closely mirror this trend with a delay of approximately 1-2 weeks. Counts in the dry portion of replicate 1, as well as both portions of replicate 2 show little homology to background numbers. Least squares means analysis of significant effects found in the repeated measures procedures revealed significant differences between both cultivar and humidity treatments were primarily due to the action of the crape myrtle cultivar "Biloxi" in the misted portion of the first replicate. This cultivar group held the highest numbers of leafhoppers of any group throughout the entire first population peak, often by a factor of 3. Most significant differences between treatment and cultivar were found within this peak. The exception to this phenomenon was that within the misted portion of the first replicate, leafhopper numbers on the cultivar "Tonto" were significantly lower when compared to "Osage" in weeks 16 through 18 and when compared to "Biloxi" in week 19. These differences, however, were not of great enough magnitude to affect between-treatment interactions. It is possible that the preference for "Biloxi" in the first peak was due to its placement in the plot, as it was located at the corner closest to a natural forest habitat and may be an immigration point for GWSS entering the plot. If this group of four trees is discounted there were no recognizable trends for preference of cultivar or irrigation treatment.

In 2005, the incidence of cadavers killed by *Hirsutella homalodisca* within the field plot did not closely follow fluctuations in GWSS populations. Mycosed cadavers appeared with greatest regularity beginning at the tail of the first population peak, until week 20. This time period was characterized by lower GWSS populations, but also by almost weekly shifts in host cultivar preference. Sticky trap data show much lower populations after week 11, but while plot populations were lower, the difference was not as pronounced. Mean cadaver numbers per tree were significantly higher in 2004 than 2005 ( $t = 7.43$ ,  $p < 0.0001$ ). The last sample time for the plot in 2004 occurred from 8/17/04 to 8/28/04. During this time, mean GWSS cadavers per tree was  $4.44 \pm 3.74$  ( $N = 64$ ). The same trees sampled on 8/24/05 had  $0.31 \pm 0.48$  mean cadavers per tree. Total cadaver number for all trees at this time in 2004 was 284 compared to 20 for 2005. There is no obvious explanation for this, though host/pathogen interactions are often cyclical in insect systems. On all sample dates in 2004 where live GWSS counts were taken, leafhopper numbers were higher than in 2005, suggesting a higher total population in 2004. Whether a critical host density threshold was met in 2004 but not in 2005, is unknown, but may represent the most likely explanation for 2004 cadaver counts surpassing those from 2005 by more than an order of magnitude. Differences in cadaver numbers between misted and dry replicates were pronounced in 2004, but slight in 2005. This slight difference was probably an artifact owing to the much higher host numbers on the "Biloxi" cultivar in the first misted replicate. By revisiting the same GWSS cadavers every week and noting their condition, it was possible to ascertain that individuals initially displaying the *Hirsutella homalodisca* phenotype frequently developed *Pseudogibellula formicarum* morphologies later in the season. Currently, September 25, 2005, 46% of those cadavers found in the 2005 study present some degree of *P. formicarum* morphology, with the expected proportion to be higher once removed from the field and examined with the microscope. All of these cadavers originally sporulated as *H. homalodisca*, with *P. formicarum* probably acting as a secondary saprophyte of the cadaver. These findings run counter to a previous report identifying *P. formicarum* as a primary fungal pathogen of GWSS in the southeastern U.S. (Kanga et al. 2004).

## CONCLUSIONS

We have identified and have in culture several isolates of a primary pathogen and potential GWSS biological control agent, *Hirsutella homalodisca*. Molecular methods have been established and are being used to diagnosis GWSS collected from sites throughout the southeastern US. This past two field season the dynamics of *H. homalodisca* has been examined in replicated crape myrtle plots. Mycosed GWSS developed throughout the mid-later part of the growing season in both years.

A large proportion of the mycosed GWSS infected with *H. homalodisca* later showed symptoms of *Pseudogibellula formicarum* suggesting that the later fungi may not be a primary pathogen of GWSS.

#### **REFERENCES**

Kanga, L. H., W. Jones, R. Humber and D. Boyd, Jr. 2004. Fungal pathogens of the glassy-winged sharpshooter *Homalodisca coagulata* (Homoptera: Cicadellidae). Fla. Entomol. 87:225-228.

#### **FUNDING AGENCIES**

Funding for this project was provided by the University of California Pierce's Disease Grant Program.

# SEASONAL POPULATION DYNAMICS OF GLASSY-WINGED SHARPSHOOTER EGG PARASITOID: VARIABILITY ACROSS SITES AND HOST PLANTS

## Project Leader:

Joseph G. Morse  
Department of Entomology  
University of California  
Riverside, CA 92521

## Cooperators:

David J. W. Morgan  
CDFA, PDCP  
Mount Rubidoux Field Station  
Riverside, CA 92501

Jonathan M. Lytle  
Department of Entomology  
University of California  
Riverside, CA 92521

Rodney Mendes  
CDFA, PDCP  
Riverside, CA 92507

Nick C. Toscano  
Department of Entomology  
University of California  
Riverside, CA 92521

**Reporting Period:** The results reported here are from work conducted November 2004 to September 2005.

## ABSTRACT

The California Department of Food & Agriculture (CDFA) has a number of sites in southern California where they are releasing egg parasitoids of glassy-winged sharpshooter (GWSS). To date, species released include *Gonatocerus ashmeadi*, *G. fasciatus*, *G. morrilli*, and *G. triguttatus* and very recently, a strain of *Anagrus epos* from Minnesota. CDFA monitors for parasitoid establishment and population dynamics at release sites. This project is intended to complement and expand the scope of this monitoring with an eye towards improving our understanding of the benefit of releasing alternative parasitoid species and how well they are surviving, dispersing, and impacting GWSS populations.

## INTRODUCTION

One of CDFA's parasitoid release sites in southern California is Field 7H on the UC Riverside campus. A two-year field study in and around this release site was conducted to examine the temporal and host plant distribution of *Homalodisca* oviposition and associated egg parasitism (Al-Wahaibi 2004). In the current project, we plan to expand on this study and monitoring done by CDFA in an attempt to improve our understanding of the population dynamics of endemic and released parasitoids in and around release sites. Although control programs appear to be effective at reducing GWSS populations, biological control is a more sustainable and environmentally friendly means of contributing to vector reduction and may have to suffice in much of California where chemical control is either impractical (e.g., urban areas) or economically unfeasible.

In the two-year (July 2001 – June 2003) study by Al-Wahaibi (2004) around CDFA's release site on the UC Riverside (UCR) campus, parasitism was due to a total of eight parasitoid species with *Gonatocerus ashmeadi*, *Ufens principalis* (previously *Ufens* A, Al-Wahaibi et al. 2005), *Ufens ceratus* (previously *Ufens* B), and *G. morrilli* being the most abundant. *Ufens* spp. were dominant on jojoba while on other plants, *Gonatocerus* species tended to dominate. Across all ten host plants sampled, ranked percent parasitism was *G. ashmeadi* (27.4%), *U. principalis* (19.8%), *U. ceratus* (2.9%), *G. morrilli* (2.1%), *G. incomptus* (0.4%), *G. novifasciatus* (0.3%), *G. triguttatus* (0.1%), and *G. fasciatus* (0.01%). Note, however, that these data may have been biased by the proximity of nearby hosts harboring smoke-tree sharpshooter and high levels of *Ufens* spp. on jojoba.

## OBJECTIVES (As Modified)

1. Monitor GWSS egg parasitoids in several areas in southern California at CDFA's parasitoid release sites, comparing levels of *G. ashmeadi*, *G. morrilli* (Texas strain), and *Anagrus epos* (Minnesota strain).

## RESULTS

Based on discussions with our CDFA cooperators, we have made several changes in project objectives, experimental design, and methodologies because of low levels of GWSS at several initial monitoring sites, changes in the species / strains of parasitoids CDFA has reared and released, the number of parasitoids they have been able to produce over this past year (this has been a very difficult year as far as rearing GWSS egg masses which are the cornerstone of the rearing program), and what makes practical sense within an applied management program (Shea et al. 2002) given advances in our knowledge regarding *Gonatocerus* species and the new strain of *Anagrus epos* from Minnesota (see below).

We have settled on monitoring parasitoid levels at six sites in southern California. Three sites are near the coast (Irvine, Mission Viejo, and San Juan Capistrano) and three are in the southern California interior region (Corona, Temecula, and

UCR 7H). Egg masses are collected from Eureka lemon trees at each site (initially we were monitoring navel orange at some sites but we decided it would be best to switch to the same citrus variety at all sites for comparison) and are returned to the laboratory where parasitoids are reared out and identified. The initial plan was to monitor two sites in each of three environmental regions (coastal, interior, desert) but after several months of monitoring two sites in the Mecca region of the Coachella Valley, we decided that GWSS levels were too low to obtain meaningful data, we dropped these two sites, and added a third site in both the coastal and interior areas. We checked with cooperators and thought it unlikely we could find other sites in the desert region with high GWSS levels, especially in view of the GWSS management program there. In finalizing selection of the six monitoring sites we were constrained by two major objectives: (1) sites should not be sprayed or should be sprayed at a minimal basis only with selective pesticides so that parasitoids might survive and (2) GWSS levels at each site should be at least moderately high so that we could find and collect egg masses. We now have at least several months of data from each of the six sites and feel we have met both objectives at each site.

The type of monitoring data we collect at each site is listed below. We are using CDFA's basic monitoring protocol with modifications. Note that we have two replicated sampling plots at four sites, only one at Irvine (because the site is too small for two) and six at Temecula. In Temecula, in collaboration with Dr. Nick Toscano and Mr. Rodney Mendes, we are comparing two replicates of each of three treatments for control of GWSS within an organic citrus block; treatments are (1) untreated control, (2) parasitoid releases, and (3) control of GWSS with two sprays of an organically approved spray = Pyganic + Nufilm.. Note that management of GWSS within organic citrus has been problematic within the Temecula GWSS management program being run by Dr. Toscano and thus, he expressed an interest in evaluating parasitoid releases at this site. We started this experiment with three replicates of each of the three treatments but mid-way through out study, citrus in two of the replicates was leased to a different grower who stopped watering the trees for several months. As a result, we dropped these six plots and added three new plots (one replicate of each treatment) within the portion of the ranch being run by our grower-cooperator, Mr. Albert Salazar.

1. *Sticky Cards to Monitor for Adult GWSS levels:* Use 10 yellow sticky traps in each plot to assess adult GWSS levels every two weeks.
2. *Leaf Sampling:* Count and collect the number of fresh GWSS egg masses on 10 leaves collected from the end of branches on each of 10 trees in each plot every two weeks. In contrast to method 3, this is intended to return a less-biased estimate of GWSS egg mass levels. Old egg masses are counted, but not collected. The egg mass sampling is mainly intended to estimate recent GWSS egg mass levels and to serve as a means of collecting egg masses for parasitoid rearing.
3. *Time Search for GWSS Egg Masses:* Do five two-minute time searches near the center of each plot every two weeks, looking for, counting, and collecting viable (new) GWSS egg masses. Continue sampling an additional 30 minutes until a minimum of five egg masses are found from 2 and 3 combined.
4. *Parasitoid Emergence Data:* Using egg masses collected in 2 and 3 (aim for 5-10 egg masses per date if possible), return egg masses to the lab at UCR and rear out and identify parasitoid species that are present.

Over the period of our study, there have been changes in the species / strains of parasitoids CDFA rears and releases. Our initial experimental design was to release *G. ashmeadi* and one of *G. fasciatus*, *G. morrilli*, or *G. triguttatus* at each site. As of September 2005, CDFA decided to change the strain of *G. morrilli* being released. The new strain is from Texas and contains a genetic marker, which should allow differentiation between the released *G. morrilli* and endemic populations of this species (preliminary work indicates these two strains do not interbreed, de Leon et al. 2004, 2005). Thus, we decided to revise our experimental design to compare *G. ashmeadi* and Texas *G. morrilli* releases at each of the six sites we are monitoring, allowing for a comparison of how these two species do at interior versus coastal sites (with three sites in each region). Our experimental plan was to release 250 parasitoids of each of two species in each plot every two weeks (two plots at four sites, one plot at Irvine, six plots at Temecula). Due to rearing constraints, we have not been able to achieve this target release rate. However, we feel the monitoring we are doing does have value, especially in determining levels of endemic *Gonatocerus* species prior to release of *Anagrus epos* (see below).

From the data collected to date, all three coastal sites produced a much higher percentage of *Gonatocerus morrilli* than the three interior sites. For example, in the month of May, the following data were observed from the collected egg masses: Irvine Ranch produced 29 wasps, 93% were *G. morrilli* and 7% were *G. ashmeadi*; Mission Viejo produced 112 wasps, 63% were *G. morrilli*, 20% were *G. ashmeadi*, and 18% were *G. novifasciatus*; San Juan Capistrano produced 286 wasps, 91% were *G. morrilli*, 3% were *G. ashmeadi*, and 6% were *G. novifasciatus*; Temecula produced 136 wasps, 28% were *G. morrilli*, 56% were *G. ashmeadi*, and 16% were *G. novifasciatus*; Agricultural Operations produced 64 wasps, 1.5% were *G. morrilli*, 72% were *G. ashmeadi*, and 27% were *G. novifasciatus*. It appears *G. morrilli* will continue to be the dominant parasitoid species in the coastal orchard sites throughout the year, but it may be premature to draw conclusions at this point. *G. novifasciatus* appears to be of lesser importance throughout the collections, however, it is the third most prevalent species of *Gonatocerus* in our collections.

*Anagrus epos* was collected in Minnesota by Dr. Roman Rakitov (Center for Biodiversity, Illinois Natural History Survey, Champaign, Illinois) near Glyndon, Clay Co., Minnesota, from egg masses of *Cuerna fenestella* Hamilton (a native, univoltine proconiine sharpshooter) on *Solidago* sp. (goldenrod, *Compositae*) and *Zigadenus* sp. (death camus, *Liliaceae*) and

sent to Dr. Serguei Triapitsyn at the UCR quarantine facility under an appropriate permit (Hoddle & Triapitsyn 2004, Triapitsyn & Rakitov 2005). A permit for release from Quarantine was obtained in 2005 by Dr. David Morgan and this strain is presently being reared by CDFA and has already been released at a few field sites (but not at any of the six sites we are monitoring). A major focus of our project starting in Feb. 2006 will be to monitor for establishment and persistence of this species at each of our six study sites.

As companion research to field establishment, Mr. John Lytle plans a series of experiments with the Minnesota strain of *A. epos*. The questions being asked are: (1) How will *A. epos* do in competition with *G. morrilli*, the dominant egg parasitoid in our three coastal sites? (2) How well will *A. epos* establish at coastal versus interior study sites (we will use clamp cages to compare survival at the six study sites in addition to sampling for recovery of *A. epos*)? (3) Will *A. epos* exhibit a preference for GWSS egg masses on citrus versus other leafhopper species present on grasses or other hosts (lab studies will be done to examine this question)? (4) Will the Minnesota strain of *A. epos* mate with endemic strains of *A. epos* in California or is it a different species (see the progress report in the Proceedings by Morse and Stouthamer)?

## CONCLUSIONS

Data from the first year of field monitoring has been confounded to some degree by changing experimental sites (due to low GWSS levels at some sites and the desire to monitor the same variety of citrus at each site), changes in the species of parasitoids that CDFA is releasing, and lower levels of parasitoids being available for release than was planned. When doing applied research within an evolving biological control program (Shea et al. 2002), such changes should be expected but we must admit that the data we have been able to obtain are not as “clean” as one might hope when setting up an experimental design. We are well in place, however, to run a rather clean evaluation of the establishment and persistence of the Minnesota *A. epos* strain starting Feb. 2006.

## REFERENCES

- Al-Wahaibi, A. K. 2004. Studies on two *Homalodisca* species (Hemiptera: Cicadellidae) in southern California: biology of the egg stage, host plant and temporal effects on oviposition and associated parasitism, and the biology and ecology of two of their egg parasitoids, *Ufens A* and *Ufens B* (Hymenoptera: Trichogrammatidae). Ph.D. Dissertation, University of California, Riverside. 435 pp.
- Al-Wahaibi, A. K., A. K. Owen, and J. G. Morse. 2005. Description and behavioural biology of two *Ufens* species (Hymenoptera: Trichogrammatidae), egg parasitoids of *Homalodisca* species (Hemiptera: Cicadellidae) in southern California. *Bull. Entomol. Res.* 95: 275-288.
- de León, J. H. and W. A. Jones. 2005. Genetic differentiation among geographic populations of *Gonatocerus ashmeadi*, the predominant egg parasitoid of the glassy-winged sharpshooter, *Homalodisca coagulata*. *J. Insect Sci.* 5:2. Available online: [insectscience.org/5.2](http://insectscience.org/5.2).
- de León, J. H., W. A. Jones, and D. J. W. Morgan. 2004. Molecular distinction between populations of *Gonatocerus morrilli*, egg parasitoids of the glassy-winged sharpshooter from Texas and California: Do cryptic species exist? *J. Insect Sci.* 4:39, Available online: [insectscience.org/4.39](http://insectscience.org/4.39).
- de León, J. H., W. A. Jones, S. Setamou, and D. J. W. Morgan. 2005. *Gonatocerus morrilli* (Hymenoptera: Mymaridae), a primary egg parasitoid of the glassy-winged sharpshooter (*Homalodisca coagulata*) exists in nature as a cryptic species complex. *Molecular Ecol.* (Submitted).
- Hoddle, M. S., and S. V. Triapitsyn. 2004. Searching for and collecting egg parasitoids of glassy-winged sharpshooter in the central and eastern USA, pp. 342-344. *In: Proceedings of the 2004 Pierce's Disease Research Symposium*, December 7-10, 2004, Coronado Island Marriott Resort, Coronado, California, organized by California Department of Food and Agriculture (compiled by M. Athar Tariq, S. Oswalt, P. Blincoe, A. Ba, T. Lorick and T. Esser), Copeland Printing, Sacramento, California, 391 p.
- Shea, K., H. P. Possingham, W. W. Murdock, and R. Roush. 2002. Active adaptive management in insect pest and weed control: intervention with a plan for learning. *Ecol. Appl.* 12: 927-936.
- Triapitsyn, S. V., and R. A. Rakitov. 2005. Egg parasitoids (Hymenoptera: Mymaridae and Trichogrammatidae) of *Cuerna* sharpshooters (Hemiptera: Cicadellidae) in the USA. Abstracts, 12th International Auchenorrhyncha Congress and 6th International Workshop on Leafhoppers and Planthoppers of Economic Significance, University of California, Berkeley, 8-12 August 2005.

## FUNDING AGENCIES

Funding for this project was provided by the University of California Pierce's Disease Grant Program.

# THE ANAGRUS EPOS COMPLEX: A LIKELY SOURCE OF EFFECTIVE CLASSICAL BIOLOGICAL CONTROL AGENTS FOR GLASSY-WINGED SHARPSHOOTER CONTROL

## Project Leaders:

Joseph G. Morse and Richard Stouthamer  
Department of Entomology  
University of California  
Riverside, CA 92521

## Cooperators:

Serguei Triapitsyn  
Department of Entomology  
University of California  
Riverside, CA 92521

David J.W. Morgan  
CDFA, PDCP  
Mount Rubidoux Field Station  
Riverside, CA 92501

Rodney Mendes  
CDFA, PDCP  
Riverside, CA 92507

Jonathan M. Lytle and Nick C. Toscano  
Department of Entomology  
University of California  
Riverside, CA 92521

**Reporting Period:** The results reported here are from work conducted May 2005 to September 2005.

## ABSTRACT

The purpose of the work planned in this project is to determine whether the “Minnesota strain” of the mymarid, *Anagrus epos* Girault (*A. epos*), we have in culture on glassy-winged sharpshooter (GWSS) is the same species as *A. epos* strains previously released in California, how it compares with other “*A. epos*” strains, and whether there are other strains of “*A. epos*” that should be imported for biological control of GWSS. Without understanding what species we have and how the Minnesota strain is related to similar strains, it is difficult to know how to proceed in selecting strains of this species to culture for mass-rearing and release in California for GWSS control. Concurrently, we will evaluate field releases and establishment of the Minnesota *A. epos* strain at six release sites in southern California.

## INTRODUCTION

*Anagrus epos* is a common and seemingly widespread egg parasitoid of leafhoppers (Cicadellidae) in North America. It was first described from a collection in Illinois in 1911 (Girault 1911). Location records for this species also include Colorado, Kentucky, New Mexico, and New York in the U. S. as well as Baja California and Sonora in Mexico (Triapitsyn 1998). While commonly collected as a parasitoid of grape leafhopper species (*Erythroneura* spp.), a recent collection of *A. epos* from the egg mass of the sharpshooter genus *Cuerna* in Minnesota was the first time this species had been collected from a sharpshooter species (Hoddle & Triapitsyn 2004). Wasps from this collection have been reared continuously since June 2004 in the UC Riverside quarantine facility on eggs of the GWSS. This species is particularly promising for application in the biological control of the GWSS because it is a gregarious species and twelve or more wasps emerge from each egg. Another apparent advantage of this species is that it will also parasitize the eggs of several other leafhopper species (R. Krugner, unpublished data), thus allowing it to expand its numbers even at times of the year when GWSS eggs are not present. We also expect this strain may do quite well in the colder regions of central and northern California based on where it was collected.

Like many minute parasitoids, identification to species in this group is exceedingly difficult because of the lack of adult morphological features. Species identifications have been made using light microscopy to determine the presence of key morphological features for *A. epos*. A recent taxonomic revision of the genus *Anagrus* associated with vineyards in North America (Triapitsyn 1998) has shown that: 1) more species are present than previously thought, 2) some species have a very wide geographic distribution and 3) relatively few morphological characters are available for distinguishing these species, leaving several authors to think that *A. epos* is not a single species but a complex of different species (e.g., Pickett et al. 1987). The morphological characters that are used for differentiating closely related *Anagrus* spp. can be variable and thus, species limits are often difficult to assess without supporting data from their biology and from DNA sequences. The purpose of the work proposed here is to determine whether the “Minnesota strain” of “*A. epos*” we have in culture on GWSS is actually this species, how it compares to other “*A. epos*” strains, and whether there are other strains of “*A. epos*” that should be imported for biological control of GWSS. Without understanding what species we have and how it is related to other similar strains, it is difficult to know how to proceed in selecting strains of this species to culture for mass-rearing and release in California to control GWSS. Due to limitations on what is practical (economically) to rear and mass-release and also because of restrictions on importing and releasing exotic parasitoids in California without understanding their taxonomy, we feel we must better understand this species complex. We intend to use three approaches to determine the species identity of different *Anagrus epos* populations: (1) Reassess key morphological features using scanning electron microscopy (SEM) to determine if subtle morphological differences exist between *Anagrus epos* populations which could indicate species



differences (Dr. Triapitsyn will conduct this work). (2) Conduct mating compatibility studies to determine if different populations of *A. epos* are reproductively isolated, or if mating occurs, whether offspring from different strains are viable, thereby defining species groups on the basis of successful interbreeding (Ph.D. student John Lytle working with Dr. Morse). (3) Determine if molecular differences exist between *Anagrus epos* populations collected from different regions by comparing mitochondrial and ribosomal DNA sequences (Dr. Stouthamer). Molecular dissimilarities generally indicate the existence of different species. Results from these three methods of investigation (morphology, behavior, and genetics) will be evaluated together to establish the identity of the species in the *A. epos* complex. Once the different species have been determined, we will test them for their suitability in the biological control of GWSS using laboratory studies and field release evaluations (Drs. Morgan and Morse).

## OBJECTIVES

1. Examination of male and female *A. epos* complex populations for unique morphological characters
2. Molecular characterization of mitochondrial and ribosomal DNA of *A. epos* populations
3. Mating compatibility studies between *A. epos* strains
4. Field release and evaluation of the "Minnesota strain" of *A. epos*

## RESULTS

### Progress on Objectives 1-3

The experimental plan laid out in our research proposal was to collect dead specimens of various *A. epos* strains and related species for taxonomic examination (Objective 1) and genetic work (Objective 2) in Year 1. Objective 3 is scheduled for Year 2 once we have the results of Objectives 1 and 2 research, which will tell us which strains of *A. epos* to concentrate on other than the "Minnesota strain" we currently have in culture on GWSS egg masses.

The mymarid *Anagrus epos* Girault was collected and reared in early June 2004 by Dr. Roman Rakitov (Center for Biodiversity, Illinois Natural History Survey, Champaign, Illinois) near Glyndon, Clay Co., Minnesota, from egg masses of *Cuerna fenestella* Hamilton (a native, univoltine proconiine sharpshooter) on *Solidago* sp. (goldenrod, *Compositae*) and *Zigadenus* sp. (death camas, *Liliaceae*) and sent to Dr. Serguei Triapitsyn at the UCR quarantine facility under an appropriate permit (Hoddle & Triapitsyn 2004, Triapitsyn and Rakitov 2005). This is the first representative of the genus *Anagrus* ever reared from eggs of a proconiine sharpshooter. At the UCR quarantine laboratory during summer 2004, S. Triapitsyn and V. Berezovskiy were able to establish a colony of this species on eggs of GWSS, which is a fictitious host for *A. epos* (GWSS does not occur in Minnesota). *Anagrus epos* is a gregarious species: 3-5 adult wasps emerged from smaller eggs of the original host, *Cuerna fenestella*, whereas up to 12 adult wasps emerged from larger eggs of GWSS. Under quarantine laboratory conditions (temperature 24°C, RH ca. 50%), the first two generations of *A. epos* developed from egg to adult within 20-21 days; for unknown reasons, it took the next two generations much longer (more than 30 days) to develop under the same conditions. In September 2004, the colony of *A. epos* was turned over to Dr. Joseph Morse, and it has been successfully maintained since then by Rodrigo Krugner, a Ph.D. graduate student. A release permit was received by Dr. David Morgan (CDFA), who established another colony of *A. epos* at the Mt. Rubidoux CDFR rearing facility in Riverside and has released this species in selected locations in California against GWSS (<http://www.cdfa.ca.gov/phpps/pdcp/BioCtrlRep/gwBioIndex.htm>).

Triapitsyn (1998) re-described *A. epos* from the type material and other specimens collected in Centralia, IL, and also indicated its additional distribution in North America (Mexico: Baja California, Sonora; USA: Colorado, Illinois Kentucky, New Mexico). In CO and NM, it is a parasitoid of *Erythroneura* leafhoppers on grapes; also indicating that morphologically, it is a variable species (and thus possibly a complex of several cryptic species). The specimens from Minnesota are within this variation range and are possibly also members of such a complex. The species related to *A. epos* are *Anagrus daanei* S. Triapitsyn (Canada: British Columbia; USA: California, Michigan, New York, Washington) and *Anagrus tretiakovae* S. Triapitsyn (Mexico: Baja California, Coahuila; USA: Arizona, Delaware, Illinois, Michigan, Maryland, New Mexico, New York, Washington); in AZ and NM (and Mexico), it is a known parasitoid of *Erythroneura* leafhoppers on grapes.

For the planned molecular and morphological comparison, S. Triapitsyn made several attempts to collect *A. epos* and *A. tretiakovae* during summer 2005 but they were not as productive as expected for the following reasons. First, the USDA importation permit to bring *Anagrus* spp. into UCR quarantine was received only September 9, 2005, after a long delay. Thus, the most productive method of collecting specimens (collecting large amounts of plant material showing signs of leafhopper damage, sending it to the UCR quarantine facility, and rearing it out there) could not be utilized. Second, the primary habitat of *A. tretiakovae* in Arizona (the organic table grape vineyards near Dateland, in the Harquahala Valley, and near Stanfield, AZ) were completely removed for economic reasons (per telephone conversation with Steve Pavich, owner). At S. Triapitsyn's request, Doug Yanega, the Senior Museum Scientist at the UC Riverside Entomology Research Museum, attempted to collect *A. tretiakovae* in the wine vineyards near Tucson, AZ, but neither the parasitoid nor its hosts, *Erythroneura* spp., were found there.

Third, our collaborator's attempts to rear *A. epos* from grapes at Caborca and Costa de Hermosillo, Sonora, Mexico, were also unsuccessful this summer. Agustín Fú-Castillo notified us that all the vineyards in the vicinity of Sonora were treated with an insecticide against the vine mealybug, and as a result, the usually very common *A. epos* could not be collected this summer.

Fourth, S. Triapitsyn made a trip to Grand Junction/Palisade area of Colorado in mid July 2005 to try to collect *A. epos* in the vineyards there. He found very light leafhopper infestations of *Erythroneura vulnerata* Fitch in the vineyards in Palisade, but they were present only in the untreated rows where a weather station was located. Unfortunately, no *Anagrus* emerged from numerous leaves with signs of leafhopper damage (from inside the vine) he collected. An *Anagrus* sp., collected by sweeping grape leaves infested with *E. vulnerata*, unfortunately turned out to belong to an unrelated species, *A. nigriventris* Girault.

*Anagrus erythroneurae* S. Triapitsyn & Chiapinni (it will be used as an out-group for comparison) is presently being collected (September 2005) in Fresno-Parlier area by our collaborators Dr. Kent Daane and Mr. Glenn Yokota (UC Berkeley). Later in the fall or next spring, they will also assist by collecting *A. daanei* from blackberry and/or grapes.

Finally, another attempt to collect *A. epos* and perhaps *A. tretiakovae* was made by S. Triapitsyn September 26-27, 2005. He was able to collect four males of *A. tretiakovae* by sweeping a pesticide-free vineyard and preserved them in 95% ethanol for molecular study. In addition, he collected leaves with leafhopper damage and shipped them under a permit to the UCR quarantine facility. We are hopeful that additional specimens will emerge.

#### **Progress on Objective 4**

As laid out in the research proposal funding this work, we have initiated monitoring of endemic and released parasitoids of GWSS at each of six Eureka lemon field sites in southern California (for details see the progress report in this Proceedings by Morse). A grant from the UC Pierce's Disease Research Program funded Years 1 (2004-05) and 2 (2005-06) of field monitoring whereas Year 2 (2006-07) will be funded by this (the *Anagrus*) project.

We are on track to study the release of the Minnesota strain of *A. epos* at each of the six study sites commencing with releases in February 2006.

#### **Progress on Related Objectives**

Ph.D. student Rodrigo Krugner has been rearing and studying the Minnesota strain of *A. epos*, first in quarantine and more recently, in the UCR Insectary after Dr. Morgan received the permit allowing it to be taken out of quarantine. Mr. Krugner's research is focusing on the basic biology of *A. epos* including (1) host specificity studies, (2) host egg age preference, (3) longevity of *A. epos* adults, (4) fecundity and fertility, (5) development of a temperature-dependent (degree day) model of the immature stage, and (6) sex allocation by *A. epos* females.

#### **CONCLUSIONS**

We are slightly behind schedule in collecting specimens of various *A. epos* strains and related species for taxonomic examination and genetic work but have done what is possible given the poor luck we've had this year in field collecting these parasitoids. However, we are much further along than would have been predicted in biological studies with *Anagrus epos* and have made a breakthrough in rearing this strain, which should allow substantial progress in field research over 2006-07.

#### **REFERENCES**

- Girault, A. A. 1911. Descriptions of North American Mymaridae with synonymic notes on described genera and species. *Trans. Amer. Entomol. Soc.* 37: 253-324.
- Hoddle, M. S., and S. V. Triapitsyn. 2004. Searching for and collecting egg parasitoids of glassy-winged sharpshooter in the central and eastern USA, pp. 342-344. *In: Proceedings of the 2004 Pierce's Disease Research Symposium, December 7-10, 2004, Coronado Island Marriott Resort, Coronado, California, organized by California Department of Food and Agriculture (compiled by M. Athar Tariq, S. Oswalt, P. Blincoe, A. Ba, T. Lorick and T. Esser), Copeland Printing, Sacramento, California.*
- Pickett, C. H., L. T. Wilson, D. González, and D. L. Flaherty. 1987. Biological control of variegated grape leafhopper. *Calif. Agric.* 41 : 14-16.
- Triapitsyn, S. V. 1998. *Anagrus* (Hymenoptera: Mymaridae) egg parasitoids of *Erythroneura* spp. and other leafhoppers (Homoptera: Cicadellidae) in North American vineyards and orchards: a taxonomic review. *Trans. Amer. Entomol. Soc.* 124: 77-111.
- Triapitsyn, S. V., and R. A. Rakitov. 2005. Egg parasitoids (Hymenoptera: Mymaridae and Trichogrammatidae) of *Cuerna* sharpshooters (Hemiptera: Cicadellidae) in the USA. Abstracts, 12th International Auchenorrhyncha Congress and 6th International Workshop on Leafhoppers and Planthoppers of Economic Significance, University of California, Berkeley, 8-12 August 2005.

#### **FUNDING AGENCIES**

Funding for this project was provided by the University of California's Pierce's Disease Grant Program.

## THE AREA-WIDE PEST MANAGEMENT OF GLASSY-WINGED SHARPSHOOTER IN TULARE COUNTY

### Project Team:

Beth Stone-Smith USDA, APHIS, PPQ, WR Arvin, CA 93203	Judy Stewart-Leslie GWSS Area-Wide Program Exeter, CA 93221	Gary Kunkel Tulare County Tulare, CA 93274	Sean Hardy CDFA, PDCP Fresno, CA
Bill Appleby Tulare County Tulare, CA 93274	Don Borges Tulare County Tulare, CA 93274	Dennis Haines Tulare County Tulare, CA 93274	Jesse Churchill CDFA, PDCP Tulare, CA 93274

**Reporting Period:** The results reported here are from work conducted January 2005 through September 2005.

### ABSTRACT

Tulare County has 113,000 acres of citrus, not all of which is infested with glassy-winged sharpshooter (GWSS) (Figure 1). With Pierce's Disease (PD) documented in the county, and 62,000 acres of grapes, in 2005 we wanted to continue to suppress overall GWSS populations and keep the northernmost populations from moving into the county's un-infested citrus acreage. Citrus is the most important year-round reproductive host for GWSS in Tulare County, so treatments were focused in this acreage. Previous years area-wide treatments dropped GWSS populations significantly, therefore treatments in 2005 were relatively minimal in comparison.

### INTRODUCTION

Tulare County has a very diverse agricultural system including 113,000 acres of citrus and 62,000 acres of grapes. This diversity and subsequent host range along with PD in the county, makes it a challenging system to manage GWSS populations. A successful area-wide management program for GWSS was already operational in Kern County to the south, and as GWSS populations were detected in Tulare County, the request for an area-wide treatment program was made in order to suppress building insect populations and to see where exactly the northernmost infestations were located in commercial citrus.

In the spring of 2003 an area-wide trapping program in Tulare County was initiated to determine relative GWSS population abundance. Traps were placed on a ¼ mile grid throughout the county's commercial citrus belt and extending into adjacent (permanent) commercial crops. Over 5000 traps are serviced on a weekly basis. In the fall of that same year, an area-wide treatment program for GWSS in citrus was employed. The focus was a foliar "knock-down" treatment, in citrus that had GWSS detections. The chemical Assail™ (active ingredient: acetamiprid) was used on the majority of acreage where organic status was not an issue. Over 38,000 acres of citrus were treated.

In 2004, treatments focused on remaining GWSS populations following the 2003 foliar applications. Ideally, we would have liked to have followed up those foliar treatments with a systemic chemical, on all of the 38,000 acres treated the previous fall, but fiscally that was not an option. Treatment areas were assessed throughout the year and the citrus acreage that was recommended for treatment was treated with the systemic chemical Admire® (active ingredient: imidicloprid). Over 17,000 acres of citrus were treated.

The treatment focus in 2005 was again, to follow up on remaining GWSS populations and suppress those populations before they spread into additional surrounding acreage. A major concern in doing area-wide treatments is trying to effectively treat a specific area, getting an efficacious treatment, and not having to treat that same area again the following year. A number of variables add to the difficulty in treating this insect pest in Tulare County. Some of these variables are: the diversity of agriculture and subsequent host range, treating citrus groves that are on domestic water sources, treating with a systemic chemical on very hilly areas (uptake problems), grower's having the proper irrigation system for an Admire® treatment, irrigation systems being up to regulation, efficacy of prior treatments, location of nearby infested organic citrus, surrounding urban areas, small acreages of citrus that are not considered commercial citrus acreage for treatment, and surrounding growers who may have opted not to treat in prior years. Along with the sheer number of growers to be contacted and treatments organized in a timely manner, an area-wide treatment regime in citrus acreage that was so large, was a difficult undertaking.

### OBJECTIVES

1. Continue the overall suppression of GWSS populations in the infested citrus acreage of Tulare County.
2. Stop GWSS populations from spreading further north of where populations are currently detected in Tulare County.

### RESULTS AND CONCLUSIONS

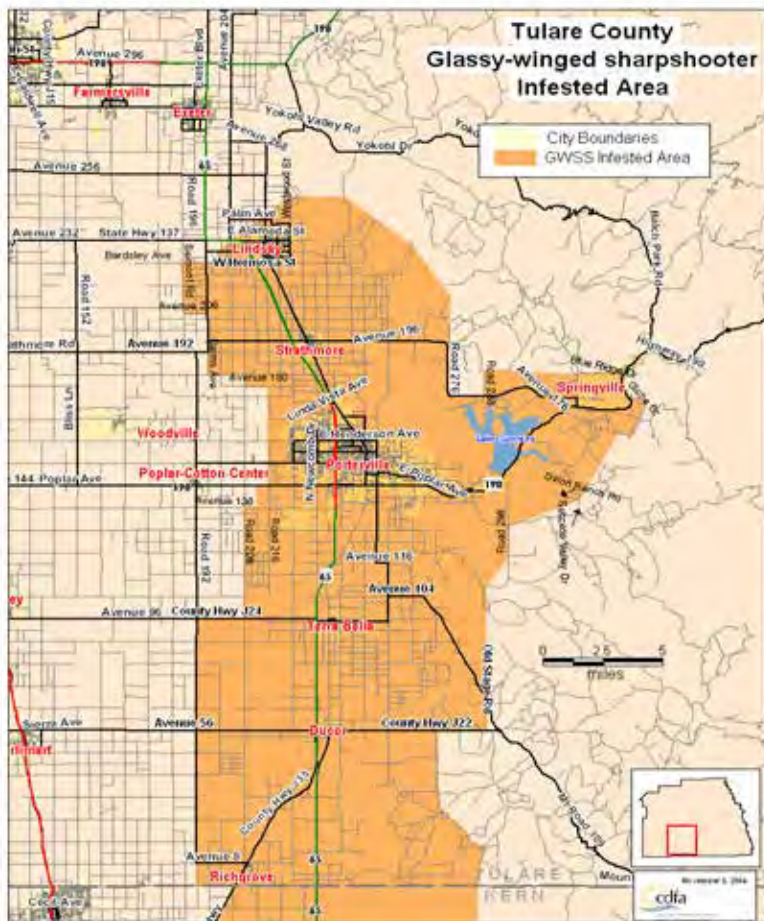
As with any area-wide program, program success in Tulare County was dependent upon the participation of growers to treat recommended acreage, as well as the teamwork of federal, state, county and contract program officials. Trapping data in

2005 indicated residual GWSS populations in a number of areas. Trapping data (current and past), treatment history, proximity to urban landscape, and in-field survey data provided by the County were all assessed prior to making a treatment recommendation. Due to the flight capabilities of this insect, treatment recommendations were made to include citrus within a ¼ mile buffer from trap finds that were deemed treatable by the program. Northern trap finds were treated with a foliar chemical, followed up with an Admire® treatment to try and ensure that those populations were knocked out to the best of the program’s ability and not able to move further north. A ½ mile treatment buffer was used for these northern finds. A total of 4,789 acres of commercial citrus were treated in 2005.

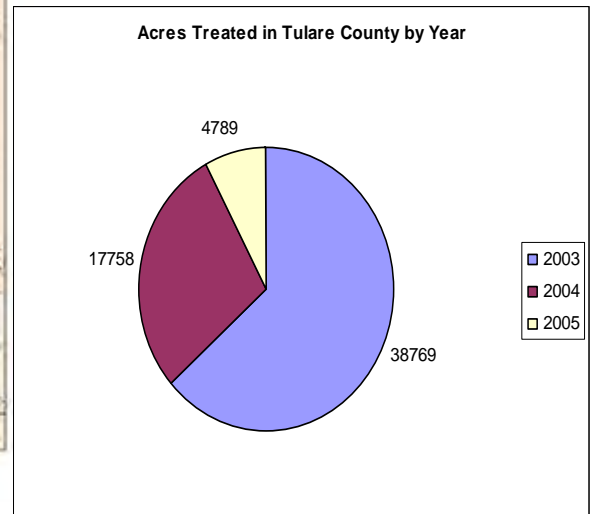
GWSS Trapping Summary			GWSS	GWSS
County	Year	# of Traps	TotalCount	AveCount
Tulare	2003	5,161	48,639	9.42
Tulare	2004	5,210	9,704	1.86
Tulare	2005	5,121	913	0.18

### FUNDING AGENCIES

Funding for this project was provided by the USDA Animal and Plant Health Inspection Service.

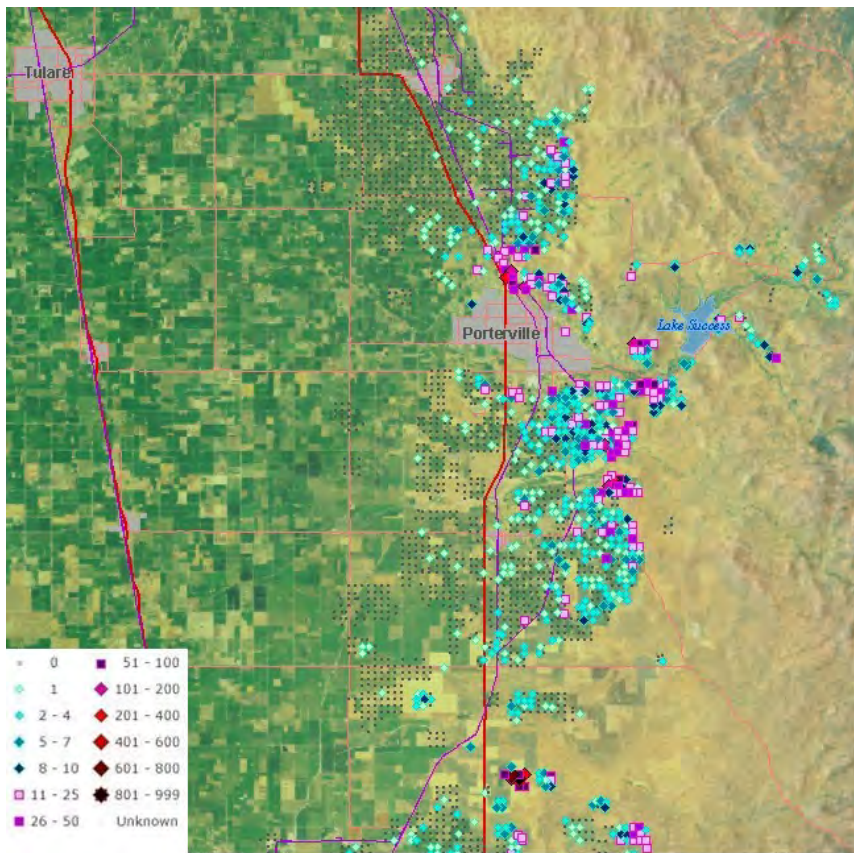


**Figure 1.** GWSS infested area of Tulare county.



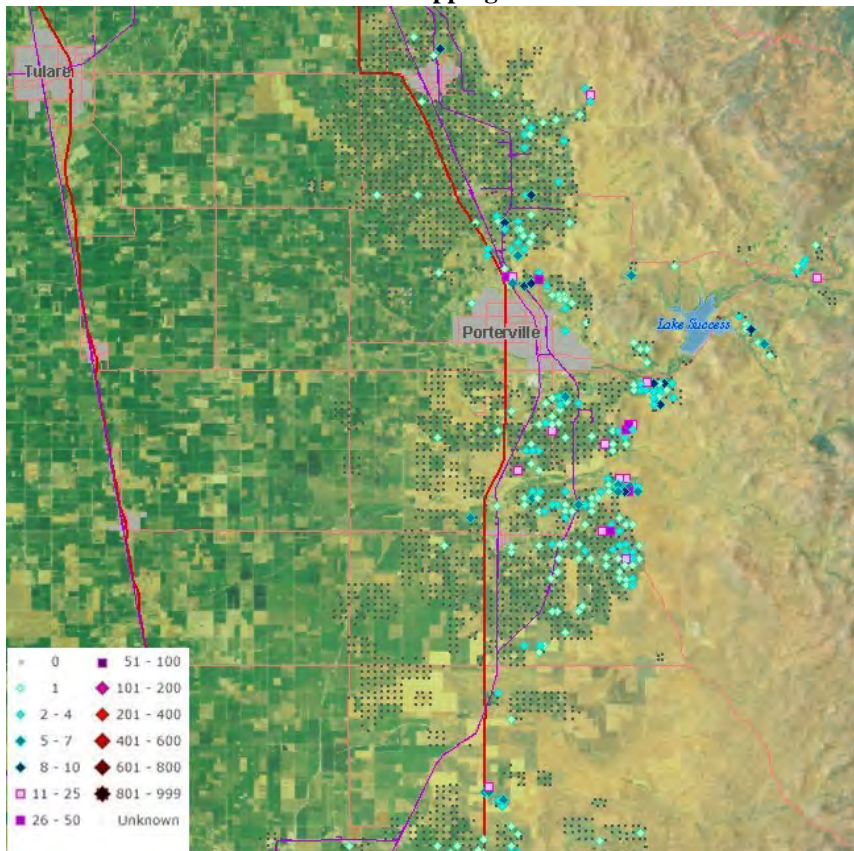
**Figure 2.** Total citrus acres treated in 2003, 2004 and 2005 under the GWSS Area-wide Program.

**Year To Date Trapping Totals 2004**



**Figure 3.** 1/1/04 through 9/24/04 GWSS trapping totals in Tulare County.

**Year To Date Trapping Totals 2005**



**Figure 4.** 1/1/05 through 9/23/05 GWSS trapping totals in Tulare County.

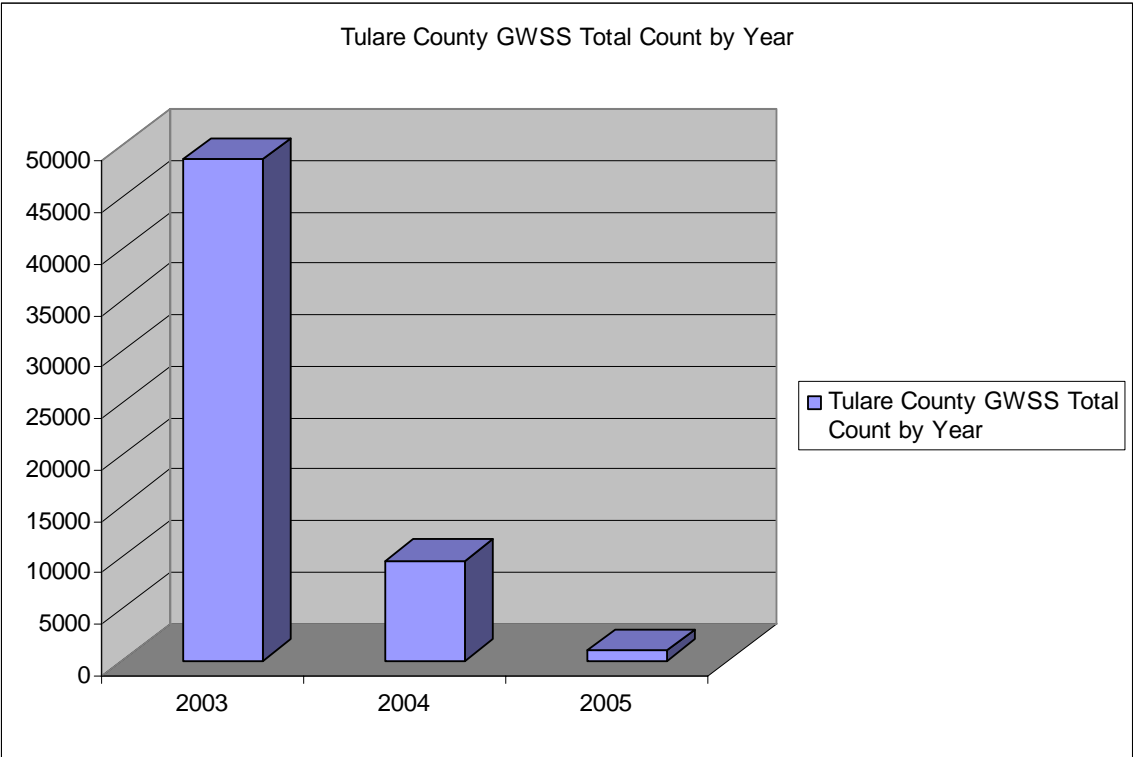


Figure 5. GWSS total trap catches on yellow-sticky traps in Tulare County by year.

Tulare County Weekly Trap Summary

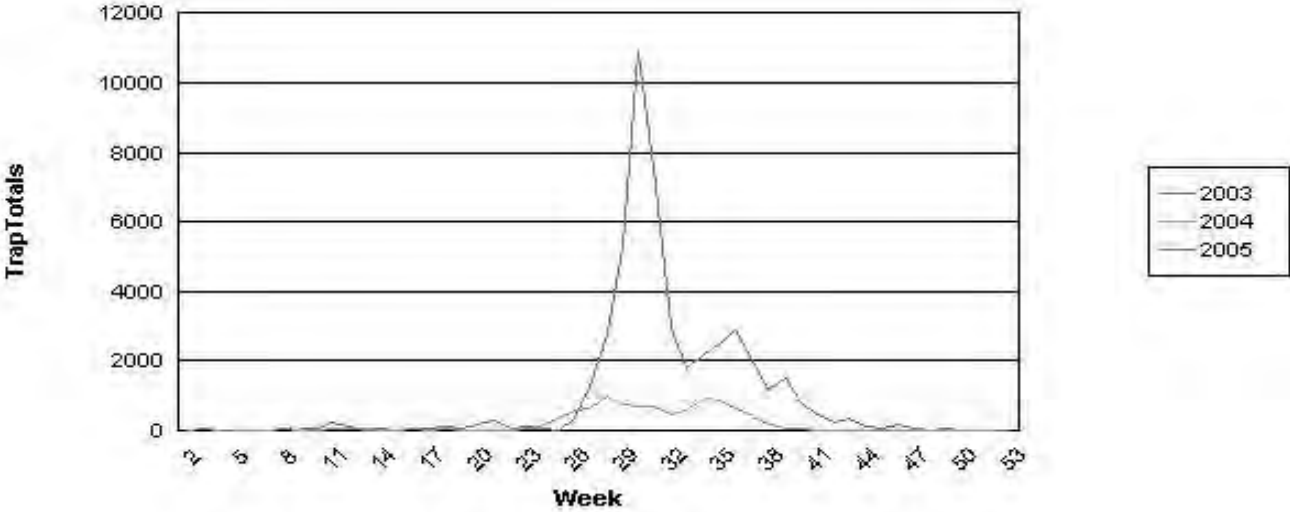


Figure 6. GWSS weekly trap summary in Tulare County by year.

# LABORATORY AND FIELD EVALUATIONS OF NEONICOTINOID INSECTICIDES AGAINST THE GLASSY-WINGED SHARPSHOOTER

## Project Leaders:

Nick Toscano and Frank Byrne  
Department of Entomology  
University of California  
Riverside, CA 92521

## Cooperators:

Mac Learned, Ed Ishida, and Manuel Jiminez  
Bayer CropScience

Carmen Gispert  
UC Cooperative Extension  
Riverside County  
Riverside, CA

Ben Drake  
Drake Enterprises  
Temecula, CA

**Reporting Period:** The results reported here are from work conducted July 2004 to October 2005.

## ABSTRACT

Admire and Platinum applications were compared in a Temecula vineyard. In previous trials conducted on both citrus and grapevines, we observed superior rates of uptake with Platinum despite lower application rates. In our most recent trial conducted in a Temecula vineyard, applications of Platinum at 11 fl oz/acre resulted in higher concentrations of active ingredient in the xylem fluid compared with applications of Admire at 16 fl oz/acre. Although peak levels of thiamethoxam declined more rapidly than imidacloprid, effective concentrations of both neonicotinoids persisted within vines during the season to provide adequate protection against glassy-winged sharpshooter (GWSS).

In studies conducted in two Coachella Valley vineyards, we found that the size girdling of vines at the time of Admire application did not impact the uptake of imidacloprid. At one vineyard, we did observe distinct differences in the overall levels of imidacloprid present within vines sampled at two distances from the irrigation pumps. Thus, during the course of application, vines nearest the injection source could receive significantly more insecticide than those further away.

Admire (32 fl oz/acre) applied to flood-irrigated citrus achieved threshold levels of imidacloprid within five weeks; these levels were then maintained for up to four months.

The binding capacity of Coachella vineyard soils was considerably lower compared with Temecula and Napa vineyard soils. In soil column studies, the imidacloprid elution profiles were very similar for Temecula and Napa soils. Dramatic differences in the uptake of imidacloprid following Admire applications in vineyards at these locations can be attributed to differences in irrigation practices.

## INTRODUCTION

Studies began in 2001 to evaluate the performance of imidacloprid (Admire) and thiamethoxam (Platinum) against GWSS on mature citrus. The results from that work established that the effectiveness of both insecticides at suppressing insect populations was due to highly efficient uptake, within-tree distribution and persistence throughout the growing season (Castle et al., 2005). Imidacloprid has been the mainstay of area-wide treatment programs for the GWSS since these programs were initiated. In the aforementioned study, thiamethoxam was equally efficient at suppressing populations, but its uptake into trees was considerably faster. Both products persisted for several months. Similar studies have since been conducted to evaluate the behavior of these chemicals in grape vines located in Temecula and Coachella Valley vineyards. Our initial work with vines was designed to establish treatment schedules for Admire, which was registered for use in grape pest management (Byrne et al., 2005). We have optimized Admire treatment strategies for growers in Temecula vineyards – a carefully timed application of 16 fl oz/acre will protect vines for much of the season, allowing for an additional rate of 16 fl oz/acre if required later in the season. We have shown that at the time when the threat of GWSS migration into vineyards is at its peak, the titers of imidacloprid in the xylem fluid are sufficient to control the insects when applications have been made in late March and early April. The delays in uptake that were observed with Admire treatments to mature citrus did not occur in grapevines, thereby providing growers with the possibility of reacting quickly to an imminent outbreak. Uptake of thiamethoxam into vines was also efficient. The results from our study provided valuable information to growers regarding application rates and will result in better insecticide management for the Temecula Valley viticultural area. In Coachella Valley, we are currently evaluating application strategies for growers. Our work has highlighted the variability that exists between vineyards in terms of the uptake of neonicotinoids. Soil type seems to contribute significantly to this, and we are now investigating the interaction between soil type and irrigation.

In this report, we include data on (1) the uptake and persistence of imidacloprid (Admire) and thiamethoxam (Platinum) within grapevines in Temecula, (2) the impact of girdling on the uptake of imidacloprid in grapevines in the Coachella

Valley. (3) the uptake of imidacloprid applied to flood-irrigated citrus, and (4) the impact of soil type on insecticide movement in soils sampled from three vine growing regions.

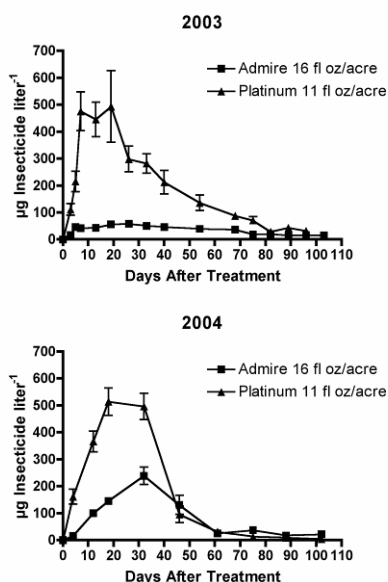
## OBJECTIVES

1. Determine the impact of soil type and irrigation on the uptake and residual persistence of imidacloprid and thiamethoxam.
2. Determine the best combination of application rates and number of applications of imidacloprid and thiamethoxam in order to maximize and extend protection to vineyards.
3. Determine the absorption, distribution and residual persistence of foliar applications of acetamiprid within grapevines.

## RESULTS

### Neonicotinoid uptake in Temecula vineyards

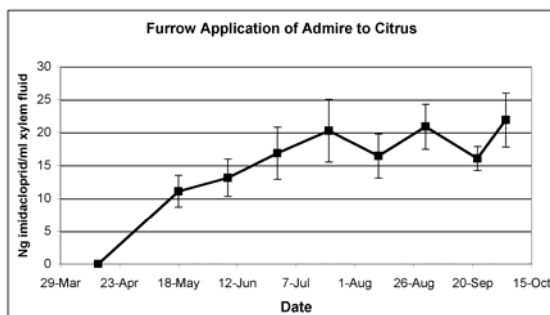
We evaluated the uptake of imidacloprid (Admire) and thiamethoxam (Platinum) over two years in the same vineyard (Sirah grapes) (Figure 1). The profiles for Platinum (applied at 11 fl oz/acre) were similar in both years, and were characterized by a rapid increase of thiamethoxam to a peak level of ca. 500 ng imidacloprid/ml xylem fluid, followed by a relatively rapid decline in concentrations. Although Admire was applied at 16 fl oz/acre, peak imidacloprid levels were much lower than those measured for thiamethoxam. Nevertheless, imidacloprid concentrations present within vines remained above the desired threshold of 10 ng/ml xylem fluid during the trial period.



**Figure 1.** Uptake profiles for imidacloprid (applied as Admire at 16 fl oz/acre) and thiamethoxam (applied as Platinum at 11 fl oz/acre) in 2003 and 2004 at the same vineyard. On each sampling date, xylem fluid was extracted from the same vines (n=16 for both treatments). Values are means  $\pm$ SEM.

### Impact of irrigation on Admire uptake

The uptake of Admire applied during furrow irrigation of citrus was investigated in a commercial orchard (Figure 2). In a previous study (Castle et al., 2004), it was established that a minimum of 10 ppb (ng/ml xylem fluid) imidacloprid was required for effective control of GWSS. The trees in this study were treated with 32 fl oz per acre of Admire on April 14, 2004. The first xylem samples were extracted five weeks after the application. At this time, the average concentration of imidacloprid within the xylem was above the target threshold. Following the initial sampling, there was a steady increase in the imidacloprid levels up until the final samples were extracted on Oct 4. Based upon these results, furrow irrigation would seem to be a viable option for Admire application in orchards that still practice this method of irrigation.



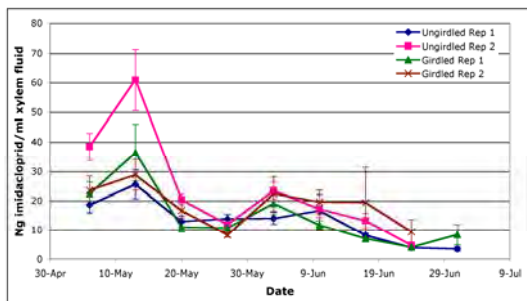
**Figure 2.** Uptake profiles for imidacloprid applied as Admire at 32 fl oz/acre during flood irrigation of citrus trees. On each sampling date, xylem fluid was extracted from two terminal branches from each of 12 trees. Values are means  $\pm$ SEM.



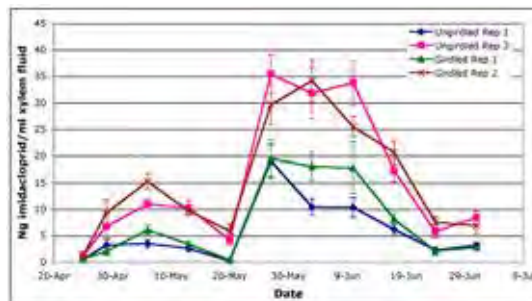
### Impact of girdling on the uptake of Admire in Coachella vineyards

In our 2004 report, we presented data that suggested a potential impact of size-girdling on the uptake of imidacloprid in Coachella Valley vineyards. In 2005, we conducted independent assessments at two vineyards to determine whether size-girdling of vines at the time of Admire treatments (by chemigation) had a deleterious effect on subsequent levels of imidacloprid present in xylem fluid (extracted from canes above the girdle) (Figures 3 and 4). At both locations, we replicated our experiment within each block, with 20 rows between replicates. For each replicate, girdled and ungirdled vines were sampled from each row to minimize inter-row variation.

In general, we did not observe any dramatic effect of girdling. At both vineyards, comparisons of girdled and ungirdled vines within the same replicate showed no significant differences. However, at one vineyard (Figure 4), there was a distinct separation of uptake profiles between replicates. At this time, we are not sure what caused this anomaly; however, we suspect that the closer proximity of replicate #2 (girdled and ungirdled) vines to the irrigation pumps (the injection source of the Admire) resulted in the delivery of higher amounts of Admire to these vines. At the other vineyard (Figure 3), we did not observe this phenomenon, despite the closer proximity of replicate #1 to the Admire injection source.



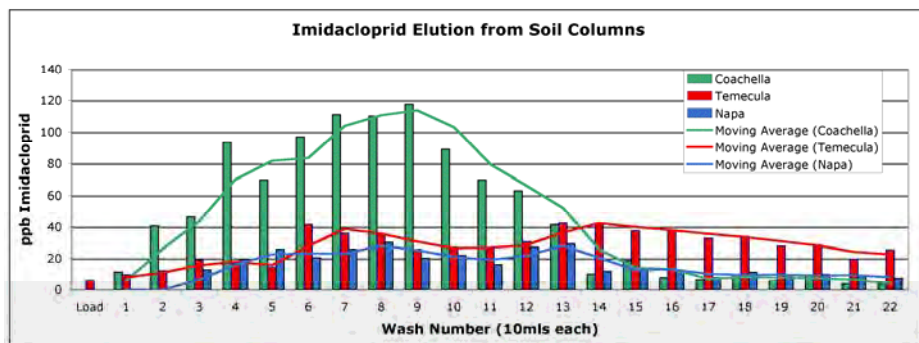
**Figure 3.** Uptake of imidacloprid into vines that were either size-girdled or not (ungirdled) at the time of the Admire application (application rate was 16 fl oz/acre). Girdled and ungirdled vines were sampled at two locations within the treated block. At each location (replicate), xylem fluid was extracted from 16 girdled and 16 ungirdled vines. The same vines were sampled on each sampling date throughout the trial. Each point is the mean  $\pm$ SEM for 16 vines.



**Figure 4.** Uptake of imidacloprid into vines that were either size-girdled or not (ungirdled) at the time of the Admire application (application rate was 16 fl oz/acre). Girdled and ungirdled vines were sampled at two locations within the treated block. At each location (replicate), xylem fluid was extracted from 16 girdled and 16 ungirdled vines. The same vines were sampled on each sampling date throughout the trial. Each point is the mean  $\pm$ SEM for 16 vines.

### Effect of soil type on the movement of imidacloprid

In soil column studies, we measure the movement of insecticides through a column of soil (Figure 5). The elution profile can provide important information on the behavior of an insecticide in different soil types. In our vineyard studies, we have encountered two distinctive soil types. In Coachella Valley, the soils are generally sandy and have poor binding potential under the high irrigation load. In contrast, the Temecula Valley and Napa Valley soils have higher clay contents, with a greater capacity to bind insecticides. This increased binding capacity will retard the movement of imidacloprid downwards, holding the insecticide in the upper layers of the soil where it can be solubilized during irrigation and thus made available to the roots for uptake. Without irrigation, uptake is likely to be compromised, as we have observed from our studies in Temecula and Napa (the latter study was conducted by Ed Weber, UC Cooperative Extension, Napa). In the Napa study, irrigation was minimal compared with the Temecula study, and this probably accounted for the low levels of imidacloprid detected in the Napa Valley vines.



**Figure 5.** Elution of imidacloprid from soil columns prepared from Coachella, Temecula and Napa vineyard soils. Equal quantities of imidacloprid were loaded (in 10ml) onto the columns, which were then washed with successive 10ml volumes of water. As each 10ml wash was added to the top of the column, 10mls (the eluate) was displaced at the bottom. The imidacloprid content in each eluate was quantified by ELISA. The graph shows a typical elution profile for the soil types found in these vineyards.

## CONCLUSIONS

Management of sharpshooter populations is key to minimizing the spread of Pierce's disease (PD). The neonicotinoids have been effective at achieving area-wide management of this important disease vector, resulting in a dramatic decrease in the incidence of PD. The value of our work has been in the optimization of several neonicotinoid insecticides for use in citrus orchards and vineyards. We have identified rates of insecticide necessary to protect vineyards from GWSS infestations. And, equally important, we have identified certain situations when soil type and irrigation practices are not compatible with their use. Our studies are ongoing with other members of the neonicotinoid insecticide class.

## REFERENCES

- Byrne F.J., Castle S.J., Bi, J.L. and N.C. Toscano. 2005. Application of competitive ELISA for the quantification of imidacloprid titers in xylem fluid extracted from grapevines. *J. Econ. Entomol.* 98: 182-187.
- Castle, S.J., Byrne, F.J., Bi, J.L., and N.C. Toscano. 2005. Spatial and temporal distribution of imidacloprid and thiamethoxam in citrus and impact on *Homalodisca coagulata* Wells populations. *Pest Manage. Sci.* 61: 75-84.

## FUNDING AGENCIES

Funding for this project was provided by the CDFA Pierce's Disease and Glassy-winged Sharpshooter Board, with additional support from the California Desert Grape Administrative Committee, and Bayer CropScience.

**RIVERSIDE COUNTY GLASSY-WINGED SHARPSHOOTER AREA-WIDE MANAGEMENT PROGRAM  
IN THE COACHELLA AND TEMECULA VALLEYS**

**Project Leaders:**

Nick C. Toscano  
Department of Entomology  
University of California  
Riverside, CA 92521

Carmen Gispert  
UC Cooperative Extension  
Indio, CA 92201

**Operations Coordinator:**

Gregory Ballmer  
Department of Entomology  
University of California  
Riverside, CA 92521

**Cooperators:**

Rodney Mendes  
CDFA, PDCP  
Riverside, CA 92507

John Snyder  
Riverside County  
Riverside, CA 92502

Thomas Perring  
Department of Entomology  
University of California  
Riverside, CA 92521

Robert Mulherin  
Riverside County  
Riverside, CA 92502

**Reporting Period:** The results reported here are from work conducted October 2004 to September 2005.

**ABSTRACT**

Riverside County has two general areas where citrus groves interface with vineyards, the Coachella Valley and the Temecula Valley. The Coachella Valley has 10,438 acres of table grapes in proximity to 12,000 acres of citrus and the Temecula Valley has 2,000 acres of wine grapes in proximity to 1,600 acres of citrus which are vulnerable to Pierce's disease (PD), *Xylella fastidiosa* (Xf). The grapes in the Coachella and Temecula areas of Riverside County are in jeopardy because of the glassy-winged sharpshooter (GWSS), the vector of the PD bacterium, build up in adjacent citrus groves. Citrus is an important year around reproductive host of GWSS in Riverside County, but also one that concentrates GWSS populations over the winter months during the time that grapes and many ornamental hosts are dormant. GWSS weekly monitoring in citrus in grapes began in March 2000 in Temecula Valley and 2003 in Coachella Valley by trapping and visual inspections. Systemic insecticides such as Admire (imidacloprid), gave excellent control. Coachella Valley GWSS populations have increased since the treatment program was initiated in 2003 but have declined substantially relative to the pre-action levels due to insecticide applications.

**INTRODUCTION**

The wine grape industry and its connecting tourist industry in Temecula Valley generate \$100 million in revenue for the economy of the area. GWSS/PD caused a 30% vineyard loss and almost brought this wine growing region to its knees. An area-wide GWSS management program initiated in the spring of 2000 saved the industry from a 100% loss. Only a continuation of an area-wide GWSS management program will keep the vineyards viable in Temecula. The table grape industry in the Coachella Valley is represented by 10,465 acres of producing vines, which generate fresh market grapes valued at an average of \$110 million annually. The GWSS was identified in the Coachella Valley in the early 1990's. Population increases of this insect in Coachella Valley in the last three years have increased the danger of PD occurrence in this area, as has occurred in similar situations in the Temecula Valley and San Joaquin Valley. In July 2002, the occurrence of Xf, the PD bacterium, was found in 13 vines from 2 adjacent vineyards in the southeastern part of Coachella Valley. With this discovery, and the increasing GWSS populations, there was and is a real need to continue an area-wide GWSS/PD management program, to prevent an economic disaster to the work forces and connecting small businesses of Mecca, Thermal, Coachella, Indio, etc. that depend upon the vineyards for a big portion of their incomes. Only a continuation of an area wide GWSS/PD management program will keep the vineyards viable in Coachella. At present there are no apparent biological or climatological factors that will limit the spread of GWSS or PD. GWSS has the potential to develop high population densities in citrus. Insecticide treatments in citrus groves preceded and followed by trapping and visual inspections to determine the effectiveness of these treatments are needed to manage this devastating insect vector and bacterium. Approximately 5,200 acres of citrus in Riverside County were treated for the GWSS in February through July, 2004 between a cooperative agreement with USDA-APHIS and the Riverside Agricultural Commissioner's Office under the "Area-Wide Management of the Glassy-Winged Sharpshooter in the Coachella and Temecula Valleys." The cost of Riverside County GWSS treatments was close to \$1,000,000.

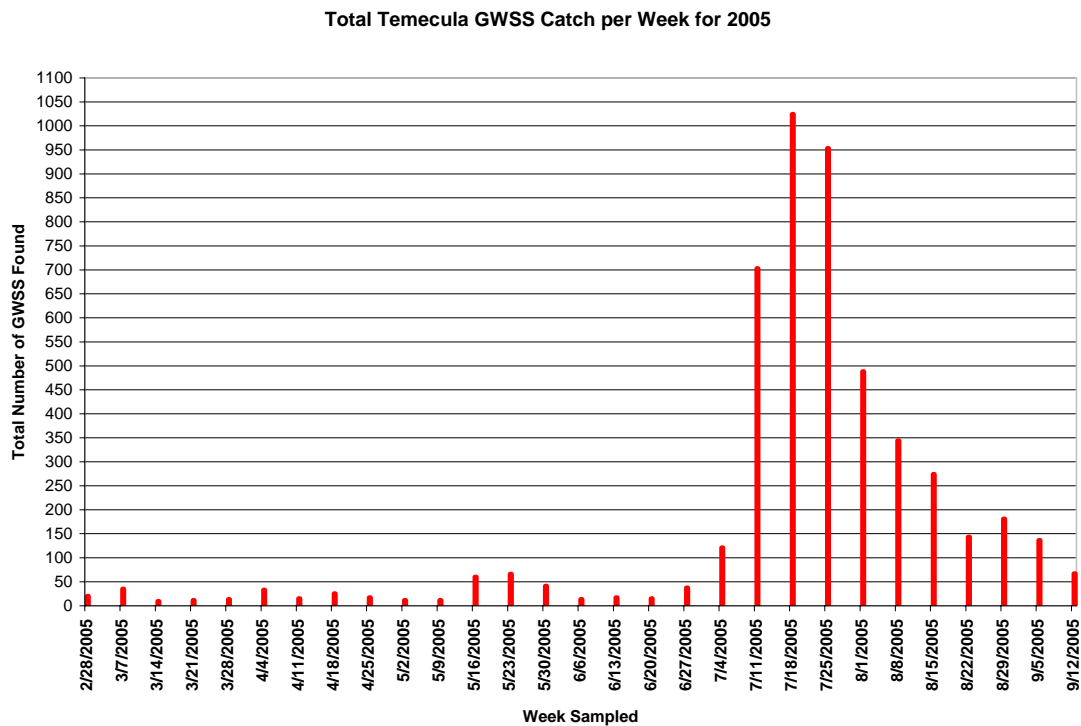
**OBJECTIVES**

1. Delineate target areas for follow-up treatments to suppress GWSS populations in the Temecula Valley and Coachella Valley for 2005.
2. Determine the impact of the 2003 GWSS area-wide treatments to suppress GWSS populations in citrus groves and adjacent vineyards.

## RESULTS AND CONCLUSIONS

The programs in Coachella and Temecula were dependent upon grower, pest management consultants, citrus and vineyard manager's participation. The areas encompass approximately 28,000 acres. Representatives of various agencies were involved in the program, they were as follows: USDA-ARS, USDA-APHIS, CDFA, Riverside County Agricultural Commissioner, UC Riverside, UC Cooperative Extension, and grower consultants. Representatives of these agencies meet to review the program. Newsletters are sent to growers, managers, wineries, and agencies with information on GWSS populations and insecticide treatments via e-mail. The information from Temecula is sent weekly, while information from Coachella goes to the various parties monthly.

The GWSS/PD citrus groves and vineyards within the GWSS/PD management areas were monitored weekly to determine the need and effect of insecticide treatments on GWSS populations. Yellow sticky traps (7 x 9 inches) were used to help determine GWSS population densities and dispersal/movement within groves and into vineyards (Figures 1 and 2). A total of 986 GWSS yellow sticky traps are monitored weekly. Based on trap counts and visual inspection, approximately 4,000 and 700 acres of citrus were treated in Coachella and Temecula, respectively for GWSS control in 2005. In Temecula and Coachella Valley treatments for GWSS in citrus were initiated when at least 1-2 GWSS adults were found at the same trap location for two consecutive weeks. In Temecula Valley only the citrus where the GWSS was found were treated. In Coachella Valley all citrus located within a 0.5 mile radius from the trap find were treated as a preventive measure to protect surrounding groves. The decision to treat more area from GWSS finds in Coachella than what was treated in Temecula differed because of terrain, urban development and the history of GWSS blow-ups in Kern County and Temecula Valley the fourth year after GWSS area-wide programs were initiated. Approximately 90% of the citrus was treated with a single application of Admire/Merit (imidacloprid) at 36 ounces per acre; 9% with PyGanic (1.4% Pyrethrins) at 7 pints per acre; and the remainder with Assail (acetamiprid) at the rate of 2 ounces per acre. PyGanic was used to treat organically grow citrus. In most areas where PyGanic was used to manage GWSS a follow up treatment of PyGanic was applied within two weeks after the first application.



**Figure 1.** In 2005, high numbers of adult GWSS were caught on the yellow sticky traps in Temecula, with populations peaking in July reaching a total of almost 1,050 trapped.

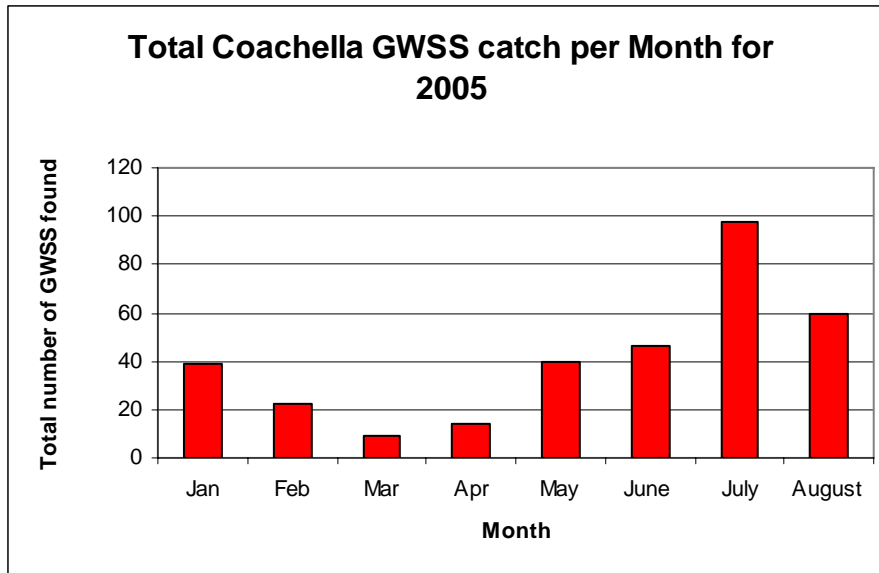


Figure 2. GWSS populations in Coachella Valley peaked in July with a high of 100 trapped.

For a successful area-wide GWSS management program with large acreages of citrus, a management program has to be initiated. Organic insecticides are not as effective as the neonicotinoid insecticides such as Admire or Assail for controlling GWSS. Therefore, organic insecticides will have to be applied more frequently than its synthetic counterpart. In our Riverside County GWSS area wide program organic citrus groves pose challenges to area-wide GWSS management programs (Figure 3).

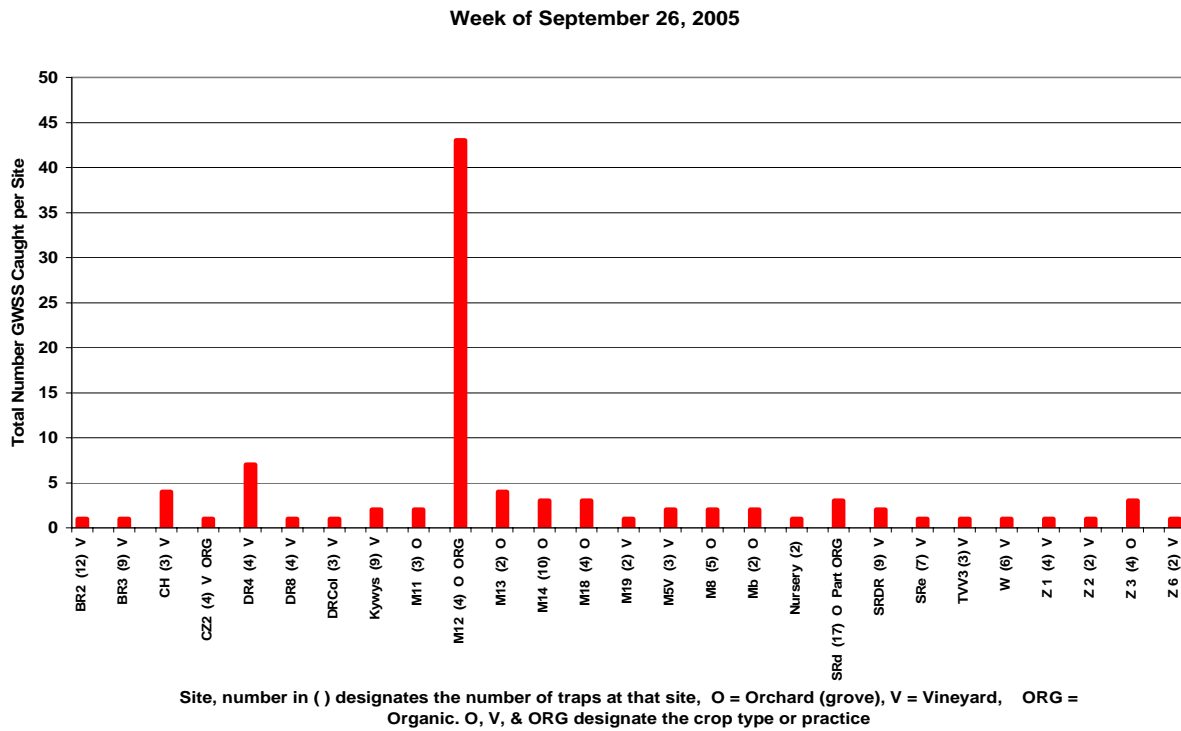


Figure 3. Temecula GWSS adults caught for the week of September 26, 2005.

**FUNDING AGENCIES**

Funding for this project was provided by the USDA Animal and Plant Health Inspection Service, and the CDFA Pierce’s Disease and Glassy-winged Sharpshooter Board.

**Additional Note:** We would like to especially thank Ben Drake of Drake Enterprises for his input and counsel, and the grape and citrus growers, managers, and pest control advisors for their needed cooperation to make the Riverside County GWSS area wide management program successful. We want to thank Heavenly Clegg for her development of the Temecula GWSS newsletter and Gevin Kenny for managing the Temecula GWSS monitoring and data analysis. We would especially want to thank CDFA's Rosie Yacoub for bar coding of the GWSS sticky traps, which resulted in simplifying our data input and mapping of GWSS populations in Temecula and Coachella Valleys.

## COMPATIBILITY OF SELECT INSECTICIDES WITH NATURAL ENEMIES OF THE GLASSY-WINGED SHARPSHOOTER AND OTHER PESTS

### Project Leaders:

Nick C. Toscano and Joseph G. Morse  
Department of Entomology  
University of California  
Riverside, CA 92521

Timothy J. Henneberry  
WCRL, USDA, ARS  
Phoenix, AZ 85040

### Cooperators:

Nilima Prabhaker  
Department of Entomology  
University of California  
Riverside, CA 92521

Steven Castle and Steve Naranjo  
WCRL, USDA, ARS  
Phoenix, AZ 85040

**Reporting Period:** The results reported here are from work conducted November 2004 to September 2005.

### ABSTRACT

The toxicity of two insect growth regulators (IGRs), buprofezin and pyriproxyfen; three neonicotinoids, acetamiprid, imidacloprid and thiamethoxam; and three conventional insecticides, bifenthrin, fenpropathrin, and chlorpyrifos; were tested in the laboratory for compatibility with egg parasitoids (*Gonatocerus ashmeadi*, *Gonatocerus triguttatus*) of glassy-winged sharpshooter (GWSS), *Homalodisca coagulata* and against *Aphytis melinus* (*A. melinus*), an endoparasitoid of armored scale insects found on citrus in California. Most of the selected insecticides tested are used against GWSS and other pests on citrus and grapes. Survivorship of adult parasitoids on citrus leaves with residues of these insecticides (within Petri dishes) was determined after 24, 48 and 72h. Our results indicated that a number of insecticides tested are toxic to the egg parasitoids, *Gonatocerus* spp., as well as to *A. melinus* under laboratory conditions. Results from this study allow ranking of the eight insecticides based on their increasing toxicity as follows for *Gonatocerus* spp.: fenpropathrin > pyriproxyfen > buprofezin > imidacloprid > thiamethoxam > acetamiprid > bifenthrin > chlorpyrifos. All insecticides tested were highly toxic to *A. melinus*. In additional studies, higher concentrations of imidacloprid and thiamethoxam were found to be toxic over time to two predators, *Geocoris punctipes* and *Orius insidiosus*. Results from laboratory studies suggest that both systemics, imidacloprid and thiamethoxam, may not preserve these parasitoids as much as expected. To understand these bioassay results with the two systemics, further studies included the quantification of imidacloprid and thiamethoxam in both the parasitoids and the test citrus leaves by ELISA kits. Results indicated the presence of varying levels of these two compounds in the parasitoids as well as in citrus leaves suggesting that although parasitoids are non-plant feeders, they were exposed to the systemic chemicals. Further research is underway to determine how the parasitoids are exposed to the two systemics.

Relative numbers of GWSS and its natural enemies from Riverside were determined using two sampling methods, collection of fresh GWSS egg masses on two host plants (citrus and willow) and using yellow sticky cards. Relative numbers of the pest (GWSS) and beneficials (*Gonatocerus ashmeadi*, *Gonatocerus triguttatus* and *Ufens* spp.) varied based on the sampling method. Seasonal patterns were obvious with higher parasitoid numbers in summer compared to fall collections with a parasitism rate at >90% based on the egg collection method. Few predators were observed on the yellow sticky cards.

### INTRODUCTION

Many insecticides that have been used to suppress GWSS populations appear to be quite effective (Akey et al. 2001, Bethke et al. 2001, Prabhaker et al. 2005). However, there is little information available on the long-term impact that different control measures are having on GWSS populations and its natural enemies on citrus and grapes. Although biological control has been the foundation of citrus IPM in California for many years, it is now threatened by the arrival of several new pests and greater use of non-selective insecticides to control these new pests. In particular, the recent registration of new insecticides for use on citrus is creating uncertainty over the longer-term impact they may have on established IPM programs (Grafton-Cardwell and Gu 2003). It is therefore essential to attain greater understanding of the various control options for GWSS in citrus and how they can be best integrated with existing, successful management programs. The overall objective of this research proposal is to help determine IPM compatible management tactics by focusing on chemical control being used against GWSS and by evaluating their impact upon several important biological control agents. To address this goal, the impact of various insecticides including those that are used against GWSS and other pests on citrus was assessed against GWSS egg parasitoids and *A. melinus* using two bioassay techniques, a Petri dish assay and systemic uptake bioassay (Prabhaker et al. 2005). The insecticides evaluated in this study included three conventional compounds, chlorpyrifos, bifenthrin, and fenpropathrin; two IGRs, pyriproxyfen and buprofezin; and three neonicotinoids, acetamiprid, imidacloprid, and thiamethoxam.

## OBJECTIVES

1. Monitor citrus orchards in Riverside Co., Ventura Co. and Coachella Valley to determine the relative abundance of select parasitoids and predators before and after treatment
2. Evaluate select foliar and systemic GWSS pesticides used on citrus and grapes for their impact on GWSS egg parasitoids such as *Gonatocerus ashmeadi* and *Gonatocerus triguttatus* as well as other parasitoids in the system such as *A. melinus*.
3. Determine if honeydew produced by homopteran insects on citrus can be contaminated with systemic insecticides such as imidacloprid and thiamethoxam.
4. Determine the impact of imidacloprid and thiamethoxam residues within plant or within plant-feeding intoxicated insects, on the survivorship of *Gonatocerus ashmeadi* (*G. ashmeadi*), *Gonatocerus triguttatus* (*G. triguttatus*), and *A. melinus*.

## RESULTS

### Monitoring

Two sampling methods, collection of fresh GWSS egg masses and use of yellow sticky cards were used to survey the relative abundance of natural enemies including parasitoids and predators that are active against GWSS and other pests in citrus orchards in Riverside Co. The survey was initiated in July 2004 and continued through November 2004. Subsequent surveys were conducted from June 2005 through September 2005. Yellow sticky traps were posted at multiple locations within each orchard for continuous monitoring of GWSS and natural enemies and were changed once a week. Significant differences were found in the numbers of parasitoids collected from GWSS egg masses compared to the numbers collected on sticky traps. Data collected from the sticky traps showed a significantly lower number of parasitoids relative to GWSS (<10%). In contrast, direct observations of the numbers of parasitoids that emerged from egg masses were much higher than GWSS immatures, thus showing a higher rate of parasitism using this method. Numbers of parasitoids were much higher in summer than in early fall. This trend was observed by both monitoring techniques. The majority of the GWSS egg masses collected in September 2005 from Riverside Co. were parasitized by *Gonatocerus* spp. (mixed populations of *G. ashmeadi* and *G. triguttatus*). These results provided a picture of relative GWSS activity within each orchard in addition to providing limited information on the activity and abundance of natural enemies. Our results indicate that both techniques were necessary to assess the activity of beneficials because of the significant differences obtained in relative numbers based on the monitoring technique. Predators were observed in lower numbers compared to parasitoids.

### Toxicological responses of *Gonatocerus* spp.

Bioassay responses of *Gonatocerus* spp. under laboratory conditions to the two IGRs by the Petri dish method generated LC<sub>50</sub>s that were higher than with the neonicotinoids (Table 1). Pyriproxyfen showed low toxicity to the parasitoids after 96h of exposure, when exposed to the insects as leaf residues in the Petri dish at higher concentrations. Similar results were observed with buprofezin. Toxicity was quite low for the first 96h but increased over time. The most toxic neonicotinoid to *Gonatocerus* spp. was acetamiprid as indicated by a low LC<sub>50</sub> of 0.034  $\mu$ g/mL, followed by thiamethoxam at 0.312  $\mu$ g/mL, a 9-fold difference between the two compounds. A larger difference in toxicity was observed between the two systemics, imidacloprid and thiamethoxam. Both compounds were toxic to *Gonatocerus* spp. but thiamethoxam was more toxic after 24h exposure as indicated by the lower LC<sub>50</sub> compared to imidacloprid which exhibited a higher LC<sub>50</sub> of 11.06  $\mu$ g/mL at 48 h observation, which decreased further after 72h exposure. Imidacloprid was not toxic to these insects at tested doses during the first 24h of exposure. A notable difference in responses of the parasitoids to fenpropathrin was observed using the Petri dish technique (Table 1). The LC<sub>50</sub>s determined were the highest among all the insecticides tested and indicated that fenpropathrin was less toxic to *Gonatocerus* spp in contrast to the lower LC<sub>50</sub> value observed with bifenthrin. This is a major difference in activity for the same class of chemistry. The most toxic compound among all classes of chemistry evaluated was chlorpyrifos as seen by the low LC<sub>50</sub>.

### Toxicological responses of *A. melinus*

Results with *A. melinus* were quite different from those obtained with *Gonatocerus* spp. (Table 2). The LC<sub>50</sub> values were much lower to most of the compounds for *A. melinus* indicating that these insects were quite susceptible to these insecticides. In some of the bioassays, *A. melinus* were so susceptible that mortality averaged 90-95% for most of the tested concentrations. These results suggest that *A. melinus* is more susceptible than *Gonatocerus* spp. as measured by the Petri dish technique. In general, *A. melinus* mortality was high even at 24h compared to the GWSS egg parasitoids.

### Toxicological responses of predators

Susceptibility of two predators, *Geocoris punctipes* and *Orius insidiosus*, to imidacloprid and thiamethoxam was also evaluated. Both systemic compounds were toxic to these predators (Table 3), although these results are not surprising because *Geocoris* spp. and *Orius* spp. are plant feeders at times. The LC<sub>50</sub> values were low to both compounds but only after 72 or 96h exposure.



### **Quantification of imidacloprid and thiamethoxam**

Quantitative estimates of imidacloprid and thiamethoxam were made using ELISA kits to determine if the mortality observed was correlated to levels of the compounds in leaves. Variable levels of imidacloprid were detected in the homogenates of both insects and bioassay leaves as well as in the surface leaf washes of citrus leaves. These results indicated that imidacloprid is present on treated leaves as well as in the insect. Similar results were observed with systemically applied thiamethoxam. These results will assist in interpretation of our bioassay results with systemic compounds.

### **Impact of residues of insecticides in honeydew**

Results of this objective have not been completed. When tests were conducted to expose *A. melinus* by contact with surface residues of citrus leaves from trees that were treated with imidacloprid two years prior in a Riverside Co. location, results showed high mortality (92%) of *A. melinus*. This test was conducted to assess toxicity in general to *A. melinus* because these parasitoids will feed on available honeydew in citrus and not just on armored scales. If there are residues of treated compounds such as imidacloprid and/or thiamethoxam in honeydew, ELISA tests can determine if the systemic chemicals can be detected in honeydew produced by homopterans. Results were not conclusive because some of the insects showed mortality as high as 45% when confined on leaves from untreated trees. Future research plans will include more replications of this test.

### **Work in Progress**

Work is in progress evaluating the impact of imidacloprid and thiamethoxam within plants on the survivorship of *Gonatocerus* spp. and *A. melinus*. Our preliminary results have shown that systemics have an impact on GWSS egg parasitoids and *A. melinus*. The potential for mortality caused by systemic insecticides in non-plant feeding insects such as parasitoids of GWSS needs to be evaluated further. The lethal effects on *Gonatocerus* spp. and *A. melinus* that occurred when exposed to systemically treated plant surfaces will be measured further by quantifying the titers of either imidacloprid or thiamethoxam within the leaf tissue as well as in GWSS eggs or scale nymphs in which parasitoids develop. In future tests, we will attempt to relate survivorship of parasitoids to the titers of either material within the treated leaf tissue or within GWSS eggs. The effect of imidacloprid and thiamethoxam treatments on *Gonatocerus* spp. will be studied during the second year of this research project.

### **CONCLUSIONS**

Differences were observed in estimates of the relative numbers of natural enemies of GWSS using two monitoring methods. Numbers of parasitoids and rates of parasitism were much higher using the egg mass collection method versus the yellow sticky card technique. Both techniques showed seasonal differences in numbers of natural enemies, with higher levels in summer than in fall. This study helped fill the gap in knowledge regarding the effect of selected insecticides against natural enemies of GWSS. The work reported here investigated the toxicological effects of three neonicotinoids, imidacloprid (Admire), acetamiprid (Assail) and thiamethoxam (Platinum); two IGRs, buprofezin (Applaud) and pyriproxyfen (Esteem); two pyrethroids, bifenthrin (Capture) and fenpropathrin (Danitol); and an organophosphate, chlorpyrifos (Lorsban); against parasitoids of GWSS and *A. melinus*. Contrary to widespread assumption that systemic insecticides may not be toxic to natural enemies, our data showed that systemically applied imidacloprid and thiamethoxam were toxic to parasitoids that do not feed on plant tissue. Additionally, naturally occurring honeydew on citrus leaves may be toxic to *A. melinus*. These data will help determine the relative compatibility of particular insecticides to foraging natural enemies.

### **REFERENCES**

- Akey, D. H., T. J. Henneberry and N. C. Toscano. 2001. Insecticides sought to control adult glassy-winged sharpshooter. Calif. Agric. 55: 22-27.
- Bethke, J. A., M. J. Blua and R. A. Redak. 2001. Effect of selected insecticides on *Homalodisca coagulata* (Homoptera: Cicadellidae) and transmission of oleander leaf scorch in a greenhouse study. J. Econ. Entomol. 94: 1031-1036.
- Grafton-Cardwell, E. and P. Gu. 2003. Conserving vedalia beetle, *Rodolia cardinalis* (Mulsant) (Coleoptera: Coccinellidae), in citrus: A continuing challenge as new insecticides gain registration. J. Econ. Entomol. 96: 1388-1398.
- Morse, J. G. and R. F. Luck. 2003. The History of Integrated Pest Management of Citrus in California. Proceedings of the International Society of Citriculture, Orlando, FL, Dec. 3-7, 2000, Volume 2. pp. 805-807.
- Prabhaker, N., S. J. Castle, F. J. Byrne, T. J. Henneberry and N. C. Toscano. 2005. Establishment of baseline susceptibility data to various insecticides for glassy-winged sharpshooter, *Homalodisca coagulata* Say (Homoptera: Cicadellidae) by comparative bioassay techniques. JEE (In Press).

**Table 1.** Toxicity of various insecticides to *Gonatocerus* spp.

Compound	Bioassay Technique	Exposure Time	# Tested	LC50 (µg/mL)
Buprofezin	Petri dish	72	232	115.21
Pyriproxyfen		24		102.78
Acetamiprid	Petri dish	24	267	0.062
Imidacloprid	Uptake	24	253	166.64
		48		11.06
Thiamethoxam	Uptake	24	295	0.312
Bifenthrin	Petri dish	24	198	0.034
		48	252	0.007
Fenpropathrin	Petri dish	24	248	323.30
		48		278.05
Chlorpyrifos	Petri dish	24	208	0.002

**Table 2.** Toxicity of various insecticides to *A. melinus*

Compound	Bioassay Technique	Exposure Time	# Tested	LC50 (µg/mL)
Buprofezin	Petri dish	24	812	0.215
Pyriproxyfen		24		0.436
Acetamiprid	Petri dish	24	823	0.017
Imidacloprid	Uptake	24	905	2.147
		48		0.416
Imidacloprid + honey		24	1564	0.0008
Thiamethoxam	Uptake	24	1695	0.044
Bifenthrin	Petri dish	24	738	0.001
Fenpropathrin	Petri dish	24	854	0.064
		48		0.008
Chlorpyrifos	Petri dish	24	578	0.0007

**Table 3.** Toxicity of two neonicotinoids to two predators using an uptake bioassay technique

Compound	Exposure time	# Tested	LC <sub>50</sub> (µg/mL)
<i>Orius insidiosus</i>			
Imidacloprid	24	294	1.38
	72		0.018
Thiamethoxam	24	268	0.307
	72		0.007
<i>Geocoris punctipes</i>			
Imidacloprid	96	240	1.94
Thiamethoxam	96	250	5.39

**FUNDING AGENCIES**

Funding for this project was provided by the CDFR Pierce's Disease and Glassy-winged Sharpshooter Board.

**PREPARING AND SUBMITTING FOR PUBLICATION A PICTORIAL, ANNOTATED KEY TO  
GONATOCERUS SPECIES AND OTHER GENERA AND SPECIES OF MYMARIDAE (HYMENOPTERA) –  
EGG PARASITIDS OF HOMALODISCA SPP. AND OTHER PROCONIINE SHARPSHOOTERS  
IN NORTH AMERICA, WITH EMPHASIS ON THE SPECIES NATIVE OR INTRODUCED TO CALIFORNIA**

**Project Leader:**

Serguei V. Triapitsyn  
Department of Entomology  
University of California  
Riverside, CA 92521

**Cooperators:**

David J.W. Morgan  
CDFA, PDCP  
Mount Rubidoux Field Station  
Riverside, CA

Danel B. Vickerman  
Department of Entomology  
University of California  
Riverside, 92521

**Reporting Period:** The results reported here are from work conducted October 6, 2004 to December 31, 2005.

**ABSTRACT**

This is the final report on this 1.5 yearlong taxonomic project (it was extended at no cost from 1 July 2005 till 31 December 2005). Two scientific papers, one (Triapitsyn et al. in review) with the description of a new species of *Gonatocerus* from Mexico and South America and the other (Triapitsyn in review) with an annotated, illustrated key to *Gonatocerus* species and two other genera and species of Mymaridae (Hymenoptera) – egg parasitoids of *Homalodisca* spp. and other proconiine sharpshooters (Hemiptera: Cicadellidae: Proconiini) in North America, have been submitted for publication in *Zootaxa* (a WWW-based taxonomic journal). Following their publication (if accepted), the electronic reprints of both will be made available online with free access to anyone at <http://www.mapress.com/zootaxa/>, with interactive links from the CDFA Pierce's Disease Control Program and the UC ANR GWSS Workgroup websites. In this report, a tentative key (which excludes the descriptions of the new species from Mexico and South America and also two new species from California, both from the *morilli* subgroup of the *ater* species group of *Gonatocerus*) is given to facilitate recognition of the genera and species of Mymaridae that are known parasitoids of proconiine sharpshooter eggs in the Nearctic region.

**INTRODUCTION**

In North America, egg masses of proconiine sharpshooters, which are known or potential vectors of *Xylella fastidiosa*, are parasitized by various Mymaridae and Trichogrammatidae. An illustrated, annotated key to the genera and species of such Trichogrammatidae was already published (Triapitsyn 2003). However, a pictorial key, which could be used by non-taxonomists for recognition of the genera and species of Mymaridae, which are largely responsible for native biological control of proconiine sharpshooters in California, was lacking. In addition to the native mymarid parasitoids, several exotic species of *Gonatocerus* have been released recently in California as part of a classical biological control program against the glassy-winged sharpshooter (GWSS), *Homalodisca coagulata* (Say), conducted by University of California, Riverside (UCR), CDFA, and USDA researchers. The forthcoming key (Triapitsyn in review) will be a useful tool to distinguish them from other species of the same genus with similar host associations.

Moreover, because of the easy availability of proconiine sharpshooter eggs in California due to the establishment and outbreak of GWSS, there is a real possibility of non-intentional introductions of exotic egg parasitoids from countries in Central and South America. It is possible that one of the species to be described in the forthcoming publication (Triapitsyn in review) from California could be one of such self-introduced species.

Egg masses of the closely related *Homalodisca* and *Oncometopia* species, including GWSS, are parasitized by many species of *Gonatocerus*, all of which are members of the *ater* species group. *Acmopolynema* is the other mymarid genus that parasitizes eggs of *Homalodisca*. One species of *Anagrus*, *A. epos* Girault, has been recently discovered as yet another genus of Mymaridae capable of parasitizing eggs of proconiine sharpshooters (Triapitsyn & Rakitov 2005). All mymarids, including *Gonatocerus*, are difficult to determine to species without expensive and labor-intensive preparation procedures such as critical point drying and slide-mounting, and their males were not easily recognizable prior to this study. A tentative key to the mymarid genera and both sexes of the already described species of *Gonatocerus* presented here would in most cases allow for a correct identification of the most common mymarid parasitoids of *Homalodisca* and other proconiine sharpshooters directly in ethanol, although dry- or slide-mounting may be necessary for correct identification of some specimens.

## OBJECTIVES

1. Prepare and submit for publication a pictorial, annotated key to mymarid egg parasitoids (mainly *Gonatocerus* spp.) of proconiine sharpshooters in North America, with emphasis on the species native or introduced to California. The experimental procedures used to accomplish this objective can be found in Triapitsyn (2004).

## RESULTS

Currently, we are at the final stage of this project (preparatory and curatorial work with voucher and other museum specimens has been mostly completed). Preliminary work on this project has taken much more time than had been anticipated, because of the large number of specimens that had to be sorted, curated, and identified in the UCR and other taxonomic collections in the USA and northern Mexico. Hundreds of specimens from UCR have been point-mounted from alcohol, labeled, and identified. Slide mounts of selected species have been made. Numerous specimens of egg parasitoids from the CDFA surveys in California (assembled by Dr. David Morgan) have also been identified. Scanning electron micrographs of selected species and all the illustrations have been made. A manuscript with the description of one new species of *Gonatocerus* from Mexico and South America was prepared and submitted for publication (Triapitsyn et al. in review). A scientific paper with a key to the mymarid egg parasitoids of the proconiine sharpshooters in the Nearctic region was completed (Triapitsyn in review). A preliminary key to the mymarid genera and both sexes of *Gonatocerus* spp. (excluding the three new species to be described elsewhere) follows.

### Key to genera and species of Mymaridae, egg parasitoids of Proconiini (Cicadellidae) in the Nearctic region

1 Tarsi 4-segmented.....	2
- Tarsi 5-segmented ( <i>Gonatocerus</i> Nees) .....	3
2 Metasoma distinctly petiolate; forewing blade with dark bands and modified setae.....	<i>Acmopolynema sema</i> Schauff
- Metasoma sessile; forewing blade without dark bands and modified setae .....	<i>Anagrus epos</i> Girault
3 Female (flagellum clavate, consisting of 8-segmented funicle and 1-segmented clava) .....	4
- Male (flagellum filiform, 11-segmented) .....	11
4 Propodeum (laterad of submedial carinae) distinctly rugose ( <i>morrilli</i> subgroup) .....	.....the <i>G. morrilli</i> (Howard) complex, etc.
- Propodeum (laterad of submedial carinae) smooth ( <i>ater</i> subgroup) .....	5
5 Forewing with cubital row of microtrichia complete, extending to base of marginal vein.....	6
- Forewing with cubital row of microtrichia incomplete, not extending to base of marginal vein (no microtrichia behind marginal vein, at most a few microtrichia just behind apex of venation) .....	9
6 F5-F7 distinctly lighter than other funicle segments .....	<i>G. atriclavus</i> Girault
- F5-F7 more or less concolorous with other funicle segments .....	7
7 Forewing blade with a narrow, distinct brown fascia extending from stigmal vein to hind margin.....	..... <i>G. fasciatus</i> Girault
- Forewing blade without such a fascia, hyaline or slightly, more or less uniformly, infumated .....	8
8 Head and mesosoma mostly yellow, with some brown .....	<i>G. triguttatus</i> Girault
- Head and mesosoma mostly dark brown.....	<i>G. ashmeadi</i> Girault
9 Forewing blade with a distinct infumate spot just beyond apex of venation, not reaching anterior margin.....	..... <i>G. novifasciatus</i> Girault
- Forewing blade without infumate spot ( <i>G. incomptus/impar</i> complex).....	10
10 F3-F8 each with 2 longitudinal sensilla.....	<i>G. incomptus</i> Huber
- At least one funicle segment among F3-F6 without longitudinal sensilla or only with 1 sensillum, in different combinations .....	<i>G. impar</i> Huber, ? <i>G. sp(p)</i> . near <i>incomptus/impar</i>
11 Propodeum (laterad of submedial carinae) distinctly rugose ( <i>morrilli</i> subgroup) .....	.....the <i>G. morrilli</i> (Howard) complex, etc.
- Propodeum (laterad of submedial carinae) smooth ( <i>ater</i> subgroup) .....	12
12 Forewing with cubital row of microtrichia complete, extending to base of marginal vein.....	13
- Forewing with cubital row of microtrichia incomplete, not extending to base of marginal vein (no microtrichia behind marginal vein, at most a few microtrichia just behind apex of venation) .....	16

13 Forewing blade with a narrow, distinct brown fascia extending from stigmal vein to hind margin .....	<i>G. fasciatus</i> Girault
- Forewing blade without such a fascia, hyaline or slightly, more or less uniformly, infumated.....	14
14 Mesosoma dorsally mostly yellow-orange or light brown to brown, with some dark brown .....	15
- Mesosoma completely dark brown .....	<i>G. ashmeadi</i> Girault
15 Mesosoma dorsally mostly yellow-orange, with some brown and dark brown .....	<i>G. triguttatus</i> Girault
- Mesosoma dorsally mostly light brown to brown, with some dark brown .....	<i>G. atriclavus</i> Girault
16 Forewing blade with a distinct infumate spot just beyond apex of venation, not reaching anterior margin .....	
.....	<i>G. novifasciatus</i> Girault
- Forewing blade hyaline, without infumate spot (the <i>G. incomptus/impar</i> complex).....	
.....	<i>G. incomptus</i> Huber, <i>G. impar</i> Huber, ? <i>G. sp(p)</i> . near <i>incomptus /impar</i>

**CONCLUSIONS**

Research resulting from this project would be of significant benefit to biological control (especially to the CDFG/Pierce’s Disease Biological Control Program) specialists, ecologists, and vineyard supervisors that manage the Pierce’s disease (PD) threat posed by GWSS. The forthcoming key (Triapitsyn in review) would enable even non-taxonomists to quickly identify both sexes of mymarid egg parasitoids of *Homalodisca* spp. in California, differentiate native vs. introduced species of *Gonatocerus*, provide information on candidate species of Mymaridae for introduction as part of biological control programs, facilitate surveys for assessing levels of egg parasitism of *H. coagulata* in the vineyards and orchards in California, and indicate all known host associations of the mymarid species important for native or classical biological control of GWSS and related species and genera of sharpshooters.

**REFERENCES**

Triapitsyn, S. V. An annotated key to the fairyfly (Hymenoptera: Mymaridae) egg parasitoids of proconiine sharpshooters (Hemiptera: Cicadellidae: Proconiini) in the Nearctic region, with description of two new species of *Gonatocerus* Nees from California. *Zootaxa (In Review)*.

Triapitsyn, S. V. 2003. Taxonomic notes on the genera and species of Trichogrammatidae (Hymenoptera) - egg parasitoids of the proconiine sharpshooters (Hemiptera: Clypeorrhyncha: Cicadellidae: Proconiini) in southeastern USA. *Transactions of the American Entomological Society* 129 : 245-265.

Triapitsyn, S. V. 2004. Preparing and submitting for publication a pictorial, annotated key to *Gonatocerus* species and other genera and species of Mymaridae (Hymenoptera) – egg parasitoids of *Homalodisca* spp. and other proconiine sharpshooters in North America, with emphasis on the species native or introduced to California, pp. 382-384. *In: Proceedings of the 2004 Pierce’s Disease Research Symposium, December 7-10, 2004, Coronado Island Marriott Resort, Coronado, California, organized by California Department of Food and Agriculture (compiled by M. Athar Tariq, S. Oswalt, P. Blincoe, A. Ba, T. Lorick and T. Esser), Copeland Printing, Sacramento, California, 391 p.*

Triapitsyn, S. V. and Rakitov. R. A. 2005. Egg parasitoids (Hymenoptera: Mymaridae and Trichogrammatidae) of *Cuerna* sharpshooters (Hemiptera: Cicadellidae) in the USA. Abstracts, [Poster - Ecology] P-10-11, 12<sup>th</sup> International Auchenorrhyncha Congress and 6<sup>th</sup> International Workshop on Leafhoppers and Planthoppers of Economic Significance, University of California, Berkeley, 8-12 August 2005.

Triapitsyn, S. V., D. B. Vickerman, J. M. Heraty and G. A. Logarzo. A new species of *Gonatocerus* (Hymenoptera: Mymaridae), egg parasitoid of the proconiine sharpshooters (Hemiptera: Cicadellidae) in the New World. *Zootaxa* (in review).

**FUNDING AGENCIES**

Funding for this project was provided by the CDFG Pierce’s Disease and Glassy-winged Sharpshooter Board.

## OPTIMIZATION OF ADMIRE APPLICATIONS IN NORTH COAST VINEYARDS

### Project Leaders:

Ed Weber  
UC Cooperative Extension  
Napa, CA 94559

Frank J. Byrne and Nick C. Toscano  
Department of Entomology  
University of California  
Riverside, CA 92521

**Reporting Period:** The results reported here are from work conducted March 2004 to August 2005.

### ABSTRACT

Xylem fluid samples from commercial vineyards treated with Admire were collected and analyzed for imidacloprid content in July 2005. Additionally, vines that had been treated with Admire at differential rates in a 2004 study were re-evaluated in 2005. Imidacloprid was not detected in most samples collected in 2005 and was usually at low levels when detected. These results corroborate our results from 2004 that indicate that the use of Admire in North Coast vineyards may have limited effectiveness compared to its use in other regions in California. Limiting irrigation in order to manage vine growth and berry size for premium wine production may prevent the effective use of Admire in some growing regions for control of sharpshooters.

### INTRODUCTION

Admire insecticide (Bayer CropSciences) is widely used in grapes and citrus for control of the glassy-winged sharpshooter (GWSS) and to limit the spread of Pierce's disease (PD). It is a soil-applied product that delivers the active ingredient imidacloprid, a neonicotinoid insecticide that has been shown to be very effective against GWSS and other sucking insects (1). In Northern California, Admire is sometimes used against populations of blue-green sharpshooters, the most common vector of PD in this region, as well as to treat for other pests.

Admire is applied to vineyards through a drip system. It is recommended that it be applied to moist soils in order to enhance its downward movement into the root zone and its uptake into vines. Most research on uptake and persistence of imidacloprid in grapevines has been done in Southern California in warm regions on sandy or loam soils where vines are irrigated at relatively high rates (2,3,4). In the heavier soils and cooler climates common in North Coast vineyards, there are questions about the best application strategy for Admire in order to ensure effective levels of imidacloprid in grapevines.

In 2004, we conducted a trial (5) to investigate different application regimes of Admire in a Napa County vineyard. The vineyard is located in a cool region (Carneros), is planted on a loam soil with 15% clay content and had minimal irrigation during the 2004 growing season. In 2005, we re-tested vines in this trial to see if there was any further uptake of Admire a year after the applications were made. In addition, we sampled ten other vineyards to test for imidacloprid levels following grower-applied treatments of Admire.

### OBJECTIVE

Evaluate the uptake and sustained concentrations of imidacloprid in grapevines planted on clay loam soils in a cool region (Carneros) following different application regimes of Admire insecticide.

### RESULTS

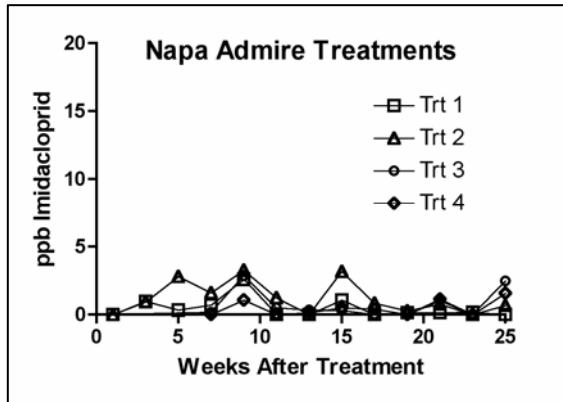
Admire treatments in the 2004 study were as follows:

- T1: 32 oz (full rate) in March
- T2: 16 oz in March / 16 oz in May
- T3: 32 oz in May
- T4: 16 oz in May / 16 oz in July

There were three replications of each treatment. Each replicate included three vine rows and extended the length of the vineyard block (136 vines). There was an untreated buffer row between each replicate. The vineyard was irrigated prior to each Admire application to ensure moist soil conditions, and water was applied for several hours after the injections were completed to move the material into the root zone. Other than the irrigations made in conjunction with our treatment applications, only 5 gallons per vine of additional irrigation was applied prior to harvest.

Xylem fluid samples were collected one week after the initial applications and continued every two weeks through September 2004. At each sampling, 200-500 microliters of xylem fluid were extracted from each of eight vines within every replicate, and were kept separate. A different set of vines were sampled each week. Fluid extractions were made using a pressure bomb equipped with a large chamber that could accommodate shoots up to 18 inches in length. Samples were frozen on dry ice in the field and subsequently held in a freezer. Samples were shipped frozen overnight to UC Riverside and analyzed using a commercial ELISA detection kit (EnviroLogix, ME) (2).

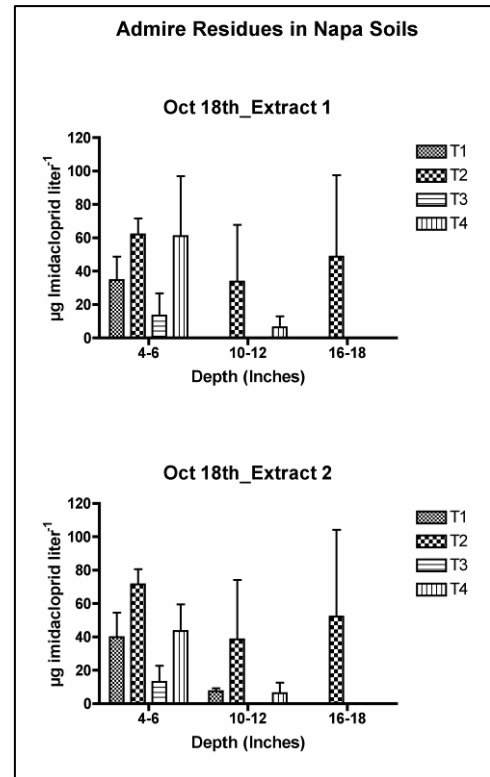
Figure 1 summarizes the results of the 2004 study. None of the treatments resulted in effective uptake of imidacloprid as measured by our analysis. Average imidacloprid concentrations (N=24) for each treatment on each sampling date ranged from 0 to 3.71 ppb. 74% of the average values were less than 1 ppb. Ten ppb is considered to be a minimum threshold level for protection against sharpshooter feeding (3).



**Figure 1.** Imidacloprid levels in grape xylem fluid following treatment with Admire. Each point is the mean of 24 vines.

In consideration of these poor uptake results, we collected soil samples in October 2004 to determine if imidacloprid was bound in the soil. Soil samples were collected from three depths below a drip emitter at one vine in each of the twelve replications in the trial. Sample depths were 4-6 inches, 10-12 inches and 16-18 inches.

From each of these 36 samples, 20g of soil was washed in water for one hour and then centrifuged. A diluted sample of the supernatant was evaluated for imidacloprid by ELISA. These procedures were repeated to generate two extractions per soil sample. The results are shown in Figure 2. Imidacloprid was detected at the 4-6 inch level in all treatments. However, at the 16-18 inch depth it was found in only one of the treatments.



**Figure 2.** Imidacloprid levels in water washes of Napa soil samples. Each bar is the mean  $\pm$  SEM of 3 samples.

Because these results indicated that there was still considerable imidacloprid in the upper soil profile in October 2004, we decided to re-test vines in 2005 to see if there was any improved uptake following winter rains. A nearby Carneros weather station (California Irrigation Management Information System station 109) recorded 22.29 inches of rain from October 2004 to May 2005.

In May 2005, two vines from each replicate were sampled and xylem fluid was tested as previously described. These samples all tested negative for imidacloprid.

In addition to re-testing vines from the 2004 trial, in June 2005 we sampled vines in several Napa County vineyards that had a history of Admire applications to see if we could detect better uptake compared to our Carneros trial site.

We collected 116 xylem fluid samples from ten vineyards: eight in Napa County and two in Sonoma County. The vineyards were all planted on loam to clay loam soils typical of the region. Samples were immediately frozen on dry ice and later analyzed for imidacloprid content as previously described. Results are summarized in Table 1.

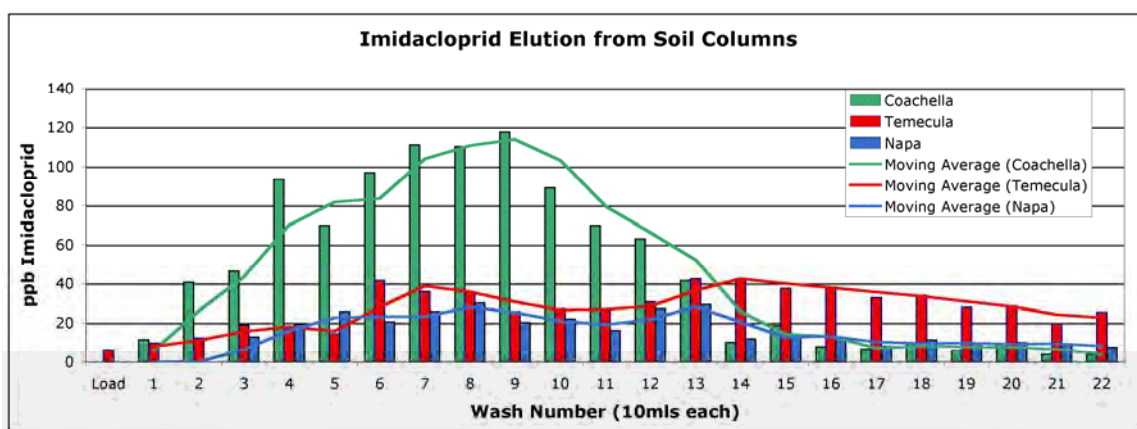
**Table 1:** Imidacloprid levels in June 2005 samples from vineyards treated with Admire.

Vineyard	Admire history*	# vines tested	# vines in imidacloprid ranges			
			0	1-6 ppb	7-10 ppb	> 10 ppb
Napa 1	a/b	12	9	3	0	0
Napa 2	b	18	8	7	2	1
Napa 3	c	18	13	3	1	1
Napa 4	b	24	22	2	0	0
Napa 5	b	12	4	8	0	0
Napa 6	c	8	6	2	0	0
Sonoma 1	d	16	13	3	0	0
Sonoma 2	e	8	7	1	0	0
<b>All sites</b>		<b>116</b>	<b>82</b>	<b>29</b>	<b>3</b>	<b>2</b>

\* a – 16 oz Admire March 2004 & 2005  
 b – 16 oz Admire March 2003, 2004 & 2005  
 c – 32 oz Admire March 2004 & 2005  
 d – 16 oz Admire Oct. 2004 and March 2005  
 e – 16 oz Admire June 2005

The results from this survey of vineyards indicated poor uptake of imidacloprid at all of the sites. Imidacloprid was not detected in 71% of the samples. Only 2 samples had levels above the 10 ppb threshold considered necessary for effective control of sharpshooters.

Soil column studies (4) showed that imidacloprid was bound more strongly to the Napa soils as compared to soils from Temecula or Coachella (Figure 3). Combined with the low irrigation rates typically applied to most North Coast vineyards (0-0.5 acre-feet per season), achieving effective levels of imidacloprid in vines via Admire applications to the soil will be difficult.



**Figure 3.** Elution of imidacloprid from soil columns prepared from Coachella, Temecula and Napa vineyard soils. Equal quantities of imidacloprid were loaded (in 10ml) onto the columns, which were then washed with successive 10ml volumes of water. As each 10ml wash was added to the top of the column, 10mls (the eluate) was displaced at the bottom. The imidacloprid content in each eluate was quantified by ELISA. The graph shows a typical elution profile for the soil types found in these vineyards.

## CONCLUSIONS

The use of Admire in North Coast vineyards is unlikely to provide the same levels of control of sharpshooters as experienced in Southern California. Uptake of imidacloprid in this region appears to be limited both by the nature of the soils, as well as the climatic conditions and prevailing viticultural practices that limit the amount of water applied to the vines during the growing season.



## REFERENCES

1. Castle, S.J., Byrne, F.J., Bi, J.L., and Toscano, N.C. 2004. Spatial and temporal distribution of imidacloprid and thiamethoxam in citrus and impact on *Homalodisca coagulata* populations. *Pest Management Science* 61: 75-84.
2. Toscano, N., et al. 2002. Laboratory and field evaluation of imidacloprid and thiamethoxam against GWSS on citrus and grapes. *Proceedings, Pierce's Disease Research Symposium* pp 141-142. Coronado Island Marriott Resort, San Diego, CA. Dec. 15-18, 2002.
3. Toscano, N., et al. 2003. Laboratory and field evaluation of imidacloprid and thiamethoxam and acetamiprid against the glassy-winged sharpshooter on grapevines. *Proceedings, Pierce's Disease Research Symposium*, pp 315-317. Coronado Island Marriott Resort, San Diego, CA. Dec. 8-11, 2004.
4. Toscano, N., et al. 2004. Laboratory and field evaluations of imidacloprid (Admire), thiamethoxam (Platinum) and acetamiprid (Assail) against the glassy-winged sharpshooter. *Proceedings, Pierce's Disease Research Symposium*, pp 371-374. Coronado Island Marriott Resort, San Diego, CA. Dec. 7-10, 2004.
5. Weber, E.A., Byrne, F.J. and Toscano, N.C. 2004. Optimization of Admire Treatments in North Coast Vineyards. *Proceedings, Pierce's Disease Research Symposium* pp388-390. Coronado Island Marriott Resort, San Diego, CA. Dec. 7-10, 2004.

## FUNDING AGENCIES

Funding for this project was provided by the CDFG Pierce's Disease and Glassy-winged Sharpshooter Board.

## AUTHOR INDEX

(First Authors)

Andersen, P. C. ....	141	Kirkpatrick, B. ....	237, 242
Arora, A.K. ....	219	Koh, M.L. ....	279
Backus, E. ....	85	Labavitch, J. ....	34
Baumgartner, K. ....	3	Lacava, P.T. ....	247
Bextine, B. ....	145	Lampe, D. ....	251
Black, M.C. ....	150	Lauzon, C. ....	254
Boucias, D. ....	283	Leite, B. ....	212, 213
Bruening, G. ....	221	Leopold, R.A. ....	349, 354
Byrne, F.J. ....	287, 290	Li., Y. ....	215
Carbajal, D. ....	81	Lin, H. ....	39, 43, 47, 170
Castle, S. ....	89	Lindow, S.E. ....	173, 177, 214, 258
Chareonkajonchai, S. ....	225	Luck, R.F. ....	181, 359
Chen, J. ....	152	Mathews, M. ....	214
Cook, D. ....	7	Miller, T.A. ....	263
Cooksey, D.A. ....	155	Mizell, III, R.F. ....	117, 364, 367
Coudron, T.A. ....	93	Morse, J. ....	370, 373
Daane, K.M. ....	97, 226, 229	Nunney, L. ....	185
Dandekar, A.M. ....	12, 233	Parker, J. ....	266
de León, J.H. ....	293, 298, 302, 306	Patt, J.M. ....	122
Federici, B.A. ....	310	Perring, T.M. ....	50, 124, 269
Fournier, V. ....	314	Purcell, A.H. ....	189, 193, 196
Francis, M. ....	211	Ramirez, J.L. ....	273, 276
Gabriel, D.W. ....	158	Reisch, B. ....	54, 58
Gilchrist, D. ....	15, 18	Rost, T.L. ....	62
Goolsby, J.A. ....	101, 318	Shackel, K. ....	66
Groves, R. ....	22, 105	Stone-Smith, B. ....	376
Hagler, J. ....	109, 321	Thomas, J.D. ....	279
Hill, B.L. ....	26	Toscano, N.C. ....	380, 384, 388
Hix, R.H. ....	30	Triapitsyn, S.V. ....	392
Hoch, H.C. ....	162, 211	Walker, A. ....	72, 77
Hoddle, M.S. ....	325, 330, 334, 338, 341	Weber, E. ....	128, 395
Igo, M.M. ....	166	Wong, F. ....	200
Johnson, M.W. ....	113	Young, G.M. ....	208
Jones, W.A. ....	343	Zalom, F.G. ....	131, 135
Kaya, H.K. ....	345		