

Haier SERVICE MANUAL

LED TV

Model No. 48DR3505

MSD3393LU Chassis



WARNING

This service information is designed for experienced repair technicians only and is not designed for use by the general public. It does not contain warnings or cautions to advise non-technical individuals of potential dangers in attempting to service a product. Products powered by electricity should be serviced or repaired only by experienced professional technicians. Any attempt to service or repair the product or products dealt with in this service information by anyone else could result in serious injury or death.

©2014 Qingdao Haier Electronics Co., Ltd.

All rights reserved. Unauthorized copying and distribution is a violation of law.

CONTENTS

Chapter 1. General Information

1-1. Document Information	3
1-2. General Guidelines.....	3
1-3. Important Notice.....	3
1-3-1. Follow the regulations and warnings	3
1-3-2. Be careful to the electrical shock	3
1-3-3. Electro static discharge (ESD).....	3
1-3-4. About lead free solder (PbF).....	4
1-3-5. Use the genewing parts (specified parts)	4
1-3-6 Safety check after repairment.....	4
1-3-7. Ordering Spare Parts.....	6
1-3-8. Photo used in this manual	6
1-4. How to Read this Service Manual	6
Using icons	6

Chapter 2. Specification

2-1. Specification list.....	8
2-2. External pictures (four faces).....	9

Chapter 3. Disassemble and Assemble

3-1. 48D3505	11
3-1-1. Remove the Stand.....	11
3-1-2. Remove the Back Cabinet	11
3-1-3. Remove the Mainboard.....	11
3-1-4. Remove the Power Supply Module	11
3-1-5. Remove the Speaker.....	11
3-1-6. Remove the Remote Control Board	12
3-1-7. Remove the Key Board.....	12

Chapter 4. Location of Controls and Components

4-1. Board Location	13
4-2. Mainboard	14
4-2-1. Function Description	14
4-2-2. Connector definition	14
4-3. Power Supply Module	15
4-3-1. Function Description	15

4-3-2. Connector definition	15
4-4. LCD Panel	16
Chapter 5. Installation Instructions	
5-1. Accessories	18
5-2. External Equipment Connections.....	19
Chapter 6. Operation Instructions	
6-1. Front Panel Controls.....	20
6-2. Back Panel Controls	21
6-3. Setting Up Your Remote Control	22
Chapter 7. Electrical Parts	
7-1. Block Diagram.....	23
7-2. Circuit Diagram.....	30
Chapter 8. Measurements and Adjustments	
8-1. Service Mode	31
8-1-1.How to enter into Service Mode.....	31
8-1-2.How to exit	31
8-2. Measurements and Adjustments	31
8-2-1. The Main Menu	31
8-2-2. General Setting	32
8-2-3. Picture	32
8-2-4. Sound.....	33
8-2-5. Debug.....	33
8-3. Software Update	34
8-3-1. 3393.72 software update	34
Chapter 9. Trouble shooting	
9-1. Simple check	35
9-2. Mainboard IC Introduction.....	38
9-3. Mainboard Failure Check.....	39
9-4. Pannel Failure.....	45

Chapter 1. General Information

1-1. Document Information

Document format: Adobe PDF

Author: Zhu Yapeng

Compiler:

1-2. General Guidelines

When servicing, observe the original lead dress. If a short circuit is found, replace all parts which have been overheated or damaged by the short circuit.

After servicing, see to it that all the protective devices such as insulation barriers, insulation papers shields are properly installed.

After servicing, make the following leakage current checks to prevent the customer from being exposed to shock hazards.

- 1) Leakage Current Cold Check
- 2) Leakage Current Hot Check
- 3) Prevention of Electro Static Discharge (ESD) to Electrostatically Sensitive

1-3. Important Notice

1-3-1. Follow the regulations and warnings

Most important thing is to list up the potential hazard or risk for the service personnel to open the units and disassemble the units. For example, we need to describe properly how to avoid the possibility to get electrical shock from the live power supply or charged electrical parts (even the power is off).



This symbol indicates that high voltage is present inside. It is dangerous to make any kind of contact with any inside part of this product.



This symbol indicates that there are important operating and maintenance instructions in the literature accompanying the appliance.

1-3-2. Be careful to the electrical shock

To prevent damage which might result in electric shock or fire, do not expose this TV set to rain or excessive moisture. This TV must not be exposed to dripping or splashing water, and objects filled with liquid, such as vases, must not be placed on top of or above the TV.

1-3-3. Electro static discharge (ESD)

Some semiconductor (solid state) devices can be damaged easily by static electricity. Such

components commonly are called Electrostatically Sensitive (ES) Devices. The following techniques should be used to help reduce the incidence of component damage caused by electrostatic discharge (ESD).

Electrostatically Sensitive (ES) Devices

Some semiconductor (solid-state) devices can be damaged easily by static electricity. Such components commonly are called Electrostatically Sensitive (ES) Devices. Examples of typical ES devices are integrated circuits and some field-effect transistors and semiconductor "chip" components. The following techniques should be used to help reduce the incidence of component damage caused by static by static electricity.

1. Immediately before handling any semiconductor component or semiconductor-equipped assembly, drain off any electrostatic charge on your body by touching a known earth ground. Alternatively, obtain and wear a commercially available discharging wrist strap device, which should be removed to prevent potential shock reasons prior to applying power to the unit under test.

2. After removing an electrical assembly equipped with ES devices, place the assembly on a conductive surface such as aluminum foil, to prevent electrostatic charge buildup or exposure of the assembly.

1-3-4. About lead free solder (PbF)

This product is manufactured using lead-free solder as a part of a movement within the consumer products industry at large to be environmentally responsible. Lead-free solder must be used in the servicing and repairing of this product.

1-3-5. Use the genuing parts (specified parts)

Special parts which have purposes of fire retardant (resistors), high-quality sound (capacitors), low noise (resistors), etc. are used.

When replacing any of components, be sure to use only manufacture's specified parts shown in the parts list.

Safety Component

- Components identified by mark have special characteristics important for safety.

1-3-6 Safety check after repairment

Confirm that the screws, parts and wiring which were removed in order to service are put in the original positions, or whether there are the positions which are deteriorated around the serviced places serviced or not. Check the insulation between the antenna terminal or external metal and the AC cord plug blades. And be sure the safety of that.

General Servicing Precautions

1. Always unplug the receiver AC power cord from the AC power source before:
 - a. Removing or reinstalling any component, circuit board module or any other receiver assembly.
 - b. Disconnecting or reconnecting any receiver electrical plug or other electrical connection.
 - c. Connecting a test substitute in parallel with an electrolytic capacitor in the receiver.

CAUTION: A wrong part substitution or incorrect polarity installation of electrolytic capacitors may result in an explosion hazard.

2. Test high voltage only by measuring it with an appropriate high voltage meter or other voltage measuring device (DVM, FETVOM, etc) equipped with a suitable high voltage probe.

Do not test high voltage by "drawing an arc".

3. Do not spray chemicals on or near this receiver or any of its assemblies.
4. Unless specified otherwise in this service manual, clean electrical contacts only by applying the following mixture to the contacts with a pipe cleaner, cotton-tipped stick or comparable non-abrasive applicator; 10% (by volume) Acetone and 90% (by volume) isopropyl alcohol (90%-99% strength).

CAUTION: This is a flammable mixture.

Unless specified otherwise in this service manual, lubrication of contacts is not required. Capacitors may result in an explosion hazard.

5. Do not defeat any plug/socket B+ voltage interlocks with which receivers covered by this service manual might be equipped.
6. Do not apply AC power to this instrument and/or any of its electrical assemblies unless all solid-state device heat sinks are correctly installed.
7. Always connect the test receiver ground lead to the receiver chassis ground before connecting the test receiver positive lead.

Always remove the test receiver ground lead last. Capacitors may result in an explosion hazard.

8. Use with this receiver only the test fixtures specified in this service manual.

CAUTION: Do not connect the test fixture ground strap to any heat sink in this receiver.

9. Remove the antenna terminal on TV and turn on the TV.
10. Insulation resistance between the cord plug terminals and the external exposure metal should be more than Mohm by using the 500V insulation resistance meter.
11. If the insulation resistance is less than M ohm, the inspection repair should be required. If you have not the 500V insulation resistance meter, use a Tester. External exposure metal: Antenna terminal Headphone jack.

12. Use only a grounded-tip soldering iron to solder or unsolder ES devices.

13. Use only an anti-static type solder removal device. Some solder removal devices not classified as "anti-static" can generate electrical charges sufficient to damage ES devices.

14. Do not use freon-propelled chemicals. These can generate electrical charges sufficient to damage ES devices.

15. Do not remove a replacement ES device from its protective package until immediately before you are ready to install it.

(Most replacement ES devices are packaged with leads electrically shorted together by conductive foam, aluminum foil or comparable conductive material).

16. Immediately before removing the protective material from the leads of a replacement ES device, touch the protective material to the chassis or circuit assembly into which the device will be installed.

CAUTION: Be sure no power is applied to the chassis or circuit, and observe all other safety precautions.

17. Minimize bodily motions when handling unpackaged replacement ES devices. (Otherwise harmless motion such as the brushing together of your clothes fabric or the lifting of your foot from a carpeted floor can generate static electricity sufficient to damage an ES device.)

1-3-7. Ordering Spare Parts

Please include the following informations when you order parts. (Particularly the Version letter)

1. Model number, serial number and software version

The model number and serial number can be found on the back cover of each product. Software version can be found in the Spare Parts List.

2. Spare part No. and description

Spare part No. and description can be found in the Spare Parts List.

1-3-8. Photo used in this manual

The illustration and photos used in this Service Manual may not base on the final design of products, which may differ from your products in some way.

1-4. How to Read this Service Manual

Using icons

Icons are used to attract the attention of the reader to specific information. The meaning of each icon is described in the table below:



Note:

A "note" provides information that is not indispensable, but may nevertheless be valuable to the reader, such as tips and tricks.

Caution:

A “caution ” is used when there is danger that the reader, through incorrect manipulation, may damage equipment, loose data, get an unexpected result or has to restart(part of) a procedure.

**Warning:**

A “warning” is used when there is danger of personal injury.

Reference:

A “reference” guides the reader to other places in this binder or in this manual, where he/she will find additional information on a specific topic.

Chapter 2. Specification

2-1. Specification list

Model	48DR3505
Screen Size	47.6"
Aspect Ratio	16:9
Resolution	1920x1080
Brightness (cd/m ²)	250
Contrast	1200:1
Response Time (ms)	8
Angel of View	H:160°, V:150°
Color Display	16.7M
OSD Language	English,French,Spanish.
Color System	NTSC
Audio System	MN
Audio Output Power (Built-in) (W)	8W×2
Audio Output Power (outer) (W)	No
Total Power Input (W)	140W
Voltage Range (V)	AC100V~240V
Power Frequency (Hz)	50~60Hz
Time of Sleep Timer (MINS)	240Min
Net Weight (KG)	22.7 lbs
Gross Weight (KG)	21.8 lbs
Dimensions with Stand	42.7" x 26.2" x 9.8"
Dimensions without Stand	42.7" x 24.8" x 3.0"

2-2. External pictures (four faces)



Front Side

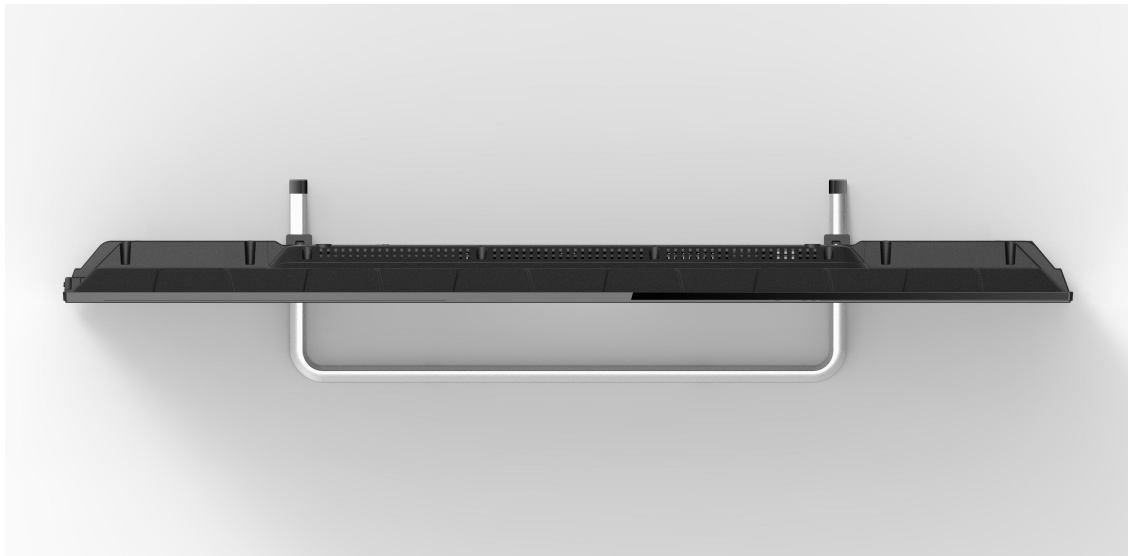

Up Side



Right Side



Back Side

Chapter 3. Disassemble and Assemble

3-1. 48DR3505

3-1-1. Remove the Stand

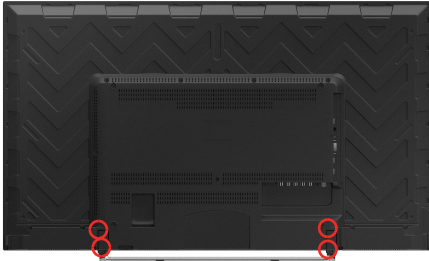

1. Lay down the TV set .
2. Remove the four screws from the stand which in the picture above.
3. Remove the stand.



3-1-2. Remove the Back Cabinet

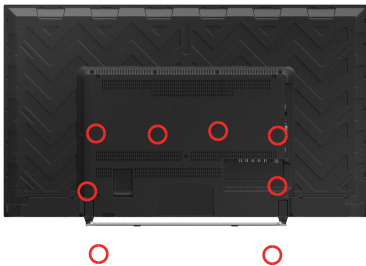

1. Remove the screws indicated with red circles.
2. Flip machine, panel side up.
3. Carefully raise the Front shell from bottom.

3-1-3. Remove the Mainboard

1. Remove the six screws indicated with red circles.
2. Remove the Mainboard.



3-1-5. Remove the Speaker

Remove the Speaker indicated by red circle in below picture.



3-1-6. Remove the Remote Control Board And the Key Board

Remove the Remote Control Board and the Key Board indicated by red circle in below picture.



Chapter 4. Location of Controls and Components

4-1. Board Location

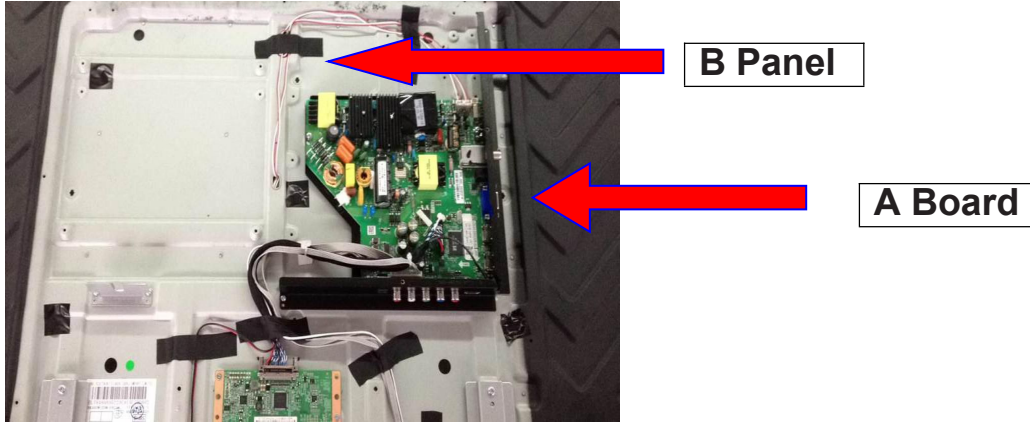

No.	Model	Description
A Board	TP.MS3393.PC821	Mainboard
B Panel	ST4761B01-5	LCD Panel

4-2. Mainboard

4-2-1. Function Description

Process signal which incept from exterior equipment then translate into signal that panel can display.

4-2-2. Connector definition

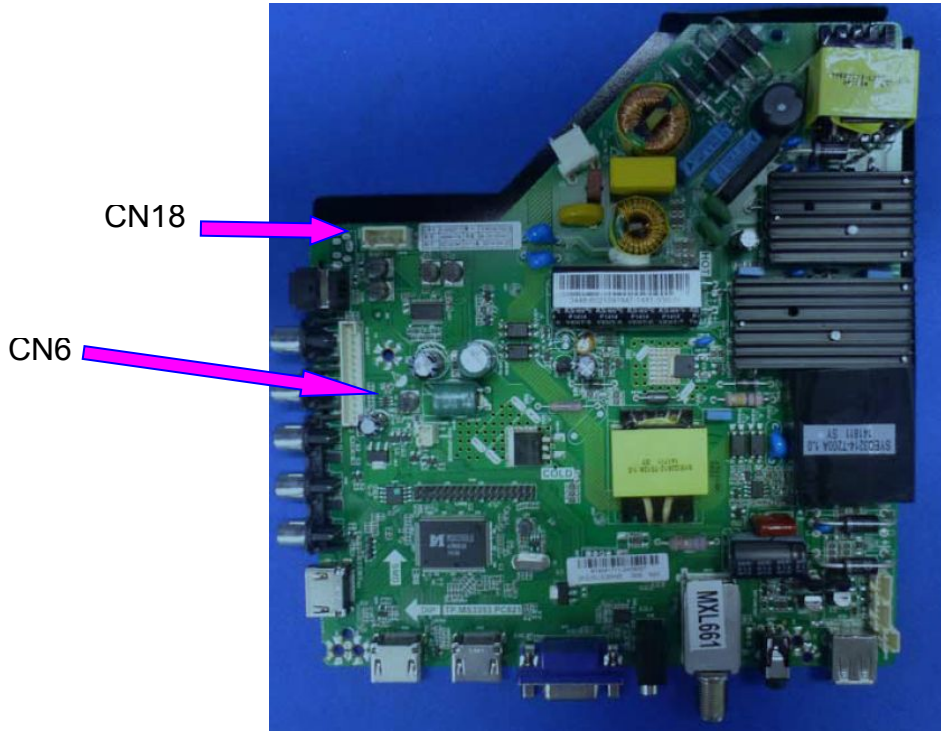

IR & Key Interface CN6	
Pin number	Signal name
1	5V
2	RED
3	GRE
4	IR
5	GND
6	K0
7	K1
8	K2
9	K3
10	K4
11	K5
12	K6
13	K7
14	GND

Speaker connector CN18	
Pin number	Signal name
1	ROUT+
2	ROUT-
3	LOUT-
4	LOUT+

4-4. LCD Panel

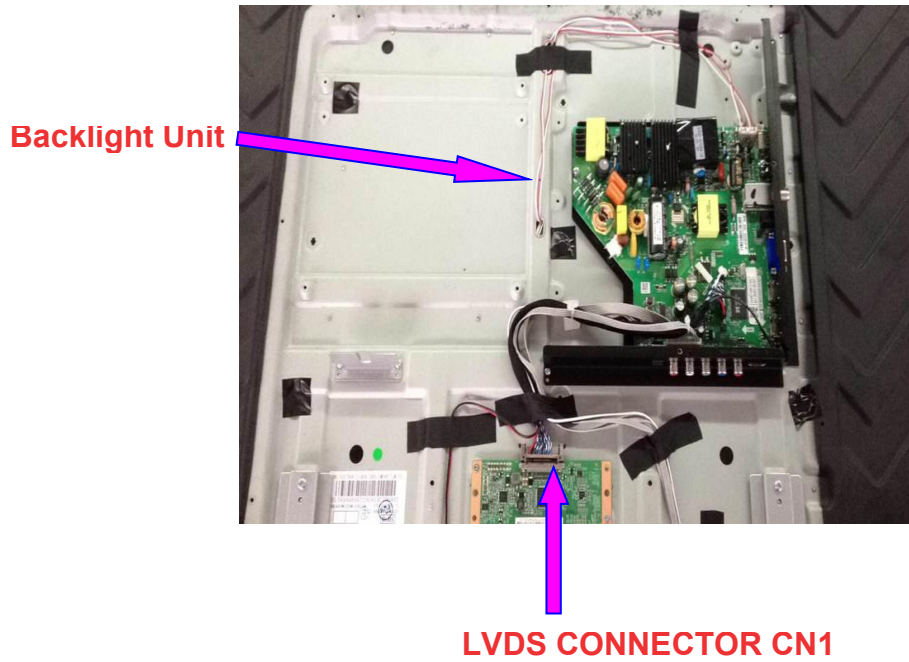

Connector Definition

Backlight Unit

Pin No.	Symbol	Description
1	IRLED1	Cathode
2	IRLED2	Anode
3	IRLED3	Cathode
4	IRLED4	Anode

Pin No.	Symbol	Description	Note
1	WP	Write Protect (High: Write Enable, Low or Open: Write Disable)	
2	SCL	I2C Serial Clock (for adjust VCOM)	
3	SDA	I2C Serial Data (for adjust VCOM)	
4	NC	No Connection	
5	NC	No Connection	
6	NC	No Connection	
7	LVDS_SEL	LVDS Data Format Selection	
8	NC	No Connection	
9	NC	No Connection	
10	NC	No Connection	
11	GND	Ground	
12	RO[0]N	Odd LVDS Signal -	
13	RO[0]P	Odd LVDS Signal +	
14	RO[1]N	Odd LVDS Signal -	
15	RO[1]P	Odd LVDS Signal +	
16	RO[2]N	Odd LVDS Signal -	
17	RO[2]P	Odd LVDS Signal +	
18	GND	Ground	
19	ROCLK-	Odd LVDS Clock -	
20	ROCLK+	Odd LVDS Clock +	
21	GND	Ground	
22	RO[3]N	Odd LVDS Signal -	
23	RO[3]P	Odd LVDS Signal +	
24	NC	No Connection	
25	NC	No Connection	
26	NC	No Connection	
27	NC	No Connection	
28	RE[0]N	Even LVDS Signal -	
29	RE[0]P	Even LVDS Signal +	
30	RE[1]N	Even LVDS Signal -	
31	RE[1]P	Even LVDS Signal +	
32	RE[2]N	Even LVDS Signal -	
33	RE[2]P	Even LVDS Signal +	
34	GND	Ground	
35	ROCLK-	Even LVDS Clock -	
36	ROCLK+	Even LVDS Clock +	
37	GND	Ground	
38	RE[3]N	Even LVDS Signal -	
39	RE[3]P	Even LVDS Signal +	
40	NC	No Connection	
41	NC	No Connection	
42	NC	No Connection	
43	NC	No Connection	
44	GND	Ground	
45	GND	Ground	
46	GND	Ground	
47	NC	No Connection	
48	12V	DC power supply	
49	12V	DC power supply	
50	12V	DC power supply	
51	12V	DC power supply	

Chapter 5. Installation Instructions

5-1. Accessories

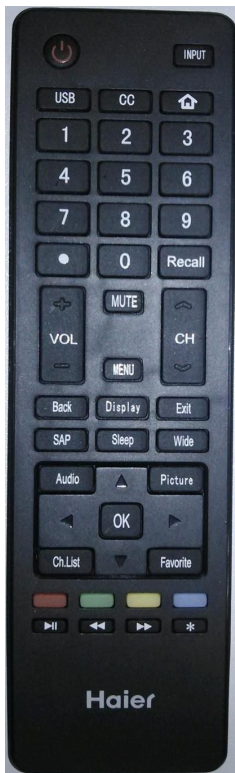

Remote Control



Batteries

5-2. External Equipment Connections

Antenna Connection

Connect your aerial to the back of the TV into the ANTENNA IN socket.

Improve Your Signal

To improve picture quality in a poor signal area, use a signal amplifier (not supplied).

Connect Your PC to the TV

You can use your TV as a monitor for your personal computer by connecting it with a VGA cable (not supplied).

- A Read your computer user guide and check it has a VGA connector.
- B Turn off your TV and PC.
- C Connect a D type 15-pin VGA interface cable to the VGA video interface connector on the PC. Connect the other end of the cable to the PC interface connector on the TV. Tighten the screws on the VGA connectors and connect the audio cable (not supplied) to the audio input socket on the back of the TV.
- D Turn on the TV firstly and then the PC.
- E Press the Source button on the TV or TV remote control to set the video input mode to PC.
- F Once the image shows, if there is noise present, change the PC mode to other resolutions, change the refresh rate to other rate or adjust the brightness and contrast on the menu until the picture is clear.

Connect a DVD Player to Your TV

Connect the DVD video outputs (Y, P_b, P_r) to the COMPONENT (Y, P_b, P_r) IN socket on your TV.

- A Turn on the DVD player and insert a DVD disk.
- B Press the SOURCE button to select COMPONENT mode.
- C Refer to the DVD player user guide for operating instructions.

Connect a DVD Player or VCR to Your TV

There are two ways in which you can connect a DVD player or VCR to your TV. Make sure that both the TV and DVD player or VCR are switched off before you connect them.

HDMI Input

- A Connect the cable from the HDMI device to the TV HDMI socket.
- B Press the **SOURCE** button to select HDMI mode.
- C Refer to the HDMI device user guide for how to operate.

Chapter 6. Operation Instructions

6-1. Front Panel Controls

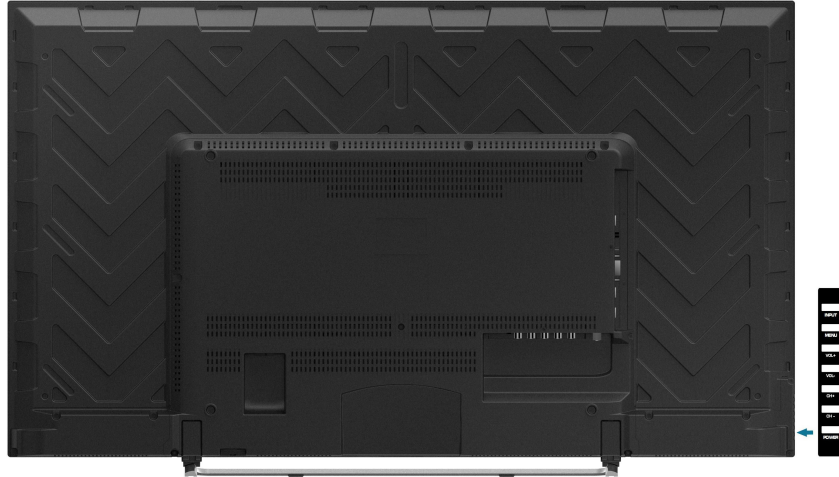

-
- | | | |
|---|-------|----------------------------------|
| 1 | POWER | Press to turn the TV on and off. |
| 2 | CH- | TV channel down. |
| 3 | CH+ | TV channel up. |
| 4 | VOL- | Press to decrease the volume. |
-

-
- | | | |
|---|-------|--|
| 5 | VOL+ | Press to increase the volume. |
| 6 | MENU | Press to select the main menu. |
| 7 | INPUT | Toggles between all the available input sources. |
-

6-2. Back Panel Controls

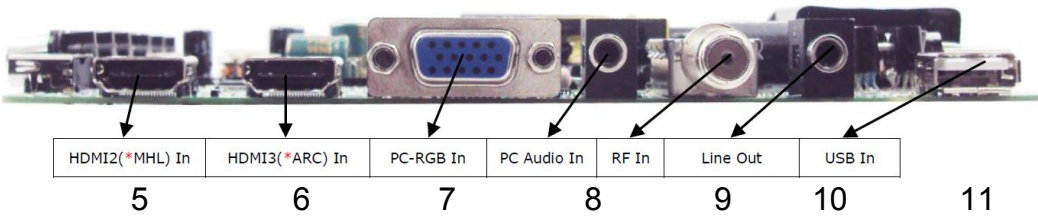
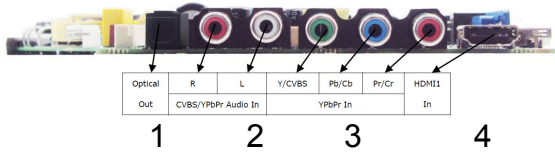

- | | | |
|----|------------|--------|
| 1 | Optical | output |
| 2 | AV | input |
| 3 | YPbPr | input |
| 4 | HDMI3 | input |
| 5 | HDMI2(MHL) | input |
| 6 | HDMI2 | input |
| 7 | VGA | input |
| 8 | PC Audio | input |
| 9 | RF | input |
| 10 | Line out | output |
| 11 | USB | input |

6-3. Setting Up Your Remote Control

When using the remote control, aim it towards the remote sensor on the TV.

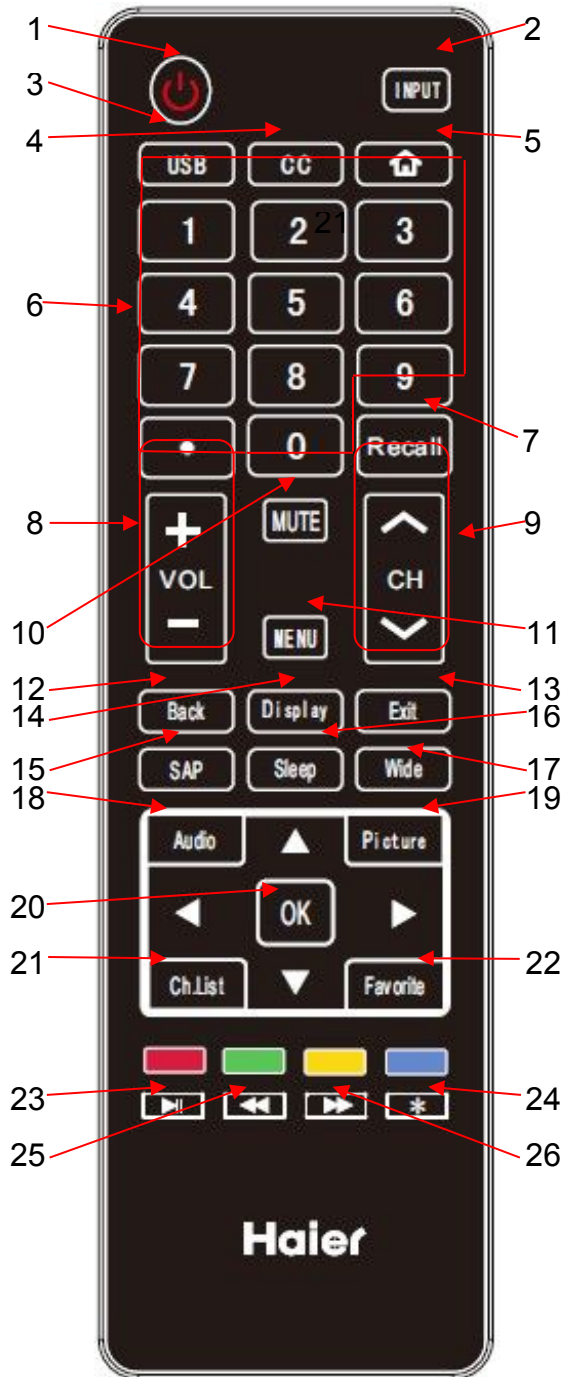

- 1 POWER.
- 2 INPUT.
- 3 USB Shortcut button.
- 4 CC.
- 5 HOME;
- 6 Program Number Channel selection.
- 7 RECALL button.
- 8 VOL+/VOL-: Volume selection.
- 9 CH^/CHv: Channel selection.
- 10 Mute.
- 11 Menu button.
- 12 Back button.
- 13 Exit button.
- 14 DISPLAY button.
- 15 SAP button.
- 16 Sleep button.
- 17 Wide button.
- 18 Audio button.
- 19 Picture Mode.
- 20 OK button.
- 21 Channel List.
- 22 Favorite program.
- 23 Play / Pause button (only for USB).
- 24 EPG button.
- 25 Fast Reverse (only for USB).
- 26 Fast Forward (only for USB).

Chapter 7. Electrical Parts

7-1. Circuit Diagram

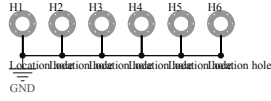
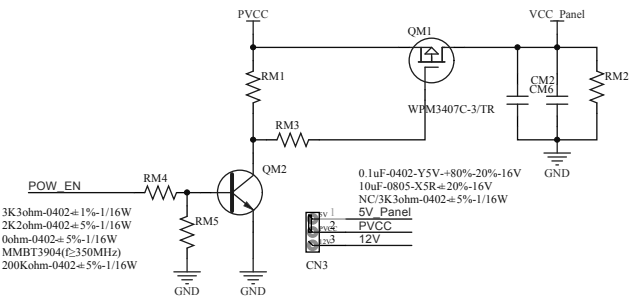
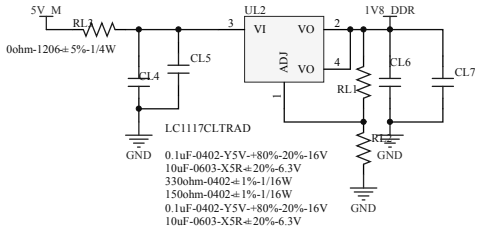
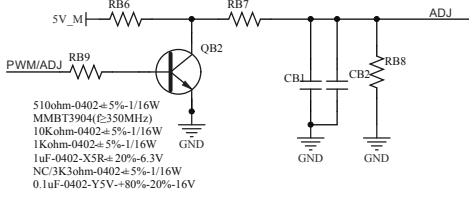
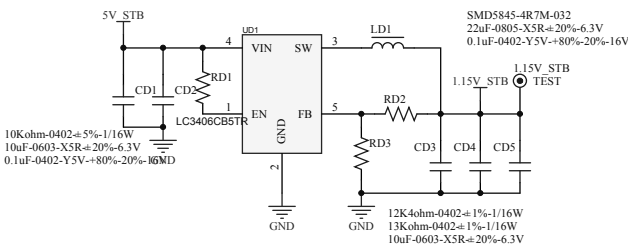
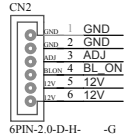
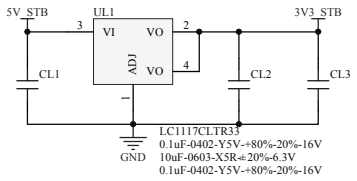
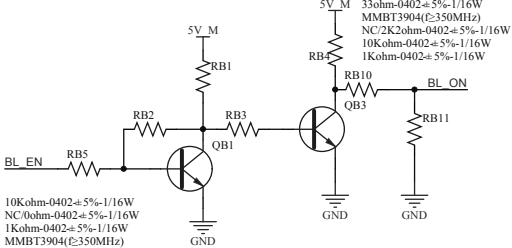
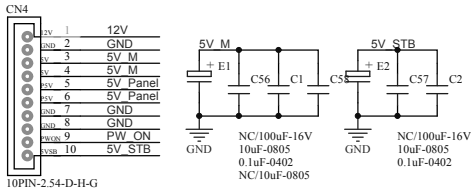

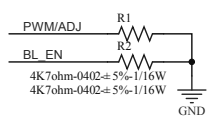
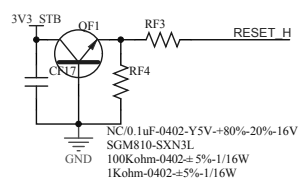
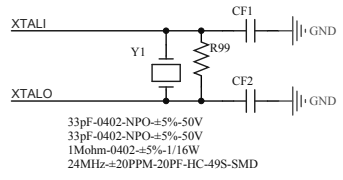
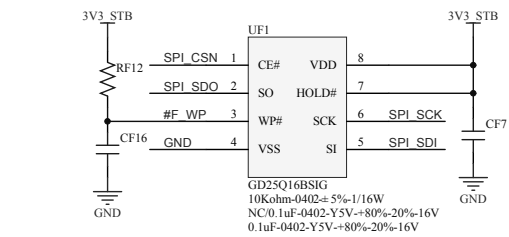
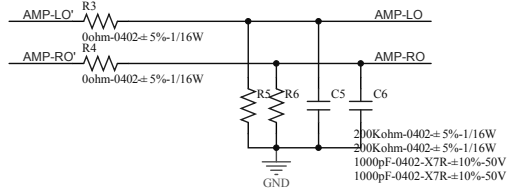
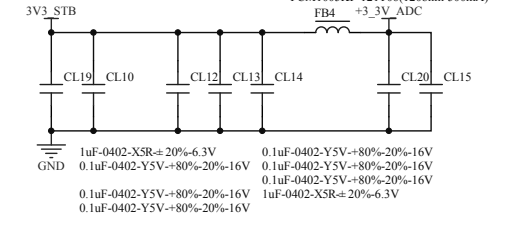
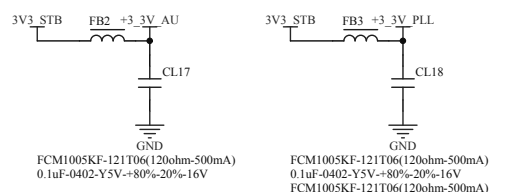
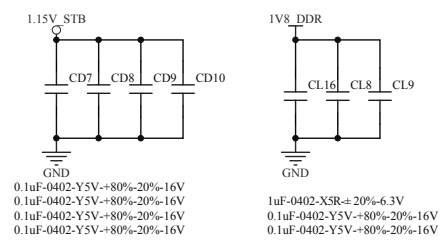
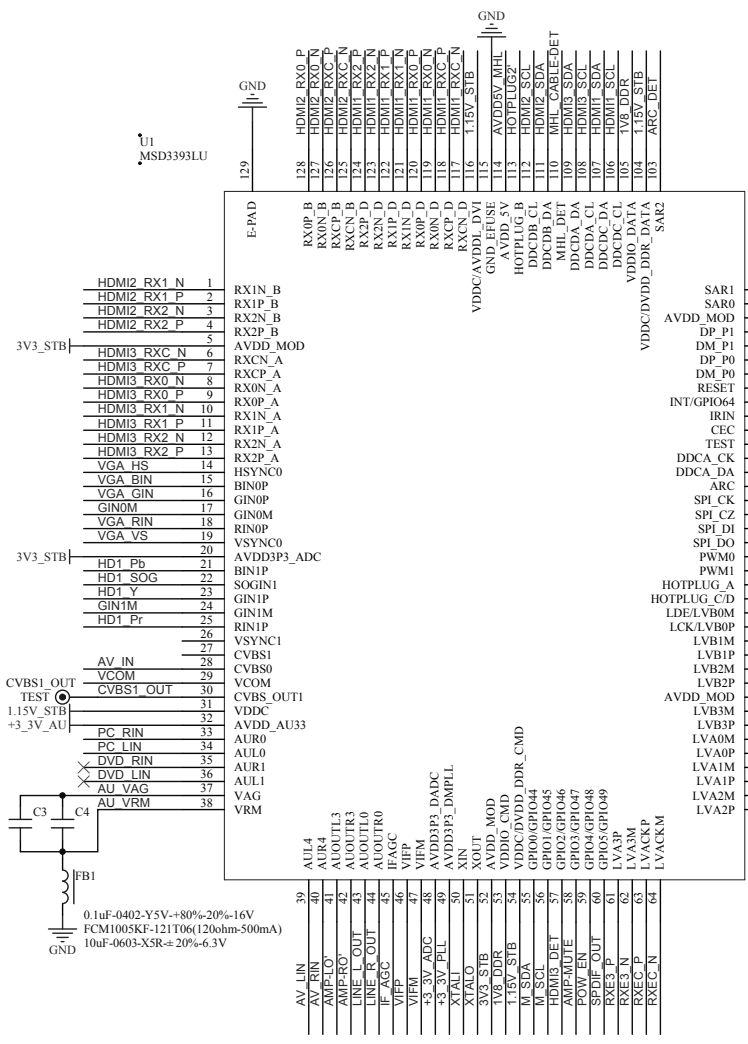

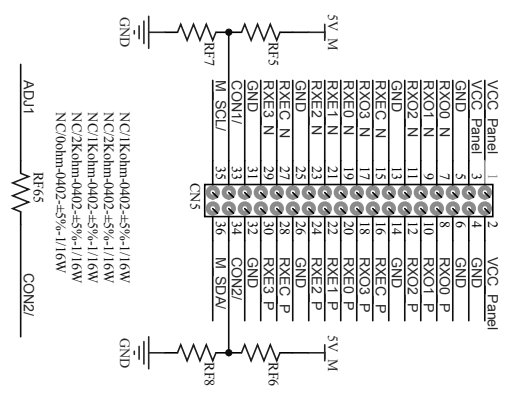
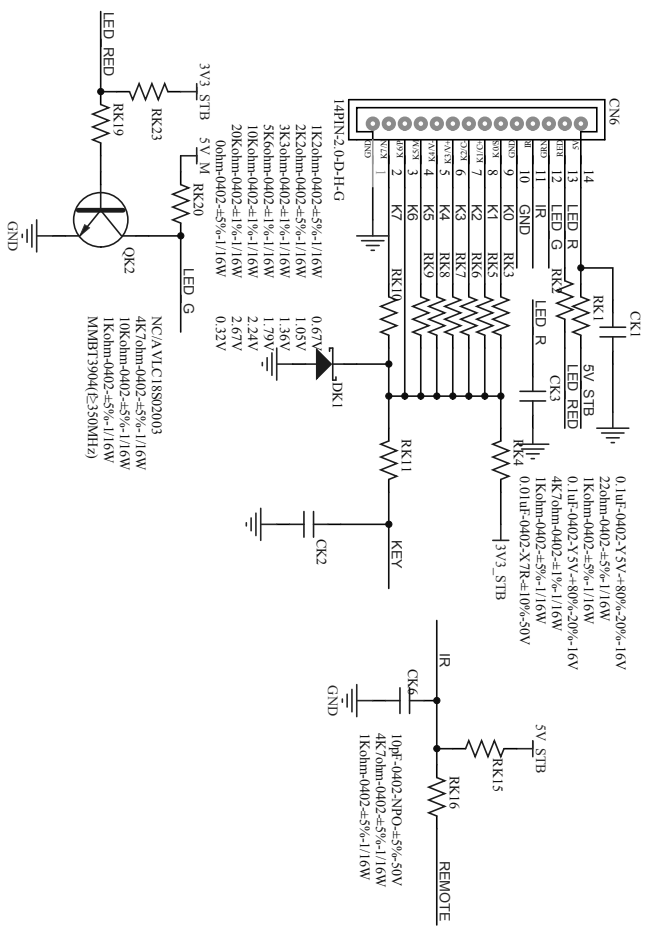

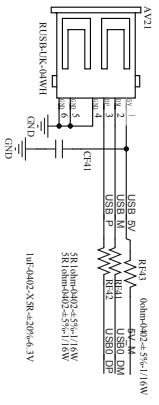
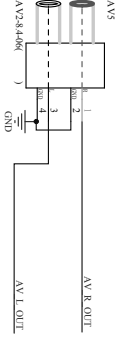
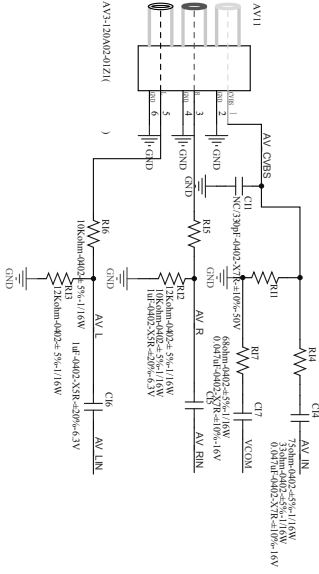
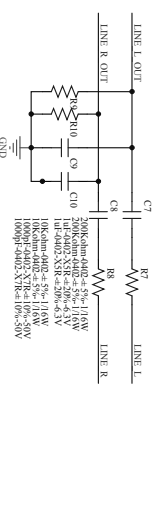
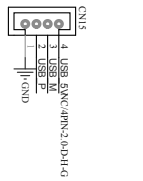
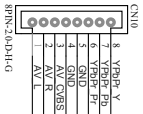
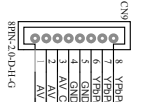
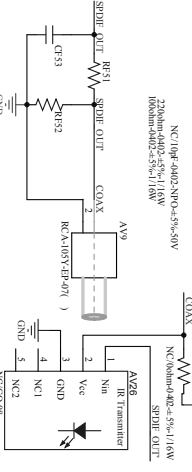
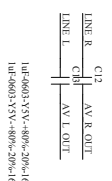
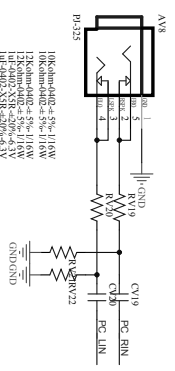
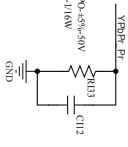
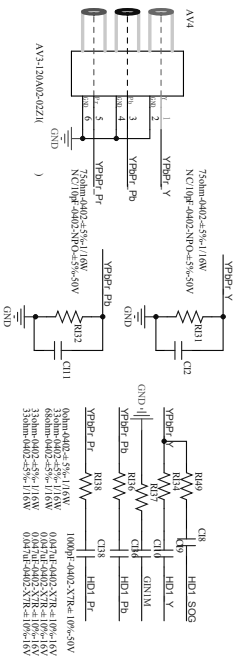
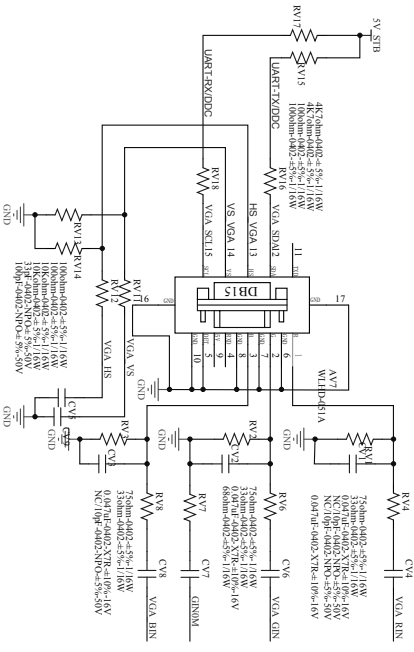

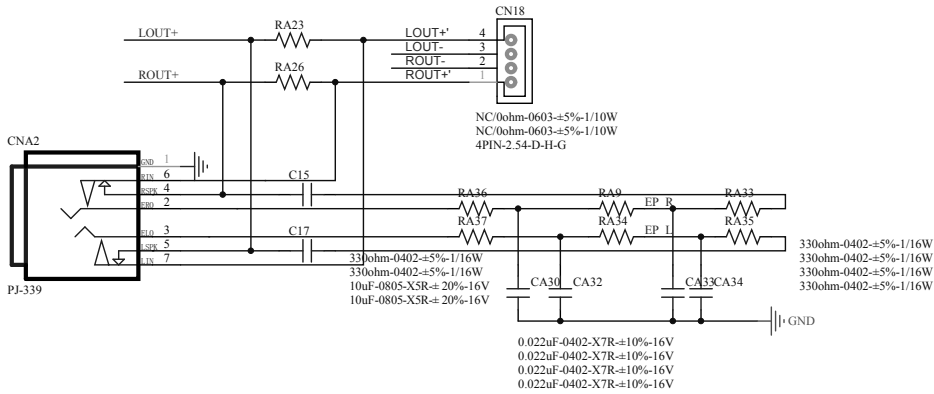
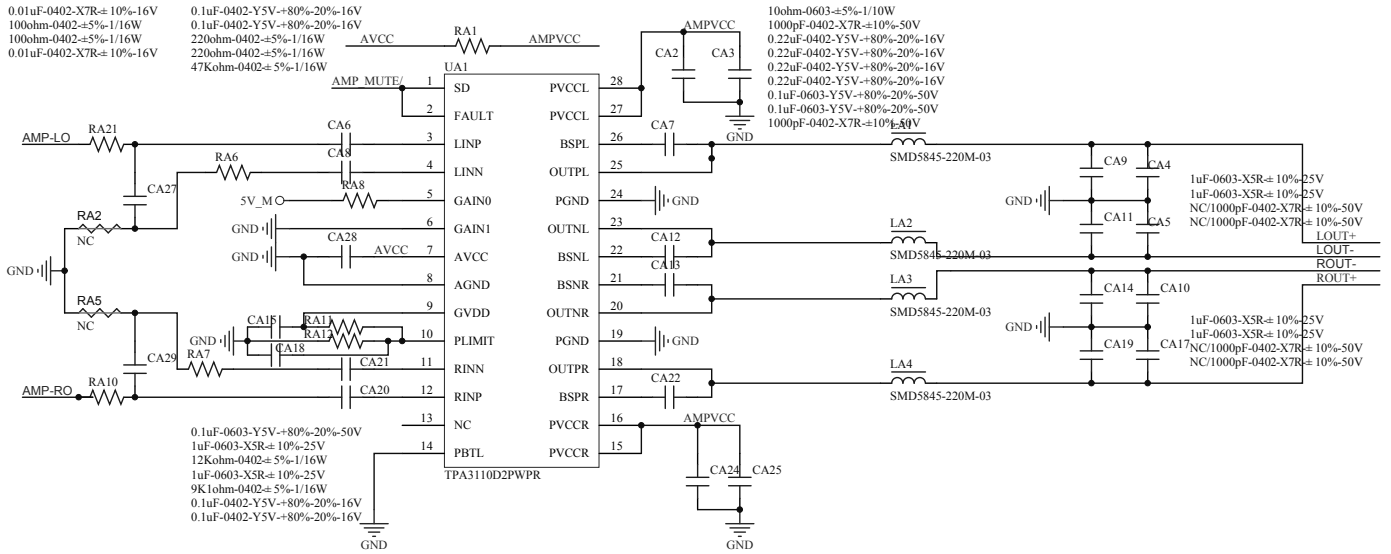
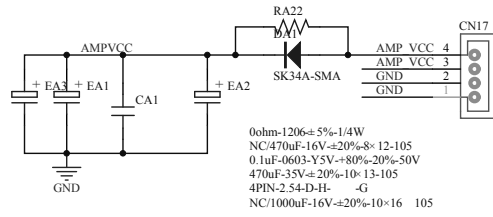

7-2 . Wiring Connection Diagram

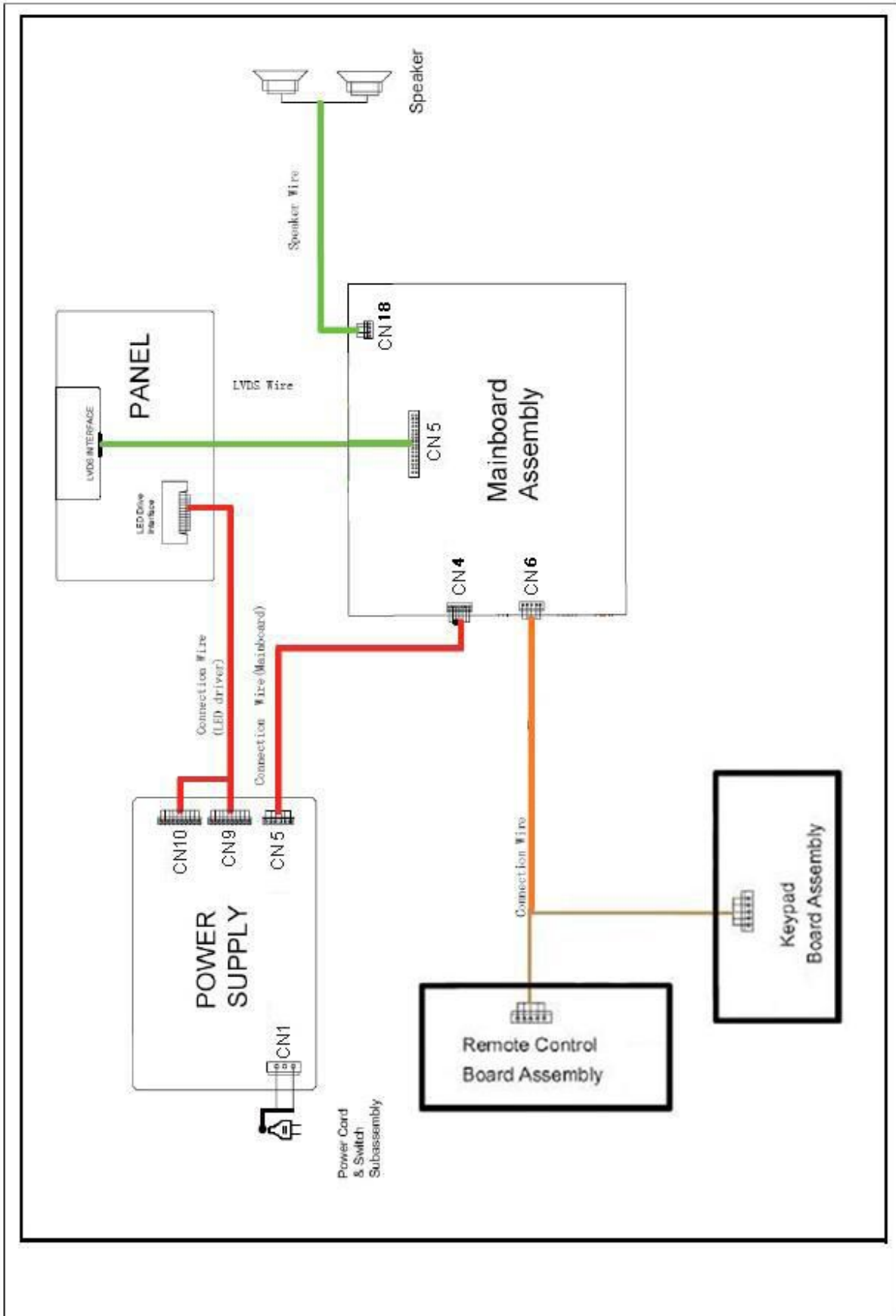

Chapter 8. Measurements and Adjustments

8-1. Service Mode

8-1-1. How to enter into Service Mode

The way to the factory mode menu:

Step 1: Press Menu,

Step 2: Input "8893",

System will be into the factory mode menu when 2 steps above are done.

At the end of the main factory menu, you can see the edition of the software,

```
like this" BUILD TIME    2014.09.15 23:45:32
                VERSION      v1.0 "
```

8-1-2. How to exit

If you want to exit this factory menu, please press the button "Exit" on the remote. system will be out the factory mode menu.

8-2. Measurements and Adjustments

8-2-1. The Main Menu

In factory mode menu, press up/down button to choose the up/down item, press right or OK button to the submenu. press MENU button to go back.



8-2-2. GENERAL SETTING

- 1)Init Flash;
- 2)Uart Enable:Choose on or off in Uart Enable;
- 3)Dbg Message Enable: Choose on or off in Dbg Message Enable;
- 4)Test Pattern: Choose the Pattern picture;
- 5)Dynamic Contrast: Choose on or off in Dynamic Contrast;
- 6)Power On Mode:Choose on or off in Power On Mode;
- 7)Mirror Control: Choose on or off in Mirror Control;
- 8)Front End Status
- 9)Timer Test
- 10)SSC
- 11)Erase Flash
- 12)PQ Advance Debug: Choose on or off in PQ Advance Debug;
- 13)Factory remote:Open or close the Factory remote;
- 14)Factory CH Export.



8-2-3. PICTURE

Adjust the Picture Mode,Picture Curve, White Balance and OverScan in different source.



8-2-4. SOUND

Adjust the values of Sound Mode, Volume Curve, Audio Output and True Volume in different source.

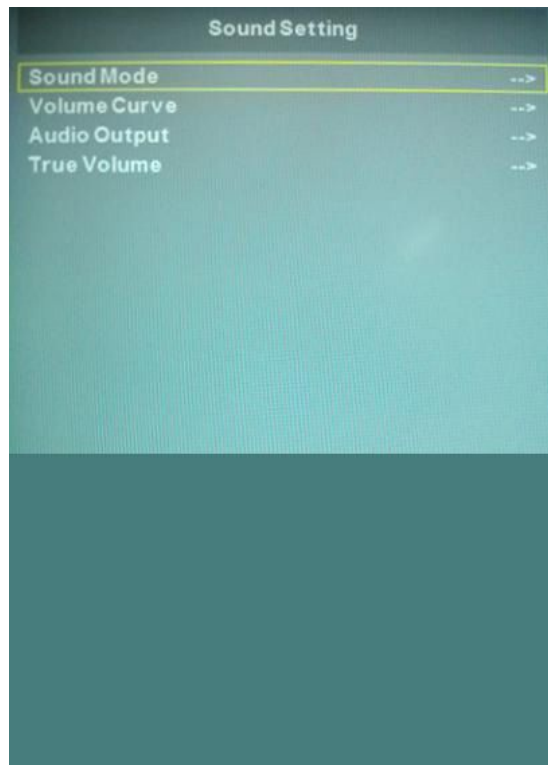

8-2-5. Panel Setting

- 1) LVDS Bit Mode: choose the Bit;
- 2) LVDS MAP: choose the MAP;
- 3) LVDS ODD/Even: choose ODD or Even;
- 4) Backlight: Adjust the value of backlight;
- 5) Reset Panel Setting Data
- 6) 6MX0 LVDS Map: choose the 6MX0 LVDS MAP;
- 7) 6MX0 Channel: choose the 6MX0 Channel;
- 8) 6MX0 Mirror: choose the 6MX0 Mirror;
- 9) 6MX0 Demo: choose the 6MX0 Demo;
- 10) 6MX0 Update.

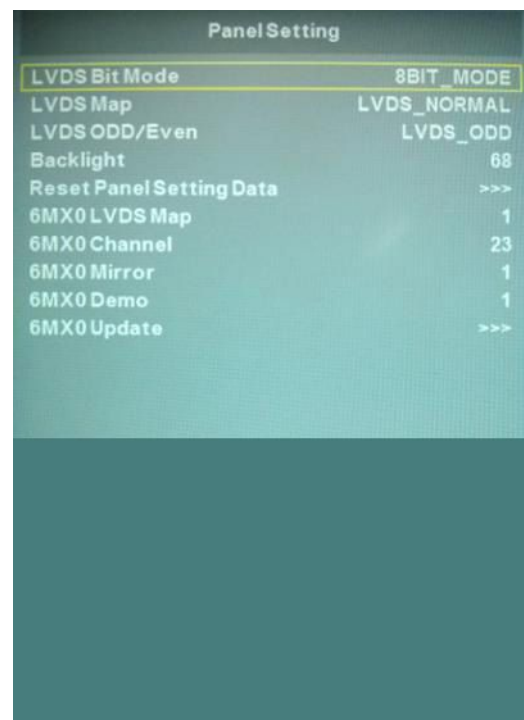

8-3. Software Update

8-3-1. MSD3393LU software update

1. Copy the software files to a USB disk on the root directory;



2. Insert the USB disk when the AC power is off;
3. Turn on the AC power in turn to begin;
4. Turn off the AC power until the indicator light fast twinkling;
5. Pull out the USB disk and power on the television.

Note:

Do not turn off the TV while it is updating.

Chapter 9. Trouble shooting

9-1. Simple check

No picture/ No sound	<p>Verify if the television is properly plugged</p> <p>Verify if the television is properly supplied power</p> <p>Verify if electricity is available.</p>
Blank screen	<p>Verify if correct signals are input</p> <p>Press SOURCE button to change signal input to TV input</p> <p>Restart the television if power supply is interrupted</p>
No sound	<p>Press the MUTE button and verify that Mute mode is active.</p> <p>Switch to another channel to check whether the same problem occurs.</p> <p>Press the VOL+ button to see if the problem can be solved.</p>
Poor sound	<p>Verify that the sound system is correct. Refer to the user manual for instructions on how to adjust it.</p>
No picture on some channel	<p>Verify if correct channel is selected.</p> <p>Adjust the antenna.</p> <p>Make adjustments by Fine Tune and MANUAL Scan.</p>
No color for some channel program (black and white)	<p>Verify that the same problem exists on other channels.</p> <p>Check the picture and sound systems.</p> <p>Refer to the relevant instructions in the manual to adjust the colour.</p>
Spots with some or all pictures	<p>Verify if the antenna is correctly connected.</p> <p>Verify if the antenna is in good condition.</p> <p>Make fine adjustment of channel.</p>
Television is not working	<p>Disconnect the television from the power supply for 10 seconds, then reconnect the television. If the problem persists, contact an authorised after-sales service provider for technical assistance.</p>
Television out of control	<p>Disconnect the television from power supply and 10 seconds later, connect the television to the power supply. If the problem still exists, contact authorized after-sales service for technical assistance.</p>

9-2. Mainboard IC Introduction

Top view

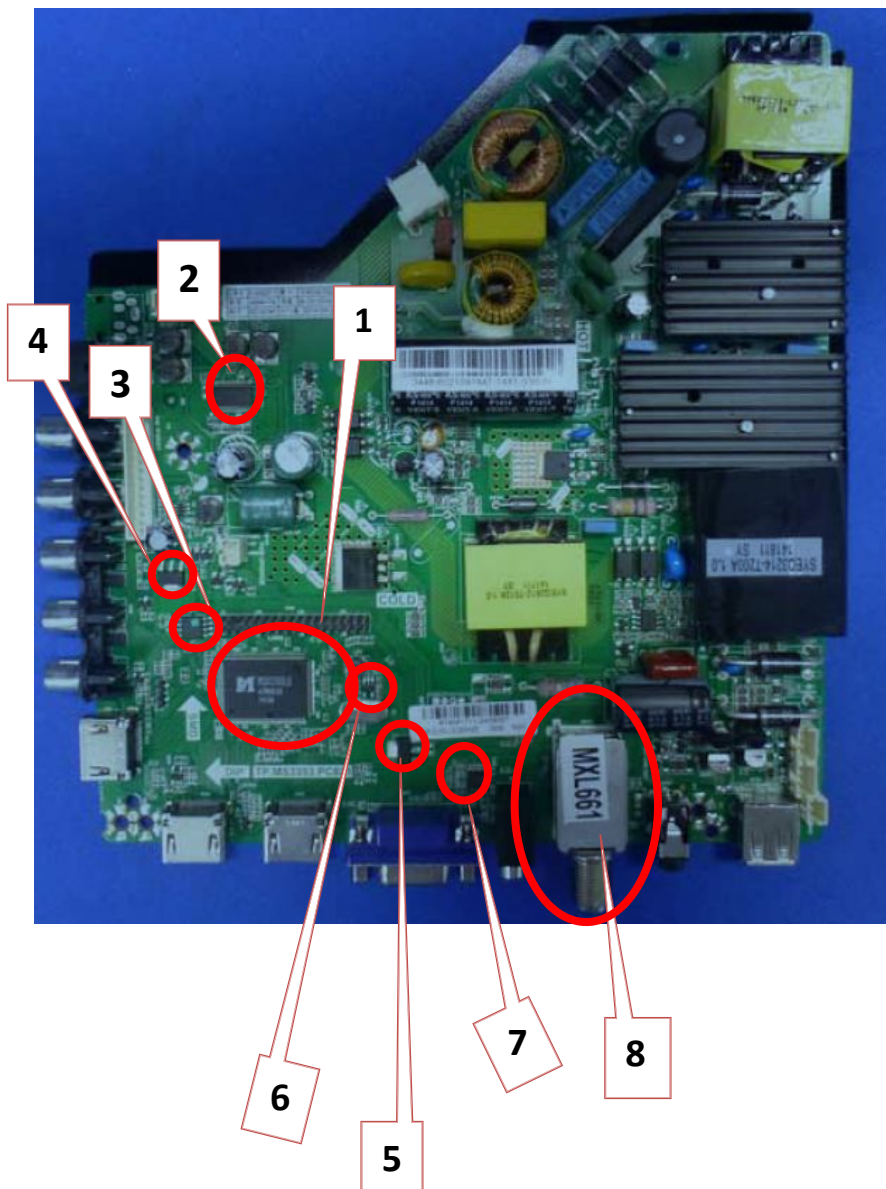

Bottom view

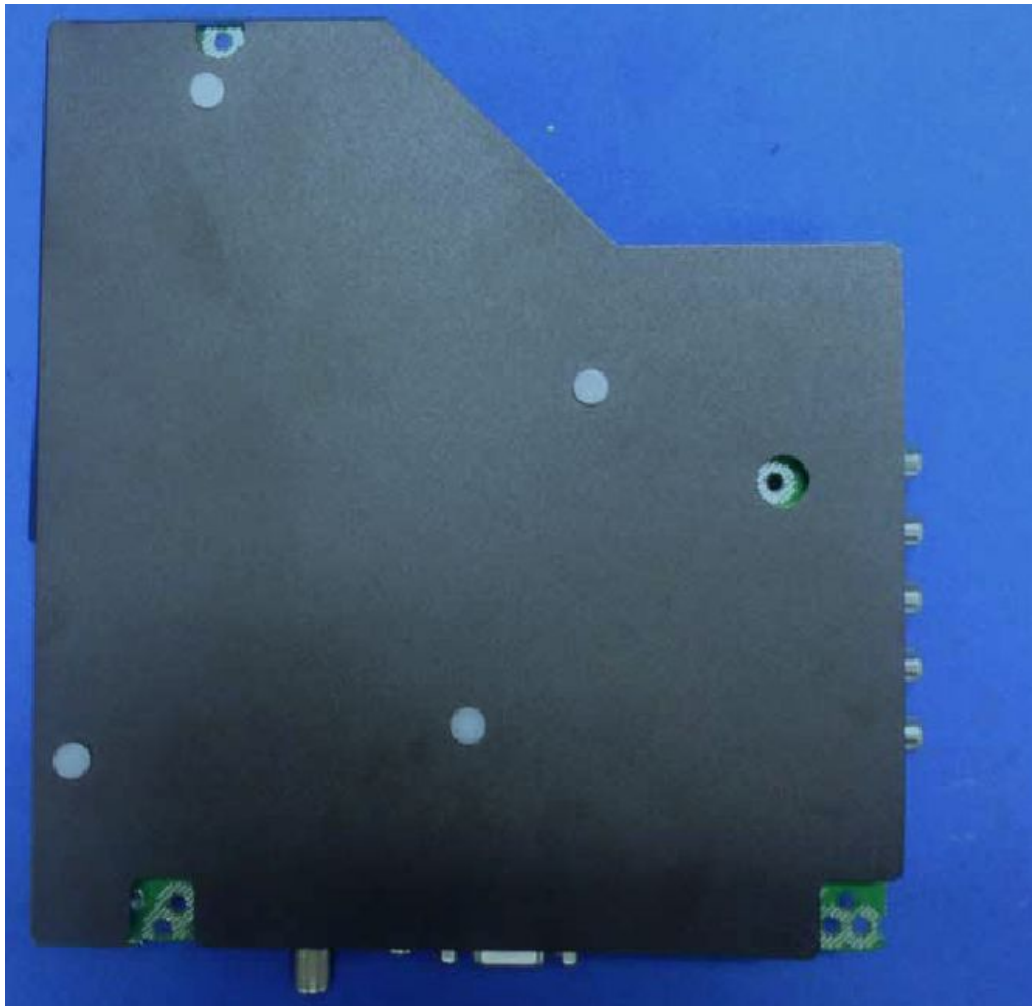

1. Mainchip—MSD3393LU(U1)
2. Audio Amplifier—TPA3110D2PWPR (UA1)
3. Main Flash Memory—GD25Q32BSIG (UF1)
4. DC/DC convertor 5V-1.8V for MSD3393LU (U1)—LC1117CLTRAD (UL2)
5. voltage convertor 5V to 3.3V_STB —LC1117CLTR33 (UL1)
6. voltage convertor 5V to 1.15V_STB —LC3406CB5TR (UD1)
7. voltage convertor 5V to 3V for tuner—LC1117CLTR33 (UT1)
8. Tuner —SDCL1005CR33JTDF (RFT1)

Please check the Schematic Diagram for the particular support

9-3. Mainboard Failure Check

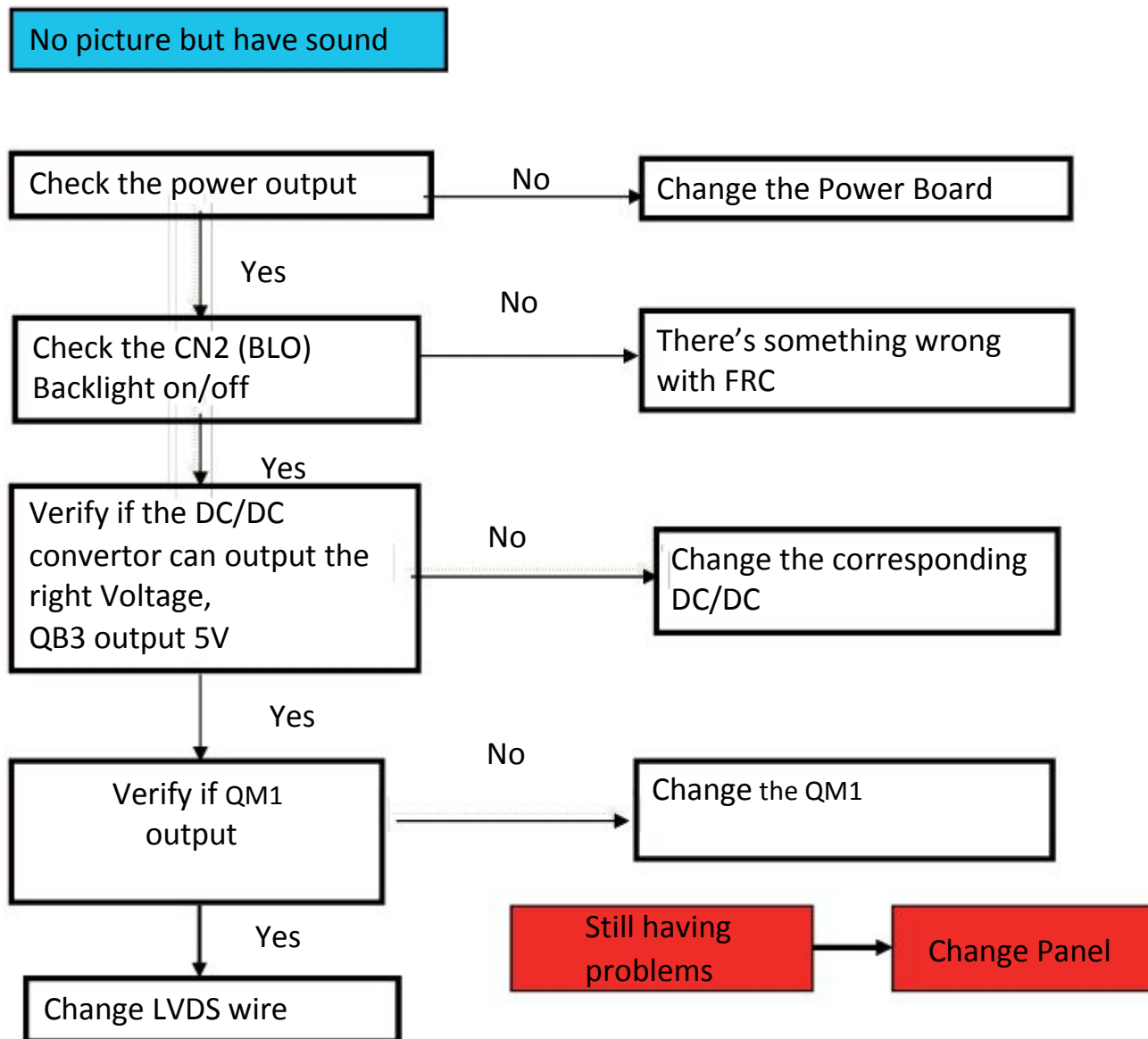

No sound but have picture

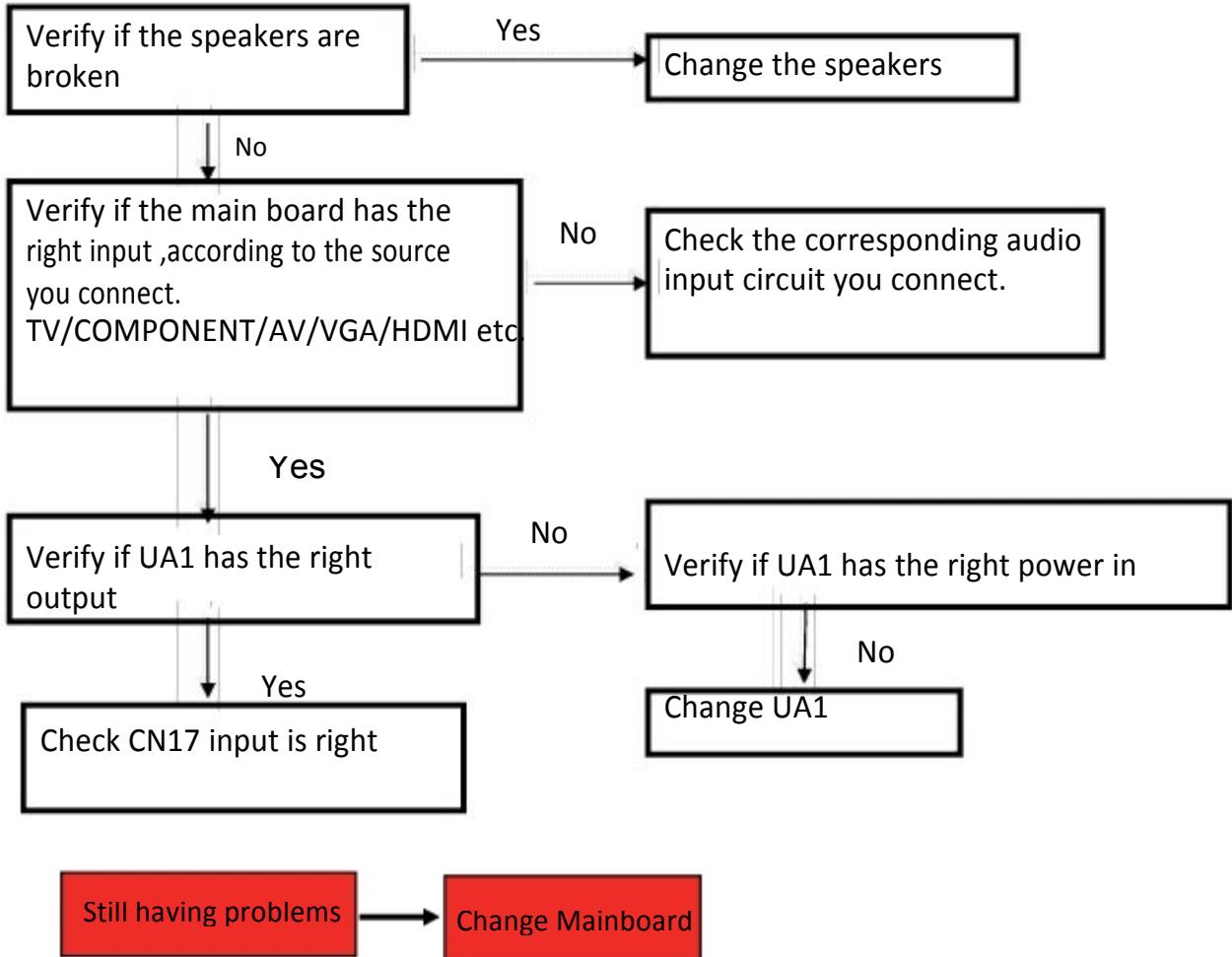

No sound No picture

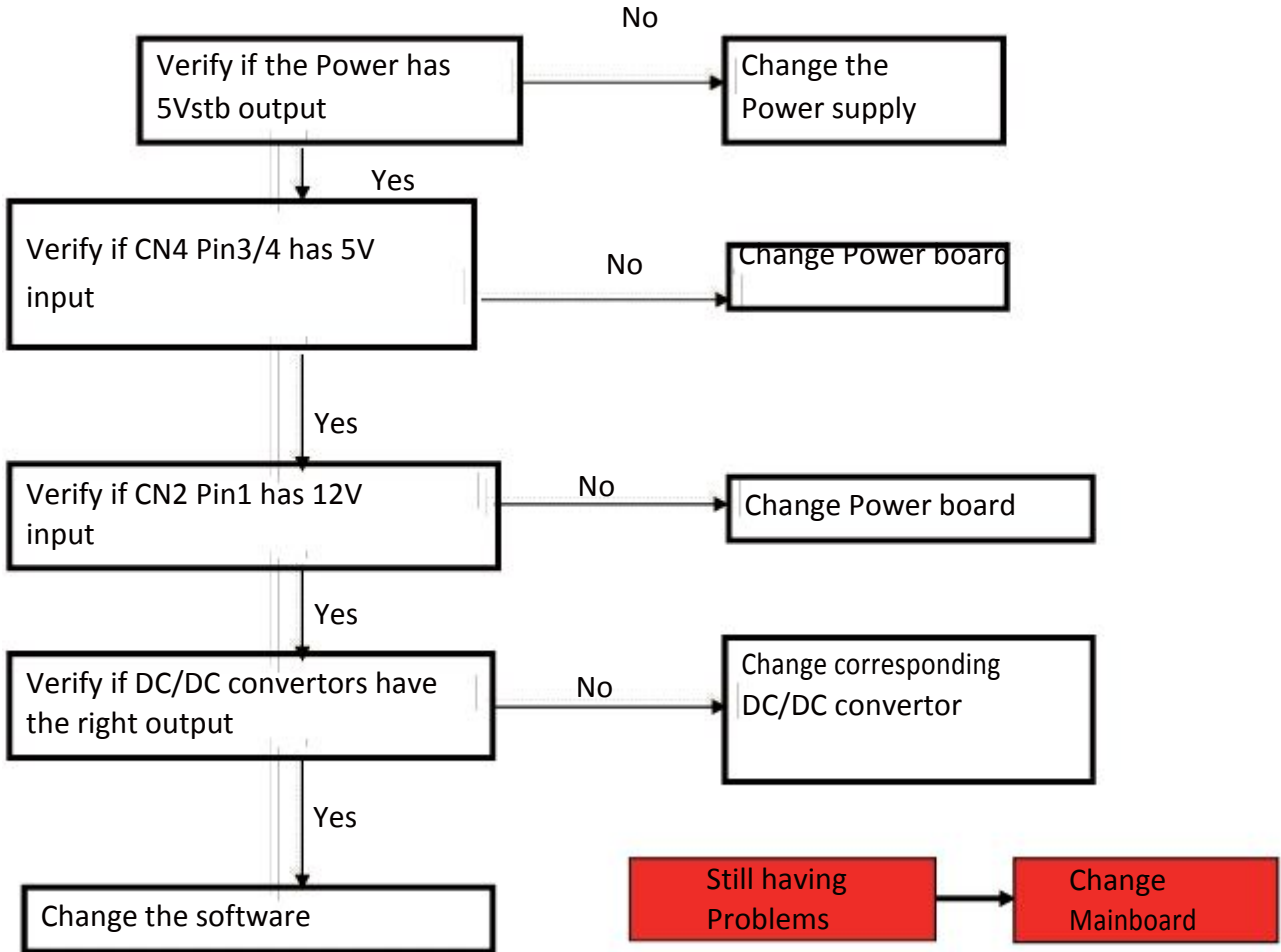

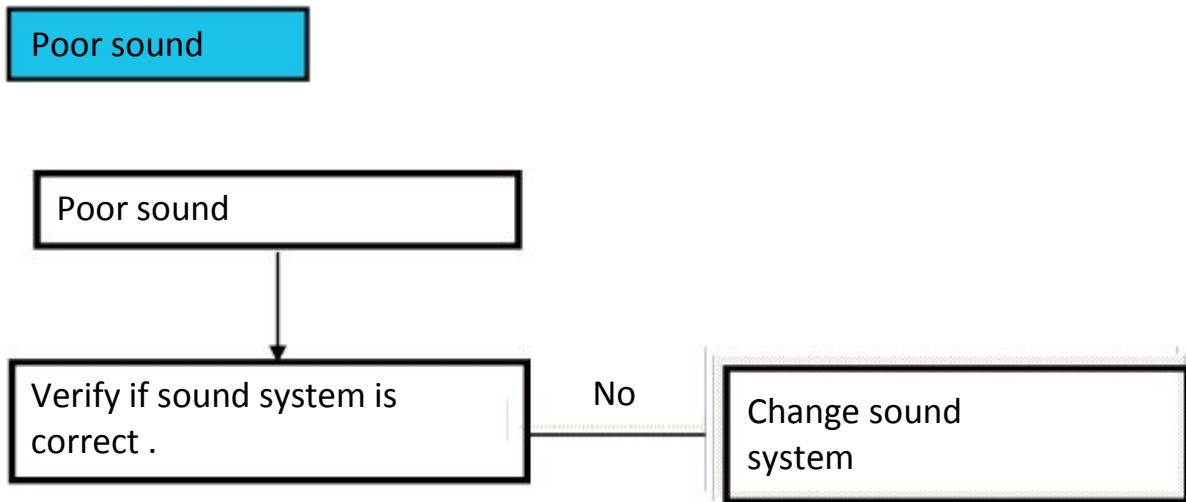

For ease of use, recommend that customer format the picture and sound settings in the automatic option.

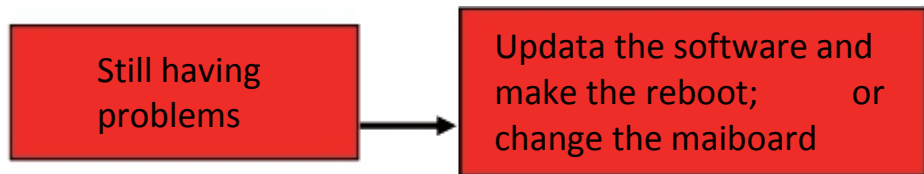

No color for some channel program (black and white)

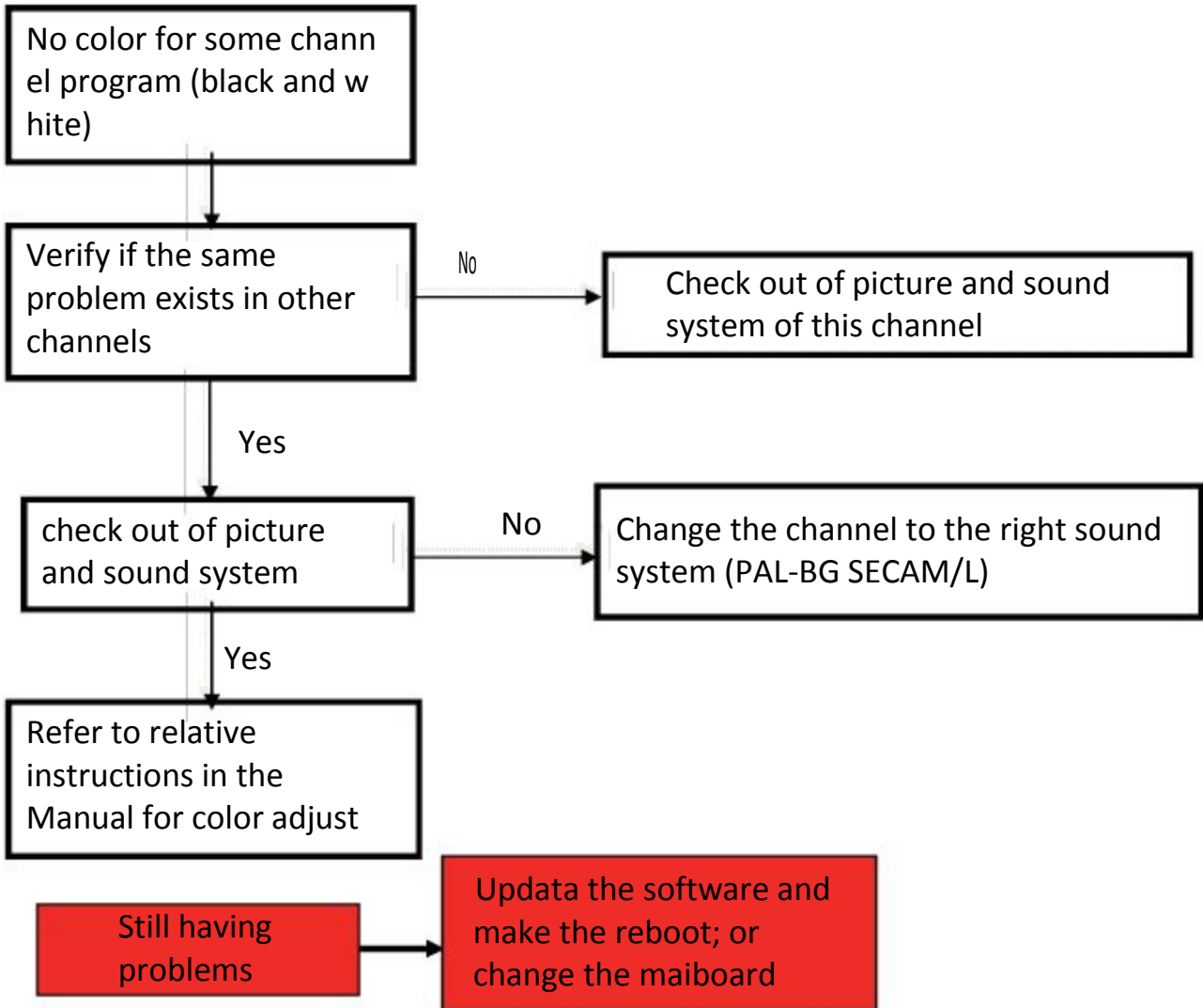



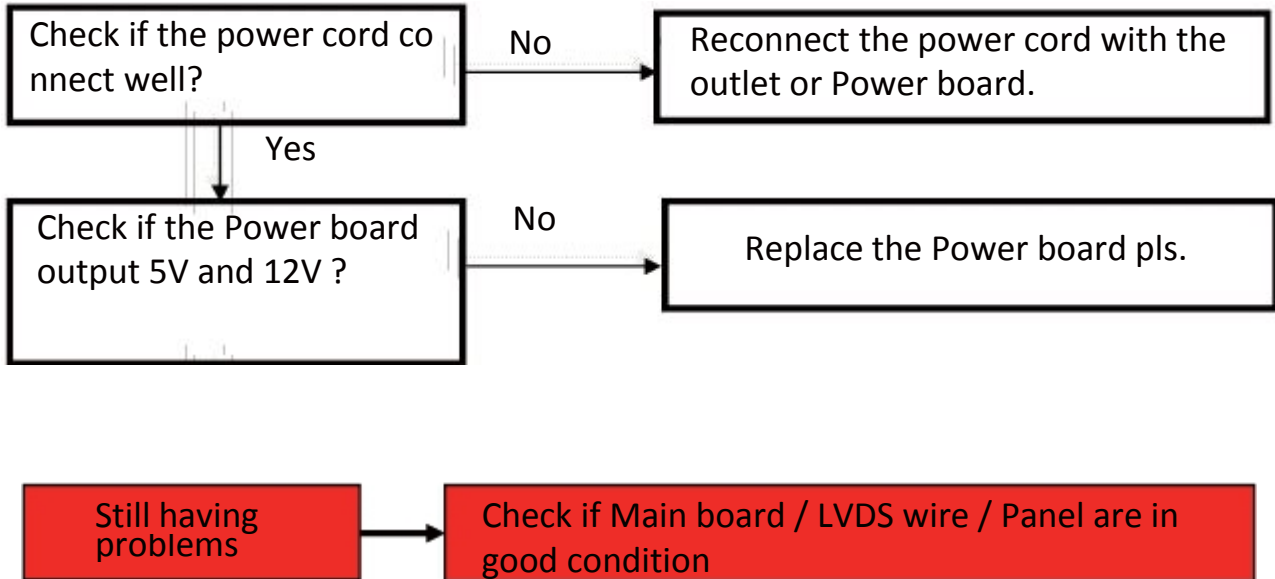

How to know whether the Power board is broken?







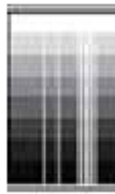

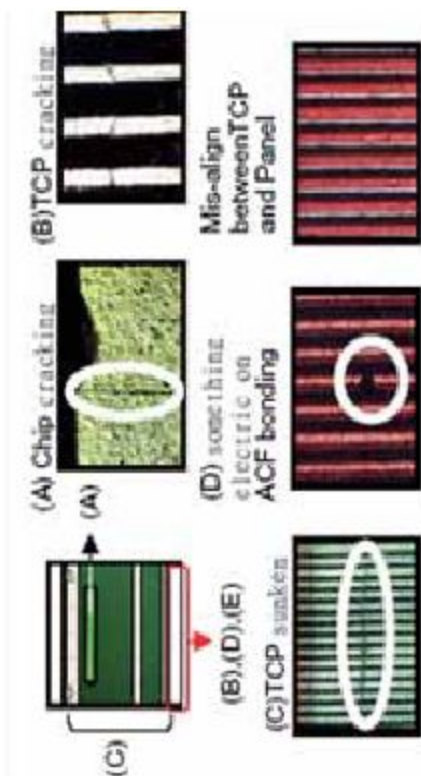
9-4. Pannel Failure



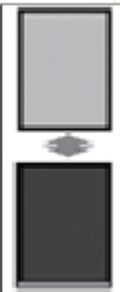
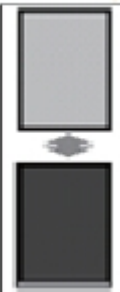

Failure Mode



Part	Name	Description	Phenomena	Failure cause
TCP	V B/D	Vertical bar		Block Defect :TCP cracking or cracking Dim or L/D :TCP Sunken
	V Dim	Vertal gray line		:TCP lead cracking :ACF bonding short :Awful environment and something electric enter into LCD
	V L/D	Vertical color line(light or dark forever)		: Mis-align between TCP and Panel : Panel failure : TCP failure
TCP	H B/D	Horizontal bar		(A) Chip cracking (B)TCP cracking
	H Dim	Horizontal gary line		(D) something electric on ACF bonding (B),(D),(E) (C)TCP sunken
	H L/D	Horizontal line(light or dark forever)		Mis-align between TCP and Panel



Part	Name	Description	Phenomena	Failure Cause
Panel or Polarizer	Dot Defect	Bright dot dark dot in pannel		Incoming Inspection Standard
	Polarizer Bubble	Bladder in Polarizer		Bladder between Polarizer and top glass
	Polarizer Scratch	Polarizer Scratch		Tine or rigidity arose
Circuit	F/inside Polarizer	Eyewinker inside Polarizer		Eyewinker inside Polarizer
	Flashing	Bright and dark display alternately		<ol style="list-style-type: none"> 1. Chip lose action 2. IC ahort or jointiog bad 3. Pannel and vsc connect bad

Part	Name	Description	Phenomena	Failure Cause
	White Screen	B/L normal, only white screen display		Maybe caused by surge current and EDS
	Black Screen	B/L normal, only Black screen display		
Circuit	Flicker	Crosstalk		LCD Vcom imbalance
	Abnormal Color	Only color abnormal		Capacitance improper bring crosstalk inside LCD pannel
	Abnormal Color	Only color abnormal		1. Chip lose action 2. IC short or jointion bad 3. Pannel and vsc connect bad

Part	Name	Description	Phenomena	Failure cause
	Mechanical Noise	When turn panel, appear cacophony		Caused by Mechanica noise of backlight unit
	Ripple	Connectric circle		Caused by between mechanism and pannel
	B/L off	B/L lose action		*Connect badness between wire and electrode
	B/L dark	B/L brightness darker than normal		*Connect badnessShort between wire and electrode
	B/L wire damaged	B/L wire damaged		Operation abnormal or systemic noise
	B/L wire open	Without backlight		Operation abnormal or systemic noise
	B/L shut down	B/L shutdown in sometime		Short bitween lamp housing and wire, Because consume power too much
	F/M	F/M inB/L , white,back Rotundity or wirelike		F/M in B/L unit

Part	Name	Description	Phenomena	Failure Cause
Light leakage	Brightness at bottom of LCM brighter than normal		B/L unit badness	
Mechanical or B/L	Uniformity	B/L brightness asymmetric		Sheet in B/L unit is uneven
	Mount hole	Lack screw or screw damage		*Lack screw Screw damage

Sincere Forever



Haier Group

Haier Industrial Park, No.1, Haier Road
266101, Qingdao, China
<http://www.haier.com>