

CHRISTIE®

CINEMA PRODUCTS AND SERVICES

2024 Catalog

Innovation in every frame™

Christie has the integrated cinema solutions to inspire and engage moviegoers, and keep your theatre running smoothly 24/7



6 | Projection

- 8 | CineLife
- 10 | CineLife+
- 26 | PLF
- 28 | Mystique Cinema
- 29 | CineLife+ IMB-S4



38 | Vive Audio

- 42 | LA Series
- 46 | LS Series
- 50 | S Series
- 52 | Amplifiers



32 | Lamps

- 34 | Xenolite/UP



56 | Services and support

- 60 | Cinergy
- 62 | Command Station

RGB pure laser projectors use banks of laser diodes in individual red, green and blue color primaries. These diodes are color-mixed to produce a nearly infinite amount of pure, rich colors in the visible spectrum, including pure white light.

OUR MASTERY OF LIGHT

Artists, they say, come in three kinds: Those with a good eye. Those with great hands. And the exceptional few, the Vermeers and the Michelangelos, blessed with both.

But it takes many pairs of skilled hands to put films in front of audiences. And ours must be safe hands. Masters of the light that paints the pictures filmmakers make and audiences crave.

So unless a projector improves image quality, we won't introduce it. And we'll only use technology we believe to be right for cinema. Technology that advances the industry we're a part of. That's why we were founding members of the Laser Illuminated Projector Association (LIPA). That's why we value our close working relationship with film directors like Ang Lee and James Cameron.

We have long championed Xenon Illumination; we champion it still. Its purity wins it an enduring place in mainstream cinema. And we champion RGB laser as a viable replacement. Our mastery of light has taught us it has a natural role in cinema.

If we expect audiences to leave their homes and pay to enter cinemas, their experience must be incomparable. And it must provide a return on investment that makes cinema worth your investment.

Our job is to reveal the imagined worlds locked in a filmmaker's eye and to make film's illusion complete. To be masters of light.

"He tries to trick you. I try to enlighten you. Which is the more noble pursuit?
May we have the lights, please..."

The Illusionist. Directed by Neil Burger, 2006

PROJECTION

We led the global transition from film to digital and continue to be firmly established as the industry standard with Christie recognized as its market leader.



CP4455-RGB

"I've just seen my dream come true, right before my eyes. This is what I've been working for. The 4K high frame rate 3D and brightness of the CP4450-RGB provide an immersive experience that has changed my relationship with movies."

Ang Lee, three-time Academy Award®-winning filmmaker

As the first licensee of DLP Cinema® technology, Christie knew the challenge of making cinema digital mainstream was never wholly technical. It needed the enthusiasm of both the filmmakers and the exhibitor community. It needed to inspire and engage moviegoers.

That original insight still holds true today. RGB laser projection in the majority of theatres is fast becoming a practical reality, frame rate and resolution is increasing - but so too are audience and exhibitor expectations. So when we say Christie delivers the complete cinema experience, we must mean just that. Technology, though we love it, is just the means to achieving it.

We are proud to say that we build some of the finest cinema projectors anywhere in the world, and we are proud of the technology we develop to make them. But we're prouder still of the experiences they create and the businesses they help build.



CP2309-RGB

Small-screen auditoriums | Boutique cinemas | Post-production | Screening rooms



Supercharge your small screen cinema with the Christie CineLife™ CP2309-RGB DCI-compliant projector. Featuring patented Christie Real|Laser™ solid-state illumination and CineLife electronics, the CP2309-RGB delivers 9,000 lumens of brightness, greater than 95% of the Rec. 2020 color space, and a 2000:1 contrast ratio for amazing cinematic experiences. Its compact, light, all-in-one form factor doesn't require any external chillers for a seamless installation.

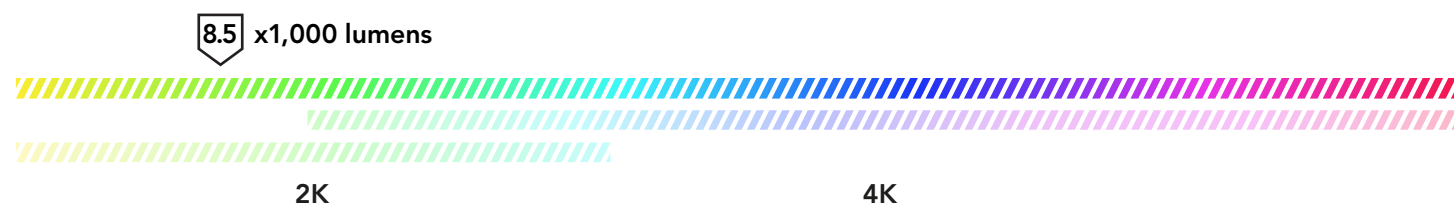

Key features



Expanded color gamut approaching Rec. 2020, greater brightness and contrast



Uses MPD technology to improve image quality on all screen types with Enhanced Wavelength Diversity (EWD)



50,000+ hours of optimal performance



Sealed optics protect against dust ingress



Works with existing Christie accessories and lenses

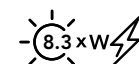

Best-in-class operational efficiency – 8.3 lumens per watt

Specifications		CP2309-RGB
Brightness	nominal	Up to 8,500 lumens
	lifetime	>50,000 hours ¹
Screen size		44' (13.5m)
Contrast ratio		2000:1 full field on/off with standard high brightness lens
Digital micromirror device		• 0.69" S2K 3-chip DMD DLP Cinema® • 2048 x 1080 pixels (2K)
Color gamut	native gamut	>90% of Rec. 2020 coverage
Processing electronics		• Christie CineLife™ Series-3 (Series-2 IMB compatible) ² • HDMI v1.4a x2 • 16-channel AES (w/ Christie IMB-S3 via RJ45 x2) • 2K120 / 4K 30fps (w/Christie IMB-S3) • Built-in automation controller • 3D Sync Connector (12V 1A powered) ³
Lens mount configuration		Fully motorized intelligent lens system (ILS)
Lenses		• 1.2 - 1.72 • 1.33 - 2.1 • 1.62 - 2.7 • 2.09 - 3.9
Power consumption		1025W ⁴ , max DCI brightness, at 25 C, 3500 BTU/hr
Power input requirements		• Input A 200-240 VAC at 50-60 Hz, 9A max • Input B (UPS input): 100-240 VAC at 50-60 Hz, 8A max
Laser class		Class 1 – Risk Group 3
Dimensions (w/o lens)	size (L x W x H)	42.6 x 25.0 x 13.3" (1083 x 635 x 337mm)
Weight		160lbs max (73kg)
Accessories		• Christie IMB-S3 • NAS-S3 5.4TB storage • Rack mount pedestal • Rack mount pedestal adaptor • Extraction duct adaptor

¹ Subject to variables specific to each installation. Please see Christie cinema RGB pure laser best practices guide for more information.
² Supports third party IMB models from Dolby, GDC and others. Please contact Christie for updated compatibility list.
³ Supports most conventional 3D systems except "color-separation" based 3D (i.e. 6P). Visit the website for more information
⁴ Typical power consumption. May be impacted by environmental conditions.

Front view

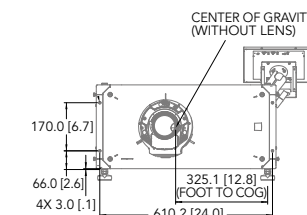

Side view

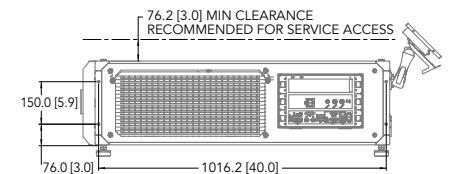

Top view

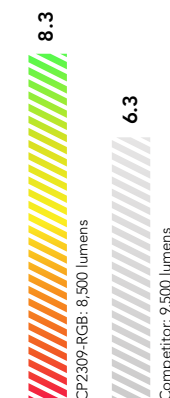
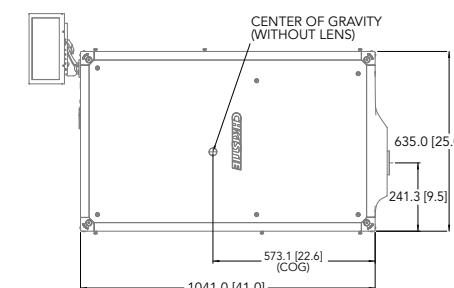

Efficiency against competition Lumens per watt

Discover more

[CP2309-RGB datasheet](#)
Key features and specifications of the CP2309-RGB digital cinema projector

[Christie Real|Laser FAQ](#)
Frequently asked questions about Real|Laser illumination technology



CP2420-Xe

Medium-screen auditoriums | Event cinema | Post-production | Screening rooms



The Christie CP2420-Xe is a compact digital cinema projector that provides the lowest upfront investment for DCI-compliant cinema on screens up to 70' (21m) wide. It uses our ultra-fast CineLife+™ Series 4 electronics platform and features our intuitive easy-to-use UI. Your audience will enjoy the realistic, true-to-life experience created by the native daylight spectrum that Xenon lamps closely replicate – plus the flawless image cinemagoers expect and love.

22 x1,000 lumens



Key features



Affordable performance – Christie Xenolite® long-life, lower power consumption lamps



Easy to install – lightweight all-in-one chassis for flexible mounting



Ultra-fast processing – HDMI 2.0 and 4x 12 GB SDI inputs for 1.06 G pixels per sec



Flexibility of brightness – Operates with either standard 2kW, 3kW and high performance 3kW lamps



Reliability – split power operation for use with UPS

Specifications

	CP2420-Xe	
Brightness	lamp	• 2.0kW (CDXL-20) 003-000598-XX • 3.0kW (CDXL-30SD) 003-001165-XX • 3.0kW (CDXL-30) 003-000599-XX • 3.0kW (CDXL-30SUP) 003-006951-XX
	nominal	Up to 22,000 lumens
Screen size	71' (21m) ¹	
Contrast ratio	>2000:1 full field on/off	
Supported frame rates	• 2D up to 120fps • 3D up to 60fps/eye	
Digital micromirror device	• 1.2" 2K 3-chip DMD DLP Cinema* • 2048 x 1080 pixels (2K) • Upgradable to 1.38" 4K (4096 x 2160 pixels)	
Power input requirements	• Main input: 200-240 VAC at 50-60 Hz, 23A max • UPS input: 100-240 VAC at 50-60 Hz, 10A max	
Number of colors	35.2 trillion	
Lenses	• HB and HC: 1.0:1 (HB lens) • 1.25-1.83:1 • 1.45-2.05:1 • 1.60-2.40:1 • 1.80-3.0:1 • 2.15-3.60:1 • 3.0-4.30:1 (HB lens) • 4.3-6.0:1 (HB lens) • 5.5 -8.5:1 (HB lens)	
Power consumption	4200W ² max	
Power supply	3.3kW low-ripple switch mode power supply	
Standard inputs	• HDMI 2.0 x2 • 12G SDI x4	
Weight	As installed 256lbs max (116kg)	
Accessories	• Variable aperture kit • Rack mount pedestal	

¹ Maximum screen size depends upon various factors such as screen gain, lamp age, geometry, etc. Consult your Christie representative for detailed analysis. Measured at screen center.

² Typical power consumption. May be impacted by environmental conditions.

Spectrum comparison between Xenon lamp and daylight

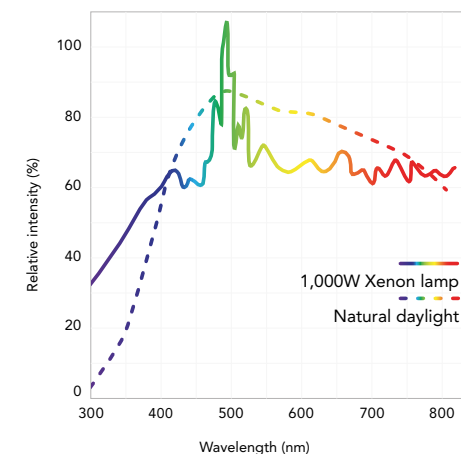

Christie® Xenolite short arc Xenon lamps
Engineered for superior performance in all cinema applications



Front view

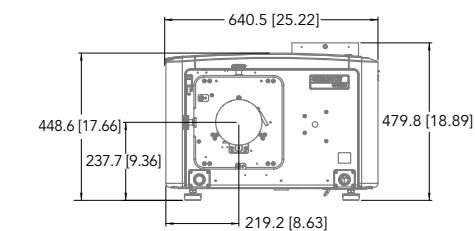

Side view

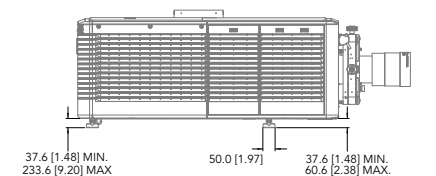

Top view

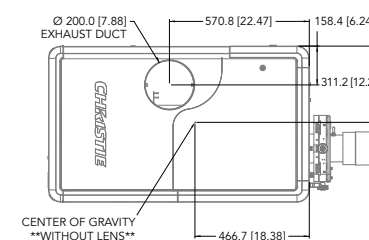

Discover more

[Christie CP2420-Xe datasheet](#)
Key features and specifications of the CP2420-Xe digital cinema projector

[Xenon – Tried, tested and true](#)
Why Xenon illumination is the preferred choice over laser phosphor for mainstream cinema



CP4420-Xe

Medium-screen auditoriums | Event cinema | Post-production | Screening rooms



Christie CineLife+™ CP4420-Xe offers established longevity and dependability, excellent image performance, the lowest operating costs on screens up to 70' (21m) wide, our ultra fast CineLife+ electronics platform, and an intuitive easy-to-use UI. Your audience will enjoy the realistic, true-to-life experience created by the native daylight spectrum that Xenon lamps closely replicate – plus the flawless image cinemagoers expect and love.

22 x1,000 lumens



Key features



Affordable performance – Christie Xenolite® long-life, lower power consumption lamps



Easy to install – lightweight all-in-one chassis for flexible mounting



Ultra-fast processing – HDMI 2.0 and 4x 12 GB SDI inputs for 1.06 G pixels per sec



Flexibility of brightness – Operates with either standard 2kW, 3kW and high performance 3kW lamps



Reliability – split power operation for use with UPS

Specifications

CP4420-Xe

Brightness	lamp	• 2.0kW (CDXL-20) 003-000598-XX • 3.0kW (CDXL-30SD) 003-001165-XX • 3.0kW (CDXL-30) 003-000599-XX • 3.0kW (CDXL-30SUP) 003-006951-XX
	nominal	Up to 22,000 lumens
Screen size		71' (21m) ¹
Contrast ratio		2000:1 full field on/off
Supported frame rates		• 2D up to 120fps • 3D up to 60fps/eye
Digital micromirror device		• 1.4" Enhanced 4K 3-chip DMD DLP Cinema® • 4096 x 2160 pixels (4K)
Power input requirements		• Main input: 200-240 VAC at 50-60 Hz, 23A max
Number of colors		35.2 trillion
Lenses		• HB and HC: 1.0:1 (HB lens) • 1.25-1.83:1 • 1.45-2.05:1 • 1.60-2.40:1 • 1.80-3.0:1 • 2.15-3.60:1 • 3.0-4.30:1 (HB lens) • 4.3-6.0:1 (HB lens) • 5.5 -8.5:1 (HB lens)
Power consumption		4200W ² max
Power supply		3.3kW low-ripple switch mode power supply
Standard inputs		• HDMI 2.0 x2 • 12G SDI x 4
Weight		As installed 256lbs max (116kg)
Accessories		• Variable aperture kit • Rack mount pedestal

¹ Maximum screen size depends upon various factors such as screen gain, lamp age, geometry, etc. Consult your Christie representative for detailed analysis. Measured at screen center.

² Typical power consumption. May be impacted by environmental conditions.

Spectrum comparison between Xenon lamp and daylight

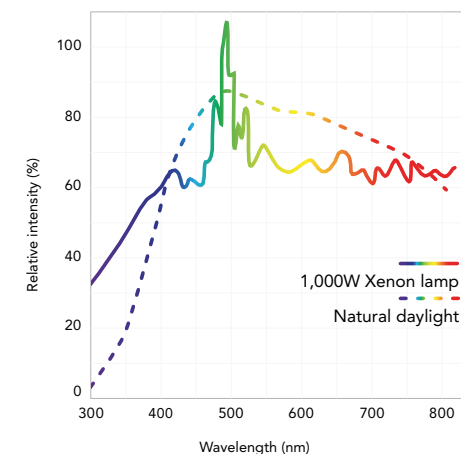

Christie® Xenolite short arc Xenon lamps
Engineered for superior performance in all cinema applications



Front view

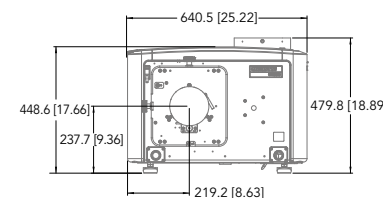

Side view

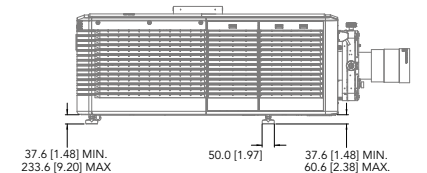

Top view

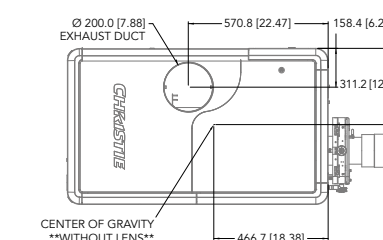

Discover more

[Christie CP4420-Xe datasheet](#)
Key features and specifications of the CP4420-Xe digital cinema projector

[Xenon – Tried, tested and true](#)
Why Xenon illumination is the preferred choice over laser phosphor for mainstream cinema



CP2406-RBe | CP2409-RBe | CP2411-RBe

Small-screen auditoriums | Boutique cinemas | Screening rooms



Upgrade your small-screen cinemas with our affordable yet high-performing RBe projectors. With enhanced laser phosphor illumination and CineLife+2K™ electronics designed specifically for 2K projectors, these models deliver better on-screen images and longer operational life in an easy-to-use interface.

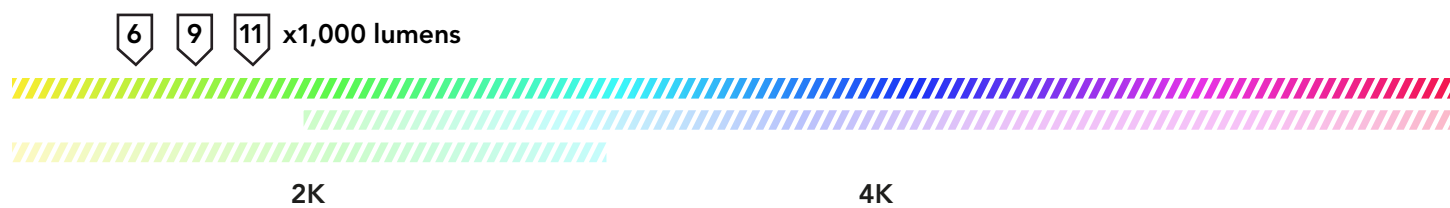

Key features



50,000 hours of stable DCI brightness with low-maintenance operation



Provides perfect alignment throughout the entire image

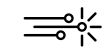

Higher optical efficiency from laser diodes



Fully sealed optics allow for zero dust-ingress



Consumes less than 3W of power in Hibernate mode



Easy to operate - adds UX inspired interface for playback, scheduling, and content management



Fully-compatible with existing accessories including the Christie Rack Mount Pedestal and existing cinema lenses for additional cost saving

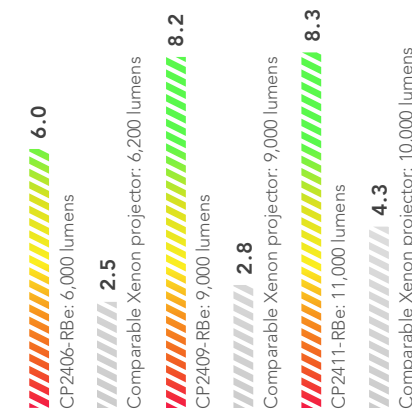

Efficiency against competition Lumens per watt

Specifications	CP2406-RBe	CP2409-RBe	CP2411-RBe
Brightness	nominal	Up to 6,000 DCI lumens	Up to 9,000 DCI lumens
	lifetime	50,000 hours (<25°C ambient) ¹	
Screen size	Up to 36' (11m)	Up to 42' (12m)	Up to 47' (14m)
Contrast ratio	2000:1 full field on/off		
Digital micromirror device	• 0.69" S2K 3-chip DMD DLP Cinema® • 2048 x 1080 pixels (2K)		
Color gamut	native gamut	> DCI-P3	
Processing electronics	• Christie® CineLife+™ 2K Series (Series-2 IMB compatible) ² • HDMI 2.0 x 2 • 1G Ethernet x1 • Remote UI • Electronic Color Convergence (ECC)		
Noise level	49 dBA nominal at 25°C ³	50 dBA nominal at 25°C ³	51 dBA nominal at 25°C ³
Lens mount configuration	Fully motorized intelligent lens system (ILS)		
Lenses	• 1.2 - 1.72 • 1.33 - 2.1 • 1.62 - 2.7 • 2.09 - 3.9 • 0.83 - 1.2 (coming soon)		
Input line voltage	Single phase 200-240V		
Hibernate	< 3W		
Power consumption	1,000W max ⁴	1,200W max ⁴	1,390W max ⁴
Laser class	Class 1 – Risk Group 3		
Dimensions (w/o lens)	size (L x W x H) 27.4 x 27.1 x 15.9" (696 x 688 x 404mm)	27.4 x 27.1 x 15.6" (696 x 688 x 395mm)	27.4 x 27.1 x 15.9" (696 x 688 x 404mm)
Weight	As installed: 137lbs max (62kg)		
Accessories	• Rack mount stand • Touch panel controller (optional)		

¹ Subject to variables specific to each installation. Please see Christie's laser best practices guide for more information.
² Supports Christie IMB-S4 and legacy Series 2 IMBs. A list of supported versions is available upon request.
³ Specific operating conditions may apply.
⁴ Typical power consumption. May be impacted by environmental conditions. Subject to change.

Front view

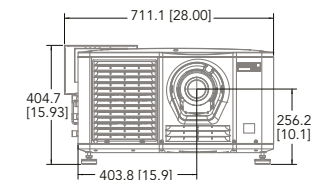

Side view

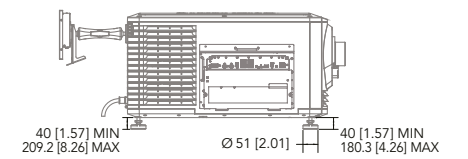

Top view

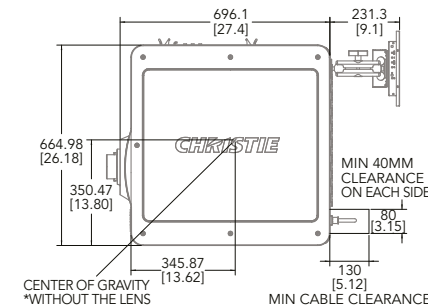

Discover more

[CP2406-RBe datasheet](#)
Key features and specifications

[CP2409-RBe datasheet](#)
Key features and specifications

[CP2411-RBe datasheet](#)
Key features and specifications



CP2415-RGB | CP2420-RGB

Small- to medium-screen auditoriums | Event cinema | Post-production | Screening rooms



With the latest RGB pure laser technology at a low TCO, upgrading from Series 1 and 2 2K to Christie® CP2415/20-RGB suddenly makes a lot more sense. Featuring CineLife+™ electronics and RealLaser™ illumination, CP2415-RGB and CP2420-RGB excel in image quality, operational lifetime, and overall cost. Their compact, all-in-one form factor doesn't require any external chillers or parts for a seamless installation into any booth. As volatile energy costs continue to rise, this operationally efficient, carbon-conscious system yields real savings on your energy bill.

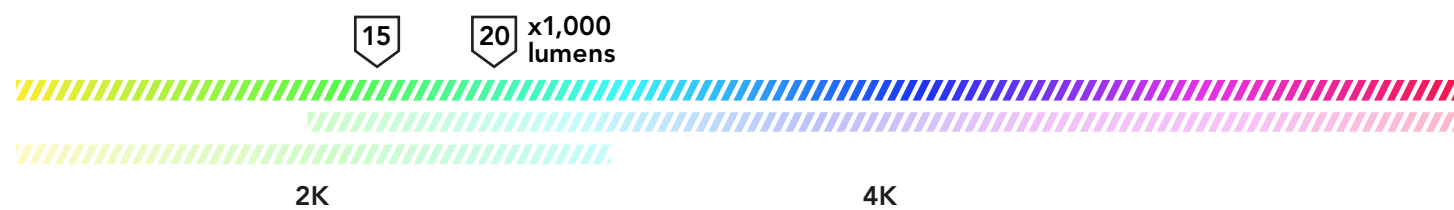

Key features



Ultra-fast processing – HDMI 2.0 and 4x 12 GB SDI inputs for 1.06 G pixels per sec



Long-lasting light source – over 50,000 hours of optimal performance



Low maintenance – sealed optics for protection against dust ingress



Enhanced Wavelength Diversity (EWD) – utilising MPD technology to improve image quality on all screen types

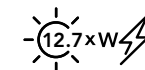

Best-in-class operational efficiency – 12.7 lumens per watt (CP2415-RGB) / 12.9 lumens per watt (CP2420-RGB)

Specifications	CP2415-RGB	CP2420-RGB	
Brightness	nominal	Up to 15,000 lumens	Up to 20,000 lumens
	lifetime	>50,000 hours ¹	
Screen size	52' (15m)	63' (19m)	
Contrast ratio	Up to 6000:1 full field on/off ²		
Supported frame rates	•2D up to 120fps •3D up to 60fps/eye		
Digital micromirror device	•0.98" mDC2K 3-chip DMD DLP Cinema® •2048 x 1080 (2K)		
Color gamut native	>95% of Rec. 2020 coverage		
Processing electronics	•Christie CineLife+™ Series (Series-2 IMB compatible) • HDMI 2.0 x2 • 1G Ethernet x1 • 12G SDI x 4 • DisplayPort 1.2 x2 • Remote UI • Electronic Color Convergence (ECC)		
Lens mount configuration	Fully motorized Intelligent Lens System (ILS™)		
Lenses ³	•1.05:1 • 1.20-1.75:1 • 1.39-1.9:1 • 1.5-2.2:1 • 1.75-2.4:1 • 1.9-3.0:1 •2.4-3.9:1 • 3.9-6.52		
Power consumption	1180W ⁴ , max DCI brightness, at 25 C, 4030 BTU/hr	1545W ⁴ , max DCI brightness, at 25 C, 5270 BTU/hr	
Power input requirements	• Input A: 200-240 VAC at 50-60 Hz, 10A max • Input B (UPS input): 100-240 VAC at 50-60 Hz, 10A (8A typical at 120V, 4030 BTU/hr)	• Input A: 200-240 VAC at 50-60 Hz, 12A max • Input B (UPS input): 100-240 VAC at 50-60 Hz, 10A max	
Laser class	Class 1 – Risk Group 3		
Dimensions (w/o lens)	size (L x W x H) •42.6 x 25.0 x 13.3" (1083 x 635 x 337mm)		
Weight	As installed: 174lbs max (79kg)	As installed: 176lbs max (80kg)	
Accessories	• Touch panel controller (optional) • Rack mount pedestal • Rack mount pedestal adaptor • Extraction duct adaptor		

¹ Subject to variables specific to each installation. Please see Christie cinema RGB pure laser best practices guide for more information. ² Supports legacy Series 2 IMBs. A list of supported versions is available upon request. ³ Available in HB and UHC lens versions. ⁴ Typical power consumption. May be impacted by environmental conditions.

Front view

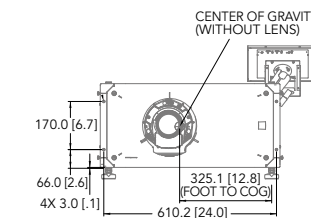

Side view

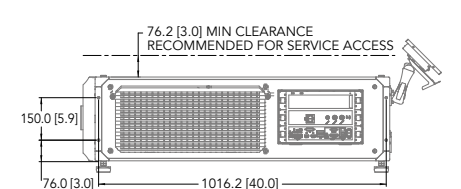

Top view

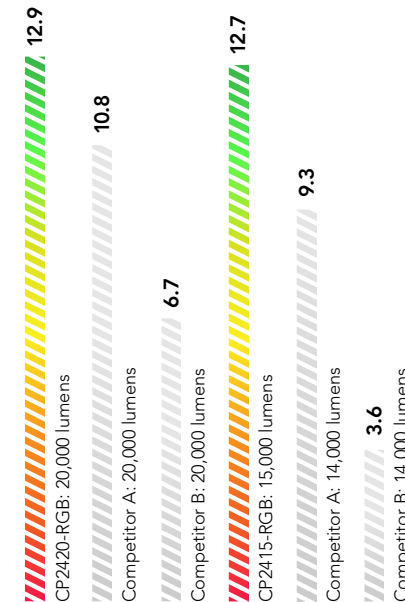
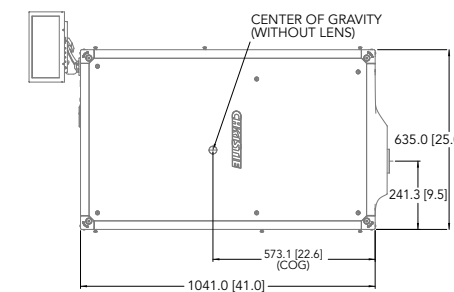

Efficiency against competition Lumens per watt

Discover more

[CP2415-RGB datasheet](#)
Key features and specifications of the CP2415-RGB digital cinema projector

[CP2420-RGB datasheet](#)
Key features and specifications of the CP2420-RGB digital cinema projector



CP4415m-RGB | CP4420m-RGB

Small- to medium-screen auditoriums | Event cinema | Post-production | Screening rooms



Christie® CP4415m-RGB and CP4420m-RGB pure laser cinema projectors bring an affordable 4K laser presentation to mainstream theatres. Featuring CineLife+™ electronics and RealLaser™ illumination, these compact, all-in-one DCI-compliant projectors excel in image quality and operational life while providing a low total cost of ownership (TCO).

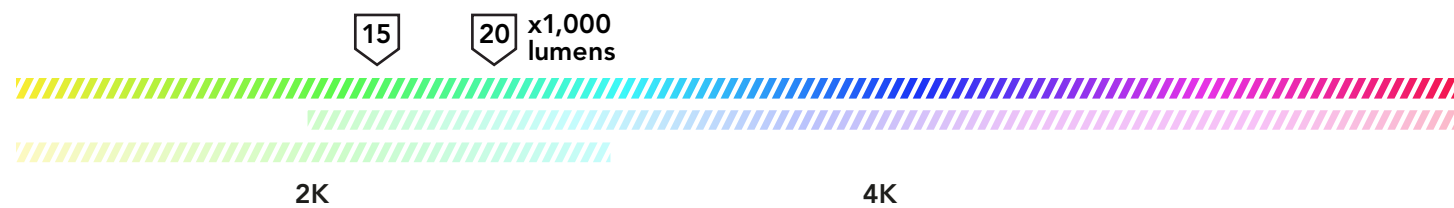

Key features



Ultra-fast processing – HDMI 2.0 and 4x 12 GB SDI inputs for 1.06 G pixels per sec



Long-lasting light source – over 50,000 hours of optimal performance



Low maintenance – sealed optics for protection against dust ingress



Enhanced Wavelength Diversity (EWD) – utilising MPD technology to improve image quality on all screen types

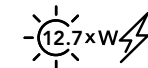

Best-in-class operational efficiency – 12.7 lumens per watt (CP4415m-RGB) / 12.9 lumens per watt (CP4420m-RGB)

Specifications	CP4415m-RGB	CP4420m-RGB
Brightness	nominal	Up to 15,000 lumens
	lifetime	>50,000 hours ¹
Screen size	52' (15m)	63' (19m)
Contrast ratio	Up to 2000:1 full field on/off ²	
Supported frame rates	•2D up to 120fps •3D up to 60fps/eye	
Digital micromirror device	•0.98" DC4K DMD DLP Cinema® •4096 x 2160 (4K)	
Color gamut native	>95% of Rec. 2020 coverage	
Processing electronics	•Christie® CineLife+™ Series (Series-2 IMB compatible) • HDMI 2.0 x2 • 1G Ethernet x1 • 12G SDI x 4 • DisplayPort 1.2 x2 • Remote UI • Electronic Color Convergence (ECC)	
Lens mount configuration	Fully motorized Intelligent Lens System (ILS™)	
Lenses ³	•1.05:1 • 1.20-1.75:1 • 1.39-1.9:1 • 1.5-2.2:1 • 1.75-2.4:1 • 1.9-3.0:1 •2.4-3.9:1 • 3.9-6.52	
Power consumption	1180W ⁴ , max DCI brightness, at 25 C, 4030 BTU/hr	1545W ⁴ , max DCI brightness, at 25 C, 5270 BTU/hr
Power input requirements	• Input A: 200-240 VAC at 50-60 Hz, 10A max • Input B (UPS input): 100-240 VAC at 50-60 Hz, 10A (8A typical at 120V, 4030 BTU/hr)	• Input A: 200-240 VAC at 50-60 Hz, 12A max • Input B (UPS input): 100-240 VAC at 50-60 Hz, 10A max
Laser class	Class 1 – Risk Group 3	
Dimensions (w/o lens)	size (L x W x H) •42.6 x 25.0 x 13.3" (1083 x 635 x 337mm)	
Weight	As installed: 174lbs max (79kg)	As installed: 176lbs max (80kg)
Accessories	• Touch panel controller (optional) • Rack mount pedestal • Rack mount pedestal adaptor • Extraction duct adaptor	

¹ Subject to variables specific to each installation. Please see Christie cinema RGB pure laser best practices guide for more information. ² Supports legacy Series 2 IMBs. A list of supported versions is available upon request. ³ Available in HB and UHC lens versions. ⁴ Typical power consumption. May be impacted by environmental conditions.

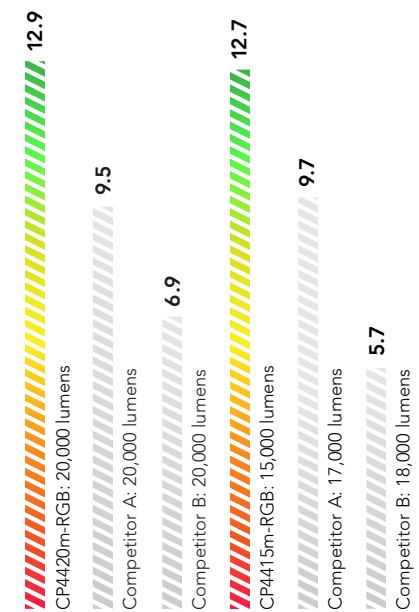

Efficiency against competition Lumens per watt

Front view

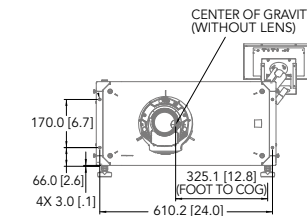

Side view

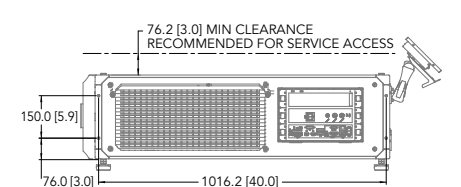

Top view

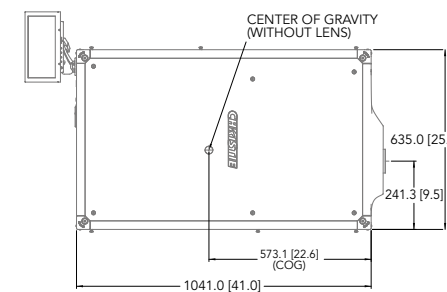

Discover more

[CP4415m-RGB datasheet](#)
Key features and specifications of the CP4415m-RGB digital cinema projector

[CP4420m-RGB datasheet](#)
Key features and specifications of the CP4420m-RGB digital cinema projector



Key features



Ultra-fast processing – HDMI 2.0 and 4x 12 GB SDI inputs for 1.06 G pixels per sec



Long-lasting light source –over 50,000 hours of optimal performance



Low maintenance – sealed optics for protection against dust ingress

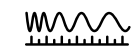

Enhanced Wavelength Diversity (EWD) – uses MPD technology to improve image quality on all screen types

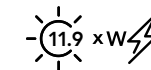

Best-in-class operational efficiency – 11.9 lumens per watt (CP4415-RGB) / 12.9 lumens per watt (CP4420-RGB)

Specifications

	CP4415-RGB	CP4420-RGB
Brightness	nominal	Up to 15,000 lumens ¹
	lifetime	>50,000 hours ²
Screen size	52' (15m)	63' (19m)
Contrast ratio	Up to 6000:1 full field on/off ³	
Supported frame rates	•2D up to 120fps •3D up to 60fps/eye	
Digital micromirror device	•1.38" Enhanced 4K 3-chip DMD DLP Cinema ⁴ •4096 x 2160 (4K)	
Color gamut native	>95% of Rec.2020 coverage	
Processing electronics	•Christie® CineLife+™ Series (Series-2 IMB compatible) ⁴ •HDMI 2.0 x2 •4K 120 fps ⁵ •1G Ethernet x1 •12G SDI x4 •DisplayPort 1.2 x2 •Remote UI •Electronic Color Convergence (ECC)	
Lens mount configuration	Fully motorized Intelligent Lens System (ILS™)	
Lenses ⁶	•HB and UHC: 1.13-1.66 •1.31-1.85 •1.45-2.17 •1.63-2.71 •1.95-3.26 •2.71-3.89 •3.89-5.43 •4.98-7.69	
Power consumption	1265W, max DCI brightness, at 25 C, 4320 BTU/hr	1555W, max DCI brightness, at 25 C, 5305 BTU/hr
Power input requirements	•Input A: 200-240 VAC at 50-60 Hz, 10A max •Input B (UPS input): 100-240 VAC at 50-60 Hz, 10A max	•Input A: 200-240 VAC at 50-60 Hz, 15A max •Input B (UPS input): 100-240 VAC at 50-60 Hz, 10A max
Laser class	Class 1 – Risk Group 3	
Dimensions (w/o lens)	size (L x W x H) •37.2 x 28.0 x 20.7" (944 x 711 x 525mm)	
Weight	As installed: 238lbs (108kg)	
Accessories	•Rack mount pedestal •Rack mount pedestal adaptor •Extraction duct adaptor	•Touch panel controller (optional) •Enhanced 4K HB and UHC lens suite available

¹With existing high brightness cinema lens. ² Subject to variables specific to each installation. Please see Christie cinema RGB pure laser best practices guide for more information. ³With new UHC cinema lens. ⁴Supports legacy Series 2 IMBs. A list of supported versions is available upon request. ⁵With the GDC SR-6400 IMB. ⁶Typical power consumption. May be impacted by environmental conditions.

CP4415-RGB | CP4420-RGB

Small- to medium-screen auditoriums | Event cinema | Post-production | Screening rooms



Christie® CP4415-RGB and CP4420-RGB pure laser cinema projectors bring a premium moviegoing experience to mainstream theatres. Featuring CineLife+™ electronics and RealLaser™ illumination, these compact, all-in-one DCI-compliant projectors excel in image quality and operational lifetime while providing a low cost of ownership.

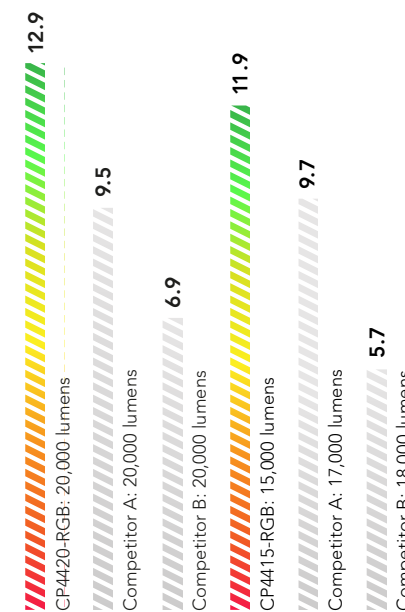

Efficiency against competition
Lumens per watt

Front view

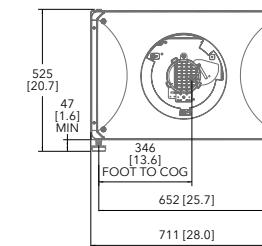

Side view

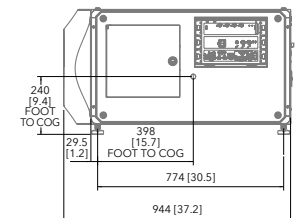

Top view

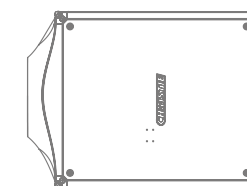

Discover more

[CP4415-RGB datasheet](#)
Key features and specifications of the CP4415-RGB digital cinema projector

[CP4420-RGB datasheet](#)
Key features and specifications of the CP4420-RGB digital cinema projector



CP4425-RGB | CP4435-RGB

Large-screen auditoriums | Event cinema | Post-production



The Christie® CP4425-RGB and CP4435-RGB pure laser cinema projectors enable exhibitors to impress audiences with incredibly colorful and detailed, true-to-life images while benefiting from an affordable platform that will perform well into the future. Bring a premium moviegoing experience to mainstream theatres with this compact, all-in-one DCI-compliant projector that features CineLife+™ electronics and Real|Laser™ illumination.

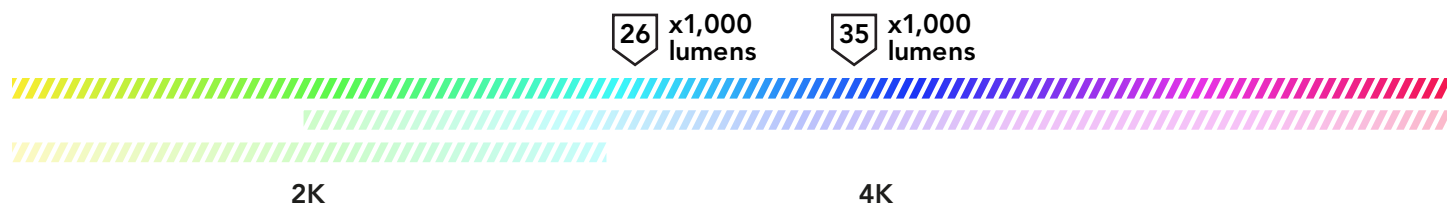

Key features



Ultra-fast processing – HDMI 2.0 and 4x 12 GB SDI inputs for 1.06 G pixels per sec



Long-lasting light source –over 50,000 hours of optimal performance



Low maintenance – sealed optics for protection against dust ingress



Enhanced Wavelength Diversity (EWD) – uses MPD technology to improve image quality on all screen types

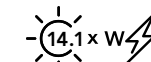

Best-in-class operational efficiency – 14.1 lumens per watt (CP4425-RGB) / 14.5 lumens per watt (CP4435-RGB)

Specifications

	CP4425-RGB	CP4435-RGB	
Brightness	nominal	Up to 26,000 lumens ¹	Up to 35,000 lumens ¹
	lifetime	>50,000 hours ²	
Screen size	76' (23m)	89' (27m)	
Contrast ratio	Up to 6000:1 full field on/off ³		
Supported frame rates	•2D up to 120fps •3D up to 60fps/eye		
Digital micromirror device	•1.38" Enhanced 4K 3-chip DMD DLP Cinema ⁴ •4096 x 2160 (4K)		
Color gamut native	>95% of Rec. 2020 coverage		
Processing electronics	•Christie® CineLife+™ Series (Series-2 IMB compatible) ⁴ •HDMI 2.0 x2 •4K 120 fps ⁵ •1G Ethernet x1 •12G SDI x4 •DisplayPort 1.2 x2 •Remote UI •Electronic Color Convergence (ECC)		
Lens mount configuration	Fully motorized Intelligent Lens System (ILS™)		
Lenses	•HB and UHC: 1.13-1.66 •1.31-1.85 •1.45-2.17 •1.63-2.71 •1.95-3.26 •2.71-3.89 •3.89-5.43 •4.98-7.69		
Power consumption	1,840W ⁶ , max DCI brightness at 25 C 6,280 BTU/hr	2,400W ⁶ , max DCI brightness at 25 C 8,240 BTU/hr	
Power input requirements	•Input A: 200-240 VAC at 50-60 Hz, 17A max •Input B (UPS input): 100-240 VAC at 50-60 Hz, 10A max		
Laser class	Class 1 – Risk Group 3		
Dimensions (w/o lens)	size (L x W x H) •37.2 x 28.0 x 20.7" (944 x 711 x 525mm)		
Weight	As installed: 267lbs (121kg)		
Accessories	•Rack mount pedestal •Rack mount pedestal adaptor •Extraction duct adaptor	•Touch panel controller (optional) •Enhanced 4K HB and UHC lens suite available	

¹With existing high brightness cinema lens.
²Subject to variables specific to each installation. Please see Christie's laser best practices guide for more information.
³With new UHC cinema lens.
⁴Supports legacy Series 2 IMBs. A list of supported versions is available upon request.
⁵With the GDC SR-6400 IMB. ⁶Typical power consumption. May be impacted by environmental conditions.

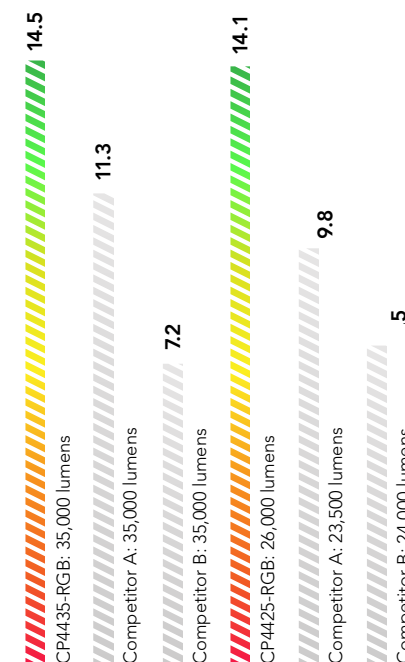

Efficiency against competition Lumens per watt

Front view

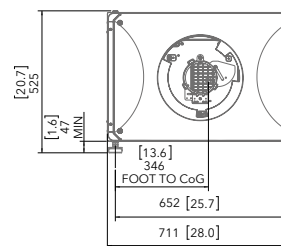

Top view

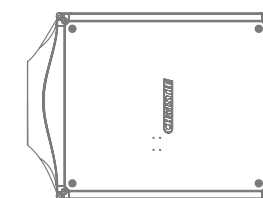

Side view

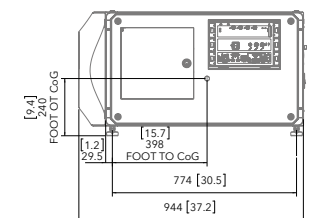

Discover more

[CP4425-RGB datasheet](#)
Key features and specifications of the CP4425-RGB digital cinema projector

[CP4435-RGB datasheet](#)
Key features and specifications of the CP4435-RGB digital cinema projector



CP4445-RGB | CP4455-RGB

Premium Large-Format (PLF) auditoriums | Advanced format cinema | Event cinema



Christie CP4445-RGB and CP4455-RGB pure laser cinema projectors define the premium moviegoing experience for large format theatres. Featuring CineLife+™ electronics and Real|Laser™ illumination, this compact DCI-compliant projector excels in image quality, operational lifetime, and onscreen brightness. With CP4440-RGB, exhibitors can impress audiences with incredibly colorful and detailed, true-to-life 4K images while benefiting from a platform designed to support the content and formats of the future.



Key features



Ultra-fast processing with HDMI 2.0 and 4x 12 GB SDI inputs for 1.06 G pixels per sec



Enhanced Wavelength Diversity (EWD) – uses MPD technology to improve image quality on all screen types



Over 50,000 hours of stable DCI brightness



Capable of playing back incredibly high bit-rate content up to 4K120



Tool-free filter replacements and fully-sealed optics for protection against dust-ingress

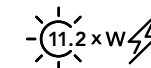

Best-in-class operational efficiency – 11.1 lumens per watt (CP4445-RGB) / 12.4 lumens per watt (CP4455-RGB)

Specifications	CP4445-RGB	CP4455-RGB	
Brightness	nominal	Up to 47,000 lumens with HB lens, 35,000 lumens with UHC lens ¹	Up to 57,000 lumens with HB lens, 42,000 lumens with UHC lens ¹
	lifetime	>50,000 hours ²	
Screen size	99' (30m)	114' (34m)	
Contrast ratio	Up to 6000:1 sequential with UHC lens, 2000:1 with standard high brightness lens		
Supported frame rates	•2D up to 120fps •3D up to 60fps/eye		
Digital micromirror device	•1.38" Enhanced 4K 3-chip DMD DLP Cinema® •4096 x 2160 (4K)		
Color gamut native gamut	>95% of Rec. 2020 coverage		
Processing electronics	•Christie® CineLife+™ Series (Series-2 IMB compatible) ³ •HDMI 2.0 x2 •4K 120 fps ⁴ •1G Ethernet x1 •12G SDI x4 •DisplayPort 1.2 x2 •Remote UI •Electronic Color Convergence (ECC)		
Lens mount configuration	Fully motorized Intelligent Lens System (ILS™)		
Lenses	•HB and UHC: 0.9:1 (HB) •1.13-1.66 •1.31-1.85 •1.45-2.17 •1.63-2.71 •1.95-3.26 •2.71-3.89		
Power consumption	4185W ⁵ including chiller, max DCI brightness, at 25 C 14,270 BTU/hr	4630 ⁶ including chiller, max DCI brightness, at 25 C 15,790 BTU/hr	
Power input requirements	•Input A and Input B: 200-240 VAC at 50-60 Hz, 16A max each •UPS Input: 200-240 VAC at 50-60 Hz, Single phase, 10A max •Chiller: 200-240 VAC at 50-60 Hz, 20A max		
Laser class	Class 1 – Risk Group 3		
Noise level	<70dBA at 25 C		
Environment	•Ambient temperature: 15-30 C •Humidity (non-condensing): 20-80% •Altitude: <3,000m		
Dimensions size (w/o lens) (L x W x H)	•Projector head: 61.1 x 28.0 x 22.0" (1551.1 x 710.6 x 559.6mm) •Projector pedestal: 53.9 x 29.8 x 29.1" (1369.8 x 756.0 x 739.4mm)		
Weight	Projector head: 368lbs (167kg)		
Accessories	•Rack mount pedestal •50 Hz chiller •60 Hz chiller •Chiller setup kit plumbing •Coolant ⁷ •Chiller setup kit ducts		

¹With Enhanced Wavelength Diversity (EWD). ²Subject to variables specific to each installation. Please see Christie's laser best practices guide for more information. ³Supports legacy Series 2 IMBs. A list of supported versions is available upon request. ⁴With the GDC SR-6400 IMB. ⁵Typical power consumption. May be impacted by environmental conditions. ⁶10L bottle of 702 coolant. Requires 3 bottles per projector.

Front view

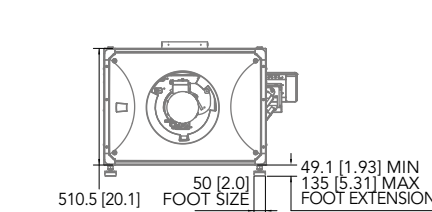

Side view

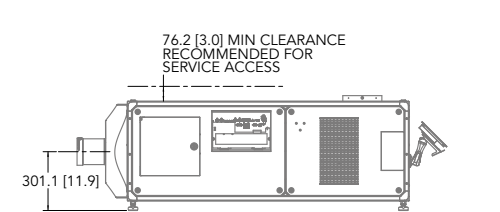

Top view

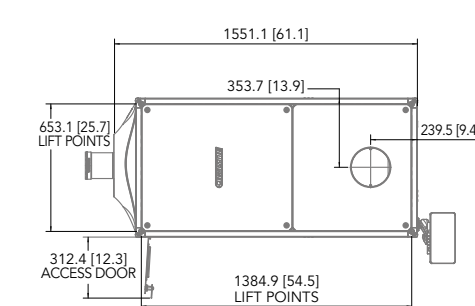

Discover more

[CP4445-RGB datasheet](#)
Key features and specifications of the CP4445-RGB digital cinema projector

[CP4455-RGB datasheet](#)
Key features and specifications of the CP4455-RGB digital cinema projector

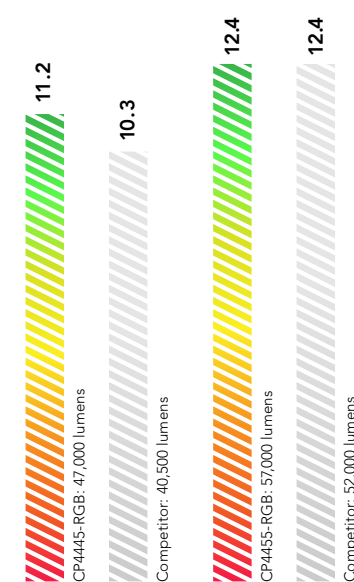

Efficiency against competition Lumens per watt



MYSTIQUE CINEMA

PLF auditoriums | Super-bright 2D/3D presentations | Perfect dual-projection alignment



Christie Mystique™ Cinema is a fully built-in dual-projection integration kit for DCI-compliant cinema projectors. This auto-calibrating image alignment software and camera kit easily aligns images from both projectors within seconds for a completely seamless image on your largest screens. Purchase Mystique Cinema with either 2K or 4K Christie CineLife+™ cinema projectors or as a standalone integration kit for existing projectors. It's cost-effective with low upfront costs and no ongoing revenue sharing to worry about. Delivers unmatched brightness, clarity, and superior 2D and 3D images.

Discover more



[Mystique Cinema brochure](#)
Key features, benefits, and uses for the Christie Mystique Cinema solution



[Christie white label PLF brochure](#)
Elevate your cinema offering with next-gen Premium Large Format solutions



CINELIFE+ IMB-S4

Alternative content | Content management and storage | Post-production



Christie CineLife+™ IMB-S4 integrated media block is a low-cost, feature-rich media server for CineLife+ Series 4 cinema projectors. The IMB-S4 converts and delivers packaged feature film content within a secure, DCI-compliant environment. It works alongside CineLife+ processing electronics to give exhibitors everything they need to offer audiences a premium moviegoing experience.

IMB-S4 also integrates with our intuitive CineLife+ remote UI for a seamless projector-IMB experience. The IMB-S4 is compatible with all major Theatre Management Systems (TMSs) and allows for out-of-the-box High Frame Rate (HFR) playback in 4K at up to 96fps.

Discover more



[Christie CineLife+ IMB-S4 data sheet](#)
Key features, benefits, specifications and uses for the Christie CineLife+ IMB



IMAGE QUALITY

What's the most damning review of any film any cinemagoer can give today?
"I could have watched that at home."

When people leave cinemas, they talk about story, performances, and action. Perhaps only film buffs will talk about image quality. And yet, ironically, great image quality – consistently high brightness, contrast, resolution, frame rates, resolution and a wide color gamut – is why people choose to go to the movies instead of streaming video at home.

And why – when the next not-to-be-missed, Oscar-nominated release comes around – they won't wait to see it at home. They'll want this to be the best film they've ever seen – they'll want to see it at its best; they'll want an occasion. They'll want cinema. That's why image quality is important, not for technical reasons or artistic purity, but because it lifts cinema into a special place that other ways of watching movies can't reach.

As RGB laser becomes mainstream, that gap will widen further. Christie RGB pure laser projection already exceeds the DCI-P3 color standard and achieves >95% of Rec. 2020, giving filmmakers new palettes and audiences new perspectives. Our ability to put more light where it's needed makes 3D more than a mere novelty. Our contrast ratios make details leap from the screen. Our light sources are consistent high performers – 50,000 hours to 80% brightness.

And now the CineLife+ Series with Christie RealLaser™ illumination. Their RGB pure laser light needs no external cooling; they're cost-effective and easy for exhibitors to install. So now, even more audiences can experience RGB laser projection. And have even less reason to stay home.

"Let us weave a garland of pearls made of the teardrops. Color the pearls with the colors of the iris..."

Paheli. Directed by Amol Pelekar, 2005

LAMPS

Christie Xenolite lamps set high levels of performance – with a wide choice of both brightness and power levels, which makes them ideal for many screen sizes and for both new and existing theatres.

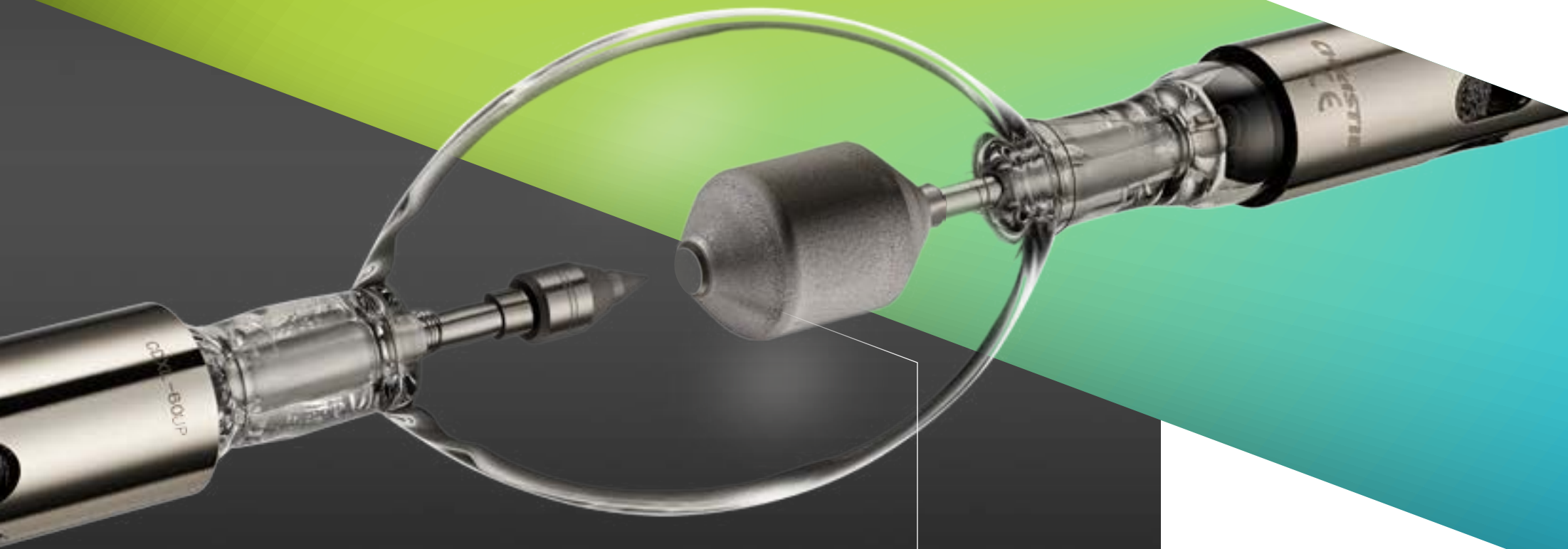

CDXL-60UP

“HOYTS uses Christie lamps exclusively across our circuit because they deliver unmatched performance and reliability. We endeavor to deliver the best possible visual experience in every session and we wouldn’t trust any other brand of lamp in our Christie projectors.”

**Adam Wrightson, General Manager –
HOYTS Cinema Technology Group**

The true strength of these lamps comes from their unrivalled brightness and color reproduction audiences love. And a longevity and reliability that lowers your total cost of ownership.

Our Superior Performance and Ultimate Performance Xenolite® lamps provide increased brightness and 30% longer life than comparable Xenon lamps and still have 99.999% in-theatre uptime. They boast less brightness drop-off, lower power requirements, and less frequent replacements.

And you get a better illumination source, one perfectly matched to digital cinema’s needs and capable of reliably producing captivating 2D and 3D experiences with exceptional color fidelity.

All of which means we can offer longer, more comprehensive warranties – giving you more life from each lamp and your audience the experience of seeing cinema the way it’s meant to be seen.



Not ready for RGB pure laser?

That's okay. With over 65,000 Christie Xenon cinema projectors still in use today, we continue to invest in improving the illumination technology behind your investments. Brighter for longer until you're ready to transition to a Christie RealLaser solution!

Learn more at:
lamptolaser.com



LAMPS

Cinema/exhibition | Post-production | On-screen advertising
Digital film mastering | Multi-media theatrical productions



Optimize your digital cinema system with the right Christie combination. Select from a suite of Christie Xenolite® lamps to lower operating costs, increase light output and efficiency, and save maintenance costs. Christie Xenolite lamps provide 99.999% reliability. And we back our lamps and projectors with excellent warranties for even more security.

Our Superior Performance (SP) and Ultimate Performance (UP) Xenolite lamps are not only brighter, they last much longer than comparable Xenon lamps while still offering the same extraordinary 99.999% in-theater uptime.

Discover more



Christie Xenolite digital cinema lamp brochure



Contains the power, lumens, air extraction and warranty information for all Christie Xenon lamps along with the best lamp practices

Xenon – Tried, tested and true



Producing impressive light output, accurate color reproduction and boasting 99.999% reliability, this "lightning in a bottle" technology is the dependable workhorse trusted by exhibitors everywhere large format auditoriums. Advance cinema storytelling with CineLife+.

SOLARIA AND CINELIFE/+ SERIES

Optimize your digital cinema system by pairing the right lamp and projector. Select from a suite of Christie Xenolite® lamps to increase light output and efficiency and save on maintenance costs. Xenolite lamps in Christie projectors provide 99.999% reliability and are backed by excellent warranties for even more security.

CP2308



Designed for seamless use with our cinema projectors, Xenolite lamps provide high output and brightness in a cost-efficient, high-performance package.



CDXL-14M



CDXL-16M



CDXL-19SC CDXL-21S1
CDXL-19SUP CDXL-21SUP

CP2215/CP2415-Xe



High-performance Xenolite lamps are the best option for illuminating your CP2215 digital cinema projector and are designed to deliver mission-critical reliability.



CDXL-14M



CDXL-16M
CDXL-18SD

CDXL-20SD
CDXL-23S
CDXL-23SUP

CP2220/CP2420-Xe/ CP4220/CP4420-Xe



Consistent quality, 99.999% proven uptime, longer lamp life and lower operating costs make Christie Xenolite lamps and cinema projectors a winning combination.



CDXL-20LB
CDXL-20
CDXL-20SP



CDXL-30
CDXL-30SP



CDXL-30SD
CDXL-30SUP

CP2230/CP4230



Consistent quality, 99.999% proven uptime, longer lamp life and lower operating costs make Xenolite lamps and cinema projectors a winning combination.



CDXL-20LB
CDXL-20
CDXL-20SP



CDXL-30
CDXL-30SP



CDXL-45
CDXL-45SP



CDXL-60
CDXL-60SP
CDXL-60UP



DESIGNED TO DELIVER ULTIMATE PERFORMANCE

Xenolite lamps	CDXL-14M ¹	CDXL-16M ¹	CDXL-18SD	CDXL-19SC ²	CDXL-19SUP ²	CDXL-20SD	CDXL-21S1 ²	CDXL-21SUP ²	CDXL-23S	CDXL-23SUP
Part number	003-003066-01	003-003900-01	003-002742-01	003-005366-01	003-007005-01	003-001976-01	003-004258-01	003-006734-01	003-004769-01	003-006970-01
Operational details										
estimated average expected life (hrs)	3,500 hrs	3,500 hrs	2,100 hrs	1,800 hrs	2,200 hrs	1,500 hrs	1,500 hrs	1,800 hrs	1,000 hrs	1,100 hrs
warranty	100% warranty to 3,000 hrs	100% warranty to 3,000 hrs	100% warranty to 1,750 hrs	100% warranty to 1,500 hrs	100% warranty to 1,900 hrs	100% warranty to 1,000 hrs	100% warranty to 1,000 hrs	100% warranty to 1,500 hrs	100% warranty to 700 hrs	100% warranty to 900 hrs
maximum lumen output ³	3,800/5,000 lumens (CP2308/CP2215, CP2415-Xe)	6,200/8,000 lumens (CP2308/CP2215, CP2415-Xe)	10,000 lumens (CP2215, CP2415-Xe)	7,000 lumens (CP2308)	7,000 lumens (CP2308)	12,000 lumens (CP2215, CP2415-Xe)	9,000 lumens (CP2308)	9,000 lumens (CP2308)	15,000 lumens (CP2215/CP2415-Xe)	15,000 lumens (CP2215, CP2415-Xe)
projector air extraction requirement	450 CFM ⁴									
Compatibility	CP2308 • CP2415-Xe CP2215	CP2215 CP2415-Xe	CP2308	CP2308	CP2215 CP2415-Xe	CP2308	CP2308	CP2215 CP2415-Xe	CP2215 CP2415-Xe	
Technical data										
rated input power	1,430W	1,600W	1,800W	1,900W	1,900W	2,000W	2,100W	2,100W	2,300W	2,300W
rated current	73.5A	72A	75A	72A	77.7A	75A	80A	83.5A	85A	91A
operating wattage range	1,000-1,430W	1,000-1,600W	1,260-1,800W	1,610-1,900W	1,610-1,900W	1,400-2,000W	1,610-2,100W	1,610-2,100W	1,610-2,300W	1,610-2,300W
rated voltage	19.5V	22.2V	24.0V	26.3V	25V	26.5V	26.5V	25V	27.0V	25V
horizontal	±5°	±5°	±5°	±5°	±5°	±5°	±5°	±5°	±5°	±5°
base surface temperature	200 C max	200 C max	200 C max	200 C max	200 C max	200 C max	200 C max	200 C max	200 C max	200 C max



CP2308



CP2215/CP2415-Xe



CP2220/CP2420-Xe



CP2230



CP4220/CP4230

¹ Cost efficient ² For use only in CP2308 projectors. ³ Color corrected/center lumens ⁴ Exhaust extraction is optional. Extraction with the optional extraction duct requires 450 CFM



“Wanda Cinemas are renowned across China for providing a very high-level of image quality and screen brightness, mainly thanks to Christie projectors and Xenolite lamps. We rely on the dependability and prolonged brightness of Xenolite lamps and trusted Christie projectors to provide the high standards our customers count.”

Jack Wang, CTO, WANDA Film Holding Co., Ltd.

CDXL-20LB	CDXL-20	CDXL-20SP ¹	CDXL-30	CDXL-30SP	CDXL-30SD	CDXL-30SUP	CDXL-45	CDXL-45SP	CDXL-60	CDXL-60SP	CDXL-60UP
003-005079-01	003-000598-02	003-004251-01	003-000599-02	003-004252-01	003-001165-01	003-006951-01	003-000600-03	003-004253-02	003-000601-03	003-004254-02	003-006912-01
Operational details											
3,500 hrs		4,000 hrs	2,500 hrs	2,800 hrs	1,500 hrs	1,900 hrs	1,200 hrs	1,500 hrs	900 hrs	1,100 hrs	1,300 hrs
100% warranty to 2400 hrs		100% warranty to 3,200 hrs	100% warranty to 1,500 hrs	100% warranty to 1,900 hrs	100% warranty to 1,000 hrs	100% warranty to 1,500 hrs	100% warranty to 1,000 hrs	100% warranty to 1,300 hrs	100% warranty to 600 hrs	100% warranty to 800 hrs	100% warranty to 1,000 hrs
8,000 lumens (CP2220, CP2420-Xe, CP2230, CP4230)	10,000 lumens (CP2220/CP2420-Xe, CP4220/CP4420-Xe, CP2230/CP4230)		17,000 lumens (CP2220/CP2420-Xe, CP4220/CP4420-Xe, CP2230/CP4230)		22,000 lumens (CP2220, CP4220, CP2420-Xe, CP4420-Xe)		24,000/26,000 lumens (CP2230/CP4230)		32,000/34,000 lumens (CP2230/CP4230)		
450 CFM							600 CFM				
CP2220 • CP4220 • CP2420-Xe CP2230 • CP4230 • CP4420-Xe					CP2220 • CP2420-Xe CP4220 • CP4420-Xe		CP2230 CP4230				
2,000W			3,000W			4,500W			6,000W		
80A		110A			100A		145A		155A		165A
1,400-2,000W			2,100-3,000W			2,100-3,000W			3,150-4,500W		4,200-6,000W
25V		27V			30V		25V		31.5V		39V
±5°		±5°			±5°		±5°		±5°		±5°
200 C max		200 C max			200 C max		200 C max		200 C max		200 C max

HEAR THE DIFFERENCE

Where do you find the most carefully considered, technically brilliant, wholly immersive sound?

Probably not in concert halls, or even in recording studios. These days you'll find it in cinemas.

Christie Vive Audio® is a complete solution built for one purpose: to bring premium cinema sound to any theatre – and any seat in any theatre.

It combines the superior performance of planar ribbon drivers with line array loudspeaker design and powerful Class D amplification to immerse audiences in the latest highly detailed cinema audio formats.

It's the ultimate cinema sound experience, and it's been designed so that every seat will benefit from pure, directional sound that makes movies come alive.

Cinema audio isn't rock and roll audio, and it's not concert hall audio. It has a very different purpose; one that only a company fully immersed in the industry fully appreciates.

CHRISTIE
VIVE AUDIO

"Show these gentlemen
to the best seat in the house..."

Un monstre à Paris. Directed by Bibo Bergeron, 2011



VIVE AUDIO

Which is faster? Sound or light? The unexpected answer, in the human brain at least, is sound. Your brain reacts to sound in point-zero-five seconds – it takes four times that to react to light.



LA4/S215

Even though we think of vision as our primary sense, hearing is equally but subtly just as important. It once kept us safe from tigers in the dark; it's still the sense we rely on first when interpreting the world. Or a movie.

Evolution has seen to that. And that has huge implications for cinema. It means cinema sound isn't just about clear dialogue and subwoofer explosions. It's not secondary to what's on-screen because the brain processes sound first. Watching films has more to do with listening than anyone ever imagines; in many ways sound extends film beyond the screen, it's the true third dimension. And that's what makes Christie Vive Audio® so important.

Vive Audio certainly makes dialogue clear and explosions rumble – and does so very well. But its real genius is that it does so for every audience member in every seat, front row to back, side aisle to center. It leaves no blank spots, no missing moments and everyone gets the film they paid for, the full story, fully delivered, just as the director intended.

Achieving this means using some advance audio techniques. We use ribbon driver technology because its low mass reacts instantly to audio signals, unlike compression drivers. Clarity is enhanced, distortion is much lower, transient responses are ultra-fast, and there's no high-frequency breakup. Everything sounds more natural.

It's also why we use Vive Audio cinema amplifiers to complement the high-performance features of those ribbon drivers. High-power output and efficiency for dynamic, detailed sound.

Finally, our line array loudspeakers, known for their coverage and directionality, deliver every decibel. To every customer. In every seat.



LA SERIES

Small- to medium-screen auditoriums | Immersive | Premium Large-Format (PLF) auditoriums | Event cinema | Screening rooms



Advanced loudspeakers that are the ideal platform for today's immersive cinema audio applications. Comprising line array, surround and ceiling surround loudspeakers, the LA Series can be configured to support all DCI-specified distributed and immersive audio formats. And you can combine certain models with our S115 or S215 subwoofers to create full-range screen channel systems or corner surrounds.



Key features



Planar ribbon driver technology ensures perfect timbre-matching across the lineup



Dramatically higher RMS to peak max



Higher SPL ratio than compression driver systems



Approximately four times the optimal listening area than typical systems



Meets a minimum 5:1 safety rating for installation



Versatile installation capabilities with a variety of M8 and M10 fittings



Backed by a limited five-year warranty

Line array loudspeakers



LA3i
145-013105-01



LA4
145-120104-01



LA5
145-122106-01

System type	Fixed arcuate ribbon driver line array, two-way, passive, in a single sealed enclosure		Fixed arcuate ribbon driver line array, two-way, bi-amplified design, in a single sealed enclosure
Driver components	HF: 12 x 3.5" with Kapton diaphragm and Neodymium magnets MF: 8 x 5.25" paper/ Kevlar composite mid-bass cone drivers	HF: 8 x 6.5" with Neodymium magnets MF: 8 x 6.5" paper/ Kevlar composite mid-bass cone drivers	HF: 12 x 6" with Neodymium magnets MF: 12 x 6.5" paper/ Kevlar composite mid-bass cone drivers
Maximum SPL	127dB SPL continuous, 128.8dB SPL peak	131dB SPL continuous, 143dB SPL peak	131dB SPL continuous, 143dB SPL peak
System coverage	100° horizontal / 40° vertical dispersion	120° horizontal / 40° vertical dispersion	120° horizontal / 50° vertical dispersion

Performance specifications are typical. Due to constant research, specifications are subject to change without notice.

Discover more



[LA Series brochure](#)
Key features and specifications of the Vive Audio LA Series loudspeakers



[Psychoacoustic proximity effect of line array systems whitepaper](#)
Read how this phenomenon enables audiences to experience a truly immersive audio visual environment



Line array loudspeakers

Make every seat in the house the best seat. Line array loudspeakers are renowned for their ability to produce superior coverage and directionality meaning your customers benefit from impeccably detailed audio no matter where they sit in the auditorium.

Typical listening area comparison

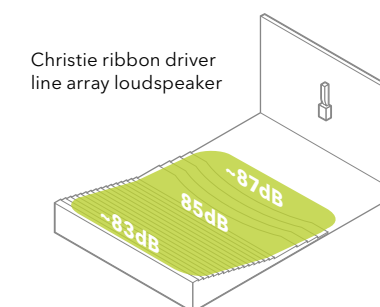
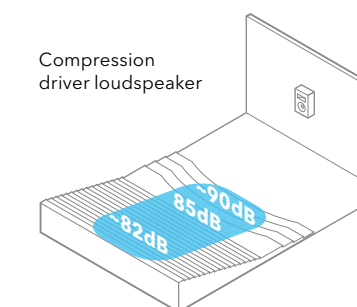



Surround loudspeakers

Ceiling surround loudspeakers



LA3Si
145-182102-01



LA4S
145-106108-03



LA3C
145-111104-02



LA4C
145-144100-01

System type	Coaxial parabolic ribbon driver line array, 2-way, passive, in a single ported enclosure			
Driver components	HF: 6 x 3.5" with Kapton® diaphragm and Neodymium magnets MF: 4 x 5.25" paper/Kevlar composite mid-bass cone drivers	HF: 4 x 6" with Kapton diaphragm and Neodymium magnets MF: 4 x 6.5" paper/Kevlar composite mid-bass cone drivers	HF: 12 x 3.5" with Kapton diaphragm and Neodymium magnets MF: 8 x 5.25" paper/Kevlar composite mid-bass cone drivers	HF: 8 x 6" with Kapton diaphragm and Neodymium magnets MF: 8 x 6.5" paper/Kevlar composite mid-bass cone drivers
Maximum SPL	119.6dB SPL continuous, 131dB SPL peak	119.6dB SPL continuous, 131dB SPL peak	124.5dB SPL continuous, 136.5dB SPL peak	130dB SPL continuous, 142dB SPL peak
System coverage	120° horizontal / 120° vertical dispersion	128.5dB SPL continuous, 140.5dB SPL peak	120° horizontal / 120° vertical dispersion	120° horizontal / 100° vertical dispersion

Ribbon driver technology

Extremely low in mass, ribbon drivers react instantaneously to audio signals providing greatly enhanced clarity, dramatically reduced distortion, and ultra-fast transient response, eliminating the effects of high-frequency breakup and power compression. Speech, effects, music, and alternative content sound more natural and lifelike for an enhanced listening experience that audiences notice.



Premium cinema sound

Christie Vive Audio™ LA Series loudspeakers feature extremely fast transient response times thanks to low-mass planar ribbon driver technology. This eliminates the effects of high-frequency breakup and power compression while delivering dramatically reduced distortion, enhanced intelligibility, and high dynamic range for the most accurate reproduction of the original source material.



LS SERIES

Small- to medium-screen auditoriums | Immersive | Post-production | Boutique cinema | Screening rooms



Cost-effective cinema line source loudspeakers that provide accurate reproduction of high dynamic range and high resolution DCI-specified audio for small-to-medium sized theatres. With advanced planar ribbon driver technology, the LS Series includes four-way screen channel systems with dual planar ribbon tweeters and two-way surround channel loudspeakers.



Key features



Planar ribbon drivers provide better RMS-to-peak max SPL ratio than compression driver systems for enhanced voice intelligibility, superb sonic balance and less distortion



High-efficiency design enables the use of lower power amplifiers – for overall cost-savings



Acoustically isolated and extensively damped to minimize driver interaction and enhance small-level signal resolution



Rotatable MF-HF waveguides on screen channel loudspeakers increase installation options



Higher resolution audio and dynamic range reproduction than standard cinema audio loudspeaker systems



Sophisticated crossover design with frequency shading technology and optimized acoustic integration of transducers provide a wide horizontal dispersion and controlled vertical dispersion pattern



Backed by a limited five-year warranty

Screen channels



LS1
145-170109-01



LS2
145-172101-01

System type	Four-way, bi-amp, ported enclosure	
Driver components	HF: high output 2 x 3" planar ribbon with Kapton® diaphragm and Neodymium magnets MF: 6.5" paper/Kevlar high-efficiency midrange with 38mm edge-wound voice coil LF: 15" paper composite cone driver with 100mm diameter voice coil	HF: high output 6" and 3" planar ribbon with Kapton diaphragm and Neodymium magnets MF: 6.5" paper/Kevlar high-efficiency midrange with 51mm edge-wound voice coil LF: 2 x 15" paper composite cone driver with 100mm diameter voice coil
Maximum SPL	123dB SPL continuous, 126dB SPL peak	126.5dB SPL continuous, 129dB SPL peak
System coverage	100° horizontal / 40° vertical dispersion	

Discover more



LS Series brochure
Key features and specifications of the Vive Audio LS Series loudspeakers



Advantages of Christie Vive Audio planar ribbon driver and line array technologies for cinema sound whitepaper
Find out which technology building blocks form the best foundation for the accurate reproduction of today's leading audio formats





Surround loudspeakers



LS1S
145-171100-01



LS2S
145-173102-01



LS5S
145-175104-01

Ceiling surround loudspeakers



LS2C
145-186106-01

System type Coaxial parabolic ribbon driver line array, 2-way, passive, in a single ported enclosure

Driver components	HF: 3.5" planar ribbon driver with Kapton® diaphragm and Neodymium magnets	HF: 3" planar ribbon driver with Kapton diaphragm and Neodymium magnets	HF: 3" planar ribbon driver with Kapton diaphragm and Neodymium magnets	2" annular ribbon HF driver with Kapton diaphragm, Neodymium magnets and 1.2" exit coaxially mounted within 12" paper Kevlar composite cone driver
	LF: 8" paper/Kevlar composite cone with 51mm diameter edge-wound voice coil	LF: 8" paper/Kevlar composite cone with 51mm diameter edge-wound voice coil	LF: 10" paper/Kevlar composite cone with 64mm diameter edge-wound voice coil	
Maximum SPL	114dB SPL continuous, 117dB SPL peak	116.5dB SPL continuous, 119dB SPL peak	121dB SPL continuous, 123dB SPL peak	130dB SPL continuous, 142dB SPL peak
System coverage	100° horizontal / 50° vertical dispersion			100° spherical cone

Cost-effective, high-performance cinema audio

Featuring planar ribbon drivers, Vive Audio® LS Series provides dramatically higher RMS-to-peak max SPL ratio than compression drivers, improving performance and intelligibility. Rotatable waveguides, slim enclosures, and multiple mounting options make the LS Series easy to discreetly install into any space-constrained auditorium





S SERIES

Mainstream cinema | Immersive auditoriums | Post-production | Premium Large-Format (PLF) auditoriums | Screening rooms

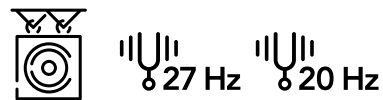

Christie Vive Audio® S Series subwoofers offer low distortion, low power compression, and minimal turbulence to deliver extended low frequency response at extremely high output levels for powerful and deep bass. S118LP and S218LP models are engineered for the reproduction of Low Frequency Effects (LFE). Combine the S115 and S215 with our LA Series loudspeakers to create full-range audio systems that can be used as screen channels or as corner surrounds for bass management. Integrated fly points offer installation flexibility.



Discover more

S Series brochure
Key features and specifications of the Vive Audio S Series subwoofers

Cinema audio: How new technologies are helping realize DCI audio specifications whitepaper
An integrated systems approach can enable cinemas to realize the potential of the DCI audio soundtrack



S115 145-108100-01 **S215** 145-103105-01 **S118LP** 145-180100-01 **S218LP** 145-181101-01

Application	Bass management	Bass management	Low frequency effects	Low frequency effects
System type	Subwoofer, ported enclosure, with EBS tuning			
Driver components	1 x 15" low frequency driver with dual 4" voice coils and long linear excursion	2 x 15" low frequency drivers each with dual 4" voice coils and long linear excursion	1 x 18" low frequency driver with dual 4" voice coils and long linear excursion	2 x 18" low frequency drivers each with dual 4" voice coils and long linear excursion
Frequency response	27-300 Hz at -10dB 30-250 Hz at -6dB	27-300 Hz at -10dB 30-250 Hz at -6dB	20-250 Hz at -10dB 24-200 Hz at -6dB	20-250 Hz at -10dB 24-200 Hz at -6dB
Maximum SPL	125dB SPL continuous, 137dB SPL peak	131dB SPL continuous, 143dB SPL peak	127.5dB SPL continuous, 139.5dB SPL peak	133.5dB SPL continuous, 145.5dB SPL peak
Sensitivity	1W/1m: 97dB (40-150 Hz)	1W/1m: 100dB (40-150 Hz)	1W/1m: 97dB (40-150 Hz)	1W/1m: 100dB (40-150 Hz)
Power handling	600W (AES) continuous 1,200W (IEC) short term	1,200W (AES) continuous 2,400W (IEC) short term	1,000W (AES) continuous 2,000W (IEC) short term	2,000W (AES) continuous 4,000W (IEC) short term
Rated impedance	8 ohms	4 ohms	8 ohms	4 ohms

Key features



High cubic displacement cabinet, heavily cross-braced, ported and tuned



Each driver has a discrete, internal ported enclosure for optimal performance



Extra-large port area with rounded edges for minimal air turbulence noise



S115 and S215 models are overhead rated for safe installs and use integrated fly points



Backed by a limited five-year warranty



POWERSOFT AMPLIFIERS

Mainstream cinema | Immersive auditoriums |
Post-production | Premium Large-Format (PLF) auditoriums

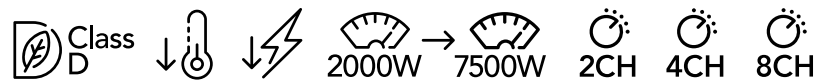

Drawing from Powersoft's pioneering developments, the Duocanali and Quattrocanali amplifiers offer truly amazing sound quality and pair exceptionally well with our Vive Audio® loudspeaker range. Featuring the latest advances in switched-mode technology, Class-D design, and high-power capabilities, these class-leading, energy-efficient amplifiers also feature numerous developments including Smart Rail Management technology, which helps lower overall power consumption in a compact 1RU chassis design.

Discover more

Quattrocanali Series
Key features and specifications of the Quattrocanali Series

Duecanali Series
Key features and specifications of the Duecanali Series

Cinema audio: How new technologies are helping realize DCI audio specifications whitepaper
An integrated systems approach can enable cinemas to realize the potential of the DCI audio soundtrack

	DUECANALI 4804 145-051118-XX	QUATTROCANALI 1204 145-048114-XX	QUATTROCANALI 2404 145-045111-XX	QUATTROCANALI 4804 145-042118-XX
--	--	--	--	--

Output power per channel	3,000W at 2 Ω 2,400W at 4 Ω 1,250W at 8 Ω	4,00W at 2 Ω 3,00W at 4 Ω 3,00W at 8 Ω	800W at 2 Ω 600W at 4 Ω 600W at 8 Ω	1,500W at 2 Ω 1,200W at 4 Ω 1,200W at 8 Ω	
Bridge mode	6,000W at 4 Ω 4,800W at 8 Ω	800W at 4 Ω 600W at 8 Ω	1,600W at 4 Ω 1,200W at 8 Ω	3,000W at 4 Ω 2,400W at 8 Ω	
Max unclipped output voltage @ 8 Ω Bridge mode	142V peak	70V peak	100V peak	139V peak	
Current	80A peak	33A peak	45A peak		
Power supply	Universal, regulated switch mode with Power Factor Correction (PFC)				
Nominal power requirement	100-240V +/- 10%, 50-60 Hz				
Operating voltage	60V - 264V	90V -264V			
Power consumption	Idle	115V: 30.3W - 0.34A 230V: 31.0W - 0.32A	115V: 31.0W - 0.45A 230V: 31.8W - 0.26A	115V: 31.0W - 0.45A 230V: 31.8W - 0.26A	115V: 31.0W - 0.47A 230V: 32.0W - 0.28A
	1/8 of max power @ 4 Ω	115V: 777W - 7.0A 230V: 753W - 3.9A	115V: 227W - 2.1A 230V: 251W - 1.4A	115V: 406W - 2.1A 230V: 438W - 2.39A	115V: 823W - 7.7A 230V: 840W - 4.3A
Operating temperature range	32-113 F (0-45 C)				
Thermal dissipation	Idle	115V: 103 BTU/h 230V: 106 BTU/h	115V: 107 BTU/h 230V: 109 BTU/h	115V: 107 BTU/h 230V: 109 BTU/h	115V: 106 BTU/h 230V: 107 BTU/h
	1/8 of max power @ 4 Ω	0115V: 606 BTU/h 230V: 522 BTU/h	115V: 262 BTU/h 230V: 345 BTU/h	115V: 361 BTU/h 230V: 361 BTU/h	115V: 759 BTU/h 230V: 840 BTU/h

Key features

Universal switch-mode power supply up to 4000VAC tolerant with Power Factor Correction

Fixed frequency switch-mode output stage for high-grade sound accuracy

Fully protected circuit design with thermal protection

Standard Phoenix® connectors: analog audio outputs, aux supply, alarms, and GPIO

Easy to set up - User-selectable gain/sensitivity with digital gain-attenuator control, built-in defeatable clip limiters and gate selection per channel

Compact 1RU size for reduced rack cost and space

VHF protection - protects loudspeakers against non-audible, strong, non-musical high frequency signals

PREMIUM LARGE-FORMAT

When the Lumière Brothers began in 1895, cinema was a novelty, and that was its purpose. It has grown from a fairground attraction in a sideshow tent to stand tall among the arts. Showmanship remains inescapably part of cinema's DNA.

It no longer relies on fairground barkers and colored balloons to attract an audience - studios may prefer to put actors on chat show sofas - but that's showmanship.

Which is probably why much cinema innovation is initially dismissed as nothing more than a showman's novelty. Because it once was; the Talkies were seen as a novelty that couldn't last. Color was a pretty irrelevance. CGI was for teenagers and geeks. Yet they all lasted. And they lasted for reasons every showman knows. They lasted because they offered something audiences wanted. They had an appeal beyond novelty.

What about Premium Large-Format (PLF) cinema? Will it last? We think it passes the showman's test. Because going to the cinema is an active choice.

And this is where PLF scores, because once the choice to go is made, others naturally follow. Should we invite friends? Should we eat first? Where will we sit? Why don't we pay a little extra for better seating, premium picture quality, and sound. Why don't we make it special?

Christie has been waving its own set of colored balloons in PLF's favor for some time now, producing and championing the tech to make it happen - with Christie RealLaser™ projection illumination and with Vive Audio systems to complement the premium visuals with premium sound. Projectors with RealLaser™ are cost-effective, energy efficient, and easy to install in new sites and existing booths.

Even before the main feature starts, we have the digital display technology to create exciting lobbies, immersive corridors, and - most important of all - the knowledge to make it all come together in a package audiences want.

In every cinema manager and exhibitor is a showman's heart with showman instincts. Our instincts say PLF is a differentiator that's here to stay.

"The audience thirsts
for adventure."

Rango. Directed by Gore Verbinski. 2011



SUPPORT

What happens when something happens?
Support matters.



“At Christie, we know that there are many variables that affect a typical installation, so we leverage our decades of experience to be a part of your solution from the beginning.”

**Judson Cross, Sr. Manager,
Solutions Development**

Christie Professional Services offers comprehensive and far-reaching support. We exist for more than your peace of mind; we're here to keep your business wheels turning and your revenue streams flowing.

We're also here to stop the unexpected from happening — with planned maintenance, remote system diagnosis, defined test schedules, and comprehensive training programs.

Widely recognized as industry-leading, we resource globally but deliver locally. We offer the strength and reach of a global brand — with a local office that speaks your language and provides faster response times.

If something does happen, be rest assured that what happens next is as predictable, professional — and every bit as world-class — as our products.



A SERVICE EXPERIENCE THAT PLACES YOU FRONT AND CENTER

Christie® Professional Services is more than a service provider. We're your dedicated support team powered by innovative technology with solutions designed to place you at the very center.

We prioritize clear communication and responsiveness and are committed to providing a service experience unlike any other. We take great pride in not only detecting and resolving your unexpected system issues but also doing so swiftly and efficiently with Cinergy, our advanced remote monitoring and management software.

With 95 years of experience, you can count on us to ensure the highest quality visual experiences and keep your equipment running flawlessly show after show.

Premium comprehensive services

Design and installation services

Transcend your guest's audio-visual expectations with help from our experienced design team. We can create an environment that goes beyond your expectations and is cost-effective. Here's some of what we can help you do:

- Design your space to attract more customers.
- Install and calibrate your projector to ensure undisputed picture quality.

- Install and calibrate your audio system for a premium immersive experience where every seat's in the sweet spot.

Monitoring your displays – day and night

We understand that downtime is not an option, and it's our mission to keep your equipment running and revenue flowing. No matter the time, day or night, 365 days a year, our world-class Network Operations Centers (NOCs) do just that.

We're here to help you troubleshoot, schedule preventative maintenance, and deploy our field team for on-site repair. Using the latest predictive maintenance tools and Cinergy, our service experts spot potential issues before they impact your display system and provide advanced notice of software upgrades for timely maintenance.

People, process, technology – every step of the way

Every aspect of your display system gets our attention and support. We handle everything from technical design to procuring the right mix of media players, software, and integrated technologies for your digital networks. We also monitor and manage equipment and systems in real-time and provide on-site service, complete logistics, and parts support when needed.

As an industry-leading technology provider, we offer:

- Partnerships with business leaders so you crystallize your project goals and identify challenges and opportunities to deliver a high commercial-value solution.
- Tailored service options designed to fit your unique requirements and budget.
- Consistent global services through a single point of contact. From simple repairs to end-to-end support, all your locations can access almost immediate event resolution expertise.
- Global leadership in technical AV expertise, including the infrastructure, multi-platform, and multi-vendor technology skills you need.
- Quick, accessible, reliable support.
- Remote service and automated cloud-based options to help speed up problem-solving and control your IT infrastructure support costs.
- Proactive monitoring and event notifications that help minimize theatre disruptions.
- Locally stocked parts for speedy parts replacement.
- Training and certification.
- Proof of potential cost-savings with our data, analytics, and reporting capabilities.

We build Christie Professional Services on a responsive, customer-oriented model that streamlines trouble ticket flow and significantly improves support accountability. Our world-class NOC facilities conduct daily operations and communications, including service desk, field services, remote monitoring and management, integration, staging, and logistics.

24/7/365 NOC service desk support

Call on Christie and get support from the people who know your equipment best.

Remote monitoring and management with Cinergy

We securely monitor, detect, and resolve issues before they become critical, often without requiring a technician on-site.

On-site maintenance and repair

Feel confident knowing we routinely inspect your equipment so it's maintained and running at peak performance levels.

Emergency field service

You never expect to need emergency service until you do. When that happens, our service experts are ready to get your equipment back up and running quickly.

Extended warranty

Plan for a bright future with our ChristieCare plans that provide complete system protection and maximum flexibility.

Critical inventory management

We forecast, deploy, and reserve critical spare parts at our central and forward-stocking locations for expedited case resolution and repair.

Real-time case management portal

Our Cinergy case management portal keeps you close to your service cases and equipment status — anytime, anywhere.

Electronic RMA

With a single call to our help desk, you can generate a claim form and authorize it electronically to receive replacement parts.

Training and certification

We've got you covered with free online webinars and training sessions to help increase your Christie product knowledge and earn CTS-RU credits. We also offer classroom training at our facilities, or, for a fee, we can come to you.

Partner Portal

Through our secure, password-protected Partner Portal site, you can access a wealth of online technical resources for both active and discontinued products, such as user and service manuals, CAD drawings, Revit files, communication protocols, instruction sheets, calculators, design tools, demo source material, software, and firmware downloads.

Global and local support

We believe industry-leading support should be resourced globally, delivered locally, and secured through an unwavering commitment to training. We equip all our offices with technical facilities and offer full support services in local languages.

Design and build services
Experiential design | Project-based engineering

Post-support services
Managed services

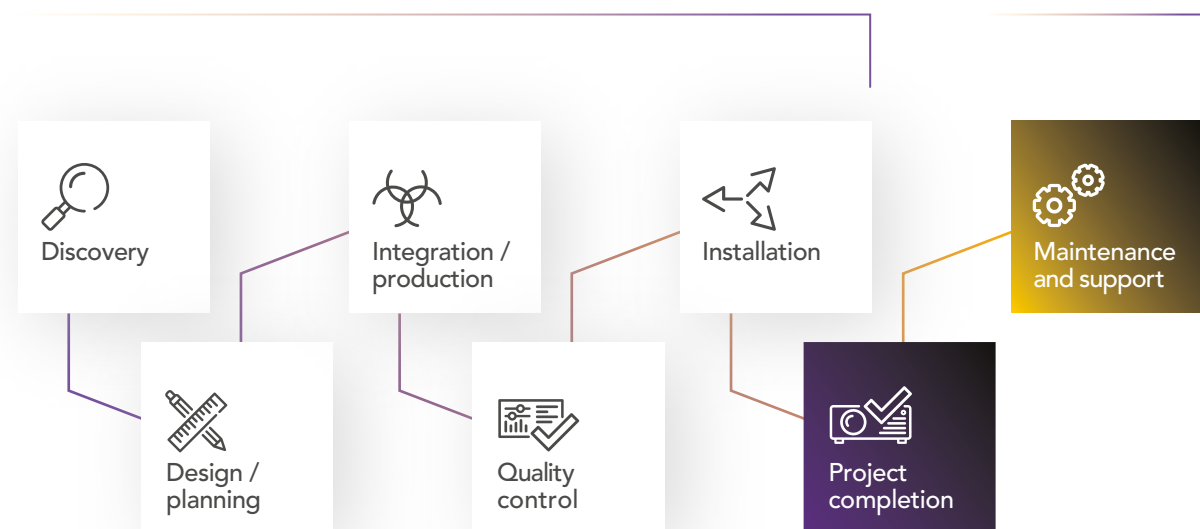



CINERGY

REMOVE THE COMPLEXITY OF MANAGING IT ALL. LET CINERGY DO THE WORK FOR YOU.

With the right tools at your fingertips, establish your own network operations center and watch your confidence soar.

With Cinergy, our cloud-based theatre management platform, we can remotely monitor and skillfully troubleshoot your critical systems issues or provide you the opportunity to do so yourself. Our software allows you to automate your operations and monitor your assets precisely how you want, all from one centralized platform.

Say goodbye to missed shows and achieve maximum efficiency by automating key delivery, tracking consumables, and resolving potential showstoppers before they happen. And while our software runs behind the scenes, you're free to focus on what matters most — delivering the best audience experience.

Cinergy software is easy-to-use, compatible, and secure

You'll find Cinergy works the way you expect it to, from set-up to showtime and seamlessly integrates with your cinema equipment, no matter the manufacturer. Cinergy is also built secure from the ground up, so your data remains yours, always.

Did you know more exhibitors use Cinergy than any other solution? Cinergy supports more than 26,000 screens, monitors 60,000 devices, and delivers 2,000,000 KDMs per month!



Work smarter, not harder. Do more with Cinergy.

- Key delivery and trusted device list (TDL) management**
Automatically receive keys directly to the screen with full auditing capabilities and proactive alerting.
- System health monitoring**
Ensure the best possible presentation for your guests and prevent dark screens with around-the-clock monitoring, error detection, and resolution.
- Asset tracking**
Gain unprecedented transparency into the status and attributes of your equipment, theatres, and auditoriums.
- Performance reporting**
Access pre-built reports, equipment data, and user-customizable dashboards and widgets.

- Content monitoring**
View show schedules, KDM information, and playlists while staying a step ahead with proactive alerting.
- Secure remote access**
Access devices anywhere, anytime, without having to worry about lost or stolen data.
- Ticketing and knowledge management**
Streamline all communication within a ticket towards a solution.
- Preventative maintenance**
Create customized maintenance plans across an entire theatre circuit and schedule service with provider integration capabilities.
- Lamp and consumables management**
Track lamp inventory and alerts while optimizing usage.
- Business intelligence reporting**
Create, schedule, and deliver tailored reports to make informed decisions and drive business performance.
- Mobile app functionality**
Access key Cinergy components right from your smartphone or tablet.





CINERGY

YOUR WISH IS OUR COMMAND

Spend less time in the booth and more time with your customers.

With Cinergy Command Station, we give you the control you crave right at your fingertips. The Command Station app lets you perform booth operations and control equipment from anywhere in your theatre.

With a tablet in hand, theatre managers can be in more than one place at a time, and quickly and effortlessly interface with each auditorium remotely. Command and control equipment? Check. Start and stop playlists? Raise and lower audio levels? Adjust lighting? Check, check, check.

Command Station provides greater insight into your theatre equipment and operations and provides the utmost flexibility while doing so. The app drives productivity and efficiency across your theater operations and allows your staff to focus on what matters most: your audience and their experience.

With Command Station, anything's possible

Remote access and control

Interface with your auditoriums quickly, effortlessly, and remotely

Real-time system health updates

Prevent dark screens by detecting issues before they become critical

Centralized asset management

Gain unprecedented transparency into equipment status and attributes

Automated operations

Drive efficiency across your operations and plan for unpredictable events

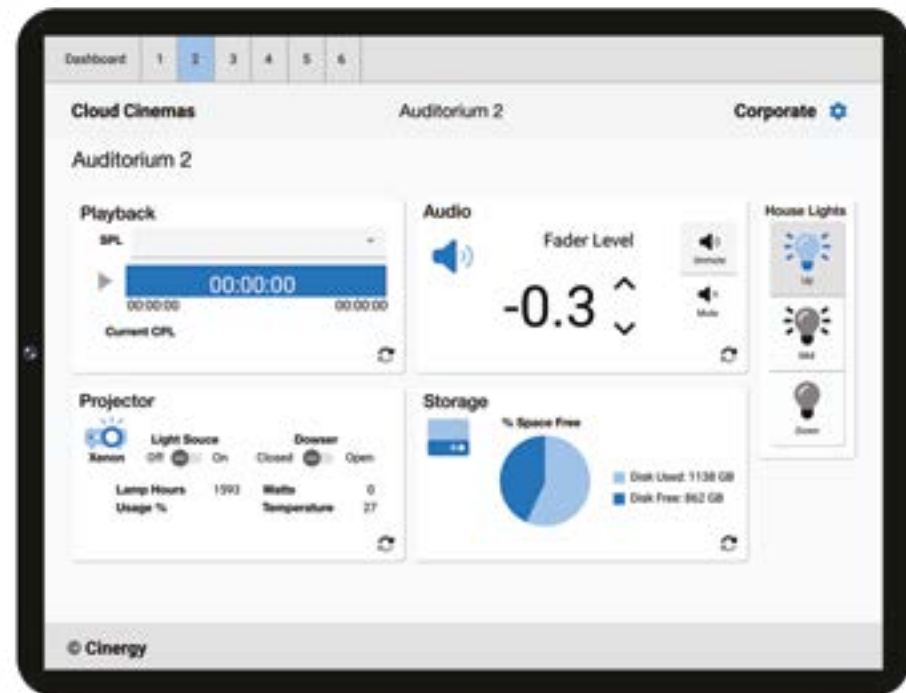

WARRANTY COVERAGE

Our standard limited warranty, the foundation service agreement for all Christie products, covers the replacement and service for critical parts and accessories. For enhanced support and complete managed services, Christie offers extended warranties. We'll work with you to protect your investment beyond the standard warranty and tailor agreements to your unique requirements. Check the status of your Christie warranty at any time.

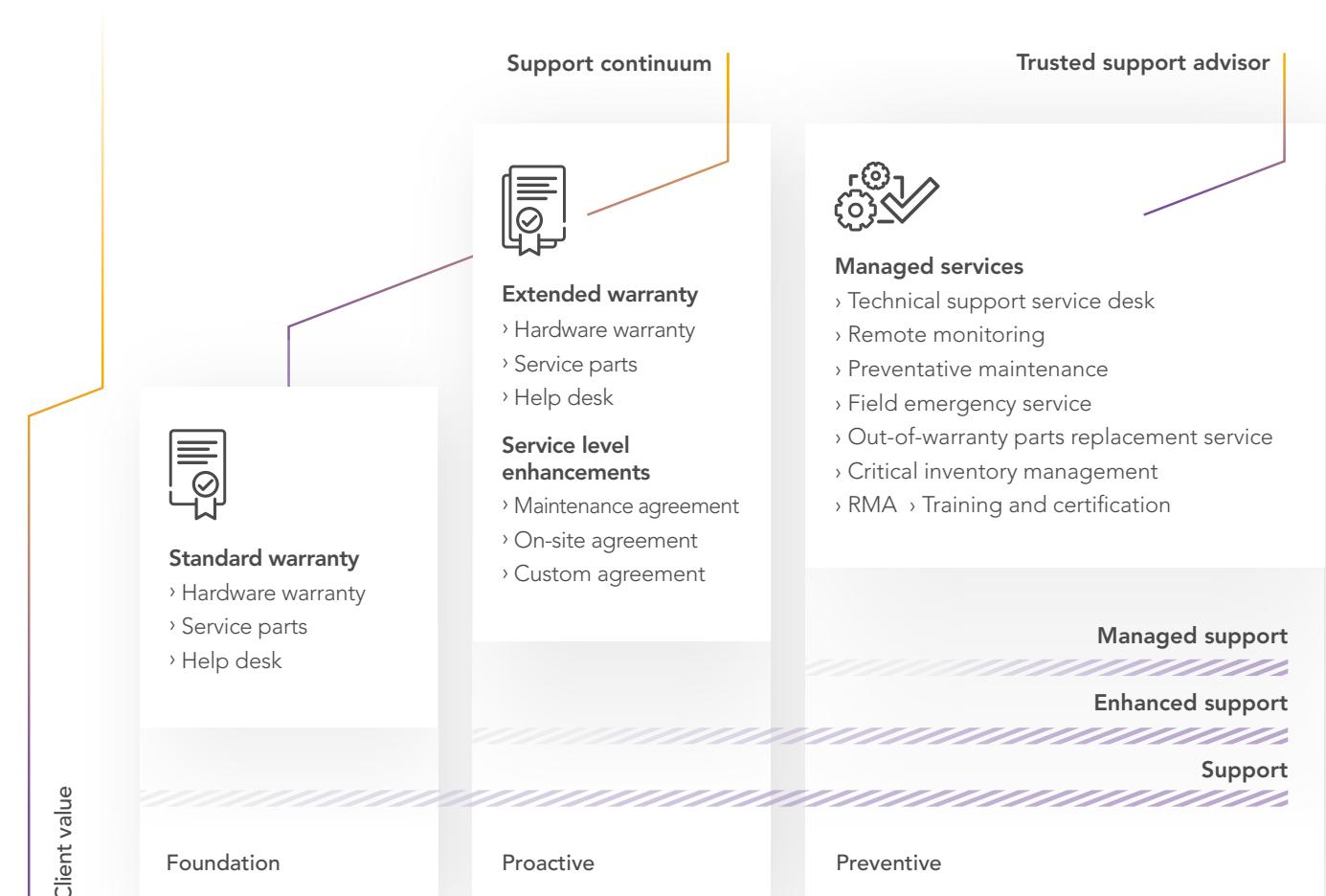

HOW CAN WE HELP YOU TODAY?

We understand that downtime isn't an option.

While it's possible to send Christie products out into the world alone — they're designed and engineered to exacting standards — that's not the Christie way. We're here when you need us, making sure that your show always goes on.

We provide industry-leading support globally and deliver it locally in your language, so you'll get parts and services quickly and conveniently.

We stand behind our products with robust warranties — including a lamp warranty known to be the best in the business.

Christie warranties, support, and training come together to form a package unlike any other — from standard warranties and proactive plans to our managed services that can predict and prevent problems.

We're committed to support just as much as we are to the illumination source, design, and electronics. That's what makes a Christie a Christie — dependable, revenue-generating, fully supported, and in daily use in over 60,000 cinemas worldwide.



“What are you, scared of the dark?”

The Shawshank Redemption. Directed by Frank Darabont, 1994

TERMS AND CONDITIONS

1. Purchase and Sale

The purchase order will be subject to acceptance or rejection by Christie (acceptance may be evidenced in writing or by shipment of the Products). Upon acceptance of the purchase order by Christie, the Purchaser and Christie will be in a binding agreement for the purchase and sale of the Products and provision of Services on these terms and conditions (the "Agreement").

2. Applicable terms and conditions

Nothing contained in any purchase order, sales confirmation or other document will modify this Agreement unless agreed to in writing by both parties.

3. Delivery and risk of loss

(a) Unless otherwise specified on the quotation,

- (i) shipments of the Products will be made EXW warehouse at such location as Christie may designate, Incoterms® 2010,
- (ii) all risk of loss of or damage to, the Products will pass to the Purchaser when the Products are delivered by Christie to the carrier for shipment, and
- (iii) Purchaser will pay all freight and insurance charges, all duties, value added, sales, use, excise or similar taxes, and any and all costs or charges incurred after delivery of the Products to the carrier for shipment.

(b) Christie will not be liable in any respect for any loss or damage caused by any failure or delay in making delivery.

(c) Notwithstanding delivery and the passing of risk in the Products, or any other provision of these conditions, the title to the Products will not pass to the Purchaser until Christie has received in cash or cleared funds representing payment in full of the price of the Products and all other goods agreed to be sold by Christie to the Purchaser for which payment is then due.

4. Payment

(a) Unless otherwise specified on the quotation or agreed to in writing by both parties and subject to satisfactory credit approval, payment terms are net 30 days from the date of invoice and invoices may be sent at any time on or after shipment of the Products, or completion of the Services. All payments for Products and Services are payable in currency specified on the first page of this Agreement.

(b) If Purchaser fails to make payment in full by the due date then, without prejudice to any other rights or remedies available to Christie, Christie will be entitled to:

- (i) charge the Purchaser interest on the unpaid portion of any invoice not paid in full when due at a rate equal to the lower of 1.5% per month (a part month being treated as a full month for the purpose of calculating interest) of the unpaid balance or the highest interest rate permitted under applicable law,
- (ii) terminate and cancel any other agreements with the Purchaser, and
- (iii) withhold warranty coverage contemplated by section 8.

5. Product specifications

The specifications of the Products are those set out in Christie's catalog in effect from time to time. Christie reserves the right to make any changes in the specifications of the Products that are required to conform to any applicable laws or that do not materially affect the quality or performance of the Products.

6. Purchaser facility access (if applicable)

Where the Services require that the personnel of Christie or its subcontractors have access to the Purchaser's facility, the Purchaser will provide such access and will provide such resources and items as may be reasonably necessary.

7. Acceptance, rejection, etc.

(a) Where the Services include installation of the Products by Christie, the Purchaser will be deemed to have accepted the Products upon certification by Christie to the Purchaser that the Products have been installed and are operating properly.

(b) Where the Services do not include installation by Christie, Purchaser will inspect all Products immediately upon delivery to the final shipping destination and will accept or reject the Products within 10 days after the date of delivery. Purchaser may only reject Products that are nonconforming goods or which are defective. Any failure to reject Products within such 10 day period will be deemed acceptance. Purchaser expressly waives any right Purchaser may have to revoke acceptance after the expiration of such 10 day period.

(c) Acceptance of Products by Purchaser will be without prejudice to any rights Purchaser may have under the warranty pursuant to section 8(a).

(d) No Products may be returned to Christie except in accordance with Christie's return policy, which, among other things, requires that a return material authorization (RMA) number be obtained prior to returning any item to Christie.

8. Warranty

(a) Provided that the Purchaser has paid to Christie all amounts owing to Christie in payment for the Products and Services, the Products are warranted to Purchaser under Christie's standard limited warranty, a copy of which will be provided by Christie upon request. Notwithstanding the foregoing, the standard limited warranty will not apply in respect of any defects arising from any design or specifications provided by the Purchaser.

(b) Except as expressly set forth in this agreement, Christie makes no other warranties whatsoever to purchaser, and specifically disclaims all other warranties, whether written or oral, express, implied or statutory, including without limitation any implied warranty of merchantability, satisfactory quality, fitness for a particular use or purpose or noninfringement.

9. Limitation of liability

Under no circumstances will Christie be liable to Purchaser for any consequential, incidental, indirect, special or punitive damages, including without limitation damages for lost profits, lost revenues, lost business or loss of use of products, whether or not Christie is advised that such damages will or may occur, and whether such damages are claimed based on breach of contract, breach of warranty, negligence, strict liability in tort, or any other legal or equitable theory. No action, regardless of form, arising out of this agreement or the sale of products to purchaser may be brought against Christie more than one year after the date of accrual of the cause of action.

10. Indemnification by Purchaser

Purchaser will indemnify Christie, its affiliates, and their respective officers, directors, shareholders, employees, agents, legal representatives, successors and assigns from and against any claim, damage, liability, loss, cost, expense, obligation, action or cause of action arising out of any breach by Purchaser of its obligations under this Agreement or any negligent or willful misconduct of Purchaser. Purchaser's obligations under this section 10 will survive the expiration or termination of this Agreement.

11. Infringement

(a) Christie will indemnify Purchaser and its officers, directors, shareholders, employees, agents, legal representatives, successors and assigns from and against any claim, damage, liability, loss, cost, expense, obligation, action or cause of action arising out of any actual or alleged infringement of any Products sold by Christie to Purchaser on any patent, trademark or copyright of any third party, provided that:

- (i) Purchaser gives Christie prompt written notice of any third party claim which is or may be covered under this indemnity, and
- (ii) Christie is given full power and authority to defend or settle any such third party claim.

(b) Purchaser may, by counsel of its own choosing and at its sole expense, participate in any legal proceeding or settlement relating to any matter as to which a claim is made by Purchaser under this indemnity.

(c) In the event of any infringement of any Products on any patent, trademark or copyright of any third party, Christie will, at its sole option and expense:

- (i) modify the infringing item to make it non-infringing,
- (ii) replace the infringing item with a non-infringing item with equal or better functionality,
- (iii) procure for Purchaser the right to continue using the infringing item, or
- (iv) if none of the above alternatives is commercially practical, refund the purchase price of the infringing item less depreciation computed on a three year straight-line basis.

(d) Christie will not have any liability under the indemnity set forth in section 11(a) for, and Purchaser will indemnify Christie, its affiliates, and their respective officers, directors, shareholders, owners, employees, agents, legal representatives, successors and assigns from and against any claim, damage, liability, loss, cost, expense, obligation, action or cause of action arising out of:

- (i) compliance with the Purchaser's designs, specifications or instructions,
- (ii) modification of any Product by a party other than Christie,
- (iii) the use of any Product in combination with any other product, or
- (iv) the use of any Product in any manner which infringes a method or process patent.

(e) The provisions of this Section 11 are in lieu of all other express, implied or statutory warranties against infringement and will be the sole and exclusive remedy for intellectual property infringement of any kind. In no event will Christie's total liability for such infringement exceed the aggregate sum paid by purchaser for the allegedly infringing product.

12. Software

(a) Off-the-Shelf Software. Any third party, standard, off-the-shelf software included or installed in any Products is provided under the end user license agreement applicable to such software.

(b) Other Software. The Purchaser will not acquire any ownership interest in any software or firmware installed in any Products as of the time of sale of such Products to Purchaser, or in any software or firmware update or upgrade made available by Christie for any Products after the time of sale of such Products to Purchaser. The Purchaser will be entitled to use such software or firmware, or any such software or firmware updates or upgrades, solely for purposes of, and in connection with, use of the Products.

13. Intellectual property rights

All intellectual property generated or derived by Christie in the course of performing the Services will be the exclusive property of Christie. Christie reserves all of its rights in its intellectual property including all patents, trademarks, copyrights, trade secrets, design rights and other intellectual property, and Purchaser agrees that Purchaser will have no interest in any such intellectual property. Purchaser will not acquire any intellectual property rights in or to any Product modifications (including software modifications) developed by Christie in the course of performing this Agreement. Purchaser will at all times respect all intellectual property rights of Christie.

14. Confidentiality

"Confidential Information" means all non-public technical, financial or business information, including without limitation technology, inventions, data, software, price lists, customer lists, marketing plans and financial statements, disclosed by either party ("Disclosing Party") to the other party ("Receiving Party") in connection with this Agreement, in whatever form disclosed, whether by written material, oral disclosure or visual demonstration, or by observation by the Receiving Party. Each party agrees to hold the other party's Confidential Information in strict confidence and not to disclose such Confidential Information to any third party without the prior written consent of the Disclosing Party. The Receiving Party agrees to use Confidential Information of the Disclosing Party only in connection with the Receiving Party's performance under this Agreement and for no other purpose. The Receiving Party will use the same degree of care, but no less than a reasonable degree of care, as it uses with respect to its own Confidential Information to prevent unauthorized disclosure of the Disclosing Party's Confidential Information to third parties. The restrictions of this section 14 do not apply to information that is

(a) known to the Receiving Party at the time of receipt,

(b) independently developed by the Receiving Party without any use of the Disclosing Party's Confidential Information,

(c) lawfully obtained by the Receiving Party from a third party not bound by any obligation of confidentiality to the Disclosing Party,

(d) in the public domain when received or thereafter enters the public domain through no fault of the Receiving Party;

(e) provided by the Disclosing Party to third parties without restriction; or

(f) disclosed by the Receiving Party pursuant to statute, regulation, or the order of a court of competent jurisdiction, provided that the Receiving Party promptly notifies the Disclosing Party of such required disclosure in order to permit the Disclosing Party to seek a protective order or other appropriate relief. The Disclosing Party will be entitled to enforce the provisions of this section 14 by injunctive or other equitable relief, without need of showing actual damages.

15. Export controls

Purchaser will comply with all applicable export control laws as in effect from time to time.

16. Force majeure

If the performance of this Agreement or of any obligation hereunder by either party is prevented by reason of war, civil disturbance, terrorism, fire, flood, earthquake, typhoon or other natural disaster, strikes, labor disputes, governmental action, or any other act or condition whatsoever beyond the reasonable control of such party, such party will, except for payment obligations, be excused from performance for so long as such cause continues.

17. Enforcement

(a) If Purchaser fails to pay any amounts owing to Christie, Purchaser will reimburse Christie for all collection costs and expenses, including without limitation reasonable legal fees, incurred by Christie in collecting such amounts. In addition, if litigation is commenced by either party in connection with this Agreement, the prevailing party in such litigation will be entitled to recover its costs and legal fees incurred in connection with such litigation, including any appeal.

(b) The rights and remedies of the parties hereunder are cumulative, and the exercise of any one right or remedy will not prejudice the exercise of any other right or remedy.

(c) If any provision of this Agreement is found to be invalid or unenforceable by law, that provision will cease to operate and will be considered severed from this Agreement. All remaining provisions will continue to be valid and binding on the parties.

(d) No failure to exercise, and no delay in exercising, any right or remedy on any one occasion will limit or constitute the waiver of the exercise of any right or remedy on any other occasion. To be effective, any waiver must be in writing and signed by the party making the waiver. No waiver of any provision will constitute a waiver of any other provision, whether or not similar, nor will any waiver constitute a continuing waiver.

18. Termination

(a) Either party may terminate this Agreement upon written notice to the other party if the other party fails to remedy a material breach of any of its representations, warranties or other obligations under this Agreement within 30 days following receipt of a written notice of said breach.

(b) Either party may immediately terminate this Agreement upon written notice, but without prior advance notice, to the other party if:

- (i) the other party is declared insolvent or bankrupt by a court of competent jurisdiction,
- (ii) a voluntary petition of bankruptcy is filed in any court of competent jurisdiction by such other party, or
- (iii) this Agreement is assigned by such other party for the benefit of creditors.

(c) Upon the termination of this Agreement:

- (i) all rights and duties of the parties under this Agreement will terminate except to the extent otherwise expressly provided in this Agreement, and
- (ii) each party will, at the request of the other party, return to the other party any Confidential Information of the other party or certify that such Confidential Information has been destroyed. Purchaser expressly acknowledges and agrees that Christie may exercise its termination rights without incurring any obligation or liability to Purchaser by reason of such termination.

(d) Sections 8-17, 18(c), 18(d), and 20 and any accrued payment obligations or existing claims will survive any expiration or termination of this Agreement.

19. Notices

Any notice or other communication to be given under this Agreement will be in writing and will be deemed given on the date of transmission when sent by facsimile transmission (if sent by 4:00 pm Eastern Time or the next day if sent after 4:00 pm Eastern Time), with electronic confirmation of transmission, on the third day after the date of mailing when mailed by registered or certified mail, postage prepaid, return receipt requested, or when sent by recognized courier service (such as FedEx), or on the date of actual delivery, whichever is the earlier, and will be sent to Purchaser or Christie, as the case may be, at the address shown on the quotation, or at such other address as either party may hereafter designate by written notice to the other.

20. General

This Agreement

- (i) constitutes the entire agreement of the parties with respect to the subject matter of this Agreement and supersedes and replaces all written and oral agreements in respect thereof;
- (ii) is governed by the laws of the State of California, USA;
- (iii) is not subject to the UN Convention on Contracts for the International Sale of Goods;
- (iv) is not assignable by the Purchaser without the prior written consent of Christie; and
- (v) is binding on, and will ensure to the benefit of, the parties and their respective successors and permitted assigns.

Corporate offices

Christie Digital Systems USA, Inc.
Cypress
PH: +1 714-236-8610
Christie Digital Systems Canada
Inc.
Kitchener
PH: +1 519-744-8005

Worldwide offices

Australia
PH: +61 (0) 7 3624 4888
Brazil
PH: +55 11 3181-2952
China (Beijing)
PH: +86 10 6561 0240
China (Shanghai)
PH: +86 21 6030 0500

China (Shenzhen)
PH: + 86 755 3680 7000
Colombia
PH: +57 (315) 652-9620
Germany
PH: +49 221 99 512-0
India
PH: +91 (080)6708 9999

Mexico
PH: +52 (55) 4744-1791
Singapore
PH: +65 6877 8737
South Korea
PH: +82 2 702 1601
Spain
PH: +34 (0) 91 633 99 90

United Arab Emirates
PH: +971 (0) 4 503 6800
United Kingdom
PH: +44 (0) 118 977 8000
United States (Arizona)
PH: +1 602-943-5700
United States (Texas)
PH: +1 469-757-4420

For the most current specification information, please visit christiedigital.com

Copyright 2024 Christie Digital Systems USA, Inc. All rights reserved. Our centers of excellence for manufacturing in Kitchener, Ontario, Canada and in Shenzhen, China are ISO 9001:2015 Quality Management System-certified. All brand names and product names are trademarks, registered trademarks or tradenames of their respective holders. "Christie" is a trademark of Christie Digital Systems USA, Inc., registered in the United States of America and certain other countries. DLP® and the DLP logo are registered trademarks of Texas Instruments. Performance specifications are typical. Due to constant research, specifications are subject to change without notice.

