





E-FULLY

14-53



E-HARDTAIL

54-79



E-ROAD

80-83



E-OFFROAD

84-97



E-ONROAD

98-119



E-URBAN

120-136



INFO

138-170



MADE IN AUSTRIA



Seit Jahrzehnten beweist KTM seine Kompetenz als einflussreicher und globaler Fahrradhersteller.

Die Fahrradtechnik hat sich vielfach verändert und enorme Fortschritte gemacht. Im Laufe dieser Zeit hat sich KTM zu einem der letzten verbliebenen Vollsortimenter entwickelt. Eines jedoch ist immer gleich geblieben: KTM baut nach wie vor "Bikes – Made in Austria".

Bereits das erste KTM Fahrrad Fleetwing trug 1964 das Gütesiegel Made in Austria. Mehr als 50 Jahre später ist KTM stolz darauf, seine Fahrräder wieder mit diesem Siegel zu versehen, das für höchste Qualität und modernste Technologien steht. Mittlerweile wird in mehr als 50 Ländern weltweit auf KTM Bikes – Made in Austria vertraut.



KTM has spent decades developing into an influential player in the global bicycle sector.

Bike technologies have changed enormously and the progress has been significant especially in the last decade. As the decades have past KTM finally became a manufacturer that covers the whole range of bikes. But one thing has never changed: KTM still builds bikes at its base in Mattighofen awarding the badge – Made in Austria.

The first KTM bike the Fleetwing, displayed the quality label Made in Austria (1964). More than 50 years later KTM is proud to label the biggest part of its bikes again with that mark standing for highest quality and state-of-the-art technologies. In addition to this, more than 50 countries around the world trust in KTM Bikes – Made in Austria.



1964



1972



1978



1982



1991



1994



2000



2003



2009



2020

KTM E-HISTORY

25 Jahre Erfahrung und Erfolg mit Elektrorädern.



1994

ÖAMTC 2000 26"

Das erste KTM Fahrrad mit E-Antrieb wurde bereits 1994 für den österreichischen Automobilclub ÖAMTC produziert.



1998

CITY BLITZ

Das erste Elektro-Rad von KTM, mit einer Auszeichnung von „extra energy“ – am Berg stark und schnell. 21.999,- öS (1.599 €)



2009

eRACE

Auf der Bike Expo 2009 in München wurde von KTM mit dem in 2008 entwickelten eRace erstmals ein geländetaugliches E-MTB vorgestellt.



2010

eLYCAN 26"

Das erste Fullsuspension E-Bike von KTM mit BionX Nabenmotor und 120 mm Federweg am Hinterbau.



2014

MACINA LYCAN

Fully mit 130mm Federweg und BOSCH-Elektroantrieb.



2012

MACINA NUVINCI

Trekkingrad mit stufenloser NuVinci Nabenschaltung.



2011

eSHOPPER

Auf der Eurobike im September 2011 wurde der eSHOPPER mit dem Design Award in Gold ausgezeichnet.



2010

eGNITION

Das erste E-Freeride mit 180mm Federweg von KTM. Im September 2010 mit dem Eurobike Design Award ausgezeichnet.



2014

MACINA MINI ME

Der erste Berührungspunkt der Jugend mit der Elektromobilität.



2018

MACINA FUN

Testsieg mit Bestnote beim großen E-Bike Test der Stiftung Warentest.



2019

MACINA GRAN 8 BELT

1. Platz in der Kategorie "Urban" beim Focus Design & Innovation Award 2019



2020

MACINA PROWLER

Das erste KTM E-Fully mit Carbon Rahmen und 625 Wh Akku.



Macina Fun 9 SI-P51



KTM Macina Gran 8 Belt PS

STRAIGHT LINE LINK



ANTI SQUAT

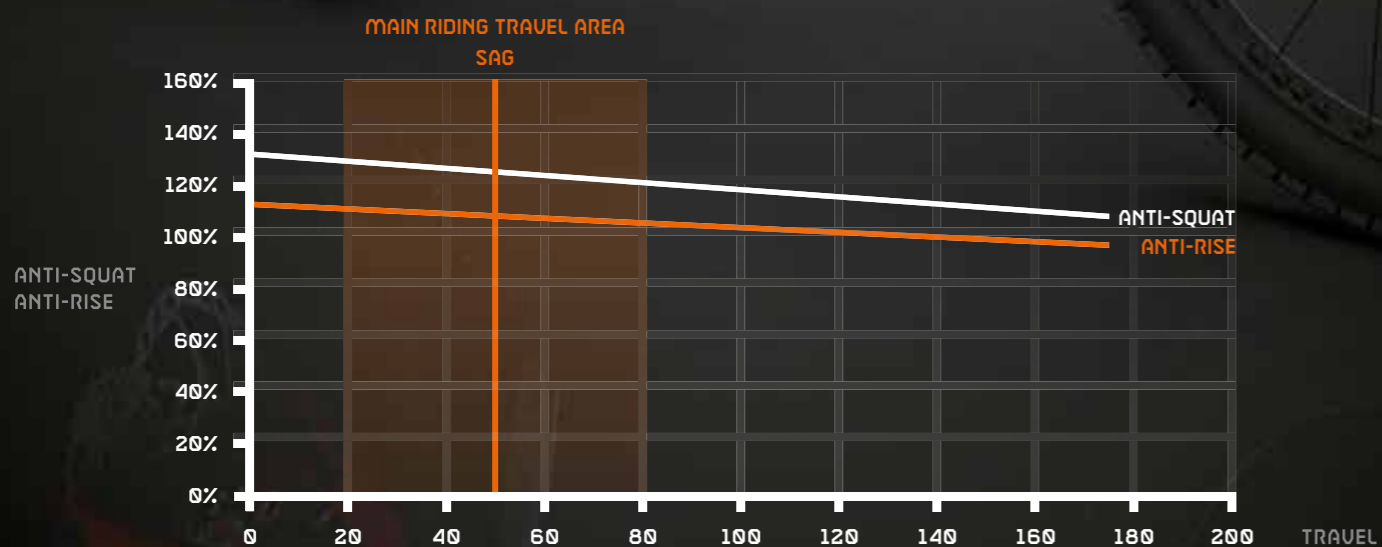

GRAVITY CASTING

Durch die Gravity Casting Technik werden besonders hochbelastbare Aluminium Gussteile gefertigt. Die aufwendigen Konstruktionen bieten ein hohes Maß an Integrationsmöglichkeiten des kompletten Antriebssystems.

By using the Gravity Casting technology high stressed alloy cast parts get achieved. Precisely designed parts achieve great options for integrating the complete electric drive unit.



Der Boost Standard erhöht die Steifigkeit und ermöglicht ein effizienteres und präziseres Handling des Bikes. Durch die breitere Nabe lassen sich robustere Laufräder bauen.

The Boost Standard increases stiffness and allows a very efficient and precise handling of the bike. The wider hub makes it possible to build more robust wheels.

BOOST 148mm

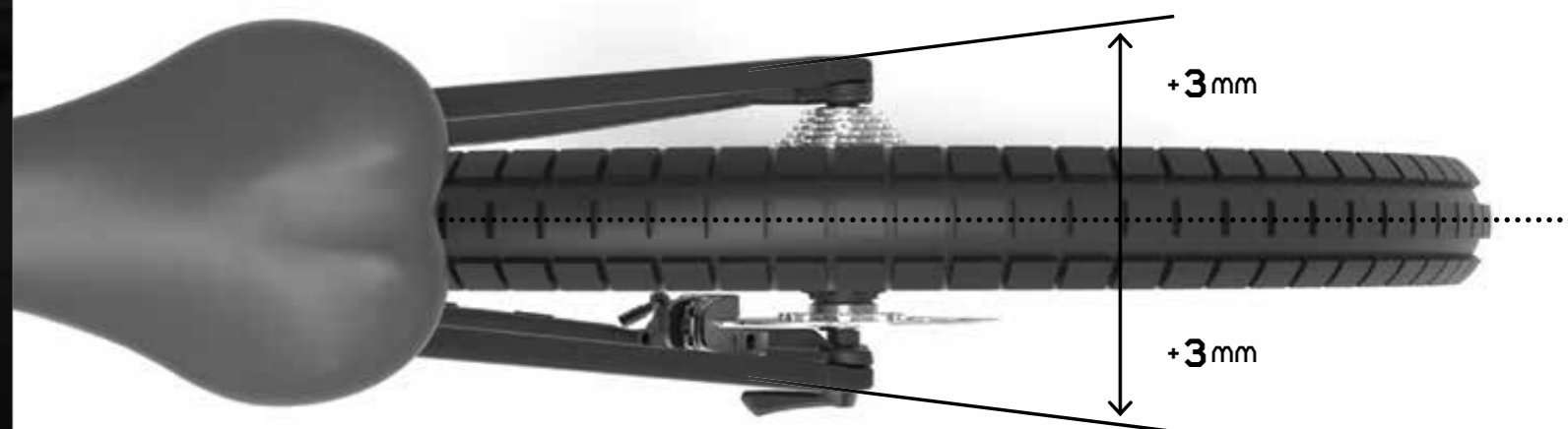

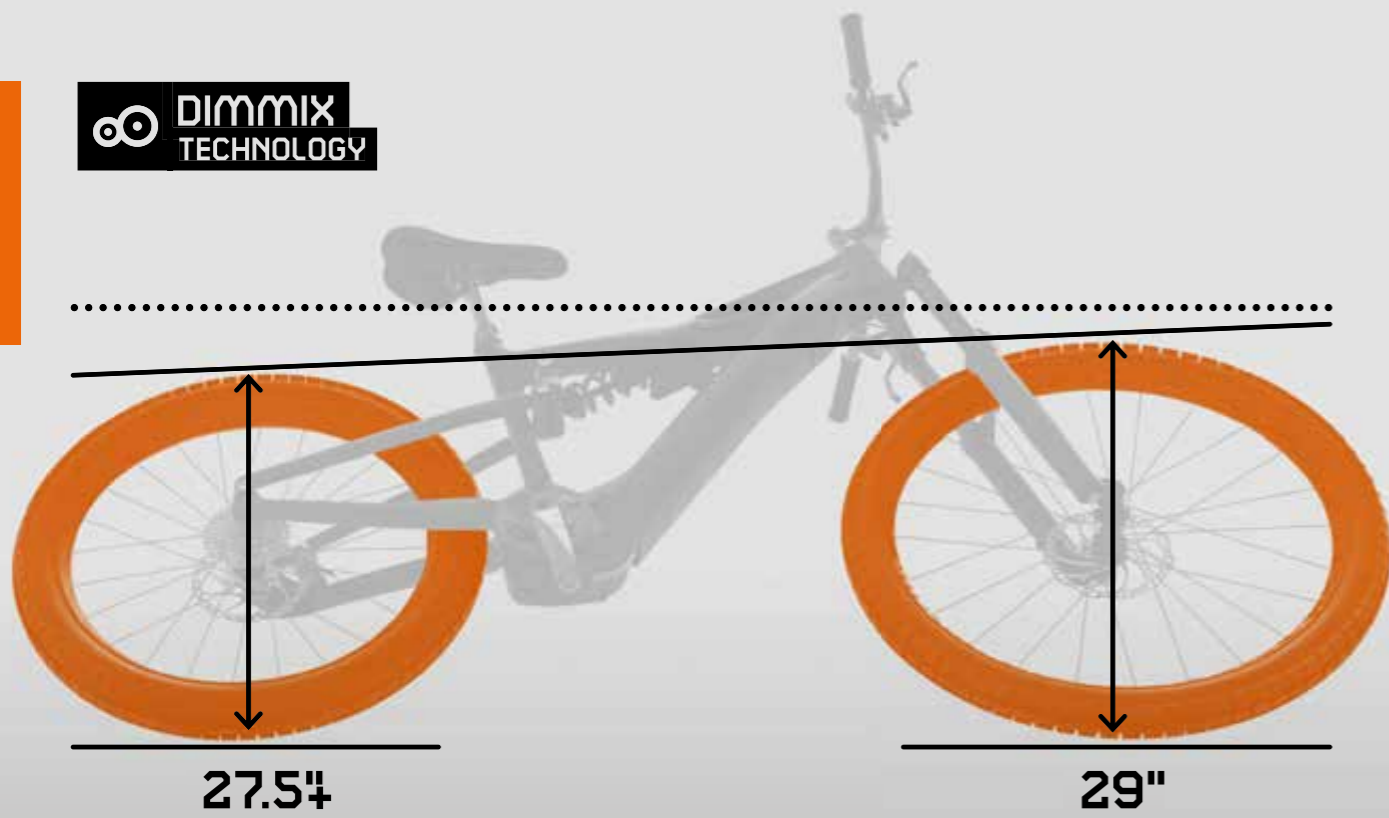

Die DiMMiX (Dimensions Mix) Technologie verbindet die Vorteile eines fahrpräzisen, spurstabilen 29" Laufrades vorne mit einem traktionsstarken, robusten 27,5" PLUS Laufrad hinten.

The DiMMiX (Dimensions Mix) technology combines the advantages of riding a precise, stable 29" front wheel with a traction-rich manoeuvrable 27.5" PLUS wheel at the back.



Der voll in den Rahmen integrierte „Bosch Powertube“ Lithium-Ionen Akku, eröffnet dank kompakter Abmessungen neue Möglichkeiten zu einem reduzierten und modernen Design. Neu im Programm ist neben dem 500 Wh „Bosch Powertube“ die 625 Wh Version, welche in einem innovativen, neuen Rahmenkonzept Platz findet. Beide Versionen lassen sich leicht abnehmen, oder auch direkt am Rad laden.

The fully frame integrated lithium-ion battery, the Bosch Powertube, thanks to its compact dimensions ensures a sleek and modern design. The new addition to the range beside the 500 Wh Bosch Powertube is the 625 Wh version, which finds its place in an innovative, new developed frame concept. Both versions of the battery can be removed from or charged straight on the bike.

KTM E-BIKE FRAME TYPES

RAIL MOUNT



DIRECT MOUNT



DIRECT MOUNT US



UNDER COVER



MONOCOQUE CASTING

Buchstäblich aus einem Guss wird hier die komplette Akku- und Motoraufnahme gefertigt. Unschöne Schweißnähte verschwinden und ein gewichtsoptimierter Rahmen bleibt. Diese Technologie wird bei allen Undercover-Rahmen mit Bosch CX Motor verwendet.

With this technology, the whole battery-engine-fixation is literally produced in one whole piece. Unattractive welds disappear and what remains is just a weight optimized frame. This technology is used for all Bosch CX engine bikes with undercover frame.



BELT DRIVE

Weniger Wartungsaufwand. Witterungsbeständiger und rostfrei. Laufruhig sowie belastbar. Einfach zu Reinigen. Kein zusätzliches Schmierfett erforderlich. *Less maintenance.*

Wheaterproof and rust free. Smooth operation and resilient. Dirt can be cleaned with water. No need for grease.

LIGHT LINK

Der KTM Light Link hilft dir, auf einfachstem Weg dein E-Bike mit einer wertigen Lichtanlage auszustatten, die aus dem E-Bike Akku gespeist wird. Hierfür haben wir schon bei der Produktion, bei jedem E-Bike mit Light Link, die Kabel für dich vorbereitet. Der Eingriff, eine Lampe zu montieren, dauert nur wenige Minuten.

The KTM Light Link offers you the possibility to equip your E-Bike with a proper light solution. Therefore all KTM E-Bikes with light link are already prepared with the light cable connection to the battery. Thus it takes only a couple of minutes to install a light.

LIGHT FENDER CARRIER

	LFC	LFC READY
Macina Kapoho Prestige		●
Macina Kapoho Master		●
Macina Kapoho 2971		●
Macina Kapoho 2972		●
Macina Kapoho 2973		●
Macina Chacana 291		●
Macina Chacana 292		●
Macina Chacana 293		●
Macina Chacana 294		●
Macina Chacana LFC	●	
Macina Lycan 271		●
Macina Lycan 271 Glory		●
Macina Lycan 272 Glory		●
Macina Team 291		●
Macina Team 292		●
Macina Team 292 Glory		●
Macina Team XL		●
Macina Team LFC	●	
Macina Race 291		●
Macina Race 271		●
Macina Action 291		●
Macina Action 271		●
Macina Ride 291		●
Macina Ride 271		●
Macina Scout 271		●
Macina Scout 272		●
Macina Scout 271 LFC	●	
Macina Scout 272 LFC	●	
Macina Cross 610		●
Macina Cross 620		●
Macina Cross 510		●
Macina Cross 520		●
Macina Cross LFC	●	
Macina Sprint		●
Macina Gran 610	●	
Macina Gran 510	●	

Mit dem LFC-System werden Offroad-Räder allwettertauglich gemacht und dies auf minimalistische Weise mit maximaler Effizienz. Das Rücklicht wird im Schutzblech integriert, das Alu-Schutzblech schützt und verrutscht nicht – die einfache Bedienung steht im Vordergrund.

First easy to use solution for equipping offroad-ebikes with safety features like light, fender, carrier without huge effort. Ease of use in adding carrier, light and mud-fender for prepared offroad frames ready for LFC.

Voll Ausgestattet



Fully equipped

Nachrüstbar



Upgradeable



LIGHT



FENDER



CARRIER



MACINA PROWLER



MACINA PROWLER SONIC
XX1 AXS 1*12 16-19



MACINA PROWLER PRESTIGE
XTR 1*12 20



MACINA PROWLER MASTER
DEORE XT 1*12 21

MACINA KAPOHO



MACINA KAPOHO PRESTIGE
XTR 1*12 24



MACINA KAPOHO MASTER
DEORE XT 1*12 25



MACINA KAPOHO 2971
DEORE XT 1*12 26-29



MACINA KAPOHO 2972
SLX 1*12 30



MACINA KAPOHO 2973
DEORE 1*10 31



MACINA KAPOHO LTD
SX 1*12 32

MACINA CHACANA



MACINA CHACANA 291
DEORE XT 1*12 35



MACINA CHACANA 292
DEORE XT/SLX 1*12 36



MACINA CHACANA 293
SLX 1*12 37



MACINA CHACANA 294
DEORE 1*10 38



MACINA CHACANA LFC
SLX 1*11 40-43

MACINA LYCAN



MACINA LYCAN 271
SLX 1*12 46



MACINA LYCAN 271 GLORY
SLX 1*12 47



MACINA LYCAN 272 GLORY
DEORE 1*10 52

MACINA

PROWLER

SONIC



Das Ass im Trikotärmel.

Für 2020 ist unser Entwicklungsteam mit dem MACINA PROWLER buchstäblich ‚All In‘ gegangen. Bis ins letzte Detail wurde dieses Bike durchdacht, konzipiert und auf Perfektion getrimmt. 180 mm Federweg an der Gabel und 170 mm Federweg am Heck machen

schnell klar, dass dieses Bike für den anspruchsvollen Trail- und Enduro-Einsatz gedacht ist. Der Carbon-Rahmen ist auf der bewährten DiMMiX-Bereifung unterwegs: 29“-LaufRAD an der Front für optimales Handling und

Fahrstabilität, gepaart mit der 27“ PLUS-Bereifung am Heck für beste Kraftübertragung und Traktion, spielen im schweren Gelände all ihre Vorteile aus. Mit dem MACINA PROWLER und seinem leistungsstarken Bosch Performance Line CX Motor der vierten Generation, sowie dem schlank integrierten Bosch PowerTube 625 Wh Akku, hast Du den ‚Royal Flush‘ deiner Biker-Clique!

The Ace up your jersey sleeve.

For 2020 our development team has literally gone ‚All In‘ with the MACINA PROWLER. This bike has been thought through, conceived and trimmed to perfection down to the last detail. 180 mm suspension

travel at the fork and 170 mm suspension travel at the rear quickly make it clear that this bike is intended for demanding trail and enduro use. The carbon frame is fitted with the proven DiMMiX

tyres: 29“ wheel at the front for optimum handling and riding stability paired with the 27“ PLUS tyres at the rear for best power transmission and traction, show all its advantages in difficult terrain. With the MACINA PROWLER and its powerful fourth generation Bosch Performance Line CX engine, as well as the slim integrated Bosch PowerTube 625 Wh battery, you have the ‚Royal Flush‘ of your biker clique!



PT-CX 6K6

625 WH BATTERY

170 mm REAR

1x12 SRAM XX1 AXS

LIGHT LINK



MACINA

PROWLER

SONIC

FRAME Macina Prowler Dimmix Performance Carbon SLL-LTE 170mm; PT625 Bosch Gen. 4 / M-0136
FORK RockShox Lyrik Ultimate 29" 180mm
SHOCK RockShox SuperDeluxe coil Select+ 250x75
MOTOR Bosch PERFORMANCE CX Gen. 4 - 25km/h / 75Nm
DISPLAY Bosch KIOX TFT Display with Remote
BATTERY Bosch PowerTUBE 625Wh hor.
CHARGER Bosch FAST Charger 6A
R. DERAILL. Sram XX1 Eagle AXS 12speed
SHIFTLEV. Sram Eagle AXS
CRANKSET FSA CK-702/IS Carbon 160mm

CHAINRING SRAM X-Sync 2 Eagle 36T Direct Mount
SPROCKET Sram XX1 Eagle XG-1299 / 10-50
CHAIN Sram XX1 Eagle 12s
BRAKE Shimano XTR M9120 4-Piston
ROTOR Shimano MT900 CL 203 / 180 Freeza
WHEEL F DT Swiss HXC 1200 Spline 30 Carbon CL 110-15TA 622x30TSS TLR
WHEEL R DT Swiss HXC 1200 Spline 30 Carbon CL 148-12TA584x30TSS TLR
TIRE F Maxxis Minion DHF 3C-MaxxTerra/EXO/TR 63-622
TIRE R Maxxis Minion DHR II 3C-MaxxTerra/EXO/TR 66-584

GRIP Ergon GE10 Evo ergonomic
BAR KTM Prime Trail35 Carbon rizer20 800mm
STEM KTM Team Trail35 Kiox
HEADSET KTM Team angle limit 1.1/8-1.5"
SADDLE Ergon SM10 E-Mountain Sport
SEATPOST RockShox Reverb AXS wireless
PEDAL MTB-Pedal VP-539 nylon
CATEGORY E4
SYSTEM WEIGHT 120 kg (permissible total weight)
WEIGHT 23,5 kg (without pedals)



black matt (space orange + glossy)

020400103 MACINA PROWLER SONIC S / 43cm

020400108 MACINA PROWLER SONIC M / 48cm

020400113 MACINA PROWLER SONIC L / 53cm

MACINA

PROWLER

PRESTIGE

PT-CX 6K6

625 WH BATTERY

170 mm REAR

1x12 SHIMANO XTR



LIGHT LINK



FRAME	Macina Prowler Dimmix Performance Carbon SLL-LTE 170mm; PT625 Bosch Gen. 4 / M-0136
FORK	RockShox Lyrik Select+ 29" 180mm
SHOCK	RockShox SuperDeluxe coil Select+ 250x75
MOTOR	Bosch PERFORMANCE CX Gen. 4 - 25km/h / 75Nm
DISPLAY	Bosch KIOX TFT Display with Remote
BATTERY	Bosch PowerTUBE 625Wh hor.
CHARGER	Bosch FAST Charger 6A
R. DERAILL.	Shimano XTR M9100-12 SGS shadow+
SHIFTLEV.	Shimano XTR M9100-12
CRANKSET	KTM TEAM ISIS 160mm Q16
CHAINRING	Shimano SM-CR80 36T

SPROCKET	Shimano Deore XT M8100-12 / 10-51
CHAIN	Shimano Deore XT M8100-12
BRAKE	Shimano XTR M9120 4-Piston
ROTOR	Shimano MT900 CL 203 / 180 Freeza
WHEEL F	KTM E-Team Trail 29 CL 110-15TA 622x30TC TLR made by DT Swiss
WHEEL R	KTM E-Team Trail 27 CL 148-12TA 584x35TC TLR made by DT Swiss
TIRE F	Schwalbe Eddy Current Front Evo SuperGravity TLE 62-622
TIRE R	Schwalbe Eddy Current Rear Evo SuperGravity TLE 70-622

GRIP	Ergon GE10 Evo ergonomic
BAR	KTM Prime Trail35 Carbon rizer20 800mm
STEM	KTM Team Trail35 Kiox
HEADSET	KTM Team angle limit 1.1/8>1.5"
SADDLE	Ergon SM10 E-Mountain
SEATPOST	RockShox Reverb
PEDAL	MTB-Pedal VP-539 nylon
CATEGORY	◆ E4
SYSTEM WEIGHT	135 kg (permissible total weight)
WEIGHT	24,5 kg (without pedals)



■ black matt (space orange glossy)

- 🔪 020401103 MACINA PROWLER PRESTIGE S / 43cm
- 🔪 020401108 MACINA PROWLER PRESTIGE M / 48cm
- 🔪 020401113 MACINA PROWLER PRESTIGE L / 53cm

MACINA

PROWLER

MASTER

PT-CX 6K6

625 WH BATTERY

170 mm REAR

1x12 SHIMANO DEORE XT



LIGHT LINK



FRAME	Macina Prowler Dimmix Performance Carbon SLL-LTE 170mm; PT625 Bosch Gen. 4 / M-0136
FORK	RockShox Lyrik Select 29" 180mm
SHOCK	RockShox SuperDeluxe coil Select+ 250x75
MOTOR	Bosch PERFORMANCE CX Gen. 4 - 25km/h / 75Nm
DISPLAY	Bosch KIOX TFT Display with Remote
BATTERY	Bosch PowerTUBE 625Wh hor.
CHARGER	Bosch FAST Charger 6A
R. DERAILL.	Shimano Deore XT M8100-12 SGS shadow+
SHIFTLEV.	Shimano Deore XT M8100-12
CRANKSET	KTM TEAM ISIS 160mm Q16

CHAINRING	Shimano SM-CR80 36T
SPROCKET	Shimano SLX M7100-12 / 10-51
CHAIN	Shimano SLX M7100-12
BRAKE	Shimano MT520 4-Piston
ROTOR	Shimano RT64 CL 203 / 180
WHEEL F	KTM E-Comp Trail 29 CL 110-15TA 622x30TC TLR made by DT Swiss
WHEEL R	KTM E-Comp Trail 27 CL 148-12TA 584x35TC TLR made by DT Swiss
TIRE F	Maxxis Minion DHF 3C-MaxxTerra/EXO/TR 63-622
TIRE R	Maxxis Minion DHR II 3C-MaxxTerra/EXO/TR 70-584

GRIP	Ergon GE10 Evo ergonomic
BAR	KTM Team Trail35 rizer25 800mm
STEM	KTM Team Trail35 Kiox
HEADSET	KTM Team angle limit 1.1/8>1.5"
SADDLE	Selle Italia X3 E-Bike flow
SEATPOST	KTM Comp dropper internal w/remote
PEDAL	MTB-Pedal VP-539 nylon
CATEGORY	◆ E4
SYSTEM WEIGHT	134 kg (permissible total weight)
WEIGHT	24,1 kg (without pedals)



■ black matt (black glossy)

- 🔪 020402103 MACINA PROWLER MASTER S / 43cm
- 🔪 020402108 MACINA PROWLER MASTER M / 48cm
- 🔪 020402113 MACINA PROWLER MASTER L / 53cm

ALL IN. ALL OUT.



MIPS®
SYSTEM

LOOSE
FIT

1ST LEVEL SHOCK
ABSORBING PROTECTORS

DURABLE
FABRIC

MACINA

KAPOHO

PRESTIGE

PT-CX 6K6

625 WH BATTERY

160 mm REAR

1x12 SHIMANO XTR



FRAME Macina Kapoho Dimmix Performance Carbon SLL-LTE 160mm; PT625 Bosch Gen. 4 / M-0146

FORK FOX 36 Float 29" Factory e-bike 160mm (Kashima)

SHOCK FOX Float DPX2 Factory 3Position 250x70

MOTOR Bosch PERFORMANCE CX Gen. 4 - 25km/h / 75Nm

DISPLAY Bosch KIOX TFT Display with Remote

BATTERY Bosch PowerTUBE 625Wh hor.

CHARGER Bosch FAST Charger 6A

R. DERAILL. Shimano XTR M9100-12 SGS shadow+

SHIFTLEV. Shimano XTR M9100-12

CRANKSET KTM TEAM ISIS 160mm Q16

CHAINRING Shimano SM-CR80 36T

SPROCKET Shimano Deore XT M8100-12 / 10-51

CHAIN Shimano Deore XT M8100-12

BRAKE Shimano XTR M9120 4-Piston

ROTOR Shimano MT900 CL 203 / 180 Freeza

WHEEL F KTM E-Prime Trail 29 CL 110-15TA 622x30TC TLR made by DT Swiss

WHEEL R KTM E-Prime Trail 27 CL 148-12TA 584x35TC TLR made by DT Swiss

TIRE F Schwalbe Eddy Current Front Evo SuperGravity TLE 62-622

TIRE R Schwalbe Eddy Current Rear Evo SuperGravity TLE 70-622

GRIP Ergon GE10 Evo ergonomic

BAR KTM Prime Trail35 Carbon rizer20 800mm

STEM KTM Team Trail35 Kiox

HEADSET KTM Team angle limit 1.1/8-1.5"

SADDLE Ergon SM10 E-Mountain

SEATPOST FOX Transfer Factory internal

PEDAL MTB-Pedal VP-539 nylon

CATEGORY E4

SYSTEM WEIGHT 134 kg (permissible total weight)

WEIGHT 23,9 kg (without pedals)



black matt (space orange glossy)

- 020404103 MACINA KAPOHO PRESTIGE S / 43cm
- 020404108 MACINA KAPOHO PRESTIGE M / 48cm
- 020404113 MACINA KAPOHO PRESTIGE L / 53cm

MACINA

KAPOHO

MASTER

PT-CX 6K6

625 WH BATTERY

160 mm REAR

1x12 SHIMANO DEORE XT



FRAME Macina Kapoho Dimmix Performance Carbon SLL-LTE 160mm; PT625 Bosch Gen. 4 / M-0146

FORK FOX 36 Float 29" Rhythm e-bike 160mm

SHOCK FOX Float DPX2 Performance 3Position 250x70

MOTOR Bosch PERFORMANCE CX Gen. 4 - 25km/h / 75Nm

DISPLAY Bosch KIOX TFT Display with Remote

BATTERY Bosch PowerTUBE 625Wh hor.

CHARGER Bosch FAST Charger 6A

R. DERAILL. Shimano Deore XT M8100-12 SGS shadow+

SHIFTLEV. Shimano Deore XT M8100-12

CRANKSET KTM TEAM ISIS 160mm Q16

CHAINRING Shimano SM-CR80 36T

SPROCKET Shimano SLX M7100-12 / 10-51

CHAIN Shimano SLX M7100-12

BRAKE Shimano MT520 4-Piston

ROTOR Shimano RT64 CL 203 / 180

WHEEL F KTM E-Comp Trail 29 CL 110-15TA 622x30TC TLR made by DT Swiss

WHEEL R KTM E-Comp Trail 27 CL 148-12TA 584x35TC TLR made by DT Swiss

TIRE F Maxxis Minion DHF 3C-MaxxTerra/EXO/TR 63-622

TIRE R Maxxis Minion DHR II 3C-MaxxTerra/EXO/TR 70-584

GRIP Ergon GE10 Evo ergonomic

BAR KTM Team Trail35 rizer25 800mm

STEM KTM Team Trail35 Kiox

HEADSET KTM Team angle limit 1.1/8-1.5"

SADDLE Selle Italia X3 E-Bike flow

SEATPOST KTM Comp dropper internal w/remote

PEDAL MTB-Pedal VP-539 nylon

CATEGORY E4

SYSTEM WEIGHT 134 kg (permissible total weight)

WEIGHT 24,1 kg (without pedals)



black matt (white glossy)

- 020405103 MACINA KAPOHO MASTER S / 43cm
- 020405108 MACINA KAPOHO MASTER M / 48cm
- 020405113 MACINA KAPOHO MASTER L / 53cm

MACINA

KAPOHO

2971



DIMMIX

SLL LTE
160 mmGEN4
CXLIGHT
LINKKIOX
DISPLAYINTEGRATED
KICKSTAND MOUNTBOOST
148mmCX POWERTUBE
625 WH

Uphill. Downhill. Warum nicht beides?

Bereits der bloße Gedanke an die Aussicht von der Bergspitze und der anschließenden Abfahrt runter ins Tal bereiten dir Schmetterlinge im Bauch? Aber wie hochkommen, wenn der nächste Lift in weiter Entfernung liegt und du ohnehin lieber abseits des Gedöns unterwegs bist? Und warum eigentlich immer nur Downhill? Das MACINA KAPOHO ist die Antwort für alle, die den Trail nicht nur runter- sondern

auch hochklettern wollen! Mit dem neuen Bosch Performance Line CX Motor der vierten Generation sowie dem vollintegrierten Bosch PowerTube 625 Wh Akku haben wir unserem KAPOHO – Made in Austria – nun ein Upgrade verpasst! Die perfekt abgestimmte Laufradkombination (DiMMiX) verbindet die Vorteile eines fahrpräzisen, spurstabilen 29" Laufrades vorne mit einem traktionsstarken 27.5" PLUS Laufrad hinten. Mit dem MACINA KAPOHO und seinen 160 mm Federweg meisterst du jeden noch so knackigen Trail. Egal ob Uphill- oder Downhill. LFC ready.

Uphill. Downhill. Why not both?

The mere thought of the breathtaking view from the top of the mountain and the subsequent descent down to the valley is enough to get your heart racing. But how do you get up there if the next lift is far away and you prefer to be away from hustle and bustle anyway? And why should the fun always be in the downhill? The MACINA KAPOHO is the answer for everyone. For those who not only wants to ride down the

trail but also up it! With the new fourth generation Bosch Performance Line CX motor and the fully integrated Bosch PowerTube 625 Wh battery, we have now given our KAPOHO – Made in Austria – an upgrade! The perfectly tuned wheel combination (DiMMiX) combines the advantages of a precise, track-stable 29" front wheel with a traction-strong 27.5" PLUS wheel at the rear. With the MACINA KAPOHO and its 160 mm suspension travel you can master any trail, no matter how technical. Whether it's uphill or downhill. LFC ready.



PT-CX 6K6

625 WH BATTERY

160 mm REAR

1x12 SHIMANO DEORE XT



MACINA

KAPOHO

2971



FRAME Macina Kapoho Dimmix Alloy6061 SLL-LTE 160mm; PT625 Bosch Gen. 4 / M-0166

FORK FOX 36 Float 29" Performance e-bike 160mm

SHOCK FOX Float DPX2 Performance 3Position 250x70

MOTOR Bosch PERFORMANCE CX Gen. 4 - 25km/h / 75Nm

DISPLAY Bosch KIOX TFT Display with Remote

BATTERY Bosch PowerTUBE 625Wh hor.

CHARGER Bosch FAST Charger 6A

R. DERAILL. Shimano Deore XT M8100-12 SGS shadow+

SHIFTLEV. Shimano Deore XT M8100-12

CRANKSET KTM TEAM ISIS 160mm Q16

CHAINRING Shimano SM-CR80 36T

SPROCKET Shimano SLX M7100-12 / 10-51

CHAIN Shimano SLX M7100-12

BRAKE Shimano Deore XT M8120 4-Piston

ROTOR Shimano MT800 CL 203 / 180 Freeza

WHEEL F KTM E-Team Trail 29 CL 110-15TA 622x30TC TLR made by DT Swiss

WHEEL R KTM E-Team Trail 27 CL 148-12TA 584x35TC TLR made by DT Swiss

TIRE F Maxxis Minion DHF 3C-MaxxTerra/EXO/TR 63-622

TIRE R Maxxis Minion DHR II 3C-MaxxTerra/EXO/TR 70-584

GRIP Ergon GE10 Evo ergonomic

BAR KTM Team Trail35 rizer25 800mm

STEM KTM Team Trail35 Kiox

HEADSET KTM Team angle limit 1.1/8>1.5"

SADDLE Ergon SM10 E-Mountain

SEATPOST FOX Transfer Performance internal

PEDAL MTB-Pedal VP-539 nylon

CATEGORY E4

SYSTEM WEIGHT 144 kg (permissible total weight)

WEIGHT 25.2 kg (without pedals)



black matt (orange)

- 020406103 MACINA KAPOHO 2971 S / 43cm
- 020406108 MACINA KAPOHO 2971 M / 48cm
- 020406113 MACINA KAPOHO 2971 L / 53cm

MACINA

KAPHOHO

2972

PT-CX 6K4

625 WH BATTERY

160 mm REAR

1x12 SHIMANO SLX



FRAME Macina Kapoho Dimmix Alloy6061 SLL-LTE 160mm; PT625 Bosch Gen.4 / M-0166
FORK RockShox 35 gold RL 29" 160mm 15x110
SHOCK FOX Float DPX2 Performance 3Position 250x70
MOTOR Bosch PERFORMANCE CX Gen.4 - 25km/h / 75Nm
DISPLAY Bosch KIOX TFT Display with Remote
BATTERY Bosch PowerTUBE 625Wh hor.
CHARGER Bosch STANDARD Charger 4A
R. DERAILL. Shimano SLX M7100-12 SGS shadow+
SHIFTLEV. Shimano SLX M7100-12
CRANKSET KTM COMP ISIS 160mm Q16
CHAINRING FSA Megatooth steel 36T

SPROCKET Shimano SLX M7100-12 / 10-51
CHAIN Shimano SLX M7100-12
BRAKE Tektro HD-M750/E730 4-Piston
ROTOR Tektro TR203-45 2.3mm CL 203 / 180
WHEEL F KTM Line - Shimano SLX M7110B CL 32H 110-15TA
 Ambrosio E30 Trail 32H 622x30TC
 DT Champion 2.0 black
WHEEL R KTM Line - Shimano SLX M7110B CL 32H 148-12TA
 Ambrosio E30 Trail 32H 584x30TC
 DT Alpine II 2.34 black
TIRE F Maxxis Minion DHF 3C-MaxxTerra EXO/TR 63-622

TIRE R Maxxis Minion DHR II 3C-MaxxTerra EXO/TR 70-584
GRIP Ergon GE10 Evo ergonomic
BAR KTM Team Trail35 rizer25 800mm
STEM KTM Team Trail35 Kiox
HEADSET KTM Team angle limit 1.1/8-1.5"
SADDLE Selle Italia X3 E-Bike flow
SEATPOST KTM Comp dropper internal w/remote
PEDAL MTB-Pedal VP-539 nylon
CATEGORY \blacklozenge E4
SYSTEM WEIGHT 144 kg (permissible total weight)
WEIGHT 25,7 kg (without pedals)



\blacksquare epicgrey matt (black + yellow)

\blacktriangledown 020407103 MACINA KAPOHO 2972 S / 43cm
 \blacktriangledown 020407108 MACINA KAPOHO 2972 M / 48cm
 \blacktriangledown 020407113 MACINA KAPOHO 2972 L / 53cm

MACINA

KAPHOHO

2973

PT-CX 6P4

625 WH BATTERY

160 mm REAR

1x10 SHIMANO DEORE



FRAME Macina Kapoho Dimmix Alloy6061 SLL-LTE 160mm; PT625 Bosch Gen.4 / M-0166
FORK Suntour Zeron 35 coil 29" LOR 150mm 15x110 taper
SHOCK Suntour Tri-Air 3CR 250x70
MOTOR Bosch PERFORMANCE CX Gen.4 - 25km/h / 75Nm
DISPLAY Bosch PURION LCD Display
BATTERY Bosch PowerTUBE 625Wh hor.
CHARGER Bosch STANDARD Charger 4A
R. DERAILL. Shimano Deore M6000-10 GS shadow+
SHIFTLEV. Shimano Deore M6000-10 w/Display

CRANKSET KTM COMP ISIS 160mm Q16
CHAINRING FSA Megatooth steel 34T
SPROCKET Shimano Deore HG500-10 / 11-42
CHAIN Shimano E6090-10 e-bike
BRAKE Shimano MT420 4-Piston
ROTOR Shimano RT64 CL 203 / 180
WHEEL F KTM Line - Shimano Deore M6010B CL 32H 110-15TA
 Ambrosio E30 Trail 32H 622x30TC
 DT Champion 2.0 black
WHEEL R KTM Line - Shimano Deore M6010B CL 32H 148-12TA
 Ambrosio E30 Trail 32H 584x30TC
 DT Alpine II 2.34 black

TIRE F Schwalbe Nobby Nic Perf. TLR 60-622
TIRE R Schwalbe Nobby Nic Perf. TLR 70-584
GRIP KTM Comp Lock
BAR KTM Comp Trail35 rizer15 780mm
STEM KTM Team Trail35
HEADSET KTM Team angle limit 1.1/8-1.5"
SADDLE Selle Italia X3 E-Bike flow
SEATPOST KTM Comp dropper internal w/remote
PEDAL MTB-Pedal VP-195E alloy
CATEGORY \blacklozenge E4
SYSTEM WEIGHT 143 kg (permissible total weight)
WEIGHT 24,7 kg (without pedals)



\blacksquare olive grey matt (black)

\blacktriangledown 020408103 MACINA KAPOHO 2973 S / 43cm
 \blacktriangledown 020408108 MACINA KAPOHO 2973 M / 48cm
 \blacktriangledown 020408113 MACINA KAPOHO 2973 L / 53cm

MACINA

KAPOHO

LTD

PT-CX SP4

500 WH BATTERY

160 mm REAR

1x12 SRAM SX



FRAME Macina Kapoho 27.5" Alloy6061 POP160mm: Bosch Gen.2 / M-8496

FORK RockShox 35 gold RL 29" 160mm 15x110

SHOCK RockShox Monarch RL 200x57

MOTOR Bosch PERFORMANCE CX Gen.2 - 25km/h / 75Nm

DISPLAY Bosch PURION LCD Display

BATTERY Bosch PowerTUBE 500Wh hor.

CHARGER Bosch STANDARD Charger 4A

R. DERAILL. Sram SX Eagle 12speed

SHIFTLEV. Sram SX Eagle E-Click

CRANKSET KTM Delta 160mm (ISIS)

CHAINRING SRAM X-Sync 2 Eagle 16T

SPROCKET Sram SX Eagle PG1210 / 11-50

CHAIN Sram NX Eagle 12s

BRAKE Shimano MT420 4-Piston

ROTOR Shimano RT64 CL 203 / 180

WHEEL F KTM Line - Shimano Deore M6010B CL 32H 110-15TA
Mavic E-XM430 32H 622x30TSS
DT Champion 2.0 black

WHEEL R KTM Line - Shimano Deore M6010B CL 32H 148-12TA
Mavic E-XM435 32H 584x35TSS
DT Alpine II 2.34 black

TIRE F Schwalbe Nobby Nic Perf. TLR 60-622

TIRE R Schwalbe Nobby Nic Perf. TLR 70-584

GRIP KTM Comp Lock

BAR KTM Comp rizer25 740mm

STEM KTM Comp 7°

HEADSET KTM Team drop/in 1.1/8>1.5" +5

SADDLE KTM Line MTB

SEATPOST KTM Comp dropper external w/remote

PEDAL MTB-Pedal VP-195E alloy

CATEGORY E4

SYSTEM WEIGHT 130 kg (permissible total weight)

WEIGHT 23,9 kg (without pedals)



black matt (black+orange glossy)

- 020409101 MACINA KAPOHO LTD XS / 41cm
- 020409103 MACINA KAPOHO LTD S / 43cm
- 020409108 MACINA KAPOHO LTD M / 48cm
- 020409113 MACINA KAPOHO LTD L / 53cm

E-FULLY

NO LIMITS. NO EXCUSES.

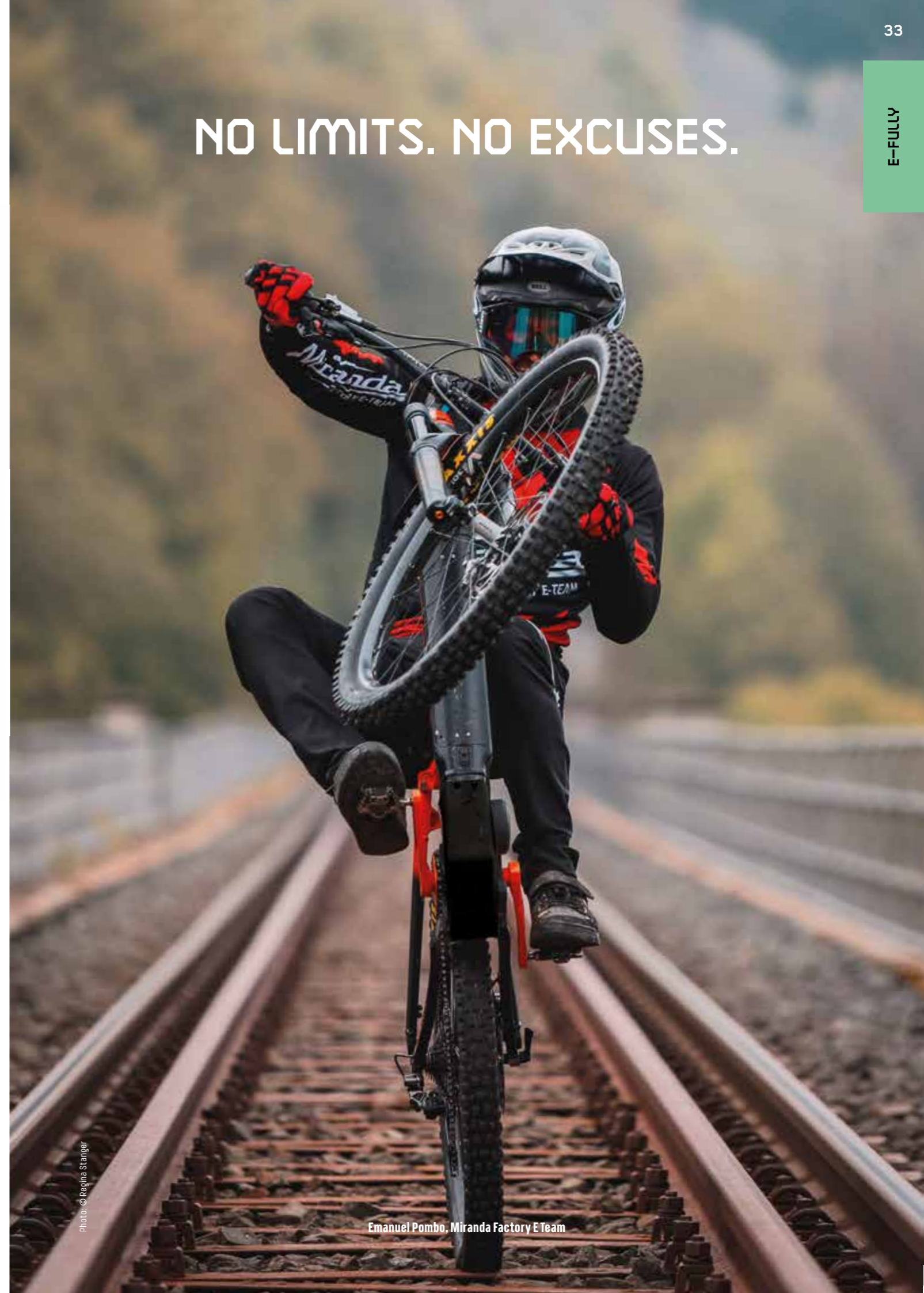

Photo: © Regina Stanger

Emanuel Pombo, Miranda Factory E Team

NEVER. STOP. EXPLORING.

COMFORT
CUT

CROSSOVER
DESIGN

REMOVABLE
INNER PANT



Steeg, Salzkammergut

oberösterreich.at



MACINA

CHACANA

291

PT-CX 6K6

625 WH BATTERY

125 mm REAR

1x12 SHIMANO DEORE XT



FRAME Macina Chacana 29" Alloy6061 SLL-E 125mm; PT625 Bosch Gen. 4 / M-0186

FORK FOX 34 Float 29" Performance e-bike 130mm

SHOCK FOX Float DPS Performance 3Position 230x57.5

MOTOR Bosch PERFORMANCE CX Gen. 4 - 25km/h / 75Nm

DISPLAY Bosch KIOX TFT Display with Remote

BATTERY Bosch PowerTUBE 625Wh hor.

CHARGER Bosch FAST Charger 6A

R. DERAILL. Shimano Deore XT M8100-12 SGS shadow+

SHIFTLEV. Shimano Deore XT M8100-12

CRANKSET KTM TEAM ISIS 170mm Q16

CHAINRING Shimano SM-CR80 38T with Chainguard

SPROCKET Shimano SLX M7100-12 / 10-51

CHAIN Shimano SLX M7100-12

BRAKE Shimano Deore XT M8120 4-Piston

ROTOR Shimano MT800 CL 203 / 180 Freeza

WHEEL F KTM E-Comp Trail 29 CL 110-15TA 622x30TC TLR made by DT Swiss

WHEEL R KTM E-Comp Trail 29 CL 148-12TA 622x30TC TLR made by DT Swiss

TIRE F Schwalbe Racing Ray Evo Snake Skin TLE 60-622

TIRE R Schwalbe Racing Ralph Evo SnakeSkin TLE 60-622

GRIP Ergon GE10 Evo ergonomic

BAR KTM Team rizer15 740mm

STEM KTM Team Kiox

HEADSET KTM Team angle limit 1.1/8-1.5"

SADDLE Ergon SM10 Sport Men

SEATPOST FOX Transfer Performance internal

PEDAL MTB-Pedal VP-197 alloy (light)

CATEGORY E3

SYSTEM WEIGHT 142 kg (permissible total weight)

WEIGHT 23,8 kg (without pedals)



epicgrey matt (black+white)

020410103 MACINA CHACANA 291 S / 43cm

020410108 MACINA CHACANA 291 M / 48cm

020410113 MACINA CHACANA 291 L / 53cm

MACINA

CHACANA

292

PT-CX 6K6

625 WH BATTERY

125 mm REAR

1x12 SHIMANO DEORE XT



FRAME Macina Chacana 29" Alloy6061 SLL-E 125mm; PT625 Bosch Gen.4 / M-0186

FORK FOX 34 Float 29" Rhythm e-bike 130mm

SHOCK FOX Float DPS Performance 3Position 230x57.5

MOTOR Bosch PERFORMANCE CX Gen.4 - 25km/h / 75Nm

DISPLAY Bosch KIOX TFT Display with Remote

BATTERY Bosch PowerTUBE 625Wh hor.

CHARGER Bosch FAST Charger 6A

R. DERAILL. Shimano Deore XT M8100-12 SGS shadow+

SHIFTLEV. Shimano SLX M7100-12

CRANKSET KTM TEAM ISIS 170mm Q16

CHAINRING Shimano SM-CR80 38T with Chainguard

SPROCKET Shimano SLX M7100-12 / 10-51

CHAIN Shimano SLX M7100-12

BRAKE Shimano MT520 4-Piston

ROTOR Shimano RT64 CL 203 / 180

WHEEL F Mavic E-Crossmax 29 CL 110-15TA/622x30TSS TLR

WHEEL R Mavic E-Crossmax 29 CL 148-12TA/622x30TSS TLR

TIRE F Schwalbe Racing Ray Evo SnakeSkin TLE 60-622

TIRE R Schwalbe Racing Ralph Evo SnakeSkin TLE 60-622

GRIP Ergon GE10 Evo ergonomic

BAR KTM Team rizer15 740mm

STEM KTM Team Kiox

HEADSET KTM Team angle limit 1.1/8>1.5"

SADDLE Ergon SM10 Sport Men

SEATPOST KTM Comp dropper internal w/remote

PEDAL MTB-Pedal VP-197 alloy (light)

CATEGORY E3

SYSTEM WEIGHT 143 kg (permissible total weight)

WEIGHT 24,3 kg (without pedals)



■ black matt (white)

- 🔪 020411103 MACINA CHACANA 292 S / 43cm
- 🔪 020411108 MACINA CHACANA 292 M / 48cm
- 🔪 020411113 MACINA CHACANA 292 L / 53cm

MACINA

CHACANA

293

PT-CX 6I4

625 WH BATTERY

125 mm REAR

1x12 SHIMANO SLX



FRAME Macina Chacana 29" Alloy6061 SLL-E 125mm; PT625 Bosch Gen.4 / M-0186

FORK RockShox 35 gold RL 29" 130mm 15x110

SHOCK RockShox Deluxe Select+ 230x57.5

MOTOR Bosch PERFORMANCE CX Gen.4 - 25km/h / 75Nm

DISPLAY Bosch INTUVIA LCD Display with Remote

BATTERY Bosch PowerTUBE 625Wh hor.

CHARGER Bosch STANDARD Charger 4A

R. DERAILL. Shimano SLX M7100-12 SGS shadow+

SHIFTLEV. Shimano SLX M7100-12

CRANKSET KTM TEAM ISIS 170mm Q16

CHAINRING Shimano SM-CR80 38T with Chainguard

SPROCKET Shimano SLX M7100-12 / 10-51

CHAIN Shimano SLX M7100-12

BRAKE Tektro HD-M750/E730 4-Piston

ROTOR Tektro TR203-45 2.3mm CL 203 / 180

WHEEL F KTM Line - Shimano SLX M7110B CL 32H 110-15TA Ambrosio E30 Trail 32H 622x30TC DT Champion 2.0 black

WHEEL R KTM Line - Shimano SLX M7110B CL 32H 148-12TA Ambrosio E30 Trail 32H 622x30TC DT Alpine II 2.34 black

TIRE F Schwalbe Racing Ray Evo SnakeSkin TLE 60-622

TIRE R Schwalbe Racing Ralph Evo SnakeSkin TLE 60-622

GRIP Ergon GE10 Evo ergonomic

BAR KTM Comp rizer15 720mm

STEM KTM Comp 7"

HEADSET KTM Team angle limit 1.1/8>1.5"

SADDLE Ergon SM10

SEATPOST KTM Comp dropper internal w/remote

PEDAL MTB-Pedal VP-195E alloy

CATEGORY E3

SYSTEM WEIGHT 143 kg (permissible total weight)

WEIGHT 24,9 kg (without pedals)



■ space orange (black)

- 🔪 020412103 MACINA CHACANA 293 S / 43cm
- 🔪 020412108 MACINA CHACANA 293 M / 48cm
- 🔪 020412113 MACINA CHACANA 293 L / 53cm

MACINA

CHACANA

294

PT-CX 6P4

625 WH
BATTERY125 mm
REAR1x10 SHIMANO
DEORE

FRAME Macina Chacana 29" Alloy6061 SLL-E 125mm; PT625 Bosch Gen.4 / M-0186

FORK Suntour XCR 34 air 29" LOR 130mm 15x110 taper

SHOCK RockShox Deluxe Select+ 230x57.5

MOTOR Bosch PERFORMANCE CX Gen.4 - 25km/h / 75Nm

DISPLAY Bosch PURION LCD Display

BATTERY Bosch PowerTUBE 625Wh hor.

CHARGER Bosch STANDARD Charger 4A

R. DERAILL. Shimano Deore M6000-10 GS shadow+

SHIFTLEV. Shimano Deore T6000-10 w/Display

CRANKSET KTM COMP ISIS 170mm Q16

CHAINRING FSA Megatooth steel 36T with Chainguard

SPROCKET Shimano Deore HG500-10 / 11-42

CHAIN Shimano E6090-10 e-bike

BRAKE Shimano MT420 4-Piston

ROTOR Shimano RT64 CL 203 / 180

WHEEL F KTM Line - Shimano Deore M6010B CL 32H 110-15TA
Ambrosio E30 Trail 32H 622x30TC
DT Champion 2.0 black

WHEEL R KTM Line - Shimano Deore M6010B CL 32H 148-12TA
Ambrosio E30 Trail 32H 622x30TC
DT Alpine II 2.34 black

TIRE F Schwalbe Nobby Nic Perf. TLR 60-622

TIRE R Schwalbe Nobby Nic Perf. TLR 60-622

GRIP KTM Comp Lock

BAR KTM Comp rizer15 720mm

STEM KTM Comp 7"

HEADSET KTM Team angle limit 1.1/8>1.5"

SADDLE Ergon SM10

SEATPOST KTM Comp 30.9/400

PEDAL MTB-Pedal VP-195E alloy

CATEGORY E3

SYSTEM WEIGHT 143 kg (permissible total weight)

WEIGHT 24,3 kg (without pedals)



■ black matt (orange)

- 🔪 020413103 MACINA CHACANA 294 S / 43cm
- 🔪 020413108 MACINA CHACANA 294 M / 48cm
- 🔪 020413113 MACINA CHACANA 294 L / 53cm

E-FULLY

YOUR ADVENTURE AWAITS.



oberösterreich.at



Hallstättersee

MACINA

CHACANA

LFC



Dein Abenteuer wartet.

Das MACINA CHACANA ist deine tägliche Medizin gegen Fernweh! Der neue, kraftvolle Bosch Performance Line CX Motor der vierten Generation sowie der vollintegrierte Bosch PowerTube 625 Wh Akku, bringen dich selbst durch das

unwegsamste Gelände. 29" Laufräder sowie die 130 mm Federgabel und 125 mm Federweg hinten, sorgen für optimale Fahrstabilität, höchsten Komfort sowie Traktion. Der Hinterbau wurde mit einem hohen Anti-Squat Wert ausgestattet,

was dir auf steilen Uphill-Passagen hilft, die Kontrolle über dein Bike zu behalten. Der ebenfalls hohe Anti-Rise Wert reduziert ein mögliches Überschlagsgefühl beim Bremsen auf steilen Abfahrten. Egal, ob du lieber auf flowigen Single-Trails unterwegs bist, oder entspannt unberührte Natur entdecken möchtest – das MACINA CHACANA bringt dich stets an dein Ziel! LFC ready.

Your adventure awaits.

The MACINA CHACANA is your daily medicine against wanderlust! The new powerful fourth generation Bosch Performance Line CX motor and the fully integrated Bosch PowerTube 625 Wh battery takes you through even

the most difficult terrain. 29" wheels, 130 mm suspension fork and 125 mm rear travel provides optimum driving stability, comfort and traction. The rear triangle is equipped with a high Anti-Squat value, which helps you to

keep control over your bike on steep uphill passages. The high anti-rise value reduces a possible rollover feeling when braking on steep descents. Whether you prefer to ride flowing single trails or want to discover untouched nature in a relaxed way – the MACINA CHACANA always brings you to your destination. LFC ready.



MACINA CHACANA LFC

PT-CX 614

625 WH BATTERY

125 mm REAR

1x11 SHIMANO SLX



FRAME Macina Chacana 29" Alloy 6061 SLL-E 125mm; PT625 Bosch Gen. 4 / M-0186

FORK Suntour XCR 34 air 29" LOR 130mm 15x110 taper

SHOCK RockShox Deluxe Select+ 230x57.5

MOTOR Bosch PERFORMANCE CX Gen. 4 - 25km/h / 75Nm

DISPLAY Bosch INTUVIA LCD Display with Remote

BATTERY Bosch PowerTUBE 625Wh hor.

CHARGER Bosch STANDARD Charger 4A

R. DERAILL. Shimano SLX M7000-11 GS shadow+

SHIFTLEV. Shimano SLX M7000-11 w/Display

CRANKSET KTM COMP ISIS 170mm Q16

CHAINRING FSA Megatooth steel 38T with Chainguard

SPROCKET Shimano SLX M7000-11 / 11-46

CHAIN Shimano E8000-11 e-bike

BRAKE Shimano MT420 4-Piston (3-Finger)

ROTOR Shimano RT64 CL 203 / 180

WHEEL F KTM Line - Shimano Deore M6010B CL 32H 110-15TA Ambrosio E30 Trail 32H 622x30TC DT Champion 2.0 black

WHEEL R KTM Line - Shimano Deore M6010B CL 32H 148-12TA Ambrosio E30 Trail 32H 622x30TC DT Alpine II 2.34 black

TIRE F Schwalbe Smart Sam Perf. 57-622

TIRE R Schwalbe Smart Sam Perf. 57-622

GRIP KTM Comp Ergo Lock

BAR KTM Comp rizer15 720mm

STEM KTM Comp 7°

HEADSET KTM Team angle limit 1.1/8>1.5"

SADDLE Selle Royal Lookin

SEATPOST KTM Comp 30.9/400

PEDAL MTB-Pedal VP-195E alloy

CARRIER Wingee alloy fender- rails (platform option)

LIGHT F B&M Lumotec IQ-XS LED 70Lux

FENDER Racktime Alu 72mm B&M Xeltec

KICKSTAND KTM 28" adjust

CATEGORY E2

SYSTEM WEIGHT 145 kg (permissible total weight)

WEIGHT 26,6 kg (without pedals)



black matt (white)

- 020414103 MACINA CHACANA LFC S / 43cm
- 020414108 MACINA CHACANA LFC M / 48cm
- 020414113 MACINA CHACANA LFC L / 53cm

MACINA

LYCAN 277

GLORY

GEN4
CX

GEN 4 CX

TAPERED
STEERERREMOTE
DROPPER POSTGRAVITY
CASTINGLIGHT
LINKSLL E
125 mmBOOST
148mmINTEGRATED
KICKSTAND MOUNTHYDROFORM
POWERTUBECX
POWERTUBE
625 WH

Der Weg ist das Ziel.

Egal ob Panorama-Runde oder Feierabend Ausfahrt – das MACINA LYCAN ist dein treuer Begleiter jeder Tour. Mit der 140 mm Federgabel und den 140 mm Federweg am Heck liegt sein Einsatzgebiet im All-Mountain-Bereich. Die 27" Bereifung sorgt dabei für die optimale Wendigkeit. Der leistungsstarke Bosch Performance

Line CX Motor der vierten Generation sowie der Bosch PowerTube 625 Wh Akku sind in einem Aluminium Full-Suspension Rahmen der Extraklasse perfekt integriert. Mit dem MACINA LYCAN GLORY gibt es den KTM-Klassiker nun erstmals auch als Damen E-Fully. Die Auswahl der Komponenten wurde hier – in Zusammenarbeit mit Sportlerinnen von BLOOMERS – speziell auf die Bedürfnisse von Frauen angepasst. LFC ready.

The path is the goal.

No matter if you're taking on the trails or going for a quick after work ride – the MACINA LYCAN is your faithful companion on every outing. With the 140 mm suspension fork and the 140 mm travel at the rear, the MACINA

LYCAN is ideal for all-mountain use. Its 27" tyres ensure optimum manoeuvrability. The powerful fourth generation Bosch Performance Line CX motor and the Bosch PowerTube 625 Wh battery are perfectly integrated in a top-class aluminium full suspension frame. With the MACINA LYCAN GLORY, the KTM classic is now also available as a Lady E-Fully for the first time. In cooperation with BLOOMERS sportswomen, the selection of components has been specially adapted to the needs of female riders. LFC ready.

MACINA LYCAN 271

E-FULLY

PT-CX 614

625 WH BATTERY

145 mm REAR

1x12 SHIMANO SLX



LFE
LIGHT FENDER
CARRIER
READY

FRAME Macina Lycan 27.5" Alloy6061 SLL-E 145mm; PT625 Bosch Gen.4 / M-0196
FORK RockShox Recon RL 27.5" 140mm 15x110
SHOCK RockShox Deluxe Select+ 230x62.5
MOTOR Bosch PERFORMANCE CX Gen.4 - 25km/h / 75Nm
DISPLAY Bosch INTUVIA LCD Display with Remote
BATTERY Bosch PowerTUBE 625Wh hor.
CHARGER Bosch STANDARD Charger 4A
R. DERAILL. Shimano SLX M7100-12 SGS shadow+
SHIFTLEV. Shimano SLX M7100-12
CRANKSET KTM COMP ISIS 170mm Q16

CHAINRING Shimano SM-CR80 36T
SPROCKET Shimano SLX M7100-12 / 10-51
CHAIN Shimano SLX M7100-12
BRAKE Shimano MT420 4-Piston
ROTOR Shimano RT64 CL 203 / 180
WHEEL F KTM Line - Shimano SLX M7110B CL 32H 110-15TA
Ambrosio E30 Trail 32H 584x30TC
DT Champion 2.0 black
WHEEL R KTM Line - Shimano SLX M7110B CL 32H 148-12TA
Ambrosio E30 Trail 32H 584x30TC
DT Alpine II 2.34 black

TIRE F Schwalbe Nobby Nic Perf. TLR 65-584
TIRE R Schwalbe Nobby Nic Perf. TLR 65-584
GRIP Ergon GE10 Evo ergonomic
BAR KTM Comp rizer25 740mm
STEM KTM Comp 7°
HEADSET KTM Team angle limit 1.1/8>1.5"
SADDLE Ergon SM10
SEATPOST KTM Comp dropper internal w/remote
PEDAL MTB-Pedal VP-195E alloy
CATEGORY E3
SYSTEM WEIGHT 142 kg (permissible total weight)
WEIGHT 24 kg (without pedals)



■ black matt (orange)
🔪 020415100 MACINA LYCAN 271 XS / 40cm
🔪 020415103 MACINA LYCAN 271 S / 43cm
🔪 020415108 MACINA LYCAN 271 M / 48cm
🔪 020415113 MACINA LYCAN 271 L / 53cm

MACINA LYCAN 271 GLORY

E-FULLY

PT-CX 614

625 WH BATTERY

145 mm REAR

1x12 SHIMANO SLX



LFE
LIGHT FENDER
CARRIER
READY

FRAME Macina Lycan 27.5" Alloy6061 SLL-E 145mm; PT625 Bosch Gen.4 / M-0196
FORK RockShox Recon RL 27.5" 140mm 15x110
SHOCK RockShox Deluxe Select+ 230x62.5
MOTOR Bosch PERFORMANCE CX Gen.4 - 25km/h / 75Nm
DISPLAY Bosch INTUVIA LCD Display with Remote
BATTERY Bosch PowerTUBE 625Wh hor.
CHARGER Bosch STANDARD Charger 4A
R. DERAILL. Shimano SLX M7100-12 SGS shadow+
SHIFTLEV. Shimano SLX M7100-12
CRANKSET KTM COMP ISIS 170mm Q16

CHAINRING Shimano SM-CR80 36T
SPROCKET Shimano SLX M7100-12 / 10-51
CHAIN Shimano SLX M7100-12
BRAKE Shimano MT420 4-Piston
ROTOR Shimano RT64 CL 203 / 180
WHEEL F KTM Line - Shimano SLX M7110B CL 32H 110-15TA
Ambrosio E30 Trail 32H 584x30TC
DT Champion 2.0 black
WHEEL R KTM Line - Shimano SLX M7110B CL 32H 148-12TA
Ambrosio E30 Trail 32H 584x30TC
DT Alpine II 2.34 black

TIRE F Schwalbe Nobby Nic Perf. TLR 65-584
TIRE R Schwalbe Nobby Nic Perf. TLR 65-584
GRIP Ergon GE10 Evo ergonomic
BAR KTM Comp rizer25 740mm
STEM KTM Comp 7°
HEADSET KTM Team angle limit 1.1/8>1.5"
SADDLE Ergon SMA10 Gel Women
SEATPOST KTM Comp dropper internal w/remote
PEDAL MTB-Pedal VP-195E alloy
CATEGORY E3
SYSTEM WEIGHT 142 kg (permissible total weight)
WEIGHT 24 kg (without pedals)



■ lightgrey matt (white+rose)
🔪 020415500 MACINA LYCAN 271 vv XS / 40cm
🔪 020415503 MACINA LYCAN 271 GLORY S / 43cm
🔪 020415508 MACINA LYCAN 271 GLORY M / 48cm
🔪 020415513 MACINA LYCAN 271 GLORY M / 53cm

Inspired by
Bloomers
women in their elements

Erster Bloomers-Design-Thinking-Workshop bei KTM Fahrrad.

FROM WOMEN. FOR WOMEN.



Bereits in zweiter Generation wird KTM Fahrrad von starken Frauen gelenkt.

Johanna Urkauf zieht seit dem Vorjahr die Fäden des Unternehmens und rückte ihrer Mutter, Carol Urkauf-Chen, die in den Aufsichtsrat wechselte, nach.

Auf Frauenpower in der zum großen Teil Männer dominierten Fahrradbranche, setzt KTM auch bei der GLORY LINE. Dafür trafen im vergangenen Sommer beim „Bloomers – Design Thinking Workshop“, die Geschäftsführung, sowie Designer und Entwickler aus dem Hause KTM auf 13 Frauen aus der Szene, um das Thema „WOMEN ON BIKES“ nicht nur zu diskutieren, sondern spezielle Wünsche und Ansprüche, auch umzusetzen.

Das Endergebnis zeigt sich in der neuen GLORY LINE. Die Glory-Räder erstrahlen nicht nur in speziellem Design, sondern warten auch mit technischen Anpassungen. Spezielle Sättel und Griffe, kürzere Vorbauten, oder leichtere Übersetzungen sollen maximalen Fahrspaß garantieren.



NEW KTM GLORY LINE

Inspired by

Bloomers
women in their elements



ANNA WEISS
CO-FOUNDER
BLOOMERS

„Keine Lippenbekenntnisse: KTM bewies, dass es ihnen ernst ist mit den Frauen.“

Die gesamte Geschäftsführung samt aller Verantwortlicher nahm am Workshop teil. Die Offenheit, die Kritikfähigkeit und die ehrliche Neugier, mit der die KTM Manager*innen den Frauen begegneten, ist einzigartig in der Branche.“



Already in second generation, KTM Bike Industries is led by strong women.



Johanna Urkauf followed the footsteps of her mother Carol Urkauf-Chen, and is now at the helm of the company as managing director since last year.

We at KTM are proud to have Johanna Urkauf in charge and it is something quite special in the male dominated bicycle industry. Women's power is also the key word and was a key part in the thinking behind the KTM GLORY LINE. In summer last year, KTM held the Bloomers – Design Thinking Workshop, where the management, as well as designers and developers of KTM, met 13 opinion leading women who hail from the bike scene.

The aim was not only to discuss the topic of "WOMEN ON BIKES", but to realise and implement the special wishes of women as well. From this exciting meeting we can now show you the results in the new GLORY LINE: with different designs and technical adjustments like special saddles, grips, shorter stems or lighter gear ratios, we feel we have created a range of bikes women will love to ride. With comfort and design at the heart of this line, we hope all women of the world will be inspired to ride a KTM Glory.





"Small differences with a huge impact!"



"I attach particular importance to unique colouring and adapted geometry!"



"Perfectly matched specifications guarantee optimum riding pleasure!"



"In competition I can rely on my KTM bike. It has the ability to be dependable, aggressive and smooth!"



CORINA DRUML
KTM FACTORY TEAM



ANNA SPIELMANN
KTM FACTORY TEAM



ANGELIKA TANZREITER
KTM FACTORY TEAM



KATHARINA SADNIK
& HER SISTER THERESA



MACINA
LYCAN 271 GLORY
SLX 1*12
47



MACINA
LYCAN 272 GLORY
DEORE 1*10
52



MACINA
TEAM 292 GLORY
SLX 1*11
61



MACINA
RACE 271 GLORY
DEORE 1*10
66

MACINA

LYCAN

272 GLORY



PT-CX 6P4

625 WH BATTERY

145 mm REAR

1x10 SHIMANO DEORE



FRAME Macina Lycan 27.5" Alloy6061 SLL-E 145mm: PT625 Bosch Gen.4 / M-0196

FORK Suntour XCR 34 air 29" LOR 140mm 15x110 taper

SHOCK RockShox Deluxe Select+ 230x62.5

MOTOR Bosch PERFORMANCE CX Gen.4 - 25km/h / 75Nm

DISPLAY Bosch PURION LCD Display

BATTERY Bosch PowerTUBE 625Wh hor.

CHARGER Bosch STANDARD Charger 4A

R. DERAILL. Shimano Deore M6000-10 GS shadow+

SHIFTLEV. Shimano Deore M6000-10 w/Display

CRANKSET KTM COMP ISIS 170mm Q16

CHAINRING FSA Megatooth steel 34T

SPROCKET Shimano Deore HG500-10 / 11-42

CHAIN Shimano E6090-10 e-bike

DRAKE Shimano MT420 4-Piston

ROTOR Shimano RT64 CL 203 / 180

WHEEL F KTM Line - Shimano Deore M6010B CL 32H 110-15TA
Ambrosio E30 Trail 32H 584x30TC
DT Champion 2.0 black

WHEEL R KTM Line - Shimano Deore M6010B CL 32H 148-12TA
Ambrosio E30 Trail 32H 584x30TC
DT Alpine II 2.34 black

TIRE F Schwalbe Nobby Nic Perf. TLR 65-584

TIRE R Schwalbe Nobby Nic Perf. TLR 65-584

GRIP KTM Comp Ergo Lock

BAR KTM Comp rizer25 740mm

STEM KTM Comp 7"

HEADSET KTM Team angle limit 1.1/8-1.5"

SADDLE Selle Italia X3 XP Lady

SEATPOST KTM Comp 30.9/400

PEDAL MTB-Pedal VP-195E alloy

CATEGORY E3

SYSTEM WEIGHT 143 kg (permissible total weight)

WEIGHT 24,2 kg (without pedals)



■ deeppurple (seafoam green)

- 🔪 020416100 MACINA LYCAN 272 GLORY XS / 40cm
- 🔪 020416103 MACINA LYCAN 272 GLORY S / 43cm
- 🔪 020416108 MACINA LYCAN 272 GLORY M / 48cm
- 🔪 020416113 MACINA LYCAN 272 GLORY L / 53cm

Inspired by

Bloomers
women in their elements

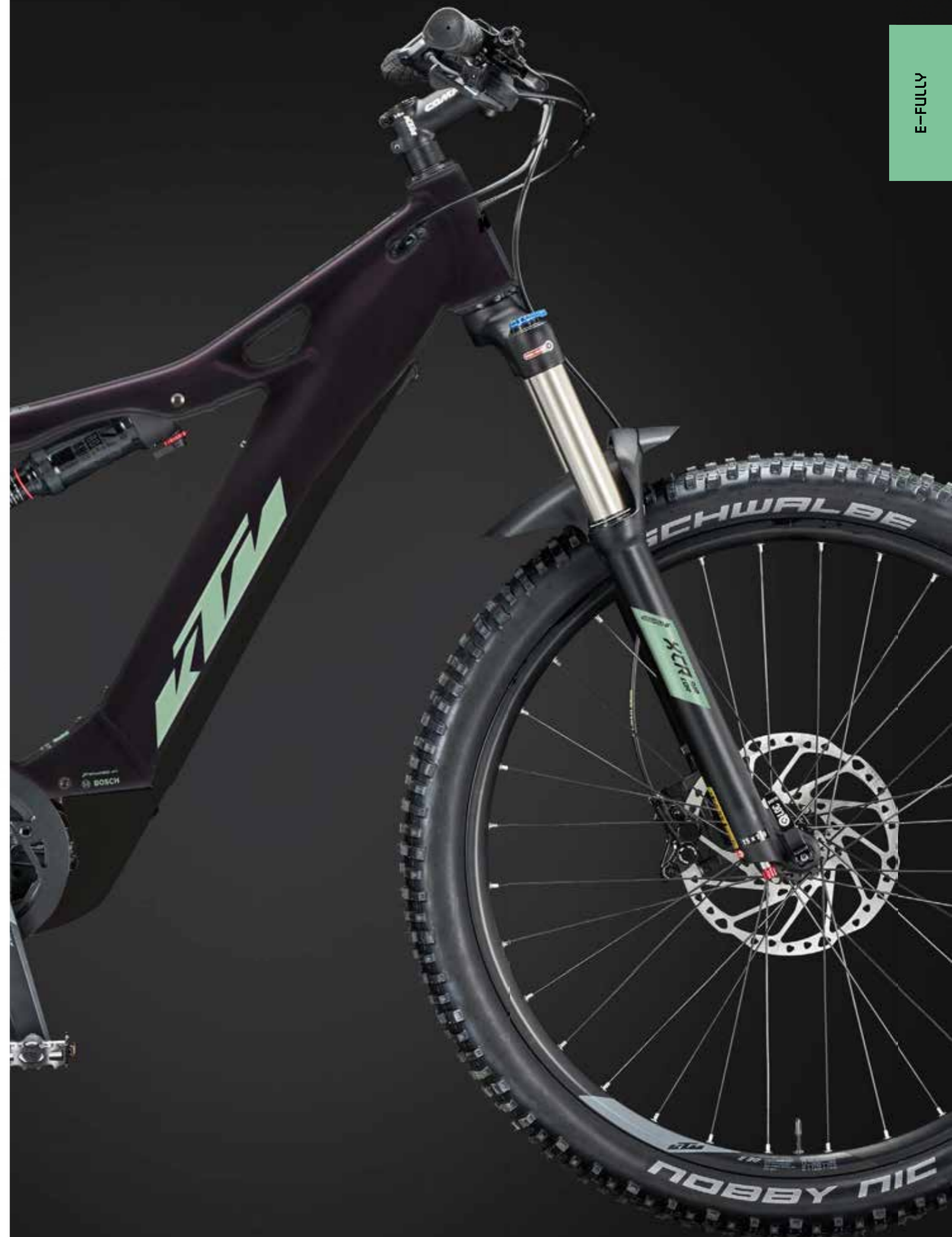



MACINA TEAM / RACE



MACINA
TEAM 291
SLX 1*12 56-59



MACINA
TEAM 292
SLX 1*11 60



MACINA
TEAM 292 GLORY
SLX 1*11 61



MACINA
TEAM XL
SLX 1*11 62



MACINA
TEAM LFC
SLX 1*11 63



MACINA
RACE 291
DEORE 1*10 64



MACINA
RACE 271
DEORE 1*10 65



MACINA
RACE 271 GLORY
DEORE 1*10 66

MACINA ACTION / RIDE



MACINA
ACTION 291
ALIVIO 1*9 68



MACINA
ACTION 271
ALIVIO 1*9 69



MACINA
RIDE 291
ACERA 1*9 70



MACINA
RIDE 271
ACERA 1*9 71

MACINA MINI ME



MACINA
MINI ME 241
ALTUS 1*9 72-75

MACINA SCOUT



MACINA
SCOUT 271
SLX 1*12 76



MACINA
SCOUT 272
DEORE 1*10 77



MACINA
SCOUT 271 LFC
SLX 1*12 78



MACINA
SCOUT 272 LFC
DEORE 1*10 79

MACINA

TEAM

291

GRAVITY
CASTINGLIGHT
LINKKIOX
DISPLAYHYDROFORM
POWERTUBECX POWERTUBE
625 WHINTEGRATED
KICKSTAND MOUNT

Eröffnet neue Möglichkeiten.

Mit dem "eRace" stellte KTM im Jahr 2009 erstmals ein Offroad-taugliches E-Bike vor und gilt seither in Sachen elektrisch angetriebenen Geländesport als Pionier. Elf Jahre später präsentieren wir euch nun unser neues Top-of-the-line E-Hardtill: das MACINA TEAM! Ausgestattet mit dem neuen, gewichtsreduzierten Bosch Performance Line CX Motor der vierten Generation sowie dem

schlanken und vollintegrierten Bosch PowerTube 625 Wh Akku, lässt dich der KTM-Newcomer von Almhütte zu Almhütte oder durch die Wälder jagen. Neben bewährten Technologien wie Gravity Casting, verbessert speziell die neuentwickelte Motoraufhängung die Steifigkeit des Rahmens enorm. Das MACINA TEAM ist dein unkomplizierter und zuverlässiger Partner für sportlich ausgelegte Touren im leichten Gelände sowie auf Wald- und Schotterwegen. Natürlich LFC ready.

Enables new possibilities.

With the "eRace" in 2009, KTM introduced an offroad-capable E-Bike for the first time and have been a pioneer in the field of electrically powered off-road sports ever since. Eleven years later, we now present you our new top-of-the-line E-Hardtill: the MACINA TEAM! Equipped with the new, weight-reduced Bosch Performance Line CX motor of the fourth generation and the slim and fully integrated Bosch PowerTube 625

Wh battery, the KTM newcomer lets you chase from alpine hut to alpine hut and through the most technical woodland. In addition, technologies such as Gravity Casting, the newly developed motor suspension improves the rigidity of the frame enormously. The MACINA TEAM is your uncomplicated and reliable partner for sporty tours in easy terrain such as forest and gravel paths. LFC ready.

HUNTS YOU THROUGH THE WOODS.



Raschberg, Salzkammergut

oberösterreich.at



MACINA TEAM 291

PT-CX 6K4

625 WH BATTERY

1x12 SHIMANO SLX



FRAME Macina MTB 29" Alloy6061; PT625Wh Bosch Gen.4 / M-0666
FORK FOX 32 Float 29" Rhythm e-bike 120mm
MOTOR Bosch PERFORMANCE CX Gen.4 - 25km/h / 75Nm
DISPLAY Bosch KIOX TFT Display with Remote
BATTERY Bosch PowerTUBE 625Wh hor.
CHARGER Bosch STANDARD Charger 4A
R. DERAILL. Shimano SLX M7100-12 SGS shadow+
SHIFTLEU. Shimano SLX M7100-12
CRANKSET KTM TEAM ISIS 170mm Q16
CHAINRING Shimano SM-CR80 38T with Chainguard

SPROCKET Shimano SLX M7100-12 / 10-51
CHAIN Shimano SLX M7100-12
BRAKE Shimano MT420 4-Piston
ROTOR Shimano RT64 CL 180 / 180
WHEEL F KTM Line - Shimano SLX M7110B CL 32H 110-15TA
 Ambrosio E30 Trail 32H 622x30TC
 DT Champion 2.0 black
WHEEL R KTM Line - Shimano SLX M7110B CL 32H 148-12TA
 Ambrosio E30 Trail 32H 622x30TC
 DT Alpine II 2.34 black
TIRE F Schwalbe Nobby Nic Perf. TLR 60-622

TIRE R Schwalbe Nobby Nic Perf. TLR 60-622
GRIP Ergon GE10 Evo ergonomic
DAR KTM Team flat 2X 720mm
STEM KTM Team Kiox
HEADSET KTM Team angle limit 1.1/8-1.5"
SADDLE Ergon SM10
SEATPOST KTM Team 30.9/400
PEDAL MTB-Pedal VP-195E alloy
CATEGORY E3
SYSTEM WEIGHT 140 kg (permissible total weight)
WEIGHT 22.1 kg (without pedals)



black matt (white)

020420103 MACINA TEAM 291 S / 43cm

020420108 MACINA TEAM 291 M / 48cm

020420113 MACINA TEAM 291 L / 53cm

MACINA TEAM 292

E-HARDTAIL

PT-CX 614

625 WH BATTERY

1×11 SHIMANO SLX



LFE
LIGHT FENDER
CARRIER
READY

FRAME Macina MTB 29" Alloy6061; PT625Wh Bosch Gen.4 / M-0666
FORK RockShox Recon RL 29" 120mm 15x110
MOTOR Bosch PERFORMANCE CX Gen.4 - 25km/h / 75Nm
DISPLAY Bosch INTUVIA LCD Display with Remote
BATTERY Bosch PowerTUBE 625Wh hor.
CHARGER Bosch STANDARD Charger 4A
R. DERAILL. Shimano SLX M7000-11 GS shadow+
SHIFTLEV. Shimano SLX M7000-11 w/Display
CRANKSET KTM COMP ISIS 170mm Q16
CHAINRING FSA Megatooth steel 38T with Chainguard

SPROCKET Shimano SLX M7000-11 / 11-46
CHAIN Shimano E8000-11 e-bike
BRAKE Shimano MT420 4-Piston
ROTOR Shimano RT54 CL 180 / 180
WHEEL F KTM Line - Shimano Deore M6010B CL 32H 110-15TA Ambrosio E30 Trail 32H 622x30TC DT Champion 2.0 black
WHEEL R KTM Line - Shimano Deore M6010B CL 32H 148-12TA Ambrosio E30 Trail 32H 622x30TC DT Alpine II 2.34 black
TIRE F Schwalbe Nobby Nic Perf. TLR 60-622

TIRE R Schwalbe Nobby Nic Perf. TLR 60-622
GRIP KTM Comp Lock
BAR KTM Comp flat 2X 720mm
STEM KTM Comp 7°
HEADSET KTM Team angle limit 1.1/8>1.5"
SADDLE KTM Line MTB
SEATPOST KTM Comp 30.9/400
PEDAL MTB-Pedal VP-195E alloy
CATEGORY E3
SYSTEM WEIGHT 141 kg (permissible total weight)
WEIGHT 22.7 kg (without pedals)



black matt (orange glossy)

- 🔗 020421103 MACINA TEAM 292 S / 43cm
- 🔗 020421108 MACINA TEAM 292 M / 48cm
- 🔗 020421113 MACINA TEAM 292 L / 53cm

MACINA TEAM 292 GLORY

E-HARDTAIL

PT-CX 614

625 WH BATTERY

1×11 SHIMANO SLX



LFE
LIGHT FENDER
CARRIER
READY

FRAME Macina MTB 29" Alloy6061; PT625Wh Bosch Gen.4 / M-0666
FORK RockShox Recon RL 29" 120mm 15x110
MOTOR Bosch PERFORMANCE CX Gen.4 - 25km/h / 75Nm
DISPLAY Bosch INTUVIA LCD Display with Remote
BATTERY Bosch PowerTUBE 625Wh hor.
CHARGER Bosch STANDARD Charger 4A
R. DERAILL. Shimano SLX M7000-11 GS shadow+
SHIFTLEV. Shimano SLX M7000-11 w/Display
CRANKSET KTM COMP ISIS 170mm Q16
CHAINRING FSA Megatooth steel 38T with Chainguard

SPROCKET Shimano SLX M7000-11 / 11-46
CHAIN Shimano E8000-11 e-bike
BRAKE Shimano MT420 4-Piston
ROTOR Shimano RT54 CL 180 / 180
WHEEL F KTM Line - Shimano Deore M6010B CL 32H 110-15TA Ambrosio E30 Trail 32H 622x30TC DT Champion 2.0 black
WHEEL R KTM Line - Shimano Deore M6010B CL 32H 148-12TA Ambrosio E30 Trail 32H 622x30TC DT Alpine II 2.34 black
TIRE F Schwalbe Nobby Nic Perf. TLR 60-622

TIRE R Schwalbe Nobby Nic Perf. TLR 60-622
GRIP KTM Comp Ergo Lock
BAR KTM Comp flat 2X 700mm
STEM KTM Comp 7°
HEADSET KTM Team angle limit 1.1/8>1.5"
SADDLE KTM Line MTB Lady
SEATPOST KTM Comp 30.9/400
PEDAL MTB-Pedal VP-195E alloy
CATEGORY E3
SYSTEM WEIGHT 141 kg (permissible total weight)
WEIGHT 22.7 kg (without pedals)



eveblue (mandarin)

- 🔗 020421530 MACINA TEAM 292 GLORY XS / 38cm
- 🔗 020421533 MACINA TEAM 292 GLORY S / 43cm
- 🔗 020421538 MACINA TEAM 292 GLORY M / 48cm

Inspired by

Bloomers
women in their elements

MACINA TEAM XL

E-HARDTAIL



PT-CX 614

625 WH BATTERY

1x11 SHIMANO SLX

FRAME Macina MTB 29" Alloy6061; PT625Wh Bosch Gen.4 / M-0666

FORK Suntour XCR 34 air 29" LOR 120mm 15x110 taper

MOTOR Bosch PERFORMANCE CX Gen.4 - 25km/h / 75Nm

DISPLAY Bosch INTUVIA LCD Display with Remote

BATTERY Bosch PowerTUBE 625Wh hor.

CHARGER Bosch STANDARD Charger 4A

R. DERAILL. Shimano SLX M7000-11 GS shadow+

SHIFTLEV. Shimano SLX M7000-11 w/Display

CRANKSET KTM COMP ISIS 170mm Q16

CHAINRING FSA Megatooth steel 38T with Chainguard

SPROCKET Shimano SLX M7000-11 / 11-46

CHAIN Shimano E8000-11 e-bike

BRAKE Tektro HD-M750/E730 4-Piston

ROTOR Tektro TR203-17 2.3mm 6L 203 / 180

WHEEL F KTM Line - DT Swiss 370 6bolt 32H 110-15TA Ryde Andra40 Disc 32H 622x25C DT Alpine II 2.34 black

WHEEL R KTM Line - DT Swiss 370 6bolt 32H 148-12TA Ryde Andra40 Disc 32H 622x25C DT Alpine II 2.34 black

TIRE F Schwalbe Smart Sam Plus Perf. DD GreenGuard 57-622

TIRE R Schwalbe Smart Sam Plus Perf.

GRIP DD GreenGuard 57-622

BAR Ergon GE10 Evo ergonomic

STEM Ergotec low rizer GH15 Savety 740mm

HEADSET Ergotec Piranha2 6"

SADDLE KTM Team angle limit 1.1/8>1.5"

SEATPOST Selle Royal Viaggio

PEDAL Ergotec Skalar 30.9/400

CATEGORY MTB-Pedal VP-195E alloy

SYSTEM WEIGHT E3

WEIGHT 165 kg (permissible total weight)
24,8 kg (without pedals)



■ black matt (white glossy)

- 🔗 020422103 MACINA TEAM XL S / 43cm
- 🔗 020422108 MACINA TEAM XL M / 48cm
- 🔗 020422113 MACINA TEAM XL L / 53cm
- 🔗 020422117 MACINA TEAM XL XL / 57cm

MACINA TEAM LFC

E-HARDTAIL



PT-CX 614

625 WH BATTERY

1x11 SHIMANO SLX

FRAME Macina MTB 29" Alloy6061; PT625Wh Bosch Gen.4 / M-0666

FORK Suntour XCR 34 air 29" LOR 120mm 15x110 taper

MOTOR Bosch PERFORMANCE CX Gen.4 - 25km/h / 75Nm

DISPLAY Bosch INTUVIA LCD Display with Remote

BATTERY Bosch PowerTUBE 625Wh hor.

CHARGER Bosch STANDARD Charger 4A

R. DERAILL. Shimano SLX M7000-11 GS shadow+

SHIFTLEV. Shimano SLX M7000-11 w/Display

CRANKSET KTM COMP ISIS 170mm Q16

CHAINRING FSA Megatooth steel 38T with Chainguard

SPROCKET Shimano SLX M7000-11 / 11-46

CHAIN Shimano E8000-11 e-bike

BRAKE Shimano MT420 4-Piston (3-Finger)

ROTOR Shimano RT54 CL 180 / 180

WHEEL F KTM Line - Shimano Deore M6010B CL 32H 110-15TA Ambrosio Sport Disc 32H 622x23C DT Champion 2.0 black

WHEEL R KTM Line - Shimano Deore M6010B CL 32H 148-12TA Ambrosio Sport Disc 32H 622x23C DT Alpine II 2.34 black

TIRE F Schwalbe Smart Sam Perf. 57-622

TIRE R Schwalbe Smart Sam Perf. 57-622

GRIP KTM Comp Ergo Lock

BAR KTM Comp rizer15 680mm

STEM KTM Comp 7"

HEADSET KTM Team angle limit 1.1/8>1.5"

SADDLE Selle Royal Lookin

SEATPOST KTM Comp 30.9/400

PEDAL MTB-Pedal VP-195E alloy

CARRIER Wingee alloy fender- plattform (snap-it)

LIGHT F B&M Lumotec IQ-XS LED 70Lux

FENDER Racktime Alu 72mm B&M Xeltec

KICKSTAND Hebie 28" adjust

CATEGORY E2

SYSTEM WEIGHT 144 kg (permissible total weight)

WEIGHT 25,2 kg (without pedals)



■ black matt (black glossy)

- 🔗 020423103 MACINA TEAM LFC S / 43cm
- 🔗 020423108 MACINA TEAM LFC M / 48cm
- 🔗 020423113 MACINA TEAM LFC L / 53cm

MACINA RACE 291

E-HARDTAIL

PT-CX 512

500 WH BATTERY

1×10 SHIMANO DEORE



LFE
LIGHT FENDER
CARRIER
READY

FRAME Macina MTB 29" Alloy6061; PT500Wh Bosch Gen.4 / M-0766
FORK Suntour XCM 34 coil 29" NLO 100mm 15x110 taper
MOTOR Bosch PERFORMANCE CX Gen.4 - 25km/h / 75Nm
DISPLAY Bosch INTUVIA LCD Display with Remote
BATTERY Bosch PowerTUBE 500Wh hor.
CHARGER Bosch COMPACT Charger 2A
R. DERAILL. Shimano Deore M6000-10 GS shadow+
SHIFTLEV. Shimano Deore M6000-10 w/Display
CRANKSET KTM COMP ISIS 170mm Q16

CHAINRING FSA Megatooth steel 36T with Chainguard
SPROCKET Shimano Deore HG500-10 / 11-42
CHAIN Shimano E6090-10 e-bike
BRAKE Shimano MT420 4-Piston
ROTOR Shimano RT30 CL 180 / 180
WHEEL F KTM Line - Shimano MT400B CL 32H 110-15TA Ambrosio Sport Disc 32H 622x23C DT Champion 2.0 black
WHEEL R KTM Line - Shimano Deore M6010B CL 32H 148-12TA Ambrosio Sport Disc 32H 622x23C DT Alpine II 2.34 black
TIRE F Schwalbe Smart Sam K-Guard 57-622

TIRE R Schwalbe Smart Sam K-Guard 57-622
GRIP KTM Comp Lock
BAR KTM Comp flat 2X 720mm
STEM KTM Comp 7"
HEADSET KTM Team drop/in 1.1/8"-1.5" +5
SADDLE KTM Line MTB
SEATPOST KTM Comp 30.9/400
PEDAL MTB-Pedal VP-195E alloy
CATEGORY E3
SYSTEM WEIGHT 141 kg (permissible total weight)
WEIGHT 22.9 kg (without pedals)



■ black matt (orange)

- 🔗 020424103 MACINA RACE 291 S / 43cm
- 🔗 020424108 MACINA RACE 291 M / 48cm
- 🔗 020424113 MACINA RACE 291 L / 53cm

MACINA RACE 271

E-HARDTAIL

PT-CX 512

500 WH BATTERY

1×10 SHIMANO DEORE



LFE
LIGHT FENDER
CARRIER
READY

FRAME Macina MTB 27.5" Alloy6061; PT500Wh Bosch Gen.4 / M-0776
FORK Suntour XCM 34 coil 27.5" NLO 100mm 15x110 taper
MOTOR Bosch PERFORMANCE CX Gen.4 - 25km/h / 75Nm
DISPLAY Bosch INTUVIA LCD Display with Remote
BATTERY Bosch PowerTUBE 500Wh hor.
CHARGER Bosch COMPACT Charger 2A
R. DERAILL. Shimano Deore M6000-10 GS shadow+
SHIFTLEV. Shimano Deore M6000-10 w/Display
CRANKSET KTM COMP ISIS 170mm Q16

CHAINRING FSA Megatooth steel 36T with Chainguard
SPROCKET Shimano Deore HG500-10 / 11-42
CHAIN Shimano E6090-10 e-bike
BRAKE Shimano MT420 4-Piston
ROTOR Shimano RT30 CL 180 / 180
WHEEL F KTM Line - Shimano MT400B CL 32H 110-15TA Ambrosio Sport Disc 32H 584x23C DT Champion 2.0 black
WHEEL R KTM Line - Shimano Deore M6010B CL 32H 148-12TA Ambrosio Sport Disc 32H 584x23C DT Alpine II 2.34 black

TIRE F Schwalbe Smart Sam K-Guard 57-584
TIRE R Schwalbe Smart Sam K-Guard 57-584
GRIP KTM Comp Lock
BAR KTM Comp rizer15 680mm
STEM KTM Comp 7"
HEADSET KTM Team drop/in 1.1/8"-1.5" +10
SADDLE KTM Line MTB
SEATPOST KTM Comp 30.9/350
PEDAL MTB-Pedal VP-195E alloy
CATEGORY E3
SYSTEM WEIGHT 141 kg (permissible total weight)
WEIGHT 22.5 kg (without pedals)



■ black matt (orange)

- 🔗 020425100 MACINA RACE 271 XS / 38cm
- 🔗 020425103 MACINA RACE 271 S / 43cm
- 🔗 020425108 MACINA RACE 271 M / 48cm

MACINA

RACE

271 GLORY



PT-CX 512

500 WH BATTERY

1x10 SHIMANO DEORE



FRAME Macina MTB 27.5" Alloy6061: PT500Wh Bosch Gen.4 / M-0776

FORK Suntour XCM 34 coil 27.5" NLO 100mm 15x110 taper

MOTOR Bosch PERFORMANCE CX Gen.4 - 25km/h / 75Nm

DISPLAY Bosch INTUVIA LCD Display with Remote

BATTERY Bosch PowerTUBE 500Wh hor.

CHARGER Bosch COMPACT Charger 2A

R. DERAILL. Shimano Deore M6000-10 GS shadow+

SHIFTLEV. Shimano Deore M6000-10 w/Display

CRANKSET KTM COMP ISIS 170mm Q16

CHAINRING FSA Megatooth steel 36T with Chainguard

SPROCKET Shimano Deore HG500-10 / 11-42

CHAIN Shimano E8090-10 e-bike

BRAKE Shimano MT420 4-Piston

ROTOR Shimano RT30 CL 180 / 180

WHEEL F KTM Line - Shimano MT400B CL 32H 110-15TA Ambrosio Sport Disc 32H 584x23C DT Champion 2.0 black

WHEEL R KTM Line - Shimano Deore M6010B CL 32H 148-12TA Ambrosio Sport Disc 32H 584x23C DT Alpine II 2.34 black

TIRE F Schwalbe Smart Sam K-Guard 57-584

TIRE R Schwalbe Smart Sam K-Guard 57-584

GRIP KTM Comp Ergo Lock

BAR KTM Comp rizer15 680mm

STEM KTM Comp 7°

HEADSET KTM Team drop/in 1.1/8>1.5" +10

SADDLE KTM Line MTB Lady

SEATPOST KTM Comp 30.9/350

PEDAL MTB-Pedal VP-195E alloy

CATEGORY E3

SYSTEM WEIGHT 141 kg (permissible total weight)

WEIGHT 22.5 kg (without pedals)



■ deeppurple (white)

📍 020425130 MACINA RACE 271 GLORY XS / 38cm

📍 020425133 MACINA RACE 271 GLORY S / 43cm

📍 020425138 MACINA RACE 271 GLORY M / 48cm

Inspired by

Bloomers
women in their elements

COMFORT CUT

WIDE COMFORTABLE WAISTBAND

ERGONOMIC LADY PAD

ZIP POCKET



oberösterreich.at



Raschberg, Salzkammergut

MACINA

ACTION

291

UC-CX5P2

500 WH BATTERY

1x9 SHIMANO ALIVIO



FRAME Macina MTB 29" Alloy6061 MC; UC-PP500Wh Bosch Gen.4 / M-0626

FORK Suntour XCM 34 coil 29" NLO 100mm 15x110 taper

MOTOR Bosch PERFORMANCE CX Gen.4 - 25km/h / 75Nm

DISPLAY Bosch PURION LCD Display

BATTERY Bosch PowerPACK 500Wh

CHARGER Bosch COMPACT Charger 2A

R. DERAILL. Shimano Alivio M4000-9 SGS shadow

SHIFTLEV. Shimano Altus M2010-9 w/Display

CRANKSET KTM COMP ISIS 170mm Q16

CHAINRING FSA Megatooth steel 42T

SPROCKET Shimano HG200-9 / 11-36

CHAIN Shimano E6070-9 e-bike

BRAKE Shimano MT200 2-Piston

ROTOR Shimano RT30 CL 180 / 180

WHEEL F KTM Line - Shimano MT400B CL 32H 110-15TA Ambrosio Sport Disc 32H 622x23C DT Champion 2.0 black

WHEEL R KTM Line - Shimano Deore M6010B CL 32H 148-12TA Ambrosio Sport Disc 32H 622x23C DT Alpine II 2.34 black

TIRE F Schwalbe Smart Sam K-Guard 57-622

TIRE R Schwalbe Smart Sam K-Guard 57-622

GRIP KTM Comp Lock

BAR KTM Comp flat 2X 720mm

STEM KTM Comp 7°

HEADSET KTM Team drop/in 1.1/8>1.5" +5

SADDLE KTM Line MTB

SEATPOST KTM Comp 30.9/400

PEDAL MTB-Pedal VP-195E alloy

CATEGORY E3

SYSTEM WEIGHT 140 kg (permissible total weight)

WEIGHT 21.7 kg (without pedals)



black matt (black+orange glossy)

- 020426103 MACINA ACTION 291 S / 43cm black matt
- 020426108 MACINA ACTION 291 M / 48cm black matt
- 020426113 MACINA ACTION 291 L / 53cm black matt

MACINA

ACTION

271

UC-CX5P2

500 WH BATTERY

1x9 SHIMANO ALIVIO



FRAME Macina MTB 27.5" Alloy6061 MC; UC-PP500Wh Bosch Gen.4 / M-0626

FORK Suntour XCM 34 coil 27.5" NLO 100mm 15x110 taper

MOTOR Bosch PERFORMANCE CX Gen.4 - 25km/h / 75Nm

DISPLAY Bosch PURION LCD Display

BATTERY Bosch PowerPACK 500Wh

CHARGER Bosch COMPACT Charger 2A

R. DERAILL. Shimano Alivio M4000-9 SGS shadow

SHIFTLEV. Shimano Altus M2010-9 w/Display

CRANKSET KTM COMP ISIS 170mm Q16

CHAINRING FSA Megatooth steel 42T

SPROCKET Shimano HG200-9 / 11-36

CHAIN Shimano E6070-9 e-bike

BRAKE Shimano MT200 2-Piston

ROTOR Shimano RT30 CL 180 / 180

WHEEL F KTM Line - Shimano MT400B CL 32H 110-15TA Ambrosio Sport Disc 32H 622x23C DT Champion 2.0 black

WHEEL R KTM Line - Shimano Deore M6010B CL 32H 148-12TA Ambrosio Sport Disc 32H 622x23C DT Alpine II 2.34 black

TIRE F Schwalbe Smart Sam K-Guard 57-584

TIRE R Schwalbe Smart Sam K-Guard 57-584

GRIP KTM Comp Lock

BAR KTM Comp rizer15 680mm

STEM KTM Comp 7°

HEADSET KTM Team drop/in 1.1/8>1.5" +10

SADDLE KTM Line MTB

SEATPOST KTM Comp 30.9/350

PEDAL MTB-Pedal VP-195E alloy

CATEGORY E3

SYSTEM WEIGHT 140 kg (permissible total weight)

WEIGHT 21.6 kg (without pedals)



black matt (black+orange glossy)

- 020427100 MACINA ACTION 271 XS / 38cm
- 020427103 MACINA ACTION 271 S / 43cm
- 020427108 MACINA ACTION 271 M / 48cm

MACINA

RIDE

291

UC-A+SP2

500 WH BATTERY

1x9 SHIMANO ACERA



FRAME Macina MTB 29" Alloy6061; UC-PP500Wh Bosch Gen.3 / M-9680

FORK Suntour XCM-ATB coil 29" NLO 100mm

MOTOR Bosch ACTIVE PLUS Gen.3 - 25km/h / 50Nm

DISPLAY Bosch PURION LCD Display

BATTERY Bosch PowerPACK 500Wh

CHARGER Bosch COMPACT Charger 2A

R. DERAILL. Shimano Acera M3000-9 SGS shadow

SHIFTLEV. Shimano Altus M2010-9 w/Display

CRANKSET KTM COMP BNI 170mm Q16

CHAINRING FSA steel 38T with Chainguard

SPROCKET Shimano HG200-9 / 11-36

CHAIN Shimano E6070-9 e-bike

BRAKE Shimano MT200 2-Piston

ROTOR Shimano RT30 CL 180 / 180

WHEEL F KTM Line - Shimano Acera M3050 CL 32H 100-5QR
Ambrosio Sport Disc 32H 622x23C
DT Champion 2.0 silver

WHEEL R KTM Line - Shimano Acera M3050 CL 32H 135-5QR
Ambrosio Sport Disc 32H 622x23C
DT Alpine II 2.34 silver

TIRE F Schwalbe Smart Sam K-Guard 57-622

TIRE R Schwalbe Smart Sam K-Guard 57-622

GRIP KTM Comp Lock

BAR KTM Comp rizer15 680mm

STEM KTM Comp 7°

HEADSET Ritchey OE Logic Zero 1.1/8"

SADDLE KTM Line MTB

SEATPOST KTM Comp 30.9/400

PEDAL MTB-Pedal C280DU alloy

CATEGORY E2

SYSTEM WEIGHT 141 kg (permissible total weight)

WEIGHT 22,3 kg (without pedals)



epicgrey matt (black + orange)

- 🔪 020428103 MACINA RIDE 291 S / 43cm
- 🔪 020428108 MACINA RIDE 291 M / 48cm
- 🔪 020428113 MACINA RIDE 291 L / 53cm

MACINA

RIDE

271

UC-A+SP2

500 WH BATTERY

1x9 SHIMANO ACERA



FRAME Macina MTB 27,5" Alloy6061; UC-PP500Wh Bosch Gen.3 / M-9690

FORK Suntour XCM-ATB coil 27,5" NLO 100mm

MOTOR Bosch ACTIVE PLUS Gen.3 - 25km/h / 50Nm

DISPLAY Bosch PURION LCD Display

BATTERY Bosch PowerPACK 500Wh

CHARGER Bosch COMPACT Charger 2A

R. DERAILL. Shimano Acera M3000-9 SGS shadow

SHIFTLEV. Shimano Altus M2010-9 w/Display

CRANKSET KTM COMP BNI 170mm Q16

CHAINRING FSA steel 38T with Chainguard

SPROCKET Shimano HG200-9 / 11-36

CHAIN Shimano E6070-9 e-bike

BRAKE Shimano MT200 2-Piston

ROTOR Shimano RT30 CL 180 / 180

WHEEL F KTM Line - Shimano Acera M3050 CL 32H 100-5QR
Ambrosio Sport Disc 32H 584x23C
DT Champion 2.0 silver

WHEEL R KTM Line - Shimano Acera M3050 CL 32H 135-5QR
Ambrosio Sport Disc 32H 584x23C
DT Alpine II 2.34 silver

TIRE F Schwalbe Smart Sam K-Guard 57-584

TIRE R Schwalbe Smart Sam K-Guard 57-584

GRIP KTM Comp Lock

BAR KTM Comp rizer15 680mm

STEM KTM Comp 7°

HEADSET Ritchey OE Logic Zero 1.1/8"

SADDLE KTM Line MTB

SEATPOST KTM Comp 30.9/350

PEDAL MTB-Pedal C280DU alloy

CATEGORY E2

SYSTEM WEIGHT 140 kg (permissible total weight)

WEIGHT 21,8 kg (without pedals)



epicgrey matt (black + orange)

- 🔪 020429100 MACINA RIDE 271 XS / 38cm
- 🔪 020429103 MACINA RIDE 271 S / 43cm
- 🔪 020429108 MACINA RIDE 271 M / 48cm

MACINA

MINI ME

241



iM INTEGRATED
POSTMOUNT

**INTUUIA LCD
DISPLAY**

**INTEGRATED
KICKSTAND MOUNT**

**POWERPACK
400 WH**

Zurück in die Natur.

Fernseher, Tablets, Smartphones und Computerspiele? Das ist jetzt Schnee von gestern! Mit dem MACINA MINI ME holen wir eure Kids weg von der

Couch und hinaus in die Natur. Dank elektrischer Unterstützung des auf 20 km/h gedrosselten Bosch Active Motors, werden Kraftunterschiede gegenüber Erwachsenen - insbesondere auf längeren Touren - beseitigt und das Fahrrad-Fahren somit wieder zum Spaß für die ganze Familie!

Back to nature.

Television, tablets, smartphones and computer games? It will soon be forgotten with the MACINA MINI ME. We take your kids away from the couch and back out into nature, the fresh air and to have the time of their life. Thanks to the electrical support

of the Bosch Active Motor, which is throttled down to 20 km/h, slightly reduced in power compared to adult E-Bikes, the tantrums of a long bike ride are eliminated. The MACINA MINI ME will make cycling fun for the whole family again!



CL-A 4I4

400 WH BATTERY

1x9 SHIMANO ALTUS

MACINA

MINI ME

241



FRAME Macina MTB 24" kids Alloy6061;
Bosch Gen.3 / M-5020

FORK Suntour XCR air 24" LO 63mm

MOTOR Bosch ACTIVE Gen.3 - 25km/h / 40Nm

DISPLAY Bosch INTUVIA LCD Display with Remote

BATTERY Bosch PowerPACK 400Wh

CHARGER Bosch STANDARD Charger 4A

R. DERAILL. Shimano Altus M2000-9 SGS shadow

SHIFTLEV. Shimano Altus M2010-9 w/Display

CRANKSET KTM COMP KID BNI 170mm Q16

CHAINRING FSA steel 38T with Chainguard

SPROCKET Shimano HG200-9 / 11-36

CHAIN Shimano E6070-9 e-bike

BRAKE Tektro HD-M291 (2-Finger) w/Rotor 160

WHEEL F KTM Line - Shimano M475 6bolt 100-5QR
Ambrosio Sport Disc 32H 507x23C
DT Champion 2.0 black

WHEEL R KTM Line - Shimano M475 6bolt 135-5QR
Ambrosio Sport Disc 32H 507x23C
DT Champion 2.0 black

TIRE F Schwalbe Table Top Perf. 57-507

TIRE R Schwalbe Table Top Perf. 57-507

GRIP KTM Comp Lock

BAR KTM Comp flat 560mm

STEM KTM Comp 7"

HEADSET Ritchey OE Logic Zero 1.1/8"

SADDLE KTM Line Kid

SEATPOST KTM Comp 27.2/300

PEDAL Kids-Pedal VP-225

CATEGORY E2

SYSTEM WEIGHT 69 kg (permissible total weight)

WEIGHT 18,5 kg (without pedals)



space orange (black)

020432100 MACINA MINI ME 241 KID / 34cm

MACINA

SCOUT

271

PT-CX 614

625 WH BATTERY

1×12 SHIMANO SLX



FRAME Macina Scout 27.5" Alloy6061: PT625Wh Bosch Gen.4 / T-0290

FORK Suntour XCR 34 air 27.5" LOR 80mm 15x110 taper

MOTOR Bosch PERFORMANCE CX Gen.4 - 25km/h / 75Nm

DISPLAY Bosch INTUVIA LCD Display with Remote

BATTERY Bosch PowerTUBE 625Wh hor.

CHARGER Bosch STANDARD Charger 4A

R. DERAILL. Shimano SLX M7100-12 SGS shadow+

SHIFTLEV. Shimano SLX M7100-12

CRANKSET KTM TEAM ISIS 170mm Q16

CHAINRING FSA Megatooth steel 38T with Chainguard

SPROCKET Shimano SLX M7100-12 / 10-51

CHAIN Shimano SLX M7100-12

BRAKE Tektro HD-M750/E730 4-Piston

ROTOR Tektro TR180-45 2.3mm CL 180 / 180

WHEEL F KTM Line - Shimano Deore M6010B CL 32H 110-15TA Ryde Andra40 Disc 32H 584x25C DT Champion 2.0 black

WHEEL R KTM Line - Shimano MT500 CL - QR/32H Ryde Andra40 Disc 32H 584x25C DT Alpine II 2.34 black

TIRE F Schwalbe Smart Sam Perf. DD 57-584

TIRE R Schwalbe Smart Sam Perf. DD 57-584

GRIP Ergon GP1 SD w/o Barend

BAR KTM Comp rizer15 680mm

STEM KTM Line UP+ adjust. 0-90°

HEADSET Ritchey Logic Zero Comp 1.1/8>1.5"

SADDLE Selle Royal Lookin

SEATPOST KTM Comp 30.9/350

PEDAL Trekk.-Pedal VP-616 (anti-slip)

CATEGORY E2

SYSTEM WEIGHT 142 kg (permissible total weight)

WEIGHT 25 kg (without pedals)



black matt (grey+orange)

- ✓ 020435503 MACINA SCOUT 271 US 43cm
- ✓ 020435506 MACINA SCOUT 271 US 46cm
- ✓ 020435511 MACINA SCOUT 271 US 51cm
- ✓ 020435516 MACINA SCOUT 271 US 56cm
- ✓ 020435520 MACINA SCOUT 271 US 60cm

MACINA

SCOUT

272

SI-P 514

500 WH BATTERY

1×10 SHIMANO DEORE



FRAME Macina Scout 27.5" Alloy6061: SI-PP500Wh Bosch Gen.3 / T-0280

FORK Suntour XCR 34 coil 27.5" LOR 80mm 15x110 taper

MOTOR Bosch PERFORMANCE Gen.3 - 25km/h / 65Nm

DISPLAY Bosch INTUVIA LCD Display with Remote

BATTERY Bosch PowerPACK 500Wh

CHARGER Bosch STANDARD Charger 4A

R. DERAILL. Shimano Deore M6000-10 GS shadow+

SHIFTLEV. Shimano Deore T6000-10 w/Display

CRANKSET KTM COMP BNI 170mm Q16

CHAINRING FSA steel 38T with Chainguard

SPROCKET Shimano Deore HG500-10 / 11-42

CHAIN Shimano E6090-10 e-bike

BRAKE Shimano MT420 4-Piston (3-Finger)

ROTOR Shimano RT30 CL 180 / 180

WHEEL F KTM Line - Shimano MT400B CL 32H 110-15TA Ryde Andra40 Disc 32H 584x25C DT Champion 2.0 black

WHEEL R KTM Line - Shimano Deore M6000 CL 32H 135-5QR Ryde Andra40 Disc 32H 584x25C DT Alpine II 2.34 black

TIRE F Schwalbe Smart Sam Perf. 57-584

TIRE R Schwalbe Smart Sam Perf. 57-584

GRIP Ergon GP1 SD w/o Barend

BAR KTM Comp rizer15 680mm

STEM KTM Line UP3 adjust. 0-90°

HEADSET Ritchey Logic Zero Comp 1.1/8>1.5"

SADDLE Selle Royal Lookin

SEATPOST KTM Comp 30.9/350

PEDAL Trekk.-Pedal VP-616 (anti-slip)

CATEGORY E2

SYSTEM WEIGHT 141 kg (permissible total weight)

WEIGHT 22.6kg (without pedals)



white matt (grey+yellow)

- ✓ 020436503 MACINA SCOUT 272 US 43cm
- ✓ 020436506 MACINA SCOUT 272 US 46cm
- ✓ 020436511 MACINA SCOUT 272 US 51cm
- ✓ 020436516 MACINA SCOUT 272 US 56cm

MACINA

SCOUT

271 LFC

PT-CX 614

625 WH BATTERY

1×12 SHIMANO SLX



LIGHT FENDER CARRIER

MACINA

SCOUT

272 LFC

SI-P 514

500 WH BATTERY

1×10 SHIMANO DEORE



LIGHT FENDER CARRIER

FRAME	Macina Scout 27.5" Alloy6061: PT625Wh Bosch Gen.4 / T-0290
FORK	Suntour XCR 34 air 27.5" LOR 80mm 15x110 taper
MOTOR	Bosch PERFORMANCE CX Gen.4 - 25km/h / 75Nm
DISPLAY	Bosch INTUVIA LCD Display with Remote
BATTERY	Bosch PowerTUBE 625Wh hor.
CHARGER	Bosch STANDARD Charger 4A
R. DERAILL.	Shimano SLX M7100-12 SGS shadow+
SHIFTLEV.	Shimano SLX M7100-12
CRANKSET	KTM TEAM ISIS 170mm Q16
CHAINRING	FSA Megatooth steel 38T with Chainguard
SPROCKET	Shimano SLX M7100-12 / 10-51

CHAIN	Shimano SLX M7100-12
BRAKE	Tektro HD-M750/E730 4-Piston
ROTOR	Tektro TR180-45 2.3mm CL 180 / 180
WHEEL F	KTM Line - Shimano Deore M6010B CL 32H 110-15TA
	Ryde Andra40 Disc 32H 584x25C
	DT Champion 2.0 black
WHEEL R	KTM Line - Shimano MT500 CL - QR/32H
	Ryde Andra40 Disc 32H 584x25C
	DT Alpine II 2.34 black
TIRE F	Schwalbe Smart Sam Perf. DD 57-584
TIRE R	Schwalbe Smart Sam Perf. DD 57-584
GRIP	Ergon GP1 SD w/o Barend

BAR	KTM Comp rizer15 680mm
STEM	KTM Line UP+ adjust. 0-90°
HEADSET	Ritchey Logic Zero Comp 1.1/8>1.5"
SADDLE	Selle Royal Lookin
SEATPOST	KTM Comp 30.9/350
PEDAL	Trekk.-Pedal VP-616 (anti-slip)
CARRIER	Wingee alloy fender- plattform (snap-it)
LIGHT F	B&M Lumotec IQ-XS LED 70Lux
LIGHT R	Racktime Alu 72mm B&M Xeltec
CHAINGUARD	KTM 28" adjust
CATEGORY	E2
SYSTEM WEIGHT	144 kg (permissible total weight)
WEIGHT	25,9 kg (without pedals)



black matt (black+orange glossy)

- ✓ 020437503 MACINA SCOUT 271 LFC US 43cm
- ✓ 020437506 MACINA SCOUT 271 LFC US 46cm
- ✓ 020437511 MACINA SCOUT 271 LFC US 51cm
- ✓ 020437516 MACINA SCOUT 271 LFC US 56cm
- ✓ 020437520 MACINA SCOUT 271 LFC US 60cm

FRAME	Macina Scout 27.5" Alloy6061: SI-PP500Wh Bosch Gen.3 / T-0280
FORK	Suntour XCR 34 coil 27.5" LOR 80mm 15x110 taper
MOTOR	Bosch PERFORMANCE Gen.3 - 25km/h / 65Nm
DISPLAY	Bosch INTUVIA LCD Display with Remote
BATTERY	Bosch PowerPACK 500Wh
CHARGER	Bosch STANDARD Charger 4A
R. DERAILL.	Shimano Deore M6000-10 GS shadow+
SHIFTLEV.	Shimano Deore T6000-10 w/Display
CRANKSET	KTM COMP BNI 170mm Q16
CHAINRING	FSA steel 38T with Chainguard
SPROCKET	Shimano Deore H6500-10 / 11-42

CHAIN	Shimano E6090-10 e-bike
BRAKE	Shimano MT420 4-Piston (3-Finger)
ROTOR	Shimano RT30 CL 180 / 180
WHEEL F	KTM Line - Shimano MT400B CL 32H 110-15TA
	Ryde Andra40 Disc 32H 584x25C
	DT Champion 2.0 black
WHEEL R	KTM Line - Shimano Deore M6000 CL 32H 135-5QR
	Ryde Andra40 Disc 32H 584x25C
	DT Alpine II 2.34 black
TIRE F	Schwalbe Smart Sam Perf. 57-584
TIRE R	Schwalbe Smart Sam Perf. 57-584
GRIP	Ergon GP1 SD w/o Barend
BAR	KTM Comp rizer15 680mm

STEM	KTM Line UP3 adjust. 0-90°
HEADSET	Ritchey Logic Zero Comp 1.1/8>1.5"
SADDLE	Selle Royal Lookin
SEATPOST	KTM Comp 30.9/350
PEDAL	Trekk.-Pedal VP-616 (anti-slip)
CARRIER	Wingee alloy fender- plattform (snap-it)
LIGHT F	B&M Lumotec MYC LED 50Lux
FENDER	Racktime Alu 72mm B&M Xeltec
KICKSTAND	KTM 28" adjust
CATEGORY	E2
SYSTEM WEIGHT	143 kg (permissible total weight)
WEIGHT	24,4 kg (without pedals)



steelgrey matt (black+orange)

- ✓ 020438503 MACINA SCOUT 272 LFC US 43cm
- ✓ 020438506 MACINA SCOUT 272 LFC US 46cm
- ✓ 020438511 MACINA SCOUT 272 LFC US 51cm
- ✓ 020438516 MACINA SCOUT 272 LFC US 56cm

MACINA
MEZZO



MACINA
MEZZO
ULTEGRA DI2 2*11 82-83





FAZUA EVATION 1.0

250 WH BATTERY

2x11 SHIMANO ULTEGRA Di2

MACINA

MEZZO



FRAME Macina Mezzo Road Performance Carbon; Fazua / R-0200

FORK Macina Mezzo Performance Carbon

MOTOR Fazua DRIVEPACK Evation 1.0
25km/h / 60Nm

DISPLAY Fazua TOUCH REMOTE Evation 1.0

BATTERY Fazua BATTERY PACK Evation 1.0 250Wh

CHARGER Fazua CHARGER Evation 1.0 2A

R. DERAILL. Shimano Ultegra R8050 SS Di2

F. DERAILL. Shimano Ultegra R8050 Di2

SHIFTLEV. Shimano Ultegra R8070 Di2

CRANKSET KTM Kappa ISIS 160mm Q0

CHAINRING FSA double 50/34T

SPROCKET Shimano Ultegra R8000 / 11-28

CHAIN Shimano HG701-11

BRAKE Shimano Ultegra R8070 2-Piston flatmount

ROTOR Shimano RT800 CL 140 / 140 Freeza

WHEEL F DT Swiss ER 1600 Spline DB 32 CL 100-12TA
622x18TC TLR

WHEEL R DT Swiss ER 1600 Spline DB 32 CL 142-12TA
622x18TC TLR

TIRE F Continental G-Prix 5000 TL 28-622

TIRE R Continental G-Prix 5000 TL 28-622

BAR KTM Team flare 8"

STEM KTM Team Road 8"

HEADSET KTM Team drop/in 1.1/8>1.5" +10

SADDLE Ergon SM10 Sport Men

SEATPOST KTM Team 27.2/350

PEDAL MTB-Pedal VP-197 alloy (light)

CATEGORY E1

SYSTEM WEIGHT 124 kg (permissible total weight)

WEIGHT 13.5 kg (without pedals)



black matt (space orange glossy)

020495304 MACINA MEZZO S / 44.5cm

020495308 MACINA MEZZO M / 48cm

020495312 MACINA MEZZO L / 52cm

020495315 MACINA MEZZO XL / 55cm



MACINA CROSS



MACINA CROSS 610 SLX 1*12 86-89



MACINA CROSS 620 SLX 1*11 90



MACINA CROSS 510 DEORE 1*10 91



MACINA CROSS 520 ACERA 1*9 92



MACINA CROSS LFC DEORE 1*9 93

MACINA SPRINT



MACINA SPRINT ACERA 1*9 94-97

MACINA

CROSS

610



Der perfekte Allrounder.

Das MACINA CROSS ist mit seinen vielfältigen Einsatzmöglichkeiten ein echter Allrounder! Für ausgedehnte Radtouren, Fahrten über Wald- und Schotterwege als auch für Abenteuerreisen ist dieses Bike perfekt geeignet. Die aufrechte Sitzposition bietet

dir genug Komfort, um entspannt Umgebung und Natur erkunden und genießen zu können. Nachgerüstet mit dem LFC (Light, Fender, Carrier) System, können auch unsere Offroad-Bikes allwettertauglich gemacht werden. Mit seinen schmalen Stollenreifen ist das MACINA CROSS schnell auf der Straße und schreckt dabei auch vor unbefestigtem Terrain nicht zurück!

The perfect all-rounder.

The MACINA CROSS is a real all-rounder with its wide range of possible uses! This bike is perfect for extended bike tours, a leisurely ride on a canal path and you can even take it off-road onto the forest trails. Thanks to its upright seating position, the bike offers enough

comfort to explore and enjoy the surroundings of nature in a relaxed manner. Equipped with the LFC (Light, Fender, Carrier) system, our off road bikes can be made suitable for all weather conditions. With its gravel tyres, the MACINA CROSS is super-fast on the road and does not shy away from unpaved terrain!



PT-CX 6K4

625 WH BATTERY

1x12 SHIMANO SLX



MACINA CROSS 610

FRAME	Macina Trekking Offroad Alloy6061; PT625Wh Bosch Gen.4 / T-0460
FORK	Suntour NCX-E air LO 63mm 15QLC
MOTOR	Bosch PERFORMANCE CX Gen.4 - 25km/h / 75Nm
DISPLAY	Bosch KIOX TFT Display with Remote
BATTERY	Bosch PowerTUBE 625Wh hor.
CHARGER	Bosch STANDARD Charger 4A
R. DERAILL.	Shimano SLX M7100-12 SGS shadow+
SHIFTLEV.	Shimano SLX M7100-12
CRANKSET	KTM COMP ISIS 170mm Q16
CHAINRING	Shimano SM-CR80 38T with Chainguard

SPROCKET	Shimano SLX M7100-12 / 10-51
CHAIN	Shimano SLX M7100-12
BRAKE	Shimano MT420 4-Piston (3-Finger)
ROTOR	Shimano RT64 CL 180 / 160
WHEEL F	KTM Line - DT Swiss 350 CL 32H 100-15TA DT Swiss H1950 32H 622x25TC DT Alpine III 2.34 black
WHEEL R	KTM Line - DT Swiss 370 CL 32H 135-5QR DT Swiss H1950 32H 622x25TC DT Alpine III 2.34 black
TIRE F	Schwalbe Smart Sam Perf. 47-622
TIRE R	Schwalbe Smart Sam Perf. 47-622

GRIP	Ergon GP3 SD w/Barend
BAR	KTM Team low rizer 640mm
STEM	KTM Team Kiox
HEADSET	KTM Team Trekking angle limit 1.1/8"-1.5" +5
SADDLE	Selle Royal Essenza
SEATPOST	KTM Team 30.9/350
PEDAL	MTB-Pedal VP-197 alloy (light)
KICKSTAND	Hebie 28" adjust
CATEGORY	E2
SYSTEM WEIGHT	140 kg (permissible total weight)
WEIGHT	21,9 kg (without pedals)



black matt (black+orange glossy)

- ✓ 020440106 MACINA CROSS 610 H 46cm
- ✓ 020440111 MACINA CROSS 610 H 51cm
- ✓ 020440116 MACINA CROSS 610 H 56cm
- ✓ 020440120 MACINA CROSS 610 H 60cm



black matt (black+orange glossy)

- ✓ 020440206 MACINA CROSS 610 D 46cm
- ✓ 020440211 MACINA CROSS 610 D 51cm
- ✓ 020440216 MACINA CROSS 610 D 56cm

MACINA CROSS 620

PT-CX 614

625 WH BATTERY

1×11 SHIMANO SLX



MACINA CROSS 510

PT-CX 514

500 WH BATTERY

1×10 SHIMANO DEORE



FRAME Macina Trekking Offroad Alloy6061: PT625Wh Bosch Gen.4 / T-0460
FORK Suntour NCX-D coil LO 63mm
MOTOR Bosch PERFORMANCE CX Gen.4 - 25km/h / 75Nm
DISPLAY Bosch INTUVIA LCD Display with Remote
BATTERY Bosch PowerTUBE 625Wh hor.
CHARGER Bosch STANDARD Charger 4A
R. DERAILL. Shimano SLX M7000-11 GS shadow+
SHIFTLEV. Shimano SLX M7000-11 w/Display
CRANKSET KTM COMP ISIS 170mm Q16
CHAINRING FSA Megatooth steel 42T with Chainguard

SPROCKET Shimano SLX M7000-11 / 11-46
CHAIN Shimano E8000-11 e-bike
BRAKE Shimano MT420 4-Piston (3-Finger)
ROTOR Shimano RT54 CL 180 / 160
WHEEL F KTM Line - Shimano Deore M6000 CL 32H 100-5QR Ambrosio Track Disc 32H 622x20C DT Champion 2.0 black
WHEEL R KTM Line - Shimano Deore M6000 CL 32H 135-5QR Ambrosio Track Disc 32H 622x20C DT Alpine II 2.34 black
TIRE F Schwalbe Smart Sam Perf. 47-622
TIRE R Schwalbe Smart Sam Perf. 47-622

GRIP Ergon GP3 SD w/Barend
BAR KTM Comp low rizer 640mm
STEM KTM Comp 17°
HEADSET KTM Team Trekking angle limit 1.1/8>1.5" +5
SADDLE Selle Royal Essenza
SEATPOST KTM Comp 30.9/350
PEDAL MTB-Pedal VP-195E alloy
KICKSTAND KTM 28" adjust
CATEGORY E2
SYSTEM WEIGHT 141 kg (permissible total weight)
WEIGHT 22,2 kg (without pedals)

FRAME Macina Trekking Offroad Alloy6061: PT500Wh Bosch Gen.4 / T-0930
FORK Suntour NCX-D coil LO 63mm
MOTOR Bosch PERFORMANCE CX Gen.4 - 25km/h / 75Nm
DISPLAY Bosch INTUVIA LCD Display with Remote
BATTERY Bosch PowerTUBE 500Wh hor.
CHARGER Bosch STANDARD Charger 4A
R. DERAILL. Shimano Deore M6000-10 GS shadow+
SHIFTLEV. Shimano Deore T6000-10 w/Display
CRANKSET KTM COMP ISIS 170mm Q16
CHAINRING FSA Megatooth steel 42T with Chainguard

SPROCKET Shimano Deore HG500-10 / 11-42
CHAIN Shimano E6090-10 e-bike
BRAKE Shimano MT200 2-Piston
ROTOR Shimano RT30 CL 180 / 160
WHEEL F KTM Line - Shimano Deore M6000 CL 32H 100-5QR Ambrosio Track Disc 32H 622x20C DT Champion 2.0 black
WHEEL R KTM Line - Shimano Deore M6000 CL 32H 135-5QR Ambrosio Track Disc 32H 622x20C DT Alpine II 2.34 black
TIRE F Schwalbe Smart Sam Perf. 47-622
TIRE R Schwalbe Smart Sam Perf. 47-622

GRIP Ergon GP3 SD w/Barend
BAR KTM Comp low rizer 640mm
STEM KTM Comp 17°
HEADSET KTM Team Trekking angle limit 1.1/8>1.5" +15
SADDLE KTM Line Cross
SEATPOST KTM Comp 30.9/350
PEDAL MTB-Pedal VP-195E alloy
KICKSTAND KTM 28" adjust
CATEGORY E2
SYSTEM WEIGHT 140 kg (permissible total weight)
WEIGHT 21,3 kg (without pedals)



black matt (orange)
020441106 MACINA CROSS 620 H 46cm
020441111 MACINA CROSS 620 H 51cm
020441116 MACINA CROSS 620 H 56cm
020441120 MACINA CROSS 620 H 60cm

black matt (orange)
020441206 MACINA CROSS 620 D 46cm
020441211 MACINA CROSS 620 D 51cm
020441216 MACINA CROSS 620 D 56cm



black matt (grey+orange)
020442106 MACINA CROSS 510 H 46cm
020442111 MACINA CROSS 510 H 51cm
020442116 MACINA CROSS 510 H 56cm
020442120 MACINA CROSS 510 H 60cm

black matt (grey+orange)
020442206 MACINA CROSS 510 D 46cm
020442211 MACINA CROSS 510 D 51cm
020442216 MACINA CROSS 510 D 56cm

MACINA CROSS 520

UC-CX 512

500 WH BATTERY

1×9 SHIMANO ACERA



FRAME Macina Trekking Offroad Alloy6061 MC; UC-PP500Wh Bosch Gen.4 / T-0210
FORK Suntour NEX-E25 coil NLO 63mm
MOTOR Bosch PERFORMANCE CX Gen.4 - 25km/h / 75Nm
DISPLAY Bosch INTUVIA LCD Display with Remote
BATTERY Bosch PowerPACK 500Wh
CHARGER Bosch COMPACT Charger 2A
R. DERAILL. Shimano Acera M3000-9 SGS shadow
SHIFTLEV. Shimano Altus M2010-9 w/Display
CRANKSET KTM COMP ISIS 170mm Q16
CHAINRING FSA Megatooth steel 42T with Chainguard

SPROCKET Shimano HG200-9 / 11-36
CHAIN Shimano E6070-9 e-bike
BRAKE Shimano MT200 2-Piston
ROTOR Shimano RT30 CL 180 / 160
WHEEL F KTM Line - Shimano Acera M3050 CL 32H 100-5QR
Ambrosio Track Disc 32H 622x20C
DT Champion 2.0 black
WHEEL R KTM Line - Shimano Deore M6000 CL 32H 135-5QR
Ambrosio Track Disc 32H 622x20C
DT Alpine II 2.34 black
TIRE F Schwalbe Smart Sam K-Guard 42-622
TIRE R Schwalbe Smart Sam K-Guard 42-622

GRIP KTM Comp Ergo Lock
BAR KTM Comp low rizer 640mm
STEM KTM Comp 17°
HEADSET Ritchey Logic Zero Comp 1.1/8>1.5"
SADDLE KTM Line Cross
SEATPOST KTM Comp 30.9/350
PEDAL MTB-Pedal C280DU alloy
KICKSTAND KTM 28" adjust
CATEGORY E2
SYSTEM WEIGHT 139 kg (permissible total weight)
WEIGHT 21,1 kg (without pedals)



black matt (grey+orange)
020444106 MACINA CROSS 520 H 46cm
020444111 MACINA CROSS 520 H 51cm
020444116 MACINA CROSS 520 H 56cm
020444120 MACINA CROSS 520 H 60cm

black matt (grey+orange)
020444206 MACINA CROSS 520 D 46cm
020444211 MACINA CROSS 520 D 51cm
020444216 MACINA CROSS 520 D 56cm

MACINA CROSS LFC

PT-CX 512

500 WH BATTERY

1×9 SHIMANO DEORE



FRAME Macina Trekking Offroad Alloy6061; PT500Wh Bosch Gen.4 / T-0930
FORK Suntour NEX-E25 coil NLO 63mm
MOTOR Bosch PERFORMANCE CX Gen.4 - 25km/h / 75Nm
DISPLAY Bosch INTUVIA LCD Display with Remote
BATTERY Bosch PowerTUBE 500Wh hor.
CHARGER Bosch COMPACT Charger 2A
R. DERAILL. Shimano Deore M592-9 SGS shadow
SHIFTLEV. Shimano Altus M2010-9 w/Display
CRANKSET KTM COMP ISIS 170mm Q16
CHAINRING FSA Megatooth steel 42T with Chainguard
SPROCKET Shimano HG200-9 / 11-36

CHAIN Shimano E6070-9 e-bike
BRAKE Shimano MT200 2-Piston
ROTOR Shimano RT30 CL 180 / 160
WHEEL F KTM Line - Shimano Acera M3050 CL 32H 100-5QR
Ambrosio Track Disc 32H 622x20C
DT Champion 2.0 black
WHEEL R KTM Line - Shimano Deore M6000 CL 32H 135-5QR
Ambrosio Track Disc 32H 622x20C
DT Alpine II 2.34 black
TIRE F Schwalbe Smart Sam K-Guard 42-622
TIRE R Schwalbe Smart Sam K-Guard 42-622
GRIP KTM Comp Ergo Lock
BAR KTM Comp low rizer 640mm

STEM KTM Comp 17°
HEADSET Ritchey Logic Zero Comp 1.1/8>1.5"
SADDLE Selle Royal Lookin
SEATPOST KTM Comp 30.9/350
PEDAL MTB-Pedal VP-195E alloy
CARRIER Winge alloy fender- rails (plattform option)
LIGHT F B&M Lumotec MYC LED 50Lux
FENDER Racktime Alu 52mm B&M Xeltec
KICKSTAND KTM 28" adjust
CATEGORY E2
SYSTEM WEIGHT 141 kg (permissible total weight)
WEIGHT 23,1 kg (without pedals)



epicgrey matt (black+blue)
020445106 MACINA CROSS LFC H 46cm
020445111 MACINA CROSS LFC H 51cm
020445116 MACINA CROSS LFC H 56cm
020445120 MACINA CROSS LFC H 60cm

epicgrey matt (black+blue)
020445206 MACINA CROSS LFC D 46cm
020445211 MACINA CROSS LFC D 51cm
020445216 MACINA CROSS LFC D 56cm

MACINA

SPRINT



Getrimmt auf Schnelligkeit und Leichtigkeit.

Das MACINA SPRINT ist ein leichtfüßiger Vollblutportler, der voll und ganz auf Geschwindigkeit ausgelegt ist. Die starre, direkte Aluminiumgabel bietet nicht nur eine cleane und dynamische Optik, sondern auch ein geringes Gesamtgewicht. Das Rahmen-Konzept ermöglicht einen sportiven, kräftigen und

ansprechenden Look, welcher den neuen Bosch Performance Line CX Motor der vierten Generation sowie den Bosch Powerpack formschön integriert. Kombiniert mit den schlichten aber hochwertigen Kunststoff-Spritzguss-Abdeckungen, entsteht ein Fahrrad im zeitlosen Design für urbanes und ländliches Umfeld. Seine Gravel Reifen haben einen besonders geringen Rollwiderstand und lassen dich flink durch leichtes Gelände sausen. LFC ready.

Trimmed for speed and lightness.

The MACINA SPRINT is a light-footed thoroughbred athlete which is fully dedicated to speed. The rigid, direct aluminium fork offers not only a clean and dynamic look, but also a low overall weight. The frame concept provides a sporty, powerful and appealing look that integrates the new fourth generation Bosch Performance Line CX engine

and the Bosch Powerpack. Combined with the simple but high-quality synthetic injection-moulded covers, the result is an E-Bike with a timeless design for urban and rural environments. Its Gravel tires have particularly low frictional resistance and allow you to whiz quickly through light terrain. LFC ready.

FASTER THAN YOUR SHADOW.

ADJUSTABLE VISOR

POLY-CARBONATE

ZIP POCKET

LIGHT INNER PANT

BREATHABLE MATERIAL



Weissenbach am Attersee

oberösterreich.at



MACINA SPRINT

UC-CX 512

500 WH BATTERY

1x9 SHIMANO ACERA



FRAME Macina Trekking Offroad Alloy6061 MC; UC-PP500Wh Bosch Gen.4 / T-0210
FORK Alloy Rigid Longleg, PM-Disc 9QR
MOTOR Bosch PERFORMANCE CX Gen.4 - 25km/h / 75Nm
DISPLAY Bosch INTUVIA LCD Display with Remote
BATTERY Bosch PowerPACK 500Wh
CHARGER Bosch COMPACT Charger 2A
R. DERAILL. Shimano Acera M3000-9 SGS shadow
SHIFTLEV. Shimano Altus M2010-9 w/Display
CRANKSET KTM COMP ISIS 170mm Q16
CHAINRING FSA Megatooth steel 42T with Chainguard

SPROCKET Shimano HG200-9 / 11-36
CHAIN Shimano E6070-9 e-bike
BRAKE Shimano MT200 2-Piston
ROTOR Shimano RT30 CL 180 / 160
WHEEL F KTM Line - Shimano Acera M3050 CL 32H 100-5QR
 Ambrosio Flite Disc 32H 622x20C
 DT Champion 2.0 black
WHEEL R KTM Line - Shimano Deore M6000 CL 32H 135-5QR
 Ambrosio Flite Disc 32H 622x20C
 DT Alpine II 2.34 black
TIRE F Schwalbe G-One Bite Perf. RaceGuard 50-622
TIRE R Schwalbe G-One Bite Perf. RaceGuard 50-622

GRIP KTM Comp Ergo Lock
BAR KTM Team flat 2X 680mm
STEM KTM Team Road 8°
HEADSET KTM Team Trekking
 angle limit 1.1/8">1.5" +15
SADDLE KTM Line Cross
SEATPOST KTM Team 30.9/350
PEDAL MTB-Pedal C280DU alloy
KICKSTAND KTM 28" adjust
CATEGORY E2
SYSTEM WEIGHT 139 kg (permissible total weight)
WEIGHT 20 kg (without pedals)



- black matt (black+grey glossy)
- 🔪 020447106 MACINA SPRINT H 46cm
- 🔪 020447111 MACINA SPRINT H 51cm
- 🔪 020447116 MACINA SPRINT H 56cm
- 🔪 020447120 MACINA SPRINT H 60cm

- black matt (black+grey glossy)
- 🔪 020447206 MACINA SPRINT D 46cm
- 🔪 020447211 MACINA SPRINT D 51cm
- 🔪 020447216 MACINA SPRINT D 56cm



MACINA SPORT



MACINA
SPORT ABS
DEORE XT 1*11 100



MACINA
SPORT 610
DEORE XT 1*12 102-105



MACINA
SPORT 620
SLX 1*11 106



MACINA
SPORT 630
DEORE 1*10 107



MACINA
SPORT 510
DEORE 1*10 108



MACINA
SPORT 520
ACERA 1*9 109

MACINA MILA



MACINA
MILA
DEORE XT 1*11 110

ausgenommen
Radfahrer

MACINA STYLE



MACINA
STYLE 610
DEORE XT 1*11 111



MACINA
STYLE 620
SLX 1*11 112



MACINA
STYLE 630
DEORE 1*10 113



MACINA
STYLE XL
SLX 1*11 114

MACINA TOUR/FUN



MACINA
TOUR 510
DEORE 1*9 115



MACINA
FUN 510
DEORE 1*9 118



MACINA
FUN 520
ACERA 1*9 119

MACINA

SPORT

ABS

PT-CX 6K6

625 WH
BATTERY1×11 SHIMANO
DEORE XT

FRAME Macina Trekking Onroad Alloy6061; ABS PT625Wh Bosch Gen.4 / T-0470
FORK Suntour Mobie25 air LOR 63mm 15QLC
MOTOR Bosch PERFORMANCE CX Gen.4 - 25km/h / 75Nm
DISPLAY Bosch KIOX TFT Display with Remote
BATTERY Bosch PowerTUBE 625Wh hor.
CHARGER Bosch FAST Charger 6A
R. DERAIL. Shimano Deore XT M8000-11 GS shadow+
SHIFTLEV. Shimano Deore XT M8000-11 w/Display
CRANKSET KTM TEAM ISIS 170mm Q16
CHAINRING FSA Megatooth steel 42T
SPROCKET Shimano SLX M7000-11 / 11-46

CHAIN Shimano E8000-11 e-bike
BRAKE Bosch / Magura ABS set w/Rotor 180 / 180
WHEEL F KTM Line - DT Swiss 350 6bolt 32H 100-15TA
 DT Swiss H1950 32H 622x25TC
 DT Alpine III 2.34 black
WHEEL R KTM Line - DT Swiss 370 6bolt 32H 135-5QR
 DT Swiss H1950 32H 622x25TC
 DT Alpine III 2.34 black
TIRE F Schwalbe Marathon Mondial Perf. RaceGuard 42-622
TIRE R Schwalbe Marathon Mondial Perf. RaceGuard 42-622
GRIP Ergon GP3 SD w/Barend
BAR KTM Team low rizer 640mm
STEM KTM Team Kiox

HEADSET Ritchey Logic Zero Comp 1.1/8-1.5"
SADDLE Selle Royal Essenza
SEATPOST KTM Team 30.9/350
PEDAL Trekk.-Pedal VP-616 (anti-slip)
CARRIER KTM Racktime light (snap-it)
LIGHT F B&M Lumotec IQ-X LED 150Lux
LIGHT R B&M Toplight View LED
FENDER SKS A46R 46mm black matt
CHAINGUARD KTM type 1 for Bosch Gen.4
KICKSTAND KTM 28" adjust
CATEGORY E2
SYSTEM WEIGHT 143 kg (permissible total weight)
WEIGHT 24,2 kg (without pedals)



black matt (black+orange glossy)
 020450106 MACINA SPORT ABS H 46cm
 020450111 MACINA SPORT ABS H 51cm
 020450116 MACINA SPORT ABS H 56cm
 020450120 MACINA SPORT ABS H 60cm



black matt (black+orange glossy)
 020450206 MACINA SPORT ABS D 46cm
 020450211 MACINA SPORT ABS D 51cm
 020450216 MACINA SPORT ABS D 56cm



black matt (black+orange glossy)
 020450506 MACINA SPORT ABS US 46cm
 020450511 MACINA SPORT ABS US 51cm
 020450516 MACINA SPORT ABS US 56cm

SAFETY FIRST.



oberösterreich.at



Braunau am Inn

MACINA

SPORT

610



IM INTEGRATED
POSTMOUNT

GRAVITY
CASTING

GEN4
CX

KIOX
DISPLAY

INTEGRATED
KICKSTAND MOUNT

CX POWERTUBE
625 WH

HYDROFORM
POWERTUBE

Ermöglicht neue Horizonte.

Stets aufs Neue beweist KTM seine langjährige Erfahrung in Sachen Tourenräder! Modernste Technologien und Produktionsstandards, sowie hochwertige und sorgsam ausgewählte Komponenten, sorgen für Sicherheit, Komfort und machen die vollausgestatteten E-Trekking Modelle seit Jahren zu

Bestsellern. Die reduzierte und sportive Form bietet eine hohe Alltagstauglichkeit und ergibt sich unter anderem aus der integrierten Ständeraufnahme, vollintegriertem Speedsensor sowie innenliegenden Seilen, Kabeln und Leitungen. Egal ob für sportliche, ausgedehnte Radreisen oder den täglichen Weg in die Arbeit – hier findest du garantiert deinen richtigen Begleiter!

Enables new horizons.

Again and again KTM proves its many years of experience in touring bikes! State-of-the-art technologies and production standards as well as high-quality and carefully selected components ensure safety, comfort and have made fully equipped E-Trekking models bestsellers for years. The sporty but relaxed form offers perfect suitability for

everyday use and results from the integrated stand holder, fully integrated speed sensor and internal cables and wires. No matter whether it's a sporty, extended bike tour or a daily ride to work – you're guaranteed to find the right companion in our extensive range!



PT-CX 6K6

625 WH BATTERY

1x12 SHIMANO DEORE XT

MACINA SPORT 610



FRAME Macina Trekking Onroad Alloy 6061: PT625Wh Bosch Gen. 4 / T-0450
FORK Suntour NCX-E air LO 63mm 15QLC
MOTOR Bosch PERFORMANCE CX Gen. 4 - 25km/h / 75Nm
DISPLAY Bosch KIOX TFT Display with Remote
BATTERY Bosch PowerTUBE 625Wh hor.
CHARGER Bosch FAST Charger 6A
R. DERAILL. Shimano Deore XT M8100-12 SGS shadow+
SHIFTLEV. Shimano Deore XT M8100-12
CRANKSET KTM TEAM ISIS 170mm Q16
CHAINRING Shimano SM-CR80 38T with Chainguard
SPROCKET Shimano SLX M7100-12 / 10-51
CHAIN Shimano SLX M7100-12

BRAKE Shimano MT420 4-Piston (3-Finger)
ROTOR Shimano RT64 CL 180 / 160
WHEEL F KTM Line - DT Swiss 350 CL 32H 100-15TA / DT Swiss H1950 32H 622x25TC / DT Alpine III 2.34 black
WHEEL R KTM Line - DT Swiss 370 CL 32H 135-5QR / DT Swiss H1950 32H 622x25TC / DT Alpine III 2.34 black
TIRE F Schwalbe Marathon Mondial Perf. RaceGuard 42-622
TIRE R Schwalbe Marathon Mondial Perf. RaceGuard 42-622
GRIP Ergon GP3 SD w/Barend
BAR KTM Team low rizer 640mm
STEM KTM Team Kiox
HEADSET KTM Team Trekking angle limit 1.1/8"-1.5" +5
SADDLE Selle Royal Essenza

SEATPOST KTM Team 30.9/350
PEDAL Trekk. - Pedal VP-616 (anti-slip)
CARRIER KTM Racktime light (snap-it)
LIGHT F B&M Lumotec IQ-X LED 150Lux
LIGHT R B&M Toplight View LED
FENDER SKS A46R 46mm black matt
CHAINGUARD KTM type 1 for Bosch Gen.4
KICKSTAND Hebie 28" adjust
CATEGORY E2
SYSTEM WEIGHT 142 kg (permissible total weight)
WEIGHT 23.5 kg (without pedals)



black matt (grey+orange)
 020451106 MACINA SPORT 610 H 46cm
 020451111 MACINA SPORT 610 H 51cm
 020451116 MACINA SPORT 610 H 56cm
 020451120 MACINA SPORT 610 H 60cm



black matt (grey+orange)
 020451206 MACINA SPORT 610 D 46cm
 020451211 MACINA SPORT 610 D 51cm
 020451216 MACINA SPORT 610 D 56cm



black matt (grey+orange)
 020451503 MACINA SPORT 610 US 43cm
 020451506 MACINA SPORT 610 US 46cm
 020451511 MACINA SPORT 610 US 51cm
 020451516 MACINA SPORT 610 US 56cm

MACINA

SPORT

620

PT-CX 614

625 WH BATTERY

1x11 SHIMANO SLX



FRAME Macina Trekking Onroad Alloy6061; PT625Wh Bosch Gen.4 / T-0450
FORK Suntour NCX-E air LO 63mm 15QLC
MOTOR Bosch PERFORMANCE CX Gen.4 - 25km/h / 75Nm
DISPLAY Bosch INTUVIA LCD Display with Remote
BATTERY Bosch PowerTUBE 625Wh hor.
CHARGER Bosch STANDARD Charger 4A
R. DERAILL. Shimano SLX M7000-11 GS shadow+
SHIFTLEV. Shimano SLX M7000-11 w/Display
CRANKSET KTM TEAM ISIS 170mm Q16
CHAINRING FSA Megatooth steel 42T
SPROCKET Shimano SLX M7000-11 / 11-46
CHAIN Shimano E8000-11 e-bike

BRAKE Shimano MT420 4-Piston (3-Finger)
ROTOR Shimano RT64 CL 180 / 160
WHEEL F KTM Line - Shimano Deore M6010B CL 32H 110-15TA
 Ambrosio Track Disc 32H 622x20C
 DT Champion 2.0 black
WHEEL R KTM Line - Shimano Deore M6000 CL 32H 135-5QR
 Ambrosio Track Disc 32H 622x20C
 DT Alpine II 2.34 black
TIRE F Schwalbe Marathon Mondial Perf. RaceGuard 42-622
TIRE R Schwalbe Marathon Mondial Perf. RaceGuard 42-622
GRIP Ergon GP3 SD w/Barend
BAR KTM Line low rizer 640mm
STEM KTM Line 17"

HEADSET KTM Team Trekking angle limit 1.1/8>1.5" +5
SADDLE Selle Royal Essenza
SEATPOST KTM Line 30.9/350
PEDAL Trekk.-Pedal VP-616 (anti-slip)
CARRIER KTM Racktime light (snap-it)
LIGHT F B&M Lumotec IQ-XS LED 70Lux
LIGHT R B&M Toplight View LED
FENDER SKS A46R 46mm black matt
CHAINGUARD KTM type 1 for Bosch Gen.4
KICKSTAND Hebie 28" adjust
CATEGORY E2
SYSTEM WEIGHT 143 kg (permissible total weight)
WEIGHT 23,6 kg (without pedals)



lightgrey matt (white+orange)

- ✓ 020452106 MACINA SPORT 620 H 46cm
- ✓ 020452111 MACINA SPORT 620 H 51cm
- ✓ 020452116 MACINA SPORT 620 H 56cm
- ✓ 020452120 MACINA SPORT 620 H 60cm

lightgrey matt (white+orange)

- ✓ 020452206 MACINA SPORT 620 D 46cm
- ✓ 020452211 MACINA SPORT 620 D 51cm
- ✓ 020452216 MACINA SPORT 620 D 56cm

lightgrey matt (white+orange)

- ✓ 020452503 MACINA SPORT 620 US 43cm
- ✓ 020452506 MACINA SPORT 620 US 46cm
- ✓ 020452511 MACINA SPORT 620 US 51cm
- ✓ 020452516 MACINA SPORT 620 US 56cm

MACINA

SPORT

630

PT-CX 614

625 WH BATTERY

1x10 SHIMANO DEORE



FRAME Macina Trekking Onroad Alloy6061; PT625Wh Bosch Gen.4 / T-0450
FORK Suntour NCX-D coil LO 63mm
MOTOR Bosch PERFORMANCE CX Gen.4 - 25km/h / 75Nm
DISPLAY Bosch INTUVIA LCD Display with Remote
BATTERY Bosch PowerTUBE 625Wh hor.
CHARGER Bosch STANDARD Charger 4A
R. DERAILL. Shimano Deore M6000-10 GS shadow+
SHIFTLEV. Shimano Deore T6000-10 w/Display
CRANKSET KTM COMP ISIS 170mm Q16
CHAINRING FSA Megatooth steel 42T
SPROCKET Shimano Deore HG500-10 / 11-42
CHAIN Shimano E6090-10 e-bike

BRAKE Shimano MT420 4-Piston (3-Finger)
ROTOR Shimano RT54 CL 180 / 160
WHEEL F KTM Line - Shimano Deore M6000 CL 32H 100-5QR
 Ambrosio Track Disc 32H 622x20C
 DT Champion 2.0 black
WHEEL R KTM Line - Shimano Deore M6000 CL 32H 135-5QR
 Ambrosio Track Disc 32H 622x20C
 DT Alpine II 2.34 black
TIRE F Schwalbe Marathon Mondial Perf. RaceGuard 42-622
TIRE R Schwalbe Marathon Mondial Perf. RaceGuard 42-622
GRIP Ergon GP3 SD w/Barend
BAR KTM Line low rizer 640mm
STEM KTM Line 17"

HEADSET KTM Team Trekking angle limit 1.1/8>1.5" +5
SADDLE Selle Royal Essenza
SEATPOST KTM Line 30.9/350
PEDAL Trekk.-Pedal VP-616 (anti-slip)
CARRIER KTM Racktime light (snap-it)
LIGHT F B&M Lumotec MYC LED 50Lux
LIGHT R B&M Toplight View LED
FENDER SKS A46R 46mm black matt
CHAINGUARD KTM type 1 for Bosch Gen.4
KICKSTAND KTM 28" adjust
CATEGORY E2
SYSTEM WEIGHT 143 kg (permissible total weight)
WEIGHT 23,7 kg (without pedals)



black matt (white+green)

- ✓ 020453106 MACINA SPORT 630 H 46cm
- ✓ 020453111 MACINA SPORT 630 H 51cm
- ✓ 020453116 MACINA SPORT 630 H 56cm
- ✓ 020453120 MACINA SPORT 630 H 60cm

black matt (white+green)

- ✓ 020453206 MACINA SPORT 630 D 46cm
- ✓ 020453211 MACINA SPORT 630 D 51cm
- ✓ 020453216 MACINA SPORT 630 D 56cm

black matt (white+green)

- ✓ 020453503 MACINA SPORT 630 US 43cm
- ✓ 020453506 MACINA SPORT 630 US 46cm
- ✓ 020453511 MACINA SPORT 630 US 51cm
- ✓ 020453516 MACINA SPORT 630 US 56cm

MACINA

SPORT

510

PT-CX 514

500 WH BATTERY

1x10 SHIMANO DEORE



FRAME Macina Trekking Onroad Alloy6061; PT500Wh Bosch Gen.4 / T-0940

FORK Suntour NCX-D coil LO 63mm

MOTOR Bosch PERFORMANCE CX Gen.4 - 25km/h / 75Nm

DISPLAY Bosch INTUVIA LCD Display with Remote

BATTERY Bosch PowerTUBE 500Wh hor.

CHARGER Bosch STANDARD Charger 4A

R. DERAILL. Shimano Deore M6000-10 GS shadow+

SHIFTLEV. Shimano Deore T6000-10 w/Display

CRANKSET KTM COMP ISIS 170mm Q16

CHAINRING FSA Megatooth steel 42T

SPROCKET Shimano Deore HG500-10 / 11-42

CHAIN Shimano E6090-10 e-bike

BRAKE Shimano MT200 2-Piston

ROTOR Shimano RT54 CL 180 / 160

WHEEL F KTM Line - Shimano Deore M6000 CL 32H 100-50R
Ambrosio Track Disc 32H 622x20C
DT Champion 2.0 black

WHEEL R KTM Line - Shimano Deore M6000 CL 32H 135-50R
Ambrosio Track Disc 32H 622x20C
DT Alpine II 2.34 black

TIRE F Schwalbe Marathon Mondial Perf. RaceGuard 42-622

TIRE R Schwalbe Marathon Mondial Perf. RaceGuard 42-622

GRIP Ergon GP3 SD w/Barend

BAR KTM Line low rizer 640mm

STEM KTM Line 17"

HEADSET KTM Team Trekking angle limit 1.1/8-1.5" +15

SADDLE Selle Royal Essenza

SEATPOST KTM Line 30.9/350

PEDAL Trekk.-Pedal VP-616 (anti-slip)

CARRIER KTM Racktime light (snap-it)

LIGHT F B&M Lumotec MYC LED 50Lux

LIGHT R B&M Toplight 2C LED

FENDER SKS B46R 46mm black glossy

CHAINGUARD KTM type 2 for Bosch Gen.4

KICKSTAND KTM 28" adjust

CATEGORY E2

SYSTEM WEIGHT 142 kg (permissible total weight)

WEIGHT 22.8 kg (without pedals)



■ black matt (white)

🔗 020454106 MACINA SPORT 510 H 46cm

🔗 020454111 MACINA SPORT 510 H 51cm

🔗 020454116 MACINA SPORT 510 H 56cm

🔗 020454120 MACINA SPORT 510 H 60cm



■ black matt (white)

🔗 020454206 MACINA SPORT 510 D 46cm

🔗 020454211 MACINA SPORT 510 D 51cm

🔗 020454216 MACINA SPORT 510 D 56cm



■ black matt (white)

🔗 020454503 MACINA SPORT 510 US 43cm

🔗 020454506 MACINA SPORT 510 US 46cm

🔗 020454511 MACINA SPORT 510 US 51cm

🔗 020454516 MACINA SPORT 510 US 56cm

MACINA

SPORT

520

UC-CX5I2

500 WH BATTERY

1x9 SHIMANO ACREA



FRAME Macina Trekking Onroad Alloy6061 MC; UC-PP500Wh Bosch Gen.4 / T-0200

FORK Suntour NEX-E25 coil NLO 63mm

MOTOR Bosch PERFORMANCE CX Gen.4 - 25km/h / 75Nm

DISPLAY Bosch INTUVIA LCD Display with Remote

BATTERY Bosch PowerPACK 500Wh

CHARGER Bosch COMPACT Charger 2A

R. DERAILL. Shimano Acera M3000-9 SGS shadow

SHIFTLEV. Shimano Altus M2010-9 w/Display

CRANKSET KTM COMP ISIS 170mm Q16

CHAINRING FSA Megatooth steel 42T

SPROCKET Shimano HG200-9 / 11-36

CHAIN Shimano E6070-9 e-bike

BRAKE Shimano MT200 2-Piston

ROTOR Shimano RT30 CL 180 / 160

WHEEL F KTM Line - Shimano Acera M3050 CL 32H 100-50R
Ambrosio Track Disc 32H 622x20C
DT Champion 2.0 black

WHEEL R KTM Line - Shimano Deore M6000 CL 32H 135-50R
Ambrosio Track Disc 32H 622x20C
DT Alpine II 2.34 black

TIRE F Schwalbe Marathon Mondial Perf. RaceGuard 42-622

TIRE R Schwalbe Marathon Mondial Perf. RaceGuard 42-622

GRIP Ergon GP1 SD w/o Barend

BAR KTM Line low rizer 640mm

STEM KTM Line 17"

HEADSET Ritchey Logic Zero Comp 1.1/8-1.5"

SADDLE Selle Royal Rio+

SEATPOST KTM Line 30.9/350

PEDAL MTB-Pedal C280DU alloy

CARRIER KTM Racktime light (snap-it)

LIGHT F B&M Lumotec AVY LED 40Lux

LIGHT R B&M Toplight 2C LED

FENDER SKS B46R 46mm black glossy

CHAINGUARD KTM type 3 for Bosch Gen.4

MODULE NO. KTM 28" adjust

CATEGORY E2

SYSTEM WEIGHT 141 kg (permissible total weight)

WEIGHT 23 kg (without pedals)



■ black matt (orange)

🔗 020456106 MACINA SPORT 520 H 46cm

🔗 020456111 MACINA SPORT 520 H 51cm

🔗 020456116 MACINA SPORT 520 H 56cm

🔗 020456120 MACINA SPORT 520 H 60cm



■ black matt (orange)

🔗 020456206 MACINA SPORT 520 D 46cm

🔗 020456211 MACINA SPORT 520 D 51cm

🔗 020456216 MACINA SPORT 520 D 56cm

MACINA

MILA

610

PT-CX 10K6

2x500 WH BATTERY

1x11 SHIMANO DEORE XT



FRAME	Macina Trekking Onroad Alloy6061; Dual PT-PP500Wh Bosch Gen. 4 / T-0900
FORK	Suntour NCX-E air LO 63mm 15QLC
MOTOR	Bosch PERFORMANCE CX Gen. 4 - 25km/h / 75Nm
DISPLAY	Bosch KIOX TFT Display with Remote
BATTERY	Bosch PowerTUBE 500Wh hor. / Bosch Power-PACK 500Wh
CHARGER	Bosch FAST Charger 6A
R. DERAILL.	Shimano Deore XT M8000-11 GS shadow+
SHIFTLEV.	Shimano Deore XT M8000-11 w/Display
CRANKSET	KTM TEAM ISIS 170mm Q16
CHAINRING	FSA Megatooth steel 42T
SPROCKET	Shimano SLX M7000-11 / 11-46
CHAIN	Shimano E8000-11 e-bike

DRAKE	Shimano MT420 4-Piston (3-Finger)
ROTOR	Shimano RT64 CL 180 / 160
WHEEL F	KTM Line - DT Swiss 350 CL 32H 100-15TA DT Swiss H1950 32H 622x25TC
WHEEL R	KTM Line - DT Swiss 370 CL 32H 135-5QR DT Swiss H1950 32H 622x25TC
TIRE F	Schwalbe Marathon E-Plus Perf. DD SmartGuard 47-622
TIRE R	Schwalbe Marathon E-Plus Perf. DD SmartGuard 47-622
GRIP	Ergon GP3 SD w/Barend
BAR	KTM Line rizer20 640mm

STEM	KTM Line Kiox adjust. 0-25°
HEADSET	KTM Team Trekking angle limit 1.1/8>1.5" +5
SADDLE	Selle Royal Lookin
SEATPOST	Suntour SP17-NCX suspension 30.9/350
PEDAL	Trekk.-Pedal VP-616 (anti-slip)
CARRIER	KTM Racktime tour (snap-it)
LIGHT F	B&M Lumotec IQ-X LED 150Lux
LIGHT R	B&M Toplight View LED
FENDER	SKS A55K 55mm black matt
CHAINGUARD	KTM type 1 for Bosch Gen.4
KICKSTAND	Hebie 28" adjust
CATEGORY	E2
SYSTEM WEIGHT	147 kg (permissible total weight)
WEIGHT	28,2 kg (without pedals)



stonegrey matt (black)

- 020460106 MACINA MILA H 46cm
- 020460111 MACINA MILA H 51cm
- 020460116 MACINA MILA H 56cm
- 020460120 MACINA MILA H 60cm

MACINA

STYLE

610

PT-CX 6K6

625 WH BATTERY

1x11 SHIMANO DEORE XT



FRAME	Macina Trekking Onroad Alloy6061; PT625Wh Bosch Gen. 4 / T-0450
FORK	Suntour NCX-E air LO 63mm 15QLC
MOTOR	Bosch PERFORMANCE CX Gen. 4 - 25km/h / 75Nm
DISPLAY	Bosch KIOX TFT Display with Remote
BATTERY	Bosch PowerTUBE 625Wh hor.
CHARGER	Bosch FAST Charger 6A
R. DERAILL.	Shimano Deore XT M8000-11 GS shadow+
SHIFTLEV.	Shimano Deore XT M8000-11 w/Display
CRANKSET	KTM TEAM ISIS 170mm Q16
CHAINRING	FSA Megatooth steel 42T
SPROCKET	Shimano SLX M7000-11 / 11-46
CHAIN	Shimano E8000-11 e-bike

DRAKE	Shimano MT420 4-Piston (3-Finger)
ROTOR	Shimano RT64 CL 180 / 160
WHEEL F	KTM Line - DT Swiss 350 CL 32H 100-15TA DT Swiss H1950 32H 622x25TC
WHEEL R	KTM Line - DT Swiss 370 CL 32H 135-5QR DT Swiss H1950 32H 622x25TC
TIRE F	Schwalbe Energizer Plus Perf. GreenGuard 47-622
TIRE R	Schwalbe Energizer Plus Perf. GreenGuard 47-622
GRIP	Ergon GP3 SD w/Barend
BAR	KTM Line rizer20 640mm
STEM	KTM Line Kiox adjust. 0-25°

HEADSET	KTM Team Trekking angle limit 1.1/8>1.5" +5
SADDLE	Selle Royal Lookin
SEATPOST	Suntour SP17-NCX suspension 30.9/350
PEDAL	Trekk.-Pedal VP-616 (anti-slip)
CARRIER	KTM Racktime tour (snap-it)
LIGHT F	B&M Lumotec IQ-X LED 150Lux
LIGHT R	B&M Toplight View LED
FENDER	SKS A55K 55mm black matt
CHAINGUARD	KTM type 1 for Bosch Gen.4
KICKSTAND	Hebie 28" adjust
CATEGORY	E2
SYSTEM WEIGHT	144 kg (permissible total weight)
WEIGHT	24,9 kg (without pedals)



black matt (grey+orange)

- 020461106 MACINA STYLE 610 H 46cm
- 020461111 MACINA STYLE 610 H 51cm
- 020461116 MACINA STYLE 610 H 56cm
- 020461120 MACINA STYLE 610 H 60cm



black matt (grey+orange)

- 020461206 MACINA STYLE 610 D 46cm
- 020461211 MACINA STYLE 610 D 51cm
- 020461216 MACINA STYLE 610 D 56cm



black matt (grey+orange)

- 020461503 MACINA STYLE 610 US 43cm
- 020461506 MACINA STYLE 610 US 46cm
- 020461511 MACINA STYLE 610 US 51cm
- 020461516 MACINA STYLE 610 US 56cm

MACINA STYLE

620

PT-CX 614

625 WH BATTERY

1x11 SHIMANO SLX



MACINA STYLE

630

PT-CX 614

625 WH BATTERY

1x10 SHIMANO DEORE



FRAME Macina Trekking Onroad Alloy6061: PT625Wh Bosch Gen.4 / T-0450
FORK Suntour NCX-E air LO 63mm 15QLC
MOTOR Bosch PERFORMANCE CX Gen.4 - 25km/h / 75Nm
DISPLAY Bosch INTUVIA LCD Display with Remote
BATTERY Bosch PowerTUBE 625Wh hor.
CHARGER Bosch STANDARD Charger 4A
R. DERAILL. Shimano SLX M7000-11 GS shadow+
SHIFTLEV. Shimano SLX M7000-11 w/Display
CRANKSET KTM TEAM ISIS 170mm Q16
CHAINRING FSA Megatooth steel 42T
SPROCKET Shimano SLX M7000-11 / 11-46
CHAIN Shimano E8000-11 e-bike

DRAKE Shimano MT420 4-Piston (3-Finger)
ROTOR Shimano RT54 CL 180 / 160
WHEEL F KTM Line - Shimano Deore M6010 CL 32H 100-15TA
 Ambrosio Track Disc 32H 622x20C
 DT Champion 2.0 black
WHEEL R KTM Line - Shimano Deore M6000 CL 32H 135-5QR
 Ambrosio Track Disc 32H 622x20C
 DT Alpine II 2.34 black
TIRE F Schwalbe Energizer Plus Perf. GreenGuard 47-622
TIRE R Schwalbe Energizer Plus Perf. GreenGuard 47-622
GRIP Ergon GP3 SD w/Barend
BAR KTM Line rizer20 640mm
STEM KTM Line UP+ adjust. 0-90°

HEADSET KTM Team Trekking angle limit 1.1/8-1.5" +5
SADDLE Selle Royal Lookin
SEATPOST Suntour SP17-NCX suspension 30.9/350
PEDAL Trekk.-Pedal VP-616 (anti-slip)
CARRIER KTM Racktime tour (snap-it)
LIGHT F B&M Lumotec IQ-XS LED 70Lux
LIGHT R B&M Toplight View LED
FENDER SKS A55K 55mm black matt
CHAINGUARD KTM type 1 for Bosch Gen.4
KICKSTAND Hebie 28" adjust
CATEGORY E2
SYSTEM WEIGHT 14.4 kg (permissible total weight)
WEIGHT 25.2 kg (without pedals)

FRAME Macina Trekking Onroad Alloy6061: PT625Wh Bosch Gen.4 / T-0450
FORK Suntour NCX-D coil LO 63mm
MOTOR Bosch PERFORMANCE CX Gen.4 - 25km/h / 75Nm
DISPLAY Bosch INTUVIA LCD Display with Remote
BATTERY Bosch PowerTUBE 625Wh hor.
CHARGER Bosch STANDARD Charger 4A
R. DERAILL. Shimano Deore M6000-10 GS shadow+
SHIFTLEV. Shimano Deore T6000-10 w/Display
CRANKSET KTM COMP ISIS 170mm Q16
CHAINRING FSA Megatooth steel 42T
SPROCKET Shimano Deore HG500-10 / 11-42
CHAIN Shimano E6090-10 e-bike

DRAKE Shimano MT420 4-Piston (3-Finger)
ROTOR Shimano RT54 CL 180 / 160
WHEEL F KTM Line - Shimano Deore M6000 CL 32H 100-5QR
 Ambrosio Track Disc 32H 622x20C
 DT Champion 2.0 black
WHEEL R KTM Line - Shimano Deore M6000 CL 32H 135-5QR
 Ambrosio Track Disc 32H 622x20C
 DT Alpine II 2.34 black
TIRE F Schwalbe Energizer Plus Perf. GreenGuard 47-622
TIRE R Schwalbe Energizer Plus Perf. GreenGuard 47-622
GRIP Ergon GP3 SD w/Barend
BAR KTM Line rizer20 640mm
STEM KTM Line UP3 adjust. 0-90°

HEADSET KTM Team Trekking angle limit 1.1/8-1.5" +5
SADDLE Selle Royal Lookin
SEATPOST Suntour SP17-NCX suspension 30.9/350
PEDAL Trekk.-Pedal VP-616 (anti-slip)
CARRIER KTM Racktime tour (snap-it)
LIGHT F B&M Lumotec MYC LED 50Lux
LIGHT R B&M Toplight View LED
FENDER SKS A55K 55mm black matt
CHAINGUARD KTM type 1 for Bosch Gen.4
KICKSTAND KTM 28" adjust
CATEGORY E2
SYSTEM WEIGHT 14.4 kg (permissible total weight)
WEIGHT 25.4 kg (without pedals)



- lightgrey matt (white+orange)
- 020462106 MACINA STYLE 620 H 46cm
- 020462111 MACINA STYLE 620 H 51cm
- 020462116 MACINA STYLE 620 H 56cm
- 020462120 MACINA STYLE 620 H 60cm

- lightgrey matt (white+orange)
- 020462206 MACINA STYLE 620 D 46cm
- 020462211 MACINA STYLE 620 D 51cm
- 020462216 MACINA STYLE 620 D 56cm

- lightgrey matt (white+orange)
- 020462503 MACINA STYLE 620 US 43cm
- 020462506 MACINA STYLE 620 US 46cm
- 020462511 MACINA STYLE 620 US 51cm
- 020462516 MACINA STYLE 620 US 56cm

- black matt (white+green)
- 020463106 MACINA STYLE 630 H 46cm
- 020463111 MACINA STYLE 630 H 51cm
- 020463116 MACINA STYLE 630 H 56cm
- 020463120 MACINA STYLE 630 H 60cm

- black matt (white+green)
- 020463206 MACINA STYLE 630 D 46cm
- 020463211 MACINA STYLE 630 D 51cm
- 020463216 MACINA STYLE 630 D 56cm

- black matt (white+green)
- 020463503 MACINA STYLE 630 US 43cm
- 020463506 MACINA STYLE 630 US 46cm
- 020463511 MACINA STYLE 630 US 51cm
- 020463516 MACINA STYLE 630 US 56cm

MACINA STYLE XL

PT-CX 614
625 WH BATTERY
1x11 SHIMANO SLX

PT-CX 514
500 WH BATTERY
1x9 SHIMANO DEORE

MACINA TOUR 510



FRAME Macina Trekking Onroad Alloy6061: PT625Wh Bosch Gen.4 / T-0450
FORK Suntour NCX-D coil LO 63mm (HD)
MOTOR Bosch PERFORMANCE CX Gen.4 - 25km/h / 75Nm
DISPLAY Bosch INTUVIA LCD Display with Remote
BATTERY Bosch PowerTUBE 625Wh hor.
CHARGER Bosch STANDARD Charger 4A
R. DERAILL. Shimano SLX M7000-11 GS shadow+
SHIFTLEV. Shimano SLX M7000-11 w/Display
CRANKSET KTM COMP ISIS 170mm Q16
CHAINRING FSA Megatooth steel 42T
SPROCKET Shimano SLX M7000-11 / 11-46
CHAIN Shimano E8000-11 e-bike

BRAKE Shimano MT420 4-Piston (3-Finger)
ROTOR Shimano RT54 CL 180 / 180
WHEEL F KTM Line - Shimano Deore M6000 CL 36H 100-5QR
Ryde Andra40 Disc 36H 622x25C
DT Alpine II 2.34 black
WHEEL R KTM Line - Shimano Deore M6000 CL 36H 135-5QR
Ryde Andra40 Disc 36H 622x25C
DT Alpine II 2.34 black
TIRE F Schwalbe Marathon E-Plus Perf. DD SmartGuard 47-622
TIRE R Schwalbe Marathon E-Plus Perf. DD SmartGuard 47-622
GRIP Ergon GP1 SD w/o Barend
BAR Ergotec Lady Town GH16 620mm
STEM Ergotec Swell RE70 adjust.

HEADSET KTM Team Trekking angle limit 1.1/8>1.5" +5
SADDLE Selle Royal Viaggio City
SEATPOST Ergotec Skalar 30.9/350
PEDAL Trekk.-Pedal VP-616 (anti-slip)
CARRIER KTM Racktime tour (snap-it)
LIGHT F B&M Lumotec IQ-XS LED 70Lux
LIGHT R B&M Toplight View LED
FENDER SKS A55K 55mm black matt
CHAINGUARD KTM type 1 for Bosch Gen.4
KICKSTAND KTM 28" adjust
CATEGORY E2
SYSTEM WEIGHT 167 kg (permissible total weight)
WEIGHT 25.9 kg (without pedals)

FRAME Macina Trekking Onroad Alloy6061: PT500Wh Bosch Gen.4 / T-0940
FORK Suntour NCX-D coil LO 63mm
MOTOR Bosch PERFORMANCE CX Gen.4 - 25km/h / 75Nm
DISPLAY Bosch INTUVIA LCD Display with Remote
BATTERY Bosch PowerTUBE 500Wh hor.
CHARGER Bosch STANDARD Charger 4A
R. DERAILL. Shimano Deore M592-9 SGS shadow
SHIFTLEV. Shimano Altus M2010-9 w/Display
CRANKSET KTM COMP ISIS 170mm Q16
CHAINRING FSA Megatooth steel 42T
SPROCKET Shimano HG201-9 / 11-36
CHAIN Shimano E6070-9 e-bike

BRAKE Shimano MT200 2-Piston
ROTOR Shimano RT54 CL 180 / 160
WHEEL F KTM Line - Shimano Deore M6000 CL 32H 100-5QR
Ambrosio Track Disc 32H 622x20C
DT Champion 2.0 black
WHEEL R KTM Line - Shimano Deore M6000 CL 32H 135-5QR
Ambrosio Track Disc 32H 622x20C
DT Alpine II 2.34 black
TIRE F Schwalbe Energizer Plus Perf. GreenGuard 47-622
TIRE R Schwalbe Energizer Plus Perf. GreenGuard 47-622
GRIP Ergon GP1 SD w/o Barend
BAR KTM Line rizer20 640mm
STEM KTM Line UP3 adjust. 0-90°

HEADSET KTM Team Trekking angle limit 1.1/8>1.5" +15
SADDLE Selle Royal Lookin
SEATPOST KTM Line Elegance suspension 30.9/300
PEDAL Trekk.-Pedal VP-616 (anti-slip)
CARRIER KTM Racktime tour (snap-it)
LIGHT F B&M Lumotec MYC LED 50Lux
LIGHT R B&M Toplight 2C LED
FENDER SKS A55K 55mm black matt
CHAINGUARD KTM type 2 for Bosch Gen.4
MODULE NO. KTM 28" adjust
CATEGORY E2
SYSTEM WEIGHT 143 kg (permissible total weight)
WEIGHT 24 kg (without pedals)



- 020464106 MACINA STYLE XL H 46cm
- 020464111 MACINA STYLE XL H 51cm
- 020464116 MACINA STYLE XL H 56cm
- 020464120 MACINA STYLE XL H 60cm
- 020464123 MACINA STYLE XL H 63cm

- black matt (grey)
- 020464206 MACINA STYLE XL D 46cm
 - 020464211 MACINA STYLE XL D 51cm
 - 020464216 MACINA STYLE XL D 56cm

- black matt (grey)
- 020464506 MACINA STYLE XL US 46cm
 - 020464511 MACINA STYLE XL US 51cm
 - 020464516 MACINA STYLE XL US 56cm



- black matt (white+blue)
- 020465106 MACINA TOUR 510 H 46cm
 - 020465111 MACINA TOUR 510 H 51cm
 - 020465116 MACINA TOUR 510 H 56cm
 - 020465120 MACINA TOUR 510 H 60cm

- black matt (white+blue)
- 020465206 MACINA TOUR 510 D 46cm
 - 020465211 MACINA TOUR 510 D 51cm
 - 020465216 MACINA TOUR 510 D 56cm

- black matt (white+blue)
- 020465503 MACINA TOUR 510 US 43cm
 - 020465506 MACINA TOUR 510 US 46cm
 - 020465511 MACINA TOUR 510 US 51cm
 - 020465516 MACINA TOUR 510 US 56cm

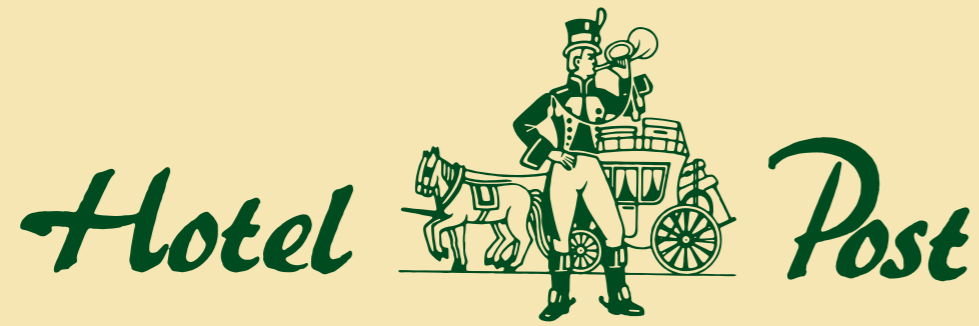

Weißenbach am Attersee



Sommerfrische am Attersee

Radurlaub im Salzkammergut

www.hotelpost-attersee.at

Sport, Kultur und Erholung



E-Bike, MTB & Rennrad Touren

Rund um den Attersee finden sich für alle sportbegeisterten E-Bike, Mountainbike- & Rennrad Fans zahlreiche Touren. Das umliegende Höllengebirge bietet für Mountainbiker die idealen Voraussetzungen. Von knackigen Trails bis hin zu gemütlichen Forststraßen - im Salzkammergut ist für jeden etwas dabei. Im Umkreis von 20 - 45 km erreichen Sie Bad Ischl und die schönsten Seen des Salzkammerguts. Wolfgangsee, Mondsee, Fuschlsee und Hallstättersee befinden sich praktisch vor Ihrer Haustüre.

Seenrunde Salzkammergut

Das Hotel Post liegt in einer der idyllischsten Regionen Österreichs. Herrliche Landschaften lassen sich auf dem Rad erkunden. Ein wunderschöner Tagesausflug rund um den Schafberg beginnt direkt am Hotel in Richtung Bad Ischl. Von der Kaiserstadt geht es in Richtung Wolfgangsee, wo Sie einen wunderbaren Blick auf den Schafberg genießen. Von St. Gilgen aus überwinden Sie den Scharfling, gelangen direkt an den Mondsee und fahren auf sanftem Gelände zurück zum Hotel.



KTM Fahrräder und eBikes für Hotelgäste

Für seine Gäste bietet das Hotel Post ein ganz aussergewöhnliches Zuckerl. Sie können kostenlos KTM eBikes und normale Fahrräder benutzen und damit die Gegend erkunden. Die herrlichen Salzkammergut Radwege warten nur auf Sie.

Hotel Post am Attersee GmbH
Ischler Straße 1
A-4854 Weißenbach / Attersee
Tel.: +43 (0) 7663 / 8141
Fax.: +43 (0) 7663 / 8141-45
office@hotelpost-attersee.at

MACINA

FUN

510

UC-P 514

500 WH BATTERY

1×9 SHIMANO DEORE



FRAME	Macina Trekking Onroad Alloy6061; UC-PP500Wh Bosch Gen.3 / T-9700
FORK	Suntour NEX-E25 coil NLO 63mm
MOTOR	Bosch PERFORMANCE Gen.3 - 25km/h / 65Nm
DISPLAY	Bosch INTUVIA LCD Display with Remote
BATTERY	Bosch PowerPACK 500Wh
CHARGER	Bosch STANDARD Charger 4A
R. DERAILL.	Shimano Deore M592-9 SGS shadow
SHIFTLEV.	Shimano Altus M2010-9 w/Display
CRANKSET	KTM COMP BNI 170mm Q16
CHAINRING	FSA steel 42T
SPROCKET	Shimano HG201-9 / 11-36

CHAIN	Shimano E6070-9 e-bike
BRAKE	Shimano MT420 4-Piston (3-Finger)
ROTOR	Shimano RT30 CL 180 / 160
WHEEL F	KTM Line - Shimano Acera M3050 CL 32H 100-50R Ambrosio Track Disc 32H 622x20C DT Champion 2.0 black
WHEEL R	KTM Line - Shimano Deore M6000 CL 32H 135-50R Ambrosio Track Disc 32H 622x20C DT Alpine II 2.34 black
TIRE F	Schwalbe Energizer Plus Perf. GreenGuard 40-622
TIRE R	Schwalbe Energizer Plus Perf. GreenGuard 40-622
GRIP	Ergon GP1 SD w/o Barend
BAR	KTM Line rizer20 640mm

STEM	KTM Line UP3 adjust. 0-90°
HEADSET	Ritchey OE Logic Zero 1.1/8"
SADDLE	Selle Royal Lookin
SEATPOST	Suntour SP17-NCX suspension 30.9/350
PEDAL	Trekk.-Pedal VP-616 (anti-slip)
CARRIER	KTM Racktime tour (snap-it)
LIGHT F	B&M Lumotec AVY LED 40Lux
LIGHT R	B&M Toplight 2C LED
FENDER	SKS B46R 46mm black glossy
KICKSTAND	KTM 28" adjust
CATEGORY	E2
SYSTEM WEIGHT	143 kg (permissible total weight)
WEIGHT	24,5 kg (without pedals)



- black matt (grey+orange)
- 020466106 MACINA FUN 510 H 46cm
 - 020466111 MACINA FUN 510 H 51cm
 - 020466116 MACINA FUN 510 H 56cm
 - 020466120 MACINA FUN 510 H 60cm

- black matt (grey+orange)
- 020466206 MACINA FUN 510 D 46cm
 - 020466211 MACINA FUN 510 D 51cm
 - 020466216 MACINA FUN 510 D 56cm

- black matt (grey+orange)
- 020466503 MACINA FUN 510 US 43cm
 - 020466506 MACINA FUN 510 US 46cm
 - 020466511 MACINA FUN 510 US 51cm
 - 020466516 MACINA FUN 510 US 56cm

MACINA

FUN

520

SI-A+514

500 WH BATTERY

1×9 SHIMANO DEORE



FRAME	Macina Trekking Onroad Alloy6061; Si-PP500Wh Bosch Gen.3 / T-9690
FORK	Suntour NEX-E25 coil NLO 63mm
MOTOR	Bosch ACTIVE PLUS Gen.3 - 25km/h / 50Nm
DISPLAY	Bosch INTUVIA LCD Display with Remote
BATTERY	Bosch PowerPACK 500Wh
CHARGER	Bosch STANDARD Charger 4A
R. DERAILL.	Shimano Acera M3000-9 SGS shadow
SHIFTLEV.	Shimano Altus M2010-9 w/Display
CRANKSET	KTM COMP BNI 170mm Q16
CHAINRING	FSA steel 42T
SPROCKET	Shimano HG200-9 / 11-36
CHAIN	Shimano E6070-9 e-bike

BRAKE	Shimano MT200 2-Piston
ROTOR	Shimano RT30 CL 180 / 160
WHEEL F	KTM Line - Shimano Acera M3050 CL 32H 100-50R Ambrosio Track Disc 32H 622x20C DT Champion 2.0 black
WHEEL R	KTM Line - Shimano Acera M3050 CL 32H 135-50R Ambrosio Track Disc 32H 622x20C DT Alpine II 2.34 black
TIRE F	Schwalbe Energizer Plus Perf. GreenGuard 40-622
TIRE R	Schwalbe Energizer Plus Perf. GreenGuard 40-622
GRIP	Ergon GP1 SD w/o Barend
BAR	KTM Line rizer20 640mm
STEM	KTM Line UP3 adjust. 0-90°

HEADSET	Ritchey OE Logic Zero 1.1/8"
SADDLE	Selle Royal Essenza
SEATPOST	KTM Line Elegance suspension 30.9/300
PEDAL	Trekk.-Pedal VP-616 (anti-slip)
CARRIER	KTM Racktime tour (snap-it)
LIGHT F	B&M Lumotec AVY LED 40Lux
LIGHT R	B&M Toplight 2C LED
FENDER	SKS B46R 46mm black glossy
KICKSTAND	KTM 28" adjust
CATEGORY	E2
SYSTEM WEIGHT	143 kg (permissible total weight)
WEIGHT	24,6 kg (without pedals)



- eveblue matt (grey)
- 020467506 MACINA FUN 520 US 46cm
 - 020467511 MACINA FUN 520 US 51cm
 - 020467516 MACINA FUN 520 US 56cm



MACINA GRAN



MACINA GRAN 610 NEXUS 1*5

122-125



MACINA GRAN 510 NEXUS 1*5

126

MACINA CITY



MACINA CITY 5 ABS BELT NEXUS 1*5

127



MACINA CITY 5 610 BELT NEXUS 1*5

128



MACINA CITY 5 510 NEXUS 1*5

129

MACINA CENTRAL



MACINA CENTRAL 5 XL NEXUS 1*5

130



MACINA CENTRAL 5 RT XL NEXUS 1*5

131



MACINA CENTRAL 5 NEXUS 1*5

132



MACINA CENTRAL 5 RT NEXUS 1*5

133



MACINA CENTRAL 8 NEXUS 1*8

134



MACINA CENTRAL 8 RT NEXUS 1*8

135

MACINA FOLD



MACINA FOLD NEXUS 1*8

136

MACINA

GRAN

610



Die Innenstadt ist dein Bezirk.

Ewige Staus und lange Parkplatzsuche waren gestern. Das MACINA GRAN ist dein neuer bester Freund, wenn es ums Pendeln geht. Perfekt um rasch in die Arbeit oder durch das Innenstadtgewühl zum nächsten Termin zu gelangen - unsere E-Urban und Citybikes bringen dich sicher, entspannt und ohne

Schwitzen an dein Ziel. Die wartungsfreie Shimano Nexus Nabenschaltung erlaubt es dir, auch im Stand zu schalten, wenn du beispielsweise vor einer Ampel halten musst. Eine besonders hohe Alltagstauglichkeit steht hierbei im Vordergrund. Mit unseren E-Urban und Citybikes gehört die Stadt nur dir!

Downtown is your district.

Eternal traffic jams and the annoying long search for parking is so yesterday. The MACINA GRAN is your new best friend, it is perfect for quickly getting to work or through the crowded city to your next appointment - our

E-Urban and Citybikes take you safely, relaxed and without sweating to your destination. The maintenance-free Shimano Nexus hub gears allow you to shift even when stationary, for example when you have to stop at a traffic light. The MACINA GRAN was designed with your commuting needs in mind. With our E-Urban and Citybikes the city belongs only to you!



PT-CX6C06

625 WH BATTERY

1x5 SHIMANO NEXUS

LFE
LIGHT
FENDER
CARRIER

MACINA GRAN 610

FRAME Macina Trekking Alloy6061 IGH belt: PT625Wh Bosch Gen.4 / T-0770
FORK Alloy Rigid Longleg, PM-Disc TA15
MOTOR Bosch PERFORMANCE CX Gen.4 - 25km/h / 75Nm
DISPLAY Bosch SMARTPHONE HUB with Remote
BATTERY Bosch PowerTUBE 625Wh hor.
CHARGER Bosch FAST Charger 6A
SHIFTLEV. Shimano Nexus 5 Revoshifter
CRANKSET KTM TEAM ISIS 170mm Q16
CHAINRING Front-Sprocket Gates CDX 39T
SPROCKET Gates rear-sprocket 28T
CHAIN Gates drive-belt 118T CDX

BRAKE Shimano MT400 2-Piston (3-Finger)
ROTOR Shimano RT64 CL 180 / 160
WHEEL F KTM Line - Shimano Deore M6010 CL 36H 100-15TA
 Ambrosio Track Disc 36H 622x20C
 DT Champion 2.0 black
WHEEL R KTM Line - Shimano Nexus 5 SG-C700050 CL 32H
 Ambrosio Track Disc 36H 622x20C
 DT Alpine II 2.34 black
TIRE F Schwalbe Energizer Plus Perf. GreenGuard 47-622
TIRE R Schwalbe Energizer Plus Perf. GreenGuard 47-622
GRIP Ritchey WCS Classic leather (Nexus)
BAR Ergotec Lady Town GH16 620mm

STEM KTM Line UP+ adjust. 0-90°
HEADSET KTM Team Trekking angle limit 1.1/8>1.5" +5
SADDLE Selle Royal Lookin
SEATPOST KTM Line 30.9/350
PEDAL Trekk. -Pedal VP-616 (anti-slip)
CARRIER Wingee alloy fender- rails (plattform option)
LIGHT F B&M Lumotec IQ-XS LED 70Lux
KICKSTAND KTM 28" adjust
CATEGORY E2
SYSTEM WEIGHT 14.3 kg (permissible total weight)
WEIGHT 24.2 kg (without pedals)



■ black matt (black glossy)

- 🔪 020470106 MACINA GRAN 610 H 46cm
- 🔪 020470111 MACINA GRAN 610 H 51cm
- 🔪 020470116 MACINA GRAN 610 H 56cm
- 🔪 020470120 MACINA GRAN 610 H 60cm



■ black matt (black glossy)

- 🔪 020470206 MACINA GRAN 610 D 46cm
- 🔪 020470211 MACINA GRAN 610 D 51cm
- 🔪 020470216 MACINA GRAN 610 D 56cm
- 🔪 020470216 MACINA GRAN 610 D 56cm

MACINA GRAN 510

E-URBAN



LFE
LIGHT
FENDER
CARRIER

PT-CX 5P4

500 WH BATTERY

1x5 SHIMANO NEXUS

FRAME	Macina Trekking Alloy6061 IGH belt; PT625Wh Bosch Gen.4 / T-0770
FORK	Alloy Rigid Longleg, PM-Disc 9QR
MOTOR	Bosch PERFORMANCE CX Gen.4 - 25km/h / 75Nm
DISPLAY	Bosch PURION LCD Display
BATTERY	Bosch PowerTUBE 500Wh hor.
CHARGER	Bosch STANDARD Charger 4A
SHIFTLEV.	Shimano Nexus 5 Revoshifter
CRANKSET	KTM TEAM ISIS 170mm Q16
CHAINRING	Front-Sprocket Gates CDX 39T
SPROCKET	Gates rear-sprocket 28T
CHAIN	Gates drive-belt 118T CDX

BRAKE	Shimano MT400 2-Piston (3-Finger)
ROTOR	Shimano RT30 CL 180 / 160
WHEEL F	KTM Line - Shimano Alivio M4050 CL 36H 100-5QR
	Ambrosio Track Disc 36H 622x20C
	DT Champion 2.0 black
WHEEL R	KTM Line - Shimano Nexus 5 S6-C70005D CL 32H
	Ambrosio Track Disc 36H 622x20C
	DT Alpine II 2.34 black
TIRE F	Schwalbe Energizer Plus Perf. GreenGuard 47-622
TIRE R	Schwalbe Energizer Plus Perf. GreenGuard 47-622
GRIP	Ritchey WCS Classic leather (Nexus)
BAR	Ergotec Lady Town GH16 620mm

STEM	KTM Line UP+ adjust. 0-90°
HEADSET	KTM Team Trekking angle limit 1.1/8>1.5" +5
SADDLE	Selle Royal Lookin
SEATPOST	KTM Line 30.9/350
PEDAL	Trekk.-Pedal VP-616 (anti-slip)
CARRIER	Wingee alloy fender- rails (plattform option)
LIGHT F	B&M Lumotec MYC LED 50Lux
FENDER	KTM 28" adjust
CATEGORY	E2
SYSTEM WEIGHT	142 kg (permissible total weight)
WEIGHT	23,6 kg (without pedals)



■ black matt (black glossy)

- ✓ 020471106 MACINA GRAN 510 H 46cm
- ✓ 020471111 MACINA GRAN 510 H 51cm
- ✓ 020471116 MACINA GRAN 510 H 56cm
- ✓ 020471120 MACINA GRAN 510 H 60cm



■ black matt (black glossy)

- ✓ 020471206 MACINA GRAN 510 D 46cm
- ✓ 020471211 MACINA GRAN 510 D 51cm
- ✓ 020471216 MACINA GRAN 510 D 56cm

MACINA CITY 5 ABS BELT

E-URBAN



PT-CX 6K6

625 WH BATTERY

1x5 SHIMANO NEXUS

FRAME	Macina City US Alloy6061 belt; PT625Wh Bosch Gen.4 / T-0740
FORK	Suntour Mobie25 air LOR 63mm 15QLC
MOTOR	Bosch PERFORMANCE CX Gen.4 - 25km/h / 75Nm
DISPLAY	Bosch KIOX TFT Display with Remote
BATTERY	Bosch PowerTUBE 625Wh hor.
CHARGER	Bosch FAST Charger 6A
SHIFTLEV.	Shimano Nexus 5 Revoshifter
CRANKSET	KTM COMP ISIS 170mm Q16
CHAINRING	Front-Sprocket Gates CDX 39T
SPROCKET	Gates rear-sprocket 28T
CHAIN	Gates drive-belt 120T CDX

BRAKE	Bosch / Magura ABS set w/Rotor 180 / 180
WHEEL F	KTM Line - DT Swiss 370 6bolt 32H 100-15TA
	Ambrosio Track Disc 32H 622x20C
	DT Champion 2.0 black
WHEEL R	KTM Line - Shimano Nexus 5 S6-C70005D CL 32H
	Ambrosio Track Disc 32H 622x20C
	DT Alpine II 2.34 black
TIRE F	Schwalbe Energizer Plus Perf. GreenGuard 47-622
TIRE R	Schwalbe Energizer Plus Perf. GreenGuard 47-622
GRIP	Ergon GP1 short w/o Barend
BAR	Ergotec Lady Town GH16 620mm
STEM	KTM Line Kiox adjust. 0-25°

HEADSET	Ritchey Logic Zero Comp 1.1/8>1.5"
SADDLE	Selle Royal Lookin
SEATPOST	Suntour SP17-NCX suspension 30.9/350
PEDAL	Trekk.-Pedal VP-616 (anti-slip)
CARRIER	KTM Racktime tour (snap-it)
LIGHT F	B&M Lumotec IQ-XS LED 70Lux
LIGHT R	B&M Toplight View LED
FENDER	SKS B53T 53mm black matt
KICKSTAND	KTM 28" adjust
CATEGORY	E2
SYSTEM WEIGHT	145 kg (permissible total weight)
WEIGHT	26,8 kg (without pedals)



■ black matt (grey-white)

- ✓ 020475506 MACINA CITY 5 ABS US 46cm
- ✓ 020475511 MACINA CITY 5 ABS US 51cm
- ✓ 020475516 MACINA CITY 5 ABS US 56cm

MACINA

CITY

5 610 BELT

PT-CX 616

625 WH BATTERY

1x5 SHIMANO NEXUS



FRAME Macina City US Alloy6061 belt: PT625Wh Bosch Gen.4 / T-0730

FORK Suntour NCX-E air LO 63mm

MOTOR Bosch PERFORMANCE CX Gen.4 - 25km/h / 75Nm

DISPLAY Bosch INTUVIA LCD Display with Remote

BATTERY Bosch PowerTUBE 625Wh hor.

CHARGER Bosch FAST Charger 6A

SHIFTLEV. Shimano Nexus 5 Revoshifter

CRANKSET KTM COMP ISIS 170mm Q16

CHAINRING Front-Sprocket Gates CDX 39T

SPROCKET Gates rear-sprocket 28T

CHAIN Gates drive-belt 120T CDX

BRAKE Shimano MT400 2-Piston (3-Finger)

ROTOR Shimano RT30 CL 180 / 160

WHEEL F KTM Line - Shimano Deore M6000 CL 36H 100-5QR

WHEEL R KTM Line - Shimano Nexus 5 SG-C70005D CL 32H Ambrosio Track Disc 36H 622x20C DT Alpine II 2.34 black

TIRE F Schwalbe Energizer Plus Perf. GreenGuard 47-622

TIRE R Schwalbe Energizer Plus Perf. GreenGuard 47-622

GRIP Ergon GP1 short w/o Barend

BAR KTM Line Noirette Plus 660mm

STEM KTM Line UP+ adjust. 0-90°

HEADSET KTM Team Trekking angle limit 1.1/8>1.5" +5

SADDLE Selle Royal Lookin

SEATPOST Suntour SP17-NCX suspension 30.9/350

PEDAL Trekk.-Pedal VP-616 (anti-slip)

CARRIER KTM Racktime tour (snap-it)

LIGHT F B&M Lumotec IQ-XS LED 70Lux

LIGHT R B&M Toplight View LED

FENDER SKS B53T 53mm black matt

KICKSTAND KTM 28" adjust

CATEGORY E2

SYSTEM WEIGHT 145 kg (permissible total weight)

WEIGHT 27,1 kg (without pedals)



■ black matt (white+grey)

- ✓ 020476503 MACINA CITY 5 610 US 43cm
- ✓ 020476506 MACINA CITY 5 610 US 46cm
- ✓ 020476511 MACINA CITY 5 610 US 51cm
- ✓ 020476516 MACINA CITY 5 610 US 56cm

MACINA

CITY

5 510

PT-CX 514

500 WH BATTERY

1x5 SHIMANO NEXUS



FRAME Macina City US Alloy6061: PT625Wh Bosch Gen.4 / T-0750

FORK Suntour NCX-D coil LO 63mm

MOTOR Bosch PERFORMANCE CX Gen.4 - 25km/h / 75Nm

DISPLAY Bosch INTUVIA LCD Display with Remote

BATTERY Bosch PowerTUBE 500Wh hor.

CHARGER Bosch STANDARD Charger 4A

SHIFTLEV. Shimano Nexus 5 Revoshifter

CRANKSET KTM COMP ISIS 170mm Q16

CHAINRING FSA Megatooth steel 38T

SPROCKET ESJOT 30T

CHAIN KMC Z1eHX

BRAKE Shimano MT400 2-Piston (3-Finger)

ROTOR Shimano RT30 CL 180 / 160

WHEEL F KTM Line - Shimano Deore M6000 CL 36H 100-5QR Ambrosio Track Disc 36H 622x20C DT Champion 2.0 black

WHEEL R KTM Line - Shimano Nexus 5 SG-C70005D CL 32H Ambrosio Track Disc 36H 622x20C DT Alpine II 2.34 black

TIRE F Schwalbe Energizer Plus Perf. GreenGuard 47-622

TIRE R Schwalbe Energizer Plus Perf. GreenGuard 47-622

GRIP Ergon GP1 short w/o Barend

BAR KTM Line Noirette Plus 660mm

STEM KTM Line UP+ adjust. 0-90°

HEADSET KTM Team Trekking angle limit 1.1/8>1.5" +5

SADDLE Selle Royal Lookin

SEATPOST Suntour SP17-NCX suspension 30.9/350

PEDAL Trekk.-Pedal VP-616 (anti-slip)

CARRIER KTM Racktime tour (snap-it)

LIGHT F B&M Lumotec MYC LED 50Lux

LIGHT R B&M Toplight View LED

FENDER SKS B53T 53mm black matt

CHAINGUARD KTM type 4 for Bosch Gen.4

KICKSTAND KTM 28" adjust

CATEGORY E2

SYSTEM WEIGHT 145 kg (permissible total weight)

WEIGHT 26,5 kg (without pedals)



■ lightgrey matt (white+blue)

- ✓ 020477503 MACINA CITY 5 510 US 43cm
- ✓ 020477506 MACINA CITY 5 510 US 46cm
- ✓ 020477511 MACINA CITY 5 510 US 51cm
- ✓ 020477516 MACINA CITY 5 510 US 56cm

MACINA

CENTRAL

5 XL

SI-P 514

500 WH BATTERY

1x5 SHIMANO NEXUS



FRAME Macina City US Alloy6061: Si-PP500Wh Bosch Gen.3 / T-9680

FORK Suntour NCX-D coil LO 63mm (HD)

MOTOR Bosch PERFORMANCE Gen.3 - 25km/h / 65Nm

DISPLAY Bosch INTUVIA LCD Display with Remote

BATTERY Bosch PowerPACK 500Wh

CHARGER Bosch STANDARD Charger 4A

SHIFTLEV. Shimano Nexus 5 Revoshifter

CRANKSET KTM COMP BNI 170mm Q16

CHAINRING FSA steel 38T Direct Mount

SPROCKET ESJOT 30T

CHAIN KMC Z1eHX

BRAKE Magura HS22 Evo2

WHEEL F KTM Line - Shimano Deore T610 36H 100-50R
Ryde Andra40 36H 622x25C
DT Alpine II 2.34 black

WHEEL R KTM Line - Shimano Nexus 5 SG-C70005V FW 36H
Ryde Andra40 36H 622x25C
DT Alpine II 2.34 black

TIRE F Schwalbe Marathon E-Plus Perf. DD SmartGuard 40-622

TIRE R Schwalbe Marathon E-Plus Perf. DD SmartGuard 40-622

GRIP Ergon GP1 short w/o Barend

BAR Ergotec Lady Town GH16 620mm

STEM Ergotec Swell RE70 adjust.

HEADSET Ritchey OE Logic Zero 1.1/8"

SADDLE Selle Royal Viaggio City

SEATPOST Ergotec Skalar 30.9/350

PEDAL Trekk.-Pedal VP-616 (anti-slip)

CARRIER KTM Racktime tour (snap-it)

LIGHT F B&M Lumotec EYC LED 50Lux

LIGHT R B&M Toplight 2C LED

FENDER SKS B53T 53mm black glossy

CHAINGUARD SKS Chainbow 38T

KICKSTAND KTM 28" adjust

CATEGORY E2

SYSTEM WEIGHT 166 kg (permissible total weight)

WEIGHT 25.2 kg (without pedals)



■ black matt (grey)

- 🔗 020480503 MACINA CENTRAL 5 XL US 43cm
- 🔗 020480506 MACINA CENTRAL 5 XL US 46cm
- 🔗 020480511 MACINA CENTRAL 5 XL US 51cm
- 🔗 020480516 MACINA CENTRAL 5 XL US 56cm

MACINA

CENTRAL

5 RT XL

SI-P 514

500 WH BATTERY

1x5 SHIMANO NEXUS



FRAME Macina City US Alloy6061: Si-PP500Wh Bosch Gen.3 / T-9680

FORK Suntour NCX-D coil LO 63mm (HD)

MOTOR Bosch PERFORMANCE Gen.3 - 25km/h / 65Nm

DISPLAY Bosch INTUVIA LCD Display with Remote

BATTERY Bosch PowerPACK 500Wh

CHARGER Bosch STANDARD Charger 4A

SHIFTLEV. Shimano Nexus 5 Revoshifter

CRANKSET KTM COMP BNI 170mm Q16

CHAINRING FSA steel 38T Direct Mount

SPROCKET ESJOT 30T

CHAIN KMC Z1eHX

BRAKE Magura HS22 Evo2

WHEEL F KTM Line - Shimano Deore T610 36H 100-50R
Ryde Andra40 36H 622x25C
DT Alpine II 2.34 black

WHEEL R KTM Line - Shimano Nexus 5 SG-C70005C CB 36H
Ryde Andra40 36H 622x25C
DT Alpine II 2.34 black

TIRE F Schwalbe Marathon E-Plus Perf. DD SmartGuard 40-622

TIRE R Schwalbe Marathon E-Plus Perf. DD SmartGuard 40-622

GRIP Ergon GP1 short w/o Barend

BAR Ergotec Lady Town GH16 620mm

STEM Ergotec Swell RE70 adjust.

HEADSET Ritchey OE Logic Zero 1.1/8"

SADDLE Selle Royal Viaggio City

SEATPOST Ergotec Skalar 30.9/350

PEDAL Trekk.-Pedal VP-616 (anti-slip)

CARRIER KTM Racktime tour (snap-it)

LIGHT F B&M Lumotec EYC LED 50Lux

LIGHT R B&M Toplight 2C LED

FENDER SKS B53T 53mm black glossy

CHAINGUARD SKS Chainbow 38T

KICKSTAND KTM 28" adjust

CATEGORY E2

SYSTEM WEIGHT 166 kg (permissible total weight)

WEIGHT 25.2 kg (without pedals)



■ black matt (grey)

- 🔗 020481503 MACINA CENTRAL 5 RT XL US 43cm
- 🔗 020481506 MACINA CENTRAL 5 RT XL US 46cm
- 🔗 020481511 MACINA CENTRAL 5 RT XL US 51cm
- 🔗 020481516 MACINA CENTRAL 5 RT XL US 56cm

MACINA

CENTRAL

5



SI-P 514

500 WH BATTERY

1x5 SHIMANO NEXUS

FRAME Macina City US Alloy6061: Si-PP500Wh Bosch Gen.3 / T-9680

FORK Suntour NEX-E25 coil NLO 63mm

MOTOR Bosch PERFORMANCE Gen.3 - 25km/h / 65Nm

DISPLAY Bosch INTUVIA LCD Display with Remote

BATTERY Bosch PowerPACK 500Wh

CHARGER Bosch STANDARD Charger 4A

SHIFTLEV. Shimano Nexus 5 Revoshifter

CRANKSET KTM COMP BNI 170mm Q16

CHAINRING FSA steel 38T Direct Mount

SPROCKET ESJOT 30T

CHAIN KMC Z1eHX

BRAKE Magura HS11 Evo2

WHEEL F KTM Line - Shimano Acera T3000 36H 100-5QR

WHEEL R KTM Line - Shimano Nexus 5 SG-C70005V FW 36H Ambrosio Track 36H 622x20C DT Alpine II 2.34 silver

TIRE F Schwalbe Energizer Plus Perf. GreenGuard 40-622

TIRE R Schwalbe Energizer Plus Perf. GreenGuard 40-622

GRIP Ergon GP1 short w/o Barend

BAR KTM Line Noirette Plus 660mm

STEM KTM Line UP3 adjust. 0-90°

HEADSET Ritchey OE Logic Zero 1.1/8"

SADDLE Selle Royal Freeway

SEATPOST KTM Line Elegance suspension 30.9/300

PEDAL Trekk.-Pedal VP-616 (anti-slip)

CARRIER KTM Racktime tour (snap-it)

LIGHT F B&M Lumotec AVY LED 40Lux

LIGHT R B&M Toplight 2C LED

FENDER SKS B53T 53mm black glossy

CHAINGUARD SKS Chainbow 38T

KICKSTAND KTM 28" adjust

CATEGORY E2

SYSTEM WEIGHT 144 kg (permissible total weight)

WEIGHT 25,3 kg (without pedals)



■ black matt (grey+green)

- 🔗 020482503 MACINA CENTRAL 5 US 43cm
- 🔗 020482506 MACINA CENTRAL 5 US 46cm
- 🔗 020482511 MACINA CENTRAL 5 US 51cm
- 🔗 020482516 MACINA CENTRAL 5 US 56cm

MACINA

CENTRAL

5 RT



SI-P 514

500 WH BATTERY

1x5 SHIMANO NEXUS COASTERBRAKE

FRAME Macina City US Alloy6061: Si-PP500Wh Bosch Gen.3 / T-9680

FORK Suntour NEX-E25 coil NLO 63mm

MOTOR Bosch PERFORMANCE Gen.3 - 25km/h / 65Nm

DISPLAY Bosch INTUVIA LCD Display with Remote

BATTERY Bosch PowerPACK 500Wh

CHARGER Bosch STANDARD Charger 4A

SHIFTLEV. Shimano Nexus 5 Revoshifter

CRANKSET KTM COMP BNI 170mm Q16

CHAINRING FSA steel 38T Direct Mount

SPROCKET ESJOT 30T

CHAIN KMC Z1eHX

BRAKE Magura HS11 Evo2

WHEEL F KTM Line - Shimano Acera T3000 36H 100-5QR

WHEEL R KTM Line - Shimano Nexus 5 SG-C70005C CB 36H Ambrosio Track 36H 622x20C DT Alpine II 2.34 silver

TIRE F Schwalbe Energizer Plus Perf. GreenGuard 40-622

TIRE R Schwalbe Energizer Plus Perf. GreenGuard 40-622

GRIP Ergon GP1 short w/o Barend

BAR KTM Line Noirette Plus 660mm

STEM KTM Line UP3 adjust. 0-90°

HEADSET Ritchey OE Logic Zero 1.1/8"

SADDLE Selle Royal Freeway

SEATPOST KTM Line Elegance suspension 30.9/300

PEDAL Trekk.-Pedal VP-616 (anti-slip)

CARRIER KTM Racktime tour (snap-it)

LIGHT F B&M Lumotec AVY LED 40Lux

LIGHT R B&M Toplight 2C LED

FENDER SKS B53T 53mm black glossy

CHAINGUARD SKS Chainbow 38T

KICKSTAND KTM 28" adjust

CATEGORY E2

SYSTEM WEIGHT 143 kg (permissible total weight)

WEIGHT 24,3 kg (without pedals)



■ black matt (grey+green)

- 🔗 020483503 MACINA CENTRAL 5 RT US 43cm
- 🔗 020483506 MACINA CENTRAL 5 RT US 46cm
- 🔗 020483511 MACINA CENTRAL 5 RT US 51cm
- 🔗 020483516 MACINA CENTRAL 5 RT US 56cm

MACINA

CENTRAL

8



SI-A+4I2

400 WH BATTERY

1x8 SHIMANO NEXUS

MACINA

CENTRAL

8 RT



SI-A+4I2

400 WH BATTERY

1x8 SHIMANO NEXUS COASTERBRAKE

FRAME Macina City US Alloy6061: Si-PP500Wh Bosch Gen.3 / T-9680

FORK Suntour CR85-E25 coil 63mm

MOTOR Bosch ACTIVE PLUS Gen.3 - 25km/h / 50Nm

DISPLAY Bosch INTUVIA LCD Display with Remote

BATTERY Bosch PowerPACK 400Wh

CHARGER Bosch COMPACT Charger 2A

SHIFTLEV. Shimano Nexus 8 Revoshifter

CRANKSET KTM COMP BNI 170mm Q16

CHAINRING FSA steel 38T Direct Mount

SPROCKET Shimano Nexus 22T

CHAIN KMC Z1eHX

BRAKE Magura HS11 Evo2

WHEEL F KTM Line - Shimano Acera T3000 36H 100-5QR
Ambrosio Track 36H 622x20C
DT Champion 2.0 silver

WHEEL R KTM Line - Shimano Nexus 8 SG-C60018V FW 36H
Ambrosio Track 36H 622x20C
DT Alpine II 2.34 silver

TIRE F Schwalbe Energizer Plus Perf. GreenGuard 40-622

TIRE R Schwalbe Energizer Plus Perf. GreenGuard 40-622

GRIP Ergon GP1 short w/o Barend

BAR KTM Line Noirette Plus 660mm

STEM KTM Line UP3 adjust. 0-90°

HEADSET Ritchey OE Logic Zero 1.1/8"

SADDLE Selle Royal Freeway

SEATPOST KTM Line Elegance suspension 30.9/300

PEDAL Trekk.-Pedal VP-616 (anti-slip)

CARRIER KTM Racktime tour (snap-it)

LIGHT F B&M Lumotec AVY LED 40Lux

LIGHT R B&M Toplight 2C LED

FENDER SKS B53T 53mm black glossy

CHAINGUARD SKS Chainbow 38T

KICKSTAND KTM 28" adjust

CATEGORY E2

SYSTEM WEIGHT 143 kg (permissible total weight)

WEIGHT 24,7 kg (without pedals)

FRAME Macina City US Alloy6061: Si-PP500Wh Bosch Gen.3 / T-9680

FORK Suntour CR85-E25 coil 63mm

MOTOR Bosch ACTIVE PLUS Gen.3 - 25km/h / 50Nm

DISPLAY Bosch INTUVIA LCD Display with Remote

BATTERY Bosch PowerPACK 400Wh

CHARGER Bosch COMPACT Charger 2A

SHIFTLEV. Shimano Nexus 8 Revoshifter

CRANKSET KTM COMP BNI 170mm Q16

CHAINRING FSA steel 38T Direct Mount

SPROCKET Shimano Nexus 22T

CHAIN KMC Z1eHX

BRAKE Magura HS11 Evo2

WHEEL F KTM Line - Shimano Acera T3000 36H 100-5QR
Ambrosio Track 36H 622x20C
DT Champion 2.0 silver

WHEEL R KTM Line - Shimano Nexus 8 SG-C60018C CB 36H
Ambrosio Track 36H 622x20C
DT Alpine II 2.34 silver

TIRE F Schwalbe Energizer Plus Perf. GreenGuard 40-622

TIRE R Schwalbe Energizer Plus Perf. GreenGuard 40-622

GRIP Ergon GP1 short w/o Barend

BAR KTM Line Noirette Plus 660mm

STEM KTM Line UP3 adjust. 0-90°

HEADSET Ritchey OE Logic Zero 1.1/8"

SADDLE Selle Royal Freeway

SEATPOST KTM Line Elegance suspension 30.9/300

PEDAL Trekk.-Pedal VP-616 (anti-slip)

CARRIER KTM Racktime tour (snap-it)

LIGHT F B&M Lumotec AVY LED 40Lux

LIGHT R B&M Toplight 2C LED

FENDER SKS B53T 53mm black glossy

CHAINGUARD SKS Chainbow 38T

KICKSTAND KTM 28" adjust

CATEGORY E2

SYSTEM WEIGHT 143 kg (permissible total weight)

WEIGHT 25,1 kg (without pedals)



white matt (black+red)

- ✓ 020484503 MACINA CENTRAL 8 US 43cm
- ✓ 020484506 MACINA CENTRAL 8 US 46cm
- ✓ 020484511 MACINA CENTRAL 8 US 51cm



white matt (black+red)

- ✓ 020485503 MACINA CENTRAL 8 RT US 43cm
- ✓ 020485506 MACINA CENTRAL 8 RT US 46cm
- ✓ 020485511 MACINA CENTRAL 8 RT US 51cm
- ✓ 020485516 MACINA CENTRAL 8 RT US 56cm

MACINA FOLD

E-URBAN



PT-A+SP4

500 WH BATTERY

1x8 SHIMANO NEXUS

FRAME Macina Fold 20" Alloy6061 IGH belt: PT500Wh Bosch Gen.3 / T-9300
FORK Macina Fold 20" Alloy6061 PM-disc
MOTOR Bosch ACTIVE PLUS Gen.3 - 25km/h / 50Nm
DISPLAY Bosch PURION LCD Display
BATTERY Bosch PowerTUBE 500Wh vert.
CHARGER Bosch STANDARD Charger 4A
SHIFTLEV. Shimano Nexus 8 Revoshifter
CRANKSET KTM Delta BNI160mm Q16
CHAINRING Front-Sprocket Gates CDX 55T
SPROCKET Gates rear-sprocket 22T
CHAIN Gates drive-belt 115T CDX
BRAKE Shimano Altus BR-M315 2-Piston

ROTOR Shimano RT54 CL 160 / 160
WHEEL F KTM Line - Shimano Alivio M4050 CL 32H 100-5QR
 Ambrosio Pulse 32H 406x19C
 DT Champion 2.0 black
WHEEL R KTM Line - Shimano Nexus 8 SG-C600180 CL 32H
 Ambrosio Pulse 32H 406x19C
 DT Alpine II 2.34 black
TIRE F Schwalbe Marathon Plus Perf. SmartG. 47-406
TIRE R Schwalbe Marathon Plus Perf. SmartG. 47-406
GRIP Ergon GP1 short w/o Barend
BAR KTM Banzei 25.4 560mm
STEM KTM Banzei 12" folding
HEADSET KTM Banzei 1. 1/8"

SADDLE Selle Royal Hertz
SEATPOST KTM Banzei 34/400
PEDAL Trekk.-Pedal VP-F80 folding
CARRIER KTM Racktime Banzei (snap-it)
LIGHT F B&M Lumotec EYC LED 50Lux
LIGHT R B&M Xeltec Mini (o. Standlicht)
FENDER SKS B53T 53mm black glossy
KICKSTAND KTM 20"-24" adjust
CATEGORY E2
SYSTEM WEIGHT 120 kg (permissible total weight)
WEIGHT 24 kg (without pedals)



orange (black)

020490200 MACINA FOLD 20"



Almdudler
 From Austria
 with Love.
 And Herbs.



BOSCH

Invented for life



A NEW ERA FOR E-MOUNTAIN BIKERS

Kontrolle übernehmen. Die Fahrt beherrschen. Der Schwerkraft trotzen. Die neue Performance Line CX macht's möglich. Mit kraftvollem, direktem Ansprechverhalten und gesteigerter Kontrolle. Double the fun mit der neuen Performance Line CX.

Taking control. Mastering the journey. Defying gravity. The new Performance Line CX makes this possible. With powerful, direct response and increased control. Double the fun with the new Performance Line CX.



#FeelTheFlow

WEBSITE ANSEHEN
bosch-ebike.at

VISIT THE WEBSITE
bosch-ebike.com



DIE BOSCH DRIVE UNITS Für noch mehr Flow

KTM rüstet eBikes mit Antrieben von Bosch aus – mit den Drive Units Active Line, Active Line Plus, Performance Line und Performance Line CX. ePowered by Bosch, das bedeutet: mehr Leichtigkeit und Freude an der Bewegung – aktiv und entspannt zugleich.

DIE BOSCH DRIVE UNITS For even more flow

KTM fits eBikes with drive units from Bosch, using Active Line, Active Line Plus, Performance Line and Performance Line CX Drive Units. ePowered by Bosch means: greater ease and enjoyment of activity – active and relaxed at the same time.

ACTIVE LINE Der elegante Begleiter

ACTIVE LINE An elegant companion



- Leiser Motor für noch mehr Fahrfreude ohne störende Nebengeräusche.
- Harmonisch dosierte Beschleunigung.
- Kaum spürbarer Tretwiderstand über 25 km/h oder im Off-Modus.
- Ausgezeichnet mit dem Red Dot Award.
- The quiet motor provides even more riding enjoyment without annoying extraneous noises.
- Smoothly controlled acceleration.
- Barely perceptible pedal resistance above 25 km/h or in off mode.
- Winner of the Red Dot Design Award.

ACTIVE LINE PLUS

Die Drive Unit für Entdecker

ACTIVE LINE PLUS

The drive unit for explorers



- Optimal dosierte Unterstützung für einen Ausflug oder für Touren auch außerhalb der Stadtgrenzen.
- Einzigartiges Fahrerlebnis: Erleben Sie eine harmonisch dosierte Beschleunigung mit einem Drehmoment von bis zu 50 Nm.
- Kaum spürbarer Tretwiderstand im Off-Modus oder bei Geschwindigkeiten von über 25 km/h.
- Optimal support for an excursion – including beyond city limits.
- Unique riding experience: Experience gentle customised acceleration with a maximum torque of up to 50 Nm.
- Barely perceptible pedal resistance in off mode or at speeds above 25 km/h.

PERFORMANCE LINE

Sportlich unterwegs

PERFORMANCE LINE

Sporty riding



- Genug Power für Freizeit, City und Berge.
- Bis zu 65 Nm bzw. 75 Nm (Performance Line Speed) Drehmoment für volle Fahrfreude auch im Gelände.
- Unterstützung bis 25 km/h oder bis 45 km/h (Performance Line Speed).
- Natürliches Fahrgefühl fast ohne Tretwiderstand.
- Stark im Antritt – kraftvolle Unterstützung ab dem ersten Tritt.
- Plenty of power für leisure trips, city cycling and mountain biking.
- Torque of up to 65 Nm or 75 Nm (Performance Line Speed) for complete riding pleasure, even off-road.
- Support up to 25 km/h or 45 km/h (Performance Line Speed).
- Natural riding sensation with almost no pedal resistance.
- Off to a good start – powerful support as soon as you step onto the pedals.

PERFORMANCE LINE CX

Eine neue Ära für eMountainbiker

PERFORMANCE LINE CX

A new era for eMountain bikers



- Der kraftvollste Antrieb von Bosch für anspruchsvolle Fahrer.
- Kompakt und leicht für ein natürliches Fahrgefühl.
- Mit bis zu 340 % perfekt dosierte Unterstützung.
- Extrem druckvolle, verzögerungsfreie Beschleunigung.
- The most powerful drive from Bosch for demanding riders.
- Compact and lightweight a natural riding sensation.
- With up to 340 % perfectly delivered support
- Extremely powerful acceleration with no delays.

PURION



INTUUIA



SMARTPHONEHUB



COBI.BIKE



BOSCH DISPLAYS

Intelligenz am Lenker

Entscheiden Sie anhand der gewünschten Funktionen, welches Display das richtige für Sie ist.

BOSCH DISPLAYS

Intelligence on the handlebar

Choose the right display for you, depending on the functions you require.

	PURION	INTUUIA	KIOX
5 Fahrmodi <i>5 riding modes</i>	●	●	●
Schaltempfehlung <i>Shift recommendation</i>	○	●	○
Schiebehilfe <i>Walk assistance</i>	●	●	●
Hochauflösendes Display <i>High resolution display</i>	○	○	●
Integriertes Display <i>Integrated display</i>	●	●	●
Aufladen per USB <i>USB charging option</i>	○	●	●
Spritzwasserdicht <i>Splash-proof</i>	●	●	●
Navigation <i>Navigation</i>	○	○	○
Fitnesstracking <i>Fitness tracking</i>	○	○	●
eShift-kompatibel <i>Compatible with eShift</i>	○	●	●
DualBattery-kompatibel <i>Compatible with DualBattery</i>	●	●	●
Apps von Drittanbietern <i>Third-party apps</i>	○	○	●
Diebstahlschutz <i>Theft protection</i>	○	○	●

PURION

Kompakter Purist



- Übersichtliches Display: Ladezustand, Geschwindigkeit, Fahrmodus, Reichweite, Trip-Distanz, Gesamtdistanz.
- Optimale Lesbarkeit: Durch das von hinten beleuchtete, spiegelfreie Display erkennen eBiker alle Fahrdaten auch bei direkter Sonneneinstrahlung.

PURION

Compact purist

- *Clearly arranged display: Charge status, speed, riding mode, range, trip distance and total distance.*
- *Outstanding readability: The backlit non-glare display allows eBikers to read all riding data clearly, even in direct sunlight.*



INTUUIA

Clever und übersichtlich

- Höchster Bedienkomfort: einfache Steuerung über die separate Bedieneinheit.
- Ideal für unterwegs: Auch vom eBike abgenommen lassen sich alle wichtigen Informationen, wie zum Beispiel die Gesamtdistanz, abrufen.

INTUUIA

Clever and clear

- *Maximum ease of use: easy control thanks to the separate control unit.*
- *Ideal for travelling: Even when removed from the eBike, all important information such as the total distance can be displayed.*

SMARTPHONEHUB

Intelligenz am Lenker



Mit Smartphone und COBI.Bike Smartphone-App wird der SmartphoneHub zur intelligenten Steuerzentrale, die navigiert, Fitnesswerte im Blick behält und mit anderen Diensten und Apps verbunden werden kann. **NEU:** Das integrierte Display zeigt die wichtigsten Fahrdaten und ermöglicht das Fahren auch ohne Smartphone.

- Connected Biking: von der Navigation über Fitnessstracking bis hin zur Integration von Diensten wie Strava oder komoot.
- Navigation: wahlweise mit 2D- oder 3D-Kartenansicht. Die Navigationsanweisungen erfolgen per Sprachausgabe.
- Integriertes Display: Das 1,52-Zoll-Display zeigt die wichtigsten Fahrdaten an und erlaubt die Steuerung auch ohne Smartphone.
- Remote Compact: komfortable Bedienung mit dem Daumen, ohne den Lenker loszulassen.

SMARTPHONEHUB

Intelligence on your handlebar

Thanks to the smartphone and the COBI.Bike smartphone app, the SmartphoneHub can become an intelligent control centre that navigates, keeps an eye on fitness readings and connects to other services and apps. **NEW:** The integrated display shows the most important riding data, so that you can continue riding even without a smartphone.

- Connected biking – from navigation and fitness tracking to the integration of services such as Strava or komoot.
- Navigation: either with 2D or 3D map view. The navigation instructions are issued by voice output.
- Integrated display: The 1.52-inch display shows the most important riding data and enables the eBike to be controlled even without a smartphone.
- Remote Compact: Comfortable operation with the thumb, without letting go of the handlebar.

COBI.BIKE



Smart unterwegs



COBI.Bike verbindet das eBike mit der digitalen Welt: egal ob Navigation, Fitness, Musik oder Telefonieren mit Bluetooth-Kopfhörern. Alles geht – beim Fahren. Mit dem wetterfesten COBI.Bike Hub bekommt das Smartphone endlich seinen festen Platz und wird mit Strom versorgt. Perfekt positioniert und sicher gehalten – gesteuert mit der Bedieneinheit am Lenker.

- Connected Biking – von der Navigation über Fitnessstracking bis hin zur Integration von Diensten wie Strava oder komoot.
- Navigation: wahlweise mit 2D- oder 3D-Kartenansicht. Die Navigationsanweisungen erfolgen per Sprachausgabe.
- Integrierter Lautsprecher für Klingel und Alarmanlage.
- Für eBikes und herkömmliche Fahrräder.

COBI.BIKE

Smart while on the go

COBI.Bike connects the eBike to the digital world: whether navigation, fitness or music or phoning with Bluetooth headphones. It's all possible – on the move. With the weatherproof COBI.Bike hub, the smartphone finally gets a place of its own and is supplied with power. Perfectly positioned and securely held in place – operated via the control unit on the handlebar.

- Connected biking – from navigation and fitness tracking to the integration of services such as Strava or komoot.
- Navigation: either with 2D or 3D map view. The navigation instructions are issued by voice output.
- Integrated loudspeaker for bell and alarm system.
- For eBikes and conventional bicycles.



KIOX

Sportlich und vernetzt

Das sportliche Display ist die Verbindung zur vernetzten eBike-Welt von Bosch. Alle relevanten Fahrdaten werden von Kiox aufgezeichnet und über das per Bluetooth verbundene Smartphone an das Online-Portal eBike Connect übertragen. Die App zeichnet GPS-Daten auf. Diese Informationen werden mit den Fahrdaten zusammengeführt – für eine Übersicht und Auswertung aller Aktivitäten nach der Fahrt in der App oder im Online-Portal www.ebike-connect.com. Zusätzliche Sicherheit bietet Lock, die clevere Ergänzung zum mechanischen Schloss. Sie deaktiviert bei Abziehen des Kiox die Motorunterstützung und erst das Aufstecken desselben Kiox entriegelt die Sperre wieder.

KIOX

Sporty connectivity

The sporty display is the connection to the networked eBike world of Bosch. Kiox records all the relevant riding data and transfers it to the eBike Connect online portal via the smartphone's Bluetooth connection. The app records the GPS data. This information is combined with the riding data – for an overview and analysis of all activities after the trip in the app or in the online portal www.ebike-connect.com. 'Lock' offers added security as a smart complement to the mechanical lock. It deactivates motor support when the Kiox is disconnected and the electronic lock is only released again when the same Kiox is reconnected.

Automatische Synchronisation

NEU

Immer alle Informationen zur Hand: Daten werden automatisch per Bluetooth zwischen Kiox und der App synchronisiert. Auch Software-Updates lassen sich komfortabel und kabellos auf den Bordcomputer laden.

Automatic synchronisation

All information at your fingertips at all times: Data is automatically synchronised by Bluetooth between Kiox and the app. Even software updates can be loaded comfortably and wirelessly on the on-board computer.



Vorteile auf einen Blick:

- Kiox lässt sich mit einem Herzfrequenzmesser verbinden, um das Training optimal auszurichten.
- Das Display zeigt, ob über oder unter der persönlichen Durchschnittsgeschwindigkeit gefahren wird, und spornt so zu mehr Leistung an.
- Kiox punktet mit stylischer Optik: Screen mit kräftiger Farbgebung, eine übersichtliche Benutzeroberfläche, Magnethalterung für einen aufgeräumten Look am Lenker.
- Über die Tasten kann der Bordcomputer sicher und komfortabel mit dem Daumen bedient werden.
- Bruchsicher – auch bei Dreck oder Steinschlag: Das Display aus kratzfestem Glas ist ein guter Partner im Gelände oder in der Stadt.
- Licht: Das Licht lässt sich bequem über die mechanische Taste am Kiox einschalten.
- Einstellungen: Durch die Statusübersicht können Einstellungen einfach und schnell geändert werden. Aus Sicherheitsgründen ist das nur im Stand möglich.
- Lademöglichkeit: Über die USB-Schnittstelle können externe Geräte geladen werden, zum Beispiel das Smartphone.

Advantages at a glance:

- Kiox can be combined with a heart-rate monitor to get the most out of training.
- The display shows you whether you're riding at above or below your personal average speed, motivating you to push yourself even harder.
- Kiox scores points for its stylish appearance: The screen with strong colours, clearly laid out user interface and magnetic mount ensures a tidy looking handlebar.
- The buttons allow the on-board computer to be operated safely and comfortably using your thumb.
- Unbreakable glass – impervious to dirt or stone chippings: the scratch-resistant glass display is an ideal partner both off-road and in the city.
- Light: You can turn on the light using the mechanical button on the Kiox.
- Settings: Settings can be changed quickly and easily from the status overview display. For safety reasons, you can only do so when the eBike is at a standstill.
- Device recharging: External devices such as your smartphone can be recharged via the USB port.



BOSCH eBIKE APPS

BOSCH eBIKE APPS



eBIKE CONNECT APP

Connected Biking mit Kiox

Das sportliche Display verbindet den eBiker mit der vernetzten eBike-Welt von Bosch. Mit der eBike Connect App kann Kiox via Bluetooth Low Energy mit dem Smartphone verbunden werden, zum Beispiel um die eigenen Aktivitäten auszuwerten – für ein ganz persönliches und interaktives Connected Biking Erlebnis. Im Online-Portal ebike-connect.com haben eBiker alle relevanten Informationen auf einem Tablet oder am PC im Blick.

Wieder zu Hause, können die gefahrene Strecke betrachtet und Performance-Daten wie Geschwindigkeits-, Trittfrequenz- und Herzfrequenzprofil ausgewertet werden. Und wer über einen Strava Account verfügt, kann seine Daten mit einem Klick dort hochladen.

eBIKE CONNECT APP

Connected biking with Kiox

The sporty display connects the eBiker to the networked eBike world of Bosch. The eBike Connect app allows riders to connect Kiox via Bluetooth Low Energy with the smartphone, for example, in order to evaluate their own activities – for a very personal and interactive Connected Biking experience. eBikers will have all relevant information in view on a tablet or PC in the ebike-connect.com online portal.

Back home, riders can view the route travelled and evaluate performance data such as altitude, speed, cadence and heart rate profile. Riders who have a Strava account can upload their data there with a single click.



COBI.BIKE SMARTPHONE-APP

Smarter unterwegs

Dem eBiker steht mit der COBI.Bike Smartphone-App eine moderne, vollintegrierte Steuerzentrale zur Verfügung – mit Echtzeit-Fitnessdaten, Tour-Planung und -Aufzeichnung, Sprachausgabe sowie der Möglichkeit, mit anderen Diensten und Apps verbunden zu werden.

- **Konnektivität:** Der SmartphoneHub und COBI.Bike Smartphone-App vernetzen das eBike mit der digitalen Welt – von der Navigation über Musik hören, Fitnesstracking und Telefonieren bis hin zur Integration von anderen Diensten und Apps wie etwa Strava und komoot.
- **Navigation:** Die COBI.Bike Smartphone-App weiß, wo es langgeht – wahlweise mit 2D- oder 3D-Kartenansicht. Die Navigationsanweisungen erfolgen auch per Sprachausgabe.
- **Fitnessdaten:** eBiker haben die wichtigsten Trainingsdaten wie Leistung, Kadenz und Kalorienverbrauch mit der COBI.Bike Smartphone-App immer im Blick, per Knopfdruck werden diese auch vorgelesen. Zudem lässt sich auch ein Herzfrequenzmesser verbinden.
- **Unterhaltung:** Ganz einfach der Lieblingsmusik oder dem neuesten Krimi lauschen: Mit der COBI.Bike Smartphone-App haben eBiker Zugriff auf Musik- und Hörbuch-Streaming-Dienste wie Spotify oder Audible.
- **Digitaler Schutzengel:** Über die COBI.Bike Smartphone-App können sich eBiker bequem und schnell mit dem Bosch Emergency Assistant verbinden und dabei auch im Notfall ihren aktuellen Standort übermitteln.

COBI.BIKE SMARTPHONE APP

Smarter while on the go

The COBI.Bike smartphone app provides the eBiker with a modern, fully integrated control centre – with real-time fitness data, ride planning and recording options, voice output and the option of connecting to other services and apps.

- **Connectivity:** The SmartphoneHub and the COBI.Bike smartphone app connect the eBike to the digital world – from navigation, music, fitness tracking, or phoning to the integration of other services and apps such as Strava or komoot if they wish.
- **Navigation:** The COBI.Bike smartphone app points the way – with optional 2D or 3D map view. The navigation instructions are also issued by voice output.
- **Fitness data:** The COBI.Bike smartphone app gives eBikers a permanent overview of the most important training data, such as performance, cadence and calorie consumption; this information can also be played back at the press of a button. It is also possible to connect a heart rate monitor.
- **Entertainment:** The easy way to listen to your favourite music or the latest thriller: the COBI.Bike smartphone app allows eBikers access to music and audio book streaming services, such as Spotify or Audible.
- **A digital guardian angel:** The COBI.Bike smartphone app enables eBikers to connect quickly and easily to the Bosch Emergency Assistant and even transmit their current location in an emergency.



BOSCH AKKUS

Mehr Energie für unterwegs

Effiziente, ausdauernde und modernste eBike-Akkus – die Akkus von Bosch vereinen enorme Laufleistung, lange Lebensdauer und geringes Gewicht mit ergonomischem Design und einfachem Handling. Die hochwertigen Lithium-Ionen-Akkus sind mit einem Batterie-Management-System ausgestattet, das wichtige potenzielle Fehlerquellen erkennt und die Zellen bestmöglich vor Überlastung schützt.



Integrierter Akku

Stylish-elegant: Die PowerTube lässt sich perfekt in den Rahmen integrieren und bietet neue eBike-Designs. Jetzt zusätzlich in einer neuen Variante: PowerTube 625 für noch mehr Flexibilität.

Integrated rechargeable battery

Stylishly elegant: the PowerTube can be integrated perfectly in the frame to create new eBike designs. Now available in a new variant: PowerTube 625 for even more flexibility.



PowerTube 500
PowerTube 625 **NEU**



Rahmenakku

Sportlich-dynamisch: Der PowerPack liegt als Rahmenakku nah am Schwerpunkt und sorgt für eine optimale Gewichtsverteilung.

Frame battery

Sporty & dynamic: When used as a frame battery, the PowerPack sits close to the centre of gravity of your eBike to ensure optimal weight distribution.



PowerPack 400
PowerPack 500



DualBattery

Doppelte Energie: Die Koppelung von zwei Bosch eBike-Akkus ermöglicht einen Energieinhalt bis zu 1.000 Wh.

DualBattery

Double the power: Combining two Bosch eBike rechargeable batteries provides an energy content of up to 1,000 Wh.



DualBattery
PowerTube + PowerPack
(Integrierter Akku und Rahmenakku)

(Integrated rechargeable battery and frame battery)

BOSCH BATTERIES

More energy for travelling

Efficient, durable, state-of-the-art eBike batteries – Bosch rechargeable batteries combine impressive mileage performance, a long service life and low weight with an ergonomic design and simple handling. The high-quality lithium-ion batteries have a battery management system that detects significant potential sources of error and protects cells against overload.

LEBENSDAUER

Tipps für viele gemeinsame Kilometer



Faktoren, die die Lebensdauer verkürzen:

- Starke Beanspruchung
- Lagerung bei über 30 °C Umgebungstemperatur
- Längere Lagerung in ganz vollem oder völlig leerem Zustand
- Abstellen des eBikes in der prallen Sonne



Faktoren, die die Lebensdauer verlängern:

- Geringe Beanspruchung
- Lagerung bei einer Temperatur zwischen 0 und 20 °C
- Lagerung in einem ca. 30 – 60%igen Ladezustand
- Abstellen des eBikes im Schatten oder in kühlen Räumen



Factors that shorten the service life:

- Heavy-load use
- Storage at over 30°C ambient temperature
- Prolonged storage in a fully charged or fully discharged state
- Parking the eBike in direct sunlight



Factors that extend the service life:

- Low-load use
- Storage at a temperature between 0 and 20°C
- Storage at approx. 30 – 60 % charge status
- Parking the eBike in the shade or a cool location

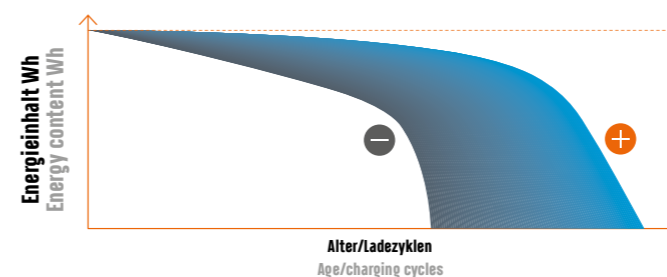

Die Abbildung zeigt typische Verläufe für den Energieinhalt über Nutzungsdauer und -häufigkeit.

The figure shows typical curves for energy content over usage duration and frequency.

Reichweite selbst berechnen:

Mit dem Reichweiten-Assistenten können typische Reichweiten unter verschiedenen Rahmenbedingungen ermittelt werden.

bosch-ebike.at/reichweite

Calculate the range yourself:

You can use the Range Assistant to calculate typical ranges under various conditions.

bosch-ebike.com/en/service/range-assistant



BOSCH CHARGER

Zuverlässige Energielieferanten



COMPACT CHARGER - DER BEGLEITER

Der Compact Charger ist das ideale Ladegerät für alle eBiker, die viel unterwegs sind. Er wiegt weniger als 600 g und hat 40 % weniger Volumen als der Standard Charger.

COMPACT CHARGER - THE COMPANION

The Compact Charger is the ideal charger for all eBikers who are constantly on the move. It weighs less than 600 grams and is 40 % less bulky than the Standard Charger.



Fast Charger - der Schnellste

Der Fast Charger ist das derzeit schnellste Bosch eBike-Ladegerät und versorgt den eBike-Akku in kürzester Zeit mit Energie. Der Fast Charger ist ideal für eBikes, die viel im Einsatz sind und schnell wieder startklar sein müssen. Optimal für DualBattery mit bis zu 1.000 Wh.

Fast Charger - the fastest

The Fast Charger is the fastest Bosch eBike charger and will recharge a Bosch eBike battery in the shortest possible time. The Fast Charger is ideal for eBikes that are often used and that need to be ready for takeoff again as quickly as possible. Perfect for DualBattery with up to 1,000 Wh.

BOSCH CHARGER

Reliable power source



STANDARD CHARGER - DER GENERALIST

Der robuste und funktionale Standard Charger ist der Allrounder unter den Bosch Ladegeräten. Er bietet ein ideales Verhältnis zwischen Leistung, Gewicht und Größe und ist vielseitig einsetzbar.

STANDARD CHARGER - THE ALL-ROUNDER

The robust, functional standard charger is the all-rounder among Bosch chargers. It offers the ideal balance between performance, weight and size and is extremely versatile.

Ladezeiten

Die Ladezeit ist abhängig von der Kapazität des Akkus und vom Charger. Wie schnell die verschiedenen Akkus mit einem bestimmten Charger wieder aufgeladen werden können, verrät die folgende Grafik.

Charging times

The charging time depends on the capacity of the battery and charger. The following graphic shows how quickly the various batteries can be recharged using each specific charger.

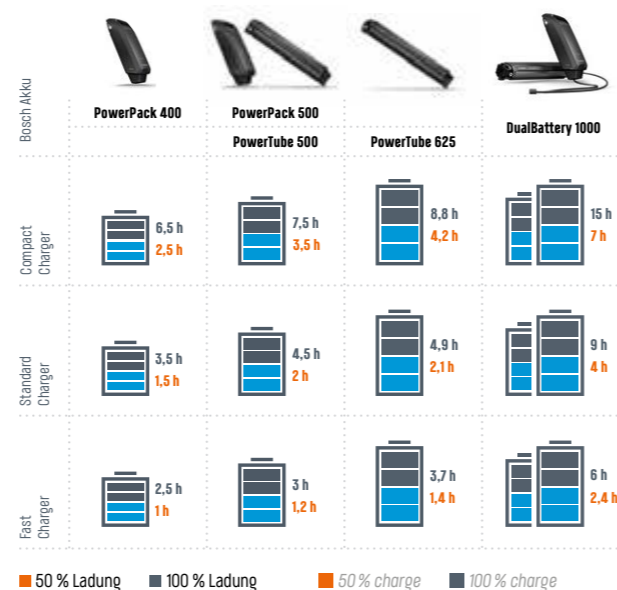

BOSCH eBIKE ABS

Mehr Sicherheit, mehr Stabilität



Moderne und leistungsfähige Bremssysteme haben Bremsverhalten und Bremsweg optimiert. Das erste serienreife Antiblockiersystem für eBikes ist die logische Konsequenz aus dieser Entwicklung. Bosch eBike ABS wurde für City-, Touring- und Trekking-Räder mit 28-Zoll-Rädern entwickelt und bietet speziell in diesem Segment erhöhten Schutz.

Hier ist Ihr Sicherheits-Plus:

- Sie können Ihre Vorderradbremse aktiver und effizienter einsetzen.
- Optimierte Fahrstabilität und Lenkbarkeit Ihres eBikes während des Bremsvorgangs, vor allem bei rutschigen Fahrbahnbedingungen.
- Bei extrem starkem Überbremsen des Vorderrads verringert die Hinterrad-Abheberegelung die Wahrscheinlichkeit eines Überschlags.

ABS für das Vorderrad

Front-wheel ABS



BOSCH eBIKE ABS

Greater safety, improved stability

Modern and powerful braking systems have optimised braking behaviour and braking distance. The first production-ready anti-lock braking system for eBikes is the next logical step of this development. The Bosch eBike ABS was specifically designed for city, touring and trekking bikes with 28-inch wheels and thus offers increased protection especially in this segment.

The safety advantages:

- More controlled and efficient use of the front brake.
- Optimised riding stability and manageability of your eBike during braking, especially under slippery road conditions.
- When the front wheel is significantly overbraked, the rear wheel lift control reduces the risk of an accident.

Hinterrad-Abheberegelung

Rear wheel lift control



Drive Units *Drive Units*

	Active Line Cruise 25 km/h		Active Line Plus Cruise 25 km/h		Performance Line Cruise 25 km/h		Performance Line CX 25 km/h
	Kettenschaltung Derailleur system	Nabenschaltung Hub gear system	Kettenschaltung Derailleur system	Nabenschaltung Hub gear system	Kettenschaltung Derailleur system	Nabenschaltung Hub gear system	Kettenschaltung/ Nabenschaltung Derailleur system/hub gear system
Schaltart <i>Gear type</i>							
Unterstützungsstufe (%) <i>Support level (%)</i>	Turbo: 250 Sport: 170 Tour: 100 Eco: 40	Turbo: 250 Sport: 170 Tour: 100 Eco: 40	Turbo: 270 Sport: 180 Tour: 100 Eco: 40	Turbo: 250 Sport: 170 Tour: 100 Eco: 40	Turbo: 300 Sport/eMTB: 120-300 Tour: 120 Eco: 55	Turbo: 300 Sport: 200 Tour: 120 Eco: 55	Turbo: 340 eMTB: 140-340 Tour: 140 Eco: 60
Maximal mögliches Antriebsdrehmoment (Nm) (umgerechnet auf ein Übersetzungsverhältnis 1:1 Tretkurbel zu Kettenblatt) <i>Maximum possible drive torque (Nm) (converted to a gear ratio of 1:1 crankset to chainring)</i>	Turbo: 40 Sport: 38 Tour: 35 Eco: 30	Turbo: 40 Sport: 38 Tour: 35 Eco: 30	Turbo: 50 Sport: 45 Tour: 40 Eco: 35	Turbo: 50 Sport: 45 Tour: 40 Eco: 35	Turbo: 65 eMTB: 60 Tour: 45 Eco: 35	Turbo: 65 Sport: 60 Tour: 45 Eco: 35	Turbo: 75 eMTB: 75 Tour: 60 Eco: 40
Unterstützung bis maximale Trittfrequenz (U/min) <i>Maximum cadence (rpm) with drive support</i>	Turbo: 100 Sport: 100 Tour: 100 Eco: 100	Turbo: 100 Sport: 100 Tour: 100 Eco: 100	Turbo: 105 Sport: 105 Tour: 105 Eco: 105	Turbo: 105 Sport: 105 Tour: 105 Eco: 105	Turbo: >120 Sport: >120 Tour: >120 Eco: >120	Turbo: >120 Sport: >120 Tour: >120 Eco: >120	Turbo: >120 eMTB: >120 Tour: >120 Eco: >120
Anfahrverhalten <i>Start-up behaviour</i>	harmonisch <i>smooth</i>	harmonisch <i>smooth</i>	harmonisch agil <i>smooth and agile</i>	harmonisch agil <i>smooth and agile</i>	sportlich <i>sporty</i>	dynamisch <i>dynamic</i>	sehr sportlich <i>very sporty</i>
Max. Unterstützung bis <i>Max. support up to</i>	25 km/h	25 km/h	25 km/h	25 km/h	25 km/h	25 km/h	25 km/h
Rücktrittfunktion <i>Backpedal function</i>	nein <i>no</i>	optional <i>optional</i>	nein <i>no</i>	optional <i>optional</i>	nein <i>no</i>	nein <i>no</i>	nein <i>no</i>
Schalterkennung <i>Gear shift detection</i>	ja <i>yes</i>	nein <i>no</i>	ja <i>yes</i>	nein <i>no</i>	ja <i>yes</i>	nein <i>no</i>	ja (dynamisch) <i>yes (dynamic)</i>
Gewicht <i>Weight</i>	2,9 kg <i>2.9 kg</i>	2,9 kg <i>2.9 kg</i>	3,2 kg <i>3.2 kg</i>	3,2 kg <i>3.2 kg</i>	< 3,2 kg <i>< 3.2 kg</i>	< 3,2 kg <i>< 3.2 kg</i>	< 2,9 kg <i>< 2.9 kg</i>

Akkus *Batteries*

	PowerPack 400	PowerPack 500	PowerTube 500	PowerTube 625
Montageart <i>Mounting type</i>	Rahmenakku <i>Frame battery</i>	Rahmenakku <i>Frame battery</i>	Im Rahmen: horizontal/vertikal <i>In the frame: horizontal/vertical</i>	Im Rahmen: horizontal/vertikal <i>In the frame: horizontal/vertical</i>
Spannung <i>Voltage</i>	36 V	36 V	36 V	36 V
Kapazität <i>Capacity</i>	11,0 Ah <i>11.0 Ah</i>	13,4 Ah <i>13.4 Ah</i>	13,4 Ah <i>13.4 Ah</i>	17,4 Ah <i>17.4 Ah</i>
Energiegehalt <i>Energy content</i>	ca. 400 Wh <i>approx. 400 Wh</i>	ca. 500 Wh <i>approx. 500 Wh</i>	ca. 500 Wh <i>approx. 500 Wh</i>	ca. 625 Wh <i>approx. 625 Wh</i>
Gewicht <i>Weight</i>				
Rahmenakku: <i>Frame Battery:</i>	ca. 2,5 kg <i>approx. 2.5 kg</i>	ca. 2,6 kg <i>approx. 2.6 kg</i>	ca. 2,8 kg <i>approx. 2.8 kg</i>	ca. 3,5 kg <i>approx. 3.5 kg</i>
Gepäckträgerakku: <i>Rack battery:</i>	ca. 2,6 kg <i>approx. 2.6 kg</i>	ca. 2,6 kg <i>approx. 2.6 kg</i>		
Größe <i>Size</i>				
Rahmenakku <i>Frame Battery</i>	325 x 92 x 90 mm	325 x 92 x 90 mm		
Horizontal <i>Horizontal</i>			349 x 84 x 65 mm	416 x 84 x 65 mm
Vertikal <i>Vertical</i>			349 x 65 x 84 mm	416 x 65 x 84 mm
Kompatibel mit DualBattery <i>Compatible with DualBattery</i>	●	●	●	●

Charger *Chargers*

	Compact Charger	Standard Charger	Fast Charger
Ladestrom <i>Charging current</i>	max. 2 A	max. 4 A	max. 6 A
Spannung <i>Voltage</i>	100-240 V	220-240 V	220-240 V
Größe <i>Size</i>	ca. 160 x 75 x 45 mm <i>approx. 160 x 75 x 45 mm</i>	ca. 190 x 86 x 54 mm <i>approx. 190 x 86 x 54 mm</i>	200 x 90 x 60 mm <i>approx. 200 x 90 x 60 mm</i>
Kabellängen <i>Cable lengths</i>	AC-Input: ca. 1,5 m, DC-Output: ca. 1,0 m <i>AC Input: approx. 1.5 m, DC Output: approx. 1.0 m</i>		
Stecker <i>Connectors</i>	länderspezifischer Netzstecker <i>country-specific power plug</i>		
Gewicht <i>Weight</i>	ca. 600 g <i>approx. 600 g</i>	ca. 800 g <i>approx. 800 g</i>	1.000 g
Kompatibilität <i>Compatibility</i>	Active Line / Active Line Plus / Performance Line / Performance Line CX kompatibel <i>Active Line/Active Line Plus/Performance Line/Performance Line CX compatible</i>		



Modulare Antriebe für hybride eBikes

KTM stattet das E-Road Modell Macina Mezzo mit dem Fazua evation Antriebssystem aus, dem leichtesten und kompaktesten elektrischen Antriebssystem seiner Klasse.

Ein natürliches Fahrgefühl ist das Markenzeichen des Antriebs, der typischerweise in Bergauf-Passagen, bei Gegenwind beim Anfahren und bei Geschwindigkeiten unter 25km/h seine Leistung entfaltet.

AKKU

Der Akku ist mit 252 Wh bewusst kompakt gehalten um den Bauraum nicht unnötig aufzudehnen. Ein Akkugewicht von 1,4 kg ist daher möglich.

REMOTE

Das Remote FX ist vollständig im Oberrohr des Rahmen integriert und verschmilzt förmlich mit dem Bike. Das Cockpit des Macina Mezzos ist somit aufgeräumt - die überflüssigen Kabel zum Remote gehören der Vergangenheit an.

Über die sensible Touchfläche lassen sich intuitiv die Unterstützungsstufen wechseln - der Fahrerwunsch landet somit blitzschnell beim Antriebssystem. Informationen über Akkuladestand und System Health können über die fünf seitlich positionierten LEDs abgelesen werden.

Ein intelligenter Lichtsensor stellt zudem sicher, dass die Helligkeit der LEDs den äußeren Umständen entsprechend angepasst ist.

Modular drives for hybrid eBikes

KTM equips the E-Road model Macina Mezzo with the Fazua evation propulsion system, the lightest and most compact electric propulsion system in its class.

A natural driving feeling is the hallmark of the drive, which typically performs in uphill passages, in headwinds, at start-up and at speeds below 25km/h.

BATTERY PACK

The battery is deliberately kept compact with 252 Wh in order not to unnecessarily expand the installation space. A battery weight of 1.4 kg is therefore possible.

REMOTE

The remote FX is fully integrated into the top tube of the frame and literally merges with the bike. The cockpit of the Macina Mezzo is thus cleaned up - the superfluous cables to the remote are a thing of the past.

Via the sensitive touch surface, the support levels can be switched intuitively - the driver's request ends up in the drive system at lightning speed. Battery level and system health information can be read from the five LEDs located on the side.

An intelligent light sensor also ensures that the brightness of the LEDs is adapted to the external circumstances.



MOTOREINHEIT

Der speziell für den kleinen Bauraum entwickelter hocheffizienter bürstenlose Motor befindet sich in der modular entnehmbaren Motoreinheit neben dem ebenfalls modular entnehmbaren 252 Wh Akku. Die Nenndauerleistung liegt beim 250W.

Die Motoreinheit kann einfach und schnell mit einem Handgriff aus dem Unterrohr entnommen werden. Der schlanke Durchmesser des Drivepacks ermöglicht Rahmendesigns, die auf den ersten Blick kaum von unmotorisierten Bikes unterschieden werden können.

Optional bietet Fazua eine Blende an, mit der man das E-Road Bike innerhalb von Sekunden zu einem unmotorisierten Rennrad umrüsten kann. Durch den Tausch von Motoreinheit und Batterie mit der Blende wird das Bike 2,9 kg leichter.



TRETLAGERGETRIEBE

Das Remote FX ist vollständig im Oberrohr des Rahmen integriert und verschmilzt förmlich mit dem Bike. Das Cockpit des Macina Mezzos ist somit aufgeräumt - die überflüssigen Kabel zum Remote gehören der Vergangenheit an.

Über die sensible Touchfläche lassen sich intuitiv die Unterstützungsstufen wechseln - der Fahrerwunsch landet somit blitzschnell beim Antriebssystem. Informationen über Akkuladestand und System Health können über die fünf seitlich positionierten LEDs abgelesen werden.

Ein intelligenter Lichtsensor stellt zudem sicher, dass die Helligkeit der LEDs den äußeren Umständen entsprechend angepasst ist.

DRIVEPACK

The highly efficient brushless motor, developed especially for the small installation space, is located in the modular removable motor unit next to the modularly removable 252 Wh battery. The nominal continuous power is 250W.

The Drivepack can be easily and quickly removed with a handle from the down tube. The slim diameter of the Drivepack enables frame designs that can hardly be distinguished from unmotorized bikes at first sight.

Optionally, Fazua offers a cover that can be used to convert the E-Road Bike into a non-motorized roadrace bike within seconds. By replacing the engine unit and battery with the panel, the bike is 2.9 kg lighter.

APP

Fazua bietet eine kostenfreie App mit vielen für Sportler attraktiven Features an. Viele sportive Radfahrer wollen ihre Daten sammeln und analysieren. Die Fazua App ist mit allen Fazua evation Antriebssystemen kompatibel und hilft mehr über Training und Fahrrad zu erfahren.

Folgende Funktionen bietet die App:

- GPS-Navigation und -Ortung
- Powermeter
- Tachometer
- Technischer Überblick, Batteriezustand
- Support, direkter Zugang zum Fazua Service
- Teile Fahrten mit Freunden
- Zusammenfassung und Analyse der gesammelten Daten der Fahrt im Detail

BOTTOM BRACKET

The remote FX is fully integrated into the top tube of the frame and literally merges with the bike. The cockpit of the Macina Mezzo is thus cleaned up - the superfluous cables to the remote are a thing of the past.

Via the sensitive touch surface, the support levels can be switched intuitively - the driver's request ends up in the drive system at lightning speed. Battery level and system health information can be read from the five LEDs located on the side.

An intelligent light sensor also ensures that the brightness of the LEDs is adapted to the external circumstances.

APP

Fazua offers a free app with many attractive features for athletes. Many sportive cyclists want to collect and analyze their data. The Fazua app is compatible with all Fazua evation propulsion systems and helps to learn more about training and cycling.

The app offers the following functions:

- GPS navigation and localization
- Power meter
- Speedometer
- Technical overview, battery condition
- Support, direct access to the Fazua service
- Share trips with friends
- Summary and analysis of the collected data of the trip in detail

KEY FEATURES

Tretlagergetriebe Bottom Bracket	55 Nm			1,3 kg
Motoreinheit Drivepack	250 W			1,9 kg
Drivepack Akku	250 Wh	36 V		1,4 kg
Remote Remote	3 Modi	75% / 150% / 240%		
Ladegerät Charger	2 A	Ladezeit Charging time	3,5 h	0,6 kg

E-FAQ

AMPERE (A)

Elektrische Einheit für die Stromstärke.

AMPERESTUNDE (AH)

Elektrische Einheit für die Ladung - gibt an, welche Stromstärke über eine Zeitdauer von einer Stunde, in unserem Fall aus dem Akku, entnommen werden kann.

DREHMOMENT (NM)

Physikalische Einheit - die an einem um eine Achse drehbaren Körper in Umfangrichtung wirkende Kraft, multipliziert mit ihrem Abstand von der Drehachse, dem Kraftarm - das Drehmoment kann zum Beispiel im Fall des E-Bikes die Drehung des Laufrades beschleunigen.

WATTSTUNDE (WH)

Einheit für die Arbeit - gibt an, welche Leistung über eine Zeitdauer von einer Stunde, in unserem Fall aus dem Akku, entnommen werden kann. Die Angabe der Wattstunden ist wesentlich transparenter als die Angabe der Amperestunden, da die Leistung ein Multiplikationsprodukt aus Spannung und Stromstärke ist und sich über diesen Wert wesentlich besser auf die Reichweite rückschließen lässt.

ANTRIEBSSYSTEM

Um höchstmögliche Zuverlässigkeit erreichen zu können, setzt KTM ausschließlich auf Originalbauteile von namhaften Antriebssystem-Herstellern. Umfangreiche Testfahrten und Labortests und die intensive Zusammenarbeit mit den Antriebssystem-Herstellern gewährleisten eine einwandfreie Funktion aller Systemkomponenten und deren höchstmögliche Lebensdauer. Durch die individuell auf das jeweilige Einsatzgebiet abgestimmte Software Programmierung werden Fahrgefühl, Handhabung, sowie Reichweiten (siehe REICHWEITE) auf das Maximum optimiert.

ABS

Das Anti Blockier System ist ein technisches System, das die Fahrsicherheit erhöht. Das ABS wirkt beim Bremsen des Fahrrades einem möglichen Blockieren des Vorderrades durch Reduktion des Bremsdruckes entgegen. Dadurch wird das Überschlagen bzw. Abheben des Hinterrades vermieden und auch das Fahren von Kurven trotz angezogener Bremse ermöglicht. Das ABS wirkt nur bei eingeschaltetem Antriebssystem.

APP

Eine App oder auch Applikation ist eine Computer- oder Smartphone Software, die eine bestimmte Funktion für einen Benutzer erfüllt.

BEDIENCOMPUTER / DISPLAY

Über den Bediencomputer erfolgt die Einstellung des Antriebssystems, auch werden verschiedene Betriebszustände und Tachoparameter angezeigt. Je nach Ausführung gibt es hier unterschiedliche Möglichkeiten zur Anzeige:

- LCD/TFT Display: Die Anzeige bestimmter Betriebszustände erfolgt direkt in Zahlenwerten oder Balken. Zum Beispiel wird der Restladezustand des Akkus über einen Balken am Display angezeigt. Weitere Werte, wie die Geschwindigkeit und der Unterstützungsgrad, werden über einen Zahlenwert am Display angezeigt. Je nach Wertigkeit sind hier auch Textmeldungen in Farbe und feinauflösende Grafiken möglich.

- LED Anzeige: Die Anzeige eines bestimmten Betriebszustandes erfolgt über mehrere Lämpchen. Zum Beispiel wird der Restladezustand des Akkus über fünf Lämpchen angezeigt - leuchten fünf Lämpchen, ist der Akku voll aufgeladen - leuchten zwei Lämpchen, ist er noch etwa zu 20 bis 40 Prozent aufgeladen, usw.

BELEUCHTUNG / LIGHT-LINK

Um nicht nur tagsüber mit dem KTM E-Bike sicher unterwegs zu sein, setzt KTM ausschließlich neueste LED Beleuchtungstechnik ein, welche mit einer Beleuchtungsstärke von bis zu 150 Lux die Nacht zum Tag werden lässt. Die

HÄUFIG GESTELLTE FRAGEN/ BEGRIFFSKLÄRUNG

Lichtanlage wird bei allen E-Bike Modellen ausschließlich aus dem Akku versorgt. Der Verzicht auf einen Nabendynamo verbessert die Gesamteffizienz des E-Bikes.

Sämtliche KTM Offroad E-Bikes sind mit dem sogenannten Light-Link ausgestattet. Die Lichtkabel für Front- und Rücklicht sind dabei bereits vorverlegt - eine Nachrüstung von Beleuchtungseinrichtungen ist somit einfach möglich. Die dafür verwendeten Beleuchtungseinrichtungen müssen von KTM freigegeben sein.

BÜRSTENLOSER GLEICHSTROMMOTOR

Beim bürstenlosen Gleichstrommotor ist im Gegensatz zu einem konventionellen Gleichstrommotor keine Verbindung über die sogenannten Kontakt-bürsten vom Rotor zum Stator gegeben, die verschleißten können. Der bürstenlose Gleichstrommotor ist somit wartungsfrei. Der Rotor besteht aus Permanentmagneten, der Stator aus mehreren Magnetspulen.

COBI READY

Das Cobi Cockpit verbindet das Smartphone mit dem E-Bike. Über die dazugehörige App werden verschiedenste Assistenzfunktionen verfügbar. Bei bestimmten KTM E-Bike Modellen mit Bosch Intuvia Display ist eine Nachrüstung möglich. Fragen Sie dazu Ihren KTM-Fachhändler.

E-BIKES

Bei E-Bikes lässt sich im Vergleich zu konventionellen Pedelecs auch unabhängig vom Pedalieren, zum Beispiel durch einen Drehgriff am Lenker, die Fahrgeschwindigkeit regulieren. Landläufig wird diese Definition oft nicht angewendet. Per Definition sind alle in diesem Katalog als E-Bikes bezeichneten Modelle tatsächlich Pedelecs.

ENTWICKLUNG

Jahrelange Erfahrung der KTM Entwicklung tragen zu einer maximalen Zuverlässigkeit der verschiedenen KTM E-Bike Modelle bei. Sämtliche von KTM verwendete Komponenten, werden unter höchsten Qualitätsanforderungen konstruiert und laufend optimiert. Der Einsatz von modernster Prüftechnik sichert den von KTM gewohnt hohen Standard und übertrifft die Vorgaben der relevanten Normen und Richtlinien.

GEPÄCKTRÄGER

Sämtliche KTM E-Bike Modelle mit Straßenausstattung sind mit unserem bewährten KTM Gepäckträgersystem ausgestattet, welches die schnelle, einfache und werkzeuglose Montage von kompatiblen RackTime „Snap-It“ Zubehör ermöglicht. Verschiedene passende Taschen und Korbsysteme sind als Original KTM Zubehör über Ihren KTM Fachhändler erhältlich.

Achtung: Bei sämtlichen KTM Modellen die exklusiv für die ZEG hergestellt werden, kommt Gepäckträger zum Einsatz, die auf dem „Carry More“ System basieren. Die Systeme „Snap-It“ und „Carry More“ sind untereinander nicht kompatibel.

GESUNDHEIT

Durch regelmäßiges aktives Radfahren wird die körperliche Gesundheit nachhaltig gefordert. Es spricht also nichts mehr dagegen, sich ein gut durchdachtes und modern designtes E-Bike von KTM zu gönnen und sich damit gesundheitsbewusst im Stadtverkehr und auch auf dem Land fortzubewegen. KTM wünscht Ihnen dabei viel Spaß.

KINDER E-BIKES

Bitte beachten Sie, dass die KTM Kinder E-Bikes zur Sicherheit durch die Benutzung durch Kinder bestimmten Beschränkungen unterliegen:

- Die Unterstützungsgeschwindigkeit ist auf 20km/h begrenzt.
- Die Schiebehilfe ist deaktiviert
- Beim Einschalten befindet sich das E-Bike zuerst im Off-Modus
- Die höchstzulässige Gesamtzuladung (Fahrer+Gepäck) liegt bei 50kg

Spezielle Hinweise für KTM Kinder E-Bikes:

- Kinder E-Bikes sind für Personen ab dem vollendeten 8. Lebensjahr nach einer umfassenden Einführung geeignet
- Kinder E-Bikes sind nur für die Benutzung auf befestigten Radwegen und Straßen

und nicht für die Benutzung auf Gehwegen geeignet

- Bei der Benutzung von Kinder E-Bikes ist darauf zu achten, dass Kinder einen geprüften Fahrradhelm und geeignetes, festes Schuhwerk tragen

KOSTEN

Der Kaufpreis eines E-Bikes ist tendenziell etwas höher als der eines konventionellen Fahrrads. Diese Tatsache sollte jedoch nicht vor einem Kauf abschrecken. Im fairen Vergleich von E-Bikes mit kraftstoffbetriebenen Kleinmotorrädern oder Autos sprechen Unterhalts- und Betriebskosten eindeutig für das E-Bike.

LAUFRÄDER

Um den erhöhten Ansprüchen - höheres Fahrradgesamtwgewicht und höhere Geschwindigkeit - gerecht zu werden, setzt KTM auf leichtlaufende Naben, zuverlässige und stabile Felgen und verstärkte Speichen. Die Kraft wird somit optimal vom Antrieb auf die Straße übertragen.

LFC = LIGHT/FENDER/CARRIER

Viele unserer KTM Offroad-Modelle sind mit dem so genannten LFC = Light/ Fender/Carrier (Licht/Schutzblech/Gepäckträger) Set ausgestattet oder können damit nachgerüstet werden. Wird nachgerüstet, dürfen hier nur von KTM geprüfte und freigegebene Komponenten verwendet werden. Dabei ändert sich die Verwendungskategorie auf 2 bzw. E2. Mehr Informationen über die Verwendungskategorien finden sie im Kapitel „Bestimmungsgemäßer Gebrauch“.

MAXIMALE LEISTUNG

Die maximale Leistung ist die vom Hersteller angegebene Leistung, die der Motor kurzfristig aufbringen kann, um zum Beispiel das Rad zu beschleunigen.

NENNDAUERLEISTUNG

Die Nenndauerleistung ist die vom Hersteller angegebene mittlere Leistung, bei der der Motor dauerhaft betrieben werden kann (für Pedelecs 250 W).

PEDELEC

Pedelec ist eine allgemeine Bezeichnung für ein Elektrofahrrad, welches hybrid mit Elektromotor und Muskelkraft betrieben wird. Pedelec steht für PEDal ELectric Cycle. Der Elektromotor steuert einen großen Leistungsanteil zur Tretkraft hinzu. Ohne Pedalieren (ohne Kurbelbewegung) gibt der Motor keine Leistung ab. Per Definition sind alle in diesem Katalog als E-Bikes bezeichneten Modelle tatsächlich Pedelecs. Europäische Definition des Pedelecs: Fahrräder mit Trethilfe, die mit einem elektromotorischen Hilfsantrieb mit einer maximalen Nenndauerleistung von 0,25 kW [250 Watt] ausgestattet sind, dessen Unterstützung sich mit zunehmender Fahrzeug-geschwindigkeit progressiv verringert und beim Erreichen einer Geschwindigkeit von 25 km/h oder früher, wenn der Fahrer im Treten einhält, unterbrochen wird. Geschwindigkeiten über 25 km/h können ausschließlich durch Muskelkraft erreicht werden. Da Pedelecs als Fahrräder gelten, sollten folgende Punkte beachtet werden:

- Radwege: Radwege dürfen ohne Ausnahme benutzt werden.
- Führerschein: Es besteht keine Führerscheinplicht.
- Helm: Grundsätzlich besteht auch keine Helmpflicht. KTM empfiehlt dennoch das Tragen eines geeigneten und geprüften Fahrradhelmes.
- Versicherung: Für Pedelecs muss keine Haftpflichtversicherung abgeschlossen werden.

Um den von KTM gewohnten hohen Standard gerecht zu werden, werden die Vorgaben aus folgende Normen bzw. Richtlinien übertroffen:

- EN 15194, Fahrräder - Elektromotorisch unterstützte Räder - EPAC - Fahrräder
- Maschinenrichtlinie 2006/42/EG des europäischen Parlaments und Rates vom 17. Mai 2006
- Richtlinie 2014/30/EC des europäischen Parlamentes und Rates vom 26. Februar 2014, zur Harmonisierung der Rechtsvorschriften der Mitglied-staaten über die elektromagnetische Verträglichkeit

RAHMEN

Bei einer Fahrt mit dem E-Bike wirken wesentlich höhere Kräfte auf den

Fahrradrahmen als bei Fahrten mit einem konventionellen Fahrrad. Die KTM E-Bike Rahmen wurden aus diesem Grund speziell für diese erhöhten Ansprüche optimiert. Angepasste Wandstärken und spezielle Schnittstellen am KTM E-Bike Rahmen sorgen für eine hohe Stabilität und eine sichere Aufnahme sämtlicher E-Bike Komponenten. Zudem sind die Kabel durch die Innenverlegung vor Beschädigung geschützt, was zugleich für eine aufgeräumte Optik sorgt.

REICHWEITE

Grundsätzlich ist die Reichweite von verschiedenen Bedingungen stark abhängig (Unterstützungsstufe, Fahrergewicht, Geländebeschaffenheit, Windverhältnisse, Reifendruck und Umgebungstemperatur) und kann nur als Schätzwert angegeben werden. Die in diesem Katalog angegebenen Reichweiten sind Angaben des jeweiligen Antriebssystem-Herstellers und beziehen sich auf optimalste Bedingungen. Optimale, beziehungsweise ideale Bedingungen sind: Ebenes / flaches Gelände ohne Gegenwind, 20°C Außentemperatur, besonders schmale, profillose Reifen, Fahrergewicht unter 70kg.

SOFTWARE

Software ist ein Oberbegriff für ausführbare Programme und die zu diesen gehörenden Daten. Mit ihrer Hilfe ist ein softwaregesteuertes Gerät in der Lage, Aufgaben zu erledigen. Auch in den elektronischen Antriebskomponenten steckt sehr viel Software Know-How um das Pedelec je nach Wunsch komfortabel, kraftvoll und auch sicher anzutreiben.

SOFTWARE UPDATE

Da die Software für elektronische Antriebskomponenten oft sehr komplex ist, entwickelt sich diese über einen langen Zeitraum weiter. Oft führen Erkenntnisse aus der täglichen Anwendung zu Softwareänderungen, auch Software Updates genannt. Diese können von Ihrem KTM Fachhändler durchgeführt werden.

TUNING

Unter Tuning versteht man die Erhöhung der Leistung bzw. auch der Geschwindigkeitsbegrenzung der Pedalierunterstützung des jeweiligen Antriebssystems anhand von Parameteränderungen oder sogenannter nachrüstbarer Tuningkits. Aufgrund der strengen gesetzlichen Bestimmungen sind Veränderungen dieser Art weder erlaubt noch empfohlen. Die bestehen gesetzlichen Bestimmungen existieren zur Vermeidung gefährlicher Situationen. Auch wird durch Veränderungen dieser Art der Verschleiß des Antriebssystems und der Komponenten erheblich gesteigert.

UMWELTFREUNDLICHKEIT

E-Bike-fahren ist nicht nur für umweltfreundliche Trendsetter. Statistisch gesehen sind 60% der Autofahrten kürzer als 7,5 km. Mit dem E-Bike können solche Kurzstrecken perfekt und mit wesentlich geringerem Energie-verbrauch als mit einem kraftstoffbetriebenen Kleinmotorrad oder Auto bewältigt werden. Dies bedeutet weniger Abgase und Lärm. Auch Staus und Parkplatzsorgen lösen sich in Luft auf.

VERWENDUNGSKATEGORIE / BESTIMMUNGSGEMÄSSER GEBRAUCH

Fahrradrahmen und die dazugehörigen Komponenten werden generell für unterschiedliche Einsatzzwecke und Nutzungsarten konzipiert. Jeder Fahrradtyp ist dabei für einen bestimmten Einsatzzweck vorgesehen. KTM stellt Fahrräder und Pedelecs für viele Verwendungskategorien her. Mehr Informationen über die Verwendungskategorien finden sie im Kapitel „Bestimmungsgemäßer Gebrauch“. Die Verwendungskategorie und die maximal mögliche Belastung des E-Bikes (höchstzulässiges Gesamtgewicht) sind am Typenschild des E-Bikes, das im Tretlagerbereich des Rahmens angebracht ist, vermerkt. Das höchstzulässige Gesamtgewicht des jeweiligen E-Bike Modells stellt die Summe aus EPAC-Gewicht + Fahrer + Gepäck dar, und darf keinesfalls überschritten werden.

WASSERFESTIGKEIT / REINIGUNG

Generell sind die verbauten hochwertigen Antriebssysteme und Komponenten wasserdicht gestaltet. Dies gilt vor allem für den Einsatz unter normalen Fahrbedin-gungen einschließlich starkem Regen. Verwenden Sie aber für die Reinigung Ihres KTM E-Bikes keinesfalls einen Dampfstrahler oder Hochdruckreiniger. Durch den hohen Druck könnte Wasser durch sämtliche Abdichtungen eindringen und das Antriebssystem und die Komponenten schädigen.

E-FAQ

AMPERE (A)

Unit of measurement of electric current.

AMPERE HOUR (AH)

Unit of measurement for electric charge which indicates the electric current that can be drawn from the battery over a period of an hour.

TORQUE (NM)

Torque is a physical unit of measurement, the force acting on a body circumferentially, multiplied by its distance from the axis of rotation, the lever arm of force; a case in point is the e-bike where the torque can accelerate the rotation of the wheel.

WATT HOUR (WH)

Electric unit of measurement for work; indicates the amount of energy that can be drawn from the battery over a period of an hour. Measuring the energy in watt hours instead of ampere hours is much more transparent because the energy is calculated by multiplying voltage and electric current and therefore this value makes it easier to deduce the operating range.

DRIVE UNIT

To achieve highest possible reliability, KTM uses exclusively genuine components from well-known manufacturers of drive units. Extensive test rides and laboratory tests as well as close cooperation with manufacturers of drive units ensure fault-free operation and maximum lifespan of all system components. The software programming, which is individually adjusted to the respective field of use, optimises the cycling experience, handling as well as the operating ranges (see OPERATING RANGE).

ABS

The Anti-Blocking System is a technical system that increases driving safety. When braking the bicycle, the ABS counteracts a possible locking of the front wheel by reducing the brake pressure. This prevents the rear wheel from overturning or taking off and also allows the bike to take bends despite the brake being applied. The ABS only works when the drive system is switched on.

APP

An app or application is a computer or smartphone software that performs a specific function for a user.

DISPLAY

The drive system is set via the operating computer and various operating states and tachometer parameters are also displayed. Depending on the version, there are different display options:

- LCD/TFT Display: Certain operating states are displayed directly in numerical values or bars. For example, the remaining state of charge of the battery is indicated by a bar on the display. Other values, such as speed and level of support, are indicated on the display by a numerical value. Depending on the value, text notifications in colour and high-resolution graphics are also possible.

- LED display: A certain operating status is indicated by several lights. For example, the remaining state of charge of the battery is indicated by five lights - five lights light up, if the battery is fully charged - two lights light up, if it is still 20 to 40 percent charged, etc.

LIGHTS / LIGHT-LINK

In order to not only be safe during the day with the KTM E-Bike, KTM exclusively uses the latest LED lighting technology, which turns night into day with an illuminance of up to 150 lux. The lighting system on all E-Bike models is powered exclusively by the battery. The absence of a hub dynamo improves the overall efficiency of the e-bike. All KTM Offroad E-Bikes are equipped with the so-called Light-Link. The light cables for the front and rear lights are already pre-installed - retrofitting of lighting equipment is therefore easy. The lighting equipment used must be approved by KTM.

FREQUENTLY ASKED QUESTIONS / TERMINOLOGY

BRUSHLESS DC MOTOR

In contrast to conventional DC motors, the brushless DC motor has no connection between the rotor and the stator via the so-called contact brushes which are prone to wear. Thus the brushless DC motor is maintenance-free. The rotor consists of permanent magnets, the stator consists of several magnetic coils.

COBI READY

The Cobi Cockpit connects the smartphone with the E-Bike. Various assistance functions are available via the corresponding app. Certain KTM E-Bike models with Bosch Intuvia Display can be retrofitted. Ask your KTM dealer about this.

E-BIKES

In contrast to conventional pedelecs, even regardless of pedalling, with e-bikes the speed can be controlled by means of a twist grip throttle on the handlebar. Although the term "pedelec" is not commonly used, by definition all e-bike models in this catalogue are actually pedelecs.

DEVELOPMENT

KTM's years of experience in the development of e-bikes have contributed to a maximum reliability of the various KTM e-bike models. All components used by KTM are designed to satisfy the highest quality requirements and are continually optimised. Using cutting-edge test technology, KTM maintains its high standards and not only complies with the requirements of the relevant standards and guidelines but surpasses them.

CARRIER

All KTM Road E-Bike models are equipped with our proven KTM Luggage Carrier System, which allows quick, easy and tool-free mounting of compatible RackTime "Snap-It" accessories. Various matching bags and basket systems are available as original KTM accessories from your KTM dealer.

Attention: All KTM models manufactured exclusively for the ZEG use carriers based on the "Carry More" system. The systems "Snap-It" and "Carry More" are not compatible with each other.

HEALTH

Regular cycling substantially enhances your physical well-being. Why not treat yourself to a well thought-out and state-of-the-art KTM e-bike and enjoy getting around in the city as well as in the country in a health-conscious manner. KTM wishes you a lot of fun riding your e-bike.

KIDS E-BIKES

Please note that KTM Kids E-Bikes are subject to certain safety restrictions:

- The support speed is limited to 20km/h.
- The pushing aid is deactivated.
- When switching on, the E-Bike is first in Off mode.
- The maximum permissible total load (driver + luggage) is 50 kg.

Special instructions for KTM Kids E-Bikes:

- Kids E-Bikes are suitable for people over the age of 8 after a comprehensive introduction.
- Kids E-Bikes are only suitable for use on paved cycle paths and roads and not for use on sidewalks.
- When using Kids E-Bikes, care must be taken to ensure that children wear a tested bicycle helmet and suitable solid shoes.

COSTS

An e-bike is slightly more expensive than a conventional bicycle. However, don't let the cost factor put you off buying an e-bike. If you make a fair comparison between e-bikes with petrol-fuelled mopeds or cars, maintenance and running costs are convincing reasons to consider buying an e-bike.

WHEELS

To meet the increased demands - higher total weight and higher speed - KTM relies on smooth-running hubs, reliable and stable rims and reinforced spokes. The power is thus optimally transferred from the drive to the road.

LFC = LIGHT/FENDER/CARRIER

Many of our KTM offroad models are equipped with the so-called LFC = Light/Fender/Carrier (light/fender/carrier) set or can be retrofitted with it. If retrofitted, only components tested and approved by KTM may be used. The usage category changes to 2 or E2. More information about the use categories can be found in the chapter "Intended use".

MAXIMUM POWER

The maximum power is the output specified by the manufacturer which the motor can generate for a short period of time, for instance in order to accelerate the bike.

CONTINUOUS RATED POWER

The continuous rated power is the average output specified by the manufacturer at which the motor can be continuously run (for pedelecs 250 watts).

PEDELEC

Pedelec is a generic term for an electric bicycle powered in a hybrid way by an electric motor and by muscle power. Pedelec stands for PEDal ELECTric Cycle. The electric motor greatly assists the pedalling force. Without pedalling (without crank movement) the motor delivers no power. However, by definition all models which are defined as e-bikes in this catalogue are actually pedelecs. European definition of the pedelec: bicycles with pedal assistance which are equipped with an auxiliary electric motor having a continuous rated power of 0.25 kW (250 watts) of which the output is progressively reduced with increasing vehicle speed and finally cut off when the bicycle reaches a speed of 25 km/h or sooner, if the cyclist stops pedalling. Speeds over 25 km/h can only be reached by muscle force. As pedelecs are classed as bicycles the following instructions should be followed:

- Cycle paths: cycle paths can be used without exception.
- Driving licence: no licence necessary.
- Helmet: basically helmets are not mandatory. However, KTM recommends wearing a suitable and tested helmet.
- Insurance: with pedelecs it is not necessary to take out liability insurance

In order to maintain its high standard, KTM surpasses the requirements of the following standards and guidelines:

- Standard EN 15194, bicycles - electrically power assisted cycles - EPAC - bicycles
- Machinery directive 2006/42/EC of the European Parliament and of the Council of 17 May 2006
- Directive 2014/30/EC of the European Parliament and of the Council of 26 February 2014 on the harmonisation of the laws of the Member States relating to the electromagnetic compatibility

FRAME

Compared to riding a conventional bicycle, there are substantially higher forces acting on the bicycle frame. For this reason the KTM e-bike frames were specially designed to fulfil these increased requirements. Adapted wall thicknesses and special interfaces at the KTM e-bike frame ensure a high level of stability and safe storage of all e-bike components. Furthermore, running the cables internally protects them against damage while ensuring a tidy appearance.

OPERATING RANGE

In principle, the operating range greatly depends on various conditions (level of pedalling assistance, weight of cyclist, type of terrain, wind conditions, tyre pressure and ambient temperature). Therefore it is only possible to give an estimated value. The operating ranges given in this catalogue are information from the respective manufacturer of the drive unit and refer to optimum conditions. Optimum or ideal conditions are: flat terrain without headwind, 20° C outside temperature, particularly narrow tyres without profile, weight of rider less than 70 kg.

SOFTWARE

Software is a generic term for executable programs and their associated data. With its help, a software-controlled device is able to perform tasks. There is also a lot of software know-how in the electronic drive components to drive the pedelec comfortably, efficiently and safely as requested.

SOFTWARE UPDATE

Since software for electronic drive components is often very complex, it continues to evolve over a long period of time. Often findings from the daily application lead to software changes or software updates. These can be done by your KTM dealer.

TUNING

Tuning means increasing the power or speed limitation of the pedal support of the respective drive system by means of parameter changes or so-called retrofittable tuning kits. Due to the strict legal regulations, changes of this kind are neither permitted nor recommended. The existing legal regulations exist to avoid dangerous situations. Changes of this type also considerably increase wear on the drive system and components.

ENVIRONMENT-FRIENDLINESS

E-bikes are not only popular with environment-conscious trendsetters. Statistically, 60 per cent of car rides are shorter than 7.5 km. With the e-bike such short distances can be covered consuming considerably less energy compared to a petrol-fuelled moped or car. Apart from reduced emissions and noise, traffic jams and parking worries are a thing of the past.

CATEGORIZATION / INTENDED USE

Bicycle frames and the associated components are generally designed for different purposes and types of use. Each bicycle type is designed for a specific purpose. KTM manufactures bicycles and pedelecs for many use categories. More information about the use categories can be found in the chapter "Intended use".

The usage category and the maximum possible load of the E-Bike (maximum permissible total weight) are indicated on the type plate of the E-Bike, which is located in the bottom bracket area of the frame. The maximum permissible total weight of the respective e-bike model is the sum of EPAC weight + rider + luggage and must not be exceeded under any circumstances.

WATERPROOF / CLEANING

In general, the high-quality drive systems and components used are designed to be watertight. This is particularly true for use under normal driving conditions, including heavy rain. However, do not use a steam jet or high-pressure cleaner to clean your KTM E-Bike. Due to the high pressure, water could penetrate through seals and damage the drive system and components.

BESTIMMUNGSGEMÄSSER

GEBRAUCH

INTENDED USE

Fahrradrahmen und die dazu gehörigen Komponenten werden generell für unterschiedliche Einsatzzwecke und Nutzungsarten konzipiert. Jeder Fahrradtyp ist dabei für einen bestimmten Einsatzzweck gedacht. KTM stellt viele Kategorien von Mountainbikes, Straßen-, Renn- und Cyclocrossrädern, Trekking-, Touren-, Lasten- und Reiserädern sowie Kinder- und Jugendrädern her.

Wird bei der Nutzung des Fahrrades die Belastungsgrenze überschritten, so können das Fahrrad bzw. die dazu gehörigen Komponenten beschädigt werden. Falls dies der Fall ist, können Komponenten aufgrund von Vorschäden bereits bei einer viel geringeren Belastung versagen. Aus diesem Grund ist es wichtig, das Fahrrad entsprechend dem Einsatzzweck zu nutzen. Für Schäden, die aus der Nichteinhaltung der jeweiligen Belastungsgrenzen resultieren, bzw. welche aus Fehlgebrauch des Fahrrades stammen, haften Hersteller und Fachhändler nicht. Um die langfristige Sicherheit Ihres erworbenen Produkts auf Dauer gewährleisten zu können, ist die Einhaltung der vom Hersteller in der Gebrauchsanweisung vorgeschriebenen Betriebs-, Wartungs- und Instandhaltungsvorgaben zwingend erforderlich.

Machen Sie sich dazu vor allem mit den Kapiteln „Wartungs- und Pflegeintervalle“ sowie „Gewährleistung und Garantie“ vertraut.

Im nachstehenden Abschnitt werden unterschiedliche Kategorien definiert, welche sämtliche Einsatzzwecke und Belastungsgrenzen berücksichtigen. Ergänzend zu diesem Abschnitt empfehlen wir Ihnen, die Anleitungen der Komponentenhersteller bezüglich Informationen über bestimmungsgemäßen Gebrauch heranzuziehen.

KATEGORISIERUNG

Die KTM Fahrrad GmbH gibt die Kategorien 0-5 bzw. EPAC-Kategorien E0-E5 vor, welche sich vor allem in ihren Einsatzzwecken deutlich voneinander unterscheiden. Die verschiedenen Kategorien sind auf den nachfolgenden Seiten beschrieben.

Die zutreffende Kategorie ist direkt am Fahrrad/EPAC, im Bereich des Unter- bzw. Sattelrohrs, in Form eines Aufklebers (Fahrrad-Aufkleber - Symbolabbildung 1 / EPAC Aufkleber - Symbolabbildung 2) vermerkt. Zusätzlich informiert dieser Aufkleber über sämtliche relevante Daten Ihres Fahrrades/EPACs

Bitte beachten Sie die Kategorie Ihres Fahrrades/EPACs und informieren Sie sich genau über die jeweils zutreffenden Einsatzzwecke bzw. Belastungsgrenzen. Auf diesem Sticker befindet sich bei EPACs auch die CE-Kennzeichnung.

Mit der CE-Kennzeichnung erklärt der Hersteller gemäß EU-Verordnung, „dass das Produkt den geltenden Anforderungen entspricht, die in den Harmonisierungsrechtsvorschriften der Gemeinschaft über ihre Anbringung festgelegt sind.“

Bicycle frames and the pertinent components are designed for various functions and types of use. Each type of bicycle is designed with a specific use in mind. KTM manufactures a whole host of categories of mountain bikes, road bicycles, racing bikes and cyclo-cross bikes, trekking bikes, touring bikes, cargo bicycles and expedition bikes as well as bicycles for children and youngsters.

If the maximum load is exceeded while using the bike, the bicycle and its components may be damaged. If your bicycle is damaged, it may fail even when placed under a lesser degree of further stress due to preliminary damage. Therefore, please make sure to use the bicycle only for its intended purpose. The manufacturer and specialist dealer do not accept liability for damage resulting from non-observance of the respective maximum load or from improper use of the bicycle. In order to ensure the long-term safety of your purchased product, observing the operating, maintenance and servicing instructions contained in the manufacturer's operating manual is obligatory.

In particular, please familiarize yourself with the chapters "Maintenance and Service Intervals" and "Warranty" of the user manual.

The following section defines various categories which specify all types of intended use and maximum load levels. In addition, we recommend consulting the component manufacturers' instructions relating to proper use.

CATEGORIZATION

KTM Fahrrad GmbH specifies Categories 0-5 or E0-E5, which are clearly distinguished from one another primarily by their intended purpose. The different categories are described on the following pages.

A label is positioned on the bicycle's down- or seat tube (bicycle-sticker - illustration 1 / EPAC sticker - illustration 2). In addition, this label informs about all relevant data of your bicycle/EPAC.

Please note the category of your bike / EPAC and inform yourself exactly about the respectively applicable purposes or load limits. This sticker also contains the CE mark on EPACs.

With the CE mark, the manufacturer declares in accordance to the EU regulation "that the product complies with the applicable requirements set out in the Community harmonization legislation for its installation."



Symbolabbildung 3 "Short Fender"
Illustration 3 "Short Fender"

Achtung: Werden bei Offroad Modellen zusätzlich Gepäckträger, Schutzbleche oder ein Kettenschutz montiert, ändert sich die Kategorie automatisch auf 2 bzw. E2. Ausgenommen sind sogenannte „Short Fenders“ (Symbolabbildung 3), die ohne Streben an der Gabel oder am Rahmen bzw. Sattel montiert werden können.

Attention: If additional luggage racks, mudguards or chain guards are mounted on offroad models, the category automatically changes to 2 or E2. Exceptions are so-called "short fenders" (Illustration 3), which can be mounted on the fork, frame or saddle without strays.



Symbolabbildung 1 "Fahrrad-Aufkleber"
Illustration 1 "bicycle-label"

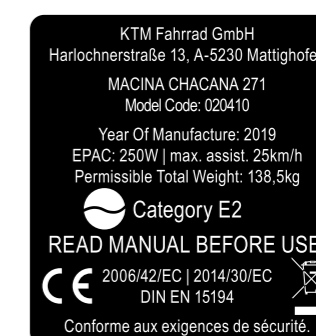

Symbolabbildung 2 "EPAC-Aufkleber"
Illustration 2 "EPAC-label"

	Fahrrad-Aufkleber	EPAC-Aufkleber	Bicycle-Label	EPAC-Label
Zeile 1 - 2:	Name und Anschrift des Herstellers des Fahrrades	Name und Anschrift des Herstellers des EPACs	Name and address of the bike manufacturer	Name and address of the EPAC manufacturer
Zeile 3-4:	Modellbezeichnung inkl. spezifischer Baugruppennummer	Modellbezeichnung inkl. spezifischer Baugruppennummer	Model designation including specific assembly number	Model designation including specific assembly number
Zeile 5:	Höchstzulässiges Gesamtgewicht des Fahrrades*	Herstellungsjahr des EPACs	Maximum permissible total weight of the bikes*	Year of manufacture of the EPAC
Zeile 6:		Art der Maschine (EPAC), Nenndauerleistung des Motors (250 Watt), maximale Unterstützungsgeschwindigkeit des Motors (25 km/h).		Type of machine (EPAC). Continuous rated power of the motor (250 watts). Maximum support speed of the motor (25 km/h).
Zeile 7:		Höchstzulässiges Gesamtgewicht des EPACs*		Maximum permissible total weight of the EPAC*
Zeile 8:	ISO 4210-2: Fahrräder - Sicherheitstechnische Anforderungen an Fahrräder		ISO 4210-2 = Bicycles - Safety requirements for bicycles	
Zeile 11-12:		2006/42/EC = Maschinenrichtlinie 2014/30/EC = EMV-Richtlinie EN 15194 = Fahrräder - Elektromotorisch unterstützte Räder - EPAC Fahrräder		2006/42/EC = Machinery Directive 2014/30/EC = EMC Directive EN 15194 = Bicycles - Electromotive Assisted Wheels - EPAC Bicycles

*Das höchstzulässige Gesamtgewicht des jeweiligen Fahrradmodells stellt die Summe aus Fahrradgewicht + Fahrer + Zuladung dar und darf keinesfalls überschritten werden

*The maximum permissible total weight of the respective bicycle model represents the sum of bicycle weight + rider + luggage and must not be exceeded under any circumstances.

KATEGORIE 0 / E0



FAHRRAD-TYPEN

Kinderfahrräder

CHARAKTERISTIK DER KATEGORIE 0 / E0

Diese Fahrräder sind ausschließlich für Kinder gedacht. Fahrräder der Kategorie 0 / E0 dürfen keinesfalls von Jugendlichen oder Erwachsenen verwendet werden. Kinder dürfen niemals ohne Aufsicht Rad fahren. Außerdem sollten Kinder stets abseits von Straßenverkehr und anderen Gefahren oder Hindernissen und angepasst an ihre Fertigkeiten fahren.

ERLAUBTER EINSATZ

Die Verwendung von Fahrrädern aus der Kategorie 0 / E0 ist nur unter elterlicher Aufsicht gestattet.

NICHT ERLAUBTER EINSATZ

Kinder dürfen nicht in der Nähe von Gefällen, Bordsteinen, Treppen, Geländeabbrüchen, Kanaldeckeln sowie auf Wegen, die von Kraftfahrzeugen genutzt werden, Fahrrad fahren.

WISSENSWERTES

Die maximal einstellbare Sattelhöhe (siehe Kapitel „Anpassungen am Fahrrad“) darf nicht weniger als 435mm betragen sowie 635mm nicht übersteigen. Die Sattelhöhe stellt den senkrechten Abstand zwischen Boden und Oberkante des Sattels dar (Abb. 6).

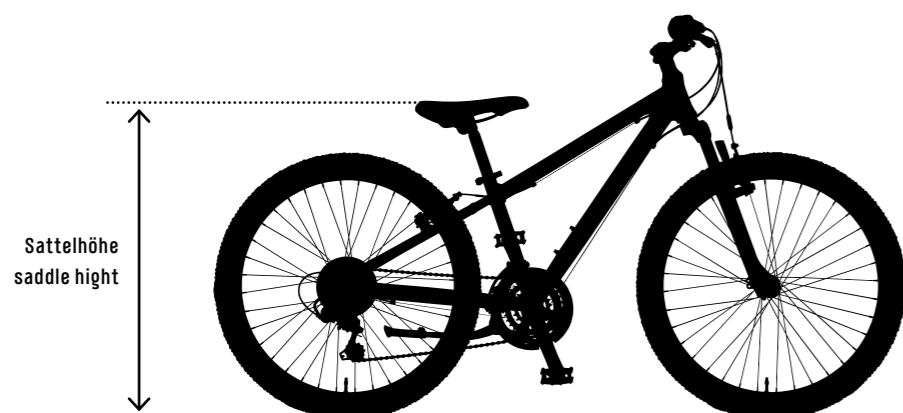

TYPE OF BICYCLE

Children's bikes

FEATURES OF CATEGORY 0 / E0

These bikes are intended exclusively for children. Category 0 / E0 bicycles must not be used by youngsters or adults. Children should always be under the supervision of an adult while riding the bike. Furthermore, children should always cycle well away from road traffic and other dangers or obstacles and in accordance with their individual skills.

PERMITTED USE

The use of Category 0 / E0 bicycles is only allowed under the supervision of an adult.

NOT PERMITTED FOR USE

Children must not ride their bike in the vicinity of downward slopes, kerbstones, stairs, precipices, manhole covers as well as on paths used by motor vehicles.

FURTHER INFORMATION

The maximum adjustable saddle height (see chapter "Adjusting Your Bicycle") must not be less than 435 mm, while not exceeding 635 mm. The saddle height is the vertical distance between floor and top edge of the saddle (fig. 3).

KATEGORIE 1 / E1



FAHRRAD-TYPEN

Road Race, Time Trial, Triathlon

CHARAKTERISTIK DER KATEGORIE 1 / E1

Hierbei handelt es sich um die Kategorie von Fahrrädern, welche für den Einsatz auf gepflasterten Straßen oder glatten Fahrbahnen ausgelegt sind. Der Kontakt zwischen Reifen und Fahrbahn kann dabei unbeabsichtigt verloren gehen.

ERLAUBTER EINSATZ

Ausschließlich für den Einsatz auf asphaltierten Straßen.

NICHT ERLAUBTER EINSATZ

Für Offroad und Einsatz mit Gepäckträger oder Fahrradtaschen nicht geeignet.

WISSENSWERTES

Länderspezifisch kann es möglich sein, dass zum legalen Einsatz auf öffentlichen Straßen eine Nachrüstung mit Scheinwerfer, Reflektoren, Schutzblechen etc. nötig ist, um den nationalen Gesetzen zu entsprechen. Die für Trainingszwecke oder Wettkämpfe erforderliche sicherheitstechnische Ausstattung des Fahrrades aus Kategorie 1 wird mitgeliefert und muss vom Benutzer oder Fachmann regelmäßig überprüft und – falls erforderlich – instandgesetzt werden. Bei Schäden, welche aus der Benutzung des Rennrades im Gelände, aus Überladung und aus nicht ordnungsgemäßer Beseitigung von Mängeln resultieren, haften Hersteller und Fachhändler nicht.

TYPE OF BICYCLE

Road Race, Time Trial, Triathlon

FEATURES OF CATEGORY 1 / E1

This category refers to bicycles that are designed to be ridden on paved or smooth roads. The tyres may unintentionally lose contact with the road.

PERMITTED USE

Only for use on paved roads.

NOT PERMITTED FOR USE

Not suitable for off-road use in combination with luggage rack or panniers.

FURTHER INFORMATION

In some countries it may be necessary to retrofit the bicycle with head lights, reflectors, mudguards, etc. in order to use the bike on public roads in compliance with the national legislation. The Category 1 bicycle comes with the safety-related equipment required for training purposes or competitions. This equipment must be checked and if necessary repaired by the user or a trained specialist at regular intervals. The manufacturer and specialist dealer do not accept any liability for damage resulting from off-road cycling, overloading or incorrect remedy of defects.

KATEGORIE 2/E2

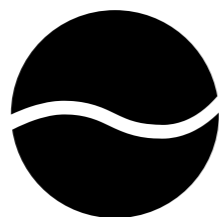

FAHRRAD-TYPEN

City, Trekking Onroad, Trekking Offroad, Cyclocross, Mountainbike Casual

CHARAKTERISTIK DER KATEGORIE 2 / E2

Hierbei handelt es sich um die Kategorie von Fahrrädern, welche den Einsatzzweck der Kategorie 1/E1 und zusätzlich ungepflasterte Landstraßen und Schotterwege sowie Strecken mit mäßiger Steigung / Gefälle umfasst. Kontakt mit unebenem Untergrund ist möglich. Die Reifen können dadurch den Bodenkontakt verlieren. Sprünge dürfen eine Höhe von 15 cm nicht überschreiten.

ERLAUBTER EINSATZ

Für asphaltierte Straßen, gut befestigte Schotterwege sowie Fahrradwege.

NICHT ERLAUBTER EINSATZ

Für den darüber hinaus gehenden Offroad-Einsatz sowie die Verwendung als Mountainbike bzw. für die Durchführung diverser Freestyle-Tricks nicht geeignet. Manche dieser Räder verfügen zwar über Federungssysteme, diese dienen jedoch lediglich dem Komfort, nicht aber der Geländetauglichkeit.

WISSENSWERTES

Fahrräder dieser Kategorie entsprechen bis auf Ausnahmen auf Grund ihrer Konzeption und Ausstattung, wie aktive (Rücklicht, Scheinwerfer) und passive (Reflektoren) Beleuchtungseinrichtungen, den gesetzlichen Anforderungen des Straßenverkehrs. Zudem ist die Nutzung auch auf für den Fahrradverkehr freigegebenen Feld- und Waldwegen gestattet. Die für diesen Einsatzzweck erforderliche sicherheitstechnische Ausstattung wurde mitgeliefert und muss vom Benutzer oder Fachmann regelmäßig überprüft und – falls erforderlich – instandgesetzt werden.

Einige Fahrräder dieser Kategorie entsprechen allerdings nicht den gesetzlichen Anforderungen des Straßenverkehrs und sind somit als Sportgeräte anzusehen. Falls Ihr Fahrrad nicht mit aktiven (Rücklicht, Scheinwerfer) und passiven (Reflektoren) Beleuchtungseinrichtungen ausgestattet ist, sind diese vor der Nutzung auf öffentlichen Straßen mit Komponenten, entsprechend der jeweiligen nationalen Gesetze und Vorschriften nachzurüsten.

TYPE OF BICYCLE

City, Trekking On-road, Trekking Off-road, Cyclocross, Mountain bike casual

FEATURES OF CATEGORY 2 / E2

This category refers to bicycles that can be used on unpaved roads and gravel paths as well as trails with moderate inclines / slopes in addition to the intended use of Category 1/E1. Contact with uneven ground poses no problems. Tyres may lose contact with the road. Jumps must not exceed a height of 15 cm.

PERMITTED USE

For paved roads, hard-surface gravel paths as well as cycle paths.

NOT PERMITTED FOR USE

Not suitable for off-road use that goes beyond the intended purpose. Furthermore, it should not be used as mountain bike or for freestyle tricks. Some of these bikes comprise suspension systems that enhance comfort, but do not increase off-road capability.

FURTHER INFORMATION

Although there are some exceptions, Category 2 bicycles comply with the legal requirements for participation in road traffic thanks to their design and equipment such as active (rear light, head light) and passive (reflectors) lighting systems. On top of this, these bikes can also be used on unpaved field and forest trails where bicycles are allowed. Category 2 bikes come with the safety-related equipment required for this type of use. This equipment must be checked and if necessary repaired by the user or a trained specialist at regular intervals.

However, some bicycles of this category do not comply with the legal requirements for road traffic and must therefore be regarded as sports equipment. Bicycles that do not comprise active (rear light, head light) and passive (reflectors) lighting systems need to be retrofitted with components compliant with the respective national legislation and regulations prior to usage on public roads.

KATEGORIE 3/E3



FAHRRAD-TYPEN

Mountainbike: Cross Country, Marathon, Tour

CHARAKTERISTIK DER KATEGORIE 3 / E3

Hierbei handelt es sich um die Kategorie von Fahrrädern, welche den Einsatzzweck der Kategorien 1/E1 und 2/E2 beinhaltet. Zusätzlich umfasst diese Kategorie unerschlossene Strecken sowie technische Bereiche. Sprünge bis zu 60 cm sind hier inbegriffen.

ERLAUBTER EINSATZ

Von leichtem bis hin zu anspruchsvollem Gelände (kleine Hindernisse, wie Wurzeln, Steine und Rinnen auf losem sowie festem Untergrund), während Cross-Country- oder Wettkampfeinsätzen. Cross-Country-, Marathon- und Tour-Komponenten (Reifen, Federung, Rahmen, Antrieb) verfügen über geringes Gewicht und sind für Wendigkeit und Geschwindigkeit ausgelegt.

NICHT ERLAUBTER EINSATZ

Für alle extremen Formen des Fahrens bzw. Springens wie z.B. Freeriding, Enduro, Downhill, Freestyle-Tricks u.dgl. nicht geeignet.

WISSENSWERTES

Diese Fahrräder sind aufgrund ihrer Konzeption und Ausstattung nicht dazu bestimmt, auf öffentlichen Straßen eingesetzt zu werden. Vor der Nutzung auf öffentlichen Straßen muss das Rad, entsprechend der jeweiligen nationalen Gesetze und Vorschriften, mit Beleuchtung, Schutzblech etc. nachgerüstet werden. Die für den Einsatz im Gelände erforderliche sicherheitstechnische Ausstattung wird mitgeliefert und muss vom Benutzer oder Fachmann regelmäßig überprüft und – falls erforderlich – instandgesetzt werden. Cross-Country-, Marathon- und Tour-Mountainbikes sind leichter, bergauf schneller und wendiger als All Mountain-, Trail- und Enduro-Mountainbikes. Antriebseffizienz und Klettereigenschaften werden bei Fahrrädern der Kategorie 3 über Robustheit gesetzt.

TYPE OF BICYCLE

Mountain bike: Cross Country, Marathon, Tour

FEATURES OF CATEGORY 3 / E3

This category refers to bicycles encompassing the intended use described in Categories 1/E1 and 2/E2. In addition, this category is suitable for undeveloped terrain as well as technical applications. Jumps up to a height of 60 cm are included in this field of use.

PERMITTED USE

Ranging from easy to challenging terrain (small obstacles such as roots, stones and trenches on loose as well as solid ground), for cross-country use or competitions. Cross-country, marathon and tour components (tyres, suspension, frame, drive unit) are lightweight and are particularly designed for excellent manoeuvrability and speed.

NOT PERMITTED FOR USE

Not suitable for extreme forms of riding or jumping such as freeriding, enduro, downhill, freestyle tricks, etc.

FURTHER INFORMATION

Due to their special design and equipment, these bicycles are not intended for use on public roads. Prior to cycling on public roads, the bicycle must be retrofitted with lighting, mudguard, etc. in compliance with the applicable national legislation and regulations. Category 3 bikes come with the safety-related equipment required for off-road usage. This equipment must be checked and if necessary repaired by the user or a trained specialist at regular intervals. Cross-country, marathon and tour bikes are more lightweight, faster going uphill and boast better manoeuvrability than all-mountain bikes, trail and enduro mountain bikes. With Category 3 bikes, propulsion efficiency and climbing capabilities are given priority over sturdiness.

KATEGORIE 4/E4



FAHRRAD-TYPEN

Mountainbike: Trail, All Mountain, Enduro

CHARAKTERISTIK DER KATEGORIE 4 / E4

Hierbei handelt es sich um die Kategorie von Fahrrädern, welche den Einsatzzweck der Kategorien 1/E1, 2/E2 und 3/E3 beinhaltet. Darüber hinaus umfasst diese Kategorie eingeschränkten Downhill-Einsatz. Downhills dürfen bis zu einer Geschwindigkeit von 40 km/h ausgeübt werden, solange Sprünge eine Höhe von 120 cm nicht überschreiten. Der Einsatz eines Fahrrades unter diesen Bedingungen ist stark von der Erfahrung und den Fähigkeiten des Fahrers abhängig.

ERLAUBTER EINSATZ

Fahrräder aus dieser Kategorie sind robuster und solider gebaut als Cross-Country-, Marathon- oder Tour-Mountainbikes. Auf Grund des höheren Federweges kann anspruchsvolleres Gelände mit größeren Hindernissen und Sprüngen bewältigt werden. Fahrräder aus dieser Kategorie decken einen großen Einsatzbereich ab.

NICHT ERLAUBTER EINSATZ

Einsatzgebiete, die den genannten Verwendungszweck überschreiten.

WISSENSWERTES

Diese Fahrräder sind aufgrund ihrer Konzeption und Ausstattung nicht dazu bestimmt auf öffentlichen Straßen eingesetzt zu werden. Vor der Nutzung auf öffentlichen Straßen muss das Rad, entsprechend der jeweiligen nationalen Gesetze und Vorschriften, mit Beleuchtung, Schutzblech etc. nachgerüstet werden. Die für den Einsatz im Gelände erforderliche sicherheits-technische Ausstattung wird mitgeliefert und muss vom Benutzer oder Fachmann regelmäßig überprüft und – falls erforderlich – instandgesetzt werden.

Da diese Kategorie eine Vielzahl von Einsatzgebieten abdeckt, ist es unerlässlich, die Grenzen des Einsatzzwecks dieser Räder zu kennen.

TYPE OF BICYCLE

Mountain bike: Trail, All Mountain, Enduro

FEATURES OF CATEGORY 4 / E4

This category refers to bicycles encompassing the intended use of Categories 1/E1, 2/E2 and 3/E3. In addition, this category is suitable for limited downhill use. Downhill rides are possible up to a speed of 40 km/h as long as the jumps do not exceed a height of 120 cm. Riding a bicycle under these conditions depends heavily on the rider's experience and capabilities.

PERMITTED USE

Category 4 bicycles have a particularly sturdy and solid construction compared to cross-country, marathon or tour mountain bikes. Due to the longer suspension travel, it is possible to tackle bigger obstacles and jumps. Bicycles of this category cover a broad range of applications.

NOT PERMITTED FOR USE

Fields of use which go beyond the mentioned intended purpose.

FURTHER INFORMATION

Due to their special design and equipment, these bicycles are not intended for use on public roads. Prior to cycling on public roads, the bicycle must be retrofitted with lighting, mudguard, etc. in compliance with the applicable national legislation and regulations. Category 4 bikes come with the safety-related equipment required for off-road usage. This equipment must be checked and if necessary repaired by the user or a trained specialist at regular intervals.

As this category covers a wide range of applications, it is vital to know the limits of the intended purpose for these bicycles.

KATEGORIE 5/E5



FAHRRAD-TYPEN

Fahrradtypen Mountainbike: Gravity, Freeride, Downhill

CHARAKTERISTIK DER KATEGORIE 5 / E5

Hierbei handelt es sich um die Kategorie von Fahrrädern, welche den Einsatzzweck der Kategorien 1/E1, 2/E2, 3/E3 und 4/E4 beinhaltet. Die Fahrräder sind zudem für Sprünge jeder Art bei darauffolgender Landung im abschüssigen Geländebereich sowie Geschwindigkeiten über 40 km/h ausgelegt. Die Verwendung in grobem, unwegsamem Gelände ist ebenfalls erlaubt. Der Einsatz eines Fahrrades unter diesen Bedingungen ist stark von der Erfahrung und den Fähigkeiten des Fahrers abhängig.

ERLAUBTER EINSATZ

Fahrräder für den oben genannten Einsatzzweck ermöglichen das Fahren in selektivem Gelände. Gravity-, Freeride-, und Downhill-Bikes sind äußerst robust gebaut und bieten sehr viel Federweg um Hindernisse bestmöglich bewältigen zu können. Aufgrund der hohen Belastung ist ein besonders pfleglicher und sorgsamer Umgang mit den Komponenten von Nöten.

NICHT ERLAUBTER EINSATZ

Verwendung über den persönlichen Grenzbereich.
Lassen Sie daher vernünftige Selbsteinschätzung walten.

WISSENSWERTES

Diese Fahrräder sind aufgrund ihrer Konzeption und Ausstattung nicht dazu bestimmt auf öffentlichen Straßen eingesetzt zu werden. Vor der Nutzung auf öffentlichen Straßen muss das Rad, entsprechend der jeweiligen nationalen Gesetze und Vorschriften, mit Beleuchtung, Schutzblech etc. nachgerüstet werden. Die für den Einsatz im Gelände erforderliche sicherheits-technische Ausstattung wird mitgeliefert und muss vom Benutzer oder Fachmann regelmäßig überprüft und – falls erforderlich – instandgesetzt werden. Wenn Sie beabsichtigen im Gelände zu fahren, welches dieser Kategorie entspricht, sollten Sie geeignete Sicherheitsmaßnahmen, wie beispielsweise häufigere Wartungsintervalle, ergreifen. Legen Sie großen Wert auf persönliche Sicherheitsausrüstung, wie z.B. einen geeigneten Helm und Protektoren. Bitte beachten Sie, dass Fehleinschätzung oder das Überschätzen der eigenen Fähigkeiten in dieser Kategorie schnell zu einem Unfall mit schweren Verletzungen oder gar Todesfolge führen kann.

TYPE OF BICYCLE

Mountain bike: Gravity, Freeride, Downhill

FEATURES OF CATEGORY 5 / E5

This category refers to bicycles encompassing the intended use of Categories 1/E1, 2/E2, 3/E3 and 4/E4. Furthermore, these bicycles are ideally suited for any kind of jumps with subsequent landing on sloping terrain as well as speeds up to 40 km/h. They can also be used in rough and difficult terrain. Riding a bicycle under these conditions depends heavily on the rider's experience and capabilities.

PERMITTED USE

Bicycles with the aforementioned intended use allow for riding in selective terrain. Gravity, freeride and downhill bikes have an extremely sturdy design and provide long suspension travel in order to successfully tackle obstacles. Due to the high stress, please make sure that you take good care of the components.

NOT PERMITTED FOR USE

Usage beyond your personal capabilities.
Therefore, knowing your capabilities and limitations is essential.

FURTHER INFORMATION

Due to their special design and equipment, these bicycles are not intended for use on public roads. Prior to cycling on public roads, the bicycle must be retrofitted with lighting, mudguard, etc. in compliance with the applicable national legislation and regulations. Category 4 bikes come with the safety-related equipment required for off-road usage. This equipment must be checked and if necessary repaired by the user or a trained specialist at regular intervals. If you intend to go off-road in terrain for which this category is suitable, you should take appropriate safety measures such as adhering to frequent maintenance intervals. Please attach the utmost importance to wearing safety equipment such as a suitable helmet and protectors. Bear in mind that misjudging or overestimating your own riding abilities in this category may easily result in accidents causing serious injuries or, at worst, death.

E-MTB

GEO

- A** Größe in cm
Size in cm
- A** Größe
Size
- A** Größe in Zoll
Size in inch
- B** Sitzrohrlänge
Seat tube length
- C** Oberrohrlänge
Top tube length
- D** Sitzwinkel
Seat angle
- E** Lenkwinkel
Head angle
- F** Steuerrohrlänge
Head tube length
- G** Kettenstrebenlänge
Chainstay length
- H** Radstand
Wheelbase
- I** Stack
Stack
- J** Reach
Reach
- K** Überstandshöhe
Standover height
- L** Tretlagerabsenkung
BB drop

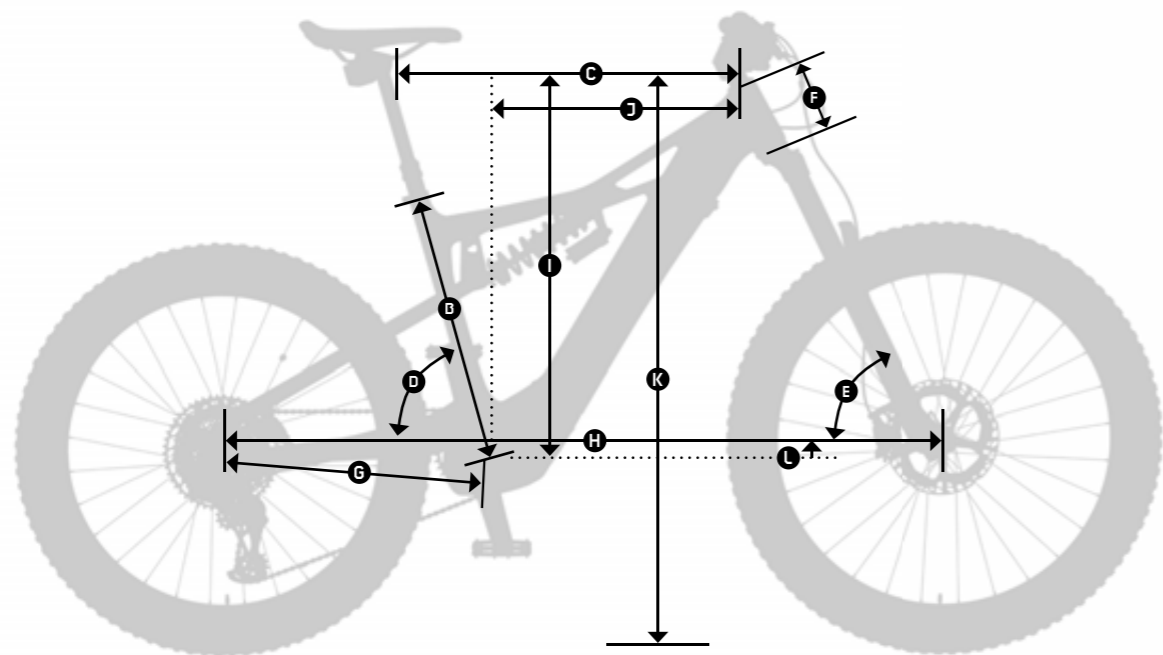

	A	A	A	B	C	D	E	F	G	H	I	J	K	L
MACINA PROWLER DIMMIX	43	S	17	430	590	76.5° (74.6°)	65°	100	442	1220	607	444	801	4
	48	M	19	450	610	76.5° (74.5°)	65°	110	442	1242	616	462	804	4
	53	L	21	480	640	76.5° (74.4°)	65°	125	442	1275	630	489	808	4
MACINA KAPOHO PRESTIGE & MASTER DIMMIX	43	S	17	430	589	76.8° (74.9°)	65.3°	100	442	1216	605	447	796	9
	48	M	19	450	609	76.8° (74.8°)	65.3°	110	442	1238	614	465	798	9
	53	L	21	480	639	76.8° (74.8°)	65.3°	125	442	1271	627	492	805	9
MACINA KAPOHO 2971 & 2972 & 2973 DIMMIX	43	S	17	430	590	76.5° (74.6°)	66.0°	100	442	1206	607	444	804	7
	48	M	19	450	610	76.5° (74.5°)	66.0°	110	442	1228	616	462	807	7
	53	L	21	480	640	76.5° (74.4°)	66.0°	125	442	1261	630	489	812	7
MACINA KAPOHO LTD DIMMIX	41	XS	16	410	565	74.0°	66.0°	120	495	1210	623	389	831	7
	43	S	17	430	585	74.0°	66.0°	120	495	1230	624	409	831	7
	48	M	19	480	605	74.0°	66.0°	125	495	1251	628	428	852	7
	53	L	21	530	625	74.0°	66.0°	137	495	1273	635	448	880	7
MACINA CHACANA 29"	43	S	17	430	585	74.5° (72.65°)	67.0°	120	476	1191	629	410	785	38
	48	M	19	450	605	74.5° (72.55°)	67.0°	125	476	1212	634	429	788	38
	53	L	21	480	635	74.5° (72.45°)	67.0°	137	476	1243	645	456	791	38
MACINA LYCAN 27"	38	XS	15	400	565	74.5° (72.4°)	66.5°	120	450	1150	595	400	767	15
	43	S	17	430	585	74.5° (72.3°)	67.0°	120	450	1164	598	419	766	15
	48	M	19	450	605	74.5° (72.2°)	67.0°	125	450	1185	603	438	770	15
	53	L	21	480	635	74.5° (72.1°)	67.0°	137	450	1217	614	465	773	15
MACINA TEAM 29"	38	XS	15	400	560	73.0°	68.5°	120	465	1107	618	371	790	60
	43	S	17	430	589	73.0°	78.5°	120	465	1136	618	400	796	60
	48	M	19	480	605	73.0°	69.0°	125	465	1147	625	414	815	60
	53	L	21	530	625	73.0°	69.0°	137	465	1167	636	430	842	60
MACINA RACE 29"	43	S	17	430	589	73.0°	70.5°	120	465	1100	618	400	745	62
	48	M	19	480	607	73.0°	71.0°	125	465	1112	625	416	761	62
	53	L	21	530	625	73.0°	71.0°	137	465	1132	636	431	792	62
MACINA RACE 27"	38	XS	15	400	568	73.0°	69.0°	125	445	1075	588	388	732	47
	43	S	17	430	575	73.0°	70.0°	125	445	1077	595	393	736	47
	48	M	19	480	594	73.0°	70.0°	137	445	1097	607	408	752	47
MACINA ACTION 27"	38	XS	15	400	568	73.0°	69.0°	125	445	1087	587	388	737	47
	43	S	17	430	575	73.0°	70.0°	125	445	1089	590	395	746	47
	48	M	19	480	594	73.0°	70.0°	137	445	1108	601	410	775	47
MACINA RIDE 27"	38	XS	15	400	566	73.0°	69.5°	125	460	1092	606	380	763	47
	43	S	17	430	574	73.0°	70.0°	125	460	1094	608	388	770	47
	48	M	19	480	594	73.0°	70.0°	137	460	1115	619	405	792	47
MACINA MINI ME	34	XS	13.5	340	529	72.5°	70.0°	120	432	1016	518	366	677	40

E-TREKKING

GEO

- A** Größe in cm
Size in cm
- A** Größe
Size
- A** Größe in Zoll
Size in inch
- B** Sitzrohrlänge
Seat tube length
- C** Oberrohrlänge
Top tube length
- D** Sitzwinkel
Seat angle
- E** Lenkwinkel
Head angle
- F** Steuerrohrlänge
Head tube length
- G** Kettenstrebenlänge
Chainstay length
- H** Radstand
Wheelbase
- I** Stack
Stack
- J** Reach
Reach
- K** Überstandshöhe
Standover height
- L** Tretlagerabsenkung
BB drop

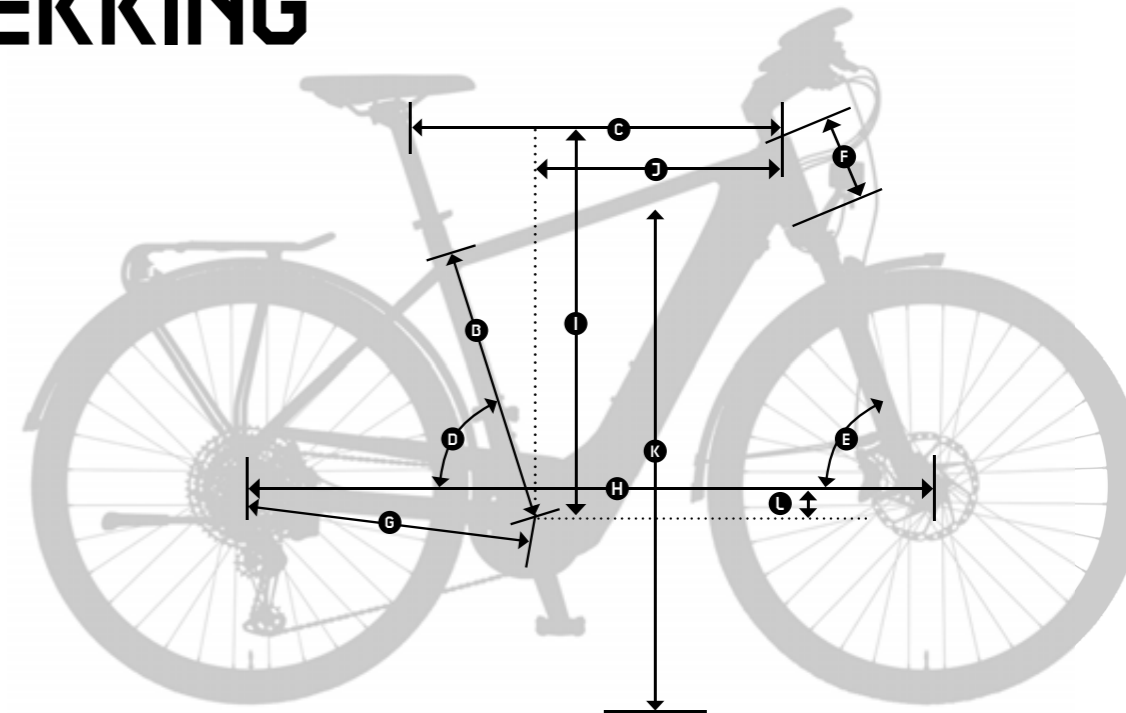

	A	A	A	B	C	D	E	F	G	H	I	J	K	L
MACINA SCOUT 271 & 271 LFC	43	XS	17	430	582	73.0°	69.5°	160	474	1108	630	372	411	55
	46	S	18	460	590	73.0°	73.0°	160	474	1103	635	378	411	55
	51	M	20	510	603	73.0°	70.0°	174	474	1115	648	384	411	55
	56	L	22	560	622	73.0°	70.0°	190	474	1134	663	397	411	55
MACINA SCOUT 272 & 272 LFC	43	XS	17	430	580	71.5°	69.5°	160	492	1125	629	373	423	55
	46	S	18	460	590	71.5°	70°	160	492	1129	631	379	423	55
	51	M	20	510	605	71.5°	70°	174	492	1137	644	385	423	55
	56	L	22	560	626	71.5°	70°	190	492	1156	660	398	423	55
MACINA CROSS 610 & 620	43	XS	17	430	575	73.0°	70.0°	120	452	1082	582	397	-	55
MACINA SPORT ABS & 610 & 620 & 630	46	S	18	460	575	73.0°	70.5°	120	452	1077	582	397	796	55
MACINA STYLE 610 & 620 & 630 & XL	51	M	20	510	588	73.0°	70.5°	137	452	1090	599	405	819	55
MACINA MILA	56	L	22	560	599	73.0°	70.5°	155	452	1102	615	411	851	55
MACINA GRAN 610 & 510	60	XL	23.5	600	615	73.0°	70.5°	174	452	1120	633	422	877	55
MACINA CROSS 510 & LFC	46	S	18	460	575	73.0°	70.0°	120	452	1077	582	397	776	55
MACINA SPORT 510	51	M	20	510	588	73.0°	70.5°	137	452	1090	599	405	805	55
MACINA TOUR 510	56	L	22	560	599	73.0°	70.5°	155	452	1102	615	411	835	55
	60	XL	23.5	600	615	73.0°	70.5°	174	452	1120	633	422	862	55
MACINA CROSS 520	46	S	18	460	575	73.0°	70.5°	120	452	1077	582	397	781	55
MACINA SPRINT	51	M	20	510	588	73.0°	70.5°	137	452	1090	599	405	813	55
MACINA SPORT 520	56	L	22	560	599	73.0°	70.5°	155	452	1102	615	411	846	55
	60	XL	23.5	600	615	73.0°	70.5°	174	452	1120	633	422	874	55
MACINA FUN 510	46	S	18	460	575	73.0°	71.0°	120	463	1081	584	396	787	55
	51	M	20	510	588	73.0°	71.0°	137	463	1094	601	405	818	55
	56	L	22	560	599	73.0°	71.0°	155	463	1106	618	411	851	55
	60	XL	23.5	600	615	73.0°	71.0°	174	463	1123	636	422	880	55
MACINA SPORT ABS & 610 & 620 & 630 & 510 / MACINA STYLE 610 & 620 & 630 & XL / MACINA TOUR 510 US	43	XS	17	430	577	71.5°	69.5°	160	474	1095	622	370	409	60
	46	S	18	460	591	71.0°	70.0°	160	474	1101	625	382	409	60
	51	M	20	510	603	71.0°	70.0°	174	474	1112	638	387	409	60
MACINA CITY S ABS DELT & 610 DELT & 510	56	L	22	560	622	71.0°	70.0°	190	474	1130	653	400	409	60
	60	XL	23.5	600	638	71.0°	70.0°	195	474	1145	657	413	409	60
MACINA FUN 510 & 520	43	XS	17	430	590	71.5°	69.5°	160	492	1111	623	375	421	60
US	46	S	18	460	597	71.5°	70.0°	160	492	1113	625	381	421	60
MACINA CENTRAL	51	M	20	510	605	71.5°	70.0°	174	492	1123	387	638	421	60
	56	L	22	560	620	71.5°	70.0°	190	492	1141	653	400	421	60
MACINA FOLD				uni-size	400	615	72.0°	71.0°	165	422	1109	435	489	390 +20*

*Tretlager-
überhöhung

E-ROAD

- A** Größe in cm
Size in cm
- A** Größe
Size
- A** Größe in Zoll
Size in inch
- B** Sitzrohrlänge
Seat tube length
- C** Oberrohrlänge
Top tube length
- D** Sitzwinkel
Seat angle
- E** Lenkwinkel
Head angle
- F** Steuerrohrlänge
Head tube length
- G** Kettenstrebenlänge
Chainstay length
- H** Radstand
Wheelbase
- I** Stack
Stack
- J** Reach
Reach
- K** Überstandshöhe
Standover height
- L** Tretlagerabsenkung
BB drop

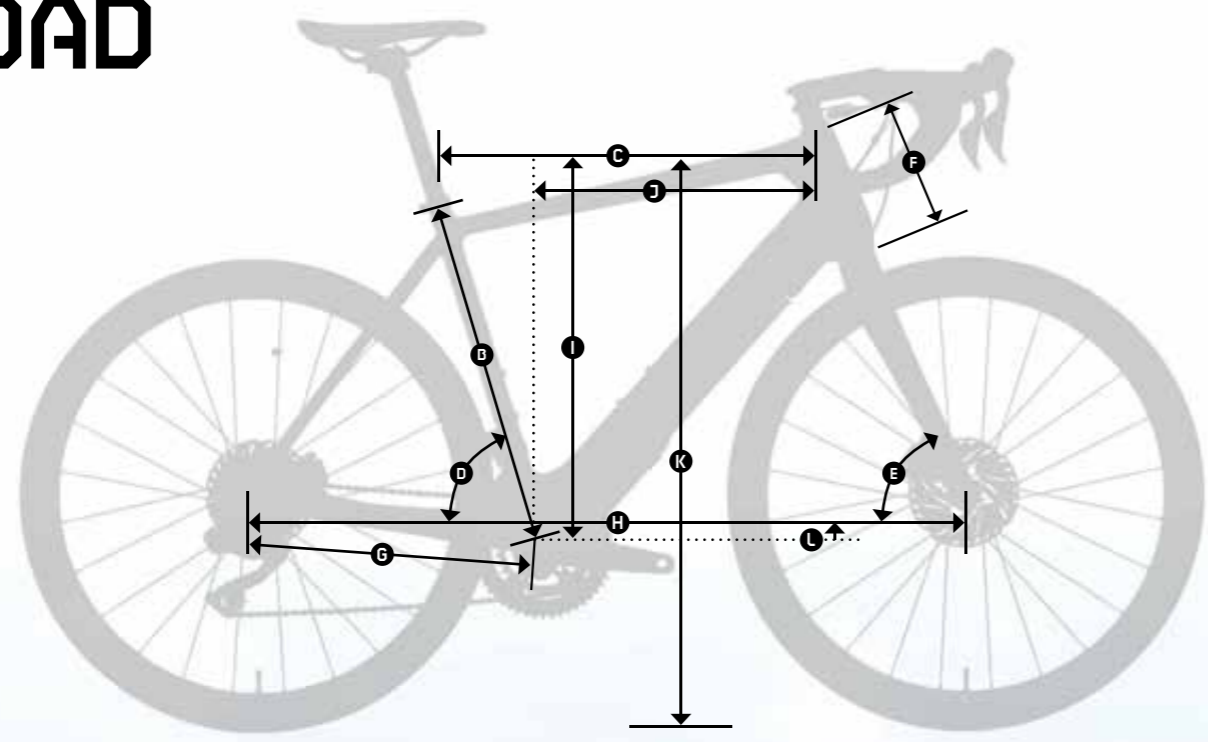

	A	A	A	B	C	D	E	F	G	H	I	J	K	L
MACINA MEZZO	44,5	S	18	445	535	74,0°	71,5°	150	420	1000	553	377	737	72
	48	M	19	480	555	73,5°	72,0°	170	420	1010	574	385	764	72
	52	L	20,5	520	575	73,0°	72,5°	190	420	1020	594	393	792	72
	55	XL	21,5	550	595	73,0°	72,5°	205	420	1040	609	409	815	72





KTM-BIKES.AT

**KTM FAHRRAD
GMBH**

Harlochnerstraße 13
5230 Mattighofen
Austria

**KTM FAHRRAD
DEUTSCHLAND GMBH**

Adolf-Kolping-Straße 34
D-84359 Simbach am Inn
Germany