

# Cisco UCS C220 M7 SFF Rack Server

A printed version of this document is only a copy and not necessarily the latest version. Refer to the following link for the latest released version:

<https://www.cisco.com/c/en/us/products/servers-unified-computing/ucs-c-series-rack-servers/datasheet-listing.html>



---

# CONTENTS

<b>OVERVIEW</b>	<b>2</b>
<b>DETAILED VIEWS</b>	<b>4</b>
Detailed Chassis Front View	4
Detailed Chassis Rear Views	5
One Half-Height Riser	6
Three Half-Height Risers	7
Two Full-Height Risers	8
<b>BASE SERVER STANDARD CAPABILITIES and FEATURES</b>	<b>10</b>
<b>CONFIGURING the SERVER</b>	<b>14</b>
STEP 1 SELECT SERVER SKU	15
STEP 2 SELECT RISERS (REQUIRED)	16
STEP 3 SELECT CPU(s) (REQUIRED)	18
STEP 4 SELECT MEMORY (REQUIRED)	23
Memory configurations and mixing rules	26
STEP 5 SELECT DRIVE CONTROLLERS (OPTIONAL)	30
RAID Volumes and Groups	30
STEP 6 SELECT DRIVES (OPTIONAL)	34
STEP 7 SELECT OPTION CARD(s) (OPTIONAL)	38
ORDER OPTIONAL PCIe OPTION CARD ACCESSORIES	40
STEP 8 ORDER GPU CARDS (OPTIONAL)	41
STEP 9 ORDER POWER SUPPLY (REQUIRED)	42
STEP 10 SELECT INPUT POWER CORD(s) (REQUIRED)	43
STEP 11 ORDER TOOL-LESS RAIL KIT (REQUIRED) AND REVERSIBLE CABLE MANAGEMENT ARM (OPTIONAL)	47
STEP 12 SELECT MANAGEMENT CONFIGURATION (OPTIONAL)	48
STEP 13 ORDER SECURITY DEVICES (REQUIRED)	49
STEP 14 SELECT LOCKING SECURITY BEZEL (OPTIONAL)	50
STEP 15 ORDER M.2 SATA SSDs (OPTIONAL)	51
STEP 16 ORDER M.2 NVMe AND RAID CONTROLLER(OPTIONAL)	52
STEP 17 SELECT OPERATING SYSTEM AND VALUE-ADDED SOFTWARE	53
STEP 18 CHOOSE OPTIONAL OPERATING SYSTEM MEDIA KIT	57
<b>SUPPLEMENTAL MATERIAL</b>	<b>58</b>
Block Diagrams	58
Chassis	60
Risers	62
Serial Port Details	65
KVM Cable	65
<b>UPGRADING or REPLACING CPUs and Memory</b>	<b>66</b>
<b>SPARE PARTS</b>	<b>67</b>
<b>TECHNICAL SPECIFICATIONS</b>	<b>80</b>
Dimensions and Weight	80
Power Specifications	81
Environmental Specifications	86
Compliance Requirements	87
<b>DISCONTINUED EOL PRODUCTS</b>	<b>88</b>

## OVERVIEW

The Cisco UCS C220 M7 SFF server extends the capabilities of Cisco's Unified Computing System portfolio in a 1U form factor with the 5<sup>th</sup> Gen. Intel® Xeon® Scalable Processors, 16 DIMM slots per CPU for DDR5-5600 Memory DIMMs with DIMM capacity points up to 128GB or 4<sup>th</sup> Gen. Intel® Xeon® Scalable Processors, 16 DIMM slots per CPU for DDR5-4800 Memory DIMMs with DIMM capacity points up to 128GB.

The Cisco UCS C220 M7 server harnesses the power of the latest Intel® Xeon® Scalable Processors and offers the following:

### CPU:

- Up to 2x 5<sup>th</sup> Generation Intel® Xeon® Scalable Processors with up to 60 cores per processor or
- Up to 2x 4<sup>th</sup> Generation Intel® Xeon® Scalable Processors with up to 52 cores per processor.

### Memory:

- Up to 4TB with 32 x 128GB DDR5-5600 DIMMs, in a 2-socket configuration with 5<sup>th</sup> Gen. Intel® Xeon® Scalable Processors or
- Up to 4TB with 32 x 128GB DDR5-4800 DIMMs, in a 2-socket configuration with 4<sup>th</sup> Gen. Intel® Xeon® Scalable Processors.

The server provides an internal slot for one of the following:

- SATA Interposer to control SATA drives from the PCH (AHCI) or
- Cisco 24G Tri-mode RAID controller with cache backup to control SAS/SATA/NVMe drives or
- Cisco 12G RAID controller with cache backup to control SAS/SATA drives or
- Cisco 12G SAS pass-through HBA to control SAS/SATA drives

**mLOM:** The UCS C220 M7 SFF server has a single 1GBE management port. A modular LAN on motherboard (mLOM)/OCP 3.0 module provides up to two 100GBE ports. A connector on the front of the chassis provides KVM functionality.

There are several options to choose from:

- **Option 1 UCSC-C220-M7S (see [Figure 1 on page 3](#)):**
  - Drive bays 1-10 supports up to 10 front facing SFF SAS/SATA HDDs/SSDs or NVMe SSDs with hardware raid (optionally up to 4 of the slots can be direct-attach NVMe).
  - One to three half-height PCIe risers or one to two full-height PCIe risers
- **Option 2 UCSC-C220-M7N (see [Figure 1 on page 3](#)):**
  - Drive bays 1 - 10 support only NVMe PCIe drives.
  - One to three half-height PCIe risers, or one to two full-height PCIe risers

The Cisco UCS C220 M7 SFF server can be used standalone, or as part of the Cisco Unified Computing System, which unifies computing, networking, management, virtualization, and storage access into a single integrated architecture, enabling end-to-end server visibility, management, and control in both bare metal and virtualized environments.

See [Figure 1 on page 3](#) for front and rear views of the UCS C220 M7 server.

Figure 1 Cisco UCS C220 M7 SFF Rack Server

Front View



Rear View (one half-height riser card version)



Rear View (three half-height riser card version)



Rear View (two full-height riser card version - shown with riser blanks installed)



# DETAILED VIEWS

## Detailed Chassis Front View

Figure 2 shows the detailed front view of the Cisco UCS C220 M7 SFF Rack Server

Figure 2 Detailed Chassis Front View

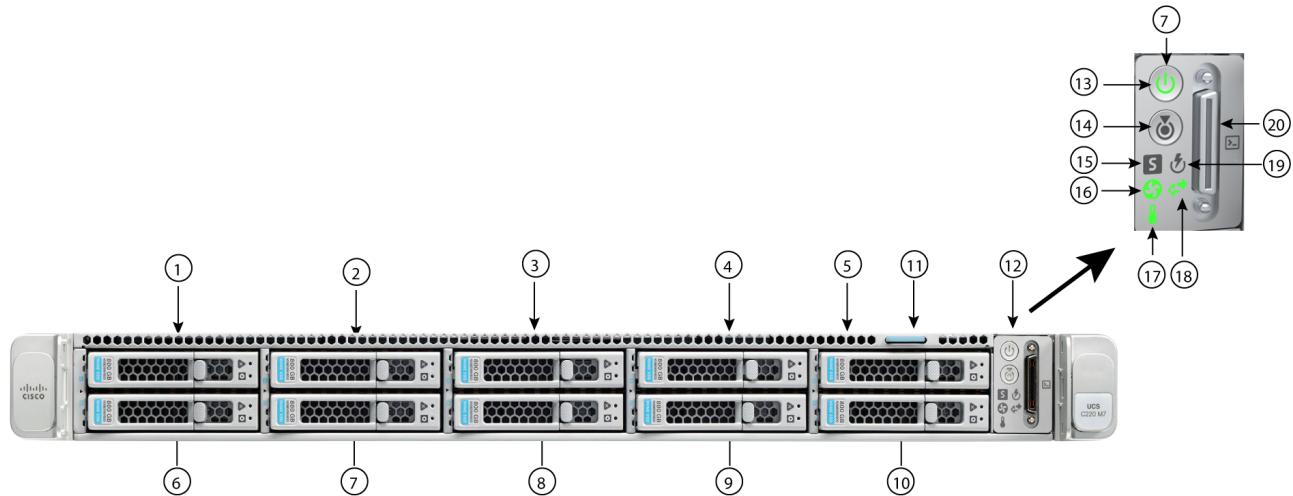

1 - 4	<p><b>Option 1 UCSC-C220-M7S</b></p> <ul style="list-style-type: none"> <li>■ Drive bays 1 - 4 support SAS/SATA hard drives and solid state drives (SSDs) or NVMe PCIe drives.<sup>1,2</sup></li> </ul> <p><b>Option 2 UCSC-C220-M7N</b></p> <ul style="list-style-type: none"> <li>■ Drive bays 1 - 4 support only NVMe PCIe drives</li> </ul>	15	System status LED
5 - 10	<p><b>Option 1 UCSC-C220-M7S</b></p> <ul style="list-style-type: none"> <li>■ Drive bays 5 - 10 support SAS/SATA hard drives and solid state drives (SSDs) only</li> </ul> <p><b>Option 2 UCSC-C220-M7N<sup>3</sup></b></p> <ul style="list-style-type: none"> <li>■ Drive bays 5 - 10 support NVMe PCIe drives only.</li> </ul>	16	Fan status LED
11	Asset tag location	17	Temperature status LED
12	Control panel	18	Network link activity LED
13	Power button/power status LED	19	Power supply status LED
14	Unit Identification button/LED	20	KVM connector (used with KVM cable that provides two USB 2.0, one VGA, and one serial connector)

**Notes:**

1. You can mix and match in drive bays 1 - 4. For example, slots 1 and 2 can hold NVMe drives and slots 3 and 4 can hold SAS/SATA HDDs or SSDs.
2. If using a SATA Interposer board, up to a maximum of 8 SATA-only drives can be configured (slots 1-4 and 6-9 only)

## Detailed Chassis Rear Views

*Figure 3* shows the details of the rear panel for the UCS C220 M7 with one rear half-height PCIe riser.

*Figure 4* shows the details of the rear panel for the UCS C220 M7 with three rear half-height PCIe risers.

*Figure 5* shows the details of the rear panel for the UCS C220 M7 with two rear full-height PCIe risers.

## One Half-Height Riser



**NOTE:** 1-CPU servers support 1 and 2 half-height risers. 2-CPU servers support all three half-height risers.

**Figure 3** Chassis Rear View (one half-height, 3/4 length PCIe riser)

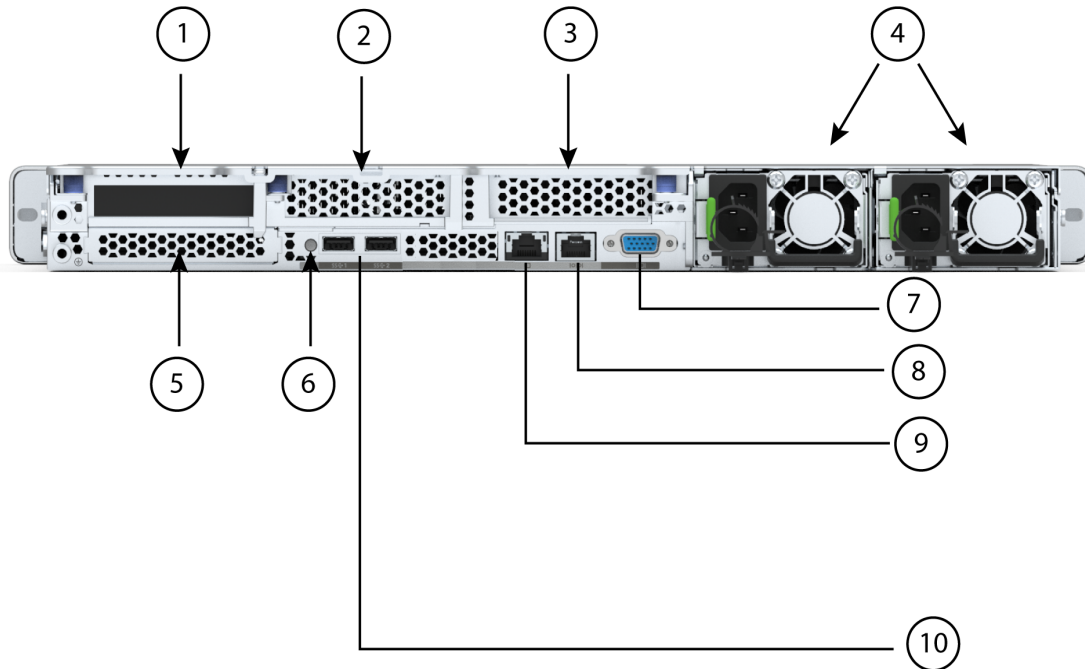

1	There are two half height riser 1 options: <b>Riser 1A PCIe Gen4 (CPU1 control)</b> <ul style="list-style-type: none"> <li>■ Supports one PCIe slot (slot 1)</li> <li>■ Slot 1 is half-height, 3/4 length, x16, NCSI, Single Wide GPU</li> </ul> <b>Riser 1B PCIe Gen5 (CPU1 control)</b> <ul style="list-style-type: none"> <li>■ Supports one PCIe slot (slot 1)</li> <li>■ Slot 1 is half-height, 3/4 length, x16, NCSI, Single Wide GPU</li> </ul>	6	System ID pushbutton/LED
2	Riser 2 blanking panel	7	VGA display port (DB15 connector)
3	Riser 3 blanking panel	8	COM port (RJ45 connector)
4	Power supplies (two, redundant as 1+1)	9	1GBE dedicated Ethernet management port
5	Modular LAN on motherboard (mLOM)/OCP 3.0 slot	10	USB 3.0 ports (two)

### Three Half-Height Risers



**NOTE:**

- Only 2-CPU servers support all three half-height risers.
- Gen4 and Gen5 risers cannot be mixed.

**Figure 4 Chassis Rear View (three half-height, 3/4 length PCIe risers)**

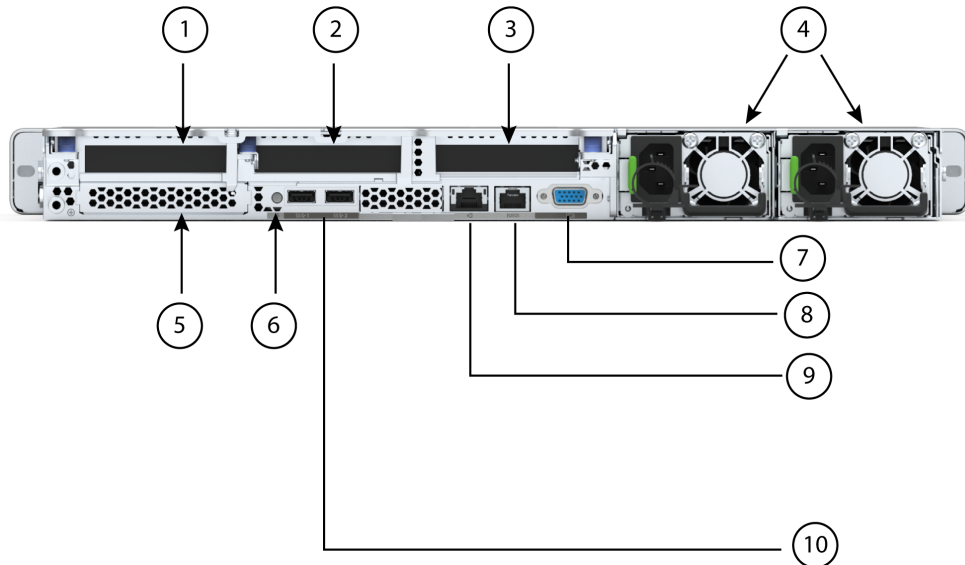

<p><b>1</b></p>	<p>There are two half height riser 1 options:</p> <p><b>Riser 1A PCIe Gen4 (CPU1 control)</b></p> <ul style="list-style-type: none"> <li>■ Supports one PCIe slot (slot 1)</li> <li>■ Slot 1 is half-height, 3/4 length, x16, NCSI, Single Wide GPU</li> </ul> <p><b>Riser 1B PCIe Gen5 (CPU1 control)</b></p> <ul style="list-style-type: none"> <li>■ Supports one PCIe slot (slot 1)</li> <li>■ Slot 1 is half-height, 3/4 length, x16, NCSI, Single Wide GPU</li> </ul>	<p><b>6</b></p>	<p>System ID pushbutton/LED</p>
<p><b>2</b></p>	<p>There are two half height riser 2 options:</p> <p><b>Riser 2A PCIe Gen4 x16 (CPU1 control)</b></p> <ul style="list-style-type: none"> <li>■ Supports one PCIe slot (slot 2)</li> <li>■ Slot 2 is half-height, 3/4 length, x16, Single Wide GPU</li> </ul> <p><b>Riser 2B PCIe Gen5 x16 (CPU1 control)</b></p> <ul style="list-style-type: none"> <li>■ Supports one PCIe slot (slot 2)</li> <li>■ Slot 2 is half-height, 3/4 length, x16, Single Wide GPU</li> </ul>	<p><b>7</b></p>	<p>VGA display port (DB15 connector)</p>



3	There is one half height riser 3 option: <b>Riser 3A PCIe Gen4 x16 (CPU2 control)</b> <ul style="list-style-type: none"> <li>■ Supports one PCIe slot (slot 3)</li> <li>■ Slot 3 is half-height, 3/4 length, x16, NCSI, Single Wide GPU</li> </ul>	8	COM port (RJ45 connector)
4	Power supplies (two, redundant as 1+1)	9	1GBE dedicated Ethernet management port
5	Modular LAN on motherboard (mLOM)/OCP 3.0 slot	10	USB 3.0 ports (two)

## Two Full-Height Risers



**NOTE:** 1-CPU servers support only full-height riser 1 while 2-CPU servers support both full-height risers.

Figure 5 Chassis Rear View (two full-height, 3/4-length PCIe risers)

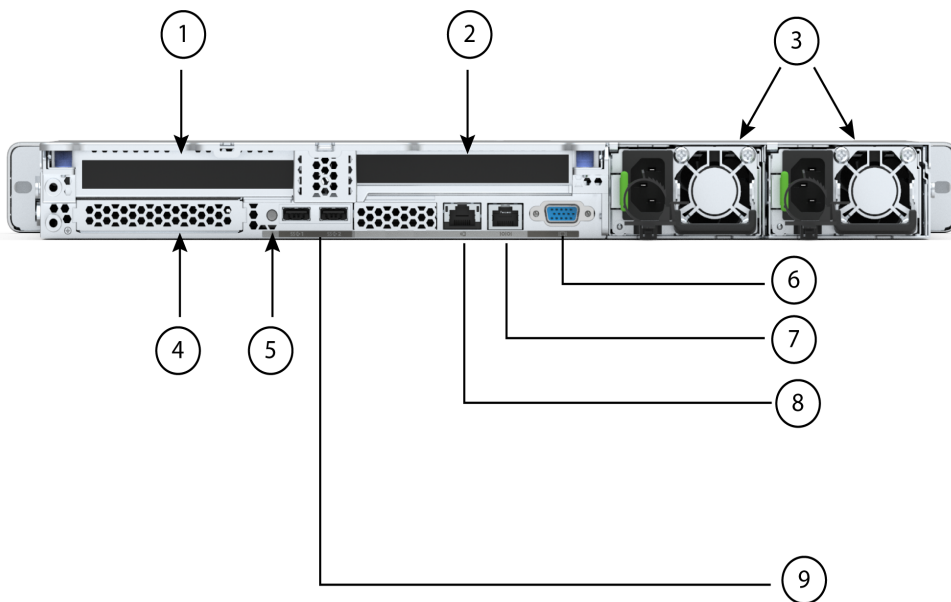

## DETAILED VIEWS

---

1	<b>Riser 1C PCIe Gen5 (CPU1 control)</b> <ul style="list-style-type: none"><li>■ Supports one PCIe slot (slot 1)</li><li>■ Slot 1 is full-height, 3/4 length, x16,NCSI, Single Wide GPU</li></ul>	6	VGA display port (DB15 connector)
2	<b>Riser 3C PCIe Gen5 x16 (CPU2 control)</b> <ul style="list-style-type: none"><li>■ Supports one PCIe slot (slot 3)</li><li>■ Slot 3 is Full-height, 3/4 length, x16, NCSI, Single Wide GPU</li></ul>	7	COM port (RJ45 connector)
3	Power supplies (two, redundant as 1+1)	8	1GBE dedicated Ethernet management port
4	Modular LAN on motherboard (mLOM)/OCP 3.0 slot	9	USB 3.0 ports (two)
5	System ID pushbutton/LED	-	-

## BASE SERVER STANDARD CAPABILITIES and FEATURES

*Table 1* lists the capabilities and features of the base server. Details about how to configure the server for a particular feature or capability (for example, number of processors, disk drives, or amount of memory) are provided in *CONFIGURING the SERVER, page 14*.

**Table 1 Capabilities and Features**

Capability/Feature	Description
Chassis	One rack unit (1RU) chassis
CPU	<ul style="list-style-type: none"> <li>■ One or two 5<sup>th</sup> Gen. Intel® Xeon® Scalable Processors or One or two 4<sup>th</sup> Gen. Intel® Xeon® Scalable Processors.</li> <li>■ Each CPU has 8 channels with up to 2 DIMMs per channel, for up to 16 DIMMs per CPU</li> <li>■ UPI Links: Up to 3 at 20GT/s</li> </ul>
Chipset	Intel® C741 series chipset
Memory	<ul style="list-style-type: none"> <li>■ 32 total DDR5-5600 MT/s DIMM slots with 5<sup>th</sup> Gen. Intel® Xeon® Scalable Processors (16 per CPU) or 32 total DDR5-4800 MT/s DIMM slots with 4<sup>th</sup> Gen. Intel® Xeon® Scalable Processors</li> <li>■ Up to 4TB DDR5-5600 DIMM memory capacity (32x 128GB DIMMs) with 5<sup>th</sup> Gen. Intel® Xeon® Scalable Processors or Up to 4TB DDR5-4800 DIMM memory capacity (32x 128GB DIMMs) with 4<sup>th</sup> Gen. Intel® Xeon® Scalable Processors</li> <li>■ Up to 75% peak bandwidth increase over DDR4-3200, with on-die ECC; all densities are Registered DIMMs (RDIMMs)</li> </ul>
Video	<p>The Cisco Integrated Management Controller (CIMC) provides video using the Matrox G200e video/graphics controller:</p> <ul style="list-style-type: none"> <li>■ Integrated 2D graphics core with hardware acceleration</li> <li>■ Embedded DDR memory interface supports up to 512 MB of addressable memory (8 MB is allocated by default to video memory)</li> <li>■ Supports display resolutions up to 1920 x 1200 16bpp @ 60Hz</li> <li>■ High-speed integrated 24-bit RAMDAC</li> <li>■ Single lane PCI-Express host interface running at Gen 1 speed</li> </ul>
Power subsystem	<p>Up to two of the following hot-swappable power supplies:</p> <ul style="list-style-type: none"> <li>■ 770 W (AC)</li> <li>■ 1200W (AC)</li> <li>■ 1600 W (AC)</li> <li>■ 2300 W (AC)</li> </ul> <p>One power supply is mandatory; one more can be added for 1 + 1 redundancy.</p>
Front Panel	A front panel controller provides status indications and control buttons
ACPI	This server supports the advanced configuration and power interface (ACPI) 6.2 standard.
Fans	Eight hot-swappable fans for front-to-rear cooling
Infiniband	The InfiniBand architecture is supported by the PCI slots.

Table 1 Capabilities and Features (continued)

Capability/Feature	Description
Expansion slots	<ul style="list-style-type: none"> <li>■ Half-height riser slots (select up to three)                             <ul style="list-style-type: none"> <li>• Riser 1A PCIe Gen4 x16 HH</li> <li>• Riser 1B PCIe Gen5 x16 HH</li> <li>• Riser 2A PCIe Gen4 x16 HH</li> <li>• Riser 2B PCIe Gen5 x16 HH</li> <li>• Riser 3A PCIe Gen4 x16 HH (CPU2 Control)</li> </ul> </li> <li>■ Full-height riser slots (select up to two)                             <ul style="list-style-type: none"> <li>• Riser 1C PCIe Gen5 x16 FH</li> <li>• Riser 3C PCIe Gen5 x16 FH (CPU2 Control)</li> </ul> </li> </ul>
Interfaces	<ul style="list-style-type: none"> <li>■ Rear panel                             <ul style="list-style-type: none"> <li>• One 1Gbase-T RJ-45 management port</li> <li>• One RS-232 serial port (RJ45 connector)</li> <li>• One DB15 VGA connector</li> <li>• Two USB 3.0 port connectors</li> <li>• One flexible modular LAN on motherboard (mLOM/OCP 3.0) slot that can accommodate various interface cards</li> </ul> </li> <li>■ Front panel                             <ul style="list-style-type: none"> <li>• One KVM console connector (supplies two USB 2.0 connectors, one VGA DB15 video connector, and one serial port (RS232) RJ45 connector)</li> </ul> </li> </ul>
Integrated management processor	<p>Baseboard Management Controller (BMC) running Cisco Integrated Management Controller (CIMC) firmware.</p> <p>Depending on your CIMC settings, the CIMC can be accessed through the 1GE dedicated management port. Cisco virtual interface card (VIC).</p> <p>CIMC manages certain components within the server, such as the Cisco 12G SAS HBA.</p>

Table 1 Capabilities and Features (continued)

Capability/Feature	Description
Internal storage devices	<p><b>Drive storage:</b></p> <p>Drives are installed into front-panel drive bays, which provide hot-swappable access for SAS/SATA or NVMe drives. The server is orderable in two different versions:</p> <ul style="list-style-type: none"> <li>■ UCSC-C220-M7S (option 1): <ul style="list-style-type: none"> <li>• Up to 10 SFF SAS/SATA hard drives (HDDs) or SAS/SATA/NVMe solid state drives (SSDs).</li> <li>• Optionally, up to four direct-attach SFF NVMe PCIe SSDs. These drives must be placed in front drive bays 1, 2, 3, and 4 only, can be mixed with SAS/SATA drives, and are controlled from CPU 2. The rest of the bays (5 - 10) can be populated with SAS/SATA/NVMe SSDs or HDDs. Two CPUs are required when choosing direct-attach NVMe SSDs.</li> <li>• If using a SATA Interposer, up to 8 SATA-only drives can be installed (slots 1-4 and 6-9 only).</li> </ul> </li> <li>■ UCSC-C220-M7N (option 2): <ul style="list-style-type: none"> <li>• Up to 10 2.5-inch direct-attach NVMe SSDs. only.</li> <li>• The drives in slots 1, 2, 3, 4, 6, and 7 are connected to CPU 2 and the drives in slots 5, 8, 9, and 10 are connected to CPU1. Up to 4 drives are allowed with single CPU configuration and can only be installed in slots 5, 8, 9, and 10.</li> </ul> </li> </ul> <p><b>Other storage:</b></p> <ul style="list-style-type: none"> <li>■ A mini-storage module connector on the motherboard supports a boot-optimized RAID controller carrier that holds up to two SATA M.2 SSDs.</li> <li>■ 8GB FlexMMC utility storage for staging of firmware and other user data. 8GB FlexMMC storage is built into the motherboard on M7.</li> </ul>

Table 1 Capabilities and Features (continued)

Capability/Feature	Description						
Storage controllers	<p><b>Internal storage controllers:</b></p> <p>The SATA Interposer board, 24G Tri-mode RAID controller, 12G RAID controller or 12G SAS HBA. Only one of these at a time can be used.</p> <ul style="list-style-type: none"> <li>■ SATA Interposer board                             <ul style="list-style-type: none"> <li>• AHCI support up to eight SATA-only drives (slots 1-8)</li> </ul> </li> <li>■ Cisco 24G Tri-mode RAID controller                             <ul style="list-style-type: none"> <li>• RAID support (RAID 0, 1, 5, 6, 10, 50, 60, RAID0, and RAID00)</li> <li>• Supports up to 10 internal SAS/SATA/NVMe drives</li> </ul> </li> <li>■ Cisco 12G RAID controller                             <ul style="list-style-type: none"> <li>• RAID support (RAID 0, 1, 5, 6, 10, 50, 60, RAID0, and RAID00)</li> <li>• Supports up to 10 internal SAS/SATA drives</li> </ul> </li> <li>■ Cisco 12G SAS HBA                             <ul style="list-style-type: none"> <li>• No RAID support</li> <li>• JBOD/Pass-through Mode support</li> <li>• Supports up to 10 SAS/SATA internal drives</li> </ul> </li> </ul> <p><b>External storage controllers:</b></p> <ul style="list-style-type: none"> <li>■ Cisco 12G 9500-8e 12G SAS HBA for external JBOD attach</li> </ul>						
Modular LAN on Motherboard (mLOM)/ Open Compute Project (OCP) 3.0 slot	<p>The dedicated mLOM/Open Compute Project (OCP) 3.0 slot on the motherboard can flexibly accommodate the following cards:</p> <ul style="list-style-type: none"> <li>■ Cisco Virtual Interface Cards</li> <li>■ Open Compute Project (OCP) 3.0 network interface card</li> </ul>						
Fabric Interconnect	Compatible with the Cisco UCS 6454, 64108 and 6536 fabric interconnects						
UCSM <sup>1</sup>	UCS Manager (UCSM) 4.3(2) or later runs in the Fabric Interconnect and automatically discovers and provisions some of the server components.						
CIMC	Cisco Integrated Management Controller 4.3(1) or later						
Intersight	Intersight provides server management capabilities						
Firmware standards	<table border="0"> <tr> <td>UEFI Spec</td> <td>2.9</td> </tr> <tr> <td>ACPI</td> <td>6.5</td> </tr> <tr> <td>SMBIOS Ver</td> <td>3.6</td> </tr> </table>	UEFI Spec	2.9	ACPI	6.5	SMBIOS Ver	3.6
UEFI Spec	2.9						
ACPI	6.5						
SMBIOS Ver	3.6						

## CONFIGURING the SERVER

Follow these steps to configure the Cisco UCS C220 M7 SFF Rack Server:

- **STEP 1 SELECT SERVER SKU, page 15**
- **STEP 2 SELECT RISERS (REQUIRED), page 16**
- **STEP 3 SELECT CPU(s) (REQUIRED), page 18**
- **STEP 4 SELECT MEMORY (REQUIRED), page 23**
- **STEP 5 SELECT DRIVE CONTROLLERS (OPTIONAL), page 30**
- **STEP 6 SELECT DRIVES (OPTIONAL), page 34**
- **STEP 7 SELECT OPTION CARD(s) (OPTIONAL), page 38**
- **STEP 8 ORDER GPU CARDS (OPTIONAL), page 41**
- **STEP 9 ORDER POWER SUPPLY (REQUIRED), page 42**
- **STEP 10 SELECT INPUT POWER CORD(s) (REQUIRED), page 43**
- **STEP 11 ORDER TOOL-LESS RAIL KIT (REQUIRED) AND REVERSIBLE CABLE MANAGEMENT ARM (OPTIONAL), page 47**
- **STEP 12 SELECT MANAGEMENT CONFIGURATION (OPTIONAL), page 48**
- **STEP 13 ORDER SECURITY DEVICES (REQUIRED), page 49**
- **STEP 14 SELECT LOCKING SECURITY BEZEL (OPTIONAL), page 50**
- **STEP 15 ORDER M.2 SATA SSDs (OPTIONAL), page 51**
- **STEP 16 ORDER M.2 NVMe AND RAID CONTROLLER(OPTIONAL), page 52**
- **STEP 18 CHOOSE OPTIONAL OPERATING SYSTEM MEDIA KIT, page 57**
- **SUPPLEMENTAL MATERIAL, page 58**

## STEP 1 SELECT SERVER SKU

Top level ordering product ID (PID) is shown in [Table 2](#).

**Table 2 Top level ordering PID (Major Line Bundle)**

Product ID (PID)	Description
UCS-M7-MLB	UCS M7 RACK, BLADE MLB This major line bundle (MLB) consists of the Rack Server (UCSC-C220-M7S or UCSC-C220-M7N) with software PIDs. Use this PID to begin a new configuration.

Select one product ID (PID) as shown in [Table 3](#).



**CAUTION:** This product may not be purchased outside of the approved bundles (must be ordered under the MLB)

**Table 3 PID of the C220 M7 SFF Rack Base Server**

Product ID (PID)	Description
UCSC-C220-M7S (option 1)	Small form-factor (SFF) drives, with 10-drive backplane. <ul style="list-style-type: none"> <li>■ Front facing drive bays 1-10 support 2.5in SAS/SATA/NVMe SSDs depending on controller type installed.</li> <li>■ Optionally, front-loading drive bays 1, 2, 3, and 4 support 2.5-inch direct-attach NVMe SSDs and the rest can be SAS/SATA HDDs or SSDs.</li> </ul>
UCSC-C220-M7N (option 2)	Small form-factor (SFF) drives, with 10-drive backplane. <ul style="list-style-type: none"> <li>■ Front-loading drive bays 1–10 support 2.5-inch NVMe SSDs (only) drives.</li> </ul>

**The Cisco UCS C220 M7 SFF Server:**

- Includes a 10 drive backplane.
- Does not include power supply, CPU, memory, hard disk drives (HDDs), solid-state drives (SSDs), NVMe drives, SD cards, riser 1, riser 2, riser 3, tool-less rail kit, or PCIe cards.
- Use the steps on the following pages to configure the server with the components that you want to include.



## STEP 2 SELECT RISERS (REQUIRED)

The riser PIDs are listed in [Table 4](#).



### CAUTION:

- Full-height risers cannot be mixed with half-height risers.
- Gen4 and Gen5 risers cannot be mixed.

Table 4 PIDs of the Risers and Riser Blanks

Product ID (PID)	Description
<b>Riser 1 Option</b>	
UCSC-RIS1A-22XM7	UCS C-Series M7 1U Riser 1A PCIe Gen4 x16 HH <ul style="list-style-type: none"> <li>■ Half-height riser 1 (controlled by CPU 1)</li> <li>■ One x16 PCIe Gen4 riser, standard PCIe, supports Cisco VIC, half-height, 3/4 length</li> </ul>
UCSC-RIS1B-22XM7	UCS C-Series M7 1U Riser 1B PCIe Gen5 x16 HH <ul style="list-style-type: none"> <li>■ Half-height riser 1 (controlled by CPU 1)</li> <li>■ One x16 PCIe Gen5 riser, standard PCIe, supports Cisco VIC, half-height, 3/4 length</li> </ul>
UCSC-RIS1C-22XM7	UCS C-Series M7 1U Riser 1C PCIe Gen5 x16 FH <ul style="list-style-type: none"> <li>■ Full-height riser 1 (controlled by CPU 1)</li> <li>■ One x16 PCIe Gen5 riser, standard PCIe, supports Cisco VIC, full-height, 3/4 length</li> </ul>
<b>Riser 2 Option</b>	
UCSC-RIS2A-22XM7	UCS C-Series M7 1U Riser 2A PCIe Gen4 x16 HH <ul style="list-style-type: none"> <li>■ Half-height riser 2 (controlled by CPU 1)</li> <li>■ One x16 PCIe Gen4 riser, standard PCIe, half-height, 3/4 length</li> </ul>
UCSC-RIS2B-22XM7	UCS C-Series M7 1U Riser 2B PCIe Gen5 x16 HH <ul style="list-style-type: none"> <li>■ Half-height riser 2 (controlled by CPU1)</li> <li>■ One x16 PCIe Gen5 riser, standard PCIe, half-height, 3/4 length</li> </ul>
<b>Riser 3 Option</b>	
UCSC-RIS3A-22XM7	UCS C-Series M7 1U Riser 3A PCIe Gen4 x16 HH (CPU2) <ul style="list-style-type: none"> <li>■ Half-height riser 3 (controlled by CPU 2)</li> <li>■ One x16 PCIe Gen4 riser, standard PCIe, supports Cisco VIC, half-height, 3/4 length</li> </ul>
UCSC-RIS3C-22XM7	UCS C-Series M7 1U Riser 3C PCIe Gen5 x16 FH (CPU2) <ul style="list-style-type: none"> <li>■ Full-height riser 3 (controlled by CPU 2)</li> <li>■ One x16 PCIe Gen5 riser, standard PCIe, supports Cisco VIC, full-height, 3/4 length</li> </ul>
<b>Accessories/spare included along with selected risers:</b>	
<ul style="list-style-type: none"> <li>■ UCSC-FBRS2-C220M7 for riser 2 and UCSC-FBRS-C220-D riser filler blank for riser 3 is auto included, if riser 2 or riser 3 are not selected. UCSC-FBRSF-220M7 is auto included if only one full height riser is selected</li> </ul>	

Approved Configurations

---

- (1) Half-height riser 1A, 2A, and 3A only. riser 1A and 2A are controlled from CPU1 and Riser 3 is controlled from CPU2.
- (2) Half-height risers 1B, 2B, and 3A only. Risers 1B and 2B are controlled from CPU1 and Riser 3A is controlled from CPU2
- (3) Full-height risers 1C and 3C only. Riser 1C is controlled from CPU1 and riser 3C is controlled from CPU2.

## STEP 3 SELECT CPU(s) (REQUIRED)

The standard CPU features are:

- The 5<sup>th</sup> Gen. Intel® Xeon® Scalable Processors are paired with Intel® C741 series chipset:
  - Up to 60 cores
  - Cache size of up to 300 MB
  - Power: Up to 300Watts
  - UPI Links: Up to 3 at 20GT/s
- The 4<sup>th</sup> Gen. Intel® Xeon® Scalable Processors are paired with Intel® C741 series chipset:
  - Up to 52 cores
  - Cache size of up to 105 MB
  - Power: Up to 300Watts
  - UPI Links: Up to 3 at 16GT/s

### Select CPUs



**NOTE:** If you try to upgrade an existing C220M7 Server from 4<sup>th</sup> Gen CPUs to 5<sup>th</sup> Gen CPUs, an air duct (UCSC-AD-C220M7=) must require. Please refer to the [installation guide](#) for more details.

- The available 5<sup>th</sup> Gen. Intel® Xeon® Scalable CPUs are listed in [Table 5](#). See [Table 7 on page 21](#) for CPU suffix notations.
- The available 4<sup>th</sup> Gen. Intel® Xeon® Scalable CPUs are listed in [Table 6](#). See [Table 7 on page 21](#) for CPU suffix notations.



**CAUTION:** Normal operating temperature is limited to 35° C [95° F], and is lowered to 28° C [82.4° F], with a fan fault.

Table 5 Available 5<sup>th</sup> Gen. Intel® Xeon® Scalable CPUs

Product ID (PID)	Segment/Workload	Maximum Socket (S)	Cores (C)	Clock Freq (GHz)	Power (W)	Cache Size (MB)	Highest DDR5 DIMM Clock Support (MT/s)
<b>8000 Series Processors</b>							
UCS-CPU-I8581V <sup>1</sup>	1-S Cloud/SaaS	1S	60	2.00	270	300.00	4800
UCS-CPU-I8571N <sup>1</sup>	1-S Networking	1S	52	2.40	300	300.00	4800
UCS-CPU-I8562Y+	2S Performance	2S	32	2.80	300	60.00	5600
UCS-CPU-I8558U <sup>1</sup>	1-Socket Optimized	1S	48	2.00	300	260.00	4800

Table 5 Available 5<sup>th</sup> Gen. Intel® Xeon® Scalable CPUs

Product ID (PID)	Segment/Workload	Maximum Socket (S)	Cores (C)	Clock Freq (GHz)	Power (W)	Cache Size (MB)	Highest DDR5 DIMM Clock Support (MT/s)
<b>6000 Series Processors</b>							
UCS-CPU-I6554S	Storage	2S	36	2.20	270	180.00	5200
UCS-CPU-I6548Y+	2S Performance	2S	32	2.50	250	60.00	5200
UCS-CPU-I6548N	Networking	2S	32	2.80	250	60.00	5200
UCS-CPU-I6544Y	2S Performance	2S	16	3.60	270	45.00	5200
UCS-CPU-I6542Y	2S Performance	2S	24	2.90	250	60.00	5200
UCS-CPU-I6538Y+	2S Mainline	2S	32	2.20	225	60.00	5200
UCS-CPU-I6538N	Networking	2S	32	2.10	205	60.00	5200
UCS-CPU-I6534	2S Performance	2S	8	3.90	195	22.50	4800
UCS-CPU-I6530	2S Mainline	2S	32	2.10	270	160.00	4800
UCS-CPU-I6526Y	2S Performance	2S	16	2.80	195	37.50	5200
<b>5000 Series Processors</b>							
UCS-CPU-I5520+	2S Mainline	2S	28	2.20	205	52.50	4800
UCS-CPU-I5515+	2S Performance	2S	8	3.20	165	22.50	4800
UCS-CPU-I5512U <sup>1</sup>	1-Socket Optimized	1S	28	2.10	185	52.50	4800
<b>4000 Series Processors</b>							
UCS-CPU-I4516Y+	2S Mainline	2S	24	2.20	185	45.00	4400
UCS-CPU-I4514Y	2S Mainline	2S	16	2.00	150	30.00	4400
UCS-CPU-I4510T <sup>2</sup>	EDGE (IOT)	2S	12	2.00	115	30.00	4400
UCS-CPU-I4510 <sup>2</sup>	2S Mainline	2S	12	2.40	150	30.00	4400
UCS-CPU-I4509Y <sup>2</sup>	2S Mainline	2S	8	2.60	125	22.50	4400
<b>3000 Series Processors</b>							
UCS-CPU-I3508U <sup>1,2</sup>	1-Socket Optimized	1S	8	2.10	125	22.50	4400
<b>Accessories/spare included with CPU configuration:</b>							
<ul style="list-style-type: none"> <li>■ UCSC-HSLP-C220M7</li> </ul>							
<b>NOTE:</b> if you are adding a second CPU later, you may need to order accessories spares with it.							

Notes:

1. You cannot have two of these CPUs in a two-CPU configuration and you cannot later upgrade to a 2-CPU system with two of these CPUs.
2. Available post first customer ship (FCS).

Table 6 Available 4th Gen. Intel® Xeon® Scalable CPUs

Product ID (PID)	Segment/Workload	Maximum Socket (S)	Cores (C)	Clock Freq (GHz)	Power (W)	Cache Size (MB)	Highest DDR5 DIMM Clock Support (MT/s)
<b>8000 Series Processors</b>							
UCS-CPU-I8471N <sup>1</sup>	5G/Networking	1S	52	1.80	300	97.50	4800
UCS-CPU-I8470N	5G/Networking	2S	52	1.70	300	97.50	4800
UCS-CPU-I8462Y+	2S Performance	2S	32	2.80	300	60.00	4800
UCS-CPU-I8461V <sup>1</sup>	Cloud/SaaS/Media	1S	48	2.20	300	97.50	4800
UCS-CPU-I8460Y+	2S Performance	2S	40	2.00	300	105.00	4800
UCS-CPU-I8454H	IMDB/Analytics	2S	32	2.10	270	82.50	4800
UCS-CPU-I8452Y	2S Mainline	2S	36	2.00	300	67.50	4800
UCS-CPU-I8450H	IMDB/Analytics	2S	28	2.00	250	75.00	4800
UCS-CPU-I8444H	IMDB/Analytics	2S	16	2.90	270	45.00	4800
<b>6000 Series Processors</b>							
UCS-CPU-I6454S	Storage	2S	32	2.20	270	60.00	4800
UCS-CPU-I6448Y	2S Performance	2S	32	2.10	225	60.00	4800
UCS-CPU-I6448H	IMDB/Analytics	2S	32	2.40	250	60.00	4800
UCS-CPU-I6444Y	2S Performance	2S	16	3.60	270	45.00	4800
UCS-CPU-I6442Y	2S Performance	2S	24	2.60	225	60.00	4800
UCS-CPU-I6438Y+	2S Mainline	2S	32	2.00	205	60.00	4800
UCS-CPU-I6438N	5G/Networking	2S	32	2.00	205	60.00	4800
UCS-CPU-I6438M	Cloud/SaaS/Media	2S	32	2.20	205	60.00	4800
UCS-CPU-I6434H	IMDB/Analytics	2S	8	3.70	195	22.50	4800
UCS-CPU-I6434	2S Performance	2S	8	3.70	195	22.50	4800
UCS-CPU-I6430	2S Mainline	2S	32	2.10	270	60.00	4400
UCS-CPU-I6428N	5G/Networking	2S	32	1.80	185	60.00	4000
UCS-CPU-I6426Y	2S Performance	2S	16	2.50	185	37.50	4800
UCS-CPU-I6421N <sup>1</sup>	5G/Networking	1S	32	1.80	185	60.00	4400
UCS-CPU-I6418H	IMDB/Analytics	2S	24	2.10	185	60.00	4800
UCS-CPU-I6416H	IMDB/Analytics	2S	18	2.20	165	45.00	4800
UCS-CPU-I6414U <sup>1</sup>	1S gen. purpose	1S	32	2.00	250	60.00	4800
<b>5000 Series Processors</b>							
UCS-CPU-I5420+	2S Mainline	2S	28	2.00	205	52.50	4400

Table 6 Available 4th Gen. Intel® Xeon® Scalable CPUs

Product ID (PID)	Segment/Workload	Maximum Socket (S)	Cores (C)	Clock Freq (GHz)	Power (W)	Cache Size (MB)	Highest DDR5 DIMM Clock Support (MT/s)
UCS-CPU-I5418Y	2S Mainline	2S	24	2.00	185	45.00	4400
UCS-CPU-I5418N	5G/Networking	2S	24	1.80	165	45.00	4000
UCS-CPU-I5416S	Storage	2S	16	2.00	150	30.00	4400
UCS-CPU-I5415+	2S Performance	2S	8	2.90	150	22.50	4400
UCS-CPU-I5412U <sup>1</sup>	1S gen. purpose	1S	24	2.10	185	45.00	4400
UCS-CPU-I5411N <sup>1</sup>	5G/Networking	1S	24	1.90	165	45.00	4400
<b>4000 Series Processors</b>							
UCS-CPU-I4416+	2S Mainline	2S	20	2.00	165	37.50	4000
UCS-CPU-I4410Y	2S Mainline	2S	12	2.00	150	30.00	4000
UCS-CPU-I4410T	IOT	2S	10	2.70	150	26.25	4000
<b>3000 Series Processors</b>							
UCS-CPU-I3408U <sup>1</sup>	1S gen. purpose	1S	8	1.80	125	22.50	4000
<b>Accessories/spare included with CPU configuration:</b>							
<ul style="list-style-type: none"> <li>■ UCSC-HSLP-C220M7</li> </ul>							
Please note, if you are adding a second CPU later, you may need to order accessories with it.							

Notes:

1. You cannot have two of these CPUs in a two-CPU configuration and you cannot later upgrade to a 2-CPU system with two of these CPUs.

Table 7 CPU Suffixes

CPU Suffix	Description	Features
P	Cloud (IaaS)	Designed for cloud IaaS environments to deliver higher frequencies at constrained TDPs
V	Cloud (SaaS)	Designed for high rack density, maximize VM/core, and lower power VM environment
M	Media Transcode	Designed for Media processing, AI, and HPC workloads
H	DB and Analytics	Designed for Data Analytics and Big Data usages
N	Network/5G/Edge (High TDP/Low latency)	Designed and optimized for a range of broadly-deployed network and 5G workload environments from Edge to the Data Center
S	Storage & HCI	Designed for Storage usages and workloads

Table 7 CPU Suffixes

CPU Suffix	Description	Features
T	Long-life Use/High Tcase	Designed for Network Environment-Building System (NEBS) and IoT market
U	1-Socket	Optimized for targeted platforms adequately served by the cores, memory bandwidth and IO capacity available from a single processor
Y	General SKU with SST-PP	Designator is used for general SKU stack to highlight SST-PP (Speed Select Technology Performance Profile) feature enabled
+	Feature Plus SKU	Designed to enable 1 instance of each DSA, IAA, QAT, DLB embedded accelerator

### Supported Configurations

- For 1-CPU systems, the server can support up to:
  - two half-height risers 1 and 2, or
  - one full-height riser 1
- For 2-CPU systems, the server can support up to:
  - three half-height risers 1, 2, and 3, or
  - two full-height risers 1 and 2,
- For the UCSC-C220-M7S:
  - 2 CPUs are required if direct-attach NVMe drives are selected
- For the UCSC-C220-M7N:
  - Select one or two identical CPUs
  - Up to 4 drives are allowed with 1-CPU configuration and can only be installed in slots 5, 8, 9, and 10.

The selection of 1 or 2 CPUs depends on the desired server functionality. See the following sections:

- [STEP 4 SELECT MEMORY \(REQUIRED\), page 23](#)
- [STEP 5 SELECT DRIVE CONTROLLERS \(OPTIONAL\), page 30](#)
- [STEP 6 SELECT DRIVES \(OPTIONAL\), page 34](#)
- [STEP 7 SELECT OPTION CARD\(s\) \(OPTIONAL\), page 38](#)

## STEP 4 SELECT MEMORY (REQUIRED)

The [Table 8](#) below describes the main memory DIMM features supported on Cisco UCS C220 M7 Rack server.

**Table 8 C220 M7 Main Memory Features**

Memory DIMM server technologies	Description
DDR5 memory clock speed	4th Gen. CPU: Up to 4800MT/s 1DPC; Up to 4400MT/s 2DPC
	5th Gen. CPU: Up to 5600MT/s 1DPC; Up to 4400MT/s 2DPC
Operational voltage	1.1 Volts
DRAM fab density	16Gb and 24Gb
DRAM DIMM type	RDIMM (Registered DDR5 DIMM with on die ECC)
Memory DIMM organization	Eight memory DIMM channels per CPU; up to 2 DIMMs per channel
Maximum number of DRAM DIMM per server	32 (2-Socket)
DRAM DIMM Densities and Ranks	16GB 1Rx8, 32GB 1Rx4, 64GB 2Rx4, 128GB 4Rx4
	48GB 1Rx4, 96GB 2Rx4 - 5th Gen. only
Maximum system capacity (DRAM DIMMs only)	4TB (32x 128GB)



Figure 6 Cisco UCS 220 M7 Memory Organization

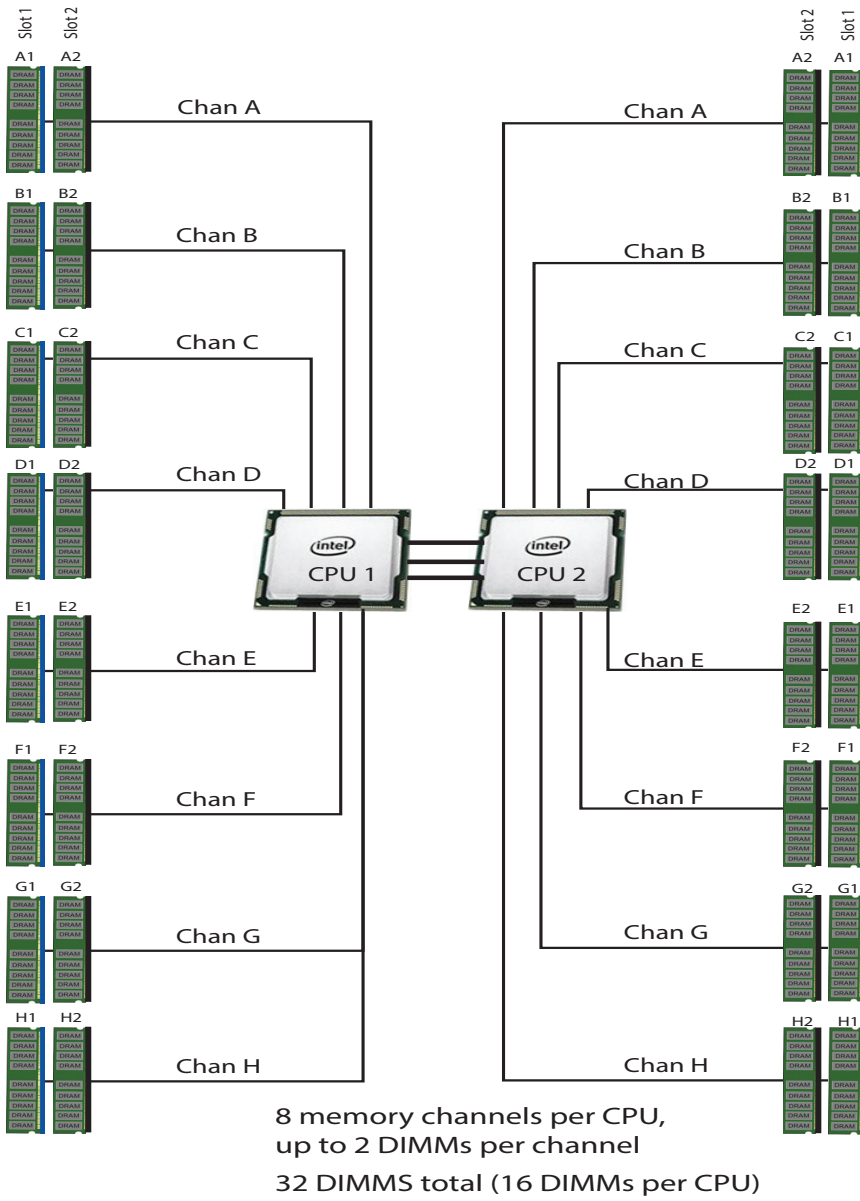

Select DIMMs and Memory Mirroring

Select the memory configuration and whether or not you want the memory mirroring option. The available memory DIMMs and mirroring option are listed in [Table 9](#).



**NOTE:** When memory mirroring is enabled, the memory subsystem simultaneously writes identical data to two channels. If a memory read from one of the channels returns incorrect data due to an uncorrectable memory error, the system automatically retrieves the data from the other channel. A transient or soft error in one channel does not affect the mirrored data, and operation continues unless there is a simultaneous error in exactly the same location on a DIMM and its mirrored DIMM. Memory mirroring reduces the amount of memory available to the operating system by 50% because only one of the two populated channels provides data.

Table 9 Available DDR5 DIMMs

Product ID (PID)	PID Description
<b>DDR5-4800MT/s PID list</b>	
UCS-MRX16G1RE1	16GB DDR5-4800 RDIMM 1Rx8 (16Gb)
UCS-MRX32G1RE1	32GB DDR5-4800 RDIMM 1Rx4 (16Gb)
UCS-MRX64G2RE1	64GB DDR5-4800 RDIMM 2Rx4 (16Gb)
UCS-MR128G4RE1	128GB DDR5-4800 RDIMM 4Rx4 (16Gb)
<b>DDR5-5600MT/s PID list<sup>1</sup></b>	
UCS-MRX16G1RE3	16GB DDR5-5600 RDIMM 1Rx8 (16Gb)
UCS-MRX32G1RE3	32GB DDR5-5600 RDIMM 1Rx4 (16Gb)
UCS-MRX48G1RF3 <sup>2</sup>	48GB DDR5-5600 RDIMM 1Rx4 (24Gb)
UCS-MRX64G2RE3	64GB DDR5-5600 RDIMM 2Rx4 (16Gb)
UCS-MRX96G2RF3	96GB DDR5-5600 RDIMM 2Rx4 (24Gb)
UCS-MR128G4RE3	128GB DDR5-5600 RDIMM 4Rx4 (16Gb)
<b>Memory Mirroring Option</b>	
N01-MMIRRORD	Memory mirroring option
<b>Accessories/spare included with Memory configuration:</b>	
<ul style="list-style-type: none"> <li>■ UCS-DDR5-BLK<sup>3</sup> is auto included for the unselected DIMMs slots</li> </ul>	

Notes:

1. DDR5-5600 supported on Intel Xeon 5th gen. CPUs only.
2. Available post first customer ship (FCS).
3. Any empty DIMM slot must be populated with a DIMM blank to maintain proper cooling airflow.

## Memory configurations and mixing rules

- **Golden Rule:** Memory on every CPU socket shall be configured identically.
- System speed is dependent on the CPU DIMM speed support. Refer to [Available 4th Gen. Intel® Xeon® Scalable CPUs, page 20](#) and [Available 5th Gen. Intel® Xeon® Scalable CPUs, page 18](#) for DIMM speeds.
- For full details on supported memory configurations see the [M7 Memory Guide](#).
- DIMM Count Rules:

Table 10 Allowed DIMM Count for 1-CPU and 2-CPU

Allowed DIMM Count rules	Minimum Count	Maximum Count	Allowed Count	Not Allowed Count
<b>16GB, 32GB, 64GB, 128GB, (4th and 5th Gen. CPUs)</b>				
DIMM count for 1 CPU	1	16	1,2,4,6,8,12,16	3,5,7,9,10,11,13,14,15
DIMM count for 2-CPU	2	32	2,4,8,12,16,24,32	6,10,14,18,20,22,26,28,30
<b>48GB (5th Gen. CPUs Only)</b>				
DIMM count for 1 CPU	1	8	1,6,8	2,3,4,5,7,9,10,11,12,13,14,15,16
DIMM count for 2-CPU	2	16	2,12,16	4,6,8,10,14,18,20,22,24,26,28,30,32
<b>96GB (5th Gen. CPUs Only)</b>				
DIMM count for 1 CPU	1	16	1,6,8,12,16	2,3,4,5,7,9, 10,11,13,14,15
DIMM count for 2-CPU	2	32	2,12,16,24,32	4,6,8,10,14,18,20,22,26,28,30

**NOTE(1):** 12 DIMMs count for 1-CPU, 24 DIMMs count and for 2-CPU configurations are only allowed when all DIMMs have the same density.

- DIMM Population Rules:
  - Each channel has two memory slots (for example, channel A = slots A1 and A2). See [golden rule](#) above.
    - A channel can operate with one or two DIMMs installed.
    - If a channel has only one DIMM, populate slot 1 first (the blue slot).
  - When both CPUs are installed, populate the memory slots of each CPU identically. Fill the blue slots (slot 1) in the memory channels first according to the recommended DIMM populations in [Table 11.0](#), [Table 11.1](#) and [Table 11.2](#).

**Table 11.0 M7 DIMM population order for 16GB, 32GB, 64GB, and 128GB**

#DIMMs per CPU	DIMM Population - 16GB, 32GB, 64GB, 128GB(4th and 5th Gen. CPUs) <sup>1</sup>	
	Slot 1 (Blue)	Slot 2 (Black)
1	A1	-
2	A1, G1	-
4	A1, C1, E1, G1	-
6	A1, C1, D1, E1, F1, G1	-
8	A1, B1, C1, D1, E1, F1, G1, H1	-
12 <sup>2</sup>	A1, B1, C1, D1, E1, F1, G1, H1	A2, C2, E2, G2
16	A1, B1, C1, D1, E1, F1, G1, H1	A2, B2, C2, D2, E2, F2, G2, H2

**Notes:**

1. See [DIMM Mixing Rules](#) for allowed combinations across slots 1 and 2.
2. Only valid when DIMMs in blue and black slots are the same density.

**Table 11.1 M7 DIMM population order for 48GB**

#DIMMs per CPU	DIMM Population - 48GB (5th Gen. CPUs only) <sup>1,2</sup>	
	Slot 1 (Blue)	Slot 2 (Black)
1	A1	-
6	A1, C1, D1, E1, F1, G1	-
8	A1, B1, C1, D1, E1, F1, G1, H1	-

**Notes:**

1. 48GB DIMMs cannot be mixed with other DIMM capacities.
2. Only 1 DPC supported by 48GB.

**Table 11.2 M7 DIMM population order for 96GB**

#DIMMs per CPU	DIMM Population - 96GB (5th Gen. CPUs only) <sup>1</sup>	
	Slot 1 (Blue)	Slot 2 (Black)
1	A1	-
6	A1, C1, D1, E1, F1, G1	-
8	A1, B1, C1, D1, E1, F1, G1, H1	-
12 <sup>2</sup>	A1, B1, C1, D1, E1, F1, G1, H1	A2, C2, E2, G2
16 <sup>2</sup>	A1, B1, C1, D1, E1, F1, G1, H1	A2, B2, C2, D2, E2, F2, G2, H2

## Notes:

1. 96GB DIMMs cannot be mixed with other DIMM capacities.
2. Only valid when DIMMs in blue and black slots are the same density.

- DIMM Mixing Rules:

- Higher rank DIMMs shall be populated on Slot 1.
- Mixing different DIMM densities in the same slot across channels is not supported. All populated slots of the same color must have the same DIMM density.
- Mixing X4 and X8 DIMMs is not allowed
- Mixing 16Gb DRAM based and 24Gb DRAM based DIMMs is not allowed. Therefore, 48GB and 96GB cannot be mixed with any other memory DIMMs
- 48GB supports 1 DIMM Per Channel (1DPC) only
- The DIMM mixing rules matrix is described in the [Table 12](#) and [Table 13](#), below

**Table 12 Supported DIMM mixing and population across 2 slots in each channel - 16GB, 32GB, 64GB, and 128GB**

Channel Mixing		DIMM Slot 2 (Black)			
DIMM Slot 1 (Blue)		16GB	32GB	64GB	128GB
		1Rx8	1Rx4	2Rx4	4Rx4
16GB	1Rx8	Yes <sup>1</sup>	No	No	No
32GB	1Rx4	No	Yes <sup>1</sup>	No	No
64GB	2Rx4	No	Yes <sup>2</sup>	Yes <sup>1</sup>	No
128GB	4Rx4	No	No	No	Yes <sup>1</sup>

## Notes:

1. For 2,4,6, 8 DIMMs count, only populate slot 1 (Blue slot). see [Table 11.0](#) for details
2. When mixing two different DIMM densities, all 8 channels per CPU must be populated. Use of fewer than 8 channels (16 slots per CPU) is not supported.

**Table 13 Supported DIMM mixing and population across 2 slots in each channel - 48GB and 96GB DIMMs**

Channel Mixing		DIMM Slot 2 (Black)	
DIMM Slot 1 (Blue)		48GB	96GB
		1Rx4	2Rx4
48GB	1Rx4	No	No
96GB	2Rx4	No	Yes <sup>1</sup>

## Notes:

1. For 6, 8 DIMMs count, only populate slot 1 (Blue slot). see [Table 11.2](#) for details

- Memory Limitations:
  - Memory on every CPU socket shall be configured identically.
  - Refer to [Table 11.0](#), [Table 11.1](#) and [Table 11.2](#), and [Table 12](#) and [Table 13](#), for DIMM population and DIMM mixing rules.
  - Cisco memory from previous generation servers (DDR3 and DDR4) is not supported with the M7 servers.
- For best performance, observe the following:
  - For optimum performance, populate at least one DIMM per memory channel per CPU. When one DIMM per channel is used, it must be populated in DIMM slot 1 (blue slot farthest away from the CPU) of a given channel.
  - The maximum 2 DPC speed is 4400 MT/s, refer to [Table 14.0](#) and [Table 14.1](#) for the details.

Table 14.0 DDR5-4800 DIMM 1DPC and 2DPC max speed matrix - 4th Gen. CPU

4th Gen. CPU Shelves and Memory Speed	1DPC	2DPC
	All RDIMMs	All RDIMMs
Platinum Series 8	4800 MT/s	4400 MT/s
Gold Series 6	4800 MT/s	4400 MT/s
Gold Series 5	4400 MT/s	4400 MT/s
Silver Series 4	4000 MT/s	4000 MT/s
Bronze Series 3	4000 MT/s	4000 MT/s

Table 14.1 DDR5-5600 DIMM 1DPC and 2DPC max speed matrix - 5th Gen. CPU

5th Gen. CPU Shelves and Memory Speed	1DPC	2DPC
	All RDIMMs	All RDIMMs
Platinum Series 8	5600 MT/s	4400 MT/s
Gold Series 6	5200 MT/s	4400 MT/s
Gold Series 5	4800 MT/s	4400 MT/s
Silver Series 4	4400 MT/s	4400 MT/s
Bronze Series 3	4400 MT/s	4400 MT/s



**NOTE:** For full details on supported memory configurations see the [M7 Memory Guide](#).

## STEP 5 SELECT DRIVE CONTROLLERS (OPTIONAL)

The following list summarizes how drives are controlled on the server:

- Servers with SATA drives (only) are controlled by an Intel C621 PCH through the SATA Interposer (AHCI)
- Up to 10 SAS/SATA/NVMe drives are controlled through a Cisco 24G Tri-mode RAID controller
- Up to 10 SAS/SATA drives are controlled through a Cisco 12G SAS RAID controller.
- Up to 10 SAS/SATA drives are controlled through a Cisco 12G SAS pass-through HBA.



**NOTE:** PCIe drives are controlled directly from the CPUs.

---

## RAID Volumes and Groups

When creating each RAID volume, follow these guidelines:

- Use the same capacity for each drive in each RAID volume
- For the Cisco 12G SAS RAID controller, use either all SAS HDDs, or all SAS SSDs, or all SATA SSDs in each RAID volume
- For the Cisco 24G Tri-mode RAID controller, use either all SAS HDDs, or all SAS SSDs, or all SATA SSDs or NVMe SSDs in each RAID volume.



**NOTE:** 240 virtual drives (VDs) per controller, with up to 64 per disk group with the 12G Raid Controller, and 16 per disk group with the 24G Tri Mode Controller.

---

RAID Controller Options

If you do not want the default AHCI 8 SATA-only drive setup (8 internal drives in drive bays 1-8 and 2 SATA M.2 drives), select one of the following from [Table 15](#).

- One Cisco 24G Tri-mode RAID controller or
- One Cisco 12G RAID controller or
- One Cisco 12G SAS HBA



**NOTE:**

- If the Cisco 24G Tri-mode RAID controller, 12G SAS RAID controller or Cisco 12G SAS HBA is selected, it is factory-installed in a dedicated slot.
- All RAID controllers are only supported on UCSC-C220-M7S For UCSC-C220-M7N, drives are controlled directly from the CPU.
- The default solution is AHCI, which supports a limited number of drives, operating systems, and virtualized environments. For a more comprehensive solution, choose a controller from [Table 15](#).
- vSAN HCL listed/qualified component is UCSC-SAS-T-D

**Table 15 Hardware Controller Options**

Product ID (PID)	PID Description
<b>Controllers for Internal Drives</b>	
UCSC-RAID-HP <sup>1,2</sup>	<p>Cisco Tri-Mode 24G SAS RAID Controller w/4GB Cache</p> <ul style="list-style-type: none"> <li>■ This RAID controller supports up to 10 SAS HDDs and SAS/SATA/NVMe SSDs operating at 3Gbps, 6Gbps, 12Gbps and 24Gbps. It includes a SuperCap and a 4GB flash-back write cache (FBWC).</li> <li>■ Supports RAID0, RAID00, 1, 5, 6, 10, 50, 60, and JBOD mode and supports mixed RAID and JBOD mode.</li> <li>■ The RAID controller plugs directly into a dedicated slot.</li> <li>■ For all self-encrypting drives (SED), standalone Management (CIMC/UCSM) is supported for configuring and managing local keys. For now, SED drives are managed with local key management only. Third-party key management will be supported (KMIP compliant).</li> </ul>
UCSC-RAID-T-D	<p>Cisco M6 12G SAS RAID Controller with 4GB FBWC (16 Drives)</p> <ul style="list-style-type: none"> <li>■ This RAID controller supports up to 10 SAS HDDs and SAS/SATA SSD operating at 3Gbps, 6Gbps, and 12Gbps. It includes a SuperCap and a 4GB flash-back write cache (FBWC).</li> <li>■ Supports RAID0, RAID00, 1, 5, 6, 10, 50, 60, and JBOD mode and supports mixed RAID and JBOD mode.</li> <li>■ The RAID controller plugs directly into a dedicated slot.</li> <li>■ For all self-encrypting drives (SED), standalone Management (CIMC/UCSM) is supported for configuring and managing local keys. For now, SED drives are managed with local key management only. Third-party key management will be supported (KMIP compliant).</li> </ul>



Table 15 Hardware Controller Options (*continued*)

Product ID (PID)	PID Description
UCSC-SAS-T-D	<p>Cisco M6 12G SAS HBA for (16 Drives)</p> <ul style="list-style-type: none"> <li>■ This SAS HBA supports up to 10 SAS HDDs and SAS/SATA SSDs operating at 3Gbps, 6Gbps, and 12Gbps.</li> <li>■ No RAID support</li> <li>■ Supports JBOD or pass-through mode</li> <li>■ The 12G SAS HBA plugs directly into a dedicated slot.</li> </ul>
<b>Controller for External Drives</b>	
UCSC-9500-8E-D	<p>Cisco 12G 9500-8e 12G SAS HBA for external JBOD attach</p> <ul style="list-style-type: none"> <li>■ External Storage HBA plugs in to PCIe slot</li> <li>■ This controller is half-height half-length and can be installed in riser 1, 2, or 3.</li> </ul>
<b>SATA Interposer</b>	
UCSC-SATAIN-220M7	<p>UCS C220 M7 SATA Interposer Board (for control of up to 8 SATA-only drives using AHCI)</p> <ul style="list-style-type: none"> <li>■ The default configuration is Advanced Host Control Interface (AHCI), which supports SATA-only drives. A maximum of 8 SATA drives are supported with AHCI and this configuration requires a SATA interposer board, which plugs directly into the drive backplane. The SATA Interposer supports drives in slots 1-8.</li> <li>■ AHCI is limited to Windows and Linux operating systems only. There is no VMware support for AHCI.</li> </ul>
<p><b>Accessories/spare included with drive controller (For UCSC-C220-M7S):</b></p> <ul style="list-style-type: none"> <li>■ UCSC-RDBKT-22XM7 is included with the selection of UCSC-SAS-T-D drive controller.</li> <li>■ CBL-SAS-C220M7, CBL-SCAP-C220-D, UCS-SCAP-D and UCSC-RDBKT-22XM7 are included with the selection of UCSC-RAID-T-D drive controller</li> <li>■ CBL-SAS-Y-C220M7, CBL-SCAP-C220-D, UCS-SCAP-D and UCSC-HPBKT-22XM7 are included with the selection of UCSC-RAID-HP drive controller.</li> </ul> <p><b>NOTE:</b> If you are adding drive controller later as spare, you may need to order cables/supercap/super cables and controllers bracket with it.</p>	

**Notes:**

1. When ordering UCSC-RAID-HP, please note that mixing SAS/SATA and NVMe drives in a single RAID volume is not supported. Virtual drives can only be created with drives of the same type
2. U.3 NVMe drives selected with the Tri-mode RAID controller (UCSC-RAID-HP) will be set to RAID attached as the factory default. The U.3 drives in slots 1-4 can however operate in U.2 mode, directly attached to the CPU. This mode can be changed from the Cisco IMC if desired.

Select one of the RAID Configuration option from the following [Table 16](#).



**CAUTION:** All RAID options require drives of same sector size and media type. The smallest drive capacity will be used to calculate the RAID volume size.

**Table 16 RAID Configuration Options**

Product ID (PID)	PID Description
<b>NOTE:</b> Not available for Cisco 12G SAS HBA	
R2XX-SRAID0D	Enable single disk RAID 0 Setting.
R2XX-RAID0D	Factory preconfigured RAID striping option Enable RAID 0 Setting. Requires two or more drive.
R2XX-RAID00D	Factory preconfigured RAID striping option Enable RAID 00 Setting. Requires two or more drive.
R2XX-RAID1D	Factory preconfigured RAID mirroring option Enable RAID 1 Setting. Requires even number of drives (minimum of two).
R2XX-RAID5D	Factory preconfigured RAID option Enable RAID 5 Setting. Requires a minimum of three drives
R2XX-RAID6D	Factory preconfigured RAID option Enable RAID 6 Setting. Requires a minimum of four drives.
R2XX-RAID10D	Factory preconfigured RAID option Enable RAID 10 Setting. Requires even number of drives (minimum of 2 drives per span)
R2XX-RAID50D	Factory preconfigured RAID option Enable RAID 50 Setting. Requires minimum of three drives per span
R2XX-RAID60D	Factory preconfigured RAID option Enable RAID 60 Setting. Requires minimum of four drives per span.

**Approved Configurations**

Cisco UCS C220 M7 SFF server can be ordered as follows:

- UCSC-C220 M7S (10-drive SAS/SATA/NVMe backplane and optionally 4 of those can be direct-attach NVMe)
- UCSC-C220-M7N (10-drive direct-attach NVMe only)
- There is no RAID support for direct-attach NVMe drives.

## STEP 6 SELECT DRIVES (OPTIONAL)

The standard disk drive features are:

- 2.5-inch small form factor
- Hot-pluggable
- Drives come mounted in sleds

### Select Drives

- The available NVMe SSDs drives for **UCSC-C220-M7N** and **UCSC-C220-M7S** are listed in [Table 17](#)
- The available SAS/SATA SSDs and HDDs drives for **UCSC-C220-M7S** listed [Table 18](#)



**CAUTION:** Cisco uses solid state drives (SSDs) from a number of vendors. All solid state drives (SSDs) are subject to physical write limits and have varying maximum usage limitation specifications set by the manufacturer. Cisco will not replace any solid state drives (SSDs) that have exceeded any maximum usage specifications set by Cisco or the manufacturer, as determined solely by Cisco.

Table 17 Available NVMe drives for UCSC-C220-M7N and UCSC-C220-M7S

Product ID (PID)	PID Description	Drive Type	Form Factor	Capacity
<b>PCIe/NVMe SFF (2.5-inch) SFF drives</b>				
UCS-NVMEXP-I400-D	400GB 2.5in U.2 Intel P5800X Optane NVMe Extreme Perform SSD	NVMe	U.2	400 GB
UCS-NVMEXP-I800-D	800GB 2.5in U.2 Intel P5800X Optane NVMe Extreme Perform SSD	NVMe	U.2	800 GB
UCS-NVME4-1600-D	1.6TB 2.5in U.2 P5620 NVMe High Perf High Endurance	NVMe	U.2	1.6 TB
UCS-NVME4-1920-D	1.9TB 2.5in U.2 P5520 NVMe High Perf Medium Endurance	NVMe	U.2	1.9 TB
UCS-NVME4-3200-D	3.2TB 2.5in U.2 P5620 NVMe High Perf High Endurance	NVMe	U.2	3.2 TB
UCS-NVME4-3840-D	3.8TB 2.5in U.2 P5520 NVMe High Perf Medium Endurance	NVMe	U.2	3.8 TB
UCS-NVME4-6400-D	6.4TB 2.5in U.2 P5620 NVMe High Perf High Endurance	NVMe	U.2	6.4 TB
UCS-NVME4-7680-D	7.6TB 2.5in U.2 P5520 NVMe High Perf Medium Endurance	NVMe	U.2	7.6 TB
UCS-NVME4-15360-D	15.3TB 2.5in U.2 P5520 NVMe High Perf Medium Endurance	NVMe	U.2	15.3 TB
UCS-NVMEQ-1536-D	15.3TB 2.5in U.2 P5316 NVMe High Perf Low Endurance	NVMe	U.2	15.3 TB
UCS-NVMEG4-M960-D <sup>1</sup>	960GB 2.5in U.3 Micron P7450 NVMe High Perf Medium Endurance	NVMe	U.3	960 GB
UCS-NVMEG4-M1920D <sup>1</sup>	1.9TB 2.5in U.3 Micron P7450 NVMe High Perf Medium Endurance	NVMe	U.3	1.9 TB

**Table 17 Available NVMe drives (continued)for UCSC-C220-M7N and UCSC-C220-M7S**

Product ID (PID)	PID Description	Drive Type	Form Factor	Capacity
UCS-NVMEG4-M3840D <sup>1</sup>	3.8TB 2.5in U.3 Micron P7450 NVMe High Perf Medium Endurance	NVMe	U.3	3.8 TB
UCS-NVMEG4-M7680D <sup>1</sup>	7.6TB 2.5in U.3 Micron P7450 NVMe High Perf Medium Endurance	NVMe	U.3	7.6 TB
UCS-NVMEG4-M1536D <sup>1</sup>	15.3TB 2.5in U.3 MicronP7450 NVMe High Perf Medium Endurance	NVMe	U.3	15.3 TB
UCS-NVMEG4-M1600D <sup>1</sup>	1.6TB 2.5in U.3 Micron P7450 NVMe High Perf High Endurance	NVMe	U.3	1.6 TB
UCS-NVMEG4-M3200D <sup>1</sup>	3.2TB 2.5in U.3 Micron P7450 NVMe High Perf High Endurance	NVMe	U.3	3.2 TB
UCS-NVMEG4-M6400D <sup>1</sup>	6.4TB 2.5in U.3 Micron P7450 NVMe High Perf High Endurance	NVMe	U.3	6.4 TB
■ CBL-FNVME-C220M7 is auto included with selection of U.3 NVMe drives and Raid controller UCSC-RAID-HP.				

**Notes:**

1. Only U.3 drives are allowed with RAID 24G Tri-mode RAID Controller and NVMe Hardware RAID.

**Table 18 Available SAS/SATA SSD and HDDs for UCSC-C220-M7S**

Product ID (PID)	PID Description	Drive Type	Capacity
<b>HDDs</b>			
<b>HDDs (10K RPM)</b>			
UCS-HD600G10KJ4-D	600 GB 12G SAS 10K RPM SFF HDD	SAS	600 GB
UCS-HD12TB10KJ4-D	1.2 TB 12G SAS 10K RPM SFF HDD	SAS	1.2 TB
UCS-HD18TB10KJ4-D	1.8 TB 12G SAS 10K RPM SFF HDD (4K)	SAS	1.8 TB
UCS-HD24TB10KJ4-D	2.4 TB 12G SAS 10K RPM SFF HDD (4K)	SAS	2.4 TB
<b>Enterprise Performance SAS/SATA SSDs (High endurance, supports up to 10X or 3X DWPD (drive writes per day))</b>			
<b>SATA</b>			
UCS-SD480G63XEP-D	480 GB 2.5in Enterprise Performance 6G SATA SSD(3X endurance)	SATA	480 GB
UCS-SD960G63XEP-D	960 GB 2.5in Enterprise performance 6G SATA SSD(3X endurance)	SATA	960 GB
UCS-SD19T63X-EP-D	1.9 TB 2.5in Enterprise performance 6G SATA SSD(3X endurance)	SATA	1.9 TB
UCS-SD38T63X-EP-D	3.8 TB 2.5in Enterprise performance 6G SATA SSD(3X endurance)	SATA	3.8 TB
UCS-SD480GBM3XEPD	480GB SATA SSD 3DWPD	SATA	480 GB
UCS-SD960GBM3XEPD	960GB SATA SSD 3DWPD	SATA	960 GB
UCS-SD19TBM3XEP-D	1.9TB SATA SSD 3DWPD	SATA	1.9 TB
<b>SAS</b>			
UCS-SD800GK3XEP-D	800 GB 2.5in Enterprise Performance 12G SAS SSD(3X endurance)	SAS	800 GB
UCS-SD16TK3X-EP-D	1.6 TB 2.5in Enterprise Performance 12G SAS SSD(3X endurance)	SAS	1.6 TB
UCS-SD32TK3X-EP-D	3.2 TB 2.5in Enterprise Performance 12G SAS SSD(3X endurance)	SAS	3.2 TB
UCS-SD16TKA3XEP-D	1.6TB 2.5in Enterprise Performance 12G SAS SSD(3X endurance)	SAS	1.6 TB
UCS-SD32TKA3XEP-D	3.2TB 2.5in Enterprise Performance 12G SAS SSD(3X endurance)	SAS	3.2 TB

Table 18 Available SAS/SATA SSD and HDDs (*continued*)for UCSC-C220-M7S

Product ID (PID)	PID Description	Drive Type	Capacity
UCS-SD64TS3XEP-D	6.4TB 2.5in Enterprise Performance 12G SAS SSD(3X endurance)	SAS	6.4 TB
<b>Enterprise Value SAS/SATA SSDs (Low endurance, supports up to 1X DWPD (drive writes per day))</b>			
<b>SATA</b>			
UCSSD480G6I1XEVD	480GB 2.5 inch Enterprise Value 6G SATA SSD	SATA	480 GB
UCSSD960G6S1XEVD	960GB 2.5 inch Enterprise Value 6G SATA SSD	SATA	960 GB
UCSSD960G6I1XEVD	960GB 2.5 inch Enterprise Value 6G SATA SSD	SATA	960 GB
UCS-SD19T6S1XEVD	1.9TB 2.5 inch Enterprise Value 6G SATA SSD	SATA	1.9 TB
UCS-SD38T6S1XEVD	3.8 TB 2.5 inch Enterprise Value 6G SATA SSD	SATA	3.8 TB
UCS-SD38T6I1XEVD	3.8TB 2.5 inch Enterprise Value 6G SATA SSD	SATA	3.8 TB
UCS-SD76T6S1XEVD	7.6TB 2.5 inch Enterprise Value 6G SATA SSD	SATA	7.6 TB
UCS-SD76TM1X-EV-D	7.6TB 2.5 inch Enterprise Value 6G SATA SSD	SATA	7.6 TB
UCS-SD240GBM1XEVD	240GB SATA SSD 1DWPD	SATA	240 GB
UCS-SD480GBM1XEVD	480GB SATA SSD 1DWPD	SATA	480 GB
UCS-SD960GBM1XEVD	960GB SATA SSD 1DWPD	SATA	960 GB
UCS-SD16TBM1XEVD	1.6GB SATA SSD 1DWPD	SATA	1.6 TB
UCS-SD19TBM1XEVD	1.9TB SATA SSD 1DWPD	SATA	1.9 TB
UCS-SD38TBM1XEVD	3.8TB SATA SSD 1DWPD	SATA	3.8 TB
UCS-SD76TBM1XEVD	7.6TB SATA SSD 1DWPD	SATA	7.6 TB
UCS-SDB960SA1VD	960GB 2.5in 6G SATA Enter Value 1X Samsung G1PM893A SSD	SATA	960 GB
UCS-SDB1T9SA1VD	1.9TB 2.5in 6G SATA Enter Value 1X Samsung G1PM893A SSD	SATA	1.9 TB
UCS-SDB3T8SA1VD	3.8TB 2.5in 6G SATA Enter Value 1X Samsung G1PM893A SSD	SATA	3.8 TB
UCS-SDB7T6SA1VD	7.6TB 2.5in 6G SATA Enter Value 1X Samsung G1PM893A SSD	SATA	7.6 TB
<b>SAS</b>			
UCS-SD960GK1XEVD	960GB 2.5 inch Enterprise Value 12G SAS SSD	SAS	960 GB
UCS-SD19TK1X-EV-D	1.9TB 2.5 inch Enterprise Value 12G SAS SSD	SAS	1.9 TB
UCS-SD38TK1X-EV-D	3.8TB 2.5 inch Enterprise Value 12G SAS SSD	SAS	3.8 TB
UCS-SD76TK1X-EV-D	7.6TB 2.5 inch Enterprise Value 12G SAS SSD	SAS	7.6 TB
UCS-SD15TK1X-EV-D	15.3TB 2.5 inch Enterprise Value 12G SAS SSD	SAS	15.3 TB
UCS-SD19TKA1XEVD	1.9TB 2.5 inch Enterprise Value 12G SAS SSD	SAS	1.9 TB
UCS-SD38TKA1XEVD	3.8TB 2.5 inch Enterprise Value 12G SAS SSD	SAS	3.8 TB
UCS-SD76TKA1XEVD	7.6TB 2.5 inch Enterprise Value 12G SAS SSD	SAS	7.6 TB
UCS-SD76TS1X-EV-D	7.6TB 2.5 inch Enterprise Value 12G SAS SSD	SAS	7.6 TB
UCS-SD15TKA1XEVD	15.3TB 2.5 inch Enterprise Value 12G SAS SSD	SAS	15.3 TB
<b>Self-Encrypted Drives (SED) (1X or 3X)</b>			
<b>SATA</b>			
UCSSD38TBEM2NK9-D	3.8TB Enterprise value SATA SSD (1X, SED) Non FIPS	SATA	3.8 TB
<b>SAS</b>			
UCS-SD800GBKNK9-D	800GB Enterprise Performance SAS SSD (3X DWPD, SED) FIPS140-2	SAS	800 GB

Table 18 Available SAS/SATA SSD and HDDs (*continued*)for UCSC-C220-M7S

Product ID (PID)	PID Description	Drive Type	Capacity
UCS-SD960GBKNK9-D	960GB Enterprise Value SAS SSD (1X DWPD, SED) FIPS140-2	SAS	960 GB
UCS-SD16TBKNK9-D	1.6TB Enterprise performance SAS SSD (3X DWPD, SED) FIPS140-2	SAS	1.6 TB
UCS-SD38TBKNK9-D	3.8TB Enterprise Value SAS SSD (1X DWPD, SED) FIPS140-2	SAS	3.8 TB
UCS-SD76TBKNK9-D	7.6TB Enterprise value SAS SSD (1X DWPD, SED-FIPS) FIPS140-2	SAS	7.6 TB
UCS-SD16TBKANK9-D	1.6TB 2.5" Enterprise performance 12GSAS SSD(3DWPD,SED-FIPS) FIPS140-2	SAS	1.6 TB
UCS-SD38TBKANK9-D	3.8TB 2.5" Enterprise value 12G SAS SSD (1DWPD, SED-FIPS) FIPS140-2	SAS	3.8 TB
UCS-SD76TBKANK9-D	7.6TB Enterprise value SAS SSD (1DWPD, SED-FIPS) FIPS140-2	SAS	7.6 TB
UCS-SD960GM2NK9-D	960GB SED SSD 1DWPD	SAS	960 GB
UCS-SD19TEM2NK9-D	1.9TB SED SSD 1DWPD	SAS	1.9 TB
UCS-SD38TEM2NK9-D	3.8TB SED SSD 1DWPD	SAS	3.8 TB
UCS-SD76TEM2NK9-D	7.6TB SED SSD 1DWPD	SAS	7.6 TB
<b>Accessories/spare included with drives (For UCSC-C220-M7S):</b>			
<ul style="list-style-type: none"> <li>■ CBL-FNVME-C220M7 is auto included with selection of U.3 NVMe drives and Raid controller UCSC-RAID-HP</li> <li>■ CBL-SATA-C220-D is included with the selection of the SATA drives.</li> <li>■ UCSC-BBLKD-M7 is included for the not selected front storage device.</li> </ul>			
<b>NOTE:</b> If you are adding drive later as spare, you may need to order cables with it.			

**Caveats**

- With the UCSC-C220-M7S:
  - You can choose only SATA HDDs when using AHCI with a SATA Interposer. The drives must be installed in slots 1-8.
  - Unless RAID 24G Tri-mode RAID Controller and NVMe Hardware RAID are selected, SFF NVMe drives are connected directly to CPU2 and not managed by any drive controller.
  - If you order any direct-attach NVMe SFF drives, you must also order two CPUs.
  - You can mix HDDs and SSDs as long as you keep all HDDs in their own RAID volume and all SSDs in their own RAID volume.
  - SED drives can be mixed with the non-SED drives in [Table 18 on page 35](#).
- SFF NVMe drives are bootable in UEFI mode only.

## STEP 7 SELECT OPTION CARD(S) (OPTIONAL)

For up-to-date server compatibility, please check the Hardware and Software compatibility list (HCL) at <https://ucshcltool.cloudapps.cisco.com/public/>.

The standard PCIe card offerings are:

- Modular LAN on Motherboard (mLOM)
- Open Compute Project (OCP) 3.0
- Virtual Interface Cards (VICs)
- Network Interface Cards (NICs)
- Host Bus Adapters (HBAs)

### Select Option Cards

The available option cards are listed in [Table 19](#)

**Table 19 Available PCIe Option Cards**

Product ID (PID)	PID Description	Location	Card Size <sup>1</sup>
<b>Modular LAN on Motherboard (mLOM)</b>			
UCSC-M-V5Q50G-D	Cisco VIC 15428 4x 10/25/50G mLOM C-Series	mLOM	HHHL, SS
UCSC-M-V5D200G-D	Cisco VIC 15238 2x 40/100/200G mLOM C-Series	mLOM	HHHL, SS
UCSC-M-V5Q50GV2-D	Cisco VIC 15427 4x 10/25/50G mLOM C-Series w/Secure Boot <sup>5</sup>	mLOM	HHHL, SS
UCSC-M-V5D200GV2D	Cisco VIC 15237 2x 40/100/200G mLOM C-Series w/Secure Boot <sup>5</sup>	mLOM	HHHL, SS
<b>Open Compute Project (OCP)</b>			
UCSC-O-ID10GC-D <sup>2</sup>	Intel X710T2LOCPV3G1L 2x10GbE RJ45 OCP 3.0 NIC	OCP	SFF
<b>Virtual Interface Cards (VICs)</b>			
UCSC-P-V5Q50G-D	Cisco VIC 15425 4x 10/25/50G PCIe C-Series w/Secure Boot <sup>5</sup>	Riser 1 or 3	HHHL, SS
UCSC-P-V5D200G-D	Cisco VIC 15235 2x 40/100/200G PCIe C-Series w/Secure Boot <sup>5</sup>	Riser 1 or 3	HHHL, SS
<b>Network Interface Cards (NICs)</b>			
<b>1GbE NICs</b>			
UCSC-P-IQ1GC	Cisco-Intel I710-T4L 4x1GBASE-T NIC	Riser 1, 2, or 3	HHHL, SS
<b>10GbE NICs</b>			
UCSC-PCIEID10GF-D	Intel X710-DA2 Dual Port 10Gb SFP+ NIC	Riser 1, 2, or 3	HHHL, SS
UCSC-PCIEIQ10GF-D	Intel X710 quad-port 10G SFP+ NIC	Riser 1, 2, or 3	HHHL, SS
UCSC-P-ID10GC-D	Cisco-Intel X710T2LG 2x10GBE RJ45 PCIe NIC	Riser 1, 2, or 3	HHHL, SS
UCSC-P-IQ10GC-D	Cisco-Intel X710T4LG 4x10GBE RJ45 PCIe NIC	Riser 1, 2, or 3	HHHL, SS
<b>25GbE NICs</b>			
UCSC-P-I8D25GF-D <sup>3</sup>	Cisco-Intel E810XXVDA2 2x25/10GBE SFP28 PCIe NIC	Riser 1, 2, or 3	HHHL, SS

Table 19 Available PCIe Option Cards (*continued*)

Product ID (PID)	PID Description	Location	Card Size <sup>1</sup>
UCSC-P-I8Q25GF-D <sup>3</sup>	Cisco-Intel E810XXVDA4L 4x25/10GBE SFP28 PCIe NIC	Riser 1C or 3C	FHHL, SS
UCSC-P-N6D25GF-D <sup>3</sup>	Cisco-NVDA MCX631102AS-ADAT CX6Lx 2x25GbE SFP28 x8 PCIe NIC	Riser 1, 2, or 3	HHHL, SS
<b>100GbE NICs</b>			
UCSC-P-MCD100GF-D <sup>3,4</sup>	Cisco-MLNX MCX623106AC-CDAT 2x100GbE QSFP56 PCIe NIC (with Crypto)	Riser 1, 2, or 3	HHHL, SS
UCSC-P-MDD100GF-D <sup>3,4</sup>	Cisco-MLNX MCX623106AS-CDAT 2x100GbE QSFP56 PCIe NIC	Riser 1, 2, or 3	HHHL, SS
UCSC-P-I8D100GF-D <sup>3,4</sup>	Cisco-Intel E810CQDA2 2x100 GbE QSFP28 PCIe NIC	Riser 1, 2, or 3	HHHL, SS
<b>Host Bus Adapters (HBAs)</b>			
UCSC-P-Q6D32GF-D	Cisco-QLogic QLE2772 2x32GFC Gen 6 Enhanced PCIe HBA	Riser 1, 2, or 3	HHHL, SS
UCSC-P-B7D32GF-D	Cisco-Emulex LPe35002-M2-2x32GFC Gen 7 PCIe HBA	Riser 1, 2, or 3	HHHL, SS
UCSC-PCIEQD16GF-D	Qlogic QLE2692 dual-port 16G FC HBA	Riser 1, 2, or 3	HHHL, SS
UCSC-PCIEBD16GF-D	Emulex LPe31002 dual port 16G FC HBA	Riser 1, 2, or 3	HHHL, SS
UCSC-P-Q7D64GF	Cisco-QLogic QLE2872, 2x64GFC Gen 7 PCIe HBA	Riser 1, 2, or 3	HHHL, SS
<b>External Storage HBA</b>			
UCSC-9500-8E-D	Cisco 12G 9500-8e 12G SAS HBA for external JBOD attach	Riser 1, 2, or 3	HHHL, SS
<b>Accessories/spare included with PCI Card.</b>			
<ul style="list-style-type: none"> <li>■ UCSC-OCP3-KIT-D is included along with the selection UCSC-O-ID10GC-D card</li> </ul>			

Notes:

1. HHHL = half-height, half-length; FHHL = full-height, half-length; SS = single-slot; DS = double-slot. SFF = small form factor.
2. For installation in the mLOM slot, you can order either an mLOM VIC, or the OCP NIC - but not both. If ordering the OCP NIC, the OCP Mechanical Kit (UCSC-OCP3-KIT) must also be installed in order to mount OCP NIC in the mLOM slot.
3. When present, the recommended Fan Speed Control policy setting is balanced.
4. NICs with 16 active electrical lanes, such as the 100G NICs, can be inserted in slots with 8 active electrical lanes. The NIC will function but may exhibit degraded performance.
5. This Virtual Interface Cards incorporate VIC Secure Boot technology

**Approved Configurations**

**(1) 1-CPU Systems**

- You can select up to two of the PCIe option cards listed in [Table 19](#) to be installed in Riser 1 and Riser 2. Riser 1 and Riser 2 is controlled by CPU 1. Risers 3 cannot installed in a 1-CPU system.

**(2) 2-CPU Systems**

- You can select up to two of the PCIe option cards listed in [Table 19](#) for a two-riser system and up to three of the PCIe option cards for a three-riser system. Risers 1 and 2 are controlled by CPU and riser 3 is controlled by CPU 2.



## Caveats

- For 1-CPU systems:
  - Half Height Riser 1 and Riser 2 is supported. Full Height Riser 1 is supported
  - Only a single plug-in PCIe VIC card is supported and must be installed in Riser 1. However, in addition to the one PCIe VIC card, you can also choose to install an mLOM/OCP 3.0 card in the mLOM slot at the rear of the chassis.
- For 2-CPU systems:
  - All risers (Risers 1, 2, and 3) are supported
  - Two plug-in PCIe VIC cards can be installed in 2-CPU systems. VICs can be placed in Riser 1 or 3 only for 1U in half height riser combination. For full height riser, you can use either Riser 1 or 2 for the VICs. In addition, you can order an mLOM/OCP 3.0 card, which is installed in the mLOM/OCP 3.0 slot at the rear of the chassis and thus have three VIC cards in operation at the same time. See [Table 19 on page 38](#) for the selection of plug-in and mLOM VIC cards. See also [Figure 7 on page 60](#) for the mLOM VIC card slot.
- To help ensure that your operating system is compatible with the card you have selected, or to see additional cards that have been qualified to work with the UCS C220 M7 server, but are not sold on the Cisco pricelist, check the Hardware Compatibility List at this URL:  
[http://www.cisco.com/en/US/products/ps10477/prod\\_technical\\_reference\\_list.html](http://www.cisco.com/en/US/products/ps10477/prod_technical_reference_list.html)
- For installation in the mLOM slot, you can order either an mLOM VIC, or the OCP NIC - but not both. If ordering the OCP NIC, the OCP Mechanical Kit (UCSC-OCP3-KIT) must also be installed in order to mount OCP NIC in the mLOM slot.

## ORDER OPTIONAL PCIe OPTION CARD ACCESSORIES

- At the time of first launch, the 3rd Party Ethernet adapters were tested for interoperability with an initial selection of Optical Modules and Cables. Please check the Product Briefs for this initial list of interoperable optics and cables at <https://www.cisco.com/c/en/us/products/servers-unified-computing/third-party-adapters-listing.html>.
- For list of supported optics and cables for VIC 15428 and VIC 15238, refer to the VIC 15000 series data sheet at <https://www.cisco.com/c/en/us/products/collateral/interfaces-modules/unified-computing-system-adapters/ucs-vic-15000-series-ds.htm>
- Cisco Transceiver Module Group (TMG) conducts tests with Cisco optics and cables and publishes the results in the TMG Compatibility Matrix. The latest compatibility with optical modules and DACs can be found at <https://tmgmatrix.cisco.com/>
- Refer to the these links for additional connectivity options.

<b>Intel:</b>
<a href="#">Product Guide</a>
<a href="#">Speed White Paper</a>

## STEP 8 ORDER GPU CARDS (OPTIONAL)



**CAUTION:**

- Gen4 and Gen5 risers cannot be mixed, for example: If UCSC-RIS2A-C22XM7 (GEN4) is selected, cannot select UCSC-RIS2B-C22XM7 (GEN5)

### Select GPU Options

The available GPU PCIe options are listed in [Table 20](#).

Table 20 Available PCIe GPU Cards<sup>1</sup>

Product ID (PID)	PID Description	Card Size	Maximum cards Per node	Riser Compatibility
UCSC-GPU-L4	NVIDIA L4:70W, 24GB, 1-slot HHHL GPU	HHHL, single-wide	3	Gen 4 & Gen 5 Half Height and Full Hight Riser
UCSC-GPU-FLEX140	Intel GPU Flex 140, Gen4x8, HHHL, 75W PCIe	HHHL, single-wide	3	Gen 5 and Gen 4 Half Height Risers

**Notes:**

1. Refer to [installation guide](#) for the more details.



**NOTE:**

- All GPU cards must be procured from Cisco as there is a unique SBIOS ID required by CIMC and UCSM
- GPUs cannot be mixed.

## STEP 9 ORDER POWER SUPPLY (REQUIRED)

Power supplies share a common electrical and physical design that allows for hot-plug and tool-less installation into M7 C-series servers. Each power supply is certified for high-efficiency operation and offers multiple power output options. This allows users to “right-size” based on server configuration, which improves power efficiency, lowers overall energy costs and avoids stranded capacity in the data center.

Use the power calculator at the following link to determine the needed power based on the options chosen (CPUs, drives, memory, and so on):

<http://ucspowercalc.cisco.com>



### WARNING:

- Starting 1<sup>st</sup> January 2024, only Titanium rated PSUs are allowed to be shipped to European Union (EU), European Economic Area (EEA), United Kingdom (UK), Switzerland and other countries that adopted Lot 9 Regulation.
- DC PSUs are not impacted by Lot 9 Regulation and are EU/UK Lot 9 compliant

Table 21 Power Supply

Product ID (PID)	PID Description
<b>PSU (Input High Line 210VAC)</b>	
UCSC-PSU1-770W-D	UCS C-series 770W AC PSU (Not EU/UK Lot 9 Compliant)
UCSC-PSUV21050D-D	Cisco UCS 1050W -48V DC Power Supply for Rack Server <b>Platinum</b>
UCSC-PSUV21050DCI <sup>1</sup>	1050W -48V DC power supply for C-Series servers (India)
UCSC-PSU1-1200W-D	1200W Titanium power supply for C-Series Servers <b>Titanium</b>
UCSC-PSU1-1600W-D	UCS 1600W AC PSU <b>Platinum</b> (Not EU/UK Lot 9 Compliant)
UCSC-PSU1-2300W-D	2300W Power supply for C-series servers <b>Titanium</b>
<b>PSU (Input Low Line 110VAC)</b>	
UCSC-PSU1-770W-D	UCS C-series 770W AC PSU (Not EU/UK Lot 9 Compliant)
UCSC-PSU1-1200W-D	1200W Titanium power supply for C-Series Servers <b>Titanium</b>
UCSC-PSU1-2300W-D	2300W Power supply for C-series servers <b>Titanium</b>

**Notes:**

1. This power supply supported with NO-POWER-CORD and CAB-48DC-40A-8AWG



### NOTE:

- In a server with two power supplies, both power supplies must be identical.
- Refer to [Power Specifications, page 81](#) section for the full details on the each power supply.

## STEP 10 SELECT INPUT POWER CORD(S) (REQUIRED)

Using [Table 22](#) and [Table 23](#), select the appropriate AC power cords. You can select a minimum of no power cords and a maximum of two. If you select the option R2XX-DMYPWRCORD, no power cord is shipped with the server.



**NOTE:** [Table 22](#) lists the power cords for servers that use power supplies less than 2300 W. [Table 23](#) lists the power cords for servers that use 2300 W power supplies. Note that the power cords for 2300 W power supplies use a C19 connector so they only fit the 2300 W power supply connector.

**Table 22 Available Power Cords (for server PSUs less than 2300 W)**

Product ID (PID)	PID Description	Images
NO-POWER-CORD	ECO friendly green option, no power cable will be shipped	
CAB-48DC40A8AWG-D	C-Series -48VDC PSU Power Cord, 3.5M, 3 Wire, 8AWG, 40A	<p>Figure 1-3 CAB-48DC-40A-8AWG, DC Power Cord (3.5 m)</p>
CAB-N5K6A-NA	Power Cord, 200/240V 6A, North America	
CAB-AC-L620-C13-D	AC Power Cord, NEMA L6-20 - C13, 2M/6.5ft	
CAB-C13-CBN	CABASY,WIRE,JUMPER CORD, 27" L, C13/C14, 10A/250V	
CAB-C13-C14-2M	CABASY,WIRE,JUMPER CORD, PWR, 2 Meter, C13/C14,10A/250V	

Table 22 Available Power Cords (for server PSUs less than 2300 W)

Product ID (PID)	PID Description	Images
CAB-C13-C14-AC	CORD,PWR,JMP,IEC60320/C14,IEC60320/C13, 3.0M	
CAB-250V-10A-AR	Power Cord, 250V, 10A, Argentina	
CAB-9K10A-AU	Power Cord, 250VAC 10A 3112 Plug, Australia	
CAB-250V-10A-CN	AC Power Cord - 250V, 10A - PRC	
CAB-9K10A-EU	Power Cord, 250VAC 10A CEE 7/7 Plug, EU	
CAB-250V-10A-ID	Power Cord, 250V, 10A, India	
CAB-C13-C14-3M-IN	Power Cord Jumper, C13-C14 Connectors, 3 Meter Length, India	Image not available
CAB-C13-C14-IN	Power Cord Jumper,C13-C14 Connectors,1.4 Meter Length, India	Image not available
CAB-250V-10A-IS	Power Cord, SFS, 250V, 10A, Israel	

Table 22 Available Power Cords (for server PSUs less than 2300 W)

Product ID (PID)	PID Description	Images
CAB-9K10A-IT	Power Cord, 250VAC 10A CEI 23-16/VII Plug, Italy	
CAB-9K10A-SW	Power Cord, 250VAC 10A MP232 Plug, Switzerland	
CAB-9K10A-UK	Power Cord, 250VAC 10A BS1363 Plug (13 A fuse), UK	
CAB-9K12A-NA <sup>1</sup>	Power Cord, 125VAC 13A NEMA 5-15 Plug, North America	
CAB-250V-10A-BR	Power Cord - 250V, 10A - Brazil	
CAB-C13C142M-JP-D	Power Cord C13-C14, 2M/6.5ft Japan PSE mark	Image not available
CAB-9K10A-KOR <sup>1</sup>	Power Cord, 125VAC 13A KSC8305 Plug, Korea	Image not available
CAB-ACTW	AC Power Cord (Taiwan), C13, EL 302, 2.3M	Image not available
CAB-JPN-3PIN	Japan, 90-125VAC 12A NEMA 5-15 Plug, 2.4m	Image not available
CAB-48DC40A-INT-D	C-Series -48VDC PSU PWR Cord, 3.5M, 3 Wire, 8AWG, 40A (INT)	Image not available
CAB-48DC-40A-AS-D	C-Series -48VDC PSU PWR Cord, 3.5M, 3Wire, 8AWG, 40A (AS/NZ)	Image not available

Notes:

1. This power cord is rated to 125V and only supported for PSU rated at 1050W or less

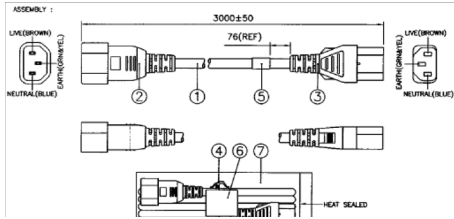
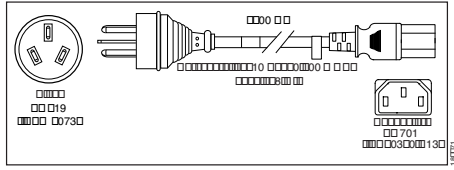
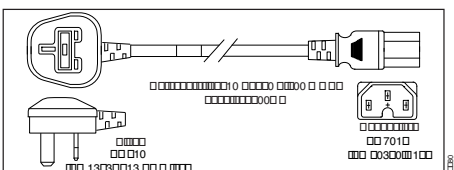
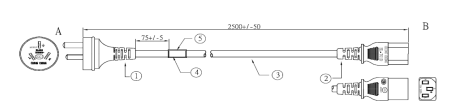
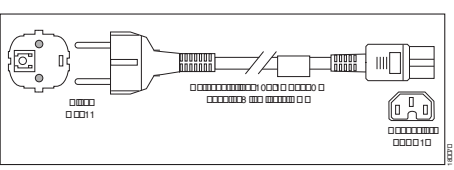
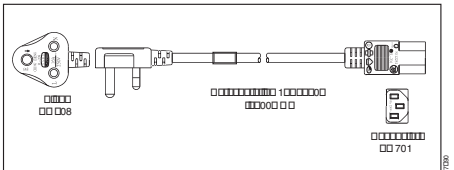
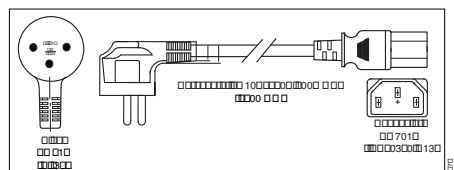
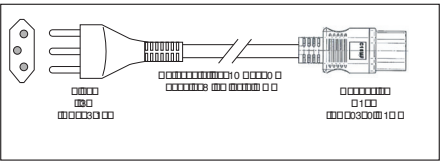
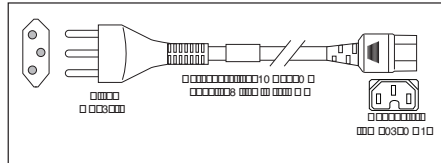
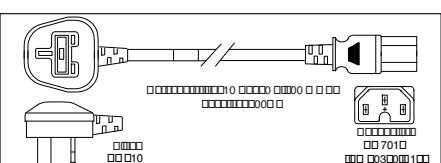
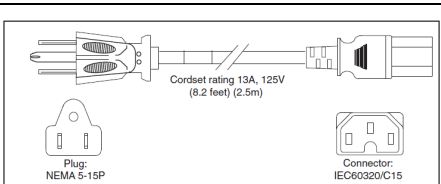
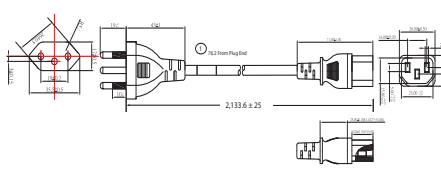
Table 23 Available Power Cords (for servers with 2300 W PSUs)

Product ID (PID)	PID Description	Images
CAB-C19-CBN	Cabinet Jumper Power Cord, 250 VAC 16A, C20-C19 Connectors	Not applicable
CAB-S132-C19-ISRL	S132 to IEC-C19 14ft Israeli	Image not available
CAB-IR2073-C19-AR	IRSM 2073 to IEC-C19 14ft Argen	Image not available
CAB-BS1363-C19-UK	BS-1363 to IEC-C19 14ft UK	Image not available
CAB-SABS-C19-IND	SABS 164-1 to IEC-C19 India	Image not available
CAB-C2316-C19-IT	CEI 23-16 to IEC-C19 14ft Italy	Image not available
CAB-US515P-C19-US	NEMA 5-15 to IEC-C19 13ft US	Image not available
CAB-US520-C19-US	NEMA 5-20 to IEC-C19 14ft US	Image not available
CAB-US620P-C19-US	NEMA 6-20 to IEC-C19 13ft US	Image not available
CAB-9K16A-BRZ	Power Cord 250VAC 16A, Brazil, Src Plug EL224-C19	Image not available
CAB-9K16A-KOR	Power Cord 250VAC 16A, Korea, Src Plug	Image not available
CAB-AC-16A-AUS	Power Cord, 250VAC, 16A, Australia C19	Image not available
CAB-AC-2500W-EU	Power Cord, 250Vac 16A, Europe	Image not available
CAB-AC-2500W-INT	Power Cord, 250Vac 16A, INTL	Image not available
CAB-AC-2500W-ISRL	Power Cord,250VAC,16A,Israel	Image not available
CAB-AC-C19-TW	Power Cord, 250 V, 16A, C19, Taiwan	Image not available
CAB-AC-C6K-TWLK	Power Cord, 250Vac 16A, twist lock NEMA L6-20 plug, US	Image not available
CAB-AC16A-CH	16A AC Power Cord For China	Image not available
CAB-ACS-16	AC Power Cord (Swiss) 16A	Image not available
CAB-C19-C20-3M-JP	Power Cord C19-C20, 3M/10ft Japan PSE mark	Image not available
CAB-C19-C20-IND	Power Cord C19-C20 India	Image not available
UCSB-CABL-C19-BRZ	NBR 14136 to C19 AC 14FT POWER CORD, BRAZIL	Image not available
NO-POWER-CORD	ECO friendly green option, no power cable will be shipped	Image not available

## STEP 11 ORDER TOOL-LESS RAIL KIT (REQUIRED) AND REVERSIBLE CABLE MANAGEMENT ARM (OPTIONAL)

- Tool-less Rail Kit:

Select a tool-less rail kit (or no rail kit) from [Table 24](#).



**NOTE:**

- Cisco recommends a minimum quantity of 1 Rail Kit
- If you plan to rackmount your UCS C220 M7 server, you must order a tool-less rail kit.

**Table 24 Tool-less Rail Kit Options**

Product ID (PID)	PID Description
UCSC-RAIL-D	Ball Bearing Rail Kit for C220 & C240 M6/M7 rack servers
UCSC-RAIL-NONE-D	No rail kit option

- Optional Reversible Cable Management Arm:

The reversible cable management arm mounts on either the right or left slide rails at the rear of the server and is used for cable management. Select an Optional Reversible Cable Management Arm from [Table 25](#).



**NOTE:** If you plan to rackmount your UCS C220 M7 server, you must order a tool-less rail kit. The same rail kits and CMAs are used for M6 and M7 servers.

**Table 25 Cable Management Arm**

Product ID (PID)	PID Description
UCSC-CMA-C220-D	Reversible CMA for C220 M6/M7 ball bearing rail kit

For more information about the tool-less rail kit and cable management arm, check the [Cisco UCS C220 M7 Installation Guide](#).



## STEP 12 SELECT MANAGEMENT CONFIGURATION (OPTIONAL)

By default, the C220 M7 server NIC mode is configured to be Shared LOM Extended. This NIC mode allows any LOM port or adapter card port to be used to access the Cisco Integrated Management Controller (CIMC). The Cisco VIC card must be installed in a slot with NCSI support.



### NOTE:

- There are no LOM ports on the C220 and C240 M7 servers. Servers ordered without a VIC or OCP card will ship in Dedicated network mode, unless otherwise specified by a configurable SW PID (**UCSC-CCARD-01**)
- For full details on all the NIC mode settings, see

[https://www.cisco.com/c/en/us/td/docs/unified\\_computing/ucs/c/hw/C220M7/install/b-c220-m7-installation-guide.html](https://www.cisco.com/c/en/us/td/docs/unified_computing/ucs/c/hw/C220M7/install/b-c220-m7-installation-guide.html)

Table 26 Management Configuration Ordering Information

Product ID (PID)	PID Description
UCSC-DLOM-01-D	Dedicated Mode BIOS setting for C-Series Servers <ul style="list-style-type: none"> <li>■ To change the default NIC mode to Dedicated NIC mode, select this card.</li> <li>■ In Dedicated NIC mode, the CIMC can be accessed only through the dedicated management port.</li> <li>■ See <i>Chassis Rear View (two full-height, 3/4-length PCIe risers)</i>, page 8 for the location of the management port</li> </ul>
UCSC-CCARD-01-D	Cisco Card Mode BIOS setting for C-Series Servers <ul style="list-style-type: none"> <li>■ To change the default NIC mode to Cisco Card Mode, select this card.</li> <li>■ If Cisco card selected, a VIC or MLOM must also be included in the configuration. if OCP card is included in the configuration, a VIC card must be selected.</li> <li>■ In this mode, you can assign an IP address to the CIMC using DHCP and from there you can fully automate your deployment.</li> </ul>

In addition, the optional software PIDs listed in [Table 33 on page 53](#) can be ordered for setting the server to operate in various modes.

## STEP 13 ORDER SECURITY DEVICES (REQUIRED)

A Trusted Platform Module (TPM) is a computer chip (microcontroller) that can securely store artifacts used to authenticate the platform (server). These artifacts can include passwords, certificates, or encryption keys. A TPM can also be used to store platform measurements that help ensure that the platform remains trustworthy. Authentication (ensuring that the platform can prove that it is what it claims to be) and attestation (a process helping to prove that a platform is trustworthy and has not been breached) are necessary steps to ensure safer computing in all environments.

A chassis intrusion switch gives a notification of any unauthorized mechanical access into the server.

The security device ordering information is listed in [Table 27](#)



**NOTE:**

- The TPM module used in this system conforms to TPM v1.2 and 2.0, as defined by the Trusted Computing Group (TCG). It is also SPI-based.
- TPM installation is supported after-factory. However, a TPM installs with a one-way screw and cannot be replaced, upgraded, or moved to another server. If a server with a TPM is returned, the replacement server must be ordered with a new TPM.

**Table 27 Security Devices**

Product ID (PID)	PID Description
UCSX-TPM-002C-D	Trusted Platform Module 2.0 for UCS servers
UCSC-INT-SW02-D	C220 and C240 M7 Chassis Intrusion Switch
UCSX-TPM-OPT-OUT-D	OPT OUT, TPM 2.0, TCG, FIPS140-2, CC EAL4+ Certified <sup>1</sup>

**Notes:**

1. Please note that Microsoft certification requires a TPM 2.0 for bare-metal or guest VM deployments. Opt-out of the TPM 2.0 voids the Microsoft certification

## STEP 14 SELECT LOCKING SECURITY BEZEL (OPTIONAL)

An optional locking bezel can be mounted to the front of the chassis to prevent unauthorized access to the drives.

Select the locking bezel from [Table 28](#).

**Table 28** Locking Bezel Option

Product ID (PID)	Description
UCSC-BZL-C220-D	C220 M7 Security Bezel

## STEP 15 ORDER M.2 SATA SSDs (OPTIONAL)

- Order one or two matching M.2 SATA SSDs from [Table 29](#) along with a boot-optimized RAID controller (see [Table 30](#)). See [Figure 7 on page 60](#) for the location of the module connector on the motherboard. This connector accepts the boot-optimized RAID controller. Each boot-optimized RAID controller can accommodate up to two SATA M.2 SSDs.



**NOTE:**

- It is recommended that M.2 SATA SSDs be used as boot-only devices.
- Order one or two identical M.2 SATA SSDs for the boot optimized RAID controller
- You cannot mix M.2 SATA SSD capacities.

**Table 29 M.2 SATA SSDs**

Product ID (PID)	PID Description
UCS-M2-I240GB-D	240GB SATA M.2 SSD
UCS-M2-I480GB-D	480GB SATA M.2 SSD
UCS-M2-240G-D	240GB M.2 SATA Micron G2 SSD
UCS-M2-480G-D	480GB M.2 SATA SSD
UCS-M2-960G-D	960GB M.2 SATA Micron G2 SSD

- Order Cisco boot optimized M.2 RAID controller from [Table 30](#). The boot optimized RAID controller plugs into a connector on the motherboard and holds up to two M.2 SATA drives.



**NOTE:**

- The Cisco boot optimized M.2 RAID controller supports VMWare, Windows and Linux Operating Systems
- The Cisco boot optimized M.2 RAID controller supports RAID 1 and JBOD mode
- The Cisco boot optimized M.2 RAID controller is available only with 240GB, 480GB, and 960GB M.2 SSDs.
- CIMC is supported for configuring of volumes and monitoring of the controller and installed SATA M.2 drives
- The SATA M.2 drives can boot in UEFI mode only. Legacy boot mode is not supported
- Hot-plug replacement is not supported. The server must be powered off.

**Table 30 Boot-Optimized RAID Controller**

Product ID (PID)	PID Description
UCS-M2-HWRAID-D	Cisco Boot optimized M.2 RAID controller (holds up to two M.2 SATA SSDs)

## STEP 16 ORDER M.2 NVMe AND RAID CONTROLLER(OPTIONAL)

- Order one or two matching M.2 NVMe from [Table 31](#) along with a boot-optimized RAID controller (see [Table 32](#)). See [Figure 7 on page 60](#) for the location of the module connector on the motherboard. This connector accepts the boot-optimized RAID controller. Each boot-optimized RAID controller can accommodate up to two SATA M.2 NVMe



### NOTE:

- It is recommended that M.2 NVMe be used as boot-only devices.
- Order one or two identical M.2 NVMe for the boot optimized RAID controller
- You cannot mix M.2 NVMe capacities.

Table 31 M.2 NVMe

Product ID (PID)	PID Description
UCS-NVM2-400GB	400GB M.2 Boot NVMe
UCS-NVM2-960GB	960GB M.2 Boot NVMe

- Order Cisco boot optimized M.2 NVMe RAID controller from [Table 32](#). The boot optimized RAID controller plugs into a connector on the motherboard and holds up to two M.2 NVMe drives.

Table 32 Boot-Optimized RAID Controller

Product ID (PID)	PID Description
UCS-M2-NVRAID	Cisco M.2 NVMe BOOT RAID Controller (HHHL)

Table 33 Riser supported Matrix for M.2 NVMe Boot Raid Controller

Risers- Gen	Risers Slot	UCS-M2-NVRAID - Slot
3HH Gen4 Risers	1A, 2A, 3A	2A
2HH Gen5 Risers 1HH Gen4 Risers	1B, 2B, 3B	2B
2FH Gen4 Risers	1C, 3C	1C

## STEP 17 SELECT OPERATING SYSTEM AND VALUE-ADDED SOFTWARE

Select

- Cisco Software ([Table 33](#))
- Operating System ([Table 34](#))



**NOTE:**

- See this link for operating system guidance: <https://ucshcltool.cloudapps.cisco.com/public/>
- VMware is on Compliance Hold. Contact the [Compute-Vmware-Hold@cisco.com](mailto:Compute-Vmware-Hold@cisco.com) mailer to see if you are allowed to receive VMware Licenses

**Table 34 OEM Software**

Product ID (PID)	PID Description
<b>VMware vCenter</b>	
VMW-VCS-STD-D1A	VMware vCenter 7 Server Standard, 1 yr support required
VMW-VCS-STD-D3A	VMware vCenter 7 Server Standard, 3 yr support required
VMW-VCS-STD-D5A	VMware vCenter 7 Server Standard, 5 yr support required
VMW-VCS-FND-D1A	VMware vCenter Server 7 Foundation (4 Host), 1 yr supp reqd
VMW-VCS-FND-D3A	VMware vCenter Server 7 Foundation (4 Host), 3 yr supp reqd
VMW-VCS-FND-D5A	VMware vCenter Server 7 Foundation (4 Host), 5 yr supp reqd

**Table 35 Operating System**

Product ID (PID)	PID Description
<b>Microsoft Windows Server</b>	
MSWS-22-ST16CD	Windows Server 2022 Standard (16 Cores/2 VMs)
MSWS-22-ST16CD-NS	Windows Server 2022 Standard (16 Cores/2 VMs) - No Cisco SVC
MSWS-22-DC16CD	Windows Server 2022 Data Center (16 Cores/Unlimited VMs)
MSWS-22-DC16CD-NS	Windows Server 2022 DC (16 Cores/Unlim VMs) - No Cisco SVC
MSWS-19-ST16CD	Windows Server 2019 Standard (16 Cores/2 VMs)
MSWS-19-ST16CD-NS	Windows Server 2019 Standard (16 Cores/2 VMs) - No Cisco SVC
MSWS-19-DC16CD	Windows Server 2019 Data Center (16 Cores/Unlimited VMs)

Table 35 Operating System (continued)

Product ID (PID)	PID Description
MSWS-19-DC16CD-NS	Windows Server 2019 DC (16 Cores/Unlim VMs) - No Cisco SVC
<b>Red Hat</b>	
RHEL-2S2V-D1A	Red Hat Enterprise Linux (1-2 CPU,1-2 VN); 1-Yr Support Req
RHEL-2S2V-D3A	Red Hat Enterprise Linux (1-2 CPU,1-2 VN); 3-Yr Support Req
RHEL-2S2V-D5A	Red Hat Enterprise Linux (1-2 CPU,1-2 VN); 5-Yr Support Req
RHEL-VDC-2SUV-D1A	RHEL for Virt Datacenters (1-2 CPU, Unlim VN) 1 Yr Supp Req
RHEL-VDC-2SUV-D3A	RHEL for Virt Datacenters (1-2 CPU, Unlim VN) 3 Yr Supp Req
RHEL-VDC-2SUV-D5A	RHEL for Virt Datacenters (1-2 CPU, Unlim VN) 5 Yr Supp Req
<b>Red Hat Ent Linux/ High Avail/ Res Strg/ Scal</b>	
RHEL-2S2V-D1S	Red Hat Enterprise Linux (1-2 CPU,1-2 VN); Prem 1Yr SnS Reqd
RHEL-2S2V-D3S	Red Hat Enterprise Linux (1-2 CPU,1-2 VN); Prem 3Yr SnS Reqd
RHEL-2S-HA-D1S	RHEL High Availability (1-2 CPU); Premium 1-yr SnS Reqd
RHEL-2S-HA-D3S	RHEL High Availability (1-2 CPU); Premium 3-yr SnS Reqd
RHEL-2S-RS-D1S	RHEL Resilent Storage (1-2 CPU); Premium 1-yr SnS Reqd
RHEL-2S-RS-D3S	RHEL Resilent Storage (1-2 CPU); Premium 3-yr SnS Reqd
RHEL-VDC-2SUV-D1S	RHEL for Virt Datacenters (1-2 CPU, Unlim VN) 1 Yr SnS Reqd
RHEL-VDC-2SUV-D3S	RHEL for Virt Datacenters (1-2 CPU, Unlim VN) 3 Yr SnS Reqd
<b>Red Hat SAP</b>	
RHEL-SAP-2S2V-D1S	RHEL for SAP Apps (1-2 CPU, 1-2 VN); Prem 1-Yr SnS Reqd
RHEL-SAP-2S2V-D3S	RHEL for SAP Apps (1-2 CPU, 1-2 VN); Prem 3-Yr SnS Reqd
RHEL-SAPSP-D3S	RHEL SAP Solutions Premium - 3 Years
RHEL-SAPSS-D3S	RHEL SAP Solutions Standard - 3 Years
<b>VMware</b>	
VMW-VSP-STD-D1A	VMware vSphere 7 Std (1 CPU, 32 Core) 1-yr, Support Required
VMW-VSP-STD-D3A	VMware vSphere 7 Std (1 CPU, 32 Core) 3-yr, Support Required
VMW-VSP-STD-D5A	VMware vSphere 7 Std (1 CPU, 32 Core) 5-yr, Support Required
VMW-VSP-EPL-D1A	VMware vSphere 7 Ent Plus (1 CPU, 32 Core) 1Yr, Support Reqd
VMW-VSP-EPL-D3A	VMware vSphere 7 Ent Plus (1 CPU, 32 Core) 3Yr, Support Reqd
VMW-VSP-EPL-D5A	VMware vSphere 7 Ent Plus (1 CPU, 32 Core) 5Yr, Support Reqd

Table 35 Operating System (*continued*)

Product ID (PID)	PID Description
<b>SUSE</b>	
SLES-2S2V-D1A	SUSE Linux Enterprise Svr (1-2 CPU,1-2 VM); 1-Yr Support Req
SLES-2S2V-D3A	SUSE Linux Enterprise Svr (1-2 CPU,1-2 VM); 3-Yr Support Req
SLES-2S2V-D5A	SUSE Linux Enterprise Svr (1-2 CPU,1-2 VM); 5-Yr Support Req
SLES-2SUVM-D1A	SUSE Linux Enterprise Svr (1-2 CPU,Unl VM) LP; 1Y Supp Req
SLES-2SUVM-D3A	SUSE Linux Enterprise Svr (1-2 CPU,Unl VM) LP; 3Y Supp Req
SLES-2SUVM-D5A	SUSE Linux Enterprise Svr (1-2 CPU,Unl VM) LP; 5Y Supp Req
SLES-2S-LP-D1A	SUSE Linux Live Patching Add-on (1-2 CPU); 1yr Support Req
SLES-2S-LP-D3A	SUSE Linux Live Patching Add-on (1-2 CPU); 3yr Support Req
SLES-2S2V-D1S	SUSE Linux Enterprise Svr (1-2 CPU,1-2 VM); Prio 1-Yr SnS
SLES-2S2V-D3S	SUSE Linux Enterprise Svr (1-2 CPU,1-2 VM); Prio 3-Yr SnS
SLES-2S2V-D5S	SUSE Linux Enterprise Svr (1-2 CPU,1-2 VM); Prio 5-Yr SnS
SLES-2SUVM-D1S	SUSE Linux Enterprise Svr (1-2 CPU,Unl VM) LP; Prio 1Y SnS
SLES-2SUVM-D3S	SUSE Linux Enterprise Svr (1-2 CPU,Unl VM) LP; Prio 3Y SnS
SLES-2SUVM-D5S	SUSE Linux Enterprise Svr (1-2 CPU,Unl VM) LP; Prio 5Y SnS
SLES-2S-HA-D1S	SUSE Linux High Availability Ext (1-2 CPU); 1yr SnS
SLES-2S-HA-D3S	SUSE Linux High Availability Ext (1-2 CPU); 3yr SnS
SLES-2S-HA-D5S	SUSE Linux High Availability Ext (1-2 CPU); 5yr SnS
SLES-2S-GC-D1S	SUSE Linux GEO Clustering for HA (1-2 CPU); 1yr Sns
SLES-2S-GC-D3S	SUSE Linux GEO Clustering for HA (1-2 CPU); 3yr SnS
SLES-2S-GC-D5S	SUSE Linux GEO Clustering for HA (1-2 CPU); 5yr SnS
SLES-2S-LP-D1S	SUSE Linux Live Patching Add-on (1-2 CPU); 1yr SnS Required
SLES-2S-LP-D3S	SUSE Linux Live Patching Add-on (1-2 CPU); 3yr SnS Required
<b>SLES and SAP</b>	
SLES-SAP-2S2V-D1S	SLES for SAP Apps (1-2 CPU, 1-2 VM); Priority 1-Yr SnS
SLES-SAP-2S2V-D3S	SLES for SAP Apps (1-2 CPU, 1-2 VM); Priority 3-Yr SnS
SLES-SAP-2S2V-D5S	SLES for SAP Apps (1-2 CPU, 1-2 VM); Priority 5-Yr SnS
SLES-SAP-2S2V-D1A	SLES for SAP Apps w/ HA (1-2 CPU, 1-2 VM); 1-Yr Support Reqd
SLES-SAP-2S2V-D3A	SLES for SAP Apps w/ HA (1-2 CPU, 1-2 VM); 3-Yr Support Reqd



Table 35 Operating System (*continued*)

Product ID (PID)	PID Description
SLES-SAP-2S2V-D5A	SLES for SAP Apps w/ HA (1-2 CPU, 1-2 VM); 5-Yr Support Reqd

## STEP 18 CHOOSE OPTIONAL OPERATING SYSTEM MEDIA KIT

Select the optional operating system media listed in [Table 35](#).

Table 36 OS Media

Product ID (PID)	PID Description
MSWS-19-ST16CD-RM	Windows Server 2019 Stan (16 Cores/2 VMs) Rec Media DVD Only
MSWS-19-DC16CD-RM	Windows Server 2019 DC (16Cores/Unlim VM) Rec Media DVD Only
MSWS-22-ST16CD-RM	Windows Server 2022 Stan (16 Cores/2 VMs) Rec Media DVD Only
MSWS-22-DC16CD-RM	Windows Server 2022 DC (16Cores/Unlim VM) Rec Media DVD Only

# SUPPLEMENTAL MATERIAL

## Block Diagrams

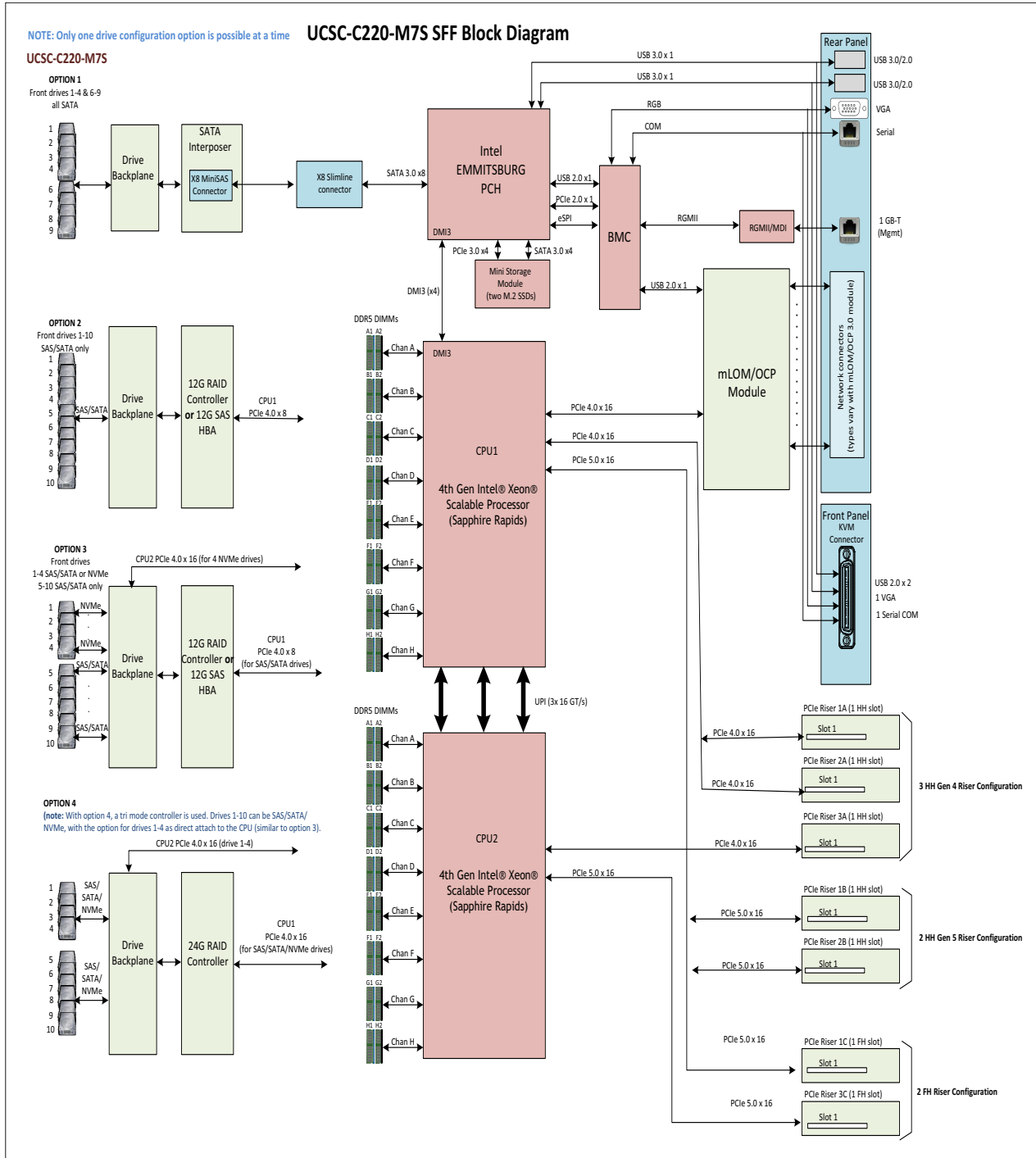

NOTE: Only one drive configuration option is possible at a time **UCSC-C220-M7N SFF Block Diagram**

UCSC-C220-M7N

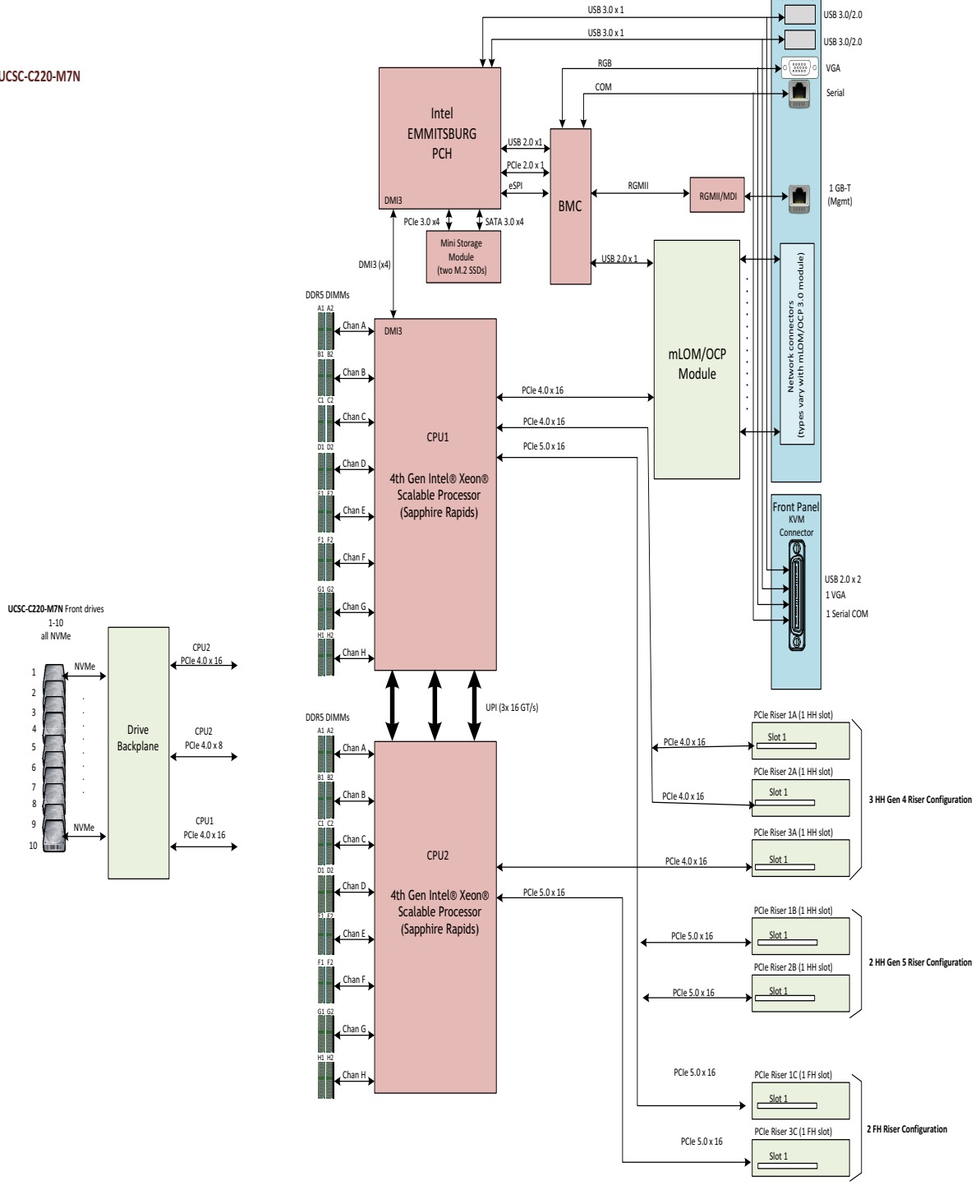

## Chassis

Figure 7 and Figure 8 shows the Internal views of the C220 M7 chassis with the top cover removed.

Figure 7 C220 M7 SFF With Top Cover Off (full-height, full-width PCIe cards)

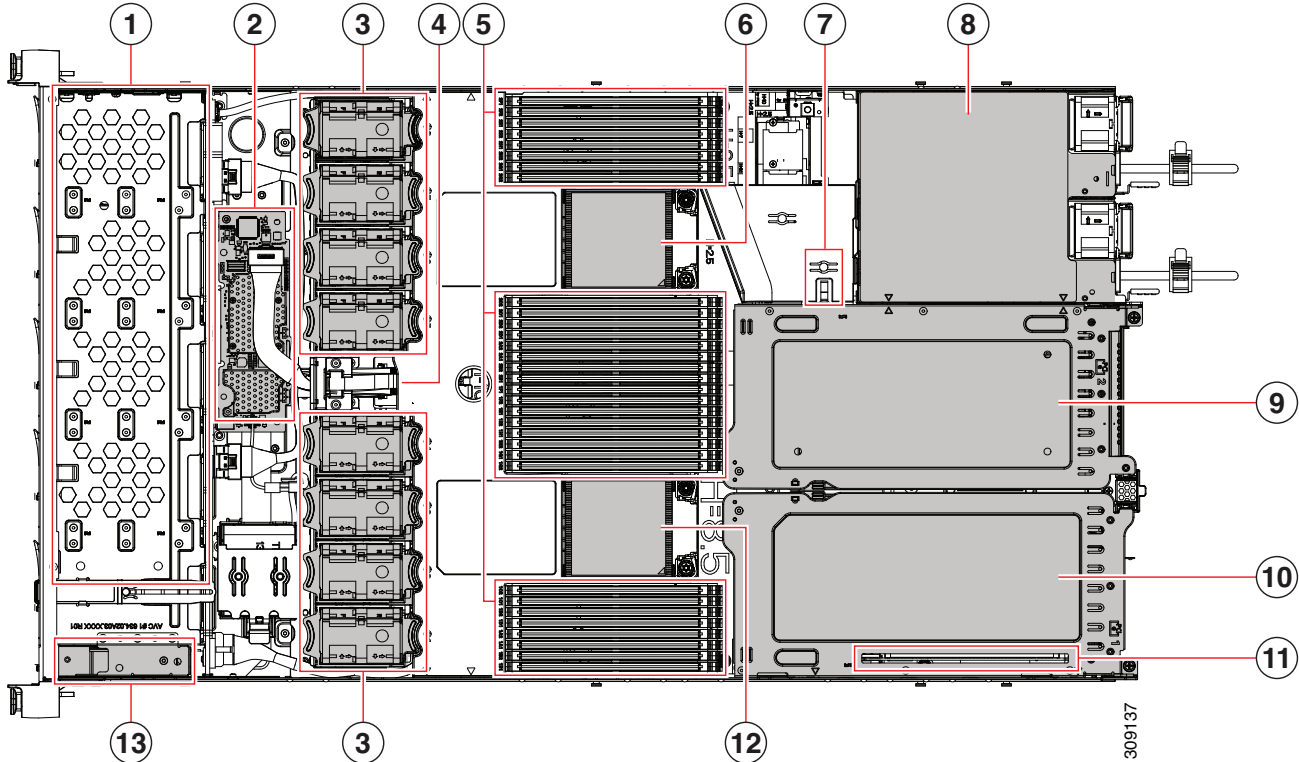

1	Front-loading drive bays	2	M7 modular RAID card (or SATA Interposer)
3	Cooling fan modules (eight) Each fan is hot-swappable	4	Supercap module mounting bracket
5	DIMM sockets on motherboard, 32 total, 16 per CPU CPUs are arranged in groups of eight sockets above the top CPU and below the bottom CPU, and 16 sockets between the CPUs.	6	Motherboard CPU2 socket
7	M.2 module connector, supporting a boot-optimized RAID controller with connectors for up to two SATA M.2 SSDs.	8	Two power supplies
9	PCIe riser 3 Accepts 1 full height, full width PCIe riser card	10	PCIe riser 1 Accepts 1 full height, full width PCIe riser card
11	Modular LOM (mLOM) card bay on chassis floor(x16 PCIe lane) Connector shown, but the card bay sits below PCIe riser 1.	12	Motherboard CPU1 socket
13	Front Panel Controller board	-	

Figure 8 C220 M7 SFF With Top Cover Off (full-height, half-width PCIe cards)

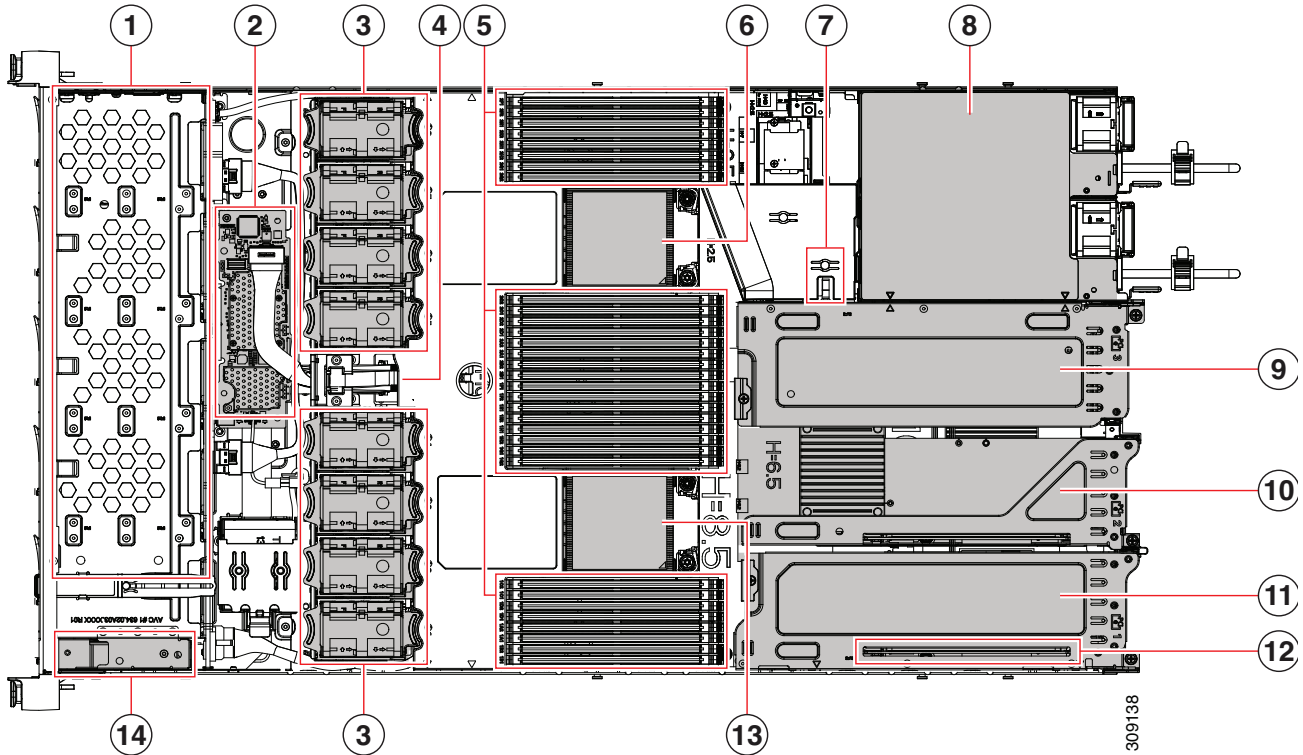

1	Front-loading drive bays	2	M7 modular RAID card (or SATA Interposer)
3	Cooling fan modules (eight) Each fan is hot-swappable	4	Supercap module mounting bracket
5	DIMM sockets on motherboard, 32 total, 16 per CPU CPUs are arranged in groups of eight sockets above the top CPU and below the bottom CPU, and 16 sockets between the CPUs.	6	Motherboard CPU2 socket
7	M.2 module connector, supporting a boot-optimized RAID controller with connectors for up to two SATA M.2 SSDs.	8	Two power supplies
9	PCIe riser 3 Accepts 1 half height, half width PCIe riser card	10	PCIe riser 2 Accepts 1 half height, half width PCIe riser card
11	PCIe riser 1 Accepts 1 half height, half width PCIe riser card	12	Modular LOM (mLOM)/OCP 3.0 card bay on chassis floor (x16 PCIe lane) Connector shown, but the card bay sits below PCIe riser slot 1.
13	Motherboard CPU1 socket	14	Front Panel Controller board

## Risers

*Figure 9* shows the locations of the PCIe riser connectors on the C220 M7 SFF motherboard. The allowed configurations are:

- Half-height risers in riser 1 connector, riser 2 connector, and riser 3 connector, or
- Full-height risers in riser 1 connector and riser 3 connector.

See *Figure 10* and *Figure 11* for more details.

Figure 9 C220 M7 SFF Riser Connector Locations  
C220 M7 SFF Motherboard

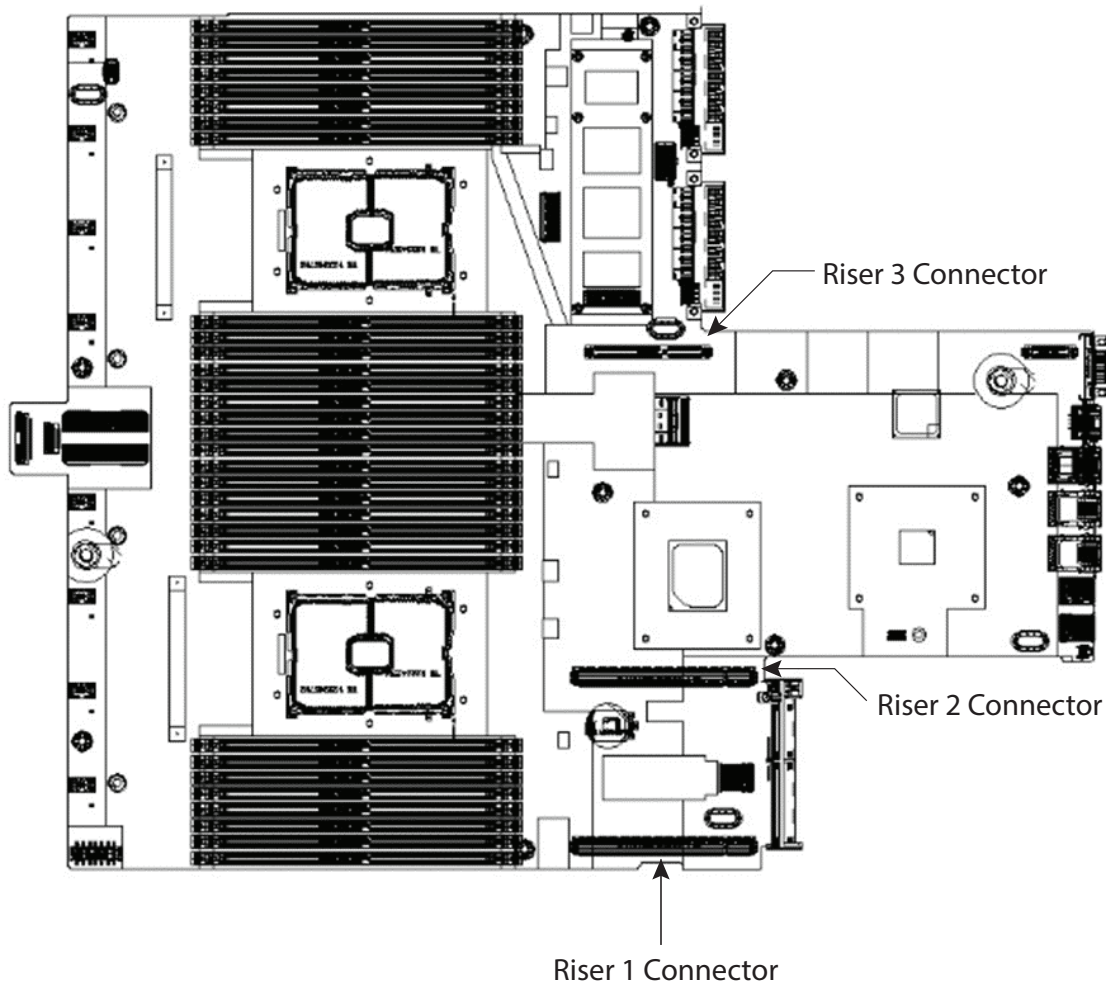
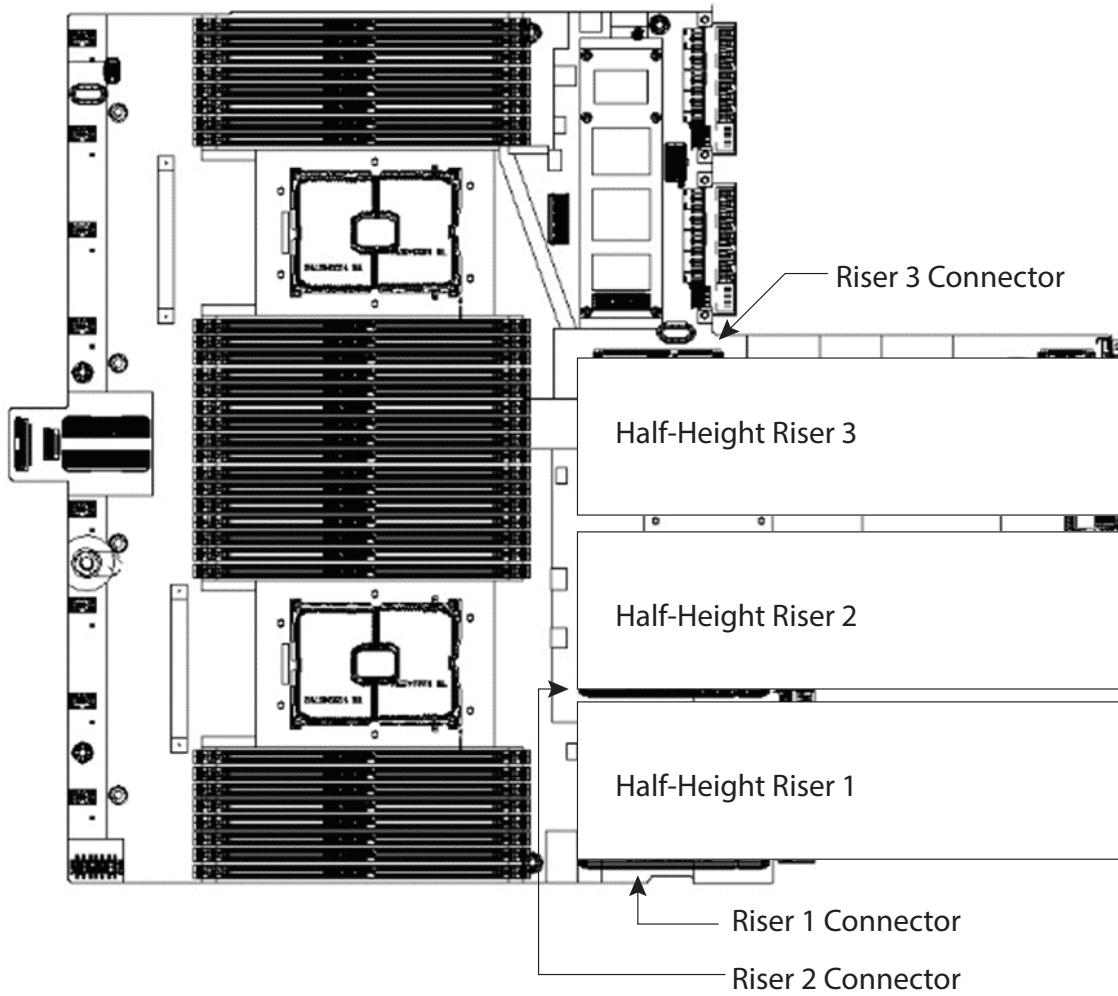

Figure 10 shows three half-height risers plugged into their respective connectors.

Figure 10 C220 M7 SFF With Three Half-Height Risers Plugged In  
C220 M7 SFF Motherboard





**Figure 11** shows two full-height risers plugged in. Note that riser 1 is plugged into the riser 1 connector and riser 2 is plugged into the riser 3 connector. Riser 2 connector is not used.

**Figure 11** C220 M7 SFF With Two Full-Height Risers Plugged In  
C220 M7 SFF Motherboard

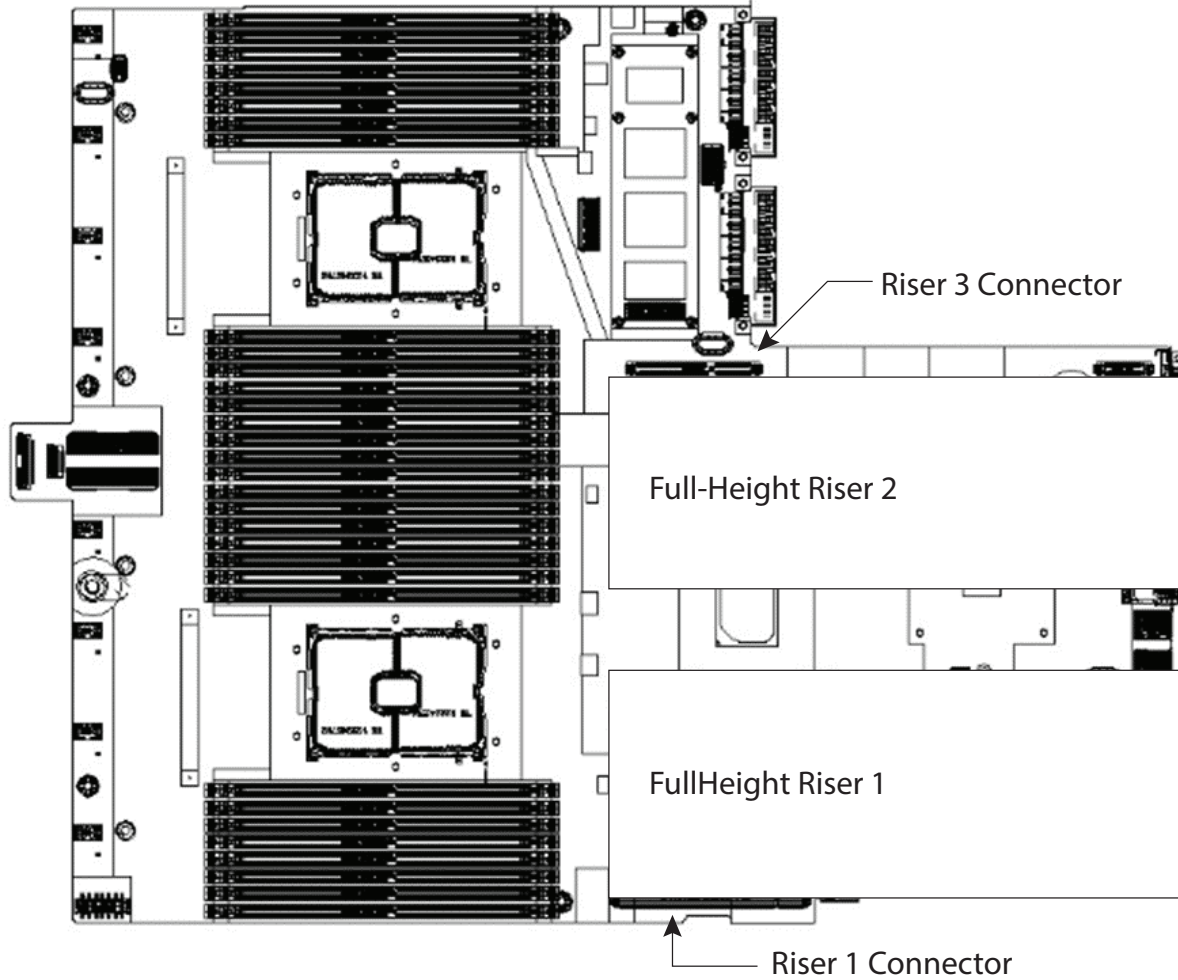

## Serial Port Details

The pinout details of the rear RJ-45 serial port connector are shown in [Figure 12](#).

**Figure 12** Serial Port (Female RJ-45 Connector) Pinout  
Serial Port (RJ-45 Female Connector)

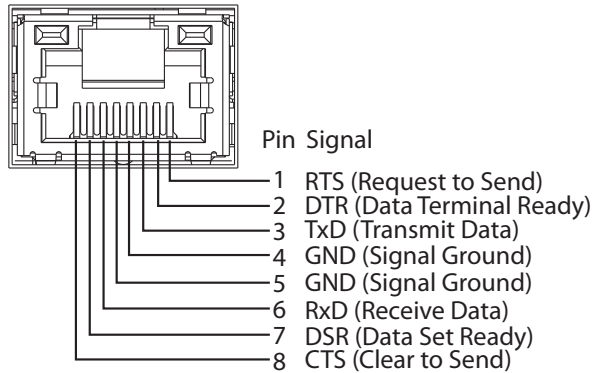

## KVM Cable

The KVM cable provides a connection into the server, providing a DB9 serial connector, a VGA connector for a monitor, and dual USB ports for a keyboard and mouse. With this cable, you can create a direct connection to the operating system and the BIOS running on the server.

The KVM cable ordering information is listed in [Table 36](#).

**Table 37** KVM Cable

Product ID (PID)	PID Description
N20-BKVM	KVM cable for UCS Server console port

**Figure 13** KVM Cable

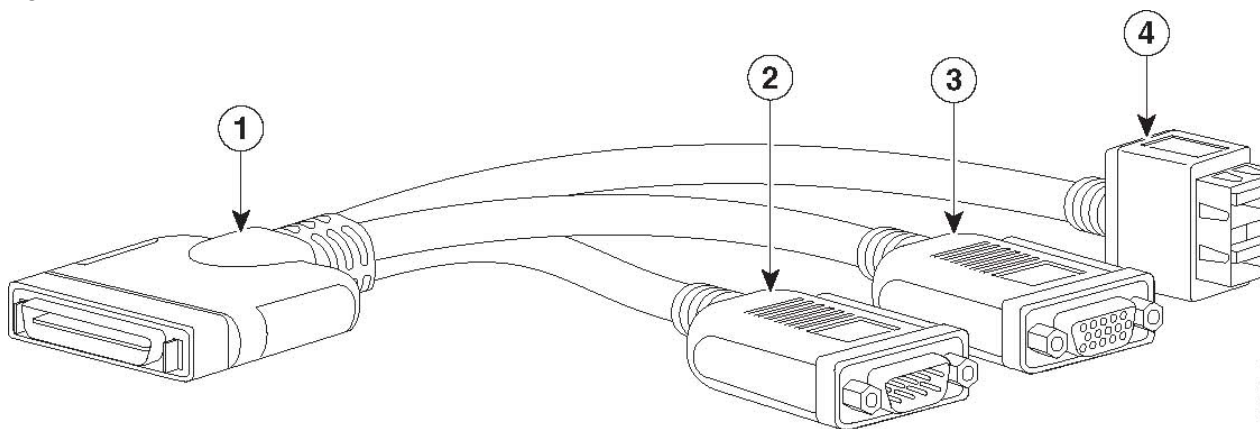

1	Connector (to server front panel)	3	VGA connector (for a monitor)
2	DB-9 serial connector	4	Two-port USB connector (for a mouse and keyboard)

## UPGRADING or REPLACING CPUs and Memory

- Refer to [Cisco UCS C220 M7 Server Installation and Service Guide](#) to upgrading or replacing the CPUs
- Refer to [Cisco UCS C220 M7 Server Installation and Service Guide](#) to upgrading or replacing the Memory

## SPARE PARTS

This section lists the upgrade and service-related parts for the UCS C220 M7 server. Some of these parts are configured with every server.



**NOTE:** Some spare parts you order may also require accessories for full functionality. For example, drives or RAID controllers may need accompanying cables. CPUs may need heatsinks, thermal paste, and installation tools. The spares and their accessory parts are listed in [Table 37](#).

Table 38 Spare Parts

Product ID (PID)	Description
<b>Risers</b>	
<b>Riser 1 Option</b>	
UCSC-RIS1A-22XM7=	UCS C-Series M7 1U Riser 1A PCIe Gen4 x16 HH
UCSC-RIS1B-22XM7=	UCS C-Series M7 1U Riser 1B PCIe Gen5 x16 HH
UCSC-RIS1C-22XM7=	UCS C-Series M7 1U Riser 1C PCIe Gen5 x16 FH
<b>Riser 2 Option</b>	
UCSC-RIS2A-22XM7=	UCS C-Series M7 1U Riser 2A PCIe Gen4 x16 HH
UCSC-RIS2B-22XM7=	UCS C-Series M7 1U Riser 2B PCIe Gen5 x16 HH
<b>Riser 3 Option</b>	
UCSC-RIS3A-22XM7=	UCS C-Series M7 1U Riser 3A PCIe Gen4 x16 HH (CPU2)
UCSC-RIS3C-22XM7=	UCS C-Series M7 1U Riser 3C PCIe Gen5 x16 FH (CPU2)
<b>Riser Blank</b>	
UCSC-FBRS2-C220M7=	C220 M7 Riser2 HH Filler Blank
UCSC-FBRS-C220-D=	C220M7 HH Riser3 blank
UCSC-FBRSF-220M7=	C220 M7 Riser FH Filler Blank
<b>CPUs</b>	
<p><b>Note:</b> If you are ordering a second CPU, see the <b>CPU Accessories</b> section in this table for additional parts you may need to order for the second CPU.</p>	
<b>5th Gen. CPUs</b>	
<b>8000 Series Processors</b>	
UCS-CPU-I8581V=	
UCS-CPU-I8571N=	
UCS-CPU-I8562Y+=	
UCS-CPU-I8558U=	
<b>6000 Series Processors</b>	
UCS-CPU-I6554S=	
UCS-CPU-I6548Y+=	
UCS-CPU-I6548N=	
UCS-CPU-I6544Y=	
UCS-CPU-I6542Y=	

Table 38 Spare Parts

Product ID (PID)	Description
UCS-CPU-I6538Y+==	
UCS-CPU-I6538N=	
UCS-CPU-I6534=	
UCS-CPU-I6530=	
UCS-CPU-I6526Y=	
<b>5000 Series Processors</b>	
UCS-CPU-I5520+==	
UCS-CPU-I5515+==	
UCS-CPU-I5512U=	
<b>4000 Series Processors</b>	
UCS-CPU-I4516Y+==	
UCS-CPU-I4514Y=	
UCS-CPU-I4510T=	
UCS-CPU-I4510=	
UCS-CPU-I4509Y=	
<b>3000 Series Processors</b>	
UCS-CPU-I3508U=	
<b>4th Gen. CPUs</b>	
<b>8000 Series Processors</b>	
UCS-CPU-I8471N=	
UCS-CPU-I8470N=	
UCS-CPU-I8462Y+==	
UCS-CPU-I8461V=	
UCS-CPU-I8460Y+==	
UCS-CPU-I8454H=	
UCS-CPU-I8452Y=	
UCS-CPU-I8450H=	
UCS-CPU-I8444H=	
<b>6000 Series Processors</b>	
UCS-CPU-I6454S=	
UCS-CPU-I6448Y=	
UCS-CPU-I6448H=	
UCS-CPU-I6444Y=	
UCS-CPU-I6442Y=	
UCS-CPU-I6438Y+==	
UCS-CPU-I6438N=	

Table 38 Spare Parts

Product ID (PID)	Description
UCS-CPU-I6438M=	
UCS-CPU-I6434H=	
UCS-CPU-I6434=	
UCS-CPU-I6430=	
UCS-CPU-I6428N=	
UCS-CPU-I6426Y=	
UCS-CPU-I6421N=	
UCS-CPU-I6418H=	
UCS-CPU-I6416H=	
UCS-CPU-I6414U=	
<b>5000 Series Processors</b>	
UCS-CPU-I5420+=	
UCS-CPU-I5418Y=	
UCS-CPU-I5418N=	
UCS-CPU-I5416S=	
UCS-CPU-I5415+=	
UCS-CPU-I5412U=	
UCS-CPU-I5411N=	
<b>4000 Series Processors</b>	
UCS-CPU-I4416+=	
UCS-CPU-I4410Y=	
UCS-CPU-I4410T=	
<b>3000 Series Processors</b>	
UCS-CPU-I3408U=	
<b>CPU Accessories</b>	
UCSC-HSLP-C220M7=  <b>Note:</b> Order this Heatsink, if you are adding additional CPU/spare CPU	UCS C220 M7 Heatsink for & C240 GPU Heatsink

Table 38 Spare Parts





Product ID (PID)	Description
UCS-CPU-TIM=  <b>Note:</b> This part is included with the purchase of spare CPU.Can be ordered separately.	Single CPU thermal interface material syringe for M5 server HS seal <sup>1</sup>
UCS-M6-CPU-CAR=  <b>Note:</b> This part is included with the purchase of spare CPU.Can be ordered separately.	Spare CPU Carrier for M7
UCSX-HSCK=  <b>Note:</b> This part is included with the purchase of spare CPU.Can be ordered separately.	UCS CPU/Heatsink Cleaning Kit, for up to 4 CPU/heatsink sets
UCS-CPUAT=  <b>Note:</b> This part is included with the purchase of spare CPU.Can be ordered separately.	CPU Assembly Tool for Servers
UCSC-FAN-C22XM7=	UCS C-Series M7 1U Fan
<b>Memory</b>	
UCS-MRX16G1RE1=	16GB DDR5-4800 RDIMM 1Rx8 (16Gb)
UCS-MRX32G1RE1=	32GB DDR5-4800 RDIMM 1Rx4 (16Gb)
UCS-MRX64G2RE1=	64GB DDR5-4800 RDIMM 2Rx4 (16Gb)
UCS-MR128G4RE1=	128GB DDR5-4800 RDIMM 4Rx4 (16Gb)
UCS-MRX16G1RE3=	16GB DDR5-5600 RDIMM 1Rx8 (16Gb)
UCS-MRX32G1RE3=	32GB DDR5-5600 RDIMM 1Rx4 (16Gb)
UCS-MRX48G1RF3 <sup>2</sup> =	48GB DDR5-5600 RDIMM 1Rx4 (24Gb)
UCS-MRX64G2RE3=	64GB DDR5-5600 RDIMM 2Rx4 (16Gb)
UCS-MRX96G2RF3=	96GB DDR5-5600 RDIMM 2Rx4 (24Gb)
UCS-MR128G4RE3=	128GB DDR5-5600 RDIMM 4Rx4 (16Gb)

Table 38 Spare Parts



Product ID (PID)	Description
UCS-DDR5-BLK= 	UCS DDR5 DIMM Blanks
<b>Note:</b> Order this DIMM Blank, if you are not using DIMM slots. Any empty DIMM slot must be populated with a DIMM blank to maintain proper cooling airflow.	
<b>RAID Controllers</b>	
	
<b>Note:</b> When ordering additional RAID controllers, you may need to order a cable/supercap to connect from the RAID controller to the motherboard. See the <b>RAID Controller Accessories</b> section in this table.	
UCSC-RAID-HP=	Cisco Tri-Mode 24G SAS RAID Controller w/4GB Cache
<b>UCSC-RAID-HP= accessories</b> (note: the below accessories only required if it is not in the system configuration. Must select all option within a single accessory or OPTOUT PID.	
UCS-SCAP-D=	M6 SuperCap
CBL-SCAP-C220-D=	C220/C240M6 1U/2U Super Cap cable
CBL-SAS-Y-C220M7=	C220M7 SAS CABLE; MB CPU1 P-1 to HP RAID Controller
UCSC-HPBKT-22XM7=	UCS C-Series M7 1U HP RAID Controller Bracket
UCSC-OPTOUT=	Opt out from Ordering Accessories
UCSC-RAID-T-D=	Cisco M6 12G SAS RAID Controller with 4GB FBWC (16 Drives)
<b>UCSC-RAID-T-D= accessories</b> (note: the below accessories only required if it is not in the system configuration. Must select all option within a single accessory or OPTOUT PID.	
UCS-SCAP-D=	M6 SuperCap
CBL-SCAP-C220-D=	C220/C240M6 1U/2U Super Cap cable
CBL-SAS-C220M7=	C220M7 SAS CABLE; MB CPU1 P-1 to SAS RAID Controller
UCSC-RDBKT-22XM7=	UCS C-Series M7 1U RAID/HBA Controller Bracket
UCSC-OPTOUT=	Opt out from Ordering Accessories
UCSC-SAS-T-D=	Cisco M6 12G SAS HBA for (16 Drives)
<b>UCSC-SAS-T-D= accessories</b> (note: the below accessories only required if it is not in the system configuration. Must select all option within a single accessory or OPTOUT PID.	
UCSC-RDBKT-22XM7=	UCS C-Series M7 1U RAID/HBA Controller Bracket
CBL-SAS-C220M7=	C220M7 SAS CABLE; MB CPU1 P-1 to SAS RAID Controller
<b>Controller for External Drives</b>	
UCSC-9500-8E-D=	Cisco 12G 9500-8e 12G SAS HBA for external JBOD attach
<b>SATA Interposer</b>	
UCSC-SATAIN-220M7=	UCS C220 M7 SATA Interposer Board (for control of up to 8 SATA-only drives using AHCI)



Table 38 Spare Parts

Product ID (PID)	Description
<b>Drives</b>	
 <p><b>Note:</b> When ordering additional SAS/SATA or NVMe front or rear drives, you may need to order a cable to connect from the drive to the motherboard. See the <b>Drive Cables</b> section in this table.</p>	
<b>PCIe/NVMe SFF (2.5-inch) SFF drives</b>	
UCS-NVMEXP-I400-D=	400GB 2.5in U.2 Intel P5800X Optane NVMe Extreme Perform SSD
UCS-NVMEXP-I800-D=	800GB 2.5in U.2 Intel P5800X Optane NVMe Extreme Perform SSD
UCS-NVME4-1600-D=	1.6TB 2.5in U.2 P5620 NVMe High Perf High Endurance
UCS-NVME4-1920-D=	1.9TB 2.5in U.2 P5520 NVMe High Perf Medium Endurance
UCS-NVME4-3200-D=	3.2TB 2.5in U.2 P5620 NVMe High Perf High Endurance
UCS-NVME4-3840-D=	3.8TB 2.5in U.2 P5520 NVMe High Perf Medium Endurance
UCS-NVME4-6400-D=	6.4TB 2.5in U.2 P5620 NVMe High Perf High Endurance
UCS-NVME4-7680-D=	7.6TB 2.5in U.2 P5520 NVMe High Perf Medium Endurance
UCS-NVME4-15360-D=	15.3TB 2.5in U.2 P5520 NVMe High Perf Medium Endurance
UCS-NVMEQ-1536-D=	15.3TB 2.5in U.2 P5316 NVMe High Perf Low Endurance
UCS-NVMEG4-M960-D=	960GB 2.5in U.3 Micron P7450 NVMe High Perf Medium Endurance
UCS-NVMEG4-M1920D=	1.9TB 2.5in U.3 Micron P7450 NVMe High Perf Medium Endurance
UCS-NVMEG4-M3840D=	3.8TB 2.5in U.3 Micron P7450 NVMe High Perf Medium Endurance
UCS-NVMEG4-M7680D=	7.6TB 2.5in U.3 Micron P7450 NVMe High Perf Medium Endurance
UCS-NVMEG4-M1536D=	15.3TB 2.5in U.3 Micron P7450 NVMe High Perf Medium Endurance
UCS-NVMEG4-M1600D=	1.6TB 2.5in U.3 Micron P7450 NVMe High Perf High Endurance
UCS-NVMEG4-M3200D=	3.2TB 2.5in U.3 Micron P7450 NVMe High Perf High Endurance
UCS-NVMEG4-M6400D=	6.4TB 2.5in U.3 Micron P7450 NVMe High Perf High Endurance
<b>HDDs</b>	
<b>HDDs (10K RPM)</b>	
UCS-HD600G10KJ4-D=	600 GB 12G SAS 10K RPM SFF HDD
UCS-HD12TB10KJ4-D=	1.2 TB 12G SAS 10K RPM SFF HDD
UCS-HD18TB10KJ4-D=	1.8 TB 12G SAS 10K RPM SFF HDD (4K)
UCS-HD24TB10KJ4-D=	2.4 TB 12G SAS 10K RPM SFF HDD (4K)
<b>Enterprise Performance SAS/SATA SSDs (High endurance, supports up to 10X or 3X DWPD (drive writes per day))</b>	
<b>SATA</b>	
UCS-SD480G63XEP-D=	480 GB 2.5in Enterprise Performance 6G SATA SSD(3X endurance)
UCS-SD960G63XEP-D=	960 GB 2.5in Enterprise performance 6G SATA SSD(3X endurance)
UCS-SD19T63X-EP-D=	1.9 TB 2.5in Enterprise performance 6G SATA SSD(3X endurance)
UCS-SD38T63X-EP-D=	3.8 TB 2.5in Enterprise performance 6G SATA SSD(3X endurance)
UCS-SD480GBM3XEPD=	480GB SATA SSD 3DWPD
UCS-SD960GBM3XEPD=	960GB SATA SSD 3DWPD
UCS-SD19TBM3XEP-D=	1.9TB SATA SSD 3DWPD

Table 38 Spare Parts

Product ID (PID)	Description
<b>SAS</b>	
UCS-SD800GK3XEP-D=	800 GB 2.5in Enterprise Performance 12G SAS SSD(3X endurance)
UCS-SD16TK3X-EP-D=	1.6 TB 2.5in Enterprise Performance 12G SAS SSD(3X endurance)
UCS-SD32TK3X-EP-D=	3.2 TB 2.5in Enterprise Performance 12G SAS SSD(3X endurance)
UCS-SD16TKA3XEP-D=	1.6TB 2.5in Enterprise Performance 12G SAS SSD(3X endurance)
UCS-SD32TKA3XEP-D=	3.2TB 2.5in Enterprise Performance 12G SAS SSD(3X endurance)
UCS-SD64TS3XEP-D=	6.4TB 2.5in Enterprise Performance 12G SAS SSD(3X endurance)
<b>Enterprise Value SAS/SATA SSDs (Low endurance, supports up to 1X DWPD (drive writes per day))</b>	
<b>SATA</b>	
UCSSD480G6I1XEVD=	480GB 2.5 inch Enterprise Value 6G SATA SSD
UCSSD960G6S1XEVD=	960GB 2.5 inch Enterprise Value 6G SATA SSD
UCSSD960G6I1XEVD=	960GB 2.5 inch Enterprise Value 6G SATA SSD
UCS-SD19T6S1XEVD=	1.9TB 2.5 inch Enterprise Value 6G SATA SSD
UCS-SD38T6S1XEVD=	3.8 TB 2.5 inch Enterprise Value 6G SATA SSD
UCS-SD38T6I1XEVD=	3.8TB 2.5 inch Enterprise Value 6G SATA SSD
UCS-SD76T6S1XEVD=	7.6TB 2.5 inch Enterprise Value 6G SATA SSD
UCS-SD240GBM1XEVD=	240GB SATA SSD 1DWPD
UCS-SD480GBM1XEVD=	480GB SATA SSD 1DWPD
UCS-SD960GBM1XEVD=	960GB SATA SSD 1DWPD
UCS-SD16TBM1XEVD=	1.6GB SATA SSD 1DWPD
UCS-SD19TBM1XEVD=	1.9TB SATA SSD 1DWPD
UCS-SD38TBM1XEVD=	3.8TB SATA SSD 1DWPD
UCS-SD76TBM1XEVD=	7.6TB SATA SSD 1DWPD
UCS-SDB960SA1VD=	960GB 2.5in 6G SATA Enter Value 1X Samsung G1PM893A SSD
UCS-SDB1T9SA1VD=	1.9TB 2.5in 6G SATA Enter Value 1X Samsung G1PM893A SSD
UCS-SDB3T8SA1VD=	3.8TB 2.5in 6G SATA Enter Value 1X Samsung G1PM893A SSD
UCS-SDB7T6SA1VD=	7.6TB 2.5in 6G SATA Enter Value 1X Samsung G1PM893A SSD
<b>SAS</b>	
UCS-SD960GK1XEVD=	960GB 2.5 inch Enterprise Value 12G SAS SSD
UCS-SD19TK1X-EV-D=	1.9TB 2.5 inch Enterprise Value 12G SAS SSD
UCS-SD38TK1X-EV-D=	3.8TB 2.5 inch Enterprise Value 12G SAS SSD
UCS-SD76TK1X-EV-D=	7.6TB 2.5 inch Enterprise Value 12G SAS SSD
UCS-SD15TK1X-EV-D=	15.3TB 2.5 inch Enterprise Value 12G SAS SSD
UCS-SD19TKA1XEVD=	1.9TB 2.5 inch Enterprise Value 12G SAS SSD
UCS-SD38TKA1XEVD=	3.8TB 2.5 inch Enterprise Value 12G SAS SSD
UCS-SD76TKA1XEVD=	7.6TB 2.5 inch Enterprise Value 12G SAS SSD
UCS-SD76TS1X-EV-D=	7.6TB 2.5 inch Enterprise Value 12G SAS SSD
UCS-SD15TKA1XEVD=	15.3TB 2.5 inch Enterprise Value 12G SAS SSD
<b>Self-Encrypted Drives (SED) (1X or 3X)</b>	

Table 38 Spare Parts



Product ID (PID)	Description
<b>SATA</b>	
<b>SAS</b>	
UCS-SD800GBKNK9-D=	800GB Enterprise Performance SAS SSD (3X DWPD, SED) FIPS140-2
UCS-SD960GBKNK9-D=	960GB Enterprise Value SAS SSD (1X DWPD, SED) FIPS140-2
UCS-SD16TBKNK9-D=	1.6TB Enterprise performance SAS SSD (3X DWPD, SED) FIPS140-2
UCS-SD38TBKNK9-D=	3.8TB Enterprise Value SAS SSD (1X DWPD, SED) FIPS140-2
UCS-SD76TBKNK9-D=	7.6TB Enterprise value SAS SSD (1X DWPD, SED-FIPS) FIPS140-2
UCS-SD16TBKANK9-D=	1.6TB 2.5" Enterprise performance 12GSAS SSD(3DWPD,SED-FIPS) FIPS140-2
UCS-SD38TBKANK9-D=	3.8TB 2.5" Enterprise value 12G SAS SSD (1DWPD, SED-FIPS) FIPS140-2
UCS-SD76TBKANK9-D=	7.6TB Enterprise value SAS SSD (1DWPD, SED-FIPS) FIPS140-2
UCS-SD960GM2NK9-D=	960GB SED SSD 1DWPD
UCS-SD19TEM2NK9-D=	1.9TB SED SSD 1DWPD
UCS-SD38TEM2NK9-D=	3.8TB SED SSD 1DWPD
UCS-SD76TEM2NK9-D=	7.6TB SED SSD 1DWPD
<b>Drive Cables</b>	
CBL-SATA-C220-D=	SATA cable C220M7 (1U)
 <b>Note:</b> Order this cable if you are adding a front SAS/SATA drive.	
CBL-FNVME-C220M7=	C220M7 NVMe CABLE; MB to BP (NVMe 1-4) Y-CBL
 <b>Note:</b> You may need to order this cable if you are adding a front NVMe drive to UCSC-C220-M7S	
<b>Drive Blanking Panel</b>	
UCSC-BBLKD-M7	UCS C-Series M7 SFF drive blanking panel
<b>PCIe Cards</b>	
<b>Modular LAN on Motherboard (mLOM)</b>	
UCSC-M-V5Q50G-D=	Cisco UCS VIC 15428 Quad Port 10/25G/50G CNA MLOM
UCSC-M-V5D200G-D=	Cisco UCS VIC 15238 Dual Port 40/100/200G CNA MLOM
UCSC-M-V5Q50GV2-D=	Cisco UCS VIC 15427 Quad Port CNA MLOM with Secure Boot
UCSC-M-V5D200GV2D=	Cisco UCS VIC 15238 Dual Port CNA MLOM with Secure Boot
<b>Open Compute Project (OCP)</b>	
UCSC-O-ID10GC-D=	Intel X710T2LOCPV3G1L 2x10GbE RJ45 OCP 3.0 NIC
<b>Virtual Interface Cards (VICs)</b>	

Table 38 Spare Parts

Product ID (PID)	Description
UCSC-P-V5Q50G-D=	Cisco UCS VIC 15425 Quad Port 10/25/50G CNA PCIE
UCSC-P-V5D200G-D=	Cisco UCS VIC 15235 Dual Port 40/100/200G CNA PCIE
<b>Network Interface Cards (NICs)</b>	
<b>1GbE NICs</b>	
UCSC-P-IQ1GC=	Cisco-Intel I710-T4L 4x1GBASE-T NIC
<b>10GbE NICs</b>	
UCSC-PCIEID10GF-D=	Intel X710-DA2 Dual Port 10Gb SFP+ NIC
UCSC-PCIEIQ10GF-D=	Intel X710 quad-port 10G SFP+ NIC
UCSC-P-ID10GC-D=	Cisco-Intel X710T2LG 2x10GBE RJ45 PCIe NIC
UCSC-P-IQ10GC-D=	Cisco-Intel X710T4LG 4x10GBE RJ45 PCIe NIC
<b>25GbE NICs</b>	
UCSC-P-I8D25GF-D=	Cisco-Intel E810XXVDA2 2x25/10GBE SFP28 PCIe NIC
UCSC-P-I8Q25GF-D=	Cisco-Intel E810XXVDA4L 4x25/10GBE SFP28 PCIe NIC
UCSC-P-N6D25GF-D=	Cisco-NVDA MCX631102AS-ADAT CX6Lx 2x25GbE SFP28 x8 PCIe NIC
<b>100GbE NICs</b>	
UCSC-P-MCD100GF-D=	Cisco-MLNX MCX623106AC-CDAT 2x100GbE QSFP56 PCIe NIC (with Crypto)
UCSC-P-MDD100GF-D=	Cisco-MLNX MCX623106AS-CDAT 2x100GbE QSFP56 PCIe NIC
UCSC-P-I8D100GF-D=	Cisco-Intel E810CQDA2 2x100 GbE QSFP28 PCIe NIC
<b>Host Bus Adapters (HBAs)</b>	
UCSC-P-Q6D32GF-D=	Cisco-QLogic QLE2772 2x32GFC Gen 6 Enhanced PCIe HBA
UCSC-P-B7D32GF-D=	Cisco-Emulex LPe35002-M2-2x32GFC Gen 7 PCIe HBA
UCSC-PCIEQD16GF-D=	Qlogic QLE2692 dual-port 16G FC HBA
UCSC-PCIEBD16GF-D=	Emulex LPe31002 dual port 16G FC HBA
UCSC-P-Q7D64GF=	Cisco-QLogic QLE2872, 2x64GFC Gen 7 PCIe HBA
<b>External Storage HBA</b>	
UCSC-9500-8E-D=	Cisco 12G 9500-8e 12G SAS HBA for external JBOD attach
<b>GPU</b>	
UCSC-GPU-L4=	NVIDIA L4:70W, 24GB, 1-slot HHL GPU
UCSC-GPU-FLEX140=	Intel GPU Flex 140, Gen4x8, HHL, 75W PCIe
<b>Power Supply</b>	
<b>PSU (Input High Line 210VAC)</b>	
UCSC-PSU1-770W-D=	UCS C-series 770W AC PSU (Not EU/UK Lot 9 Compliant)
UCSC-PSUV21050D-D=	Cisco UCS 1050W -48V DC Power Supply for Rack Server <b>Platinum</b>
UCSC-PSUV21050DCI=	1050W -48V DC power supply for C-Series servers (India)
UCSC-PSU1-1200W-D=	1200W Titanium power supply for C-Series Servers <b>Titanium</b>
UCSC-PSU1-1600W-D=	UCS 1600W AC PSU Platinum (Not EU/UK Lot 9 Compliant)
UCSC-PSU1-2300W-D=	2300W Power supply for C-series servers <b>Titanium</b>
<b>PSU (Input Low Line 110VAC)</b>	

Table 38 Spare Parts

Product ID (PID)	Description
UCSC-PSU1-770W-D=	UCS C-series 770W AC PSU (Not EU/UK Lot 9 Compliant)
UCSC-PSU1-1200W-D=	1200W Titanium power supply for C-Series Servers <b>Titanium</b>
UCSC-PSU1-2300W-D=	2300W Power supply for C-series servers <b>Titanium</b>
<b>Power Cords</b>	
NO-POWER-CORD=	ECO friendly green option, no power cable will be shipped
CAB-48DC40A8AWG-D=	C-Series -48VDC PSU Power Cord, 3.5M, 3 Wire, 8AWG, 40A
CAB-N5K6A-NA=	Power Cord, 200/240V 6A, North America
CAB-AC-L620-C13-D=	AC Power Cord, NEMA L6-20 - C13, 2M/6.5ft
CAB-C13-CBN=	CABASY,WIRE,JUMPER CORD, 27" L, C13/C14, 10A/250V
CAB-C13-C14-2M=	CABASY,WIRE,JUMPER CORD, PWR, 2 Meter, C13/C14,10A/250V
CAB-C13-C14-AC=	CORD,PWR,JMP,IEC60320/C14,IEC6 0320/C13, 3.0M
CAB-250V-10A-AR=	Power Cord, 250V, 10A, Argentina
CAB-9K10A-AU=	Power Cord, 250VAC 10A 3112 Plug, Australia
CAB-250V-10A-CN=	AC Power Cord - 250V, 10A - PRC
CAB-9K10A-EU=	Power Cord, 250VAC 10A CEE 7/7 Plug, EU
CAB-250V-10A-ID=	Power Cord, 250V, 10A, India
CAB-C13-C14-3M-IN=	Power Cord Jumper, C13-C14 Connectors, 3 Meter Length, India
CAB-C13-C14-IN=	Power Cord Jumper,C13-C14 Connectors,1.4 Meter Length, India
CAB-250V-10A-IS=	Power Cord, SFS, 250V, 10A, Israel
CAB-9K10A-IT=	Power Cord, 250VAC 10A CEI 23-16/VII Plug, Italy
CAB-9K10A-SW=	Power Cord, 250VAC 10A MP232 Plug, Switzerland
CAB-9K10A-UK=	Power Cord, 250VAC 10A BS1363 Plug (13 A fuse), UK
CAB-9K12A-NA=	Power Cord, 125VAC 13A NEMA 5-15 Plug, North America
CAB-250V-10A-BR =	Power Cord - 250V, 10A - Brazil
CAB-C13C142M-JP-D=	Power Cord C13-C14, 2M/6.5ft Japan PSE mark
CAB-9K10A-KOR=	Power Cord, 125VAC 13A KSC8305 Plug, Korea
CAB-ACTW=	AC Power Cord (Taiwan), C13, EL 302, 2.3M
CAB-JPN-3PIN=	Japan, 90-125VAC 12A NEMA 5-15 Plug, 2.4m
CAB-48DC40A-INT-D=	C-Series -48VDC PSU PWR Cord, 3.5M, 3 Wire, 8AWG, 40A (INT)
CAB-48DC-40A-AS-D=	C-Series -48VDC PSU PWR Cord, 3.5M, 3Wire, 8AWG, 40A (AS/NZ)
CAB-C19-CBN=	Cabinet Jumper Power Cord, 250 VAC 16A, C20-C19 Connectors
CAB-S132-C19-ISRL=	S132 to IEC-C19 14ft Israeli
CAB-IR2073-C19-AR=	IRSM 2073 to IEC-C19 14ft Argen
CAB-BS1363-C19-UK=	BS-1363 to IEC-C19 14ft UK
CAB-SABS-C19-IND=	SABS 164-1 to IEC-C19 India
CAB-C2316-C19-IT=	CEI 23-16 to IEC-C19 14ft Italy
CAB-L520P-C19-US =	NEMA L5-20 to IEC-C19 6ft US
CAB-US515P-C19-US=	NEMA 5-15 to IEC-C19 13ft US

Table 38 Spare Parts

Product ID (PID)	Description
CAB-US520-C19-US=	NEMA 5-20 to IEC-C19 14ft US
CAB-US620P-C19-US =	NEMA 6-20 to IEC-C19 13ft US
<b>Rail Kit</b>	
UCSC-RAIL-D=	Ball Bearing Rail Kit for C220 & C240 M6/M7 rack servers
UCSC-RAIL-NONE-D=	No rail kit option
UCSC-CMA-C220-D=	Reversible CMA for C220 M6/M7 ball bearing rail kit
<b>Security</b>	
UCSC-DLOM-01-D=	Dedicated Mode BIOS setting for C-Series Servers
UCSC-CCARD-01-D=	Cisco Card Mode BIOS setting for C-Series Servers
UCSX-TPM-002C-D=	Trusted Platform Module 2.0 for UCS servers
UCSC-INT-SW02-D=	C220 and C240 M7 Chassis Intrusion Switch
UCSX-TPM-OPT-OUT-D=	OPT OUT, TPM 2.0, TCG, FIPS140-2, CC EAL4+ Certified
<b>Security</b>	
UCSC-BZL-C220-D=	C220 M7 Security Bezel
<b>M.2 SATA SSD and M.2 RAID controller</b>	
UCS-M2-I240GB-D=	240GB SATA M.2 SSD
UCS-M2-I480GB-D=	480GB SATA M.2 SSD
UCS-M2-240G-D=	240GB M.2 SATA Micron G2 SSD
UCS-M2-960G-D=	960GB M.2 SATA Micron G2 SSD
UCS-M2-HWRAID-D=	Cisco Boot optimized M.2 RAID controller (holds up to two M.2 SATA SSDs)
<b>M.2 NVMe and M.2 RAID controller</b>	
UCS-NVM2-400GB=	400GB M.2 Boot NVMe
UCS-NVM2-960GB=	960GB M.2 Boot NVMe
UCS-M2-NVRAID=	Cisco M.2 NVMe BOOT RAID Controller (HHHL)
<b>Operating system and Software</b>	
<b>VMware vCenter</b>	
VMW-VCS-STD-D1A =	VMware vCenter 7 Server Standard, 1 yr support required
VMW-VCS-STD-D3A=	VMware vCenter 7 Server Standard, 3 yr support required
VMW-VCS-STD-D5A=	VMware vCenter 7 Server Standard, 5 yr support required
VMW-VCS-FND-D1A=	VMware vCenter Server 7 Foundation (4 Host), 1 yr supp reqd
VMW-VCS-FND-D3A=	VMware vCenter Server 7 Foundation (4 Host), 3 yr supp reqd
VMW-VCS-FND-D5A=	VMware vCenter Server 7 Foundation (4 Host), 5 yr supp reqd
<b>Microsoft Windows Server</b>	
MSWS-22-ST16CD =	Windows Server 2022 Standard (16 Cores/2 VMs)
MSWS-22-ST16CD-NS=	Windows Server 2022 Standard (16 Cores/2 VMs) - No Cisco SVC
MSWS-22-DC16CD=	Windows Server 2022 Data Center (16 Cores/Unlimited VMs)
MSWS-22-DC16CD-NS=	Windows Server 2022 DC (16 Cores/Unlim VMs) - No Cisco SVC
MSWS-19-ST16CD=	Windows Server 2019 Standard (16 Cores/2 VMs)

Table 38 Spare Parts

Product ID (PID)	Description
MSWS-19-ST16CD-NS=	Windows Server 2019 Standard (16 Cores/2 VMs) - No Cisco SVC
MSWS-19-DC16CD=	Windows Server 2019 Data Center (16 Cores/Unlimited VMs)
MSWS-19-DC16CD-NS=	Windows Server 2019 DC (16 Cores/Unlim VMs) - No Cisco SVC
<b>Red Hat</b>	
RHEL-2S2V-D1A=	Red Hat Enterprise Linux (1-2 CPU,1-2 VN); 1-Yr Support Req
RHEL-2S2V-D3A=	Red Hat Enterprise Linux (1-2 CPU,1-2 VN); 3-Yr Support Req
RHEL-2S2V-D5A=	Red Hat Enterprise Linux (1-2 CPU,1-2 VN); 5-Yr Support Req
RHEL-VDC-2SUV-D1A=	RHEL for Virt Datacenters (1-2 CPU, Unlim VN) 1 Yr Supp Req
RHEL-VDC-2SUV-D3A=	RHEL for Virt Datacenters (1-2 CPU, Unlim VN) 3 Yr Supp Req
RHEL-VDC-2SUV-D5A=	RHEL for Virt Datacenters (1-2 CPU, Unlim VN) 5 Yr Supp Req
<b>Red Hat Ent Linux/ High Avail/ Res Strg/ Scal</b>	
RHEL-2S2V-D1S=	Red Hat Enterprise Linux (1-2 CPU,1-2 VN); Prem 1Yr SnS Reqd
RHEL-2S2V-D3S=	Red Hat Enterprise Linux (1-2 CPU,1-2 VN); Prem 3Yr SnS Reqd
RHEL-2S-HA-D1S=	RHEL High Availability (1-2 CPU); Premium 1-yr SnS Reqd
RHEL-2S-HA-D3S=	RHEL High Availability (1-2 CPU); Premium 3-yr SnS Reqd
RHEL-2S-RS-D1S=	RHEL Resilent Storage (1-2 CPU); Premium 1-yr SnS Reqd
RHEL-2S-RS-D3S=	RHEL Resilent Storage (1-2 CPU); Premium 3-yr SnS Reqd
RHEL-VDC-2SUV-D1S=	RHEL for Virt Datacenters (1-2 CPU, Unlim VN) 1 Yr SnS Reqd
RHEL-VDC-2SUV-D3S=	RHEL for Virt Datacenters (1-2 CPU, Unlim VN) 3 Yr SnS Reqd
<b>Red Hat SAP</b>	
RHEL-SAP-2S2V-D1S=	RHEL for SAP Apps (1-2 CPU, 1-2 VN); Prem 1-Yr SnS Reqd
RHEL-SAP-2S2V-D3S=	RHEL for SAP Apps (1-2 CPU, 1-2 VN); Prem 3-Yr SnS Reqd
RHEL-SAPSP-D3S=	RHEL SAP Solutions Premium - 3 Years
RHEL-SAPSS-D3S=	RHEL SAP Solutions Standard - 3 Years
<b>VMware</b>	
VMW-VSP-STD-D1A=	VMware vSphere 7 Std (1 CPU, 32 Core) 1-yr, Support Required
VMW-VSP-STD-D3A=	VMware vSphere 7 Std (1 CPU, 32 Core) 3-yr, Support Required
VMW-VSP-STD-D5A=	VMware vSphere 7 Std (1 CPU, 32 Core) 5-yr, Support Required
VMW-VSP-EPL-D1A=	VMware vSphere 7 Ent Plus (1 CPU, 32 Core) 1Yr, Support Reqd
VMW-VSP-EPL-D3A=	VMware vSphere 7 Ent Plus (1 CPU, 32 Core) 3Yr, Support Reqd
VMW-VSP-EPL-D5A=	VMware vSphere 7 Ent Plus (1 CPU, 32 Core) 5Yr, Support Reqd
<b>SUSE</b>	
SLES-2S2V-D1A=	SUSE Linux Enterprise Svr (1-2 CPU,1-2 VM); 1-Yr Support Req
SLES-2S2V-D3A=	SUSE Linux Enterprise Svr (1-2 CPU,1-2 VM); 3-Yr Support Req
SLES-2S2V-D5A=	SUSE Linux Enterprise Svr (1-2 CPU,1-2 VM); 5-Yr Support Req
SLES-2SUVVM-D1A=	SUSE Linux Enterprise Svr (1-2 CPU,Unl VM) LP; 1Y Supp Req
SLES-2SUVVM-D3A=	SUSE Linux Enterprise Svr (1-2 CPU,Unl VM) LP; 3Y Supp Req
SLES-2SUVVM-D5A=	SUSE Linux Enterprise Svr (1-2 CPU,Unl VM) LP; 5Y Supp Req
SLES-2S-LP-D1A=	SUSE Linux Live Patching Add-on (1-2 CPU); 1yr Support Req
SLES-2S-LP-D3A=	SUSE Linux Live Patching Add-on (1-2 CPU); 3yr Support Req
SLES-2S2V-D1S=	SUSE Linux Enterprise Svr (1-2 CPU,1-2 VM); Prio 1-Yr SnS

Table 38 Spare Parts

Product ID (PID)	Description
SLES-2S2V-D3S=	SUSE Linux Enterprise Svr (1-2 CPU,1-2 VM); Prio 3-Yr SnS
SLES-2S2V-D5S=	SUSE Linux Enterprise Svr (1-2 CPU,1-2 VM); Prio 5-Yr SnS
SLES-2SUVM-D1S=	SUSE Linux Enterprise Svr (1-2 CPU,Unl VM) LP; Prio 1Y SnS
SLES-2SUVM-D3S=	SUSE Linux Enterprise Svr (1-2 CPU,Unl VM) LP; Prio 3Y SnS
SLES-2SUVM-D5S=	SUSE Linux Enterprise Svr (1-2 CPU,Unl VM) LP; Prio 5Y SnS
SLES-2S-HA-D1S=	SUSE Linux High Availability Ext (1-2 CPU); 1yr SnS
SLES-2S-HA-D3S=	SUSE Linux High Availability Ext (1-2 CPU); 3yr SnS
SLES-2S-HA-D5S=	SUSE Linux High Availability Ext (1-2 CPU); 5yr SnS
SLES-2S-GC-D1S=	SUSE Linux GEO Clustering for HA (1-2 CPU); 1yr SnS
SLES-2S-GC-D3S=	SUSE Linux GEO Clustering for HA (1-2 CPU); 3yr SnS
SLES-2S-GC-D5S=	SUSE Linux GEO Clustering for HA (1-2 CPU); 5yr SnS
SLES-2S-LP-D1S=	SUSE Linux Live Patching Add-on (1-2 CPU); 1yr SnS Required
SLES-2S-LP-D3S=	SUSE Linux Live Patching Add-on (1-2 CPU); 3yr SnS Required
<b>SLES and SAP</b>	
SLES-SAP-2S2V--D1S=	SLES for SAP Apps (1-2 CPU, 1-2 VM); Priority 1-Yr SnS
SLES-SAP-2S2V-D3S=	SLES for SAP Apps (1-2 CPU, 1-2 VM); Priority 3-Yr SnS
SLES-SAP-2S2V-D5S=	SLES for SAP Apps (1-2 CPU, 1-2 VM); Priority 5-Yr SnS
SLES-SAP-2S2V-D1A=	SLES for SAP Apps w/ HA (1-2 CPU, 1-2 VM); 1-Yr Support Reqd
SLES-SAP-2S2V-D3A=	SLES for SAP Apps w/ HA (1-2 CPU, 1-2 VM); 3-Yr Support Reqd
SLES-SAP-2S2V-D5A=	SLES for SAP Apps w/ HA (1-2 CPU, 1-2 VM); 5-Yr Support Reqd

**Notes:**

1. This part is included with the purchase of option or spare CPU or CPU processor kits.
2. Available post first customer ship (FCS).



# TECHNICAL SPECIFICATIONS

## Dimensions and Weight

Table 39 UCS C220 M7 Dimensions and Weight

Parameter	Value
Height	1.70 in. (4.3 cm)
Width (including slam latches)	16.9 in. (42.9 cm)
Depth	30 in. (76.2 cm)
Weight	
Weight with following options and no rail kit: 1*HDD, 1*CPU(with Heat Sink), 1*DIMM, 1*1600W PSU, mLOM card, 3HH rear wall, 3HH riser cage1, 3HH riser cage2, 3HH riser cage3, Raid tray, BBU module (with holder)	15.05 kgs = 33.18 lbs (3HH SKU)
Weight with following options and no rail kit: 1*HDD, 1*CPU(with Heat Sink), 1*DIMM, 1*1600W PSU, mLOM card, 2FH rear wall, 2FH riser cage1, 2FH riser cage2, Raid tray, BBU module (with holder)	15.1 kgs = 33.29 lbs (2FH SKU)
Weight with following options and including rail kit: 1*HDD, 1*CPU(with Heat Sink), 1*DIMM, 1*1600W PSU, mLOM card, 3HH rear wall, 3HH riser cage1, 3HH riser cage2, 3HH riser cage3, Raid tray, BBU module (with holder)	18.8 kgs = 41.45 lbs (3HH SKU)
Weight with following options and including rail kit: 1*HDD, 1*CPU(with Heat Sink), 1*DIMM, 1*1600W PSU, mLOM card, 2FH rear wall, 2FH riser cage1, 2FH riser cage2, Raid tray, BBU module (with holder),	18.85 kgs = 41.56 lbs (2FH SKU)
Weight with following options and no rail kit: 10*HDDs, 2*CPUs(with Heat Sink), 32*DIMMs, 2*1600W PSUs, mLOM card, 3HH rear wall, 3HH riser cage1, 3HH riser cage2, 3HH riser cage3, Raid tray, BBU module (with holder)	19.73 kgs = 43.5 lbs (3HH SKU)
Weight with following options and no rail kit: 10*HDDs, 2*CPUs(with Heat Sink), 32*DIMMs, 2*1600W PSUs, mLOM card, 2FH rear wall, 2FH riser cage1, 2FH riser cage2, Raid tray, BBU module (with holder)	19.78 kgs = 43.61 lbs (2FH SKU)
Weight with following options and including rail kit: 10*HDDs, 2*CPUs(with Heat Sink), 32*DIMMs, 2*1600W PSUs, mLOM card, 3HH rear wall, 3HH riser cage1, 3HH riser cage2, 3HH riser cage3, Raid tray, BBU module (with holder)	23.49 kgs = 51.79 lbs (3HH SKU)
Weight with following options and including rail kit: 10*HDDs, 2*CPUs(with Heat Sink), 32*DIMMs, 2*1600W PSUs, mLOM card, 2FH rear wall, 2FH riser cage1, 2FH riser cage2, Raid tray, BBU module (with holder)	23.54 kgs = 51.9 lbs (2FH SKU)

## Power Specifications

The server is available with the following types of power supplies:

- 770 W (AC) power supply (see [Table 39](#))
- 1050W DC power supply (see [Table 40](#))
- 1200 W (AC) power supply (see [Table 41](#))
- 1600 W (AC) power supply (see [Table 42](#))
- 2300 W (AC) power supply (see [Table 43](#))

**Table 40 UCS C220 M7 770 W (AC) Power Supply Specifications**

Parameter	Specification			
Input Connector	IEC320 C14			
Input Voltage Range (Vrms)	100 to 240			
Maximum Allowable Input Voltage Range (Vrms)	90 to 264			
Frequency Range (Hz)	50 to 60			
Maximum Allowable Frequency Range (Hz)	47 to 63			
Maximum Rated Output (W)	770			
Maximum Rated Standby Output (W)	36			
Nominal Input Voltage (Vrms)	100	120	208	230
Nominal Input Current (Arms)	8.8	7.4	4.2	3.8
Maximum Input at Nominal Input Voltage (W)	855	855	855	846
Maximum Input at Nominal Input Voltage (VA)	882	882	882	872
Minimum Rated Efficiency (%) <sup>1</sup>	90	90	90	91
Minimum Rated Power Factor <sup>1</sup>	0.97	0.97	0.97	0.97
Maximum Inrush Current (A peak)	15			
Maximum Inrush Current (ms)	0.2			
Minimum Ride-Through Time (ms) <sup>2</sup>	12			

**Notes:**

1. This is the minimum rating required to achieve 80 PLUS Platinum certification, see test reports published at <http://www.80plus.org/> for certified values
2. Time output voltage remains within regulation limits at 100% load, during input voltage dropout

Table 41 UCS C220 M7 SFF Power Specifications (1050 W V2 DC power supply)

Parameter	Specification
Input Connector	Molex 42820
Input Voltage Range (V rms)	-48
Maximum Allowable Input Voltage Range (V rms)	-40 to -72
Frequency Range (Hz)	NA
Maximum Allowable Frequency Range (Hz)	NA
Maximum Rated Output (W)	1050
Maximum Rated Standby Output (W)	36
Nominal Input Voltage (V rms)	-48
Nominal Input Current (A rms)	24
Maximum Input at Nominal Input Voltage (W)	1154
Maximum Input at Nominal Input Voltage (VA)	1154
Minimum Rated Efficiency (%) <sup>1</sup>	91
Minimum Rated Power Factor <sup>1</sup>	NA
Maximum Inrush Current (A peak)	15
Maximum Inrush Current (ms)	0.2
Minimum Ride-Through Time (ms) <sup>2</sup>	5

**Notes:**

1. This is the minimum rating required to achieve 80 PLUS Platinum certification, see test reports published at <http://www.80plus.org/> for certified values
2. Time output voltage remains within regulation limits at 100% load, during input voltage dropout

Table 42 UCS C220 M7 1200 W (AC) Power Supply Specifications

Parameter	Specification			
Input Connector	IEC320 C14			
Input Voltage Range (Vrms)	100 to 240			
Maximum Allowable Input Voltage Range (Vrms)	90 to 264			
Frequency Range (Hz)	50 to 60			
Maximum Allowable Frequency Range (Hz)	47 to 63			
Maximum Rated Output (W) <sup>1</sup>	1100	1200		
Maximum Rated Standby Output (W)	48			
Nominal Input Voltage (Vrms)	100	120	208	230
Nominal Input Current (Arms)	12.97	10.62	6.47	5.84
Maximum Input at Nominal Input Voltage (W)	1300	1264	1343	1340
Maximum Input at Nominal Input Voltage (VA)	1300	1266	1345	1342
Minimum Rated Efficiency (%) <sup>2</sup>	90	90	91	91
Minimum Rated Power Factor <sup>2</sup>	0.97	0.97	0.97	0.97
Maximum Inrush Current (A peak)	20			
Maximum Inrush Current (ms)	0.2			
Minimum Ride-Through Time (ms) <sup>3</sup>	12			

Notes:

1. Maximum rated output is limited to 1100W when operating at low-line input voltage (100-127V)
2. This is the minimum rating required to achieve 80 PLUS Titanium certification, see test reports published at <http://www.80plus.org/> for certified values
3. Time output voltage remains within regulation limits at 100% load, during input voltage dropout

Table 43 UCS C220 M7 1600 W (AC) Power Supply Specifications

Parameter	Specification			
Input Connector	IEC320 C14			
Input Voltage Range (V rms)	200 to 240			
Maximum Allowable Input Voltage Range (V rms)	180 to 264			
Frequency Range (Hz)	50 to 60			
Maximum Allowable Frequency Range (Hz)	47 to 63			
Maximum Rated Output (W)	1600			
Maximum Rated Standby Output (W)	36			
Nominal Input Voltage (V rms)	100	120	208	230
Nominal Input Current (A rms)	NA	NA	8.8	7.9
Maximum Input at Nominal Input Voltage (W)	NA	NA	1778	1758
Maximum Input at Nominal Input Voltage (VA)	NA	NA	1833	1813
Minimum Rated Efficiency (%) <sup>1</sup>	NA	NA	90	91
Minimum Rated Power Factor <sup>2</sup>	NA	NA	0.97	0.97
Maximum Inrush Current (A peak)	30			
Maximum Inrush Current (ms)	0.2			
Minimum Ride-Through Time (ms) <sup>2</sup>	12			

**Notes:**

1. This is the minimum rating required to achieve 80 PLUS Platinum certification, see test reports published at <http://www.80plus.org/> for certified values
2. Time output voltage remains within regulation limits at 100% load, during input voltage dropout

Table 44 UCS C220 M7 2300 W (AC) Power Supply Specifications

Parameter	Specification			
Input Connector	IEC320 C20			
Input Voltage Range (Vrms)	100 to 240			
Maximum Allowable Input Voltage Range (Vrms)	90 to 264			
Frequency Range (Hz)	50 to 60			
Maximum Allowable Frequency Range (Hz)	47 to 63			
Maximum Rated Output (W) <sup>1</sup>	2300			
Maximum Rated Standby Output (W)	36			
Nominal Input Voltage (Vrms)	100	120	208	230
Nominal Input Current (Arms)	13	11	12	10.8
Maximum Input at Nominal Input Voltage (W)	1338	1330	2490	2480
Maximum Input at Nominal Input Voltage (VA)	1351	1343	2515	2505
Minimum Rated Efficiency (%) <sup>2</sup>	92	92	93	93
Minimum Rated Power Factor <sup>2</sup>	0.99	0.99	0.97	0.97
Maximum Inrush Current (A peak)	30			
Maximum Inrush Current (ms)	0.2			
Minimum Ride-Through Time (ms) <sup>3</sup>	12			

Notes:

1. Maximum rated output is limited to 1200W when operating at low-line input voltage (100-127V)
2. This is the minimum rating required to achieve 80 PLUS Titanium certification, see test reports published at <http://www.80plus.org/> for certified values
3. Time output voltage remains within regulation limits at 100% load, during input voltage dropout



**NOTE:** For configuration-specific power specifications, use the Cisco UCS Power Calculator at this URL: <http://ucspowercalc.cisco.com>

## Environmental Specifications

The environmental specifications for Cisco UCS C220 M7 SFF server are listed in [Table 44](#).

**Table 45 UCS C220 M7 Environmental Specifications**

Parameter	Minimum
Operating Temperature	5 °C to 35 °C (supports ASHRAE Class A4 and/or Class A3 and/or Class A2) ASHRAE Class A3 will be generic test profile unless otherwise specified by product engineering. System shall continue to operate with a single fan failure (one failed impeller in dual impeller housings) across the ASHRAE recommended operating range of 18 °C to 27 °C. While undesired, increased power consumption and/or acoustic noise is permitted during a fan fail event.
Non-Operating Temperature	Dry bulb temperature of -40 °C to 65 °C (-40 °F to 149 °F)
Operating Relative Humidity	8% to 90% relative humidity, non-condensing, with maximum wet bulb 28 °C (82.4 °F) within operational temperature range of 5 °C to 50 °C (41 °F to 122 °F)
Non-Operating Relative Humidity	5% to 93% relative humidity, non-condensing, with a maximum wet bulb temperature of 28 °C across the 20 °C to 40 °C dry bulb range.
Maximum Operating Duration	Unlimited
Operating Altitude	A maximum elevation of 3050 meters (10,006 ft)
Non-Operating Altitude	An elevation of 0 to 12,000 meters (39,370 ft)
Sound Power level, Measure A-weighted per ISO7779 LWAd (Bels) Operation at 23 °C (73 °F)	1RU: 5.5B 2RU: 5.8B Racked product: 6.8B
Sound Pressure level, Measure A-weighted per ISO7779 LpAm (dBA) Operation at 23 °C (73 °F)	1RU: 40dB 2RU: 43dB Racked product: 55dB

## Compliance Requirements

The regulatory compliance requirements for C-Series servers are listed in [Table 45](#).

**Table 46 UCS C-Series Regulatory Compliance Requirements**

Parameter	Description
Regulatory Compliance	Products should comply with CE Markings per directives 2014/30/EU and 2014/35/EU
Safety	UL 60950-1 / 62368-1 CAN/CSA-C22.2 No. 60950-1, CAN/CSA-C22.2 No. 62368-1 EN 60950-1 / EN 62368-1 IEC 60950-1 / IEC 62368-1 AS/NZS 60950-1/62368.1 GB4943
EMC - Emissions	47CFR Part 15 (CFR 47) Class A AS/NZS CISPR32 Class A CISPR32 Class A EN55032 Class A ICES003 Class A VCCI Class A EN61000-3-2 EN61000-3-3 KN32 Class A CNS13438 Class A
EMC - Immunity	EN55024 CISPR24 EN300386 KN35



## DISCONTINUED EOL PRODUCTS

Below is the list of parts were previously available for this product and are no longer sold. Please refer to the EOL Bulletin Links via table below to determine if still supported.

Table 47 EOS

Product ID	Description	EOL/EOS link
<b>Drives</b>		
UCS-M2-240GB-D	240GB M.2 SATA Micron G1 SSD	<a href="https://www.cisco.com/c/en/us/products/collateral/servers-unified-computing/ucs-c-series-rack-servers/unified-computing-accessories-eol.html">https://www.cisco.com/c/en/us/products/collateral/servers-unified-computing/ucs-c-series-rack-servers/unified-computing-accessories-eol.html</a>
UCS-M2-960GB-D	960GB M.2 SATA Micron G1 SSD	<a href="https://www.cisco.com/c/en/us/products/collateral/servers-unified-computing/ucs-c-series-rack-servers/unified-computing-accessories-eol.html">https://www.cisco.com/c/en/us/products/collateral/servers-unified-computing/ucs-c-series-rack-servers/unified-computing-accessories-eol.html</a>
UCS-SD240GM1XEVD	240GB 2.5in Enter Value 6G SATA Micron G1 SSD	<a href="https://www.cisco.com/c/en/us/products/collateral/servers-unified-computing/ucs-c-series-rack-servers/unified-computing-accessories-eol.html">https://www.cisco.com/c/en/us/products/collateral/servers-unified-computing/ucs-c-series-rack-servers/unified-computing-accessories-eol.html</a>
UCS-SD76TM1X-EV-D	7.6TB 2.5in Enter Value 6G SATA Micron G1 SSD	<a href="https://www.cisco.com/c/en/us/products/collateral/servers-unified-computing/ucs-c-series-rack-servers/unified-computing-accessories-eol.html">https://www.cisco.com/c/en/us/products/collateral/servers-unified-computing/ucs-c-series-rack-servers/unified-computing-accessories-eol.html</a>
UCS-SD480GM1XEVD	480 GB 2.5in Enter Value 6G SATA Micron G1 SSD	<a href="https://www.cisco.com/c/en/us/products/collateral/servers-unified-computing/ucs-c-series-rack-servers/unified-computing-accessories-eol.html">https://www.cisco.com/c/en/us/products/collateral/servers-unified-computing/ucs-c-series-rack-servers/unified-computing-accessories-eol.html</a>
UCSSD76TBEM2NK9-D	7.6TB 2.5in Enter Value 6G SATA Micron G1 SSD (SED)	<a href="https://www.cisco.com/c/en/us/products/collateral/servers-unified-computing/ucs-c-series-rack-servers/unified-computing-accessories-eol.html">https://www.cisco.com/c/en/us/products/collateral/servers-unified-computing/ucs-c-series-rack-servers/unified-computing-accessories-eol.html</a>
UCSSD960GBM2NK9-D	960GB 2.5in Enter Value 6G SATA Micron G1 SSD (SED)	<a href="https://www.cisco.com/c/en/us/products/collateral/servers-unified-computing/ucs-c-series-rack-servers/unified-computing-accessories-eol.html">https://www.cisco.com/c/en/us/products/collateral/servers-unified-computing/ucs-c-series-rack-servers/unified-computing-accessories-eol.html</a>
UCS-SD16TM1X-EV-D	1.6TB 2.5in Enter Value 6G SATA Micron G1 SSD	<a href="https://www.cisco.com/c/en/us/products/collateral/servers-unified-computing/ucs-c-series-rack-servers/unified-computing-accessories-eol.html">https://www.cisco.com/c/en/us/products/collateral/servers-unified-computing/ucs-c-series-rack-servers/unified-computing-accessories-eol.html</a>
UCS-SD38TM1X-EV-D	3.8TB 2.5in Enter Value 6G SATA Micron G1 SSD	<a href="https://www.cisco.com/c/en/us/products/collateral/servers-unified-computing/ucs-c-series-rack-servers/unified-computing-accessories-eol.html">https://www.cisco.com/c/en/us/products/collateral/servers-unified-computing/ucs-c-series-rack-servers/unified-computing-accessories-eol.html</a>



Americas Headquarters  
Cisco Systems, Inc.  
San Jose, CA

Asia Pacific Headquarters  
Cisco Systems (USA) Pte. Ltd.  
Singapore

Europe Headquarters  
Cisco Systems International BV Amsterdam,  
The Netherlands

Cisco has more than 200 offices worldwide. Addresses, phone numbers, and fax numbers are listed on the Cisco Website at [www.cisco.com/go/offices](http://www.cisco.com/go/offices).

Cisco and the Cisco Logo are trademarks of Cisco Systems, Inc. and/or its affiliates in the U.S. and other countries. A listing of Cisco's trademarks can be found at [www.cisco.com/go/trademarks](http://www.cisco.com/go/trademarks). Third party trademarks mentioned are the property of their respective owners. The use of the word partner does not imply a partnership relationship between Cisco and any other company. (1005R)

