



Cisco Small Business Products & Solutions Overview



Cisco
Small
Business

Agenda

1

Introduction

2

Product & Solutions Overview

3

Positioning

4

Resources and URLs

Typical Small Office/Branch Network

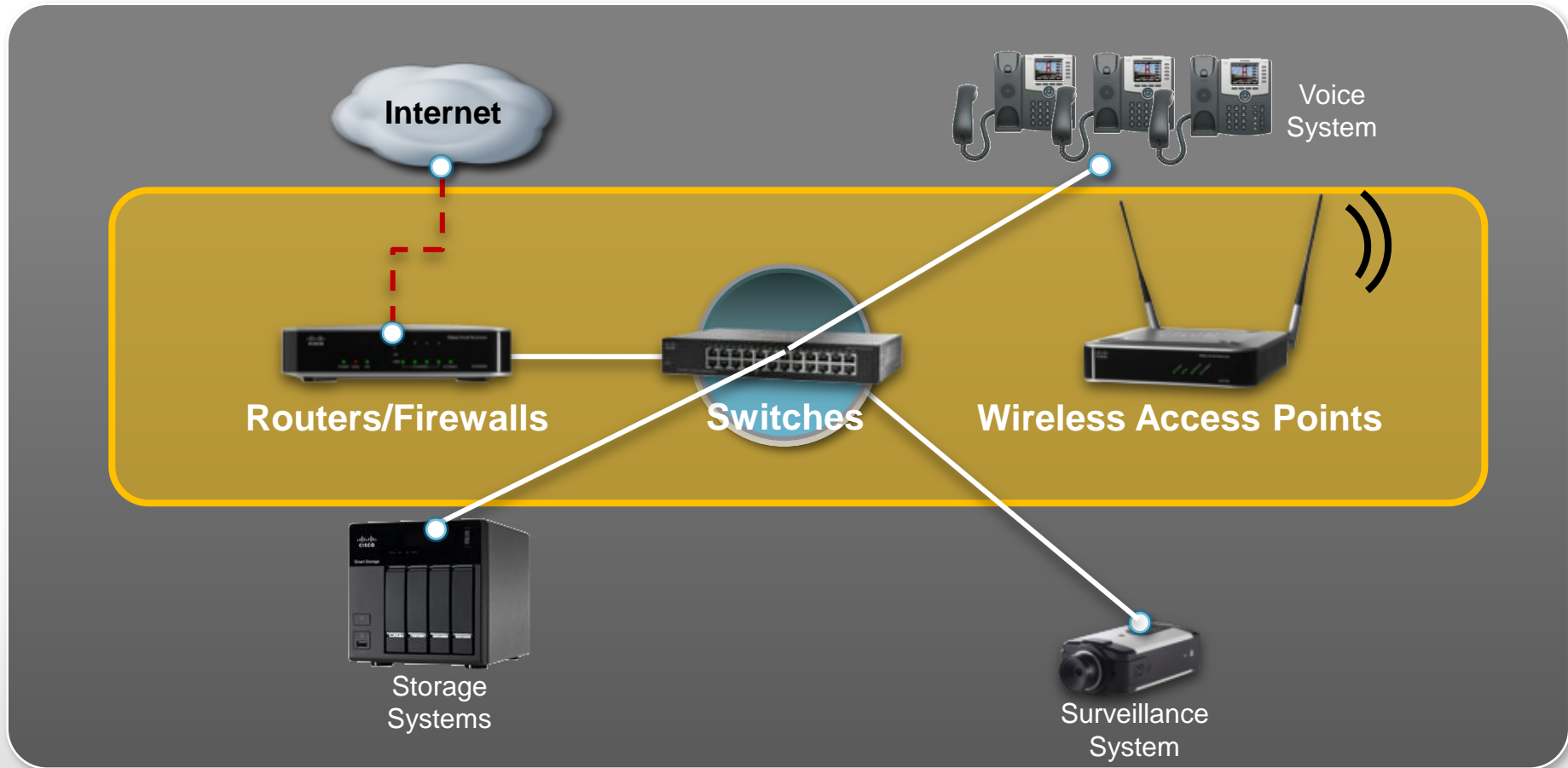

Complete Portfolio

Communicate

Secure

Connect

Broadest Portfolio of
Products and Solutions
for Small Business



Firewall

Anti-Virus



UTM

Anti-Spam





VPN

Unified
Communications



Small Business Portfolio Categories

Over 100 Products Purpose Built for Small Business

		
Purpose-built for small business		Enterprise-class
Price-competitive for small business		Perceived to be expensive
Point products	Tested, integrated solutions	Custom solutions
Off-the-shelf, GUI device configuration	Simple solution configuration, CCA	Custom solution configuration, CLI, CCP
Warranty + Cisco Small Business Support & Services		Smart Care, SMARTnet, Smart Foundation
Small Business Support Center		TAC
18 month lifecycle	Long product lifecycle, investment protection	

Cisco Small Business Portfolio

Cisco Small Business

Cisco Small Business Pro

Cisco Classic

Switching

100 Series
300 Series



ESW500



Cisco Catalyst



Routing

RV
WRV



SRP500



ISR G2



Security & Surveillance

RV
WRV
WVC/PVC/CVC



SA500



ASA



Voice

PAP
SPA



UC500
SPA500



CME, CMBE,
9900, 8900, 7900, 6900, 3900



Wireless

WAP
WET



AP500



AIRONET



Small Business Switching Landscape

Cost



Advanced LAN Switching

- Intelligent services
- FE, GbE, 10 Gbps, stacking
- Cisco IOS Software, CLI support
- Network-wide support

Solution Integration

- Standalone or part of a system
- 8- to 48-port FE/GbE configurations
- Solution level configuration/management
- “Peace of Mind” support

Functionality

Easy to Use Switches

- Simple, reliable connectivity
- DIY simplicity (unmanaged options)
- Device level configuration/management
- Warranty, simple support

Cisco Small Business Switching Portfolio

Cost
↑

Cisco Catalyst



Cisco Catalyst 2960 Series
SMARTnet

\$725 List (24-port FE LAN Lite Image)

Cisco Small Business Pro



Cisco ESW 500 Series
SB Support/Service

Functionality
→

\$659 List (24-port FE Managed)

Cisco Small Business



Unmanaged, Smart, and Managed
Warranty, Support Center, Community

\$333 List (24-port FE Managed)

Switching for Small Business

One Portfolio: A Spectrum of Choices



Cisco Small Business

Switching Portfolio . . . from basic connectivity to fully managed switching

Price-Performance

Managed Stackable

SFE/SGE Series

- Advanced QoS, security and availability
- 8 to 48-port 10/100 and 10/100/1000 models
- PoE options
- Stackable up to
- Managed entire stack as one



Managed

Cisco® 300 Series Switches

- Enhanced QoS, security, and availability
- 8- to 48-port 10/100 and 10 to 52 10/100/1000 models
- PoE options
- Simplified configuration and troubleshooting
- Designed for small officewide infrastructure



Smart Switches

SLM Switches

- Basic QoS, security, and availability
- Simple, basic web-managed interface
- 5- to 48-port 10/100 and 10/100/1000 models
- PoE options
- Ideal for basic management



Cisco 100 Series Switches

Unmanaged Switches

- Ready-to-use simplicity; no device management
- Zero configuration; zero customization
- No security or VLANs
- 5- to 24-port 10/100 and 10/100/1000 models
- Desktop and rack-mount
- Do-it-yourself small business



Function, Flexibility, Scalability











Cisco 100 Series Unmanaged Switches List Price: \$ 35 - \$413



SD216

Supercharge Your Business Network

The Cisco 100 Series provides a reliable, high-performance network foundation for your business, with zero configuration required.

	Product Model	Ports	Expansion Ports	Switch Capacity	Placement	List Price
	Fast Ethernet					
	SF 100D-05	5-port 10/100		1 Gbps	Desktop	\$35
	SF 100D-08	8-port 10/100		1.6 Gbps	Desktop	\$57
	SF 100D-16	16-port 10/100		3.2 Gbps	Desktop	\$92
	SF 100-16	16-port 10/100		3.2 Gbps	Rackmount	\$98
	SF 100-24	24-port 10/100		4.8 Gbps	Rackmount	\$143
	SF 102-24	24-port 10/100	2 Combo ^a mini-GBIC slots	8.8 Gbps	Rackmount	\$206
	Gigabit Ethernet					
	SG 100D-08	8-port 10/100/1000		16 Gbps	Desktop	\$92
	SG 100-16	16-port 10/100/1000		32 Gbps	Rackmount	\$275
	SG 100-24	22-port 10/100/1000	2 Combo ^a mini-GBIC slot	48 Gbps	Rackmount	\$365
	SG 102-24	22-port 10/100/1000	2 Combo ^a mini-GBIC slot	48 Gbps	Desktop or Rackmount	\$413

SD208P



Unmanaged 8-Port 10/100 Switch with PoE
List Price: \$170

Entry-level PoE switch

- Similar to SD208 in software feature set
 - 4 ports of PoE with 32 Watt power budget
 - Port Priority (Ports 1-4 high priority)

Cisco 300 Series Switches Comparison



List Price: \$ 200-1,300
 24-port FE @ \$333
 24-port FE w/ PoE @ \$725

	Cisco® SRW Switches	300 Series
Product Name Change	–	Yes
Energy-Efficient Technology	No	Yes
Fanless	Five models	Eleven models
Additional Gigabit Ethernet Ports	Standard	Four additional on Gigabit Ethernet models
Layer 3 (Static L3/Routing)	No	Yes
IPv6	–	All models
Management and Configuration	GUI, SNMP, and Menu CLI	GUI, SNMP, TextView/CLI, Cisco® Discovery Protocol, Smartports, and FindIT
Localization and Globalization	English only	Seven languages: GUI, documents, and support
Warranty	Five years	Limited Lifetime

Cisco 300 Series

Model Pricing



Model Name	Product ID	Description	List Price
SF300-08	SRW208-K9	8 10/100 ports	\$217.00
SF302-08	SRW208G-K9	8 10/100; 2 Combo mini-GBIC ports	\$267.00
SF302-08P	SRW208P-K9	8 10/100 PoE ; 2 Combo mini-GBIC ports	\$387.00
SF302-08MP	SRW208MP-K9	8 10/100 Maximum PoE; 2 Combo mini-GBIC ports	\$521.00
SF300-24	SRW224G4-K9	24 10/100; 2 10/100/1000 ports; 2 Combo mini-GBIC ports	\$333.00
SF300-24P	SRW224G4P-K9	24 10/100 PoE ; 2 10/100/1000 ports; 2 Combo mini-GBIC ports	\$725.00
SF300-48	SRW248G4-K9	48 10/100; 2 10/100/1000 ports; 2 Combo mini-GBIC ports	\$762.00
SF300-48P	SRW248G4P-K9	48 10/100 PoE; 2 10/100/1000 ports; 2 Combo mini-GBIC ports	\$1356.00
SG300-10	SRW2008-K9	8 10/100/1000; 2 Combo mini-GBIC ports	\$319.00
SG300-10P	SRW2008P-K9	8 10/100/1000 PoE; 2 Combo mini-GBIC ports	\$516.00
SG300-10MP	SRW2008MP-K9	8 10/100/1000 Max PoE; 2 Combo mini-GBIC ports	\$616.00
SG300-20	SRW2016-K9	18 10/100/1000 ports; 2 Combo mini-GBIC ports	\$546.00
SG300-28	SRW2024-K9	26 10/100/1000 ports; 2 Combo mini-GBIC ports	\$783.00
SG300-28P	SRW2024P-K9	26 10/100/1000 PoE; 2 Combo mini-GBIC ports	\$1076.00
SG300-52	SRW2048-K9	50 10/100/1000 ports; 2 Combo mini-GBIC ports	\$1357.00

Small Business Switch Accessories

Mini-GBIC/SFP Transceivers List Price: \$ 108 - \$365

100 Mbps Transceivers

MFEBX1

100 BASE-BX-20U SFP transceiver

- 1310-nm wavelength for single-mode fiber
- For distances up to 20 kilometers



MFEFX1

100 BASE-FX SFP transceiver

- 1310-nm wavelength for multimode fiber
- Support for 100-Mbps speed up to 2 km



MFELX1

100 BASE-LX SFP transceiver

- 1310-nm wavelength for single-mode fiber
- For distances up to 10 km

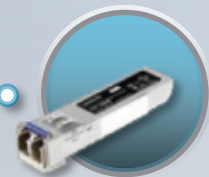

Gigabit Transceivers

MGBBX1

1000BASE-BX-20U SFP transceiver

- 1310-nm wavelength for single-mode fiber
- For distances up to 40 km

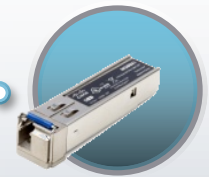

MGBLH1

1000BASE-LH SFP transceiver

- 1310-nm wavelength for single-mode fiber
- For distances up to 40 km



MGBLX1

1000BASE-LX SFP transceiver

- 1310-nm wavelength for single-mode fiber
- For distances up to 10 km



MGBSX1

1000BASE-SX SFP transceiver

- 850-nm wavelength for multimode fiber
- For distances up to 550 meters



Small Business Routing Landscape

Cost



Nonstop Connectivity

- Modular design for optimal flexibility
- Best-in-class security
- Cisco IOS software, CLI support
- Network-wide support

Higher Performance, Security

- Standalone or part of a system
- Enhanced security, hybrid VPN
- Solution level configuration/management
- “Peace of Mind” support

Functionality

Basic Business-Class Connectivity

- Simple, reliable connectivity
- Business-class security and VPN
- Device level configuration/management
- Warranty, simple support

Cisco Small Business Routing Portfolio

Cost



Cisco Integrated Services Routers



800, 1900, 2900 Series ISRs

SMARTnet

\$450 List (ADSL SOHO Router)

Cisco Small Business Pro



SR 520-T1



SA 500 Series

SB Service (SB/KR only)

Functionality

Cisco Small Business



RVx



WRVx



RV0xx

Warranty, Support Center, Community

\$600 List (Secure Router)

\$114 List (Wireless VPN Router)

Cisco Small Business Routing

Price-Performance

Cisco Integrated Services Routers



800, 1900, 2900 Series

- High-performance, nonstop connectivity
- Cisco IOS Software
- Modular design (1900 / 2900 Series)
- Best-in-class security
- CLI

Pro Series



SR 520-T1



SA 500 Series

- Standalone or part of integrated solution
- Routing or security focus
- IPS, IPsec / SSL VPN, content filtering
- Available Pro Service
- Cisco Configuration Assistant (CCA)

Small Business Series



RV Series, RVS, WRVS models

- Basic connectivity right out of the box
- Basic routing capabilities
- Secure VPN for remote and site-to-site access
- Simple browser-based configuration

Function, Flexibility, Scalability

Cisco Small Business Routers

	Basic, Secure Access		High Performance, High Security		Redundant WAN		
	WRV210	RV120W	RVS4000	WRVS4400N	RV042	RV082	RV016
Integrated Switch	4-port Fast Ethernet	4-port Fast Ethernet	4-port Gigabit Ethernet	4-port Gigabit Ethernet	4-port Fast Ethernet	8-port Fast Ethernet	16-port Fast Ethernet
WAN Connections	Single FE	Single FE	Single GbE	Single GbE	Dual FE	Dual FE	Up to 7 FE
Wireless support	802.11g	802.11n	—	802.11n	—	—	—
VPN connectivity	IPSec	IPSec	IPSec	IPSec	IPSec	IPSec	IPSec
Max VPN connections	10	10	5	5	50	100	100
Advanced SPI firewall	Yes	Yes	Yes	Yes	Yes	Yes	Yes
Intrusion Prevention System (IPS)	—	—	Yes	Yes	—	—	—
Optional Trend Micro ProtectLink Service	—	—	Yes	Yes	Yes	Yes	Yes
List Price	\$114	\$189	\$163	\$252	\$246	\$425	\$595

Small Business Wireless Landscape

Cost

Wireless Is Critical to the Business

- Advanced mobility applications
- Strongest security, highly scalable
- Centralized management
- Network-wide support

Wireless is Desirable for the Business

- Solution integration, up to 10 APs
- Seamless roaming for wireless voice
- Solution level configuration/management
- “Peace of Mind” support

Functionality

Wireless is Desirable for the Business

- Simple deployments, 1–2 APs
- Business-class security and features
- Device level configuration/management
- Warranty, simple support

Cisco Small Business Wireless Access Point Portfolio

Cost



Cisco Unified Wireless Network



Cisco Aironet® 1140/1250
SMARTnet

\$795 List (802.11g/n single-band AP)

Cisco Small Business Pro



AP 541N*
SB Service (SG/KR)

Functionality

Cisco Small Business



WAP200 / 200E / 2000 / WET 200 WAP4410N

Warranty, Support Center, Community

\$163 List (802.11b/g Wireless AP)

\$499 List (Dual Band Clustering AP)

* local certification is required in most countries

SRP500

SBTG SP Managed CPE

Feature Functionality/Price



Entry Level
Data, Voice, Wireless
Ethernet Based

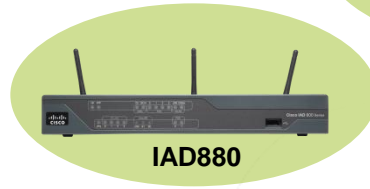
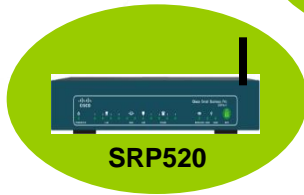

Data, Voice, Security
Advanced IOS features
Ethernet/xDSL/T1/Cable

SRP 500 Series

Data, Voice, Wireless, 3G, Security
Application Intelligence
Ethernet/DSL

SOHO

Small Business
up to 10

Small Business
up to 50

Small Business
up to 100

Cisco SRP 500 Series

Best for

- For small businesses with up to 50 users

Features

- Support for voice, data, security, and applications
- Integrated voice ports
- Ethernet or ADSL (Annex A/B) WAN termination
- Firewall and IPsec VPN
- Built-in 4-port managed switch
- Built-in 802.11n wireless access point
- 3G ready through USB modem
- Interoperable with most DSLAMs and soft switches
- Near zero-touch deployment

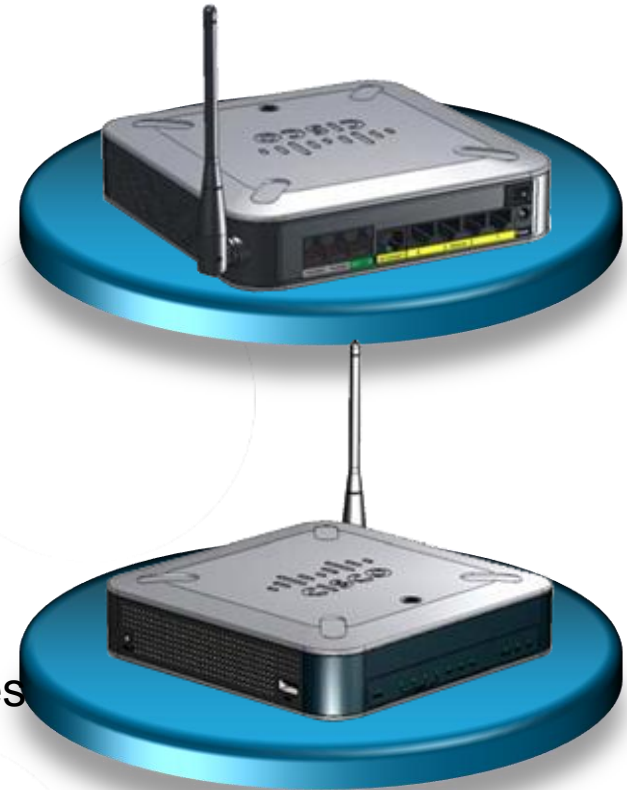

Flexible, Cost-Effective CPE for Small Businesses

SRP = Services Ready Platform

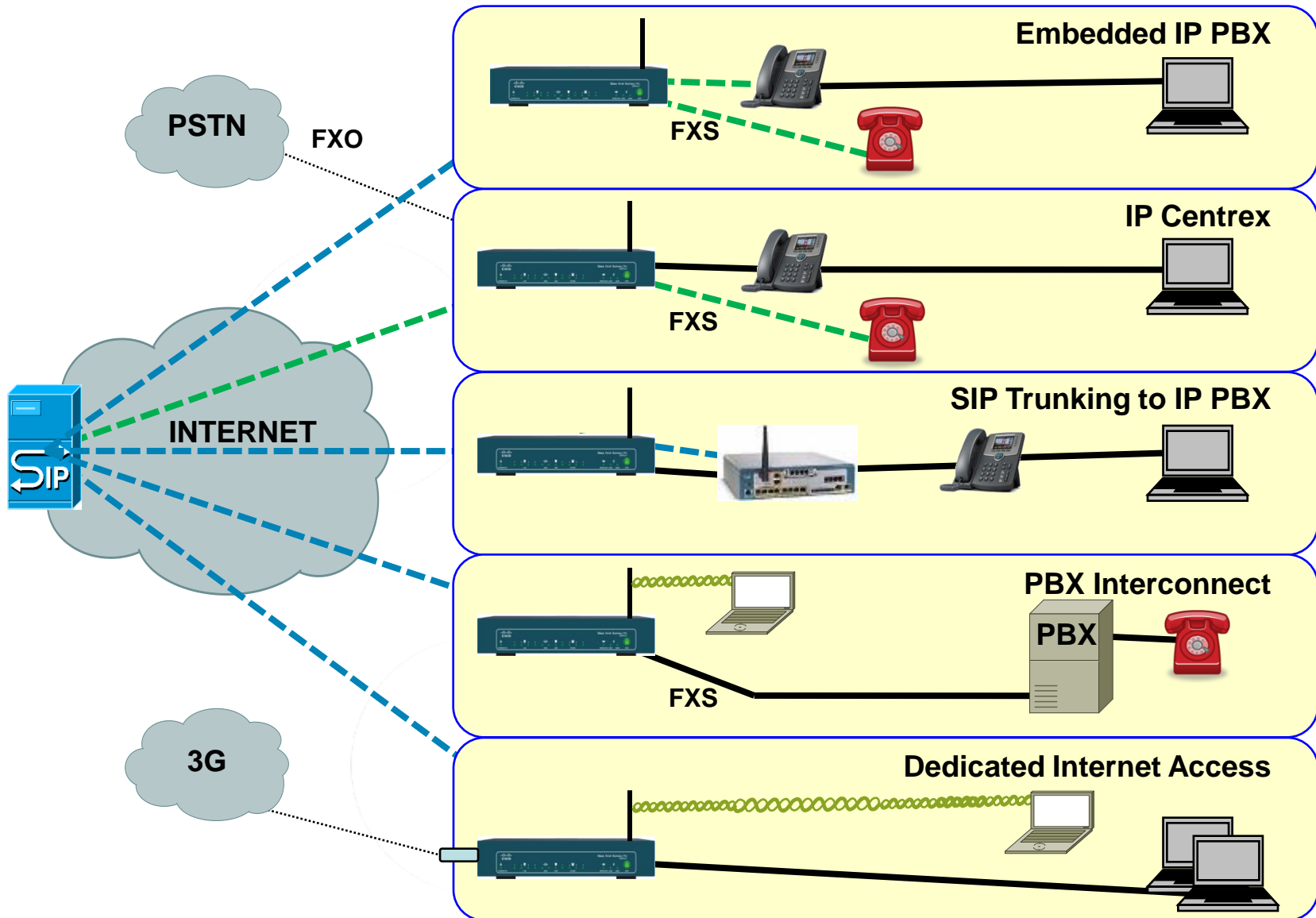

Cisco SRP 500 Series Models

				Available Q3 FY11		
	SRP 521	SRP 526	SRP 527	SRP 541	SRP 546	SRP 547
WAN	FE	ADSL2+ (ISDN)	ADSL2+ (POTS)	GbE	ADSL2+ (ISDN)	ADSL2+ (POTS)
Backup WAN	-			GbE		
LAN	4-port FE			4-port GbE		
Wireless	802.11b/g/n, 1 fixed antenna			802.11b/g/n, 2 SMA antennae		
FXS/FXO	2 / 1 (relay)			4 / 1 (active)		
USB 2.0	1			2		
Built-in 3G USB Drivers	Yes			Yes		
Security	NAT, Firewall, IPsec and GRE VPN					
List Price	\$ 300 – 350			\$ 600 – 650		
Price to SP	\$ 200 – 250			\$ 400 – 500		

SRP500 3G Mobile Broadband USB Modem Compatibility

Make	Model	Technology
Novatel	U720	EVDO Rev 0/A
Novatel	U727	EVDO Rev 0/A
Huawei	E172 (E170 also supported)	HSDPA ***
Huawei	E220	HSDPA ***
Huawei	E270	HSDPA ***
Huawei	E272	HSDPA ***
Sierra Wireless	AC595U	EVDO Rev 0/A
Sierra Wireless	597U Compass	EVDO Rev 0/A
Sierra Wireless	875U	HSDPA
Sierra Wireless	880U	HSDPA
Sierra Wireless	881U	HSDPA
UTStarcom/Pantech	UM175	EVDO Rev A
Sierra Wireless	598U	EVDO Rev A
Sierra Wireless	Compass 885U	HSDPA
Sierra Wireless	Compass 888	HSDPA
Novatel Wireless	U760	EVDO Rev A
Option	iCON 322	HSDPA
Novaltel	MC950D	HSDPA
Huawei	E226	HSDPA
Huawei	EC1260	EVDO Rev A
Huawei	168C	EVDO Rev A
ZTE	MF636	HSDPA

Cisco Small Business Wireless Access Point Portfolio

Price-Performance

Cisco



Cisco Aironet 1130AG Access Point

- Advanced wireless access points & controllers
- 802.11 b/g/n on selected models
- Dual radios operate in both 2.4 and 5Ghz
- Advanced security
- Migration to controller based & centralized management

Small Business Pro



Cisco AP541N Clustering Access Point

- Standalone or part of integrated Pro solution
- 802.11 a/b/g/n
- Dual Band with Clustering technology
- Enhanced security
- Cisco Configuration Assistant (CCA)
- SB Pro Service & Small Business Support Center (SBSC)

Small Business Series



Cisco WAP4400N Access Point

- Easy to use wireless access points
- 802.11 b/g
- Robust security features
- Indoor/Outdoor deployment options
- Single-device level GUI

Function, Flexibility, Scalability

Cisco Small Business Wireless

Main Office

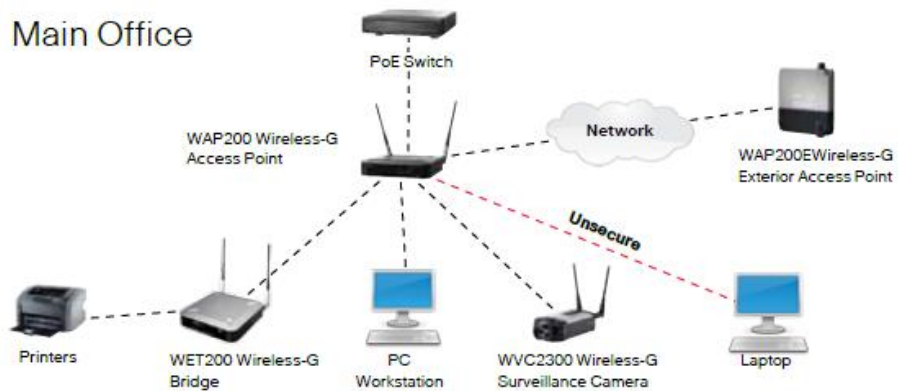

Up to 4 km

Nearby Office

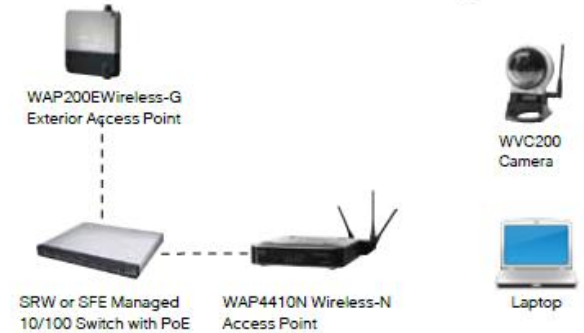

Cisco Small Business Series:



WAP4410N

Wireless-N connectivity
IEEE 802.11n compliant

Key Features:

- Multiple BSSIDs (4) – Segment wireless network amongst workgroups & guests
- Wireless Distribution System (WDS) – Bridging and Repeater capabilities for extended reach and deployment scenarios.
- Robust security capabilities such as WPA2, an 802.1x supplicant, Rogue AP Detection



WAP200

Affordably priced and high-performance

Key Features:

- Multiple BSSIDs
- Strong QoS – 802.1p/q and WMM
- PoE or External Power
- WPA2, WPA-ENT, WPA-PSK
- SSID to VLAN mapping
- Removable antennas
- Advanced Wireless Features
- Roaming
- Load Balancing
- Auto-Channel Selection



WAP200E

Expand wireless access outside

Key Features:

- PoE – PD power means AP can be powered from a PoE switch
- 1x2 MIMO – better coverage and range
- QoS (WMM, 802.1p), VLANs,
- WPA2, 802.1x
- Multiple BSSIDs; Roaming and Auto-channel selection
- NEMA IP53 Weatherproof housing



WET200

Connect peripherals wirelessly

Key Features:

- PoE – PD power means Bridge can be powered from a PoE switch
- 1x2 MIMO – better coverage and range
- QoS (WMM, 802.1p), VLANs, 802.1x,
- WPA2 security
- Removable antennas



WAP2000

Affordable and feature-rich

Key Features:

- Metal Enclosure
- Dual Images
- Multiple BSSIDs
- Strong QoS – 802.1p/q and WMM
- PoE or External Power
- WPA2, WPA-ENT, WPA-PSK
- Advanced Wireless Features
- Roaming
- Auto-Channel Selection

Cisco IP Video Surveillance

Cost



High Performance

- Wider coverage (pan, tilt, zoom)
- Clear images, even in low light
- Indoor and outdoor environments
- Optimal network integration

Indoor/Outdoor Environments

- Fixed areas of surveillance coverage
- Flexible connectivity and power options
- Indoor and outdoor environments
- Support for custom enclosures

Functionality

Basic Indoor Surveillance

- Just getting started with IP video
- Simple coverage requirements
- Indoor environments
- DIY simplicity

Cisco Small Business IP Video Surveillance Portfolio

Cost



Cisco Small Business



WVC210

\$349 List (Wireless PTZ)



2300 Series

\$443 List (Wired PoE, CCD)



PVC300

\$794 List (Wired PoE, PTZ, 1.6x optical zoom)

Functionality

Warranty, Support Center, Community

Secure

Small Business Video Surveillance Solution



Advanced Video Monitoring Software (AVMS)

NEW

NEW

VC 220 Dome IP Camera



VC 240 Bullet IP Camera

NEW

NEW

SMART Designs

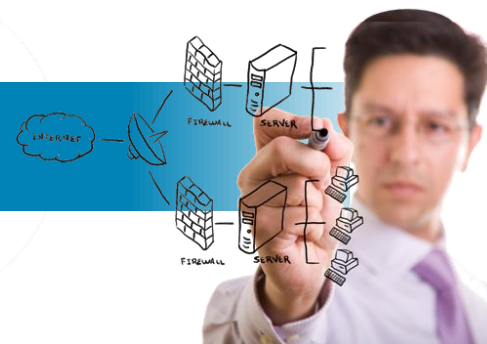

Surveillance Trends

Form Factors

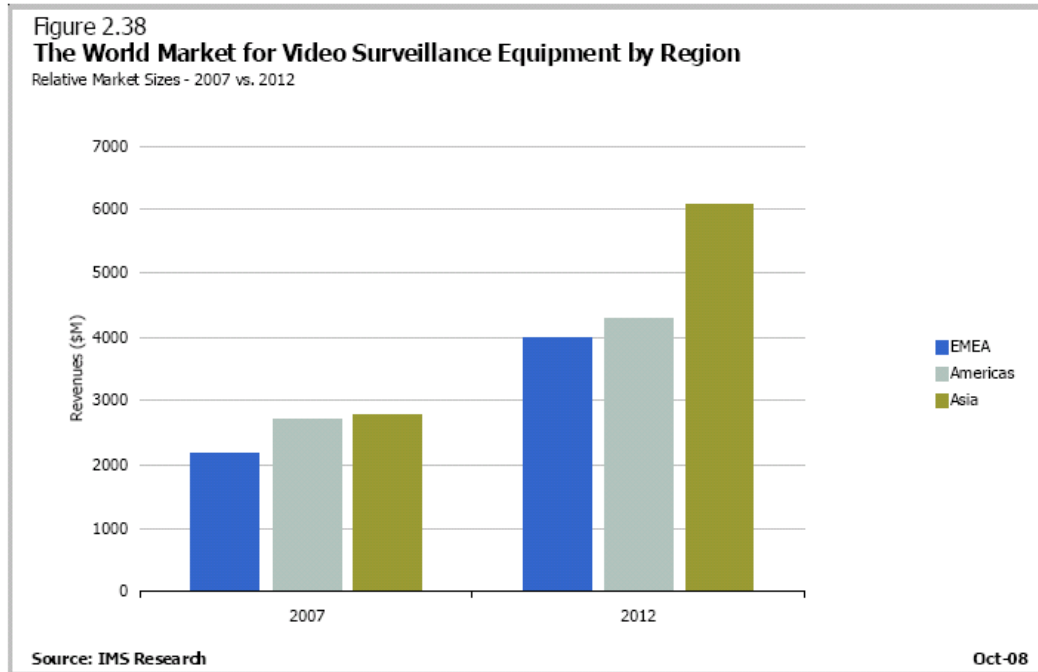
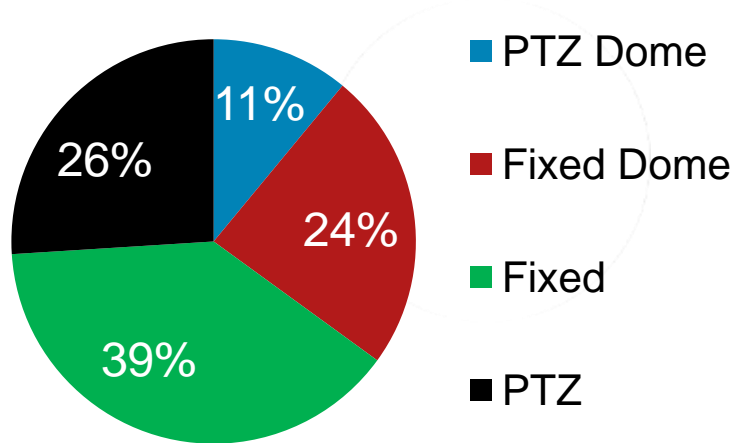

Complete Surveillance Solution

■ Flexible Camera Solutions

- Day / Night
- Indoor / Outdoor
- Pan Tilt Zoom, Optical Zoom
- Wide Dynamic Range Sensors
- Digital Input / Output
- 2-way Audio
- Power Over Ethernet / Wireless
- Replaceable Lenses

■ All-in-One Video Monitoring System

- Free Basic version & 30 day Advanced trial with all cameras
- Basic Plus & Advanced versions
- Scales to 64 camera solutions, 3rd party HW
- Mobile & Remote access solutions
- Counting Application
- Point of Sales integration
- E-Map integration
- Instant Alerts



■ Enclosures, Storage, Lenses

- Zoom, Wide Angle Lens
- Outdoor Enclosures
- Network Attached Storage



IP Surveillance Camera Portfolio



Features	Benefits	WVC210	WVC2300	PVC2300	PVC300	VC220	VC240
802.11g Wireless	Easy wireless setup option	Yes	Yes	No	No	No	No
UPnP AV Server	Easy viewing access via client	No	No	No	No	Yes	Yes
LCD Status	Displays IP address and Status	Yes	No	No	No	No	No
External IO Ports	Option to connect to 3 rd -party systems (i.e. Door access, Alarm Systems etc.)	0/0	2/2	2/2	1/1	1/1	1/1
Interchangeable CS lenses	Compatibility with standard camera lenses	No	Yes	Yes	No	No	NO
Pan Tilt	Viewing control of the lenses	Yes	No	No	Yes	No	No
POE Powered	Convenient setup without the need of dedicated power outlet	No	No	Yes	Yes	Yes	Yes
Optional Enclosures	Availability of compatible enclosure SKUs	No	Yes	Yes	Yes	Yes	No (built-in)
Optical Zoom	Clearer zoom capabilities compared to digital zoom	No	No	No	Yes	Yes	Yes
Day/Night	Night-mode viewing for low-light conditions	No	Yes	Yes	No	Yes	Yes
Image Sensor	Type of sensor (i.e. WDR Wide Dynamic Range & CCD supports better image quality)	1/4" CMOS	1/4" CCD	1/4" CCD	1/4" CCD	1/4" WDR CMOS	1/4" WDR CMOS
List Price		\$349	\$500	\$443	\$794	\$794	\$921

IP Surveillance Solution Components



- IP Video Surveillance Cameras

- PC-Based Monitoring/Recording Software (Video Monitoring Software-VMS)



*Basic VMS for up to 16 cameras bundled for FREE

*Basic Plus & Advanced VMS for up to 64 cameras sold separately



- Storage Solution – NAS (*Optional – for more video storage capacity*)



Basic Plus & Advanced Video Monitoring Software

- 3 tiers of Video Monitoring Software.
 - Basic (included with camera) feature set
 - “Basic Plus” tier includes all of basic features plus remote client access.
 - The “Advanced” tier includes all of the features within the AVMS family.
- All skus branded Cisco Small Business.

		# of Cameras Supports				
SKU “Type”	List Price	4	8	16	32	64
L-VM300-64 “Advanced”	\$11,111	Green	Green	Green	Green	Green
L-VM300-32 “Advanced”	\$7,143	Green	Green	Green	Green	White
L-VM300-16 “Advanced”	\$3,175	Green	Green	Green	White	White
L-VM300-08 “Advanced”	\$1,587	Green	Green	White	White	White
L-VM300-04 “Advanced”	\$1,000	Green	White	White	White	White
L-VM200-32 “Basic Plus”	\$1,587	Yellow	Yellow	Yellow	Yellow	White
SWVMS16 “Basic” (Free)		Blue	Blue	Blue	White	White

Advanced feature set with analytics

Basic Plus Client/Server Remote Access

Basic/Free Feature Set

Versus Axis Camera Station

- Cisco works with 3rd party camera vendors, Axis only supports Axis cameras
- Cisco scales to 64 cameras, Axis only 50
- AVMS supports multi-monitor viewing (vs. single monitor)
- Cisco has 12 viewing formats, Axis only 6
- Video Image Enhancement included with Cisco, Additional license for Axis
- Localized to 22 languages, Axis only 5 languages

Street Prices	Axis Camera One	Cisco Small Business Basic Video Monitoring	Cisco Small Business Basic Plus Video Monitoring	Cisco Small Business Advanced Video Monitoring
1 Camera	Free	Free	N/A	N/A
4 Cameras	\$616	Free	N/A	\$788
8 Cameras	\$1016	Free	N/A	\$1250
16 Cameras	\$1527	Free	N/A	\$2500
32 Cameras	\$3060	No Solution	\$1250	\$5625
64 Cameras	No solution	No Solution	No Solution	\$8750

Small Business Gateway Security

Cost

Specialized Security

- Modular design for optimal flexibility
- Best-in-class security
- Cisco IOS Software, CLI support
- Network-wide support

Higher Performance, Security

- Standalone or part of a system
- Unified Threat Management (UTM)
- Solution level configuration/management
- “Peace of Mind” support

Functionality

Basic Business-Class Security

- Simple, reliable connectivity
- Business-class security and VPN
- Device level configuration/management
- Warranty, simple support

Cisco Small Business Gateway Security Portfolio

Cost



Cisco



ASA 5500 Series; 800, 1900, 2900 Series ISRs

SMARTnet

Cisco Small Business Pro



SR 520-T1



SA 500 Series

Pro Service

Functionality

Cisco Small Business



RVx

WRVx

RV0xx

Warranty, Support Center, Community

Cisco Small Business Security Gateway Solutions

Cisco



ASA & ISR Series

- Specialized security needs
- Advanced networking capabilities
- Highest level of technical support and premium services
- Partners with security specialized staff

Small Business Pro



SA 500 Series and SR 520-T1

- Business with less than 100 employees
- Customer wants all-in-one (UTM) functionality
- Security designed for small business
- Easy configuration and deployment
- Small Business Pro Service
- Enables partners with limited security training

Small Business



RV Series

- For “do it yourself” small business
- Transactional support

Price-Performance

Function, Flexibility, Scalability

Complete Network & Data Security Cisco SA 500 Series



Unified Threat Management (UTM) Security Solution



- Business Grade Firewall
- Email Security
- Web Threat Protection
- URL Filtering
- Site-to-Site and Remote Access VPN
- Secure 802.11n Wireless
- Supports up to 100 Users

Cisco
Small
Business
Pro

Starting at \$550
Small Business Pro Service \$69



Cisco Small Business Security Portfolio

A	Small Business Routers	SR520	SA500 Series	ISR	ASA
Category	Small Business	Small Business Pro	Small Business Pro	Cisco	Cisco
Mgmt	Device GUI	CCA	CCA	CLI	CLI
Where	Single net device	Single net device	Single net device	Single net device	Appliance
FW	Basic SPI	Enhanced SPI	Enhanced SPI	Advanced – IOS SPI/AI	Advanced – IOS SPI/AI
IPS	Limited (RVS4000, WRVS4400N only)	Cisco IOS	Yes	Cisco IPS (ISR870 higher)	AIP-SSM
Content Filter	Trend Micro Gateway OR Desktop (RVS4000, WRVS4400N, RV0xx)	Cisco IOS Content	Trend Micro Gateway & Desktop	Cisco IOS Content	CSC-SSM
VPN	SSL/IPsec (5-100)	SSL/IPsec/DM (10)	SSL/IPsec (100)	SSL/IPsec/Get/DM/V P3 (5-20)	SSL/IPsec/Get/DM (10-750)
VLAN	IPsec (5-100)	IPsec (10)	IPsec (16)	IPsec (5-20)	IPsec (3-150)
Compliance	–	–	–	FIPS, EAL4, EAL4+	FIPS, EAL4, EAL4+
Partner effort	O	>	>	>>	>>
Platforms	RVL2x0, WRV2x0, RVS4000, WRVS4400N, RV0xx	SR520	SA520, SA520W, SA540	ISR 800, 1800, 2800 series	ASA 5505, 5510, 5520

Cisco SMB

Cisco SA500 Series

Cisco Small
Business Pro



All-in-One (UTM)
Security for Small
Business

Model Number	Cisco® SA 520	Cisco® SA 520W	Cisco® SA 540
Firewall Performance	200 Mbps	200 Mbps	300 Mbps
VPN Performance	65 Mbps \$550	65 Mbps \$700	85 Mbps \$850
Connections	15,000	15,000	40,000
LAN Ports	4	4	8
WAN Ports	1	1	1
Optional Ports (for LAN, DMZ, or WAN load balanced or redundancy)	1	1	1
Wireless (802.11 b/g/n)	-	YES	-
IPsec VPN Tunnels	50 max.	50 max.	100 max.
SSL VPN Tunnels	2 seats included; license required to upgrade to 25 seats (maximum).		50 seats (max.) included
Email and Web Security (via Subscription)	Trend Micro ProtectLink Gateway with more than 3 million virus patterns, 420,000+ spyware patterns, and 80+ URL filtering categories.		

Cisco ProtectLink Solutions

Licensed
Feature

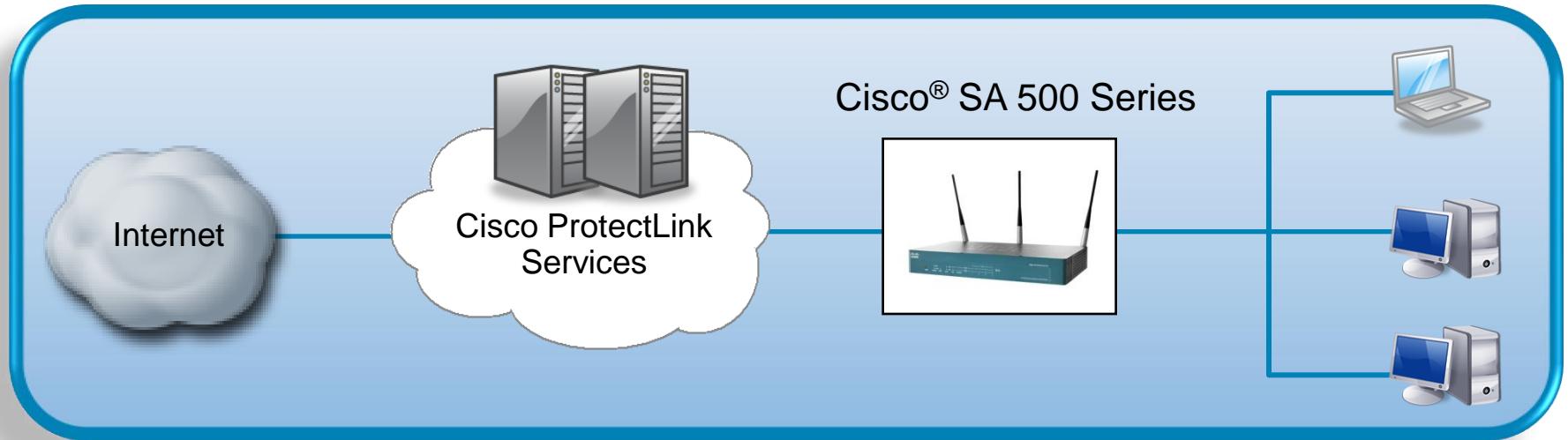

- **Cisco ProtectLink Solutions:**

- **Web:** Web threat protection and URL filtering
- **Gateway:** Email security, web threat protection, and URL filtering.
- **Endpoint:** antivirus, POP email spam filtering, and web threat protection for Windows systems with policy enforcement at gateway.
- **Install at Any Time:** Functionality is enabled via a license key that can be easily added at a later date without additional hardware installation.
- **Annual Subscription-Based Offering:** Provides a recurring revenue opportunity for partners since customers renew their subscriptions annually.

Cisco ProtectLink Endpoint

Licensed
Feature

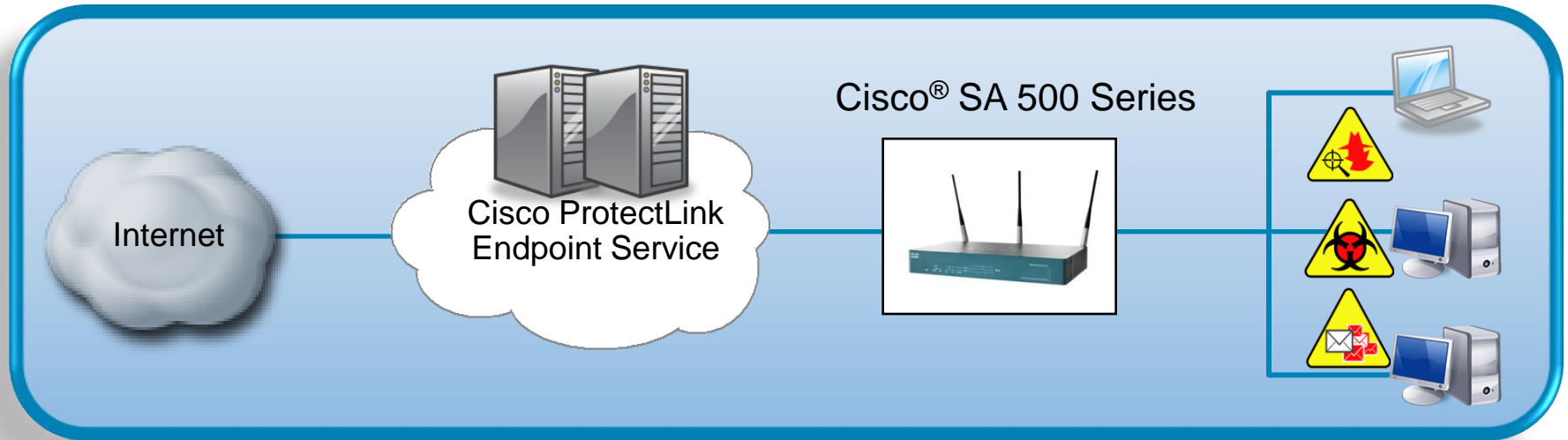

- **Local Layered Protection:** Protection in and out of the office against viruses, POP email spam, and web threats for Windows PCs and servers with policy enforcement by the SA 500.
- **Easy to deploy and manage:** One time cloud activation for entire network and download of each endpoint client. Ongoing automatic updates mean minimal administration. Real-time status reports help management.
- **Annual subscription-based offering:** Provides a recurring revenue opportunity for partners because customers renew their subscriptions annually

Cisco Small Business Pro SA 500

Feature License SKUs

Part Number	Description	List Price
L-SA500-IPS-1YR=	IPS license for SA 500 devices 1 year	\$150
L-PL-WEB-1=	ProtectLink Unlimited Web Threat + URL Filtering 1 year	\$160
L-PL-GW-25MAX-1=	ProtectLink Gateway Unlimited Web + 25 Max Email Seats 1 year	\$400
L-PL-GW-100MAX-1=	ProtectLink Gateway Unlimited Web + 100 Max Email Seats 1 year	\$750
L-PLEP-5=	ProtectLink Endpoint Incremental 5-seat license 1 year	\$185
L-PLEP-25=	ProtectLink Endpoint Incremental 25-seat license 1 year	\$770
VeriSign VIP	VIP, which provides two factor authentication for SSL VPN, can be purchased directly from VeriSign. Please see www.cisco.com/go/viptoken for details.	

Part Number	Description	List Price
L-SA500-IPS-3YR	IPS license for SA 500 devices 3 year	\$240
L-PL-WEB-3=	ProtectLink Unlimited Web Threat + URL Filtering 3 year	\$250
L-PL-GW-25MAX-3=	ProtectLink Gateway Unlimited Web + 25 Max Email Seats 3 year	\$650
L-PL-GW-100MAX-3=	ProtectLink Gateway Unlimited Web + 100 Max Email Seats 3 year	\$1200
L-PLEP-5-3YR=	ProtectLink Endpoint 5-seat Incremental 3 year	\$300
L-PLEP-25-3YR=	ProtectLink Endpoint 25-seat Incremental 3 year	\$1250

3 year skus provide up to a 46% discount compared to 3 times annual license purchase

Cisco Small Business Pro SA 500

Hardware + License Bundles

Part Number	Description	List Price
SA520-WEB-BUN3-K9	SA520 with 3 year IPS and ProtectLink Web License	\$850
SA520-GW25-BUN3-K9	SA520 with 3 year IPS and ProtectLink Gateway 25 License	\$1,300
SA520-GW100BUN3-K9	SA520 with 3 year IPS and ProtectLink Gateway 100 License	\$1,950
SA520W-WEB-BUN3-K9	SA520W with 3 year IPS and ProtectLink Web License	\$1,000
SA520W-GW25BUN3-K9	SA520W with 3 year IPS and ProtectLink Gateway 25 License	\$1,450
SA520W-GW100BN3-K9	SA520W with 3 year IPS and ProtectLink Gateway 100 License	\$2,100
SA540-WEB-BUN3-K9	SA540 with 3 year IPS and ProtectLink Web License	\$1,150
SA540-GW25-BUN3-K9	SA540 with 3 year IPS and ProtectLink Gateway 25 License	\$1,600
SA540-GW100BUN3-K9	SA540 with 3 year IPS and ProtectLink Gateway 100 License	\$2,250

3 year bundles provide up to a 40% discount compared to 3 years of annual license purchase

Small Business Network Storage

Cost

High-Performance Data Protection

- Built for small business
- Performance, affordability, ease of use
- Built-in and add-on applications
- “Peace of Mind” support

Functionality

Cisco Small Business Network Storage Portfolio

Cost



Cisco Small Business



NSS 300 Series Smart Storage

Pro Service, Warranty, Support Center, Community

Functionality



Smart Storage Models

List Price: \$ 900-5,600

- NSS 300 Series Smart Storage consists of three chassis
 - 2-Bay Desktop
 - 4-Bay Desktop
 - 6-Bay Desktop



- NSS 300 Series Smart Storage Hard Drive Configurations
 - Fully Populated with 2TB Drives
 - Fully Populated with 1TB Drives
 - No Drives

Cisco Smart Storage

Mini Server for Small Businesses

Storage & Data Appliance (300 Series)



- Multipurpose Storage & Application devices
- Secure, Reliable, Scalable storage solutions for any environment
- Applications capable



File Server



Backup Server



Web Server



MySQL Server



Remote Replication



Download Station



Multimedia Station



FTP Server



UPnP Media Server (with built-in TwonkyMedia Server)



iTunes Server

Supports Add-On PKG applications:



Smart Storage Solution Bill of Material

Table 1. Smart Storage Hardware Options





Model	SKU	Description
Cisco NSS 322 	NSS322D00-K9 \$913	2-Bay Smart Storage – Hard Drive not included
	NSS322D02-K9 \$1,492	2-Bay Smart Storage – With two 1 TB Hard Drives (2 TB)
	NSS322D04-K9 \$1,822	2-Bay Smart Storage – With two 2 TB Hard Drives (4 TB)
Cisco NSS 324 	NSS324D00-K9 \$1,365	4-Bay Smart Storage – Hard Drive not included
	NSS324D04-K9 \$2,373	4-Bay Smart Storage – With four 1 TB Hard Drives (4 TB)
	NSS324D08-K9 \$3,740	4-Bay Smart Storage – With four 2 TB Hard Drives (8 TB)
Cisco NSS 326 	NSS326D00-K9 \$1,825	6-Bay Smart Storage – Hard Drive not included
	NSS326D06-K9 \$4,873	6-Bay Smart Storage – With six 1 TB Hard Drives (6 TB)
	NSS326D12-K9 \$5,625	6-Bay Smart Storage – With six 2 TB Hard Drives (12 TB)

Table 2. Accessories

Model	SKU	Description
Cisco NSS 300 Series Smart Storage 	HDT020	Hard Drive Tray
	HDT021	Hard Drive Tray with 1 TB Hard Drive
	HDT022	Hard Drive Tray with 2 TB Hard Drive
	NSS030	External Power Adapter for NSS 322 Smart Storage

Small Business Unified Communications

Cost



Router-based Solution

- Enterprise branch office solution
- Scales to 350 users
- Cisco IOS Software, CLI support
- Network-wide support

Complete Communications Platform

- Built for small business
- Scales to 100 users
- Vertical market applications
- “Peace of Mind” support

Functionality



Cisco Small Business Unified Communications Solutions

Cost



Cisco



Cisco Unified Communications Manager Express
SMARTnet

Cisco Small Business/Pro





Cisco Smart Business Communications System
Pro Service

Functionality



Cisco Small Business VoIP solutions

	Analog Telephone Adapters and Gateways	UC320 Voice System <i>(FCS Q1CY11)</i>	SPA IP Phones
Business Size	Up to 8 users	Up to 24 users	1- n (Hosted)
Integrated Services	Voice and Basic call control (end point) <i>VoIP Lines</i>	Voice, Business Call control, Voicemail, AA <i>Basic IP PBX PSTN, ISDN</i>	Voice, Basic and Business Call Control (end point) <i>VoIP Lines IP Centrex endpoint</i>
Call Control	SPA VoIP (SIP)	SPA VoIP (SIP)	SPA VoIP (SIP)
Platform	 <p>SPA ATAs (SPA, PAP, WRP)</p>	 <p>UC320</p>	 <p>SPA IP Phones (SPA900 Series)</p>

UC320 – Target customer profile

- SOHO/SB: 1 – 24 users (sweet spot 4 - 16 users)
- With basic telephony requirements, KTS or PBX
 - Greenfield or KTS replacement, many Y2K
- May require voicemail, hunt group or auto attendant
- Can benefit from integrated data capabilities
- ***Key purchase considerations are reliability, service and price***



“I see the UC320 as a great product and perfect for the average small to medium business type.”

Frank Lofreso – Multi-Tech Solutions Corp. Market Test September 2010

Cisco UC320 Premise Deployment 12 Users

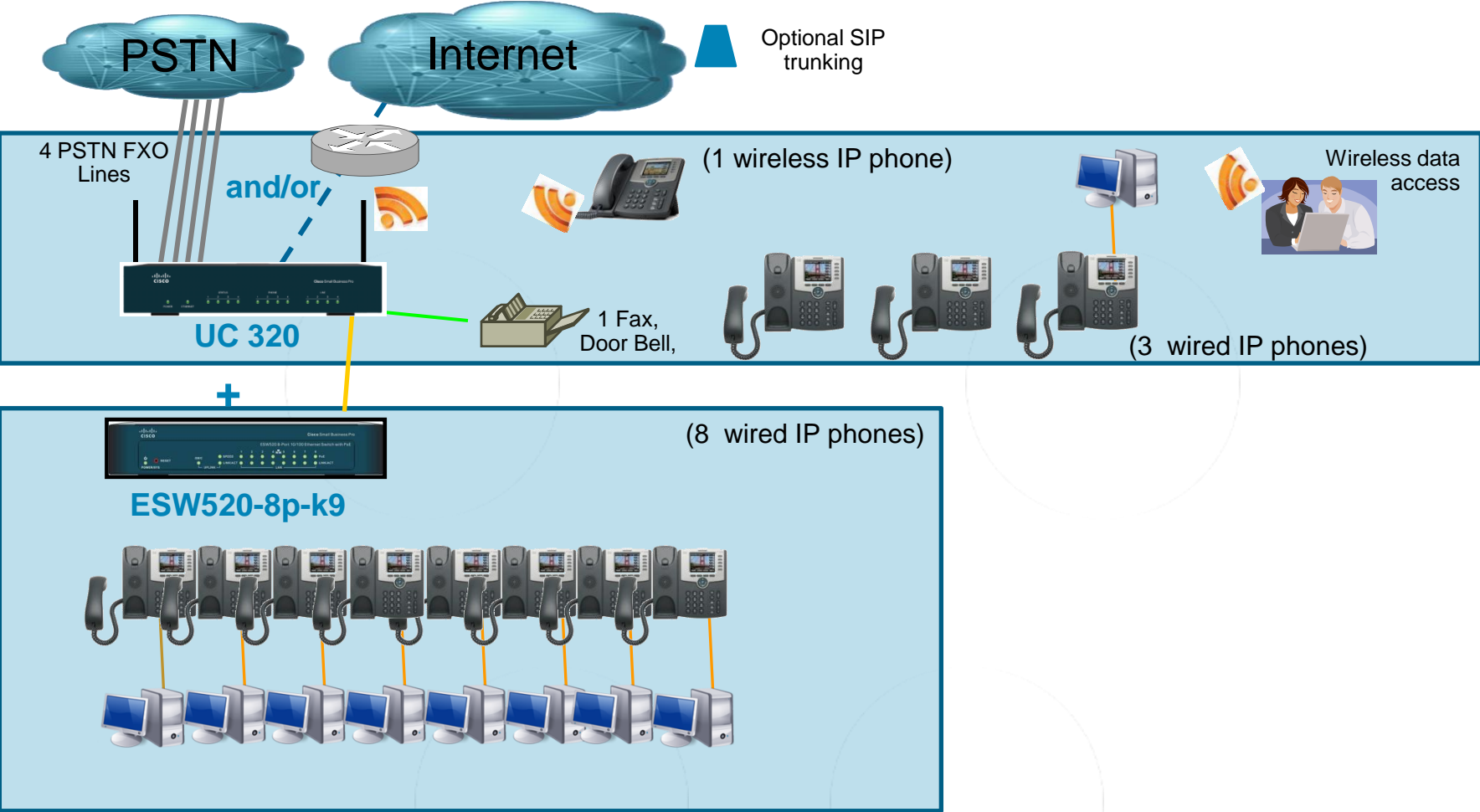

- Notes:
- Possible to add more wireless IP Phones e.g. SPA525G (max. Of 4 phones)

Cisco UC320 Overview

Wireless B/G/N Access Point

Wireless Voice LAN

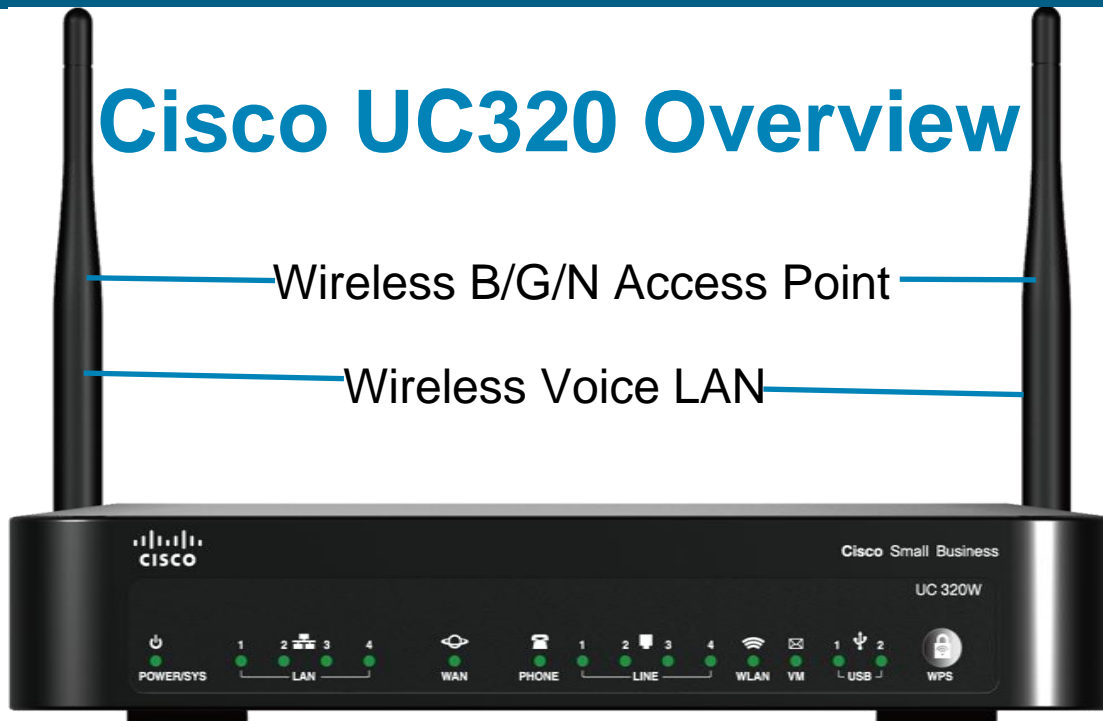

- Up to 24 users
- Up to 12 PSTN, via SPA 8800
 - Up to 4 SIP accounts/trunks
 - Lifeline (FXS – FXO failover)
 - Local 911 even with SIP
- 2 USB ports
- Support for SPA300 and SPA500 wired and wireless phones

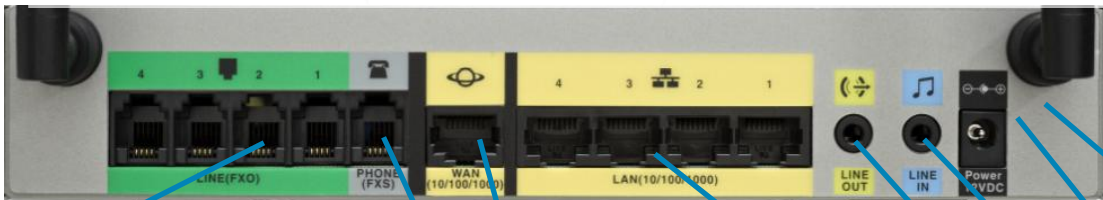

4 FXO/Line ports
(universal config)

1 FXS port for Phone/fax

Up to 1 Gb WAN Ethernet

Internal Voicemail, 12h capacity

Integrated Auto-attendant

Music on Hold

Paging out

4 Gb LAN ports

Communicate

Complete Small Business IP Phone Portfolio



SPA 301 and SPA 303



- No display / display
- Limited feature set
- Replace SPA 901, 921, and 941
- List \$83 / \$125

SPA 501



Paper label
Buttons on phone: 8
List \$135

SPA 502 and SPA 504



Buttons on phone:
▪ SPA 502/504: 0/4
▪ List \$164 / \$189

SPA 508 and SPA 509



Buttons on phone:
▪ SPA 508: 8
▪ SPA 509: 12
▪ List \$225 / \$240

SPA 525G2



Buttons on Phone: 5
▪ Wi-Fi
▪ Mobile Link (Bluetooth)
▪ Screen saver
▪ MP3 music player
▪ List \$430

Dynamic Soft Keys and Monochrome Backlit Display

HD voice (wideband audio) available across the SPA IP Phone portfolio

Entry Level Phones	Retail Desk or Break Room	Office Employee	Administrator and Manager	Executive or Remote Worker
--------------------	---------------------------	-----------------	---------------------------	----------------------------

SPA 500S



- Sidecar for SPA 500 Series phones
- 32 programmable keys
- No display (paper)
- Up to 2 supported per SPA 500 phone
- Powered by IP phone
- \$95

Cisco SPA 303 and SPA 500 Series Comparison

Feature	SPA 303	SPA 500
Backlit LCD	N	Y
Line keys/programmable buttons	3	0 / 4 / 5 / 8 / 12
Integrated PoE	N	Y
Enhanced/premium acoustics	N	Y
Expansion module support	N	Y
5V/2A power adapter included	Y	N
10/100 BASE-T switched Ethernet port for PC	Y	Y
Cisco list price	\$125	\$189 SPA 504G price

The Cisco SPA 301 has a list price of \$83 and supports the same features as the Linksys-branded SPA 901

Cisco Small Business

VoIP ATA / IAD / Gateways



Cisco SPA 8000
8 FXS ports



Cisco SPA 8800
4 FXO ports
4 FXS ports



Cisco PAP2T
2 FXS ports



Cisco SPA 2102
2 FXS
Internet router



Cisco SPA 3102
1 FXS
1 FXO
Internet router



FXS ports support

- Full phone system features from analog phone
- Independent telephone numbers per port

- Cisco Small Business Series
- Cisco Small Business Pro Series

Pre-Sales and Support

Cisco Smart Designs @ Partner Central

- Best-practice designs
- Simplifies partner deployment
- Role-based for different partner functions

Support:

Cisco Small Business Support Community



Useful Resources

- Small Business Partner Central for SPs
 - http://www.cisco.com/web/partners/sell/smb/service_provider.html
- Small Business SP RTM Best Practices
 - <https://cisco.webex.com/ciscosales/lsr.php?AT=pb&SP=MC&rID=46854347&rKey=09b24eb7c38cb8a9>
- Cisco Smart Designs
 - <http://www.cisco.com/go/smartdesigns/SBCS>
- Managed Service Creation
 - http://www.in.cisco.com/sp/campaigns/managed/smb_envision_sub.shtml
- Quick Pricing Tool
 - <http://www.cisco.com/web/partners/sell/enablement/quickpricingtool.html>

Contacts

Areas	Contact	Email
Sales	Willy Yapit or the Cisco AM covering your Account	wyapit@cisco.com
Technical Pre-Sales	Eugene Antonio	eantonio@cisco.com

