





EVERYTHING ABOUT THE KITCHEN

Automatic juicer	52
Bag sealer	57
Bar mixer / milk frother	51
Beer dispenser	53
Bread maker	65
Built-in microwaves with grill	84
Chocolate fountain	33
Citrus juicer	52
Coffee grinder	13
Coffee machines	8
Contact grills	68
Cotton candy maker	32
Crêpe maker	25
Donut maker	25
Egg boiler	33
Electric knife	36
Electric lunchbox	57
Espresso machine	12
Food dryer	55
Food processor	48
Food slicer	35
Fondue deep fat pan	58
Fondue set	71
Fryers	58
Hamburger grill	28
Hand blender	37
Hand blender set	38
Hand mixer	40
Hand mixer sets	41
Hot dog maker	68
Hotplates	87
Ice cream cone maker	24
Ice cream maker	29
Ice cube maker	31
Induction hot plates	89
Kitchen scales	54
Kneading machines	42
Microwaves	82
Milk frother	13
Mincer	49
Mini oven	80
Muffin maker	26
Multi chopper	40
Multi express	39
Multi grill	28
Multi oven	81
Multi pizza oven	80



Party pans	69
Pepper/salt mill	34
Popcorn maker	32
Preserving boiler	87
Raclette grills	72
Rice cooker	64
Sandwich toaster	26
Smoothie maker	51
Steamer	67
Tea and water kettle	14
Toaster	19
Universal mixer	50
Waffle maker	22
Yoghurt maker	31

TEXTIL CARE

Fabric steamer	99
Shirts/blouses and pants ironer	98
Shoe polishing machines	100
Steam brush	90
Steam ironing station	97
Steam irons	91
Textile cleaner	116
Travelling steam iron / steam brush	90

FLOOR CARE

Battery- & floor vacuum cleaner	107
Battery vacuum cleaner	105
Hand vacuum cleaner	106
Shampoo vacuum cleaner	115
Steam cleaner	102
Steam mop	104
Wet and dry vacuum cleaner	114

PERSONAL CARE

Alcohol tester	117
Bathroom scales	117
Facial sauna	119
Foot massager	118
Hair and beard trimmer	121
Hair crimper	122
Hair dryer	123
Hair straightener	122
Hot air curling brush	123
Nose and ear hair remover	120



INDOOR CLIMATE COOL / HEAT

Air conditioning units	130
Air cooler	129
Convactor heaters	140
Cool bag	133
Cool boxes	134
Electric fireplaces	144
Fan heaters	136
Insect killer	126
Oil radiators	141
Standing fans	127
Table fans	126
Tower fan	128

SEASONAL PRODUCTS

Barbecue standing grill	77
Barbecue table grills	77
Doner vertikall multigrill	79
Electric beef grill	76
Electric charcoal lighter	75
Gas grill	78



CLATRONIC[®]

In special issue of "Focus" the brand "Clatronic" was certified with the german test signet "Germanys best household electronics".

There were investigated 20.000 brands from 274 product segments, based on 107 million statements from online media and social media.

More informations: www.deutschlandtest.de

DEUTSCHLAND
TEST

**DEUTSCHLANDS
BESTE**

HAUSHALTSELEKTROGERÄTE

 **CLATRONIC®**

VERBRAUCHERBEWERTUNGEN
ZU 20 000 MARKEN

www.deutschlandtest.de

FOCUS  **MONEY**



Kettle WK 3445



- Max. capacity 1.7 litres
- Simple handling due to cable-free technology – easy to pour in and out
- Safety hinged lid with one-hand operation
- Lime filter (removable)
- On/off switch (illuminated)
- Stainless steel heating element
- Automatic and manual switch-off
- 2 external water level indicators
- Rubber soft touch handle
- Base station with cord storage
- Evaporation/overheating protection
- 220–240 V, 50 Hz, 1850–2200 W

Toaster TA 3565



- Compact 2-slice toaster
- Cool touch housing
- Bread roll attachment (integrated)
- Defrost/reheat/quick-stop function
- Continuously adjustable thermostat
- 2 indicator lights
- Automatic and manual switch-off
- Crumb drawer
- Base station with cord storage
- 220–240 V, 50/60 Hz, 600–700 W



Coffee machine KA 3473



- For 12–14 cups of coffee (approx. 1.5 litres)
- Anti-drip protection
- Filter holder (removable)
- On/off switch with indicator light
- Water level indicator
- Heating plate with automatic switch-off
- Cord storage
- 230 V, 50 Hz, 900 W

Sandwich toaster ST 3477



- Triangular sandwich plates
- Non-stick coating
- Heat-insulated handle
- Automatic temperature controller
- 2 indicator lights for power and heating (baking lights)
- Locking system
- Safety shutdown
- Overheating protection
- 220–240 V, 50/60 Hz, 750 W



1 cup coffee machine
KA 3356



1 cup coffee machine
KA 3733



8

- 1 cup coffee machine for filter coffee
 - Space-saving design (ideal when out and about)
 - Incl. ceramic cup
 - Permanent nylon filter (removable)
 - On/off switch with indicator light
 - Automatic switch-off
 - Non-slip tray (removable)
- 220–240 V, 50 Hz, 270–330 W
■ W x H x D approx. 130 x 175 x 155 mm

- 1 cup coffee machine for filter coffee in a high-quality stainless steel design
 - Coffee to go – simple, fast and fresh, with the familiar taste of an aromatic filter coffee
 - Incl. double-walled stainless steel thermo cup and aroma cap with drinking spout (400 ml capacity)
 - Compact, space-efficient and environmentally friendly – brew coffee directly into the stainless steel cup and reuse it (reduction of plastic and paper cups)
 - Rubberized „Soft touch“-coating on the stainless steel cup
 - Permanent nylon filter (removable)
 - On/off switch with indicator light
 - Automatic switch-off
 - Stainless steel cup suitable for all common cup holders (e.g. in the car)
- 220–240 V, 50/60 Hz, 650–750 W
■ W x H x D approx. 138 x 275 x 175 mm



Incl. double-walled stainless steel thermo cup



Stainless steel cup suitable for all common cup holders (e.g. in the car)

● Art. no. 263 155
EAN 4 006 160 631 555 PU 6



4 006 160 631 555

● Art. no. 263 881
EAN 4 006 160 638 813 PU 4



4 006 160 638 813



Coffee machine
KA 3473

Coffee machine
KA 3473

- For 12–14 cups of coffee approx. 1.5 litres)
- Anti-drip protection
- Filter holder (removable)
- On/off switch with indicator light
- Heating plate with automatic switch-off
- Water level indicator
- Cord storage

- 230 V, 50 Hz, 900 W
- W x H x D approx. 190 x 330 x 205 mm

- For 12–14 cups of coffee (approx. 1.5 litres)
- Anti-drip protection
- Filter holder (removable)
- On/off switch with indicator light
- Heating plate with automatic switch-off
- Water level indicator
- Cord storage

- 230 V, 50 Hz, 900 W
- W x H x D approx. 190 x 330 x 205 mm



Can also be combined as a suitable set

● **Art. no. 263 589**
 EAN 4 006 160 635 898 PU 6
 ● **Art. no. 263 591**
 EAN 4 006 160 635 911 PU 6



● **Art. no. 263 933**
 EAN 4 006 160 639 339 PU 6





10

Coffee machine
KA 3562



- For 12–14 cups of coffee (approx. 1.5 litres)
- High-quality stainless steel application
- Anti-drip protection
- Filter holder (removable)
- On/off switch with indicator light (blue illuminated)
- Heating plate with automatic switch-off
- Water level indicator

- 220–240 V, 50/60 Hz, 900 W
- W x H x D approx. 180 x 325 x 260 cm

Coffee machine
KA 3642



- For 12–14 cups of coffee (approx. 1.5 litres)
- Stainless steel front
- Programmable 24 hour LCD digital timer
- Anti-drip protection
- Filter holder (removable)
- 2 indicator lights
- 4 control buttons
- Heating plate with automatic switch-off
- Water level indicator

- 220–240 V, 50/60 Hz, 900 W
- W x H x D approx. 180 x 310 x 220 mm



Programmable 24 hour LCD digital timer

● Art. no. 263 649
EAN 4 006 160 636 499 PU 4



● Art. no. 263 337
EAN 4 006 160 633 375 PU 4





Thermo coffee machine
KA 3327



- For 8–10 cups of coffee (approx. 1 litre)
- Thermo jug (double-walled)
- Anti-drip protection
- Filter holder (removable)
- On/off switch with indicator light
- Automatic switch-off
- Water level indicator

- 220–240 V, 50/60 Hz, 870 W max.
- W x H x D approx. 185 x 340 x 210 mm

Thermo coffee machine
KA 3328



- 2 thermo jugs (double-walled) for 8–10 cups of coffee each (2x 1 litre)
- Anti-drip protection
- Filter holder (removable)
- On/off switch with indicator light
- Automatic switch-off
- Water level indicator

- 220–240 V, 50/60 Hz, 870 W max.
- W x H x D approx. 185 x 340 x 210 mm

Art. no. 263 127
EAN 4 006 160 631 272 PU 6



Art. no. 263 126
EAN 4 006 160 631 265 PU 4





Thermo coffee machine
KA 3756

- For 8–10 cups of coffee (approx. 1.2 litres)
- Stainless steel thermo jug (double-walled) with flavour seal – no temperature loss
- Stainless steel front
- Anti-drip protection
- Filter holder (removable)
- On/off switch with indicator light
- Automatic switch-off
- Water level indicator

- 220–240 V, 50/60 Hz, 800 W
- W x H x D approx. 226 x 327 x 183 mm



Double-walled stainless steel thermo jug with flavour seal – no temperature loss



Espresso machine
ES 3643

- Espresso and cappuccino pump machine
- Stainless steel front
- Constant pump pressure of up to 15 bar
- Swivelling stainless steel steam nozzle with foaming and hot water function
- Steam quantity continuously adjustable
- Steam nozzle tip removable for easy cleaning
- Cup warming function with stainless steel insert
- 1.6 litres transparent water tank (removable)
- External water level indicator
- Collection cup with stainless steel drip grid (removable)
- 2 indicator lights
- Automatic switch-off
- Operational readiness indication
- Accessories: 2 filter holders (1 and 2 cups), coffee measure, tamper

- 220–240 V, 50 Hz, 850 W
- W x H x D approx. 250 x 295 x 280 mm



Cup warming function



Swivelling stainless steel steam nozzle with foaming and hot water function





Stainless steel housing

Cold and warm foaming function

Electric coffee grinder KSW 3307



Electric coffee grinder KSW 3306



Milk frother MS 3693



- Electric coffee grinder with beater
 - Stainless steel housing
 - Stainless steel beater blade
 - Stainless steel bean container (aroma protection and hygienic)
 - Transparent lid
 - Capacity for approx. 40 g beans (20 cups of coffee)
 - Powerful 120 watt motor
 - Safety circuit – operation only possible with lid in place
 - Safety pushbutton also for pulsed operation
 - Degree of grinding can be selected by the length of operation
 - Cord storage
- 220–240 V, 50–60 Hz, 120 W
- W x H x D approx. 100 x 200 x 100 mm

- Electric coffee grinder with beater
 - Stainless steel beater blade
 - Stainless steel bean container (aroma protection and hygienic)
 - Transparent lid
 - Capacity for approx. 40 g beans (20 cups of coffee)
 - Powerful 120 watt motor
 - Safety circuit – operation only possible with lid in place
 - Safety pushbutton also for pulsed operation
 - Degree of grinding can be selected by the length of operation
 - Cord storage
- 220–240 V, 50–60 Hz, 120 W
- W x H x D approx. 100 x 200 x 100 mm

- Integrated heating function
 - Creates foamy milk in seconds
 - Also suitable for hot and cold chocolate
 - Container non-stick coated (approx. 550 ml)
 - Milk foam quantity: approx. 300 ml
 - Electronic – Multi function switch (illuminated):
 - Frothing the milk warm
 - Frothing the milk cold – ideal for iced coffee
 - Heating the milk
 - Concealed heating element
 - Automatic switch-off
 - Incl. lid with splash guard function
 - Additional stirrer for hot drinks without frothing (e.g. cocoa)
 - Lid removable for easy cleaning
- 220–240 V, 50/60 Hz, 500 W
- W x H x D approx. 160 x 175 x 113 mm

Art. no. 283 024
EAN 4 006 160 830 248 PU 6



Art. no. 283 023
EAN 4 006 160 830 231 PU 6

Art. no. 283 032
EAN 4 006 160 830 323 PU 6



Art. no. 263 832
EAN 4 006 160 638 325 PU 4





Cold and warm foaming function

Milk frother MS 3326



Milk frother MS 3089



Cordless

Tea maker TK 3715



- Integrated heating function
- Creates foamy milk in seconds
- Also suitable for hot and cold chocolate
- Mixing container (750 ml)
- Non-stick coated (inside/outside)
- Milk foam quantity: approx. 500 ml
- Electronic – 3 function switches:
 - Frothing the milk warm
 - Frothing the milk cold – ideal for iced coffee
 - Heating the milk
- Concealed heating element
- Automatic switch-off
- Incl. lid with splash guard function
- Mixing container and lid removable for easy cleaning
- 230–240 V, 50 Hz, 600–650 W
- W x H x D approx. 180 x 173 x 165 mm

- Creates foamy milk in seconds
- Soft touch housing
- Stainless steel whisk
- Easy to clean
- Battery operation: 2x 1,5 V (AA/UM3) (batteries not included)
- W x H x D approx. 47 x 225 x 32 mm

- Cordless tea maker with percolator tea-brewing system
- Perfect tea enjoyment with traditional tea making
- For 8–10 cups of tea (approx. 1 litre)
- Simple handling due to cable-free technology – easy to pour in and out
- Thanks to the noble design suitable as a serving jug
- 360° connector allows convenient operation for right and left handers
- Permanent stainless steel tea filter (removable)
- On/off switch
- Indicator light
- BPA free
- Concealed stainless steel heating element
- Base station with cord storage
- Evaporation/overheating protection
- 220–240 V, 50/60 Hz, 600–720 W
- W x H x D approx. 190 x 225 x 150 mm



Permanent stainless steel tea filter (removable)



Percolator tea-brewing system

Art. no. 263 125
EAN 4 006 160 631 258 PU 4



4 006 160 631 258

Art. no. 262 161
EAN 4 006 160 621 617 PU 20

Art. no. 263 917
EAN 4 006 160 639 179 PU 20

Art. no. 263 918
EAN 4 006 160 639 186 PU 20

Art. no. 263 919
EAN 4 006 160 639 193 PU 20



4 006 160 621 617

Art. no. 263 889
EAN 4 006 160 638 899 PU 4



4 006 160 638 899



Stainless steel



Travel kettle
WKR 3624



Kettle
WK 3462



- Ideal when travelling and on the move
- Capacity up to 0.5 litre
- Stainless steel housing
- Incl. 2 cups each 170 ml, transport / travel bag and coffee spoon
- On/off switch
- BPA free
- Concealed stainless steel heating element
- Indicator light
- Automatic switch-off
- Evaporation/overheating protection

- 120/230 V, 50/60 Hz, 1000 W
- W x H x D approx. 160 x 170 x 105 mm

- Compact kettle, also ideal for travel and single households
- Capacity up to 1.0 litre
- Simple handling due to cable-free technology – easy to pour in and out
- Safety hinged lid with one-hand operation
- Lime filter (removable)
- On/off switch (illuminated)
- Stainless steel heating element
- Automatic and manual switch-off
- 2 external water level indicators
- Non-slip soft touch handle
- Incl. base station
- Evaporation/overheating protection

- 220–240 V, 50 Hz, 750–900 W
- W x H x D approx. 185 x 220 x 115 mm



Incl. transport / travel bag



Incl. 2 cups à 170 ml and coffee spoon



Compact kettle, also ideal for travel and single households

Art. no. 263 729
EAN 4 006 160 637 298 PU 6



Art. no. 263 229
EAN 4 006 160 632 767 PU 6
Art. no. 263 342
EAN 4 006 160 633 429 PU 6





Kettle
WK 3445



Kettle
WK 3452



16

- Capacity up to 1.7 litres
 - Simple handling due to cable-free technology – easy to pour in and out
 - Safety hinged lid with one-hand operation
 - Lime filter (removable)
 - On/off switch (illuminated)
 - Stainless steel heating element
 - Automatic and manual switch-off
 - 2 external water level indicators
 - Non-slip soft touch handle
 - Base station with cord storage
 - Evaporation/overheating protection
- 220–240 V, 50 Hz, 1850–2200 W
 - W x H x D approx. 220 x 255 x 140 mm

- Capacity up to 1.8 litres
 - Simple handling due to cable-free technology – easy to pour in and out
 - 360° connector
 - Lockable safety hinged lid with one-hand operation
 - Lime filter (removable)
 - On/off switch (illuminated)
 - Concealed stainless steel heating element
 - Automatic and manual switch-off
 - 2 external water level indicators
 - Base station with cord storage
 - Overheating protection
- 220–240 V, 50 Hz, 1850–2200 W
 - W x H x D approx. 225 x 255 x 150 mm



Can also be combined as a suitable set

- Art. no. 263 210
EAN 4 006 160 632 101 PU 6
- Art. no. 263 932
EAN 4 006 160 639 322 PU 6
- Art. no. 263 212
EAN 4 006 160 632 125 PU 6



4 006 160 632 101

- Art. no. 263 217
EAN 4 006 160 632 170 PU 6
- Art. no. 263 227
EAN 4 006 160 632 279 PU 6



4 006 160 632 170



Stainless steel

Kettle
WKS 3766

Kettle
WKS 3692



- Capacity up to 1.7 litres
- Stainless steel housing
- Simple handling due to cable-free technology – easy to pour in and out
- 360° connector
- Safety hinged lid with one-hand operation
- On/off switch (blue illuminated)
- BPA free
- Concealed stainless steel heating element
- Automatic and manual switch-off
- Base station with cord storage
- Evaporation/overheating protection

- 220–240 V, 50 Hz, 1850–2200 W
- WxHxD approx. 220 x 242 x 140 mm

- Capacity up to 1.5 litres
- Stainless steel housing
- Simple handling due to cable-free technology – easy to pour in and out
- 360° connector
- Safety hinged lid with one-hand operation
- On/off switch (blue illuminated)
- BPA free
- Concealed stainless steel heating element
- Automatic and manual switch-off
- Base station with cord storage
- Evaporation/overheating protection

- 220–240 V, 50 Hz, 1850–2200 W
- WxHxD approx. 230 x 233 x 142 mm

Art. no. 263 959
EAN 4 006 160 639 599 PU 6



Art. no. 263 849
EAN 4 006 160 638 493 PU 6
Art. no. 263 833
EAN 4 006 160 638 332 PU 6





Stainless steel



Kettle
WKS 3288

- Capacity up to 1.7 litres
 - Stainless steel thermo housing
 - Simple handling due to cable-free technology – easy to pour in and out
 - 360° connector
 - Lockable safety hinged lid
 - Lime filter (removable and washable)
 - On/off switch
 - BPA free
 - Indicator light (blue illuminated)
 - Concealed stainless steel heating element
 - Automatic and manual switch-off
 - 2 external water level indicators
 - Base station with cord storage (stainless steel sheathed)
 - Evaporation/overheating protection
- 220–240 V, 50 Hz, 1850–2200 W
■ W x H x D approx. 220 x 250 x 145 mm



Glass kettle
WKS 3744 G



- Capacity up to 1.7 litres
 - Glass/stainless steel housing
 - Water container made of heat-resistant safety glass
 - Simple handling due to cable-free technology – easy to pour in and out
 - 360° connector
 - Lockable safety hinged lid
 - On/off switch
 - BPA free
 - Concealed stainless steel heating element
 - Automatic and manual switch-off
 - Water level indicator
 - Base station with cord storage (stainless steel sheathed)
 - Evaporation/overheating protection
- 220–240 V, 50/60 Hz, 1850–2200 W
■ W x H x D approx. 220 x 245 x 160 mm



Glass/stainless steel housing

Art.no. 263 090
EAN 4 006 160 630 909 PU 6



4 006160 630909

Art. no. 263 935
EAN 4 006 160 639 353 PU 4



4 006160 639353



Toaster
TA 3565



- Compact 2-slice toaster
 - Cool touch housing
 - Bread roll attachment (integrated)
 - Defrost/reheat/quick-stop function
 - Continuously adjustable browning level
 - 2 indicator lights
 - Automatic and manual switch-off
 - Crumb drawer
 - Base station with cord storage
- 220–240 V, 50/60 Hz, 600–700 W
 - WxHxD approx. 285 x 240 x 165 mm



Toaster
TA 3554



- Compact 2-slice toaster
 - Cool touch housing
 - Bread roll attachment (removable)
 - Defrost/reheat/quick-stop function
 - Continuously adjustable browning level
 - 3 indicator lights (blue illuminated)
 - Automatic and manual switch-off
 - Crumb drawer
 - Cord storage
- 220–240 V, 50/60 Hz, 870 W max.
 - WxHxD approx. 260 x 170 x 145 mm



Integrated bread roll attachment



Can also be combined as a suitable set

- Art. no. 263 628
EAN 4 006 160 636 284 PU 6
- Art. no. 263 931
EAN 4 006 160 639 315 PU 6
- Art. no. 263 630
EAN 4 006 160 636 307 PU 6



- Art. no. 263 639
EAN 4 006 160 636 390 PU 6
- Art. no. 263 634
EAN 4 006 160 636 345 PU 6





Stainless steel housing

Toaster
TA 3690

Toaster
TA 3620



- 2-slice toaster
- Stainless steel insert
- Cool touch housing
- Bread roll attachment (removable)
- Defrost/reheat/quick-stop function
- Continuously adjustable browning level
- 3 indicator lights (white illuminated)
- Automatic and manual switch-off
- Crumb drawer
- Cord storage
- 220–240 V, 50/60 Hz, 850 W max.
- WxHxD approx. 295 x 185 x 185 mm

- 2-slice toaster
- Stainless steel housing
- Bread roll attachment (removable)
- Defrost/reheat/quick-stop function (blue illuminated)
- Continuously adjustable browning level
- Centring function
- Automatic and manual switch-off
- Crumb drawer
- Cord storage
- 220–240 V, 50/60 Hz, 750–850 W
- WxHxD approx. 270 x 180 x 150 mm



Defrost/reheat/quick-stop function
(blue illuminated)

Art. no. 263 846
EAN 4 006 160 638 462 PU 4



Art. no. 263 718
EAN 4 006 160 637 182 PU 4





Toaster
TA 3534



- 4-slice long-slot toaster
- Heat-insulated cool touch housing
- Bread roll attachment (removable)
- Defrost/reheat/quick-stop function
- Continuously adjustable browning level
- 3 LED indicator lights
- Automatic switch-off
- Crumb drawer
- Cord storage

- 220–240 V, 50/60 Hz, 1200–1400 W
- WxHxD approx. 375 x 175 x 165 mm



Toaster
TA 3687



- 4-slice long-slot toaster
- Stainless steel housing
- Bread roll attachment (removable)
- Defrost/reheat/quick-stop function (blue illuminated)
- Continuously adjustable browning level
- Centring function
- Automatic and manual switch-off
- Crumb drawer
- Cord storage

- 220–240 V, 50/60 Hz, 1200 W
- WxHxD approx. 366 x 184 x 165 mm

Art. no. 263 614
EAN 4 006 160 636 147 PU 6



Art. no. 263 829
EAN 4 006 160 638 295 PU 4



ETM TESTMAGAZIN · URTEIL	
Clatronic WA 3491	
GUT	82,0 %
Im Test: 11 Herz-Waffeleisen Testurteile: 4x sehr gut, 6x gut, 1x befriedigend www.etm-testmagazin.de	Heft 05/2017



Waffle maker WA 3491



Waffle maker WA 3492



- Large baking surfaces: approx. Ø 18 cm (non-stick coated)
 - Preparation in a few minutes
 - Heat-insulated handle
 - Continuously adjustable browning level
 - 2 indicator lights for power and heating (baking lights)
 - Secure stand due to rubberized feet
 - Overheating protection
- 220–240 V, 50 Hz, 1200 W
 - W x H x D approx. 205 x 115 x 250 mm

- Stainless steel insert
 - Large baking surfaces: approx. Ø 18 cm (non-stick coated)
 - Preparation in a few minutes
 - Heat-insulated handle
 - Continuously adjustable browning level
 - 2 indicator lights for power and heating (baking lights)
 - Overheating protection
- 220–240 V, 50/60 Hz, 1000 W
 - W x H x D approx. 200 x 100 x 260 mm

● Art. no. 261 679
EAN 4 006 160 616 798 PU 6

● Art. no. 261 680
EAN 4 006 160 616 804 PU 6



● Art. no. 261 681
EAN 4 006 160 616 811 PU 4





PREIS-/LEISTUNGSSIEGER	
ETM TESTMAGAZIN · URTEIL	
Clatronic WA 3606	
GUT	84,8 %
Im Test: 6 belgische Waffeleisen Testurteile: 2x sehr gut, 3x gut, 1x befriedigend www.etm-testmagazin.de	Heft 05/2017



Waffle maker WA 3772



- Special waffle maker for trendy bubble waffles – in typical shape with bubble structure, crispy on the outside and fluffy on the inside
- Preparation in a few minutes
- Large, hexagonal baking surfaces (non-stick coated)
- Rotation function (180°) for uniform baking results
- Heat-insulated handles
- Indicator lights for power and heating (baking lights)
- Secure stand due to rubberized feet
- Overheating protection
- 220–240 V, 50/60 Hz, 700 W
- WxHxD approx. 215 x 115 x 290 mm

Waffle maker WA 3606



- Waffle maker for Belgian waffles
- Stainless steel insert
- 2 large baking surfaces, approx 21.5 x 13.5 cm each (non-stick coated)
- Preparation in a few minutes
- 2 waffles for each baking procedure
- Heat-insulated handle
- Continuously adjustable browning level
- 2 indicator lights for power and heating (baking lights)
- Secure stand due to rubberized feet
- Overheating protection
- Safety shutdown
- Cord storage
- 230 V, 50 Hz, 800 W
- WxHxD approx. 225 x 115 x 200 mm



Rotation function (180°) for uniform baking results



Large, hexagonal baking surfaces (non-stick coated)



Stainless steel insert

Art. no. 263 965
EAN 4 006 160 639 650 PU 4



Art. no. 271 705
EAN 4 006 160 717 051 PU 4





Waffle maker WA 3745



Ice cream cone maker HA 3494



- Stainless steel insert and lid
 - Preparation in a few minutes
 - 2 baking surfaces (non-stick coated)
 - 2 waffles for each baking procedure
 - Heat-insulated handle
 - Continuously adjustable browning level
 - 2 indicator lights for power and heating (baking lights)
 - Secure stand due to rubberized feet
 - Overheating protection
 - Cord storage
- 220–240 V, 50/60 Hz, 1200 W
 - W x H x D approx. 315 x 85 x 230 mm

- Large baking surface: approx. Ø 18 cm (non-stick coated)
 - Heat-insulated handle
 - Continuously adjustable browning level
 - 2 indicator lights for power and heating (baking lights)
 - Secure stand due to rubberized feet
 - Incl. ice cream cone
 - Overheating protection
- 220–240 V, 50 Hz, 1200 W
 - W x H x D approx. 205 x 115 x 250 mm



2 baking surfaces (non-stick coated)



Continuously adjustable browning level



Incl. squirrel cone

Art. no. 263 934
EAN 4 006 160 639 346 PU 4



4 006 160 639 346

Art. no. 261 683
EAN 4 006 160 616 835 PU 6



4 006 160 616 835

TESTURTEIL
Haus & Garten Test
 Endnote 1,4
sehr gut
 Clatronic
 CM 3372
 Ein Mittelklasse-Gerät mit
 gleichmäßigem Backergebnis
 Im Test: Crêpesmaker
 Ausgabe 1/2019 · www.hausgartentest.de



Crêpe maker
 CM 3372



Donut maker
 DM 3495



- Large baking surface: approx. Ø 29 cm (non-stick coated)
 - Paper-thin crêpes, quickly and easily prepared
 - Also suitable for making tortillas, wraps, enchiladas, tacos and much more
 - Heat-insulated plastic base
 - Continuously adjustable thermostat
 - 2 indicator lights for power and heating (baking lights)
 - Base station with cord storage
 - Incl. batter distributor
- 220–240 V, 50/60 Hz, 900 W
 - WxHxD approx. 325 x 80 x 370 mm

- For baking up to 7 bagels/donuts
 - Baking surfaces non-stick coated
 - Heat-insulated handle
 - 2 indicator lights for power and heating (baking lights)
 - Secure stand due to rubberized feet
 - Overheating protection
- 220–240 V, 50/60 Hz, 900 W
 - WxHxD approx. 225 x 115 x 225 mm



Also suitable for making tortillas, wraps, enchiladas, tacos and much more



Incl. batter distributor

Art. no. 251 121
 EAN 4 006 160 511 215 PU 4



Art. no. 261 684
 EAN 4 006 160 616 842 PU 6





Muffin maker
MM 3496



- For baking up to 7 muffins
- Muffin diameter approx. 4.5 cm
- Baking surfaces non-stick coated
- Heat-insulated handle
- 2 indicator lights for power and heating (baking lights)
- Secure stand due to rubberized feet
- Overheating protection

- 220–240 V, 50/60 Hz, 900 W
- WxHxD approx. 225 x 115 x 225 mm



Sandwich toaster
ST 3477



- Triangular sandwich plates
- Non-stick coating
- Heat-insulated handle
- Automatic temperature controller
- 2 indicator lights for power and heating (baking lights)
- Locking system
- Safety shutdown
- Overheating protection

- 220–240 V, 50/60 Hz, 750 W
- WxHxD approx. 230 x 80 x 230 mm



Can also be combined as a suitable set

● Art. no. 261 685
EAN 4 006 160 616 859 PU 6



● Art. no. 261 658
EAN 4 006 160 616 583 PU 6



● Art. no. 263 930
EAN 4 006 160 639 308 PU 6

● Art. no. 261 660
EAN 4 006 160 616 606 PU 6



NEW! Sandwich toaster
ST 3778



Sandwich toaster
ST 3629



- Stainless steel insert
- Triangular sandwich plates
- Non-stick coating
- Heat-insulated handle
- Automatic temperature controller
- 2 indicator lights for power and heating (baking lights)
- Secure stand due to rubberized feet
- Locking system
- Overheating protection

- 220–240 V, 50/60 Hz, 750 W
- WxHxD approx. 235 x 95 x 235 mm

- 4-slice sandwich toaster
- Stainless steel insert
- Triangular sandwich plates
- Non-stick coating
- Heat-insulated handle
- Automatic temperature controller
- 2 indicator lights for power and heating (baking lights)
- Secure stand due to rubberized feet
- Locking system
- Overheating protection and overtemperature protection

- 220–240 V, 50/60 Hz, 1400 W
- WxHxD approx. 270 x 105 x 325 mm



Stainless steel insert



Stainless steel insert

Art. no. 263 973
EAN 4 006 160 639 735 PU 6



Art. no. 263 736
EAN 4 006 160 637 366 PU 4





Multi grill
ST/WA 3670



- Sandwich toaster, waffle maker and contact grill
- Versatile use by three different removable plates (sandwich/waffle/grill plates), e.g. for Belgian waffles and tasty sandwich variations, as well as for fast double-sided contact grilling
- Stainless steel insert
- Baking plates non-stick coated and changeable
- Heat-insulated handle
- 2 indicator lights for power and heating (baking lights)
- Secure stand due to rubberized feet
- Locking system
- Overheating protection

- 220–240 V, 50/60 Hz, 800 W
- W x H x D approx. 240 x 105 x 220 cm



Hamburger grill
HBM 3696



- Hamburger grill for even and low-fat grilling of Hamburger patties
- Versatile use for e.g. vegetable burger, fish cake etc.
- 2 large grill surfaces, each approx. 10.5 cm Ø (non-stick coated)
- Extra deep grooves for strong grill pattern
- Stainless steel insert
- 2 Hamburger patties per grilling process
- Heat-insulated handle
- 2 indicator lights for power and heating
- Temperature „ready“ display
- Removable fat collecting tray (easy to clean)
- Cord storage
- Overheating protection
- Secure stand due to rubberized feet

- 220–240 V, 50/60 Hz, 1000 W
- W x H x D approx. 240 x 100 x 196 mm



Stainless steel insert



Grill plates



Sandwich plates



Waffle plates



2 large grill surfaces, each approx. 10.5 cm Ø (non-stick coated)

Art. no. 263 805
EAN 4 006 160 638 059 PU 4



Art. no. 263 866
EAN 4 006 160 638 660 PU 4





Stainless steel housing



Multi grill MG 3519



- Multi grill for double-sided, fat-free grilling
- 700 watt
- Stainless steel housing
- Short cooking times
- Non-stick coated grill plates with extra deep grooves for strong grill pattern
- Heat-insulated handle
- Indicator light
- Grill surfaces: 23 x 14.5 cm
- Cord storage
- Versatile use for e.g. panini, steaks, fish or vegetables
- 220–240 V, 50/60 Hz, 700 W
- W x H x D approx. 270 x 95 x 230 mm

Ice cream maker ICM 3764



- Ice cream maker for preparing sorbet, ice cream and frozen yoghurt
- Double-walled ice cream maker with cold reservoir (H: 13.8 cm; Ø 20 cm)
- Transparent lid with refill opening
- For up to 1500 ml ice cream
- Preparation time (ice cream): 20–40 min.
- Mixer and motor housing removable for easy cleaning
- Incl. recipe suggestions
- Secure stand due to rubberized feet
- 220–240 V, 50 Hz, 12 W
- W x H x D approx. 200 x 225 x 210 mm



Stainless steel housing



Transparent lid with refill opening



Double-walled ice cream maker with cold reservoir



Mixer and motor housing removable for easy cleaning

Art. no. 261 711
EAN 4 006 160 617 115 PU 6



4 006 160 617 115

Art. no. 263 956
EAN 4 006 160 639 568 PU 2



4 006 160 639 568

ETM TESTMAGAZIN - URTEIL	
Clatronic ICM 3650	
GUT	90,3 %
Im Test: 5 Eismaschinen mit Kühlakku Testurteile: 1× sehr gut, 4× gut www.etm-testmagazin.de	Heft 08/2017



Sensor touch control panel



Ice cream maker
ICM 3650



NEW! Ice cream maker
ICM 3784



- Ice cream maker for preparing sorbet, ice cream and frozen yoghurt
 - 2 double-walled ice container with cold reservoir, suitable for direct ice consumption
 - Transparent lid with 2 refill openings
 - For up to 2x 500 ml ice cream
 - Preparation time (ice cream): 15–45 min.
 - Incl. timer (0–60 min.)
 - Mixer and motor housing removable for easy cleaning
 - Incl. recipe suggestions
 - Secure stand due to rubberized feet
- 220–240 V, 50 Hz, 12 W
■ W x H x D approx. 280 x 230 x 130 mm

- Ice cream maker for preparing sorbet, ice cream and frozen yoghurt
 - High-quality LED display and sensor touch control panel
 - Digital timer (variable time setting of 5–120 min.)
 - 3 programs
 - Preparation time: 20–25 min.
 - For up to 1200 ml ice cream
 - Professional compressor for fully automatic cooling
 - Transparent lid with refill opening
 - Incl. recipe suggestions
 - Removable ice cream maker (H: 10.0 cm; Ø 13.0 cm), stirring element and motor housing for easy cleaning
 - Stirring element with powerful, quiet motor
 - Secure stand due to rubberized feet
 - Incl. ice cream scoop
- 220–240 V, 50 Hz, 110 W
■ W x H x D approx. 375 x 265 x 230 mm



2 double-walled ice container with cold reservoir, suitable for direct ice consumption



High-quality LED display



Transparent lid with refill opening

Art. no. 263 774
EAN 4 006 160 637 748 PU 4



Art. no. 263 982
EAN 4 006 160 639 827 PU 1





Ice cube maker
EWB 3526



- Compact ice cube maker without complicated installation for producing ice cubes quickly and simply at the press of a button
- Ideal for camping, office, kitchen or house bar
- No water pipe required, simply fill drinkable water into the tank (2.2 litres water tank)
- Approx. 10–15 kg ice cubes in 24 hours (approx. 90 g in 10 min., corresponding to 9 ice cubes)
- LED display and acoustic signal when the ice cube container is full or the water tank is empty
- Energy-saving mode – automatic switch-off at the end of the program
- Electronic control (START/STOP)
- 3 indicator lights (ice full, empty water, operation)
- Visual check through viewing window in the lid
- Low-noise
- 220–240 V, 50 Hz, 0,8 A
- W x H x D approx. 245 x 330 x 370 mm



Yoghurt maker
JM 3344



- Easy preparation of up to 1.1 litres of yoghurt
- 7 practical portion jars with screw cap (capacity: 160 ml)
- On/off switch (illuminated)
- Transparent lid
- Additional jars in a set of 6 also available as an option: EG JM 3344, product number: 251 125
- 220–240 V, 50 Hz, 15 W
- W x H x D approx. 240 x 150 x 265 mm



LED displays



For approx. 10–15 kg ice cubes

Suitable replacement jar:
EG JM 3344
Art. no.: 251 125
EAN: 4 006 160 511 253



Art. no. 261 712
EAN 4 006 160 617 122 PU 1



4 006 160 617 122

Art. no. 251 119
EAN 4 006 160 511 192 PU 6



4 006 160 511 192

TESTURTEIL
Haus & Garten Test
 Endnote 1,7
gut
 Clatronic
 ZWM 3478
**Wie vom Volksfest
 und kinderleicht herzustellen**
 Im Test: Zuckerwattemaschinen
 Ausgabe 1/2019 - www.hausgartentest.de



TESTURTEIL
Haus & Garten Test
 Endnote 1,9
gut
 Clatronic
 Popcorn-Maker
**Bringt das Kinogefühl
 ins Wohnzimmer**
 Im Test: Popcorn-Maker
 Ausgabe 1/2018 - www.hausgartentest.de



Cotton candy maker
 ZWM 3478



- Large cotton candy bowl:
 Ø approx. 27 cm
- Transparent splash guard (removable)
- Dish and splash guard dishwasher safe
- Quartz heating element
- Secure stand due to suction feet
- Incl. measuring spoon and
 10 wooden sticks

- 220–240 V, 50/60 Hz, 500 W
- W x H x D approx. 275 x 235 x 275 mm

Popcorn maker
 PM 3635



- Calorie-conscious popcorn production by hot air
 (without fat)
- A healthy and tasty snack for the whole family
- Quick preparation (2–3 portions in approx. 2 minutes)
- Easy handling
- Healthy preparation without oil
- Incl. portioning tray (for example for butter, corn etc.)
- Transparent lid
- On/off switch

- 220–240 V, 50/60 Hz, 1200 W
- W x H x D approx. 165 x 350 x 180 mm



Incl. wooden sticks



Easy portioning for example
 for butter, corn etc.

Art. no. 261 661
 EAN 4 006 160 616 613 PU 4



Art. no. 263 335
 EAN 4 006 160 633 351 PU 6



TESTURTEIL
Haus & Garten Test
 Endnote 1,8
gut
 Clatronic
 SKB 3248
**Kinderleicht Kaskaden
 aus Schokolade genießen**
 Im Test: Schokoladenbrunnen
 Ausgabe 1/2019 - www.hausgartentest.de



Stainless steel

Chocolate fountain
 SKB 3248



- Chocolate fountain for an exclusive buffet experience
 - Stainless steel housing
 - For dipping in various types of fruit or pastries
 - Extra-smooth cascades for improved flow characteristics
 - Deep drip collection bowl for long-lasting chocolate enjoyment
 - Warm chocolate is transported by means of a worm shaft to the top of the fountain and then flows continuously down the fountain in gentle cascades
 - Height-adjustable feet for a perfectly balanced flow of chocolate
 - Stainless steel tower/fountain
 - Stainless steel drip tray
 - Motor and heating switchable separately by means of 2 switches
 - Secure stand due to rubberized feet
- 220–240 V, 50 Hz, 150–190 W
 - W x H x D approx. 215 x 395 x 215 mm



Art. no. 262 695
 EAN 4 006 160 626 957 PU 4



PREIS-/LEISTUNGSSIEGER
ETM TESTMAGAZIN - URTEIL
 Clatronic Eierkocher EK 3321
GUT 86,4 %
 Im Test: 4 Eierkocher
 mit Härtegradregulierung
 Testurteile: 1x sehr gut, 3x gut
 www.etm-testmagazin.de Heft 04/2016



Stainless steel

Egg boiler
 EK 3321



- Preparation of up to 7 eggs
 - Stainless steel housing
 - Electronic hardness adjuster
 - On/off switch (illuminated)
 - Acoustic signal (buzzer)
 - Removable egg holder
 - Measuring cup with egg pricker
 - Stainless steel hotplate
- 230 V, 50 Hz, 400 W
 - W x H x D approx. 220 x 155 x 185 mm

Art. no. 263 118
 EAN 4 006 160 631 180 PU 4





Egg boiler
EK 3497



- Preparation of up to 6 eggs
- Heating dish (non-stick coated)
- On/off switch (illuminated)
- Acoustic signal (buzzer)
- Removable egg holder
- Incl. measuring cup with egg pricker

- 230 V, 50 Hz, 400 W
- WxHxD approx. 220 x 130 x 135 mm



Stainless steel

Electric pepper/salt mill
PSM 3004 N



- High-quality precision ceramic grinder
- Stainless steel housing
- Adjustable ceramic grinder (from coarse to fine)
- Consistent grinding quality
- Simple refilling
- One-hand operation
- Incl. light for optimum dosing of the condiment
- Battery-operated

- Battery operation:
4x 1,5 V AA/Mignon/LR/AM3 (batteries not included)
- WxHxD approx. 45 x 220 x 45 mm



Art. no. 261 686
EAN 4 006 160 616 866 PU 6



4 006 160 616 866

Art. no. 271 572
EAN 4 006 160 715 729 PU 6



4 006 160 715 729

PREIS-/LEISTUNGSSIEGER	
ETM TESTMAGAZIN - URTEIL	
Clatronic MA 3585*	
GUT	83,6 %
Im Test: 10 Alleschneider Testurteile: 1x sehr gut, 8x gut, 1x ausreichend www.etm-testmagazin.de	Heft 10/2015
* baugleich mit dem gelisteten Modell Bonam MA 451 CB	



Food slicer
AS 2958



Metal food slicer
MA 3585



- Special stainless steel blade (rustproof)
- Powerful motor
- 3 speed levels
- Safety power switch
- Continuously adjustable cutting thickness
- Cutting thickness indication
- Food grip with finger protection
- Removable slide
- Foldable housing

- 220–240 V, 50/60 Hz, 180 W max.
- W x H x D approx. 280 x 230 x 330 mm

- Big stainless steel blade (Ø 190 mm), rustproof
- Universal serrated blade
- Motor housing: aluminium die cast
- On/off switch
- Metal guiding rail
- Metallic guiding board
- Food grip with finger protection
- Continuously adjustable cutting thickness (0–15 mm)
- Tilted supporting table with stainless steel insert, tiltable for easy cleaning
- Secure stand due to suction feet

- 220–240 V, 50/60 Hz, 150 W
- W x H x D approx. 365 x 235 x 265 mm

Art. no. 262 532
EAN 4 006 160 625 325 PU 6



Art. no. 263 683
EAN 4 006 160 636 833 PU 2



SIEGER PREIS/LEISTUNG

Haus & Garten Test 4 2013
www.hausgarten-test.de

(2,4) gut
Clatronic EM 3062

Bietet die einfachste Handhabung im Testfeld



Electric knife
EM 3062



- Special serrated stainless steel double blade (rustproof/dishwasher-safe)
 - Powerful 150 watt motor
 - Low-noise and low-vibration running
 - Safety switch
 - Release button for blades
- 230 V, 50 Hz, 150 W
 - WxHxD approx. 420 x 130 x 60 mm



Electric knife
EM 3702



- Special serrated stainless steel multipurpose blade for precise cutting of all food, incl. frozen food (rustproof/dishwasher-safe)
 - Powerful 120 watt motor
 - Stainless steel insert
 - Low-noise and low-vibration running
 - Safety switch
 - Release button for blades
 - Incl. storage box
- 220–240 V, 50/60 Hz, 120 W
 - WxHxD approx. 490 x 65 x 55 mm



Incl. storage box

Art. no. 262 986
EAN 4 006 160 629 866 PU 6



Art. no. 263 864
EAN 4 006 160 638 646 PU 6





Incl. transparent mixing container



Incl. transparent mixing container

Hand blender
SM 3081



- Stainless steel cutting blade (rustproof)
- On/off switch (countersunk)
- Powerful 180 watt motor
- Incl. transparent mixing container (500 ml)
- Hanging loop
- Wall mount incl. mounting material
- 220–240 V, 50 Hz, 180 W
- W x H x D approx. 80 x 330 x 80 mm

NEW! **Hand blender**
SM 3577



- Stainless steel cutting blade (rustproof)
- On/off switch (countersunk)
- Powerful 180 watt motor
- Incl. transparent mixing container (500 ml)
- Hanging loop
- 220–240 V, 50 Hz, 180 W
- W x H x D approx. 80 x 330 x 80 mm

Art. no. 262 160
EAN 4 006 160 621 600 PU 12



Art. no. 263 979
EAN 4 006 160 639 797 PU 8





Incl. transparent mixing container



3in1



Hand blender
SM 3577



- Stainless steel cutting blade (rustproof)
- On/off switch (countersunk)
- Powerful 180 watt motor
- Incl. transparent mixing container (500 ml)
- Hanging loop
- 220–240 V, 50 Hz, 180 W
- WxHxD approx. 80 x 330 x 80 mm

Hand blender
SM 3739



- Soft touch housing
- Stainless steel insert
- 2-level push-button switch
- High-performance 800 watt motor
- Stainless steel cutting blade
- Removable stainless steel hand blender
- Ergonomically shaped handle
- Hanging loop
- 220–240 V, 50–60 Hz, 800 W
- WxHxD approx. 65 x 370 x 65 mm

Hand blender set
SMS 3190



- 3 in 1 hand blender set:
 - Stainless steel hand blender (removable)
 - Multi chopper with stainless steel blade and working container with scale (0,5 litre)
 - Metal whisk (removable)
- Powerful 200 watt motor
- 2 speed levels
- Ergonomically shaped rubberized handle for easier handling
- Holder for hand blender and whisk
- Incl. mixing container with scale (0.7 litre)
- Hanging loop
- 230 V, 50 Hz, 200 W
- WxHxD approx. 160 x 370 x 150 mm



● Art. no. 263 921
EAN 4 006 160 639 216 PU 8
● Art. no. 263 922
EAN 4 006 160 639 223 PU 8
● Art. no. 263 923
EAN 4 006 160 639 230 PU 8

● Art. no. 263 913
EAN 4 006 160 639 131 PU 6

● Art. no. 261 803
EAN 4 006 160 618 037 PU 6





NEW! Hand blender set
SMS 3777



- 3 in 1 hand blender set:
 - Stainless steel hand blender (removable)
 - Multi chopper with stainless steel blade and working container with scale (0,5 litre)
 - Stainless steel whisk (removable)
- Silent DC motor (400 watt)
- 2 speed levels
- Ergonomically shaped rubberized handle for easier handling
- Holder for hand blender and whisk
- Incl. mixing container with scale (0.7 litre)
- Hanging loop

- 220–240 V, 50–60 Hz, 400 W
- WxHxD approx. 160 x 370 x 150 mm



Multi express
ME 3604



- Electrical shredding unit “Multi Express”
- Large and changeable high-quality drum attachments made of stainless steel, for quick and easy cutting or grating
- Easy handling
- 5 functions:
 - cutting (fine/coarse) of, for example, onions, cucumbers
 - grating (fine/coarse) of, for example, carrots, radishes
 - shredding of, for example, parmesan, nuts, potatoes
- Powerful 150 W motor
- Large refill opening (approx. Ø 60 mm)
- Wide discharge opening (approx. Ø 80 mm)
- Accessories: 2 cutting attachments (fine/coarse), 2 grating attachments (fine/coarse), 1 shredding attachment

- 220–240 V, 50/60 Hz, 150 W
- WxHxD approx. 148 x 352 x 230 mm



Art. no. 263 972
EAN 4 006 160 639 728 PU 6



Art. no. 263 701
EAN 4 006 160 637 014 PU 4





2in1



Multi chopper
& ice crusher



Multi chopper
MZ 3579

- 2 in 1 – Multi chopper and ice crusher in one
- Mixing container (1 litre capacity)
- Removable stainless steel chopping blade (rustproof)
- Incl. ice crush function
- Secure stand
- Easy to clean
- 220–240 V, 50–60 Hz, 250 W
- WxHxD approx. 175 x 220 x 175 mm



NEW! Hand mixer
HM 3775



- Powerful 400 watt motor
- 5 speed levels
- Turbo setting
- Eject button
- Stainless steel whisks and dough hooks
- All accessories are dishwasher-safe
- 220–240 V, 50 Hz, 400 W
- WxHxD approx. 190 x 150 x 80 mm



Hand mixer
HM 3014



- Powerful 250 watt motor
- 5 speed levels
- Eject button
- Stainless steel whisks and dough hooks
- All accessories are dishwasher-safe
- 230 V, 50 Hz, 250 W
- WxHxD approx. 180 x 280 x 90 mm

Art. no. 263 662
EAN 4 006 160 636 628 PU 6



Art. no. 263 970
EAN 4 006 160 639 704 PU 4



Art. no. 262 147
EAN 4 006 160 621 471 PU 6





Hand mixer set
HM 3524



- Hand mixer and blender
- Powerful 300 watt motor
- 5 speed levels
- Turbo setting
- Eject button
- Accessories: stainless steel whisks and dough hooks (extra-long), quick mixing rod
- Stainless steel whisks and dough hooks dishwasher-safe
- 220–240 V, 50–60 Hz, 300 W
- W x H x D approx. 200 x 145 x 90 mm



Hand mixer set
HMS 2739



- Powerful 250 watt motor
- 5 speed levels
- Turbo setting
- Eject button
- Large mixing bowl with automatic drive
- Accessories: stainless steel knife, 2 stainless steel whisks, 2 stainless steel dough hooks, quick mixing rod with stainless steel knife
- All accessories dishwasher-safe
- 230 V, 50/60 Hz, 250 W
- W x H x D approx. 300 x 350 x 200 mm



Incl. quick mixing rod



Incl. quick mixing rod

● Art. no. 261 707
EAN 4 006 160 617 078 PU 6



● Art. no. 261 770
EAN 4 006 160 617 702 PU 2



PREIS-/LEISTUNGSSIEGER	
ETM TESTMAGAZIN - URTEIL	
Clatronic KM 3712	
GUT	83,0 %
Im Test: 9 Rührmaschinen Testurteile: 3x sehr gut, 6x gut www.etm-testmagazin.de	Heft 04/2019



5 litres
stainless steel bowl



1100 Watt

Kneading machine KM 3712



- High-performance kneading machine with powerful 1100 watt
 - Variable electronic speed control
 - 5 litres stainless steel bowl for max. 2.5–3 kg dough preparation
 - Aluminium die-cast stirring hook – also enables the uniform mixing of sizeable quantities of dough
 - Aluminium die-cast dough hook – for heavy doughs, e.g. yeast or bread dough
 - Stainless steel whisk for light sponge cake and fluffy egg whites
 - Sturdy special gear
 - 35° swivelling multifunction arm
 - Unlocking mechanism for multifunction arm
 - Safety circuit
 - Transparent splash protection lid with refill opening (removable)
 - Particularly easy to operate and clean
 - Secure stand due to suction feet
 - Quick-action chuck for holding the tools
- 220–240 V, 50 Hz, 1100 W
 - WxHxD approx. 350 x 320 x 210 mm



● Art. no. 263 877
EAN 4 006 160 638 776 PU 1



4 006 160 638 776

● Art. no. 263 878
EAN 4 006 160 638 783 PU 1



4 006 160 638 783



5 litres stainless steel bowl



Kneading machine KM 3709

- High-performance kneading machine with powerful 1000 watt
 - Variable electronic speed control + pulse function
 - 5 litres stainless steel bowl for max. 2.5–3 kg dough preparation
 - Aluminium die-cast stirring hook – also enables the uniform mixing of sizeable quantities of dough
 - Aluminium die-cast dough hook – for heavy doughs, e.g. yeast or bread dough
 - Stainless steel whisk for light sponge cake and fluffy egg whites
 - Sturdy special gear
 - 35° swivelling multifunction arm
 - Unlocking mechanism for multifunction arm
 - Safety circuit
 - Rotary switch (blue illuminated)
 - Transparent splash protection lid with refill opening (removable)
 - Particularly easy to operate and clean
 - Secure stand due to suction feet
 - Quick-action chuck for holding the tools
- 220–240 V, 50 Hz, 1000 W
 - W x H x D approx. 366 x 299 x 215 mm



Rotary switch
(blue illuminated)

Art. no. 263 871
EAN 4 006 160 638 714 PU 1

Art. no. 263 873
EAN 4 006 160 638 738 PU 1





5 litres
stainless steel bowl

1100 Watt



44

Kneading machine KM 3711

- High-performance kneading machine with powerful 1100 watt
 - Variable electronic speed control
 - 5 litres stainless steel bowl for max. 2.5–3 kg dough preparation
 - Aluminium die-cast stirring hook – also enables the uniform mixing of sizeable quantities of dough
 - Aluminium die-cast dough hook – for heavy doughs, e.g. yeast or bread dough
 - Stainless steel whisk for light sponge cake and fluffy egg whites
 - Sturdy special gear
 - 35° swivelling multifunction arm
 - Unlocking mechanism for multifunction arm
 - Safety circuit
 - Transparent splash protection lid with refill opening (removable)
 - Particularly easy to operate and clean
 - Secure stand due to suction feet
 - Quick-action chuck for holding the tools
- 220–240 V, 50 Hz, 1100 W
 - WxHxD approx. 350 x 320 x 210 mm



● Art. no. 263 874
EAN 4 006 160 638 745 PU 1

● Art. no. 263 875
EAN 4 006 160 638 752 PU 1

● Art. no. 263 876
EAN 4 006 160 638 769 PU 1



4 006 160 638 745



4 006 160 638 752



4 006 160 638 769



1200 Watt



6.3 litres
stainless steel bowl



Kneading machine KM 3630

- High-performance kneading machine with extra-powerful 1200 watt
 - 8 speed levels (0/1/2/3/4/5/6 + pulse function)
 - 6.3 litres stainless steel bowl for max. 3–3.5 kg dough preparation
 - Aluminium die-cast stirring hook – also enables the uniform mixing of sizeable quantities of dough
 - Aluminium die-cast dough hook – for heavy doughs, e.g. yeast or bread dough
 - Stainless steel whisk for light sponge cake and fluffy egg whites
 - Sturdy special gear
 - 35° swivelling multifunction arm
 - Unlocking mechanism for multifunction arm
 - Safety circuit
 - Transparent splash protection lid with refill opening (removable)
 - Particularly easy to operate and clean
 - Secure stand due to suction feet
 - Quick-action chuck for holding the tools
- 220–240 V, 50 Hz, 1200 W
 - W x H x D approx. 402 x 326 x 212 mm



35° swivelling
multifunction arm

Art. no. 263 739
EAN 4 006 160 637 397 PU 1

Art. no. 263 753
EAN 4 006 160 637 533 PU 1





XXXL
stainless steel bowl
(10 litres)



1500 Watt



46

Kneading machine KM 3765

- Robust kneading machine with resistant metal gear
 - 8 speed levels (0/1/2/3/4/5/6 + pulse function)
 - Extra-large 10 litres stainless steel bowl for max. 6–6.5 kg dough preparation
 - High-performance long-life professional motor (1500 watt)
 - Consistent performance due to load-dependent electronic rotation speed control
 - Aluminium die-cast stirring hook – for light dough like short pastry dough, crumble dough or sponge mixture
 - Aluminium die-cast dough hook – for heavy dough like yeast dough, bread dough or pasta dough
 - Stainless steel whisk for whipping of egg white, cream, meringue and many others
 - 35° swivelling multifunction arm
 - Unlocking mechanism for multifunction arm
 - Safety circuit – machine stops when lifting the arm
 - Rotary switch (white illuminated)
 - High-quality chrome application
 - Transparent splash protection lid with refill opening
 - Soft start for slow mixing
 - Particularly easy to operate and clean
 - Secure stand due to suction feet
 - Quick-action chuck for holding the tools
- 220–240 V, 50/60 Hz, 1500 W
 - WxHxD approx. 413 x 387 x 268 mm



Rotary switch
(white illuminated)

Art. no. 263 957
EAN 4 006 160 639 575 PU 1



4 006 160 639 575

Art. no. 263 958
EAN 4 006 160 639 582 PU 1



4 006 160 639 582



LCD display

XXL
stainless steel bowl
(6.2 litres)



Incl. glass mixing container with scale and refill opening (1.5 litres)



Pasta attachments, e.g. for spaghetti, macaroni and tagliatelle

1200 Watt



Kneading machine KM 3674

- High-performance kneading machine with extra-powerful 1200 watt
- Electronic timer function / LCD display (blue illuminated)
- Consistent performance due to load-dependent electronic rotation speed control
- 12 speed levels (0/1/2/3/4/5/6/7/8/9/10) + pulse function)
- Soft start for slow mixing
- 6.2 litres stainless steel bowl for max. 3–3.5 kg dough preparation
- Glass mixing container with scale and refill opening (1.5 litres)
- Aluminium die-cast stirring hook – for light dough like short pastry dough, crumble dough or sponge mixture
- Aluminium die-cast dough hook – for heavy dough like yeast dough, bread dough or pasta dough
- Stainless steel whisk for whipping of egg white, cream, meringue and many others
- Sturdy special gear
- 35° swivelling multifunction arm with unlocking mechanism
- Transparent splash protection lid with refill opening (removable)
- Safety circuit – machine stops when lifting the arm
- Particularly easy to operate and clean
- Secure stand due to suction feet
- Quick-action chuck for holding the tools

Mincer

- Stainless steel cutter, metal neck, metal feed screw, metal refill tray, 3 stainless steel mincing disks, pastry attachment, sausage filler accessory, kebbe attachment

Pasta function

- Make pasta yourself with 3 different attachments for spaghetti, macaroni, tagliatelle
- 220–240 V, 50/60 Hz, 1200 W / W x H x D approx. 421 x 336 x 293 mm



Accessories: 3 different pasta attachments, stainless steel cutter, metal feed screw, 3 stainless steel mincing disks, metal refill tray, pastry attachment, sausage filler accessory, kebbe attachment



Incl. mincer and pasta function



Glass mixing container with scale and refill opening

Art. no. 263 811
EAN 4 006 160 638 110 PU 1





5in1



Stainless steel

Food processor KM 3646



- Stainless steel housing
 - 4 speed levels (0/1/2 + pulse function)
 - Mixing container with scale and refill opening (1.5 litres)
 - Working container with scale and refill opening (1.0 litre)
 - Cover for the refill opening can also be used as a measuring cup (3 cl)
 - High-quality, interchangeable stainless steel attachments for cutting and grating
 - Safety circuit
 - Accessories (5in1): mixing container with scale and refill opening (1.5 litres), stainless steel cutting/grating insert, dough hook, beater blade, measuring cup (3 cl)
 - Secure stand due to suction feet
-
- 220–240 V, 50 Hz, 500 W
 - W x H x D approx. 190 x 370 x 190 mm



Accessories: 1x stainless steel cutting/grating insert, dough hook, beater blade



Incl. mixing container with scale and refill opening (1.5 litres)



Art. no. 263 781

EAN 4 006 160 637 816

PU 2



4 006 160 637 816

PREIS-/LEISTUNGSSIEGER	
ETM TESTMAGAZIN - URTEIL	
Clatronic FW 3506	
GUT	82,5 %
Im Test: 13 Fleischwölfe Testurteile: 1x sehr gut, 12x gut www.etm-testmagazin.de	
Heft 11/2015	



1000 Watt



1200 Watt

Mincer
FW 3151

Mincer
FW 3506



- Stainless steel insert
 - Metal neck
 - Metal feed screw
 - Metal filling tray
 - Stainless steel cutter
 - 3 steel discs
 - Reverse function
 - Pastry attachment
 - Sausage filler accessory
 - Kebbe attachment – oriental cuisine
 - On/off switch
- 220–240 V, 50 Hz, 1000 W max.
 - W x H x D approx. 330 x 350 x 195 mm

- Chrome-plated front plate
 - Metal neck
 - Metal feed screw
 - Metal filling tray
 - Stainless steel cutter
 - 3 stainless steel discs (7/5/3 mm)
 - Reverse function
 - Pastry attachment
 - Sausage filler accessory
 - Kebbe attachment – oriental cuisine
 - On/off switch
 - Secure stand due to suction feet
- 220–240 V, 50/60 Hz, 1200 W max.
 - W x H x D approx. 330 x 355 x 170 mm



Incl. 3 steel discs, pastry attachment, kebbe attachment, sausage filler accessory



Integrated storage compartment for accessories



Incl. 3 stainless steel discs, pastry attachment, kebbe attachment, sausage filler accessory

Art. no. 263 315
EAN 4 006 160 633 153 PU 4



Art. no. 261 691
EAN 4 006 160 616 910 PU 4





5in1



Universal mixer
UM 3470

- Universal mixer for pureeing, beating, chopping up, shaking and mixing
- Ideal for preparing fruit and fitness drinks, milk shakes, cocktails, soups, salsa sauces, baby food
- Ideal for kitchen and bar
- Ice crush function
- Powerful 500 watt motor max.
- 6 speed levels (0/1/2/3/4 + pulse/turbo function)
- Removable mixing container (1.5 litres)
- Lid with refill opening
- Cover for the refill opening can also be used as a measuring cup (2 cl)
- Stainless steel blade (rustproof)
- Safety circuit – operation only possible with attached container
- Secure stand due to rubberized feet
- 220–240 V, 50/60 Hz, 500 W max.
- WxHxD approx. 160 x 400 x 160 mm



Stainless steel



Universal mixer
UM 3644

- Stainless steel universal mixer for pureeing, beating, chopping up, shaking and mixing
- Ideal for preparing fruit and fitness drinks, milk shakes, cocktails, soups, salsa sauces, baby food
- Ideal for kitchen and bar
- Stainless steel housing
- Ice crush function
- Powerful 650 watt motor
- 6 speed levels (0/1/2/3/4 + pulse function)
- Removable mixing container made of solid glass with scale (1.5 litres)
- BPA free
- Lid with refill opening
- Cover for the refill opening can also be used as a measuring cup (6.5 cl)
- 4-fold stainless steel blade with „piranha“ cut for easy mixing (rustproof)
- Safety circuit – operation only possible with attached container
- Secure stand due to rubberized feet
- 220–240 V, 50/60 Hz, 650 W
- WxHxD approx. 177 x 400 x 175 mm

Art. no. 263 583
EAN 4 006 160 635 836 PU 4



4 006 160 635 836

Art. no. 263 780
EAN 4 006 160 637 809 PU 4



4 006 160 637 809



Mixing cup also suitable as drinking cup



2in1

Smoothie maker SM 3593



- Universal mixer for pureeing, beating, chopping up, shaking and mixing, consisting of base, mixing container and lid with drinking aperture
 - "Mix & Go" – Mix your favorite shake in a few minutes. With the practical drinking aperture, you can take your freshly prepared shake with you to work, school or sports
 - Ideal for preparing fruit and fitness drinks, milk shakes, cocktails, soups, salsa sauces, baby food
 - Incl. recipe suggestions
 - Mixing container also suitable as drinking cup
 - Incl. lid with drinking aperture
 - Ideal for kitchen, bar and on the road
 - Powerful 250 watt motor
 - 1 speed level (pulse function)
 - Removable mixing container (600 ml)
 - BPA free
 - Stainless steel blade (rustproof)
 - Safety circuit – operation only possible with attached container
 - All accessories dishwasher-safe
 - Secure stand due to rubberized suction pads
- 220–240 V, 50 Hz, 250 W
■ WxHxD approx. 130 x 370 x 125 mm



Replacement bottle for Smoothie maker EF SM 3593

Art. no. 264 559
EAN 4 006 160 645 590 VE 6

Bar mixer / milk frother BM 3472



- Bar mixer and milk frother in one
 - Attractive chrome design
 - Ideal for preparing fruit and fitness drinks, milk shakes, cocktails, salsa sauces, baby food
 - Ideal for bar and kitchen
 - Powerful 65 watt motor
 - 2 speed levels
 - Stainless steel container with up to 650 ml capacity
 - Convenient cup holder with safety circuit
 - Stainless steel mixing rod
 - Secure stand due to rubberized feet
- 230 V, 50 Hz, 65 W
■ WxHxD approx. 135 x 370 x 175 mm



Incl. practical cup holder

Art. no. 263 480
EAN 4 006 160 634 808 PU 6



Art. no. 263 585
EAN 4 006 160 635 850 PU 6





Citrus juicer
ZP 3066



- Removable juice container with aroma protective cover (1.2 litres)
- 2 press cones
- Automatic start/stop function by pressing juicer cone
- Automatic clockwise/anticlockwise operation for optimal juice extraction
- Practical cord storage
- 230 V, 50 Hz, 40 W
- WxHxD approx. 180 x 230 x 180 mm



Stainless steel

Automatic juicer
AE 3666



- Professional automatic juicer in high-quality stainless steel housing
- Fresh fruit and vegetable juices quickly prepared. Rich in vital substances for well-being, fitness and health
- 30 % more juice and vitamins
- Large filler spout (65 mm Ø)
- 3 speed levels (0/1/2) for different fruit hardness
- Pulp container (approx. 1.5 litres)
- Open juice spout
- Drip-stop due to a folding juice spout
- Lock with safety switch
- Stainless steel sieve for finest juices
- Can be completely disassembled – quick and easy cleaning
- Secure stand due to rubberized suction pads
- 220–240 V, 50/60 Hz, 400 W max.
- WxHxD approx. 272 x 295 x 171 mm



Large filler spout (65 mm Ø)



Drip-stop due to a folding juice spout

Art. no. 262 988 PU 6
EAN 4 006 160 629 880



Art. no. 263 804 PU 4
EAN 4 006 160 638 042





LED display with digital temperature display



Stainless steel



Professional automatic juicer
AE 3532



Beer dispenser
BZ 3740



- Professional automatic juicer in high-quality stainless steel housing
 - Fresh fruit and vegetable juices quickly prepared. Rich in vital substances for well-being, fitness and health
 - 30 % more juice and vitamins
 - Extra large filler spout (75 mm Ø)
 - Extracts the juice from apples, carrots and other fruits within seconds without having to chop them
 - Powerful 1000 watt motor max.
 - 3 speed levels (0/1/2) for different fruit hardness
 - High volume pulp container (approx. 2.0 litres)
 - Open stainless steel juice spout
 - Flexible anti-drip juice spout – no splashes and no wiping
 - Lock with safety switch
 - Stainless steel sieve for finest juices
 - Can be completely disassembled – quick and easy cleaning
 - Secure stand due to rubberized suction pads
- 220–240 V, 50/60 Hz, 1000 W max.
 - WxHxD approx. 300 x 400 x 220 mm

- Stainless steel beer dispenser with CO₂-pressure cartridge system (for all standard 5 litres kegs)
 - High-performance and pleasant alternative to annoying shifting of crates
 - Ideal for private use e.g. small parties in the basement or garden/terrace
 - Suitable for all standard 5 litres kegs as well as 5 litres “Heineken” kegs (with integrated CO₂)
 - Continuously adjustable pressure for the correct amount of foam – enjoy beer like in a tavern
 - LED display for comfortable temperature control / refrigeration from 2 °C–12 °C
 - Easy installation of kegs – ready to use within a few minutes
 - Stainless steel removable drainage grille and drip pan removable for easy cleaning
 - User-friendly and easy to clean
 - Accessories: 3 CO₂ cartridges, cleaning kit, tap tool, adapter for barrels of the “Heineken” brand, universal adapter
- 220–240 V, 50 Hz, 65 W
 - WxHxD approx. 275 x 475 x 495 mm



Extra large filler spout (75 mm Ø)



Drip-stop – no splashes and no wiping



Continuously adjustable pressure for the correct amount of foam – enjoy beer like in a tavern



Incl. 3 CO₂ cartridges



Suitable for all standard 5 litres kegs

Art. no. 263 612
EAN 4 006 160 636 123 PU 2



Art. no. 263 920
EAN 4 006 160 639 209 PU 1





Glass kitchen scale
KW 3626



- Extra-flat digital kitchen scale
- Weighing surface made of high-quality glass
- Clearly legible LCD display
- Measurement range up to 5000 g (in 1 g steps)
- Adjustable measuring units: g, lb-oz, ml, fl-oz
- Automatic shutdown increases battery life
- On/off switch
- Tare function (additive weighed function)
- Secure stand due to rubberized feet
- Low battery indication
- Battery operation: 1x CR 2032 (battery included)
(Battery: 1x lithium, 2.80 g)
- WxHxD approx. 150 x 17 x 220 mm



Stainless steel

Stainless steel kitchen scale
KW 3367



- Extra-flat digital kitchen scale
- Weighing surface made of stainless steel
- Clearly legible LCD display
- Measurement range up to 5000 g (in 1 g steps)
- Adjustable measuring units: kg, g, lb, oz
- Automatic shutdown increases battery life
- On/off switch
- Tare function (additive weighed function)
- Battery operation: 2x AAA (batteries not included)
- WxHxD approx. 150 x 20 x 180 mm



Stainless steel

Stainless steel kitchen scale
KW 3412



- Extra-flat digital kitchen scale
- Weighing surface made of stainless steel
- Clearly legible LCD display (blue illuminated)
- Measurement range up to 5000 g (in 1 g steps)
- Adjustable measuring units: kg, g, lb, oz
- Automatic shutdown increases battery life
- On/off switch
- Tare function (additive weighed function)
- Hanging loop (blue illuminated)
- Battery operation: 3x AAA (batteries included)
(Batteries: 3x zinc-carbon, 6 g)
- WxHxD approx. 170 x 15 x 230 mm

● Art. no. 263 916 PU 6
EAN 4 006 160 639 162

● Art. no. 263 914 PU 6
EAN 4 006 160 639 148

● Art. no. 263 915 PU 6
EAN 4 006 160 639 155

● Art. no. 263 730 PU 6
EAN 4 006 160 637 304



● Art. no. 271 667 PU 6
EAN 4 006 160 716 672



● Art. no. 271 680 PU 6
EAN 4 006 160 716 801





Food dryer
DR 2751



- Food dryer for drying fruit, vegetables, herbs, meat and more. Rich in essential minerals for well-being, fitness and health
- Variable use due to 5 stackable levels (easy cleaning) for up to 3.5 kg of food to be dried*)
- Circulating air blower, circulating air function
- On/off switch
- Overheating protection

- 230 V, 50 Hz, 250 W
- W x H x D approx. 285 x 160 x 315 mm

*) For processing/drying foods that contain large amounts of water such as apples, pineapple etc.



Variable use due to 5 stackable levels (easy cleaning)



Food dryer
DR 3525



- Food dryer for drying fruit, vegetables, herbs, meat and more. Rich in essential minerals for well-being, fitness and health
- 2 temperature levels
- Variable use due to 5 transparent and stackable levels (easy cleaning) for up to 2.5 kg of food to be dried*)
- Circulation fan, air circulation function
- Overheating protection

- 220–240 V, 50 Hz, 300 W
- W x H x D approx. 330 x 315 x 327 mm

*) For processing/drying foods that contain large amounts of water such as apples, pineapple etc.



Variable use due to 5 transparent and stackable levels (easy cleaning)

Art. no. 261 767
EAN 4 006 160 617 672 PU 4



Art. no. 261 699
EAN 4 006 160 616 996 PU 4





Food dryer DR 3773



56

- Food dryer for drying fruit, vegetables, herbs, meat, mushrooms, fish and more. Rich in essential minerals for well-being, fitness and health
- Drying is a very gentle method – all ingredients are preserved
- Preparation of e.g. muesli bars, beef jerky, dried vegetable broth, granola or vegetable chips possible
- HIGH-PERFORMANCE: Dries fruit, vegetables, meat and other foods in record time to produce delicious, long-lasting snacks and ingredients without food additives.
- RIGHT TEMPERATURE: Whether preparing vitamin-rich dried fruit such as apple and banana chips or healthy vegetables such as dried tomatoes – the right temperature can be set for every taste.
- AIRFLOW CIRCULATION: Even heat distribution thanks to 360° airflow circulation ensure that no water remains in the food and that the drying time is short.
- EASY TO CLEAN: Cleaning after the drying process is not complicated at all: the 6 stainless steel storage grids and the drip tray can be rinsed off easily.
- Also suitable for preparing high-quality pet food/treats such as dried meat
- Large interior with up to 6 usable levels
- Approx 0.45 m² for up to 2.6 kg of food to be dried*)
- Comes with 6 stainless steel storage grids (29.5 x 24.5 cm per grid) for various dried foods (durable, food safe, hygienic, easy to clean, dishwasher-safe)
- Heat-insulated door with large viewing window
- On/off switch with indicator light
- Continuous temperature setting (35–70 °C)
- Overheating protection
- Accessory: 1x drip tray for fat residues and crumbs (BPA free)
- 220–240 V, 50–60 Hz, 400 W
- W x H x D approx. 325 x 295 x 370 mm

*) For processing/drying foods that contain large amounts of water such as apples, pineapple etc.



Incl. 6 stainless steel storage grids/ drying trays for various dried foods



AIRFLOW CIRCULATION: Even heat distribution thanks to 360° airflow circulation



Art. no. 263 967
EAN 4 006 160 639 674 PU 1





Bag sealer
FS 3261



- Ideal for dividing food into portions
- Electronic power adjustment
- Seals and separates in one operation
- Strong extraction pump
- With viewing window for foil stock
- 2 indicator lights
- Cord storage in base
- Incl. 1 foil roll (3 m)

- 220–240 V, 50/60 Hz, 100 W
- W x H x D approx. 330 x 80 x 125 mm

Spare rolls:

Art. no. 8900 216

EAN 4 006 160 900 217 PU 10



Art. no. 263 083
EAN 4 006 160 630 831 PU 6



Electric lunchbox
LB 3719



- Electric lunchbox – ideal for heating food in the office, at school or on the go
- Capacity approx. 1.7 litres
- Removable two-part container for food
- Incl. 2 removable high-quality food containers
- Lunchbox lid, 2 food containers suitable for microwave and dishwasher
- Practical carrying handle
- 4-point locking for safe transport
- Heating food up to 75 °C
- Removable steam outlet for easy cleaning
- Indicator light
- Easy use and cleaning
- Removable mains cable
- Accessories: 2 food containers, spoon integrated in the lid, fork and knife

- 220–240 V, 50/60 Hz, 30–40 W
- W x H x D approx. 235 x 100 x 170 mm



Incl. removable food container with lid for e.g. inserts / dessert (microwave and dishwasher-safe)



4-point locking for safe transport

Art. no. 263 890
EAN 4 006 160 638 905 PU 6





2in1



Fondue deep fat pan
FFR 2916



Deep fat fryer
FR 3771



- Cool touch housing
- Capacity: 1 litre oil/frying fat
- Deep frying basket with removable handle
- Continuously adjustable thermostat
- Control panel with display
- 6 fondue forks (colour marked)
- Protective ring against spray/fork holder
- Changeable odour and fumes filter
- Overheating protection

- 220–240 V, 50/60 Hz, 840 W
- W x H x D approx. 190 x 240 x 190 mm

- Cool touch housing
- Capacity: approx. 2.5 litres oil/frying fat
- Oil container (non-stick coated)
- Large frying basket
- Pop-up lid with viewing window (detachable)
- Continuously adjustable thermostat with indicator light (130°C–190°C)
- 2 indicator lights for temperature and operation
- Odour and fumes filter
- 2 carry/handle recesses

- 220–240 V, 50/60 Hz, 1800 W
- W x H x D approx. 300 x 215 x 300 mm



Capacity:
approx. 2.5 litres

Art. no. 282 232
EAN 4 006 160 822 328 PU 4



Art. no. 263 963
EAN 4 006 160 639 636 PU 2





Deep fat fryer
FR 3649



Hot air fryer
FR 3769 H



- Stainless steel applications
- Capacity: 2.5 litres of oil/frying fat
- Oil container (non-stick coated)
- Pop-up lid with viewing window (detachable)
- Continuously adjustable thermostat (130°C–190°C)
- 2 indicator lights for temperature and operation
- Odour and fumes filter
- Drip tray
- Carrying handles (heat-insulated)
- Overheating protection

- 220–240 V, 50/60 Hz, 1600 W
- WxHxD approx. 310 x 230 x 310 mm

- Oil and fat free hot air fryer
- Low emission of fumes and odours
- Time and energy-saving cooking
- Cool touch handle
- Capacity: 1.8 litres
- Removable container (non-stick coated) with safety switch
- Continuously adjustable thermostat (80°C–200°C)
- 30 minutes timer with end signal
- Indicator light
- Overheating protection

- 220–240 V~, 50–60 Hz, 1000 W
- WxHxD approx. 220 x 390 x 270 mm



Capacity: 2.5 litres



360° air flow:
Oil and fat free frying
by hot air circulation



Capacity: 1.8 litres

Art. no. 263 773
EAN 4 006 160 637 731 PU 2



Art. no. 263 964
EAN 4 006 160 639 643 PU 2





XL – 3.6 litres



XL – 3.6 litres

NEW! Hot air fryer
FR 3780 H



Hot air fryer
FR 3699 H



- Oil and fat free hot air fryer
 - Low emission of fumes and odours
 - Time and energy-saving cooking
 - Cool touch handle
 - Capacity: 3.6 litres
 - Non-stick coated container
 - Practical carrying handle (foldable)
 - Continuously adjustable thermostat (80°C–200°C)
 - 30 minutes timer with end signal
 - 2 indicator lights for temperature and operation
 - Automatic switch-off
 - Overheating protection
- 220–240 V, 50–60 Hz, 1350 W
■ W x H x D approx. 265 x 305 x 300 mm

- Oil and fat free hot air fryer
 - Low emission of fumes and odours
 - Time and energy-saving cooking
 - Cool touch handle
 - Capacity: 3.6 litres
 - Non-stick coated container
 - Continuously adjustable thermostat (80°C–200°C)
 - 30 minutes timer with end signal
 - 2 indicator lights for temperature and operation
 - Overheating protection
- 220–240 V, 50/60 Hz, 1400 W
■ W x H x D approx. 265 x 320 x 340 mm



Practical carrying handle (foldable)



360° air flow:
Oil and fat free frying
by hot air circulation



Capacity: 3.6 litres



360° air flow:
Oil and fat free frying
by hot air circulation



Capacity: 3.6 litres

Art. no. 263 975
EAN 4 006 160 639 759 PU 2



Art. no. 263 854
EAN 4 006 160 638 547 PU 2





XXL – 5.0 litres

NEW! Hot air fryer
FR 3782 H



- XXL capacity: approx. 5.0 litres
- Oil and fat free hot air fryer
- Stainless steel front
- 8 automatic programs incl. individual time/temperature settings
- Low emission of fumes and odours
- Time and energy-saving cooking
- Cool touch handle
- LED display with sensor touch operation
- Non-stick coated container
- Continuously adjustable thermostat (80°C–200°C)
- Automatic switch-off
- Overheating protection

- 220–240 V, 50/60 Hz, 1450 W
- W x H x D approx. 275 x 305 x 340 mm



360° air flow:
Oil and fat free frying
by hot air circulation



XXL capacity: 5.0 litres

Art. no. 263 980
EAN 4 006 160 639 803 PU 1





Sensor touch operation
/ electronic



Hot air fryer FR 3747 H



- Versatile hot air fryer for a low-fat diet
- Tasteful preparation with up to 80% less fat*)
- Low emission of fumes and odours
- Much healthier, because dishes cooked with hot air get more vitamins and nutrients*)
- 9 automatic programs incl. variable time and temperature settings
- Incl. dehydrator function – also suitable for vitamin-preserving dehydration of e.g. fruit, vegetables, herbs, meat and more. Rich in vital substances for well-being, fitness and health
- Time and energy-saving cooking
- Cool touch handle with stainless steel insert
- Capacity: approx. 11 litres
- 4 insertion heights for optimum baking results
- LED display with sensor touch operation
- Continuously adjustable thermostat (up to 200°C max.)
- Timer with end signal
- Large viewing window
- Oven light switchable
- Overheating protection
- Extensive accessories:
 - Rotating frying basket
 - Revolving spit for e.g. crispy grilled chicken
 - 2 slide-in grilles for simultaneous preparation of different food
 - Baking tray / fat collecting tray
 - Extraction tool
- 220–240 V, 50/60 Hz, 1500 W
- W x H x D approx. 340 x 370 x 330 mm

*) compared to conventional deep fat fryers



Rotating frying basket



Revolving spit for e.g. crispy grilled chicken, kebab/gyros



Baking tray / fat collecting tray



2 slide-in grilles for simultaneous preparation of different food

Art. no. 263 937
EAN 4 006 160 639 377 PU 1



4 006 160 639 377

PREIS-/LEISTUNGSSIEGER	
VON TESTMAGAZIN - URTEIL	
Clatronic FR 3587	
GUT	88,5 %
Im Test: 8 Kaltzonen-Fritteusen Testurteile: 1 x sehr gut, 7 x gut www.etm-testmagazin.de	
Heft 03/2016	



Stainless steel



Stainless steel

Stainless steel deep fat fryer FR 3586



Stainless steel deep fat fryer FR 3587



- Housing, lid and heating coil made of stainless steel
 - Cold zone technology – heating coil immersed directly in the oil for rapid heating and for odourless frying
 - Capacity: 3 litres of oil/frying fat
 - Continuously adjustable thermostat with indicator light
 - Fat container enamelled (removable)
 - Stainless steel heating coil (removable)
 - Drip tray
 - Carrying handles (heat-insulated)
 - Cord storage
 - Overheating protection
- 220–240 V, 50/60 Hz, 2000 W
■ W x H x D approx. 215 x 240 x 405 mm

- Housing, lid, heating coil and fat container made of stainless steel
 - Cold zone technology – heating coil immersed directly in the oil for rapid heating and for odourless frying
 - Capacity: 3 litres of oil/frying fat
 - Continuously adjustable thermostat with indicator light
 - Lid with viewing window
 - Stainless steel fat container (removable)
 - Stainless steel heating coil (removable)
 - Drip tray
 - Carrying handles (heat-insulated)
 - Changeable odour and fumes filter
 - Cord storage
 - Overheating protection
- 220–240 V, 50/60 Hz, 2000 W
■ W x H x D approx. 215 x 240 x 405 mm

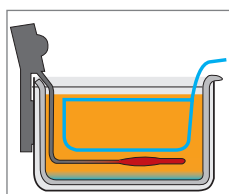

Drip tray

Cold zone technology

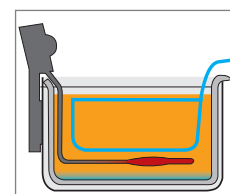

Drip tray

Cold zone technology

Art. no. 263 684
EAN 4 006 160 636 840 PU 2



Art. no. 263 685
EAN 4 006 160 636 857 PU 2





Stainless steel

Double deep fat fryer FR 3195



- Professional double deep fat fryer with 2 small frying baskets and one large frying basket for different types of food
- Housing, lid and heating coil made of stainless steel
- Cold zone technology – heating coil immersed directly in the oil for rapid heating and odourless frying
- Capacity: 4 litres of oil/frying fat
- Fat container enamelled (removable)
- Splash protection lid with filter
- Continuously adjustable thermostat up to 190 °C
- 2 indicator lights for temperature and operation
- Overheating protection
- 220–240 V, 50 Hz, 2000 W
- W x H x D approx. 227 x 375 x 385 mm

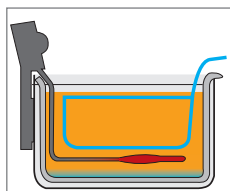

Inkl. 2 kleinen Frittierkörben und einem großen Frittierkorb
(Kapazität: 4 Liter Öl/Fett)

Art. no. 273 531
EAN 4 006 160 735 314 PU 2



2in1

Rice cooker RK 3566



- Rice cooker and steam cooker in one
- Rice cooker for easy preparation and keeping warm all types of rice, pulses, soups, cereals
- Additional aluminium steamer insert for vitaminretaining steam cooking of e.g. vegetables, potatoes and fish
- Safety glass lid with steam outlet
- Removable pot (non-stick coating)
- For max. 1300 g gross weight (yields approx. 2500 g cooked rice)
- Automatic keep warm mode
- Automatic switch-off (energy-saving)
- On/off switch
- Cool touch handles
- Removable supply cable
- Safety function: can only be switched on when pot is in position
- 3 indicator lights for cooking, keeping warm and mains
- Accessories: measuring cup (160 ml max.), rice spoon
- 220–240 V, 50 Hz, 700 W
- W x H x D approx. 310 x 310 x 260 mm



Inkl. aluminium steamer insert

Art. no. 263 235
EAN 4 006 160 632 354 PU 2



ETM TESTMAGAZIN - URTEIL	
Clatronic RK 3567	
GUT	87,9 %
<small>Im Test: 9 Reiskocher Testurteile: 1x sehr gut, 8x gut www.etm-testmagazin.de</small>	
Heft 08/2015	

PREIS-/LEISTUNGSSIEGER	
ETM TESTMAGAZIN - URTEIL	
Clatronic BBA 3505	
GUT	84,14 %
<small>Im Test: 9 Brotbackautomaten Testurteile: 1x sehr gut, 8x gut www.etm-testmagazin.de</small>	
Heft 10/2016	



2in1



Stainless steel



Jam



Wholemeal

Rice cooker RK 3567



Bread maker BBA 3505



- Rice cooker and steam cooker in one
 - Rice cooker for easy preparation and keeping warm all types of rice, pulses, soups, cereals
 - Stainless steel housing
 - Additional aluminium steamer insert for vitaminretaining steam cooking of e.g. vegetables, potatoes and fish
 - Safety glass lid with steam outlet
 - Removable pot (non-stick coating)
 - For max. 1300 g gross weight (yields approx. 2500 g cooked rice)
 - Automatic keep warm mode
 - Automatic switch-off (energy-saving)
 - On/off switch
 - Cool touch handles
 - Removable supply cable
 - Safety function: can only be switched on when pot is in position
 - 3 indicator lights for cooking, keeping warm and mains
 - Accessories: measuring cup (160 ml max.), rice spoon
- 220–240 V, 50 Hz, 700 W
 - W x H x D approx. 310 x 310 x 260 mm



Incl. aluminium steamer insert

- Fully automatic dough and bread preparation (kneading, rising, baking)
 - Non-stick coated baking tin (removable)
 - 2 litres capacity (corresponds to about 1000 g bread)
 - 12 baking programs / 39 possible combinations
 - Programs: Normal, french, wholemeal, fast baking, sweet, ultra fast baking I, ultra fast baking II, dough, jam, cake, sandwich, baking
 - Post baking function
 - Keep warm function
 - Electronic control panel with backlight LCD display
 - Timer programming up to 13 hours
 - Variably settable dough quantity
 - Variable crust browning control (light, medium, dark)
 - Cool touch housing
 - Lid with viewing window (removable)
- 230 V, 50 Hz, 600 W
 - W x H x D approx. 405 x 305 x 265 mm

Art. no. 263 236
EAN 4 006 160 632 361 PU 2



Art. no. 261 690
EAN 4 006 160 616 903 PU 2



For breads up to 1500 g

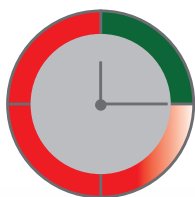

Fast baking program



Jam



Wholemeal



Gluten-free



Cake

Bread maker BBA 3774



- Fully automatic dough and bread preparation (kneading, rising, baking)
 - Non-stick coated baking tin (removable)
 - Baking tin with 3 litres capacity (for breads up to 1500 g)
 - 12 baking programs / 53 possible combinations
 - Programs: Normal, french, wholemeal, gluten-free bread, fast I, sweet, fast II, dough, jam, cake, sandwich, baking
 - Post baking function
 - Keep warm function
 - Electronic control panel with LCD display
 - Timer programming up to 13 hours
 - Variably settable dough quantity
 - Variable crust browning control (light, medium, dark)
 - Cool touch housing
 - Lid with viewing window (removable)
-
- 220–240 V, 50 Hz, 550 W
 - WxHxD approx. 280 x 300 x 330 mm

Art. no. 263 966
EAN 4 006 160 639 667 PU 2



4 006 160 639 667



Steamer
DG 3665



- Steamer for the healthy cooking of food without burning vitamins
- 3 steam cooking containers, 1 lid, 1 rise bowl
- Semi-transparent water tank (1.5 litres)
- Drip bowl for collecting liquids
- 60 minutes timer
- Water level indicator
- Water refilling possible during operation
- Easy to clean
- Overheating protection

- 220–240 V, 50 Hz, 800 W
- WxHxD approx. 325 x 400 x 240 mm



Steamer
DG 3547



- Steamer for the healthy cooking of food without burning vitamins
- Water inflow limiter – faster steam generation
- 3 steam cooking containers, 1 lid, 1 rise bowl
- Stainless steel base
- Programmable digital timer
- Incl. LCD display (blue illuminated)
- Incl. power indicator light
- Drip bowl for collecting liquids
- Water level indicator
- Water refilling possible during operation
- Easy to clean
- Overheating protection

- 220–240 V, 50/60 Hz, 700–800 W
- WxHxD approx. 310 x 445 x 240 mm



Stainless steel base incl. LCD display / timer with backlight

Art. no. 263 802
EAN 4 006 160 638 028 PU 4



Art. no. 283 044
EAN 4 006 160 830 446 PU 2





2in1

Hot dog maker
& egg boiler

Hot dog maker
HDM 3420 EK N

- Hot dog maker and egg boiler in one
- For 1 to 14 small sausages (e.g. "Frankfurter", "Vienna sausages")
- Heated stainless steel skewer
- Preparation of up to 6 eggs
- Removable egg holder
- Transparent steam tank (removable)
- Non-stick coated water bowl
- 2 separate switches for skewer and steamer (blue illuminated)
- Incl. measuring cup with egg pricker
- 230 V, 50 Hz, 380 W
- W x H x D approx. 235 x 270 x 160 mm



Art. no. 251 136
EAN 4 006 160 511 369 PU 6



4 006160 511369



Stainless steel

Contact grill
KG 3487

- Contact grill for double-sided, fat-free grilling
- Fat drainage channel and collecting tray (tray removable for easy cleaning)
- 2000 watt
- Stainless steel housing
- Continuously adjustable thermostat
- Short cooking times
- Non-stick grill plates with extra deep grooves for strong grill pattern and smooth fat drainage
- Large, heat-insulated handle
- 2 indicator lights for power and heating
- Temperature "ready" display
- Large grill area: approx. 29.5 x 23.5 cm
- Cord storage
- Versatile use for e.g. panini, steaks, fish or vegetables
- 220-240 V, 50/60 Hz, 2000 W
- W x H x D approx. 335 x 145 x 335 mm



Stainless steel housing

Art. no. 261 670
EAN 4 006 160 616 705 PU 3



4 006160 616705



Stainless steel

CLICK
HERE

180° opening

Ceramic coated



CLICK
HERE

Contact grill KG 3571



Party pan PP 3401



69

- Contact grill for double-sided, fat-free grilling
 - Barbecue grill – 180° opening enables grilling on a large surface
 - Fat drainage channel and collecting tray (tray removable for easy cleaning)
 - 2000 watt
 - Stainless steel housing
 - Continuously adjustable thermostat
 - Short cooking times
 - Scratch-resistant, ceramic coated grill plates with extra deep grooves for strong grill pattern and smooth fat drainage
 - Large, heat-insulated handle
 - 2 indicator lights for power and heating
 - Temperature “ready” display
 - Large grill areas: 2x approx. 29.5 x 23.5 cm
 - Cord storage
 - Versatile use for e.g. panini, steaks, fish or vegetables
- 220–240 V, 50/60 Hz, 2000 W
 - WxHxD approx. 356 x 145 x 336 mm

- Party pan for cooking, roasting, steaming, defrosting and keeping warm
 - Fast heating and long heat retention
 - Removable supply line with continuously adjustable thermostat
 - Non-stick coated pan (easy to clean)
 - Ø 32 cm, depth: 3.5 cm
 - Heat-resistant glass lid with handle
 - Heat-insulated carrying handles
- 220–240 V, 50/60 Hz, 1500 W
 - WxHxD approx. 380 x 160 x 400 mm



Scratch-resistant ceramic coating



Stainless steel housing



Barbecue grill – 180° opening enables grilling on a large surface

Art. no. 263 657
EAN 4 006 160 636 574 PU 3



4 006 160 636 574

Art. no. 251 129
EAN 4 006 160 511 291 PU 4



4 006 160 511 291



Party pan
PP 2914



- Party pan for cooking, roasting, steaming, defrosting and keeping warm
 - Fast heating and long heat retention
 - Removable supply line with continuously adjustable thermostat
 - Non-stick coated pan (easy to clean)
 - Ø outside approx. 40 cm, Ø inside approx. 38 cm, depth: 4 cm
 - Heat-resistant glass lid with handle
 - Heat-insulated carrying handles
- 220–240 V, 50 Hz, 1400 W
 - W x H x D approx. 450 x 140 x 400 mm



Ceramic coated

Party pan
PP 3570 C



- Party pan for cooking, roasting, steaming, defrosting and keeping warm
 - Fast heating and long heat retention
 - Removable supply line with continuously adjustable thermostat
 - Ceramic coated pan (scratch-resistant and easy to clean)
 - Ø 42 cm, depth: 9 cm
 - Heat-resistant glass lid with handle
 - Heat-insulated carrying handles
- 220–240 V, 50/60 Hz, 1500 W
 - W x H x D approx. 430 x 145 x 490 mm



Scratch-resistant ceramic coating

Art. no. 251 102
EAN 4 006 160 511 024 PU 2



4 006 160 511 024

Art. no. 263 656
EAN 4 006 160 636 567 PU 2



4 006 160 636 567



Pizza/party pan
PP 3402



- Pizza/party pan for cooking, roasting, steaming, defrosting, keeping warm and making pizzas
- Fast heating and long heat retention
- Removable supply line with continuously adjustable thermostat
- Non-stick coated pan (easy to clean)
- Ø 36 cm, depth: 3.5 cm
- Heat-resistant glass/metal lid with handle
- Heat-insulated carrying handles
- 220–240 V, 50/60 Hz, 1500 W
- WxHxD approx. 430 x 160 x 360 mm



NEW! **Fondue set**
FD 3783



- Stainless steel fondue pot, rustproof (Ø 18.5 cm)
- Filling capacity up to 1.2 litres max.
- Also ideal for chocolate & cheese fondue
- Fondue pot with encapsulated sandwich base for perfect heat distribution – also usable individually on different hobs (gas, electric, glass ceramic, halogen)
- Separate, stable hotplate made of stainless steel
- Continuously adjustable thermostat (illuminated)
- Overheating protection
- Thermal fuse
- Stainless steel splash protection with fork holder (removable)
- Accessories: 8 stainless steel fondue forks (colour marked)
- 220–240 V, 50/60 Hz, 1200–1400 W
- WxHxD approx. 285 x 180 x 185 mm



Classic fondue

Chocolate fondue

Cheese fondue



Continuously adjustable thermostat (illuminated)

Art. no. 251 130
EAN 4 006 160 511 307 PU 4



Art. no. 263 981
EAN 4 006 160 639 810 PU 4





COOL TOUCH HOUSING



COOL TOUCH HOUSING

72

Raclette grill
RG 3592



- 2 persons raclette
- Cool touch housing
- For grilling and baking
- Grill area: approx. 20.5 x 10.5 cm
- 2 pans
- Grill plate and pans non-stick coated (easy to clean)

- 230 V, 50 Hz, 350 W
- WxHxD approx. 300 x 105 x 105 mm

NEW! Raclette grill
RG 3776



- Cool touch housing
- For grilling and browning
- Removable grill plate
- Grill plate and pans non-stick coated (easy to clean)
- 8 pans
- 8 wooden spatulas
- Continuously adjustable thermostat
- Indicator light
- Grill area: approx. 40.5 x 30 cm
- Secure stand due to rubberized feet

- 220–240 V, 50/60 Hz, 1200–1400 W
- WxHxD approx. 425 x 128 x 335 mm



8 wooden spatulas

● Art. no. 263 694
EAN 4 006 160 636 949 PU 6



● Art. no. 263 971
EAN 4 006 160 639 711 PU 3





COOL TOUCH HOUSING



Raclette grill
RG 3757

- Cool touch housing
- For grilling and browning
- Removable grill plate
- Grill plate and pans non-stick coated (easy to clean)
- 8 pans
- 8 wooden spatulas
- Continuously adjustable stainless steel thermostat
- Temperature „ready“ display
- 2 indicator lights
- Grill area: approx. 42 x 21 cm
- Secure stand due to rubberized feet

- 220–240 V, 50–60 Hz, 1200–1400 W
- W x H x D approx. 420 x 120 x 210 mm



8 wooden spatulas

Art. no. 263 946
EAN 4 006 160 639 469 PU 3



ETM TESTMAGAZIN · URTEIL	
Clatronic RG 3518	
GUT	84,41 %
Im Test: 10 Raclette-Grills Testurteile: 1x sehr gut, 9x gut www.etm-testmagazin.de	Heft 12/2016



COOL TOUCH HOUSING

Raclette grill RG 3518



- Cool touch housing
 - For grilling and browning
 - Turning iron plate – combination grill area for grilling fish (smooth surface) or meat (extra deep grooves for an intense grill pattern)
 - Natural grill stone for low-fat, vitamin gentle preparation
 - Total grill area: approx. 46 x 23 cm (2x approx. 23 x 23 cm)
 - 8 pans
 - 8 wooden spatulas
 - Continuously adjustable thermostat (blue illuminated)
 - Grill plate and pans non-stick coated (easy to clean)
- 220–240 V, 50/60 Hz, 1200–1400 W
 - WxHxD approx. 465 x 150 x 235 mm



Natural grill stone for low-fat, vitamin gentle preparation



Continuously adjustable thermostat (blue illuminated)

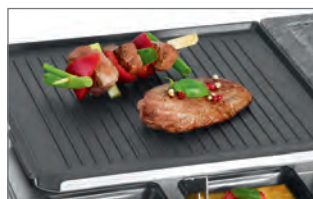

Combination grill area for grilling fish or meat (turning iron plate)



Art. no. 261 706
EAN 4 006 160 617 061 PU 2



4 006 160 617 061

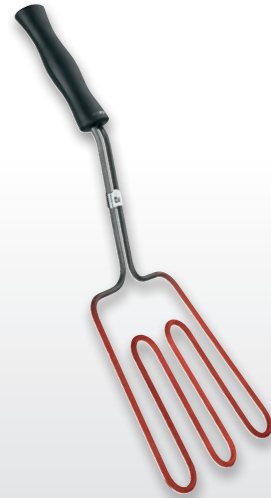

COOL TOUCH HOUSING



Raclette grill
 RG 3678



Electric charcoal lighter
 EGA 3404



- Raclette grill with hot stone and turning iron plate
- For grilling and browning
- Turning iron plate – combination grill area for grilling fish (smooth surface) or meat (extra deep grooves for an intense grill pattern)
- Natural grill stone for low-fat, vitamin gentle preparation
- 180° swivel joint allows variable positions of the two grilling plates – comfortable even for several persons
- Can also be used as a raclette for 4 people
- Grill areas: 2 x approx. 380 x 115 mm
- 8 pans
- 8 wooden spatulas
- Grill plate and pans non-stick coated (easy to clean)
- 2x on/off switch with indicator light (blue illuminated), grill areas separately switchable
- 220–240 V, 50/60 Hz, 1200 Watt (2x 600 Watt)
- W x H x D approx. 530 x 150 x 250 mm

- Electric charcoal lighter for the safe ignition of grilling charcoal and charcoal briquettes
- No chemicals, no smells
- For clean, fast grilling enjoyment
- Minimal smoke emission
- Barbecue fire ignited in about 10 minutes
- Simple operation
- Large ignition surface with 3 filaments
- Incl. metal storage aid (wall mounting possible, incl. mounting material)
- Heat-insulated handle (ergonomically designed)
- Easy to clean
- 220–240 V, 50/60 Hz, 800 W
- W x H x D approx. 200 x 75 x 510 mm

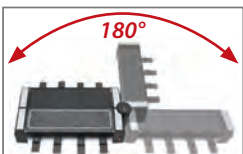

180° swiveling

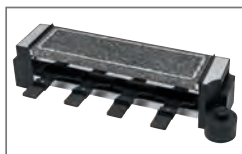

Can also be used as a raclette for 4 people

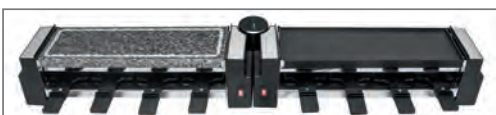

Variable and infinitely adjustable

Art. no. 263 815
 EAN 4 006 160 638 158 PU 2



Art. no. 271 676
 EAN 4 006 160 716 764 PU 6





76

Electric beef grill EBG 3760



- Professional electric top heat grill with grill temperatures of 850 °C for the perfect steak
- Ceramic high-performance infrared burner with 1600 watt
- Perfect for an especially crispy crust
- The inside of the steak remains always tender and juicy – meat pleasure as with the professional
- Cool touch housing; through active cooling ideal suitable for indoor/kitchen use
- Multifunction display – LED display with sensor touch operation and stainless steel knob
 - 5 electrical grilling programs
 - Manual operation of temperature and time
 - Electrical post cooking function
- Height-adjustable stainless steel grilling grid – adaption to the meat thickness through variable insertion heights
- Stainless steel slide-in system for grilling grid and fat collecting tray/warming tray
- Perfect for finishing sous-vide cooked meat
- Also suitable for preparing casseroles, pizzas and vegetables
- Grill area: approx. 24,5 x 16 cm
- Secure stand
- Included:
 - Stainless steel grilling grid (individually adjustable via different insertion heights)
 - Stainless steel extraction tool
 - Stainless steel fat collecting tray/warming tray
- All accessories are dishwasher-safe
- 230 V, 50 Hz, 1600 W
- WxHxD approx. 240 x 300 x 320 mm



Grilling grid and extraction tool made of high-quality stainless steel



Multifunction display – LED display with sensor touch operation and stainless steel knobs

● Art. no. 263 950
EAN 4 006 160 639 506 PU 1



4 006 160 639 506



2in1

Barbecue table grill
BQ 2977 N



Barbecue table grill
BQ 3507



Barbecue standing grill
BQS 3508



- Table grill in an attractive design with low smoke emission and low smell
- Cool touch housing
- On/off switch with indicator light
- Removable grill and heating elements for easy cleaning
- Metal drip tray
- Grill area: 35.5 x 24.5 cm
- 230 V, 50 Hz, 2000 W
- WxHxD approx. 480 x 100 x 360 mm

- Table grill in an attractive design with low smoke emission and low smell
- Continuously adjustable thermostat with indicator light
- Chromed grilling grid
- Removable grill and heating elements for easy cleaning
- Cool touch housing
- Metal drip tray
- Wind protection
- Grill area: 36 x 25 cm
- 230 V, 50 Hz, 2000 W
- WxHxD approx. 510 x 145 x 370 mm

- Standing grill in an attractive design with low smoke emission and low smell
- Continuously adjustable thermostat with indicator light
- Chromed grilling grid
- Removable grill and heating elements for easy cleaning
- Cool touch housing
- Metal drip tray
- Wind protection (removable)
- Additional middle shelf
- Can be converted to a table grill
- Grill height: approx. 80 cm
- Grill area: 35.5 x 24.5 cm
- 230 V, 50 Hz, 2000 W
- WxHxD approx. 510 x 820 x 370 mm



Can be converted to a table grill

Art. no. 262 952
EAN 4 006 160 629 521 PU 4



Art. no. 261 693
EAN 4 006 160 616 934 PU 4



Art. no. 261 697
EAN 4 006 160 616 972 PU 4





Integrated temperature display



Gas grill GG 3590

- 2x heating zones for separate temperature control (2 burners)
- Sturdy grill hood with integrated temperature display
- Control knobs for continuous temperature setting
- 48,5 x 37,5 cm grill area comprising of one enamelled grilling grid (dishwasher-safe)
- 48,5 cm long warming rack (enamelled)
- Removable fat collecting tray for easy cleaning
- 2x burners
- Housing and side trays made of powder-coated steel
- Two wheels for convenient movement
- Convenient storage basket for different grilling utensils
- Large storage room / storage for gas bottle
- Including gas pressure reduction valve and gas tube for Germany and Austria

Specifications

- Burners: 2
- Main burner: 2x 2,75 kW / 5,5 kW
- Gas consumption: 400 gr/h
- Operating pressure: 50 mbar
- Ignition: Piezo ignition system
- Gas category: 13B/P(50)
- Gas type: Butane, propane, or their mixtures
- Target destinations: D, A
- CE certification: Intertek institute, certification number: 2575DL0359CL1116
- WxHxD approx. 970 x 1000 x 550 mm



Grilling grid and warming rack (enamelled)



Convenient storage basket for different grilling utensils





3in1

Doner, chicken
and shashlik grill



Doner vertical multigrill
DVG 3686



- Doner vertical multigrill for fat-free grilling of chickens, kebab/gyros or meat skewers
- Due to the vertical position, the escaping gravy drips directly into the stainless steel fat collecting tray
- Incl. 1 rotary spit (large) for chickens or kebab/gyros
- Incl. 6 separately rotating meat skewers (small)
- Incl. stainless steel tong
- On/off switch
- Indicator light

- 220–240 V, 50/60 Hz, 1400 W
- WxHxD approx. 255 x 350 x 255 mm



1 rotary spit (large) for chickens or kebab/gyros



6 separately rotating meat skewers (small)



Art. no. 263 831
EAN 4 006 160 638 318 PU 2





Mini oven
MB 3746

Multi pizza oven
MPO 3520



- 8 litres oven capacity
- Top and bottom heat
- 2 quartz heating elements
- 60 minutes timer with end signal
- 2 variable insertion heights for optimum baking results
- Stepless temperature control (100 °C–230 °C)
- Stainless steel handle (cool touch)
- Double glazed door with large viewing window
- Indicator light
- Incl. grilling grid, baking tray
- Incl. tongs for removing the grilling grid and baking tray
- Removable crumb tray

- 220–240 V, 50/60 Hz, 650 W
- W x H x D approx. 360 x 200 x 219 mm

- Approx. 12 litres oven capacity
- Pizza oven ideal for grilling and crisping up
- Large grilling grid, perfect for pizza (26 x 25 cm)
- Including baking tray (23.5 x 22 cm)
- Top and bottom heat (combined operation possible)
- 4-level switches:
 - Top and bottom heat
 - Top heat
 - Bottom heat
 - Off
- 2 quartz heating elements
- 60 minutes timer with end signal
- Stainless steel handle
- Crumb tray
- Overheating protection

- 220–240 V, 50/60 Hz, 1000 W
- W x H x D approx. 375 x 220 x 330 mm



Incl. baking tray (25 x 18 cm)



Incl. baking tray (23.5 x 22 cm)

● Art. no. 264 561
EAN 4 006 160 645 613 PU 2

● Art. no. 261 708
EAN 4 006 160 617 085 PU 4





3in1

Convection

**Multi oven
MBG 3726**



**Multi oven
MBG 3727**



- 20 litres oven capacity
- Top and bottom heat (combined operation possible)
- 60 minutes timer with end signal
- 4-level switches:
 - Top and bottom heat
 - Top heat
 - Bottom heat
 - Off
- Stepless temperature control (90°C–230°C)
- Double glazed door with stainless steel handle
- Indicator light
- Removable crumb tray
- Incl. grilling grid, baking tray
- Incl. tongs for removing the grilling grid and baking tray
- Large viewing window
- 220–240 V, 50/60 Hz, 1300 W
- W x H x D approx. 455 x 300 x 370 mm

- 25 litres oven capacity
- Convection
- Top and bottom heat (combined operation possible)
- Revolving spit
- 60 minutes timer with end signal
- 6-level switches:
 - Top and bottom heat
 - Top and bottom heat + convection
 - Top heat + convection
 - Top heat + revolving spit
 - Top and bottom heat + revolving spit + convection
 - Off
- Stepless temperature control (100°C–230°C)
- Double glazed door with stainless steel handle
- Indicator light
- Removable crumb tray
- Incl. grilling grid, baking tray, revolving spit
- Incl. tongs for removing the grilling grid and baking tray, tool for removing the revolving spit
- Large viewing window
- 220–240 V, 50/60 Hz, 1500 W
- W x H x D approx. 480 x 295 x 405 mm



Incl. baking tray (30 x 25.5 cm)



Revolving spit

Art. no. 263 900
EAN 4 006 160 639 001 PU 1

Art. no. 263 898
EAN 4 006 160 638 981 PU 1





4in1

Convection

Pizza stone



**Multi oven
MBG 3728**



**Microwave
MW 791**



- 30 litres oven capacity
- Convection
- Top and bottom heat (combined operation possible)
- Revolving spit
- Pizza stone (Ø 29 cm)
- 90 minutes timer with end signal
- 6-level switches:
 - Top and bottom heat
 - Top and bottom heat + convection
 - Top heat + convection
 - Top heat + revolving spit
 - Top and bottom heat + revolving spit + convection
 - Off
- Stepless temperature control (100°C–230°C)
- Double glazed door with stainless steel handle
- Indicator light
- Removable crumb tray
- Incl. grilling grid, baking tray, revolving spit and pizza stone (Ø 29 cm)
- Incl. tongs for removing the grilling grid and baking tray, tool for removing the revolving spit
- Large viewing window
- 220–240 V, 50/60 Hz, 1500 W
- W x H x D approx. 510 x 330 x 410 mm

- 700 watt microwave
- 20 litres oven capacity
- 6 microwave power levels
- Rotating plate: Ø approx. 24.5 cm
- 30 minutes timer with end signal
- Oven light
- Large viewing window
- 230 V, 50 Hz, 1150 W
- W x H x D approx. 450 x 255 x 340 mm



Revolving spit



Pizza stone (Ø 29 cm)

● Art. no. 263 901
EAN 4 006 160 639 018 PU 1



4 006 160 639 018

● Art. no. 263 893
EAN 4 006 160 638 936 PU 1
● Art. no. 263 892
EAN 4 006 160 638 929 PU 1



4 006 160 638 936



Microwave with grill
MWG 792

Retro microwave with grill
MWG 790



- 700 watt microwave
- 800 watt grill
- 20 litres oven capacity
- 5 microwave power levels
- 3 levels in combined operation (grill/microwave)
- 1 grill level
- Rotating plate: Ø approx. 24.5 cm
- Grilling grid: Ø approx. 21.0 cm
- 30 minutes timer with end signal
- Oven light
- Large viewing window

- 230 V, 50 Hz, 1150 W
- W x H x D approx. 450 x 255 x 340 mm

- 700 watt microwave
- 1000 watt grill
- 20 litres oven capacity
- 5 microwave power levels
- 2 levels in combined operation (grill/microwave)
- 1 grill level
- 9 automatic programs incl. defrost program
- Quick start function
- Timer function with up to 24 h time delay
- Rotating plate: Ø approx. 25.5 cm
- Grilling grid: Ø approx. 20.0 cm
- 95 minutes timer with end signal
- Quartz heating element
- Easy Tronic
- Digital clock
- Child lock
- Oven light
- Large viewing window

- 230 V, 50 Hz, 1050 W
- W x H x D approx. 440 x 260 x 370 mm

● Art. no. 263 895
 EAN 4 006 160 638 950 PU 1
 ○ Art. no. 263 894
 EAN 4 006 160 638 943 PU 1

● Art. no. 253 149
 EAN 4 006 160 531 497 PU 1





Stand alone & under-cabinet mounting



Microwave with grill
MWG 778 U

- Stainless steel front
- 800 watt microwave
- 1000 watt grill
- 20 litres oven capacity
- 5 microwave power levels
- 2 levels in combined operation (grill/microwave)
- 1 grill level
- 8 automatic programs
- Defrost programs (selectable according to time and weight)
- Quick start function
- Rotating plate: Ø approx. 24.5 cm
- Grilling grid: Ø approx. 21.0 cm
- 95 minutes timer with end signal
- Easy Tronic, digital clock, child lock
- Oven light
- Large viewing window
- Stand alone as well as under-cabinet mounting (incl. mounting material)
- 230 V, 50 Hz, 1250 W
- WxHxD approx. 460 x 285 x 370 mm

Built-in microwave with grill
MWG 2215 EB

- Built-in microwave with frame
- Stainless steel front, stainless steel interior
- 800 watt microwave
- 1000 watt grill
- 5 microwave power levels
- 2 levels in combined operation (grill/microwave)
- 1 grill level
- 8 automatic programs
- Defrost programs (selectable according to time and weight)
- 20 litres oven capacity
- Rotating plate: Ø approx. 24.5 cm
- Grilling grid: Ø approx. 21.0 cm
- 95 minutes timer with end signal
- Start delay
- Child lock
- Oven light

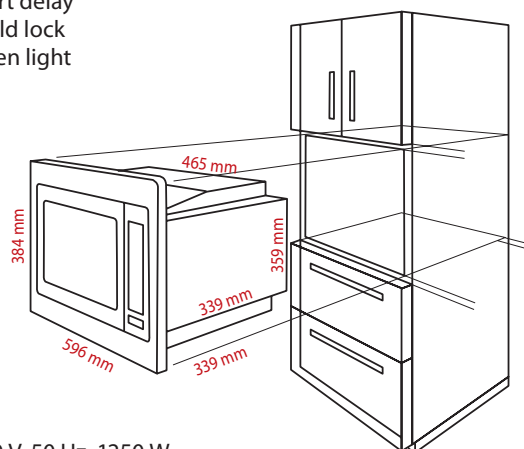

- 230 V, 50 Hz, 1250 W
- Appliance (WxHxD): 465 x 359 x 339 mm
- Appliance with frame (WxHxD): 596 x 384 x 339 mm
- Weight: approx. 14 kg



Built-under appliance

Art. no. 253 130
EAN 4 006 160 531 305 PU 1



Art. no. 622 151
EAN 4 004 470 221 510 PU 1



3in1



Built-in microwave with grill and convection
MWG 2216 H EB

- Built-in microwave with frame
- Stainless steel front, stainless steel interior
- 900 watt microwave
- 1100 watt grill
- 2500 watt convection
- 5 microwave power levels
- 2 levels in combined operation (grill/microwave)
- 2 levels in combined operation (microwave/convection)
- 1 grill level
- 10 temperature settings for convection (130°C–220°C)
- 10 automatic programs
- 2 defrost programs
- Quick start function
- 25 litres oven capacity
- Rotating plate: Ø approx. 32.0 cm
- Grilling grid: Ø approx. 26.0 cm
- 95 minutes timer with end signal
- Start delay
- Child lock
- Oven light

- 230 V, 50 Hz, 1450 W
- Appliance (W x H x D): 520 x 362 x 470 mm
- Appliance with frame (W x H x D): 595 x 460 x 470 mm
- Weight: approx. 21 kg

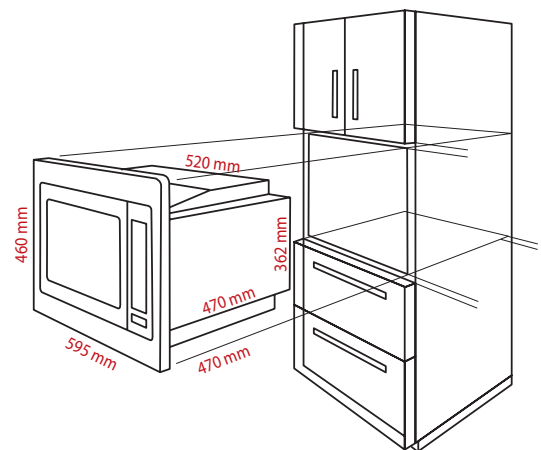

Art. no. 622 161
EAN 4 004 470 221 619 PU 1



4 004470 221619

3in1



Built-in microwave with grill and convection MWG 3001 H EB



86

- Built-in microwave in frameless design
 - Stainless steel front, stainless steel interior
 - LCD display / Digital clock
 - 900 watt microwave
 - 1300 watt grill
 - 2300 watt convection
 - 5 microwave power levels
 - 2 levels in combined operation (grill/microwave)
 - 2 levels in combined operation (microwave/convection)
 - 1 grill level
 - 5 temperature settings for convection (100°C–200°C)
 - 8 automatic programs
 - Defrost program
 - Quick start function
 - 25 litres oven capacity
 - Timer function with up to 24 h time delay
 - Rotating plate: Ø approx. 27.0 cm
 - Grilling grid: Ø approx. 22.2 cm
 - 60 minutes timer with end signal
 - Child lock
 - Oven light
-
- 230 V, 50 Hz, 2300 W
 - Appliance (W x H x D): 595 x 390 x 351 mm
 - Weight: approx. 17 kg

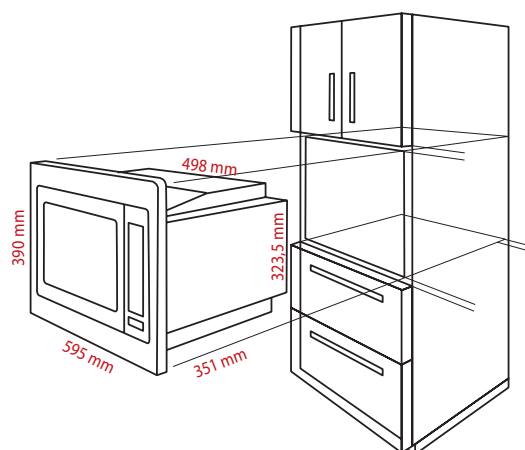

Art. no. 630 011
EAN 4 004 470 300 116 PU 1





Preserving boiler
EKA 3338



- 1800 watt
- 25 litres tank capacity for up to 14 jars
- Enamelled housing (scratch-resistant)
- Closed pot bottom, concealed stainless steel heating element
- Stepless temperature control (30°C–100°C)
- Indicator light
- Integrated drain tap for practical filling of mulled wine, punch or other hot drinks, for example
- Hard-wearing enamel (tasteless)
- Grid insert
- Plastic handles (heat-insulated)
- Overheating protection

- 230 V, 50 Hz, 1800 W
- W x H x D approx. 455 x 495 x 435 mm



Single hotplate
EKP 3582



- Hotplate: Ø approx. 180 mm, 1500 watt
- Continuously adjustable thermostat
- Indicator light
- Heat-resistant finish
- High stability
- Overheating protection

- 230 V, 50 Hz, 1500 W
- W x H x D approx. 360 x 70 x 285 mm



25 litres tank capacity for up to 14 jars



Integrated drain tap



Stepless temperature control (30–100°C)

Art. no. 263 135
EAN 4 006 160 631 357 VE 1

4 006 160 631 357

Art. no. 271 698
EAN 4 006 160 716 986 PU 4

4 006 160 716 986



Stainless steel

Double hotplate
DKP 3583



Stainless steel double hotplate
DKP 3668 E



- 2 hotplates:
 - 1x Ø approx. 180 mm, 1500 watt
 - 1x Ø approx. 150 mm, 1000 watt
- 2 continuously adjustable thermostats
- 2 indicator lights
- Heat-resistant finish
- High stability
- Overheating protection

- 230 V, 50 Hz, 2500 W
- WxHxD approx. 570 x 70 x 285 mm

- Stainless steel housing
- 2 hotplates:
 - 1x Ø approx. 180 mm, 1500 watt
 - 1x Ø approx. 150 mm, 1000 watt
- 2 continuously adjustable thermostats
- 2 indicator lights
- Incl. 2 mountable cool touch handles
- High stability
- Overheating protection

- 230 V, 50 Hz, 2500 W
- WxHxD approx. 590 x 70 x 280 mm (with handles)

Art. no. 271 699
EAN 4 006 160 716 993 PU 3



Art. no. 271 722
EAN 4 006 160 717 228 PU 3





Induction single hotplate EKI 3569



Induction double hotplate DKI 3609



- Induction single hotplate with high-quality, eco-friendly glass-ceramic cooking surface
- Scratch-resistant smooth cooking surface (very easy to clean)
- Heating only takes seconds thanks to induction technology
- ECO-Save – 55 % time savings compared to conventional cooking plates, no preheating phase, energy saving
- Automatic pot detection – automatic switch-off in the case of non-induction pots
- 10 power levels and 10 temperature levels with LED indication (60 °C–240 °C)
- Electronic sensor touch control panel with display for comfortable operation
- 3 LED indicator lights
- 180 minutes timer with automatic switch-off and end signal
- Countdown indication
- Automatic switch-off after 120 min. without operation
- Automatic switch-off after removal of the pot
- Child lock
- High stability due to non-slip feet
- Overheating protection

- 220–240 V, 50/60 Hz, 2000 W
- W x H x D approx. 290 x 65 x 370 mm

- Induction double hotplate with high-quality, eco-friendly glass-ceramic cooking surface
- Scratch-resistant smooth cooking surface (very easy to clean)
- Heating only takes seconds thanks to induction technology
- ECO-Save – 55 % time savings compared to conventional cooking plates, no preheating phase, energy saving
- Automatic pot detection – automatic switch-off in the case of non-induction pots
- LED display
- Each hob with 16 function levels – 6 power levels and 10 temperature levels (60 °C–240 °C)
- Electronic sensor touch control panel with display for comfortable operation
- 2x 3 LED indicator lights
- 180 minutes timer with automatic switch-off and end signal
- Countdown indication on the LED display
- Automatic switch-off after 120 min. without operation
- Automatic switch-off after removal of the pot
- High stability due to non-slip feet
- Overheating protection

- 220–240 V, 50/60 Hz, 3500 W max.
- W x H x D approx. 610 x 75 x 365 mm

Art. no. 263 658
EAN 4 006 160 636 581 PU 4



Art. no. 263 703
EAN 4 006 160 637 038 PU 2





Vertical steam ironing for hanging clothes



Combined attachment: textile brush attachment for gentle and efficient method of removing wrinkles from fabrics and fluffs attachment for removing wrinkles and fluffs



2in1

Steam brush DB 3717



- 2 in 1 – Vertical and horizontal steam ironing possible
- Steam brush for steam ironing, removes wrinkles and lint
- Scratch-resistant „Superglide“ ceramic soleplate with outstanding sliding behaviour
- Combined attachment:
 - Textile brush attachment: gentle and efficient method of removing wrinkles from fabrics
 - Fluffs attachment: for removing wrinkles and fluffs
- The gentle steam effect extends the lifespan of your clothes
- Saves time over traditional ironing
- Also suitable for sensitive materials
- Quick warm-up time through powerful heating element – ready to use in approx. 30 seconds
- Water tank (removable) with 200 ml capacity allows steam ironing up to 6 garments in one pass
- Use for up to 20 min. on a full tank
- Constant steam output: approx. 20 g/min.
- Ergonomically shaped handle
- 7 steam nozzles for quick and gentle smoothing of textiles
- Vertical steam ironing for hanging clothes, curtains etc.
- Extra large operation range by 1.8 m long connection cable
- On/off switch
- Indicator light
- Overheating protection
- Accessories: textile brush attachment, fluffs attachment, measuring cup
- 230 V, 50 Hz, 1100 W
- W x H x D approx. 110 x 270 x 100 mm



2in1

Travelling steam iron/ steam brush DB 3108 B



- Stepless temperature control, suitable for all types of fabric
- Open turning handle
- Indicator light
- Non-stick-coated soleplate
- Combined attachment: fluff removal and brushes
- Vertical steam function for smoothing hanging textiles
- Transparent water container (approx. 30 ml)
- 230 V, 50 Hz, 800 W
- W x H x D approx. 185 x 226 x 128 mm



Art. no. 263 891
EAN 4 006 160 638 912 PU 4



4 006 160 638 912

Art. no. 263 531
EAN 4 006 160 635 317 PU 12



4 006 160 635 317



1800 Watt max.



2000 Watt

Steam iron
DB 3703



- Special stainless steel soleplate
 - 7 functions:
 - Spray device
 - Steam jet function
 - Vertical steam
 - Dry function (steam can be switched off)
 - Self-cleaning function (switchable)
 - Anti-drip function
 - Anti-calc filter system
 - Stepless temperature control
 - Uniform steam distribution through 23 steam nozzles
 - 3-level steam control (0-1-2)
 - Transparent water container (approx. 150 ml)
 - Cable feed via 360° turnable joint
 - Indicator light
 - Accessories: measuring cup
- 220–240 V, 50/60 Hz, 1800 W max.
 ■ W x H x D approx. 110 x 140 x 265 mm

Steam iron
DB 3105



- Special stainless steel soleplate
 - With steam jet function, spray device and vertical steam
 - Stepless temperature control
 - 3-level steam control
 - Dry function (steam can be switched off)
 - Self-cleaning function
 - Transparent water container (approx. 130 ml)
 - Cable feed via 360° turnable joint
 - Indicator light
- 230 V, 50 Hz, 2000 W
 ■ W x H x D approx. 115 x 155 x 275 mm



Incl. switchable self-cleaning function



Incl. switchable self-cleaning function

Art. no. 263 855
 EAN 4 006 160 638 554 PU 6



Art. no. 263 528
 EAN 4 006 160 635 287 PU 6





2200 Watt max.

92

Steam iron DB 3704



- Special stainless steel soleplate
- 7 functions:
 - Spray device
 - Steam jet function
 - Vertical steam
 - Dry function (steam can be switched off)
 - Self-cleaning function (switchable)
 - Anti-drip function
 - Anti-calc filter system
- Stepless temperature control
- Uniform steam distribution through 34 steam nozzles
- 3-level steam control (0-1-2)
- Transparent water container (approx. 250 ml)
- Cable feed via 360° turnable joint
- Indicator light
- Accessories: measuring cup
- 220–240 V, 50/60 Hz, 2200 W max.
- WxHxD approx. 110 x 140 x 285 mm



Incl. switchable self-cleaning function



Art. no. 263 856

EAN 4 006 160 638 561

PU 6



4 006 160 638 561



Ceramic



Steam iron DB 3752

- Scratch-resistant ceramic soleplate with outstanding sliding behaviour
- 7 functions:
 - Spray device
 - Steam jet function
 - Vertical steam
 - Dry function (steam can be switched off)
 - Self-cleaning function (switchable)
 - Anti-drip function
 - Anti-calc filter system
- Stepless temperature control
- Uniform steam distribution through 25 steam nozzles
- 3-level steam control (0-1-2)
- Transparent water container (approx. 250 ml)
- Cable feed via flexible turnable joint
- Indicator light
- Accessories: measuring cup
- 220–240 V, 50–60 Hz, 2200 W max.
- WxHxD approx. 115 x 150 x 290 mm



Scratch-resistant and smooth-running ceramic soleplate



Incl. switchable self-cleaning function

Art. no. 263 941
EAN 4 006 160 639 414 PU 6



4 006 160 639 414



2600 Watt max.

Ceramic

Steam iron DB 3705



- Scratch-resistant ceramic soleplate with outstanding sliding behaviour
- 7 functions:
 - Spray device
 - Steam jet function
 - Vertical steam
 - Dry function (steam can be switched off)
 - Self-cleaning function (switchable)
 - Anti-drip function
 - Anti-calc filter system
- Stepless temperature control
- Uniform steam distribution through 40 steam nozzles
- 4-level steam control (0-1-2-3)
- Transparent water container (approx. 350 ml)
- Soft touch controls
- Rubberized handle for non-slip handling
- Cable feed via 360° turnable joint
- Indicator light
- Accessories: measuring cup
- 220–240 V, 50/60 Hz, 2600 W max.
- W x H x D approx. 125 x 145 x 300 mm



Scratch-resistant and smooth-running ceramic soleplate



Incl. switchable self-cleaning function



Art. no. 263 857

EAN 4 006 160 638 578

PU 6



4 006160 638578



2400 Watt max.

Ceramic

Cordless

Cordless steam iron
DB 3706



- Scratch-resistant ceramic soleplate with outstanding sliding behaviour
- Cordless – ironing without interfering cable
- 7 functions:
 - Spray device
 - Steam jet function
 - Vertical steam
 - Dry function (steam can be switched off)
 - Self-cleaning function (switchable)
 - Anti-drip function
 - Anti-calc filter system
- Stepless temperature control
- Uniform steam distribution through 56 steam nozzles
- 4-level steam control (0-1-2-3)
- Transparent water container (approx. 350 ml)
- Secure stand due to rubberized feet
- Flexible cable feed
- Indicator light
- 220–240 V, 50/60 Hz, 2400 W max.
- W x H x D approx. 145 x 175 x 340 mm



Scratch-resistant and smooth-running ceramic soleplate



Incl. switchable self-cleaning function



2 in 1 – also to use cordless

Art. no. 263 858
EAN 4 006 160 638 585 PU 4



4 006 160 638 585



2800 Watt max.

Ceramic

Steam iron DB 3755



- Scratch-resistant ceramic soleplate with outstanding sliding behaviour
- LED handle illumination / ready indicator
- 7 functions:
 - Spray device
 - Steam jet function
 - Vertical steam
 - Dry function (steam can be switched off)
 - Self-cleaning function (switchable)
 - Anti-drip function
 - Anti-calc filter system
- Stepless temperature control
- 3D ceramic soleplate
 - Professional steam distribution
 - 20 steam nozzles
 - Scratch-resistant Superglide ceramic coating
 - Tail-tapered reverse ironing function
- 3-level steam control (0-1-2)
- Transparent water container (approx. 400 ml)
- Cable feed via 360° turnable joint
- Accessories: measuring cup
- 220–240 V, 50/60 Hz, 2800 W max.
- W x H x D approx. 120 x 155 x 315 mm



3D ceramic soleplate: professional steam distribution, 20 steam nozzles, scratch-resistant Superglide ceramic coating, tail-tapered reverse ironing function



LED handle illumination / ready indicator



Incl. switchable self-cleaning function

Art. no. 263 949
EAN 4 006 160 639 490 PU 4



4 006 160 639 490



2400 Watt max.

Ceramic



Steam ironing station DBS 3749

- Scratch-resistant and smooth-running "Superglide" ceramic soleplate with outstanding sliding behaviour
 - 3.5 bar steam pressure with constant high steam output (max. 90 g/min.)
 - Uniform steam distribution through 11 steam nozzles
 - Horizontal and vertical steam function
 - Removable water tank (1.2 litres capacity), in case of average operation sufficient for up to 80 minutes
 - Electronic anti-drip system
 - Indicator light
 - Stepless temperature control
 - Extra large rest plate to provide the iron with a stable rest
 - Transport safety device (lockable)
 - Extra long connection cable
 - Cord storage compartment
- 220–240 V, 50–60 Hz, 2400 W max.
 - WxHxD approx. 175 x 265 x 365 mm



Scratch-resistant and smooth-running "Superglide" ceramic soleplate



Removable water tank (1.2 litres capacity)



Cord storage compartment



Transport safety device (lockable)

Art. no. 263 940
EAN 4 006 160 639 407 PU 2



4 006 160 639 407



Incl. universal pants attachment for all common fabrics such as jeans or cotton

**POWERFUL
1200
WATT**

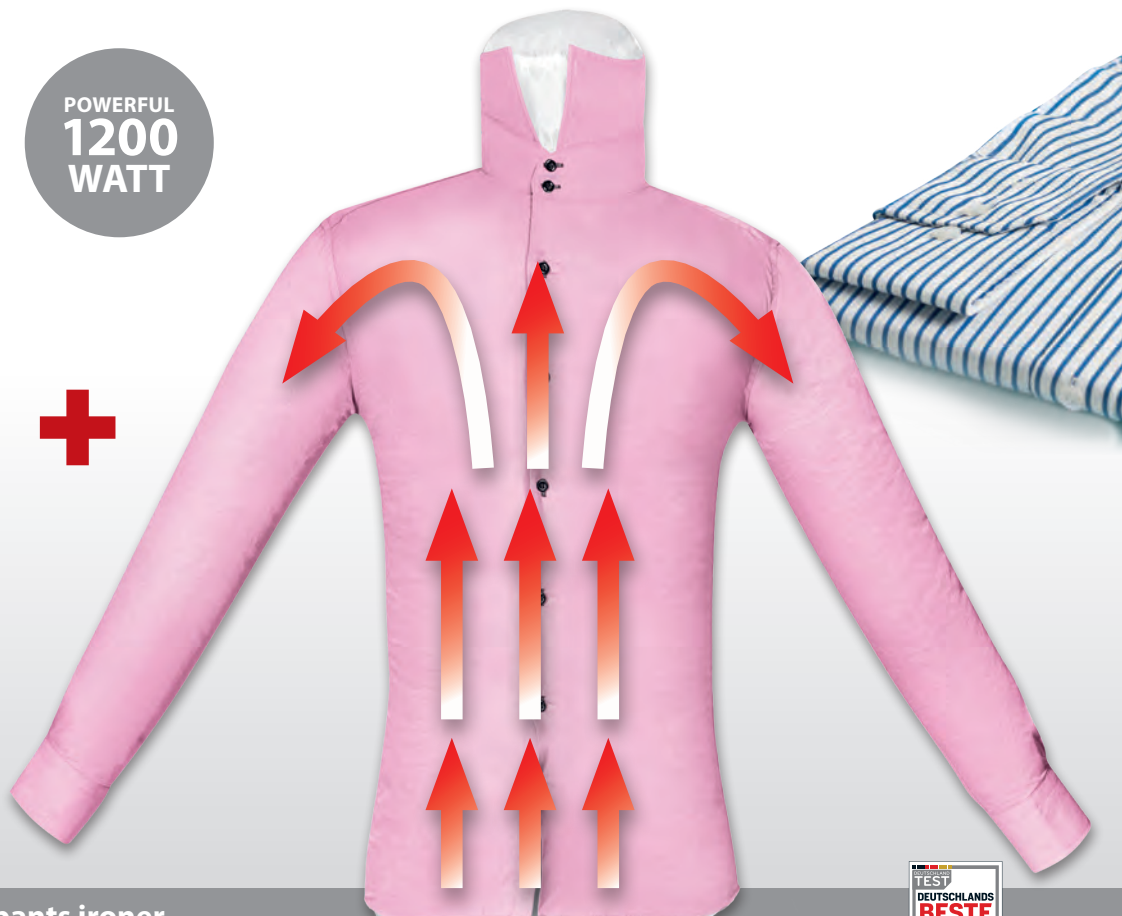

2in1

**Shirts / blouses and pants ironer
HBB 3734**



- Ironing dummy for crease-free shirts, blouses, T-shirts, pants
 - 2 in 1 function – one-step drying and ironing of e.g. outer clothing such as shirts, blouses, T-shirts and dryer-safe pullovers and pants
 - Time and energy saving – clothes dry and ironed in no time
 - Fully automatic drying and ironing in one – replaces irons and ironing boards
 - Also suitable for freshening – neutralizes odours
 - Adjustable „One size“-balloon body (XS–S–M–L–XL–XXL)
 - Incl. universal pants attachment for all common fabrics such as jeans or cotton
 - Powerful 1200 watt
 - Stepless 180 minutes automatic shut-off timer
 - LED indicator light
 - Built-in overheating protection and tilt safety device for automatic shut-off and maximum security
 - Space-efficient design with height-adjustable and removable telescopic rod
- 220–240 V, 50/60 Hz, 1200 W
 - W x H x D (Base) approx. 325 x 275 x 180 mm
 - W x H x D (with doll) approx. 1720 x 1080 x 500 mm



Replacement balloons HBB 3734

SHIRT		
Art. no.	263 911	
EAN	4 006 160 639 117	PU 1
PANT		
Art. no.	263 912	
EAN	4 006 160 639 124	PU 1



Stepless 180 minutes automatic shut-off timer



The washed/tumbled article of clothing is pulled onto the balloon body



Set the timer to the necessary period – the article of clothing is dried and ironed by the air flow



The dried and ironed article of clothing is finished and can be pulled off of the balloon body

Art. no. 263 882
EAN 4 006 160 638 820 PU 2



4 006 160 638 820



Detachable 1.2 litres capacity water tank



Vertical steam ironing for hanging clothes



Gentle and effective method for removing creases from fabrics

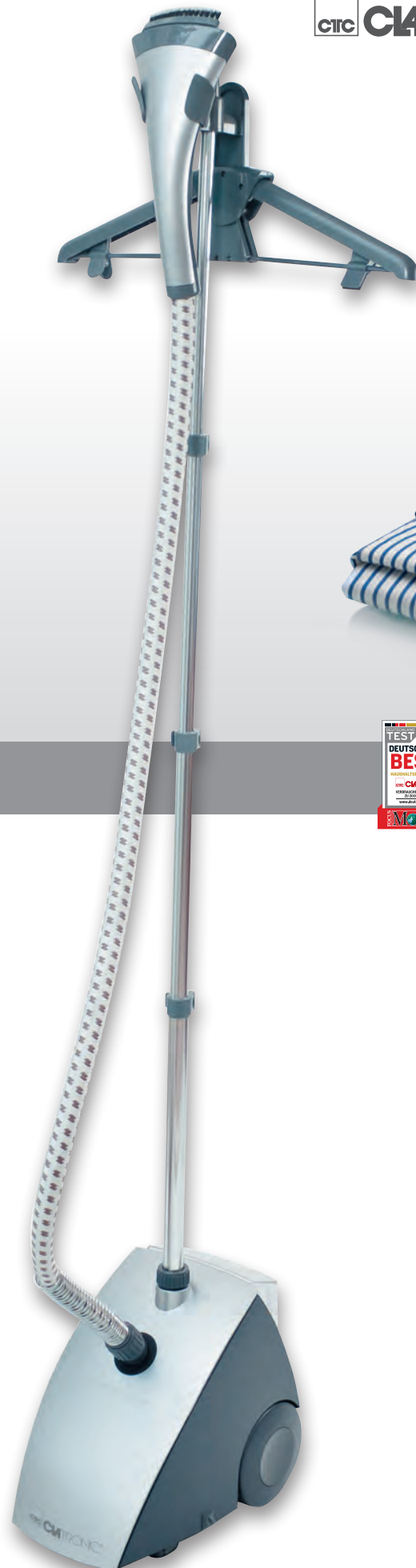

Fabric steamer TDC 3432

- Steamer for steam ironing, removes wrinkles and lint
 - Gentle and effective method for removing creases from fabrics
 - The gentle steam effect extends the lifespan of your clothes
 - Saves time over traditional ironing
 - Also suitable for sensitive materials
 - Vertical steam function
 - Quick warm-up time through 1500 watt of power – ready to use in around 50 seconds
 - Removable water tank (1.2 litres capacity)
 - Use for up to 40 mins on a full tank
 - Stepless height-adjustable telescopic pole (to 1.35 m) for individual adjustment to body height and for easy storage
 - Constant steam output: around 30 g/min.
 - Vertical steam ironing for hanging clothes, curtains etc.
 - Anti-drip system
 - Easy to transport – through 2 large rollers and 2x 360° casters
 - Accessories: trousers and clothes hanger, fabric brush attachment for removing wrinkles and bobbles
 - On/off switch (illuminated)
 - Overheating protection
 - Fire protection fuse
 - Cable length approx. 1.80 m
- 230 V, 50 Hz, 1500 W
 - W x H x D approx. 340 x 1640 x 230 mm

Art. no. 263 561
EAN 4 006 160 635 614 PU 1



4 006 160 635 614



100

Shoe polishing machine SPM 3753



- Universal shoe polishing machine for efficient care/waxing and polishing of all kinds of shoes
- Incl. two quietly running, soft rotary brushes for polishing light and dark shoes
- All brushes removable for easy cleaning
- High-quality metal housing with robust „hammerblow lacquering“
- Powerful engine
- Quiet running
- Effortless and comfortable operation by foot
- Integrated shoe cream dispenser*)
 - with stainless steel ball valve
 - for convenient refilling (removable)
 - Capacity approx. 110 ml
- Dirt collecting mat (textile) removable for easy cleaning
- Secure stand due to rubberized feet
- Speed: 1500 rpm

- 230 V, 50 Hz, 90 W
- WxHxD approx. 270 x 255 x 220 mm

*) Shoe polish/care products not included



Effortless and comfortable operation by foot



Integrated shoe cream dispenser with stainless steel ball valve



Efficient care/waxing and polishing of all kinds of shoes

Replacementsset

2 brushes + screws
Art. no. 264 573
EAN 4 006 160 645 736
PU 1

● Art. no. 263 943
 EAN 4 006 160 639 438 PU 1





Shoe polishing machine SPM 3754

- Versatile shoe polishing machine for efficient cleaning, care/waxing and polishing of all kinds of shoes
 - Incl. three quietly running rotary brushes:
 - 1x rotating cleaning brush for the coarse dirt
 - 2x rotating soft brushes for polishing light and dark shoes
 - All brushes removable for easy cleaning
 - High-quality metal housing with robust „hammerblow lacquering“
 - Powerful motor
 - Quiet running
 - Effortless and comfortable operation by foot
 - Integrated shoe cream dispenser*) in metal housing
 - with stainless steel ball valve
 - for convenient refilling (removable)
 - Capacity approx. 200 ml
 - Dirt collecting mat (rubber) removable for easy cleaning
 - 2 practical recessed grips
 - Secure stand due to rubberized feet
 - Speed: 1750 rpm
-
- 230 V, 50 Hz, 120 W
 - WxHxD approx. 400 x 255 x 250 mm

*) Shoe polish/care products not included



Effortless and comfortable operation by foot

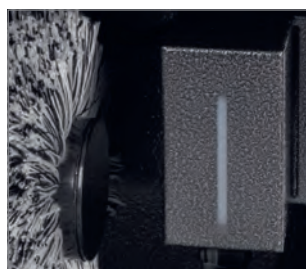

Integrated shoe cream dispenser with stainless steel ball valve



Efficient cleaning, care/waxing and polishing of all kinds of shoes

Replacementset

3 brushes + screws
Art. no. 264 574
EAN 4 006 160 645 743
PU 1

Art. no. 263 944
 EAN 4 006 160 639 445 PU 1





Incl. 360° swiveling steam nozzle



Steam cleaner
DR 3653

- Steam cleaner – cleans, degreases and disinfects without limescale residues and cleaning strips
- 3.5 bar max. steam pressure
- Approx. 250 ml water tank
- Extra-long cable (approx. 5.0 m)
- Overpressure protection
- Overheating protection
- Incl. 9 accessories: brush, angle, fleece, window and universal cleaning attachment, 360° swiveling steam nozzle, hose, measuring cup, funnel
- 220–240 V, 50/60 Hz, 900–1050 W
- WxHxD approx. 250 x 225 x 135 mm



Round brush attachment

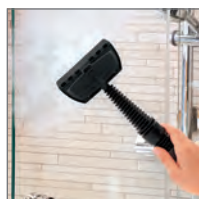

Universal cleaning attachment



Angle attachment



Fleece



Measuring cup

Art. no. 263 785
EAN 4 006 160 637 854 PU 6



4 006 160 637 854



Steam cleaner
DR 3280



- Steam cleaner – cleans, degreases and disinfects without limescale residues and cleaning strips
- 4 bar steam pressure
- Approx. 1.5 litres water tank
- Stainless steel boiler
- Indicator lights (mains and standby)
- Safety tank lid with pressure relief valve
- Overheating protection
- On/off switch protected against water spray
- Practical open carrying handle
- Smooth-running wheels
- Steam control on the handle
- Incl. 10 accessories: 2-part extendable insertable tube, floor brush with cloth holder, fleece cloth, window cleaner, 2 jet nozzle attachments, 2 round brush attachments of different sizes, funnel, measuring cup
- Integrated accessory compartment

- 220–240 V, 50/60 Hz, 1500 W
- WxHxD approx. 670 x 260 x 285 mm



Art. no. 283 013
EAN 4 006 160 830 132 PU 1





Fleece attachment for thorough cleaning



Window cleaning attachment, cleans without streaks and limescale residue



Accessories: 2x microfiber cloth, measuring cup, window cleaner, nozzle, brush, carpet glider attachment



Space-saving storage by easy separation of the components



Steam mop DR 3539

104



- Steam cleaner – cleans, degreases and disinfects at 100 °C without grease marks and residues
 - Suitable for different surfaces: e.g. laminates, wooden floors, marble, rubber, slate, ceramics
 - Cleans fabric surfaces such as carpets, mats and cushions
 - Environmentally friendly and hygienic cleaning without the use of chemicals
 - Kills bacteria through high steam power
 - Maximum disinfection and intensive cleaning
 - Ready to use in around 30 seconds
 - Approx. 300 ml water tank
 - Use for up to 30 min. on a full tank
 - Up to 25 g steam/min.
 - Carpet glider attachment
 - Aluminium telescopic tube
 - Removable handle and nozzle for easy use by hand
 - Accessories: 2x microfiber cloth, measuring cup, window cleaner, nozzle and brush set
 - Long cable (approx. 5.0 m)
 - Cable rewind
 - Fire protection fuse
-
- 220–240 V, 50/60 Hz, 1500 W
 - WxHxD approx. 260 x 1200 x 210 mm

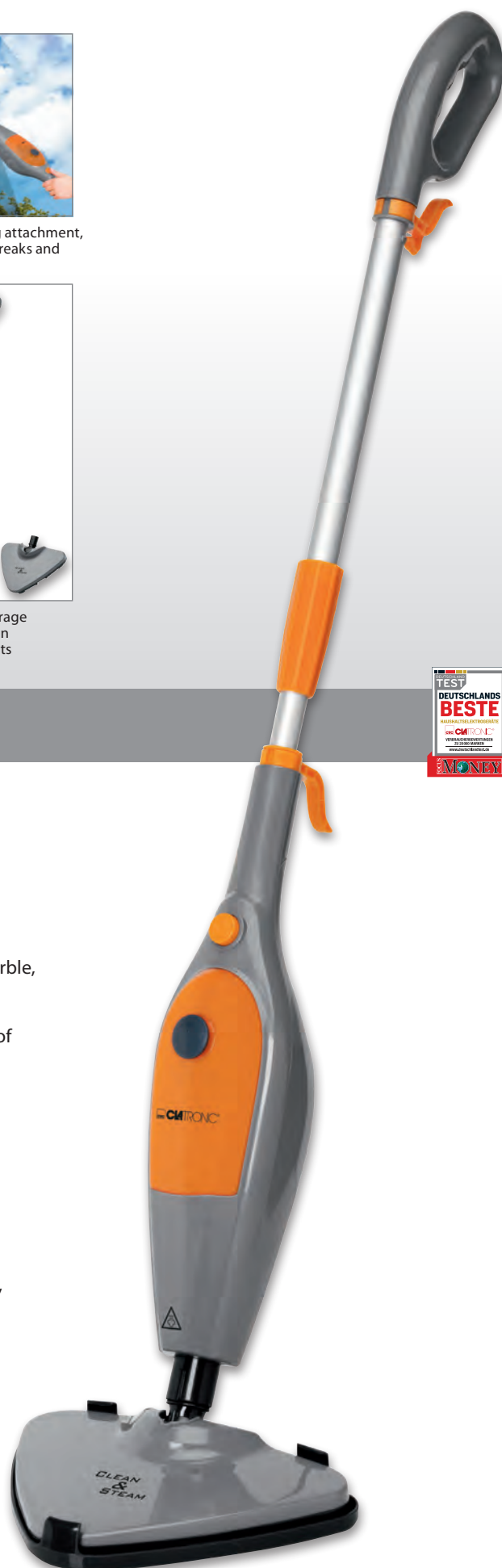

Art. no. 263 621
EAN 4 006 160 636 215 PU 3





Battery vacuum cleaner
AKS 827



- With 3 rechargeable NiMH batteries
- Crevice nozzle, brush nozzle
- Permanent dust filter (washable)
- Charge indicator light (LED)
- Charger mains adapter
- Foot/wall mounting (installation materials supplied)

- Charger mains adapter: 100–240 V, 50/60 Hz
- Rechargeable battery: 3.6 V, 1400 mAh
(Rechargeable battery: 1x nickel metal hydride, 101.15 g)
- W x H x D approx. 100 x 130 x 310 mm



Battery wet/dry vacuum cleaner
AKS 828



- Wet/dry vacuum cleaner
- Powerful battery vacuum cleaner with three rechargeable batteries
- Permanent dust filter (washable)
- Charge indicator light (LED)
- Charger mains adapter
- Accessories: crevice nozzle, attachment for wet vacuuming, wall mounting

- Charger mains adapter:
100–240 V, 50/60 Hz
- Rechargeable battery: 3.6 V, 1400 mAh
(Rechargeable battery: 1x nickel metal hydride, 109.00 g)
- W x H x D approx. 110 x 130 x 380 mm



Art. no. 281 044
EAN 4 006 160 810 448 PU 6



Art. no. 281 052
EAN 4 006 160 810 523 PU 6





12 V operation

Battery vacuum cleaner AKS 832



- Wet/dry vacuum cleaner
- Powerful battery vacuum cleaner with 10 rechargeable batteries
- Permanent dust filter (washable)
- Charge indicator light (LED)
- 12 volt and battery operation possible
- Direct drive function: with fully discharged battery, the battery vacuum cleaner can be used immediately in 12 volt operation
- Cord storage
- Accessories: 2x crevice nozzle (1x 13 cm, 1x 26 cm), attachment for wet vacuuming, brush attachment, 12 volt adapter cord
- Charger mains adapter: 100–240 V, 50/60 Hz
- Rechargeable battery: 12 V / Battery (NiMH), 1400 mAh (Rechargeable battery: 1x nickel metal hydride, 345.62 g)
- W x H x D approx. 125 x 130 x 400 mm



Attachment for wet vacuuming



360° brush attachment



Extra-long crevice nozzles, for example, for use in the car

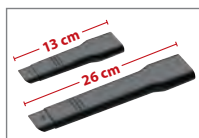

Hand vacuum cleaner HS 2631



- Hand vacuum cleaner for vacuuming of e.g. furniture, upholstery, frames, curtains, books, computers, cars and much more
- Compact size: 24 x 12 x 15 cm
- Permanent dust filter (easy to clean)
- Large operation range (6 m connection cable)
- Low weight
- Vertical storage (space-saving)
- Accessories: flexible „vacuum snout“ with crevice nozzle, small and large brush, shoulder strap
- 220–240 V~, 50/60 Hz, 700 W max.
- W x H x D approx. 110 x 185 x 360 mm



Art. no. 281 055
EAN 4 006 160 810 554 PU 4



4 006160 810554

Art. no. 282 197
EAN 4 006 160 821 970 PU 6



4 006160 821970

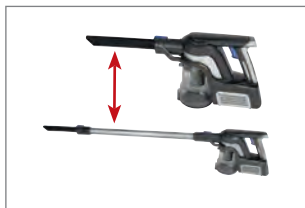

From floor vacuum cleaner to hand vacuum cleaner with one click



Practical wall mount incl. charging station and accessory holder

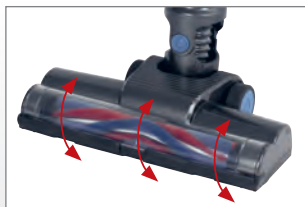

Electrically rotating floor brush



Incl. 3 additional nozzles



Battery floor vacuum cleaner BS 1312 A



- 2 in 1 – High-performance battery hand and floor vacuum cleaner for cordless cleaning
 - Eco-Cyclon twin spin battery hand and floor vacuum cleaner with 18.5 V lithium ion battery (2200 mAh)
 - Electrically rotating floor brush
 - Incl. extra long crevice nozzle (25 cm)
 - Incl. rotatable brush nozzle (90°)
 - Incl. mini special nozzle
 - Suitable for all surfaces
 - Electronic overcharge protection
 - From floor vacuum cleaner to hand vacuum cleaner with one click, suitable for vacuuming of e.g. furniture, cushions, drapes, books, car seats
 - Bagless filter technology – easy emptying by touch of a button + no need to buy expensive replacement vacuum cleaner bags later
 - HEPA filter (High efficiency particulate air filter)
 - Battery running time up to 20 minutes
 - Battery charging time approx. 5 hours
 - Aluminium suction tube
 - Electronic power adjustment (2-steps)
 - Integrated economy mode for longer battery life
 - 4-step LED battery level indicator
 - Optimum mobility with the double pivot that can be rotated up to 180°
 - Practical wall mount incl. charging station and accessories holder
 - Accessories: crevice nozzle, brush nozzle, mini special nozzle, wall mount
- 220–240 V, 50/60 Hz, 18.5 V / rechargeable battery (Li-Ion), 2200 mAh
(Rechargeable battery: 1x lithium-ion, 222.50 g)
- WxHxD approx. 335 x 225 x 120 mm

Turbo Rotation
EXTRA SUCTION POWER
through electrically rotating
floor brush





Incl. wall mount



Incl. brush attachment



Incl. crevice nozzle

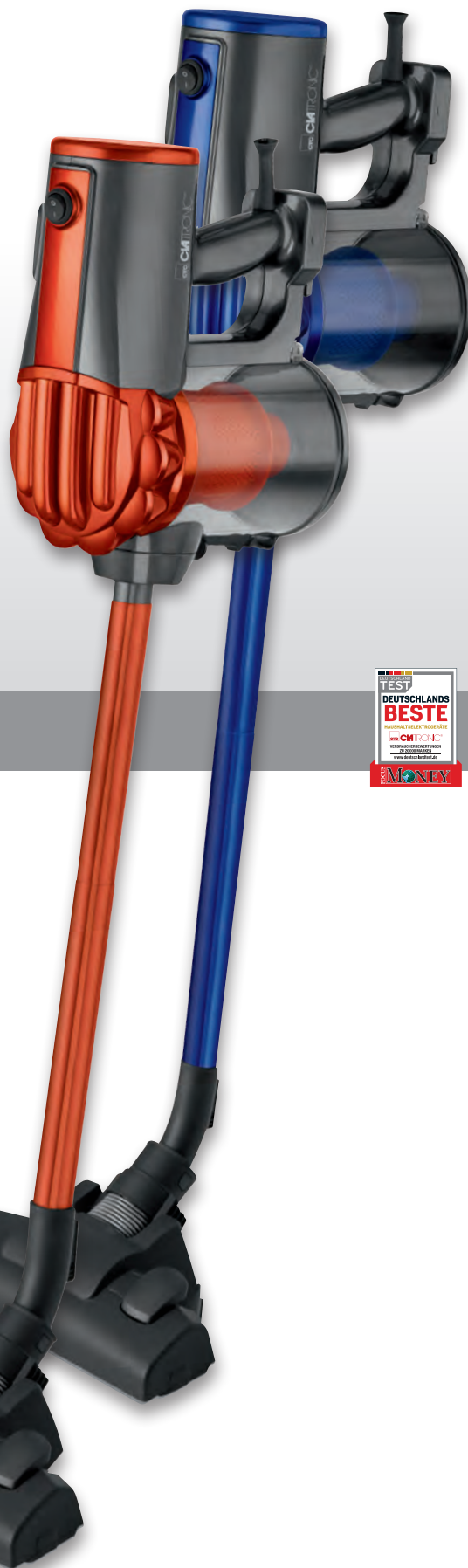

Floor vacuum cleaner
BS 1306 N



- 2 in 1 – Floor and hand vacuum cleaner in one
- Eco-Cyclon twin spin hand and floor vacuum cleaner with energy-saving 600 watt
 - Switchable floor brush
 - Incl. brush attachment
 - Incl. crevice nozzle
- Also suitable as hand vacuum cleaner for vacuuming of e.g. furniture, cushions, drapes, books, car seats
- Microfilter system
- HEPA filter (High efficiency particulate air filter)
- Two part aluminium tube (35–75 cm)
- Big operating range (6.5 m connection cable) – problem-free access to stairs and corners
- Maneuverable and of easy application thanks to its light weight
- Incl. wall mount for space-saving storage
- Accessories: brush attachment, crevice nozzle, wall mount

- 220–240 V, 50/60 Hz, 600 W
- WxHxD approx. 230 x 1300 x 130 mm (with suction tube)



Incl. floor brush (switchable)

Art. no. 263 779
EAN 4 006 160 637 793 PU 2

4 006160 637793

Art. no. 263 778
EAN 4 006 160 637 786 PU 2

4 006160 637786



Floor vacuum cleaner
BS 1300 N



- Floor vacuum cleaner with energy-saving 700 watt
- 5-fold microfilter system
- Stainless steel telescopic tube
- Switchable floor brush
- Dust bag change indicator
- Practical carrying handle
- Automatic cable rewind
- Space-saving parking aid
- 2-fold accessories: combined brush/crevice nozzle

- 220–240 V, 50–60 Hz, 700 W
- WxHxD approx. 256 x 205 x 310 mm



Incl. floor brush (switchable)



2-fold accessories: combined brush/crevice nozzle

Art. no. 271 712
EAN 4 006 160 717 129 PU 1





110

Floor vacuum cleaner BS 1308



- Eco-Cyclon twin spin floor vacuum cleaner with energy-saving 700 watt
 - Bagless filter technology
 - 4-fold microfilter system
 - HEPA filter (High efficiency particulate air filter)
 - Metal telescopic tube
 - Switchable floor brush
 - Practical carrying handle
 - Automatic cable rewind
 - Space-saving parking aid
 - 2-fold accessories: combined brush/crevice nozzle
- 220–240 V, 50/60 Hz, 700 W
 - WxHxD approx. 340 x 250 x 270 mm



2-fold accessories: combined
brush/crevice nozzle

Art. no. 263 809
EAN 4 006 160 638 097 PU 1



4 006 160 638 097

Art. no. 263 821
EAN 4 006 160 638 219 PU 1



4 006 160 638 219

Art. no. 263 820
EAN 4 006 160 638 202 PU 1



4 006 160 638 202



Turbo brush for easy removal for example of animal hair and fluff – ideal for pet owners



Floor vacuum cleaner
 BS 1308 P



- Eco-Cyclon twin spin floor vacuum cleaner with energy-saving 700 watt
- Incl. turbo brush for easy removal for example of animal hair and fluff – ideal for pet owners
- Bagless filter technology
- 4-fold microfilter system
- HEPA filter (High efficiency particulate air filter)
- Metal telescopic tube
- Switchable floor brush
- Practical carrying handle
- Automatic cable rewind
- Space-saving parking aid
- 3-fold accessories: turbo brush (11.5 cm), combined brush/crevice nozzle

- 220–240 V, 50/60 Hz, 700 W
- W x H x D approx. 340 x 250 x 270 mm



2-fold accessories: combined brush/crevice nozzle



Art. no. 263 822
 EAN 4 006 160 638 226 PU 1





ELECTRONIC

112

Floor vacuum cleaner BS 1302 N



- Eco-Cyclon twin spin floor vacuum cleaner with energy-saving 700 watt
 - Constantly high suction power by bagless cyclon twin spin technology
 - Electronic power adjustment
 - 4-fold filter system
 - HEPA filter (High efficiency particulate air filter)
 - Stainless steel telescopic tube (approx. 92 cm length)
 - Extra-large operation range (approx. 8.30 m)
 - Switchable floor brush
 - Incl. parquet brush
 - Rubberized rollers (ideal for sensitive floors)
 - Practical carrying handle
 - Automatic cable rewind
 - Space-saving parking aid
 - 2-fold accessories: combined brush/crevice nozzle
- 220–240 V, 50–60 Hz, 700 W
 - WxHxD approx. 275 x 340 x 436 mm



2-fold accessories: combined brush/crevice nozzle



Incl. parquet brush



Art. no. 271 719

EAN 4 006 160 717 198

PU 1



4 006 160 717 198



Art. no. 271 720

EAN 4 006 160 717 204

PU 1



4 006 160 717 204



Art. no. 271 721

EAN 4 006 160 717 211

PU 1



4 006 160 717 211



ELECTRONIC

Floor vacuum cleaner BS 1294 N



113

- Floor vacuum cleaner with energy-saving 700 watt
 - Electronic power adjustment
 - 2x HEPA filter (High efficiency particulate air filter)
 - Height-adjustable telescopic tube
 - Switchable floor brush
 - Bagless filter technology (no need to purchase dust bags)
 - Easy-to-empty, transparent dust-collecting container replaces conventional dust bag
 - Tank volume: 1.25 litres
 - Motor protection filter (washable)
 - Rubberized rollers (ideal for parquet floors)
 - Automatic cable rewind
 - Space-saving parking aid
 - 3-fold accessories: combined brush/crevice nozzle, upholstery nozzle
-
- 220–240 V, 50/60 Hz, 700 W
 - WxHxD approx. 365 x 265 x 285 mm

Art. no. 271 703
EAN 4 006 160 717 037 PU 1



4 006 160 717 037

3in1

Wet vacuuming
Dry vacuuming
Blower function

Accessories holder



Wet vacuuming
(e.g. spilled liquids)



Dry vacuuming
(e.g. of dirt in the car)



Blower function (e.g. for
easy removal of leaves)

114

NEW! Wet/dry vacuum cleaner
BS 1313



- High-quality stainless steel housing
 - Large and comfortable wet and dry vacuum cleaner with powerful 1200 watt
 - Tank capacity: approx. 20 litres
 - Powerful cleaning and suction power
 - Moisture (e.g. spilled liquids, wet potting soil)
 - Coarse dirt (e.g. leaves, broken glass, wood chips)
 - Dirt (e.g. dust on carpets or in the car)
 - Incl. blower function (e.g. for easy removal of leaves)
 - 3-part suction tube: variable working length from 32.0 to 92.5 cm
 - 4 smooth-running castors (360°) allow flexible working
 - Approx. 5 m cable for a large operating radius
 - Splash-proof motor housing
 - Motor/overflow protection by float valve
 - Washable permanent filters
 - Practical accessories holder on the unit for ready-to-hand and organized accessories
 - Accessories: brush/crevice attachment, wet/dry brush, 3-part suction tube, washable permanent filters
-
- 220–240 V, 50/60 Hz, 1200 W
 - WxHxD approx. 400 x 505 x 400 mm



Incl. brush and crevice nozzle



Art. no. 263 978
EAN 4 006 160 639 780 PU 1



4 006 160 639 780

4in1

Wet vacuuming
Dry vacuuming
Shampoo function
Blower function

Stainless steel tube

Accessories holder



Upholstery nozzle

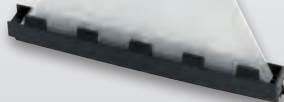

Shampoo nozzle



Wet/dry brush



Crevice nozzle

Shampoo vacuum cleaner BSS 1309



115

- Comfortable shampoo vacuum cleaner with powerful 1200 watt
 - Cleans away larger dirt just as effectively as fluids
 - Comes with separate removable tank for cleaning agent (4 litres)
 - Spray extraction for even & large-scale spreading of the cleaning agent
 - Perfect stability thanks to four pulleys
 - 2 pulleys (360°) allow for easy and flexible cleaning
 - 2-part stainless steel tube
 - Big, sturdy carrying handle
 - Dual filter system
 - Practical accessories holder on the unit for ready-to-hand and organized accessories
 - Comes with drain appliance to discharge absorbed fluids
 - Incl. blower function (e.g. for easy removal of leaves)
 - For easy and thorough cleaning of fabrics, areas, and hard floors (e.g. stone, tiles, linoleum)
 - For deep-cleaning of upholstery and rugs
 - Accessories: crevice nozzle, parquet brush, large suction nozzle (e.g. to clean carpet floors, tiles) small suction nozzle (e.g. to clean upholstery)
 - Tank capacity (wet cleaning operation): 20 litres
 - Cleaning container capacity: 4 litres
- 220-240 V, 50/60 Hz, 1200 W
 - W x H x D approx. 370 x 500 x 430 mm



Large tank capacity
(approx. 20 litres)



Shampoo tank
(approx. 4 litres)



Shampoo vacuum
cleaner



Wet/dry vacuum
cleaner



Upholstery
vacuum cleaner



Art. no. 263 850
EAN 4 006 160 638 509

PU 1



4 006 160 638 509



Convenient one-hand operation



Convenient one-hand operation



Textile mini cleaner
TC 3758



Textile mini cleaner
TC 3759



- Textile mini cleaner for effective removal of lint and small nodules (pilling)
- Suitable for almost all garments such as wool, cotton, flannel, synthetic fibres, etc.¹⁾
- Also suitable for blankets, carpets, bed linen or seat covers¹⁾
- High-quality stainless steel shaving foil (approx. Ø 32 mm)
- 3-fold spring-mounted stainless steel blade (removable for easy cleaning)
- Convenient one-hand operation
- Small and handy (ideal for on the go)
- Removable and easily washable lint container
- On/off switch
- Accessories: cleaning brush, covering cap
- Battery operation: 2x 1.5 V AA (batteries not included)
- W x H x D approx. 52 x 98 x 74 mm

¹⁾ Please test on an invisible spot before use.

- Textile mini cleaner for effective removal of lint and small nodules (pilling)
- Suitable for almost all garments such as wool, cotton, flannel, synthetic fibres, etc.¹⁾
- Also suitable for blankets, carpets, bed linen or seat covers¹⁾
- High-quality stainless steel shaving foil (approx. Ø 45 mm)
- 3-fold spring-mounted stainless steel blade (removable for easy cleaning)
- Convenient one-hand operation
- Small and handy (ideal for on the go)
- Large, removable and easily washable lint container
- On/off switch
- Safety shutdown (automatic shutdown when the shaving head is removed)
- Accessories: cleaning brush, covering cap
- Battery operation: 2x 1.5 V AA (batteries not included)
- W x H x D approx. 59 x 155 x 79 mm

¹⁾ Please test on an invisible spot before use.

Art. no. 263 947
EAN 4 006 160 639 476 PU 10



Art. no. 263 948
EAN 4 006 160 639 483 PU 10





Alcohol tester
AT 3605



- Alcohol tester in an attractive design
- Measurement standby function
- 2 digital LCD displays
 - Display in parts per thousand and g/l from 0.0 to 1.9 ‰ (red illuminated)
 - Temperature display in °C and °F
 - Time display (12/24 h)
- Optical warning at 0,2 ‰ and 0,5 ‰
- Countdown function (measuring readiness)
- Alarm function
- Automatic shutdown increases battery life
- Low weight

- Battery operation: 2x AAA (batteries not included)
- WxHxD approx. 36 x 120 x 20 mm

Glass bathroom scale
PW 3368



- Electronic glass bathroom scale with easy-to-read LCD display
- Weighing units in kg, lb, st (convertible)
- Measurement range of 2.5–150 kg (in 100 g steps)
- Low-maintenance standing surface
- Secure stand due to anti-slip feet
- Automatic shutdown increases battery life

- Battery operation: 1x CR 2032 (battery included)
(Battery: 1x lithium, 2.80 g)
- WxHxD approx. 300 x 25 x 300 mm



2 digital LCD displays for:
 – Time, temperature
 – Alcohol content (red illuminated)

Art. no. 271 704
 EAN 4 006 160 717 044 PU 12



Art. no. 271 666
 EAN 4 006 160 716 665 PU 6





Glass bathroom scale
PW 3369



- Electronic glass bathroom scale with easy-to-read LCD display
- Weighing units in kg, lb, st (convertible)
- Measurement range of 2.5–150 kg (in 100 g steps)
- Low-maintenance standing surface
- Secure stand due to anti-slip feet
- Automatic shutdown increases battery life
- Battery operation: 1x CR 2032 (battery included)
(Battery: 1x lithium, 2.80 g)
- W x H x D approx. 320 x 25 x 320 mm



Foot massager
FM 3389



- Intense whirlpool effect
- Massage burls for stimulating the foot reflex zones
- Additional massage roller (removable) for selective foot reflex zone massage
- Heated footrest
- 4-level switches:
 - 0 = off
 - 1 = massage
 - 2 = warm/whirl
 - 3 = warm/whirl/massage
- Can be used with and without water
- Splash guard (detachable)
- Water level mark
- Spout
- Large, rubberized feet for non-slip standing
- 230 V, 50 Hz, 90 W
- W x H x D approx. 300 x 120 x 380 mm



Art. no. 271 665
EAN 4 006 160 716 658 PU 6



4 006 160 716 658

Art. no. 263 186
EAN 4 006 160 631 869 PU 3



4 006 160 631 869



Facial sauna
GS 3656



- Facial sauna for cosmetic face care and inhalation
 - Cosmetic face care with facial sauna attachment – pores are opened for easier cleaning, supplies the skin with rich hydration and stimulates blood circulation
 - Incl. exchangeable inhaler for inhaling through mouth and nose
 - Relaxation for mind and soul with the aroma attachment – healthy inhalation, e.g. with specific application of essential oils
 - Indicator light
 - 3-level switches (0/1/2) for correct steam dosage
 - Overheating protection
 - Accessories: inhaler, aroma cap and measuring cup for easy filling
- 220–240 V, 50 Hz, 130 W
 - WxHxD approx. 215 x 250 x 200 mm



Inhaler for mouth and nose

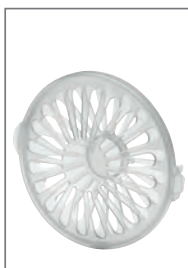

Aroma attachment



Measuring cup

Art. no. 263 790
EAN 4 006 160 637 908 PU 6



4 006 160 637 908



Nose and ear hair remover
NE 3595



- Conveniently and simply removes troublesome hairs in the nose and ears
- Incl. light for precise hair removal
- Stainless steel shaving head removable for easy cleaning
- Soft touch (partially rubberized housing)
- On/off switch
- Incl. covering cap for the shaving head
- Battery operation: 1x 1.5 V (AA) (battery not included)
- WxHxD approx. 30 x 130 x 35 mm



Includes light for improved personal grooming



Promotional packaging

Art. no. 263 687
EAN 4 006 160 636 871 PU 12



Vertical shaving head for contours/eyebrows



360° shearing head for nose and ear hairs



Nose and ear hair remover
NE 3743



- Nose/ear hair remover and contour cutter in one
- Safe and easy removal of nose and ear hairs
- Stainless steel shaving heads removable for easy cleaning:
 - Vertically mounted shaving head for:
 - Contours
 - Eyebrows
 - 360° shaving head for:
 - Nose and ear hairs
- Incl. high-quality chrome applications
- On/off switch
- Battery operation: 1x 1.5 V (AA) (battery not included)
- WxHxD approx. 21 x 150 x 21 mm



Vertically mounted shaving head and 360° shaving head



Promotional packaging

Art. no. 263 936
EAN 4 006 160 639 360 PU 8





Hair trimmer set
HSM 3441 NE



Hair and beard trimmer:

- Stainless steel precision shaving head for uniform haircut
- Stainless steel blade
- Stepless cutting length adjustment for efficient use of the comb attachments
- Comb attachments for 4 cutting lengths: 3, 6, 9, 12 mm
- Soft touch handle insert for safe handling
- Accessories: 4 comb attachments, styling comb, cleaning brush, shaving head protection, hanging loop
- 230–240 V, 50 Hz, 9 W
- W x H x D approx. 65 x 200 x 55 mm

Nose and ear hair remover:

- Conveniently and simply removes troublesome hairs in the nose and ears
- Stainless steel shaving head removable for easy cleaning
- Incl. covering cap for shaving head
- Battery operation: 1x 1.5 V (AA) (battery not included)
- W x H x D approx. 30 x 130 x 30 mm



Hair and beard trimmer
HSM/R 3313



Accumulator operation

- Stainless steel precision shaving head for uniform haircut
- Cutting lengths adjustable for professional work: 3 mm (without comb attachment); 5, 9, 13, 16 mm (with comb attachment)
- Removable comb attachment
- Mechanically folding shaving head for easy cleaning
- Easy to handle due to ergonomically shaped grip
- Soft touch handle insert
- LED charge display
- Charging station/stand including rubberized feet for stability
- Incl. 6 accessories: charging station/stand, mains charger, comb, cleaning brush, scissor, comb attachment
- Mains charger: 100–240 V, 50/60 Hz; rechargeable battery (NiMH): 800 mAh
(Rechargeable battery: 1x nickel metal hydride, 16.00 g)
- W x H x D approx. 50 x 190 x 50 mm



Art. no. 263 571
EAN 4 006 160 635 713 PU 10



Art. no. 282 243
EAN 4 006 160 822 434 PU 10





Ion technology function



122

Hair straightener HC 3660



- Ideal for fashionable hairstyles
- Ceramic plates, durable and scratch-resistant, for uniform, gentle heat distribution
- Additional tourmaline coating provides ionising function – easier styling due to anti-static effect, the hair becomes sleek and silky
- Straightens the hair without problems due to the prolonged constant temperature
- Short heat-up time
- LED indicator light
- Safety interlock
- Handy design
- On/off switch
- Heat resistant power cord
- Cable feed via 360° turnable joint
- Hanging loop
- 220–240 V, 50/60 Hz, 28–33 W
- W x H x D approx. 310 x 30 x 34 mm

Hair crimper HC 3392



- Hair crimper (chromed)
- Trouble-free styling due to the constant, long-lasting temperature
- Short heat-up time
- Indicator light
- Soft touch housing
- Cable feed via 360° turnable joint
- On/off switch
- Incl. setting-down aid
- 220–240 V, 50/60 Hz, 25 W
- W x H x D approx. 280 x 35 x 70 mm



LED indicator light

Art. no. 263 801
EAN 4 006 160 638 011 PU 6



4 006 160 638 011

Art. no. 263 183
EAN 4 006 160 631 838 PU 12



4 006 160 631 838



Hot air curling brush
HAS 3659



- Hot air curling brush for even and gentle heat distribution
- 3 exchangeable brush attachments with smooth bristles for hair-friendly styling:
 - 1 volume brush
 - 2 round brushes individual for all hair lengths and requirements (15 mm Ø and 25 mm Ø)
- 2 temperature-/power settings
- Cold setting for style fix and hairstyle finish
- Ergonomically shaped handle
- Cable feed via 360° turnable joint
- Overheating protection
- Hanging loop

- 230 V, 50/60 Hz, 600 W
- WxHxD approx. 365 x 50 x 50 mm



Hair dryer
HT 3393



- Compact travelling hair dryer
- 2 temperature/power settings
- Shaping nozzle 360° rotatable (removable)
- Rubber profile on the casing avoid slipping
- Overheating protection
- Hanging loop

- 230 V, 50 Hz, 1200 W
- WxHxD approx. 111 x 210 x 75 mm



Volume brush

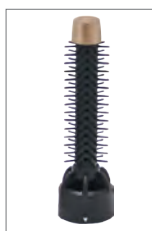

1 round brush
(15 mm Ø)

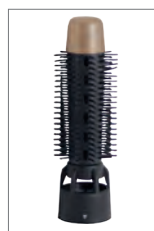

1 round brush
(25 mm Ø)

Art. no. 263 800
EAN 4 006 160 638 004 PU 6



Art. no. 263 184
EAN 4 006 160 631 845 PU 12





Hair dryer HT 3428

- Compact travelling hair dryer
- 2 temperature/power settings
- Soft touch housing
- Incl. see-through bag for practical storage and when travelling
- Hanging loop
- 230 V, 50 Hz, 1200 W
- WxHxD approx. 150 x 210 x 75 mm



Hair dryer HTD 3429

- Compact travelling hair dryer
- Folding handle
- 2 temperature/power settings
- Shaping nozzle 360° rotatable (removable)
- Soft touch housing
- Incl. volume diffuser
- Incl. see-through bag for practical storage and when travelling
- Switchable voltage: 110/230 V
- Hanging loop
- 110/230 V, 50/60 Hz, 1100–1200 W
- WxHxD approx. 170 x 235 x 75 mm



● Art. no. 264 557
 EAN 4 006 160 645 576 PU 12
 ● Art. no. 263 557
 EAN 4 006 160 635 577 PU 12



● Art. no. 264 558
 EAN 4 006 160 645 583 PU 12
 ● Art. no. 263 558
 EAN 4 006 160 635 584 PU 12



PREIS-/LEISTUNGSSIEGER	
IM TESTMAGAZIN - URTEIL	
Clatronic HT 3661	
GUT	84,9 %
Im Test: 14 Haartrockner Testurteile: 1x sehr gut, 12x gut, 1x befriedigend www.etm-testmagazin.de	Heft 11/2018



Ion technology function

Professional hair dryer HTD 3055



- Professional hair dryer with 2000 watt max.
- 3 temperature/power settings
- 2 blower stages
- Cool Shot
- Professional volume diffuser and shaping nozzle
- Air intake filter (removable)
- Rubberized housing for non-slip storage
- Soft touch handle
- Overheating protection
- Hanging loop
- 220–240 V, 50/60 Hz, 1800–2000 W
- WxHxD approx. 270 x 270 x 90 mm

Hair dryer HT 3661



- Powerful 2200 watt max.
- Ion technology function – improved possibilities of hairstyling thanks to antistatic effect, the hair is not dried out and becomes smooth and shiny
- 3 temperature/power settings
- 2 blower stages
- Cool Shot
- Shaping nozzle 360° rotatable (removable)
- Air intake filter (removable)
- Overheating protection
- Hanging loop
- 220–240 V, 50/60 Hz, 1800–2200 W
- WxHxD approx. 230 x 270 x 85 mm

Art. no. 271 554
EAN 4 006 160 715 514 PU 6



4 006 160 715 514

Art. no. 263 796
EAN 4 006 160 637 960 PU 6



4 006 160 637 960



Insect killer
IV 3340



- Environmentally-friendly killing of mosquitoes/gnats/wasps/insects without chemicals or scents
- The insects are attracted by the UV light and killed by means of an electric wire mesh
- Electric wire mesh voltage: 1500–2000 V on the mesh itself
- Covers a range of approx. 20 m²
- Specifically designed for use in closed rooms
- All-round use
- Same level of efficiency in daylight and artificial light
- Incl. suspension device
- 220–240 V, 50/60 Hz, 4 W
- WxHxD approx. 160 x 230 x 100 mm



Ø 23 cm

Table fan
VL 3601



- Oscillating (can be switched off)
- Adjustable angle of inclination
- Metal protection grid
- Secure stand
- Ø approx. 23 cm
- 2 speed levels
- 3-level switches (0/1/2)
- Practical carrying handle
- 220–240 V, 50–60 Hz, 30 W
- WxHxD approx. 275 x 375 x 220 mm



3-level switches

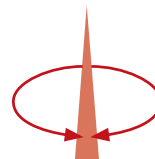

Oscillating

● Art. no. 263 136
EAN 4 006 160 631 364 PU 6



4 006160 631364

● Art. no. 263 698
EAN 4 006 160 636 987 PU 4
● Art. no. 263 924
EAN 4 006 160 639 247 PU 4



4 006160 636987



Ø 30 cm

Table fan
VL 3602

- Oscillating (can be switched off)
 - Adjustable angle of inclination
 - Metal protection grid
 - Secure stand
 - Ø approx. 30 cm
 - 3 speed levels
 - 4-level switches (0/1/2/3)
 - Practical carrying handle
- 220–240 V, 50–60 Hz, 40 W
 - W x H x D approx. 340 x 480 x 245 mm



Ø 40 cm



Standing fan
VL 3603 S

- Oscillating (can be switched off)
 - Height-adjustable
 - Adjustable angle of inclination
 - Metal protection grid
 - Secure stand
 - Ø approx. 40 cm
 - 3 speed levels
 - 4-level switches (0/1/2/3)
 - Practical carrying handle
- 220–240 V, 50–60 Hz, 45 W
 - W x H x D approx. 430 x 1250 x 640 mm



4-level switches

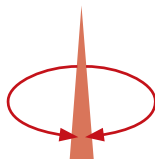

Oscillating



4-level switches

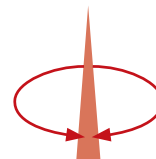

Oscillating

● Art. no. 263 699
 EAN 4 006 160 636 994 PU 4
 ● Art. no. 263 925
 EAN 4 006 160 639 254 PU 4



4 006 160 636 994

● Art. no. 263 700
 EAN 4 006 160 637 007 PU 3
 ● Art. no. 263 926
 EAN 4 006 160 639 261 PU 3



4 006 160 637 007



Ø 40 cm

CLICK
HERE

Standing fan VL 3741 S



- Oscillating (can be switched off)
- Quiet running
- Height-adjustable
- Adjustable angle of inclination
- Metal protection grid
- Incl. remote control
- 7.5 hours timer
- Secure stand
- 45 watt
- Ø approx. 40 cm
- 3 speed levels (High/Mid/Low)
- 2 electronic wind-mode functions:
 - **Sleep:** Fall-asleep program, after 30 minutes the running speed automatically decreases
 - **Nature:** Electronically programmed change of the running speed in irregular time periods
- LED indicator lights
- 220–240 V, 50/60 Hz, 45 W
- WxHxD approx. 430 x 1250 x 640 mm

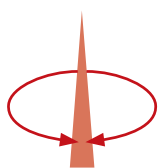

Oscillating

CLICK
HERE

Tower fan TVL 3770



- 75° oscillating (can be switched off)
- Space-saving
- Quiet running
- Protection grid
- Secure stand due to rubberized feet
- 3 speed levels
- 4-level switches (0/1/2/3)
- 120 minutes timer
- Practical carrying handle (recessed grip)
- Height: 78 cm
- 220–240 V, 50 Hz, 35 W
- WxHxD approx. 215 x 780 x 215 mm



Control panel

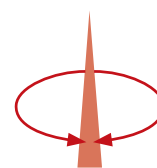

Oscillating

● Art. no. 263 927
EAN 4 006 160 639 278 PU 3



4 006160 639278

● Art. no. 263 962
EAN 4 006 160 639 629 PU 2
● Art. no. 263 961
EAN 4 006 160 639 612 PU 2



4 006160 639629



Fan / Air cooler
LK 3742



- 3 in 1 – Air cooler, air humidifier, air cleaner
- 3 blower stages
- 8 h timer
- 2 electronic wind-mode functions:
 - **Sleep:** Fall-asleep program, after 30 minutes the running speed automatically decreases
 - **Nature:** Electronically programmed change of the running speed in irregular time periods
- Remote control (incl. batteries)
- 4 smooth-running rollers for easy transport
- „Swing function“ – 90° oscillating airflow
- Incl. external water level indicator
- Incl. cord wrap
- **Air cooler:**
 - Pleasant indoor climate for your living and work space
 - 4.5 l water tank, up to 20 hours continuous operation without refilling
- **Air humidifier:**
 - Refreshes and humidifies the air in rooms of up to 20 m² for a pleasant and healthy indoor climate
 - Evaporation volume approx. 150 ml/h
- **Air cleaner:**
 - For healthier breathing air (reduces the burden of allergens, pollen, dust mites and particles, germs, and viruses)
 - Filters dust, fibers, and odours from the air
- 220–240 V, 50 Hz, 70 W
(Batteries: 2x zinc carbon, 7.20 g)
- W x H x D approx. 280 x 695 x 360 mm



Multifunction control panel

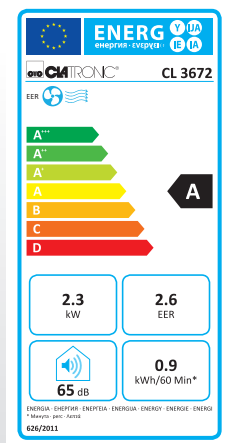

8000 BTU

130

Air conditioning unit
CL 3672

- Cooling capacity: 8000 BTU (2,3 kW)
 - Coolant: R 290
 - Air recirculation: up to 380 m³/h
 - 3 functions: cooling, dehumidifying, blowing
 - Sound level: 65 dB(A)
 - Energy efficiency class A
 - 2 filters (removable)
 - 24 hour timer
 - Fan with 2 speed levels
 - Adjustable air flaps
 - LED display (temperature and timer)
 - Condensation water recycling system
 - 4 smooth-running rollers for easy transport
 - Infrared remote control (incl. batteries)
 - Incl. 1.5 m exhaust hose and window kit
-
- 220–240 V, 50 Hz, 880 W
(Batteries: 2x zinc carbon, 7.20 g)
 - W x H x D approx. 330 x 680 x 280 mm



LED display



Incl. infrared remote control



Incl. exhaust hose



Glossy four-color packaging

Art. no. 263 808
EAN 4 006 160 638 080 PU 1



4 006 160 638 080

Free App via:

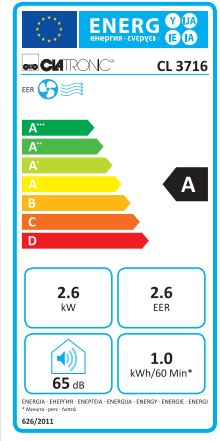

WiFi – Air conditioning unit
CL 3716

9000 BTU

131



- WiFi control – easily in a home wireless¹⁾ or via the Internet on the go
- **VOICE CONTROL** via AMAZON ALEXA + GOOGLE ASSISTANT²⁾
- Additional functions via smartphone and tablet PC³⁾ by free download a separate app⁴⁾ via
- Additional app functions:
 - Programmable timer (to the minute)
 - Sleep mode
 - Fan speed
 - Smart functions
- Individual close-up operation of the device also possible without WiFi/App control
- Sensor touch control panel
 - 24 hour timer
 - Fan with 2 speed levels
 - Adjustable air flaps
 - LED display (temperature and timer)
 - 3 in 1 – cooling, dehumidifying, ventilating
- 2 filters (removable)
- Condensation water recycling system
- Cooling capacity: 9000 BTU
- Coolant: R 290
- Air recirculation: up to 400 m³/h
- Sound level: 65 dB(A)
- Energy efficiency class A
- 4 smooth-running rollers for easy transport
- Infrared remote control (incl. batteries)
- Incl. 1.5 m exhaust hose and window kit
- Cord storage
- 220–240 V, 50 Hz, 1010 W
(Batteries: 2x zinc carbon, 7.30 g)
- W x H x D approx. 354 x 698 x 338 mm

¹⁾ 2.4 GHz WLAN (the 5 GHz standard is unsupported)

²⁾ Other services may be available

³⁾ Smartphone and tablet PC not included

⁴⁾ Apple system requirements: iOS 8.0 or higher; Android system requirements: Android 4.4 or higher



Sensor touch control panel



Available on the App Store



Available on Google Play



Incl. infrared remote control



Incl. exhaust hose



Glossy four-color packaging



4 006 160 638 875



12000 BTU



Incl. automatic swing function for optimal cooling

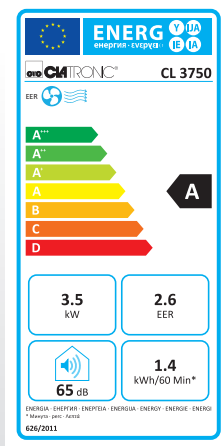

132 **WiFi – Air conditioning unit**
CL 3750

- WiFi control – easily in a home wireless¹⁾ or via the Internet on the go
- **VOICE CONTROL** via AMAZON ALEXA + GOOGLE ASSISTANT²⁾
- Additional functions via smartphone and tablet PC³⁾ by free download an own app⁴⁾ via
- Additional app functions:
 - Programmable timer (to the minute)
 - Sleep mode
 - Fan speed
 - Smart functions
- Individual close-up operation of the device also possible without WiFi/App control
- Multifunction control panel
 - 24 hour timer
 - Fan with 3 speed levels
 - Incl. automatic swing function for optimal cooling
 - LED display (temperature and timer)
 - Additional front display for convenient operation
 - 3 in 1 – cooling, dehumidifying, ventilating
- Filter (removable)
- Condensation water recycling system
- Cooling capacity: 12000 BTU / Coolant: R 290
- Air recirculation: up to 450 m³/h
- Sound level: 65 dB(A)
- Energy efficiency class A
- 4 smooth-running rollers for easy transport
- Infrared remote control (incl. batteries)
- Incl. 1.5 m exhaust hose and window kit
- Cord storage
- 220–240 V, 50 Hz, 1345 W (Batteries: 2x zinc carbon, 7.30 g)
- W x H x D approx. 350 x 800 x 470 mm

¹⁾ 2.4 GHz WLAN (the 5 GHz standard is unsupported)
²⁾ Other services may be available
³⁾ Smartphone and tablet PC not included
⁴⁾ Apple system requirements: iOS 8.0 or higher; Android system requirements: Android 4.4 or higher

Free App via:



Multifunction control panel incl. LED display



Extra front display for comfortable operation



Incl. window kit and exhaust hose

Art. no. 263 942
 EAN 4 006 160 639 421 PU 1





12 volt connector
for car operation



Cool bag
KT 3720



- Insulated thermal cool bag – ideal for camping, travel and shopping
 - Capacity (gross capacity): approx. 15 litres max.
 - For all standard 0.5/0.75/1.0 litre bottles
 - Uniform cooling due to external fan
 - Cooled up to 12°C max. below ambient temperature
 - Powerful, maintenance-free Peltier cooling system
 - Durable material (splash-proof)
 - High-quality isolation
 - Main compartment with zipper and 3 additional external storage compartments
 - Easy-to-clean interior
 - Adjustable shoulder strap for high wearing comfort
 - Cool bag foldable (space-saving)
 - Accessory: 12 volt connecting cable for car operation
-
- Power supply: DC 12 V, 50 W
 - WxHxD approx. 320 x 250 x 250 mm



3 additional, external
storage compartments



Uniform cooling
due to external fan



For all standard 0.5/0.75/1.0 litre bottles



Adjustable shoulder strap
for high wearing comfort

Art. no. 263 888
EAN 4 006 160 638 882 PU 3



4 006 160 638 882



12 volt connector



230 volt connector

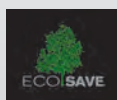

134

Cool box KB 3713 N

- Perfect for camping, travel and shopping
 - Capacity (gross capacity): 25 litres max.
 - For all standard 0.75 / 1.0 / 1.5 / 2.0 litres bottles
 - Uniform cooling due to integrated fan
 - Cooled up to 18 °C max. below ambient temperature
 - Powerful, maintenance-free Peltier cooling system
 - Energy-saving function (ECO SAVE)
 - Double-walled plastic casing with high-quality isolation
 - Special sealing rubber in the lid reduces condensation
 - Foldable handle
 - Removable lid
 - Cable storage compartment
 - Accessory: 12 volt connecting cable for car operation, 230 volt connecting cable
- Power supply:
 - Mains adapter connection: DC 12 V, 45 W
 - Mains adapter connection: AC 220–240 V~, 50/60 Hz, 55 W, 8.5 W (ECO mode)
 - WxHxD approx. 355 x 495 x 240 mm

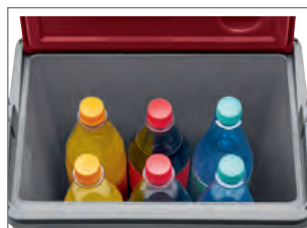
For all standard 0.75 /
1.0/1.5/2.0 litres bottles

Cable storage compartment



Art. no. 263 879

EAN 4 006 160 638 790

PU 1



4 006 160 638 790



12 volt connector



230 volt connector



Cool box KB 3714 N

- Perfect for camping, travel and shopping
- Suitable for cooling and warming
- Capacity (gross capacity): 30 litres max.
- For all standard 0.75 / 1.0 / 1.5 litres bottles
- Uniform cooling due to integrated fan
- Cooled up to 18°C max. below ambient temperature
- Powerful, maintenance-free Peltier cooling/heating system
- Energy-saving function (ECO Save)
- Rugged, double-walled plastic casing with high-quality isolation
- Special sealing rubber in the lid reduces condensation
- Foldable handle
- Removable lid
- Accessory: 12 volt connecting cable for car operation, 230 volt connecting cable

- Power supply:
 - Mains adapter connection: DC 12 V, 45/40 W
 - Mains adapter connection: AC 220–240 V~, 50/60 Hz, 55/50 W, 8.5 W (ECO mode)
- W x H x D approx. 400 x 435 x 295 mm



For all standard 0.75/1.0/1.5 litres bottles

Art.no. 263 880
EAN 4 006 160 638 806 PU 1





Socket fan heater
HL 3738



136

- Mobile, compact socket fan heater
 - 2 blower stages (electronically selectable)
 - High-quality PTC heater element
 - Comfortable heating via 12 hours timer
 - Automatic switch-off when desired temperature is reached
 - Electronic temperature setting of 15–32 °C
 - Easy operation due to LED display and large function buttons
 - Handy and space-efficient – also suitable for travelling
 - High safety through overheating protection
 - LED indicator light
 - Energy-saving 350 watt
- 220–240 V, 50/60 Hz, 350 W
 - WxHxD approx. 93 x 155 x 107 mm

„This product is only suitable for well isolated rooms or for occasional use.“



Easy operation due to
LED display and large
function buttons



Mobile fan heater
for the socket

Art. no. 263 909
EAN 4 006 160 639 094 PU 4



4 006 160 639 094



Fan heater
HL 3379



- Mobile, compact fan heater
- 2 heat settings (1000/2000 watt)
- Incl. cold stage (fan function)
- Continuously adjustable thermostat
- Indicator light
- 2 different ways of setting up
- Secure stand
- Sturdy carrying handle
- High safety through overheating protection

- 220–240 V, 50 Hz, 2000 W
- WxHxD approx. 120 x 248 x 250 mm

„This product is only suitable for well isolated rooms or for occasional use.“



Fan heater
HL 3761



- Mobile, compact fan heater
- 2 heat settings (1000/2000 watt)
- Incl. cold stage (fan function)
- Continuously adjustable thermostat
- Indicator light
- Secure stand
- Sturdy carrying handle
- High safety through overheating protection
- Safety contact switch for fire protection

- 220–240 V, 50–60 Hz, 2000 W
- WxHxD approx. 190 x 250 x 130 mm

„This product is only suitable for well isolated rooms or for occasional use.“



2 different ways of setting up

Art. no. 271 672
EAN 4 006 160 716 726 PU 4



Art. no. 263 951
EAN 4 006 160 639 513 PU 4





Fan heater
HL 3762

- Mobile, compact fan heater
 - 2 heat settings (1000/2000 watt)
 - Oscillating (can be switched off)
 - Incl. cold stage (fan function)
 - Continuously adjustable thermostat
 - Indicator light
 - Secure stand
 - Sturdy carrying handle
 - High safety through overheating protection
 - Safety contact switch for fire protection
- 220–240 V, 50/60 Hz, 2000 W
 - WxHxD approx. 220 x 290 x 165 mm

„This product is only suitable for well isolated rooms or for occasional use.“



Oscillating

Art. no. 263 953
EAN 4 006 160 639 537 PU 4



Ceramic fan heater
HL 3631

- High-quality PTC ceramic heater element for healthy, safe, quiet and efficient heating
 - Low dust accumulation
 - Quick and effective heating
 - Robust and insensitive because of long-life ceramic heating element
 - 7-level switches
 - 2 heat settings (1000/1500 watt)
 - Oscillating (can be deactivated)
 - Incl. cold stage (fan function)
 - Continuously adjustable thermostat
 - Secure stand
 - Sturdy carrying handle (foldable)
 - High safety through overheating protection
 - Safety contact switch for fire protection
- 220–240 V, 50 Hz, 1500 W
 - WxHxD approx. 191 x 267 x 141 mm

„This product is only suitable for well isolated rooms or for occasional use.“



Oscillating

Art. no. 263 740
EAN 4 006 160 637 403 PU 4





PTC ceramic heater element

Healthy, safe, quiet and efficient heating
 Low dust accumulation
 Quick and effective heating
 Long service life
 Robust and intensive



Sensor Touch-control panel



Ceramic fan heater HL 3763



- High-quality PTC ceramic heater element for healthy, safe, quiet and efficient heating
 - Low dust accumulation
 - Quick and effective heating
 - Robust and insensitive because of long-life ceramic heating element
 - Sensor touch control panel
 - LED display
 - Digital setting of room temperature (15–35°C)
 - 12 hours timer
 - Oscillating (can be switched off)
 - Sleep mode (operation with dimmed display)
 - 2 heat settings (1300/2000 watt)
 - Incl. cold stage (fan function)
 - Incl. infrared remote control (battery included)
 - Secure stand
 - Sturdy carrying handle
 - High safety through overheating protection
 - Safety contact switch for fire protection
-
- 220–240 V~, 50–60 Hz, 2000 W
 (Battery: 1x lithium, 2.40 g)
 - W x H x D approx. 180 x 610 x 200 mm

„This product is only suitable for well isolated rooms or for occasional use.“



Oscillating



Convecter heater
KH 3077 N



- Mobile heat – also suitable for heating summerhouses, garages and conservatories
- 3 heat settings (750/1250/2000 watt)
- Continuously adjustable thermostat
- Automatic temperature control
- Indicator light
- Convenient built-in carrying handles for easy transport
- Low-noise operation
- Overheating protection

- 220–240 V, 50 Hz, 1800–2000 W
- W x H x D (without feet): 570 x 375 x 110 mm
- W x H x D (with feet): 570 x 420 x 195 mm

„This product is only suitable for well isolated rooms or for occasional use.“



Convecter heater
KH 3433 N



- Mobile heat – also suitable for heating summerhouses, garages and conservatories
- 3 heat settings (750/1250/2000 watt)
- Continuously adjustable thermostat
- Automatic temperature control
- Anti-frost function
- Incl. blower function
- 3 indicator lights
- Convenient built-in carrying handles for easy transport
- Low-noise operation
- Overheating protection

- 230 V, 50 Hz, 2000 W
- W x H x D (without feet): 670 x 440 x 110 mm
- W x H x D (with feet): 670 x 480 x 195 mm

„This product is only suitable for well isolated rooms or for occasional use.“

Art. no. 281 963
EAN 4 006 160 819 632 PU 2



4 006 160 819 632

Art. no. 263 562
EAN 4 006 160 635 621 PU 1



4 006 160 635 621



Oil radiator
RA 3735

- 7 rib oil-filled radiator for effective heating of e. g. bedrooms, offices and hobby rooms
 - Mobile radiator with up to 1500 watt
 - 3 power levels (600/900/1500 watt) for setting of individual needs
 - Heat regulation via continuously adjustable thermostat controller
 - Indicator light
 - Practical cable storage
 - Slimline – particularly space-efficient due to slim design
 - Flexible use due to 4 easy-run castors and practical recessed grip
 - Integrated overheating protection and anti-tipping device for automatic shutdown and maximum safety
-
- 230 V, 50 Hz, 1500 W
 - WxHxD approx. 370 x 640 x 250 mm

„This product is only suitable for well isolated rooms or for occasional use.“



Practical recessed grip



Practical cable storage

Art. no. 263 906
EAN 4 006 160 639 063 PU 1





Oil radiator RA 3736



142

- 9 rib oil-filled radiator for effective heating of e. g. bedrooms, offices and hobby rooms
 - Mobile radiator with up to 2000 watt
 - 3 power levels (800/1200/2000 watt) for setting of individual needs
 - Heat regulation via continuously adjustable thermostat controller
 - Indicator light
 - Practical cable storage
 - Slimline – particularly space-efficient due to slim design
 - Flexible use due to 4 easy-run castors and practical recessed grip
 - Integrated overheating protection and anti-tipping device for automatic shutdown and maximum safety
- 230 V, 50 Hz, 2000 W
 - WxHxD approx. 435 x 640 x 250 mm

„This product is only suitable for well isolated rooms or for occasional use.“



Practical recessed grip



Practical cable storage

Art. no. 263 907
EAN 4 006 160 639 070 PU 1



4 006 160 639 070

505 mm

640 mm



Oil radiator
RA 3737



- 11 rib oil-filled radiator for effective heating of e.g. bedrooms, offices and hobby rooms
 - Mobile radiator with up to 2300 watt
 - 3 power levels (1000/1300/2300 watt) for setting of individual needs
 - Heat regulation via continuously adjustable thermostat controller
 - Indicator light
 - Practical cable storage
 - Slimline – particularly space-efficient due to slim design
 - Flexible use due to 4 easy-run castors and practical recessed grip
 - Integrated overheating protection and anti-tipping device for automatic shutdown and maximum safety
-
- 230 V, 50 Hz, 2300 W
 - WxHxD approx. 505 x 640 x 250 mm

„This product is only suitable for well isolated rooms or for occasional use.“



Practical recessed grip



Practical cable storage

Art. no. 263 908
EAN 4 006 160 639 087 PU 1





2in1

Fireplace + Heater

Electric fireplace EK 6023 CB



144

- Electric fireplace with flame simulation and fan heater function
- 2-stage fan heater 900 W or 1850 W, switching-on as required or automatic (overheating protection)
- Flame effect switchable in 5 steps
- Glass front
- Wall mounting
- Control via remote control possible
- Display may be faded-in to indicate the time, day of the week, brightness of the flames, heating power, room temperature display, timer programming
- On/off switch
- Close-up operation on the appliance

- 220–240 V, 50 Hz
- Heating power 900 W or 1850 W
- W x H x D approx. 660 x 520 x 142 mm

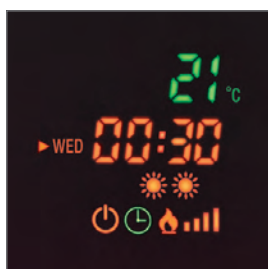

Multifunction display (can be shown as an option)



Heater function – 900/1850 watt heating power

● Art.no 660 230
EAN 4 004 470 602 302 PU 1



4 004470 602302



2in1

Fireplace + Heater

Electric fireplace
EK 6024 CB



145

- Electric fireplace with flame simulation and fan heater function
- 2-stage fan heater 900 W or 1850 W, switching-on as required or automatic (overheating protection)
- Flame effect switchable in 4 steps
- Curved glass front
- Wall mounting
- Control via remote control possible
- Removable window for easy cleaning
- Display may be faded-in to indicate the time, day of the week, brightness of the flames, heating power, room temperature display, timer programming
- On/off switch
- Close-up operation on the appliance

- 220–240 V, 50 Hz
- Heating power 900 W or 1850 W
- WxHxD approx. 880 x 560 x 155 mm

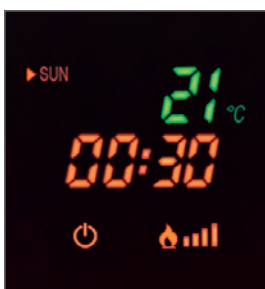

Multifunction display (can be shown as an option)



Heater function – 900/1850 watt heating power

● Art. no. 660 240
EAN 4 004 470 602 401 PU 1



4 004470 602401





Headquarter



Logistic Center (approx. 100.000 m²)



Company
presentation



Catalogue download
as PDF



CTC Clatronic Int. GmbH
 Industriering Ost 40
 D-47906 Kempen
 Phone +49 (0) 21 52/20 06-0
 Fax +49 (0) 21 52/20 06-19 99
 info@clatronic.de
 www.clatronic-germany.de

CTC Clatronic Sp. zo.o.
 Ul. Brzeska 1
 45-960 Opole
 Phone +48 (0) 77/44 77 900
 Fax +48 (0) 77/44 77 943
 clatronic@clatronic.pl
 www.clatronic.pl

CLATRONIC Far East Ltd.
 Unit 1076 10/F, KITEC
 1 Trademart Drive,
 Kowloon Bay
 Kowloon, Hong Kong
 info@clatronic.com.hk
 www.clatronic.com.hk