

# Ahoy!

\$2.95/ CAN. \$3.35 JANUARY 1988

...THE ALL-ROUND COMMODORE FAVORITE!...

**JEWEL OF A FILE!**

**JUNGLE JAKE**

FOR THE C-128

**INFOFLOW 64**  
 ICON-DRIVEN DATABASE  
**CLONE-A-MATIC**  
 UNSTOPPABLE COPIER  
 BAG THE  
**ICE TITANS**

**1987'S BEST  
 AMIGA AND  
 64/128 GAMES**

**HARDWARE  
 REVIEWS**  
 NEW 64/AMIGA RELEASES  
**TIPS AHoy!**  
 TRUNCATED ALGORITHMS  
 AND MORE FOR YOUR COMMODORE

**TEXTSAVE**  
 NO MORE  
 WINDOW PAINS!

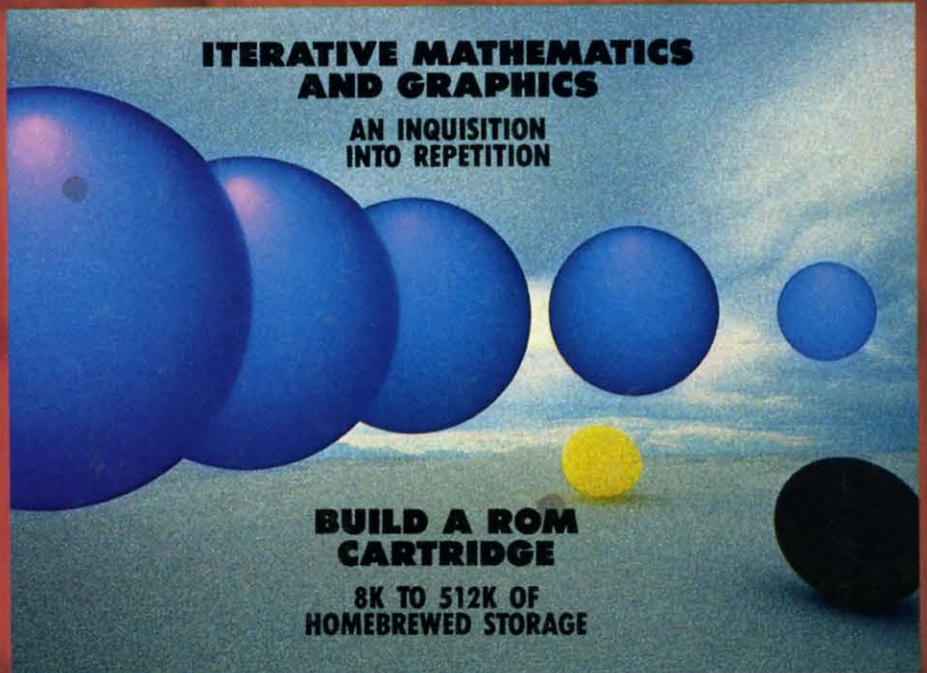

# Wizardry®

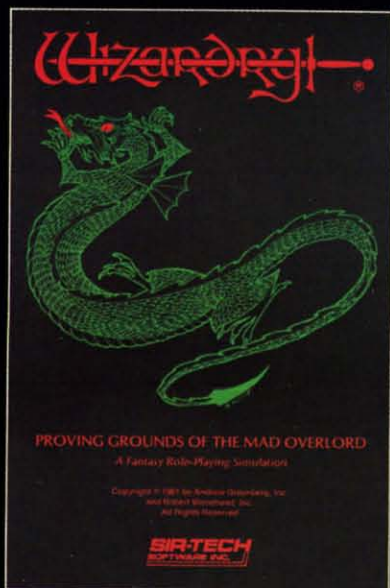

Also available for:  
Apple II Series,  
IBM PC & compatibles,  
Tandy 1000 SX & EX,  
Macintosh

Now the world of  
Wizardry comes to  
Commodore 64/128

## PROVING GROUNDS of the MAD OVERLORD



With your Commodore 64 or 128 you can now experience an exciting initiation into the internationally-acclaimed world of the Wizardry Gaming System.

Begin with the first scenario\*: Proving Grounds of the Mad Overlord. It challenges you to overcome devious tricks and sudden traps, strange and mysterious encounters, maze upon maze of puzzles, stimulating and intricate sub-plots and sophisticated themes. Ingenious multi-level, mind-bending tests abound with vile creatures, unspeakable villains, courageous adventurers and strong allies to hinder and help you achieve ultimate victory.

**SIR-TECH**

Sir-tech Software, Inc.,  
P.O. Box 245, Ogdensburg, NY 13669  
(315) 393-6633

© Registered trademark of Sir-tech Software, Inc.  
© Copyright by Sir-tech Software, Inc.  
Commodore is a registered trademark of Commodore International  
Reader Service No. 249

### PLAY IT TO THE HILT!

\* Many other Wizardry scenarios coming for Commodore players.

[www.commodore.ca](http://www.commodore.ca)

THE  
COMMODORE USERS

Ahoy!  
Access

# clipper

JANUARY 1988

Ahoy! Readers:

This issue of your Ahoy! Access Clipper offers LOTS OF SAVINGS, so many in fact that we have no room to list them. Happy holidays!

Admirally yours,

Joe Ferguson  
Director  
Ahoy! Access Club

## FROM THEIR FAMILY TO YOURS—COMPUTER DIRECT...

Protecto Enterprises' new division, **Computer Direct**, is already making a name for itself in the industry. It is a family-owned and managed company with family members in every major management function. Their pride is reflected in all phases of operation.

Recently, the **Computer Direct** has installed a mini-computer and upgraded their phone system while streamlining operations to serve you better.

And the **Computer Direct** pages always feature lots of interesting "specials" to tempt you. But even after **Computer Direct** wins your business, they'll back up the sale with their exceptional support and unusual guarantees. Their 15 DAY FREE TRIAL policy on products including software is among the best in the industry.

So when you're in the market, call **Computer Direct**. They'll always make it worth your while!

## DOUBLE FREE OFFER FROM FLOPPY HOUSE...

When you're in the market for Commodore software, **Floppy House** is an important name to remember. **Floppy House** sells a wide variety of software from arcade and adventure games to educational programs, utilities, and graphics programs. When you order from **Floppy House**, you'll always receive a wonderful bonus, "an excellent public domain version of an arcade game hit on its own disk." But until February 15, 1988, with your

order of 2 or more pieces of software at their already low prices, you'll receive ANOTHER BONUS DISK absolutely FREE. For your 2nd BONUS DISK, you may choose from either a utility or terminal program. Please make sure to indicate your choice on the **Floppy House** coupon to be found on page 3 of this *Clipper*.

For a listing of their current program selections, you'll find the **Floppy House** ad in this month's issue of *Ahoy!* If you wish to order by phone with your VISA or MasterCard (at no extra charge), simply call 1-800-633-8699, or if you're in Pennsylvania, call 1-717-838-8632. Be sure to mention that you saw this offer in the *Ahoy! Access Clipper* to qualify for your 2nd BONUS DISK. If you prefer to mail in your order, use the handy **Floppy House** coupon on page 3 of this *Clipper*. Please include \$2.50 for shipping and handling on all orders under \$100, and Pennsylvania residents need to add appropriate sales tax. **Floppy House** features 48-hour shipping on charge orders or upon receipt of a cashier's check or money order. This offer expires February 15, 1988, so why wait? Mail or phone your order TODAY!

## FREE \$19.95 ONLINE HELP PROGRAM WITH SYSRES FROM COMPUTER MART...

**SYSRES Enhanced** from **Computer Mart** is billed as "the ultimate BASIC enhancement system" for the C-64 or 128 in the 64 mode. **SYSRES** adds over 25 major commands with over 1000 additional functions. Residing in memory, **SYSRES** features an extended Super DOS Wedge which reduces even the

most complex command sequences to a few simple keystrokes. Its new, fast loader routine makes loading up to five times faster, plus it will allow you to scroll. **SYSRES** is unprotected and comes with over 110 pages of comprehensive documentation. If you really love programming, you should get **SYSRES** and see for yourself what this dynamite BASIC extension can mean to you. The price of **SYSRES** from **Computer Mart** is \$39.95.

**Computer Mart** knows that **SYSRES Enhanced** can be addictive once you learn to work with it. When you buy **SYSRES**, you'll receive their great online help program called *The Live-In Reference Manual* ABSOLUTELY FREE. Regularly selling for \$19.95, *The Live-In Reference Manual* has 17 screens of information, including ASCII characters, POKEs, color codes, selected DOS commands, BASIC keywords, abbreviations and token values, sound registers, musical notes in eight octaves, and much more! And it uses almost none of the RAM for BASIC programming. I was surprised, and am pleased to share this wonderful offer with you.

Be sure to look for **Computer Mart's** ad in this month's issue of *Ahoy!* Just clip the **Computer Mart** coupon on page 3 of this *Clipper*, and send it with your order. This offer disappears February 15, 1987, so order TODAY!

## FREE CLASSICAL MUSIC DISK WITH YOUR ORDER FROM BRIWALL...

The nice people at **Briwall** sell a variety of software for the Commodore 64, 128, and Amiga computers. They confine their product offerings to the more edifying uses of the computer, including productivity software, programming aids, graphics, and educational programs. When you read their ad in this month's issue of *Ahoy!*, you'll find they have a terrific policy of providing a FREE CLASSICAL MUSIC DISK with orders of \$100 or more. But until February 15, 1988, when you buy only \$25 from them, you'll receive Strider's Classical Music Disk ABSOLUTELY FREE. And every order you place with **Briwall** carries a MONEY BACK GUARANTEE. You may place your order either by mail, using the **Briwall** coupon on page 3 of this *Clipper*, or by phone, using their toll-free number: (800) 636-5757. VISA and MasterCard are accepted, so place your order and get your FREE DISK right away!

## 10% OFF YOUR ORDER FROM UTILITIES UNLIMITED...

Utilities Unlimited has a well-deserved reputation for its excellent copy programs. Whether you buy one of the *Super Parameters Super Nibblers* or their *Lock Pik C-64/128* book, with products from **Utilities Unlimited**, you really get your money's worth. Now, **Utilities Unlimited** proudly introduces one of their newest products, *500 Pack of Golden Oldies*, 500 parameters from years past. Selling for only \$49.95 for the 5-disk set, *500 Pack of Golden Oldies* is for Commodore enthusiasts who want to have a complete library of copy utilities without doing a lot of leg or phone work.

And to give you another reason for ordering from them, with the **Utilities Unlimited** coupon on page 3 of this *Clipper Utilities Unlimited* will give you an additional 10% OFF their already low prices. For complete ordering information, see their ad in this month's issue of *Ahoy!* They do accept VISA and MasterCard, and you may place your order by telephone. But don't forget to mention that you saw this offer in the *Ahoy! Clipper* so that you get your discount. Clip the **Utilities Unlimited** coupon or call them TODAY, because this offer expires February 15, 1988.

## HELD OVER BY POPULAR DEMAND... FREE GAME DISK WITH PURCHASE FROM MONTGOMERY GRANT...

Montgomery Grant carries a large selection of Commodore and Commodore-compatible peripherals, and their prices are certainly worthy of your consideration. They carry printers, disk drives, and peripherals, along with all other kinds of Commodore-compatible hardware. Their toll-free number makes it easy and economical to place your order, and besides having great prices, with every purchase over \$100, **Montgomery Grant** will send you a FREE GAME DISK. For more details about ordering, see their ad in this month's issue of *Ahoy!* They prefer that you place your order by phone. Just call 1-800-345-7059, or in New York, call 1-212-594-7140. And don't forget to mention this offer, so that you get your FREE GAME DISK. If you prefer to place your order through the mail, simply clip the **Montgomery Grant** coupon on page 3 of this *Clipper*. This offer expires February 15, 1988, so don't delay. Place your order TODAY!

## GET IN THE SPIRIT WITH FREE SPIRIT AND SAVE 20%...

**Free Spirit** knows that you, as devoted Commodore enthusiasts, appreciate good software. **Free Spirit** has developed 2 excellent programs for the 128. First, *Securities Analyst*, "the investment tool of the pros," at \$49.95; and *Super 81 Utilities* at \$39.95, the first utilities program on the market for the 1581 Disk Drive.

But the big holiday news is **Free Spirit's** *Christmas Classics*, an hour of delightful Christmas music, including 40 songs with words, music, and graphics, guaranteed to put you "in the spirit." You'll enjoy "Joy to the World," "Silent Night," "Jingle Bells," "The 12

Days of Christmas," and many more. *Christmas Classics* offers you all 40 songs for only \$9.95.

You surely want to invest in **Free Spirit's** *Fun Biorhythms*. It's designed to print your personal biorhythm chart on your printer. All you do is enter your birthdate, today's date, and the number of days for which you want the chart. Then press return and let your printer do the rest. Keeping in touch with your physical, emotional, and intellectual cycles can be very beneficial. This valuable program regularly sells for \$9.95, but for a limited time **Free Spirit** will save you \$2 on the cost of either *Christmas Classics* or *Fun Biorhythms*.

You'll SAVE MORE THAN 20% OFF your order for either or both of these already inexpensive program disks. Plus, **Free Spirit** will also send you their new catalog. And, **Free Spirit's** policy is always to provide FREE SHIPPING AND HANDLING. You can either clip the **Free Spirit** coupon on page 3 of this *Clipper*, or call **Free Spirit** at (312) 352-7323. Be sure to mention that you saw this offer in the *Ahoy! Clipper*. VISA and MasterCard are accepted, so why wait? This offer expires January 15, 1988, so send or phone in your order RIGHT AWAY!

## SUBSTANTIAL SAVINGS FROM LYCO COMPUTER...

Every issue, **Lyco Computer** provides an excellent special offer. This month they feature the Avatex 1200 baud Modem. The Avatex is 100% Hayes compatible, and may be used with a variety of software on the market. Since Hayes is the industry standard, with this product you get high quality and welcome compatibility at one third the price of many Hayes modems. This quality product lists for \$199, and **Lyco** usually sells it for \$99, but with the **Lyco** coupon on page 3 of this *Clipper*, you may buy this versatile product for only \$95. That's less than half the regular retail price! Find **Lyco's** ad in this month's issue of *Ahoy!*

In each issue of *Ahoy!*, you'll find great computer offerings from **Lyco Computer**. **Lyco** sells a wide variety of Commodore-compatible hardware and software at good prices. For more information on other hardware and software, you may call them at 1-800-233-8760 from anywhere in the continental United States. They will accept phone orders, but you must mention that you saw this offer in the *Ahoy! Access Clipper*. This offer expires on February 15, 1988, so hurry and complete the **Lyco** coupon right away.

## SAVE \$5 ON YOUR FIRST ORDER FROM COMPLETE DATA...

**Complete Data** is a newcomer to our *Ahoy!* scene, but I predict you'll be hearing a lot more about them in the coming months. At this point, **Complete Data** offers only eight products, but each is really a jewel within its genre.

*The Graphics Transformer* is a C-64-compatible, high speed file converter and modifier with bidirectional data file interchange between many graphics programs. *The Graphics Transformer* will allow you to take advantage of the multiple features in many graphics programs, because it allows the free interchange between otherwise incompatible

file formats. It can even save screen color data in the same manner. At \$34.95, *The Graphics Transformer* can make a big difference in your graphics capabilities!

**Complete Data's** *Moving Pictures* for the C-64/128 is an easy-to-use animation program priced at \$29.95. With *Moving Pictures* you can create your own movies with your favorite drawing programs. Once you've created your movies, you can view them separately or with your program for spectacular effects. Because of the method of storage used by *Moving Pictures*, your movie will take only a small space in memory. *Moving Pictures* also offers you easy access to help, with all system documentation contained in memory. But here's the best part: if you submit your created movie to **Complete Data's** Pick Your Flick Contest before February 1, 1988, you have a chance to win.

And when you clip the **Complete Data** coupon on page 3 of this *Clipper* and send it with your order, you'll also receive \$5 OFF your first order. VISA and MasterCard are accepted, and you may place your order by phone at (916) 842-3431, but please don't forget to mention that you saw this offer in the *Ahoy! Access Clipper*, so that you SAVE \$5.

This offer expires February 15, 1988, so mail or phone in your order RIGHT NOW!

## ARE YOU READY TO WIN? ENTER CODEQUEST '87 FROM SOFTDISK...

From now until January 31, 1988, you have a chance to win your share of over \$5000 in cash prizes. **SoftDisk, Inc.** is looking for winning programs to put into their monthly 2-disk series called LOADSTAR. LOADSTAR is their "magazine" on disk for the Commodore 64 and 128. **SoftDisk's** programming contest is called CodeQuest '87.

**SoftDisk** is looking for a variety of ready-to-run submissions for the Commodore 64 or the 128 in 64 mode, including games, graphics, music, educational programs, home and business applications, telecommunications, utilities, etc. However, entries are not limited to those categories.

Program entries must be written in BASIC or machine language in 64 mode, and submitted on a 5 1/4" diskette complete with source code (if applicable) and user documentation. A typed or written summary of your program's purpose and objective must accompany the disk, and of course, all elements must be clearly identified with the author's name, address, telephone number, and program name. Also, in order to qualify, you must sign the affidavit in the **SoftDisk** coupon on page 3 of this *Clipper*.

Entries will be judged on program content, creativity, general appeal, ease-of-use, and originality. Winners will be announced March 1, 1988. Each of the 1st, 2nd, and 3rd Place winners from each division will have their programs published in coming issues of LOADSTAR, and in addition to the prize money will receive payment for the one-time publication rights in LOADSTAR.

To enter CodeQuest '87, just complete and sign the **SoftDisk** coupon on page 3 of this *Clipper*. But don't wait, because entries must be postmarked no later than January 31, 1988, and you surely don't want to miss this great opportunity to win cash and have your original programs published!

The Ahoy! Access Clipper is published bimonthly by Ahoy! magazine and sent free to selected subscribers of Ahoy! Ahoy! is a monthly publication of Ion International Inc. The cost of a one-year subscription is \$23.00; two years are \$44.00. Inquiries regarding subscriptions to the magazine should be addressed to Ion International Inc., 45 West 34th Street, New York, New York 10001.

**SAVE \$5 ON YOUR FIRST ORDER FROM COMPLETE DATA**

Mail to: Complete Data  
P.O. Box 1052  
Yreka, CA 96097

For faster service, call 1-916-842-3431.

YES, **Complete Data**, I want to SAVE \$5 on my first order. I have checked your ad in this month's issue of *Ahoy!* for complete order information. My order is enclosed. VISA and MasterCard accepted.

Name on Credit Card \_\_\_\_\_

Credit Card # \_\_\_\_\_ Exp. Date \_\_\_\_\_

Signature \_\_\_\_\_

**FREE \$19.95 ONLINE HELP PROGRAM FROM COMPUTER MART**

Mail to: Computer Mart  
2700 NE Andresen Road / Vancouver, WA 98661

YES, **Computer Mart**, I want my FREE *Live-In Reference Manual*, valued at \$19.95. My order for *SYSRES Enhanced* is enclosed. Thanks for FREE SHIPPING AND HANDLING! VISA, MASTERCARD AND DISCOVER CARD ACCEPTED.

Name on Credit Card \_\_\_\_\_

Credit Card # \_\_\_\_\_ Exp. Date \_\_\_\_\_

Signature \_\_\_\_\_

**SAVE 10% ON YOUR FIRST ORDER FROM UTILITIES UNLIMITED**

Mail to: Utilities Unlimited  
12305 NE 152nd St. / Brush Prairie, WA 98606

For faster service, call 1-206-254-6530.

YES, **Utilities Unlimited**, I want to SAVE 10% on my first order. I have read the ordering instructions in your ad in this month's issue of *Ahoy!* and either my full payment is enclosed or my credit card information appears below. Thanks for the savings! VISA AND MASTERCARD ACCEPTED.

Name on Credit Card \_\_\_\_\_

Credit Card # \_\_\_\_\_ Exp. Date \_\_\_\_\_

Signature \_\_\_\_\_

**SAVE ON THE AVATEX HAYES-COMPATIBLE MODEM FROM LYCO COMPUTER**

Mail to: Lyco Computer  
P.O. Box 5088 / Jersey Shore, PA 17740

For faster service, call 1-800-233-8760.

YES, **Lyco**, I want to SAVE NOW on the Avatex 1200 Baud Hayes-Compatible Modem. I have checked your ad in this month's issue of *Ahoy!* for complete order information. My order is enclosed. CREDIT CARD ORDERS: PLEASE ADD 4%.

Name on Credit Card \_\_\_\_\_

Credit Card # \_\_\_\_\_ Exp. Date \_\_\_\_\_

Signature \_\_\_\_\_

**FREE GAME DISK WITH \$100 PURCHASE FROM MONTGOMERY GRANT**

Mail to: Montgomery Grant  
Penn Station / Main Concourse / New York, NY 10001

For faster service, call 1-800-345-7059.  
In NY, call 1-212-594-7140.

YES, **Montgomery Grant**, I want to get my FREE GAME DISK. Enclosed is my order for \$100 or more. I have checked your ad for the details about ordering. Thanks.

Name on Credit Card \_\_\_\_\_

Credit Card # \_\_\_\_\_ Exp. Date \_\_\_\_\_

Signature \_\_\_\_\_

**WIN CASH FOR YOUR PROGRAMS ENTER SOFTDISK'S CODEQUEST '87**

Mail to: SoftDisk, Inc.  
606 Common St. / P.O. Box 30008 / Shreveport, LA 71130

YES, **SoftDisk**, I want to win cash prizes in your CodeQuest '87 Programming Contest. I have carefully labeled all of the elements of my submission, completed the form below and signed the affidavit of originality which appears on this coupon. Thanks for this great opportunity!

Name \_\_\_\_\_

Address \_\_\_\_\_

City/State/Zip \_\_\_\_\_

Telephone: Day \_\_\_\_\_ Night \_\_\_\_\_

Social Security # \_\_\_\_\_

**DOUBLE FREE OFFER FROM FLOPPY HOUSE**

Mail to: Floppy House Software  
20 South Chestnut Street / Palmyra, PA 17078

For faster service, call 1-800-633-8699.  
In PA, call 1-717-838-8632.

YES, **Floppy House**, I want my 2nd BONUS DISK. Enclosed is my order for two or more programs at your already discounted prices. I have indicated my preference for a utility or terminal program below. Also, enclosed is \$2.50 for shipping and handling, if my order is under \$100. Thanks!  Utility Program  Terminal Program. Pennsylvania residents: Please add appropriate sales tax. VISA AND MASTERCARD ACCEPTED (at no extra charge).

Name on Credit Card \_\_\_\_\_

Credit Card # \_\_\_\_\_ Exp. Date \_\_\_\_\_

Signature \_\_\_\_\_

**SAVE OVER 20% AND GET IN THE SPIRIT WITH FREE SPIRIT**

Mail to: Free Spirit Software, Inc.  
905 West Hillgrove, Suite 6 / La Grange, IL 60525

For faster service, call 1-312-352-7323.

YES, **Free Spirit**, I want to SAVE MORE THAN 20% on either (or both) of your *Christmas Classics* or *Fun Biorhythms*. I have enclosed \$7.95 for each of these program disks ordered. I understand you will also provide FREE SHIPPING AND HANDLING. My order is indicated below. Thanks! VISA AND MASTERCARD ACCEPTED.  *Christmas Classics*  *Fun Biorhythms*  Both Programs.

Name on Credit Card \_\_\_\_\_

Credit Card # \_\_\_\_\_ Exp. Date \_\_\_\_\_

Signature \_\_\_\_\_

**FREE CLASSICAL MUSIC DISK FROM BRIWALL**

Mail to: Briwall  
P.O. Box 129 / 56 Noble Street / Kutztown, PA 19530

For faster service, call 1-800-638-5757.

YES, **Briwall**, I want my FREE CLASSICAL MUSIC DISK. Enclosed is my order for \$25 or more. I have read your ad in this month's issue of *Ahoy!* for complete ordering instructions. VISA AND MASTERCARD ACCEPTED.

Name on Credit Card \_\_\_\_\_

Credit Card # \_\_\_\_\_ Exp. Date \_\_\_\_\_

Signature \_\_\_\_\_

PLEASE USE A SEPARATE FORM FOR EACH ENTRY  
(Photocopies of this form may be used.)

Program Name \_\_\_\_\_ Startup \_\_\_\_\_

File \_\_\_\_\_

Please list the files used to run this program: \_\_\_\_\_

\_\_\_\_\_

NOTE: Solution and maps must accompany adventure game entries.  
Affidavit of Originality

I, \_\_\_\_\_, hereby certify that the program described above and Full Name of Contestant submitted herewith as an entry in the CodeQuest '87 Programming Contest is my own original, uncolored, and heretofore unpublished work. I further warrant that this contest entry has not been submitted for consideration elsewhere. My signature below acknowledges complete understanding of the CodeQuest '87 contest rules. I understand that the decision of the judges will be final. I further understand that my entry will be considered for publication whether or not it places in the contest. Should my program be selected as a winning contest entry, or for publication only, I understand that I will receive no prize or fee payment(s) until I sign your Program Author's Contract which includes assignment of publication rights to the final version of my program to SoftDisk. I further understand that I will retain copyright to my entry in its original, unmodified form.

Signature \_\_\_\_\_

Program entries must be postmarked no later than January 31, 1988.

Name \_\_\_\_\_

Address \_\_\_\_\_

City/State/Zip \_\_\_\_\_

This offer expires February 15, 1988.

Name \_\_\_\_\_

Address \_\_\_\_\_

City/State/Zip \_\_\_\_\_

This offer expires February 15, 1988.

Name \_\_\_\_\_

Address \_\_\_\_\_

City/State/Zip \_\_\_\_\_

This offer expires February 15, 1988.

Name \_\_\_\_\_

Address \_\_\_\_\_

City/State/Zip \_\_\_\_\_

This offer expires February 15, 1988.

Name \_\_\_\_\_

Address \_\_\_\_\_

City/State/Zip \_\_\_\_\_

This offer expires January 15, 1988.

Name \_\_\_\_\_

Address \_\_\_\_\_

City/State/Zip \_\_\_\_\_

This offer expires February 15, 1988.

Name \_\_\_\_\_

Address \_\_\_\_\_

City/State/Zip \_\_\_\_\_

This offer expires February 15, 1988.

Name \_\_\_\_\_

Address \_\_\_\_\_

City/State/Zip \_\_\_\_\_

This offer expires February 15, 1988.

# Ahoy!

## CONTENTS

### DEPARTMENTS

<b>A View from the Bridge...</b> <i>of the January issue of Ahoy!</i>	<b>7</b>
<b>Scuttlebutt...</b> <i>from signs to satellites, the newest Commodore news.</i>	<b>8</b>
<b>Tips Ahoy!...</b> <i>Jay Leno should have routines as good as these.</i>	<b>46</b>
<b>Reviews...</b> <i>new software and hardware given the thrice-over.</i>	<b>63</b>
<b>Commodares...</b> <i>totally unreasonable programming challenges.</i>	<b>75</b>
<b>Program Listings...</b> <i>keypunch some stellar games and utilities.</i>	<b>81</b>

### FEATURES

<b>Rupert Report: Repetitive Processes</b> by Dale Rupert*	<b>32</b>
<b>Entertainment Software Section</b> (contents on page 41)	<b>41</b>
<b>Amiga Section</b> (contents on page 53)	<b>53</b>
<b>Ins &amp; Outs of the Expansion Port, Part II</b> by Morton Kevelson	<b>59</b>

\*Includes programs: *Iterative Solutions* (for the C-128) and *Iterative Designs* (for the C-64 and C-128)

### PROGRAMS

<b>Jungle Jake</b> for the C-128 by Cleveland M. Blakemore	<b>16</b>
<b>Ice Titans</b> for the C-64 by Cleveland M. Blakemore	<b>18</b>
<b>TextSave</b> for the C-128 by Richard Curcio	<b>20</b>
<b>Clone-a-Matic</b> for the C-64 by Buck Childress	<b>30</b>
<b>Infoflow 64</b> by Cleveland M. Blakemore	<b>70</b>
<b>Bug Repellents</b> for the C-64 and C-128 by Buck Childress	<b>82</b>
<b>Flankspeed</b> for the C-64 by Gordon F. Wheat	<b>83</b>

Cover art by James Regan; photography by COMSTOCK and Michael R. Davila

**President/Publisher**  
Michael Schneider

**Editor**

David Allikas

**Art Director**

JoAnn Case

**Managing Editor**

Michael R. Davila

**Senior Editors**

Cleveland M. Blakemore

Tim Moriarty

**Production Director**

Laura Pallini

**Technical Editors**

David Barron

Bob Lloret

**Consulting Editors**

Ben Bova

Morton Kevelson

Dale Rupert

**Entertainment Editor**

Arnie Katz

**Art Production**

Christopher Carter

**Circulation Director**

W. Charles Squires

**Advertising Director**

Lynne Dominick

**Director of Promotion**

Mark Kammerer

**Promotion Art Director**

Stacy Weinberg

**Controller**

Dan Tunick

**Advertising Representative**

JE Publishers' Representative

6855 Santa Monica Blvd., Suite 200

Los Angeles, CA 90038

(213) 467-2266

Boston (617) 437-7628

Dallas (214) 660-2253

New York (212) 724-7767

Chicago (312) 445-2489

Denver (303) 595-4331

San Francisco (415) 864-3252

ISSUE NO. 49

JANUARY 1988

*Ahoy!* (ISSN #8750-4383) is published monthly by Ion International Inc., 45 W. 34th St., Suite 500, New York, NY, 10001. Subscription rate: 12 issues for \$23.00, 24 issues for \$44.00 (Canada \$30.00 and \$55.00 respectively). Second class postage paid at New York, NY 10001 and additional mailing offices. © 1988 by Ion International Inc. All rights reserved. © under Universal International and Pan American Copyright conventions. Reproduction of editorial or pictorial content in any manner is prohibited. No responsibility can be accepted for unsolicited material. Postmaster, send address changes to *Ahoy!*, 45 W. 34th Street, Suite 500, New York, NY 10001. Direct all address changes or matters concerning your subscription to *Ahoy!*, P.O. Box #341, Mt. Morris, IL 61054 (phone: 815-734-4151). All editorial inquiries and materials for review should be sent to *Ahoy!*, 45 W. 34th St., Suite 500, New York, NY 10001.



# Lyco Computer Marketing & Consultants

## Lyco Means Total Service.



Mark "Mac" Bowser, Sales Manager

I would personally like to thank all of our past customers for helping to make Lyco Computer one of the largest mail order companies and a leader in the industry. Also, I would like to extend my personal invitation to all computer enthusiasts who have not experienced the services that we provide. Please call our trained sales staff at our toll-free number to inquire about our diverse product line and weekly specials.

First and foremost our philosophy is to keep abreast of the changing market so that we can provide you with not only factory-fresh merchandise but also the newest models offered by the manufacturers at the absolute best possible prices. We offer the widest selection of computer hardware, software and accessories.

Feel free to call Lyco if you want to know more about a particular item. I can't stress enough that our toll-free number is not just for orders. Many companies have a toll-free number for ordering, but if you just want to ask a question about a product, you have to make a toll call. Not at Lyco. Our trained sales staff is knowledgeable about all the products we stock and is happy to answer any questions you may have. We will do our best to make sure that the product you select will fit your application. We also have Saturday hours — one more reason to call us for all your computer needs.

Once you've placed your order with Lyco, we don't forget about you. Our friendly, professional customer service representatives will find answers to your questions about the status of an order, warranties, product availability, or prices.

Lyco Computer stocks a multimillion dollar inventory of factory-fresh merchandise. Chances are we have exactly what you want right in our warehouse. And that means you'll get it fast. In fact, orders are normally shipped within 24 hours. Free shipping on prepaid orders over \$50, and there is no deposit required on C.O.D. orders. Air freight or UPS Blue/Red Label shipping is available, too. And all products carry the full manufacturers' warranties.

I can't see why anyone would shop anywhere else. Selection from our huge in-stock inventory, best price, service that can't be beat—we've got it all here at Lyco Computer.

**TO ORDER, CALL TOLL-FREE: 1-800-233-8760**

**New PA Wats: 1-800-233-8760**

Outside Continental US Call: 1-717-494-1030

Hours: 9AM to 8PM, Mon. - Thurs.

9AM to 6PM, Friday — 10AM to 6PM, Saturday

For Customer Service, call 1-717-494-1670,

9AM to 5PM, Mon. - Fri.

Or write: Lyco Computer, Inc.

P.O. Box 5088, Jersey Shore, PA 17740

**Risk-Free Policy:** • full manufacturers' warranties • no sales tax outside PA • prices show 4% cash discount; add 4% for credit cards • APO, FPO, international: add \$5 plus 3% for priority • 4-week clearance on personal checks • we check for credit card theft • compatibility not guaranteed • return authorization required • price/availability subject to change • prepaid orders under \$50 in Con. U.S. add \$3.00

## COMMODORE SOFTWARE

### Access:

Echelon .....	\$25.95
Leader Board .....	\$22.95
Mach 5 .....	\$19.95
Mach - 128 .....	\$28.95
10th Frame .....	\$22.95
Triple Pack .....	\$11.95
Wld. Cl. Leader Brd. ...	\$22.95
Famous Courses #1 ...	\$11.95
Famous Courses #2 ...	\$11.95

### Epyx:

Create A Calendar .....	\$15.95
Destroyer .....	\$22.95
Fastload .....	\$19.95
Football .....	\$11.95
Movie Monster .....	\$11.95
Sub Battle .....	\$22.95
Winter Games .....	\$22.95
California Games .....	\$22.95
Super Cycle .....	\$11.95
Graphics Scrapbook ...	\$11.95
Str. Sports Basketball .	\$22.95
Wld.'s Great Baseball .	\$11.95
Summer Games II .....	\$22.95
Vorpol Utility Kit .....	\$11.95
World Games .....	\$22.95

### Unison World:

Art Gallery 1 or 2 .....	\$14.95
Print Master .....	\$17.95

### Timeworks:

Partner C64 .....	\$24.95
Partner 128 .....	\$39.95
Swift Calc 128 .....	\$29.95

### Activision:

Aliens .....	\$19.95
Champion. Basketball .	\$19.95
Hacker .....	\$8.95
Hacker 2 .....	\$19.95
Labyrinth .....	\$19.95
Music Studio .....	\$19.95
Tass Times .....	\$16.95
Titanic .....	\$11.95
Leather Goddesses ...	\$22.95
Stationfall .....	\$19.95
Lurking Horror .....	\$19.95
Top Fuel Eliminator ...	\$15.95

### Firebird:

Colossus Chess IV .....	\$19.95
Elite .....	\$18.95
Golden Path .....	\$22.95
Guild of Thieves .....	\$22.95
Pawn .....	\$22.95
Talking Teacher .....	\$22.95
Tracker .....	\$22.95
Starglider .....	\$22.95
Sentry .....	\$22.95

### Microprose:

F-15 Strike Eagle .....	\$19.95
Gunship .....	\$19.95
Kennedy Approach .....	\$13.95
Silent Service .....	\$19.95

### Sublogic:

Flight Simulator II .....	\$31.49
Jet Simulator .....	\$24.95
Night Mission Pinball ...	\$18.95

### Strategic Simulations:

Gemstone Healer .....	\$16.95
Gettysburg .....	\$33.95
Kampfgruppe .....	\$33.95
Phantasie II .....	\$22.95
Phantasie III .....	\$22.95
Ring of Zelfin .....	\$22.95
Road War 2000 .....	\$22.95
Shard of Spring .....	\$22.95
Wizards Crown .....	\$22.95
War in the S. Pacific ...	\$33.95
Wargame Constr. ....	\$16.95
Battlecruiser .....	\$33.95
Gemstone Warrior .....	\$7.95
Battle of Antietam .....	\$28.95
Colonial Conquest .....	\$22.95
Computer Ambush .....	\$33.95
B-24 .....	\$19.95

### Broderbund:

Bank St. Writer .....	\$27.95
Carmen San Diego .....	\$19.95
Graphic Lib. I, II, III ...	\$13.95
Karateka .....	\$12.95
Print Shop .....	\$25.49
Print Shop Compan. ...	\$22.95
Print Shop Paper .....	\$12.95

### Action Soft:

Up Periscope .....	\$18.95
Thunder Chopper .....	\$NEW

### Origin:

Autoduel .....	\$28.95
Ultima III .....	\$22.95
Ultima IV .....	\$33.95

Call for AMIGA titles and pricing.

## Monitors

### Thomson:

230 Amber TTL 12" .....	\$85
450 Amber TTL 15" .....	\$149
980 White TTL 20" .....	\$695
4120 CGA .....	\$225.95
4160 CGA .....	\$289
4460 EGA .....	\$359
Zenith:	
ZVM 1220 .....	\$89
ZVM 1230 .....	\$89

### Blue Chip:

BCM 12" Green TTL .....	\$79
BCM 12" Amber TTL .....	\$89
BCM 14" Color .....	\$259.95

### NEC:

Multisync .....	\$549
-----------------	-------

## THOMSON 4120 Monitor

- 14" RGBI/video composite/analogue
- Compatible with IBM and Commodore
- RGB data cable included



\$225<sup>95</sup>

## Modems

### Avatex:

1200i PC Card .....	\$89.95
1200hc Modem .....	\$95.95
2400 .....	\$209.95
2400i PC Card .....	\$199.95

### Hayes:

Smartmodem 300 .....	\$149.95
Smartmodem 1200 .....	\$285.95
Smartmodem 2400 .....	\$425.95

## Special Purchase

Data Share-Messenger Modem  
300 Baud Auto Dial Auto Answer Modem **\$29.95**

# 1-800-233-8760



**star**  
MICROWATER-100  
**NX-10**

**\$149<sup>95</sup>**

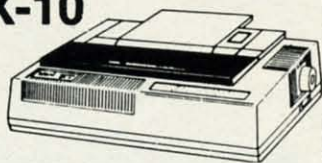

**Panasonic \$159<sup>95</sup>**  
**1080i Model II**

- Now 150 cps Draft Mode
- NLQ Mode

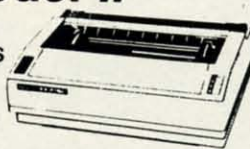

**SEIKOSHA**  
**180VC \$124<sup>95</sup>**

- 100 cps
- 20 NLQ
- Direct Connect C-64/128

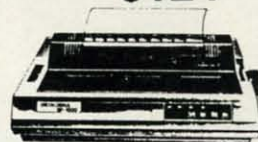

## PRINTERS

**star**  
MICROWATER-100

NP-10.....	\$134.95
NX-10.....	\$149.95
NX-10C w/interface.....	\$165.95
NL-10.....	\$199.95
NX-15.....	\$289.95
ND-10.....	\$259.95
ND-15.....	\$375.95
NR-15.....	\$409.95
NB-15 24 Pin.....	\$699.95
NB24-10 24 Pin.....	\$409.95
NB24-15 24 Pin.....	\$549.95

**OKIDATA**  
OF OKI AMERICA COMPANY

Okimate 20.....	\$119
Okimate 20 w/cart.....	\$179.95
120.....	\$189.95
180.....	\$219.95
182.....	\$209.95
192+.....	\$309.95
193+.....	\$449.95
292 w/interface.....	\$449.95
293 w/interface.....	\$589.95
294 w/interface.....	\$819.95
393.....	\$955.95

**EPSON**

LX800.....	\$175.95
FX86E.....	<b>\$289.95</b>
FX286E.....	\$429.95
EX800.....	\$374.95
EX1000.....	\$489.95
LQ800.....	\$369.95
LQ1000.....	\$549.95
LQ2500.....	\$849.95
GQ3500.....	SLOW
LQ850.....	\$499.95
LQ1050.....	\$679.95

**Panasonic**

1080i Model II.....	\$159.95
1091i Model II.....	\$179.95
1092i.....	\$295
1592.....	\$379
1595.....	\$419
3131.....	\$259
3151.....	\$399
KXP 4450 Laser.....	SCALL
1524 24 Pin.....	\$549.95

**BROTHER**

M1109.....	\$195
M1409.....	\$299
M1509.....	\$365
M1709.....	\$475
Twinwriter 6 Dot & Daisy.....	\$899
M1724L.....	\$625
HR20.....	\$339
HR40.....	\$569
HR60.....	\$709.95

**DIABLO**

D25.....	\$499.95
635.....	\$779.95

**SEIKOSHA**

SP 180Ai.....	\$124.95
SP 180VC.....	\$124.95
SP 1000VC.....	\$135.95
SP 1200VC.....	\$144.95
SP 1200Ai.....	\$155.95
SP 1200AS RS232.....	\$155.95
SL 80Ai.....	\$295.95
MP1300Ai.....	\$269.95
MP5300Ai.....	\$375.95
BP5420Ai.....	<b>\$879.95</b>
SP Series Ribbon.....	\$7.95
SK3000 Ai.....	\$349
SK3005 Ai.....	\$429

**CITIZEN**

120 D.....	\$159.95
MSP-10.....	\$259.95
MSP-40.....	\$289.95
MSP-15.....	\$324.95
MSP-45.....	\$425.95
MSP-50.....	\$359.95
MSP-55.....	\$459.95
Premiere 35.....	\$464.95
Tribute 224.....	\$624.95

**COMMODORE 128D**  
**System Special**



- Commodore 128D Computer/Drive
- Thompson 4120 Monitor

**\$649<sup>95</sup>**

**COMMODORE**

**128 D System**



**\$439<sup>95</sup>**

**COMMODORE**

HARDWARE

1541 C Disk Drive.....	\$175.95
1571 Disk Drive.....	\$215.95
1581 Disk Drive.....	SLOWEST
Indus GT C-64 Drive.....	\$169.95
Blue Chip 64C Drive.....	\$139.95
Blue Chip C 128 Drive.....	\$195.99
1802C Monitor.....	\$189.95
2002 Monitor.....	\$239.95
1901 Monitor.....	SCALL
64 C Computer.....	\$169.95
128D Computer Drive.....	\$439.95
1670 Modem.....	SCALL
C-1351 Mouse.....	\$32.95
1700 RAM.....	\$109.95
C-1750 RAM.....	\$169.95
1764 RAM C64.....	\$124.95

**Seagate** HARD DRIVES

20 meg kit.....	\$269.95*
30 meg kit.....	\$299.95*
40 meg kit.....	\$489.95*
*Drives include controller	
40 meg w/o controller.....	\$425.95

**Smarteam**  
**1200 Baud Modem**

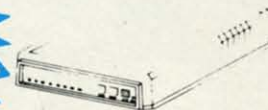

Hayes Compatible

Versatile power and performance.

**COMMODORE C-64C**  
**Computer**

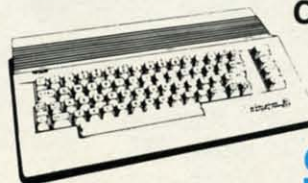

**\$169<sup>95</sup>**

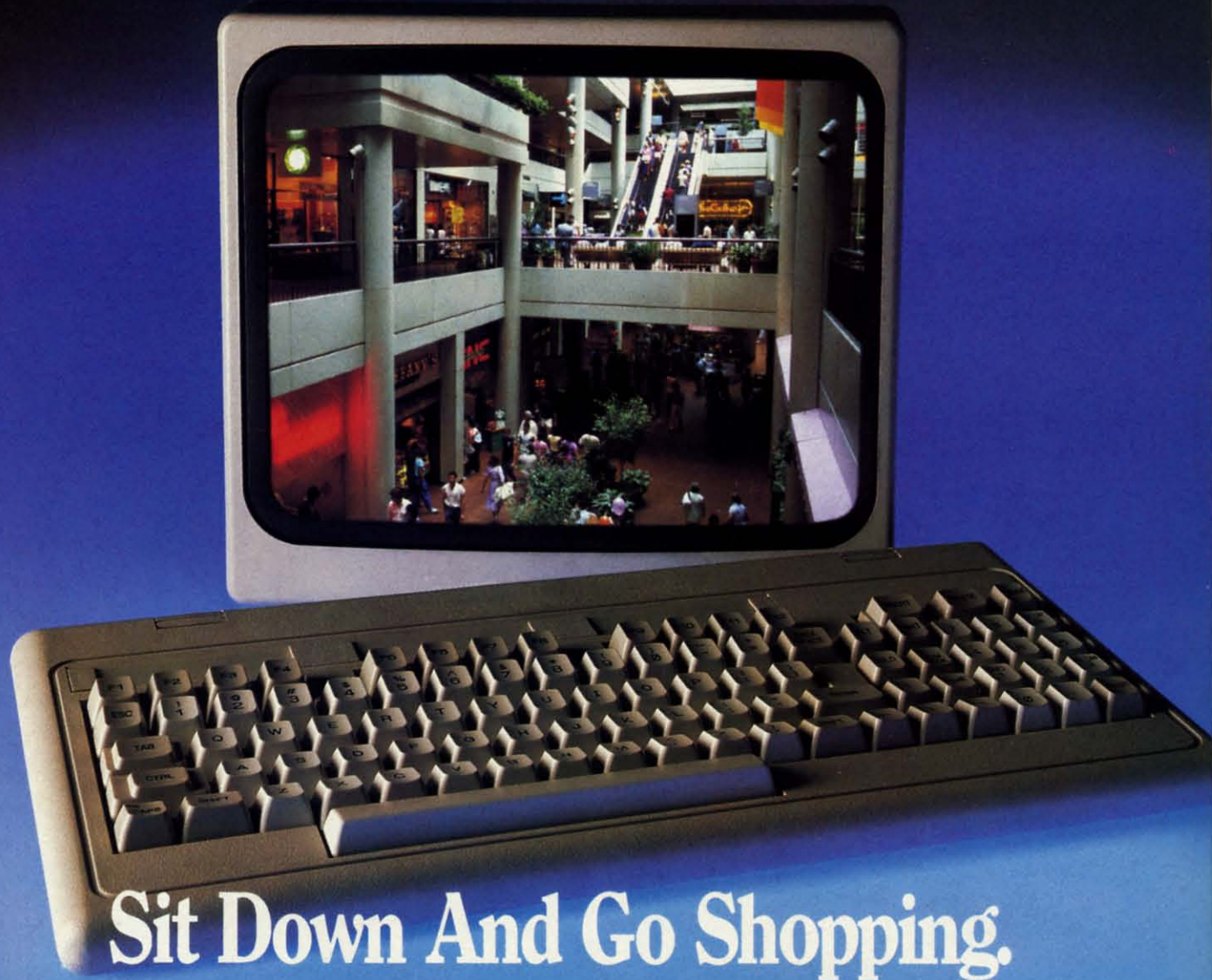

## Sit Down And Go Shopping.

**CompuServe takes you on a coast-to-coast shopping spree from the comfort and convenience of your home.**

Now you can shop the entire country through THE ELECTRONIC MALL™ from CompuServe. Stop in online at Waldenbooks, Express Music, even the Metropolitan Museum of Art. It's an easy and exciting way to buy goods and services from the nation's top merchants and businesses without ever having to leave home.

Plan your shopping adventure by department: Apparel & Accessories, Automotive, Books & Periodicals, Gifts & Novelties, Computing, Gourmet & Flowers, Hobbies & Toys, Merchandise & Electronics, Online Services, Premium Merchants, Music & Movies, Health & Beauty, Financial, Travel & Entertainment, Office & Supplies, Sports & Leisure.

You can also join Comp-u-store, a computerized discount shopping service. Access over 250,000 products with savings of up to 50%.

### **Take the 15-Minute Shopping Comparison Test:**

**Here's what you can do in 15 minutes shopping THE ELECTRONIC MALL way:**

- Look up the latest in computer accessories.
- Select one and enter the order command.
- Shop for unusual and unique gifts for every member of the family.
- Get information on that new car you've been thinking about buying.
- Request a department store catalog. Pick out a new wardrobe. Toys. Tools. Anything you wish.
- Place your order.

**Compare all that with what you can do in 15 minutes of shopping the old way:**

- Round up the family and get in the car.

**THE ELECTRONIC MALL—another valuable service from the vast world of CompuServe.**

Only CompuServe subscribers can shop online in the fabulous ELECTRONIC MALL. So join now and find an exciting selection of top-quality merchandise and useful product information services 24 hours a day, seven days a week.

CompuServe Information Services bring you information, entertainment, personal communications and more. You can access CompuServe with almost any computer and modem.

Start your own cross-country shopping spree today. To buy a CompuServe Subscription Kit, see your nearest computer dealer. To receive our informative brochure or to order direct, call or write.

## **CompuServe®**

Information Services, P.O. Box 20212  
5000 Arlington Centre Blvd., Columbus, OH 43220

**800-848-8199**

In Ohio and Canada, call 614-457-0802

An H&R Block Company

Reader Service No. 231

# VIEW FROM THE BRIDGE

**H**igh school only lasts for four years. So does the reign of an Olympic champion. And the term of a US President. (Forget about reelection—it spoils our analogy.) But *Ahoy!* has been around four years as of this month, and is still going strong! It was January 1984 when our first issue hit the stands, bearing the provocative headline: "Can the 64 Crack the Peanut?" It did—along with every other home computer made—which is why we're still here to tell about it one leap year later. Commodore's strong upward surge of late, courtesy of the Amiga 500's success, makes us confident that this won't be the last January we and our readers celebrate together.

Further cause for celebration is the fact that *Ahoy!*'s editorial staff is once again at full strength. Ace programmer Cleve Blakemore has relocated to the Big Apple from Richmond, Virginia to fill the position vacated by Tim Little. Those of you familiar with Cleve's work know that we couldn't have asked for a human being better qualified for the job. In months to come you'll see more programs from Cleve than ever before. He managed three this month—and that's without looking at the keyboard! (His neck hurt too much from staring at tall buildings.)

Equally worthy of gawking at are the contents of the January *Ahoy!*:

- *Infloflow*, the icon-driven database (April '87), was an impressive programming achievement even for BASIC 7.0. Imagine our excitement when Cleve told us he could convert it for the 64, sacrificing nothing but the 128's greater memory capacity. (Turn to page 70.)

- More than just an ape of *Donkey Kong* and other chutes and ladders games, *Jungle Jake* pits your safari-helmeted hero against such varied foes as snakes, parrots, Zulu warriors, and monkeys on seven colorful C-128 screens. (Turn to page 16.)

- We were ready to put on parkas just watching Cleve program *Ice Titans*, in which a crash-landed explorer must fight his way past the deadly denizens of a world of eternal frost. (Turn to page 18.)

- In four years of writing the column that bears his name, Dale Rupert has managed never to repeat himself. This month is as close as he'll ever come to repetition, as he deals with the *Repetitive Processes* of mathematical and graphics iteration. (Turn to page 32.)

- It's rare that a first-time contributor comes up with a utility as good as Richard Curcio's *TextSave*. The program enables the 128 user to open and close up to five windows, restoring the text below. (Turn to page 20.)

- As editor of *Electronic Games* magazine, Arnie Katz and his staff would annually award the Arkies to the best videogames of the preceding year. The tradition lives on, as for the third year in a row Arnie and the editors of *Ahoy!* select the best in Commodore entertainment software, both for the 64/128 (turn to page 41) and the Amiga (turn to page 53).

- Morton the K continues to chart *The Ins and Outs of the C-64/128 Expansion Port* with a guide to building your

own ROM cartridge of up to 512K. (Turn to page 59.)

- When Morton gets into hardware mode, he's tough to turn off. Also in this issue, he reviews the A20 hard disk drive for the Amiga (turn to page 54) and the Hotshot Plus printer interface for the C-64 family (turn to page 66). On the soft side, he supplies a detailed look at Firebird's *Advanced OCP Art Studio* (turn to page 63).

- New computerists in search of an all-purpose copy utility need look no further than Buck Childress's *Clone-a-Matic*. It will copy program, sequential, and user files, in machine language or BASIC, quickly and easily. (Turn to page 30.)

- Most of you don't need to be reminded of all the regular columns well worth a look: *Scuttlebutt*, surveying the field of coming Commodore products (turn to page 8); *Tips Ahoy!*, packing in some of the most valuable short routines you'll find in print (turn to page 46); and *Commodares*, putting programmers of all levels to the test (turn to page 75).

Whether you've been with us four years or four months, we thank you for your patronage. We can imagine no greater privilege than bringing the serious Commodore users of the world the best package of programs, articles, news, and reviews we know how. When we fail in our duty, as we sometimes do, we count on you to let us know—and you always have. Please keep it up. We want to get glassy-eyed all over again in January 1989! —David Allikas

## BRAND NEW AMIGA 2000 ONLY \$970 or NEW AMIGA 500 \$159 or NEW C128D w/built-in drive \$95

with trade-in of C128 Computer, 1571 Disk Drive, 1802 Monitor.

BRAND NEW 1581 drive \$79 with trade-in of C1571 or  
\$119 with trade-in of C1541 disk drive.

It doesn't matter what equipment you have, we want  
to trade. Call us today and trade in your equipment.

NEW & USED EQUIPMENT

We carry new and used equipment for Commodore,  
IBM compatibles, and Atari — everything from VIC20,  
C64, Atari 400/800 to the Amiga 2000 and Atari MegaST!

64C CPU w/GEOS .....	\$169	1764 256k RAM .....	\$129	1581 3-1/2" Drive .....	\$199
1381 Mouse .....	\$39	1802C Color Mon. ....	\$189	1541C Drive .....	\$169
<b>C128</b>					
*128 CPU .....	\$249	1571 Drive .....	\$225	1750 512k RAM .....	\$159
128D built-in drive .....	\$489	1700 128k RAM .....	\$99	2002 RGB Monitor .....	\$299
<b>AMIGA</b>					
A500 CPU .....	\$589	A501 512k RAM .....	\$169	A2002 RGB Mon. ....	\$299
A2000CPU .....	\$1449	A1050 256k RAM .....	\$149	A1060 SIDE CAR .....	\$799
<b>PRINTERS</b>					
Star NX-10C .....	\$199	Star NP-10 .....	\$149	Star NX-10 .....	\$169
Xetec JR Intrfc .....	\$39	Xetec SR Intrfc .....	\$59	Full Line of Star!!!	
<b>MODEMS</b>					
Avatex 1200 .....	\$85	Avatex 2400hc .....	\$199	SmartLink 2400hc .....	\$189
<b>USED PRICES</b>					
Quantities of USED products vary. Call before ordering.					
C64C CPU w/Geos .....	\$135	C64 CPU .....	\$109	C128 CPU .....	\$207
VIC20 CPU .....	\$39	1541 Drive .....	\$119	1660 Modem .....	\$34
C1802 Mono .....	\$139	Mono Monitor .....	\$39	MPS-801 Print .....	\$72

We pay cash for used equipment and accessories.

CALL for an instant price quote on your equipment. Nothing is too old or obsolete!  
Prices are subject to change without notice.

2017 13th St., Suite A  
Boulder, CO 80302

**Computer Repeats, Inc.**

VOICE: (303) 939-8144  
MODEM: (303) 939-8174

\*All reference to trade-ins in ad assume equipment to be in good working condition.  
Shipping/handling will be added to all prices. Shipping/handling is based on actual weight.  
MASTERCARD/VISA/CHOICE/C.O.D

**SATELLITE TRACKING • C-64 TERMINAL • MEMORY IMPROVEMENT • SOUND SAMPLER • TAX PROGRAM UPDATE • RAM STORAGE • STOCK PROGRAM • MUSIC DISKS • GAMES FROM EA, FIREBIRD, SUBLOGIC • AMIGA WORD PROCESSOR, POWER SUPPLY • HARD DISK BACKUP • CAR SIGN MAKER**

## SONG DISKS

More C-64 music from Free Spirit: *Gospel Greats* (\$9.95) contains "Amazing Grace," "Down by the Riverside," and 16 other religious songs. Words are displayed as the music plays.

*English & Scottish Songs—II* continues Free Spirit's collection of 17th century British folk music with "Blue Bells of Scotland," "Annie Laurie," "The Keel Row," and 17 others. As each song plays, its lyrics and historical background appear onscreen. Price is \$9.95, or \$17.95 for Volumes I and II.

Free Spirit Software, Inc., 312-352-7323 (see address list, page 12).

## BABY UNDER BOARD

Quick, before those diamond-shaped yellow car signs catch on—*Car Sign Designer* (\$29.95) will allow you to create your own. Included are two reusable plastic sign holders with suction cups, a stack of bright yellow fan-fold paper, and a C-64 program for de-

signing your sign onscreen. Up to four lines of text can be entered, with characters automatically centered and the width of the bold typeface automatically adjusted as characters are added.

Zebra Systems, Inc., 718-296-2385 (see address list, page 12).

## C-128 STOCK ANALYSIS

*Securities Analyst-128* (\$49.95) takes advantage of the 128's two video chips by displaying all text information on the 80 column monitor while displaying charts and graphs on the 40 column monitor. The marketer enters data from the newspaper or other sources, from which the program will prepare charts on weekly performance, moving average, accumulation/distribution, trailing stops, and point and figure. Analysis includes P/E ratios, coefficient of variability, beta factors, and gains percentage. Also on the program disk is a mini-word processor for keeping notes, and data on the performance

of 16 stocks.

Free Spirit Software, Inc., 312-352-7323 (see address list, page 12).

## QUICKER BROWN BOXES

New 32K (\$99) and 64K (\$129) versions of the *Quick Brown Box* battery-backed RAM cartridge for the 64 permit storage of up to 30 programs or utilities, providing access to even the longest program in under one second. Loader software is included.

Brown Boxes, Inc., 617-275-0090 (see address list, page 12).

## BOOKS

*The Viewport Technician* covers the design, development, and coding of software that can be ported among the Amiga, Atari ST, IBM PC, Macintosh, and Apple IIGS. The computers and their windowing environments are technically compared. 496 pages; \$24.95.

Scott, Foresman and Company, 312-729-3000 (see address list, page 12).

The following three from TAB:

*The Commodore Programmer's Challenge* consists of 50 problems, grouped for beginning, intermediate, and expert programmers. Solutions are written in BASIC, Pascal, and C. 240 pages; \$14.95.

*Computer Architecture and Communications* offers an overview for advanced beginners, covering processors, memory, machine codes, networks, and more. 288 pages; \$16.95.

TAB Books, Inc., 717-794-2191 (see address list, page 12).

## HARD DISK BACKUP

For use with all AmigaDOS-compatible hard disk drives, *Quarterback* (\$69.95) transfers 20 megabytes to floppy format in 45 minutes. Full/subdirectory/incremental backup and restore are supported, with automatic diskette formatting, file cataloging, and disk-



*If the sayings on those storebought signs aren't dumb enough for you, Car Sign Designer lets you write one that is.* **READER SERVICE NO. 285**

**MONEY-BACK GUARANTEE \* TOLL-FREE 24 HOUR ORDER LINE**  
**WIDE SELECTION \* NO-NONSENSE LOW PRICES \* FREE CUSTOMER**  
**SUPPORT \* FRIENDLY & KNOWLEDGABLE STAFF \* IMMEDIATE SHIPPING**  
**PERSONAL ATTENTION \* FOREIGN, CANADIAN, & SCHOOLS WELCOME . . .**

**NEED WE SAY MORE? LET US EARN YOUR BUSINESS!!**

**GRAPHICS & CAD**

- Anti-Glare Screens \$18
- Banner Machine (Cardinal) 39
- BASIC 8 (Patech) 30
- SCREEN F/X (Solo Unlmt) 29
- Billboard Maker (Sol Unlmt) 29
- CAD 3D (IHT) 39
- Cadpak-64 (Abacus) 29
- Cadpak-128 (Abacus) 45
- Colorez 128 (B-Ware) 12
- Cybervideo (Touchstone) 30
- Doodle (Crystal Rose) 29
- Flexidraw 5.5 (Inkwell) 75
- Lightpen 170C 49
- Lightpen 184C 24
- FlexiFont 24
- Galleries - each 21
- Holiday/Clip Art I/Clip Art II/  
Borders/Animals/Futuristic/  
Graphics Integrator 2 (Inkwell) 25
- Graphic Label Wizard (Kra Jax) 19
- Graphics Transformer (CDA) 25
- Home Designer 128 (Kendall) 45
- Icon Factory (Solo Unlmt) 29
- Moving Pictures (CDA) 29
- Perspectives II (Kira) 39
- Picasso's Revenge (Progress) 49
- Photo Finish (Sol Unlmt) 25
- Pop-Up Greetings (Patech) 34
- Printmaster Plus (Unison) 25
- Art Gallery I or II 17

**AIDS/UTILITIES**

- 1541/1571 Dr. Align (Free Sp) 20
- 40/80 Column Switch Cables 19
- Assembler/Monitor (Abacus) 29
- Basic 8 (Putech) 30
- BASIC Compiler 128 (Abacus) 45
- BASIC Compiler 64 (Abacus) 29
- BBS Construction Set (Kira) 43
- Big Blue Reader (Sogwap) 25
- Big Blue Reader CP/M 32
- Bobstern Pro 64 (Progress) 39
- Bobstern Pro 128 (Progress) 49
- COBOL 64 (Abacus) 29
- Communicator 64 (FR SPRT) 29
- Gnome Kit 64/128 (Kira) 20
- Gnome Speed 128 (Kira) 39
- Gnome Mac 128 (Kira) 30
- How To Get Most GEOS Book 13
- How To Get Most GEOS Disk 9
- Kyan Pascal 64 or 128 52
- Merlin 64 (Roger Wagner) 39
- Merlin 128 (Roger Wagner) 49
- Phy Exam 1541 or 1571 (Card) 29
- Power Assembler 64/128 (Sp) 30
- Power C 64/128 (Spinn) 30

- Programmer's Tool Box (Spinn)\$17
- Prototerm 128 12
- Super C 128 or 64 (Abacus) 45
- Super Graphix (Xetec) 79
- Superkit 1541 (Prism) 25
- Super Rascal 128 or 64 (Abac) 45
- Super Snapshot (K. Jax) 49
- SYSRES Enhanced (Comp Mart) 32
- Troubleshoot & Repair C64 Book 16
- Turbo Load & Save Cart (Spinn) 19
- CPMI Kit 128 (Inca) 25
- TSOS Super Assembler 39
- Kracker Jax Volumes 1-6 EACH 17
- K Jax Loaded Shotgun 17
- K Jax C128 or MSD Cannon 29
- K Jax Bull's Eye 17

**HOME/BUSINESS**

- Accountant 128 (KFS) 119
- Add-on modules 55
- BEST A/P or A/R 45
- BEST G/L or Inventory 45
- BEST Project Planner 50
- Business Form Shop (Spinn) 30
- Checkbook 128 (Nu Age) 17
- CMS Accounting 128 129
- Inventory Module 53
- Easy Working Filer/Planner  
or Writer (Spinn) 10
- Fleet System 2 + (Professional) 39
- Fleet System 4 (Professional) 59
- Fleet Filer 64 (Professional) 29
- FlexFile 64 or 128 (Cardinal) 39
- Fontmaster 128 (Xetec) 39
- Fontmaster II 64 (Xetec) 35
- GEOS 128 (Berkeley) 49
- Add-ons call
- GEOS 64 (Berkeley) 39
- Geoprint or Geodex 29
- Geocalc or Geofile 35
- Fontpak I or Despkak 1 22
- Writer's Workshop 33
- Microlawyer (Progress) 45
- Pocket Superpak 64 (Dig Sol) 49
- Pocket Superpak 2 64/128 69
- Pocket Dictionary (Dig Sol) 10
- Pocket Writer 64 (Dig Sol) 29
- Pocket Writer 2 (Dig Sol) 45
- Superbase 64 49
- Superbase 128 55
- Superscript 128 49
- ThoughtForm 64 (Gallery) 26
- Vizistar or Viziwrite 128 65
- Wordpro 128/Spell/Filepro 30
- Wordpro 64/Spell/Turbo 30

**PERSONAL**

- Bridgemaster (Radarsoft) 12

- Cardio Exercise (Bodylog) \$69
- Celebrity Cookbook (Merrill) 25
- Classical Music (Strider) 9
- Crossword (Radarsoft) 12
- Disk/Video/Mag Catalogue 128 29
- Dream Analyzer (Merrill) 25
- Enhanced Stress (Bodylog) 199
- Family Tree 128 or 64 (Genco) 32
- Hearthab (Bodylog) 16
- Muscle Development (Bodylog) 54
- Sexual Edge (Merrill) 20
- Standard Stress (Bodylog) 89
- Tempo Typing (Radarsoft) 12

**EDUCATIONAL**

- Fisher Price 17
- Peter Rabbit Reading (3-6) 19
- Peter & Wolf Music (3-7) 19
- Jungle Book Reading (6-9) 19
- First Men on Moon Math (9+) 19
- Witham Classics Graphic Adven. 9
- Alice in Wonderland 9
- Treasure Island (10+) 9
- Wizard of Oz (10+) 9
- Swiss Family Robinson (10+) 9
- Below the Root (10+) 9
- Hayden Score Imp For SAT  
Math/Verbal or Exams 17
- Spinnaker 10
- Facemaker-Amiga (3-8) 39
- Alphabet Zoo (3-7) 18
- Kids on Keys (4-9) 18
- Math Busters (8-14) 22
- Kidwriter (6-10) 22
- Homework Helper Math (10+) 29
- Homework Helper Write (10+) 29
- Early Learning Friends (3-8) 6
- Grandma's House 6
- Educational Videos-Spinnaker 29
- Readers of Lost Alpha (5-8) 12
- Adventures of Time Taxi (5-8) 12
- Search for Stolen Sentence 12
- Close Encounters of Math Kind 12
- Captain Kangaroo Videos 49
- Right Thing To Do (3-8) 9
- Favorite Adventures (3-8) 9
- Tales From Mother Goose (3-8) 9
- Silly Stories/Scary Tales (3-8) 9
- Beat The SAT - Verbal Video 18
- Beat The SAT - Math Video 18
- AMIGA 26
- Analyze 2.0 (Brown W) 119
- CLI-Mate (Progress) 30
- Express Paint (PAR) 60
- FACC (ASDG) 29
- P.H.A.S.A.R. (Finally) 79
- Microlawyer (Progress) 45

- Pagesetter (Gold Disk) \$119
- Gold Spell or Lazer Script 35
- Printmaster Plus (Brown W) 39
- Publisher 1000 (NE Soft) 149
- Logistix (Progress) 119
- Scribble (Brown W) 79
- Talking Coloring Book (JMH) 24
- Superbase (Progress) 119
- TV Text (Brown W) 79
- Videoscape (Aegis) 159
- Wordperfect 299
- Draw (Aegis) 99
- Digit! (Aegis) 64
- Viziwrite (Progress) 119
- Amiga 500-512 Exp Boards 139

**BRIWALL**

Solid Products • Solid Support

P.O. Box 129/56 Noble St.  
Kutztown, PA 19530

**TOLL-FREE 24 HOURS**  
**1-800-638-5757**  
 (ORDERS ONLY PLEASE)

**OUR PROMISE**  
**WE GUARANTEE YOUR SATISFACTION!!**  
 If, for any reason, you are not satisfied with your selection within 15 days of your receipt, simply return the product to us for a friendly refund of your purchase price. No hassles! You pay ONLY \$1.00 per returned item for handling. Defective items are replaced free of charge!

**!! FREE !!**  
**Strider's**  
**Computer Classics**  
 with order totaling  
**\$100 or more.**

**\* PRODUCT OF THE MONTH!!**

**PERSPECTIVES II**

**3-D GRAPHIC DEVELOPMENT SYSTEM**

LIST - \$50      OURS - \$39      SPECIAL - \$32

**3-D PERSPECTIVES II™** provides you with a simple and enjoyable way to draw and manipulate 3D objects and create 3D animation for use with your own programs, while taking the graphics capability of your computer to its limit!

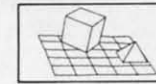
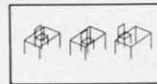

**DRAWING A NEW OBJECT**  
 The process of creating a three-dimensional computer image is divided into various stages. Create the database of object corners using keyboard control or by positioning the cursor to set x,y and z coordinates. Database values may be altered, copied or removed.

**HIDDEN LINE REMOVAL** and stereoscopic viewing mode

**OBJECT MANIPULATION:**  
 Rotate•Tumble•Enlarge•Reduce•Load•Save Center

**FILM STUDIO**  
 Film studio allows you to "photograph" objects and view them sequentially like a film (object animation)

**VIEWPOINT CHANGES:**  
 Azimuth•Elevation•Range•Focus•Horizontal and Vertical displacement

**Features**  
 Completely compatible with many 2-dimensional drawing programs! Allows the user to transfer 3-dimensional pictures to 2-dimensional software for further enhancement. Controlled by joystick/light pen, Koala Pad, Super Sketch, Flexi-Draw, Tech Sketch and others. Sophisticated user interface (G.U.L.D.E.) with pull-down menus and windows. Extensive Help Menus to aid users. Print dump facilities. Library of subroutines with documentation allows the use of 3-D PERSPECTIVES II objects and animations in your own programs.

**\*OFFER GOOD UNTIL 12/30/87**

**\* COMBINATION SPECIALS \***  
**CALL FOR LATEST SPECIALS AND PRODUCTS**

- Gnome Kit + Gnome Speed + Gnome Mae - \$59
- Photo Finish + Icon Factory + Billboard Maker - \$69
- Syntech BBS + Games Module - \$59
- Flexidraw 5.5 + 170C Pen - \$100
- Flexidraw 5.5 + 184C Pen - \$75
- Graphics Integrator 2 + Graphics Transformer + Icon Factory - \$75
- Doodle + Moving Pictures - \$48
- KFS Accountant 128 + Add-on Module - \$169
- Galleries with Flexidraw and Pen - \$19 each
- Basic 8 + Colorez 128 - \$39
- Maps Europe + USA + World - \$50
- All 5 Witham Classics - \$39
- Kids on Keys + Early Learning Friends + Grandma's House - \$28
- Easy Working Planner + Filer + Writer - \$26
- Any 3 Fisher Price Educationals - \$52
- Viziwrite 128 + Vizistar 128 - \$125
- 184C Pen with ANY Graphics Pak - \$43
- 3 or more Classical Music Disks - \$7 each
- Any 3 Kracker Jax Volumes - \$45

ORDERING INSTRUCTIONS: VISA, MasterCard, Personal Check, Money Order or COD are welcome. Shipping USA: \$3.00/ground, \$5.00/2nd Day, \$14.00/overnight. C.O.D. add \$2.00. Canada/Mexico: \$6.00 Air Mail. Foreign: \$12.00 (for Air Mail use charge & specify maximum). PA residents add 6% sales tax. Include phone number and computer/drive model with order. All items will be shipped immediately, (if we are out-of-stock, we will let you know.) Charge is per order.

For CUSTOMER SERVICE please call us:  
 Monday thru Friday, 9:30 a.m. - 4 p.m. EST  
 1 - (215) - 683 - 5699

Call or write for our FREE CATALOG,  
 describing in detail, hundreds of  
 fine products for your Commodore.

## TIRED OF WRITING PROGRAMS THAT RUN IN SLOW MOTION?

TRY:

# 64-TRAN

The first FORTRAN Development  
Environment for the Commodore 64  
or 128 (in 64 mode)

- ◆ Comprehensive manual included
- ◆ Generates relocatable machine code
- ◆ Creates fast, saveable programs
- ◆ Allows for low overhead by linking only the system routines required
- ◆ EXEC statement allows access to 6502 registers, kernal and user written machine language routines
- ◆ Block IF-THEN-ELSE-ENDIF constructs
- ◆ Minimum requirement of C64 and one disk drive
- ◆ \$50.00 each (MD residents add \$2.50 tax)

Orders and Info Call:

(301) 992-9527

Or Write To:

TRIDENT SOFTWARE

P.O. Box 180 Glenelg, MD 21737

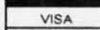

Dealer Inquires Welcome

Reader Service No. 269

ette sequence numbering and checking.  
Central Coast Software, 805-528-  
4906 (see address list, page 12).

### AMIGA WP

*Precisely* (\$79.95), an Amiga word processor, features a non-technical user interface designed for Amiga users with little computer experience. The program can print selected screen areas, such as an address for an envelope. Supported features include multi-tasking, multiple windows, keyboard macros, online help, and column cut and paste.

Central Coast Software, 805-528-  
4906 (see address list, page 12).

### WE ARE THE FORMS

The 1987 version of *Taxaid* reflects all tax law changes for tax year 1987. The program will prepare IRS Form 1040, Schedules A-E, and Form 2441 (Child Care). All calculations are automatic. For the C-64 and Plus/4;

\$44.95.

Taxaid Software, Inc., 218-834-5012  
(see address list, page 12).

### AMIGA SOUND SAMPLER

The *AudioMaster* sampling and editing program (\$59.95) lets Amiga musicians manipulate and digitally sample sound, mix sounds together, alter their waveform, and save them as instruments to be used in other Amiga music programs. The program works with any digital sound sampling hardware for the Amiga 500, 1000, or 2000. Sample lengths vary with memory available: 512K allows up to two minutes, and 8 megabytes as much as five minutes.

Aegis Development Inc., 213-392-  
9972 (see address list, page 12).

### SATELLITE DISK

*SATCOMM-64* (\$15.95) allows amateur radio operators who communicate via satellite-based transponders and BBS-like systems to track the satellites, determining access times and antenna placement. Information can be stored for 15 different satellites; entry of a time bracket can produce a printed report of up to 31 days of access times. C-64 users who are not radio operators can use the program to track easily visible satellites like the Salyut-7, MIR, and Cosmos 1870.

Strategic Marketing Resources, Inc.,  
314-256-7814 (see address list, page 12).

### RE-ACCOUNTING

Version 2.0 of *The Accountant* for the 128 features a disk file utility for rebuilding most corrupted files, a Payroll section expanded to handle 100 employees, individualized state withholding tax rates, and a third percentage deduction. The new version will not run on the 1541 disk drive.

KFS Software, Inc. (see address list,  
page 12).

### TERMINAL SOFTWARE

*The Communicator* (\$39.95), a C-64 terminal program, offers a choice of nine baud rates from 50 to 1800, plus user-defined rates. A buffer of 18,686 characters is supported, along with full printer, disk, modem, and status line support. Disk files can be sent to received with or without X-modem pro-

## A Powerful Wordprocessor for the Commodore 128®

# Fontmaster 128



Selected  
for the 1987  
CES Software  
Showcase  
Award.

From the author of *Fontmaster II* comes **Fontmaster 128**, an enhanced version for the Commodore 128. This powerful word processor with its many different print styles (fonts), turns your dot matrix printer into a more effectual tool. Term papers, newsletters, and foreign languages are just a few of its many applications.

- \* Program disk with no protection - uses hardware key
- \* Supplement disk includes foreign language fonts
- \* 56 Fonts ready to use
- \* Font editor/creator included
- \* On screen Font preview
- \* 80 column only
- \* Supports more than 110 printers
- \* Includes a 102,000 word Spell Checker

Only  
**\$69.95**

Commodore 128 is a registered trademark of Commodore Business Machines, Inc.



Inc. 2804 Arnold Rd. Salina, Ks. 67401 (913) 827-0685

Reader Service No. 263

ocols; macro key options are provided for fast transmission of frequently used commands. Video attribute options include border, background, character, cursor color, 40/64/80 column display, cursor definition, and user-defined character sets.

Free Spirit Software, Inc., 312-352-7323 (see address list, page 12).

## AMIGA POWER SUPPLY

The CPS-500 replacement power supply (\$99.95) offers Amiga 500 owners three auxiliary 117 VAC sockets with transient/spike suppression, EMI and EPI filtering, and short circuit and current limit protection. Other features are a user-serviceable all-metal chassis, six foot power cord, and remote 5V D.C. sensing.

Phoenix Electronics, Inc., 913-632-2159 (see address list, page 12).

## ELECTRONIC MUSIC

Following *It's Only Rock 'N Roll* in EA's collection of music library disks for use with an Amiga and *Instant Music*, *DeluxeVideo*, and *Deluxe Music Construction Set*, *Hot & Cool Jazz* (\$29.95) contains over 40 tunes ranging from ragtime to modern fusion. Studio-recorded, digitized instruments are available for composing.

Electronic Arts, 415-571-7171 (see address list, page 12).

## TRY TO REMEMBER

Two C-64 memory improvement programs from Sunburst, each \$65:

*Simon Says* requires kindergarteners to grownups to repeat an onscreen sequence of colors, numbers, or letters. The chain lengthens until the student misses an item. Up to four may play in competition.

*Teddy and Iggy* lets kindergarteners to second graders stack brightly colored shapes and open boxes, memorizing the sequence in which the tasks are performed.

Sunburst Communications, Inc., 800-431-1934 or 914-769-5030 (see address list, page 12).

## GAMES

One or two players must use missiles to defend their *Outpost* (\$19.95) from an onslaught of enemy laser powered bombs, sweepers, and shield bombs. The joystick- or trackball-controlled game for the 64 offers four levels of difficulty.

Free Spirit Software, Inc., 312-352-7323 (see address list, page 12).

*Scenery Disk #11* (\$24.95), for use with *Flight Simulator II* or *Jet* on the



Scenery Disk #11 for SubLOGIC's flight simulators depicts the Detroit, Pittsburgh, and Niagara Falls areas.

READER SERVICE NO. 286

## JASON—RANHEIM

PRODUCTS OF QUALITY FOR YOUR COMMODORE COMPUTER

*promenade*™ C1 The Eprom programmer respected around the world for value. Programs all popular types.  
With disk software ..... 99.50

### CAPTURE II

The best utility cartridge of its kind is now even better. Make backup disks or auto-start cartridges of your memory resident software.  
Still only ..... 39.95

### CAPTURE UPGRADE KIT

Upgrade your capture to Capture II capability with new easily installed rom.  
Includes file combiner ..... 12.95

### CPR-3 CARTRIDGE KIT

For use with Capture II. 72 K Eprom cartridge with case. (Requires *promenade* for programming Eproms.) ..... 29.95

### STARTER SET

Includes *Promenade C1*, *Capture II* and *CPR-3* kit. .... 149.95

### DELUXE SET

As above with *Datarase* Eprom eraser and 2 *CPR-3* kits ..... 199.95

### CCSZ CLOCK/CALENDAR

Cartridge provides time and date plus 8K of battery backed ram. Independent of power failures or resets.  
Many useful features ..... 49.95

### CARTRIDGE BOARDS AND CASES

PCC-2 ..... 4.95  
Basic 64 mode cartridge board  
PSC-2 ..... 5.95  
As above, socketted.  
PCC-4 ..... 17.95  
4 socket, bank switched  
PRB-4 ..... 24.95  
Ram/Eprom, battery back-up.  
CPR-B ..... 12.95  
Same as in *CPR-3* kit. Board only.  
PCCH-2 ..... 2.25  
Plastic case for above.

### EPROM ERASERS

*Datarase* ..... 34.95  
2 at a time, hobbyist type  
PE-140 ..... 89.00  
7-9 Industrial quality

### SHIPPING AND HANDLING

USA: UPS Surface ..... 3.00  
UPS 2nd day air ..... 5.00  
Mexico, Canada air mail ..... 7.00  
Other foreign air mail ..... 13.00  
To order toll free: ..... 800-421-7731  
From California: ..... 800-421-7748  
Technical support: ..... 916-823-3284  
From outside USA: ..... 916-873-3285  
MC, VISA, AMEX Welcome



JASON-RANHEIM  
COMPANY

1805 Industrial Dr.  
Auburn, California 95603

Reader Service No. 266

AHOY! 11

## TRY BEFORE YOU BUY!

Best selling games, utilities, educational, and classics, plus new releases!

- 100's of titles
- Low prices
- Same day shipping
- FREE brochure

YES, WE ACCEPT:



### RENT-A-DISC

Frederick Building #345  
Huntington, WV 25701  
(304) 529-3232

Reader Service No. 265

## CHIP CHECKER

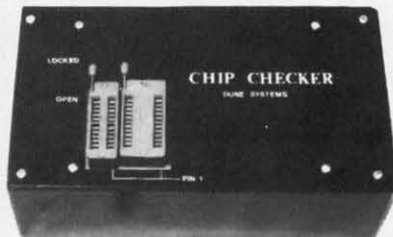

### TESTS and/or IDENTIFIES

- Over 600 Digital ICs
- 74/54 TTL + CMOS
- 14/4 CMOS
- 9000 TTL
- 8000 National and Signetics
- 14-24 Pin Chips (.3" + .6" widths)

Pressing a single key identifies/tests chips with ANY type of output in seconds. The CHIP CHECKER now also tests popular RAM chips. The CHIP CHECKER is available for the C64 or C128 for \$159. The PC compatible version is \$259.

### DUNE SYSTEMS

2603 Willa Drive  
St. Joseph, MI 49085  
(616) 983-2352

Reader Service No. 268

C-64, covers the Great Lakes area, with detailed views of Detroit, Pittsburgh, and Niagara Falls. A new default ground pattern simulates fields and other areas of varying color on the earth below.

SubLOGIC Corporation, 217-359-8482 (see address list below).

Firebird has launched its Mid-Range line with *Druid*, *Revs Plus*, *Cholo*, *Heartland*, *Silicon Dreams*, and *Jewels of Darkness* for the 64 (\$24.95 each), plus the latter two for the Amiga as well (\$29.95 each).

Firebird, 201-444-5700 (see address list below).

From Electronic Arts:

The new EA-distributed Amiga version of *Quizam* (\$34.95) contains over 2000 questions in the categories of Popular Culture, TV, Music, Movies, History, Art, Geography, and Literature, plus a question-making program.

The C-64 adaptation of *Chuck Yeager's Advanced Flight Trainer* (\$34.95) allows flight simulation fans to test and fly formation with real and experimental aircraft. A fast frame rate lets the player experience the feeling of mach-speed flight. Included are three levels of onscreen instruction from General Yeager: the first for basic flying skills,

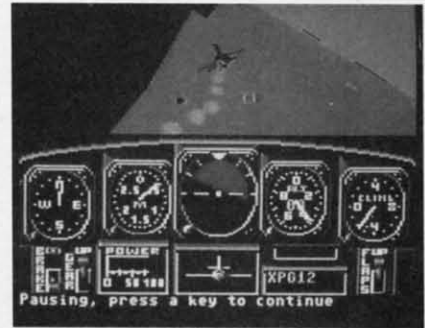

Advanced Flight Trainer: mach speeds.  
READER SERVICE NO. 287



AFT co-designer Chuck Yeager offers three levels of onscreen instruction.

the second for advanced maneuvers, and the third for acrobatic stunts.

*Halls of Montezuma* (\$39.95) traces the battle history of the United States

### Companies Mentioned in Scuttlebutt

#### ActionSoft

201 W. Springfield Ave.  
Champaign, IL 61820  
Phone: 217-398-8388

#### Activision, Inc.

2350 Bayshore Parkway  
Mountain View,  
CA 94043  
Phone: 415-960-0410

#### Aegis Development, Inc.

2210 Wilshire Blvd. #277  
Santa Monica, CA 90403  
Phone: 213-392-9972

#### Brown Boxes, Inc.

26 Concord Road  
Bedford, MA 01730  
Phone: 617-275-0090

#### Central Coast Software

268 Bowie Drive  
Los Osos, CA 93402  
Phone: 805-528-4906

#### Electronic Arts

1820 Gateway Drive  
San Mateo, CA 94404  
Phone: 415-571-7171

#### Firebird

71 North Franklin Tpke.  
Waldwick, NJ 07463  
Phone: 201-444-5700

#### Free Spirit Software

538 S. Edgewood  
LaGrange, IL 60525  
Phone: 312-352-7323

#### KFS Software, Inc.

P.O. Box 107  
1301 Seminole Blvd.,  
Suite 117  
Largo, FL 34649-0107

#### ReadySoft Inc.

P.O. Box 1222  
Lewiston, NY 14092  
Phone: 416-731-4175

#### Phoenix Electronics, Inc.

P.O. Box 156  
Clay Center, KS 67432  
Phone: 913-632-2159

#### Scott, Foresman and Co.

1900 East Lake Avenue  
Glenview, IL 60025  
Phone: 312-729-3000

#### Strategic Marketing Resources, Inc.

P.O. Box 2183  
Ellisville, MO 63011  
Phone: 314-256-7814

#### SubLOGIC Corporation

713 Edgebrook Drive  
Champaign, IL 61820  
Phone: 217-359-8482

#### Sunburst

Pleasantville, NY 10570  
Phone: 800-431-1934 or  
914-769-5030

#### TAB Books, Inc.

Blue Ridge Summit,  
PA 17214  
Phone: 717-794-2191

#### Taxaid Software Inc.

606 Second Avenue  
Two Harbors, MN 55616  
Phone: 218-834-5012

#### Ultrabyte, Inc.

P.O. Box 789  
La Canada, CA 91011  
Phone: 818-796-0576

#### Zebra Systems, Inc.

78-06 Jamaica Avenue  
Woodhaven, NY 11421  
Phone: 718-296-2385



# COMMODORE

## MONITORS

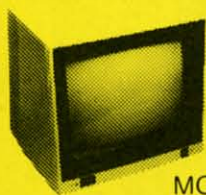

**\*\$79**

MONOCHROME

COMPOSITE

**\*\$169**

WITH PURCHASE OF GLARE GUARD



RETAIL \$400

**\*\$269**

COMMODORE RGB 1902



## PRINTERS



COMMODORE  
803 PRINTER

**\$139**



LETTER QUALITY

**\$129**

(INCLUDES  
INTERFACE)

**\$198**

COMMODORE 1200

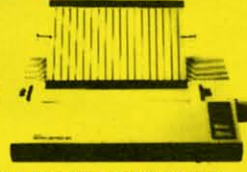

## DISK DRIVES



**\*\$138**

FSD-2 ..... \$159 \*WITH PURCHASE OF  
ENHANCER ..... \$129 EXTENDED WARRANTY

## MODEMS



1200/300  
BAUD

*"Proven Far SUPERIOR"  
to the 1670!"*

TRANSCOM  
2 YEAR WARRANTY

**\$138**

FREE TRIAL PERIOD

- 100% COMMODORE-HAYES COMPATIBLE
- AUTO DIAL/AUTO ANSWER
- BUILT IN SPEAKER
- VOLUME CONTROL
- TERMINAL SOFTWARE INCLUDED

## COMPUTERS



**\*\$228** **\*\$99**

\*(WITH PURCHASE  
OF EXTENDED  
WARRANTY)

COMMODORE PC 10s FROM .. \$488  
COMMODORE 64C ..... \$198  
AMIGA 500 ..... CALL  
PLUS 4 ..... \$98

## ACCESSORIES

64 POWER SUPPLY ..... \$29  
DISKETTES ..... 39¢ (in 100 lots)  
AMIGA RAM EXPANSION ..... \$98  
RAM EXPANSION 1764 ..... \$138  
RAM EXPANSION 1750 ..... \$188  
MOUSE ..... \$34.95  
VOICE SYNTHESIZER ..... \$79  
DATA SET ..... \$28

RS-232



**\$48**

LIGHT  
PEN



**\$89**

FAST LOAD  
CARTRIDGE



**\$29**

SURGE  
PROTECTOR



**\$19.95**

FLOPPY  
DISK FILER



**\$9.95**

PRO-TECH TRONICS

215 W. Main Street  
New Prague, MN 56071  
612-758-6268

QUICK

DELIVERY

SCHOOL P.O.'s  
ACCEPTED



# 1-800-345-5080



Marine Corps, from the Mexican War to Vietnam. As Corporate Commander you lead your forces into eight pre-programmed battle scenarios, or into ones of your own design.

For the 64 from the Datasoft subsidiary of Electronic Arts:

**Bismarck: The North Sea Chase** (\$29.95) simulates the 1941 battle between the German battleship and the British Hood. As commander of either vessel, you track your naval units with the help of a main screen map. At the same time factors like weather, time of day, and presence of mine fields and ice floes must be considered.

**Force 7** (\$19.95) rockets you into the future where you must rescue earthlings held hostage on the planet Karis. Each of your seven crew members has unique qualifications that can aid you in your assignment.

Electronic Arts, 415-571-7171 (see address list, page 12).

**ThunderChopper** (\$29.95) puts the player in control of a Hughes 530MG Defender, offering the latest in weaponry and tracking systems. 3D graphics supplied by SubLOGIC offer de-

tailed out-the-window views in day, dusk, and night flight modes.

ActionSoft, 217-398-8388 (see address list, page 12).

## NEW NIBBLER

Ultrabyte has announced Version 4.0 of their **Disk Nibbler**, which will copy most commercial software in under two minutes. One or two 1541 or 1571 drives can be used. Price is \$39.95 plus \$4.00 shipping.

Ultrabyte, 818-796-0576 (see address list, page 12).

## 64 EMULATOR

Why you'd want to is another issue entirely. But **The 64 Emulator** from ReadySoft will turn your Amiga into a Commodore 64, with all video modes including sprites and raster interrupts, plus sound and color, fully supported. The program also supports all Amiga disk drives and printers; with an optional interface cable, any C-64 disk drive or printer can be connected directly to your Amiga.

ReadySoft Inc., 416-731-4175 (see address list, page 12).

## WE WON'T PAY YOUR TAXES!

But **TAX MASTER** will help you compute them more QUICKLY and EASILY. Be the Master of your Income Taxes with **TAX MASTER**, now available for your 1987 Federal Income Taxes for the C64/C128 with single, twin, or dual disk drive and optional printer.

- **NEW** Tax laws are covered.
- **FORMS 1040, 4562, & Schedules A, B, C, D, E, and F.**
- **PERFORMS** all arithmetic CORRECTLY.
- **EASY CHANGE** of any entry with automatic RECALCULATION of the entire form.
- **TRANSFERS** numbers between forms.
- **CALCULATES** your taxes and **REFUND**. Tax tables are included.
- **SAVES** all your data to disk for future changes.
- **PRINTS** the data from each form.
- **CALCULATOR** function is built in.
- **DISCOUNT** coupon toward the purchase of next year's updated program is included.

**TAX MASTER** ..... (DISK ONLY) ..... **ONLY \$30.00**

## TIRED OF SWITCHING CABLES?

**VIDEO MASTER 128** provides continuous 80 column color (RGBI), 80 column monochrome, and audio out. Switch between 80 column monochrome and 40 column color for composite monitor. Use up to 4 monitors at once! Includes composite cable.

**VIDEO MASTER 128** ..... for Commodore 128 ..... **\$39.95**

## FED UP WITH SYNTAX ERRORS?

**HELP MASTER 64** provides Instant On-Line Help screens for all 69 BASIC commands when you need them. Takes no BASIC RAM. No interference with loading, saving, editing, or running BASIC programs. Includes 368 page BASIC reference text, more.

**HELP MASTER 64** ..... for Commodore 64 ..... **\$24.95**

## OTHER MASTER SOFTWARE ITEMS

- RESET MASTER** C64 reset switch with 2 serial ports **\$24.95**
- CHIP SAVER KIT** protects computer's chips from static **\$ 5.95**
- MODEM MASTER** user port extender **\$29.95**; with/reset **\$34.95**
- Y-NOT7** 6-foot serial Y cable, 1 male, 2 female connectors **\$15.00**
- Y-YES!** 6-foot serial Y cable, 3 male connectors **\$15.00**
- C128** 80 col monochrome cable for non-RGB monitor **\$ 9.00**
- Disk Notcher** — lets you use both sides of disk **\$ 8.00**
- 64-TRAN** Fortran compiler **\$50.00**

Send for Free Catalog  
**MASTER SOFTWARE**  
 6 Hillery Ct.  
 Randallstown, MD 21133  
 (301) 922-2962

All prices in US Dollars. Surface shipping in US & Canada is included. Foreign orders add \$5. Canadian orders use Canadian POSTAL money order. Maryland residents add 3% tax. Dealer inquiries welcome!



Reader Service No. 264



## PURE-STAT BASEBALL

**PURE-STAT BASEBALL** is a complete statistical baseball simulation for zero, one or two players, that also includes a built-in **STAT COMPILER** and a program to **TRADE PLAYERS**. **GAME PLAY, MANAGER'S DECISIONS, GRAPHICS** and a complete statistical library establish **PURE-STAT BASEBALL** as the **ULTIMATE SPORTS SIMULATION** program. **PURE-STAT BASEBALL's** underlying statistical framework simulates the realities of baseball like never before. Within this framework the program considers each **PLAYER'S BATTING STATISTICS AGAINST** both **LEFT** and **RIGHTHANDED PITCHERS**, along with the graphics and attributes of every **MAJOR LEAGUE STADIUM** from the optional **STADIUM DISK**. Every **PLAYER'S FIELDING, BASE-RUNNING** and **THROWING ABILITIES** are also considered. Optional **TEAM DISKS** are available.

Retail price: **\$39.95**

Available for: Commodore 64/128, IBM PC, and APPLE II

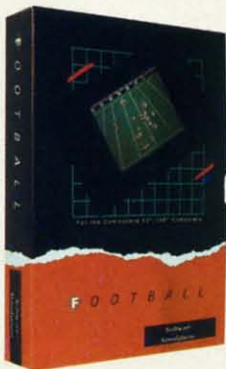

## FOOTBALL

**FOOTBALL** simulates all physical aspects of the game of football down to the finest detail, while you are controlling the movement of key players on the field. For one or two players **FOOTBALL** sets new standards in both **REALISM** and **PLAYABILITY** using an overhead 3D perspective of the football field giving full view of all 22 animated players. Every offensive receiver and running back has different individual physical attributes (**SPEED, POWER, AND CATCHING ABILITY**). Each player's performance characteristics help you determine how and when to use that player most effectively. Each quarterback has unique abilities for **SHORT, LONG** or **FLAT PASSES**, and linebackers have power ratings for tackling ability.

Retail price: **\$29.95**

Available for: Commodore 64/128, and IBM PC

## PURE-STAT COLLEGE BASKETBALL

**PURE-STAT COLLEGE BASKETBALL** is a complete statistical basketball simulation for zero, one or two players, that also includes a **STAT COMPILER**. The game uses coaching strategy and player statistics to determine the outcome of each play, while graphically depicting the sequence with 10 animated players on a basketball court. The game comes with 20 all time great college teams from past and present, and with an optional **CREATE TEAM DISK** the statistics for any college team from any division can be entered.

Retail price: **\$39.95**

Available for: Commodore 64/128, IBM PC, and APPLE II

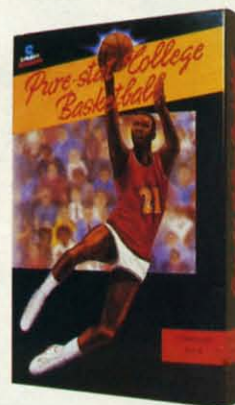

**Software Simulations**

959 MAIN ST. SUITE 204  
 STRATFORD, CT 06497  
 (203) 377-4339

Reader Service No. 270

AHOY! 15



## For the C-128

By Cleveland M. Blakemore

**J**ungle Jake is an arcade-style game for the C-128 similar to *Donkey Kong* and other multilevel challenges.

This is definitely a program worth having if you own a C-128. You'll be amazed that so much game could be packed into so little code. There are seven colorful screens of challenging play, accompanied by a variety of musical scores and hyper-nervous joystick action. You may play this one for a long time before you make it to screen 7.

The program uses the joystick in Port 2 to control Jake, a safari explorer with the power to make Olympic-quality high jumps over obstacles. His mission is to save Clarinda from the Zulus who have captured her and are boiling her for dinner in the upper left hand corner of the screen.

Move Jake left or right to get to the vines at the end of each platform, so he can climb up to the next canopy. To leap over the many predators Jake will encounter during his adventure, push the fire button.

Jake's jump has a certain amount of "float" to it, meaning he can change direction in mid-jump or even leap backwards. You'll need to get a feel for it before you can successfully get past the critters on each level.

To save Clarinda, leap to the edge of the pot she is in and touch her, avoiding the smoking coals beneath. The lovers will be temporarily reunited, but Clarinda will vanish from Jake's arms afterwards to appear on the next level.

As you make your way through the jungle, you'll find yourself plagued by snakes, parrots, Zulu warriors, and monkeys, all of them skittish and unnervingly unpredictable. If any of them catches Jake, he will lose one of the four lives displayed at the upper right hand corner.

The current score and high score are displayed on the bar at the bottom of the screen. For each platform you surmount, you'll receive a 100\*level point increase. Each completed level is worth 1000\*level points. The current level is also in the upper right hand corner.

I have only made it to the seventh level three times, and I've played the game several hundred times. Any score over 5000 is good. *Jungle Jake* is a very tough game indeed, even if you're a veteran joystick jockey.

The seven screens each have individual names:

- 1) BITE IN THE ASP
- 2) FOR THE BIRDS
- 3) ZULU COUNTRY
- 4) MONKEY BUSINESS
- 5) SNAKE YOUR BODY
- 6) PECKERS FROM ABOVE
- 7) HEADSHRINKER HEAVEN!

There is a special score of music for those rare players who make it to the seventh level, along with a congratulatory message. SEE PROGRAM LISTING ON PAGE 84

PHOTOS: MICHAEL R. DAVILA



# V4.0

**ULTRABYTE  
DISK  
NIBBLER**

**POWERFUL NEW GCR NIBBLER  
FOR COMMODORE 64 and 128 (in 64 mode)**

- Automatically copies most disks in 2 minutes or less including variable density and rapid locked protection
- 105 new parameters to make unprotected copies of recent disks. Send stamped envelope for list
- Copies up to 40 tracks using 1 or 2 1541 or 1571 drives. Copies both sides on 1571
- Copies itself (for this reason, no refunds given)

**SPECIAL — BUY A NIBBLER V4.0 AND GET  
YOUR CHOICE OF A FREE \$14.95 PROGRAM  
\$39.95 plus \$4.00 shipping**

1. Disk Surgeon V2.0 -- new disk utility ..... \$14.95
2. Ultramail -- mail list and labels ..... } both for  
Handy-Capper -- race handicapper ..... } \$14.95
3. McMurphy's Mansion -- text adventure ... } both for  
Soluware -- solutions to 10 adventures ... } \$14.95

( Above may be ordered separately for \$14.95 plus \$4.00 shipping. Foreign orders add \$2.00 )

Mastercard, Visa, Check or M.O., Calif. add 6.5% (\$2.60) sales tax. Foreign orders / COD add \$2.00. Payment must be in U.S. funds

UPDATES- Return original Ultrabyte disk with \$15.00 plus \$4.00 shipping. Foreign add \$2.00. No free disk with update

To order, write or call 24 hr. order line. For info. write.

**ULTRABYTE ( 818 ) 796 - 0576**

**P.O. Box 789 LaCanada, CA 91011 USA**

**DEALERS & DISTRIBUTORS WANTED**

Reader Service No. 253

**"FEEL LIKE  
CHALLENGING  
A 3-TIME  
WORLD  
CHAMPION?"**



**"TOP FUEL CHALLENGE IS THE CLOSEST YOU CAN  
GET TO THE HOT PAVEMENT OF THE DRAGSTRIP!"**

*— Shirley Muldowney*

Shirley Muldowney helped design this authentic 3-D professional drag-racing simulation. Based on her three world championship years, TOP FUEL CHALLENGE captures all the thrills and excitement of NHRA competition.

How can a 6-second event hold your interest? Well, TOP FUEL CHALLENGE is an entire season, from the Winternationals to the World Finals, with all the authentic action, pre-race strategy, equipment selections and budget expense considerations included. Qualify, race through a grid of challengers, and finally face Shirley in the showdown!

Choose your lane, burn out your tires, stage your dragster, watch the Christmas tree lights. Pop the clutch, hit the throttle and you're off! Watch the tach, lean out your



fuel, shift just right. By the time you pop your chute, you'll know if you've beaten the champ in one of her winning years.

Don't red-light, smoke your tires, or blow your engine. You'll need the points and prize money...it's a long season.

Put yourself in the driver's seat today! Call TOLL-FREE for the COSMI dealer nearest you, or to order direct.

TOP FUEL CHALLENGE for C-64/128 is priced at \$24.95.

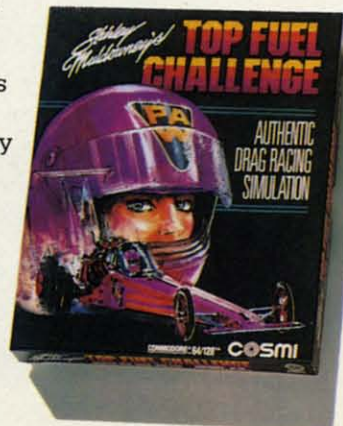

**cosmi**

(800) 843-0537

In California (800) 654-8829

415 N. Figueroa Street

Wilmington, CA 90744

Reader Service No. 282

[www.commodore.com](http://www.commodore.com)

Hey, check  
it out!



# QUAIL ELECTRONICS

?FREE? PUBLIC DOMAIN  
Your choice by the block.

Many HACKER goodies.  
Tons of parameters.

Software, hardware & accs.  
C64/128 - ST - MS-DOS

SEND FOR **FREE CATALOG**

Visa

M/C

Cash

## QUAIL ELECTRONICS

P.O. Box L-6 • Woodland, WA 98674

1 (206) 254-0324

If we don't have it, we'll help you find it!



## THE GLADIATOR

FOR THE BEGINNER AND EXPERT TOO!  
A UNIQUE GAME WITH 16 LEVELS OF DIFFICULTY PLUS 8 MORE EARNED LEVELS!

The gladiator must prove his cunning and endurance in the coliseum of death.

ALL THE SOUND AND ACTION OF THE ORIGINAL SPECTATOR SPORT

For Commodore 64/128™ and Atari 48K 800, XLs and XEs disk only

**\$14 SPECIAL OFFER \$14\***

Purchase the Gladiator and you receive the famous Ghost Hunter II game Free!

SEND \$14 PLUS \$2 SHIPPING AND HANDLING  
(CA. RESIDENTS ADD 6% SALES TAX)  
PLEASE ALLOW 2-3 WEEKS FOR DELIVERY

**RICHWOOD SOFTWARE**

3011 ALHAMBRA DRIVE, SUITE C  
CAMERON PARK, CA., 95682

916-677-6779

\*DEALERS PLEASE CALL FOR QUANTITY INFORMATION

Reader Service No. 257

18 **AHOY!**



## For the C-64 By Cleveland M. Blakemore

**Y**our shuttlecraft has crash-landed on the surface of a harsh and forbidding world—a planet of eternal frost and snow. Although you've managed to drag what remains of your equipment into a small underground cavern, your troubles are not over yet. You will have to fight for your very existence against the *Ice Titans*, the deadly inhabitants of this misty, shrouded landscape.

*Ice Titans* is a one-player game using a joystick plugged into Port 2. The joystick controls two separate laser cannons: one that moves horizontally, the other vertically. The joystick moves either ship along its axis in both the X and Y planes. The fire button launches photon blasts from the guns.

The objective is to destroy the horde of fierce aliens rushing in through the mouth of the ice cave before they destroy you.

The guns are independent. Each one can take a maximum of three blasts from an alien before it will explode. The remaining energy level of the laser cannon is indicated by its color. When

it's light gray, it is undamaged. If it's medium gray, it has sustained one hit. If it is dark gray, it is within one more hit of being destroyed. You can continue to fight on with either remaining gun as long as you can hold out.

With each new level, the aliens get faster and more numerous, until the horrid ninth level, when they really go haywire. The flashing block between the current score and high score at the bottom of the screen indicates which level you are on.

The aliens are each worth 10 points multiplied by the current level. Each time you complete a level, a fanfare sounds and you are awarded a bonus of 1000 points.

Any score over 6000 is terrific. It's hard to last very long after the seventh level, when the aliens really start to boogie.

*Ice Titans* is 100% machine language, so you'll need *Flankspeed* (see page 83) to enter it. When you have saved a copy to disk, load the program with LOAD"ICE TITANS",8,1 and type SYS 49152 when the cursor appears.  **SEE PROGRAM LISTING ON PAGE 89**



PHOTOS: MICHAEL R. DAVILA

# SAVING THE HUMAN RACE CAN BE VERY ENTERTAINING.

## DEFCON 5: The Authentic SDI Simulation.



**ENEMY LAUNCH DETECTED ALPHA ZULU 13:43.  
EXPECT VIOLATION U.S. AIRSPACE 14:09.**

YOU are at the controls of America's "Star Wars" space-based missile defense system. DEFCON 5 is an authentic simulation of our Strategic Defense Initiative.

Your computer is in command of a network of orbiting visual reconnaissance satellites and an awesome arsenal of sophisticated space-based weapons. The fate of the world is in your hands. You make the split-second decisions necessary to detect, intercept and destroy incoming enemy warheads.

Using realistic military commands you control 9 separate weapon systems, including orbiting lasers, neutral particle beam emitters, electromagnetic launchers, and nuclear-pulsed x-rays. We're at Defcon 5 and counting. Impact is imminent. Will you destroy the missiles in time to save the human race?



Reader Service No. 271

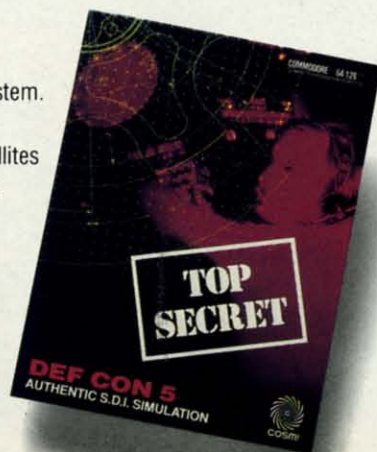

Call TOLL-FREE for the COSMI dealer nearest you, or to order direct.

DEFCON 5 is by Paul Norman, creator of the Super Huey flight simulator series.

DEFCON 5 for C-64/128 is priced at \$19.95. For IBM PC, \$24.95.

**COSMI**

(800) 843-0537

In California (800) 654-8829

415 N. Figueroa Street  
Wilmington, CA 90744

# TEXTSAVE

## Window Recovery for the C-128

By Richard Curcio

The C-128 40-column display has a number of enhancements over its C-64 counterpart, the most significant being the BASIC 7.0 WINDOW statement. A major shortcoming of this feature is that once a window has been opened, whatever was under it is lost. The utility presented here can store and recall up to five 40-column text screens, including character colors and editor values, enabling a BASIC program to open and close multiple windows, each time restoring the preceding display. The routine has other uses as well.

### THE PROGRAM

Type in *TextSave Loader* on page 88. It is a BASIC loader that POKES a machine language program into memory beginning at location 2816, the cassette buffer. The ML is relocatable, and can be POKEd elsewhere by changing the variable SA in line 110. Be sure to SAVE the loader before RUNNING it for the first time, as it erases itself with NEW when done. The loader prints the range of memory the ML occupies, adding one to the end address so that BSAVE may be used to save the ML. Once the ML has been saved, BLOAD can be used to load the ML to any other location. Available locations include the RS-232 buffers at 3072-3583, the sprite definition area at 3584-4095, and the "applications" area at 4864-7167. The ML requires 253 bytes.

*TextSave* provides five storage areas for 40-column text information. The syntax for using it is SYS TS, screen #, direction. "TS" is the location of the routine and screens are numbered 0-4. The last value in the SYS statement, "direction," determines whether data flows from the screen or to it. If direction equals zero, the current 40-column text screen is stored. Any direction value 1-255 recalls a text screen. The C-128 must be in the "system" configuration, BANK 15, before calling *TextSave*.

To temporarily open a window, simulating a "pop-up

menu," or to call attention to an error condition, use SYS TS, 2, 0 before executing the WINDOW statement. This example stores the screen in area 2. To "close" the window, restoring the previous screen contents, colors, and dimensions, SYS TS, 2, 1.

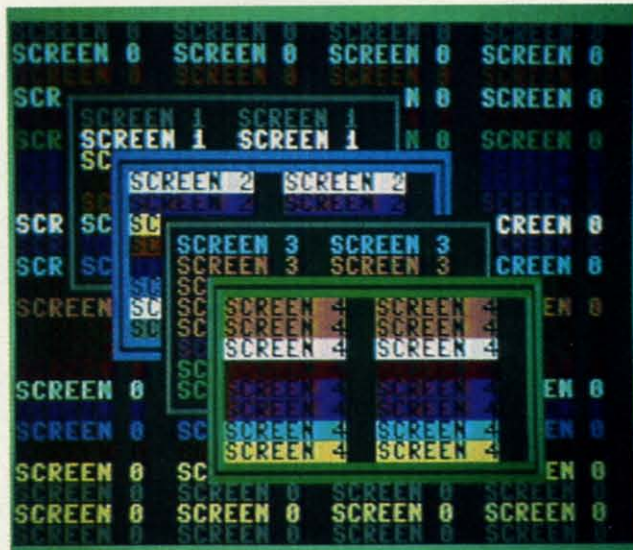

*TextSave* enables a BASIC 7.0 program to open and close multiple windows, each time restoring the preceding display.

The video information is stored in an unusual place: 80-column RAM. The 8563 80-column Video Display Controller (VDC) has its own 16K of memory. If you have a dual mode monitor such as the 1902, you can watch *TextSave* move screens 0 and 1 into the 80-column display. They will be only partially readable. As screens 1 and 2 overwrite 80-column attributes, the display becomes more unreadable. The 1024 nybbles of 40-column colors are compacted into 512 bytes, so each screen occupies 1.5K plus 40 bytes for the screen editor values. The routine checks for 40-column mode before taking any action; however, the screen editor will become confused if a screen is recalled before anything has been saved to it.

If usage of *TextSave* is restricted to screens 3 and 4, the 80-column display will still be usable for dual mode applications. The routine will not save the sixteen unused bytes immediately after the text screen, or the eight bytes of sprite data pointers. To store and recall this information as well, POKE TS + 193,0: POKE TS + 197, 8 before calling *TextSave*.

*TextSave Demo* is a BASIC program that demonstrates *TextSave*. It relies on *TextSave* being at location 2816. Run the loader program or BLOAD the ML before running the demo. The program prints five screens with windows and assorted colors, saving each screen before printing the next.

### 80-COLUMN MEMORY USAGE: NORMAL V. TEXTSAVE

Address	Normal Usage	Address	TextSave Usage
0-2047	80-col. text	0-511	screen 0 colors
		512-1535	text
		1536-2047	screen 1 colors
2048-4095	attributes	2048-3071	text
		3072-3583	screen 2 colors
4096-8191	unused	3584-4607	text
		4608-5119	screen 3 colors
		5120-6143	text
		6144-6655	screen 4 colors
		6656-7679	text
		7680-7919	5 sets of editor values (48 bytes each)
8192-16383	character set	7920-16383	unused



# MRI the best Hardware, Software, and Funware

for your Home or Business



## CABLES

- 6 ft. Monitor Cable, 5 pindn/2RCA ..... \$8.95
- 6 ft. Monitor Cable, 5 pindn/3RCA ..... \$8.95
- 6 ft. Monitor Cable, 5 pindn/4RCA ..... \$9.95
- 6 ft. Monitor Extension:
  - 5 pindn Male/5 pindn Female ..... \$8.95
  - 6 ft. 6 pindn Male/Male ..... \$6.95
  - 6 ft. Centronics Male/Male or Male/Female ..... \$14.95
  - 6 ft. RS 232, 25 pin, Male/Male or Male/Female ..... \$14.95
  - 12 ft. Joystick Extension ..... \$8.95
  - 6 ft. Rt. Angle 1541 Powercord ..... \$9.95
- 128 CABLE Why buy another monitor for your 128? This cable will allow you to use your 1701/1702 monitor with your 128 in 80 column. Save Big Money! **ONLY \$9.95**



## DISK INVADER (Latest Version)

The Hottest Copier on the Market

If you have Fast Hack'em or SuperKit, we have found **ONE better!** Need we say more? Your cost **\$34.00**. Works with 1541 and 1571 Drive.

## SOFTWARE

- Hackers Utility Kit ..... \$19.85
- C-128 Cannon ..... \$34.95
- Copy II (64/128) Latest version ..... \$39.95
- 1571 Clone Machine ..... \$49.95
- 1541/1571 Drive alignment ..... \$33.00
- Datailer 128 ..... \$19.95
- Kracker Jax Vol. 1-6 ..... \$19.95 ea
- Bull's Eye ..... \$19.95

## CASIO

### QD-100 Quick Dialer

Automatically dials stored numbers at the touch of a key • automatic redial of last number dialed • 1 touch elimination of area codes • Abbreviated dial function • Stores up to 20 data items • Big 2-tier display shows 18 characters for clear reference to names and numerals • Comes with Pouch



Retail \$49.99  
Your Cost \$29.95

### The Ultimate Handy Copier Model Z-HC1 Handy Copier

This little handheld copier is the newest to hit the market. Take it to user group meetings and copy the documentation you need instantly. Great for taking notes from any source: manuals, books, letters, etc. Other hand-held copiers are bulky and awkward; this one uses a pen type scanner to read in the information. This copier even copies graphics and enlarges.



- Easy to use • Pen type scanner • Zoom function magnifies 2X • Has repeat button for multiple copies • Clear button prevents mistakes • Has word mode and graphic mode • NiCad battery provides quick recharging (included)

Retail \$249.99  
Your Cost \$189.00

### PANASONIC RN-108 Microcassette Recorder

2 Speed Tape Selector • AC/Battery Operation with Optional AC Adaptor (RD-9443HA) • One Touch Recording • Cue and Review • Built-In Condenser Mic • Jacks: DC-In, Monitor • 2"AA" Batteries (Not Included) • Silver

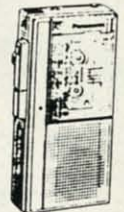

Retail \$79.99  
Your Cost \$49.95

### Vertical CPU Stand

Stand allows the user to vertically position their CPU alongside their workstation • Unit adjusts from 31 1/4" x 71 1/4" • Constructed of sturdy brushed anodized aluminum with a textured putty finish • Heavy felt pad lining to protect the CPU • Wt. 6 lbs., 8 3/4" D x 7 1/2" W x 6" H • Color Putty

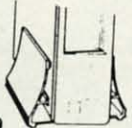

Retail \$79.99  
Your Cost \$49.95

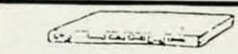

EMI Filtering 15 AMP Breaker • Surge Protection • Lighted Rocjer Switches • Master ON/OFF Switch • Heavy Metal Case

Includes a switch for computer, monitor, printer, Aux 1, Aux 2. Please add \$5.00 S & H for this item.

Retail \$99.95  
Your Cost \$49.95

### 6 Outlet Strip

Industrial grade surge and noise protection for three-wire (hot, neutral and ground lines) micro-computer and word processing applications.

These units have a 1.5 AMP breaker illuminated switch and heavy duty cord.

Retail \$42.95  
Your Cost \$19.95

### DX-650

Your Cost \$219.95

### Programmable CD Player

Digital Sound at affordable prices • 3 Beam Laser Pick-up System • Random Access program memory (20 selections) • Auto Program Search system (APSS) • Cue/Review (Scan the disc fast) • Front Loading • Auto Repeat function



### DRX-750

### Programmable CD Player

Full Function Remote Compact Disc Player • All of the Above plus Full Remote Control and LCD digital time counter with real time display



Your Cost \$299.95

## CASIO

### CM-100

### Computer Math Calculator

Dedicated Base-N-Calculator • Base conversions • Base calculations • Logical operations • Bit size designations • Display shift function • Flag display • Amorphous silicon solar battery • Comes with pouch • 1 1/4" H x 3 1/4" W x 5 1/4" D

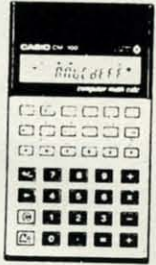

Retail \$39.99  
Your Cost \$24.95

### Notice:

We check for stolen credit cards. We do not charge your credit card until your order is shipped. All merchandise is under warranty. Guarantees will vary from manufacturer. All orders are handled as top priority and shipped on day order received.

## hp HEWLETT PACKARD



- HP-11C (Scientific) ..... \$56.00
- HP-12C (Financial) ..... \$99.00
- HP-15C (Scientific/Computer) ..... \$99.00
- HP-16C (Computer Science) ..... \$120.00



### Whistler SPECTRUM 2

Spectrum 2 delivers the kind of sensitivity that conclusively detects all police radar. On the straightaways, over hills and even around curves.

Features: Digital Display • Filter Mode • Variable Filter Setting • Variable Volume control • X and K Band Available Differentiation • Mute Mode • Dark Mode • Carry Case • 3-year warranty

Retail \$329.95  
Your Cost \$260.00

### Sharp AM/FM Stereo Personal Radio Cassette Player

Auto-stop, Stereo LED, Detachable Belt Clip, AC/DC. Color: Black or Red. Headphones included.

Retail \$69.95  
Your Cost \$35.00



### SHARP Z-70

Retail \$1,699.00

Your Cost \$1,299.00

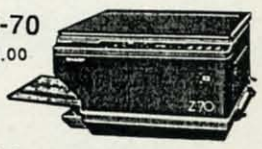

Office Copier with Reduction and Enlargement • Provides 2 reductions (1.064:1.075) and 1 enlargement (1.124:1.141) from originals up to legal size • Built-in, adjustable, legal-size cassette feed tray (manual by pass ability) • Quick warm-up in 20 seconds, 8 copies per minute • Auto Exposure control for sharp contrasts • Fully user-maintainable with self-diagnostics indicators • Wgt. 53 lbs. • NOTE: Necessary T/D Cartridge not included with copier



### GF 330 AM/FM Stereo Portable Radio Cassette Recorder

2 Way 4 Speaker • 3 Band Equalizer • Auto Stop • Soft Eject • AC/DC • Color Black

Retail \$149.00  
Your Cost \$89.00

Mirage  
Research  
International

A  
STEP  
BEYOND

To order  
Send Check or M.O. to:  
MRI  
P.O. Box 20425  
Portland, OR 97220

ORDER HOTLINE (24 hour)  
503-257-7613  
Visa & Mastercard Accepted  
Add \$3.00 S & H

# ECHELON™

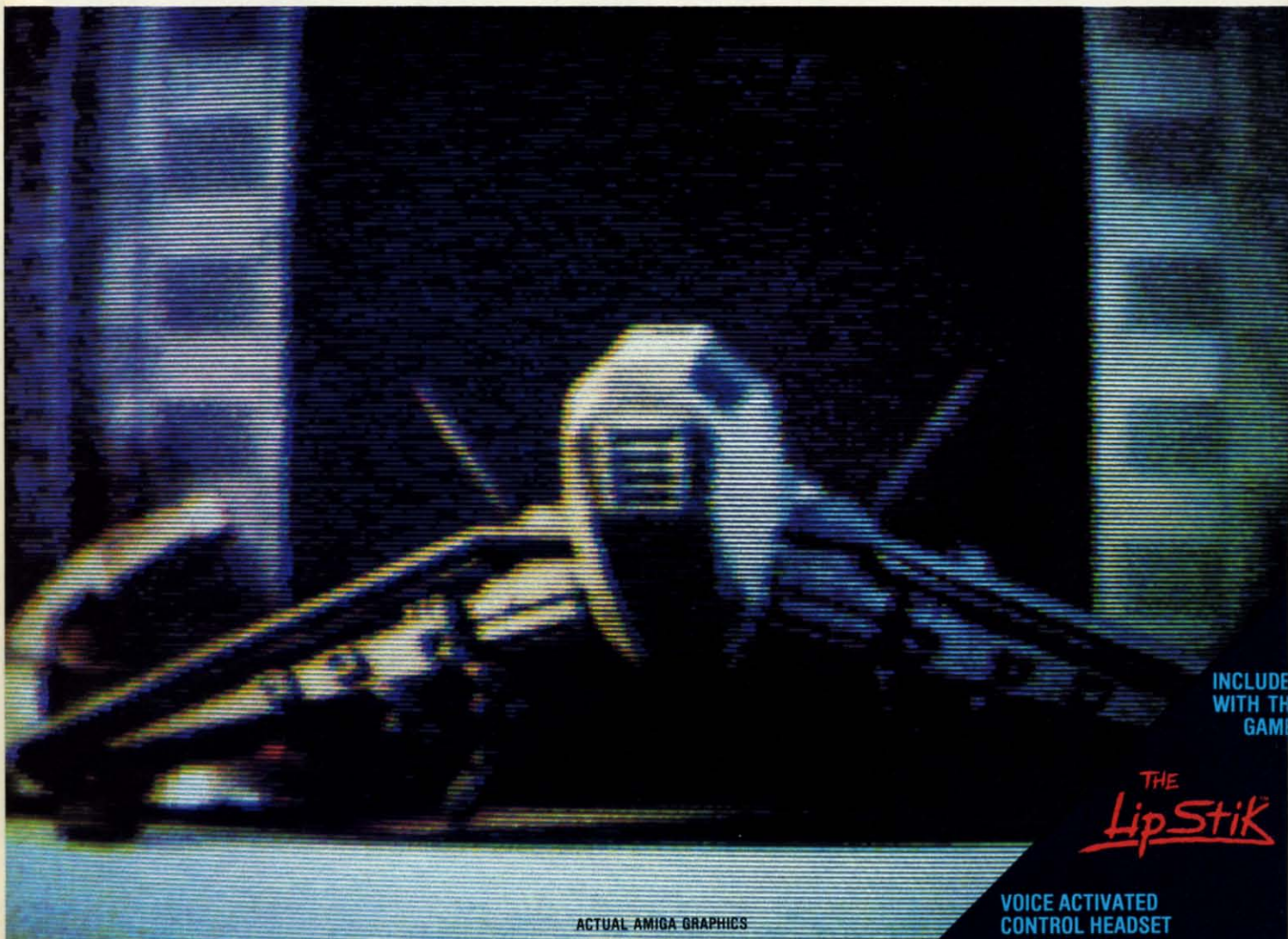

INCLUDE  
WITH THE  
GAME

THE  
*LipStik*

VOICE ACTIVATED  
CONTROL HEADSET

ACTUAL AMIGA GRAPHICS

## 3-D SPACE FLIGHT SIMULATOR

**ECHELON** . . . A top secret military facility where a few highly skilled pilots will be trained to operate the 21st Century's most awesome combat and exploration vehicle, the Lockheed C-104 Tomahawk. The C-104 spacecraft has the latest in advanced instrumentation, weaponry, and control systems.

### ACTUAL C-64 SCREENS



### Available Now For C-64/128.

Enhanced versions coming soon for APPLE, IBM, AMIGA, ATARI ST, and COMMODORE 128.



### ITS IMPRESSIVE ATTRIBUTES INCLUDE

- 4 Different "State-of-the-Art" Weapons Systems
- Bi-Directional Transporter Unit
- Unmanned RPV (Remote Piloted Vehicle) Control
- Anti-Gravity Braking and Hovering
- Forward and Reverse Thrusters
- Twin 3-D Screens
- Real-Time Infrared Vector Graphics
- Non Real-Time Computer Enhanced Graphics
- Computer Assisted Control Systems
- Computer Information Data Link
- On Board Sub-Atomic Analyzer/Decoder
- Voice Activated Control Button

**ECHELON** is a true 3-D space flight simulator that puts you at the controls of the C-104 Tomahawk and in the heart of the action. You'll experience the excitement and thrill of real spaceflight through superb three dimensional graphics. But, before you go exploring on your own, it would be wise to go through the carefully designed training simulators. These rigorous courses will develop your skills in maneuvering the spacecraft, accurate selection and use of weapons, control of RPV's, object retrieval and refuel and docking procedures. Developing these skills are essential to your survival when encountering hostile enemy spacecraft or exploring unknown terrain. **ECHELON** is available now and offers you the Simulation Adventure of a Lifetime for only \$44.95.

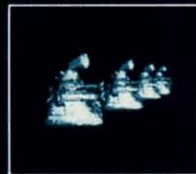

If you can't find our products at your local dealer, you can order direct. For mail orders, enclose check or money order, plus \$1.00 shipping and handling, and specify machine version desired. Order by phone on VISA, MasterCard or C.O.D. by calling TOLL FREE (800) 824-2549.

ACCESS SOFTWARE, INC. 2561 So. 1560 W. Woods Cross, UT 84087

**ACCESS**™  
Software Incorporated

Reader Service No. 245

When the final window is printed, each keypress steps backward through the previous screens. The REMs provide further explanation of the program's operation.

### A SMALL BONUS

*TextSave* can be used to store other information in the VDC RAM. Since the computer must be in BANK 15 to use this utility, RAM 0 up to address 16383 can be stored. Above 16383 the microprocessor "sees" ROM and I/O. There's little point in saving ROM, although, with caution, I/O register values can be stored and retrieved.

To use this feature, POKE the low byte and high byte of the starting address of RAM 0 memory to store/recall into locations 195 and 196. POKE the end address +1 into locations 174 and 175. Once the start and end are set up, SYS TS + 236, low, high, direction. "Low" and "high" refer to the starting address in VDC RAM to be accessed.

For example, to store a set of sprites at 12288 in 80-column memory:

```
100 POKE 195, 0: POKE 196, 3584/256: REM
START OF SPRITE DEFINITIONS
110 POKE 174, 0: POKE 175, 4096/256: REM
END OF SPRITES +1
120 BANK 15: SYS TS +236, 0, 12288/256,
0: REM STORE
```

This feature doesn't care which text mode (40/80) is active. It could conceivably be used to store 80-column screens.

If the number of bytes to be moved results in a VDC memory "end" address greater than 16383, the VDC will "roll

over" or "wrap" the address to the beginning of VDC RAM.

Since the five 40-column screens stored in VDC RAM take up slightly less than 8K, that leaves slightly more than 8K, beginning at 7920, available for other data, enough for a hi-res bit map. If you're willing to sacrifice one 40-column storage area, a hi-res color map can be stored as well. (If the color matrix and bit-map are stored as one 9K chunk, any 40-column screen editor values *TextSave* has stored will be overwritten. Refer to the table which follows.)

If you're not storing any 40-column screens, the full 16K can be used, and if you're using the 80-column display, the normally unused 4K in VDC RAM at 4096-8191 is available. One warning is in order: Unless the NMI vector is diverted, RUN STOP/RESTORE clears both the 40- and 80-column displays, regardless of which is active. This wipes out anything in VDC RAM below address 4096, including *TextSave* screens 0-2. *TextSave* can be modified to store screens beginning at 8448 in VDC memory. This is accomplished by POKE TS + 97, 33: POKE TS +29, 63. Saved screens will be protected from RUN STOP/RESTORE, but 80 columns will be unusable as screens will be stored in the area normally holding the character bit patterns. To regain the 80-column character set, SYS 49191.

By performing these POKES "on the fly," *TextSave* could store ten 40-column screens. To restore *TextSave* to its original form, POKE TS +97, 0: POKE TS +29, 30.

The table on page 20 compares *TextSave's* usage of 80-column memory with normal usage. While not as spacious as the 1700 or 1750 Memory Expanders, the 16K of VDC memory provides a modest alternative, at no extra cost. □

SEE PROGRAM LISTING ON PAGE 88

U.S.S. PHOTO

**OUT OF STATE CALL TOLL FREE FOR ORDERS ONLY**

**1-800-BUY-AT-US**

FOR CUSTOMER SERVICE & INFO CALL (718) 646-3633 **1-800-289-2887**

N.Y. & ALASKA RESIDENTS CALL TOLL FREE TO ORDER 1-800-289-2887

FOR CANADA CUSTOMER SERVICE AND INFO CALL (718)646-3633

**ASK ABOUT OUR SAME DAY SERVICE & OVERNIGHT SHIPPING**

MasterCard, VISA, Discover

**Commodore C-128**

- 128K Ram
- AC Adapter
- All Cables

**\$209<sup>95</sup>**

**Commodore C-64**

- 64K Ram • Geos
- Quantum Link
- All Cables

**\$144<sup>00</sup>**

**Commodore PC10-2**

- 640K Ram
- 2 360K Floppy Drives
- MS DOS
- 3.2 Parallel & Serial Port

**\$649<sup>95</sup>**

PC 10-1...\$509.95

**Commodore AMIGA1000**

- 512K Ram
- 1080 Monitor
- Amiga Software Package

**699<sup>95</sup>**

AMIGA 500 NOW IN STOCK

**Commodore C-64 Complete 25 Pc. Pkg.**

- Commodore 64C
- Commodore 1541 Disk Drive
- 12" Monitor
- Printer • Geos
- Quantum Link

**\$379<sup>95</sup>**

**Commodore C-64 25 Pc. Color Pkg.**

- Commodore 64C
- Commodore 1541C Disk Drive
- Color Monitor
- Printer for Commodore

**\$499<sup>95</sup>**

**Commodore C-128 D**

**\$449<sup>95</sup>**

**Commodore C-128 25 Pc. Enhanced Pkg.**

- C128K Computer
- C1571 Disk Drive
- C1902 Color Monitor
- 80 Column Printer

**\$729<sup>95</sup>**

**IBM PC/XT COMPATIBLE SYSTEM**

- 640K Ram
- 2 360K Drives
- MS DOS
- 4.7/8 MH Turbo Mono Card
- 12" Monitor
- BEAGATE 20 MB HARD DRIVE...\$299

**\$799**

LAPTOPS NOW IN STOCK! 25 Pc. Pkg.

**PRINTERS**

**COMMODORE**

MPS 803 **\$109**

MPS 1000 **\$189.95**

MPS1200 **\$229.95**

**EPSON & STAR**

NB2410 **\$459.95**

SG10C **\$169.95**

NX10C **\$189.95**

FX86E **\$329.95**

FX286E **\$449.95**

HP Laser Jet. **\$1599**

**DISK DRIVES/MONITORS**

1581 Disk Drive **\$199<sup>95</sup>**

1541C Disk Drive **\$159<sup>95</sup>**

1571 Disk Drive **\$199<sup>95</sup>**

1902 RGB Color Monitor **\$199<sup>95</sup>**

1802 Color Monitor **\$169<sup>95</sup>**

2002 Color Monitor **\$239<sup>00</sup>**

**EPSON IBM PC/XT Compatible**

- 256K Ram
- 1 360K Drive
- 12" Monitor
- Serial Parallel Port

**\$589<sup>95</sup>**

• BLUE CHIP IBM PC/XT COMPATIBLE

- 512K • 6 Expansion Slots
- 12" Monitor

**\$498**

**COME VISIT OUR RETAIL OVER-THE-COUNTER SHOWROOMS!**

**BROOKLYN, NY: 3126 AVE. U**

**QUEENS, NY: 136-17 38TH AVE.**

Company Policy: All merchandise is brand new. Visa, Mastercard, AM-Ex, Diner's Club money orders, bank checks welcome. Allow 4 weeks clearance on personal checks. Please call for C.O.D. details. N.Y. residents add sales tax. Exchange or refund (less shipping) within 15 days only if returned in original carton, packing and unfiled warranty card. Please call for authorization code prior to return. Quantities are limited and subject to availability. \* = after mfrs. rebate. No credit card fee. This ad supersedes other ads. Not responsible for typographical errors. Call for shipping and handling charges. IBM is trademark of International Business Machines.

**SEND MONEY ORDERS TO:**

3126 AVENUE U  
BROOKLYN, NY 11229

MON-FRI: 9:30 AM - 8:00 PM  
SUNDAY: 10:00 AM - 8:00 PM

Reader Service No. 242

AHOY! 23

www.commodore.com

# We Won't Be **UNDERSOLD**

\* On items marked "No One Sells This ----- For Less". Copy of valid ad required.

15 Day Free Trial • 90 Day Immediate Replacement Policy • Prices Expire 1-30-88

## Complete Commodore C64c System Sale

Computer, Disk Drive, Monitor, Printer & Software

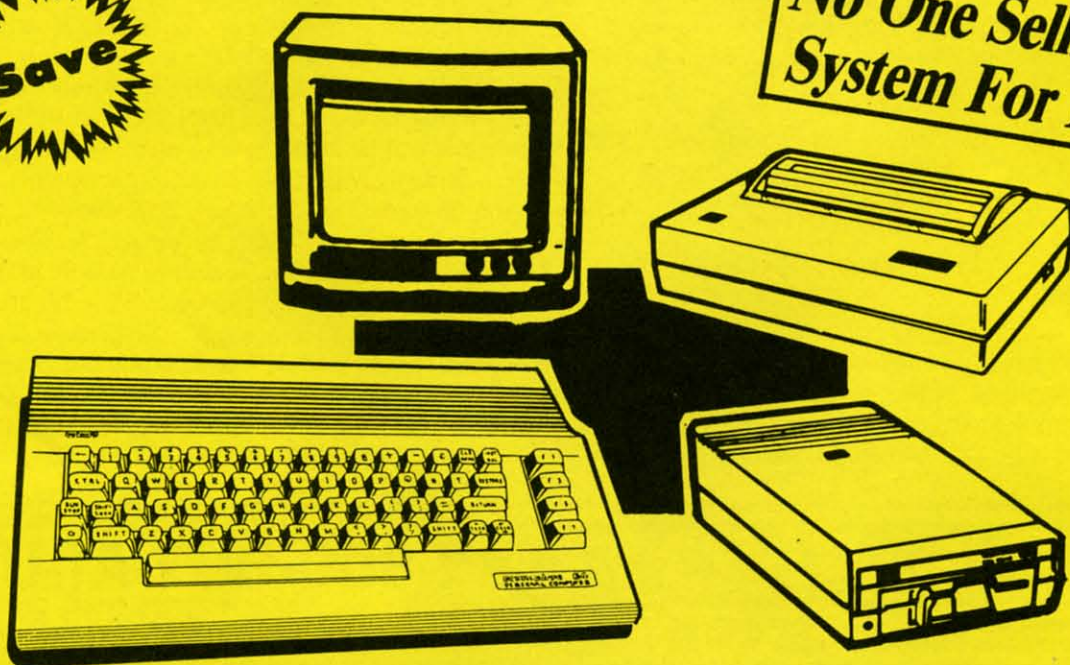

*No One Sells This  
System For Less!*

# Sale \$395<sup>95</sup>

(Add \$35.00 shipping. \*)

List \$1049

### The Complete System for \$395<sup>95</sup> Includes:

- Commodore 64c Computer
- Excelerator Plus Disk Drive
- 12" Monochrome Monitor With Connecting Cable
- Genuine IBM® Printer With Commodore Interface And 1 Roll Of Paper
- GEOS Program: Word Processor And Drawing Program



Call

## (312) 382-5050

*We Love Our Customers!*



Mail

### COMPUTER DIRECT

22292 N. Pepper Road  
Barrington, IL. 60010

Reader Service No. 236

[www.commodore.ca](http://www.commodore.ca)

# 1st In Price, Support, & Warranty

15 Day Free Trial • 90 Day Immediate Replacement Policy • Prices Expire 1-30-88

• Famous IBM® Brand •

## Genuine IBM® Printer 8 1/2" Letter Size

Super Sale

**\$49<sup>95</sup>**

List \$199

(Add \$7.50 shipping. \*)



Limited Quantities.  
1st Come, 1st Serve Basis.

*No One Sells This  
Printer For Less!*

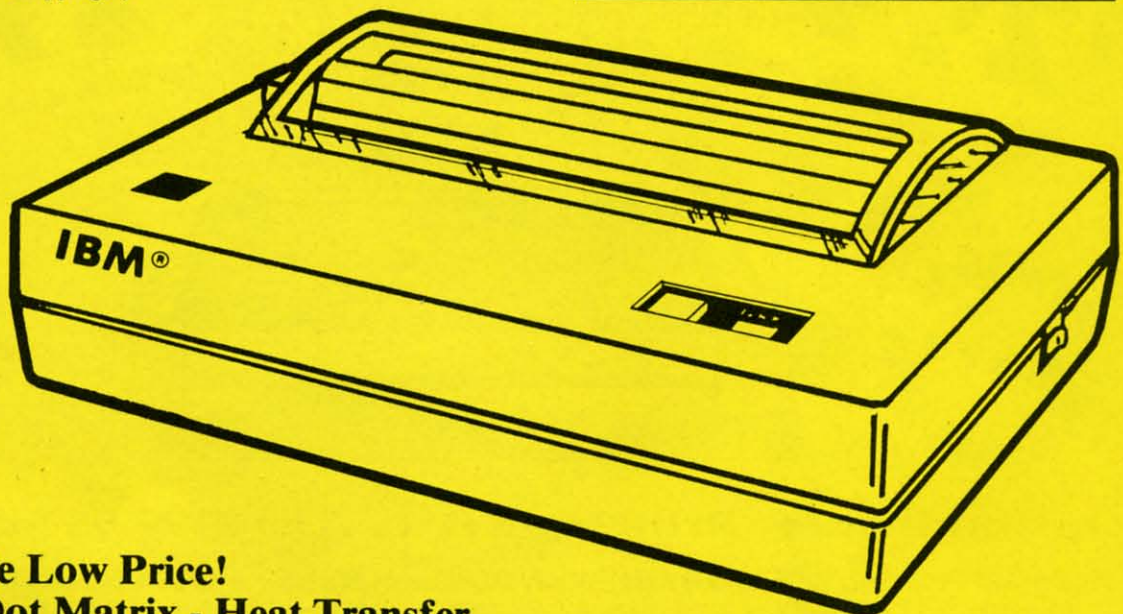

- 80 Column
- Enlarged
- Underline
- Graphics\*
- Unbelievable Low Price!
- Advanced Dot Matrix - Heat Transfer
- Upper & Lower Case (with True Lower Descenders)
- Adapters For IBM® • Apple® • Laser® • Commodore® • Atari®

(\* Graphics available with Commodore, Atari And Apple Interfaces.)

This printer comes ready to hook up to the serial port of the IBM®PC jr. Plus with low cost adapter cables you can connect the printer to the IBM®PC, XT, AT, & Compatibles, the Apple® II, Iie, & Iic, the Laser® 128, Commodore® 64, 128, SX-64, Vic 20, & Plus 4, in addition to Atari®, the Tandy 1000 and many more.

IBM, Apple, Commodore, Atari & Laser are registered trademarks of International Business Machines, Apple Computer, Commodore Business Machines, Atari Inc. & Video Technologies Respectively.

**COMPUTER DIRECT** (A Division of PROTECTO)

22292 N. Pepper Road, Barrington, IL. 60010

Call (312) 382-5050 To Order

We Love Our Customers!

\* Illinois residents add 6 1/2 % sales tax. All orders must be in U.S. Dollars. We ship to all points in the U.S., CANADA, PUERTO RICO & APO-FPO. Please call for charges outside continental U.S. or C.O.D. MAIL ORDERS enclose cashier check, money order or personal check. Allow 14 days delivery, 2 to 7 for phone orders and 1 day express mail. Prices and availability subject to change without notice. (Monitors only shipped in continental U.S.)

**VISA — MASTERCARD — C.O.D.**

# We Won't Be **UNDERSOLD**

\* On items marked "No One Sells This ----- For Less". Copy of valid ad required.

15 Day Free Trial • 90 Day Immediate Replacement Policy • Prices Expire 1-30-88

**Famous Seikosha National Brand**

# Ultra-Hi Speed Printer

☆ **300 CPS Draft - 50 CPS NLQ** ☆

**With Color Printing Capabilities**

**Sale Price**  
**\$299<sup>95</sup>**  
List \$599  
(Add \$10.00 shipping & handling.)

*No One Sells This  
Printer For Less!*

**Sale Price**  
**\$299<sup>95</sup>**  
List \$599  
(Add \$10.00 shipping & handling.)

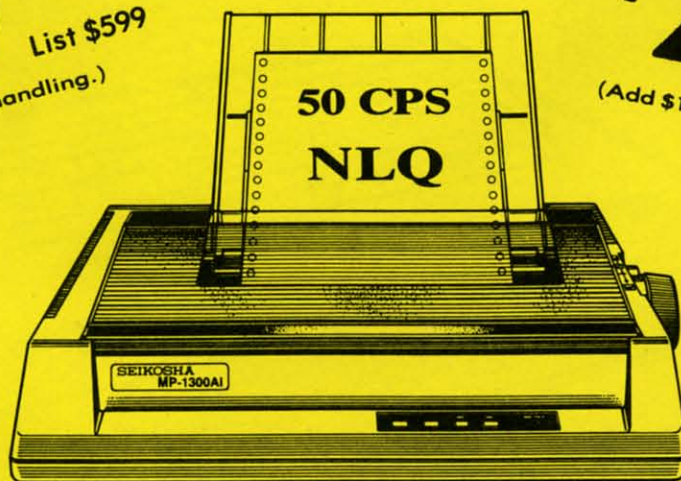

**Optional Color Printing Kit . . . List \$199.95 Sale \$99.95**

**Hi-Speed Printing (300 CPS Draft) With Minimum Noise • Superb Near Letter Quality •  
Variety of Characters and Graphics • IBM and Epson Modes • Built-in 10K Buffer •  
Built-in Parallel & Serial Interface Ports • Automatic Paper Loading and Ejection •  
Download Character Setting • Front Panel Margin Setting • Bottom Feed •  
Optional Easy Handling 7-Color Printing Kit**

**Print Method**

Impact Dot Matrix

**Print Speed**

Draft- 300 CPS NLQ- 50 CPS

**Character Sets**

185 Characters Kinds, 8 International  
Fonts, 256 Download Characters

**Dimensions**

18.5 (W) x 14.1 (D) x 5.5 (H) inch

**Weight**

Approx. 19 lbs

**Printing Direction**

Bi-directional

**Ribbon (Life exp.)**

Black: cassette (8 million characters)

**Line Spacing**

7/72", 1/8", 1/6", n/216", n/144", n/72"

**Paper Feed**

Adjustable tractor and friction feed

**Replacement Ribbons**

Black . . . . . Sale \$14.95

4-Color . . . . . Sale \$19.95



## (312) 382-5050

*We Love Our Customers!*



**Mail**

## COMPUTER DIRECT

22292 N. Pepper Road  
Barrington, IL. 60010

# 1st In Price, Support, & Warranty

15 Day Free Trial • 90 Day Immediate Replacement Policy • Prices Expire 1-30-88

• Save • **Printer Super Sale** • Save •

## 22 CPS Daisy Wheel Printer

### 13" Daisywheel Printer With True Letter Quality

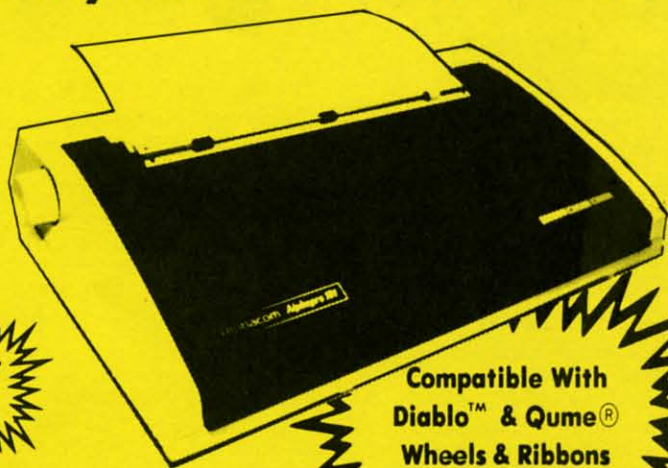

Compatible With  
Diablo™ & Qume®  
Wheels & Ribbons

(Add \$10.00 shipping & handling. \*)

*No One Sells This  
Printer For Less!*

**Low, Low Price!**

**\$99<sup>95</sup>**

List \$499

**Below Wholesale!**

#### Printing Method

- Daisy Wheel

#### Print Speed

- 18 CPS, Shannon Text
- 22 CPS, AAA Text

#### Accessories

- Daisy Print Wheel - Courier 10, 96-character
- Ribbon Cartridge - easy-change cartridge
- Both are compatible with Diablo™ and Qume®

#### Spacing and Density

- Character Spacing: 1/120" increments
- Line Spacing: 1/48" increments
- Print Pitch: 10, 12, or 15 CPI and Proportional Spacing
- Characters per Line:
  - 110 characters at 10 CPI
  - 132 characters at 12 CPI
  - 165 characters at 15 CPI

#### Operator Control

- Power On LED
- Impact Adjustment
- Reset Button
- Pause Button
- Paper Feed Button
- Self Test
- Out of Ribbon LED
- Horizontal Spacing Adjustment
- Pitch Adjustment (10, 12, or 15 CPI)

#### Print Buffer

- Standard: 93 characters

#### Paper Information

- Fan-fold, Single Sheet, or Carbon Copies
- Friction Feed
- Form Width: up to 13"
- Copy Capacity: Original plus 3 Copies

#### Size and Weight

H-5.5" W-18.9" D-11.6"  
Weight 21 lbs.

Registered Trademarks: Apple - Apple Computer Inc. IBM - International Business Machines Inc. Diablo - Xerox Inc. Qume - Qume Corporation.

### Daisy Wheels

Available In **Courier 72**, **Prestige Pica**, **Prestige Elite**, and **Script 12** for **\$9.95 each**.

**COMPUTER DIRECT** (A Division of PROTECTO)

22292 N. Pepper Road, Barrington, IL. 60010

Call **(312) 382-5050** To Order

*We Love Our Customers!*

\* Illinois residents add 6 1/4% sales tax. All orders must be in U.S. Dollars. We ship to all points in the U.S., CANADA, PUERTO RICO & APO-FPO. Please call for charges outside continental U.S. or C.O.D. **MAIL ORDERS** enclose cashier check, money order or personal check. Allow 14 days delivery, 2 to 7 for phone orders and 1 day express mail. Prices and availability subject to change without notice. (Monitors only shipped in continental U.S.)

**VISA — MASTERCARD — C.O.D.**

# We Won't Be **UNDERSOLD**

\* On items marked "No One Sells This ----- For Less". Copy of valid ad required.

15 Day Free Trial • 90 Day Immediate Replacement Policy • Prices Expire 1-30-88

## Full Size Piano/Organ Musical Keyboard **\$49<sup>95</sup>\*\***

List \$159

(Add \$5.00 shipping.)\*



\*\* Conductor Software Required

**Keyboard** — 40 Keys (A-C) gauge spring loaded to give the feel and response of a professional polyphonic keyboard instrument. Plugs right into the joystick port of the Commodore 64 or 128. This sturdy instrument comes with carrying handle, protective key cover and built-in music stand. Size: 29" x 9 1/2" x 4" Weight: 9 lbs.

**Registers (with the Conductor Software)** — Organ • Trumpet • Flute • Harpsicord • Violin • Cello • Bass • Banjo • Mandolin • Callipoe • Concertino • Bagpipe • Synthesizer 1 & 2 • Clavier 1 & 2 • Can be played over a 7 octave range • Programmable sounds

**Recording (with the Conductor Software)** — Three track sequencer plus over-dubbing with multiple instruments playing at the same time.

### The Music Teacher

List \$39.95 Sale \$24.95

Teaches how to read music and play in rhythm on the keyboard. Features trumpet, organ, violin, synthesizer instrument sounds, built-in metronome, pause-play control and set-up menu for customizing. (Disk)

### The Conductor Software

List \$29.95 Sale \$19.95

The Conductor Software teaches how a composition is put together, note by note, instrument by instrument. You will learn to play 35 songs from Bach to Rock. Then you will be ready to compose your own songs! (Disk)

**Teaches** — Scales • Bass lines • Popular songs "Bolero" to "Thriller".

**Features** — Control with attack, delay, sustain and release times •

Playback tracks while you record • Stores songs on disk • Much more

**Requires** — Above Keyboard • Commodore 64 or 128 with disk drive

### The Printed Song

List \$29.95 Sale \$19.95

Print out your composition for others to read or play. Requires The Conductor Program and printer compatible with the Commodore graphics mode such as most dot matrix printers with a graphics interface. (Disk)

## 5 1/4" Double-Sided, Double Density Floppy Disks

For As  
Low As **24¢** each

(Add \$3.00 shipping.)\*

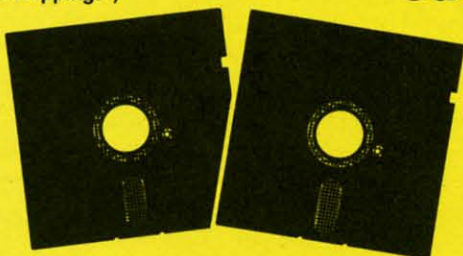

Each Disk 100% Certificatied • Automatic Dust Remover  
Free Lifetime Replacement Warranty

**1 Box of 50** ..... \$14.50 (29¢ each)  
(with sleeves)

**1 Box of 100** ..... \$24.00 (24¢ each)  
(without sleeves)

Paper Economy Sleeves ... \$5.00 per quantity of 100  
Disk Labels ..... \$3.95 per quantity of 100

## 3 1/2" Double-Sided, Double Density Micro Disks

On Sale  
For Only **99¢** each

(Add \$3.00 shipping.)\*



For use with all 3 1/2" Disk Drives.

- Compact and easy to handle
- Same tough and reliable qualities of 5 1/4" floppies other disks in a compact, cassette-like format
- Hard-plastic shell provides maximum media protection and safe handling.

Holds more data than a conventional 5 1/4" floppy disks

**Quantity of 50** ..... \$49.50 (99¢ each)



Call

**(312) 382-5050**

We Love Our Customers!



Mail

**COMPUTER DIRECT**

22292 N. Pepper Road  
Barrington, IL. 60010

Reader Service No. 236

[www.commodore.ca](http://www.commodore.ca)



# 1st In Price, Support, & Warranty

15 Day Free Trial • 90 Day Immediate Replacement Policy • Prices Expire 1-30-88

Famous Star Micronics National Brand

## Super Hi-Speed 200 CPS Printer

Star Micronics LV-2010 10" Printer with Near Letter Quality



**SALE**

**Save**

(Add \$10.00 shipping. \*)

- High Speed 200 CPS Draft
- Near Letter Quality
- Standard Pull Tractor and Automatic Single Sheet Loading
- Standard Parallel and Serial Interface Ports
- Continuous Underline
- IBM Compatible
- Ultra Hi-Resolution Bit Image Graphics

*No One Sells This  
Printer For Less!*

**Sale \$209<sup>95</sup>**

List \$499

### SPECIFICATIONS

#### Printing Method

Serial Impact Dot Matrix

#### Printing Speed

200 Characters Per Second Draft  
45 Characters Per Second NLQ

#### Print Buffer

16K Bytes

#### Paper Feed

Sprocket or Friction Feed

#### Dimensions

4½" (H) x 13½" (D) x 16¼" (W)

#### Character Sets

96 Std. ASCII; 96 NLQ ASCII -83 Special &  
50 Block Graphic Characters

#### Printing Direction

Bidirectional, logic seeking;  
Unidirectional in bit image and NLQ modes

#### Ports

Centronics Parallel and Serial

#### Line Spacing

1/6", 1/8" or 7/72" Standard  
n/72" or n/216" Programmable

**COMPUTER DIRECT** (A Division of PROTECTO)  
22292 N. Pepper Road, Barrington, IL. 60010  
**Call (312) 382-5050 To Order**  
*We Love Our Customers!*

\* Illinois residents add 6½% sales tax. All orders must be in U.S. Dollars. We ship to all points in the U.S., CANADA, PUERTO RICO & APO-FPO. Please call for charges outside continental U.S. or C.O.D. **MAIL ORDERS** enclose cashier check, money order or personal check. Allow 14 days delivery, 2 to 7 for phone orders and 1 day express mail. Prices and availability subject to change without notice. (Monitors only shipped in continental U.S.)

**VISA — MASTERCARD — C.O.D.**

# CLONE-A-MATIC

## Easy Copy Utility for All C-64 Files

### By Buck Childress

**W**hat a pain! Making backup copies of disk files can really try your patience. BASIC programs aren't too bad. You can load them, then make a save to another disk.

This gets tiring in a hurry, though. Machine language programs can be a real problem, especially if you're not familiar with ML and ML monitors. Even if you are, you have to know the starting and ending addresses. Sequential and user files are another stumbling block. If you need backups, but are tired of them resulting in Excedrin headache #64, take the easy way out with *Clone-a-Matic*.

Whether you want to make copies of BASIC or ML files, *Clone-a-Matic* is a snap to use. It grabs program, sequential, and user files up to 175 blocks long with equal ease and speed. Even files from word processors can be hacked. Here's how to use it.

After saving a copy of *Clone-a-Matic*, run it. You'll be prompted to insert the source disk into the drive. Next enter the filename. If you want to see the directory, enter \$ instead. Don't forget the directory function. It can be real handy if you're making backups of several different files. Now give the type of file. Press P for Program, S for Sequential, or U for User. *Clone-a-Matic* then reads the file

into memory.

When it's through reading, you're prompted to insert the backup disk into the drive. *Clone-a-Matic* will write the file to your backup disk. Now that the backup is complete, you have the option of copying another file. Press Y if you want to.

*Clone-a-Matic* uses machine language to read and write the files and to read the directory, so these functions are performed without delay.

Should you encounter any errors while using *Clone-a-Matic*, the error channel is automatically read and you're informed as to what went wrong.

Because *Clone-a-matic* changes important pointers and disables the STOP and RESTORE keys, there are three times when you can exit. The first two are when you're asked to insert a disk into the drive. You can press the Q key to quit at this time, if you want. The last is when *Clone-a-Matic* asks if you want to copy another file. Pressing any key other than Y will exit. When you leave *Clone-a-Matic* the pointers are returned to normal and the STOP and RESTORE keys are reenabled.

Give *Clone-a-Matic* a test drive. It really gets the job done fast.  **SEE PROGRAM LISTING ON PAGE 92**

## Looking for a Supercartridge?? Don't finalize the deal!!

Are you thinking of buying a multi-function cartridge? Well, don't make a FINAL decision until you look at this comparison chart.

Super Snapshot 64 V2.0 has just been updated to make it an even better utility than before! We've even added features like system reset capability and a sector editor!

- Super Snapshot is upgradeable. There is no need to discard your cartridge for a new version.
- Copies most memory resident software on today's market.
- Snapshotted programs run without the SS cartridge.
- Our cartridge is easily updated with up to 40K.
- Our Turbo/DOS is the most compatible fast loader tested to date.
- Attention C128 owners: An optional switch is available which allows you to disable the C64 mode with cartridge in place. \$5.00 additional.
- Super Snapshot 64 V1.0 owners may upgrade for \$20.00. Contact us for details.
- Super Snapshot 64 is for the C64 or the C128 in the 64 mode.

**Super Snapshot  
Only \$54.95**

Super Snapshot 64 (SS) Vs. the Final Cartridge® (FC)*	SS	FC
Compatible with ALL C64/C128/SX64/MSD/1541/1571/1581 equipment?	Y	N
Is the cartridge itself designed to be easily upgradeable?	Y	N
Features both pre-programmed and user-definable function keys?	Y	N
Will it print both multi-color and standard bit mapped screen dumps?	Y	N
How many different sizes can the screen dumps be printed at?	3	1
Save graphic screens to disk in either Koala™ or Doodle™ formats?	Y	N
Menu driven with easy to read, full screen windows?	Y	N
Features both a fast loader and a fast disk formatting option?	Y	N
C-64™/1581 fast load support (20+ blocks/sec.)	Y	N
Unique "RESUME" feature (proof that SS does NOT corrupt memory)?	Y	N
Does the built-in Machine Language monitor corrupt memory (see above)?	N	Y
M/L monitor accessible from a running program with resume feature intact?	Y	N
How much ROM does the cartridge contain?	32	16
How much RAM does the cartridge contain?	8	0
Does the cartridge work with popular multi-slot expansion boards?	Y	N
Is ALL Ram and Rom accessible from the Machine Language monitor?	Y	N
Is the cartridge TOTALLY invisible to software when disabled?	Y	N
Supports C128 fast mode during screen dumps?	Y	N
Does the cartridge support multiple disk drives?	Y	N
Is the cartridge supported with a FREE Kracker Jax parameter disk?	Y	N
FREE shipping and handling on all orders within the United States?	Y	N

CHECKS, MONEY ORDERS OR VISA/MASTERCARD/DISCOVER: Mail your orders to: Computer Mart, 2700 NE Andresen Road, Vancouver, WA 98661 • Phone orders welcome: (206) 695-1399 Same day shipping. No C.O.D. orders outside U.S.

PLEASE NOTE: Free shipping & handling on all orders. • C.O.D. add \$4.00 to total order. • All orders must be paid in U.S. funds. Washington residents add 7.30% sales tax to order. Orders outside of North America add \$7.50 for shipping. In Canada, order from: Marshview Software, PO Box 1212, Sackville NB E0A-3C0. Only \$69.95 CDN.

**DEALERS—WE HAVE THE SUPPORT YOU'RE LOOKING FOR!**

\*Final Cartridge is a registered trademark of H & P Computers of America. Comparison date 8-1-87.

**COMPUTER MART**



Need more info? Call or write for our free catalog.

Program submissions wanted!  
Good Commissions—  
National Marketing.

Reader Service No. 261



**S & S Wholesalers, Inc.**  
 226 Lincoln Road  
 Miami Beach, Florida 33139

**S & S Wholesalers Sizzling Summer Sale**

TO ORDER CALL TOLL FREE  
**(800) 233-6345**

These are Special Prices for AHOY Readers Only.  
 Please Specify When Calling.

**C128 COMPUTER**

**189<sup>00</sup>\***

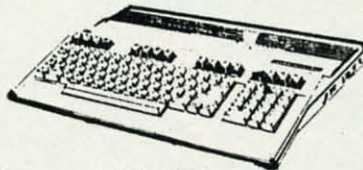

\*With Purchase of 1571 Disk Drive  
 Freight Additional

**64C COMPUTER**

**129<sup>90</sup>\***

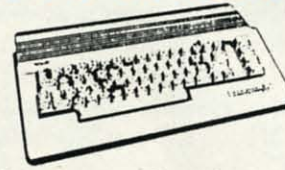

\*With Purchase of Specially Priced Software Package  
 Freight Additional

**COMMODORE MP5803**

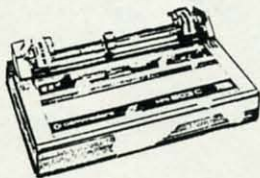

**109<sup>90</sup>\***

Freight Additional

**12" Color Monitor**

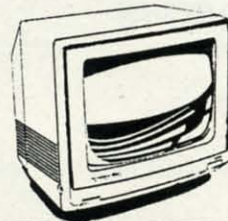

**149<sup>90</sup>\***

\*Freight Additional

**MASTERTRONIC**

*Software  
 Bonanza*

- BMX RACER
- GOLDEN TALISMEN
- 5 A SIDE SOCCER
- SLUGGER (BASEBALL)
- SPEED KING
- VIDEO POKER
- ELEKTRAGLIDE
- MASTER OF MAGIC
- CHILLER
- HOLY GRAIL

- SKYJET
- KICKSTART
- BLACK CRYSTAL
- ACTION BIKER
- LAST V8
- SPACE HUNTER
- BROADSTREET
- FINDERS KEEPERS
- NINJA
- INSTANT RECALL

**4<sup>99</sup>\***

SPECIAL 20 TITLES FOR 79<sup>90</sup>

**ZORK II  
 ZORK III**

**6<sup>77</sup>\***

**ZAXXON 6<sup>77</sup>\***

**POPEYE 6<sup>77</sup>\***

**FLIGHT  
 SIMULATOR II**

By SubLogic

**29<sup>90</sup>\***

SCENERY DISKS AVAILABLE

**WICO JOYSTICKS**

- BLACK MAX 8<sup>90</sup>
- BOSS 11<sup>77</sup>
- BAT HANDLE 14<sup>77</sup>
- 3 WAY 19<sup>77</sup>

**SUPER SPECIAL  
 KRAFT ACE  
 JOYSTICK**

**4<sup>90</sup>\***

**GEOS 29<sup>90</sup>\***

\*With the Purchase of  
 any other Berkley Program

**TIMEWORKS**

- PARTNER 128 34<sup>90</sup>
- SWIFTCALC 128 34<sup>90</sup>
- DATA MANAGER 128 34<sup>90</sup>
- WORD WRITER 128 34<sup>90</sup>

**NEWSROOM 29<sup>90</sup>**

**COMMODORE PC-10**

**529<sup>00</sup>**

FREIGHT ADDITIONAL

**OKIDATA  
 COLOR PRINTER**

**99<sup>90</sup>\***

\*With Purchase of Plug-N-Print

# RUPERT REPORT

**W**e have created machines to do much of our repetitious and tedious work. This month we will investigate two different applications of repetition, mathematical iteration and graphics iteration. Of course, we will let the computer do most of the work.

We will begin with a discussion of the mathematical iteration. If your interests are more of an artistic nature, look ahead to the next section where we will use repetition to create some op-art masterpieces.

## MATHEMATICAL ITERATION

The mathematical process called iteration may be represented in this manner:

1. Choose some value for X.
2. Evaluate some function of X.
3. Choose a new value of X based upon the results of step 2.
4. Repeat from step 2 until some criteria are met.

This looks rather abstract. An example should make it more meaningful. For example, there is a procedure taught before the days of calculators for manually extracting the square root of a number. Through a process of successive refinement (iteration), the square root of any number can be calculated to any desired accuracy. The technique of iteration to find mathematical solutions is credited to Sir Isaac Newton, and is called Newton's method.

In order to calculate the square root of a number (in fact, any root of any expression), we will use a procedure related to Newton's method called the secant method. It is very easy to implement on the computer.

For a start, we will find the square root of 3. Perhaps your mathematical background tells you that "find the square root of 3" is equivalent to the problem "find the value of X such that X squared equals 3." This second statement of the problem can be written algebraically:

$$X^2 = 3$$

Clearly you might take the square root of both sides of this equation and arrive at the original problem:

$$X = \text{SQR}(3)$$

where SQR is the BASIC square root function. Your calculator or computer effortlessly tell you that the correct value of X in the second equation is approximately 1.732.

We will use iterative methods to find the root of the first equation. The root is nothing more than the value of X which makes both sides of the expression equal. First we

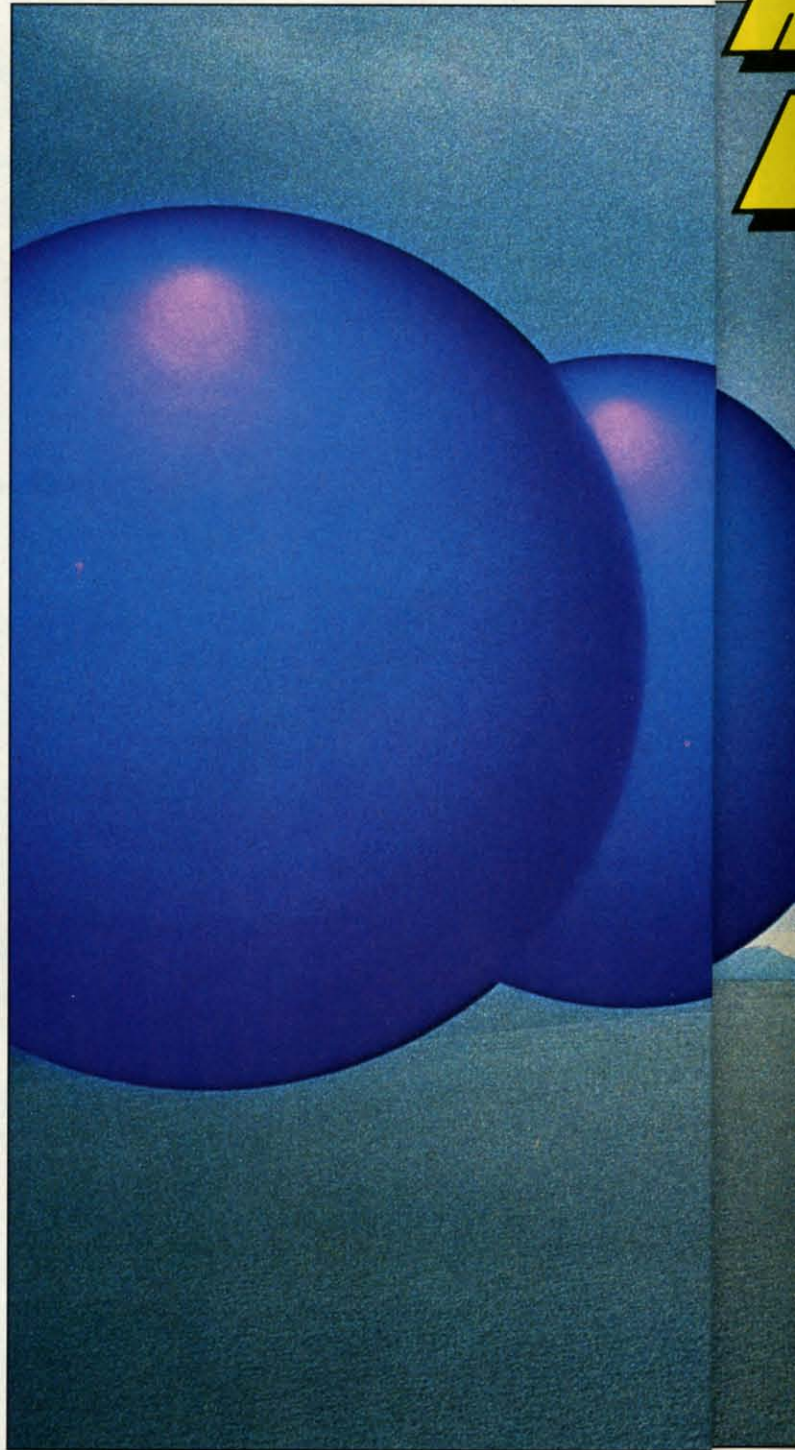

subtract 3 from both sides of the equation to get the two terms on one side, leaving zero on the other side:

$$X^2 - 3 = 0$$

Finding a root of this equation is equivalent of finding a zero of the expression  $X^2 - 3$ . A zero is merely a value of X which makes the expression on the left equal to 0. That is just what we are looking for.

# REPETITIVE PROCESSES

Iterative Mathematics  
and Imagery

BY DALE RUPERT



COMSTOCK

We will define the function of X this way in BASIC:

```
DEF FNA(X) = X ^ 2 - 3
```

If we tell the computer to PRINT FNA(7), it substitutes the value 7 for X in the right side of the function definition. It calculates 7 squared minus 3 and displays 46. Clearly 7 is not a zero of the expression since the result of using 7 for X gives 46, not 0. If we tell the computer PRINT

FNA(1), it replies -2 since 1 squared minus 3 is -2. From this we see that X=7 gives a result that is too large (46) and X=1 gives a result that is too small (-2). We are looking for a result of 0.

Let's first perform a crude form of iteration to find a zero of the expression. Try this:

```
10 DEF FNA(X) = X ^ 2 - 3  
20 FOR X=1 TO 7 STEP 0.01
```



# Bring your Commodore® to life with a **FREE** modem and software!

Now you can plug your Commodore into an exclusive network that's useful, easy, fun and inexpensive. Join Q-Link now and we'll give you a free modem and software to get you started.

Enjoy **unlimited access** to a wide range of Q-Link "Basic" services for a set fee of only \$9.95 a month. Get help from Commodore experts — use the Hotline to ask Commodore questions, or search the database of information from Commodore to answer your questions on the spot. Access Grolier's Academic American Encyclopedia™, the latest news and entertainment updates.

Special Q-Link "Plus" services let you expand your software library with **more than 10,000 public domain programs** — games, graphics, business and educational software and much more! Also, you can preview new copyrighted software before you buy. Get answers to your software questions from Berkeley Softworks, Electronic Arts and Activision, to name a few. Participate in full-color, multi-player games like Casino (includes Blackjack, Poker, Bingo and the Slots), Chess and Bridge. "Plus" services cost only an extra 8 cents per minute — **and your first hour of "Plus" service usage each month is free!**

Offer valid in the continental U.S. and Canada for new members only. Expires 6/30/88. Prices subject to change without notice. There is a communications surcharge for connection to Q-Link from Canada: 6 cents (U.S.) per minute from Montreal, Vancouver, Ottawa, Toronto, Quebec, Windsor, Kitchener and Calgary using the Tymnet network, and 15 cents (U.S.) per minute from over 85 other locations using the DATAPAC network.

Commodore is a registered trademark of Commodore Electronics, Ltd. Q-Link is a servicemark of Quantum Computer Services, Inc. Grolier's Academic American Encyclopedia is a trademark of Grolier Electronic Publishing.

With Q-Link, you can sharpen your computer skills... connect with people... discover new ways to get smart... save money every day... plus have a lot of fun!

**No-risk guarantee.** Try Q-Link without risk. If, at any time, for any reason, you are not completely satisfied, you may cancel your membership.

Order your Q-Link software and modem today by mailing this coupon to Q-Link, 8619 Westwood Center Drive, Vienna, VA 22180 or for faster service call toll-free: **1-800-782-2278 Ext. 1205**

## Q-LINK RESERVATION FORM

### Choose one:

- I need a modem.** Start my Q-Link membership by charging me now for my first 4 months at \$39.80, and send me the FREE Q-Link software and a FREE Commodore 300 baud auto-dial modem (model 1660—retail value \$69.95).
- I already have a modem.** Send me my FREE Q-Link software and start my Q-Link membership by charging me now for my first month of membership at \$9.95.

Full name \_\_\_\_\_

Address \_\_\_\_\_

City \_\_\_\_\_ State \_\_\_\_\_ Zip \_\_\_\_\_

Home phone \_\_\_\_\_

### Choose your method of payment:

- Please charge my credit card.  Check enclosed.  
 Master Card  Visa

Acct# \_\_\_\_\_ Exp. \_\_\_\_\_

Signature \_\_\_\_\_

Call toll-free 1-800-782-2278 Ext. 1205 or

mail this coupon to:  
 Q-Link, 8619 Westwood Center Drive,  
 Vienna, VA 22180



The Commodore Connection.

```

30 PRINT X,FNA(X)
40 NEXT X

```

Watch the numbers in the right hand column flow by. Be ready to press the RUN STOP key when you see the values change from negative to positive. You know that the zero of the expression is right at that transition.

On my screen the relevant values of X and FNA(X) shown are

```

1.72999998 | -7.10005499E-03
1.73999998 | .0275999429

```

In rounded terms, FNA(1.73) is roughly -0.007 and FNA(1.74) is 0.028. That means the zero we are looking for is an X value between 1.73 and 1.74. If two-digit accuracy is all we need, then we have found the square root of 3. It is 1.7.

You could easily change the STEP size in line 20 if you need more accuracy. It would not be difficult to add some logic to the program to stop whenever the values of FNA(X) change from negative to positive. Your program could automatically tighten up the FOR-NEXT limits and repeat the process with smaller STEP sizes until any desired accuracy within the limits of the machine is obtained. This is a very understandable form of iteration. There is nothing mysterious about it.

The secant method uses some mathematical sophistication to speed up the iteration process. We won't go into the theory of the method. Books on numerical analysis and numerical methods for the computer provide the theory if you are interested. The implementation is very straightforward. Refer to *Iterative Solutions* on page 87. (The program as listed is for the C-128; C-64 users see below.)

We must provide two initial values, X0 and X. They may be any two differing values; but their choice may affect the speed of finding a solution, and it may affect the particular solution which is found (if there are more than one). Line 20 arbitrarily picks 0 and 1 for initial values.

The iteration is performed within the loop defined by DO in line 30 and LOOP WHILE in line 80. Lines 40 through 70 are repeated as long as the condition in line 80, ABS (DELTA) > 0.0001, is true. Then the loop is exited and the program ends. (C-64 users refer to the changes in lines 110 through 130.)

The quantity which is called DELTA is a function of two different values of X, the current value X and one previous value X0:

$$\text{DELTA} = (X - X_0) / (1 - \text{FNA}(X_0) / \text{FNA}(X))$$

Line 50 saves the current value as the previous value once it has been used to calculate DELTA. In line 60, a new value of X is calculated from the current value of X and DELTA:

$$X = X - \text{DELTA}$$

Line 70 displays the progress, printing X and FNA(X). If all goes well, DELTA approaches zero, implying that X is not changing much. FNA(X) eventually gets close to zero and the value of X is then the desired zero of the expression.

It would be possible to replace the conditional test in line 80 with ABS(FNA(X)), since as DELTA approaches zero, so does FNA(X). However, this gives a speed disadvantage, since FNA(X) would have to be evaluated again. The absolute value ABS is used since it gives a measure of the "dis-

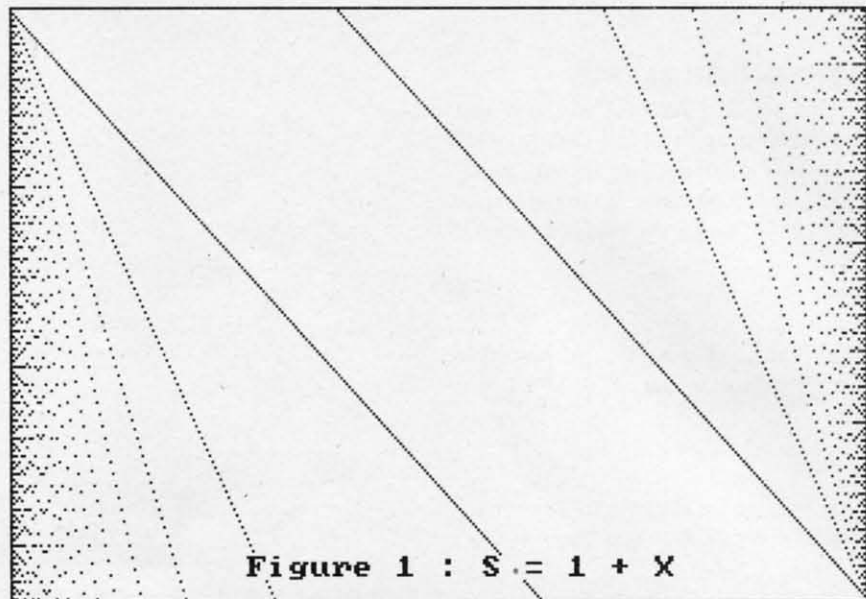

Figure 1 :  $S = 1 + X$

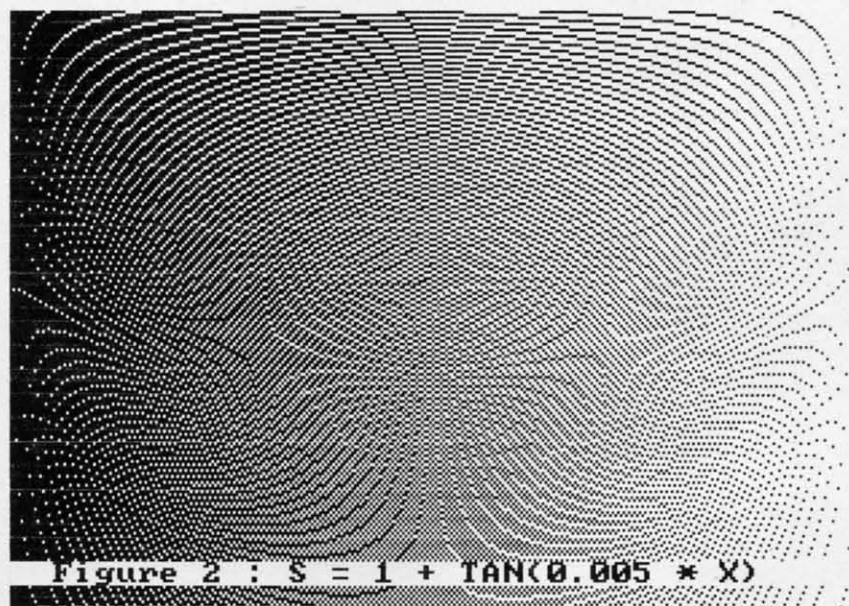

Figure 2 :  $S = 1 + \text{TAN}(0.005 * X)$

tance" that a number is from 0, regardless of the sign of the number.

### OTHER PROBLEMS

The iterative method we have just discussed is applicable to many other problems than finding square roots. How about cube roots? To find the cube root of 40, write the equation

$$X^3 = 40$$

then rearrange it as we did before to get all terms on one side:

$$X^3 - 40 = 0$$

Now change the definition of the function in line 10 to

```
DEF FNA(X) = X ^ 3 - 40
```

and run the program. In a few moments, the computer states that FNA(X) is essentially zero when X is 3.41995189. That is pretty close to the cube root of 40.

How would you find a value of X for which the trigonometric sine of X equals the tangent of X+3? Use the same procedure. Write the equation, then rearrange it:

$$\text{SIN}(X) = \text{TAN}(X + 3)$$

$$\text{SIN}(X) - \text{TAN}(X+3) = 0$$

Change the function definition in line 10 to

```
DEF FNA(X) = SIN(X) - TAN(X+3)
```

and very quickly have the answer X=0.729 radians.

What number is 5 more than its own square root? Find the answer by writing

$$X = \text{SQR}(X) + 5$$

or

$$X - \text{SQR}(X) - 5 = 0$$

Line 10 becomes

```
DEF FNA(X) = X - SQR(X) - 5
```

Here we quickly run into trouble. With the initial values given, the denominator of FNA(X) is zero, producing a "Division by zero error in 40".

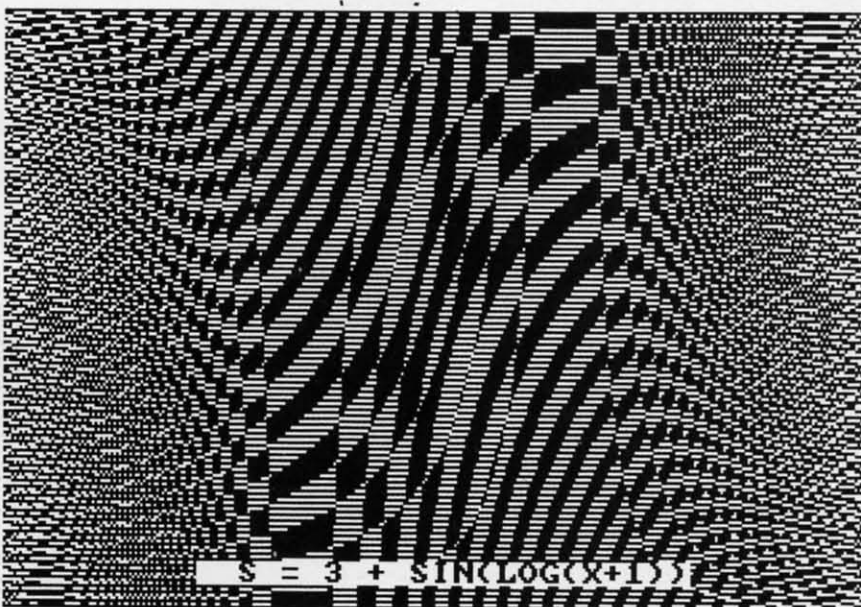
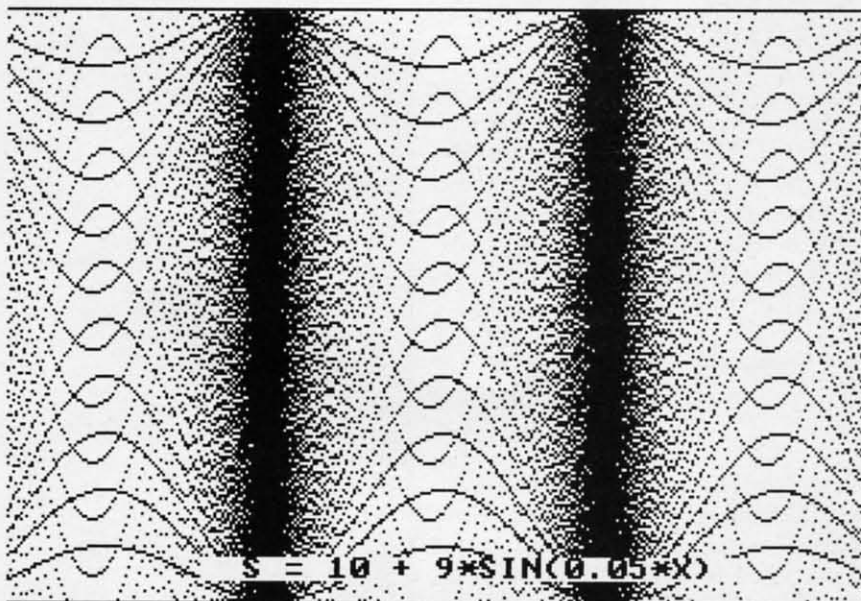

Changing the initial values to X0=0 and X=3 leads to another problem. The value of X becomes negative, and the computer gives an "Illegal quantity error in 70" when it tries to evaluate the square root of a negative number.

One possible way around this problem is to substitute Y for SQR(X) so that X becomes Y<sup>2</sup>. Change line 10 to

```
DEF FNA(Y) = Y^2 - Y - 5
```

(Note that the variable used in the DEF statement does not really matter.) Since we are now trying to solve an equation which is the square of the original variable, we may end up with an answer which doesn't belong to the original. (In the words of our algebra teachers, we had better check our answers.)

In fact, this time we succeed. The computer gives a value 2.7912874 as the root of our equation. This corresponds to Y which is actually the square root of X. The answer



# CDA COMES TO EARTH

Now you can have the same quality software that for millennia has been available throughout the universe. With titles like THE GRAPHICS TRANSFORMER, MOVING PICTURES, QUACKDAS and LEXCHECK, that have been number one sellers for centuries in other galaxies, you are guaranteed quality software without the hassle of using products that have not been tried by at least two other species. Of course with our 1987 line including NEOFONT, 1541 AUNTIE BUMP BOARD, THE MANDELBROT POSTER, and ENTROPY, we are destined to supersede the monotony of generic software . . . again. So take a look and enjoy the fabled CDA line of software, where we bring quality software to your planet.

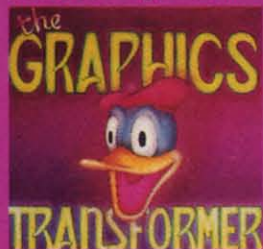

**THE GRAPHICS TRANSFORMER** — \$34.95  
(C-64/C-128)

★★★★★ (Megagalactic Software Weekly)

"... THE GRAPHICS TRANSFORMER is the greatest graphics utility since the release of OMNI-PAINT. It allows you to quickly and easily convert between ALL of the popular drawing programs (over 25 supported), and does other neat things as well. I highly recommend it to all software consumers."



**LEXCHECK** — \$29.95  
(Amiga)

\$\$\$\$\$ (Business Software & Galaxian Report)

"... [LexCheck] will help you do [everything] that you need to do with your [word-processing] programs. It will [rapidly spellcheck] all of your documents [with its 100,000 word dictionary]. I would [buy two of them] if I were you."



**MOVING PICTURES** — \$29.95  
(C-64/C-128)

★★★★★ (Transmission — The Intelligence Journal)

"... Chris Zamara & Nick Sullivan (of Transactor Magazine, Earth) did it again with the most comprehensive animation program yet available for any silicon based unit. Unfortunately, you don't have to be intelligent to use it."

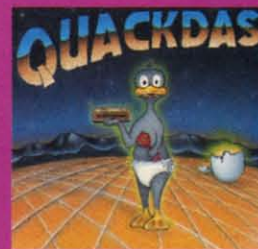

**QUACKDAS** — \$39.95  
(C-64/C-128 mode/1541/1571 mode)

★★★★★ (Operating Systems & Intergalactic Insight)

"... finally a cartridge that speeds up SAVE's as well as LOAD's (fast format, included FREE!). QUACKDAS comes complete and ready to use with its blinding speed, built in DOS wedge, sector editor, and a token disk copier! Definitely something to write home about."

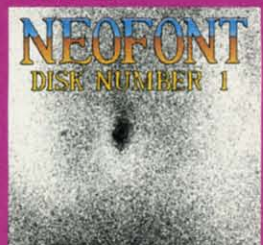

**NEOFONT** — \$29.95  
(C-64/C-128/GEOS compatible)

+ = - + !! (Crabnebula Computer Art & Design)

"... NEOFONT is the most artistic and well designed collection of fonts for the GEOS operating system. It contains over 23 different fonts, that are simply sublime. Do yourself a favor, and appreciate some REAL art."



**1541 AUNTIE BUMP BOARD** — \$49.95  
(C1541 compatible)

★★★★★ (Buyit Magazine)

"... It's surprising that the generic mortal species hadn't come up with a device to ELIMINATE the damaging knock on the 1541 disk drive before now. After looking at the circuit board, I've come to the conclusion that they did it almost as good as the Vorkons could've."



**ENTROPY** — \$29.95  
(Amiga/C-64/C-128 compatible)

??????? (The Hitchhiker's Guide to Galaxian Software)

"... an interesting implementation of an adventure game. It's hard to believe that so many abstract perversions can be contained in one place. ENTROPY is destined to become another milestone in the realm of interactive fiction."

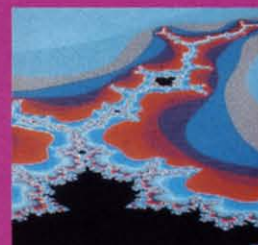

**THE MANDELBROT POSTER** — \$9.95  
(compatible)

★★★★★ (Fractagalactic & Surfer Weekly)

"... what can you say about a software company that markets posters. The fabled Mandelbrot Set is now captured on paper (where available — some restrictions might apply), using the highest resolution ever experienced to date."

P.O. Box 1052, Yreka, CA 96097  
(916) 842-3431



Please include \$3.00 s/h  
California residents add 6% sales tax  
Dealers Inquiries Invited

Reader Service No. 246

www.commodore.ca

# The Mission is Vital. The Odds are Against You.



*You're one of the elite . . . parachuting alone behind enemy lines. The enemy controls the terrain, hidden in bunkers and machine gun nests . . . you may be surrounded. You might complete the mission if you crawl through the ravine and approach from the rear . . . or maybe a frontal attack will take them by surprise.*

MicroProse has broken new ground with **AIRBORNE RANGER**, the quality action game where tactical thinking and lightning reflexes determine your fate. Your missions will vary as much as the climate and terrain. Slip silently into position to rescue prisoners trapped in "tiger pits" from a P.O.W. camp, or throw caution to the wind and try to destroy a key munitions dump in the desert. But watch out . . . enemy troops can attack from any direction.

The action is fierce as you control one soldier's battle against overwhelming odds. You'll need skill and strategy to outmaneuver your enemy, plus courage and some luck to make your escape. Along the way, search out that hidden cache of weapons and first aid supplies . . . you'll probably need them.



**AIRBORNE RANGER** is a fast-paced, quick-to-learn game with 12 desperate missions in three different regions of the world. You'll be running, walking and crawling across full-scrolling, 3-D terrain. Arm yourself with an M-16 assault rifle, bayonet, LAW rocket (Light Antitank Weapon) or time bomb, but be wary of enemy submachine guns, antitank rockets, robot minitanks, minefields and flamethrowers.

**AIRBORNE RANGER . . . More than just a great game. It's an adventure.**

**AIRBORNE RANGER** is available from a "Valued MicroProse Retailer" (VMR) near you. Call us for locations! For Commodore 64/128, IBM-PC/compatibles and Apple II+/e/c. Call or write for specific machine availability, and for MC/VISA orders if product not found locally.



**MICRO PROSE™**  
SIMULATION • SOFTWARE

180 Lakelront Drive • Hunt Valley, MD 21030 • (301) 771-1151

to our problem is  $X = 7.7912878$ , and it checks! This number is 5 more than its square root.

If you want real troubles, try finding the number which is 5 less than its square root. You will quickly get into complex numbers (with real and imaginary parts), a topic we will reserve for future discussions. With this problem, the secant method happily iterates as long as you let it. It never converges to a root, since there is no real root.

You may find other problems which the secant method can't handle. There are several other iterative methods available, although each has its own problems of more complicated programming, slow performance, or limited applications. The secant method is a good general purpose method, but it is not foolproof. Refer to a text on numerical analysis for other possibilities.

We will leave mathematical iterations with a final example which shows the importance of the initial values for  $X_0$  and  $X$ . Change line 10 to

```
10 DEF FNA(X)=SIN(X)
```

What values of  $X$  make  $SIN(X)$  zero? There are infinitely many of them. The general expression is  $X = n * PI$  where  $n$  is any integer,  $PI$  is roughly 3.14, and  $X$  is in radians.

When you run *Iterative Solutions* with  $X_0=0$  and  $X=1$ , the program gives a divide by 0 error. In line 20 change  $X_0$  to 1 and  $X$  to 3, and the root  $X=3.14$  is quickly reached. Now change  $X_0$  to 3 and  $X$  to 6. The solution is found to be 6.28. In general, the solution reached depends upon the initial values. A rough graph of the equation may help to choose the initial values in order to find the desired root.

## ITERATIVE IMAGES

After that mathematical workout, let's take it easy with some interesting graphics. We will experiment with a very simple program to produce surprisingly complicated-looking graphics. Refer to the program *Iterative Designs* on page 87.

The program draws points on the screen. The points are drawn along vertical lines from the top of the screen to the bottom, and the lines progress from left to right. The vertical spacing between the points on each line depends upon a formula which we will manipulate.

The program is written for the C-128, which uses the `DRAW 1,X,Y` command to plot a point at coordinate  $(X,Y)$ . (Use *Iterative Designs 64* for the C-64.) The screen coordinate system runs left-to-right horizontally (the  $X$  direc-

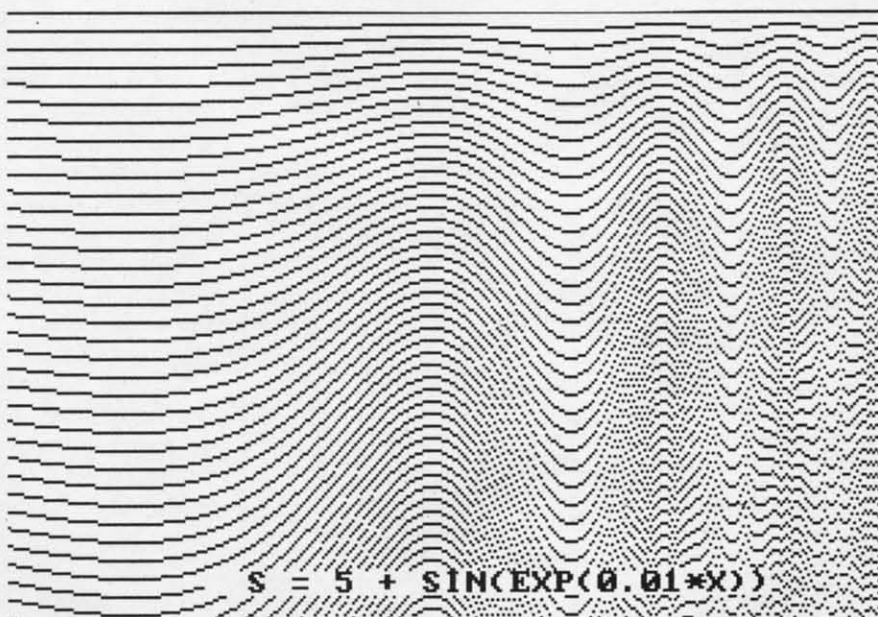
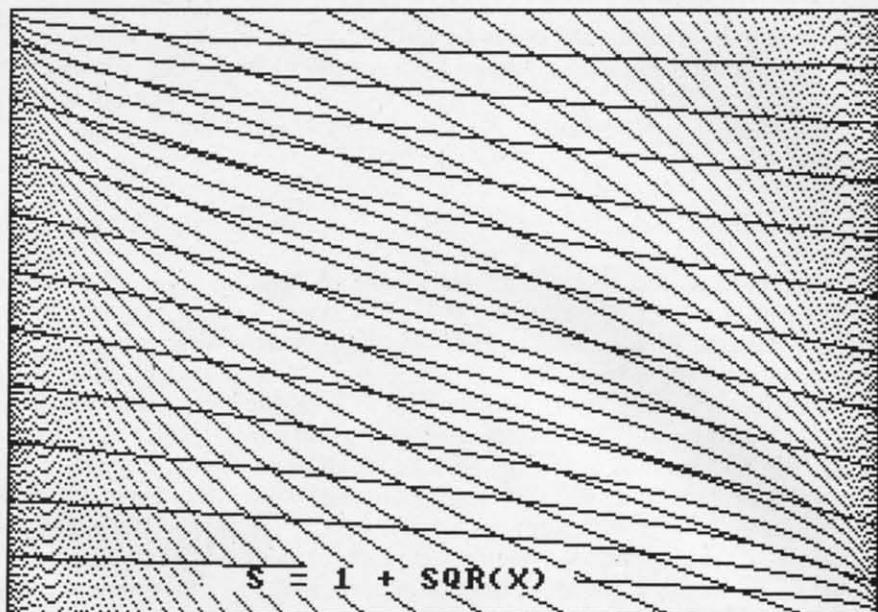

tion) from 0 to 319, and vertically top-to-bottom (the  $Y$  direction) from 0 to 199.

The outer  $X$  loop defines the horizontal position of each vertical line. The inner  $Y$  loop moves downward with step size  $S$  along the given line, plotting a point at every position which is a multiple of  $S$ .

For example, assume the formula for  $S$  in line 40 is  $S=X+1$ , where  $X$  runs from 0 to 319. The first vertical line at  $X=0$  would consist of all points a distance 1 apart ( $S=1$ ). The next vertical line at  $X=1$  would contain every other point since  $S$  has the value 2. The third vertical line at  $X=2$  would contain every third point since  $S$  is 3, and so on. This continues until the last vertical line at  $X=319$  is plotted. Here  $Y$  is initially 0, so the top dot is plotted. The step size  $S$  is now 320, so  $Y$  is incremented to 320. Since that is outside the range of the  $Y$  loop, the program ends.

Consequently the result of  $S=X+1$  is a collection of vertical lines, each of which has fewer points plotted on it than the adjacent one to the left has. That's how it should look

theoretically. In actuality, the eye is tricked into seeing a series of diagonal lines fanning outward from the upper left corner of the screen.

If you change line 40 in *Iterative Designs* to  $S=X+1$  and add line 65,

65 DRAW 1, 319-X, 199-Y

you will get the results shown in Figure 1. Line 65 draws the same image as line 60 except that its X and Y coordinates are reversed. X goes left to right from 319 to 0, and Y goes top to bottom from 199 to 0.

Notice that if S were set to X rather than to X+1, the program would be stuck. X is initially 0, so the step size of the first Y loop would be 0. FOR-NEXT loops take forever when the increment value is 0! Keep that in mind when you try some of your own formulas for S.

Line 10 of the program saves the current graphics mode of the C-128 in G0. If the RGR function returns a value of 6 or greater, it means that the original screen mode was 80-column mode 5. My computer automatically switches from 80-column mode to 40-column mode when the GRAPHIC 0 statement is executed in line 20 (see *Green Screen Blues*, August 1987 *Ahoy!*). GRAPHIC 1,1 selects and clears the hi-res graphics screen.

If you generally use the 80-column screen but must man-

ually switch your monitor back and forth to the 40-column screen, you might add a statement prompting you to switch the monitor and to press any key when ready. Something like this will work:

15 PRINT "FLIP THE SWITCH TO 40-COLUMNS THEN PRESS ANY KEY" : GETKEY A\$

Line 90 causes the program to wait for you to press any key to continue. That way you can get a screen dump to your printer or to a disk file (if you have such software loaded) before switching back to the text screen. Line 100 returns to the original text mode.

Not much more needs to be said about the operation of this program. I have had several evenings of enjoyment changing the formula for S in line 40 and watching the display. Hopefully you will too.

The main problem with the program is its speed. You can increase the speed significantly by putting a STEP statement at the end of line 30. STEP 5 would cause every fifth vertical line to be drawn. This is a handy way to get a rough idea about the looks of a new S formula without waiting so long. If the image looks promising, change the X loop step size back to 1 to get the highest resolution. If you have a compiler, this would be a program for it.

C-64 users must use *Iterative Designs 64* which produces the same results as *Iterative Designs* just discussed, although it is somewhat slower. The graphics routines were originally presented in June 1985's *Rupert Report*, *The Ultimate Resolution*. This program uses a set of subroutines in order to duplicate the graphics modes and the point DRAW statement of the C-128. GOSUB 1000 initializes the graphics screen. GOSUB 3000 returns to text mode.

Line 60 (and any other DRAW statements such as line 65 mentioned above) are replaced with GOSUB 2000. The routine at 2000 lights the pixel at coordinate (X,Y). Refer to the June and July 1985 *Rupert Reports* for a discussion of the graphics routines and for an assembly language implementation of them.

Figure 2 shows the results for S given in the listings:  $S = 1 + \text{TAN}(0.005 * X)$ . Figures 3 through 12 show some of the other patterns possible with these programs. You might add other lines such as

66 DRAW 1,199-Y,199-X

for even more variation.

We have briefly delved into the concepts of mathematical and graphical iteration. More sophisticated iterative processes are available which can produce even more powerful images. We will discuss some of these other procedures in future articles. This was just our first iteration of the subject.  **SEE PROGRAM LISTINGS ON PAGE 87**

For more information on products advertised or pictured in *Ahoy!*, fill out and return the reader service card bound between pages 66 and 67.

## COMPUTER REPAIR

**800-221-7770**

AMIGA \$100.00	AMIGA \$100.00	AMIGA \$100.00	
Commodore Disk Drive 1541 2031	\$60.00	Commodore Monitor 1701 1702	\$75.00 *
Commodore SX-64 Portable Computer	\$99.00 *	PET 64 VIC 20 64 Computers	\$45.00
Commodore Printer MPS 801 MPS 803	\$50.00	Commodore Printer 1526 MPS 802	\$75.00
MSD SD1, SD2 CBM 128 CBM 1571	\$85.00	Commodore Computer 8032 8050	\$85.00 *

WE BUY ALIVE C Commodore SERVICE CENTER PARTS

64 60.00	901225-01 10.85	901226-01 10.85
1541 NEWT 75.00	CABLES AND MISC.	901227-03 10.85
1541 ALPS' 60.00	REG 6 PIN DIN 3.95	901229-05 15.85
SX64 150.00	12' 6 PIN DIN 7.95	7701/8701 9.85
MSD 100.00	18' 6 PIN DIN 9.95	8721 16.85
APPLE 2E 450.00	1EEE TO EEE PIG BACK 29.95	8502 9.85
1526/802 45.00	1EEE TO PET PIG BACK 24.95	82S100 12.85
MPS801 35.00	POWER SUP 64 24.95	6502 3.85
SFD 1001 85.00	WICO BAT HANDLE 15.95	6532 6.29
DEAD	WICO 3 WAY 18.95	6520 3.85
64 40.00	WICO BOSS 11.95	6522 3.85
1541 NEWT 60.00	MEDIA MATE 5 CASE 6.25	6526 9.85
1541 ALPS' 40.00	TYMAC CONNECTION 48.95	6567 12.85
MSD 75.00	FLWJ DSDD 8.95	6581 9.85
SX64 100.00	8050 OR 8032 295.00	6510 9.85
MUST BE COMPLETE	5.00 SHIPPING 4.164	99
	25.00 MIN ORDER 74LS629	4.95
	15.00 APO AND BUSINESS EQUIPMENT 6560	9.85

**TC ELECTRONICS** \*  
HWY 36 PO 1129 205-  
HARTSELLE, AL. 35640 773-1077  
SEND FOR OUR COMPLETE LIST OF PARTS AND SOFTWARE

# THE YEAR'S BEST ENTERTAINMENT

## Finest Funware of 1987 for the C-64/128

By Arnie Katz and the editors of *Ahoy!*

The biggest Commodore software news story of 1987 concerns something which *didn't* happen. Despite dire predictions, the Commodore 64 and 128 home computers are alive and thriving as 1988 begins. The 64 and 128 still represent the third largest potential audience for home computer software, trailing only MS-DOS and Apple II.

Some of the software publishers who had backed away from the C-64/128 in mid-1986 reconsidered and then increased new product introductions in mid-1987.

Over 200 titles joined the Commodore 64/128 library of entertainment software in 1987, counting US editions of programs originally distributed in England, Japan, and other countries. Although the number of entertainment software programs developed primarily for the Commodore is still declining, there is no shortage of new top quality titles.

When *Ahoy!* entertainment editors reviewed the year just ended, they quickly compiled a list of nearly 50 outstanding new programs. There were at least another 50 which the judges felt they could recommend wholeheartedly. We've winnowed those 100 or so serious contenders down to the best of the best for this annual presentation. It was hard to leave so many fine programs unrecognized. There's no doubt that many of them would have won awards in 1986 or 1985.

The introduction of 16-bit computers has sharply reduced new product development on the Commodore, but the effect has not been totally negative. The process of transferring games originally designed on higher memory systems to the C-64/128 has taught programmers a lot about how to get the biggest bang for the byte. The Commodore editions of titles like *Defender of the Crown* and *The Pawn* have apparently raised the standard of quality



**Defender of the Crown: more options.**  
READER SERVICE NO. 213

for the entire Commodore software field.

The writers who regularly cover entertainment software for *Ahoy!* have collaborated on this survey of the best funware for the Commodore. The compilers hope that readers whose favorites didn't make this year's list will be understanding and charitable about this difference of opinion. The judges also apologize to publishers whose worthy submissions arrived just a little too late to make the deadline for inclusion. Rest assured, these disks will get their deferred justice next January.

The authors' modesty prohibits the inclusion of several new titles in this survey: *Omicron Conspiracy* (Epyx) and *WWF Microleague Wrestling* (MLSA) were designed by Subway Software (Arnie Katz, Bill Kunkel, and Joyce Worley). Modesty does have its limits, however, so we hope you rush out and buy them.

Now, let's go to the games...

### Strategy

Although the Commodore 64/128 remains an excellent medium for action contests, the brain games continue to dominate. The Game of the Year in 1986, *Elite* (Rainbird/Firebird Licensees), was a strategic challenge, and so is this year's top disk, *Shanghai* (Activision).

It would be hard to imagine two more



**Chessmaster 2000: multiple views.**  
READER SERVICE NO. 214

different products. *Elite* is a science fiction epic which crams an unbelievable amount of detail into a highly playable simulation of economic and military activity in outer space. This year's winner, *Shanghai*, is an elegantly simple contest which is the closest thing to a classic strategy game yet developed for the computer.

*Shanghai* contains elements of both solitaire and Mah-Jongg. The process of removing matching pairs of tiles from the playfield exerts an almost hypnotic effect on players, some of whom claim that an evening with *Shanghai* is the closest thing to a Zen experience the electronic world can offer.

The ultimate strategy game, chess, gets a fresh treatment in *Chessmaster 2000* (Software Toolworks). Not only does this program push pawns as expertly as any previous disk, but its flexibility and features, including multiple views of the board and several sets of pieces, make *Chessmaster 2000* the top choice for novices and grandmasters alike.

Another boardgame, *221B Baker Street* (Intellecreations), has also found new glory on the computer screen. Amateur sleuths travel around the elaborate playfield to collect clues and solve mind-teasing crimes.

*Robot Rascals* (Electronic Arts) is a multiplayer contest which mixes on-screen action with non-electronic ac-

tivity. Participants swap cards, set tactical traps for the unwary, and interact in a personal way which is rare in a computer game. This souped-up scavenger hunt guarantees evenings of fun for the entire family.

*President Elect 1988* (Strategic Simulations) falls into a gray area with regard to our honor roll, since it isn't completely new. An early version of the program premiered in 1983.

The revision's graphics are still primitive, but *President Elect's* premise is so compelling that most computerists will gladly overlook this shortcoming. The opportunity to personally experience historical and hypothetical elections makes *President Elect 1988* a terrific strategy game.

### Military Simulations

Wargames, though nominally strategy contests, are a breed apart. Many computer generals play no other type of game, and quite a few ardent gamers are largely ignorant about military simulations.

Actually, computers are breaking down the walls of the wargame ghetto. Computerized military simulations are easier to learn, set up, and play than the non-electronic equivalent. This has allowed some of those who previously shied away from wargames to enjoy the mental challenge without the drudgery associated with military boardgames and tabletop miniature soldiers.

The same game-system which made *Gettysburg: The Turning Point* a winner last year put the sequel, *Rebel Charge at Chickamauga* (Strategic Simulations), over the top in 1987. This

recreation of a pivotal Civil War battle exemplifies the strengths of state-of-the-art computer wargaming. Lucid documentation and smooth play mechanics let armchair commanders concentrate on winning the battle rather than navigating safely through a 100-page rulebook.

The futuristic *Ogre* (Origin Systems) presents a situation so unique that it will probably interest many computerists who normally keep wargames at arm's length. The tactical situation is unusually clear-cut, since the human player has only a few units in the struggle against a computer-directed super-tank on the battlefield of tomorrow.

*Warship* and *Wargame Construction Set* (both SS) appeal to somewhat more experienced wargamers. Their scenario construction systems extend the life of the game, because they permit the user to concoct fresh situations after the old ones are thoroughly played.

Definitely for the wargaming connoisseur are *Russia* and *Battles in Nor-*

*mandy* (Strategic Studies Group). The computer wargame field's leading design team scored a double hit in 1986 with expert level simulations of Eastern and Western front action in World War II. Authors Roger Keating and Ian Trout create the most accurate, challenging, and mentally demanding computer wargames on the market.

### Adventures

Diversity continues to be the hallmark of adventures for the Commodore 64/128. This year's best includes everything from a parser-driven text quest to a joystick-driven graphic adventure. Themes are similarly varied.

Sid Meier reveals a previously hidden talent for designing adventures in *Pirates* (MicroProse). Though widely known as a creator of simulators, Meier shows a deft hand in constructing this romantic high seas epic.

Interplay Productions teamed with independent designers to contribute two titles to the honor roll, *Tass Times in ToneTown* (Activision) and *Bard's Tale II* (Electronic Arts) this year. The former is a science fictional "Through the Looking Glass" which sends the player into a strange alternate world, while the latter continues the fantasy role-playing fun of 1986's *Bard's Tale*.

Master Designer Software specially revamped its *Defender of the Crown* (Mindscape) for the C-64/128. Their efforts yielded an arcade adventure with more strategic options than the Amiga original. It also looks better than almost all other Commodore games. The arcade sequences won't tax the average adult's coordination, yet effectively convey the spirit of the England of Robin Hood.

Some of Lucasfilm's previous titles seemed like little more than sophisticated videogames, but *Maniac Man-*



221B Baker Street: *mind-teasing.*  
READER SERVICE NO. 215



*Onscreen icons make it possible to play Tass Times in ToneTown with a minimum of typing. The object is to find Gramps, missing in a village in a strange alternate dimension.*

READER SERVICE NO. 216



*Maniac Mansion: superbly decorated.*  
READER SERVICE NO. 217

sion (Activision) is on the cutting edge of the computer adventure field. The superb artwork, cute onscreen characters, and haunted house plot give this joystick-activated contest tons of appeal for children and adults alike.

Martial arts action enlivens the more cerebral aspects of *Moebius* (Origin Systems). The player must master several mental and physical disciplines in order to succeed in this exotic quest game.

**Sports**

Quantity rose, but quality remained spotty in this popular category. Several games featured a frustrating blend of very good and very bad features. Still, there were at least four new entries which would improve anyone's software library.

The wait for a basketball statistical simulation with good graphics is over. *NBA* (The Avalon Hill Game Co.) and *Pure-Stat College Basketball* (Software Simulations), both designed by Ed Daniels and crew, are the hoop equivalent of *Super Bowl Sunday*. And that, as regular *Ahoy!* readers know, is high praise indeed.

*Superstar Ice Hockey* (Mindscape) signals the return of Ed Ringler to the computer sports arena. This action-strategy treatment of the world's fastest team sport provides for individual games and extended league play against computer or human coaches.

Skeptics have wondered when Epyx would run out of subjects for sports anthologies. *California Games* indicates that the well hasn't gone dry yet. This disk lacks the drama of an Olympic competition, but the games are handsomely illustrated and fun to play. As befits the subject matter, *California Games'* many humorous touches



**California Games: suitably light.**  
**READER SERVICE NO. 218**



**Marble Madness will stymie the best.**  
**READER SERVICE NO. 219**



**Gauntlet: gripping fantasy adventure.**  
**READER SERVICE NO. 220**

keep participants in a suitably light mood during events like skateboarding and the flying disk toss.

Also meriting mention is *World Class Leader Board* (Access). The Carver Brothers have further improved last year's already excellent *Leader Board*. This is now the best golf program for the Commodore 64/128 computer system.



**Fist: a combat/adventure combination.**  
**READER SERVICE NO. 221**

**Action**

Software publishers made our 1986 prediction of an upswing in action con-

tests look pretty good. Action-strategy titles are still much more popular than pure joystick jamborees, but the blast brigade won't be too disappointed with the 1987 crop.

The home version of *Marble Madness* (Electronic Arts), a popular 1985 coin-op, is the best new action game of 1987 for the Commodore. Directing the rolling ball around the split-level playfield is more a question of timing than speed, but it takes excellent reflexes to keep the marble moving through the tricky terrain.

Also fresh from the commercial arcades is *Gauntlet* (Mindscape). Although this fantasy free-for-all can be enjoyed solo, it really comes into its own as a two-player contest. Computerists choose characters, storm the huge multilevel dungeon together, and cooperate to kill monsters, find useful objects, and advance to the next level. As long as one character remains alive, the other reincarnates, so two determined adventurers can charge and blast for hours.

Another high quality sequel is *Fist: The Legend Continues* (Mindscape). UXB has transferred the concepts introduced in *Way of the Exploding Fist* (Spinnaker) to an adventure game setting. This makes *Fist: The Legend Continues* much more involving than the typical hand-to-hand combat program.

Beautiful fine-line graphics are the greatest attraction of *Starglider* (Rainbird/Firebird Licensees). But this lovely flying and shooting contest is more than empty calories. The action is varied and exciting as the computerist commands the graceful ship against a universe of foes.

**Action-Strategy**

Up to about four years ago, most computer games employed keyboard input. These days, many strategy games utilize joystick-activated command control to increase player interaction and involvement.

Another part of the appeal of action-strategy programs is that they test the ability to think fast. Time pressure can boost the excitement level of an action-strategy game almost as high as a pure action contest.

*Aliens* (Activision), based on the science fiction film, captures the essence of the action-strategy category. Con-

frontations with the marauding creatures are arcadelike sequences, but winning requires the computerist to skillfully deploy crew members to meet



**Aliens: out of this world action.**  
**READER SERVICE NO. 222**



**Aliens contains arcadelike sequences, but winning requires strategy.**

the constant threats from the dreaded aliens.

*Rocky Horror Show* (Activision), based on the cult classic film and stage play, gives the player the chance to do more than just wear a costume and shout lines at an uncaring movie screen. In truth, *Rocky Horror Show* could be called a graphics adventure with equal justice, because the player really gets into the bizarre world of Dr. Frankenfurter, Magenta, and the rest. We placed it here because it empha-



**A toast to the Rocky Horror Show.**  
**READER SERVICE NO. 223**

sizes movement around the mansion and avoidance of contact with computer-controlled objects as well as puzzle-solving.

*Monster Movie* (Epyx) allows the computerist to take the role of one of several different movie menaces and ravage various world capitals. The cities, depicted in two-thirds perspective, make enticing targets, and the game's movie theater framing device puts players in the proper frame of mind for all the monster mayhem.

*Auto Duel* (Origin Systems) blends menu-activated adventuring with real-time vehicular combat. The non-elec-

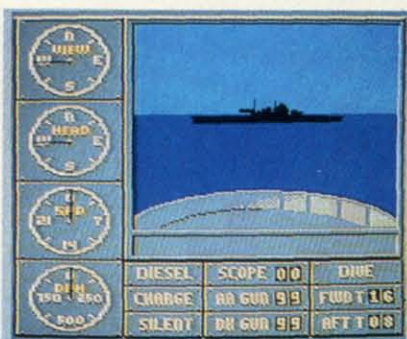

**Sub Battle Simulator: lots of detail.**  
**READER SERVICE NO. 224**

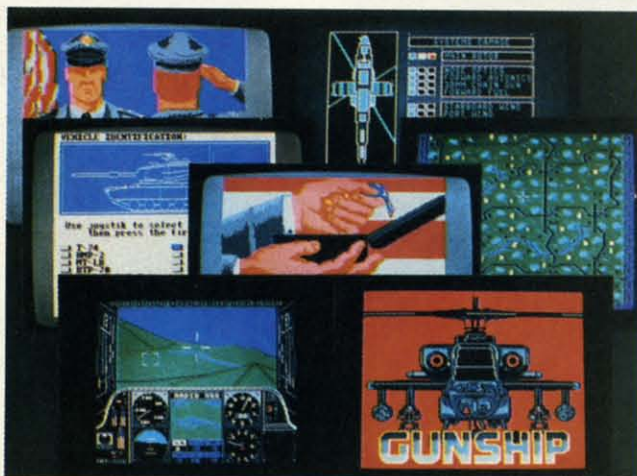

**The Gunship flight simulator from MicroProse puts the player at the controls of a modern combat helicopter. Detailed first-person graphics provide an exciting view of the action.**  
**READER SERVICE NO. 225**

tronic "Car Wars," on which *Auto Duel* is based, is a straight strategy contest, but the addition of action elements makes the electronic version much more immediate and exciting.

*Into the Eagle's Nest* (Mindscape) is a distant cousin of the venerable *Castle Wolfenstein*. The player uses the joystick to control a heroic commando who must infiltrate a four-story stronghold to accomplish a series of risky missions. *Into the Eagle's Nest* has enough shooting to wear out any trigger finger, but the action is far from mindless. Each of the enemy positions is a tactical problem which the commando must handle before German guns put a period to his exploits.

Computerized simulators are the most sophisticated action-strategy games for the home computer. This type of program is still gaining popularity, and there were at least three great ones produced last year.

*Gato* (Spectrum Holobyte) and *Sub Battle Simulator* (Epyx) concern undersea warfare, while *Gunship* (MicroProse) is the first comprehensive helicopter combat program. All sport good graphics, extensive documentation, and plenty of realistic detail.

**Looking Forward**

Development of new entertainment software for the Commodore rebounded as predicted a year ago. Now the big question is: Will the resurgence continue in 1988?

It is always tempting to forecast a boom, because it makes everyone happy. It would be overly optimistic, however, to predict that Commodore 64 entertainment will ever again equal 1985's output in quantity. The higher memory systems are here, and they will gain increasing acceptance through the end of this decade.

On the other hand, the Commodore 64/128 has not disappeared, and hardware is still selling well. Software publishers won't abandon Commodore owners as long as they represent such a huge potential sale. So, though quantity won't set records in 1988, there won't be any shortage of new products either. And with design and programming techniques still marching forward, it is likely that these new programs will keep gamers playing happily during the next 12 months. □





# BANK CARDS SAME AS CASH

## WHAT AB SWITCHES DO

AB switches allow the user to share equipment rather than buy costly duplication. Many configurations may be arranged, two computers to one disk drive and printer, or two printers to one computer etc. In our office we share a printer between a PC clone and a C128 via a parallel switch. No need to ever plug and unplug cables again, just turn a knob to switch from one peripheral to another. Below are the types we have in stock, remember if you need extra cables, we carry a large selection to meet your needs.

**\$ SAVER AB \$29.95**  
VIC-20, C16, Plus 4, C-64, OR C128 compatible. Three female 6 pin sockets, rotary switch, all metal case.

**SUPER SAVER ABCD NEW LOW PRICE \$49.95**  
VIC-20, C16, Plus 4, C-64, OR C128 compatible. Four computers to one printer and or disk drive. Five female 6 pin sockets, rotary switch.

**PARALLEL or SERIAL AB NOW ONLY \$29.95**

All pins switched, 3 female sockets, all gold pins for reliable contact, high quality rotary switch, heavy-duty metal case. Built to last for many years of dependable use. Parallel = 36 pins, serial = 25 pins.

**PARALLEL or SERIAL ABCD NOW ONLY \$39.95**

All pins switched. Has five female sockets, all gold pins, guarantees positive contact, rotary switch, all metal case. Parallel = 36 pins, serial = 25 pins.

**PARALLEL CROSSOVER Aa X Bb NEW \$44.95**

All pins switched. Four female sockets, all gold pins, rotary switch, sturdy metal case. Two computers share two printers, either computer can access printer A or B.

## CABLES NEW LOW PRICES

Drive/printer, 6 ft. 6 pin male/male	B66	\$ 5.95
Drive/printer, 9 ft. 6 pin male/male	B69	\$ 7.95
Drive/printer, 18 ft. 6 pin male/male	B618	\$12.95
Driver/printer, 6 ft. 6 pin male/fem.	A66	\$ 5.95
Monitor, 6 ft. 5 pin to 4 RCA plugs	M654	\$ 6.95
Monitor, 6 ft. 5 pin to 2 RCA plugs	M652	\$ 4.95
Monitor ext., 6 ft. 5 pin male/female	ME65	\$ 5.95
Joystick extension 12 ft. male/fem.	JS12	\$ 4.95
Joystick Y, increase, 1 fem./2 male	JSY	\$ 7.95
Joystick Y, reducer, 1 male/2 fem.	RJSY	\$ 3.95
Power disk/print male/right ang. male	PR6	\$ 6.95
Parallel, 6 ft., male to male	C6MM	\$ 9.95
Parallel, 10 ft., male to male	C10MM	\$12.95
Parallel, 20 ft., male to male	C20MM	\$19.95
Parallel, 6 ft., male to female	C6MF	\$12.95
Parallel, 10 ft., male to female	C10MF	\$16.95
Serial, 6 ft., male to male	R6MM	\$ 9.95
Serial, 6 ft., male to female	R6MF	\$ 9.95
IBM printer, 6 ft., male/male	IBP6	\$ 9.95
IBM printer, 10 ft., male/male	IBP10	\$12.95
IBM printer, 20 ft., male/male	IBP20	\$19.95
Gender change, parallel, male/male	CGMM	\$ 9.95
Gender change, parallel, fem./fem.	CGFF	\$ 9.95
Gender change, serial, male/male	RGMM	\$ 7.95
Gender change, serial, fem./fem.	RGFF	\$ 7.95

**INFORMATION:** For technical information or Oregon buyers phone: 503-246-0924.

**TO ORDER BY MAIL:** We accept VISA, MASTER CARD, money orders, certified, and personal checks. Allow 21 days for personal checks to clear.

**SHIPPING:** Add \$3.00 per order, power supplies \$4.00, power center \$5.00, \$3.00 service charge on all COD orders (no personal checks).

Foreign orders twice U.S. shipping charges. All payment must be in U.S. funds.

**TERMS:** All in stock items shipped within 48 hours of order. No sales tax or surcharge for credit cards. We cannot guarantee compatibility. All sales are final. Defective items replaced or repaired at our discretion. Return authorization required. Prices and items subject to change without notice.

**VALUE SOFT INC**  
3641 S.W. Evelyn  
Portland, OR 97219



## TURBO 2000 PC/XT SYSTEM

# \$595

- IBM PC XT Compatibility
- Phoenix BIOS
- 4.77/8 MHz Keyboard Select
- 640K RAM installed
- 8 Expansion Slots
- 150W Power Supply
- XT Slide Out Case & Speaker
- 360KB 5 1/4 Floppy Drive
- AT Style Keyboard
- TTL Mono/Hercules Graphics
- FCC Class B Certified
- Parallel & Serial Ports
- Operation Manuals
- 6 Month Limited Warranty

Plus \$10.00 shipping

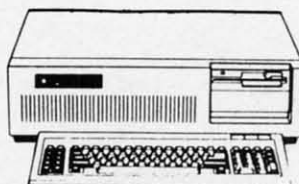

MS DOS 3.2 & GW BASIC \$84.95

## DUST COVERS

- C64/VIC20 or 1541 drive, anti static \$ 5.95
- Buy one of ea. SAVE \$1.41 C64 set \$10.49
- C128 or 1571 drive, anti static \$ 7.95
- Buy one of ea. SAVE \$1.41 C128 \$14.49

## PRINTER BUFFER

parallel \$69.95

## POWER SUPPLIES

- MAXTRON C-64, dependable heavy duty replacement. Output: 5V DC, 1.7A, 9V AC, 1.0A. UL Approved. 90 day warranty \$29.95**
- PHOENIX C-64, fused, repairable, all metal case. Output: 5V DC, 1.7A, 10V AC, 1.0A. UL approved. 1 year warranty \$39.95**
- PHOENIX C-128, fused, repairable, all metal case, 3 sockets, spike protection, EMI RFI filtering, lighted switch. Output: 5V DC, 6.0A, 10V AC, 2.0A. UL approved. 1 year warranty \$59.95**

## COOLING FAN \$29.95

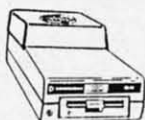

Heat is a #1 enemy to your disk drive. Reduce bad loads and costly repair bills with a fan, keep your 1541 or 1571 cool. Quiet, surge and spike protection, EMI filtering

## JOYSTICKS

- Slik Stik \$ 6.95
- Puts Stik \$ 7.95
- WICO Black Max \$11.95
- TAC 5 \$14.95
- EPYX 500XJ \$15.95

## POWER CENTER

was \$59.95

The POWER CENTER provides individual control of up to 5 components plus master on or off switch.

NEW LOW PRICE \$49.95

System protection: EMI/RFI filtering, surge and spike protection, 15 AMP breaker, heavy duty cable, 3 prong plug. Lighted rocker switches, all steel case, size: 1 3/4 H x 12 1/4 D x 15 W.

## INKWELL SYSTEMS

- Flexidraw \$84.95
- Flexifont \$24.95
- Graphics Int. II \$24.95
- Clip Art II \$19.95
- Holiday Theme \$19.95

## INTERFACES

- MODEM RS-232 INTERFACE, \$29.95
- Use standard Hayes compatible RS-232 modems with VIC-20, C-64, C-128.
- DELUX RS232C INT., Omntronix \$39.95
- Use standard Hayes compatible with the C64, C128, C64, SX64, VIC20
- HOT SHOT, printer \$49.95
- Cardco G-WIZ printer \$39.95
- Cardco Super G printer \$49.95
- PPI printer interface \$44.95
- XETEC Super Graphics printer \$54.95
- XETEC Super Graphics Jr. printer \$34.95

## APROSPAND

64 \$29.95



plugs into the cartridge port, has 4 switchable slots, fuse protected and a reset button.

## 12 PLUS \$19.95

12 in. cartridge port extension cable. Move boards and cartridges to the side of your computer. In stock.

## JOYSTICK REDUCER \$3.95

Every once in a while, our buyers find one of those odd gadgets they just can't resist. The Joy Stick Reducer is odd and low-priced. It allows one joystick to be plugged into both ports at the same time. I know you are saying, what's it good for. Stop and think, how many times have you had to try both ports before finding the right one?

## "THE STRIPPER" \$14.95

The "Stripper" removes perforated edges from print-outs. Insert 1 to 20 sheets, presto edges are gone. Clean, quick



## MODEMS, 1200 Baud

- Aprotek 12C, C64, C128, compatible \$ 99.95
- Aprotek 12AM, AMIGA compatible \$119.95
- Avatex 1200 \$ 99.95
- Avatex 1200HC, Hayes compatible \$119.95

## 40/80 COL. CABLE \$19.95

One cable for both 40 or 80 columns on the C128. Flip a switch to change modes. Plugs to the back of the monitor for a sharp display. 16 colors in 40 column, black and white in 80. Not for RGB monitors or television sets.

## DISK DOUBLER \$6.95

The original! All metal. Cuts an exact square notch in the disk. Same spot every time!



## READY RESET 64 NEW \$11.95

A reset button that you place where you want, not some out of the way place. Plugs into the serial port (of course the port is replaced for your disk drive), the button is on the end of a 15 inch cable.

## BLASTER C64, C128 \$5.95

Add automatic firepower to your games, plug-in module that makes the fire button of your joystick have machine gun action. Adjustable speed control.

## EQUIPMENT STANDS

- CURTIS printer stand with paper catcher \$18.95
- JASCO heavy duty wire printer stand \$12.95
- PC CPU stand, adjustable, plastic \$14.95
- Monitor, adjustable tilt and swivel stand \$14.95

## LIGHT PENS and MICE

- Logitech Mouse C-7 (PC compatible) \$89.95
- Optical Mouse (Microsoft PC compatible) \$79.95
- American Mouse House \$ 6.95
- American Mouse Mat \$ 7.95
- Light Pen by Tech Sketch C64/C128 \$44.95
- Touch Point Graphics Tablet C64/C128 \$29.95

## BLACK BOOK OF C128 \$15.95

The best friend a C128 user ever had. Includes C-64, C128, CPM, 1541, 1571. 261 pages of easy to find information. 75 easy to read charts and tables. The Black Book of C128 is very much like a dictionary, always ready to answer your questions.

## PROTECTION REVEALED C 64 \$15.95

A beginners guide to software protection. Written to give you a fundamental understanding of a disk and BASIC protection. Identify what you are seeing when examining a disk. Become a master of illusion. Reveals countless tricks and tips that mystify the user. The book is 141 pages and includes a free disk of 21 utility programs.

## SAM'S BOOKS

- C64 Troubleshooting & Repair Guide \$19.95
- 1541 Troubleshooting & Repair Guide \$19.95
- Computer facts VIC-20 \$19.95
- Computer facts C-64 \$19.95
- Computer facts C-128 \$19.95
- Computer facts 1541 \$19.95
- Computer facts 1571 \$19.95

## "TOUCH ME BUTTON" \$9.95

Static can KILL your COMPUTER and your PROGRAMS. Touch Me rids your system of harmful static like MAGIC before you touch your computer peripherals or other devices. The controlled electrical resistance of Touch Me, drains static charges harmlessly away to ground at low energy levels. Touch Me can add years of life to your equipment.

## GROUND FAULT IND. \$5.95

Computer equipment is very sensitive to ungrounded household wiring. Disk drives have a bizarre way of mixing up data. The Ground Fault Indicator tells you if your outlet is properly grounded.

## MISCELLANEOUS

- CARDSCO numeric keypad \$47.95
- Disk Sleeves, white tyvek, 100 pack \$ 7.95
- Write protect tabs, silver, 100 pack \$ 1.49
- Floppy wallet, 3 1/2 in., holds 15 \$ 9.95
- Floppy wallet, 5 1/4 in., holds 15 \$12.95
- Disk pages, 2 pocket, 3 hole, 10 pack \$ 6.95

# CALL TOLL FREE 1-800-544-SOFT



# TIPS AHOY!

Compiled by Michael R. Davila

Contributors to *Tips Ahoy!* will be compensated at highly competitive industry rates immediately upon acceptance. Send your best programming and hardware hints to *Tips Ahoy!*, c/o Ion International Inc., 45 West 34th Street—Suite 500, New York, NY 10001. You must include a stamped and self-addressed envelope if you want your submissions returned.

## USE A THREE—SAVE A TREE

The program below illustrates how to achieve paperless debugging by opening output to device 3 (the screen). The program prints 10 address labels spaced for tractor-fed gummed labels. After modification of the program to suit your needs, test with screen output until everything is perfect. Next change D=3 to D=4 in line 10 for a painless conversion to printer output. This technique is ideal with the C-128 80 column screen; however, it also works on the 64 and most other Commodore computers. This method also allows testing disk output onscreen, then changing D=3 to D=8 after debugging.

—Jim Frost  
La Mesa, CA

```
•10 D=3:OPEN1,D:REM FOR PRINTER D=4
•20 SP$="[3" " ]":REM ADJUST TO FIT LABEL
S
•30 PRINT#1
•40 REM CENTER TEXT ON LABEL
•50 PRINT#1,SP$"AHOY!"
•60 PRINT#1,SP$"45 WEST 34TH ST SUITE 500
"
•70 PRINT#1,SP$"NEW YORK, NY"
•80 PRINT#1,SP$"1[3"0"]1"
•90 PRINT#1
•100 I=I+1:IFI<10 THEN30
•110 CLOSE1
```

## FLIP FLOP

Here's one more way to add some excitement to those monotonous GET and WAIT statements. *Flip Flop* turns your screen inside out and outside in...flippity flop, floppity flip. It'll add some zing to your screen. It works on both the C-64 and the C-128 with a 40 column display. If you're using a C-128 in 128 mode, be sure to change the variable S in line 63000 to 4864 or some other suitable location.

Add *Flip Flop* to your own programs. Whenever you want the flipping and flopping to begin, have your program SYS 49152 for the C-64 or SYS 4864 for the C-128. For example:

```
100 SYS 49152
```

activates *Flip Flop* until a key is pressed. For the C-128,

```
-100 SYS 4864
```

does it.

On both computers, the value of the keypress is returned in location 254. If your program is using *Flip Flop* instead of a GET statement, a line such as

```
110 PRINT PEEK(254)
```

tells what key was pressed.

You can activate *Flip Flop* in direct mode, too. As a matter of fact, give yourself a demonstration. List a program, then have some fun. SYS 49152 [RETURN] activates the C-64 version. SYS 4864 [RETURN] works the C-128. Press a key to exit. *Flip Flop* waits until everything is back to normal before exiting, so it might take a second or two after the keypress.

*Flip Flop* can be relocated by changing S in line 63000. Remember to SYS to the new location if you do change it.

—Buck Childress  
Salem, OR

```
•63000 S=49152:REM *** CHANGE S TO 4864 F
OR THE C-128 ***
•63002 REM *** S CAN ALSO BE CHANGED TO R
ELOCATE IN BOTH COMPUTERS ***
•63004 FORJ=STOS+92:READA:POKEJ,A:X=X+A:N
EXTJ
•63006 IFX<>14751THENPRINT"ERROR IN DATA[
3"." ]":END
•63008 DATA169,4,162,216,160,0,133,252,13
4,254,132,251
•63010 DATA132,253,169,7,162,219,160,231,
133,100,134,102
•63012 DATA132,99,132,101,160,0,177,99,72
,177,101,72
•63014 DATA177,251,145,99,177,253,145,101
,104,145,253,104
•63016 DATA145,251,162,0,232,208,253,165,
99,208,10,198
•63018 DATA100,198,102,165,100,201,3,240,
16,198,99,198
•63020 DATA101,230,251,230,253,208,205,23
0,252,230,254,208
•63022 DATA199,32,228,255,240,166,133,254
,96
```

## 80 COLUMN TEXT DUMP

Do you ever create a screen in 80 columns that you'd like to print to the printer, but can't? Here is what the doctor prescribed: an 80 column text dump that will work on all Commodore and commercial printers. The program is written entirely in BASIC 7.0, except for a short ML routine found in the *128 Programmer's Reference Guide*. The program only prints a Low-Res Text screen, which includes

# The wait is over... but the excitement has just begun.

**M**ore than two years in the making, *Warriors of Destiny* sets the new standard for role-playing games. No other game can offer you as beautifully detailed a world or as exciting an adventure. *Ultima V* is the game for all role-playing gamers: *Warriors of Destiny* will enchant the novice and challenge the expert.

## Highlights of *Ultima V*

- Powerful new combat and magic systems, increasing in sophistication as your skill increases.
- Over twice the graphic detail, animation and sound effects of earlier games.
- Hundreds of truly life-like people who can carry on complex conversations and interactions with you.

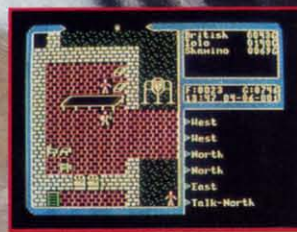
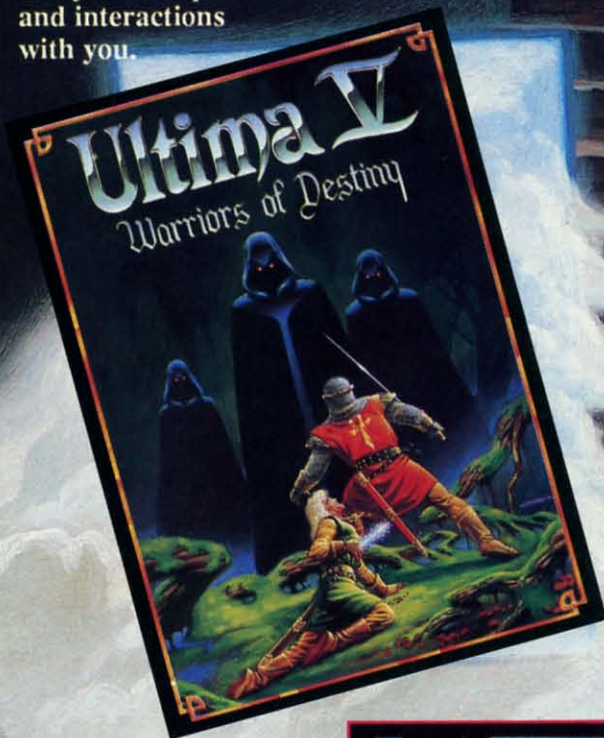

Screen displays shown from the Apple™. Others may vary. Allows the use of *Ultima IV* characters. No previous *Ultima* experience required.

Reader Service No. 240

**ORIGIN**  
SYSTEMS INC.

136 Harvey Road  
Building 'B'  
Londonderry, NH 03053

Available on Apple and Commodore

# THE MONTHLY SOFTWARE COLLECTION FOR COMMODORE® – ONLY \$6.65

## Lots of Great Software Every Month

Loadstar™ is a collection of exciting new Commodore programs, published monthly on 5¼-inch diskettes. Disk issues contain quality, ready-to-run Commodore 64 and 128 software: home and business, education, music, graphics, animation, utilities, tutorials, games, and bonus programs from popular software developers.

Loadstar provides an endless number of things to do with your Commodore. Subscribers enjoy more than a hundred programs every year for pennies each, including C-64 and C-128 programs from **Commodore Magazine**. At only \$6.65 per issue, Loadstar is your best software value.

## The Best of Loadstar Yours FREE

Loadstar will deliver three months of software, for a total of \$19.95. That's only \$6.65 per month. Order now and we will include The Best of Loadstar #3 absolutely FREE! The Best of Loadstar #3 is a double-sided disk filled with the finest programs published in Loadstar issues. You can't lose.

## Satisfaction Guaranteed

As a Loadstar subscriber, you will get software variety to make your Commodore investment pay off – plus the convenience of home delivery and our unconditional money-back guarantee. If you are not 100% satisfied with your first issue of Loadstar, you may return it for a full \$19.95 refund. The Best of Loadstar is yours to keep.

Available at Waldenbooks, B. Dalton Booksellers, and fine bookstores everywhere (cover price \$9.95). Apple and IBM PC versions also available.



## Commodore Microcomputers

Review by Steve Levin

"... I highly recommend Loadstar. If you can afford only one disk service, make it Loadstar..."

## Loadstar Subscribers Say...

"Loadstar contains a variety of programs that are usually not available anywhere else. The format is great!"

"Being user-friendly is a big plus for LOADSTAR, and what a value!"

"I have recommended LOADSTAR to my friends and they love it."

Every issue of Loadstar contains ready-to-run software for everyone in the family. For example, Loadstar Issue #40 is contained on two disks and features all of the following programs:

- All Smiles • Ohms Law • Farmer's Market
- Error Aid • Pixel Puzzler • Dugan's Art Depot
- Print Shop Composite • Beginning Bytes
- Byte by Byte • Bit by Bit • Lullaby
- Gensprite • Seq Edit • Join Four • Big League
- Matches • Math Help • Window Demo 128
- Auto-Answer Disabler • Sound Synthesizer
- plus the complete arcade game Pensate from Penguin/Polarware, and regular monthly features

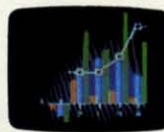

**3-Month Trial Subscription plus FREE Best of Loadstar Disk #3**

Order your 3-month Loadstar trial subscription today for just \$19.95 postage-paid. Act now and we will include our latest Best of Loadstar disk ABSOLUTELY FREE with your first issue.

CALL TOLL FREE AND ORDER NOW

**1-800-831-2694**

(In Louisiana call 318-221-8718)

**YES!** Please rush The Best of Loadstar disk #3 with the first issue of my 3-month Loadstar trial subscription. Only \$19.95 postage paid! (Overseas \$27.95)

Name \_\_\_\_\_

Address \_\_\_\_\_

City \_\_\_\_\_ State \_\_\_\_\_ Zip \_\_\_\_\_

Daytime Telephone Number (\_\_\_\_) \_\_\_\_\_

Visa  MasterCard  AmEx  Payment enclosed (U.S. funds)

--	--	--	--	--	--	--	--	--	--	--	--	--	--	--	--	--	--	--	--

Signature \_\_\_\_\_ Exp. \_\_\_\_\_

DEPT. AH12  
P.O. BOX 30008  
SHREVEPORT, LA 71130-0008

**LOADSTAR**

Reader Service No. 230

[www.commodore.ca](http://www.commodore.ca)

all the characters, and even the Commodore Low-Res Graphics; and only one mode, Uppercase/Graphics, although you can change OPEN 4,4 (line 9010) to OPEN 4,7 which will print the Upper/Lowercase set.

When entering this program, use it as a subroutine. The first couple of lines demonstrate the program, while the main program is from 9000-9040. When the program is running, press [LINE FEED] to print the screen. Have fun!

—Richard C. Jones  
Throop, PA

```

• 5 FAST
• 10 PRINT"[CLEAR] PRESS [LINE FEED] TO DU
MP SCREEN, ANYTHING ELSE EXITS":SLEEP3
• 15 SCNCLR
• 20 R=0:DO:R=R+1:PRINT"* THIS IS AN 80 CO
LUMN TEXT DUMP DEMO MADE BY RICH JONES U
SING BASIC AND ML. ";:LOOP UNTIL R=25
• 25 GETKEYK$:IF K$=CHR$(10)THEN GOSUB9000
• 30 END
• 8999 END
• 9000 VI=DEC("1800"):VO=DEC("180C"):BANK1
5
• 9005 READA$:DO UNTIL A$="END":POKE VI+I,
DEC(A$):I=I+1:READA$:LOOP
• 9010 OPEN 4,4:R=0:DO:AD=R*80
• 9015 DO:SYS VO,AD/256,18:SYS VO,AD AND 2
55,19:SYS VI,,31
• 9020 RREG A:A=A+((A<32)*-64+(A>95)*-64+(
A>63 AND A<96)*-32)
• 9025 R$=R$+CHR$(A):AD=AD+1:LOOP UNTIL AD

```

```

=R*80+80
• 9030 PRINT#4,R$:R$="":R=R+1:LOOP UNTIL R
=25:CLOSE4:RETURN
• 9035 DATA 8E,00,D6,2C,00,D6,10,FB,AD,01,
D6,60
• 9040 DATA 8E,00,D6,2C,00,D6,10,FB,8D,01,
D6,60,END

```

### INPUT ROUTINE

I have noticed that in many computer magazines readers have needed a controlled input routine. I have used this routine on several computers over the years. This version of the routine was written for a Commodore 64, but it would not be very difficult to modify it to another computer's BASIC.

—Michael D. Stemle  
Mansfield, OH

```

• 10 PRINT"[CLEAR]PLEASE SEE DOCUMENTAION"
• 20 PRINT"IN MAGAZINE."
• 30 END
• 1000 REM -----
• 1010 REM SET V TO THE MAX NO. CHARS
• 1020 REM TO BE ALLOWED TO BE INPUT
• 1030 REM
• 1040 REM V$ WILL CONTAIN THE TEXT
• 1050 REM ENTERED
• 1060 REM -----
• 1070 V$="":B$=CHR$(157)+" "+CHR$(157)
• 1080 GET A$:IF A$="" THEN 1080
• 1090 A=ASC(A$):IF A=13 THEN RETURN
• 1100 IF A<>20 THEN 1130

```



**ALSOFT**  
**RACE ANALYSIS SYSTEMS III**

**30 DAY MONEY BACK GUARANTEE**

Race Analysis Systems III is part of The Alsoft Team of exceptional handicapping software. To Order: Ask your local retailer or call (412) 233-4659 for MasterCard & Visa orders. To order by mail send check or money order to ALSOFT, 305 Large Avenue, Clairton, PA 15025. Price includes shipping. All Orders are shipped within 24 hours of receipt.

Reader Service No. 229

**AHOY! 49**

# Label Maker™

Includes  
500  
Labels

**NEW!!** PRINT LABELS FROM  
YOUR COMMODORE 64

**Label Maker™** - A program designed specifically for making labels. No need to get out the ruler - Label Maker does it all for you with pre-designed layouts for: Standard - Envelopes - Audio Cassette - File Folder - Floppy Disk & 5 more and YES we also sell the labels.

Includes a "what-you-see-is-what-you-get" screen display, edit, "freeze" areas, set a printing increment counter, and print as many copies as you need.

Plus a built-in **Database Merge Utility** gives you complete control with files from your database or word processor.

**EASILY MERGE DATA FROM:**

- Consultant
- Data Manager 2
- Data Manager 128
- Easy Script
- Fleet Filer
- Fleet System
- Paperclip
- Superbase
- & Others

**ONLY \$29.95**  
(include \$4 shipping and handling)

**Cheatsheet Products, Inc.** (412) 781-1551  
P.O. Box 111368 Dept A, Pgh. PA 15238 (800) 334-2896

Reader Service No. 273

## Slimline '64 Case

A NEW IMAGE FOR  
THAT FAVOURITE  
COMPUTER

- Easy to Fit
- Lower key height

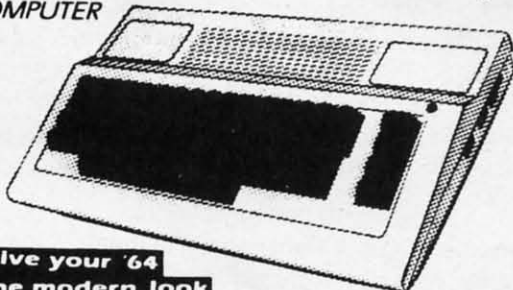

**Give your '64  
the modern look**

Now you can have that sleek new look without buying a new computer. Our replacement case will give your '64 the modern look and color you have been wanting. Installation takes just 10 minutes and requires only a Phillips screwdriver. So don't be stuck with the old look when the Slimline is here and ready for immediate shipping.

Our price of \$34.95 includes handling charges. Certified checks or postal money orders will be shipped on receipt. Personal checks must be held for 4 weeks pending bank clearance. Sorry, no COD's. Charge cards can order by calling (902) 892-6372.

**GDP**  
Grapevine Data Products

P O BOX 1886  
Charlottetown PEI  
Canada C1A 7N5

Reader Service No. 274

50 AHoy!

- 1110 IF LEN(V\$)>0 THEN V\$=LEFT\$(V\$,LEN(V\$)-1):PRINT B\$;
- 1120 GOTO 1080
- 1130 IF (A<32) OR ((A>127) AND (A<160)) OR (A>255) THEN 1080
- 1140 IF LEN(V\$)=>V THEN 1080
- 1150 V\$=V\$+A\$:PRINT A\$;
- 1160 IF A=34 THEN POKE 212,0
- 1170 GOTO 1080

### PULSATOR

*Pulsator* for the C-64 creates a pulsating effect with the high resolution screen located at 8192/\$2000.

There are two modes to this program. When you use the fade out feature, your hi-res screen will fade out until the screen is blank. It is stored in memory starting at 32768/\$8000. To fade in the screen, use the number one after the SYS command and comma. The following line creates a pulsating effect:

```
10 FORI=0TO1:SYS your starting address,I
:NEXTI:GOTO10
```

I designed two modes to let you design your own introductions to your hi-res screens. For example, if you load your screen into 32768/\$8000, you can use the fade in feature to display this screen. Then, while the screen is being displayed, you can load another one into memory and display it. This could be useful for a slide show effect.

*Note:* This program does not enable the high resolution mode for you.

-Michael Jaecks  
Alamogordo, NM

- 10 REM PULSATOR BY MICHAEL JAECKS
- 20 S=49152:REM CHANGE TO RELOCATE ML
- 30 FOR I=0TO107:READA:POKES+I,A:B=B+A:NEXTI
- 40 IFB<>15963THENPRINT"ERROR IN DATA!":END
- 50 HI=INT((S+99)/256):POKES+36,S+99-HI\*256:POKES+37,HI
- 60 HI=INT((S+107)/256):POKES+69,S+107-HI\*256:POKES+70,HI
- 70 PRINT:PRINT"SYNTAX: ";S;CHR\$(157);",0=FADE OUT OR 1=FADE IN"
- 80 PRINT"SPEED: POKE";S+107;CHR\$(157);",0-255 (INITIALLY 10)"
- 100 DATA 32,155,183,134,254,162,0,169,0
- 110 DATA 133,250,133,252,138,72,162,32
- 120 DATA 160,128,165,254,208,6,134,251
- 130 DATA 132,253,240,4,134,253,132,251
- 140 DATA 104,170,188,99,192,169,64,197
- 150 DATA 250,208,10,169,63,197,251,240
- 160 DATA 43,197,253,240,39,177,250,145
- 170 DATA 252,165,254,208,4,169,0,145
- 180 DATA 250,138,72,174,107,192,202,208
- 190 DATA 253,104,170,165,250,24,105,8
- 200 DATA 133,250,133,252,144,207,230
- 210 DATA 251,230,253,208,201,232,224,8
- 220 DATA 208,165,96,0,4,2,6,1,5,3,7,10

**ALL NEW**

## Kracker Jax

**THE REVOLUTIONARY ARCHIVAL SYSTEM!**

**Kracker Jax** is the powerful parameter-based copying system that has taken the country by storm! What IS a parameter? It's a custom program that allows your 1541 or 1571 disk drive to strip ALL copy protection from your expensive software, leaving you with UNPROTECTED, TOTALLY BROKEN BACKUPS that can even be copied with a simple last copier!

We declare **Kracker Jax** to be the best system of its kind on the market today! A bold claim? Maybe.

But don't take our word for it—if you want the REAL story on how good **Kracker Jax** is, just ask one of our customers. Don't worry. You won't have any problem finding one.

■ Easy to use—no special knowledge is required! ■ Powerful—will easily back up titles that nibblers can't! ■ Superfast—strips protection in a matter of seconds! ■ Great value—each volume has approx. 100 parameters! ■ Current—new **Kracker Jax** volumes released quarterly!

**ALL NEW VOLUME SEVEN IS NOW AVAILABLE—ORDER TODAY!**

**Kracker Jax Volumes 1-6 are still available.**  
All **Kracker Jax** Volumes are **\$19.95** each.

## Hacker's Utility Kit

**USE THE SAME TOOLS THAT THE EXPERTS USE!**

Are you ready to take control of your software? Let us help! Our **Hacker's Utility Kit** contains the most impressive array of tools ever assembled in a single package!

Our top **Kracker Jax** programmers put together a "wish list" of tools that they wanted to work with—and then went to work creating the perfect set of utilities. The result: The **Hacker's Utility Kit**. Now YOU can use the same powerful utilities that WE do—at a fraction of their true development costs! Here's what you'll get:

■ **WHOLE DISK SCANNER**—usage, error, density info fast! ■ **GCR EDITOR**—view raw data the way your system sees it! ■ **FAST DATA COPIER**—absolutely will NOT write errors! ■ **1 OR 2 DRIVE NIBBLER**—fast & powerful/state of the art! ■ **FILE TRK/SCTR TRACER**—find any sector link in a file fast! ■ **BYTE PATTERN FINDER**—finds any pattern anywhere! ■ **CUSTOM COPIER CREATOR**—the ONLY one of its kind! ■ **RELOCATABLE M/L MONITORS**—including drive monitor! ■ **FAST FORMATTER**—programmable tracks or whole disk! ■ **DISK FILE LOG**—quickly find file start/end addresses!

Professional mechanics and programmers have one thing in common: they both use the finest tools available. These tools were developed specifically to meet the demanding needs of our **Kracker Jax** programmers. They are utilities created by experts, refined under constant use, and perfected for you.

**Only \$19.95****ALL NEW**

## ELITE V4.0

**OUR POWERFUL UNDERGROUND COPIER SURFACES!**

Find out why our regular customers are able to back-up the toughest protected titles on the market. Previously available only to a selected few, the **ELITE SERIES** has been an affordable way to archive those titles considered "impossible" to back-up.

Introducing **ELITE V4**: A Series of parameters created for those titles that are protected to the **MAX!** If you've been trying to back-up one of your favorite games and had no success, then **ELITE V4** is for you. Also included as a Free Bonus is the **SHOTGUN I**, the First Nibbler of its kind on the market.

Although **ELITE V1** and **ELITE V2** have been discontinued, we are still offering **ELITE V3**. This copier is capable of backing-up one of the toughest copy protections ever created. It will back-up **V2.0** of a popular 64/128 word processor, planner, and filer (64 only).

**ELITE V4.0 with Shotgun I Only \$14.95**  
**ELITE V3.0 Only \$9.95**

**ALL NEW**

## Kracker Jax Revealed: BOOK II

**LEARN ABOUT COPY PROTECTION FROM THE EXPERTS!**

Our knowledge of protection schemes has made us famous. And we can pass that knowledge on to you! **Kracker Jax Revealed: BOOK II** is our latest release in a series of tutorial guides designed to instruct you in the fascinating areas of copy protection schemes and how to defeat them.

**BOOK II** continues the tradition which began with the original: with nothing more than a basic grasp of machine language, you can learn to control some of the newest, most advanced copy protection routines on the market today! Here's what you'll get with **BOOK II**: ■ Detailed info using 20 current new programs as examples! ■ An enhanced, all new utility disk with 20 new parameters! ■ The famous **Rapidlok™** copy system REVEALED! ■ **EXTRA BONUS**—The legendary **Hes Mon™** cartridge!

Don't be intimidated by complex protection routines. Learn how to take control of your expensive software. After all, knowledge IS power.

**BOOK I IS STILL AVAILABLE!**  
**Only \$23.50 each.** Please allow 2 weeks for delivery.

Orders outside of North America must add \$7.50 for shipping!

## The C128 Cannon

**IT'S JUST WHAT YOU'VE BEEN WAITING FOR!**

Here's the package that you C128 owners have been waiting for! The **C128 CANNON** gives you more power than you ever hoped for! Just look at some of these utilities:

■ **NIBBLER**—Works with single or dual 1571/1541 drives!  
■ **FAST COPIER**—Use for data disks or **Kracker Jax!**  
■ **FILE COPIER**—Easy file maintenance and manipulation!  
■ **1581 FAST COPIER**—81 to 81, 8 to 8, or 8 to 9. ■ **1581 FILE COPIER**—For high speed file manipulation! ■ **MFM COPIER**—Copies unprotected IBM & CP/M disks!  
■ **T/S EDITOR**—Works with 1541, 1571, and new 1581 drives!  
■ **ERROR SCANNER**—Complete with on-screen display!  
■ **DENSITY SCANNER**—Find altered densities track by track!  
■ **DIRECTORY EDITOR**—Alter & organize disk directories!  
■ **KRACKER JAX BONUS**—100 of our hottest parameters!

You've seen nibblers alone that sell for thirty-five or forty dollars. And the **100 KRACKER JAX** parameters are a twenty dollar value. Yet the entire **C128 CANNON** package sells for just \$34.95. Never before has this much power been integrated into a single, affordable product. If you own a C128, you don't need to feel left out in the cold anymore. Other companies may ignore you, but at **KRACKER JAX**, we know a powerful machine when we see one.

Let US show YOU just how powerful your C128 really is. Order your **C128 CANNON** today!

**Only \$34.95**  
**1581 Disk Version Available**



## Shotgun II

**ALL NEW****THE DOUBLE BARRELED NIBBLER IMPROVED!**

We've taken The **Shotgun**, our popular nibbler, and completely rewritten it to provide more power, more speed, and even more features than before! The result is **Shotgun II**, the new standard in high powered nibblers.

■ Capable of making copies using one or two drives!  
■ **Shotgun II** can easily copy data clear out to track 40!  
■ Auto density detection can easily be toggled on or off!  
■ The single drive copier has an on screen GCR display!  
■ Allows you to list directories from either disk drive!  
■ Superfast new "True Dual" two drive copier mode!  
■ Capable of copying **Rapidlok™** programs automatically!

And here's the good part: we've increased the performance WITHOUT increasing the price! Like the original, **Shotgun II** is available in either of two formats: 1) The **Shotgun II**, which is the utility described above. 2) The Loaded **Shotgun II**, which is the same utility packaged along with 32 of the hottest **Kracker Jax** parameters ever produced! And if you already own the original **Shotgun**, just send us your disk along with \$9.95 for **Shotgun II**.

Either way you order it, **Shotgun II** will do the job for you!

**The Shotgun II: Only \$14.95**  
**The Loaded Shotgun II:**  
**Only \$19.95**

## The Bull's-Eye

**SO GOOD, EVEN WE CAN'T BELIEVE IT!**

**Rapidlok™**. It's one of the toughest copy protection routines on the market today, and it's being used by several major software houses to copy-prohibit some of the finest titles available for the C64.

Now, you could go broke buying expensive "official" backups of programs you've already paid for. Or, you can exercise your legitimate right to make your own backups. No special knowledge or experience is required. All you need are a few blank disks and five minutes of time. **Bull's-Eye** lets you create your own custom **Rapidlok™** copiers to backup your expensive software!

We've included several custom **Rapidlok™** copiers that we created ourselves, just to get you started. **Bull's-Eye** also features a powerful new GCR nibbler developed specifically for this system!

And if all that isn't enough, **Bull's-Eye** also contains a revolutionary new copy system for **GEOST™**! It is the first copy system to be used exclusively within the **GEOST™** environment. Fully icon driven, it runs directly from the **GEOST™** desktop! And our utility doesn't just standardize **GEOST™** programs, it actually neutralizes them: your **GEOST™** programs are completely unprotected!

We've taken careful aim at your archival needs and hit the target dead center—right in the **Bull's-Eye!**

**Only \$19.95**

GEOST™ is a registered trademark of Berkeley Softworks,™

**COMPUTER MART**

Need more info? Call or write for our free catalog

Program submissions wanted!  
Good Commissions—  
National Marketing.**CHECKS, MONEY ORDERS OR VISA/MC/DISCOVER**

Mail your order to: Computer Mart

2700 NE Andresen Road/Vancouver, WA 98661

Phone orders welcome: 206-695-1393

Same day shipping/No C.O.D. orders outside U.S.



**PLEASE NOTE: Free shipping & handling on all orders • C.O.D. add \$4.00 to total order • All orders must be paid in U.S. funds.**  
Washington residents add 7.30% sales tax to order. Orders outside of North America add \$4.00 per software selection and \$7.50 per book or hardware.

**DEALERS—WE HAVE THE SUPPORT YOU'RE LOOKING FOR!**

# "SOMETHING TO BYTE INTO"

## ABACUS

Basic 128	\$38.95
Basic 64	25.75
Cadpak 128	38.95
Cadpak 64	25.95
Chartpak 128	25.95
Chartpak 64	25.95
Cobol 64	25.95
Cobol 128	37.95
Speed Term	25.95
Super C Compiler 64/128	38.95
Super Pascal	48.95

## BRODERBUND

Where in the USA is Carmen Dandiago	\$25.95
Where in the World is Carmen Sandiago	21.95
P/S Library 1-2-3 ea.	15.95
Print Shop	26.95
Print Shop Companion	21.95
Toy Shop	39.95
P/S Holiday Library	15.95

## MICROLEAGUE

Box Score/Stat Compiler	\$16.95
General Manager Disk	24.95
Micro League Baseball	24.95
Team Disks	16.95

## RIBBON

(Min. 6 per order)

Axiom Elite 5 LCD	\$ 5.95
Brother 15, 25, 35	5.95
Commodore 1525	6.95
Commodore 1526	6.95
Epson 185	6.95
Epson 85	4.95
Epson mx, fx, rx 100	6.95
Epson mx, fx, rx 80	4.95
Gorilla Banana	6.95
Juki 6000	4.95
Juki 6100	3.95
Legend 880, 1080, 808	6.95
MPS 801	6.95
MPS 803	6.95
OKI 182, 192	7.95
OKI 82, 92, 83, 93	2.25
SG 10-15	2.25
Panasonic 1081, 1091	8.95

## DATAEAST

Express Raiders	\$22.95
Commando	21.95
Karate Champ	21.95
Kung Fu Master	21.95
Tag Team Wrestling	21.95

## GAMESTAR

Baseball	\$21.95
Basketball 2 on 2	21.95
Football	21.95

## TIMeworks

Data Manager 128	\$42.95
Data Manager II	29.95
Partner 128	42.95
Swift Calc 128 w/Sideways	42.95
Swift Calc 64 w/Sideways	29.95
Word Writer 128 w/Speller	42.95
Word Writer 3 w/Speller	29.95
Partner 641	38.95

## MICROPROSE

Conflict in Vietnam	24.95
Crusade in Europe	24.95
F-15 Strike Eagle	21.95
Gunship	21.95
Silent Service	21.95
Top Gunner	18.95

## SPRINGBOARD

Certificate Maker	\$29.95
Clip Art I	20.95
Clip Art II	24.95
Clip Art III	24.95
Newsroom	29.95
Graphic Expander	21.95
Certificate Maker#1	21.95

## ACCESS

Leader Board	\$24.95
L.B. Tournament Disk	14.95
Mach I28	30.95
Mach 5	21.95
10th Frame	24.95
Triple Pack	14.95
World Class Leader Board	25.95

## HOT SELLERS

California Games	\$24.95
Defender of the Crown	21.95
Family Feud	11.95
Ghosts-n-Goblins	19.95
Jeopardy	11.95
Parallax	19.95
Pirates	24.95
Phantasia III	24.95
Rush-n-Attack & Yie Ar Kung Fu	19.95
Star Fleet 1	29.95
Street Sports Baseball	24.95
Strike Force Cobra	13.95
Super Star Ice Hockey	24.95
Tag Team Wrestling	21.95
Uchi Mata	19.95
Wheel of Fortune	11.95
X-15 Alpha Mission	19.95

## DATASOFT

Alternate Reality	\$24.95
Mind Pursuit	18.95
Never Ending Story	18.95
Gunslinger	19.95
221B Baker St	21.95

## NEW NEW NEW

Air Rally	\$19.95
Arctic Antics	15.95
Boulder Dash Cons. Set	15.95
Cholo	15.95
Chuck Yeager Flight Trainer	24.95
Dan Dare	15.95
Delta Patrol	15.95
Druid	15.95
Gauntlet	21.95
GEOS 128	39.95
GEO Calc	31.95
Heartland	15.95
Last Ninja	21.95
Maniac Mansion	21.95
Mini Putt	18.95
Paperboy	21.95

## ACCESSORIES

Infocom Invisiclues	\$ 6.00ea
AICP Disks (12)	7.95
Disk Notcher	5.95
Disk Storage Case (70)	8.95
Drive Cleaner	7.95
Flexidraw Light Pen	74.95
Messenger Modem	35.95
WICO Boss Joystick	11.50
WICO Bat Handle	
Joystick	15.50
WICO Three Way Joystick	18.95
Xetek Graphic Interface	54.95
Xetek Graphic Jr	34.95

## NEW NEW NEW

Rad Warrior	15.95
Revs +	15.95
Sanxion	15.95
Silicon Dreams	15.95
Street Sport Basketball	24.95
Sub Battle	24.95
Test Driver	18.95
Top Fuel Eliminator	18.95
4th & Inches	18.95

## ELA

America's Cup	\$22.95
Artic Fox	22.95
Auto Duel	34.95
Bard's Tale	24.95
Bard's Tale II	27.95
Chessmaster 2000	26.95
Legacy of the Ancients	21.95
Lords of Conquest	24.95
Marble Madness	21.95
Mind Mirror	21.95
Moebius	26.95
Movie Maker	24.95
Murder Party	29.95
Orge	26.95
Quizam	21.95
Scrabble	22.95
Ultima I	28.95
Ultima IV	39.95
Ultimate Wizard	22.95

## MINDSCAPE

Bop and Wrestle	\$18.95
Fairlight	18.95
Fist	19.95
High Roller	18.95
Indoor Sports	18.95
Infiltrator	18.95
Lords of Midnight	17.95

## BERKELEY SOFTWARE

GEOS	\$36.95
GEO File	31.95
GEOS Fontpak 1	18.95
GEOS Desk Pack	22.95
Geodex	24.95
Writer Work Shop	31.95

## AVALON HILL

Superbowl Sunday	\$19.95
S.B. Sunday Stat Compiler	16.95
Team Disk	12.95

## ACCOLADE

Dambusters	\$18.95
Fight Night	18.95
Hard Ball	18.95
Law of the West	18.95
PSI 5 Trading Comp	18.95
Kill Until Dead	18.95
Ace of Aces	18.95
Deceptor	12.95
Comics	18.95

## ACTIVISION

Aliens	\$21.95
Alter Ego	29.95
Cross Country Road Race	19.95
Gamemaker Bundle	34.95
Hacker II	21.95
Labyrinth	21.95
Murder on the Mississippi	21.95
Music Studio	21.95
Rocky Horror Show	18.95
Shanghai	21.95
Tass Times in Tonetown	21.95
Titanic	15.95
Transformers	21.95

## EPYX

Fast Load	\$23.95
World Karate	
Championship Baseball	18.95
World's Greatest Baseball	23.95
Super Cycle	24.95
World Games	24.95
World's Greatest Football	24.95
Movie Monster	24.95
Championship Wrestling	24.95
Destroyer	24.95
Winter Games	23.95

## FIREBIRD

Elite	\$19.95
Colossus Chess-IV	21.95
Music Systems	24.95
Advance Music Systems	49.95
The Pawn	28.95
StarGlider	24.95
Tracker	24.95

## SSI

Battle of Antietam	\$29.95
Carrier Force	36.95
Phantasia II	24.95
Rings of Zelphin	24.95
Wizard's Crown	24.95
Roadwar 2000	24.95

## SUBLOGIC

Flight Sim II	\$34.95
Football	27.95
Jet	27.95
Pure Stat Baseball	34.95
Scenery Disk 1-6 ea	14.95
Stadium Disk (baseball)	14.95
Up Periscope	18.95

# CALL US

# TOLL FREE

## Orders

# 1-800-634-AICP

## Only

**Customer Service**  
**718-351-1864**  
**10AM to 6PM**  
**E.S.T.**



**AMERICAN INTERNATIONAL  
 COMPUTER PRODUCTS**

P.O. Box 13-1861  
 Staten Island, N.Y. 10313-0010

Reader Service No. 255

**ORDER  
 INFO**

In stock items shipped within 24 hours for prepaid orders (cert. Check, visa, mc) C.O.D. Orders accepted, please add \$4.00, must be cash or cert. check ONLY. NYS residents add 8 1/4% sales tax. Advertised prices reflect a 4% discount for cash, credit card add 4%. All orders add \$3.50 shipping and handling within the Continental U.S. Personal checks allow 2 wk. for clearance. Availability and pricing subject to change without notice. Free shipping in Continental U.S. on software orders over \$150.00. DEFECTIVE EXCHANGE ONLY FOR SAME PRODUCT. Restocking fee on unopened no-defective items returned. Returns accepted within 15 days of shipping date only. All returns require Return Authorization numbers. WE DO NOT GUARANTEE COMPATIBILITY.

[www.commodore.ca](http://www.commodore.ca)



## TOPS IN AMIGA ENTERTAINMENT

### A Baker's Dozen of 1987's Best Entertainment Programs

By Arnie Katz and the editors of *Ahoy!*

In its first full year in the marketplace, the Amiga has begun to build up a truly impressive catalogue of entertainment software. Beginning this month and continuing on an annual basis, the editors who cover Amiga entertainment for *Ahoy!* will survey the year's output of games and recreations and pick the best.

There were fewer than half as many new games introduced for the Amiga as for the Commodore 64/128. Fortunately, impressive quality makes the somewhat restricted selections easier to bear.

The judges, as usual, crave the indulgence of those whose favorites didn't quite make our admittedly short list. In a similar vein, regrets are extended to those publishers whose products did not reach our office in time for inclusion in this year's survey of the Amiga entertainment scene. As fans of the old Brooklyn Dodgers shouted each October, "Wait till next year!"

Here, then, are the 13 best Amiga entertainment programs of 1987, presented in alphabetical order:

Chris Crawford's *Balance of Power* (Mindscape) makes such good use of artificial intelligence that it is actually more fun to play against the computer than a human opponent. Players painlessly absorb knowledge about the world political situation while wrestling with the problems of leading the Free World in the nuclear age.

*Chessmaster 2000* (Software Toolworks) really gives the machine's audiovisual capabilities a workout. Move over, *Sargon*; flexibility and ease of use have made *Chessmaster 2000* the new king of the 64-square world.

*Defender of the Crown* (Mindscape) was the first of Master Design Software's Cinemaware line, and many feel

*Top to bottom:*

**Defender of the Crown: finest Amiga sound.**

READER SERVICE NO. 226

**Phantasie III: best in series.**

READER SERVICE NO. 227

**Balance of Power: good use of AI.**

READER SERVICE NO. 228

it is still the best. Lush animated artwork and the best sound yet heard on an Amiga game enrich this adventure set in England in the period after the Norman Conquest.

*Earl Weaver Baseball* (Electronic Arts) is the first statistical baseball simulation written expressly for the Amiga. This hardball title, which can also be played as an action contest, is loaded with extra features. For example, a manager who can't figure out what to do next can ask Weaver for advice!

*Flight Simulator I* (SubLOGIC) is a classic computer simulator that has never looked or played better. The scenery, in particular, benefits greatly from the Amiga's astounding graphics. Designer Bruce Artwick's flight simulator is deservedly one of the best selling games of all time.

*Marble Madness* (Electronic Arts) is a faithful home version of the coin-op

#### Featured This Month:

Tops in Amiga Entertainment...53

A20 Hard Disk Drive.....54

hit. The sound and graphics are the best found in any Amiga action game.

*The Pawn* (Rainbird/Firebird Licenses) introduced a superb parser which understands more words and context than any other rival systems. Exceptional artwork, accessed through pull-down windows, adds visual excitement to this text-based tale of Kerovnia.

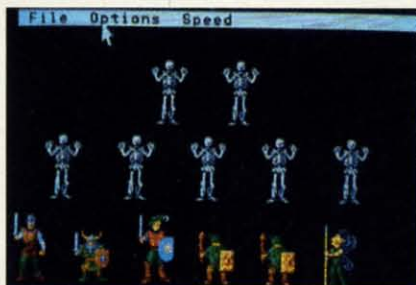

The third title in Doug Wood's graphics adventure trilogy, *Phantasie III: Wrath of Nikademis* (Strategic Sim-

Re-ink ANY FABRIC RIBBON  
**automatically** for LESS THAN  
 5 CENTS with  
**MAC INKER™**



Over 11,000  
 cartridges and  
 spools  
 supported!

**MAC INKER**

- IMAGEWRITER I AND II \$42.00
- UNIVERSAL (cartridge or spool) \$68.50
- MULTICOLOR IMAGEWRITER \$80.00
- MULTICOLOR ADAPTER ONLY \$40.00
- Shipping (first unit) \$3.00

■ **Lubricated DM INK EXTENDS PRINT-HEAD LIFE!** Black, blue, brown, red, green, yellow, purple, orange - 2 oz. bottle \$3.00; pint \$18.50. Gold, silver, indelible and OCR inks available. Heat transfer MacInkers and ink available plus a complete range of accessories for special applications.

■ Top quality, GUARANTEED, double density ribbon cartridges and reloads available.

■ DEDICATED MACINKERS AVAILABLE FOR EXTRA LARGE OR SPECIAL CARTRIDGES.

**MERCURY MODEM**

**\$149.00**

Shipping \$4.00



\*100% Hayes™ compatible! ■ 24 month warranty. ■ Status lights. ■ Speaker. ■ 300/1200 baud. ■ Call progress detection.

Quick Link communications software:

- MS DOS and Macintosh \$29.95
- with modem \$15.00
- Cable \$15.00

\*Hayes is a trademark of Hayes Microproducts.

**A BUFFER AND A DATA SWITCH!**

**PROTEUS™**



- The "Siamese" Buffer
- 64K \$199.00
- 256K \$299.00
- Cable \$10.00

shipping \$4.00

■ Proteus directs two printers (working simultaneously) and frees your computer for other applications.

■ Now you can merge a form letter with your mailing list, set up one printer with letterhead, the other with envelopes, press "START" and RELAX while

**PROTEUS DOES IT ALL—ALL AT ONCE!**

■ Compact. ■ 2 parallel ports. ■ Multiple copy capability. ■ "Flexible Capacity" buffer for each port.

1986 "Best Buy of the Year" Award! - Computer Shopper

**SPECIAL OFFER:** For orders of \$100.00 or more. Say you saw it in **AHOY!** and get a free keychain, beeper and flashlight combined! A \$15.00 value!

**ORDER TOLL-FREE**  
**1-800-547-3303**

In Oregon (503) 626-2291 (24 hour line)

We are and always will be your

**Computer Friends®**

14250 N.W. Science Park Drive  
 Portland, OR 97229, Telex 4949559  
 Dealer Inquiries Welcome.

Reader Service No. 254



**Roadwar 2000: hard driving action.**  
**READER SERVICE NO. 233**

ulations), is the best game in the series. The ability to move characters in



**Play Shanghai and an hour later...**  
**READER SERVICE NO. 234**

a party independently and the more detailed wound system are two of many

**A20 (20 Meg Hard Drive)**

**Comp-U-Save**

**Amiga 1000**

**Hardware: \$785**

As anyone who has used an Amiga for more than 10 minutes can tell you, AmigaDOS is a disk-based operating system. In fact AmigaDOS is so intimately involved with external storage that all its commands must be loaded in prior to execution. By contrast, most other disk operating systems have a small selection of often-used commands which are memory resident. It is for this reason we strongly recommend the purchase of a second disk drive for all Amiga users.

Although Amiga disks are a mere 3½" in diameter, they each store a respectable 880 kilobytes of data. Nevertheless, for many Amigas, the amount of online RAM will exceed the capacity of available disk storage. This is in sharp contrast to the rule of thumb for early microcomputer enthusiasts, which recommended a disk capacity of five to six times the available RAM.

This was fine in those bygone days when RAM was measured in four kilobyte increments and 64 kilobytes was virtually unheard of. For the Amiga, the basic unit of RAM is the megabyte or some large fraction thereof.

A popular alternative to additional floppy disk storage is the hard disk drive. Hard drives are characterized by a rigid, rapidly spinning, magnetically coated disk whose storage capacity is measured in tens of megabytes. Ten megabytes, even by today's standards, is a respectable amount of online storage. Most microcomputer hard disks are 5¼" in diameter, with 3½" units starting to appear. They achieve their massive storage capacity by a combination of high mechanical precision and the total isolation of the storage medium from the environment.

In fact the read/write heads in the hard disk drive never make direct physical contact with the magnetic media. Instead the heads float a few millionths of an inch above the data platter on a cushion of air. The inadvertent contact

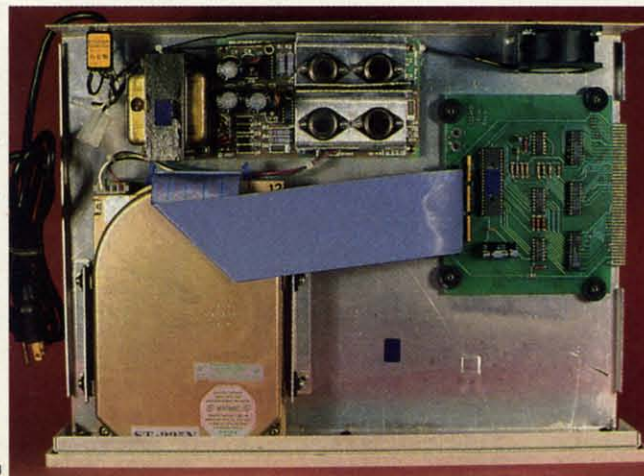

*The A20 is built around a Seagate ST225N SCSI hard drive module (bottom) with its own power supply (top) and Amiga to SCSI interface (right).*

**READER SERVICE NO. 235**

improvements Wood made in his already excellent system.

*Portal* (Activision) is the year's most innovative entertainment product for the Amiga. This electronic science fiction novel tells a story which could not have been presented in any comparable form without the computer.

*Roadwar 2000* (Strategic Simulations) concerns vehicular combat in a post-catastrophe United States. What makes it fascinating is that the fighting is merely a means toward achieving a larger goal. To win *Roadwar 2000*, the player must find the scien-

tists who can save the shattered remnants of the country before invaders, brigands, and disease destroy it.

No abstract strategy game has captivated computerists like *Shanghai* (Activision). Clearing the colorful playfields one pair of matching tiles at a time has become an addiction for thousands. Play *Shanghai* once, and you'll know why.

*Space Quest* (Sierra On Line), written by Two Guys from Andromeda, applies to science fiction the interactive graphics adventure system perfected in the *King's Quest* series. The zany co-

authors maintain a light tone through this interstellar romp.

*Starglider* (Rainbird/Firebird Licenses) is science fictional, too, but it emphasizes piloting and shooting action. The glowing linework and unusual airbrush effects of *Starglider's* illustrations make it a visual delight.

The best part of surveying the Amiga entertainment software of 1987 is knowing how much better 1988 will be. Increased understanding of the Amiga's capabilities will lead to recreational software that sets new standards for sound, graphics, and play value. □

of a head with the platter, referred to as a head crash, results in the loss of data. The drive unit must be sealed from contact with the atmosphere, as even the most minute dust particle can crash the head. Unlike a floppy disk, the hard disk platter is fixed in place and is not readily changeable.

In addition to its larger storage capacity, the hard disk drive enjoys a substantial speed advantage over its flexible brethren. When we consider the storage and speed improvements we can begin to appreciate the advantages of the hard drive. For the Amiga the large disk capacity is of particular importance. Most users rapidly discover that the 880K capacity of the floppy disk is insufficient space for AmigaDOS, fonts, printer drivers, and the utilities which inevitably become part of the operating environment.

The A20, manufactured by Phoenix Electronics, is the first hard drive to come into our possession. Although Phoenix Electronics has been serving the Commodore market for some time with a substantial line of replacement power supplies, you may not have seen their name. Phoenix is primarily an original equipment manufacturer (OEM) which prefers to market their product through third party distributors. In this case it is Comp-U-Save who will sell you the drive and will stand behind its one year warranty. Such are the intricacies of the free enterprise system.

### The Hard Drive's Hardware

This hard drive comes in an all-metal, 3" high enclosure whose length, width, and color are a reasonable

match for the Amiga 1000. In point of fact the drive is designed to sit right on top of the Amiga. Connection to the Amiga's 86 pin expansion port is via a U-shaped "staple" which also provides a straight, unbuffered pass through the expansion bus. All three of the staple's edge card connectors are of the female persuasion. This means that an additional printed circuit extension card will be required to utilize the pass through with devices which are normally designed to mate with the 86 contact printed circuit edge card connector on the Amiga.

Inside the vented metal enclosure we found a Seagate 225N hard drive module equipped with a small computer systems interface (SCSI, usually pronounced scuzzy). The front panel of the 225N is set through the front of the enclosure. Drive activity is indicated by a flickering LED set in this front panel. The SCSI port is interfaced to the Amiga's expansion port through a custom adapter designed by Phoenix Electronics. According to Phoenix, they are licensing the programmed array logic (PAL) chips for the adapter from C Ltd. These are the same PALs used by C Ltd in their own hard drive.

The hard drive is equipped with its own power supply which has sufficient capacity to power the drive and an external memory board. It should be possible to modify the supplied pass through so that an external RAM card would obtain its power from the power supply inside the hard drive. We did not do this modification for this review. The case is ventilated by a small fan which sucks air in from the rear and expels it through ventilation slots on

the left side. The hard drive components occupy about half of the volume inside the enclosure.

### The Setup

We set up our hard drive on a system consisting of an Amiga 1000 with one 5¼" and two 3½" floppy drives, a half megabyte of internal RAM, and an aMega 1 megabyte external RAM

## LOTTO CIPHER™

GET THE BEST ODDS ON ANY LOTTERY  
SIX NUMBER - PICK FOUR - DAILY GAME

- PRODUCES FOUR COMBINATIONS OF NUMBERS TO CHOOSE FROM
- ANY AMOUNT OF BALLS AND NUMBERS CAN BE PROGRAMMED.
- PRINTS OUT PAST LOTTO NUMBERS DRAWN, PAST COMPUTER PICKS, AND NUMBER DRAW FREQUENCY LIST.
- RANDOM NUMBER GENERATOR INCLUDED. \$24.94



COMMODORE, COMMODORE AMIGA, AND IBM SYSTEMS

---

## Window Magic

SUPER HI-RESOLUTION DRAWING IN MULTI OR MONO COLOR

- COPY
- FILL
- LINES
- DRAW
- COLOR SQUARES
- TYPES LETTERS AND GRAPHICS
- POLYGON SHAPES-EXPAND, SHRINK AND ROTATE, THEN STAMP ANYWHERE
- ZOOM PLOT-DRAW ON AN EXPANDED WINDOW AND YOUR DRAWING AT THE SAME TIME

- MIRROR, FLIP, AND SCROLLING WINDOWS
- ZOOM-EXPANDS A WINDOW TO DOUBLE SIZE
- SAVE AND LOAD YOUR WINDOWS ON DISK
- PRINTS ON STANDARD DOT MATRIX PRINTER
- CLONE COLOR ATTRIBUTES

\$19.95 C-64/128

---

## STOCK BROKER™

PROFITS GUARANTEED OR YOUR MONEY BACK

BUYING GOOD QUALITY, VOLATILE ISSUES AND USING THIS TRADING SYSTEM WILL HAVE YOU FULLY INVESTED AT THE LOWEST PRICES AND CONVERTING TO CASH AS THE STOCK NEARS ITS PEAK.



- TECHNICAL TRADING THAT WORKS.
- BAR GRAPH PRINT-OUTS.
- RECORD UP TO 144 STOCKS ON A DISK.

\$29.95

COMMODORE, COMMODORE AMIGA, AND IBM SYSTEMS

---

## ACORN OF INDIANA, INC.

2721 OHIO STREET  
MICHIGAN CITY, IN 46360



800-521-4536    219-879-2284

SHIPPING AND HANDLING, ADD \$1.50 - C.O.D.'S ACCEPTED  
VISA AND MASTER CARD ORDERS ADD 4%  
INDIANA RESIDENTS ADD 5% SALES TAX

Reader Service No. 243

AHOY! 55

**A20 DISK PERFORMANCE TEST RESULTS**

	DHO:	DF1:	RAM:
Total Test Time in Seconds	447	1300	182
File Creations Per Second	6	0	5
File Deletions Per Second	10	1	10
Directory Scan (Entries Per Second)	50	36	5
Seek+Read Per Second	49	17	49
Read Speed Bytes Per Second			
512 Byte Buffer	21487	11599	187245
4096 Byte Buffer	24049	12423	655360
8192 Byte Buffer	24730	12365	655360
32768 Byte Buffer	25206	12365	873813
Write Speed Bytes Per Second			
512 Byte Buffer	12483	4993	131072
4096 Byte Buffer	14979	5110	238312
8192 Byte Buffer	15511	5150	262144
32768 Byte Buffer	15420	5150	291271

card by C Ltd. This arrangement violates Commodore's specifications with regard to the loading of the expansion bus. Much to our surprise, the entire setup functioned flawlessly.

**The Performance Test**

The speed at which the disk drives transfer data is important in a disk-based operating system. In this regard AmigaDOS' floppy disk activity has not earned a reputation for high speed. The use of a hard drive does improve matters substantially. We ran several tests to measure the relative performance of the Comp-U-Save drive as compared to other systems. The first series of tests consisted of copying the "C" directory from both hard and soft disks to RAM and back again. In our case the "C" directory contained 53 files and occupied 453 disk blocks. The results are summarized in the following table:

Copy DHO:C To RAM:	All	22 secs.
Copy RAM: To DHO:Temp	All	30 secs.
Copy DFO:C To RAM:	All	51 secs.
Copy RAM: To DF1:Temp	All	173 secs.
Delete DHO:Temp/#?		10 secs.
Delete DF1:Temp/#?		40 secs.

Direct comparison of these test results with similar data published for other drives should be done with caution. Disk drive speed benchmarks are affected by a variety of system parameters including buffer size, disk contents, the time of day, and the state of mind of the system operator. In general, speed tests should be viewed as a measure of the relative performance of similar systems. For the above tests the hard drive had about one megabyte of

results were as shown in the table on this page.

All tests were done with the default number of disk buffers. The test of DHO: was done with about two megabytes of data on the disk. The test of DF1: was with a freshly formatted disk. Perhaps the most significant result of these tests is contained in the first line of the table, which shows the total time required for the complete series of tests on each device.

**The Software**

Very little is provided in terms of software support and very little is required. The Comp-U-Save hard disk comes with a copy of Workbench 1.2 on a floppy disk and on the hard drive itself. There are two files of importance to the system. The first is the "hard-disk.device" file located in the "devs" directory. This file should be copied to the "devs" directory of all your boot disks, as it contains the operating code which controls the hard disk drive. The second is the "mountlist" list file which is also contained in the "devs" directory. This file defines the structure of the hard disk in terms of how its storage capacity will be organized. The de-

fault arrangement, DHO:, sets up the hard drive as a single unit with a capacity of 21,307,392 bytes. You should also note the "startup-sequence" file in the "s" directory for an example of how to assign control of the system to the hard drive after booting up. This lets you remove the Workbench disk from DFO: after the system is initialized. Note that the contents of the provided "mountlist" file should be appended to your own "mountlist" file if you are already adding a device to your system such as a 5.25" floppy drive. The AmigaDOS Append command can be used to combine the files. The accompanying manual contains brief setup and installation instructions, listings of the mountlist files, and the drive's specifications. We also received a copy of the Seagate Universal Installation Handbook. Examination of the latter manual revealed that the ST225N does not have an automatic read/write head parking function at power off. The parking function moves the read/write head to an unused portion of the disk. This is to prevent loss of data if the head contacts the disk surface while the drive is being transported. The lack of an auto-park function mandates that the task be done via user software. We pointed out this deficiency to Phoenix, who will rectify it by providing the utility for the drive.

fault arrangement, DHO:, sets up the hard drive as a single unit with a capacity of 21,307,392 bytes.

You should also note the "startup-sequence" file in the "s" directory for an example of how to assign control of the system to the hard drive after booting up. This lets you remove the Workbench disk from DFO: after the system is initialized. Note that the contents of the provided "mountlist" file should be appended to your own "mountlist" file if you are already adding a device to your system such as a 5.25" floppy drive. The AmigaDOS Append command can be used to combine the files.

The accompanying manual contains brief setup and installation instructions, listings of the mountlist files, and the drive's specifications. We also received a copy of the Seagate Universal Installation Handbook. Examination of the latter manual revealed that the ST225N does not have an automatic read/write head parking function at power off. The parking function moves the read/write head to an unused portion of the disk. This is to prevent loss of data if the head contacts the disk surface while the drive is being transported. The lack of an auto-park function mandates that the task be done via user software. We pointed out this deficiency to Phoenix, who will rectify it by providing the utility for the drive.

**Conclusion**

The Comp-U-Save hard drive performed well in our tests. In comparison to previously published results for similar units, it would appear to be among the faster units which are presently available. It is also among the least expensive of the Amiga hard drives.

Comp-U-Save, 414 Maple Ave., Dept. F, Westbury, NY 11590 (phone: in NY 516-997-6707; rest of USA 800-356-9997). —Morton Kevelson

**LEAD THE AMIGA  
GOLD RUSH!**

We're now dishing out *Ahoy!* doubloons for the most stunning type-in games and utilities available for the Amiga. Send your best AmigaBASIC, C, or machine language programs, along with documentation and a SASE, to *Ahoy!* Program Submissions Dept., 45 West 34th Street—Suite 500, New York, New York 10001.

# Preview The Future!

## PROJECT: STEALTH FIGHTER



Stealth aircraft . . . the hottest topic of discussion in aviation circles today.

Space age technology and engineering make these aircraft virtually undetectable by enemy radar. Stealth fighters are believed to now be operating from top secret military bases, flown only on the most sensitive missions and only by the most experienced pilots.

Precise information about this next generation of Air Force jets is highly classified. But extensive research has enabled the aviation experts at MicroProse to incorporate the potential design and performance characteristics in a powerful new simulation.

Slip into the cockpit of **PROJECT: STEALTH FIGHTER** and familiarize yourself with the advanced "heads-up display" (HUD) and sophisticated 3-D out-the-cockpit view. At your disposal is a dazzling array of state-of-the-art electronics, weapons and countermeasures.

But remember, flying a stealth aircraft takes more than just fighter pilot reflexes. The real challenge is mastering the jet's electromagnetic profile to avoid enemy radar, while executing a deep-strike mission into North Africa or conducting delicate photo reconnaissance over Eastern Block seaports. Also featured are carrier and land-based takeoffs and landings, as well as land, sea, and air targets and threats.

**PROJECT: STEALTH FIGHTER** combines the combat action thrills of the best-selling F-15 STRIKE EAGLE with the sophisticated flight environment pioneered in GUNSHIP. Add the danger and suspense of clandestine missions in an innovative "invisible aircraft" and you have **PROJECT: STEALTH FIGHTER**, the latest flying challenge from MicroProse!

**PROJECT: STEALTH FIGHTER** is available from a "Valued MicroProse Retailer" (VMR) near you. Call us for locations!

For Commodore 64/128, IBM-PC/compatibles and Apple II/e/c. Call or write for specific machine availability, and for MC/VISA orders if product not found locally.



**MICRO PROSE™**  
SIMULATION • SOFTWARE

180 Laketfront Drive • Hunt Valley, MD 21030 • (301) 771-1151

Reader Service No. 232

# MONTGOMERY GRANT

115 Nassau St. NY, NY 10038  
 Bet. Beekman & Ann Sts. (212) 732-4500  
 Open Mon-Fri, 8:30-6:30/Sat, 9:30-6  
 Sun, 9:30-5:30

Penn. Station, Amtrack Level Beneath  
 Madison Sq. Garden, NY, NY 10001  
 (212) 594-7140 Open Mon-Wed, 8:30-8/Thurs  
 & Fri, 8:30-9/Sat & Sun, 10-7

FOR ORDERS AND  
 INFORMATION CALL  
 TOLL FREE  
 OPEN 7 DAYS EVERY WEEK  
 FOR ORDERS

**1 (800) 345-7058**

**1 (800) 345-7059**

IN NEW YORK STATE CALL  
**(212) 732-4500**

FOR CUSTOMER SERVICE CALL  
**(718) 965-8686 Mon-Fri 9am-4pm**

**commodore**  
**C-64C**  
  
 With Geos Program!  
**\$149.95**

**commodore**  
**C-128**  
  
**\$214.95**  
 NEW C-128/D WITH BUILT-IN DISK DRIVE **\$439**

**Commodore**  
**AMIGA 500**  
  
 • 68000 Processor  
 • 512k Ram Expandable to 9MB  
 • Graphics Processor  
**IN STOCK**

**AMIGA PERIPHERALS**  
 A-501 512K EXPANSION  
 A-1010 3.5" FLOPPY DRIVE  
 A-1020T 5.25" DISK DRIVE  
 with TRANSFORMER  
 A-1080 RGB COLOR MONITOR  
 A-1300 GENLOCK  
 A-1060 SIDECAR  
**THESE AND OTHER PERIPHERALS IN STOCK WE WILL BEAT ANY PRICE**  
 AMIGA 1000 w/ 512K .....\$699  
 AMIGA 2000.....CALL

**commodore**  
  
**C-64C COLOR PACKAGE**  
 COMMODORE C-64C COMPUTER  
 COMMODORE 1541/C DISK DRIVE  
 COMMODORE COLOR PRINTER  
 COLOR MONITOR  
 GEOS SOFTWARE PROGRAM  
**\$499**  
 COLOR MONITOR - ADD \$110

**commodore**  
  
**C-64C COMPLETE PACKAGE**  
 COMMODORE C-64/C COMPUTER  
 COMMODORE 1541 DISK DRIVE  
 COMPUTER PRINTER  
 12" MONITOR  
 GEOS SOFTWARE PROGRAM  
**\$369**

**commodore**  
  
**C-128 COMPLETE PACKAGE**  
 COMMODORE 128 COMPUTER  
 COMMODORE 1541 DISK DRIVE  
 12" MONITOR  
 COMPUTER PRINTER  
**\$469**  
 TO SUBSTITUTE 1571 FOR 1541 - ADD \$60

**commodore**  
  
**C-128 DELUXE PACKAGE**  
 COMMODORE 128 COMPUTER  
 COMMODORE 1571 DISK DRIVE  
 COMMODORE 1902 COLOR MONITOR  
 COMMODORE 1515 80 COLUMN PRINTER  
**\$729**

**EPSON EQUITY II**  
  
**IBM PC/XT COMPATIBLE PACKAGE**  
 • Equity II Computer • 640K RAM  
 Power • 360K Disk Drive • 10 MHz  
 Serial/Parallel Ports • 12" High  
 Resolution Monitor • Keyboard  
**\$899**  
 Same Package with 20MB Hard Drive **\$1169**

**BLUE CHIP**  
  
**IBM PC/XT COMPATIBLE PRINTER PACKAGE**  
 • Blue Chip Keyboard • 512K RAM  
 Expandable to 640K • 6 Expansor Slots  
 • All Hook-up Cables and Adaptors • Brother  
 30 Column Printer • 12" Monitor  
 Package of 10 Diskettes optional 20MB  
 Hard Drive **\$499**  
 Same Package with 20MB Hard Drive **\$769**

**apple**  
**PACKAGES**  
  
 Apple IIC or IIE Computer 5.25" Drive 12"  
 Monitor All Hook-up Cables and Adaptors  
 Package of 10 Diskettes  
**APPLE IIC PACKAGE \$669**  
**APPLE IIE PACKAGE \$869**

**commodore**  
**IBM PC/XT COMPATIBLE PACKAGE**  
**PC10-1**  
  
 • PC10-1 Computer  
 • 512K Expandable to 640K  
 • 360K Disk Drive  
 • Enhanced Keyboard  
 • Serial & Parallel Ports  
 • 12" Monitor  
 • All Hook-up Cables & Adaptors  
 • Package of 10 Diskettes  
**\$519**  
 Same Package with 20MB Hard Drive **\$769**  
**COMMODORE PC-10/2 640K COMPUTER w/ 2 360K DRIVES & ABOVE PACKAGE \$619**

## COMPUTER PRINTERS

**commodore**  
  
**MPS-803C PRINTER \$129**  
  
**MPS-1000 PRINTER \$179**  
  
**MPS-1200 PRINTER \$219**  
  
**DPS-1101 DAISY WHEEL PRINTER \$169**

**EPSON**  
  
 FX-86E \$309.95  
 FX-286E \$429.95  
 LQ-800 \$399.95  
 LQ-1000 \$559.95  
 EX-1000 \$489.95  
**Panasonic**  
  
 10911-II \$189.95  
 1092 \$285.00  
**OKIDATA**  
  
 OKIDATA-120 \$199.95  
 OKIMATE-20 W/PLUG'N'PRINT \$189.95  
**star**  
  
 NX-10 \$149.95 NR-15 \$405.95  
 NX-10C \$169.95 NB-15 \$689.95  
 NX-15 \$289.95 NB-2410 \$399.95  
 ND-15 \$369.95 NB-2415 \$539.95

## PERIPHERALS

**commodore**  
  
 1902 RGB COLOR MONITOR **\$229.95**  
  
 1802 COLOR MONITOR **\$169.95**  
  
 2002 COLOR MONITOR **\$239.95**  
**THOMPSON RGB COLOR MONITOR \$289.95**

**DISK DRIVES**  
  
 1541/C DISK DRIVE **\$159.95**  
  
 1571 DISK DRIVE **\$209.95**  
  
 1581 DISK DRIVE **\$199.95**  
 1351 MOUSE **\$39.95**  
 #1706 128K EXPANSION MODULE.....\$99.95  
 #1750 512K EXPANSION MODULE.....\$169.95  
 #1764 EXPANSION MODULE.....\$129.95  
 #1670 AUTOMODEM.....\$129.95  
 XETEC JUNIOR INTERFACE.....\$34.95  
 XETEC SENIOR INTERFACE.....\$54.95  
 C-128 POWER SUPPLY.....\$29.95  
 C64/C64-C POWER SUPPLY.....\$29.95  
**20MB HARD DRIVES FOR C-64/C...\$769 C-128...\$849**

NO SURCHARGE FOR CREDIT CARD ORDERS

WE INVITE CORPORATE & EDUCATIONAL CUSTOMERS



NO SURCHARGE FOR CREDIT CARD ORDERS

Certified check, Bank check, Mastercard, Visa, Am-Ex, Diner's Club, Carte-Blanche, Discover Card and C.O.D.s accepted. No additional surcharge for credit card orders. Non-certified checks must wait 4-6 weeks clearance. Money orders are non-certified checks. N.Y. residents add applicable sales tax. Prices and availability subject to change without notice. Not responsible for typographic errors. Returns of defective merchandise must have prior return authorization number, or returns will not be accepted. IBM PC/XT are registered trademarks of International Business Machine Corp. All orders can be shipped Air Express-call for details.

Reader Service No. 276

[www.commodore.ca](http://www.commodore.ca)

# THE INS AND OUTS OF THE C-64/128 EXPANSION PORT, PART II

Where We Apply Our Hard-Earned Knowledge to Expand EPROM Memory

By Morton Kevelson

Last month we had examined the expansion port in sufficient detail to permit us to go ahead with the construction of a typical ROM cartridge. Since the ROM cartridge is one of the simplest types of additions which utilize most of the expansion port's lines, it will be instructive to examine it in detail. We will also show how the basic design can be easily expanded upon to utilize the large capacity, low cost ROMs which are now available.

**WARNING:** In these projects, as in all construction projects, the users must assume all responsibility for any damage which may be inflicted upon themselves or their equipment. Incorrect application of the following suggestions could result in permanent disability to your equipment. These discussions are for informational purposes only!

The accompanying table (see page 61) shows the connections to the expansion port for an eight kilobyte cartridge using a 2764 EPROM mapped into the address range of \$8000 to \$9FFF (32768 to 40959). The majority of commercial game cartridges are of this type. The EPROM's pin designations correspond to those used by Intel in their Memory Components Handbook. Other manufacturers may use slightly different designations. For example the data lines, D0- D7, may be called

output lines, 01-08. Regardless of their labels the pin functions of all 2764 EPROMs should be the same.

In addition to the connections shown in the table, contact 9 on the expansion port should also be connected to ground (contacts 1, 22, A, or Z). When the C-64 or C-128 is powered up with this cartridge installed, the RAM in address range \$8000 to \$9FFF (32768 to 40959) will automatically be replaced by the ROM in the external cartridge. We have also provided a schematic representation of the table for the 2764 EPROM (Figure 1). Note that we have shown the 2764 as viewed from the top. The EPROM may be properly oriented by noting the position of the notch at one end of the chip. Some chip manufacturers may replace this notch with a small dimple or dot next to pin number 1.

With the proper code this cartridge will autostart. In this case the first two bytes in the ROM must contain the program startup address. The next two bytes should contain the address to go to when the RESTORE key is pressed and the next five bytes contain the characters CBM80 (\$C3, \$C2, \$CD, \$38, \$30). Note that the first three bytes of this sequence have their high bits set. Of course the initiating program code for auto-starting cartridges must be written in machine language. How-



## The latest DISK-INVADER SERIES V

THE SERIES "V" DISK-INVADER COPIES 99.90% OF PROTECTED SOFTWARE EASILY WITH POWER AND PARAMETERS TO SPARE & UPDATING ADDS EVEN MORE

- OVER 40 SPECIAL PARAMETERS built into the INVADER Copying Modules are AUTOMATICALLY called when copying the "Tough to Copy" Disks. This method of copying often produces a working copy without using a parameter. These are all installed on DISK-INVADER SIDE 1.
- OVER 200 EXTRA PARAMETERS to make working copies of recent disks that were impossible before are installed on DISK-INVADER SIDE 2. Because we UPDATE on a regular basis the quantity of extra parameters grows faster than we can advertise. We will always ship the LATEST CURRENT VERSION to purchasers. Registered owners may update earlier versions at any time for \$15.50 P & P included.

- FOR USE WITH 1 or 2 1541/1571 Drives and compatibles or MSD Dual Drive and a COMMODORE 64 or the COMMODORE 128 (used in 64 mode).

FAST FILE COPIER included with 8 second NO KNOCK PERFECT FORMATTER and the ability to issue DISK COMMANDS & DELETE unwanted files.

FAST FULL DISK COPIER for 2 1541/1571 copies in under 1 minute.  
FAST FULL DISK COPIER for 1 1541/1571 copies in under 2 minutes.

POSTAGE & PACKING INCLUDED US \$36.50  
CANADIAN \$49.50

Quebec residents add 9% sales tax.  
All orders shipped within 48 hours.

We accept VISA.

TO ORDER  
send Check or Money Order to:

**AVANTGARDE 64**  
18 Place Charny, Lorraine  
Quebec J6Z 3X9, Canada

Telephone: 1-514-621-2085

Reader Service No. 277

AHOY! 59

www.commodore.com

# TIRED OF PLAYING GAMES?

## NOW IT'S TIME FOR SOME REAL FUN!

### GRAPHIC LABEL WIZARD

This is the final step in the evolution of graphic labeling utilities. The Graphic Label Wizard can use Print Shop, Printmaster, and Software Solutions graphics!

This program achieves the perfect balance of power and flexibility. You can print a graphic and up to 8 lines of text on a standard mailing label. And you can print those 8 lines in any combination of styles that your printer supports! Print just one label—or all the labels from your data disks. Print catalog pages displaying 28 disk graphics on a single page. And our exclusive hi-res display feature allows you to load and preview on screen up to four different graphics simultaneously!

The Graphic Label Wizard works with both Commodore printers and Epson-compatible printers. And we even include 50 exciting new graphics free, just to get you started! If you're going to use a graphic labeling utility, you may as well use the best—order yours today!

FOR THE C64/C128 (IN 64 MODE) AND 1541/1571/1581 DRIVES. UNPROTECTED (EASILY TRANSFERRED TO 1581 DISKS)—ONLY \$24.95.

### GRAPHIC ART DISKS

Let's face it: you can be a bright, talented, creative person—and still not be able to draw a straight line with a ruler. Well, we can help.

We've created an exciting new series of clip art disks. Each disk is a library of 100 outstanding graphics. Each graphic is stored on the disk in both Print Shop (Side A) and Printmaster graphic formats!

Disk 1	..... Variety Pack	Disk 5	..... Americana
Disk 2	..... Christmas	Disk 6	..... Variety Pack
Disk 3	..... Variety Pack	Disk 7	..... Sports
Disk 4	..... Animals	Disk 8	..... Holidays

You can use these superb images in your signs, cards, banners, invitations, flyers, or whatever else you have in mind. These graphics are also perfect for use with the dynamic Graphics Label Wizard program! So order yours today—great art was never so affordable!

FOR THE C64/C128 (IN 64 MODE) AND 1541/1571/1581 DRIVES. UNPROTECTED (EASILY TRANSFERRED TO 1581 DISKS)  
—ONLY \$14.95 EACH.

### SYSRES ENHANCED

This is the program that will change the way you think about BASIC. SYSRES resides in memory, out of the way. It's the ultimate BASIC enhancement system for Commodore computers. It adds over 25 major commands to BASIC. It also incorporates an extended SUPER Dos-wedge, reducing even the most complex command sequences to a few simple keystrokes. It even allows you to scroll forward and backward through your BASIC programs.

SYSRES has long been the program of choice among professionals working in BASIC. It lets you create powerful macros. It allows you to edit text files and assembler source code without leaving BASIC. SYSRES can find and change any variable, phrase, or keyword anywhere in your program, with over 700 search variations available. It allows you to do a partial RENUMBER. It can list BASIC programs, sequential files, and even relative files without loading them into memory. You can even debug using a variable speed TRACE. Yet all this doesn't even scratch the surface of what this remarkable tool is capable of! And while SYSRES is addictive to programmers, it isn't addictive to the programs themselves—no run-time library is needed for SYSRES created programs!

We've enhanced SYSRES itself. We've also unprotected it, dropped \$60.00 off the original price, and included over 100 pages of detailed documentation in a professional, high quality 3 ring binder. Face it: you've just run out of excuses not to own the very best! Order yours today!

FOR THE C64/C128 (IN 64 MODE) AND 1541/1571/1581 DRIVES. UNPROTECTED (EASILY TRANSFERRED TO 1581 DISKS)—ONLY \$39.95.

### C128 HELPER

We're going to give you two very good reasons to buy this remarkable programming achievement. Reason One: The C128 Helper is an exciting new type of software—a program that allows you, the user, to easily create your own customized, menu-driven information systems! These disk based systems operate from BASIC, and appear at the touch of the HELP key. You can create your own memo pads, appointment calendars, electronic helpers for other programs, and anything else your imagination can come up with!

Reason Two: To show you just how powerful this application can be, we've included an amazing example—a complete electronic reference manual for the C128's powerful BASIC 7.0! Select a specific command, and a full screen of detailed info and examples appear. One key dumps a hardcopy to your printer, another puts you right back in BASIC 7.0, exactly where you left off!

FOR THE C64/C128 (IN 64 MODE) AND 1541/1571/1581 DRIVES. UNPROTECTED 5.25" VERSION (1541/1571 DRIVES)—ONLY \$24.95.  
UNPROTECTED 3.5" VERSION (NEW 1581 DRIVE)—ONLY \$32.45.

### SUPERCAT

Using a disk catalog system takes an investment of time and money—so why not use the very best system available? Supercat packs more power and features than any other disk library utility on the market! Supercat can catalog up to 640 disks with 5000 titles per catalog—or twice as many with two drives! It lets you load, save, edit, change, delete, and update your catalog entries.

While Supercat can print an impressive variety of lists and reports, it also incorporates advanced search and display capabilities that are perfect for the user without access to a printer. Armed with machine language routines and extensive menus and help screens, Supercat is lightning-fast, yet easy to use. And *Ahoy* magazine called Supercat "... a very powerful and versatile program." Find out why Supercat is considered the most advanced disk catalog system available—order yours today!

FOR THE C64/C128 (IN 64 MODE) AND 1541/1571 DRIVES. COPY PROTECTED (FREE BACKUP INCLUDED) —ONLY \$24.95.

Your computer is only as good as the software you use—so don't play around with second-rate software. When you're ready for some serious fun, you're ready for us! Special Bonus to Dec.-Jan.-Feb. buyers: ON-LINE HELP PROGRAM free with each order.

### COMPUTER MART

PLEASE NOTE: Free shipping and handling on all orders. C.O.D. add \$4.00 to total. All orders must be paid in U.S. funds. Washington residents add 7.3% sales tax to order. Orders outside of North America add \$4.00 per item, SYSRES™ add \$7.50.

CHECKS, MONEY ORDER OR VISA/MC/DISCOVER CARD  
Mail your order to: Computer Mart

2700 NE Andresen Road  
Vancouver, WA 98661

Phone orders welcome: 206/695-1393

Same day shipping/NO C.O.D. orders outside U.S.



Reader Service No. 279



ever, it is possible to write the bulk of the program in BASIC.

With a slight modification to the above table it is possible to add a second EPROM which will appear in the address range of \$A000 to \$BFFF (40960 to 49151). This will replace the BASIC ROM in the C-64. One application for the second ROM would be to modify the C-64's BASIC ROM and program it into an EPROM which would then be available on power up. Simply wire up a second EPROM as before with pins 20 and 22 on the EPROM connected to contact B (ROMH) on the expansion port (Figure 2). Contact 8 (GAME) will also have to be grounded along with contact 9 (EXROM).

An even simpler approach to the same application would be to substitute a 27128 EPROM for the 2764. The 27128 has a capacity of 128 kilobits (16 kilobytes), double that of the 2764. It has been designed to be pin compatible with the 2764 so that existing designs will require minimal modification. The only difference between the two chips is that pin 26, which was not used on the 2764, becomes address line A13. Of course it only requires one additional address bit to double the capacity of a memory chip. The quickest way to configure the 27128 as the 16K cartridge described above is to connect pin 26 (A13) to cartridge port contact B (ROMH) (Figure 3). Note that ROMH is active low, which means that it will be a logical zero when address range \$A000 to \$BFFF (40960 to 49151) is being accessed. To get the EPROM to function properly, simply reverse the programming of the two eight kilobyte blocks. Thus the code for address range \$8000 to \$9FFF (32768 to 40959) will be placed into the EPROM's address range of 8192 to 16384.

An alternative use for the larger capacity EPROM is to treat the 16 kilobytes as two 8 kilobyte program blocks. In this case a 27128 EPROM has the capacity to store two 8 kilobyte programs. The switching arrangement is simple, requiring minimal modification of the original design. We have shown a manual method which uses a miniature switch to select the EPROM bank (Figure 4). Closing the switch will select the EPROM's first 8 kilobytes. Opening the switch selects the second 8 kilobyte bank.

The same method can be extended to the 27256 and 27512 EPROMs. These have a capacity of 32 kilobytes and 64 kilobytes respectively. In this case up to four 8 kilobyte blocks can be placed into the 27256 and as many as eight blocks into the 27512. Bank switching the 27256 will require the use of two miniature switches (Figure 5) and the use of three switches (Figure 6) for the 27512.

Although these are rather simple projects, there are still a large number of electrical connections which must be made. Prefabricated cartridge boards are readily available at minimal cost. For example, the PCC-2 from Jason-Ranheim is a prefabricated expansion port printed circuit board which can accommodate two 2764 EPROMs as described in our second example. The board, complete with sockets for the ROMs, is only \$5.95. The board also has traces which may be modified to accommodate 27128 (16 kilobytes), 27256 (32 kilobytes), and 27512 (64 kilobyte) EPROMs.

An alternative to the hardware switches we have described is to use a set of soft switches for banking the EPROM. In this case the manually operated mechanical switch is replaced

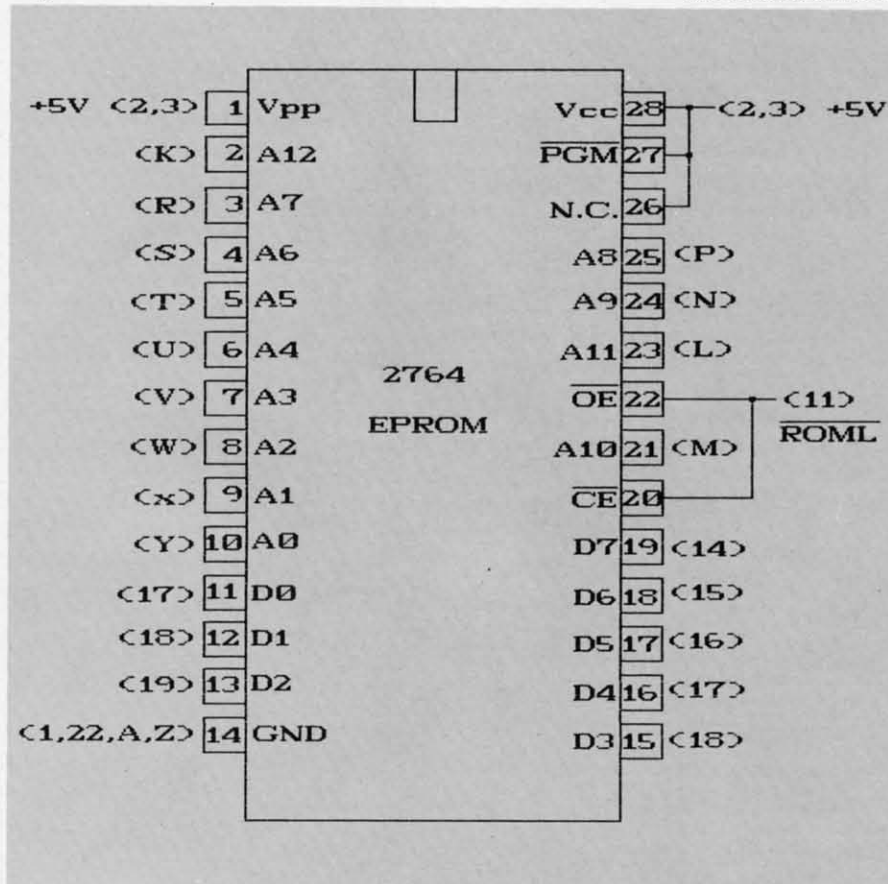

Figure 1: Connection to C-64 Cartridge Port

#### WIRING TABLE FOR 8K EPROM AT \$8000-\$9FFF

Cartridge Port		EPROM	
ID	Pin No.	Pin No.	ID
GND	1,22,A,Z	14	GND
+5V	2,3	1	Vpp
"	"	26	N.C.
"	"	27	PGM
"	"	28	Vcc
ROML	11	20	CE
"	"	22	OE
D7	14	19	D7
D6	15	18	D6
D5	16	17	D5
D4	17	16	D4
D3	18	15	D3
D2	19	13	D2
D1	18	12	D1
D0	17	11	D0
A12	K	2	A12
A11	L	23	A11
A10	M	21	A10
A9	N	24	A9
A8	P	25	A8
A7	R	3	A7
A6	S	4	A6
A5	T	5	A5
A4	U	6	A4
A3	V	7	A3
A2	W	8	A2
A1	X	9	A1
A0	Y	10	A0

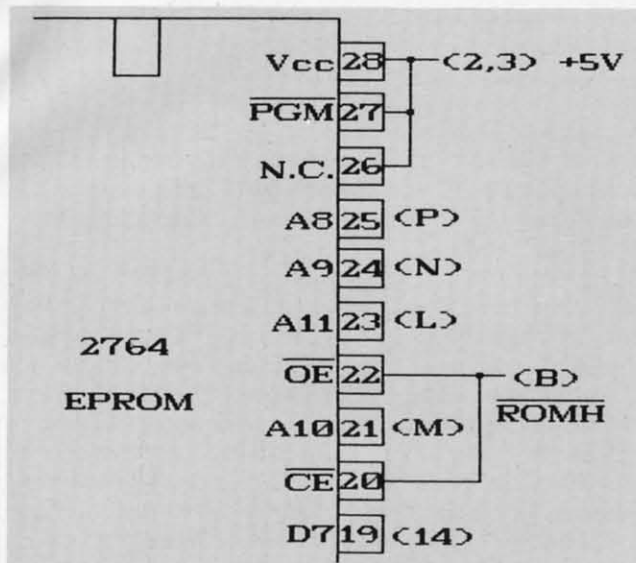

Figure 2: Modification for Cartridge in \$A000 Block

by an electrically operated electronic switch in the form of an electronic switch or latching circuit. The soft switches appear as one or two locations in the C-64's I/O address space. The switches are set or reset by writing the appropriate data to the selected address. The advantage of this approach is that the EPROMs may be banked under program control. This allows the EPROMs to be used for extended program storage. Since the EPROMs are simply memory, any programs or data can

be instantly available. The only disadvantage of the soft switch approach is that the switch setting may be inadvertently changed by a write to the wrong address.

For an example of this approach we refer you to the PCC4 cartridge board (\$17.95) from Jason-Ranheim. This board, which fits into a standard sized PCCH2 C-64 cartridge case (\$2.25), will accommodate up to four EPROMs. These EPROMs may be 2764s, 27128s, or 27256s in any combination. This gives the PCC4 a total capacity of 128 kilobytes! The onboard soft

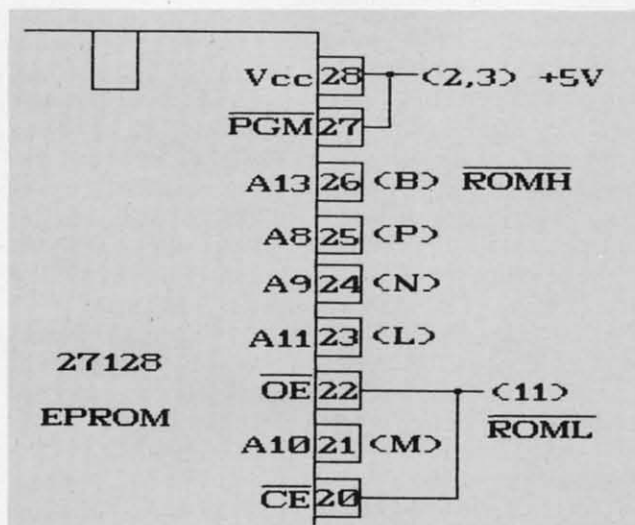

Figure 3: Modification for 27128 in \$8000 to \$BFFF Block

switches let you bank in the ROM in 8 kilobyte increments or bank out the EPROMs entirely. Of course all these projects require some means of programming the EPROMs. The Promenade (\$99.95) from Jason-Ranheim can handle all of the EPROMs we have mentioned plus many others. For a detailed discussion of EPROM programming, along with a review of the Promenade, see *PROM Programming Made Easy* in the July 1985 issue.

There are only eight contacts on the expansion port which we have not yet examined. Contact C is the popular RESET line. Momentarily connecting this contact to ground and releasing it will cause the computer to reset to the power on condition. Note that the reset sequence starts when the connection is released. In terms of software the microprocessor will start executing the code at the address which is stored in locations \$FFFC and FFFD (65532 and 65533). In the case of the Commodore 64 this address is \$FCE2 (64738). A reset may be executed from BASIC by a SYS 64738 command.

Contact D is connected directly to the microprocessor's non-maskable interrupt line (NMI). If the NMI line is momentarily grounded, the microprocessor will stop whatever it is doing at the completion of the current instruction and execute the NMI routine whose address is stored in addresses \$FFFA and \$FFFB (65530 and 65531). An NMI cannot be ignored. Contact 4 is tied directly to the microprocessor's interrupt request line (IRQ). This functions similarly to the NMI except that the IRQ can be ignored if the interrupt flag is set.

Continued on page 98

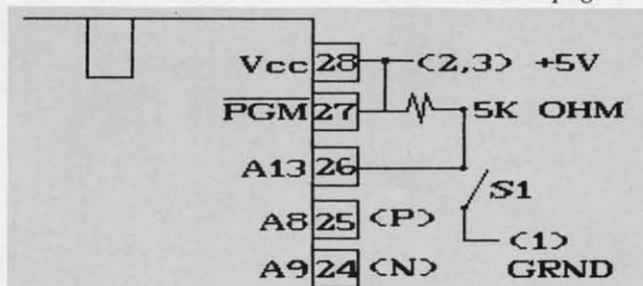

Figure 4: Modification for Bank Switching a 27128 EPROM  
S1 Closed = Bottom 8K S1 Open = Top 8K

## WIN YOUR STATE LOTTO WITH YOUR COMPUTER!

"The home computer is the most powerful tool ever held by man" (or woman for that matter)!

Are you still wasting money with random guesswork?

This amazing program will analyze the past winning lotto numbers and produce a powerful probability study on easy to read charts in just seconds. With single key presses from a menu you'll see trends, patterns, odd/even, sum totals, number frequency and more on either your screen or printer. Includes automatic number wheeling, instant updating and a built-in tutorial to get you started fast and easy!

CHECKS & CHARGE CARDS ACCEPTED WITH NO SURCHARGE.

All orders shipped same day (except personal checks).

APPLE & IBM Compatibles ..... \$24.95  
Macintosh (requires M/S Basic) ..... \$29.95  
Commodore, Atari & Radio Shack ..... \$21.95  
Back-Up Copies - \$3.00

Please add \$2.00 for shipping and handling. Phone credit given with orders.

(513) 233-2200

SOFT-BYTE



P.O. Box 5701, Forest Park  
Dayton, Ohio 45405  
AH

Reader Service No. 278

# REVIEWS

## THE ADVANCED OCP ART STUDIO Firebird Licensees, Inc. Commodore 64 Price: \$39.95

It has been some time since we have examined a dedicated graphics package for the C-64. Part of the reason is that the programs introduced early in the history of the C-64 did a satisfactory job for most users. In fact, the majority of our *Art Gallery* submissions were done with *Koala* or *DOODLE!*, both of which have been around for nearly as long as the C-64.

We were pleasantly surprised to see a new entry in the C-64 graphic market. *The Advanced OCP Art Studio* from Rainbird Software is a British product being distributed here by Firebird Licensees, Inc. When we opened the package we found two sets of program disks and manuals. A careful examination revealed that we did indeed have two different programs and not merely a duplicate set. We were a bit confused by the nomenclature which was chosen for the supplied program disks. One was identified as *The OCP Art Studio* and the other was labeled *The Advanced OCP Art Studio*.

We shortly realized that the package actually did contain two different programs. The disk labeled *The OCP Art Studio* contained a graphics program which operated in the C-64's high resolution display mode. The program on the other disk, labeled *Advanced OCP Art Studio*, functioned in the multicolor display mode. To avoid further confusion during the remainder of this review we will refer to these programs as the hi-res *Art Studio* and the multicolor *Art Studio* respectively. We will continue to call the entire package *The Advanced OCP Art Studio* as shown on the box.

The hi-res *Art Studio* utilizes the C-64's high-resolution graphic bit map as its canvas. In this mode the C-64's screen display consists of 320 horizontal pixels by 200 vertical pixels. All sixteen colors may be displayed in high resolution mode; however, there is a limitation whereby only two colors may be used in an eight pixel square character cell.

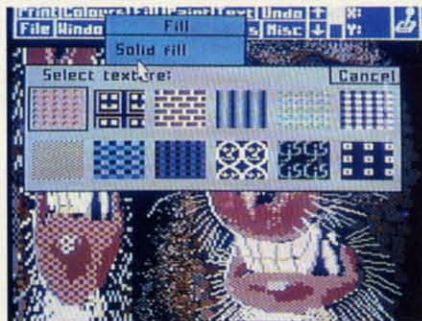

Top: screens created with the hi-res *Art Studio*. Bottom: the multicolor *Art Studio*'s built-in brushes and windows. **READER SERVICE NO. 284**

The multicolor *Art Studio* manipulates the C-64's multicolor graphic bit map display. In this mode the C-64 screen display consists of 160 horizontal pixels by 200 vertical pixels. The use of color in the multicolor mode is a bit more flexible than in the high-resolution mode. Each four by eight pixel character cell may contain any three colors plus a common screen background color. The tradeoff is in the loss of horizontal screen resolution. Note that a multicolor pixel is twice as wide as a high resolution pixel. For additional details on the C-64's bit map graphics, refer to the tutorial on this subject in the July 1987 issue.

### Operating Features

Since the versions of *The Advanced OCP Art Studio* are very similar, we will describe them simultaneously, referring to them as hi-res and multicolor, while noting the differences as they occur. The operation of the package is based upon the windows, icons, and menus type of user interface. The top three character rows, or 24 pixels, are occupied by the main menu bar. The missing part of the bit map can be scrolled up, allowing the entire bit map to be utilized. The menus can be turned

off to inspect the entire image: however, the image cannot be manipulated in view mode. The menu bar of the multicolor *Art Studio* also includes the bit map coordinates of the current cursor position.

The desired operation is selected from the menus, after which the bit map manipulation is performed. All changes to the bit map which were done between menu selection may be completely cancelled by using the UNDO feature on the main menu.

The comfort and response of the input device is an important factor in the overall performance of a computer graphics package. *The Advanced OCP Art Studio* supports a variety of input devices. The user may interface with the package via the keyboard, joystick, mouse, or Koala pad. Input device selection is via the space bar and the Commodore key. An icon at the right end of the menu indicates the currently active device. Both joystick ports are continuously active, supporting the rapid switching between two devices. Of course some operations require the use of a particular device such as the keyboard for text. Most operations will accept input from any of the supported devices.

# NOW'S THE BEST TIME TO CONNECT YOUR COMMODORE COMPUTER TO A SEIKOSHA PRINTER.

Because we're offering a \$20 SEIKOSHA Utility Disk for only \$7.95!

If you've got a Commodore® C-64 or C-128™ in your home or office, SEIKOSHA's got good news for you. We make three outstanding, easy-to-use printers that are Commodore-compatible: the SP-180VC...the SP-1000VC...and the SP-1200VC.

And starting January 1st, we're offering you a SEIKOSHA Utility Disk, valued at \$20.00, for only \$7.95 with the purchase of any of our Commodore-compatible printers. This floppy disk offers a half-dozen software programs, including: Disk Label Maker, Letterhead Maker and Calendar Maker.

All Commodore-compatible SEIKOSHA printers offer outstanding value, reliability, performance and price. And each one comes with a connecting cable, so you don't have to buy one.

## OUTSTANDING SERVICE AND SUPPORT.

Our operating philosophy accepts nothing less than the finest product technology can produce. We support that product with personal touch service of equally high professional standards, including:

- The best warranties in the business
- A National Hotline number
- 150 Authorized SEIKOSHA Service Centers in the United States and Canada

IT'S TIME YOU CONNECTED WITH COMMODORE-COMPATIBLE SEIKOSHA PRINTERS... AND GOT A SEIKOSHA UTILITY DISK FOR ONLY \$7.95!

For more information, see your local SEIKOSHA dealer or call 1-800-422-7768 or 1-201-529-4655.



SP Series (clockwise from bottom)  
SP-1200VC, SP-180VC, SP-1000VC.

We're Seikosha America Inc., established in 1985 to be the North American marketing arm for SEIKOSHA-branded printers. Two decades ago, we began to design and manufacture high quality printers for Original Equipment Manufacturers (OEM) ... our name unknown by users like you. But our tradition of making quality technological products goes back nearly a hundred years. (We're the world's leading manufacturer of precision timepieces including SEIKO, Pulsar and Lorus). Today, our goal is to be first among printers with a name you can recognize and trust.

**Seikosha**  
*America Inc.*

Technology with the Human Touch

© Copyright 1987, Seikosha America Inc. 1111 Macarthur Blvd., Mahwah, NJ 07430  
Registered trademark: Commodore—Commodore Electronics Ltd.

Reader Service No. 283

[www.commodore.ca](http://www.commodore.ca)

If you happen to have a Koala pad you will find that the package works very well with it. The results with the Animation Station from Suncom were nearly as good. The only problem with the latter device was the tendency for the cursor to jump to the top of the screen when the stylus was lifted from the pad. The solution was to release the pad's pushbutton before lifting the stylus. We were surprised at how well the pad worked with the hi-res *Art Studio*, in that it does not have sufficient resolution for the 320 horizontal pixels of the high resolution display. The Koala pad was also the only device which would only work in Port 1.

The supported mouse is the 1350, or the 1351 in trackball mode. The proportional mode of the 1351 mouse is not supported. We found that an Atari style trackball worked very well in mouse mode. Note that the joystick and the mouse/trackball send similar signals to the computer. The selection of input device adjusts the response time of the program to better accommodate the characteristics of the device. In the multicolor *Art Studio* it is possible to adjust the mouse response speed. When using a joystick we found it convenient to take advantage of this option by switching between the mouse and joystick input devices.

Although the package was supplied on disk, the file menus include options for tape storage. File operations are not limited to the storage and retrieval of full screen images. The multicolor *Art Studio* includes the ability to save fonts, patterns, and windows. The hi-res *Art Studio* only supports file operations for full bit maps and fonts. The table shows the file formats for full bit maps as used

by the package.

One of the most powerful features of both programs is the ability to manipulate sections of the bit map or windows. Any section of the image, including the entire screen, may be defined as a window. Once defined, a window may be flipped, rotated in increments of 90, 180, or 270 degrees, rescaled horizontally and vertically, cleared, and cut and pasted. A multiple flag lets the current operation be repeated any number of times. The hi-res *Art Studio* also supports two types of merges with the background, as well as a direct overlay on the existing image. The disk file support for windows in the multicolor *Art Studio* lets you easily create clip art collections.

### Color

In view of the differing restrictions placed on color by the C-64's two bit map display modes, it is important to note how each program handles color. The hi-res *Art Studio* provides for independent selection of the foreground and background colors. In addition, either color may be set to transparent. This allows operations to be performed on the bit map without affecting either of the existing foreground or background colors in a character cell.

The multicolor *Art Studio* lets you define an exclusion list and a priority list, each of which may contain up to 15 colors. The exclusion list defines which colors will not be used when performing many operations. For example, adding blue to the exclusion list will prevent the blue parts of a brush from being painted. The priority list effectively lets you define foreground and background colors for the entire picture. For example, placing red at the top of the priority list will fix all red areas of the bit map. The use of the two lists in conjunction with the window feature results in a very powerful way to manipulate the image.

### Hardcopy

Both programs offer extensive printer support. The program comes set up for the Commodore MPS-801 printer. This will also work with a dot matrix printer and a graphics interface in emulation mode. A printer setup program is provided which configures the disk to work with an Epson type printer.

The user is required to enter the printer's specific control codes for initiating bit map graphics. The setup program prompts you for the data while showing specific examples. The user will need sufficient technical expertise to pick the proper codes from the printer's manual. We managed to get *The Advanced OCP Art Studio* to work with a Gemini 10X after some experimentation.

The program supports several types of printer dumps. The hi-res *Art Studio* will scale the dump from 1 x 1 up to 5 x 5 times the original bit map. The availability of the larger scalings is dependent on the resolution of the printer. The program will also translate colors into a dot pattern gray scale. The dot patterns which are used for the gray scale cannot be adjusted by the user. For Epson type printers, you have the option of using double density mode as well.

The multicolor *Art Studio* generates only gray scale translations of the color image. The multicolor *Art Studio* supports scaling of the printout from 1 x 1 up to 16 x 16 with the independent setting of the horizontal and vertical scale factors. The actual range of available scale factors depends on the resolution of your printer or the number of dots on a printed line. Note that if you use roll paper, or if you ignore the perforations, there is no limit on vertical scaling. Printouts may be left justified, right justified, or centered.

### Text

Both programs support either left to right or top to bottom placement of text on the image. The multicolor *Art Studio* also supports right to left and bottom to top placement of text in regular, bold, or italic. The hi-res *Art Studio* does not support italic text. The scaling of text ranges from one to three with the independent setting of the horizontal and vertical scale factors.

A well-designed font editor is included with both programs. The character sets used by the package may contain up to 91 characters. The editors display the entire set in normal size. Three characters are presented enlarged, of which one may be edited. The character to be edited may be selected by scrolling through the set or by clicking on a character in the nor-

### ART STUDIO FILE FORMATS

	Hi-Res	Multicolor
Bit Map	\$2000-\$3F3F 8192-16191	\$2000-\$3F3F 8192-16191
Video Matrix	\$3F40-\$4327 16192-17191	\$3F40-\$4327 16192-17191
Border	\$4328 17192	\$4328 17192
Background		\$4329 17193
Color Memory		\$432A-\$4711 17194-18193

mal size display. Editing operations include the dot by dot creation and modification of the individual characters. Characters may also be inverted, flipped, rotated, scrolled to the right, or scrolled down. In the multicolor *Art Studio* characters may also be scrolled up or to the left. These additional operations make it easier to experiment and to correct for inadvertent overshoot.

The inclusion of a versatile text mode combined with the scalable printer dumps makes *The Advanced OCP Art Studio* a useful tool for the creation of posters or signs.

### Brushes and Patterns

In addition to a selection of variously sized and shaped paint brushes there is a collection of 12 built-in patterns in the multicolor *Art Studio* and 32 built-in textures in the hi-res *Art Studio*. The patterns may be used for area fill operations. As with the windows, there is more than one way to perform a fill. An interesting technique involves

the use of a pattern as a wash. This lets you overlay a second pattern over an area which has already been filled. The technique is difficult to describe, although it can generate very interesting results. Both programs include the ability to edit the patterns or textures, but only the multicolor *Art Studio* lets you save the patterns to disk or tape.

Sketching or painting with any of the 16 available pens is only one of the ways to create an image. The Shapes menu provides for the automatic creation of discrete and continuous lines, rectangles, triangles, circles, and rays. Solid shapes are created by simply filling one of the hollow shapes.

### Zoom

As with any pixel-based graphics package, a magnify option is required for detailed editing of the image. The magnify mode may be entered in any of three levels of magnification. Once in magnify mode, the degree of magnification may be changed. Magnify mode may be entered at any point on the bit map screen. Once in magnify mode the image may be scrolled about. Simultaneous viewing of the normal sized and magnified image is not supported. However, in the multicolor *Art Studio* you may momentarily switch to a full screen view to check the progress of your work. The current cursor coordinates are displayed only by the multicolor *Art Studio* while in magnify mode. Both programs offer a switchable grid overlay for two of the magnification levels.

### Conclusion

*The Advanced OCP Art Studio* is an easy to use, high performance bit map graphics package for the C-64. It is particularly attractive as it contains both high-resolution and multicolor programs in the same package. We did find several features in the multicolor *Art Studio* which we felt should have been included in the hi-res *Art Studio* as well.

We expect this package to be a popular choice in the Commodore 64 graphics community. We have already found several support utilities for it on QuantumLink, in particular a *Koala/DOODLE!* to *Art Studio* conversion program.

Firebird Licensees, Inc., Box No. 49,

Ramsey, NJ 07446 (phone: 201-444-5700).  
—Morton Kevelson

### HOTSHOT PLUS

Omnitronix, Inc.  
C-64/128, Plus/4, VIC 20  
Hardware; \$99.95

It seems that when the weather begins to cool we find ourselves looking at printer interfaces. Or perhaps it is the arrival of the printer interfaces that brings on the cooler weather. Whatever the case, we once again turn our attention to the link between the Commodore computer and the non-Commodore printer.

### Why an Interface

For the rest of the microcomputer world there are two accepted "standards" which define the nature of the connection between the computer and the printer. For the Commodore world there is only one standard, and it is nothing like everybody else's. The most popular connection follows the Centronics standard, which is basically an arrangement which permits the parallel transfer of eight bit data. In reality the Centronics connection is not a standard, although for all practical purposes it has become one. The RS-232 standard, which is a real industry standard, is also widely represented among printers. The RS-232 standard is designed for serial transmission of data one bit at a time. The main application of the RS-232 connection is for telecommunications devices like modems.

The Commodore computers and operating systems provide partial hardware and software support for the RS-232 standard. A special adapter cable is required to match the non-standard connector and voltage of the computer's user port to the official RS-232 devices. The Centronics connection is not supported by the Commodore computers, although it is possible via software and a suitable cable to configure the user port to behave just like a Centronics port. The driving software for the Centronics port must be loaded separately, as the computer's operating system does not support it directly. Many commercial software packages, most notably word processors, provide for support of an RS-232 or a Centronics device on the user port in addition to the approved Commodore standard.

## COMMODORE AUTHORIZED SERVICE

POWER SUPPLY (C-64)	\$29.95
C-64 REPAIR	44.95
1541/1571 ALIGNMENT	35.00
1541 REPAIR & ALIGNMENT	75.00
C-128 REPAIR	75.00
1571 REPAIR	95.00
POWER SUPPLY (C-128)	84.95
EXTENDED WARRANTY	CALL

Free Return Freight - Continental US  
Add \$10 for APO, FPO, AIR  
Save COD charge - send Check or  
Money Order. (Purchase Order Accepted)

### Second Source Engineering

2664 Mercantile Drive  
Rancho Cordova, CA 95670  
(916) 635-3725

Reader Service No. 280

The Commodore operating system directly supports printer output to the proprietary serial port. All Commodore printers and disk drives are designed to daisy chain from the serial port. Thus for maximum compatibility with the Commodore operating system, the best way to connect a printer is via the serial port. This has the added advantage of making it very easy to LIST a BASIC program.

## The Fundamental Task

The printer interface connected to the serial port must perform two tasks. First and foremost, it must provide the hardware translation between the serial port and either a Centronics or an RS-232 connection. The majority of printer interfaces are designed for use with the Centronics standard. Second, the interface should also provide for the translation of the non-standard Commodore character set to the standard ASCII which is understood by the printer. Most serial port interfaces will also perform some form of translation of the Commodore graphics symbols in a program listing to a more readable form.

The Commodore computers actually support two character sets. The default set contains the upper case alphabet and a diverse collection of graphic symbols. The alternate character set consists of the upper and lower case text characters and a part of the graphics characters. All of the characters may also be displayed in reverse mode as light text on a dark background. Under certain conditions the reverse characters are used as screen and printer control codes. The code for the Commodore character sets is often referred to as PETSCII in deference to the original PET computers which introduced the system. For most everybody else, the text code is known as ASCII for American Standard Code for Information Interchange.

Of course Commodore printers are completely conversant in the Commodore character sets. On the other hand, non-Commodore printers tend to get flustered when spoken to in PETSCII. The first Commodore printer intended for "home" use was the VIC-1515, which afflicted the user with a substandard sized paper among other things. The VIC-1515 was superseded by the VIC-

1525 which used standard paper but was still somewhat lacking in terms of print speed and print quality. Commodore users of four years ago tolerated these printers in spite of their shortcomings, as at a \$300 selling price they were considerably less expensive than anything else on the market.

In spite of their shortcomings, the VIC-1515 and 1525 set the emulation standard which all Commodore printer interfaces adhere to. The reason is simply that every piece of commercial software we have seen which requires the use of a printer will directly support the VIC-1515 and 1525 as a bare minimum. For some software the VIC-1515 is the only directly supported printer.

## The Hot Shot Plus

The Hot Shot Plus is the most recent entry in the Commodore printer interface competition. Not unexpectedly it provides several unique features above and beyond the basic tasks of printer interfacing and 1525 emulation. Some of these unique features include built-in software, special graphics modes, and the direct support of a very large RAM buffer.

## Hardware and Buffer

As with many other interfaces we have seen, the Hot Shot Plus is packaged in a VIC 20 cartridge case. Inside the Hot Shot Plus we found the mandatory microprocessor, 32 kilobytes of ROM, 8 kilobytes of RAM, no less than 16 miniature DIP switches, a reset pushbutton, and a collection of TTL "glue" chips. This works out to nearly 3300 bytes of memory per square inch of interface, somewhat more than what we have previously come across. This memory density may be boosted by the user to nearly 7900 bytes per square inch. The Hot Shot Plus will support up to 64 kilobytes of onboard static RAM. Simply replace the supplied 8 kilobyte RAM chip with a 32 kilobyte chip and install a second 32 kilobyte chip in the remaining empty socket. The onboard jumpers let the Hot Shot Plus recognize 16 kilobyte and 40 kilobyte RAM configurations as well.

The primary advantage of a large print buffer is that it will accept text at a faster rate than the printer can put

Page	Company	Svc. No.
C-4	Access Software, Inc.	244
22	Access Software, Inc.	245
55	Acorn of Indiana	243
42	Activision	216
42	Activision	217
44	Activision	222
44	Activision	223
54	Activision	234
49	Alsoft	229
52	American Int'l Computer	255
59	Avant Garde 64	277
9	Briwall	239
50	Cheatsheet Products Inc.	273
54	Comp-u-Save	235
37	Complete Data Automation	246
6	CompuServe	231
24-29	Computer Direct	236
54	Computer Friends	254
30	Computer Mart	261
51	Computer Mart	275
60	Computer Mart	279
7	Computer Repeats	267
17	Cosmi	282
19	Cosmi	271
69	COMB	-
C-3	Data East	248
12	Dune Systems	268
12	Electronic Arts	287
43	Electronic Arts	219
43	Epyx	218
44	Epyx	224
63	Firebird	284
71	Floppy House Software	250
73	Free Spirit Software	237
50	Grapevine Data Products	274
42	Intellireations	215
11	Jason-Ranheim	266
45	Lyc Computer	262
15	Master Software	264
38	MicroProse	247
44	MicroProse	225
57	MicroProse	232
41	Mindscape	213
43	Mindscape	220
43	Mindscape	221
53	Mindscape	226
53	Mindscape	228
21	Mirage Research Int'l	259
58	Montgomery Grant	276
47	Origin Systems	240
68	P.A.V.Y. Software	281
13	Pro-Tech-Tronics	238
34	Q-Link	252
18	Quail Electronics	-
12	Rent-A-Disc	265
18	Richwood Software	257
31	S&S Wholesalers Inc.	251
66	Second Source Engineering	280
64	Seikosha	283
C-2	Sir-tech Software, Inc.	249
48	Soft Disk Inc.	230
62	Soft-Byte	278
15	Software Simulations	270
41	Software Toolworks	214
53	Strategic Simulations	227
54	Strategic Simulations	233
11	SubLOGIC Corporation	286
10	Trident Software	269
40	TC Electronics	272
23	U.S.S. Photo	242
16	Ultrabyte	253
14	Utilities Unlimited	258
45	Value Soft Inc.	260
78	Wedgwood Rental	241
10	Xetec, Inc.	263
8	Zebra Systems, Inc.	285
74	Ahoy! Back Issues	-
79	Ahoy! Disk	-

The publisher cannot assume responsibility for errors in the above listing.

it on paper. This should free up the computer somewhat faster than if it had to wait for the printer to finish its job. For this application, even the Commodore slow serial bus is still several times faster than the typical printer.

The buffer in the Hot Shot Plus did offer some improvement over a direct connection to the printer. However, the buffer was not as fast as it could have been. We have seen other buffered serial port devices, with an 8K buffer, accept a short document in one third the time it took the Hot Shot Plus. The most notable shortcoming of the buffer's operation was its refusal to accept more than a minimum of text if the printer was not online. We had developed the habit of sending entire documents to our interface's buffer before even starting the printer. This was just not possible with the Hot Shot Plus.

The Hot Shot Plus draws its power from the 5 volt supply at the computer's cassette port. We measured its current drain at a healthy 250 milliamperes. This is not a significant amount

for the C-128. However, the C-64's power supply has been noted for its intolerance of additional loads. Users of the Hot Shot Plus with the C-64 should consider a supplemental 5 volt power supply for it, as described in the December 1986 issue.

### Fonts Galore

The Hot Shot Plus's buffer does have a number of other uses, particularly if it is expanded to the full 64 kilobytes. The Hot Shot Plus comes with six near letter quality fonts in its 32 kilobyte ROM. These fonts are printed at the maximum available resolution of your printer. For example, on an Epson-type printer the maximum available resolution is 240 dots per inch. Compare this to the 60 dots per inch of the draft quality text on the same printer.

Using the built-in fonts does extract a speed penalty. For many printers, graphics are printed unidirectionally while text can be printed bidirectionally. In addition, the quad-density graphics on Epson-type printers requires two passes of the printhead to access every dot. Thus near letter quality text will be printed at less than one fourth the speed of draft quality text. We emphasize that this is a limitation of the printer, not the Hot Shot Plus interface. Printers with a built-in near letter quality mode will operate with the same speed restrictions.

The Hot Shot Plus's set of six built-in fonts actually consists of a Correspondence font and a Helvetica font in regular, italic, and bold formats. Three of the DIP switches are devoted to font selection. This allows for the hardware selection of up to two additional fonts from RAM. The default eight kilobyte buffer can accept two regular fonts or one high resolution font. Regular fonts are designed on a 9 by 16 dot grid. High resolution fonts are designed on an 18 by 16 dot grid.

If the built-in buffer is expanded to its maximum of 64 kilobytes, then up to 36 additional regular fonts can be uploaded to the interface. As before, only the first eight fonts can be accessed via the DIP switches; however, all of the fonts may be accessed under software control.

### Interface Control

The Hot Shot Plus may be controlled

by the user in several ways. The hardware approach involves indirect tactile manipulation of the 16 DIP switches. A small pointed object is best for this, as the switches are much too small for the typical ham-handed hacker or even the most dainty of programmers. As we mentioned above, three of these switches are devoted to font selection. Four more are accounted for by printer selection, although only eight distinct printer types are implemented.

Two switches are occupied with the mundane tasks of device number (4 or 5) and linefeed control (to linefeed or not to linefeed upon a carriage return). The interface has four distinct operating modes which fully occupy two more DIP switches. The first operating mode results in total emulation of the 1525 printer. We must note that the first two operating system ROM revisions we received did have some emulation bugs. Hopefully these will all be swatted by the time this review sees print. The Enhanced Features Mode is an enhanced emulation mode which includes easy to read program listings. The ASCII Translation Mode converts all text characters from PETSCII to ASCII while passing all control codes to the printer without any modification. The Transparent Mode turns off all code translation, allowing the computer to communicate directly with the printer.

A single switch is devoted to a so-called CP/M mode. This is intended to correct the missing carriage returns, associated with linefeeds, which afflicted the early release of the C-128 CP/M. Hopefully, active CP/M users have upgraded their CP/M disks by now.

Last, but far from least, we acknowledge the font selection switch and the Graphics Enhancement Mode switch. The former enables the built-in fonts. The latter causes your printer to switch to double density mode. We cannot understate the significance of double density mode. It causes 1525 graphics emulation to be printed at 120 dots per inch on printers which can handle it. This does not add any additional detail to the 1525 mode graphics dumps. By doubling and overlapping the printed dots, double density does result in a denser printed image with noticeably higher contrast. This switch will also

### Knowledge will Increase many shall run to and fro-Daniel 12:4

Of man's inventions, the printing press has benefited the WORD more than any other. Now, the personal computer offers a new innovation in the presentation and study of the BIBLE! LANDMARK The Computer Reference Bible can actually HELP in your study by assisting you in gathering text and keeping permanent and organized notes and references. LANDMARK TCRB can enhance your Bible Study in three major ways:

- Searching the Bible for words, phrases or sentences.
- Creating your own Topical Files covering a Bible Study topic. Your LANDMARK files can even be converted for use in wordprocessors like Paperclip and GEOS (with Writer's Workshop)!
- Creating your Personal Bible(s). You can outline text in color, add notes to the individual verse references or directly to the text and create supplemental study files.

### NEW C64 UPDATE!

C128 Owners! Version 2.0 is now being developed, and will be added to the C64 version!

LANDMARK The Computer Reference Bible consists of the entire King James version with Individual Verse References, the Words of Christ in color, and a Concordance of 3300+ words!

LANDMARK TCRB for the Commodore 64/128 (in 64 Mode) is **\$164.95**

CALL or WRITE for our FREE Brochure!

P.A.V.Y. Software P.O. Box 1584  
Ballwin, MO 63022 (314) 527-4505  
DEALER INQUIRIES INVITED!

©1986 and Writer's Workshop are registered trademarks of Biblesoft Software. Personality is a registered trademark of Biblesoft Software. Commodore 64/128 are registered trademarks of Commodore Business Machines, Inc.

Reader Service No. 281



implement double density when doing a single density dump directly to the printer.

Perhaps the greatest beneficiaries of the double density feature will be GEOS users. We noticed a marked improvement in GEOS output, in both 1525 mode and direct to printer mode, with the double density feature. The font selection switch has an additional effect when used in conjunction with the Graphics Enhancement Mode switch. When both switches are on, a 1525 type graphics dump will be printed, using the quad-density mode on those printers which can handle it. This effectively raises the dot density to 240 dots per inch while resolution remains at 60 dots per inch. Once again, enhanced contrast and print uniformity are the prime benefits. We feel that the Hot Shot Plug's Enhanced Graphics Mode may be this interface's most useful feature.

We have wandered somewhat from the topic of interface control. The Hot Shot Plus is controlled by the traditional Commodore technique of changing secondary addresses. It also recognizes an extensive set of direct Escape code control sequences. Last but not least, the Hot Shot Plus supports a command channel as secondary address 15, just like the disk drive. As a result, many of the Hot Shot Plus's features may be accessed in four ways: hardware switches, secondary addresses, direct Escape codes, and command channel.

## ROMware and Diskware

The Hot Shot Plus is accompanied by several utility programs and a floppy disk. Interestingly enough, the utility programs are not found on the floppy disk. They are stored in the interface ROM which is treated as a ROM disk with device number 4. You cannot SAVE to this ROMdisk, but you can LOAD the utility programs from it. The simplest program is a status report from the interface which is LISTed to the screen. The ROMdisk also contains a full-featured font editor for creating or modifying interface fonts. New fonts may be stored on disk for subsequent uploading. Uploading may be done via the font editor or via the Autoup utility. This ROMdisk program reads a textfile on the disk which

tells it which fonts to upload to the interface. The program which creates the Autoup text file is found on the floppy disk.

The floppy disk also contains a copy of the built-in fonts as well as nine additional fonts. This is obviously a long way from the 42 fonts which may be needed to fill the interface's 64 kilobyte buffer. Since font designing is a time-consuming process, a possible alternate source was provided for. The floppy disk contains an X-O converter program. X-O is short of Xetec to Omnitronix. In this case Xetec refers to the Xetec Super Graphix printer interface.

The Super Graphix was the first printer interface to make extensive use of fonts. It has a built-in near letter quality font and an eight kilobyte buffer, and is accompanied by a floppy disk which contains dozens of fonts. The X-O converter program converts the Xetec fonts to a form compatible with the Omnitronix interface. Since the Xetec font disk is not readily available without the Super Graphix interface, it is not clear to us how one would apply the X-O converter utility to it. Since the Super Graphix is a very competent interface in its own right, we cannot see a strong incentive to give it up just to get access to its font disk.

While we are on the topic of Xetec we should mention that we are eagerly awaiting the appearance of the Super Graphix Gold printer interface. We understand it has already passed FCC approval and we should have a sample Real Soon Now. The Super Graphix Gold is expected to have a 32 kilobyte buffer, eight operating modes, fast serial I/O with the C-128, and numerous other features. In some ways it is reminiscent of the Device One printer interface we looked at in the December 1986 issue. Obviously the interface competition is not yet over.

## Conclusion

That about wraps it up for this installment on printer interfacing. The Hot Shot Plus is definitely shaping up as a strong contender in the Printer Interface finals. Its font handling and high density graphics make it well worth considering.

Omnitronix, Inc., 760 Harrison St., Seattle, WA 98109 (phone: 206-624-4985).  
—Morton Kavelson

## GREAT SAVINGS ON LEATHER ATTACHES



### E-X-P-A-N-D-A-B-L-E LEATHER BRIEFCASES

Make a bold, new impression at your next business meeting. Order this set of TWO bonded leather cases for the look and feel of designer attaches...without the high price, due to a factory overstock.

- TWO Factory New, First Quality Cases for ONE Low Liquidation Price.
- Rich Pigskin-Like Interior, Plus Generous Organization Pockets.
- Combination Locks Offer Security.
- Choose Burgundy or Black.

**Large Case.** It's 13" H x 18 1/4" W x 4 1/2" D and easily expands an extra 1/4" in depth if you need more room.

**Banker's Case.** Perfect for meetings where you need only a few documents. 11" H x 16 1/2" W x 2 1/2" D.

Shop and compare! You'll discover this is a great buy for TWO cases!

Compare: **\$229.00**  
Liquidation Price **\$59**  
For Set of TWO . . . . .

Burgundy: Item H-2989-7037-518 S/H: \$6.00/set  
Black: Item H-2989-7072-648 S/H: \$6.00/set  
Plus 50¢ Ins. Charge Per Order.

Credit card customers can order by phone, 24 hours a day, 7 days a week.

**Toll-Free: 1-800-328-0609**

#### SEND TO:

**COME** Authorized Liquidator  
1405 Xenium Lane N/Minneapolis, MN 55441-4494

Send **Leather Briefcase(s)** at \$59 per set, plus \$6.00 per set for ship, handling. (Minnesota residents add 6% sales tax. Sorry no C.O.D. order.)

Send **Burgundy**, Item H-2989-7037-518

Send **Black**, Item H-2989-7072-648

My check or money order is enclosed. (No delays in processing orders paid by check.)

PLEASE CHECK:  VISA  MasterCard  Discover  American Express

Acct. No. \_\_\_\_\_ Exp. \_\_\_\_\_

PLEASE PRINT CLEARLY

Name \_\_\_\_\_

Address \_\_\_\_\_ Apt. # \_\_\_\_\_

City \_\_\_\_\_

State \_\_\_\_\_ ZIP \_\_\_\_\_

Phone (\_\_\_\_) \_\_\_\_\_

Sign Here \_\_\_\_\_



Sort

# INFOFLOW 64

## Icon Database for the C-64

By Cleveland M. Blakemore

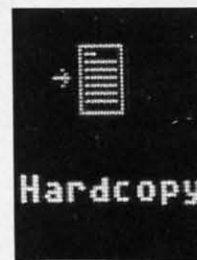

Hardcopy



Search



Current Record



Save Load

If you're familiar with *Infoflow 128*, you'll find this version for the 64 nearly identical to that program, published in the April 1987 *Ahoy!* The *Infoflow* database uses icons (pictures) instead of a menu for selection of different functions. Rather than type in a numeric choice, you use an arrow or pointer to select different pictures, at which time program flow is directed to the appropriate subroutine.

Although the following program is designed to work with Commodore's mouse, the 1350, it will also work with any high-quality joystick plugged into Port 2.

The program takes a few seconds to boot up, as it has to POKE some data into memory. When the screen reappears, you will be looking at the screen of *Infoflow 64*, an icon-operated database.

A database is a software environment that is used to keep track of information, and to organize and store it in such a way as to make the information useful to human beings.

All databases have several things in common. They have the capability to add information, modify existing information, delete information, sort information, list information, search through information, and print out information.

*Infoflow* is intended to simulate a physical filing system, with file cabinets, file drawers, trash cans, and folders. This type of layout makes it easier for the human mind to visualize exactly what's going on at the storage level. You can think of each different file, with categories like Stamps, Tapes, or Personal Information, as being a drawer in a file cabinet. Each folder in this file cabinet would be a RECORD, and each record would have several FIELDS, or categories of information.

For instance, in a drawer called PERSONAL DATA, we might have 50 records. Each record might have three fields, such as Name, Address, Phone Number. Each field should have an entry, so that any time we want, we can find information for that record, like the phone number of one of our friends, in the record with his name.

*Infoflow 64* accesses this information through icons, each icon representing a different operation to be performed on the data. There are eight icons to choose from on the screen. Touch an icon and push the fire button to access it.

The upper four icons are labeled SAVE/LOAD (disk drive with disk above it), NEW FILE (filing cabinet), DELETE

(trash can), and VIEW/ADD (eyeball).

The lower four are labeled SORT (file cabinet with letters "ABC" beside it), SEARCH (picture of several folders with arrow running alongside them), HARDCOPY (arrow pointing to manuscript), CURRENT RECORD (file cabinet with drawer open and folder to left side).

Our filing cabinet is empty when the program first starts, so we'll either have to load in an old file previously created or initialize a new file. To create a new file, select the icon NEW FILE. There is a beep, and we see the prompt "File-name", indicating *Infoflow* needs to know what we are going to call the new file we are creating. We'll type in "Personal" and hit RETURN.

*Infoflow* has a special input routine that accepts commas, colons, and even quotation marks. Using commas in addresses and lists is often very important, but BASIC 2.0 issues an EXTRA IGNORED error when it finds a comma in the input buffer. *Infoflow's* input routine also ignores all cursor movements and control characters, accepting only alphanumeric input. The only control keys functioning are the DELETE key to back up over mistakes, and the RETURN key. This input routine saves a lot of hassle and trouble normally associated with BASIC's input command. *Infoflow* also uses GET# to retrieve and save information to disk, because INPUT# does not properly receive strings with embedded commas.

Since *Infoflow* prefixes files on the disk with an "IF" to identify only those files pertinent to it, filenames are limited to 10 characters or less. This should not prove to be a problem, unless you have similar files you want to save, and 10 characters is not enough to give them distinctive names. You could label one file in uppercase, and the other in lowercase, if you have such a problem.

After typing in the file name, you will be asked for the number of fields. Type in "3" (Name, Address, Phone) and hit RETURN. The maximum number of fields permitted is 22. Now the program prompts you for the Name and Length of each field. Type in the name of each field and the maximum length, in characters, you will want each field to be limited to. If you are not sure, the default is 160. Hit the space bar and RETURN at the length prompt if you want the field to default to 160 characters. The max length for any field is 254 characters, which is pretty darned big,

PHOTOS: MICHAEL R. DAVILA

# FREE!

BONUS GIFT WITH ANY SOFTWARE ORDER — AN EXCELLENT PUBLIC DOMAIN VERSION OF AN ARCADE HIT GAME ON ITS OWN DISK.

## ARCADE GAMES

Bop & Rumble	\$19.95
California Games	26.95
Cauldron	19.95
Championship Baseball	19.95
Elite	19.95
Flight Simulator II	32.95
FS II Indiv. Scenery Disks	14.50
Gauntlet	23.95
GFL Football or GBA Basketball	23.95
Mini Putt	19.95
NBA Basketball	26.95
Paperboy	23.95
Pirates	26.95
Sentry	26.95
Street Sports Baseball	26.95
Sub Battle Simulator	26.95
Superbowl Sunday	20.95
Superbowl Sun. Data Disks	13.95
Superbowl Sun. General Manager	19.95
Superstar Ice Hockey	23.95
Top Fuel Eliminator	19.95
World Class Leader Board	26.95
W.C. Famous Courses 1 or 2	13.95

## ADVENTURE AND MIND GAMES

Bard's Tale II	\$28.95
Blue Powder, Grey Smoke	34.95
Bridge Baron	26.95
Chessmaster 2000	28.95
Defender of the Crown	23.95
Eternal Dagger-Wizard Crown 2	26.95
Guild of Thieves	26.95
Intrigue	19.95
Jewels of Darkness	17.95
Legacy of the Ancients	21.95
Little Computer People	11.95
Maniac Mansion	23.95
Phantasia I II or III	26.95
Plundered Hearts	23.95
Silicon Dreams	17.95
Strip Poker	20.95
Strip Poker Data Disks	14.95
Vegas Gambler	19.95
Where (USA) is Carmen San Diego	29.95

## EDUCATIONAL PROGRAMS

Algae Blaster	\$33.95
Cave of the Word Wizard	18.95
Donald Duck's Playground	17.95
Evelyn Wood's Dynamic Reader	21.95
Magic Spells	23.95
Perfect Score SAT	49.95
Rainy Day Games	19.95
Reader Rabbit	26.95
Sky Travel	28.95
Stickybear Series (each)	19.95
ABC, Math, Numbers, Reading	
Reading Comprehension, Typing	
Talking Teacher	26.95
Ticket to Paris (or London)	21.95

## WORD PROC.-DATA BASES SPREADSHEETS-BUSINESS

Filer's Choice	\$26.95
Fleet System 2	37.95
Fontmaster II	34.95
Planner's Choice	26.95
Pocket Filer II	39.95
Pocket Planner II	39.95
Pocket Writer II	39.95
Superbase 64	55.95
Superpack (all 3 Pocket Series)	69.95
Superscript	34.95
Writer's Choice	26.95
Word Writer 3	34.95

## GRAPHICS & MUSIC

Advanced Art Studio	\$27.95
Advanced Music System	49.95
Business Card Maker	40.95
Computer Eyes	99.00
Create a Calendar	19.95
Create with Garfield Deluxe	26.95
Doodle	26.95
Flexidraw	CALL
Graphics Integrator 2	23.95
GEOS	40.95
GEODEX	26.95
GEODRAW	34.95
GEOS Desktop I	21.95
GEOS Fontpack I	19.95
GEOS Writer's Workshop	34.95
Icon Factory	26.95
Newsroom	33.95
Newsroom Clip Art 1 or 3	19.95
Newsroom Clip Art 2	24.95

Perspectives II	44.95
Photo Finish	23.95
Printmaster Plus (Program)	23.95
Printmaster Art Gallery 1 or 2	15.95
Printshop (Program)	29.95
Printshop Graph. Lib. 1, 2 or 3	15.95
Printshop Holiday Edition	15.95
Screen FX	25.95
Teddy Bear-reels of Fun	26.95
Toy Shop	39.95
Video Title Shop	20.95

## COMMODORE 64 MISC.

1541 Physical Exam	\$33.95
Assembler/Monitor 64	26.95
Basic Compiler	26.95
Bob's Term Pro 64	36.95
Bulls Eye	15.95
Copy II 64/128	26.95
CSM Disk Alignment	32.95
Family Tree	45.95
Kracker Jax-Vol. 1 to 6 each	15.95
Loaded Shotgun	15.95
Merlin 64	34.95
Micro Lawyer	41.95
Oxford Pascal	34.95
Snapshot	40.95
TSDS Super Assembler	38.95

## COMMODORE 128 SOFTWARE

1571 Clone Machine	\$37.95
1571 Physical Exam	33.95
Big Blue Reader	21.95
Big Blue Reader (incl. CP/M)	31.95
Bob's Term Pro	59.95
CAD Pack 128	42.95
Digital Superpak II	69.95
Geos 128	47.95
Fleet System 4 (w/Filer)	56.95
Fontmaster 128	41.95
Mach 128	32.95
Merlin 128	48.95
Partner 128	47.95
Pocket Filer II	39.95
Pocket Planner II	39.95
Pocket Writer II	39.95
S. Porter's Pers Financial Plan	47.95
Super PASCAL	42.95
Term Paper Writer	33.95
The C128 Canon	25.95
Timeworks Data Manager 128	47.95
Timeworks Swiftcalc w/Sideways	47.95
Timeworks Word Writer 128	47.95

## HARDWARE & PERIPHERALS

1351 Commodore Mouse	\$ 32.95
1764 RAM Expansion	134.00
Avatex 1200HC Modem	119.00
PRO-TECH Vinyl Covers	PRICE
C-64/C-64C/C128, 1541/1571	5.95
Most Printers	6.95
Most Monitors	10.95
CPS 10 (Servicable) Power Sup.	39.95
CPS 30 (Servicable) Power Sup.	31.95
Disks DS/DD 10 pack black/grey	6.95
Disks DS/DD 100+ (Per 10)	5.45
Disks DS/DD 10 pack (Colored)	6.95
Epyx 500XJ Joystick	13.95
Estes 128 Servicable Power Sup.	59.95
Incontroller	13.95
Inland File Box (Holds 60)	7.95
Inland File Box (Holds 120)	11.95
Microflight Joystick (For FSII)	54.95
Mouse House	5.95
Mouse Pad	6.95
PRINTER RIBBONS	PRICE
Commodore MPS 801 or 1525	6.95
Commodore 802/1526	7.95
Commodore MPS1000/Epson LX80	5.95
Epson MX/FX/RX 80	5.95
Epson MX/FX/RX 80 Color	6.95
Panasonic 1090/1091/etc.	8.95
Seikosha SP1000	7.95
Seikosha SP1000 Color	8.95
Star Gemini 10x/SG10	1.95
Star Gemini 10x/SG10 Color	3.50
Star NX10/NP10	5.95
Star NX10/NP10 Color	6.95
Peak RS232 Modem Interface	24.95
Six Outlet Surge Suppressor	19.95
Tac-2 Joystick	9.95
Xetec Super Graphic Jr.	39.95
Xetec Super Graphic Sr.	59.95

## LEROY'S C-64 CHEATSHEETS \$2.95 ea.

Basic	Blanks (Set of 3)
Calc Result (Adv)	Calc Result Easy
Comal	Consultant
Data Manager 64	Disk 1541
Doodle	Easy Calc
Easy Script	Elite
Fleet System 2	Flight Sim. II
For the Beginner	GEOS
HES Writer	LOGO Sheet 1 or 2
Manager	Multiplan
Newsroom	Paperclip
Pocket Writer	Practicalc
Practicalc II	Printer 1525/801
Printer 1526/802	Printer Epson MX
Printer Gemini 10	Printer Okidata
Programmer's Aid	Quick Brown Fox
Script 64	Simon's Basic
Sky Travel	Smart Terminal 64
Speedscript	Sprites Only
Superbase 64	Superscript
Swiftcalc	Term 64
Vidtex	VIP Terminal
Word Pro 3/1	Word Pro 64

Write Now

## LEROY'S 128 CHEATSHEETS \$6.50 ea.

Basic 7.0	Blanks (Set of 3)
Data Manager 128	Disk 1571
Easy Script	Elite
Fleet System 3	Flight Sim. II
For the Beginner	Multiplan
Newsroom	Paperclip 128
Paperclip II	Pocket Writer
Superbase 128	Superscript
Word Pro	Word Writer 128

MAILING CHARGE ON  
LEROY'S CHEATSHEETS  
\$1.00

## ORDERING & TERMS

- \* VISA & Master Card - no additional charge
- \* \$2.50 Shipping charge - Shipping free on orders over \$100.00
- \* LEROY'S total mailing charge \$1.00 for any quantity
- \* C.O.D. orders - add \$1.90 extra
- \* PA residents add 6% Sales Tax
- \* FPO & APO - no additional charge
- \* We try to keep our prices as low as possible to serve our valued customers. In order to do this we are prosecuting credit card fraud to the full extent of the law.

## AMIGA SOFTWARE - CALL



Reader Service No. 250

a lot bigger than the BASIC input buffer can even handle!

Now the computer will approximate how many records can be held in memory simultaneously and ask you if you want to proceed. If you like the file you have designed, hit A for accept. If you hit R the program will return to the main menu without creating the file. It will take a moment for the program to erase the file and return to the command screen.

When you return to the command screen, you will notice that CURRENT RECORD has been set to 1 and that the available record space left in memory is displayed at lower right, to keep you informed of how many more records you can fit into this file.

Now that we have a file created, let's go to VIEW/ADD and start putting something into it. Once you enter VIEW/ADD you will find yourself looking at the record number set in CURRENT RECORD. You can flip forward through the records by moving the mouse or joystick right, and you can go back by moving it left. If you push your controller up, you will be in Insert/Modify mode, at which time you can make new entries in each field, or hit RETURN to leave the previous entry for that field unchanged. You will be limited to the maximum number of characters for that field that you set when you created the file. If you go over the 40 column line length, the screen will be scrolled down to make room for your input. If you input more than 80 characters, it may mess up some of the screen formatting, but when you are finished, the record will be printed over again correctly formatted.

If you enter a new record at the end of the file, the end-of-files pointer will be bumped up by one. Each time you enter a new record at the end of the file, the pointer will be bumped up by one to make room for another entry. The first field of each record is considered the "header"—if this header is blank, the record is considered blank. To make a new entry, you must put something in the header.

To exit from Insert/Modify, hit the button on your controller to return to the icon screen. You will notice that the last record you accessed will be set beneath the CURRENT RECORD icon.

It may seem too slow to move to the record you want in Insert/Modify. You might want to jump around very quickly in a large file, from record to record. This is the purpose of the CURRENT RECORD icon. Move your arrow to it and push the button. Now you can move rapidly forwards or backwards with your controller through the record numbers. For a fast change, move it left or right. For a really fast change, move up to count by tens through the records forward, or down to count backwards by tens. Once you have the record you want set beneath the icon, hit the button to exit. Now this is the first record you will examine if you enter VIEW/ADD again.

If you want to get rid of some old records in a hurry, select DELETE, the trash can. You will be prompted to delete the (C)urrent record, (S)can, delete (A)ll Records, or (E)xit (in case you decide you were a bit hasty). Hit C and the current record number will be erased. If you hit S, you will be able to flip through the records as in VIEW/ADD, and select records to be deleted by pushing SHIFT-D. Hit SHIFT-E to exit Scan. You will notice that when-

ever a record is deleted, all the records above it are moved down to fill in the blank, and the end-of-file pointer is decremented by one.

If you select A for All records, the program will verify with a Yes-No prompt in case you have second thoughts. Otherwise the whole file will be erased irretrievably from memory, and you will be returned to the icon screen.

You will probably want to SORT your records alphabetically sooner or later, and there is a very fast Shell-Metznert sorting routine in the program for just this purpose. Select the field you want the sorting routine to use for comparisons (usually 1 for the header) and there will be a delay as the sort routine works, depending on the size of the file. The program returns with SORT COMPLETE before you are returned to the icon screen.

If you are looking for a certain entry, group of letters, or subject in your database file, you will want to use the SEARCH icon. The maximum length of the string to search for is 24 characters. After you hit RETURN, the program will display every occurrence of that string in your file, at which time you can either modify or insert information for that entry, just like in VIEW/ADD. Each time you hit the button, the computer will begin the search again, displaying each occurrence of that string, until it reaches the end-of-file marker. The search command does not find imbedded strings; it only locates strings that are the first occurrence in that field. For example, if you type in "Letter" for your search string, *Infocflow* will find "Letterman,Dave" but would miss "Dave Letterman."

If you are going grocery shopping, or you want to call each customer you have in your database, you will need a HARDCOPY. The program prompts you for the range of records you want printed. The defaults are the beginning and ending markers for the file. The hardcopy will be aborted if the printer is not turned on.

After all this arrow moving and clicking, you may want to wrap things up and call it a day, so go to SAVE/LOAD and save your file to disk. Any existing file with the same name will be scratched and replaced with the new one.

Now that your data is safe on the disk, move your arrow to the lowest line on the screen and hit the button. The QUIT? bar lights up. Moving your arrow in any other direction will take you back to the screen, but clicking the button twice exits *Infocflow*.

The SAVE/LOAD routines and all program I/O are monitored for errors to prevent system crashes if the printer is off line, if the drive device number is wrong, etc.

You'll find that *Infocflow* is one of the simplest, fastest databases you'll ever use. C-64 owners need no longer envy the 128 version, since this adaptation is almost identical to that program, with the exception of memory. *Infocflow 64* has less than 30% of the memory available to the 128 mode program, but it should come in handy for any small filing application. A moderate sized Address file can hold about 200 records—more than enough for ordinary use.

If you should accidentally hit RUN STOP/RESTORE, you'll have to type POKE648,4 blindly to get the cursor back, since *Infocflow 64* operates up in the third bank of the VIC chip. The best way to exit is through the QUIT icon. □

SEE PROGRAM LISTING ON PAGE 93



## SUPER DISK UTILITIES

for the C128 & 1571

Super Disk Utilities is the ultimate utilities disk for the 1571 disk drive and C128 computer. Super Disk Utilities is a full featured disk utility system that will perform virtually every CBM DOS function available. No need for numerous utility disks to perform various functions. SDU does it all!

- Copy whole disks (with 1 or 2 drives)
- Perform many CP/M and MS-DOS utility functions
- Edit any track or sector with the Super Disk Editor
- Perform numerous DOS functions such as rename a disk, rename a file, change disk format (without affecting data), scratch or unscratch files, lock or unlock files, erase a track or a whole disk, create auto-boot and much more!

SDU helps you learn the inner workings of the 1571 drive with the 1571 Memory Monitor and unique RAM Writer. With these options you can assemble, disassemble any section of drive RAM or ROM. Use the Ram Writer to program the 1571 RAM yourself! SDU uses an options window to display all possible choices available at any given time. No need to memorize hidden commands. SDU fully supports a second 1571 drive. Many of the utility functions also work on the 1541 drive. SDU performs many MFM utility functions including analyze MFM disk format, format MFM disks, read a CP/M + directory, format in CP/M + (GCR format) and more. Super Disk Utilities is available for only \$39.95!

## SUPER 81 UTILITIES

Super 81 Utilities is a complete utilities package for the 1581 disk drive and C128 computer. Among the many Super 81 Utilities features are:

- Copy whole disks from 1541 or 1571 format to 1581 partitions
- Copy 1541 or 1571 files to 1581 disks
- Copy 1581 files to 1571 disks
- Backup 1581 disks or files with 1 or 2 1581's
- 1581 Disk Editor, Drive Monitor, RAM Writer
- Supplied on both 3½" and 5¼" diskettes so that it will load on either the 1571 or 1581 drive
- Perform many CP/M and MS-DOS utility functions
- Perform numerous DOS functions such as rename a disk, rename a file, scratch or unscratch files, lock or unlock files, create auto-boot and much more!

Super 81 Utilities uses an option window to display all choices available at any given time. A full featured disk utilities system for the 1581 for only **\$39.95!**

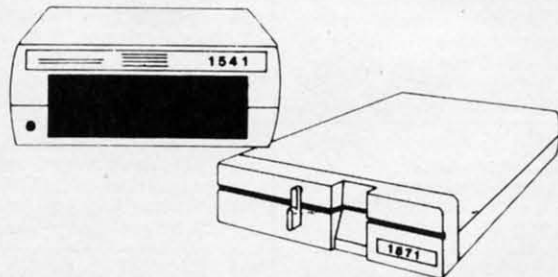

## 1541/1571 Drive Alignment

1541/1571 Drive Alignment reports the alignment condition of the disk drive as you perform adjustments. On screen help is available while the program is running. Includes features for speed adjustment and stop adjustment. Complete instruction manual on aligning both 1541 and 1571 drives. Even includes instructions on how to load alignment program when nothing else will load! Works on the C64, SX64, C128 in either 64 or 12 mode, 1541, 1571 in either 1541 or 1571 mode! Autoboos to all modes. Second drive fully supported. Program disk, calibration disk and instruction manual only **\$4.95!**

## SECURITIES ANALYST-128

Securities Analyst-128 displays text information in 80 column mode while simultaneously displaying charts and graphs in 40 column mode. Stock data may be saved on disk or printed on a dot matrix or 1520 Printer/Plotter. Among the many types of charts which may be prepared are weekly performance, moving average, accumulation/distribution, trailing stops, point and figure. Analysis includes P/E ratios, co-efficient of variability, beta factor and more. Use the investment tool of the pros! Only **\$49.95!**

## THE COMMUNICATOR

Fastest, easiest, most efficient, feature-packed terminal program available for the C64! Terminal emulation includes VT52, Tektronix-4010 & more. Supports Commodore & Hayes compatible modems. **\$39.95**

## FREE SHIPPING & HANDLING!

Order with check, money order, VISA, Mastercard. COD orders add \$4.00. Foreign orders (except APO, FPO & Canada) add \$4.00. Illinois residents add 8% sales tax. Immediate shipping!



*Free Spirit Software, Inc.*

905 W. Hillgrove, Suite 6  
La Grange, IL 60525  
(312) 352-7323

# BACK ISSUES OF *Ahoy!*

<b>#2—FEB. '84</b> Illustrated tour of the 1541! Artificial intelligence! Synapse's Ihor Wolosenko interviewed! String functions! And ready to enter: Music Maker Part III! Screen Manipulation! Night Attack! Relative Files!	<b>#3—MAR. '84</b> Anatomy of the 64! Printer interfacing for VIC & 64! Educational software series begins! VIC game buyer's guide! And ready to enter: Address Book! Space Lanes! Random Files on the 64! Dynamic Power!	<b>#5—MAY '84</b> Future of Commodore! Inside BASIC storage! Memory management on the VIC & 64! Guide to spreadsheets! Hurray for arrays! And ready to enter: Math Master! Air Assault! Biorhythms! VIC Calculator!	<b>#6—JUNE '84</b> Game programming column begins! Code generating programs! Rupert on inputting! Memory management continues! And ready to enter: Post Time for the 64 & VIC! Alpinet! Sound Concept!
<b>#7—JULY '84</b> MSD dual disk drive! Database buyer's guide! Training your cursor! Screen displays! File Sleuth! Users Groups! And ready to enter: Renumbering! Checklist! Math Defender! Brisk! What's My Job?	<b>#8—AUG. '84</b> Choosing a word processor! Computational wizardry! Creating your own word games! Sound on the 64! And ready to enter: Micro-Minder! Directory Assistance! The Terrible Twins! Words Worth!	<b>#9—SEPT. '84</b> Program your own text adventure! Build a C-64 cassette interface! Video RAM! Word processors, part III! And ready to enter: Salvage Diver! DOS! Sound Explorer! The Castle of Darkness! Base Conversions!	<b>#10—OCT. '84</b> C-64 graphics programs! Bit-mapped graphics! Joystick programming! Graphics processing! And ready to enter: VIC 40 Column Operating System! BAM Read & Print! Emerald Elephant! Lawn Job!
<b>#11—NOV. '84</b> Music programs & keyboards for the 64! Graphics feature continues! 2-D arrays! And ready to enter: PTE word processor! Block Editor! Alternate Character Set for the 64! Tunnel of Tomachon!	<b>#12—DEC. '84</b> Buyer's guide to printers! 1525 printer tutorial! Fast graphics with custom characters! User Guide to KMMM Pascal! Diving into BASIC! And ready to enter: Construction Co.! Space Patrol! Cross Ref!	<b>#13—JAN. '85</b> VIC and 64 OS exposed! Sprites! Insert a 1541 device # disconnect switch! Ghostbusters! And ready to enter: Ultra Mail! Music Tutor! Alice in Adventureland! Midprint! To the Top! Tape/Disk Transfer!	<b>#14—FEB. '85</b> Printer interfacing! Multi-color sprites! Modems! Bulletin Boards! Theory of game design! Buying a modem! And ready to enter: Futurewar! Fontasia! VIC Eraser! Insurance Agent! Flankspeed! Telelink 64!
<b>#15—MAR. '85</b> Creating multiscreen gameboards! Inside the Plus/4! Commodore DOS! And ready to enter: Old Routine! Programmable Functions! Automatic Line Nos.! Home Budget! Salmon Run! Numerology!	<b>#16—APR. '85</b> Assembly language column begins! Programming the joystick! 1541 disk drive alternatives! The Kernel! And ready to enter: Hop Around! Faster 64! Booter! Elecheck! BASIC Trace! Space Hunt!	<b>#17—MAY '85</b> Disk drive enhancements! Install a reset switch! Assembler escapades! And ready to enter: Super Duper! Two-Column Directory! DSKDU! Raid! DOS Plus! Font Editor! Tile Time! Interrupt Wedge!	<b>#18—JUNE '85</b> Music & graphics entry system! How modems work! Inside the 6510! And ready to enter: Quad-Print! Mapping 4.4! Towers of Hanoi! Speedy! Duck Shoot! Bit Dumping! Screen Magic! 6510 Simulator!
<b>#19—JULY '85</b> PROM Programming! 3-part harmonies on VIC/64! Speeding pixels! And ready to enter: Auto-Append! Script Analysis! Wizard of Im! Lucky Lottery! Brainframe! Etch! Printat! Autos: Leasing v. Buying!	<b>#20—AUG. '85</b> Inside the 128! Real-world simulations! Sound effects! Modems! And ready to enter: Windows! Formatter! Sound-a-Rama! Screen Dump! Selectachrome! Disintegrator! Fidgets! Gators N Snakes!	<b>#21—SEP. '85</b> Inside the 1571 drive and 128 keyboard! Sprite programming! And ready to enter: Fastnew! Go-lister! File Lock! Dragon Type! Superhero! Auto-Gen! Moxey's Porch! Fish Math! Ahoy!Dock! Invetive!	<b>#22—OCT. '85</b> Create cartoon characters! Infinitesimal intrigue! Secrets of copy protection! And ready to enter: Shotgun Maestro! Solitaire! Mystery at Mycroft! Mews! Gravi-nauts! 1541 Cleaning Utility! Shadey Dump!
<b>#23—NOV. '85</b> Guide to adventure gaming! ML sprite manipulation! BASIC for beginners! And ready to enter: Lightning Loader! Knight's Tour! Chopper Flight! Rhythmic Bits! Instant Bug Repellent! File Scout! Slither!	<b>#24—DEC. '85</b> Speech synthesizer! The IBM Connection! The year's 25 best entertainments! And ready to enter: Gypsy Starship! Directory Manipulator! Cloak! Gameloader! Jewel Quest! Lineout! Santa's Busy Day!	<b>#25—JAN. '86</b> Build a speech synthesizer! Survey of sports games! And ready to enter: Martian Monsters! Streamer Font! Microsim! Haunted Castle! Knockout! Infraraid! Alarm Clock! Memory Check! Scratch Pad!	<b>#26—FEB. '86</b> Windows! Build an auto-exec cartridge! Align your 1541! Survey of flight simulators! Structured programming! And ready to enter: Arenal! Head to Head! Crabfight! Treasure Wheel! Character Dump!
<b>#27—MAR. '86</b> Programming educational games! Memory dumpers! Choosing a copy program! Custom characters! And ready to enter: Ahoy!Term 128! Trivia Game Maker! Brickbusters! Easy Lister! Programmer's Aid!	<b>#28—APR. '86</b> Comet catching! Survey of action and strategy games! Screen dumping! And ready to enter: Chrono-Wedge! Mr. Mysto! Air Rescue! Notemaker! Screen Window! JCALC! Hidden Cavern! Swoop!	<b>#29—MAY '86</b> 128 graphic bit map! Epyx strategy guide! 128 commands! ML music programming! And ready to enter: Bigprint! Star Search! Failsafe! English Darts! Ski Folly! Free RAM Check! Alchemist's Apprentice!	<b>#30—JUNE '86</b> Debugging dilemmas! Public domain software! Winning at Ultima! Computer Aided Design! And ready to enter: LazyBASIC! Got A Match? Star Strike! Queen's and Bishop's Tours! Shaker! Trackdown!
<b>#31—JULY '86</b> Inside the Amiga! Conditional branching! Chess programs! 128 and 64 DOS! And ready to enter: Screen Sleuth! Skull Castle! Head-on! Nebergall Run! Word-count! Crazy Joe! Fidgets' Music School!	<b>#32—AUG. '86</b> Inside the Amiga, part III! Approaching infinity! C-64 war simulations! Pascal for beginners! ML graphics! And ready to enter: Reversal! Highlight! Disk Cataloger! Meteor Run! Trim! Step On It! Flap!	<b>#33—SEPT. '86</b> Windows and viewports! Sound & music on the 64! COMAL! And ready to enter: The Last Ninja! Speech64! Multi RAM! Dogcatcher! Trapped! Matchblocks! Variable Manager! Dual Dump! Mine Canyon!	<b>#34—OCT. '86</b> Build a digital oscilloscope! ML speed techniques! And ready to enter: Vault of Terror! Quick Change! Penguins! Attack Force! Disk Checkup! Dvorak Keyboard! Mountaineer Mack! 128 to 64 Autoboot!
<b>#35—NOV. '86</b> C-128 shadow registers! Data file handling! PROMAL! Habitat! And ready to enter: Teleporter! 128 RAM Check! Discs of Daedalus! Guardian! Tempins! Syntax Patrol! Deluxe List! Long Lines! Detonation!	<b>#36—DEC. '86</b> File manipulation! C-128 shadow registers! Football games! And ready to enter: The Artist! Minotaur Maze! Mouse in the House! Lazy Source Code! Rebels and Lords! Speedway! The Editor! Micro City!	<b>#37—JAN. '87</b> Pointers and the monitor! Best games of '86! DOS for beginners! And ready to enter: Vortex! Hanger 14! BASIC Ahoy! Catacombs! Lixter! Dark Fortress! PermaLine! Starfighter! Bugout! Screens!	<b>#38—FEB '87</b> Hacking into machine language utilities! Amiga RAM expanders! And ready to enter: Window Magic! Crunchman! User Conventions! The Adventurer! More BASIC 128! Jailbreak! Turtle Rescue! 640!
<b>#39—MAR. '87</b> Basic esthetics! Survey of video digitizers! Multiplayer games! And ready to enter: C-64 Compressor! Wizard Tag! Turbopoke! Rescue 128! Lights Out! Pinball Arcade! Stow Away! Caverns of Geehonk!	<b>#40—APR. '87</b> Inside the Amiga 2000! Fractals! Baseball games! COMAL, turtle graphics, and Logo! And ready to enter: Infoflow! Laps! Pieman! List Formatter! Scrambler! Extended Background Mode! Planet Duel!	<b>#41—MAY '87</b> Kernal power! 64 and Amiga graphics! Microworlds in COMAL! Brain games! Dark Fortress master maps! And ready to enter: Moondog! Startup! Illusion Master! Wall Crawler! Scavenger Hunt!	<b>#42—JUNE '87</b> Megaflops and microseconds! Sci-fi braingames! C-64 to Amiga file transfer! And ready to enter: D-Snap! Wraiths! Galactic Cab Co.! Cave of the Ice Ape! ALT-Key 128! Power Squares! 128 Multi RAM!
<b>#43—JULY '87</b> Real world interfacing! Bit map graphics tutorial! C-64 graphic conversion! Martial arts software! And ready to enter: Wizard Tag III! Data Creator! Plink & Plonk! Univaders! Data Express! 128 Scroller!	<b>#44—AUG. '87</b> Electronic screen swapping on the C-128! Science fiction action games! The death of GOTO! Amiga reviews! And ready to enter: Archer! Banner Print! Route 64! Steeplechase! Batter Up! Scanner!	<b>#45—SEP. '87</b> The 128 versus The Clones! Building an Amiga trackball! MSD update! CES Report! And ready to enter: Crystallus! Spriteshell! Hoops! Chainmail! No News! PS to GEOS! Centerfold! Red Alert!	<b>#46—OCT. '87</b> A rainbow of data structures! BASIC 8.0 reviewed! Buying guide to COMAL! Tips Ahoy! Art Gallery! And ready to enter: Empire! C-64 RAMDrive! Hotfoot! Platforms! Spray-Cam! Jam Attack!
<b>#47—NOV. '87</b> The ins and outs of data organization! Overview of C-64 memory expanders! Commodores! And ready to enter: Orbit! RAMCO! A-Maze-Ing! Line Sentry! Desert Front! Paper Route! Flash Flood!	<b>#48—DEC. '87</b> Exploring artificial intelligence! Expansion port tutorial! Memory expanders! And ready to enter: Redirect! Silhouette! Fueling Station! Take Two! Pizza Boy! Sprite-On! Warship! Cliffhanger!	<b>Why read Ahoy! only once a month? Order the back issues listed here and fill up those boring in-between weeks with all the programs, articles, and reviews you've missed!</b>	

**Use coupon or facsimile.**

**If ordering more than four issues, list choices on a separate sheet.**

Please send me

\_\_\_\_ copies of issue # \_\_\_\_\_ copies of issue # \_\_\_\_\_  
 \_\_\_\_ copies of issue # \_\_\_\_\_ copies of issue # \_\_\_\_\_

**ALL ISSUES \$4.00  
 EXCEPT #2, #3, & #21 (\$10.00)**

Enclosed please find my check or money order for \$\_\_\_\_\_ (outside the USA add \$1.00 per copy)

NAME \_\_\_\_\_

ADDRESS \_\_\_\_\_

CITY \_\_\_\_\_ STATE \_\_\_\_\_ ZIP \_\_\_\_\_

Send to: *Ahoy!* Back Issues, Ion International Inc., 45 West 34th Street—Suite 500, New York, NY 10001.

# COMMODORES

By Dale Rupert

**E**ach month, we'll present several challenges designed to stimulate your synapses and toggle the bits in your cerebral random access memory. We invite you to send your solutions to:

Commodares, c/o Ahoy!  
P.O. Box 723  
Bethel, CT 06801

We will print and discuss the cleverest, simplest, shortest, most interesting and/or most unusual solutions. Be sure to identify the *name* and *number* of the problems you are solving. Also show sample runs if possible. Be sure to tell what makes your solutions unique or interesting, if they are.

Programs on diskette (1541 format only) are welcome, but they must be accompanied by listings. You must enclose a stamped, self-addressed envelope if you want any of your materials returned. Solutions received by the middle of the month shown on the magazine cover are most likely to be discussed, but you may send solutions and comments any time. Your original programming problems, suggestions, and ideas are equally welcome. The best ones will become *Commodares!*

## PROBLEM #49-1: ROME REVISITED

This problem was submitted by Richard van Frank (Montclair, NJ). Very simply, the user enters an integer from 1 to 3999. The computer displays the Roman numeral for that integer. Some of you may recall this problem from the October 1984 *Commodares*. I don't generally accept duplications, since I know some of you have been solving these problems since the first issue of *Ahoy!* in January 1984. On the other hand, those of you who solved this problem before are probably much better programmers than you were then, so give it another try. (It might be interesting to compare your present solution with your previous one.)

## PROBLEM #49-2: SCORE KEEPER

Try this one from Joseph Sweely (Pennsauken, NJ). Write a routine which allows the user to enter a score and his initials. The routine saves and displays the top five scores in order (along with the initials) that have been entered since the program was started. This routine would typically be used as part of a game program.

## PROBLEM #49-3: SPRITE FLIPPER

Here is another one from Joseph Sweely. Write a program that flips (reverses) a sprite from left to right. Define a sprite with DATA statements and display it. Then call the Sprite Flipper routine which flips the sprite and displays it facing the opposite direction.

## PROBLEM #49-4: EASY AS...

Using only +, -, /, \*, and exponentiation operations (no trigonometric or transcendental functions), calculate pi as accurately as you can. PRINT 22/7 is a start, but surely you can do better than that.

This month we will discuss the best solutions to *Commodares* from the September issue of *Ahoy!* Before we begin, let me mention a letter from Charles Kluepfel (Bloomfield, NJ) concerning the probability calculation for *Problem #42-2: Cliff Hanger*. Charles sent an analysis of the problem which is more complicated than the analysis originally presented. The following program calculates the probability of successfully reaching one end of the log or the other to be 0.087, or roughly once out of every 12 tries. This agrees with the trial runs I made with this problem. Send a self-addressed, stamped envelope to me if you would like to see Charles' analysis of this problem.

```
• 1 REM =====
• 2 REM      PROBABILITY CALCULATION FOR
• 3 REM      PROBLEM #42-2:CLIFF HANGER
• 4 REM      BY
• 5 REM      CHARLES KLUEPFEL
• 6 REM =====
• 10 N=10:Y=10:F=2[UPARROW](-10):T=F
• 20 FOR N=11 TO 17
• 30 F=F*(2*N-Y-2)*(2*N-Y-1)/(N*(N-Y))/4 :
      T=T+F
• 40 NEXT
• 50 PRINT USING "#.[6"#""]";2*T
```

Now for this month's solutions. The first was *Problem #45-1: Ideal Input* suggested by Bret Ekstrand (Signal Hill, CA). The challenge was to write a routine which allows the user to input commas, quotation marks, and colons as well as text without the "Extra Ignored" error or other problems associated with the INPUT command. The subroutine should take exactly whatever the user types and store it in U\$. Also the INST/DEL key should work properly.

There were many solutions to this one. The most obvious answer is to use the GET statement (Commodore 64) or the GETKEY statement (Commodore 128). These statements read a character at a time and are not affected by commas or other troublesome keystrokes. The two problems with using the GET or GETKEY statements are 1) they don't display the input characters on the screen, and 2) they don't provide a cursor.

The following program from Jim Speers (Niles, MI) solves the cursor problem with the POKE statements in lines 110 and 150.

```

•1 REM =====
•2 REM   COMMODARES PROBLEM #45-1 :
•3 REM   IDEAL INPUT
•4 REM   SOLUTION BY
•5 REM   JIM SPEERS
•6 REM =====
•100 TY=204:IF FRE(0)<>FRE(1) THEN TY=259
9
•110 U$="":POKE TY,0
•120 GET Z$:IF Z$="" THEN 120
•130 IF Z$=CHR$(13) THEN 150
•140 U$=U$+Z$:PRINT Z$;:GOTO 120
•150 POKE TY,1:PRINT" ":PRINT:PRINT"[DOWN
][DOWN]"U$

```

Line 100 determines the proper POKE location for the C-64 or the C-128. FRE(0) and FRE(1) have the same value on the C-64, hence TY is given the value 204. On the C-128, FRE(0) returns the amount of free program memory, and FRE(1) gives the amount of free variable storage. These two numbers will generally be different, and TY will have the value 2599.

POKE TY,0 turns the cursor on, and POKE TY,1 turns it back off, but only for the 40-column screen. If you use the 80-column screen on the C-128, Brendon Bourdo (Grand Haven, MI) suggested using this Escape-U command to enable the cursor:

```

115 PRINT CHR$(27)"U" : REM ENABLE 80-CO
LUMN CURSOR

```

Another alternative is to use Escape-S (PRINT CHR\$(27)

## SOFTWARE RENTAL

1. **INEXPENSIVE** — most programs \$5—\$8 per week.
2. **SELECTION** — over 1,000 programs in stock for Atari and Commodore plus hundreds of programs for IBM, Atari ST, Amiga and Apple.
3. **TRY** before you buy — first months rent applies toward purchase.
4. **BUY USED** programs at discounted prices.

### FOR FREE LISTING CALL

1-800-433-2938 (outside Texas)  
1-817-292-7396 (inside Texas)



**WEDGWOOD RENTAL**  
5316 Woodway Drive  
Fort Worth, Texas 76133



"S"). Escape-S turns on a block cursor, and Escape-U turns on an underline cursor. Take your pick.

With this program, you may enter any keystrokes. If you press the quotation mark, it is displayed and the computer enters "quote mode." Now the cursor movements and color codes are displayed as ASCII characters. A second quotation mark exits from quote mode. Now cursor movements and color commands are implemented immediately. In either case, all keystrokes are saved in U\$.

Pressing DEL deletes the previous character as it normally does, but the DEL keystroke is also saved in U\$. As a result, when you press Enter to terminate your input, you may momentarily see the deleted character displayed on the screen before it is erased. Some readers used statements such as these to treat the DEL key separately so that it did not become part of U\$:

```

IF K$=CHR$(20) THEN U$=LEFT$(U$,LEN(U$)-
1) : PRINT K$

```

CHR\$(20) is the ASCII code for the DEL key. The LEFT\$ statement drops the previously typed character from the end of U\$. The PRINT statement causes the last character to be erased from the screen.

Bill Stech (Coshocton, OH) said if you don't like the way the BASIC INPUT statement works, the simple solution is to rewrite BASIC. And here's how he did it on the C-64.

```

•1 REM =====
•2 REM   COMMODARES PROBLEM #45-1 :
•3 REM   IDEAL INPUT
•4 REM   SOLUTION BY
•5 REM   BILL STECH
•6 REM ===== C-64 ONLY =====
•100 POKE 1,55 :REM SELECT ROM BASIC
•105 PRINT"THIS TAKES OVER 40 SECONDS[3".
"j]"
•110 FOR T=40960 TO 49151:POKE T,PEEK(T):
NEXT
•120 POKE 44136,0:POKE 44183,0:POKE 43968
,255:POKE 44140,0:POKE 44144,0
•130 POKE 1,54 :REM SELECT RAM BASIC
•140 INPUT U$ :REM CAN USE COMMAS NOW
•150 PRINT U$

```

Line 110 transfers BASIC from ROM to RAM so that it can be changed. Line 120 makes the changes. Line 130 selects the RAM version of BASIC which now allows commas (and everything else) to be entered with the INPUT statement. Bill said the only side effect is that multiple items cannot be contained in DATA statements since commas are not allowed there either. The solution is to select ROM BASIC first with POKE 1,55, then READ the data, and finally switch back to RAM BASIC with POKE 1,54. If a reset occurs, just POKE 1,54 to reactivate RAM BASIC. That's the easy way to fix the parts of BASIC you don't like.

*Problem #45-2: Fade Away* was an interesting challenge from John Yergaw (London, ONT). The only requirement was to make a word on the screen fade away. Clever *Commodore* readers were able to find no fewer than six dis-



tinctively different ways of doing that.

The most common approach is exemplified by this program from David Alan Wright (New Britain, CT).

```
•1 REM =====
•2 REM   COMMODARES PROBLEM #45-2 :
•3 REM   FADE AWAY
•4 REM   SOLUTION BY
•5 REM   DAVID ALAN WRIGHT
•6 REM =====
•10 POKE53281,0:POKE53280,0:C$(1)="[WHITE
][c 8][c 5][c 4][BLACK]":C$(2)="[WHITE][
YELLOW][c 3][c 1][RED][c 2][BLACK]":C$(3
)="[WHITE][c 7][BLUE][BLACK]"
•20 C$(4)="[WHITE][c 6][CYAN][GREEN][BLAC
K]":FORI=1TO4:FORJ=1TOLEN(C$(I)):PRINTMI
D$(C$(I),J,1)"[UP]FADE"
•30 FOR K=1TO500 : NEXTK,J,I
•40 PRINT"[WHITE]"
```

This program fades a word from white to black four times, each time in a different color band. The MID\$ statement in line 20 takes one color code at a time from the C\$( ) arrays. After the color code is printed, the word "FADE" is shown in the chosen color.

Paul Schmidt (San Diego, CA) took a similar approach, but he arranged all the colors in one string for use on a monochrome monitor only in 40-column mode. Change C\$(1) in the program above to

```
C$(1)="[WHITE][c 6][YELLOW][c 8][CYAN][G
REEN][c 3][c 5][c 7][PURPLE][c 1][RED][c
4][c 2][BLUE][BLACK]"
```

You may remove the I FOR/NEXT loop in line 20 to see just Paul's solution. Remove the cursor-up code from the "FADE" string in line 20 to see all the shades displayed on the screen.

Clayton Whisman (Winchester, KY) sent the following solution for the C-64.

```
•1 REM =====
•2 REM   COMMODARES PROBLEM #45-2 :
•3 REM   FADE AWAY
•4 REM   SOLUTION BY
•5 REM   CLAYTON WHISMAN
•6 REM ===== C-64 ONLY =====
•10 PRINT"[CLEAR]":PRINTTAB(1)"[10][DOWN]
"[FADE]":PRINTCHR$(142):CLR
•20 POKE56334,PEEK(56334)AND254:POKE1,PEE
K(1)AND251
•30 FORI=1TO511:POKEI+12288,PEEK(I+53248)
:NEXTI
•40 POKE1,PEEK(1)OR4:POKE56334,PEEK(56334
)OR1:POKE53272,(PEEK(53272)AND240)+12
•50 FORX=0TO7:FORN=1TO4:READA:POKEA,0:FOR
T=1TO30:NEXTT:NEXTN:NEXTX:END
•70 DATA 12339,12297,12327,12335,12337,12
303,12321,12329
```

```
•80 DATA 12340,12296,12324,12328,12343,12
301,12323,12334
•90 DATA 12336,12298,12322,12332,12341,12
299,12325,12330
•100 DATA 12338,12302,12320,12333,12342,1
2300,12326,12331
```

This program randomly turns off bits in the characters F,A, D, and E. The program works so well in fact that the READY prompt when the program is done looks like this: "R Y." Press RUN STOP/RESTORE to return the characters to normal.

Norman Richards (Angleton, TX) sent two unique solutions to this problem. They are combined into the following program.

```
•1 REM =====
•2 REM   COMMODARES PROBLEM #45-2 :
•3 REM   FADE AWAY
•4 REM   SOLUTION BY
•5 REM   NORMAN RICHARDS
•6 REM =====
•10 REM ---- FIRST PROGRAM ----
•20 FORA=100TO1STEP-1:PRINT"[CLEAR][5][DO
WN]"][4][RIGHT]"FIRST":FORB=1TOA:NEXT:P
RINT"[CLEAR]":NEXTA
•100 REM ---- SECOND PROGRAM ----
•110 W$="SECOND"
•120 L=LEN(W$):C$="[HOME][5][DOWN]"][5][R
IGHT]":D$="[HOME][5][DOWN]"][4][RIGHT]
]"
•130 FOR I=1 TO L:FOR B=1 TO 5
•140 PRINT C$" "W$" "
•150 FOR A=1 TO 50 : NEXT
•160 PRINT D$" "W$" "
•170 FOR A=1 TO 50 : NEXT
•180 NEXT B
•190 D=D+1:IF D=2 THEN D=0:W$=RIGHT$(W$,L
EN(W$)-1):GOTO 210
•200 W$=LEFT$(W$,LEN(W$)-1)
•210 NEXT I
•220 PRINT"[CLEAR]"
```

The first one-liner fades the word by blinking it away. The second program rattles the word from side to side until it has vanished.

The next solution is from Robert Marcus (Agincourt, ONT). This is similar to Clayton's program in that it turns off bits within character memory.

```
•1 REM =====
•2 REM   COMMODARES PROBLEM #45-2 :
•3 REM   FADE AWAY
•4 REM   SOLUTION BY
•5 REM   ROBERT MARCUS
•6 REM ===== C-64 ONLY =====
•50 PRINTCHR$(142)CHR$(147)
•60 PRINTTAB(82)"THERE WILL BE A SLIGHT D
ELAY BEFORE"
```

```

•65 PRINTTAB(82)"THE CHARACTERS BEGIN TO
FADE BEFORE"
•70 PRINTTAB(82)"YOUR EYES"
•100 POKE254,PEEK(56):POKE56,56:CLR:REM P
ROTECT CHAR. MEM. FROM BASIC
•105 DIMN(7):N(0)=3:N(1)=1:N(2)=6:N(3)=0:
N(4)=5:N(5)=7:N(6)=4:N(7)=2
•110 POKE 56334,PEEK(56334)AND254
•120 POKE 1,PEEK(1)AND251
•130 FORI=0TO272:POKEI+14336,PEEK(I+53248
):NEXT:REM MOVE FIRST 34 CHARACTERS
•140 POKE1,PEEK(1)OR4
•150 POKE56334,PEEK(56334)OR1
•160 POKE53272,(PEEK(53272)AND240)OR14:RE
M NEW CHAR. MEM. LOCATION
•170 PRINTTAB(85)"NOW WE SHALL BEGIN FADI
NG OUT"
•180 FORI=0TO7:BI(I)=2[UPARROW]I:NEXT:REM
SET BIT
•190 FORJ=0TO7:FORI=14344TO14608
•200 POKEI,PEEK(I)ANDNOT(BI(N(J))):NEXT:N
EXT:REM WIPE OUT CHAR'S BIT BY BIT
•220 PRINT"[CLEAR]":POKE53272,(PEEK(53272
)AND240)OR4:REM RETURN TO ROM CHAR MEM.
•230 POKE56,PEEK(254):CLR:REM PUT TOP OF
MEM BACK

```

This program works only on the C-64. The full screen of text will vanish before your very eyes.

The final solution to this problem is the short program written by Tom Griffin (Owatonna, MN). This is a very clever application of the fading letters concept.

```

•1 REM =====
•2 REM   COMMODARES PROBLEM #45-2 :
•3 REM   FADE AWAY
•4 REM   SOLUTION BY
•5 REM   TOM GRIFFIN
•6 REM =====
•10 PRINTCHR$(147):POKE646,0:POKE53281,0:
POKE53280,0:DIMC(12):M=55445
•15 A$=" COMMODARES ":PRINT:PRINT:PRINT
:PRINTA$A$A$:FORL=0TO12:READC(L):NEXT
•20 FORP=1TO50:FORL=0TO12:POKEM+P+L,C(L):
NEXT:NEXT:GOTO200
•25 DATA 0,11,12,15,1,1,1,1,1,15,12,11,0

```

Tom's solution causes the words to fade in and out as if a spotlight were panning them. C-128 users should change the POKE 646,0 in line 10 to POKE 241,0. This program must be run in 40-column mode on the C-128. Very impressive indeed, Tom!

*Problem #45:3 Super Bowl* was suggested by Oren Dalton (El Paso, TX). It was a rather tough problem. Jim Speers (Niles, MI) sent the easiest solution to understand.

```

•1 REM =====
•2 REM   COMMODARES PROBLEM #45-3 :
•3 REM   SUPER BOWL

```

```

•4 REM   SOLUTION BY
•5 REM   JIM SPEERS
•6 REM =====
•100 DIMMX$(20),MN$(20),MX(20),MN(20)
•110 B$="[10"/"]":FORI=1TO8:READX$(I),X(I
),Y(I):NEXTI:A$="X"
•120 FORI=1TO4:READX1$(I),X1(I),Y1(I):NEX
TI:FORI=1TO10:MN(I)=300:NEXTI:NX=1:NN=1
•130 DATAXX,30,30,XX/,29,20,X/X,20,20,X/
/,20,20,/XX,20,20,/X/,20,20,//X,19,10
•140 DATA///,19,10,XX,25,20,X/,20,20,/X,2
0,20,/,19,10
•150 FORA=1TO6:FORB=A+1TO7:FORC=B+1TO8:FO
RD=C+1TO9:FORE=D+1TO10
•160 S$=B$:MID$(S$,A)=A$:MID$(S$,B)=A$:MI
D$(S$,C)=A$:MID$(S$,D)=A$:MID$(S$,E)=A$
•170 GOSUB200:NEXTE,D,C,B,A
•180 PRINT"[CLEAR][DOWN][RVSON] MAXIMUM [
RVSOFF]":FORI=1TONX:PRINTMX$(I);MX(I):NE
XTI
•190 PRINT"[DOWN][RVSON] MINIMUM [RVSOFF]
":FORI=1TONN:PRINTMN$(I);MN(I):NEXTI:END
•200 SX=15:SN=15:FORI=1TO8:T$=MID$(S$,I,3
)
•210 FORJ=1TO8:IFT$<>X$(J)THEN230
•220 SX=SX+X(J):SN=SN+Y(J):J=8
•230 NEXTJ,I:T$=MID$(S$,9,2):FORJ=1TO4:IF
T$<>X1$(J)THEN250
•240 SX=SX+X1(J):SN=SN+Y1(J)
•250 NEXTJ:IFSX>MX(NX)THENNX=1:MX(NX)=SX:
MX$(NX)=S$:GOTO270
•260 IFSX=MX(NX)THENNX=NX+1:MX(NX)=SX:MX$
(NX)=S$
•270 IFSN<MN(NN)THENNN=1:MN(NN)=SN:MN$(NN
)=S$:RETURN
•280 IFSN=MN(NN)THENNN=NN+1:MN(NN)=SN:MN$
(NN)=S$
•290 RETURN

```

The problem was to find the minimum and maximum bowling scores possible for a game with five spares and five strikes. We assumed (for simplicity) that only five pins were dropped after the tenth frame. Jim assumed that for the maximum score, the first ball of a spare following a strike was a 9. For the minimum the first ball of the spare was a gutter ball (0).

With strikes in both the 9th and 10th frames, Jim assumed that all five pins made after the 10th frame were on the first extra ball for the maximum. For the minimum he assumed the first extra ball scored no pins. Recall that the score for a strike is 10 points plus the scores on the next two balls. The score for a spare is 10 points plus the score on the next ball. Strikes are shown as X's and spares are shown as /s.

In Jim's program for the C-128, lines 100-140 create the necessary variables. Notice how the scores are stored in the DATA statements. Lines 150-170 create all possible strings containing five strikes and five spares. Line 160 must be changed for the C-64 which does not allow MID\$ on

# Ahoy! DISK

Why type in the listings in this month's *Ahoy!* when we've done it for you? All the programs in this issue are available on the current *Ahoy! Disk* for \$8.95. Isn't your time worth more than that?

Use the coupon at the bottom of this page to order disks for individual months, a disk subscription, or the special anthology disks described below.

(You can also subscribe to the *Ahoy! Disk Magazine*—disk and magazine packaged together at a special reduced rate. See the card bound between pages 66 and 67.)

## BEST OF '84

Address Book (3/84)  
Air Assault (5/84)  
Alpiner (6/84)  
Checklist (7/84)  
Construction Co. (12/84)  
DOS (9/84)  
Emerald Elephant (10/84)  
I Got Biorhythm (5/84)  
Lawn Job (10/84)  
Lunar Lander (4/84)  
Math Master (5/84)  
Micro Minder (8/84)  
Multi Draw 64 (1/84)  
Name That Star (4/84)  
Post Time (6/84)  
Salvage Diver (9/84)  
Space Lanes (VIC) (3/84)  
Space Lanes (64) (3/84)  
Space Patrol (12/84)  
VIC 40 (10/84)

## BEST OF '85

Ahoy! Dock (9/85)  
Auto Line Numbers (3/85)  
Directory Manipulator (12/85)  
File Lock (9/85)  
Fantasia (2/85)  
Futurewar! (2/85)  
Gameloader (12/85)  
Home Budget (3/85)  
Jewel Quest (12/85)  
Lightning Loader (11/85)  
Midprint (1/85)  
Music Tutor (1/85)  
Salmon Run (3/85)  
Screen Dump (8/85)  
Telelink (2/85)  
Tile Time (5/85)

## BEST OF '86

Disk Cataloger (8/86)  
Dogcatcher (9/86)  
Fidgits' Music School (7/86)  
Flap! (8/86)  
Guardian (11/86)  
Head to Head (2/86)  
Highlight (8/86)  
JCALC (4/86)  
Meteor Run (8/86)  
Mine Canyon (9/86)  
Mountaineer Mack (10/86)  
Star Strike (6/86)  
Step On It (8/86)  
Syntax Patrol (9/86)  
Teleporter (11/86)  
Tenpins (11/86)  
1541 Alignment Check (2/86)

## BEST UTILITIES

Auto Append (7/85)  
BASIC Trace (4/85)  
Base Conversions (9/84)  
Booter (4/85)  
Commodore Font Editor (5/85)  
DOS (9/84)  
Fastnew (9/85)  
Formatter (8/85)  
Lucky Lottery (7/85)  
Maestro (10/85)  
Micro Minder (8/84)  
Printat (7/85)  
Screen Bit Dump (6/85)  
Screen Magic (6/85)  
Start & End File Address (9/85)  
Two Column Directory (5/85)  
Windows (8/85)  
1541 Cleaning Utility (10/85)

## BEST UTILITIES II

Alarm Clock (1/86)  
BASIC Relocator (1/86)  
Bigprint (5/86)  
Chrono-Wedge (4/86)  
Disk Checkup (10/86)  
Fallsafe (5/86)  
Long Lines (11/86)  
Programmer's Aid (3/86)  
Quick Change (10/86)  
Reversed Remarks (7/86)  
Screen Sleuth (7/86)  
Screen Window (4/86)  
Speech64 (9/86)  
The Editor (12/86)  
Trackdown (6/86)  
Very-Able (3/86)  
128 to 64 Autoboot (10/86)

## BEST GAMES

Alpiner (6/84)  
Construction Co. (12/84)  
Disintegrator (8/85)  
Dragon Type (9/85)  
Duck Shoot (6/85)  
Emerald Elephant (10/84)  
Gators N Snakes (8/85)  
Gravinauts (10/85)  
Lawn Job (10/84)  
Mystery at Mycroft Mews (10/85)  
Name That Star (4/84)  
Post Time (6/84)  
Salvage Diver (9/84)  
Script Analysis (7/85)  
Space Patrol (12/84)  
Tile Time (5/85)  
Wizard of Im (7/85)

## BEST GAMES II

Actionauts (4/86)  
Air Rescue (4/86)  
Brickbusters (3/86)  
Crabfight (2/86)  
English Darts (5/86)  
Got a Match? (6/86)  
Haunted Castle (1/86)  
Head On (7/86)  
Knockout (1/86)  
Micro City (12/86)  
Minotaur Maze (12/86)  
Penguins (10/86)  
Ski Folly (5/86)  
Star Search (5/86)  
Swoop (4/86)  
The Last Ninja (9/86)

## BEST C-128

Ahoy!Term (3/86)  
Dark Fortress (1/87)  
Dual Dump (9/86)  
Extended Background Mode (4/87)  
Inflow (4/87)  
List Formatter (4/87)  
More BASIC 128 (2/87)  
Nebergall Run (7/86)  
Planet Duel (4/87)  
Queen's and Bishop's Tours (6/86)  
Rescue 128 (3/87)  
The Artist (12/86)  
Variable Manager (9/86)  
Wordcount (7/86)  
128 to 64 Autoboot (10/86)

We've collected *Ahoy!*'s best programs onto the Anthology Disks described here.

Please note that many of these programs will be unusable without the documentation printed in the issues of *Ahoy!* listed in parentheses.

### SINGLE ISSUE AND SUBSCRIPTION PRICES

(Postage and Handling Included)

	U.S.A.	CANADA	ELSEWHERE
<input type="checkbox"/> January '88 <i>Ahoy!</i> Disk	\$ 8.95	\$ 12.95	\$ 13.95
<input type="checkbox"/> 12-Month Disk Subscription	\$ 79.95	\$ 99.95	\$124.95
<input type="checkbox"/> 24-Month Disk Subscription	\$149.95	\$179.95	—

### BACK ISSUES \$8.95

In Canada add \$2.00 per issue; outside US and Canada add \$4.00 per issue.

<input type="checkbox"/> —	\$8.95	<input type="checkbox"/> —	\$8.95
<input type="checkbox"/> —	\$8.95	<input type="checkbox"/> —	\$8.95
<input type="checkbox"/> —	\$8.95	<input type="checkbox"/> —	\$8.95
<input type="checkbox"/> —	\$8.95	<input type="checkbox"/> —	\$8.95

### ANTHOLOGY DISKS \$10.95 EACH

- Best of '84       Best Utilities  
 Best of '85       Best Utilities II  
 Best of '86       Best Games  
 Best of C-128     Best Games II

Send coupon or facsimile to: **Ahoy! Program Disk**  
Ion International Inc.  
45 West 34th Street, Suite  
New York, NY 10001

NAME \_\_\_\_\_  
ADDRESS \_\_\_\_\_  
CITY \_\_\_\_\_ STATE \_\_\_\_\_ ZIP \_\_\_\_\_

Make check or money order payable to **Double L Software**. N.Y. State Residents must add 8 1/4% sales tax.



the left side of the assignment statement. Each statement of the form `MID$(S$,X)=A$` can be replaced by

`S$=LEFT$(S$,X-1)+A$+MID$(S$,X+1)`

The subroutine at line 200 calculates each score and compares it with the current minimum and maximum. The minimum and maximum are saved in line 250-280. There are fourteen combinations that give the minimum score of 165, and four combinations that give the maximum score of 231.

Congratulations also to Robert Marcus (Agincourt, ONT) and Gary Bond (Topeka, KS) for good solutions to a tough challenge.

The final problem is #45:4 *Fast Factorial*, suggested by Thomson Fung (San Diego, CA). The problem was to write assembly language code to calculate 5 factorial ( $5! = 5*4*3*2*1 = 120$ ), leaving the results in the X register. The shortest solution is this one by Larry Schafer (Westphalia, MI).

```

•1 REM =====
•2 REM   COMMODARES PROBLEM #45-4 :
•3 REM   FAST FACTORIAL
•4 REM   SOLUTION BY
•5 REM   LARRY SCHAFFER
•6 REM == MONITOR/ASSEMBLER LISTING ==
•10 :LDA #5      ;START WITH A=5
•11 :ASL        ; A=A*2=5*2
•12 :ASL        ; A=5*2*2=5*4
•13 :
•14 :STA $52     ;SAVE 5*4
•15 :ASL        ;A=5*4*2
•16 :ADC $52     ;A=5*4*2+5*4=5*4*3
•17 :
•18 :ASL        ;A=A*2=5*4*3*2
•19 :
•20 :TAX        ;PUT A INTO X

```

To enter this program into the C-128 monitor, type `MONITOR` from `BASIC`. Then enter `A0C00 LDA #5` to store the program beginning at address `$0C00`. Press `RETURN` and continue entering just the instructions (`ASL`, `ASL`, `STA $52`, `ASL`, `ADC $52`, `ASL`, `TAX`, `BRK`), pressing `RETURN` after each one. The `BRK` provides an end of the program for the monitor.

To see that the program is in memory, enter `D0C00`. You should see the instructions in addresses `0C00` through `0C0B`. Before executing the program, enter `R` to see the initial value in the X register. Then enter `G0C00`. The `BREAK` message will be displayed and the register values are shown. Now the A register and the X register should both have the correct answer (78 hex equals 120 decimal).

The `ASL` instruction causes the 8-bit value in the A register (accumulator) to be shifted left by one bit. This is equivalent to multiplying by 2. Lines 11 and 12 cause the original 5 in the accumulator to be multiplied by 4. To multiply a number by 3, the easiest way is to double the number and add it to its original value ( $2*X + X = 3*X$ ). Lines 14-16 multiply the A register by 3. A temporary memory location (address 52 hex) is used to store the original value

$5*4$ . Line 15 doubles this value. Line 16 adds the result to the original value just stored in address 52 hex. Now the A register contains the quantity  $5*4*3$ .

Line 18 doubles the result once more, giving  $5*4*3*2$  which is the desired answer. Line 20 puts the answer into the X register, as specified.

This problem was a relatively easy assembly language problem since only single-byte mathematics was involved. We didn't even need to worry about the carry bit. It would be harder to make a general factorial calculator. Finding even six factorial would be much more difficult since quantities greater than 256 would be involved, and more than one byte would be needed to store the quantities.

If you want to access this routine from `BASIC`, you might replace `BRK` with the following instructions from Thomson's solution:

```

JSR $FFD2
RTS

```

The subroutine at address `$FFD2` is the `BSOUT` kernel routine which displays whatever value is stored in the A register. The `RTS` instruction causes the program to return to `BASIC` rather than to the monitor. After entering the program in the monitor, type `X` to return to `BASIC`. In `BASIC`, type `SYS 3072`. This jumps to the routine at address `$0C00`. You should see the symbol corresponding to `CHR$(120)` on the screen. It was put there by the `BSOUT` routine.

Another way to see the results in the X register from `BASIC` is with `PRINT PEEK(781)` on the C-64 or `PRINT PEEK(7)` on the C-128. A better way to look at the registers on the Commodore 128 after a `SYS` statement is with the `RREG` statement:

```
RREG A,X,Y,S : PRINT X
```

The `RREG` statement stores the A, X, Y, and Status register values in the four variables listed after it. Use the `PRINT` statement to show the values of any of those variables.

Thanks to all the others with very good (although not quite as short) solutions to this problem. I am looking forward to your solutions and suggestions for next month. Keep them coming. □

Congratulations to the following people not already mentioned this month who sent valid solutions to *Commodares*:

Greg Badros (Salisbury, MD)	M. Levinton (New Rochelle, NY)
Claude Bouchard (Laval, QUE)	John Locke (Central Point, OR)
Rene Boutin (Sherbrooke, PQ)	Edgar Losberg (Huntsville, AL)
Hal Cohen (Pepper Pike, OH)	Dan Lukens (Elkhart, IN)
Ernest Croot (Bevinsville, KY)	William Nolan (Brattleboro, VT)
David Dick (Jarrettsville, MD)	Tony Northrup (Pflugerville, TX)
Richard Dowdy (Ft. Hood, TX)	David Rice (Phoenix, AZ)
Alberto Gancitano (Brooklyn, NY)	Chris Rockett (Columbia, MD)
Kris Gilbert (Cadillac, MI)	James Schuster (Fairpoint, OH)
Jeff Gilbert (Philadelphia, PA)	Jimmy Sethman
J. Williams (San Antonio, TX)	David Shobe (Lawrence, KS)
Scott Gray (New Bloomfield, MO)	Myong Sik Paek (Portland, OR)
Robert Groysman (Fair Lawn, NJ)	Paul Sobolik (Pittsburgh, PA)
Alan Gutierrez (Forest Hills, NY)	Dave Bazquez (New Orleans, LA)
Jason Ivey (Monroe, MI)	Jeff Veasey (Lovington, NM)
Jason Jowers (Jackson, TN)	M. Watson (Denham Springs, LA)
Jerry Koyne, Jr. (Winchester, IL)	Mike Weno (Cedar Rapids, IA)

# PROGRAM LISTINGS

Attention new *Ahoy!* readers! You must read the following information very carefully prior to typing in programs listed in *Ahoy!* Certain Commodore characters, commands, and strings of characters and commands will appear in a special format. Follow the instructions and listings guide on this page.



In the following pages you'll find several programs that you can enter on your Commodore computer. But before doing so, read this entire page carefully.

To insure clear reproductions, *Ahoy!*'s program listings are generated on a daisy wheel printer, incapable of printing the commands and graphic characters used in Commodore programs. These are therefore represented by various codes enclosed in brackets [ ]. For example: the SHIFT CLR/HOME command is represented onscreen by a heart . The code we use in our listings is [CLEAR]. The chart below lists all such codes which you'll encounter in our listings, except for one other special case.

The other special case is the COMMODORE and SHIFT characters. On the front of most keys are two symbols. The symbol on the left is obtained by pressing that key while holding down the COMMODORE key; the symbol on the right, by pressing that key while holding down the SHIFT key. COMMODORE and SHIFT characters are represented in our listings by a lower-case "s" or "c" followed by the symbol of the key you must hit. COMMODORE J, for example, is represented by [c J], and SHIFT J by [s J].































Additionally, any character that occurs more than two times in a row will be displayed by a coded listing. For example, [3 "[LEFT]"] would be 3 CURSOR left commands in a row, [5 "[s EP]"] would be 5 SHIFTed English Pounds, and so on. Multiple blank spaces will be noted in similar fashion: e.g., 22 spaces as [22 " "].

Sometimes you'll find a program line that's too long for the computer to accept (C-64 lines are a maximum of 80 characters, or 2 screen lines long; C-128 lines, a maximum of 160 characters, 2 or 4 screen lines in 40 or 80 columns respectively). To enter these lines, refer to the *BASIC Command Abbreviations Appendix* in your User Manual.

On the next page you'll find our *Bug Repellent* programs for the C-128 and C-64. The version for your machine will help you proofread programs after typing them. (Please note: the *Bug Repellent* line codes that follow each program line, in the whited-out area, should *not* be typed in. See instructions preceding each program.)

On the second page following you will find *Flankspeed*, our ML entry program, and instructions on its use.

Call *Ahoy!* at 212-239-6089 with any problems (if busy or no answer after three rings, call 212-239-0855).

WHEN YOU SEE	IT MEANS	YOU TYPE	YOU WILL SEE	WHEN YOU SEE	IT MEANS	YOU TYPE	YOU WILL SEE
[CLEAR]	Screen Clear	SHIFT CLR/HOME		[BLACK]	Black	CNTRL 1	
[HOME]	Home	CLR/HOME		[WHITE]	White	CNTRL 2	
[UP]	Cursor Up	SHIFT ↑ CRSR ↓		[RED]	Red	CNTRL 3	
[DOWN]	Cursor Down	↑ CRSR ↓		[CYAN]	Cyan	CNTRL 4	
[LEFT]	Cursor Left	SHIFT ← CRSR →		[PURPLE]	Purple	CNTRL 5	
[RIGHT]	Cursor Right	← CRSR →		[GREEN]	Green	CNTRL 6	
[SS]	Shifted Space	SHIFT Space		[BLUE]	Blue	CNTRL 7	
[INSERT]	Insert	SHIFT INST/DEL		[YELLOW]	Yellow	CNTRL 8	
[DEL]	Delete	INST/DEL		[F1]	Function 1	F1	
[RVSON]	Reverse On	CNTRL 9		[F2]	Function 2	SHIFT F1	
[RVSOFF]	Reverse Off	CNTRL 0		[F3]	Function 3	F3	
[UPARROW]	Up Arrow	↑		[F4]	Function 4	SHIFT F3	
[BACKARROW]	Back Arrow	←		[F5]	Function 5	F5	
[PI]	PI	π		[F6]	Function 6	SHIFT F5	
[EP]	English Pound	£		[F7]	Function 7	F7	
				[F8]	Function 8	SHIFT F7	

# BUG REPELLENT FOR THE 64 & 128 By BUCK CHILDRESS

Please note: the *Bug Repellent* programs listed here are for *Ahoy!* programs published from the May 1987 issue onward! For older programs, use the older version.

Type in, save, and run *Bug Repellent*. You'll be asked if you want automatic saves to take place. If so, you're prompted for the device, DISK (D) or TAPE (T). You then pick a starting file number, 0 through 99. Next, you enter a name, up to 14 characters long. At this point, *Bug Repellent* verifies your entries and gives you a chance to change them if you want. If no changes are needed, *Bug Repellent* activates itself. (Pressing RETURN without answering the prompts defaults to disk drive and begins your files with "00BACKUP".)

Type NEW and begin entering an *Ahoy!* program. As you enter program lines and press RETURN, a *Bug Repellent* code appears at the top of your screen. If it doesn't match the code in the program listing, an error exists. Correct the line and the codes will match.

If used, automatic saves take place every 15 minutes. When the RETURN key is pressed on a program line, the screen changes color to let you know that a save will begin in about three seconds. You may cancel the save by pressing the RUN STOP key. The file number increments after each save. It resets to 00 if 99 is surpassed. After saving, or cancelling, the screen returns to its original color and the timer resets for 15 minutes.

When you've finished using *Bug Repellent*, deactivate it by typing SYS 49152 [RETURN] for the Commodore 64 or SYS 4864 [RETURN] for the Commodore 128.

## C-64 BUG REPELLENT

```

10 PRINTCHR$(147)"LOADING AND CHECKING THE DATA[3"."]:J
=49152
20 FORB=0TO11:READA:IFA<0ORA>255THEN40
30 POKEJ+B,A:X=X+A:NEXTB:READA:IFA=XTHEN50
40 PRINT:PRINT"ERROR IN DATA LINE:"PEEK(64)*256+PEEK(63)
:END
50 X=0:J=J+12:IFJ<49456THEN20
60 POKE198,0:POKE49456,0:A$="Y":B$=A$:C$="D":D$="DISK":D
=8:PRINTCHR$(147)
70 INPUT"DO YOU WANT AUTOMATIC SAVES (Y/N)";A$:PRINT:IFA
$="Y"THEN90
80 PRINT"NO AUTOMATIC SAVES[3"."]:GOTO150
90 POKE49456,1:INPUT"DISK OR TAPE (D/T)";C$:IFC$<"D"THE
ND=1:D$="TAPE"
100 POKE49457,D:D$=D$+" DRIVE":PRINT:INPUT"FILE NUMBER (
0-99)";N
110 N$=RIGHT$(STR$(N),2):IFN<10THENN$=CHR$(48)+CHR$(N+48
)
120 F$="BACKUP":PRINT:INPUT"FILENAME";F$:F$=N$+LEFT$(F$,
14):L=LEN(F$)
130 POKE49458,L:FORJ=1TOL:POKE49458+J,ASC(MID$(F$,J,1)):
NEXTJ:PRINT
140 PRINT"SAVING DEVICE ** "D$:PRINT"STARTING WITH ** "F
$
150 PRINT:INPUT"IS THIS CORRECT (Y/N)";B$:IFB$<"Y"THEN6
0
160 POKE770,131:POKE771,164:SYS49152:END
170 DATA169,79,32,210,255,162,38,160,192,204,3,3,1507
180 DATA208,10,162,131,160,164,169,70,32,210,255,44,1615
190 DATA169,78,32,210,255,142,2,3,140,3,3,76,1113
200 DATA36,193,32,96,165,134,122,132,123,32,115,0,1180
210 DATA170,240,243,162,255,134,58,144,3,76,150,164,1799
220 DATA32,107,169,32,121,165,173,0,2,240,5,169,1215
230 DATA79,141,2,3,76,162,164,169,0,133,2,133,1064
240 DATA251,133,252,133,254,24,101,20,69,254,230,254,197
5
250 DATA24,101,21,69,254,170,230,254,164,252,185,0,1724
260 DATA2,133,253,201,34,208,6,165,2,73,255,133,1465
270 DATA2,201,32,208,4,165,2,240,8,138,24,101,1125
280 DATA253,69,254,170,44,198,254,230,252,164,253,208,23
49
290 DATA213,138,41,240,74,74,74,74,24,105,129,141,1327
300 DATA44,193,138,41,15,24,105,129,141,45,193,162,1230
310 DATA0,189,43,193,240,12,157,0,4,173,134,2,1147
320 DATA157,0,216,232,208,239,169,38,141,2,3,173,1578
330 DATA48,193,240,23,165,161,201,212,176,4,165,160,1748
340 DATA240,13,238,32,208,160,0,32,225,255,208,6,1617
350 DATA32,33,193,76,38,192,232,208,242,200,208,239,1893
360 DATA32,68,229,169,0,168,174,49,193,32,186,255,1555
370 DATA173,50,193,162,51,160,193,32,189,255,169,43,1670
380 DATA166,45,164,46,32,216,255,162,1,189,51,193,1520
390 DATA168,200,152,201,58,144,2,169,48,157,51,193,1543
400 DATA201,48,208,3,202,16,234,32,33,193,76,116,1362
410 DATA164,206,32,208,169,0,170,168,76,219,255,160,1827
420 DATA1,1,160,0,0,65,72,79,89,33,0,0,500
    
```

## C-128 BUG REPELLENT

```

10 PRINTCHR$(147)"LOADING AND CHECKING THE DATA[3"."]:J
=4864
20 FORB=0TO11:READA:IFA<0ORA>255THEN40
30 POKEJ+B,A:X=X+A:NEXTB:READA:IFA=XTHEN50
40 PRINT:PRINT"ERROR IN DATA LINE:"PEEK(66)*256+PEEK(65)
:END
50 X=0:J=J+12:IFJ<5213THEN20
60 POKE208,0:POKE5213,0:A$="Y":B$=A$:C$="D":D$="DISK":D=
8:PRINTCHR$(147)
70 INPUT"DO YOU WANT AUTOMATIC SAVES (Y/N)";A$:PRINT:IFA
$="Y"THEN90
80 PRINT"NO AUTOMATIC SAVES[3"."]:GOTO150
90 POKE5213,1:INPUT"DISK OR TAPE (D/T)";C$:IFC$<"D"THEN
D=1:D$="TAPE"
100 POKE5214,D:D$=D$+" DRIVE":PRINT:INPUT"FILE NUMBER (0
-99)";N
110 N$=RIGHT$(STR$(N),2):IFN<10THENN$=CHR$(48)+CHR$(N+48
)
120 F$="BACKUP":PRINT:INPUT"FILENAME";F$:F$=N$+LEFT$(F$,
14):L=LEN(F$)
130 POKE5215,L:FORJ=1TOL:POKE5215+J,ASC(MID$(F$,J,1)):NE
XTJ:PRINT
140 PRINT"SAVING DEVICE ** "D$:PRINT"STARTING WITH ** "F
$
150 PRINT:INPUT"IS THIS CORRECT (Y/N)";B$:IFB$<"Y"THEN6
0
160 POKE770,198:POKE771,77:SYS4864:END
170 DATA32,58,20,169,41,162,19,236,3,3,208,4,955
180 DATA169,198,162,77,141,2,3,142,3,3,224,19,1143
190 DATA208,7,32,125,255,79,78,0,96,32,125,255,1292
200 DATA79,70,70,0,96,162,0,134,251,189,0,2,1053
210 DATA240,19,201,48,144,9,201,58,176,5,133,251,1485
220 DATA232,208,238,134,252,165,251,208,3,76,198,77,2042
230 DATA169,0,166,235,164,236,133,253,133,254,142,47,193
2
240 DATA20,140,48,20,24,101,22,69,254,230,254,24,1206
250 DATA101,23,69,254,170,230,254,164,252,185,0,2,1704
260 DATA133,251,201,34,208,6,165,253,73,255,133,253,1965
270 DATA201,32,208,4,165,253,240,8,138,24,101,251,1625
280 DATA69,254,170,44,198,254,230,252,164,251,208,213,23
07
290 DATA138,41,240,74,74,74,74,24,105,65,141,88,1138
300 DATA20,138,41,15,24,105,65,141,89,20,32,79,769
310 DATA20,189,85,20,240,6,32,210,255,232,208,245,1742
320 DATA174,47,20,172,48,20,24,32,240,255,173,93,1298
330 DATA20,240,27,165,161,201,212,176,4,165,160,240,1771
340 DATA17,32,65,20,238,32,208,238,1,214,32,225,1322
350 DATA255,208,6,32,49,20,76,198,77,232,208,242,1603
360 DATA200,208,239,32,66,193,173,95,20,162,96,160,1644
370 DATA20,32,189,255,169,0,170,32,104,255,169,0,1395
380 DATA174,94,20,168,32,186,255,169,45,174,16,18,1351
390 DATA172,17,18,32,216,255,162,1,189,96,20,168,1346
400 DATA200,152,201,58,144,2,169,48,157,96,20,201,1448
410 DATA48,208,3,202,16,234,32,49,20,141,0,2,955
420 DATA76,183,77,58,59,32,65,20,206,32,208,206,1222
430 DATA1,214,169,0,170,168,76,219,255,32,79,20,1403
440 DATA169,26,141,0,214,173,0,214,16,251,96,162,1462
450 DATA0,142,0,255,96,19,18,32,32,32,32,146,804
460 DATA0,1,0,0,65,72,79,89,33,0,0,0,339
    
```

# FLANKSPEED FOR THE C-64 By GORDON F. WHEAT

*Flankspeed* will allow you to enter machine language *Ahoy!* programs without any mistakes. Once you have typed the program in, save it for future use. While entering an ML program with *Flankspeed* there is no need to enter spaces or hit the carriage return. This is all done automatically. If you make an error in a line a bell will ring and you will be asked to enter it again. To LOAD in a program Saved with *Flankspeed* use LOAD "name",1,1 for tape, or LOAD "name",8,1 for disk. The function keys may be used after the starting and ending addresses have been entered.

f1—SAVEs what you have entered so far.

f3—LOADs in a program worked on previously.

f5—To continue on a line you stopped on after LOADING in the previous saved work.

f7—Scans through the program to locate a particular line, or to find out where you stopped the last time you entered the program.

It temporarily freezes the output as well.

•100 POKE53280,12:POKE53281,11	OP	5		
•105 PRINT"[CLEAR][c 8][RVSON][15" " ]FLANKSPEED[15" " ]";	FP	•390 PRINT:PRINT"ADDRESS NOT WITHIN SPECIFIED RANGE!":B=0:		IK
•110 PRINT"[RVSON][5" " ]MISTAKEPROOF ML ENTRY PROGRAM[6" " ]"		GOTO415		HK
•115 PRINT"[RVSON][9" " ]CREATED BY G. F. WHEAT[9" " ]"	JP	•395 PRINT:PRINT"NOT ZERO PAGE OR ROM!":B=0:GOTO415		DM
•120 PRINT"[RVSON][3" " ]COPR. 1987, ION INTERNATIONAL INC. [3" " ]"	FA	•400 PRINT"?ERROR IN SAVE":GOTO415		JK
•125 FORA=54272TO54296:POKEA,0:NEXT		•405 PRINT"?ERROR IN LOAD":GOTO415		IO
•130 POKE54272,4:POKE54273,48:POKE54277,0:POKE54278,249:POKE54296,15	AJ	•410 PRINT:PRINT:PRINT"END OF ML AREA":PRINT		JO
•135 FORA=680TO699:READB:POKEA,B:NEXT	ND	•415 POKE54276,17:POKE54276,16:RETURN		BF
•140 DATA169,251,166,253,164,254,32,216,255,96	NP	•420 OPEN15,8,15:INPUT#15,A,A\$:CLOSE15:PRINTA\$:RETURN		DH
•145 DATA169,0,166,251,164,252,32,213,255,96	FL	•425 REM GET FOUR DIGIT HEX		IM
•150 B\$="STARTING ADDRESS IN HEX":GOSUB430:AD=B:SR=B	FF	•430 PRINT:PRINTB\$;:INPUTT\$		OL
•155 GOSUB480:IFB=0THEN150	FK	•435 IFLEN(T\$)<>4THENGOSUB380:GOTO430		JD
•160 POKE251,T(4)+T(3)*16:POKE252,T(2)+T(1)*16	EK	•440 FORA=1TO4:A\$=MID\$(T\$,A,1):GOSUB450:IFT(A)=16THENGOSUB380:GOTO430		AK
•165 B\$="ENDING ADDRESS IN HEX":GOSUB430:EN=B	OE	•445 NEXT:B=(T(1)*4096)+(T(2)*256)+(T(3)*16)+T(4):RETURN		KB
•170 GOSUB470:IFB=0THEN150	AM	•450 IFA\$@"ANDAS<"G"THENT(A)=ASC(A\$)-55:RETURN		GM
•175 POKE254,T(2)+T(1)*16:B=T(4)+1+T(3)*16	PE	•455 IFA\$@/"ANDAS<:""THENT(A)=ASC(A\$)-48:RETURN		NJ
•180 IFB>255THENB=B-255:POKE254,PEEK(254)+1	PG	•460 T(A)=16:RETURN		IC
•185 POKE253,B:PRINT	GM	•465 REM ADDRESS CHECK		OL
•190 REM GET HEX LINE	HG	•470 IFAD>ENTHEN385		HO
•195 GOSUB495:PRINT": [c P][LEFT]";:FORA=0TO8	EC	•475 IFB<SRORB>ENTHEN390		LE
•200 FORB=0TO1:GOTO250	ED	•480 IFB<256OR(B>40960ANDB<49152)ORB>53247THEN395		OB
•205 NEXTB	KD	•485 RETURN		HE
•210 A%(A)=T(1)+T(0)*16:IFAD+A-1=ENTHEN340	IH	•490 REM ADDRESS TO HEX		PM
•215 PRINT" [c P][LEFT]";	IJ	•495 AC=AD:A=4096:GOSUB520		AP
•220 NEXTA:T=AD-(INT(AD/256)*256):PRINT" "	FA	•500 A=256:GOSUB520		NF
•225 FORA=0TO7:T=T+A%(A):IFT>255THENT=T-255	EG	•505 A=16:GOSUB520		LG
•230 NEXT	II	•510 A=1:GOSUB520		HE
•235 IFA%(8)<>TTHENGOSUB375:GOTO195	GL	•515 RETURN		JD
•240 FORA=0TO7:POKEAD+A,A%(A):NEXT:AD=AD+8:GOTO195	GI	•520 T=INT(AC/A):IFT>9THENA\$=CHR\$(T+55):GOTO530		OC
•245 REM GET HEX INPUT	FL	•525 A\$=CHR\$(T+48)		JI
•250 GETA\$:IFA\$=""THEN250	IM	•530 PRINTA\$;:AC=AC-A*T:RETURN		AA
•255 IFA\$=CHR\$(20)THEN305	PA	•535 A\$="**SAVE**":GOSUB585		IC
•260 IFA\$=CHR\$(133)THEN535	GA	•540 OPEN1,T,1,A\$:SYS680:CLOSE1		AB
•265 IFA\$=CHR\$(134)THEN560	GO	•545 IFST=0THENEND		FB
•270 IFA\$=CHR\$(135)THENPRINT" ":GOTO620	LM	•550 GOSUB400:IFT=8THENGOSUB420		PM
•275 IFA\$=CHR\$(136)THENPRINT" ":GOTO635	IG	•555 GOTO535		FI
•280 IFA\$@"ANDAS<"G"THENT(B)=ASC(A\$)-55:GOTO295	HO	•560 A\$="**LOAD**":GOSUB585		PE
•285 IFA\$@/"ANDAS<:""THENT(B)=ASC(A\$)-48:GOTO295	HE	•565 OPEN1,T,0,A\$:SYS690:CLOSE1		PO
•290 GOSUB415:GOTO250	MI	•570 IFST=64THEN195		OI
•295 PRINTA\$"[c P][LEFT]";	DJ	•575 GOSUB405:IFT=8THENGOSUB420		CO
•300 GOTO205	JA	•580 GOTO560		GN
•305 IFA>0THEN320	PK	•585 PRINT" ":PRINTTAB(14)A\$		KA
•310 A=-1:IFB=1THEN330	FA	•590 PRINT:A\$="" :INPUT"FILENAME";A\$		IO
•315 GOTO220	BI	•595 IFA\$=""THEN590		HK
•320 IFB=0THENPRINTCHR\$(20);CHR\$(20);:A=A-1	BB	•600 PRINT:PRINT"TAPE OR DISK?":PRINT		HL
•325 A=A-1	FA	•605 GETB\$:T=1:IFB\$="D"THENT=8:A\$="@0:"+A\$:RETURN		NP
•330 PRINTCHR\$(20);:GOTO220	BF	•610 IFB\$<>"T"THEN605		KO
•335 REM LAST LINE	FK	•615 RETURN		PH
•340 PRINT" ":T=AD-(INT(AD/256)*256)	CP	•620 B\$="CONTINUE FROM ADDRESS":GOSUB430:AD=B		DD
•345 FORB=0TOA-1:T=T+A%(B):IFT>255THENT=T-255	KH	•625 GOSUB475:IFB=0THEN620		NK
•350 NEXT	OD	•630 PRINT:GOTO195		HN
•355 IFA%(A)<>TTHENGOSUB375:GOTO195	OB	•635 B\$="BEGIN SCAN AT ADDRESS":GOSUB430:AD=B		FK
•360 FORB=0TOA-1:POKEAD+B,A%(B):NEXT	OH	•640 GOSUB475:IFB=0THEN635		LN
•365 PRINT:PRINT"YOU ARE FINISHED!":GOTO535	LH	•645 PRINT:GOTO670		HI
•370 REM BELL AND ERROR MESSAGES	BO	•650 FORB=0TO7:AC=PEEK(AD+B):GOSUB505:IFAD+B=ENTHENAD=SR:GOSUB410:GOTO195		LM
•375 PRINT:PRINT"LINE ENTERED INCORRECTLY":PRINT:GOTO415	MB	•655 PRINT" ":NEXTB		LE
•380 PRINT:PRINT"INPUT A 4 DIGIT HEX VALUE!":GOTO415	LM	•660 PRINT:AD=AD+8		CD
•385 PRINT:PRINT"ENDING IS LESS THAN STARTING!":B=0:GOTO41	PK	•665 GETB\$:IFB\$=CHR\$(136)THEN195		JD
	PG	•670 GOSUB495:PRINT" ":GOTO650		KE

# JUNGLE JAKE

## FROM PAGE 16

- 10 REM JUNGLE JAKE (C)1987 CMB NC
- 20 COLOR.,1:COLOR4,1:GRAPHIC1,1:GRAPHIC.  
:PRINTCHR\$(11)CHR\$(142)"[CLEAR][7]"[DOWN]  
""]TAB(14)"[c 1]GET READY":GOSUB750 HM
- 30 PRINTTAB(11)"[3]"[DOWN]"HOLD YOUR HOR  
SES":RESTORE1070:A=3072:B=3072+767:FORX=  
ATOB:READA\$:POKEX,DEC(A\$):NEXT ME
- 40 RESTORE1340:A=4864:B=5105:FORX=ATOB:R  
EADA\$:POKEX,DEC(A\$):NEXT:POKE4603,..:POKE  
4604,. OJ
- 50 PRINT"[CLEAR][DOWN][DOWN]"TAB(7)"[GRE  
EN][s U][24][s C]"[s I]" BD
- 60 PRINTTAB(7)"[s B][YELLOW][s U][22][s  
C]"[s I][GREEN][s B]" IE
- 70 PRINTTAB(7)"[s B][YELLOW][s B] [GREE  
N][3][c 0]"SPC(17)"[YELLOW][s B][GREEN  
][s B]" HE
- 80 PRINTTAB(7)"[s B][YELLOW][s B][3]"[ ]  
GREEN][RVSON][c H][sEP][RVSOFF] [RVSON][  
c \*][sEP][c \*][RVSOFF] [RVSON][c \*][sEP]  
[SS][SS][c \*][c H][RVSOFF][SS][SS][RVSON  
][sEP][c I][c F][RVSOFF] [YELLOW][s B][G  
REEN][s B]" ME
- 90 PRINTTAB(7)"[s B][YELLOW][s B][3]"[ ]  
GREEN][RVSON][c H][c G][RVSOFF] [RVSON][  
c H][c H][RVSOFF][c \*][RVSON][c \*][SS][c  
H][RVSOFF][SS][SS][RVSON][c 0][c H][RVS  
OFF] [RVSON][SS][RVSOFF][c P] [YELLOW]  
[s B][GREEN][s B]" ML
- 100 PRINTTAB(7)"[s B][YELLOW][s B][GREEN  
][RVSON][sEP][RVSOFF] [RVSON][c H][c H]  
[RVSOFF] [RVSON][c H][c G][RVSOFF][SS][c  
\*][RVSON][SS][c H][RVSOFF] [RVSON][c F  
][c H][RVSOFF] [RVSON][SS][RVSOFF][c U]  
[YELLOW][s B][GREEN][s B]" JJ
- 110 PRINTTAB(7)"[s B][YELLOW][s B][GREEN  
][c \*][RVSON][SS][SS][RVSOFF][sEP][c \*]  
RVSON][SS][RVSOFF][sEP][c \*][SS][SS][c \*]  
][c \*][RVSON][SS][SS][RVSOFF][sEP][RVSON  
][c H][SS][c \*][RVSOFF][c \*][c I][RVSON]  
[c V][RVSOFF] [YELLOW][s B][GREEN][s B]" HM
- 120 PRINTTAB(7)"[s B][YELLOW][s B][GREEN  
][22][s C]"[YELLOW][s B][GREEN][s B]" LH
- 130 PRINTTAB(7)"[s B][YELLOW][s B][GREEN  
][RVSON][6":"]][SS]J[SS]A[SS]K[SS]E[SS][7  
":"]][RVSOFF][YELLOW][s B][GREEN][s B]" EJ
- 140 PRINTTAB(7)"[s B][YELLOW][s J][22][s  
C]"[s K][GREEN][s B]" BL
- 150 PRINTTAB(7)"[s J][24][s C]"[s K]:P  
RINTTAB(10)"[DOWN][DOWN][c 4]A GAME FOR  
THE C-128":PRINTTAB(13)"[DOWN][s W]"TAB(
- 19)"BY"TAB(26)"[s W]":PRINTTAB(9)"[DOWN]  
[c 5]CLEVELAND M. BLAKEMORE" OK
- 160 CHAR.,10,23,"[GREEN]PRESS FIRE TO BE  
GIN!" LH
- 170 RESTORE1030:READJ\$:PLAY"X0":VOL15:TE  
MPO25:G=LEN(J\$):X=1:I=.:DO:PLAYMID\$(J\$,X  
,1):X=X+1+(X=G)\*G:LOOPUNTILJOY(2)>127:X=  
FRE(1) JO
- 180 CLR:DIM L(4),L,G,N,S,D,C,Y,B,F,H,P,I  
,K,R,U,T,M,E,X,SC,HI,MN,LV,C(6),S(6),CS,  
S\$(6),VIC KD
- 190 D=.:E=4595:F=127:H=10:P=15:I=5:K=25:  
R=319:U=1:T=2:M=3:LV=.:SC=.:MN=4:VIC=532  
48:HI=PEEK(4603)+(PEEK(4604)\*256) LC
- 200 RESTORE670:FORX=.TO3:READL(X):NEXT:F  
ORX=.TO6:READC(X):NEXT:FORX=.TO6:READS(X  
) :NEXT:FORX=.TO6:READS\$(X):NEXT HH
- 210 DEFFNR(X)=RND(.)\*I+T:DEFFND(X)=INT(R  
ND(.)\*Y)\*G+N PA
- 220 DEFFNJ(X)=(C<H)\*M+(C=>H)\*-M+(C=P)\*M:  
DEFFNE(X)=(RSPPOS(U,..)<KANDL=U)OR(RSPPO  
S(U,..)>RAND(L=.ORL=T))ANDD=. GN
- 230 S\$="[5#"":PUDEF"0":RESTORE990:READ  
LT\$,D\$,V1\$,V2\$,J\$,RS\$,VC\$ GA
- 240 B\$="[RVSON]":F\$=B\$:FORX=.TO39:F\$=F\$+  
" ":B\$=B\$+CHR\$(160):NEXT:V\$="[c 2]":FORX  
=.TO11:V\$=V\$+"([DOWN][LEFT])[DOWN][LEFT]  
":NEXT:M\$="[s Q] [s Q] [s Q] [s Q]":DH\$  
="[HOME][DOWN][4"RIGHT"]][RED]":CL\$=CHR  
\$(27)+"Q" BA
- 250 CP\$="[c 5][RVSOFF][4"@""]][DOWN][4  
"LEFT"]][RVSON][s U][c T][c T][s I][DOW  
N][4"LEFT"]][c J][c @][c @][c L][DOWN][  
4"LEFT"]][s J][c 0][c 0][s K]" CL
- 260 SK\$="[c 4][RVSON][s U][3"Y"]][s I  
][DOWN][5"LEFT"]][c J][s W]+CHR\$(160)+  
"[s W][c L][DOWN][5"LEFT"]][s J][c S]+  
CHR\$(34)+CHR\$(27)+CHR\$(27)+"[RVSON][c A]  
[s K][DOWN][4"LEFT"]][3"CEP"]][DOWN][3  
"LEFT"]][s J][c I][s K]":S\$="[5#"":PU  
DEF"0":TEMPO10 KO
- 270 MOVSPR7,16,77:MOVSPR8,28,52:POKE2046  
,56:POKE2047,57:SPRITE7,..,2,..,1,..,1:SPRI  
TE8,..,9,..,1:SPRCOLOR10,12 FL
- 280 POKE4592,48:POKE4593,222:POKE4594,24  
:POKE4602,65:POKE4600,7 LO
- 290 PLAYR\$:VOL15:GOSUB450:PLAYV1\$:PLAYV  
2\$:PLAYD\$ EB
- 300 L=.:POKEVIC+21,255:FORX=.TOI:B=BUMP(  
U):B=BUMP(T):NEXT:POKE4595,1:SYS4864 MB
- 310 REM MAIN LOOP CB
- 320 DO:IFFNE(. )THENGOSUB410:ELSEIFDTHENM  
OVSPRU,+.,+D:C=C+U:D=FNJ(. ):ELSEMOVSPRU,  
+.,L(L):IFJOY(T)>FTHEND=-U:C=.:SOUNDU,E,  
K,..,R,R,. OC



•330 MOVSPRFNR(.),FND(.)#S:B=BUMP(U):LOOP UNTILBANDU	BO	:RETURN	BA
•340 IF(BANDF+T)=F+TTHENBEGIN:POKEE,,:POKE2047,58:MOVSPRU,37,55:PRINTDH\$"[s S]":SC=SC+(LV+U)*1000:GOSUB420:PLAYRS\$:FORX=.TOM:PLAYLT\$:NEXT	MP	•550 CS=7:S=2:GOSUB640:GOSUB570:GOSUB600:RETURN	FH
•350 IFLV<6THENLV=LV+U:POKEVIC+21,127:PRINTDH\$"[s A]":SLEEP2:GOTO290	CG	•560 CS=16:S=2:GOSUB610:GOSUB570:GOSUB580:RETURN	NF
•360 SLEEP2:POKEVIC+21,129:CHAR.,12,,,"[c 8]CONGRATULATIONS"+CL\$:CHAR.,9,1,"JUNGLE JAKE [WHITE]CHAMPION!"+CL\$:PLAYRS\$:PLAYVC\$:PLAYVC\$:SLEEP4:POKEVIC+21,,:GOTO400	HK	•570 FORX=2TO6:SPRITE\$,.,CS,,,,,1:POKE2039+X,S(LV):NEXT:RETURN	LO
•370 BEND	IM	•580 Y=2:G=180:N=90:RETURN	OP
•380 POKEE,,:POKE4592,U:SPRITEU,U,8,,,,,:POKE2040,59:SOUND1,6000,150,1,2000,4000,,:MOVSPRU,.#U:CHAR.,29+MN*T,U,"[RED][s W]":MN=MN-U:M\$=LEFT\$(M\$,T*MN):SLEEP3:PLAYRS\$	IO	•590 Y=360:G=1:N=.:RETURN	IJ
•390 PLAYD\$:POKEVIC+21,,:IFMNTHEGOSUB460:GOSUB420:POKE4592,48:GOTO300	FB	•600 Y=2:G=180:N=.:RETURN	HC
•400 PLAYRS\$:IFHITHEPOKE4604,INT(HI/256):POKE4603,HI-INT(HI/256)*256:RUN50:ELSERUN50	DG	•610 FORX=2TO5:MOVSPRX,170,L(X-2)-1:NEXT:MOVSPR6,170,L(3)-1:RETURN	GM
•410 POKEE,,:FORX=L(L)TOL(L+U)STEP-U:MOVSPRU,+,X:NEXT:POKEE,U:L=L+U:SC=SC+100*((LV+U)*L)	CD	•620 FORX=2TO6:MOVSPRX,170,60:NEXT:RETURN	FJ
•420 COLOR5,C(LV):CHAR.,7,24,"[RVSON]":PRINTUSINGS\$:SC:IFSC>HITHEHI=SC	ML	•630 FORX=.TO4:CHAR.,6+X*6,.,V\$:NEXT:RETURN	DC
•430 CHAR.,34,24,"[RVSON]":PRINTUSINGS\$:HI:RETURN	OB	•640 FORX=.TO4:MOVSPR2+X,72+X*48,60:NEXT:RETURN	HD
•440 REM DRAW GAME SCREEN	DH	•650 RETURN	BK
•450 POKEVIC+21,,:PRINT"[CLEAR]"CHR\$(27)"M";:CHAR.,5,10,SK\$:CHAR.,30,10,SK\$:PRINT"[RED]":CHAR.,20-LEN(S\$(LV))/2,12,S\$(LV):SLEEP1:TEMPO30:PLAYJ\$:TEMPO10	NH	•660 REM LEVEL Y-COORDS	ML
•460 PRINT"[CLEAR]":CHAR.,.,2,CP\$:COLOR5,C(LV):CHAR.,.,6,F\$:CHAR.,.,12,F\$:CHAR.,.,18,F\$:CHAR.,.,24,B\$:CHAR.,1,24,"SCORE":CHAR.,31,24,"HI":GOSUB420	AH	•670 DATA 222,174,126,78	AE
•470 CHAR.,15,24,"[RVSON]JUNGLE[RIGHT]JAKE[RVSOFF]":CHAR.,31,.,,"[c 4]LEVEL[WHITE]":PRINTLV+1;"[c 5]":CHAR.,30,1,M\$:CHAR.,38,6,LEFT\$(V\$,19):CHAR.,1,12,LEFT\$(V\$,19):CHAR.,38,18,LEFT\$(V\$,19)	AF	•680 REM LEVEL COLORS	HG
•480 FORX=1TO6:MOVSPRX,.#.:NEXT:POKE2040,48:POKE2047,58:MOVSPR1,30,221:SPRITE1,1,9,,,,,1:SPRITE8,1:D=.:C=.	PI	•690 DATA 6,12,6,5,4,8,3	PL
•490 ONLV+1GOSUB500,510,520,530,540,550,560:SLEEP1:RETURN	AP	•700 REM LEVEL SHAPES	HA
•500 CS=6:S=2:GOSUB610:GOSUB570:GOSUB580:RETURN	MB	•710 DATA 53,55,54,52,53,55,54	GO
•510 CS=11:S=2:GOSUB620:GOSUB570:GOSUB590:RETURN	AH	•720 REM LEVEL DESCRIPTIONS	KO
•520 CS=8:S=1:GOSUB610:GOSUB570:GOSUB580:RETURN	OD	•730 DATA BITE IN THE ASP,FOR THE BIRDS,ZULU COUNTRY,MONKEY BUSINESS, SNAKE YOUR BODY,PECKERS FROM ABOVE,HEADSHRINKER HEAVEN!	AO
•530 CS=9:S=3:GOSUB630:GOSUB640:GOSUB570:GOSUB600:RETURN	GG	•740 REM REDEFINED CHARACTERS	CK
•540 CS=13:S=2:GOSUB610:GOSUB570:GOSUB580		•750 RESTORE770:BANK15:SUM=0:FORI=2816TO2869:READJ:SUM=SUM+J:POKEI,J:NEXT:IFSUM<>7491THENPRINT"ERROR!":END:ELSESYS2816:POKE2604,PEEK(2604)AND240OR8	IL



# REPETITIVE PROCESSES FROM PAGE 32

## ITERATIVE SOLUTIONS (C-128)

```

.1 REM ===== IH
.2 REM          ITERATIVE SOLUTIONS      NP
.3 REM          RUPERT REPORT #49       ML
.4 REM          JF
.5 REM          C-128 VERSION            MH
.6 REM ===== MO
.10 DEF FNA(X)=X*X-3                    BA
.20 X0=0 : X=1 :REM INITIAL VALUES    FH
.30 DO                                  AL
.40 : DELTA=(X-X0)/(1-FNA(X0)/FNA(X))  KD
.50 : X0=X                               PO
.60 : X=X-DELTA                          OJ
.70 : PRINT X,FNA(X)                    DE
.80 LOOP WHILE ABS(DELTA) > 0.0001     FE
.90 END                                  NK
.100 REM ===== ML
          C-64 VERSION ==
.110 REM DELETE LINE 30                 DF
.120 REM CHANGE LINE 80 AS FOLLOWS     PD
.130 IF ABS(DELTA) > 0.0001 THEN 40    KK

```

## ITERATIVE DESIGNS (C-128)

```

.1 REM ===== IH
.2 REM          ITERATIVE DESIGNS      GF
.3 REM          RUPERT REPORT #49       ML
.4 REM          JF
.5 REM          C-128 VERSION            MH
.6 REM ===== MO
.10 G0=RGR(0) : IF G0=6 THEN G0=5      GD
.20 GRAPHIC 0 : GRAPHIC 1,1           LL
.30 FOR X=0 TO 319                    AN
.40 S=1+TAN(0.005*X)                  DM
.50 FOR Y=0 TO 199 STEP S              BD
.60 DRAW 1,X,Y                         FB
.70 NEXT Y                             CD
.80 NEXT X                             CO
.90 GETKEY A$                          FG
.100 GRAPHIC G0 :REM RESTORE MODE      MG

```

## ITERATIVE DESIGNS (C-64)

```

.1 REM ===== PA
.2 REM          ITERATIVE DESIGNS 64   PC
.3 REM          C-64 VERSION           IF
.4 REM          RUPERT REPORT #49      OO
.5 REM          JC
.9 REM ===== FOR C-64 ONLY! ===== LF
.10 GOSUB 1000 :REM INITIALIZE GRAPHICS MK
.30 FOR X=0 TO 319                    AN
.40 S=1+TAN(0.005*X)                  DM

```

```

.50 FOR Y=0 TO 199 STEP S             BD
.60 GOSUB 2000 :REM SET PIXEL AT X,Y  FF
.70 NEXT Y                             CD
.80 NEXT X                             CO
.90 GET A$ : IF A$="" THEN 90          JE
.100 GOSUB 3000                        LA
.110 END                                OO
.950 REM ***** AG
.960 REM                               FA
.970 REM >>> INITIALIZE BIT MAP MODE <<< MD
.980 REM                               GE
.990 REM SET & RESET BIT FUNCTIONS    FH
.1000 DEF FNSB(N)=PEEK(MM) OR 2[UPARROW]N IL
.1010 DEF FNRB(N)=PEEK(MM) AND (255-2[UPARROW]N) MA
.1020 VV=53248 :REM VIC-II REGISTER 0  OC
.1030 :REM >>> PUT BIT MAP AT 8192 <<< PO
          (SET BIT 3 OF VIC REGISTER 24)  HG
.1040 MM=VV+24 : POKE MM,FNSB(3)
.1050 :REM >>> SELECT BIT MAP MODE <<< EP
          (SET BIT 5 OF VIC REGISTER 17)  IK
.1060 MM=VV+17 : POKE MM,FNSB(5)
.1070 BASE=8192 :REM START BIT MAP MEMORY MH
.1080 :REM >>> CLEAR BIT MAP <<<      KK
.1090 GOSUB 4000                        JJ
.1100 :REM > SELECT COLORS C1 AND C0 <  MI
.1110 C1=1 : C0=0 : CC=16*C1 + C0      FG
.1120 :REM FILL SCREEN MEMORY WITH COLOR MB
.1130 FOR MM=1024 TO 2023:POKE MM,CC:NEXT FI
.1140 RETURN                             AG
.1150 :                                  LM
.1970 REM ===== AP
.1980 REM > TURN ON PIXEL AT (X,Y) <<< CI
.1990 REM ===== KD
.2000 BIT=7-(X AND 7)                   NG
.2010 MM=BASE+320*INT(Y/8)+8*INT(X/8)+(Y AND 7) EM
.2020 POKE MM,FNSB(BIT)                LH
.2030 RETURN                             ID
.2040 :                                  DJ
.2970 REM ===== HL
.2980 REM >>> RESET BIT MAP MODE <<< CL
.2990 REM ===== AP
.3000 MM=VV+17 : POKE MM,FNRB(5)        LA
.3010 REM RESTORE SCREEN MEMORY BASE    FL
.3020 MM=VV+24 : POKE MM,FNRB(3)        CM
.3030 RETURN                             GP
.3960 :                                  MB
.3970 =====                          LC
.3980 >>> CLEAR BIT MAP SCREEN <<<    JC
.3990 =====                          BO
.4000 FOR M=828 TO 828+43              BK
.4010 READ B : POKE M,B                 AP
.4020 CK=CK+B                           IC
.4030 NEXT                               EP
.4040 IF CK<>5133 THEN PRINT "DATA ERROR
          IN LINES 4060 - 4110" : STOP  JD
.4050 SYS 828: RETURN                   OF

```

**IMPORTANT!** Letters on white background are **Bug Repellent** line codes. Do not enter them! Pages 81 and 82 explain these codes and provide other essential information on entering **Ahoy!** programs. Refer to these pages **before** entering any programs!

•4060 DATA 76,68,3,0,32,31,64,0  
 •4070 DATA 173,63,3,133,251,173,64,3  
 •4080 DATA 133,252,174,65,3,160,0,173  
 •4090 DATA 67,3,136,145,251,208,251,230  
 •4100 DATA 252,202,48,7,208,244,172,66  
 •4110 DATA 3,208,239,96

BP •110 TS=2816 JJ  
 FA •120 BANK15:IFPEEK(TS)<>36THENPRINT"TEXTS HG  
 GD AVE NOT IN MEMORY["3!"]":END BO  
 CF •130 PRINTCHR\$(27)"M";:REM NO SCROLLING KA  
 BG •140 SCNCLR0 FI  
 NL •150 M\$="SCREEN":S=0:L=24:T=3 JH  
 •160 GOSUB420:REM FILL FIRST SCREEN KG  
 •170 SYS TS,S,0:REM STORE IT  
 •180 UC=3:UR=3:LC=24:LR=12:REM UPPER AND GA  
 LOWER COLUMN AND ROW FF  
 •190 L=7:T=1

## TEXTSAVE FROM PAGE 20

### TEXTSAVE LOADER

•100 REM TEXTSAVE LOADER  
 •110 SA=2816:REM RELOCATABLE  
 •120 CK=0:BANK15  
 •130 FORI=0TO252:READML\$:ML=DEC(ML\$):CK=C  
 K+ML:POKESA+I,ML:NEXT  
 •140 IFCK<>35500THENPRINT"DATA ERROR["3!"  
 ]":END  
 •150 PRINT"TEXTSAVE INSTALLED"SA"TO"SA+25  
 3:NEW  
 •160 DATA 24,D7,10,01,60,85,16,86  
 •170 DATA 17,A8,F0,0F,C0,05,90,03  
 •180 DATA 4C,28,7D,A9,00,18,69,30  
 •190 DATA 88,D0,FB,A8,A9,1E,A2,12  
 •200 DATA 20,CC,CD,98,E8,20,CC,CD  
 •210 DATA A0,1A,A6,17,D0,16,B9,E0  
 •220 DATA 00,20,CA,CD,88,10,F7,A0  
 •230 DATA 0D,B9,54,03,20,CA,CD,88  
 •240 DATA 10,F7,30,14,20,D8,CD,99  
 •250 DATA E0,00,88,10,F7,A0,0D,20  
 •260 DATA D8,CD,99,54,03,88,10,F7  
 •270 DATA A9,D8,85,C4,A9,00,85,C3  
 •280 DATA A9,00,A4,16,F0,06,18,69  
 •290 DATA 06,88,D0,FB,A2,12,20,CC  
 •300 DATA CD,98,E8,20,CC,CD,A6,17  
 •310 DATA D0,24,B1,C3,0A,0A,0A,0A  
 •320 DATA 85,DB,E6,C4,B1,C3,29,0F  
 •330 DATA 05,DB,C6,C4,20,CA,CD,C8  
 •340 DATA D0,E8,A5,C4,C9,DA,F0,24  
 •350 DATA E6,C4,E6,C4,D0,DC,E6,C4  
 •360 DATA 20,D8,CD,91,C3,4A,4A,4A  
 •370 DATA 4A,C6,C4,91,C3,E6,C4,C8  
 •380 DATA D0,EE,A5,C4,C9,DB,F0,04  
 •390 DATA E6,C4,D0,E2,A9,04,85,C4  
 •400 DATA A9,E8,85,AE,A9,07,85,AF  
 •410 DATA A6,17,D0,18,B1,C3,20,CA  
 •420 DATA CD,E6,C3,D0,02,E6,C4,A5  
 •430 DATA C3,C5,AE,D0,EB,A5,C4,C5  
 •440 DATA AF,D0,E5,60,20,D8,CD,91  
 •450 DATA C3,B8,50,E5,84,17,A8,8A  
 •460 DATA A2,12,20,CC,CD,98,E8,20  
 •470 DATA CC,CD,B8,50,CB

CD •200 REM OPEN 4 WINDOWS AND SAVE EACH SCR  
 FN EEN FN  
 HO •210 FORS=1TO4 GF  
 IC •220 IFS=2ORS=4THENPRINT"[RVSON]"; EE  
 •230 GOSUB360:GOSUB420 HD  
 FP •240 SYS TS,S,0 AP  
 •250 GOSUB450:PRINT"[RVSOFF]"; PK  
 •260 NEXT IH  
 AN •270 SLEEP2 EN  
 LH •280 GOSUB430:UC=1:UR=8:LC=38:LR=14:PRINT  
 ND "[RVSON]";:GOSUB360 MG  
 EF •290 PRINT"[RVSOFF][DOWN][DOWN] PRESS A K  
 PL EY TO RESTORE EACH SCREEN"; HK  
 GO •300 POKE2594,64:REM NO KEYS REPEAT LF  
 NJ •310 FORS=4TO 0 STEP-1 EA  
 GA •320 GETKEY A\$:SYS TS,S,1:REM WAIT FOR KE  
 EK YPRESS, RECALL SCREENS FN  
 CJ •330 NEXT MN  
 DK •340 POKE2594,255:PRINTCHR\$(27)"L";:REM E  
 EO NABLE KEY REPEAT, SCROLLING MN  
 PA •350 SLEEP2:END FG  
 FN •360 WINDOW UC,UR,LC,LR:REM OUTSIDE WINDO  
 OL W EM  
 BG •370 PRINT"[c A]";:FORI=UC+1TO LC-1:PRINT  
 FK "[s \*]";:NEXT:PRINT"[c S]"; AC  
 LI •380 FORI=UR+1TOLR-1:PRINT"[s -]";TAB(LC-  
 LM UC):PRINT"[s -]";:NEXT HB  
 BK •390 PRINT"[c Z]";:FORI=UC+1TO LC-1:PRINT  
 NA "[s \*]";:NEXT:PRINT"[c X]"; ME  
 NL •400 WINDOW UC+1,UR+1,LC-1,LR-1,1:REM INS  
 PL IDE WINDOW AJ  
 OO •410 RETURN CJ  
 DA •420 FORI=0TO L:GOSUB430:FORR=0TO T:COLOR  
 OC 5,C:PRINTM\$;S,:NEXT:RETURN FO  
 CO •430 C=INT(RND(0)\*16)+1:IFC=RCLR(0)THEN43  
 ML 0:REM NEW COLOR EB  
 BJ •440 RETURN EH  
 PH •450 UC=UC+3:UR=UR+3:LC=LC+3:LR=LR+3:RETU  
 CM RN:REM NEW WINDOW POSITION HC  
 EM  
 HG

### TEXTSAVE DEMO

•100 REM TEXTSAVE DEMO

JA

All this issue's programs are  
available on the *Ahoy!* Disk.  
See page 79.

# ICE TITANS FROM PAGE 18

Starting address in hex: C000

Ending address in hex: CDCA

SYS to start: 49152

Flankspeed required for entry! See page 83.

C000: A9 00 8D 21 D0 8D 15 D0 9C  
 C008: 8D 17 D0 8D 1D D0 8D 1B A1  
 C010: D0 8D 1C D0 8D AC 02 A9 41  
 C018: 06 8D 20 D0 20 28 C6 20 CB  
 C020: 42 C6 A0 27 A9 A0 99 98 6D  
 C028: 07 A9 03 99 98 DB 88 10 82  
 C030: F3 A9 12 20 D2 FF A9 9F 1C  
 C038: 20 D2 FF A2 16 8E AA 02 1F  
 C040: AE AA 02 A0 27 18 20 F0 8C  
 C048: FF A9 20 20 D2 FF AE AA 5E  
 C050: 02 CA 8E AA 02 E0 04 D0 0E  
 C058: E7 A2 18 A0 01 18 20 F0 C5  
 C060: FF A9 7A A0 CA 20 1E AB D9  
 C068: A2 18 A0 1C 18 20 F0 FF 09  
 C070: A9 89 A0 CA 20 1E AB A2 9B  
 C078: 0F A0 07 18 20 F0 FF A9 02  
 C080: 96 A0 CA 20 1E AB A9 B7 CD  
 C088: A0 C9 20 1E AB 20 65 C6 29  
 C090: 20 70 C7 A2 11 A0 0A 18 5F  
 C098: 20 F0 FF A9 B1 A0 CA 20 90  
 C0A0: 1E AB EE 86 02 20 A8 C2 6D  
 C0A8: D0 E9 20 AE C2 20 65 C6 41  
 C0B0: A9 00 8D 15 D0 8D AB 02 09  
 C0B8: 8D B2 02 20 98 C8 AD 2D 57  
 C0C0: C8 8D A9 02 A9 03 8D B0 AD  
 C0C8: 02 8D B1 02 A9 AA 8D 00 ED  
 C0D0: D0 A9 D4 8D 01 D0 A9 36 5F  
 C0D8: 8D 02 D0 A9 96 8D 03 D0 DA  
 C0E0: A2 29 8E 0C C8 8E FA 07 A0  
 C0E8: E8 8E F8 07 8E 0A C8 A2 64  
 C0F0: 21 8E FB 07 8E 0D C8 E8 F0  
 C0F8: 8E F9 07 8E 0B C8 A2 F0 7E  
 C100: 8E 32 C8 A9 01 2D 10 D0 42  
 C108: 09 02 8D 10 D0 A9 01 8D B9  
 C110: 29 D0 8D 2A D0 20 05 C2 7A  
 C118: AD AB 02 AA A0 07 BD 6A ED  
 C120: C8 99 F8 07 99 0A C8 BD AC  
 C128: 73 C8 99 27 D0 BD 36 C8 B2  
 C130: 99 02 C8 88 C0 03 D0 E6 98  
 C138: A9 07 8D A7 02 AD A7 02 77  
 C140: A8 0A AA B9 FA C7 0A A8 CC  
 C148: B9 BC C7 9D CE C7 E8 C8 6C  
 C150: B9 BC C7 9D CE C7 CE A7 39  
 C158: 02 10 E2 AD AB 02 18 0A CA  
 C160: 0A 18 69 0C 8D AF 02 A9 E0  
 C168: 03 8D 15 D0 20 32 C2 AD A1  
 C170: 1E D0 AD 1E D0 20 32 C2 11  
 C178: AD 1E D0 8D AD 02 A2 00 F4  
 C180: 20 24 C4 A2 01 20 24 C4 36

C188: 20 A8 C2 D0 03 20 41 C2 0C  
 C190: 20 01 C5 20 18 C2 20 4A DC  
 C198: C4 20 65 C5 20 F6 C3 20 A3  
 C1A0: 45 C3 20 C7 C2 AD 8D 02 91  
 C1A8: D0 FB A2 00 A0 08 CA D0 5C  
 C1B0: FD 88 D0 FA EE D4 DB AD 50  
 C1B8: B0 02 D0 08 A9 FE 2D 15 2F  
 C1C0: D0 8D 15 D0 AD B1 02 D0 37  
 C1C8: 1A A9 FD 2D 15 D0 8D 15 40  
 C1D0: D0 AD B0 02 D0 0D A9 00 89  
 C1D8: 8D 15 D0 A9 20 8D D4 07 7F  
 C1E0: 4C 77 C0 AD AF 02 D0 8D 23  
 C1E8: AD AB 02 C9 08 F0 03 EE F8  
 C1F0: AB 02 A2 64 20 80 C8 20 2F  
 C1F8: C4 C8 A9 03 8D 15 D0 20 C6  
 C200: 89 C6 4C E0 C0 AE B0 02 9F  
 C208: BD 7C C8 8D 27 D0 AE B1 F0  
 C210: 02 BD 7C C8 8D 28 D0 60 FB  
 C218: A0 0F B9 00 D0 99 E0 C7 94  
 C220: 88 10 F7 A0 07 B9 B4 C7 8E  
 C228: 2D 10 D0 99 F2 C7 88 10 23  
 C230: F4 60 AD 11 D0 10 FB 60 81  
 C238: A9 FE 85 A2 A5 A2 D0 FC 1F  
 C240: 60 AD 15 D0 29 01 F0 32 81  
 C248: AD 15 D0 29 04 D0 2B AD B2  
 C250: 00 D0 8D 04 D0 AD 01 D0 03  
 C258: 38 E9 0A 8D 05 D0 AD 10 A5  
 C260: D0 AA 29 FB A8 8A 29 01 5E  
 C268: F0 04 98 09 04 A8 98 8D D1  
 C270: 10 D0 AD 15 D0 09 04 8D 7F  
 C278: 15 D0 AD 15 D0 29 02 F0 0E  
 C280: 26 AD 15 D0 29 08 D0 1F 5B  
 C288: AD 02 D0 38 E9 0A 8D 06 C8  
 C290: D0 AD 03 D0 8D 07 D0 AD F5  
 C298: 10 D0 09 08 8D 10 D0 AD A6  
 C2A0: 15 D0 09 08 8D 15 D0 60 6B  
 C2A8: AD 00 DC 29 10 60 A2 16 85  
 C2B0: 8E AA 02 AE AA 02 A0 24 0C  
 C2B8: 20 01 EA AE AA 02 CA 8E 79  
 C2C0: AA 02 E0 06 D0 ED 60 AD 21  
 C2C8: B2 02 D0 09 AD 15 D0 29 14  
 C2D0: F0 C9 F0 D0 01 60 AD AF 0C  
 C2D8: 02 F0 FA A0 07 8C AA 02 A7  
 C2E0: B9 B4 C7 2D 15 D0 D0 4E 49  
 C2E8: A9 FF 38 F9 B4 C7 2D 10 7E  
 C2F0: D0 8D 10 D0 AE AB 02 BD 4A  
 C2F8: 6A C8 99 F8 07 99 0A C8 32  
 C300: BD 73 C8 99 27 D0 A9 05 3A  
 C308: 99 3F C8 8D B2 02 98 AA 2F  
 C310: 0A A8 A9 0A 99 00 D0 99 7A  
 C318: E0 C7 BD 5F C8 C8 99 00 09  
 C320: D0 99 E0 C7 AC AA 02 A9 36  
 C328: 00 99 F2 C7 B9 B4 C7 0D BF  
 C330: 15 D0 8D 15 D0 60 AC AA 41  
 C338: 02 88 C0 03 F0 06 8C AA B4  
 C340: 02 4C E0 C2 60 AD AD 02 EF  
 C348: C9 0C D0 01 60 29 0F D0 59  
 C350: 01 60 29 0C 4D 15 D0 8D A7

C358:	15	D0	A9	07	8D	AA	02	AC	D5	C528:	AA	68	0A	AA	98	0A	A8	BD	F8
C360:	AA	02	A9	04	18	79	B4	C7	C8	C530:	BC	C7	99	CE	C7	E8	C8	BD	54
C368:	CD	AD	02	D0	03	4C	B2	C3	7C	C538:	BC	C7	99	CE	C7	B9	E0	C7	4F
C370:	AC	AA	02	A9	08	18	79	B4	C1	C540:	99	00	D0	88	B9	E0	C7	99	2F
C378:	C7	CD	AD	02	D0	03	4C	B2	90	C548:	00	D0	AE	AA	02	AD	10	D0	03
C380:	C3	AC	AA	02	A9	01	18	79	D9	C550:	1D	F2	C7	8D	10	D0	AE	AA	EF
C388:	B4	C7	CD	AD	02	D0	09	CE	2B	C558:	02	CA	E0	03	F0	06	8E	AA	39
C390:	B0	02	20	05	C2	4C	B2	C3	ED	C560:	02	4C	06	C5	60	A2	07	8E	13
C398:	AC	AA	02	A9	02	18	79	B4	E3	C568:	A7	02	AC	A7	02	98	0A	AA	B5
C3A0:	C7	CD	AD	02	D0	09	CE	B1	40	C570:	B9	B4	C7	2D	34	C8	D0	03	A4
C3A8:	02	20	05	C2	4C	B2	C3	4C	A1	C578:	4C	1F	C6	B9	B4	C7	2D	10	1E
C3B0:	DB	C3	A9	2B	99	F8	07	99	58	C580:	D0	D0	2B	BD	00	D0	38	C9	DD
C3B8:	0A	C8	A9	01	99	27	D0	20	E7	C588:	32	90	11	B9	3F	C8	C9	05	EC
C3C0:	2E	C7	AE	AB	02	E8	20	80	9C	C590:	D0	0A	A9	19	99	3F	C8	A9	79
C3C8:	C8	AC	AA	02	A9	FF	38	F9	C6	C598:	00	8D	B2	02	BD	00	D0	38	A1
C3D0:	B4	C7	2D	15	D0	8D	15	D0	D3	C5A0:	D9	3F	C8	B0	38	B9	3F	C8	2D
C3D8:	CE	AF	02	AC	AA	02	88	C0	FB	C5A8:	9D	00	D0	4C	BD	C5	BD	00	A4
C3E0:	03	F0	06	8C	AA	02	4C	5F	BF	C5B0:	D0	38	D9	47	C8	90	26	B9	14
C3E8:	C3	20	32	C2	AD	1E	D0	20	7E	C5B8:	47	C8	9D	00	D0	B9	B4	C7	6D
C3F0:	32	C2	AD	1E	D0	60	CE	A9	5B	C5C0:	2D	35	C8	F0	0C	A9	FF	38	CA
C3F8:	02	D0	25	AD	2D	C8	8D	A9	CB	C5C8:	F9	B4	C7	2D	15	D0	8D	15	F4
C400:	02	A2	07	BD	B4	C7	2D	32	45	C5D0:	D0	BD	CE	C7	F0	07	49	FF	37
C408:	C8	F0	15	BD	0A	C8	18	7D	FC	C5D8:	09	01	9D	CE	C7	E8	BD	00	BD
C410:	1A	C8	9D	F8	07	DE	1A	C8	52	C5E0:	D0	38	D9	4F	C8	B0	09	B9	4F
C418:	10	06	BD	12	C8	9D	1A	C8	47	C5E8:	4F	C8	9D	00	D0	4C	FF	C5	81
C420:	CA	10	E0	60	AD	00	DC	29	EF	C5F0:	BD	00	D0	38	D9	57	C8	90	42
C428:	0F	8D	AA	02	A9	0F	38	ED	50	C5F8:	26	B9	57	C8	9D	00	D0	B9	21
C430:	AA	02	A8	B9	22	C8	F0	11	2C	C600:	B4	C7	2D	35	C8	F0	0C	A9	4E
C438:	8D	A8	02	A8	B9	B3	C7	3D	8B	C608:	FF	38	F9	B4	C7	2D	15	D0	C9
C440:	67	C8	F0	05	8A	A8	20	60	1A	C610:	8D	15	D0	BD	CE	C7	F0	07	CF
C448:	C4	60	A9	07	8D	A7	02	AC	02	C618:	49	FF	09	01	9D	CE	C7	CE	6E
C450:	A7	02	B9	FA	C7	F0	06	8D	FA	C620:	A7	02	30	03	4C	6A	C5	60	D9
C458:	A8	02	20	60	C4	4C	F8	C4	52	C628:	A9	D5	85	FA	A9	C8	85	FB	1C
C460:	B9	B4	C7	2D	69	C8	D0	10	D6	C630:	A0	00	B1	FA	F0	0B	20	D2	6C
C468:	AD	A8	02	0A	AA	BD	BC	C7	B7	C638:	FF	C8	D0	F6	E6	FB	4C	32	2A
C470:	08	98	0A	AA	28	4C	7E	C4	7D	C640:	C6	60	A9	C6	85	FA	A9	CA	CC
C478:	98	0A	AA	BD	CE	C7	30	1A	64	C648:	85	FB	A9	40	85	FC	A9	08	E7
C480:	F0	39	B9	02	C8	18	7D	00	C4	C650:	85	FD	A2	03	A0	00	B1	FA	C6
C488:	D0	9D	00	D0	90	2D	B9	B4	F3	C658:	91	FC	88	D0	F9	E6	FB	E6	04
C490:	C7	0D	10	D0	8D	10	D0	4C	01	C660:	FD	CA	D0	F2	60	A2	18	A9	B1
C498:	BB	C4	BD	00	D0	38	F9	02	DB	C668:	00	9D	00	D4	CA	10	FA	A9	5A
C4A0:	C8	9D	00	D0	B0	15	B9	B4	0C	C670:	F0	8D	06	D4	A9	11	8D	04	16
C4A8:	C7	4D	10	D0	8D	10	D0	A9	B6	C678:	D4	A9	0F	8D	18	D4	A9	81	AB
C4B0:	FF	38	F9	B4	C7	2D	10	D0	6D	C680:	8D	12	D4	A9	FF	8D	0F	D4	10
C4B8:	8D	10	D0	B9	B4	C7	2D	69	F3	C688:	60	20	65	C6	A0	03	A9	55	D7
C4C0:	C8	D0	12	AD	A8	02	0A	AA	79	C690:	8D	0C	D4	8D	0D	D4	8D	13	0F
C4C8:	E8	BD	BC	C7	08	98	0A	AA	49	C698:	D4	8D	14	D4	A9	21	8D	0B	47
C4D0:	E8	28	4C	DC	C4	98	0A	AA	1D	C6A0:	D4	A9	11	8D	12	D4	A9	18	66
C4D8:	E8	BD	CE	C7	30	0F	F0	17	5D	C6A8:	85	02	A9	C7	85	03	A2	06	D2
C4E0:	B9	02	C8	18	7D	00	D0	9D	69	C6B0:	8A	48	A2	00	A1	02	8D	08	5F
C4E8:	00	D0	4C	F7	C4	BD	00	D0	51	C6B8:	D4	8D	AA	02	E8	A1	02	8D	E1
C4F0:	38	F9	02	C8	9D	00	D0	60	BC	C6C0:	07	D4	E8	A1	02	8D	0F	D4	9A
C4F8:	CE	A7	02	30	03	4C	4F	C4	05	C6C8:	E8	A1	02	8D	0E	D4	AD	AA	1E
C500:	60	A9	07	8D	AA	02	AC	AA	A2	C6D0:	02	C9	32	D0	08	A9	F0	85	C7
C508:	02	AD	AD	02	39	B4	C7	F0	0E	C6D8:	A2	A5	A2	D0	FC	A9	FA	85	BB
C510:	45	AD	1B	D4	29	03	AA	BD	87	C6E0:	A2	A5	A2	D0	FC	A5	02	18	59
C518:	2E	C8	8D	A8	02	48	8A	48	62	C6E8:	69	04	85	02	A5	03	69	00	EF
C520:	98	48	20	60	C4	68	A8	68	BF	C6F0:	85	03	68	AA	CA	F0	05	8A	D7

C6F8:	48	4C	B2	C6	A9	20	8D	0B	69	C8C8:	69	31	09	80	8D	D4	07	A9	FF
C700:	D4	A9	10	8D	12	D4	A9	E6	93	C8D0:	01	8D	D4	DB	60	08	8E	93	9A
C708:	85	A2	A5	A2	D0	FC	88	F0	BF	C8D8:	9F	12	20	20	20	20	20	20	4B
C710:	03	4C	8E	C6	20	65	C6	60	61	C8E0:	20	20	20	20	20	20	20	20	E1
C718:	19	1E	12	D1	21	87	19	1E	13	C8E8:	20	20	20	20	20	20	20	20	E9
C720:	2A	3E	1F	A5	32	3C	25	A2	83	C8F0:	20	20	20	20	20	20	20	20	F1
C728:	2A	3E	1F	A5	32	3C	A9	80	ED	C8F8:	20	20	20	20	20	20	20	20	F9
C730:	8D	0B	D4	A9	0F	8D	08	D4	C0	C900:	20	20	20	20	20	20	20	20	01
C738:	A9	05	8D	07	D4	A9	F0	8D	78	C908:	20	20	20	20	20	20	20	20	09
C740:	0D	D4	A9	00	8D	0C	D4	A9	E3	C910:	20	20	20	20	20	20	20	20	11
C748:	81	8D	0B	D4	A9	0F	8D	AE	2C	C918:	92	A9	DF	12	20	20	20	20	C6
C750:	02	20	38	C2	20	01	C4	AC	FF	C920:	20	20	20	20	20	20	20	20	21
C758:	AE	02	8C	08	D4	98	18	69	8C	C928:	20	20	20	20	20	20	20	20	9B
C760:	80	8D	0C	D4	88	8C	AE	02	15	C930:	A9	DF	A9	DF	12	20	20	20	28
C768:	D0	E7	A9	80	8D	0B	D4	60	19	C938:	A9	DF	12	20	20	20	20	20	74
C770:	A9	09	8D	0C	D4	8D	00	D4	F3	C940:	20	92	A9	DF	12	20	20	20	61
C778:	8D	01	D4	A9	F5	8D	05	D4	E2	C948:	A9	20	20	DF	A9	DF	12	20	CD
C780:	A9	1F	8D	06	D4	A9	21	8D	0A	C950:	20	92	A9	DF	A9	DF	12	20	48
C788:	04	D4	A9	21	8D	0B	D4	A0	3A	C958:	20	92	A9	DF	12	20	20	20	07
C790:	32	A2	64	8A	48	A2	FF	CA	0A	C960:	20	20	92	A9	20	20	20	20	5D
C798:	D0	FD	68	AA	8E	08	D4	8E	74	C968:	DF	A9	20	20	DF	12	20	20	64
C7A0:	01	D4	8C	07	D4	CA	D0	EB	66	C970:	92	A9	DF	A9	20	20	DF	A9	FF
C7A8:	88	D0	E6	A9	20	8D	04	D4	19	C978:	20	20	20	20	20	20	DF	A9	C2
C7B0:	8D	0B	D4	60	01	02	04	08	8D	C980:	20	20	20	20	DF	A9	20	20	CA
C7B8:	10	20	40	80	00	00	00	FF	A9	C988:	DF	12	20	A0	20	92	A9	20	B7
C7C0:	01	FF	01	00	01	01	00	01	C5	C990:	20	20	20	20	20	20	20	20	91
C7C8:	FF	01	FF	00	FF	FF	00	00	C9	C998:	20	DF	A9	20	20	20	20	20	E2
C7D0:	00	00	00	00	00	00	00	00	D0	C9A0:	20	20	20	20	20	20	20	20	A1
C7D8:	00	00	00	00	00	00	00	00	D8	C9A8:	20	20	20	20	20	20	20	20	A9
C7E0:	00	00	00	00	00	00	00	00	E0	C9B0:	20	20	20	DF	12	20	00	13	36
C7E8:	00	00	00	00	00	00	00	00	E8	C9B8:	11	11	11	11	11	11	11	11	41
C7F0:	00	00	00	00	00	00	00	00	F0	C9C0:	92	20	20	20	9C	B0	C3	C3	88
C7F8:	00	00	00	00	01	07	08	04	0D	C9C8:	C3	C3	C3	C3	C3	C3	C3	C3	E6
C800:	06	02	04	03	04	06	01	01	1B	C9D0:	C3	C3	C3	C3	C3	C3	C3	C3	EE
C808:	01	01	00	00	00	00	00	00	0A	C9D8:	C3	C3	C3	C3	C3	C3	C3	C3	F6
C810:	00	00	01	01	01	01	01	01	16	C9E0:	C3	C3	C3	C3	C3	AE	0D	20	8F
C818:	01	01	00	00	00	00	00	00	1A	C9E8:	20	20	C2	9A	BC	12	BB	AC	BD
C820:	00	00	00	01	05	00	07	08	35	C9F0:	92	BE	12	20	A2	92	BE	12	7A
C828:	06	00	03	02	04	0F	02	04	4C	C9F8:	20	C3	C3	92	20	20	BC	12	42
C830:	06	08	FC	01	FF	0C	01	02	4B	CA00:	BB	AC	92	BE	12	BB	AC	92	C6
C838:	02	03	03	04	04	04	05	1E	6F	CA08:	BC	12	BB	AC	92	BE	12	AC	4F
C840:	19	19	19	19	19	19	19	1E	0E	CA10:	BB	92	B6	12	20	DF	B6	AC	8A
C848:	39	39	39	39	39	39	39	56	2F	CA18:	A2	92	BE	9C	C2	0D	20	20	B8
C850:	5A	56	56	56	56	56	56	D6	87	CA20:	20	C2	9A	AC	12	BE	BC	92	6A
C858:	BE	D6	D6	D6	D6	D6	D6	00	20	CA28:	BB	12	20	92	A2	BB	12	20	39
C860:	00	00	00	5A	79	9C	C0	44	D5	CA30:	C3	C3	92	20	20	20	12	A1	5E
C868:	11	F0	23	23	25	27	23	25	45	CA38:	92	A1	20	12	BE	BC	92	20	CC
C870:	27	25	27	03	0F	0D	0E	03	14	CA40:	12	A1	92	A1	20	12	AC	BB	C2
C878:	0E	06	04	0E	00	0B	0C	01	B6	CA48:	92	B6	A1	DF	12	B6	C3	C3	63
C880:	A0	04	38	B9	C7	07	69	00	4F	CA50:	92	A1	9C	C2	0D	20	20	20	51
C888:	C9	3A	90	02	A9	30	99	C7	5A	CA58:	AD	C3	C3	C3	C3	C3	C3	C3	60
C890:	07	88	10	EF	CA	D0	E9	60	06	CA60:	C3	C3	C3	C3	C3	C3	C3	C3	7E
C898:	A0	00	B9	C7	07	D9	E1	07	84	CA68:	C3	C3	C3	C3	C3	C3	C3	C3	86
C8A0:	F0	05	B0	0B	4C	BA	C8	C8	EA	CA70:	C3	C3	C3	C3	C3	C3	C3	C3	8E
C8A8:	C0	06	90	EE	4C	BA	C8	A0	5F	CA78:	BD	00	92	9A	53	43	4F	52	9B
C8B0:	05	B9	C7	07	99	E1	07	88	49	CA80:	45	20	30	30	30	30	30	30	07
C8B8:	10	F7	A0	05	A9	30	99	C7	A1	CA88:	00	05	48	49	47	48	20	30	FE
C8C0:	07	88	10	FA	AD	AB	02	18	CE	CA90:	30	30	30	30	30	00	9A	42	5E

**IMPORTANT!** Letters on white background are Bug Repellent line codes. Do not enter them! Pages 81 and 82 explain these codes and provide other essential information on entering Ahoy! programs. Refer to these pages before entering any programs!

CA98:	59	20	43	4C	45	56	45	4C	CE	CC58:	02	DB	40	02	66	40	06	3C	61
CAA0:	41	4E	44	20	4D	2E	20	42	72	CC60:	60	06	5A	60	07	18	E0	07	88
CAA8:	4C	41	4B	45	4D	4F	52	45	FA	CC68:	E7	E0	03	E7	C0	01	FF	80	5E
CAB0:	00	50	52	45	53	53	20	46	A5	CC70:	00	FF	00	00	C3	00	00	FF	34
CAB8:	49	52	45	20	54	4F	20	42	BF	CC78:	00	00	7E	00	00	3C	00	00	33
CAC0:	45	47	49	4E	21	00	00	00	06	CC80:	18	00	00	00	00	00	03	81	1D
CAC8:	00	00	00	00	00	00	00	00	C8	CC88:	C0	07	00	E0	0E	00	70	0E	BD
CAD0:	00	00	00	00	00	00	00	00	D0	CC90:	00	70	0F	7E	F0	07	FF	E0	67
CAD8:	00	00	00	00	00	00	04	92	6F	CC98:	02	DB	40	02	66	40	06	3C	A1
CAE0:	40	06	DB	60	0B	6D	B0	02	8E	CCA0:	60	06	5A	60	07	18	E0	07	C8
CAE8:	49	20	00	00	00	00	00	00	52	CCA8:	E7	E0	03	E7	C0	01	FF	80	9E
CAF0:	00	00	00	00	00	00	00	00	F0	CCB0:	00	E7	00	00	C3	00	00	C3	20
CAF8:	00	00	00	00	00	00	00	00	F8	CCB8:	00	09	66	90	00	3C	00	24	19
CB00:	00	00	00	00	00	EF	00	00	EF	CCC0:	18	24	80	00	01	00	00	00	7E
CB08:	00	00	00	00	00	00	00	00	08	CCC8:	00	00	00	00	00	00	00	00	C8
CB10:	00	00	00	00	00	00	00	0F	1F	CCD0:	10	00	00	0C	00	00	38	00	25
CB18:	00	00	1F	00	0E	3F	00	0E	92	CCD8:	00	10	00	00	0C	00	00	38	2D
CB20:	3F	00	0F	FF	00	0F	FF	00	7D	CCE0:	00	00	10	00	00	0C	00	00	FC
CB28:	0F	FF	00	0E	3F	00	0E	3F	D1	CCE8:	38	00	00	10	00	00	0C	00	3D
CB30:	00	00	1F	00	00	0F	00	00	5E	CCF0:	00	38	00	00	10	00	00	0C	45
CB38:	00	00	00	00	00	00	00	00	38	CCF8:	00	00	18	00	00	10	00	00	21
CB40:	00	00	00	00	00	00	51	83	15	CD00:	00	00	00	00	00	FF	00	00	FF
CB48:	05	F1	39	05	61	FF	07	79	5F	CD08:	00	00	00	00	00	00	00	00	08
CB50:	BB	02	A1	93	02	A0	FE	06	EA	CD10:	00	00	00	00	00	00	00	00	10
CB58:	A1	7D	87	97	83	CB	89	FE	6E	CD18:	00	00	00	00	00	00	00	00	18
CB60:	32	40	31	C6	26	32	2A	19	66	CD20:	00	00	00	00	00	00	00	00	20
CB68:	32	12	01	B2	02	00	B3	FA	11	CD28:	00	00	00	FF	80	00	FF	80	29
CB70:	1F	B0	0A	20	33	CA	27	B6	46	CD30:	00	3E	00	00	3E	00	00	FF	AC
CB78:	52	12	78	A2	09	01	40	04	46	CD38:	80	01	FF	C0	03	FF	E0	03	61
CB80:	83	F0	3F	C0	00	FF	01	83	79	CD40:	FF	E0	03	FF	E0	03	00	00	08
CB88:	00	39	39	00	61	FF	05	79	DA	CD48:	00	00	00	00	00	00	00	00	48
CB90:	BB	05	A1	93	07	A0	FE	02	2F	CD50:	00	00	00	00	00	00	00	00	50
CB98:	A1	7D	82	97	83	C6	89	FE	A4	CD58:	00	00	00	00	24	00	00	01	7D
CBA0:	3E	40	31	C7	26	32	2F	19	B8	CD60:	00	01	54	00	00	29	00	00	DE
CBA8:	32	12	01	32	02	3E	31	FA	8C	CD68:	94	80	00	2A	00	01	54	80	7D
CBB0:	40	30	0A	40	31	EA	27	B6	65	CD70:	00	12	00	00	28	00	00	00	AA
CBB8:	52	12	78	A2	09	01	42	3F	C3	CD78:	00	00	00	00	00	00	00	00	78
CBC0:	82	82	00	07	F2	FF	00	FF	BF	CD80:	00	00	00	00	00	00	80	00	01
CBC8:	00	01	18	80	42	7E	42	A2	08	CD88:	01	00	08	80	28	20	04	01	5F
CBD0:	5A	45	D2	7E	4B	AA	3C	55	49	CD90:	09	40	4A	40	10	01	09	00	7E
CBD8:	A5	18	A5	A3	81	C5	C0	42	2A	CD98:	12	00	54	08	48	00	02	25	76
CBE0:	03	60	24	02	10	18	0C	0C	AA	CDA0:	44	28	92	10	00	25	00	52	27
CBE8:	24	30	02	18	40	01	3C	80	55	CDA8:	42	4A	00	11	10	29	44	00	C3
CBF0:	00	99	00	00	99	00	00	80	A4	CDB0:	00	2A	94	15	00	00	00	28	AC
CBF8:	80	00	80	80	00	80	80	03	7E	CDB8:	14	45	00	80	08	44	24	00	03
CC00:	01	00	07	FE	00	FF	00	FF	07	CDC0:	91	00	20	00	01	00	00	00	73
CC08:	00	01	18	80	42	7E	42	A2	47	CDC8:	FF	00	FF	C8					
CC10:	5A	45	D2	7E	4B	AA	3C	55	88										
CC18:	A5	18	A5	A3	81	C5	C0	42	69										
CC20:	03	60	24	02	10	18	0C	0C	E9										
CC28:	24	30	02	18	40	01	3C	80	94										
CC30:	00	99	00	00	99	00	01	01	65										
CC38:	00	01	01	00	01	01	00	01	3D										
CC40:	01	80	00	FF	C0	FF	03	81	07										
CC48:	C0	07	00	E0	0E	00	70	0E	7D										
CC50:	00	70	0F	7E	F0	07	FF	E0	27										

## CLONE-A-MATIC FROM PAGE 30

•10 REM \*\*\* CLONE-A-MATIC \*\*\* BUCK CHILDR  
ESS \*\*\* HA  
•20 REM \*\*\* P.O. BOX 13575, SALEM, OR 97  
309 \*\*\* MJ



```

•30 PRINT"[CLEAR]LOADING DATA[3"."]":FORJ
=53000TO53182:READA:POKEJ,A:X=X+A:NEXTJ
•40 IFX<>28499THENPRINT"[DOWN]ERROR IN DA
TA[3"."]":END
•50 POKE808,234:POKE52,32:POKE56,32
•60 CLR:PRINT"[CLEAR][DOWN]INSERT SOURCE
DISK";:GOSUB250
•70 PRINT"[DOWN][DOWN]NAME OF FILE (PRESS
$ FOR"
•80 INPUT"THE DIRECTORY)";N$
•90 IFN$="$"THENSYS53087:GOTO70
•100 IFLEN(N$)<1ORLEN(N$)>16THENPRINT"[DO
WN]1 TO 16 CHARACTERS[3"."]":GOTO70
•110 INPUT"[DOWN]TYPE OF FILE - PRG/SEQ/U
SR (P/S/U)";T$
•120 IFT$<>"P"ANDT$<>"S"ANDT$<>"U"THEN110
•130 GOSUB290:IFER=1THEN220
•140 OPEN5,8,5,N$+",""+T$+",R":GOSUB300:IF
ER=1THEN220
•150 PRINT"[DOWN]READING[3"."]":SYS53000:
GOSUB300:CLOSE5:CLOSE15:IFER=1THEN220
•160 IFPEEK(252)>206THENPRINT"[DOWN]FILE
TOO LONG TO COPY[3"."]":GOTO220
•170 PRINT"[DOWN][DOWN]INSERT BACKUP DISK
";:POKE198,0:GOSUB250
•180 GOSUB290:IFER=1THEN220
•190 OPEN5,8,5,N$+",""+T$+",W":GOSUB300:IF
ER=1THEN220
•200 PRINT"[DOWN]WRITING[3"."]":SYS53043:
GOSUB300:CLOSE5:CLOSE15:IFER=1THEN220
•210 PRINT"[DOWN][DOWN]COPY COMPLETE[3".
"]"
•220 INPUT"[DOWN][DOWN]COPY ANOTHER FILE
(Y/N)";F$
•230 IFF$="Y"THEN60
•240 GOTO280
•250 PRINT", THEN PRESS RETURN.":PRINT"PR
ESS Q TO QUIT."
•260 GETA$:IFA$=CHR$(13)THENRETURN
•270 IFA$<>"Q"THEN260
•280 POKE52,160:POKE56,160:CLR:POKE808,23
7:END
•290 OPEN15,8,15:PRINT#15,"I"
•300 INPUT#15,EN$,EM$,ET$,ES$:IFEN$="00"
T
HENRETURN
•310 PRINT"[DOWN]"EN$","EM$","ET$","ES$:C
LOSE5:CLOSE15:ER=1:RETURN
•320 DATA169,0,162,32,133,251,133,253,134
,252,134,254
•330 DATA162,5,32,198,255,32,207,255,160,
0,145,251
•340 DATA165,144,208,12,230,251,208,241,2
30,252,165,252
•350 DATA201,207,144,233,76,204,255,169,5
4,133,1,162
•360 DATA5,32,201,255,160,0,177,253,32,21
0,255,165
•370 DATA253,197,251,208,13,165,254,197,2

```

```

52,208,7,169
•380 DATA55,133,1,76,204,255,230,253,208,
226,230,254
•390 DATA76,60,207:REM END COPY ROUTINE..
.BEGIN DIRECTORY
•400 DATA169,147,32,210,255,169,36,133,25
1,169,5,162
•410 DATA8,160,0,32,186,255,169,1,162,251
,160,0
•420 DATA32,189,255,32,192,255,162,5,32,1
98,255,32
•430 DATA207,255,32,207,255,32,207,255,32
,207,255,32
•440 DATA207,255,72,32,207,255,168,104,17
0,165,144,240
•450 DATA8,32,204,255,169,5,76,195,255,15
2,32,205
•460 DATA189,169,32,32,210,255,32,225,255
,240,234,32
•470 DATA207,255,208,243,169,13,32,210,25
5,184,80,201

```

## INFOFLOW 64 FROM PAGE 70

```

•10 REM INFOFLOW 64 (C)1987 "[s C][s M][s
B]"
•20 POKE53280,11:POKE53281,.
•30 V=53248:SPBASE=49152+1016:S=54272:JP=
56320:DEFFNJF(V)=((PEEK(JP)AND16)=.)
•40 DEFFNM(V)=INT(V/RL%):PLOT=53180
•50 NF$="[DOWN][c 5] [s N]O [s F]ILE IN [
s M]EMORY!":FE$="[DOWN][c 5][s F]ILE [s
C]URRENTLY IN [s M]EMORY!":Q$="[RVSON]
[s Q][s U][s I][s T] "
•60 DIMBO(7):FORI=.TO7:BO(I)=2[UPARROW]I:
NEXT:CR$=CHR$(13)
•70 GOSUB2010
•80 POKEV+21,.:POKEV+16,16:FORI=.TO7:POKE
SPBASE+I,32+I:NEXT:POKEV+39,15
•90 FORI=V+40TOV+46:POKEI,6:NEXT:FORI=512
00TO51711:READA:POKEI,A:NEXT
•100 FORI=VTOV+15:READA:POKEI,A:NEXT
•110 FORI=53000TO53223:READA:POKEI,A:NEXT
:SYS53000
•120 B$="[CLEAR][c 7][RVSON] *[12" "][s I
]NFO[s F]LOW 64[13" "]* "
•130 GOSUB140:GOTO220
•140 PRINTB$:PRINTTAB(2)"[6"[DOWN]"][s S]
AVE"SPC(6)"[s N]EW"SPC(6)"[s D]ELETE"SPC
(4)"[s V]IEW/[s A]DD"
•150 PRINTTAB(2)"[s L]OAD"SPC(6)"[s F]ILE
"SPC(5)"[s R]ECORD"SPC(4)"[s R]ECORD[DOW
N]"
•160 FORX=.TO39:PRINT"[c @]";:NEXT:PRINT:
PRINTTAB(32)"[DOWN][c A][c R][c S][DOWN]
[3"[LEFT]"][c Q][s +][c W][DOWN][LEFT][L

```

EFT][c E][c X]"	MH	I):NEXTI,J	CF
•170 PRINTTAB(2)"[DOWN][s S]ORT"SPC(6)"[s S]EARCH"SPC(3)"[s H]ARDCOPY"SPC(2)"[s C]URRENT"	KM	•440 CLOSE2:OPEN15,8,15:INPUT#15,DS,DS\$:CLOSE15:PRINT"[WHITE]"DS\$:GOSUB1830	EJ
•180 PRINTTAB(31)"[s R]ECORD"	BO	•450 GOTO600	NL
•190 PRINT"[DOWN][DOWN][c 5][RVSON] * (C) 1987 [s B]Y [s C]LEVELAND [s M]. [s B]LAKEMORE * ";	PO	•460 REM LOAD FILE	JM
•200 PRINTSPC(3)"[RVSOFF][c 4][s S][s P][s A][s C][s E] [s I][s N] [s M][s E][s M][s O][s R][s Y] [s F][s O][s R] [WHITE][4"0"] [c 4] [s R]ECORDS!":PRINTTAB(15)"[BLUE]";Q\$;"[HOME]"	GF	•470 IFEFTHENPRINTFE\$:GOSUB1830:GOSUB1780:RETURN	PI
•210 POKEV+16,16:POKEV,160:POKEV+1,115:POKEV+21,255:RETURN	PD	•480 PRINT"[DOWN][c 8][s F]ILENAME:[BLUE]";:A=12:GOSUB1930:A\$=IN\$	LL
•220 WAITJP,16,16	CI	•490 CLOSE2:OPEN2,8,2,"[s I][s F]"+"A\$+",S,R"	KO
•230 C=PEEK(V+30):C=PEEK(V+30)AND254:FORI=1TO7:IFBO(I)=CTHENC=I	PB	•500 CLOSE15:OPEN15,8,15:INPUT#15,A,DS\$:IFA>.THEN600	ON
•240 NEXT	HC	•510 INPUT#2,RL%,TL,EF,N,FT\$	MF
•250 ONCGOSUB300,620,800,1080,1220,1380,1430	EO	•520 DIMR\$(TL,N),N\$(N),L%(N)	OI
•260 X=PEEK(V):I=PEEK(V+1)	PE	•530 FORI=1TON:INPUT#2,N\$(I):INPUT#2,L%(I)	DF
•270 IF(PEEK(V+16)AND1)=1ANDX>8ANDX<60ANDI>150ANDI<187THENGOSUB1620:GOTO220	GG	•540 NEXT	KA
•280 IFI<235THEN220	HF	•550 FORJ=1TOEF	BA
•290 WAITJP,16,..:SYSLOT,15,24:PRINT"[c 7]";Q\$"[LEFT][LEFT]?"":GOSUB1740:GOSUB1740:GOSUB1740	PK	•560 FORI=1TON	NN
•295 IFFNJF(.)=.ANDUSR(.)=.THEN295	HK	•570 GET#2,A\$:IFA\$<>CR\$THENR\$(J,I)=R\$(J,I)+A\$:GOTO570	HI
•296 IFFNJF(.)THENPOKE648,4:POKE679,..:SYS679	MH	•580 NEXTI,J:EF=EF+1:CR=1	CI
•297 SYSLOT,15,24:PRINT"[BLUE]";Q\$;GOTO220	JD	•590 CLOSE2:INPUT#15,DS,DS\$	PO
•300 REM SAVE/LOAD FILE	FK	•600 PRINT"[WHITE]"DS\$;:CLOSE15:GOSUB1830	PB
•310 GOSUB1810	IK	•610 GOSUB1780:GOSUB1750:RETURN	BF
•320 OPEN15,8,15:CLOSE15	JH	•620 REM INITIALIZE NEW FILE	ML
•330 IFST<>.THENPRINT"[CLEAR][s D][s R][s I][s V][s E] [s O][s F][s F] [s L][s I][s N][s E]!":GOSUB1830:GOSUB1780:GOSUB1750:RETURN	FO	•630 GOSUB1810:IFEFTHENPRINT"[DOWN][DOWN]";FE\$:GOSUB1830:GOSUB1780:GOSUB1750:RETURN	BG
•340 POKE198,0:PRINT"[RVSON][c 8][s S][RVSOFF]AVE OR [RVSON][s L][RVSOFF]OAD?"	LO	•640 RL%=.:TL=.:PRINT"[c 8] [s F]ILENAME:[BLUE]";:A=10:GOSUB1930:FT\$=IN\$	MJ
•350 WAIT198,1:GETA\$:IFA\$<>"L"ANDA\$<>"S"THENGOSUB1780:RETURN	PE	•650 PRINT"[s N]UMBER OF FIELDS:"":A=2:GOSUB1930:N=VAL(IN\$):IFN<1ORN>22THEN650	JN
•360 IFA\$="L"THEN470	MC	•660 DIMN\$(N),L%(N)	GG
•370 REM SAVE FILE TO DISK	BK	•670 FORX=1TON:PRINT"[s N]AME [s F]IELD #";X;"[LEFT]:"":A=39:GOSUB1930:N\$(X)=IN\$	BF
•380 IFEF=.THENPRINTNF\$:GOSUB1830:GOSUB1780:GOSUB1750:RETURN	PP	•680 A\$=""":PRINT"[s L]ENGTH [s F]IELD #";X;"[LEFT]:"":A=3:GOSUB1930:A\$=IN\$	BO
•390 PRINT"[CLEAR][c 8][s S][s A][s V][s I][s N][s G][SS][s F][s I][s L][s E][BLU E] ";FT\$:A\$=FT\$	BP	•690 IFVAL(A\$)>.ANDVAL(A\$)<255THENL%(X)=ABS(VAL(A\$)):GOTO710	HG
•400 OPEN15,8,15,"S:[s I][s F]"+"A\$:CLOSE15:OPEN2,8,2,"[s I][s F]"+"A\$+",S,W"	AG	•700 PRINT"[s D]EFAULT (160) !":L%(X)=160	BL
•410 J=EF-1:PRINT#2,RL%;CR\$;TL;CR\$;J;CR\$;N;CR\$;FT\$	BC	•710 RL%=RL%+L%(X):NEXT	LJ
•420 FORX=1TON:PRINT#2,N\$(X);CR\$;L%(X):NEXT	NK	•720 RL%=RL%+3*(N+1)+5:TL=FM(FRE(.)):EF=2:DIMR\$(TL,N)	MN
•430 FORJ=1TOEF-1:FORI=1TON:PRINT#2,R\$(J,		•730 PRINT"[s T]HIS FILE WILL PERMIT AT L EAST"	LO
		•740 PRINTFM(FRE(.));" [s R]ECORDS."	FK
		•750 PRINT"[DOWN][RVSON][s A][RVSOFF]CCEPT OR [RVSON][s R][RVSOFF]EJECT?"	ID
		•760 GETA\$:IFA\$<>"A"ANDA\$<>"R"THEN760	GK
		•770 IFA\$="R"THENRUN	HG
		•780 PRINT"[DOWN][c 7][s E]MPTY [s F]ILE [s C]REATED."":CR=1:EF=1:GOSUB1830:GOSUB1780:GOSUB1750	LL
		•790 RETURN	KH
		•800 REM DELETE RECORD(S)	NP
		•810 GOSUB1810:IFEF=.THENPRINTNF\$:GOSUB18	

30:GOSUB1780:GOSUB1750:RETURN	CH	•1160 IFCR<>ATHEN1110	LO
•820 PRINT"[c 8][RVSON][s C][RVSOFF]URREN T [s R]ECORD, [RVSON][s S][RVSOFF]CAN [s F]ILE, [RVSON][s A][RVSOFF]LL OR [RVSON ][s E][RVSOFF]XIT?"	JI	•1170 GOTO1120	OD
•830 GETA\$:IFA\$<>"E"ANDA\$<>"S"ANDA\$<>"C"A NDA\$<>"A"THEN830	JG	•1180 PRINT"[HOME][3"[DOWN]]"[c 8]";:FORX =1TON:PRINTN\$(X);":[BLUE]";	NI
•840 IFA\$="E"THENGOSUB1780:RETURN	JG	•1190 A=L%(X):IN\$=" ":GOSUB1940:PRINT"[c 8]";:IFIN\$<>" "THENR\$(CR,X)=MID\$(IN\$,2)	AG
•850 IFA\$="S"THEN990	JG	•1200 NEXT:IFCR=EFANDR\$(CR,1)<>" "THENEF=C	AG
•860 IFA\$="C"THENGOSUB910:GOSUB1780:RETUR N	FN	R+1:IFEFT>TLTHENEF=TL	LG
•870 PRINT"[DOWN][DOWN][s D][s E][s L][s E][s T][s E][SS][s A][s L][s L][SS][s R] [s E][s C][s O][s R][s D][s S]![SS][s A] [s R][s E][SS][s Y][s O][s U][SS][s S][s U][s R][s E]?[SS]([s Y]/[s N])"	OI	•1210 GOTO1110	AK
•880 GETA\$:IFA\$<>"Y"ANDA\$<>"N"THEN880	NC	•1220 REM SORT RECORDS	LE
•890 IFA\$="Y"THENRUN	NC	•1230 REM SHELL METZNER ALGORITHM	MH
•900 GOSUB1780:RETURN	CI	•1240 GOSUB1810:IFEFT=.THENPRINTNF\$:GOSUB1 830:GOSUB1780:GOSUB1750:RETURN	BM
•910 PRINT"[DOWN][DOWN][s D][s E][s L][s E][s T][s I][s N][s G][4"."]"	DM	•1250 FORX=1TON:PRINTX;"[LEFT]. ";N\$(X):N EXT	DA
•920 FORI=1TON:R\$(CR,I)="" :NEXT:FORX=1TOE F-1	PH	•1260 PRINT"[c 8][DOWN][s S]ORT BY WHICH [s F]IELD? (1 -";N;"[LEFT]) :";:A=2:GOSU B1930	HC
•930 IFR\$(X,1)=""THENFORI=1TON:R\$(X,I)=R\$( X+1,I):R\$(X+1,I)="" :NEXTI	LF	•1270 X=VAL(IN\$):IFX<10RX>NTHEN1260	DF
•940 NEXTX	LF	•1280 M=EF-1:PRINT:PRINT"[DOWN][DOWN][s S ]TAND BY[3"."][s S]ORTING [s F]ILE!"	ON
•950 IFEFT>1ANDEF<>CRTHENEF=EF-1	JO	•1290 M=INT(M/2):IFM=.THEN1370	HI
•960 GOSUB1860:PRINT"[DOWN][DOWN][s @] [s R][s E][s C][s O][s R][s D][SS]#";CR;"[ s D][s E][s L][s E][s T][s E][s D]."	JK	•1300 K=(EF-1)-M:J=1	DH
•970 GOSUB1830:RETURN	JK	•1310 I=J	GD
•980 GOTO1070	JI	•1320 L=I+M:IFR\$(I,X)<=R\$(L,X)THEN1350	EP
•990 POKE198,.:PRINT"[HOME][DOWN][RVSON][ BLUE][s S][s H][s I][s F][s T]-[s E] [s T][s O][SS][s E]XIT, [s S][s H][s I][s F ][s T]-[s D] [s T][s O] [s D]ELETE[6" " ] "	IN	•1330 FORR=1TON:A\$=R\$(I,R):R\$(I,R)=R\$(L,R ) :R\$(L,R)=A\$:NEXT	EN
•1000 GETA\$:JY=USR(.):IFJY=.ANDA\$=""THEN1 000	GO	•1340 I=I-M:IFI>=1THEN1320	HJ
•1010 IFJY=3THENCRCR=CR+1	GO	•1350 J=J+1:IFJ>KTHEN1290	MH
•1020 IFJY=7THENCRCR=CR-1	EB	•1360 GOTO1310	KH
•1030 IFA\$="[s D]"THENGOSUB910	OH	•1370 PRINT"[DOWN][DOWN][s @] [s S][s O][ s R][s T][SS][s C][s O][s M][s P][s L][s E][s T][s E][s D].":GOSUB1830:GOSUB1780 :GOSUB1750:RETURN	MF
•1040 IFA\$="[s E]"THENGOSUB1780:RETURN	CE	•1380 REM SEARCH RECORDS, FIND STRING	JE
•1050 IFCR>EFTHENCRCR=EF	CE	•1390 GOSUB1810:IFEFT=.THENPRINTNF\$:GOSUB1 830:GOSUB1780:GOSUB1750:RETURN	GJ
•1060 IFCR<1THENCRCR=1	IK	•1400 PRINT"[HOME][DOWN][c 8][s S]EARCH [ s S]TRING:[BLUE]";:A=23:GOSUB1930:S\$=IN\$	MN
•1070 GOSUB1860:GOTO1000	FP	•1410 FORJ=1TOEF-1:FORI=1TON:IFLEFT\$(R\$(J ,I),LEN(S\$))=S\$THENCRCR=J:GOSUB1110:CR=J	JE
•1080 REM VIEW RECORDS	GI	•1420 NEXTI,J:PRINT"[c 8][DOWN][RIGHT] [s @] [s S]EARCH [s C]OMPLETED.";:CR=1:GOS UB1830:GOSUB1780:RETURN	LJ
•1090 GOSUB1810:IFEFT=.THENPRINTNF\$:GOSUB1 830:GOSUB1780:GOSUB1750:RETURN	GL	•1430 REM HARDCOPY	HK
•1100 GOSUB1110:GOSUB1780:RETURN	JB	•1440 GOSUB1810:IFEFT=.THENPRINTNF\$:GOSUB1 830:GOSUB1780:GOSUB1750:RETURN	LP
•1110 GOSUB1850	LM	•1450 PRINT"[CLEAR][RVSON][BLUE][3"*"]][3" "]][s R]ECORD [s R]ANGE FOR [s H]ARDCOPY [4" "][3"*"] "	DL
•1120 JY=USR(.):A=CR:IFFNJF(.)THENRETURN	NK	•1460 A\$="" :PRINT"[s F]ROM:";:A=3:GOSUB19 30	BA
•1130 IFJY=3THENCRCR=CR+1:IFCR>EFTHENCRCR=EF: GOTO1110	EB	•1470 F=VAL(IN\$)	HN
•1140 IFJY=7THENCRCR=CR-1:IFCR<1THENCRCR=1:GO TO1110	BH	•1480 IFF<10RF>EFTHEN1460	BG
•1150 IFJY=1THENPRINT"[HOME][DOWN]";:GOTO 1180	EB	•1490 A\$="" :PRINT"[s T]O:";:A=3:GOSUB1930	OM
	AC	•1500 L=VAL(IN\$)	MB
	AF	•1510 IFL<10RL>EFTHEN1490	CN
	LN	•1520 PRINT"[CLEAR]":PRINT"[c 8][3"[DOWN]	
	CD		
	PJ		
	JD		
	AD		

"][s @] [s P][s R][s I][s N][s T][s I][s N][s G] [s F][s I][s L][s E] ";FT\$	EF	•1920 REM SAFE BASIC INPUT	CK
•1530 OPEN15,4,15:CLOSE15	FN	•1930 FORI=.TO39:PRINTCHR\$(32);:NEXT:PRINT"[UP]";:IN\$=""	JI
•1540 IFST<>.THENPRINT"[3"[DOWN]]"[s P][s R][s I][s N][s T][s E][s R] [s O][s F][s F] [s L][s I][s N][s E][4"!]"":GOSUB1830:GOSUB1780:RETURN	EH	•1940 POKE198,.:POKE204,.	NP
•1550 OPEN4,4,7:CMD4	MB	•1950 WAIT198,15:GETZ\$:Z=ASC(Z\$):IFZ>95AND(Z<193ORZ>218)THEN1950	IK
•1560 FORJ=FTOL:CR=J:GOSUB1880:PRINT:NEXT	NJ	•1960 ZL=LEN(IN\$):IFZL=ATHEN1980	IK
•1570 PRINT#4,""	GE	•1970 IFZ>31THENIN\$=IN\$+Z\$:PRINTZ\$;:GOTO1950	JH
•1580 CLOSE4	AC	•1980 IFZ=13ANDZLTHENPOKE204,1:PRINT" ":RETURN	BH
•1590 PRINT"[c 8][3"[DOWN]]"[s @] [s D]ON E.":GOSUB1780	DP	•1990 IFZ=20ANDZLTHENIN\$=LEFT\$(IN\$,ZL-1):PRINT" [LEFT][LEFT] [LEFT]";	HI
•1600 GOSUB1750:RETURN	HF	•2000 GOTO1950	CD
•1610 REM CURRENT RECORD BAR	IG	•2010 POKE56578,PEEK(56578)OR3:POKE56576,PEEK(56576)AND252	PO
•1620 IFEF=.THENRETURN	IG	•2020 POKE53272,PEEK(53272)AND15:POKE648,192:POKE53272,(PEEK(53272)AND240)OR12	OL
•1630 WAITJP,16,.	GM	•2030 PRINTCHR\$(147)CHR\$(8)CHR\$(14)"[c 7] [s P]LEASE [s S]TAND [s B]Y[4".]"	EM
•1640 IFFNJF(.)THENIN\$=STR\$(CR):SYSPLOT,32,20:PRINT"[BLUE]";:WAITJP,16,.:GOTO1790	IJ	•2040 FORX=1TO33:READA:POKE680+X,A:NEXT:POKE56334,PEEK(56334)AND254	MB
•1650 JY=USR(.)	AE	•2050 POKE1,PEEK(1)AND251:SYS681:POKE1,PEEK(1)OR4:POKE56334,PEEK(56334)OR1	DG
•1660 IFJY=3THENCRCR=CR+1	PB	•2060 READA:IFA=-1THENRETURN	JJ
•1670 IFJY=7THENCRCR=CR-1	BM	•2070 FORX=.TO7:READD:POKE63488+A*8+X,D:NEXT:GOTO2060	LC
•1680 IFJY=1THENCRCR=CR+10	AD	•2080 DATA 169,,133,251,133,253,169,208,133,252,169,240,133,254,162,16	GO
•1690 IFJY=5THENCRCR=CR-10	FO	•2090 DATA 160,,177,251,145,253,136,208,249,230,252,230,254,202,208,240,96	IK
•1700 IFCR<1THENCRCR=1	ML	•2100 DATA91,250,12,248,64,127,64,64,126	HP
•1710 IFCR>EFTHENCRCR=EF	HM	•2110 DATA107,169,169,33,32,32,32,0	HN
•1720 IN\$=STR\$(CR):SYSPLOT,32,20:PRINT"[c 7]";:GOSUB1910	JJ	•2120 DATA110,254,6,10,18,34,194,66,66	OP
•1730 GOTO1640	CE	•2130 DATA112,224,191,129,129,255,,32,112	MC
•1740 REM BELL	HG	•2140 DATA113,64,64,127,64,64,127,64,127	FL
•1750 POKES+24,15:POKES+5,.:POKES+6,247:POKES+1,50:POKES+4,17	JB	•2150 DATA114,15,16,32,64,255,128,255,129	DN
•1760 POKES,2:FORX=.TO175:NEXT:POKES+4,16:RETURN	OB	•2160 DATA115,130,2,2,2,130,130,130,130	EC
•1770 REM SWITCH TO COMMAND SCREEN	ML	•2170 DATA125,130,130,130,130,132,136,144,224,-1	PF
•1780 GOSUB140:SYSPLOT,23,23:PRINT"[c 5]";:IFRL%THENIN\$=STR\$(FNM(FRE(.))):GOSUB1910	BC	•2180 REM SPRITE DATA	AF
•1790 GOSUB1750:IN\$=STR\$(CR):SYSPLOT,32,20:PRINT"[BLUE]";:GOSUB1910:RETURN	FC	•2190 DATA0,,,,,0	EM
•1800 REM SWITCH TO TEXT	DE	•2200 DATA0,,,3,255,128	KN
•1810 POKEV+21,.:PRINTB\$:GOSUB1750:RETURN	LN	•2210 DATA2,1,,2,2,0	OH
•1820 REM DELAY	CL	•2220 DATA2,4,,2,2,0	BC
•1830 FORI=.TO5000:NEXT:RETURN	MK	•2230 DATA2,1,,2,,128	HG
•1840 REM PRINT ONE RECORD	ML	•2240 DATA2,96,64,2,144,32	FE
•1850 POKE780,.:POKE781,1:POKE782,.:POKE783,.:SYS59903	GG	•2250 DATA3,8,16,,4,8	GG
•1860 FORI=2TO24:POKE780,.:POKE781,I:POKE782,.:POKE783,.:SYS59903:NEXT	GN	•2260 DATA0,2,4,,1,2	EN
•1870 PRINT"[HOME][DOWN][DOWN]";	LD	•2270 DATA0,,129,,65	GP
•1880 PRINT"[c 8][RVSON] [s R][s E][s C][s O][s R][s D][SS]# ";CR;"[LEFT] IN [s F][s I][s L][s E][SS]";FT\$;" "	MD	•2280 DATA0,,34,,20	EF
•1890 FORX=1TON:PRINT"[c 8]";N\$(X);": ";"[BLUE]";R\$(CR,X):NEXT:RETURN	DO	•2290 DATA0,,8,,0	PD
•1900 REM OUTPUT RIGHT JUSTIFIED STRING	OI	•2300 DATA0,7,255,240,7,227	JI
•1910 PRINTRIGHT\$("[4"0"]"+(RIGHT\$(IN\$,LEN(IN\$)-1)),4):RETURN	PO	•2310 DATA240,7,221,224,7,221	PN
		•2320 DATA240,7,221,240,7,227	HH
		•2330 DATA240,7,255,240,7,247	CO
		•2340 DATA240,7,247,240,7,247	JN
		•2350 DATA240,7,255,240,,0	JF

•2360	DATA0,255,255,255,198,0	EF	•2870	DATA32,32,63,64,32,32	OH
•2370	DATA3,197,255,227,197,64	PC	•2880	DATA128,,32,7,252,32	CP
•2380	DATA35,197,255,227,192,0	EC	•2890	DATA4,7,224,4,4,0	EB
•2390	DATA3,255,255,255,,0	LJ	•2900	DATA0,4,,255,132,0	GB
•2400	DATA0,,128,,64	OG	•2910	DATA128,252,,128,128,0	HD
•2410	DATA0,,36,15,255,20	LM	•2920	DATA128,128,,128,128,0	KB
•2420	DATA16,3,12,32,5,124	AA	•2930	DATA255,128,,255,,0	OC
•2430	DATA64,9,,255,241,0	OJ	•2940	DATA0,,127,255,,64	KF
•2440	DATA128,17,,143,17,0	PJ	•2950	DATA1,,94,1,,64	BE
•2450	DATA128,17,,255,241,0	IG	•2960	DATA1,,95,253,,64	NN
•2460	DATA128,17,,143,17,0	DN	•2970	DATA1,16,95,253,8,64	DO
•2470	DATA128,17,,128,17,0	IC	•2980	DATA1,252,95,253,8,64	JA
•2480	DATA255,241,,128,17,0	HI	•2990	DATA1,16,95,253,,64	AB
•2490	DATA128,17,,143,18,0	GM	•3000	DATA1,,95,253,,64	IF
•2500	DATA128,20,,255,248,0	KH	•3010	DATA1,,95,253,,64	MH
•2510	DATA0,,,,,0	IP	•3020	DATA1,,64,1,,127	IG
•2520	DATA0,60,,66,0	HL	•3030	DATA255,,,,,0	PK
•2530	DATA3,255,192,4,,32	DL	•3040	DATA0,255	GE
•2540	DATA3,255,192,2,,64	EO	•3050	REM ICON LOCATIONS	GN
•2550	DATA2,82,64,2,82,64	HL	•3060	DATA 165,160,45,80,117,80,200,80,30	DJ
•2560	DATA2,82,64,2,82,64	GE	•3070	DATA 80,45,162,130,160,205,160	JP
•2570	DATA2,82,64,2,82,64	HC	•3080	REM INTERRUPT ROUTINE	II
•2580	DATA2,82,64,2,82,64	II	•3090	DATA 120,169,31,141,20,3,169,207,14	BI
•2590	DATA2,82,64,2,,64	AD		1,21,3,169,166,141,17	
•2600	DATA3,255,192,,,0	CK	•3100	DATA 3,169,207,141,18,3,88,96,173,,	IM
•2610	DATA0,,,,,0	OG		220,41,15,133,253	
•2620	DATA0,,,,,0	PM	•3110	DATA 169,15,56,229,253,168,185,221,	FI
•2630	DATA0,,,,,255	JF		207,240,8,141,168,2,160	
•2640	DATA0,3,,192,4,60	GM	•3120	DATA 0,32,60,207,76,163,207,173,168	HA
•2650	DATA32,8,66,16,16,153	FD		,2,10,170,189,202,207	
•2660	DATA8,32,189,4,16,153	OG	•3130	DATA 8,152,10,170,40,48,25,240,43,1	OK
•2670	DATA8,8,66,16,4,60	LJ		73,220,207,24,125,0	
•2680	DATA32,3,,192,,255	IK	•3140	DATA 208,157,,208,144,31,169,1,77,1	AF
•2690	DATA0,,,,,0	DG		6,208,141,16,208,76	
•2700	DATA0,,,,,0	EM	•3150	DATA 120,207,189,,208,56,237,220,20	JB
•2710	DATA0,,,,,0	HK		7,157,,208,176,8,169	
•2720	DATA0,255,,8,15	IL	•3160	DATA 1,77,16,208,141,16,208,173,168	BH
•2730	DATA255,20,16,3,34,32	DP		,2,10,170,232,189,202	
•2740	DATA5,62,64,9,34,255	DM	•3170	DATA 207,8,152,10,170,232,40,48,15,	IM
•2750	DATA241,34,128,17,,143	JJ		240,23,173,220,207,24	
•2760	DATA17,60,128,17,34,255	MA	•3180	DATA 125,,208,157,,208,76,162,207,1	MK
•2770	DATA241,34,128,17,60,143	LG		89,,208,56,237,220	
•2780	DATA17,34,128,17,34,128	LI	•3190	DATA 207,157,,208,96,76,49,234,173,	PM
•2790	DATA17,60,255,241,,128	MC		,220,41,15,133,253	
•2800	DATA17,28,128,17,34,143	LG	•3200	DATA 169,15,56,229,253,168,185,221,	BI
•2810	DATA18,32,128,20,32,255	CG		207,168,169,,108,5,0	
•2820	DATA248,34,,28,255	JC	•3210	DATA 32,155,183,138,72,32,155,183,1	NP
•2830	DATA0,,,,,0	MN		04,168,24,76,240,255,0	
•2840	DATA15,128,,1,131,255	PB	•3220	DATA 0,,255,1,255,1,,1,1,,1,255,1,2	BM
•2850	DATA2,130,1,4,130,1	HN		55,0	
•2860	DATA8,,1,16,63,225	EJ	•3230	DATA 255,255,2,,1,5,,7,8,6,,3,2,4	FD

## HIGHEST PRICES PAID FOR PROGRAMS!

Ahoy! paces the industry in payment for high-quality, magazine-length Commodore software. Send your best utilities, games, or productivity programs on disk, along with documentation and a stamped, self-addressed envelope, to Ahoy! Program Submissions Dept., Ion International Inc., 45 West 34th Street—Suite 500, New York, New York 10001. Allow at least 2 weeks for reply.

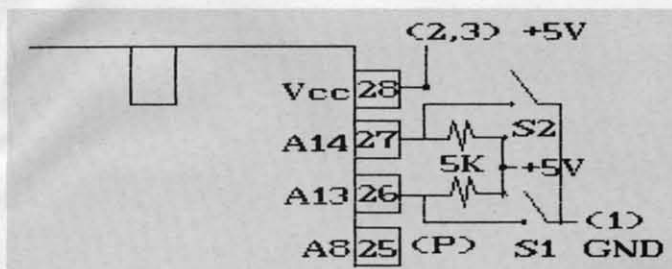

Figure 5:

Modification for Bank Switching a 27256 EPROM

S1	S2	8K Quarter
C	C	First
O	C	Second
C	O	Third
O	O	Fourth

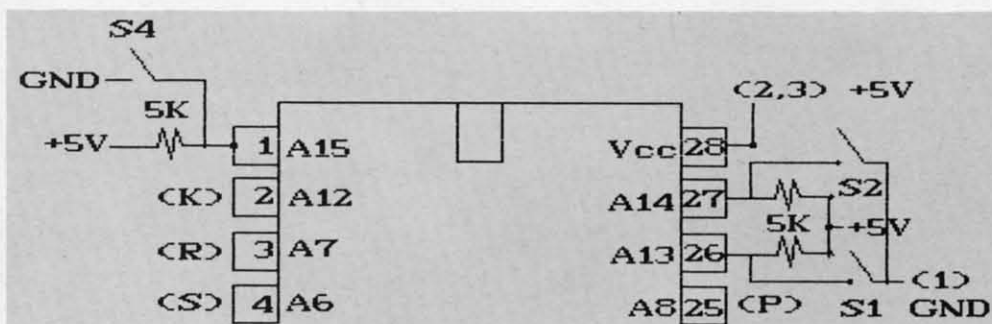

Figure 6:

Modification for Bank Switching a 27512 EPROM

S4	ROM Half	S1	S2	8K Quarter
C	Bottom	C	C	First
O	Top	O	C	Second
		C	O	Third
		O	O	Fourth

## EXPANSION PORT, PART 2

Continued from page 62

Contacts 12 (bus available, BA) and 13 (direct memory access, DMA) are designed to function together. These allow an external device, such as the 1700 and 1764 RAM expansion modules, to halt the microprocessor and take control of the data and address buses. This permits direct access to the C-64's RAM by external devices.

Contacts 7 (I/O 1) and 10 (I/O 2) go low when the address ranges \$DE00 to \$DEFF (56832 to 57087) and \$DF00 to \$DFFF (57088 to 57343) appear on the address bus. This per-

mits up to 512 bytes to be used by external I/O chips which can greatly expand the C-64's interfacing abilities. The PCC4 mentioned above makes use of these lines for its soft switch at \$DFFF (57343) or \$DEFF (57087). Contact E brings out phase 2 of the system clock which is used for timing the I/O devices. The Microtroll from Slide Mountain Systems, which we reviewed last month (see page 67, December), makes extensive use of these three I/O lines.

Finally, contact 6 brings out the dot clock. This signal pulses at a rate of approximately eight million times each second (8.18 MHz for NTSC and 7.88 for PAL systems). This allows external devices to be precisely synchronized with the computer's video display. The Turbo Processor from Swisscomp, also reviewed last month (see page 63, December), divides this signal by two to clock its 65816 microprocessor at approximately 4 MHz.

An analysis of the expansion port quickly shows why in

most cases only one cartridge may be used at a time. At the very least each cartridge should have complete control of the GAME and EXROM lines. Also, ROMs mapped in the same address range will present conflicting data on the address bus. Thus the minimum requirements for an expansion chassis which supports independently controllable cartridges are the facilities for the discrete control of EXROM, GAME, ROML, and ROMH in each slot.

We have demonstrated that the complete complement of microprocessor

control lines which are present on the expansion port is what makes possible the versatile cartridges we have become accustomed to. The selection of products we have been reviewing represent only a small sample of the applications for this orifice. □

Most back issues of *Ahoy!* are available for \$4.00 each. See page 74 of this magazine for details.

...COMING IN THE FEBRUARY ISSUE OF *AHOY!* (ON SALE JANUARY 5)...

**C-64 POWER SUPPLIES**

A LOOK INSIDE THE BLACK BOX

**SOUND ENLIGHTENMENT**

INVESTIGATING AUDIBLE WAVE PHENOMENA

PLUS

• COFFEE BREAK  
• THRESHOLD  
AND OTHER 64 AND 128 PROGRAMS

# Out of the *Arcade* and Into Your Computer!



**KARATE CHAMP**™ Put on your black belt and challenge your friends or the computer. For Commodore 64/128™ and Apple II™ series.

**KUNG-FU MASTER**™ Battle the evil forces to rescue the captive fair maiden. For Commodore 64/128™ and Apple II™ series.

**TAG TEAM WRESTLING**™ Battle your way through the Title Matches on your quest for the belt. For Commodore 64/128™, Apple II™ series, and IBM.

**COMMANDO**™ As the crack shot Commando, battle overwhelming odds to reach the fortress. For Commodore 64/128™, Apple II™ series, and IBM.

**EXPRESS RAIDER**™ Bandits have seized the Gold City Express. Rescue the passengers, save the train, and recapture the loot! For Commodore 64/128™.

**BREAKTHRU**™ Your mission is to retrieve the secret fighter plane stolen by renegades. For Commodore 64/128™.

**VICTORY ROAD**™ Our heroes from *Ikari Warriors*™ are back to battle the most fearsome enemies of all. For Apple II™ series, IBM, and Commodore 64/128™.



## **IKARI WARRIORS**™

You and your partner are engaged in guerilla warfare as you battle your way through jungles, rivers, and ruins. For Commodore 64/128™, Apple II™ series, and IBM.

## **KID NIKI, RADICAL NINJA**™

This "rad" and "bad" punk dude is out to rescue his spike-haired girlfriend from the clutches of the Stone Wizard! For Apple II™ series and Commodore 64/128™.

## **SPEED BUGGY**™

Conquer a variety of courses by running into flags, jumping over obstacles, and driving on two wheels to gain time and bonus points. For Commodore 64/128™ and Atari ST™.

**DATA EAST USA, INC.**  
470 Needles Drive, San Jose, California  
95112. (408) 286-7074.



© 1987 DATA EAST USA, INC. \* KUNG-FU MASTER, COMMANDO, VICTORY ROAD, IKARI WARRIORS, KID NIKI, AND SPEED BUGGY ARE MFD. UNDER LICENSE FROM IREM CORP., CAPCOM USA, SNK CORP., SNK CORP., IREM CORP., AND TATSUMI, RESPECTIVELY. COMMODORE, APPLE, IBM, AND ATARI ARE REGISTERED TRADEMARKS OF COMMODORE ELECTRONICS LTD., APPLE COMPUTERS, INC., IBM CORP., AND ATARI CORP., RESPECTIVELY.

Reader Service No. 248

A NEW STANDARD FOR THE UNIVERSE

... NOW AVAILABLE ON EARTH

# THE LipStik PLUS<sup>TM</sup>

VOICE ACTIVATED  
CONTROL HEADSET



The LipStik Plus is a revolutionary idea in game control that adds a new dimension of excitement and realism to joystick operated programs. The LipStik Plus is "voice activated" and functions as an extra control button. It does not replace your joystick but is used *with* it to enhance and expand your game playing enjoyment. Just plug your joystick into the LipStik Plus. Because it's so simple and doesn't require additional interface software, the LipStik Plus works with thousands of existing games. Virtually 95% of all games that use a joystick are compatible with the LipStik Plus. It can also be used with most popular home Video Arcade Machines such as the Atari 2600, 5200 and the Sears Arcade Machine.

The LipStik Plus adds new life to games you've grown tired of playing. Using the headset gives you a greater feeling of power and control than a joystick alone. The first time you use it with your favorite game you'll know what we mean. You'll find yourself getting more absorbed in the action than you ever thought possible.

**Suggested Retail Price:**

\$24.95 Commodore 64/128/VIC 20/Amiga  
Atari Computers 400/800/XL/XE/ST  
Atari Game Machines 2600/5200/7800  
\$29.95 Apple IIE, IIC, IIGS (II & II + w/adaptor)  
IBM & Compatibles (w/joystick card)

If you can't find our products at your local dealer, you can order direct. For mail orders, enclose check or money order, plus \$3.00 shipping and handling, and specify machine version desired. Order by phone on VISA, MasterCard or C.O.D. by calling TOLL FREE (800) 824-2549.

ACCESS SOFTWARE, INC. 2561 So. 1560 W. Woods Cross, UT 84087

  
ACCESS<sup>TM</sup>  
Software Incorporated  
[www.commodore.ca](http://www.commodore.ca)