

Continental 
The Future in Motion

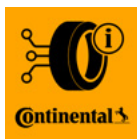

Truck, bus and van tyres

Technical Data Book



Continental TireTech



www.continental-truck-tires.com

Issue 1/2024

Our concept for lowering overall driving costs

We know that cost efficiency is the key. And this is precisely why Continental Truck Tyres pay in the long-term, as their performance benefits extend beyond a tyre's normal lifespan to be repeated again and again, thanks to the ContiLifeCycle.

The durability of Continental Truck Tyres begins with the new tyre and is considerably extended by options including professional regrooving, intelligent casing management (ContiCasingManagement) and our premium retread. The mutually harmonised components of the ContiLifeCycle make a considerable contribution to the reduction of tyre costs and help you to lower your overall driving costs.

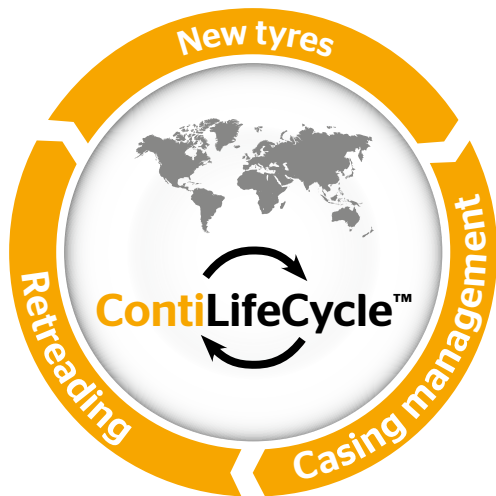

New Continental tyres

They are long-lasting, fuel-saving, retreadable and regroovable, and help you to lower your overall driving costs.



Casing management

ContiCasingManagement ensures best casing asset management through professional tools such as ContiCasingAccount.



Retreading

The cost-effective, eco-friendly and premium quality solution to prolong the life of your Continental tyres.

Contents

- General hints**
- Safety remarks 4
- Operating instructions (UN Reg. 142) 5
- Tyre designations 6
- Units of measurement and definitions..... 9
- Sidewall designations..... 10
- Load capacities for various maximum design speeds..... 12
- Air pressure multiplier for increased load capacity due to maximum design speed 14
- Load capacities of tyres in special cases (UN Reg. 142)..... 15
- Truck chassis with crane superstructure (mobile crane)..... 16
- Bus tyre fitment 17
- Wheels and rims..... 18

- Winter tyre regulations for trucks & buses** 20

- Truck and bus tyres**
- Tread pattern overview Goods | People | Construction..... 26
- M+S and Three Peak Mountain Snow Flake (3PMSF) Designation 34
- VECTO..... 38
- Specifications and load capacities 42
- Regrooving recommendations..... 76

- Maintenance and care** 144

- Damage to truck, bus and coach tyres** 148

- EU tyre label**..... 158

- EU Taxonomy**..... 160

- Transporter and van tyres** 162
- Specifications and load capacities 168

- Imprint** 190

- Terms and Explanations** 191

- Technical Customer Services** 192

Safety remarks

The extensive technical data and other information relating to tyres and accessories on the following pages have been compiled to reflect as accurately and completely as possible the current state of development.

If this "Technical Data Book" is to be used as a basis for particularly important decisions, further data covering relevant standards such as ETRTO¹⁾, TRA*, DIN²⁾ and WdK³⁾ can also be used. Special information can, of course, also be obtained from us at the following address:

Continental Reifen Deutschland GmbH
P.O. Box 169
30001 Hannover
Germany

This data book is for information purposes only. All liability is excluded, whether for damage or for other legal reasons (see also page 2).

All designs are in compliance with DOT⁴⁾ regulations and are marked accordingly.

All tyres have been type-approved in accordance with UN⁵⁾ Reg. 54 and 117 and thus fulfill the requirements of the applicable EU regulations.

The data provided in this guide is based on average operating conditions as normally found in central Europe.

Please contact us with respect to operating conditions differing from the above, e.g. for uses outside Central Europe.

The tyre sizes given in this guide are not always identical to the ones available in the size range.

Lower inflation pressure, greater loads or higher speeds than those recommended by the vehicle or tyre manufacturer shorten the service life of the tyre.

These instructions must be followed if vehicle safety - and that of those fitting tyres - is to be guaranteed. This applies above all to instructions regarding tyre pressure.

Failure to comply with these instructions could result in tyre damage that may even lead to tyre blow-outs under certain circumstances. This, in turn, could cause traffic accidents involving damage to property and/or personal injury (see also page 5).

1) ETRTO - The European Tyre and Rim Technical Organisation, Brussels
2) DIN - Deutsches Institut für Normung, Berlin (German Institute for Standardisation)
3) WdK - Wirtschaftsverband der deutschen Kautschuk-Industrie, Frankfurt/Main
4) DOT - Department of Transportation
5) UN - United Nations
6) EU - European Union, previously EEC
*) TRA - The tire and Rim Association, Inc. in Copley, OH, USA

Operating instructions

UN Reg. 142 (see also UN Reg. 54 & UN Reg. 117)

Load capacity and speed

When determining the minimum tyre size necessary for the axle of a vehicle, the authorised weight and the maximum design speed of the vehicle should always be used as a basis. Trailers must be equipped with tyres suited for maximum speeds of at least 100 km/h, unless the trailer is clearly marked for a lower speed. Nominal load capacity = 100% load, as indicated by the load index*.

Maximum speed

A speed symbol (SI) is used to designate the speed rating of a tyre. The speed rating indicates the maximum speed assigned as per nominal load capacity of the tyre. The load capacity can be exceeded when the vehicle, due to its construction, has a lower maximum speed and vice versa (see the tables on page 12 and 13).

Inflation pressure

The inflation pressures indicated in the tables are minimum values given for reference purposes. All inflation pressures apply to the "cold" tyre, i.e. the state in which the tyre is in after having stood outdoors for several hours, not exposed to intense sunlight.

M+S tyres M+S

M+S marked tyres provide a tread pattern or structure that is designed to deliver performance that exceeds that of a standard tyre on snow and other surfaces with low adhesion.

Alpine (3-peak mountain with a snowflake or 3PMSF) Symbol

Snow tyres that have proven their superior winter performance by passing a dedicated snow performance test may be marked with the Alpine symbol according to UN Reg. 117.

Free Rolling Tyres (FRT)

Trailer tyres marked as Free Rolling Tyres (FRT) are tyres specifically designed for the equipment of trailers (non driven/ trailing axles). This is the axle position where they will deliver their best performance.

Mixed fitment

(radial/crossply) While it is permissible for a vehicle weighing more than 2.8 t to be fitted axlewise with tyres of different construction, it is recommended that tyres of the same type be fitted in all wheel positions.

Rims

Only the specified rims may be mounted on new commercial vehicles series. Tapered bead seat rims with a diameter of 16" or less should be equipped with safety shoulders (e.g. round hump) if tubeless radial tyres are fitted on them. The rim sizes printed in bold type in the table on page 34 are optimal Continental sizes with respect to service life, wear pattern and durability.

Wheels

The load capacity must be adequate in all cases.

* See table on page 6

Tyre designations

Load indices (LI)

LI	kg	LI	kg	LI	kg	LI	kg	LI	kg	LI	kg
19	77.5	50	190	81	462	112	1120	143	2725	174	6700
20	80	51	195	82	475	113	1150	144	2800	175	6900
21	82.5	52	200	83	487	114	1180	145	2900	176	7100
22	85	53	206	84	500	115	1215	146	3000	177	7300
23	87.5	54	212	85	515	116	1250	147	3075	178	7500
24	90	55	218	86	530	117	1285	148	3150	179	7750
25	92.5	56	224	87	545	118	1320	149	3250	180	8000
26	95	57	230	88	560	119	1360	150	3350	181	8250
27	97.5	58	236	89	580	120	1400	151	3450	182	8500
28	100	59	243	90	600	121	1450	152	3550	183	8750
29	103	60	250	91	615	122	1500	153	3650	184	9000
30	106	61	257	92	630	123	1550	154	3750	185	9250
31	109	62	265	93	650	124	1600	155	3875	186	9500
32	112	63	272	94	670	125	1650	156	4000	187	9750
33	115	64	280	95	690	126	1700	157	4125	188	10000
34	118	65	290	96	710	127	1750	158	4250	189	10300
35	121	66	300	97	730	128	1800	159	4375	190	10600
36	125	67	307	98	750	129	1850	160	4500	191	10900
37	128	68	315	99	775	130	1900	161	4625	192	11200
38	132	69	325	100	800	131	1950	162	4750	193	11500
39	136	70	335	101	825	132	2000	163	4875	194	11800
40	140	71	345	102	850	133	2060	164	5000	195	12150
41	145	72	355	103	875	134	2120	165	5150	196	12500
42	150	73	365	104	900	135	2180	166	5300	197	12850
43	155	74	375	105	925	136	2240	167	5450	198	13200
44	160	75	387	106	950	137	2300	168	5600	199	13600
45	165	76	400	107	975	138	2360	169	5800	200	14000
46	170	77	412	108	1000	139	2430	170	6000	201	14500
47	175	78	425	109	1030	140	2500	171	6150	202	15000
48	180	79	437	110	1060	141	2575	172	6300	203	15500
49	185	80	450	111	1090	142	2650	173	6500	204	16000

Tyre designations

In the past the tyre load capacity category was indicated solely by a PR number. Nowadays, a tyre's load capacity as well as its speed capability are usually indicated by a load index and a speed symbol.

The load index (LI) is a numerical code which precisely indicates the tyre's load carrying capacity.

A speed symbol (SI) is used to designate the speed rating of the tyre, as shown in the representation below.

The use of the LI and SI was prompted by the introduction of UN* Reg. 54 according to which pneumatic tyres intended for road use at speeds in excess of 80 km/h must carry an operational designation comprising LI (single/dual) and SI. Alongside the nominal operational designation a tyre may also bear an additional operational designation, e.g. with a lower LI and an SI for higher speeds. These specifications have to be included.

Example:
315/70 R 22.5 152/148 L



An uncoded maximum load-capacity and tyre-pressure data in lbs (1 lbs = 0.454 kg) and psi (pounds per square inch - 1 bar = 14.5 psi) may also be moulded into the tyre.

In addition, different load version of same tyre size may be distinguished by load range letters.

These specifications form part of the designation according to US Regulation FMVSS 119**, which covers all new pneumatic tyres for light trucks, trucks, buses and trailers intended for use on public highways as well as motorcycle tyres.

Date of manufacture

The last 4 digits of the DOT ID no. indicate the week and year of manufacture.

Year 2022

e. g. DOT XXX XXXXXX 1522

15th week

Speed symbols (SI)

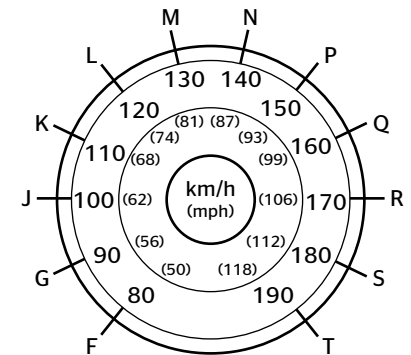

* UN - United Nations
** FMVSS = Federal Motor Vehicle Safety Standard

Tyre designations

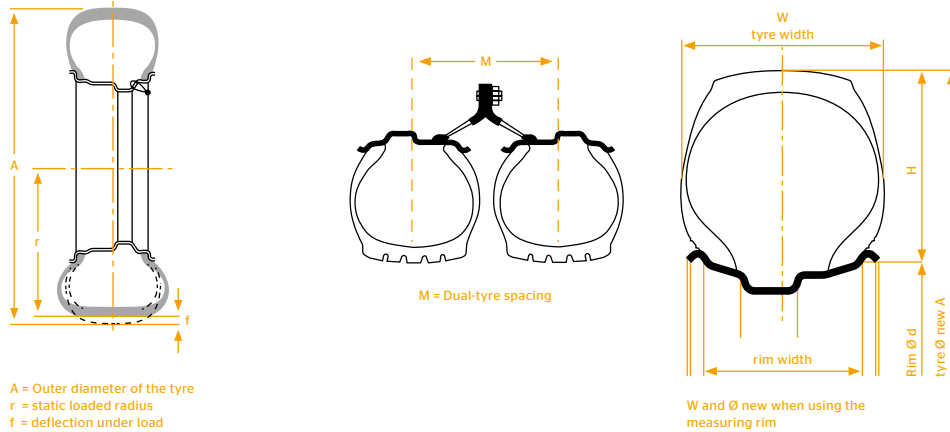

Example of designation		Example comprises details of		
Tyre size ¹⁾	Service description ²⁾	Tyre width code W	H:W %	Rim dia code d
185 R 14 C	102/100 N	185 mm	- 90	14
195/75 R 16 C	107/105 N	195 mm	75	16
12 R 22.5	152/148 L	300 mm	- 90	22.5
315/80 R 22.5	156/150 L (154/150 M) ³⁾	315 mm	80	22.5
12.00 R 20	154/150 K	300 mm	100	20
365/80 R 20	160/- K	365 mm	80	20
385/65 R 22.5	160/- K	385 mm	65	22.5
275/70 R 22.5	148/145 J	275 mm	70	22.5
295/80 R 22.5	152/148 M	295 mm	80	22.5

1) "R" = radial design
 "C" = light truck (van) tyre with L1 for single tyres = 121 and below, see also page 5
 2) Service description = load index for single/dual tyres plus speed symbol (see also tables on following pages)
 3) Supplementary service description

Units of measurement and definitions

(ISO 4223-1)

As a matter of principle, the technical data in the tables always complies with the international standards as specified by ISO and the ETRTO. Further details such as other tyre sizes or designs, plus the static radius and the rolling circumference comply with DIN/WdK Guidelines.

Lengths
 are given in millimetres (mm).

Rim width
 The linear distance between the flanges of the rim.

Cross-section
 Half the difference between the overall diameter and the nominal rim diameter.

Tyre width
 The section width of an inflated tyre mounted on its theoretical rim and indicated in the tyre size designation.

Outer diameter
 The diameter of an inflated tyre at the outermost surface of the tread.

Nominal rim diameter
 It is a size code figure for reference purposes only, as indicated in the tyre and rim size designation.

Inflation pressure
 Tyre inflation pressure is given in bar based on cold tyres.

Outer diameter New *
 is a nominal size which refers to the tread centre.

Max. outer diameter in service
 is the maximum diameter permitted in the tread centre as a result of permanent growth during tyre use. Dynamic deformations are not included.

Cross-section width New *
 is a nominal size which refers to the smooth tyre wall.

* Construction size

Max. operational width
 is the maximum permitted width. This includes scuff ribs, decorative ribs, lettering and permanent growth during use. Dynamic deformations are not included.

Static loaded radius
 is the distance from the tyre centre to the ground level. Measurements are checked on fitted-tyres inflated to the inflation pressure specified in applicable standards (ETRTO or TRA).

Rolling circumference
 is the distance covered by each revolution of the tyre defined in ISO 9112.

Load capacities
 are given in kgs (weight in the sense of mass)

Dual-tyre spacing
 Maintaining the minimum spacing distance ensures that the two tyres in a dual fitment arrangement function without any infringement of the ETRTO standards providing the tyres are not fitted with chains. In the course of development, a variety of designations for tyre dimensions have been introduced, some of which are used concurrently. The following combination is most frequently used: tyre width in mm, then H : W (height : width) in % and finally the codes for the tyre construction - for example R for "radial" and "-" for "crossply" - and the nominal rim diameter as code. When planning vehicle wheel space, automotive designers must proceed on the basis of the maximum values for tyre width and outer diameter, taking into account the tyre's static and dynamic deformation. In this way they ensure that all standardly approved tyres will fit in all cases. If this is not possible in exceptional cases, appropriate measures are to be taken to exclude any possible risk to safety.

Sidewall markings

The tyre designation markings satisfy both the US Regulation (FMVSS 119) and (UN Reg. 54), applicable in Europe and other countries.

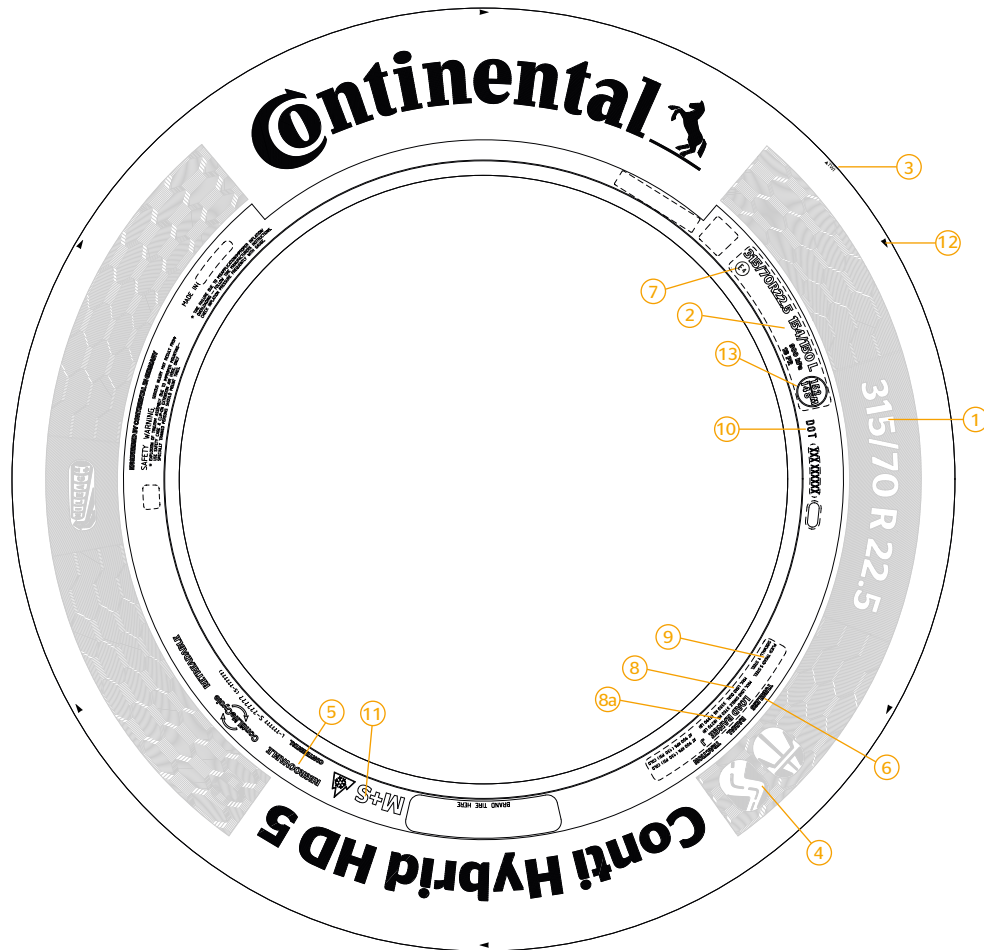

- ① **Size designation**
315 = tyre nominal section width in mm
70 = nominal aspect ratio (nominal height to nominal width = 70%)
R = radial construction
22.5 = nominal rim diameter
- ② **Service description**
Consisting of
154 = load index for single fitment
150 = load index for dual fitment
L = speed symbol
- ③ **TWI**
Tread Wear Indicator
- ④ **Recommended use**
only Continental Truck Tyres
- ⑤ **Regroovable**
The manufacturer has designed the tyre for regrooving
- ⑥ **Tubeless**
Tube Type
- ⑦ **E** = tyres complies with requirement set out in UN Reg. 54
4 = country code for the country in which the approval number was issued (here: 4 = Netherlands)
- ⑧ **US load designation**
For single/dual fitment and indication of max. inflation pressure in psi (1 bar = 14.5 psi)
- ⑧a **Load range**
In accordance with US Reg. FMVSS 119
- ⑨ **Data as per US safety standard on inner construction or number of plies, in this case**
Tread: under the tread there are five steel cord plies (including casing)
Sidewall: viewed from the side there is one steel cord ply (in this case the casing ply)
- ⑩ **DOT**
= U.S. Department of Transportation (responsible for tyre safety standards)
Tyre complies with requirement set out in US Reg. FMVSS 119
- ⑪ **M+S and 3PMSF**
Designation for winter use suitability (Mud & Snow and Three-Peak Mountain Snowflake)
- ⑫ **Rotation**
Recommended direction of rotation
- ⑬ **Single Point**
Alternative load and speed

Explanation

DOT = Department of Transportation

UN = United Nations

ETRTO = The European Tyre and Rim
Technical Organisation, Brussels

FMVSS = Federal Motor Vehicle Safety Standard

Not all tyre markings listed above apply to the shown Conti Hybrid HD5 315/70 R 22.5. Some of them were added for explanation purposes only.

Load capacities

for various maximum design speeds

Maximum speed in km/h (determined by vehicle design)	C-tyres with load index 121 (1450 kg) or less as single fitments Approved load capacity in % of the nominal load capacity ²⁾ equals the load index for reference speed				
	L (120)	M (130)	N (140)	P (150)	Q-T (160-190)
160	-	-	-	-	100
155	-	-	-	-	100
150	-	-	-	100	100
140	-	-	100	100	100
138	-	-	100	100	100
136	-	-	100	100	100
134	-	-	100	100	100
132	-	-	100	100	100
130	-	100	100	100	100
128	-	↑	100	100	100
126	-	↑	100	100	100
124	-	↑	100	100	100
122	-	↑	100	100	100
120	100	↑	100	100	100
118	↑	↑	100.5	↑	↑
116	↑	↑	101	↑	↑
114	↑	↑	101.5	↑	↑
112	↑	↑	102	↑	↑
110	↑	↑	102.5	↑	↑
108	↑	↑	103	↑	↑
106	↑	↑	103.5	↑	↑
104	↑	↑	104	↑	↑
102	↑	↑	104.5	↑	↑
100	↑	↑	105	↑	↑
95	↑	↑	106.5	↑	↑
90	see column N	see column N	107.5	see column N	see column N
85	↑	↑	108.5	↑	↑
80	↑	↑	110	↑	↑
75	↑	↑	111	↑	↑
70	↑	↑	112.5	↑	↑
65	↑	↑	113.5	↑	↑
60	↑	↑	115	↑	↑
55	↑	↑	117.5	↑	↑
50	↑	↑	120	↑	↑
45	↑	↑	122	↑	↑
40 ¹⁾	↑	↑	125	↑	↑
35 ¹⁾	↑	↑	129	↑	↑
30 ¹⁾	↑	↑	135	↑	↑
25 ¹⁾	↑	↑	142	↑	↑
20 ¹⁾	↑	↑	150	↑	↑
15 ¹⁾	↑	↑	160	↑	↑
Application restricted speed	↑	↑		↑	↑
10 ¹⁾	↑	↑	175	↑	↑
5 ¹⁾	↑	↑	190	↑	↑
Stationary ¹⁾	↑	↑	210	↑	↑

Load capacities

for various maximum design speeds

Maximum speed in km/h (determined by vehicle design)	Tyres with load index 122 (1500 kg) or more as single fitments Approved load capacity in % of the nominal load capacity ²⁾ equals the load index for reference speed					
	F (80)	G (90)	J (100)	K (110)	L (120)	M (130)
130	-	-	-	-	-	100
127.5	-	-	-	-	-	100
125	-	-	-	-	-	100
122.5	-	-	-	-	-	100
120	-	-	-	-	100	100
117.5	-	-	-	-	↑	100
115	-	-	-	-	↑	100
112.5	-	-	-	-	↑	100
110	-	-	-	100	↑	100
107.5	-	-	-	↑	↑	100
105	-	-	-	↑	↑	100
102.5	-	-	-	↑	↑	100
100	-	-	100	↑	↑	100
95	-	-	↑	↑	↑	101
90	-	100	↑	↑	↑	102
85	-	102	↑	↑	↑	103
80	100	↑	↑	↑	↑	104
75	102.5	↑	↑	↑	↑	105.5
70	105	↑	↑	↑	↑	107
65	107.5	↑	↑	↑	↑	108.5
60	↑	↑	↑	↑	↑	110
55	↑	↑	↑	↑	↑	111
50	↑	↑	↑	↑	↑	112
45	↑	↑	↑	↑	↑	113
40 ¹⁾	↑	↑	↑	↑	↑	115
35 ¹⁾	see column M	see column M	see column M	see column M	see column M	119
30 ¹⁾	↑	↑	↑	↑	↑	125
25 ¹⁾	↑	↑	↑	↑	↑	135
20 ¹⁾	↑	↑	↑	↑	↑	150
15 ¹⁾	↑	↑	↑	↑	↑	165
Application restricted speed	↑	↑	↑	↑	↑	
10 ^{1) 3)}	↑	↑	↑	↑	↑	180
5 ^{1) 3)}	↑	↑	↑	↑	↑	210
Stationary ^{1) 3)}	↑	↑	↑	↑	↑	250

1) Dual-tyres = 2 x single load capacity
 2) A sign indicating the max speed must be attached to trailers restricted to speeds below 100 km/h (62 mph).
 3) Ask the tyre manufacturer about these applications.

Tyres with SI ratings P and Q under full load at speeds of over 140 km/h should be inflated an extra 0.1 bar for every excess 10 km/h. No excess loads are applicable over 65 km/h for tyres on heavy trailers (with laden weight > 3.5 t). The load/speed variation given on this page do not apply to the additional service description (the so called Single Point).

See general notes on page 5.

This table is only applicable in conjunction with air pressure multiplier on page 14. If applied please check dual spacing (dual tyre contact) and rim status.

Air pressure multiplier

for increased load capacity due to maximum design speed

Maximum speed in km/h (determined by vehicle type)	Air pressure multiplier for reference speed (speed index) of tyre	
	F, G, J, K, L, M 80 km/h - 130 km/h	N, P, Q, R, S 140 km/h - 180 km/h
140		1
135		1
130	1	1
125	1	1
120	1	1
115	1	1.01
110	1	1.02
105	1	1.06
100	1	1.06
95	1	1.08
90	1	1.09
85	1	1.10
80	1	1.12
75	1.01	1.14
70	1.02	1.15
65	1.04	1.15
60	1.06	1.18
55	1.07	1.22
50	1.08	1.25
45	1.09	1.28
40	1.10	1.30
35	1.11	1.30
30	1.13	1.30
25	1.17	1.30
20	1.21	1.30
15	1.25	1.30
10	1.30	1.35
5	1.40	1.35
0	1.40	1.40

The multipliers cited are to be used for an operating pressure of up to 10 bar.

Example: In the case of a K-rated tyre (110 km/h) and nominal inflated pressure of 7.5 bar, the inflation pressure can be increased to 8.25 bar if the vehicle's maximum design speed is set at 40 km/h (1.1 x 7.5 bar) to exploit an increased load capacity of 115% of nominal load capacity.

Load capacities of tyres in special cases

UN Reg. 142

Case	Type of service	Approved load capacity as % of the nominal load capacity in the tables
1	Special-service vehicles: Fire brigade vehicles with special superstructures, road flushers, road sweepers, garbage trucks, cherry-pickers, municipal service vehicles of a similar nature and other public utility vehicles, provided that their maximum vehicle design speed does not exceed 60 km/h.	110
2	Commercial vehicles: With special superstructures (concrete mixers, aircraft refuellers) used in local service with maximum vehicle design speeds not in excess of 60 km/h.	110
3	Regular-service buses - Class I or Class A (M2 or M3): Vehicles in urban and suburban service constructed with areas for standing passengers to allow frequent passenger movement.	115
4	Aircraft refuellers (internal use only in airport): Aircraft refuellers at speeds of up to 30 km/h (inflation pressure + 15%, for dual fitment, use single tyre load capacity for each tyre).	135

Please note: This chart is not applicable in conjunction with the charts on pages 12 or 13 in correspondence with the chart on page 14.

Truck chassis with crane superstructure (mobile crane)

Tyre size	PR	Single/ dual fitment	Load capacity (kg) per axle and speed (km/h)								Tyre pres- sure ²⁾ bar (psi)
			Statio- nary ¹⁾	10	20	50	65	70	75	80	
10.00 R 20	16	S	16500	12000	10000	7700	7200	7000	6800	6700	9.0 (131)
11 R 22.5		D	33000	24000	20000	14000	13000	12800	12400	12000	
11.00 R 20	16	S	17900	13000	10800	8300	7800	7600	7400	7200	10.0 (145)
12 R 22.5		D	35800	26000	21600	14800	14000	13600	13200	12800	
12.00 R 20	18	S	20500	14750	12300	9200	8700	8550	8400	8250	10.0 (145)
13 R 22.5		D	41000	29500	24600	16600	15700	15400	15200	14800	
14.00 R 20	18	S	22500	16200	13500	10080	9675	9450	9225	9000	8.0 (116)
		D	45000	32400	27000	18100	17400	17000	16600	16500	
12.00 R 24	20	S	25000	18000	15000	11450	10675	10450	10280	10000	10.0 (145)
		D	48700	35000	29200	20000	18700	18300	18000	17500	

1) When boom is swung out in unfavourable position

2) For inflation pressure of 8.0 bar (116 psi) and over use valve slit cover plate

Bus tyre fitment

Recommended inflation pressures for tyres on urban and suburban buses with areas for standing passengers. (15% extra load capacity from nominal load capacity).

Tyre size	Load index	Single/ dual fitment	Max. permitted axle weight (kg) for inflation pressure (bar) (psi)									
			4.5 (65)	5.0 (69)	5.5 (80)	6.0 (87)	6.5 (94)	7.0 (102)	7.5 (109)	8.0 (116)	8.5 (123)	9.0 (131)
			10.00 R 20	146 143	S D		4730 8600	5110 9285	5480 9955	5840 10615	6200 11265	6550 11905
385/55 R 22.5	160 158	S S	5940 5875	6465 6390	6975 6900	7480 7395	7975 7885	8465 8365	8940 8845	9420 9310	9885 9775	10350
275/70 R 22.5	152 150 148 148 145	S S S D D	4685 4420 4155 8320 7660	5100 4815 4525 9050 8330	5505 5190 4880 9770 8995	5900 5565 5235 10470 9645	6290 5935 5585 11165 10280	6675 6295 5925 11850 10910	7055 6660 6255 12520 11530	7430 7010 6590 13185 12140	7795 7360 6915 13840 12740	8165 7705 7245 14490 13340
305/70 R 22.5	156 154 152 150 154 150 148	S S S S D D D	5525 4950 4685 4630 10365 8850 8710	6015 5390 5100 5035 11280 9625 9475	6490 5815 5505 5435 12175 10390 10225	6960 6235 5900 5830 13055 11140 10965	7420 6645 6290 6215 13915 11875 11690	7870 7050 6675 6595 14765 12600 12405	8320 7450 7055 6970 15605 13315 13105	8765 7850 7430 7335 16430 14025 13800	9200 8235 7795 7705 17250 14720 14490	8625 8165
295/80 R 22.5	154 152 149 148	S S D D	5180 4905 8985 8710	5640 5335 9775 9475	6085 5760 10550 10225	6525 6175 11310 10965	6960 6585 12060 11690	7385 6985 12795 12405	7805 7385 13525 13105	8210 7775 14235 13800	8625 8165 14950 14490	
11 R 22.5	148 145	S D	4355 8015	4740 8725	5110 9415	5480 10090	5840 10760	6200 11420	6550 12065	6900 12710	7245 13340	

Wheels and rims

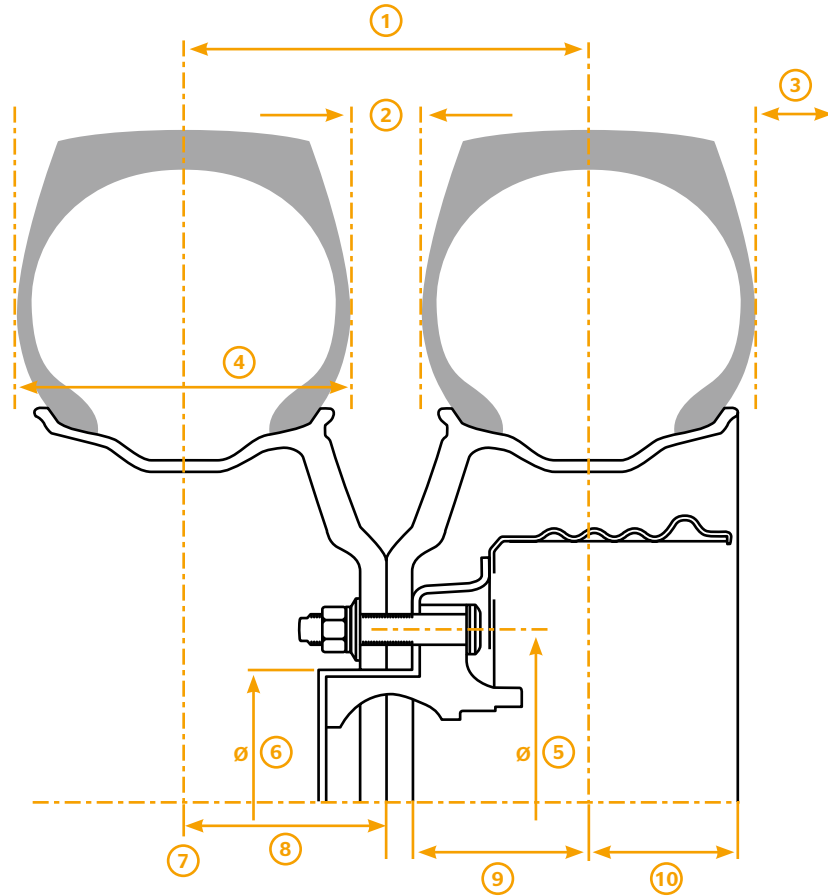

- ① dual spacing = 2x outset
- ② tyre clearance
- ③ vehicle clearance
- ④ tyre section width
- ⑤ bolt circle diameter
- ⑥ centre hole diameter
- ⑦ tyre centre line
- ⑧ outset
- ⑨ inset / offset
- ⑩ backspace

Outset

The distance from the mounting surface of the wheel to the rim centerline when the rim centerline is mounted outboard of the hub face. This dimension is the same as the 1/2 DUAL SPACING dimension.

Dual Spacing (main parameter for twin tyre fitment) = 2 x outset

Inset / offset (main parameter for single tyre fitment)

The offset is the distance from the centre of the wheel to the inside surface of the wheel disk on the hub (inset = outset - wheel disk thickness). The wheel insertion depth can be positive, negative or zero.

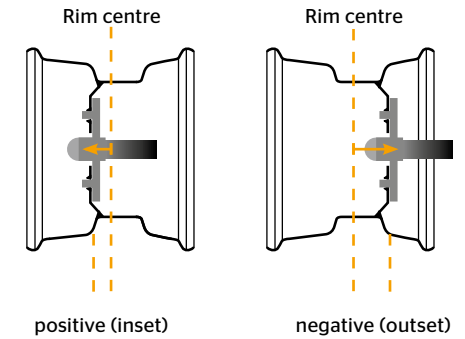

The insertion depth not only ensures adequate space for the brake drums, it also determines drive characteristics, tracking width, steering swivel, pin offset and wheel bearing guidance. In the case of dual tyre fitment, the insertion depth also influences the distance between centres.

There are three main types of rim for commercial vehicle tyres:

One-piece well base rims for tubeless tyres

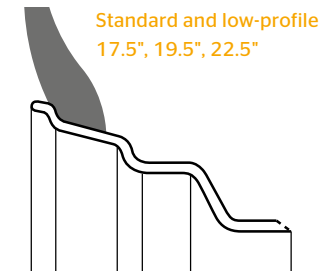
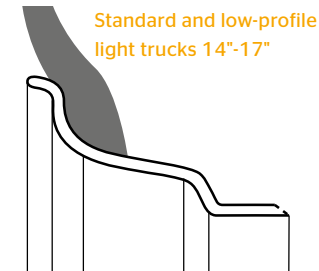

Multi-part flat base rims for tubeless tyres

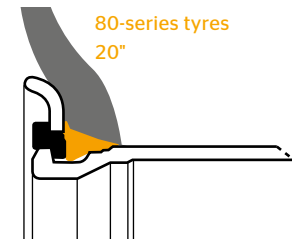

Multi-part flat base rims for tyres with inner tubes

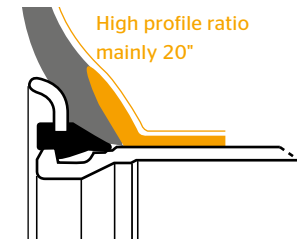

Please contact rim manufacturers for detailed information regarding available rim sizes and variants.

COUNTRY	TYRE REGULATIONS	SNOW CHAIN REGULATIONS	FURTHER INFORMATION
 Albania	No general winter tyre regulations.	Snow chains for the drive axle must be carried in the vehicle. Use according to traffic signs and road conditions.	Studded tyres prohibited.
 Austria	Winter tyres compulsory from 1 November to 15 April. Risk of driving ban and heavy fines if you do not comply (€35 up to €5,000). Vehicles > 3.5 t GVW must be equipped with tyres marked M+S and/or with the Alpine symbol (3PMSF) on at least one drive axle with a min. tread depth of 6 mm (bias) and 5 mm (radial). Winter tyres are compulsory for buses (categories M2, M3) from 1 November to 15 March.	Snow chains must be carried in the vehicle for at least two drive axle tyres from 1 November to 15 April. Exceptions for public service buses apply. Use on roads covered with snow and ice.	Studded tyres are prohibited for vehicles > 3.5 t GVW.
 Belgium	No general winter tyre regulations. Symmetric fitting compulsory for M+S and winter tyres.	Snow chains only allowed on roads covered with snow and/or ice.	Symmetric fitting compulsory
 Bosnia-Herzegovina	From 15 November to 15 April there are two options that are mandatory for vehicles with more than 8 seats and for vehicles with > 3.5 t GVW: Option 1: Tyres with winter profile on the drive axle with min. 4 mm tread depth. Option 2: Tyres with standard profile with min. 4 mm tread depth; in case of winter conditions (e.g. snow fall, freezing rain), snow chains need to be mounted on the drive axle.	Snow chains must be carried in the vehicle from 15 November to 15 April.	A snow shovel and a bag of sand weighing between 25 kg and 50 kg must be carried in the vehicle. Studded tyres prohibited.
 Belarus	No general winter tyre regulations.	Snow chains only allowed on roads covered with snow and ice.	Studded tyres allowed.
 Bulgaria	From 15 November to 1 March summer or winter tyres with minimum 4 mm tread depth are mandatory.	Snow chains must be carried in the vehicle from 1 November to 31 March. Usage is compulsory on mountain passes when indicated by traffic signs.	Studded tyres prohibited. Without adequate winter equipment, entry into the country may be refused or a driving ban may be issued.
 Croatia	Winter tyres compulsory from 15 November to 15 April. M+S tyres are compulsory on the drive axle of vehicles > 3.5 t GVW.	Snow chains required for the drive axle in certain conditions (if the vehicle is equipped with SU tyres). Snow chains compulsory in some regions (Lika/Gorski Kotar).	Studded tyres prohibited. Commercially used vehicles must carry a snow shovel.
 Czech Republic	Winter tyres compulsory from 1 November to 31 March depending on road conditions in winter, or if indicated by „winter kit” sign. M+S tyres with min. 6 mm tread depth must be fitted on the drive axle of vehicles > 3.5 t GVW.	Differing traffic signs possible. Snow chains are compulsory if indicated by traffic signs on at least 2 drive wheels of vehicles with 3 or more axles.	Studded tyres prohibited.
 Denmark	No general winter tyre regulations.	Snow chains allowed from 1 November to 15 April.	Studded tyres allowed from 1 November to 15 April. If fitted, studded tyres should be mounted on all axles during this period.

COUNTRY	TYRE REGULATIONS	SNOW CHAIN REGULATIONS	FURTHER INFORMATION
 Estonia	Winter tyres compulsory for vehicles < 3.5 t GVW (radial tyres with min. 3 mm tread depth) from 1 December to 1 March (also from October to April depending on weather). Heavier vehicles do not require winter tyres, but minimum tread depth of 3 mm is mandatory.	Snow chains are compulsory if indicated by traffic signs on at least 2 drive wheels of vehicles with 3 or more axles.	Studded tyres allowed between 15 October and 31 March.
 Finland	Mandatory winter tyres from 1 November to 31 March, if winter conditions; on non-steering drive axles 3PMSF or POR or studded tyres. M+S marked tyres allowed until 30 November 2024 On drive axle min. 5 mm and all other axles min. 3 mm tread depth.	Snow chains only allowed on roads covered with snow and ice.	Studded tyres allowed between 1 November to 31 March if winter conditions prevail.
 France	Winter equipment is mandatory for vehicles driving on roads marked with the B26 and/or B58 sign. The following changes apply from 2021: From 1 November to 31 March, at the discretion of the local authorities (préfectures), N1/N2/N3 vehicles with trailers to be fitted with removable anti-skid devices (e.g. snow chains) at least 2 driven wheels. N1/N2/N3 vehicles without trailers to be fitted with 3PMSF winter tyres at least 2 wheels of each axle. Bus M2/M3: To be fitted with removable anti-skid devices at least 2 driven wheels or (3PMSF winter tyres on the front steer axle and at least 2 driving wheels) There is a transition period until November 2024 for M+S tyres already in use.	Use of snow chains when indicated by traffic signs.	Vehicles < 3.5 t GVW: Studded tyres allowed from 1 November to 31 March, max. speed 90 km/h. Vehicles with studded tires have to be labelled with a sticker. Studded tyres are prohibited for vehicles > 3.5 t GVW.
 Germany	In wintry weather conditions vehicles with > 3.5 t GVW must be fitted with tyres marked with 3PMSF at the wheel positions of the permanently driven axles and front steering axles. M+S tyres produced before 1 January 2018 are accepted until 30 September 2024.	Use of snow chains when indicated by traffic signs. Studded tyres prohibited. Exception: Route via "Kleines Deutsches Eck".	€60 fine for unsuitable tyres; €80 fine for causing obstruction/disturbance of traffic due to unsuitable tyres; €100 fine for causing hazardous situation due to unsuitable tyres; €120 fine for causing an accident due to unsuitable tyres. Plus 1 point in each case (Flensburg points system).
 Great Britain	No general winter tyre regulations.	Snow chains only allowed on roads covered with snow and ice.	Studded tyres allowed, but only on snow & ice covered roads, and as long as the street surface does not get damaged. Non compliance can result in a penalty fine.





COUNTRY	TYRE REGULATIONS	SNOW CHAIN REGULATIONS	FURTHER INFORMATION
 Hungary	No general winter tyre regulations.	Snow chains only allowed on roads covered with snow and ice. It may be compulsory to apply and carry snow chains under certain weather conditions (max. speed: 50 km/h). In wintry conditions, foreign vehicles may be denied access if no snow chains are carried on board.	Studded tyres prohibited.
 Iceland	Vehicles < 3.5 t GVW: Studded tyres allowed from 1 November to 31 March, max. speed 90 km/h. Vehicles with studded tyres have to be labelled with a sticker. Studded tyres are prohibited for vehicles > 3.5 t GVW.	Snow chains are forbidden in conditions where they can cause damage to roads.	Studded tyres allowed part of the year (1 November to 14 April).
 Ireland	No general winter tyre regulations.	Snow chains only allowed when roads covered with snow and ice.	
 Italy	No general winter tyre regulations. Exceptions are indicated by traffic signs.	An anti-skid device (e.g. snow chains) must be carried in the vehicle.	
 Kosovo	From 15 November to 15 March, transport vehicles ≤ 3.5 t GVW must use winter tyres (M+S marked) on all wheels, or summer tyres with minimum tread depth of 4 mm and with snow chains placed on driven wheels. Buses and transport vehicles > 3.5 t GVW must use snow chains or winter tyres (M+S marked) on driven wheels.	Snow chains allowed on driven wheels.	Studded tyres prohibited.
 Latvia	Winter tyres (M+S) compulsory for vehicles < 3.5 t GVW from 1 December to 1 March. Minimum 4 mm tread depth. Heavier vehicles do not require winter tyres, but a minimum tread depth of 3 mm is mandatory.	Snow chains only allowed on roads covered with snow and ice.	Studded tyres allowed between 1 October and 30 April for vehicles > 3.5 t GVW.
 Liechtenstein	No general winter tyre regulations. However, there are liability issues if unsuitable tyres are used. The vehicle equipment must be suitable for the weather conditions.	Snow chains allowed. Not necessary in valleys. In the mountains, traffic signs indicate if snow chains are compulsory.	Vehicles > 7.5 t GVW: Studded tyres allowed from 1 November to 30 April, max. speed 80 km/h. If fitted, all tyres should be equipped with studs. Vehicles with studded tyres have to be labelled with a sticker.
 Lithuania	Winter tyres compulsory for vehicles < 3.5 t GVW from 1 November to 1 April. Heavier vehicles do not require winter tyres, but a minimum tread depth of 1.6 mm is mandatory.	Snow chains only allowed on roads covered with snow and ice.	Studded tyres allowed between 1 November and 1 April.

COUNTRY	TYRE REGULATIONS	SNOW CHAIN REGULATIONS	FURTHER INFORMATION
 Luxembourg	All drive axles on trucks and buses need to be equipped with winter tyres (M+S suffices) during winter conditions (snow, ice, glazed frost).	Snow chains only allowed on roads covered with snow and ice.	Studded tyres prohibited.
 Macedonia	No general winter tyre regulations.	Snow chains must be carried in the vehicle from 15 October to 15 March if the vehicle has only standard tyres fitted.	Coaches and heavy trucks must carry snow shovels. Studded tyres prohibited.
 Montenegro	Tyres marked with the M+S symbol or winter tyres compulsory from November to April on specific roads, specified by Ministry of Police. Min. 4 mm tread depth.	Snow chains for the drive axle must be carried in the vehicle. Use according to traffic signs and conditions.	Studded tyres prohibited. Buses and trucks must carry a snow shovel.
 Netherlands	No general winter tyre regulations.	Snow chains not allowed on public roads.	Studded tyres prohibited.
 Norway	Vehicles > 3.5 t GVW must be fitted with winter tyres from 15 November until 31 March: 3PMSF tyres on drive axle and front steer axle, M+S or 3PMSF tyres on free rolling axles. Depending on the region, tyres must have min. 5 mm tread depth during the winter season. In south Norway: between 1 November and first Monday after Easter. In north Norway: between 16 October and 30 April.	It is mandatory for vehicles > 3.5 t GVW to carry snow chains in the period when it is legal to use studs. A truck with trailer must carry 7 chains.	Studding only allowed on winter tyres. Studded tyres (average protrusion: 1.7 mm) allowed from 1 November to the first Sunday after Easter. In Nordland, Troms and Finnmark: from 16 October to 30 April. Trucks and trailers: studded tyres on the same axle. If twin-mounted, one tyre is sufficient. In Trondheim and Oslo a fee is charged for the usage of studded tyres: daily tickets may be acquired at vending machines along the arterial roads or by telephone or text message (send from a Norwegian, Swedish or Danish telephone number). Monthly and annual tickets for Trondheim may be acquired at Trondheim City Parking Office in Erling, Skakkes Gate 40, 7012 Trondheim. Daily tickets cost about €3.90, monthly tickets about €52 and annual tickets about €155 (costs double for vehicles > 3.5 t GVW). A violation is fined with €97.
 Poland	No general winter tyre regulations.	Snow chains only allowed on roads covered with snow and ice. Adequate traffic signs on roads where snow chains are compulsory.	Studded tyres prohibited.
 Portugal	No general winter tyre regulations.	Snow chains temporarily compulsory when indicated by traffic signs (high-altitude regions only).	Studded tyres prohibited.
 Romania	In case of wintry road conditions M+S or winter tyres are compulsory for the drive axle of all vehicles > 3.5 t GVW and vehicles transporting people (with more than 9 seats).	Vehicles > 3.5 t GVW have to be equipped with snow chains which need to be mounted when indicated by respective traffic signs.	Shovel and sand required for vehicles > 3.5 t GVW. Studded tyres prohibited.



COUNTRY	TYRE REGULATIONS	SNOW CHAIN REGULATIONS	FURTHER INFORMATION
 Russia	In December, January and February, passenger light truck, trucks and buses must be equipped on all axles with tyres marked M+S or with the 3PMSF-Symbol (Three-Peak Mountain Snowflake symbol) Minimum tread depth: 4 mm.	Snow chains are recommended but not compulsory.	Use of studded tyres is forbidden in the summer months (June, July, August).
 Serbia	Winter tyres (M+S) and min. 4 mm tread depth compulsory from November to April. Use according to traffic signs and conditions.	Snow chains for drive axle must be carried in the vehicle. Use according to traffic signs and conditions.	Studded tyres prohibited. Buses and trucks must carry a snow shovel.
 Slovakia	Winter/M+S tyres compulsory for trucks > 3.5 t GVW from 15 November to 31 March on the drive axle (min. 3 mm tread depth).	Snow chains must be carried in the vehicle. Use according to traffic signs and conditions.	Studded tyres prohibited.
 Slovenia	From 15 November to 15 March there are two options that are mandatory on vehicles > 3.5 t GVW: Option 1: winter tyres at least on the drive axle (min. 3 mm tread depth) Option 2: standard tyres, but chains must be carried in the vehicle to be mounted on the drive axle in case of winter conditions.	Snow chains must be carried in vehicles > 3.5 t GVW if no winter tyres are fitted.	Studded tyres prohibited.
 Spain	High mountain roads with red level (15/TV-87): Buses can drive with tyres marked with the 3PMSF symbol (Three-Peak Mountain Snowflake symbol) in all positions and minimum tread depth 4 mm. Rigid trucks between 3.5 t and 7.5 t GVW only for garbage collection, food distribution, transport of fluxes and assistance vehicles can drive with winter tyres in all positions and minimum tread depth 4 mm. Other trucks not allowed to drive.	High mountain roads with red level (15/TV-87): Snow chains in rigid trucks between 3.5 t and 7.5 t GVW and buses, if no winter tyres are fitted.	Usage of studded tyres with up to 2 mm studs are allowed on snow-covered roads.
 Sweden	In wintry weather conditions, minimum tread depth is 5 mm on all axles except trailers (1,6 mm). Vehicles > 3.5 t GVW must be equipped with 3PMSF, POR or studded tyres on front and drive axles, on other axles M+S tyres are also allowed. Until 30 November 2024, it is allowed to use M+S (specially developed for winter) on all axles.	Snow chains recommended to be carried in the vehicle.	Studded tyres are allowed from 1 October to 15 April. Depending on the weather conditions this period may be extended. Maximum of 50 studs per meter circumference in tyres produced after 1 July 2013. Please note exceptions on specific roads.

COUNTRY	TYRE REGULATIONS	SNOW CHAIN REGULATIONS	FURTHER INFORMATION
 Switzerland	No general winter tyre obligation exists. However, the vehicle must be equipped according to the road conditions and be safe to operate. If unsuitable tires were fitted in case of an accident, be aware of potential liability issues (e.g. limited insurance benefits). In winter conditions, situational regulations (snow chains) are possible, e.g. on Alpine passes.	Use of snow chains in case of respective road signs and conditions	Studded tyres are allowed for vehicles < 7.5 t GVW between 1 November and 30 April on snow-covered roads. Max. speed 80 km/h. Studded tyres have to be labeled with a sticker 80 km/h.
 Turkey	It is obligatory to equip vehicles used for passenger and goods transport with winter tyres on regional roads for 4 months between December 1st and April 1st. Within the provincial borders, local governors decide whether to enforce winter tyre regulation and make necessary announcements according to average local temperatures. It is obligatory to fit winter tyres on drive axles of trucks, tractors, tankers and buses, and on all axles of light trucks, vans and taxis, minibuses, vans and commercial cars. Any tyre to be replaced on the road has to be replaced with a winter tyre. Within the obligatory period, winter tyres should bear (M+S) symbol or snowflake symbol (3PMSF) or both on the sidewall. The tread depth and pattern of retreaded tyres should comply with winter tyres even if they bear (M+S) symbol on the shoulder. Winter tyres should have a tread depth of min. 4 mm for trucks, tractors, tankers and buses and 1.6 mm for light trucks, vans and cars.	Having or using a tyre chain with the vehicle does not absolve drivers from their obligation to use winter tyres.	Only studded tyres that can be used on ice can substitute winter tyres. The tread depth should be measured from the tread center.
 Ukraine	No general winter tyre regulations.	Snow chains only allowed on roads covered with snow and ice.	Studded tyres are allowed.

We are currently not aware of general winter tyre rules / snow chain regulations for trucks in the following countries: Cyprus, Greece and Malta. Please consult the traffic regulations in the respective countries for special snow chain and studded tyre rules.

Despite careful research, we cannot guarantee that the information is correct and complete.

M+S



Tyres marked with M+S (Mud+Snow) provide a tread pattern or structure that is designed to deliver performance that exceeds that of a standard tyre in snowy conditions. The M+S label is not subject to a defined test procedure.

Three-Peak Mountain Snowflake (3PMSF) tyres deliver winter performance that is legally certified. These tyres have to pass a test on a snow-covered road and have at least 25% better traction than a standard reference tyre.



Winter tyres from Continental are marked with the snowflake symbol on the tyre wall. Not only do Continental winter tyres easily outperform M+S tyres, they also significantly exceed the requirements of the "Three-Peak Mountain Snowflake" symbol (3PMSF). The development of winter tyres from Continental is based on many years of experience and practical knowledge gained from using the tyres in the low temperatures found in Scandinavian countries. These special winter tyres offer a distinct advantage for a safe journey on snow-covered or icy roads.

For optimum traction and high driving safety in colder weather, Continental recommends fitting winter tyres on all axles of your trucks and buses.



<https://www.continental-tires.com/products/b2b/business-know-how/winter-regulations/>

Tread pattern overview



Goods Motorway

STEER AXLE

Conti EcoPlus HS3+



Conti EcoPlus HS3+ AC



Conti EcoPlus HS3



50 / 55 series

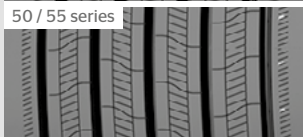

Conti EfficientPro S / S+



HSL2+ ECO-PLUS



HSL2+ ECO-PLUS AC



DRIVE AXLE

Conti EcoPlus HD3+

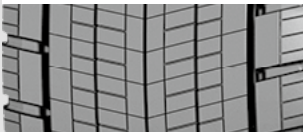

Conti EcoPlus HD3

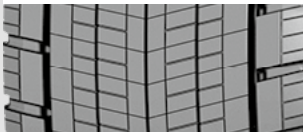

Conti EfficientPro D / D+



TRAILER AXLE

Conti EcoPlus HT3+

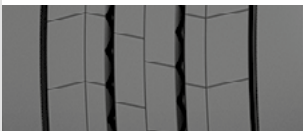

Conti EcoPlus HT3

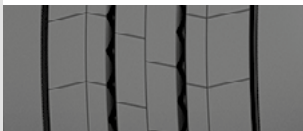

HTL2 ECO-PLUS



Goods Regional

STEER AXLE

Conti Hybrid HS5



Conti EcoRegional HS3+



Conti EcoRegional HS3



Conti Hybrid HS3+



Conti Hybrid HS3



Conti Hybrid LS3

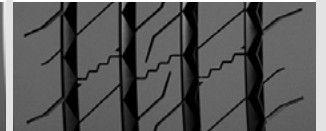

HSR 2



HSR 1

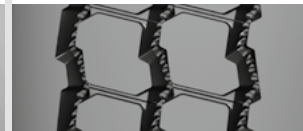

HSR

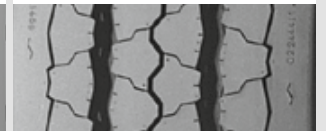

LSR 2+

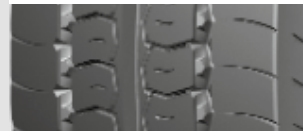

LSR 1+



LSR 1



LSR+



Tread pattern overview



DRIVE AXLE

Conti Hybrid HD5



Conti EcoRegional HD3 / HD3+



Conti Hybrid HD3

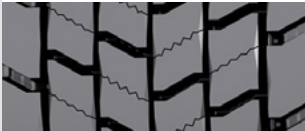

Conti Hybrid LD3

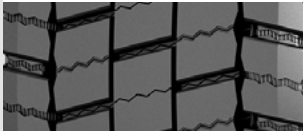

TRAILER AXLE

Conti Hybrid HT3+

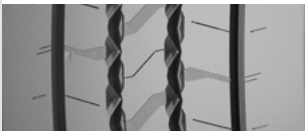

Conti Hybrid HT3



HTR 2

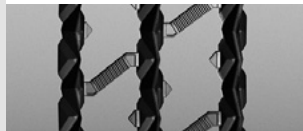

HL - High Load

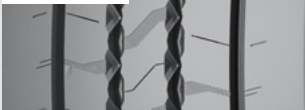

ED - Extra Duty



SR - Severe Regional

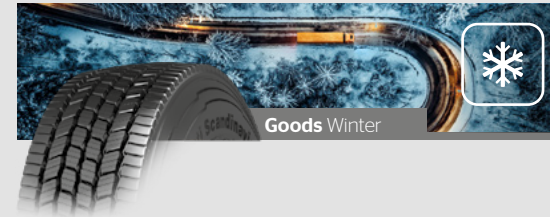

STEER AXLE

Conti Scandinavia HS3



HSW 2 SCANDINAVIA



Conti Scandinavia LS3



DRIVE AXLE

Conti Scandinavia HD3

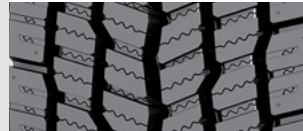

Conti ScanExtreme HD3



HDW 2 SCANDINAVIA

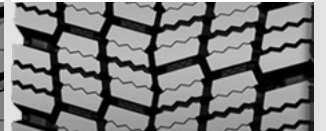

Conti Scandinavia LD3



TRAILER AXLE

Conti Scandinavia HT3

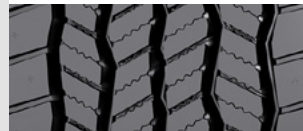

HTW 2 SCANDINAVIA



Tread pattern overview

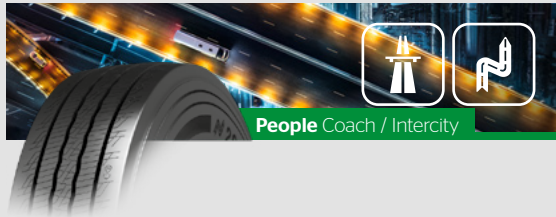

People Coach / Intercity

ALL AXLE

Conti Coach HA3



Conti CoachRegio HA3



DRIVE AXLE

Conti CoachRegio HD3

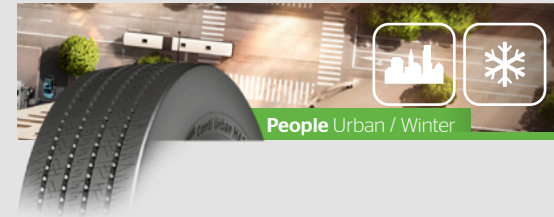
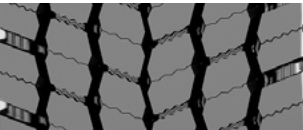

People Urban / Winter

ALL AXLE

Conti Urban HA3



HSW 2+ COACH



HSW 2 COACH



Conti Urban Scan HA3+



Conti Urban Scan HA3

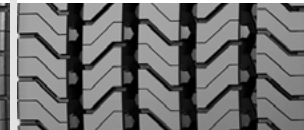

DRIVE AXLE

HDW 2 COACH



Conti Urban Scan HD3

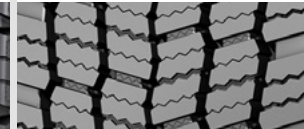

Tread pattern overview

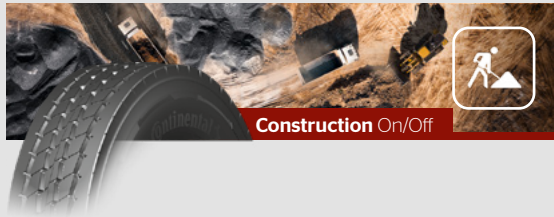

STEER AXLE

CrossTrac HS3

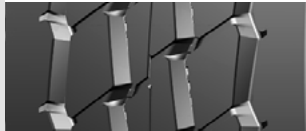

HSC 1

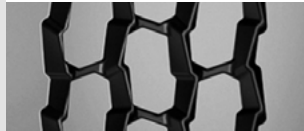

HSC



LSC

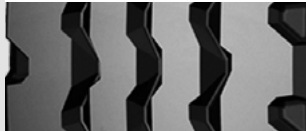

DRIVE AXLE

CrossTrac HD3



HDC 1



HDC

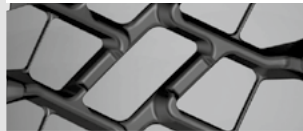

55 / 65 series



TRAILER AXLE

CrossTrac HT3



HTC 1



HTC

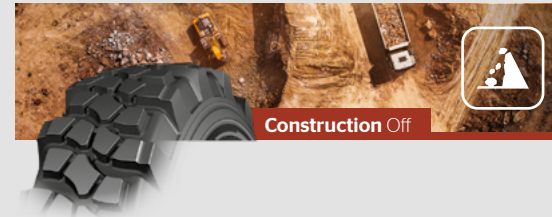

STEER AXLE

HSO+ SAND



HCS



HSO



LCS



DRIVE AXLE

HDO



M+S and Three Peak Mountain Snow Flake (3PMSF) Designation



All Continental drive axle tyres carry the M+S designation. In addition, some special steering axle and trailer tyres are marked M+S. The best performance on mud, snow and ice is provided by tyres showing the Three Peak Mountain Snowflake (3PMSF) symbol. All tyres suitable for winter and marked M+S and/or 3PMSF are listed below.

“Snow tyre’ means a tyre [...] designed to achieve in snow conditions a performance better than a normal tyre [...].”

Source: Economic Commission for Europe of the United Nations (UN/ECE), R117

Steer

Tyre size	M+S		Tread Pattern
245/70 R 17.5	•	•	Conti Hybrid LS3
265/70 R 17.5	•	•	Conti Hybrid LS3
			LCS
205/75 R 17.5	•	•	Conti Hybrid LS3
215/75 R 17.5	•	•	Conti Hybrid LS3
			Conti Scandinavia LS3
225/75 R 17.5	•	•	Conti Hybrid LS3
235/75 R 17.5	•	•	Conti Hybrid LS3
			Conti Scandinavia LS3
9.5 R 17.5	•	•	LSC
			LSC
225/70 R 19.5	•	•	Conti Hybrid HS3
245/70 R 19.5	•	•	Conti Hybrid HS3
			Conti Urban HA3 M+S
265/70 R 19.5	•	•	Conti Hybrid HS3
			Conti Scandinavia HS3
			Conti Urban HA3 M+S

Tyre size	M+S		Tread Pattern
285/70 R 19.5	•	•	Conti Hybrid HS3
			Conti Scandinavia HS3
305/70 R 19.5	•	•	Conti Hybrid HS3
355/50 R 22.5	•	•	Conti EcoPlus HS3
			HSW 2 SCAN
385/55 R 22.5	•	•	Conti EcoPlus HS3+
			Conti EcoPlus HS3
			Conti Hybrid HS5
			Conti Hybrid HS3+
			Conti EcoRegional HS3+
			Conti EfficientPro S+
			Conti EcoRegional HS3
			Conti EfficientPro S
			Conti Hybrid HS3
			Conti Scandinavia HS3
HSW 2 SCAN			

Steer

Tyre size	M+S		Tread Pattern
295/60 R 22.5	•	•	Conti EcoPlus HS3
315/60 R 22.5	•	•	Conti EcoPlus HS3+
			Conti EcoPlus HS3
			HSW 2 SCAN
			Conti Urban HA3 M+S
385/65 R 22.5	•	•	Conti EcoPlus HS3+
			Conti Hybrid HS5
			Conti Hybrid HS3+
			Conti EcoRegional HS3+
			Conti EcoRegional HS3
			Conti Hybrid HS3
			Conti Scandinavia HS3
			HSW 2 SCAN
			HSC 1
			HSC 1
445/65 R 22.5	•		HCS
275/70 R 22.5	•	•	Conti Hybrid HS3
			Conti Urban HA3 M+S
			Conti UrbanScan HA3+
			Conti UrbanScan HA3
305/70 R 22.5	•	•	Conti Urban HA3 M+S
315/70 R 22.5	•	•	Conti EcoPlus HS3+
			Conti EcoPlus HS3
			Conti Hybrid HS5
			Conti Hybrid HS3+
			Conti EcoRegional HS3+
			Conti EfficientPro S+
			Conti EcoRegional HS3
			Conti EfficientPro S
			Conti Hybrid HS3
			HSR 1
Conti Scandinavia HS3			
HSW 2 SCAN			
295/80 R 22.5	•	•	Conti Hybrid HS5
			Conti Hybrid HS3+
			Conti EcoRegional HS3
			Conti Hybrid HS3

Tyre size	M+S		Tread Pattern
295/80 R 22.5	•	•	Conti Scandinavia HS3
			HSW 2 SCAN
			Conti Coach HA3
			HSW 2+ COACH
			HSW 2 Coach
315/80 R 22.5	•	•	Conti EcoPlus HS3+
			Conti EcoPlus HS3
			Conti Hybrid HS5
			Conti Hybrid HS3+
			Conti EcoRegional HS3+
			Conti EcoRegional HS3
			Conti Hybrid HS3
			HSR 1
			Conti Scandinavia HS3
			HSW 2 SCAN
Conti Coach HA3			
Conti Coach HA3 AT			
HSW 2+ COACH			
HSW 2 Coach			
HSC 1			
10 R 22.5	•		T9
11 R 22.5	•		HSC 1
12 R 22.5	•	•	Conti Hybrid HS3
			HSC 1
13 R 22.5	•		HSC 1
			HSO
7.50 R 16	•	•	LSR 2+
			LSR +
			HSO + SAND
365/85 R 20	•		HCS
395/85 R 20	•		HCS
12.00 R 20	•		HSC
14.00 R 20	•		HSO SAND
			HCS
325/95 R 24 (12.00 R 24)	•		HSC 1
			HCS

Drive

Tyre size	M+S		Tread Pattern
245/70 R 17.5	•	•	Conti Hybrid LD3
265/70 R 17.5	•	•	Conti Hybrid LD3
205/75 R 17.5	•	•	Conti Hybrid LD3
215/75 R 17.5	•	•	Conti Hybrid LD3
	•	•	Conti Scandinavia LD3
225/75 R 17.5	•	•	Conti Hybrid LD3
235/75 R 17.5	•	•	Conti Hybrid LD3
	•	•	Conti Scandinavia LD3
8.5 R 17.5	•		LDR 1+
9.5 R 17.5	•	•	LDR 1
10 R 17.5	•	•	LDR 1
225/70 R 19.5	•	•	Conti Hybrid HD3
245/70 R 19.5	•	•	Conti Hybrid HD3
265/70 R 19.5	•	•	Conti Hybrid HD3
	•	•	Conti Scandinavia HD3
285/70 R 19.5	•	•	Conti Hybrid HD3
	•	•	Conti Scandinavia HD3
305/70 R 19.5	•	•	Conti Hybrid HD3
315/45 R 22.5	•	•	Conti EcoPlus HD3
295/55 R 22.5	•	•	Conti EcoPlus HD3+
	•	•	Conti EcoPlus HD3
	•	•	Conti Hybrid HD3
385/55 R 22.5	•	•	HDU 1
	•	•	HDC
295/60 R 22.5	•	•	Conti EcoPlus HD3+
	•	•	Conti EcoPlus HD3
	•	•	Conti Hybrid HD3
	•	•	HDW 2 SCAN
315/60 R 22.5	•	•	Conti EcoPlus HD3+
	•	•	Conti EcoPlus HD3
	•	•	Conti Hybrid HD3
	•	•	Conti Hybrid HD3
	•	•	HDW 2 SCAN
385/65 R 22.5	•	•	HDC
255/70 R 22.5	•	•	HDR
275/70 R 22.5	•	•	Conti Hybrid HD3
	•	•	HDW 2 SCAN
	•	•	Conti UrbanScan HD3

Tyre size	M+S		Tread Pattern
305/70 R 22.5	•	•	HDR
315/70 R 22.5	•	•	Conti EcoPlus HD3+
	•	•	Conti EcoPlus HD3
	•	•	Conti Hybrid HD5
	•	•	Conti EcoRegional HD3+
	•	•	Conti EfficientPro D+
	•	•	Conti EcoRegional HD3
	•	•	Conti EfficientPro D
	•	•	Conti Hybrid HD3
	•	•	HDR+
	•	•	Conti Scandinavia Ext HD3
	•	•	Conti Scandinavia HD3
295/80 R 22.5	•	•	HDL 1 ECO-PLUS
	•	•	Conti Hybrid HD5
	•	•	Conti EcoRegional HD3
	•	•	Conti Hybrid HD3
	•	•	HDR+
	•	•	Conti Scandinavia Ext HD3
315/80 R 22.5	•	•	Conti EcoPlus HD3+
	•	•	Conti EcoPlus HD3
	•	•	Conti Hybrid HD5
	•	•	Conti EcoRegional HD3+
315/80 R 22.5	•	•	Conti EcoRegional HD3
	•	•	Conti Hybrid HD3
	•	•	HDR+
	•	•	Conti Scandinavia Ext HD3
	•	•	Conti Scandinavia HD3
	•	•	HDW 2 SCAN
	•	•	Conti CrossTrac HD3
	•	•	HDC 1
	•	•	HDO

Drive

Tyre size	M+S		Tread Pattern
10 R 22.5	•	•	RMS
11 R 22.5	•	•	HDR
12 R 22.5	•	•	HDC 1
13 R 22.5	•	•	HDW
	•	•	Conti CrossTrac HD3
	•	•	HDO
7.00 R 16	•		LDR+
7.50 R 16	•	•	LDR+
12.00 R 20	•	•	HDC
325/95 R 24 (12.00 R 24)	•	•	HDC 1
12.00 R 24	•	•	HDC 1

Trailer

Tyre size	M+S		Tread Pattern
205/65 R 17.5	•	•	HTR 2+
	•		HTR 2
245/70 R 17.5	•	•	HTR 2+
	•		HTR 2
	•	•	Conti Scandinavia HT3
215/75 R 17.5	•	•	HTR 2+
	•		HTR 2
	•	•	Conti Scandinavia HT3
235/75 R 17.5	•	•	HTR 2+
	•		HTR 2
	•	•	Conti Scandinavia HT3
445/45 R 19.5	•		Conti Hybrid HT3
	•	•	Conti Hybrid HT3
	•	•	HTW 2 SCAN
435/50 R 19.5	•		Conti Hybrid HT3
	•	•	Conti Hybrid HT3
385/55 R 19.5	•	•	Conti Hybrid HT3+
	•		Conti Hybrid HT3

Trailer

Tyre size	M+S		Tread Pattern
245/70 R 19.5	•	•	Conti Hybrid HT3
	•		Conti Hybrid HT3
265/70 R 19.5	•	•	Conti Hybrid HT3
	•		Conti Hybrid HT3
	•	•	Conti Scandinavia HT3
285/70 R 19.5	•		Conti Hybrid HT3
	•	•	Conti Hybrid HT3
	•	•	Conti Scandinavia HT3
385/55 R 22.5	•	•	Conti EcoPlus HT3+
	•	•	Conti Hybrid HT5
	•	•	Conti Hybrid HT3+
	•		Conti Hybrid HT3
	•	•	Conti Hybrid HT3 SR
385/65 R 22.5	•	•	Conti Scandinavia HT3
	•	•	HTW 2 SCAN
	•	•	Conti EcoPlus HT3+
	•	•	Conti Hybrid HT5
	•	•	Conti Hybrid HT3+ HL
425/65 R 22.5	•	•	Conti Hybrid HT3
	•		Conti Hybrid HT3 SR
	•		HTR
	•	•	Conti Scandinavia HT3
275/70 R 22.5	•	•	HTW 2 SCAN
	•	•	Conti CrossTrac HT3
	•		HTR 2
7.50 R 15	•	•	HTR 2
	•	•	HTR 2
8.25 R 15	•	•	HTR 2
	•	•	HTR 2

The EU has introduced new regulations for truck manufacturers.

These will mean cutting average CO₂ emissions from new heavy-duty vehicles by 15% by 2025 and by 45% by 2030.

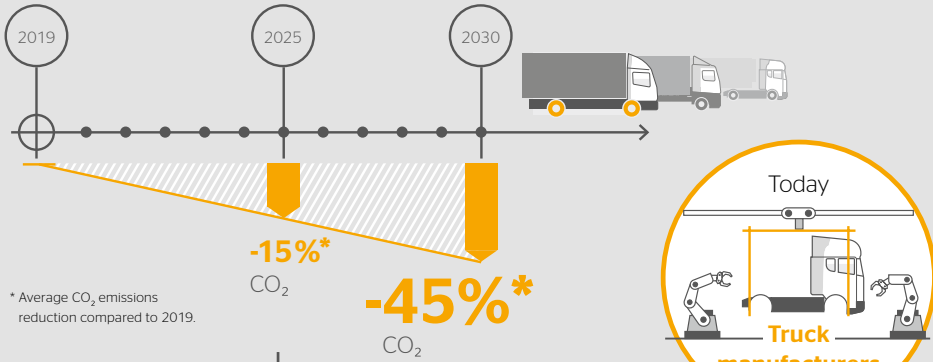

* Average CO₂ emissions reduction compared to 2019.



The CO₂ emissions regulation became effective on **August 14, 2019.**

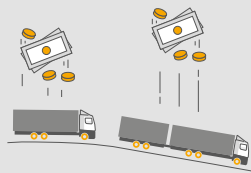

Penalties

If manufacturers fail to comply, they will incur penalty payments for each vehicle.

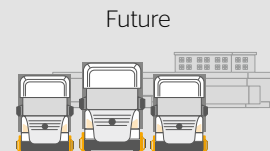

Fleets

The focus is currently on truck manufacturers.*

* Future regulations are expected to cover fleet operators as well.

Which vehicles are affected?

January 2019*

Large trucks (rigid and tractor) with a 4x2 and 6x2 axle configuration and a GVW > 16t.

January 2020**

Vehicles (rigid and tractor) with a GVW > 7.5t.

July 2020**

Vehicles (rigid and tractor) with a 6x4 and 8x4 axle configuration (all weights).

Extended regulations will affect further vehicle configurations and trailers in the future.

* HDV CO₂ regulation (EU 2019/1242) & VECTO regulation (EU 2017/2400)

** VECTO regulation (EU 2017/2400)

Vehicle groups 1, 2, 3, 4, 5, 9, 10, 11, 12 and 16.

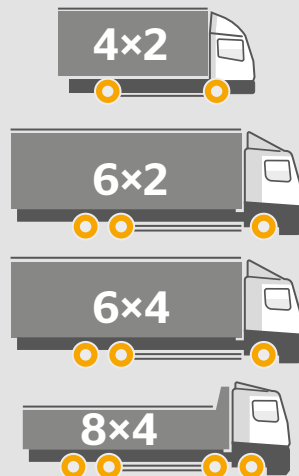

Why is this so important?

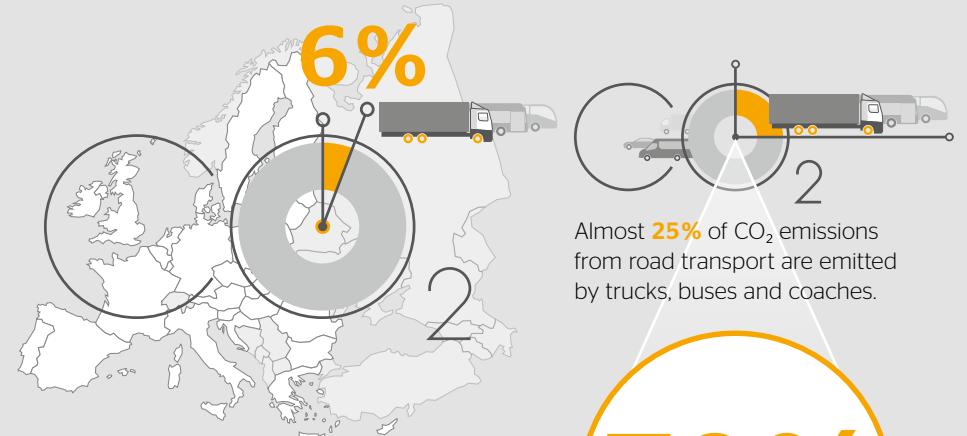

Trucks, buses and coaches account for **6%** of total EU carbon emissions.



CO₂ emissions will keep rising dramatically as volumes of road freight continue to increase.

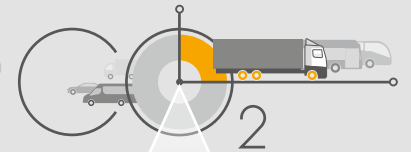

Almost **25%** of CO₂ emissions from road transport are emitted by trucks, buses and coaches.



Large trucks account for up to **70%** of the total CO₂ emissions from heavy-duty vehicles.

Please visit Continental website for further information.

<https://www.continental-tires.com/transport/fleetsolutions/co2-regulations-vecto>



CO₂ emissions & fuel consumption

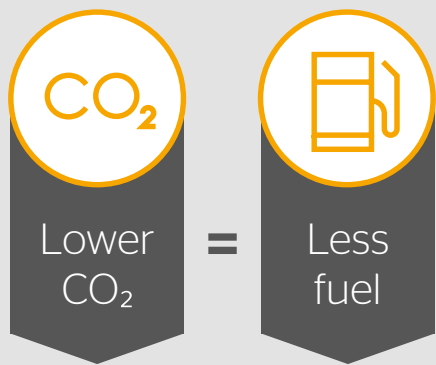

The level of CO₂ emissions is directly related to fuel consumption.



3

main factors impacting on fuel consumption and CO₂ emissions.

Fleet operating costs

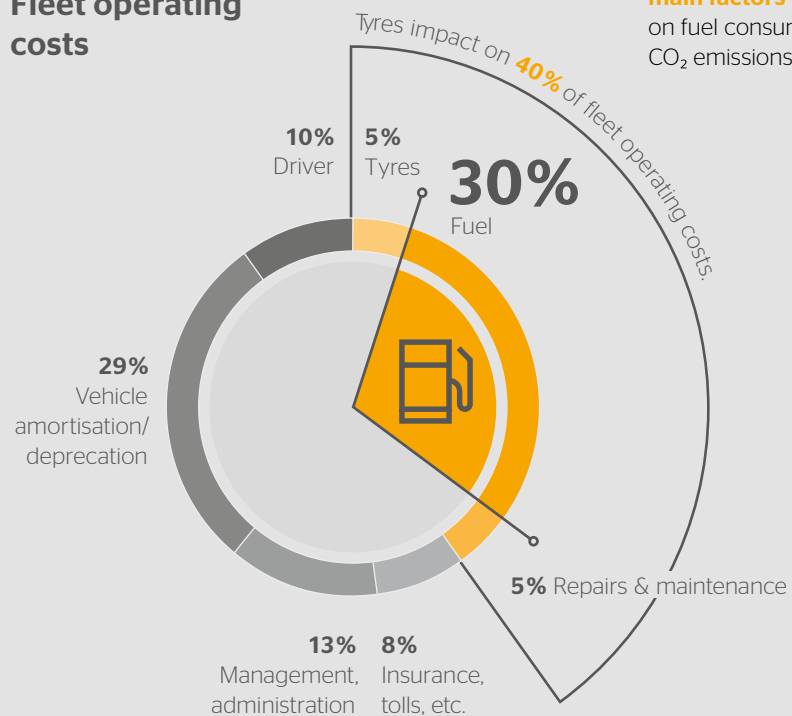

What is VECTO?



Vehicle Energy Consumption Calculation Tool

VECTO is a mandatory, digital simulation tool that has been developed by the EU to ensure that the CO₂ emissions reduction targets are met.

With VECTO, vehicle manufacturers can simulate the CO₂ emissions and fuel consumption of individual vehicle configurations.

As inputs, the tool uses a number of parameters:



Driving behavior

- › **Type of route**
 - long haul (few stops, constant speed)
 - regional distribution (many stops, variable speed)
 - urban
- › **Braking and acceleration**
- › **Speed profile**





Payloads

› **Heavy and/or light cargo and load distribution**

Vehicle configuration

› **Different vehicle configurations**, such as rigid truck or truck and trailer combinations (including simulation of a standard trailer).

Specifications and load capacities





Tyre size	Operating code			EU tyre label (EU Reg. 2020/740)						Rim		Tyre dimensions						Load capacity (kg) per axle at inflation											
																		pressur ⁶⁾ (bar) (psi)											
	Pattern	LI/SI ¹⁾	TT/TL ²⁾	 ³⁾	 ⁴⁾	 ⁵⁾	M+S		Rim-width	Min. distance between rim centres	Max. standard value in service	Design value	Static radius	Rolling circumference	LI ¹⁾	Tyre fit-ment	3.25 (47)	3.5 (51)	3.75 (54)	4.0 (58)	4.25 (62)	4.5 (65)	4.75 (69)	5.0 (69)	5.25 (73)	5.5 (80)			
7.50 R 16	HSO + SAND	116/114 N	TT	-	-		•	5.00	230	208					116	S	1925	2040	2160	2275	2385	2500							
		112/110 N	TT	-	-		•	5.50	236	213					112	S	1725	1830	1935	2035	2135	2240							
	HSO + SAND		TT	-	-		•	6.00	242	218	818				200														
								6.50	247	224					205						114	D	3635	3860	4075	4295	4505	4720	
																	4.5 (65)	5.0 (73)	5.5 (80)	6.0 (87)	6.5 (94)	7.0 (102)	7.5 (109)	8.0 (116)	8.5 (123)	9.0 (131)			
205/70 R 15	HTR	124/122 K	TT	D	C	A/70		5.00	228	206					124	S													
								5.50	233	211	681										2090	2255	2420	2580	2735	2895	3045	3200	
								6.00	240	217											122	D	3920	4235	4540	4840	5135	5425	5715
6.50								246	223											122	D	3920	4235	4540	4840	5135	5425	5715	6000
7.50 R 15	HTR+	135/133 G (134/132 K)	TT	D	C	A/71	•	5.00	232	212					135	S													
								5.50	238	217											134	S	2850	3075	3295	3515	3730	3940	4150
	HTR	135/133 G (134/132 K)	TT	D	C	A/70		6.00	244	223	784				133	D	2770	2990	3205	3420	3630	3835	4035	4240					
								6.50	250	228					132	D	5385	5815	6235	6645	7050	7450	7845	8240					
8.25 R 15	HTR+	143/141 G (141/140 K)	TT	D	C	A/71	•	5.50	253	235					143	S													
								6.00	259	240											141	S	3560	3845	4120	4395	4665	4930	5190
	HTR	143/141 G (141/140 K)	TT	C	C	A/70		6.50	265	246	848				141	D	6735	7270	7795	8310	8815	9315	9810	10300					
								7.00	270	252					140	D	6540	7055	7565	8065	8560	9045	9525	10000					
7.00 R 16	LSR+	117/116 L	TT	E	C	A/70		5.50	228	206	800				117	S													
	LDR+	117/116 L	TT	E	C	B/72	•	6.00	235	212					116	D	4320	4660	5000										
7.50 R 16	LSR 2+	122/121 L	TL	-	-		•	5.00	230	208					122	S													
								5.50	236	213											121	S	2290	2470	2650	2825	3000		
	LSR+	121/120 L	TT	D	C	A/65	•	6.00	242	218	818				121	D	4430	4780	5125	5465	5800								
								6.50	247	224					120	D	4275	4615	4950	5275	5600								
LDR+	121/120 L	TT	E	C	A/70	•																							
10/0 R 17.5	LSR 1	134/132 L	TL	D	C	A/70		6.75	277	256					134	S													
								7.50	286	264	875										132	D	5490	5925	6355	6775	7185	7595	8000
205/65 R 17.5	HTR 2+	132/130 J (133/133 G)	TL	D	C	A/70	•	6.00	231	213	721				133	S													
								6.75	239	220											132	S	2495	2695	2890	3080	3270	3455	3640
	HTR 2	132/130 J (133/133 G)	TL	D	C	A/70	•								129	S	2310	2495	2675	2850	3025	3195	3365	3530	3700				
																					133	D							
	HTR 2	132/130 J (133/133 F)	TL	D	C	A/70	•								132	D	4995	5390	5780	6165	6540	6910	7280	7640	8000				
																				130	D	4745	5125	5490	5855	6215	6565	6915	7260
HTR 2	129/127 K (132/132 G)	TL	D	C	A/69	•								127	D	4370	4720	5060	5395	5725	6045	6370	6685	7000					





Tyre size	Operating code			EU tyre label (EU Reg. 2020/740)						Rim		Tyre dimensions						Load capacity (kg) per axle at inflation										
																		pressur ⁶⁾ (bar) (psi)										
	Pattern	LI/SI ¹⁾	TT/TL ²⁾	C ³⁾	C ⁴⁾	A/70	•	•	Rim-width	Min. distance between rim centres	Max. standard value in service		Design value		Static radius	Rolling circumference	LI ¹⁾	Tyre fit-ment	5.0 (73)	5.5 (80)	6.0 (87)	6.5 (94)	7.0 (102)	7.5 (109)	8.0 (116)	8.5 (123)	9.0 (131)	9.5 (137)
											Width + 1 %	Outer-Ø ± 1 %	± 1.5 %	± 2 %														
245/70 R 17.5	HTL 2 ECO-PLUS	143/141 L (146/146 F)	TL	C	C	A/70	•	•	6.75	270	250	803		240	789	364	2406	146 S	3590	3870	4150	4425	4695	4965	5225	5485	5745	6000
	Conti Hybrid LS3	136/134 M	TL	C	C	A/71	•	•	7.50	279	258			248	789	364	2406	143 S	3405	3675	3940	4200	4455	4710	4955	5205	5450	
	Conti Hybrid LD3	136/134 M	TL	D	C	B/76	•	•											136 S	2930	3160	3390	3610	3835	4050	4265	4480	
	HTR 2+	143/141 L (146/146 F)	TL	C	C	A/71	•	•											146 D	7180	7745	8305	8855	9395	9930	10455	10975	11490
	HTR 2	143/141 L (146/146 F)	TL	C	C	B/71	•												141 D	6435	6945	7445	7935	8420	8900	9370	9835	10300
	Conti Scandinavia HT3	143/141 L (146/146 F)	TL	D	C	B/72	•	•											134 D	5545	5985	6415	6840	7260	7670	8075	8480	
265/70 R 17.5	Conti Hybrid LS3⁷⁾	139/136 M	TL	C	C	A/71	•	•	6.75	286	264	831		254	817	376	2492	139 S	3175	3430	3675	3920	4160	4395	4625	4860		
	Conti Hybrid LD3⁷⁾	139/136 M	TL	D	C	B/76	•	•	7.50	295	272			262	817	376	2492	136 D	5860	6325	6780	7225	7670	8105	8535	8960		
	LCS⁷⁾	139/136 M	TL	D	C	A/74	•																					
205/75 R 17.5	Conti Hybrid LS3	124/122 M	TL	C	C	A/71	•	•	5.25	222	205	765		197	753	353	2297	124 S	2310	2495	2675	2850	3025	3200				
	Conti Hybrid LD3	124/122 M	TL	D	C	B/74	•	•	6.00	231	213			205				122 D	4335	4680	5015	5350	5675	6000				
215/75 R 17.5	Conti Hybrid LS3	126/124 M	TL	D	C	A/71	•	•	6.00	239	220	779		212	767	359	2339	135 S	2720	2940	3150	3360	3565	3765	3965	4165	4360	
	LSR 1+	126/124 M	TL	-	-	-			6.75	246	228			219				126 S	2595	2800	3005	3200	3400					
	Conti Hybrid LD3	126/124 M	TL	D	C	B/74	•	•										133 D	5145	5555	5955	6350	6735	7120	7495	7870	8240	
	HTR 2+⁷⁾	135/133 K	TL	C	C	A/71	•	•											124 D	4885	5275	5655	6030	6400				
	HTR 2⁷⁾	135/133 K	TL	D	C	B/73	•																					
	Conti Scandinavia LS3	126/124 M	TL	D	C	B/73	•	•																				
	Conti Scandinavia LD3	126/124 M	TL	D	C	B/75	•	•																				
Conti Scandinavia HT3⁷⁾	135/133 K	TL	D	C	B/72	•	•																					
225/75 R 17.5	Conti Hybrid LS3	129/127 M	TL	C	C	A/71	•	•	6.00	246	228	797		219	783	366	2388	129 S	2675	2885	3095	3295	3500	3700				
	Conti Hybrid LD3	129/127 M	TL	D	C	B/76	•	•	6.75	254	235			226	783	366	2388	127 D	5060	5460	5855	6240	6620	7000				





Tyre size	Operating code			EU tyre label (EU Reg. 2020/740)					Rim		Tyre dimensions				Tyre fit-ment	Load capacity (kg) per axle at inflation pressur ⁶⁾ (bar) (psi)													
											Max. standard value in service		Design value			Static radius	Rolling circumference	4.5 (65)	5.0 (73)	5.5 (80)	6.0 (87)	6.5 (94)	7.0 (102)	7.5 (109)	8.0 (116)	8.5 (123)	9.0 (131)		
	Pattern	LI/SI ¹⁾	TT/TL ²⁾	C ³⁾	C ⁴⁾	A/71 ⁵⁾	M+S	Rim-width	Min. distance between rim centres	Width	Outer-Ø	Width + 1 %	Outer-Ø ± 1 %	± 1.5 %														± 2 %	LI ¹⁾
																Width	Outer-Ø	Width + 1 %	Outer-Ø ± 1 %	± 1.5 %	± 2 %								
235/75 R 17.5	Conti Hybrid LS3	132/130 M	TL	C	C	A/71	•	•	6.75	262	242	811		233	797	372	2431	144	S	3495	3775	4045	4315	4580	4835	5095	5345	5600	
	Conti Hybrid LD3	132/130 M	TL	D	C	B/76	•	•	7.50	271	251			241				143	S	3405	3675	3940	4200	4455	4710	4955	5205	5450	
	HTR 2+	143/141 K (144/144 F)	TL	C	C	A/71	•	•											144	D	6995	7550	8095	8630	9160	9675	10190	10695	11200
	HTR 2	143/141 K (144/144 F)	TL	C	C	B/71	•												141	D	6435	6945	7445	7935	8420	8900	9370	9835	10300
	Conti Scandinavia LS3	132/130 M	TL	C	C	B/73	•	•											130	D	5215	5630	6035	6435	6825	7215	7600		
	Conti Scandinavia LD3	132/130 M	TL	D	C	B/75	•	•																					
	Conti Scandinavia HT3	143/141 K (144/144 F)	TL	D	C	B/72	•	•																					
8 R 17.5	LSR	117/116 L	TL	-	-				5.25	225	208			200				117	S	2220	2395	2570							
									6.00	234	216			208			116	D	4320	4660	5000								
									6.75	243	225			216	799														
8.5 R 17.5	LSR 1+	121/120 L	TL	-	-				5.25	233	215			207				121	S	2350	2535	2720	2900						
									6.00	242	224	817					120	D	4535	4895	5250	5600							
9.5 R 17.5	LSR 1	129/127 L	TL	D	C	A/70			6.00	262	242			233				131	S	2675	2885	3095	3300	3500	3700	3900			
									6.75	270	250	859					129	S	2675	2885	3095	3295	3500	3700					
																	128	D	4940	5335	5715	6095	6470	6835	7200				
																	127	D	5060	5460	5855	6240	6620	7000					
9.5 R 17.5	LDR 1	129/127 L (131/128 K)	TL	D	C	A/71																							
9.5 R 17.5	LDR 1	129/127 L (131/128 M)	TL	D	C	A/70																							
10 R 17.5	LDR 1	134/132 L	TL	D	C	B/74			6.75	277	256			246				134	S	2910	3140	3365	3590	3810	4025	4240			
									7.50	286	264	875					132	D	5490	5925	6355	6775	7185	7595	8000				
445/45 R 19.5	Conti Hybrid HT3	160 J	TL	B	C	B/72	•		14.00		453			436				160	S	5165	5620	6065	6505	6935	7360	7775	8190	8595	9000
	Conti Hybrid HT3	160 J	TL	B	C	B/73	•	•	15.00		464	911		446	895	416	2712												
	HTW 2 SCAN	160 J	TL	C	C	B/73	•	•																					
435/50 R 19.5	Conti Hybrid HT3	160 J	TL	B	C	B/73	•	•	14.00		456			438				160	S	5165	5620	6065	6505	6935	7360	7775	8190	8595	9000
	Conti Hybrid HT3	160 J	TL	B	C	B/72	•		15.00		466	949		448	931	431	2821												

Tyre size	Operating code			EU tyre label (EU Reg. 2020/740)						Rim		Tyre dimensions						Load capacity (kg) per axle at inflation pressur ⁶⁾ (bar) (psi)																												
	Pattern	LI/SI ¹⁾	TT/TL ²⁾	C ³⁾	C ⁴⁾	A/B ⁵⁾	•	•	Rim-width	Min. distance between rim centres	Max. standard value in service		Design value		Static radius ± 1.5 %	Rolling circumference ± 2 %	LI ¹⁾	Tyre fit-ment	4.5 (65)	5.0 (73)	5.5 (80)	6.0 (87)	6.5 (94)	7.0 (102)	7.5 (109)	8.0 (116)	8.5 (123)	9.0 (131)																		
											Width + 1 %	Outer-Ø ± 1 %	Width + 1 %	Outer-Ø ± 1 %																																
285/70 R 19.5	Conti Hybrid HS3	146/144 M	TL	C	C	A / 69	•	•	7.50	311	287	911				276	283	895	413	2730	150	S																								
	Conti Hybrid HD3	146/144 M	TL	C	C	B / 74	•	•	8.25	318	294												291	146	S	3445	3745	4045	4335	4620	4905	5185	5460	5730	6000											
	Conti Hybrid HT3	150/148 K	TL	C	C	B / 73	•	•	9.00	311	294	303										148	D																							
	Conti Hybrid HT3	150/148 K	TL	C	B	B / 73	•															144	D	6430	6995	7550	8095	8630	9160	9675	10190	10695	11200													
	Conti Scandinavia HS3	146/144 M	TL	D	C	B / 72	•															148	S	3785	4120	4445	4765	5080	5390	5695	6000	6300														
	Conti Scandinavia HS3	145/143 M	TL	D	C	B / 73	•															145	D	6970	7585	8185	8775	9355	9930	10490	11050	11600														
	Conti Scandinavia HD3	146/144 M	TL	D	C	B / 75	•															148	S																							
	Conti Scandinavia HD3	145/143 M	TL	D	C	B / 75	•															145	D																							
	Conti Scandinavia HT3	150/148 K	TL	C	C	B / 72	•															148	S																							
Conti Scandinavia HT3	150/148 K	TL	C	C	B / 72	•		145														D																								
305/70 R 19.5	Conti Hybrid HS3	148/145 M	TL	C	C	A / 70	•	•														8.25	334	309	941				297	305	923	424	2815	148	S											
	Conti Hybrid HD3	148/145 M	TL	C	C	B / 76	•	•	9.00	343	317			305	145	D	6970	7585	8185	8775	9355	9930	10490	11050										11600												
365/85 R 20	HCS	164 J	TL	-	-		•		10.00		379	1152				364	1128	518	3440	164	S		6865	7405	7940	8465	8985	9495	10000																	
395/85 R 20	HCS	168 J (166 K)	TL	-	-		•		10.00		401	1206				386	1180	540	3599	168	S		7685	8295	8895	9485	10065	10635	11200																	
10.00 R 20	HSR	146/143 K	TT	D	C	B / 73			6.50	305	276	1074				265	270	273	275	1052	485	3209	146	S																						
									7.00	311	281												143	D	4115	4445	4765	5080	5390	5695	6000															
									7.33	314	284														7480	8075	8655	9230	9795	10350	10900															
									7.50	316	286																																			
									8.00	322	291																																			
11.00 R 20	HSR	150/146 K	TT	C	C	B / 73			7.33	321	290	1104				279	281	286	1082	498	3300	150	S																							
									7.50	323	292											146	D	4380	4725	5070	5405	5735	6060	6380	6700															
									8.00	329	297													7845	8470	9080	9680	10270	10855	11430	12000															
									8.50	335	303																																			
									9.00	340	308																																			
12.00 R 20	HSR	154/150 K	TT	C	C	B / 73			7.33	346	307	1146				301	307	313	1122	515	3422	154	S																							
									8.00	353	313											151	D	4905	5290	5675	6050	6420	6785	7140	7500															
	HSC	154/151 K	TT	D	D	B / 71	•	8.50	360	319																																				
	HDC	154/150 K	TT	E	C	B / 76	•	•	9.00	366	324																																			





See page 191 for footnotes

Tyre size	Operating code			EU tyre label (EU Reg. 2020/740)					Rim		Tyre dimensions						Tyre fitment		Load capacity (kg) per axle at inflation												
																			pressur ⁶⁾ (bar) (psi)												
	Pattern	LI/SI ¹⁾	TT/TL ²⁾	 ³⁾	 ⁴⁾	 ⁵⁾	M+S		Rim-width	Min. distance between rim centres	Width	Outer-Ø	Max. standard value in service	Design value		Static radius	Rolling circumference	LI ¹⁾	Tyre fitment	4.5 (65)	5.0 (73)	5.5 (80)	6.0 (87)	6.5 (94)	7.0 (102)	7.5 (109)	8.0 (116)	8.5 (123)	9.0 (131)		
14.00 R 20	HSO SAND	160/157 K	TL	-	-		•	9.00	414	367	1268		360	1238	564	3776	166	S													
	HSO SAND	160/157 K	TT	-	-		•	10.00	426	377			370				164	S													
	HCS	164/160 K (166/160 G)	TL	-	-		•										160	S													
315/45 R 22.5	Conti EcoPlus HD3 ⁷⁾	147/145 L	TL	D	C	B / 76	•	9.75	345	319	868		307	856	405	2594	147	S													
355/50 R 22.5	Conti EcoPlus HS3 ⁷⁾	156 K	TL	C	C	A / 70	•	11.75		375	942		361	928	436	2812	156	S	4590	4995	5390	5780	6165	6540	6910	7280	7640	8000			
	HSW 2 SCAN ⁷⁾	156 K	TL	C	C	B / 73	•																								
295/55 R 22.5	Conti EcoPlus HD3+ ⁷⁾	147/145 K	TL	C	C	A / 73	•	9.00	329	304	908		292	896	422	2715	147	S	3530	3840	4145	4445	4740	5025	5315	5595	5875	6150			
	Conti EcoPlus HD3 ⁷⁾	147/145 K	TL	C	B	A / 72	•	9.75	338	312			300				145	D	6660	7245	7820	8385	8940	9485	10025	10555	11080	11600			
	Conti Hybrid HD3 ⁷⁾	147/145 K	TL	C	C	A / 73	•																								
385/55 R 22.5	Conti EcoPlus HS3+ ⁷⁾	160 K (158 L)	TL	B	B	A / 71	•	11.75		396	1012		381	996	464	3018	160	S	5165	5620	6065	6505	6935	7360	7775	8190	8595	9000			
	Conti EcoPlus HS3 ⁷⁾	160 K (158 L)	TL	B	B	A / 70	•	12.25		401			386				158	S	5110	5555	6000	6430	6855	7275	7690	8095	8500				
	Conti EcoPlus HT3+ ⁷⁾	160 K (158 L)	TL	A	C	A / 70	•																								
	Conti EcoPlus HT3 ⁷⁾	160 K (158 L)	TL	A	C	A / 69																									
	Conti Hybrid HS5 ⁷⁾	160 K (158 L)	TL	C	B	B / 73	•																								
	Conti Hybrid HS3+ ⁷⁾	160 K (158 L)	TL	C	B	A / 71	•																								
	Conti EcoRegional HS3+ ⁷⁾	160 K (158 L)	TL	B	B	A / 71	•																								
	Conti EcoRegional HS3 ⁷⁾	160 K (158 L)	TL	C	B	A / 71	•																								
	Conti EfficientPro S+ ⁷⁾	160 K (158 L)	TL	A	C	A / 71	•																								
Conti EfficientPro S ⁷⁾	160 K (158 L)	TL	A	B	A / 71	•																									

Tyre size	Operating code			EU tyre label (EU Reg. 2020/740)						Rim		Tyre dimensions						Load capacity (kg) per axle at inflation pressur ⁶⁾ (bar) (psi)													
												Max. standard value in service		Design value				Static radius	Rolling circumference												
	Pattern	LI/SI ¹⁾	TT/TL ²⁾	 ³⁾	 ⁴⁾	 ⁵⁾	M+S		Rim-width	Min. distance between rim centres	Width	Outer-Ø	Width + 1 %	Outer-Ø ± 1 %	± 1.5 %	± 2 %	LI ¹⁾			Tyre fit-ment	4.5 (65)	5.0 (73)	5.5 (80)	6.0 (87)	6.5 (94)	7.0 (102)	7.5 (109)	8.0 (116)	8.5 (123)	9.0 (131)	
385/55 R 22.5	Conti Hybrid HS3⁷⁾	160 K (158 L)	TL	C	B	B / 73	•	•	11.75 12.25		396 401	1012		381 386	996	464	3018	160 158	S S	5165	5620	6065	6505	6935	7360	7775	8190	8595	9000		
	Conti Hybrid HT3+⁷⁾	160 K (158 L)	TL	B	C	A / 70	•	•												5110	5555	6000	6430	6855	7275	7690	8095	8500			
	Conti Hybrid HT3⁷⁾	160 K (158 L)	TL	B	B	A / 70	•	•																							
	Conti Hybrid HT3 SR⁷⁾	160 K (158 L)	TL	C	B	B / 71	•	•																							
	Conti Scandinavia HS3⁷⁾	160 K (158 L)	TL	C	B	B / 73	•	•																							
	Conti Scandinavia HS3 ED⁷⁾	160 K (158 L)	TL	C	B	B / 74	•	•																							
	HSW 2 SCAN⁷⁾	160 K (158 L)	TL	D	C	B / 73	•	•																							
	Conti Scandinavia HT3⁷⁾	160 K (158 L)	TL	D	B	B / 74	•	•																							
	HTW 2 SCAN⁷⁾	160 K (158 L)	TL	D	C	B / 73	•	•																							
	HDU 1	160 K	TL	C	C	A / 69	•	•																							
HDC	158 K (160 J)	TL	D	C	B / 76	•	•																								
295/60 R 22.5	Conti EcoPlus HS3⁷⁾	150/147 L	TL	C	C	A / 69	•	•	9.00 9.75	329 338	304 312	940		292 300	926	435	2806	150 147	S D	3845	4185	4515	4840	5160	5475	5790	6095	6400	6700		
	Conti EcoPlus HD3+⁷⁾	150/147 L	TL	C	C	A / 73	•	•												7060	7685	8290	8890	9480	10055	10630	11190	11750	12300		
	Conti EcoPlus HD3⁷⁾	150/147 L	TL	C	B	A / 72	•	•																							
	Conti Hybrid HD3⁷⁾	150/147 L	TL	D	C	A / 73	•	•																							
	HDW 2 SCAN⁷⁾	150/147 L	TL	D	C	B / 75	•	•																							





Tyre size	Operating code			EU tyre label (EU Reg. 2020/740)						Rim		Tyre dimensions						Load capacity (kg) per axle at inflation										
																		pressur ⁶⁾ (bar) (psi)										
	Pattern	LI/SI ¹⁾	TT/TL ²⁾	 ³⁾	 ⁴⁾	 ⁵⁾	M+S		Rim-width	Min. distance between rim centres	Max. standard value in service	Design value	Static radius	Rolling circumference	LI ¹⁾	Tyre fit-ment	4.5 (65)	5.0 (73)	5.5 (80)	6.0 (87)	6.5 (94)	7.0 (102)	7.5 (109)	8.0 (116)	8.5 (123)	9.0 (131)		
315/60 R 22.5	Conti EcoPlus HS3+ ⁷⁾	154/150 L	TL	C	C	A / 70	• •	9.00	344	318						156	S	4305	4685	5055	5420	5780	6130	6480	6825	7160	7500	
	Conti EcoPlus HS3 ⁷⁾	154/150 L	TL	C	B	A / 70	• •	9.75	352	326	966					154	S	4075	4435	4785	5130	5470	5805	6135	6460	6780	7100	
	HSL 2+ ECO-PLUS ⁷⁾	152/148 L	TL	C	B	A / 70										150	D	7695	8370	9035	9685	10325	10955	11580	12195	12800	13400	
	Conti EcoPlus HD3+ ⁷⁾	152/148 L	TL	B	C	A / 73	• •									148	D	7235	7870	8495	9105	9710	10305	10885	11465	12035	12600	
	Conti EcoPlus HD3 ⁷⁾	152/148 L	TL	C	B	B / 75	• •																					
	Conti Hybrid HD3 ⁷⁾	152/148 L	TL	C	C	A / 73	• •																					
	HSW 2 SCAN ⁷⁾	154/150 L	TL	C	C	B / 73	• •																					
	HDW 2 SCAN ⁷⁾	152/148 L	TL	D	C	B / 75	• •																					
	Conti Urban HA3 M+S	156/150 J	TL	C	C	A / 71	• •																					
	Conti Urban HA3 M+S	156 J	TL	-	-		• •																					
	Conti Urban HA3 M+S	154/148 J (156/150 F)	TL	C	C	A / 71	• •																					
	Conti Urban HA3 M+S	152/148 J (154/150 E)	TL	C	C	A / 71	• •																					





Tyre size	Operating code			EU tyre label (EU Reg. 2020/740)						Rim		Tyre dimensions				Tyre fit-ment		Load capacity (kg) per axle at inflation pressur ⁶⁾ (bar) (psi)											
																		Max. standard value in service		Design value		Static radius	Rolling circumference	4.5 (65)	5.0 (73)	5.5 (80)	6.0 (87)	6.5 (94)	7.0 (102)
	Pattern	LI/SI ¹⁾	TT/ TL ²⁾	B ³⁾	B ⁴⁾	A/70 ⁵⁾	M+S ⁶⁾	Rim-width	Min. distance between rim centres	Width	Outer-Ø	Width + 1 %	Outer-Ø ± 1 %	± 1.5 %	± 2 %	LI ¹⁾	S												
385/65 R 22.5	Conti EcoPlus HS3+⁷⁾	160 K (158 L)	TL	B	B	A/70	• •	11.75 12.25		405 410	1092			389 394	1072	496	3248	164 162 160 158	S S S S	5740	6245	6740	7225	7705	8175	8640	9100	9550	10000
	HSL 2+ ECO-PLUS⁷⁾	160 K (158 L)	TL	C	B	A/70																							
	Conti EcoPlus HT3+⁷⁾	160 K (158 L)	TL	A	C	A/70	• •																						
	Conti EcoPlus HT3⁷⁾	160 K (158 L)	TL	A	C	A/69																							
	HTL 2 ECO-PLUS⁷⁾	160 K (158 L)	TL	B	D	A/70																							
	Conti Hybrid HS5⁷⁾	164 K	TL	C	B	A/71	• •																						
	Conti Hybrid HS3+⁷⁾	164 K	TL	C	B	A/71	• •																						
	Conti Hybrid HS3+⁷⁾	160 K (158 L)	TL	C	B	A/71	• •																						
	Conti EcoRegional HS3+⁷⁾	164 K	TL	B	B	A/71	• •																						
	Conti EcoRegional HS3⁷⁾	164 K	TL	C	B	A/71	• •																						
	Conti Hybrid HS3⁷⁾	160 K (158 L)	TL	C	B	A/71	• •																						
	HSR 2⁷⁾	164 K	TL	C	C	B/73																							
	HSR 2⁷⁾	160 K (158 L)	TL	-	-																								
	Conti Hybrid HT3+ HL⁷⁾	164 K	TL	B	C	A/70	• •																						
	Conti Hybrid HT3⁷⁾	160 K (158 L)	TL	C	C	B/73	•																						
	Conti Hybrid HT3 SR⁷⁾	160 K (158 L)	TL	C	B	B/72	•																						
	Conti Hybrid HT3 ED⁷⁾	164 K	TL	C	B	B/73	•																						
	HTR 2 ED⁷⁾	160 K (158 L)	TL	B	C	B/71	•																						
HTR⁷⁾	160 K (158 L)	TL	C	C	A/70	•																							





Tyre size	Operating code			EU tyre label (EU Reg. 2020/740)						Rim		Tyre dimensions				Tyre fit-ment		Load capacity (kg) per axle at inflation pressur ⁶⁾ (bar) (psi)										
																		Max. standard value in service		Design value		Static radius	Rolling circumference	4.5 (65)	5.0 (73)	5.5 (80)	6.0 (87)	6.5 (94)
	Pattern	LI/SI ¹⁾	TT/TL ²⁾				M+S		Rim-width	Min. distance between rim centres	Width	Outer-Ø	Width + 1 %	Outer-Ø ± 1 %	± 1.5 %	± 2 %	LI ¹⁾	Tyre fit-ment										
385/65 R 22.5	Conti Scandinavia HS3	164 K (158 L)	TL	C	B	B / 74	•	•	11.75 12.25		405 410	1092	389 394	1072	496	3248	164 162 160 158	S S S S	5740 5455 5165 5110	6245 5935 5620 5555	6740 6405 6065 6000	7225 6865 6505 6430	7705 7320 6935 6855	8175 7765 7360 7275	8640 8210 7775 7690	9100 8645 8190 8095	9550 9075 8595 8500	10000 9500 9000
	Conti Scandinavia HS3 ED	164 K (158 L)	TL	C	B	A / 73	•	•																				
	HSW 2 SCAN ⁷⁾	164 K	TL	C	B	B / 73	•	•																				
	HSW 2 SCAN ⁷⁾	160 K (158 L)	TL	D	C	B / 73	•	•																				
	Conti Scandinavia HT3	164 K (158 L)	TL	C	B	B / 74	•	•																				
	HTW 2 SCAN ⁷⁾	160 K (158 L)	TL	D	C	B / 73	•	•																				
	Conti CrossTrac HS3 ⁷⁾	164 K	TL	C	B	B / 72	•	•																				
	Conti CrossTrac HS3 ⁷⁾	160 K (158 L)	TL	C	B	B / 72	•	•																				
	Conti CrossTrac HT3 ⁷⁾	160 K (158 L)	TL	C	A	B / 72	•	•																				
	HSC 1 ⁷⁾	164 K	TL	C	C	B / 73	•																					
	HSC 1 ⁷⁾	160 K (158 L)	TL	-	-		•	•																				
	HDC	164 J (162 K)	TL	D	C	B / 75	•	•																				
	HDC	162 K (164 J)	TL	D	C	B / 75	•	•																				
HTC 1 ED	160 K	TL	D	B	B / 73	•																						
425/65 R 22.5	HTR 2	165 K	TL	B	C	B / 73	•		12.25 13.00 14.00		439 447 458	1146	422 430 440	1124	518	3406	165	S	6190	6735	7270	7795	8310	8815	9315	9810	10300	
	HTC	165 K	TL	C	C	B / 74	•	•																				
445/65 R 22.5	HTR 2	169 K	TL	C	C	B / 73			13.00 14.00		462 472	1174	444 454	1150	529	3485	169	S	6660	7245	7820	8385	8940	9485	10025	10555	11080	11600
	HCS	169 K	TL	-	-		•																					
255/70 R 22.5	HSR 2	140/137 M (142/140 L)	TL	D	C	A / 69			6.75 7.50 8.25	278 287 295	257 265 272	944	247 255 262	930	434	2837	142 140 140 137	S S D D	3185 3155 6010 5805	3465 3430 6540 6315	3740 3700 7055 6815	4010 3970 7565 7305	4275 4230 8065 7790	4535 4490 8560 8265	4795 4745 9045 8735	5045 5000 9525 9200	5300 10000	
	HSR 2 SA	140/137 M (142/140 L)	TL	C	C	A / 69																						
	HDR	140/137 M (142/140 L)	TL	D	C	B / 75	•	•																				





See page 191 for footnotes





Tyre size	Operating code			EU tyre label (EU Reg. 2020/740)							Rim		Tyre dimensions						Load capacity (kg) per axle at inflation											
																			pressur ⁶⁾ (bar) (psi)											
	Pattern	LI/SI ¹⁾	TT/TL ²⁾	C ³⁾	B ⁴⁾	A/69	•	•	Rim-width	Min. distance between rim centres	Max. standard value in service		Design value		Static radius	Rolling circumference	LI ¹⁾	Tyre fit-ment	4.5 (65)	5.0 (73)	5.5 (80)	6.0 (87)	6.5 (94)	7.0 (102)	7.5 (109)	8.0 (116)	8.5 (123)	9.0 (131)		
											Width + 1 %	Outer-Ø ± 1 %	± 1.5 %	± 2 %																
275/70 R 22.5	Conti Hybrid HS3 ⁷⁾	148/145 M	TL	C	B	A/69	•	•	7.50	303	280	974	269	958	445	2922	152	S	4075	4435	4785	5130	5470	5805	6135	6460	6780	7100		
	Conti Hybrid HD3 ⁷⁾	148/145 M	TL	D	C	A/73	•	•	8.25	311	287	974	276	958	445	2922	150	S	3845	4185	4515	4840	5160	5475	5790	6095	6400	6700		
	HDW 2 SCAN ⁷⁾	148/145 M	TL	E	C	B/75	•	•									148	S	3615	3935	4245	4550	4855	5150	5440	5730	6015	6300		
	Conti Urban HA3 ⁷⁾	150/145 J (152/148 E)	TL	C	B	A/70											148	D	7235	7870	8495	9105	9710	10305	10885	11465	12035	12600		
	Conti Urban HA3 M+S	152/148 J	TL	D	B	A/70	•	•																						
	Conti UrbanScan HA3+	152/148 J	TL	D	C	B/73	•	•																						
	Conti UrbanScan HA3 ⁷⁾	150/145 J (152/148 E)	TL	D	C	B/73	•	•																						
	Conti UrbanScan HD3 ⁷⁾	150/145 J (152/148 E)	TL	D	C	B/75	•	•																						
	HTC	148/145 J	TL	E	C	B/76	•	•																						
305/70 R 22.5	HSR 1	152/148 L (150/148 M)	TL	C	B	A/70			8.25	334	309	1018	297	1000	463	3050	156	S	4805	5230	5645	6050	6450	6845	7235	7620	8000			
	HDR	150/148 M	TL	D	C	B/75	•	•	9.00	343	317	1018	305	1000	463	3050	154	S	4305	4685	5055	5420	5780	6130	6480	6825	7160	7500		
	Conti Urban HA3 M+S	156/154 K	TL	C	C	A/71	•	•									152	S	4075	4435	4785	5130	5470	5805	6135	6460	6780	7100		
	Conti Urban HA3 M+S	152/148 K (154/150 E)	TL	C	C	A/71	•	•									150	S	4025	4380	4725	5070	5405	5735	6060	6380	6700			
																	154	D	9015	9810	10585	11350	12100	12840	13570	14285	15000			
315/70 R 22.5	Conti EcoPlus HS3+ ⁷⁾	156/150 L (154/150 M)	TL	B	B	A/71	•	•	9.00	351	318	1032	312	1014	468	3093	156	S	4590	4995	5390	5780	6165	6540	6910	7280	7640	8000		
	Conti EcoPlus HS3 ⁷⁾	156/150 L (154/150 M)	TL	B	B	A/69	•	•	9.75	360	326	1032	320	1014	468	3093	154	S	4305	4685	5055	5420	5780	6130	6480	6825	7160	7500		
	Conti EcoPlus HD3+ ⁷⁾	154/150 L (152/148 M)	TL	B	C	A/73	•	•									152	S	4265	4640	5010	5370	5725	6075	6420	6760	7100			
	Conti EcoPlus HD3 ⁷⁾	154/150 L (152/148 M)	TL	B	B	A/72	•	•									150	D	7695	8370	9035	9685	10325	10955	11580	12195	12800	13400		
	Conti Hybrid HS5 ⁷⁾	156/150 L (154/150 M)	TL	C	B	A/70	•	•									148	D	7575	8240	8890	9535	10165	10785	11395	12000	12600			
	Conti Hybrid HS3+ ⁷⁾	156/150 L (154/150 M)	TL	C	B	A/70	•	•																						
	Conti EcoRegional HS3+ ⁷⁾	156/150 L (154/150 M)	TL	B	B	A/70	•	•																						

Tyre size	Operating code			EU tyre label (EU Reg. 2020/740)						Rim		Tyre dimensions					Load capacity (kg) per axle at inflation pressur ⁶⁾ (bar) (psi)													
	Pattern	LI/SI ¹⁾	TT/TL ²⁾	 ³⁾	 ⁴⁾	 ⁵⁾	M+S		Rim-width	Min. distance between rim centres	Max. standard value in service	Design value		Static radius	Rolling circumference	LI ¹⁾	Tyre fit-ment	4.5 (65)	5.0 (73)	5.5 (80)	6.0 (87)	6.5 (94)	7.0 (102)	7.5 (109)	8.0 (116)	8.5 (123)	9.0 (131)			
315/70 R 22.5	Conti EcoRegional HS3 ⁷⁾	156/150 L (154/150 M)	TL	C	B	A/70	•	•	9.00	351	318 1032	312 320	1014	468	3093	156	S	4590	4995	5390	5780	6165	6540	6910	7280	7640	8000			
	Conti EfficientPro S+ ⁷⁾	156/150 L (154/150 M)	TL	A	C	A/70	•	•	9.75	360						154	S	4305	4685	5055	5420	5780	6130	6480	6825	7160	7500			
	Conti EfficientPro S ⁷⁾	156/150 L (154/150 M)	TL	A	B	A/70	•	•								152	S	4265	4640	5010	5370	5725	6075	6420	6760	7100				
	Conti Hybrid HS3 ⁷⁾	156/150 L (154/150 M)	TL	C	B	A/70	•	•								150	D	7695	8370	9035	9685	10325	10955	11580	12195	12800	13400			
	Conti Hybrid HS3 ⁷⁾	154/150 L (152/148 M)	TL	C	B	A/70	•	•								148	D	7575	8240	8890	9535	10165	10785	11395	12000	12600				
	HSR 1 ⁷⁾	154/150 L (152/148 M)	TL	C	B	A/70	•																							
	Conti Hybrid HD5 ⁷⁾	154/150 L (152/148 M)	TL	C	C	B/76	•	•																						
	Conti EcoRegional HD3+ ⁷⁾	154/150 L (152/148 M)	TL	C	C	A/73	•	•																						
	Conti EcoRegional HD3 ⁷⁾	154/150 L (152/148 M)	TL	C	C	A/73	•	•																						
	Conti EfficientPro D+ ⁷⁾	154/150 L (152/148 M)	TL	A	C	A/73	•	•																						
	Conti EfficientPro D ⁷⁾	154/150 L (152/148 M)	TL	A	C	A/71	•	•																						
	Conti Hybrid HD3 ⁷⁾	154/150 L (152/148 M)	TL	C	B	A/73	•	•																						
	HDR +	152/148 M (154/150 L)	TL	D	C	B/75	•	•																						
	Conti Scandinavia HS3 ⁷⁾	156/150 L (154/150 M)	TL	C	B	B/72	•	•																						
	HSW 2 SCAN ⁷⁾	156/150 L (154/150 M)	TL	D	C	B/73	•	•																						
	HSW 2 SCAN ⁷⁾	154/150 L (152/148 M)	TL	D	C	B/73	•	•																						
	Conti Scandinavia Ext HD3 ⁷⁾	154/150 L (152/148 M)	TL	D	D	A/73	•	•																						
	Conti Scandinavia HD3 ⁷⁾	154/150 L (152/148 M)	TL	D	B	B/75	•	•																						
	HDW 2 SCAN ⁷⁾	154/150 L (152/148 M)	TL	D	C	B/75	•	•																						

Tyre size	Operating code			EU tyre label (EU Reg. 2020/740)						Rim		Tyre dimensions				LI ¹⁾	Tyre fit-ment	Load capacity (kg) per axle at inflation pressur ⁶⁾ (bar) (psi)											
																		Max. standard value in service		Design value		Static radius	Rolling circumference						
	Pattern	LI/SI ¹⁾	TT/TL ²⁾	 ³⁾	 ⁴⁾	 ⁵⁾	M+S		Rim-width	Min. distance between rim centres	Width	Outer-Ø	Width + 1 %	Outer-Ø ± 1 %	± 1.5 %			± 2 %	4.5 (65)	5.0 (73)	5.5 (80)			6.0 (87)	6.5 (94)	7.0 (102)	7.5 (109)	8.0 (116)	8.5 (123)
295/80 R 22.5	HSL 2+ ECO-PLUS	154/148 M	TL	C	B	A / 70			8.25	326	302	1062		290	1044	487	3184	154	S	4505	4905	5290	5675	6050	6420	6785	7140	7500	
	HSL 2+ ECO-PLUS⁷⁾	152/148 M	TL	C	B	A / 70		9.00	335	310				298				152	S	4265	4640	5010	5370	5725	6075	6420	6760	7100	
	HSL 1+ COACH⁷⁾	152/148 M	TL	C	B	B / 73												149	D	7815	8500	9175	9835	10485	11125	11760	12380	13000	
	HDL 1 ECO-PLUS⁷⁾	152/148 M	TL	D	C	B / 74	•	•										148	D	7575	8240	8890	9535	10165	10785	11395	12000	12600	
	Conti Hybrid HS5⁷⁾	154/149 M	TL	C	B	A / 70	•	•																					
	Conti Hybrid HS3+⁷⁾	154/149 M	TL	C	B	A / 70	•	•																					
	Conti EcoRegional HS3⁷⁾	154/149 M	TL	C	B	A / 70	•	•																					
	Conti Hybrid HS3⁷⁾	154/149 M	TL	C	B	A / 69	•	•																					
	Conti Hybrid HS3⁷⁾	152/148 M	TL	C	B	A / 69	•	•																					
	Conti Hybrid HD5⁷⁾	152/148 M	TL	D	B	B / 76	•	•																					
	Conti EcoRegional HD3⁷⁾	152/148 M	TL	C	C	A / 73	•	•																					
	Conti Hybrid HD3⁷⁾	152/148 M	TL	D	B	A / 73	•	•																					
	HDR +⁷⁾	152/148 M	TL	E	C	B / 75	•	•																					
	Conti Scandinavia HS3⁷⁾	154/149 M	TL	C	B	B / 72	•	•																					
	Conti Scandinavia HS3⁷⁾	152/148 M	TL	C	B	B / 72	•	•																					
	HSW 2 SCAN⁷⁾	152/148 M	TL	D	C	B / 73	•	•																					
	Conti Scandinavia Ext HD3⁷⁾	152/148 M	TL	D	C	A / 73	•	•																					
	Conti Scandinavia HD3⁷⁾	152/148 M	TL	D	B	B / 75	•	•																					
	HDW 2 SCAN⁷⁾	152/148 M	TL	E	C	B / 75	•	•																					
	Conti Coach HA3⁷⁾	154/149 M	TL	B	B	A / 70	•	•																					
Conti Coach HA3 ED⁷⁾	154/149 M	TL	C	B	A / 70																								

Tyre size	Operating code			EU tyre label (EU Reg. 2020/740)						Rim		Tyre dimensions				LI ¹⁾	Tyre fit-ment	Load capacity (kg) per axle at inflation pressur ⁶⁾ (bar) (psi)															
																		Max. standard value in service		Design value		Static radius	Rolling circumference	4.5 (65)	5.0 (73)	5.5 (80)	6.0 (87)	6.5 (94)	7.0 (102)	7.5 (109)	8.0 (116)	8.5 (123)	9.0 (131)
	Pattern	LI/SI ¹⁾	TT/TL ²⁾	 ³⁾	 ⁴⁾	 ⁵⁾	M+S		Rim-width	Min. distance between rim centres	Width	Outer-Ø	Width + 1 %	Outer-Ø ± 1 %	± 1.5 %			± 2 %	4.5 (65)	5.0 (73)	5.5 (80)	6.0 (87)	6.5 (94)	7.0 (102)	7.5 (109)	8.0 (116)	8.5 (123)	9.0 (131)					
295/80 R 22.5	Conti Coach HA3 AC ⁷⁾	154/149 M	TL	-	-				8.25	326	302	1062		290	1044	487	3184	154	S	4505	4905	5290	5675	6050	6420	6785	7140	7500					
	Conti CoachRegio HA3 ⁷⁾	154/149 M	TL	C	B	A / 71	•	•	9.00	335	310			298				152	S	4265	4640	5010	5370	5725	6075	6420	6760	7100					
	Conti CoachRegio HD3 ⁷⁾	154/149 M	TL	C	B	A / 73	•	•										149	D	7815	8500	9175	9835	10485	11125	11760	12380	13000					
	HSU	152/148 J	TL	D	C	A / 70													148	D	7575	8240	8890	9535	10165	10785	11395	12000	12600				
	HSW 2+ COACH ⁷⁾	154/149 M	TL	C	C	B / 73	•	•																									
	HSW 2 Coach ⁷⁾	154/149 M	TL	D	C	B / 73	•	•																									
	HSW 2 Coach ⁷⁾	152/148 M	TL	D	C	B / 73	•	•																									
	Conti CrossTrac HS3	154/149 K	TL	C	B	B / 72	•	•																									
	Conti CrossTrac HS3	152/148 K	TL	C	B	B / 72	•	•																									
	Conti CrossTrac HD3	152/148 K	TL	D	C	B / 76	•	•																									
	HSC 1 ED	152/148 K	TL	-	-		•																										
	HDC 1 ED	152/148 K	TL	-	-		•																										
315/80 R 22.5	Conti EcoPlus HS3+ AC ⁷⁾	156/150 L (154/150 M)	TL	**	**				9.00	351	318	1096		312	1076	500	3282	158	S	4880	5310	5730	6145	6550	6950	7345	7735	8120	8500				
	Conti EcoPlus HS3+ ⁷⁾	156/150 L (154/150 M)	TL	B	B	A / 70	•	•	9.75	360	326			320				156	S	4805	5230	5645	6050	6450	6845	7235	7620	8000					
	Conti EcoPlus HS3 ⁷⁾	156/150 L (154/150 M)	TL	B	B	A / 69	•	•										154	S	4505	4905	5290	5675	6050	6420	6785	7140	7500					
	HSL 2+ ECO-PLUS AC ⁷⁾	156/150 L (154/150 M)	TL	-	-														150	D	8055	8760	9455	10140	10810	11470	12120	12765	13400				
	Conti EcoPlus HD3+ ⁷⁾	156/150 L (154/150 M)	TL	B	C	A / 73	•	•																									
	Conti EcoPlus HD3 ⁷⁾	156/150 L (154/150 M)	TL	B	B	A / 72	•	•																									
	HDL 2 ECO-PLUS ⁷⁾	156/150 L (154/150 M)	TL	**	**		•																										
	Conti Hybrid HS5 ⁷⁾	156/150 L (154/150 M)	TL	C	B	A / 71	•	•																									
	Conti Hybrid HS3+ ⁷⁾	156/150 L (154/150 M)	TL	C	B	A / 70	•	•																									

Tyre size	Operating code			EU tyre label (EU Reg. 2020/740)						Rim		Tyre dimensions				Tyre fitment		Load capacity (kg) per axle at inflation pressure ⁶⁾ (bar) (psi)											
	Pattern	LI/SI ¹⁾	TT/TL ²⁾	 ³⁾	 ⁴⁾	 ⁵⁾	M+S		Rim-width	Min. distance between rim centres	Width	Outer-Ø	Design value	Static radius	Rolling circumference	LI ¹⁾	Tyre fitment	4.5 (65)	5.0 (73)	5.5 (80)	6.0 (87)	6.5 (94)	7.0 (102)	7.5 (109)	8.0 (116)	8.5 (123)	9.0 (131)		
315/80 R 22.5	Conti EcoRegional HS3+ ⁷⁾	156/150 L (154/150 M)	TL	B	B	A/70	•	•	9.00	351	318	1096					158	S	4880	5310	5730	6145	6550	6950	7345	7735	8120	8500	
	Conti EcoRegional HS3 ⁷⁾	156/150 L (154/150 M)	TL	C	B	A/70	•	•	9.75	360	326						156	S	4805	5230	5645	6050	6450	6845	7235	7620	8000		
	Conti Hybrid HS3 ⁷⁾	156/150 L (154/150 M)	TL	C	B	A/69	•	•									154	S	4505	4905	5290	5675	6050	6420	6785	7140	7500		
	HSR 2	158/150 L	TL	C	C	B/73											150	D	8055	8760	9455	10140	10810	11470	12120	12765	13400		
	HSR 2 ⁷⁾	156/150 L (154/150 M)	TL	C	C	B/73																							
	HSR 2 ED ⁷⁾	156/150 L (154/150 M)	TL	D	C	B/73																							
	HSR 1 ⁷⁾	156/150 L (154/150 M)	TL	C	B	A/70	•																						
	Conti Hybrid HD5 ⁷⁾	156/150 L (154/150 M)	TL	C	C	B/75	•	•																					
	Conti EcoRegional HD3+ ⁷⁾	156/150 L (154/150 M)	TL	C	C	A/73	•	•																					
	Conti EcoRegional HD3 ⁷⁾	156/150 L (154/150 M)	TL	C	C	A/73	•	•																					
	Conti Hybrid HD3 ⁷⁾	156/150 L (154/150 M)	TL	D	B	A/73	•	•																					
	HDR+ ⁷⁾	156/150 L (154/150 M)	TL	D	C	B/75	•	•																					
	HTR ⁷⁾	156/150 K	TL	C	C	B/72																							
	Conti Scandinavia HS3 ⁷⁾	156/150 L (154/150 M)	TL	C	B	B/72	•	•																					
	Conti Scandinavia HS3 ED ⁷⁾	156/150 L (154/150 M)	TL	-	-		•	•																					
	HSW 2 SCAN ⁷⁾	156/150 L (154/150 M)	TL	D	C	B/73	•	•																					
	Conti Scandinavia Ext HD3 ⁷⁾	156/150 L (154/150 M)	TL	D	D	B/76	•	•																					
Conti Scandinavia HD3 ⁷⁾	156/150 L (154/150 M)	TL	D	B	B/75	•	•																						
HDW 2 SCAN ⁷⁾	156/150 L (154/150 M)	TL	E	C	B/75	•	•																						

Tyre size	Operating code			EU tyre label (EU Reg. 2020/740)						Rim		Tyre dimensions				Load capacity (kg) per axle at inflation																
																pressur ⁶⁾ (bar) (psi)																
	Pattern	LI/SI ¹⁾	TT/TL ²⁾				M+S		Rim-width	Min. distance between rim centres	Max. standard value in service	Design value		Static radius	Rolling circumference	LI ¹⁾	Tyre fit-ment	4.5 (65)	5.0 (73)	5.5 (80)	6.0 (87)	6.5 (94)	7.0 (102)	7.5 (109)	8.0 (116)	8.5 (123)	9.0 (131)					
315/80 R 22.5	Conti Coach HA3 ⁷⁾	156/150 L (154/150 M)	TL	B	B	A / 71	•	•	9.00	351	318	1096		312	1076	500	3282	158	S	4880	5310	5730	6145	6550	6950	7345	7735	8120	8500			
	Conti Coach HA3 AT	156/150 L	TL	-	-		•		9.75	360	326			320				156	S	4805	5230	5645	6050	6450	6845	7235	7620	8000				
	HSW 2+ COACH ⁷⁾	156/150 L (154/150 M)	TL	C	C	B / 73	•	•										154	S	4505	4905	5290	5675	6050	6420	6785	7140	7500				
	HSW 2 Coach ⁷⁾	156/150 L (154/150 M)	TL	D	C	B / 73	•	•											150	D	8055	8760	9455	10140	10810	11470	12120	12765	13400			
	Conti CrossTrac HS3 ⁷⁾	156/150 K	TL	C	B	B / 72	•	•																								
	Conti CrossTrac HD3 ⁷⁾	156/150 K	TL	D	B	B / 76	•	•																								
	HSC 1 ⁷⁾	156/150 K	TL	D	C	B / 73	•																									
	HSC 1 ED ⁷⁾	156/150 K	TL	D	C	B / 73	•	•																								
	HDC 1 ⁷⁾	156/150 K	TL	D	C	B / 74	•	•																								
	HDC 1 ED ⁷⁾	156/150 K	TL	D	C	B / 74	•	•																								
HDO	156/150 G	TL	-	-		•																										
9 R 22.5	HSR	133/131 L	TL	D	C	A / 70			6.00	250	231	986		222	970	455	2959	133	S	2890	3145	3395	3640	3880	4120							
								6.75	259	239				230				131	D	5475	5955	6430	6895	7350	7800							
10 R 22.5	RMS	144/142 K	TL	D	C	B / 74	•	•	6.75	277	256	1038		246	1020	474	3091	144	S	3530	3840	4145	4445	4740	5030	5315	5600					
	HSR	144/142 K	TL	D	C	A / 70			7.50	286	264			254				140	S	3320	3610	3900	4180	4455	4730	5000						
	T9	140/138 K	TL	-	-		•											142	D	6685	7275	7850	8420	8975	9525	10065	10600					
11 R 22.5	HSR	148/145 L	TL	C	C	A / 70			7.50	306	283	1070		272	1050	489	3203	148	S	3785	4120	4445	4765	5080	5390	5695	6000	6300				
	HDR	148/145 L	TL	E	C	B / 75	•	•	8.25	314	290			279				145	D	6970	7585	8185	8775	9355	9930	10490	11050	11600				
	HTR	148/145 L	TL	C	C	A / 70																										
	HSU 1	148/145 J	TL	E	C	A / 70																										
	HSC 1	148/145 K	TL	D	C	B / 73	•																									

Tyre size	Operating code			EU tyre label (EU Reg. 2020/740)					Rim		Tyre dimensions				Load capacity (kg) per axle at inflation pressur ⁶⁾ (bar) (psi)																	
															Pattern	LI/SI ¹⁾	TT/TL ²⁾	C ³⁾	C ⁴⁾	A/70 ⁵⁾	M+S	Rim-width	Min. distance between rim centres	Max. standard value in service		Design value		Static radius	Rolling circumference	LI ¹⁾	Tyre fitment	Load capacity (kg) per axle at inflation pressur ⁶⁾ (bar) (psi)
	Width	Outer-Ø	Width + 1 %	Outer-Ø ± 1 %	± 1.5 %	± 2 %	4.5 (65)	5.0 (73)	5.5 (80)	6.0 (87)	6.5 (94)	7.0 (102)	7.5 (109)	8.0 (116)										8.5 (123)	9.0 (131)							
																										8.25	329					304
12 R 22.5	Conti Hybrid HS3	152/148 L (150/148 M)	TL	C	C	A/70	•	•	8.25	329	304	1104		292	1084	504	3306	152	S	4265	4640	5010	5370	5725	6075	6420	6760	7100				
	HSR 1 ED	152/148 L (150/148 M)	TL	D	C	A/70			9.00	338	312	1104		300	1084	504	3306	150	S	4225	4600	4960	5320	5670	6020	6360	6700					
	Conti CityPlus HA3	152/148 L (150/148 M)	TL	C	C	B/71													148	D	7575	8240	8890	9535	10165	10785	11395	12000	12600			
	HSC 1	152/148 K	TL	D	C	B/72	•	•																								
	HSC 1 ED	152/148 K	TL	D	C	B/73	•	•																								
	HDC 1	152/148 K	TL	E	C	B/74	•	•																								
13 R 22.5	HSR	154/150 L (156/150 K)	TL	D	C	A/70			9.00	352	319	1146		313	1124	521	3428	156	S	4590	4995	5390	5780	6165	6540	6910	7280	7640	8000			
	HDW	154/150 K	TL	E	C	B/74	•	•	9.75	360	326	1146		320	1124	521	3428	154	S	4505	4905	5290	5675	6050	6420	6785	7140	7500				
	Conti CrossTrac HS3 ⁷⁾	156/150 K	TL	D	B	A/70	•	•											149	S	4315	4695	5070	5435	5795	6150	6500					
	Conti CrossTrac HD3 ⁷⁾	156/150 K	TL	E	C	B/75	•	•											154	D	8615	9370	10115	10840	11560	12265	12960	13650	14325	15000		
	HSC 1 ⁷⁾	156/150 K	TL	D	C	B/73	•												150	D	8055	8760	9455	10140	10810	11470	12120	12765	13400			
	HSC 1 ED	156/154 K	TL	D	C	B/73	•	•											146	D	7970	8675	9360	10035	10700	11355	12000					
	HSC 1 ED ⁷⁾	156/150 K	TL	D	C	B/73	•	•																								
	HDC 1 ED	156/150 G (154/150 K)	TL	E	C	B/74	•	•																								
	HSO	149/146 J	TL	-	-		•																									
HDO	154/150 G	TL	-	-		•																										
325/95 R 24 (12.00 R 24)	HSR 1	162/160 K	TT	C	D	B/73			8.50	368	326	1252		320	1228	568	3745	162	S		6210	6705	7185	7665	8130	8590	9050	9500				
	HSC 1	162/160 K	TT	D	D	B/73	•		10.00	374	332	1252		325	1228	568	3745	160	D		11770	12705	13620	14520	15410	16280	17145	18000				
	HDC 1	162/160 K	TT	C	C	B/74	•	•																								
	HCS	162/160 K	TT	-	-		•																									
12.00 R 24	HDC 1	160/156 K	TT	D	C	B/74	•	•	7.33	346	307	1250		301	1226	567	3739	160	S		5885	6350	6810	7260	7705	8140	8570	9000				
									8.00	353	313	1250		307	1226	567	3739	156	D		10465	11290	12105	12905	13695	14475	15240	16000				
									8.50	360	319	1250		313	1226	567	3739															
									9.00	366	324	1250		318	1226	567	3739															

Regrooving recommendations

All Continental tyres on which regrooving is permitted have on both sidewalls, in accordance with ECE regulation 54, the word **REGROOVABLE**

The additional tread depth of up to 4 mm gained by regrooving means a significant increase in performance.

As part of their design, all-steel truck tyres have a so-called tread stock between the upper edge of the belt and the tread grooves. This tread stock is intended to prevent stones etc. penetrating into the steel belt and the casing.

Provided it is marked "REGROOVABLE", a commercial vehicle tyre may be regrooved down to a residual undertread thickness of 2 mm above the breaker or belt. All additional regulations of the respective country must be met.

Although tyres can be retreaded after reaching the legal wear limit, regrooving is not advisable in every case. The tread stock thickness is reduced and stones etc. can more easily penetrate and damage the steel belts, leading to rust formation. This has a negative effect on the tyre's suitability for retreading.

The best time for regrooving is when the tread is worn down to about 3 mm. The tyre must then be checked to make sure the wear is even all round. Attention should be paid to local or uneven wear patches.

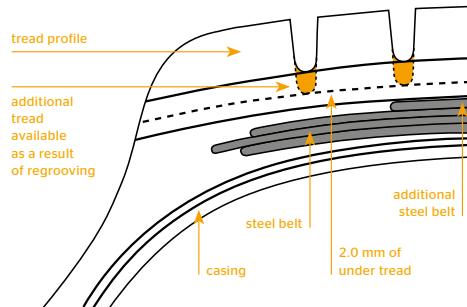

Example:

Tyre size	315/80 R 22.5
Original tread depth of new tyre	20.0 mm
Additional tread as a result of regrooving	4.0 mm

Regrooving should be carried out by an expert, in order to avoid premature failure as well as any reduction in the tyre's suitability for retreading.

In some countries (e.g. Germany for KOM-100 coaches and Austria for coaches) regrooving of front axle tyres for coaches is prohibited. In general, regrooving on front axle coach tyres is not recommended.

All Continental tyres on which regrooving is permitted are marked "regroovable".

Segment Goods Motorway

Conti EcoPlus HS3 / XL / Conti EcoPlus HS3+

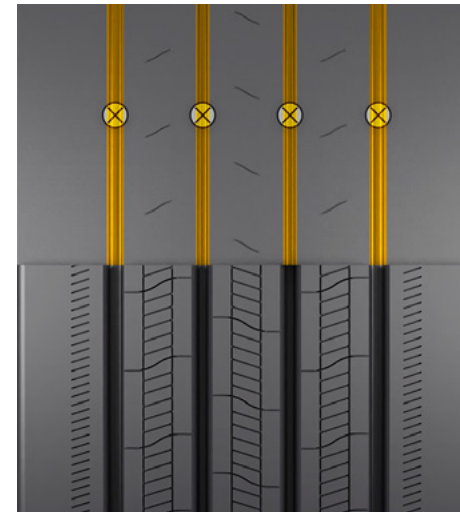

Size	Depth (mm)	Approximate Width (mm)
315/70 R 22.5	2.5	A:10 B:8
315/80 R 22.5	3.0	A:10 B:8

Conti EcoPlus HS3 / XL / Conti EcoPlus HS3+



Size	Depth (mm)	Approximate Width (mm)
355/50 R 22.5	2.5	A:10 B:8
385/55 R 22.5	3.0	A:10 B:8
385/65 R 22.5	3.0	A:10 B:8

⊗ Tread depth measuring points

Segment Goods Motorway

Conti EcoPlus HS3 / XL / Conti EcoPlus HS3+

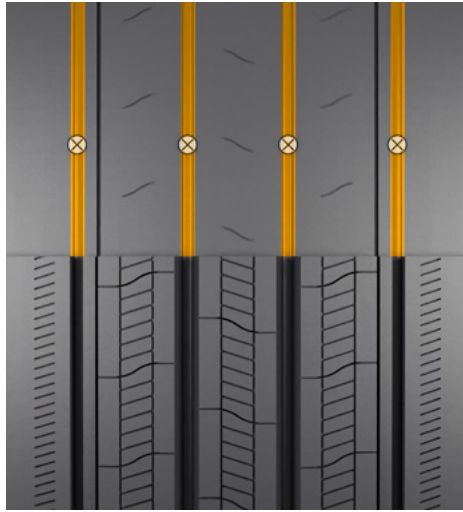

Size	Depth (mm)	Approximate Width (mm)
295/60 R 22.5	3.5	7.0
315/60 R 22.5	3.0	7.0

Conti EcoPlus HS3 AC / Conti EcoPlus HS3+ AC



Size	Depth (mm)	Approximate Width (mm)
315/80 R 22.5	3.0	9.0 / 10.0*

* Conti EcoPlus HS3 AC: 9.0 mm
Conti EcoPlus HS3+ AC: 10.0 mm

Conti EfficientPro S / S+



Size	Depth (mm)	Approximate Width (mm)
385/55 R 22.5	3.0	A:11 B:8

Conti EfficientPro S / S+



Size	Depth (mm)	Approximate Width (mm)
315/70 R 22.5	3.0	A:11 B:9

Segment Goods Motorway

HSL2+ EcoPlus / HSL2+ EcoPlus AC

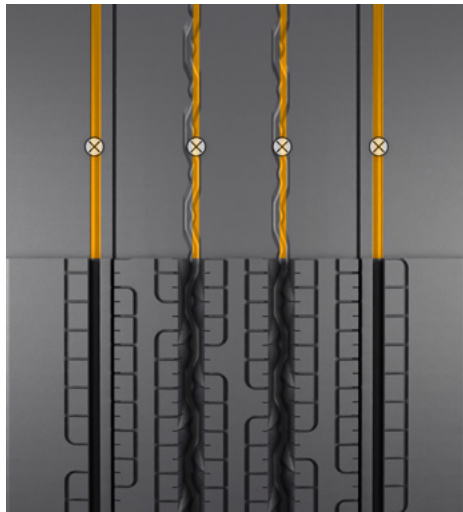

	A	B	B	A
	Depth (mm)		Approximate Width (mm)	
Size				
315/60 R 22.5	3.5		A:16 B:12	
315/70 R 22.5	3.5		A:16 B:12	
315/80 R 22.5	3.5		A:16 B:12	

HSL2+ EcoPlus / HSL2+ EcoPlus AC

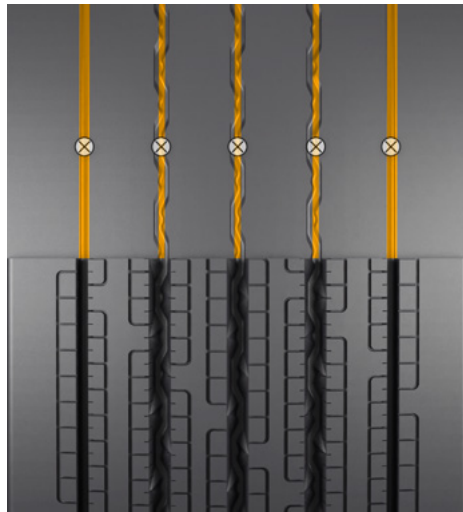

	A	B	B	B	A
	Depth (mm)		Approximate Width (mm)		
Size					
385/65 R 22.5	3.0		A:16 B:12		

Conti EcoPlus HD3 / ContiRe / Conti EcoPlus HD3+

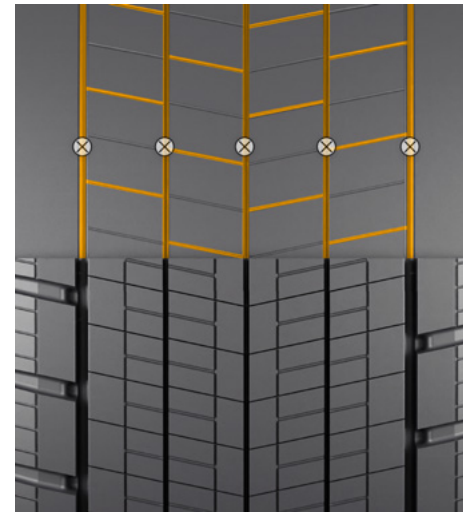

	A	B	B	B	B	B	B	B	A
	Depth (mm)		Approximate Width (mm)						
Size									
295/55 R 22.5	3.0		A:8 B:5						
295/60 R 22.5	2.5		A:7 B:5						
315/60 R 22.5	4.0		A:8 B:5						
315/70 R 22.5	3.0		A:8 B:5						
315/80 R 22.5	3.0		A:8 B:5						

Conti EcoPlus HD3 / ContiRe

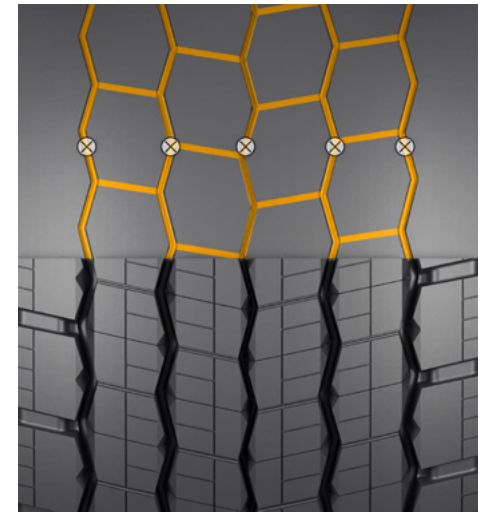

	A	B	A	B	B	A	B	A
	Depth (mm)		Approximate Width (mm)					
Size								
315/45 R 22.5	2.5		A:7 B:5					

⊗ Tread depth measuring points

Segment Goods Motorway

Conti EfficientPro D /D+

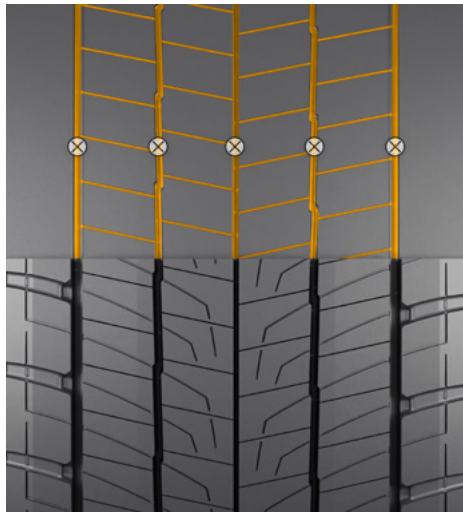

A B B B B B B B A

Size	Depth (mm)	Approximate Width (mm)
315/70 R 22.5	3.0	A:8 B:5

Conti EcoPlus HT3 / ContiRe / Conti EcoPlus HT3+

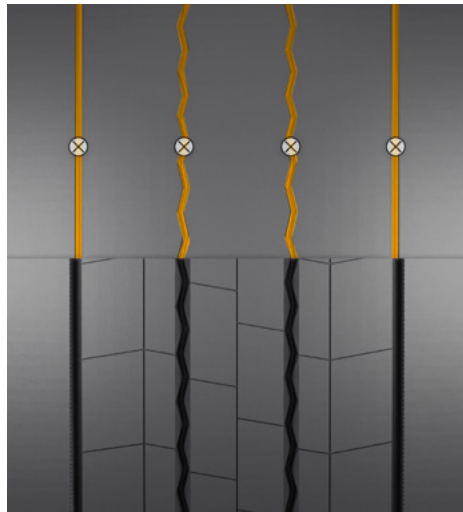

Size	Depth (mm)	Approximate Width (mm)
385/55 R 19.5	2.5	6
385/55 R 22.5	2.5	6
385/65 R 22.5	2.5	6

HTL 2 ECO-PLUS

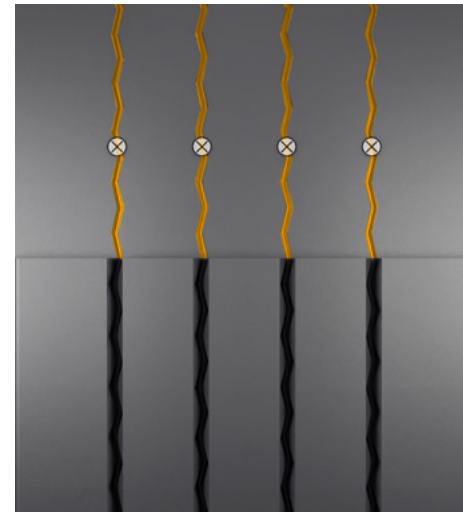

Size	Depth (mm)	Approximate Width (mm)
385/65 R 22.5	3.0	12

HTL 2 ECO-PLUS

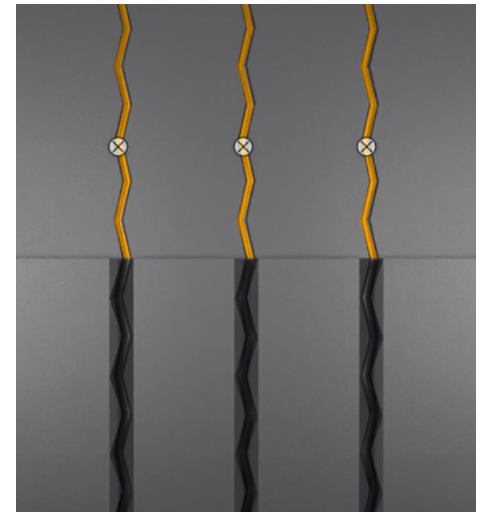

Size	Depth (mm)	Approximate Width (mm)
245/70 R 17.5	2.5	8
215/75 R 17.5	2.5	8
235/75 R 17.5	2.5	8

⊗ Tread depth measuring points

Segment Goods Motorway

HDL 1 ECO-PLUS

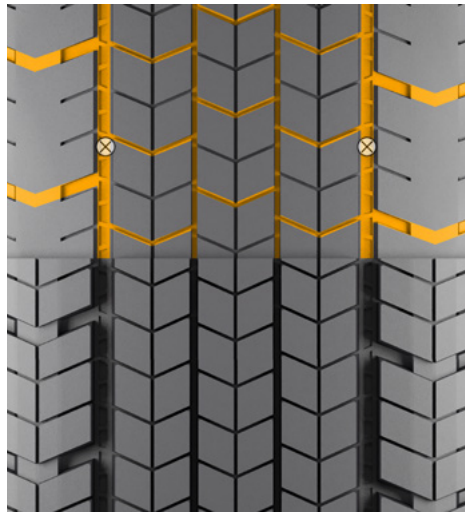

Size	Depth (mm)	Approximate Width (mm)
295/80 R 22.5	3.0	A:10 B:5-6

⊗ Tread depth measuring points

Segment Goods Regional

Conti Hybrid HS5

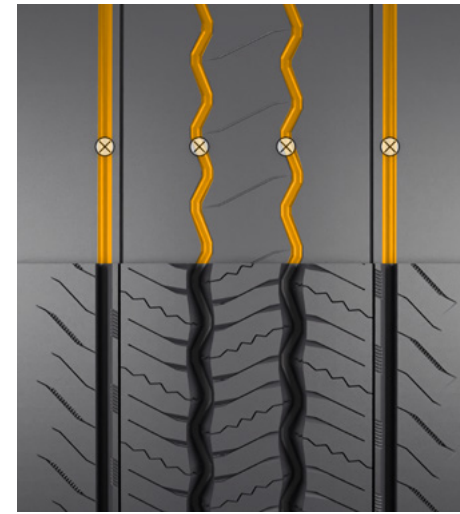

Size	Depth (mm)	Approximate Width (mm)
315/70 R 22.5	3.0	7

Conti Hybrid HS5

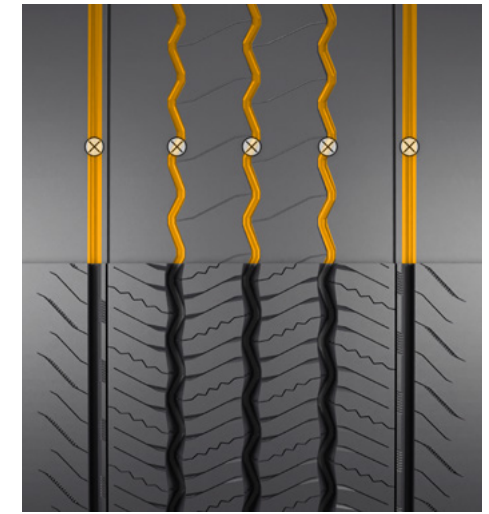

Size	Depth (mm)	Approximate Width (mm)
385/55 R 22.5	3.0	7

Segment Goods Regional

Conti Hybrid HS5

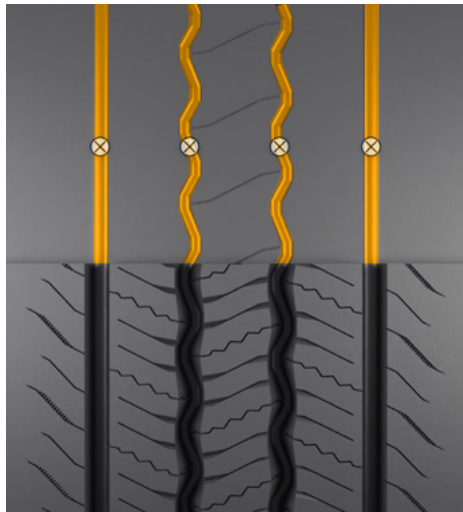

Size	Depth (mm)	Approximate Width (mm)
315/80 R 22.5	3.0	9

Conti Hybrid HS5

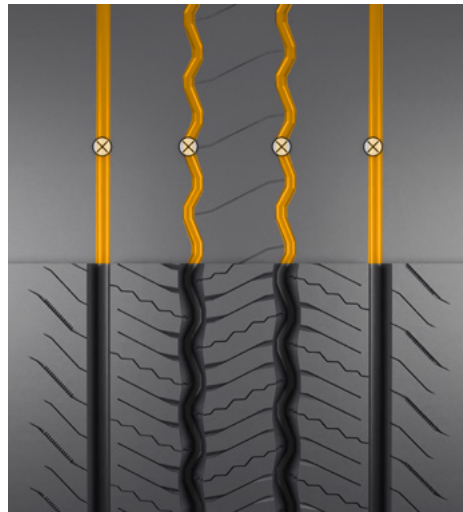

Size	Depth (mm)	Approximate Width (mm)
385/65 R 22.5	3.0	A:10 B:9

Conti EcoRegional HS3 / HS3+

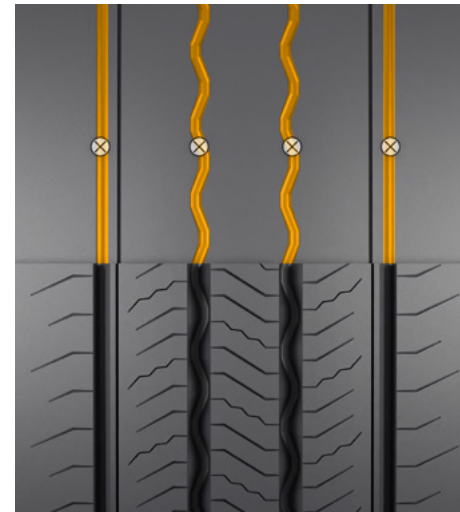

Size	Depth (mm)	Approximate Width (mm)
315/70 R 22.5	3.0	7

Conti EcoRegional HS3 / HS3+

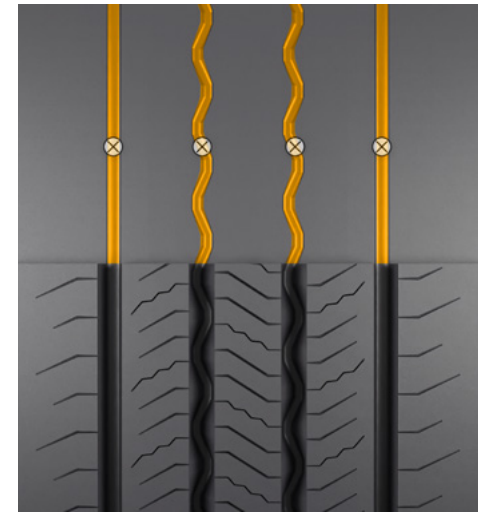

Size	Depth (mm)	Approximate Width (mm)
295/80 R 22.5	3.0	A:10 B:8
315/80 R 22.5	3.0	A:10 B:8

Segment Goods Regional

Conti EcoRegional HS3 / HS3+

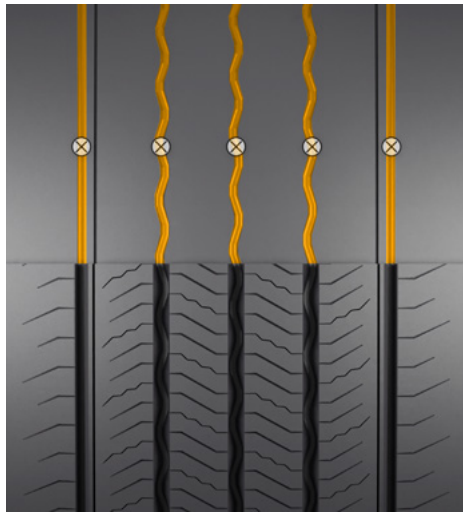

Size	Depth (mm)	Approximate Width (mm)
385/55 R 22.5	3.0	8

Conti EcoRegional HS3 / HS3+

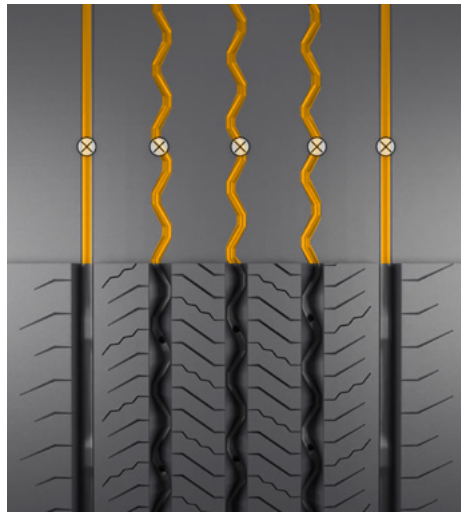

Size	Depth (mm)	Approximate Width (mm)
385/65 R 22.5	3.0	9

Conti Hybrid LS3

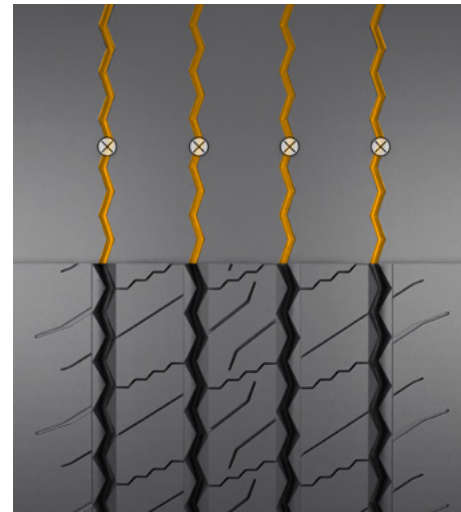

Size	Depth (mm)	Approximate Width (mm)
245/70 R 17.5	2.0	5
265/70 R 17.5	2.5	6
205/75 R 17.5	2.5	5
215/75 R 17.5	2.5	6
225/75 R 17.5	2.5	6
235/75 R 17.5	2.5	6

Segment Goods Regional

HSR 2 XL



Size	Depth (mm)	Approximate Width (mm)
315/80 R 22.5	3.5	10

HSR 2 XL

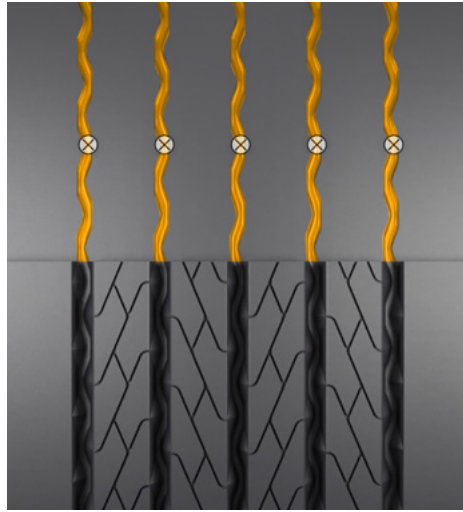

Size	Depth (mm)	Approximate Width (mm)
385/65 R 22.5	3.0	10-12

HSR 1

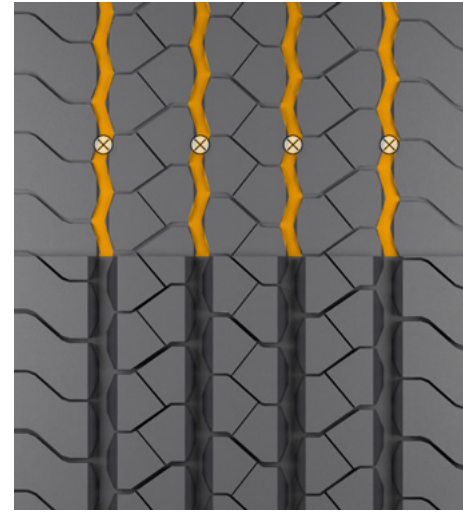

Size	Depth (mm)	Approximate Width (mm)
305/70 R 22.5	2.5	10-12

⊗ Tread depth measuring points

Segment Goods Regional

HSR

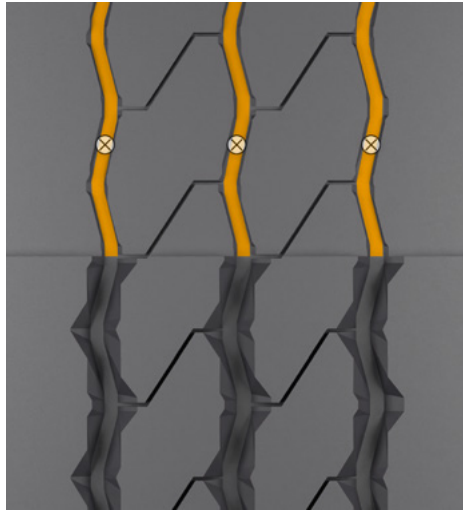

Size	Depth (mm)	Approximate Width (mm)
10.00 R 20	3.5	7-8
11.00 R 20	3.0	7-8
12.00 R 20	2.5	7-8
235/75 R 17.5	2.5	6

HSR



Size	Depth (mm)	Approximate Width (mm)
9 R 22.5	3.0	A:10-12 B:4-5
10 R 22.5	3.5	A:10-12 B:4-5
11 R 22.5	3.0	A:10-12 B:4-5
13 R 22.5	2.5	A:10-12 B:4-5

LSR 1+ / LSR 1

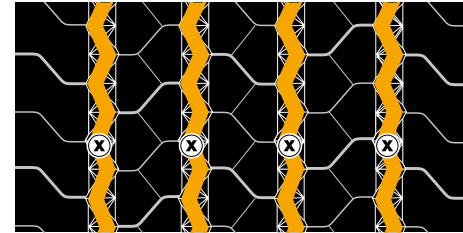

Size	Depth (mm)	Approximate Width (mm)
8.5 R 17.5	2.0	7-8
9.5 R 17.5	2.5	7-8
10 R 17.5	2.5	7-8

LSR+

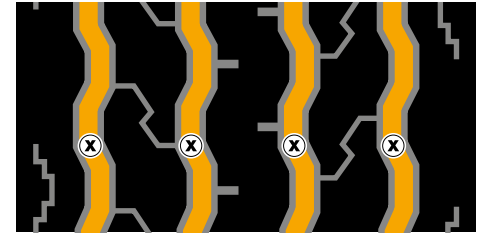

Size	Depth (mm)	Approximate Width (mm)
7.00 R 16	1.5	7
7.50 R 16	1.5	7

⊗ Tread depth measuring points

Segment Goods Regional

Conti Hybrid HD5

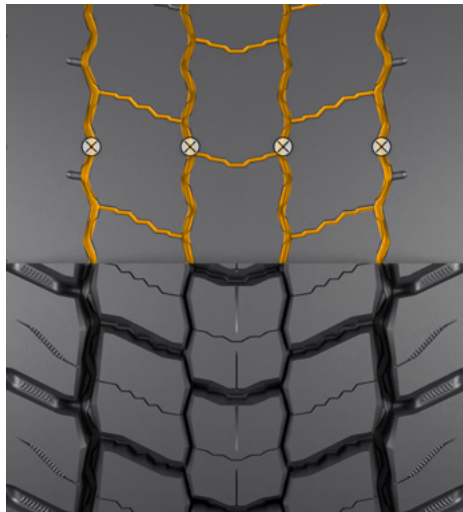

	A	B	A	B	A	B	A
	Depth (mm)		Approximate Width (mm)				
Size							
315/80 R 22.5	3.0		A:7 B:5				

Conti Hybrid HD5

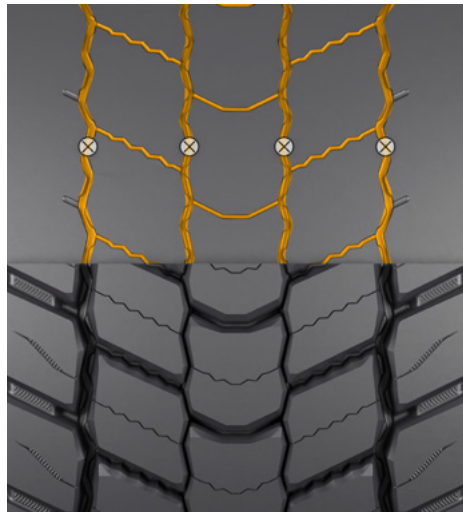

	A	B	A	B	A	B	A
	Depth (mm)		Approximate Width (mm)				
Size							
315/70 R 22.5	3.0		A:8 B:5				

Conti EcoRegional HD3 / HD3+

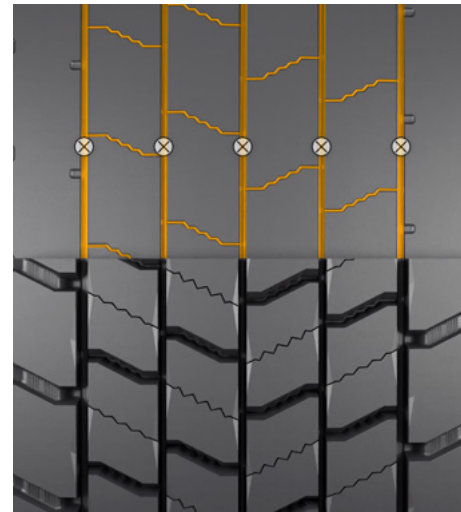

	A	B	B	B	B	B	B	B	A
	Depth (mm)		Approximate Width (mm)						
Size									
315/70 R 22.5	3.0		A:7 B:6						
295/80 R 22.5	3.0		A:7 B:6						
315/80 R 22.5	3.0		A:7 B:6						

⊗ Tread depth measuring points

Segment Goods Regional

HDR

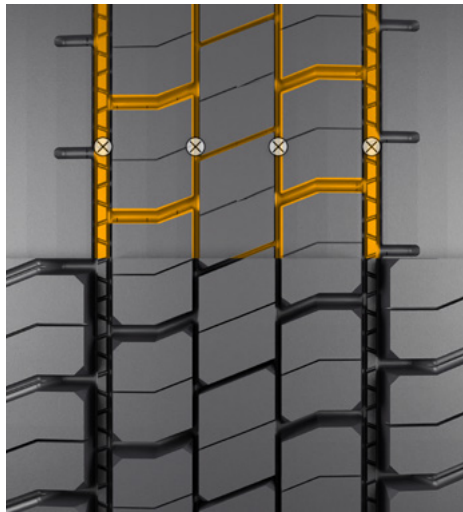

Size	A	A	B	B	B	A	A
	Depth (mm)			Approximate Width (mm)			
11 R 22.5	3.5			A:10-12 B:5-7			

HDR

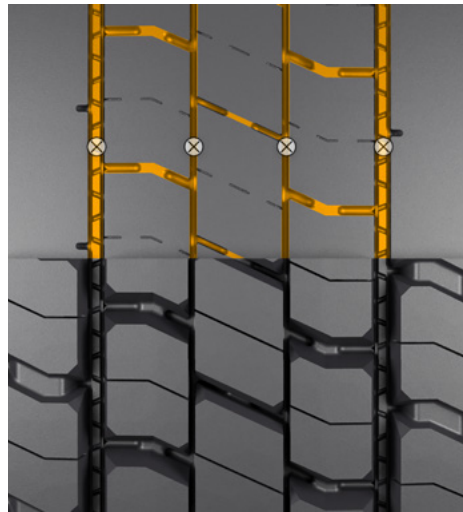

Size	A	A	B	B	B	A	A
	Depth (mm)			Approximate Width (mm)			
255/70 R 22.5	2.5			A:10-12 B:5-7			
305/70 R 22.5	2.0			A:10-12 B:5-7			

LDR 1+



Size	A	B	B	B	A
	Depth (mm)			Approximate Width (mm)	
8.5 R 17.5	2.0			A:11 B:5-7	

LDR 1+

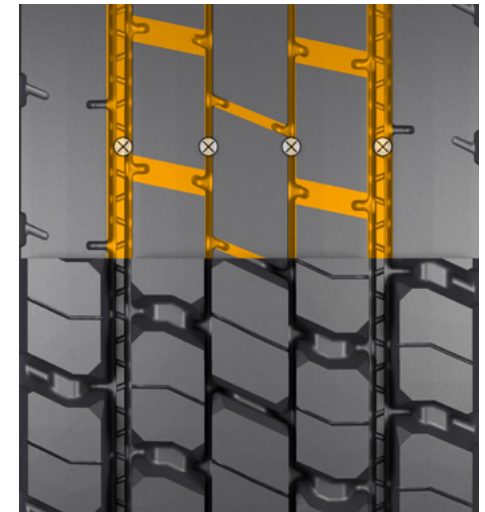

Size	A	A	B	B	B	A	A
	Depth (mm)			Approximate Width (mm)			
10 R 17.5	2.5			A:11 B:5-7			

⊗ Tread depth measuring points

Segment Goods Regional

Conti Hybrid HD3 / ContiRe / HD3+

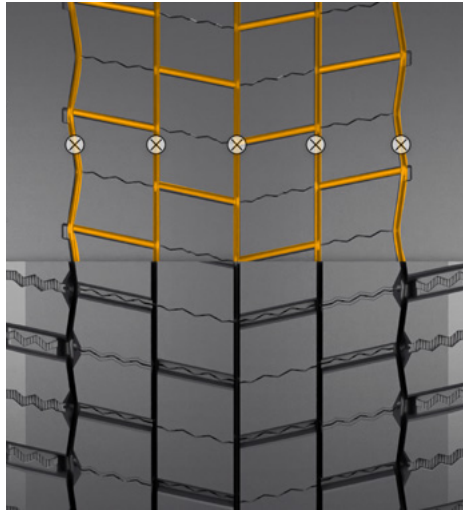

Size	Depth (mm)	Approximate Width (mm)
245/70 R 19.5	3.0	5
265/70 R 19.5	3.0	5

Conti Hybrid HD3 / ContiRe / HD3+

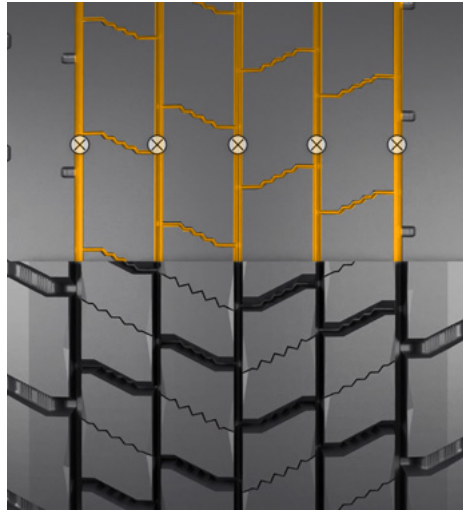

A B B B B B B B A

Size	Depth (mm)	Approximate Width (mm)
295/55 R 22.5	3.0	A:7 B:6

Conti Hybrid LD3

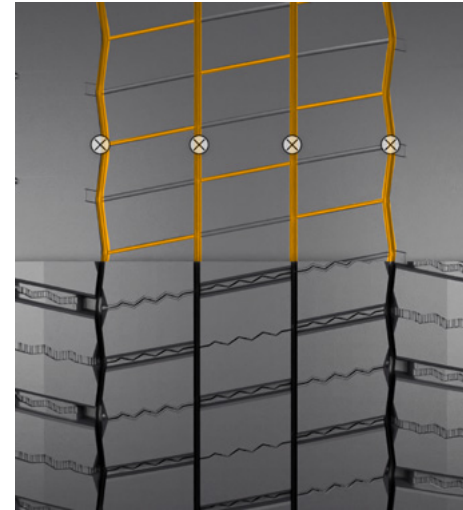

Size	Depth (mm)	Approximate Width (mm)
245/70 R 17.5	2.0	5
265/70 R 17.5	2.5	5
205/75 R 17.5	2.5	5
235/75 R 17.5	2.5	5

LDR+

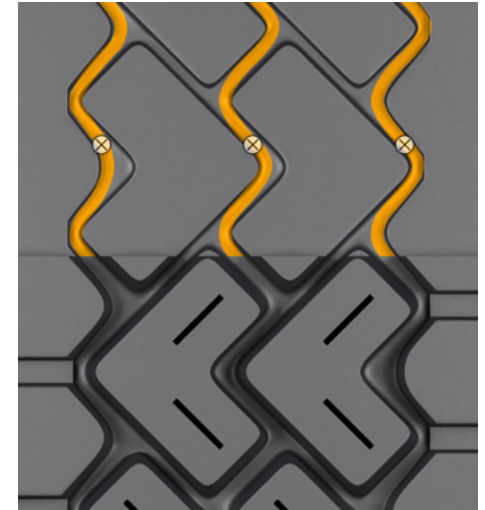

Size	Depth (mm)	Approximate Width (mm)
7.00 R 16	1.5	7
7.50 R 16	1.5	7

⊗ Tread depth measuring points

Segment Goods Regional

Conti Hybrid HT3 / ContiRe

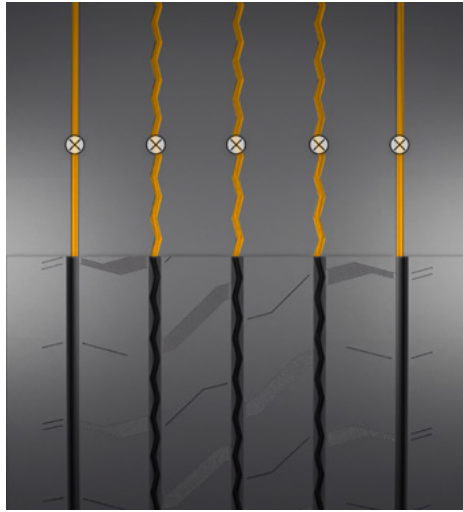

Size	Depth (mm)	Approximate Width (mm)
445/45 R 19.5	2.5	A:8 B:6
435/50 R 19.5	2.5	A:8 B:6

Conti Hybrid HT3 / ContiRe / HT3+

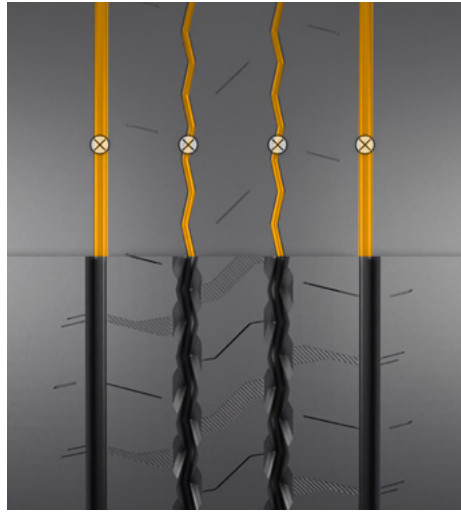

Size	Depth (mm)	Approximate Width (mm)
385/55 R 19.5	2.5	A:10 B:7
385/55 R 22.5	3.0	A:10 B:7

Conti Hybrid HT3 / ContiRe / HT3+ / HL

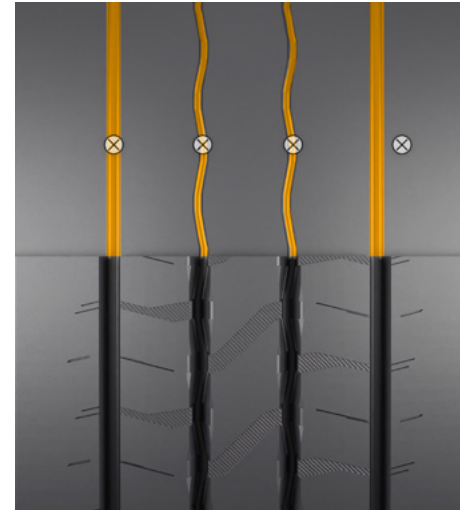

Size	Depth (mm)	Approximate Width (mm)
385/65 R 22.5	3.5	A:10 B:8

⊗ Tread depth measuring points

Segment Goods Regional

Conti Hybrid HT3 SR

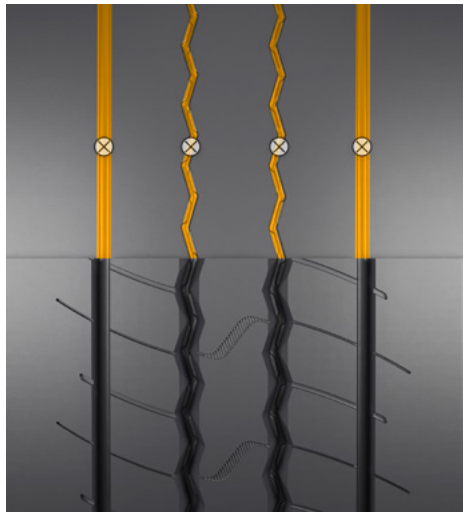

	A	B	B	A
		Depth (mm)		Approximate Width (mm)
Size				
385/55 R 22.5		3.0		A:10 B:8
385/65 R 22.5		3.5		A:10 B:8

Conti Hybrid HT3 WR

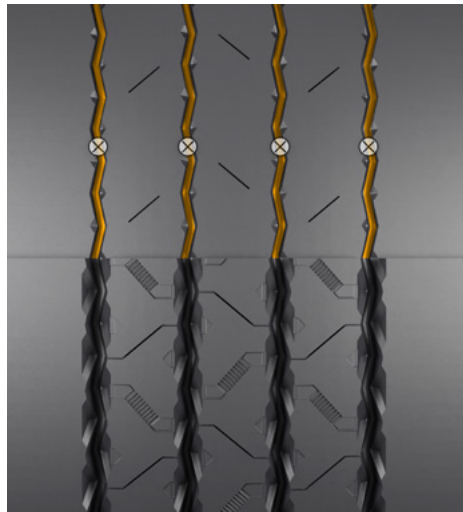

	A	B	B	A
		Depth (mm)		Approximate Width (mm)
Size				
385/65 R 22.5		3.5		8

Conti Hybrid HT3 ED

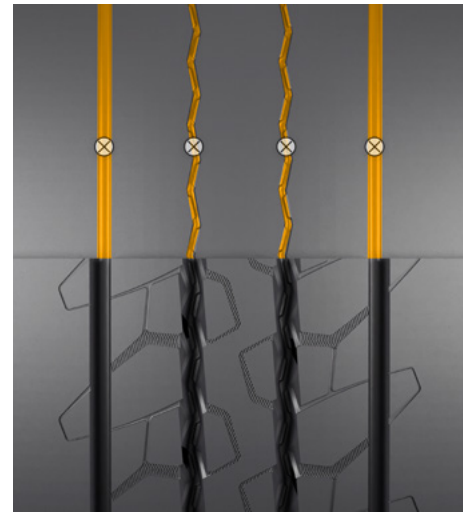

	A	B	B	A
		Depth (mm)		Approximate Width (mm)
Size				
385/65 R 22.5		3.5		A:10 B:8

Segment Goods Regional

HTR 2 / XL / ContiRe

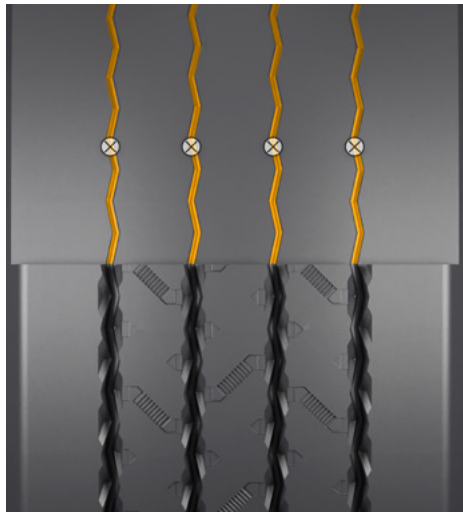

Size	Depth (mm)	Approximate Width (mm)
385/55 R 22.5	3.5	8-10
385/65 R 22.5	3.0	11
425/65 R 22.5	3.0	13
445/65 R 22.5	3.5	13

HTR 2+

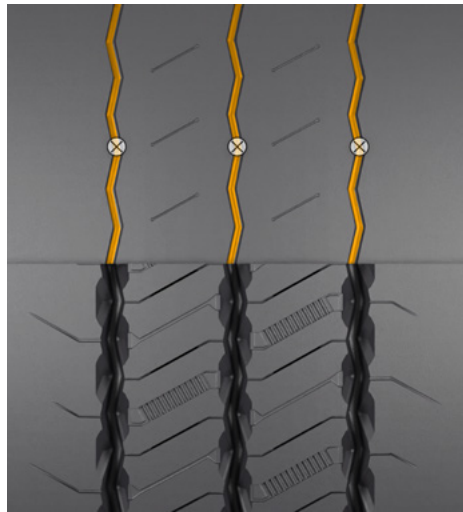

Size	Depth (mm)	Approximate Width (mm)
205/65 R 17.5	2.5	7
245/70 R 17.5	2.5	6
215/75 R 17.5	2.5	7
235/75 R 17.5	2.5	6

HTR 2 / XL / ContiRe

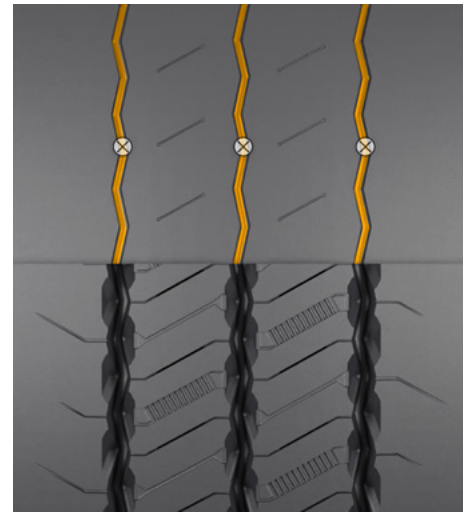

Size	Depth (mm)	Approximate Width (mm)
205/65 R 17.5	2.5	7
245/70 R 17.5	2.5	6
215/75 R 17.5	2.5	7
235/75 R 17.5	2.5	6

HTR 2 / ContiRe



Size	Depth (mm)	Approximate Width (mm)
295/60 R 22.5	2.5	10

⊗ Tread depth measuring points

Segment Goods Regional

HTR

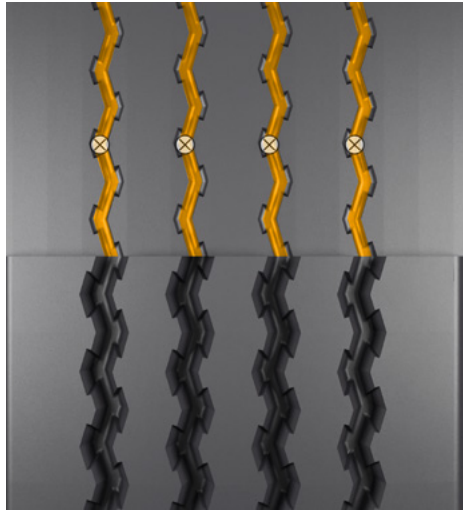

Size	Depth (mm)	Approximate Width (mm)
385/65 R 22.5	3.5	7-8
315/80 R 22.5	3.5	7-8

HTR

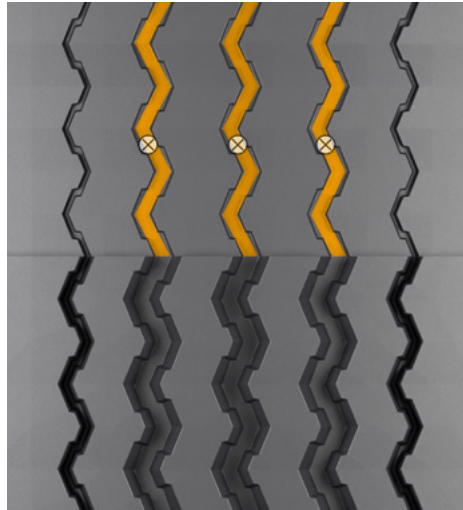

Size	Depth (mm)	Approximate Width (mm)
11 R 22.5	3.5	7-8
205/70 R 15	1.5	7-8

Segment Goods Winter

Conti Scandinavia HS3



Size	Depth (mm)	Approximate Width (mm)
315/70 R 22.5	2.5	A:8 B:6
295/80 R 22.5	3.0	A:8 B:6
315/80 R 22.5	3.0	A:8 B:6

Conti Scandinavia HS3



Size	Depth (mm)	Approximate Width (mm)
385/55 R 22.5	3.0	A:8 B:6
385/65 R 22.5	3.0	A:8 B:6

Conti Scandinavia HS3 ED



Size	Depth (mm)	Approximate Width (mm)
385/55 R 22.5	3.0	8
385/65 R 22.5	3.0	8

Conti Scandinavia LS3



Size	Depth (mm)	Approximate Width (mm)
215/75 R 17.5	2.5	5
235/75 R 17.5	2.5	5
265/70 R 19.5	3.0	7
285/70 R 19.5	3.0	7

⊗ Tread depth measuring points

Segment Goods Winter

HSW 2 SCANDINAVIA

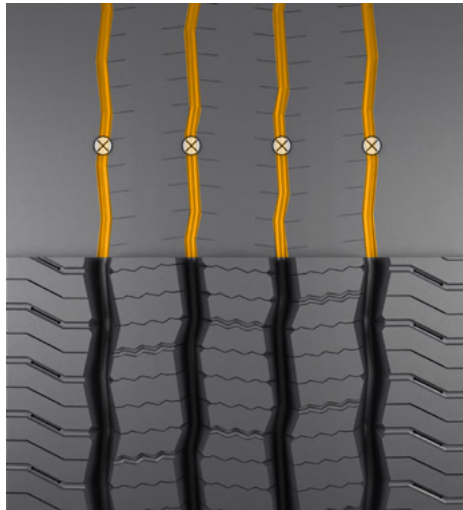

Size	Depth (mm)	Approximate Width (mm)
355/50 R 22.5	2.5	10
315/60 R 22.5	3.0	8
315/70 R 22.5	2.5	8
295/80 R 22.5	3.0	8
315/80 R 22.5	3.5	8

HSW 2 SCANDINAVIA XL

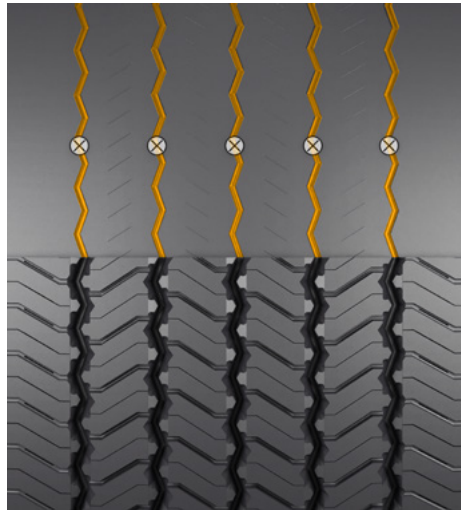

Size	Depth (mm)	Approximate Width (mm)
385/55 R 22.5	3.0	10-12
385/65 R 22.5	3.5	10-12

Conti Scandinavia HD3

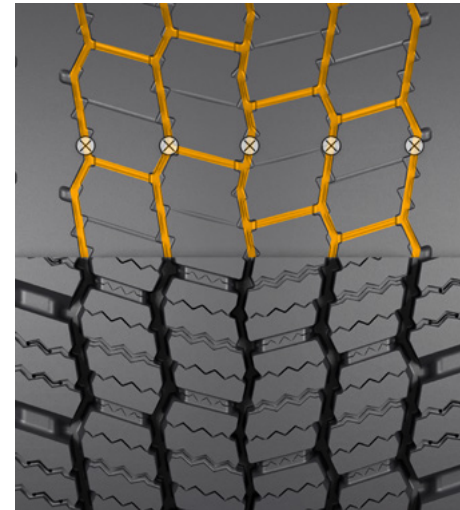

Size	Depth (mm)	Approximate Width (mm)
265/70 R 19.5	3.0	6

Conti Scandinavia HD3

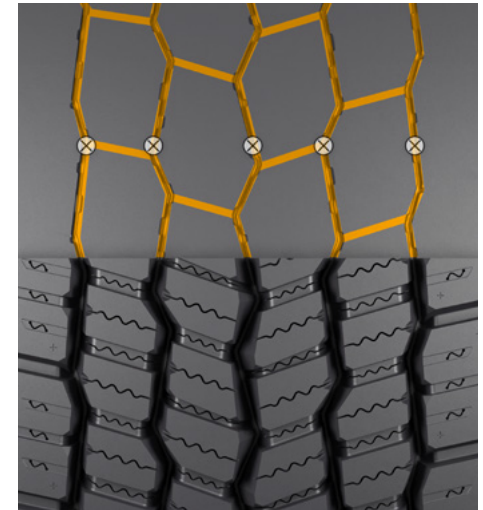

Size	Depth (mm)	Approximate Width (mm)
315/70 R 22.5	3.0	5
295/80 R 22.5	3.0	5
315/80 R 22.5	3.0	5

⊗ Tread depth measuring points

Segment Goods Winter

Conti Scandinavia HD3 ED



Size	Depth (mm)	Approximate Width (mm)
385/55 R 22.5	3.0	8
385/65 R 22.5	3.0	8

Conti ScanExtreme HD3



A A B A A A B A A

Size	Depth (mm)	Approximate Width (mm)
315/70 R 22.5	3.0	A:7 B:5
295/80 R 22.5	2.5	A:7 B:5
315/80 R 22.5	3.0	A:7 B:5

HDW 2 SCAN / ContiRe

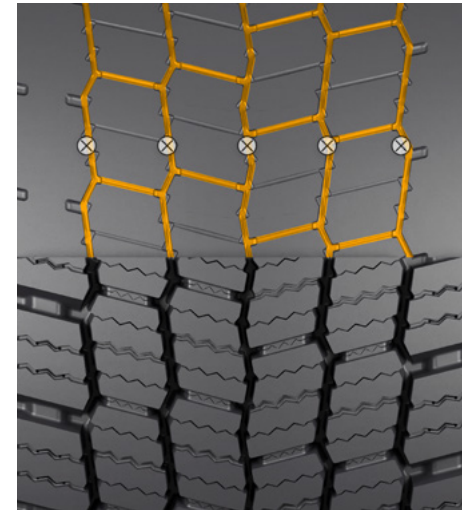

Size	Depth (mm)	Approximate Width (mm)
315/60 R 22.5	4.0	6

Conti Scandinavia LD3

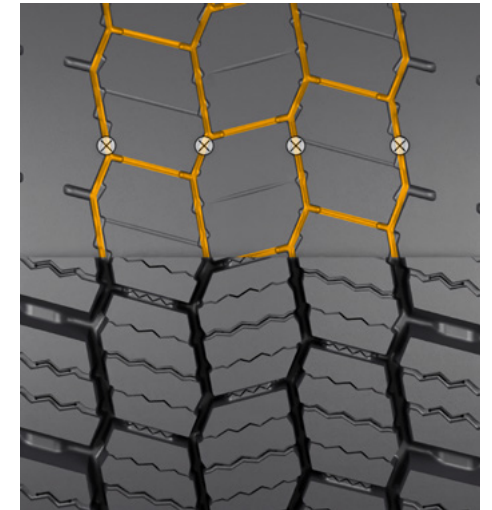

Size	Depth (mm)	Approximate Width (mm)
215/75 R 17.5	2.5	6
235/75 R 17.5	2.5	6

⊗ Tread depth measuring points

Segment Goods Winter

HDW

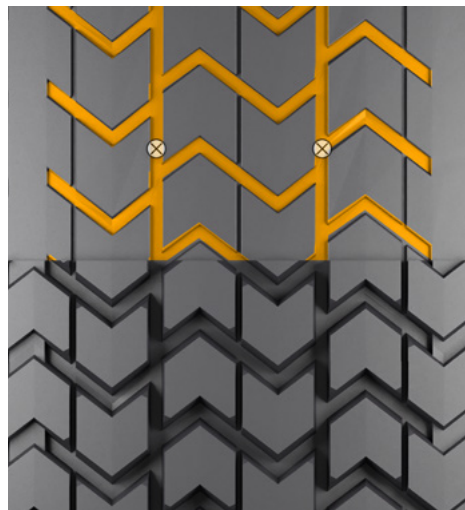

Size	Depth (mm)	Approximate Width (mm)
13 R 22.5	4.0	8-10

Segment Goods Winter

Conti Scandinavia HT3

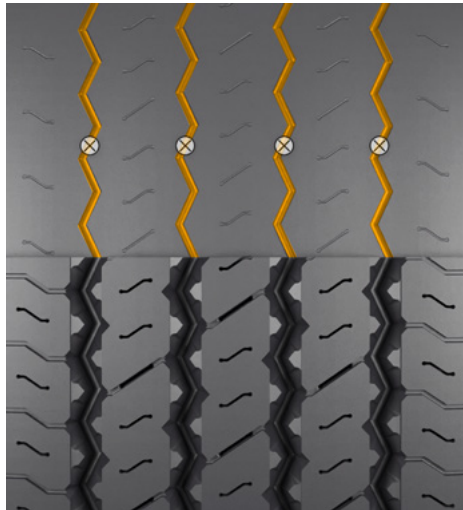

Size	Depth (mm)	Approximate Width (mm)
265/70 R 19.5	3.0	6
285/70 R 19.5	3.0	7

Conti Scandinavia HT3



Size	Depth (mm)	Approximate Width (mm)
385/55 R 22.5	3.0	8
385/65 R 22.5	3.0	8

Conti Scandinavia HT3

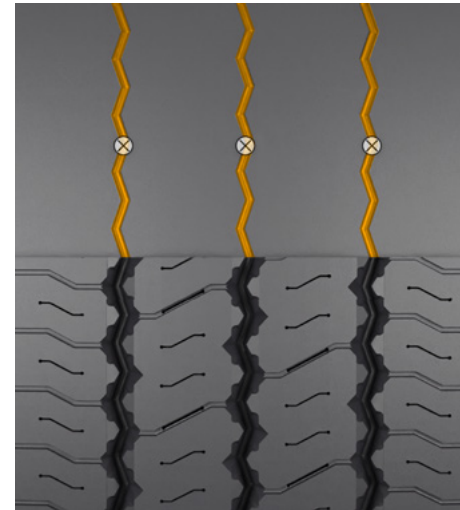

Size	Depth (mm)	Approximate Width (mm)
245/70 R 17.5	2.5	6
215/75 R 17.5	2.5	6
235/75 R 17.5	2.5	6

⊗ Tread depth measuring points

Segment Goods Winter

HTW 2 SCAN / ContiRe

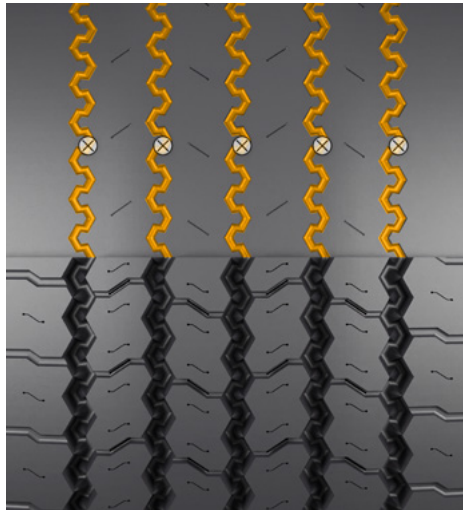

Size	Depth (mm)	Approximate Width (mm)
385/55 R 22.5	3.0	10
385/65 R 22.5	3.0	10

HTW 2 SCAN / ContiRe

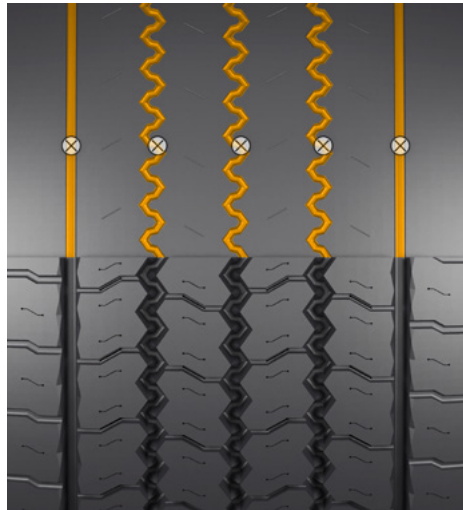

Size	Depth (mm)	Approximate Width (mm)
445/45 R 19.5	2.0	A:11 B:8

⊗ Tread depth measuring points

Segment People Coach / Intercity

Conti Coach HA3

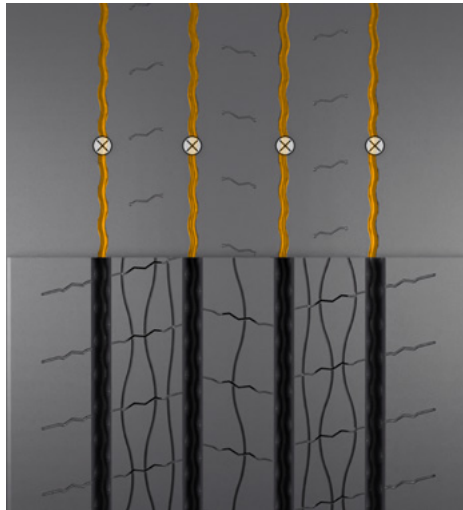

Size	Depth (mm)	Approximate Width (mm)
295/80 R 22.5	3.5	6-7
315/80 R 22.5	3.0	6-7

Conti Coach HA3 ED

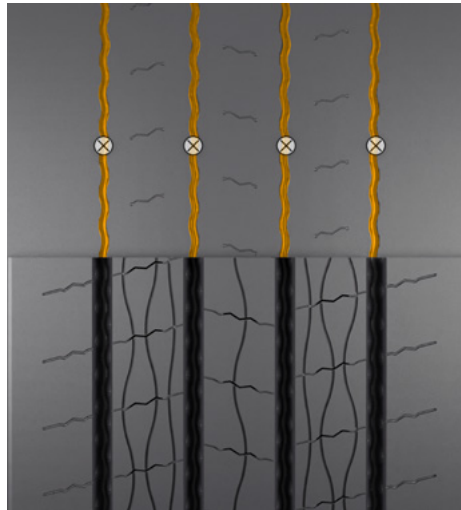

Size	Depth (mm)	Approximate Width (mm)
295/80 R 22.5	4.0	6-7

Conti Coach HA3 AC

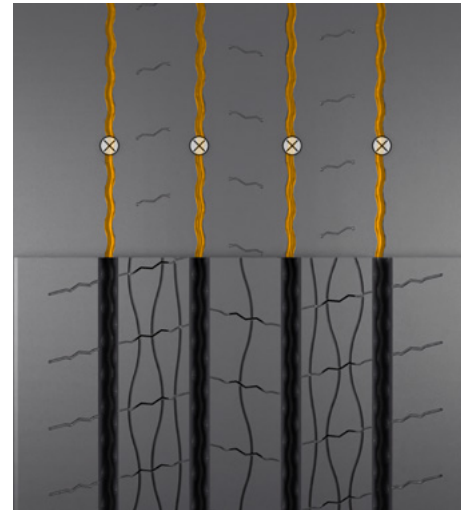

Size	Depth (mm)	Approximate Width (mm)
295/80 R 22.5	2.5	6-7

⊗ Tread depth measuring points

Segment People Coach / Intercity

Conti CoachRegio HA3

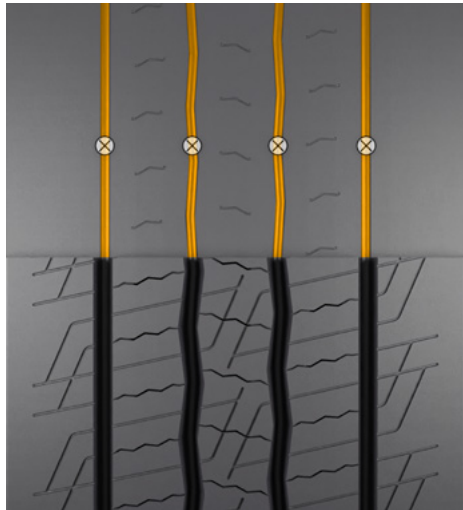

Size	Depth (mm)	Approximate Width (mm)
295/80 R 22.5	3.0	6-7

Conti CoachRegio HD3

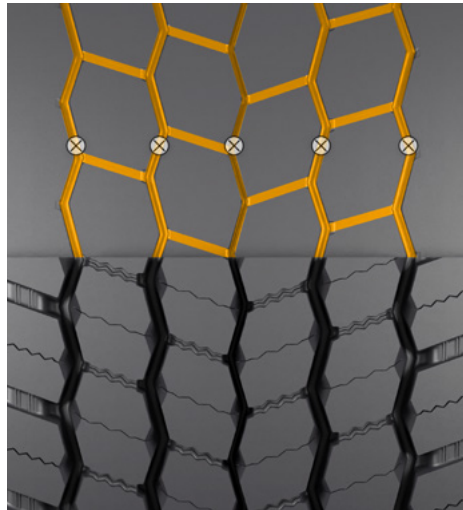

Size	Depth (mm)	Approximate Width (mm)
295/80 R 22.5	3.0	A:7 B:5

HDU 1



Size	Depth (mm)	Approximate Width (mm)
385/55 R 22.5	3.5	10-12

⊗ Tread depth measuring points

Segment People Urban / Winter

Conti Urban HA3

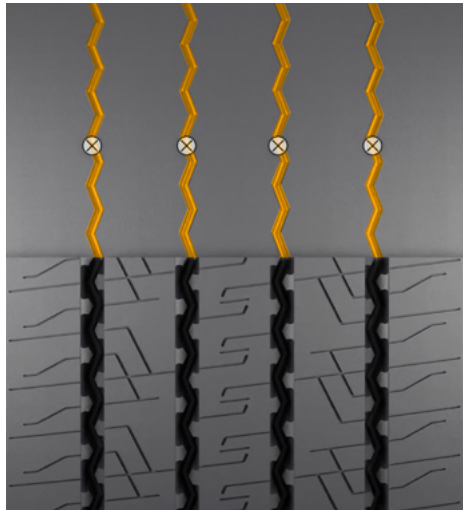

Size	Depth (mm)	Approximate Width (mm)
275/70 R 22.5	3.5	6-7

Conti Urban HA3 M+S / ContiRe

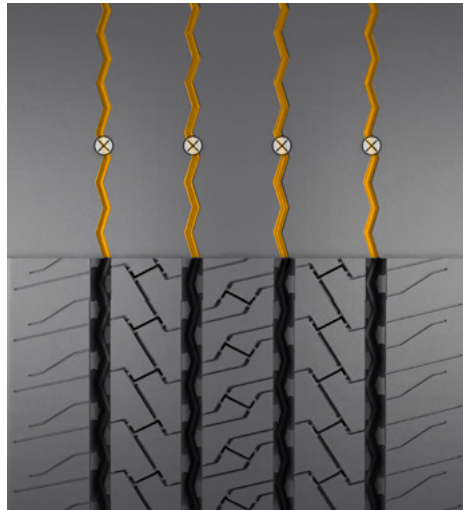

Size	Depth (mm)	Approximate Width (mm)
265/70 R 19.5	3.0	6

Conti Urban HA3 M+S / ContiRe

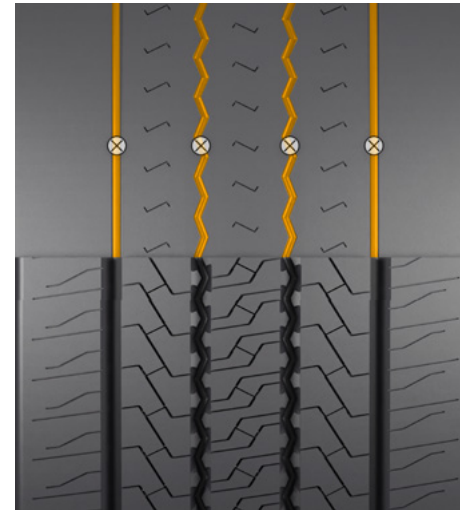

Size	Depth (mm)	Approximate Width (mm)
315/60 R 22.5	3.0	A:9-10 B:7-8

Conti Urban HA3 M+S / ContiRe



Size	Depth (mm)	Approximate Width (mm)
305/70 R 22.5	2.5	7-8

⊗ Tread depth measuring points

Segment People Urban / Winter

HSW 2+ COACH / ContiRe

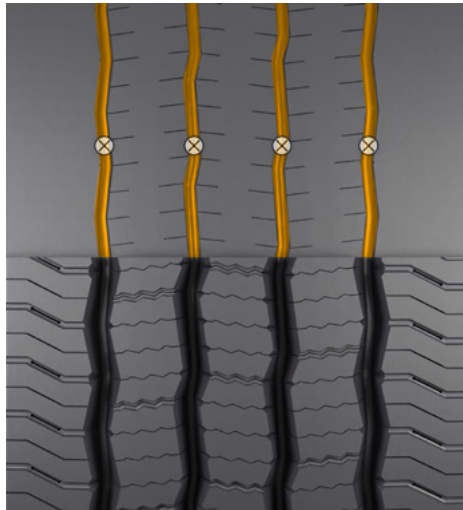

Size	Depth (mm)	Approximate Width (mm)
295/80 R 22.5	3.0	10

Conti UrbanScan HA3+ / Conti UrbanScan HA3

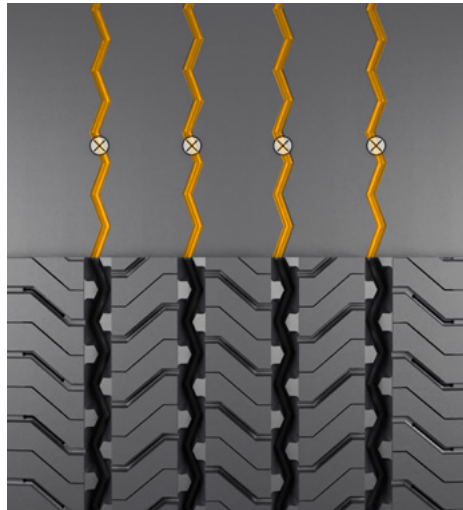

Size	Depth (mm)	Approximate Width (mm)
275/70 R 22.5	3.0	7-8

HDW 2 COACH

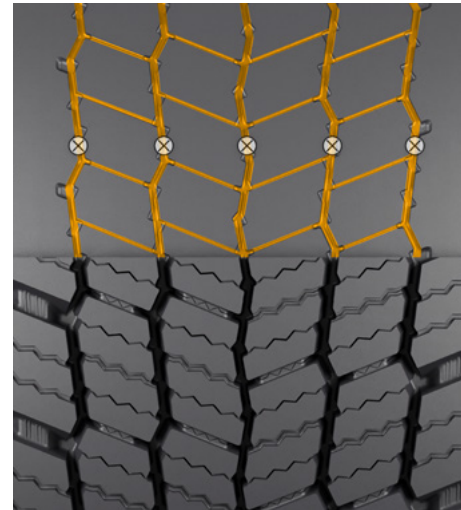

Size	Depth (mm)	Approximate Width (mm)
295/80 R 22.5	3.0	A:6 B:4

⊗ Tread depth measuring points

Segment People Urban / Winter

Conti UrbanScan HD3 / ContiRe

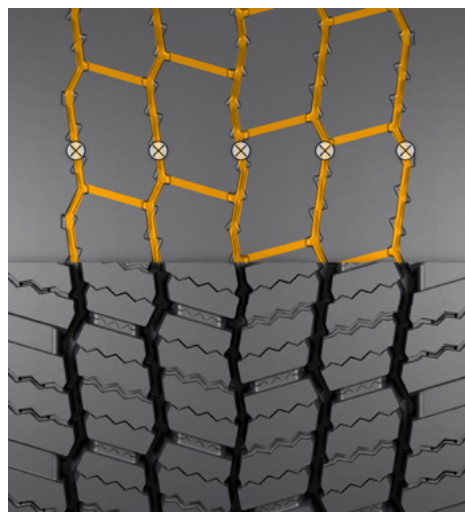

Size	Depth (mm)	Approximate Width (mm)
275/70 R 22.5	3.5	6-7

HSU

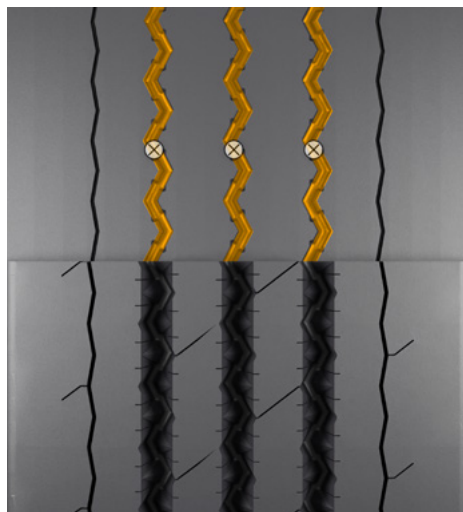

Size	Depth (mm)	Approximate Width (mm)
295/80 R 22.5	4.0	8-10

Segment Construction On / Off

Conti CrossTrac HA3

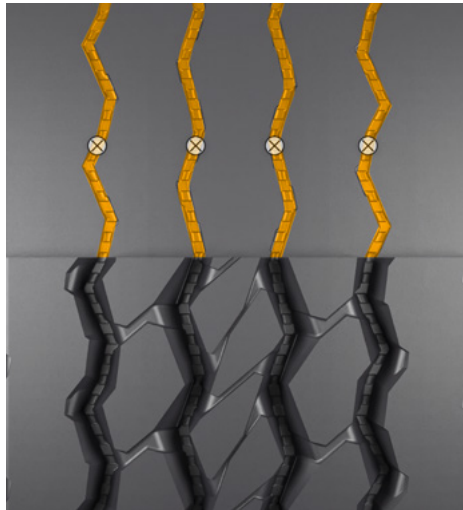

Size	Depth (mm)	Approximate Width (mm)
295/80 R 22.5	3.5	9

Conti CrossTrac HS3

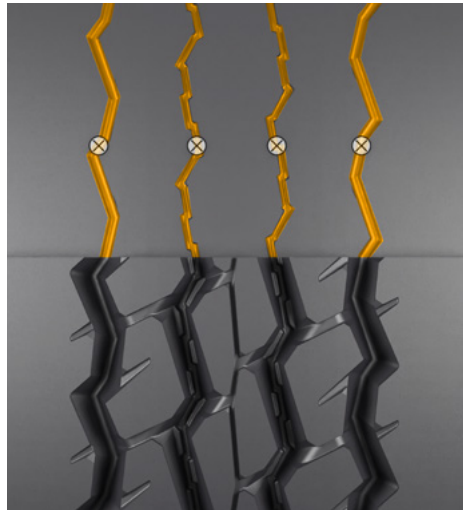

Size	Depth (mm)	Approximate Width (mm)
295/80 R 22.5	3.5	8
315/80 R 22.5	3.0	8

Conti CrossTrac HS3 / Conti CrossTrac HS3 HL

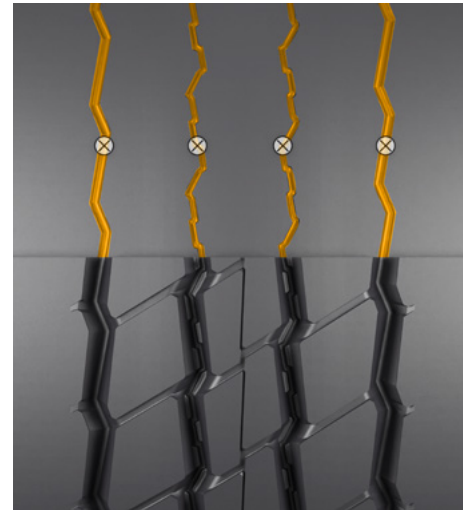

Size	Depth (mm)	Approximate Width (mm)
385/65 R 22.5	3.5	A:8 B:6
315/80 R 22.5	3.0	A:8 B:8

Conti CrossTrac HS3 / Conti CrossTrac HS3 HL

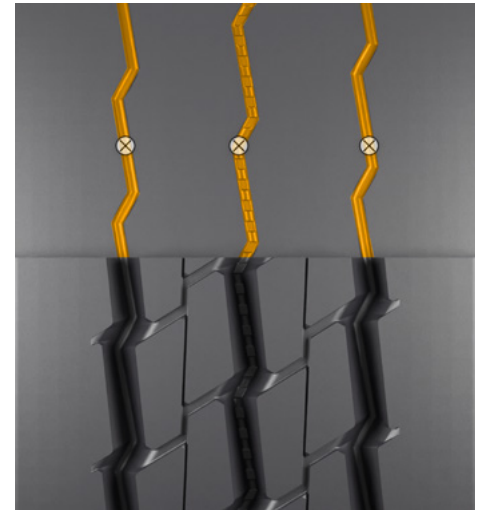

Size	Depth (mm)	Approximate Width (mm)
13 R 22.5	3.5	8

⊗ Tread depth measuring points

Segment Construction On / Off

HSC 1

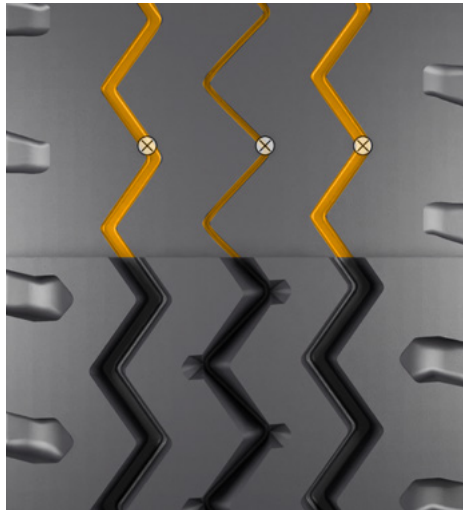

Size	Depth (mm)	Approximate Width (mm)
325/95 R 24*	3.5	10-12

* alternative tread pattern

HSC 1 / ED

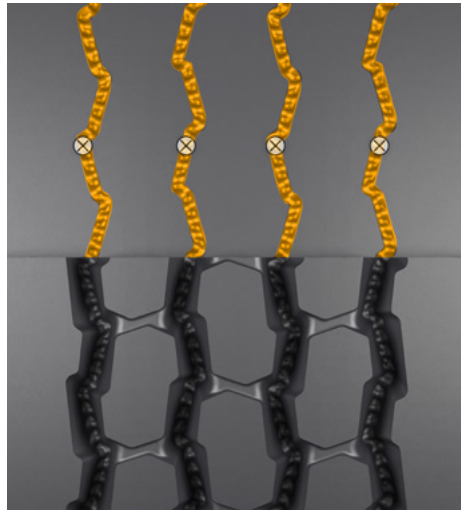

Size	Depth (mm)	Approximate Width (mm)
385/65 R 22.5	3.5	12
295/80 R 22.5	3.5	12
315/80 R 22.5	3.0	12

HSC 1 / ED

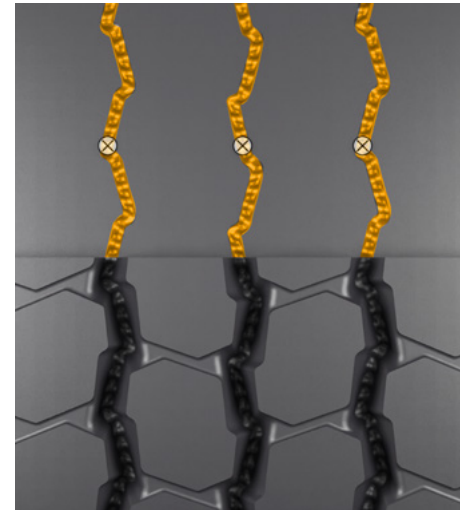

Size	Depth (mm)	Approximate Width (mm)
11 R 22.5	3.5	12
12 R 22.5	3.5	12
13 R 22.5	3.5	12

HSC

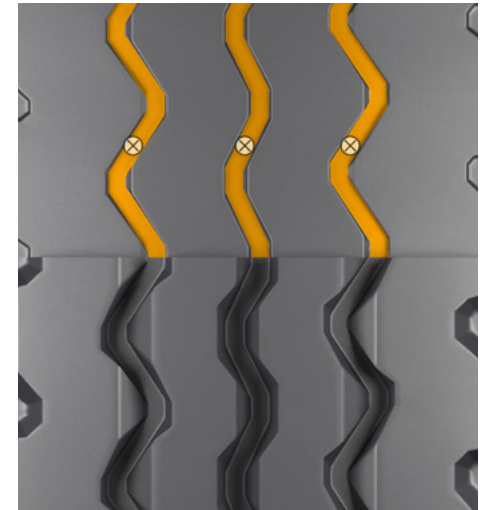

Size	Depth (mm)	Approximate Width (mm)
12.00 R 20	3.0	10-12

Segment Construction On / Off

LSC

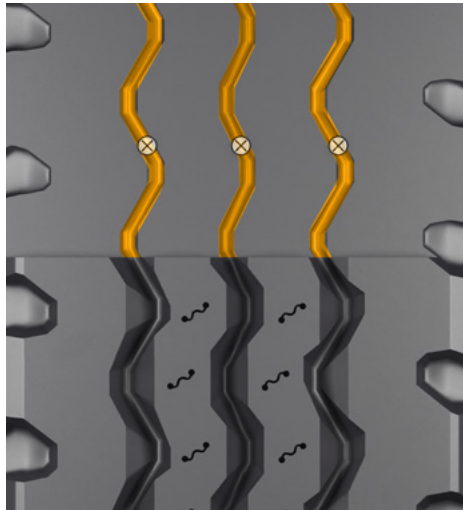

Size	Depth (mm)	Approximate Width (mm)
9.5 R 17.5	2.0	10

Conti CrossTrac HD3

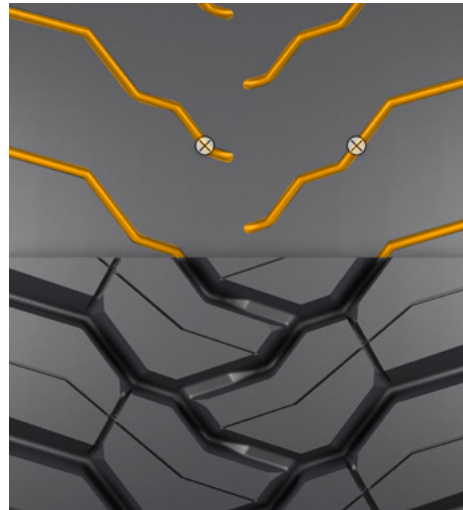

Size	Depth (mm)	Approximate Width (mm)
295/80 R 22.5	3.5	8
315/80 R 22.5	3.5	8
13 R 22.5	3.5	8

HDC 1 / ContiRe

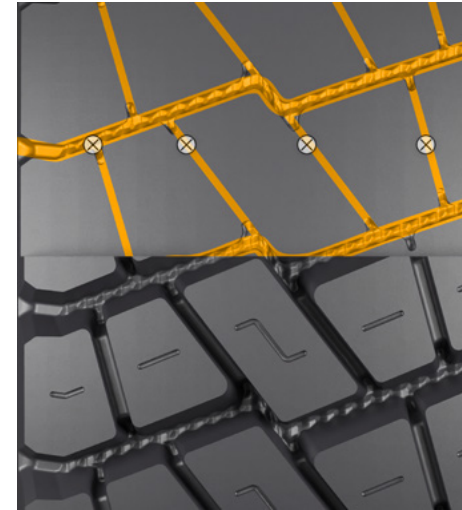

Size	Depth (mm)	Approximate Width (mm)
12 R 22.5	3.5	A:12 B:7
13 R 22.5	3.5	A:12 B:7
325/95 R 24	3.5	A:12 B:7

HDC 1 / ContiRe

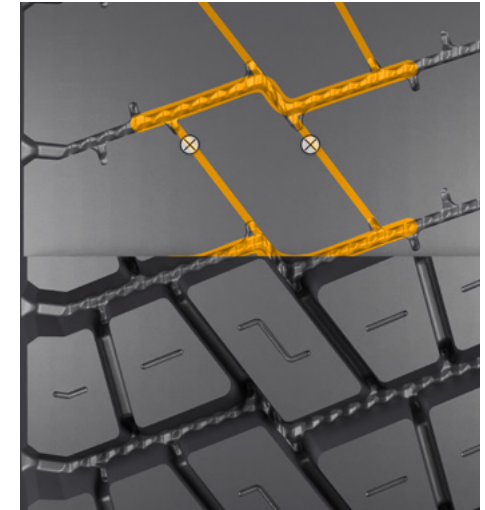

Size	Depth (mm)	Approximate Width (mm)
295/80 R 22.5	3.5	A:12 B:7
315/80 R 22.5	3.5	A:12 B:7

⊗ Tread depth measuring points

Segment Construction On / Off

HDC 1 ED



Size	A	B	A	A	B	A
	Depth (mm)		Approximate Width (mm)			
315/80 R 22.5	3.5		A:12 B:7			
12 R 22.5	3.5		A:12 B:7			
13 R 22.5	3.5		A:12 B:7			

HDC

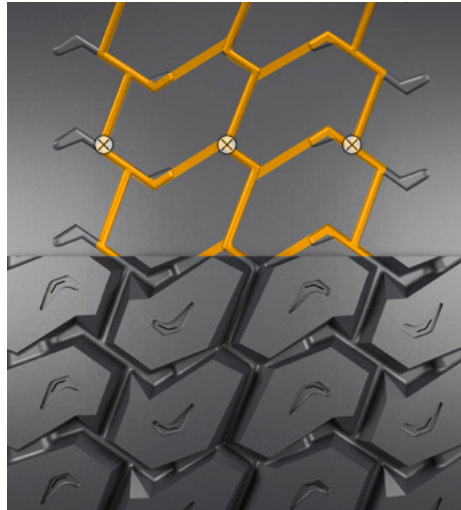

Size	Depth (mm)	Approximate Width (mm)
385/65 R 22.5	3.5	10-12

HDC

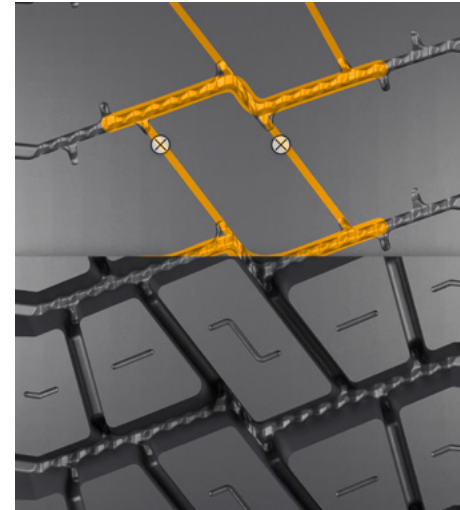

Size	Depth (mm)	Approximate Width (mm)
385/55 R 22.5	3.5	10-12
12.00 R 20	3.5	10-12

Segment Construction On / Off

Conti CrossTrac HT3

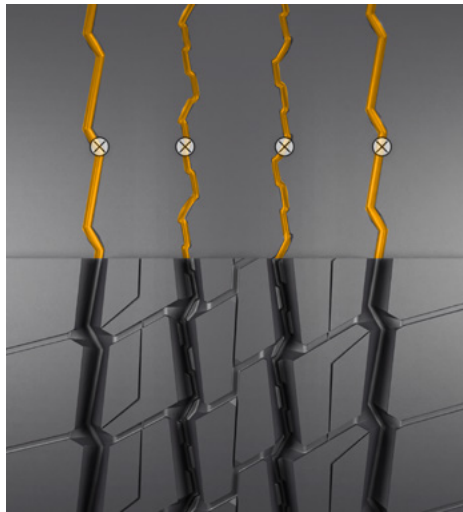

Size	Depth (mm)	Approximate Width (mm)
385/65 R 22.5	3.5	A:8 B:6

HTC 1 / ED

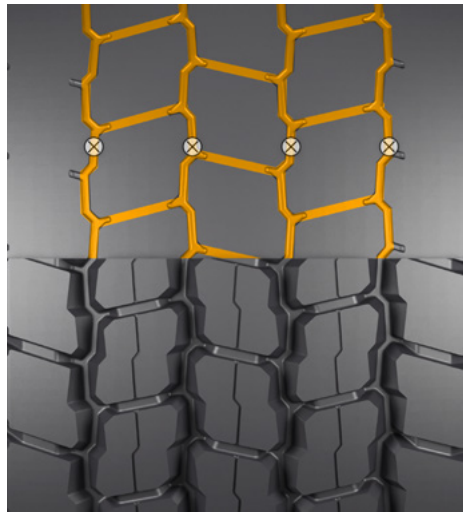

Size	Depth (mm)	Approximate Width (mm)
385/65 R 22.5	3.5	A:10 B:7
445/65 R 22.5	3.5	A:10 B:7

HTC

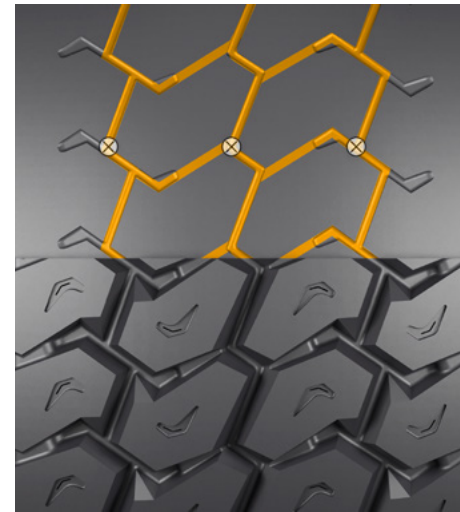

Size	Depth (mm)	Approximate Width (mm)
425/65 R 22.5	3.5	10-12
275/70 R 22.5	3.5	10-12

Segment Construction Off

HSO+ SAND / HSO SAND



Size	Depth (mm)	Approximate Width (mm)
7.5 R 16 C	1.5	5
12.00 R 20	3.0	12-14
14.00 R 20	4.0	12-14

HCS



Size	Depth (mm)	Approximate Width (mm)
365/85 R 20	4.0	A:18 B:10
395/85 R 20	4.0	A:18 B:10
14.00 R 20	4.0	A:18 B:10
325/95 R 24	3.5	A:17 B:7

HSO / T9



Size	Depth (mm)	Approximate Width (mm)
13 R 22.5	3.0	8

LCS / HCS

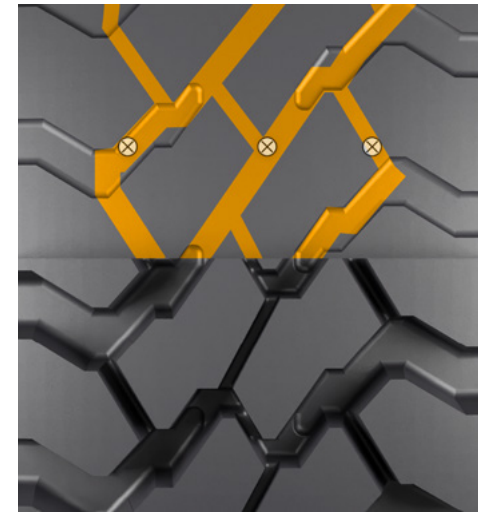

Size	Depth (mm)	Approximate Width (mm)
265/70 R 17.5	2.0	A:15 B:6
445/65 R 22.5	3.5	A:25 B:7

⊗ Tread depth measuring points

Segment Construction Off

HDO

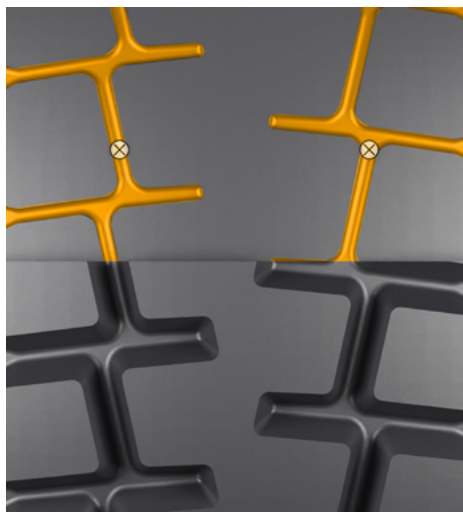

Size	Depth (mm)	Approximate Width (mm)
315/80 R 22.5	3.5	10-12
13 R 22.5	4.0	10-12

Maintenance and care

The prerequisite for successful maintenance and care is the correct choice of tyre, in accordance with the recommendations of the tyre manufacturer. Refer also previous sections on this subject.

Storage

Unused tyres should be stored in cool, dry, dark and lightly ventilated rooms. Tyres which are not fitted on rims should be stored standing up. Avoid contact with fuel, lubricants, solvents and chemicals.

Should tyres, tubes and bead flaps need to be stored temporarily, they may age more quickly and develop cracks if they are exposed to intense sunlight or extreme heat. Effective air circulation accelerates this process.

Inner tubes may be particularly affected if their packaging is damaged.

Fitting the tyre

Before taking off a tyre, unscrew and remove the valve core; then wait until all the air has escaped. If a tube-type tyre is fitted with an angled valve as per DIN 7786-80 GD 80, unscrew the valve stem and wait until the escaping air ceases to make noise before removing the tyre.

Particular care should be taken when fitting the tyre. Only rust-free rims of the right size should be used. These should not be damaged or show any signs of wear and tear. The loose flange side should be examined with great care.

Always use new tubeless valves or new inner tubes and flaps on new tyres or new seals for tubeless metal valves.

Take special care after tyre repairs: inner tubes stretch in use and may form dangerous folds when re-fitted. If in doubt, always fit new inner tubes in order to avoid tube failure.

It is particularly important with large tyres that these should already fit on the rim flange with as little inflation pressure as possible. See ETRTO recommendations on Commercial Vehicle Tyres, under Tyre Fitting section.

As a guide:
When fitting, it is recommended to inflate in 2 stages. Inflate initially to 1.5 bar and inspect the tyre to confirm the tyre is fit for service with no bulges or potential separations and the beads are correctly located against the rim flange. In 2nd stage always place in a safety cage and inflate gradually to the specified inflation pressure. At no point during this phase should the tyre be left unattended.

Should the tyre bead be jammed on the rim and the pressure too high, the bead may get damaged or even destroyed.

With tube type tyres, check that valves still move freely after the filler nozzle has been removed. This is important for later inflation pressure checks under difficult conditions.

Fast-running wheels should be balanced statically and dynamically to ensure smooth running.

Fitting the wheel on to the vehicle

Vehicle axle data such as toe-in, king pin inclination and castor as well as axle alignment must be checked and if necessary adjusted to within tolerances.

Only then should the wheel be fitted.

When fitting make sure that the axle hub is perfectly centered. Extra care is necessary with large, heavy tyres which do not have special centering.

If necessary, re-balance the wheel when it is fitted on the vehicle.

Always remember to check that the valve cores move freely and are easily accessible. Valve extensions are necessary for dual tyres.

Checking the inflation pressure requires the free movement and easy access of the valve cores, even when they have become dirty during operation.

Valve caps, preferably high pressure type, must be fitted.

On rolling road testers where the vehicle performance is examined, restrictive testing regulations must be observed: depending on the roller diameter only short tests may be carried out and these must always be below maximum speed.

If a vehicle has all the same type of tyres e.g. radial tyres, this will guarantee optimum driving characteristics and maximum driving stability.

The use of different tyre designs on each axle should be a rare exception. Where vehicles are being used on the highway, minimum tread depths as specified in the latest national regulations must be observed. For motor vehicles, trailers or semitrailers it is essential that tyres of the same construction are fitted to the same axle.

Minimum tread depth

The legal minimum tread depth is normally 1.6 mm (e.g. in Germany) and must cover the complete width and circumference of the tread. The depth should be measured in the tread groove with the tread wear indicator (the area with the indicator should not be measured).

Vehicle in operation

The inflation pressure must be correct. Otherwise poor vehicle handling and pronounced, irregular tread wear are inevitable.

If pressure is insufficient, the rolling resistance will increase and with it the fuel consumption. Hidden defects in the tyre may also occur which later lead to tyre failure.

Tyre inflation pressures specified by vehicle and tyre manufacturers are contained in the vehicle manual and, for example, on the vehicle wheel arch. These may vary with different loads and service conditions, and must be adjusted accordingly. Specified inflation pressures always apply to cold tyres. An increase in inflation pressure during running is normal and must never be re-adjusted. Do not reduce pressure when the tyres are hot.

Never use different inflation pressures for the same axle.

The spare wheel should be inflated to at least the maximum inflation pressure given in the vehicle manual. Remember to always include the spare wheel when checking inflation pressures.

A balanced, even style of driving reduces the strain on the tyres. Every harsh reaction on the accelerator, brakes or steering shortens the life of the tyres.

The same also applies of course to all other forms of peak strain such as severe scuffing of the tyre along the kerb or driving over obstacles that may be in the road. These can all result in damage to the tyre construction.

Strain on the tyre should be avoided. This has the same effect as insufficient pressure.

Do not exceed the tyre's permitted maximum speed, otherwise tyre damage is possible.

Maintenance and care of the vehicle's tyres

The high quality standard of the tyres and vehicle, which is achieved by the measures and recommendations stated above, can only be ensured by the regular checking of all factors.

For example, pressure checks and external inspections of the tyres (including the sidewalls to the inside of the vehicle and between dual tyres).

Pressure checking devices and small replacement parts such as valve inserts, caps and extensions should always be close at hand.

Tyres age as a result of physical and chemical processes and this may impair their performance.

Tyres, which are fitted to mainly stationary vehicles or those which are not used regularly, are particularly prone to premature ageing.

Unfavourable weather conditions also accelerate the ageing process as well as the storage conditions that were covered in the previous section.

An expert should always be called in to make a qualified judgment on the tyres.

Regrooving of the tread pattern – usually when there are 2 or 3 millimetres of tread depth left – should be carried out only by qualified experts when the word "REGROOVABLE" is displayed on the tyre sidewall.

Tyre repairs

Tyre damage may initially be just a question of damage to the outer rubber: however, this apparently superficial damage can eventually extend down to, or into, the tyre's reinforcing materials (casing/belt). Therefore no time should be lost in taking the tyre to a specialist for assessment as soon as any external damage is detected.

Damage to the reinforcing materials, for instance due to a nail puncture or a deep cut, is particularly dangerous because dirt and moisture may penetrate during the time between when the damage occurred and when it was detected. This may even result in more serious damage to the reinforcing materials. Damage to the inside of a tyre can also cause a slow puncture.

The tyre is then driven underinflated and consequently subjected to excessive strain. All these factors can make a tyre non-repairable by the time the damage is finally discovered. If the tyre is repaired regardless, even if it is repaired by a reputable tyre specialist, it is possible that tyre failure can still occur as a result of an overstrained area, other than that originally damaged.

This is why each tyre must be carefully inspected by a tyre expert before it is repaired. For only a specially trained person can decide whether it is possible to repair the tyre and whether the tyre will be capable of delivering safe performance after the repair. Repairs must be carried out by an authorised workshop, which is then responsible for inspecting the tyre and for doing the job properly.

Repairs to the wheels are forbidden.

Damage to truck, bus and coach tyres caused by external factors

Damage to truck, bus and coach tyres may be caused by a variety of external factors.

For example, improper axle alignment or incorrect storage can damage a tyre, as can driving with insufficient tyre pressure. The following chapter describes common damage to the tread area, the sidewall and the bead caused by external factors, and gives recommendations that will help you to prevent avoidable damage.

Tread

Abnormal one-sided wear

Cause

Abnormal one-sided tread wear arises as a result of tyre constraint caused by wheels being inclined to the direction of motion. Scale-like or feather-edged wear is often seen at the shoulders. This wear pattern comes about by excessive toe-in/ toe-out values or crooked axles. It also occurs if corners are regularly taken at excessive speeds.

Recommendation

Correct axle and wheel alignment

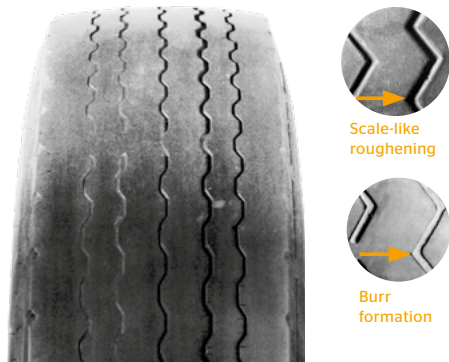

Abnormal one-sided wear on both sides in shoulder area

Cause

Wear patterns of this nature are caused by high lateral strain, for example by taking corners quickly and by underinflated tyres. A high centre of gravity on the vehicle further increases this tendency toward pronounced wear.

Recommendation

Ensure sufficient tyre pressure to stabilise the tyre crosssection for the load condition.

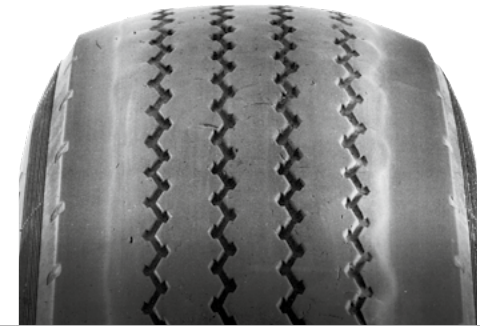

Abnormal centre wear

Cause

Tyre pressure which is too high or a high proportion of journeys without load or only with partial load.

Recommendation

Adjust the tyre pressure for the load situation.



Abnormal one-sided wear in shoulder area

Cause

Occurs predominantly with trailer tyres as a result of

- > high centre of gravity of vehicle
- > unsteady loads
- > one-sided load distribution
- > bent trailer tow-bar
- > play in the trailer coupling ring

Recommendation

When wear patterns of this sort occur, the vehicle should be checked to see if any of these possible causes apply.

In order to stabilise the tyre cross-section, be sure to maintain maximum permitted tyre pressure.



Scale-like wear

Cause

Strain caused by slipping is a result of high circumferential or lateral forces and is increased by excessive tyre pressure or insufficient wheel load.

Recommendation

Adjust the tyre pressure to the load situation.



Tramline wear

Cause

An unfavourable combination of various vehicle vibrations in low wear use, e.g. on motorways. Only occurs on tyres on non-driven axles (front axle or trailer).

Free-wheeling grooves have no influence on the structural durability of the tyre.

Recommendation

In the case of tractor tyres: continued use on driven axle.



Spotty wear

Cause

Difference in diameter on dual tyres.

Varying tyre pressure on dual tyres. The tyre running on lower pressure is subject to excessive slip.

Irregularities on the vehicle, e.g. too much play in bearings or joints or defective suspension.

Recommendation

Only fit dual tyres of approximately the same diameter.

Keep both tyres in dual arrangement inflated to specified pressure level.

Remove any play in bearings and/or joints or repair the suspension (springs, shock absorbers).



Circumferential damage

Cause

Cuts caused for example by bent or protruding vehicle parts or by foreign objects trapped in the wheel house.

Recommendation

Regular inspection of the vehicle and its tyres for such causes.



Exposed steel cords

Cause

Regrooving too deep and going to the belt. Damage of this nature, combined with the effect of dirt and moisture, causes the steel cords to rust. This may render the tyre unsuitable for retreading. In the final stages this can even lead to premature tyre failure.

Recommendation

Remove the tyre immediately and retread it if possible.

The tyre manufacturer's instructions regarding regrooving should be followed under all circumstances.

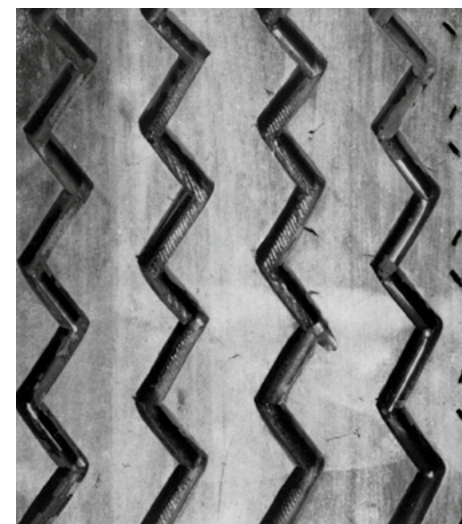

Flat spot

Cause

Localised wear of the size of the ground contact patch, caused by:

- › excessive sharp braking (emergency stop)
- › brakes locking, for example as a result of incorrect adjustment of the trailer brakes or defective brakes

Recommendation

- › Avoid unnecessary harsh braking.
- › Check brakes and braking system and have adjusted where necessary.
- › Install automatic anti-lock brake system.

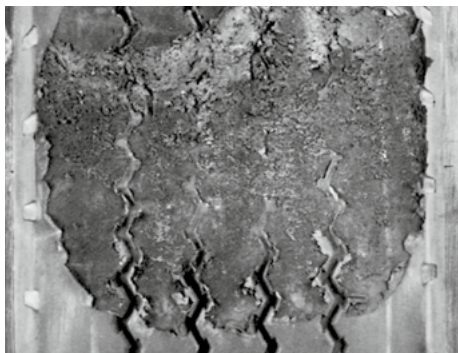

Stressed tread area, cuts caused by spinning, cuts

Cause

Spinning of the drive wheels on stony ground - can be exacerbated by moisture and overinflation.

Recommendation

Adjust the tyre pressure to the load situation. Use special tyres if necessary.



Cuts

Cause

Effect of sharp-edged objects (stones, glass, metal, etc.)

Recommendation

If tyres with deep localised cuts can be repaired or retreaded, this should be done by a tyre expert.



Break up of the tread due to impact break

Cause

Break in the casing caused by sudden sharp deformation of the tyre, e.g. when driving over an angular object at high speed.

This is exacerbated by overinflation or overloading.

Recommendation

- › If obstacles cannot be avoided, they should be passed slowly.
- › Tyre pressure should be adjusted to the load situation.

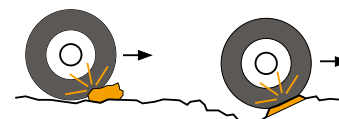

Inside of the tyre

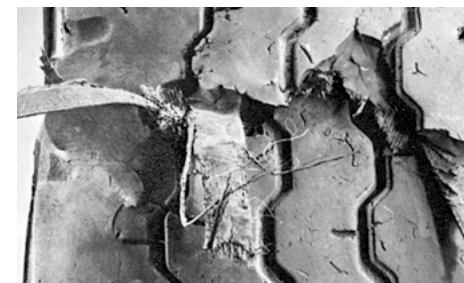

Outside of the tyre

Sidewall

Cuts

Cause

Effect of sharp-edged objects (stones, glass, metal, etc.)

Recommendation

If tyres with deep localised cuts can be repaired or retreaded, this should be done by a tyre expert.

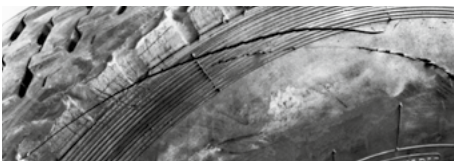
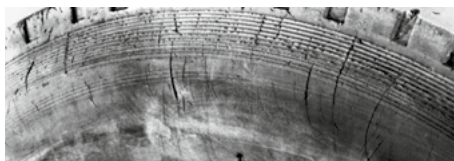

Casing rupture due to impact

Cause

Rupture in the casing caused by sudden, sharp deformation of the tyre following forceful impact by an obstacle or object.

This is accentuated by excessively high tyre pressure or overloading.

Recommendation

- › If obstacles cannot be avoided, they should be passed slowly.
- › Tyre pressure should be adjusted to the load situation.



Casing rupture due to fatigue

Cause

Temporarily driving with insufficient tyre pressure or on a flat tyre, e.g. due to a nail puncture.

Recommendation

- › Tyres which must be removed prematurely due to damage should be checked with particular care for further usability. Often it is very difficult or impossible to establish initial damages to the casing, which may lead to premature tyre failure.
- › If a tyre in a dual arrangement fails, stop the vehicle as soon as possible to prevent the second tyre from being damaged as well.
- › Adjust the tyre pressure to the load situation.



Casing rupture due to foreign object trapped between twin tyres

Cause

If stones etc. remain trapped between dual tyres, this may lead to severe sidewall damage or to a break in the casing.

Recommendation

Regularly check for and remove any trapped foreign objects. To do this, tyres must be deflated and in some cases the outer wheel removed.



Rupture damage

Cause

A sharp-edged foreign object penetrates a localised area and causes the casing to rupture.

Recommendation

Tyres damaged in this way cannot normally be repaired; they must be replaced.



Chafing

Cause

Frequent bumping into and scraping along kerbs. Sometimes this may result in casing damage.

Recommendation

- › Check the sidewalls regularly.
- › If the tyre shows excessive wear, fit the wheel to a less endangered position or rotate the tyre on its rim.
- › Replace the tyre when the damage goes as deep as the casing.
- › Use a special tyre if necessary, e.g. for buses.



Destruction of the casing

Cause

Driving with insufficient tyre pressure. Excessive flexing and the heat then produced may cause complete loss of tyre pressure:

- › penetrating nails or similar sharp objects
- › leaking valves
- › defective tubes and bead flaps
- › hairline cracks in the rim (for tubeless tyres)

Recommendation

- › Check tyre pressure regularly.
- › Establish cause of loss in tyre pressure and rectify.
- › Use only new tubes and bead flaps.



Bead

Scorched bead

Cause

Excessive warmth on brakes and rims as a result of sustained braking or malfunctioning brakes.

Recommendation

- › Regularly check the brakes and the braking system.
- › Use retarder or constant throttle.

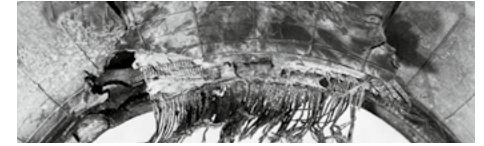
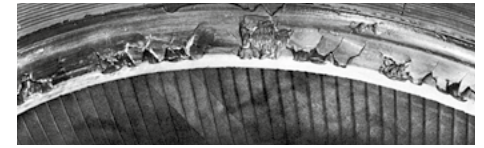

Bead damage due to rim

Cause

Locally deformed rim or corrosion of the rim flange.

Recommendation

- › Check the rim for damage and replace if necessary.
- › Remove any rust from the rim and renew protective coating before fitting.
- › Use suitable fitting lubricants (e.g. CONTIFIX).



Bead damaged due to mounting

Cause

- › Using incorrect or sharp-edge fitting tools.
- › Fitting without the aid of lubricants.

Note

Excessive warming of the brake drums, leading to hardening of the beads, can set the stage for this type of damage.

Recommendation

Follow fitting instructions.

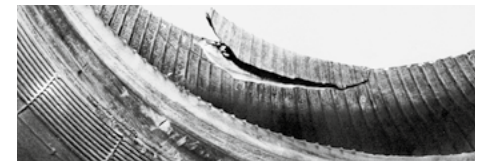

EU Tyre Label 2021 (EU Reg. 2020/740)

Information on the new EU regulation

Continental welcomes the new EU tyre labelling rules, extending the scheme to cover heavy-duty vehicles. It provides consumers, fleet operators and tyre retailers with objective, reliable and comparable information on three important tyre performance characteristics: the tyre's rolling resistance, wet grip and external rolling noise. A pictogram indicating if the tyre is suitable for use in in severe snow conditions (winter and all-season tyres) is present in tyres fulfilling such performance levels.

The new EU tyre label



The new EU tyre labelling scheme is effective from **1st May 2021**.

EPREL Database



The EU tyre label

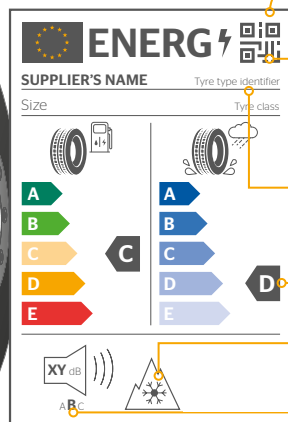

What's new?

QR code individual per "tyre type identifier" with Link to new European Product Database for Energy Labelling (EPREL), where the tyre label and the product information sheet can be accessed in different file formats.

Additional information
(tyre type identifier = art. no.)

Reclassification for lower label classes:
D is the new E; F and G merge to form E.

Options for including pictograms relating to severe snow conditions (3PMSF).

Noise classes: ABC replace sound waves.

Find out more online: the EU tyre label generator

Find out more about the parameter values of Continental tyres online: comprehensive, clear and accessible at all times. With the label generator you can quickly and easily find the appropriate EU tyre label parameters for your Continental tyres. Visit our label generator online at:

<https://www.continental-tires.com/products/b2b/business-know-how/eu-tire-label-search/>

All new label parameters including the links to the label and product information sheet will also be provided via our electronic price catalogue (PRICAT) for direct use in ERP systems.

<https://www.continental-tires.com/products/b2c/tire-knowledge/eu-tire-label/>



What you need to know about the EU Taxonomy

In 2022 the EU introduced a new classification system for sustainable economic activities: **the EU Taxonomy**. It defines whether certain business activities can be declared as sustainable.

The EU Taxonomy aims to foster transparency and prevention of greenwashing. In the future it will be easier for the public, including customers and investors, to compare companies with each other.

Starting with the key benefits, **we will provide you with the most relevant information**, which can help to grow your sustainable business.

How can your company benefit?



Transparency

Be **transparent** and declare your **sustainable economic activities**.



Customer satisfaction

Meet your **customers' demands** and use the EU Taxonomy as a **sales argument**.



Economic benefits

The EU Taxonomy helps to achieve a **better customer retention** and price realization.



Resource efficiency

Decrease your **carbon footprint** and help to reach the **climate objectives**.



Comparability

The standardization of reporting simplifies the assessment of business activities and **prevents greenwashing**.



Green capital

Qualify for **sustainability incentives** with your EU Taxonomy aligned business.

Which transport services are relevant for the EU Taxonomy?

The EU Taxonomy identifies transport services for freight and passengers as one economic activity with the potential for substantial contribution to EU climate mitigation objectives.

Who is obliged to report?

While fulfilling the criteria of the EU Taxonomy is still voluntary, the non-financial reporting is **mandatory** for companies on condition of:

>500 employees

publically listed

As of reporting for financial year **2025** large companies that fulfill **2 out of the 3** following criteria are also affected:

>250 employees

>€40 mill. turnover

>€20 mill. total assets

Please note: As of 2026, small and medium-sized listed companies also need to report.

How the EU Taxonomy affects your fleet and tires

What do you as a fleet customer need to know?

To meet the EU Taxonomy criteria, **Low or Zero Tailpipe Emission Vehicles** qualify, and tires used for your fleet need to meet the **EU tire label criteria** (see below).

That means: Without the right tires, you cannot declare your business activities as EU Taxonomy aligned!

Which vehicle categories are affected?

Zero Tailpipe Emission Vehicles (ZTEV) - e.g. electric vehicles - qualify for the EU Taxonomy. Exemptions are made for certain low-emission vehicles. The following vehicles may also qualify:

- > Low-emission N2/N3 vehicles in accordance with Regulation (EU) 2019/1242, article 3 (12)
- > M2/M3 vehicles with internal combustion engine (ICE) and emission standard Euro 6/VI* **until end of 2025**
- > M1/N1 vehicles with lower than 50 g CO₂ per km **until end of 2025**

* Most recent applicable stage of the Euro VI heavy-duty emission type approval (where applicable).



Light-duty road transport (MC, passenger freight): **M1, N1, L**



Heavy-duty road passenger transport: **M2, M3**



Heavy-duty freight road transport services: **N2, N3**

Which tire label values need to be met?

To be aligned with the EU Taxonomy, these two EU tire label criteria must be met:



The identification of EU Taxonomy aligned tires

is based on the EPREL* data base depending on tire category (C1, C2, C3), tire size, 3PMSF (y/n), load capacity index, speed category and ice (C1).

* Product database with energy labels and product information sheets. Learn more at: <https://eprel.ec.europa.eu/screen/product/tyres>



Please note: The highest populated class is not automatically a label value "A" if no other tire fulfills that value. What counts is the highest class in that more than one tire is registered (= "populated").

Fuel efficiency class

Two highest populated classes

Class	Entries	%
A	0	0.0
B	0	0.0
C	10	9.0
D	57	51.4
E	44	39.6

External rolling noise class

Highest populated class

Class	Entries	%
A	57	51.4
B	54	48.6
C	0	0.0

Example: EPREL* extract for a C3 tire in 225/75 R 17.5 with 3PMSF and U1 120 SI M (status: June 19, 2023). Blue = two highest/highest populated classes.

How can we help you?

We will give our best to support you on how you can meet the tire-related EU Taxonomy criteria. While the regulations evolve, we will strive to give you updates on the latest status of the ruling and how it can impact your business.

With our products and our solutions, we are your partner on the road to sustainability. For more detailed information, please don't hesitate to **contact your Continental sales representative**.

Transporter and van tyres



Transporter and van tyres

VanContact™ Ultra

For transporters and vans

- > Benefit from superb durability and high sidewall robustness
- > Experience low rolling resistance due to a special compound concept tailor-made for vans
- > Enjoy excellent mileage enabled by its closed pattern design
- > Symmetric tread pattern



Tyre dimensions	
Tyre width in mm	185–235
Rim size in inches	14–17
Speed Symbol	Q / R / S / T / H
Tyre cross-section	series 55–82
Load Index	99–121

B-C A B / 71 dB *

VanContact™ Eco

For transporters and vans

- > Maximum fuel efficiency
- > Enhanced mileage
- > Noise- and comfort-optimised performance
- > Symmetric tread pattern



Tyre dimensions	
Tyre width in mm	185–235
Rim size in inches	15–17
Speed Symbol	R / S / T / H
Tyre cross-section	series 60–75
Load Index	100–121

A-B A B / 70-72 dB *

ContiVanContact™ 100

For transporters and vans

- > High level of efficiency thanks to higher mileage
- > Improved durability on all roads and thus longer service life
- > High safety reserves for heavy loads
- > Symmetric tread pattern



Tyre dimensions	
Tyre width in mm	165–285
Rim size in inches	14–17
Speed Symbol	Q / R / S / T / H
Tyre cross-section	series 60–82
Load Index	89–131

B-D A-C B / 71-72 dB *

ContiVanContact™ 200

For transporters and vans

- > Safe journey thanks to shorter braking distances on wet roads
- > Considerably reduced rolling resistance for lower fuel consumption and greater efficiency
- > Safe handling in all situations, even under heavy loads
- > Symmetric tread pattern



Tyre dimensions	
Tyre width in mm	195–235
Rim size in inches	15–17
Speed Symbol	R / T / H / V
Tyre cross-section	series 55–75
Load Index	95–121

B A-B B / 72 dB *

Transporter and van tyres

VanContact™ Winter

For transporters and vans

- > Shorter braking distances and improved traction on snow
- > High aquaplaning safety and shorter braking distances on wet roads
- > Improved rolling resistance
- > Directional tread pattern



Tyre dimensions	
Tyre width in mm	165–285
Rim size in inches	14–17
Speed Symbol	Q / R / S / T / H
Tyre cross-section	series 55–82
Load Index	89–131



VanContact™ A/S Ultra

For transporters and vans

- > Benefit from superb durability and high sidewall robustness
- > Experience outstanding grip on snow with our intelligent snow catchers and smart 3D sipes
- > Enjoy the low rolling resistance and high mileage enabled by its functionalized polymers
- > Directional tread pattern



Tyre dimensions	
Tyre width in mm	195–235
Rim size in inches	15–17
Speed Symbol	Q / R / S / T / H
Tyre cross-section	series 55–75
Load Index	99–121



M+S

'Snow tyre' means a tyre whose tread pattern, tread compound or structure is primarily designed to perform better in snow conditions than a normal tyre with regard to its ability to initiate or maintain vehicle motion.

VanContact™ 4Season

For transporters and vans

- > All-year efficiency due to reduced fuel consumption
- > High braking performance on wet, muddy and snowy roads
- > Excellent handling and braking on dry roads
- > Symmetric tread pattern



Tyre dimensions	
Tyre width in mm	185–285
Rim size in inches	14–17
Speed Symbol	N / Q / R / S / T / H
Tyre cross-section	series 55–82
Load Index	99–126



VanContact™ Camper

For campers and mobile homes

- > A robust construction boosts safety during temporarily increased loads according to CP standards
- > Excellent handling and braking on dry roads
- > High braking performance on wet, muddy and snowy roads
- > Symmetric tread pattern











Tyre dimensions	
Tyre width in mm	215–255
Rim size in inches	15–18
Speed Symbol	R
Tyre cross-section	series 55–75
Load Index	109–120











The Alpine symbol identifies winter tyres according to UN regulations. The snow performance of these winter tyres has to be proven by objective tests and meet or exceed defined limits. These tyres provide high performance with regards to safety and control on snow and in general on winter road conditions.

Specifications and load capacities

Size	Tyre Pattern	PR	LI/SI ¹⁾	EU tyre label					Rim (meas- uring rim bold)	Tyre dimensions in mm				New tyre		Radius stat + / - 2 % (mm)	Rolling circum- ference + 1.5 % - 2.5 % (mm)	PR	LI	Pos.	Load capacity (kg) per axle at a tyre pressure (bar) ⁶⁾																								
				 ³⁾	 ⁴⁾	 ⁵⁾	M+S			Std.	Spec.	Std.	Spec.	Width	Outer- Ø						Width	Outer- Ø	3.0	3.3	3.5	3.8	4.0	4.3	4.5	4.8	5.0	5.3	5.5	5.8	6.0										
185R 14 C	VanContact Ultra	8	102/100 Q	B	A	B / 71		5J	191	191				183		296	1970	8	102	S	1225	1310	1390	1465	1545	1620	1700																		
	VanContact AP	8	102/100 Q	C	B	B / 72		5½J	196	196	662	668		188	650	296	1970	8	100	T	2310	2465	2615	2765	2910	3055	3200																		
	ContiVanContact 100	8	102/100 Q	C	B	B / 72																																							
	VanContact Winter	8	102/100 Q	D	B	B / 73	• •																																						
	VanContact 4Season	8	102/100 R	C	A	B / 73	• •																																						
	VancoFourSeason	8	102/100 Q	D	C	B / 72	•																																						
195R 14 C	VanContact AP	8	106/104 Q	D	B	B / 72		5J	201	201				193		302	2018	8	106	S	1370	1460	1550	1640	1725	1815	1900																		
	ContiVanContact 100	8	106/104 Q	C	B	B / 72		5½J	206	206	678	684		198	666	302	2018	8	104	T	2600	2770	2940	3110	3275	3435	3600																		
	ContiVanContact 100	8	106/104 S	-	-			6J	211	211				203																															
	VancoWinter 2	8	106/104 Q	D	C	B / 73	• •																																						
205R 14 C	VanContact AP	8	109/107 P	D	B	B / 72		5½J	211	211				203		310	2079	8	109	S	1485	1585	1680	1780	1870	1965	2060																		
	Vanco 2	8	109/107 P	C	C	B / 71		6J	216	216	700	706		208	686	310	2079	8	107	T	2815	3005	3185	3370	3545	3725	3900																		
215R 14 C	VanContact AP	8	112/110 P	D	B	B / 72		5½J	222	222				213		316	2121	8	112	S	1615	1725	1830	1935	2035	2135	2240																		
								6J	227	227	714	720		218	700	316	2121	8	110	T	3065	3265	3465	3660	3855	4050	4240																		
								6½J	232	232				223																															
185/75 R 14 C	ContiVanContact 100	8	102/100 R	B	A	B / 72		5J	191	191	646	650		184	634	289	1921	8	102	S	1175	1250	1330	1405	1480	1555	1625	1700																	
								5½J	196	196				189							T	2215	2360	2505	2645	2785	2925	3060	3200																
								6J	201	201				194																															
195/75 R 14 C	Vanco 2	8	106/104 Q	C	C	B / 71		5J	199	199				191		295	1963	8	106	S	1315	1400	1485	1570	1655	1735	1815	1900																	
								5½J	204	204	660	666		196	648	295	1963	8	104	T	2490	2655	2815	2975	3135	3290	3445	3600																	
								6J	209	209				201																															
165/70 R 14 C	ContiVanContact 100	6	89/87 R	C	B	B / 72		4½J	172	172				165				6	89	S	970	1030	1095	1160																					
	VanContact Winter	6	89/87 R	D	B	B / 73	• •	5½J	182	182				175	588	271	1782	6	87	T	1820	1940	2060	2180																					
								5J	177	177	598	602		170																															
175/70 R 14 C	VancoContact 2	6	95/93 T	C	B	B / 72		4½J	179	179				172				6	95	S	1150	1230	1305	1380																					
	VanContact Winter	6	95/93 T	E	B	B / 73	• •	5J	184	184	612	616		177	602	276	1824	6	93	T	2170	2315	2460	2600																					
								5½J	189	189				182																															
175/65 R 14 C	ContiVanContact 100	6	90/88 T	C	B	B / 72		5J	184	184	594	598		177		269	1770	6	90	S	1000	1070	1135	1200																					
	VanContact Winter	6	90/88 T	E	B	B / 73	• •	5½J	189	189				182	584	269	1770	6	88	T	1870	1995	2115	2240																					
195R 15 C	ContiVanContact 100	8	106/104 S	C	B	B / 72		5J	201	201				193		314	2091	8	106	S	1370	1460	1550	1640	1725	1815	1900																		
								5½J	206	206	703	709		198	690	314	2091	8	104	T	2600	2770	2940	3110	3275	3435	3600																		
								6J	211	211				203																															

Size	Tyre			EU tyre label				Rim (measuring rim bold)	Tyre dimensions in mm				New tyre		Radius stat. +/- 2% (mm)	Rolling circumference + 1.5% - 2.5% (mm)	PR	LI	Pos.	Load capacity (kg) per axle at a tyre pressure (bar) ⁶⁾																					
	Pattern	PR	LI/SI ¹⁾	 ³⁾	 ⁴⁾	 ⁵⁾	M+S 		Std.	Spec.	Std.	Spec.	Width	Outer-Ø						Width	Outer-Ø	3.0	3.3	3.5	3.8	4.0	4.3	4.5	4.8	5.0	5.3	5.5	5.8	6.0							
195/70 R 15 C	VanContact Ultra	8	104/102 R	C	A	B / 71		5J	199	199				191		8	104	S	1300	1385	1470	1555	1635	1715	1800																
	VanContact Eco	8	104/102 R	A	A	B / 72		5½J	204	204				196			102	T	2455	2620	2780	2935	3090	3245	3400																
	VanContact AP	8	104/102 R	D	B	B / 72		6J	209	209	665	671		206																											
	VanContact Ice	8	104/102 R	-	-		• •																																		
	VanContact Viking	8	104/102 R	D	C	B / 73	• •																																		
	VanContact Winter	8	104/102 R	D	B	B / 73	• •																																		
	VanContact A/S Ultra	8	104/102 R	C	B	B / 73	• •																																		
	VanContact 4Season	8	104/102 R	C	A	B / 73	• •																																		
	VancoFourSeason	8	104/102 R (97 T)	D	C	B / 72	•																																		
205/70 R 15 C	VanContact Ultra	8	106/104 R	B	A	B / 71		5½J	212	212				204		8	106	S	1370	1460	1550	1640	1725	1815	1900																
	VanContact AP	8	106/104 R	D	B	B / 72		6J	217	217	681	687		209	669	306	2027	104	T	2600	2770	2940	3110	3275	3435	3600															
	Vanco 2	8	106/104 R	C	C	B / 71		6½J	222	222				214																											
	VanContact Ice	8	106/104 R	-	-		• •																																		
	VanContact Viking	8	106/104 R	D	C	B / 73	• •																																		
	VanContact Winter	8	106/104 R	D	B	B / 73	• •																																		
	VanContact 4Season	8	106/104 R	C	A	B / 73	• •																																		
215/70 R 15 C	VanContact Ultra	8	109/107 S	B	A	B / 71		5½J	220	220				211		8	109	S	1485	1585	1680	1780	1870	1965	2060																
	VanContact Eco	8	109/107 S	A	A	B / 72		6J	225	225				216			107	T	2815	3005	3185	3370	3545	3725	3900																
	VanContact AP	8	109/107 S	C	B	B / 72		6½J	230	230	695	701		221	683	311	2069																								
	ContiVanContact 100	8	109/107 S	C	B	B / 72		7J	235	235				226																											
	VanContact Ice	8	109/107 R	-	-		• •																																		
	VanContact Viking	8	109/107 R	D	C	B / 73	• •																																		
	VanContact Winter	8	109/107 R	C	B	B / 73	• •																																		
	VanContact A/S Ultra	8	109/107 R	C	B	B / 73	• •																																		
	VanContact A/S Ultra	8	109/107 S	B	B	B / 73	• •																																		
	VanContact 4Season	8	109/107 R	C	A	B / 73	• •																																		
VanContact 4Season	8	109/107 S	C	A	B / 73	• •																																			
215/70 R 15 CP	VanContact Camper	8	109 R	C	A	B / 73	• •	5½J	220	220				211		8	109	FAS	1425	1520	1610	1705	1795	1880	1970	2060															
	VancoCamper	8	109 R	D	B	B / 72		6J	225	225	695	701		216			109	RAS	1265	1350	1430	1515	1595	1675	1750	1830	1905	1980	2060												
								6½J	230	230				221	683	311	2069	1.85 x 109	RAT	2635	2810	2980	3150	3320	3485	3645	3810														





Size	Tyre			EU tyre label					Rim (meas- uring rim bold)	Tyre dimensions in mm				New tyre			Rolling circum- ference + 1.5 % - 2.5 % (mm)	PR	LI	Pos.	Load capacity (kg) per axle at a tyre pressure (bar) ⁶⁾																				
	Pattern	PR	LI/SI ¹⁾	 ³⁾	 ⁴⁾	 ⁵⁾	M+S 	Std.		Spec.	Std.	Spec.	Width	Outer-Ø	Width	Outer-Ø					stat. +/- 2 % (mm)	3.0	3.3	3.5	3.8	4.0	4.3	4.5	4.8	5.0	5.3	5.5	5.8	6.0							
225/70 R 15 C	VanContact Ultra	8	112/110 R (115 N)	B	A	B / 71		6J 6½J 7J	232 237 242	232 237 242	709	715	223 228 233	697	317	2112	8	112 110	S T	1615 3065	1725 3265	1830 3465	1935 3660	2035 3855	2135 4050	2240 4240															
	VanContact Ultra	8	112/110 S	B	A	B / 71																																			
	VanContact Eco	8	112/110 R (115 N)	A	A	B / 72																																			
	VanContact AP	8	112/110 R	C	B	B / 72																																			
	ContiVanContact 100	8	112/110 R (115 N)	B	B	B / 72																																			
	VanContact Viking	8	112/110 R	D	C	B / 73	• •																																		
	VanContact Winter	8	112/110 R (115 N)	D	B	B / 73	• •																																		
	VanContact A/S Ultra	8	112/110 S	B	B	B / 73	• •																																		
	VanContact A/S Ultra	8	112/110 R	B	B	B / 73	• •																																		
	VanContact 4Season	8	112/110 R	C	A	B / 73	• •																																		
205/65 R 15 C	VanContact Ultra	6	102/100 T	C	A	B / 71		5½J 6J 6½J	212 217 222	212 217 222	657	663	204 209 214	647	297	1960	6	102 100	S T	1420 2675	1515 2850	1605 3025	1700 3200																		
	VanContact Winter	6	102/100 T	E	B	B / 73	• •																																		
	VanContact 4Season	6	102/100 T	C	A	B / 72	• •																																		
215/65 R 15 C	VanContact Ultra	6	104/102 T	C	A	B / 71		6J 6½J 7J	225 230 235	225 230 235	673	677	216 221 226	661	303	2003	6	104 102	S T	1505 2840	1605 3030	1700 3215	1800 3400																		
	VanContact Eco	6	104/102 T	B	A	B / 71																																			
	ContiVanContact 100	6	104/102 T	C	B	B / 72																																			
	VanContact Winter	6	104/102 T	D	B	B / 73	• •																																		
	VanContact A/S Ultra	6	104/102 T	C	B	B / 73	• •																																		
	VanContact 4Season	6	104/102 T	C	A	B / 73	• •																																		
185/55 R 15 C	VanContact Winter	6	90/88 T	D	B	B / 73	• •	5½J 6J	202 207	202 207	593	597	194 199	585	272	1773	6	90 88	S T	1000 1870	1070 1995	1135 2115	1200 2240																		
205R 16 C	Vanco 2	8	110/108 T	C	C	B / 72		5½J 6J 6½J	211 216 221	211 216 221	750	756	203 208 213	736	335	2230	8	110 108	S T	1530 2890	1630 3080	1730 3270	1830 3455	1925 3640	2025 3820	2120 4000															
175/75 R 16 C	Vanco 2	8	101/99 R	D	C	B / 72		4½J 5J 5½J	179 184 189	179 184 189	678	684	172 177 182	668	308	2024	8	101 99	S T	1140 2145	1215 2285	1290 2425	1365 2565	1435 2700	1505 2835	1580 2965	1650 3100														
	VanContact Winter	8	101/99 R	D	B	B / 73	• •																																		
185/75 R 16 C	VanContact Ultra	8	104/102 R	B	A	B / 71		5J 5½J 6J	191 196 201	191 196 201	696	700	184 189 194	684	314	2073	8	104 102	S T	1245 2350	1325 2505	1405 2660	1485 2810	1565 2960	1645 3110	1720 3255	1800 3400														
	VanContact Eco	8	104/102 R	A	A	B / 72																																			
	ContiVanContact 100	8	104/102 R	B	B	B / 72																																			
	VanContact Winter	8	104/102 R	D	B	B / 73	• •																																		
	VanContact 4Season	8	104/102 R	C	A	B / 73	• •																																		

Size	Tyre			EU tyre label				Rim (meas- uring rim bold)	Tyre dimensions in mm				New tyre		Radius stat. +/- 2 % (mm)	Rolling circum- ference + 1.5 % - 2.5 % (mm)	PR	LI	Pos.	Load capacity (kg) per axle at a tyre pressure (bar) ⁶⁾																										
	Pattern	PR	LI/SI ¹⁾	 ³⁾	 ⁴⁾	 ⁵⁾	M+S 		Std.	Spec.	Std.	Spec.	Width	Outer- Ø						Width	Outer- Ø	3.0	3.3	3.5	3.8	4.0	4.3	4.5	4.8	5.0	5.3	5.5	5.8	6.0												
195/75 R 16 C	VanContact Ultra	8	107/105 R	B	A	B / 71		5J	199	199				191		8	107	S	1350	1435	1525	1610	1695	1780	1865	1950																				
	VanContact AP	8	107/105 R	D	B	B / 72		5½J 6J	204 209	204 209	710	716		196 201	698	320	2115	T	2560	2730	2895	3060	3220	3380	3540	3700																				
	ContiVanContact 200	8	107/105 R	B	A	B / 72																																								
	ContiVanContact 100	8	107/105 R	B	B	B / 72																																								
	VanContact Viking	8	107/105 R	D	C	B / 73	• •																																							
	VanContact Winter	8	107/105 R	C	B	B / 73	• •																																							
	VanContact 4Season	8	107/105 R	C	A	B / 73	• •																																							
	VancoFourSeason	8	107/105 R	D	C	B / 72	•																																							
	VanContact Ultra	10	110/108 R	B	A	B / 71											10	110 108	S T	1350 2555	1440 2725	1530 2890	1615 3055	1705 3215	1790 3375	1870 3535	1955 3690	2035 3845	2120 4000																	
	ContiVanContact 100	10	110/108 R	B	B	B / 72																																								
	VanContact Winter	10	110/108 R	C	B	B / 73	• •																																							
	VanContact A/S Ultra	10	110/108 R	C	B	B / 73	• •																																							
	VanContact 4Season	10	110/108 R	C	A	B / 73	• •																																							
205/75 R 16 C	VanContact AP	8	110/108 R	D	B	B / 72		5½J 6J 6½J	211 216 221	211 216 221	726	732		203 208 213	714	326	2163	8	110 108	S T	1465 2765	1560 2950	1660 3130	1750 3310	1845 3485	1935 3655	2030 3830	2120 4000																		
	ContiVanContact 200	8	110/108 R	B	A	B / 72																																								
	ContiVanContact 100	8	110/108 R	B	B	B / 72																																								
	VanContact Ice	8	110/108 R	-	-		• •																																							
	VanContact Viking	8	110/108 R	D	C	B / 73	• •																																							
	VanContact Winter	8	110/108 R	C	B	B / 73	• •																																							
	VanContact 4Season	8	110/108 R	C	A	B / 73	• •																																							
	VancoFourSeason	8	110/108 R	D	C	B / 72	•																																							
	VanContact Ultra	10	113/111 R	B	A	B / 71											10	116 113 114 111	S S T T	1595 1465 3015 2785	1700 1565 3215 2970	1805 1660 3410 3150	1910 1755 3605 3330	2010 1850 3795 3505	2110 1940 3985 3680	2205 2030 4170 3850	2305 2120 4355 4020	2400 2210 4535 4190	2500 2300 4720 4360																	
	VanContact Eco	10	116/114 R (113 R)	A	A	B / 72																																								
	ContiVanContact 100	10	113/111 R	C	B	B / 72																																								
	VanContact Winter	10	113/111 R	D	B	B / 73	• •																																							
	VanContact A/S Ultra	10	113/111 R	C	B	B / 73	• •																																							
VanContact 4Season	10	113/111 R	C	A	B / 73	• •																																								





Size	Tyre	PR	LI/SI ¹⁾	EU tyre label				Rim (measuring rim bold)	Tyre dimensions in mm				New tyre	Radius	Rolling circumference +1.5% -2.5% (mm)	PR	LI	Pos.	Load capacity (kg) per axle at a tyre pressure (bar) ⁶⁾																				
				3)	4)	5)	M+S		Width	Outer-Ø	Width	Outer-Ø							stat. +/- 2% (mm)	3.0	3.3	3.5	3.8	4.0	4.3	4.5	4.8	5.0	5.3	5.5	5.8	6.0							
215/75 R 16 C	VanContact Ice	8	113/111 R	D	C	B / 73	• •	5½J	220	220			211			8	113	S	1590 1695 1800 1900 2000 2100 2200 2300																				
	VanContact Winter	8	113/111 R	C	B	B / 73	• •	6J	225	225	740	748	216	728	332	2206	111	T	3015 3215 3410 3605 3795 3985 4175 4360																				
	VanContact 4Season	8	113/111 R	C	A	B / 72	• •	7J	235	235			221																										
	VanContact Ultra	10	116/114 R	B	A	B / 71										10	121	S	1720 1835 1945 2060 2165 2275 2380 2485 2590 2695 2795 2900																				
	VanContact Eco	10	116/114 R	A	A	B / 72											116	S	1595 1700 1805 1910 2010 2110 2205 2305 2400 2500																				
	ContiVanContact 100	10	121/119 R	B	B	B / 72											119	T	3230 3445 3655 3860 4065 4270 4470 4665 4860 5055 5245 5440																				
	ContiVanContact 100	10	116/114 R	C	B	B / 72											114	T	3015 3215 3410 3605 3795 3985 4170 4355 4535 4720																				
	VancoCamper	10	116/114 R	C	B	B / 72																																	
	VanContact Viking	10	116/114 R	C	C	B / 73	• •																																
	VanContact Winter	10	116/114 R	C	B	B / 73	• •																																
	VanContact A/S Ultra	10	116/114 R	B	B	B / 73	• •																																
	VanContact 4Season	10	116/114 R	C	A	B / 73	• •																																
225/75 R 16 C	VanContact Winter	8	116/114 R	C	B	B / 73	• •	6J	232	232	758	764	223	744	338	2254	8	116	S	1730 1845 1955 2065 2175 2285 2390 2500																			
								6½J	237	237			228				114	T	3265 3480 3695 3905 4110 4315 4520 4720																				
								7J	242	242			233																										
	ContiVanContact 200	10	121/120 R	B	A	B / 72										10	121	S	1720 1835 1945 2060 2165 2275 2380 2485 2590 2695 2795 2900																				
	ContiVanContact 100	10	121/120 R (122 L)	B	B	B / 72											118	S	1685 1795 1905 2015 2120 2225 2330 2435 2535 2640																				
																	120	T	3325 3545 3760 3975 4185 4395 4600 4805 5005 5205 5400 5600																				
																	116	T	3195 3405 3610 3820 4020 4220 4415 4615 4805 5000																				
	ContiVanContact 100	10	118/116 R	C	B	B / 72																																	
	VanContact Ice	10	121/120 N (118 R)	-	-		• •																																
	VanContact Viking	10	121/120 N (118 R)	D	C	B / 73	• •																																
	VanContact Winter	10	121/120 R (122 L)	C	B	B / 73	• •																																
	VanContact A/S Ultra	10	121/120 R	B	B	B / 73	• •																																
VanContact A/S	10	121/120 R	C	B	B / 72	• •																																	
VanContact 4Season	10	121/120 R	C	A	B / 73	• •																																	
VancoFourSeason 2	10	121/120 R	D	B	B / 73	• •																																	
225/75 R 16 CP	VancoCamper	8	116 R	C	B	B / 72		6J	232	232	758	764	223	744	338	2254	8	116	FAS	1730 1845 1955 2065 2175 2285 2390 2500																			
								6½J	237	237			228					116	RAS	1535 1640 1740 1840 1935 2030 2125 2220 2315 2405 2500																			
	VanContact Camper	10	118 R	C	A	B / 73	• •	7J	242	242			233					1.85 x 116	RAT	3200 3410 3620 3825 4030 4230 4425 4625																			
																		10	118	FAS	1685 1795 1905 2015 2120 2225 2330 2435 2535 2640																		
																		118	RAS	1515 1615 1715 1810 1905 2000 2095 2185 2280 2370 2460 2550 2640																			
																		1.85 x 118	RAT	3120 3325 3530 3730 3925 4120 4315 4505 4695 4880																			
215/70 R 16 C	ContiVanContact 100	6	108/106 T	B	B	B / 72		5½J	220	220			211			6	108	S	1670 1780 1890 2000																				
								6J	225	225			216				106	T	3175 3385 3595 3800																				
								6½J	230	230	720	726	221	708	324	2145																							
								7J	235	235			226																										

See page 191 for footnotes

Size	Tyre		EU tyre label							Rim (meas-uring rim bold)	Tyre dimensions in mm				New tyre		Radius stat. +/- 2 % (mm)	Rolling circum-ference + 1.5 % - 2.5 % (mm)	PR	LI	Pos.	Load capacity (kg) per axle at a tyre pressure (bar) ⁶⁾																
	Pattern	PR	LI/SI ¹⁾	B ³⁾	A ⁴⁾	B / 71 ⁵⁾	M+S ⁶⁾	T	Width		Outer-Ø		Width	Outer-Ø	Load capacity (kg) per axle at a tyre pressure (bar) ⁶⁾																							
									Std.		Spec.	Std.			Spec.	3.0						3.3	3.5	3.8	4.0	4.3	4.5	4.8	5.0	5.3	5.5	5.8	6.0					
195/65 R 16 C	VanContact Ultra	8	104/102 T (100 T)	B	A	B / 71			5½J 6J 6J	204 214 209	204 214 209			196 206 201				8	104 102	S T	1245 2350	1325 2505	1405 2660	1485 2810	1565 2960	1645 3110	1720 3255	1800 3400										
	VanContact Eco	8	104/102 T (100 T)	A	A	B / 72																																
	ContiVanContact 100	8	104/102 T (100 T)	B	B	B / 72																																
	VanContact Winter	8	104/102 T (100 T)	D	B	B / 73	•	•																														
	VanContact A/S Ultra	8	104/102 T (100 T)	B	B	B / 73	•	•																														
	VanContact 4Season	8	104/102 T (100 T)	C	A	B / 73	•	•																														
205/65 R 16 C	ContiVanContact 100	6	103/101 H	C	B	B / 72			5½J 6J 6½J	212 217 222	212 217 222	682	688		204 209 214				6 8	103 101 107 105	S T S T	1460 2760	1560 2940	1655 3120	1750 3300													
	VanContact Ultra	8	107/105 T (103 T)	B	A	B / 71																1350 2560	1435 2730	1525 2895	1610 3060	1695 3220	1780 3380	1865 3540	1950 3700									
	VanContact Eco	8	107/105 T (103 T)	A	A	B / 71																																
	VanContact AP	8	107/105 T (103 T)	C	B	B / 72																																
	ContiVanContact 200	8	107/105 T (103 H)	B	A	B / 72																																
	ContiVanContact 200	8	107/105 T (103 T)	B	A	B / 72																																
	ContiVanContact 100	8	107/105 T (103 T)	-	-																																	
	VanContact Ice	8	107/105 R (103 R)	D	C	B / 73	•	•																														
	VanContact Viking	8	107/105 R (103 R)	D	C	B / 73	•	•																														
	VanContact Winter	8	107/105 T (103 T)	C	B	B / 73	•	•																														
	VancoWinter 2	8	107/105 T (103 T)	E	C	B / 73	•	•																														
	VanContact A/S Ultra	8	107/105 T (103 H)	B	B	B / 73	•	•																														
	VanContact 4Season	8	107/105 T (103 H)	B	A	B / 73	•	•																														
	VancoFourSeason 2	8	107/105 T (103 H)	D	B	B / 73	•	•																														

Size	Tyre			EU tyre label				Rim (meas- uring rim bold)	Tyre dimensions in mm				New tyre		Radius stat. + / - 2 % (mm)	Rolling circum- ference + 1.5 % - 2.5 % (mm)	PR	LI	Pos.	Load capacity (kg) per axle at a tyre pressure (bar) ⁶⁾																				
	Pattern	PR	LI/SI ¹⁾	 ³⁾	 ⁴⁾	 ⁵⁾	M+S 		Std.	Spec.	Std.	Spec.	Width	Outer-Ø						Width	Outer-Ø	3.0	3.3	3.5	3.8	4.0	4.3	4.5	4.8	5.0	5.3	5.5	5.8	6.0						
235/65 R 16 C	VanContact Ultra	8	115/113 R	B	A	B / 71		6½J	245	245				235		8	115	S	1680	1790	1900	2010	2115	2220	2325	2430														
	VanContact Eco	8	115/113 R	A	A	B / 72		7J	250	250	724	730		240	712	325	2157	T	3180	3395	3600	3805	4005	4205	4405	4600														
	VanContact AP	8	115/113 R	C	B	B / 72		7½J	255	255				245																										
	ContiVanContact 200	8	115/113 R	B	A	B / 72																																		
	ContiVanContact 100	8	115/113 R	-	-																																			
	ContiVanContact 100	8	115/113 R	B	B	B / 72																																		
	VanContact Winter	8	115/113 R	C	B	B / 73	• •																																	
	VanContact A/S Ultra	8	115/113 R	B	B	B / 73	• •																																	
	VanContact 4Season	8	115/113 R	B	A	B / 73	• •																																	
	VancoFourSeason 2	8	115/113 R	D	B	B / 73	• •																																	
	VanContact Ultra	10	121/119 R	B	A	B / 71											10	121	S	1720	1835	1945	2060	2165	2275	2380	2485	2590	2695	2795	2900									
	VanContact Eco	10	121/119 R	A	A	B / 72											118	S	1685	1795	1905	2015	2120	2225	2330	2435	2535	2640												
	VanContact AP	10	121/119 R	C	B	B / 72											119	T	3230	3445	3655	3860	4065	4270	4470	4665	4860	5055	5245	5440										
	ContiVanContact 200	10	121/119 R	B	A	B / 72											116	T	3195	3405	3610	3820	4020	4220	4415	4615	4805	5000												
	ContiVanContact 100	10	121/119 R	B	B	B / 72																																		
	VanContact Ice	10	121/119 N (118 R)	-	-		• •																																	
	VanContact Viking	10	121/119 N (118 R)	C	C	B / 73	• •																																	
	VanContact Winter	10	121/119 R	C	B	B / 73	• •																																	
	VancoWinter 2	10	118/116 R (115 S)	C	C	B / 73	• •																																	
	VanContact A/S Ultra	10	121/119 R	B	B	B / 73	• •																																	
VanContact 4Season	10	121/119 R	B	A	B / 73	• •																																		
VanContact 4Season	10	121/119 Q	B	A	B / 73	• •																																		
235/65 R 16 CP	VanContact Camper	8	115 R	C	A	B / 73	• •	6½J	245	245				235		8	115	FAS	1680	1790	1900	2010	2115	2220	2325	2430														
								7J	250	250	724	730		240	712	325	2157	115	RA S	1495	1595	1690	1785	1880	1975	2065	2160	2250	2340	2430										
								7½J	255	255				245				1.85 x 115	RA T	3110	3315	3520	3720	3915	4110	4305	4495													
285/65 R 16 C	ContiVanContact 100	10	131 R	D	A	B / 71		8J	299	299				287		10	131	S	2315	2470	2620	2770	2915	3060	3205	3345	3485	3625	3760	3900										
	VanContact Winter	10	131 R	E	A	B / 73	• •	8½J	304	304	790	798		292	776	351	2351																							
	VanContact A/S	10	131 R	D	A	A / 71	• •	9J	309	309				297																										

Size	Tyre				EU tyre label				Rim (meas- uring rim bold)	Tyre dimensions in mm				New tyre		Radius stat. + / - 2 % (mm)	Rolling circum- ference + 1.5 % - 2.5 % (mm)	PR	LI	Pos.	Load capacity (kg) per axle at a tyre pressure (bar) ⁶⁾											
	Pattern	PR	LI/SI ¹⁾	3)	4)	5)	M+S	Std.		Spec.	Std.	Spec.	Width	Outer-Ø	Width						Outer-Ø	3.0	3.3	3.5	3.8	4.0	4.3	4.5	4.8	5.0	5.3	5.5
195/60 R 16 C	VanContact Ultra	6	99/97 H	B	A	B / 71			5½J	204	204			196		6	99	S	1295	1380	1465	1550										
	ContiVanContact 100	6	99/97 H	C	B	B / 72			6J	209	209	650	654	201	640	297	1939	T	2440	2600	2760	2920										
	VanContact Winter	6	99/97 T	D	B	B / 73	•	•	6½J	214	214			206																		
	VanContact A/S Ultra	6	99/97 H	C	B	B / 73	•	•																								
	VanContact 4Season	6	99/97 H	C	A	B / 73	•	•																								
205/60 R 16 C	VanContact Winter	6	100/98 T	D	B	B / 73	•	•	6J	217	217	662	666	209	652	301	1976	S	1335	1425	1510	1600										
									6½J	222	222			214				T	2505	2675	2835	3000										
215/60 R 16 C	VanContact Ultra	6	103/101 T	B	A	B / 71			6J	225	225			216		6	103	S	1460	1560	1655	1750										
	VanContact Eco	6	103/101 T	A	A	B / 72			6½J	230	230	674	680	221	664	306	2012	T	2760	2940	3120	3300										
	ContiVanContact 100	6	103/101 T	B	A	B / 72			7J	235	235			226																		
	VanContact Winter	6	103/101 T	D	B	B / 73	•	•																								
	VanContact A/S Ultra	6	103/101 T	B	B	B / 73	•	•																								
	VanContact 4Season	6	103/101 T	C	A	B / 73	•	•																								
225/60 R 16 C	VancoContact 2	6	105/103 H (101 H)	C	B	B / 72			6½J	237	237	686	692	228	676	311	2048	S	1545	1645	1750	1850										
									7J	242	242			233				T	2925	3120	3310	3500										
285/55 R 16 C	VanContact A/S	10	126 N	E	A	B / 72	•	•	8½J	304	304			292		10	126	S	2020	2150	2285	2415	2540	2665	2790	2915	3040	3160	3280	3400		
	VanContact 4Season	10	126 N	D	A	B / 72	•	•	9J	309	309	732	738	297	720	329	2182															
225/75 R 17 C	VanContact Winter	6	114/112 Q	C	B	B / 73	•	•	6J	232	232	784	790	223	770	351	2333	S	1970	2100	2230	2360										
	VanContact A/S Ultra	6	114/112 Q	B	B	B / 73	•	•	6½J	237	237			228				T	3745	3995	4235	4480										
	VanContact 4Season	6	114/112 Q	C	A	B / 73	•	•	7J	242	242			233																		
205/70 R 17 C	ContiVanContact 100	10	115/113 R	C	B	B / 72			5½J	212	212			204		10	115	S	1550	1655	1755	1855	1950	2050	2145	2240	2335	2430				
	VanContact Ice	10	115/113 R	D	C	B / 73	•	•	6J	217	217	732	738	209	720	331	2182	T	2935	3130	3325	3510	3700	3880	4065	4245	4420	4600				
	VanContact Winter	10	115/113 R	C	B	B / 73	•	•	6½J	222	222			214																		
	VanContact 4Season	10	115/113 R	C	A	B / 73	•	•																								

Size	Tyre			EU tyre label					Rim (meas- uring rim bold)	Tyre dimensions in mm				New tyre		Radius stat. +/- 2% (mm)	Rolling circum- ference + 1.5% - 2.5% (mm)	PR	LI	Pos.	Load capacity (kg) per axle at a tyre pressure (bar) ⁶⁾																	
	Pattern	PR	LI/SI ¹⁾	 ³⁾	 ⁴⁾	 ⁵⁾	M+S			Std.	Spec.	Std.	Spec.	Width	Outer- Ø						Width	Outer- Ø	3.0	3.3	3.5	3.8	4.0	4.3	4.5	4.8	5.0	5.3	5.5	5.8	6.0			
215/60 R 17 C	VanContact Winter	6	104/102 H	D	B	B / 73	• •	6J	225	225					216		6	104	S	1505	1605	1700	1800															
								6½J	230	230	700	706			221	690		T	102	T	2840	3030	3215	3400														
	VanContact Ultra	8	109/107 T (104 H)	B	A	B / 71											8	109	S	1425	1520	1610	1705	1795	1880	1970	2060											
	VanContact Eco	8	109/107 T (104 H)	A	A	B / 71																																
	ContiVanContact 200	8	109/107 T (104 H)	B	A	B / 72																																
	VanContact Ice	8	109/107 R	D	C	B / 73	• •																															
	VanContact Viking	8	109/107 R	D	C	B / 73	• •																															
	VanContact Winter	8	109/107 T (104 H)	C	B	B / 73	• •																															
	VanContact A/S Ultra	8	109/107 T (104 H)	B	B	B / 73	• •																															
VanContact 4Season	8	109/107 T (104 H)	B	A	B / 73	• •																																
235/60 R 17 C	VanContact 4Season	8	114/112 R	C	A	B / 73	• •	6½J	245	245					235		8	114	S	1630	1740	1845	1950	2055	2155	2260	2360											
								7J	250	250	726	730			240	714		T	112	T	3100	3305	3505	3705	3900	4095	4290	4480										
	VanContact Ultra	10	117/115 R	B	A	B / 72			7½J	255	255						10	117	S	1640	1750	1855	1960	2065	2170	2270	2370	2470	2570									
	VanContact Eco	10	117/115 R	A	A	B / 72																																
	ContiVanContact 200	10	117/115 R	B	A	B / 72																																
	ContiVanContact 100	10	117/115 R	C	A	B / 72																																
	VanContact Ice	10	117/115 R	-	-		• •																															
	VanContact Viking	10	117/115 R	D	C	B / 73	• •																															
	VanContact Winter	10	117/115 R	C	B	B / 73	• •																															
VanContact A/S Ultra	10	117/115 R	B	B	B / 73	• •																																

Size	Tyre			EU tyre label				Rim (meas- uring rim bold)	Tyre dimensions in mm				New tyre Width	Outer Ø	Radius stat. +/- 2 % (mm)	Rolling circum- ference + 1.5 % - 2.5 % (mm)	PR	LI	Pos.	Load capacity (kg) per axle at a tyre pressure (bar) ⁶⁾																		
	Pattern	PR	LI/SI ¹⁾	³⁾	⁴⁾	⁵⁾	M+S		Std.	Spec.	Std.	Spec.								Std.	Spec.	3.0	3.3	3.5	3.8	4.0	4.3	4.5	4.8	5.0	5.3	5.5	5.8	6.0				
225/55 R 17 C	VanContact Ultra	8	109/107 H (104 H)	B	A	B / 71		6½J	237	237				228		8	109	S	1425	1520	1610	1705	1795	1880	1970	2060												
	ContiVanContact 200	8	109/107 H (104 H)	B	A	B / 72		7J	242	242	690	694		233	680	315	2060	T	2700	2875	3050	3225	3395	3565	3730	3900												
	VanContact Ice	8	109/107 R (104 R)	-	-		• •																															
	VanContact Viking	8	109/107 R (104 R)	D	C	B / 73	• •																															
	VanContact Winter	8	109/107 T (104 T)	C	B	B / 73	• •																															
	VancoWinter 2	8	109/107 T (104 T)	C	C	B / 73	• •																															
	VanContact A/S Ultra	8	109/107 H (104 H)	C	B	B / 73	• •																															
	VanContact 4Season	8	109/107 H (104 H)	C	B	B / 73	• •																															
255/55 R 18 CP	VanContact Camper	10	120 R	C	A	B / 73	• •	7½J	271	271	749	753		260	737	341	2233	10	120	FAS	1785	1905	2020	2135	2250	2360	2475	2580	2690	2800								
								8J	276	276				265					120	RA S	1605	1710	1815	1920	2020	2120	2220	2320	2415	2515	2610	2705	2800					
								8½J	281	281				270					1.85 x 120	RA T	3310	3525	3745	3955	4165	4370	4575	4780	4980	5180								

Imprint

Technical data manuals for other tyre groups:

Tyres for passenger cars and vans:

Technical Data Book Car, 4x4, Van Tyres

Industrial-tyres:

Tyre Service Data Industrial Vehicles

Motorcycle tyres:

Technical Manual Motorcycle tyres

The content of this publication is provided for information only and without responsibility. Continental Reifen Deutschland GmbH makes no representations about the accuracy, reliability, completeness or timeliness of the information in this publication. Continental Reifen Deutschland GmbH may, in its sole discretion, revise the information contained herein at any time without notice. Continental Reifen Deutschland GmbH's obligations and responsibilities regarding its products are governed solely by the agreements under which they are sold. Unless otherwise agreed in writing, the information contained herein does not become part of these agreements.

This publication does not contain any guarantee or agreed quality of Continental Reifen Deutschland GmbH's products or any warranty of merchantability, fitness for a particular purpose and noninfringement. Continental Reifen Deutschland GmbH may make changes in the products or services described at any time without notice. This publication is provided on an "as is" basis. To the extent permitted by law, Continental Reifen Deutschland GmbH makes no warranty, express or implied, and assumes no liability in connection with the use of the information contained in this publication. Continental Reifen Deutschland GmbH is not liable for any direct, indirect, incidental,

consequential or punitive damages arising out of the use of this publication. Information contained herein is not intended to announce product availability anywhere in the world.

The trademarks, service marks and logos (the Trademarks) displayed in this publication are the property of Continental Reifen Deutschland GmbH and/or its affiliates. Nothing in this publication should be construed as granting any license or right to the Trademarks. Without the express written consent of Continental Reifen Deutschland GmbH the use of the Trademarks is prohibited. All text, images, graphics and other materials in this publication are subject to the copyright and other intellectual property rights of Continental Reifen Deutschland GmbH and/or its affiliates. Continental Reifen Deutschland GmbH owns the copyrights in the selection, coordination and arrangement of the materials in this publication. These materials may not be modified or copied for commercial use or distribution.

Copyright © 2023
Continental Reifen Deutschland GmbH
All rights reserved.

Terms and Explanations

Load Index

The nominal load carrying capacity of a tyre is expressed as the Load Index (LI) and is expressed in kg. In addition to this, a maximum speed is also determined in connection with the nominal load carrying capacity (refer to speed symbol).

Speed symbol and maximum speed (km/h)

A speed symbol (SI) is used to designate the speed rating of a tyre. The speed rating indicates the maximum speed assigned as per nominal load capacity of the tyre.

PR (obsolete)

„Ply-rating“ (also called „PR“), was an international designation for the solidity of the tyre casing. In the past, the tyre load-carrying class was only expressed by means of a PR number. The exact designation of load carrying capacity is nowadays expressed as a numerical code, namely the Load Index (or LI).

TT/TL

Tubeless - tyres without inner tube
Tube Type - tyres with inner tube

Minimum distance between rim centres

Adherence to the minimum distance between rim centres ensures the fault-free performance of two tyres in accordance with the ETRTO Standard without chains, when mounted dually (refer also to page 5).

Maximum standard value in service

This is the maximum permissible width in accordance with the ETRTO Standard. Dynamic deformations are not included.

Design value

Width and external diameter as provided by the manufacturer.

Stat. radius

Distance from the centre of the wheel to the road surface.

Rolling circumference

The distance covered on each revolution of the tyre.

Tyre fitment

Describes single (S) or dual fitment (D).

Load carrying capacity in kg per axle at an inflation pressure in bar or psi

Axle load carrying capacities with single or dual fitment at an adjusted inflation pressure in bar and psi (1 bar = 14.5 psi).

Explanation of footnotes

- Data acc. to ETRTO Standards Manual
- 1) LI = Load indices (Single/Dual fitment), SI = Speed Symbol
- 2) TT = Tube Type, TL = Tubeless
- 3) Fuel efficiency
- 4) Wet grip

- 5) External rolling noise (Format :grade / value in dB)
- 6) For tyre pressures of 8,0 bar (116 psi) or greater, use valve silt cover plate
- 7) Also available as ContiRe
- 8) Label values shown represent former EU tyre label values (European Commission Reg. 1222/2009)

Technical Customer Services

Country	Postal address	Phone	E-Mail	Website
Andorra, Monaco: (Coordinated via France)	Continental France SNC 60610 La Croix Saint-Ouen, Rue Irene Joliot Curie 80, France	+33 820 902 900	tcs.france@conti.de	www.continental-pneus.fr
North Macedonia: (Coordinated via Hungary)	Continental Hungaria Kft. Edison utca 2, Budaoers Koezep-Magyarország 2040 Hungary	+36 20 5097358	hungary.tcs@conti.de	www.continental.hu
Albania, Kosovo (Coordinated via Romania)	Continental Automotive Products SRL Tires Division Avram Imbroane 9, 300129 Timisoara, PO. 300129, Romania	+40 356 404 524	adria.tcs@conti.de	www.continental.al
Austria	Continental Reifen Austria GmbH Technischer Kundendienst, Triester Straße 14 A-2351 Wiener Neudorf	+43 (0) 2236/40402589	austria.tcs@continental.com	www.continental.at
Baltic States: Estonia, Latvia, Lithuania	Continental Opony Polska Sp.z o.o. ul. Zwirki i Wigury 16C PL 02-092 Warszawa, Poland	+370 657 77720	baltic.tcs@continental.com	www.continental-tires.com/ ee/et/ www.continental.lv www.continental.lt
Belarus (Coordinated via Poland)	Continental Opony Polska Sp.z o.o. ul. Zwirki i Wigury 16C PL 02-092 Warszawa, Poland	Mobile: LT +370 69916813 Mobile: PL +48 609 1104 71	belarus.tcs@continental.com	
BeNeLux: Belgium, Netherlands, Luxembourg	Continental Benelux srl/bv Hermeslaan 1B, B-1831 Diegem, Belgium	+32 (0)27102211	CustomerServiceBelgium@conti.de CustomerServiceNL@conti.de	www.continental.be www.continental-tires.com/ nl/nl/
Bulgaria (Coordinated via Romania)	Continental Automotive Products SRL Tires Division Avram Imbroane 9, 300129 Timisoara, Romania	+40 356 404 524	adria.tcs@conti.de	www.continental.bg
Czech Republic	Continental Barum s.r.o. Objizdna 1628 765 02 Otrokovice, Czech Republic	+420 577 511 111	cz.tcs@continental.cz	www.continental.cz
Denmark	Continental Daek Danmark A/S Banemarksvej 50 E, 2605 Broendby, Denmark	+45 43 23 04 10	co_cod@conti.de	www.continental-daek.dk
Finland	Continental Rengas Oy PL 2 ; FIN-02661 Espoo Hevosenkentä 3, 02600 Espoo, Finland	+358 9 329 900 / ext.3 Technical Service.	tekninenpalvelu.finland@conti.de	www.continental-rengas.fi
France	Continental France SNC 60610 La Croix Saint-Ouen, Rue Irene Joliot Curie 80, France	+33 820 902 900	tcs.france@conti.de	www.continental-pneus.fr
Germany	Continental Reifen Deutschland GmbH, Technischer Kundendienst, Jaedekamp 30, D-30419 Hanover, Germany	+49 (0) 800 7238284	technik.pkw-lkw@conti.de	www.continental.de
Greece (Coordinated via Belgium)	Continental Benelux srl/bv Hermeslaan 1B, B-1831 Diegem, Belgium	+32 (0)27102211	CustomerServiceBelgium@ conti.de	www.continental-tires.com/ gr/el/
Hungary	Continental Hungaria Kft. Edison utca 2, Budaoers Koezep-Magyarország 2040 Hungary	+36 20 5097358	hungary.tcs@conti.de	www.continental.hu
Italy	Continental Italia S.p.a. Via Gioacchino Winckelmann, 1 20146 - Milano, Italy	+39 02 42410329	italy.cs.box@conti.de	www.continental-pneumatici.it
Middle East/Near East (MENA)	Continental Middle East DMCC Jumeirah Lakes Towers - Cluster Y, JBC 3, 4th Floor PO. Box 336519, Dubai, United Arab Emirates	+971 (0) 456 159 00	me.tcs@conti.de	www.continental-me.com
Moldova (Coordinated via Poland)	Continental Opony Polska Sp.z o.o. ul. Zwirki i Wigury 16C, 02-092 Warsaw, Poland	+48 538 979 155	moldova.tcs@continental.com	

Country	Postal address	Phone	E-Mail	Website
North Africa	Continental Tyre North-Africa SARL Tour Casablanca Finance City Lot 57 - Étage 14 - Casa Anfa 20220 Casablanca Morocco	+212 5 22 78 54 08 +212 6 61 71 67 74	northafrica.tcs@conti.de	
Norway	Continental Dekk Norge Rakkestadveien 55, 1814 Askim Norway	+4723068040	tekniskservice@conti.de	www.continental.no
Poland	Continental Opony Polska Sp. z o.o. ul. Zwirki i Wigury 16C 02-092 Warsaw, Poland	+48 22 577-13-00	dzial.techniczny@conti.de	www.continental-opony.pl
Portugal	Continental Pneus (Portugal), S.A. Rua Adelino Leitão nº 330, 4761 - 906 Lousado, Portugal	+351 252 428824	servicos.tecnicos@continental. com	www.continental-pneus.pt
Republic of South Africa (RSA)	Continental Tyre S.A. (Pty) Ltd., 6 Cadle Street, New Brighton West, Gqeberha, South Africa	Gauteng +27 60 503 6545 KwaZulu-Natal +27 83 512 6833 Western Cape +27 60 503 9603 Eastern Cape +27 83 656 3737	rsa.tcs@conti.co.za	www.continental.co.za
Romania	Continental Automotive Products SRL Tires Division Avram Imbroane 9, 300129 Timisoara, PO. 300129, Romania	+40 356 404 524	romania.tcs@conti.de	www.continental-tires.com/ ro/ro/
Saudi Arabia	Al-Muttak Continental L.L.C. Albasateen Square, 2nd Floor - Office No. 107 Jeddah - Saudi Arabia	Jeddah: +966 548651239 Riyadh: +966 507942332 Dammam: +966 549006050	ksa.tcs@conti.de	www.continental-me.com
Slovakia	Continental Barum s.r.o. Objizdna 1628 765 02 Otrokovice, Czech Republic	+420 577 511 111	cz.tcs@continental.cz	www.continental.sk
SouthEast Europe: Bosnia&Herzegovina, Croatia, Montenegro, Serbia, Slovenia	Continental Adria pnevmatike d.o.o. Zagrebska cesta 104, 2000 Maribor, Slovenia	+38624503429	adria.tcs@conti.de	www.continental.ba www.continental.hr www.continental-tires.com/ rs/sr/ www.continental.si
Spain	Continental Tires Espana, S.L.U. P.E. San Fernando de Henares Edificio Munich Avda. Castilla nº2-1ªPlanta B-C E. 28830 San Fernando Henares (Madrid), Spain	+34 91 660 36 27	customerservice.es@conti.de	www.continental-neumati- coses
Sweden	Continental Däck Sverige AB Prognosgatan 2 S - 50464 Borås Sweden	+46 200 456 000	sweden.tcs@continental.com	www.continental-däck.se
Switzerland	Continental Suisse SA, Customer Service, Lerzenstrasse 19A 8953 Dietikon, Switzerland	+41 (0) 44 745 56 00	kundendienst.ch@conti.de	www.continental-reifen.ch
Türkiye	Continental Lastikleri Türkiye Küçükbakkalköy Mah. Kayışdağı Cad. Allianz Tower 1/26 34750 Ataşehir İstanbul, Türkiye	+90 216 587 00 00	hizmet@conti.de	www.continental-hastikleri.com.tr
Ukraine	Continental Opony Polska Sp.z o.o. ul. Zwirki i Wigury 16C, 02-092 Warsaw, Poland	+48 538 979 155	ukraine.tcs@continental.com	www.continental.ua
United Kingdom (UK) & Eire	Continental Tyre Group Ltd Building DC2, Castle Mound Way, Central Park, Rugby, CV23 0WB, UK	+44 1788 566 240	administrator.technical@conti.de	www.continental-tyres.co.uk

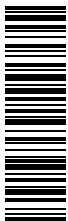

64GD8.uk

64GD8.uk 2024.01

Continental Reifen Deutschland GmbH
Büttnerstraße 25
30165 Hannover
Germany

www.continental-truck-tyres.com
www.continental-corporation.com