

VIVID TV BOX VTB-101



Operation Manual

Please browse our online catalogue to view our full product range.
44-48 Maitland Road, Mayfield East, NSW, 2304 Australia, sales@converters.tv
Phone +61 249689313 Fax +61 249689314
www.converters.tv

Introduction

The compact unit easily turns your LCD, CRT monitor, plasma display or projector into a multimedia center. With a built-in TV tuner and multiple video ports, you can connect DVD players, digital cameras, VCRs or even game consoles. It has a custom built-in V-chip so the content can be filtered. It provides S-video, composite (RCA) video connectors, audio pass-through and front-panel headphone support.

With advanced scaling technology, the unit provides 3:2 pull down correction that eliminates jitter from DVD movies that originated from motion picture films. Motion and adaptive de-interlacing also improves the clarity and sharpness of the overall image producing sharp, clear, saturated images.

The PIP (Picture In Picture) function allows that users are able to have a small square on the screen showing something from TV tuner, S-Video or Composite input. Users can select PIP input from TV tuner, S-Video, Composite. The size, position, quality of the PIP is also adjustable.

Users can also adjust contrast, brightness, color, hue and channel from the remote control and on-screen menu. The TVBOX with its built-in V chip allows controlled programming based on a selected rating system.

Closed caption technology displays text overlay of spoken audio over video. A RGB computer pass-through function also lets you watch TV or enjoy a DVD movie without turning on your computer. SAP/MTS stereo allows the reception of audio other than main programming audio. Auto tuning features let you tune the TV broadcast and cable TV channels automatically.

Precautions







1. Do not expose this product to direct sunlight.
2. Keep the unit away from radiator, heat sources and magnetic field.
3. Do not place it in very dusty or humid locations.
4. Use this unit in a horizontal position only.
5. Do not put heavy objects on top of the converter.
6. Put the unit in an open space that has good ventilation.
7. If the unit is acting abnormally keep the unit away from TV or other electronic equipment.
8. Unplug the unit from the power supply when it is not to be used for a long period of time.

Features

- Stand-alone, Plug-n-Play. No software drivers required and no messy PC installation routines.
- No PC compatibility problems & special firmware design for some famous PDPs (Plasma Displays).
- Built-in TV tuner, support up to 125 channels with Fine Tuning function.
- Provide user-friendly OSD (on screen display) to control functions.
- Automatic source standard detection (NTSC/PAL/SECAM for video or S-Video).
- Auto-scan air/cable TV channels, channel rename, and channel editing functions.
- Full screen TV display, support VGA (640x480), SVGA (800x600) and XGA (1024x768) display resolution.
- DE-INTERLACE function provides can provide high quality pictures with sharp & stable image output to VGA/DVI out.
- Support 60Hz & 75Hz Output Freq. Display function.
- Compatible for multi-signal inputs: TV tuner, Video, S-Video & VGA.
- Support Sleep Timer Setting.
- Available in NTSC/PAL/SECAM model
- Localized TV system menu selection.
- Re-mapping function for programming your favorite channels.
- Fully functional infrared remote control.
- Supports 3:2 pull-down for film mode.
- Support input and MTS/Stereo output for NTSC
- Support 15pin D-Sub graphic card (VGA in); 15pin D-Sub monitor (VGA out).
- Support Picture in Picture (PIP).
- Channel Swap, Channel Rename, Channel Edit provide flexible and comprehensive functionality in TV function.
- Support FM radio (Option).
- Support Nicam / Stereo for Pal (Option).
- Support protection of Channel setting: V-Chip for USA NTSC system. (Option).

Front Panel



1.  **POWER**
Pressing this button to switch the unit On or Off.
2.  **VIDEO SOURCE SELECTION**
Select the video source between TV/Cable, S-Video, AV or PC
3. **POWER LED / INFRARED RECEIVER**
Lights when the TV BOX is powered up and ready to operate. Receive the Infrared signal from the remote control.
4.  Decrease the sound volume
5.  Increase the sound volume
6.  Adjust channel decrease
7.  Adjust channel increase

Rear Panel



1. **DC In-** Connect to a 12V power supply
2. **VGA Out-** Connect your 15 Pin Monitor to the VGA output.
3. **VGA In-** Using the 15 pin VGA cable provided, connect one side to the VGA output on your pc and the other side to the VGA In of your unit.
4. **Line Out** – Please connect it to your PC/external speakers.

5. **Line In-** Please connect the audio from the sound card to Line In port. Thus you should be able to have sound from PC/external speakers even when your unit is in sound by mode.
6. **S-Video-** Please connect it to the S-Video In port when the external Video device is S-Video.
7. **Video In-** Please connect the external video from VCR, LD/VCD/DVD or video game console to the Video In port.
8. **Audio (R + L)-** Please connect the external audio to the Audio In port.
9. **RF In (VHF/UHF)-** Please connect your RF cable to RF IN port to receive antenna or cable TV signal.

Connection and Installation

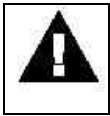

1. To prevent damage to your equipment due to ground potential influence, make sure that all devices on the installation are properly grounded. Consult your dealer for technical details if necessary.
2. Please turn off the power of all devices before connection.

To install the unit for the analog TV and A/V device connection, please refer to the diagram below.

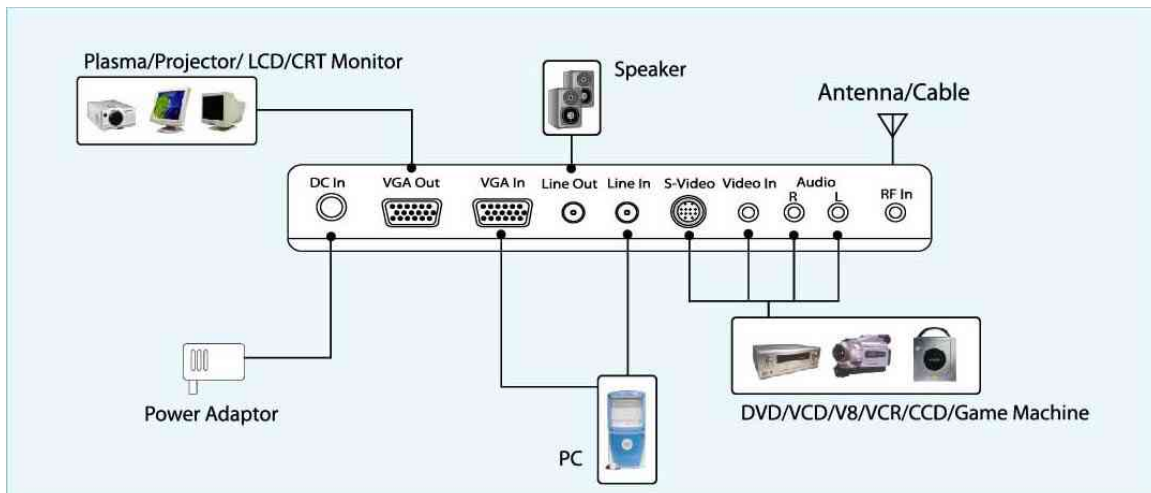

Notes-

- * Audio/Video connection: For audio connection, please use RCA audio (L/R) connector. For video connection, please choose either RCA video connector or S-Video connector.
- * Moreover, for connection to a stand alone, please omit those connections associated with PC.

Operation Instruction

Initial Settings

For all function settings of the unit, you can use the supplied remote control unit.

Please refer to the following steps below:

1. Install 2 AAA batteries into the Remote Control.
2. Power on the unit or press the Power button on the Remote Control
3. Press the “Source” button to select signal source.
4. Press the “Autoscan” button to scan and memorize all the channels.
5. After the auto scan is finished, please press channel “+”, “-“ or channel number keys to select channels.
6. Press the “Menu” button and the OSD Main Menu window appears.
7. Press ◀ or ▶, to select the OSD Sub Menu.
8. Press “ENTER” for the he selected Sub Menu
9. If you don’t want to select the Sub MENU, press” EXIT” button.



Source Select Setting

Source Select Sub-Menu provides *TV*, *AV*, *S-VIDEO*, *YCbCr* and *PC* mode selections.

1. In the SOURCE Sub Menu, press ◀ or ▶ button to choose the Video Source; TV; AV; S-video; FM; PC.



2. Press “ENTER” to select the source.
3. Press “EXIT” to return to the Main “MENU”.

PICTURE setting

Picture Sub-Menu provides **BRIGHTNESS, CONTRAST, COLOR, TINT, SHARPNESS** adjustment modes AND **RESET**.

1. In the **Picture** Sub-MENU, PRESS ◀ or ▶ button to choose the required item.

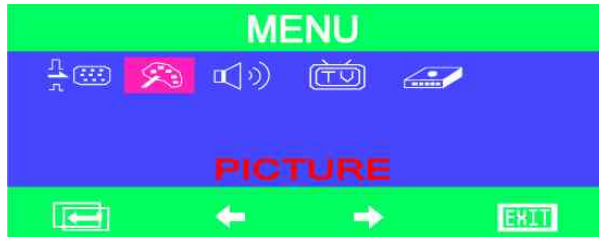

2. Press ◀ or ▶ button to adjust the selected item.

E.g. To adjust the level of brightness:



3. Press **ENTER** to confirm the setting.
4. Select **Reset** to clear all adjustments and return to factory settings.
5. When finished making all picture adjustments, press the “Exit” button to return the main menu.

SOUND Setting

The **SOUND** Sub-Menu provides **BASS, TREBLE, BALANCE** adjustment modes and the **RESET** mode.

1. In the **SOUND** Sub MENU, Press ◀ or ▶ button to choose the required item.

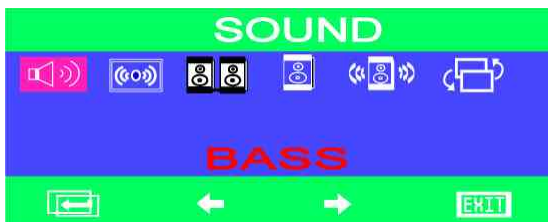

2. Press “Enter” to select the item.

3. To adjust the selected item by **Left** and **Right** button.

E.g. Adjusted Bass level:

BASS  50

LOUDNESS function enhances the audio volume from the TV BOX. Press **Left** or **Right** to turn it on or off.



SURROUND function activates the surround effects of the TV Box. Press the **Left** or **Right** to turn it on or off.



4. When finished, press “Exit” to return to SOUND Sub MENU.
5. Select RESET to clear all adjustment and return to factory setting.
6. When finished, press the “Exit” button to return to the Main MENU.

TV FUNCTION Setting

The **TV FUNCTION** Sub-Menu provides **AIRCATV**, **CHANNEL SWAP**, **CHANNEL RENAME**, **CHANNEL EDIT**, **CHANNEL MEMORY**, **FINETUNE** and **AUTO SCAN** functionality. **AIRCATV** function is only available on the model which is built in TV frequency table.

1. Select **AIRCATV**, **CHANNEL SWAP**, **CHANNEL RENAME**, **CHANNEL EDIT**, **FINETUNE** or **AUTO SCAN**, by pressing **Left** or **Right** button and press “ENTER” to confirm the setting.





2. Before scanning channels, please select the appropriate broadcasting system in **AIR (ANTENNA) and CATV (Cable)**.



- To scan program channels automatically, press the *AUTOSCAN* button. After finishing the *AUTOSCAN*, the scanned program channel will be saved.

Channel Swapping

Press  or  and "Enter" button to enter the **CHANNEL SWAP** function.



The **Original** column remains the present channel number. Key in the channel number you like to swap at the **TARGET** column.



For example, if you want to change the channel 11 to channel 22. Press the number key on the remote control unit. After key in the number 22, the channel 11 will be swapped with the channel 22.

Channel Rename

The **CHANNEL RENAME** function allows you to edit the channel's name. After you edit the channel name, it will show below the channel number.

Press **←** or **→** and "Enter" button to enter the **CHANNEL RENAME** function.



After entered the **CHANNEL RENAME** function, the Channel List dialog will show up. Press the button **↓↑** to select the channel you want to rename then press "Enter" to enter the channel rename dialog.



(No TV Frequency table built-in)

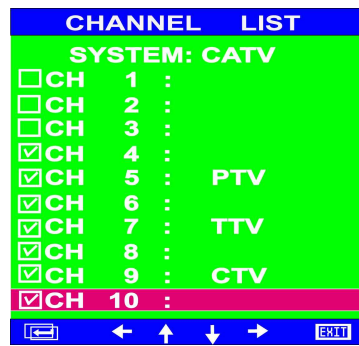

(With TV Frequency table built-in)

Note: "SYSTEM SELECT" selection is only available on the model, which is built-in TV frequency table.

The CHANNEL RENAME function provides 5 characters for user's edit. Press the **↓↑** to select the character, press **←** **→** to move to the next character you want to change.

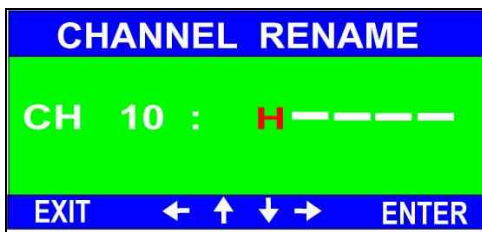

After you have entered the channel name, press “Enter” then the channel name will be saved.

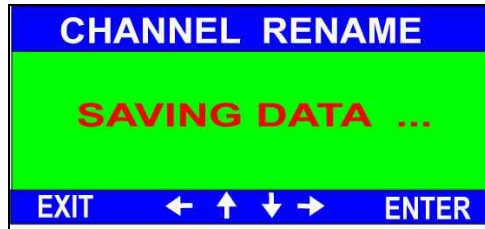

The channel list will depend on the channels you’ve scanned. The scanned channel will be marked with a check, which means this channel is available.

All the channels will be listed on the channel list screen. Each screen shows 10 channels. You can press to move to the next page.



(No TV Frequency table)



(With TV Frequency table)

1. Channel Editing

Select the “CHANNEL EDIT” function on the TV Function Screen by pressing the or button. Then press the “Enter” button to enter the function.



Press or to select “ADD” or “ERASE” functionality.



The channels are not actually removed or added but skipped from or recovered to the channel table. You can still select the removed channel by pressing the channel number.

Adding a channel.

- For example to add CH 60 use the Remote Control unit, to select CH 60, then enter the TV function sub-menu, press ◀ or ▶ button to enter the **CHANNEL EDIT**. And then press ◀ or ▶ button to access **ADD**, and confirm **ADD** by pressing the “Enter” button on your Remote Controller.

Erasing a channel

- For example to Erase CH 60 Use the Remote control unit, to select CH60, and then enter the TV function sub-menu, press ◀ or ▶ button to enter CH Edit and then press ◀ or ▶ button to access **ERASE**, and confirm Erase by passing the “Enter” button on your Remote Controller. After Adding/Erasing a channel, press the “**Exit**” button to return to the TV function sub-menu. When you have finished Channel Editing; press the ”**Exit**” button again to return to the main menu.



5. Fine Tuning

Press ◀ or ▶ and “Enter” button to enter the **FINE TUNE** function. Press ◀ or ▶ to fine-tune the frequency of the current channel to make it clear, then press “Exit” to return to TV Function sub-menu once finished.







6. Favorite Channel Setting

The favorite channel setting function provides 5 channels for setting your own favorite channels. You can set your favorite channel from OSD or your remote control unit.

Press  or  and “Enter” button to select the CHANNEL MEMORY function.



In the **CHANNEL MEMORY** sub menu, press     buttons to move the square mark and press the “Enter” button to set the current channel on the position you demand. When the square mark move to the Favorite column, press the “Enter” button to **DISABLE** or **ENABLE** the favorite channel function.

When the **FAVORTIE** column is selected on **ENABLE**, you can only select the channels on the list by press channel up or channel down on your remote control. To disable the function, move the square mark on the **FAVORITE** column and press the “Enter” button to disable it.



SYSTEM SETTING

The **SYSTEM SETTING** Sub-Menu provides **RESOLUTION**, **OSD POSITION**, **OSD COLOR**, **SYSTEM INFO**, **SLEEP SETTING** and **SYSTEM RESET** functionalities.

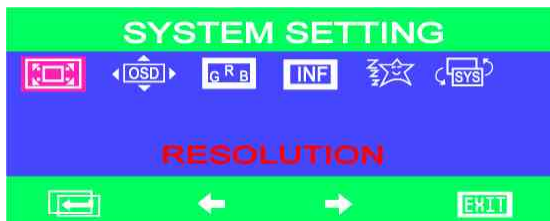

RESOLUTION Setting

The **RESOLUTION** Sub-Menu provides **640 X 480@60Hz**, **800 X 600@60Hz**, **1024 X 768@60Hz**, **640x480@75Hz**, **800x600@75Hz**, **1024x768@75Hz** modes



1. To enter your demand resolutions, press **←** or **→** button to select one of them, then press **“Enter”** to confirm the setting and **Exit** to main menu

OSD FUNCTION Setting

The **OSD FUNCTION** Sub-Menu provides **OSD POSITION**, **OSD COLOR** settings.

- 1 Press the **“Enter”** button to choose the **“OSD POSITION”**, another **“OSD POSITION”** sub-menu appears, Use **↑↓** or **← →** buttons to move the position of menu position on the display. After setting, press the **“Exit”** button to return to the OSD function Sub-Menu.

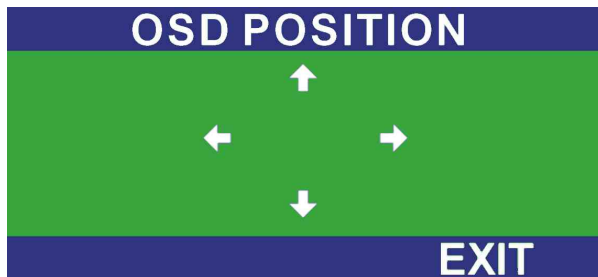

3. Press **“Enter”** button to choose the **“OSD COLOR”**, using the **←** or **→** button to choose your favorite OSD color. After setting, press **“Exit”** to return to the OSD function sub-Menu.



Press the **←** or **→** button to switch the color selection, and choose the colour you like.



SYSTEM INFO

Press **←** **→** and the Enter button to entry the system info sub menu.



You can see the details information of the TV box from the system info sub menu.

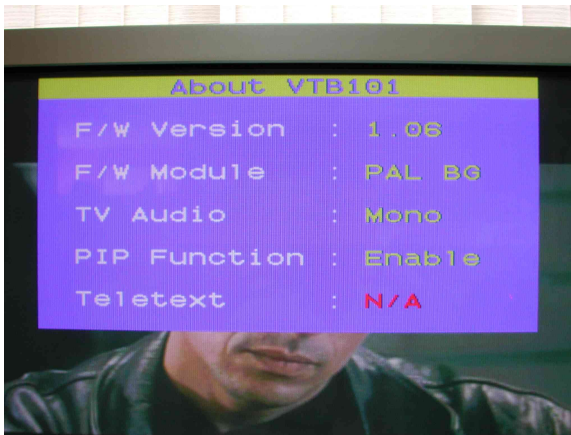

SLEEP SETTING

SLEEP SETTING function provides the functionality switches off the TV Box automatically as desired; **5, 10, 15, 30, 60, 90** minute options.



Press **← →** to select the sleep time.

SYSTEM RESET function

Press **← →** to select the SYSTEM RESET function and the Enter button. You can see the LED at the front panel will blink. After stopping blinking, all the settings of the TV box are restored to the default setting (factory setting).



PIP (Picture-In-Picture) Function

The Picture-In-Picture function provides the user the ability to see the TV and work on the PC at the same time. To activate the PIP function, press the PIP button on the remote control unit, the sub-screen will appear on your PC.



Press the **DISPLAY** button to display the information of your video source and volume.
Press the **MUTE** button to turn off the sound.

Switch the video resource to **TV**, **AV**, and **S-video**, press the **SOURCE** button on the remote control unit. If you want to change the PIP screen size, then press the PIP button. The PIP function provides 3 screen sizes (small, medium, and large) for PIP selection. Please refer the figures below.

Moving the PIP screen by pressing the menu button, and use the **←** **→** and **↑****↓** buttons to move the PIP screen position and press the EXIT button to return to the other operation.

For the best video quality and the performance of the PIP function, it is recommended that you to set your PC monitor resolution on 1024x768@60Hz.

FM Function Setting (Option)

FM function is for you to listen to the FM radio with the TV box, this function only available on the TV BOX built in the FM chipset, and it is optional.

Press **←** or **→** button and then pressing “**ENTER**” to enter the FM function.



After you have entered the FM function, the FM radio mode - a black blank screen will show up. The number shows on the right top corner of the screen is the frequency number of the FM radio. FM radio frequency range: 88.00~108.00

Use the number keys on the remote control unit to key in the radio frequency number of the radio channel you preferred. Or press the **↑** **↓** to tune the frequency up and down 0.05MHz. To perform the quick search, toggle the **↕** button about 1.5 seconds. The function will search up or down the radio channel automatically.

The TV BOX provides **SOURCE**, **FM FAVORITE** and **SOUND** functions to enhance the functionality in FM mode.



Press **←** or **→** button to select the functions, the operations of **SOURCE SELECT** and **SOUND** functions are as same as the chapter 4-1-1 and 4-1-3, please reference the chapters to operate the function.

How to record you favorite radio channel...

The FM function provides 8 radio stations for you to set your own favorite channels. Please follow the instructions to set your favorite channels.

1. Tune the radio frequency to the channel, **e.g.89.50**. Press the **FAV.SET** button on the remote control unit; the FM FAVORITE dialog will pop up. Press **↑ ↓** to select which station you prefer. After you decide the station number, press “Enter”, the radio channel will be set to the station number you chose, **e.g. station 1**. Then press “Exit” to return to the FM radio mode.



FM FAVORITE	
1:	89.50
2:	99.70
3:	92.10
4:	98.90
5:	107.70
6:	100.70
7:	96.10
8:	103.30

1. After you have tuned the channel you prefer, **e.g. 100.7**, press the “Menu” button on the remote control, and press **←** or **→** and the “Enter” button to enter the **FM FAVORITE** function.



Press **↑ ↓** to select which station you prefer. After you have decided the station number, press “Enter”, the radio channel will be set to the station number you chose, **e.g. station**. Press “Exit” to return to the FM radio mode.



FM FAVORITE	
1:	89.50
2:	99.70
3:	92.10
4:	98.90
5:	107.70
6:	100.70
7:	96.10
8:	103.30

Press the **FAVORITE** button on the remote control unit to switch your FM favorite channels. The number beyond the frequency number on the right top corner of the screen shows the station number of radio channel locates.

Remote Control Functions

Please browse our online catalogue to view our full product range.
44-48 Maitland Road, Mayfield East, NSW, 2304 Australia, sales@converters.tv
Phone +61 249689313 Fax +61 249689314
www.converters.tv

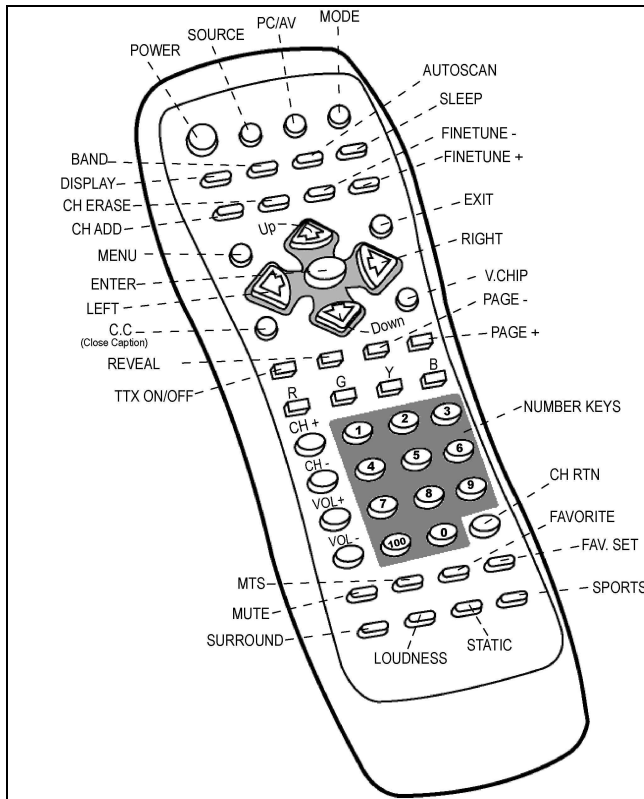

1. POWER

Powers the unit on and off.

2. SOURCE

Selects the video source between TV/cable, AV, S-video and YCbCr (Component).

3. PC/AV

Switches the AV and PC modes.

4. MODE

Adjusts the video resolution – 1024x768, 800x600, 640x480

5. DISPLAY

Displays current setting information on your screen.

6. PIP

Activate to the PIP mode, adjust the PIP screen by clicking the button

7. AUTOSCAN

Scan program channels automatically and save scanned channels.

8. SLEEP

Automatically switches off the TV Box as desired; 5, 10, 15, 30, 60, 90 minute options.

9. CH ADD

Adds the current channel, which you lose from the TV cable.

10. CH ERASE

Press the button to erase the current channel, which you don't like to see.

11. FINE TUNE -

Tunes the TV channel signal down by continuous clicking the button.

12. FINE TUNE +





Tunes the TV channel signal up by continuous clicking the button.

13. MENU

Press the button to pop up the OSD MENU

14. Arrow Buttons

Press the "Arrow" button to choose the items on the main menu or Sub-menu.

Press     button to choose item on the menu or to move the OSD position.

15. EXIT

Exits the current menu selection and return to the previous menu. Press this key repeatedly to close all items.

16. ENTER

Selects the currently highlighted menu item or to confirm the setting.

17. C.C (This function is only supported by USA/NTSC area)

Enables / disables the closed caption function.

18. V.CHIP (This function is only supported by USA/NTSC area)

Locks the channel for security considerations.

19. NUMBER KEYS

Selects the channel or key in the values.

20. CH + / -

Click to switch the channel forward and back.

21. VOL + /-

Click to turn the volume louder or lower.

22. CH RTN

Press the button to return the last channel.

23. MUTE

Mutes the volume.

24. MTS

Enables the MTS function in NTSC system. If you are in Pal system area, press this button to execute the "Nicam" stereo function.

25. FAVORITE

Press the button to switch on the "Favorite Channel"

26. FAV.SET

Sets the current channel to “Favorite Channel”.

27. SURROUND

Activates the surround effect.

28. LOUDNESS

Enhances the volume setting

29. STATIC

Enables Interlace Mode

30. SPORTS

Enables De-interlace Mode

Favorite Channel Setting

1. Go to the channel you want, press “ **FAVSET** ” button on the remote control unit. The favorite channel setting OSD will pop up.



2. Press the “Favorite” button to select the position to put the channel. The favorite channel selection will follow position sequence.



3. After deciding the position, press the “FAVSET” button, the channel will be set.

To replace the channel on your favorite channel list please follow the step 1. Then press the “FAVSET” button; where the new ones will replace the original channel.

Trouble Shooting

Symptom	Solution
No picture on monitor	<ul style="list-style-type: none">● Make sure the power cord is connected to AC outlet, DC plug is connected to DC IN port and the power is on.● Check the connection of your source signal.
The IR control can't control product	<ul style="list-style-type: none">● Make sure if batteries installed are not weak.
If you still have difficulties that you can't resolve using the tips described above, please unplug and plug in the AC cord to reset your product. Otherwise, please call your local agency for servicing.	

Specifications

Power	DC 12V 1200mA Center positive
Video Input	Composite video RCA connector.
S-Video Input	S-Video 4-pin mini DIN connector
Audio Input	Stereo R+L RCA connectors
Line In	Phone Jack 3.5φ
Line Out	Phone Jack 3.5φ
RF In	F-Female connector for NTSC system EC-Female connector for Pal system
VGA Output	D-Sub 15 pin Female connector
VGA Input	D-Sub 15 pin Male connector
Power Consumption	15W nominal
Support VGA Frequency	60Hz & 75Hz
Resolution mode	640 x 480, 800 x 600, 1024 x 768
Dimensions (L*W*H)	225 x 160 x 31mm
Weight	1.8 kg