



COPADATA
do it your way

zenon manual

zenon Editor:

v.8.00





COPA-DATA

©2018 Ing. Punzenberger COPA-DATA GmbH

All rights reserved.

Distribution and/or reproduction of this document or parts thereof in any form are permitted solely with the written permission of the company COPA-DATA. Technical data is only used for product description and are not guaranteed qualities in the legal sense. Subject to change, technical or otherwise.

Contents

1. Welcome to COPA-DATA help	7
2. Editor	7
3. Start editor.....	9
4. Compatibility.....	9
5. Start page.....	10
5.1 Opening the start page using a symbol in the menu bar	11
5.2 View if no workspace is loaded.....	12
5.3 View if no project is activated for the workspace.....	14
5.4 View for active workspace with active project	14
5.5 View for the start page with missing screens	16
6. User interface.....	16
6.1 Adjust view.....	18
6.2 Position window.....	19
6.3 Full-screen mode.....	24
6.4 Keyboard shortcuts	26
7. Toolbars	31
7.1 Toolbar dockable windows	34
7.2 Toolbar alignment.....	34
7.3 Toolbar screens	37
7.4 Toolbar symbols.....	39
7.5 Toolbar Editor profiles	41
7.6 Toolbar Elements	42
7.7 Toolbar Production and Facility Scheduler	44
7.8 Toolbar Remote Transport.....	45
7.9 Toolbar Report Generator.....	46
7.10 Toolbar Runtime files	47
7.11 Toolbar visibility levels.....	48
7.12 Toolbar Macro List	49

7.13	Toolbar detail view.....	50
7.14	Toolbar properties	51
8.	Menu bar	53
8.1	File.....	54
8.2	Edit	55
8.2.1	Screens and symbols	56
8.2.2	Reporting.....	60
8.3	View	62
8.4	Screens.....	62
8.5	Symbol.....	64
8.6	Window.....	66
8.7	Help	67
8.8	Tools.....	67
8.8.1	Setting	69
9.	Editor profiles.....	85
9.1	Predefined profiles.....	86
9.2	Administrate Editor profiles with the task bar	90
9.3	Administrate Editor profiles via menu	91
9.4	Administrate Editor profiles with the task bar	92
9.5	Select the editor profile in the context menu	93
9.6	Delete Editor profiles	93
9.7	Individual naming of editor profiles	93
10.	Project Manager	94
10.1	Workspace	95
10.1.1	Workspace detail view	97
10.2	Detail view of the Project Manager	98
10.2.1	Edit entries	100
10.2.2	Toolbar detail view	101
10.2.3	Navigation in the list view	105
10.2.4	Filter list entries.....	106
10.2.5	Replace text in selected column.....	108
10.2.6	Replace text in limit values.....	109
10.2.7	Show/hide columns.....	110

10.2.8	Column settings	113
10.3	Files	115
10.3.1	Graphics	116
10.3.2	Help	118
10.3.3	Multimedia	120
10.3.4	Texts and Formats	122
10.3.5	Drivers	124
10.3.6	Report Viewer.....	127
10.3.7	Others.....	129
10.4	General symbol library	130
10.5	Selection dialogs	131
10.5.1	Archive variables	131
10.5.2	User selection: individual user	133
10.5.3	User Groups.....	134
10.5.4	Screens	135
10.5.5	Files.....	136
10.5.6	Data Types	137
10.5.7	Filter screens	137
10.5.8	Functions	140
10.5.9	Frames	141
10.5.10	Driver.....	142
10.5.11	Variables.....	142
11.	Main window	146
12.	Properties window	146
12.1	Grouped view	150
12.2	Dialog view	151
12.2.1	Deactivate the automatic scrolling of comboboxes under Windows 10.....	151
12.3	All properties.....	152
12.4	Favorites.....	152
12.5	Sort properties	153
12.6	Linked properties	154
13.	Property help	155
14.	Output window	156

15. Status line	159
16. Closing the Editor	159

1. Welcome to COPA-DATA help

ZENON VIDEO-TUTORIALS

You can find practical examples for project configuration with zenon in our YouTube channel (https://www.copadata.com/tutorial_menu). The tutorials are grouped according to topics and give an initial insight into working with different zenon modules. All tutorials are available in English.

GENERAL HELP

If you cannot find any information you require in this help chapter or can think of anything that you would like added, please send an email to documentation@copadata.com.

PROJECT SUPPORT

You can receive support for any real project you may have from our Support Team, who you can contact via email at support@copadata.com.

LICENSES AND MODULES

If you find that you need other modules or licenses, our staff will be happy to help you. Email sales@copadata.com.

2. Editor

zenon consists of two main components; Editor and Runtime. Projects are created in the Editor, operation and monitoring is done in the Runtime. The Editor is available as a 32-bit version and a 64-bit version from zenon 7.10. Projects can be edited with both versions. You can read details on compatibility with versions before zenon 7.10 in the Project conversion manual, in the 64-bit version chapter.

In this **Editor** handbook, you get to know the essential components of the Editor and information about using the Project Manager (on page 94), toolbars (on page 31), menus (on page 53) and Editor profiles (on page 85). You can find more information about the context menu of the elements in chapter Screens.

AMENDMENT TO THE SIZE SETTING OF THE OPERATING SYSTEM

If the **Change size of all elements** property is executed in the Control Panel of the operating system or a resizing level is selected manually, then:

- ▶ The selected enlargement factor in the zenon Editor is taken into account
- ▶ The size and positioning of the objects is amended

SQL SERVER

zenon Editor works with an SQL database. This is also installed when the zenon Editor is installed. To make a connection, the Editor connects to the zenon SQL server (zenDBSrv.exe). This makes the connection to the SQL server.



Attention

The database folder must not be compressed.

Default path: %ProgramData%\COPA-DATA\SQL (Version)

If the folder has been compressed, no more project data can be written. MS SQL then only supports read access.

MULTI-MONITOR OPERATION

If several monitors are in use on one PC, dialogs, toolbars etc. can be moved to other monitors. Their position is saved and retained for when the editor is next started.



Information

If only the main monitor is available when the editor is restarted, elements that are moved may not be displayed in a visible area. To arrange all elements back on the main monitor again, activate the standard profile (on page 91). This can be used to revert the positions to default.

3. Start editor

You have multiple options to start the Editor:

- ▶ Click on the zenon symbol on your desktop.
- ▶ Use the Windows menu file -> COPA-DATA -> zenon Editor.
- ▶ Start using the Startup Tool. This tool allows the administration of multiple versions of zenon and the configuration of the Editor and the Runtime before you start.
- ▶ Using Windows Autostart.
- ▶ Double click on a workspace file (**.wsp6**). The 32-bit version of the zenon Editor is thus always opened.

DIENST ZENADMINSRV

The `zenAdminSrv` service must be started to start the editor. If the service is not available, you will be informed of this with a corresponding error message. Activate the service and restart the editor.

When starting using Windows Autostart, zenon tries to start the editor five times and then cancels this with the error message, stating that the service cannot be located.

4. Compatibility

The zenon Editor is fully backwards compatible. Projects that were created with an earlier version can be opened and edited at any time.

When opening a project with a lower version number:

- ▶ the project is automatically converted
- ▶ a backup of the project is automatically created

Attention: Converted projects can no longer be opened in an editor with a lower version number. The project backup created during conversion can still be opened and edited.

COMPATIBILITY BETWEEN THE EDITOR AND RUNTIME:

With the zenon Editor, Runtime files can be created for different versions of Runtime. The Runtime version therefore does not need to correspond to the Editor version. This backward compatibility is particularly suited for use of mixed systems. For example: A project that was planned with the editor for version 7.60 can also be started with Runtime 6.20 SP4.

Attention

If, in a project with a later version of the Editor, properties are shown that are not available in the earlier version, these are not available. This can lead to unwanted results in Runtime.

CREATING RUNTIME FILES

To create Runtime files in the editor for earlier versions:

1. Select the project in the project tree.
2. Navigate to the **General** section in project properties.
3. Open the **Create Runtime files for** property drop-down list.
4. Select the desired version from the drop-down list

Attention: In order to ensure consistency of Runtime files, all Runtime files must be newly created each time this property is changed. The configurations for all drivers are converted. Settings that do not exist in the respective version are set to the default setting.

XML

Data exported in XML is then available for import into later Editor versions.

Exception: If data from the RGM is saved to Runtime directly as an XML file using the export function, this cannot be reimported.

5. Start page

The start page display is activated by default.

If the start page is closed, it can be opened again via **View** and **Start Page** or a symbol in the menu bar (on page 11).

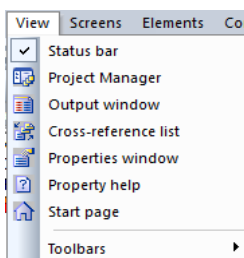

The start page allows actions for the reading and creation of project content, which always relate to the project that is currently active in the Editor.

Note: The Editor menu of the start page is updated each time a workspace is opened, but the **zenon6.ini** file is only opened in the Editor is closed. When the editor is opened again, the **zenon6.ini** entry is read and the start page is displayed according to this entry.

Example: If the start page was opened when the Editor was closed, it is displayed when the Editor is opened again.

You can do the following in the start page:

- ▶ create a new project
- ▶ restore an existing project
- ▶ restore a project backup
- ▶ open the License Administration

If a workspace is opened or closed in the Editor or the active project is amended, one of the following Editors statuses can occur:

- ▶ No workspace loaded
- ▶ Workspace without active project loaded
- ▶ Workspace with active project loaded: Active project is incomplete

The start page then switches to one of the following modes:

- ▶ Start page in "no workspace loaded" status
- ▶ Start page in "workspace without active project" status
- ▶ Start page in "active project loaded" status



Information

Note that the start page is not available for all OEM versions.

5.1 Opening the start page using a symbol in the menu bar

If you want to open the start page using a symbol in the menu bar, you must add the symbol at the desired place in the menu bar beforehand.

To add a symbol in the menu bar of the editor:

1. Go to **Tools** and **Settings...**
2. Open the **Commands** tab.

3. Highlight the **Dockable windows** entry under categories.
The attendant entries are displayed under Commands.
4. Left-click on the start page and drag the entry into the desired menu bar.
The symbol is added to the corresponding menu bar.
5. Close the dialog by clicking on **OK**.

Note: To remove the symbol from the menu bar again, carry out points 1 to 3 again. Left-click on the symbol in the menu bar and drag it to the Dialog Settings window. The symbol is removed from the menu bar as soon as the left mouse button is released.

5.2 View if no workspace is loaded

No workspace is loaded in the Project Manager of zenon Editor.

The following actions are available:

- ▶ **New workspace...:**
Opens the dialog **New** for creating a new workspace.
- ▶ **Open workspace...:**
Opens the file selection dialog for the selection of a *.wsp6 workspace file.
- ▶ **Restore workspace backup...:**
Opens the dialog to restore an existing workspace backup file.
- ▶ **Open license administration...:**
Opens the **License Manager**.

The last workspaces used in the Editor are shown under **Last workspaces** on the right-hand side of the screen.

The view of an entry is enlarged by clicking on the red arrow of a workspace. This enlarged view offers additional information about the projects contained in the workspace.

Click on one of the displayed workspaces if you want to open it.

The view of the start page is amended accordingly as soon as a workspace is loaded.

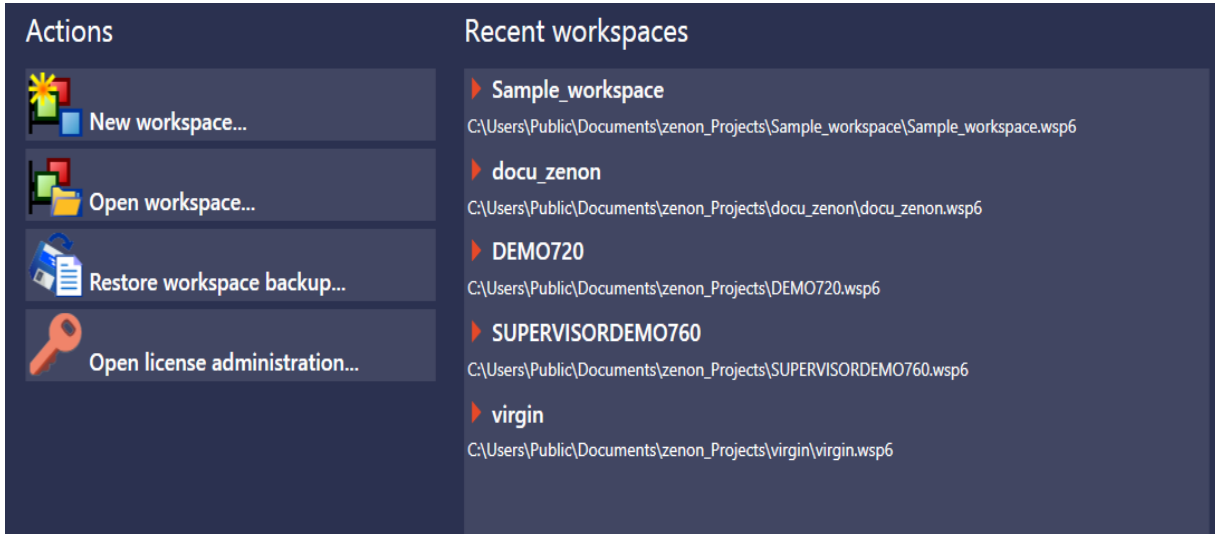

The screenshot shows the Zenon start page interface. On the left, the 'Actions' panel contains four buttons: 'New workspace...', 'Open workspace...', 'Restore workspace backup...', and 'Open license administration...'. On the right, the 'Recent workspaces' panel lists four workspaces with their file paths:

- Sample_workspace**: C:\Users\Public\Documents\zenon_Projects\Sample_workspace\Sample_workspace.wsp6
- docu_zenon**: C:\Users\Public\Documents\zenon_Projects\docu_zenon\docu_zenon.wsp6
- DEMO720**: C:\Users\Public\Documents\zenon_Projects\DEMO720.wsp6
- SUPERVISORDEMO760**: C:\Users\Public\Documents\zenon_Projects\SUPERVISORDEMO760.wsp6
- virgin**: C:\Users\Public\Documents\zenon_Projects\virgin\virgin.wsp6

ENHANCED VIEW

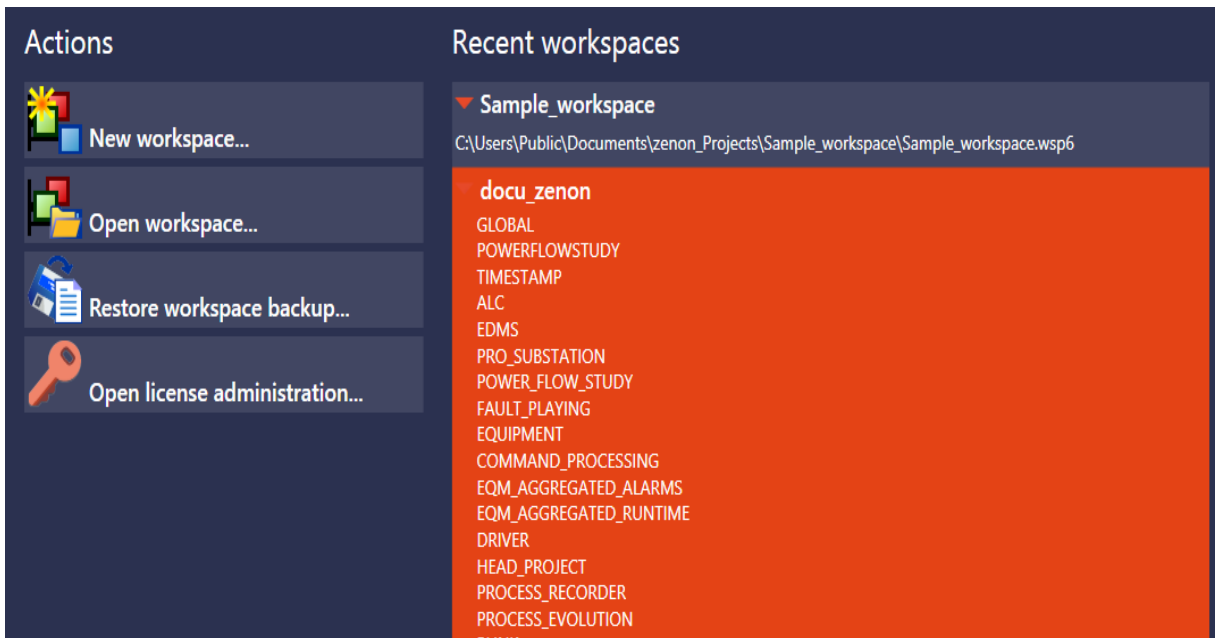

The screenshot shows the Zenon start page interface in 'Enhanced View'. The 'Actions' panel is identical to the previous view. The 'Recent workspaces' panel shows the 'Sample_workspace' workspace expanded, revealing a detailed list of components for the 'docu_zenon' workspace:

- Sample_workspace**: C:\Users\Public\Documents\zenon_Projects\Sample_workspace\Sample_workspace.wsp6
- docu_zenon** (expanded):
 - GLOBAL
 - POWERFLOWSTUDY
 - TIMESTAMP
 - ALC
 - EDMS
 - PRO_SUBSTATION
 - POWER_FLOW_STUDY
 - FAULT_PLAYING
 - EQUIPMENT
 - COMMAND_PROCESSING
 - EQM_AGGREGATED_ALARMS
 - EQM_AGGREGATED_RUNTIME
 - DRIVER
 - HEAD_PROJECT
 - PROCESS_RECORDER
 - PROCESS_EVOLUTION
 - PLANK

5.3 View if no project is activated for the workspace

No active project is loaded in the Project Manager of zenon Editor.

The following actions are available:

- ▶ **New project...:**
Opens the dialog for creating a new project.
- ▶ **Insert existing project...:**
Opens the dialog to add an existing project.
- ▶ **Restore project backup...:**
Opens the dialog to restore a project backup.
- ▶ **Open license administration...:**
Opens the **License Manager**.

WINDOW WITH PROJECT CONFIGURATION NOTES

Brief help with tips for basic project configuration steps is displayed in the right-hand part of the view.

Click on the **Back** and **Next** buttons to move between the themes.

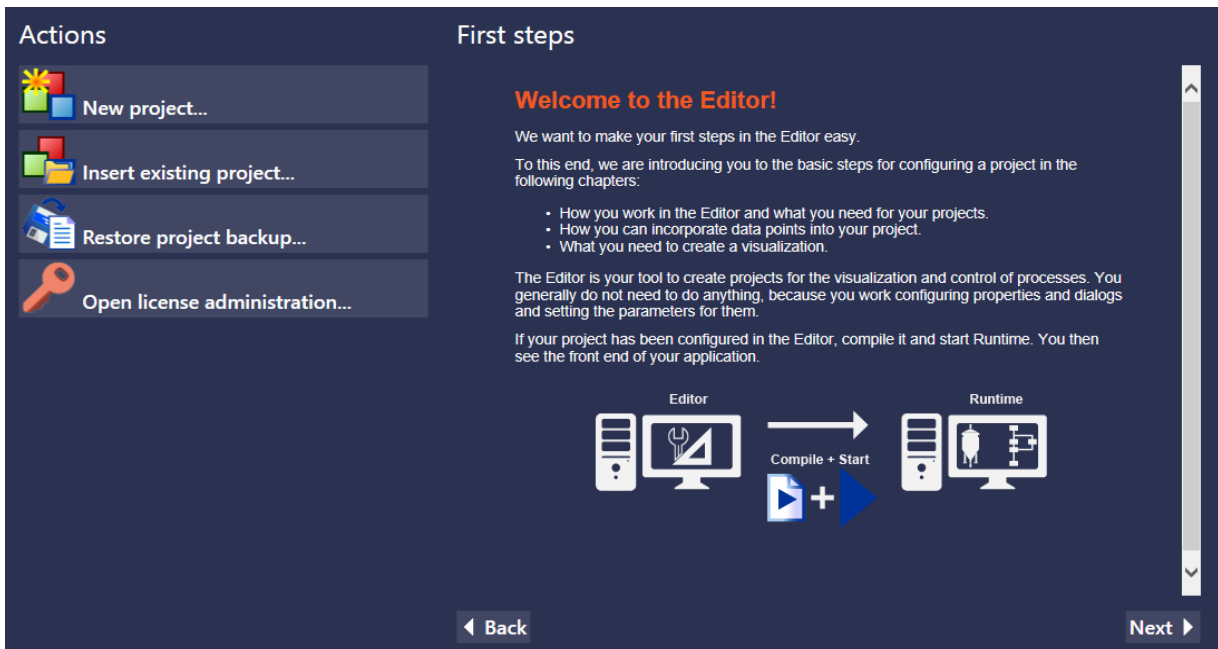

Actions

- New project...
- Insert existing project...
- Restore project backup...
- Open license administration...

First steps

Welcome to the Editor!

We want to make your first steps in the Editor easy.

To this end, we are introducing you to the basic steps for configuring a project in the following chapters:

- How you work in the Editor and what you need for your projects.
- How you can incorporate data points into your project.
- What you need to create a visualization.

The Editor is your tool to create projects for the visualization and control of processes. You generally do not need to do anything, because you work configuring properties and dialogs and setting the parameters for them.

If your project has been configured in the Editor, compile it and start Runtime. You then see the front end of your application.

Editor → Compile + Start → Runtime

◀ Back Next ▶

5.4 View for active workspace with active project

An active project is selected in the Project Manager of zenon Editor.

The following options are available under **Connection**:

- ▶ **Create driver...**
Opens the dialog to create a new driver.
- ▶ **Create variable...:**
Opens the dialog to Create a variable.

The following options are available under **Visualization**:

- ▶ **Create frame...**
Creates a new frame.
- ▶ **Create screen...:**
Opens the dialog to create a new screen.

The following options are available under **Execution**:

- ▶ **Create function...:**
Opens the dialog to create a new function.

WINDOW WITH PROJECT CONFIGURATION NOTES

Brief help with tips for basic project configuration steps is displayed in the right-hand part of the view.

Click on the **Back** and **Next** buttons to move between the themes.

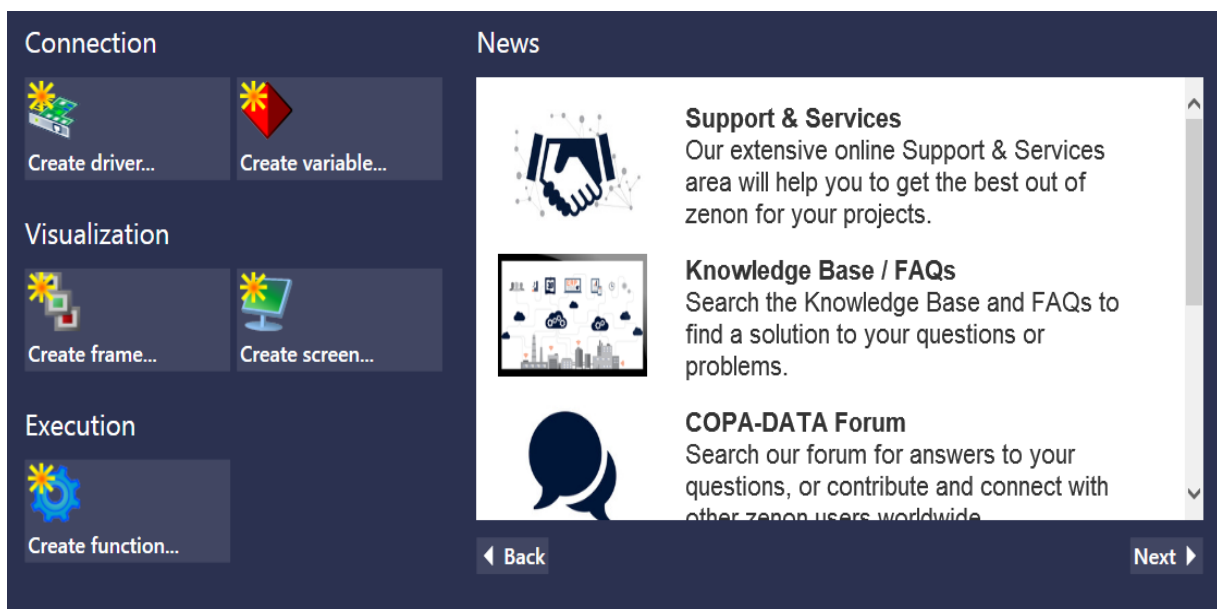

The screenshot displays a software interface with a dark blue background. On the left, there are three sections: 'Connection', 'Visualization', and 'Execution'. Each section contains two buttons with icons and text labels. The 'Connection' section has 'Create driver...' and 'Create variable...'. The 'Visualization' section has 'Create frame...' and 'Create screen...'. The 'Execution' section has 'Create function...'. On the right, there is a 'News' section with a white background and a vertical scrollbar. It contains three items: 'Support & Services' with a handshake icon, 'Knowledge Base / FAQs' with a cityscape icon, and 'COPA-DATA Forum' with a speech bubble icon. At the bottom of the 'News' section, there are 'Back' and 'Next' buttons.

5.5 View for the start page with missing screens

Screen files for the zenon start page that are not present are shown by means of error messages or error symbols.

Missing content of the project configuration notes are highlighted in that the **Back** and **Next** buttons are grayed out. The missing graphics are shown with an error symbol for the view in the window.

6. User interface

The Editor's user interface consists of different areas:

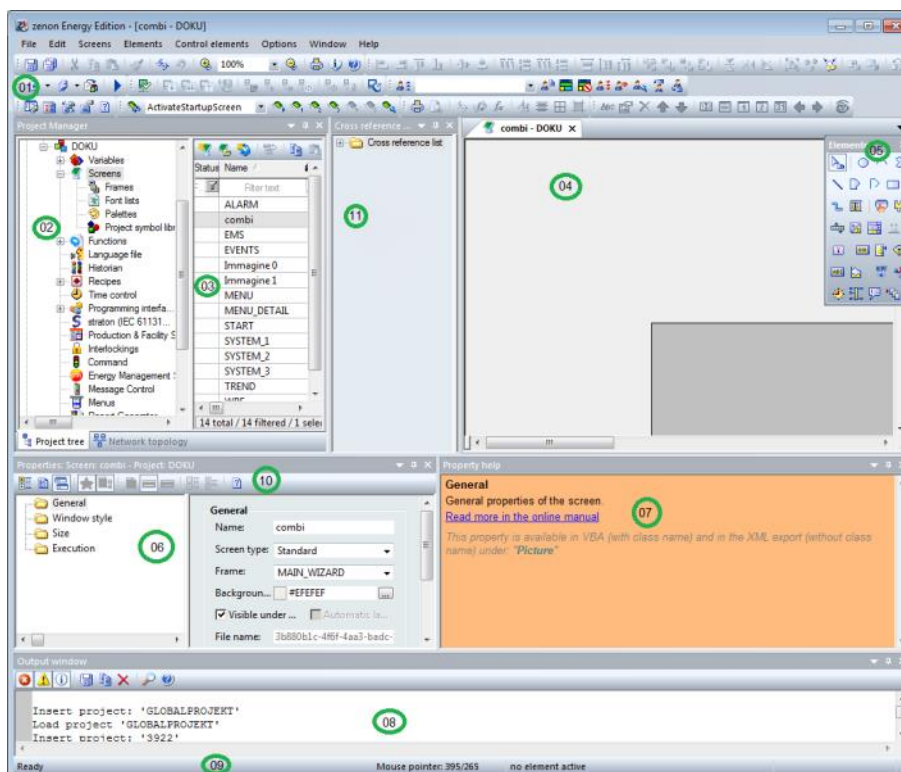

Element	Contents
01 - Toolbars:	<p>A collection of Toolbars (on page 31) for the Editor and its modules. They are available for:</p> <ul style="list-style-type: none"> ▶ Dockable (on page 34) windows ▶ Alignment (on page 34) ▶ Screens (on page 37) / Symbols (on page 39) ▶ Editor profiles (on page 41) ▶ Elements (on page 42) ▶ Menu bar (on page 39) ▶ Production & Facility Scheduler (on page 44) ▶ Remote Transport (on page 45) ▶ Report Generator (on page 46) ▶ Runtime Files (on page 47) ▶ Visibility levels (on page 48) ▶ VBA macros (on page 49)
02 - Project Manager:	Tree view of the Project Manager.
03 - Detail view of the Project Manager:	Details for the module selected in the Project Manager.
04 - Main window:	Main work space; here documents such as screens or reports are displayed.
05 - Toolbar elements:	Toolbar for screen elements - vector elements and dynamic elements.
06 - Properties	Displays the properties of a selected object. Three modes are available and can be selected from the Properties toolbar (on page 51).
07 - Properties help:	Displays short help messages for properties of screens, variables, functions and other elements which can be engineered.
08 - Output window	Messages are displayed here if projects are compiled and sent to Runtime.
09 - Status bar:	Shows status information for Editor readiness and screens.
10 - Toolbar properties:	Defines display and sorting options of the properties, shows Properties help (on page 155).
11 - Cross-reference list:	

You choose which windows are shown:

- ▶ in the **Drop-down list** under **Options** or

The arrangement of the windows can be adjusted (on page 18) individually. Just the main window cannot be hidden.

6.1 Adjust view

All editor windows can be individually grouped. The properties for window grouping can be opened by right-clicking on the window border. Your own settings can be saved as Editor profiles (on page 85).

WINDOW CONTEXT MENU

Option	Status	Function
Undocked	active	The selected window can be freely positioned on the desktop. It is displayed in the main window. You can show multiple windows in the Main Window and switch between them. Double-clicking on the title bar switches between Unanchored and Dock .
	Inactive (default)	The selected window is docked. The dock property is active.
Dock	active (default)	Windows can be moved anywhere you want while the left mouse button is pressed. When being moved, a Positioning aid (on page 19) shows the position where the window is to be inserted. On releasing the mouse button, the window is docked on to the surrounding windows. When switching from Unanchored to Dock , the window is inserted to its last docked position. Double-clicking on the title bar switches between Unanchored and Dock . Hint: If you want to move a window without docking it, hold down Ctrl whilst moving it. In this case, no positioning aid is displayed.
	Inactive	Windows can be moved anywhere you want while the left mouse button is pressed. On releasing the button, they are shown on the relevant location in the foreground. The Unanchored property is active.

Display in main window	active	The window is displayed in the main window as a tab. All tabs are displayed in the main window. You change between the individual tabs by clicking on the window titles. To display a tab as a window again, open the context menu with a right click on the window title and switch the Switch in main window property to <i>Inactive</i> .
	<i>Inactive</i> (default)	The window is displayed normally.
Fade out automatically	active	As soon as the window loses the mouse focus, it is placed into the background. The window title is displayed in the left border of the editor. To put the window back into the foreground, move the mouse over the window title.
	<i>Inactive</i> (default)	The window is always displayed in the foreground.
Close		The selected window is closed. To show it again, choose Menu bar -> Options -> Window name

6.2 Position window

POSITIONING

All windows in the zenon Editor can be positioned wherever you want on the desktop using:

- ▶ Drag & drop: Windows are dragged to the desired position and either placed freely (**unanchored**) or docked.
- ▶ Double-clicking on the title bar: switches between **Unanchored** and **Dock**.

POSITIONING AIDS

When moving windows from the Editor interface, positioning aids are displayed. These represent windows or their borders.

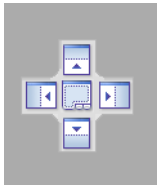

This element represents a window area in the Editor.



This element represents the border area of the Editor.

POSITION WINDOW

To position an element as docked:

1. Move the element with the mouse into the desired area
2. The positioning aid is displayed
3. This represents a window and its areas:
 - a) Center: whole window
 - b) Top: upper half
 - c) Bottom: lower half
 - d) Right: right half
 - e) Left: left halfor the border of the Editor
4. Move the mouse to the central positioning aid or to a positioning aid on the border of the editor and from there to the desired area
5. The area in the Editor where the element was placed when the mouse button was released is colored in blue
6. Move the mouse within the positioning aid to the desired area that is displayed in blue
7. Let the mouse button go and the element is placed
8. If a window is placed on a pre-existing window, both windows are displayed at the same location using tabs.

EXAMPLES

1. The **Properties** windows is moved to Docked.
2. In doing so, the positioning aids are displayed.

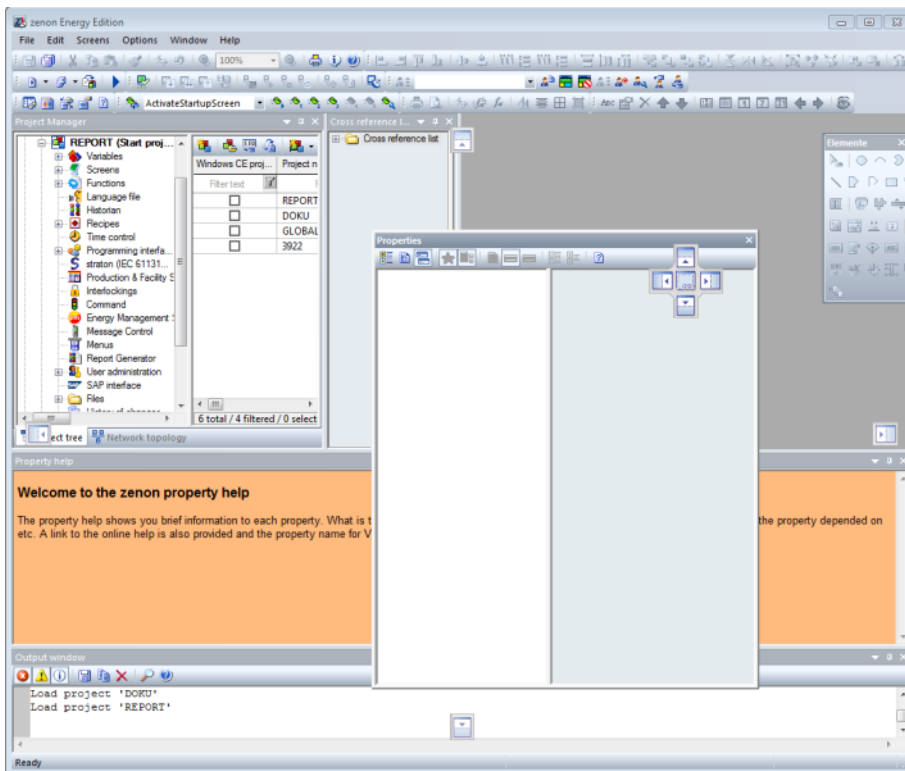

3. The mouse pointer is led over the upper arrow of the positioning aid.

4. The insertion area is marked in blue in the Editor.

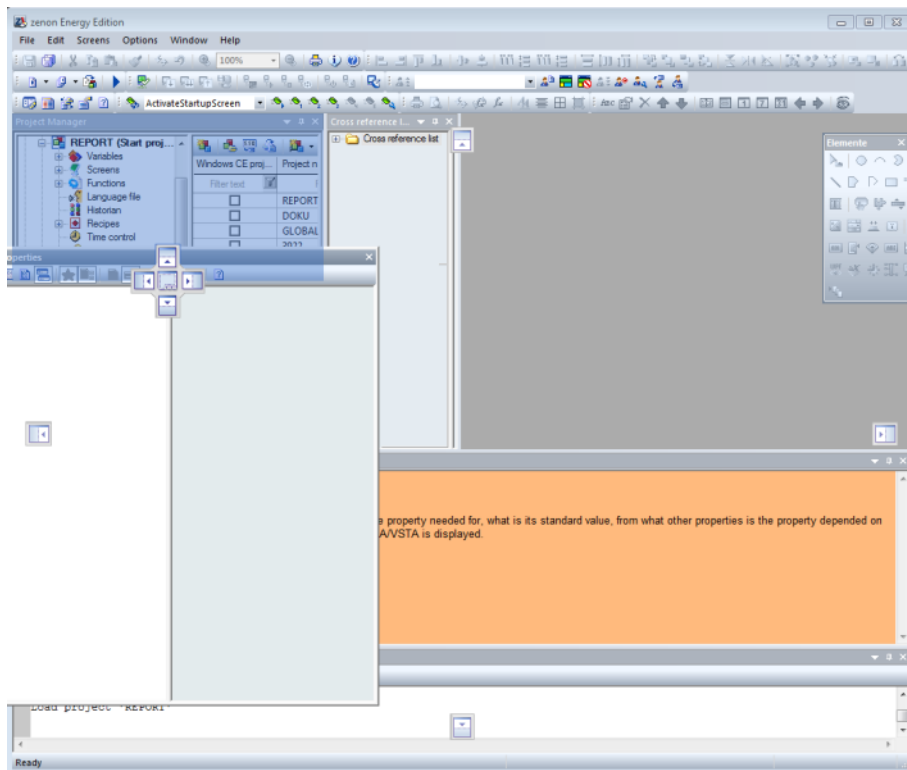

5. The window is inserted at the highlighted point when the mouse button is released:

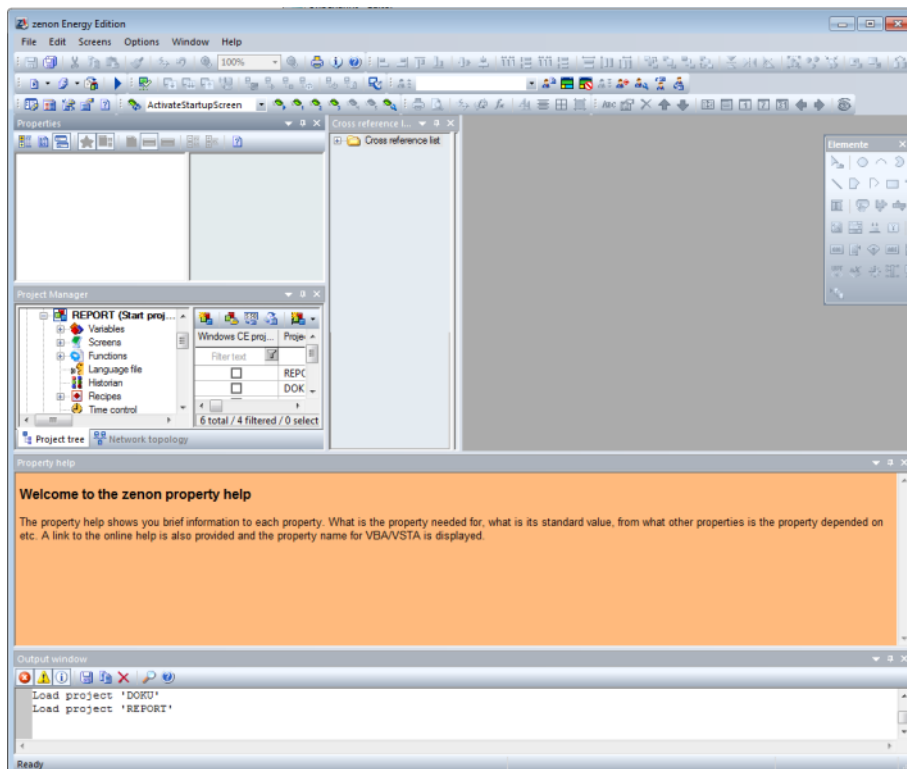

6. Now the mouse pointer is moved to above the upper border positioning aid.
7. The insertion area is again marked in blue in the Editor.

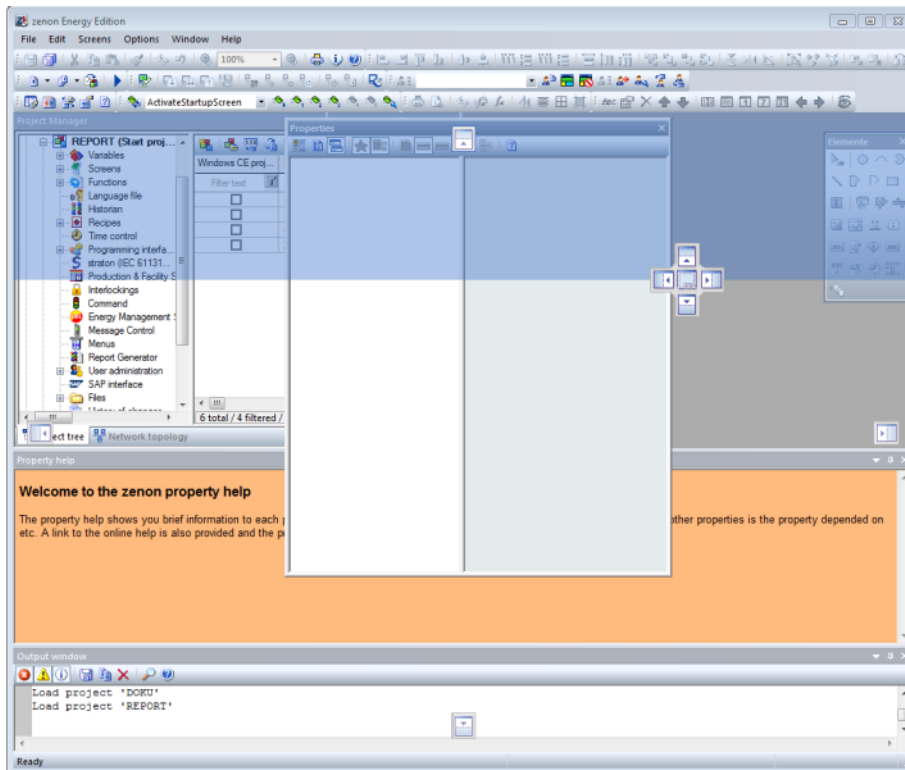

8. The window is inserted at the highlighted point when the mouse button is released:

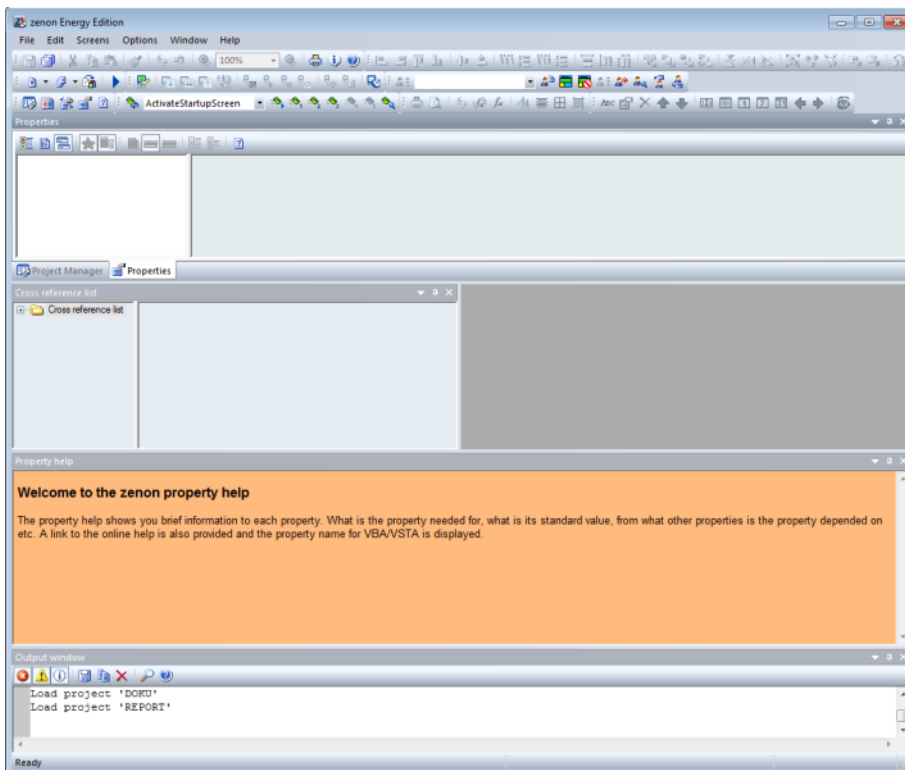

6.3 Full-screen mode

In the zenon Editor you can switch the main window to full-screen mode. For that

- ▶ use keyboard shortcut `Shift+F9`
- or
- ▶ select entry **Full-screen mode** in drop-down list **Window**

The full-screen hides all remaining windows and shows only the main window with all opened documents (screens, reports, ...) in full-screen mode.

Note: The **Control elements** menu can still be called up in full-screen mode.

The full-screen mode can be closed by:

- ▶ the displayed button for closing the full-screen mode
- ▶ the short key `Shift+F9`

WORK IN FULL-SCREEN MODE

In full-screen mode a menu for closing the full-screen mode and for displaying certain windows and toolbars is displayed.

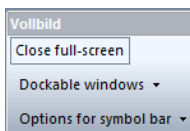

Parameter	Description
Close full-screen	Closes the full-screen mode. You can also use the keyboard shortcut <code>Shift+F9</code> or the <code>Esc</code> key.
Dockable windows	<p>Drop-down list for opening windows.</p> <ul style="list-style-type: none"> ▶ Properties ▶ Property help <p>At the first use, windows are displayed at fixed defined position. Then they can be positioned freely and are displayed at the individually defined position when they are displayed again in full-screen mode.</p>
Toolbars	<p>Drop-down list for opening toolbars:</p> <ul style="list-style-type: none"> ▶ Screens ▶ Alignment ▶ Visibility level ▶ Elements <p>At the first use, toolbars are displayed at fixed defined position. Then they can be positioned freely and are displayed at the individually defined position when they are displayed again in full-screen mode.</p>

6.4 Keyboard shortcuts

GENERAL

Command	Key combination
Open help	F1
Start/stop full screen mode	Shift+F9
Remote: Close full-screen mode	Ctrl+Alt+Shift+F
Start VSTA Editor	Alt+F10
Start VBA Editor	Alt+F11
Wizards: Open selection	Alt+F12
Open file explorer for current project with focus on SQL folder. Corresponds to: %ProgramData%\COPA-DATA\ [SQL-Ordner] \ [UID] \FILES	Ctrl+Alt+E
Open file explorer with focus on project files from the current project. For example: C:\Users\Public\Documents\zenon_Projects\[Project]\INI\[Rechner]\INI	Ctrl+Alt+D
Open file explorer with focus on Runtime files from the current project. For example: C:\Users\Public\Documents\zenon_Projects\[Project]\INI	Ctrl+Alt+R
Start Runtime; create changed Runtime files beforehand.	F5
Create changed Runtime files.	F7

EDITOR PROFILES

Command	Key combination
Load Editor profile 1	Shift+F1
Load Editor profile 2	Shift+F2
Load Editor profile 3	Shift+F3
Load Editor profile 4	Shift+F4

Load Editor profile 5	Shift+F5
Load Editor profile 6	Shift+F6
Load Editor profile 7	Shift+F7
Load Editor profile 8	Shift+F8
save current Editor view as:	
Editor profile 1	Ctrl+Shift+F1
Editor profile 2	Ctrl+Shift+F2
Editor profile 3	Ctrl+Shift+F3
Editor profile 4	Ctrl+Shift+F4
Editor profile 5	Ctrl+Shift+F5
Editor profile 6	Ctrl+Shift+F6
Editor profile 7	Ctrl+Shift+F7
Editor profile 8	Ctrl+Shift+F8

GRAPHIC EDITOR:

Note for shortcuts: The plus sign (+) means that keys are pressed together.
For example:

Ctrl+A means: Hold down the Control key and then press the **A** key.

Ctrl++ means: Hold down the Control key and then press the plus key.

GENERAL

Command	Key combination
Main window: Scroll content with 'moving hand'	Press and hold Space
Close current screen	Ctrl+F4
Open properties	Alt+Enter key

SELECT

Command	Key combination
Select several objects	Hold down the Shift or Control key
Deselect selected object during multi-select	Ctrl+mouse click
Selection: Change sort order. Defines the element on which all others realign	Hold down the Shift key when selecting
Select hidden objects	<ol style="list-style-type: none"> 1. Press the Alt key 2. Click object and move it
Select all elements of a screen.	Ctrl+A
Select next element according to the order of their creation	Tab
Select previous element according to the order of their creation	Shift key+Tab

POSITIONING

Command	Key combination
Move selected object.	Arrow keys
Move by 10 pixels each time you press an arrow key	Shift key+Arrow key
Move only horizontally or only vertically	Hold down the Shift key when moving
Centers the selected object in the working section	H

ACTIONS

Command	Key combination
Saves changes	Ctrl+S
Pastes element from the clipboard	Ctrl+V

	Shift+Ins
Inserts element from the clipboard at its original position; original and copy lie congruently on top of each user	Ctrl+Shift+V
Copies selected element.	Ctrl+C Ctrl+Ins
Copy instead of move	Hold down the Control key when moving
Duplicates the selected element. You can find more detailed information in the Duplicating elements section.	Ctrl+D
Deletes selected element	Del
Cuts out the selected element	Shift key+Del Ctrl+X
Undoes changes	Ctrl+Z Alt+Backspace
Add or delete node in the selected element. Add: Mouse cursor turns to plus symbol (+). Delete: Mouse cursor turns to minus symbol (-). Works for polylines, polygons and pipe elements.	Ctrl+Shift key
Cancel drawing of polylines and polygons	S
Cancel drawing of polylines and polygons and delete the section which was drawn last	Esc
Move selected elements one level up	+
Move selected elements one level down	-
Move selected elements to the foreground	Ctrl++
Move selected elements to the background	Ctrl+-

SCALING

Command	Key combination
Change size	<p>Move mouse cursor to the handle so that the mouse cursor changes to an arrow. After that you can position, with pixel precision, using the arrow keys or in steps of 10 pixels with the Shift key held down.</p> <p>Note: If an angle dissimilar to 0 via</p>

	property Rotation angle [°] was defined for an element, scaling via arrow keys is not possible.
Scaling object around the center	Hold down the Alt key when scaling.
Proportional scaling	Hold down the Shift key when scaling.

ZOOM

Reduce view	Ctrl + Shift key +-
Enlarge view	Ctrl + Shift key ++
Set view to 100%	Ctrl + Alt + 0
Amend the view to the space available in the Editor and display it proportionally	Ctrl + 0

ZOOM WITH THE MOUSE

Reduce view	Ctrl + scroll wheel of the mouse downwards
Enlarge view	Ctrl + scroll wheel upwards

DETAIL VIEW

Command	Key combination
Create a new element for the respective module	Ins
Edit the selected column	F2
Copy a selected list element	Ctrl+C
Insert a list element which was copied beforehand	Ctrl+V
Delete a selected list element	Del
Scroll up several elements in the list	Pg up
Scroll down several elements in the list	Pg down
Navigate in the list	Arrow key

RUNTIME

Command	Key combination
---------	-----------------

Browse through open Window windows.	Alt+Tab
Stopping the Runtime.	Alt+F4

ELEMENTS CONTEXT MENU

Create element group	Creates an element group. The keyboard shortcut <code>Ctrl + G</code> can also be used for this.
Resolve	Resolves an element group into its screen elements. The keyboard shortcut <code>Ctrl + Shift key + G</code> can also be used for this.
Full-screen mode	Close full-screen mode: <code>Shift key + F9</code>

7. Toolbars

The main toolbars are per default positioned below the **Menu bar**. - With the exception of the **Elements** toolbar, which is displayed to the right of the **Main window**. When you move the mouse arrow over a symbol, information about the function of the symbol is displayed in the status line.

The following main toolbars are available:

- ▶ Dockable (on page 34) windows
- ▶ Alignment (on page 34)
- ▶ Screens (on page 37) / Symbols (on page 39)
- ▶ Editor profiles (on page 41)
- ▶ Elements (on page 42)
- ▶ Menu bar (on page 39)
- ▶ Production & Facility Scheduler (on page 44)
- ▶ Remote Transport (on page 45)
- ▶ Report Generator (on page 46)
- ▶ Runtime Files (on page 47)
- ▶ Visibility levels (on page 48)
- ▶ VBA macros (on page 49)

The following windows have unique toolbars that are displayed in the upper part of the screen:

- ▶ Details workspace (on page 50)
- ▶ Properties (on page 51)



Information

*The titles of the toolbars always correspond to the language that was activated in the zenon Editor when the toolbar was displayed for the first time. For example: If you used the toolbar **Screens** for the first time in German, the name will be retained even when you switch the Editor later to English.*

If you want to switch the names to another language, you have to delete first all Editor profiles, then start the Editor in the desired language and activate the toolbars.

Editor profiles are not deleted in zenon, but on file system level. For details see chapter Deletion of Editor profiles (on page 93).

ACTIONS WITH SYMBOLS AND TOOLBARS

Options for toolbars can be changed in: **Tools -> Settings -> Toolbar tab** (on page 84)

Actions for toolbars:

- ▶ position anywhere on-screen
- ▶ close
- ▶ open

Actions for symbols:

- ▶ delete
- ▶ add

POSITION TOOLBAR

1. Left-click on a free area of the toolbar.
2. Move the toolbar to the desired location on the screen.
A rectangle shows where and how the toolbar is inserted.
3. Release the mouse button to position the toolbar

Note: Toolbars which include drop-down lists can only be positioned horizontally.

CLOSE TOOLBAR

You can close toolbars either by using the **View** drop-down list or the **Settings** menu under **Extras**.

DROP-DOWN LIST: FASTEST WAY IN ORDER TO CLOSE A TOOLBAR

1. Click on the **Options** drop-down list
2. Navigate to Toolbars
3. Click on the entry for the toolbar you want to close

SETTINGS: MAKES IT POSSIBLE TO CLOSE SEVERAL TOOLBARS AT ONCE

1. Open the **Extras -> Settings -> Tab:** (on page 84) menu **Toolbar (on page 84)**.
2. Remove the checkmark next to the desired toolbar
3. Confirm with **OK**.

OPEN TOOLBAR

You either open tool bars directly by selecting the it in the **View** menu entry or in the **Settings** entry in the **Extras** menu entry. Select the **Tool Bars** tab in the **Settings** dialog.

DROP-DOWN LIST: FASTEST WAY IN ORDER TO OPEN A TOOLBAR

1. Click on the **View** menu entry:
2. Navigate to Toolbars
3. Click on the entry for the toolbar you want to open

SETTINGS: MAKES IT POSSIBLE TO OPEN SEVERAL TOOLBARS AT ONCE

1. Open the **Extras -> Settings -> Tab:** (on page 84) menu **Toolbar (on page 84)**.
2. Set the checkmark next to the desired toolbar
3. Confirm with **OK**.

ADD SYMBOLS

1. Open the **Extras -> Settings -> Tab:** (on page 82) menu **Commands (on page 82)**.
2. Choose a category from the left window.
3. Click on the desired symbol in the right window with the left mouse button.
4. Hold down the left mouse button and drag the symbol to the desired position in the toolbar.

DELETE SYMBOLS

1. Open, in the **Extras -> Settings -> Tab** (on page 84) menu: **Toolbar (on page 84)**.

All symbols in all toolbars in the editor are activated

2. Click with the left mouse button on the symbol.
3. Move the symbol away from the toolbar and release the mouse button

7.1 Toolbar dockable windows

The following hidden or closed windows can be reactivated with the help of toolbar **Dockable windows**.

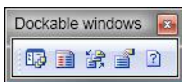

Symbol	Description
Project Manager	Activates the Project Manager.
Output window	Activates the output window.
Cross-reference list	Activates the cross reference list.
Properties window	Activates the properties window .
Property help	Activates the property help window.
Options for toolbar	<p>Clicking on the arrow opens the submenu:</p> <p>Active: Toolbar is displayed.</p> <p>If the toolbar is not displayed, it can be activated using the Options -> Toolbar menu.</p> <p>Note: For free placed toolbar (undocked from the Editor) options are not displayed. The toolbar can be closed by clicking on button X.</p>

7.2 Toolbar alignment



Symbol	Description
align left	Aligns all elements with the left margin of the element that was marked first.
align right	Aligns all elements with the right margin of the element that was marked first.
Align up	Aligns all elements with the upper margin of the element that was marked first.
Align down	Aligns all elements with the bottom margin of the element that was marked first.
Horizontal center	Aligns the marked element with the horizontal screen center. If multiple elements were selected, all elements are aligned according to the one selected first.
Vertical center	Aligns the marked element with the vertical screen center. If multiple elements were selected, all elements are aligned according to the one selected first.
Same x-distance	Lines the selected elements in the order of selection up on the x-axis. The first two elements determine the distance.
Same y-distance	Lines the selected elements up in the order of selection on the y-axis. The first two elements determine the distance.
Same x-distribution:	Distributes all selected elements along the x-axis between the two elements that were selected first. For this option, at least three elements must be selected.
Same y-distribution:	Distributes all selected elements along the y-axis between the two elements that were selected first. For this option, at least three elements must be selected.
Same width	Marked elements are adjusted to the width of the first chosen element. Note: Adjustment is according to optical coordinates. For details, see the explanation under this table.
Same height	Marked elements are adjusted to the height of the first chosen element. Note: Adjustment is according to optical coordinates. For details, see the explanation under this table.
Same size	Marked elements are adjusted to the width and height of the first chosen element. Note: Adjustment is according to optical coordinates. For details, see the explanation under this table.
Window to foreground	Moves selected elements into foreground
One level forward	Moves selected elements one level forward.
One level back	Moves selected elements one level back.

Window to the background	Moves selected elements to the background.
flip horizontally	Flips the selected element on a horizontal axis.
Flip vertically	Flips the selected element on a vertical axis.
flip 90°	Turns the selected item 90° CCW.
Create element group	Creates a new element group from all selected elements.
Disband element group	The element group is broken up into its original elements; the element group no longer exists.
Single edit mode element group	Enables you to edit individual elements of an element group. Button switches between individual editing mode and symbol editing mode.
Insert in existing element group	Opens the list of element groups in order to add the element to an element group of the list.
Remove from element group	Deletes the highlighted element from the active element group.
Replace links	Opens the dialog in order to replace linked variables or functions with dynamic elements. You can find more details in the Substitution of process variables in dynamic elements chapter.
Options for toolbar	Clicking on the arrow opens the submenu: <i>Active:</i> Toolbar is displayed. If the toolbar is not displayed, it can be activated using the Options -> Toolbar menu. <i>Note:</i> For free placed toolbar (undocked from the Editor) options are not displayed. The toolbar can be closed by clicking on button X.

ADAPTATION OF THE SAME WIDTH/HEIGHT/SIZE

The adaptation of size of rotated and non-rotated elements orientates itself to the visual coordinates, not the logical ones. The stretching of rotated elements is understood as a surface of the rectangle within which the lines of the rotated element are located (bounding rectangle).

FOR EXAMPLE

Two elements before adaptation:

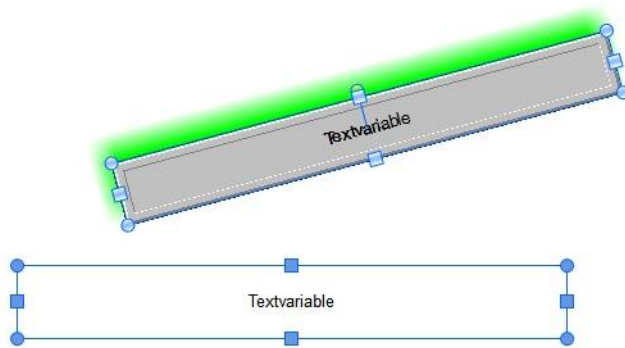

After adaptation using Same height:

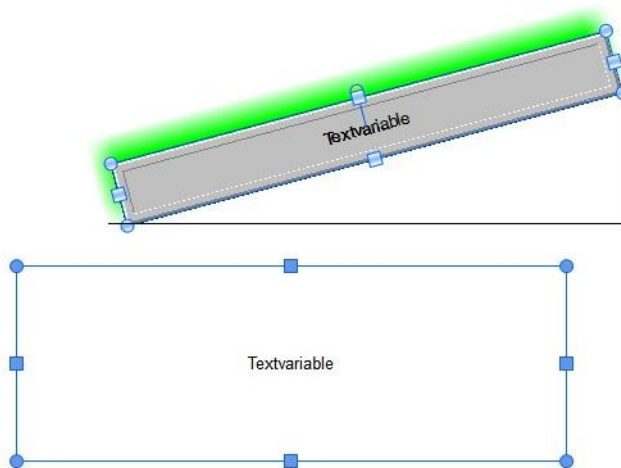

7.3 Toolbar screens

A toolbar is available for editing screens. Per default, it is displayed below the menu bar.

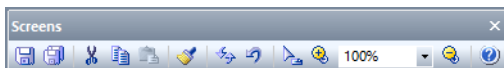

Symbol	Description
Save screen	Save the current screen.
Save all	Saves all changed screens.
Cut	Cuts the selected element and stores it in the clipboard; works across projects, too. Only available if an element has been selected.
Copy	Saves a copy of the current screen to the clipboard. Only available if an element has been selected.
Paste	Inserts (i.e. pastes) a screen from the clipboard. Only available if the clipboard contains data.
Transfer format	Transfers the formatting of the element that has just been selected to the next element that is selected.
Redraw screen	Refreshes the display.
Undo	Allows undoing up to 100 actions. By default, 10 actions can be undone. Define the number of actions: Options -> Settings ->Settings -> number of undoable actions. Enter a number between 1 and 100.
Edit mode	Switches from Zoom to Edit mode .
Zoom	<p>Provides three zoom modes:</p> <ul style="list-style-type: none"> ▶ Variable zoom: A predefined value can be selected from the combobox, or you can directly enter any value between 15% and 1600%. ▶ Zoom tool: It is possible to zoom directly in the screen at the click of a mouse with the two magnifier symbols (+ and -). Click on the magnifier symbol to switch to zoom mode. Now click in the screen to change the size. The <code>Ctrl</code> key switches between the reduce/enlarge. The defined zoom is saved for each single screen. To end the zoom mode, click on the Editing Mode symbol in the Elements tool bar. ▶ Amend: Automatically selects a zoom factor between 15 - 1600%, so that the complete screen is shown in full and in proportion in the Editor. The current zoom factor is shown in the combobox. <p>Keyboard combinations:</p> <ul style="list-style-type: none"> ▶ Reduce view: Keys: <code>Ctrl + Shift + -</code> ▶ Enlarge view: Keys: <code>Ctrl + Shift + +</code> ▶ Set view to 100%: Keys: <code>Ctrl + Alt + 0</code> ▶ Amend the view to the space available in the Editor and display it proportionally: Keys: <code>Ctrl + 0</code> <p>Control using the mouse:</p> <ul style="list-style-type: none"> ▶ <code>Ctrl + mouse scroll wheel downwards</code>: Reduce view

	<ul style="list-style-type: none"> ▶ Ctrl + mouse scroll wheel upwards: Enlarge view Reduction/enlargement is carried out under 100% in 25% steps, under 800% in 50% steps and over 800% in 100% steps
Help	Opens online help.
Options for toolbar	<p>Clicking on the arrow opens the submenu:</p> <p>Active: Toolbar is displayed.</p> <p>If the toolbar is not displayed, it can be activated using the Options -> Toolbar menu.</p> <p>Note: For free placed toolbar (undocked from the Editor) options are not displayed. The toolbar can be closed by clicking on button X.</p>

7.4 Toolbar symbols

The symbol library can be operated from the context menu or the toolbar:



COMMANDS IN THE CONTEXT MENU AND TOOLBAR

Context Menu	Description
Symbol new	Creates a new symbol.
Open symbol	Opens the symbol in the symbol editor for editing purposes.
New symbol group	A new symbol group is created and can be filled with selected symbols from the library or with self-defined symbols. (Copy and Paste). Only available in the global symbol library.
Insert symbol as element group in screen	Creates an element group from the symbol and adds this to a screen (for details, see the Element groups chapter).
Insert symbol in screen	Links the symbol in the screen (for details, see the Symbols chapter).
Linked elements	Opens the sub-menu with linked elements and the possibility to jump back into the starting element.
Jump back to starting element	Jumps back to the starting element (only toolbar).
Copy	Copies the selected symbol to the clipboard (only hierarchical view).
Paste	Inserts the copied symbol in the active group (only hierarchical view).
Delete	Deletes the selected symbol or symbol group (only hierarchical view). Attention: Deleting cannot be undone!
Expand/collapse node	Allows expansion/reduction of the selected node or all nodes in the hierarchical view.
Flat view	Arranges all symbols in a flat view. Facilitates the search for certain symbols. Note: In this view, you can't create nor delete symbols and it is also impossible to copy or insert symbols from the clipboard.
Hierarchic view	Sorts all symbols hierarchical in subgroups and shows dependencies.
Export selected as XML...	Opens the dialog for XML-export of the selected symbols. (For details, see chapter Import/Export of symbols.)
Export screen/symbol as a graphic file...	Exports the screen/symbol as a graphics file. The file selection dialog offers the corresponding graphics formats supported on the system. In principle, all Windows Imaging Component (WIC) codecs that support <code>saving</code> are provided for selection. The size of the graphics results from the screen or symbol to be exported.
Import XML	Imports symbols from an XML-file (see chapter Import/Export of symbols).

Remove all filters	Removes all filter settings.
Edit selected cell	Opens the selected cell for editing. The binocular symbol in the header shows which cell has been selected in a highlighted line. Only cells that can be edited can be selected.
Replace text in selected cell	Opens the dialog for searching and replacing texts.
Properties	Opens the Properties window.
Help	Opens online help.

7.5 Toolbar Editor profiles

Editor profiles are administrated using the corresponding toolbar.

 Symbol	Description
Load standard profile	Resets all settings for display and position of windows and content and display of toolbars to the delivery conditions and loads the zenon standard profile.
Select Editor profile	Selection of an Editor profile from a drop-down list (on page 93) with 10 profiles.
Load selected Editor profile	Loads the profile selected in Select Editor profile .
Save selected Editor profile	Saves the current window settings to the profile which is displayed in Select Editor profile .
Load predefined profiles (on page 86)	Loads the profiles predefined by COPA-DATA to the first three storage locations and links them with the modules. Already existing profiles are overwritten.
Remove profile allocations (on page 86)	Removes all links of the predefined profiles to the modules.
Automatic saving of the Editor profiles	<p>Active: Changes to the current profile are saved automatically if another profile is called.</p> <p>Inactive: Changes are not saved when another profile is called; when the profile is called the next time, the original positions are restored.</p>
Assign individual names to Editor profile.	Opens a Dialog (on page 93) in which you can give Editor profiles individual names.
Options for toolbar	<p>Clicking on the arrow opens the submenu:</p> <p>Active: Toolbar is displayed.</p> <p>If the toolbar is not displayed, it can be activated using the Options -> Toolbar menu.</p> <p>Note: For free placed toolbar (undocked from the Editor) options are not displayed. The toolbar can be closed by clicking on button X.</p>

Note: Further options for import and export can be added using the user-defined amendment of the commands (on page 82) for the toolbar.

7.6 Toolbar Elements



Symbol	Function
Edit mode	Switches from Zoom to Edit mode .
Ellipse/Circle	With frame and fill color, type of frame and fill pattern (circle).
Arc of a circle	With definable line thickness, line color and line type.
Segment of a circle	Draws circle segment with an opening angle of 180° (changeable), definable line thickness, color and line type.
Line	With definable line thickness, line color and line type.
Polygon	With frame and fill color, type of frame and fill pattern.
Polyline	With line type and line color.
Rectangle	With frame and fill color, type of frame and fill pattern.
Pipe	With frame and fill color, type of frame and fill pattern
Static text	With font color and selection of the type of font.
Button	Operating field in button display.
Combined element	Display of one or more variables on a screen point in color or symbol (chained characters).
Universal slider	Slider control or rotating control.
Switch	Simple command initiation or set value input element
Combo-/Listbox	Link values of variables with text messages.
Command Processing element	Only available with a license for SICAM 230
Button for screen alarming	Only available with a license for SICAM 230
Numeric value	Display values numerically.
Bar display	Display value as bar graph.
Pointer instrument	Value in instrument display.
Dynamic text	Display limit value texts
Trend element	Simple line graphics
WPF element	Displays valid WPF XAML files.
ActiveX Element	Insert ActiveX elements.
Clock	Show date and time.
Options for toolbar	Clicking on the arrow opens the submenu: Active: Toolbar is displayed. If the toolbar is not displayed, it can be activated using the Options -> Toolbar menu.

Note: For free placed toolbar (undocked from the Editor) options are not displayed. The toolbar can be closed by clicking on button X.

7.7 Toolbar Production and Facility Scheduler

The Production Facility Scheduler can be edited via a toolbar, too.

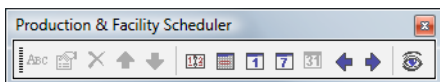

Symbol	Description
Rename	Enables renaming of equipment.
Properties	Opens a window with the properties of the equipment.
Delete	Deletes the selected equipment after a confirmation.
Sort ascending	Sorts the selected table / column ascending.
Sort descending	Sorts the selected table / column descending.
Change date	Opens the dialog where a date is entered; switches to this date.
Show today	Switches from the shown date to the current date.
Day view	Shows a day in the calendar.
Week view	Displays a week in the calendar.
Month view	Displays a month in the calendar.
Previous element	Goes one element back in the calendar according to the entered value (one day, one week or one month).
Next element	Goes one element forward in the calendar according to the entered value (one day, one week or one month).
Switching points preview	Opens the switching points preview.
Options for toolbar	<p>Clicking on the arrow opens the submenu:</p> <p>Active: Toolbar is displayed.</p> <p>If the toolbar is not displayed, it can be activated using the Options -> Toolbar menu.</p> <p>Note: For free placed toolbar (undocked from the Editor) options are not displayed. The toolbar can be closed by clicking on button X.</p>

7.8 Toolbar Remote Transport

A development computer can set up remote connections to other stations. The **Remote transport** toolbar provides functions for the transfer and request of data.



Symbol	Description
Remote Transport: Connection settings	Opens the configuration dialog of the Remote Transport for setting the target system and the target folder.
Remote Transport: Establishing a connection	Establishes a Remote Transport connection to the remote system.
Remote: Transfer changed Runtime files	Transfers all Runtime files that were changed on the development computer to the target computer since the last change.
Remote: Read back all Runtime files	Reads back all Runtime files from the engineered folders on the remote system into the local Runtime folder.
Remote: Set start project	Sets the active project as the start project on the remote system.
Remote: Start Runtime	Starts Runtime on the remote system.
Remote: Exit Runtime	Stops Runtime on the remote system.
Remote: Reload project	Executes the reload function on the remote system.
Remote Desktop: Start connection	Starts a connection to operate the target computer using zenon Remote Desktop. This allows visual operation.
Options for toolbar	<p>Clicking on the arrow opens the submenu:</p> <p>Active: Toolbar is displayed.</p> <p>If the toolbar is not displayed, it can be activated using the Options -> Toolbar menu.</p> <p>Note: For free placed toolbar (undocked from the Editor) options are not displayed. The toolbar can be closed by clicking on button X.</p>

Further symbols can be added using the toolbar options (on page 82).

Symbol	Description
Transfer all Runtime files	Transfers all Runtime files to the target system.
Restart OS	Starts the operating system of the target computer after confirmation. Under Windows CE this option is not supported.
Get system status	Determines system status of the target computer and writes data to the output window. The following are determined: <ul style="list-style-type: none"> ▶ Computer name ▶ Operating system ▶ Runtime active/not active ▶ Start project ▶ Real memory ▶ Drives ▶ Remote serial number ▶ Remote zenon version
Change password and display licensing	Opens dialog for connection establishing. Enables: <ul style="list-style-type: none"> ▶ Changing the password for the connection establishment ▶ Display and change to the licensing of the target computer (for versions older than 8.00) ▶ Configuration of the encryption at the target computer

Note: All commands for Remote Transport are available in the project's context menu.

7.9 Toolbar Report Generator

A toolbar is available in the Editor for the Report Generator.

To call this up, if it is not visible:

1. Open the **Extras -> Settings -> Tab:** (on page 84) menu **Toolbar** (on page 84)
2. Activate the checkbox next to **Report Generator**.
3. Confirm with **OK**.



Symbol	Description
Print report	Prints the report on the default printer.
Report - Page view	Opens the report in a preview. The report can be enlarged or minimized in the preview (zoom), you can leaf through it and it is printable.
Refresh report	Refreshes the display.
Recalculate functions	Recalculates the formulas in the report.
Function wizard	Opens a dialog that helps with the configuration of functions.
Font	Opens the dialog for cell formatting - focused on the Font tab.
Text alignment	Opens the dialog for cell formatting - focused on the Alignment tab.
Border	Opens the dialog for cell formatting - focused on the Border tab.
Pattern	Opens the dialog for cell formatting - focused on the Pattern tab.
Options for toolbar	<p>Clicking on the arrow opens the submenu:</p> <p>Active: Toolbar is displayed.</p> <p>If the toolbar is not displayed, it can be activated using the Options -> Toolbar menu.</p> <p>Note: For free placed toolbar (undocked from the Editor) options are not displayed. The toolbar can be closed by clicking on button X.</p>

7.10 Toolbar Runtime files

A toolbar is available to transfer files from the Editor to the Runtime or vice versa:

Symbol	Description
Create changed Runtime files	Creates Runtime files of all files that were changed in the Editor. The drop-down menu allows to choose whether Runtime files of the active project or of all loaded projects shall be created.
Create all Runtime Files	Creates Runtime files of all files that are available in the Editor. The drop-down menu allows to choose whether Runtime files of the active project or of all loaded projects shall be created.
Import Runtime files	Files that can be changed in the Runtime (like recipes or user administration) are imported from the Runtime in the Editor.
Files that can be changed in Runtime	Opens the dialog to administer files that can be changed in Runtime.
Start the Runtime	Starts Runtime.
Options for toolbar	<p>Clicking on the arrow opens the submenu:</p> <p>Active: Toolbar is displayed.</p> <p>If the toolbar is not displayed, it can be activated using the Options -> Toolbar menu.</p> <p>Note: For free placed toolbar (undocked from the Editor) options are not displayed. The toolbar can be closed by clicking on button X.</p>

7.11 Toolbar visibility levels

Similar to CAD programs, you can define visibility levels in the Editor and allocate them with unique elements. That way you can easily hide unused elements in complex images and show them again anytime. 15 visibility levels are available. Levels are allocated using the properties **Visibility level** in the node **General**. Individual levels can be activated and deactivated using the buttons of the **Visibility levels** toolbar:



Symbol	Description
Show all visibility levels	Shows all levels.
Hide all visibility levels	Hides all levels.
Visibility level [No]	Shows / hides the relevant visibility level.
Options for toolbar	<p>Clicking on the arrow opens the submenu:</p> <p>Active: Toolbar is displayed.</p> <p>If the toolbar is not displayed, it can be activated using the Options -> Toolbar menu.</p> <p>Note: For free placed toolbar (undocked from the Editor) options are not displayed. The toolbar can be closed by clicking on button X.</p>



Information

Visibility levels only apply to the Editor and have no effect in Runtime.

Note on control elements: Control elements are always displayed at the uppermost position. That also applies if they are covered by other elements in the Editor. This ensures that they can always be reached.

7.12 Toolbar Macro List

Macros that were created with VBA can be administrated via toolbar-item **Macro list**.

If a filter is selected, this selection is also visible in the tool bar.



Symbol	Description
Reload list of VBA/VSTA macros	Loads all <code>Public Sub Name ()</code> macros that are included in myWorkspace and in modules to the drop-down list of the toolbar.
Search Macro	Search for macros via combobox input field or selection from drop-down list. The drop-down list is adjusted to the widest element when opened.
Drop-down list Macros	Contains all loaded macros for selection.
Execute selected macro	Executes the macro selected in the drop-down list.
execute allocated macro #<x>	Executes the macro allocated with the symbol.
Allocate macros	Opens the allocation dialog for macros. Up to 5 macros can be allocated with the symbols 1 to 5.
VBA	Filters for VBA-macros. Only VBA-macros are displayed.
VSTA	Filters for VSTA-macros. Only VSTA-macros are displayed.
ALL	Cancel the current filter and all macros are displayed.
AZ	Sorts macros in ascending order from 0 - 9 and A - Z.
ZA	Sorts macros in descending order from Z - A and 9 - 0.
Options for toolbar	Clicking on the arrow opens the submenu: Active: Toolbar is displayed. If the toolbar is not displayed, it can be activated using the Options -> Toolbar menu. Note: For free placed toolbar (undocked from the Editor) options are not displayed. The toolbar can be closed by clicking on button X.



Information

If the macro assignment dialog does not list all macros from **myWorkspace**, execute the function **Reload list of VBA macros** in the toolbar.

7.13 Toolbar detail view

The project manager detail view shows matching toolbars depending on the active node. These correspond with the contents of the relevant context menu. You can find help for the unique toolbars in the relevant chapter, for example: Variable detail view toolbar.

7.14 Toolbar properties

The properties of an object are shown and can be edited in the properties-window. A toolbar is available for administration of the properties screen.

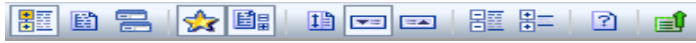

Symbol	Description
Grouped view (on page 150) (default)	<p>All properties of the selected object are logically grouped; the groups can be sorted alphabetically or logically. With the context menu, properties can be added to or removed from the Favorites.</p> <p>Standard for manual: Hints in the manual concerning the properties always use the grouped view. The contents of the groups are the same as in the dialog view.</p>
All properties (on page 152)	<p>All properties of the selected object are displayed in a list. With the context menu, properties can be added to or removed from the Favorites.</p>
Dialog view (on page 151)	<p>All properties are grouped logically like in the Grouped view, the groups are displayed sorted by application priority in dialog form. In this view, no favorites can be defined.</p>
Show/hide favorites (on page 152)	<p>Shows / hides the node Favorites in the top spot of the views Grouped view or All settings. The most frequently used properties are collected here.</p> <p>Default favorites are proposed.</p> <p>Add / remove entries to the favorites: You can do this either by using the context menu Add to favorites or by moving the desired properties to the favorites toolbar using Drag&Drop.</p> <p>The order of the properties in the favorites is determined by the sorting criterion (ascending, descending, logic).</p> <p>In the Dialog view favorites cannot be created.</p>
Show/hide all properties	<p>Shows or hides all nodes in the views Grouped and All Properties.</p>
Sorted logically (default)	<p>Displays the properties logically sorted according to application frequency instead of alphabetically sorted in the views Grouped and All properties.</p>
Sort ascending/descending	<p>Displays the properties either in ascending or descending alphabetical order in the views Grouped and All properties.</p>
Open/close all sections	<p>Shows / hides all nodes in the views Grouped and All Properties.</p> <p>Exception: The node of the current property is not closed, if Close all nodes is selected.</p>
Display properties help (on page 155)	<p>Displays the integrated help for the properties (properties help).</p>
Release property	<p>Symbols: Releases the selected property.</p>
Options for toolbar	<p>Clicking on the arrow opens the submenu:</p> <p>Active: Toolbar is displayed.</p> <p>If the toolbar is not displayed, it can be activated using the Options -> Toolbar menu.</p>

	Note: For free placed toolbar (undocked from the Editor) options are not displayed. The toolbar can be closed by clicking on button X.
--	--

8. Menu bar

The menu bar contains - depending on the selected module and element - drop-down lists for the following elements.

BASIC

- ▶ File
- ▶ Edit
- ▶ View
- ▶ Screens
- ▶ Tools
- ▶ Window
- ▶ Help

SCREENS AND SYMBOLS

If a screen is opened, new menu items are added to the bar:

- ▶ Elements
- ▶ Control elements

If the **General symbol library** is activated, the menu item **Screens** is replaced with the menu item **Symbols** .

REPORT

When a report is opened:

- ▶ The **Screens** menu is replaced with **Report**
- ▶ The **Format** menu is added
- ▶ The commands in the **Edit** (on page 55) menu are replaced

8.1 File

The following actions are possible:

Menu item	Action
Project new	Opens the dialog for creating a new project.
Insert project into workspace	Opens the dialog to insert an existing project into the Editor.
Insert project 5.50	Opens the dialog to insert a project created with Editor 5.50.
Restore project backup	Opens the dialog to load the last version of a project saved in a project backup.

WORKSPACE

Actions for the workspace.

Menu item	Action
New	Opens the dialog for creating a new workspace.
Open	Opens the dialog for creating an existing workspace.
Save	Saves the current workspace.
Save as	Saves the current workspace. Name and desired storage place can be chosen.
Close	Closes the current workspace
Create backup	Opens the dialog for the backup of all current workspace projects. The backup is stored in a compressed *.wsb-file.
Load backup	Opens the dialog for loading the projects that were saved during a backup of the workspace.

GENERAL CONFIGURATION

General settings.

Menu item	Action
Open License Administration	Opens the License Manager . Licenses can be activated, returned and managed with this tool. The serial number is needed for this.
Standard	Opens the dialog for configuration of standard settings for the save location and the printer for <ul style="list-style-type: none"> ▶ AML ▶ CEL ▶ Values ▶ Protocols ▶ Screenshots ▶ Notepad
Control panel	Opens the control panel of the operating system.
Existing workspaces	List of existing workspaces. The last five chosen settings are shown. The updated list is written to zenon6.ini when the workspace is changed.
Exit	Terminates the zenon Editor

8.2 Edit

The content of the **Edit** menu bar depends on the selected configuration:

- ▶ The entries differ according to the last or currently opened project configuration in the main window.
Note: This results in entries for the configuration currently open in the main window are also offered in the **Edit** menu for other nodes.
- ▶ The menu entries are now only offered for the following nodes:
 - **Screens** (on page 56)
 - Report Generator (on page 60)

8.2.1 Screens and symbols

When selecting a screen or symbol, the **Edit** menu provides special functions.

The following actions are possible:

Parameter	Description
Undo	<p>Undoes the last action.</p> <p>The number of possible undo actions is defined under the Extras menu entry in the Settings (on page 70) menu entry. Configure the desired value in the Settings dialog in the Undo steps option.</p> <p>Attention: It is not possible to undo action in the Frame Editor.</p>
Cut	<p>Cuts the selected objects and stores them in the clipboard.</p> <p>Only available if at least one item of project configuration content has been selected.</p>
Copy	<p>Copies the selected objects and stores them in the clipboard.</p> <p>Only available if at least one item of project configuration content has been selected.</p>
Duplicate	<p>Duplicates a highlighted object. The duplicate is added at the bottom, moved to the right.</p> <p>For details, see the Duplicating elements chapter in the Screens manual.</p>
Paste	<p>Pastes copied or cut objects from the clipboard. Elements are always pasted centered in the editing area. If there are multiple objects, their positions in relation to each other are retained.</p>
Paste in same position	<p>The copy of the object is pasted in the same position as the original.</p> <p>Only available if Copy or Cut has previously been carried out.</p>
Delete	<p>Deletes marked elements. Deletion is carried out without a request for confirmation beforehand.</p>
Transfer format	<p>Transfers the formatting of the selected element to a different element.</p>
Select all	<p>Marks all objects in the main window.</p>

Replace links	<p>Opens the dialog in order to replace linked variables or functions with dynamic elements.</p> <p>You can find more details in the Substitution of process variables in dynamic elements chapter.</p>
Element Position	<p>Changes the position of marked elements The availability of entries depends on the current position of the selected elements.</p> <p>Selection of the position from the context menu:</p> <ul style="list-style-type: none"> ▶ Foreground Moves selected elements into foreground ▶ Background Moves selected elements to the background. ▶ Forwards Moves selected elements one level forward. ▶ Backwards Moves selected elements one level back. <p>ALT + left-click selects elements from deeper levels.</p>
Align	<p>Repositions selected elements. The first element selected always serves as an orientation point for the alignment.</p> <ul style="list-style-type: none"> ▶ Left Moves selected element left ▶ Right Moves selected element right ▶ Top Moves selected elements upwards ▶ Bottom Moves selected elements downwards
Arrange	<p>Rearranges elements. Starting point is the first marked element.</p> <p>If only one element is highlighted, context menu entries are grayed out.</p>

same width	<p>Marked elements are adjusted to the width of the first chosen element.</p> <p>Note: With rotated elements, the width is orientated to optical coordinates, not to logical coordinates. For details, see the Toolbar orientation (on page 34) chapter.</p>
same height	<p>Marked elements are adjusted to the height of the first chosen element.</p> <p>Note: With rotated elements, the height is orientated to optical coordinates, not to logical coordinates. For details, see the Toolbar orientation (on page 34) chapter.</p>
same size	<p>Marked elements are adjusted to the width and height of the first chosen element.</p> <p>Note: With rotated elements, the size is orientated to optical coordinates, not to logical coordinates. For details, see the Toolbar orientation (on page 34) chapter.</p>
horizontal center	Moves marked elements in the horizontal center of the first selected element.
vertical center	Moves marked elements in the vertical center of the first selected element.
same distance in x-plane	Marked elements are grouped in a way that the distance on the X-axis is the same between them. The first two elements determine the distance.
same distance in y-plane	Marked elements are grouped in a way that the distance on the y-axis is the same between them. The first two elements determine the distance.
same allocation in x-plane	Distributes all marked elements along the x-axis between the two elements that were first selected. For this option, at least three elements must be selected.
same allocation in y-plane	distributes all marked elements along the y-axis between the two elements that were first marked. For this option, at least three elements must be selected.
flip horizontally	Flips the selected element on a horizontal axis.
flip vertically	Flips the selected element on a vertical axis.
flip 90°	Rotates the selected element 90° counterclockwise.
Symbol	the context menu entries vary according to the type of selection

	(screen element or symbol).
Create element group	Creates a new element group from all selected elements.
Disband element group	The element group is broken up into its original elements and no longer exists.
Single edit mode element group	Enables you to edit individual elements of an element group. Switches between individual editing mode and element editing mode.
Insert in existing element group...	Opens the list of element groups in order to add the active element to an element group of the list.
Remove from element group	Removes the deleted element from the element group.
Convert symbol into element group	Converts a symbol into an element group. The symbol is disconnected from the original symbol in the library and can only be changed locally. This conversion cannot be undone.
Symbol list...	Opens a list of all symbols and element groups that are used in the current screen.
Tab order for focus	<p>Stipulation of horizontal or vertical order for keyboard operation.</p> <p>You can find the configuration steps in the Define sequence within template chapter in the Runtime manual.</p>
Order for left/right	Determines the horizontal order.
Order for up/down	Determines the vertical order.
Properties...	Opens properties window and jumps to the properties group of the selected element there.

SELECTION VIA LASSO

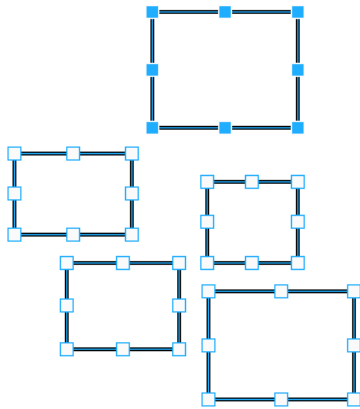

When selecting the elements by means of a lasso, the alignment is orientated to the element that was selected before use of the lasso. Internal prioritization is undertaken if no element was selected before the use of the lasso. This prioritized element is emphasized graphically in COPA-DATA. In this case, the sizing handles are displayed as filled squares.

Example view of a prioritized element

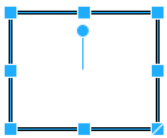

8.2.2 Reporting

For Reports, the **Edit** menu provides the following entries:

Command	Description
Cut	<p>Cuts highlighted area and copies it to the clipboard.</p> <p>Only available if at least one item of project configuration content has been selected.</p>
Copy	<p>Copies highlighted area to the clipboard.</p> <p>Only available if at least one item of project configuration content has been selected.</p>
Paste	<p>Pastes the contents of the clipboard.</p> <p>Only available if Copy or Cut has previously been carried out.</p>
Paste enhanced	<p>Provides advanced paste options for cell operations. Selection from context menu.</p> <ul style="list-style-type: none"> ▶ All: Pastes the complete content of the clipboard. ▶ Formulas: Only pastes the formula content to the clipboard. ▶ Value: Only pastes content of the clipboard with value: Caution: The relationship to formulas is lost in the process. ▶ Format: Only takes on the format of the content saved in the clipboard without content <p>Only available if Copy or Cut has previously been carried out.</p>
Fill	<p>Copies the content of the selected cell and transfers it to all further highlighted cells.</p> <p>Selection from context menu.</p> <ul style="list-style-type: none"> ▶ Downwards: Content is copied into selected cells below the selection (column). ▶ To the right: Content is copied into selected cells to the right of the selection (column).
Remove	<p>Removes content from the highlighted cells.</p> <p>Selection from context menu.</p> <ul style="list-style-type: none"> ▶ All: Complete content is removed from highlighted cells. ▶ Content only: Only content values are removed from highlighted cells. The format of the cells is retained in the process. ▶ Format: Only formatting of the highlighted cells is removed. All content is

	retained in the process.
Delete column/row	Deletes highlighted columns or rows.
Insert column/row	<p>Inserts new columns or rows.</p> <p>Insertion is carried out above the row or to the left of the column. As many rows/columns are inserted as are highlighted in the worksheet.</p> <p>Tip: always highlight the complete lines or columns by clicking on the column or line markers. Multiple selection is possible if the <code>Shift</code> key is held down.</p>
Search/replace	Opens the dialog for searching and replacing table content.

8.3 View

The following actions are possible:

Menu item	Action
Status line	Shows / hides the Editor Status line . Which is not identical with the status line of the Project Manager in the Detail view (on page 98).
Project Manager	Shows the window Project Manager (on page 94) .
Output window	Shows the Output window (on page 156) .
Cross-reference list	Shows the Cross reference list .
Properties window	Shows the Properties window (on page 146) .
Property help	Shows the window Properties help (on page 155)
Toolbars	Drop-down list for displaying and hiding toolbars.

8.4 Screens

This menu entry is only shown if a zenon screen is open in the main window.

The following actions are possible:

Menu item	Action
Save screen	Saves the current screen.
Save all screens	Saves all screens.
Full-screen mode	<p>The full-screen hides all remaining windows and shows only the main window with all opened documents (screens, reports, ...) in full-screen mode.</p> <p>Note: The Control elements menu can still be called up in full-screen mode.</p> <p>The full-screen mode can be closed by:</p> <ul style="list-style-type: none"> ▶ the displayed button for closing the full-screen mode ▶ the short key <code>Shift+F9</code>
Redraw screen	Refreshes the display.
Display grid	Switches the grid on or off.
Use grid	<p>Switches usage of the grid on or off.</p> <p>On: All objects are automatically aligned with the grid.</p>
Use magnetic points	<p>Switches magnetic points on or off.</p> <p>Usage: If you move an object near the handling point of another object, it snaps in place at the handling point.</p>
Zoom	<p>Allows changes to the resolution size in fixed steps between 15% and 1600%.</p> <p>Amend: automatically selects a zoom factor between 15 - 1600%, so that the complete screen is shown in full and in proportion in the Editor.</p>
Export screen/symbol as a graphic file	<p>Saves the selected screen or symbol in a graphics file.</p> <p>The following is saved:</p> <ul style="list-style-type: none"> ▶ In screens: the selected screen with all elements and symbols ▶ In the symbol editor: the selected symbol <p>The file browser is opened for saving. Select the save location, filename and type here.</p>
Insert vector graphics	<p>Opens the dialog for inserting an external vector graphic.</p> <p>Supports some versions of the file types DXF and PLT.</p> <p>Note: Import of vector graphics is not available for the 64-bit Editor.</p>



Information

As soon as a screen element is active, the menu **Elements** is displayed. It offers all **vector elements** and **dynamic elements** analog to the toolbar elements for selection. When you select special screen types the menu **Control elements** is displayed in addition. It offers predefined control elements in accordance with the selected screen type.

8.5 Symbol

This menu entry is only shown if a zenon screen is open in the main window.

The following actions are possible:

Menu item	Action
Save symbol	Saves the current symbol.
Save all symbols	Saves all symbols.
Change symbol size / background color	<p>Opens the dialog for configuration of symbol size and background color.</p> <p>Note: Changes of the background color always affect all symbols in the global system library.</p>
Toolbar	Opens a list of all symbols and element groups that are used in the current screen.
Full-screen mode	<p>The full-screen hides all remaining windows and shows only the main window with all opened documents (screens, reports, ...) in full-screen mode.</p> <p>Note: The Control elements menu can still be called up in full-screen mode.</p> <p>The full-screen mode can be closed by:</p> <ul style="list-style-type: none"> ▶ the displayed button for closing the full-screen mode ▶ the short key <code>Shift+F9</code>
Redraw symbol	Refreshes the display.
Display grid	Switches the grid on or off.
Use grid	<p>Switches usage of the grid on or off.</p> <p>On: All objects are automatically aligned with the grid.</p>
Use magnetic points	<p>Switches magnetic points on or off.</p> <p>Usage: If you move an object near the handling point of another object, it snaps in place at the handling point.</p>
Tab order for focus	<p>Stipulation of horizontal or vertical order for keyboard operation.</p> <p>You can find the configuration steps in the Define sequence within template chapter in the Runtime manual.</p> <ul style="list-style-type: none"> ▶ Order for left/right: Determines the horizontal order. ▶ Order for up/down: Determines the vertical order.
Zoom	<p>Allows changes to the resolution size in fixed steps between 15% and 1600%.</p> <p>Amend: automatically selects a zoom factor between 15 -</p>

	1600%, so that the complete screen is shown in full and in proportion in the Editor.
Export screen/symbol as a graphic file	<p>Saves the selected screen or symbol in a graphics file. The following is saved:</p> <ul style="list-style-type: none"> ▶ In screens: the selected screen with all elements and symbols ▶ In the symbol editor: the selected symbol <p>The file browser is opened for saving. Select the save location, filename and type here.</p>
Insert vector graphics	Opens the dialog for inserting an external vector graphic.

8.6 Window

The following actions are possible:

Menu item	Action
Full-screen mode	<p>The full-screen hides all remaining windows and shows only the main window with all opened documents (screens, reports, ...) in full-screen mode.</p> <p>Note: The Control elements menu can still be called up in full-screen mode.</p> <p>The full-screen mode can be closed by:</p> <ul style="list-style-type: none"> ▶ the displayed button for closing the full-screen mode ▶ the short key <code>Shift+F9</code>
Close	Closes the active window
Divide	Divides the main window and positions the active windows accordingly.
List of windows	Displays open windows. A maximum of 9 windows are listed.
Window	<p>Opens the dialog to administer windows open in the main window:</p> <ul style="list-style-type: none"> ▶ Activate ▶ save (multiple selection is possible) ▶ close (multiple selection is possible) <p>The active window is preselected.</p>

8.7 Help

The following actions are possible:

Menu item	Action
About...	Calls up the dialog to display the version and license information.
First steps	Calls up the section Tutorials in the online help.
Help	Opens the online help
zenon Video Tutorials	Calls up the COPA-DATA YouTube channel with examples of project configuration in a web browser. This call is carried out by means of HTTPS. To do this, the computer must have Internet access and the corresponding port must be enabled.
Update documentation...	Calls up the Documentation Download Tool to update the help.

8.8 Tools

The following actions are possible:

Menu item	Action
Start Editor Wizards	<p>Opens the dialog for selecting a wizard.</p> <p>Note: This menu item is only available if you have activated VBA/VSTA in the file <code>zenon6.ini</code>. Activate VBA by checking that the entry EIN=1 exists in area [VBA].</p>
Manage Editor services	Opens the dialog to manage Editor services
Open Add-In	<p>Opens the Editor predefined in the Settings (on page 69) for Add-In programming.</p> <p>SharpDevelop is started if no development environment has been pre-defined. An error message is given if the pre-defined development environment cannot be opened.</p>
Open VSTA Editor with WorkspaceAddin	<p>Opens the VSTA editor.</p> <p>Note: This menu item is only available if you have activated VSTA in the file <code>zenon6.ini</code>. Activate VBA by checking that the entry ON=1 exists in area [VSTA].</p>
Open VBA Editor	<p>Opens the Visual Basic Editor</p> <p>Note: This menu item is only available if you have activated VBA in the file <code>zenon6.ini</code>. Activate VBA by checking that the entry EIN=1 exists in area [VBA].</p>
Manage Editor Add-Ins	Opens the dialog to manage Add-Ins.
Update Editor VBA/VSTA wizards	<p>Opens the dialog for an update of the wizards.</p> <p>For details, read the Update wizards section in the Wizards chapter.</p> <p>Note: This menu item is only available if you have activated VBA VSTA in the file <code>zenon6.ini</code>. Activate VBA by checking that the entry EIN=1 exists in area [VBA].</p>
Update of the Windows CE Runtime	Opens the application for updating a Windows CE Runtime.
Compile project for web	Compiles a project for use with the HTML Web Engine.
Define new menu entry	<p>Opens the dialog to implement external programs with their own menu entry.</p> <p>Hint: If you already created another menu entry it is shown in this place. New and additional menu items are created using Tools -> Settings -> Menu tools (on page 76).</p>
Editor administration of editor profiles	Opens the Submenu (on page 91) for administration of the Editor profiles.
Settings	Opens the dialog for the configuration of the general settings (on page 70), menus (on page 76), color schemes (on page 78), Add-Ins (on page 80), commands (on page 82) and toolbars (on page 84).

8.8.1 Setting

In this dialog, you stipulate the basic settings for zenon and configure the appearance using the tabs:

- ▶ **Settings** (on page 70): General settings for the user interface.
- ▶ **Menu tools** (on page 76): Creation of further content for the Extras drop-down list.
- ▶ **Color scheme** (on page 78): Selection of a color scheme for the Editor.
- ▶ **Add-Ins** (on page 80): Selection of the development environment for Add-Ins.
- ▶ **Commands** (on page 82): Stipulation of which commands are available in the toolbars.
- ▶ **Toolbars** (on page 84): Stipulation of which tool bars are visible and resetting of changes for tool bars and menus.

Settings

Define the basic settings for zenon in the dialog **Settings**.

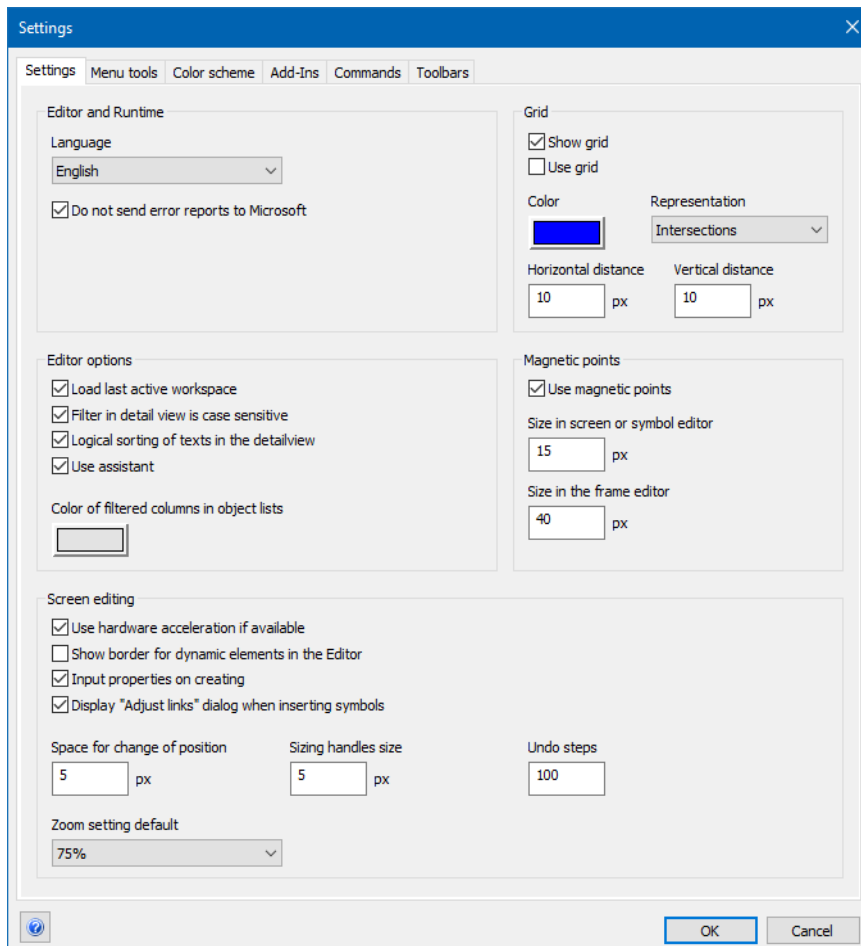

EDITOR AND RUNTIME

Option	Description
selected language	<p>Choose the language for the Editor's user interface. Selection of the display language from a drop-down list.</p> <p>The Editor must be closed and started again for a language change. The default language of the Editor is English.</p>
Do not send the bug report to Microsoft	<p>Checkbox for the notification of Microsoft in the event of an error.</p> <ul style="list-style-type: none"> ▶ Active: Prevents transmission of a bug report to Microsoft if a program crashes. ▶ Inactive:

	<p>A bug report is sent to Microsoft in the event of an error.</p> <p>Default: activated</p>
--	--

EDITOR OPTIONS

Option	Description
Load last active workspace	<p>Checkbox to amend which workspaces are loaded when the zenon Editor is loaded.</p> <ul style="list-style-type: none"> ▶ Active: The last active workspaces are loaded and displayed in the project manager when the editor is started (default). ▶ Inactive: No workspace is loaded when the editor is started. Existing projects and workspaces can be opened and new ones can be created using the context-sensitive menu. <p>Default: active</p>
The filter in the detail view is case sensitive.	<p>Checkbox for case sensitivity when entering filter terms.</p> <ul style="list-style-type: none"> ▶ Active: The filter in the list view is case sensitive. ▶ Inactive: The filter in the list view makes no difference between capital and small letters. <p>Default: Inactive</p>
Logical sorting of texts in the detail view	<ul style="list-style-type: none"> ▶ Stipulates the logic of the sorting of file names with numbers. ▶ Active: File names with numbers are logically sorted in the list view. The sorting follows the correct numerical sequence. Example: variable1, variable2, variable10, variable 14 ▶ Inactive: File names with numbers are sorted alphabetically in the list view Example: variable1, variable10, variable14, variable2 <p>Default: active</p>
Use assistant	<p>Checkbox to activate project content using a dialog-based assistant as support when creating complex project configuration content.</p> <ul style="list-style-type: none"> ▶ Active:

	<p>Step-by-step configuration using dialogs is offered for selected projects.</p> <ul style="list-style-type: none"> ▶ Inactive: No support from the assistant when configuring a project. <p>Default: active</p> <p>Note: The activation cannot be amended for individual project configuration assistants. The checkbox activates or deactivates the general availability of assistants.</p> <p>Assistants are available for the following project configuration content:</p> <ul style="list-style-type: none"> ▶ Creation of an archive ▶ Configuration of a new zenon screen ▶ Configuration of the combined element screen element ▶ Configuration of the universal slider screen element ▶ Configuration of an SAP function call
<p>Color of the filtered columns in configurable lists</p>	<p>Configuration of the background color for the highlighting of filtered columns in configurable lists.</p> <p>Clicking on the color field opens a dialog to select a color.</p>

SCREEN EDITING

Option	Description
<p>Use hardware acceleration if available</p>	<p>Reduction of main processor load by delegating special processor-intensive tasks to hardware specialized in these tasks.</p> <ul style="list-style-type: none"> ▶ Active: Hardware acceleration is used. ▶ Inactive: Hardware acceleration is not used. <p>Default: active</p>
<p>Show border for dynamic elements in the Editor</p>	<p>Type of display of screen elements when configuring a project in the main window.</p> <ul style="list-style-type: none"> ▶ Active: Dynamic elements are shown in the Editor with a frame. ▶ Inactive: Dynamic elements are shown in the Editor with a frame. <p>Default: active</p>

Input properties on creating	<p>For configuration elements that are linked to variables, for example, the dialog can be shown automatically after placement in the main window.</p> <ul style="list-style-type: none"> ▶ Active: If you create a dynamic element, the dialog boxes for detailed settings, like for example variable selection, open automatically. ▶ Inactive: The dynamic element is drawn; related properties must be defined separately. An assignment or selection dialog is not offered. <p>Default: <i>active</i></p>
Show "Adjust links" dialog when inserting symbols	<p>Option for an optional subsequent dialog when placing symbols (with pre-configured linkings) in the main window.</p> <ul style="list-style-type: none"> ▶ Active: When inserting a symbol with existing links into a screen, the Replace linkings dialog is opened. ▶ Inactive: The dialog is not opened. Links can be substituted anytime using the command Replace link in the context menu. <p>Default: <i>active</i></p>
Space for change of position	<p>Prevents unwanted moving of elements Before an element is really moved, it has to be moved at least by the stated number of pixels.</p>
Size of selection markers	<p>Allows the setting of the pixel size of corner points.</p>
Undo steps	<p>Allows undoing up to 250 actions.</p> <ul style="list-style-type: none"> ▶ Minimum: 1 ▶ Maximum: 250 <p>Default: 100</p>
Default zoom setting	<p>When a screen/symbol is opened for the first time, the zoom factor configured under Default zoom setting is used for the display in the main window of the Editor. if this zoom factor is amended for a screen/symbol, the respective zoom factor is also saved after the editor is closed. The screen/symbol is shown with the same zoom factor the next time it is opened.</p> <p>Default: 100 %</p>

GRID

Options for the display of the configuration environment in the main window of the zenon Editor.

Option	Description
Display grid	Display of a grid in the main window of the zenon Editor. <ul style="list-style-type: none"> ▶ <i>Active:</i> Shows the grid that can be defined in the main window under Grid type. ▶ <i>Inactive:</i> Grid is not displayed.
Use grid	Use of the grid for project configuration steps. <ul style="list-style-type: none"> ▶ <i>Active:</i> Screen elements are automatically aligned with the grid. This function is independent from the option Display grid. ▶ <i>Inactive:</i> Screen elements are not orientated to the grid during configuration.
Color	Defines the grid color. Clicking on the color field opens the pull-down menu to select a color. The windows color palette is used for selection.
Display	Drop-down list with the type of grid display: <ul style="list-style-type: none"> ▶ full ▶ Intersections
Vertical space	Defines the vertical distance between individual lines of the grid. Therefore, it also defines how finely scaled element sized can be displayed. Recommended grid distance: 10 pixel
Horizontal space	Defines the horizontal distance between individual lines of the grid. Therefore, it also defines how finely scaled element sized can be displayed. Recommended grid distance: 10 pixel

MAGNETIC POINTS

Elements have magnetic points. If you move an element and its selection marker comes near the selection marker of another element, the selection marker of the selected element is locked there and aligns itself on it.

Option	Description
Use magnetic points	Checkbox for the activation of connection areas. <ul style="list-style-type: none"> ▶ <i>Active:</i> Project configuration content finds its place in the grid and orientates itself accordingly. ▶ <i>Inactive:</i> No locating and orientation to connection points. Default: <i>active</i>
Size in screen or symbol editor	Defines the size of the magic area in pixels (square selection markers). Default: 15 px
Size in the frame editor	Defines the size of the connection area in pixels (square selection markers) for the positioning of frames in relation to other frames or screen borders. Default: 40 px

CLOSE DIALOG

Option	Description
OK	Applies settings and closes the dialog.
Cancel	Discards all changes and closes the dialog.

Menu tools

In the dialog **Menu tools** you implement external programs in the Editor's menu structure. Individually implemented programs are shown at the end of menu item **Tools**.

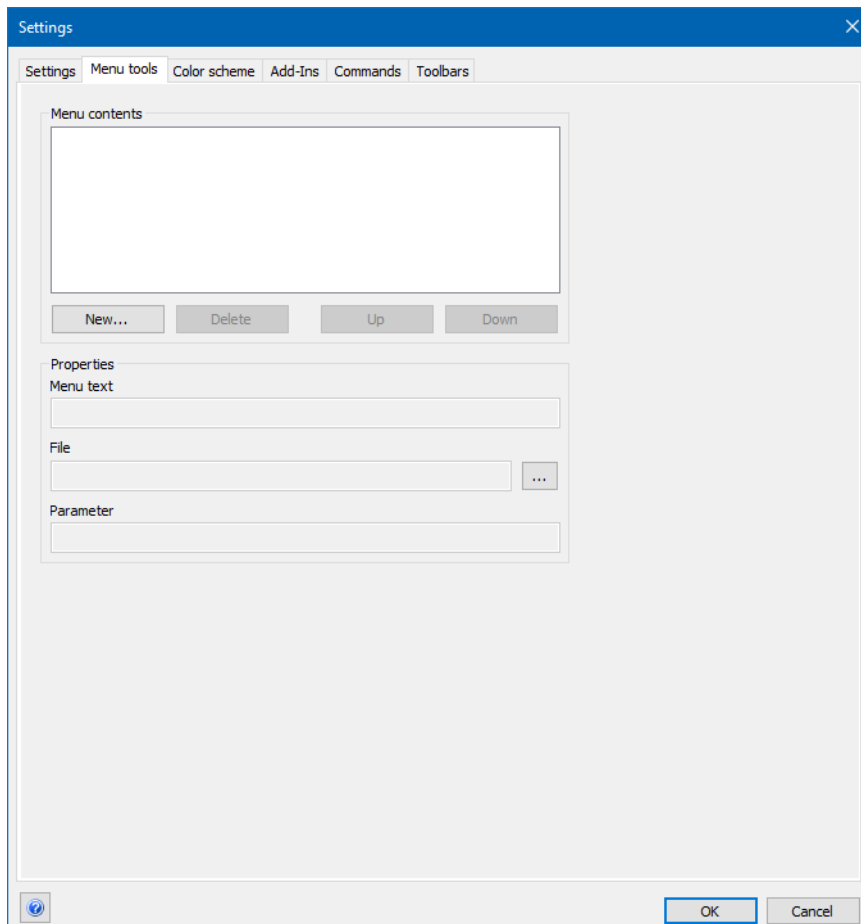

MENU CONTENTS

Option	Action
Menu contents	Lists all previously-integrated external programs.
New	Adds a new menu item.
Delete	Deletes an existing entry from the menu.
Move up	Moves the selected menu item upwards in the list and in the menu.
Move down	Moves the selected menu item downwards in the list and in the menu.
Menu text	Name under which the new menu is displayed in the options.
File	Name and path of the external program (*.exe-file) that shall be called up.
Parameter	Additional switches for calling up programs, for example file names.

CLOSE DIALOG

Option	Description
OK	Applies settings and closes the dialog.
Cancel	Discards all changes and closes the dialog.

EXAMPLE

- ▶ **Menu text:** Text editor
- ▶ **File:** C:\Windows\notepad.exe
- ▶ **Parameters:** C:\test.txt

*Calls up Notepad and opens the file **test.exe**. If this file is not available, you can create it.*

Color scheme

You define the color scheme for the Editor in this tab.

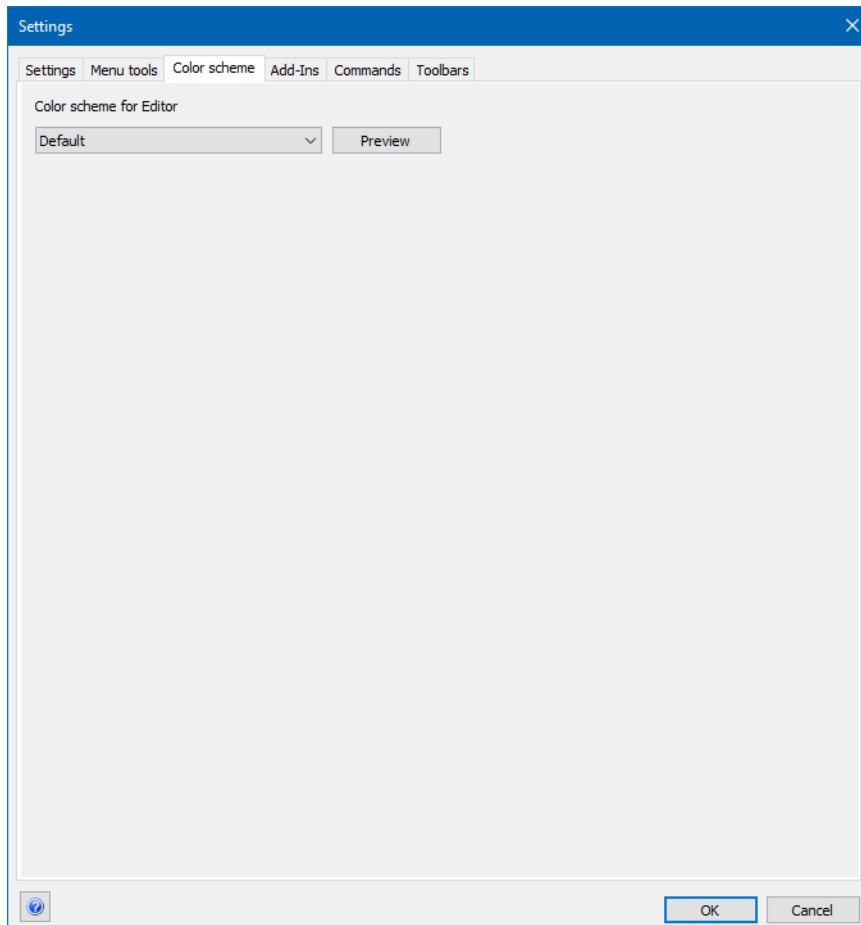

COLOR SCHEME FOR EDITOR

Parameter	Description
Color scheme for Editor	Clicking on the drop-down list opens the list where it can be selected.
Preview	Changes the color scheme of the Editor. The dialog window remains open.
OK	Applies changes and closes dialog.
Cancel.	Discards changes and closes dialog.

CLOSE DIALOG

Option	Description
OK	Applies settings and closes the dialog.
Cancel	Discards all changes and closes the dialog.

Add-Ins

You configure the options for the add-ins in this tab.

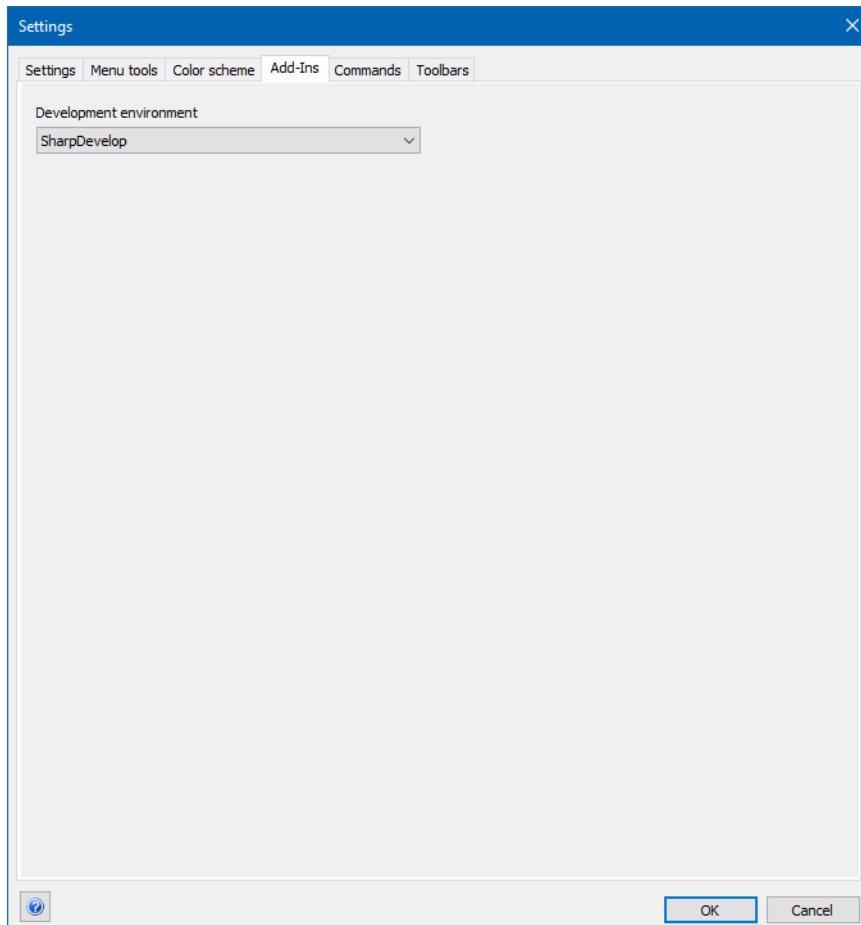

Option	Description
Development Environment	<p>Selection of the development environment for Add-Ins that are to be started when clicking on Open Add-In Editor.</p> <p>Select from drop-down list. The list contains all development environments available on the computer for Add-Ins.</p> <ul style="list-style-type: none">▶ Default: Visual Studio If this is not installed: Sharp Develop

CLOSE DIALOG

Option	Description
OK	Applies settings and closes the dialog.
Cancel	Discards all changes and closes the dialog.

Commands

In the dialog **Commands** you define, which commands are available in the toolbars.

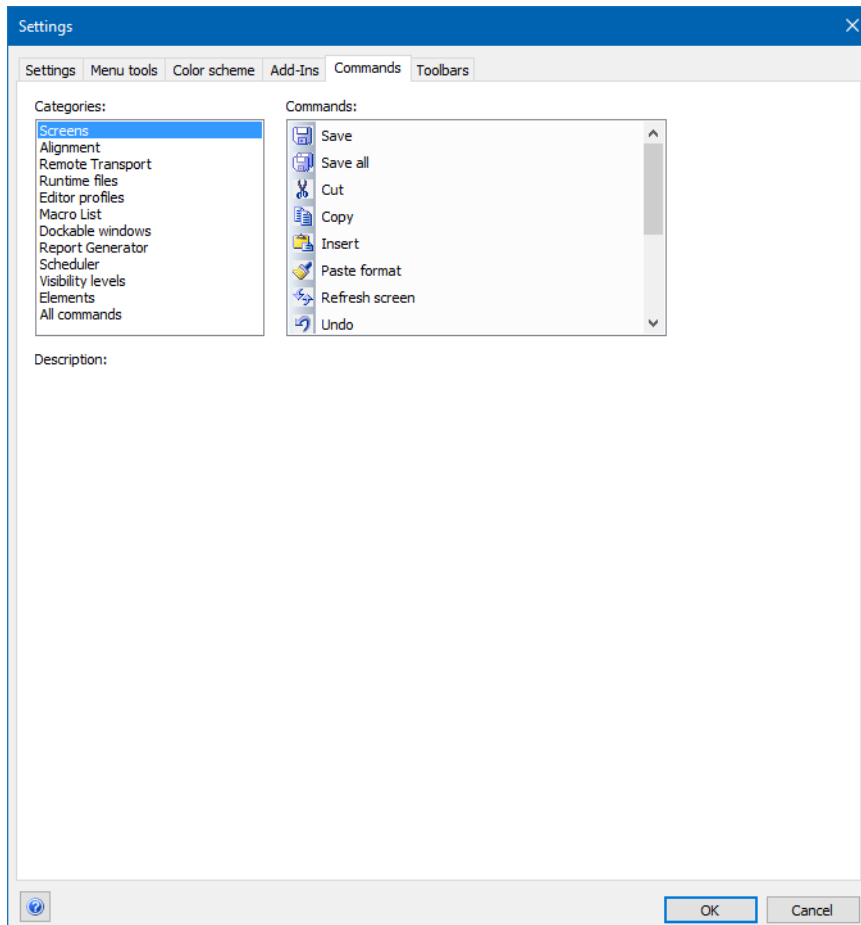

CATEGORIES

Option	Action
Categories	Select the category that includes the desired command.

COMMANDS

Option	Action
Commands	List of available commands.
Description	Text for tooltip If you move the mouse pointer over the button, the description is shown as tooltip.

CLOSE DIALOG

Option	Description
OK	Applies settings and closes the dialog.
Cancel	Discards all changes and closes the dialog.

ADD SYMBOLS

1. Open the **Extras -> Settings -> Tab:** (on page 82) menu **Commands (on page 82)**.
2. Choose a category from the left window.
3. Click on the desired symbol in the right window with the left mouse button.
4. Hold down the left mouse button and drag the symbol to the desired position in the toolbar.

DELETE SYMBOLS

1. Open, in the **Extras -> Settings -> Tab** (on page 84) menu: **Toolbar (on page 84)**.
All symbols in all toolbars in the editor are activated
2. Click with the left mouse button on the symbol.
3. Move the symbol away from the toolbar and release the mouse button



Information

*To undo changes to a toolbar and to restore the delivery conditions, change to tab **Toolbar**. Select the appropriate toolbar and click on the **Reset** button or on **Reset all**, to return all toolbars to the original state.*

Toolbars

You define the visibility of tool bars and reset changes to tool bars and menus in the **Tool Bars** dialog.

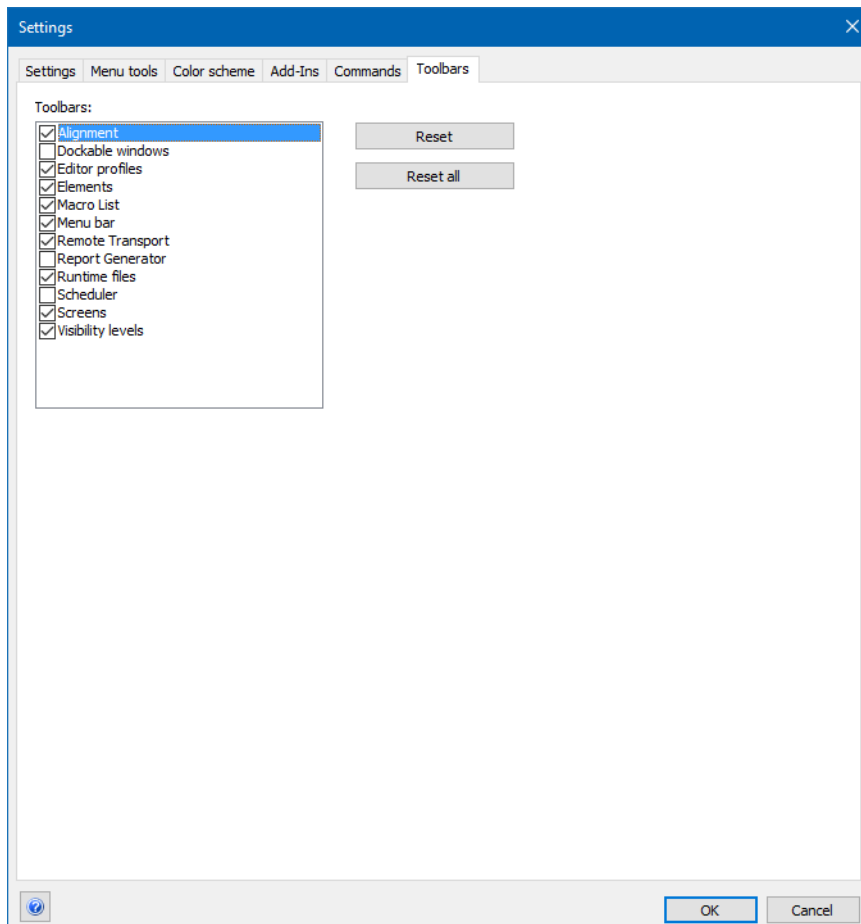

TOOLBARS

Option	Action
Toolbars	Checkbox active: Toolbar is shown in the editor.
Reset	Restores initial status for highlighted toolbar.
Reset all	Restores initial status for all toolbars.

CLOSE DIALOG

Option	Description
OK	Applies settings and closes the dialog.
Cancel	Discards all changes and closes the dialog.

9. Editor profiles

The Editor starts with default settings with predefined windows. You can group windows and activate them to your liking. You can find details in chapter [Adjust view](#) (on page 18).

Note:

- ▶ Optimal functionality is only guaranteed in full-screen mode.
- ▶ Editor profiles work version-specifically. Export and import to and from different versions is not supported.

PERSONAL SETTINGS

Your personal settings are administrated in profiles. These can be reached via

- ▶ the task bar **Editor profiles**
(see: [Administrate Editor profiles with the task bar](#) (on page 90))
- ▶ the entry **Manage Editor profile** in the menu bar **Tools**
(see [Administrate Editor profiles via menu](#) (on page 91))
- ▶ with keyboard shortcuts
(see [administrate Editor profiles with keyboard shortcuts](#) (on page 92))

You can also allocate single modules to editor profiles using the context menu (see [Choose Editor profiles from the context-sensitive menu](#) (on page 93)) or you can use predefined profiles (on page 86).



Information

For divided windows - as in the Project Manager with main view and detail view - the width definition always applies to the whole window. The correct relationship of the window elements is defined when starting and closing the Editor.

If the ratio of the window elements to one another is changed, calling up a profile only leads to the complete window being set to the defined values. The ratio of, for example, the main view and detail view to one another is not changed.

9.1 Predefined profiles

In zenon three predefined profiles are available. You optimize the layout of the Editor for:

- ▶ List view (variables, functions, recipes etc.):
Profile 1 on storage location P1:
- ▶ Screens:
Profile 2 on storage location P2:
- ▶ Default for general tasks:
Profile 3 on storage location P3:

Pre-defined profiles must be explicitly activated. They overwrite the storage locations P1, P2 and P3. If they are activated, the respective assigned profile is applied when a node in the project tree is selected. If automatic assignment of the profiles is deactivated, there is no more automatic assignment when a node is changed. The storage locations P1, P2 and P3 continue to contain the corresponding profiles. These can be further assigned manually or overwritten by self-defined profiles.

SELECT PREDEFINED PROFILE

You can either activate or deactivate these profiles. For this you either use the Symbols (on page 90) in the toolbar for editor profiles or:

1. Open the menu **Tools**
2. click on **Manage Editor profile**
 - **Load predefined profiles:** Loads the predefined profiles to the first three storage locations and links them with the modules. Already existing profiles are overwritten.
 - **Remove profile allocations:** Removes all links of the predefined profiles to the modules.

To use the profiles select Editor profile -> [Profile number] at the desired module.

 **Attention**

When activating a pre-defined profile, the corresponding settings are assigned to the save locations P1, P2 and P3 and these are renamed to P1, P2 and P3. Individual settings and naming for all other save locations (P4 to P10) are lost. The standard profile remains.

ERROR MESSAGE WHEN DISPLAYING PREDEFINED PROFILES

If you receive an error message mentioning the **zenAdminSrv** when selecting a predefined profile, this can have to reasons:

1. Service **zenAdminSrv** runs with a lower version number as the current Editor.
Solution: Update the service.
2. The profiles were removed from the default folder:
Solution: Copy file **Predefined Editor Profiles.epf** to folder
C:\ProgramData\COPA-DATA\zenonxxx\EdProfiles (xxx equals the current zenon version number).

PROFILES

PROFILE 1: LIST VIEW

Optimized display for editing variables and list views.

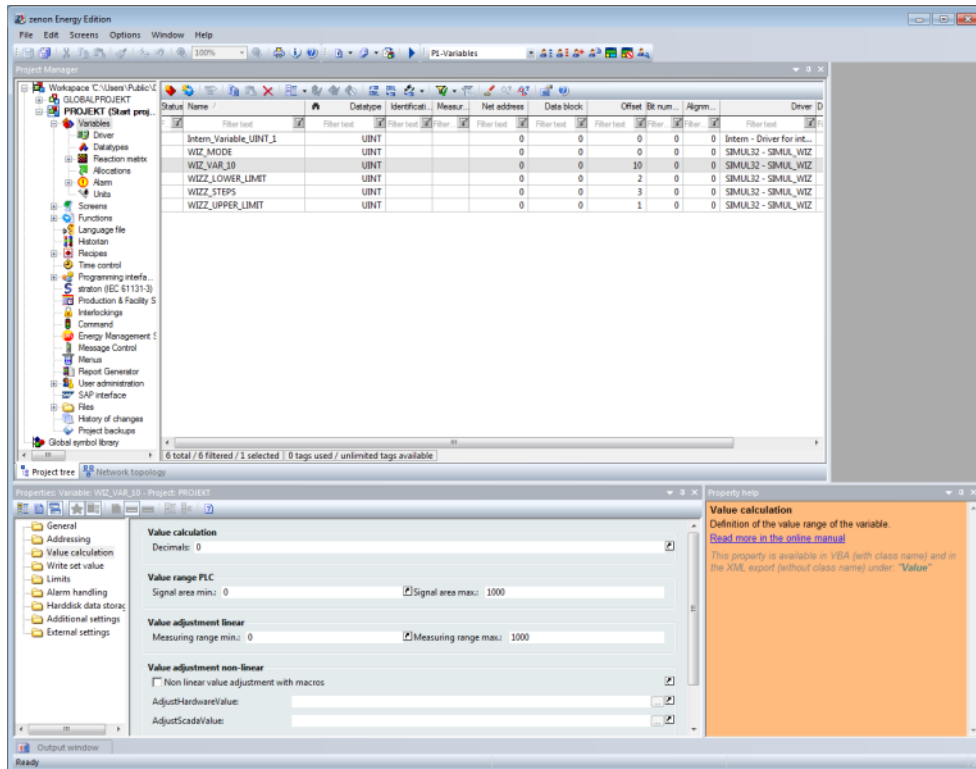

PROFILE 2: SCREENS

Optimized display for editing screens.

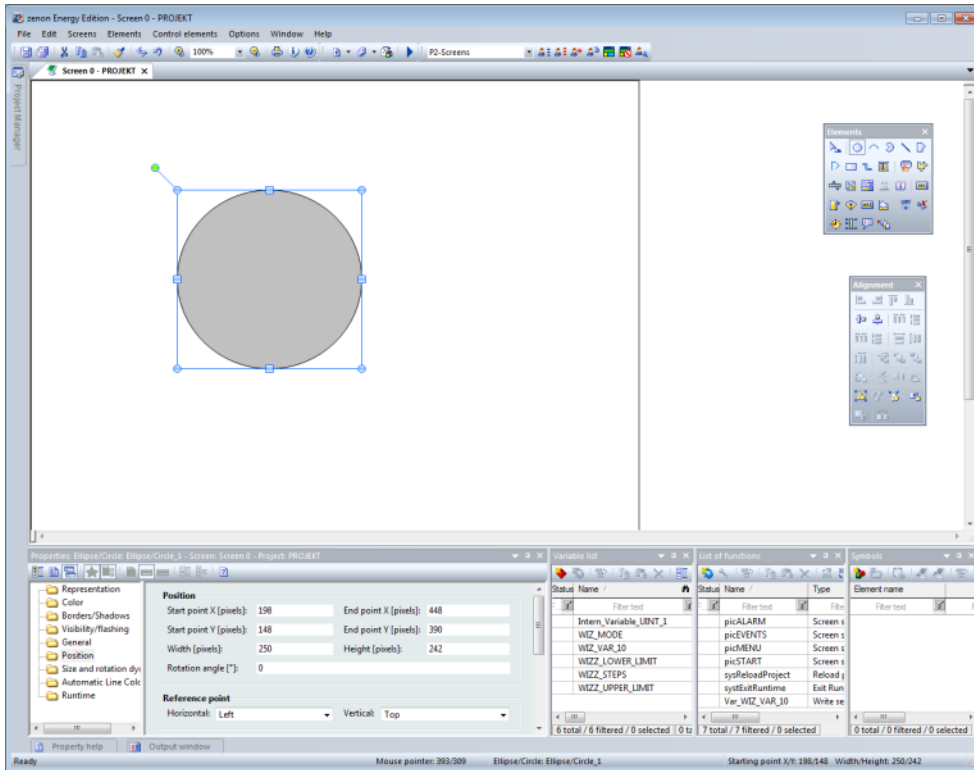

PROFILE 3: STANDARD

Default view, optimized for modules which are not based in lists.

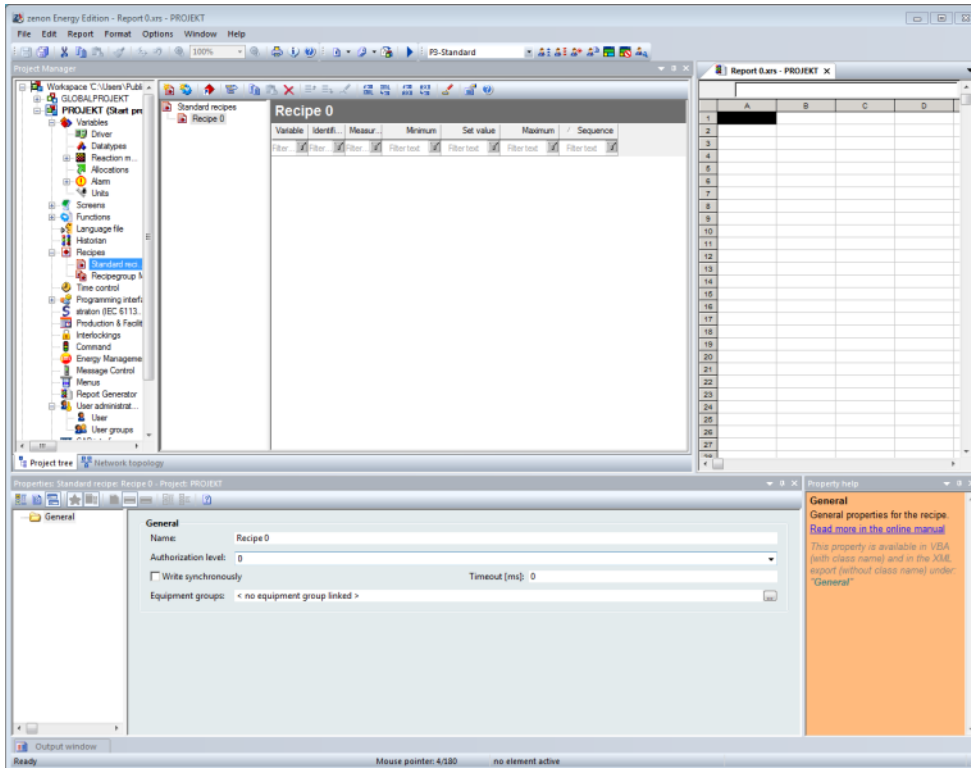

9.2 Administrate Editor profiles with the task bar

The task bar for the Editor profiles is shown by default in the middle of the second line of symbols. If it was deactivated, right-click next to the task bars and choose **Editor profiles**. You get the following task bar:



Symbol	Description
Load standard profile	Resets all settings for display and position of windows and content and display of toolbars to the delivery conditions and loads the zenon standard profile.
Select Editor profile	Selection of an Editor profile from a drop-down list (on page 93) with 10 profiles.
Load selected Editor profile	Loads the profile selected in Select Editor profile .
Save selected Editor profile	Saves the current window settings to the profile which is displayed in Select Editor profile .
Load predefined profiles (on page 86)	Loads the profiles predefined by COPA-DATA to the first three storage locations and links them with the modules. Already existing profiles are overwritten.
Remove profile allocations (on page 86)	Removes all links of the predefined profiles to the modules.
Automatic saving of the Editor profiles	Active: Changes to the current profile are saved automatically if another profile is called. Inactive: Changes are not saved when another profile is called; when the profile is called the next time, the original positions are restored.
Assign individual names to Editor profile.	Opens a Dialog (on page 93) in which you can give Editor profiles individual names.
Options for toolbar	Clicking on the arrow opens the submenu: Active: Toolbar is displayed. If the toolbar is not displayed, it can be activated using the Options -> Toolbar menu. Note: For free placed toolbar (undocked from the Editor) options are not displayed. The toolbar can be closed by clicking on button X.

Note: Further options for import and export can be added using the user-defined amendment of the commands (on page 82) for the toolbar. To export or import Editor profiles, choose the relevant option in the Main menu (on page 91) under **Options -> Editor administrate Editor profiles**.

9.3 Administrate Editor profiles via menu

In the menu, choose Options -> Editor administrate Editor profile for the administration of your Editor profiles.

You have the following possibilities:

Option	Function
Name	Opens a Dialog (on page 93) in which you can give profiles individual names.
Load standard profile	Resets all window setting to the factory default settings and loads the zenon standard profile.
Load predefined profiles (on page 86)	Loads the profiles predefined by COPA-DATA to the first three storage locations and links them with the modules. Already existing profiles are overwritten.
Remove profile allocation (on page 86)	Removes all links of the predefined profiles to the modules.
Export	Opens the data manager and saves the settings as a .zip file at any desired save location.
Import	Opens the data manager in order to import saved settings as a .zip file from any desired save location.

To select or save individual editor profiles, use the corresponding functions in the tool bar (on page 90) or keyboard shortcuts (on page 92).

9.4 Administrate Editor profiles with the task bar

The following actions are possible:

Command	Key combination
Load Editor profile 1	Shift+F1
Load Editor profile 2	Shift+F2
Load Editor profile 3	Shift+F3
Load Editor profile 4	Shift+F4
Load Editor profile 5	Shift+F5
Load Editor profile 6	Shift+F6
Load Editor profile 7	Shift+F7
Load Editor profile 8	Shift+F8

save current Editor view as:	
Editor profile 1	Ctrl+Shift+F1
Editor profile 2	Ctrl+Shift+F2
Editor profile 3	Ctrl+Shift+F3
Editor profile 4	Ctrl+Shift+F4
Editor profile 5	Ctrl+Shift+F5
Editor profile 6	Ctrl+Shift+F6
Editor profile 7	Ctrl+Shift+F7
Editor profile 8	Ctrl+Shift+F8

9.5 Select the editor profile in the context menu

In the project manager, editor profiles in the context menu can be selected for each project and each sub-area of a project and assigned on a permanent basis: Right-click on the branch -> Editor profiles -> choose.

An assignment can be removed by clicking **None** in the context menu.

9.6 Delete Editor profiles

To reset your profile data:

1. Delete the complete `Editor` folder in the path
`C:\Users\USERNAME\AppData\Local\COPA-DATA\zenon\Editor`
 Note: `USERNAME` must be replaced by the username of the logged in Windows user.
2. Delete the entry for the profile in the Windows registry under:
`HKEY_CURRENT_USER\Software\COPA-DATA\EditorProfiles`

9.7 Individual naming of editor profiles

Editor profiles can be designed and named individually. The names are given directly in the tool bar (on page 90), using a keyboard shortcut (on page 92) or by means of a dialog.

To configure individual profiles:

1. Set up the editor as desired.

2. Open the dialog for assigning an individual name:
 - Tool bar, **Assign individual names for editor profiles** or
 - Menu -> Options -> Editor manage editor profiles -> name

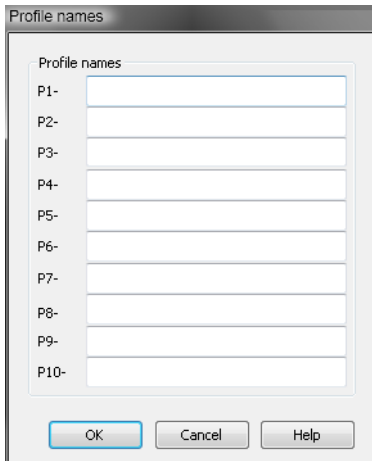

3. Enter the desired name in the field after the desired editor profile short description.



Attention

When activating a pre-defined profile, the corresponding settings are assigned to the save locations P1, P2 and P3 and these are renamed to P1, P2 and P3. Individual settings and naming for all other save locations (P4 to P10) are lost. The standard profile remains.

You can call up the first eight editor profiles in the Editor at any time with the keyboard shortcuts **Shift + F1** to **Shift + F8**. Or you select the desired editor profile using the corresponding symbol in the tool bar (on page 90).

10. Project Manager

The Project Manager is per default located on the left side of the screen directly below the toolbars. It can be displayed in two views:

- ▶ Project tree
- ▶ Network topology

PROJECT TREE

The project tree contains:

- ▶ The **workspace** on the left side with the projects and the **General symbol library**:

- All loaded projects with their variables, functions, screens etc are available in the workspace.
 - The **General symbol library** contains predefined graphics and offers the possibility to create new graphics.
- ▶ a detail view on the right side:
This lists all elements and settings for the section selected in the tree view.

NETWORK TOPOLOGY

The network topology view displays all projects in the workspace topologically and enables all network components involved to be tested, as well as testing remote transport of the Runtime files to the respective computer.

You can read details about this in the network section in the Testing network topology for validity chapter.

10.1 Workspace

In the workspace, the following components of a project are administrated:

- ▶ Variables
 - Drivers
 - Data Types
 - Reaction matrix
 - Allocations
 - Alarm
 - Measuring Units
- ▶ Screens
 - Frames
 - Fonts
 - Color Palettes
 - Symbol Library
- ▶ Functions
 - Scripts
- ▶ Language File
- ▶ Historian

- ▶ Recipes
 - Standard Recipes
 - Recipegroup Manager
- ▶ Batch Control
- ▶ Time Control
- ▶ Programming Interfaces
 - Process Control Engine
 - Macro List
 - VSTA
- ▶ zenon Logic is an IEC 61131-3 programming environment.
- ▶ Production & Facility Scheduler
- ▶ Interlockings
- ▶ Command Processing
- ▶ **Load Management**
- ▶ Message Control
- ▶ Menus
- ▶ Report Generator
- ▶ User Administration
 - Users
 - User Groups
- ▶ SAP Interface
- ▶ Files: inserts external files. Drivers are not directly integrated in zenon, they are implemented via an external program.
 - Graphics
 - Help
 - Multimedia
 - Texts and Formats
 - Drivers
 - Report Viewer
 - Others
- ▶ History of Changes
- ▶ Equipment Modeling
- ▶ Project Backups

The availability of unique components is subject to the chosen license. You can see which modules your license includes by clicking Help -> Info about ...

If you want to buy additional licenses, contact your distributor or sales@copadata.com.



Information

*Unique elements of the Project Manager like variables or functions can be shown in an extra window. To do so, click **Open in new window** in the context menu. This way, you can simultaneously edit for example variables and functions.*

10.1.1 Workspace detail view

Projects are administered in the detail view of the workspace. Only projects that are currently loaded are shown, that is the active projects and the projects with the **Keep project in memory** option active.

TOOLBAR



Symbol	Description
Project new	Opens the dialog to create a new project.
Insert project into workspace	Opens the dialog to add an existing project.
Insert project 5.50	Opens the file browser to select a project from version 5.50.
Restore project backup	Opens the dialog to restore a project backup.
Delete selected project	Deletes the selected project after a confirmation message. If several projects are selected, the one that was highlighted last is deleted.
Workspace	<p>Actions for the workspace:</p> <ul style="list-style-type: none"> ▶ New: Opens dialog to create a new workspace. ▶ Open: Opens dialog to open an existing workspace. ▶ Save: Saves the workspace. ▶ Save as: Saves the workspace under a different name. ▶ Close: Closes the active workspace. ▶ Create backup: Opens the dialog for creating a backup. ▶ Restore backup: Opens the dialog for restoring a backup.
Open VSTA Editor with WorkspaceAddin	Opens the VSTA editor with the zenon workspace add-in.
Open VBA Editor	Opens the VBA Editor.
Wizards	Opens the dialog with the wizards.
Update wizards	Opens the dialog to update the wizards.
Remove all filters	Removes all set filter.
Properties	Opens the properties window.
Help	Opens online help.

These actions are also available as commands in the context menu of the **Workspace** node.

10.2 Detail view of the Project Manager

If an element is chosen in the tree view of the Project Manager, the detail view shows all included objects and their properties.

in tabular view, you can:

Action	Course of action
free to choose columns:	Right-click on a column title -> context-sensitive menu -> column choice
Change column width:	<ul style="list-style-type: none"> ▶ Move the mouse on the column title separator until the mouse pointer changes to a cross ▶ keep the left mouse button pressed ▶ Stretch column to desired width
Sort columns:	Clicking on the column title changes the sorting order of the list (ascending / descending).
Format column	Right-click on a column title -> context-sensitive menu -> format column
Group properties	Right click on a column title -> context-sensitive menu -> group according to that column or: Right-click on a column title -> context-sensitive menu -> cancel grouping
Adjust display to window width	Right-click on a column title -> context-sensitive menu -> adjust size to window width
Remove columns	Right-click on a column title -> context-sensitive menu -> remove this column

CONTEXT MENU

Command	Action
Ascending	sorts the column in ascending order
Descending	sorts the column in descending order
Group on this column	Groups elements according to this column
Resolve grouping	Cancels existing grouping
Column selection...	a dialog for choosing the columns which shall be displayed is opened
Format column...	Opens a dialog for formatting the column
Adjust size to window width	all columns are distributed in the whole window
Remove this column	removes column from the view

COLUMNS

The columns that are available in the detail view can be configured individually.

The following columns are only filled with information for multi-user projects:

- ▶ **User**

- ▶ **Element**
- ▶ **Module**
- ▶ **Status**
- ▶ **Time**
- ▶ **Time changed**
- ▶ **Target**

STATUS LINE

In lists, the status line of the detail view shows information about available, filtered and chosen elements.



Example

Display status line detail view:

39 total / 30 filtered / 2 selected

this means:

- ▶ 39 elements are available
- ▶ 30 are displayed based on the filter settings
- ▶ 2 were chosen

For variables, the number of used and licensed TAGs is also displayed, for example: 32 TAGs used / unlimited TAGs available.



Information

*Detailed information concerning editing and managing elements can be found in chapter **Edit entries** (on page 100) and in the description of the respective elements.*

10.2.1 Edit entries

You have multiple options to edit the entries:

Route	Course of actions
Toolbar detail view	<ul style="list-style-type: none"> ▶ Select the cell you want to edit by left-clicking on it. ▶ Click on the buttons Edit selected cell in the toolbar.
Context Menu	<ul style="list-style-type: none"> ▶ Click on the desired cell with the right mouse button. ▶ In the context menu select the entry Edit selected cell.
Delayed double-click	<ul style="list-style-type: none"> ▶ Mark the desired cell with a delayed-double click (click twice slowly).
Properties window	<ul style="list-style-type: none"> ▶ Mark the desired element. ▶ Edit the desired entry in the window Properties.
F2 KEY	<ul style="list-style-type: none"> ▶ Select the cell you want to edit by left-clicking on it. ▶ Press the F2 key.



Information

The whole cell is marked if you click into a cell. You can see which cell you have selected by the binoculars symbol in the column title.



Attention

Exceptions

- ▶ You can change only properties in the detail view that are changeable in the properties window. For example, the name of a system variable cannot be edited.
- ▶ In the History of changes, it is not possible to make changes at all because of FDA rules.
- ▶ In project backups you can only edit the backup name.

10.2.2 Toolbar detail view

On the upper border of the detail view, there is a toolbar which offers you all the functions that you can also find in the context menu. Depending on what you selected in the project tree (e.g. screens, variables, symbols, etc.) you will see different buttons in the toolbar.

Buttons that cannot be used at the moment are grayed out.

TOOLBAR



Symbol	Action
New variable	Opens the dialog for creating a new variable.
Create standard function	Opens the wizard for selecting the variables and the set values and creates a matching function. The action is documented in the output window.
Variable use	Creates a project analysis for selected variables in the current project and displays it as a result list in its own window.
Display unused variables	Creates a project analysis for unused variables in the current project and displays it as a result list in its own window.
Jump back to starting element	Jumps back to the initial position in the zenon Editor. Note: This context menu entry is only available if a jump to the current position has been made from another position with the Linked elements context menu entry.
Copy	Copies the selected entries to the clipboard.
Paste	Pastes the content from the clipboard. If an entry with the same name already exists, the content is pasted as " Copy of... ".
Delete	Deletes selected entries after a confirmation from list.
Expand/collapse	Drop-down list in order to expand or to collapse all nodes or the selected nodes.
Activate all	Activates all inactive elements of a structure variable.
Activate	Activates the selected elements of a structure variable.
Deactivate	Deactivates the selected elements of a structure variable.
Export selected as XML...	Exports selected elements as an XML file.
Import XML	Imports variables from an XML file.
Import/Export	Opens the menu for importing and exporting of -Step 7 projects, dBase and CSV. Note: For additional information please read the chapter Step 7-project import in the book import - export.
Extended filter	Activate/Deactivate expanded filter Activating opens the dialog to select the filter criteria.

Remove all filters	Removes all filter settings.
Edit selected cell	Opens the selected cell for editing. The binocular symbol in the header shows which cell has been selected in a highlighted line. Only cells that can be edited can be selected.
Replace text in selected column	Opens the dialog for searching and replacing texts.
Replace text in limit values	Opens the dialog for the selection of the Dynamic properties Once the property has been selected, the search and replace dialog is opened by clicking on OK .
Properties	Opens the Properties window.
Help	Opens online help.

CONTEXT MENU

Menu item	Action
New variable	Opens the dialog for creating a new variable.
Create standard function	Opens the wizard for selecting the variables and the set values and creates a matching function. The action is documented in the output window.
Linked elements	Opens the submenu with linked elements.
Variable use	Creates a project analysis for selected variables in the current project and displays it as a result list in its own window.
Display unused variables	Creates a project analysis for unused variables in the current project and displays it as a result list in its own window.
Copy	Copies the selected entries to the clipboard.
Paste	Pastes the content from the clipboard. If an entry with the same name already exists, the content is pasted as " Copy of... ".
Delete	Deletes selected entries after a confirmation from list.
Expand/collapse node	Allows all or selected nodes to be expanded or collapsed. Selection: <ul style="list-style-type: none"> ▶ Expand all ▶ Collapse all ▶ Expand selected ▶ Reduce selected
Activate all	Activates all inactive elements of a structure variable.

Activate	Activates the selected elements of a structure variable.
Deactivate	Deactivates the selected elements of a structure variable.
Export selected as XML...	Exports all selected entries as an XML file.
Import XML	Imports entries from an XML file.
Extended import/export	Opens the menu for importing and exporting of -Step 7 projects, dBase and CSV. Note: For additional information please read the chapter Step 7-project import in the book import - export.
Extended filter	Activate/Deactivate expanded filter Activating opens the dialog to select the filter criteria.
Remove all filters	Removes all filter settings.
Edit selected cell	Opens the selected cell for editing. The binocular symbol in the header shows which cell has been selected in a highlighted line. Only cells that can be edited can be selected.
Replace text in selected column	Opens the dialog for searching and replacing texts.
Replace text in limit values	Opens the dialog for the selection of the Dynamic properties Once the property has been selected, the search and replace dialog is opened by clicking on OK .
Properties	Opens the Properties window.
Help	Opens online help.

10.2.3 Navigation in the list view

To navigate in a list:

1. Click in the column to be searched.
2. Enter the first character to start the search. If no entry with this initial character exists, the search is immediately stopped.
3. The first found entry is selected. An input field is displayed. The first character of the column text is selected.
Note: You can only enter search criteria in this field. It is not possible to change the element's name.
4. Enter further characters to limit the search. If no matching entry is found, the entered character is rejected and the selection stays at the current position.

5. If more than one entry exists for the search criteria, the user can reach the other entries by pressing `Ctrl+up` or `Ctrl+down`.
6. With `Backspace` the last character of the search criteria is deleted and a new search with the remaining characters is initiated. The search can be stopped by deleting the last character.

SORTING

You can select multiple columns simultaneously for sorting the list view.

1. Click the column heading of the column with the first sorting criteria
2. Hold down the shift key and click on the title with the second sorting criteria;
3. You can add as many columns as you like

For example: Sorting according to data block and offset then shows firstly all datablocks and all attendant addresses correctly sorted.

Hint: A second click on the column title changes the sorting order.

10.2.4 Filter list entries

Elements of the detail view can be filtered and sorted according to different criteria:

Style	Course of actions
Alphabetic sorting	<p>Mouse click on a column title: The list is sorted according to the according column. A second mouse-click on the column title inverts the sorting.</p>
Entering filter criteria	<p>Directly below the column title is the location of the Field for filter criteria. Here, criteria are entered.</p> <p>Now only elements are shown that are corresponding to the entered search criteria.</p> <p>To show all objects once again, you have to delete the filter criteria.</p> <p>If you click on the filter field, a drop-down list opens listing the last used filters of this column.</p>
Filtering on checkboxes	<p>Lists with checkboxes (e.g. templates) can be sorted and filtered according to active or inactive checkboxes.</p> <p>This works in the same way as alphabetic sorting.</p> <p>You can find a drop-down list for the filtering criteria with the selection for active, inactive or all checkboxes beneath the cell under the column title.</p>
Placeholder	<p>There are several place holders available for filtering criteria:</p> <ul style="list-style-type: none"> ▶ * replaces a character sequence. Example: *1 filters all elements that end with the character 1, for example Variable1. Wildcards can only be used as a prefix or suffix. ▶ ? replaces a unique character Example: Variable? filters all elements that start with the character sequence variable and possess an additional character, e.g. variable1, variable2, variable3 ...
Logical Link	<p>Filter words can be linked with the logical expressions AND and OR. This also works in conjunction with wildcards (*), but not with placeholders for an individual character (?).</p>
Cell contents as filter criterion	<p>Words or character sequences from a cell of the detail view can be defined as filters:</p> <ul style="list-style-type: none"> ▶ Highlight the desired entry. ▶ Hold down the ALT key and click on the cell. ▶ The entry is released in an editing field. ▶ Select any chain of characters with the mouse. ▶ Move the selected part with pressed left mouse button (Drag&Drop) on the filter row of the column head. ▶ The chosen chain of characters becomes the new filter text.
Filter effect linked elements	<p>Elements that are linked with the current element can be displayed using the option linked elements. If you reach an element in the detail view via this option, for example a variable, then this element is shown regardless of the current filter settings. If it is not available in the current filter, it is shown on the end of the list regardless and is selected automatically.</p>
Change	<p>After an object has been selected in the detail view or has been created via the</p>

properties	<p>context menu, its parameters can be defined and changed in the properties window.</p> <p>Multiple selection is allowed here. If multiple objects have been selected in parallel, you can change their properties together.</p> <p>Entries and changes in the properties window are valid for all selected objects. Existing entries are overwritten. The properties window provides now only properties that are valid for all selected objects.</p>
Extended filters for variables	<p>Especially for variables there is a dialog for refinement of the filters. You can reach it via:</p> <ul style="list-style-type: none"> ▶ the symbol activate extended filter in the detail view toolbar or ▶ the command Extended filter in the context menu <p>Thus, the standard filters are expanded with the elements Data types, Selection flags and String filters (variable name, identification, reaction matrix).</p>

- ▶ Execute filter: Pressing the `Enter` key in the filter field carries out the filtering.
- ▶ Delete filter: To remove the filter, click on the **Remove all filters** button in the toolbar or select the **Remove all filters** command in the context menu.

10.2.5 Replace text in selected column

zenon supports **search/replace** functionality for strings (e.g. screen names, variable names, variable identifications). You can replace texts in active columns and within limit values.



Attention

Only texts are considered that are situated in open structures (variables or data types). Closed structures do not exist as a target for the editor and must be expanded before the search.

REPLACE TEXT IN SELECTED COLUMN:

1. Activate the dialog with the symbol **Replace text in selected column** or the relevant command in the context menu.
2. Define the parameters for 'search and replace' in the dialog.

- The replacement takes place in the active column. You can identify the active column by the **Binoculars** symbol beneath the column title.

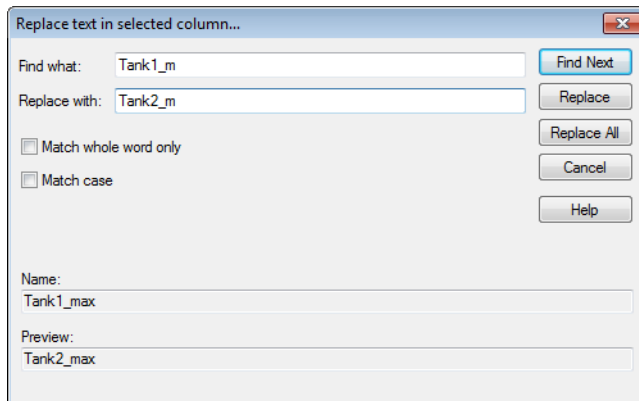

Attention

*If language switching is used for variable identification (recognizable from the key word @), the **Show untranslated keywords** property must be activated for correct finding and replacing. To activate it:*

- ▶ navigate to the **Graphical design** node in properties
- ▶ Check the **Show untranslated keywords** property checkbox

10.2.6 Replace text in limit values

To replace text in limit values:

- ▶ Activate the dialog with the symbol Replace text in limit values or the relevant command in the context menu.
- ▶ Choose the desired dynamic property from the selection window.

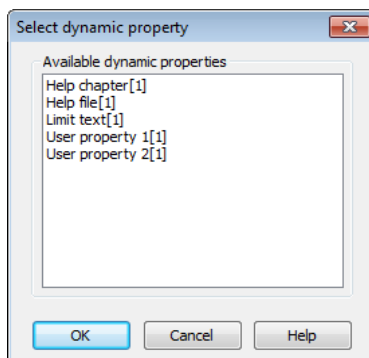

- You are now in the dialog **Replace text in limit values**.

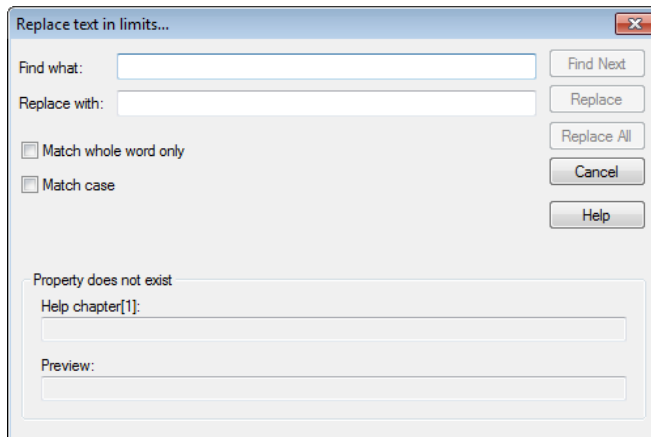

Attention

Only texts are considered that are situated in open structures (variables or data types). Closed structures do not exist as a target for the editor and must be expanded before the search.

10.2.7 Show/hide columns

You can show and hide the columns available in the detail view to your liking; you can sort them in any order you like. The following settings can be also be reached using screen switching dialogs for some screens.

SHOW / HIDE COLUMNS

1. Right-click on a column title.
2. Select **Select column** from the context menu.

The dialog for configuration is opened.

3. Select or deselect the desired columns.

You highlight several columns by holding down the `Shift` key or the `Ctrl` key

Available columns lists all columns that are still available. **Selected columns** displays all active columns.

CONFIGURATION DIALOG

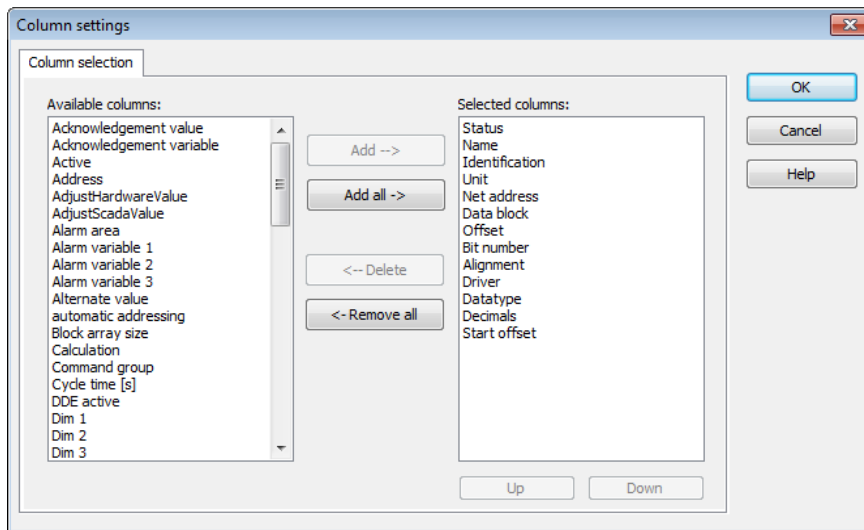

Note: The modules available depend on the module whose view is configured.

Option	Function
Available columns	List of columns that can be displayed in the table.
Selected columns	Columns that are displayed in the table.
Add ->	Moves the selected column from the available ones to the selected items. After you confirm the dialog with OK, they are shown in the detail view.
Add all ->	Moves all available columns to the selected columns.
<- Remove	Removes the marked columns from the selected items and shows them in the list of available columns. After you confirm the dialog with OK, they are removed from the detail view.
<- Remove all	All columns are removed from the list of the selected columns.
Up	Moves the selected entry upward. This function is only available for unique entries, multiple selection is not possible.
Down	Moves the selected entry downward. This function is only available for unique entries, multiple selection is not possible.

CLOSE DIALOG

Options	Description
OK	Applies settings and closes the dialog.
Cancel	Discards all changes and closes the dialog.
Help	Opens online help.

ARRANGE COLUMNS

The columns can be ordered according to your interests. There are two possibilities for doing so

1. In the dialog **Column settings** via buttons **up** and **down**.
2. In the detail view of the Project Manager by **dragging & dropping** with the mouse:
 - Click with the mouse on the desired column title.
 - Hold down the left mouse button
 - and move the column title to the desired location. Two red arrows mark the location where the column is inserted.
 - Place the column by releasing the mouse button.

10.2.8 Column settings

Configuration of the properties of the columns for configurable lists. The settings have an effect on the respective list in the Editor or - when configuring screen switching - in Runtime.

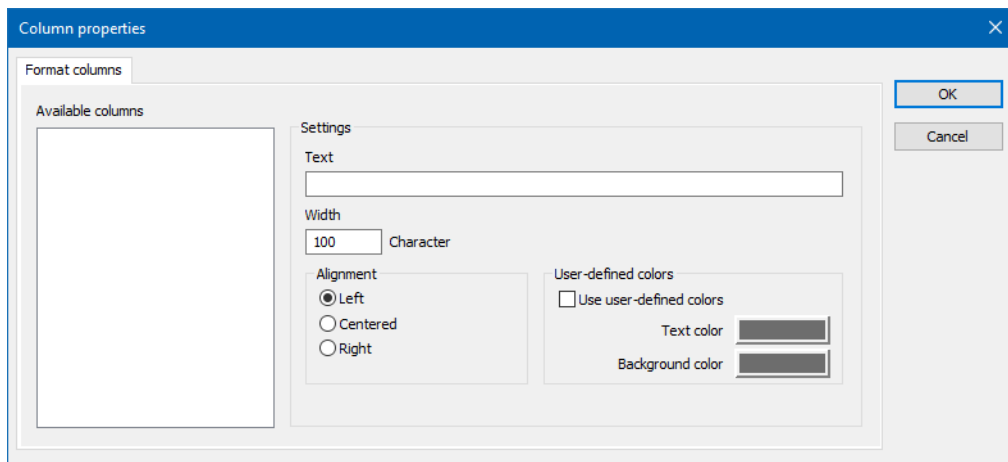

AVAILABLE COLUMNS

Option	Description
Available columns	List of the available columns via Column selection . The highlighted column is configured via the options in the Settings area.

SETTINGS

Option	Description
Settings	Settings for selected column.
Labeling	Name for column title. The column title is online language switchable. To do this, the @ character must be entered in front of the name.
Width	Width of the column in characters. Calculation: Number time average character width of the selected font.
Alignment	Alignment. Selection by means of radio buttons. Possible settings: <ul style="list-style-type: none"> ▶ Left: Text is justified on the left edge of the column. ▶ Centered: Text is displayed centered in the column. ▶ Right: Text is justified on the right edge of the column.
User-defined colors	Properties in order to define user-defined colors for text and background. The settings have an effect on the Editor and Runtime. Note: <ul style="list-style-type: none"> ▶ These settings are only available for configurable lists. ▶ In addition, the respective focus in the list can be signaled in Runtime by means of different text and background colors. These are configured using the project properties.
User defined colors	<i>Active:</i> User-defined colors are used.
Text color	Color for text display. Clicking on the color opens the color palette to select a color.
Background color	Color for the display of the cell background. Clicking on the color opens the color palette to select a color.

Lock column filter in the Runtime	<ul style="list-style-type: none"> ▶ <i>Active</i>: The filter for this column cannot be changed in Runtime. <p>Note: Only available for:</p> <ul style="list-style-type: none"> ▶ Batch Control ▶ Extended Trend ▶ Filter screens ▶ Message Control ▶ Recipe Group Manager ▶ Shift Management ▶ Context List
--	---

CLOSE DIALOG

Option	Description
OK	Applies all changes in all tabs and closes the dialog.
Cancel	Discards all changes in all tabs and closes the dialog.
Help	Opens online help.

10.3 Files

External files can be integrated in a project in the Project Manager via the node **Files**. An external program has to be used to edit external files. This means: You can for example integrate a video clip. But you need the according software for editing it. zenon only manages these files.

The following external files are available for you:

- ▶ Graphics (on page 116)
- ▶ Help (on page 118)
- ▶ Multimedia (on page 120)
- ▶ Texts and Formats (on page 122)
- ▶ Drivers (on page 124)
- ▶ Report Viewer (on page 127)
- ▶ Others (on page 129)

SUB FOLDERS

You can create sub folders on the nodes **Help**, **Lists**, **Multimedia** and **Others**. Select the entry **New folder** in the context menu. By using sub folders, you can change the language in Runtime for documents, too.

Attention

Subfolders are only suitable for organizing language switching. All other elements such as graphics, multimedia files etc. must always be stored in the uppermost hierarchy of the folder, because they cannot be accessed by zenon from subfolders.

CONTEXT MENU

Menu item	Action
Importing graphics file	Opens the File Manager for selecting a file.
Importing language table	Opens the File Manager for selecting a file.
Importing help file	Opens the File Manager for selecting a file.
Importing multimedia file	Opens the File Manager for selecting a file.
Importing list file	Opens the File Manager for selecting a file.
Importing driver data	Opens the File Manager for selecting a file.
Importing report template	Opens the File Manager for selecting a file.
Importing other file	Opens the File Manager for selecting a file.
Help	Opens online help.

10.3.1 Graphics

Graphics files for background graphics in screens, report generator or for dynamic elements (button, switch, combined element).

The following formats are available:

Pixel graphics

- ▶ *.bmp
- ▶ *.gif
- ▶ *.jpg
- ▶ *.png
- ▶ *.tif

Note: Not available for combined element and report generator.

Vector graphics

- ▶ *.wmf
- ▶ *.xaml

Note: Available only for WPF element! The XAML-files cannot be previewed in the detail view!

CONTEXT MENU

Menu item	Action
Add file	Opens the File Manager for selecting a file.
New folder	Inserts a new sub-folder.
Rename folder	Enables renaming of self-created sub-folders.
Delete folder	Deletes the selected self-created folder after a confirmation message.
Editor profile	Opens the drop-down list with predefined editor profiles (on page 85).
Help	Opens online help.

Graphics toolbar and context menus



CONTEXT MENU GRAPHICS

Menu item	Action
Add file	Opens the File Manager for selecting a file.
Process file externally	Opens your operating system's default program for editing the selected file.
Process file externally with	Opens a list of suitable programs for editing the selected file.
Copy	Copies the selected entries to the clipboard.
Paste	Pastes the content from the clipboard. If an entry with the same name already exists, the content is pasted as " Copy of... ".
Delete	Deletes selected entries after a confirmation from list.
Edit selected cell	Opens the selected cell for editing. The binocular symbol in the header shows which cell has been selected in a highlighted line. Only cells that can be edited can be selected.
Replace text in selected column	Opens the dialog for searching and replacing texts.
Properties	Opens the Properties window.
Remove all filters	Removes all filter settings.
Help	Opens online help.

10.3.2 Help

Folder for help files for the Runtime help of the project. They are saved in *.chm format.

CONTEXT MENU

Menu item	Action
Add file	Opens the File Manager for selecting a file.
New folder	Inserts a new sub-folder.
Rename folder	Enables renaming of self-created sub-folders.
Delete folder	Deletes the selected self-created folder after a confirmation message.
Editor profile	Opens the drop-down list with predefined editor profiles (on page 85).
Help	Opens online help.

Help toolbar and context menus



CONTEXT MENU HELP

Menu item	Action
Add file	Opens the File Manager for selecting a file.
Process file externally	Opens your operating system's default program for editing the selected file.
Process file externally with	Opens a list of suitable programs for editing the selected file.
Copy	Copies the selected entries to the clipboard.
Paste	Pastes the content from the clipboard. If an entry with the same name already exists, the content is pasted as " Copy of... ".
Delete	Deletes selected entries after a confirmation from list.
Edit selected cell	Opens the selected cell for editing. The binocular symbol in the header shows which cell has been selected in a highlighted line. Only cells that can be edited can be selected.
Replace text in selected column	Opens the dialog for searching and replacing texts.
Properties	Opens the Properties window.
Remove all filters	Removes all filter settings.
Help	Opens online help.

10.3.3 Multimedia

The following formats of audio- and video files can be implemented:

- ▶ *.avi
- ▶ *.mp3
- ▶ *.mpeg
- ▶ *.wav

Please note that the corresponding codecs are required on the Runtime device for playback of these files.

CONTEXT MENU

Menu item	Action
Add file	Opens the File Manager for selecting a file.
New folder	Inserts a new sub-folder.
Rename folder	Enables renaming of self-created sub-folders.
Delete folder	Deletes the selected self-created folder after a confirmation message.
Editor profile	Opens the drop-down list with predefined editor profiles (on page 85).
Help	Opens online help.

Multimedia toolbar and context menus



CONTEXT MENU MULTIMEDIA

Menu item	Action
Add file	Opens the File Manager for selecting a file.
Process file externally	Opens your operating system's default program for editing the selected file.
Process file externally with	Opens a list of suitable programs for editing the selected file.
Copy	Copies the selected entries to the clipboard.
Paste	Pastes the content from the clipboard. If an entry with the same name already exists, the content is pasted as " Copy of... ".
Delete	Deletes selected entries after a confirmation from list.
Edit selected cell	Opens the selected cell for editing. The binocular symbol in the header shows which cell has been selected in a highlighted line. Only cells that can be edited can be selected.
Replace text in selected column	Opens the dialog for searching and replacing texts.
Properties	Opens the Properties window.
Remove all filters	Removes all filter settings.
Help	Opens online help.

10.3.4 Texts and Formats

Texts and formats are:

- ▶ Text files for display in the project
file extension: `.txt`
- ▶ Format files for formatting printouts
file extension: `.frm`
- ▶ HTML files that are shown in the HTML screen
file extension: `.htm` or `.html`

CONTEXT MENU

Menu item	Action
Add file	Opens the File Manager for selecting a file.
New folder	Inserts a new sub-folder.
Rename folder	Enables renaming of self-created sub-folders.
Delete folder	Deletes the selected self-created folder after a confirmation message.
Editor profile	Opens the drop-down list with predefined editor profiles (on page 85).
Help	Opens online help.

Texts and formats toolbar and context menu



CONTEXT MENU TEXTS AND FORMATS

Menu item	Action
Add file	Opens the File Manager for selecting a file.
Process file externally	Opens your operating system's default program for editing the selected file.
Process file externally with	Opens the selected file in the standard editor of the file format or offers a selection of suitable editors.
Copy	Copies the selected entries to the clipboard.
Paste	Pastes the content from the clipboard. If an entry with the same name already exists, the content is pasted as " Copy of... ".
Delete	Deletes selected entries after a confirmation from list.
Edit selected cell	Opens the selected cell for editing. The binocular symbol in the header shows which cell has been selected in a highlighted line. Only cells that can be edited can be selected.
Replace text in selected column	Opens the dialog for searching and replacing texts.
Properties	Opens the Properties window.
Remove all filters	Removes all filter settings.
Help	Opens online help.

10.3.5 Drivers

Driver files can be implemented in the following formats:

- ▶ *.cfg
- ▶ *.iso
- ▶ *.tcp
- ▶ *.bur
- ▶ *.fms
- ▶ *.bec
- ▶ *.ovd
- ▶ *.nmp

- ▶ *.ini
- ▶ *.h11
- ▶ *.lst
- ▶ *.dde
- ▶ *.lon
- ▶ *.opc
- ▶ *.ecs

Usually you don't need to enter them here. The files are automatically created when a driver is created and are saved here.

CONTEXT MENU

Menu item	Action
Add file	Opens the File Manager for selecting a file.
New folder	Inserts a new sub-folder.
Rename folder	Enables renaming of self-created sub-folders.
Delete folder	Deletes the selected self-created folder after a confirmation message.
Editor profile	Opens the drop-down list with predefined editor profiles (on page 85).
Help	Opens online help.

Driver toolbar and context menu



CONTEXT MENU DRIVERS

Menu item	Action
Add file	Opens the File Manager for selecting a file.
Process file externally	Opens your operating system's default program for editing the selected file.
Process file externally with	Opens a list of suitable programs for editing the selected file.
Copy	Copies the selected entries to the clipboard.
Paste	Pastes the content from the clipboard. If an entry with the same name already exists, the content is pasted as " Copy of... ".
Delete	Deletes selected entries after a confirmation from list.
Edit selected cell	Opens the selected cell for editing. The binocular symbol in the header shows which cell has been selected in a highlighted line. Only cells that can be edited can be selected.
Replace text in selected column	Opens the dialog for searching and replacing texts.
Properties	Opens the Properties window.
Remove all filters	Removes all filter settings.
Help	Opens online help.

10.3.6 Report Viewer

Report templates are files in RDL 2.0 format, which can be opened, displayed and edited in the zenon Report Viewer.

CONTEXT MENU

Menu item	Action
Add file	Opens the file manager for selecting a report definition file .
New folder	Inserts a new sub-folder.
Rename folder	Enables renaming of self-created sub-folders.
Delete folder	Deletes the selected self-created folder after a confirmation message.
Editor profile	Opens the drop-down list with predefined editor profiles (on page 85).
Help	Opens online help.

Note: Only present if Report Generator and Report Viewer are licensed.

Not available if the **Windows CE project** option (project properties **General**) is active.

Report Viewer toolbar and context menu



REPORT TEMPLATE CONTEXT MENU

Menu item	Action
New report definition file	Open the dialog to create a new RDL file on the basis of the previously-defined data sets.
Open report definition file	Opens the program linked to the RFL files to edit an existing definition file. zenon first looks for MS Report Builder, then for MS Report Designer by default.
Create standard function	Only available in the toolbar. Create a screen switch to a <i>Report Viewer</i> screen to be selected and enters the selected RDL file into the Report definition file .
Jump back to starting element	With linked elements, jumps back to the element from which the report template was jumped to. Only present in the context menu if linked elements are present.
Copy	Copies the selected entries to the clipboard.
Paste	Pastes the content from the clipboard. If an entry with the same name already exists, the content is pasted as " Copy of... ".
Delete	Deletes selected entries after a confirmation from list.
Import existing report definition file	Opens dialog to import existing report definition files. These must be of RDL 2.0 type.
Remove all filters	Removes all filter settings.
Edit selected cell	Opens the selected cell for editing. The binocular symbol in the header shows which cell has been selected in a highlighted line. Only cells that can be edited can be selected.
Replace text in selected column	Opens the dialog for searching and replacing texts.
Properties	Opens the Properties window.
Help	Opens online help.

10.3.7 Others

Folder for storage of any file type.

CONTEXT MENU

Menu item	Action
Add file	Opens the File Manager for selecting a file.
New folder	Inserts a new sub-folder.
Rename folder	Enables renaming of self-created sub-folders.
Delete folder	Deletes the selected self-created folder after a confirmation message.
Editor profile	Opens the drop-down list with predefined editor profiles (on page 85).
Help	Opens online help.

Other toolbar and context menu



CONTEXT MENU OTHERS

Menu item	Action
Import file	Opens the File Manager for selecting a file.
Process file externally	Opens your operating system's default program for editing the selected file.
Process file externally with	Opens a list of suitable programs for editing the selected file.
Jump back to starting element	Jumps back to the initial position in the zenon Editor. Note: This context menu entry is only available if a jump to the current position has been made from another position with the Linked elements context menu entry.
Copy	Copies the selected entries to the clipboard.
Paste	Pastes the content from the clipboard. If an entry with the same name already exists, the content is pasted as " Copy of... ".
Delete	Deletes selected entries after a confirmation from list.
Remove all filters	Removes all filter settings.
Edit selected cell	Opens the selected cell for editing. The binocular symbol in the header shows which cell has been selected in a highlighted line. Only cells that can be edited can be selected.
Replace text in selected column	Opens the dialog for searching and replacing texts.
Properties	Opens the Properties window.
Help	Opens online help.

10.4 General symbol library

zenon is supplied with pre-defined graphics. These are saved in the **General symbol library** module. The symbols in the folder **Screens** can only be used for the current screen; the symbols of the **General symbol library** can be used in every project .

You can also create your own symbols as well as group symbols or link them. You can find details in chapter **Screens/symbols**.

10.5 Selection dialogs

In zenon selected dialogs and filtered lists are available for the selection of specific elements. They are valid for the whole system and list the current projects and sub projects. They are available for:

- ▶ Archive variables
- ▶ User
- ▶ User groups
- ▶ Screens
- ▶ Files
- ▶ Data Types
- ▶ Filter screens
- ▶ Functions
- ▶ Frames
- ▶ Drivers
- ▶ Variables

Detailed information about the views can be found in chapter Detail view of the Project Manager (on page 98), detailed information about filtering of the lists can be found in the subchapter Filtering list entries (on page 106).

Detailed information about the selection dialogs for functions and variables and the replacement of chosen functions or variables can be found in the subchapters:

- ▶ Functions (on page 140)
- ▶ Variables (on page 142)

10.5.1 Archive variables

To select variables of an archive, there is a dialog available that offers all previously-created and configured archives for selection.

Note: These variables can also be used throughout projects sometimes. When selecting throughout projects, ensure that the corresponding projects are available in Runtime.

LINKING OF VARIABLES

To select variables:

1. Select the desired archive

2. Open the archive tree.
3. Open the variable list.
4. Select the desired variables.

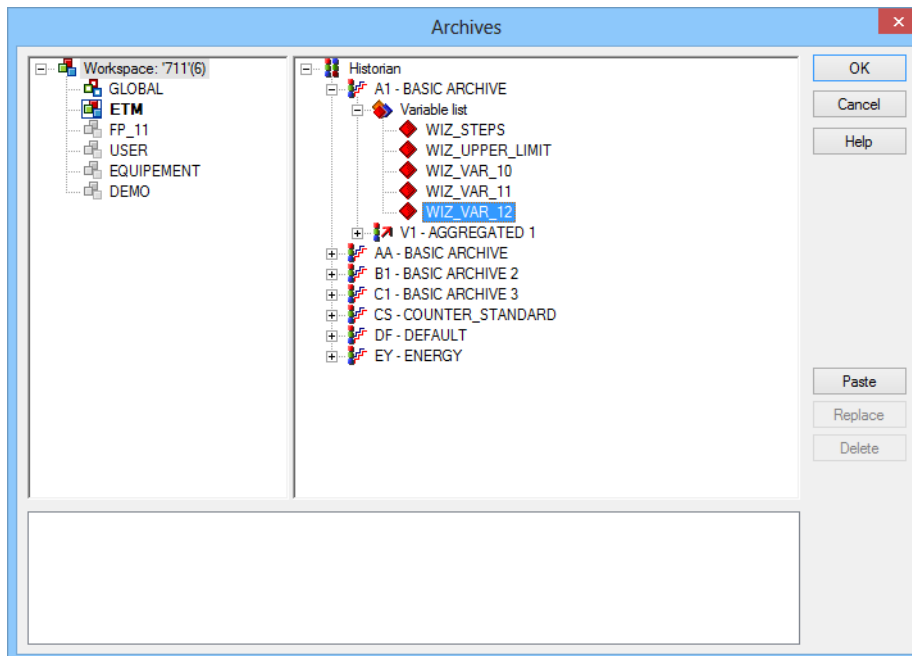

Parameter	Description
Project tree	Selection of the project from which the variable is to be selected.
Selection window	Selection of the variables that are to be linked. It can be linked in two ways: <ul style="list-style-type: none"> ▶ Double-clicking on the desired variable ▶ Select the desired variables and then click on Paste or Replace
Paste	Adds the variable selected in the selection window to the list of variables .
Replace	Adds the variables selected in the selection window to the list of variables and replaces the variables in this list in the process. If several variables have been selected in the selection window , the one that was selected last was added.
Delete	Deletes the selected variable from the list of variables .
List of variables	List of the variables selected for linking.
OK	Applies settings and closes the dialog.
Cancel	Discards all changes and closes the dialog.
Help	Opens online help.

Note: The size of this dialog can be adjusted. The position and size of the dialog window are saved in the Editor, Runtime and zenon Web Client independently of the project.

10.5.2 User selection: individual user

In the **user selection** dialog, you select a user in Runtime for use in another module.

To select a user:

1. Highlight the desired driver in the list of existing users.
2. Confirm the settings with **OK**.

The user is added.

USER SELECTION DIALOG

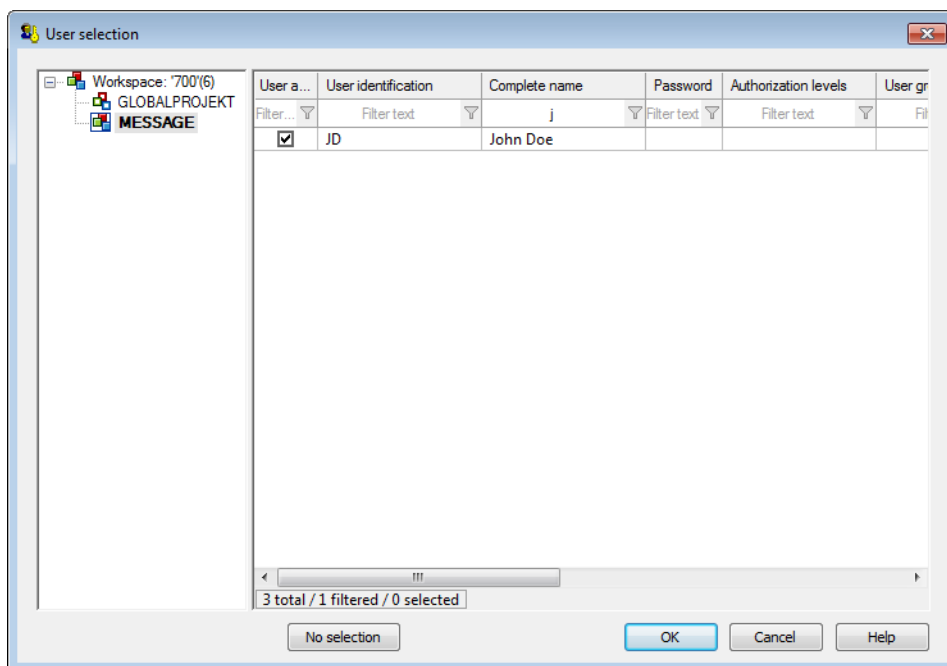

Option	Description
List workspace	Display and selection of the projects from which users can be selected.
List user	Display of the users of the selected projects. The list can be filtered.
No selection	An already existing user is deselected.

CLOSE DIALOG

Options	Description
OK	Applies settings and closes the dialog.
Cancel	Discards all changes and closes the dialog.
Help	Opens online help.

10.5.3 User Groups

Selection of user groups.

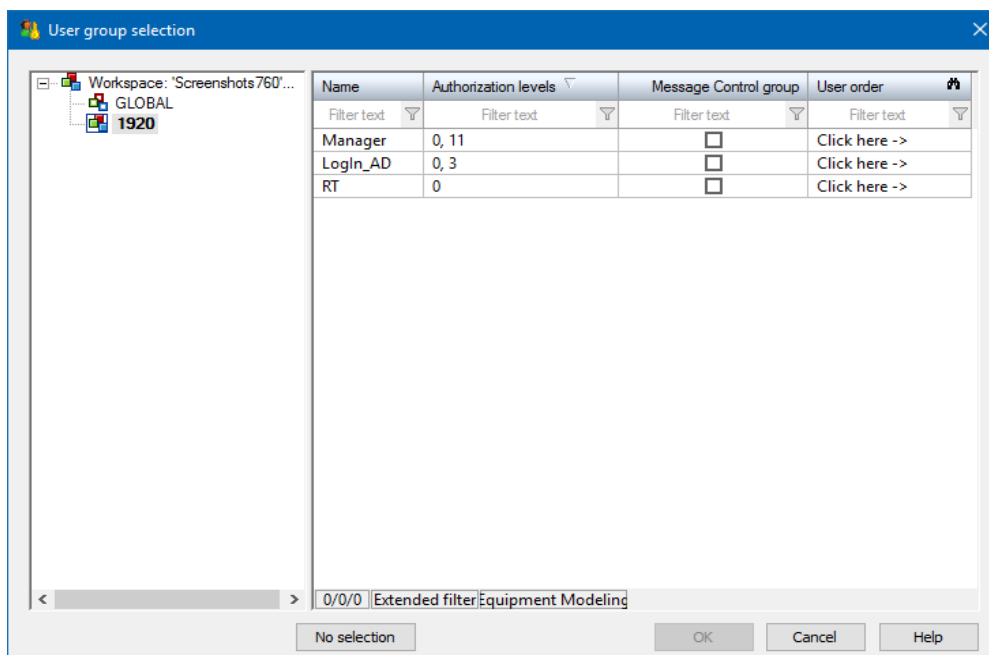

Option	Description
List workspace	Display and selection of the projects from which user groups can be selected.
List of user groups	Display of the user groups of the selected projects. The list can be filtered.
No selection	An already selected user group is deselected.

CLOSE DIALOG

Options	Description
OK	Applies settings and closes the dialog.
Cancel	Discards all changes and closes the dialog.
Help	Opens online help.

10.5.4 Screens

In the screens selection dialog, screens can be selected for the execution of functions from:

- ▶ Current project
- ▶ Subprojects

- ▶ All projects in the workspace with the **Keep project in memory** option active

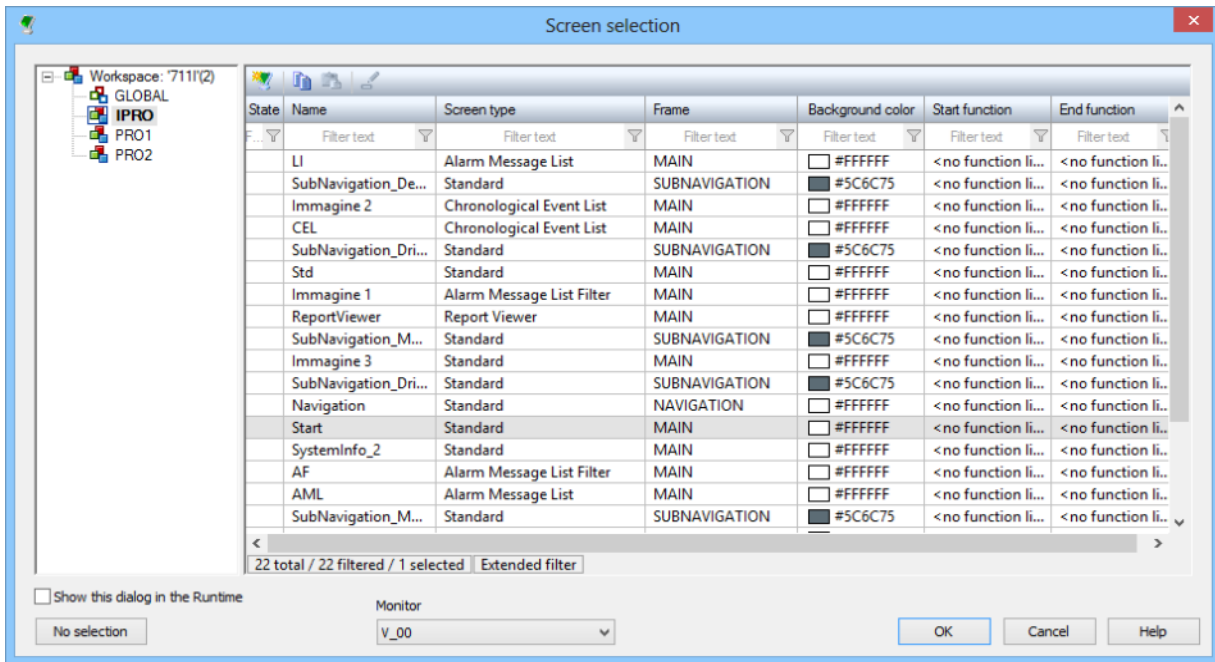

Parameters	Description
Project tree window	Displays all projects in the workspace. Screens can be selected from the current project and from all projects with the Keep project in memory option active
Screens window	Selection of the screen. If several screens are selected, the screen at the top of the list is used for the execution of the function.
No selection	Removes selection and closes dialog.
OK	Applies settings and closes the dialog.
Cancel	Discards all changes and closes the dialog.
Help	Opens online help.

10.5.5 Files

In the selection dialog **Files**, you can select files of the current project or sub projects in a filterable view.

- ▶ If desired files in the `Files/Graphics` (on page 115) nodes are not yet present in the Project Manager, these can be added in the selection dialog.

- ▶ to select a file directly from any desired folder on the computer, the **Direct file selection** property must be activated.

10.5.6 Data Types

In the selection dialog Data types, the data types of the current project or the sub projects can be selected in a filterable view.

10.5.7 Filter screens

When screen switching on a screen with filter to other screens (AML filter, CEL filter, time filter), a dialog for screen selection is opened for:

- ▶ Calling screen
- ▶ Screens to be updated

SELECTION OF SCREEN TO BE CALLED UP

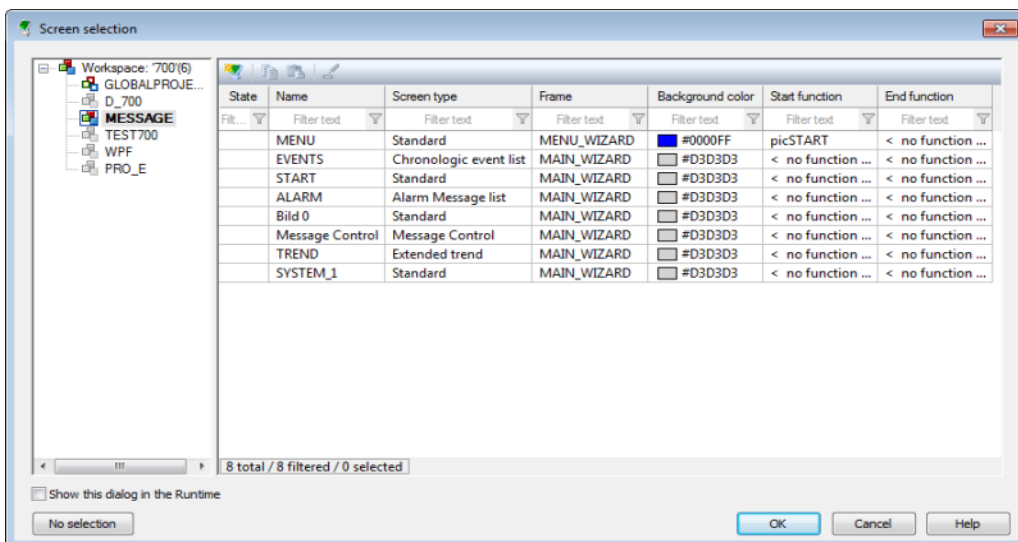

Parameter	Description
Project tree window	Displays the current project. Screens can only be selected from this project.
Screens window	Selection of the screen. If several screens are selected, the screen is switched to the first selected screen.
No selection	Has no function for this screen selection.
OK	Applies settings and closes the dialog.
Cancel	Discards all changes and closes the dialog.
Help	Opens online help.

SELECTION OF SCREEN TO BE UPDATED

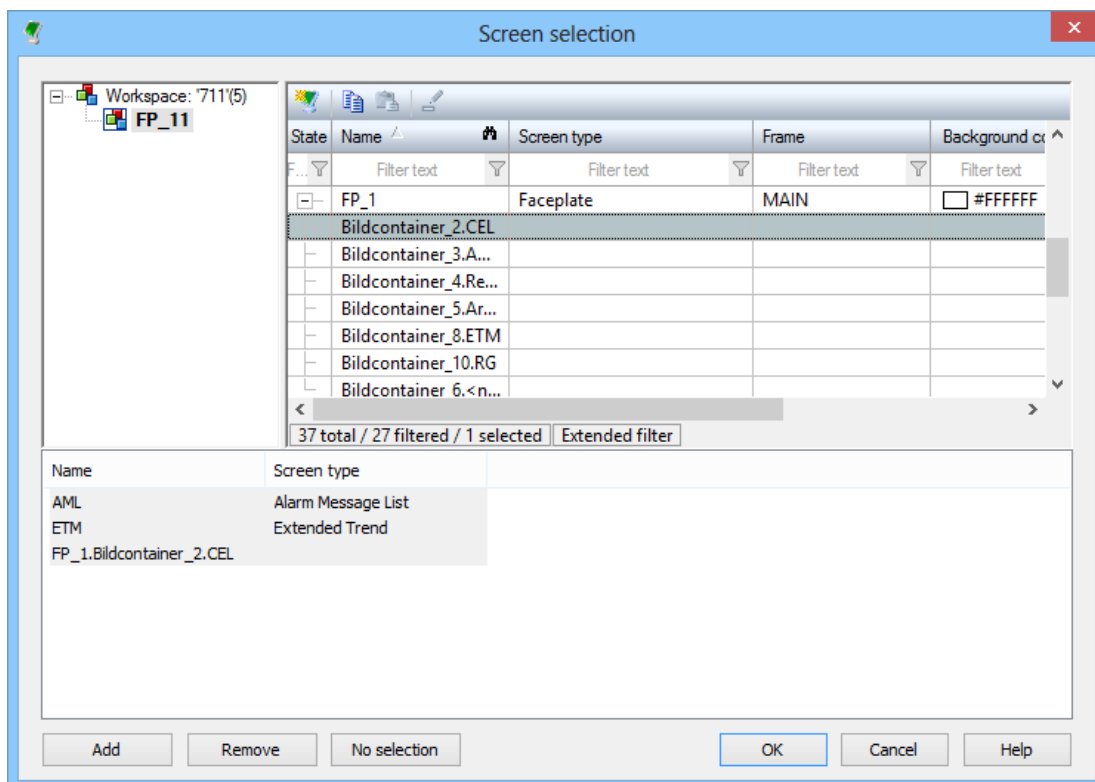

Parameter	Description
Project tree window	Displays the current project. Screens can only be selected from this project.
Screens window	Selection of the screens that are to be updated. Subscreens of faceplates can also be selected for screen switching to AML filter, CEL filter, time filter, equipment model and shift management. For these screens, the name of the faceplate screen is placed in front of the subscreen in order to clearly distinguish them from other screens. Multiple selection is possible. Add by double-clicking or using the Add button.
Window selection	Lists all selected screens.
Add	Adds the elements highlighted in the <code>screens</code> window to the selection window.
Remove	Deletes highlighted elements from the selection window.
No selection	Removes all currently-linked screens.
OK	Applies settings and closes the dialog.
Cancel	Discards all changes and closes the dialog.
Help	Opens online help.

10.5.8 Functions

In order to select functions, a filtered dialog is opened:

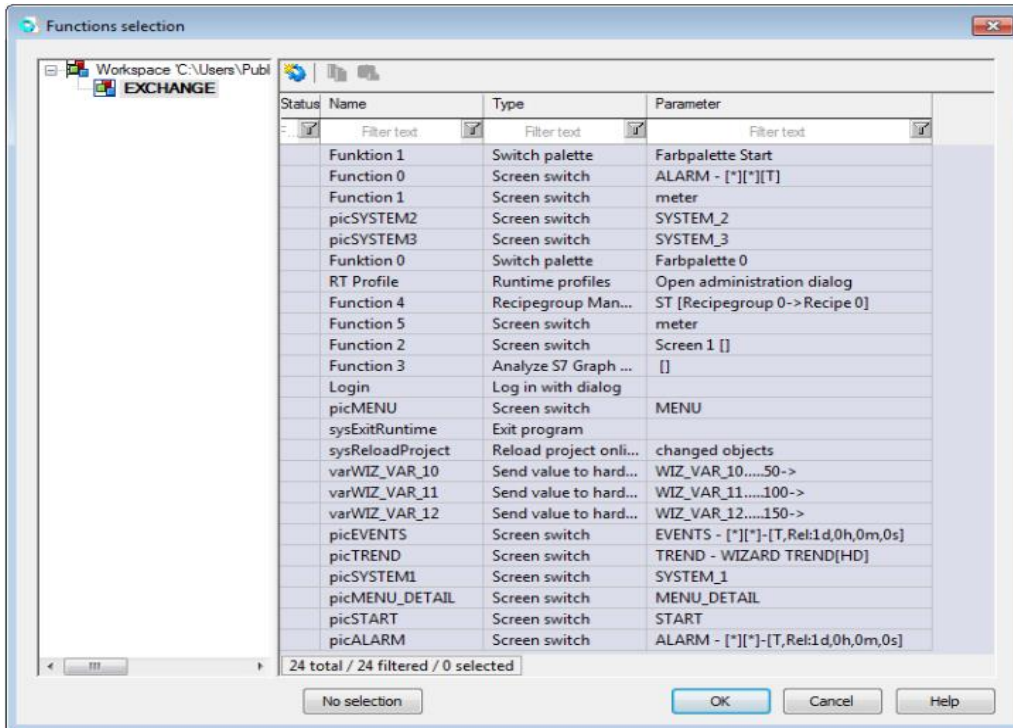

Element	Description
Project tree	Definition of the project from which the function should be selected.
Selection window	Selection of the function.
No selection	Depending on the element: <ul style="list-style-type: none"> ▶ the dialog is canceled ▶ already linked functions are deleted

Hint: The size of this dialog can be adjusted. The dialog size and position are saved.

CHANGE LINKED FUNCTION

1. manually
 - in the Project Manager's Detail view (on page 95) open the functions
 - drag the desired function on the element while holding the left mouse button
 - the previous function is substituted by the new one
2. automatic

- Select the entry Replace links from the context menu. For more details see chapter Substitution of variables and functions in dynamic elements.

10.5.9 Frames

In the **frame selection** dialog, frames can be selected for the execution of functions, from:

- ▶ Current project
- ▶ Subprojects
- ▶ All projects in the workspace with the **Keep project in memory** option active

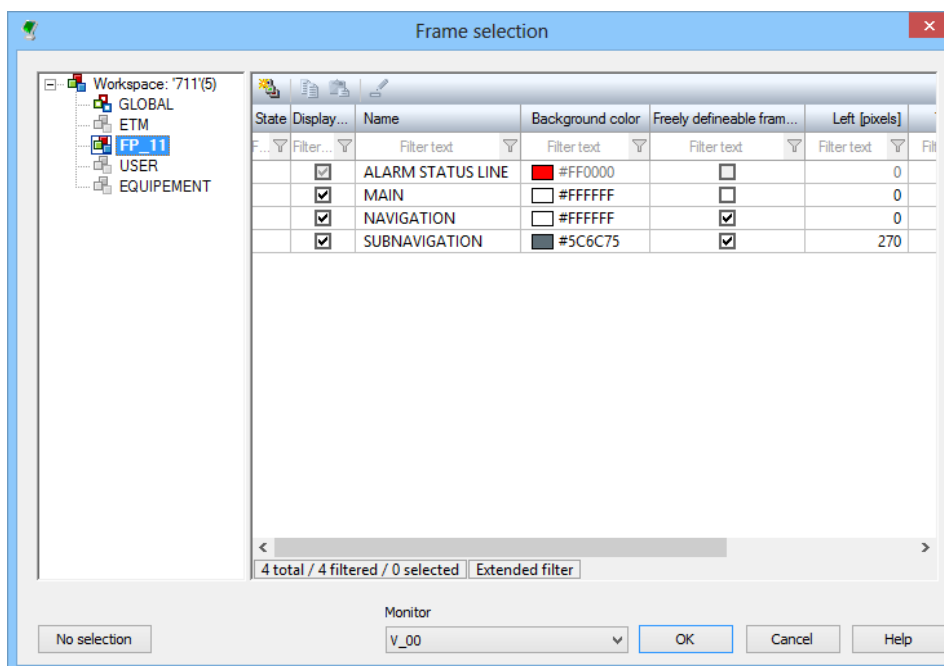

Parameter	Description
Project tree window	Displays all projects in the workspace. Frames can be selected from the current project and from all projects with the Keep project in memory option active.
Frames window	Selection of a frame. If several frames are selected, the frame at the top of the list is used to execute the function.
No selection	Removes selection and closes dialog.
OK	Applies settings and closes the dialog.
Cancel	Discards all changes and closes the dialog.
Help	Opens online help.

10.5.10 Driver

In the selection dialog **Drivers**, the drivers of the current project or of the sub projects can be selected in a filterable view.

10.5.11 Variables

In order to select variables, a filtered dialog is displayed.

These variables can also be used throughout projects sometimes. When selecting throughout projects, ensure that the corresponding projects are available in Runtime.

LINKING A VARIABLE

Elements that can only be linked with one unique variable open the following dialog:

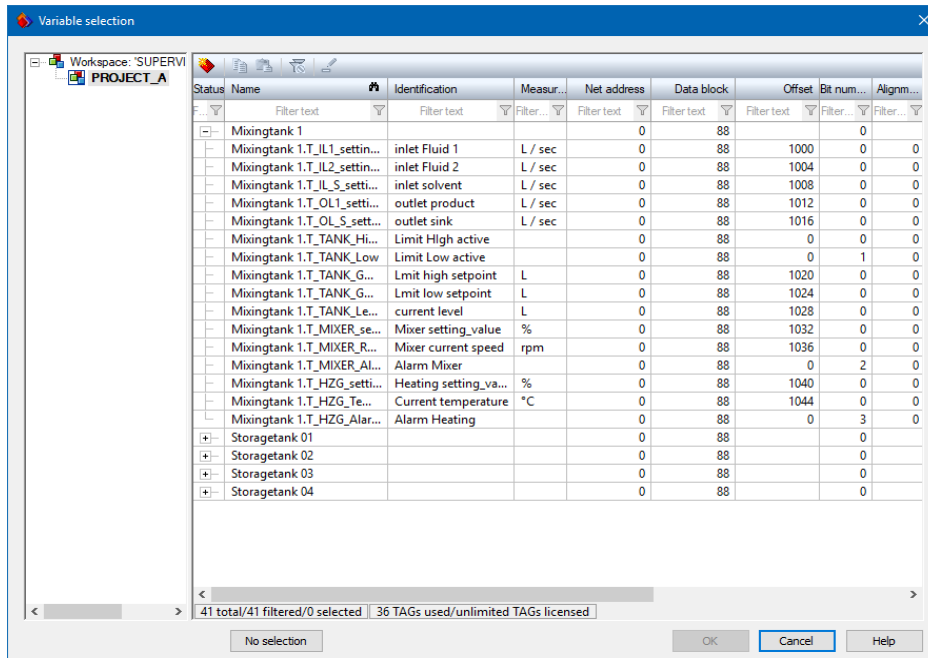

Element	Description
Project tree	Selection of the project from which the variable is to be selected.
Selection window	Selection of the variable which shall be linked. It can be linked in two ways: <ul style="list-style-type: none"> ▶ By double-clicking on the desired variable: The dialog is closed automatically. ▶ By selecting the desired variable and subsequently clicking OK.
No selection	Depending on the element: <ul style="list-style-type: none"> ▶ the dialog is canceled ▶ Variables that are already linked are deleted (such as linked lot variables in the Historian)

Note: The size of this dialog can be adjusted. The position and size of the dialog window are saved in the Editor, Runtime and zenon Web Client independently of the project.

ERROR TREATMENT

If the desired variable is not displayed, there can be several reasons for this:

- ▶ You have selected a filter and the desired variable does not match the filter: Check whether there is a filter active in the filter line. The information about filtered elements that is displayed at the bottom of the selection window also helps when checking for an active filter.

- ▶ The dialog is filtered by the Editor and the variable does not match the filter. The filtered switching then occurs if only a certain data type is permitted. For example, with a `numeric value` data element, no string variables can be linked.
- ▶ You have selected the wrong project in the project tree.

Attention

The dialog generally allows the selection of several variables using the conventional Windows keyboard shortcuts. In selection dialogs for just one variable, only one can be linked however. With multiple selection, the first variable selected is assigned to the element.

LINKING MULTIPLE VARIABLES:

Elements that can be linked to multiple variables open the following dialog:

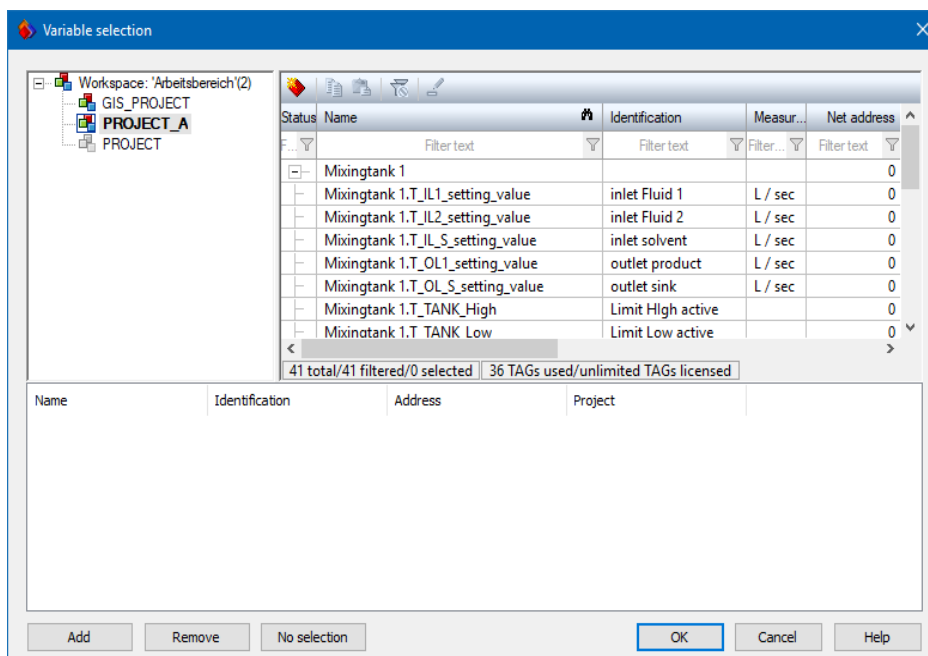

Element	Description
Project tree	Definition of the project from which the variable shall be selected.
Selection window	Selection of the variables: <ul style="list-style-type: none"> ▶ Double click the selected variable in order to add it to the variable list. ▶ You can move the selected variable to the variable list via Drag&Drop ▶ Select the desired variable. With the help of <code>Ctrl</code> or <code>Shift</code> multi-selection is possible. By clicking Add the selected variables are added to the variable list.
Variable List	Lists all selected variables.
Add	Adds the currently selected variable of the selection window to the variable list.
Remove	Removes the variables which are selected in the variable list from the list.
No selection	Depending on the element: <ul style="list-style-type: none"> ▶ the dialog is canceled ▶ certain links such as lot variables in archiving can be released

Note: The size of this dialog can be adjusted. The position and size of the dialog window are saved in the Editor, Runtime and zenon Web Client independently of the project.

ERROR TREATMENT

If the desired variable is not displayed, there can be several reasons for this:

- ▶ You have selected a filter and the desired variable does not match the filter: Check whether there is a filter active in the filter line. The information about filtered elements that is displayed at the bottom of the selection window also helps when checking for an active filter.
- ▶ The dialog is filtered by the Editor and the variable does not match the filter. The filtered switching then occurs if only a certain data type is permitted. For example, with a `numeric value` data element, no string variables can be linked.
- ▶ You have selected the wrong project in the project tree.

CHANGE LINKED VARIABLE

Select the **Replace links** entry from the context menu of the element. For more details see chapter Substitution of variables and functions in dynamic elements.

11. Main window

In the main window documents such as screens, reports, etc. are displayed and edited. The main window is the only window that cannot be hidden.

OPEN MULTIPLE DOCUMENTS PARALLEL.

You can display multiple screens in the main window at the same time. The screens can be selected with tabs at the top of the main window and can be positioned via options in menu item **Windows**. When switching the tabs, the elements in the properties window are amended to the selected tab.

To close open screens, use the keyboard shortcut `Ctrl+F4`, the context menu or the command `Screen-> Close`.

CONTEXT MENU DOCUMENTS

Right-click on the tab of a document in order to open the context menu.

Parameters	Description
Save	Saves the document.
Close	Closes the document.
Close all others	Closes all other documents.

POSITION ELEMENTS IN THE SCREEN

Activate elements by clicking on the symbol in the Toolbar elements (on page 42) and open them with the mouse in the main window.

There are multiple possibilities for moving the elements:

- ▶ Move quickly: Click element and position it with the mouse.
- ▶ Position exactly: Click element and position it with the arrow keys.
- ▶ Turning: Rotate the element with the "handle" on the **Reference point** as desired.

12. Properties window

The properties window displays parameters and properties of objects that were selected in the detail view of the Project Manager, or of elements that were selected in a screen. You enter values and

parameters in the properties window or change them for marked objects and elements. When switching the tab in the main window, the properties displayed in the properties window are amended to the active tab.

The settings for view, sorting and the favorites are saved for the next start of the Editor. When editing a property of an element in the property window, the last selected property is offered automatically, when another element is selected.

Note: Properties that cause fundamental changes are shown in curly brackets.
For example: {New limit value}.

MULTISELECT

If you choose multiple objects at the same time (multiselect), all properties that are different in the chosen elements are shown with an orange background or are marked in red in the properties window. The properties of the last respective element selected are displayed. In the group view (on page 150) and All properties (on page 152), a selected property can then be transferred to all other highlighted objects by pressing the `Return` key. (not possible in the dialog view (on page 151).)



Example

*Several objects with different fill colors are highlighted. The last highlighted element has a green fill color. The **Fill color** property is then displayed in green, the value **#32CD32** is highlighted in red. Clicking in the input field and pressing the `Return` key transfers the green property to all highlighted elements.*

KEYBOARD OPERATION

You can navigate in the properties, too, by using the keyboard:

Key	Function
Tab or Up	Switches to the next property.
Shift+Tab or arrow down	Changes to the preceding property.
Enter or arrow right	Opens a node.
Left	Closes a node.
Pos 1	Jumps to the first node.
End	Jumps to the last node.

TOOLBAR

The properties of an object are shown and can be edited in the properties-window. A toolbar is available for administration of the properties screen.



Symbol	Description
Grouped view (on page 150) (default)	<p>All properties of the selected object are logically grouped; the groups can be sorted alphabetically or logically. With the context menu, properties can be added to or removed from the Favorites.</p> <p>Standard for manual: Hints in the manual concerning the properties always use the grouped view. The contents of the groups are the same as in the dialog view.</p>
All properties (on page 152)	<p>All properties of the selected object are displayed in a list. With the context menu, properties can be added to or removed from the Favorites.</p>
Dialog view (on page 151)	<p>All properties are grouped logically like in the Grouped view, the groups are displayed sorted by application priority in dialog form. In this view, no favorites can be defined.</p>
Show/hide favorites (on page 152)	<p>Shows / hides the node Favorites in the top spot of the views Grouped view or All settings. The most frequently used properties are collected here.</p> <p>Default favorites are proposed.</p> <p>Add / remove entries to the favorites: You can do this either by using the context menu Add to favorites or by moving the desired properties to the favorites toolbar using Drag&Drop.</p> <p>The order of the properties in the favorites is determined by the sorting criterion (ascending, descending, logic).</p> <p>In the Dialog view favorites cannot be created.</p>
Show/hide all properties	<p>Shows or hides all nodes in the views Grouped and All Properties.</p>
Sorted logically (default)	<p>Displays the properties logically sorted according to application frequency instead of alphabetically sorted in the views Grouped and All properties.</p>
Sort ascending/descending	<p>Displays the properties either in ascending or descending alphabetical order in the views Grouped and All properties.</p>
Open/close all sections	<p>Shows / hides all nodes in the views Grouped and All Properties.</p> <p>Exception: The node of the current property is not closed, if Close all nodes is selected.</p>
Display properties help (on page 155)	<p>Displays the integrated help for the properties (properties help).</p>
Release property	<p>Symbols: Releases the selected property.</p>
Options for toolbar	<p>Clicking on the arrow opens the submenu:</p> <p>Active: Toolbar is displayed.</p> <p>If the toolbar is not displayed, it can be activated using the Options -> Toolbar menu.</p>

Note: For free placed toolbar (undocked from the Editor) options are not displayed. The toolbar can be closed by clicking on button X.

12.1 Grouped view

The Grouped views active per default. It groups properties that logically belong together,

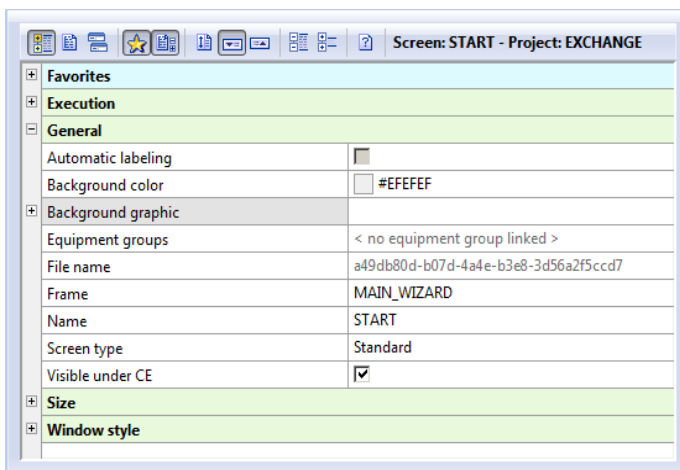

All properties can be hidden and shown using the toolbar.



Information

Hints in the manual concerning the properties always use the **grouped view**. The contents of the groups are the same as in the **dialog view**.

12.2 Dialog view

The Dialog view summarizes properties in groups and presents them in dialogs.

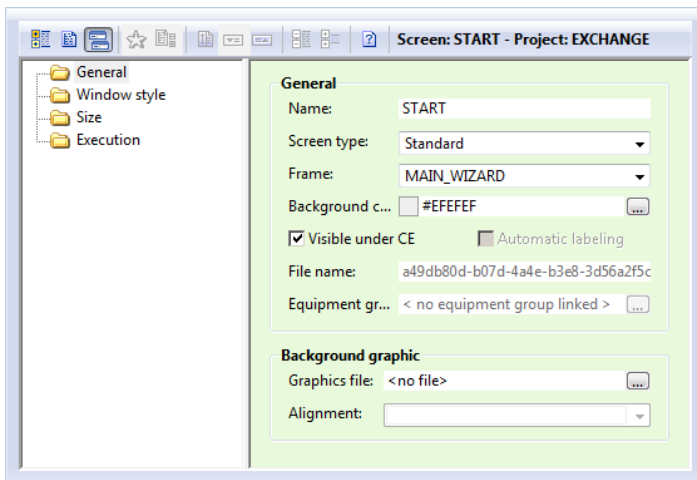

In the Dialog view it is not possible to create favorites and to hide properties.

12.2.1 Deactivate the automatic scrolling of comboboxes under Windows 10

Under Windows 10, the mouse and touchpad property **Scroll inactive windows when I hover over them** is activated by default. In the dialog view, this leads to the setting being amended in the combobox as soon as you move over a combobox with the mouse pointer (with **Create Runtime files for** for example) and scroll.

To deactivate this property and thus automatic scrolling:

1. Open the **Settings** under Windows 10
2. Go to **Devices**
3. Go to **Mouse and touchpad**
4. Deactivate the **Scroll inactive windows when I hover over them** property.

12.3 All properties

All `properties` are displayed in an alphabetically ordered list.

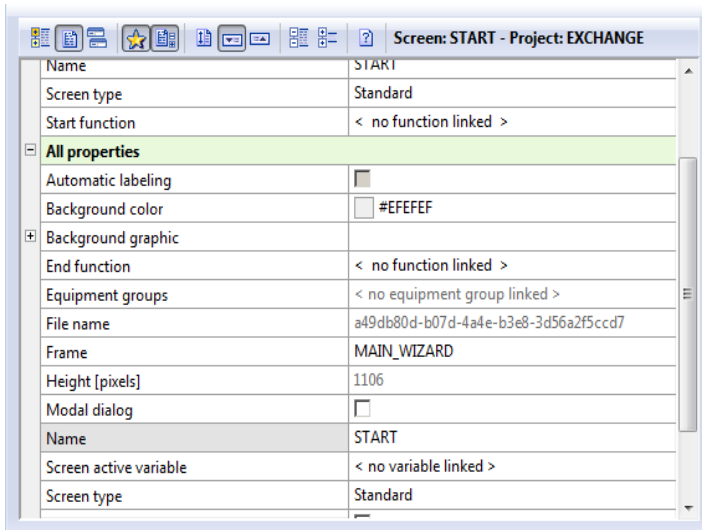

All `properties` can be hidden and shown using the toolbar.

12.4 Favorites

The views `Grouped` and `All properties` have a node **Favorites** on the top position of the window. Here are properties shown that are used quite often.

Default favorites are proposed. To add own entries:

- ▶ Right-click on the desired property.
- ▶ In the context menu, choose **<Property> add to favorites**
- ▶ The order of the properties in the favorites is determined by the Sort key (on page 153) (ascending, descending, logic).

To remove entries:

- ▶ Right-click on the desired property.
- ▶ In the context menu, choose **<Property> remove from favorites**

Favorites can be shown or hidden using the appropriate button in the toolbar.
Attention: In the Dialog view favorites cannot be created.

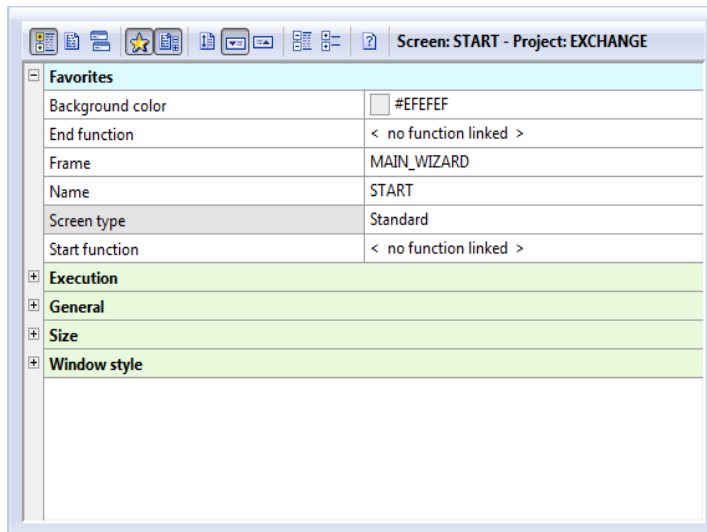

12.5 Sort properties

The sort key is defined with the buttons **Sorted logically**, **Sorted ascending** or **Sorted descending** in the toolbar. Per default the properties are sorted logically. They can be sorted alphabetically, too.

SORTED LOGICALLY

The properties are sorted logically according to the likeliness of usage. This is only possible in the views *Grouped* and *All Properties*.

SORT ASCENDING / DESCENDING

Here, properties can be sorted alphabetically ascending or descending. These options are possible in the views *Grouped*, *All Properties* and **Favorites**.

CLOSE AND EXPAND NODES

It is possible to close all nodes and to expand them again in the views *Grouped* and *All properties*. The node of the current property is not closed, if *Close all nodes* is selected.

12.6 Linked properties

Values can be linked for some properties such as variables or parameters. In this case, the value always changes if the value of the source property has been changed.

If an element accepts values from another property, this is shown with an arrow next to the value of the property.

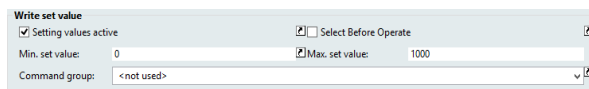

SEPARATE LINKING

To remove the linking of a value:

1. Right-click on the property
2. Select, in the context menu, the entry that separates the reference to the source property (wording dependent on the property)
 Note: You can also separate all values that have been transferred from the source property at once.

The linking is also removed if you overwrite the value with another value.

Changes to the source value therefore no longer have an effect on this value. The linking symbol (arrow) is no longer displayed.

RESTORE LINKING

To relink a separated value to the original source value again:

1. Right-click on the property
2. Select, in the context menu, the entry that reestablishes the reference to the source value (wording dependent on the property)
 Note: You can also reestablish all values that come from the source property at once.

This property therefore always accepts the respective current value of the source property. The linking symbol (arrow) is displayed again.

13. Property help

A separate window with help information on the individual properties can be shown.

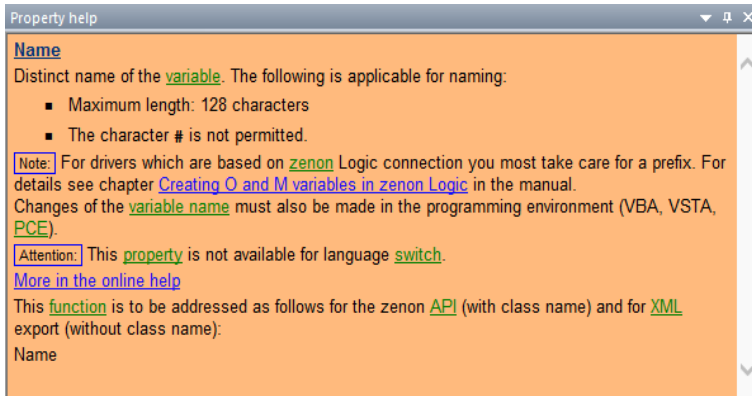

To show the properties help:

- ▶ Select the symbol **Show properties help** (far right) in the properties toolbar.
- ▶ Or: Or choose the command **Property help** from the menu **View**.
- ▶ Otherwise right-click on any title bar and choose the command **Property help** in the context-sensitive menu.

Close properties help:

- ▶ Click the **X** on the right border of the title bar

Unlike the online help that can be called up by pressing the **F1** key, this integrated properties help only describes the individually-selected property.

You get:

- ▶ A short description of the currently-selected property.
- ▶ A link to the more comprehensive online help.
- ▶ A link to the COPA-DATA YouTube channel with examples of project configuration.
Note: This link is not visible for OEM customers.
- ▶ The property name information for the API.

The properties help can be undocked like other windows, you can position it anywhere you want on the screen.

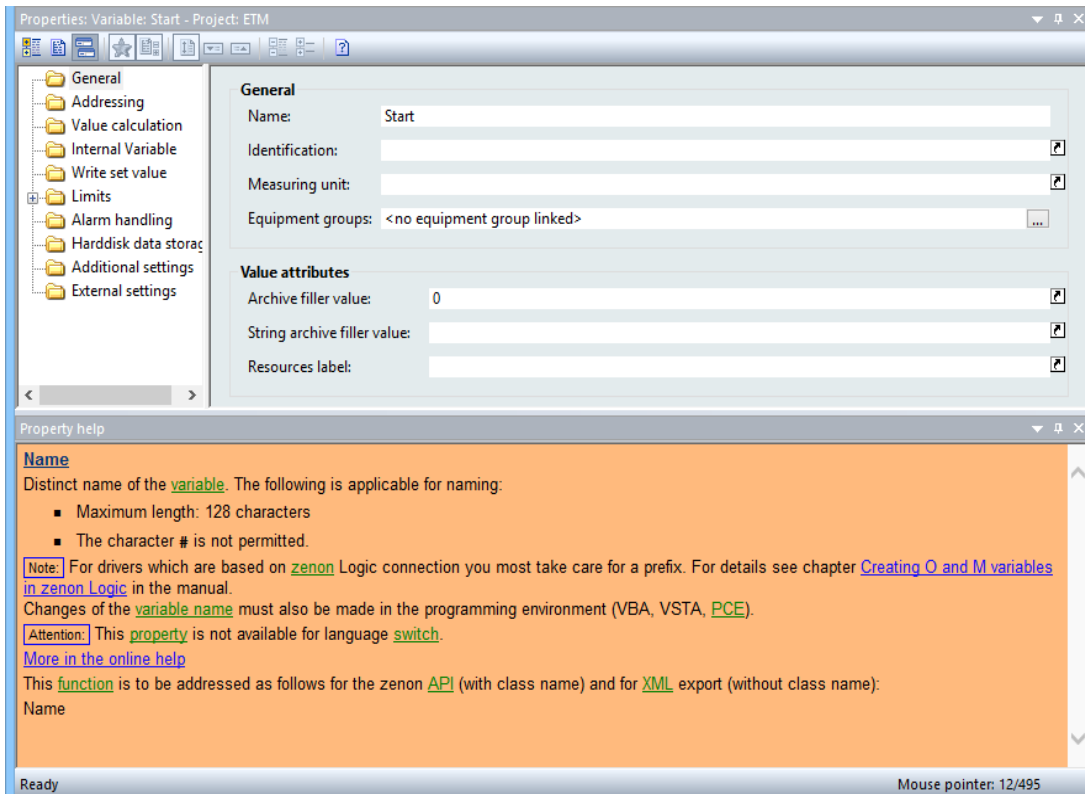

LINKED PROPERTIES

You can find information on linked properties in the Linked properties (on page 154) chapter.

14. Output window

The output window shows status information and error messages during startup of the Editor and during compilation and transfer of a project. The information is divided into different types:

- ▶ **Error**
- ▶ **Warnings**

► Messages

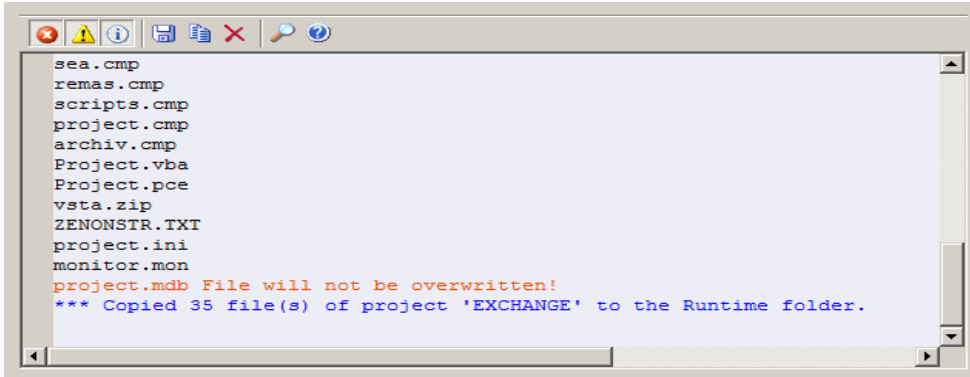

```

sea.cmp
remas.cmp
scripts.cmp
project.cmp
archiv.cmp
Project.vba
Project.pce
vsta.zip
ZENONSTR.TXT
project.ini
monitor.mon
project.mdb File will not be overwritten!
*** Copied 35 file(s) of project 'EXCHANGE' to the Runtime folder.

```

These information messages can be shown and hidden individually. The settings for information display are retained after the Editor is closed; they are also valid for the display of new information. But no information is lost, because the settings only affect the display and not the collection of information.

Example: If warnings are hidden, they are not displayed until the display is turned on again. From that point on, all warnings are displayed. The warnings that were accumulated in the meantime are also shown.

The blue information messages cannot be hidden, because they are project-related messages that must always be visible.

TOOL BAR AND CONTEXT MENU



Symbols and context menu offer the same options. The symbols' meaning from left to right:

Symbol / entry context menu	Description
Display errors	<p>Active: Errors are shown in red.</p> <p>Inactive: Errors are hidden.</p> <p>The chosen condition can be combined with warnings and messages and is retained when the editor is closed.</p>
Display warnings	<p>Active: Warnings are shown in orange.</p> <p>Inactive: Warnings are hidden.</p> <p>The chosen condition can be combined with Errors and messages and is retained when the editor is closed.</p>
Show messages	<p>Active: Messages are shown in black.</p> <p>Inactive: Messages are hidden.</p> <p>The chosen condition can be combined with errors and messages and is retained when the editor is closed.</p>
Save	Saves the whole content of the output window to a LOG-file. You are free to choose storage location and file name.
Copy	Copies the selected list entry to the Windows Clipboard.
Delete	Deletes the whole contents of the output window. After this action is executed, it is not possible anymore to access the deleted contents of the output window.
Search	Opens the dialog for text search within the output window.
Help	Opens this help page.



Example

Delete the contents of the output window with the relevant symbol or the context menu, then generate the Runtime-files. The relevant information is provided in the output window. This information is enclosed by blue messages.

1. Click on the symbol **Messages**: The standard messages (black) are hidden.
2. Once again generate Runtime-files, the messages stay hidden.
3. Now, hide also the display of **errors** (red) and **warnings** (orange).
4. The blue project-related messages stay visible.
5. Generate again runtime-files, show the **messages** again. All messages generated since the output window was deleted are visible again.

15. Status line

The Editor status bar provides information about (depending on the selected object):

Ready Mouse pointer: 337/868 Trend element: Trend-Element_1 Starting point X/Y: 420/340 Width/Height: 90/60

- ▶ Disposition of the Editor:
- ▶ Function of the symbol over which the mouse pointer is located.
- ▶ Position of the mouse pointer in screens.
- ▶ Type and name of the active element in a screen.
- ▶ Starting point (x/y axis), width and height of the active element in a screen.
The 0/0 point of the axis is located in the upper left corner.

In reports, the status line has no function.

16. Closing the Editor

When closing the Editor or closing or switching the workspace, all projects are checked for changes. If there are projects whose latest Runtime files have not been created, they are listed in a dialog and offered for creation.

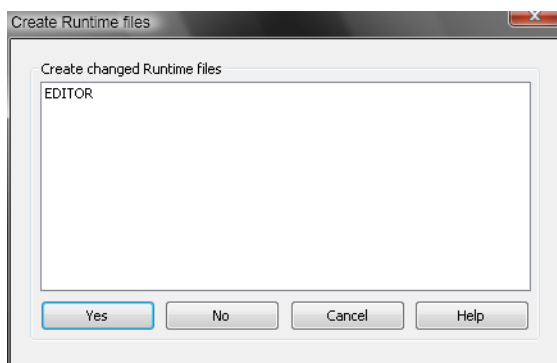

Parameters	Description
Yes	The Runtime files of all projects in the lists are created. Then the Editor is closed.
No	Runtime Files are not created. Then the Editor is closed.
Cancel	Runtime Files are not created. The Editor is not closed.